

# IDEAComm 3278

**IDEA**  
**IDEA**ssociates  
The best IDEAs for personal computers.

Rev. A P/N 400-11842

IDEAcomm 3278  
IBM PC to Mainframe  
Communications Card

Installation and  
Reference Manual

IDEAssociates, Inc.  
35 Dunham Road  
Billerica, MA 01821  
(617) 663-6878



## IDEAssociates, Inc. Limited Warranty

IDEAssociates, Inc., guarantees this IDEA Product to be in good working order for a period of 1 year from the date of purchase from IDEA or an authorized IDEA dealer. If this Product fails to be in good working order at any time during this one year warranty period, IDEA will, at its option, repair or replace this product at no additional charge except as set forth below. Repair parts and replacement products will be furnished on an exchange basis and will be either reconditioned or new. All replaced parts and products become the property of IDEAssociates. This limited warranty does not include service to repair damage to the product resulting from accident, disaster, misuse, abuse, or non-IDEA modification of the product.

Limited Warranty service can be obtained by delivering the product during the one year warranty period to an authorized IDEA dealer or by sending the product to IDEAssociates.

CONTINUED NEXT PAGE

IDEA Associates will not accept products without a Materials Return Authorization (MRA) number issued by its Customer Support Department, with a proof of purchase date. If this product is delivered to IDEA by mail, you agree to insure the product or assume risk of loss or damage in transit, to prepay shipping charges to the warranty service location and to use the original shipping container or equivalent.

ALL EXPRESS AND IMPLIED WARRANTIES FOR THIS PRODUCT INCLUDING THE WARRANTIES OF MERCHANTABILITY AND FITNESS FOR A PARTICULAR PURPOSE, ARE LIMITED IN DURATION TO A PERIOD OF 1 YEAR FROM THE DATE OF PURCHASE, AND NO WARRANTIES, WHETHER EXPRESS OR IMPLIED, WILL APPLY AFTER THIS PERIOD. SOME STATES DO NOT ALLOW LIMITATIONS ON HOW LONG AN IMPLIED WARRANTY LASTS, SO THE ABOVE LIMITATIONS MAY NOT APPLY TO YOU.

IF THIS PRODUCT IS NOT IN GOOD WORKING ORDER AS WARRANTED ABOVE, YOUR SOLE REMEDY SHALL BE REPAIR OR REPLACEMENT AS PROVIDED ABOVE. IN NO EVENT WILL

CONTINUED NEXT PAGE

IDEA BE LIABLE TO YOU FOR ANY DAMAGES, INCLUDING ANY LOST PROFITS, LOST SAVINGS OR OTHER INCIDENTAL OR CONSEQUENTIAL DAMAGES, ARISING OUT OF THE USE OF OR INABILITY TO USE SUCH PRODUCT, EVEN IF IDEA OR AN AUTHORIZED IDEA PERSONAL COMPUTER DEALER HAS BEEN ADVISED OF THE POSSIBILITY OF SUCH DAMAGES, OR FOR ANY CLAIM BY ANY OTHER PARTY.

SOME STATES DO NOT ALLOW THE EXCLUSION OR LIMITATION OF INCIDENTAL OR CONSEQUENTIAL DAMAGES FOR CONSUMER PRODUCTS, SO THE ABOVE LIMITATIONS OR EXCLUSIONS MAY NOT APPLY TO YOU.

THIS WARRANTY GIVES YOU SPECIFIC LEGAL RIGHTS, AND YOU MAY ALSO HAVE OTHER RIGHTS WHICH MAY VARY FROM STATE TO STATE.

1941, 1942, 1943, 1944, 1945, 1946, 1947, 1948, 1949, 1950, 1951, 1952, 1953, 1954, 1955, 1956, 1957, 1958, 1959, 1960, 1961, 1962, 1963, 1964, 1965, 1966, 1967, 1968, 1969, 1970, 1971, 1972, 1973, 1974, 1975, 1976, 1977, 1978, 1979, 1980, 1981, 1982, 1983, 1984, 1985, 1986, 1987, 1988, 1989, 1990, 1991, 1992, 1993, 1994, 1995, 1996, 1997, 1998, 1999, 2000, 2001, 2002, 2003, 2004, 2005, 2006, 2007, 2008, 2009, 2010, 2011, 2012, 2013, 2014, 2015, 2016, 2017, 2018, 2019, 2020, 2021, 2022, 2023, 2024, 2025

(blank page)

1941, 1942, 1943, 1944, 1945, 1946, 1947, 1948, 1949, 1950, 1951, 1952, 1953, 1954, 1955, 1956, 1957, 1958, 1959, 1960, 1961, 1962, 1963, 1964, 1965, 1966, 1967, 1968, 1969, 1970, 1971, 1972, 1973, 1974, 1975, 1976, 1977, 1978, 1979, 1980, 1981, 1982, 1983, 1984, 1985, 1986, 1987, 1988, 1989, 1990, 1991, 1992, 1993, 1994, 1995, 1996, 1997, 1998, 1999, 2000, 2001, 2002, 2003, 2004, 2005, 2006, 2007, 2008, 2009, 2010, 2011, 2012, 2013, 2014, 2015, 2016, 2017, 2018, 2019, 2020, 2021, 2022, 2023, 2024, 2025

1941, 1942, 1943, 1944, 1945, 1946, 1947, 1948, 1949, 1950, 1951, 1952, 1953, 1954, 1955, 1956, 1957, 1958, 1959, 1960, 1961, 1962, 1963, 1964, 1965, 1966, 1967, 1968, 1969, 1970, 1971, 1972, 1973, 1974, 1975, 1976, 1977, 1978, 1979, 1980, 1981, 1982, 1983, 1984, 1985, 1986, 1987, 1988, 1989, 1990, 1991, 1992, 1993, 1994, 1995, 1996, 1997, 1998, 1999, 2000, 2001, 2002, 2003, 2004, 2005, 2006, 2007, 2008, 2009, 2010, 2011, 2012, 2013, 2014, 2015, 2016, 2017, 2018, 2019, 2020, 2021, 2022, 2023, 2024, 2025

## Notice

### Copyright

Copyright 1985 by IDEAssociates, Inc.  
All rights reserved.

### Trademarks

IBM is a registered trademark of  
International Business Machines.

IDEAcomm 3278 is a trademark of  
IDEAssociates Incorporated.

IRMA is a trademark of Digital  
Communications Associates, Inc.

### Documentation

IDEAssociates has made every effort to ensure accuracy of this manual. We welcome your comments and corrections. (See the Customer Survey card in this manual.) However, IDEAssociates specifically disclaims any implied warranties or merchantability of the contents of this manual, and shall not be liable for errors contained in it.



IDEAssociates has an established network of computer dealers throughout the United States and Europe. To place an order or to locate the nearest dealer, call nationwide at (800) 257-5027.

## Table of Contents

IDEAssociates Limited	iii
Warranty	
Notice	vii
Overview	xvii

### Section I: Introduction

Reference Publications	1-2
Organization of the Manual	1-3
Notation Conventions	1-5
Inventory Checklist	1-7

**Section II: Hardware Installation**

1-1  
1-2  
1-3  
1-4  
1-5  
1-6  
1-7  
1-8  
1-9  
1-10  
1-11  
1-12  
1-13  
1-14  
1-15  
1-16  
1-17  
1-18  
1-19  
1-20  
1-21  
1-22  
1-23  
1-24  
1-25  
1-26  
1-27  
1-28  
1-29  
1-30  
1-31  
1-32  
1-33  
1-34  
1-35  
1-36  
1-37  
1-38  
1-39  
1-40  
1-41  
1-42  
1-43  
1-44  
1-45  
1-46  
1-47  
1-48  
1-49  
1-50  
1-51  
1-52  
1-53  
1-54  
1-55  
1-56  
1-57  
1-58  
1-59  
1-60  
1-61  
1-62  
1-63  
1-64  
1-65  
1-66  
1-67  
1-68  
1-69  
1-70  
1-71  
1-72  
1-73  
1-74  
1-75  
1-76  
1-77  
1-78  
1-79  
1-80  
1-81  
1-82  
1-83  
1-84  
1-85  
1-86  
1-87  
1-88  
1-89  
1-90  
1-91  
1-92  
1-93  
1-94  
1-95  
1-96  
1-97  
1-98  
1-99  
1-100

- Getting Started 2-1
- Careful 2-1
- Serial Number 2-2
- Hardware 2-3
  - Installation Overview 2-3
  - Tool Requirements 2-4
- Opening the IBM 2-5
  - Preliminary Steps 2-5
  - Cover Removal 2-6
- Checking Switches 2-8
  - Checking Switch Bank 1 - Interrupt Request Line 2-9
  - Checking Switch Bank 2 - Memory Address 2-12
  - Checking Switch Bank 3 - PC I/O Address 2-14
- Inserting the IDEAcmm 3278 Card 2-16
  - Support Track 2-17
  - Card Insertion 2-18
  - Card Alignment 2-19
- Replacing the IBM Cover 2-20
- Replacing the Cover Screws 2-21
- Recabling the IBM 2-22
- Hardware Diagnostics 2-23
  - Copying the Software 2-23
  - Running the IDEAcmm 3278 Hardware Diagnostics 2-23
- Connecting a Coaxial Cable 2-27

### Section III: Using IDEComm 3278

Using IDEComm 3278	3-1
Operating Modes	3-2
IDEComm 3278 Commands	3-2
GO	3-5
Hot Key	3-6
PRINT	3-8
HELP	3-11
TYPE	3-13
DIRECTORY	3-15
SEND	3-16
CAPTURE	3-20
IDEComm 3278 Attribute Bytes	3-22
EXIT (Terminating)	3-24
EXIT (Command Mode)	3-25
Program Messages	3-26

### Section IV: Operations

Keyboard Equivalents	4-1
Local Print Capability	4-4
Status Line Symbol Equivalents	4-4

Section V: Configuring IDEAcmm 3278  
Software

The Configuration Utility	5-1
Using the Configuration Program	5-2
The Main Menu	5-2
Overview of Options	5-4
Option A - Configure Power-Off	5-5
Option B - Configure Local Printer	5-8
Option C - Configure Nationality	5-11
Option D - Configure 3278 Keyboard	5-14
Notes on Keyboard Configuration	5-16
Option E - Configure Display	5-23
Field Colors	5-26
Option F - Configure Compatibility	5-29
Native	5-31
IRMA	5-31
Both	5-31
Making Configuration Changes	
Permanent	5-32
Preserving the Original Configuration	5-32
Configuration Messages	5-33

**Appendix A: IDEComm 3278 Software Messages**

Program Messages	A-1
Diagnostic Messages	A-7

**Appendix B: Technical Information**

IDEComm 3278 Hardware	
System Overview	B-1
Diagnostic Overview	B-2
Performing Individual	
Diagnostic Tests	B-4
Product Specifications	B-7

**Appendix C: File Transfer Facility**

Running XFER	C-2
Editing the Parameters	C-5
File Mode	C-6
Record Length	C-8
PC File	C-8
Host File	C-9
Ending the Edit	C-9
Transferring a File	C-9
Terminating XFER	C-12
Batch Mode	C-12
XFER Program Messages	C-18

**Appendix D: IDEA3278 Support  
Subroutines in BASIC**

**Error Code Definitions** **D-21**

**Appendix E: IDEAcomm 3278 Switch  
Settings**

<b>Changing Factory Switch Settings</b>	<b>E-1</b>
<b>Switch Bank 1</b>	<b>E-2</b>
<b>Switch Bank 2</b>	<b>E-3</b>
<b>Switch Bank 3</b>	<b>E-3</b>
<b>Editing the HFIG File</b>	<b>E-4</b>
<b>Changing IDEAdisk Switch Bank 1 Settings</b>	<b>E-9</b>

**Appendix F: Glossary**

**Appendix G: Customer Support  
Information**

<b>Repair Policy</b>	<b>G-1</b>
<b>Warranty Card</b>	<b>G-3</b>
<b>Limited Warranty</b>	<b>G-3</b>

Customer Survey Form

Product: IDEAcomm 3278  
Manual (Rev. 0)

1. Were there any errors in the manual? If yes, list page numbers and kind of error:
  
  
  
  
  
  
  
  
  
  
2. Was information: easy to understand \_\_\_\_\_ difficult \_\_\_\_\_ List information that was hard to find:
  
  
  
  
  
  
  
  
  
  
3. Was information: complete \_\_\_\_\_ incomplete \_\_\_\_\_
  
  
  
  
  
  
  
  
  
  
4. What features of the product did you particularly like?
  
  
  
  
  
  
  
  
  
  
5. What features would you like to see added to the product in future revisions?





NO POSTAGE  
NECESSARY  
IF MAILED  
IN THE  
UNITED STATES

**BUSINESS REPLY MAIL**  
FIRST CLASS PERMIT NO. 50 BILLERICA, MA

Postage will be paid by addressee

**IDEAssociates, Inc.**  
35 Dunham Road  
BillERICA, MA 01821

Attn: Documentation Dept.



FOLD HERE

6. Compared to similar manuals, how would you rate the documentation?  
Better than most \_\_\_\_\_  
Average \_\_\_\_\_ Worse than most \_\_\_\_\_
  
7. Please rate your knowledge of personal computers:  
Experienced \_\_\_\_\_ Some previous use \_\_\_\_\_  
First-time user \_\_\_\_\_
  
8. Please use the rest of this page for additional comments.

## Overview

The IDEAComm 3278 is a communications card that emulates an IBM 3278 or 3279 terminal. It supplies users with all the functionality of an IBM PC, plus access to mainframe information and applications. IDEAComm 3278 also provides a file transfer program that allows the user to transfer files in both directions.

The IDEAComm 3278 is connected to the IBM 3274/3276 via a coax cable. The IDEAComm 3278 supports Bisync and SNA/SDLC protocols, and its features include:

- o support of 3278-2, 3279 S2A and S2B terminals
- o coax connection to:
  - IBM 3274 controller with type "A" adapters, SNA/SDLC or BSC
  - IBM 3276 remote terminal controller, SNA/SDLC or BSC

- o advanced file transfer in TSO and VM/CMS environments. (One keystroke uploads or downloads files from the mainframe.)
- o compatible with mainframe software packages that support either of the following interfaces:

IDEA Native Mode (software written for the IDEA high performance Native interface)

IRMA Mode (software written for IRMA interface)

- o ability to easily and quickly remap the keyboard
- o can hot key between emulation and DOS applications
- o national language character set support
- o diagnostics
- o support for screen prints to PC printer or to the printer attached to the control unit
- o ability to remap 3279 color attributes

Users can reconfigure the keyboard keys for greater flexibility, thereby tailoring keys for special applications as well as configuring the keys to correspond to international market needs.

In 3279 emulation mode, users can configure colors for special application requirements.

Built with the quality for which IDEA products are known, the IDEComm 3278 comes with a one year limited warranty.

(blank page)

Section I:  
Introduction

The IDEAComm 3278 card allows the PC/XT/AT to be connected by coaxial cable to an IBM 3274 or 3276 control unit. The IDEAComm 3278 software permits a PC to emulate an IBM 3278/3279 Display Station. A typical system configuration is shown in Figure 1-1.

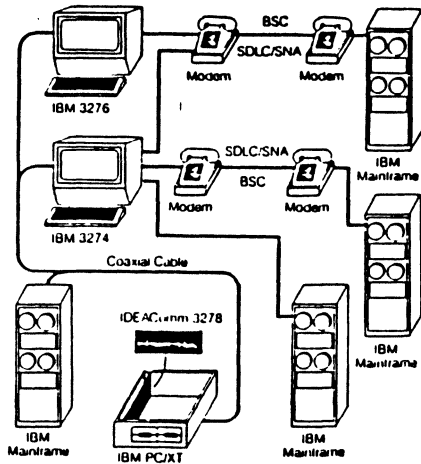

Figure 1-1: Typical System Configuration

## Reference Publications

For details of the programs and data streams used by the IBM 3270, refer to the IBM publications:

- o GA18-2181 IBM 3270 Information Display System 3276 Control Unit Display Station, Description and Programmer's Guide.
- o GA23-0061 IBM 3270 Information Display System 3274 Control Unit, Description and Programmer's Guide.

For details of the keyboard and screen operations possible on the 3270, refer to the following IBM publication:

- o GA27-2742 Operator's Guide for IBM 3270 Information Display Systems.

## Organization of the Manual

This manual is the basic reference for the IDEComm 3278 Communications package.

- Overview presents a summary of the IDEComm 3278's capabilities.
- Section I provides information on the setup of the user manual, notation conventions, reference publications, and an inventory checklist.
- Section II covers hardware installation and diagnostics.
- Section III information on loading IDEComm 3278 and making it resident.
- Section IV describes keyboard equivalents.
- Section V covers configuring IDEComm 3278 software.



- Appendix A    IDEAComm 3278 software messages are listed.
- Appendix B    provides technical information and diagnostic information.
- Appendix C    describes File Transfer (XFER).
- Appendix D    subroutines in BASIC.
- Appendix E    describes alternate switch settings.
- Appendix F    is a glossary of terms.
- Appendix G    offers customer support information.

## Notation Conventions

The following conventions are used in this manual:

- [ ]** Square brackets indicate optional fields.
- ...** Ellipses indicate that a field may not be repeated.
- |** A vertical bar indicates a choice. Choose one of the items separated by the vertical bar. One of the items must be entered, unless the items are also surrounded by square brackets.
- <filespec>** A field shown as filespec indicates a standard file specification of the following form: disk name:filename.ext
- punctuation** Punctuation other than brackets, ellipses, and braces should not be entered as shown.

**delimiters**

Commands must be separated from their operands by one or more blanks. Multiple operands, are separated from each other by a comma, a comma followed by one or more blanks, or by one or more blanks. Blanks and commas may not appear within operands.

**b**

The character "b" indicates a blank or space character.

**Ctrl-  
character**

Ctrl-character indicates a character that is generated by pressing the Ctrl key and the indicated "character" together.

In the screen illustrations of this manual, the characters that you must enter, appear in bold type. They are shown in lowercase letters, but may generally be entered in upper- or lowercase letters. Commands entered at the system prompt must be followed by pressing the (Enter) key. The first reference to command names in the text also appear in bold type. The names of keys that are referenced in this manual appear as they do on the your IBM PC/XT/AT keyboard. Unless noted, the case of the letters you enter for commands is not critical.

### Inventory Checklist

You should have received the following components:

- o IDEAComm 3278 card
- o Support guide
- o IDEAComm 3278 Software
- o Installation and Reference Guide (this book)
- o Warranty Card



## Section II

### Hardware Installation

#### Getting Started

When you open your IDEComm 3278 package, the first thing you notice will be the amount of packing material we have placed around the IDEComm 3278 card. This ensures that you receive an undamaged card.

Please save your box and inside packaging material. If you need to return the card for repair, this packaging will provide the safest shipping container.

#### Careful!

During the installation process, please be careful with the IDEComm 3278 card. Dropping the card and similar accidents may result in improper operation.

## **Serial Number**

Please turn your IDEComm 3278 card to the circuit side. You will find the serial number along the top edge. Record this number NOW on both your warranty card and on the following line in this manual.

Serial Number \_\_\_\_\_

Please write the version number on your software diskette(s) here:

\_\_\_\_\_

## Hardware

### Installation Overview

The IDEComm 3278 card can be installed with the following steps:

1. Opening the IBM PC.
2. Checking IDEComm 3278 card switches.
3. Inserting the IDEComm 3278 card.
4. Replacing the IBM PC Cover.
5. Connecting the coaxial cable.
6. Running hardware diagnostics.



Read through the whole installation procedure before proceeding.

#### **Tool Requirements**

1. A medium size flat blade screwdriver.
2. Pliers or a 1/4 inch socket wrench may be needed to remove the back cover of some models of the IBM PC.
3. IDEAcomm 3278 card.
4. Coaxial cable.

## Opening the IBM

### Preliminary Steps

Turn off the IBM power switch.

Turn off power to any peripheral devices (printer, monitor, hard disk, etc.).

If you have an AT, unlock it.

Unplug the computer and all peripherals from the wall outlet.

Carefully note where each cable is attached. Disconnect all cables from the back of the IBM.

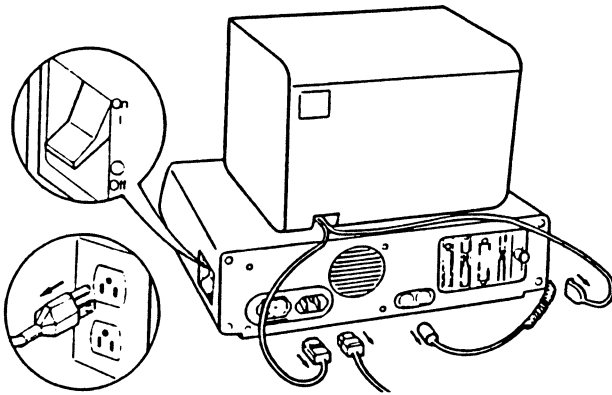

Figure 2-1: Disconnecting the Cables

**(Cover Removal)**

Move your keyboard and all peripheral equipment away from the work area.

Position the IBM to allow rear access.

With an AT, you must remove the back panel first. Pull firmly to detach the plastic fasteners.

The cover is attached by two or five screws. With a flat blade screwdriver, remove the cover mounting screws by turning the screwdriver counter-clockwise, as shown below.

Certain models may require the use of pliers or a 1/4 inch socket wrench.

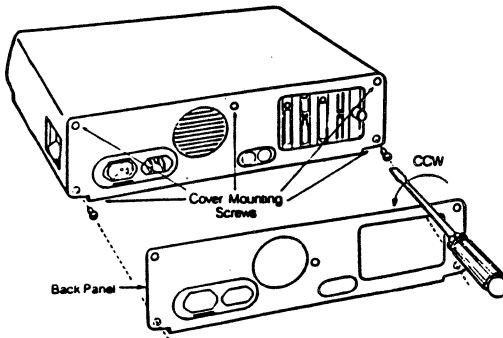

**Figure 2-2: Removing the Mounting  
Screws (CCW)**

Carefully slide the cover away from the rear of the unit. When the cover will go no further, tilt it up and remove it from the base. See the sketch below. The AT requires no tilting.

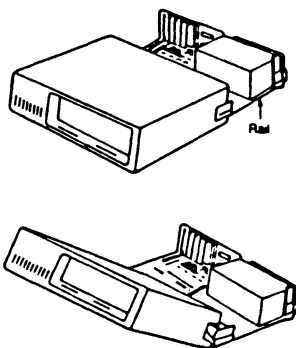

**Figure 2-3: Removing the Cover**

## Checking Switches

Refer to Figure 2-4 for the location of switch banks 1, 2, and 3.

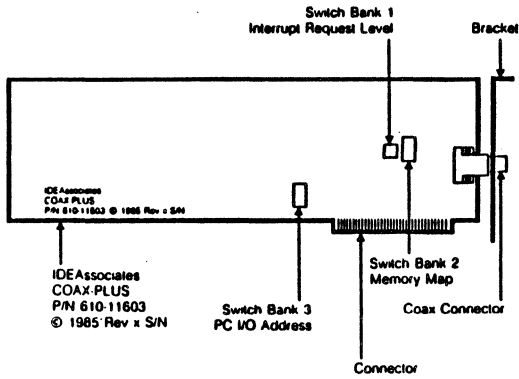

Figure 2-4: IDEAcomm 3278 Card

### Checking Switch Bank 1 - Interrupt Request Line

Switch Bank 1 on the IDEAcomm 3278 card selects the interrupt request line (IRQ).

The switches on Switch Bank 1 were set to IRQ5 at the factory and should look like those shown in Figure 2-5A if they are sliding switches or Figure 2-5B if they are rocker switches.

See Appendix E for information on alternate IRQ settings.

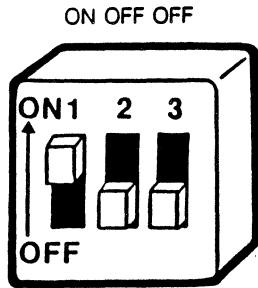

**Figure 2-5A: Switch Bank 1 Factory Settings - IRQ5 - (Sliding Switches)**

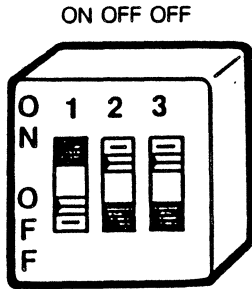

**Figure 2-5B: Switch Bank 1 Settings - IRQ5 - (Rocker Switches)**

If the settings are different, change them to correspond to Figure 2-5A or B.

#### NOTE

To set sliding switches, simply slide the tab to the ON or OFF position.

To set rocker switches, press down the ON side of the switch to set it to ON or press down the OFF side of the switch to set it to OFF. Use care when setting rocker switches.



## Checking Switch Bank 2 - Memory Address

Switch Bank 2 on the IDEAcomm 3278 card sets the memory address.

The switches on Switch Bank 2 were set to D000 and 64K at the factory and should look like those shown in Figure 2-6A if they are sliding switches or Figure 2-6B if they are rocker switches.

See Appendix E for information on alternate settings.

### NOTE

If you are using an IDEAdisk (with memory address D000) with IDEAcomm 3278, note that you must change the IDEAdisk settings in order to avoid an address conflict. Refer to Appendix E for information on changing the IDEAdisk settings.

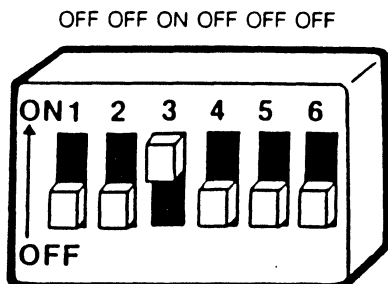

**Figure 2-6A: Switch Bank 2 Settings  
D000 and 64K  
(Sliding Switches)**

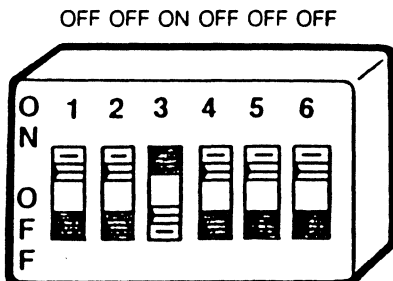

**Figure 2-6B: Switch Bank 2 Settings  
D000 and 64K  
(Rocker Switches)**

### **Checking Switch Bank 3 - PC I/O Address**

Switch Bank 3 on the IDEAcomm 3278 card sets the PC I/O address.

The switches on Switch Bank 3 were set to 220-227 Hex at the factory and should look like those shown in Figure 2-7A if they are sliding switches or Figure 2-7B if they are rocker switches.

See Appendix E for information about alternate switch settings.

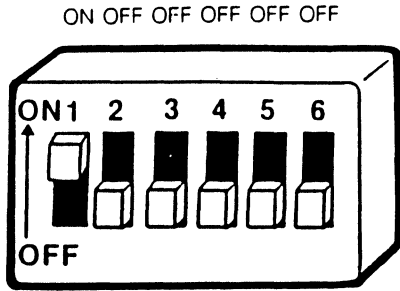

**Figure 2-7A: Switch Bank 3 Settings  
(220-227 Hex)  
(Sliding Switches)**

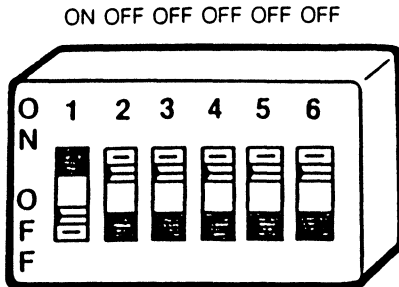

**Figure 2-7B: Switch Bank 3 Settings  
(220-227 Hex)  
(Rocker Switches)**

### Inserting the IDEComm 3278 Card

Once the switch settings are verified, you can insert the IDEComm 3278 card into any empty full size expansion slot on your IBM PC.

Use a flat blade screwdriver to remove the screw that holds the system expansion slot cover in place (turn the screw counterclockwise (CCW)). Refer to Figure 2-8.

Save the screw for installation of the IDEComm 5251 card.

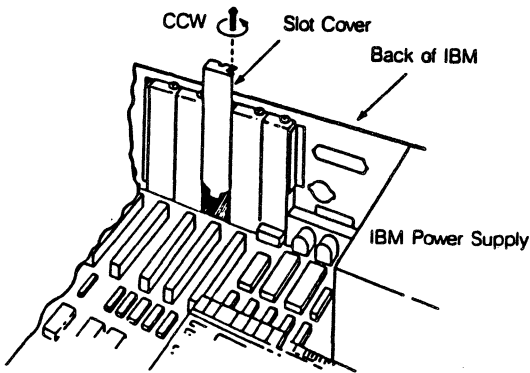

Figure 2-8: Removing the Slot Cover

## Support Track

A Support Guide is enclosed in your IDEComm 3278 package. Be sure that the Support Guide slot fingers are pointing down. Press the Support Guide into the holes in the front panel of the IBM. Note that if you have an IBM AT, the guides are already built into the system.

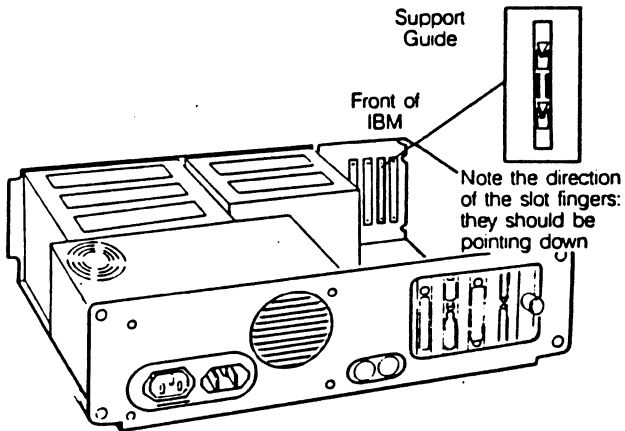

Figure 2-9: Pressing the Support Guide in Place

## Card Insertion

Hold the card by both corners. Slide it down through the Support Guide, and firmly press the card into the expansion slot. Be sure the card is held by the support guide.

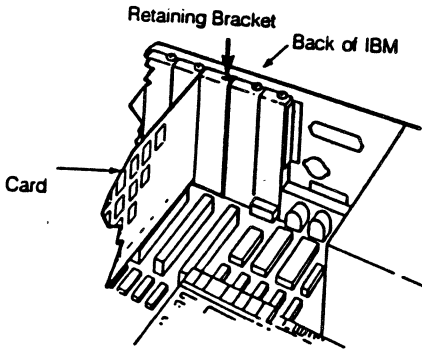

Figure 2-10: Inserting the Card

## Card Alignment

Align the hole in the IDEComm 3278 card retaining bracket with the hole in the rear panel of the computer. Insert the screw through the 2 holes and turn it clockwise (CW).

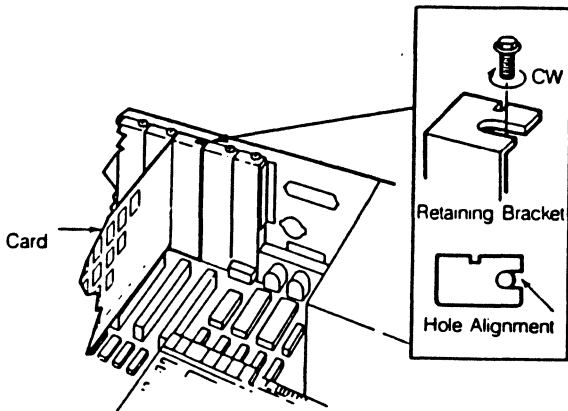

Figure 2-11: Aligning the Card



## Replacing the IBM Cover

If you have any other options to install, do so now, before replacing the cover.

Replace the IBM cover by positioning it as shown, and carefully sliding it toward the rear of the computer. The AT requires no tilting.

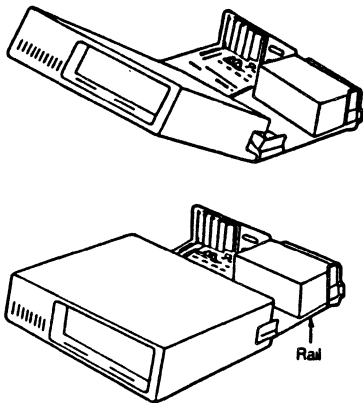
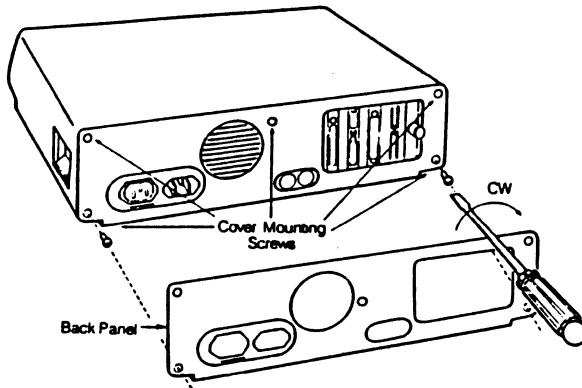

Figure 2-12: Replacing the IBM Cover

### Replacing the Cover Screws

When the cover is on, align the screws with the threaded tabs on the back of the cover. Tighten the screws using a flat blade screwdriver. Turn the screws clockwise (CW).

If you have an AT, replace the back panel by pressing it into the plastic fasteners. Relock the AT if this seems desirable.



**Figure 2-13: Tightening the Cover Screws**

## Recabling the IBM

You are now ready to recable your system. Please refer to the IBM Guide to Operations, "Set-up," for recabling the keyboard, monitor, printer, and other peripherals.

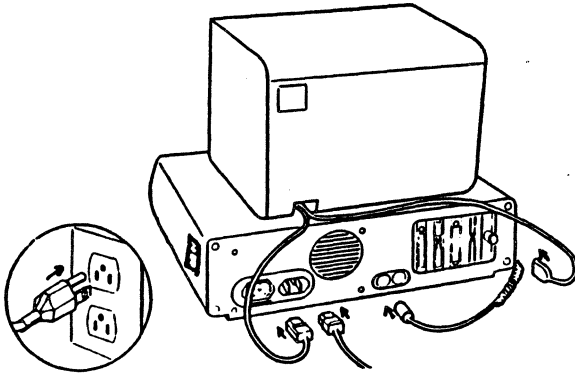

Figure 2-14: Recabling the System

## Hardware Diagnostics

After installing the IDEAComm 3278 card, test the basic functionality of the hardware by running the diagnostic program to make sure that it is operating correctly.

### **Copying the Software**

Before you use the diagnostic program or any IDEA software, make a backup copy of the software. To do this, you need your DOS diskette, a blank formatted diskette and the IDEAComm diskette.

Use the DOS COPY command to make the backup copy. For instructions on formatting a blank diskette or for information on the COPY command, refer to your DOS manual. Use the backup copy and put the original away for safekeeping.

### **Running the IDEAComm 3278 Hardware Diagnostics**

To run the diagnostic program make sure that the coax cable has not yet been connected. The diagnostic program may not function properly if you have already connected the PC to the IBM mainframe computer.

Type the following command to start the diagnostic program:

```
A>TEST3278 <CR>
```

The program performs a series of tests on your PC and the IDEAcmm 3278 card.

As each test is completed, the name of the test and the word Passed is printed on the screen. After the last test has been successfully completed, the following message is displayed at the bottom of the screen:

```
TEST3278-001 All IDEA3278 functions  
complete
```

Refer to Figure 2-15.

IDEA3278 Diagnostic Utility  
Version x.xx  
Copyright(c) 198x IDEAAssociates, Inc.

Host micro I/O control port test . . . . . Passed  
8X305 instruction memory/addressing test . . . Passed  
8X305 I/O addressing test . . . . . Passed  
Host micro screen memory test . . . . . Passed  
8X305 screen memory test . . . . . Passed  
8X305 8K offset jam test . . . . . Passed  
IRMA simulation test . . . . . Passed  
Auto response loopback test . . . . . Passed  
Digital coax loopback test . . . . . Passed  
Analog coax loopback test . . . . . Passed

TEST3278-001 All IDEA3278 functions complete

Figure 2-15: Diagnostic Test Screen

Note that your system is returned to DOS once the test is completed.

If a test is not passed during diagnostic testing, the word Failed is displayed next to the failed test. Also, the diagnostic program stops, an error message is displayed and the system is returned to DOS. Refer to Appendix A for an explanation of a diagnostic message.

Refer to Appendix B for information on performing diagnostic tests one at a time and for an explanation of what each test checks.

### Connecting a Coaxial Cable

After successfully running the diagnostics, you are ready to connect a coaxial cable from your PC to the IBM mainframe computer.

Make certain that the locking mechanism of the coaxial connector is fully engaged.

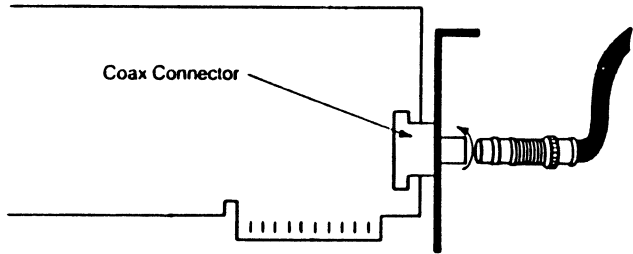

Figure 2-16: Connecting a Coaxial Cable

Make sure the coaxial cable is already connected to the IBM controller. The coaxial cable must be connected to an active controller before the IDEComm 3278 emulation will start.





### Section III:

#### Using IDEComm 3278

This section provides all the information you should need to load and use the IDEComm 3278 Command and IDEComm 3278 Emulation Modes under normal conditions. Command Mode commands and switching between Modes are also described.

#### Using IDEComm 3278

To use the IDEComm 3278 program, type the command shown below.

```
A>IDEA3278 <CR>
```

The following IDEComm 3278 initiation message is displayed when the program is loaded. The > character is the Command Mode prompt.

```
IDEA3278, Vn.n, SERIAL xx-nnnnn  
COPYRIGHT (c):  
Coaxsys-MICRO-INTEGRATION, IE  
Systems 198n  
COPYRIGHT (c): IDEAssociates Inc.  
1983-1984-1985  
>
```

You must enter at least one command to begin communications.

### Operating Modes

IDEAcomm 3278 has two modes of operation:

- o Command Mode is used to issue a variety of commands such as SEND, GO, DIR, etc.
- o 3278 Emulation Mode is the emulated 3278/9 screen. The Hot Key feature (explained in this section) makes it possible to make the IDEAcomm 3278 program a part of DOS, so that you can switch between Emulation and DOS with a single keystroke.

### IDEAcomm 3278 Commands

A few simple commands in Command Mode enable you to do a variety of things with IDEAcomm 3278.

IDEAcomm 3278 commands have the following syntax:

<operation>b<operand>[delimiter operand]...

where:

- <operation> Specifies the command to be executed.
- <operand> Specifies the operand(s) required by the command. Operands may not contain imbedded commas or blanks.
- delimiter Must be a comma, one or more blanks, or a comma followed by one or more blanks.

A summary of the commands, abbreviations, and uses is given in Table 3-1. In this manual, the abbreviated form is used for all commands.

Table 3-1 shows the abbreviations, and description of the IDEAComm 3278 software commands.

Table 3-1: IDEAComm 3278 Commands

<u>Command</u>	<u>Abbre- viation</u>	<u>Description</u>
CAPTURE	C	Capture a 3278 screen format for off line use.
DIR	D	Display a disk directory.
EXIT	EXIT	Return to the operating system (only if IDEAComm 3278 is not permanently resident).
GO	G	Enter 3278 Mode from Command Mode.
HELP	H	Display helpful information.

PRINT	P	Assign a file or printer as the local copy printer.
SEND	S	Send a screen to the host computer.
TYPE	T	Display a file.

### **GO Command: Entering 3278 Emulation Mode**

To enter 3278 Emulation Mode, type the following:

```
┌───────────  
>GO <CR>
```

The GO command can be abbreviated as G.

After this command is issued, the PC screen is cleared and the PC is placed in 3278 Emulation Mode. See Section IV for a description of the 3278 keyboard operations that may be performed in Emulation Mode.

If you want to use the local print feature in 3278 Emulation Mode, you must first define your printer file or device in the Command Mode. See the PRINT command in this section.

To return to Command Mode, press the key configured as the EXIT key. (The default EXIT key is CTRL E.)

### **Making IDEAComm 3278 Resident - Using the Hot Key**

You can make the IDEAComm 3278 program resident in memory by using the hot key. This enables you to switch back and forth between IDEAComm 3278 and some other PC activity without logging off of the host. For example, while you are running IDEAComm 3278 and are connected to a remote, you may need to see a directory of your disk drive, edit a file with a text editor, or you may want to upload or download files using IDEAComm's advanced file transfer utility (XFER).

To make IDEAComm 3278 resident, run IDEAComm 3278 and use the GO Command to go into 3278 Emulation Mode. Press both SHIFT keys together. When one or both keys are released, the screen clears and you will see the DOS prompt. IDEAComm 3278 is now resident. You can toggle into or out of 3278 Emulation Mode by pressing the two SHIFT keys together. Using the two SHIFT keys in this way is called HOT KEYING and the SHIFT keys are referred to as HOT KEYS.

You can toggle into IDEAComm 3278 at any time, whether the system is idle or whether a program or command is executing. You can toggle out of IDEAComm 3278 at any time while you are in 3278 Emulation Mode. You will go back to whatever command or program was executing when you toggled into IDEAComm 3278, and will continue from where that command or program left off. If nothing was executing, you will go back to the DOS prompt.

After you have made IDEAComm 3278 resident, the only way to exit from IDEAComm 3278 is by pressing both SHIFT keys (hot keying) while in 3278 Emulation Mode.



Note that once you make IDEComm 3278 resident, it remains resident until you reboot the operating system.

### PRINT Command

You may configure the local printer to be either a printer on your personal computer system or an IBM printer attached to your 3274 or 3276 control unit. Refer to Section V for configuration information. Use the configuration software described in Section V to enter the configuration you require.

The PRINT command is a Command Mode command and is used to direct output to a physical printer or to a disk file. The PRINT command assigns a location, it does not write data to a printer.

If you configure it as a printer on your personal computer system, then you may use the IDEComm 3278 PRINT command to define the local printer to be either a physical printer or a logical printer (a disk file). You must assign the printer to either a physical printer or filename before going into emulation.

Note that if you define a physical printer as the printer that is attached to the IBM 3274/76 mainframe control unit, the PRINT command has no effect. When you press the Local Print key (CTRL P) the information displayed on your screen is sent to the location specified in the configuration software.

Optionally, you can configure the IDEAComm software to use the printer that is attached to the IBM 3274/76 mainframe control unit using the configuration utility described in Section V. With this configuration, the PRINT command has no effect. When you request the Print Screen feature, it goes to your IBM control unit printer.

The format of the PRINT command is:

PRINT PRN

(to print to a printer) or

PRINT <filespec>

(to print to a file)

The abbreviated PRINT command is P.

PRN defines your PC's list device as the printer.

<filespec> is the complete name (including drive specification) of the file to which the print output is directed. If no drive is specified, then the default drive is assumed.

To assign the logical 3278 Print Screen printer to a file named PRNFILE.TXT on Drive B, enter the command shown below. Each time the local print key is used, the data is sent to the named file.

```
>PRINT B:PRNFILE.TXT <CR>
```

The printer definition remains in effect until you enter another PRINT command or exit IDEAComm 3278. The print line length is always 80 characters.

To assign the logical 3270 local printer to the list device, type:

```
>P PRN <CR>
```

Printer destined data will be sent to the list device each time the local print key is used.

Remember that if you configure IDEComm 3278 to use the 3270 printer attached to the control unit, the PRINT command has no effect.

### **HELP Command: Getting Information**

You can use the HELP command to display information about IDEComm 3278 commands. When you type HELP, a file named IDEA3278.HLP is displayed.

To use the HELP Command, type:

 >HELP <CR>

The HELP Command may be abbreviated as H.

To exit the HELP file, press the D key.

This file is displayed one page (screen) at a time. If the file is longer than one page, the last line on the screen gives you the option of cancelling the display by pressing the D key or continuing to the next page by pressing any other key.

The IDEA3278.HLP file supplied with IDEAComm 3278 contains a description of the IDEAComm 3278 commands and what they do. It also contains a list of IBM 3270 keyboard keys and provides IDEAComm 3278 keyboard equivalents. You may edit the IDEA3278.HLP file to include any information you think necessary, such as telephone numbers of your host computer.

If you wish to customize the HELP file, the following considerations apply.

- o The file must be named IDEA3278.HLP and reside on the same disk as the IDEAComm 3278 program.
- o Lines longer than 80 characters are wrapped on the next line.
- o All logical lines must end with carriage return/line feed (0DH, 0AH).

- o Upper- and lowercase ASCII characters are supported.
- o Horizontal tabs (09H) are not expanded.
- o The file is displayed one full screen at a time, less one line to allow for the message at the bottom of the screen. You may want to format your file so that the breaks between screens occur at reasonable places.

**TYPE Command: Displaying the Contents of a File**

This command displays the contents of a file on the screen, one screenful at a time. Lines longer than 80 characters are wrapped onto the next line.

Upper- and lowercase characters are supported and no translation is performed on the data. Horizontal tabs are **not** expanded. Screen attribute characters (for example, in a file created by a CAPTURE command) are displayed as spaces. High and low intensity attributes are ignored by the TYPE command, but non-display fields are displayed as spaces.

If the file is longer than one page, the last line on the screen gives you the option of cancelling the display by pressing the D key or continuing to the next page by pressing any other key.

The TYPE command has the syntax:

```
>T <filespec>
```

<filespec> Specifies the name of the file to be displayed.

**EXAMPLES:**

The following command will display the contents of a file on the current drive named JOBXYZ.001.

```
>T JOBXYZ.001 <CR>
```

The next command will display the contents of a file on drive B named JOBWED.ASM.

```
>T B:JOBWED.ASM <CR>
```

## DIRECTORY Command: Displaying a File Directory

The DIRECTORY command is used to display the directory of the specified drive.

The format of the DIRECTORY command is:

```
DIR [disk drive:]
```

The abbreviated DIRECTORY command is D.

[Disk drive:] specifies the drive containing the disk directory to be displayed. If the [disk drive:] parameter is omitted, the current drive is assumed.

To display the directory of the current disk, enter the following command:

```
>D <CR>
```

To display the directory of the disk on drive B, type:

```
>D B: <CR>
```



## **SEND Command: Sending Prepared Screens to the Host**

IDEAcomm 3278 allows you to prepare screens of data offline from the host computer, then send these screens to the host without operator intervention. The screens can be prepared using an editor, a data entry program, or by using a program that you write. No matter how the screens are prepared, IDEAcomm 3278 treats data in the screen file as a series of keystrokes that are used to put data onto the 3278 screen. You must format the screen files so that the data in the files goes into the proper location on the screen.

Data in the files can be any displayable ASCII characters, plus the tab character. Other characters cannot be sent and will stop the send operation if they are present in the file. Screens in the file are separated by the carriage return/line feed sequence so that each logical record in the file is one screen.

(Note that you may also use the XFER file transfer utility described in Appendix C to move whole files of data to and from a host.)

You can use the CAPTURE command to capture screen formats to allow you to create the proper input formats easily.

The SEND command has the format:

```
S <filespec>[,<filespec>...]
  [/P|/NP]
```

where:

<filespec> Is the name of a file to be transmitted. Up to eight filenames may be specified, separated by commas.

/P Specifies that the transmission is to be in Prompt Mode.

/NP Specifies that the transmission is to be in No-Prompt Mode.

The mode may be specified only once per command, and applies to all files in the command.

If both /P and /NP are omitted, Prompt Mode is assumed.

When you enter a SEND command, IDEAcmm 3278 goes into 3278 Mode.

With the No-Prompt option, each file named in the command is read and file data is used to fill unprotected fields in the display buffer. When a carriage return is encountered in the file data, the current display buffer is transmitted to the host computer. If the end of the display buffer is reached before a carriage return is encountered, the file record wraps around to the beginning of the buffer. After the remote responds by unlocking the keyboard, this process is repeated until end-of-file on the last file specified. Transmitted data is displayed to you as the screen is filled.

With the Prompt option, each file named is read and file data is used to fill unprotected fields in the display buffer as in No-Prompt Mode. In Prompt Mode, however, your action is required to transmit the display data to the host. You may move the cursor on the display and modify data in the buffer through keyboard action, you may cause the screen to be sent to the host by using the RETURN or PF keys, and you

may cause the screen to be bypassed (not sent to the host) by using the CLEAR key. The CLEAR key AID is not sent to the host during SEND processing. After the keyboard is unlocked, the next record from the file is read and processed as above.

Data from the file is placed in unprotected display locations in both modes. Tab (09H) characters in the file cause a programmatic tab to the next unprotected field.

All protected fields are logically treated as autoskip, so that it is not possible to enter data into any field except an unprotected field.

Data existing in unprotected display fields will be overwritten with file data.

Modified Data Tags (MDTs) for fields that have data inserted are set. MDTs are not set for fields that are tabbed over.

After all files have been sent, IDEAcmm remains in 3278 Emulation Mode. Reentering Command Mode during file transmission aborts the transmission.

## **CAPTURE Command: Capturing a Screen Format**

IDEAcomm 3278 software provides a convenient way to capture screen formats. These formats can then be used as models to write programs that create data to be sent to the mainframe using the SEND command.

The IDEAcomm 3278 CAPTURE command has the format:

**C <filespec>**

**<filespec>** Specifies the name of the file that is to contain the screen format.

When you CAPTURE a screen format, IDEAcomm 3278 creates a file that contains the screen image. The file is a single record of 1,920 characters. The first character in the file is the first character on the screen and the last character in the file is the last character on the screen. If the absolute value of a character is

greater than 191 (the 2 high-order bits are one), the character is an IBM attribute character.\* If the value of the character is 191 or less (the 2 high-order bits are zero), it is an ASCII data character. It may also be a null character (00H). The data is captured exactly as it appears on the screen, with all data, both protected field data and unprotected field data. Data in nondisplay fields is not captured, but is replaced by null characters (00H) in the CAPTURE file.

\*Refer to Table 3-2 for information on IDEAcmm 3278 Attribute Bytes. Also, see the IBM publications listed in Section I for more information about the 3270 screen.

(IDEAcomm 3278 Attribute Bytes)

The attribute bytes written into the CAPTURE file by IDEAcomm 3278 are the same as the IBM attribute bytes, except that the second-highest order (X'40') bit is always one. The IBM attribute bytes sometimes have this bit set and sometimes they do not, depending on the other bits in the byte. The following table shows the definition of the IDEAcomm 3278 bits.

Table 3-2: IDEAcomm 3278 Attribute Bytes

BIT	DESCRIPTION
0	Always 1
1	Always 1
2	0 = Unprotected 1 = Protected
3	0 = Alphanumeric 1 = Numeric
4&5	00 = Normal intensity, not pen detectable 01 = Normal intensity, pen detectable 10 = High intensity, pen detectable 11 = Nondisplay
6	Always 0
7	0 = Field has not been modified 1 = Field has been modified

Note that a screen that is captured cannot be used with the SEND command, because some of the characters are not ASCII characters.

**EXAMPLES:**

The following command writes the contents of the screen to a file on drive B called SCREEN01.CAP.

```
>C B:SCREEN01.CAP <CR>
```

The next command writes the contents of the screen to a file on the current drive called FORM.XYZ.

```
>C FORM.XYZ <CR>
```



**EXIT Command: Terminating IDEComm  
3278**

To exit the IDEComm 3278 program and return to the operating system, enter the following command while in Command Mode:

**>EXIT <CR>**

You must spell out the word EXIT.

**NOTE**

If you have made IDEComm 3278 resident, you can no longer exit this way. See the next page for information on Exiting.

## **Exiting 3278 Mode, Entering Command Mode**

To exit 3278 Emulation Mode and receive the IDEAcmm Command prompt, press the key configured as the EXIT key.

IDEAcmm 3278 leaves 3278 Emulation Mode, clears the terminal screen, and enters Command Mode. Data in the 3278 buffer is preserved and will be redisplayed if a GO command is issued to reenter the 3278 Emulation Mode.

You would enter Command Mode to, for example, change the logical 3270 printer device or to exit IDEAcmm 3278 and return to the operating system.

### **EXAMPLE:**

To enter Command Mode, press the key configured as the EXIT key. The default EXIT key is CTRL E.

The terminal screen is cleared and the IDEAComm 3278 startup message and command prompt is displayed:

```
IDEA3278, Vn.n, SERIAL xx-nnnnn  
COPYRIGHT (c) 198n,  
Micro-Integration, Inc.  
Distributed by distributor name
```

```
>
```

### Program Messages

The IDEAComm 3278 program issues messages that inform you of current execution status. All messages are of the form:

XFER-*nnn* message text

where:

*nnn* Is a unique message identifier that provides easy reference to the message explanation. IDEAComm 3278 program messages are documented in detail in Appendix A.

message text Is a short message briefly describing the action required, condition found, or program status.

## Section IV:

### Operations

IDEAcomm 3278 allows your PC to perform all the keyboard and screen functions of an IBM 3278/79 display terminal. It also allows you to do things that you cannot do on a real 3278, such as transfer files to or from the PC and from the PC to the host or capture screen data into PC files. IDEAcomm 3278 lets you use a LOCAL PRINT key to copy the screen to a file or to the printer.

#### Keyboard Equivalents

The IDEAcomm 3278 program automatically defines your PC keys as 3278 keys when you are in Emulation Mode. Refer to Figure 4-1 for a list of the 3278 keyboard characters and their PC equivalents.

You can redefine the PC's 3278 keyboard characters to define 3270 keys not present on the real personal computer keyboard. You can change key definitions by using the configuration program described in Section V. For example, the 3270 keys RESET, SYS REQUEST, PA1, and PA2 are commonly used keys that usually are not physically present on a personal computer keyboard. In this case you might type CTRL R on your keyboard for the 3270 RESET key.

Other than the key changes noted above, IDEAComm 3278 keyboard operations duplicate those of an IBM 3278. See the IBM publications listed in Section I for a description of the 3270 keyboard and screen operations.

3278 Keyboard

01-PF1	(F1 )	18-PF18	(ALT/F8 )	35-BACK TAB	(SHIFT/TAB)
02-PF2	(F2 )	19-PF19	(ALT/F9 )	36-NEW LINE	(CTRL/N )
03-PF3	(F3 )	20-PF20	(ALT/F10)	37-INSERT	(INS )
04-PF4	(F4 )	21-PF21	(CTRL/F1)	38-DELETE	(DEL )
05-PF5	(F5 )	22-PF22	(CTRL/F2)	39-ERASE EOP	(CTRL/L )
06-PF6	(F6 )	23-PF23	(CTRL/F3)	40-ERASE INPUT	(CTRL/K )
07-PF7	(F7 )	24-PF24	(CTRL/F4)	41-FIELD MARK	(CTRL/F )
08-PF8	(F8 )	25-PA1	(CTRL/F5)	42-LOCAL PRINT	(CTRL/P )
09-PF9	(F9 )	26-PA2	(CTRL/F6)	43-CURSR RIGHT	(RTARROW )
10-PF10	(F10 )	27-TEST	(CTRL/T )	44-CURSR LEFT	(LFARROW )
11-PF11	(ALT/F1)	28-ENTER	(RETURN )	45-CURSR UP	(UFARROW )
12-PF12	(ALT/F2)	29-CLEAR	(CTRL/Z )	46-CURSR DOWN	(DNARROW )
13-PF13	(ALT/F3)	30-RESET	(CTRL/R )	47-CURSR SEL	(CTRL/W )
14-PF14	(ALT/F4)	31-EXIT	(CTRL/E )	48-SYS REQ	(CTRL/S )
15-PF15	(ALT/F5)	32-DUP	(CTRL/U )	49-ATTN	(CTRL/V )
16-PF16	(ALT/F6)	33-HOME	(HOME )	50-DEV CNCL	(CTRL/Q )
17-PF17	(ALT/F7)	34-TAB	(TAB )	51-IDENT	(CTRL/Y )
				52-BACK SPACE	(BKSPACE )



















Figure 4-1: PC's Default 3278 Keyboard Equivalents

## Local Print Capability

The Local Print key (Ctrl P) lets you copy the data displayed on the screen to a file or printer. Any serial or parallel printer configured for your PC can accept screens. To use the Local Print key, you must first direct the output to a specified file or printer entered via the PRINT command while in the Command Mode. Next, from the 3278 Emulation Mode enter Ctrl P. This causes the information currently displayed on the screen to be written to the file or device specified in the PRINT command. If a disk file was specified, each time Ctrl P is entered the new information is appended to data already in the file. If you did not issue a PRINT command, entering Ctrl P will do nothing. The LOCAL PRINT key is defined in Figure 4-1.

## Status Line Symbol Equivalents

The 3278 reserves a line at the bottom of the screen called the Status Line. The IBM 3278 uses special symbols on this line to show the status of the 3278 operation. The IDEAComm 3278 software also emulates this feature of the IBM 3278, but uses a slightly different set of status symbols. The differences are shown in Figure 4-2.

IBM Symbol	IDEA3278 Symbol
A	A
B	B
6	6
	
	
	
B	B
	
X	x
	(
	)
	
	
	
4	4
A	A
	
	

**Figure 4-2: PC'S 3278 Status Symbol Equivalents**





## Section V:

### Configuring IDEAcmm 3278 Software

#### The Configuration Utility

The IDEAcmm 3278 program allows you to configure various options of the software such as, remap the keyboard, set nationality, and set up field attributes for 3279 color monitor emulation etc.

When you receive the IDEAcmm 3278 program, it is ready to run. The options have been set to default values and all 3270 keys have been defined as described in the IDEAcmm 3278 HELP file. You can reconfigure IDEAcmm 3278 by running the Configuration Program. This program provides you with a series of menus that step you through the configuration process.

The first menu, called the Main Menu, allows you to select the options you want to configure. When you select an option on the Main Menu, subsidiary menus are then displayed to do the configuration you select. The following text describes each menu and the options you can enter.

## Using the Configuration Program

The configuration program, CFGI.COM is on your copy of the IDEComm 3278 software diskette. To run the program, place the IDEComm diskette in Drive A and type the following command:

```
A>CFGI <CR>
```

The Main Configuration Menu is displayed.

### The Main Menu

The Main Menu is displayed when you start the configuration utility and each time you complete a configuration item selected from the Main Menu. Other menus are displayed when you select one of the lettered options and press RETURN.

```
*****
*
* IDEA3278 Configuration Program   Vnn.nn.nn
* Copyright(c) 198n, IDEAssociates, Inc.
* Copyright (C) 198n, Micro-Integration, Inc.
*
*****
```

Select an Option:

- A - Configure Power-Off
  - B - Configure Local Printer
  - C - Configure Nationality
  - D - Configure 3278 Keyboard
  - E - Configure Display
  - F - Configure Compatibility
- 
- 1 - Exit with no changes
  - 2 - Exit and change configuration

--> <--

Figure 5-1: Configuration Main Menu

## (Overview of Options)

- A - The Power-Off option can either simulate a 3278 power-off condition when you exit the IDEAComm 3278 program, or it can keep the 3278 in a power-on condition when the IDEAComm 3278 program is not running.
- B - The Local Printer key can be configured to either send print requests to the printer or file defined using the PRINT command, to send them to the 3270 printer attached to the IBM control unit.
- C - The 3270 Keyboard option allows you to change the current definition of a specific key. IDEA's remapping process is quick and easy to use.
- D - With the Configure Nationality is for users with non-U.S.A. keyboards. This option allows you to change the character set you wish the emulated 3278 keyboard to use.
- E - On the Configure Display menu, you can specify whether you will be running IDEAComm 3278 on a PC with a monochrome or a color display and can set colors for a color display.

- F - The Configure Compatibility Menu allows you to choose Native mode, IRMA mode, or Both.
- 1 - If you select Option 1 and press RETURN, the Configuration Program ends without saving any changes you have made. The configuration file will remain the same as it was before you started the Configuration Program.
- 2 - If you select Option 2 and press RETURN, the Configuration Program ends and makes your configuration changes permanent.

#### **Option A - Configure Power-Off**

When you select Option A on the Main Menu and press RETURN, the Power-Off Menu is displayed.

**Power-Off**

Do you wish to simulate 3278 power-off  
when the IDEA3278 program is exited?

Enter Y or N -->N<--

Press <ESC> to return to Main Menu with no change.  
Press <RETURN> to return to Main Menu and accept change.

**Figure 5-2: Power-Off Menu**

**5-6 Configuring Software**

The current value for the option is shown. You can press RETURN to accept the value displayed, change the value, or press ESC to cancel any changes you have made and return to the Main Menu.

If you enter Y, the IDEAComm 3278 program simulates a 3278 power off when you exit the IDEAComm 3278 program. This erases the buffer that holds the 3278 screen data and the screen is erased. This feature has no effect if you use the resident feature.

If you enter N, the 3278 screen is saved while the IDEAComm 3278 program is not running. When you run IDEAComm 3278 again, the data that was on the screen when you exited will be redisplayed. In this case, the 3278 data is erased only when you turn off your PC.

After you make your selection and press RETURN, the Main Menu screen appears.



## **Option B - Configure Local Printer**

When you select Option B on the Main Menu and press RETURN, the Local Printer Menu is displayed.

Local Printer

Select an option:

- A - Use PC printer or file for local prints
- B - Use 3270 printer for local prints

-->A<--

Press <ESC> to return to Main Menu with no change.  
Press <RETURN> to return to Main Menu and accept change.

Figure 5-3: Local Printer Menu

The current value for this option is shown. You can press RETURN to accept the value displayed, change the value, or press ESC to cancel any changes you have made and return to the Main Menu.

If you select A, when you make a print request by pressing the key defined as the Local Print key, the request is sent to the printer or file you defined using the PRINT command.

If you select B, any print request made by pressing the Local Print key is sent to the IBM control unit for processing by a 3270 printer attached to that unit.

After you make your selection and press RETURN, the Main Menu is displayed.

## **Option C - Configure Nationality**

The Configure Nationality menu allows your IDEAComm 3278 to support one of the international language character sets displayed on the menu. When you select Option C on the Main Menu, the Nationality Menu is displayed.

## Nationality

Select an option:

- A - US English
- B - UK English
- C - Austrian/German
- D - French AZERTY
- E - Italian
- F - Norwegian
- G - Spanish
- H - Swedish
- I - French Canadian
- J - Portuguese

-->A<--

Press <ESC> to return to Main Menu with no change.  
Press <RETURN> to go on to next screen and accept change.

Figure 5-4: Nationality Menu

## 5-12 Configuring Software

This menu allows you to select the appropriate character set for IDEAcmm 3278 for various languages.

The languages displayed on your menu may differ from those shown in Figure 5-4. Also, you must have the corresponding language file (a filename with a .LNG extension) on your disk for the language you select. After you have configured the new language, you do not need to keep the other language files on the disk you use to execute the Configuration Program or IDEAcmm 3278.

Enter the letter corresponding to the desired language, then press RETURN to return to the Main Menu. Pressing ESC returns you to the Main Menu without changing the previous option.

## Option D - Configure 3270 Keyboard

When you select Option D on the Main Menu and press RETURN, the 3270 Keyboard Menu is displayed.

01-PF1	(F1 )	18-PF18	(ALT/F8 )	35-BACK TAB	(SHIFT/TAB)
02-PF2	(F2 )	19-PF19	(ALT/F9 )	36-NEW LINE	(CTRL/N )
03-PF3	(F3 )	20-PF20	(ALT/F10)	37-INSERT	(INS )
04-PF4	(F4 )	21-PF21	(CTRL/F1)	38-DELETE	(DEL )
05-PF5	(F5 )	22-PF22	(CTRL/F2)	39-ERASE EOF	(CTRL/L )
06-PF6	(F6 )	23-PF23	(CTRL/F3)	40-ERASE INPUT	(CTRL/K )
07-PF7	(F7 )	24-PF24	(CTRL/F4)	41-FIELD MARK	(CTRL/F )
08-PF8	(F8 )	25-PA1	(CTRL/F5)	42-LOCAL PRINT	(CTRL/P )
09-PF9	(F9 )	26-PA2	(CTRL/F6)	43-CURSR RIGHT	(RTARROW )
10-PF10	(F10 )	27-TEST	(CTRL/T )	44-CURSR LEFT	(LFARROW )
11-PF11	(ALT/F1)	28-ENTER	(RETURN )	45-CURSR UP	(UPARROW )
12-PF12	(ALT/F2)	29-CLEAR	(CTRL/Z )	46-CURSR DOWN	(DNARROW )
13-PF13	(ALT/F3)	30-RESET	(CTRL/R )	47-CURSR SEL	(CTRL/W )
14-PF14	(ALT/F4)	31-EXIT	(CTRL/E )	48-SYS REQ	(CTRL/S )
15-PF15	(ALT/F5)	32-DUP	(CTRL/U )	49-ATTN	(CTRL/V )
16-PF16	(ALT/F6)	33-HOME	(HOME )	50-DEV CNCL	(CTRL/Q )
17-PF17	(ALT/F7)	34-TAB	(TAB )	51-IDENT	(CTRL/Y )
				52-BACK SPACE	(BKSPACE )

Select the 3270 key you want to define --> <--.  
 Leave selection blank to return to Main Menu and accept changes.  
 Press <ESC> to return to Main Menu with no changes.  
 Press <RETURN> to accept selection and go on to next screen.

Figure 5-5: 3270 Keyboard Menu



The menu shows you a list of 3270 keys that may not be present on your keyboard. It allows you to change the way you simulate the key. The current definition of each key is shown inside the parentheses.

Note that the PA-3 key is not supported by IDEAComm 3278.

#### NOTES ON KEYBOARD CONFIGURATION

There are several things you should keep in mind as you define your keyboard.

1. The Configuration Program does not allow you to use one of your keyboard keys for more than one 3270 key. You cannot, for instance, use Ctrl Z for both CLEAR and ENTER. Likewise, you cannot use two different keys to represent the same 3270 key. For example, you cannot use both Ctrl Y and Ctrl Z for PF1.

2. The Configuration Program does not allow you to leave any 3270 keys undefined. If any keys are undefined, the message **\*\*UNDEFINED KEY(S)\*\*** appears on the 3270 Keyboard Menu and you are not able to return to the Main Menu until you define them.
3. When you change a key definition in the Configuration Program, the IDEAcmm 3278 HELP file is not automatically updated. Use a text editor to change the IDEAcmm 3278 keyboard equivalents in the HELP file.
4. You cannot use Ctrl/Alt/Delete for any key because this key combination reboots the operating system.

Use the form in Table 5-1 to keep a record of any changes you make to the keyboard configuration.

Table 5-1: User Defined 3270 Keyboard Equivalents Form

3270 Key	Config.	3270 Key	Config.	3270 Key	Config.
PF1	_____	PF18	_____	BACK TAB	_____
PF2	_____	PF19	_____	NEW LINE	_____
PF3	_____	PF20	_____	INSERT	_____
PF4	_____	PF21	_____	DELETE	_____
PF5	_____	PF22	_____	ERASE EOF	_____
PF6	_____	PF23	_____	ERASE INPUT	_____
PF7	_____	PF24	_____	FIELD MARK	_____
PF8	_____	PA1	_____	LOCAL PRINT	_____
PF9	_____	PA2	_____	CURSR RIGHT	_____
PF10	_____	TEST	_____	CURSR LEFT	_____
PF11	_____	ENTER	_____	CURSR UP	_____
PF12	_____	CLEAR	_____	CURSR DOWN	_____
PF13	_____	RESET	_____	CURSR SEL	_____
PF14	_____	EXIT	_____	SYS REQ	_____
PF15	_____	DUP	_____	ATTN	_____
PF16	_____	HOME	_____	DEV CNCL	_____
PF17	_____	TAB	_____	IDENT	_____
				BACK SPACE	_____

To change the definition of a key on the emulated 3270 keyboard, type in the number of the key you want to change, then press RETURN. If, for instance, you want to change the CLEAR key, you would type 29 <CR>. When you type in a key number and press RETURN, the menu shown in Figure 5-6 is displayed.

**3270 Key Definition**

Press the xxxxxxxxxxx key sequence.

—>

xxxxxxxxxx previously defined as yyyyyyy

**Figure 5-6: 3270 Key Definition Screen**

On the actual menu, xxxxxxxxxxxx will show the 3270 key you are defining and yyyyyyyy will show the current definition.

To change the definition, press the PC key that is to be interpreted as the 3270 key. The screen will redisplay the 3270 Keyboard Menu which now shows the new key definition. You can continue to define keys, or you can return to the Main Menu by pressing RETURN without typing a number.

#### EXAMPLE

To change the PF1 key definition to Ctrl Z:

1. Type 1 (the PF1 key number) and press RETURN on the 3270 Keyboard Menu.
2. Type Ctrl Z on the 3270 Key Definition Screen.

## **Option E - Configure Display**

When you select Option E on the Main Menu and press RETURN, the Display Menu is shown.



Display Type

Select an option:

- A - Color display
- B - Monochrome Display

-->A<--

Press <ESC> to return to Main Menu with no change.  
Press <RETURN> to go on to next screen and accept change.

Figure 5-7: Display Menu

## 5-24 Configuring Software

You use this menu to specify whether you are running IDEAComm 3278 on a PC with a monochrome or a color display and to select the colors IDEAComm 3278 will use to display fields with various attributes.

If you choose A and press RETURN, the Display Field Colors screen appears. Refer to Figure 5-8.

## Field Colors

Select a color option for each field type:

A-Blue B-Red C-Magenta D-Green E-Cyan F-Yellow G-White H-Black I-Off

Unprotected	Alphanumeric	Nondetectable	Normal Intensity	-->D<--	Green
Unprotected	Alphanumeric	Detectable	Normal Intensity	-->D<--	Green
Unprotected	Alphanumeric	Detectable	High Intensity	-->B<--	Red
Unprotected	Numeric	Nondetectable	Normal Intensity	-->D<--	Green
Unprotected	Numeric	Detectable	Normal Intensity	-->D<--	Green
Unprotected	Numeric	Detectable	High Intensity	-->B<--	Red
Protected	Alphanumeric	Nondetectable	Normal Intensity	-->A<--	Blue
Protected	Alphanumeric	Detectable	Normal Intensity	-->A<--	Blue
Protected	Alphanumeric	Detectable	High Intensity	-->G<--	White
Auto Skip		Nondetectable	Normal Intensity	-->A<--	Blue
Auto Skip		Detectable	Normal Intensity	-->A<--	Blue
Auto Skip		Detectable	High Intensity	-->G<--	White
Status Line				-->A<--	Blue
Status Line Messages				-->F<--	Yellow

Press &lt;TAB&gt; to select next field.

Press &lt;ESC&gt; to return to Main Menu with no changes.

Press &lt;RETURN&gt; to return to Main Menu and accept changes.

Figure 5-8: Display Field Colors Screen

The Display Field Colors screen lists all possible combinations of attributes that a field on the screen may have, and shows the color currently selected for fields with each combination. (For a complete explanation of fields and attributes, see the IBM publications listed in Section I.) A list of possible colors and the letter you should enter to select each is also shown. When the menu appears, the cursor is on the first line of the list of attribute combinations. To move the cursor to the next line, press the TAB key. To change the display color for fields with a given attribute combination, move the cursor to the appropriate line and enter the letter corresponding to the desired color. For example, to change unprotected numeric detectable normal intensity fields to blue, tab to the 5th line and type A.

Fields configured as Off (choice I) are not displayed.

After entering all your changes, press RETURN to return to the Main Menu and to write your changes. Press ESC to return to the Main Menu without changing the original settings.

If you choose B on the Display Menu and press RETURN, the Main Menu will be displayed. IDEComm 3278 will display fields on the 3278 screen using high and low intensity as on a standard monochrome IBM 3278 display station. Any colors previously configured on the Display Field Colors screen will be ignored. Remember that to exit without making changes, you must use the ESC key.

#### NOTE

If your personal computer has a color display and you specify monochrome, IDEComm 3278 will display all fields as either green or white.

If your personal computer has a monochrome display, you must specify monochrome or your 3278 display may not be stable.

## Option F - Configure Compatibility

When you select Option F on the Main Menu and press RETURN, the Compatibility Menu is displayed.

## Compatibility

Select an option:

- A - NATIVE
- B - IRMA
- C - Both

-->C<--

Press <ESC> to return to Main Menu with no change.  
Press <RETURN> to return to Main Menu and accept change.

Figure 5-9: Compatibility Menu

## 5-30 Configuring Software

### **NATIVE**

Native mode provides extremely fast transmission speeds. If you choose this option, you can run programs written for IDEA Native mode, but you cannot run IRMA compatible software.

### **IRMA**

Use the IRMA mode when you are linking to a mainframe application that requires the IRMA interface. If you choose this mode, you cannot run programs written for IDEA Native mode.

### **BOTH**

If you plan to use both IDEA Native programs and IRMA compatible programs, choose the BOTH option. Note, however, that the BOTH mode causes some degradation in performance. Therefore, if you do not plan to use IRMA compatible programs, choose NATIVE. If you do plan to use IRMA compatible programs, choose IRMA mode.



### Making Configuration Changes Permanent

After you have gone through the configuration process, at the Main Menu you can keep pressing RETURN to cycle through all the menus. This gives you a chance to check the configuration changes you made. When you are satisfied that you have set the configuration correctly, select Option 2 on the Main Menu, then press RETURN to make your configuration permanent.

### Preserving the Original Configuration

If you decide to keep the original values, enter Option 1 at the Main Menu, then press RETURN. This stops the Configuration Program without making any changes.

After the configuration is complete, you are ready to use the Emulation program.

## Configuration Messages

The Configuration Program has a set of status messages to assist you during the configuration process. When applicable, these messages appear near the bottom of the configuration menus. A list of the messages and a description of each follows.

**Error opening configuration file**  
**Error closing configuration file**  
**Error writing configuration file**

The operating system detected an I/O error while the configuration program was attempting to access the configuration file IDEA3278.UCM. If the error occurred while opening the file, the file may not be present on the current disk.

### **Invalid character**

The character you entered is not within the range of characters allowable for the current option. For example, you may have entered a letter where a number is required.

### **Invalid option**

What you entered is not in the list of allowable options given in the menu.

### **Invalid key number**

In the 3270 Keyboard Menu, you selected a key number other than those listed.

### **Key sequence not definable**

Certain keys on the personal computer keyboard may not be used to define 3270 keys.

### **\*\*UNDEFINED KEY(S)\*\***

When this message appears in the 3270 Keyboard menu, it means that one or more 3270 keys currently are not defined, and you must define a personal computer key to represent them before returning to the Main Menu.

## Appendix A:

### IDEAcomm 3278 Software Messages

#### Program Messages

The IDEAcomm 3278 program issues messages about the status or the operation at hand. All messages are in the following form:

IDEAcomm 3278-n message text

"n" is a unique message identifier.

**IDEAcomm 3278-001      EXITED IDEAcomm  
3278**

In response to the EXIT command, IDEAcomm 3278 has returned to the operating system.

**IDEAcomm 3278-002      INVALID COMMAND**

The command just entered was not a valid IDEAcomm 3278 command. Re-enter the correct command.

**IDEAcomm 3278-003      UNABLE TO OPEN  
FILE - <filespec>**

IDEAcomm 3278 was unable to open the file specified by <filespec>..

On input, you may have specified a file that does not exist. Check the spelling or check the disk directory with the DIR command.

On output, the disk may be read-only, the disk may have a bad sector, or the disk or directory may be full.

**IDEAcomm 3278-004      UNABLE TO CLOSE  
FILE - <filespec>**  
IDEAcomm 3278 was unable to close the file specified by <filespec>.

**IDEAcomm 3278-005      INVALID FILENAME  
SPECIFIED**  
A filename in the previous command was not specified properly. The syntax of the name is not correct.

Reenter the command, specifying the correct filename.

**IDEAcomm 3278-006      I/O ERROR ON FILE  
- <filespec>**  
A non-recoverable file I/O error has occurred. The current operation in progress has been aborted.

The file data may have been compressed,  
or the disk may be full or have a bad  
sector.

Recreate the file or use a different  
disk and retry the operation.

IDEAcomm 3278-007      FILE ALREADY  
EXISTS - DELETE (Y OR N? - <filespec>  
The file specified by <filespec>  
already exists.

Reply "Y" to delete the existing file  
and create a new file with the same  
name.

Reply "N" to preserve the existing  
file, then reissue the previous command  
using a different filename.

IDEAcomm 3278-008      DIRECTORY  
LISTING

This message precedes the disk  
directory listing produced by the  
IDEAcomm 3278 DIRECTORY command.

**IDEAcomm 3278-009      INVALID DEVICE  
SPECIFIED**  
The disk identifier specified for a  
file in the previous command was not in  
the range A to P.

Reissue the command using the proper  
disk device identifier.

**IDEAcomm 3278-010      INVALID OPTION  
SPECIFIED**  
A SEND command option other than /P or  
/NP was entered.

Reenter the command with a valid  
option.

**IDEAcomm 3278-011      nn FILES LISTED**  
The DIRECTORY command has listed a  
directory of nn files.

**IDEAcomm 3278-012      INVALID CHARACTER  
IN SEND FILE**  
While processing a SEND command,  
IDEAcomm 3278 has found a character  
other than a valid ASCII graphics  
character in one of the files being  
sent. The SEND operation has been  
ended.

Remove the invalid character or recreate the file, and SEND the file again. You must also SEND any files specified in the SEND command after the bad file. All files preceding the bad file have been sent successfully.

**IDEAcomm 3278-013      MORE THAN EIGHT  
FILES SPECIFIED**

More than eight filenames were specified in one SEND command. Only eight are allowed.

Reissue the command, specifying eight or fewer filenames.

**IDEAcomm 3278-014      FILE ALREADY OPEN  
AS A PRINT FILE - <filespec>**

A filename specified in a TYPE or SEND command has already been specified in a PRINT command.

Change the printer assignment with another PRINT command then reissue the command that produced the error.

**IDEAcomm 3278-015      UNABLE TO LOAD  
MICROCODE**

IDEAcomm 3278 was unable to load the microcode program and start emulation. Make sure that the cable you have connected to the 3278 card is attached to an active IBM controller.



Ensure that the IDEAcmm 3278 board is installed properly.

**IDEAcmm 3278-016 NO UNPROTECTED FIELDS**

While processing a SEND command, IDEAcmm 3278 has attempted to put data onto the screen when the screen has no unprotected fields. The current SEND operation is ended.

Ensure that the SEND file matches the screen formats used by the host and SEND the file again. You must also SEND any files specified in the SEND command after the bad file. All files preceding the bad file have been sent successfully.

**IDEAcmm 3278-017 NON-NUMERIC CHARACTER IN NUMERIC FIELD**

While processing a SEND command, IDEAcmm 3278 has attempted to put non-numeric data into a numeric-only field on the screen. The current SEND operation is ended.

Correct the file and SEND the file again. You must also SEND any files specified in the SEND command after the bad file. All files preceding the bad file have been sent successfully.

**IDEAcomm 3278-018 IDEAcomm 3278**

**RESIDENT - EXIT IGNORED**

You have entered an EXIT command while IDEAcomm 3278 is resident (i.e., after pressing both SHIFT keys to make IDEAcomm 3278 resident in memory).

To exit IDEAcomm 3278 when it is resident, you must GO into 3278 Emulation Mode and press both SHIFT keys at the same time. To make IDEAcomm 3278 non-resident again, you must reboot the O/S.

### Diagnostic Messages

**TEST3278-001 ALL IDEAcomm 3278  
FUNCTIONS COMPLETE**

All the diagnostic routines ran to completion without error indicating the hardware is functioning properly.

**TEST3278-002 IDEAcomm 3278 NOT IN  
SYSTEM**

There was no response to the host microcomputer I/O request indicating that the IDEAcomm 3278 board may not be installed in the system.

**TEST3278-003      WCS INSTRUCTION MEMORY  
ERROR**

In trying to write to the instruction memory of IDEAcomm 3278 problems were encountered indicating a possible bad instruction memory IC or I/O switch setting error.

**TEST3278-004      8X305 ADDRESS ERROR**

This indicates some problem with the 8X305 microcontroller's ability to address the instruction memory.

**TEST3278-005      8X305 I/O ERROR**

This indicates a problem with the ability of the 8X305 microcontroller to perform I/O to the control port of the host microcomputer.

**TEST3278-006      HOST SCREEN MEMORY  
ERROR**

The dual-port screen memory that is resident on the IDEAcomm 3278 hardware does not pass a memory test from the host microcomputer side of the interface. This indicates a possible problem with the screen memory circuits, the dual-port access circuitry, or a memory switch error.

**TEST3278-007      8X305 SCREEN MEMORY  
ERROR**

This indicates a problem with the 8X305 microcontroller's ability to modify the screen memory from within the IDEAcmm 3278 hardware, indicating a problem with the internal bus drivers and control circuitry.

**TEST3278-008      8X305 8K OFFSET JAM  
ERROR**

This indicates a problem with 8X305 microcontrollers' ability to modify the screen memory with a unique data pattern. This indicates that the problem is in the internal bus driver and control circuitry.

**TEST3278-009      IRMA SIMULATION ERROR**

This indicates a problem sequencing the board and host through a short dialog using all the IRMA type data passing and handshaking.

**TEST3278-010      AUTO RESPONSE LOOPBACK  
FAILED**

This indicates a problem with some component between the LSI support circuits and the coax connector, possibly the relay.

**TEST3278-011      DIGITAL COAX LOOPBACK  
FAILED**

This indicates a problem with the LSI coax support circuits.

**TEST3278-012      ANALOG COAX LOOPBACK  
FAILED**

This indicates some problem with the analog components between the LSI support circuits and the coax connector.



## Appendix B:

### Technical Information

#### IDEAcomm 3278 Hardware System Overview

The IDEAcomm 3278 communications package exists in the PC as four contiguous ports in the I/O space and 4 kbytes of dual-port RAM in the memory space. The I/O ports are used for controlling the high-speed, on-board 8X305 microcontroller and for downloading the 8X305 instructions to its instruction memory. The 4 kbytes of dual-port RAM are used for storing the image of the emulated 3278 screen. This screen image is updated by the 8X305 in real time as instructed by the IBM 3274 or 3276 Control Unit connected to the other end of the coax cable. The PC must read the screen image in the dual-port RAM, convert it into the proper format, and finally display it on the physical screen for you to see.

## Diagnostic Overview

The diagnostic tests should be performed if you suspect a problem with your card or PC, when changes are made to switch settings, or when new cards or hardware are added to your system. The IDEComm 3278 hardware diagnostics determine if the IDEComm 3278 card and your PC are fully functional.

The diagnostic tests are performed in the following order:

0. Ability of the PC to address the IDEComm 3278 card I/O port.
1. Read/write memory address test of the 8X305 instruction memory (writable-control-store).
2. Ability of the 8X305 to run a simple program.
3. PC's read/write access to the screen memory resident on the IDEComm 3278 card.
4. 8X305 read/write access to the screen memory resident on the IDEComm 3278 card.

5. 8X305 ability to write unique pattern using 8K jam in the screen memory.
6. IRMA compatibility test setting up IRMA type dialog using all the appropriate flags.
7. Ability of IDEA3278 board to respond to poll requests from host.
8. Ability of the coax support circuits resident on the IDEAComm 3278 card to perform a digital loopback test.
9. Ability of the coax support circuits resident on the IDEAComm 3278 card to perform an analog loopback test.



Performing Individual Diagnostic Tests

If necessary, you can test specific hardware components using the TEST3278/1 Diagnostic Tests.

To allow this level of testing, type the following:

TEST3278 /1

The following menu is displayed:

IDEA3278 Diagnostic Program  
Copyright(c) 198x IDEAssociates Inc.  
Version x.xx

Select Test Option:

- (0) Host micro I/O control port.
- (1) 8X305 instruction memory/addressing.
- (2) 8X305 I/O addressing.
- (3) Host micro screen memory.
- (4) 8X305 screen memory.
- (5) 8X305 8K offset jam.
- (6) IRMA simulation.
- (7) Auto response loopback.
- (8) Coax digital loopback.
- (9) Coax analog loopback.
- (X) Exit IDEA3278 diagnostics.

--> <--

Figure B-1: Diagnostics Menu

Type in the number of the option you wish to choose. The test begins immediately. The test is performed continuously until you press any key. Pressing any key stops the test and displays a message telling you that the test was passed, or a diagnostic error message indicating the type of failure found.

After receiving a passed or failed message, press any key to continue. Type X to end the IDEAComm 3278 diagnostics.

If you received an error message, refer to Appendix A for a description of that message.

## Product Specifications

### **Description:**

One controller card for the IBM PC, XT, AT or portable provides linkage to IBM 3274/3276 controllers. Software includes:

- o Runtime emulation program: IDEAcomm  
3278
- o Off line diagnostic program:  
TEST3278
- o Off line configuration program: CFGI
- o Off line configuration program: HFIG

**Prerequisite:**

- o IBM PC, XT, AT, or portable with 128K memory.
- o IBM terminal controllers:
  - 3274 with type "A" adapters.  
Channel attached.  
SNA/SDLC or BSC remote.
  - 3276 Remote terminal controller,  
SNA/SDLC or BSC Mainframes with  
integral type "A" adapters.

**Compatibility:**

Complete emulation of IBM 3278 terminals:

- o 2.5 Megabits/second.
- o coax attached.
- o On-board controller computer requires no intervention by IBM PC 8088.

**Software:**

- o Capture screens of data with IBM 3270 attributes.
- o Local print to file or IBM PC or control unit printer.
- o Keyboard can be remapped by user.
- o Simulate power off when in Emulation Mode for security or stay on line for convenience.
- o Extensive diagnostics.
- o Microcode is loaded from a disk for ease of updating.
- o Full screen access to 3278/9 display memory.

**Physical Dimensions:**

- o 13 1/4" x 4" x 1/2".

**Single PC Board:**

- o Fits into any full size slot.

**Power:**

- o 2.0 Amp at +5 Volts.

**Cable Connectors:**

- o BNC connector on back panel attaches to RG-62U coaxial cable.

## Appendix C:

### File Transfer Facility (XFER)

The auxiliary program XFER can be used in conjunction with IDEAComm 3278 to transfer files between your Personal Computer and a VM/CMS or TSO environment.

The IDEAComm 3278 program allows communications to be established between your personal computer and the host. It causes your personal computer to appear to both you and the host to be an IBM 3278 terminal. Once IDEAComm 3278 is resident, when you exit IDEAComm 3278 and run XFER, the host still sees your personal computer as a 3278 terminal, which enables XFER to transfer data between your computer and the host.



## Running XFER

The file IDEA3278.UCM is required by XFER and must be present on the default disk.

To use XFER, you must first run IDEAComm 3278. Log on to the host and be at the TSO or CMS command level. Exit from IDEAComm 3278 to DOS by making IDEAComm 3278 resident by using the hot key. Do not use the EXIT command because IDEAComm 3278 will not become resident.

A>XFER <CR>

XFER will begin executing and will display the following menu:

**File Transfer C-3**

IDEA3278 File Transfer System - Ver. X.XX - October xx, 198x  
COPYRIGHT(C) 198x, 198x, IDEAssociates, Inc.  
COPYRIGHT(C) 198x, Micro Integration, Inc.

---

F1 - SEND FILE TO HOST  
F2 - RECEIVE FILE FROM HOST

F5 - EDIT INITIALIZATION PARAMETERS

---

FILE MODE	- T <TEXT>	RECORD LENGTH (1-255) - 255
RECORD FORMAT	- V <VARIABLE>	PC File .....
HOST FILE	- .....	

---

XFER-028 F10-EXIT

SELECT FUNCTION

C-4 File Transfer

Figure D-1: XFER Menu

To select an option from this menu, press the appropriate function key (F1), (F2), (F5), or (F10).

To exit XFER and return to the operating system, press (F10). You cannot exit while in the process of sending or receiving a file.

### Editing the Parameters

Before transferring a file you must specify the initialization parameters. To do this, press the F5 key. The cursor will go into FILE MODE field on the menu and the SELECT FUNCTION message is replaced by the message:

---

Press TAB for next field, CR to end edit

You can edit any parameter by pressing the TAB key to move the cursor to the field for that parameter and then typing in the new value. When you TAB out of the HOST FILE field the cursor will go into FILE MODE field, so you can cycle through the list of parameters as often as you wish.

When you type a character into the first position of a field that already has a name in it, XFER covers the rest of the field with blocks. Pressing the backspace key erases the character before the cursor and backs up the cursor one position. If you backspace from the first position in a field, XFER will restore the original value that was present when you came into the field. You may also restore the original value by entering CTRL C at any position in a field. If you attempt to enter an invalid character, XFER will not accept the character.

### File Mode

The FILE MODE may be either text or binary.

Text file mode should be used for transferring files containing only ASCII characters, field separators, and record separators.

Since characters with a hexadecimal value greater than 7FH (127) cannot be transferred, files containing such characters must be transferred in binary file mode. When a file is sent to the host in binary mode, each byte to be transmitted is translated into two bytes, both less than 7FH. To convert back to the original characters, the file must then be run through a translation program on the host or be received from a host by another personal computer running XFER in binary file mode. When a file is received from the host in binary file mode, each pair of bytes is translated into a single byte.

#### NOTE

Specifying binary file mode automatically selects fixed record format and record length 80. The record length and record format shown on the menu are ignored.

## Record Length

When transferring files with variable length records, you should use variable format and record length 255. XFER uses record separator characters in the file to determine the end of each record. Records longer than the length you specify will be broken up and will be transferred as two or more partial records.

Files with fixed length records may or may not contain record separators. When transferring these files, you should use fixed format and specify the actual record length. Short records will be padded to the specified length.

## PC File

For the PC file you may specify any filename that is valid on DOS, up to 14 characters. If the file specified for a send operation does not exist, XFER will display an error message when you attempt the send operation. If the file specified for a receive operation already exists, XFER will give you the option of deleting and over-writing the file or specifying a different filename.

## Host File

You may specify any filename that is valid for the host system, and it can contain up to 44 characters. If the file specified for a receive operation does not exist on the host, XFER will display an error message when you attempt the receive operation. If the file specified for a send operation already exists on the host, XFER will give you the option of deleting and over-writing the file, or specifying a different filename.

## Ending the Edit

After you have specified all parameters, press the ENTER key. XFER will store the values shown on the menu, the SELECT FUNCTION message will appear again, and you are ready to transfer the file.

## Transferring a File

To send the data from the PC file to the host and write it to the specified host file, press the F1 key. To receive the data from the host file and write it to the specified PC file on your personal computer, press the F2 key.



After you press the F1 or F2 key it will take a moment for the host to get ready for the transfer operation. The message:

```
XFER-026  INITIALIZING  HOST
```

will appear to let you know that the initialization is proceeding. If for some reason the host cannot be initialized you will see an error message.

When the host is ready, XFER will display a message to indicate that the file transfer is taking place.

During file transfer, the F10 key does not cause XFER execution to terminate, but it can be used to interrupt file transfer. If you press F10 during the file transfer, XFER will display the message:

```
XFER-013  KEYBOARD INTERRUPT -  
CONTINUE (<Y> or N)?
```

If you reply N, the transfer will stop and the messages:

---

XFER-020      FUNCTION ABORTED BY  
OPERATOR

and:

---

SELECT FUNCTION

will be displayed. If you reply Y, the file transfer will resume and the number of bytes transferred is displayed on the screen.

When the file has been transferred, the messages:

---

XFER-018      FILE TRANSFER COMPLETE

and:

---

SELECT FUNCTION

will appear. If you wish, you may specify new parameters and do another transfer.

## Terminating XFER

After you have completed all desired transfers, press the (F10) key to exit XFER and return to the operating system.

## Batch Mode

You may run XFER as a batch program, rather than interactively, by specifying the transfer parameters on the command line. You may do this by entering the XFER command line and parameters directly on your personal computer console, or by including the command line in a batch file.

The XFER command line has the syntax:

XFER

```
<direction>[/R][<mode>][<format>][RL=nnn  
]<PCfilename><hostfilename>
```

**<direction>**

Specifies the direction of file transfer.

**UPLOAD, UP, or U** Specifies that data is to be sent from the PC file to the host file.

**DOWNLOAD, DOWN, or D** Specifies that data is to be received from the host file to the PC file.

**/R**

Indicates that the XFER program is to remain active after the file transfer operation. After the transfer is complete, XFER will go into interactive mode. XFER will also remain active if certain errors occur which prevent the file transfer from aborting. However, some errors cause XFER to terminate even if /R is specified.

If /R is omitted, then XFER terminates after the file transfer.

<mode>

Specifies the file transfer mode.

TEXT or T            Specifies that the file is  
to be transferred in text  
mode.

BINARY,  
BIN, or B            Specifies that the file is  
to be transferred in  
binary mode.

If both TEXT and BINARY  
are omitted, TEXT is  
assumed.

<format>

Specifies the record format for the  
file transfer.

VARIABLE,  
VAR, or V            Specifies variable record  
format.

FIXED,  
FIX, or F            Specifies fixed record  
format.

If both VARIABLE and FIXED are omitted,  
VARIABLE is assumed.

**RL =nnn**

Specified record length, where nnn is in the range 1 to 255. If this parameter is omitted, record length 255 is assumed.

**<PCfilename>**

Specifies the name of the file on your personal computer system to or from which data is to be transferred.

**<Hostfilename>**

Specifies the name of the file on the host system to or from which data is to be transferred.

The host filename consists of all characters, including spaces, between <PCfilename> and the end of the XFER command line. (Spaces are valid characters in filenames on some hosts.)

The parameters may be separated by any combination of spaces, tabs, and commas. The meaning of the parameters is explained in this section under "Editing the Parameters".

The command line must be terminated by a <CR>, and may be longer than 80 characters.

The XFER program recognizes parameters by means of keywords, so it is not necessary to enter any delimiters for parameters which are omitted. However, if you omit parameters you may not use filenames which match the keywords. For example, if you omit format and record length, you may not specify a PC filename of VAR.

After completing the file transfer specified by the command line parameters, XFER terminates execution and returns control to the DOS operating system (O/S).

If XFER is executed from a batch file, XFER returns an error code to the PC's batch processor equal to the message number of the XFER console message for that error. The batch processor may be programmed to process the error codes. If no error occurs, XFER returns an error code of zero.

**EXAMPLE:**

Create a file called MYXFER.BAT containing:

```
XFER U B F RL=80 SALES.MON  
STORE523 SALES
```

```
XFER D A:DATA.001 DATA.001
```

Run IDEComm 3278, logon to your host system, and exit IDEComm 3278. Type the following:

```
A>MYXFER <CR>
```

on your console. Your personal computer will execute XFER twice. First, the file SALES.MON will be sent from the currently logged disk on your personal computer to the file STORE523 SALES on the host system, transmitted in binary mode, with fixed length 80 byte records. Next, the file DATA.001 on the host system will be received into the file DATA.001 on drive A on your personal computer, in text mode with variable record format and record length 255. Control is then returned to DOS.



## XFER Program Messages

The XFER program displays messages to inform you of various conditions. When applicable, these messages will appear on the XFER menu near the bottom of the screen.

All messages are of the form:

XFER-nnn message text

nnn is unique message identifier that provides easy reference to the message explanation in this chapter.

message text is a short message briefly describing the action required, condition found, or program status.

Whenever the message asks for a yes or no (Y or N) reply, the default value will be displayed enclosed in angle brackets:<>. If you enter <CR>, or enter anything other than Y or N, XFER will take the default.

A list of the messages and a brief description of each is given below.

**XFER-001**    **IDEA3278.UCM NOT FOUND ON  
DEFAULT DRIVE**

The IDEA3278.UCM file, which is required by XFER, was not found on the disk on the default drive.

Ensure that the file is present and that you are executing XFER from the proper disk. Run XFER again.

**XFER-002**    **ERROR READING IDEA3278.UCM**  
An I/O error occurred while XFER was trying to read the configuration file IDEA3278.UCM.

**XFER-003**    **BAD RECORD LENGTH -  
RE-ENTER**

A record length not in the range 1-255 bytes was specified on the menu.

Specify a valid record length.

**XFER-004**    **NO PC FILE SPECIFIED**

You must specify the name of a file on your personal computer for the send or receive operation.

**XFER-005**    **NO HOST FILE SPECIFIED**

You must specify the name of a file on the the host system for the send or receive operation.

**XFER-006 NOT AT RECOGNIZABLE COMMAND LEVEL**

To perform a file transfer, you must be logged onto TSO or VM and be at command level.

Go into IDEAComm 3278 Emulation Mode and get back to command level by pressing the key configured as the EXIT key. (The default EXIT key is CTRL E.)

**XFER-007 HOST STATUS TIMEOUT - CONTINUE (<Y> OR N)?**

The host has not responded to a transmission within 15 seconds.

Reply Y if you wish to continue; reply N if you wish to abort. If this message occurs frequently, you should reply N and investigate the cause. If this message recurs immediately, you may not be connected to the host or the keyboard may be locked.

**NOTE**

Each time you reply Y to this message, the time-out interval is increased by 5 seconds.

**XFER-008 CONTROL UNIT TIMEOUT -  
CONTINUE (<Y> OR N)?**

The control unit was unable to accept data from your personal computer.

Reply Y if you wish to continue; reply N if you wish to abort.

You may not have run IDEA3278 before running XFER.

**XFER-009 HOST FILE CLOSE ERROR -  
FUNCTION ABORTED**

The host system was unable to close the host file and save your data set after a send operation. The filename which you specified for <hostfilename> in the send operation is a valid filename, but you are not allowed to access it.

Specify a different host filename and send the file again.

**XFER-010 PC FILE OPEN ERROR -  
FUNCTION ABORTED**

XFER was unable to open the PC file you specified for a send or receive operation.

For a send operation, this means that the file does not exist. For a receive operation, the disk directory may be full.

**XFER-011 PC FILE I/O ERROR -  
FUNCTION ABORTED**

An I/O error occurred on a PC file during a send or receive operation.

The disk may be full or you may have a bad sector.

**XFER-012 HOST FILE OPEN ERROR -  
FUNCTION ABORTED**

XFER was unable to open the host file specified for a send or receive operation.

**XFER-013 KEYBOARD INTERRUPT -  
CONTINUE (<Y> OR N)?**

You have pressed the F10 key during a file transfer operation.

Reply Y if you wish to continue the operation; reply N if you wish to abort.

**XFER-014 HOST NOT RESPONDING AS EXPECTED - FUNCTION ABORTED**  
During a send or receive operation, the host system has not responded properly. XFER has aborted the transfer operation.

Go into IDEAComm 3278 and investigate the cause. Ensure that you are at the TSO or VM command level. See if any messages have been received to the terminal screen.

**XFER 015 INVALID BINARY FILE - FUNCTION ABORTED**  
A file being received from the host in binary file mode contains invalid characters. See the discussion of file mode earlier in this chapter.

**XFER 016 INVALID DRIVE SPECIFIED - RE-ENTER**  
The disk drive specified for a PC file is not in the range A through P.

Enter a valid drive identifier.

**XFER-017 FILENAME NOT UNIQUE  
(CONTAINS WILDCARDS) - RE-ENTER**  
You may transfer only one file at a time. You may not use "wildcard" characters in filenames to transfer a whole group of files. For example, COAXDAT.\* is a illegal filename for XFER.

Specify a unique filename containing no "wildcard" characters.

**XFER-018 FILE TRANSFER COMPLETE**  
A send or receive operation has been successfully completed. XFER is ready for you to select another function.

**XFER-019 PC FILE ALREADY EXISTS -  
DELETE (Y OR <N>)**  
A PC file specified for a receive operation already exists.

Reply Y to delete the file and over-write it with the new data received from the host. Reply N to preserve the existing file, then specify a new PC file for the receive operation.

**XFER-020      FUNCTION ABORTED BY  
OPERATOR**

You have aborted a send or receive operation, for example, by pressing the F10 key and then answering N when asked if you want to continue.

**XFER-021      RECEIVE FILE CREATION ERROR  
- FUNCTION ABORTED**

XFER was unable to create the PC file specified for a receive operation.

The disk may be read-only. The disk may have a bad sector. The disk or directory may be full.

**XFER-022      FILE DELETION ERROR -  
FUNCTION ABORTED**

XFER was unable to delete a file.

The disk may be read-only.

**XFER-023      FILENAMES NOT SPECIFIED**

You have not specified both a PC file and a host file for a send or receive operation.

Enter the required filename(s).



**XFER-024 BYTES RECEIVED nnnnn**

This message indicates the number of bytes received from the host during the current transfer operation.

**XFER-025 (F10) - INTERRUPT**

This message is on the screen during a send or receive operation to indicate that the F10 key may be used to interrupt the transfer operation.

**XFER-026 INTITALIZING HOST**

XFER is preparing the host for a file transfer operation.

**XFER-027 RESTORING HOST CONFIGURATION**

After a file transfer, XFER is restoring the host system to its previous configuration.

**XFER-028 F10 - EXIT**

This message is on the screen when XFER is not in the process of transferring a file, to indicate that the F10 key may be used to exit XFER.

**XFER-029 BYTES SENT TO HOST nnnnn**

This message indicates the number of bytes sent to the host during the current transfer operation.

**XFER-030 HOST FILE EXISTS - DELETE  
(Y OR <N>)?**

A host file specified for a send operation already exists.

Reply Y to delete the file and overwrite it with the new data sent from the PC file. Reply N to preserve the existing file, then specify a new host file for the send operation.

**XFER-031 COMMAND LINE ERROR -  
FUNCTION NOT RECOGNIZED - FILE TRANSFER  
ABORTED**

Something other than UPLOAD, UP, U, DOWNLOAD, DOWN, or D was specified as the first parameter of the XFER command line.

**XFER-032 COMMAND LINE ERROR -  
INVALID RECORD LENGTH - FILE TRANSFER  
ABORTED**

A record length not in the range 1 to 255 was specified in the RL = parameter in the XFER command line.

**XFER-033 COMMAND LINE ERROR -  
INVALID PC FILE NAME - FILE TRANSFER  
ABORTED**

The syntax of the filename specified for the <pcfile> parameter of the XFER command line is incorrect.

**XFER-034**    **COMMAND LINE ERROR - NO  
HOST FILE SPECIFIED - FILE TRANSFER  
ABORTED**

No filename was specified for the  
<hostfile> parameter in the XFER  
command line.

**XFER-035**    **COMMAND LINE ERROR -  
INVALID CHARACTER - FILE TRANSFER  
ABORTED**

The XFER command line contains a  
character other than displayable ASCII  
characters or the tab character.

**XFER-036**    **COMMAND LINE ERROR -  
MISSING PARAMETERS - FILE TRANSFER  
ABORTED**

A required parameter has been omitted  
from the XFER command line. You are  
required to enter the <direction>,  
<pcfile>, and <hostfile> parameters.

**XFER-037**    **COMMAND LINE ERROR - EXTRA  
CHARACTERS - FILE TRANSFER ABORTED**  
Characters have been found in the XFER  
command line following the <hostfile>  
parameter. The <hostfile> may be  
longer than 44 characters, or the  
command line may not be terminated by a  
<CR>.

**XFER-038    EXITED XFER FILE TRANSFER**  
In response to the F10 key, XFER has  
ended execution and returned you to the  
operating system.



## Appendix D:

### IDEA3278 Support Subroutines in BASIC

This appendix should be used by anyone who wants to customize their software to run with the IDEAcmm 3278 card.

IDEASUPP.BAS is a Basic Program consisting solely of subroutines to aid you in interfacing your own code with the IDEAcmm 3278 card.

There are five files related to the Basic support subroutines:

1. IDEASUPP.BAS      Basic subroutines  
                              sparsely commented.
2. IDEASUPP.LST      Commented list file  
                              of Basic  
                              subroutines.
- \*3. ASDISTBL.DAT     ASCII to display  
                              data file.
- \*4. DSPTBL.DAT        Display to ASCII  
                              data file.
- \*5. ASCSCAN.DAT      ASCII to scan code  
                              data file.

\*These files are used in the Initialization Subroutine and must be present on disk when running the Initialization Subroutine of IDEASUPP.BAS.

The following pages provide you with three lists:

- o Subroutines and Descriptions
- o Reserved Variables
- o Error Code Definitions

as well as Notes to Users.

**ROUTINE: INIT (Initialize)**

**LINE #:** 50000

**DESCRIPTION:** Table initialization

**INPUT** None

**VARIABLES:**

**OUTPUT** None

**VARIABLES:**

**COMMENT:** Must be executed prior to general use of other subroutines.

**ROUTINE: XPOR (Execute Power On  
Reset)**

**LINE #: 50100**

**DESCRIPTION: Resets IDEComm 3278 card**

**INPUT  
VARIABLES: None**

**OUTPUT  
VARIABLES: None**

**COMMENT: Used for reactivating  
IDEComm 3278**



**ROUTINE: STDNM (Set Trigger Location  
And Mask)**

**LINE #: 50400**

**DESCRIPTION:** Set trigger of a given  
bit pattern at a given  
location

**INPUT** I.VRO% - Row  
**VARIABLES:** I.VCL% - Column  
I.VMS% - Mask Value  
I.VVL% - Value

**OUTPUT** I.VER% - Error Code  
**VARIABLES:**

**COMMENT:** The mask causes a trigger  
when the bits specified  
in the mask are set to 1  
in the byte at the  
specified location. A  
mask of 0FFH will trigger  
only when the value  
I.VVL% matches the value  
at the specified  
location. A mask of 0  
will trigger on any  
change of the value at  
the specified location.

**ROUTINE:** WTRIG (Wait For Trigger)

**LINE #:** 50500

**DESCRIPTION:** Wait for trigger

**INPUT VARIABLES:** I.VTO% - Maximum Time To Wait In Seconds.

**OUTPUT VARIABLES:** I.VER% - Error Code  
I.VTO% - Time Left From Total Time Allowed

**COMMENT:** Used in conjunction with STDNM. Waits until bits in mask specified in STDNM are on in location specified in STDNM.

**ROUTINE: KEYS (Send Keystrokes)**

**LINE #:** 50600

**DESCRIPTION:** Send ASCII string as a series of keystrokes

**INPUT VARIABLES:** I.VST\$ - I/O String

**OUTPUT VARIABLES:** I.VER% - Error Code

**COMMENT:** Used for emulating keyboard input.

**ROUTINE: FIND (Find Field)**

**LINE #:** 50700

**DESCRIPTION:** Find specified unprotected field on IDEAcmm 3278 screen

**INPUT VARIABLES:** I.VFL% - Field Number. Routine is to find the I.VFL%th unprotected field.

**OUTPUT  
VARIABLES:**

**I.VER%** - Error Code

**I.VCB%** - Pointer To  
Leading Attribute

**I.VCE%** - Pointer To  
Trailing Attribute

**I.VFS%** - Length of Field

**I.VRO%** - Row of first  
byte in field after  
leading attribute

**I.VCL%** - Column of first  
byte in field after  
leading attribute

**I.BUF%(0)** - Internal  
Buffer. Contains leading  
attribute

**COMMENT:**

**FIND counts and accesses  
only unprotected fields.**

**ROUTINE: FNEXT (Find Next Field)**

**LINE #: 50800**

**DESCRIPTION: Find next unprotected field**

**INPUT VARIABLES: I.VFL% - Field Number**

**OUTPUT VARIABLES: I.VER% - Error Code**

**I.VCB% - Pointer To Leading Attribute**

**I.VCE% - Pointer To Trailing Attribute**

**I.VFS% - Length of Field**

**I.VRO% - Row of first byte in field after leading attribute.**

**I.VCL% - Column of first byte in field after leading attribute.**

**I.BUF%(0) - Internal Buffer. Contains leading attribute.**

**COMMENT: Field number is incremented and FIND is executed.**

**ROUTINE: RDFLD (Read Field)**

**LINE #: 50900**

**DESCRIPTION:** Field is read from  
IDEAcomm 3278 buffer into  
internal buffer

**INPUT** I.VCB% - Pointer to  
**VARIABLES:** Leading Attribute  
  
I.VFS% - Length of Field

**OUTPUT** I.BUF%() - Internal  
**VARIABLES:** Buffer

**COMMENT:** Should be called only  
after FIND or FNEXT.

**ROUTINE:** WRFLD (Write Field)

**LINE #:** 51000

**DESCRIPTION:** Write field from internal buffer to IDEAComm 3278 Buffer. Set the Modified Data Tag.

**INPUT VARIABLES:** I.BUF%() - Internal Buffer

I.VCB% - Pointer to Leading Attribute

I.VFS% - Length of Field

**OUTPUT VARIABLES:** I.VER% - Error Code

**COMMENT:** Usually called after FIND and PUTSTR.

**ROUTINE:** GTSTR (Get String)

**LINE #:** 51100

**DESCRIPTION:** Convert internal buffer  
into ASCII string.

**INPUT** I.BUF%() - Internal  
**VARIABLES:** Buffer

I.VFS% - Length of Field

I.VOO% - Offset

**OUTPUT** I.VER% - Error Code  
**VARIABLES:**

I.VST\$ - I/O String  
I.VOO% - Offset

**COMMENT:** Returns character string  
of up to 254 characters.  
If field length is  
greater than 254 then  
I.VOO% points to next  
position in buffer. Used  
in conjunction with FIND  
and RDFLD.



**ROUTINE: PUTSTR (Put String)**

**LINE #: 51200**

**DESCRIPTION: Put ASCII string into buffer.**

**INPUT VARIABLES: I.VST\$ - I/O String**

**I.VOO% - Offset**

**OUTPUT VARIABLES: I.VER% - Error Code**

**I.VOO% - Offset**

**I.BUF%() - Internal Buffer**

**COMMENT: Used in conjunction with WRFLD and FIND to load fields into IDEAComm 3278 buffer.**

**ROUTINE:** RDABSR (Read Absolute Address)

**LINE #:** 51300

**DESCRIPTION:** Convert IDEComm 3278 display to string.

**INPUT VARIABLES:**

- I.VRO% - Row
- I.VCL% - Column
- I.VRR% - Number of Positions

**OUTPUT VARIABLES:**

- I.VER% - Error Code
- I.VRO% - Row of character after last character read.
- I.VCL% - Column of character after last character read.
- I.VST\$ - I/O String

**COMMENT:** Used for access to status line and protected fields. Status Line is Row 0.

**ROUTINE: GTCP (Get Cursor Position)**

**LINE #: 51400**

**DESCRIPTION: Return current cursor position**

**INPUT VARIABLES: None**

**OUTPUT VARIABLES:**

- I.VER% - Error Code**
- I.VCL% - Column**
- I.VRO% - Row**

**COMMENT: If IDEAComm 3278 is in a changing state then I.VRO% may be out of range. If so, GTCP returns an error code.**

ROUTINE: ALSTAT (Align Shift  
Status)

LINE #: 52000

DESCRIPTION: Sends scan code and shift  
status code to IDEAcomm  
3278.

INPUT I.SHIFT% - Shift Status  
VARIABLES:  
I.SCAN% - Scan Code

OUTPUT I.VER% - Error Code  
VARIABLES:

COMMENT: I.SHIFT% should contain  
64 if the scan code is  
SHIFTed, 128 if the scan  
code is ALTed, 0 if  
neither SHIFTed or ALTed.

**ROUTINE: SSCANT (Send Scan Code)**

**LINE #: 52200**

**DESCRIPTION: Send scan code to  
IDEAcomm 3278**

**INPUT I.SCAN% - Scan Code  
VARIABLES:**

**OUTPUT I.VER% - Error Code  
VARIABLES:**

**COMMENT: Time out will occur in  
approximately one second  
if scan code is not  
taken.**

**ROUTINE:** VRC (Verify Row Column)

**LINE #:** 52500

**DESCRIPTION:** Verify row and column variables

**INPUT VARIABLES:** I.VCL% - Column

I.VRO - Row

**OUTPUT VARIABLES:** I.VER% - Error Code

**COMMENT:** Determines whether row and column are within valid range and returns result in I.VER%. If both row and column are out of range, returns "row out of range."

## RESERVED VARIABLES

The following variables should NOT BE CHANGED:

I.DOWNALT%  
I.UPALT%  
I.DOWNSHIFT%  
I.UPSHIFT%  
I.DISASC%  
I.ASCMS% (  
I.ASCAN% (  
I.TRIG%  
I.TMASK%  
I.VAL%  
I.CSHIFT%

The following variables may be changed, but must be USED AS INTENDED. For example, I.VCL% must always contain a valid column address and should not be used for something like storing scan codes.

I.VCL%	Column
I.VRO%	Row
I.VCB%	Pointer to Leading Attribute
I.VCE%	Pointer to Trailing Attribute
I.VER%	Error Code
I.VST\$	I/O String
I.VFS%	Length of Field
I.VFL%	Field Number
I.VVL%	Value
I.VMS%	Mask Value
I.SHIFT%	Shift Status
I.SCAN%	Scan Code
I.VVR%	Character Length
I.VOO%	Offset
I.BUF%()	Internal Buffer



The following are temporary variables used within subroutines only. These variables should NOT BE USED FOR LONG TERM STORAGE.

I.TEMP%

I.TEMP1%

I.TEMP\$

I.ABS%

I.X%

I.COUNT%

## ERROR CODE DEFINITIONS

- 0 NO ERROR
- 1 NOT USED
- 2 ROW OUT OF RANGE
- 3 COLUMN OUT OF RANGE
- 4 NOT USED
- 5 NOT USED
- 6 FIELD ERROR
- 7 FIELD NOT FOUND
- 8 PROTECTED FIELD
- 9 TIME OUT ERROR
- 10 TRIGGER TIME OUT ERROR
- 11 NOT USED
- 12 FIELD OVERFLOW ERROR

## NOTES TO USERS

- o The initialization subroutine must be executed once prior to using the other subroutines.
- o If an error occurs (i.e., I.VER%<>0), then I.VER% must be set to zero prior to another subroutine call.
- o In using the PUTSTR and GTSTR subroutines, I.VOO% must be set to zero prior to the subroutine call unless the call is in continuation of a long field (i.e., field length is greater than 254).
- o During operation the keyboard may become locked. This may be detected via a PEEK at location 8. If a value of 246 is found then the keyboard is locked.

- o Keyboard Locked (Input Inhibited) may occur for a variety of reasons. The reason is given by the characters at locations 9-16 (columns 10-17 of the status line). The characters and the conditions which they indicate are explained in detail in the IBM publications listed in Section I of this manual. The most common reasons are:
  1. display is in state of change, or
  2. an invalid keystroke was sent.
- o To check for display in state of change (i.e., display is being updated by the Host), check for Keyboard Locked. Wait a few seconds and check again. If the keyboard is still locked then the display was probably not in state of change.
- o An invalid keystroke may occur for one of several reasons, for example, typing a character into a protected field, or typing a non-numeric character into a numeric field.

The reason is given by the characters at locations 9-16 (columns 10-17 of the status line). The characters and the conditions which they indicate are explained in detail in the IBM publications listed in the Section I.

To remedy this condition, a Reset keystroke must be emulated. This is done by setting the variables I.SHIFT% = 0 and I.SCAN% = 52 and calling the subroutine ALSTAT.

- o If the keyboard remains locked for a few seconds after a Reset, or if a Time Out occurs on the ALSTAT subroutine, then it may be necessary to reset the IDEAComm 3278 card. This is done by a call to XPOR.
- o If the keyboard remains locked after executing XPOR, then some type of hardware problem can be assumed. For example, the coax cable may be disconnected or the control unit may be turned off or malfunctioning.

## Appendix E:

### IDEAcomm 3278 Switch Settings

Use this appendix if you have a conflict with the factory address and another board in your IBM PC. Note that the factory settings are valid whether you have an IBM PC, XT, AT, or Portable.

If you make changes to the I/O address or the memory address switches you must also change the parameters listed in the memory map setup screen (HFIG). Refer to Figure E-1.

#### Changing Factory Switch Settings

Switch Bank 1 - Select Interrupt\_  
Request Line to PC

The factory setting for switch bank 1 is IRQ5. No other settings are appropriate at this time.

IRQ5

Switch	<u>1</u>	<u>2</u>	<u>3</u>
	ON	OFF	OFF

Switch Settings E-1

## Switch Bank 2 - Memory Address

The factory settings for switch bank 2 are D000 and 64K. The following text provides additional information. If you change your memory address, you must change the memory address listed in the HFIG file.

### (Switch Address Map)

	Switch No.
A14	----- 6
A15	----- 5
A16	----- 4
A17	----- 3
A18	----- 2
A19	----- 1

Switches 1 through 4 on switch bank 2 are used to determine the starting memory address (for example, factory setting D000).

Switch 5 and 6 selects the amount of screen memory on the card (for example, factory setting 64K).

When switches 5 and 6 are both OFF, the setting is 64K. When switches 5 and 6 are both ON, the setting is 16K.

### **Switch Bank 3 - I/O Address**

Switch settings on switch bank 3 are set to 220-227 Hex at the factory. The following text provides additional information. If you change your I/O address, you must change the I/O address listed in the CFG file.

Note that on switches 1 through 4, only the switch you choose should be set to ON, the other three switches are OFF.



<u>Switch No.</u>	<u>I/O Address</u>
1	220-227
2	228-22F
3	230-237
4	238-23F
5	A15 (Same as on Switch Bank 2)
6	A16 (Same as on Switch Bank 2)

### Editing the HFIG File

Selecting an alternate address setting requires two steps:

1. Change the IDEAComm 3278 switch settings for the I/O or Memory address.
2. Change the IDEA3278.UCM configuration file by using the HFIG Memory Map Setup (see Figure E-1).

To edit the file HFIG to select hardware changes, make sure that IDEA3278.UCM and HFIG.EXE are on your diskette.

Place the diskette with these files in drive A and close the drive door.

At the prompt type the following:

```
A>HFIG <CR>
```

The following screen is displayed:

IDEA3278 Memory Map Setup  
Copyright(c) 198x IDEAssociates, Inc.

V.x.xx

	Current Address	Desired Address
I/O Port	227	227
Screen Buffer	D000	D000

Select Option

- 1) Change I/O Port Address
- 2) Change Screen Buffer Address
- 3) Exit

Choice:

Figure E-1: Memory Map Setup Screen

## E-6 Switch Settings

If you select Option 1, the following messages are displayed at the bottom of your screen:

Change I/O Port Address

Enter three hexadecimal digits:

[Press Enter to complete; Esc to cancel]

[Valid ports are 227, 22F, 237, 23F]

If you select Option 2, the following messages are displayed at the bottom of your screen:

Change Screen Buffer Address

Enter four hexadecimal digits:

[Press Enter to complete; Esc to cancel]

[Min C000, Max EF00]

If you select Option 3, the following message is displayed at the bottom of your screen:

Exit to DOS

Enter Y or N:

If you type N, you return to the Memory Map Screen. If you type Y, the following message is displayed:

Write Out Desired Addresses [Y or N]:

If you choose Y, the new parameters you entered in the Memory Map Screen are written to the IDEA3278.UCM file. If you choose N, the new parameters are not saved. In either case, your system is returned to DOS.

## Changing IDEAdisk Switch Bank 1 Settings

If you are using an IDEAdisk with IDEComm 3278, you must change the address on the IDEAdisk SASI card. For example, to change the card address from D000 to E000, locate Switch Bank 1 on your IDEAdisk card. Reset switch number 6 to ON. Next move the jumper cap on the SASI card to the right-hand position. Your address has been changed from D000 to E000.



## Appendix F:

### Glossary

#### **Asynchronous communications**

Method of communications whereby data is sent as soon as it is ready.

#### **Asynchronous communications interface adapter**

A device providing the data formatting and control necessary to permit asynchronous communications with a microcomputer.

#### **ASCII**

American Standard Code for Information Interchange, a coding scheme wherein letters, numbers, and special symbols are represented as unique seven-bit values, allowing for standardization between data communications devices.

#### **Backup**

A duplicate copy of data.

#### **Batch file**

A file that contains batch commands. It is faster to run than retyping the commands each time. Such filenames end with the extension .BAT.



**Baud**

Unit related to bits per second, used to measure the rate at which information moves between computers.

**Bit**

Abbreviation for "binary digit."  
A bit is the smallest unit of information recognized by a computer, expressed as the digits 1 or 0.

**Bits per second (bps)**

The instantaneous bit speed with which a device or channel transmits a character.

**Boot**

To bring up or restart the IBM. A diskette or partition is bootable if it contains the DOS files that will start the Bootable. Used of a partition or disk to which command transfers at startup time.

**Buffer**

Temporary storage, for characters that need to be collected prior to processing.

**Cable**

A group of wires connecting two or more pieces of equipment.

**Character**

An alphanumeric symbol.

**Connector**

The attachment at the end of a cable, by which it connects to the pins in another connector.

**Controller**

A board or card that runs a device.

**Data rate**

The speed at which data is sent to a receiving computer or device, measured in bits per second.

**Dedicated line**

A telephone line or other data link with no switching facilities.  
Synonymous with leased line, private line, nonswitched line.

**Dedicated machine**

A PC or other microcomputer designed to handle a special, usually single, task. A dedicated server PC could only be used to service user requests, not as both server and workstation.

**Disk controller**

A hardware device that controls a physical disk drive.

**Disk operating system (DOS)**

An operating system for the IBM PC/XT/AT and Portable Computers.

**Download**

To transfer information from a host computer to another computer.

**Driver**

Software that controls a device.

**EBCDIC**

Extended Binary Coded Decimal Information Code, a coding scheme wherein letters, numbers and special symbols are represented as unique six-bit values, allowing for standardization between data communications devices; popularized by IBM.

**Error Detection**

Software routines that identify and often correct erroneous data.

**Format**

To prepare a disk so it can be used by DOS or another operating system. A hard format lays down tracks and sectors on a disk. A soft format marks sectors that are bad so the operating system will not use them.

**Host Adapter Card**

A card that plugs into the IBM system board and is connected to a disk drive controller by a controller cable.

**Host adapter**

A hardware device that serves as a link between the IBM PC and the disk controller.

**Host computer**

Primary or controlling computer in a multiple computer system upon which the smaller computers depend to allocate the resources of the system.

**Interrupt**

A processor feature that allows the currently executing program to be deferred in favor of servicing another.

**K or KB**

Abbreviation for kilobyte. 1,024 bytes (characters) of information.

**MB**

Abbreviation for megabyte (1 million bytes).

**Operand**

An operand is the entity operated upon. It is generally designated by an address part of an instruction.

**Option memory**

RAM memory located on option boards.

**Parallel transmission**

Simultaneous transmission of all bits in a byte.

**Peripheral**

A noncomputing input or output device, such as a printer or hard disk drive.

**Protocol**

Rules by which computers exchange information, including the organization of the units of data to be transferred.

**RAM**

Random access memory. Items in RAM can be randomly retrieved and augmented. Each byte can be accessed regardless of its location. Information is eradicated when the computer is turned off.

**Reboot**

To bring up the operating system in the middle of a session. This is accomplished by pressing the Ctrl, Alt and Del keys simultaneously.

**ROM**

Read only memory, usually a chip used for hardware configuration in a system.

**Serial transmission**

Communications method where data is sent in a regular pattern of bits.

**Server PC**

Microcomputer used by network as source of disk drives and information.

**Synchronous communications**

Communication method where speed and flow of information being transmitted is controlled by equally spaced clock signals or pulses.

**System memory**

The amount of RAM installed on the IBM PC system board.

**Terminal Mode**

Condition of your PC when it is connected to a host computer.

## Appendix G:

### Customer Support Information

#### Repair Policy

If your product is still under the original one year limited warranty, IDEA will repair or replace it at no charge. If the product is out of the warranty period, IDEA will repair it and charge you on a time and materials basis.

If you are having problems with your IDEA product, take the following steps:

1. Call your dealer for assistance.
2. If your dealer is not able to provide a solution, call the IDEA Technical Support Department at (800) 257-5027. (Be sure that you have the serial numbers from your software diskette and from your IDEA hardware.) If the Technical Support representative determines that your product requires factory service, you will be given a Materials Return Authorization (MRA) number by Technical Support. IDEA will not accept returned products without an MRA number.



3. Box the product in the original shipping container or other secure package. Write your MRA number on the top of the box. For all warranty repairs, enclose a copy of the original purchase receipt as proof of date of purchase.
4. Ship by the most economical means to:

IDEAssociates, Inc.  
35 Dunham Road  
Billerica, MA 01821  
Attn: MR No. \_\_\_\_\_

When you ship this product, you agree to insure the product or assume risk of loss or damage in transit and to prepare shipping charges to the factory.

Once your product has been repaired, IDEA will return it to you by UPS or the most economical carrier at IDEA's expense.

### Warranty Card

Please complete and promptly return the enclosed warranty card. The warranty card should be filed by the party who installs the IDEA product.

### Limited Warranty

For IDEAssociates' Limited Warranty, see the first page of this manual.

