

Hardware Guide



IDEAcomm® 5251/Plus

IDEA®

IDEAcomm® 5251/Plus

IBM Midrange
Communications
for the IBM PC and PS/2

Hardware Guide

IDEA

Warning

The IDEComm 5251/Plus and 5251/Plus MC cards generate and use radio frequency energy and if not installed and used properly, that is, in strict accordance with the manufacturer's instructions, may cause interference to radio and television reception. They have been type tested and found to comply with the limits for a Class A computing device in accordance with the specifications in Subpart J of Part 15 of FCC Rules, which are designed to provide reasonable protection against such interference in a commercial environment. Operation of this equipment in a residential area is likely to cause interference, in which case the user at his own expense will be required to take whatever measures may be required to correct the interference.

NOTE

External cables not supplied by the manufacturer of this equipment must be shielded to maintain compliance with the FCC rules.

Le présent appareil numérique n'émet pas de bruits radioélectriques dépassant les limites applicables aux appareils numériques de classe A prescrites dans le règlement sur le brouillage radioélectrique édicté par le Ministère des Communications du Canada.

IDEA, Inc.

Limited Warranty



IDEA, Inc., guarantees this IDEA Product to be in good working order for a period of 1 year from the date of purchase from IDEA or an authorized IDEA dealer. If this Product fails to be in good working order at any time during this one year warranty period, IDEA will, at its option, repair or replace this product at no additional charge except as set forth below. Repair parts and replacement products will be furnished on an exchange basis and will be either reconditioned or new. All replaced parts and products become the property of IDEA. This limited warranty does not include service to repair damages to the product resulting from accident, disaster, misuse, abuse, or non-IDEA modification of the product.

Limited Warranty service can be obtained by delivering the product during the one year warranty period to an authorized IDEA dealer or by sending the product to IDEA. IDEA will not accept products without a Materials Return Authorization (MRA) number issued by its Customer Support Department, with a proof of purchase date. If this product is delivered to IDEA by mail, you agree to insure the product or assume risk of loss or damage in transit, to prepay shipping charges to the warranty service location and to use the original shipping container or equivalent.

**ALL EXPRESS AND IMPLIED WARRANTIES
FOR THIS PRODUCT INCLUDING THE
WARRANTIES OF MERCHANTABILITY AND**

Continued

FITNESS FOR A PARTICULAR PURPOSE, ARE LIMITED IN DURATION TO A PERIOD OF 1 YEAR FROM THE DATE OF PURCHASE, AND NO WARRANTIES, WHETHER EXPRESS OR IMPLIED, WILL APPLY AFTER THIS PERIOD. SOME STATES DO NOT ALLOW LIMITATIONS ON HOW LONG AN IMPLIED WARRANTY LASTS, SO THE ABOVE LIMITATIONS MAY NOT APPLY TO YOU.

IF THIS PRODUCT IS NOT IN GOOD WORKING ORDER AS WARRANTED ABOVE, YOUR SOLE REMEDY SHALL BE REPAIR OR REPLACEMENT AS PROVIDED ABOVE. IN NO EVENT WILL IDEA BE LIABLE TO YOU FOR ANY DAMAGES, INCLUDING ANY LOST PROFITS, LOST SAVINGS OR OTHER INCIDENTAL OR CONSEQUENTIAL DAMAGES ARISING OUT OF THE USE OF OR INABILITY TO USE SUCH PRODUCT, EVEN IF IDEA OR AN AUTHORIZED IDEA PERSONAL COMPUTER DEALER HAS BEEN ADVISED OF THE POSSIBILITY OF SUCH DAMAGES, OR FOR ANY CLAIM BY ANY OTHER PARTY.

SOME STATES DO NOT ALLOW THE EXCLUSION OR LIMITATION OF INCIDENTAL OR CONSEQUENTIAL DAMAGES FOR CONSUMER PRODUCTS, SO THE ABOVE LIMITATIONS OR EXCLUSIONS MAY NOT APPLY TO YOU.

THIS WARRANTY GIVES YOU SPECIFIC LEGAL RIGHTS, AND YOU MAY ALSO HAVE OTHER RIGHTS WHICH MAY VARY FROM STATE TO STATE

To obtain Limited Warranty coverage, you must complete and return the enclosed Warranty Card.

Information on warranty service is in the appendix on Customer Support at the end of this manual.

Table of Contents

Warning	ii
IDEA, Inc. Limited Warranty	iii
Notice	vii
Copyright	vii
Trademarks	vii
Service	vii
Section I: Introduction	1-1
Overview of the IDEAcomm 5251/Plus Card ..	1-4
Making the IDEA Card Operational (a Summary)	1-4
Organization and Scope of the Documentation	1-5
Section II: Installing the PC Card	2-1
Section III: Installing the Micro Channel Card	3-1
Section IV: Termination and Cabling of the Card	4-1
Section V: Using PC Support on the AS/400: the Adapter Handler	5-1
Overview	5-1
Overview of Steps	5-1
Software Installation	5-2
Restrictions on Rerunning Setup	5-5
Messages from IDEA Software	5-6
Appendix A: The TWINDIAG Diagnostic Program	A-1
Running the Program	A-1

**Appendix B: Attaching the IDEA TWINAX
Line to IBM Remote Controllers B-1**

**Appendix C: Identifying PC Cards and Switch
Settings C-1**
5251/Gold PC Cards Revision 10 and Higher . C-2
TWINAX Plus Rev. D and E PC Cards C-5
TWINAX Plus PC New Rev. C Settings C-8
TWINAX PC Rev. A, B, and Older C Settings C-12
Quick Reference Chart for TWINAX Switches C-13

Appendix D: Glossary D-1

Appendix E: IDEA Products E-1
Midrange Terminals E-1
Internetworking Solutions E-1
Midrange Printers E-2
Midrange Communication Processors E-2
PC and Mac to Midrange Communications E-3
Mainframe Communications E-4
Super Communications E-4

Appendix F: Customer Support Information F-1

Index Index-1

Notice



Copyright

Copyright ©1995 by IDEA®. All rights reserved.

Trademarks

IDEAcomm, IDEAssociates, and IDEA are registered with the U. S. Patent and Trademark office by IDEAssociates, Inc.

IBM, PS/2, PC Support, and Micro Channel are trademarks of International Business Machines Corporation. AS/400 is a trademark of International Business Machines Corporation.

Service

IDEA has an established network of computer dealers throughout the United States and worldwide. To place an order or to locate the nearest dealer, call nationwide at (800) 257-5027. In Massachusetts, call (508)-663-6878. In Canada, call (800) 446-5280.

Section I: Introduction



The IDEAcomm 5251 card, when combined with the appropriate emulation software, provides local twinax communications for a PC or PS/2 to the IBM midrange system. The Adapter Handler software, which is shipped with the card, provides connection with IBM's PC Support on the AS/400.

Note

For other emulation functions, this card is used with one of the IDEAcomm 5251 software packages, with a manual listed on page 1-5.

Handling the IDEA Card

During unpacking and installation, please be careful with the IDEAcomm card. Keep all food and beverages away from the card. Do not bend or drop the card.

Serial Number and Version Number

Please turn your IDEComm card to the component side. The serial number is on a sticker on the card. (It is also on the box.) Record this number NOW on both your warranty card and on the following line in this manual.

Serial Number: _____

Date of Purchase: _____

Please write the version number of your software diskette here:

Version Number: _____

Inventory Checklist

The following is a list of the components you should have received:

- IDEAcomm 5251/Plus or 5251/Gold card, PC version or Micro Channel version
- Short twinaxial cable with 15 pin serial connector and T-connector
- Diskette(s), 3 1/2 inches and 5 1/4"

Caution

This diskette contains all the files needed for installing micro channel hardware with a 7 LU board (IDEAcomm 5251/Plus). If you have a 4 LU board, use the files in the subdirectory named 4LU. See Section III.

Do not run SETUP from the diskette unless you are using PC Support/400. See Section V.

- Hardware Guide (this book)
- Warranty card

What the User Must Supply

1. Medium size flat blade screwdriver for opening the PC
2. Pliers or a 1/4 inch socket wrench to remove the back cover of some models of the PC
3. Small flat blade screwdriver for attaching the TWINAX cable connector
4. Twinaxial cable with connectors
5. Software (unless you are using the card only for AS/400 PC Support described in Section V).

Overview of the IDEAcomm 5251/Plus Card

The IDEAcomm card:

- works with IDEAcomm 5251/Plus, IDEAcomm 5251/Gateway Plus, and IDEAcomm 5251/OS software to link the PC or PS/2 series to an IBM System 36/38 or AS/400 minicomputer, or to the IBM5294, 5394, 5494, or IBM 5251 Model 12 remote controllers, via a twinaxial cable.
- works with its own software driver, IDEAH.EXE, to provide access to PC Support on the AS/400.

Making the IDEA Card Operational (a Summary)

1. On the PC family and PS/2 Model 30, set the I/O address switches on the PC card.
2. Install the card in the PC or PS/2.

On the PS/2 Models 50 – 80, boot from the Reference Diskette and run the IBM automatic configuration program.

3. With IDEAcomm 5251/Plus, IDEAcomm 5251/Gateway Plus, or IDEAcomm 5251/OS, refer to the software manual for further steps.

For PC Support with the AS/400, run the SETUP program described in Section V of this manual.

Organization and Scope of the Documentation

This manual is the basic reference for hardware installation and diagnostics for the IDEAcmm 5251/Plus communications package. It is the only reference for the AS/400 PC Support communications package.

Related Publications

The *IDEAcmm 5251/Plus Software Guide* is sold with the IDEAcmm 5251/Plus software packages. It includes how to configure and run emulation with DOS and how to use features such as the keyboard editor.

The *IDEAcmm 5251 for Windows Guide* is sold with the IDEAcmm 5251 for Windows software packages. It described how to configure and run emulation, including emulation as a Gateway user, with Microsoft Windows.

The *IDEAcmm 5251 Gateway/Plus Guide* is sold with the IDEAcmm 5251 Gateway/Plus software, which allows several PCs or PS/2s on a network compatible with NetBIOS to share one IDEAcmm 5251/Plus card.

The *IDEAcmm 5251/Plus Technical Reference Guide* is available free to customers who purchase an IDEAcmm 5251/Plus software package. It includes information on advanced topics, including the IDEA and IBM applications programming interfaces and IDEA support of IBM printer commands.

The *IDEAcmm 5251/OS Guide* is sold with the IDEAcmm 5251/OS software package. It includes how to configure and run emulation with OS/2.

Notation Conventions

PC	Refers to an IBM PC, XT, AT, or PS/2 Model 30 or compatible.
TWINAX	The name of the IDEComm 5251/Plus software program.
System 3X	The 3X stands for the IBM System/36 and /38.
IBM midrange	The 3X and AS/400 mini-computers.
UPPERCASE	Information in upper case must be entered as shown. It can be entered in upper or lower case, but is displayed on the screen in upper case.
lowercase	Fields in lower case indicate variable information.
pathname	A field shown as pathname indicates a standard DOS file specification of the form: [drive:][directory\]filename[.ext].
<Enter>	Press the Enter key.
[]	Square brackets indicate optional fields. The square brackets should not be entered.

Section II:

Installing the PC Card

Use this section if you have a PC series microcomputer or a PS/2 Model 30. For other models of the PS/2, see Section III.

Installation Overview

1. Open the PC.
2. Check switches on the IDEComm card.
3. Insert the card in the PC.
4. Replace the PC cover.
5. "Terminate" the card if it is the last device on the cable or run (Section IV).
6. Connect the twinaxial cable (Section IV and Appendix B).
7. Run **SETUP** from the accompanying diskette **only** if you will use PC/Support on the AS/400.

Please read through this entire section before beginning installation.

A Note on Memory Addresses

The memory address of the IDEA card is set automatically. Please note that some versions of Revisions 10 and 11 of the 5251/Gold PC card support memory addresses C000, D000, and E000. All other revisions of the 5251/Gold card support addresses C000, C800, D000, D800, E000, and E800.

Opening the PC

Preliminary Steps

- Turn off the PC power switch.
- Turn off power to any peripheral devices (printer, monitor, hard disk, and so on.).
- If you have an AT, unlock it.
- Unplug the computer and all peripherals from the wall outlet.
- Carefully note where each cable is attached so that you can reattach them later. Disconnect all cables from the back of the PC.

Cover Removal

- Move your keyboard and all peripheral equipment away from the work area.
- Position the PC or PS/2 to allow rear access.
- With an AT, you must remove the back panel first. Pull firmly to detach the plastic fasteners.
- The cover is attached by two or five screws. With a flat blade screwdriver, remove the cover mounting screws by turning the screwdriver counter-clockwise. Certain models may require the use of pliers or a 1/4 inch socket wrench.
- Carefully slide the cover away from the rear of the unit. When the cover will go no further, tilt it up and remove it from the base. The AT requires no tilting.

Checking Switches on the Card

Below is a diagram of the IDEAcomm 5251/Gold card Revision 10 and higher. Other cards are shown in Appendix C.

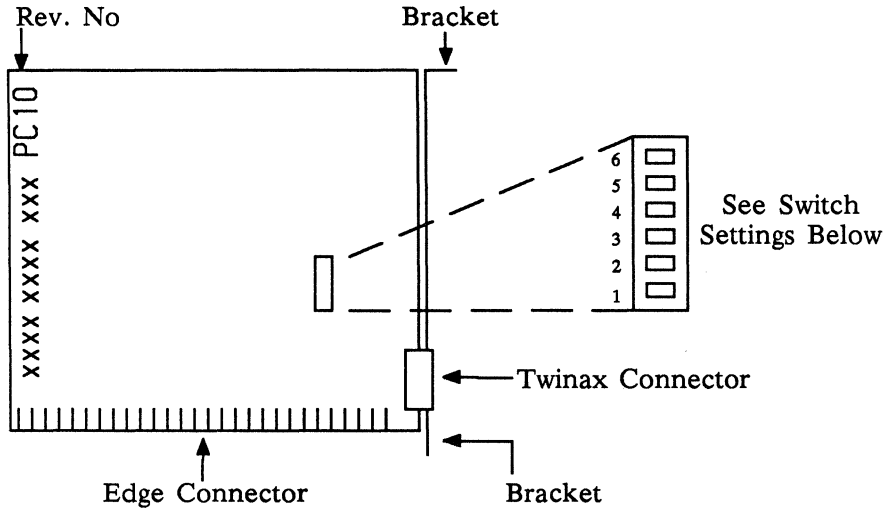
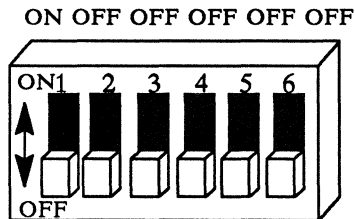

Figure 2-1: The IDEAcomm 5251/Gold Card Rev. 10 and Higher

The switch positions are set at the factory for I/O address 368-369. Change the default setting if you have another card with the same I/O address.



Switch Bank
Factory Settings

1	always OFF
2	always OFF
3 & 4:	I/O Address:
ON ON	308-309
OFF ON	328-329
ON OFF	348-349
OFF OFF	368-369
5	always OFF
6	always OFF

Inserting the IDEComm Card

Once the switch settings are verified, you can insert the IDEComm card into any empty expansion slot on your PC. Use a flat blade screwdriver to remove the screw that holds the system expansion slot cover in place (turn the screw counterclockwise). Refer to Figure 2-2.

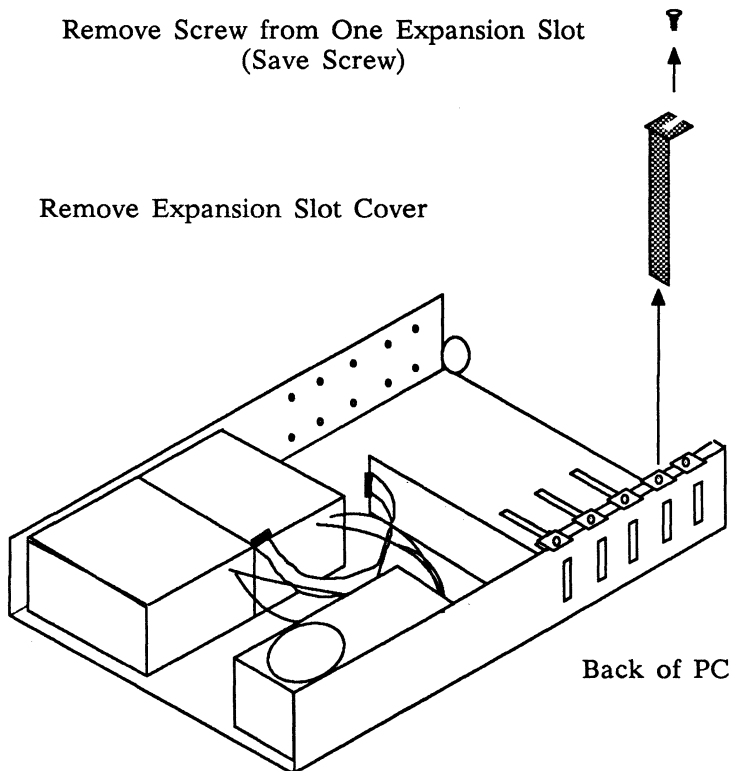

Figure 2-2: Removing the Slot Cover

Save the screw for aligning the card.

Inserting and Aligning the Card

Hold the card by both top corners and firmly press it into the expansion slot, being sure that the bracket slides into the PC board.

Align the hole in the IDEComm card retaining bracket with the hole in the rear panel of the PC and insert through both the screw from the last step. Using a flat blade screwdriver, turn the screw clockwise.

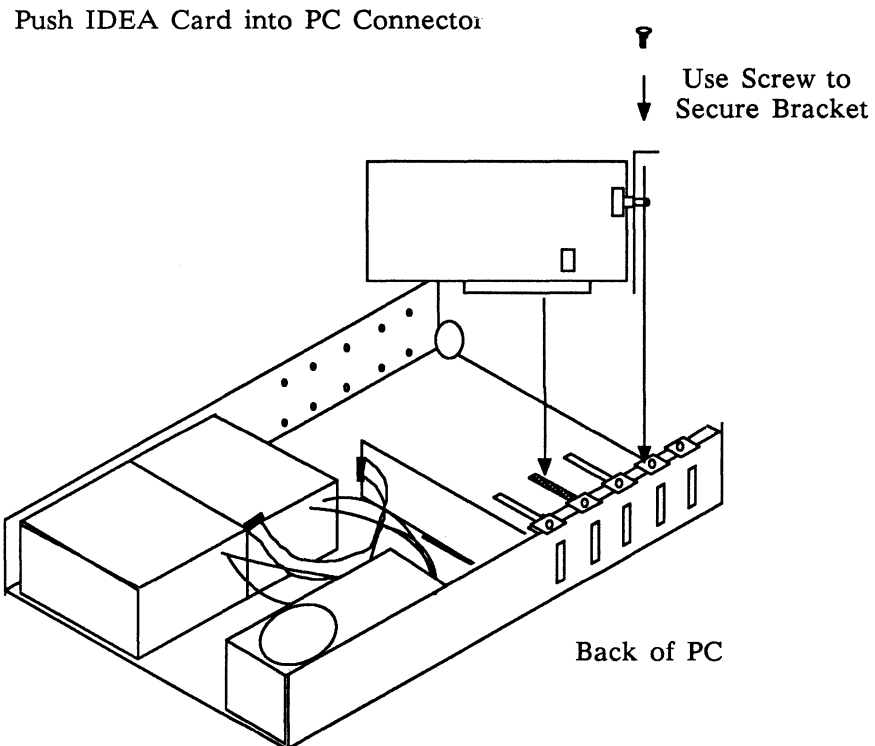

Figure 2-3: Inserting and Aligning the Card

Replacing the Cover

- If you have any other options to install, do so now.
- Replace the microcomputer cover and cover screws.
- If you have an AT, replace the back panel.
- Recable your system.
- Reattach any peripherals.

Section III:

Installing the Micro Channel Card



Use this section if you have a PS/2 model 50 – 80.

The IDEAcomm 5251/Plus micro channel card requires version 4.03 or higher of IDEAcomm software.

Installation Overview

Hardware memory and I/O addresses used by the IDEAcomm card are configurable by software. A configuration utility on the Reference Diskette supplied with the PS/2 uses a configuration file supplied by IDEA to set up the computer. The setup procedure for hardware can be summarized in the following steps.

1. Copy IDEA's configuration file @6060.ADF to the Reference Diskette.
2. Turn off the PS/2 and insert the card.
3. Boot with the Reference Diskette.
4. Run "automatic configuration" from within IBM's configuration program.
5. If this card is last on the twinaxial cable run, "terminate" it.
6. Connect the twinaxial cable (Section IV).
7. Run **SETUP** from the accompanying diskette **only** if you will use PC/Support on the AS/400.

Automatic configuration of the hardware works as follows: Each card installed in a PS/2 computer has a unique ID number and a corresponding configuration file (ADF file), which contains the configuration parameters for that card. The card's ID number is in the configuration file copied to the Reference Diskette, which is used to boot up the computer.

During automatic configuration, the computer polls each expansion slot in the PS/2 for a card. It reads the ID number of each installed card and then checks for a corresponding number in the ADF filenames on the Reference Diskette. When a matching file is found, the computer reads down the list of configuration parameters in that file and assigns the first valid options available, avoiding address conflicts with any other cards installed. The configuration information is then saved in the computer's ROM.

Automatic Configuration

CAUTION

Before using either the IDEA diskette or the IBM Reference Diskette, make a copy of each and file the originals for safekeeping.

If you have the 4 LU board, use the files in the subdirectory 4LU on your diskette.

If you are using 32K micro channel cards, for example, in a Gateway server, you cannot use automatic configuration. You must do a manual configuration as described further on.

1. Copy your card's configuration file, @6060.ADF, from your IDEAComm diskette to a backup copy of IBM's Reference Diskette.
2. Power down and open the PS/2 (see instructions at the end of this section).
3. Plug the IDEAComm card (shown on the next page) into any free expansion slot in the PS/2. Refer to *Installing Options* in your IBM PS/2 manual.
4. Replace the PS/2 cover and recable your system.
5. Power up the PS/2 with the Reference Diskette (containing the IDEAComm ADF file) inserted in your diskette drive.

Note

The first time you boot up after installing the card, Error 165 (adapter configuration error) will appear on the screen. This is normal, as later explained in the program.

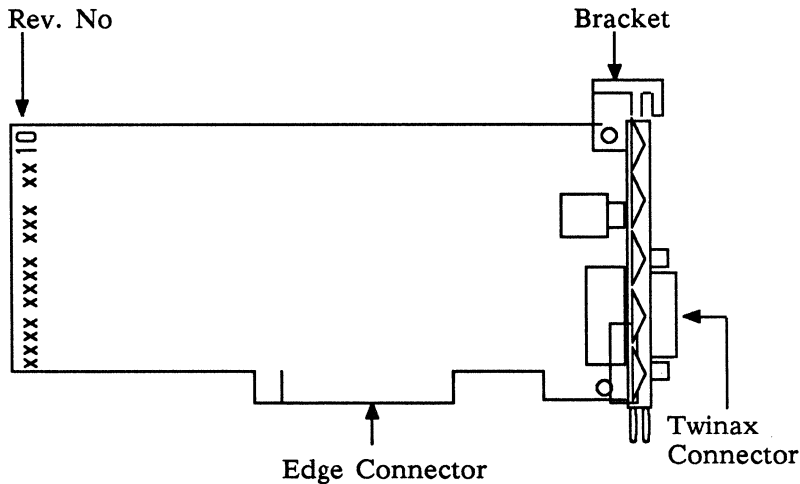

Figure 3-1: The IDEAcomm Micro Channel Card

6. Follow the program's instructions. Enter Y (Yes) to the question, **“Automatically configure the system?”**

When automatic configuration is completed, you are then instructed to reboot the system. First remove the Reference Diskette, and then press the Enter key to reboot.

Verifying Automatic Configuration

If you wish to verify the automatic configuration of the system, proceed as follows:

1. Reboot the computer from the IBM Reference Diskette.
2. From the Main Menu, enter Set Configuration (option 3).
3. From the Set Configuration Menu, press 1 to select View Configuration.

Each card installed is listed next to its respective slot number on the View Configuration Screen. If automatic configuration is successful, then the IDEA card will be listed on the View Configuration Screen as shown below:

Slot X – IDEAcmm 5251 [4 or 7] LU Card

Adapter Memory Location Segment xxxx
Adapter I/O Location [IO Base 0xxx]

Note

An asterisk beside either the I/O port or memory address indicates an address conflict between the IDEA card and another card installed in the PS/2. If this occurs, remove the conflicting hardware.

Manual Configuration

Manual configuration of the hardware gives you more control over the configuration process. Use manual configuration if you want a device to have a particular address, or if you want to verify the validity of each parameter as you enter it.

1. Complete steps 1–5 in the Automatic Configuration section.
2. From the Main Menu, enter Set Configuration (option 3).
3. From the Set Configuration Menu, press 2 to select Change Configuration. Enter and save your configuration parameters as directed. The configuration options provided in IDEA's ADF file are listed below:

I/O Port Configuration Memory Segment Address

I/O port 308	C000 (default)
I/O port 328	C400 ¹
I/O port 348	C800
I/O port 368 (default)	CC00 ¹
	D000
	D400 ¹
	D800
	DC00 ¹

¹ four-LU card only

Notes

An asterisk beside either the I/O port or memory address indicates an address conflict. In most cases, this conflict can be resolved by simply selecting a different configuration value.

If you are using 32K micro channel cards, for example, in a Gateway server, you must configure the 32K card on a 32K memory segment address. Valid addresses include C000, C800, D000, and D800.

Opening the PS/2

These instructions, which are also in the IBM manual for your PS/2, are provided as an aid to the Automatic Configuration steps on page 3-3.

Preliminary Steps

- Turn off the PS/2 power switch.
- Turn off power to any peripheral devices (printer, monitor, hard disk, and so on).
- Unplug the computer and all peripherals from the wall outlet.
- Carefully note where each cable is attached so that you can reattach them later. Disconnect all cables from the back of the PS/2.
- Unlock the PS/2 cover from the side of the unit.
- Loosen the two cover screws.
- Carefully slide the cover away from the unit.
- Insert the card in a free expansion slot.

Section IV:

Termination and Cabling of the Card



Termination of the Card

In order for the equipment to function correctly, the last device on the twinax run must be terminated. (Twinax run refers to the cable that connects to a controller.) Current hardware packages provide a termination switch on the T-connector. You can terminate older cards by using the termination switch on the back of the card or by attaching an external terminator to the end of the outbound twinax adapters.

Terminating from the T-Connector

After installing the card as indicated in Section II or III, make the twinaxial connection:

1. Connect the T-connector cable to the twinaxial connector (15 pin 'D' shaped connector) on the IDEAcomm card. Attach your twinaxial cable that runs from the IBM midrange or controller to one half of the T-connector.
2. If this is the last terminal on the cable run, set the switch on the T-connector to TERM. If this is not the last terminal, set the switch to THRU and connect another cable to the other half of the T-connector.

Caution

If IDEAcmm is not the LAST terminal on the twinax run, you must set the termination switch to THRU, not TERM.

If you have a terminator on the T-connector, you must set the termination switch to THRU.

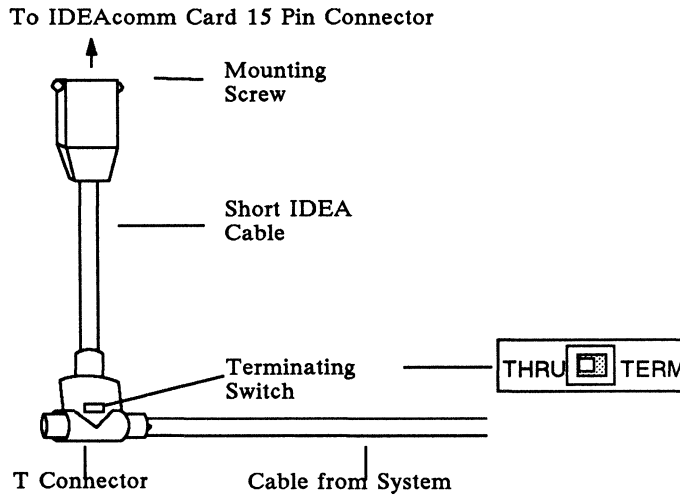

Figure 4-1: T Connector with Switch Set to THRU
(for All But Last Terminal on Run)

Terminating with the Switch on the Older Card

If the T-Connector does not have a TERM/THRU switch, you can terminate the card with its own switch. Locate the termination switch that protrudes through the retaining bracket on the IDEComm card (Figure 2-1 or 3-1). Notice that the words TERM and THRU are etched in the metal bracket on the card. To terminate the card, flip the switch to TERM (toward the top of the card). To remove termination, flip the switch to THRU (toward the bottom of the card).

Note

If IDEComm is not the LAST terminal on the twinax run, you must set the termination switch to THRU, not TERM.

Terminating Revisions B and C of the Older TWINAX Card

Revisions B and C of the TWINAX (not TWINAX Plus) cards use jumpers for TERM and THRU. See page C-12.

Terminating with an External Terminator

For information on attaching an external terminator, refer to Connecting the Twinaxial Cable on the next page.

For information on creating a twinax run and installing it on the IBM controller, see Appendix B.

Connecting the Twinaxial Cable

1. Locate the 15-pin male connector on the IDEA card. This connector protrudes from the rear panel of the PC (Figure 4-2). Attach this connector to the 15-pin female twinaxial cable connector provided by IDEA. Tighten the two mounting screws using a flat blade screwdriver to turn the screws clockwise.
2. Attach the round end of the twinaxial cable connector to the T-connector. (Push the T-connector into the cable connector so that the key on the cable connector fits into the slot on the T-connector. Then twist the collar of the twinaxial cable connector until it fits tightly onto the T-connector.)

Attach the twinaxial cable run (the cable that connects to the controller) to the T-connector.

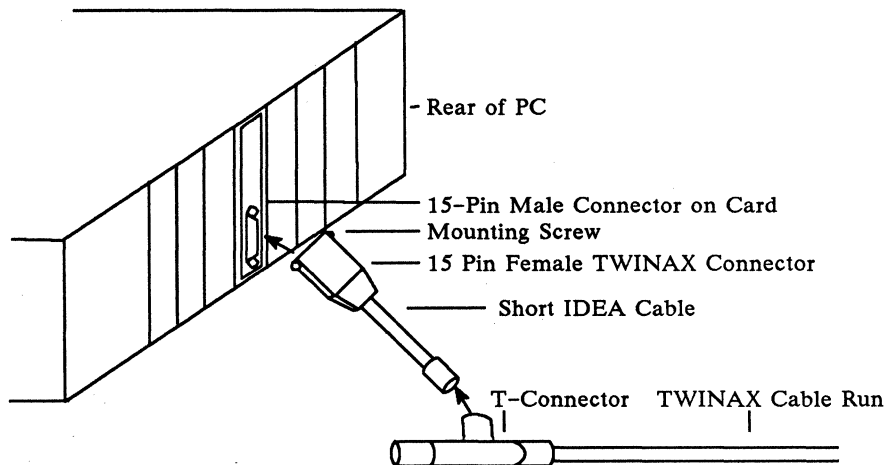



Figure 4-2: Connecting the Twinaxial Cable

Section V: Using PC Support on the AS/400: the Adapter Handler



Overview

This appendix is for users who wish to use IBM's PC Support with the 5251/Plus card instead of IDEALink file transfer on the AS/400.

This IDEAComm 5251/Plus package allows a PC or PS/2 to achieve a fully functional local communications link with IBM's AS/400 PC Support program. Files on your diskette contain software programs that serve as the installer and adapter handler. No other software is required on the microcomputer.

Note

This product does not include any emulation except in connection with AS/400 PC Support. For PC Support 36, PC Support 38, and all other software, use the IDEAComm 5251 for DOS, IDEAComm 5251 for Windows, IDEAComm 5251/OS, or IDEAComm 5251 Gateway/Plus emulation product.

Overview of Steps

If you have a PC, XT, AT, or PS/2 Model 30, use Section II for hardware installation and Section V for software installation. If you have another model of the PS/2, use Section III for hardware installation and Section V for software installation.

Note

If you have the 4 LU board, be sure to use the files in the subdirectory 4LU on your diskette. See Appendix C for how to identify a 4 LU board.

Software Installation

Caution

This product cannot be used at the same time as IDEAcomm 5251/Plus or 5251/Gateway Plus software (TWINAX). Do not invoke the TWINAX program when using this product.

On the AS/400, running IBM's PC Support with the IDEAcomm 5251 hardware requires the following procedures.

1. Run IBM's installation program, INSTALL, for PC Support as documented in your IBM manual. However, **do not reboot when instructed.**
2. Place the IDEA diskette in Drive A. Type:

A: <Enter>

Run the IDEA program SETUP to copy files from the IDEA diskette to the directory you

choose and to specify the board memory and I/O addresses.

SETUP presents the following screen:

<p style="text-align: center;">IDEAcomm 5251 Adapter Handler Version xx.xx Copyright (C) 198x IDEAssociates, Inc. SETUP - Configuration Program</p>
<p>Destination [disk][\directory\][batch file name] : C:\PCS\STARTPCS.BAT Hardware memory address: D000: Hardware I/O address: 0368</p>
<p style="text-align: center;">Use cursor keys to move between fields Type changes to selected field and press Enter to accept. Press <ESC> to exit program of <F1> for help.</p>

Caution

Use care with the Enter key. This key accepts information only for the line where the cursor is positioned. If you change the memory or I/O address and then return to the line with the destination name and press Enter, the memory and I/O address will be changed back to the ones already stored.

If you have changed your PC card switches or used different addresses in the IBM Automatic Configuration program for the Micro channel card, change these addresses here. (The address is read from the TWINAX7.UCM file if one exists in the directory you select.)

In case an error message is displayed, use the cursor keys to move to another field if you

cannot correct the error at once. Error messages are self explanatory.

3. **SETUP** copies the files from the IDEA diskette to the directory from which you will invoke PC Support. The IDEA software queries for the directory you want to use. (IDEA recommends the subdirectory C:\PCS, which is created by IBM's INSTALL. If you are using a two-diskette system and no hard disk, however, see the third example below.)

Some examples of entries for disk, directory, and file name are:

a. **C:\SETUP**

In this case, the SETUP program will fill in C:\SETUP\STARTPCS.BAT.

b. **MINE**

In this case, the SETUP program will fill in C:\PCS\MINE.BAT.

c. **B:\AUTOEXEC**

In this case, SETUP fills in B:\AUTOEXEC.BAT. This is necessary if you are rerunning SETUP on a two-diskette drive system with no hard disk. In this case, SETUP prompts you to insert your working diskette DSKT01 in drive B. DSKT01 is the diskette that IBM's INSTALL program created.

4. **SETUP** makes the necessary changes to the IBM batch file STARTPCS.BAT (or to the batch file that you specify) to allow you to use IBM's software with the IDEA hardware. The most notable change is that it replaces E5250AH.COM or WSEAH.COM with

IDEAH.EXE in the .BAT file. SETUP also makes a copy of the original file, renaming it filename.BAK.

5. Reboot.
6. Continue with IBM's instructions for further configuration, running PC Support, and transferring files.

Restrictions on Rerunning Setup

Each time you install an old or new version of IBM PC Support (or run IBM's INSTALL program for any reason), you must repeat the steps above.

Note for Users of Two-Diskette Systems

On a two-diskette drive system, the IBM INSTALL program puts the call to STARTPCS.BAT in the file AUTOEXEC.BAT in directory PCS on Drive B (DSKT01). When you first run SETUP, it checks for this location of the file. However, if you later rerun SETUP, be sure to insert IBM's Diskette-01 in Drive B, and to indicate the location of the file. See example 3 on page 5-4 above.

IDEA recommends that you enter B:AUTOEXEC as the file location on the SETUP screen. If you instead enter B:\PCS\STARTPCS, you must enter again any changes you originally made to I/O and memory address, as these changes were saved in AUTOEXEC.BAT, but not in STARTPCS.

If SETUP gives you the message **Invalid Configuration path or file name**, check that you have the correct diskette in the drive you indicate. IBM's DSKT01 has AUTOEXEC.BAT; DSKT02 has PCS\STARTPCS.

Messages from IDEA Software

When called from STARTPCS or another batch file, IDEAH.EXE may produce the following messages:

IDEA 000: Unidentified Error Occurred

Reboot and repeat the steps at the beginning of this section. If the error persists, call IDEA Technical Support.

IDEA 002: File I/O Error, .UCM file not found (name)

The file TWINAX7.UCM (or TWINAX4.UCM) was not found in the directory expected.

IDEA 003: File I/O Error, .MC file not found (name)

The file IDEAH.MC was not found in the expected directory.

IDEA 004: File I/O Error, Access Denied (name)

One of the files listed in Section I is restricted, hidden, or being used by another program. The pathname also may not be typed correctly.

IDEA 005: Insufficient File Handles (name)

The CONFIG.SYS file does not allow enough files to be open at once. Add the command **FILES=20** to the CONFIG.SYS file and retry.

IDEA 006: I/O Error accessing Configuration File (name)

The file TWINAXn.UCM is damaged or is not in the expected directory. Be sure that you have only one of the files TWINAX4.UCM or TWINAX7.UCM. If necessary, recopy it from the IDEA diskette.

IDEA 007: Memory Test Failure

The screen buffer test was executed and failed. Verify that the board setting for the PC memory address matches that set in SETUP.EXE. Verify that the address set for the micro channel card by the IBM Reference Diskette matches SETUP.EXE.

IDEA 008: I/O Error accessing Microcode File

The file IDEAH.MC is damaged, has the wrong version number, or has been stopped.

IDEA 009: PS/2 Configuration Error

The IDEAComm micro channel card either is not installed or cannot be found.

IDEA 010: PS/2 Installation Error

The configuration could not be determined from values read from the card. The ADF file may be corrupted; recopy it to the IBM Reference Diskette and rerun the IBM configuration program. If the message persists, call IDEA Technical Support.

IDEA 012: Adapter already in use

Either the program TWINAX.EXE is running, or the IDEA PC Support software is already running. If TWINAX.EXE is running, remove it from memory (deinstall it).

IDEA 013: Microcode loaded and running

The IDEA software was successfully started.

IDEA 014: Display adapter not supported

The PC or PS/2 is using an adapter not supported, such as the PCjr display adapter.

Appendix A: The TWINDIAG Diagnostic Program



Running the Program

In order to run the TWINDIAG Diagnostic Program, set the termination switch to the TERM position (see Figure 4-2). Note that the following files are required and should be copied to the hard disk:

TWINDIAG.EXE
TWINAX7.UCM
Z80MEM.TSK

Note

The older program TWINDIAG.COM, if it exists in the same directory, must be deleted or renamed before you enter the command TWINDIAG.

Type the following at the DOS prompt:

TWINDIAG <Enter>

You see the following menu:

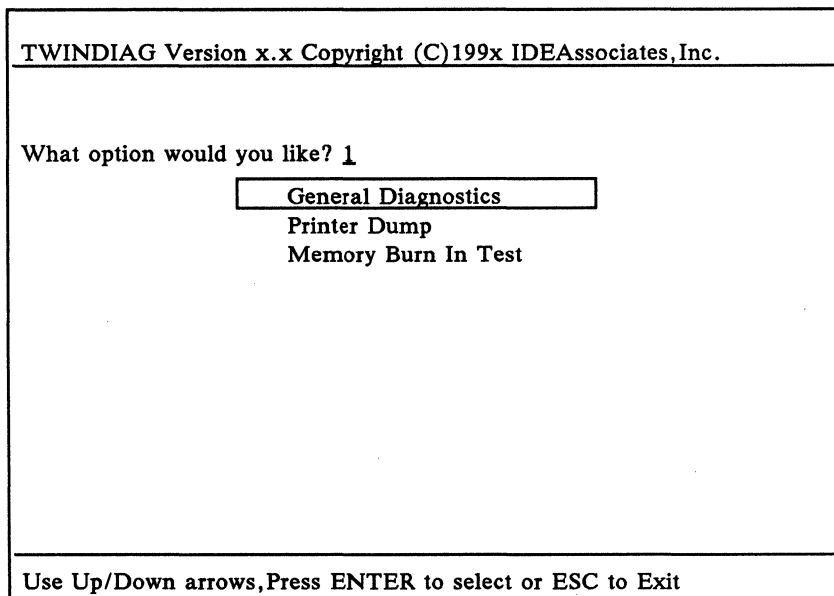

Figure A-1: TWINDIAG Main Menu

Use the arrow keys to select a test, or type in the number of the test.

TWINDIAG General Diagnostics

To assure that this first test performs correctly, you should disconnect the card's cable from the host or controller. (TWINAX should not be resident.) If your card passes this diagnostic you will see a screen similar to the one shown in Figure A-2.

```
TWINDIAG Ver. x.x Copyright (C)199x IDEAssociates, Inc.
-----
MEMORY MAP ==>  C0000 ==> NO MEMORY FOUND
                  C4000 ==> NO MEMORY FOUND
                  C8000 ==> Non IDEA MEMORY FOUND
                  CC000 ==> NO MEMORY FOUND
                  D0000 ==> NO MEMORY FOUND
                  D4000 ==> NO MEMORY FOUND
                  CD000 ==> MEMORY FOUND for H/W Addr ==> 0308
                  .
                  .
                  .
                  F4000 ==>NO MEMORY FOUND
TWINDIAG-061     TESTING PAGE (n)
.
.
==>Testing H/W Address 0308 with Memory at DC00 <==
TWINDIAG-016     MEMORY TESTS PASSED.
TWINDIAG-020     INITIAL TRANSMITTER TEST PASSED.
TWINDIAG-022     TRANSMITTER/RECEIVER LOOPBACK TEST PASSED

(These diagnostics repeat for any other addresses/cards found)
                Press <Enter> to continue
```

Figure A-2: Example of Screen from TWINDIAG
(IDEA Card is Disconnected from the Host or Controller)

The screen shows:

1. All memory on all cards in one Server
(Non-IDEA MEMORY indicates another manufacturer's adapter card.)
2. For the each I/O port address in turn, messages appear as TWINDIAG tests the card. Message explanations start on page A-4.

After all cards are tested, Enter returns you to the main menu.

If you want to know what station addresses the system found that are currently active on the twinaxial run, do not disconnect the cable from the card. The diagnostic test will not be run, but a screen similar to the one shown in Figure A-3 will be displayed.

```

TWINDIAG Ver x.x Copyright (C)199x IDEAssociates, Inc.
-----
MEMORY MAP ==> C000 ==> NO MEMORY FOUND
              C4000 ==> NO MEMORY FOUND
              C8000 ==> NO MEMORY FOUND
.
.
              DC000 ==> MEMORY FOUND for HW Addr =>0308

==> Testing H/W Address 0308 with memory at DC00 <==
TWINDIAG-016 MEMORY TESTS PASSED.
TWINDIAG-018 LINE ACTIVE - UNABLE TO PERFORM
              TRANSMITTER TESTS. DISCONNECT
              CABLE FOR COMPLETE DIAGNOSTICS.
              NOW PERFORMING LINE ACTIVITY TESTS etc.
STATION==> 0      PENDING
              ==> 1      PENDING
              ==> 2      ONLINE
              .
              .
              ==> 6      OFFLINE
              Press <Enter> to return to Main Menu
```

Figure A-3: Example of Screen from TWINDIAG (IDEA Card is Connected to the Host or Controller)

The words to the right of STATION have the following meaning:

- ONLINE: The station was addressed by the host and responded.
- OFFLINE: The station was not addressed by the host.
- PENDING: The station was addressed by the host and did not respond.

Printer Dump from TWINDIAG

This is not supported with the hardware only package.

Memory Test from TWINDIAG

This tests memory on the IDEComm card. You see a display similar to the following:

TWINDIAG Version x.x Copyright (C) 198x IDEAssociates, Inc.

Pass Number xxxxx

Location 0-1FFF a Errors have occurred.

Location 2000-3FFF b Errors have occurred.

Location 4000-5FFF c Errors have occurred. (32K card only)

Location 6000-7FFF d Errors have occurred. (32K card only)

Press any key to terminate test.

Figure A-4: TWINDIAG Memory Test

This test continues until you press any key.

If you are having problems with your card and this test shows errors, report the errors to IDEA Technical Support.

TWINDIAG Error Messages

TWINDIAG-001 MEMORY TEST PC SIDE FAILED LOWER BANK ZERO FILL.

The memory located from 0 Hex to 1FFF Hex did not retain zeros stored there.

TWINDIAG-002 MEMORY TEST PC SIDE FAILED UPPER BANK ZERO FILL.

The memory located from 2000 Hex to 3FFF Hex did not retain zeros stored there. The memory located from 0 Hex to 1FFF Hex did not retain the value of 0FF Hex stored there.

TWINDIAG-003 MEMORY TEST PC SIDE FAILED LOWER BANK 0FFH FILL.

The memory located from 2000 Hex to 3FFF Hex did not retain the value of 0FF Hex stored there.

TWINDIAG-004 MEMORY TEST PC SIDE FAILED UPPER BANK 0FFH FILL.

Memory not found at the location specified in the configuration file.

TWINDIAG-005 CONFIGURATION ERROR -- UNABLE TO CONTINUE.

There has been an error during an attempt to load data from TWINAX7.UCM. If you have Revision 10 or 11 of the 5251/Gold card, see the note on memory addresses on page 2-1.

TWINDIAG-006 MEMORY FAILURE -- UNABLE TO CONTINUE.

The memory has failed at least one test.

TWINDIAG-007 UNABLE TO LOAD CONFIGURATION FILE -- DIAGNOSTICS ABORTED

There has been an error during an attempt to load data from TWINAX7.UCM.

**TWINDIAG-008 MEMORY TEST PC SIDE
FAILED ADDRESS TEST.**

The memory as seen by the PC or PS/2 has failed an address integrity test.

**TWINDIAG-009 Z80 MEMORY TEST FILE
NOT FOUND.**

There has been an error during an attempt to load the Z80MEM.TSK file.

TWINDIAG-010 Z80 FAILED STARTUP.

An attempt to start the Z80 has failed.

**TWINDIAG-011 MEMORY TEST Z80 SIDE
FAILED LOWER BANK ZERO FILL.**

The memory located from 0 Hex to 1FFF Hex failed to retain zeros stored there.

**TWINDIAG-012 MEMORY TEST Z80 SIDE
FAILED UPPER BANK ZERO FILL.**

The memory located from 2000 Hex to 3FFF Hex failed to retain zeros stored there.

**TWINDIAG-013 MEMORY TEST Z80 SIDE
FAILED LOWER BANK 0FFH FILL.**

The memory located from 0 Hex to 1FFF Hex failed to retain the value of 0FF Hex stored there.

**TWINDIAG-014 MEMORY TEST Z80 SIDE
FAILED UPPER BANK 0FFH FILL.**

The memory located from 2000 Hex to 3FFF Hex failed to retain the value of 0FF Hex stored there.

**TWINDIAG-015 MEMORY TEST Z80 SIDE
FAILED ADDRESS TEST.**

The memory as seen by the Z80 has failed an address integrity test.

TWINDIAG-016 MEMORY TESTS PASSED.

The memory has passed all tests.

TWINDIAG-017 Z80 NOT RESPONDING TO REQUEST

The Z80 has not responded to a command in the allotted time. It may be receiving data from a controller.

TWINDIAG-018 LINE ACTIVE -- UNABLE TO PERFORM TRANSMITTER TESTS. DISCONNECT CABLE FOR COMPLETE DIAGNOSTICS.

The receiver is receiving data that originates outside of this card, that is, from a controller. Leaving the cable connected will allow station addresses to be located. Disconnecting the cable will allow transmitter tests.

TWINDIAG-019 TRANSMITTER TIME OUT -- TRANSMITTER FAILURE -- ABORTED.

The simple transmitter test has failed.

TWINDIAG-020 INITIAL TRANSMITTER TEST PASSED

The simple transmitter test has passed.

TWINDIAG-021 LOOPBACK TEST FAILED

A simple loopback test has failed.

TWINDIAG-022 TRANSMITTER/RECEIVER LOOPBACK TEST PASSED

The loopback test has passed.

TWINDIAG-023 FIFO TEST FAILED

The FIFO register failed to hold exactly 16 words.

TWINDIAG-024 FIFO TEST PASSED.

The FIFO register has been tested and confirmed to 16 words deep.

TWINDIAG-025 INVALID PARAMETER SPECIFIED.

An invalid parameter was specified on the command line.

TWINDIAG-026 PS/2 ERROR - BOARD NOT INSTALLED

The PS/2 expansion slots were polled to locate the card ID number, and the IDEAcmm micro channel card was not found.

TWINDIAG-027 PS/2 ERROR - POS REGISTER 2 FAILURE

Programmable Option Select Register 2 test failed. The problem may be card related. Call IDEA Technical Support for assistance.

TWINDIAG-028 PS/2 ERROR - POS REGISTER 3 FAILURE

Programmable Option Select Register 3 test failed. The problem may be card related. Call IDEA Technical Support for assistance.

TWINDIAG-029 PS/2 ERROR - COULD NOT DETERMINE BOARD CONFIGURATION

The configuration could not be determined from values read from the card. The ADF file may be corrupt, or the problem may be card related. Call IDEA Technical Support for assistance.

TWINDIAG-030-3 INTERRUPT n TEST ON THE MICRO-CHANNEL BOARD PASSED

The IDEA micro channel board is set for interrupt n and working.

TWINDIAG-034 TWINAX NOT RESIDENT, UNABLE TO PERFORM PRINTER DUMP

To perform the printer dump, be sure that TWINAX is loaded (type TWINAX and press Enter), and resident (press Shift-Shift). Then invoke TWINDIAG.

TWINDIAG-035 NO PRINTERS CONFIGURED, PRINTER DUMP ABORTED

You must have at least one printer configured with IDEACFIG or INSTALL in the software package.

TWINDIAG-035 EMULATION MICROCODE IS RUNNING

Twinax emulation microcode is running on an IDEA card. Return to emulation, exit, and terminate the microcode. Then run TWINDIAG.

TWINDIAG-036 DUPLICATE CONFIGURATION FILES TWINAX4.UCM AND TWINAX7.UCM FOUND

Rename or delete one of the files before running TWINDIAG.

TWINDIAG-037 TWINAX MICROCODE NOT RUNNING. UNABLE TO PERFORM PRINTER DUMP

Emulation should be running with at least one printer configured before you execute TWINDIAG's printer dump.

TWINDIAG-038 WARNING! THIS TEST WILL HALT TWINAX MICROCODE. SESSIONS WILL HAVE TO BE RESTARTED.

Twinax emulation microcode is running on the IDEA card. Return to emulation, exit, and terminate the microcode.

TWINDIAG-039 TWINAX IS RESIDENT, UNABLE TO PERFORM DIAGNOSTICS.

Twinax emulation microcode is running on an IDEA card. Return to emulation, exit, and terminate the microcode.

TWINDIAG-040 NO PRINTERS CONFIGURED.

The Printer dump runs only on printer sessions.

TWINDIAG-051-054 INTERRUPT n TEST FAILED

The IDEA card is not set for this interrupt.

Appendix B: Attaching the IDEA Twinaxial Line to IBM Remote Controllers



The IDEAcmm card can be attached to the IBM 5251 Model 12 or IBM 5294, 5394 or 5494 remote controller (referred to as 5x94) for the IBM System 3X. (The 5394 can be set up as a 5294 controller, also.)

Since an IBM controller is limited in the number of devices it can support, check your controller to determine the maximum number of devices you can attach. Note that the configuration of the 5251 Model 12 differs from the configuration of the 5x94. The following text describes how to reconfigure your controller when you add the IDEAcmm card.

Adding IDEComm to a 5x94 Remote Controller

1. Verify that all workstations (terminals and printers) are powered ON. (Note that the 5x94 does not recognize any device that is powered off.)
2. Check the twinaxial cables on all display devices and printers to be sure they are firmly attached.
3. At the PC or PS/2 with the IDEComm card, load TWINAX and go into emulation. The cursor will be at the upper right corner of the screen.
4. At the controller, set the TEST/NORMAL switch to TEST, then set the POWER switch to ON.
5. From any display station (5251 11, 5291 1, 5292, 3180, 3196) or from a microcomputer with IDEComm emulation loaded, press the CMD key, then the BACKSPACE key. This allows the controller to recognize the devices attached to its ports.

A setup screen displays the attached devices. Verify that the station addresses correspond to the work stations and printers you attached. If this screen does not accurately reflect the attached devices, refer to the IBM Setup Procedure document for the controller for instructions. Press the Enter key twice to save the configuration.

Note

The system operator at your host site must now configure a new device at the host if he or she has not already done this.

IDEAcomm to a 5251 Model 12 Remote Controller

The switch settings on the Port Selector Switch Bank (located on the back of the 5251 Model 12) determine which ports are active. Refer to Table B-1 for appropriate switch settings. The 5251 Model 12 periodically polls ports that are active to determine which devices are currently on line.

Attaching IDEAcomm to an Existing Twinaxial Run

If a twinaxial run is already attached to an active port, you do not need to change the Port Selector Switch Bank settings when adding IDEAcomm.

Creating a New Run

If you have the first device on a Model 12 port, you must set the Port Selector Switch Bank switches to activate the port. (Refer to Table B-1 for appropriate switch settings.)

At the host, if a new device is varied on and the Port Switch Setting switches are incorrect, a DEVICE MISMATCH ERROR occurs when the controller is connected to the host System 3X.

Switch Settings on the 5251 Model 12 Controller

Switch Settings				
Active Ports	1	2	3	4
1	OFF	OFF		
1, 2	OFF	ON		
1, 2, 3	ON	OFF		
1, 2, 3, 4	ON	ON		
5			OFF	OFF
5, 6			OFF	ON
5, 6, 7			ON	OFF
5, 6, 7, 8			ON	ON

Appendix C: Identifying PC Cards and Switch Settings



This appendix is for users with the PC and PS/2 Model 30 series. Cards are listed newest first.

A Note on Memory Addresses

The memory address of the IDEA card is set by software. Please note that some versions of Revisions 10 and 11 of the 5251/Gold PC card support memory addresses C000, D000, and E000. All other revisions of the 5251/Gold card, 5251/Plus short card, and 5251/Plus Revisions D and E support addresses C000, C800, D000, D800, E000, and E800.

5251/Gold PC Cards Revision 10 and Higher

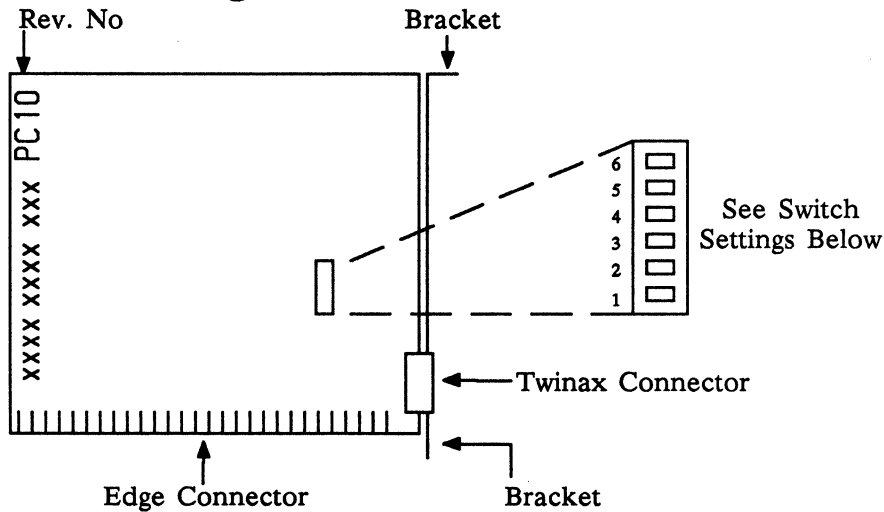

Figure C-1: 5251/G Card Revision 10 and Higher (supports 7 LUs or Sessions)

The switch positions are set at the factory for I/O address 368-369. Change the default setting if you have another card with the same I/O address.

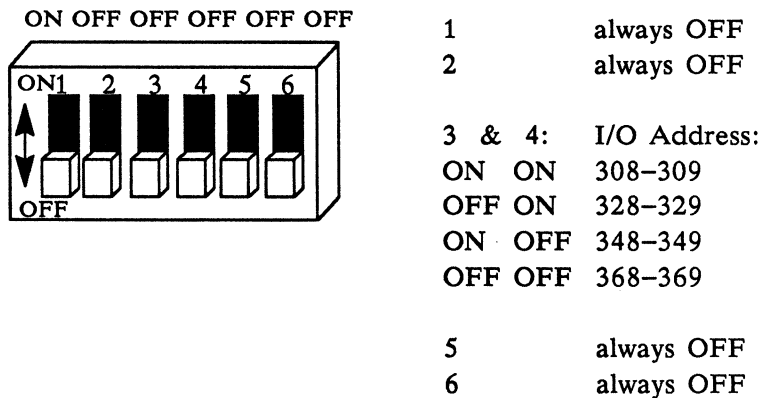

Figure C-2: Revision 10 Switch Settings

The PC Short Card Rev. C and D

Below is a diagram of the IDEAcomm 5251/Plus short card.

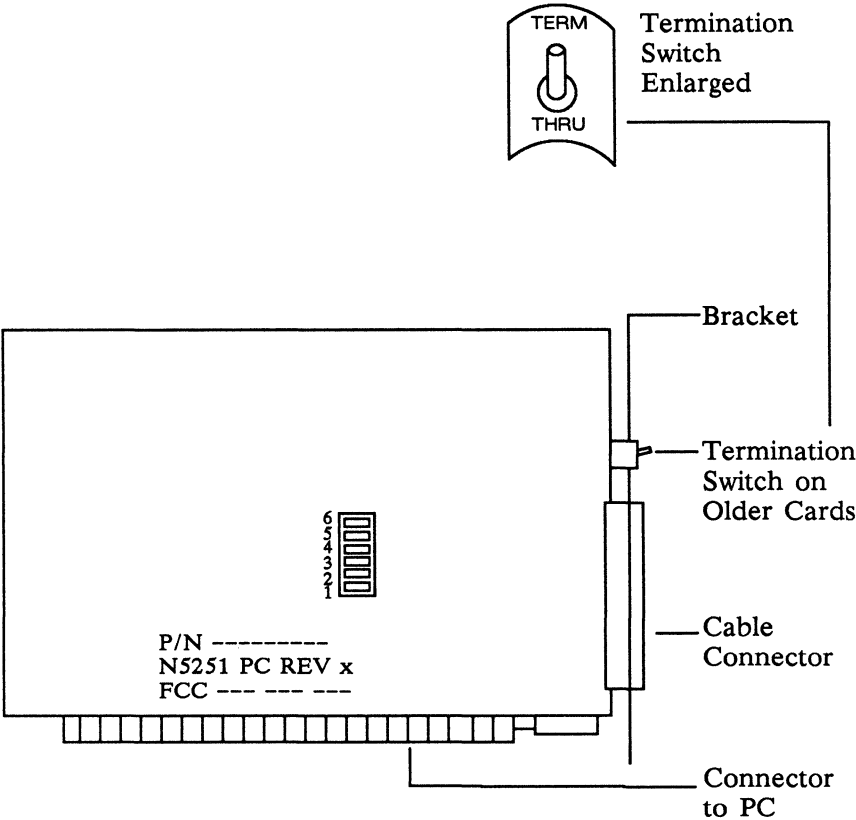

Figure C-3: The IDEAcomm 5251/Plus PC Short Card (Supports 4 or 7 LUs or Sessions)

The settings for the switch bank are as follows:

Position	Meaning	Default Setting
1	Reserved:	OFF
2	Reserved:	OFF
3 & 4	I/O Address: ON ON 308-309 OFF ON 328-329 ON OFF 348-349 OFF OFF 368-369	OFF OFF (368-369)
5	Reserved:	OFF
6	Reserved:	OFF

OFF OFF OFF OFF OFF OFF

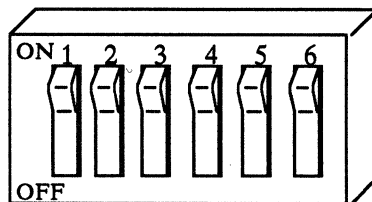

Figure C-4: Switch Settings for Short Card

TWINAX Plus Rev. D and E PC Cards

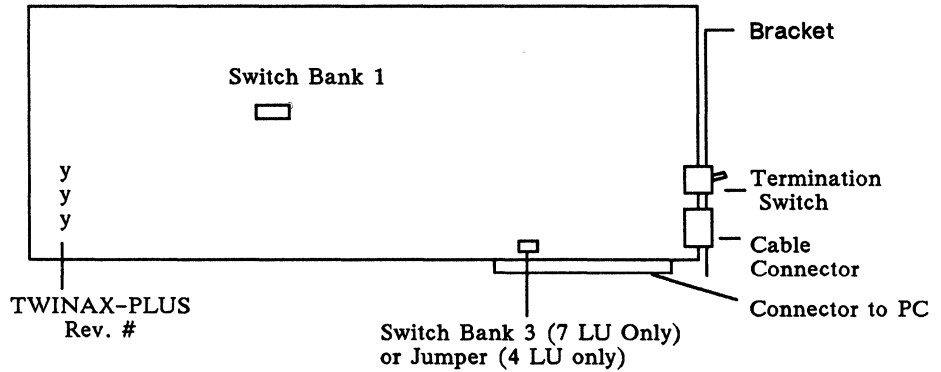

Figure C-5: The IDEAComm 5251 or 5251/Plus Card Rev. D and E (E supports 4 or 7 LUs or Sessions – see Switch Bank 3); D supports 4 LUs.

Memory on the Rev. D and E Cards

The memory address for the TWINAX-PLUS Rev. D and E cards is configured through the program `INSTALL` or `IDEACFIG`. You do not need to check anything on the card.

If you use the `INSTALL` program, the memory address is set by the software automatically depending on your options, and is written to the `TWINAXn.UCM` file.

If you use the `IDEACFIG` program, you should enter the appropriate memory address on the User Interface Options menu. If you are using a PC, XT, or Portable, enter `E000`. If you are using an AT or PS/2 with a standard monitor, enter `C000`. If you have an AT with an EGA monitor, enter `C800`.

Switch Bank 1: I/O Address

The switches on switch bank 1 were set to 368 Hex at the factory and should look like those shown in Figure C-6:

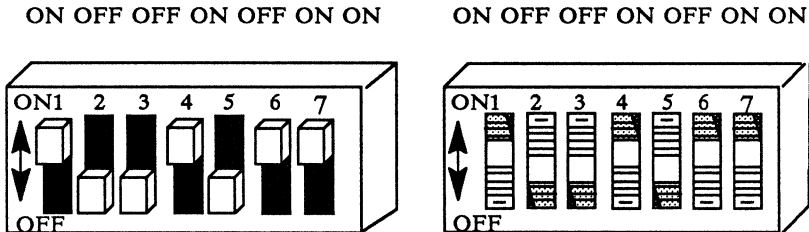

Sliding Switches

Rocker Switches

Figure C-6: Switch Bank 1: I/O Address 368 Hex
(Rev. D and E Cards)

Note

To set sliding switches, simply slide the tab to the ON or OFF position.

To set rocker switches, press down the ON side of the switch to set it to ON or press down the OFF side of the switch to set it to OFF. Use care when setting rocker switches.

If you need to change to address 370 because of a conflict with another card, use the setting in Figure C-7:

ON OFF OFF OFF ON ON ON

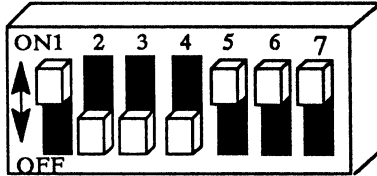

Sliding Switches

ON OFF OFF OFF ON ON ON

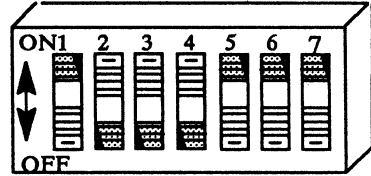

Rocker Switches

Figure C-7: Switch Bank 1 — I/O Address of 370 Hex (Rev. D and E Cards)

In order to set the hardware I/O Address to 370 Hex, you must also run the IDEACFIG program on the IDEAComm diskette. You must change the Hardware I/O Address displayed on the User Interface Options menu to reflect the new I/O Address of 370 Hex.

Switch Bank 3 – 7 LU Boards Only

This switch is used only on the 32K (7 LU) product. In Release 5.2, all switches are set OFF on this switch.

TWINAX Plus PC New Rev. C Settings

The TWINAX-PLUS REV. C card is functionally equivalent to the TWINAX-PLUS Rev. D card. However, because the design of the TWINAX-PLUS Rev. C card is slightly different, you must use the switch settings listed here.

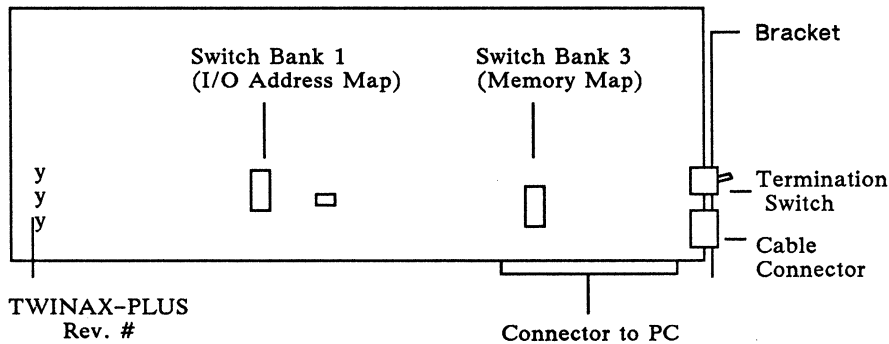

Figure C-8: The IDEAComm 5251/Plus Card Rev. C
(supports 4 LUs or Sessions)

Note

To set sliding switches, simply slide the tab to the ON or OFF position.

To set rocker switches, press down the ON side of the switch to set it to ON or press down the OFF side of the switch to set it to OFF. Use care when setting rocker switches.

Switch Bank 1: I/O Address

The switches on switch bank 1 were set to 368 Hex at the factory and should look like those shown in Figure C-9:

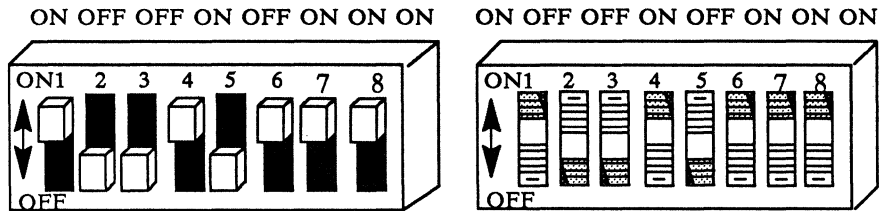

Sliding Switches

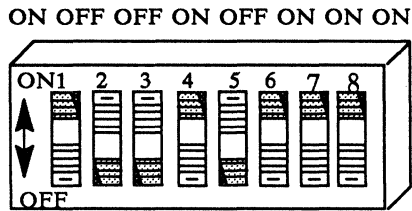

Rocker Switches

Figure C-9: Switch Bank 1 — I/O Address of 368 Hex (Rev. C Card)

If you have an address conflict (because of the presence of another board, for example), you should change the address to 369 Hex. See Figure C-10:

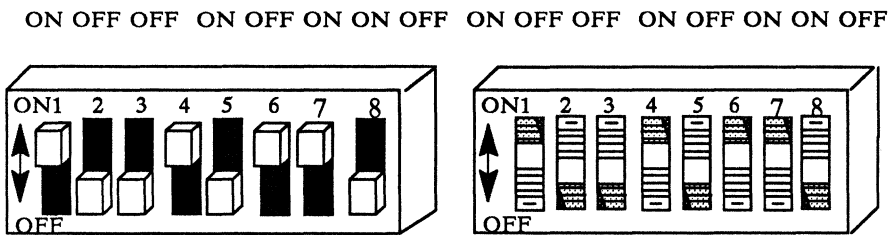

Sliding Switches

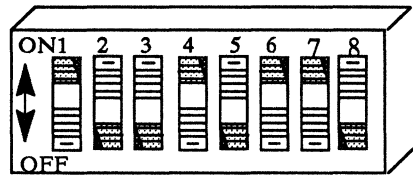

Rocker Switches

Figure C-10: I/O Address of 369 Hex (Rev. C Card)

In order to set the hardware I/O Address to 369 Hex, you must also run the IDEACFIG program on the IDEAComm 5251 diskette. You must change the Hardware I/O Address displayed on the User Interface Options menu to reflect the new I/O Address of 369 Hex.

Switch Bank 3 -- Memory Address for PC, XT, Portable

Your TWINAX-PLUS Rev. C card is set at the factory with a memory address of E000.

Note that there are two different settings for switch bank 3. Address E000 (the factory setting) is for an PC, XT, or Portable, as shown in Figure C-11:

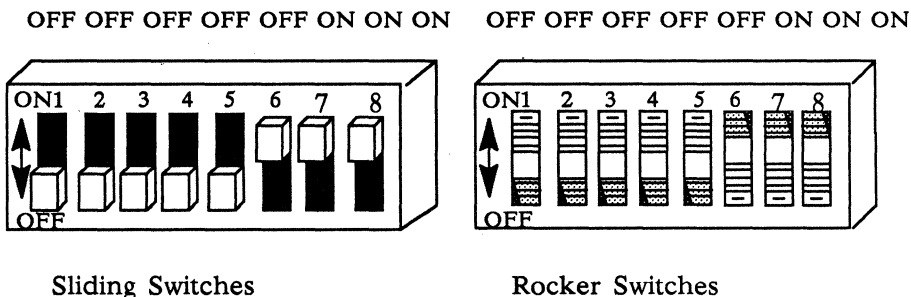

Figure C-11: Switch Bank 3—Factory Setting E000 for PC, XT, and Portable (Rev. C Card)

Switch Bank 3 --Memory Address for the AT

If your personal computer is an AT, you must reset your switches to an address of C000. An AT with VGA may use C000 for VGA, so you might use D800 for the IDEA card. See the table on the next page.

Changing Switch Bank 3 Settings

Switch settings on bank 3 have the following meanings:

Switch	C000	C400	C800	D000	D800	E000
3	OFF	OFF	OFF	OFF	OFF	OFF
4	OFF	OFF	OFF	OFF	OFF	OFF
5	ON	ON	ON	ON	ON	OFF
6	ON	ON	ON	OFF	OFF	ON
7	ON	ON	OFF	ON	OFF	ON
8	ON	OFF	ON	ON	ON	ON

The settings for switches 1 and 2 remain unchanged.

Notes

Please consult the possible restrictions on memory addresses for this card on page C-13.

In order to change the hardware Memory Address, you must also run the IDEACFIG program on the IDEAcomm 5251 diskette. You must change the Hardware Memory Address displayed on the User Interface Options menu to reflect the new Memory Address of D000.

TWINAX PC Rev. A, B, and Older C Settings

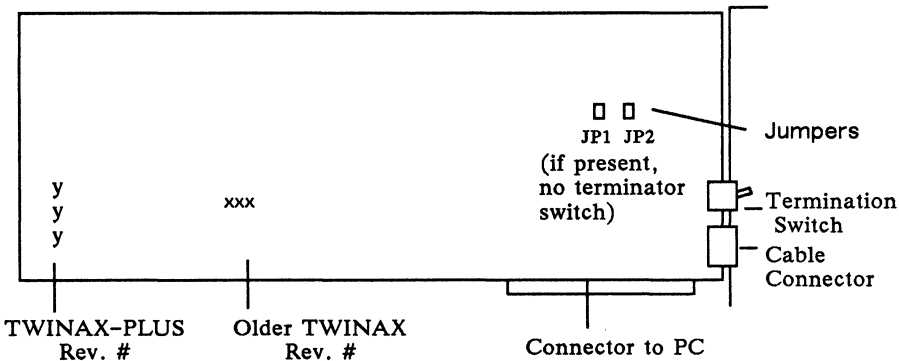

Figure C-12: The IDEAComm 5251 PC Card Rev. A, B, and C (supports 4 LUs or Sessions)

Some of these cards use jumpers instead of a switch for TERM and THRU:

TWINAX Rev. B

Both JP1 and JP2 high = TERM

Both JP1 and JP2 low = THRU

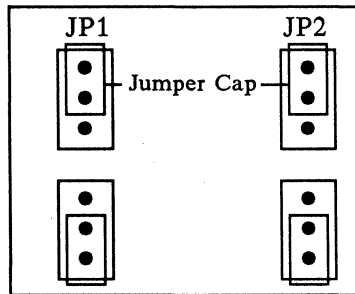

TWINAX REV. C
(Not Rev. C TWINAX Plus)

Both JP1 and JP2 low = TERM

Both JP1 and JP2 high = THRU

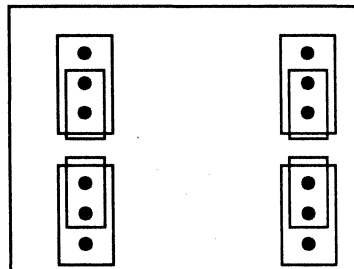

Quick Reference Chart for TWINAX Switches

See the chart on page C-14 for a quick reference of switch settings.

Be aware that the following addresses may be restricted on your personal computer:

A0000 through BE000	- Display adapters
C0000	- IBM 3270 PC Adapter
C8000	- XT Fixed disk or SCSI device
CA000	- IBM 3270 PC Adapter
CC000	- primary IBM LAN adapter
CE000	- 3278/79 Emulation Adapter
D0000 through D6000	- PC Cluster
DA000	- Voice Communications Adapter
D8000	- Token Ring overhead
DC000	- Alternate IBM LAN Adapter - (PC Network or Token Ring)
E0000 through FE000	- System ROM or unused

Memory Address (Factory Setting C000 or E000)

5251 Card	PC Type	Memory Address	Switches OFF	Switches ON
OLD TWINAX Rev. A,B,C Switch Bank SW2	PC,XT,PPC, PS/2M30	E000	12345	678
	AT	C000	1345	2678
	AT & EGA	C400	13456	278
		C800	13458	267
TWINAX-PLUS Rev. C Switch Bank SW3	PC,XT,PPC, PS/2M30	E000	12345	678
	AT	C000	1234	5678
	AT & EGA	C400	12348	567
		C800	12347	568
	AT & VGA	D800	123467	58
TWINAX-PLUS Rev. D, E	All	n/a	n/a	n/a
Short Card	All	n/a	n/a	n/a
5251/Gold	All	n/a (see p.C-1)	n/a	n/a

I/O Address (Factory Setting 368 Hex)

5251 Card	I/O Address	Switches OFF	Switches ON
OLD TWINAX Rev. A,B,C Switch Bank SW1	368 Hex	358	12467
TWINAX-PLUS Rev. C Switch Bank SW1	368 Hex	235	14678
TWINAX-PLUS Rev. D, E Switch Bank SW1	368 Hex	235	1467
Short Card	368 Hex	123456	none
5251/Gold	368 Hex	123456	none

PPC: IBM Portable PC

EGA: Enhanced Graphics Adapter

Appendix D:

Glossary



Adapter Handler

IDEA's combination of hardware and software that allows communication with the AS/400's PC Support.

ADF File

File containing address information for the micro channel card. It must be transferred to the IBM Reference Diskette before automatic or manual configuration is run with this diskette.

Backup

A duplicate copy of data.

Board

In this manual, **board** and **card** are used interchangeably for the small printed circuit boards that can be added to the PC or PS/2 family.

Boot

To bring up or restart the microcomputer.

Bootable

Used of a partition or disk to which command transfers at startup time. A diskette or partition is **bootable** if it contains the DOS files that will start the operating system when the personal computer is powered on.

Card

In this manual, **card** and **board** are used interchangeably for the small printed circuit boards that plug into the personal computer.

Disk operating system (DOS)

An operating system for the PC and PS/2 series of computers.

Driver

Software that controls a device.

I/O address

The address through which data is sent from the personal computer. This is set with switches on the IDEA card.

INSTALL (IBM program)

The program that installs PC Support on the personal computer.

Memory address

The address of the card's memory (A000 through E000). This address is set with software on most IDEA cards.

Micro channel card

A card or board that works in the micro channel bus of the PS/2 models 50 and higher.

Midrange

The IBM System 36, 38, or AS/400.

Parallel port

Interface located on a host adapter card used for connection with a parallel device such as a printer or mouse. It provides parallel transmission, which is simultaneous transmission of all bits in a byte.

PC Support

An IBM program that allows file transfer and other functions between a personal computer and an IBM midrange.

Peripheral

A noncomputing input or output device, such as a printer or hard disk drive.

Port

A connection that allows communications between a computer and another device.

Reference Diskette

The IBM diskette that comes with your microchannel PS/2.

Remote controller

A computer that connects to the minicomputer through telephone lines, and coordinates signals from several devices.

SETUP program

The IDEA program that sets addresses for the Adapter Handler that allows PC Support.

Serial (COM) port

Common serial communications interface used by devices such as modems and laser printers. It allows serial transmission, whereby data is sent in a regular pattern of bits.

System 3X

The IBM System/36, or /38.

TWINAX

The IDEA emulation program or card. Twinax is the name of an IBM protocol. Twinaxial cable is a type of cable used in IBM midrange installations.

Twinaxial run

A series of one or more devices all on the same twinaxial cable that connects to the controller.

Appendix E:

IDEA Products



For information or to order these products, call IDEA at (800) 257-5027. In Massachusetts call (508) 663-6878.

Midrange Terminals

IDEA's midrange system terminals comply with the strictest safety standards, including the Swedish Recommendation MPR-II. Fully compatible with IBM's InfoWindow terminal series, IDEA terminals have split screens, alternate station addressing, record/playback, type-ahead keyboard buffering, and a hardware lock. The 102/3 or 122 key keyboard supports 16 languages.

IDEA 276 features 3476 emulation with green, amber or white screen, 2 sessions, printer support.

IDEA 277 in addition to the above offers 4 sessions, which may include 2 printer sessions, emulation of a wide range of displays, full graphics printing, 80 or 132 column display, and support of a large selection of serial and parallel PC printers.

IDEA 277P includes all of the above but offers a 15 inch high-resolution screen.

IDEA 277C offers all of the features of IDEA 277P with a VGA compatible color monitor and a wide choice of color sets.

Internetworking Solutions

IDEAhub offers a flexible approach to wire management of LANs for Token Ring and Ethernet, supporting four hot-swappable media modules with a comprehensive configuration and

management facility and optional rack mounting.

IDEAcomm BRouter is a high performance bridge/router, with an on-board RISC co-processor with one LAN and two WAN ports, supporting an extensive set of protocols at high throughputs.

IDEAcomm WANserver is the first "plug and play" wide area link for PC LANs. Because it is installed in a file server, the need for a separate configuration is eliminated. It supports five connections per file server, enabling the creation of large networks.

Midrange Printers

IDEA 224, compatible with IBM's 4224 printers, supports IBM's IPDS and AFP, including bar codes, with automatic switching between a midrange host and a PC, and exceptional materials handling.

IDEA 487 heavy duty dot matrix includes bar code support, superior paper and forms handling.

IDEA 234 includes OCR and bar code support, heavy duty line matrix printing up to 800 lines per minute, reduced power requirements, low maintenance ideal for data processing applications.

IDEA 209/216 laser printers are compatible with the IBM 3812-1 with 4 configurations, automatic envelope feeder, additional cartridge fonts, bar coding, and auto-switching to print from the midrange host and PCs.

Midrange Communication Processors

IDEA Concert offers a powerful extension to IBM 5x94 type remote controllers, fully compatible with your installed devices and LAN gateways. They allow multiple logical sessions on a single session terminal, and support popular IBM and third party products including IBM PC Support/36 and /38. Token Ring or Ethernet gateway and downstream node configurations unify SNA with LANs.

IDEA Concert 10100 supports 8 twinax devices and 50 sessions, delivering remote connections to the smallest branches. Mounts in a 19 inch rack.

IDEA Concert 10300 features multi-host communications, 14 or 28 devices and 64 logical sessions.

IDEA Concert 10400 offers the features of the 10394 with five slots and 128 logical sessions.

IDEA Concert 10500 is a high performance processor with the features of the 10494, supporting as many as 56 twinax devices and 256 sessions.

IDEA Concert 10600 offers the features of the 10500, with 84 twinax devices and 500 sessions.

PC and Mac to Midrange Communications

IDEAcomm 5251/Plus hardware provides a local twinaxial link with IBM midrange systems, supporting a wide range of display and printer emulation. Its IDEAcomm Adapter Handler software provides access to AS/400 PC Support.

IDEAcomm 5251 for DOS provides a local software link with 7 host sessions and 5292-2 compatible graphics support.

IDEAcomm 5251 for Windows provides a local software link, including full mouse support, font selection, 5292-2 graphics support, and copy/paste functions for both text and graphics.

IDEAcomm 5251 for OS/2 allows a 286/386 based PC running under OS/2 to use the IDEAcomm 5251/Plus hardware. It is a Presentation Manager application, providing multi-window displays with graphics and mouse support.

IDEAcomm 5251/Gateway Plus allows multiple PCs or PS/2s attached to an IBM NetBIOS or Novell SPX/IPX compatible LAN to link with an IBM midrange using one IDEAcomm 5251/Plus board.

IDEAcomm 5251/Gateway AH hardware provides

connections to AS/400 PC Support.

IDEAcomm 5250/Remote Gateway links remote PCs or PS/2s attached to an IBM NetBIOS compatible LAN to an IBM midrange system with only one IDEAcomm 5250/Remote card.

IDEAcomm Mac hardware and software provide local access for the Macintosh SE, Macintosh II family, and Macintosh Quadra family to IBM 36 or 38 and AS/400 systems, including display and printer emulation and file transfer.

IDEAcomm 5250/Remote hardware provides remote access to an IBM midrange. Also included is the adapter handler for AS/400 PC support.

IDEAcomm 5250/Remote software provides remote access to an IBM midrange with 9 sessions emulating 5251 series terminals, printers, and cluster controllers.

IDEAcomm 5250/Remote Share allows four remote PCs or PS/2s to communicate with a System 3X.

IDEALink file transfer, included with all midrange communications products, provides bi-directional file transfer between the PC and the host.

Mainframe Communications

IDEA Coax Multiplexers connect 32 CUT or DFT/DSL devices to one controller port via a single fiber or coaxial cable as long as 5000 feet. Compatible with IBM's 3299 Model 2.

IDEAcomm COAX provides 3270 terminal emulation, full compatibility with most popular IBM and third-party software, including IRMA file transfers, CUT emulation, and 132 column support.

Super Communications

IDEAcomm Gateway connects single and networked PCs to multiple IBM midrange or mainframe hosts. Each user may have 5250 and 3270, notepad, and DEC VT320 sessions, and HLLAPI support.

Appendix F: Customer Support Information



IDEAssociates provides technical support for its PC based emulation products by the following support mechanisms.

Bulletin Board Service (BBS)

The BBS is provided as a means by which users can download software updates or fixes to IDEAcomm products. The BBS can be reached at

1 (508) 667-0280 (1200 and 2400 baud) or
1 (508) 667-3654 (1200 to 9600 baud)

The BBS communication parameters are 8 data bits, 1 stop bit, and no parity. First time users need to answer a number of questions and then assign themselves a password for future connection to the BBS. When this process is complete you will reach a menu system. Once you have selected the file(s) and file transfer protocol that you are using, you will be given 60 seconds in which to initiate the download.

The file transfer protocol that you select on the BBS (for example, XMODEM CRC) must also be supported in the modem software that you are using to connect to the BBS.

Technical Support Hot Line

The Technical Support hot line can be reached at the numbers on the next page.

Support is available:

Monday–Thursday 9.00 a.m. – 7:30 p.m. EST

Friday 9:00 a.m. – 5:30 p.m.

Support problems can also be faxed to the attention of Technical Support at (508) 663–8851. A response will be provided via return fax or by telephone, depending on the nature of the request and any specified preference.

If you have any problems using our product, please follow these steps before contacting our technical support staff.

1. Make sure your computer system meets all the hardware requirements listed in the manual.
2. Referring to your manual, carefully check all the cables to make sure they are connected correctly.
3. Complete the following checklist:
 - Software name _____
Serial number _____
Version number _____
 - Computer brand name _____
Model number _____
RAM (memory) _____ bytes
Operating system (name and version, e.g., P.C.–DOS version 2.0) _____
 - Manufacturer and model number of:
Video adapter board _____
Printer/Plotter _____
Expansion RAM board _____

Hard disk system _____
Modem _____
Other _____

4. Be sure you can answer the following questions:
 - Did the program ever work properly? If so, have you changed anything in your operating environment?
 - Did any error messages appear? If so, what were they?
 - What is the exact sequence of steps required to produce the problem?
5. With your computer on and the software loaded, call the number where you bought the product, or IDEA Technical Support at the number below.

Repair Policy

If your product is still under the original one year limited warranty, IDEA will repair or replace it at no charge. If the warranty period has expired, IDEA will repair the product and charge you at its current charges.

If you are having problems with your IDEA product, take the following steps:

1. Go through the checklist above.
2. Call the IDEA Technical Support Department at (800) 343-0056. In Massachusetts, call (508) 663-6878. In Canada, call (800) 446-5280. (Be sure that you have the serial numbers from your software diskette and from your IDEA hardware.) If the Technical Support representative determines that your product requires factory service, you will be issued a

Return Materials Authorization (RMA) number.
IDEA will not accept returned products without
an RMA number.

3. Box the product in the original shipping container or other secure package. Write your RMA number clearly on the outside of the box. For all warranty repairs, enclose a copy of the original purchase receipt as proof of date of purchase.
4. Ship by the most economical means to:

IDEA
RMA # _____
29 Dunham Road
Billerica, MA 01821

Once your product has been repaired, IDEA will return it to you by UPS or the most economical carrier at IDEA's expense.

Limited Warranty

For IDEA's Limited Warranty, see page iii of this manual.

Index

A

ADF file, 3-2
Adapter Handler defined, D-1
Addresses available in IBM memory, C-13

B

Board defined, D-1
Boot defined, D-1
Bootable defined, D-1
Bulletin board service, F-1

C

Card defined, D-1
Checklist of parts, 1-3
Configuration with IBM Reference Diskette, 3-3
Customer support, F-1

D

Diagnostics (TWINDIAG), A-3
Driver defined, D-2

E

Error messages, TWINDIAG, A-6
Error messages, SETUP, 5-7

F

FCC certification, ii

G

Glossary, D-1

H

Hardware, micro channel, installing, 3-1
Hardware, PC, installing, 2-1

I

I/O address, Rev. A, B, and older C cards, C-12
I/O address, Rev. C card, C-8
I/O address, Rev. D and higher cards, C-6
IBM Reference Diskette, with micro channel, 3-3
IBM remote controller, attaching, B-1
IDEAcomm 5251 and 5251/Plus features, 1-4
IDEAcomm/AH features, 5-1
INSTALL (IBM program), 5-2
Installation, micro channel hardware, 3-1
Installation, PC hardware, 2-1
Inventory checklist, 1-3

M

Memory address, Rev. A, B, older C cards, C-12
Memory address, Rev. C card, C-9
Memory address, Rev. D and E cards, C-5
Memory diagnostics from TWINDIAG, A-5
Messages, TWINDIAG, A-6
Messages, SETUP, 5-7
Micro channel card, installing, 3-1

P

Parallel (printer) port, D-2
PC card, installing, 2-1
PC Support, 5-1
Peripheral defined, D-2
Port defined, D-3
Printer diagnostics from TWINDIAG, A-5

R

Reference Diskette, using with micro channel, 3-3
Remote IBM controller, attaching, B-1
Repair policy, F-3

S

SETUP program, 5-2
Serial (COM) port, D-3
Serial number, 1-2
Switch settings, 2-3, C-1

T

Telephone support, F-2
TWINAX program, 5-2

W

Warranty, iii

