

# UDS 801 A/C Direct Connect Installation and Operation Manual

---

HB

1085.50



Universal Data Systems



**MOTOROLA INC.**  
*Information Systems Group*



**UDS 801 A/C**

**Direct Connect**

**Installation and Operation Manual**

Document No. 6801504402004  
January, 1985

**Universal Data Systems, Inc.**  
5000 Bradford Drive  
Huntsville, Alabama 35805-1953  
Telephone: (205) 837-8100



**WARRANTY REGISTRATION CARD**

For your warranty protection, this sale is recorded at Universal Data Systems, Inc. through information received on this card. Please fill out this card and mail it to the factory within 5 days -- thank you. Fold this page in thirds and staple it. It is already addressed and stamped.

**WARRANTY PROTECTION**

NAME \_\_\_\_\_ STREET \_\_\_\_\_ CITY \_\_\_\_\_ STATE \_\_\_\_\_ ZIP \_\_\_\_\_  
TITLE \_\_\_\_\_  
COMPANY \_\_\_\_\_ AREA CODE \_\_\_\_\_ PHONE \_\_\_\_\_  
PRODUCT MODEL \_\_\_\_\_ SERIAL # \_\_\_\_\_  
PLACE OF PURCHASE \_\_\_\_\_ \$ PRICE PAID \_\_\_\_\_ DATE OF PURCHASE \_\_\_\_\_ TODAY'S DATE \_\_\_\_\_  
INTENDED APPLICATION(S) \_\_\_\_\_

**CONSUMER INFORMATION**

I learned about this product through:

- Retail store
- Direct mail
- Another person
- Salesman
- Trade show
- Magazine: \_\_\_\_\_  
Name
- Other: \_\_\_\_\_

Magazines I regularly read:

- Info World
- Creative Computing
- Nibble
- Byte
- Other: \_\_\_\_\_  
Name

WHAT OTHER UNIVERSAL DATA SYSTEMS' PRODUCTS WOULD YOU BE INTERESTED IN? \_\_\_\_\_  
\_\_\_\_\_  
\_\_\_\_\_

1. Did the shipping container and equipment arrive in good condition?  
 YES       NO \_\_\_\_\_

2. Did you receive the manual and specified accessories?  
 YES       NO \_\_\_\_\_

3. General Comments: \_\_\_\_\_  
\_\_\_\_\_  
\_\_\_\_\_

\_\_\_\_\_  
Company Name

\_\_\_\_\_  
Address

\_\_\_\_\_  
City State Zip Code

**Business Reply Card**

First Class Permit No. 702 Huntsville, AL

**UNIVERSAL DATA SYSTEMS  
5000 Bradford Dr.  
Huntsville, AL 35805-9990**



No Postage  
Necessary  
If Mailed in  
The United States

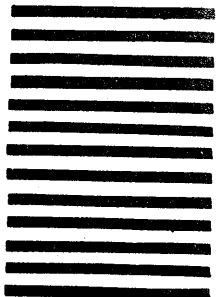

ATTEN: QUALITY CONTROL DEPT.

## **Universal Data Systems, Inc.**

### **WARRANTY**

Universal Data Systems warrants that equipment manufactured and sold by them is free from defects in material and workmanship. Under this warranty, our obligation is limited to repairing or replacing any equipment or parts (not already carrying a separate warranty of their supplier) proved to be defective by our inspection within one year after sale to their original purchaser. This warranty shall not apply to equipment or parts thereof which are normally consumed in operation, or to any equipment which shall have been repaired or altered outside our plant in any way, so as to, in the judgement of Universal Data Systems, affect its stability or reliability, nor which has been operated in a manner exceeding its specifications, nor which has been subject to misuse, negligence, or accident, nor which has been altered, effaced, or has had the serial number removed. Universal Data Systems does not assume any liability for consequential damages, and, in any event, our liability shall not exceed the original purchase price.

### **TECHNICAL SERVICE - RETURNED EQUIPMENT AND PARTS**

Universal Data Systems has instituted a toll-free WATS line for the technical support of our customers. The number is **1-800-221-4380**. Do not return any item without first calling the toll-free number to receive service or technical instructions. NOTE: The toll-free number is direct to the Technical Services Department. Please feel free to use it for Technical information, Application information and Modem/Data Communication Fault Isolation. If the lines are busy, please call back.

**"PLEASE CALL US, WE'RE HERE TO HELP YOU"**

## PREFACE

### IMPORTANT INSTRUCTIONS TO USER

Your 801 Direct Connect A/C has been approved by the Federal Communications Commission (FCC) as not being harmful to the telephone network when connected directly to the telephone lines. To fully comply with Part 68, FCC Docket 19528, the following should be read carefully and followed completely where applicable:

1. The FCC Rules require that all direct connection to the telephone lines must be made through standard plugs and jacks as called out in the Rules. No connection can be made to party lines or coin lines. Prior to connecting your device you must:
  - a. Call your local telephone company and inform them that you have an FCC registered device which you wish to connect to their lines. Give them the 14-digit FCC Registration Number and Ringer Equivalence Number, both of which are on the label located on the outside of your device. The FCC Registration Number is AK396F-13219-DI-E. The Ringer Equivalence is 0.0.
  - b. Inform your local telephone company that the jack (connector) required for your device is:

#### NOTE

The type data jack is determined by the associated modem.

\*RJ16X is required for A and A1 leads when using an exclusion key telephone.

<u>Mode</u>	<u>USOC</u>
Programmable	RJ45S
Permissive	RJ11C
	*RJ16X

- c. After the telephone company has installed the required jack, you can connect your ACU by inserting the mating plug of your equipment into the jack.
- d. Operation of your ACU is described in the instructions provided at time of delivery.
- e. All repairs must be accomplished as described in the enclosed repair procedure instructions.



2. If it appears that your ACU is malfunctioning, it should be disconnected from the telephone line until it can be determined whether your equipment or the telephone line is the source of trouble. If your equipment needs repair, it should not be reconnected until such repairs are made.
3. Your ACU has been designed to prevent harm to the public network. If your ACU malfunctions, the telephone company may temporarily disconnect it.
4. The telephone company may make changes in its communication facilities, equipment, operations or procedures. If such changes render any customer's terminal equipment incompatible with telephone company communications facilities, the customer shall be given adequate notice to allow him an opportunity to maintain uninterrupted service.

**SERVICE REQUIREMENTS**

In the event of equipment malfunction, all repairs will be performed by Universal Data Systems, Inc.

This equipment has been registered with the FCC for direct connection to the telephone network. Under the FCC program, no customer is authorized to repair this equipment. This applies to equipment both in and out of warranty. If such unauthorized repair is performed, the registration of the equipment for direct connection to the network will be null and void.

Complies with Part 68, FCC Rules.

Contains device with FCC Registration Number..... AK396F-13219-DI-E

Ringer Equivalence..... 0.0

**WARNING**

**This equipment generates, uses, and can radiate radio frequency energy. If not installed and used in accordance with the instruction manual, this equipment may cause interference to radio communications. It has been tested and found to comply with the limits for a Class A computing device pursuant to Subpart J of Part 15 FCC Rules, which are designed to provide reasonable protection against such interference when operated in a commercial environment. Operation of this equipment in a residential area is likely to cause interference in which case the user, at his own expense, will be required to take whatever measures may be required to correct the interference.**

## TABLE OF CONTENTS

<u>Para.</u>		<u>Page</u>
<b>CHAPTER 1. INTRODUCTION</b>		
1.1	General . . . . .	1-1
1.2	Physical Description. . . . .	1-1
1.3	Specifications. . . . .	1-2
1.4	Physical Characteristics . . . . .	1-2
1.5	UDS Supplied Equipment. . . . .	1-2
<b>CHAPTER 2. GENERAL INSTALLATION</b>		
2.1	General . . . . .	2-1
2.2	Site Preparation. . . . .	2-1
2.3	Installation Procedure. . . . .	2-1
2.3.1	Tools/Equipment/Material Required. . . . .	2-1
2.3.2	Unpacking. . . . .	2-1
2.4	Mechanical Assembly - Table Top Installation. . . . .	2-2
2.5	Electrical Installation . . . . .	2-2
<b>CHAPTER 3. RS-232-C INTERFACE</b>		
3.1	Interface Connections for Serial Input ACU. . . . .	3-1
3.1.1	RS-232-C Input, ACU and DCE Share One Computer Port. . . . .	3-1
3.1.2	RS-232-C Input, ACU Has a Dedicated Computer Port. . . . .	3-1
3.2	Operation, RS-232-C Port Shared with DCE. . . . .	3-4
3.3	Operation, Dedicated RS-232-C Port for ACU. . . . .	3-5
3.4	Interface Format. . . . .	3-5
3.4.1	General. . . . .	3-5
3.4.2	Message Format . . . . .	3-6
3.4.3	Control Characters - From DTE. . . . .	3-6
3.4.4	Data Format - From DTE . . . . .	3-7
3.4.5	Abort Procedure - From DTE . . . . .	3-7
3.4.6	Dial Digit Characters - From DTE . . . . .	3-7
3.4.7	Re-Dial Format - From DTE. . . . .	3-8
3.4.8	Response Character - From ACU. . . . .	3-8
3.4.9	Response Format - From ACU . . . . .	3-8
3.5	Strap and Switch Settings for RS-232-C Serial Input . . . . .	3-10
3.6	Manual Test or Call . . . . .	3-14
3.7	Rear Panel Signal Definitions RS-232-C Interface. . . . .	3-15
3.7.1	DTE Connector. . . . .	3-15
3.7.2	DCE Connector. . . . .	3-16
3.7.3	Public Switched Telephone Network (PSTN) Interface . . . . .	3-17
3.7.4	DCE Interface. . . . .	3-18

**TABLE OF CONTENTS - CONTINUED**

<u>Para.</u>		<u>Page</u>
<b>CHAPTER 4. RS-366-A INTERFACE</b>		
4.1	Interface Connections for Parallel Input ACU. . . . .	4-1
4.2	Operation, Dedicated RS-366-A Port. . . . .	4-2
4.3	Strap and Switch Settings for RS-366-A Parallel Input .	4-5
4.4	Manual Test or Call . . . . .	4-10
4.5	Rear Panel Signal Definitions RS-366-A Interface. . . .	4-11
4.5.1	801 A/C Parallel Input Configuration . . . . .	4-11
4.5.2	Data Terminal Equipment (DTE) Interface. . . . .	4-11
4.5.3	Data Communication Equipment (DCE) Connector . . . .	4-12
4.5.4	Public Switched Telephone Network (PSTN) Interface .	4-14
4.5.5	Data Communication Equipment (DCE) Interface . . . .	4-15

**LIST OF FIGURES**

<u>Figure</u>		<u>Page</u>
1	UDS 801 A/C . . . . .	1-0
2	UDS 801 A/C (Rear View) . . . . .	1-0
3	801 A/C with Cover Removed. . . . .	1-2
4	801 A/C Interconnection Diagram When ACU and DCE Share One RS-232-C Port . . . . .	3-2
5	801 A/C Interconnection Diagram When ACU Has a Dedicated RS-232-C Port . . . . .	3-3
6	Strap Map . . . . .	3-9
7	801 A/C Interconnection Diagram When ACU Has a Dedicated RS-366-A Port . . . . .	4-3
8	Strap Map . . . . .	4-4
9	Illustration of DTE/ACU Interface . . . . .	4-13



---

**Figure 1**  
**UDS 801 A/C**

---

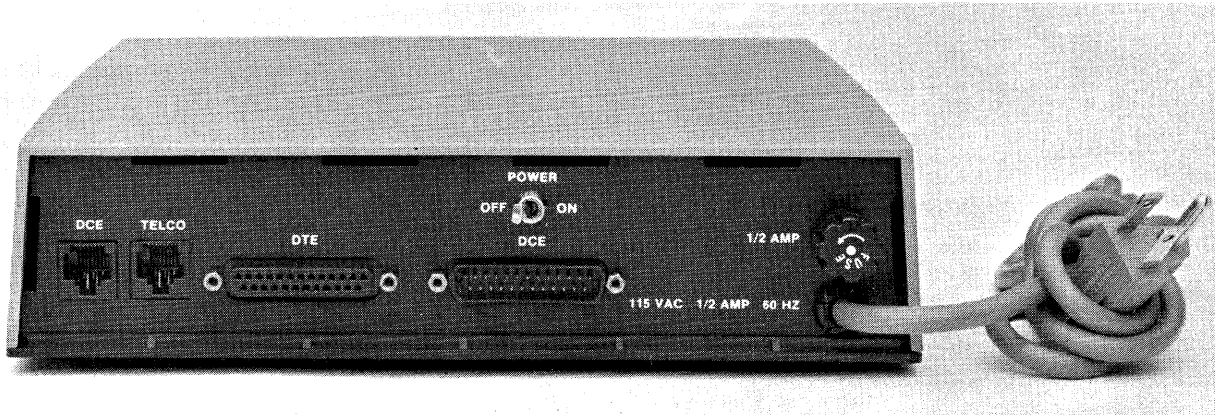

---

**Figure 2**  
**UDS 801 A/C (Rear View)**

---

## **Chapter 1 Introduction**

### **Contents**

- 1.1 General
- 1.2 Physical Description
- 1.3 Specifications
- 1.4 Physical Characteristics
- 1.5 UDS Supplied Equipment

#### **1.1 GENERAL**

The UDS 801 A/C is a Direct Connect Automatic Calling Unit (ACU) that enables a data terminal to establish calls through the telephone network. The basic ACU contains all the options required to support parallel (RS-366-A) or serial (RS-232-C) data input from the terminal. Calls can be completed using either pulse or DTMF (tone) dialing methods as selected by the user or by the ACU in response to line conditions and the availability of tone dialing from the Central Office.

The design of the 801 A/C utilizes microprocessor technology resulting in many advantages. The most obvious is a great reduction in the space required by the circuitry. This allows mounting all the components required for parallel or serial interface, pulse or tone dialing on a single PC board with ample room for an internal power supply. The less obvious but more important benefits are the increased reliability and reduced power consumption which minimize the amount of maintenance required.

The microprocessor's "intelligence" is best shown in a dialing option that gives the ACU the responsibility of determining whether or not DTMF dialing is available from the user's Central Office. If the dial tone is not broken by the first tone pair transmitted, the ACU will hang up and then re-dial the number using the pulse method. This feature is available in all modes of interface and use (i.e., serial, parallel and front panel manual test).

#### **1.2 PHYSICAL DESCRIPTION**

The 801 A/C comes in an attractive plastic housing. The rear panel of the unit is metal to provide the necessary rigidity and strength for the interface connectors, power cord, fuse and associated components.

The front panel contains a TEST/NORM switch, DPR CONT, and six Light Emitting Diode (LED) indicators, one each for POWER ON, CRQ, DLO, PND, DPR and COS.

The rear panel contains a power cord, fuse, power ON/OFF switch, and interface connections for DTE, DCE and TELCO.

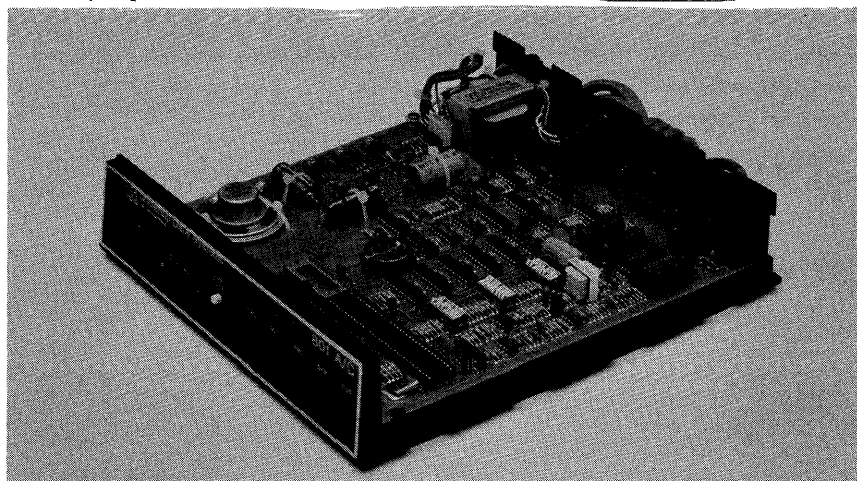

**Figure 3**  
**801 A/C With Cover Removed**

The unit features a cover that can be easily removed without the use of tools. Removing the top cover exposes all of the internal components of the ACU. The power supply transformer is mounted on the base of the housing and connects to the Printed Circuit Board (PCB) by a small cable. All other switches, connectors and indicators are mounted on the PC board and project through the front and rear panels for access. This, along with the easily removable front panel, allows easy assembly and disassembly of the ACU when maintenance or service is needed.

### 1.3 SPECIFICATIONS

The 801 A/C can utilize either pulse type or touch tone type dialing.

### 1.4 PHYSICAL CHARACTERISTICS

The 801 A/C Dialer is a stand-alone desk mount unit with the following dimensions:

Length .....	10.32 inches
Width .....	9.3 inches
Height .....	2.25 inches
Weight .....	3.4 pounds
Environmental Conditions ..	0° - 50°C
Humidity Tolerance .....	95% non-condensing
Primary Power .....	115 Vac + 10%
	60 Hz Single Phase
	10 watts nominal

### 1.5 UDS SUPPLIED EQUIPMENT

<u>UDS PART NO.</u>	<u>DESCRIPTION</u>
610201920301	Cable RJ45S
610202020301	Cable RJ11C

## **Chapter 2**

### **General Installation**

#### **Contents**

- 2.1 General
- 2.2 Site Preparation
- 2.3 Installation Procedure
  - 2.3.1 Tools/Equipment/Material Required
  - 2.3.2 Unpacking
- 2.4 Mechanical Assembly - Table Top Installation
- 2.5 Electrical Installation

#### **2.1 GENERAL**

This chapter provides the information required to plan and accomplish the mechanical and electrical installation of the Automatic Calling Unit for use with an RS-232-C terminal, and how to reconfigure the unit by use of strap options. Service personnel should be familiar with the complete installation procedure before attempting to install the ACU.

#### **2.2 SITE PREPARATION**

The installation should be clean, well lighted, and free from extremes of temperature, humidity, shock and vibration. See Section 1.3 for detailed information on these items. Be sure that there is a 4-inch minimum space at the rear of the unit for signal line and interface cable clearance.

The ACU should be installed within 6 feet of a grounded ac outlet capable of furnishing 115 Vac at 10 watts, and no further than 50 feet from the associated data terminal.

#### **2.3 INSTALLATION PROCEDURE**

Please read the complete installation procedures before attempting to install the UDS 801 A/C.

##### **2.3.1 Tools/Equipment/Material Required**

A normal installation will require only a screwdriver to secure the RS-232-C 25-pin D series connector(s) to the rear of the ACU and to flip the option selection switches on the PC board.

##### **2.3.2 Unpacking**

After unpacking the equipment shipping crate, check the contents against the packing list. Inspect the equipment carefully for any damage that may have occurred in shipment. If any damage is noted, contact the shipper's agent. If there is damage or a material shortage, contact the nearest UDS representative or Universal Data Systems, 5000 Bradford Drive, Huntsville, Alabama 35805, (205) 837-8100 for advice and assistance. UDS suggests that you keep the shipping crate and packing material in case you have to return the ACU.

#### **2.4 MECHANICAL ASSEMBLY - TABLE TOP INSTALLATION**

The UDS 801 A/C is designed for placement on a table top or bench and arrives at the site completely assembled.

#### **2.5 ELECTRICAL INSTALLATION**

Ac power is supplied to the ACU through a 7-foot line cord with a grounded 3-wire plug. If chassis (protective) ground is connected through the third prong of the ac power plug, a separate ground wire is not required.



## **Chapter 3**

### **RS-232-C Interface**

#### **Contents**

- 3.1 Interface Connections for Serial Input ACU
  - 3.1.1 RS-232-C Input, ACU and DCE Share One Computer Port
  - 3.1.2 RS-232-C Input, ACU Has a Dedicated Computer Port
- 3.2 Operation, RS-232-C Port Shared with DCE
- 3.3 Operation, Dedicated RS-232-C Port for ACU
- 3.4 Interface Format
  - 3.4.1 General
  - 3.4.2 Message Format
  - 3.4.3 Control Characters - From DTE
  - 3.4.4 Data Format - From DTE
  - 3.4.5 Abort Procedure - From DTE
  - 3.4.6 Dial Digit Characters - from DTE
  - 3.4.7 Re-Dial Format - From DTE
  - 3.4.8 Response Character - From ACU
  - 3.4.9 Response Format - From ACU
- 3.5 Strap and Switch Settings for RS-232-C Serial Input
- 3.6 Manual Test or Call
- 3.7 Rear Panel Signal Definitions RS-232-C Interface
  - 3.7.1 DTE Connector
  - 3.7.2 DCE Connector
  - 3.7.3 Public Switched Telephone Network (PSTN) Interface
  - 3.7.4 DCE Interface

#### **3.1 INTERFACE CONNECTIONS FOR SERIAL INPUT ACU**

The UDS 801 A/C interfaces to the DTE, DCE and the PSTN (Public Switched Telephone Network). The interface connectors are located on the rear panel of the ACU.

##### **3.1.1 RS-232-C Input, ACU and DCE Share One Computer Port**

The UDS 801 A/C can be configured to share one computer port in series with the DCE. In this mode, the ACU is transparent to both the DTE and the DCE except during dialing operations. The ACU monitors the DTE connector for dial commands and the DCE connector for DSR OFF required to enter dial mode. See the following diagram (Figure 4) for shared port connections.

##### **3.1.2 RS-232-C Input, ACU Has A Dedicated Computer Port**

The UDS 801 A/C can be controlled from a computer port dedicated to RS-232-C input to the dialer alone. In this configuration, the 801 monitors the DTE inputs for dial commands and the TELCO connector to determine if the line is in use prior to call initiation. See Figure 5 for dedicated port connections.

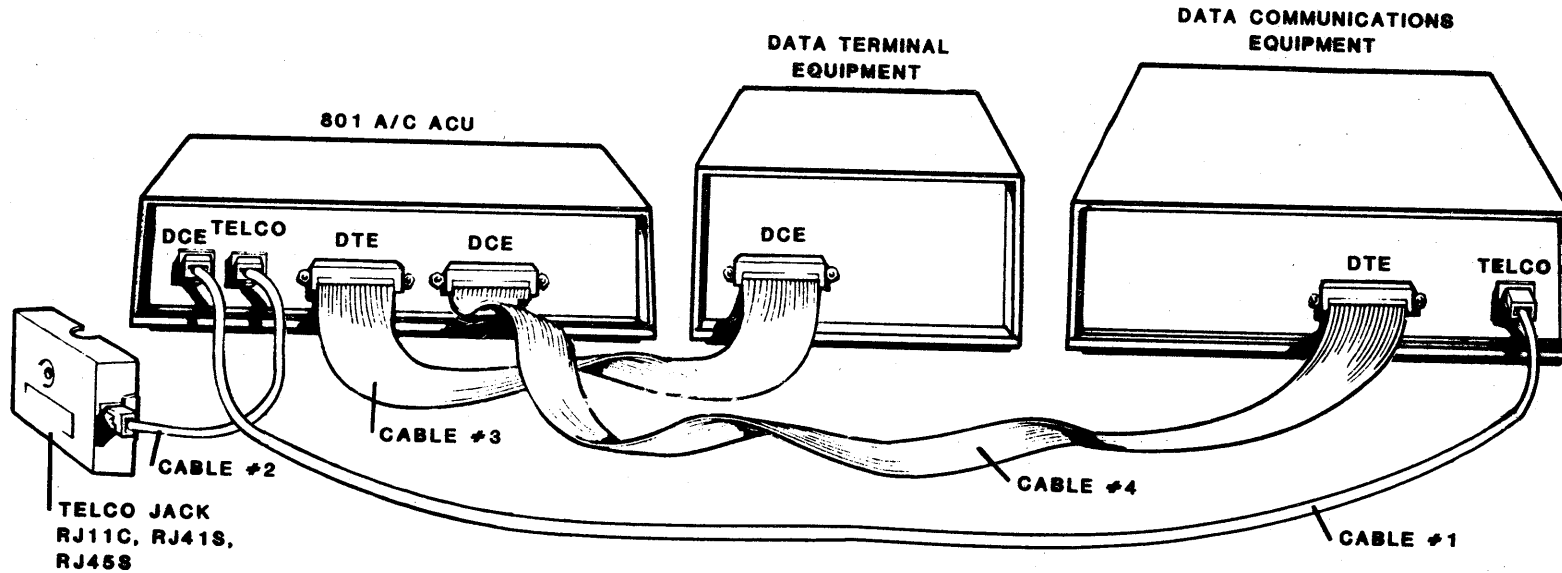

IF DCE IS UDS TYPE:

1. Cable 1 is UDS 1020192.
2. Cable 2 is UDS 1020192 if Data Jack is Programmable or Fixed Loss Type. (RJ45S or RJ41S)
3. Cable 2 is UDS 1020202 if Data Jack is Permissive Type. (RJ11C)
4. Cable 3 is part of DTE Equipment.
5. Cable 4 is UDS 1020204, 6 Feet in Length.
6. Functions not Utilized by UDS Modems.
7. Functions not Utilized if Data Jack is Permissive Type
8. Pin 1 and 2 is Tip and Ring if Data Jack is Fixed Loss Type.

CABLE #1	FUNCTION
PIN 1	A Note 6
2	C Note 6
3	D1
4	DATA TIP
5	DATA RING
6	A1
7	PR Note 7
8	PC Note 7

CABLE #2	FUNCTION
PIN 1	TIP Note 8
2	RING Note 8
3	MI
4	TIP
5	RING
6	MIC
7	PR Note 7
8	PC Note 7

IF DCE IS NOT UDS TYPE:

1. Cable 2 is UDS 1020192 if Data Jack is Programmable or Fixed Loss Type. (RJ45S or RJ41S)
2. Cable 2 is UDS 1020202 if Data Jack is Permissive Type. (RJ11C)
3. Cable 1 is Special. Consult UDS Engineering.
4. Cable 3 is part of DTE Equipment
5. Cable 4 is UDS 1020204, 6 Feet in Length.

**Figure 4**  
**801 A/C Interconnection Diagram When ACU and DCE Share One RS-232-C Port**

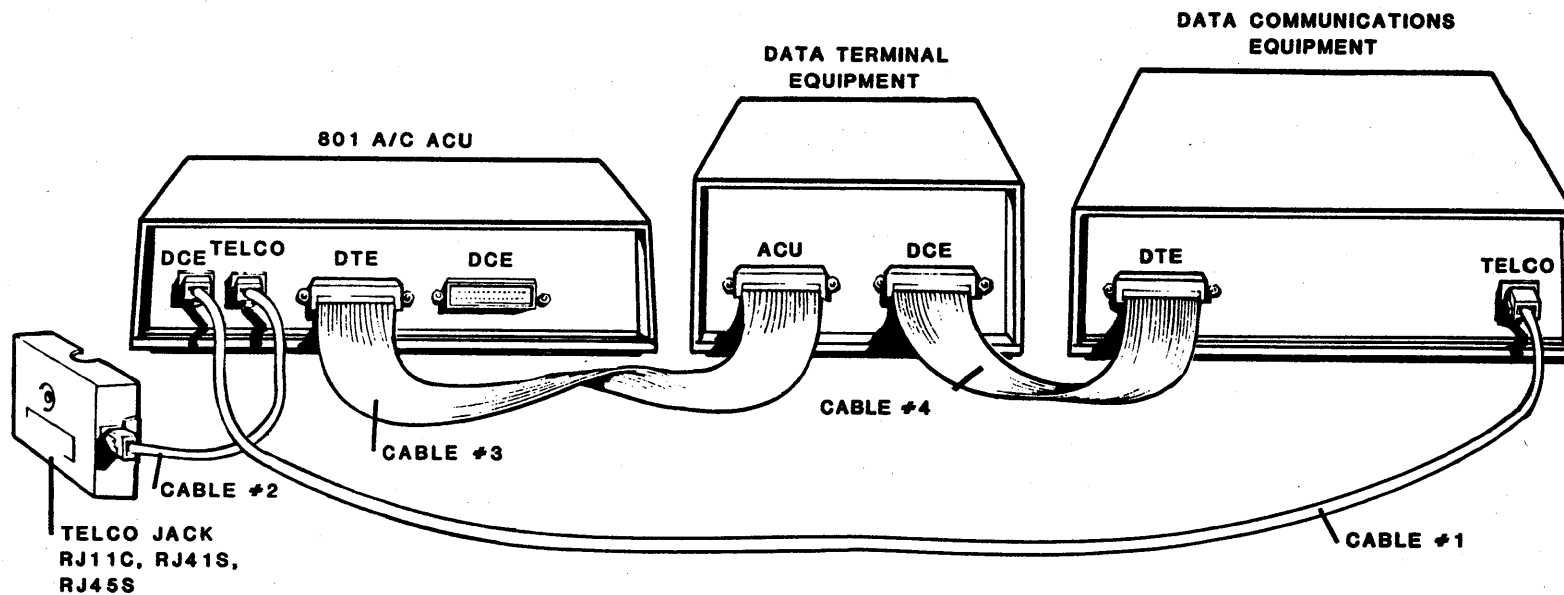

IF DCE IS UDS TYPE:

1. Cable 1 is UDS 1020192.
2. Cable 2 is UDS 1020192 if Data Jack is Programmable or Fixed Loss Type. (RJ45S or RJ41S)
3. Cable 2 is UDS 1020202 if Data Jack is Permissive Type. (RJ11C)
4. Cable 3 and 4 are part of Data Terminal Equipment.
5. Functions not Utilized by UDS Modems.
6. Function not Utilized if Data Jack is Permissive Type.
7. Pin 1 and 2 is Tip and Ring when Fixed Loss Data Jack is Installed.

CABLE #1	FUNCTION
PIN 1	A Note 5
2	C Note 5
3	D1
4	DATA TIP
5	DATA RING
6	A1
7	PR Note 6
8	PC Note 6

CABLE #2	FUNCTION
PIN 1	TIP Note 7
2	RING Note 7
3	MI
4	TIP
5	RING
6	MIC
7	PR Note 6
8	PC Note 6

IF DCE IS NOT UDS TYPE:

1. Cable 2 is UDS 1020192 if Data Jack is Programmable or Fixed Loss Type. (RJ45S or RJ41S)
2. Cable 2 is UDS 1020202 if Data Jack is Permissive Type. (RJ11C)
3. Cable 1 is Special. Consult UDS Engineering.
4. Cable 3 and 4 are part of DTE Equipment.

Figure 5  
801 A/C Interconnection Diagram When ACU Has a Dedicated RS-232-C Port

### 3.2 OPERATION, RS-232-C PORT SHARED WITH DCE

To start the call sequence (DSR from DCE must be "Off"), the dialer will look for the STX character to be transmitted serially from the DTE. The dialer will begin the call sequence when the STX character is detected. If any character other than the defined set is received, the dialer will transmit an ASCII "E" to the DTE. The DTE must turn "Off" RTS (if used) and reinitiate the dial sequence. If RTS is provided by the DTE, the dialer will respond with CTS. The data format is as follows:

Character 1..... STX

Character 2-X..... Dialer Digits

Character X+1..... (Option) End of Number

Character X+2..... Last Digit Character (Follows EON Digit, If Used, or Last Dialer Digit)

Character X+3..... ETX (Follows Last Digit Character)

If the DTE wishes to abort the session any time before call completion, the DTE should send an EOT character preceded by STX. When the ACU recognizes the EOT character, an ASCII "A" is transmitted to the DTE and the ACU logic is reset.

After the data is loaded in and the ETX is received, Tip and Ring from the modem are monitored. (NOTE: If the modem DSR line is "On", the ACU will not accept the serial data in). If the modem is "On Hook", the dialer will start the dial sequence.

Next, the dialer detects dial tone and proceeds to dial the stored telephone number. When the dialer detects Last Digit Character, the Answer Tone detector and Busy detector are enabled. If the dialer detects an End of Number character, it will turn the line over to the DCE.

When the dialer detects an answer tone or an End of Number character, the COS LED is set "On" and an ASCII character "C" is transmitted to the DTE. The DSR and CD lines are also turned "On" to the DTE. The DCE equipment is set to an "Off Hook" condition. If the dialer detects a busy signal from the telephone line, a Busy character (ASCII "B") is transmitted to the terminal. During the dialing operation, an abort timer is enabled. If the timer times out, an Abort character (ASCII "A") is transmitted to the DTE. If the DTE wants to redial the same stored number, the data format to the dialer is STX followed by ETX. The dialer will repeat the dial sequence.

If the dialer receives a tandem digit (ASCII "=" or ":") during the dial sequence, the dialer resets and looks for a new dial tone. If the dialer receives a pause digit (ASCII ">" or ";") the dial sequence pauses for a selected period and then resumes. The pause time is selectable to be 1 second or 4 seconds (Switch C, #5).

When the dialer has completed the call sequence, either due to an abort or a successful call completion, the dialer serially transmits this information to the DTE. The dialer also transmits information to the DTE if the DCE is "Off Hook". The data format is as follows:

Character..... DLO (ASCII "D") if DCE is "Off Hook"  
(Not used if RS-232-C port is shared with DCE.)

COS (ASCII "C") if call completion is successful and raise DSR

ACR (ASCII "A") if call is aborted

BUSY (ASCII "B") if remote end is Busy

ERROR (ASCII "E") if an error is detected in the received data from the DTE.

**NOTE**

If the DTE wants to redial a number, the data format is STX followed by ETX. The dialer will dial the stored telephone number.

**3.3 OPERATION, DEDICATED RS-232-C PORT FOR ACU**

The call sequence is the same as noted in Section 3.2 except that DSR from the modem is not monitored. The ACU monitors Tip and Ring from the modem, and if the modem is "Off Hook" (Data Mode), the ACU will not accept the serial dial information. A DLO character is transmitted to the DTE if the modem is already in Data mode.

**3.4 INTERFACE FORMAT**

**3.4.1 General**

While a modem may be capable of answering incoming calls, an automatic dialing unit initiates all outgoing calls, under external control, using dc dial pulsing or touch tones and transfers the line to the modem when the circuit is established and handshaking is complete.

### 3.4.2 Message Format

The serial data between the DTE and the 801 A/C is standard serial ASCII. The character consists of a start bit, 7 or 8 data bits (Switch B, #2), odd or even parity bit and a parity bit or no parity bit (Switch B, #1 and #3). Incoming data received by the ACU from the DTE must have at least one stop bit. Response data transmitted from the ACU to the DTE will always have at least one stop bit. If bit 8 is used, its sense is ignored by the ACU and is always a Space when transmitted in response from ACU to DTE. If the user selects 7 data bits with parity off, incoming data received by the ACU from the DTE must have at least 2 stop bits. All other combinations of parity and data bit options require only one stop bit.

Bit Function	Start Bit	Bit 1	Bit 2	Bit 3	Bit 4	Bit 5	Bit 6	Bit 7	Bit 8 If Used	Parity If Used	Stop Bit 1	Stop Bit 2 To DTE Only

### 3.4.3 Control Characters - From DTE

	<u>Bit Pattern</u>							<u>Function</u>
	7	6	5	4	3	2	1	
STX	0	0	0	0	0	1	0	Start Format
ETX	0	0	0	0	0	1	1	End Format
EOT	0	0	0	0	1	0	0	Abort call before call initiation and during dial process

### 3.4.4 Data Format - From DTE

<u>Character No.</u>	<u>Function</u>
1	STX
2 through X	Dial Digits (desired length) (up to 25 digits)
X+1	End of Number (follows last dialer digit) (option)
X+2	Last Digit (follows last dial digit character)
X+3	ETX (follows last digit character)

### 3.4.5 Abort Procedure - From DTE

The DTE may abort the call at any time by transmitting an EOT character (preceded by STX).

### 3.4.6 Dial Digit Characters - From DTE (Switch C, #6 = "On")

<u>Digit</u>	<u>Bit Pattern</u>							<u>ASCII</u>
	7	6	5	4	3	2	1	
0	0	1	1	0	0	0	0	0
1	0	1	1	0	0	0	1	1
2	0	1	1	0	0	1	0	2
3	0	1	1	0	0	1	1	3
4	0	1	1	0	1	0	0	4
5	0	1	1	0	1	0	1	5
6	0	1	1	0	1	1	0	6
7	0	1	1	0	1	1	1	7
8	0	1	1	1	0	0	0	8
9	0	1	1	1	0	0	1	9
*	0	1	1	1	0	1	0	:
#	0	1	1	1	0	1	1	;
EON	0	1	1	1	1	0	0	<
* Tandem Digit	0	1	1	1	1	0	1	=
Pause	0	1	1	1	1	1	0	>
Last Digit	0	1	1	1	1	1	1	?

\*The last 6 characters of the dial digits are switch selectable to be either the set above or as follows. Only the dial digits change - the bit pattern and ASCII characters stay the same.

(Switch C, #6 = OFF)

<u>Digit</u>	<u>Bit Pattern</u>							<u>ASCII</u>
	7	6	5	4	3	2	1	
Tandem Digit	0	1	1	1	0	1	0	:
Pause	0	1	1	1	0	1	1	;
EON	0	1	1	1	1	0	0	<
Unused	0	1	1	1	1	0	1	=
Unused	0	1	1	1	1	1	0	>
Last Digit	0	1	1	1	1	1	1	?

### 3.4.7 Re-Dial Format - From DTE

The DTE may direct the dialer to re-dial the last dial digit character presented to the dialer in a previous session by transmitting an STX character immediately followed by an ETX character.

### 3.4.8 Response Character - From ACU

<u>Mnemonic</u>	<u>ASCII</u>	<u>Bit Pattern</u>							<u>Function</u>
		7	6	5	4	3	2	1	
DLO	D	1	0	0	0	1	0	0	Data Line Occupied
COS	C	1	0	0	0	0	1	1	Call Original Status
ACR	A	1	0	0	0	0	0	1	Abandon Call and Retry
BUSY	B	1	0	0	0	0	1	0	Busy (Remote)
ERROR	E	1	0	0	0	1	0	1	Character Error

### 3.4.9 Response Format - From ACU

If DCE is Off Hook, then the ACU turns transmits DLO (ASCII "D") to the DTE.

If call is completed normally, then DSR is turned "On" from the modem and the ACU transmits COS (ASCII "C") to the DTE.

If call is not completed, then ACR (ASCII "A") is transmitted to the DTE.

If remote end is BUSY, then BUSY (ASCII "B") is transmitted to the DTE.

If received character is received with error, then the ACU transmits ERROR (ASCII "E") to the DTE.



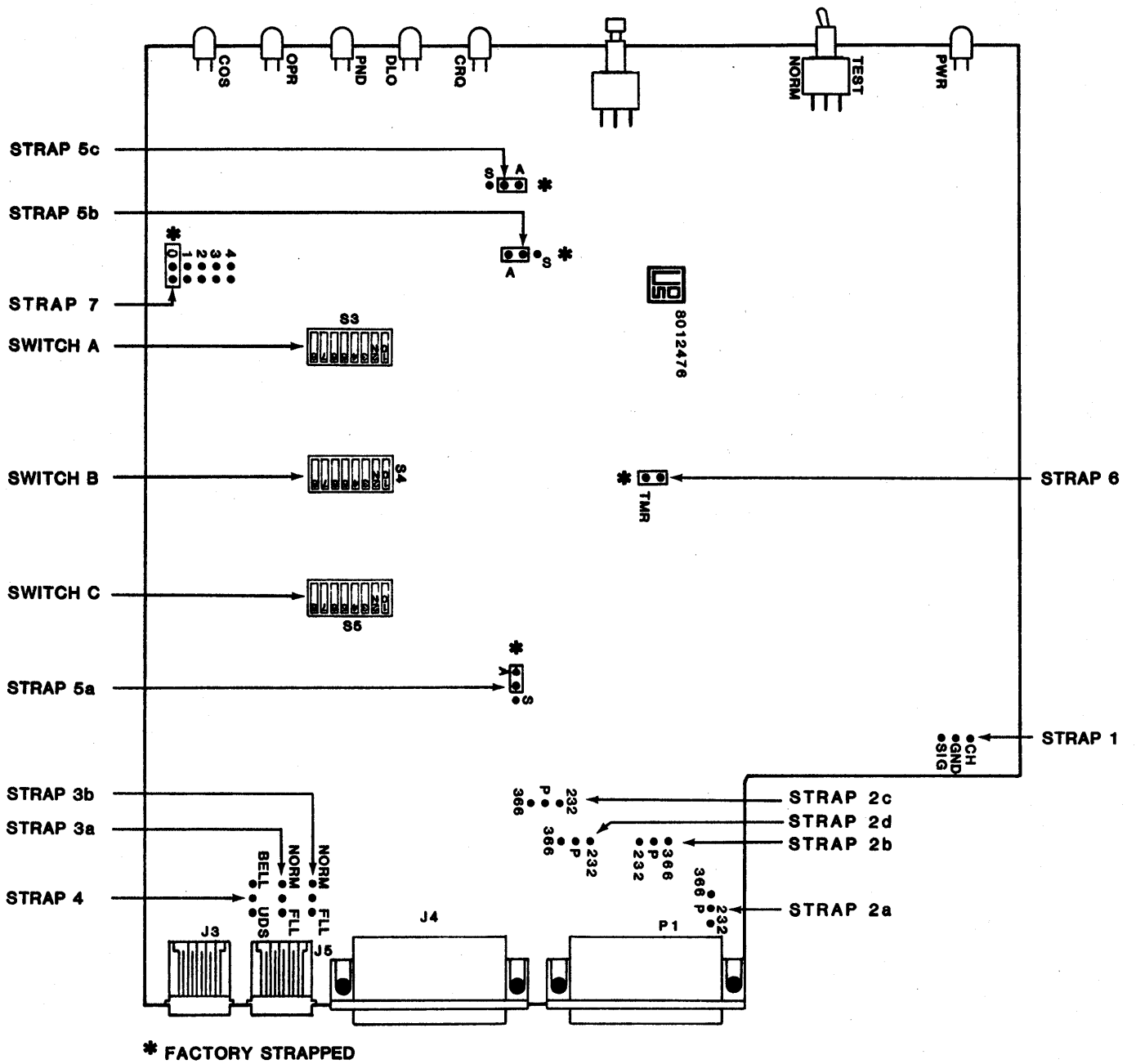

Figure 6  
Strap Map

### 3.5 STRAP AND SWITCH SETTINGS FOR RS-232-C SERIAL INPUT

Please refer to Figure 6, Strap Map, for the location of straps and switches on the board.

With the strap in the position shown below, the ACU chassis ground is connected to the RS-232-C frame ground signal (pin 1) and also to the RS-232-C signal ground (pin 7).

#### STRAP 1

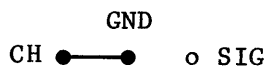

With the strap in the position shown below (or not installed, since the printed circuit incorporates this position), the 801 ac board signal ground is connected to the RS-232-C signal ground (pin 7).

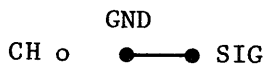

#### STRAPS 2a, 2b, 2c AND 2d, TYPE INTERFACE

All four straps must be configured from P to 232 for RS-232-C input operation.

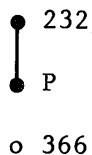

#### STRAPS 3a AND 3b, TYPE DATA JACK

The data jack may be a Programmable, Permissive or Fixed Loss type.

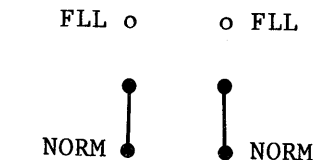

Programmable or  
Permissive Data Jack

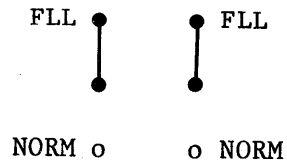

Fixed Loss Data  
Jack

### STRAP 4, TYPE MODEM

The DCE (modem) may be a UDS unit or a Bell or Bell type modem.

Strapped for UDS Modem, provides dry contact closure of DCE data jack pins 3 and 6, to take the DCE offhook.



BELL ○

Strapped for Bell type modem, provides contact closure to ground of DCE data jack pins 3 and 6, to take the DCE offhook.

UDS ○



### STRAP 5a, 5b, 5c

These straps are not user options and should always be strapped to the "A" side as shown for proper operation of the ACU.

S ○



### STRAP 6

Strap 6 is not a user option and should be in place during operation.

### STRAP 7

Strap 7 is for factory test purposes only and the strap must always be inserted across the two pins marked 0.

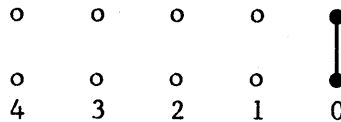

**Switches:**

Switch A

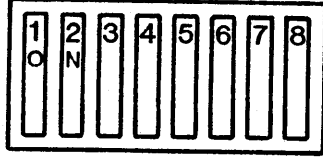

Switch A is marked S3 on the PC board and controls dialing options.

- #1: OFF = Auto search for DTMF capability and fall back to pulse dialing if dial tone is not broken.  
ON = Dial as selected by #2.
- #2: OFF = Verify valid dial tone and DTMF dial.  
ON = Verify valid dial tone and pulse dial.  
NOTE: This switch is ignored when #1 and #3 are both OFF.
- #3: OFF = Verify valid dial tone.  
ON = Do not wait for valid dial tone, blind dial.
- #4: OFF = Audio OFF.  
ON = Audio ON.
- #5: OFF = Verify ABT for 1 sec and take DCE Off Hook, option for full-duplex DCEs (103/212).  
ON = Hold phone lines until ABT has stopped then take DCE Off Hook, Option for half-duplex DCEs (201/202).
- #6, #7 and #8: Set to OFF  
OFF = RS-232-C interface.  
ON = RS-366-A interface.

Switch B

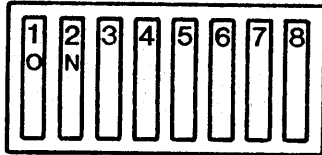

Switch B is marked S4 on PC board and controls serial interface (RS-232-C) options.

- #1: OFF = Even parity  
ON = Odd parity  
Ignored when #3 is OFF
- #2: OFF = 7 bits  
ON = 8 bits
- #3: OFF = Parity OFF  
ON = Parity ON (Read #1)
- #4: OFF = Not used  
Keep switched to OFF position

#5, #6, #7 and #8: Bit rate options

<u>SWITCH #</u> <u>BIT RATE</u>	#5	#6	#7	#8
9600 bps	ON	ON	ON	ON
4800	OFF	ON	ON	ON
2400	ON	OFF	ON	ON
1200	OFF	OFF	ON	ON
600	ON	ON	OFF	ON
300	OFF	ON	OFF	ON
150	ON	OFF	OFF	ON
134.5	OFF	OFF	OFF	ON
110	ON	ON	ON	OFF
75	OFF	ON	ON	OFF

Switch C

Switch C is marked S5 on PC board and controls timer options.

#1 and #2: Abort timer options.

<u>ABORT TIMEOUT</u>	<u>SWITCH #1</u>	<u>#2</u>
32 secs	ON	ON
48	OFF	ON
96	ON	OFF
DIS(abled)	OFF	OFF (No abort timeout)

#3 and #4: Off Hook Delay options. Determines length of pulse given DCE on pins 3 and 6 of DCE 8-pin modular connector to take DCE Off Hook.

<u>OFF HOOK DELAY</u>	<u>SWITCH #3</u>	<u>#4</u>
0.16 secs	OFF	OFF
0.64	ON	OFF
1.28	OFF	ON
2.56	ON	ON

#5: Pause time option. Determines pause length when pause character is encountered.

OFF = 1 sec.  
ON = 4 secs.

#6: Tandem digit option. Selects tandem and pause digits.

OFF = Tandem digit 10<sub>10</sub> (":" ASCII)  
 Pause digit 11<sub>10</sub> (";" ASCII)  
 ON = Tandem digit 13<sub>10</sub> ("=" ASCII)  
 Pause digit 14<sub>10</sub> (">" ASCII)

The ON position is suggested for DTMF dialing to enable the full 12 digit dial character set (0-9, # and \*).

#7: Is not used and should be in the OFF position.

#8: Line delay option. Controls timing of the transfer of Tip and Ring lines to the DCE.

OFF = Tip and Ring transferred immediately following MI-MIC pulse to DCE.

ON = Tip and Ring transferred 250 milliseconds after MI-MIC pulse.

### 3.6 MANUAL TEST OR CALL

The 801 A/C allows the operator to manually dial the last stored telephone number. To dial, the toggle switch (on front panel of housing) is placed in the test position. The dialer assumes control of the line interface. The OH Relay is turned "On" and the dialer monitors dial tone. After dial tone detection, the PND indicator is turned "On". The operator must press the DPR switch until the PND indicator turns "Off". The operator should release the DPR switch. PND indicator will turn "On" again. The operator should press the DPR switch again. The sequence continues until the last digit is dialed.

After the last digit is dialed, the dialer will monitor the line for answer tone and/or busy signals. When the answer tone is detected, the COS indicator will turn "On". The operator should turn the toggle switch to the normal position.

There are two methods for entering a telephone number to the ACU for Manual Test or Call. The first method is to complete a normal, automatic dialing sequence, and the second method is to enter standard data format as described previously with an EOT character immediately preceding the ETX. The latter method causes an abort sequence with no automatic calling taking place. Both methods store the Dialer Digits as transmitted by the DTE and these digits can then be utilized for manual testing.

### 3.7 REAR PANEL SIGNAL DEFINITIONS RS-232-C INTERFACE

#### 3.7.1 DTE Connector (RS-232-C Compatible, Serial Input)

The ACU connects to the DTE by means of a 25-pin connector. The receptacle on the ACU is a Cannon DB-25S or equivalent. The DTE should have a cable no longer than 50 feet with a Cinch or Cannon plug per DB-19604-432 plus a DB-51226-1 hood or equivalent.

All 25 pins of the RS-232-C interface are routed through the ACU to the DCE, by way of the DCE connector. The following signals are monitored by the ACU and are seized and controlled during the calling sequence.

<u>PIN #</u>	<u>NAME</u>	<u>FUNCTION</u>
2	TD	Serial Input Data (from DTE)
3	RD	Serial Output Data (to DTE)
4	RTS	Request to Send (from DTE)
5	CTS	Clear to Send (to DTE)
6	DSR	Data Set Ready (to DTE)
7	SG	Signal Ground
8	CD	Carrier Detect (to DTE)
9	+12 Vdc	
10	-12 Vdc	

The interface signals are defined as follows:

- A. Serial Input - The ACU control information is routed to the ACU on this line. When the ACU shares a data port with the DCE, this line becomes DCE Transmit Data.
- B. Serial Output - Serial Control Data from the ACU to the DTE. When the ACU shares a data port with the DCE, this line becomes DCE Receive Data.
- C. Request to Send - The DTE can, optionally, indicate call initiation to the ACU. This signal is not required but the ACU will respond if it is presented.
- D. Clear to Send - The On condition (in response to RTS, if given) indicates that the ACU is ready to receive data (from the DTE) on the Serial Input line.
- E. Data Set Ready - The ACU turns On the DSR line when the ACU is transmitting a character on the Serial Output line.
- F. Carrier Detect - The Carrier Detect line is turned On when the ACU is transmitting a character on the Serial Output line.

### 3.7.2 DCE Connector (RS-232-C Compatible, 25-Pin)

The ACU connects to the DCE by means of a 25-pin connector. The plug on the ACU is a Cannon DB-25P or equivalent. (Note: The DCE connector is used only when the ACU shares a data port with the DCE.) The cable between the ACU and the DCE is supplied by UDS.

The pin functions are as follows:

#### RS-232-C INTERFACE PIN ASSIGNMENTS

PIN	NAME	TO	TO	FUNCTION	(CCITT)	CIRCUIT (EIA)
		DTE	DCE			
		←	→			
		← ACU →				
1	FG			Frame Ground	101	(AA)
2	TD		→	Transmitted Data	103	(BA)
3	RD	←		Received Data	104	(BB)
4	RTS		→	Request to Send	105	(CA)
5	CTS	←		Clear to Send	106	(CB)
6	DSR	←		Data Set Ready	107	(CC)
7	SG			Signal Ground	102	(AB)
8	DCD	←		Data Carrier Detect	109	(CF)
9		←		Positive dc Test Voltage		
10		←		Negative dc Test Voltage		
11				Unassigned		
12	(S)DCD	←		Sec. Data Carrier Detect	122	(SCF)
13	(S)CTS	←		Sec. Clear to Send	121	(SCB)
14	(S)TD		→	Sec. Transmitted Data	118	(SBA)
15	TC	←		Transmitter Clock	114	(DB)
16	(S)RD	←		Sec. Received Data	119	(SBB)
17	RC	←		Receiver Clock	115	(DD)
18			→	Receiver Dibit Clock		
19	(S)RTS		→	Sec. Request to Send	120	(SCA)
20	DTR		→	Data Terminal Ready	108.2	(CD)
21	SQ	←		Signal Quality Detect	110	(CG)
22	RI	←		Ring Indicator	125	(CE)
23			→	Data Rate Select	111/112	(CH/CI)
24	(TC)		→	Ext. Transmitter Clock	113	(DA)
25			→	Busy		

#### NOTE

Some functions may not be used on some type DCEs.



### 3.7.3 Public Switched Telephone Network (PSTN) Interface (8-Pin Modular Connector)

The PSTN interface consists of a registered protective circuit and a USOC data jack. The ACU connects to the PSTN by means of a cord with a modular plug on both ends (supplied by UDS). An 8-pin modular plug connects to the jack marked TELCO on the rear panel. The other end of the cord is an 8-pin plug to mate to a programmable data jack or a 6-pin plug to mate to a permissive data jack.

The pin functions are as follows:

- Pin 1            Ring side of telephone line for fixed loss data jack.
- Pin 2            Tip side of telephone line for fixed loss data jack.
- Pin 3            MI (or A) - Goes to switchhook in exclusion key telephone.
- Pin 4            Ring - Ring side of telephone line.
- Pin 5            Tip - Tip side of telephone line.
- Pin 6            MIC (A1) - Goes to switchhook in exclusion key telephone  
(Common return for pin 3).
- Pin 7            PR - goes to data jack program resistor. Not used if data  
jack is permissive type.
- Pin 8            PC - Goes to data jack program resistor (See pin 7).  
Not used if data jack is permissive type.

### 3.7.4 DCE Interface (8-Pin Modular Connector)

When the ACU is not making a call, the PSTN interface connector functions are routed through the DCE (8-pin modular) connector to be used by the DCE. When the ACU is making a call, the DCE connector functions are controlled by the ACU.

The DCE must have a registered protective interface which allows direct connection to the PSTN.

The connection from the ACU to the DCE is made by means of a cord with an 8-pin modular plug on one end and a customer-specified connector on the other end. If the DCE is manufactured by UDS, the cable has an 8-pin modular plug on both ends (same cable used for ACU to PSTN connection).

The pin functions for the DCE connectors on the ACU are as follows:

- Pin 1        A - The DCE provides a contact closure between pin 1 and pin 6 when the DCE (or key telephone) is On Line (other than UDS modems).
- Pin 2        C - The DCE provides a contact closure between pin 2 and pin 6 when the DCE is in Data mode (other than UDS modems).
- Pin 3        DI - When the ACU is inactive, DI is the switchhook function from an exclusion key telephone (if a telephone is used in the system). During dialing, the ACU controls DI and pulses the line to cause the DCE to enter the Data mode after call completion. The pulse is a contact closure between pin 3 and pin 6.
- Pin 4        Ring (RM) - Ring side of telephone line when the ACU is inactive. When the ACU is active, Ring and Tip (RM and TM) are terminated into a 600 ohms load.
- Pin 5        Tip (TM) - Tip side of line - mate to pin 4.
- Pin 6        MIC (A1) - Common return for pins 1, 2, and 3.
- Pin 7        PR (PRM) - Goes to data jack program resistor - ACU does not use this line. Not used if data jack is permissive type.
- Pin 8        PC (PCM) - Goes to data jack program resistor (return for pin 7).

## **Chapter 4**

### **RS-366 Interface**

#### **Contents**

- 4.1 Interface Connections for Parallel Input ACU
- 4.2 Operation, Dedicated RS-366-A Port
- 4.3 Strap and Switch Settings for RS-366-A Parallel Input
- 4.4 Manual Test or Call
- 4.5 Rear Panel Signal Definitions RS-366-A Interface
  - 4.5.1 801 A/C Parallel Input Configuration
  - 4.5.2 Data Terminal Equipment (DTE) Interface
  - 4.5.3 Data Communication Equipment (DCE) Connector
  - 4.5.4 Public Switched Telephone Network (PSTN) Interface
  - 4.5.5 Data Communication Equipment (DCE) Interface

#### **4.1 INTERFACE CONNECTIONS FOR PARALLEL INPUT ACU**

The UDS 801 A/C interfaces to the DTE, DCE and the PSTN (Public Switched Telephone Network). The interface connectors are located on the rear panel of the ACU.

The UDS 801 A/C permits automatic dialing in systems where a parallel RS-366-A dialing port is available. The dialer interfaces to the Data Terminal Equipment (DTE), Data Communications Equipment (DCE), and the Public Switched Telephone Network (PSTN). The interface to the DTE is in accordance with EIA Standard RS-366-A. The interface to the PSTN is a USOC (telephone company supplied) data jack. The DCE interfaces to the ACU in the same manner as it interfaces to the PSTN. The DCE must be registered for direct connect to the PSTN. The DCE could be a modem with external Data Access Arrangement (DAA). DAA must be 1001F or 1001D type. Three switches and two straps in the correct configuration determine RS-366-A compatibility. See the following sections on strap and switch settings.

See the following diagram, Figure 7 for parallel port cabling configuration.

#### 4.2 OPERATION, DEDICATED RS-366-A PORT

The dialing sequence starts when the DTE turns "On" CRQ. (If the DCE is in Data Mode, the DLO line will be "On" and the DTE should not attempt to place a call).

When CRQ turns "On", the ACU disconnects the DCE from the telephone line and terminates the DCE Tip and Ring into a 600 ohm load. The ACU goes Off Hook and verifies the receipt of dial tone from the TELCO. When dial tone is received, the ACU turns "On" PND to the DTE. The ACU recognizes dial tone if the signal is there continuously for approximately one second. The frequency should be between 200 and 1000 Hz. The level must be  $\geq -42$  dB.

When PND turns "On", the DTE should set the digit lines (NB1, NB2, NB4, NB8) to the desired state for the first dial digit. After the lines are set, DPR should be turned "On". When DPR turns "On", the ACU monitors the digit lines and checks for Tandem digit ( $13_{10}$  or  $10_{10}$ ) or End of Number digit ( $12_{10}$ ).

If the digit is a Tandem digit code, the ACU resets PND and looks for dial tone or a busy signal on the communication lines. If a busy signal is received, the ACR line is turned "On", and the call sequence is halted. The DTE should turn "Off" CRQ.

If dial tone is received, the ACU turns "On" PND and looks for DPR turn "On". The DTE must turn "Off" DPR after the ACU turns "Off" PND. During the dialing sequence, PND will turn "Off" and then turn back "On" again if DPR is turned "Off". After the last digit is dialed, the DTE may give the ACU and EON code ( $12_{10}$ ) on the digit line and turn DPR "On" or the DTE may hold DPR "Off" depending on the system configuration (software option). If the ACU is given an EON code, the ACU turns "On" COS and places the DCE in Data Mode. If the ABT option is used, the ACU detects the tone, turns "On" COS and places the DCE in Data Mode. The ACU will recognize a signal as the Answer Back Tone if it is 2125 Hz  $\pm$  100 Hz, the level is  $\emptyset$  to -42 dB, and it occurs for at least 0.75 seconds.

When COS turns "On", the DTE may then perform the normal data functions through the DCE. The ACU (abort) timer is enabled throughout the dial sequence but is reset and restarted each time PND turns "Off".

Call termination is accomplished by turning "Off" CRQ any time prior to call completion. After call completion, call termination is accomplished by the DCE.

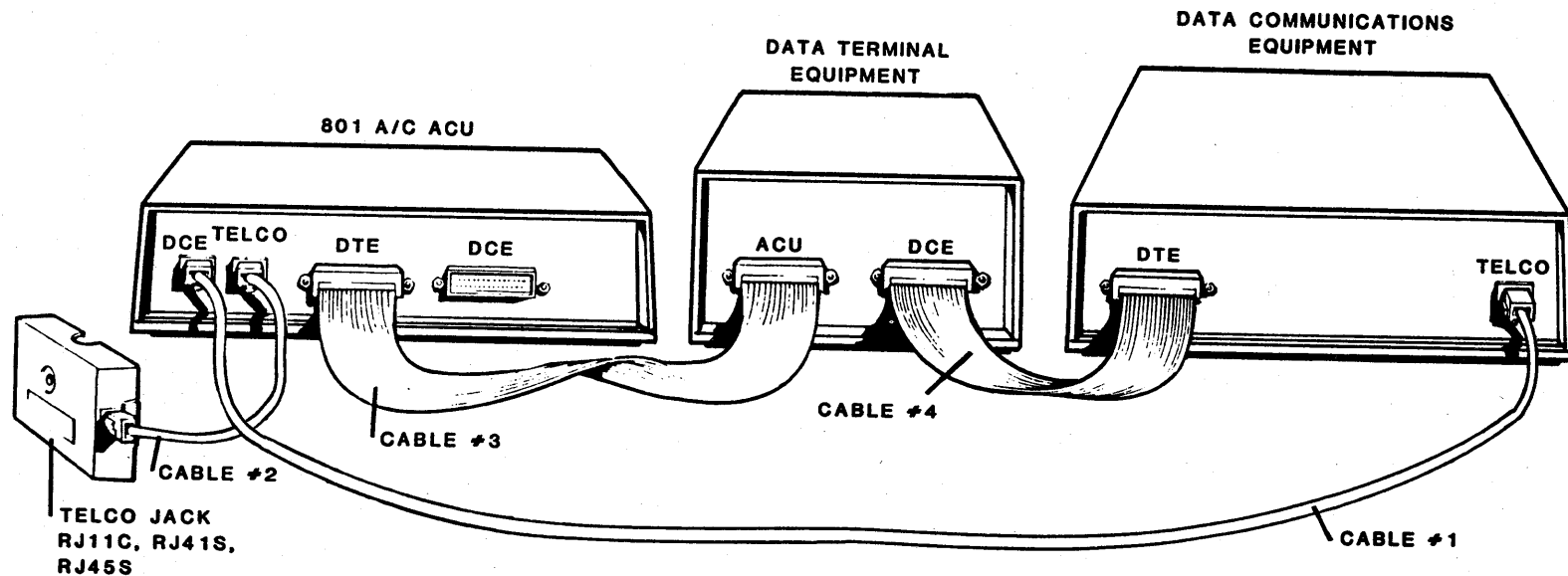

IF DCE IS UDS TYPE:

1. Cable 1 is UDS 1020192.
2. Cable 2 is UDS 1020192 if Data Jack is Programmable or Fixed Loss Type. (RJ45S or RJ41S)
3. Cable 2 is UDS 1020202 if Data Jack is Permissive Type. (RJ11C)
4. Cable 3 and 4 are part of Data Terminal Equipment.
5. Functions not Utilized by UDS Modems.
6. Function not Utilized if Data Jack is Permissive Type.
7. Pin 1 and 2 is Tip and Ring when Fixed Loss Data Jack is Installed.

CABLE #1	FUNCTION
PIN 1	A Note 5
2	C Note 5
3	D1
4	DATA TIP
5	DATA RING
6	A1
7	PR Note 6
8	PC Note 6

CABLE #2	FUNCTION
PIN 1	TIP Note 7
2	RING Note 7
3	MI
4	TIP
5	RING
6	MIC
7	PR Note 6
8	PC Note 6

IF DCE IS NOT UDS TYPE:

1. Cable 2 is UDS 1020192 if Data Jack is Programmable or Fixed Loss Type. (RJ45S or RJ41S)
2. Cable 2 is UDS 1020202 if Data Jack is Permissive Type. (RJ11C)
3. Cable 1 is Special. Consult UDS Engineering.
4. Cable 3 and 4 are part of DTE Equipment.

4-3

Figure 7  
801 A/C Interconnection Diagram When ACU Has a Dedicated RS-366-A Port

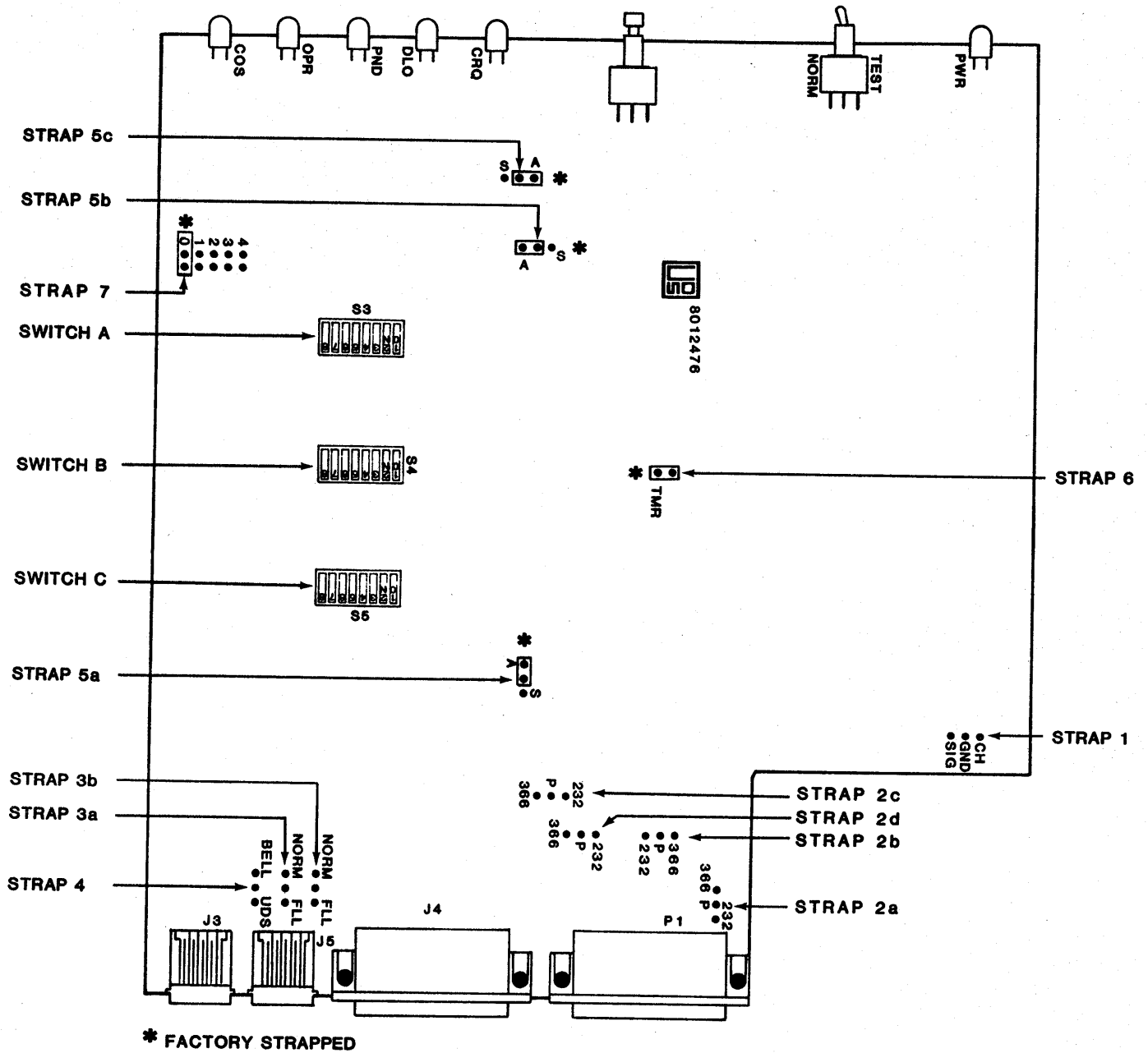

Figure 8  
Strap Map

### 4.3 STRAP AND SWITCH SETTINGS FOR RS-366-A PARALLEL INPUT

Please refer to Figure 8, Strap Map, for the location of straps and switches on the board.

With the strap in the position shown below, the ACU chassis ground is connected to the RS-366-A frame ground signal (pin 1) and also to the RS-366-A signal ground (pin 7).

#### STRAP 1

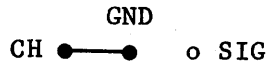

With the strap in the position shown below (or not installed, since the printed circuit incorporates this position), the 801 A/C board signal ground is connected to the RS-366-A signal ground (pin 7).

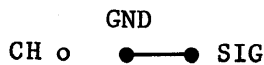

#### STRAPS 2a, 2b, 2c AND 2d, TYPE INTERFACE

All four straps must be configured from P to 366 for RS-366-A input operation.

o 232



#### STRAPS 3a AND 3b, TYPE DATA JACK

The data jack may be a Programmable, Permissive or Fixed Loss type.

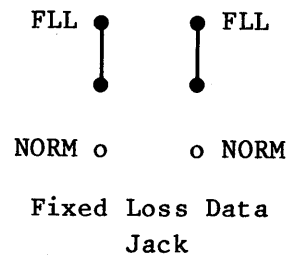
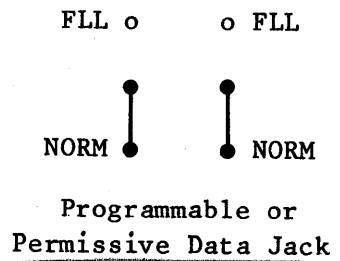

**STRAP 4, TYPE MODEM**

The DCE (modem) may be a UDS unit or a Bell or Bell type modem.

Strapped for UDS Modem, provides dry contact closure of DCE data jack pins 3 and 6, to take the DCE offhook.

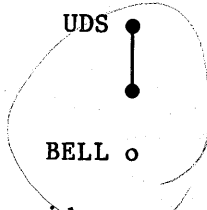

Strapped for Bell type modem, provides contact closure to ground of DCE data jack pins 3 and 6, to take the DCE offhook.

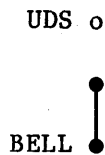

**STRAP 5a, 5b, 5c**

These straps are not user options and should always be strapped to the "A" side as shown for proper operation of the ACU.



**STRAP 6**

Strap 6 is not a user option and should be in place during operation.

**STRAP 7**

Strap 7 is for factory test purposes only and the strap must always be inserted across the two pins marked 0.

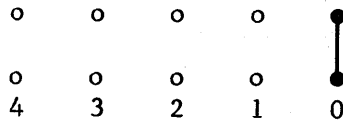



Switches:

Switch A

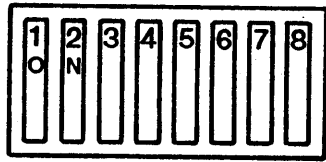

Switch A is marked S3 on the PC board and controls dialing options.

- #1: OFF = Auto search for DTMF capability and fall back to pulse dialing if dial tone is not broken.  
ON = Dial as selected by #2.
- #2: OFF = Verify valid dial tone and DTMF dial.  
ON = Verify valid dial tone and pulse dial.  
NOTE: This switch is ignored when #1 and #3 are both OFF.
- #3: OFF = Verify valid dial tone.  
ON = Do not wait for valid dial tone, blind dial.
- #4: OFF = Audio OFF.  
ON = Audio ON.
- #5: OFF = Verify ABT for 1 sec and take DCE Off Hook option for full-duplex DCEs (103/212).  
ON = Hold phone lines until ABT has stopped then take DCE Off Hook Option for half-duplex DCEs (201/202).
- #6, #7 and #8: Set to ON  
OFF = RS-232-C interface.  
ON = RS-366-A interface.

Switch B

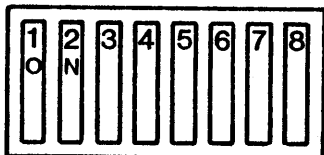

Switch B is marked S4 on PC board and controls serial interface (RS-232) options. This switch is ignored during RS-366-A operation.

- #1: OFF = Even parity  
ON = Odd parity  
Ignored when #3 is OFF
- #2: OFF = 7 bits  
ON = 8 bits
- #3: OFF = Parity OFF  
ON = Parity ON (Read #1)
- #4: OFF = Not used  
Keep switched to OFF position

#5, #6, #7 and #8: Bit rate options *all off*

<u>SWITCH #</u> <u>BIT RATE</u>	#5	#6	#7	#8
9600 bps	ON	ON	ON	ON
4800	OFF	ON	ON	ON
2400	ON	OFF	ON	ON
1200	OFF	OFF	ON	ON
600	ON	ON	OFF	ON
300	OFF	ON	OFF	ON
150	ON	OFF	OFF	ON
134.5	OFF	OFF	OFF	ON
110	ON	ON	ON	OFF
75	OFF	ON	ON	OFF

Switch C

Switch C is marked S5 on PC board and controls timer options.

#1 and #2: Abort timer options.

<u>ABORT TIMEOUT</u>	<u>SWITCH #1</u>	<u>#2</u>
32 secs	ON	ON
48	OFF	ON
96	ON	OFF
DIS(abled)	OFF	OFF (No abort timeout)

#3 and #4: Off Hook Delay options. Determines length of pulse given DCE on pins 3 and 6 of DCE 8-pin modular connector to take DCE Off Hook.

<u>OFF HOOK DELAY</u>	<u>SWITCH #3</u>	<u>#4</u>
0.16 secs	OFF	OFF
0.64	ON	OFF
1.28	OFF	ON
2.56	ON	ON

#5: Pause time option. Determines pause length when pause character is encountered.

OFF = 1 sec.  
 ON = 4 secs.

#6: Tandem digit option. Selects tandem and pause digits.

OFF = Tandem digit 10<sub>10</sub> (":" ASCII)  
 Pause digit 11<sub>10</sub> (";" ASCII)  
 ON = Tandem digit 13<sub>10</sub> ("=" ASCII)  
 Pause digit 14<sub>10</sub> (">" ASCII)

The ON position is suggested for DTMF dialing to enable the full 12 digit dial character set (0-9, # and \*).

#7: Is not used and should be in the OFF position.

#8: Line delay option. Controls timing of the transfer of Tip and Ring lines to the DCE.

OFF = Tip and Ring transferred immediately following MI-MIC pulse to DCE.

ON = Tip and Ring transferred 250 milliseconds after MI-MIC pulse.

Dial Digit Character Sets - from DTE (Switch C, #6 ON)

<u>Digit</u>	<u>NB8</u>	<u>NB4</u>	<u>NB2</u>	<u>NB1</u>
0	0	0	0	0
1	0	0	0	1
2	0	0	1	0
3	0	0	1	1
4	0	1	0	0
5	0	1	0	1
6	0	1	1	0
7	0	1	1	1
8	1	0	0	0
9	1	0	0	1
*	1	0	1	0
#	1	0	1	1
EON	1	1	0	0
* Tandem Digit	1	1	0	1
Pause	1	1	1	0
Unused	1	1	1	1

\*The last 6 characters of the dial digits are switch selectable to be either the set above or as follows: (Switch C, #6 = OFF)

<u>Digit</u>	<u>NB8</u>	<u>NB4</u>	<u>NB2</u>	<u>NB1</u>
Tandem Digit	1	0	1	0
Pause	1	0	1	1
EON	1	1	0	0
Unused	1	1	0	1
Unused	1	1	1	0
Unused	1	1	1	1

#### 4.4 MANUAL TEST OR CALL

The 801 A/C allows the operator to manually dial the last stored telephone number. To dial, the toggle switch (on front panel of housing) is placed in the TEST position. The dialer assumes control of the line interface. The OH relay is turned "On" and the dialer monitors dial tone. After dial tone detection, the PND indicator is turned "On". The operator must press the DPR switch until the PND indicator turns "Off". The operator should release the DPR switch. PND indicator will turn "On" again. The operator should press the DPR switch again. The sequence continues until the last digit is dialed.

After the last digit is dialed, the dialer will monitor the line for answer tone and/or busy signals. When the answer tone is detected, the COS indicator will turn "On". The operator should turn the toggle switch to the NORMAL position.

The method for entering a telephone number to the ACU in parallel interface is to present the digits in the usual manner and then drop CRQ (Call Request) after the last digit is acknowledged by the ACU dropping the PND (Present Next Digit) signal to the DTE. The Manual Test procedure can also be accomplished after the completion of any normal dialing sequence.

## 4.5 REAR PANEL SIGNAL DEFINITIONS RS-366-A INTERFACE

### 4.5.1 801 A/C Parallel Input Configuration

### 4.5.2 Data Terminal Equipment (DTE) Interface

The ACU connects to the DTE by means of an EIA standard, RS-366-A 25-pin connector (rear of housing). The receptacle on the ACU is a Cannon DB-25S. The DTE should have a cable not longer than 50 feet with a cinch or Cannon plug per DB-19604-432 plus a DB-51226-1 hood or equivalent. Connector functions are as follows:

<u>Pin #</u>	<u>Function</u>
1	Frame GND
2	Digit Present (DPR)
3	Abandon Call and Retry (ACR)
4	Call Request (CRQ)
5	Present Next Digit (PND)
6	Power Indication (PWI)
7	Signal GND
9	+12 Mon.
10	-12 Mon.
13	Call Origination Status (COS)
14	Digit Lead 1 (NB1)
15	Digit Lead 2 (NB2)
16	Digit Lead 3 (NB4)
17	Digit Lead 4 (NB8)
22	Data Line Occupied (DLO)

#### NOTE

All pins not listed must be left open (not used) by DTE.

The interface signals are defined as follows:

- Call Request (CRQ)..... The "On" condition indicates the DTE is initiating a call.
- Digit Leads (NB1, NB2, NB4, NB8)... Signals are presented by the DTE on the four leads in parallel giving a 4-bit binary representation of the digit to be dialed. NB8 is the most significant bit.
- Digit Present (DPR)..... The "On" condition indicates that the status of the digit leads may be read by the ACU.
- Present Next Digit (PND)..... The "On" condition indicates that the ACU is ready to receive a digit from the DTE.
- Call Origination Status (COS)..... This circuit is turned on when the ACU completes the dialing process.
- Data Line Occupied (DLO)..... The "On" condition indicates that the associated DCE is Off Hook (on the telephone line) or the associated telephone is in use. (The line is also on when the ACU is making a call).
- Abandon Call and Retry (ACR)..... The ACR line turns on if an event has not occurred within the desired time, or the called line (remote end) is BUSY.

#### **4.5.3 Data Communication Equipment (DCE) Connector**

(25-Pin Connector)

This connector is not used when the ACU is a parallel input type (see Section for Serial Input ACU).

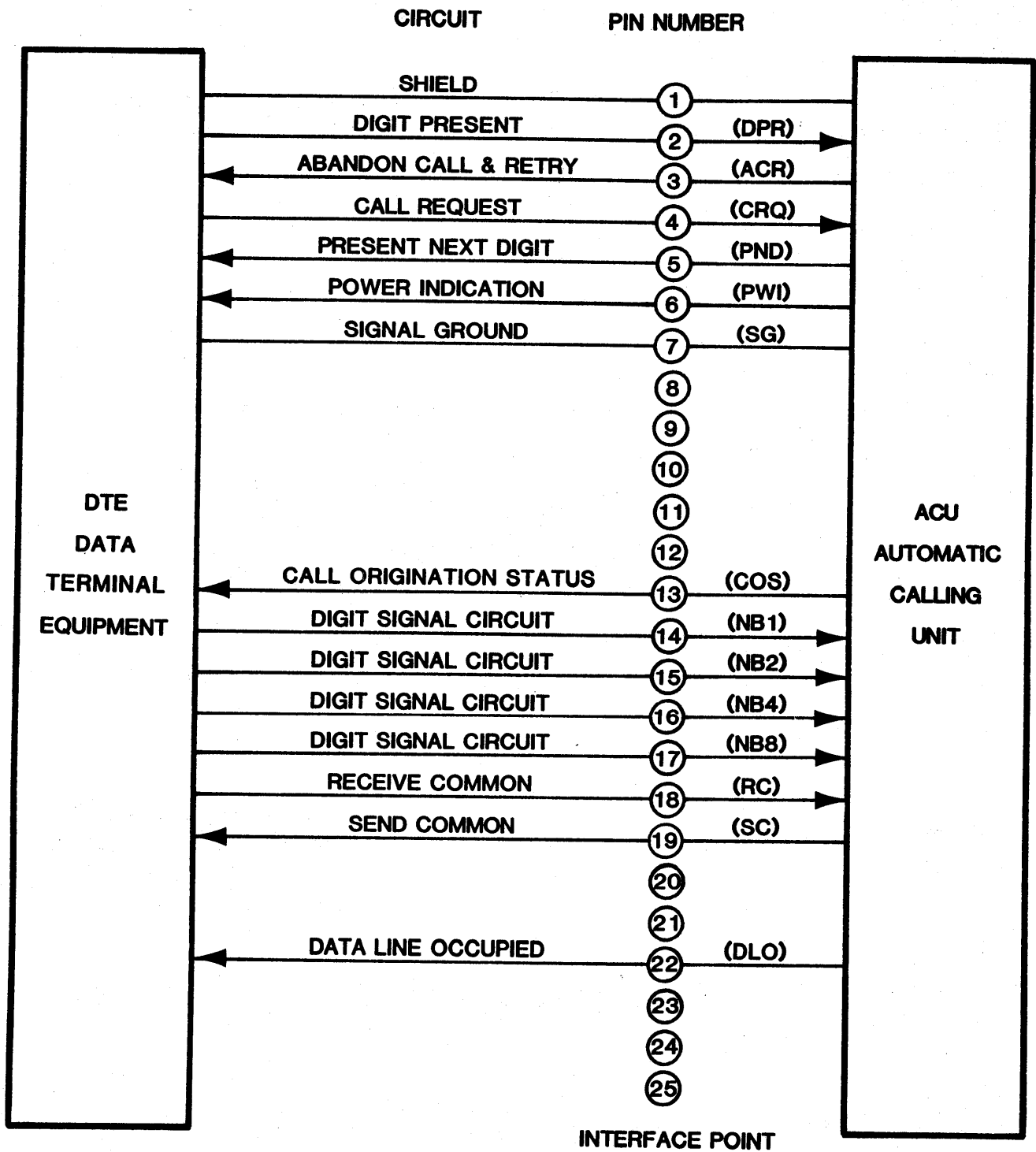

**Figure 9**  
**Illustration of DTE/ACU Interface**

#### 4.5.4 Public Switched Telephone Network (PSTN) Interface

(8-Pin Modular Connector)

The PSTN interface consists of a registered protective circuit and a USOC (Universal Service Ordering Code) data jack. The ACU connects to the PSTN by means of a cord with a modular plug on both ends (supplied by UDS). An 8-pin modular plug connects to the jack marked TELCO on the rear of the ACU housing. The other end of the cord is an 8-pin plug to mate to a programmable data jack or a 6-pin plug to mate to a permissive data jack.

The pin functions are as follows:

Pin 1..... No connection.

Pin 2..... No connection.

Pin 3..... MI (or A) - Goes to switch hook in exclusion key telephone.  
Not used if system does not utilize manual call/answer.

Pin 4..... Ring - Ring side of telephone line.

Pin 5..... Tip - Tip side of telephone line.

Pin 6..... MIC (A1) - Goes to switch hook in exclusion key telephone  
(common return for pin 3).

Pin 7..... PR - Goes to data jack program resistor. Not used if data  
jack is permissive type.

Pin 8..... PC - Goes to data jack program resistor (see pin 7). Not used if  
data jack is permissive type.



#### 4.5.5 Data Communication Equipment (DCE) Interface

(8-Pin Modular Connector)

When the ACU is not active (making a call), the PSTN interface connector functions are routed through the DCE (8-pin modular) connector to be used by the DCE. When the ACU is making a call, the DCE connector functions are controlled by the ACU.

The DCE must have a registered protective interface which allows direct connection to the PSTN. The DCE may be a modem with an external 1001F or 1001D DAA.

The connection from the ACU to the DCE is made by means of a cord with an 8-pin modular plug on one end and a customer specified connector on the other end. If the DCE is manufactured by UDS, the cable has an 8-pin modular plug on both ends (same cable used for ACU to PSTN connection).

The pin functions (DCE connector on ACU) are as follows:

- Pin 1..... A - The DCE provides a contact closure between pin 1 and pin 6 when the DCE (or Key Telephone) is "On Line".
- Pin 2..... C -The DCE provides a contact closure between pin 2 and pin 6 when the DCE is in data mode.
- Pin 3..... D1 - When the ACU is inactive, D1 is the switchhook function from an Exclusion Key Telephone (if a telephone is used in the system).  
  
During dialing, the ACU controls D1 and pulses the line (contact closure to pin 6) to cause the DCE to enter the data mode after call completion.
- Pin 4..... Ring - (RM) - Ring side of telephone line when the ACU is inactive. When the ACU is active, ring and tip (RM and TM) are terminated into a 600 ohm load.
- Pin 5..... Tip - (TM) - Tip side of line - mate to pin 4.
- Pin 6..... A1 - Common return for pin 1, 2, and 3.
- Pin 7..... PR (PRM) - Goes to data jack program resistor - ACU does not use this line. Not used if data jack is permissive type.
- Pin 8..... PC (PCM) - Goes to data jack program resistor (return for pin 7).

**NOTE**

Pins 1 and 2 are not used on UDS modems.





