

Bay Networks

The Merged Company of SynOptics and Wellfleet

Customizing VINES Services

Part No. 110045 A

Customizing VINES Services

Router Software Version 8.10
Site Manager Software Version 2.10

Part No. 110045 Rev. A
February 1995



Bay Networks

The Merged Company of SynOptics and Wellfleet

Copyright © 1995 Bay Networks, Inc.

All rights reserved. Printed in USA. February 1995.

The information in this document is subject to change without notice. This information is proprietary to Bay Networks, Inc.

The software described in this document is furnished under a license agreement or nondisclosure agreement and may only be used in accordance with the terms of that license. The terms of the Software License are provided with the documentation.

Restricted Rights Legend

Use, duplication, or disclosure by the government is subject to restrictions as set forth in subparagraph (c)(1)(ii) of the Rights in Technical Data and Computer Software clause at DFARS 252.227-7013.

Notice for All Other Executive Agencies

Notwithstanding any other license agreement that may pertain to, or accompany the delivery of, this computer software, the rights of the Government regarding its use, reproduction, and disclosure are as set forth in the Commercial Computer Software-Restricted Rights clause at FAR 52.227-19.

Trademarks of Bay Networks, Inc.

ACE, BLN, BN, and Wellfleet are registered trademarks and AFN, AN, ASN, BCN, BCNX, BLNX, BNX, CN, FN, FRE, LN, PPX, Bay Networks, and the Bay Networks logo are trademarks of Bay Networks, Inc.

Third-Party Trademarks

3Com is a registered trademark of 3Com Corporation.

AIX, NetView, and IBM are registered trademarks of International Business Machines Corporation.

AppleTalk and EtherTalk are registered trademarks of Apple Computer, Inc.

AT&T and ST are registered trademarks of American Telephone and Telegraph Company.

DEC, DECnet, VAX, and VT100 are trademarks of Digital Equipment Corporation.

Distinct is a registered trademark and Distinct TCP/IP is a trademark of Distinct Corporation.

Fastmac and MADGE are trademarks of Madge Networks, Ltd.

Hayes is a registered trademark of Hayes Microcomputer Products, Inc.

HP is a registered trademark of Hewlett-Packard Company.

Intel is a registered trademark of Intel Corporation.

IPX, NetWare, and Novell are registered trademarks of Novell, Inc.

MCI is a registered trademark of MCI Communications Corporation.

Microsoft, MS, and MS-DOS are registered trademarks and Windows is a trademark of Microsoft Corporation.

Motif and OSF/Motif are registered trademarks of Open Software Foundation, Inc.

Motorola is a registered trademark of Motorola, Inc.

NetBIOS is a trademark of Micro Computer Systems, Inc.

Open Look and UNIX are registered trademarks of UNIX System Laboratories, Inc.

Sun and Solaris are registered trademarks and SPARCstation is a trademark of Sun Microsystems, Inc.

VINES is a registered trademark of Banyan Systems Incorporated.

X Window System is a trademark of the Massachusetts Institute of Technology.

Xerox is a registered trademark and XNS is a trademark of Xerox Corporation.

All other trademarks and registered trademarks are the property of their respective owners.

Bay Networks Software License

This Software License shall govern the licensing of all software provided to licensee by Bay Networks ("Software"). Bay Networks will provide licensee with Software in machine-readable form and related documentation ("Documentation"). The Software provided under this license is proprietary to Bay Networks and to third parties from whom Bay Networks has acquired license rights. Bay Networks will not grant any Software license whatsoever, either explicitly or implicitly, except by acceptance of an order for either Software or for a Bay Networks product ("Equipment") that is packaged with Software. Each such license is subject to the following restrictions:

1. Upon delivery of the Software, Bay Networks grants to licensee a personal, nontransferable, nonexclusive license to use the Software with the Equipment with which or for which it was originally acquired, including use at any of licensee's facilities to which the Equipment may be transferred, for the useful life of the Equipment unless earlier terminated by default or cancellation. Use of the Software shall be limited to such Equipment and to such facility. Software which is licensed for use on hardware not offered by Bay Networks is not subject to restricted use on any Equipment, however, unless otherwise specified on the Documentation, each licensed copy of such Software may only be installed on one hardware item at any time.
2. Licensee may use the Software with backup Equipment only if the Equipment with which or for which it was acquired is inoperative.
3. Licensee may make a single copy of the Software (but not firmware) for safekeeping (archives) or backup purposes.
4. Licensee may modify Software (but not firmware), or combine it with other software, subject to the provision that those portions of the resulting software which incorporate Software are subject to the restrictions of this license. Licensee shall not make the resulting software available for use by any third party.
5. Neither title nor ownership to Software passes to licensee.
6. Licensee shall not provide, or otherwise make available, any Software, in whole or in part, in any form, to any third party. Third parties do not include consultants, subcontractors, or agents of licensee who have licensee's permission to use the Software at licensee's facility, and who have agreed in writing to use the Software only in accordance with the restrictions of this license.

-
7. Third-party owners from whom Bay Networks has acquired license rights to software that is incorporated into Bay Networks products shall have the right to enforce the provisions of this license against licensee.
 8. Licensee shall not remove or obscure any copyright, patent, trademark, trade secret, or similar intellectual property or restricted rights notice within or affixed to any Software and shall reproduce and affix such notice on any backup copy of Software or copies of software resulting from modification or combination performed by licensee as permitted by this license.
 9. Licensee shall not reverse assemble, reverse compile, or in any way reverse engineer the Software. [Note: For licensees in the European Community, the Software Directive dated 14 May 1991 (as may be amended from time to time) shall apply for interoperability purposes. Licensee must notify Bay Networks in writing of any such intended examination of the Software and Bay Networks may provide review and assistance.]
 10. Notwithstanding any foregoing terms to the contrary, if licensee licenses the Bay Networks product "Site Manager," licensee may duplicate and install the Site Manager product as specified in the Documentation. This right is granted solely as necessary for use of Site Manager on hardware installed with licensee's network.
 11. This license will automatically terminate upon improper handling of Software, such as by disclosure, or Bay Networks may terminate this license by written notice to licensee if licensee fails to comply with any of the material provisions of this license and fails to cure such failure within thirty (30) days after the receipt of written notice from Bay Networks. Upon termination of this license, licensee shall discontinue all use of the Software and return the Software and Documentation, including all copies, to Bay Networks.
 12. Licensee's obligations under this license shall survive expiration or termination of this license.

Contents

Chapter 1

VINES Overview

VINES Networks	1-2
VINES Architecture	1-3
VINES Network Addressing	1-5
How the Router for VINES Services Works	1-8
VINES Data Link Protocols	1-8
VINES Routing Protocols	1-10
VINES Internet Protocol	1-11
VINES Nonsequenced Routing Update Protocol	1-13
VINES Sequenced Routing Update Protocol	1-16
VINES Nonsequenced Address Resolution Protocol	1-18
VINES Sequenced Address Resolution Protocol	1-19
VINES Internet Control Protocol	1-19
For More Information	1-20

Chapter 2

VINES Implementation Notes

Enabling VINES on a Synchronous Line	2-2
Using the Inverse Address Resolution Protocol for VINES Internet Address Resolution	2-2
Assigning a Network ID to Your Router	2-3
Configuring Routers for Serverless Network Segments	2-3
VINES Security Limitation for Serverless Network Segments	2-3
Configuring Routers for Multiple Hop Topologies	2-4
Configuring Routers to Source Route over Token Ring Networks	2-5
Making the Transition from Bridging VINES to Routing VINES	2-7
Help Thy Neighbor Support	2-9
Using Multipath with Load Sharing	2-9
Partially Meshed Frame Relay Network Support	2-10

Chapter 3

Editing VINES Parameters

Accessing VINES Parameters	3-2
Editing VINES Global Parameters	3-3
VINES Global Parameter Descriptions	3-4
Editing VINES Interface Parameters	3-9
VINES Interfaces Parameter Descriptions	3-10
Deleting VINES from the Router	3-18

Index

Figures

Figure 1-1.	VINES Server and Its Clients	1-2
Figure 1-2.	VINES Network	1-6
Figure 1-3.	VINES Internet Address Format	1-7
Figure 1-4.	VINES Fragmentation Protocol Header	1-9
Figure 1-5.	VINES Internet Protocol Header	1-11
Figure 1-6.	VINES Nonsequenced Routing Update Protocol Header	1-13
Figure 1-7.	VINES Nonsequenced Address Resolution Protocol Header	1-18
Figure 1-8.	VINES Internet Control Protocol Header	1-19
Figure 2-1.	Routers Configured on a Serverless Network Segment	2-4
Figure 2-2.	Source Routing across a Token Ring Network	2-6
Figure 2-3.	Configuring Multiple Loops in a Bridged Environment	2-8
Figure 3-1.	Configuration Manager Window	3-2
Figure 3-2.	Edit VINES Global Parameters Window	3-3
Figure 3-3.	VINES Interfaces Window	3-9

Tables

Table 1-1.	VINES Protocol Stack	1-3
Table 1-2.	Assignment of Subnetwork Numbers	1-7
Table 1-3.	VINES Routing Tables	1-14
Table 3-1.	Broadcast Class Options	3-7



About This Guide

If you are responsible for configuring and managing Wellfleet® routers, you need to read this guide.

This guide describes how to customize Wellfleet router software for VINES® services.

Refer to this guide for

- An overview of the VINES routing protocol and a description of how the VINES services work (see the “VINES Overview” chapter)
- Implementation notes that may affect how you configure VINES routing services (see the “VINES Implementation Notes” chapter)
- Instructions on editing VINES global and interface parameters and configuring VINES services (see the “Editing VINES Parameters” chapter)

For information and instructions about the following topics, see *Configuring Wellfleet Routers*.

- Initially configuring and saving a VINES interface
- Retrieving a configuration file
- Rebooting the router with a configuration file

Before You Begin

Before using this guide, you must complete the following procedures:

- Create and save a configuration file that contains at least one VINES interface.
- Retrieve the configuration file in local, remote, or dynamic mode.

Refer to *Configuring Wellfleet Routers* for instructions.

How to Get Help

For additional information or advice, contact the Bay Networks Help Desk in your area:

United States	1-800-2LAN-WAN
Valbonne, France	(33) 92-966-968
Sydney, Australia	(61) 2-903-5800
Tokyo, Japan	(81) 3-328-0052

Conventions

arrow character (→)	Separates menu and option names in instructions. Example: Protocols→AppleTalk identifies the AppleTalk option in the Protocols menu.
<i>italic text</i>	Indicates variable values in command syntax descriptions, new terms, file and directory names, and book titles.
screen text	Indicates data that appears on the screen. Example: Set Trap Monitor Filters
quotation marks (“ ”)	Indicate the title of a chapter or section within a book.

vertical line (|)

Indicates that you enter only one of the parts of the command. The vertical line separates choices. Do not type the vertical line when entering the command.

Example: If the command syntax is

show at routes | nets, you enter either

show at routes or **show at nets**, but not both.

Acronyms

ARP	Address Resolution Protocol
HDLCL	high data link control
ICMP	Internet Control Message Protocol
ICP	Internet Control Protocol
IPC	Interprocess Communication
IEEE	Institute of Electrical and Electronic Engineers
IP	Internet Protocol
ISO	International Organization for Standardization
MAC	media access control
OSI	Open Systems Interconnection
RTP	Routing Update Protocol
SMDS	Switched Multimegabit Data Services
SNAP	Subnetwork Access Protocol
SPP	Sequenced Packet Protocol
TCP	Transmission Control Protocol
UDP	User Datagram Protocol
VINES	Virtual Networking System

Chapter 1

VINES Overview

This chapter contains an overview of Virtual Networking System (VINES). It contains information on the

- VINES network organization, network architecture, and addressing scheme
- Router software for VINES services, including the data link and routing protocols

VINES Networks

Banyan[®] Systems developed VINES software to provide support for networking personal computers. Based upon UNIX[®] System 5.3, VINES uses a distributed system environment that allows PC users to communicate and share hardware (for example, printers, disk space, and modems) and software resources (for example, files and applications) easily and transparently on a network.

To a PC user, VINES presents a complex, multivendor network as a single-vendor network. Resources from all servers on the network are available to individual PCs. System administrators control access to these resources.

A VINES network consists of servers, clients, and various communications hardware connected over LANs and WANs (Figure 1-1):

- *Servers* are computers that run VINES server software and provide connectivity and services, such as file and print services, to PC users. Banyan or one of several other vendors can manufacture the VINES server hardware.
- *Clients* are PCs that run VINES client software and use the services provided by servers.

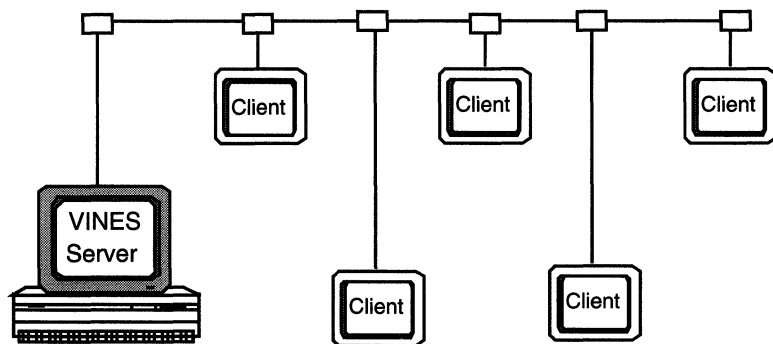

Figure 1-1. VINES Server and Its Clients

Datagrams called *VINES internet packets* route information within a VINES environment. Each VINES internet packet contains the source and destination address requirements that allow a router to route the packet between nodes on the network. Each VINES packet is a discrete unit of data that travels independently on the network layer.

VINES Architecture

The VINES architecture reflects the International Organization for Standardization (ISO) for Open System Interconnection (OSI). Banyan designed VINES to support both existing and future OSI model requirements. The VINES protocol stack has seven layers; the lower three layers deliver and route data, while the upper layers handle application-specific processes (Table 1-1).

Table 1-1. VINES Protocol Stack

Layer	Protocol or Application
Application	VINES services, VINES Tasker, UNIX, DOS, and StreetTalk
Presentation	VINES Matchmaker Data Type Representations
Session	VINES Matchmaker Remote Procedure Calls
Transport	VINES Interprocess Communication (IPC) Protocol VINES Sequenced Packet Protocol (SPP), Transmission Control Protocol (TCP), and User Datagram Protocol (UDP)
Network	VINES Internet Protocol (IP) VINES Internet Control Protocol (ICP) VINES Nonsequenced Address Resolution Protocol (ARP) VINES Sequenced ARP VINES Nonsequenced Routing Update Protocol (RTP) VINES Sequenced RTP X.25, X.3, X.29, and IP used by TCP, ICMP, and NetBIOS

continued on the next page

Table 1-1. VINES Protocol Stack *(continued)*

Layer	Protocol or Application
Data Link	VINES Fragmentation Protocol Drivers for Block Asynchronous, High Data Link Control (HDLC), Token Ring, Ethernet, other LANS, and Institute of Electrical and Electronic Engineers (IEEE) 802.x standards
Physical	Broadband, baseband, point-to-point, and twisted pair

At the data link level, VINES currently supports several IEEE standards, including Ethernet, Token Ring, and 802.x. VINES also provides its own proprietary data link protocol, VINES Fragmentation Protocol, which breaks up and reassembles packets that are too large to travel over certain media. However, only routers configured over synchronous lines support VINES Fragmentation Protocol.

At the networking level, VINES supports both industry standard protocols such as TCP/IP, X.25, and AppleTalk[®], and its own set of networking protocols. These include VINES

- Internet Protocol
- Nonsequenced Routing Update Protocol
- Sequenced Routing Update Protocol
- Nonsequenced Address Resolution Protocol
- Sequenced Address Resolution Protocol
- Internet Control Protocol

Upper layer protocols include VINES print and file service applications and the VINES naming protocol, StreetTalk.

StreetTalk is a distributed directory service that contains the names and attributes of all critical network resources. Each resource on a VINES network has a StreetTalk name that is globally unique.

StreetTalk names have the following format:

`item@group@organization`

where

- *item* identifies a user or resource on the network
- *group* identifies the group to which the item belongs
- *organization* identifies the organization to which the group belongs

VINES adapts to changes in the network topology; because the VINES network refers to each resource by name, you can move or replace it and the PCs can still locate it. System administrators control which resources end users on the network can access.

VINES Network Addressing

Each node grouping on a VINES network consists of a service node and the client nodes to which the service node provides address resolution and routing services (refer to Figure 1-2). Note that this is a logical grouping; client nodes may or may not map directly to the same physical media.

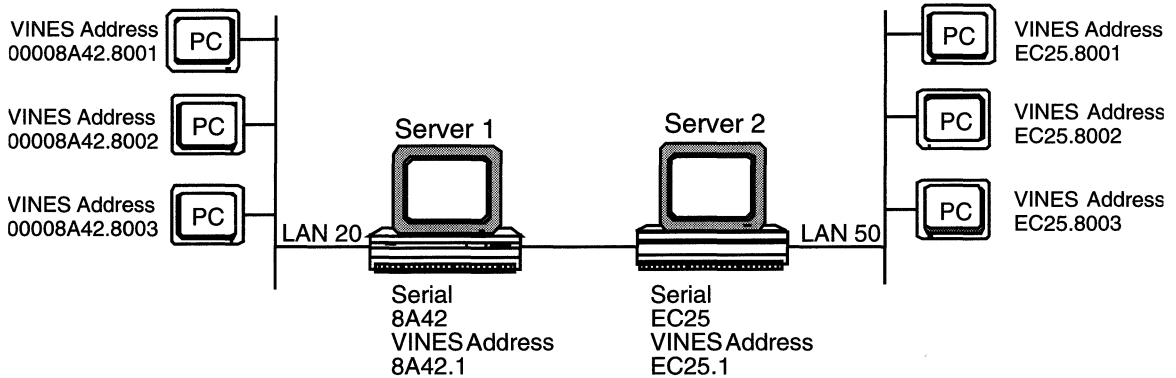

KEY:

LAN = LANAddress

Serial = Serial Number

VINESAddress = Network Number.Subnetwork Number

Figure 1-2. VINES Network

When a client node becomes active on the network, it broadcasts a query request to all servers. All reachable servers respond. The client node chooses the first server that responds and requests a VINES internet address from that server. The service node assigns a unique, 48-bit VINES internet address to the client node.

The VINES internet address is independent of any data-link-layer address assigned to a node on a physical medium. The 48-bit VINES internet addresses consist of two fields (refer to Figure 1-3):

- The 32-bit network number field

The network number is the serial number of the server node and identifies the logical grouping of nodes on a VINES network.

- The 16-bit subnetwork number field

The subnetwork number identifies the node within the server node's logical grouping.

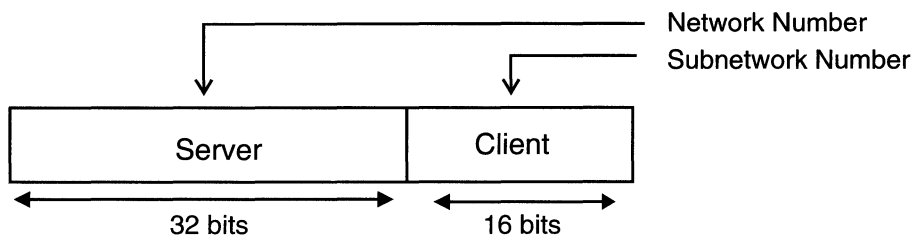

Figure 1-3. VINES Internet Address Format

The internet address for each service node in a VINES network is its network number, integrated with the subnetwork number 1. The service node assigns unique internet addresses to all other client nodes in its subnetwork by integrating its network number with a unique subnetwork number for each node. The service node assigns subnetwork numbers as shown in Table 1-2.

Table 1-2. Assignment of Subnetwork Numbers

Subnetwork number(s)	Node Type
1	Server only
2 to 0x7fff	Unused
0x8001 to 0xffffe	Clients only
ffff	Broadcast

How the Router for VINES Services Works

On a VINES network, the router maintains the network topology and uses both IEEE standard and VINES proprietary protocols to route packets through the network. The router supplies client nodes with addresses only if there are no other servers on the network.

The following sections describe the VINES data link and routing protocols that the router uses.

VINES Data Link Protocols

The VINES data link protocols support the exchange and broadcast of data frames between neighboring server and client nodes on the network. The maximum frame size is 1500 bytes.

In addition to supporting most of the IEEE standards, the VINES Fragmentation Protocol breaks up packets that are too large to travel over certain media into smaller-sized frames and reassembles them. However, the Fragmentation Protocol supports routers configured over synchronous lines only. For example, if a node on an IBM[®] PC LAN attempts to send a packet to a node on an Ethernet LAN over a synchronous network, the Fragmentation Protocol fragments the packet into smaller-sized frames. This enables the router to transport the packets over an Ethernet LAN.

The Fragmentation Protocol has a 2-byte header that stores information and follows the data link header in a VINES frame (refer to Figure 1-4).

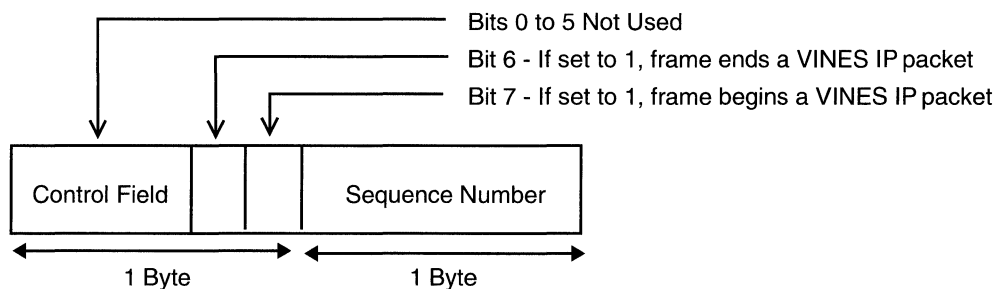

Figure 1-4. VINES Fragmentation Protocol Header

The first byte of the header contains a control field and the second byte contains a sequence number. The value of the control field indicates whether the frame begins or ends in a VINES IP packet. Only the first fragment includes the VINES IP header.

The value of the sequence number field is modulo 256. The node that originated the frame determines this value. The receiving node uses this value to determine the correct order in which to reassemble the data packet as it receives fragments. If the receiving node receives the fragments out of order, the intermediate node discards all fragments and the partially reassembled packet.

VINES Routing Protocols

The VINES network layer protocols route VINES data packets to destination nodes using the fastest route available. They also distribute the current network topology throughout the network. The VINES network layer supports connectionless (datagram) services only. The maximum packet length on a VINES network is 1500 bytes, including the VINES Internet Protocol header.

The following sections describe our implementation of the VINES networking protocols. These include VINES

- Internet Protocol
- Nonsequenced Routing Update Protocol
- Sequenced Routing Update Protocol
- Nonsequenced Address Resolution Protocol
- Sequenced Address Resolution Protocol
- Internet Control Protocol

VINES Internet Protocol

VINES Internet Protocol (IP) routes packets from the source node to the destination node. The IP packet header specifies the destination node's internet address. All internet packets begin with a VINES IP header that identifies the source and destination node addresses, and contains an identifier for the next protocol in the packet, a transport control byte, the length of the entire packet, and a software checksum, if needed. A header for another network layer protocol or transport layer protocol follows the VINES IP header (Figure 1-5).

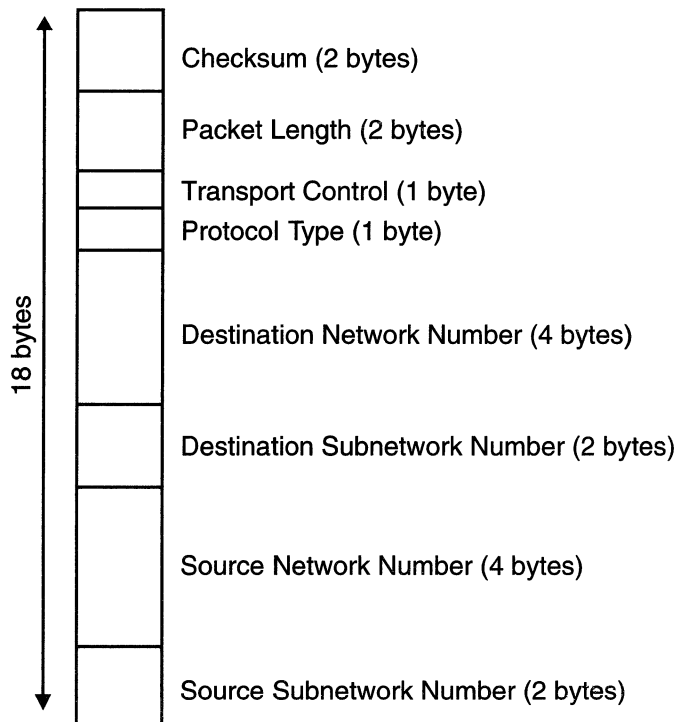

Figure 1-5. VINES Internet Protocol Header

When the router receives a packet, the VINES IP entity on the router handles the packet according to how it is addressed, as follows:

□ Packets destined for the router

When the router receives a packet addressed to itself, it first reassembles the packet, if it is fragmented. Next, the router ensures that the packet is not corrupted by checking the checksum, if there is one. Finally, it passes the packet up to the next level for processing.

□ Broadcast packets

When the router receives a broadcast packet, it checks the packet's hop count to ensure that it is not zero. In most cases, if the hop count is zero, the router discards the packet (unless it is a *StreetTalk* or *Time Sync Service* packet). If the node accepts the packet, the router decrements the hop count by one before retransmitting the packet on all interfaces except for the one that received it.

If the broadcast packet is a *StreetTalk broadcast packet*, which propagates *StreetTalk* information, or a *Time Sync Service broadcast packet*, which propagates time information, the router ignores the hop count. First, the router checks to see if the interface that provides the best path back to the originating node received the packet. If it did, the router retransmits the packet on all other interfaces (without modifying the hop count field). Otherwise, the router determines that the packet has looped back, and discards it.

The router recognizes a *StreetTalk* broadcast packet or a *Time Sync Service* broadcast packet by examining the destination port field of the packet's ICP header. The router sets the destination port field to 0x0000f for all *StreetTalk* packets and 0x0007 for all *Time Sync Service* packets.

- Nonbroadcast packets

When the router receives a nonbroadcast packet with a different destination address, the router must forward the packet. First, it reassembles the packet, if necessary. Then, it refers to its next hop routing table to determine the next hop. Finally, it forwards the packet to this hop.

VINES Nonsequenced Routing Update Protocol

The VINES Nonsequenced Routing Update Protocol (Nonsequenced RTP) maintains a local routing table that VINES IP can refer to when it selects paths. Nonsequenced RTP also distributes this information about the network topology among the servers and clients in the network. Nonsequenced RTP packets have a 4-byte header that immediately follows the VINES IP header (Figure 1-6).

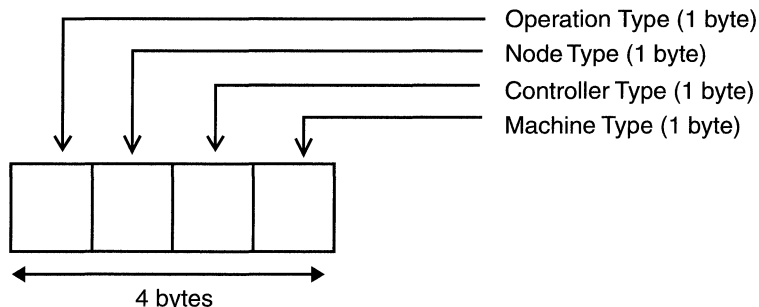

Figure 1-6. VINES Nonsequenced Routing Update Protocol Header

The four fields of the header are as follows:

- *Operation type* specifies the packet type: routing request, update, or redirect or response.
- *Node type* specifies the type of node that originated the packet: service or client.
- *Controller type* specifies the type of controller that originated the packet: single-buffer or multibuffer LAN card.

- *Machine type* specifies the type of processor that originated the packet.

Nonsequenced RTP distinguishes between service nodes and client nodes on the network. Service nodes route packets addressed to other nodes; they are usually servers. Client nodes do not perform any routing services. Both service nodes and client nodes maintain two routing tables: a *table of all known networks* and a *table of neighbors*. When you configure both Nonsequenced RTP and Sequenced RTP on the router, the protocols share these routing tables (Table 1-3).

Table 1-3. VINES Routing Tables

Table Entry	Contents
Table of Networks	Network number
	Network sequence number* This equals 0 for nonsequenced routes.
	Time stamped sequence number*
	Routing metric to reach the network
	Sequenced advertised metric*
	Next hop used to reach the network
Table of Neighbors	Network number
	Subnetwork number
	Sequence number* This equals 0 for nonsequenced neighbors.
	Medium over which the packet can reach the neighbor
	LAN address of neighbor
	Routing metric used to reach the neighbor
	Sequence advertised metric*

*Used for Sequenced RTP only.

For service nodes, the table of networks contains an entry for all known networks, except for the server's own. Client nodes keep track only of the networks with which they are currently communicating, thus reducing table space. For service nodes, the table of neighbors contains an entry for each neighboring node. Client nodes keep track only of the neighbors with which they are currently communicating.

The Nonsequenced RTP entities exchange these four types of packets:

□ Nonsequenced routing update packets

Every node on a VINES network periodically broadcasts nonsequenced routing update packets. Nodes on LAN and high-speed media send out nonsequenced routing update packets every 90 seconds. These packets inform neighbors of the node's existence and type. Routes remain in a neighbor's routing table for 6 minutes. If the neighbor does not hear from the node again within 6 minutes, the neighbor marks the route as unreachable and removes it from the routing table. The packets sent out by service nodes also include a list of all networks known to the service node and the cost of reaching these networks from that service node.

On server-to-server connectivity and over WAN connections (TCP/IP, X.25, HDLC, Block Asynchronous), service nodes send out five full nonsequenced routing update packets when the node first comes up on the network. Afterwards, nonsequenced routing update packets are generated only when you make routing changes to the network. All routes permanently remain in a node's routing table for these types of connections.

□ Nonsequenced routing request packets

A client node generates nonsequenced routing request packets when it needs information about the network topology.

□ Nonsequenced routing response packets

In response to receiving a nonsequenced routing request packet, service nodes generate nonsequenced routing response packets that describe the network topology.

- Nonsequenced routing redirect packets

A service node generates nonsequenced routing redirect packets when it determines that a better path exists for forwarding packets between nodes. The service node sends a nonsequenced routing redirect packet to the last hop that forwarded the packet, informing it of the existence of a better route. The service node also sends the original packet toward the destination.

VINES Sequenced Routing Update Protocol

VINES Sequenced Routing Update Protocol (Sequenced RTP) differs from Nonsequenced RTP in that routers identify routing information packets with sequence numbers. Each router on the network has a sequence number that it advertises to neighboring routers. The neighboring router uses the sequence numbers to determine if its routing table contains the most current and accurate routing information. Routers also use sequence numbers to time stamp changes in the network topology.

With Sequenced RTP, routers and servers in a network consisting of only VINES Version 5.50 devices do not perform periodic broadcasts of full routing tables; this reduces the network bandwidth usage. A router sends out routing table information only when

- A network topology change occurs
- Another router or client requests the information
- The network contains routers or servers configured for both Sequenced and Nonsequenced RTP

The router sends out the routing table information as sequenced routing update and sequenced routing response packets. (Refer to the Table 1-3 for details about the routing tables and their contents.) Depending on the amount of information and the type of physical media, a single update or response can consist of one or more sequenced packets. Sequenced routing update and response packets have a 32-bit sequence number ranging from 0x0 to 0xffffffff.

Each time a change occurs to a router's local network topology, the router verifies the sequence number, records the information in its routing table, and broadcasts a sequenced routing update packet to its immediate neighbors. The packet contains the router's own sequence number incremented by one. This new sequence number indicates that the router is transmitting new routing table information.

VINES Sequenced RTP has the following advantages:

- Reduces network bandwidth usage (when you set the RTP Mode parameter to Sequenced RTP or Automode)
- Allows the router to interoperate with Banyan servers or clients running VINES Version 4.11 or Version 5.50 software

You can configure your VINES interface to support Sequenced RTP only, Nonsequenced RTP only, or Automode (both Sequenced RTP and Nonsequenced RTP), using the RTP Mode parameter. (Refer to Chapter 3 for details about using Site Manager to access this parameter.) However, if you configure the interface for Sequenced RTP only, the network connected to all of the interfaces must have Banyan Version 5.50 servers or clients. Likewise, if you configure the interface for Nonsequenced RTP only, the network must have Banyan Version 4.11 servers or clients.

In a mixed network, that is, one running both Sequenced and Nonsequenced RTP and configured for Automode, the router sends out a nonsequenced routing update packet only when it receives a nonsequenced routing update packet from a server, router, or client. Otherwise, the router advertises sequenced routing update packets only.

VINES Nonsequenced Address Resolution Protocol

The VINES Nonsequenced Address Resolution Protocol (Nonsequenced ARP) allows service nodes to provide address resolution services to client nodes that do not have VINES internet addresses. VINES uses the VINES IP services to deliver address resolution packets between nodes.

A VINES Nonsequenced ARP packet is prefixed with an 8-byte header and follows the VINES IP header (Figure 1-7).

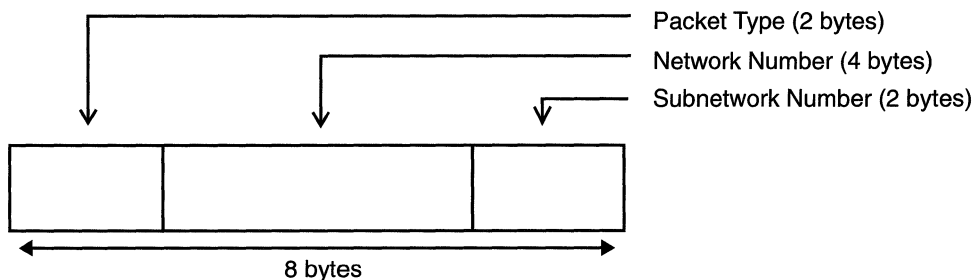

Figure 1-7. VINES Nonsequenced Address Resolution Protocol Header

VINES Nonsequenced ARP defines two types of entities:

❑ Address resolution services

Nodes that can route VINES packets and have a static, unique, 32-bit network number implement these services; they are usually service nodes.

❑ Address resolution clients

Nodes that do not have a VINES address implement these clients; they are usually client nodes.

VINES Sequenced Address Resolution Protocol

VINES Sequenced Address Resolution Protocol (Sequenced ARP) works with Sequenced RTP. With VINES Sequenced ARP, a client receives an assignment response that includes the VINES address, sequence number, and metric of the routing server. The routers that receive the VINES 5.50 client Sequenced ARP requests or assignment requests will respond automatically with Sequenced ARP response packets.

You can disable or enable VINES ARP on a router, using the ARP Enable parameter. Refer to Chapter 3 for details about this parameter.

VINES Internet Control Protocol

VINES Internet Control Protocol (ICP) supports certain transport layer protocol entities by reporting network errors and topological conditions. A VINES ICP packet has a 4-byte header and follows the VINES IP header (Figure 1-8).

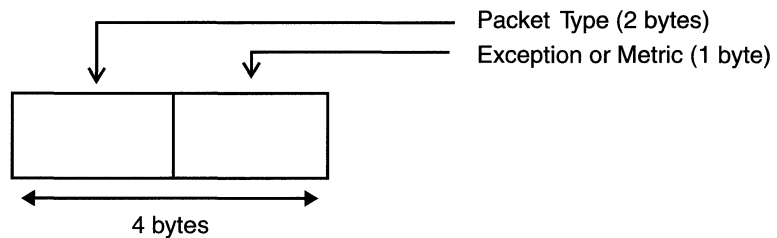

Figure 1-8. VINES Internet Control Protocol Header

The ICP entity generates these two types of ICP packets:

□ Exception notification packets

These packets specify that network layer exceptions occurred during the routing of transport layer messages. The ICP entity generates exception notification packets when

- VINES IP cannot properly route or receive a VINES IP packet. For example, a service node receives a packet containing an unknown destination address.
- The packet has the error subfield enabled in the VINES IP header's transport control field.

□ Metric notification packets

These packets contain metric information about the final transmission medium used to reach a client node. The ICP entity generates metric notification packets when

- The entity routes a packet with the metric subfield enabled in the transport control field of the VINES IP header.
- The destination address in the VINES IP header specifies a node that is a neighbor of the service node.

For More Information

The following documentation provides technical detail on VINES protocol implementation.

VINES Architecture Definition. Banyan Systems Inc. April 1993.

VINES Protocol Definition. Banyan Systems Inc. June 1993.

Chapter 2

VINES Implementation Notes

This chapter contains some basic guidelines for configuring VINES services on your router. It describes what you need to know if you want to

- ❑ Configure the router on a synchronous line
- ❑ Use the Inverse ARP feature for internet address resolution
- ❑ Assign a network ID to the router
- ❑ Configure the router on a serverless network segment or to source route over Token Ring networks
- ❑ Make the transition from bridging to routing VINES
- ❑ Use the multipath with load sharing feature

Enabling VINES on a Synchronous Line

If you want to route VINES packets over synchronous protocols, such as Standard Sync, Frame Relay, Point-to-Point, Switched Multimegabit Data Services (SMDS), or Asynchronous Transfer Mode (ATM), you must enable VINES support on a synchronous line. To do this, you must specify two synchronous line parameters:

- Clocking source (internal or external)
- Synchronous line speed

To configure these parameters:

1. Select the synchronous connector on which you enabled VINES support from the Configuration Manager window.
2. Click on the Edit Lines button. The Synchronous Line Parameters window appears.
3. Set the Clock Source parameter to External or Internal, as appropriate for your network.
4. Enter the line speed for the Clock Speed parameter.
5. Click on the Save button to save your changes and exit the window.

Using the Inverse Address Resolution Protocol for VINES Internet Address Resolution

You use VINES Inverse ARP to determine the VINES internet address of the neighbor router on the other end of a virtual circuit in a Frame Relay or ATM network. When a new virtual circuit comes up on the Frame Relay or ATM interface, the VINES software sends an Inverse ARP request with its VINES internet address to this data link connection. The router on the other end of the new data link connection responds with an Inverse ARP response, which includes the VINES internet address of its neighbor. When the original router receives the request, it learns the new neighbor's internet address.

Assigning a Network ID to Your Router

When you enable VINES on the router, we recommend that you accept the default network ID. The router uses its system controller's serial number to calculate the network ID. This guarantees that the number is unique.

However, if you choose to specify a different network ID, make sure the number you assign is unique within the VINES network. Refer to “Editing VINES Global Parameters” in Chapter 3 for details on enabling the network ID parameter.

Configuring Routers for Serverless Network Segments

If you enable VINES on a circuit that contains no VINES servers, then you must enable VINES ARP on the circuit so that the router can provide address resolution services to client nodes on this circuit.

You enable ARP using the ARP Enable parameter. Refer to “Editing VINES Interface Parameters” in Chapter 3 for details on enabling this parameter.

VINES Security Limitation for Serverless Network Segments

VINES login location restriction is a security feature that limits the client's login capability, using a specific LAN segment. This feature does not work on a serverless circuit.

A VINES server specifies a LAN segment, using the server name and slot number. The router has no server name, so it cannot name the segment. When the client attempts to log in to the router, the login fails.

Configuring Routers for Multiple Hop Topologies

If your VINES network topology has two or more hops between client nodes and the server that services the circuit, you must

- Set the circuit's ARP Enable parameter to Enable so that the VINES router can provide address resolution services to any client nodes.
- Set the Remote Client Privileges parameter to Enable on those circuits that connect the routers to the server. This allows the client nodes to communicate with the server, even though they are separated by more than one hop.

Note: When you enable the Remote Client Privileges parameter, you automatically enable the Serverless Networks for WANs parameter. Banyan does not recommend using serverless networks on a WAN because the high cost increases delays and may terminate sessions. We, however, do support this configuration.

Figure 2-1 shows a sample VINES network in which the VINES server is separated from the client nodes by two routers.

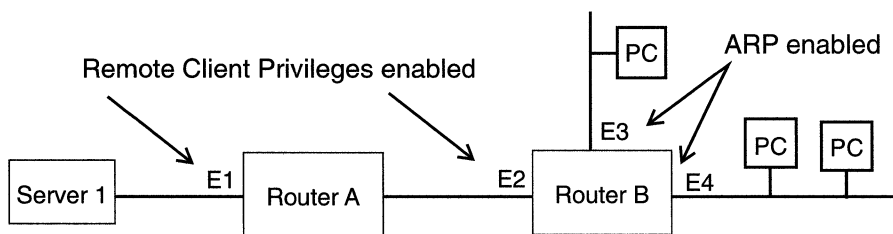

Figure 2-1. Routers Configured on a Serverless Network Segment

For the server and client nodes to communicate, we configured the routers in this way:

- ❑ Enabled VINES on circuits E1, E2, E3, E4
- ❑ Set the ARP Enable parameter to Enable on circuits E3 and E4 so that Router B can provide address resolution services to the client nodes on these circuits
- ❑ Set the Remote Client Privileges parameter to Enable on circuits E1 and E2, so that the client nodes on circuits E3 and E4 can reach the server via Routers A and B

As a result, the server and client nodes on this network can communicate, even though they are separated by more than one hop.

Configuring Routers to Source Route over Token Ring Networks

The router configured for VINES services can route over Token Ring networks that contain one or more source routing bridges. In a source routing network, every end station that sends out a frame supplies the frame with the necessary route descriptors so that it can be source routed across the network. Thus, for VINES routers to route packets across a source routing network, they must act like end stations. That is, they must supply route descriptors for each packet before they send it out onto the network.

With end node support enabled, whenever a router running VINES receives a packet and determines that the packet's next hop is located across a source routing network, the router does the following:

- ❑ Adds the necessary RIF information to the packet's MAC header
- ❑ Sends the packet out onto the network where it is source routed toward the next hop

Upon receiving the packet from the Token Ring network, the peer router strips off the RIF field and continues to route the packet toward the destination network address (Figure 2-2).

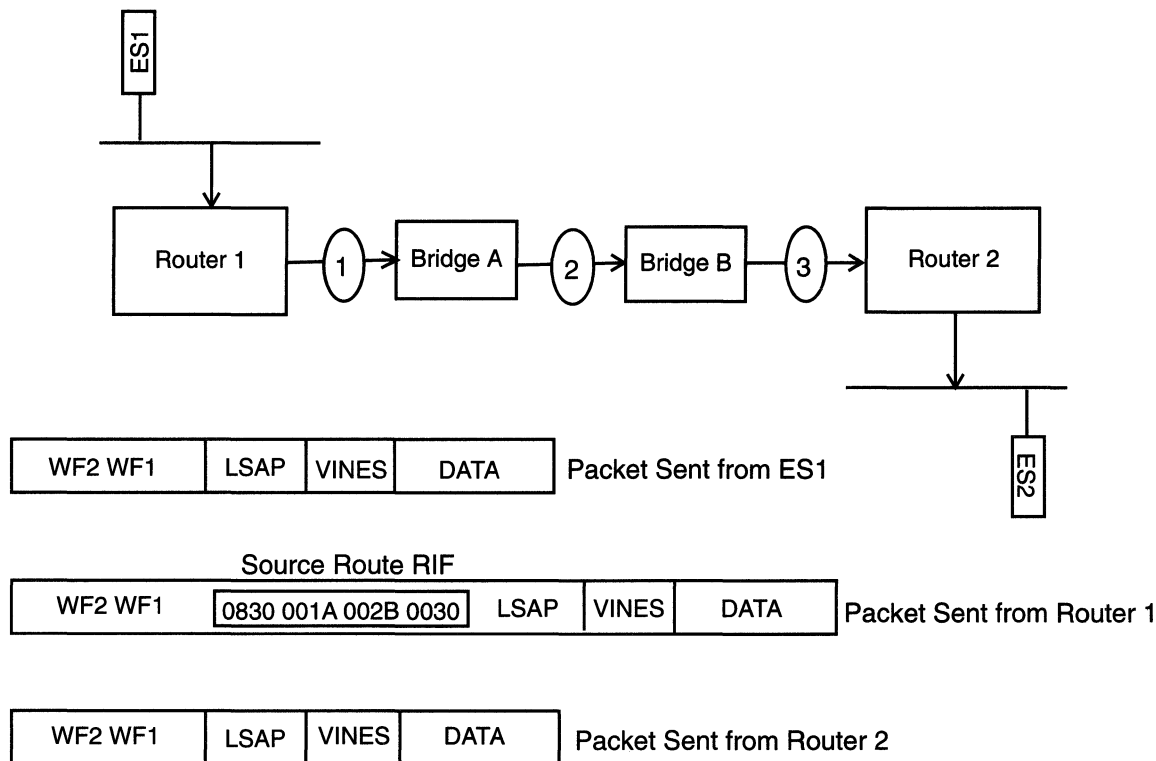

Figure 2-2. Source Routing across a Token Ring Network

You configure source route end node support on a per-circuit basis by setting the End Station Enable parameter to Enable. Refer to “Editing VINES Interface Parameters” in Chapter 3 for details on enabling this parameter.

Making the Transition from Bridging VINES to Routing VINES

If you want to move from bridging VINES to routing VINES over WANs, you need to configure VINES and temporarily disable the Fragmentation Protocol (FRP) header on each VINES WAN interface connected to a bridge.

Note: You may also need to disable the FRP header so that your router can interoperate with other routers that do not support the Fragmentation Protocol.

You use the Use of FRP Header parameter to disable the FRP header; the default value of this parameter is Enable. (Refer to Chapter 3 for details on using Site Manager to access the Use of FRP Header parameter.)

For example, Figure 2-3 shows multiple loops in a bridged environment.

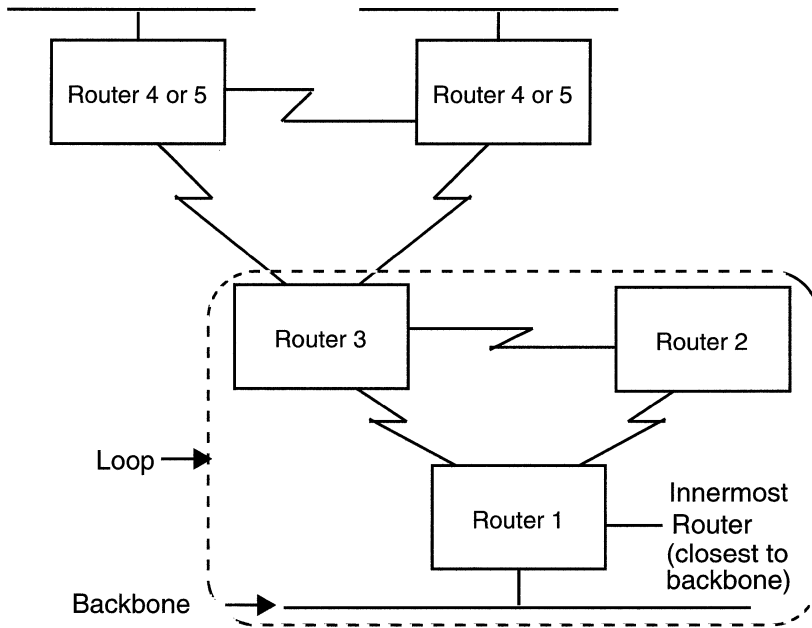

Figure 2-3. Configuring Multiple Loops in a Bridged Environment

You must make the transition to VINES routing from the innermost loop first, and then move outward. To do this:

1. Use Site Manager to select the router in the loop that is connected to the backbone.
2. Configure VINES on the interfaces you want. (Refer to *Configuring Wellfleet Routers* for details on configuring the interfaces.)
3. Select Protocols→Vines→Interfaces from the Configuration Manager window. The Edit Vines Interface window appears.
4. Disable the Use of FRP Header parameter on all VINES WAN interfaces that are connected to routers that are bridging only. If there is a router in the loop that is not connected to another loop, select that router next. Then repeat Steps 2 to 4.

A router connected to another loop should be the last router you configure in that loop (Router 3 in Figure 2-3). The numbers shown in the routers in Figure 2-3 indicate the order in which you should configure the routers. Note that with Router 4 or 5, it does not matter which one you configure first because neither one connects to another loop.

5. Enable the Use of FR Header parameter on all the WAN interfaces after you configure all routers in the loops, and they are routing with VINES enabled.

Help Thy Neighbor Support

VINES services for the router supports the Help Thy Neighbor feature. If a neighbor advertises that a network is unreachable, and the router has an alternative connection to that network, the router issues a “changes only” routing update. This advertises the connection to the neighbor and in the next scheduled update.

For details about the Help Thy Neighbor feature, refer to *VINES Protocol Definition*, listed in the “For More Information” section in Chapter 1.

Using Multipath with Load Sharing

A router on a VINES network does not record multiple nonequal-cost paths to the same destination. However, when one path fails, the router quickly learns these other paths and uses one as an alternate path.

When there are multiple equal-cost paths to a destination network on a VINES network, the router records all of the paths in the VINES routing table. For data transfer to this destination, the router accesses the multiple paths in a round-robin fashion to achieve load sharing.

Partially Meshed Frame Relay Network Support

Some Frame Relay networks may not be fully meshed. That is, there may not be nodes that have virtual circuits to all other nodes in the network. For a router running VINES to successfully route VINES Security, Net Time, File Service, and StreetTalk packets over Frame Relay configurations that are not fully meshed, the router may have to send frames back over the same interface from which they came.

Banyan developed Split Horizon so that a router running VINES does not advertise routes to an interface where it learned these routes. However, Split Horizon alone is not sufficient to work on Frame Relay configurations that are not fully meshed. Therefore, you must disable the Split Horizon for STALK Enable parameter. (Refer to Chapter 3 for details about disabling this parameter.)

For example, if you configure a router in group mode for Frame Relay, Frame Relay treats a group mode circuit like one circuit, even though there are physically two links. If you leave the Split Horizon for STALK parameter set to its default, Enable, the router does not send the VINES packets out through the interfaces from which they originally came. For VINES to operate successfully, you must configure the router with the Split Horizon for STALK Enable parameter disabled for VINES.

Chapter 3

Editing VINES Parameters

Once you enable a VINES interface, you can use Site Manager to edit VINES parameters and customize VINES services. This chapter describes how to use Site Manager to

- Edit VINES global and interface parameters.
- Delete VINES globally from the router.

Note: The instructions in this chapter assume that you have already configured at least one VINES interface on the router. If you have not yet configured a VINES interface, or want to add additional VINES interfaces, refer to *Configuring Wellfleet Routers* for instructions.

For details on configuring VINES filters, refer to *Configuring Filter Options for Wellfleet Routers*.

Editing VINES Global Parameters

To edit VINES global parameters:

1. Select the Protocols→Vines→Edit Vines Global option from the Configuration Manager window (refer to Figure 3-1). The VINES Global Parameters window appears (Figure 3-2).

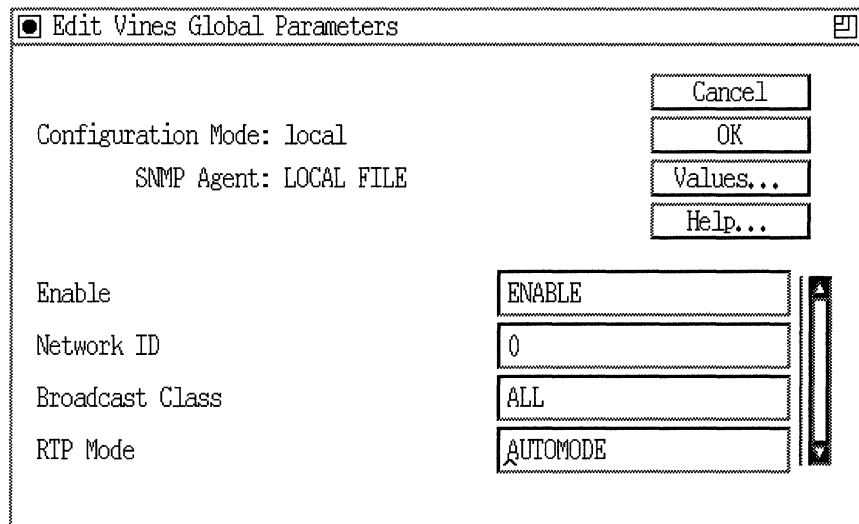

Figure 3-2. Edit VINES Global Parameters Window

2. Edit the parameters, using the descriptions in the next section as a guide.
3. Click on the OK button to save your changes and exit the window. Site Manager returns you to the Configuration Manager window.

VINES Global Parameter Descriptions

Use these parameter descriptions as a guide when you configure the parameters on the VINES Global Parameters window (refer to Figure 3-2).

Parameter:	Enable
Default:	Enable
Options:	Enable Disable
Function:	Enables or disables the VINES router on the entire router.
Instructions:	Set to Disable if you want to disable VINES. Otherwise, accept the default, Enable.
MIB Object ID:	1.3.6.1.4.1.18.3.5.8.1.2

Parameter: Network ID

Default: Variable

Options: 1 to 2097151

Function: Specifies the router's network ID (network number). The network ID is the 32-bit high-order portion of the node's internet address.

Instructions: We strongly recommend that you accept the default value that the router assigns. However, if you assign a different network ID, note the following:

- All internet addresses assigned to client nodes in this router's network will begin with the Network ID you specify here.
- The VINES router will modify the number you enter here so that the first 11 bits reflects the range of Bay Networks assigned numbers. (For example, if you enter 1 as the network ID, the router will precede this number with 0x304.)

MIB Object ID: 1.3.6.1.4.1.18.3.5.8.1.4

Parameter:	Broadcast Class
Default:	All
Options:	All No Charge Low Cost LANs Server All Server No Charge Server Low Cost Server LANs
Function:	<p>Specifies which nodes residing on the router's interfaces should receive broadcast packets generated by this router. This parameter allows you to control the number of extraneous broadcast packets that nodes receive.</p> <p>For example, the default class, All, specifies that all nodes residing on the router's interfaces should receive broadcast packets. In contrast, the class Low specifies that only those nodes on interfaces to which a low cost is associated should receive broadcast packets. Refer to Table 3-1 for a list of the broadcast classes and their meanings.</p>
Instructions:	We recommend accepting the default All. Each broadcast class setting is shown in Table 3-1.
MIB Object ID:	1.3.6.1.4.1.18.3.5.8.1.6

Table 3-1. Broadcast Class Options

Broadcast Class	Nodes to Receive Packets
All	All reachable nodes on any interface
No Charge	All reachable nodes except those on media that impose a packet charge
Low Cost	All reachable nodes residing on low-cost media (4800 bits per second serial lines, or faster)
LANs	All reachable nodes on high-speed media (LANs)
Server All	All reachable service nodes, regardless of media cost
Server No Charge	All reachable service nodes except those residing on media that impose a packet charge
Server Low Cost	All reachable service nodes residing on low-cost media (4800 bits per second serial lines, or faster)
Server LANs	All reachable service nodes on high-speed media (LANs)

Parameter: RTP Mode

Default: Automode

Options: Automode | Nonsequenced | Sequenced

Function: Specifies whether this router supports Sequenced RTP only (Sequenced), Nonsequenced RTP only (Nonsequenced), or both Sequenced and Nonsequenced RTP (Automode).

Instructions: Select Sequenced if you want your router to support Sequenced RTP only, or Nonsequenced if you want your router to support Nonsequenced RTP only. Otherwise, accept the default, Automode, to support both Sequenced and Nonsequenced RTP.

MIB Object ID: 1.3.6.1.4.1.18.3.5.8.1.9

Note: When you change the RTP mode of your router, you must isolate the router to allow other routers to age it. Wait at least 6 minutes before you bring the router back onto the network. (Refer to the “VINES Sequenced Routing Update Protocol” section in Chapter 1 for details about the RTP mode.)

Editing VINES Interface Parameters

To edit a VINES interface:

1. Select Protocols→Vines→Interfaces from the Configuration Manager window (refer to Figure 3-1). The Edit VINES Interface Window appears (Figure 3-3).

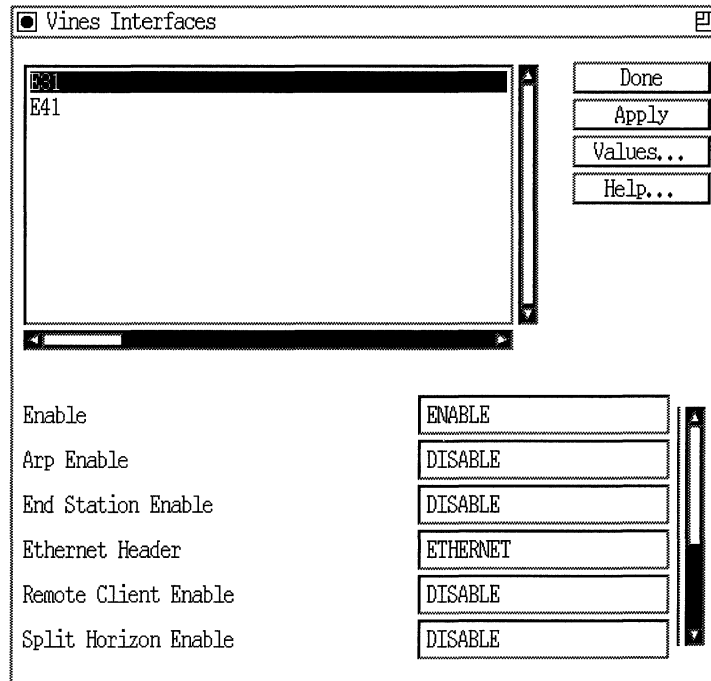

Figure 3-3. VINES Interfaces Window

2. Edit the parameters, using the descriptions in the next section as a guide.
3. Click on the Apply button to save your changes when you are done.
4. Click on the Done button to exit the window. Site Manager returns you to the Configuration Manager window.

Note: When you reconfigure an interface in dynamic mode, VINES restarts on that interface.

VINES Interfaces Parameter Descriptions

Use these parameter descriptions as a guide to configure the parameters on the VINES Interfaces Window (refer to Figure 3-3).

Parameter: **Enable**
Default: Enable
Options: Enable | Disable
Function: Enables or disables VINES over this interface.
Instructions: Disable only if you want VINES disabled over this interface. Otherwise, accept the default, Enable.
MIB Object ID: 1.3.6.1.4.1.18.3.5.8.8.1.2

Parameter: **ARP Enable**
Default: Disable
Options: Enable | Disable
Function: Specifies whether this interface supports VINES ARP. With ARP enabled, the router can provide address resolution services to client nodes on this interface that have not yet been assigned addresses.
Instructions: Enable ARP only if there are no server nodes on this circuit.
MIB Object ID: 1.3.6.1.4.1.18.3.5.8.8.1.12

Parameter: End Station Enable

Default: Disable

Options: Enable | Disable

Function: Specifies whether this interface supports source routing end stations.

Instructions: Select Enable if this is a Token Ring interface and if source routing is enabled on the VINES servers and clients in this ring.

MIB Object ID: 1.3.6.1.4.1.18.3.5.8.8.1.13

Parameter: Ethernet Header

Default: Ethernet

Options: Ethernet | SNAP

Function: Specifies the type of encapsulation that this interface supports at the data link level. If this circuit is not an Ethernet circuit, this parameter is ignored.

Instructions: Accept the default, Ethernet. (Future Banyan VINES releases will support SNAP.)

MIB Object ID: 1.3.6.1.4.1.18.3.5.8.8.1.19

Parameter: Remote Client Enable

Default: Disable

Options: Enable | Disable

Function: When you enable this parameter, client nodes can communicate with server nodes that are multiple hops away by turning off the hop count decrementor. Also enables serverless WANs.

Instructions: Enable only if this router also connects to a serverless network segment, and this is the inbound circuit toward the server. Refer to the section “Configuring Routers for Serverless Network Segments” in Chapter 2 for more information.

MIB Object ID: 1.3.6.1.4.1.18.3.5.8.8.1.37

Note: Banyan does not recommend using serverless networks on a WAN because the high cost increases delays and may terminate sessions. We, however, do support such a configuration.

Parameter: Split Horizon Enable

Default: Disable

Options: Enable | Disable

Function: When you enable this parameter, the routes received through an interface are not included in the routing update packets sent out that interface. This parameter is used for debugging purposes only.

Instructions: Accept the default, Disable.

MIB Object ID: 1.3.6.1.4.1.18.3.5.8.8.1.38

Parameter: Interface Cost

Default: 0

Options: 0 to 65535

Function: Overrides the default Banyan specified cost.

Instructions: To change the default interface cost, you must use the Configured Interface Cost parameter in the VINES Interfaces window.

MIB Object ID: 1.3.6.1.4.1.18.3.5.8.8.1.39

Parameter: SMDS Broadcast

Default: None

Options: A multicast address

Function: Provides a broadcast address for this VINES interface in a SMDS network. If you enter a value for this parameter, then the SMDS switch, rather than the router, will broadcast the message.

Instructions: Enter the multicast address for all VINES routers provided by the SMDS subscription agreement.

MIB Object ID: 1.3.6.1.4.1.18.3.5.8.8.1.45

Parameter: Frame Relay Broadcast

Default: None

Options: Any decimal number

Function: Provides a broadcast address for this VINES interface in a Frame Relay network. If you enter a value for this parameter, then the Frame Relay switch, rather than the router, will broadcast the message.

Instructions: Enter the broadcast address provided by the Frame Relay subscription agreement.

MIB Object ID: 1.3.6.1.4.1.18.3.5.8.8.1.46

Parameter: Configured MAC Address

Default: None

Options: 0 | a user-specified MAC address | if the interface is on an SMDS circuit, the same complete SMDS E.164 address you entered in the Individual Address parameter box in the SMDS Configuration Window

Function: Specifies a MAC (media access control) address for this VINES interface. The router uses its VINES address and this MAC address when transmitting and receiving packets on this interface.

Instructions: Select 0 to configure the router to use its VINES address and the circuit's MAC address when transmitting packets on this interface.

Enter your own MAC address to configure the router to use its VINES address and the specified MAC address when transmitting packets on this interface.

MIB Object ID: 1.3.6.1.4.1.18.3.5.8.8.1.47

Parameter: Configured Interface Cost

Default: 0

Options: 0 to 65535

Function: Overrides the default Banyan specified cost.

Instructions: Select 0 to use the default Banyan specified cost. Otherwise, enter a new cost. For example, enter 3 to override the default Banyan cost and set the cost to 3.

MIB Object ID: 1.3.6.1.4.1.18.3.5.8.8.1.49

Parameter: Use of FRP Header

Default: Enable

Options: Enable | Disable

Function: Specifies whether this interface supports a Fragmentation Protocol (FRP) header.

Instructions: Disable only if you want the FRP header disabled over this interface. If you want to move from bridging VINES to routing VINES, you must temporarily disable this parameter. Or, you may want to disable this parameter so that your router can interoperate with other routers that do not support the Fragmentation Protocol.

MIB Object ID: 1.3.6.1.4.1.18.3.5.8.8.1.51

Parameter: Inverse ARP Enable

Default: Enable

Options: Enable | Disable

Function: Specifies whether this interface supports Inverse ARP.

Instructions: When you enable this parameter, VINES learns the data link connection identifier numbers for a neighbor in a Frame Relay or ATM network. (Refer to Chapter 2 for details on using Inverse ARP for VINES Internet address resolution.)

MIB Object ID: 1.3.6.1.4.1.18.3.5.8.8.1.62

Parameter: Split Horizon for STALK Enable

Default: Enable

Options: Enable | Disable

Function: Specifies whether this interface supports Split Horizon for routing StreetTalk (STALK) packets.

Instructions: When you disable this parameter, the VINES router supports Frame Relay configurations that are not fully meshed for routing VINES Security, Net Time, File Service, and StreetTalk packets.

Accept the default, Enable, if you want to enable Split Horizon.

MIB Object ID: 1.3.6.1.4.1.18.3.5.8.8.1.63

Parameter: Use Perm. Nonsequenced Neighbors

Default: Disable

Options: Enable | Disable

Function: When the RTP mode is set to Automode or Sequenced, this parameter specifies whether the VINES interface treats its nonsequenced neighbors as static or permanent entries in the VINES routing table.

Instructions: Enable only if the RTP mode is set to Automode or Sequenced and you want to prevent the router from timing out nonsequenced neighbors. Sequenced routers age out their nonsequenced neighbors that reside on a WAN every hour. This causes the router to broadcast full RTP updates, which consumes bandwidth.

MIB Object ID: 1.3.6.1.4.1.18.3.5.8.8.1.65

Deleting VINES from the Router

To delete VINES from all router circuits on which it is currently configured:

1. Select **Protocols**→**Vines**→**Delete Vines from the Configuration Manager window** (refer to Figure 3-1). A window appears that prompts:

Do you REALLY want to delete Vines?
2. Click on the OK button. Site Manager returns you to the Configuration Manager window. VINES is no longer configured on the router.

If you look at the Configuration Manager window, you will see that the connectors for circuits on which VINES was the only protocol enabled are no longer highlighted. You must reconfigure the circuits for these connectors. (Refer to the *Configuring Wellfleet Routers* guide for details on configuring the circuits.)

Index

A

Addressing. *See* VINES
ARP Enable interface parameter, 3-10

B

Banyan VINES. *See* VINES
Broadcast Class global parameter, 3-6

C

Clients. *See* VINES
Configured Interface Cost interface parameter, 3-15
Configured MAC Address interface parameter, 3-15
Connectionless services, 1-10

D

Data link layer protocols. *See* VINES

E

Enable global parameter, 3-4
Enable interface parameter, 3-10
End Station Enable interface parameter, 3-11
Ethernet Header interface parameter, 3-11

F

Fragmentation Protocol, 1-8
Frame Relay Broadcast interface parameter, 3-14

H

Help Thy Neighbor support, 2-9

I

IEEE support, 1-4, 1-8
Interface Cost interface parameter, 3-13
Internet Control Protocol (ICP), 1-4, 1-19
Internet Protocol (IP), 1-4, 1-11 to 1-13
 VINES IP header, 1-11, 1-13, 1-19
Inverse Address Resolution Protocol (Inverse ARP), 2-2
Inverse ARP Enable interface parameter, 3-16

M

MAC address, specifying for VINES interface, 3-15

N

- Network ID global parameter, 3-5
- Network ID, assigning to router, 2-3
- Network organization. *See* VINES
- Nonsequenced Address Resolution Protocol (Nonsequenced ARP), 1-4, 1-18
 - address resolution
 - clients, 1-18
 - services, 1-18
- Nonsequenced Routing Update Protocol (Nonsequenced RTP), 1-4, 1-13 to 1-16

O

- OSI, support of, 1-3

P

- Packet
 - broadcast, 1-12
 - destined for the router, 1-12
 - exception notification, 1-20
 - maximum length for VINES, 1-10
 - metric notification, 1-20
 - nonbroadcast, 1-13
 - nonsequenced routing redirect, 1-16
 - nonsequenced routing request, 1-15
 - nonsequenced routing response, 1-15
 - nonsequenced routing update, 1-15
 - TimeSync Service broadcast, 1-12
 - VINES internet, 1-3
- Parameters
 - accessing from Site Manager, 3-2
 - descriptions for. *See* the individual index entries
 - global, 3-4 to 3-8
 - editing the, 3-3 to 3-8
 - interface, 3-10 to 3-17

- editing the, 3-9 to 3-17

Protocol stack. *See* VINES

R

- Remote Client Enable interface parameter, 3-12
- Router
 - assigning network ID to, 2-3
 - configuring
 - for multiple hop topologies, 2-4
 - for serverless segments, 2-3
 - to source route over token ring, 2-5
 - deleting VINES from a, 3-18
- RTP Mode global parameter, 3-8

S

- Sequenced Address Resolution Protocol (Sequenced ARP), 1-4, 1-19
- Sequenced Routing Update Protocol (Sequenced RTP), 1-4, 1-16 to 1-17
- Serverless segment
 - configuring router for a, 2-3
 - VINES login location restriction for a, 2-3
- Servers. *See* VINES
- SMDS Broadcast interface parameter, 3-14
- Split Horizon Enable interface parameter, 3-13
- Split Horizon for STALK Enable interface parameter, 2-10, 3-17
- StreetTalk. *See* VINES
- Synchronous line, enabling VINES on, 2-2

T

Table of all known networks. *See* VINES

Table of neighbors. *See* VINES

TimeSync Service broadcast packet. *See*
Packet

U

Use of FRP Header interface parameter,
3-16

Use of Perm. Non-Sequenced Neighbors
interface parameter, 3-17

V

VINES

- addressing
 - network number, 1-6
 - overview of, 1-5
 - subnetwork number, 1-6
- architecture of, 1-3
- clients, 1-2
- deleting from the router, 3-18
- enabling on a synchronous line, 2-2
- enabling on an interface, 3-4
- Fragmentation Protocol, 1-4
- Frame Relay network support, 2-10
- Help Thy Neighbor feature, 2-9
- implementation notes for, 2-1 to 2-9
- login location restriction for, 2-3
- making the transition from bridging to
 - routing, 2-7 to 2-9
- multiple paths, 2-9
- naming protocol, StreetTalk, 1-4
- network organization, 1-2
- networking protocols, 1-4
- overview of, 1-1 to 1-20
- protocol stack, 1-3
- protocols

- address resolution, 1-4
- data link layer, 1-8 to 1-9
- routing tables
 - table of all known networks, 1-14
 - table of neighbors, 1-14
- servers, 1-2
- Split Horizon, 2-10
- StreetTalk, 2-10

VINES internet packet, 1-3

Virtual Networking System. *See* VINES

