

Vortex86EX

Fact Sheet

32-BIT x86 MICRO PROCESSOR

Revision History

Rev.	Date	History
REV 1.0	2012/10/08	1. Init Draft version.
REV 1.1	2012/12/12	<ol style="list-style-type: none"> 1. Add HW JTAG register1 bit27-29, Flash FFFBCh bit3-5, NB 64h bit27-29 description. 2. Boot mode update. 3. PCIE target register update. 4. Add Ball Map in 4.1 and PIN Out Table in 4.2 5. Update pin list, signal description. 6. Add Flash FFFBCh bit3-5, NB 64h bit27-29 description. 7. Boot mode update. 8. Add PCI-E target. 9. Add Functions Block Diagram in 3.2 and move System Block Diagram from 3.2 to 3.1
REV 1.2	2013/04/30	<ol style="list-style-type: none"> 1. Modify the acronym of Secondary ATA Timing Register in 13.5.27. 2. Modify the description of Pin TXN, TXP, RXN and RXP in 4.4 Signal Description. 3. Remove "3.3V power supply" from Features in 14.2 Fast Ethernet control unit. 4. Modify the value of UART Baud Rate to "57600" in TABLE Baud Rates, Divisors and 1.8432MHzCrystals in 11.3.12. Serial Port Register Definition. 5. Add the DDR Timing information in 22.2 DDRIII Interface. 6. Modify the Description of 05h – 04h PMDC, MSAC, IOSAC in 14.4. 7. Modify the "External 10/100M PHY" to "RJ45 LAN Port" in 3.2 Functions Block Diagram.
REV 1.3	2013/05/25	<ol style="list-style-type: none"> 1. Modify the minimum of RTC_VDD33 from 2.0 to 2.45 in 21.3 Recommended DC Operating Conditions. 2. Add the reference information about VPF in 10.7.2 Power-Down/Power-Up Considerations. 3. Modify the ball name of H1 and H2 in Chap. 4. PIN Function List. 4. Remove the 08h-0Dh of SPI Control Registers from 7.3.14 SPI Control Registers. 5. Modify the reset value of Interrupt Pin from 03h to 02h in 21.3.2. Full-Duplex SPI Configuration Space Register.

Vortex86EX

32-Bit x86 Micro Processor

		<ol style="list-style-type: none"> 6. Add Pin Pull-up / Pull-down Description in 4.6. 7. Add the information in 4.5 PIN Capacitance Description. 8. Modify the capacity of SATA from 1.5G to 3.0G, add “up to the fast speed” in I2C bus and correct I/O Voltage $1.8 \pm 10\%$ to $1.8V \pm 5\%$ in chap.2. Features. 9. Modify bit 7& bit 5 of SD Control Register to Reserved. 10. Add Control Register 4 in 7.1.5. Control Registers. 11. The IDSEL in PCI-E Configuration Space Registers is in AD12/Device1/F[0]. 12. Turn M3 & N3 to NC Pin in Chap. 4. 13. Modify the description of bit 2(AICS) of BA+01h (ADC Control Register). 14. Modify the Function Diagram. 15. Add the information in bit 0 (RST) of 0x00h (Global Control Register) in 18.6. List of CAN Memory Register. 16. Modify the description of PreScale1 of I2C0 Clock Frequency Control1 in 11.3.20. I2C Registers. 17. Modify bit 0 of PMBASE+20h, 24h & 28h and bit 5 of 2C & 30h to Reserved bits in 11.3.28. ACPI Register. 18. Fill in the blanks of Max Power and Typical Power in 21.1 Performance and the blank of 21.5 Temperature. 19. Modify ROMCS# to GPCS# in 22.3 ISA Bus Interface. 20. Take off FRAME# from the figures of System Reset.
REV 1.4	2013/06/11	<ol style="list-style-type: none"> 1. Remove information I2C1 .from SB F[0] Internal I2C Control Register (D7h-D4h). 2. Modify M3 & N3 to AVDD_PERX12 and AVSS_PERX12. 3. Correct page 31, SATA Power, PIN L13 to PIN L3, PIN L14 To PIN L4 4. Correct page 34, 1.2V Power, PIN R5 to PIN P5

DMP reserves the right to make changes without further notice to any products or data herein to improve reliability, function, or design. Information furnished by DMP is believed to be accurate and reliable. However, DMP does not assure any liability arising out of the application or use of this information, nor the application or use of any product or circuit described herein, neither does it convey any license under its patent rights nor the rights of others.

Copyright © 2013 DMP Electronics INC. All rights reserved.

CONTENTS

1. Overview	9
2. Features	9
3. Block Diagram	11
3.1 System Block Diagram	11
3.2 Functions Block Diagram.....	12
3.3 PCI Device List	13
4. PIN Function List.....	14
4.1 BGA Ball Map	14
4.2 PIN Out Table	17
4.3 Pin List Table	20
4.4 Signal Description.....	22
4.5 PIN Capacitance Description.....	33
4.6 PIN Pull-up / Pull-down Description	33
4.7 The Registers only reset by power-good.....	40
5. System Address Map.....	41
5.1 Memory Address Ranges	41
5.1.1 Dos Compatibility Region	42
5.1.2 Extended Memory Region	43
5.2 Memory Shadowing.....	44
5.3 I / O Address Space.....	44
6. Operation Mode.....	45
7. Register Sets	46
7.1 Core Registers.....	46
7.1.1 General-Purpose Registers (Detail information in Chap.11.1.1).....	46
7.1.2 Segment Registers (Detail information in Chap.11.1.2).....	46
7.1.3 Instruction Pointer (Detail information in Chap.11.1.3).....	47
7.1.4 Flags Register (Detail information in Chap.11.1.4).....	47
7.1.5 Control Registers (Detail information in Chap.11.1.5).....	47
7.1.6 System Address Registers (Detail information in Chap.11.1.6).....	47
7.1.7 FPU Registers (Detail information in Chap.11.1.7).....	47
7.2 CPU MSR Registers.....	48
7.2.1 MSR Registers (Detail information in Chap.11.2).....	48
7.3 I / O Mapped Registers.....	49
7.3.1 PCI Configuration Registers (Detail information in Chap.11.3.1).....	49
7.3.2 Slave DMA Controller Registers(Detail information in Chap.11.3.2).....	49
7.3.3 DMA Page Registers (Detail information in Chap.11.3.3).....	50
7.3.4 Master DMA Controller Registers (Detail information in Chap.11.3.4).....	50
7.3.5 DMA High Page Registers (Detail information in Chap.11.3.5).....	51
7.3.6 Timer / Counter Registers (Detail information in Chap.11.3.6).....	51
7.3.7 Indirect Access Registers (Detail information in Chap.11.3.7).....	51
7.3.8 Master Interrupt Controller Registers (Detail information in Chap.11.3.8).....	51
7.3.9 Slave Interrupt Controller Registers (Detail information in Chap.11.3.9).....	51
7.3.10 Interrupt Edge / Level Control Registers (Detail information in Chap.11.3.10).....	52
7.3.11 Keyboard / Mouse Control Registers(Detail information in Chap.11.3.11).....	52
7.3.12 Serial Port Registers (Detail information in Chap.11.3.12).....	52
7.3.13 Parallel Port Registers (Detail information in Chap.11.3.13).....	54
7.3.14 SPI Control Registers (Detail information in Chap.11.3.14).....	54
7.3.15 GPIO Registers (Detail information in Chap.11.3.15).....	55
7.3.16 NMI Status and Control Register (Detail information in Chap.11.3.16).....	56
7.3.17 WDT Registers (Detail information in Chap.11.3.17).....	56
7.3.18 CMOS Memory & RTC Registers (Detail information in Chap.11.3.18).....	57
7.3.19 System Control Register(Detail information in Chap.11.3.19).....	57
7.3.20 I2C Registers(Detail information in Chap.11.3.20).....	57
7.3.21 DOS 4Gpage Access Registers(Detail information in Chap.11.3.21).....	58
7.3.22 Spare Registers(Detail information in Chap.11.3.22).....	58
7.3.23 SMM Registers(Detail information in Chap.11.3.23).....	58
7.3.24 Fast Ethernet MAC Registers(Detail information in Chap.14.7).....	59
7.3.25 USB 1.1 OHCI Operation Registers(Detail information in Chap.12.3.2).....	61
7.3.26 USB 2.0 EHCI Operation Registers(Detail information in Chap.12.3.4).....	62
7.3.27 USB Device Operation Registers(Detail information in Chap.15.4).....	63

Vortex86EX

32-Bit x86 Micro Processor

7.3.28	SD/SATA Controller Registers(Detail information in Chap.13.7)	64
7.3.29	HDA Controller Registers(Detail information in Chap.16.4)	65
7.3.30	ADC Registers(Detail information in Chap.11.3.24)	66
7.3.31	ACPI Registers (Detail information in Chap.11.3.25)	66
7.3.32	CrossBar Config Registers (Detail information in Chap.11.3.26)	67
7.4	Configuration Space Registers	72
7.4.1	NB Function 0 Configuration Space Registers (IDSEL = AD11/Device 0) (Detail information in Chap.11.3.1)	73
7.4.2	NB Function 1 Configuration Registers (IDSEL = AD11/Device0/Function1) (Detail information in Chap.11.3.2)	74
7.4.3	SB Configuration Space Registers (IDSEL = AD18/Device 7/Function 1) (Detail information in Chap.11.3.4)	75
7.4.4	MAC PCI Configuration Space Registers (IDSEL = AD19/Device 8) (Detail information in Chap.14.4)	76
7.4.5	USB1.1 Configuration Space Registers (IDSEL = AD21/Device10/Function0(Detail information in Chap.12.3.1)	76
7.4.6	USB2.0 Configuration Space Registers (IDSEL = AD21/Device10/Function1) (Detail information in Chap.12.3.3)	77
7.4.7	USB Device PCI Configuration Registers Definition ((IDSEL = AD26/Device15/Function0) (Detail information in Chap.15.3)	78
7.4.8	SD/SATA Configuration Space Registers (IDSEL = AD23/Device12/Function0) (Detail information in Chap.13.5)	79
7.4.9	HDA Configuration Space Registers (IDSEL = AD25/Device14/Function0) (Detail information in Chap.16.3)	80
7.4.10	PCI-E Configuration Space Registers (IDSEL = AD12/Device1/Function0) (Detail information in Chap.12.3)	81
7.4.11	Motion Controller Configuration Space Registers (IDSEL = AD27/Device16/Function0) (Detail information in Chap.20.3.1)	82
7.4.12	PCIe Target Configuration Space Registers (Detail information in Chap.19.1)	83
7.4.13	Duplex SPI Configuration Space Registers (IDSEL = AD27/Device16/Function1) (Detail information in Chap.20.3.2)	84
8.	Instruction Set	85
9.	Addressing Modes	86
9.1	Register and Immediate Modes	86
9.2	32-Bit Memory Addressing Modes	86
9.3	Differences between 16- and 32-bit Addresses	88
10.	Functional Description	89
10.1	SoC Core	89
10.2	L1 Cache	91
10.3	L2 Cache	92
10.4	DDR3 Controller	92
10.5	DMA Controller	93
10.5.1	DMA Transfer Modes	94
10.5.2	DMA Transfer Types	95
10.5.3	DMA Timings	96
10.5.4	DREQ and DACK# Latency Control	96
10.5.5	Channel Priority	96
10.5.6	Register Functionality	97
10.5.7	Address Compatibility Mode	97
10.5.8	Summary of DMA Transfer Sizes	97
10.5.9	Address Shifting When Programmed for 16-Bit I/O Count by Words	98
10.5.10	Autoinitialize	98
10.5.11	Software Commands	98
10.6	Watchdog Timer	100
10.6.1	Set the watchdog timer function	100
10.6.2	Set the watchdog timer Counter	100
10.6.3	Read the watchdog timer counter value	101
10.6.4	Clear the watchdog timer counter	101
10.7	Real Time Clock	102
10.7.1	Clock Accuracy	102
10.7.2	Power-Down/Power-UpConsiderations	102
10.7.3	Time, Calendar, and Alarm Locations	102
10.7.4	Control Registers	106
10.7.5	SRAM	109

10.7.6	Interrupts	109
10.7.7	Oscillator Control Bits	110
10.7.8	Periodic Interrupt Selection.....	110
10.7.9	Update Cycle	111
10.8	ProgrammableTimer	112
10.8.1	Programming the Interval Timer	113
10.9	Programmable Interrupt Controller	117
10.9.1	Programming the Interrupt Controller	117
10.9.2	End-of-Interrupt Operation.....	119
10.9.3	Modes of Operation	120
10.9.4	Cascade Mode	121
10.9.5	Edge- and Level-Triggered Mode	122
10.9.6	Interrupt Masks.....	122
10.9.7	Reading the Interrupt Controller Status	123
10.9.8	Interrupt Steering.....	124
10.10	KeyBoard Controller	124
10.10.1	Host Interface	126
10.10.2	Data Registers and Status Register.....	126
10.10.3	Keyboard and Mouse Interface.....	127
10.10.4	KIRQ and MIRQ.....	127
10.10.5	A20M_ Setting.....	127
10.11	PARALLEL PORT.....	129
10.11.1	IBM XT/AT COMPATIBLE, BI-DIRECTIONAL AND EPP MODES.....	131
10.11.2	EXTENDED CAPABILITIES PARALLEL PORT.....	145
10.11.3	ISA IMPLEMENTATION STANDARD	146
10.11.4	OPERATION.....	156
10.11.5	DMA TRANSFERS	158
10.12	FIFO UART	161
10.12.1	Transmit Operation.....	161
10.12.2	Receive Operation.....	162
10.12.3	MODEM Control Lines.....	162
10.12.4	FIFO Interrupt Mode Operation	162
10.12.5	FIFO Polled Mode Operation.....	164
10.12.6	Timing Waveforms	164
10.13	GPIO Interface.....	165
10.14	DOS 4Gpage Access.....	165
10.15	Flash Strap	167
10.15.1	Flash Strap Region Summary.....	167
10.15.2	CrossBar Config	167
10.15.3	Ethernet MAC Address	168
10.15.4	PLL Config & Others.....	169
10.15.5	Customer Data	169
11. Register Description		170
11.1	Core Registers.....	170
11.1.1	General-Purpose Registers.....	170
11.1.2	Segment Registers	173
11.1.3	Instruction Pointer Register	176
11.1.4	Flags Register	176
11.1.5	Control Registers.....	180
11.1.6	System Address Registers	185
11.1.7	FPU Registers	188
11.2	CPU MSR Registers.....	198
11.3	I / O Mapped Registers.....	202
11.3.1	PCI Configuration Registers	202
11.3.2	Slave DMA Control Registers	203
11.3.3	DMA Pager Registers	213
11.3.4	Master DMA Control Registers	216
11.3.5	DMA High Page Registers.....	224
11.3.6	Timer / Counter Registers.....	226
11.3.7	Indirect Access Registers	229
11.3.8	Indirect Access Registers for WDT0.....	229
11.3.9	Indirect Access Registers for GPIO P0/P1.....	232
11.3.10	Indirect Access Registers for Lock / Unlock	233
11.3.11	Master Interrupt Control Registers.....	234

11.3.12	Slave Interrupt Control Registers.....	235
11.3.13	Interrupt Edge / Level Control Registers.....	236
11.3.14	Keyboard / Mouse Control Registers.....	238
11.3.15	Serial Port Registers.....	239
11.3.16	Parallel Port Register.....	256
11.3.17	SPI Control Registers.....	257
11.3.18	GPIO Registers.....	260
11.3.19	NMI Status and Control Register.....	274
11.3.20	WDT Registers.....	275
11.3.21	CMOS Memory & RTC Registers.....	278
11.3.22	System Function Register.....	279
11.3.23	I2C Registers.....	279
11.3.24	DOS 4Gpage Access.....	284
11.3.25	Spare Registers.....	286
11.3.26	SMM Registers.....	291
11.3.27	ADC Registers.....	293
11.3.28	ACPI Registers.....	296
11.3.29	CrossBar Config Registers.....	304
11.4	PCI Configuration Space Registers (by request).....	314
11.4.1	North Bridge Function 0 Configuration Registers.....	314
11.4.2	North Bridge Function 1 Configuration Registers.....	338
11.4.3	South Bridge Function 0 Configuration Registers.....	361
11.4.4	South Bridge Function 1 Configuration Registers.....	390
12.	USB2.0 Host Controller.....	399
12.1	Features.....	399
12.1.1	USB1.1 Host Controller.....	399
12.1.2	USB2.0 Host Controller.....	399
12.2	General Descriptions.....	400
12.3	Register Definition.....	400
12.3.1	USB1.1 Configuration Space Register.....	400
12.3.2	USB1.1 Operational Registers.....	408
12.3.3	Open Host Controller Interface Operational Registers.....	409
12.3.4	Control and Status Partition.....	410
12.3.5	Memory Pointer Partition.....	418
12.3.6	Frame Counter Partition.....	423
12.3.7	Root Hub Partition.....	427
12.3.8	EHCI Configuration Space.....	435
12.3.9	USB2.0 Configuration Space.....	435
12.3.10	EHCI Operational Registers.....	442
12.3.11	Host Controller Capability Register.....	442
12.3.12	Host Controller Operational Register.....	445
13.	SD/SATA Controller.....	453
13.1	Overview.....	453
13.2	Features.....	453
13.3	List of PCI Configuration Registers.....	454
13.4	List of PCI I/O Registers.....	455
13.4.1	List of PCI I/O Register - Bus Master IDE I/O Registers.....	455
13.4.2	IDE Interface and Status Registers from PCI I/O View (PCI IO Space Mapping).....	456
13.5	PCI Configuration Registers Definition.....	457
13.6	PCI I/O Register -- Bus Master IDE I/O Registers.....	482
13.7	IDE Interface and Status Registers.....	485
14.	Fast Ethernet Control Unit.....	491
14.1	Overview.....	491
14.2	Features.....	491
14.3	MAC Block Diagram.....	492
14.4	MAC PCI Configuration Space Registers.....	492
15.	USB Device Control Unit.....	495
15.1	Overview.....	495
15.2	Features.....	495
15.3	USB Device PCI Configuration Registers Definition.....	496
15.4	USB Device Operational Registers.....	502
16.	High Definition Audio control Uint.....	512

16.1	Overview.....	512
16.2	Features	512
16.3	HDA PCI Configuration Space Registers	513
16.4	HDA Operational Registers	519
17.	PCI to PCI Express Bridge Control Unit	520
17.1	Overview.....	520
17.2	Features	520
17.3	PCI to PCI Express Bridge PCI Configuration Registers Definition	520
18.	CAN Controller	538
18.1	Overview.....	538
18.2	Features	538
18.3	List of PCI Configuration Registers	539
18.4	PCI Configuration Registers Definition	540
18.5	List of CAN Memory Registers	548
18.6	List of CAN Memory Register	550
18.7	Procedural Guide.....	571
18.7.1	Finding the correct prescaler and bus timing to use: Using an Example	571
18.7.2	Transmitting a message:	573
18.7.3	Receiving a message:	574
19.	PCI-e Target Register Definition	575
19.1	Configuration Space Register.....	575
19.2	PCI Configuration Register.....	576
19.3	IO Mapped Register Format.....	577
20.	MISC Control Unit	588
20.1	Overview.....	588
20.2	Features	588
20.3	MISC PCI Configuration Registers Definition.....	588
20.3.1	Motion Controller Configuration Space Register.....	588
20.3.2	Full-Duplex SPI Configuration Space Register	589
20.4	Full-Duplex SPI Controller.....	590
20.4.1	Timing diagram for each mode	590
20.4.2	Block diagram.....	591
20.4.3	IO/Memory Mapped Registers Definition.....	591
21.	Electrical Specifications.....	598
21.1	Performance Characteristics	598
21.2	Absolute Maximum Ratings.....	598
21.3	Recommended DC Operating Conditions (T _A).....	600
21.4	DC Characteristics.....	601
21.5	Temperature	601
22.	AC Electrical Characteristics.....	603
22.1	System Reset	603
22.1.1	Normal System Reset.....	603
22.1.2	Fast System Reset	604
22.2	DDRIII Interface.....	605
22.3	ISA Bus Interface.....	607
23.	Package Information.....	610

1. Overview

The **Vortex86EX** is a low-power, good performance and fully static 32-bit X86 processor with the compatibility of Windows based, Linux and most popular 32-bit RTOS. It also integrates 16KB write through 4-way L1 cache, 128KB write through/write back 4-way L2 cache, PCIE bus in at 2.5 GHz, DDR3, CrossBar Interface, ROM controller, ISA, I2C, SPI, IPC (Internal Peripheral

Controllers with DMA and interrupt timer/counter included), Fast Ethernet, FIFO UART, USB2.0 Host, USB Device, PCIe Device, SD/SATA and CAN controller within a single 288-pin LPGA package to form a system-on-a-chip (**SOC**). It provides an ideal solution for the low-cost and power-efficiency embedded system to bring about desired performance.

2. Features

X86 Processor Core

- 6-stage pipeline
- 400MHz (typical)

Floating point unit support

- Extends CPU instruction set to include Trigonometric, Logarithmic and Exponential
- Implements ANSI/IEEE standard 754-1985 for binary Floating-Point Architecture

Branch prediction unit

- Branch target buffer

Translation Lookaside buffer

- 32 I/D translation lookaside buffer

Embedded I / D Separated L1 Cache

- 16K I-Cache, 16K D-Cache

Embedded L2 Cache

- 4-way 128KB L2 Cache
- Write through or write back policy

DDRIII Control Interface

- 16 bits data bus
- 2 rank
- DDRIII clock support up to 300MHz
- DRAM size maximum support up to 2GB

CrossBar Interface

- 10 CrossBar port for digital function select. (each port is 8 pins, total 80 pins)
- CrossBar Port0-3 support CrossBar-Bit group selection
- CrossBar Port4-9 support CrossBar-Port group selection

SD Interface

- SD x 1 at IDE Primary Channel

SATA Interface

- SATA 3.0G (1 Port) at IDE Secondary Channel

Ethernet MAC Controller + PHY

PCIE Control Interface

- Up to 1 sets PCIE device

PCIE Target Interface

USB 2.0 Host Support

- Supports HS, FS and LS
- 2 port

USB 1.1 Device Support

- 1 port
- Supports FS with 3 programmable endpoint

HDA Controller

- 1 input stream, 1 output stream

ADC Interface x 8

I2C bus

- Compliant w/t V2.1
- Some master code (general call, START and CBUS) not support.

SPI Boot Interface

- For boot up function from SPI flash
- Half duplex
- Support SPI Flash Size up to 128MB

Full Duplex SPI Controller

- Some master code (general call, START and CBUS) not support.

Vortex86EX

32-Bit x86 Micro Processor

- Support SPI Device x2 (Chip Select x2)

CAN Bus Controller

- Compatible with the CAN2.0A/2.0B
- Support 1 CAN Bus channel

Motor Control Interface Support

- 1groups of controller, 4 controllers per group
- Each controller can configure to PWM/Servo/Sensor Interface mode
- Controller interconnect to the other with routing network in the same group

X-ISA Bus Interface

- Subset ISA Bus (remove some ISA Bus pins)
- AT clock programmable
- 8/16 Bit ISA device with Zero-Wait-State
- Generate refresh signals to ISA interface during DRAM refresh cycle
- Support Max ISA Clock 33M
- Support 1 channel ISA DMA
- Support ISA IRQ x 9

DMA Controller

Interrupt Controller

MTBF Counter

Counter / Timers

- 1 sets of 8254 timer controller

Real Time Clock

- Less than 2.5uA (3.0V) power consumption in Internal RTC Mode while chip is power-off.

FIFO UART Port x 10 (10 sets COM Port)

- Compatible with 16C550 / 16C552
- Default internal pull-up
- Supports the programmable baud rate generator with the data rate from 50 to 6M bps
- The character options are programmable for 1 start bits; 1, 1.5 or 2 stop bits; even, odd or no parity; 5~8 data bits
- Support TXD_En Signal on COM1-8

- Port 80h output data could be sent to COM1 by software programming

- Support half-duplex mode
- Enhanced low IO access latency

Parallel Port

- Supports SPP/EPP/ECP mode

General Programmable I/O

- Supports 80 programmable I / O pins
- Each GPIO pin can be individually configured to be an input/output pin
- GPIO_P0~GPIO_P9 can be program by 8051A
- All GPIO port with interrupt support (input/output)

PS / 2 Keyboard and Mouse Interface Support

- Compatible with 8042 controller

Speaker out

JTAG Interface supported for S.W. debugging

Input clock

- 25 MHz
- 32.768 KHz

Output clock

- one clock output select from 14.318MHz /24MHz /25MHz/ ISA Clock

Operating Voltage Range

- Core voltage: 1.2 V \pm 5%
- I / O voltage: 1.5V \pm 5%, 1.8V \pm 5 %, 3.3 V \pm 10 %

Operating temperature

- -40°C ~ 85°C

Package Type

- 16x16mm TFBGA-288
- Ball pictch 0.8mm

Vortex86EX

32-Bit x86 Micro Processor

3. Block Diagram

3.1 System Block Diagram

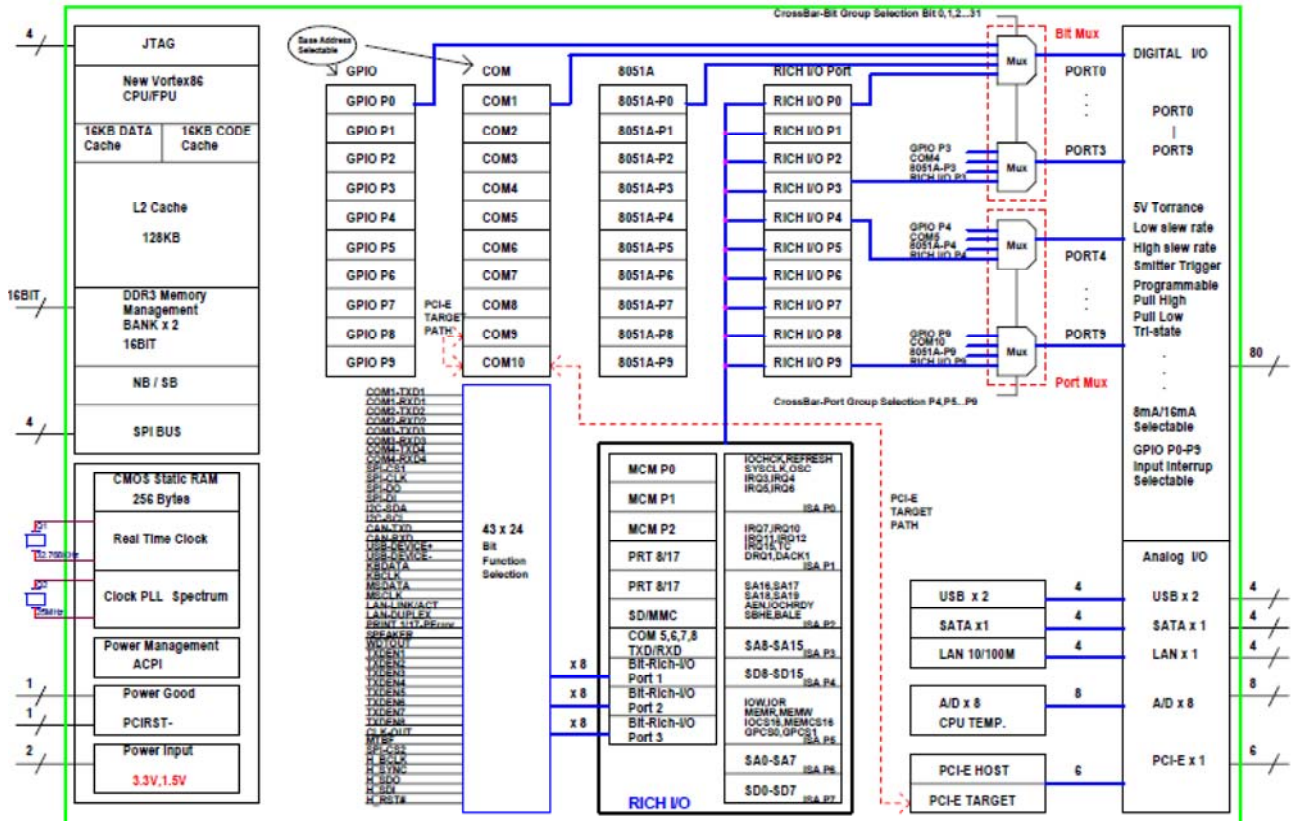

3.2 Functions Block Diagram

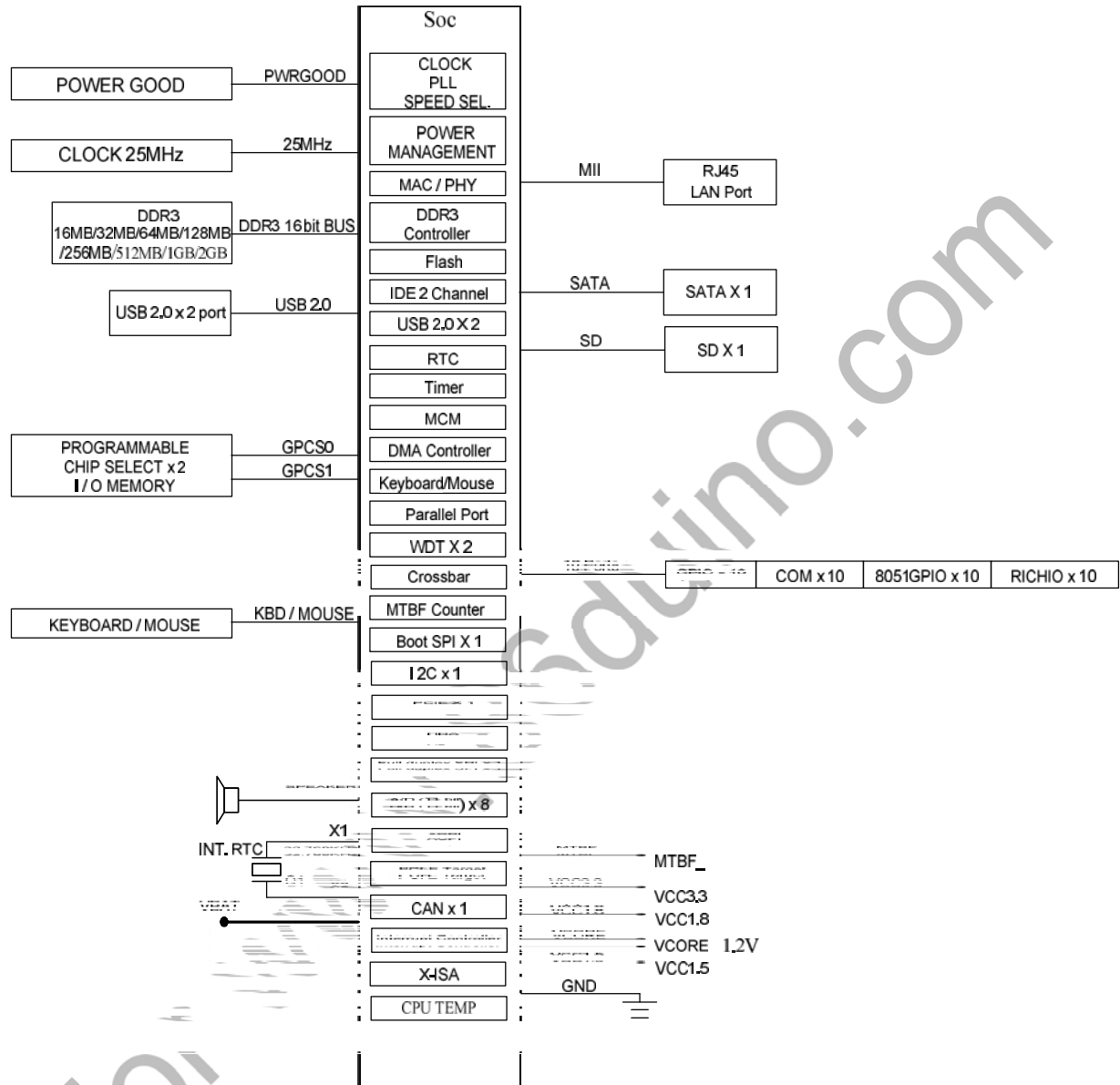

3.3 PCI Device List

ID SEL	AD 11	AD 12	AD13 - AD17	AD18	AD19	AD 20	AD21	AD 22	AD 23	AD 24	AD 25	AD26	AD 27	AD 28
Device#	0	1	2 – 6	7	8	9	10	11	12	13	14	15	16	17
Function	NB	PCIE0		SB	MAC		USB 2.0 HOST		IDE		HDA	USB Device	MC & SPI	CAN
Fun0	NB0			SB0			OHCI						MC	
Fun1	NB1			SB1			EHCI						SPI	

PS. 1. USB 2.0 Host Controller supports 2 port
2 PCIE0, Interrupt Routing: INTA, INTB, INTC, INTD

4. PIN Function List

4.1 BGA Ball Map

G	F	E	D	C	B	A
ADC_IN7	ADC_IN5	ADC_IN4	USB1_DP	AVDD_USB33	USB2_DP	AVDD_USB12
ADC_IN6	ADC_IN2	ADC_IN1	USB1_DM	AVSS_USB33	USB2_DM	AVSS_USBPPLL12
ADC_IN3	ADC_IN0	NC_Ball	AVDD_USBPPLL12	AVDD_USBBAS33	AVSS_USBBAS33	PCIRST#
TMS_0	SPI_CS	SPI_CK	VDD18_1	USB1_EXT12K	USB2_EXT12K	ISA_RST
SPI_DO	VSS	TCK_0	PCIE_MSEL	PORT9[4]	POWER_GOOD	PORT9[7]
		TDO_0	PORT9[2]	PORT9[0]	PORT9[3]	PORT9[6]
		TDI_0	PORT0[1]	VSS	PORT9[1]	PORT9[5]
		PORT0[7]	PORT0[6]	PORT0[0]	PORT0[2]	PORT0[3]
		PORT0[5]	PORT7[7]	PORT0[4]	PORT7[4]	PORT7[2]
		VSS	PORT7[6]	VDD33	PORT7[5]	PORT7[3]
		PORT6[3]	PORT6[6]	PORT6[7]	PORT7[1]	PORT7[0]
		PORT5[5]	PORT5[7]	PORT6[5]	PORT6[4]	PORT6[2]
		VSS	PORT5[4]	PORT5[6]	PORT6[0]	PORT6[1]
		PORT4[1]	PORT5[0]	VDD33	PORT5[2]	PORT5[3]
VSS	PORT2[7]	PORT2[6]	PORT4[0]	PORT4[4]	VSS	PORT5[1]
PORT1[7]	PORT2[4]	PORT2[5]	PORT3[5]	PORT3[7]	PORT4[6]	PORT4[7]
PORT1[5]	PORT2[2]	VDD33	PORT3[4]	PORT3[6]	VDD33	PORT4[5]
PORT1[4]	VSS	PORT2[3]	PORT3[2]	VSS	PORT4[2]	PORT4[3]
PORT1[3]	PORT2[0]	PORT2[1]	PORT3[0]	PORT3[1]	PORT3[3]	VSS

Vortex86EX

32-Bit x86 Micro Processor

P	N	M	L	K	J	H
PCIE1_RXIP	PCIE1_REFCLKN	AVSS_SATA	SATA_TXOP	SATA_RXIP	SATA_REFCLKP	RTC_XIN
PCIE1_RXIN	PCIE1_REFCLKP	AVDD_SATA12	SATA_TXON	SATA_RXIN	SATA_REFCLKN	RTC_XOUT
REG_VCTRL18	AVSS_PERX12	AVDD_PERX12	AVSS_SATARX12	AVDD_SATARX12	AVDD_ADC33	RTC_VSS
AVSS_EPHYBG18	AVSS_PEP12	AVDD_PEP12	AVSS_SATAPLL12	AVDD_SATAPLL12	AVSS_ADC33	RTC_VDE
VDD12	AVDD_PE33	AVDD_TEMP18	AVDD_SATA33	AVSS_TEMP18	RTC_NMR	SPI_DI
			VDD12	VSS	VDD12	
			VDD12		VDD12	
			VDD12	VSS	VDD12	
MA13	MA1	VSS	PORT8[0]	VSS	PORT8[6]	PORT1[6]
MA12	MA14	VDD15	MA6	PORT8[1]	PORT8[5]	PORT1[2]
MA11	MA4	MA8	RST	PORT8[2]	PORT8[7]	VDD33
WE	BA1	VSS	BA0	VSS	PORT8[4]	PORT1[1]
MA15	BA2	VDD15	MA0	VDD33	PORT8[3]	PORT1[0]

Vortex86EX

32-Bit x86 Micro Processor

W	V	U	T	R
EPHY_TXN	EPHY_TXP	AVSS_EPHYTX18	AVSS_PE	PCIE1_TXOP
EPHY_RXN	EPHY_RXP	REG_AVSS33	AVDD_PE12	PCIE1_TXON
AVDD_EPHYPLL18	AVSS_EPHYPLL18	REG_AVDD33	REG_FB12	REG_FB18
XIN	XOUT	REG_VCTRL12	AVDD_EPHYBG18	EPHY_ISET
SATA_PHY_CLK_P	SATA_PHY_CLK_N	VSS	VDD18	VDD33_1
PLLCK100_0_P	PLLCK100_0_N	DIF_VDD18	AVDD_SBPLL18	VSS
PLLCK100_1_P	PLLCK100_1_N	DIF_VSS18	AVSS_SBPLL18	VDD12
DIF_VDD12	DIF_VSS12	AVDD_NBPLL18	AVSS_NBPLL18	VREF
VDD15	VSS	VDD15	ZQ0	VSS
DQ08	DQ10	DQ11	VSS	DQ00
DQ09	DQS1P	DQ01	DQ02	DQ03
DQS1N	VSS	DQS0P	VSS	VDD15
VDD15	DM1	DQS0N	DM0	TEST_ODT1
DQ12	VSS	DQ04	DQ06	CS1
DQ13	DQ15	DQ05	DQ07	VSS
SDRAMCLK0N	DQ14	MA3	MA5	VDD15
SDRAMCLK0P	VSS	MA2	MA9	MA7
TEST_ODT0	RAS	VSS	CAS	VSS
VSS	CS0	CKE0	MA10	VDD15

4.2 PIN Out Table

Ball No.	Function	Ball No.	Function	Ball No.	Function	Ball No.	Function
A1	AVDD_USB12	D16	PORT3[5]	K11	VSS	T5	VDD18
A2	AVSS_USBPLL12	D17	PORT3[4]	K15	VSS	T6	AVDD_SBPLL18
A3	PCIRST#	D18	PORT3[2]	K16	PORT8[1]	T7	AVSS_SBPLL18
A4	ISA_RST	D19	PORT3[0]	K17	PORT8[2]	T8	AVSS_NBPLL18
A5	PORT9[7]	E1	ADC_IN4	K18	VSS	T9	ZQ0
A6	PORT9[6]	E2	ADC_IN1	K19	VDD33	T10	VSS
A7	PORT9[5]	E3	NC_Ball	L1	SATA_TXOP	T11	DQ02
A8	PORT0[3]	E4	SPI_CK	L2	SATA_TXON	T12	VSS
A9	PORT7[2]	E5	TCK_0	L3	AVSS_SATARX12	T13	DM0
A10	PORT7[3]	E6	TDO_0	L4	AVSS_SATAPLL12	T14	DQ06
A11	PORT7[0]	E7	TDI_0	L5	AVDD_SATA33	T15	DQ07
A12	PORT6[2]	E8	PORT0[7]	L9	VDD12	T16	MA5
A13	PORT6[1]	E9	PORT0[5]	L10	VDD12	T17	MA9
A14	PORT5[3]	E10	VSS	L11	VDD12	T18	CAS
A15	PORT5[1]	E11	PORT6[3]	L15	PORT8[0]	T19	MA10
A16	PORT4[7]	E12	PORT5[5]	L16	MA6	U1	AVSS_EPHYTX18
A17	PORT4[5]	E13	VSS	L17	RST	U2	REG_AVSS33
A18	PORT4[3]	E14	PORT4[1]	L18	BA0	U3	REG_AVDD33
A19	VSS	E15	PORT2[6]	L19	MA0	U4	REG_VCTRL12
B1	USB2_DP	E16	PORT2[5]	M1	AVSS_SATA	U5	VSS
B2	USB2_DM	E17	VDD33	M2	AVDD_SATA12	U6	DIF_VDD18
B3	AVSS_USBBAS33	E18	PORT2[3]	M3	AVDD_PERX12	U7	DIF_VSS18
B4	USB2_EXT12K	E19	PORT2[1]	M4	AVDD_PEPLL12	U8	AVDD_NBPLL18
B5	POWER_GOOD	F1	ADC_IN5	M5	AVDD_TEMP18	U9	VDD15
B6	PORT9[3]	F2	ADC_IN2	M15	VSS	U10	DQ11
B7	PORT9[1]	F3	ADC_IN0	M16	VDD15	U11	DQ01

Vortex86EX

32-Bit x86 Micro Processor

Ball No.	Function	Ball No.	Function	Ball No.	Function	Ball No.	Function
B8	PORT0[2]	F4	SPI_CS	M17	MA8	U12	DQS0P
B9	PORT7[4]	F5	VSS	M18	VSS	U13	DQS0N
B10	PORT7[5]	F15	PORT2[7]	M19	VDD15	U14	DQ04
B11	PORT7[1]	F16	PORT2[4]	N1	PCIE1_REFCLKN	U15	DQ05
B12	PORT6[4]	F17	PORT2[2]	N2	PCIE1_REFCLKP	U16	MA3
B13	PORT6[0]	F18	VSS	N3	AVSS_PERX12	U17	MA2
B14	PORT5[2]	F19	PORT2[0]	N4	AVSS_PEPLL12	U18	VSS
B15	VSS	G1	ADC_IN7	N5	AVDD_PE33	U19	CKE0
B16	PORT4[6]	G2	ADC_IN6	N15	MA1	V1	EPHY_TXP
B17	VDD33	G3	ADC_IN3	N16	MA14	V2	EPHY_RXP
B18	PORT4[2]	G4	TMS_0	N17	MA4	V3	AVSS_EPHYPLL18
B19	PORT3[3]	G5	SPI_DO	N18	BA1	V4	XOUT
C1	AVDD_USB33	G15	VSS	N19	BA2	V5	SATA_PHY_CLK_N
C2	AVSS_USB33	G16	PORT1[7]	P1	PCIE1_RXIP	V6	PLLCK100_0_N
C3	AVDD_USBBAS33	G17	PORT1[5]	P2	PCIE1_RXIN	V7	PLLCK100_1_N
C4	USB1_EXT12K	G18	PORT1[4]	P3	REG_VCTRL18	V8	DIF_VSS12
C5	PORT9[4]	G19	PORT1[3]	P4	AVSS_EPHYBG18	V9	VSS
C6	PORT9[0]	H1	RTC_XIN	P5	VDD12	V10	DQ10
C7	VSS	H2	RTC_XOUT	P15	MA13	V11	DQS1P
C8	PORT0[0]	H3	RTC_VSS	P16	MA12	V12	VSS
C9	PORT0[4]	H4	RTC_VDE	P17	MA11	V13	DM1
C10	VDD33	H5	SPI_DI	P18	WE	V14	VSS
C11	PORT6[7]	H15	PORT1[6]	P19	MA15	V15	DQ15
C12	PORT6[5]	H16	PORT1[2]	R1	PCIE1_TXOP	V16	DQ14
C13	PORT5[6]	H17	VDD33	R2	PCIE1_TXON	V17	VSS
C14	VDD33	H18	PORT1[1]	R3	REG_FB18	V18	RAS
C15	PORT4[4]	H19	PORT1[0]	R4	EPHY_ISET	V19	CS0
C16	PORT3[7]	J1	SATA_REFCLKP	R5	VDD33_1	W1	EPHY_TXN
C17	PORT3[6]	J2	SATA_REFCLKN	R6	VSS	W2	EPHY_RXN
C18	VSS	J3	AVDD_ADC33	R7	VDD12	W3	AVDD_EPHYPLL18

Vortex86EX

32-Bit x86 Micro Processor

Ball No.	Function	Ball No.	Function	Ball No.	Function	Ball No.	Function
C19	PORT3[1]	J4	AVSS_ADC33	R8	VREF	W4	XIN
D1	USB1_DP	J5	RTC_NMR	R9	VSS	W5	SATA_PHY_CLK_P
D2	USB1_DM	J9	VDD12	R10	DQ00	W6	PLLCK100_0_P
D3	AVDD_USBPLL12	J10	VDD12	R11	DQ03	W7	PLLCK100_1_P
D4	VDD18_1	J11	VDD12	R12	VDD15	W8	DIF_VDD12
D5	PCIE_MSEL	J15	PORT8[6]	R13	TEST_ODT1	W9	VDD15
D6	PORT9[2]	J16	PORT8[5]	R14	CS1	W10	DQ08
D7	PORT0[1]	J17	PORT8[7]	R15	VSS	W11	DQ09
D8	PORT0[6]	J18	PORT8[4]	R16	VDD15	W12	DQS1N
D9	PORT7[7]	J19	PORT8[3]	R17	MA7	W13	VDD15
D10	PORT7[6]	K1	SATA_RXIP	R18	VSS	W14	DQ12
D11	PORT6[6]	K2	SATA_RXIN	R19	VDD15	W15	DQ13
D12	PORT5[7]	K3	AVDD_SATARX12	T1	AVSS_PE	W16	SDRAMCLK0N
D13	PORT5[4]	K4	AVDD_SATAPLL12	T2	AVDD_PE12	W17	SDRAMCLK0P
D14	PORT5[0]	K5	AVSS_TEMP18	T3	REG_FB12	W18	TEST_ODT0
D15	PORT4[0]	K9	VSS	T4	AVDD_EPHYBG18	W19	VSS

4.3 Pin List Table

Function	Symbol	PIN Sum
SYSTEM	PWRGOOD, XOUT_25, XIN_25, PCIRST#, STRAP_PE HTS	5 PINs
DDRIII Interface	DRAMRST#, DRAMCLK, DRAMCLK#, RAS#, CAS#, WE#, CKE, CS1#, CS0#, DQM[1:0], DQS[1:0], DQS#[1:0], ODT[1], ODT[0], BA[2:0], MD[15:0], MA[15:0], ZQ, VREF	54 PINs
CrossBar Interface	CBAR_P0[7:0], CBAR_P1[7:0], CBAR_P2[7:0], CBAR_P3[7:0], CBAR_P4[7:0], CBAR_P5[7:0], CBAR_P6[7:0], CBAR_P7[7:0], CBAR_P8[7:0], CBAR_P9[7:0], CBAR_DEVRST	81 PINs
USB Interface	USB_DP, USB_DM, USB1_DP, USB1_DM, USB_REXT, USB_REXT1	6 PINs
PCIE Bus Interface	PE0_CLKP, PE0_CLKN, PE0_TXP, PE0_TXN, PE0_RXP, PE0_RXN, , DIF0_PCIE_PLLCLK100_P, DIF0_PCIE_PLLCLK100_N, DIF1_CLK100_P, DIF1_CLK100_N	10 PINs
SATA Interface	SATA_CLKP, SATA_CLKN, SATA_TXP, SATA_TXN, SATA_RXP, SATA_RXN, DIF1_SATA_PHY_CLK_P, DIF1_SATA_PHY_CLK_N	8 PINs
Ethernet Interface	ISET, TXN, TXP, RXN, RXP	5 PINs
SPI Interface	SPI_CS#/ STRAP_BMS, SPI_CK/STRAP_JTAG, SPI_DO/STRAP_HDM, SPI_DI	4 PINs
RTC Interface	RTC_PS, RTC_XOUT, RTC_XIN	3 PINs
JTAG Interface	TDO, TMS, TCK, TDI	4 PINs
ADC Interface	ADC_IN0, ADC_IN1, ADC_IN2, ADC_IN3, ADC_IN4, ADC_IN5, ADC_IN6, ADC_IN7,	8 PINs
Embedded Regulator	REG_AVDD33, REG_AVSS33, REG_VCTRL18, REG_FB18, REG_VCTRL12, REG_FB12	6 PINs
USB Power Interface	AVDD_USB33, AVSS_USB33, AVDD_USB12, AVDD_USBBAS33, AVSS_USBBAS33, AVDD_USBPLL12, AVSS_USBPLL12	7 PINs
PCIE Power Interface	AVDD_PE33, AVDD_PE12, AVSS_PE, AVDD_PEPLL12, AVSS_PEPLL12, AVDD_PERX12, AVSS_PERX12	5 PINs

Vortex86EX

32-Bit x86 Micro Processor

Function	Symbol	PIN Sum
SATA Power Interface	AVDD_SATA33, AVDD_SATA12, AVSS_SATA, AVDD_SATAPLL12, AVSS_SATAPLL12, AVDD_SATARX12, AVSS_SATARX12	7 PINs
Ethernet Power	AVDD_EPHYPLL18, AVSS_EPHYPLL18, AVDD_EPHYBG18, AVSS_EPHYBG18, AVSS_EPHYTX18	5 PINs
ADC Power	AVDD_ADC33, AVSS_ADC33, AVDD_TEMP18, AVSS_TEMP18	4 PINs
System PLL Power	AVDD_NBPLL18, AVSS_NBPLL18, AVDD_SBPLL18, AVSS_SBPLL18	4 PINs
Battery Power	RTC_VDD33, RTC_VSS	2 PINs
Differential PAD Power	DIF_VDD18, DIF_VSS18, DIF_VDD12, DIF_VSS12	4 PINs
NC	NC	3 PINs
1.2V Power	VDD12 (8 PINs)	8 PINs
1.5 Power	VDD15 (8 PINs)	8 PINs
1.8V Power	VDD18 (2 PINs)	2 PINs
3.3V Power	VDD33(7 PINs)	7 PINs
Digital Ground	VSS (28 PINs)	28 PINs

4.4 Signal Description

This chapter provides a detailed description of SoC signals. A signal with the symbol "#" at the end of itself indicates that this pin is low active. Otherwise, it is high active.

The following notations are used to describe the signal types:

- I Input pin
- O Output pin
- OD Output pin with open-drain
- I/O Bi-directional Input/Output pin

System (5 PINs)

PIN No.	Symbol	Type	Description
B5	PWRGOOD	I	Power-Good Input. This signal comes from Power Good of the power supply to indicate that the power is available. The SoC uses this signal to generate reset sequence for the system.
V4	XOUT_25	O	Crystal-out. Frequency output from the inverting amplifier (oscillator).
W4	XIN_25	I	Crystal-in. 25MHz frequency input, <u>within +/- 30 ppm tolerance</u> , to the amplifier (oscillator).
A3	PCIRST#	O	PCI Reset. This pin is used to reset PCI devices. When it is asserted low, all the PCI devices will be reset.
D5	STRAP_PE_HTS	I	PCIe Host / Target Select. Strap pin for PCIe Interface is selected to Host or Target mode. Pull low to PCIe Target. Pull high to PCIe Host. (default internal pull-high)

DDRIII Interface (54 PINs)

PIN No.	Symbol	Type	Description
L17	DRAMRST#	O	Active Low Asynchronous Reset. Reset is active when RESET# is LOW and otherwise. RESET# must be set as HIGH during normal operation.
W17 W16	DRAMCLK DRAMCLK1	O	Clock output. This pin provides the fundamental timing for the DDRII controller.
V18	RAS#	O	Row Address Strobe. When asserted, this signal latches row address on positive edge of the DDRII clock. This signal also allows row access and pre-charge.

Vortex86EX

32-Bit x86 Micro Processor

PIN No.	Symbol	Type	Description
T18	CAS#	O	Column Address Strobe. When asserted, this signal latches column address on the positive edge of the DDRII clock. This signal also allows column access and pre-charge.
P18	WE#	O	Memory Write Enable. This pin is used as a write enable for the memory data bus.
U19	CKE	O	Clock Enable. CKE HIGH activates, and CKE LOW deactivates internal clock signals, and device input buffers and output drivers.
R14 V19	CS1# CS0#	O	Chip Select CS1# & CS0#. These two pins activate the DDRIII devices. First Bank of DDRIII accepts any command when the CS0# pin is active low. Second Bank of DDRIII accepts any command when the CS1# pin is active low.
V13, T13	DQM[1:0]	O	Data Mask DQM[1:0]. These pins act as synchronized output enables during read cycles and byte masks during write cycles.
V11, U12	DQS[1:0]	I/O	Data Strobe DQS[1:0] for DDRIII only. Output with write data, input with the read data for source synchronous operation.
W12, U13	DQS#[1:0]	I/O	Data Strobe DQS#[1:0] for DDRIII only. Output with write data, input with the read data for source synchronous operation.
W18	ODT[0]	O	On Die Termination Control for DDRII only. ODT(registered HIGH) enables on die termination resistance internal to the DDR3 SDRAM.
R13	ODT[1]	O	On Die Termination Control for DDRII only. ODT(registered HIGH) enables on die termination resistance internal to the DDR3 SDRAM.
T9	ZQ	O	Reference Voltage for DDRIII only. Reference Pin for ZQ calibration
R8	VREF	I	Reference voltage for DDRIII only. Reference voltage for inputs for SSTL interface.
N19, N18, L18	BA[2:0]	O	Bank Address BA[2:0]. These pins are connected to DDRIII as bank address pins.

Vortex86EX

32-Bit x86 Micro Processor

PIN No.	Symbol	Type	Description
V15, V16, W15, W14, U10, V10, W11, W10, T15, T14, U15, U14, R11, T11, U11, R10	MD[15:0]	I/O	Memory Data MD[15:0] . These pins are connected to the DDRIII data bus.
P19, N16, P15, P16, P17, T19, T17, M17, R17, L16, T16, N17, U16, U17, N15, L19	MA[15:0]	O	Memory Address MA[15-0] . Normally, these pins are used as the row and column address for DDRIII.

CrossBar Interface (81 PINs)

PIN No.	Symbol	Type	Description
E8, D8, E9, C9, A8, B8, D7, C8	CBAR_P0[7:0]	I/O	CrossBar Port 0[7:0]. PIN function is select by CrossBar mechanism. This port support CrossBar-Bit select by group.
G16, H15, G17, G18, G19, H16, H18, H19	CBAR_P1[7:0]	I/O	CrossBar Port 1[7:0]. PIN function is select by CrossBar mechanism. This port support CrossBar-Bit select by group.
F15, E15, E16, F16, E18, F17, E19, F19	CBAR_P2[7:0]	I/O	CrossBar Port 2[7:0]. PIN function is select by CrossBar mechanism. This port support CrossBar-Bit select by group.
C16, C17, D16, D17, B19, D18, C19, D19	CBAR_P3[7:0]	I/O	CrossBar Port 3[7:0]. PIN function is select by CrossBar mechanism. This port support CrossBar-Bit select by group.
A16, B16, A17, C15, A18, B18, E14, D15	CBAR_P4[7:0]	I/O	CrossBar Port 4[7:0]. PIN function is select by CrossBar mechanism. This port only support CrossBar-Port select by group.
D12, C13, E12, D13, A14, B14, A15, D14	CBAR_P5[7:0]	I/O	CrossBar Port 5[7:0]. PIN function is select by CrossBar mechanism. This port only support CrossBar-Port select by group.
C11, D11, C12, B12, E11, A12, A13, B13	CBAR_P6[7:0]	I/O	CrossBar Port 6[7:0]. PIN function is select by CrossBar mechanism. This port only support CrossBar-Port select by group.
D9, D10, B10, B9, A10, A9, B11, A11	CBAR_P7[7:0]	I/O	CrossBar Port 7[7:0]. PIN function is select by CrossBar mechanism. This port only support CrossBar-Port select by group.
J17, J15, J16, J18, J19, K17, K16, L15	CBAR_P8[7:0]	I/O	CrossBar Port 8[7:0]. PIN function is select by CrossBar mechanism. This port only support CrossBar-Port select by group.
A5, A6, A7, C5, B6, D6, B7, C6	CBAR_P9[7:0]	I/O	CrossBar Port 9[7:0]. PIN function is select by CrossBar mechanism. This port only support CrossBar-Port select by group.

Vortex86EX

32-Bit x86 Micro Processor

PIN No.	Symbol	Type	Description
A4	CBAR_DEVRS T	O	CrossBar Device Reset This reset signal is manual controled by software for device accessed in CrossBar.

USB Interface (6 PINs)

PIN No.	Symbol	Type	Description
D1 D2	USB_DP USB_DM	I/O	Universal Serial Bus Controller 0 Port 0. These are the serial data pair for USB Port 0. 15kΩ pull down resistors are connected to DP and DM internally.
B1 B2	USB1_DP USB1_DM	I/O	Universal Serial Bus Controller 0 Port 1. These are the serial data pair for USB Port 1. 15kΩ pull down resistors are connected to DP and DM internally.
C4	USB_REXT	I	Universal Serial Bus Controller 0 External Reference Resistance 12kΩ ±1%
B4	USB_REXT1	I	Universal Serial Bus Controller 1 External Reference Resistance 12kΩ ±1%

PCI-E Bus Interface (10 PINs)

PIN No.	Symbol	Type	Description
P1 P2	PE0_RXP PE0_RXN	I	PCI-E Differential serial data input. P: positive; N: negative
R1 R2	PE0_TXP PE0_TXN	O	PCI-E Differential serial data output. P: positive; N: negative
N2 N1	PE0_CLKP PE0_CLKN	I	PCI-E Differential reference clock. P: positive; N: negative
W6 V6	DIF0_PCIE_PLL CLK100_P DIF0_PCIE_PLL CLK100_N	O	PCI-E Differential Clock 100MHz from Internal PLL P: positive; N: negative
W7 V7	DIF1_CLK100_ P DIF1_CLK100_ N	O	PCI-E Differential Clock 100MHz to Port0 P: positive; N: negative

Serial ATA Interface (8 PINs)

PIN No.	Symbol	Type	Description
L1 L2	SATA_TXP SATA_TXN	O	Serial ATA Device Controller TX Port. These are the serial ATA Transmitter pair for Serial ATA Device.
K1 K2	SATA_RXP SATA_RXN	I	Serial ATA Device Controller RX Port. These are the serial ATA Receive pair for Serial ATA Device.
J1 J2	SATA_CLKP SATA_CLKN	I	Differential PLL Reference Clock Pair.
W5 V5	DIF1_SATA_PH Y_CLK_P DIF1_SATA_PH Y_CLK_N	O	Differential Clock Pair from Internal PLL.

Ethernet Interface (5 PINs)

PIN No.	Symbol	Type	Description
R4	ISET	I	ISET: External resistor 6.02kΩ ±1% connecting pin for BIAS
W1	TXN	O	TXN: 10B-T/100BT transmitting output pin/ receiving input pin (negative)
V1	TXP	O	TXP: 10B-T/100BT transmitting output pin/ receiving input pin (positive)
W2	RXN	I	RXN: 10B-T/100BT receiving input pin/ transmitting output pin (negative)
V2	RXP	I	RXP: 10B-T/100BT receiving input pin/ transmitting output pin (positive)

SPI Interface (4 PINs)

Ball No.	Symbol	Type	Description
F4	SPI_CS#	O	SPI Chip Select
	STRAP_BMS	I	Boot Mode Select Pull it high to select Normal boot (Reset 250ms). Default internal pull-high. Pull it low to select Fast boot.
E4	SPI_CK	O	SPI Clock
	STRAP_JTAG	I	JTAG enable Pull it high to enable JTAG. (default internal pull-high)
G5	SPI_DO	O	SPI Data Output / Output pin , connected with input of flash.

Vortex86EX

32-Bit x86 Micro Processor

	STRAP_HDM	I	<p>Flash Strap Hardware Default Mode.</p> <p>Pull it high to ignore flash strap data. Use hardware default safe setting.</p> <p>Pull it low to get flash strap data for hardware setting. (default internal pull-low)</p>
H5	SPI_DI	I	SPI Data Input / Input pin, connected with output of flash.

RTC Interface (3 PINs)

PIN No.	Symbol	Type	Description
J5	RTC_PS	I	RTC Battery Power Sense.
H2	RTC_XOUT	O	Crystal-out. Frequency output from the inverting amplifier (oscillator)
H1	RTC_XIN	I	Crystal-in. 32.768KHz frequency input, within +/- 20 ppm tolerance, to the amplifier (oscillator).

ADC Interface (8 PINs)

PIN No.	Symbol	Type	Description
G1, G2, F1, E1, G3, F2, E2, F3	ADC_IN[7:0]	I	ADC Analog Input

JTAG Interface (4 PINs)

PIN No.	Symbol	Type	Description
E6	TDO	O	TDO: JTAG Test Data Output pin.
G4	TMS	I	TMS: JTAG Test Mode Select pin.
E5	TCK	I	TCK: JTAG Test Clock Input pin.
E7	TDI	I	TDI: JTAG Test Data Input pin.

Embedded Regulator (6 PINs)

PIN No.	Symbol	Type	Description
U3	REG_AVDD33	P	Analogue Power. Embedded Regulator 3.3V PAD Power.
U2	REG_AVSS33	G	Analogue Ground Embedded Regulator 3.3V PAD Ground
P3	REG_VCTRL18	O	Voltage Control for 1.8 Regulator
R3	REG_FB18	I	Feedback from 1.8V Regulator
U4	REG_VCTRL12	O	Voltage Control for 1.2 Regulator
T3	REG_FB12	I	Feedback from 1.2V Regulator

USB Power (7 PINs)

PIN No.	Symbol	Type	Description
C1	AVDD_USB33	P	Analogue Power: USB 3.3V Power
C2	AVSS_USB33	G	Analogue Ground: USB 3.3V Ground
A1	AVDD_USB12	P	Analogue Power: USB 1.2V Power
C3	AVDD_USBBAS 33	P	Analogue Power: USB Base Voltage 3.3V Power
B3	AVSS_USBBAS 33	G	Analogue Ground: USB Base Voltage 3.3V Ground
D3	AVDD_USBPLL 12	P	Analogue Power: USB PLL Power
A2	AVSS_USBPLL 12	G	Analogue Ground: USB PLL Ground

PCIE Power (7 PINs)

PIN No.	Symbol	Type	Description
N5	AVDD_PE33	P	Analogue Power PCIE 3.3V Power
T2	AVDD_PE12	P	Analogue Power PCIE 1.2V Power
M3	AVDD_PERX12	P	Analogue Power PCIE Receiver 1.2V Power
N3	AVSS_PERX12	G	Analogue Ground PCIE Receiver 1.2V Ground
T1	AVSS_PE	G	Analogue Ground PCIE Analogue Ground
M4	AVDD_PEPLL1 2	P	Analogue Power PCIE PLL 1.2V Power
N4	AVSS_PEPLL12	G	Analogue Ground PCIE Analogue PLL 1.2V Ground

SATA Power (7 PINs)

PIN No.	Symbol	Type	Description
L5	AVDD_SATA33	P	Analogue Power SATA PHY: 3.3V Analogue Power
M2	AVDD_SATA12	P	Analogue Power SATA PHY: 1.2V Analogue Power
M1	AVSS_SATA	G	Analogue Ground SATA PHY: Analogue Ground
K3	AVDD_SATARX 12	P	Analogue Power SATA PHY: Receiver 1.2V Analogue Power
L3	AVSS_SATARX 12	G	Analogue Ground SATA PHY: Receiver Analogue Ground
K4	AVDD_SATAPL L12	P	Analogue Power SATA PHY: PLL 1.2V Analogue Power
L4	AVSS_SATAPLL 12	G	Analogue Ground SATA PHY: PLL Analogue Ground

Ethernet Power (5 PINs)

PIN No.	Symbol	Type	Description
W3	AVDD_EPHYPL L18	P	Analogue Power Internal Ethernet PHY PLL 1.8V Power
V3	AVSS_EPHYPL L18	G	Analogue Ground Internal Ethernet PHY PLL 1.8V Ground
T4	AVDD_EPHYB G18	P	Analogue Power Internal Ethernet PHY Band Gap 1.8V Power
P4	AVSS_EPHYBG 18	G	Analogue Ground Internal Ethernet PHY Band Gap 1.8V Ground
U1	AVSS_EPHYTX 18	G	Analogue Ground Internal Ethernet PHY TX 1.8V Ground

ADC Power (4 PINs)

PIN No.	Symbol	Type	Description
J3	AVDD_ADC33	P	Analogue Power. ADC 3.3V Power
J4	AVSS_ADC33	G	Analogue Ground. ADC 3.3V Ground
M5	AVDD_TEMP18	P	Analogue Power. Temperature Sensor 1.8V Power
K5	AVSS_TEMP18	G	Analogue Ground. Temperature Sensor 1.8V Ground

System PLL Power (4 PINs)

PIN No.	Symbol	Type	Description
U8	AVDD_NBPLL1 8	P	Analogue Power. CPU/DRAM PLL Analog Power
T8	AVSS_NBPLL1 8	G	Analogue Ground. CPU/DRAM PLL Analog Ground
T6	AVDD_SBPLL1 8	P	Analogue Power. SB System PLL Analog Power
T7	AVSS_SBPLL1 8	G	Analogue Ground. SB System PLL Analog Ground

Battery POWER (2 PINs)

PIN No.	Symbol	Type	Description
H4	RTC_VDD33	P	Battery power for RTC.
H3	RTC_VSS	G	Battery ground for RTC.

Differential PAD Power (4 PINs)

PIN No.	Symbol	Type	Description
W8	DIF_VDD12	P	Differential PAD 1.2V Power.
V8	DIF_VSS12	G	Differential PAD 1.2V Ground.
U6	DIF_VDD18	P	Differential PAD 1.8V Power.
U7	DIF_VSS18	G	Differential PAD 1.8V Ground.

NC Pin (1 PIN)

PIN No.	Symbol	Type	Description
E3	NC	NC	NC.

1.2V POWER (8 PINS)

PIN No.	Symbol	Type	Description
J10, J11, J9, L10, L11, L9, P5, R7	VDD12	P	<i>Core power.</i>

1.5V POWER (8 PINS)

PIN No.	Symbol	Type	Description
M16, M19, R12, R16, R19, U9, W13, W9	VDD15	P	<i>1.5V DDR Power.</i>

1.8V POWER (2 PINS)

PIN No.	Symbol	Type	Description
T5, D4	VDD18	P	<i>1.8V Power.</i>

3.3V Power (7 PINS)

PIN No.	Symbol	Type	Description
B17, C10, C14, E17, H17, K19, R5	VDD33	P	<i>I/O PAD Power.</i>

Digital Ground (28 PINS)

PIN No.	Symbol	Type	Description
A19, B15, C18, C7, E10, E13, F18, F5, G15, K11, K15, K18, K9, M15, M18, R15, R18, R6, R9, T10, T12, U18, U5, V12, V14, V17, V9, W19	VSS	G	<i>Digital Ground.</i>

4.5 PIN Capacitance Description

Symbol	Parameter	Min.	Typ.	Max.	Unit
C _{IN}	3.3V Input Capacitance	1.94304	2.05082	2.08563	pF
C _{BID}	3.3V Bi-directional Capacitance	2.18057(max loading=40)	2.21818(max loading=40)	2.2269(max loading=40)	pF

VGA:

Symbol	Parameter	Min.	Max.	Unit
C _{BID}	3.3V Bi-directional Capacitance	2(max loading=40)	2.5(max loading=40)	pF

South-Bridge:

Symbol	Parameter	Min.	Typ.	Max.	Unit
C _{IN}	3.3V Input Capacitance	3.144	3.143	3.216	pF
C _{BID}	3.3V Bi-directional Capacitance	3.179	3.116	3.099	pF

4.6 PIN Pull-up / Pull-down Description

PIN Name	Type	Driving Current	Pull-Up	Pull-Down	Schmitt Trigger	5V I/O Tolerant	Slew Rate	Description
PWRGOOD	I	--	--	--	Y	--	--	
XOUT_25M	O	--	--	--	--	--	--	
XIN_25M	I	--	--	--	--	--	--	
PCIRST#	O	Note8	--	Y	--	--	--	Note2
ISA_RSTDRV	O	Note8	--	--	--	--	--	
DRAMCLK	O	Note3	--	--	--	--	FIX	DDR3 signal
DRAMCLK#	O	Note3	--	--	--	--	FIX	DDR3 signal
DRAMCLK1	O	Note3	--	--	--	--	FIX	DDR3 signal
DRAMCLK#1	O	Note3	--	--	--	--	FIX	DDR3 signal
RAS#	O	Note3	--	--	--	--	FIX	DDR3 signal
CAS#	O	Note3	--	--	--	--	FIX	DDR3 signal
WE#	O	Note3	--	--	--	--	FIX	DDR3 signal
CKE	O	Note3	--	--	--	--	FIX	DDR3 signal
CS0#	O	Note3	--	--	--	--	FIX	DDR3 signal

Vortex86EX

32-Bit x86 Micro Processor

PIN Name	Type	Driving Current	Pull-Up	Pull-Down	Schmitt Trigger	5V I/O Tolerant	Slew Rate	Description
CS1#	O	Note3	--	--	--	--	FIX	DDR3 signal
DQM[3:0]	O	Note3	--	--	--	--	FIX	DDR3 signal
DQS[3:0]	I/O	Note3	--	--	--	--	FIX	DDR3 signal
DQS#[3:0]	I/O	Note3	--	--	--	--	FIX	DDR3 signal
ODT[1:0]	O	Note3	--	--	--	--	FIX	DDR3 signal
BA[2:0]	O	Note3	--	--	--	--	FIX	DDR3 signal
MD[31:0]	I/O	Note3			--	--	FIX	DDR3 signal
MA[14:0]	O	Note3	--	--	--	--	FIX	DDR3 signal
DP1	I/O	--	--	--	--	--	--	Note4
DM1	I/O	--	--	--	--	--	--	Note4
DP2	I/O	--	--	--	--	--	--	Note4
DM2	I/O	--	--	--	--	--	--	Note4
P1_EXT12K	I	--	--	--	--	--	--	Note4
P2_EXT12K	I	--	--	--	--	--	--	Note4
SATA_PHY_C LK	O							
SATA_PHY_C LK#	O							
EARXIP_A	I							
EARXIN_A	I							
EAREFCLKP	I							
EAREFCLKN	I							
EXTXOP_A	O							
EXTXON_A	O							
PCIE_MSEL	I	8~10mA	--	--	--	--	--	
PLLCK100_0_p	O							
PLLCK100_0_n	O							
PLLCK100_1_p	O							
PLLCK100_1_n	O							
EARXIP0	I							
EARXIN0	I							

Vortex86EX

32-Bit x86 Micro Processor

PIN Name	Type	Driving Current	Pull-Up	Pull-Down	Schmitt Trigger	5V I/O Tolerant	Slew Rate	Description
EAREFCLKP0	I							
EAREFCLKN0	I							
EXTXOP0	O							
EXTXON0	O							
EPHY_ISET	I	--	--	--	--	--	--	Note5
EPHY_RXN	I/O	--	--	--	--	--	--	
EPHY_EXP	I/O	--	--	--	--	--	--	
EPHY_TXN	I/O	--	--	--	--	--	--	
EPHY_TXP	I/O	--	--	--	--	--	--	
EPHY_ATSTN	I/O	--	--	--	--	--	--	Note6
EPHY_ATSTP	I/O	--	--	--	--	--	--	Note6
SPI_CS#	O	8~10mA	Y	--	--	--	--	
SPI_CK	O	8~10mA	--	Y	--	--	S	
SPI_DO	O	8~10mA	--	Y	--	--	S	
SPI_DI	I	8~10mA	Y	--	--	--	S	
TDO	O	8mA	--	--	--	--	S	
TMS	I	8mA	--	--	--	--	S	
TCK	I	8mA	--	--	--	--	S	
TDI	I	8mA	--	--	--	--	S	
RTC_VSS	I	--	--	--	--	--	--	
RTC_XOUT	O	--	--	--	--	--	--	
RTC_XIN	I	--	--	--	--	--	--	
PORT0[0]	I/O	BA+30h[2]	BA+30h[0]	BA+30h[1]	BA+30h[3]	Y	BA+30h[4]	Note7
PORT0[1]	I/O	BA+31h[2]	BA+31h[0]	BA+31h[1]	BA+31h[3]	Y	BA+31h[4]	Note7
PORT0[2]	I/O	BA+32h[2]	BA+32h[0]	BA+32h[1]	BA+32h[3]	Y	BA+32h[4]	Note7
PORT0[3]	I/O	BA+33h[2]	BA+33h[0]	BA+33h[1]	BA+33h[3]	Y	BA+33h[4]	Note7

Vortex86EX

32-Bit x86 Micro Processor

PIN Name	Type	Driving Current	Pull-Up	Pull-Down	Schmitt Trigger	5V I/O Tolerant	Slew Rate	Description
PORT0[4]	I/O	BA+34h [2]	BA+34h[0]	BA+34h[1]	BA+34h[3]	Y	BA+34 h[4]	Note7
PORT0[5]	I/O	BA+35h [2]	BA+35h[0]	BA+35h[1]	BA+35h[3]	Y	BA+35 h[4]	Note7
PORT0[6]	I/O	BA+36h [2]	BA+36h[0]	BA+36h[1]	BA+36h[3]	Y	BA+36 h[4]	Note7
PORT0[7]	I/O	BA+37h [2]	BA+37h[0]	BA+37h[1]	BA+37h[3]	Y	BA+37 h[4]	Note7
PORT1[0]	I/O	BA+38h [2]	BA+38h[0]	BA+38h[1]	BA+38h[3]	Y	BA+38 h[4]	Note7
PORT1[1]	I/O	BA+39h [2]	BA+39h[0]	BA+39h[1]	BA+39h[3]	Y	BA+39 h[4]	Note7
PORT1[2]	I/O	BA+3Ah [2]	BA+3Ah[0]	BA+3Ah[1]	BA+3Ah[3]	Y	BA+3A h[4]	Note7
PORT1[3]	I/O	BA+3Bh [2]	BA+3Bh[0]	BA+3Bh[1]	BA+3Bh[3]	Y	BA+3B h[4]	Note7
PORT1[4]	I/O	BA+3Ch [2]	BA+3Ch[0]	BA+3Ch[1]	BA+3Ch[3]	Y	BA+3C h[4]	Note7
PORT1[5]	I/O	BA+3Dh [2]	BA+3Dh[0]	BA+3Dh[1]	BA+3Dh[3]	Y	BA+3D h[4]	Note7
PORT1[6]	I/O	BA+3Eh [2]	BA+3Eh[0]	BA+3Eh[1]	BA+3Eh[3]	Y	BA+3E h[4]	Note7
PORT1[7]	I/O	BA+3Fh [2]	BA+3Fh[0]	BA+3Fh[1]	BA+3Fh[3]	Y	BA+3F h[4]	Note7
PORT2[0]	I/O	BA+40h [2]	BA+40h[0]	BA+40h[1]	BA+40h[3]	Y	BA+40 h[4]	Note7
PORT2[1]	I/O	BA+41h [2]	BA+41h[0]	BA+41h[1]	BA+41h[3]	Y	BA+41 h[4]	Note7
PORT2[2]	I/O	BA+42h [2]	BA+42h[0]	BA+42h[1]	BA+42h[3]	Y	BA+42 h[4]	Note7
PORT2[3]	I/O	BA+43h [2]	BA+43h[0]	BA+43h[1]	BA+43h[3]	Y	BA+43 h[4]	Note7
PORT2[4]	I/O	BA+44h [2]	BA+44h[0]	BA+44h[1]	BA+44h[3]	Y	BA+44 h[4]	Note7
PORT2[5]	I/O	BA+45h [2]	BA+45h[0]	BA+45h[1]	BA+45h[3]	Y	BA+45 h[4]	Note7
PORT2[6]	I/O	BA+46h	BA+46h[BA+46h[BA+46h[Y	BA+46	Note7

Vortex86EX

32-Bit x86 Micro Processor

PIN Name	Type	Driving Current	Pull-Up	Pull-Down	Schmitt Trigger	5V I/O Tolerant	Slew Rate	Description
		[2]	0]	1]	3]		h[4]	
PORT2[7]	I/O	BA+47h [2]	BA+47h[0]	BA+47h[1]	BA+47h[3]	Y	BA+47 h[4]	Note7
PORT3[0]	I/O	BA+48h [2]	BA+48h[0]	BA+48h[1]	BA+48h[3]	Y	BA+48 h[4]	Note7
PORT3[1]	I/O	BA+49h [2]	BA+49h[0]	BA+49h[1]	BA+49h[3]	Y	BA+49 h[4]	Note7
PORT3[2]	I/O	BA+4Ah [2]	BA+4Ah[0]	BA+4Ah[1]	BA+4Ah[3]	Y	BA+4A h[4]	Note7
PORT3[3]	I/O	BA+4Bh [2]	BA+4Bh[0]	BA+4Bh[1]	BA+4Bh[3]	Y	BA+4B h[4]	Note7
PORT3[4]	I/O	BA+4Ch h[2]	BA+4Ch[0]	BA+4Ch[1]	BA+4Ch[3]	Y	BA+4C h[4]	Note7
PORT3[5]	I/O	BA+4Dh h[2]	BA+4Dh[0]	BA+4Dh[1]	BA+4Dh[3]	Y	BA+4D h[4]	Note7
PORT3[6]	I/O	BA+4Eh [2]	BA+4Eh[0]	BA+4Eh[1]	BA+4Eh[3]	Y	BA+4E h[4]	Note7
PORT3[7]	I/O	BA+4Fh [2]	BA+4Fh[0]	BA+4Fh[1]	BA+4Fh[3]	Y	BA+4F h[4]	Note7
PORT4[0]	I/O	BA+50h [2]	BA+50h[0]	BA+50h[1]	BA+50h[3]	Y	BA+50 h[4]	Note7
PORT4[1]	I/O	BA+51h [2]	BA+51h[0]	BA+51h[1]	BA+51h[3]	Y	BA+51 h[4]	Note7
PORT4[2]	I/O	BA+52h [2]	BA+52h[0]	BA+52h[1]	BA+52h[3]	Y	BA+52 h[4]	Note7
PORT4[3]	I/O	BA+53h [2]	BA+53h[0]	BA+53h[1]	BA+53h[3]	Y	BA+53 h[4]	Note7
PORT4[4]	I/O	BA+54h [2]	BA+54h[0]	BA+54h[1]	BA+54h[3]	Y	BA+54 h[4]	Note7
PORT4[5]	I/O	BA+55h [2]	BA+55h[0]	BA+55h[1]	BA+55h[3]	Y	BA+55 h[4]	Note7
PORT4[6]	I/O	BA+56h [2]	BA+56h[0]	BA+56h[1]	BA+56h[3]	Y	BA+56 h[4]	Note7
PORT4[7]	I/O	BA+57h [2]	BA+57h[0]	BA+57h[1]	BA+57h[3]	Y	BA+57 h[4]	Note7
PORT5[0]	I/O	BA+58h	BA+58h[BA+58h[BA+58h[Y	BA+58	Note7

Vortex86EX

32-Bit x86 Micro Processor

PIN Name	Type	Driving Current	Pull-Up	Pull-Down	Schmitt Trigger	5V I/O Tolerant	Slew Rate	Description
		[2]	0]	1]	3]		h[4]	
PORT5[1]	I/O	BA+59h [2]	BA+59h[0]	BA+59h[1]	BA+59h[3]	Y	BA+59 h[4]	Note7
PORT5[2]	I/O	BA+5Ah [2]	BA+5Ah[0]	BA+5Ah[1]	BA+5Ah[3]	Y	BA+5A h[4]	Note7
PORT5[3]	I/O	BA+5Bh [2]	BA+5Bh[0]	BA+5Bh[1]	BA+5Bh[3]	Y	BA+5B h[4]	Note7
PORT5[4]	I/O	BA+5C h[2]	BA+5Ch[0]	BA+5Ch[1]	BA+5Ch[3]	Y	BA+5C h[4]	Note7
PORT5[5]	I/O	BA+5D h[2]	BA+5Dh[0]	BA+5Dh[1]	BA+5Dh[3]	Y	BA+5D h[4]	Note7
PORT5[6]	I/O	BA+5Eh [2]	BA+5Eh[0]	BA+5Eh[1]	BA+5Eh[3]	Y	BA+5E h[4]	Note7
PORT5[7]	I/O	BA+5Fh [2]	BA+5Fh[0]	BA+5Fh[1]	BA+5Fh[3]	Y	BA+5F h[4]	Note7
PORT6[0]	I/O	BA+60h [2]	BA+60h[0]	BA+60h[1]	BA+60h[3]	Y	BA+60 h[4]	Note7
PORT6[1]	I/O	BA+61h [2]	BA+61h[0]	BA+61h[1]	BA+61h[3]	Y	BA+61 h[4]	Note7
PORT6[2]	I/O	BA+62h [2]	BA+62h[0]	BA+62h[1]	BA+62h[3]	Y	BA+62 h[4]	Note7
PORT6[3]	I/O	BA+63h [2]	BA+63h[0]	BA+63h[1]	BA+63h[3]	Y	BA+63 h[4]	Note7
PORT6[4]	I/O	BA+64h [2]	BA+64h[0]	BA+64h[1]	BA+64h[3]	Y	BA+64 h[4]	Note7
PORT6[5]	I/O	BA+65h [2]	BA+65h[0]	BA+65h[1]	BA+65h[3]	Y	BA+65 h[4]	Note7
PORT6[6]	I/O	BA+66h [2]	BA+66h[0]	BA+66h[1]	BA+66h[3]	Y	BA+66 h[4]	Note7
PORT6[7]	I/O	BA+67h [2]	BA+67h[0]	BA+67h[1]	BA+67h[3]	Y	BA+67 h[4]	Note7
PORT7[0]	I/O	BA+68h [2]	BA+68h[0]	BA+68h[1]	BA+68h[3]	Y	BA+68 h[4]	Note7
PORT7[1]	I/O	BA+69h [2]	BA+69h[0]	BA+69h[1]	BA+69h[3]	Y	BA+69 h[4]	Note7
PORT7[2]	I/O	BA+6Ah [2]	BA+6Ah[0]	BA+6Ah[1]	BA+6Ah[3]	Y	BA+6A h[4]	Note7

Vortex86EX

32-Bit x86 Micro Processor

PIN Name	Type	Driving Current	Pull-Up	Pull-Down	Schmitt Trigger	5V I/O Tolerant	Slew Rate	Description
PORT7[3]	I/O	BA+6Bh[2]	BA+6Bh[0]	BA+6Bh[1]	BA+6Bh[3]	Y	BA+6Bh[4]	Note7
PORT7[4]	I/O	BA+6Ch[2]	BA+6Ch[0]	BA+6Ch[1]	BA+6Ch[3]	Y	BA+6Ch[4]	Note7
PORT7[5]	I/O	BA+6Dh[2]	BA+6Dh[0]	BA+6Dh[1]	BA+6Dh[3]	Y	BA+6Dh[4]	Note7
PORT7[6]	I/O	BA+6Eh[2]	BA+6Eh[0]	BA+6Eh[1]	BA+6Eh[3]	Y	BA+6Eh[4]	Note7
PORT7[7]	I/O	BA+6Fh[2]	BA+6Fh[0]	BA+6Fh[1]	BA+6Fh[3]	Y	BA+6Fh[4]	Note7
PORT8[0]	I/O	BA+70h[2]	BA+70h[0]	BA+70h[1]	BA+70h[3]	Y	BA+70h[4]	Note7
PORT8[1]	I/O	BA+71h[2]	BA+71h[0]	BA+71h[1]	BA+71h[3]	Y	BA+71h[4]	Note7
PORT8[2]	I/O	BA+72h[2]	BA+72h[0]	BA+72h[1]	BA+72h[3]	Y	BA+72h[4]	Note7
PORT8[3]	I/O	BA+73h[2]	BA+73h[0]	BA+73h[1]	BA+73h[3]	Y	BA+73h[4]	Note7
PORT8[4]	I/O	BA+74h[2]	BA+74h[0]	BA+74h[1]	BA+74h[3]	Y	BA+74h[4]	Note7
PORT8[5]	I/O	BA+75h[2]	BA+75h[0]	BA+75h[1]	BA+75h[3]	Y	BA+75h[4]	Note7
PORT8[6]	I/O	BA+76h[2]	BA+76h[0]	BA+76h[1]	BA+76h[3]	Y	BA+76h[4]	Note7
PORT8[7]	I/O	BA+77h[2]	BA+77h[0]	BA+77h[1]	BA+77h[3]	Y	BA+77h[4]	Note7
PORT9[0]	I/O	BA+78h[2]	BA+78h[0]	BA+78h[1]	BA+78h[3]	Y	BA+78h[4]	Note7
PORT9[1]	I/O	BA+79h[2]	BA+79h[0]	BA+79h[1]	BA+79h[3]	Y	BA+79h[4]	Note7
PORT9[2]	I/O	BA+7Ah[2]	BA+7Ah[0]	BA+7Ah[1]	BA+7Ah[3]	Y	BA+7Ah[4]	Note7
PORT9[3]	I/O	BA+7Bh[2]	BA+7Bh[0]	BA+7Bh[1]	BA+7Bh[3]	Y	BA+7Bh[4]	Note7
PORT9[4]	I/O	BA+7Ch[2]	BA+7Ch[0]	BA+7Ch[1]	BA+7Ch[3]	Y	BA+7Ch[4]	Note7
PORT9[5]	I/O	BA+7Dh[2]	BA+7Dh[0]	BA+7Dh[1]	BA+7Dh[3]	Y	BA+7Dh[4]	Note7

Vortex86EX

32-Bit x86 Micro Processor

PIN Name	Type	Driving Current	Pull-Up	Pull-Down	Schmitt Trigger	5V I/O Tolerant	Slew Rate	Description
		h[2]	0]	1]	3]		h[4]	
PORT9[6]	I/O	BA+7Eh [2]	BA+7Eh[0]	BA+7Eh[1]	BA+7Eh[3]	Y	BA+7E h[4]	Note7
PORT9[7]	I/O	BA+7Fh [2]	BA+7Fh[0]	BA+7Fh[1]	BA+7Fh[3]	Y	BA+7F h[4]	Note7

Definition:

--: Not need to specify

Y: Yes

F: Fast

S: Slow

The pull-up/pull-down resistance is 75KΩ

Note1: USB analog IO pad

Note2: A PCI type IO pad.

Note3: define by North Function1 84h.

Note4: USB analog IO pad

Note5: BIAS external resistor connecting pin

Note6: External Phy test pin

Note7: BA (Base Address) defined on South Bridge Function PCI config 65-64h, pPORT0~9 setting depend on recommend multi-function Pin Pull-up/Down list

Note8: Programmable through South config register 48h

4.7 The Registers only reset by power-good

These registers are only reset by PowerGood

1. GPIO_0~9 Direction register
2. GPIO_0~9 Data register
3. GPIO Port Config Registers
4. WatchDog Timer_0 3Ch Indirect access register
5. WatchDog Timer_1 ADh register

5. System Address Map

The SoC supports 4 Gbytes of addressable memory space and 64 Kbytes of addressable I/O space. In order to be compatible with PC/AT system, the lower 1 Mbytes of this addressable memory is divided into regions which can be individually controlled with programmable attributes such as disable, read/write, write only, or read only (see Chapter 11, Register Description section for details on attribute programming).

5.1 Memory Address Ranges

Figure 5-1 represents SoC memory address map. It shows the main memory regions defined and supported by the SoC. At the highest level, the address space is divided into two main conceptual regions. One is the 0–1-Mbyte DOS compatibility region and the other is 1-Mbyte to 4-Gbyte extended memory region. The SoC supports several main memory types (reference 10.4). The main memory type and size in the system will be auto-detected by the system BIOS.

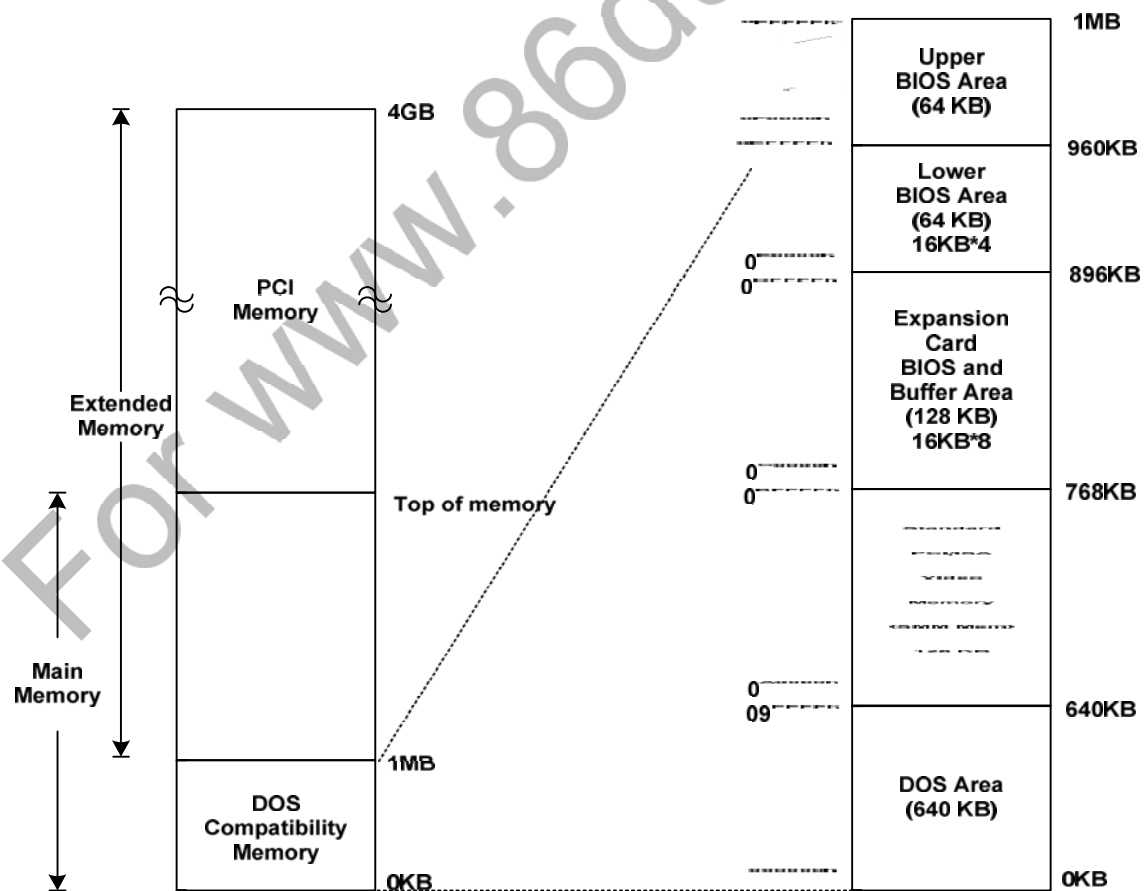

Figure 5-1. Memory Address Map

5.1.1 Dos Compatibility Region

The first region of memory is called the Dos Compatibility Region because it is defined for early PC. This area is divided into the following address regions:

0–640-Kbyte DOS Area

640–768-Kbyte Video Buffer Area

768–896-Kbyte in 16-Kbyte sections (total of 8 sections) - Expansion Area

896–960-Kbyte in 16-Kbyte sections (total of 4 sections) - Extended System BIOS Area

960-Kbyte–1-Mbyte Memory (BIOS Area) - System BIOS Area

From 640 Kbytes – 1Mbytes: it can be divided into fourteen ranges which can be enabled or disabled independently for both read and write. These regions can also be mapped to either main DRAM or PCI by system BIOS. (See A/B Page control Register and Memory Attribute Register in Section 3, Chapter 11.)

DOS Area (00000–9FFFFh)

The DOS area (00000h – 9FFFFh) is 640 Kbytes in size. It is always mapped to the main memory controlled by the SoC.

Video Buffer Area (A0000–BFFFFh)

The 128-Kbyte graphics adapter memory region is normally mapped to a video device on the PCI bus (typically VGA controller). This area is controlled by the A/B Page control Register. It can be mapped to either main DRAM or PCI for both read and write command.

ISA Expansion Area (C0000–DFFFFh)

This 128-Kbyte ISA Expansion region is divided into eight 16-Kbyte segments. Each segment can be assigned one of four Read/Write states: read-only, write-only, read/write, or disabled. Typically, these blocks are mapped through the PCI bridge to ISA space. Memory that is disabled is not remapped.

Extended System BIOS Area (E0000–EFFFFh)

This 64-Kbyte area is divided into four 16-Kbyte segments. Each segment can be assigned independent read and write attributes so it can be mapped either to main DRAM or to PCI. Typically, this area is used for RAM or ROM. Memory that is disabled is not remapped.

System BIOS Area (F0000–FFFFFh)

This area is a single 64-Kbyte segment that can be assigned read and write attributes. It is by default (after reset) read/write disabled and cycles are forwarded to PCI. By manipulating the read/write attributes, the SoC can “shadow” BIOS into main memory. Memory that is disabled is not

remapped.

5.1.2 Extended Memory Region

This memory region covers 10_0000h (1 Mbytes) to FFFF_FFFFh (4 Gbytes minus 1) address range and is divided into the following regions:

DRAM memory from 1 Mbytes to a top of memory

PCI Memory space from the top of memory to 4 Gbytes

High BIOS area from 4 Gbytes to 4 Gbytes minus 16 Mbytes

Main DRAM Address Range (0010_0000h to Top of Main Memory)

The address range from 1 Mbytes to the top of main memory is mapped to the main memory address range controlled by the SoC. All accesses to addresses within this range are forwarded to the main memory.

PCI Memory Address Range (Top of Main Memory to 4 Gbytes)

The address range from the top of main DRAM to 4 Gbytes is normally mapped to PCI. The PMC forwards all accesses within this address range to PCI.

1. High BIOS Area (FF00_0000–FFFF_FFFFh)

The top 16 Mbytes of the Extended Memory Region is reserved for System BIOS (High BIOS), extended BIOS for PCI devices, and the A20 alias of the system BIOS. The CPU begins execution from the High BIOS after reset. This region is mapped to the PCI so that the upper subset of this region is aliased to 16 Mbytes minus 256 Kbytes range. The actual address space required for the BIOS is less than 2 Mbytes.

5.2 Memory Shadowing

Any block of memory that can be designated as read only or write only can be “shadowed” into PMC DRAM memory. Typically, this is done to allow ROM code to execute more rapidly out of main DRAM. ROM is used as read only during the copy process while DRAM at the same time is designated write only. After copying, the DRAM is designated read only so that ROM is shadowed. CPU bus transactions are routed accordingly. The PMC does not respond to transactions originating from PCI or ISA masters and targeted at shadowed memory blocks.

5.3 I/O Address Space

The SoC positively decodes accesses to all internal registers, including PCI configuration registers (CF8h and CFCh), PC/AT Compatible IO registers (8237, 8254 & 8259), and all relocatable IO space registers (UART).

6. Operation Mode

The SoC supports three operation modes: protected mode, real-address mode and flat mode. The operation mode determines which instructions and architectural features are accessible:

Protected mode. In this mode all instructions and architectural features are available, providing the highest performance and capability. This is the recommended mode for all new applications and operating systems.

Among the capabilities of protected mode is the ability to directly execute “real-address mode” 8086 software in a protected, multitasking environment. This feature is called virtual-8086 mode, although it is not actually a processor mode. Virtual-8086 mode is actually a protected mode attribute that can be enabled for any task.

Real-address mode. It provides the programming environment of the 8086 processor with a few extensions (such as the ability to switch to protected or system management mode). The processor is placed in real-address mode following power-up or a reset.

Flat mode. In general, this mode is similar with Real-Address mode. But there is one difference involved, i.e. Flat mode can access 4GBytes address.

7. Register Sets

The SoC contains three sets of software accessible registers (Core registers, I/O Mapped registers and Configuration registers).

7.1 Core Registers

The SoC provides 24 Core Registers. The 16 Base Architecture Registers (General-purpose Registers, Segment Registers, Flags Register and Instruction Pointer) are used in general system and application programming. The other 8 system-level registers (Control Registers and System Address Registers) can be used only by system-level programs. These registers are shown below. The details will be described in Register Description in Chapter 11.

7.1.1 General-Purpose Registers (Detail information in Chap.11.1.1)

Register Name
EAX
EBX
ECX
EDX
ESI
EDI
EBP
ESP

7.1.2 Segment Registers (Detail information in Chap.11.1.2)

Register Name
Code Segment Register – CS
Stack Segment Register – SS
Data Segment Register – DS
Data Segment Register – ES
Data Segment Register – FS
Data Segment Register – GS

7.1.3 Instruction Pointer (Detail information in Chap.11.1.3)

Register Name
Instruction Pointer

7.1.4 Flags Register (Detail information in Chap.11.1.4)

Register Name
Flags Register (EFLAGS)

7.1.5 Control Registers (Detail information in Chap.11.1.5)

Register Name
Control Register 0
Control Register 1
Control Register 2
Control Register 3
Control Register 4

7.1.6 System Address Registers (Detail information in Chap.11.1.6)

Register Name
Global Descriptor Table Register
Interrupt Descriptor Table Register
Local Descriptor Table Register
Task State Segment Register

7.1.7 FPU Registers (Detail information in Chap.11.1.7)

Register Name
FPU Data Register R0
FPU Data Register R1
FPU Data Register R2
FPU Data Register R3
FPU Data Register R4
FPU Data Register R5
FPU Data Register R6
FPU Data Register R7
X87 FPU Status Register
X87 FPU Control Word

7.2 CPU MSR Registers

7.2.1 MSR Registers (Detail information in Chap.11.2)

MSR Index	MSR Name
10h	Time-Stamp Counter
174h	IA32_SYSENTER_CS
175h	IA32_SYSENTER_ESP
176h	IA32_SYSENTER_EIP
CFCFCF00h	Reserved
D0D0D000h	Instruction Counter Register
D0D0D001h	User Instruction Counter Register
D0D0D002h	Instruction Counter Control Register

7.3 I / O Mapped Registers

The I/O Mapped Registers are usually used to control the SoC integrated peripherals or to store the peripherals' data, addresses and statuses. We divided these I/O Mapped Registers into fourteen subsets, including **PCI Configurations Registers, Slave DMA Controller Registers, DMA Page Registers, Master DMA Controller Registers, DMA High Page Registers, Timer / Counter Registers, Interrupt Edge/Level Control Registers, NMI Status and Control Register, CMOS Memory & RTC Registers, System Control Register** and **Serial Port Registers**. These registers have fixed IO Address except Serial Port Registers.

The base address of Serial Port Registers is programmable via the Internal UART IO Address Register in Vortex86EX_SB Configuration Space Register.

These registers are listed as below. In Chapter 11, Register Description will show more detailed information about these registers.

7.3.1 PCI Configuration Registers (Detail information in Chap.11.3.1)

IO Address	Register Name
0CFBh-0CF8h	PCI Configuration Address Register
0CFFh-0CFCh	PCI Configuration Data Register

7.3.2 Slave DMA Controller Registers(Detail information in Chap.11.3.2)

IO Address	Register Name
00h	Slave DMA Channel 0 Base/Current Address Register
01h	Slave DMA Channel 0 Base/Current Count Register
02h	Slave DMA Channel 1 Base/Current Address Register
03h	Slave DMA Channel 1 Base/Current Count Register
04h	Slave DMA Channel 2 Base/Current Address Register
05h	Slave DMA Channel 2 Base/Current Count Register
06h	Slave DMA Channel 3 Base/Current Address Register
07h	Slave DMA Channel 3 Base/Current Count Register
08h	Slave DMA Command/Status Register
09h	Slave DMA Command/Request Register
0Ah	Slave DMA Command/Single Mask Register
0Bh	Slave DMA Mode Register
0Ch	Slave DMA Set/Clear First/Last Clear F/F Register
0Dh	Slave DMA Temporary/Master Disable Register
0Eh	Slave DMA Clear Mask/Mode register pointer Register
0Fh	Slave DMA Write Mask Register

7.3.3 DMA Page Registers (Detail information in Chap.11.3.3)

IO Address	Register Name
81h	DMA Page Register – DMA Channel 2
82h	DMA Page Register – DMA Channel 3
83h	DMA Page Register – DMA Channel 1
87h	DMA Page Register – DMA Channel 0
89h	DMA Page Register – DMA Channel 6
8Ah	DMA Page Register – DMA Channel 7
8Bh	DMA Page Register – DMA Channel 5

7.3.4 Master DMA Controller Registers (Detail information in Chap.11.3.4)

IO Address	Register Name
C0h	Master DMA Channel 4 Base/Current Address Register
C2h	Master DMA Channel 4 Base/Current Count Register
C4h	Master DMA Channel 5 Base/Current Address Register
C6h	Master DMA Channel 5 Base/Current Count Register
C8h	Master DMA Channel 6 Base/Current Address Register
CAh	Master DMA Channel 6 Base/Current Count Register
CCh	Master DMA Channel 7 Base/Current Address Register
CEh	Master DMA Channel 7 Base/Current Count Register
D0h	Master DMA Command/Status Register
D2h	Master DMA Command/Request Register
D4h	Master DMA Command/Single Mask Register
D6h	Master DMA Mode Register
D8h	Master DMA Set/Clear First/Last Clear F/F Register
DAh	Master DMA Temporary/Master Disable Register
DCh	Master DMA Clear Mask/Mode register pointer Register
DEh	Master DMA Write Mask Register

7.3.5 DMA High Page Registers (Detail information in Chap.11.3.5)

IO Address	Register Name
481h	DMA High Page Register – DMA Channel 2.
482h	DMA High Page Register – DMA Channel 3.
483h	DMA High Page Register – DMA Channel 1.
487h	DMA High Page Register – DMA Channel 0.
489h	DMA High Page Register – DMA Channel 6.
48Ah	DMA High Page Register – DMA Channel 7.
48Bh	DMA High Page Register – DMA Channel 5.

7.3.6 Timer / Counter Registers (Detail information in Chap.11.3.6)

IO Address	Register Name
40h	Timer / Counter 0 Count Register
41h	Timer / Counter 1 Count Register
42h	Timer / Counter 2 Count Register
43h	Timer / Counter Control Register

7.3.7 Indirect Access Registers (Detail information in Chap.11.3.7)

IO Address	Register Name
22h	Address Index Register for indirect access GPIO & WDT0
23h	Data Register for indirect access GPIO & WDT0

7.3.8 Master Interrupt Controller Registers (Detail information in Chap.11.3.8)

IO Address	Register Name
20h	Master Interrupt Request/Interrupt Service/Interrupt Command Register
21h	Master Interrupt Mask Register

7.3.9 Slave Interrupt Controller Registers (Detail information in Chap.11.3.9)

IO Address	Register Name
A0h	Slave Interrupt Request/Interrupt Service/Interrupt Command Register
A1h	Slave Interrupt Mask Register

7.3.10 Interrupt Edge / Level Control Registers (Detail information in Chap.11.3.10)

IO Address	Register Name
4D0h	Master Interrupt Edge/Level Control Register
4D1h	Slave Interrupt Edge/Level Control Register

7.3.11 Keyboard / Mouse Control Registers (Detail information in Chap.11.3.11)

IO Address	Register Name
60h	Output Buffer Register
64h	Input Buffer / Status / Command Register

7.3.12 Serial Port Registers (Detail information in Chap.11.3.12)

UART Config Registers

(Base Address Refers to the Register of index 61h-60h, SB Function0 PCI Configuration Register)

IO Address	Register Name
BA + 00h	Internal UART1 IO Control Register
BA + 04h	Internal UART2 IO Control Register
BA + 08h	Internal UART3 IO Control Register
BA + 0Ch	Internal UART4 IO Control Register
BA + 10h	Internal UART5 IO Control Register
BA + 14h	Internal UART6 IO Control Register
BA + 18h	Internal UART7 IO Control Register
BA + 1Ch	Internal UART8 IO Control Register
BA + 20h	Internal UART9 IO Control Register
BA + 24h	Internal UART10 IO Control Register

Serial Port Registers

- (UART1 Base Address Refers to UART Config Register Offset 00h)
- (UART2 Base Address Refers to UART Config Register Offset 04h)
- (UART3 Base Address Refers to UART Config Register Offset 08h)
- (UART4 Base Address Refers to UART Config Register Offset 0Ch)
- (UART5 Base Address Refers to UART Config Register Offset 10h)
- (UART6 Base Address Refers to UART Config Register Offset 14h)
- (UART7 Base Address Refers to UART Config Register Offset 18h)
- (UART8 Base Address Refers to UART Config Register Offset 1Ch)
- (UART9 Base Address Refers to UART Config Register Offset 20h)
- (UART10 Base Address Refers to UART Config Register Offset 24h)

IO Address	Register Name
BA + 0h	Transmit/Receive Data Buffer (DLAB=0)
BA + 0h	LSB of Baud Rate Generator Divisor Latches (DLAB=1)
BA + 1h	Interrupt Enable Register (DLAB=0)
BA + 1h	MSB of Baud Rate Generator Divisor Latches (DLAB=1)
BA + 2h	Interrupt Identification Register
BA + 2h	FIFO Control Register
BA + 3h	Line Control Register
BA + 4h	Modem Control Register
BA + 5h	Line Status Register
BA + 6h	Modem Status Register
BA + 7h	Scratchpad Register

UART Global Interrupt Status

(Base Address defined on SB Function 1 PCI CFG 81- 80h)

IO Address	Register Name
BA + 0h	UART Global Interrupt Status Register

7.3.13 Parallel Port Registers (Detail information in Chap.11.3.13)

(Base Address Refers to the Register of index B3h-B0h, IDSEL = AD18/SB of PCI Configuration Register)

IO Address	Register Name
BA + 0h	Data Port register
BA + 1h	Status Port Register
BA + 2h	Control Port Register
BA + 3h	EPP ADDR Port Register
BA + 4h	EPP Data PORT 0 Register
BA + 5h	EPP Data PORT 1 Register
BA + 6h	EPP Data PORT 2 Register
BA + 7h	EPP Data PORT 3 Register

7.3.14 SPI Control Registers (Detail information in Chap.11.3.14)

IO Address	Register Name
00h	Flash SPI Output Data Register
01h	Flash SPI Input Register
02h	Flash SPI Control Register
03h	Flash SPI Status Register
04h	Flash SPI Chip Select Register
05h	Flash SPI Error Status Register
06h	Flash SPI Control Register2

7.3.15 GPIO Registers (Detail information in Chap.11.3.15)

GPIO Port Config Registers

(Base Address Refers to the Register of index 63h-62h, SB Function0 PCI Configuration Register)

IO Address	Register Name
BA + 00h	General-Purpose I/O Data & Direction Decode Enable
BA + 04h	General-Purpose I/O Port0 Data & Direction Decode Address
BA + 08h	General-Purpose I/O Port1 Data & Direction Decode Address
BA + 0Ch	General-Purpose I/O Port2 Data & Direction Decode Address
BA + 10h	General-Purpose I/O Port3 Data & Direction Decode Address
BA + 14h	General-Purpose I/O Port4 Data & Direction Decode Address
BA + 18h	General-Purpose I/O Port5 Data & Direction Decode Address
BA + 1Ch	General-Purpose I/O Port6 Data & Direction Decode Address
BA + 20h	General-Purpose I/O Port7 Data & Direction Decode Address
BA + 24h	General-Purpose I/O Port8 Data & Direction Decode Address
BA + 28h	General-Purpose I/O Port9 Data & Direction Decode Address

GPIO Interrupt Config Registers

(Base Address Refers to the Register of index 67h-66h, SB Function0 PCI Configuration Register)

IO Address	Register Name
BA + 00h	General-Purpose I/O Interrupt Status Decode Address
BA + 04h	General-Purpose I/O Interrupt Port Select
BA + 08h	General-Purpose I/O Interrupt Control 0 Register
BA + 0Ch	General-Purpose I/O Interrupt Control 1 Register

GPIO Registers

GPIO0 **DATA_PORT_BASE_ADDR** defined on GPIO Port Config Register offset 04h

GPIO1 **DATA_PORT_BASE_ADDR** defined on GPIO Port Config Register offset 08h

GPIO2 **DATA_PORT_BASE_ADDR** defined on GPIO Port Config Register offset 0Ch

GPIO3 **DATA_PORT_BASE_ADDR** defined on GPIO Port Config Register offset 10h

GPIO4 **DATA_PORT_BASE_ADDR** defined on GPIO Port Config Register offset 14h

GPIO5 **DATA_PORT_BASE_ADDR** defined on GPIO Port Config Register offset 18h

GPIO6 **DATA_PORT_BASE_ADDR** defined on GPIO Port Config Register offset 1Ch

GPIO7 **DATA_PORT_BASE_ADDR** defined on GPIO Port Config Register offset 20h

GPIO8 **DATA_PORT_BASE_ADDR** defined on GPIO Port Config Register offset 24h

GPIO9 **DATA_PORT_BASE_ADDR** defined on GPIO Port Config Register offset 28h

GPIO0 **DIRECTION_BASE_ADDR** defined on GPIO Port Config Register offset 06h

GPIO1 **DIRECTION** **_BASE_ADDR** defined on GPIO Port Config Register offset 0Ah
 GPIO2 **DIRECTION** **_BASE_ADDR** defined on GPIO Port Config Register offset 0Eh
 GPIO3 **DIRECTION** **_BASE_ADDR** defined on GPIO Port Config Register offset 12h
 GPIO4 **DIRECTION** **_BASE_ADDR** defined on GPIO Port Config Register offset 16h
 GPIO5 **DIRECTION** **_BASE_ADDR** defined on GPIO Port Config Register offset 1Ah
 GPIO6 **DIRECTION** **_BASE_ADDR** defined on GPIO Port Config Register offset 1Eh
 GPIO7 **DIRECTION** **_BASE_ADDR** defined on GPIO Port Config Register offset 22h
 GPIO8 **DIRECTION** **_BASE_ADDR** defined on GPIO Port Config Register offset 26h
 GPIO9 **DIRECTION** **_BASE_ADDR** defined on GPIO Port Config Register offset 2Ah
 GPIO **Interrupt Status 0-1** **_BASE_ADDR** defined on GPIO Interrupt Config Register offset 00h

IO Address	Register Name
BA + 00h	GPIO PORT0 Data Register
BA + 00h	GPIO PORT1 Data Register
BA + 00h	GPIO PORT2 Data Register
BA + 00h	GPIO PORT3 Data Register
BA + 00h	GPIO PORT4 Data Register
BA + 00h	GPIO PORT5 Data Register
BA + 00h	GPIO PORT6 Data Register
BA + 00h	GPIO PORT7 Data Register
BA + 00h	GPIO PORT8 Data Register
BA + 00h	GPIO PORT9 Data Register
BA + 00h	GPIO PORT0 Direction Register
BA + 00h	GPIO PORT1 Direction Register
BA + 00h	GPIO PORT2 Direction Register
BA + 00h	GPIO PORT3 Direction Register
BA + 00h	GPIO PORT4 Direction Register
BA + 00h	GPIO PORT5 Direction Register
BA + 00h	GPIO PORT6 Direction Register
BA + 00h	GPIO PORT7 Direction Register
BA + 00h	GPIO PORT8 Direction Register
BA + 00h	GPIO PORT9 Direction Register
BA + 00h	GPIO Interrupt Status 0 Register
BA + 01h	GPIO Interrupt Status 1 Register

7.3.16 NMI Status and Control Register (Detail information in Chap.11.3.16)

IO Address	Register Name
61h	NMI Status and Control Register

7.3.17 WDT Registers (Detail information in Chap.11.3.17)

WDT1 Control Register

IO Address	Register Name
A8h	WDT1 Control Register
A9h	WDT1 Signal Select Control Register
AAh	WDT1 Counter 0 Register
ABh	WDT1 Counter 1 Register
ACh	WDT1 Counter 2 Register
ADh	WDT1 Status Register

WDT Reload Register

IO Address	Register Name
65h	WDT0 Reload Register
AEh	WDT1 Reload Register

7.3.18 CMOS Memory & RTC Registers (Detail information in Chap.11.3.18)

IO Address	Register Name
70h	CMOS Memory Address Register
71h	CMOS Memory Data Register

7.3.19 System Control Register(Detail information in Chap.11.3.19)

IO Address	Register Name
92h	System Control Register

7.3.20 I2C Registers(Detail information in Chap.11.3.20)

(Base Address Refers to the Register of index D7h-D4h, IDSEL = AD18/SB of PCI Configuration Register)

IO Address	Register Name
BA + 00h	I2C0 Control Register
BA + 01h	I2C0 Status Register
BA + 02h	I2C0 MY_Address Register
BA + 03h	I2C0 TX_Address Register
BA + 04h	I2C0 Transmit/Receive Data
BA + 05h	I2C0 Clock Frequency Control1
BA + 06h	I2C0 Clock Frequency Control2
BA + 07h	I2C0 Extra Control Register

7.3.21 DOS 4Gpage Access Registers(Detail information in Chap.11.3.21)

IO Address	Register Name
E3h – E0h	D4GA1 Control and Source Address Register
E7h – E4h	D4GA1 Destination Address Register
EBh – E8h	D4GA2 Control and Source Address Register
EFh – ECh	D4GA2 Destination Address Register

7.3.22 Spare Registers(Detail information in Chap.11.3.22)

IO Address	Register Name
80h	Spare Register
84h	Spare Register
85h	Spare Register
86h	Spare Register
88h	Spare Register
8Ch	Spare Register
8Dh	Spare Register
8Eh	Spare Register
8Fh	Spare Register
480h	Spare Register
484h	Spare Register
485h	Spare Register
486h	Spare Register
488h	Spare Register
48Ch	Spare Register
48Dh	Spare Register
48Eh	Spare Register
48Fh	Spare Register

7.3.23 SMM Registers(Detail information in Chap.11.3.23)

IO Address	Register Name
B2h	Software SMI Trigger Port2

(Base Address Refers to the Register of index 4Dh-4Ch, IDSEL = AD18/SB of PCI Configuration Register)

IO Address	Register Name
BA + 00h	SMI Event Status Register
BA + 04h	SMI Event Control Register
BA + 08h	SMI function Control
BA + 09h	SMM Status
BA + 0Ah	Software SMI Trigger Port1

7.3.24 Fast Ethernet MAC Registers(Detail information in Chap.14.7)

(Base Address Refers to the Register of index 10h/14h, Device 8 of PCI Configuration Register)

IO Address	Register Name
BA + 00h	MAC Control Register 0
BA + 04h	MAC Control Register 1
BA + 08h	MAC Bus Control Register
BA + 0Ch	MAC TX Interrupt Control Register
BA + 10h	MAC RX Interrupt Control Register
BA + 14h	MAC TX Poll Command Register
BA + 18h	MAC RX Buffer Size Register
BA + 1Ah	MAC RX Descriptor Control Register
BA + 1Ch	MAC Last Status Register
BA + 20h	MAC MDIO Control Register
BA + 24h	MAC MDIO Read Data Register
BA + 28h	MAC MDIO Write Data Register
BA + 2Ch	MAC TX Descriptor Start Address 0 Register
BA + 30h	MAC TX Descriptor Start Address 1 Register
BA + 34h	MAC RX Descriptor Start Address 0 Register
BA + 38h	MAC RX Descriptor Start Address 1 Register
BA + 3Ch	MAC INT Status Register
BA + 40h	MAC INT Enable Register
BA + 44h	MAC Event Counter INT Status Register
BA + 48h	MAC Event Counter INT Enable Register
BA + 50h	MAC Successfully Received Packet Counter Register
BA + 52h	MAC Event Counter 0 Register
BA + 54h	MAC Event Counter 1 Register
BA + 56h	MAC Event Counter 2 Register
BA + 58h	MAC Event Counter 3 Register
BA + 5Ah	MAC Successfully Transmit Packet Counter Register
BA + 5Ch	MAC Event Counter 4 Register
BA + 5Eh	MAC Pause Frame Counter Register
BA + 60h	MAC Hash Table Word 0
BA + 62h	MAC Hash Table Word 1
BA + 64h	MAC Hash Table Word 2
BA + 66h	MAC Hash Table Word 3
BA + 68h	MAC Multicast Address first two bytes Register

Vortex86EX

32-Bit x86 Micro Processor

BA + 6Ah	MAC Multicast Address second two bytes Register
BA + 6Ch	MAC Multicast Address last two bytes Register
BA + 70h	MAC Multicast Address first two bytes Register
BA + 72h	MAC Multicast Address second two bytes Register
BA + 74h	MAC Multicast Address last two bytes Register
BA + 78h	MAC Multicast Address first two bytes Register
BA + 7Ah	MAC Multicast Address second two bytes Register
BA + 7Ch	MAC Multicast Address last two bytes Register
BA + 80h	MAC Multicast Address first two bytes Register
BA + 82h	MAC Multicast Address second two bytes Register
BA + 84h	MAC Multicast Address last two bytes Register
BA + 88h	MAC PHY Status Change Configuration Register
BA + 8Ah	MAC PHY Status Register
BA + 8Ch	Phy Status Register 2
BA + ACh	MAC Memory BIST Control Register
BA + B6h	MDC Speed Control Register
BA + BCh	MAC ID

7.3.25 USB 1.1 OHCI Operation Registers(Detail information in Chap.12.3.2)

(OHCI1 Base Address Refers to the Register of index 10h, Device 10, Function 0 of PCI Configuration Register)

IO Address	Register Name
BA + 00h	HC Revision Register
BA + 04h	HC Control Register
BA + 08h	HC Command Status Register
BA + 0Ch	HC Interrupt Status Register
BA + 10h	HC Interrupt Enable Register
BA + 14h	HC Interrupt Disable Register
BA + 18h	HC HCCA Register
BA + 1Ch	HC Period Current ED Register
BA + 20h	HC Control Head ED Register
BA + 24h	HC Control Current ED Register
BA + 28h	HC Bulk Head ED Register
BA + 2Ch	HC Bulk Current ED Register
BA + 30h	HC Done Head Register
BA + 34h	HC Fm Interval Register
BA + 38h	HC Fm Remaining Register
BA + 3Ch	HC Fm Number Register
BA + 40h	HC Periodic Start Register
BA + 44h	HC LS Threshold Register
BA + 48h	HC Rh Descriptor A Register
BA + 4Ch	HC Rh Descriptor B Register
BA + 50h	HC Rh Status Register
BA + 54h	HC Rh Port Status [1] Register
BA + 58h	HC Rh PortStatus [2] Register

7.3.26 USB 2.0 EHCI Operation Registers(Detail information in Chap.12.3.4)

(EHCI1 Base Address Refers to the Register of index 10h, Device 10, Function 1 of PCI Configuration Register)

IO Address	Register Name
BA + 00h	Capability Register Length Register
BA + 03h – 02h	Host Controller Interface Version Number
BA + 07h – 04h	Structural Parameters Register
BA + 0Bh – 08h	Capability Parameters Register
BA + 23h – 20h	USB2.0 Command Register
BA + 27h – 24h	USB2.0 Status Register
BA + 2Bh – 28h	USB2.0 Interrupt Enable Register
BA + 2Fh – 2Ch	USB2.0 Frame Index register
BA + 37h – 34h	Periodic Frame List Base Address Register
BA + 3Bh – 38h	Current Asynchronous List Address Register
BA + 63h – 60h	Configured Flag Register
BA + 67h – 64h	Port 0 Status and Control Register
BA + 6Bh – 68h	Port 1 Status and Control Register

7.3.27 USB Device Operation Registers(Detail information in Chap.15.4)

(Base Address Refers to the Register of index 10h, Device 15, Function 0 of PCI Configuration Register)

IO Address	Register Name
BA+ 00h	USB device address register
BA + 02h	Control function register
BA + 07h – 06h	Frame number register
BA + 0Bh – 08h	Interrupt enable register
BA + 0Fh – 0Ch	Interrupt status register
BA + 10h	Control endpoint 0 type register
BA + 12h	OUT endpoint 1 type register
BA + 14h	IN endpoint 1 type register
BA + 16h	OUT endpoint 2 type register
BA + 18h	IN endpoint 2 type register
BA + 1Ah	OUT endpoint 3 type register
BA + 1Ch	IN endpoint 3 type register
BA + 44h	Endpoint 0 setup token transaction data buffer start address register
BA + 48h	Endpoint 0 OUT token transaction data buffer start address register
BA + 4Ch	Endpoint 0 IN token transaction data buffer start address register
BA + 50h	Endpoint 1 OUT token transaction data buffer start address register
BA + 54h	Endpoint 1 IN token transaction data buffer start address register
BA + 58h	Endpoint 2 OUT token transaction data buffer start address register
BA + 5Ch	Endpoint 2 IN token transaction data buffer start address register
BA + 60h	Endpoint 3 OUT token transaction data buffer start address register
BA + 64h	Endpoint 3 IN token transaction data buffer start address register
BA + 68h	Test mode register
BA + 7Eh	Interrupt configuration register

7.3.28 SD/SATA Controller Registers(Detail information in Chap.13.7)

(Base Address1 Refers to the Register of index 10h, Device 12, Function 0 of PCI Configuration Register)

(Base Address2 Refers to the Register of index 14h, Device 12, Function 0 of PCI Configuration Register)

(Base Address3 Refers to the Register of index 18h, Device 12, Function 0 of PCI Configuration Register)

(Base Address4 Refers to the Register of index 1Ch, Device 12, Function 0 of PCI Configuration Register)

(Base Address5 Refers to the Register of index 20h, Device 12, Function 0 of PCI Configuration Register)

IO Address	Register Name
BA[1] + 00h	Primary IDE Data Register
BA[1] + 01h	Primary IDE Error/Feature Register
BA[1] + 02h	Primary IDE Sector Count Register
BA[1] + 03h	Primary IDE Sector Number Register
BA[1] + 04h	Primary IDE Cylinder Low Register
BA[1] + 05h	Primary IDE Cylinder High Register
BA[1] + 06h	Primary IDE Device/Head Register
BA[1] + 07h	Primary IDE Command/Status Register
BA[2] + 06h	Primary IDE Device Control/Alternate Status Register
BA3 + 00h	Secondary Data Register
BA3 + 01h	Secondary IDE Error/Feature Register
BA3 + 02h	Secondary IDE Sector Count Register
BA3 + 03h	Secondary IDE Sector Number Register
BA3 + 04h	Secondary IDE Cylinder Low Register
BA3 + 05h	Secondary IDE Cylinder High Register
BA3 + 06h	Secondary IDE Device/Head Register
BA3 + 07h	Secondary IDE Command/Status Register
BA4 + 06h	Secondary IDE Device Control/Alternate Status Register
BA5 + 01h - 00h	Bus Master IDE Command Register for Primary Channel
BA5 + 03h - 02h	Bus Master IDE Status Register for Primary Channel
BA5 + 07h - 04h	Bus Master Descriptor Table Pointer Register for Primary Channel
BA5 + 09h - 08h	Bus Master IDE Command Register for Secondary Channel
BA5 + 0Bh - 0Ah	Bus Master IDE Status Register for Secondary Channel
BA5 + 0Fh - 0Ch	Bus Master Descriptor Table Pointer Register for Secondary Channel

7.3.29 HDA Controller Registers(Detail information in Chap.16.4)

(Base Address1 Refers to the Register of index 10h, Device 14, Function 0 of PCI Configuration Register)

IO Address	Register Name
BA + 00h	GCAP – Global Capabilities
BA + 02h	VMIN – Minor Version
BA + 03h	VMAJ – Major Version
BA + 04h	OUTPAY – Output Payload Capability
BA + 06h	INPAY – Input Payload Capability
BA + 08h	GCTL – Global Control
BA + 0Ch	WAKEEN – Wake Enable
BA + 0Eh	STATESTS – State Change Status
BA + 10h	GSTS – Global Status
BA + 18h	OUTSTRMPAY – Output Stream Payload Capability
BA + 1Ah	INSTRMPAY – Input Stream Payload Capability
BA + 20h	INTCTL – Interrupt Control
BA + 24h	INTSTS – Interrupt Status
BA + 30h	Wall Clock Counter
BA + 38h	SSYNC – Stream Synchronization
BA + 40h	CORB Lower Base Address
BA + 48h	CORBWP – CORB Write Pointer
BA + 4Ah	CORBWP – CORB Read Pointer
BA + 4Ch	CORBCTL – CORB Control
BA + 4Dh	CORBSTS – CORB Status
BA + 4Eh	CORBSIZE – CORB Size
BA + 50h	RIRBLBASE – RIRB Lower Base Address
BA + 58h	RIRBWP – RIRB Write Pointer
BA + 5Ah	RINTCNT – Response Interrupt Count
BA + 5Ch	RIRBCTL – RIRB Control
BA + 5Dh	RIRBSTS – RIRB Status
BA + 5Eh	RIRBSIZE – RIRB Size
BA + 60h	Immediate Command Output Interface
BA + 64h	Immediate Response Input Interface
BA + 68h	Immediate Command Status
BA + 80h	{IOB}SDnCTL – Input/Output/Bidirectional Stream
BA + 83h	{IOB}SD0STS – Input/Output/Bidirectional Stream
BA + 84h	{IOB}SDnLPIB – Input/Output/Bidirectional Stream
BA + 88h	{IOB}SDnCBL – Input/Output/Bidirectional Stream
BA + 8Ch	{IOB}ISDnLVI – Input/Output/Bidirectional Stream
BA + 90h	{IOB}SDnFIFOS – Input/Output/Bidirectional Stream

BA + 92h	{IOB}SDnFMT – Input/Output/Bidirectional Stream
BA + 98h	{IOB}SDnBDPL – Input/Output/Bidirectional Stream

7.3.30 ADC Registers(Detail information in Chap.11.3.24)

(ADC I/O Base Address Refers to the Register of index E1h-E0h, IDSEL = AD18/SB PCI Function 1 Configuration Register)

IO Address	Register Name
BA + 00h	AUX Channel Select Register
BA + 01h	ADC Control Register
BA + 02h	ADC Status Register
BA + 03h	ADC Data Register

7.3.31 ACPI Registers (Detail information in Chap.11.3.25)

(ACPI I/O Base Address Refers to the Register of index F8h-F9h, IDSEL = AD18/SB PCI Function 0 Configuration Register)

IO Address	Register Name
PMBASE+00h	PM1 Status Register
PMBASE+02h	PM1 Enable Register
PMBASE+04h	PM1 Control Register
PMBASE+06h	PM2 Control Register, Reserved now
PMBASE+08h	Power Management Timer Register
PMBASE+10h	Processor Control Register
PMBASE+14h	Processor LVL2 Register
PMBASE+15h	Processor LVL3 Register
PMBASE+20h	General Purpose Status Register. Generate wakeup event
PMBASE+24h	General Purpose Enable Register
PMBASE+28h	General Purpose SMI Register
PMBASE+2Ch	Global Status Register. Generate SMI event
PMBASE+30h	Global Enable Register
PMBASE+34h	Global Control Register
PMBASE+36h	Software SMI Command Register
PMBASE+38h	I/O Trap 1 Control Register
PMBASE+3Ch	I/O Trap 2 Control Register
PMBASE+40h	I/O Trap 3 Control Register
PMBASE+44h	I/O Trap 4 Control Register
PMBASE+48h	Trapped Status Register
PMBASE+4Ch	Trapped Write Data Register
PMBASE+36h	Software SMI Command Register
PMBASE+38h	I/O Trap 1 Control Register

7.3.32 CrossBar Config Registers (Detail information in Chap.11.3.26)

(Base Address Refers to the Register of index 65h-64h, SB Function0 PCI Configuration Register)

IO Address	Register Name
BA+00h	RichIO Port 0 Selection
BA+01h	RichIO Port 1 Selection
BA+02h	RichIO Port 2 Selection
BA+03h	RichIO Port 3 Selection
BA+04h	RichIO Port 4 Selection
BA+05h	RichIO Port 5 Selection
BA+06h	RichIO Port 6 Selection
BA+07h	RichIO Port 7 Selection
BA+08h	RichIO Port 8 Selection
BA+09h	RichIO Port 9 Selection
BA+0Ah – BA+0Fh	Reserved
BA+10h	Bit-RichIO Port0[0] Select
BA+11h	Bit-RichIO Port0[1] Select
BA+12h	Bit-RichIO Port0[2] Select
BA+13h	Bit-RichIO Port0[3] Select
BA+14h	Bit-RichIO Port0[4] Select
BA+15h	Bit-RichIO Port0[5] Select
BA+16h	Bit-RichIO Port0[6] Select
BA+17h	Bit-RichIO Port0[7] Select
BA+18h	Bit-RichIO Port1[0] Select
BA+19h	Bit-RichIO Port1[1] Select
BA+1Ah	Bit-RichIO Port1[2] Select
BA+1Bh	Bit-RichIO Port1[3] Select
BA+1Ch	Bit-RichIO Port1[4] Select
BA+1Dh	Bit-RichIO Port1[5] Select
BA+1Eh	Bit-RichIO Port1[6] Select
BA+1Fh	Bit-RichIO Port1[7] Select
BA+20h	Bit-RichIO Port2[0] Select
BA+21h	Bit-RichIO Port2[1] Select
BA+22h	Bit-RichIO Port2[2] Select
BA+23h	Bit-RichIO Port2[3] Select
BA+24h	Bit-RichIO Port2[4] Select
BA+25h	Bit-RichIO Port2[5] Select
BA+26h	Bit-RichIO Port2[6] Select

Vortex86EX

32-Bit x86 Micro Processor

BA+27h	Bit-RichIO Port2[7] Select
BA+28h	On-Chip Device Power-Down Control 0
BA+2Ch	On-Chip Device Power-Down Control 1
BA+30h	CrossBar PAD Attribut Port0[0]
BA+31h	CrossBar PAD Attribut Port0[1]
BA+32h	CrossBar PAD Attribut Port0[2]
BA+33h	CrossBar PAD Attribut Port0[3]
BA+34h	CrossBar PAD Attribut Port0[4]
BA+35h	CrossBar PAD Attribut Port0[5]
BA+36h	CrossBar PAD Attribut Port0[6]
BA+37h	CrossBar PAD Attribut Port0[7]
BA+38h	CrossBar PAD Attribut Port1[0]
BA+39h	CrossBar PAD Attribut Port1[1]
BA+3Ah	CrossBar PAD Attribut Port1[2]
BA+3Bh	CrossBar PAD Attribut Port1[3]
BA+3Ch	CrossBar PAD Attribut Port1[4]
BA+3Dh	CrossBar PAD Attribut Port1[5]
BA+3Eh	CrossBar PAD Attribut Port1[6]
BA+3Fh	CrossBar PAD Attribut Port1[7]
BA+40h	CrossBar PAD Attribut Port2[0]
BA+41h	CrossBar PAD Attribut Port2[1]
BA+42h	CrossBar PAD Attribut Port2[2]
BA+43h	CrossBar PAD Attribut Port2[3]
BA+44h	CrossBar PAD Attribut Port2[4]
BA+45h	CrossBar PAD Attribut Port2[5]
BA+46h	CrossBar PAD Attribut Port2[6]
BA+47h	CrossBar PAD Attribut Port2[7]
BA+48h	CrossBar PAD Attribut Port3[0]
BA+49h	CrossBar PAD Attribut Port3[1]
BA+4Ah	CrossBar PAD Attribut Port3[2]
BA+4Bh	CrossBar PAD Attribut Port3[3]
BA+4Ch	CrossBar PAD Attribut Port3[4]
BA+4Dh	CrossBar PAD Attribut Port3[5]
BA+4Eh	CrossBar PAD Attribut Port3[6]
BA+4Fh	CrossBar PAD Attribut Port3[7]
BA+50h	CrossBar PAD Attribut Port4[0]
BA+51h	CrossBar PAD Attribut Port4[1]
BA+52h	CrossBar PAD Attribut Port4[2]

Vortex86EX

32-Bit x86 Micro Processor

BA+53h	CrossBar PAD Attribut Port4[3]
BA+54h	CrossBar PAD Attribut Port4[4]
BA+55h	CrossBar PAD Attribut Port4[5]
BA+56h	CrossBar PAD Attribut Port4[6]
BA+57h	CrossBar PAD Attribut Port4[7]
BA+58h	CrossBar PAD Attribut Port5[0]
BA+59h	CrossBar PAD Attribut Port5[1]
BA+5Ah	CrossBar PAD Attribut Port5[2]
BA+5Bh	CrossBar PAD Attribut Port5[3]
BA+5Ch	CrossBar PAD Attribut Port5[4]
BA+5Dh	CrossBar PAD Attribut Port5[5]
BA+5Eh	CrossBar PAD Attribut Port5[6]
BA+5Fh	CrossBar PAD Attribut Port5[7]
BA+60h	CrossBar PAD Attribut Port6[0]
BA+61h	CrossBar PAD Attribut Port6[1]
BA+62h	CrossBar PAD Attribut Port6[2]
BA+63h	CrossBar PAD Attribut Port6[3]
BA+64h	CrossBar PAD Attribut Port6[4]
BA+65h	CrossBar PAD Attribut Port6[5]
BA+66h	CrossBar PAD Attribut Port6[6]
BA+67h	CrossBar PAD Attribut Port6[7]
BA+68h	CrossBar PAD Attribut Port7[0]
BA+69h	CrossBar PAD Attribut Port7[1]
BA+6Ah	CrossBar PAD Attribut Port7[2]
BA+6Bh	CrossBar PAD Attribut Port7[3]
BA+6Ch	CrossBar PAD Attribut Port7[4]
BA+6Dh	CrossBar PAD Attribut Port7[5]
BA+6Eh	CrossBar PAD Attribut Port7[6]
BA+6Fh	CrossBar PAD Attribut Port7[7]
BA+70h	CrossBar PAD Attribut Port6[0]
BA+71h	CrossBar PAD Attribut Port6[1]
BA+72h	CrossBar PAD Attribut Port6[2]
BA+73h	CrossBar PAD Attribut Port6[3]
BA+74h	CrossBar PAD Attribut Port6[4]
BA+75h	CrossBar PAD Attribut Port5[5]
BA+76h	CrossBar PAD Attribut Por8[6]
BA+77h	CrossBar PAD Attribut Port8[7]
BA+78h	CrossBar PAD Attribut Port9[0]

Vortex86EX

32-Bit x86 Micro Processor

BA+79h	CrossBar PAD Attribut Port9[1]
BA+7Ah	CrossBar PAD Attribut Port9[2]
BA+7Bh	CrossBar PAD Attribut Port9[3]
BA+7Ch	CrossBar PAD Attribut Port9[4]
BA+7Dh	CrossBar PAD Attribut Port9[5]
BA+7Eh	CrossBar PAD Attribut Port9[6]
BA+7Fh	CrossBar PAD Attribut Port9[7]
BA+80h - BA+83h	Reserved
BA+84h	CrossBar-Port Group Selection, Port4
BA+85h	CrossBar-Port Group Selection, Port5
BA+86h	CrossBar-Port Group Selection, Port6
BA+87h	CrossBar-Port Group Selection, Port7
BA+88h	CrossBar-Port Group Selection, Port8
BA+89h	CrossBar-Port Group Selection, Port9
BA+8Ah - BA+8Fh	Reserved
BA+90h	CrossBar-Bit Group Selection, Port0[0]
BA+91h	CrossBar-Bit Group Selection, Port0[1]
BA+92h	CrossBar-Bit Group Selection, Port0[2]
BA+93h	CrossBar-Bit Group Selection, Port0[3]
BA+94h	CrossBar-Bit Group Selection, Port0[4]
BA+95h	CrossBar-Bit Group Selection, Port0[5]
BA+96h	CrossBar-Bit Group Selection, Port0[6]
BA+97h	CrossBar-Bit Group Selection, Port0[7]
BA+98h	CrossBar-Bit Group Selection, Port1[0]
BA+99h	CrossBar-Bit Group Selection, Port1[1]
BA+9Ah	CrossBar-Bit Group Selection, Port1[2]
BA+9Bh	CrossBar-Bit Group Selection, Port1[3]
BA+9Ch	CrossBar-Bit Group Selection, Port1[4]
BA+9Dh	CrossBar-Bit Group Selection, Port1[5]
BA+9Eh	CrossBar-Bit Group Selection, Port1[6]
BA+9Fh	CrossBar-Bit Group Selection, Port1[7]
BA+A0h	CrossBar-Bit Group Selection, Port2[0]
BA+A1h	CrossBar-Bit Group Selection, Port2[1]
BA+A2h	CrossBar-Bit Group Selection, Port2[2]
BA+A3h	CrossBar-Bit Group Selection, Port2[3]
BA+A4h	CrossBar-Bit Group Selection, Port2[4]
BA+A5h	CrossBar-Bit Group Selection, Port2[5]
BA+A6h	CrossBar-Bit Group Selection, Port2[6]

Vortex86EX

32-Bit x86 Micro Processor

BA+A7h	CrossBar-Bit Group Selection, Port2[7]
BA+A8h	CrossBar-Bit Group Selection, Port3[0]
BA+A9h	CrossBar-Bit Group Selection, Port3[1]
BA+AAh	CrossBar-Bit Group Selection, Port3[2]
BA+ABh	CrossBar-Bit Group Selection, Port3[3]
BA+ACH	CrossBar-Bit Group Selection, Port3[4]
BA+ADh	CrossBar-Bit Group Selection, Port3[5]
BA+AEh	CrossBar-Bit Group Selection, Port3[6]
BA+AFh	CrossBar-Bit Group Selection, Port3[7]

7.4 Configuration Space Registers

The SoC integrated two PCI base bridges – Host-to-PCI Bridge, ISA-to-PCI Bridge, one MAC, two IDE, one USB1.1 host, one USB2.0 host and one USB device. These two bridges contain their own PCI Configuration Space. Configuration Space Registers reside in PCI Configuration Space and specify PCI configuration, DRAM configuration, operating parameters, and optional system features.

During hardware reset, the SoC sets its internal configuration registers to predetermine default states. The default state represents the minimum functionality feature set required to successfully bring up the system. Hence, it does not represent the optimal system configuration. It is the responsibility of the system initialization software (usually BIOS) to properly determine the DRAM configurations, operating parameters and optional system features that are applicable, and to program the registers accordingly.

7.4.1 NB Function 0 Configuration Space Registers (IDSEL = AD11/Device 0) (Detail information in Chap.11.3.1)

Offset (HEX)	Register Name
01h – 00h	Vendor ID Register
03h – 02h	Device ID Register
05h – 04h	Command Register
07h – 06h	Status Register
08h	Revision ID Register
0Bh – 09h	Class Code Register
0Eh	Header Type Register
2Dh – 2Ch	Subsystem Vendor ID Register
2Fh – 2Eh	Subsystem Device ID Register
43h – 40h	SPI Base Address Register
48h	Clock Output Control Register
4Bh	PCI Clock Control Register
50h	SPI Flash Decode Size Control
51h	Flash Strap Checksum Status
63h – 60h	STRAP Register 1
67h – 64h	STRAP Register 2
6Dh - 6Ch	Memory Bank Register
73h - 70h	NB Control Register
77h – 74h	DDRIII Configuration Register
7Bh -78h	DDRIII Memory Timing Register 1
7Fh - 7Ch	DDRIII Memory Timing Register 2
82h	High Page SMM Range Register
83h	A/B Page and SMM Range Register
87h – 84h	Shadow RAM Register
93h – 90h	Customer ID Register
97h – 94h	Spare 1 Register
9Bh – 98h	Spare 2 Register
9Fh – 9Ch	Spare 3 Register
A3h – A0h	Host Control Register
ABh – A8h	Temperature Sensor Configuration Register
C5h – C4h	Reserved
EFh – D0h	Customer Data Register
F3h – F0h	Reserved
F7h – F4h	Reserved
FBh – F8h	Reserved
FCh	Reserved
FDh	Reserved

7.4.2 NB Function 1 Configuration Registers (IDSEL = AD11/Device0/Function1) (Detail information in Chap.11.3.2)

Offset (HEX)	Register Name
83h-80h	FJZ-PHY Control Register 1
87h-84h	FJZ-PHY Control Register 2
8Bh-88h	FJZ-PHY Control Register 3
93h-90h	FJZ-PHY DRAM Control Register 1
97h-94h	FJZ-PHY DRAM Control Register 2
9Bh-98h	FJZ-PHY DRAM Control Register 3
9Fh-9Ch	FJZ-PHY DRAM Control Register 4
ABh-A8h	PLL Test Control Register
BFh - BCh	DDRIII Power Saving Control Register
C3h – C0h	DDRIII Control Option Register 1
C7h – C4h	DDRIII Control Option Register 2
CBh – C8h	DDRIII Control Option Register 3
CDh – CCh	DDRIII Control Option Register 4
CFh - CEh	DDRIII Control Option Register 5
D0h	PLL Test mode Register
EBh-E8h	L2 Cache Control Register
ECh	Reserved
F1h-F0h	DDRIII ZQ calibration long register
F3h-F2h	DDRIII ZQ calibration short register
F7h-F4h	NB Control Option Register 1
F9h-F8h	Update PHY's IO & delay line
FAh	Reset DRAMC & PHY

7.4.3 SB Configuration Space Registers (IDSEL = AD18/Device 7/Function 1) (Detail information in Chap.11.3.4)

Offset (HEX)	Register Name
01h – 00h	Vendor ID Register
03h – 02h	Device ID Register
05h – 04h	Command Register
07h – 06h	Status Register
08h	Revision ID Register
0Bh – 09h	Class Code Register
0Eh	Header Type Register
2Dh – 2Ch	Subsystem Vendor ID Register
2Fh – 2Eh	Subsystem Device ID Register
4Bh – 4Ah	Buffer Strength Register
63h – 60h	PCI-e Target Config Reg0
67h – 64h	PCI-e Target Config Reg1
6Bh – 68h	PCI-e Target Config Reg2
6Fh – 6Ch	PCI-e Target Config Reg3
81h – 80h	Global UART Interrupt Status Base Address Register
B7h – B4h	Extend PCI Interrupt Routing Table Register 2
DEh	8051 A Control Register
E3h – E0h	ADC Control Register

7.4.4 MAC PCI Configuration Space Registers (IDSEL = AD19/Device 8) (Detail information in Chap.14.4)

Offset (HEX)	Register Name
01h – 00h	Vendor ID Register
03h – 02h	Device ID Register
05h – 04h	Command Register
07h – 06h	Status Register
08h	Revision ID Register
0Bh – 09h	Class Code Register
0Eh	Header Type Register
13h – 10h	I/O Base Address Register
17h – 14h	Memory Base Address Register
2Dh – 2Ch	Subsystem Vendor ID Register
2Fh – 2Eh	Subsystem Device ID Register
33h-30h	Expansion ROM Base Address Register
3Dh – 3Ch	Interrupt Control Register

7.4.5 USB1.1 Configuration Space Registers (IDSEL = AD21/Device10/Function0)(Detail information in Chap.12.3.1)

Offset (HEX)	Register Name
01h – 00h	Vendor ID Register
03h – 02h	Device ID Register
05h – 04h	Command Register
07h – 06h	Status Register
08h	Revision ID Register
0Bh – 09h	Class Code Register
0Ch	Cache Line Size Register
0Dh	Latency Timer Register
0Eh	Header Type Register
13h – 10h	Base Address Register
2Dh – 2Ch	Subsystem Vendor ID Register
2Fh – 2Eh	Subsystem Device ID Register
3Dh – 3Ch	Interrupt Control Register
3Eh	Minimum Grant Register
3Fh	Max. Latency Register
43h – 40h	Reserved
47h - 44h	Reserved

7.4.6 USB2.0 Configuration Space Registers (IDSEL = AD21/Device10/Function1) (Detail information in Chap.12.3.3)

Offset (HEX)	Register Name
01h – 00h	Vendor ID Register
03h – 02h	Device ID Register
05h – 04h	Command Register
07h – 06h	Status Register
08h	Revision ID Register
0Bh – 09h	Class Code Register
0Ch	Cache Line Size Register
0Dh	Latency Timer Register
0Eh	Header Type Register
13h – 10h	Base Address Register
2Dh – 2Ch	Subsystem Vendor ID Register
2Fh – 2Eh	Subsystem Device ID Register
3Dh – 3Ch	Interrupt Control Register
3Eh	Minimum Grant Register
3Fh	Max Latency Register
43h – 40h	Reserved
47h – 44h	Reserved

7.4.7 USB Device PCI Configuration Registers Definition ((IDSEL = AD26/Device15/Function0) (Detail information in Chap.15.3)

Offset (HEX)	Register Name
01h – 00h	Vendor ID Register
03h – 02h	Device ID Register
05h – 04h	Command Register
07h – 06h	Status Register
08h	Revision ID Register
0Bh – 09h	Class code Register
0Ch	Cache Line Size Register
0Dh	Latency Timer Register
0Eh	Header Type Register
13h – 10h	Base Address Register
2Dh – 2Ch	Subsystem Vendor ID Register
2Fh – 2Eh	Subsystem Device ID Register
3Dh – 3Ch	Interrupt Control Register
3Eh	Minimum Grant Register
3Fh	Max Latency Register
40h	Class Code Configuration Register

7.4.8 SD/SATA Configuration Space Registers (IDSEL = AD23/Device12/Function0) (Detail information in Chap.13.5)

Offset (HEX)	Register Name
01h – 00h	Vendor ID Register
03h – 02h	Device ID Register
05h – 04h	Command Register
07h – 06h	Status Register
08h	Revision ID Register
09h	Program Interface Register
0Ah	Sub-class code Register
0Bh	Base Class Code Register
0Ch	Cache Line Size Register
0Dh	Latency Timer Register
0Eh	Header Type Register
0Fh	Built-in Self Test Register
13h – 10h	Primary Channel Command Block Base Address Register
17h – 14h	Primary Channel Control Block Base Address
1Bh – 18h	Secondary Channel Command Block Base Address Base Address Register
1Fh – 1Ch	Secondary Channel Control Block Base Address
23h – 20h	Bus Master Base Address Register
2Dh – 2Ch	Subsystem Vendor ID Register
2Fh – 2Eh	Subsystem Device ID Register
33h – 30h	Expansion ROM base address register
34h	Capabilities pointer register
3Ch	Interrupt Line Register
3Dh	Interrupt Pin Register
3Eh	Minimum Grant Register
3Fh	Max Latency Register
41h – 40h	Primary ATA Timing
43h – 42h	Secondary ATA Timing
44h	Primary and Secondary Device 1 ATA Timing
48h	Ultra DMA Control Register
4Bh – 4Ah	Ultra DMA Timing Register
54h – 57h	IDE I/O configuration
90h	MISC Register

7.4.9 HDA Configuration Space Registers (IDSEL = AD25/Device14/Function0) (Detail information in Chap.16.3)

Offset (HEX)	Register Name
01h – 00h	Vendor ID Register
03h – 02h	Device ID Register
05h – 04h	Command Register
07h – 06h	Status Register
08h	Revision ID Register
0Bh - 09h	Class Code Register
0Ch	Cache Line Size Register
0Dh	Latency Timer Register
0Eh	Header Type Register
13h – 10h	Base Address Register
2Dh – 2Ch	Subsystem Vendor ID Register
2Fh – 2Eh	Subsystem Device ID Register
3Dh - 3Ch	Interrupt Control Register
3Eh	Minimum Grant Register
3Fh	Max Latency Register
40h	HDA Control Register

7.4.10 PCI-E Configuration Space Registers (IDSEL = AD12/Device1/Function0) (Detail information in Chap.12.3)

Offset (HEX)	Register Name
01h – 00h	Vendor ID Register
03h – 02h	Device ID Register
05h – 04h	Command Register
07h – 06h	Status Register
08h	Revision ID Register
0Bh – 09h	Class Code Register
0Ch	Cache Line Size Register
0Dh	Latency Timer Register
0Eh	Header Type Register
1Ah – 18h	Bus Number Register
1Bh	Secondary Latency Timer Register
1Dh – 1Ch	IO Base & Limit Register
1Fh – 1Eh	Secondary Status Register
23h – 20h	Memory Base & Limit Register
27h – 24h	Prefetchable Memory Base & Prefetchable Limit Register
34h	Capabilities List Pointer Register
3Dh – 3Ch	Interrupt Control Register
3Fh – 3Eh	Minimum Grant Register
41h – 40h	Capabilities List Register
43h – 42h	Capabilities List Register
47h – 44h	Device Capabilities Register
49h – 48h	Device Control Register
4Bh – 4Ah	Device Status Register
4Fh – 4Ch	Link Capabilities Register
51h – 50h	Link Control Register
53h – 52h	Link Device Status Register
57h – 54h	Slot Capabilities Register
59h – 58h	Slot Control Register
5Bh – 5Ah	Slot Status Register
5Dh – 5Ch	Root Control Register
63h – 60h	Root Status Register
67h – 64h	MISC Register
6Bh – 68h	MISC Register
6Fh – 6Ch	MISC Register

81h – 80h	MSI Capability Register
83h – 82h	MSI Message Control Register
87h – 84h	MSI Message Address Register
89 – 88h	MSI Message Data Register
91 – 90h	PM Capability Register
93 – 92h	PCI PM Capability Register
97h – 94h	PCI PM Control & Status Register

7.4.11 Motion Controller Configuration Space Registers (IDSEL = AD27/Device16/Function0)
 (Detail information in Chap.20.3.1)

Offset (HEX)	Register Name
01h – 00h	Vendor ID Register
03h – 02h	Device ID Register
05h – 04h	Command Register
07h – 06h	Status Register
08h	Revision ID Register
0Bh – 09h	Class Code Register
0Ch	Cache Line Size Register

7.4.12 PCIe Target Configuration Space Registers (Detail information in Chap.19.1)

Offset (HEX)	Register Name
01h – 00h	Vendor ID
03h – 02h	Device ID
05h – 04h	Command
07h – 06h	Status
08h	Revision ID
09h	Program Interface
0Ah	Sub-class code
0Bh	Base Class Code
0Ch	Cache Line Size
0Dh	Latency Timer
0Eh	Header Type
0Fh	Built-in Self Test
10h-13h	Base Address Register
14h-17h	Reserved
18h-2Bh	Reserved
2Ch-2Dh	Sub-system Vendor ID
2Eh-2Fh	Sub-system Device ID
30h-33h	Reserved
34h	Cap. Pointer
35h-37h	Reserved
38h-3Bh	Reserved
3Ch	Interrupt Line
3Dh	Interrupt Pin
3Eh	MIN_GNT
3Fh	MAX_LAT
40h-43h	EX System Status Reg

7.4.13 Duplex SPI Configuration Space Registers (IDSEL = AD27/Device16/Function1)
(Detail information in Chap.20.3.2)

Offset (HEX)	Register Name
01h – 00h	Vendor ID Register
03h – 02h	Device ID Register
05h – 04h	Command Register
07h – 06h	Status Register
08h	Revision ID Register
0Bh – 09h	Class Code Register
0Ch	Cache Line Size Register

8. Instruction Set

The SoC core instruction set can be divided into 11 categories of operations:

Data Transfer

Arithmetic

Shift/Rotate

String Manipulation

Bit Manipulation

Control Transfer

High Level Language Support

Operating System Support

Processor Control

All the SoC core instructions operate on 0, 1, 2 or 3 operands, where an operand resides in a register, in the instruction itself or in memory. Most zero operand instructions (e.g., CLI, STI) take only one byte. One operand instruction is generally two bytes long. The average instruction is 3.2 bytes long. Since the SoC has a 32-byte instruction queue, an average of 10 instructions will be prefetched. The use of two operands permits the following types of common instructions:

Register to Register

Memory to Register

Memory to Memory

Immediate to Register

Register to Memory

Immediate to Memory

The operands can be 8-, 16-, or 32-bit long. As a general rule, when 32-bit code is being executed, operands are 8 or 32 bits; when the existing 80286 or 8086 code (16-bit code) is being executed, operands are 8 or 16 bits. Prefixes can be added to all instructions, which override the default length of the operands (i.e., use 32-bit operands for 16-bit code, or 16-bit operands for 32-bit code).

9. Addressing Modes

The SoC core provides a total of 11 addressing modes for instructions to specify operands. The addressing modes are optimized to allow the efficient execution of high-level languages such as C and FORTRAN, and they cover the vast majority of data references needed by high-level languages.

9.1 Register and Immediate Modes

Two of the addressing modes provide for instructions that operate on register or immediate operands:

Register Operand Mode: The operand is located in one of the 8-, 16- or 32-bit general registers.

Immediate Operand Mode: The operand is included in the instruction as part of the opcode.

9.2 32-Bit Memory Addressing Modes

The remaining 9 modes provide a mechanism for specifying the effective address of an operand. The linear address consists of two components: the segment base address and an effective address. The effective address is calculated by using combinations of the following four address elements:

Displacement: An 8-, or 32-bit immediate value, following the instruction.

Base: The contents of any general-purpose register. The base registers are generally used by compilers to point to the start of the local variable area.

Index: The contents of any general-purpose register except for ESP. The index registers are used to access the elements of an array, or a string of characters.

Scale: The index register's value can be multiplied by a scale factor: 1, 2, 4 or 8. Scaled index mode is especially useful for accessing arrays or structures.

Combinations of these 4 components make up the 9 additional addressing modes. There is no performance penalty for using any of these addressing combinations, since the effective address calculation is pipelined with the execution of other instructions. The one exception is the simultaneous use of Base and Index components, which require one additional clock.

The effective address (EA) of an operand is calculated according to the following formula.

$$EA = \text{Base Reg} + (\text{Index Reg} \cdot \text{Scaling}) + \text{Displacement}$$

Direct Mode: The operand's offset is contained as part of the instruction as an 8-, 16- or 32-bit

displacement.

Example: INC Word PTR [500]

Register Indirect Mode: A **Base** register contains the address of the operand.

Example: MOV [ECX], EDX

Based Mode: A **Base** register's contents are added to a **Displacement** to form the operand's offset.

Example: MOV ECX, [EAX + 24]

Index Mode: An **Index** register's contents are added to a **Displacement** to form the operand's offset.

Example: ADD EAX, TABLE[ESI]

Scaled Index Mode: An **Index** register's contents are multiplied by a **Scaling** factor that is added to a **Displacement** to form the operand's offset.

Example: IMUL EBX, TABLE[ESI • 4], 7

Based Index Mode: The contents of a **Base** register are added to the contents of an **Index** register to form the effective address of an operand.

Example: MOV EAX, [ESI] [EBX]

Based Scaled Index Mode: The contents of an **Index** register is multiplied by a **Scaling** factor and the result is added to the contents of a **Base** register to obtain the operand's offset.

Example: MOV ECX, [EDX • 8] [EAX]

Based Index Mode with Displacement: The contents of an **Index** register and a **Base** register's contents and a **Displacement** are all summed together to form the operand offset.

Example: ADD EDX, [ESI] [EBP + 00FFFFFF0H]

Based Scaled Index Mode with Displacement: The contents of an **Index** register are multiplied by a **Scaling** factor and the result is added to the contents of a **Base** register and a **Displacement** to form the operand's offset.

Example: MOV EAX, LOCALTABLE [EDI • 4] [EBP + 80]

9.3 Differences between 16- and 32-bit Addresses

In order to provide software compatibility with the 80286 and 8086, the SoC core can execute 16-bit instructions in Real and Protected Modes. The processor determines the size of the instructions it is executing by examining the D bit in the CS segment Descriptor. If the D bit is 0, all operand lengths and effective addresses are assumed to be 16 bits long. If the D bit is 1, the default length for operands and addresses is 32 bits. In Real Mode, the default size for operands and addresses is 16 bits.

Regardless of the default precision of the operands or addresses, the SoC core is able to execute either 16- or 32-bit instructions. This is specified via the use of override prefixes. Two prefixes, the **Operand Size Prefix** and the **Address Length Prefix**, override the value of the D bit on an individual instruction basis.

Example: The SoC core is executing in Real Mode and the programmer needs to access the EAX registers. The assembler code for this might be MOV EAX, 32-bit MEMORYOP, and ASM486 Macro Assembler automatically determines that an Operand Size Prefix is needed and generates it.

Example: The D bit is 0, and the programmer intends to use Scaled Index addressing mode to access an array. The Address Length Prefix allows the use of MOV DX, TABLE [ESI • 2]. The assembler uses an Address Length Prefix since, with D= 0, the default addressing mode is 16 bits.

Example: The D bit is 1, and the programmer intends to store a 16-bit quantity. The Operand Length Prefix is used to specify only a 16-bit value: MOV MEM16, DX.

The OPERAND LENGTH and Address Length Prefixes can be applied separately or in combination to any instruction. The address Length Prefix does not allow addresses over 64 Kbytes to be accessed in Real Mode. A memory address that exceeds FFFFH will result in a General Protection Fault. An Address Length Prefix only allows the use of the additional SoC addressing modes.

When executing 32-bit code, the SoC core uses either 8- or 32-bit displacements, and any register can be used as base or index registers. When executing 16-bit code, the displacements are either 8 or 16 bits, and the base and index register conform to the 80286 mode 1

10. Functional Description

The core of the SoC is an x86-compatible, 6-stage pipeline CPU core. In addition, the SoC includes a 16-bit DDRII controller, PCI bus controller, AT/PC compatible peripheral (DMA controller, Interrupt controller and Timer) and UART. The SoC is a highly integrated SOC that is suitable for embedded system. With the inherent high performance of CPU core, the SoC enables the designers to take the advantage to implement a wide variety of performance intensive applications, such as IP sharing, access point, home gateway, and internet appliance, while still maintains the lowest overall system cost.

The following sections will discuss the sub-function of the SoC.

10.1 SoC Core

The SoC integrates a high speed and high performance CPU core that is designed on advanced 32-bit, 6-stage pipeline architecture. The CPU core of SoC implements an MMU (Memory Management Unit) with 32 TLB buffers. With the MMU, the SoC is compatible with a wide variety of operating systems, including MS Windows, Linux and most popular modern RTOS.

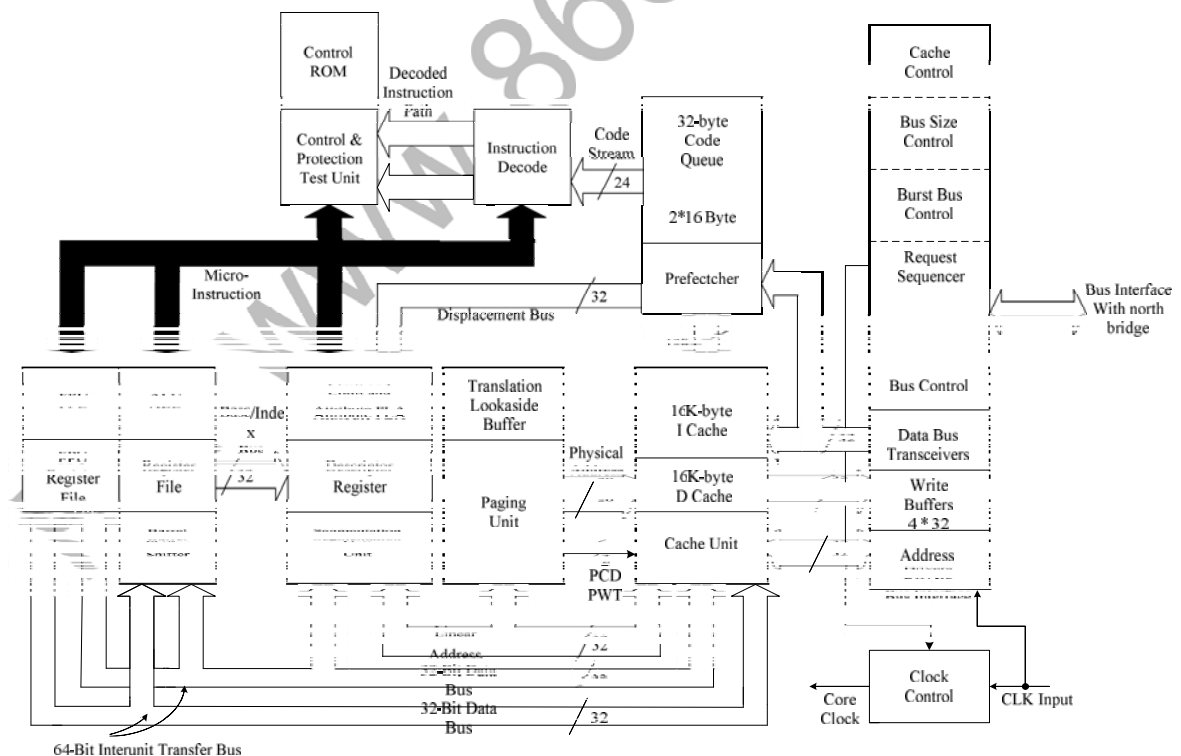

Figure 10-1. SoC Core Block Diagram

This SoC core contains all the features of the 486DX microprocessor with enhancements to increase its performance. The instruction set includes the complete 486SX microprocessor instruction set along with extensions to serve new applications.

Bus Unit

The bus unit manages data transfers, instruction prefetches and control functions between the processor's internal units and the SoC NB. Internally, the bus unit communicates with the cache and the instruction prefetch units through the 32-bit bus. Externally, the bus unit provides the processor with bus functions, including external bus cycles, memory read/write, instruction fetch, cache line fill, etc.,

Prefetch Unit

When the BUS UNIT is not performing bus cycles to execute an instruction, the instruction prefetch unit uses the BUS UNIT to prefetch instructions. By reading instructions before they are needed, the processor rarely needs to wait for an instruction prefetch cycle on the processor bus.

Instruction prefetch cycles read 16-byte blocks of instructions, starting at addresses numerically greater than the last-fetched instruction. The prefetch unit, which has a direct connection to the paging unit, generates the starting address. The 16-byte prefetched blocks are read into both the prefetch and cache units simultaneously. The prefetch queue in the prefetch unit stores 32 bytes of instructions. As each instruction is fetched from the queue, the code part is sent to the instruction decode unit and (depending on the instruction) the displacement part is sent to the segmentation unit, where it is used for address calculation. If loops are encountered in the program being executed, the prefetch unit gets copies of previously executed instructions from the cache.

Decode Unit

The instruction decode unit receives instructions from the instruction prefetch unit and translates them in a two-stage process into low-level control signals and microcode entry points, as shown in Figure 10-.1. Most instructions can be decoded at a rate of one per clock.

The decode unit simultaneously processes instruction prefix bytes, opcodes, modR/M bytes, and displacements. The outputs include hardwired microinstructions to the segmentation, and integer units. The instruction decode unit is flushed whenever the instruction prefetch unit is flushed.

Memory Management Unit

The on-chip memory management unit (MMU) is completely compatible with the X86 microprocessor.

The memory management unit (MMU) consists of a segmentation unit and a paging unit. Segmentation allows management of the logical address space by providing easy data and code relocatability and efficient sharing of global resources. The paging mechanism operates beneath segmentation and is transparent to the segmentation process. Paging is optional and can be disabled by system software. Each segment can be divided into one or more 4 Kbytes segments. To

implement a virtual memory system, full restartability for all page and segment faults is supported.

Memory is organized into one or more variable length segments, each up to four gigabytes (2^{32} bytes) in size. A segment can have attributes associated with it, which include its location, size, type (i.e., stack, code or data), and protection characteristics. Each task can have a maximum of 16,381 segments, each up to four gigabytes in size. Thus each task has a maximum of 64 terabytes (trillion bytes) of virtual memory.

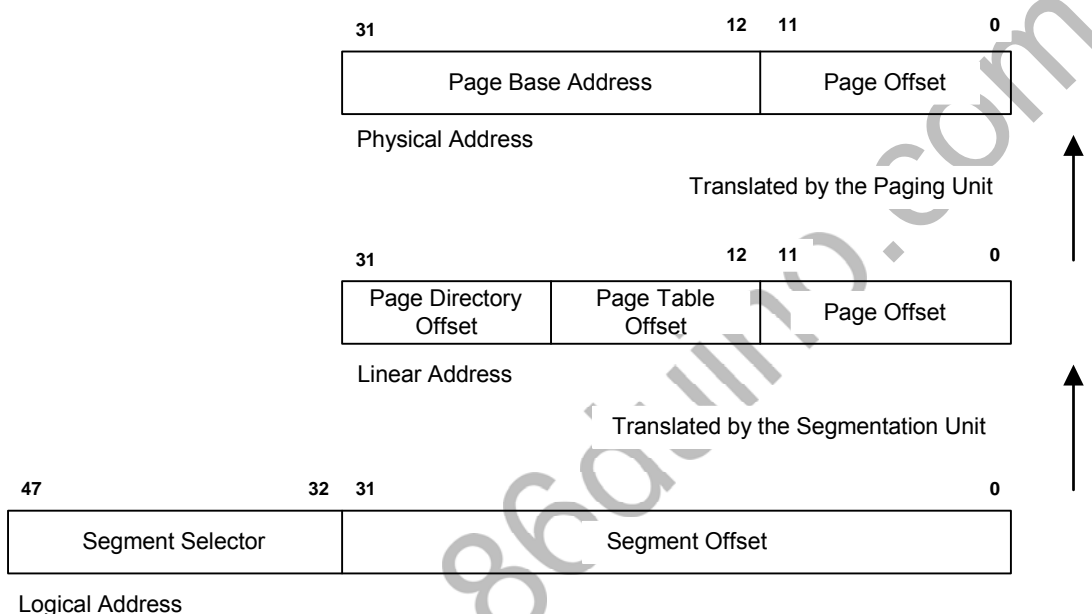

Figure 10-2. Segmentation and Paging Address Formats

The segmentation unit provides four levels of protection for isolating and protecting applications and the operating system from each other. The hardware-enforced protection allows the design of systems with a high degree of integrity.

10.2 L1 Cache

In order to maximize the performance, the SoC integrated a 4-way, 16Kbyte code and 16Kbyte data cache in it. The level 1 cache supports write through policy. The on-chip L1 cache allows frequently used data and code to be stored on chip reducing accesses to the external bus. It significantly reduces the penalty of performance to access these codes and data from external slower memory devices.

10.3 L2 Cache

In order to maximize the performance, the SoC also integrated a 4-way, 128Kbytes cache in it. The level 2 cache supports write through/write back policy. The on-chip L2 cache allows frequently used data and code to be stored on chip reducing accesses to the memory. It significantly reduces the penalty of performance to access these codes and data from external slower memory devices.

10.4 DDR3 Controller

The SoC integrates a main memory DDR3 controller that supports a 16-bit DDR3 data bus width. The SoC DDR3 interface runs up to 300MHz. All of DDR3 SDRAM configurations provided by SoC are listed as below:

¿ **DDR3 16-bit data width:**

One Chip Select			
Memory Size	DDR3 SDRAM Type		
	X4	X8	X16
64MB			32Mb*16*1*1
128MB		64Mb*8*2*1	64Mb*16*1*1
256MB	128Mb*4*4*1	128Mb*8*2*1	128Mb*16*1*1
512MB	256Mb*4*4*1	256Mb*8*2*1	256Mb*16*1*1
1GB	512Mb*4*4*1	512Mb*8*2*1	512Mb*16*1*1
2GB	1Gb*4*4*1	1Gb*8*2*1	

Two Chip Select			
Memory Size	DDR3 SDRAM Type		
	X4	X8	X16
64MB			
128MB			32Mb*16*1*2
256MB		64Mb*8*2*2	64Mb*16*1*2
512MB	128Mb*4*4*2	128Mb*8*2*2	128Mb*16*1*2
1GB	256Mb*4*4*2	256Mb*8*2*2	256Mb*16*1*2
2GB	512Mb*4*4*2	512Mb*8*2*2	512Mb*16*1*2

10.5 DMA Controller

The DMA circuitry incorporates the functionality of two 82C37 DMA controllers with seven independently programmable channels (Figure 10-4). Master DMA Controller (DMA-1) corresponds to DMA Channels 0–3 and Slave DMA Controller (DMA-2) corresponds to Channels 5–7. DMA Channel 4 is used to cascade the two controllers and will default to cascade mode in the DMA Channel Mode (DCM) Register. This channel is not available for any other purpose. In addition to accepting requests from DMA slaves, the DMA controller also responds to requests that are initiated by software. Software may initiate a DMA service request by setting any bit in the DMA Channel Request Register to a 1.

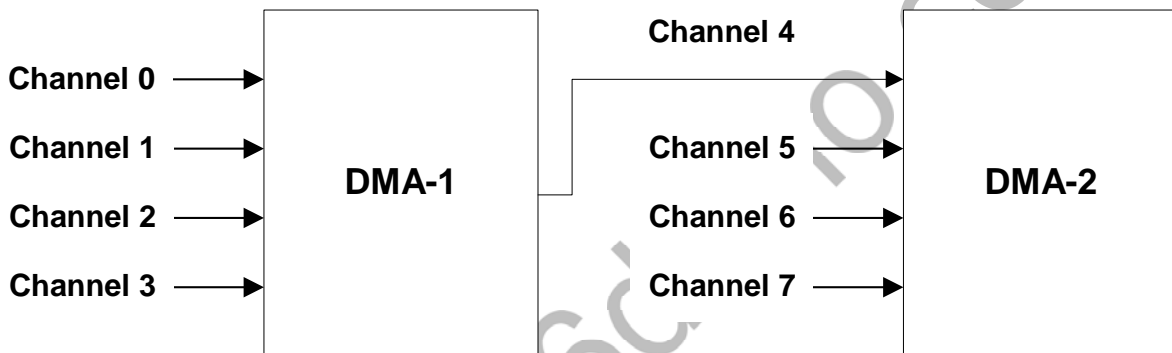

Figure 10-4. Internal DMA Controller

Each DMA channel is hardwired to the compatible settings for DMA device size: channel 3-0 are hardwired to 8-bit, count-by-bytes transfers, and channel 7-5 are hardwired to 16-bit, count-by-words (address shifted) transfers. The SoC SB provides the timing control and data size translation necessary for the DMA transfer between the memory (ISA or DRAM) and the ISA Bus IO.

The SoC SB provides 24-bit addressing in compliance with the ISA-Compatible specification. Each channel includes a 16-bit ISA-Compatible Current Register, which holds the 16 least-significant bits of the 24-bit address, an ISA-Compatible Page Register which contains the eight next most significant bits of address.

The DMA controller also features refresh address generation, and auto-initialization following a DMA termination.

The DMA controller is at any time either in master mode or slave mode. In master mode, the DMA controller is either servicing a DMA slave's request for DMA cycles, or allowing a 16-bit ISA master to use the bus via a cascaded DREQ signal. In slave mode, the SoC SB monitors both the ISA Bus and PCI, decoding and responding to I/O read and write commands that address its registers.

Note that a DMA device (I/O device) is always on the ISA Bus, but the memory referenced is located on either an ISA Bus device or on PCI. When the SoC SB is running a compatible DMA

cycle, it drives the MEMR# or MEMW# strobes if the address is less than 16 Mbytes (000000h–FFFFFFh). These memory strobes are generated regardless of whether the cycle is decoded for PCI or ISA memory. The SMEMR# and SMEMW# are generated if the address is less than 1 Mbytes (0000000h–00FFFFFFh). If the address is greater than 16 Mbytes (1000000h–7FFFFFFh), the MEMR# or MEMW# strobe is not generated to avoid aliasing issues.

10.5.1 DMA Transfer Modes

The channels can be programmed for any of four transfer modes. The transfer modes include single, block, demand, or cascade. Each of the three active transfer modes (single, block, and demand) can perform three different types of transfers (read, write or verify). Please note that SoC SB does not support memory-to-memory transfers.

Single Transfer Mode

In single transfer mode, the DMA is programmed to make one transfer only. The byte/word count is decremented and the address decremented or incremented following each transfer. When the byte/word count “rolls over” from zero to FFFFh, a Terminal Count (TC) causes an auto-initialization if the channel has been programmed to do so.

To be recognized, DREQ must be held active until DACK# becomes active. If DREQ is held active throughout the single transfer, the bus is released after a single transfer. With DREQ asserted high, the DMA I/O device rearbiterates for the bus. Upon winning the bus, another single transfer is performed. This allows other ISA bus masters a chance to acquire the bus.

Block Transfer Mode

In Block Transfer mode, the DMA is activated by DREQ to continue making transfers during the service until a TC, caused by either a byte/word count going to FFFFh, is encountered. DREQ need only be held active until DACK# becomes active. If the channel has been programmed for it, an auto-initialization occurs at the end of the service. In this mode, it is possible to lock out other devices for a period of time (including refresh) if the transfer count is programmed to a large number.

Demand Transfer Mode

In Demand Transfer mode, the DMA channel is programmed to continue making transfers until a TC (Terminal Count) is encountered, or until the DMA I/O device releases DREQ. Thus, transfers may continue until the I/O device has exhausted its data capacity. After the I/O device catches up, the DMA service is re-established when the DMA I/O device reasserts the channel’s DREQ. During the time between services when the system is allowed to operate, the intermediate values of address and byte/word count are stored in the DMA controller Current Address and Current Byte/Word Count Registers. A TC can cause an auto-initialize at the end of the service, if the channel has been programmed for it.

Cascade Mode

In Cascade Mode, the DMA controller will respond to DREQ with DACK, but SoC SB will not drive IOR#, IOW#, MEMR#, MEMW#, LA[23:17], SA[19:0], and SBHE#.

Cascade mode is also used to allow direct access of the system by 16-bit bus masters. These devices use the DREQ and DACK signals to arbitrate for the ISA Bus. The ISA master asserts its ISA master request line (DREQ[x]) to the DMA internal arbiter. If the ISA master wins the arbitration, SoC SB responds with an ISA master acknowledge (DACK[x]) signal active. Upon sampling the DACK[x] line active, the ISA master takes control of the ISA Bus. While an ISA Master owns the bus, BALE is always driven high while AEN is always driven low. The ISA master has control of the ISA Bus and may run cycles until it negates the DREQ[x] line.

10.5.2 DMA Transfer Types

Each of the three active transfer modes (Single, Block, or Demand) can perform three different types of transfers. They are Read, Write and Verify.

Write Transfers

Write transfers move data from an ISA I/O device to memory located on the ISA Bus or in system DRAM. For transfers using compatible timing, SoC SB will activate ISA Memory control signals to indicate a memory write as soon as the DMA provides the address. The PCI transfer is initiated after the data is valid on the ISA Bus. Data steering is used to steer the data to the correct byte lane during these DMA transfers. When the memory is located on the ISA Bus, a PCI cycle is not initiated.

The DMA device (I/O device) is either an 8- or 16-bit device and is located on the ISA Bus. The size of the DMA device is fixed for each channel.

Read Transfers

Read transfers move data from ISA memory or the system DRAM, to an ISA I/O device. SoC SB activates the IOW# command and the appropriate DRAM and ISA Memory control signals to indicate a memory read. Data steering is used to steer the data to the correct byte lane during these DMA transfers. When the cycle involves DRAM, the PCI read transaction is initiated as soon as the DMA address is valid. When the memory is located on the ISA Bus, a PCI cycle is not initiated.

Verify Transfer

Verify transfers are pseudo transfers. The DMA controller generates addresses as in normal read or write transfers. However, SoC SB does not activate the ISA memory and I/O control lines. Only the DACK lines will go active. SoC SB asserts the appropriate DACK signal for nine SYSCLKs. If Verify transfers are repeated during Block or Demand DMA requests, each additional pseudo transfer will add eight SYSCLKs. The DACK lines will not be toggled for repeated transfers.

10.5.3 DMA Timings

ISA-Compatible timing is provided for ISA DMA slave devices that reside on add in cards. The repetition rate for ISA-Compatible DMA cycles is eight SYSCLK periods.

When SoC SB negates PHOLD# one clock after driving FRAME# asserted for a bus master IDE transaction, and another transaction is pending which will cause SoC SB to acquire the PCI bus, it will drive PHOLD# asserted for the next transaction three clocks after TRDY# is driven negated for the current transaction.

10.5.4 DREQ and DACK# Latency Control

The SoC SB DMA arbiter maintains a minimum DREQ to DACK# latency on all DMA channels when programmed in compatible mode. This is to support older devices such as the 8272A. The DREQs are delayed by eight SYSCLKs prior to being seen by the arbiter logic. This delay guarantees a minimum 1 msec DREQ to DACK# latency. Software requests will not have this minimum request to DACK# latency.

10.5.5 Channel Priority

For priority resolution, the DMA consists of two logical channel groups: channel 0–3 and channel 4–7. Each group may be in either fixed or rotate mode, as determined by the DMA Command Register.

DMA I/O slaves normally assert their DREQ line to arbitrate for DMA service. However, a software request for DMA service can be presented through each channel's DMA Request Register. A software request is subject to the same prioritization as any hardware request. Please see the detailed register description for Request Register programming information in the DMA Register description section.

Fixed Priority

The initial fixed priority structure is as follows:

High priority...Low priority
(0, 1, 2, 3) (5, 6, 7)

The fixed priority ordering is 0, 1, 2, 3, 5, 6, and 7. In this scheme, Channel 0 has the highest priority, and channel 7 has the lowest priority. Channel 3-0 of DMA-1 assume the priority position of Channel 4 in DMA-2, thus take the priority

over channel 5, 6, and 7.

Rotating Priority

Rotation allows for "fairness" in priority resolution. The priority chain rotates so that the last channel serviced is assigned the lowest priority in the channel group (0–3, 5–7).

Channel 0–3 rotate as a group of four. They are always placed between Channel 5 and Channel 7

in the priority list.

Channel 5–7 rotate as part of a group of four. That is, channel 5–7 form the first three positions in the rotation, while channel group (0–3) comprises the fourth position in the arbitration.

10.5.6 Register Functionality

Please see the “DMA Register description” section for detailed information on register programming, bit definitions, and default values/functions of the DMA registers after CPURST is valid.

DMA Channel 4 is used to cascade the two DMA controllers together and should not be programmed for any mode other than cascade. The DMA Channel Mode Register for channel 4 will default to cascade mode. Special attention should also be taken when programming the Command and Mask Registers as related to channel 4.

10.5.7 Address Compatibility Mode

Whenever the DMA is operating, the addresses do not increment or decrement through the High and Low Page Registers. This is compatible with the 82C37 and Page Register implementation used in the PC-AT. This mode is set after CPURST is valid.

10.5.8 Summary of DMA Transfer Sizes

Table 10.1 lists each of the DMA device transfer sizes. The column labeled “Current Byte/Word Count Register” indicates that the register contents represent either the number of bytes to be transferred or the number of 16-bit words to be transferred. The column labeled “Current Address Increment/Decrement” indicates the number added to or taken from the Current Address register after each DMA transfer cycle. The DMA Channel Mode Register determines the Current Address Register will be incremented or decremented.

Table 10.1: DMA Transfer Size

DMA Device Data Size and Word Count	Current Byte/Word Count Register	Current Address Increment/Decrement
8-Bit I/O, Count by Bytes	Bytes	Bytes
16-Bit I/O, Count by Words (Address Shifted)	Words	1

10.5.9 Address Shifting When Programmed for 16-Bit I/O Count by Words

The SoC SB maintains compatibility with the implementation of the DMA in the PC AT that uses the 82C37. The DMA shifts the addresses for transfers to/from a 16-bit device count-by-words. Note that the least significant bit of the Low Page Register is dropped in 16-bit shifted mode. When the Current Address Register is programmed (when the DMA channel is in this mode), the Current Address must be programmed to an even address with the address value shifted right by 1 bit. The address shifting is as follows:

Table 10.2: Address Shifting in 16-bit I/O DMA Transfers

Output Address	8-Bit I/O Programmed Address (Channel 0-3)	16-Bit I/O Programmed Address (Channel 5-7) (Shifted)
A0	A0	0
A[16:1]	A[16:1]	A[15:0]
A[23:17]	A[23:17]	A[23:17]

Note:

The least significant bit of the Page Register is dropped in 16-bit shifted mode.

10.5.10 Autoinitialize

By programming a bit in the DMA Channel Mode Register, a channel may be set up as an autoinitialize channel. When a channel undergoes autoinitialization, the original values of the Current Page, Current Address and Current Byte/Word Count Registers are automatically restored from the Base Page, Address, and Byte/Word Count Registers of that channel following TC. The Base Registers are loaded simultaneously with the Current Registers by the microprocessor when the DMA channel is programmed and remains unchanged throughout the DMA service. The mask bit is not set when the channel is in autoinitialize. Following autoinitialize, the channel is ready to perform another DMA service, without CPU intervention, as soon as a valid DREQ is detected.

10.5.11 Software Commands

There are three additional special software commands that can be executed by the DMA controller. The three software commands are:

1. Clear Byte Pointer Flip-Flop
2. Master Clear
3. Clear Mask Register

They do not depend on any specific bit pattern on the data bus.

Clear Byte Pointer Flip-Flop

This command is executed prior to writing or reading new address or word count information to/from the DMA controller. This initializes the flip-flop to a known state so that subsequent accesses to register contents by the microprocessor will address upper and lower bytes in the correct sequence.

When the Host CPU is reading or writing DMA registers, two Byte Pointer flip-flops are used, one for channel 0–3 and one for channel 4–7. Both of these act independently. There are separate software commands for clearing each of them (0Ch for channel 0–3, 0D8h for channel 4–7).

DMA Master Clear

This software instruction has the same effect as the hardware reset. The Command, Status, Request, and Internal First/Last Flip-Flop Registers are cleared and the Mask Register is set. The DMA controller will enter the idle cycle.

There are two independent master clear commands; 0Dh which acts on channel 0–3, and 0DAh which acts on channel 4–7.

Clear Mask Register

This command clears the mask bits of all four channels, enabling them to accept DMA requests. I/O port 00Eh is used for channel 0–3 and I/O port 0DCh for channel 4–7.

10.6 Watchdog Timer

The watchdog timer uses 32.768kHz frequency source to count a 24-bit counter so the time range is from 30.5 μ sec to 512 sec with resolution 30.5 μ sec. When timer times out, a system reset, NMI or IRQ may happen to be decided by BIOS programming.

10.6.1 Set the watchdog timer function

Index 37h:

Bit 6=0, Disable watchdog timer

Bit 6=1, Enable watchdog timer

Index 3Ch:

Bit 7=0, Read only/Write one clear, Watchdog timer time out event dose not happen.

Bit 7=1, Read only/Write one clear, Watchdog timer time out event happens.

Index 3Bh, 3Ah, 39h : Counter

	3Bh	3Ah	39h
	D7.....D0	D7.....D0	D7.....D0
Counter	Most SBit..... Least SBit		

10.6.2 Set the watchdog timer Counter

- (1) Set Bit 6 = 0 to disable the timer
- (2) Write the desired counter value to 3Bh, 3Ah, 39h.
- (3) Set Bit 6= 1 to enable the timer, the counter will being to count up.
- (4) When counter reaches the setting value, the time out will generate signal setting by index 38h bit[7:4]
- (5) BIOS can read index 3Ch Bit 7 to decide whether the Watchdog timeout event will happen or not.

Index 38h : Bit[7:4] : time out generate signal select

Index 38h D[7:4]	timeout generate signal
0000	Reserved
0001	IRQ[3]
0010	IRQ[4]
0011	IRQ[5]
0100	IRQ[6]
0101	IRQ[7]
0110	IRQ[9]
0111	IRQ[10]
1000	IRQ[11]
1001	IRQ[12]
1010	IRQ[14]
1011	IRQ[15]
1100	NMI
1101	System reset
1110	Reserved
1111	Reserved

10.6.3 Read the watchdog timer counter value

- (1) Read the value in register index 3Bh, 3Ah, 39h. This is the setting value of counter.

10.6.4 Clear the watchdog timer counter

- (1) Set Bit 6 = 0 to disable timer. This will also clear counter at the same time.

10.7 Real Time Clock

10.7.1 Clock Accuracy

The accuracy of the clock is dependent upon the accuracy of the crystal and the accuracy of the match between the capacitive load of the oscillator circuit and the capacitive load for which the crystal was trimmed. Additional error is added by crystal frequency drift caused by temperature shifts. External circuit noise coupled into the oscillator circuit can result in the clock running fast. Figure 10-5 shows a typical PC board layout for isolation of the crystal and oscillator from noise.

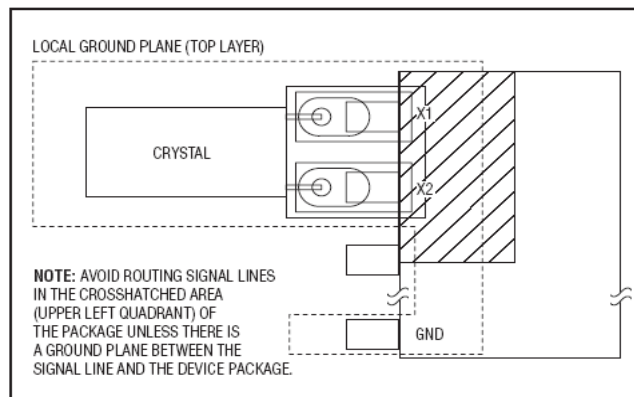

Figure 10-5. Layout Example

10.7.2 Power-Down/Power-Up Considerations

The real-time clock continues to operate, and the RAM, time, calendar, and alarm memory locations remain nonvolatile regardless of the VDD_BAT input level. **VDD_BAT** must remain within the minimum and maximum limits when VDD_BAT is not applied. When VDD_BAT is applied and exceeds the range (please refer to RTC_VDD33 in Chapter Recommend DC Operating Conditions), the device becomes accessible after t_{REC} —if the oscillator is running and the oscillator countdown chain is not in reset (Register A). This time allows the system to stabilize after power is applied. If the oscillator is not enabled, the oscillator enable bit is enabled on power-up, and the device becomes immediately accessible.

10.7.3 Time, Calendar, and Alarm Locations

The time and calendar information is obtained by reading the appropriate register bytes. The time, calendar, and alarm are set or initialized by writing the appropriate register bytes. Invalid time or date entries result in undefined operation. The contents of the 10 time, calendar, and alarm bytes can be either binary or binary-coded decimal (BCD) format. The day-of-week register increments at midnight, incrementing from 1 through 7. The day-of-week register is used by the daylight saving

function, so the value 1 is defined as Sunday. The date at the end of the month is automatically adjusted for months with fewer than 31 days, including correction for leap years. Before writing the internal time, calendar, and alarm registers, the SET bit in Register B should be written to logic 1 to prevent updates from occurring while access is being attempted. In addition to writing the 10 time, calendar, and alarm registers in a selected format (binary or BCD), the data mode bit (DM) of Register B must be set to the appropriate logic level. All 10 time, calendar, and alarm bytes must use the same data mode. The SET bit in Register B should be cleared after the data mode bit has been written to allow the RTC to update the time and calendar bytes. Once initialized, the RTC makes all updates in the selected mode. The data mode cannot be changed without reinitializing the 10 data bytes. Tables 2A and 2B show the BCD and binary formats of the time, calendar, and alarm locations. The 24-12 bit cannot be changed without reinitializing the hour locations. When the 12-hour format is selected, the higher-order bit of the hours byte represents PM when it is logic 1. The time, calendar, and alarm bytes are always accessible because they are double-buffered. Once per second the seven bytes are advanced by one second and checked for an alarm condition. If a read of the time and calendar data occurs during an update, a problem exists where seconds, minutes, hours, etc., may not correlate. The probability of reading incorrect time and calendar data is low. Several methods of avoiding any possible incorrect time and calendar reads are covered later in this text.

The three alarm bytes can be used in two ways. First, when the alarm time is written in the appropriate hours, minutes, and seconds alarm locations, the alarm interrupt is initiated at the specified time each day, if the alarm-enable bit is high. In this mode, the "0" bits in the alarm registers and the corresponding time registers must always be written to 0 (Table 10.3 and 10.4). Writing the 0 bits in the alarm and/or time registers to 1 can result in undefined operation. The second use condition is to insert a "don't care" state in one or more of the three alarm bytes. The don't care code is any hexadecimal value from C0 to FF. The two most significant bits of each byte set the don't-care condition when at logic 1. An alarm is generated each hour when the don't-care bits are set in the hours byte. Similarly, an alarm is generated every minute with don't-care codes in the hours and minute alarm bytes. The don't-care codes in all three alarm bytes create an interrupt every second.

All 128 bytes can be directly written or read, except for the following:

- 1) Registers C and D are read-only.
- 2) Bit 7 of register A is read-only.
- 3) The MSB of the second byte is read-only.

Table 10.3: Time, Calendar, and Alarm Data Modes—BCD Mode (DM = 0)

ADDRESS	BIT 7	BIT 6	BIT 5	BIT 4	BIT 3	BIT 2	BIT 1	BIT 0	FUNCTION	RANGE
00H	0	10 Seconds		Seconds		Seconds		Seconds	00-59	
01H	0	10 Seconds		Seconds		Seconds Alarm		Seconds Alarm	00-59	
02H	0	10 Minutes		Minutes		Minutes		Minutes	00-59	
03H	0	10 Minutes		Minutes		Minutes Alarm		Minutes Alarm	00-59	
04H	AM/P	0	0	10	Hours		Hours		Hours	1-12+AM/PM 00-23
	M		10 Hours							
05H	AM/P	0	0	10	Hours		Hours Alarm		Hours Alarm	1-12+AM/PM 00-23
	M		10 Hours							
06H	0	0	0	0	0	Day		Day	01-07	
07H	0	0	10 Date		Date		Date		Date	01-31
08H	0	0	0	10	Month		Month		Month	01-12
09H	10 Years		Year		Year		Year		Year	00-99
0AH	UIP	DV2	DV1	DV0	RS3	RS2	RS1	RS0	Control	-
0BH	SET	PIE	AIE	UIE	SQWE	DM	24/12	DSE	Control	-
0CH	IRQF	PF	AF	UF	0	0	0	0	Control	-
0DH	VRT	0	0	0	0	0	0	0	Control	-
0EH-7FH	X	X	X	X	X	X	X	X	RAM	-

X = Read/Write Bit.

Note: Unless otherwise specified, the state of the registers is not defined when power is first applied. Except for the seconds register, 0 bits in the time and date registers can be written to 1, but may be modified when the clock updates. 0 bits should always be written to 0 except for alarm mask bits.

Vortex86EX

32-Bit x86 Micro Processor

Table 10.4 :Time, Calendar, and Alarm Data Modes—Binary Mode (DM =1)

ADDRESS	BIT 7	BIT 6	BIT 5	BIT 4	BIT 3	BIT 2	BIT 1	BIT 0	FUNCTION	RANGE
00H	0	0	Seconds						Seconds	00-3B
01H	0	0	Seconds						Seconds Alarm	00-3B
02H	0	0	Minutes						Minutes	00-3B
03H	0	0	Minutes						Minutes Alarm	00-3B
04H	AM/PM	0	0	0	Hours			Hours	01-0C+AM/PM	
	0			Hours			00-17			
05H	AM/PM	0	0	0	Hours			Hours Alarm	01-0C+AM/PM	
	0			Hours			00-17			
06H	0	0	0	0	0	Day		Day	01-07	
07H	0	0	0	Date				Date	01-1F	
08H	0	0	0	0	Month			Month	01-0C	
09H	0	Year						Year	00-63	
0AH	UIP	DV2	DV1	DV0	RS3	RS2	RS1	RS0	Control	-
0BH	SET	PIE	AIE	UIE	SQWE	DM	24/12	DSE	Control	-
0CH	IRQF	PF	AF	UF	0	0	0	0	Control	-
0DH	VRT	0	0	0	0	0	0	0	Control	-
0EH-7FH	X	X	X	X	X	X	X	X	RAM	-

X = Read/Write Bit.

Note: Unless otherwise specified, the state of the registers is not defined when power is first applied. Except for the seconds register, 0 bits in the time and date registers can be written to 1, but may be modified when the clock updates. 0 bits should always be written to 0 except for alarm mask bits.

10.7.4 Control Registers

The real-time clocks have four control registers that are accessible at all times, even during the update cycle.

Control Register A

MSB

LSB

BIT7	BIT6	BIT5	BIT4	BIT3	BIT2	BIT1	BIT0
UIP	DV2	DV1	DV0	RS3	RS2	RS1	RS0

Bit 7: Update-In-Progress (UIP). This bit is a status flag that can be monitored. When the UIP bit is a 1, the update transfer occurs soon. When UIP is a 0, the update transfer does not occur for at least 244 μ s. The time, calendar, and alarm information in RAM is fully available for access when the UIP bit is 0. The UIP bit is read-only and is not affected by $\overline{\text{RESET}}$. Writing the SET bit in Register B to a 1 inhibits any update transfer and clears the UIP status bit.

Bits 6, 5, and 4: DV2, DV1, DV0. These three bits control the clock divider chain and are used to program the RTC for clock frequencies

DV2	DV1	DV0	Clock Frequency	Comment
0	0	0	X	Not support
0	0	1	X	
0	1	0	32768Hz	
1	X	X	Any	Divider chain held reset

The divider chain reset facility can be used for precise timing; when the reset is released, the first update cycle will occur one half second later. These bits are not affected by NRST.

Bits 3 to 0: Rate Selector (RS3, RS2, RS1, RS0). These four rate-selection bits select one of the 13 taps on the 15-stage divider or disable the divider output. The tap selected can be used to generate an output square wave (SQW pin) and/or a periodic interrupt. The user can do one of the following:

- 1) Enable the interrupt with the PIE bit;
- 2) Enable the SQW output pin with the SQWE bit;

3) Enable both at the same time and the same rate;

or

4) Enable neither.

Table 3 lists the periodic interrupt rates and the squarewave frequencies that can be chosen with the RS bits. These four read/write bits are not affected by $\overline{\text{RESET}}$.

Control Register B

MSB

LSB

BIT7	BIT6	BIT5	BIT4	BIT3	BIT2	BIT1	BIT0
SET	PIE	AIE	UIE	SQWE	DM	24/12	DSE

Bit 7: SET. When the SET bit is 0, the update transfer functions normally by advancing the counts once per second. When the SET bit is written to 1, any update transfer is inhibited, and the program can initialize the time and calendar bytes without an update occurring in the midst of initializing. Read cycles can be executed in a similar manner. SET is a read/write bit and is not affected by $\overline{\text{RESET}}$ or internal functions of the device.

Bit 6: Periodic Interrupt Enable (PIE). The PIE bit is a read/write bit that allows the periodic interrupt flag (PF) bit in Register C to drive the $\overline{\text{IRQ}}$ pin low. When the PIE bit is set to 1, periodic interrupts are generated by driving the $\overline{\text{IRQ}}$ pin low at a rate specified by the RS3–RS0 bits of Register A. A 0 in the PIE bit blocks the $\overline{\text{IRQ}}$ output from being driven by a periodic interrupt, but the PF bit is still set at the periodic rate. PIE is not modified by any internal device functions, but is cleared to 0 on $\overline{\text{RESET}}$.

Bit 5: Alarm Interrupt Enable (AIE). This bit is a read/write bit that, when set to 1, permits the alarm flag (AF) bit in Register C to assert $\overline{\text{IRQ}}$. An alarm interrupt occurs for each second that the three time bytes equal the three alarm bytes, including a don't-care alarm code of binary 11XXXXXX. The AF bit does not initiate the $\overline{\text{IRQ}}$ signal when the AIE bit is set to 0. The internal functions of the device do not affect the AIE bit, but is cleared to 0 on $\overline{\text{RESET}}$.

Bit 4: Update-Ended Interrupt Enable (UIE). This bit is a read/write bit that enables the update-end flag (UF) bit in Register C to assert $\overline{\text{IRQ}}$. The $\overline{\text{RESET}}$ pin going low or the SET bit going high clears the UIE bit.

The internal functions of the device do not affect the UIE bit, but is cleared to 0 on $\overline{\text{RESET}}$.

Bit 3: Square-Wave Enable (SQWE). When this bit is set to 1, a square-wave signal at the

frequency set by the rate-selection bits RS3–RS0 is driven out on the SQW pin. When the SQWE bit is set to 0, the SQW pin is held low. SQWE is a read/write bit and is cleared by $\overline{\text{RESET}}$. SQWE is low if disabled, and is high impedance when VCC is below VPF. SQWE is cleared to 0 on $\overline{\text{RESET}}$.

Bit 2: Data Mode (DM). This bit indicates whether time and calendar information is in binary or BCD format. The DM bit is set by the program to the appropriate format and can be read as required. This bit is not modified by internal functions or $\overline{\text{RESET}}$. A 1 in DM signifies binary data, while a 0 in DM specifies BCD data.

Bit 1: 24/12. The 24/12 control bit establishes the format of the hours byte. A 1 indicates the 24-hour mode and a 0 indicates the 12-hour mode. This bit is read/write and is not affected by internal functions or $\overline{\text{RESET}}$.

Bit 0: Daylight Saving Enable (DSE). This bit is a read/write bit that enables two daylight saving adjustments when DSE is set to 1. On the first Sunday in April, the time increments from 1:59:59 AM to 3:00:00 AM. On the last Sunday in October when the time first reaches 1:59:59 AM, it changes to 1:00:00 AM. When DSE is enabled, the internal logic test for the first/last Sunday condition at midnight. If the DSE bit is not set when the test occurs, the daylight saving function does not operate correctly. These adjustments do not occur when the DSE bit is 0. This bit is not affected by internal functions or $\overline{\text{RESET}}$.

Control Register C

MSB

LSB

BIT7	BIT6	BIT5	BIT4	BIT3	BIT2	BIT1	BIT0
IRQF	PF	AF	UF	0	0	0	0

Bit 7: Interrupt Request Flag (IRQF). This bit is set to 1 when any of the following are true:

PF = PIE = 1

AF = AIE = 1

UF = UIE = 1

Any time the IRQF bit is 1, the $\overline{\text{IRQ}}$ pin is driven low. This bit can be cleared by reading Register C or with a $\overline{\text{RESET}}$.

Bit 6: Periodic Interrupt Flag (PF). This bit is read-only and is set to 1 when an edge is detected on the selected tap of the divider chain. The RS3 through RS0 bits establish the periodic rate. PF is set to 1 independent of the state of the PIE bit. When both PF and PIE are 1s, the $\overline{\text{IRQ}}$ signal is active and sets the IRQF bit. This bit can be cleared by reading Register C or with a $\overline{\text{RESET}}$.

Bit 5: Alarm Interrupt Flag (AF). A 1 in the AF bit indicates that the current time has matched the alarm time. If the AIE bit is also 1, the \overline{IRQ} pin goes low and a 1 appears in the IRQF bit. This bit can be cleared by reading Register C or with a \overline{RESET} .

Bit 4: Update-Ended Interrupt Flag (UF). This bit is set after each update cycle. When the UIE bit is set to 1, the 1 in UF causes the IRQF bit to be a 1, which asserts the \overline{IRQ} pin. This bit can be cleared by reading Register C or with a \overline{RESET} .

Bits 3 to 0: Unused. These bits are unused in Register C. These bits always read 0 and cannot be written.

Control Register D

MSB

LSB

BIT7	BIT6	BIT5	BIT4	BIT3	BIT2	BIT1	BIT0
VRT	0	0	0	0	0	0	0

Bit 7: Valid RAM and Time (VRT). This bit indicates the condition of the battery connected to the VDD_BAT pin. This bit is not writable and should always be 1 when read. If a 0 is ever present, an exhausted internal lithium energy source is indicated and both the contents of the RTC data and RAM data are questionable. This bit is unaffected by \overline{RESET} .

Bits 6 to 0: Unused. The remaining bits of Register D are not usable. They cannot be written and they always read 0.

10.7.5 SRAM

The general-purpose SRAM bytes are not dedicated to any special function within the device. They can be used by the processor program as battery-backed memory and are fully available during the update cycle.

10.7.6 Interrupts

The RTC family includes three separate, fully automatic sources of interrupt for a processor. The alarm interrupt can be programmed to occur at rates from once per second to once per day. The periodic interrupt can be selected for rates from 500ms to 122 μ s. The updateended interrupt can be used to indicate to the program that an update cycle is complete. Each of these independent interrupt conditions is described in greater detail in other sections of this text.

The processor program can select which interrupts, if any, are to be used. Three bits in Register B enable the interrupts. Writing a logic 1 to an interrupt-enable bit permits that interrupt to be initiated when the event occurs. A 0 in an interrupt- enable bit prohibits the \overline{IRQ} pin from being asserted from that interrupt condition. If an interrupt flag is already set when an interrupt is enabled, \overline{IRQ} is

immediately set at an active level, although the interrupt initiating the event may have occurred earlier. As a result, there are cases where the program should clear such earlier initiated interrupts before first enabling new interrupts.

When an interrupt event occurs, the relating flag bit is set to logic 1 in Register C. These flag bits are set independent of the state of the corresponding enable bit in Register B. The flag bit can be used in a polling mode without enabling the corresponding enable bits. The interrupt flag bit is a status bit that software can interrogate as necessary. When a flag is set, an indication is given to software that an interrupt event has occurred since the flag bit was last read; however, care should be taken when using the flag bits as they are cleared each time Register C is read. Double latching is included

with Register C so that bits that are set remain stable throughout the read cycle. All bits that are set (high) are cleared when read, and new interrupts that are pending during the read cycle are held until after the cycle is completed. One, two, or three bits can be set when reading Register C. Each used flag bit should be examined when Register C is read to ensure that no interrupts are lost.

The second flag bit method is used with fully enabled interrupts. When an interrupt flag bit is set and the corresponding interrupt-enable bit is also set, the $\overline{\text{IRQ}}$ pin is asserted low. $\overline{\text{IRQ}}$ is asserted as long as at least one of the three interrupt sources has its flag and enable bits set. The IRQF bit in Register C is a 1 whenever the $\overline{\text{IRQ}}$ pin is driven low. Determination that the RTC initiated an interrupt is accomplished by reading Register C. A logic 1 in bit 7 (IRQF bit) indicates that one or more interrupts have been initiated by the device. The act of reading Register C clears all active flag bits and the IRQF bit.

10.7.7 Oscillator Control Bits

When SoC are shipped from the factory, the internal oscillator is turned off. This prevents the lithium energy cell from being used until the device is installed in a system.

A pattern of 010 in bits 4 to 6 of Register A turns the oscillator on and enables the countdown chain. A pattern of 1xx (DV2 = 1, DV1 = X, DV0 = X) turns the oscillator on, but holds the countdown chain of the oscillator in reset. All other combinations of bits 4 to 6 keep the oscillator off.

10.7.8 Periodic Interrupt Selection

The periodic interrupt causes the $\overline{\text{IRQ}}$ pin to go to an active state from once every 500ms to once every 122 μ s. This function is separate from the alarm interrupt, which can be output from once per second to once per day. The periodic interrupt rate is selected using the same Register A bits that select the square-wave frequency (Table 10.5). Changing the Register A bits affects the square-wave frequency and the periodic-interrupt output. However, each function has a separate enable bit in Register B. The SQWE bit controls the square-wave output. Similarly, the PIE bit in Register B enables the periodic interrupt. The periodic interrupt can be used with software counters to measure inputs, create output intervals, or await the next needed software function.

Table 10.5: Periodic Interrupt Rate and Square-Wave Output Frequency

SELECT REGISTER A				t_{PI} PERIODIC INTERRUPT RATE
RS3	RS2	RS1	RS0	
0	0	0	0	None
0	0	0	1	3.90625ms
0	0	1	0	7.8125ms
0	0	1	1	122.070 μ s
0	1	0	0	244.141 μ s
0	1	0	1	488.281 μ s
0	1	1	0	976.5625 μ s
0	1	1	1	1.953125ms
1	0	0	0	3.90625ms
1	0	0	1	7.8125ms
1	0	1	0	15.625ms
1	0	1	1	31.25ms
1	1	0	0	62.5ms
1	1	0	1	125ms
1	1	1	0	250ms
1	1	1	1	500ms

10.7.9 Update Cycle

The device executes an update cycle once per second regardless of the SET bit in Register B. When the SET bit in Register B is set to 1, the user copy of the doublebuffered time, calendar, and alarm bytes is frozen and does not update as the time increments. However, the time countdown chain continues to update the internal copy of the buffer. This feature allows time to maintain accuracy independent of reading or writing the time, calendar, and alarm buffers, and also guarantees that time and calendar information is consistent. The update cycle also compares each alarm byte with the corresponding time byte and issues an alarm if a match or if a don't-care code is present in all three positions.

There are three methods that can handle RTC access that avoid any possibility of accessing inconsistent time and calendar data. The first method uses the updateended interrupt. If enabled, an interrupt occurs after every update cycle that indicates over 999ms is available to read valid time and date information. If this interrupt is used, the IRQF bit in Register C should be cleared before leaving the interrupt routine.

A second method uses the update-in-progress bit (UIP) in Register A to determine if the update cycle is in progress. The UIP bit pulses once per second. After the UIP bit goes high, the update transfer occurs 244µs later. If a low is read on the UIP bit, the user has at least 244µs before the time/calendar data is changed. Therefore, the user should avoid interrupt service routines that would cause the time needed to read valid time/calendar data to exceed 244µs.

The third method uses a periodic interrupt to determine if an update cycle is in progress. The UIP bit in Register A is set high between the setting of the PF bit in Register C (Figure 10-6). Periodic interrupts that occur at a rate greater than t_{BUC} allow valid time and date information to be reached at each occurrence of the periodic interrupt. The reads should be complete within 1(t_{PI}/2 + t_{BUC}) to ensure that data is not read during the update cycle.

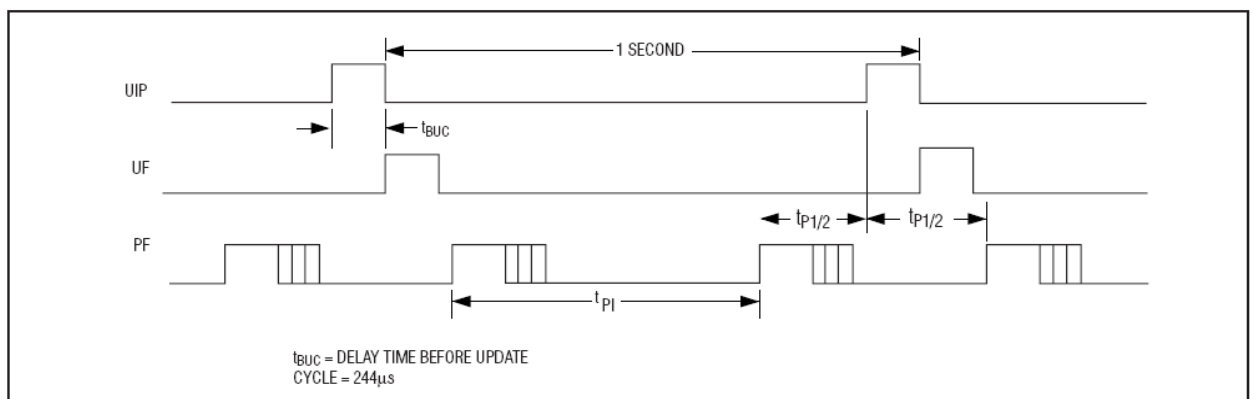

Figure 10-6. UIP and Periodic Interrupt Timing

10.8 Programmable Timer

SoC SB contains three counters that are equivalent to those found in the 82C54 programmable interval timer. The three counters are contained in one timer unit, referred to as Timer-1. Each counter output provides a key system function. Counter 0 is connected to interrupt controller IRQ0 and provides a system timer interrupt for a time-of-day, diskette time-out, or other system timing functions. Counter 1 generates a refresh request signal and Counter 2 generates the tone for the speaker. The 14.31818-MHz counters normally use OSC as a clock source.

Counter 0, System Timer

This counter functions as the system timer by controlling the state of IRQ0 and is typically programmed for Mode 3 operation. The counter produces a square wave with a period equal to the product of the counter period (838 ns) and the initial count value. The counter loads the initial count value one counter period after software writes the count value to the counter I/O address. The counter initially asserts IRQ0 and decrements the count value by two each counter period. The counter negates IRQ0 when the count value reaches 0. It then reloads the initial count value and

again decrements the initial count value by two each counter period. The counter then asserts IRQ0 when the count value reaches 0, reloads the initial count value, and repeats the cycle, alternately asserting and negating IRQ0.

Counter 1, Refresh Request Signal

This counter provides the refresh request signal and is typically programmed for Mode 2 operation. The counter negates refresh request for one counter period (838 ns) during each count cycle. The initial count value is loaded one counter period after being written to the counter I/O address. The counter initially asserts refresh request, and negates it for one counter period when the count value reaches 1. The counter then asserts refresh request and continues counting from the initial count value.

Counter 2, Speaker Tone

This counter provides the speaker tone and is typically programmed for Mode 3 operation. The counter provides a speaker frequency equal to the counter clock frequency (1.193 MHz) divided by the initial count value. The speaker must be enabled by a write to port 061h (see NMI Status and Control ports).

10.8.1 Programming the Interval Timer

The counter/timers are programmed by I/O accesses and are addressed as though they are contained in one 82C54 interval timer. A single Control Word Register controls the operation of all three counters. The interval timer is an I/O-mapped device. Several commands are available:

The Control Word Command specifies:

- which counter to read or write
- the operating mode
- the count format (binary or BCD)

The Counter Latch Command latches the current count so that it can be read by the system. The countdown process continues. The Read Back Command reads the count value, programmed mode, the current state of the OUT pins, and the state of the Null Count Flag of the selected counter.

The Read/Write Logic selects the Control Word Register during an I/O write when address lines A[1:0]=11. This condition occurs during an I/O write to port address 043h, the address for the Control Word Register on Timer 1. If the CPU writes to port 043h, the data is stored in the Control Word Register and is interpreted as the Control Word used to define the operation of the Counters.

The Control Word Register is write only. Counter status information is available with the read back Command.

Because the timer counters wake up in an unknown state after power up, multiple refresh requests may be queued. To avoid possible multiple refresh cycles after power up, program the timer counter immediately after power up.

Write Operations

Programming the interval timer is a simple process:

1. Write a control word.
2. Write an initial count for each counter.
3. Load the least and/or most significant bytes (as required by Control Word bit 5 and 4) of the 16-bit counter.

The programming procedure for the SoC SB timer is very flexible. Only two conventions need to be observed. First, for each counter, the control word must be written before the initial count is written. Second, the initial count must follow the count format specified in the control word (least significant byte only, most significant byte only, or least significant byte and then most significant byte).

Since the Control Word Register and the three counters have separate addresses (selected by the A1 and A0 inputs), and each control word specifies the counter it applies to (SC0 and SC1 bits), no special instruction sequence is required. Any programming sequence that follows the conventions above is acceptable.

A new initial count may be written to a counter at any time without affecting the counter's programmed mode. Counting will be affected as described in the mode definitions. The new count must follow the programmed count format.

If a counter is programmed to read/write 2-byte counts, the following precaution applies: A program must not transfer control between writing the first and second byte to another routine which also writes into that same counter. Otherwise, the counter will be loaded with an incorrect count.

Interval Timer Control Word Format

The control word specifies the counter, the operating mode, the order and size of the count value, and whether it counts down in a 16-bit or binary-coded decimal (BCD) format. After writing the control word, a new count may be written at any time. The new value will take effect according to the programmed mode.

If a counter is programmed to read/write 2-byte counts, the following precaution applies: A program must not transfer control between writing the first and second byte to another routine which also writes into that same counter. Otherwise, the counter will be loaded with an incorrect count. The count must always be completely loaded with both bytes.

Read Operations

It is often desirable to read the value of a counter without disturbing the count in progress. There

are three possible methods for reading the counters: a simple read operation, the Counter Latch Command, and the Read Back Command.

Counter I/O Port Read

The first method is to perform a simple read operation. To read the counter, which is selected with the A1 and A0 inputs (port 040h, 041h, or 042h), the CLK input of the selected counter must be inhibited by using either the GATE input or external logic. Otherwise, the count may be in the process of changing when it is read, giving an undefined result. When reading the count value directly, follow the format programmed in the control register: read LSB, read MSB, or read LSB then MSB. Within the SoC SB timer unit, the GATE input on Counter 0 and Counter 1 is tied high. Therefore, the direct register read should not be used on these two counters. The GATE input of Counter 2 is controlled through I/O port 061h. If the GATE is disabled through this register, direct I/O reads of port 042h will return the current count value.

Counter Latch Command

The Counter Latch Command latches the count at the time the command is received. This command is used to ensure that the count read from the counter is accurate (particularly when reading a 2-byte count). The count value is then read from each counter's Count Register as was programmed by the Control Register.

The selected counter's output latch (OL) latches the count at the time the Counter Latch Command is received. This count is held in the latch until it is read by the CPU (or until the Counter is reprogrammed). The count is then unlatched automatically and the OL returns to "following" the counting element (CE). This allows reading the contents of the counters "on the fly" without affecting counting in progress. Multiple Counter Latch Commands may be used to latch more than one counter. Each latched counter's OL holds its count until it is read. Counter Latch Commands do not affect the programmed mode of the counter in any way. The Counter Latch Command can be used for each counter in the SoC SB timer unit.

If a Counter is latched and then, some time later, latched again before the count is read, the second Counter Latch Command is ignored. The count read would be the count at the time the first Counter Latch Command was issued.

With either method, the count must be read according to the programmed format; specifically, if the counter is programmed for 2-byte counts, 2 bytes must be read. The 2 bytes do not have to be read one right after the other. Read, write, or programming operations for other counters may be inserted between them.

Another feature of the SoC SB timer is that reads and writes of the same counter may be interleaved. For example, if the Counter is programmed for 2-byte counts, the following sequence is valid:

Read least significant byte.

Write new least significant byte.

Read most significant byte.

Write new most significant byte.

If a counter is programmed to read/write 2-byte counts, a program must not transfer control between reading the first and second byte to another routine which also reads from that same counter. Otherwise, an incorrect count will be read.

Read Back Command

The third method uses the Read Back Command. The Read Back Command is used to determine the count value, programmed mode, and current states of the OUT pin and Null Count flag of the selected counter or counters. The Read Back Command is written to the Control Word Register, which causes the current states of the above-mentioned variables to be latched. The value of the counter and its status may then be read by I/O access to the counter address.

The Read Back Command may be used to latch multiple counter output latches (OL) by setting the COUNT_ bit D5=0 and selecting the desired counter(s). This single command is functionally equivalent to several counter latch commands, one for each counter latched. Each counter's latched count is held until it is read (or the counter is reprogrammed). Once read, a counter is automatically unlatched. The other counters remain latched until they are read. If multiple count Read Back Commands are issued to the same counter without reading the count, all but the first are ignored (i.e. the count which will be read is the count at the time the first Read Back Command was issued).

The Read Back Command may also be used to latch status information of selected counter(s) by setting STATUS_ bit D4=0. Status must be latched to be read. The status of a counter is accessed by a read from that counter's I/O port address.

If multiple counter status latch operations are performed without reading the status, all but the first are ignored. The status returned from the read is the counter status at the time the first status Read Back Command was issued.

Both count and status of the selected counter(s) may be latched simultaneously by setting both the COUNT_ and STATUS_ bits[5:4]=00. This is functionally the same as issuing two consecutive, separate Read Back Commands. The above discussions apply here also. Specifically, if multiple count and/or status Read Back Commands are issued to the same counter(s) without any intervening reads, all but the first are ignored.

If both count and status of a counter are latched, the first read operation from that counter will return the latched status, regardless of which was latched first. The next one or two reads (depending on whether the counter is programmed for one or two type counts) return the latched count. Subsequent reads return unlatched count.

10.9 Programmable Interrupt Controller

SoC SB provides an ISA-Compatible interrupt controller that incorporates the functionality of two 82C59 interrupt controllers (Figure 10-7). The two controllers are cascaded, providing 13 external and three internal interrupts. The master interrupt controller provides IRQ[7:0] and the slave interrupt controller provides IRQ[15:8]. The three internal interrupts are used for internal functions only. IRQ0 is available to the user only when an external IO APIC is enabled. IRQ2 is used to cascade the two controllers and is not available to the user. IRQ0 is used as a system timer interrupt and is tied to Interval Timer 0, Counter 0. IRQ13 is reserved. The remaining 13 interrupt lines (IRQ[15:14,12:3,1]) are available for external system interrupts. IRQ[1] is fixed to edge trigger mode, IRQ[15:14, 12:3] edge or level sense selections are programmable on an individual channel-by-channel basis.

The Interrupt unit also supports interrupt steering. SoC SB can be programmed to allow the four PCI active low interrupts (PIRQ[A:D]#) to be internally routed to one of 11 interrupts (IRQ[15:14,12:9,7:3]).

The Interrupt Controller consists of two separate 82C59 cores. Interrupt Controller 1 (CNTRL-1) and Interrupt Controller 2 (CNTRL-2) are initialized separately and can be programmed to operate in different modes. The default settings are: 80x86 Mode, Edge Sensitive (IRQ[0:15]) Detection, Normal EOI, Non-Buffered Mode, Special Fully Nested Mode disabled, and Cascade Mode. CNTRL-1 is connected as the Master Interrupt Controller and CNTRL-2 is connected as the Slave Interrupt Controller.

Note that IRQ13 is generated internally (as part of the coprocessor error support) by SoC SB. IRQ[12]/M is generated internally (as part of the mouse support) when bit-4 in the XBCS is set to a 1. When set to a 0, the standard IRQ[12] function is provided and IRQ[12] appears externally.

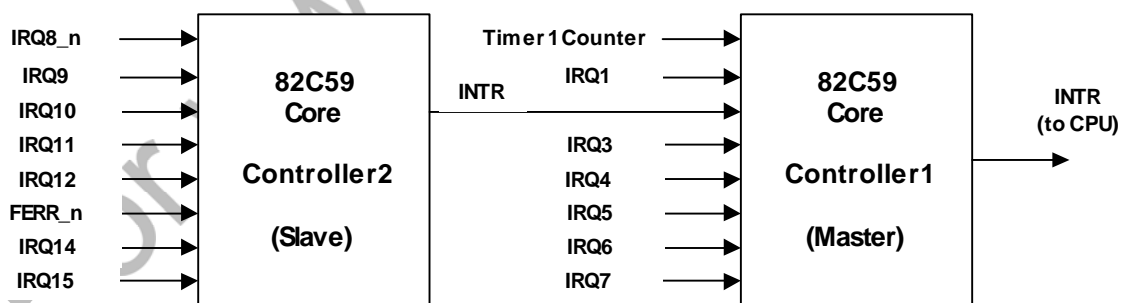

Figure 10-7. Interrupt Controller Block Diagram

10.9.1 Programming the Interrupt Controller

The Interrupt Controller accepts two types of command words generated by the CPU or bus master:

Initialization Command Words (ICWs)

Before normal operation begins, each Interrupt Controller in the system must be initialized. In the 82C59, this is a 2- to 4-byte sequence. However, for SoC SB, each controller must be initialized with a 4-byte sequence. This 4-byte sequence is required to configure the interrupt controller correctly for the SoC SB implementation. This implementation is ISA-Compatible.

The four initialization command words are referred to by their acronyms: ICW1, ICW2, ICW3, and ICW4. The base address for each interrupt controller is a fixed location in the I/O memory space, at 0020h for CNTRL-1 and at 00A0h for CNTRL-2. An I/O write to the CNTRL-1 or CNTRL-2 base address with data bit 4 equal to 1 is interpreted as ICW1. For SoC SB-based ISA systems, three I/O writes to “base address + 1” (021h for CNTRL-1 and 0A1h for CNTRL-2) must follow the ICW1. The first write to “base address + 1” (021h/0A1h) performs ICW2, the second write performs ICW3, and the third write performs ICW4.

ICW1 starts the initialization sequence. ICW2 is programmed to provide bits[7:3] of the interrupt vector that will be released onto the data bus by the interrupt controller during an interrupt acknowledge. A different base [7:3] is selected for each interrupt controller. ICW3 is programmed differently for CNTRL-1 and CNTRL-2, and has a different meaning for each controller.

For CNTRL-1, the master controller, ICW3 is used to indicate which IRQx input line is used to cascade CNTRL-2, the slave controller. Within the SoC SB interrupt unit, IRQ2 on CNTRL-1 is used to cascade the INTR output of CNTRL-2. Consequently, bit 2 of ICW3 on CNTRL-1 is set to a 1, and the other bits are set to 0's.

For CNTRL-2, ICW3 is the slave identification code used during an interrupt acknowledge cycle. CNTRL-1 broadcasts a code to CNTRL-2 over three internal cascade lines if an IRQ[x] line from CNTRL-2 won the priority arbitration on the master controller and was granted an interrupt acknowledge by the CPU. CNTRL-2 compares this identification code to the value stored in ICW3, and if the code is equal to bits[2:0] of ICW3, CNTRL-2 assumes responsibility for broadcasting the interrupt vector during the second interrupt acknowledge cycle pulse.

ICW4 must be programmed on both controllers. At the very least, bit 0 must be set to a 1 to indicate that the controllers are operating in an x86 Architecture-based system.

Operation Command Words (OCWs)

These are the command words which dynamically reprogram the Interrupt Controller to operate in various interrupt modes. Any interrupt line can be masked by writing an OCW1. A 1 written in any bit of this command word will mask incoming interrupt requests on the corresponding IRQx line.

OCW2 is used to control the rotation of interrupt priorities when operating in the rotating priority mode and to control the End of Interrupt (EOI) function of the controller. OCW3 is used to set up reads of the ISR and IRR, to enable or disable the Special Mask Mode (SMM), and to set up the interrupt controller in polled interrupt mode. The OCWs can be written into the Interrupt Controller any time after initialization.

10.9.2 End-of-Interrupt Operation

End of Interrupt (EOI)

The In Service (IS) bit can be set to 0 automatically following the trailing edge of the second INTA# pulse (when AEOI bit in ICW1 is set to 1) or by a command word that must be issued to the Interrupt Controller before returning from a service routine (EOI command). An EOI command must be issued twice with this cascaded interrupt controller configuration, once for the master and once for the slave.

There are two forms of EOI commands: Specific and Non-Specific. When the Interrupt Controller is operated in modes that preserve the fully nested structure, it can determine which IS bit to set to 0 on EOI. When a Non-Specific EOI command is issued, the Interrupt Controller automatically sets to 0 and the highest IS bit of those that are set to 1. Since in the fully nested mode, the highest IS level was necessarily the last level acknowledged and serviced. A Non-Specific EOI can be issued with OCW2 (EOI=1, SL=0, R=0).

When a mode is used that may disturb the fully nested structure, the Interrupt Controller may no longer be able to determine the last level acknowledged. In this case, a Specific End of Interrupt must be issued that includes as part of the command the IS level to be reset. A specific EOI can be issued with OCW2 (EOI=1, SL=1, R=0, and L0–L2 is the binary level of the IS bit to be set to 0).

Note that an IS bit that is masked by an IMR bit will not be cleared by a non-specific EOI if the Interrupt Controller is in the Special Mask Mode.

Automatic End of Interrupt (AEOI) Mode

If AEOI=1 in ICW4, then the Interrupt Controller operates in AEOI mode continuously until reprogrammed by ICW4. Note that reprogramming ICW4 implies that ICW1, ICW2, and ICW3 must be reprogrammed first, in sequence. In this mode, the Interrupt Controller automatically performs a Non-Specific EOI operation at the trailing edge of the last interrupt acknowledge pulse. Note that from a system standpoint, this mode should be used only when a nested multi-level interrupt structure is not required within a single Interrupt Controller. The AEOI mode can only be used in a master Interrupt Controller and not in a slave Interrupt Controller (on CNTRL-1 but not CNTRL-2).

10.9.3 Modes of Operation

Fully Nested Mode

This mode is entered after initialization unless another mode is programmed. The interrupt requests are ordered in priority from 0 through 7 (0 being the highest). When an interrupt is acknowledged, the highest priority request is determined and its vector placed on the bus. Additionally, a bit of the Interrupt Service Register (IS[0:7]) is set. This IS bit remains set until the microprocessor issues an End of Interrupt (EOI) command immediately before returning from the service routine. Or, if the AEOI (Automatic End of Interrupt) bit is set, this IS bit remains set until the trailing edge of the second INTA#. While the IS bit is set, all further interrupts of the same or lower priority are inhibited, while higher levels will generate an interrupt (which will be acknowledged only if the microprocessor internal interrupt enable flip-flop has been re-enabled through software).

After the initialization sequence, IRQ0 has the highest priority and IRQ[7] the lowest. Priorities can be changed, as will be explained in the rotating priority mode.

The Special Fully Nested Mode

This mode will be used in the case of a system where cascading is used, and the priority has to be conserved within each slave. In this case, the special fully nested mode will be programmed to the master (using ICW4). This mode is similar to the normal nested mode with the following exceptions:

When an interrupt request from a certain slave is in service, this slave is not locked out from the master's priority logic and further interrupt requests from higher priority IRQs within the slave will be recognized by the master and will initiate interrupts to the processor. (In the normal nested mode, a slave is masked out when its request is in service and no higher requests from the same slave can be serviced.)

When exiting the Interrupt Service routine, the software has to check whether the interrupt serviced was the only one from that slave. This is done by sending a Non-Specific End of Interrupt (EOI) command to the slave and then reading its In-Service Register and checking for zero. If it is empty, a Non-Specific EOI can be sent to the master too. If not, no EOI should be sent.

Automatic Rotation (Equal Priority Devices)

In some applications, there are a number of interrupting devices of equal priority. Automatic rotation mode provides for a sequential 8-way rotation. In this mode, a device receives the lowest priority after being serviced. In the worst case, a device requesting an interrupt will have to wait until each of seven other devices are serviced at most once.

There are two ways to accomplish automatic rotation using OCW2: the Rotation on Non-Specific EOI Command (R=1, SL=0, EOI=1) and the Rotate in Automatic EOI Mode which is set by (R=1, SL=0 and EOI=0) and cleared by (R=0, SL=0 and EOI=0).

Specific Rotation (Specific Priority)

The programmer can change priorities by programming the bottom priority and thus fixing all other priorities. For example, if IRQ[5] is programmed as the bottom priority device, IRQ[6] will be the highest priority device.

The Set Priority Command is issued in OCW2 where: R=1, SL=1; L0–L2 is the binary priority level code of the bottom priority device. See the register description for the bit definitions.

Note that, in this mode, internal status is updated by software control during OCW2. However, it is independent of the End of Interrupt (EOI) command (also executed by OCW2). Priority changes can be executed during an EOI command by using the Rotate on Specific EOI Command in OCW2 (R=1, SL=1, EOI=1 and L0–L2=IRQ level to receive bottom priority).

Poll Command

The Polled Mode can be used to conserve space in the interrupt vector table. Multiple interrupts that can be serviced by one interrupt service routine do not need separate vectors if the service routine uses the poll command.

The Polled Mode can also be used to expand the number of interrupts. The polling interrupt service routine can call the appropriate service routine, instead of providing the interrupt vectors in the vector table.

In this mode, the INTR output is not used and the microprocessor internal Interrupt Enable flip-flop is reset, disabling its interrupt input. Service to devices is achieved by software using a Poll Command.

The Poll command is issued by setting P=1 in OCW3. The Interrupt Controller treats the next I/O read pulse to the Interrupt Controller as an interrupt acknowledge, sets the appropriate IS bit if there is a request, and reads the priority level. Interrupts are frozen from the I/O write to the I/O read.

This mode is useful if there is a routine command common to several levels so that the INTA# sequence is not needed (saving ROM space)

10.9.4 Cascade Mode

The Interrupt Controllers in SoC SB are interconnected in a cascade configuration with one master and one slave. This configuration can handle up to 15 separate priority levels.

The master controls the slaves through a three-line internal cascade bus. When the master drives 010b on the cascade bus, this bus acts like a chip select to the slave controller.

In a cascade configuration, the slave interrupt outputs are connected to the master interrupt request inputs. When a slave request line is activated and afterwards acknowledged, the master enables the corresponding slave to release the interrupt vector address during the second INTA# cycle of the interrupt acknowledge sequence.

Each Interrupt Controller in the cascaded system must follow a separate initialization sequence and

can be programmed to work in a different mode. An EOI Command must be issued twice: once for the master and once for the slave.

10.9.5 Edge- and Level-Triggered Mode

In ISA systems, this mode is programmed by using bit 3 in ICW1. With SoC SB, this bit is disabled and a new register for edge and level triggered mode selection, per interrupt input, is included. This is the Edge/Level control Registers ELCR1 and ELCR2. The default programming is equivalent to programming the LTIM bit (ICW1 bit 3) to a 0 (all interrupts selected for edge triggered mode). Note that IRQ0, 1, 2, 8, and 13 cannot be programmed for level sensitive mode and cannot be modified by software.

If an ELCR bit=0, an interrupt request is recognized by a low to high transition on the corresponding IRQx input. The IRQ input can remain high without generating another interrupt.

If an ELCR bit=1, an interrupt request is recognized by a high level on the corresponding IRQ input and there is no need for an edge detection. The interrupt request must be removed before the EOI command is issued to prevent a second interrupt from occurring.

In both the edge and level triggered modes, the IRQ inputs must remain active until the falling edge of the first INTA#. If the IRQ input goes inactive before this time, a default IRQ[7] occurs when the CPU acknowledges the interrupt. This can be a useful safeguard for detecting interrupts caused by spurious noise glitches on the IRQ inputs. To implement this feature, the IRQ[7] routine is used for "clean up" simply executing a return instruction, thus ignoring the interrupt. If IRQ[7] is needed for other purposes, a default IRQ[7] can still be detected by reading the ISR. A normal IRQ[7] interrupt sets the corresponding ISR bit; a default IRQ[7] does not set this bit. However, if a default IRQ[7] routine occurs during a normal IRQ[7] routine, the ISR remains set. In this case, it is necessary to keep track of whether or not the IRQ[7] routine was previously entered. If another IRQ[7] occurs, it is a default.

10.9.6 Interrupt Masks

Masking on an Individual Interrupt Request Basis

Each interrupt request input can be masked individually by the Interrupt Mask Register (IMR). This register is programmed through OCW1. Each bit in the IMR masks one interrupt channel if it is set to a 1. Bit 0 masks IRQ0, Bit 1 masks IRQ1, and so forth. Masking an IRQ channel does not affect the other channels' operation, with one exception. Masking IRQ2 on CNTRL-1 will mask off all requests for service from CNTRL-2. The CNTRL-2 INTR output is physically connected to the CNTRL-1 IRQ2 input.

Special Mask Mode

Some applications may require an interrupt service routine to dynamically alter the system priority structure during its execution under software control. For example, the routine may wish to inhibit

lower priority requests for a portion of its execution but enable some of them for another portion.

The difficulty is that if an Interrupt Request is acknowledged and an End of Interrupt command did not reset its IS bit (i.e., while executing a service routine), the Interrupt Controller would have inhibited all lower priority requests with no easy way for the routine to enable them.

The Special Mask Mode enables all interrupts not masked by a bit set in the Mask Register. Interrupt service routines that require dynamic alteration of interrupt priorities can take advantage of the Special Mask Mode. For example, a service routine can inhibit lower priority requests during a part of the interrupt service and then enable some of them during another part.

In the Special Mask Mode, when a mask bit is set to 1 in OCW1, it inhibits further interrupts at that level and enables interrupts from all other levels (lower as well as higher) that are not masked.

Thus, any interrupt may be selectively enabled by loading the Mask Register with the appropriate pattern.

If there is no Special Mask Mode and an interrupt service routine acknowledges an interrupt without issuing an EOI to clear the IS bit, the interrupt controller inhibits all lower priority requests. The Special Mask Mode provides an easy way for the interrupt service routine to selectively enable only the interrupts needed by loading the Mask register.

The special Mask Mode is set by OCW3 where: SSMM=1 and SMM=1, and cleared where SSMM=1 and SMM=0.

10.9.7 Reading the Interrupt Controller Status

The input status of several internal registers can be read to update the user information on the system. The Interrupt Request Register (IRR) and In-Service Register (ISR) can be read via OCW3. The Interrupt Mask Register (IMR) is read via a read of OCW1. Brief descriptions of the ISR, the IRR, and the IMR follow.

Interrupt Request Register (IRR): 8-bit register which contains the status of each interrupt request line. Bits that are clear indicate interrupts that have not requested service. The Interrupt Controller clears the IRR's highest priority bit during an interrupt acknowledge cycle. (Not affected by IMR).

In-Service Register (ISR): 8-bit register indicating the priority levels currently receiving service. Bits that are set indicate interrupts that have been acknowledged and their interrupt service routine started. Bits that are cleared indicate interrupt requests that have not been acknowledged, or interrupt request lines that have not been asserted. Only the highest priority interrupt service routine executes at any time. The lower priority interrupt services are suspended while higher priority interrupts are serviced. The ISR is updated when an End of Interrupt Command is issued.

Interrupt Mask Register (IMR): 8-bit register indicating which interrupt request lines are masked.

The IRR can be read when, prior to the I/O read cycle, a Read Register Command is issued with OCW3 (RR=1 and RIS=0). The ISR can be read when, prior to the I/O read cycle, a Read Register Command is issued with OCW3 (RR=1 and RIS=1).

The interrupt controller retains the ISR/IRR status read selection following each write to OCW3. Therefore, there is no need to write an OCW3 before every status read operation, as long as the current status read corresponds to the previously selected register. For example, if the ISR is selected for status read by an OCW3 write, the ISR can be read over and over again without writing to OCW3 again. However, to read the IRR, OCW3 will have to be reprogrammed for this status read prior to the OCW3 read to check the IRR. This is not true when polling mode is used. Polling Mode overrides status read when P=1 and RR=1 in OCW3.

After initialization, the Interrupt Controller is set to read the IRR. As stated, OCW1 is used for reading the IMR. The output data bus will contain the IMR status whenever I/O read is active and the address is 021h or 061h (OCW1).

10.9.8 Interrupt Steering

SoC SB can be programmed to allow four PCI programmable interrupts (PIRQ[A:D]#) to be internally routed to one of 11 interrupts IRQ[15,14,12:9,7:3]. PCLK is used to synchronize the PIRQx# inputs. The PIRQx# lines are run through an internal multiplexer that assigns, or routes, an individual PIRQx# line to any one of 11 IRQ inputs. The assignment is programmable through the PIRQx Route Control registers. One or more PIRQx# lines can be routed to the same IRQx input. If interrupt steering is not required, the Route Registers can be programmed to disable steering.

Bits[3:0] in each PIRQx Route Control register are used to route the associated PIRQx# line to an internal IRQ input. Bit 7 in each register is used to disable routing of the associated PIRQx#.

The PIRQx# lines are defined as active low, level sensitive to allow multiple interrupts on a PCI Board to share a single line across the connector. When a PIRQx# is routed to specify IRQ line, the software must change the IRQ's corresponding ELCR bit to level sensitive mode. This means that the selected IRQ can no longer be used by an ISA device.

10.10 KeyBoard Controller

The keyboard controller is implemented using an 8-bit microcontroller that is capable of executing the 8042 instruction set. For general information, please refer the description of the 8042 in the 8-bit controller handbook. In addition, the microcontroller can enter power-down mode by executing two types of power-down instructions. The 8-bit microcontroller has 256 bytes of RAM for data memory and 8 Kbytes of ROM for the program storage.

The ROM codes may come from various vendors (or users), and are programmed during the manufacturing process. To assist in developing ROM codes, the keyboard controller has an

external access mode. In the external access mode, the internal ROM is disabled and the instructions executed by the microcontroller come from an externally connected ROM.

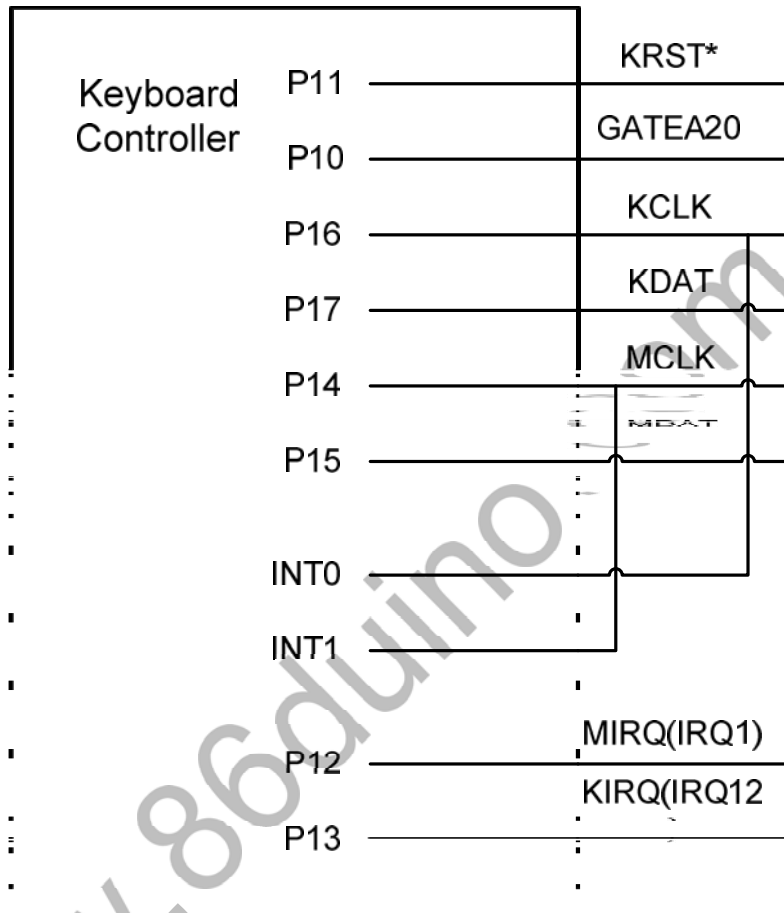

Figure 10-8. Keyboard and Mouse Interface

10.10.1 Host Interface

The keyboard controller interfaces with the system through the 8042 style host interface. The table 10.6 shows how the interface decodes the control signals.

Table 10.6 : Data Register READ/WRITE Controls

Host Address ^{Note}	R/W*	Function
60h	R	READ DATA
60h	W	WRITE DATA , (Clear F1)
64h	R	READ Status
64h	W	WRITE Command , (set F1)

Note : These are the default values of the LDN5, 60h and 61h (DATA); LDN5, 62h and 63h (Command). All these registers are programmable.

READ DATA : This is an 8-bit read only register. When read, the KIRQ output is cleared and OBF flag in the status register is cleared.

WRITE DATA: This is an 8-bit write only register. When written, the F1 flag of the Status register is cleared and the IBF bit is set.

READ Status : This is an 8-bit read only register. Refer to the description of the Status register for more information.

WRITE Command : This is an 8-bit write only register. When written, both F1 and IBF flags of the Statusregister are set.

10.10.2 Data Registers and Status Register

The keyboard controller provides two data registers: one is DBIN for data input, and the other is DBOUT for data output. Each of the data registers is 8 bits wide. A write (microcontroller) to the DBOUT will load Keyboard Data Read Buffer, set OBF flag and set the KIRQ output. A read (microcontroller) of the DBIN will read the data from the Keyboard Data or Command Write Buffer and clear the IBF flag.

The status register holds information concerning the status of the data registers, the internal flags and some user-defined status bits. Please refer to Table 10.7. The bit 0 OBF is set to "1" when the microcontroller writes a data into DBOUT, and is cleared when the system initiates a DATA READ operation. The bit 1 IBF is set to "1" when the system initiates a WRITE operation, and is cleared when the microcontroller executes an "IN A, DBB" instruction. The FO and F1 flags can be set or reset when the microcontroller executes the clear and complement flag instructions. F1 also holds the system WRITE information when the system performs the WRITE operations.

Table 10.7 : Status Register

7	6	5	4	3	2	1	0
ST7	ST6	ST5	ST4	F1	F0	IBF	OBF

10.10.3 Keyboard and Mouse Interface

KCLK is the keyboard clock pin. Its output is the inversion of pin P16 of the 8042, and the input of KCLK is connected to the TO pin of the 8042. KDAT is the keyboard data pin; its output is the inversion of pin P17 of the microcontroller, and the input of KDAT is connected to the P17 of the microcontroller. MCLK is the mouse clock pin; its output is the inversion of pin P14 of the microcontroller and the input of MCLK is connected to the P14 pin of the microcontroller. MDAT is the Mouse data pin- its output is the inversion of pin P15 of the microcontroller, and the input of MDAT is connected to the P15 of the microcontroller. KRST# is pin P11 of the microcontroller. GATEA20 is the pin P10 of the microcontroller. These two pins are used as software controlled or user defined outputs. External pull-ups may be required for these pins.

10.10.4 KIRQ and MIRQ

KIRQ is the Interrupt request for keyboard (Default 'ROD, and MIRQ is the interrupt request for mouse (Default IRQ[12]). KIRQ is internally connected to P13 pin of the microcontroller, and MIRQ is internally connected to pin P12 of the microcontroller.

10.10.5 A20M_ Setting

The SOC A20M_ pin can be control with internal 8051 KB controller, internal PORT 92h and external KB controller. The detail functional block shows as below.

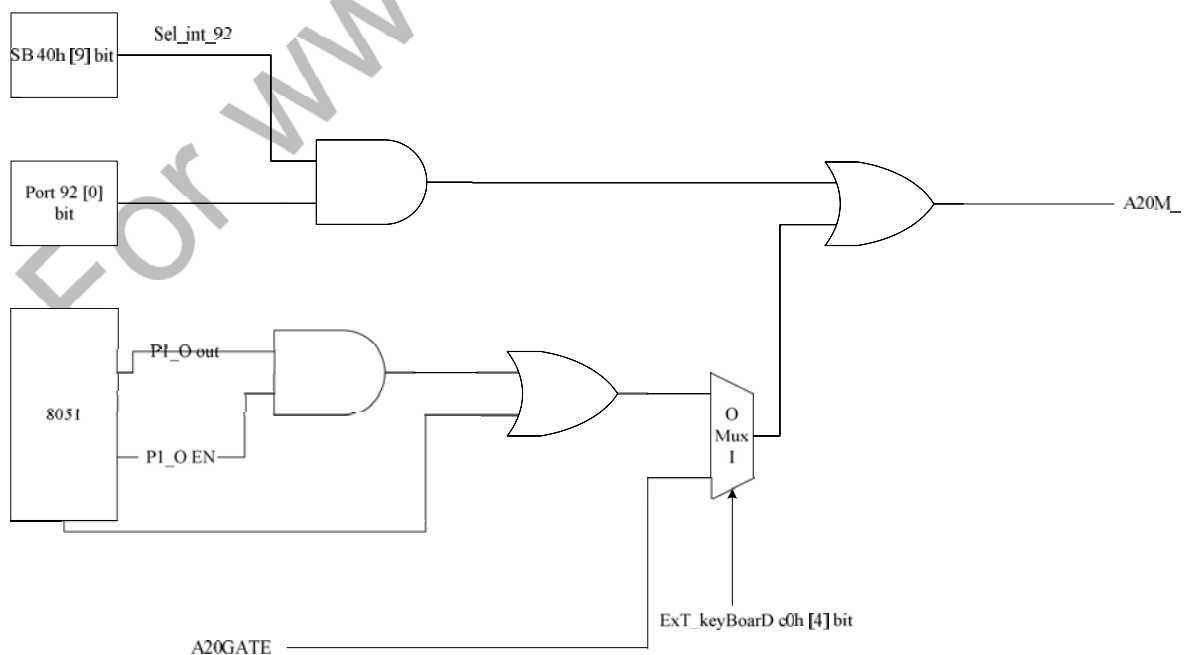

For www.86duino.com

10.11 PARALLEL PORT

The SoC incorporate one IBM XT/AT compatible parallel port. The SoC support the optional PS/2 type bi-directional parallel port (SPP), the Enhanced Parallel Port (EPP) and the Extended Capabilities parallel port (ECP) modes. Refer to the SoC Configuration Registers and Hardware Configuration description for information on disabling, power down, changing the base address of the parallel port, and selecting the mode of operation.

The functionality of the Parallel Port is achieved through the use of eight addressable ports, with their associated registers and control gating. The address map of the Parallel Port and EPP registers are shown below:

DATA PORT	BASE ADDRESS + 00H
STATUS PORT	BASE ADDRESS + 01H
CONTROL PORT	BASE ADDRESS + 02H
EPP ADDR PORT	BASE ADDRESS + 03H
EPP DATA PORT 0	BASE ADDRESS + 04H
EPP DATA PORT 1	BASE ADDRESS + 05H
EPP DATA PORT 2	BASE ADDRESS + 06H
EPP DATA PORT 3	BASE ADDRESS +

The bit map of Parallel Port and EPP registers:

	D0	D1	D2	D3	D4	D5	D6	D7	Note
DATA PORT	PD0	PD1	PD2	PD3	PD4	PD5	PD6	PD7	1
STATUS PORT	TMOUT	1	1	nERR	SLCT	PE	nACK	BUSY	1
CONTROL PORT	nSTROBE	nAUTOFD	nINIT	SLIN	IRQ	DIR	1	1	1
EPP ADDR PORT	PD0	PD1	PD2	PD3	PD4	PD5	PD6	PD7	2,3
EPP DATA PORT 0	PD0	PD1	PD2	PD3	PD4	PD5	PD6	PD7	2,3
EPP DATA PORT 1	PD0	PD1	PD2	PD3	PD4	PD5	PD6	PD7	2,3
EPP DATA PORT 2	PD0	PD1	PD2	PD3	PD4	PD5	PD6	PD7	2,3
EPP DATA PORT 3	PD0	PD1	PD2	PD3	PD4	PD5	PD6	PD7	2,3

Note 1: These registers are available in all modes.

Note 2: These registers are only available in EPP mode.

Note 3 : For EPP mode, IOCHRDY must be connected to the ISA bus.

Table 10.8 : Parallel Port Connector

HOST CONNECTOR	STANDARD	EPP	ECP
1	NStrobe	nWrite	nStrobe
2-9	PData<0:7>	PData<0:7>	PData<0:7>
10	NAck	Intr	nAck
11	Busy	nWait	Busy , PeriphAck(3)
12	PError	(NU)	PError , nAckReverse(3)
13	Select	(NU)	Select
14	NAutoFd	nDStrb	nAutoFd, HostAck(3)
15	NFault	(NU)	nFault(1) nPeriphRequest(3)

HOST CONNECTOR	STANDARD	EPP	ECP
16	NInit	(NU)	nInit(1) nReverseRqst(3)
17	NSelectin	nAStrb	nSelectIn(1,3)

(1) = Compatible Mode

(3) = High Speed Mode

10.11.1 IBM XT/AT COMPATIBLE, BI-DIRECTIONAL AND EPP MODES

DATA PORT

ADDRESS OFFSET = 00H

The Data Port is located at an offset of '00H' from the base address. During a WRITE operation, the Data Register latches the contents of the data bus with the rising edge of the nIOW input. The contents of this register are buffered (non inverting) and output onto the PD0 - PD7 ports. During a READ operation in SPP mode, PD0 - PD7 ports are buffered (not latched) and output to the host CPU.

STATUS PORT

ADDRESS OFFSET = 01H

The Status Port is located at an offset of '01H' from the base address. The contents of this register are latched for the duration of an nIOR read cycle. The bits of the Status Port are defined as follows:

BIT 0 TMOUT - TIME OUT

This bit is valid in EPP mode only and indicates that a 10 usec time out has occurred on the EPP bus. A logic 0 means that no time out error has occurred; a logic 1 means that a time out error has been detected. This bit is cleared by a RESET. Writing a one to this bit clears the time out status bit. On a write, this bit is self clearing and does not require a write of a zero. Writing a zero to this bit has no effect.

BITS 1, 2 - are not implemented as register bits, during a read of the Printer Status Register these bits are a high level.

BIT 3 nERR – nERROR

The level on the nERROR input is read by the CPU as bit 3 of the Printer Status Register. A logic 0 means an error has been detected; a logic 1 means no error has been detected.

BIT 4 SLCT - PRINTER SELECTED STATUS

The level on the SLCT input is read by the CPU as bit 4 of the Printer Status Register. A logic 1

means the printer is on line; a logic 0 means it is not selected.

BIT 5 PE - PAPER END

The level on the PE input is read by the CPU as bit 5 of the Printer Status Register. A logic 1 indicates a paper end; a logic 0 indicates the presence of paper.

BIT 6 nACK - nACKNOWLEDGE

The level on the nACK input is read by the CPU as bit 6 of the Printer Status Register. A logic 0 means that the printer has received a character and can now accept another. A logic 1 means that it is still processing the last character or has not received the data.

BIT 7 BUSY - BUSY

The complement of the level on the BUSY input is read by the CPU as bit 7 of the Printer Status Register. A logic 0 in this bit means that the printer is busy and cannot accept a new character. A logic 1 means that it is ready to accept the next character.

CONTROL PORT

ADDRESS OFFSET = 02H

The Control Port is located at an offset of '02H' from the base address. The Control Register is initialized by the RESET input, bits 0 to 5 only being affected; bits 6 and 7 are hard wired high.

BIT 0 nSTROBE - STROBE

This bit is inverted and output onto the nSTROBE output.

BIT 1 nAUTOFD - AUTOFEED

This bit is inverted and output onto the nAUTOFD output. A logic 1 causes the printer to generate a line feed after each line is printed. A logic 0 means no autofeed.

BIT 2 nINIT - nINITIATE OUTPUT

This bit is output onto the nINIT output without inversion.

BIT 3 SLCTIN - PRINTER SELECT INPUT

This bit is inverted and output onto the nSLCTIN output. A logic 1 selects the printer; a logic 0 means the printer is not selected.

BIT 4 IRQ - INTERRUPT REQUEST ENABLE

The interrupt request enable bit when set to a high level may be used to enable interrupt requests

from the Parallel Port to the CPU. An interrupt request is generated on the IRQ port by a positive going nACK input. When the IRQE bit is programmed low the IRQ is disabled.

BIT 5 DIR - PARALLEL CONTROL DIRECTION Parallel Control Direction is valid in extended mode. In printer mode, the direction is always out regardless of the state of this bit. In bi-directional mode, a logic 0 means that the printer port is in output mode (write); a logic 1 means that the printer port is in input mode (read).

Bits 6 and 7 during a read are a high level, and cannot be written.

EPP ADDRESS PORT

ADDRESS OFFSET = 03H

The EPP Address Port is located at an offset of '03H' from the base address. During a WRITE operation, the contents of DB0 - DB7 are buffered (non inverting) and output onto the PD0 - PD7 ports, the leading edge of nLOW causes an EPP ADDRESS WRITE cycle to be performed, the trailing edge of IOW latches the data for the duration of the EPP write cycle. During a READ operation, PD0 - PD7 ports are read, the leading edge of IOR causes an EPP ADDRESS READ cycle to be performed and the data output to the host CPU, the deassertion of ADDRSTB latches the PData for the duration of the IOR cycle. This register is only available in EPP mode.

EPP DATA PORT 0

ADDRESS OFFSET = 04H

The EPP Data Port 0 is located at an offset of '04H' from the base address. During a WRITE operation, the contents of DB0-DB7 are buffered (non inverting) and output onto the PD0 - PD7 ports, the leading edge of nLOW causes an EPP DATA WRITE cycle to be performed, the trailing edge of IOW latches the data for the duration of the EPP write cycle. During a READ operation, PD0 - PD7 ports are read, the leading edge of IOR causes an EPP READ cycle to be performed and the data output to the host CPU, the deassertion of DATASTB latches the PData for the duration of the IOR cycle. This register is only available in EPP mode.

EPP DATA PORT 1

ADDRESS OFFSET = 05H

The EPP Data Port 1 is located at an offset of '05H' from the base address. Refer to EPP DATA PORT 0 for a description of operation. This register is only available in EPP mode.

EPP DATA PORT 2

ADDRESS OFFSET = 06H

The EPP Data Port 2 is located at an offset of '06H' from the base address. Refer to EPP DATA

PORT 0 for a description of operation. This register is only available in EPP mode.

EPP DATA PORT 3

ADDRESS OFFSET = 07H

The EPP Data Port 3 is located at an offset of '07H' from the base address. Refer to EPP DATA PORT 0 for a description of operation. This register is only available in EPP mode.

EPP 1.9 OPERATION

When the EPP mode is selected in the configuration register, the standard and bidirectional modes are also available. If no EPP Read, Write or Address cycle is currently executing, then the PDx bus is in the standard or bi-directional mode, and all output signals (nSTROBE, nAUTOFD, nINIT) are as set by the SPP Control Port and direction is controlled by DIR of the Control port.

In EPP mode, the system timing is closely coupled to the EPP timing. For this reason, a watchdog timer is required to prevent system lockup. The timer indicates if more than 10usec have elapsed from the start of the EPP cycle (nIOR or nIOW asserted) to nWAIT being deasserted (after command). If a time-out occurs, the current EPP cycle is aborted and the time-out condition is indicated in Status bit 0.

During an EPP cycle, if nSTROBE is active, it overrides the EPP write signal forcing the PDx bus to always be in a write mode and the nWRITE signal to always be asserted.

Software Constraints

Before an EPP cycle is executed, the software must ensure that the control register bit DIR is a logic "0" (ie a 04H or 05H should be written to the Control port). If the user leaves DIR as a logic "1", and attempts to perform an EPP write, the chip is unable to perform the write (because DIR is a logic "1") and will appear to perform an EPP read on the parallel bus, no error is indicated.

EPP 1.9 Write

The timing for a write operation (address or data) is shown in timing diagram EPP1.9 Write Data or Address cycle. IOCHRDY is driven active low at the start of each EPP write and is released when it has been determined that the write cycle can complete. The write cycle can complete under the following circumstances:

1. If the EPP bus is not ready (nWAIT is active low) when nDATASTB or nADDRSTB goes active then the write can complete

when nWAIT goes inactive high.

2. If the EPP bus is ready (nWAIT is inactive high) then the chip must wait for it to go active low before changing the state of

nDATASTB, nWRITE or nADDRSTB. The write can complete once nWAIT is determined inactive.

Write Sequence of operation

1. The host selects an EPP register, places data on the SData bus and drives nLOW active.
2. The chip drives IOCHRDY inactive (low).
3. If WAIT is not asserted, the chip must wait until WAIT is asserted.
4. The chip places address or data on PData bus, clears PDIR, and asserts nWRITE.
5. Chip asserts nDATASTB or nADDRSTRB indicating that PData bus contains valid information, and the WRITE signal is valid.
6. Peripheral deasserts nWAIT, indicating that any setup requirements have been satisfied and the chip may begin the

termination phase of the cycle.
7. a) The chip deasserts nDATASTB or nADDRSTRB, this marks the beginning of the termination phase. If it has not already done so, the peripheral should latch the information byte now.
b) The chip latches the data from the SData bus for the PData bus and asserts (releases) IOCHRDY allowing the host to complete the write cycle.
8. Peripheral asserts nWAIT, indicating to the host that any hold time requirements have been satisfied and acknowledging the termination of the cycle.
9. Chip may modify nWRITE and nPDATA in preparation for the next cycle.

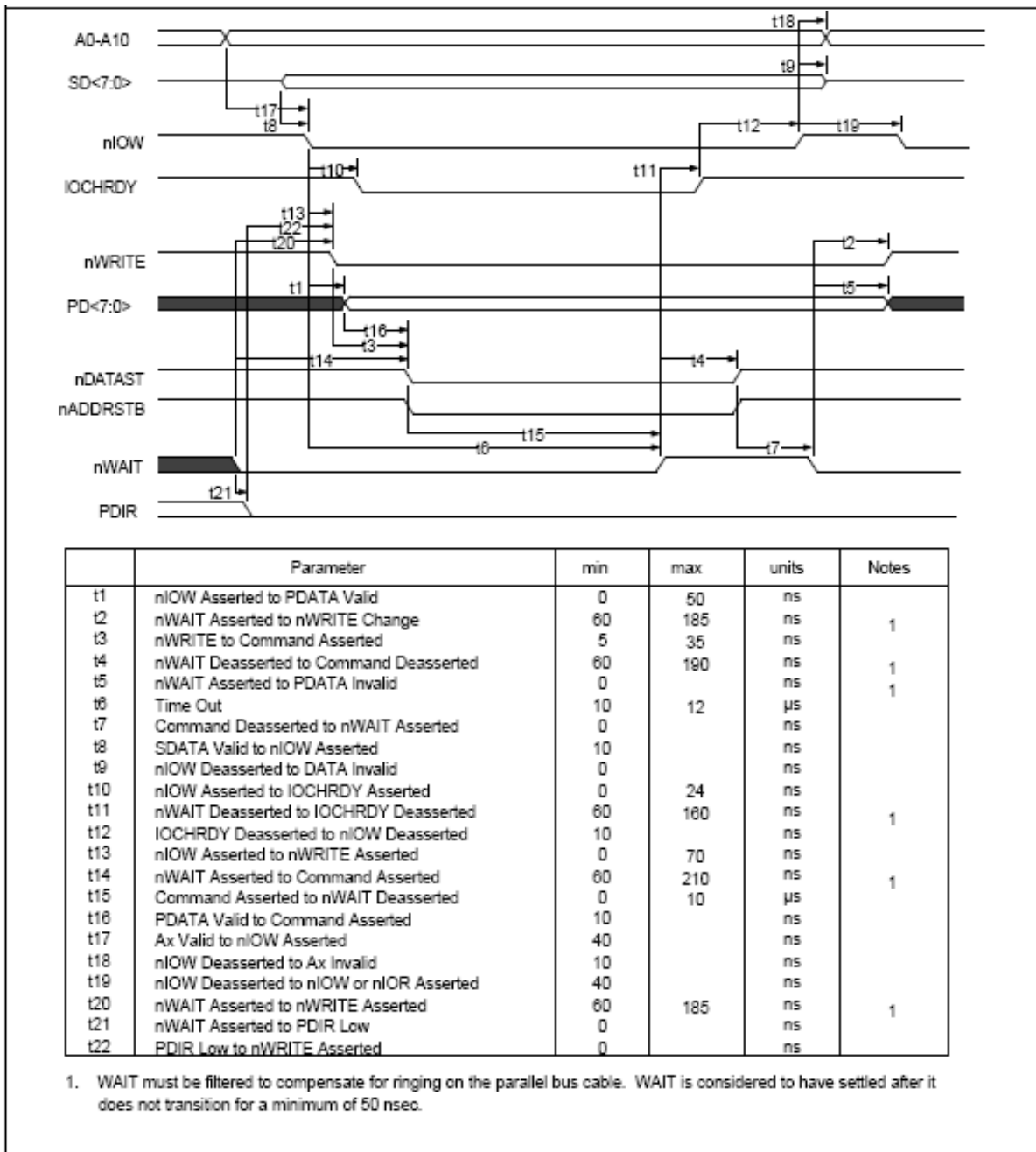

EPP1.9 Data or Address Write Cycle

EPP 1.9 Read

The timing for a read operation (data) is shown in timing diagram EPP1.9 Read Data cycle. IOCHRDY is driven active low at the start of each EPP read and is released when it has been determined that the read cycle can complete. The read cycle can complete under the following circumstances:

1.If the EPP bus is not ready (nWAIT is active low) when nDATASTB goes active then the read can complete when nWAIT goes

inactive high.

2.If the EPP bus is ready (nWAIT is inactive high) then the chip must wait for it to go active low before changing the state of

WRITE or before nDATASTB goes active. The read can complete once nWAIT is determined inactive.

Read Sequence of Operation

1. The host selects an EPP register and drives nIOR active.
2. The chip drives IOCHRDY inactive (low).
3. If WAIT is not asserted, the chip must wait until WAIT is asserted.
4. The chip tri-states the PData bus and deasserts nWRITE.
5. Chip asserts nDATASTB or nADDRSTRB indicating that PData bus is tri-stated, PDIR is set and the nWRITE signal is valid.
6. Peripheral drives PData bus valid.
7. Peripheral deasserts nWAIT, indicating that PData is valid and the chip may begin the termination phase of the cycle.
8. a) The chip latches the data from the PData bus for the SData bus, deasserts nDATASTB or nADDRSTRB, this marks the beginning of the termination phase.
b) The chip drives the valid data onto the SData bus and asserts (releases) IOCHRDY allowing the host to complete the read cycle.
9. Peripheral tri-states the PData bus and asserts nWAIT, indicating to the host that the PData bus is tri-stated.
10. Chip may modify nWRITE, PDIR and nPDATA in preparation for the next cycle.

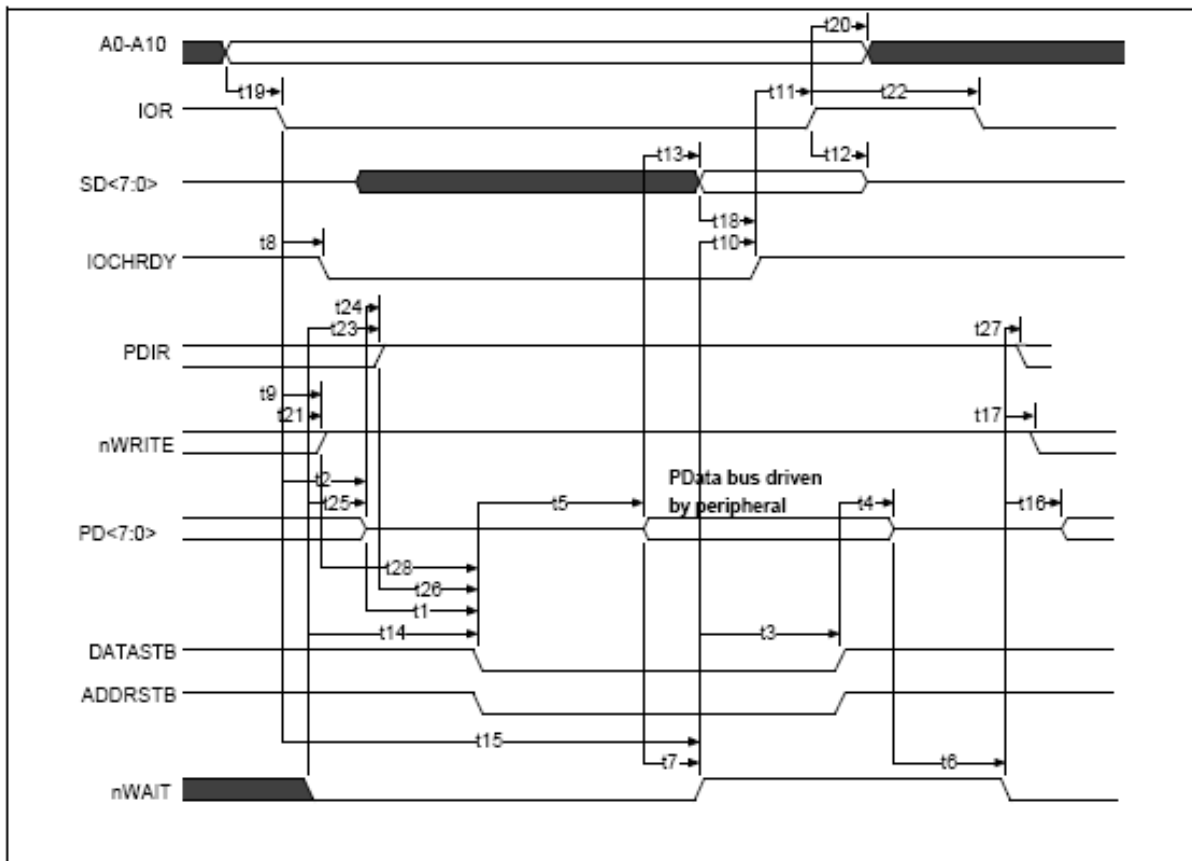

EPP1.9 Data or Address Read Cycle

	Parameter	min	max	units	Notes
t1	PDATA Hi-Z to Command Asserted	0	30	ns	
t2	nIOR Asserted to PDATA Hi-Z	0	50	ns	
t3	nWAIT Deasserted to Command Deasserted	60	180	ns	1
t4	Command Deasserted to PDATA Hi-Z	0		ns	
t5	Command Asserted to PDATA Valid	0		ns	
t6	PDATA Hi-Z to nWAIT Deasserted	0		µs	
t7	PDATA Valid to nWAIT Deasserted	0		ns	
t8	nIOR Asserted to IOCHRDY Asserted	0	24	ns	
t9	nWRITE Deasserted to nIOR Asserted	0		ns	2
t10	nWAIT Deasserted to IOCHRDY Deasserted	60	160	ns	1
t11	IOCHRDY Deasserted to nIOR Deasserted	0		ns	
t12	nIOR Deasserted to SDATA Hi-Z (Hold Time)	0	40	ns	
t13	PDATA Valid to SDATA Valid	0	75	ns	
t14	nWAIT Asserted to Command Asserted	0	195	ns	
t15	Time Out	10	12	µs	
t16	nWAIT Deasserted to PDATA Driven	60	190	ns	1
t17	nWAIT Deasserted to nWRITE Modified	60	190	ns	1,2
t18	SDATA Valid to IOCHRDY Deasserted	0	85	ns	3
t19	Ax Valid to nIOR Asserted	40		ns	
t20	nIOR Deasserted to Ax Invalid	10	10	ns	
t21	nWAIT Asserted to nWRITE Deasserted	0	185	ns	
t22	nIOR Deasserted to nIOW or nIOR Asserted	40		ns	
t23	nWAIT Asserted to PDIR Set	60	185	ns	1
t24	PDATA Hi-Z to PDIR Set	0		ns	
t25	nWAIT Asserted to PDATA Hi-Z	60	180	ns	1
t26	PDIR Set to Command	0	20	ns	
t27	nWAIT Deasserted to PDIR Low	60	180	ns	1
t28	nWRITE Deasserted to Command	1		ns	

1. nWAIT is considered to have settled after it does not transition for a minimum of 50 ns.
2. When not executing a write cycle, EPP nWRITE is inactive high.
3. 85 is true only if t7 = 0.

EPP1.9 Data or Address Read Cycle Timing Parameter

EPP 1.7 OPERATION

When the EPP 1.7 mode is selected in the configuration register, the standard and bidirectional modes are also available. If no EPP Read, Write or Address cycle is currently executing, then the PDX bus is in the standard or bi-directional mode, and all output signals (STROBE, AUTOFD, INIT) are as set by the SPP Control Port and direction is controlled by PCD of the Control port.

In EPP mode, the system timing is closely coupled to the EPP timing. For this reason, a watchdog timer is required to prevent system lockup. The timer indicates if more than 10usec have elapsed from the start of the EPP cycle (nIOR or nIOW asserted) to the end of the cycle (nIOR or nIOW deasserted). If a time-out occurs, the current EPP cycle is aborted and the time-out condition is indicated in Status bit 0.

Software Constraints

Before an EPP cycle is executed, the software must ensure that the control register bits D0, D1 and D3 are set to zero. Also, bit D5 (PCD) is a logic "0" for an EPP write or a logic "1" for an EPP read.

EPP 1.7 Write

The timing for a write operation (address or data) is shown in timing diagram EPP 1.7 Write Data or Address cycle. IOCHRDY is driven active low when nWAIT is active low during the EPP cycle. This can be used to extend the cycle time. The write cycle can complete when nWAIT is inactive high.

Write Sequence of Operation

1. The host sets PDIR bit in the control register to a logic "0". This asserts nWRITE.
2. The host selects an EPP register, places data on the SData bus and drives nIOW active.
3. The chip places address or data on PData bus.
4. Chip asserts nDATASTB or nADDRSTRB indicating that PData bus contains valid information, and the WRITE signal is valid.
5. If nWAIT is asserted, IOCHRDY is deasserted until the peripheral deasserts nWAIT or a time-out occurs.
6. When the host deasserts nIOW the chip deasserts nDATASTB or nADDRSTRB and latches the data from the SData bus for the PData bus.
7. Chip may modify nWRITE, PDIR and nPDATA in preparation of the next cycle.

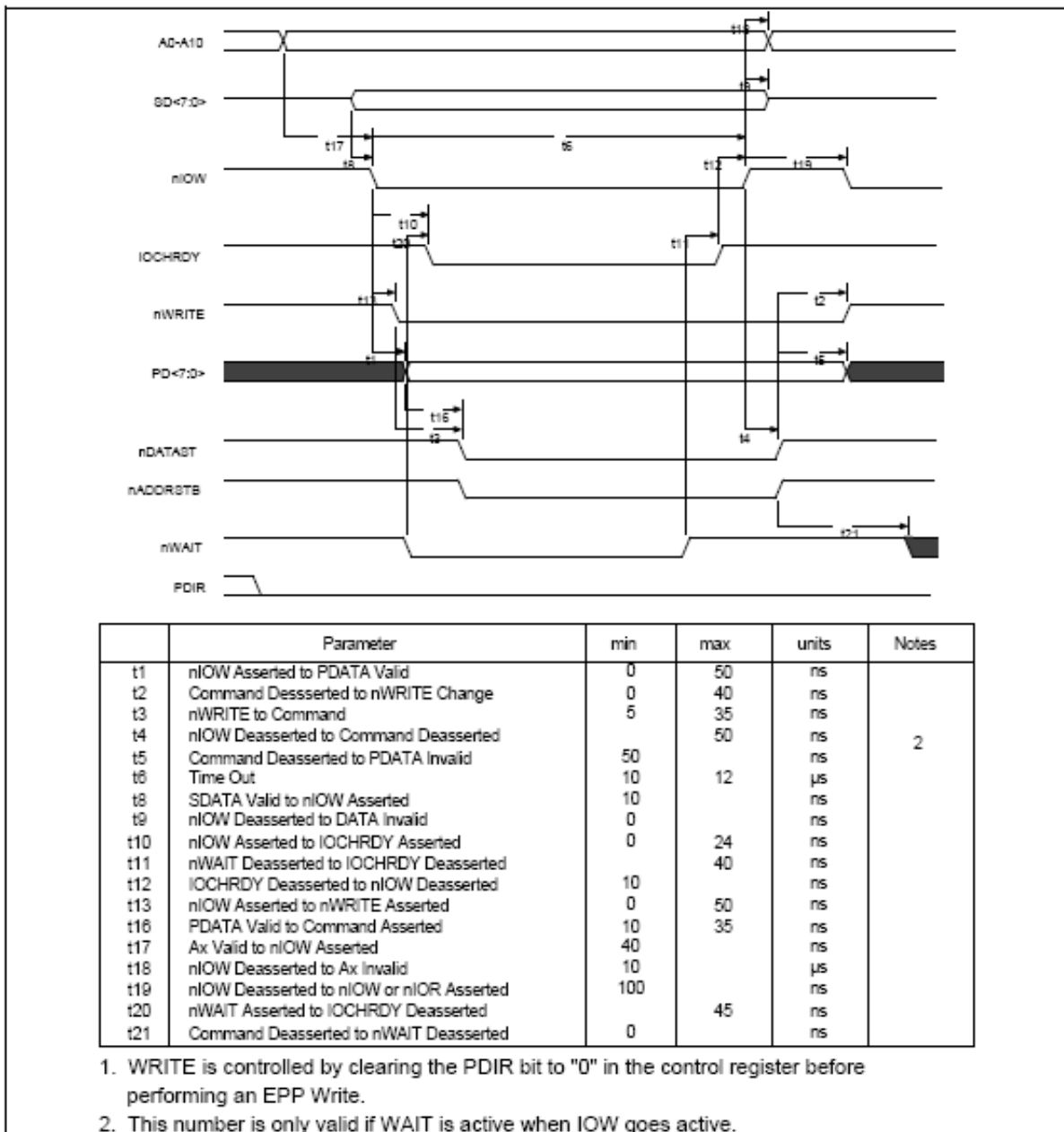

EPP 1.7 Data or Address Write Cycle

EPP 1.7 Read

The timing for a read operation (data) is shown in timing diagram EPP 1.7 Read Data cycle. IOCHRDY is driven active low when nWAIT is active low during the EPP cycle. This can be used to extend the cycle time. The read cycle can complete when nWAIT is inactive high.

Read Sequence of Operation

1. The host sets PDIR bit in the control register to a logic "1". This deasserts nWRITE and tri-states the PData bus.
2. The host selects an EPP register and drives nIOR active.
3. Chip asserts nDATASTB or nADDRSTRB indicating that PData bus is tri-stated, PDIR is set and the nWRITE signal is valid.
4. If nWAIT is asserted, IOCHRDY is deasserted until the peripheral deasserts nWAIT or a time-out occurs.
5. The Peripheral drives PData bus valid.
6. The Peripheral deasserts nWAIT, indicating that PData is valid and the chip may begin the termination phase of the cycle.
7. When the host deasserts nIOR the chip deasserts nDATASTB or nADDRSTRB.
8. Peripheral tri-states the PData bus.
9. Chip may modify nWRITE, PDIR and nPDATA in preparation of the next cycle.

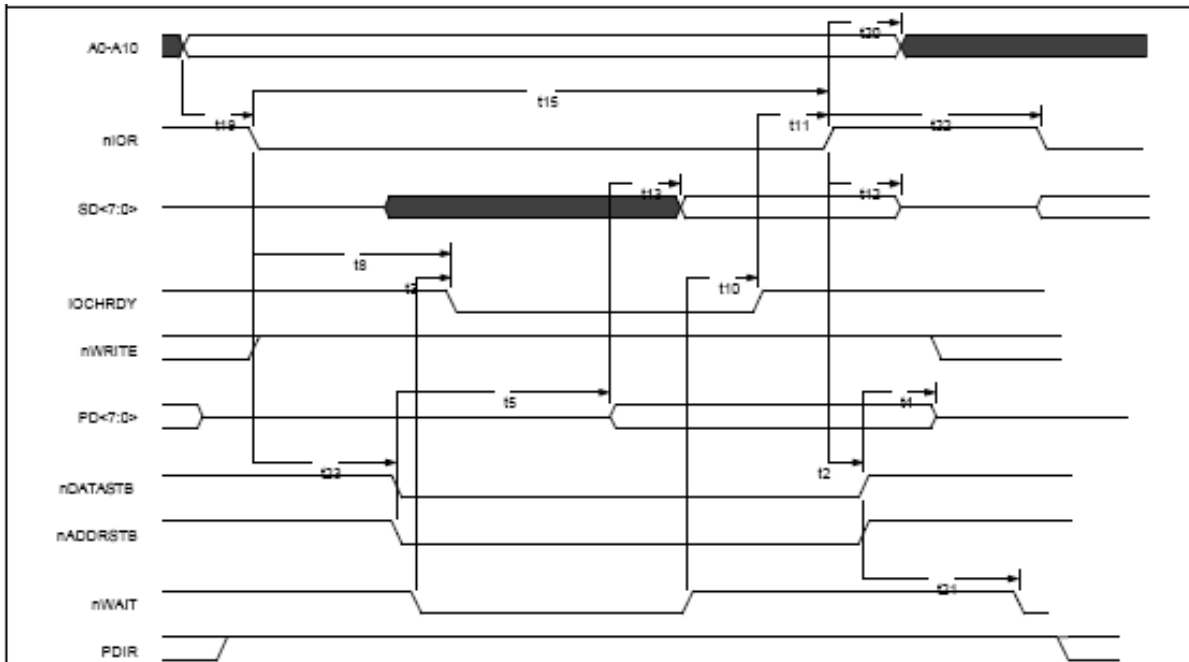

	Parameter	min	max	units	Notes
t2	nIOR Deasserted to Command Deasserted		50	ns	
t3	nWAIT Asserted to IOCHRDY Deasserted	0	40	ns	
t4	Command Deasserted to PDATA Hi-Z	0		ns	
t5	Command Asserted to PDATA Valid	0		ns	
t8	nIOR Asserted to IOCHRDY Asserted		24	ns	
t10	nWAIT Deasserted to IOCHRDY Deasserted		50	ns	
t11	IOCHRDY Deasserted to nIOR Deasserted	0		ns	
t12	nIOR Deasserted to SDATA High-Z (Hold Time)	0	40	ns	
t13	PData Valid to SDATA Valid		40	ns	
t15	Time Out	10	12	µs	
t19	Ax Valid to nIOR Asserted	40		ns	
t20	nIOR Deasserted to Ax Invalid	10		ns	
t21	Command Deasserted to nWAIT Deasserted	0		ns	
t22	nIOR Deasserted to nIOW or nIOR Asserted	40		ns	
t23	nIOR Asserted to Command Asserted		55	ns	

1. WRITE is controlled by setting the PDIR bit to "1" in the control register before performing an EPP Read.

EPP 1.7 Data or Address Read Cycle

Table 10.9 : EPP Pin Descriptions

EPP Signal	EPP NAME	TYPE	EPP DESCRIPTION
nWRITE	nWrite	O	This signal is active low. It denotes a write operation.
PD<0:7>	Address/Data	I/O	Bi-directional EPP byte wide address and data bus.
INTR	Interrupt	I	This signal is active high and positive edge triggered. (Pass through with no inversion, Same as SPP.)
nWAIT	nWait	I	This signal is active low. It is driven inactive as a positive acknowledgement from the device that the transfer of data is completed. It is driven active as an indication that the device is ready for the next transfer.
nDATASTB	nData Strobe	O	This signal is active low. It is used to denote data read or write operation.
nRESET	nReset	O	This signal is active low. When driven active, the EPP device is reset to its initial operational mode.
nADDRSTB	nAddress Strobe	O	This signal is active low. It is used to denote address read or write operation.
PE	Paper End	I	Same as SPP mode.
SLCT	Printer Selected Status	I	Same as SPP mode.
Nerr	nError	I	Same as SPP mode.
DIR	Parallel Port Direction	O	This output shows the direction of the data transfer on the parallel port bus. A low means an output/write condition and a high means an input/read condition. This signal is normally a low (output/write) unless PCD of the control register is set or if an EPP read cycle is in progress.

Note 1: SPP and EPP can use 1 common register.

Note 2: nWrite is the only EPP output that can be over-ridden by SPP control port during an EPP cycle. For correct EPP read cycles, DIR is required to be a low.

10.11.2 EXTENDED CAPABILITIES PARALLEL PORT

ECP provides a number of advantages, some of which are listed below. The individual features are explained in greater detail in the remainder of this section.

- ε High performance half-duplex forward and reverse channel
- ε Interlocked handshake, for fast reliable transfer
- ε Channel addressing for low-cost peripherals
- ε Maintains link and data layer separation
- ε Permits the use of active output drivers
- ε Permits the use of adaptive signal timing
- ε Peer-to-peer capability

Vocabulary

The following terms are used in this document:

assert: When a signal asserts it transitions to a "true" state, when a signal deasserts it transitions to a "false" state.

forward: Host to Peripheral communication.

reverse: Peripheral to Host communication.

PWord: A port word; equal in size to the width of the ISA interface. For this implementation, PWord is always 8 bits.

1: A high level.

0: A low level.

These terms may be considered synonymous:

- ε PeriphClk, nAck
- ε HostAck, nAutoFd
- ε PeriphAck, Busy
- ε nPeriphRequest, nFault
- ε nReverseRequest, nInit
- ε nAckReverse, PError

- z Xflag, Select
- z ECPMode, nSelectIn
- z HostClk, nStrobe

The bit map of the Extended Capabilities Parallel Port registers is :

	D7	D6	D5	D4	D3	D2	D1	D0	Note
data	PD7	PD6	PD5	PD4	PD3	PD2	PD1	PD0	
ecpAFifo	Addr	Address field							2
dsr	nBusy	nAck	PError	Select	nFault	1	1	1	1
dcr	0	0	Direction	ackIntEn	SelectIn	nInit	autofd	strobe	1
cFifo	Parallel Port Data FIFO								2
ecpDFifo	ECP Data FIFO								2
tFifo	Test FIFO								2
cnfgA	0	0	0	1	0	0	0	0	
cnfgB	0	intrValue	IRQx 2	IRQx 1	IRQx 0	0	0	0	
ecr	MODE			nErrIntrEn	dmaEn	serviceIntr	full	empty	

Note 1: These registers are available in all modes.

Note 2: All FIFOs use one common 16 byte FIFO.

10.11.3 ISA IMPLEMENTATION STANDARD

This specification describes the standard ISA interface to the Extended Capabilities Port (ECP). All ISA devices supporting ECP must meet the requirements contained in this section or the port will not be supported by Microsoft.

Description

The port is software and hardware compatible with existing parallel ports so that it may be used as a standard LPT port if ECP is not required. The port is designed to be simple and requires a small number of gates to implement. It does not do any "protocol" negotiation, rather it provides an automatic high burst-bandwidth channel that supports DMA for ECP in both the forward and reverse directions.

Small FIFOs are employed in both forward and reverse directions to smooth data flow and improve the maximum bandwidth requirement. The size of the FIFO is 16 bytes deep. The port supports an automatic handshake for the standard parallel port to improve compatibility mode transfer speed.

Table 10.10 : ECP Pin Descriptions

NAME	TYPE	DESCRIPTION
nStrobe	O	During write operations nStrobe registers data or address into the slave on the asserting edge (handshakes with Busy).
PData 7:0	I/O	Contains address or data.
nAck	I	Indicates valid data driven by the peripheral when asserted. This signal handshakes with nAutoFd in reverse.
PeriphAck (Busy)	I	This signal deasserts to indicate that the peripheral can accept data. This signal handshakes with nStrobe in the forward direction. In the reverse direction this signal indicates whether the data lines contain ECP command information or data. The peripheral uses this signal to flow control in the forward direction. It is an "interlocked" handshake with nStrobe. PeriphAck also provides command information in the reverse direction.
PError (nAckReverse)	I	Used to acknowledge a change in the direction the transfer (asserted = forward). The peripheral drives this signal low to acknowledge nReverseRequest. It is an "interlocked" handshake with nReverseRequest. The host relies upon nAckReverse to determine when it is permitted to drive the data bus.
Select	I	Indicates printer on line.
nAutoFd (HostAck)	O	Requests a byte of data from the peripheral when asserted, handshaking with nAck in the reverse direction. In the forward direction this signal indicates whether the data lines contain ECP address or data. The host drives this signal to flow control in the reverse direction. It is an "interlocked" handshake with Ack. HostAck also provides command information in the forward phase.

NAME	TYPE	DESCRIPTION
nFault (nPeriphRequest)	I	Generates an error interrupt when asserted. This signal provides a mechanism for peer-to-peer communication. This signal is valid only in the forward direction. During ECP Mode the peripheral is permitted (but not required) to drive this pin low to request a reverse transfer. The request is merely a "hint" to the host; the host has ultimate control over the transfer direction. This signal would be typically used to generate an interrupt to the host CPU.
nInit	O	Sets the transfer direction (asserted = reverse, deasserted = forward). This pin is driven low to place the channel in the reverse direction. The peripheral is only allowed to drive the bi-directional data bus while in ECP Mode and HostAck is low and nSelectIn is high.
nSelectIn	O	Always deasserted in ECP mode.

Register Definitions

The register definitions are based on the standard IBM addresses for LPT. All of the standard printer ports are supported. The additional registers attach to an upper bit decode of the standard LPT port definition to avoid conflict with standard ISA devices. The port is equivalent to a generic parallel port interface and may be operated in that mode. The port registers vary depending on the mode field in the ecr. The table below lists these dependencies. Operation of the devices in modes other than those specified is undefined.

Table 10.11 : ECP Register Definitions

NAME	ADDRESS(Note 1)	ECP MODES	FUNCTION
data	+000h R/W	000-001	Data Register
ecpAFifo	+000h R/W	011	ECP FIFO (Address)
dsr	+001h R/W	All	Status Register
dcr	+002h R/W	All	Control Register
cFifo	+400h R/W	010	Parallel Port Data FIFO
ecpFifo	+400h R/W	011	ECP FIFO (DATA)
tFifo	+400h R/W	110	Test FIFO
cnfgA	+400h R	111	Configuration Register A
cnfgB	+401h R/W	111	Configuration Register B
ecr	+402h R/W	All	Extended Control Register

Note 1: These addresses are added to the parallel port base address as selected by configuration register.

Note 2: All addresses are qualified with AEN. Refer to the AEN pin definition.

Table 10.12 : Mode Descriptions

MODE	DESCRIPTION*
000	SPP mode
001	PS/2 Parallel Port mode
010	Parallel Port Data FIFO mode
011	ECP Parallel Port mode
100	EPP mode (If this option is enabled in the configuration registers)
101	(Reserved)
110	Test mode
111	Configuration mode

*Refer to ECR Register Description

DATA and ecpAFifo PORT

ADDRESS OFFSET = 00H

Modes 000 and 001 (Data Port)

The Data Port is located at an offset of '00H' from the base address. The data register is cleared at initialization by RESET. During a WRITE operation, the Data Register latches the contents of the data bus on the rising edge of the nIOW input. The contents of this register are buffered (non inverting) and output onto the PD0 - PD7 ports. During a READ operation, PD0 - PD7 ports are read and output to the host CPU.

Mode 011 (ECP FIFO - Address)

A data byte written to this address is placed in the FIFO and tagged as an ECP Address. The hardware at the ECP port transmits this byte to the peripheral automatically. The operation of this register is only defined for the forward direction (direction is 0). Refer to the ECP Parallel Port Forward Timing Diagram, located in the Timing Diagrams section of this data sheet.

DEVICE STATUS REGISTER (dsr)

ADDRESS OFFSET = 01H

The Status Port is located at an offset of '01H' from the base address. Bits 0 - 2 are not implemented as register bits, during a read of the Printer Status Register these bits are a high level. The bits of the Status Port are defined as follows:

BIT 3 nFault

The level on the nFault input is read by the CPU as bit 3 of the Device Status Register.

BIT 4 Select

The level on the Select input is read by the CPU as bit 4 of the Device Status Register.

BIT 5 PError

The level on the PError input is read by the CPU as bit 5 of the Device Status Register. Printer Status Register.

BIT 6 nAck

The level on the nAck input is read by the CPU as bit 6 of the Device Status Register.

BIT 7 nBusy

The complement of the level on the BUSY input is read by the CPU as bit 7 of the Device Status Register.

DEVICE CONTROL REGISTER (dcr)

ADDRESS OFFSET = 02H

The Control Register is located at an offset of '02H' from the base address. The Control Register is initialized to zero by the RESET input, bits 0 to 5 only being affected; bits 6 and 7 are hard wired high.

BIT 0 STROBE – STROBE

This bit is inverted and output onto the nSTROBE output.

BIT 1 AUTOFD – AUTOFEED

This bit is inverted and output onto the nAUTOFD output. A logic 1 causes the printer to generate a line feed after each line is printed. A logic 0 means no autofeed.

BIT 2 nINIT - nINITIATE OUTPUT

This bit is output onto the nINIT output without inversion.

BIT 3 SELECTIN

This bit is inverted and output onto the nSLCTIN output. A logic 1 on this bit selects the printer; a logic 0 means the printer is not selected.

BIT 4 ackIntEn - INTERRUPT REQUEST ENABLE

The interrupt request enable bit when set to a high level may be used to enable interrupt requests from the Parallel Port to the CPU due to a low to high transition on the nACK input. Refer to the description of the interrupt under Operation, Interrupts.

BIT 5 DIRECTION

If mode=000 or mode=010, this bit has no effect and the direction is always out regardless of the state of this bit. In all other modes, Direction is valid and a logic 0 means that the printer port is in output mode (write); a logic 1 means that the printer port is in input mode (read).

Bits 6 and 7 during a read are a high level, and cannot be written.

cFifo (Parallel Port Data FIFO)

ADDRESS OFFSET = 400h

Mode = 010

Bytes written or DMAed from the system to this FIFO are transmitted by a hardware handshake to the peripheral using the standard parallel port protocol. Transfers to the FIFO are byte aligned. This

mode is only defined for the forward direction.

ecpDFifo (ECP Data FIFO)

ADDRESS OFFSET = 400H

Mode = 011

Bytes written or DMAed from the system to this FIFO, when the direction bit is 0, are transmitted by a hardware handshake to the peripheral using the ECP parallel port protocol. Transfers to the FIFO are byte aligned.

Data bytes from the peripheral are read under automatic hardware handshake from ECP into this FIFO when the direction bit is 1. Reads or DMAs from the FIFO will return bytes of ECP data to the system.

tFifo (Test FIFO Mode)

ADDRESS OFFSET = 400H

Mode = 110

Data bytes may be read, written or DMAed to or from the system to this FIFO in any direction. Data in the tFIFO will not be transmitted to the parallel port lines using a hardware protocol handshake. However, data in the tFIFO may be displayed on the parallel port data lines.

The tFIFO will not stall when overwritten or underrun. If an attempt is made to write data to a full tFIFO, the new data is not accepted into the tFIFO. If an attempt is made to read data from an empty tFIFO, the last data byte is reread again. The full and empty bits must always keep track of the correct FIFO state. The tFIFO will transfer data at the maximum ISA rate so that software may generate performance metrics.

The FIFO size can be determined by writing bytes to the FIFO and checking the full bit.

Data bytes are always read from the head of tFIFO regardless of the value of the direction bit. For example if 44h, 33h, 22h is written to the FIFO, then reading the tFIFO will return 44h, 33h, 22h in the same order as was written.

cnfgA (Configuration Register A)

ADDRESS OFFSET = 400H

Mode = 111

This register is a read only register. When read, 10H is returned. This indicates to the system that this is an 8-bit implementation. (PWord = 1 byte)

cnfgB (Configuration Register B)

ADDRESS OFFSET = 401H

Mode = 111

BIT 7 Reserved

During a read is a low level. This bit can not be written.

BIT 6 intrValue

Returns the value on the ISA iRq line to determine possible conflicts.

BITS 5:3 Reflect the IRQ resource assigned for ECP port

cnfgB[5:3]	IRQ resource
000	reflect other IRQ resources selected by PnP register (default)
001	IRQ[7]
010	IRQ[9]
011	IRQ[10]
100	IRQ[11]
101	IRQ[14]
110	IRQ[15]
111	IRQ[5]

BITS 2:0 Reserved

During a read are a low level. These bits cannot be written.

ecr (Extended Control Register)

ADDRESS OFFSET = 402H

Mode = all

This register controls the extended ECP parallel port functions.

BITS 7,6,5

These bits are Read/Write and select the Mode.

BIT 4 nErrIntrEn

Read/Write (Valid only in ECP Mode)

1: Disables the interrupt generated on the asserting edge of nFault.

0: Enables an interrupt pulse on the high to low edge of nFault. Note that an interrupt will be generated if nFault is asserted (interrupting) and this bit is written from a 1 to a 0. This prevents interrupts from being lost in the time between the read of the ecr and the write of the ecr.

BIT 3 dmaEn

Read/Write

1: Enables DMA (DMA starts when serviceIntr is 0).

0: Disables DMA unconditionally.

BIT 2 serviceIntr

Read/Write

1: Disables DMA and all of the service interrupts.

0: Enables one of the following 3 cases of interrupts. Once one of the 3 service interrupts has occurred serviceIntr bit shall be set to a 1 by hardware, it must be reset to 0 to re-enable the interrupts. Writing this bit to a 1 will not cause an interrupt.

case dmaEn=1:

During DMA (this bit is set to a 1 when terminal count is reached).

case dmaEn=0 direction=0:

This bit shall be set to 1 whenever there are writeIntrThreshold or more bytes free in the FIFO.

case dmaEn=0 direction=1:

This bit shall be set to 1 whenever there are readIntrThreshold or more valid bytes to be read from the FIFO.

BIT 1 full

Read only

1: The FIFO cannot accept another byte or the FIFO is completely full.

0: The FIFO has at least 1 free byte.

BIT 0 empty

Read only

1: The FIFO is completely empty.

0: The FIFO contains at least 1 byte of data.

Table 10.13 : Extended Control Register

R/W	MODE
000:	Standard Parallel Port mode. In this mode the FIFO is reset and common collector drivers are used on the control lines (nStrobe, nAutoFd, nInIt and nSelectIn). Setting the direction bit will not tri-state the output drivers in this mode.
001:	PS/2 Parallel Port mode. Same as above except that direction may be used to tri-state the data lines and reading the data register returns the value on the data lines and not the value in the data register. All drivers have active pull-ups (push-pull).
010:	Parallel Port FIFO mode. This is the same as 000 except that bytes are written or DMAed to the FIFO. FIFO data is automatically transmitted using the standard parallel port protocol. Note that this mode is only useful when direction is 0. All drivers have active pull-ups (push-pull).
011:	ECP Parallel Port Mode. In the forward direction (direction is 0) bytes placed into the ecpDFifo and bytes written to the ecpAFifo are placed in a single FIFO and transmitted automatically to the peripheral using ECP Protocol. In the reverse direction (direction is 1) bytes are moved from the ECP parallel port and packed into bytes in the ecpDFifo. All drivers have active pull-ups (push-pull).
100:	Selects EPP Mode: In this mode, EPP is selected if the EPP supported option is selected in SB offset B3-B0h configuration register. All drivers have active pull-ups (push-pull).
101:	Reserved
110:	Test Mode. In this mode the FIFO may be written and read, but the data will not be transmitted on the parallel port. All drivers have active pull-ups (push-pull).
111:	Configuration Mode. In this mode the configA, configB registers are accessible at 0x400 and 0x401. All drivers have active pull-ups (push-pull).

10.11.4 OPERATION

Mode Switching/Software Control

Software will execute P1284 negotiation and all operation prior to a data transfer phase under programmed I/O control (mode 000 or 001). Hardware provides an automatic control line handshake, moving data between the FIFO and the ECP port only in the data transfer phase (modes 011 or 010).

Setting the mode to 011 or 010 will cause the hardware to initiate data transfer.

If the port is in mode 000 or 001 it may switch to any other mode. If the port is not in mode 000 or 001 it can only be switched into mode 000 or 001. The direction can only be changed in mode 001.

Once in an extended forward mode the software should wait for the FIFO to be empty before switching back to mode 000 or 001. In this case all control signals will be deasserted before the mode switch. In an ecp reverse mode the software waits for all the data to be read from the FIFO before changing back to mode 000 or 001. Since the automatic hardware ecp reverse handshake only cares about the state of the FIFO it may have acquired extra data which will be discarded. It may in fact be in the middle of a transfer when the mode is changed back to 000 or 001. In this case the port will deassert nAutoFd independent of the state of the transfer. The design shall not cause glitches on the handshake signals if the software meets the constraints above.

ECP Operation

Prior to ECP operation the Host must negotiate on the parallel port to determine if the peripheral supports the ECP protocol. This is a somewhat complex negotiation carried out under program control in mode 000. After negotiation, it is necessary to initialize some of the port bits. The following are required:

Set Direction = 0, enabling the drivers.

Set strobe = 0, causing the nStrobe signal to default to the deasserted state.

Set autoFd = 0, causing the nAutoFd signal to default to the deasserted state.

Set mode = 011 (ECP Mode)

ECP address bytes or data bytes may be sent automatically by writing the ecpAFifo or ecpDFifo respectively.

Note that all FIFO data transfers are byte wide and byte aligned. Address transfers are byte-wide and only allowed in the forward direction.

The host may switch directions by first switching to mode = 001, negotiating for the forward or reverse channel, setting direction to 1 or 0, then setting mode = 011. When direction is 1 the hardware shall handshake for each ECP read data byte and attempt to fill the FIFO. Bytes may then be read from the ecpDFifo as long as it is not empty .

ECP transfers may also be accomplished (albeit slowly) by handshaking individual bytes under

program control in mode = 001, or 000.

Termination from ECP Mode

Termination from ECP Mode is similar to the termination from Nibble/Byte Modes. The host is permitted to terminate from ECP Mode only in specific well-defined states. The termination can only be executed while the bus is in the forward direction. To terminate while the channel is in the reverse direction, it must first be transitioned into the forward direction.

Command/Data

ECP Mode supports two advanced features to improve the effectiveness of the protocol for some applications. The features are implemented by allowing the transfer of normal 8-bit data or 8-bit commands.

When in the forward direction, normal data is transferred when HostAck is high and an 8-bit command is transferred when HostAck is low. The most significant bit of the command indicates a channel address.

When in the reverse direction, normal data is transferred when PeriphAck is high and an 8-bit command is transferred when PeriphAck is low. The most significant bit of the command is always zero. Reverse channel addresses are seldom used and may not be supported in hardware.

Pin Definition

The drivers for nStrobe, nAutoFd, nIntr and nSelectIn are open-collector in mode 000 and are push-pull in all other modes.

ISA Connections

The interface can never stall causing the host to hang. The width of data transfers is strictly controlled on an I/O address basis per this specification. All FIFO-DMA transfers are byte wide, byte aligned and end on a byte boundary. (The PWord value can be obtained by reading Configuration Register A, cnfgA, described in the next section.) Single byte wide transfers are always possible with standard or PS/2 mode using program control of the control signals.

Interrupts

The interrupts are enabled by **serviceIntr** in the **ecr** register.

serviceIntr = 1 Disables the DMA and all of the service interrupts.

serviceIntr = 0 Enables the selected interrupt condition. If the interrupting condition is valid, then the interrupt is generated immediately when this bit is changed from a 1 to a 0. This can occur during Programmed I/O if the number of bytes removed or added from/to the FIFO does not cross the threshold.

The interrupt generated is ISA friendly in that it must pulse the interrupt line low, allowing for interrupt sharing. After a brief pulse low following the interrupt event, the interrupt line is tri-stated so that other interrupts may assert.

An interrupt is generated when:

For DMA transfers: When **serviceIntr** is 0, **dmaEn** is 1 and the DMA TC is received.

For Programmed I/O:

When **serviceIntr** is 0, **dmaEn** is 0, **direction** is 0 and there are **writeIntrThreshold** or more free bytes in the FIFO. Also, an interrupt is generated when **serviceIntr** is cleared to 0 whenever there are **writeIntrThreshold** or more free bytes in the FIFO.

(1) When **serviceIntr** is 0, **dmaEn** is 0, **direction** is 1 and there are **readIntrThreshold** or more bytes in the FIFO. Also, an interrupt is generated when **serviceIntr** is cleared to 0 whenever there are **readIntrThreshold** or more bytes in the FIFO.

When **nErrIntrEn** is 0 and **nFault** transitions from high to low or when **nErrIntrEn** is set from 1 to 0 and **nFault** is asserted.

When **ackIntrEn** is 1 and the **nAck** signal transitions from a low to a high.

FIFO Operation

All data transfers to or from the parallel port can proceed in DMA or Programmed I/O (non-DMA) mode as indicated by the selected mode. The FIFO is used by selecting the Parallel Port FIFO mode or ECP Parallel Port Mode. (FIFO test mode will be addressed separately.) After a reset, the FIFO is disabled. Each data byte is transferred by a Programmed I/O cycle or **IDE_PDRQ** depending on the selection of DMA or Programmed I/O mode.

10.11.5 DMA TRANSFERS

DMA transfers are always to or from the **ecpDFifo**, **tFifo** or **CFifo**. DMA utilizes the standard PC DMA services. To use the DMA transfers, the host first sets up the direction and state as in the programmed I/O case. Then it programs the DMA controller in the host with the desired count and memory address. Lastly it sets **dmaEn** to 1 and **serviceIntr** to 0. The ECP requests DMA transfers from the host by activating the **IDE_PDRQ** pin. The DMA will empty or fill the FIFO using the appropriate direction and mode. When the terminal count in the DMA controller is reached, an interrupt is generated and **serviceIntr** is asserted, disabling DMA. The FIFO is enabled directly by asserting **nPDACK** and addresses need not be valid. **IDE_PINT** is generated when a TC is received.

DMA may be disabled in the middle of a transfer by first disabling the host DMA controller. Then setting **serviceIntr** to 1, followed by setting **dmaEn** to 0, and waiting for the FIFO to become empty or full. Restarting the DMA is accomplished by enabling DMA in the host, setting **dmaEn** to 1, followed by setting **serviceIntr** to 0.

DMA Mode - Transfers from the FIFO to the Host

(**Note:** In the reverse mode, the peripheral may not continue to fill the FIFO if it runs out of data to transfer, even if the chip continues to request more data from the peripheral.)

The ECP activates the **IDE_PDRQ** pin whenever there is data in the FIFO. The DMA controller must respond to the request by reading data from the FIFO. The ECP will deactivate the **IDE_PDRQ** pin when the FIFO becomes empty or when the TC becomes true (qualified by nPDACK), indicating that no more data is required. **IDE_PDRQ** goes inactive after nPDACK goes active for the last byte of a data transfer (or on the active edge of nIOR, on the last byte, if no edge is present on nPDACK). If **IDE_PDRQ** goes inactive due to the FIFO going empty, then **IDE_PDRQ** is active again as soon as there is one byte in the FIFO. If **IDE_PDRQ** goes inactive due to the TC, then **IDE_PDRQ** is active again when there is one byte in the FIFO, and **serviceIntr** has been re-enabled. (Note: A data underrun may occur if **IDE_PDRQ** is not removed in time to prevent an unwanted cycle.)

Programmed I/O Mode or Non-DMA Mode

The ECP or parallel port FIFOs may also be operated using interrupt driven programmed I/O. Software can determine the writeIntrThreshold, readIntrThreshold, and FIFO depth by accessing the FIFO in Test Mode.

Programmed I/O transfers are to the ecpDFifo at 400H and ecpAFifo at 000H or from the ecpDFifo located at 400H, or to/from the tFifo at 400H. To use the programmed I/O transfers, the host first sets up the direction and state, sets dmaEn to 0 and **serviceIntr** to 0.

The ECP requests programmed I/O transfers from the host by activating the PINTR pin. The programmed I/O will empty or fill the FIFO using the appropriate direction and mode.

Programmed I/O - Transfers from the FIFO to the Host

In the reverse direction an interrupt occurs when serviceIntr is 0 and readIntrThreshold bytes are available in the FIFO. If at this time the FIFO is full it can be emptied completely in a single burst, otherwise readIntrThreshold bytes may be read from the FIFO in a single burst.

readIntrThreshold = 4 data bytes in FIFO

An interrupt is generated when **serviceIntr** is 0 and the number of bytes in the FIFO is less than or equal to 4. The **IDE_PINT** pin can be used for interrupt-driven systems. The host must respond to the request by reading data from the FIFO. This process is repeated until the last byte is transferred out of the FIFO. If at this time the FIFO is full, it can be completely emptied in a single burst, otherwise a minimum of 4 bytes may be read from the FIFO in a single burst.

Programmed I/O - Transfers from the Host to the FIFO

In the forward direction an interrupt occurs when serviceIntr is 0 and there are writeIntrThreshold or

more bytes free in the FIFO. At this time if the FIFO is empty it can be filled with a single burst before the empty bit needs to be re-read. Otherwise it may be filled with `writeIntrThreshold` bytes.

`writeIntrThreshold` = 12 free bytes in FIFO

An interrupt is generated when `serviceIntr` is 0 and the number of bytes in the FIFO is greater than or equal to 12. The `IDE_PINT` pin can be used for interrupt-driven systems. The host must respond to the request by writing data to the FIFO. If at this time the FIFO is empty, it can be completely filled in a single burst, otherwise a minimum of 4 bytes may be written to the FIFO in a single burst. This process is repeated until the last byte is transferred into the FIFO.

For www.86duino.com

10.12 FIFO UART

The SoC integrates an improved version of Universal Asynchronous Receiver/Transmitter (UART). The internal 16-byte FIFOs are activated and allowed to be stored in both receive and transmit modes. The UART performs serial-to-parallel conversion on data characters received from a peripheral device or a MODEM, and parallel-to-serial conversion on data characters received from the CPU. The CPU can read the complete status of the UART at any time during the functional operations. Reported status information includes the types and conditions of the transfer operations being performed by the FIFO UART, as well as any error conditions (parity, overrun, framing, or break interrupt).

- ⌘ Programmable word length, stop bit and parity
- ⌘ Programmable baud rate generator
- ⌘ Interrupt generator
- ⌘ Loop-back mode
- ⌘ Scratch register
- ⌘ Two 16-byte FIFOs

The UART includes a programmable baud rate generator that is capable of dividing the timing reference clock input by divisors of 1 to ($2^{16} - 1$), and producing a 16x clock for driving the internal transmitter logic. Provisions are also included to use this 16x clock to drive the receiver logic. The UART has complete MODEM-control capability, and a processor interrupt system. Interrupts can be programmed to the user's requirements, minimizing the computing required to handle the communications link.

10.12.1 Transmit Operation

Transmission is initiated by writing the data to be sent to the TX Holding Register or to the TX FIFO (if enabled). The data will then be transferred to the TX Shift Register together with a start bit and parity and stop bits as determined by the Line Control Register. The bits to be transmitted are then shifted out of the TX Shift Register with the output from the baud rate generator as the clock.

If enabled, an interrupt will be generated when the TX Holding Register becomes empty.

When FIFOs are enabled (i.e. Bit 0 of the FIFO Control Register is set), the FIFO UART can store up to 16 bytes of data for transmission at a time. Transmission will continue until the TX FIFO is empty. The FIFO readiness to accept more data is indicated by TXRDY# or, if the transfer is interrupt driven, by INTR.

10.12.2 Receive Operation

Data is sampled into the RX Shift Register with either the baud rate generator or RCLK. A filter is used to remove spurious inputs that last for less than two periods of the clock.

When the complete word has been clocked into the receiver, the data bits are transferred to the RX Buffer Register or to the RX FIFO (if enabled) to be read by the CPU. The receiver also checks for a stop bit and for correct parity as determined by the Line Control Register.

If enabled, an interrupt will be generated when data has been transferred to the RX Buffer Register. Interrupts can also be generated for incorrect parity or a missing stop bit (frame error).

When FIFOs are enabled (i.e. Bit 0 of the FIFO Control Register is set), the FIFO UART can store up to 16 bytes of received data at a time. Depending on the selected mode, either RXRDY# or INTR will go active to indicate that it is available when the RX FIFO contains 1, 4, 8 or 14 bytes of data.

10.12.3 MODEM Control Lines

The output Modem Control lines **RTS#**, **DTR#**, **OUT1#**, and **OUT2#** can be set or cleared by writing to the MODEM Control Register.

The current status of the input Modem Control lines **DCD#**, **RI#**, **DSR#** and **CTS#** can be read from the Modem Status Register. Bit 2 of this register will be set if the **RI#** line has been changed from low to high since the register was last read.

If enabled, an interrupt will be generated when any of **DSR#**, **CTS#**, **RI#** or **DCD#** is asserted.

10.12.4 FIFO Interrupt Mode Operation

When the RCVR FIFO and receiver interrupts are enabled (**FCR0** = 1 and **IER0** = 1), RCVR interrupts will occur as follows:

- ⌘ The receive data available interrupt will be issued to the CPU when the FIFO has reached its programmed trigger level; it will be cleared as soon as the FIFO drops below its programmed trigger level.
- ⌘ The IIR receive data available indication also occurs when the FIFO trigger level is reached, and like the interrupt, it is cleared when the FIFO drops below the trigger level.
- ⌘ The receiver line status interrupt (**IIR** = 6), as before, has higher priority than the received data available (**IIR** = 04)
- ⌘ The data ready bit (**LSR0**) is set as soon as a character is transferred from the shift register to the RCVR FIFO. It is reset when the FIFO is empty.

When RCVR FIFO and receiver interrupts are enabled, RCVR FIFO timeout interrupts will occur as

follows:

- ∴ A FIFO timeout interrupt will occur, if the following conditions exist:
 - × at least one character is in the FIFO
 - × the most recent serial character received was longer than 4 continuous character times ago (if 2 stop bits are programmed and the second one is included in this time delay).
 - × the most recent CPU read of the FIFO was longer than 4 continuous character times ago.

The maximum time between a received character and a timeout interrupt will be 160 ms at 300 baud with a 12-bit receive character (i.e., 1 Start, 8 Data, 1 Parity and 2 Stop Bits).

- ∴ Character times are calculated by using the RCLK input for a clock signal (this makes the delay proportional to the baud rate).
- ∴ When a timeout interrupt has occurred, it is cleared and the timer is reset when the CPU reads one character from the RCVR FIFO.
- ∴ When a timeout interrupt has not occurred, the timeout timer is reset after a new character is received or after the CPU reads the RCVR FIFO.

When the XMIT FIFO and transmitter interrupts are enabled (FCR0 = 1 and IER1= 1), XMIT interrupts will occur as follows:

- ∴ The transmitter holding register interrupt (02) occurs when the XMIT FIFO is empty; it is cleared as soon as the transmitter holding register is written (1 to 16 characters may be written to the XMIT FIFO while servicing this interrupt) or the IIR is read.
- ∴ The transmitter FIFO empty indications will be delayed 1 character time minus the last stop bit time whenever the following occurs: THRE = 1 and there have not been at least two bytes at the same time in the transmit FIFO, since the last THRE = 1. The first transmitter interrupt after FCR0 is changed will be immediate if it is enabled. Character timeout and RCVR FIFO trigger level interrupts have the same priority as the current received data available interrupt; XMIT FIFO empty has the same priority as the current transmitter holding register empty interrupt.

10.12.5 FIFO Polled Mode Operation

With FCR0 = 1, resetting IER0, IER1, IER2, IER3 or all to zero puts the UART in the FIFO Polled Mode of operation. Since the RCVR and XMITTER are controlled separately, either one or both can be in the polled mode of operation. In this mode, the user's program will check RCVR and XMIT-TER status via the LSR, as stated previously:

LSR0 will be set as long as there is one byte in the RCVR FIFO.

LSR1 to LSR4 will specify which error(s) has occurred. Character error status is handled the same way as in the interrupt mode. The IIR is not affected since IER2 = 0.

LSR5 will indicate when the XMIT FIFO is empty.

LSR6 will indicate that both the XMIT FIFO and shift register are empty.

LSR7 will indicate whether there are any errors in the RCVR FIFO.

There is no trigger level reached or timeout condition indicated in the FIFO Polled Mode. However, the RCVR and XMIT FIFOs are still fully capable of holding characters.

10.12.6 Timing Waveforms

The following timing diagrams are given as a guide when inputs to the FIFO UART must be valid, and when outputs are valid. Many of the signals are synchronized with XIN. The actual set-up and delay time will also depend on the technology used for the FIFO UART.

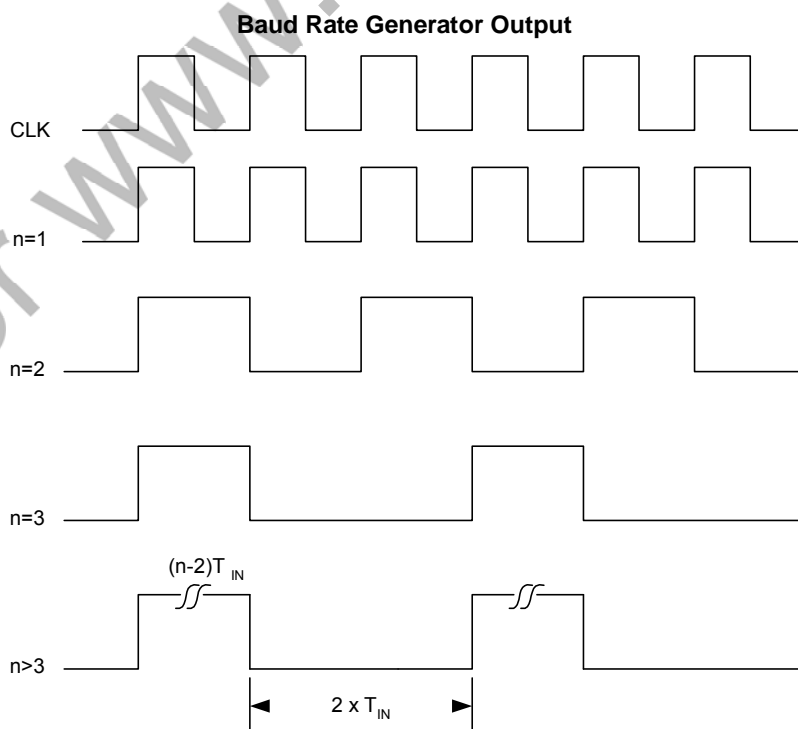

MODEM Control Timig

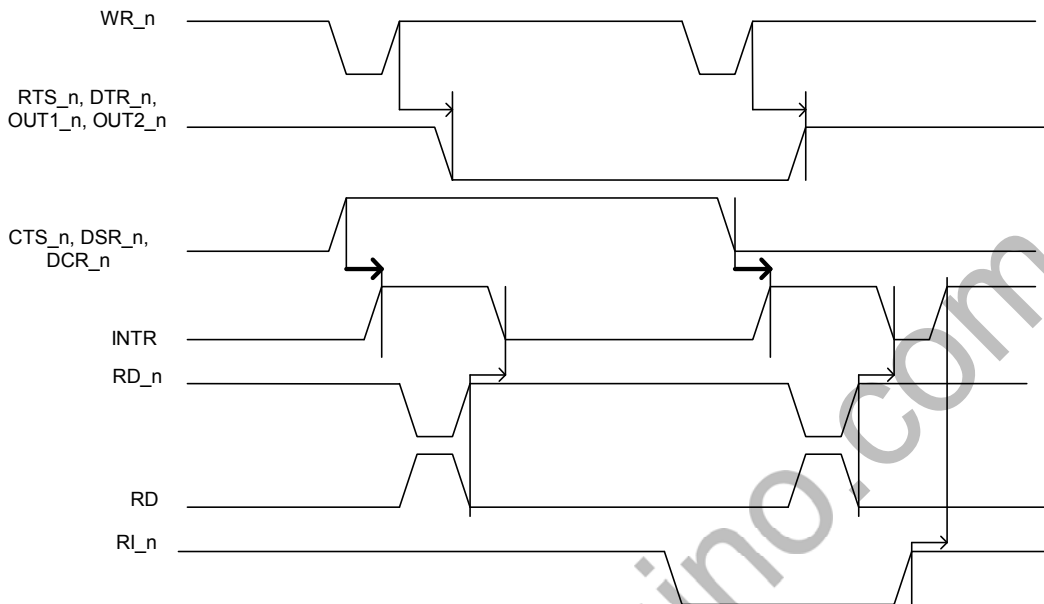

10.13 GPIO Interface

80 GPIO pins are provided by the SoC for general usage in the system. All GPIO pins are independent and can be configured as inputs or outputs, with or without pull-up/pull-down resistors.

10.14 DOS 4Gpage Access

⌘ **Programming Flow:**

map physical address 3C000h(PSA) to physical address 00380000h(PDA).

Bank size is 32Kbyte. Used D4GA1.

OUT 00380000h to IO port E4h ; PDA=00380000h

OUT 8203C000h to IO port E0h ; D4GA1 enable, BS 32Kbyte, PSA=3C000h

D4GA1 address translation function enabled

All physical address in 3C000h~3CFFFh will translate to 00380000h~00380FFFh.

For example, access 3C194h. Hardware will automatically translate to 00380194h

Dword writes physical address 3CFFFh. Hardware writes first byte to physical address 00380FFFh and last 3byte into physical address 003D000h~003D002h.

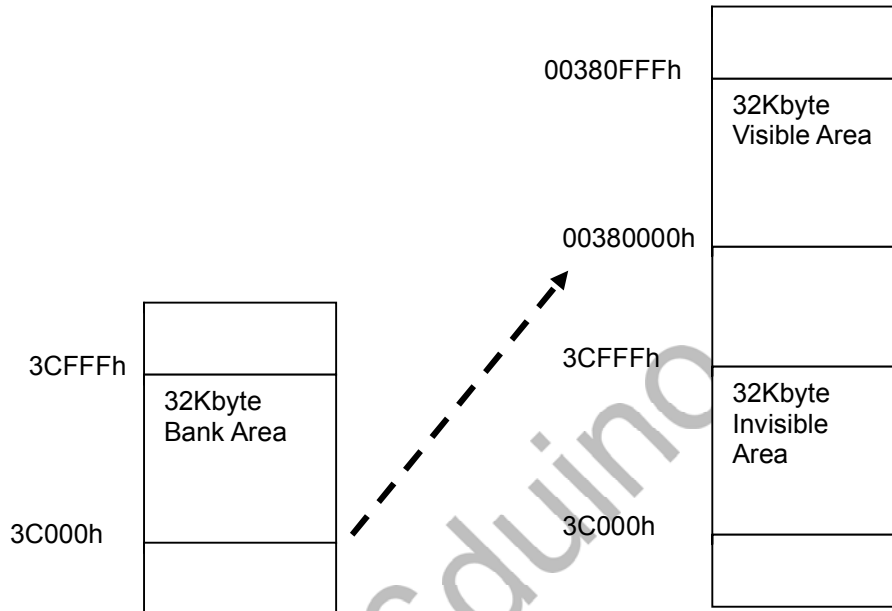

⌘ **Dynamic Change Source/Destination Address flow:**

Bank size is 32Kbyte. Used D4GA1.

Stage1: map physical address 3C000h(PSA) to physical address 00380000h(PDA).

Stage2: map physical address 3C000h(PSA) to physical address 00400000h(PDA).

OUT 00380000h to IO port E4h ; PDA=00380000h, stage1

OUT 8203C000h to IO port E0h ; D4GA1 enable, BS 32Kbyte, PSA=3C000h

:

Normal program

:

OUT 00400000h to IO port E4h ; PDA=00400000h, stage2

wbinvd ; Invalidate L1 cache

:

Normal program

10.15 Flash Strap

In Vortex86EX, some functions and system configuration are strapped by specified address location data value (flash region). We call this behavior “Flash Strap”. In system reset (even hardware reset or software reset), Vortex86EX will re-do Flash Strap.

10.15.1 Flash Strap Region Summary.

Flash Address Location	Flash Strap Function
(FFF)FFD00h - (FFF)FFDEFh	CrossBar Config
(FFF)FFFB0h – (FFF)FFFB5h	Ethernet MAC Address
(FFF)FFFB6h –(FFF)FFFB7h, (FFF)FFFB8h –(FFF)FFFBFh	PLL Config for Clock Frequency & Others Function Strap.
(FFF)FFFC0h –(FFF)FFDFh	Customer Data

10.15.2 CrossBar Config

- ⌘ “CrossBar Flash Strap Header” must be 9A5BC341h, otherwise it’s recognized as format error. When CrossBar format error, CrossBar config will be reset to default value.
- ⌘ “CrossBar Flash Strap Checksum” is calculated by below algorithm. If CrossBar checksum error, CrossBar config will be reset to default value.
- ⌘ (FFF)FFD10h –(FFF)FFDEFh: These config format are the same as “CrossBar Config Registers” (check Chap.11.3.26).

Flash Address Location	CrossBar Config Flash Strap
(FFF)FFD00h –(FFF)FFD03h	CrossBar Flash Strap Header = “9A5BC341h”
FFF)FFD04h –(FFF)FFD07h	CrossBar Flash Strap Checksum
(FFF)FFD10h –(FFF)FFD19h	RichIO Port 0, 1, 2, ..., 9 Selection
(FFF)FFD20h –(FFF)FFD27h	Bit-RichIO Port0 Select
(FFF)FFD28h –(FFF)FFD2Fh	Bit-RichIO Port1 Select
(FFF)FFD30h –(FFF)FFD37h	Bit-RichIO Port2 Select
(FFF)FFD38h –(FFF)FFD3Bh	On-Chip Device Power-Down Control 0
(FFF)FFD3Ch –(FFF)FFD3Fh	On-Chip Device Power-Down Control 1
(FFF)FFD40h –(FFF)FFD8Fh	CrossBar PAD Attribute
(FFF)FFD90h –(FFF)FFD99h	CrossBar-Port Group Selection, Port0, Port1, ..., Port9
(FFF)FFDA0h - (FFF)FFDEFh	CrossBar-Bit Group Selection, Bit 0,1,2, ..., 79

CrossBar Checksum[31:0] = Summation(FFD20h[7:0], FFD21h[7:0], FFD22h[7:0], ..., FFDEFh[7:0])

Flash Location	CrossBar Config
FFD10h~FFD19h	RichIO Port 0, 1, 2, ..., 9 Selection
FFD20h~FFD27h	Bit-RichIO Port0 Select
FFD28h~FFD2Fh	Bit-RichIO Port1 Select
FFD30h~FFD37h	Bit-RichIO Port2 Select
FFD38h~FFD3Bh	On-Chip Device Power-Down Control 0
FFD3Ch~FFD3Fh	On-Chip Device Power-Down Control 1
FFD40h~FFD4Fh	CrossBar PAD Attribute
FFD50h~FFD8Fh	CrossBar PAD Attribute
FFD90h~FFD99h	CrossBar-Port Group Selection, Port0, Port1, ..., Port9
FFDA0h~FFDEFh	CrossBar-Bit Group Selection, Bit 0,1,2, ..., 79

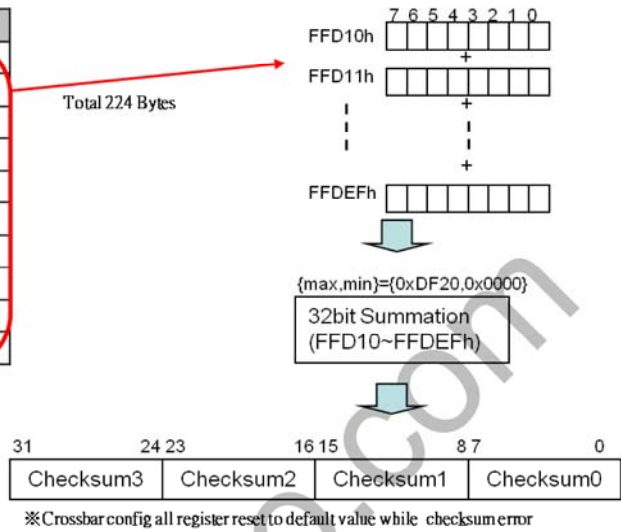

10.15.3 Ethernet MAC Address

Flash Address Location	Flash Strap Function
(FFF)FFFB0h	MAC Address Byte 0
(FFF)FFFB1h	MAC Address Byte 1
(FFF)FFFB2h	MAC Address Byte 2
(FFF)FFFB3h	MAC Address Byte 3
(FFF)FFFB4h	MAC Address Byte 4
(FFF)FFFB5h	MAC Address Byte 5

10.15.4 PLL Config & Others

⌘ “PLL Flash Strap Checksum” is calculated by below algorithm. If PLL checksum error, PLL config will be reset to default value.

TMP_SUM[9:0] = Summation(FFFB6h[7:0], FFFB7h[7:0], FFFBBh[7:0], FFFBCh[7:0])

PLL Checksum[3:0] = Summation(TMP_SUM[9:8], TMP_SUM[7:4], TMP_SUM[3:0])

Flash Address Location	Flash Strap Function
(FFF)FFFB6h	CPU_NS
(FFF)FFFB7h	Bits[1:0] = CPU_MS Bits[3:2] = CPU_RS Bits[5:4] = CPU_DIV Bits[6] = DRAM_DIV
(FFF)FFFBh	Bits[3:0] = PCI_DIV Bits[5:4] = PCI_Mode Bits[6] = PLL1M Bits[7] = PLL2M
(FFF)FFFBCh	Bits[2:0] = PLL1_IPSEL Bit[3] = DIS_D3WL Bit[4] = DIS_D3GT Bit[5] = DIS_SPlbp
(FFF)FFFB Dh	Bits[7:4] = Checksum
(FFF)FFFB E h	BOARD ID(L)
(FFF)FFFB F h	Bits[3:0] = BOARD ID(H)

10.15.5 Customer Data

⌘ These regions are encoded data for Customer usage. After system reset, these data are decoded to NB function0 Config Registers.

Flash Address Location	Flash Strap Function
(FFF)FFFC0h - (FFF)FFFDFh	Decode to NB Function0 Config Reg D0h – Efh

11. Register Description

In this chapter, we give the detailed descriptions for each register in SoC.

11.1 Core Registers

11.1.1 General-Purpose Registers

The 32-bit general-purpose data registers EAX, EBX, ECX, EDX, ESI, EDI, EBP and ESP are provided for holding the Operands for logical and arithmetic operations, Operands for address calculations or Memory pointers.

As shown below, the lower 16 bits of the general-purpose registers map directly to the register set found in the 8086 and 286 processors and can be referenced with the names AX, BX, CX, DX, BP, SP, SI, and DI. Each of the lower two bytes of the EAX, EBX, ECX, and EDX registers can be referenced by the names AH, BH, CH, and DH (high bytes) and AL, BL, CL, and DL (low bytes).

Register Name: EAX
Reset Value: -----

31 30 29 28 27 26 25 24 23 22 21 20 19 18 17 16 15 14 13 12 11 10 9 8 7 6 5 4 3 2 1 0

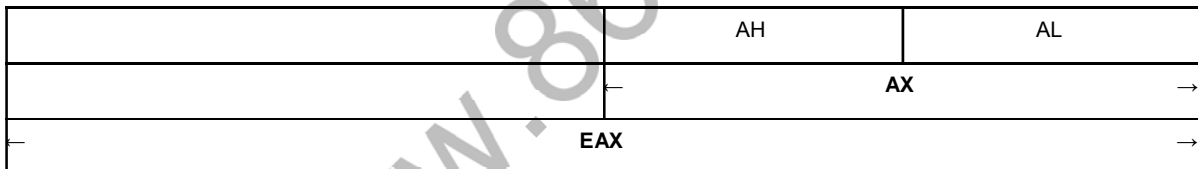

Bit	Name	Attribute	Description
31-0	EAX	R/W	The EAX registers are available for general storage of operands, results and pointers. For special purpose, the EAX holds the accumulator's operands or results data.

Vortex86EX

32-Bit x86 Micro Processor

Register Name: EBX
Reset Value: -----

31 30 29 28 27 26 25 24 23 22 21 20 19 18 17 16 15 14 13 12 11 10 9 8 7 6 5 4 3 2 1 0

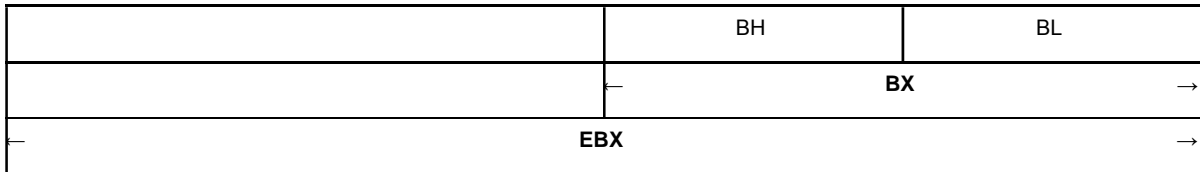

Bit	Name	Attribute	Description
31-0	EBX	R/W	The EBX registers are available for general storage of operands, results and pointers. For special purpose, the EBX holds a pointer which points to data in the DS segment.

Register Name: ECX
Reset Value: -----

31 30 29 28 27 26 25 24 23 22 21 20 19 18 17 16 15 14 13 12 11 10 9 8 7 6 5 4 3 2 1 0

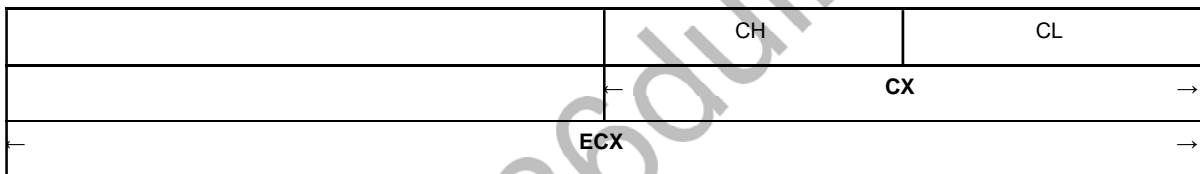

Bit	Name	Attribute	Description
31-0	ECX	R/W	The ECX registers are available for general storage of operands, results and pointers. For special purpose, the ECX holds a string pointer or the counter values of loop operations.

Vortex86EX

32-Bit x86 Micro Processor

Register Name: EDX
Reset Value: -----

31 30 29 28 27 26 25 24 23 22 21 20 19 18 17 16 15 14 13 12 11 10 9 8 7 6 5 4 3 2 1 0

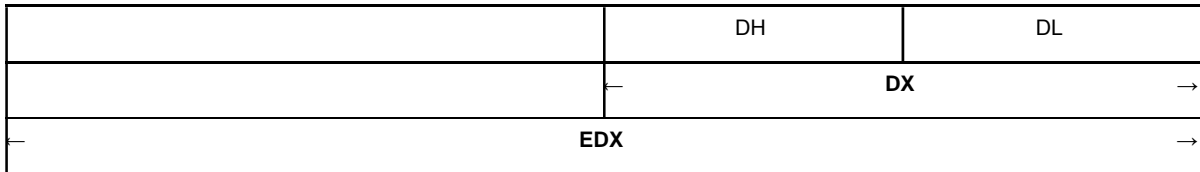

Bit	Name	Attribute	Description
31-0	EDX	R/W	The EDX registers are available for general storage of operands, results and pointers. For special purpose, the EDX holds an I/O pointer.

Register Name: ESI
Reset Value: -----

31 30 29 28 27 26 25 24 23 22 21 20 19 18 17 16 15 14 13 12 11 10 9 8 7 6 5 4 3 2 1 0

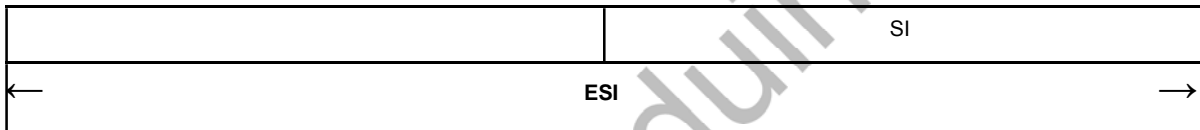

Bit	Name	Attribute	Description
31-0	ESI	R/W	Pointer to data in the segment pointed to by the DS register; source pointer for string operations.

Register Name: EDI
Reset Value: -----

31 30 29 28 27 26 25 24 23 22 21 20 19 18 17 16 15 14 13 12 11 10 9 8 7 6 5 4 3 2 1 0

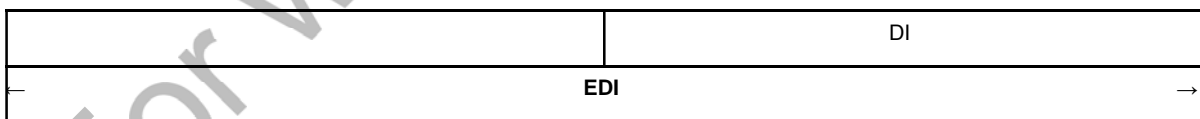

Bit	Name	Attribute	Description
31-0	EDI	R/W	Pointer to data (or destination) in the segment pointed to by the ES register; destination pointer for string operations.

Register Name: EBP
Reset Value: -----

31 30 29 28 27 26 25 24 23 22 21 20 19 18 17 16 15 14 13 12 11 10 9 8 7 6 5 4 3 2 1 0

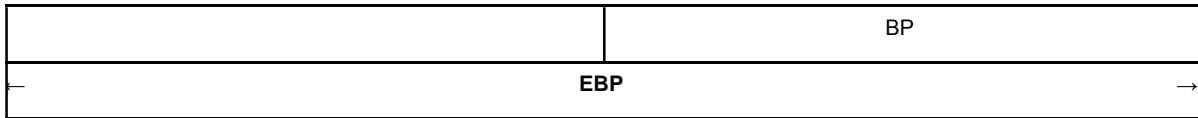

Bit	Name	Attribute	Description
31-0	EBP	R/W	Stack pointer (in the SS segment).

Register Name: ESP
Reset Value: -----

31 30 29 28 27 26 25 24 23 22 21 20 19 18 17 16 15 14 13 12 11 10 9 8 7 6 5 4 3 2 1 0

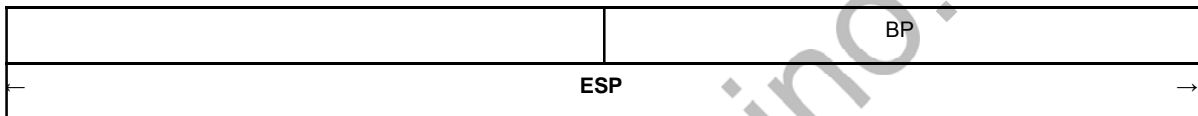

Bit	Name	Attribute	Description
31-0	EBP	R/W	Pointer to data on the stack (in the SS segment).

11.1.2 Segment Registers

Six 16-bit segment registers hold segment selector values identifying the currently addressable memory segments. In protected mode, each segment may range in size from one byte up to the entire linear and physical address space of the machine, which is 4 Gbytes (2^{32} bytes). In real address mode, the maximum segment size is fixed at 64 Kbytes (2^{16} bytes).

Register Name: Code segment Register (CS)
Reset Value: ----

15 14 13 12 11 10 9 8 7 6 5 4 3 2 1 0

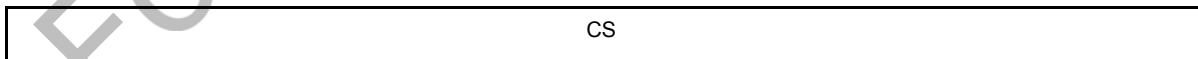

Bit	Name	Attribute	Description
15-0	CS	R/W	The Code Segment Register – CS holds the 16-bit code segment selector which points to the code segment.

Register Name: Stack segment Register (SS)
Reset Value: ----

Vortex86EX

32-Bit x86 Micro Processor

15 14 13 12 11 10 9 8 7 6 5 4 3 2 1 0

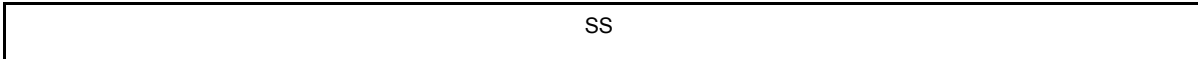

Bit	Name	Attribute	Description
15-0	SS	R/W	The Stack Segment Register –SS holds the 16-bit stack segment selector.

Register Name: Data segment Register (DS)

Reset Value: ----

15 14 13 12 11 10 9 8 7 6 5 4 3 2 1 0

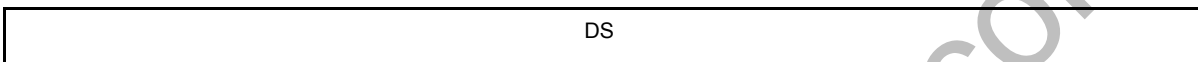

Bit	Name	Attribute	Description
15-0	DS	R/W	The Data Segment Register – DS holds the data segment selector.

Register Name: Data segment Register (ES)

Reset Value: ----

15 14 13 12 11 10 9 8 7 6 5 4 3 2 1 0



Bit	Name	Attribute	Description
15-0	ES	R/W	The Data Segment Register – ES holds the data segment selector.

Register Name: Data segment Register (FS)

Reset Value: ----

15 14 13 12 11 10 9 8 7 6 5 4 3 2 1 0

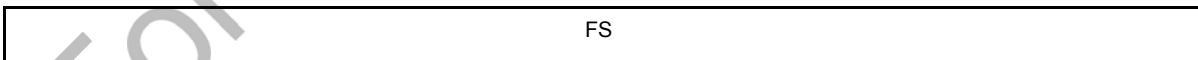

Bit	Name	Attribute	Description
15-0	FS	R/W	The Data Segment Register – FS holds the data segment selector.

Register Name: Data segment Register (GS)

Reset Value: ----

15 14 13 12 11 10 9 8 7 6 5 4 3 2 1 0

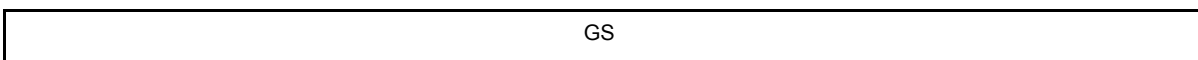

Vortex86EX

32-Bit x86 Micro Processor

Bit	Name	Attribute	Description
15-0	GS	R/W	The Data Segment Register – GS holds the data segment selector.

For www.86duino.com

11.1.3 Instruction Pointer Register

The instruction pointer is a 32-bit register named EIP.

Register Name: Instruction Pointer (EIP)

Reset Value: -----

31 30 29 28 27 26 25 24 23 22 21 20 19 18 17 16 15 14 13 12 11 10 9 8 7 6 5 4 3 2 1 0



Bit	Name	Attribute	Description
31-0	EIP	R/W	EIP holds the offset of the next instruction to be executed. The offset is always relative to the base of the code segment (CS). The lower 16 bits (bits 0-15) of the EIP contain the 16-bit instruction pointer named IP, which is used for 16-bit addressing.

11.1.4 Flags Register

The flags register is a 32-bit register named EFLAGS. The defined bits and bit fields within EFLAGS control certain operations and indicate the status of the SoC core. The lower 16 bits (bits 0-15) of EFLAGS contain the 16-bit register named FLAGS, which is most useful when the processor executes 8086 and 80286 codes.

EFLAGS bits 1, 3, 5, 15 and 19-31 are “undefined”. When these bits are stored during interrupt processing or with a PUSHF instruction (push flags onto stack), a one is stored in bit 1 and zeros in bit 3, 5, 15 and 19-31.

Register Name: Flags Register (EFLAGS)

Reset Value: -----

31 30 29 28 27 26 25 24 23 22 21 20 19 18 17 16 15 14 13 12 11 10 9 8 7 6 5 4 3 2 1 0

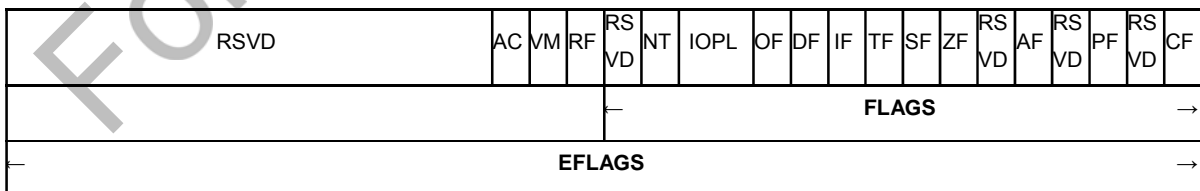

Bit	Name	Attribute	Description
31-19	RSVD	RO	Reserved.

Bit	Name	Attribute	Description																
18	AC	R/W	<p>Alignment Check.</p> <p>The AC bit enables the generation of faults if a memory reference is to a misaligned address. Alignment faults are enabled when AC is set to 1. A misaligned address is a word access to an odd address, a dword access to an address that is not on a dword boundary, or an 8-byte reference to an address that is not on a 64-bit word boundary.</p> <p>Alignment faults are only generated by programs running at privilege level 3. The AC bit setting is ignored at privilege levels 0, 1 and 2. Note that references to the descriptor tables (for selector loads) or the task state segment (TSS) are implicitly level 0 references even if the instructions causing the reference are executed at level 3. Alignment faults are reported through interrupt 17, with an error code of 0. Table 2.1 gives the alignments required for the SoC core data types.</p> <table border="1" style="margin-left: auto; margin-right: auto;"> <thead> <tr> <th>Memory Access</th> <th>Alignment (Byte Boundary)</th> </tr> </thead> <tbody> <tr> <td>Word</td> <td>2</td> </tr> <tr> <td>Dword</td> <td>4</td> </tr> <tr> <td>Selector</td> <td>2</td> </tr> <tr> <td>48-bit Segmented Pointer</td> <td>4</td> </tr> <tr> <td>32-bit Flat Pointer</td> <td>4</td> </tr> <tr> <td>32-bit Segmented Pointer</td> <td>2</td> </tr> <tr> <td>48-bit "Pseudo-Descriptor"</td> <td>4</td> </tr> </tbody> </table> <p>Note:</p> <p>Several instructions on the SoC core generate misaligned references, even if their memory address is aligned. For example, on this processor core, the SGDT/SIDT (store global/internet descriptor table) instruction reads/writes two bytes, and then reads/writes four bytes from a "pseudo-descriptor" at the given address. The SoC core will generate misaligned references unless the address is on a 2 mod 4 boundary. The SoC core will not cause any AC faults if the effective address given in the instruction has the proper alignment.</p>	Memory Access	Alignment (Byte Boundary)	Word	2	Dword	4	Selector	2	48-bit Segmented Pointer	4	32-bit Flat Pointer	4	32-bit Segmented Pointer	2	48-bit "Pseudo-Descriptor"	4
Memory Access	Alignment (Byte Boundary)																		
Word	2																		
Dword	4																		
Selector	2																		
48-bit Segmented Pointer	4																		
32-bit Flat Pointer	4																		
32-bit Segmented Pointer	2																		
48-bit "Pseudo-Descriptor"	4																		

Bit	Name	Attribute	Description
17	VM	R/W	<p>Virtual 8086 Mode.</p> <p>The VM bit provides virtual 8086 mode within protected mode. If set while the SoC core is in protected mode, the processor core will switch to virtual 8086 operation, handling segment loads as the 8086 does, but generating exception 13 faults on privileged opcodes. The VM bit can be set only in protected mode, by the IRET instruction (if the current privilege level = 0) and by task switches at any privilege level. The VM bit is unaffected by POPF. PUSHF always pushes a 0 in this bit, even if executing in virtual 8086 mode. The EFLAGS image pushed during interrupt processing or saved during task switches will contain a 1 in this bit if the interrupted code was executing as a virtual 8086 task.</p>
16	RF	R/W	<p>Resume Flag.</p> <p>The RF flag is used in conjunction with the debug register breakpoints. It is checked at instruction boundaries before breakpoint processing. When RF is set, it causes any debug fault to be ignored on the next instruction. RF is then automatically reset at the successful completion of every instruction (no faults are signaled) except the IRET instruction, the POPF instruction, and JMP, CALL, and INT instructions causing a task switch. These instructions set RF to the value specified by the memory image. For example, at the end of the breakpoint service routine, the IRET instruction can pop an EFLAG image having the RF bit set and resume the program's execution at the breakpoint address without generating another breakpoint fault on the same location.</p>
15	RSVD	RO	Reserved.
14	NT	R/W	<p>Nested Task.</p> <p>This flag applies to Protected Mode. NT is set to indicate that the execution of this task is nested within another task. If set, it indicates that the current nested task's Task State Segment (TSS) has a valid back link to the previous task's TSS. This bit is set or reset by control transfers to other tasks. The value of NT in EFLAGS is tested by the IRET instruction to determine whether to do an inter-task return or an intra-task return. A POPF or an IRET instruction will affect the setting of this bit according to the image popped, at any privilege level.</p>
13-12	IOPL	R/W	<p>Input/Output Privilege Level.</p> <p>This two-bit field applies to Protected Mode. IOPL indicates the numerically maximum CPL (current privilege level) value permitted to execute I/O instructions without generating an exception 13 faults or consulting the I/O Permission Bitmap. It also indicates the maximum CPL value allowing alteration of the IF (INTR Enable Flag) bit when new values are popped into the EFLAG register. POPF and IRET instructions can alter the IOPL field when executed at CPL = 0. Task switches can always alter the IOPL field when the new flag image is loaded from the incoming task's TSS.</p>

Vortex86EX

32-Bit x86 Micro Processor

Bit	Name	Attribute	Description
11	OF	R/W	Overflow Flag. OF is set if the operation resulted in signed overflow. Signed overflow occurs when the operation resulted in carry/borrow into the sign bit (high-order bit) of the result but did not result in a carry/borrow out of the high-order bit, or vice-versa. For 8-, 16- and 32-bit operations, OF is set according to overflow at bit 7, 15 and 31 respectively.
10	DF	R/W	Direction Flag. DF defines whether ESI and/or EDI register postdecrement or postincrement during the string instructions. Postinstruction occurs if DF is reset. Post decrement occurs if DF is set.
9	IF	R/W	INTR Enable Flag. The IF flag, when set, allows recognition of external interrupts signaled on the INTR pin. When IF is reset, external interrupts signaled on the INTR are not recognized. IOPL indicates the maximum CPL value allowing alteration of the IF bit when new values are popped into EFLAGS or FLAGS.
8	TF	R/W	Trap Enable Flag. TF controls the generation of exception 1 trap when single-stepping through code. When TF is set, the SoC core generates an exception 1 trap after the next instruction is executed. When TF is reset, exception 1 traps occur only as a function of the breakpoint addresses loaded into debug registers DR[0:3].
7	SF	R/W	Sign Flag. SF is set if the high-order bit of the result is set, it is reset otherwise. For 8-, 16- and 32-bit operations, SF reflects the state of bit 7, 15 and 31 respectively.
6	ZF	R/W	Zero Flag. ZF is set if all bits of the result are 0. Otherwise it is reset.
5	RSVD	RO	Reserved.
4	AF	R/W	Auxiliary Carry Flag. The Auxiliary Flag is used to simplify the addition and subtraction of packed BCD quantities. AF is set if the operation results in a carry out of bit 3 (addition) or a borrow into bit 3 (subtraction). Otherwise AF is reset. AF is affected by carry out of, or borrow into bit 3 only, regardless of overall operand length: 8, 16 or 32 bits.
3	RSVD	RO	Reserved.
2	PF	R/W	Parity Flags. PF is set if the low-order eight bits of the operation contain an even number of "1"s (even parity). PF is reset if the low-order eight bits have odd parity. PF is a function of only the low-order eight bits, regardless of operand size.
1	RSVD	RO	Reserved.

Bit	Name	Attribute	Description
0	CF	R/W	Carry Flag. CF is set if the operation results in a carry out of (addition), or a borrow into (subtraction) the high-order bit. Otherwise CF is reset. For 8-, 16- or 32-bit operations, CF is set according to carry/borrow at bit 7, 15 or 31 respectively.

11.1.5 Control Registers

CR0 contains 10 bits for control and status purposes. The function of the bits in CR0 can be categorized as follows:

SoC Core Operating Modes: PG, PE (Table 5.2)

On-Chip Cache Control Modes: CD, NW (Table 5.3)

On-Floating Point Unit Control: TS, EM, MP, NE (Table 5.4)

Alignment Check Control: AM

Supervisor Write Protect: WP

Register Name: Control Register 0 (CR0)

Reset Value: -----

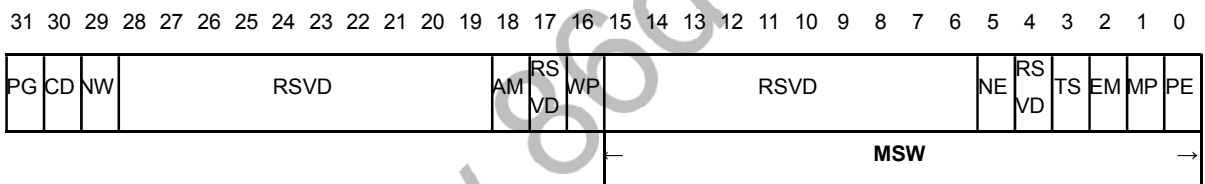

Table 11.2. SoC Core Operating Modes

PG	PE	Mode
0	0	REAL Mode. Exact 8086 semantics, with 32-bit extensions available with prefixes.
0	1	Protected Mode. Exact 80286 semantics, plus 32-bit extensions through both prefixes and “default” prefix setting associated with code segment descriptors. Also, a submode is defined to support a virtual 8086 within the context of the extended 80286 protection model.
1	0	UNDEFINED. Loading CR0 with this combination of PG and PE bits will raise a GP fault with error code 0.
1	1	Paged Protected Mode. All the facilities of Protected mode, with paging enabled underneath segmentation.

Table 11.3 On-Chip Cache Control Modes

CD	NW	Operating Mode
1	1	Cache fills disabled, write-through and invalidates disabled.
1	0	Cache fills disabled, write-through and invalidates enabled.
0	1	INVALID. If CR0 is loaded with this configuration of bits, a GP fault with error code is raised.
0	0	Cache fills enabled, write-through and invalidates enabled.

Table 11.4 SoC Core Floating Point Instruction Control

CR0 BIT			Instruction Type	
EM	TS	MP	Floating-Point	Wait
0	1	0	Trap 7	Execute
0	1	1	Trap 7	Trap 7
1	0	0	Trap 7	Execute
1	0	1	Trap 7	Execute
1	1	0	Trap 7	Execute
1	1	1	Trap 7	Trap 7

The low-order 16 bits of CR0 are also known as the Machine Status Word (MSW), for compatibility with the 80286 protected mode. LMSW and SMSW (load and store MSW) instructions are taken as special aliases of the load and store CR0 operations, where only the low-order 16 bits of CR0 are involved. The LMSW and SMSW instructions in the SoC core work in an identical fashion to the LMSW and SMSW instructions in the 80286 (i.e., they only operate on the low-order 16 bits of CR0 and ignore the new bits). New SoC core operating systems should use the MOV CR0, Reg instruction.

The defined CR0 bits are described below.

Bit	Name	Attribute	Description
31	PG	R/W	Paging Enable. The PG bit is used to indicate whether paging is enabled (PG = 1) or disabled (PG = 0). See Table 5.2.
30	CD	R/W	Cache Disable. The CD bit is used to enable the on-chip cache. When CD = 1, the cache will not be filled on cache misses. When CD = 0, cache fills may be performed on misses. See Table 5.3. The state of the CD bit, the cache enable input pin (KEN_), and the relevant page cache disable (PCD) bit determine if a line read in response to a cache miss will be installed in the cache. A line is installed in the cache only if CD = 0 and KEN_ and PCD are both zero. The relevant PCD bit comes from either the page table entry, page directory entry or control register 3. Refer to Section 5.6 for more details on page cacheability. CD is set to one after RESET.
29	NW	R/W	Not Write-Through. The NW bit enables on-chip cache write-through and write-invalidate cycles (NW = 0). When NW = 0, all writes, including cache hits, are sent out to the pins. Invalidate cycles are enabled when NW = 0. During an invalidate cycle, a line will be removed from the cache if the invalidate address hits in the cache. See Table 5.3. When NW = 1, write-through and write-invalidate cycles are disabled. A write will not be sent to the pins if the write hits in the cache. With NW = 1, the only write cycles that reach the external bus are cache misses. Write hits with NW = 1 will never update main memory. Invalidate cycles are ignored when NW = 1.
28-19	RSVD	RO	Reserved.
18	AM	R/W	Alignment Mask. The AM bit controls whether the alignment check (AC) bit in the flag register (EFLAGS) can allow an alignment fault. AM = 0 disables the AC bit. AM = 1 enables the AC bit. AM = 0 is the 386 microprocessor compatible mode. The 386 microprocessor software may load incorrect data into the AC bit in the EFLAGS register. Setting AM = 0 will prevent AC faults from occurring before the SoC Core has created the AC interrupt service routine.
17	Rsvd	RO	Reserved.

Vortex86EX

32-Bit x86 Micro Processor

Bit	Name	Attribute	Description
16	WP	R/W	<p>Write Protect.</p> <p>WP protects read-only pages from supervisor write access. The 386 microprocessor allows a read-only page to be written from privilege level 0-2. The SoC Core is compatible with the 386 microprocessor when WP = 0. WP = 1 forces a fault on a write to a read-only page from any privilege level. Operating systems with Copy-on-Write features can be supported with the WP bit. Refer to Section 5.5.3 for further details on use of the WP bit.</p>
15-6	RSVD	RO	Reserved.
5	NE	R/W	<p>Numerics Exception.</p> <p>For the SoC Core, interrupt 7 will be generated upon encountering any floating-point instruction regardless of the value of the NE bit. It is recommended that NE = 1 for normal operation of the SoC Core.</p>
4	RSVD	RO	Reserved.
3	TS	R/W	<p>Task Switch.</p> <p>The TS bit is set whenever a task switch operation is performed. Execution of floating point instructions with TS = 1 will cause a “device not available” (DNA) fault (trap vector 7). With MP = 0, the value of the TS bit is a “don’t care” for the WAIT instructions, i.e., these instructions will not generate trap 7.</p>
2	EM	R/W	<p>Emulate Coprocessor.</p> <p>The EM bit should be set to one for the SoC Core. This will cause the processor core to trap via interrupt vector 7 (Device Not Available) to a software exception handler whenever it encounters a floating-point instruction. If EM bit is 0, the system will hang.</p>
1	MP	R/W	<p>Monitor Coprocessor.</p> <p>For normal operation of the SoC Core, it is required to set this bit as zero (MP = 0). The MP bit is used in conjunction with the TS bit to determine if WAIT instructions should trap. For MP = 0, the value of TS is a “don’t care” for these type of instructions.</p>
0	PE	R/W	<p>Protection Enable.</p> <p>The PE bit enables the segment based protection mechanism. If PE = 1, protection is enabled. When PE = 0, the SoC Core operates in REAL mode, with segment based protection disabled, and addresses formed as in an 8086. Refer to Table 5.2.</p>

Register Name: Control Register 1 (CR1)

Reset Value: -----

31 30 29 28 27 26 25 24 23 22 21 20 19 18 17 16 15 14 13 12 11 10 9 8 7 6 5 4 3 2 1 0

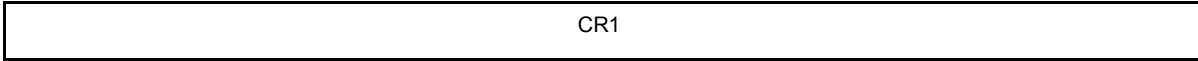

Bit	Name	Attribute	Description
31-0	CR1	--	Control Register 1.

Register Name: Control Register 2 (CR2)

Reset Value: -----

31 30 29 28 27 26 25 24 23 22 21 20 19 18 17 16 15 14 13 12 11 10 9 8 7 6 5 4 3 2 1 0

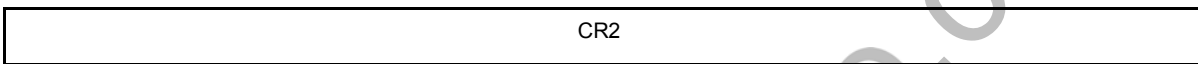

Bit	Name	Attribute	Description
31-0	CR2	R/W	Control Register 2. (Page Fault Linear Address Register) CR2 holds the 32-bit linear address that caused the last page fault detected. The error code pushed onto the page fault handler's stack when it is invoked provides additional status information on this page fault.

CR3 contains the physical base address of the page directory table. The page directory is always page aligned (4 Kbyte-aligned).

In the SoC Core, CR3 contains two bits, page write-through (PWT, bit 3) and (PCD, bit 4), which control page cacheability. The page table entry (PTE) and page directory entry (PDE) also contain PWT and PCD bits. When a page is accessed in external memory, the state of PWT and PCD are driven out on the PWT and PCD pins. The source of PWT and PCD can be CR3, the PTE or the PDE. PWT and PCD are sourced from CR3 when the PDE is being updated. When paging is disabled (PG = 0 in CR0), PCD and PWT are assumed to be 0, regardless of their state in CR3.

A task switch through a task state segment (TSS) which changes the values in CR3, or an explicit load into CR3 with any value, will invalidate all cached page table entries in the translation look aside buffer (TLB).

The page directory base address in CR3 is a physical address. The page directory can be paged out while its associated task is suspended, but the operating system must ensure that the page directory is resident in physical memory before the task is dispatched. The entry in the TSS for CR3 has a physical address, with no provision for a present bit. This means that the page directory for a task must be resident in physical memory. The CR3 image in a TSS must point to this area, before the task can be dispatched through its TSS.

Register Name: Control Register 3 (CR3)

Reset Value: -----

31 30 29 28 27 26 25 24 23 22 21 20 19 18 17 16 15 14 13 12 11 10 9 8 7 6 5 4 3 2 1 0

PDBR	RSVD	PC D	PW T	RSVD
------	------	---------	---------	------

Bit	Name	Attribute	Description
31-12	PDBR	R/W	Page Directory Base Register. The page directory is always page aligned (4 Kbyte-aligned). This alignment is enforced by the only storing bits 20-31 in CR3.
11-5	RSVD	RO	Reserved.
4	PCD	R/W	Page Cache Disable.
3	PWT	R/W	Page Write-Through.
2-0	RSVD	RO	Reserved.

11.1.6 System Address Registers

Four special registers are defined to reference the tables or segments supported by the SoC Core protection model. These tables or segments are:

GDT (Global Descriptor Table)

IDT (Interrupt Descriptor Table)

LDT (Local Descriptor Table)

TSS (Task State Segment)

The address of these tables and segments are stored in special registers, the System Address and System Segment Registers. These registers are named GDTR, IDTR, LDTR and TR respectively.

Vortex86EX

32-Bit x86 Micro Processor

The GDTR holds the 32-bit linear base address and 16-bit limit of the GDT, respectively.

Since the GDT segments are global to all tasks in the system, the GDT are defined by 32-bit linear addresses (subject to page transition if paging is enabled) and 16-bit limit values.

Register Name: Global Descriptor Table Register (GDTR)

Reset Value: -----

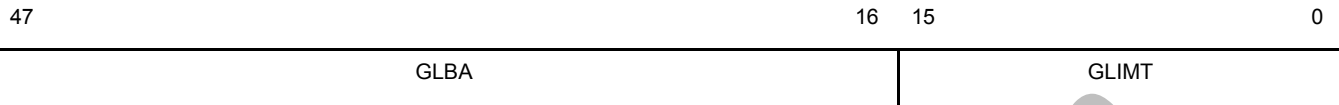

Bit	Name	Attribute	Description
47-16	GLBA	RW	Linear Base addresses of GDT. This field saves the 32-bit linear address of Global Descriptor Table.
15-0	GLMT	RW	Limit of GDT. This field saves the 16-bit limit values of Global Descriptor Table.

The IDTR holds the 32-bit linear base address and 16-bit limit of the IDT, respectively.

Since the IDT segments are global to all tasks in the system, the IDT are defined by 32-bit linear addresses (subject to page transition if paging is enabled) and 16-bit limit values.

Register Name: Interrupt Descriptor Table Register (IDTR)

Reset Value: -----

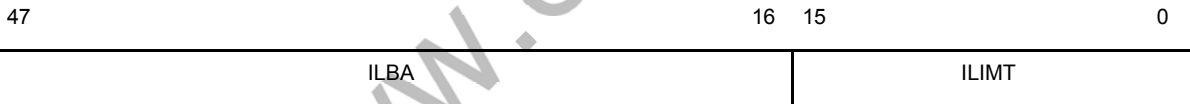

Bit	Name	Attribute	Description
47-16	ILBA	RW	Linear Base addresses of IDT. This field saves the 32-bit linear address of Interrupt Descriptor Table.
15-0	ILMT	RW	Limit of IDT. This field saves the 16-bit limit values of Interrupt Descriptor Table.

The LDTR holds the 16-bit selector for the LDT descriptor.

Since the LDT segment is task specific segment, the LDT are defined by selector value stored in the system segment register.

Register Name: Local Descriptor Table Register (LDTR)

Reset Value: ----

15 14 13 12 11 10 9 8 7 6 5 4 3 2 1 0

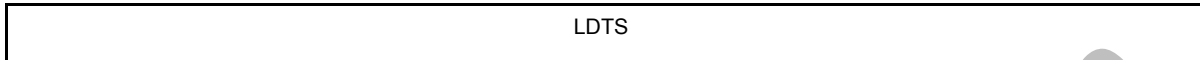

Bit	Name	Attribute	Description
16-0	LDTs	R/W	Selector of LDT descriptor. The LDTR holds the 16-bit selector for the LDT descriptor.

The TSSR holds the 16-bit selector for the TSS descriptor.

Since the TSS segment is task specific segment, the TSS is defined by selector value stored in the system segment register.

Register Name: Task State Segment Register (TSSR)

Reset Value: ----

15 14 13 12 11 10 9 8 7 6 5 4 3 2 1 0



Bit	Name	Attribute	Description
16-0	TSSs	R/W	Selector of TSS descriptor. The TSSR holds the 16-bit selector for the TSS descriptor.

11.1.7 FPU Registers

Register Name: FPU Data Register R0
Reset Value: -----

Double Extended-Precision Flating Point.

79 78 64 63 0

Sig n	Exponent	Significand
----------	----------	-------------

Bit	Name	Attribute	Description
79	Sign	R/W	Sign Bit.
78-64	Exp	R/W	Exponent.
63-0	Signd	R/W	Significand.

Double-Precision Flating Point

63 62 52 51 0

Sig n	Exponent	Significand
----------	----------	-------------

Bit	Name	Attribute	Description
63	Sign	R/W	Sign Bit.
62-52	Exp	R/W	Exponent
51-0	Signd	R/W	Significand

Single-Precision Flating Point

31 30 29 28 27 26 25 24 23 22 21 20 19 18 17 16 15 14 13 12 11 10 9 8 7 6 5 4 3 2 1 0

Sig n	Exponent	Significand
----------	----------	-------------

Bit	Name	Attribute	Description
31	Sign	R/W	Sign Bit.
30-23	Exp	R/W	Exponent.
22-0	Signd	R/W	Significand.

Vortex86EX
32-Bit x86 Micro Processor

Register Name: FPU Data Register R1

Reset Value: -----

Double Extended-Precision Floating Point

79 78 64 0



Bit	Name	Attribute	Description
79	Sign	R/W	Sign Bit.
78-64	Exp	R/W	Exponent.
63-0	Signd	R/W	Significand.

Double-Precision Floating Point

63 62 52 51 0

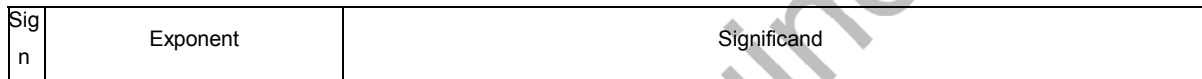

Bit	Name	Attribute	Description
63	Sign	R/W	Sign Bit.
62-52	Exp	R/W	Exponent.
51-0	Signd	R/W	Significand.

Single-Precision Floating Point

31 30 29 28 27 26 25 24 23 22 21 20 19 18 17 16 15 14 13 12 11 10 9 8 7 6 5 4 3 2 1 0

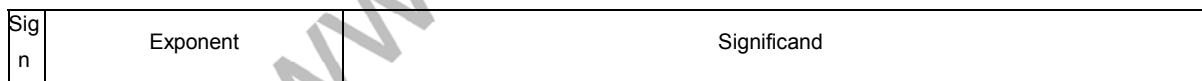

Bit	Name	Attribute	Description
31	Sign	R/W	Sign Bit.
30-23	Exp	R/W	Exponent.
22-0	Signd	R/W	Significand.

Vortex86EX

32-Bit x86 Micro Processor

Register Name: FPU Data Register R3
Reset Value: -----

Double Extended-Precision Flating Point

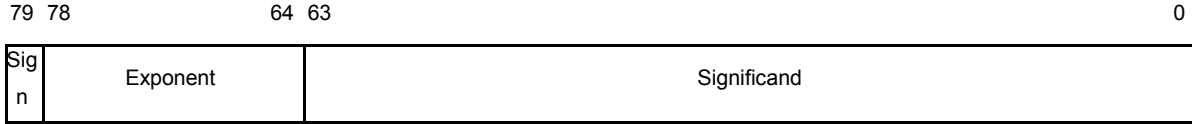

Bit	Name	Attribute	Description
79	Sign	R/W	<i>Sign Bit.</i>
78-64	Exp	R/W	<i>Exponent.</i>
63-0	Signd	R/W	<i>Significand.</i>

Double-Precision Flating Point

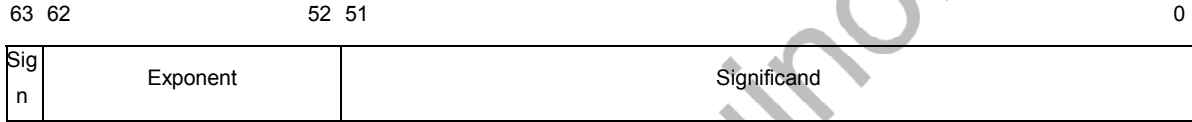

Bit	Name	Attribute	Description
63	Sign	R/W	<i>Sign Bit.</i>
62-52	Exp	R/W	<i>Exponent.</i>
51-0	Signd	R/W	<i>Significand.</i>

Single-Precision Flating Point

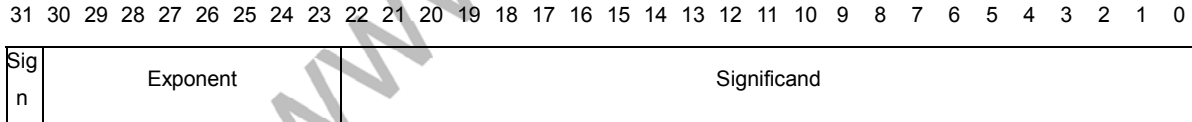

Bit	Name	Attribute	Description
31	Sign	R/W	<i>Sign Bit.</i>
30-23	Exp	R/W	<i>Exponent.</i>
22-0	Signd	R/W	<i>Significand.</i>

Vortex86EX

32-Bit x86 Micro Processor

Register Name: FPU Data Register R6
Reset Value: -----

Double Extended-Precision Flating Point

79 78 64 63 0

Sig n	Exponent	Significand
----------	----------	-------------

Bit	Name	Attribute	Description
79	Sign	R/W	Sign Bit.
78-64	Exp	R/W	Exponent.
63-0	Signd	R/W	Significand.

Double-Precision Flating Point

63 62 52 51 0

Sig n	Exponent	Significand
----------	----------	-------------

Bit	Name	Attribute	Description
63	Sign	R/W	Sign Bit.
62-52	Exp	R/W	Exponent.
51-0	Signd	R/W	Significand.

Single-Precision Flating Point

31 30 29 28 27 26 25 24 23 22 21 20 19 18 17 16 15 14 13 12 11 10 9 8 7 6 5 4 3 2 1 0

Sig n	Exponent	Significand
----------	----------	-------------

Bit	Name	Attribute	Description
31	Sign	R/W	Sign Bit.
30-23	Exp	R/W	Exponent.
22-0	Signd	R/W	Significand.

Vortex86EX

32-Bit x86 Micro Processor

Register Name: FPU Data Register R7
Reset Value: -----

Double Extended-Precision Flating Point

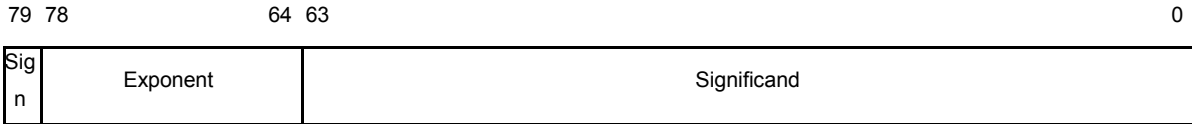

Bit	Name	Attribute	Description
79	Sign	R/W	Sign Bit.
78-64	Exp	R/W	Exponent.
63-0	Signd	R/W	Significand.

Double-Precision Flating Point

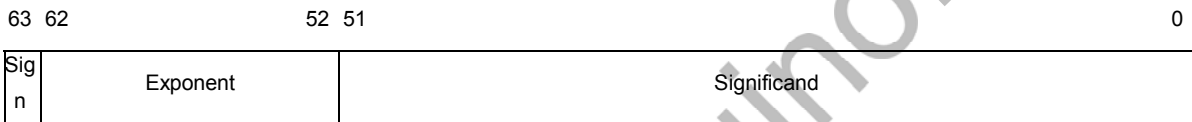

Bit	Name	Attribute	Description
63	Sign	R/W	Sign Bit.
62-52	Exp	R/W	Exponent.
51-0	Signd	R/W	Significand.

Single-Precision Flating Point

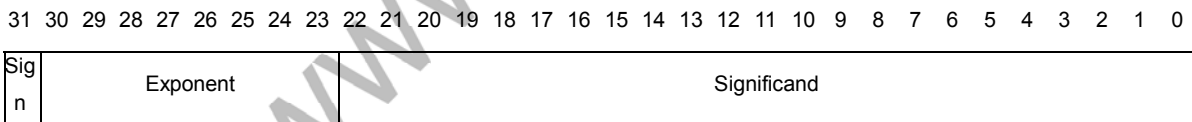

Bit	Name	Attribute	Description
31	Sign	R/W	Sign Bit.
30-23	Exp	R/W	Exponent.
22-0	Signd	R/W	Significand.

Vortex86EX

32-Bit x86 Micro Processor

Register Name: X87 FPU Status Register

Reset Value: ----

15	14	13	12	11	10	9	8	7	6	5	4	3	2	1	0
B	C3	TOP			C2	C1	C0	ES	SF	PE	UE	OE	ZE	DE	IE

Bit	Name	Attribute	Description
15	B	R/W	FPU Busy.
14	C3	R/W	Condition Code Flags. The four condition code flags (C0 through C3) indicate the results of floating-point comparison and arithmetic operations.
13-11	TOP	R/W	Top of Stack (TOP) Pointer. A pointer to the x87 FPU data register that is currently at the top of the x87 FPU register stack.
10	C2	R/W	Condition Code Flags. The four condition code flags (C0 through C3) indicate the results of floating-point comparison and arithmetic operations.
9	C1	R/W	Condition Code Flags. The four condition code flags (C0 through C3) indicate the results of floating-point comparison and arithmetic operations.
8	C0	R/W	Condition Code Flags. The four condition code flags (C0 through C3) indicate the results of floating-point comparison and arithmetic operations.
7	ES	R/W	Error Summary Status.
6	SF	R/W	Stack Fault.
5	PE	R/W	Precision Exception Flags.
4	UE	R/W	Underflow Exception Flags.
3	OE	R/W	Overflow Exception Flags.
2	ZE	R/W	Zero Divide Exception Flags.
1	DE	R/W	Denormalized Operand Exception Flags.
0	IE	R/W	Invalid Operation Exception Flags.

Vortex86EX

32-Bit x86 Micro Processor

Register Name: X87 FPU Control Word
Reset Value: ----

15	14	13	12	11	10	9	8	7	6	5	4	3	2	1	0
Rsvd	X	RC	PC	Rsvd	PM	UM	OM	ZM	DM	IM					

Bit	Name	Attribute	Description
15-13	RSVD	RO	Reserved.
12	X	R/W	Infinity Control. The infinity control flag is provided for compatibility with the 287 Math Coprocessor.
11-10	RC	R/W	Rounding Control.
9-8	PC	R/W	Precision Control.
7-6	RSVD	RO	Reserved.
5	PM	R/W	Precision Exception Masks.
4	UM	R/W	Underflow Exception Masks.
3	OM	R/W	Overflow Exception Masks.
2	ZM	R/W	Overflow Exception Masks.
1	DM	R/W	Denormal Operand Exception Masks.
0	IM	R/W	Invalid Operation Exception Masks.

11.2 CPU MSR Registers

MSR Index: 10h
MSR Name: Time-Stamp Counter
Reset Value: 00000000_00000000h

63 0

TSC	
-----	--

Bit	Name	Attribute	Description
63-0	TSC	RO	<i>Time-Stamp Counter.</i>

MSR Index: 174h
MSR Name: IA32_SYSENTER_CS
Reset Value: 00000000_00000000h

63 16 15 0

RSVD	SETR_CS
------	---------

Bit	Name	Attribute	Description
63-16	RSVD	RO	Reserved.
15-0	SETR_CS	R/W	CS Selector for SYSENTER.

MSR Index: 175h
MSR Name: IA32_SYSENTER_ESP
Reset Value: 00000000_00000000h

63 32 31 0

RSVD	SETR_ESP
------	----------

Bit	Name	Attribute	Description
63-32	RSVD	RO	<i>Reserved.</i>
31-0	SETR_ESP	R/W	<i>ESP for for SYSENTER.</i>

Vortex86EX

32-Bit x86 Micro Processor

MSR Index: 176h
MSR Name: IA32_SYSENTER_EIP
Reset Value: 00000000_00000000h

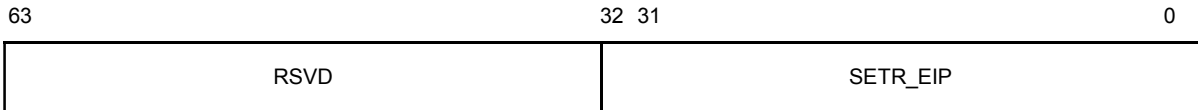

Bit	Name	Attribute	Description
63-32	RSVD	RO	<i>Reserved.</i>
31-0	SETR_EIP	R/W	<i>EIP for SYSENTER.</i>

MSR Index: CFCFCF00h
MSR Name: Reserved

For www.86duino.com

Vortex86EX

32-Bit x86 Micro Processor

Vortex86EX supports 2 instruction counters. One is automatically updates every second. Another is user control the start/stop time.

MSR Index: D0D0D000h
MSR Name: Instruction Counter Register
Reset Value: 00000000h

63 62 0

ICO	IC
-----	----

Bit	Name	Attribute	Description
63	ICO	RO	<i>Instruction Counter Overflow.</i>
62-0	IC	RO	63 bits <i>Instruction Counter.</i> Hardware counts the executed instruction and updated this register every second.

MSR Index: D0D0D001h
MSR Name: User Instruction Counter Register
Reset Value: 00000000h

63 62 0

UICO	UIC[62:32]
------	------------

Bit	Name	Attribute	Description
63	UICO	RO	<i>User Instruction Counter Overflow.</i>
62-0	UIC	RO	63 bits <i>User Instruction Counter.</i> Hardware clears this counter and starts to count the executed instruction when program write MSR D0D0D002[0] = 1. Hardware stops to count when program write MSR D0D0D002[0] = 0

Vortex86EX

32-Bit x86 Micro Processor

MSR Index: D0D0D002h
MSR Name: Instruction Counter Control Register
Reset Value: 00000000h

63

3 2 1 0

RSVD	UIC	ICE	UICC	UICE
------	-----	-----	------	------

Bit	Name	Attribute	Description
63-3	RSVD	RO	Reserved.
2	ICE	RW	CPU Instruction Counter Enable. 0: Disabled 1: Enabled
1	UICC	RW	User Instruction Counter Clear (Write Clear). 0: Disabled (default) 1: Enabled
0	UICE	RW	User Instruction Start / Stop Control: 0: Let UIC stop to count 1: Let UIC start to count

11.3 I/O Mapped Registers

11.3.1 PCI Configuration Registers

Configuration Address Register is a 32-bit register accessed only when referenced as a Dword. A byte or word reference will pass through the Configuration Address Register onto the PCI bus as an I/O cycle.

I/O Port: CF8h — Accessed as a Dword
Register Name: PCI Configuration Address Register
Reset Value: 0000000h

	31	30	29	28	27	26	25	24	23	22	21	20	19	18	17	16	15	14	13	12	11	10	9	8	7	6	5	4	3	2	1	0
	CE	RSVD					BN					DN			FN			RN			RSVD											

Bit	Name	Attribute	Description
31	CE	R/W	Configuration Enable. When this bit is set to 1, accesses to PCI configuration space are enabled. If this bit is reset to 0, accesses to PCI configuration space are disabled.
30-24	Rsvd	RO	Reserved.
23-16	BN	R/W	Bus Number. When the bus number is programmed to 00h, the target of the configuration cycle is either the North-Bridge or the PCI Device that is connected to the North-Bridge. If the bus number is programmed to 00h and the North-Bridge is not the target, a Type 0 configuration cycle is generated on PCI Bus. IF the bus number is non-zero, a Type 1 configuration cycle is generated on PCI bus with the bus number mapped to AD[23:16] during the address phase.
15-11	DN	R/W	Device Number. This field selects one agent on the PCI bus. During a Type 1 configuration cycle, this field is mapped to AD[15:11]. During a Type 0 configuration cycle, this field is decoded and one of AD[31:11] is driven to 1.
10-8	FN	R/W	Function Number. This field allows the configuration registers of a particular function in a multi-function device to be accessed. The SoC North Bridge only responds to configuration cycle with a function number of 000b.
7-2	RN	R/W	Register Number. This field selects one register within a particular Bus, Device, and Function as specified by the other fields in the Configuration Address Register.
1-0	Rsvd	RO	Reserved.

Configuration Data Register is a 32-bit read/write window into configuration space. The portion of configuration space that is referenced by Configuration Data Register is determined by the contents of Configuration Address Register.

I/O Port: CFCh — Accessed as a Dword
Register Name: PCI Configuration Data Register
Reset Value: 00000000h

31 30 29 28 27 26 25 24 23 22 21 20 19 18 17 16 15 14 13 12 11 10 9 8 7 6 5 4 3 2 1 0

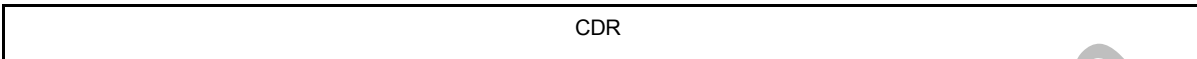

Bit	Name	Attribute	Description
31-0	CDR	R/W	If bit 31 of PCI Configuration Address Register is 1, any I/O reference that falls in the PCI Configuration Data Register space is mapped to configuration space using the contents of PCI Configuration Address Register.

11.3.2 Slave DMA Control Registers

I/O Port: 00h
Register Name: Slave DMA Channel 0 Base/Current Address Register
Reset Value: --

7 6 5 4 3 2 1 0

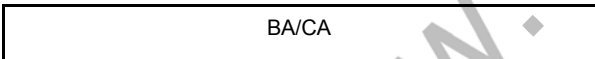

Bit	Name	Attribute	Description
7-0	BA/CA	R/W	<p>Read: Current Address Register.</p> <p>Read the 16-bit Current Address Register for DMA channel 0. The first 8-bit read will return the low portion of the word, and the second read will return the upper portion of the word.</p> <p>The current Address Register holds the current memory address used in a DMA transfer. It is automatically incremented or decremented after each DMA memory transfer.</p> <p>Write: Base and Current Address Register.</p> <p>Two sequential 8-bit I/O writes load a 16-bit value into this register. The first 8-bit write loads the low portion of the word, and the second 8-bit write loads the high portion of the word. The Base Address Register is Write-Only.</p> <p>The Base Address Register is used to hold the original value of the Current Address Register, and is not incremented or decremented during the DMA transfer.</p>

Vortex86EX

32-Bit x86 Micro Processor

I/O Port: 01h
Register Name: Slave DMA Channel 0 Base/Current Count Register
Reset Value: --

7 6 5 4 3 2 1 0

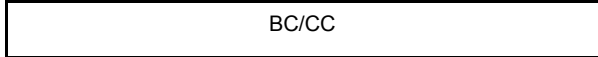

Bit	Name	Attribute	Description
7-0	BC/CC	R/W	<p>Read: Current Count Register.</p> <p>Read the 16-bit Current Count Register for DMA channel 0. The first 8-bit read will return the low portion of the word, and the second read will return the upper portion of the word.</p> <p>The Current Count Register holds 1 plus the remaining number of transfers to occur. A value of 100h indicates 101h transfers remain. This register is decremented after each transfer. When the register rolls from 0 to FFFFh, the transfer is complete.</p> <p>Write: Base and Current Count Register.</p> <p>Two sequential 8-bit I/O writes load a 16-bit value into this register. The first 8-bit write loads the low portion of the word, and the second 8-bit write loads the high portion of the word. The Base Count Register is Write-Only.</p> <p>The Base Count Register is used to hold the original value of the Current Count Register.</p>

I/O Port: 02h
Register Name: Slave DMA Channel 1 Base/Current Address Register
Reset Value: --

7 6 5 4 3 2 1 0

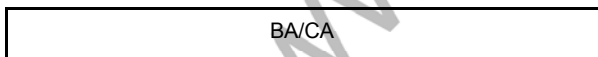

The definitions of bit[7:0] for Slave DMA Channel 1 Base/Current Address are the same as those of bit[7:0] for Slave DMA Channel 0 Base/Current Address Register at I/O address 00h.

I/O Port: 03h
Register Name: Slave DMA Channel 1 Base/Current Count Register
Reset Value: --

7 6 5 4 3 2 1 0

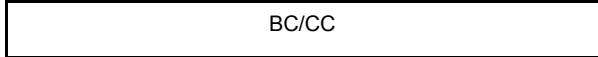

The definitions of bit[7:0] for Slave DMA Channel 1 Base/Current Count are the same as those of bit[7:0] for Slave DMA Channel 0 Base/Current Count Register at I/O address 01h.

I/O Port: 04h
Register Name: Slave DMA Channel 2 Base/Current Address Register
Reset Value: --

7 6 5 4 3 2 1 0

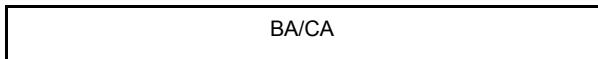

The definitions of bit[7:0] for Slave DMA Channel 2 Base/Current Address are the same as those of bit[7:0] for Slave DMA Channel 0 Base/Current Address Register at I/O address 00h.

I/O Port: 05h
Register Name: Slave DMA Channel 2 Base/Current Count Register
Reset Value: --

7 6 5 4 3 2 1 0

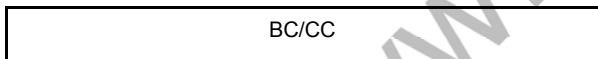

The definitions of bit[7:0] for Slave DMA Channel 2 Base/Current Count are the same as those of bit[7:0] for Slave DMA Channel 0 Base/Current Count Register at I/O address 01h.

I/O Port: 06h
Register Name: Slave DMA Channel 3 Base/Current Address Register
Reset Value: --

7 6 5 4 3 2 1 0

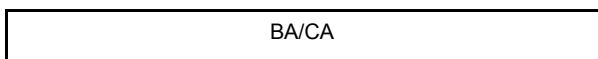

The definitions of bit[7:0] for Slave DMA Channel 3 Base/Current Address are the same as those of bit[7:0] for Slave DMA Channel 0 Base/Current Address Register at I/O address 00h.

I/O Port: 07h
Register Name: Slave DMA Channel 3 Base/Current Count Register
Reset Value: --

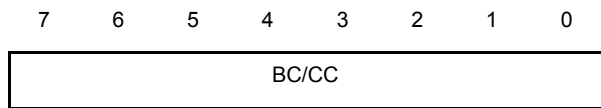

The definitions of bit[7:0] for Slave DMA Channel 3 Base/Current Count are the same as those of bit[7:0] for Slave DMA Channel 0 Base/Current Count Register at I/O address 01h.

READ: Status Register

The Status register is available to be read out of the 82C37A by the microprocessor. It contains information about the status of the devices at this point. This information includes which channels have reached a terminal count and which channels have pending DMA requests. Bit 0-3 are set every time a TC is reached by that channel or an external EOP is applied. These bits are cleared upon RESET, Master Clear, and on each Status Read. Bits 4-7 are set whenever their corresponding channel is requesting service, regardless of the mask bit state. If the mask bits are set, the Status register can be polled by software to determine which channels have DREQs, and selectively clear a mask bit, thus allowing user defined service priority. Status bit 4-7 are updated while the clock is high, and latched on the falling edge. Status Bit 4-7 are cleared upon RESET or Master Clear.

I/O Port: 08h
Register Name: Slave DMA Command/Status Register
Reset Value: 00000010b/00x0x0x0

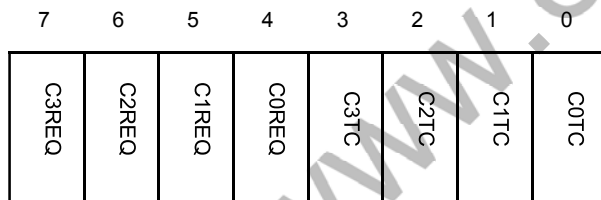

Bit	Name	Attribute	Description
7	C3REQ	R	= 1 DMA Channel 3 request
6	C2REQ	R	= 1 DMA Channel 2 request
5	C1REQ	R	= 1 DMA Channel 1 request
4	C0REQ	R	= 1 DMA Channel 0 request
3	C3TC	R	= 1 DMA Channel 3 has reached terminal count
2	C2TC	R	= 1 DMA Channel 2 has reached terminal count
1	C1TC	R	= 1 DMA Channel 1 has reached terminal count
0	C0TC	R	= 1 DMA Channel 0 has reached terminal count

Write: Command Register

This 8-bit register controls the operation of the DMA. The register is cleared by a hardware reset or a Master Disable instruction (port 0Dh). The command value used by PCs is 0. Normally all bits are left at 0, except bit 2 is typically set to 1 to disable the controller while writing to DMA registers. This register is a write-only.

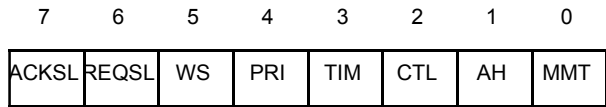

Bit	Name	Attribute	Description
7	ACKSL	W	= 1: DACK sense active high = 0: DACK sense active low
6	REQSL	W	= 1: DREQ sense active low = 0: DREQ sense active high
5	WS	W	= 1: Extended write selection = 0: Late write selection = X: if bit-3 = 0
4	PRI	W	= 1: Rotating priority = 0: Fixed priority
3	TIM	W	= 1: Compressed timing = 0: Normal timing = X: if bit-1 = 0
2	CTL	W	= 1: Control disable = 0: Control enable
1	AH	W	= 1: Channel 0 address hold enable = 0: Channel 0 address hold disable = X: if bit-0 = 0
0	MMT	W	= 1: Memory-to-memory transfers enable = 0: Memory-to-memory transfers disable

In addition to initiating a request for DMA service by asserting a hardware request line, software can also initiate a DMA request. The Request Register is used to both set and clear any channel's soft request bit. The DMA controller does not need to be in Block mode to use this function, as set in the Mode Register (port 0Bh). When reading the Request register, bits 4-7 will always read as ones, and bits 0-3 will display the request bits of channels 0-3 respectively.

I/O Port: 09h
Register Name: Slave DMA Command/Request Register
Reset Value: --

7	6	5	4	3	2	1	0
RSVD				SR	CS		

Write Command

Bit	Name	Attribute	Description
7-3	RSVD	RO	Reserved.
2	SR	WO	= 1: Set request bit = 0: Clear request bit
1-0	CS	WO	= 00: Channel 0 select = 01: Channel 1 select = 10: Channel 2 select = 11: Channel 3 select

Read Request

Bit	Name	Attribute	Description
7-4	RSVD	RO	4'b1111
3	SDRQ3	RO	soft request register , channel 3
2	SDRQ2	RO	soft request register , channel 2
1	SDRQ1	RO	soft request register , channel 1
0	SDRQ0	RO	soft request register , channel 0

Vortex86EX

32-Bit x86 Micro Processor

The mask register is used to disable or enable individual incoming requests. Setting a mask bit on disables the selected channel. Hardware reset disables all channels by setting all mask bits.

I/O Port: 0Ah
Register Name: Slave DMA Command/Single Mask Register
Reset Value: --

7	6	5	4	3	2	1	0
RSVD				SM	CS		

Bit	Name	Attribute	Description
7-3	RSVD	RO	Reserved.
2	SM	W	= 1: Set mask bit = 0: Clear mask bit
1-0	CS	W	= 00: Channel 0 select = 01: Channel 1 select = 10: Channel 2 select = 11: Channel 3 select

Read: Command Register

7	6	5	4	3	2	1	0
ACKSL	REQSL	WS	PRI	TIM	CTL	AH	MMT

Bit	Name	Attribute	Description
7	ACKSL	RO	= 1: DACK sense active high = 0: DACK sense active low
6	REQSL	RO	= 1: DREQ sense active low = 0: DREQ sense active high
5	WS	RO	= 1: Extended write selection = 0: Late write selection = X: if bit-3 = 0
4	PRI	RO	= 1: Rotating priority = 0: Fixed priority
3	TIM	RO	= 1: Compressed timing = 0: Normal timing = X: if bit-1 = 0
2	CTL	RO	= 1: Control disable = 0: Control enable
1	AH	RO	= 1: Channel 0 address hold enable = 0: Channel 0 address hold disable = X: if bit-0 = 0
0	MMT	RO	= 1: Memory-to-memory transfers enable

Vortex86EX

32-Bit x86 Micro Processor

Bit	Name	Attribute	Description
			= 0: Memory-to-memory transfers disable

The Mode Register indicates the mode of operation for each of the four DMA channels 0 to 3. Each channel has a separate 6-bit mode register and each is loaded through the Mode Register port.

I/O Port: 0Bh
Register Name: Slave DMA Mode Register
Reset Value: --

7	6	5	4	3	2	1	0
MT	AD/AI	ATI	TT	CS			

Bit	Name	Attribute	Description
7-6	MT	W	Mode Type Selection. = 00: Demand mode = 01: Single mode = 10: Block mode = 11: Cascade mode
5	AD/AI	W	= 1: Address decrement select = 0: Address increment select
4	ATI	W	= 1: Auto initialization enable = 0: Auto initialization disable
3-2	TT	W	Transfer Type. = 00: Verify operation = 01: Write operation = 10: Read operation = 11: not valid = xx: if they are in cascade mode (bit 6 & 7)
1-0	CS	W	Channel Selection. = 00: Channel 0 select = 01: Channel 1 select = 10: Channel 2 select = 11: Channel 3 select

Vortex86EX

32-Bit x86 Micro Processor

Read the register will read the mode register. And mode register counter will increase.

First read is the channel 0 mode register. Second read is Channel 1 and third is channel 2 and fourth is Channel 3.

Bit	Name	Attribute	Description
7-6	MT	R	Mode Type Selection. = 00: Demand mode = 01: Single mode = 10: Block mode = 11: Cascade mode
5	AD/AI	R	= 1: Address decrement select = 0: Address increment select
4	ATI	R	= 1: Auto initialization enable = 0: Auto initialization disable
3-2	TT	R	Transfer Type. = 00: Verify operation = 01: Write operation = 10: Read operation = 11: not valid = xx: if they are in cascade mode (bit 6 & 7)
1-0	CS	R	2'b11

I/O Port: 0Ch

Register Name: Slave DMA Set/Clear First/Last Clear F/F Register

Reset Value: --

7 6 5 4 3 2 1 0

CFF

Bit	Name	Attribute	Description
7-0	CFF	R	Any value to this port causes the internal First/Last flip-flop to be cleared in DMA controller 1. This is done before any 8-bit reads or writes to 16-bit registers that require two successive 8-bit port accesses to complete the word transfer. After the flip-flop is cleared, a 16-bit DMA register is accessed by reading or writing the low byte followed by the high byte. The flip-flop can only be cleared, and is not readable.

Vortex86EX

32-Bit x86 Micro Processor

I/O Port: 0Dh
Register Name: Slave DMA Temporary/Master Disable Register
Reset Value: --

7 6 5 4 3 2 1 0



Bit	Name	Attribute	Description
7-0	TP/MD	R/W	<p>Read: Temporary Register.</p> <p>The Temporary Register holds data during memory-to-memory data transfers. After the transfer is complete, the Temporary Register holds the last data transfer. The Temporary Register can be read when the DMA controller is not performing a DMA transfer. The register is cleared by a reset.</p> <p>Write: Master Disable Register.</p> <p>Writing any value to this port resets the DMA controller. This command has the same action as a hardware reset. The mask register is set (channel 0 to 3 disabled). The Command, Status, Request, Temporary, and the Byte flip-flop are all cleared.</p>

I/O Port: 0Eh
Register Name: Slave DMA Clear Mask/Mode register pointer Register
Reset Value: --

7 6 5 4 3 2 1 0

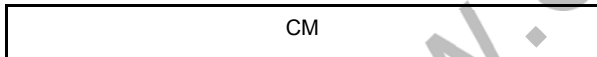

Write:

Bit	Name	Attribute	Description
7-0	CM	W	<p>Clear Mask Register.</p> <p>Writing any value to this port clears the mask register. Clearing the Mask Register will enable all four channels to accept DMA requests. This register is write-only.</p>

Read: (clear the pointer value: which point to "channel # mode register")

Bit	Name	Attribute	Description
7-0	CM	R	<p>Clear Mode and Counter Register.</p> <p>Read this port clears the Mode register Counter</p>

I/O Port: 0Fh
Register Name: Slave DMA Write Mask Register
Reset Value: 1111_0000b

7	6	5	4	3	2	1	0
RSVD				C3SM	C2SM	C1SM	C0SM

Bit	Name	Attribute	Description
7-4	RSVD	RO	Reserved.
3	C3SM	R/W	= 1: Channel 3 set mask bit = 0: Channel 3 clear mask bit
2	C2SM	R/W	= 1: Channel 2 set mask bit = 0: Channel 2 clear mask bit
1	C1SM	R/W	= 1: Channel 1 set mask bit = 0: Channel 1 clear mask bit
0	C0SM	R/W	= 1: Channel 0 set mask bit = 0: Channel 0 clear mask bit

11.3.3 DMA Pager Registers

I/O Port: 81h
Register Name: DMA Page Register – DMA Channel 2
Reset Value: --

7	6	5	4	3	2	1	0
DP2							

Bit	Name	Attribute	Description
7-0	DP2	W/R	This register holds the address bits A[23:16] to use for DMA transfers to memory for channel 2. The lower 16 bits of address are generated by the DMA controller. This allows DMA transfers in the first 16MB of memory.

Vortex86EX

32-Bit x86 Micro Processor

I/O Port: 82h
Register Name: DMA Page Register – DMA Channel 3
Reset Value: --

7 6 5 4 3 2 1 0

DP3

Bit	Name	Attribute	Description
7-0	DP3	W/R	This register holds the address bits A[23:16] to use for DMA transfers to memory for channel 3. The lower 16 bits of address are generated by the DMA controller. This allows DMA transfers in the first 16MB of memory.

I/O Port: 83h
Register Name: DMA Page Register – DMA Channel 1
Reset Value: --

7 6 5 4 3 2 1 0

DP1

Bit	Name	Attribute	Description
7-0	DP1	W/R	This register holds the address bits A[23:16] to use for DMA transfers to memory for channel 1. The lower 16 bits of address are generated by the DMA controller. This allows DMA transfers in the first 16MB of memory.

I/O Port: 87h
Register Name: DMA Page Register – DMA Channel 0
Reset Value: --

7 6 5 4 3 2 1 0

DP0

Bit	Name	Attribute	Description
7-0	DP0	W/R	This register holds the address bits A[23:16] to use for DMA transfers to memory for channel 0. The lower 16 bits of address are generated by the DMA controller. This allows DMA transfers in the first 16MB of memory.

Vortex86EX

32-Bit x86 Micro Processor

I/O Port: 89h
Register Name: DMA Page Register – DMA Channel 6
Reset Value: --

7 6 5 4 3 2 1 0

DP6	RDB
-----	-----

Bit	Name	Attribute	Description
7-1	DP6	W/R	This register holds the address bits A[23:17] to use for DMA transfers to memory for channel 6. The lower 16 bits of address A[16:1] are generated by the DMA controller. A[0] is forced to 0. This allows DMA transfers in the first 16MB of memory.
0	RDB	W/R	Redundant bit.

I/O Port: 8Ah
Register Name: DMA Page Register – DMA Channel 7
Reset Value: --

7 6 5 4 3 2 1 0

DP7	RDB
-----	-----

Bit	Name	Attribute	Description
7-1	DP7	W/R	This register holds the address bits A[23:17] to use for DMA transfers to memory for channel 7. The lower 16 bits of address A[16:1] are generated by the DMA controller, A[0] is forced to 0. This allows DMA transfers in the first 16MB of memory.
0	RDB	W/R	Redundant bit.

I/O Port: 8Bh
Register Name: DMA Page Register – DMA Channel 5
Reset Value: --

7 6 5 4 3 2 1 0

DP5	RDB
-----	-----

Bit	Name	Attribute	Description
7-1	DP5	W/R	This register holds the address bits A[23:17] to use for DMA transfers to memory for channel 5. The lower 16 bits of address A[16:1] are generated by the DMA controller, A[0] is forced to 0. This allows DMA transfers in the first 16MB of memory.
0	RDB	W/R	Redundant bit.

11.3.4 Master DMA Control Registers

I/O Port: C0h
Register Name: Master DMA Channel 4 Base/Current Address Register
Reset Value: --

7 6 5 4 3 2 1 0

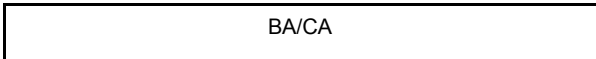

Bit	Name	Attribute	Description
7-0	BA/CA	R/W	DMA Channel 4 is used for a cascade function from slave DMA. Channel 4 is unavailable for other uses.

I/O Port: C2h
Register Name: Master DMA Channel 4 Base/Current Count Register
Reset Value: --

7 6 5 4 3 2 1 0

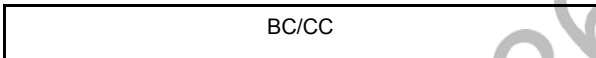

Bit	Name	Attribute	Description
7-0	BC/CC	R/W	DMA Channel 4 is used for a cascade function from slave DMA. Channel 4 is unavailable for other uses.

I/O Port: C4h
Register Name: Master DMA Channel 5 Base/Current Address Register
Reset Value: --

7 6 5 4 3 2 1 0

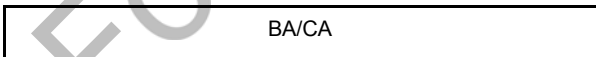

On AT and EISA systems, DMA channel 5 is an unassigned channel, used for high-speed transfers between memory and the I/O bus. On PS/2, channel 5 is used for hard disk DMA operations.

The definitions of bit[7:0] for Master DMA Channel 5 Base/Current Count are the same as those of bit[7:0] for Slave DMA Channel 0 Base/Current Count Register at I/O address 00h.

I/O Port: C6h
Register Name: Master DMA Channel 5 Base/Current Count Register
Reset Value: --

7 6 5 4 3 2 1 0

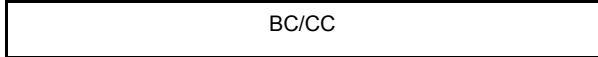

On AT and EISA systems, DMA channel 5 is an unassigned channel, used for high-speed transfers between memory and the I/O bus. On PS/2, channel 5 is used for hard disk DMA operations.

The definitions of bit[7:0] for Master DMA Channel 5 Base/Current Count are the same as those of bit[7:0] for Slave DMA Channel 0 Base/Current Count Register at I/O address 01h.

I/O Port: C8h
Register Name: Master DMA Channel 6 Base/Current Address Register
Reset Value: --

7 6 5 4 3 2 1 0

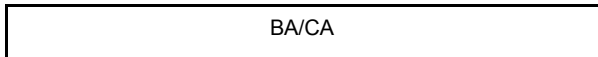

DMA Channel 6 is an unassigned channel, used for high-speed transfers between memory and the I/O bus. The definitions of bit[7:0] for Master DMA Channel 6 Base/Current Address are the same as those of bit[7:0] for Slave DMA Channel 0 Base/Current Address Register at I/O address 00h.

I/O Port: CAh
Register Name: Master DMA Channel 6 Base/Current Count Register
Reset Value: --

7 6 5 4 3 2 1 0



DMA Channel 6 is an unassigned channel, used for high-speed transfers between memory and the I/O bus. The definitions of bit[7:0] for Master DMA Channel 6 Base/Current Count are the same as those of bit[7:0] for Slave DMA Channel 0 Base/Current Count Register at I/O address 01h.

I/O Port: CCh
Register Name: Master DMA Channel 7 Base/Current Address Register
Reset Value: --

7 6 5 4 3 2 1 0

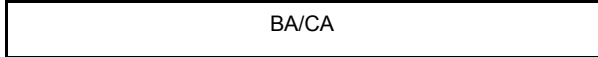

DMA Channel 7 is an unassigned channel, used for high-speed transfers between memory and the I/O bus. The definitions of bit[7:0] for Master DMA Channel 7 Base/Current Address are the same as those of bit[7:0] for Slave DMA Channel 0 Base/Current Address Register at I/O address 00h.

I/O Port: CEh
Register Name: Master DMA Channel 7 Base/Current Count Register
Reset Value: --

7 6 5 4 3 2 1 0

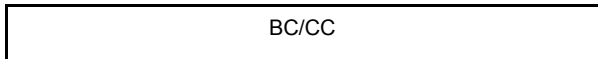

DMA Channel 7 is an unassigned channel, used for high-speed transfers between memory and the I/O bus. The definitions of bit[7:0] for Master DMA Channel 7 Base/Current Count are the same as those of bit[7:0] for Slave DMA Channel 0 Base/Current Count Register at I/O address 01h.

I/O Port: D0h
Register Name: Master DMA Command/Status Register
Reset Value: 00000010b/00x0x0x0

The DMA Status Register holds flag (bit 0-3) indicating when each channel has reached the Terminal Count (transfer completed). When this register is read, these lower four bits are cleared. The status register also contains flags for pending DMA requests on each of the four channels. DMA requests occur by associating the desired DMA channel request line.

READ: Status Register

7 6 5 4 3 2 1 0

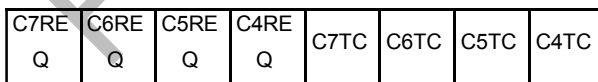

Bit	Name	Attribute	Description
7	C7REQ	R	= 1: DMA Channel 7 request
6	C6REQ	R	= 1: DMA Channel 6 request
5	C5REQ	R	= 1: DMA Channel 5 request
4	C4REQ	R	DMA Channel 4 used for cascade

3	C7TC	R	= 1: DMA Channel 7 has reached terminal count
2	C6TC	R	= 1: DMA Channel 6 has reached terminal count
1	C5TC	R	= 1: DMA Channel 5 has reached terminal count
0	C4TC	R	DMA Channel 4 used for cascade

Write: Command Register

This 8-bit register controls the operation of the DMA. The register is cleared by a hardware reset or a Master Disable instruction (port DAh). The command value used by PCs is 0. Normally all bits are left at 0, except bit 2 is typically set to 1 to disable the controller while writing to DMA registers. This register is write-only.

7	6	5	4	3	2	1	0
ACKSL	REQSL	WS	PRI	TIM	CTL	AH	MMT

Bit	Name	Attribute	Description
7	ACKSL	W	= 1: DACK sense active high = 0: DACK sense active low
6	REQSL	W	= 1: DREQ sense active low = 0: DREQ sense active high
5	WS	W	= 1: Extended write selection = 0: Late write selection = X: if bit 3 = 0
4	PRI	W	= 1: Rotating priority = 0: Fixed priority
3	TIM	W	= 1: Compressed timing = 0: Normal timing = X: if bit 1 = 0
2	CTL	W	= 1: Control disable = 0: Control enable
1	AH	W	= 1: Channel 4 address hold enable = 0: Channel 4 address hold disable = X: if bit 0 = 0
0	MMT	W	= 1: Memory-to-memory transfers enable = 0: Memory-to-memory transfers disable

In addition to initiating a request for DMA service by asserting a hardware request line, software can also initiate a DMA request. The Request Register is used to both set and clear any channel's soft request bit. The DMA controller does need to be in Block mode to use this function, as set in the Mode Register (port D6h). When reading the Request register, bits 4-7 will always read as ones, and bits 0-3 will display the request bits of channels 4-7 respectively

I/O Port: D2h
Register Name: Master DMA Command/Request Register
Reset Value: --

7	6	5	4	3	2	1	0
RSVD				SR	CS		

WRITE Command

Bit	Name	Attribute	Description
7-3	Rsvd	RO	Reserved.
2	SR	W	= 1: Set request bit = 0: Clear request bit
1-0	CS	W	= 00: Channel 4 select = 01: Channel 5 select = 10: Channel 6 select = 11: Channel 7 select

READ Request

Bit	Name	Attribute	Description
7-4	RSVD	RO	4'b1111
3	SDRQ7	RO	soft request register , channel 7
2	SDRQ6	RO	soft request register , channel 6
1	SDRQ5	RO	soft request register , channel 5
0	SDRQ4	RO	soft request register , channel 4

Vortex86EX

32-Bit x86 Micro Processor

The mask register is used to disable or enable individual incoming requests. Setting a mask bit on disables the selected channel. Hardware reset disables all channels by setting all mask bits.

I/O Port: D4h
Register Name: Master DMA Command/Single Mask Register
Reset Value: --

7	6	5	4	3	2	1	0
RSVD				SM	CS		

Bit	Name	Attribute	Description
7-3	RSVD	RO	Reserved.
2	SM	W	= 1: Set mask bit = 0: Clear mask bit
1-0	CS	W	= 00: Channel 4 select = 01: Channel 5 select = 10: Channel 6 select = 11: Channel 7 select

The Mode Register indicates the mode of operation for each of the four DMA channels 4 to 7. Each channel has a separate 6-bit mode register and each is loaded through the Mode Register port.

I/O Port: D6h
Register Name: Master DMA Mode Register
Reset Value: --

7	6	5	4	3	2	1	0
MT	AD/AI	ATI	TT		CS		

Bit	Name	Attribute	Description
7-6	MT	W	Mode Type Selection. = 00: Demand mode = 01: Single mode = 10: Block mode = 11: Cascade mode
5	AD/AI	W	= 1: Address decrement select = 0: Address increment select
4	ATI	W	= 1: Autoinitialization enable = 0: Autoinitialization disable
3-2	TT	W	Transfer Type. = 00: Verify operation = 01: Write operation = 10: Read operation

Vortex86EX

32-Bit x86 Micro Processor

Bit	Name	Attribute	Description
			= 11: not valid = xx: if they are in cascade mode (bits 6 & 7)
1-0	CS	W	Channel Selection. = 00: Channel 4 select = 01: Channel 5 select = 10: Channel 6 select = 11: Channel 7 select

I/O Port: D8h
Register Name: Master DMA Set/Clear First/Last Clear F/F Register
Reset Value: --

7 6 5 4 3 2 1 0

CFF

Bit	Name	Attribute	Description
7-0	CFF	W	Any value to this port causes the internal First/Last flip-flop to be cleared in DMA controller 1. This is done before any 8-bit reads or writes to 16-bit registers that require two successive 8-bit port accesses to complete the word transfer. After the flip-flop is cleared, a 16-bit DMA register is accessed by reading or writing the low byte followed by the high byte. The flip-flop can only be cleared, and is not readable.

I/O Port: DAh
Register Name: Master DMA Temporary/Master Disable Register
Reset Value: --

7 6 5 4 3 2 1 0

TP/MD

Bit	Name	Attribute	Description
7-0	TP/MD	R/W	<p>Read: Temporary Register.</p> <p>The Temporary Register holds data during memory-to-memory data transfers. After the transfer is complete, the Temporary Register holds the last data transfer. The Temporary Register can be read when the DMA controller is not performing a DMA transfer. The register is cleared by a reset.</p> <p>Write: Master Disable Register.</p> <p>Writing any value to this port resets master DMA control. This command has the same action as a hardware reset. The mask register is set (channel 4 to 7</p>

Vortex86EX

32-Bit x86 Micro Processor

			disabled). The Command, Status, Request, Temporary, and the Byte flip-flop are all cleared.
--	--	--	---

I/O Port: DCh
Register Name: Master DMA Clear Mask/Mode register pointer Register
Reset Value: --

7 6 5 4 3 2 1 0

CM

WRITE:

Bit	Name	Attribute	Description
7-0	CM	W	<i>Clear Mask Register.</i> Writing any value to this port clears the mask register. Clearing the Mask Register will enable all four channels to accept DMA requests. This register is write-only.

READ: (clear the pointer value: which point to "channel # mode register")

Bit	Name	Attribute	Description
7-0	CM	R	<i>Clear Mode and Counter Register</i> Read this port clears the Mode register Counter

The mask register is used to disable or enable individual incoming requests. Setting a mask bit on disables the selected channel. A hardware reset disables all channels by setting all mask bits.

I/O Port: DEh
Register Name: Master DMA Write Mask Register
Reset Value: xxxx_0000b

7 6 5 4 3 2 1 0

RSVD	C7SM	C6SM	C5SM	C4SM
------	------	------	------	------

Bit	Name	Attribute	Description
7-4	RSVD	RO	<i>Reserved.</i>
3	C7SM	W	= 1: Channel 7 sets mask bit = 0: Channel 7 clears mask bit
2	C6SM	W	= 1: Channel 6 sets mask bit = 0: Channel 6 clears mask bit
1	C5SM	W	= 1: Channel 5 sets mask bit = 0: Channel 5 clears mask bit
0	C4SM	W	= 1: Channel 4 sets mask bit = 0: Channel 4 clears mask bit

11.3.5 DMA High Page Registers

I/O Port: 481h
Register Name: DMA High Page Register – DMA Channel 2
Reset Value: 00h

7 6 5 4 3 2 1 0

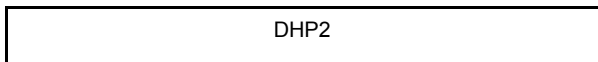

Bit	Name	Attribute	Description
7-0	DHP2	W/R	This register holds the address bits A[31:24] to use for DMA transfers for channel 2. Always write this register after the base and low page registers are written. A write to this channel's base address register or a write to the low page register at port 81h automatically clears this register. This ensures compatibility with DMA on AT system.

I/O Port: 482h
Register Name: DMA High Page Register – DMA Channel 3
Reset Value: 00h

7 6 5 4 3 2 1 0

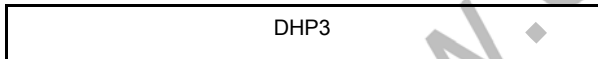

Bit	Name	Attribute	Description
7-0	DHP3	W/R	This register holds the upper 8 bits of the 32-bit address for channel 3. See port 481h for details.

I/O Port: 483h
Register Name: DMA High Page Register – DMA Channel 1
Reset Value: 00h

7 6 5 4 3 2 1 0

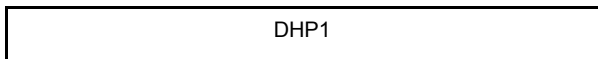

Bit	Name	Attribute	Description
7-0	DHP1	W/R	This register holds the upper 8 bits of the 32-bit address for channel 1. See port 481h for details.

Vortex86EX

32-Bit x86 Micro Processor

I/O Port: 487h
Register Name: DMA High Page Register – DMA Channel 0
Reset Value: 00h

7 6 5 4 3 2 1 0



Bit	Name	Attribute	Description
7-0	DHP0	W/R	This register holds the upper 8 bits of the 32-bit address for channel 0. See port 481h for details.

I/O Port: 489h
Register Name: DMA High Page Register – DMA Channel 6
Reset Value: 00h

7 6 5 4 3 2 1 0

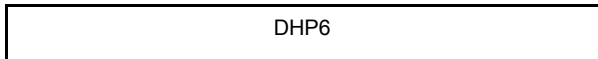

Bit	Name	Attribute	Description
7-0	DHP6	W/R	This register holds the upper 8 bits of the 32-bit address for channel 6. See port 481h for details.

I/O Port: 48Ah
Register Name: DMA High Page Register – DMA Channel 7
Reset Value: 00h

7 6 5 4 3 2 1 0



Bit	Name	Attribute	Description
7-0	DHP7	W/R	This register holds the upper 8 bits of the 32-bit address for channel 7. See port 481h for details.

I/O Port: 48Bh
Register Name: DMA High Page Register – DMA Channel 5
Reset Value: 00h

7 6 5 4 3 2 1 0



Bit	Name	Attribute	Description
7-0	DHP5	W/R	This register holds the upper 8 bits of the 32-bit address for channel 5. See port 481h for details.

11.3.6 Timer / Counter Registers

I/O Port: 40h
Register Name: Timer/Counter 0 Count Register
Reset Value: --

7 6 5 4 3 2 1 0

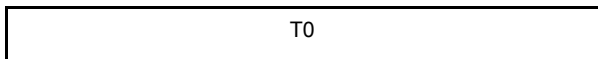

Bit	Name	Attribute	Description
7-0	T0	R/W	Timer 0 is used for system clocking. It is normally programmed for mode 3, periodic square wave operation. The Count is loaded with 0 to generate a pulse 18.2 times per second.

I/O Port: 41h
Register Name: Timer/Counter 1 Count Register
Reset Value: --

7 6 5 4 3 2 1 0

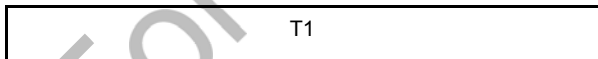

Bit	Name	Attribute	Description
7-0	T1	R/W	Timer 1 is used for DRAM refresh. It is normally programmed for mode 2, rate generator operation. The count is loaded with 12h to generate a pulse every 15 us.

Vortex86EX

32-Bit x86 Micro Processor

I/O Port: 42h
Register Name: Timer/Counter 2 Count Register
Reset Value: --

7 6 5 4 3 2 1 0

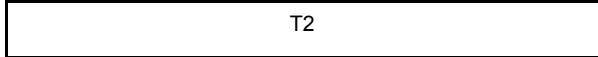

Bit	Name	Attribute	Description
7-0	T2	R/W	Timer 2 is used for speaker operations and general purpose.

All the three timers are controlled by the modes set through this register.

I/O Port: 43h
Register Name: Timer/Counter Control Register
Reset Value: --

7 6 5 4 3 2 1 0

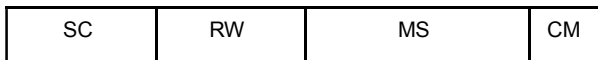

Bit	Name	Attribute	Description
7-6	SC	W	Select Counter. 00b: Select Counter 0 01b: Select Counter 1 10b: Select Counter 2 11b: Read-Back Command

Control Word Command: (Select Counter = 00b, 01b, 10b)

Bit	Name	Attribute	Description
5-4	RW	W	Read/Write. 00b: Counter Latch Command 01b: Read/Write least significant byte only 10b: Read/Write most significant byte only 11b: Read/Write least significant byte first, then most significant byte
3-1	MS	W	000b: Mode 0 001b: Mode 1 010b: Mode 2 011b: Mode 3 100b: Mode 4 101b: Mode 5 110b: Mode 2 111b: Mode 3

Vortex86EX

32-Bit x86 Micro Processor

Bit	Name	Attribute	Description
0	CM	W	0b: Binary Counter mode (16-bit) 1b: BCD Counter mode (4 Binary Coded Decimal digits)

Counter Latch Command

SC1, SC0 – Specify counter to be latched

RW0, RW1 – 00 designates Counter Latch Command

D7	D6	D5	D4	D3	D2	D1	D0
SC1	SC0	0	0	X	X	X	X

SC1	SC0	Counter
0	0	0
0	1	1
1	0	2
1	1	Read-Back Command

Read-back command: (Select Counter = 11b)

Bit	Name	Attribute	Description
5-4	command	W	Select command. 00b: Read-back status of selected counter(s) first, then count of selected counter(s) 01b: Read-back count of selected counter(s) 10b: Read-back status of selected counter(s) 11b: X
3-1	counter	W	Select counter. 001b: Select counter 1 001b: X 010b: Select counter 2 011b: X 100b: Select counter 3 101b: X 110b: X 111b: X
0	RSVD	W	Must be 0

11.3.7 Indirect Access Registers

Indirect access registers for Watch-dog timer, GPIO PORT 0,1

Index port is for I/O port 22h

Index port 13h (00: lock register, C5h: unlock register) for lock/unlock function

Index port 37h, 39h, 3Ah, 3Bh, 3Ch for Watchdog timer

Index port 46h, 47h, 4Ch, 4Dh, 4Eh, 4Fh for GPIO port 0, 1

I/O Port: 22h
Register Name: Address Index Register
Reset Value: --

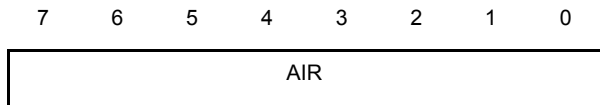

Bit	Name	Attribute	Description
7-0	AIR	R/W	Register address selection

I/O Port: 23h
Register Name: Data Register
Reset Value: --

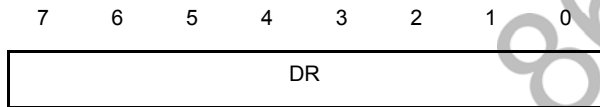

Bit	Name	Attribute	Description
7-0	DR	R/W	Data access from AIR pointed address

11.3.8 Indirect Access Registers for WDT0

Index Port (22h) = 37h, Data Port (23h) definition, Default Value 40h

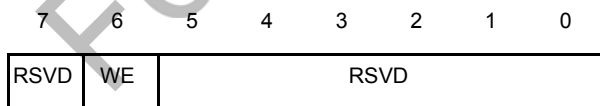

Bit	Name	Attribute	Description
7	RSVD	RO	Reserved.
6	WE	R/W	WDT0 Enable Control (Write bit6=1 to reload WDT0 counter) 0: Disable WDT0 1: Enable WDT0 (default)
5-0	RSVD	RO	Reserved.

Index Port (22h) = 38h, Data Port (23h) definition, Default Value D0h

7 6 5 4 3 2 1 0

SSEL	RSVD
------	------

Bit	Name	Attribute	Description	
7-4	SSEL	RW	Signal Select after WDT0 timeout	
			B[7-4]	Signal
			0000	Reserved
			0001	IRQ[3]
			0010	IRQ[4]
			0011	IRQ[5]
			0100	IRQ[6]
			0101	IRQ[7]
			0110	IRQ[9]
			0111	IRQ[10]
			1000	IRQ[11]
			1001	IRQ[12]
			1010	IRQ[14]
			1011	IRQ[15]
			1100	NMI
			1101	System Reset (default)
1110	Reserved			
1111	Reserved			
3-0	RSVD	RO	Reserved.	

Index Port (22h) = 39h, Data Port (23h) definition, Default Value 00h

7 6 5 4 3 2 1 0

CNT0

Bit	Name	Attribute	Description
7-0	CNT0	RW	WDT0 Counter 0. WDT0 counter [7-0]. Resolution is 30.5us

Vortex86EX

32-Bit x86 Micro Processor

Index Port (22h) = 3Ah, Data Port (23h) definition, Default Value 00h

7 6 5 4 3 2 1 0

CNT1

Bit	Name	Attribute	Description
7-0	CNT1	RW	WDT0 Counter 1. WDT0 counter [15-8]. Resolution is 30.5us

Index Port (22h) = 3Bh, Data Port (23h) definition, Default Value 20h

7 6 5 4 3 2 1 0

CNT2

Bit	Name	Attribute	Description
7-0	CNT2	RW	WDT0 Counter 2. WDT0 counter [23-16]. Resolution is 30.5us

Index Port (22h) = 3Ch, Data Port (23h) definition, Default Value 00h

7 6 5 4 3 2 1 0

WDTF	WDTRL	RSVD
------	-------	------

Bit	Name	Attribute	Description
7	WDTF	RWC	WDT Flag. 0: WDT0 timeout event does not happen 1: WDT0 timeout event happens (write 1 to clear this flag)
6	WDTRL	W	Write this bit=1 to reload WDT0 internal counter. The write this bit = 0 and read data is invalid.
5-0	RSVD	RO	Reserved.

11.3.9 Indirect Access Registers for GPIO P0/P1

Index Port (22h) = 46h, Data Port (23h) definition, Default Value FF

7 6 5 4 3 2 1 0

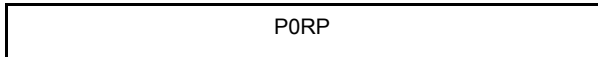

Bit	Name	Attribute	Description
7-0	P0RP	RD	GPIO Port 0 Read Port [7-0].

Index Port (22h) = 47h, Data Port (23h) definition, Default Value FFh

7 6 5 4 3 2 1 0

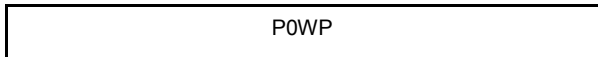

Bit	Name	Attribute	Description
7-0	P0WP	R/W	GPIO Port 0 Write Port [7-0].

Index Port (22h) = 4Ch, Data Port (23h) definition, Default Value FF

7 6 5 4 3 2 1 0

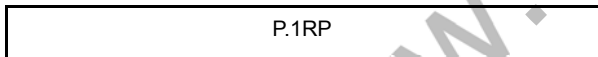

Bit	Name	Attribute	Description
7-0	P1RP	RD	GPIO Port 1 Read Port [7-0].

Index Port (22h) = 4Dh, Data Port (23h) definition, Default Value FFh

7 6 5 4 3 2 1 0

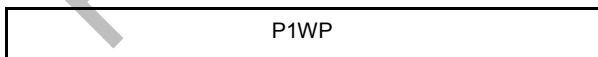

Bit	Name	Attribute	Description
7-0	P1WP	R/W	GPIO Port 1 Write Port [7-0].

Index Port (22h) = 4Eh, Data Port (23h) definition, Default Value 00h

7 6 5 4 3 2 1 0

P0DIR

Bit	Name	Attribute	Description
7-0	P0DIR	R/W	<i>GPIO Port 0 Direction.</i> 0: GPIO pin is input mode 1: GPIO pin is output mode

Index Port (22h) = 4Fh, Data Port (23h) definition, Default Value 00h

7 6 5 4 3 2 1 0

P1DIR

Bit	Name	Attribute	Description
7-0	P1DIR	R/W	<i>GPIO Port 1 Direction.</i> 0: GPIO pin is input mode 1: GPIO pin is output mode

11.3.10 Indirect Access Registers for Lock / Unlock

Index Port (22h) = 13h, Data Port (23h) = C5h; Unlock function, Port 22h/23h for GPIO/WDT0 works

Index Port (22h) = 13h, Data Port (23h) = 00h ; Lock GPIO/WDT0 function

11.3.11 Master Interrupt Control Registers

I/O Port: 20h

Register Name: Master Interrupt Request/Interrupt Service/Interrupt Command Register

Reset Value: --

7 6 5 4 3 2 1 0

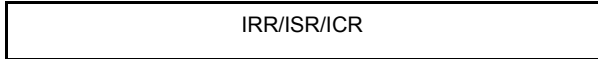

Bit	Name	Attribute	Description
7-0	IRR/ISR/ICR	R/W	<p>Read: Interrupt Request/Interrupt Service Register.</p> <p>This function reads the contents of the Interrupt Request Register (IRR) or the Interrupt Service Register (ISR). You specify which register to read by sending a command to port 20h. A command value of 0Ah selects IRR, and value 0Bh selects ISR. Once a command is sent, multiple reads can be made to get the contents of the same register. It is not necessary to resend the register selection command.</p> <p>Write: Interrupt Command Register.</p> <p>This controls initialization and operation of the interrupt controller for interrupt request line 0 to 7.</p>

The interrupt mask register indicates which interrupt requests are allowed (value 0) and disabled (value 1).

I/O Port: 21h

Register Name: Master Interrupt Mask Register

Reset Value: --

7 6 5 4 3 2 1 0

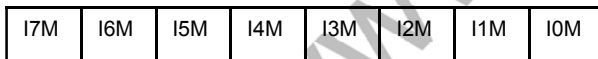

Bit	Name	Attribute	Description
7	I7M	R/W	= 0: IRQ 7 Enabled = 1: IRQ 7 Disabled
6	I6M	R/W	= 0: IRQ 6 Enabled = 1: IRQ 6 Disabled
5	I5M	R/W	= 0: IRQ 5 Enabled = 1: IRQ 5 Disabled
4	I4M	R/W	= 0: IRQ 4 Enabled = 1: IRQ 4 Disabled
3	I3M	R/W	= 0: IRQ 3 Enabled = 1: IRQ 3 Disabled
2	I2M	R/W	= 0: IRQ 2 Enabled = 1: IRQ 2 Disabled

Bit	Name	Attribute	Description
1	I1M	R/W	= 0: IRQ 1 Enabled = 1: IRQ 1 Disabled
0	I0M	R/W	= 0: IRQ 0 Enabled = 1: IRQ 0 Disabled

11.3.12 Slave Interrupt Control Registers

I/O Port: A0h

Register Name: Slave Interrupt Request/Interrupt Service/Interrupt Command Register

Reset Value: --

7 6 5 4 3 2 1 0

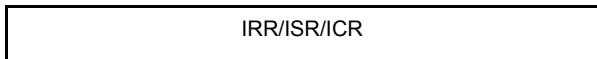

Bit	Name	Attribute	Description
7-0	IRR/ISR/ICR	R/W	<p>Read: Interrupt Request/Interrupt Service Register.</p> <p>This function reads the contents of the Interrupt Request Register (IRR) or the Interrupt Service Register (ISR). You specify which register to read by sending a command to port A0h. A command value of 0Ah selects IRR, and value 0Bh selects ISR. Once a command is sent, multiple reads can be made to get the contents of the same register. It is not necessary to resend the register selection command.</p> <p>Write: Interrupt Command Register.</p> <p>This controls initialization and operation of the interrupt controller for interrupt request line 8 to 15.</p>

The interrupt mask register indicates which interrupt requests are allowed (value 0) and which are disabled (value 1).

I/O Port: A1h

Register Name: Slave Interrupt Mask Register

Reset Value: --

7 6 5 4 3 2 1 0

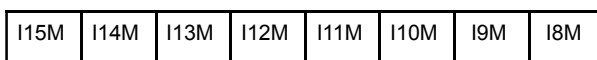

Bit	Name	Attribute	Description
7	I15M	R/W	= 0: IRQ 15 Enabled = 1: IRQ 15 Disabled
6	I14M	R/W	= 0: IRQ 14 Enabled

Bit	Name	Attribute	Description
			= 1: IRQ 14 Disabled
5	I13M	R/W	= 0: IRQ 13 Enabled = 1: IRQ 13 Disabled
4	I12M	R/W	= 0: IRQ 12 Enabled = 1: IRQ 12 Disabled
3	I11M	R/W	= 0: IRQ 11 Enabled = 1: IRQ 11 Disabled
2	I10M	R/W	= 0: IRQ 10 Enabled = 1: IRQ 10 Disabled
1	I9M	R/W	= 0: IRQ 9 Enabled = 1: IRQ 9 Disabled
0	I8M	R/W	= 0: IRQ 8 Enabled = 1: IRQ 8 Disabled

11.3.13 Interrupt Edge / Level Control Registers

This register controls the triggering type for each IRQ line. Clear the bit to program edge sensitive. Set the bit to program level sensitive mode. Before writing this register, read the contents first. Do not change the state of IRQ 0, 1 and 2 bits, as these are set by the motherboard manufacturer's BIOS to reflect the specific board design.

I/O Port: 4D0h
Register Name: Master Interrupt Edge/Level Control Register
Reset Value: 00h

7 6 5 4 3 2 1 0

IR7TM	IR6TM	IR5TM	IR4TM	IR3TM	IR2TM	IR1TM	IR0TM
-------	-------	-------	-------	-------	-------	-------	-------

Bit	Name	Attribute	Description
7	IR7TM	R/W	IRQ[7] Edge/Level Triggered Mode 0: Edge Triggered Mode 1: Level Triggered Mode
6	IR6TM	R/W	IRQ[6] Edge/Level Triggered Mode 0: Edge Triggered Mode 1: Level Triggered Mode
5	IR5TM	R/W	IRQ[5] Edge/Level Triggered Mode 0: Edge Triggered Mode 1: Level Triggered Mode
4	IR4TM	R/W	IRQ[4] Edge/Level Triggered Mode 0: Edge Triggered Mode

Vortex86EX

32-Bit x86 Micro Processor

Bit	Name	Attribute	Description
			1: Level Triggered Mode
3	IR3TM	R/W	IRQ[3] Edge/Level Triggered Mode 0: Edge Triggered Mode 1: Level Triggered Mode
2	IR2TM	RO	IRQ2 Triggered Mode (do not change it)
1	IR1TM	RO	IRQ1 Triggered Mode (do not change it)
0	IR0TM	RO	IRQ0 Triggered Mode (do not change it)

This register controls the triggering type for each IRQ line. Clear the bit to program edge sensitive. Set the bit to program level sensitive mode. Before writing this register, read the contents first. Do not change the state of IRQ 8 and IRQ 13, as these are set by the motherboard manufacturer's BIOS to reflect the specific board design.

I/O Port: 4D1h
Register Name: Slave Interrupt Edge/Level Control Register
Reset Value: 00h

7 6 5 4 3 2 1 0

IR15T	IR14T	IR13T	IR12T	IR11T	IR10T	IR9TM	IR8TM
M	M	M	M	M	M		

Bit	Name	Attribute	Description
7	IR15TM	R/W	<i>IRQ[15] Edge/Level Triggered Mode.</i> 0: Edge Triggered Mode 1: Level Triggered Mode
6	IR14TM	R/W	<i>IRQ[14] Edge/Level Triggered Mode.</i> 0: Edge Triggered Mode 1: Level Triggered Mode
5	IR13TM	RO	<i>IRQ13 Triggered Mode.</i> (do not change)
4	IR12TM	R/W	<i>IRQ[12] Edge/Level Triggered Mode.</i> 0: Edge Triggered Mode 1: Level Triggered Mode
3	IR11TM	R/W	<i>IRQ[11] Edge/Level Triggered Mode.</i> 0: Edge Triggered Mode 1: Level Triggered Mode
2	IR10TM	R/W	<i>IRQ[10] Edge/Level Triggered Mode.</i> 0: Edge Triggered Mode 1: Level Triggered Mode
1	IR9TM	R/W	<i>IRQ[9] Edge/Level Triggered Mode.</i> 0: Edge Triggered Mode 1: Level Triggered Mode

Bit	Name	Attribute	Description
0	IR8TM	RO	IRQ8 Triggered Mode. (do not change it)

11.3.14 Keyboard / Mouse Control Registers

Internal decode port 60h/64h when SB PCI CFG register C0h bit4=0

I/O Port: 60h
Register Name: Output Buffer Register
Reset Value: --

7 6 5 4 3 2 1 0

OBR

Bit	Name	Attribute	Description
7-0	OBR	R/W	Output Buffer Register.

I/O Port: 64h
Register Name: Input Buffer/Status/Command Register
Reset Value: --

7 6 5 4 3 2 1 0

IBSCR

Bit	Name	Attribute	Description
7-0	IBSCR	R/W	Status and command of the keyboard controller

11.3.15 Serial Port Registers

UART Config Registers

(Base Address Refers to the Register of index 61h-60h, SB Function0 PCI Configuration Register)

Register Offset: BA + 00h
Register Name: Internal UART 1 Control Register
Reset Value: 00000000h

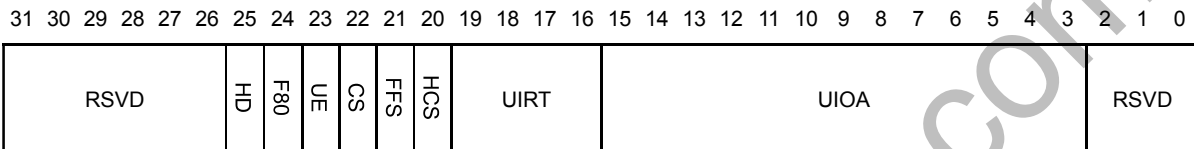

Bit	Name	Attribute	Description
31-25	RSVD	RO	Reserved.
25	HD	R/W	Half-duplex mode (using SOUT for TX & RX). 0: Disabled (default) 1: Enabled
24	F80	R/W	Forward port 80h to UART1 data port when this bit set.
23	UE	R/W	Enable/Disable Internal UART IO Address Decode 0: Disabled (default) 1: Enabled
22	CS	R/W	UART Clock Selection. When SB Fun0 C0h bit31(SBCLK)=0, 0: 24MHz/13 (default), 1: 24MHz When SB Fun0 C0h bit31(SBCLK)=1, 0: 48MHz/26 (default), 1: 48MHz
21	FFS	R/W	FIFO size Select. 1: 32 bytes FIFO 0: 16 bytes FIFO(default)
20	HCS	R/W	High Speed UART Clock Ratio Selection , when SB C0h bit31(SBCLK)=1 and CS=1 0: 1/16 (default) 1: 1/8
19-16	UIRT	R/W	UART IRQ Routing Table. Bit19 Bit18 Bit17 Bit16 Routing Table 0 0 0 0 Disable. (default) 0 0 0 1 IRQ[9] 0 0 1 0 IRQ[3] 0 0 1 1 IRQ[10] 0 1 0 0 IRQ[4] 0 1 0 1 IRQ[5]

Vortex86EX

32-Bit x86 Micro Processor

Bit	Name	Attribute	Description
			0 1 1 0 IRQ[7] 0 1 1 1 IRQ[6] 1 0 0 0 IRQ[1] 1 0 0 1 IRQ[11] 1 0 1 0 Reserved 1 0 1 1 IRQ[12] 1 1 0 0 Reserved 1 1 0 1 IRQ[14] 1 1 1 0 Reserved 1 1 1 1 IRQ[15] These four bits are used to route UART IRQ to any 8259 Interrupt lines. The BIOS should be used to inhibit the setting of the reserved value.
15-3	UIOA	R/W	Internal UART IO Address. The Bit[15:3] contain the base IO address A[15:3] of internal UART.
2-0	RSVD	RO	Reserved. All are '0's. To write any value to these bits causes no effect.

Register Offset: BA + 04h, 08h, 0Ch, 10h, 14h, 18h, 1Ch, 20h, 24h

Register Name: Internal UART 2,3,4,5,6,7,8,9,10 Control Register

Reset Value: 00000000h

31 30 29 28 27 26 25 24 23 22 21 20 19 18 17 16 15 14 13 12 11 10 9 8 7 6 5 4 3 2 1 0

RSVD	HD	RSVD	UE	CS	FFS	HCS	UIRT	UIOA	RSVD
------	----	------	----	----	-----	-----	------	------	------

Bit	Name	Attribute	Description
31-26	RSVD	RO	Reserved.
25	HD	R/W	Half-duplex mode (using SOUT for TX & RX) 0: Disabled (default) 1: Enabled
24	RSVD	RO	Reserved.
23	UE	R/W	Enable/Disable Internal UART IO Address Decode. 0: Disabled (default) 1: Enabled
22	CS	R/W	UART Clock Selection. When SB Fun0 C0h bit31(SBCLK)=0, 0: 24MHz/13 (default), 1: 24MHz When SB Fun0 C0h bit31(SBCLK)=1, 0: 48MHz/26 (default), 1: 48MHz
21	FFS	R/W	FIFO size Select. 1: 32 bytes FIFO 0: 16 bytes FIFO(default)

Vortex86EX

32-Bit x86 Micro Processor

Bit	Name	Attribute	Description																																																																																
20	HCS	RW	High Speed UART Clock Ratio Selection , when SB C0h bit31(SBCLK)=1 and CS=1 0: 1/16 (default) 1: 1/8																																																																																
19-16	UIRT	RW	<p>UART IRQ Routing Table.</p> <p>Bit19 Bit18 Bit17 Bit16 Routing Table</p> <table style="width: 100%; border-collapse: collapse;"> <tr> <td style="text-align: center;">0</td> <td style="text-align: center;">0</td> <td style="text-align: center;">0</td> <td style="text-align: center;">0</td> <td>Disable. (default)</td> </tr> <tr> <td style="text-align: center;">0</td> <td style="text-align: center;">0</td> <td style="text-align: center;">0</td> <td style="text-align: center;">1</td> <td>IRQ[9]</td> </tr> <tr> <td style="text-align: center;">0</td> <td style="text-align: center;">0</td> <td style="text-align: center;">1</td> <td style="text-align: center;">0</td> <td>IRQ[3]</td> </tr> <tr> <td style="text-align: center;">0</td> <td style="text-align: center;">0</td> <td style="text-align: center;">1</td> <td style="text-align: center;">1</td> <td>IRQ[10]</td> </tr> <tr> <td style="text-align: center;">0</td> <td style="text-align: center;">1</td> <td style="text-align: center;">0</td> <td style="text-align: center;">0</td> <td>IRQ[4]</td> </tr> <tr> <td style="text-align: center;">0</td> <td style="text-align: center;">1</td> <td style="text-align: center;">0</td> <td style="text-align: center;">1</td> <td>IRQ[5]</td> </tr> <tr> <td style="text-align: center;">0</td> <td style="text-align: center;">1</td> <td style="text-align: center;">1</td> <td style="text-align: center;">0</td> <td>IRQ[7]</td> </tr> <tr> <td style="text-align: center;">0</td> <td style="text-align: center;">1</td> <td style="text-align: center;">1</td> <td style="text-align: center;">1</td> <td>IRQ[6]</td> </tr> <tr> <td style="text-align: center;">1</td> <td style="text-align: center;">0</td> <td style="text-align: center;">0</td> <td style="text-align: center;">0</td> <td>IRQ[1]</td> </tr> <tr> <td style="text-align: center;">1</td> <td style="text-align: center;">0</td> <td style="text-align: center;">0</td> <td style="text-align: center;">1</td> <td>IRQ[11]</td> </tr> <tr> <td style="text-align: center;">1</td> <td style="text-align: center;">0</td> <td style="text-align: center;">1</td> <td style="text-align: center;">0</td> <td>Reserved</td> </tr> <tr> <td style="text-align: center;">1</td> <td style="text-align: center;">0</td> <td style="text-align: center;">1</td> <td style="text-align: center;">1</td> <td>IRQ[12]</td> </tr> <tr> <td style="text-align: center;">1</td> <td style="text-align: center;">1</td> <td style="text-align: center;">0</td> <td style="text-align: center;">0</td> <td>Reserved</td> </tr> <tr> <td style="text-align: center;">1</td> <td style="text-align: center;">1</td> <td style="text-align: center;">0</td> <td style="text-align: center;">1</td> <td>IRQ[14]</td> </tr> <tr> <td style="text-align: center;">1</td> <td style="text-align: center;">1</td> <td style="text-align: center;">1</td> <td style="text-align: center;">0</td> <td>Reserved</td> </tr> <tr> <td style="text-align: center;">1</td> <td style="text-align: center;">1</td> <td style="text-align: center;">1</td> <td style="text-align: center;">1</td> <td>IRQ[15]</td> </tr> </table> <p>These four bits are used to route UART IRQ to any 8259 Interrupt lines. The BIOS should be used to inhibit the setting of the reserved value.</p>	0	0	0	0	Disable. (default)	0	0	0	1	IRQ[9]	0	0	1	0	IRQ[3]	0	0	1	1	IRQ[10]	0	1	0	0	IRQ[4]	0	1	0	1	IRQ[5]	0	1	1	0	IRQ[7]	0	1	1	1	IRQ[6]	1	0	0	0	IRQ[1]	1	0	0	1	IRQ[11]	1	0	1	0	Reserved	1	0	1	1	IRQ[12]	1	1	0	0	Reserved	1	1	0	1	IRQ[14]	1	1	1	0	Reserved	1	1	1	1	IRQ[15]
0	0	0	0	Disable. (default)																																																																															
0	0	0	1	IRQ[9]																																																																															
0	0	1	0	IRQ[3]																																																																															
0	0	1	1	IRQ[10]																																																																															
0	1	0	0	IRQ[4]																																																																															
0	1	0	1	IRQ[5]																																																																															
0	1	1	0	IRQ[7]																																																																															
0	1	1	1	IRQ[6]																																																																															
1	0	0	0	IRQ[1]																																																																															
1	0	0	1	IRQ[11]																																																																															
1	0	1	0	Reserved																																																																															
1	0	1	1	IRQ[12]																																																																															
1	1	0	0	Reserved																																																																															
1	1	0	1	IRQ[14]																																																																															
1	1	1	0	Reserved																																																																															
1	1	1	1	IRQ[15]																																																																															
15-3	UIOA	RW	Internal UART IO Address. The Bit[15:3] contain the base IO address A[15:3] of internal UART.																																																																																
2-0	Rsvd	RO	Reserved. All are '0's. To write any value to these bits causes no effect.																																																																																

Serial Port Registers

The system programmer may access any of the UART registers. These registers control UART operations including transmission and reception of data.

- (UART1 Base Address Refers to UART Config Register Offset 00h)
- (UART2 Base Address Refers to UART Config Register Offset 04h)
- (UART3 Base Address Refers to UART Config Register Offset 08h)
- (UART4 Base Address Refers to UART Config Register Offset 0Ch)
- (UART5 Base Address Refers to UART Config Register Offset 10h)
- (UART6 Base Address Refers to UART Config Register Offset 14h)
- (UART7 Base Address Refers to UART Config Register Offset 18h)
- (UART8 Base Address Refers to UART Config Register Offset 1Ch)
- (UART9 Base Address Refers to UART Config Register Offset 20h)
- (UART10 Base Address Refers to UART Config Register Offset 24h)

An output to this register stores a byte into the UART's transmit holding buffer. An input gets a byte from the receive buffer of the UART. These are two separate registers within the UART. To access this register, the Divisor Latch Access Bit (DLAB) must be zero. DLAB is bit 7 in the line control register 3.

I/O Port: Base Address + 0h
Register Name: Transmit/Receive Data Buffer (DLAB=0)
Reset Value: --



Bit	Name	Attribute	Description
7-0	TD/RD	R/W	Read: This register holds the received incoming data byte. Write: This register contains the data byte to be transmitted.

Vortex86EX

32-Bit x86 Micro Processor

The UART contains a programmable baud generator that is capable of taking any clock input from DC to 24 MHz and dividing it by any divisor from 2 to $2^{16}-1$. The output frequency of the baud generator is 16 X the baud [divisor # = (frequency input) / (baud rate X 16)]. Two 8-bit latches store the divisor in a 16-bit binary format. These divisor latches must be loaded during initialization to ensure proper operation of the baud generator. Upon loading either of the divisor latches, a 16-bit baud counter is immediately loaded. The Table listed below provides decimal divisors to use with crystal frequencies of 1.8432 MHz and 24 MHz, respectively. For baud rates of 38400 and below, the error obtained is minimal. The accuracy of the desired baud rate is dependent on the crystal frequency chosen. Using a divisor of zero is not recommended.

I/O Port: Base Address + 0h
Register Name: LSB of Baud Rate Generator Divisor Latches (DLAB=1)
Reset Value: 01h



Bit	Name	Attribute	Description
7-0	LBR	R/W	This register contains the LSB (Least Significant Byte) of divisor latches.

TABLE Baud Rates, Divisors and 1.8432MHzCrystals

Baud Rate	Decimal Divisor for 16 X Clock	Percent Error
50	2304	-
75	1536	-
110	1047	0.026
134.5	857	0.058
150	768	-
300	384	-
600	192	-
1200	96	-
1800	64	-
2000	58	0.69
2400	48	-
3600	32	-
4800	24	-
7200	16	-
9600	12	-
19200	6	-
38400	3	-
57600	2	2.68
115200	1	-

TABLE Baud Rates, Divisors and 24MHzCrystals

Decimal Divisor for 16 X Clock	Baud Rate	Percent Error
1	Not Support	
2	750000	
3	500000	
4	375000	
5	300000	
6	250000	
7	214285	
8	187500	
9	166666	
10	150000	
11	136363	
12	125000	
13	115384	
14	107142	

TABLE Baud Rates, Divisors and 48MHzCrystals

Decimal Divisor for 16 X Clock	Baud Rate	Percent Error
1	3,000,000	
2	1,500,000	
3	1,000,000	
4	750,000	
5	600,000	
6	500,000	
7	428,571	
8	375,000	
9	333,333	
10	300,000	
11	272,727	
12	250,000	
13	230,769	
14	214,286	

Vortex86EX

32-Bit x86 Micro Processor

Decimal Divisor for 16 X Clock	Baud Rate	Percent Error
15	200,000	
16	187,500	
17	176,471	
18	166,667	
19	157,895	
20	150,000	
...	...	
65,536	46	

TABLE Baud Rates, Divisors and 48MHzCrystals

Decimal Divisor for 8 X Clock	Baud Rate	Percent Error
1	6,000,000	
2	3,000,000	
3	2,000,000	
4	1,500,000	
5	1,200,000	
6	1,000,000	
7	857,143	-6.99%
8	750,000	
9	666,667	
10	600,000	
11	545,455	
12	500,000	
13	461,538	0.16%
14	428,571	
15	400,000	
16	375,000	
17	352,941	
18	333,333	
19	315,789	
20	300,000	
...	...	
65,536	92	

This register enables the five types of UART interrupts. Each interrupt can individually activate the interrupt (INTR) output signal. It is possible to totally disable the interrupt system by resetting bit 0 through 3 of the Interrupt Enable Register (IER). Similarly, setting bits of the IER register to a logic 1 enables the selected interrupt(s). Disabling an interrupt prevents it from being indicated as active in the IIR and from activating the INTR output signal. All other system functions operate in their normal manner, including the settings of the Line Status and MODEM Status Registers. Table II shows the contents of the IER. Details on each bit are listed as follows.

I/O Port: Base Address + 1h
Register Name: Interrupt Enable Register (DLAB=0)
Reset Value: 00h

7	6	5	4	3	2	1	0
RSVD		MSI	RLSI	THREI	RDAI		

Bit	Name	Attribute	Description
7-4	RSVD	RO	Reserved. Must be always '0'
3	MSI	R/W	Modem Status Interrupt. 0: Disabled 1: Enabled
2	RLSI	R/W	Received Line Status Interrupt. 0: Disabled 1: Enabled
1	THREI	R/W	Transmitter Holding Register Empty Interrupt. 0: Disabled 1: Enabled
0	RDAI	R/W	Received Data Available Interrupt. 0: Disabled 1: Enabled

I/O Port: Base Address + 1h
Register Name: MSB of Baud Rate Generator Divisor Latches (DLAB=1)
Reset Value: 00h

7	6	5	4	3	2	1	0
MBR							

Bit	Name	Attribute	Description
7-0	MBR	R/W	This register contains the MSB (Most Significant Byte) of divisor latches.

Vortex86EX

32-Bit x86 Micro Processor

In order to provide minimum software overhead during data character transfers, the UART prioritizes interrupts into four levels and records these in the interrupt Identification Register. The four levels of interrupt conditions in order of priority are Receiver Line Status, Received Data Ready, Transmitter Holding Register Empty, and MODEM Status.

When the CPU accesses the IIR, the UART freezes all interrupts and indicates the highest priority pending interrupt to the CPU. While this CPU access is occurring, the UART records new interrupts; however, it does not change its current indication until the access is complete.

I/O Port: Base Address + 2h
Register Name: Interrupt Identification Register
Reset Value: 01h

7 6 5 4 3 2 1 0

FIFOE	RSVD	FIFOM	PT	IP
-------	------	-------	----	----

Bit	Name	Attribute	Description
7-6	FIFOE	RO	These two bits are set to '1' when the FIFO Control Register bit 0 = '1'.
5-4	RSVD	RO	Reserved. Must be returned all '0's.
3	FIFOM	RO	In non-FIFO Mode This bit is a '0'. In FIFO Mode This bit is set to '1' along with bit 2 when a timeout interrupt is pending
2-1	PT	RO	Indicate the Highest Priority Interrupt Pending 00: Modem Status Interrupt (Lowest Priority) 01: Transmitter Holding Register Empty Interrupt 10: Received Data Ready Interrupt 11: Receiver Line Status Interrupt (Highest Priority)
0	IP	RO	Interrupt Pending. 0: Interrupt Pending 1: No Interrupt Pending

TABLE Interrupt Control Functions

FIFO Mode Only	Interrupt Identification Register			Interrupt Set and Reset Functions				
	Bit 3	Bit 2	Bit 1	Bit0	Priority Level	Interrupt Type	Interrupt Source	Interrupt Rest Control
	0	0	0	1	-	None	None	-
	0	1	1	0	Highest	received line status	overrun error, parity error, framing error or break Interrupt	reading the line status register
	0	1	0	0	Second	received data available	received data available or trigger level reached	reading the receiver buffer register or the FIFO dropping below the trigger level
	1	1	0	0	Second	character timeout Indication	no characters have been removed from or Input to the RCVR FIFO during the last 4 Characters times and there is at least 1 character in it during this time.	reading the receiver buffer register
	0	0	1	0	Third	transmitter holding register empty	transmitter holding register empty	reading the IIR register (if the source of interrupt is available) or writing into the transmitter holding register
	0	0	0	0	Fourth	MODEM Status	clear to send, data set ready , ring Indicator, or data carrier detect	reading the MODEM Status register

Vortex86EX

32-Bit x86 Micro Processor

This is a write only register at the same location as the IIR (the IIR is a read only register). This register is used to enable the FIFOs, clear the FIFOs, set the RCVR FIFO trigger level, and select the type of DMA signaling.

I/O Port: Base Address + 2h
Register Name: FIFO Control Register
Reset Value: 00h

7 6 5 4 3 2 1 0

TL	RSVD	CTF	CRF	FE
----	------	-----	-----	----

Bit	Name	Attribute	Description
7-6	TL	WO	These two bits are used to set the trigger level (bytes) for Receive FIFO interrupt 00: 1 byte 01: 4 bytes 10: 8 bytes 11: 14 bytes
5-3	Rsvd	RO	Reserved.
2	CTF	WO	Writing a '1' to this bit will clear all bytes in transmitted FIFO and reset its counter to 0. The shift register is not cleared
1	CRF	WO	Writing a '1' to this bit will clear all bytes in received FIFO and reset its counter to 0. The shift register is not cleared
0	FE	WO	Setting this bit to a "1" enables both the transmitted and received FIFOs. Clearing this bit to a "0" disables both the transmitted and received FIFOs and clears all bytes from both FIFOs. When changing from FIFO Mode to non-FIFO (16450) mode, data are automatically cleared from the FIFOs. This bit must be a 1 when other bits in this register are written to or they will not be properly programmed.

Vortex86EX

32-Bit x86 Micro Processor

The system programmer specifies the format of the asynchronous data communications exchange and sets the Divisor Latch Access bit via the Line Control Register (LCR). The programmer can also read the contents of the Line Control Register. The read capability simplifies system programming and eliminates the need for separate storage in system memory of the line characteristics. Table II shows the contents of the LCR. Details on each bit are listed as follows:

I/O Port: Base Address + 3h
Register Name: Line Control Register
Reset Value: 00h

7	6	5	4	3	2	1	0
DLAB	BC	SP	EOP	PE	NSB	SCN	

Bit	Name	Attribute	Description
7	DLAB	R/W	Divisor Latch Access Bit (DLAB). It must be set to '1' to access the divisor latch of the baud generator during a Read or Write operation. It must be set to a '0' to access the Receive Buffer, the Transmitter Holding Register or the interrupt Enable Register.
6	BC	R/W	Break Control Bit. It causes a break condition to be transmitted to the receiving UART. 0: Disable the break 1: Force the serial out (SOUT) to the Spacing ('0') State
5	SP	R/W	Stick Parity bit. When bits 3, 4 and 5 are logic 1s, the Parity bit is transmitted and checked as a '0'. If bits 3 and 5 are '1's and bit 4 is a '0', the Parity bit is transmitted and checked as a '1'. If bit 5 is a logic 0, Stick Parity is disabled.
4	EOP	R/W	Even/Odd parity bit selected when parity is enabled 0: Odd parity selected 1: Even parity selected
3	PE	R/W	Parity Enabled/Disabled. 0: Parity disabled 1: Parity enabled When this bit is set to a '1', a parity bit will be generated between the last data word and STOP bit when data is being transmitted, and check the parity bit when data is being received.
2	NSB	R/W	Stop bit. This bit specifies the number of Stop bits transmitted and received in each serial character. Set 0: One Stop bit is generated in the transmitted data. Set 1: One and a half stop bits are generated for a 5-bit word length characters. Two stop bits are generated for either 6-, 7-, or 8-bit word length characters. The receiver checks the first Stop bit only, regardless of the number of Stop bits selected.

Vortex86EX

32-Bit x86 Micro Processor

Bit	Name	Attribute	Description
1-0	SCN	R/W	These two bits specify the number of bits in each transmitted and received serial characters. 00: 5 bits 01: 6 bits 10: 7 bits 11: 8 bits

This register controls the interface with the MODEM or data set (or a peripheral device emulating a MODEM). The contents of the MODEM Control Register are indicated in Table II and are described as below.

I/O Port: Base Address + 4h
Register Name: Modem Control Register
Reset Value: 00h

7 6 5 4 3 2 1 0

RSVD	LBF	INTE	RSVD	RTS	DTR
------	-----	------	------	-----	-----

Bit	Name	Attribute	Description
7-5	RSVD	RO	Reserved. Must be all '0's
4	LBF	R/W	<p>This bit provides the loop back feature for diagnostic testing of the Serial Port. When this bit is set to '1', the following occurs:</p> <ol style="list-style-type: none"> 1) The Transmitter serial out (SOUT) is set to the Marking State ('1'). 2) The receiver Serial Input (SIN) is disconnected. 3) The output of the Transmitter Shift Register is "looped back" into the Receiver Shift Register input. 4) All MODEM Control inputs (CTS#, DSR#, RI# and DCD#) are disconnected. 5) The four MODEM Control outputs (DTR#, RTS#, OUT1 and OUT2) are internally connected to the four MODEM Control inputs (CTS#, DSR#, RI# and DCD#). 6) The Modem Control output pins are forced to be inactive high. 7) Data transmitted are immediately received. <p>This feature allows the processor to verify the transmit- and receive-data paths of the Serial Port. In the diagnostic mode, the receiver and the transmitter interrupts are fully operational. The MODEM Control Interrupts are also operational but the interrupts' sources are now the lower four bits of the MODEM Control Register instead of the MODEM Control inputs. The interrupts are still controlled by the Interrupt Enable Register.</p>
3	INTE	R/W	Interrupt Enable. This bit is used to enable a UART interrupt. When OUT2 is a '0', the serial port interrupt output is forced to the high impedance state - disabled. When OUT2 is a '1', the serial port interrupt output is enabled.
2	Rsvd	RO	Reserved.

Vortex86EX

32-Bit x86 Micro Processor

Bit	Name	Attribute	Description
1	RTS	R/W	This bit controls the Request To Send (RTS#) output. When this bit is set to a '1', the RTS# output is forced to a '0'. When this bit is a '0', the RTS# output is forced to a '1'.
0	DTR	R/W	This bit controls the Data Terminal Ready (DTR#) output. When this bit is set to a '1', the DTR# output is forced to a '0'. When this bit is a '0', the DTR# output is forced to a '1'.

This register provides status information to the CPU concerning the data transfer.

I/O Port: Base Address + 5h
Register Name: Line Status Register
Reset Value: 60h

7	6	5	4	3	2	1	0
EB	TEMT	THRE	BI	FE	PE	OE	DR

Bit	Name	Attribute	Description
7	EB	R/W	This bit is permanently set to a logic "0" in the 450 mode. In the FIFO mode, this bit is set to a logic "1" when there is at least one parity error, framing error or break indication in the FIFO. This bit is cleared when the LSR is read if there are no subsequent errors in the FIFO.
6	TEMT	R/W	Transmitter Empty (TEMT). This bit is set to a '1' whenever the Transmitter Holding Register (THR) and Transmitter Shift Register (TSR) are both empty. It is reset to a '0' whenever either the THR or TSR contains a data character. This bit is a read only bit. In the FIFO mode, this bit is set whenever the THR and TSR are both empty,
5	THRE	R/W	Transmitter Holding Register Empty (THRE). This bit indicates that the Serial Port is ready to accept a new character for transmission. In addition, this bit causes the Serial Port to issue an interrupt when the Transmitter Holding Register interrupt enable is set high. The THRE bit is set to a '1' when a character is transferred from the Transmitter Holding Register into the Transmitter Shift Register. This bit is reset to '0' whenever the CPU loads the Transmitter Holding Register. In the FIFO mode, this bit is set when the transmit FIFO is empty. It is cleared when at least 1 byte is written to the transmit FIFO. This bit is a read only bit.

Bit	Name	Attribute	Description
4	BI	R/W	Break Interrupt (BI). This bit is set to a '1' whenever the received data input is held in the Spacing state ('0') for longer than a full word transmission time (that is, the total time of the start bit + data bits + parity bits + stop bits). The BI is reset after the CPU reads the contents of the Line Status Register. In the FIFO mode, this error is associated with the particular character in the FIFO it applies to. This error is indicated when the associated character is at the top of the FIFO. When a break occurs, only one zero character is loaded into the FIFO. Restarting after a break is received requires the serial data (RXD) to be '1' for at least 1/2 bit time.
3	FE	R/W	Framing Error (FE). This bit indicates that the received character does not have a valid stop bit. This bit is set to a '1' whenever the stop bit following the last data bit or parity bit is detected as a zero bit (Spacing level). The FE is reset to a '0' whenever the Line Status Register is read. In the FIFO mode, this error is associated with the particular character in the FIFO it applies to. This error is indicated when the associated character is at the top of the FIFO. The Serial Port will try to resynchronize after a framing error. To do this, it assumes that the framing error was due to the next start bit, so it samples this 'start' bit twice and then takes in the 'data'.
2	PE	R/W	Parity Error (PE). This bit indicates that the received data character does not have the correct even or odd parity, as selected by the even parity select bit. The PE is set to a '1' upon detection of a parity error and is reset to a '0' whenever the Line Status Register is read. In the FIFO mode, this error is associated with the particular character in the FIFO it applies to. This error is indicated when the associated character is at the top of the FIFO.
1	OE	R/W	Overrun Error (OE). This bit indicates that the data in the Receiver Buffer Register were not read before the next character was transferred into the register, thereby destroying the previous character. In FIFO mode, an overrun error will occur only when the FIFO is full and the next character has been completely received in the shift register. The character in the shift register is overwritten but not transferred to the FIFO. The OE indicator is set to a '1' immediately upon detection of an overrun condition, and reset whenever the Line Status Register is read.
0	DR	R/W	Data Ready (DR). It is set to a '1' whenever a complete incoming character has been received and transferred into the Receiver Buffer Register or the FIFO. This bit is reset to a '0' by reading all of the data in the Receiver Buffer Register or the FIFO.

Vortex86EX

32-Bit x86 Micro Processor

This register provides the current state of the control lines from the MODEM (or peripheral device) to the CPU. In addition to this current-state information, four bits of the MODEM Status Register provide change information. These bits are set to logic 1s whenever a control input from the MODEM changes state. They are reset to logic 0s whenever the CPU reads the MODEM Status Register. The contents of the MODEM Status Register are indicated in Table II and described as below.

I/O Port: Base Address + 6h
Register Name: Modem Status Register
Reset Value: x0h

7	6	5	4	3	2	1	0
DCD	RI	DSR	CTS	DDCD	TERI	DDSR	DCTS

Bit	Name	Attribute	Description
7	DCD	RW	This bit is the complement of the Data Carrier Detect (DCD#) input. If bit 4 of the MCR is set to '1', this bit is equivalent to OUT2 in the Modem Control Register.
6	RI	RW	This bit is the complement of the Ring Indicator (RI#) input. If bit 4 of the MCR is set to '1', this bit is equivalent to OUT1 in the Modem Control Register.
5	DSR	RW	This bit is the complement of the Data Set Ready (DSR#) input. If bit 4 of the MCR is set to '1', this bit is equivalent to DTR# in the Modem Control Register.
4	CTS	RW	This bit is the complement of the Clear To Send (CTS#) input. If bit 4 of the MCR is set to '1', this bit is equivalent to RTS# in the Modem Control Register.
3	DDCD	RW	Delta Data Carrier Detect (DDCD). This bit is set to '1' whenever the DCD# input to the chip has changed the state since the last time the MSR (Modem Status Register) was read. It is reset to a '0' whenever the MODEM Status Register is read.
2	TERI	RW	Trailing Edge of Ring Indicator (TERI). This bit is set to '1' whenever the RI# input has been changed from '0' to '1'. It is reset to '0' whenever the MODEM Status Register is read.
1	DDSR	RW	Delta Data Set Ready (DDSR). This bit indicates that the DSR# input to SoC has changed the state since the last time the MSR (Modem Status Register) was read. This bit is set to '1' whenever DSR# input from the MODEM has changed the state. It is reset to '0' whenever the MODEM Status Register is read.
0	DCTS	RW	Delta Clear To Send (DCTS). This bit indicates that the CTS# input to the SoC has changed the state since the last time the MSR (Modem Status Register) was read. This bit is set to '1' whenever CTS# input from the MODEM has changed the state. It is reset to '0' whenever the MODEM Status Register is read.

Note: Whenever bit 0, 1, 2 or 3 is set to a logic "1", a MODEM Status Interrupt is generated.

Vortex86EX

32-Bit x86 Micro Processor

This 8-bit Read/Write Register does not control the UART in any way. It is intended as a scratchpad register used by the programmer to hold data temporarily.

I/O Port: Base Address + 7h
Register Name: Scratchpad Register
Reset Value: --

7 6 5 4 3 2 1 0

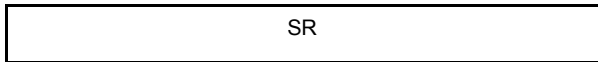

Bit	Name	Attribute	Description
7-0	SR	R/W	This 8-bit read/write register has no effect on the operation of the Serial Port. It is intended as a scratchpad register to be used by the programmer to hold data temporarily.

(Base Address defined on SB Function 1 PCI CFG 81- 80h)

Register Offset: BA+0
Register Name: UART Global Interrupt Status Register
Reset Value: 00000000h

15 14 13 12 11 10 9 8 7 6 5 4 3 2 1 0

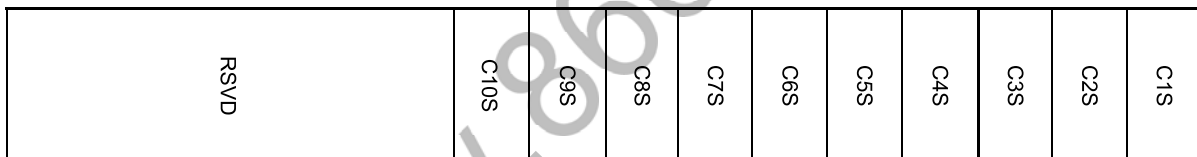

Bit	Name	Attribute	Description
15-10	RSVD	RO	Reserved.
9	C10IS	RO	COM10 Interrupt Status.
8	C9IS	RO	COM9 Interrupt Status.
7	C8IS	RO	COM8 Interrupt Status.
6	C7IS	RO	COM7 Interrupt Status.
5	C6IS	RO	COM6 Interrupt Status.
4	C5IS	RO	COM5 Interrupt Status.
3	C4IS	RO	COM4 Interrupt Status.
2	C3IS	RO	COM3 Interrupt Status.
1	C2IS	RO	COM2 Interrupt Status.
0	C1IS	RO	COM1 Interrupt Status.

11.3.16 Parallel Port Register

The system programmer may access any of the PP registers. These registers control PP operations including transmission and reception of data.

(Base Address Refers to the Register of index B3h-B0h, SB PCI Configuration Register)

DATA PORT	BASE ADDRESS + 00H
STATUS PORT	BASE ADDRESS + 01H
CONTROL PORT	BASE ADDRESS + 02H
EPP ADDR PORT	BASE ADDRESS + 03H
EPP DATA PORT 0	BASE ADDRESS + 04H
EPP DATA PORT 1	BASE ADDRESS + 05H
EPP DATA PORT 2	BASE ADDRESS + 06H
EPP DATA PORT 3	BASE ADDRESS + 07H

The bit map of these registers is:

	D0	D1	D2	D3	D4	D5	D6	D7	Note
DATA PORT	PD0	PD1	PD2	PD3	PD4	PD5	PD6	PD7	1
STATUS PORT	TMOUT	1	1	nERR	SLCT	PE	nACK	NBusy	1
CONTROL PORT	STROBE	AUTOFD	nINIT	SLC	IRQE	PCD	1	1	1
EPP ADDR PORT	PD0	PD1	PD2	PD3	PD4	PD5	PD6	PD7	2,3
EPP DATA PORT 0	PD0	PD1	PD2	PD3	PD4	PD5	PD6	PD7	2,3
EPP DATA PORT 1	PD0	PD1	PD2	PD3	PD4	PD5	PD6	PD7	2,3
EPP DATA PORT 2	PD0	PD1	PD2	PD3	PD4	PD5	PD6	PD7	2,3
EPP DATA PORT 3	PD0	PD1	PD2	PD3	PD4	PD5	PD6	PD7	2,3

11.3.17 SPI Control Registers

BASE_ADDR defined on NB PCI CFG 40h

Register Offset: BASE_ADDR+00h
Register Name: Flash SPI Output Data Register
Reset Value: --

7 6 5 4 3 2 1 0



Bit	Name	Attribute	Description
7-0	OUTDAT	WO	Data Output to SPI when write. No function when read.

Register Offset: BASE_ADDR+01h
Register Name: Flash SPI Input Register
Reset Value: FFh

7 6 5 4 3 2 1 0

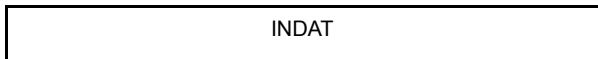

Bit	Name	Attribute	Description
7-1	INDAT	R/W	Data Input from SPI when read. Preload data from SPI when write

Vortex86EX

32-Bit x86 Micro Processor

It is not recommended to modify this register when SPI operation.

Register Offset: BASE_ADDR+02h
Register Name: Flash SPI Control Register
Reset Value: 52h

7	6	5	4	3	2	1	0
RSVD	FRE	AFDIS	FIEN	CKDIV			

Bit	Name	Attribute	Description
7	RSVD	RO	Reserved
6	FRE	R/W	Fast Read Enable (This bit can be set if it is NOT AMTEL flash, and Bit 5 must be 0)
5	AFDIS	R/W	0: Auto-fetch enable 1: Auto-fetch disable Reset to 0 if flash ROM write protect (default).
4	FIEN	R/W	FIFO Mode Enable when set.
3-0	CKDIV	R/W	SPI Clock Divided. The SPI clock is 100MHz/(2 * SPI clock divided) , 0 is not allowed

Register Offset: BASE_ADDR+03h
Register Name: Flash SPI Status Register
Reset Value: 10h

7	6	5	4	3	2	1	0
BUSY	FIFU	IDR	ODC	RSVD			

Bit	Name	Attribute	Description
7	BUSY	RO	SPI controller is BUSY .
6	FIFU	RO	FIFO Full.
5	IDR	RO	Input Data Ready when set.
4	ODC	RO	Output complete/FIFO empty when set.
3-0	RSVD	RO	Reserved.

Vortex86EX

32-Bit x86 Micro Processor

Register Offset: BASE_ADDR+04h
Register Name: Flash SPI Chip Select Register
Reset Value: 01h

7 6 5 4 3 2 1 0

RSVD	CS
------	----

Bit	Name	Attribute	Description
7-1	RSVD	RO	Reserved.
0	CS	R/W	0: SPI CS# is low 1: SPI CS# is high

Register Offset: BASE_ADDR+05h
Register Name: Flash SPI Error Status Register
Reset Value: 00h

7 6 5 4 3 2 1 0

RSVD	WCTE	DOLE	FIURE	FIORE	FHOPE
------	------	------	-------	-------	-------

Bit	Name	Attribute	Description
7-5	RSVD	RO	Reserved.
4	WCTE	R/WC	Error status 4. Write SPI Control Register when controller is busy. Write 1 to clear.
3	DOLE	R/WC	Error status3. Input data overlap. Write 1 to clear.
2	FIURE	R/WC	Error status2, FIFO Under-run . Write 1 to clear.
1	FIORE	R/WC	Error status1, FIFO Over-run . Write 1 to clear.
0	FHOPE	R/WC	Error status0, CPU fetch during SPI port operation. Write 1 to clear.

Register Offset: BASE_ADDR+06h
Register Name: Flash SPI Control Register 2
Reset Value: 0xxxxx01b (depend on boot flash type)

7 6 5 4 3 2 1 0

RSVD	DVID	RCT	AM	CLKDIS
------	------	-----	----	--------

Bit	Name	Attribute	Description
7	RSVD	RO	Reserved.
6-4	DVID	RO	Detected Vendor ID: 000b:Others 001:MXIC 010:EON 011:MICRON

			100:WINBOND 101:SPANSION 110~111: Reserved
3	RCT	RO	Flash Read Command Type: 0: legacy read command 1: direct 4 byte read command
2	AM	RO	Address Mode. 0: 3 byte address mode 1: 4 byte address mode
1-0	CLKDIS	R/W	Set delay time to gated SPI clock, When SPI CTRL IDLE and no CPU Req. 00: 128T 01: 256T (default) 10: 512T 11: 1024T

11.3.18 GPIO Registers

GPIO Port Config Registers

(Base Address Refers to the Register of index 63h-62h, SB Function0 PCI Configuration Register)

Register Offset: BA + 0h

Register Name: General-Purpose I/O Data & Direction Decode Enable

Reset Value: 00000000h

31 30 29 28 27 26 25 24 23 22 21 20 19 18 17 16 15 14 13 12 11 10 9 8 7 6 5 4 3 2 1 0

RSVD	GDEN
------	------

Bit	Name	Attribute	Description
31-10	RSVD	RO	Reserved.
9-0	GDEN	R/W	GPIO data & Direction port 0 – 9 Decode Enable Bit0 for Port0, Bit1 for Port1, ..., Bit9 for Port9 1: Enabled 0: Disabled

Vortex86EX

32-Bit x86 Micro Processor

Register Offset: BA + 04h, 08h, 0Ch, 10h, 14h, 18h, 1Ch, 20h, 24h, 28h
Register Name: General-Purpose I/O 0,1,2,3,4,5,6,7,8,9 Data & Direction Decode Address
Reset Value: 00000000h

31	30	29	28	27	26	25	24	23	22	21	20	19	18	17	16	15	14	13	12	11	10	9	8	7	6	5	4	3	2	1	0
DBA																DPBA															

Bit	Name	Attribute	Description
31-16	DBA	R/W	<i>GPIO Direction Base Address.</i>
15-0	DPBA	R/W	<i>GPIO Data Port Base Address.</i>

GPIO Interrupt Config Registers

(Base Address Refers to the Register of index 67h-66h, SB Function0 PCI Configuration Register)

Register Offset: BA + 0h
Register Name: General-Purpose I/O Interrupt Status Decode Address
Reset Value: 00000000h

31	30	29	28	27	26	25	24	23	22	21	20	19	18	17	16	15	14	13	12	11	10	9	8	7	6	5	4	3	2	1	0
RSVD									GIEN	RSVD									ISBA												

Bit	Name	Attribute	Description
31-24	RSVD	RO	<i>Reserved.</i>
23	GIEN	R/W	<i>GPIO Interrupt Status port decode Enable.</i> 1: Enabled 0: Disabled
22-16	RSVD	RO	<i>Reserved.</i>
15-0	ISBA	R/W	<i>GPIO Interrupt Status port Base Address.</i>

Vortex86EX

32-Bit x86 Micro Processor

Register Offset: BA + 04h
Register Name: General-Purpose I/O Interrupt Port Select
Reset Value: 00000000h

31 30 29 28 27 26 25 24 23 22 21 20 19 18 17 16 15 14 13 12 11 10 9 8 7 6 5 4 3 2 1 0

RSVD	GIS1	GIS0
------	------	------

Bit	Name	Attribute	Description
31-8	RSVD	RO	Reserved.
7-4	GIS1	RW	GPIO interrupt Control 1 , GPIO Port Select 0000: Not Select 0001: GPIO Port 0 0010: GPIO Port 1 0011: GPIO Port 2 0100: GPIO Port 3 0101: GPIO Port 4 0110: GPIO Port 5 0111: GPIO Port 6 1000: GPIO Port 7 1001: GPIO Port 8 1010: GPIO Port 9 1011 ~ 1111: Reserved
3-0	GIS0	RW	GPIO interrupt Control 0 , GPIO Port Select 0000: Not Select 0001: GPIO Port 0 0010: GPIO Port 1 0011: GPIO Port 2 0100: GPIO Port 3 0101: GPIO Port 4 0110: GPIO Port 5 0111: GPIO Port 6 1000: GPIO Port 7 1001: GPIO Port 8 1010: GPIO Port 9 1011 ~ 1111: Reserved

Vortex86EX

32-Bit x86 Micro Processor

Register Offset: BASE + 08h
Register Name: General-Purpose I/O Interrupt Control 0 Register
Reset Value: 0000FF00h

31 30 29 28 27 26 25 24 23 22 21 20 19 18 17 16 15 14 13 12 11 10 9 8 7 6 5 4 3 2 1 0

COINTCTL	En	IKP	COINTR	COINTL	COINTM
----------	----	-----	--------	--------	--------

Bit	Name	Attribute	Description																																																																	
31-24	COINTCTL	R/W	GPIO PORT Interrupt Control 0 Register. Bit0 for Port[0], Bit1 for Port [1], ..., Bit7 for Port [7] 1: trigger the interrupt continuously if level is activated and match interrupt keep period settings. 0: Trigger the Interrupt once if level is activated.																																																																	
23	En	R/W	GPIO PORT Interrupt Control 0 Function Enable bit. 0: Disable (Default) 1: Enable																																																																	
22-20	IKP	R/W	Interrupt Keep Period. Interrupt will be generated while the event loading time of any one of port [7-0] is longer than the following time parameters. Reference 14.318MHz 000: 002ms 001: 005ms 010: 010ms 011: 020ms 100: 040ms 101: 060ms 110: 080ms 111: 100ms																																																																	
19-16	COINTR	R/W	GPIO PORT Interrupt Control 0 Routing Register. <table style="margin-left: 20px; border-collapse: collapse;"> <thead> <tr> <th style="text-align: left;">Bit 11</th> <th style="text-align: left;">Bit 10</th> <th style="text-align: left;">Bit 9</th> <th style="text-align: left;">Bit 8</th> <th style="text-align: left;">Routing Table</th> </tr> </thead> <tbody> <tr><td>0</td><td>0</td><td>0</td><td>0</td><td>Disable.</td></tr> <tr><td>0</td><td>0</td><td>0</td><td>1</td><td>IRQ[9]</td></tr> <tr><td>0</td><td>0</td><td>1</td><td>0</td><td>IRQ[3]</td></tr> <tr><td>0</td><td>0</td><td>1</td><td>1</td><td>IRQ[10]</td></tr> <tr><td>0</td><td>1</td><td>0</td><td>0</td><td>IRQ[4]</td></tr> <tr><td>0</td><td>1</td><td>0</td><td>1</td><td>IRQ[5]</td></tr> <tr><td>0</td><td>1</td><td>1</td><td>0</td><td>IRQ[7]</td></tr> <tr><td>0</td><td>1</td><td>1</td><td>1</td><td>IRQ[6]</td></tr> <tr><td>1</td><td>0</td><td>0</td><td>0</td><td>IRQ[1]</td></tr> <tr><td>1</td><td>0</td><td>0</td><td>1</td><td>IRQ[11]</td></tr> <tr><td>1</td><td>0</td><td>1</td><td>0</td><td>Reserved</td></tr> <tr><td>1</td><td>0</td><td>1</td><td>1</td><td>IRQ[12]</td></tr> </tbody> </table>	Bit 11	Bit 10	Bit 9	Bit 8	Routing Table	0	0	0	0	Disable.	0	0	0	1	IRQ[9]	0	0	1	0	IRQ[3]	0	0	1	1	IRQ[10]	0	1	0	0	IRQ[4]	0	1	0	1	IRQ[5]	0	1	1	0	IRQ[7]	0	1	1	1	IRQ[6]	1	0	0	0	IRQ[1]	1	0	0	1	IRQ[11]	1	0	1	0	Reserved	1	0	1	1	IRQ[12]
Bit 11	Bit 10	Bit 9	Bit 8	Routing Table																																																																
0	0	0	0	Disable.																																																																
0	0	0	1	IRQ[9]																																																																
0	0	1	0	IRQ[3]																																																																
0	0	1	1	IRQ[10]																																																																
0	1	0	0	IRQ[4]																																																																
0	1	0	1	IRQ[5]																																																																
0	1	1	0	IRQ[7]																																																																
0	1	1	1	IRQ[6]																																																																
1	0	0	0	IRQ[1]																																																																
1	0	0	1	IRQ[11]																																																																
1	0	1	0	Reserved																																																																
1	0	1	1	IRQ[12]																																																																

			1	1	0	0	Reserved	
			1	1	0	1	IRQ[14]	
			1	1	1	0	Reserved	
			1	1	1	1	IRQ[15]	
15-8	C0INTL	R/W	GPIO PORT Interrupt Control 0 Level Register.					Bit0 for Port [0], Bit1 for Port [1], ..., Bit7 for Port [7] 1: Interrupt activated on Port low level 0: Interrupt activated on Port high level
7-0	C0INTM	R/W	GPIO PORT Interrupt Control 0 Mask Register: This mask register is workable when Port [x] is at input or output mode. If Port [x] is at output mode and interrupt level set as high, the interrupt will occur base on the GPIO_PORT interrupt control register.					Bit0 for Port[0], Bit1 for Port [1], ..., Bit7 for Port [7] 1: Enable Interrupt happen 0: Disable interrupt

Register Offset: BASE + 0Ch
Register Name: General-Purpose I/O Interrupt Control 1 Register
Reset Value: 0000FF00h

31	30	29	28	27	26	25	24	23	22	21	20	19	18	17	16	15	14	13	12	11	10	9	8	7	6	5	4	3	2	1	0
C1INTCTL								En	IKP	C1INTR	C1INTL						C1INTM														

Bit	Name	Attribute	Description
31-24	C1INTCTL	R/W	GPIO PORT Interrupt Control 1 Register. Bit0 for Port[0], Bit1 for Port [1], ..., Bit7 for Port [7] 1: trigger the interrupt continuously if level is activated and match interrupt keep period settings. 0: Trigger the Interrupt once if level is activated.
23	En	R/W	GPIO PORT Interrupt Control 1 Function Enable bit. 0: Disable (Default) 1: Enable
22-20	IKP	R/W	Interrupt Keep Period. Interrupt will be generated while the event loading time of any one of port [7-0] is longer than the following time parameters . Reference 14.318MHz 000: 002ms 001: 005ms 010: 010ms 011: 020ms 100: 040ms 101: 060ms

			110: 080ms 111: 100ms																																																																																
19-16	C1INTR	RW	<p>GPIO PORT Interrupt Control 1 Routing Register</p> <p>Bit 11 Bit 10 Bit 9 Bit 8 Routing Table</p> <table style="margin-left: 20px;"> <tr><td>0</td><td>0</td><td>0</td><td>0</td><td>Disable.</td></tr> <tr><td>0</td><td>0</td><td>0</td><td>1</td><td>IRQ[9]</td></tr> <tr><td>0</td><td>0</td><td>1</td><td>0</td><td>IRQ[3]</td></tr> <tr><td>0</td><td>0</td><td>1</td><td>1</td><td>IRQ[10]</td></tr> <tr><td>0</td><td>1</td><td>0</td><td>0</td><td>IRQ[4]</td></tr> <tr><td>0</td><td>1</td><td>0</td><td>1</td><td>IRQ[5]</td></tr> <tr><td>0</td><td>1</td><td>1</td><td>0</td><td>IRQ[7]</td></tr> <tr><td>0</td><td>1</td><td>1</td><td>1</td><td>IRQ[6]</td></tr> <tr><td>1</td><td>0</td><td>0</td><td>0</td><td>IRQ[1]</td></tr> <tr><td>1</td><td>0</td><td>0</td><td>1</td><td>IRQ[11]</td></tr> <tr><td>1</td><td>0</td><td>1</td><td>0</td><td>Reserved</td></tr> <tr><td>1</td><td>0</td><td>1</td><td>1</td><td>IRQ[12]</td></tr> <tr><td>1</td><td>1</td><td>0</td><td>0</td><td>Reserved</td></tr> <tr><td>1</td><td>1</td><td>0</td><td>1</td><td>IRQ[14]</td></tr> <tr><td>1</td><td>1</td><td>1</td><td>0</td><td>Reserved</td></tr> <tr><td>1</td><td>1</td><td>1</td><td>1</td><td>IRQ[15]</td></tr> </table>	0	0	0	0	Disable.	0	0	0	1	IRQ[9]	0	0	1	0	IRQ[3]	0	0	1	1	IRQ[10]	0	1	0	0	IRQ[4]	0	1	0	1	IRQ[5]	0	1	1	0	IRQ[7]	0	1	1	1	IRQ[6]	1	0	0	0	IRQ[1]	1	0	0	1	IRQ[11]	1	0	1	0	Reserved	1	0	1	1	IRQ[12]	1	1	0	0	Reserved	1	1	0	1	IRQ[14]	1	1	1	0	Reserved	1	1	1	1	IRQ[15]
0	0	0	0	Disable.																																																																															
0	0	0	1	IRQ[9]																																																																															
0	0	1	0	IRQ[3]																																																																															
0	0	1	1	IRQ[10]																																																																															
0	1	0	0	IRQ[4]																																																																															
0	1	0	1	IRQ[5]																																																																															
0	1	1	0	IRQ[7]																																																																															
0	1	1	1	IRQ[6]																																																																															
1	0	0	0	IRQ[1]																																																																															
1	0	0	1	IRQ[11]																																																																															
1	0	1	0	Reserved																																																																															
1	0	1	1	IRQ[12]																																																																															
1	1	0	0	Reserved																																																																															
1	1	0	1	IRQ[14]																																																																															
1	1	1	0	Reserved																																																																															
1	1	1	1	IRQ[15]																																																																															
15-8	C1INTL	RW	<p>GPIO PORT Interrupt Control 1 Level Register.</p> <p>Bit0 for Port [0], Bit1 for Port [1], ..., Bit7 for Port [7]</p> <p>1: Interrupt activated on Port low level 0: Interrupt activated on Port high level</p>																																																																																
7-0	C1INTM	RW	<p>GPIO PORT Interrupt Control 1 Mask Register: This mask register is workable when Port [x] is at input or output mode. If Port [x] is at output mode and interrupt level set as high, the interrupt will occur base on the GPIO_PORT interrupt control register.</p> <p>Bit0 for Port[0], Bit1 for Port [1], ..., Bit7 for Port [7]</p> <p>1: Enable Interrupt happen 0: Disable interrupt</p>																																																																																

GPIO Data/Direction/Status Registers

BASE_ADDR defined on GPIO Port Config Register offset 04h

Register Offset: BASE_ADDR+00h
Register Name: GPIO PORT0 Data Register
Reset Value: FFh

7 6 5 4 3 2 1 0

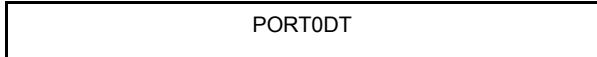

Bit	Name	Attribute	Description
7-0	PORT0DT	R/W	<i>PORT0 GPIO Data.</i>

BASE_ADDR defined on GPIO Port Config Register offset 08h

Register Offset: BASE_ADDR+00h
Register Name: GPIO PORT1 Data Register
Reset Value: FFh

7 6 5 4 3 2 1 0

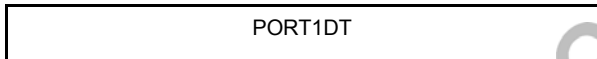

Bit	Name	Attribute	Description
7-0	PORT1DT	R/W	<i>PORT1 GPIO Data.</i>

BASE_ADDR defined on GPIO Port Config Register offset 0Ch

Register Offset: BASE_ADDR+00h
Register Name: GPIO PORT2 Data Register
Reset Value: FFh

7 6 5 4 3 2 1 0

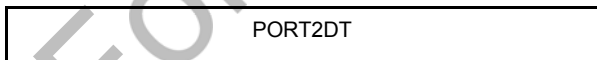

Bit	Name	Attribute	Description
7-0	PORT2DT	R/W	<i>PORT2 GPIO Data.</i>

BASE_ADDR defined on GPIO Port Config Register offset 10h

Register Offset: BASE_ADDR+00h
Register Name: GPIO PORT3 Data Register
Reset Value: FFh

7 6 5 4 3 2 1 0

PORT3DT

Bit	Name	Attribute	Description
7-0	PORT3DT	RW	<i>PORT3 GPIO Data.</i>

BASE_ADDR defined on GPIO Port Config Register offset 14h

Register Offset: BASE_ADDR+00h
Register Name: GPIO PORT4 Data Register
Reset Value: FFh

7 6 5 4 3 2 1 0

PORT4DT

Bit	Name	Attribute	Description
7-0	PORT4DT	R/W	<i>PORT4 GPIO Data.</i>

BASE_ADDR defined on GPIO Port Config Register offset 18h

Register Offset: BASE_ADDR+00h
Register Name: GPIO PORT5 Data Register
Reset Value: FFh

7 6 5 4 3 2 1 0

PORT5DT

Bit	Name	Attribute	Description
7-0	PORT5DT	R/W	PORT5 GPIO data

BASE_ADDR defined on GPIO Port Config Register offset 1Ch

Register Offset: BASE_ADDR+00h
Register Name: GPIO PORT6 Data Register
Reset Value: FFh

7 6 5 4 3 2 1 0

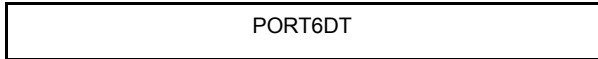

Bit	Name	Attribute	Description
7-0	PORT6DT	R/W	PORT6 GPIO Data.

BASE_ADDR defined on GPIO Port Config Register offset 20h

Register Offset: BASE_ADDR+00h
Register Name: GPIO PORT7 Data Register
Reset Value: FFh

7 6 5 4 3 2 1 0

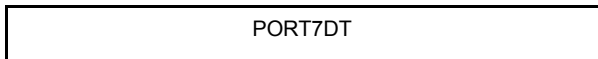

Bit	Name	Attribute	Description
7-0	PORT7DT	R/W	<i>PORT7 GPIO Data.</i>

BASE_ADDR defined on GPIO Port Config Register offset 24h

Register Offset: BASE_ADDR+00h
Register Name: GPIO PORT8 Data Register
Reset Value: FFh

7 6 5 4 3 2 1 0

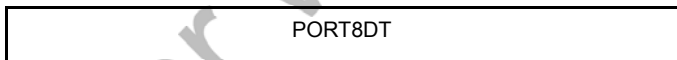

Bit	Name	Attribute	Description
7-0	PORT8DT	R/W	<i>PORT8 GPIO Data.</i>

BASE_ADDR defined on GPIO Port Config Register offset 28h

Register Offset: BASE_ADDR+00h
 Register Name: GPIO PORT9 Data Register
 Reset Value: FFh

7 6 5 4 3 2 1 0

PORT9DT

Bit	Name	Attribute	Description
7-0	PORT9DT	R/W	PORT9 GPIO Data.

BASE_ADDR defined on GPIO Port Config Register offset 06h

Register Offset: BASE_ADDR+00h
 Register Name: GPIO PORT0 Direction Register
 Reset Value: 00h

7 6 5 4 3 2 1 0

PORT0DR

Bit	Name	Attribute	Description
7-0	PORT0DR	R/W	PORT0 GPIO Direction Setting. 0: Direction is INPUT. 1: Direction is OUTPUT

BASE_ADDR defined on GPIO Port Config Register offset 0Ah

Register Offset: BASE_ADDR+00h
 Register Name: GPIO PORT1 Direction Register
 Reset Value: 00h

7 6 5 4 3 2 1 0

PORT1DR

Bit	Name	Attribute	Description
7-0	PORT1DR	R/W	PORT1 GPIO Direction Setting. 0: Direction is INPUT. 1: Direction is OUTPUT

BASE_ADDR defined on GPIO Port Config Register offset 0Eh

Register Offset: BASE_ADDR+00h
Register Name: GPIO PORT2 Direction Register
Reset Value: 00h

7 6 5 4 3 2 1 0

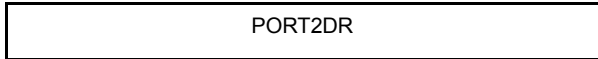

Bit	Name	Attribute	Description
7-0	PORT2DR	R/W	PORT2 GPIO Direction Setting. 0: Direction is INPUT. 1: Direction is OUTPUT

BASE_ADDR defined on GPIO Port Config Register offset 12h

Register Offset: BASE_ADDR+00h
Register Name: GPIO PORT3 Direction Register
Reset Value: 00h

7 6 5 4 3 2 1 0

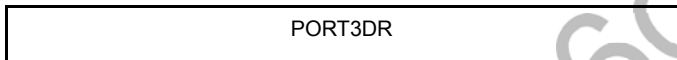

Bit	Name	Attribute	Description
7-0	PORT3DR	R/W	PORT3 GPIO Direction Setting. 0: Direction is INPUT. 1: Direction is OUTPUT

BASE_ADDR defined on GPIO Port Config Register offset 16h

Register Offset: BASE_ADDR+00h
Register Name: GPIO PORT4 Direction Register
Reset Value: 00h

7 6 5 4 3 2 1 0

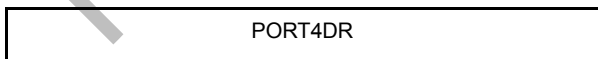

Bit	Name	Attribute	Description
7-0	PORT4DR	R/W	PORT4 GPIO Direction Setting. 0: Direction is INPUT. 1: Direction is OUTPUT

BASE_ADDR defined on GPIO Port Config Register offset 1Ah

Register Offset: BASE_ADDR+00h
Register Name: GPIO PORT5 Direction Register
Reset Value: 00h

7 6 5 4 3 2 1 0

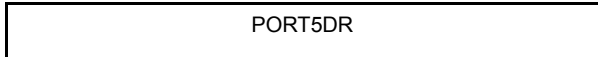

Bit	Name	Attribute	Description
7-0	PORT5D R	R/W	PORT5 GPIO Direction Setting. 0: Direction is INPUT. 1: Direction is OUTPUT

BASE_ADDR defined on GPIO Port Config Register offset 1Eh

Register Offset: BASE_ADDR+00h
Register Name: GPIO PORT6 Direction Register
Reset Value: 00h

7 6 5 4 3 2 1 0

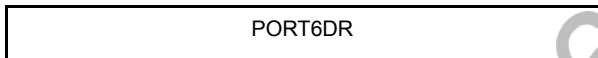

Bit	Name	Attribute	Description
7-0	PORT6DR	R/W	PORT6 GPIO Direction Setting. 0: Direction is INPUT. 1: Direction is OUTPUT

BASE_ADDR defined on GPIO Port Config Register offset 22h

Register Offset: BASE_ADDR+00h
Register Name: GPIO PORT7 Direction Register
Reset Value: 00h

7 6 5 4 3 2 1 0

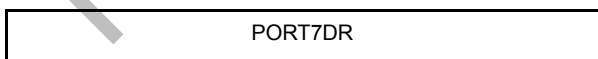

Bit	Name	Attribute	Description
7-0	PORT7D R	R/W	PORT7 GPIO Direction Setting. 0: Direction is INPUT. 1: Direction is OUTPUT

BASE_ADDR defined on GPIO Port Config Register offset 26h

Register Offset: BASE_ADDR+00h
 Register Name: GPIO PORT8 Direction Register
 Reset Value: 00h

7 6 5 4 3 2 1 0

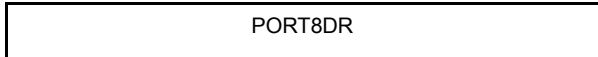

Bit	Name	Attribute	Description
7-0	PORT8DR	R/W	PORT8 GPIO Direction Setting. 0: Direction is INPUT. 1: Direction is OUTPUT

BASE_ADDR defined on GPIO Port Config Register offset 2Ah

Register Offset: BASE_ADDR+00h
 Register Name: GPIO PORT9 Direction Register
 Reset Value: 00h

7 6 5 4 3 2 1 0

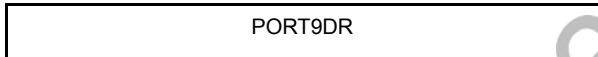

Bit	Name	Attribute	Description
7-0	PORT9DR	R/W	PORT9 GPIO Direction Setting. 0: Direction is INPUT. 1: Direction is OUTPUT

GPIO Interrupt Status Registers

BASE_ADDR defined on GPIO Interrupt Config Register offset 00h

I/O Port: BASE_ADDR +00h
 Register Name: GPIO PORT Interrupt Status 0 Register
 Reset Value: 00h

7 6 5 4 3 2 1 0

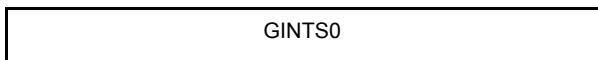

Bit	Name	Attribute	Description
7-0	GINTS0	RW1C	GPIO Port Interrupt Status 0 Register. Bit 0 for Selected PortX[0], Bit1 for Selected PortX[1], ... ,Bit 7 for Selected PortX[7]

Vortex86EX

32-Bit x86 Micro Processor

Bit	Name	Attribute	Description
			1: means Selected PortX[x] with interrupt event triggered 0: No interrupt event triggered Write "1" to clear the interrupt status

I/O Port: BASE_ADDR + 01h
Register Name: GPIO PORT Interrupt Status 1 Register
Reset Value: 00h

7 6 5 4 3 2 1 0

GINTS1

Bit	Name	Attribute	Description
7-0	GINTS1	RW1C	GPIO Port Interrupt Status 1 Register. Bit 0 for Selected PortX[0], Bit1 for Selected PortX[1], ... ,Bit 7 for Selected PortX[7] 1: means Selected PortX[x] with interrupt event triggered 0: No interrupt event triggered Write "1" to clear the interrupt status

11.3.19 NMI Status and Control Register

I/O Port: 61h
Register Name: NMI Status and Control Register
Reset Value: 00xx0000b

7 6 5 4 3 2 1 0

SSS	ISS	T2S	RCT	IOE	PSE	SDE	T2E
-----	-----	-----	-----	-----	-----	-----	-----

Bit	Name	Attribute	Description
7	SSS	RO	SERR_ NMI Source Status. Bit 7 is set if a system board agent (PCI devices or main memory) detects a system board error and pulses the PCI SERR_ line. This interrupt source is enabled by setting bit 2 to 0. To reset the interrupt, set bit 2 to 0 and then set it to '1'. When writing to port 061, bit 7 must be a 0. If allowing NMI interrupt, the IO address 70h bit 7 set to 0 is needed.
6	ISS	RO	IOCHK_ NMI Source Status. Bit 6 is set if an expansion board asserts an IOCHK_ on the ISA Bus. This interrupt source is enabled by setting bit 3 to 0. To reset the interrupt, set bit 3 to 0 and then set it to '1'. When writing to port 061, bit 6 must be a 0. If allowing NMI interrupt, the IO address 70h bit 7 set to 0 is needed.
5	T2S	RO	Timer Counter 2 OUT Status. The Counter 2 OUT signal state is reflected in Bit 5. The value on this bit following a read is the current state of the Counter 2 OUT signal. Counter 2 must be programmed by following a CPURST for this bit to have a determinate value. When writing to port 061, bit 5 must be a 0.
4	RCT	RO	Refresh Cycle Toggle. The Refresh Cycle Toggle signal toggles from either 0 to 1 or 1 to 0 by following every refresh cycle. When writing to port 061, bit 5 must be a 0.
3	IOE	R/W	ISA IOCHK_ Enable. 1 = Disable and Clear IOCHK_ status. 0 = Enable.
2	PSE	R/W	PCI SERR_ Enable. 1 = Disable and Clear SERR_ status. 0 = Enable.
1	SDE	R/W	Speaker Data Enable. 0 = SPKR output is 0. 1 = the SPKR output is the Counter 2 OUT signal value.
0	T2E	R/W	Timer Counter 2 Enable. 0 = Disable; 1 = Enable.

11.3.20 WDT Registers

WDT1 Control Register

I/O Port: A8h
Register Name: WDT1 Control Register
Reset Value: 00h

7	6	5	4	3	2	1	0
RSVD	WE	RSVD					

Bit	Name	Attribute	Description
7	RSVD	RO	Reserved.
6	WE	R/W	WDT1 Enable Control. (Write bit6=1 to reload WDT1 counter) 0: Disable WDT1(default) 1: Enable WDT 1
5-0	RSVD	RO	Reserved.

I/O Port: A9h
Register Name: WDT1 Signal Select Control Register
Reset Value: 00h

7	6	5	4	3	2	1	0
SSEL				RSVD			

Bit	Name	Attribute	Description																												
7-4	SSEL	R/W	Signal Select after WDT1 timeout <table border="1" style="width: 100%; border-collapse: collapse; margin-top: 5px;"> <thead> <tr> <th style="width: 15%;">B[7-4]</th> <th style="width: 85%;">Signal</th> </tr> </thead> <tbody> <tr><td style="text-align: center;">0000</td><td>Reserved (default)</td></tr> <tr><td style="text-align: center;">0001</td><td>IRQ[3]</td></tr> <tr><td style="text-align: center;">0010</td><td>IRQ[4]</td></tr> <tr><td style="text-align: center;">0011</td><td>IRQ[5]</td></tr> <tr><td style="text-align: center;">0100</td><td>IRQ[6]</td></tr> <tr><td style="text-align: center;">0101</td><td>IRQ[7]</td></tr> <tr><td style="text-align: center;">0110</td><td>IRQ[9]</td></tr> <tr><td style="text-align: center;">0111</td><td>IRQ[10]</td></tr> <tr><td style="text-align: center;">1000</td><td>IRQ[11]</td></tr> <tr><td style="text-align: center;">1001</td><td>IRQ[12]</td></tr> <tr><td style="text-align: center;">1010</td><td>IRQ[14]</td></tr> <tr><td style="text-align: center;">1011</td><td>IRQ[15]</td></tr> <tr><td style="text-align: center;">1100</td><td>NMI</td></tr> </tbody> </table>	B[7-4]	Signal	0000	Reserved (default)	0001	IRQ[3]	0010	IRQ[4]	0011	IRQ[5]	0100	IRQ[6]	0101	IRQ[7]	0110	IRQ[9]	0111	IRQ[10]	1000	IRQ[11]	1001	IRQ[12]	1010	IRQ[14]	1011	IRQ[15]	1100	NMI
B[7-4]	Signal																														
0000	Reserved (default)																														
0001	IRQ[3]																														
0010	IRQ[4]																														
0011	IRQ[5]																														
0100	IRQ[6]																														
0101	IRQ[7]																														
0110	IRQ[9]																														
0111	IRQ[10]																														
1000	IRQ[11]																														
1001	IRQ[12]																														
1010	IRQ[14]																														
1011	IRQ[15]																														
1100	NMI																														

Vortex86EX

32-Bit x86 Micro Processor

			1101	System Reset	
			1110	SMI	
			1111	Reserved	
3-0	RSVD	RO	Reserved.		

I/O Port: AAh
Register Name: WDT1 Counter 0 Register
Reset Value: 00h

7 6 5 4 3 2 1 0

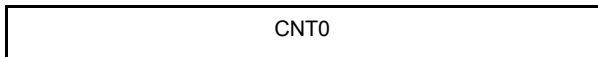

Bit	Name	Attribute	Description
7-0	CNT0	R/W	WDT1 Counter 0 WDT1 counter [7-0]. Resolution is 30.5us

I/O Port: ABh
Register Name: WDT1 Counter 1 Register
Reset Value: 00h

7 6 5 4 3 2 1 0

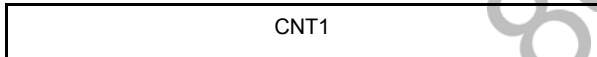

Bit	Name	Attribute	Description
7-0	CNT1	R/W	WDT1 Counter 1. WDT1 counter [15-8]. Resolution is 30.5us

I/O Port: ACh
Register Name: WDT1 Counter 2 Register
Reset Value: 00h

7 6 5 4 3 2 1 0

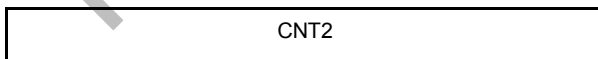

Bit	Name	Attribute	Description
7-0	CNT2	R/W	WDT1 Counter 2. WDT1 counter [23-16]. Resolution is 30.5us

Vortex86EX

32-Bit x86 Micro Processor

I/O Port: ADh
Register Name: WDT1 Status Register
Reset Value: 00h

7 6 5 4 3 2 1 0

WDTF	RSVD
------	------

Bit	Name	Attribute	Description
7	WDTF	R/WC	WDT1 Flag. 0: WDT1 timeout event does not happen 1: WDT1 timeout event happens (write 1 to clear this flag)
6-0	RSVD	RO	Reserved.

WDT Reload Register

I/O Port: 65h
Register Name: WDT0 Reload Register
Reset Value: --

7 6 5 4 3 2 1 0

WDTRL

Bit	Name	Attribute	Description
7-0	WDTRL	W	Write this port to reload WDT0 internal counter. The read data is unknown.

I/O Port: AEh
Register Name: WDT1 Reload Register
Reset Value: --

7 6 5 4 3 2 1 0

WDTRL

Bit	Name	Attribute	Description
7-0	WDTRL	W	Write this port to reload WDT1 internal counter. The read data is unknown.

11.3.21 CMOS Memory & RTC Registers

This port is shared with the real-time clock. Do not modify the contents of this register without considering the effects on the state of the other bits. Reads and writes to this register address flow through to the ISA Bus. Reads to register 70h will cause X-Bus reads, but no RTCCS# or RTCALE will be generated. (The RTC has traditionally been write-only to port 70h.)

I/O Port: 70h
Register Name: CMOS Memory Address Register
Reset Value: --

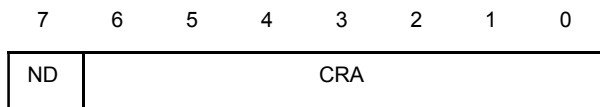

Bit	Name	Attribute	Description
7	ND	W	= 1: NMI disabled (used in normal access to CMOS RAM)(default) = 0: Allowed non-maskable interrupt, NMI interrupt 2
6-0	CRA	W	CMOS RAM Address for the next read or write Use SB C0h bit3 to select Page 0 or page 1. Address 00h~14h direct access to Page0, no matter SB C0h bit3 set to 0 or 1.

I/O Port: 71h
Register Name: CMOS Memory Data Register
Reset Value: --

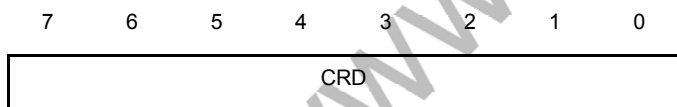

Bit	Name	Attribute	Description
7-0	CRD	W/R	RTC Data written to standard RAM bank address selected via CMOS Memory Address Register (70h).

11.3.22 System Function Register

I/O Port: 92h
Register Name: System Control Register
Reset Value: 00h

7 6 5 4 3 2 1 0

RSVD	FGA	FSR
------	-----	-----

Bit	Name	Attribute	Description
7-2	RSVD	RO	Reserved. Returns "0" when read.
1	FGA	R/W	Fast Gate A20. Set Index 41h bit1(P92S) and bit2 (P92FE) as '1' in SB Configuration Register to activate the Fast Gate A20 control. 0: A20GATE# is low 1: A20GATE# is high This bit has no effect when Index 41h bit1 is set as "0" in SB Configuration Register.
0	FSR	R/W	Fast System Reset. Set '1' to SB Configuration Register Index 41 bit 2 and '1' to this bit to Reset System

11.3.23 I2C Registers

Register Offset: BA + 0h
Register Name: I2C0 Control Register
Reset Value: 00h

7 6 5 4 3 2 1 0

Sw_Inten	RX_Inten	TX_Inten	Nak_Inten	ARL_Inten	STP_Inten	STOP	NAKEN
----------	----------	----------	-----------	-----------	-----------	------	-------

Bit	Name	Attribute	Description
7	Sw_Inten	R/W	Slave write Interrupt Enable. When enabled, it will generate interrupt signal at slave mode to request software writing TX Data. This bit is only needed at slave mode
6	RX_Inten	R/W	RX Interrupt Enable. When enabled, it will generate interrupt signal while RX Data buffer has data to be read
5	TX_Inten	R/W	TX Interrupt Enable. When enabled, it will generate interrupt signal while TX_Data or Tx_Addr was sent out successfully.
4	Nak_Inten	R/W	Nak Interrupt Enable. When enabled, it will generate interrupt signal while

Vortex86EX

32-Bit x86 Micro Processor

Bit	Name	Attribute	Description
			master mode receive unpredictable "Nak" from outside slave
3	ARL_Inten	R/W	Arbitration Loss Interrupt Enable. When enabled, it will generate interrupt signal while arbitration loss occurs
2	STP_Inten	R/W	Slave Mode Stop Interrupt Enable. When enabled, it will generate interrupt signal while slave mode is ended by outside master issuing STOP.
1	STP	R/W	Writing a 1 to this bit will cause the hardware to send NAK+Stop signal after current byte transfer. It will be auto cleared while STOP is sent out on the i2c bus. This should be used only when the device is a master.
0	NAKEen	R/W	1: This causes the I ² C-bus controller to send an Nak after each byte. 0: This causes the I ² C-bus controller to send an Ack after each byte. This bit is only needed at slave mode

Register Offset: BA + 1h
Register Name: I2C0 Status Register
Reset Value: 01h

7	6	5	4	3	2	1	0
Sw_Req	RX_Rdy	TX_Done	Nak_err	ARL	SlaveSTP	BBusy	MS_

Bit	Name	Attribute	Description
7	Sw_Req	R/WC	1: Slave request software to write TX data Write 1 to this bit will clear to "0"
6	RX_Rdy	R/WC	1: Master/Slave has data to be read Write 1 to this bit will clear to "0"
5	TX_Done	R/WC	1: Master/Slave send TX_Address or TX data successfully Write 1 to this bit will clear to "0"
4	Nak_err	R/WC	1: Unpredictable Nak is received Write 1 to this bit will clear to "0"
3	ARL	R/WC	1: Arbitration loss . Write 1 to this bit will clear to "0"
2	SlaveSTP	R/WC	1: Slave receive STOP condition Write 1 to this bit will clear to "0"
1	BBUSY	RO	The bus is considered to be busy after the Start condition and free again at a certain time interval after the Stop condition.
0	MS_	RO	1 : Master mode (Default) 0 : Slave mode

Vortex86EX

32-Bit x86 Micro Processor

Register Offset: BA + 2h
Register Name: I2C0 My_Address Register
Reset Value: 00h

7 6 5 4 3 2 1 0

My Slave Address	TCE
------------------	-----

Bit	Name	Attribute	Description
7-1	My_Addr	R/W	7-bits slave address which is checked by internal slave module. If address is match it will switch to slave mode. Processor can write proper value into this register to identify itself
0	TCE	R/W	I2C START/STOP timing constraint is dynamic with the clock rate setting. (Max(half of clock cycle, spec timing)) 1: Enabled 0: Disabled

Register Offset: BA + 3h
Register Name: I2C0 Transmit Address Register
Reset Value: 00h

7 6 5 4 3 2 1 0

TX Slave Address	R/W
------------------	-----

Bit	Name	Attribute	Description
7-0	TX_Addr	R/W	8-bit address register for Master to start a transaction. Processor can write this register to generate START + Slave Address + R/W on i2c bus. If Processor writes a macrocode into this register, it will send out macrocode and switch to high-speed mode at proper timing.

Register Offset: BA + 4h
Register Name: I2C0 Transmit/Receive Data Register
Reset Value: 00h

7 6 5 4 3 2 1 0

Data

Bit	Name	Attribute	Description
7-0	Data	R/W	8-bit data register for I ² C-bus Tx/Rx operation. Processor can write this register to transmit DATA or read this register to receive data.

Vortex86EX

32-Bit x86 Micro Processor

Register Offset: BA + 5h
Register Name: I2C0 Clock Frequency Control1
Reset Value: 0Ah

7 6 5 4 3 2 1 0

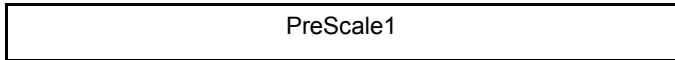

Bit	Name	Attribute	Description
7-0	PreScale1	R/W	Processor can write this register value from 0 to 255 to control the frequency of SCLH. PS: If PreScale1 < 10, SCLH frequency = 33M÷10 = 3.3Mhz

Register Offset: BA + 6h
Register Name: I2C0 Clock Frequency Control2
Reset Value: 88h

7 6 5 4 3 2 1 0

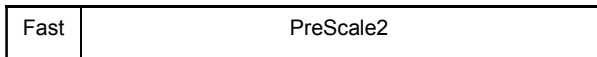

Bit	Name	Attribute	Description
7	Fast	R/W	1: Fast mode 0: Standard Mode
6-0	PreScale2	R/W	Processor can write this register value from 0 to 255 to control the frequency of SCL. At F/S Mode, SCL frequency = 33M÷(PreScale1) ÷(PreScale2+1)

Vortex86EX

32-Bit x86 Micro Processor

Register Offset: BA + 7h
Register Name: I2C0 Extra Control Register
Reset Value: 00h

7	6	5	4	3	2	1	0
I2c_RST	Latch_time	No_filter	No_drive	DIMC	DI196	DIAR	DIDC

Bit	Name	Attribute	Description
7	I2c_RST	R/W	Write "1" will reset i2c controller except pre-scale registers (for keep the speed setting). After reset, Controller will send out 10 dummy clocks to ensure no any slave driving data because of incomplete operation of the Master (maybe other master), auto clear after reset complete.
6	Latch_time	R/W	Master/Slave latch data location(it only affects high speed mode) 0: Normal 1: Delay 30ns than normal
5	No_filter	R/W	0: with de-glitch circuit (default) 1: disable de-glitch circuit.
4	No_drive	R/W	0: clock pin may drive high directly at some duration for higher clock rate 1: disable this function. Always open-drain.
3	DIMC	R/W	Identification ability for master code 0: Enable 1: Disable
2	DI196	R/W	Auto exit from busy state after 1.96ms 0: Enable 1: Disable
1	DIAR	R/W	Auto read when read data, it need dummy write to data to trigger read 0: Disable 1: Enable
0	DIDC	R/W	Dummy clock when i2c reset 0: Enabled 1: Disabled

11.3.24 DOS 4Gpage Access

Register Offset: E3h – E0h
Register Name: D4GA1 Control and Source Address Register
Reset Value: 00000000h

31 30 29 28 27 26 25 24 23 22 21 20 19 18 17 16 15 14 13 12 11 10 9 8 7 6 5 4 3 2 1 0

EN	RSVD	BS	RSVD	PSA	RSVD
----	------	----	------	-----	------

Bit	Name	Attribute	Description
31	EN	R/W	Enable D4GA1 (DOS 4GPage Access 1) address translation function
30-26	RSVD	RO	Reserved.
25-24	BS	R/W	Bank Size for D4GA1. 00b: 16K byte 01b: 32Kbyte 10b: 64Kbyte 11b: Reserved
23-20	RSVD	RO	Reserved.
19-14	PSA	R/W	Source Address SA[19-14] , physical address. If BS=01b, SA[14] is read-only and always is 0. If BS=10b, SA[15-14] are read-only and always are 0.
13-0	RSVD	RO	Source Address SA[13-0] , These bits should always be 0.

Register Offset: E7h – E4h
Register Name: D4GA1 Destination Address Register
Reset Value: 00000000h

31 30 29 28 27 26 25 24 23 22 21 20 19 18 17 16 15 14 13 12 11 10 9 8 7 6 5 4 3 2 1 0

PDA	RSVD
-----	------

Bit	Name	Attribute	Description
31-14	PDA	R/W	Destination Address DA[31-14] , physical address. If BS=01b, DA[14] is read-only and always is 0. If BS=10b, DA[15-14] are read-only and always are 0.
13-0	RSVD	RO	Destination Address DA[13-0]. These bits should always be 0.

Vortex86EX

32-Bit x86 Micro Processor

Register Offset: EBh – E8h
Register Name: D4GA2 Control and Source Address Register
Reset Value: 00000000h

31	30	29	28	27	26	25	24	23	22	21	20	19	18	17	16	15	14	13	12	11	10	9	8	7	6	5	4	3	2	1	0
EN		RSVD				BS		RSVD				PSA				RSVD															

Bit	Name	Attribute	Description
31	EN	R/W	Enable D4GA2 (DOS 4GPage Access 2) address translation function
30-26	RSVD	RO	Reserved.
25-24	BS	R/W	Bank Size for D4GA2. 00b: 16K byte 01b: 32Kbyte 10b: 64Kbyte 11b: Reserved
23-20	RSVD	RO	Reserved.
19-14	PSA	R/W	Source Address SA[19-14], physical address. If BS=01b, SA[14] is read-only and always is 0. If BS=10b, SA[15-14] are read-only and always are 0.
13-0	RSVD	RO	Source Address SA[13-0]. These bits should always be 0.

Register Offset: EFh – ECh
Register Name: D4GA2 Destination Address Register
Reset Value: 00000000h

31	30	29	28	27	26	25	24	23	22	21	20	19	18	17	16	15	14	13	12	11	10	9	8	7	6	5	4	3	2	1	0
PDA														RSVD																	

Bit	Name	Attribute	Description
31-14	PDA	R/W	Destination Address DA[30-14], physical address. If BS=01b, DA[14] is read-only and always is 0. If BS=10b, DA[15-14] are read-only and always are 0.
13-0	RSVD	RO	Destination Address DA[13-0], always 0

- Note1:** Source and Destination Address are physical address and must be in SDRAM area.
Note2: D4GA1 and D4GA2 address can't overlap.
Note3: Must be used DWORD IO read and write (IND, OUTD)
Note4: Software must be care PSA/PDA must align Bank size.
Note5: Support dynamically change Source & Destination Address.

11.3.25 Spare Registers

I/O Port: 80h
 Register Name: Spare Register
 Reset Value: --

7 6 5 4 3 2 1 0

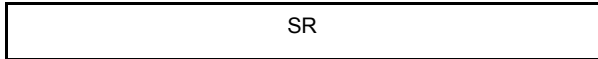

Bit	Name	Attribute	Description
7-0	SR	R/W	<i>Spare Register.</i>

I/O Port: 84h
 Register Name: Spare Register
 Reset Value: --

7 6 5 4 3 2 1 0

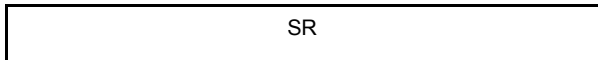

Bit	Name	Attribute	Description
7-0	SR	R/W	<i>Spare Register.</i>

I/O Port: 85h
 Register Name: Spare Register
 Reset Value: --

7 6 5 4 3 2 1 0

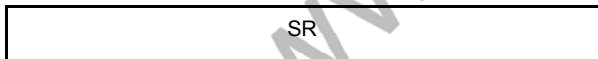

Bit	Name	Attribute	Description
7-0	SR	R/W	<i>Spare Register.</i>

Vortex86EX

32-Bit x86 Micro Processor

I/O Port: 86h
Register Name: Spare Register
Reset Value: --

7 6 5 4 3 2 1 0

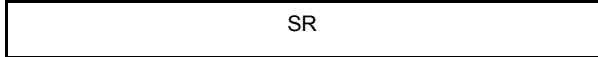

Bit	Name	Attribute	Description
7-0	SR	R/W	<i>Spare Register.</i>

I/O Port: 88h
Register Name: Spare Register
Reset Value: --

7 6 5 4 3 2 1 0

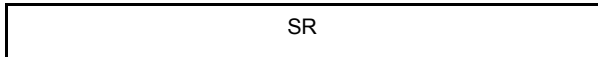

Bit	Name	Attribute	Description
7-0	SR	R/W	<i>Spare Register.</i>

I/O Port: 8Ch
Register Name: Spare Register
Reset Value: --

7 6 5 4 3 2 1 0

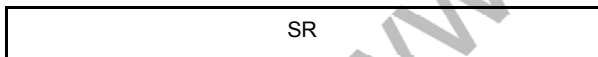

Bit	Name	Attribute	Description
7-0	SR	R/W	<i>Spare Register.</i>

I/O Port: 8Dh
Register Name: Spare Register
Reset Value: --

7 6 5 4 3 2 1 0

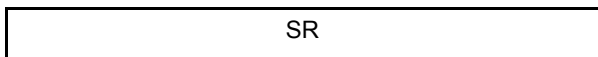

Bit	Name	Attribute	Description
7-0	SR	R/W	<i>Spare Register.</i>

Vortex86EX

32-Bit x86 Micro Processor

I/O Port: 8Eh
Register Name: Spare Register
Reset Value: --

7 6 5 4 3 2 1 0

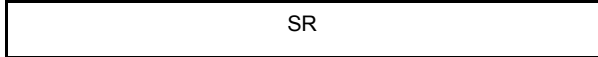

Bit	Name	Attribute	Description
7-0	SR	R/W	<i>Spare Register.</i>

I/O Port: 8Fh
Register Name: Spare Register
Reset Value: --

7 6 5 4 3 2 1 0

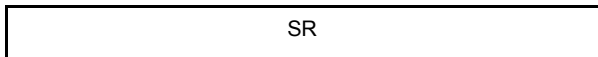

Bit	Name	Attribute	Description
7-0	SR	R/W	<i>Spare Register.</i>

I/O Port: 480h
Register Name: Spare Register
Reset Value: --

7 6 5 4 3 2 1 0

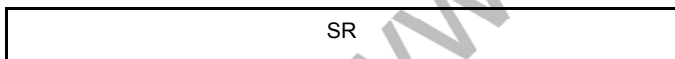

Bit	Name	Attribute	Description
7-0	SR	R/W	<i>Spare Register.</i>

I/O Port: 484h
Register Name: Spare Register
Reset Value: --

7 6 5 4 3 2 1 0

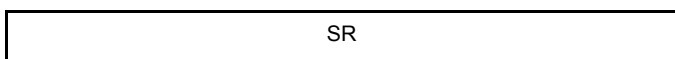

Bit	Name	Attribute	Description
7-0	SR	R/W	<i>Spare Register.</i>

Vortex86EX

32-Bit x86 Micro Processor

I/O Port: 485h
Register Name: Spare Register
Reset Value: --

7 6 5 4 3 2 1 0

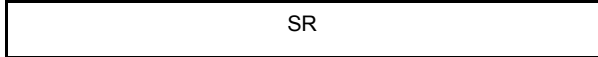

Bit	Name	Attribute	Description
7-0	SR	R/W	<i>Spare Register.</i>

I/O Port: 486h
Register Name: Spare Register
Reset Value: --

7 6 5 4 3 2 1 0

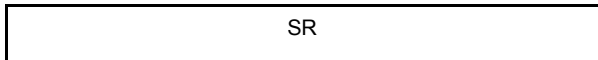

Bit	Name	Attribute	Description
7-0	SR	R/W	<i>Spare Register.</i>

I/O Port: 488h
Register Name: Spare Register
Reset Value: --

7 6 5 4 3 2 1 0

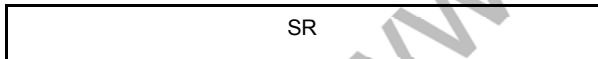

Bit	Name	Attribute	Description
7-0	SR	R/W	<i>Spare Register.</i>

I/O Port: 48Ch
Register Name: Spare Register
Reset Value: --

7 6 5 4 3 2 1 0

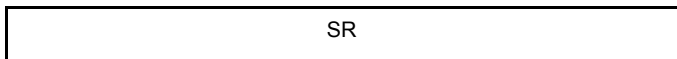

Bit	Name	Attribute	Description
7-0	SR	R/W	<i>Spare Register.</i>

Vortex86EX

32-Bit x86 Micro Processor

I/O Port: 48Dh
Register Name: Spare Register
Reset Value: --

7 6 5 4 3 2 1 0

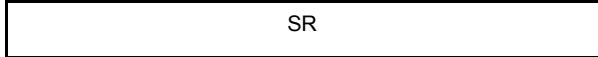

Bit	Name	Attribute	Description
7-0	SR	R/W	<i>Spare Register.</i>

I/O Port: 48Eh
Register Name: Spare Register
Reset Value: --

7 6 5 4 3 2 1 0

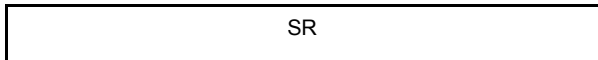

Bit	Name	Attribute	Description
7-0	SR	R/W	<i>Spare Register.</i>

I/O Port: 48Fh
Register Name: Spare Register
Reset Value: --

7 6 5 4 3 2 1 0

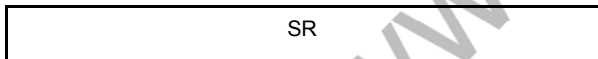

Bit	Name	Attribute	Description
7-0	SR	R/W	<i>Spare Register.</i>

11.3.26 SMM Registers

I/O Port: 0B2h
Register Name: Software SMI Trigger Port2
Reset Value: 00h

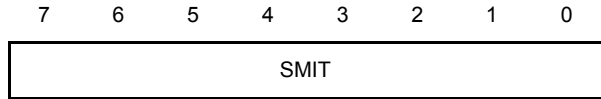

Bit	Name	Attribute	Description
7-0	SMIT	R/W	Generate a software SMI when write this port. This port is useful when SMI function Control register bit0 = 1.

Register Offset: BA+0
Register Name: SMI Event Status Register
Reset Value: 00000000h

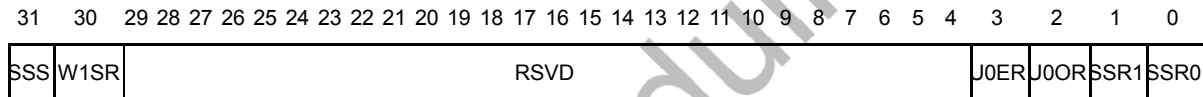

Bit	Name	Attribute	Description
31	SSS	R/WC	SMI Summary Status. If there is at least one SMI request that enabled by SMI Control Register. This bit will be '1'.
30	W1SR	R/WC	WDT1 SMI Request Event happens when Set. Write 1 to Clear.
29-4	RSVD	RO	Reserved.
3	U0ER	R/WC	USB0 EHCI SMI Request Event happens when Set. Write 1 to Clear.
2	U0OR	R/WC	USB0 OHCI SMI Request Event happens when Set. Write 1 to Clear.
1	SSR1	R/WC	Software SMI Request Event happens from port B2h when Set. Write 1 to Clear.
0	SSR0	R/WC	Software SMI Request Event happens from port BA+10 when Set. Write 1 to Clear.

Vortex86EX

32-Bit x86 Micro Processor

Register Offset: BA+4
Register Name: SMI Event Control Register
Reset Value: 00000000h

31 30 29 28 27 26 25 24 23 22 21 20 19 18 17 16 15 14 13 12 11 10 9 8 7 6 5 4 3 2 1 0

SSS	W1SE	RSVD	U0EE	U0OE	SSE1	SSE0
-----	------	------	------	------	------	------

Bit	Name	Attribute	Description
31	SSE	R/W	SMI Function Enable when set. This is a global SMI control bit. If this bit is 0, no SMI can be happen.
30	W1SE	R/W	WDT1 SMI Request Enable when set
29-4	RSVD	RO	Reserved.
3	U0EE	R/W	USB0 EHCI SMI Request Enable when set
2	U0OE	R/W	USB0 OHCI SMI Request Enable when set
1	SSE1	R/W	Software SMI Request Enable for port B2h when set.
0	SSE0	R/W	Software SMI Request Enable for port BA+10 when set.

I/O Port: BA + 8
Register Name: SMI function Control
Reset Value: 00h

7 6 5 4 3 2 1 0

RSVD	PB2E
------	------

Bit	Name	Attribute	Description
7-1	RSVD	RO	Reserved.
0	PB2E	R/W	Software SMI port B2h enable when set.

I/O Port: BA + 9
Register Name: SMM Status
Reset Value: 01h

7 6 5 4 3 2 1 0

RSVD	SAS
------	-----

Bit	Name	Attribute	Description
7-1	RSVD	RO	Reserved.
0	SAS	RO	SMIACT_ Status. This bit report the SMIACT_ signal state. '0': CPU is in SMM mode.

I/O Port: BA + 0Ah
Register Name: Software SMI Trigger Port1
Reset Value: 00h

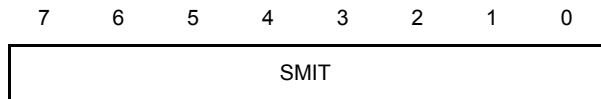

Bit	Name	Attribute	Description
7-0	SMIT	R/W	Generate a software SMI when write this port.

11.3.27 ADC Registers

(ADC I/O Base Address Refers to the Register of index E1h-E0h, IDSEL = AD18/SB PCI Function 1 Configuration Register)

Register Offset: BASE_ADDR+0h
Register Name: AUX Channel Select Register
Reset Value: 0000h

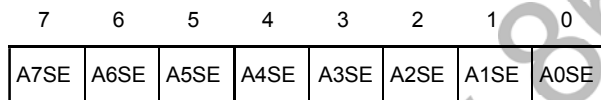

Bit	Name	Attribute	Description
7	A7SE	R/W	AUX7 scan. 0: Disabled 1: Enabled
6	A6SE	R/W	AUX6 scan. 0: Disabled 1: Enabled
5	A5SE	R/W	AUX5 scan. 0: Disabled 1: Enabled
4	A4SE	R/W	AUX4 scan. 0: Disabled 1: Enabled
3	A3SE	R/W	AUX3 scan. 0: Disabled 1: Enabled
2	A2SE	R/W	AUX2 scan.

Vortex86EX

32-Bit x86 Micro Processor

			0: Disabled 1: Enabled
1	A1SE	R/W	AUX1 scan. 0: Disabled 1: Enabled
0	A0SE	R/W	AUX0 scan. 0: Disabled 1: Enabled

Register Offset: BASE_ADDR+01h
Register Name: ADC Control Register
Reset Value: 0000h

7	6	5	4	3	2	1	0
IMC	IIT		APM	AICS	ASM	AST	

Bit	Name	Attribute	Description
7	IMC	R/W	Interrupt Mask Control. 0: Mask Interrupt generation 1: Enable Interrupt generation
6-4	IIT	R/W	Interrupt Issue Threshold. 000b: 1 data in FIFO 001b: 3 data in FIFO 010b: 5 data in FIFO 011b: 7 data in FIFO 100b: 9 data in FIFO 101b: 11 data in FIFO 110b: 13 data in FIFO 111b: 15 data in FIFO
3	APM	R/W	DC control for ADC power-down: 0: Normal mode 1: Power down mode
2	AICS	R/W	ADC Input Clock Selection in test-mode use. 0: Internal clock input 1: External clock input
1	ASM	R/W	ADC SCAN Mode. 0: One-Shot Mode, only scan once for register 0 selected channels. After scan done, AST automatically clear. 1: Auto-Scan Mode
0	AST	R/W	ADC Starts to convert data when set. 0: Stop 1: Start

Vortex86EX

32-Bit x86 Micro Processor

Register Offset: BASE_ADDR+02h
Register Name: ADC Status Register
Reset Value: 0000h

7	6	5	4	3	2	1	0
IS	RSVD						DR

Bit	Name	Attribute	Description
7	IS	RWC	Interrupt Status. When FIFO data is matching IIT, this bit will be set. Write "1" to clear
6-1	RSVD	RO	Reserved.
0	DR	RO	Data Ready in FIFO. 0: Not Ready 1: Ready

Register Offset: BASE_ADDR+04h
Register Name: ADC Data Register
Reset Value: 0000h

15	14	13	12	11	10	9	8	7	6	5	4	3	2	1	0
AC				RSVD				AOD							

Bit	Name	Attribute	Description
15-13	AC	RO	Indicate AOD[10:0] belongs which AUX Channel
12-11	RSVD	RO	Reserved.
10-0	AOD	RO	ADC Output Data [10:0]. This data is ready during Register 2 bit0 DR is set. After read data [10:0], Hardware will automatically clear DR..

11.3.28 ACPI Registers

Register Offset: PMBASE + 00h
Register Name: PM1 Status Register
Reset Value: 0000h

	15	14	13	12	11	10	9	8	7	6	5	4	3	2	1	0
WKE_STS	RSVD			RTC_STS	RSVD			GBL_STS	BM_STS	RSVD			TMR_STS			

Bit	Name	Attribute	Description
15	WKE_STS	RWC	WakeUp Status Bits. 0: Clear this bit by writing 1 to the bit location. 1: This bit gets set when the system is in the sleeping state and an enabled wakeup event occurs. Upon setting this bit system transition to the working state.
14-11	RSVD	RO	Reserved.
10	RTC_STS	RWC	RTC alarm Status Bits. 0: Clear this bit by writing 1 to the bit location. 1: This bit gets set when the RTC generate an alarm (IRQ8# assert). It will generate SCI or SMI# when RTC_EN bit (PMBASE+02h, bit10) is set
9-6	Rsvd	RO	Reserved.
5	GBL_STS	RWC	Global Status Bits. 0: Clear this bit by writing 1 to the bit location. 1: This bit gets set when an SCI is generate due to the BIOS wanting the attention the SCI handler (When BIOS write SMI/SCI trigger register, it will generate SCI and set this bit).
4	BM_STS	RWC	Bus Master Status Bits. This bit will not cause a wakeup event SCI or SMI. 0: Clear this bit by writing 1 to the bit location. 1: This bit gets set when a system bus master requests the system bus (All PCI master, ISA master and ISA DMA).
3-1	RSVD	RO	Reserved.
0	TMR_STS	RWC	Timer Carry Status bit. 0: Clear this bit by writing 1 to the bit location. 1: This bit gets set any time the 23 rd /31 st bit of a 23/32-bit counter goes high. It will generate SCI or SMI# when TMR_EN bit (PMBASE+02h, bit0) is set

Vortex86EX

32-Bit x86 Micro Processor

Register Offset: PMBASE + 02h
Register Name: PM1 Enable Register
Reset Value: 0000h

15	14	13	12	11	10	9	8	7	6	5	4	3	2	1	0
RSVD				RTC_EN	RSVD				GBL_EN	RSVD				TMR_EN	

Bit	Name	Attribute	Description												
15-11	RSVD	RO	Reserved.												
10	RTC_EN	R/W	RTC Alarm Enable bit. When both the RTC_EN bit and RTC_STS bit are set, SCI/SMI# is raised.												
9-6	RSVD	RO	Reserved.												
5	GBL_EN	R/W	Global Enable bit. When both the GBL_EN bit and GBL_STS bit are set, an SCI is raised.												
4-1	RSVD	RO	Reserved.												
0	TMR_EN	R/W	<p>Timer Carry Interrupt Enable bit. When this bit is set then an SCI or SMI event is generated any time the TMR_STS bit is set. SCI_EN bit is at PMBASE+04h, bit0.</p> <table style="width: 100%; border-collapse: collapse;"> <thead> <tr> <th style="width: 10%;">TMR_EN</th> <th style="width: 10%;">SCI_EN</th> <th style="width: 80%;">Description</th> </tr> </thead> <tbody> <tr> <td style="text-align: center;">0</td> <td style="text-align: center;">X</td> <td>No SMI# or SCI</td> </tr> <tr> <td style="text-align: center;">1</td> <td style="text-align: center;">0</td> <td>SMI#</td> </tr> <tr> <td style="text-align: center;">1</td> <td style="text-align: center;">1</td> <td>SCI</td> </tr> </tbody> </table>	TMR_EN	SCI_EN	Description	0	X	No SMI# or SCI	1	0	SMI#	1	1	SCI
TMR_EN	SCI_EN	Description													
0	X	No SMI# or SCI													
1	0	SMI#													
1	1	SCI													

Register Offset: PMBASE + 04h
Register Name: PM1 Control Register
Reset Value: 0000h

15	14	13	12	11	10	9	8	7	6	5	4	3	2	1	0
RSVD		SLP_EN	SLP_TYPx	RSVD							GBL_RLS	BM_RLD	SCI_EN		

Bit	Name	Attribute	Description
15-14	RSVD	RO	Reserved.
13	SLP_EN	WO	Sleep Enable. Setting this bit causes the system to sequence into the sleeping state associated with SLP_TYPx.
12-10	SLP_TYPx	R/W	<p>Defines the types of the sleeping state the system enters when SLP_EN bit is set to one.</p> <p>000b: Normal ON, typically maps to S0 state</p>

Vortex86EX

32-Bit x86 Micro Processor

			001b: Stop Processor clock, S1 state 010b: Suspend-to-RAM, S3 state 011b: Suspend-to-Disk, S4 state 100b: Soft Off, S5 state 101b-111b: reserved
9-3	RSVD	RO	Reserved.
2	GBL_RLS	WO	Global Release. It is used by the ACPI software to raise an event to BIOS software. 0: This bits always read as 0 1: ACPI write a 1 to this register to generate a SMI to pass execution control to the BIOS when PMBASE+30h bit2 BIOS_SMI_EN set to one. The PMBASE+28h bit2 BIOS_STS also set to indicate BIOS. When software clear BIOS_STS, hardware also clear GBL_RLS.
1	BM_RLD	R/W	Bus Master Reload. 0: Bus Master Request does not affect processor in the C3 state 1: Enable Bus Master Requests to cause processor in the C3 to transition to C0.
0	SCI_EN	R/W	SCI Enable. Selects the power management event to be either an SCI or SMI for PM1_STS bit10 (RTC Alarm). 0: Generate an SMI# 1: Generate an SCI

Register Offset: PMBASE + 08h

Register Name: Power Management Timer Register

Reset Value: 00000000h

31 30 29 28 27 26 25 24 23 22 21 20 19 18 17 16 15 14 13 12 11 10 9 8 7 6 5 4 3 2 1 0

E_TMR_VAL	TMR_VAL
-----------	---------

Bit	Name	Attribute	Description
31-24	E_TMR_VAL	RO	Reserved, must be 0 when on;y support 24bits timer.
23-0	TMR_VAL	RO	Timer Value. It returns the running count of the power management timer in S0 state. This counter run off a 3.579545MHz clock (14.31818MHz/4). It is reset to 0 during a PCI reset and continues count until the 14.31818MHz is stopped. Timer carry generates every 2.3435 seconds.

Vortex86EX

32-Bit x86 Micro Processor

Register Offset: PMBASE + 10h
Register Name: Processor Control Register
Reset Value: 00000000h

31 30 29 28 27 26 25 24 23 22 21 20 19 18 17 16 15 14 13 12 11 10 9 8 7 6 5 4 3 2 1 0



Bit	Name	Attribute	Description
31-5	RSVD	RO	Reserved. (Possible locations of the clock throttling value)
4	THT_EN	R/W	This bit enables clock throttling of clock as set in CLK_VAL field. THT_EN bit must be 0 when changing CLK_VAL field. 0: Disabled 1: Enable CPU throttling
3-0	CLK_VAL	R/W	Possible locations for the clock throttling value when THT_EN set

Register Offset: PMBASE + 14h
Register Name: Processor LVL2 Register
Reset Value: 00h

7 6 5 4 3 2 1 0

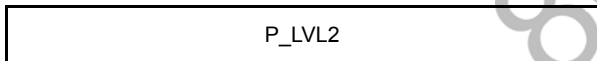

Bit	Name	Attribute	Description
7-0	P_LVL2	RO	Read this register to return all 0; write to this register have no effect. Read to this register also generate an "enter C2 power state" signal to hardware (clock control logic).

Register Offset: PMBASE + 15h
Register Name: Processor LVL3 Register
Reset Value: 00h

7 6 5 4 3 2 1 0

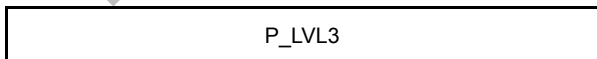

Bit	Name	Attribute	Description
7-0	P_LVL3	RO	Read this register to return all 0; write to this register have no effect. Reads to this register also generate an "enter C3 power state" signal to hardware (clock control logic).

Vortex86EX

32-Bit x86 Micro Processor

Register Offset: PMBASE + 20h
Register Name: GPE0_STS General Purpose Event 0 Status Register
Reset Value: 00000000h

31 30 29 28 27 26 25 24 23 22 21 20 19 18 17 16 15 14 13 12 11 10 9 8 7 6 5 4 3 2 1 0

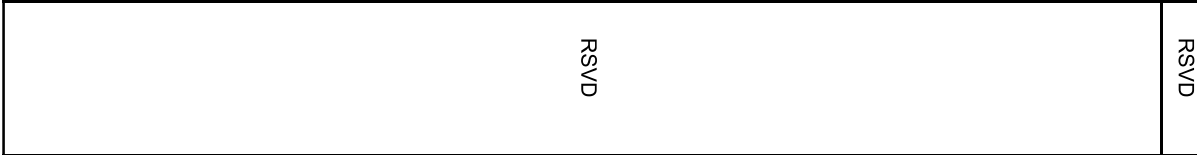

Bit	Name	Attribute	Description
31-1	RSVD	RO	Reserved.
0	RSVD	R/WC	Reserved.

Register Offset: PMBASE + 24h
Register Name: GPE0_EN General Purpose Event 0 Enable Register
Reset Value: 00000000h

31 30 29 28 27 26 25 24 23 22 21 20 19 18 17 16 15 14 13 12 11 10 9 8 7 6 5 4 3 2 1 0

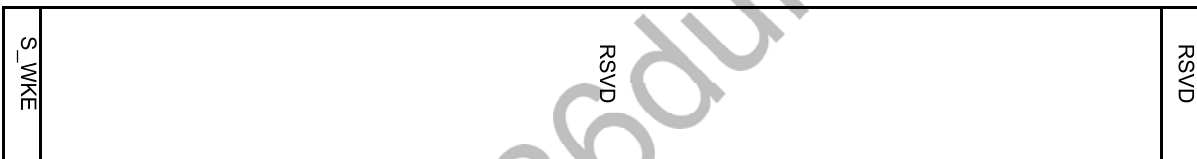

Bit	Name	Attribute	Description
31	S_WKE	R/W	S/W Wake Up Control. Set '1' will cause PMBase+0h bit15 WKE_STS to '1'. Set '0' will cause PMBase+0h bit15 WKE_STS to '0'. After WKE_STS write one clear to 0, this bit also will clear to 0.
30-1	RSVD	RO	Reserved.
0	RSVD	R/W	Reserved. 0: Disabled 1: Enable the corresponding event.

Vortex86EX

32-Bit x86 Micro Processor

Register Offset: PMBASE + 28h

Register Name: GPE0_SMI General Purpose Event 0 SMI Enable Register

Reset Value: 00000000h

31 30 29 28 27 26 25 24 23 22 21 20 19 18 17 16 15 14 13 12 11 10 9 8 7 6 5 4 3 2 1 0

RSVD	RSVD
------	------

Bit	Name	Attribute	Description
31-1	RSVD	RO	<i>Reserved.</i>
0	RSVD	R/W	<i>Reserved.</i>

Register Offset: PMBASE + 2Ch

Register Name: Global Status Register

Reset Value: 00000000h

31 30 29 28 27 26 25 24 23 22 21 20 19 18 17 16 15 14 13 12 11 10 9 8 7 6 5 4 3 2 1 0

RSVD	WDT_STS	RSVD	SLP_STS	RSVD	RSVD	USB1E_STS	USB1O_STS	BIOS_STS	B2_STS	SOFT_STS
------	---------	------	---------	------	------	-----------	-----------	----------	--------	----------

Bit	Name	Attribute	Description
31-13	RSVD	R/O	<i>Reserved.</i>
12	WDT_STS	RWC	WDT SMI Status. This bit will be set to 1 when WDT timeout and the timeout event is SMI.
11-8	RSVD	R/O	<i>Reserved.</i>
7	SLP_STS	RWC	Sleep SMI Status. This bit will be set to 1 when write "1" to PMBASE+04h bit 13 SLP_EN. And if both PMBASE+28h bit7 SLP_SMI_EN=1 and SLP_EN are set "1", that will generate SMI# and SLP_STS will set "1".
6	RSVD	RO	<i>Reserved.</i>
5	RSVD	RWC	<i>Reserved.</i>
4	USB1E_STS	RWC	Legacy USB1 EHCI SMI Status.
3	USB1O_STS	RWC	Legacy USB1 OHCI SMI Status.
2	BIOS_STS	RWC	BIOS Status. This bit is set when PMBASE+04h bit2 GBL_RLS=1. Normally it indicates ACPI passed the control to BIOS. Write 1 to clear.
1	B2_STS	RWC	I/O port B2h SMI Status. This bit is set when I/O port B2h is written. Write 1 to clear.
0	SOFT_STS	RWC	Software SMI Status. This bit is set when PMBASE+36h is written. Write 1 to

Vortex86EX

32-Bit x86 Micro Processor

			clear.
--	--	--	--------

Register Offset: PMBASE + 30h
Register Name: Global Enable Register
Reset Value: 00000000h

31 30 29 28 27 26 25 24 23 22 21 20 19 18 17 16 15 14 13 12 11 10 9 8 7 6 5 4 3 2 1 0

RSVD	WDT_EN	RSVD	SLP_SMI_EN	RSVD	RSVD	USB1E_SMI_EN	USB1O_SMI_EN	BIOS_SMI_EN	B2h_SMI_EN	SOFT_SMI_EN
------	--------	------	------------	------	------	--------------	--------------	-------------	------------	-------------

Bit	Name	Attribute	Description
31-13	RSVD	R/O	Reserved.
12	WDT_EN	R/W	0: None 1: Enable SMI# generation when WDT timeout and the timeout event is SMI.
11-8	RSVD	R/O	Reserved.
7	SLP_SMI_EN	R/W	0: None 1: Enable SMI# generation when write "1" to PMBASE+04h bit 13 SLP_EN and system will not transition to sleep state:
6	RSVD	R/O	Reserved.
5	RSVD	R/W	Reserved.
4	USB1E_SMI_EN	R/W	0: None 1: Enable SMI# generation when legacy USB1 EHCI event occurs :
3	USB1O_SMI_EN	R/W	0: None 1: Enable SMI# generation when legacy USB1 OHCI event occurs :
2	BIOS_SMI_EN	R/W	0: None 1: Enable SMI# generation when PM_BASE+04h bit2 is set :
1	B2h_SMI_EN	R/W	0: None, I/O port B2h disabled 1: Enable SMI# generation when I/O port B2h is written. (Enable I/O port b2h):
0	SOFT_SMI_EN	R/W	0: None 1: Enable SMI# generation when SMI command register(PM_BASE+36h) is written:

Vortex86EX

32-Bit x86 Micro Processor

Register Offset: PMBASE + 34h
Register Name: Global Control Register
Reset Value: 00000000h

15 14 13 12 11 10 9 8 7 6 5 4 3 2 1 0

RSVD	SCI_EN
------	--------

Bit	Name	Attribute	Description
15-1	RSVD	R/O	Reserved.
0	BIOS_RLS	R/W	BIOS Release. BIOS software write "1" to this bit to generate one SCI event (If PMBASE+2h bit5 GBL_EN=1). Upon setting this, hardware automatically set PMBASE+0h bit5 GBL_STS. This bit will be automatically cleared by hardware when GBL_STS bit cleared by software.

Register Offset: PMBASE + 36h
Register Name: Software SMI Command Register
Reset Value: 00h

7 6 5 4 3 2 1 0

P_LVL3

Bit	Name	Attribute	Description
7-0	SMI_CMD	R/W	Software SMI Command Register. Writing this register to set PMBASE+2Ch bit0 SOFT_STS. If PM_BASE+30h bit0 SOFT_SMI_EN is "1", It generates a SMI event too.

Advance Power Management I/O Control Port

I/O Port: 0B2h
Register Name: Software SMI Trigger Port2
Reset Value: 00h

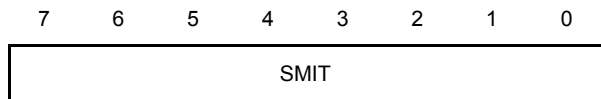

Bit	Name	Attribute	Description
7-0	SMIT	R/W	Generate a software SMI when write this port. This port is useful when B2h_SMI_EN (PMBASE+30h [1]) set 1, it will generate SMI#.

I/O Port: 0B3h
Register Name: Software SMI Port3
Reset Value: 00h

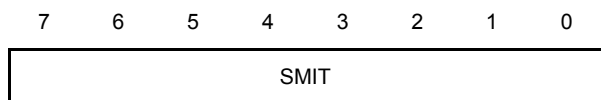

Bit	Name	Attribute	Description
7-0	SMIT	R/W	This is a scratchpad register and it's no affected to any other register or function.

11.3.29 CrossBar Config Registers

(Base Address Refers to the Register of index 65h-64h, SB Function0 PCI Configuration Register)

Register Offset: BASE + 0, 1, 2, ..., 9
Register Name: RichIO Port 0, 1, 2, ..., 9 Selection
Reset Value: 00h

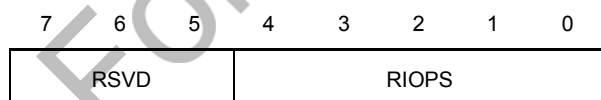

Bit	Name	Attribute	Description	
7-5	RSVD	RO	Reserved.	
4-0	SFS	R/W	Rich IO Port, Function selection.	
			function	
			00000b	No Function
			00001b	MCM P0
			00010b	MCM P1

Vortex86EX

32-Bit x86 Micro Processor

			00011b	MCM P2
			00100b	PRT 8/17 P0
			00101b	PRT 8/17 P1
			00110b	SD/MMC
			00111b	COM5 TXD5/RXD5, COM6 TXD6/RXD6, COM7 TXD7/RXD7, COM8 TXD8/RXD8
			01000b	Bit-RichIO Port0 Function defined on "Bit-RichIO Port0 Select Register"
			01001b	Bit-RichIO Port1 Function defined on "Bit-RichIO Port1 Select Register"
			01010b	Bit-RichIO Port2 Function defined on "Bit-RichIO Port2 Select Register"
			01011b	[ISA P0] IOCHCK, REFRESH, SYSCLK, OSC, IRQ3, IRQ4, IRQ5, IRQ6
			01100b	[ISA P1] IRQ7, IRQ10, IRQ11, IRQ12, IRQ15, TC, DRQ1, DACK1
			01101b	[ISA P2] SA16, SA17, SA18, SA19, AEN, IOCHRDY, SBHE, BALE
			01110b	[ISA P3] SA8-SA15
			01111b	[ISA P4] SD8-SD15
			10000b	[ISA P5] IOW, IOR, MEMR, MEMW, IOCS16, MEMCS16, GPCS0, GCS1
			10001b	[ISA P6] SA0-SA7
			10010b	[ISA P7] SD0-7

Vortex86EX

32-Bit x86 Micro Processor

Register Offset: BASE + 10h, 11h, ..., 17h

Register Name: Bit-RichIO Port0 Select

Reset Value: 00h

7	6	5	4	3	2	1	0
RSVD		BRIOPS					

Bit	Name	Attribute	Description	
7-6	RSVD	RO	Reserved.	
5-0	BRIOPS	R/W	Bit Function selection for this bit: (Some limitation need to take care for HDA, Full-duplex SPI and USB-Device in below Note.)	
			function	
			000000b	No Function
			000001b	COM1-TXD1
			000010b	COM1-RXD1
			000011b	COM2-TXD2
			000100b	COM2-RXD2
			000101b	COM3-TXD3
			000110b	COM3-RXD3
			000111b	COM4-TXD4
			001000b	COM4-RXD4
			001001b	SPI-CS1
			001010b	SPI-CLK
			001011b	SPI-DO
			001100b	SPI-DI
			001101b	I2C-SDA
			001110b	I2C-SCL
			001111b	CAN-TXD
			010000b	CAN-RXD
			010001b	USB-DEVICE+
			010010b	USB-DEVICE-
010011b	KBDATA			
010100b	KBCLK			
010101b	MSDATA			
010110b	MSCLK			
010111b	LAN-LINK/ACK			
011000b	LAN-DUPLEX			
011001b	PRINT 1/17-PErrror			

			011010b	SPEAKER
			011011b	WDTOUT
			011100b	TXDEN1
			011101b	TXDEN2
			011110b	TXDEN3
			011111b	TXDEN4
			100000b	TXDEN5
			100001b	TXDEN6
			100010b	TXDEN7
			100011b	TXDEN8
			100100b	CLK-OUT
			100101b	MTBF
			100110b	SPI-CS2
			100111b	H_BCLK
			101000b	H_SYNC
			101001b	H_SDO
			101010b	H_SDI
			101011b	H_RST#
			Note:	
			1. HDA	
			(H_BCLK, H_SYNC, H_SDO, H_SDI, H_RST#) must in the same CrossBar Port.	
			H_BCLK must in CrossBar Port Bit [0]	
			H_SYNC must in CrossBar Port Bit [1]	
			H_SDO must in CrossBar Port Bit [2]	
			H_SDI must in CrossBar Port Bit [3]	
			H_RST# must in CrossBar Port Bit [4].	
			Full-Duplex SPI	
			(SPI_CS1, SPI_CLK, SPI_DI, SPI_DO, SPI_CS2) must in the same CrossBar Port.	
			SPI_CS1 must in CrossBar Port Bit [0]	
			SPI_CLK must in CrossBar Port Bit [1]	
			SPI_DI must in CrossBar Port Bit [2]	
			SPI_DO must in CrossBar Port Bit [3]	
			SPI_CS2 must in CrossBar Port Bit [4]	
			USB Device	
			(USB-Device+, USB-Device-) must in the same CrossBar Port.	
			USB-Device+ must in CrossBar Port Bit [6]	
			USB-Device- must in CrossBar Port Bit [7]	

Vortex86EX

32-Bit x86 Micro Processor

Register Offset: BASE + 18h, 19h, ..., 1Fh
Register Name: Bit-RichIO Port1 Select
Reset Value: 00h

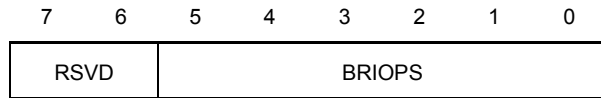

Bit	Name	Attribute	Description
7-6	RSVD	RO	Reserved.
5-0	BRIOPS	R/W	The same as "Bit-RichIO Port0 Select"

Register Offset: BASE +20h, 21h, ..., 27h
Register Name: Bit-RichIO Port2 Select
Reset Value: 00h

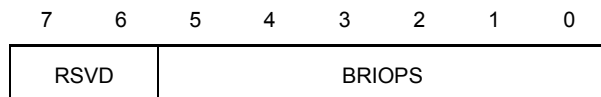

Bit	Name	Attribute	Description
7-6	RSVD	RO	Reserved.
5-0	BRIOPS	R/W	The same as "Bit-RichIO Port0 Select"

Register Offset: BA+ 28h
Register Name: On-Chip Device Power-Down Control 0
Reset Value: 00000000h

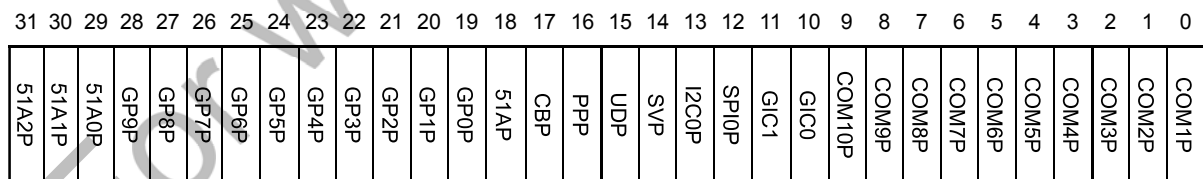

Bit	Name	Attribute	Description
31	51A2P	R/W	ON-Chip 8051A GPIO Port 2 power-down control 0: on-chip 8051A GPIO Port 2 activate (default) 1: on-chip 8051A GPIO Port 2 power-down
30	51A1P	R/W	ON-Chip 8051A GPIO Port 1 power-down control 0: on-chip 8051A GPIO Port 1 activate (default) 1: on-chip 8051A GPIO Port 1 power-down
29	51A0P	R/W	ON-Chip 8051A GPIO Port 0 power-down control

Vortex86EX

32-Bit x86 Micro Processor

			0: on-chip 8051A GPIO Port 0 activate (default) 1: on-chip 8051A GPIO Port 0 power-down
28	GP9P	RW	ON-Chip GPIO Port 9 power-down control 0: on-chip GPIO Port 9 activate (default) 1: on-chip GPIO Port 9 power-down
27	GP8P	RW	ON-Chip GPIO Port 8 power-down control 0: on-chip GPIO Port 8 activate (default) 1: on-chip GPIO Port 8 power-down
26	GP7P	RW	ON-Chip GPIO Port 7 power-down control 0: on-chip GPIO Port 7 activate (default) 1: on-chip GPIO Port 7 power-down
25	GP6P	RW	ON-Chip GPIO Port 6 power-down control 0: on-chip GPIO Port 6 activate (default) 1: on-chip GPIO Port 6 power-down
24	GP5P	RW	ON-Chip GPIO Port 5 power-down control 0: on-chip GPIO Port 5 activate (default) 1: on-chip GPIO Port 5 power-down
23	GP4P	RW	ON-Chip GPIO Port 4 power-down control 0: on-chip GPIO Port 4 activate (default) 1: on-chip GPIO Port 4 power-down
22	GP3P	RW	ON-Chip GPIO Port 3 power-down control 0: on-chip GPIO Port 3 activate (default) 1: on-chip GPIO Port 3 power-down
21	GP2P	RW	ON-Chip GPIO Port 2 power-down control 0: on-chip GPIO Port 2 activate (default) 1: on-chip GPIO Port 2 power-down
20	GP1P	RW	ON-Chip GPIO Port 1 power-down control 0: on-chip GPIO Port 1 activate (default) 1: on-chip GPIO Port 1 power-down
19	GP0P	RW	ON-Chip GPIO Port 0 power-down control 0: on-chip GPIO Port 0 activate (default) 1: on-chip GPIO Port 0 power-down
18	51AP	RW	ON-Chip 8051A power-down control (also power-down 8051A GPIO Port 0 - 9) 0: on-chip 8051A activate (default) 1: on-chip 8051A power-down
17	CBP	RW	ON-Chip CAN Bus Controller power-down control 0: on-chip CAN Bus Controller activate (default) 1: on-chip CAN Bus Controller power-down
16	PPP	RW	ON-Chip Parallel-Port power-down control 0: on-chip Parallel-Port activate (default) 1: on-chip Parallel-Port power-down

15	UDP	RW	ON-Chip USB Device power-down control 0: on-chip USB Device activate (default) 1: on-chip USB Device power-down
14	SVP	RW	ON-Chip MOTOR power-down control 0: on-chip MOTOR activate (default) 1: on-chip MOTOR power-down
13	I2C0P	RW	ON-Chip I2C0 power-down control 0: on-chip I2C0 activate (default) 1: on-chip I2C0 power-down
12	SPI0P	RW	ON-Chip SPI 0 power-down control 0: on-chip SPI 0 activate (default) 1: on-chip SPI 0 power-down.
11	GIC1	RW	ON-Chip GPIO Interrupt Control 1 power-down control 0: on-chip GPIO interrupt Control 1 activate (default) 1: on-chip GPIO interrupt Control 1 power-down
10	GIC0	RW	ON-Chip GPIO Interrupt Control 0 power-down control 0: on-chip GPIO interrupt Control 0 activate (default) 1: on-chip GPIO interrupt Control 0 power-down
9	COM10 P	RW	ON-Chip COM10 power-down control 0: on-chip COM10 activate (default) 1: on-chip COM10 power-down
8	COM9P	RW	ON-Chip COM9 power-down control 0: on-chip COM9 activate (default) 1: on-chip COM9 power-down
7	COM8P	RW	ON-Chip COM8 power-down control 0: on-chip COM8 activate (default) 1: on-chip COM8 power-down
6	COM7P	RW	ON-Chip COM7 power-down control 0: on-chip COM7 activate (default) 1: on-chip COM7 power-down
5	COM6P	RW	ON-Chip COM6 power-down control 0: on-chip COM6 activate (default) 1: on-chip COM6 power-down
4	COM5P	RW	ON-Chip COM5 power-down control 0: on-chip COM5 activate (default) 1: on-chip COM5 power-down
3	COM4P	RW	ON-Chip COM4 power-down control 0: on-chip COM4 activate (default) 1: on-chip COM4 power-down
2	COM3P	RW	ON-Chip COM3 power-down control 0: on-chip COM3 activate (default)

Vortex86EX

32-Bit x86 Micro Processor

			1: on-chip COM3 power-down
1	COM2P	RW	ON-Chip COM2 power-down control 0: on-chip COM2 activate (default) 1: on-chip COM2 power-down
0	COM1P	RW	ON-Chip COM1 power-down control 0: on-chip COM1 activate (default) 1: on-chip COM1 power-down

Register Offset: BA+ 2Ch
Register Name: On-Chip Device Power-Down Control 1
Reset Value: 0000000h

31	30	29	28	27	26	25	24	23	22	21	20	19	18	17	16	15	14	13	12	11	10	9	8	7	6	5	4	3	2	1	0
RSVD																HDAP	51A9P	51A8P	51A7P	51A6P	51A5P	51A4P	51A3P								

Bit	Name	Attribute	Description
31-8	RSVD	RO	Reserved.
7	HDAP	RW	ON-Chip HDA Device power-down control 0: on-chip HDA Device activate (default) 1: on-chip HDA Device power-down
6	51A9P	RW	ON-Chip 8051A GPIO Port 9 power-down control 0: on-chip 8051A GPIO Port 9 activate (default) 1: on-chip 8051A GPIO Port 9 power-down
5	51A8P	RW	ON-Chip 8051A GPIO Port 8 power-down control 0: on-chip 8051A GPIO Port 8 activate (default) 1: on-chip 8051A GPIO Port 8 power-down
4	51A7P	RW	ON-Chip 8051A GPIO Port 7 power-down control 0: on-chip 8051A GPIO Port 7 activate (default) 1: on-chip 8051A GPIO Port 7 power-down
3	51A6P	RW	ON-Chip 8051A GPIO Port 6 power-down control 0: on-chip 8051A GPIO Port 6 activate (default) 1: on-chip 8051A GPIO Port 6 power-down
2	51A5P	RW	ON-Chip 8051A GPIO Port 5 power-down control 0: on-chip 8051A GPIO Port 5 activate (default) 1: on-chip 8051A GPIO Port 5 power-down
1	51A4P	RW	ON-Chip 8051A GPIO Port 4 power-down control 0: on-chip 8051A GPIO Port 4 activate (default) 1: on-chip 8051A GPIO Port 4 power-down
0	51A3P	RW	ON-Chip 8051A GPIO Port 3 power-down control

Vortex86EX

32-Bit x86 Micro Processor

			0: on-chip 8051A GPIO Port 3 activate (default) 1: on-chip 8051A GPIO Port 3 power-down
--	--	--	--

Register Offset: BA + 30h, 31h, ..., 7Fh
Register Name: CrossBar PAD 0 – 79 Attribute
Reset Value: 00h

7	6	5	4	3	2	1	0
RSVD		PSR	PST	DCC	ISC		

Bit	Name	Attribute	Description
7-5	RSVD	RO	Reserved.
4	PSR	R/W	Pad Slew Rate Control. 0: low slew rate (default) 1: high slew rate
3	PST	R/W	Pad Smitter Trigger Control. 0: Disable(default) 1: Enable
2	DCC	R/W	Driving Current Control. 0: 8mA (default) 1: 16mA
1-0	ISC	R/W	Input State Control. 00 : Tri-state 01: Pull-up 10: Pull-down 11: Reserved

Register Offset: BASE + 84h, 85h, ..., 89h
Register Name: CrossBar-Port Group Selection, Port4, Port5, ..., Port9
Reset Value: 00h

7	6	5	4	3	2	1	0
RSVD			CPGS				

Bit	Name	Attribute	Description
7-5	RSVD	RO	Reserved.
4-0	CPGS	R/W	Group selection for this port: 00000b: No Function 00001b: GPIO group 00010b: COM group

Vortex86EX

32-Bit x86 Micro Processor

			00100b: 8051A GPIO group 01000b: RICH I/O group 10000b: Reserved
--	--	--	--

Register Offset: BASE + 90h, 91h, 92h, ..., AFh
Register Name: CrossBar-Bit Group Selection, Bit 0,1,2, ..., 32
Reset Value: 00h

7	6	5	4	3	2	1	0
RSVD				CBGS			

Bit	Name	Attribute	Description
7-5	RSVD	RO	Reserved.
4-0	CBGS	RW	Group selection for this bit: 00000b: No Function 00001b: GPIO group 00010b: COM group 00100b: 8051A GPIO group 01000b: RICH I/O group 10000b:Reserved

12. USB2.0 Host Controller

12.1 Features

The USB2.0 Host Controller is a two-port host controller which contains one OHCI host controller compliant with OpenHCI standard developed by Compaq, Microsoft and National Semiconductor and one EHCI host controller compliant with EHCI1.0 specification. Features of the USB2.0 host controller are described as below:

12.1.1 USB1.1 Host Controller

- ⌘ Supports all full-speed (12MHz) and low-speed (1.5MHz) devices compliant with the "USB Specification" version1.1.
- ⌘ Supports four transfers: control, bulk, interrupt and isochronous transfers.
- ⌘ Supports up to 127 devices at the same time.
- ⌘ Contains one 64-byte FIFO.

12.1.2 USB2.0 Host Controller

- ⌘ Supports all high-speed (480MHz) devices compliant with the "USB Specification" version2.0.
- ⌘ Supports four transfers: control, bulk, interrupt and isochronous transfers.
- ⌘ Supports split transaction for USB2.0 Hub plugged with USB1.1 devices.
- ⌘ Supports up to 127 devices at the same time.
- ⌘ Contains one 1K-byte FIFO.

12.2 General Descriptions

The USB 2.0 Host Controller includes one high-speed mode host controller and one USB 1.1 host controller (OHCI). The high-speed host controller implements an EHCI interface. It is used for all high-speed communications to high-speed-mode devices connected to the root ports of the USB 2.0 host controller. The communications to full- and low-speed devices connected to the root ports of the USB 2.0 host controller are provided by the USB 1.1 host controller.

12.3 Register Definition

12.3.1 USB1.1 Configuration Space Register

Register Offset: 01h – 00h
Register Name: Vendor ID Register
Reset Value : 17F3h

15 14 13 12 11 10 9 8 7 6 5 4 3 2 1 0



Bit	Name	Attribute	Description
15-0	VID	RO	Vendor ID

Register Offset: 03h – 02h
Register Name: Device ID Register
Reset Value : 6060h

15 14 13 12 11 10 9 8 7 6 5 4 3 2 1 0

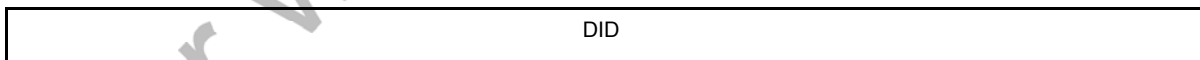

Bit	Name	Attribute	Description
15-0	DID	RO	Device ID

Vortex86EX

32-Bit x86 Micro Processor

Register Offset: 05h – 04h
Register Name: Command Register
Reset Value : 0000h

15 14 13 12 11 10 9 8 7 6 5 4 3 2 1 0

RSVD	INTD	BBE	SDE	RSVD	PER	VPS	MWIC	SCE	PME	ME	IOE
------	------	-----	-----	------	-----	-----	------	-----	-----	----	-----

Bit	Name	Attribute	Description
15-11	RSVD	RO	Reserved.
10	INTD	R/W	Interrupt Disable. This bit disables the device/function from asserting INTx# . A value of 0 enables the assertion of its INTx# signal. A value of 1 disables the assertion of its INTx# signal. This bit's state after RST# is 0.
9	BBE	RO	Back to Back Enable. USB HC only acts as a master to a single device, so this functionality is not needed.
8	SDE	R/W	SERR_ (Response) Detection Enable. If set to 1, USB HC asserts SERR_ when it detects an address parity error. SERR_ is not asserted if this bit is 0.
7	RSVD	RO	Reserved.
6	PER	R/W	Parity Error Response. This bit controls the device's response to parity errors. When the bit is set, the device must take its normal action when a parity error is detected. When the bit is 0, the device sets its Detected Parity Error status bit (bit 15 in the Status register) when an error is detected, but does not assert PERR# and continues normal operation. This bit's state after RST# is 0.
5	VPS	RO	VGA Palette Snoop. This bit controls how VGA compatible and graphics devices handle accesses to VGA palette registers. This functionality is not needed.
4	MWIC	RO	Memory Write and Invalidate Command Enable. If set to 1, USB HC is enabled to run Memory Write and Invalidate commands. The Memory Write and Invalidate Command will only occur if the cacheline size is set to 32 bytes and the memory write is exactly one cacheline.
3	SCE	RO	Special Cycle Enable. USB HC does not run special cycles on PCI. This bit is always 0.
2	PME	R/W	PCI Master Enable. If set to 1, USB HC is enabled to run PCI master cycles.
1	ME	R/W	Memory Enable. If set to 1, USB HC is enabled to respond as a target to memory cycles.
0	IOE	RO	I/O Enable. If set to 1, USB HC is enabled to respond as a target to I/O cycles.

Vortex86EX

32-Bit x86 Micro Processor

Register Offset: 07h – 06h
Register Name: Status Register
Reset Value : 0200h

15 14 13 12 11 10 9 8 7 6 5 4 3 2 1 0

DPE	SS	RMAS	RTAS	STAS	DEVSELT	DPRP	FBBC	RSVD	66C	CL	INTS	Reserved
-----	----	------	------	------	---------	------	------	------	-----	----	------	----------

Bit	Name	Attribute	Description
15	DPE	WC	Detected Parity Error. This bit is set to 1 whenever USB HC detects a parity error, even if the Parity Error (Response) Detection Enable bit is disabled. Cleared by writing a 1 to it.
14	SS	WC	SERR_ Status. This bit is set to 1 whenever the USB HC detects a PCI address parity error. Cleared by writing a 1 to it.
13	RMAS	WC	Received Master Abort Status. Set to 1 when USB HC, acting as a PCI master, aborts a PCI bus memory cycle. Cleared by writing a 1 to it.
12	RTAS	WC	Received Target Abort Status This bit is set to 1 when a USB HC generated PCI cycle (USB HC is the PCI master) is aborted by a PCI target. Cleared by writing a 1 to it.
11	STAS	RO	Signaled Target Abort Status This bit is set to 1 when USB HC signals target aborts. Cleared by writing a 1 to it.
10-9	DEVSEL T	RO	DEVSEL#n timing Read only bits indicating DEVSEL# timing when a positive decode is performed. Since DEVSEL# is asserted to meet the medium timing, these bits are encoded as 01b.
8	DPRP	WC	Data Parity Reported Set to 1 if the Parity Error Response bit is set, and USB HC detects PERR_ asserted while acting as PCI master (whether PERR_ was driven by USB HC or not).
7	FBBC	RO	Fast Back-to-Back Capable This optional read-only bit indicates whether or not the target is capable of accepting fast back-to-back transactions when the transactions are not to the same agent. This bit can be set to 1 if the device can accept these transactions and must be set to 0 otherwise.
6	RSVD	RO	Reserved Bits
5	66C	RO	66MHz Capable This optional read-only bit indicates whether or not this device is capable of running at 66 MHz. A value of zero indicates 33 MHz. A value

Vortex86EX

32-Bit x86 Micro Processor

Bit	Name	Attribute	Description
			of 1 indicates that the device is 66 MHz capable.
4	CL	RO	Capabilities List This optional read-only bit indicates whether or not this device implements the pointer for a New Capabilities linked list at offset 34h. A value of zero indicates that no New Capabilities linked list is available. A value of one indicates that the value read at offset 34h is a pointer in Configuration Space to a linked list of new capabilities.
3	INTS	RO	Interrupt Status This bit reflects the state of interrupts in the device.
2-0	RSVD	RO	Reserved Bits

Register Offset: 08h
Register Name: Revision ID Register
Reset Value : 13h

7 6 5 4 3 2 1 0

FTRVL

Bit	Name	Attribute	Description
7-0	FTRVL	RO	Functional Revision Level.

Register Offset: 0Bh – 09h
Register Name: Class Code Register
Reset Value : 0C0310h

23 22 21 20 19 18 17 16 15 14 13 12 11 10 9 8 7 6 5 4 3 2 1 0

BCLS	SUBCLS	PRGIF
------	--------	-------

Bit	Name	Attribute	Description
23-16	BCLS	RO	Base Class. The Base Class is 0Ch (Serial Bus Controller).
15-8	SUBCLS	RO	Sub Class. The Sub Class is 03h (Universal Serial Bus).
7-0	PRGIF	RO	Programming Interface. The Programming Interface is 10h (OpenHCI).

Vortex86EX

32-Bit x86 Micro Processor

Register Offset: 0Ch
Register Name: Cache Line Size Register
Reset Value : 04h

7 6 5 4 3 2 1 0

CCHLSZ

Bit	Name	Attribute	Description
7-0	CCHLSZ	RW	Cache Line Size This register identifies the system cache line size in units of 32-bit words. USB HC will only store the value of 04h and 08h in this register.

Register Offset: 0Dh
Register Name: Latency Timer Register
Reset Value : 00h

7 6 5 4 3 2 1 0

LTCTimer

Bit	Name	Attribute	Description
7-0	LTCTimer	RW	Latency Timer. This register identifies the value of the latency timer in PCI clocks for PCI bus master cycles.

Register Offset: 0Eh
Register Name: Header Type Register
Reset Value : 80h

7 6 5 4 3 2 1 0

HT

Bit	Name	Attribute	Description
7-0	HT	RO	Header Type Register. This register identifies the type of the predefined header in the configuration space. HC0 bit7 of this register is used to identify a multifunction device. When more than one USB HC is enabled, the read out value for HC0 is 80h, and those for HC1, HC2 and EHCI are 00h.

Vortex86EX

32-Bit x86 Micro Processor

Register Offset: 13h – 10h
Register Name: Base Address Register
Reset Value : 00000000h

31 30 29 28 27 26 25 24 23 22 21 20 19 18 17 16 15 14 13 12 11 10 9 8 7 6 5 4 3 2 1 0

BAD	RSVD
-----	------

Bit	Name	Attribute	Description
31-12	BAD	R/W	Base Address. POST writes the value of the memory base address to this register.
11-0	RSVD	RO	Reserved. These bits are always 0. It indicates a 4K-byte address range is requested.

Register Offset: 2Dh – 2Ch
Register Name: Subsystem Vendor ID Register
Reset Value: 0000h

15 14 13 12 11 10 9 8 7 6 5 4 3 2 1 0

SVID

Bit	Name	Attribute	Description
15-0	SVID	RO	This register contains the subsystem Vendor ID .

Register Offset: 2Fh – 2Eh
Register Name: Subsystem Device ID Register
Reset Value: 0000h

15 14 13 12 11 10 9 8 7 6 5 4 3 2 1 0

SDID

Bit	Name	Attribute	Description
15-0	SDID	RO	This register contains the subsystem Device ID .

Vortex86EX

32-Bit x86 Micro Processor

Register Offset: 3Dh – 3Ch
Register Name: Interrupt Control Register
Reset Value: 01FFh

15 14 13 12 11 10 9 8 7 6 5 4 3 2 1 0

INTP	INTL
------	------

Bit	Name	Attribute	Description
15-8	INTP	RO	Interrupt Pin. Use INT_A.
7-0	INTL	R/W	Interrupt Line. Index Interrupt Vector.

Register Offset: 3Eh
Register Name: Minimum Grant Register
Reset Value : 00h

7 6 5 4 3 2 1 0

MINGNT

Bit	Name	Attribute	Description
7-0	MINGNT	RO	Minimum Grant.

Register Offset: 3Fh
Register Name: Max Latency Register
Reset Value : 00h

7 6 5 4 3 2 1 0

MAXLAT

Bit	Name	Attribute	Description
7-0	MAXLAT	RO	Maximum Latency.

Vortex86EX

32-Bit x86 Micro Processor

Register Offset: 43h – 40h
Register Name: Reserved

Register Offset: 47h – 44h
Register Name: Reserved

For www.86duino.com

12.3.2 USB1.1 Operational Registers

The base address of these registers is programmable by the memory base address register (USB PCI configuration register offset 10h – 13h). These registers should be written as Dword. Bytes write to these registers may have unpredictable effects.

The OpenHCI Host Controller (HC) contains a set of on-chip operational registers that are mapped into a non-cacheable portion of the system addressable space. These registers are used by the Host Controller Driver (HCD). According to the functions of these registers, they are divided into four partitions, specifically for Control and Status, Memory Pointer, Frame Counter and Root Hub. All of the registers should be read and written as Dwords.

Reserved bits may be allocated in future releases of this specification. To ensure interoperability, the Host Controller Driver that does not use a reserved field should not assume that the reserved field contains 0. Furthermore, the Host Controller Driver should always preserve the value(s) of the reserved field. When a R/W register is modified, the Host Controller Driver should first read the register, modify the bits desired, then write the register with the reserved bits still containing the read value. Alternatively, the Host Controller Driver can maintain an in-memory copy of previously written values that can be modified and then written to the Host Controller register. When a write to set/clear register is written, bits written to reserved fields should be 0.

12.3.3 Open Host Controller Interface Operational Registers

Offset	Register Name
00h	HC Revision
04h	HC Control
08h	HC Command Status
0Ch	HC Interrupt Status
10h	HC Interrupt Enable
14h	HC Interrupt Disable
18h	HC HCCA
1Ch	HC Period Current ED
20h	HC Control Head ED
24h	HC Control Current ED
28h	HC Bulk Head ED
2Ch	HC Bulk Current ED
30h	HC Done Head
34h	HC Fm Interval
38h	HC Fm Remaining
3Ch	HC Fm Number
40h	HC Periodic Start
44h	HC LS Threshold
48h	HC Rh Descriptor A
4Ch	HC Rh Descriptor B
50h	HC Rh Status
54h	HC Rh Port Status [0]
58h	HC Rh Port Status [1]

Bit	Name	Attribute	Description
			hardware reset but does not alter it upon a software reset.
8	IR	R/W	<p>Interrupt Routing.</p> <p>This bit determines the routing of interrupts generated by events registered in HC Interrupt Status. If cleared, all interrupts are routed to the normal host bus interrupt mechanism. If set, interrupts are routed to the System Management Interrupt. The HCD clears this bit upon a hardware reset, but it does not alter this bit upon a software reset. The HCD uses this bit as a tag to indicate the ownership of HC.</p>
7-6	HCFS	R/W	<p>Host Controller Functional State for USB.</p> <p>00b: USB Reset 01b: USB Resume 10b: USB Operational 11b: USB Suspend</p> <p>A transition to UsbOperational from another state causes SOF generation to begin 1 ms later. The HCD may determine whether the HC has begun sending SOFs by reading the Start of Frame field of HC Interrupt Status.</p> <p>This field may be changed by the HC only in the UsbSuspend state. The HC may move from the USB Suspend state to the USB Resume state after the resume signal from a downstream port is detected.</p> <p>The HC enters USB Suspend after a software reset, whereas it enters USB Reset after a hardware reset. The latter also resets the Root Hub and asserts subsequent reset signal to downstream ports.</p>
5	BLE	R/W	<p>Bulk List Enable.</p> <p>This bit is set to enable the processing of the Bulk list in the next Frame. If cleared by the HCD, processing of the Bulk list does not occur after the next SOF. The HC checks this bit whenever it determines to process the list. When disabled, the HCD may modify the list. If HC Bulk Current ED is pointing to an ED to be removed, the HCD must advance the pointer by updating HC Bulk Current ED before the processing of the list is re-enabled.</p>
4	CLE	R/W	<p>Control List Enable.</p> <p>This bit is set to enable the processing of the Control list in the next Frame. If cleared by the HCD, the processing of the Control list does not occur after the next SOF. The HC must check this bit whenever it determines to process the list. When disabled, the HCD may modify the list. If HC Control Current ED is pointing to an ED to be removed, the HCD must advance the pointer by updating HC Control Current ED before re-enabling the processing of the list.</p>
3	IE	R/W	<p>Isochronous Enable.</p> <p>This bit is used by the HCD to enable/disable the processing of isochronous EDs. While processing the periodic list in a Frame, the HC checks the status of this bit when it finds an Isochronous ED (F=1). If set (enabled), the HC continues</p>

Vortex86EX

32-Bit x86 Micro Processor

Bit	Name	Attribute	Description								
			processing the EDs. If cleared (disabled), the HC halts processing of the periodic list (which now contains only isochronous EDs) and begins processing the Bulk/Control lists. Setting this bit is guaranteed to take effect in the next Frame (not the current Frame).								
2	PLE	R/W	<p>Periodic List Enable.</p> <p>This bit is set to enable the processing of the periodic list in the next Frame. If cleared by the HCD, the processing of the periodic list does not occur after the next SOF. The HC must check this bit before it starts processing the list.</p>								
1-0	CBSR	R/W	<p>Control Bulk Service Ratio.</p> <p>This specifies the service ratio between Control and Bulk EDs. Before processing any of the non-periodic lists, the HC must compare the ratio specified with its internal count on how many non-empty Control EDs have been processed, in determining whether to continue serving another Control ED or switching to Bulk EDs. The internal count will be retained when crossing the frame boundary. In case of reset, the HCD is responsible for restoring this value.</p> <p><u>CBSR No. of Control EDs Over Bulk EDs Served</u></p> <table style="margin-left: 40px;"> <tr> <td>0</td> <td>1:1</td> </tr> <tr> <td>1</td> <td>2:1</td> </tr> <tr> <td>2</td> <td>3:1</td> </tr> <tr> <td>3</td> <td>4:1</td> </tr> </table>	0	1:1	1	2:1	2	3:1	3	4:1
0	1:1										
1	2:1										
2	3:1										
3	4:1										

Bit	Name	Attribute	Description
1	CLF	R/W	<p>Control List Filled.</p> <p>This bit is used to indicate whether there are any TDs on the Control list. It is set by the HCD whenever it adds a TD to an ED in the Control list.</p> <p>When the HC begins to process the head of the Control list, it checks CTLF. As long as CTLF is 0, the HC will not start processing the Control list. If CF is 1, the HC will start processing the Control list and will set CLF to 0. If the HC finds a TD on the list, then the HC will set CTLF to 1, causing the Control list processing to continue. If no TD is found on the Control list, and if the HCD does not set CTLF, then CTLF will still be 0 when the HC completes processing the Control list and Control list processing will stop.</p>
0	HCR	R/W	<p>Host Controller Reset.</p> <p>This bit is set by the HCD to initiate a software reset of the HC. Regardless of the functional state of the HC, it moves to the USB Suspend state in which most of the operational registers are reset except those stated otherwise; e.g., the Interrupt Routing field of HC Control, and no Host bus accesses are allowed. This bit is cleared by the HC upon the completion of the reset operation. The reset operation must be completed within 10 μs. This bit, when set, should not cause a reset to the Root Hub and no subsequent reset signal should be asserted to its downstream ports.</p>

This register provides status on various events that cause hardware interrupts. When an event occurs, the Host Controller sets the corresponding bit in this register. When a bit is set, a hardware interrupt is generated if the interrupt is enabled in the HC Interrupt Enable Register and the Master Interrupt Enable bit is set. The Host Controller Driver may clear specific bits in this register by writing '1' to bit positions to be cleared. The Host Controller Driver may not set any of these bits. The Host Controller will never clear the bit.

Register Offset: 0Ch
Register Name: HC Interrupt Status Register
Reset Value : 00000000h

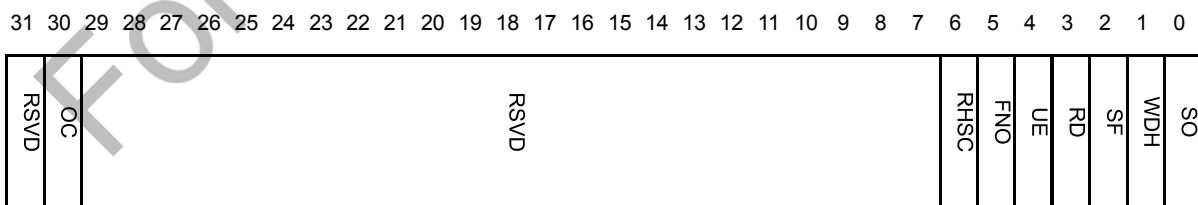

Bit	Name	Attribute	Description
31	RSVD	RO	Reserved.
30	OC	R/W	<p>Ownership Change Status.</p> <p>This bit is set by the HC when the HCD sets the Ownership Change Request field in HC Command Status. This event, when unmasked, will always generate a</p>

Bit	Name	Attribute	Description
			System Management Interrupt (SMI_) immediately.
29-7	RSVD	RO	Reserved.
6	RHSC	R/W	Root Hub Status Change Status. This bit is set when the contents of HC Rh Status or the contents of any of HC Rh Port Status [Number of Downstream Port] have changed.
5	FNO	R/W	Frame Number Overflow Status. This bit is set when the MSb of HC Fm Number (bit 15) changes values, from 0 to 1 or from 1 to 0, and after HCCA Frame Number has been updated.
4	UE	R/W	Unrecoverable Error. This bit is set when HC detects a system error not related to USB. HC should not proceed with any processing nor signaling before the system error has been corrected. HCD clears this bit after HC has been reset.
3	RD	R/W	Resume Detected Status. This bit is set when the HC detects that a device on the USB is asserting resume signaling. It is the transition from no resume signaling to resume signaling causing this bit to be set. This bit is not set when the HCD sets the USB Resume state.
2	SF	R/W	Start of Frame Status. This bit is set by the HC at each start of a frame and after the update of HCCA Frame Number. The HC also generates an SOF token at the same time.
1	WDH	R/W	Write Back Done Head Status. This bit is set immediately after the HC has written HC Done Head to HCCA Done Head. Further updates of the HCCA Done Head will not occur until this bit has been cleared. The HCD should only clear this bit after it has saved the contents of HCCA Done Head.
0	SO	R/W	Scheduling Overrun Status. This bit is set when the USB schedule for the current Frame overruns and after the update of HCCA Frame Number. A scheduling overrun will also cause the Scheduling Overrun Count of HC Command Status to be incremented.

Vortex86EX

32-Bit x86 Micro Processor

Each enabled bit in the HcInterruptEnable register corresponds to an associated interrupt bit in the HC Interrupt Status Register. The HC Interrupt Enable Register is used to control those events to generate a hardware interrupt. When a bit is set in the HC Interrupt Status Register and the corresponding bit in the HC Interrupt Enable Register is set and the Master Interrupt Enable bit is set, a hardware interrupt is requested on the host bus.

Writing a '1' to a bit in this register sets the corresponding bit, whereas writing a '0' to a bit in this register leaves the corresponding bit unchanged. On read, the current value of this register is returned.

Register Offset: 10h
Register Name: HC Interrupt Enable Register
Reset Value : 00000000h

31 30 29 28 27 26 25 24 23 22 21 20 19 18 17 16 15 14 13 12 11 10 9 8 7 6 5 4 3 2 1 0

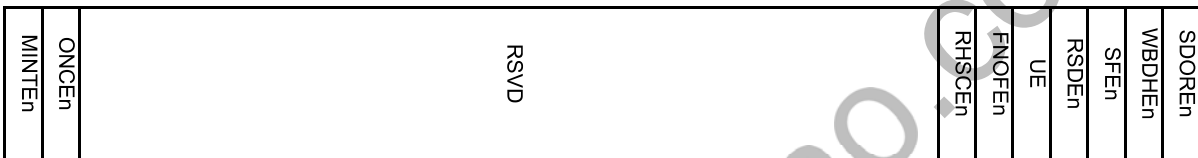

Bit	Name	Attribute	Description
31	MINTEn	R/W	Master Interrupt Enable. A '0' written to this field is ignored by the HC. A '1' written to this field enables interrupt generation due to events specified in the other bits of this register. This is used by the HCD as a Master Interrupt Enable.
30	ONCEn	R/W	Ownership Change Enable. 0: Ignore. 1: Enabled interrupt generation due to Ownership Change.
29-7	RSVD	RO	Reserved.
6	RHSCEn	R/W	Root Hub StatusChange Enable. 0: Ignore. 1: Enabled interrupt generation due to Root Hub Status Change.
5	FNOFEn	R/W	Frame Number Overflow Enable. 0: Ignore. 1: Enabled interrupt generation due to Frame Number Overflow.
4	UE	R/W	Unrecoverable Error Enable 0: Ignore 1: Enabled interrupt generation due to Unrecoverable Error.
3	RSDEn	R/W	Resume Detected Enable. 0: Ignore. 1: Enabled interrupt generation due to Resume Detect.
2	SFEn	R/W	Start of Frame Enable. 0: Ignore. 1: Enabled interrupt generation due to Start of Frame.

Bit	Name	Attribute	Description
1	WBDHEn	R/W	Write Back Done Head Enable. 0: Ignore. 1: Enabled interrupt generation due to HC Done Head Writeback,
0	SDOREn	R/W	Scheduling Overrun Enable. 0: Ignore. 1: Enabled interrupt generation due to Scheduling Overrun.

Each disabled bit in the HC Interrupt Disable Register corresponds to an associated interrupt bit in the HC Interrupt Status Register. The HC Interrupt Disable Register is coupled with the HC Interrupt Enable Register. Thus, writing a '1' to a bit in this register clears the corresponding bit in the HC Interrupt Enable Register, whereas writing a '0' to a bit in this register leaves the corresponding bit in the HC Interrupt Enable Register unchanged. On read, the current value of the HcInterruptEnable register is returned.

Register Offset: 14h
Register Name: HC Interrupt Disable Register
Reset Value : 00000000h

31 30 29 28 27 26 25 24 23 22 21 20 19 18 17 16 15 14 13 12 11 10 9 8 7 6 5 4 3 2 1 0

MINTDis	ONCDIs				RSVD	RHSCDis	FNOFDis	UNRCEDIs	RSSDIs	SFDIs	WBDHDis	SDORDIs
---------	--------	--	--	--	------	---------	---------	----------	--------	-------	---------	---------

Bit	Name	Attribute	Description
31	MINTDis	R/W	Master Interrupt Disable. A '0' written to this field is ignored by the HC. A '1' written to this field disables interrupt generation due to events specified in the other bits of this register. This field is set after a hardware or software reset.
30	ONCDIs	R/W	Ownership Change Disable. 0: Ignore. 1: Disable interrupt generation due to Ownership Change.
29-7	RSVD	RO	Reserved.
6	RHSCDis	R/W	Root Hub Status Change Disable. 0: Ignore. 1: Disable interrupt generation due to Root Hub Status Change.
5	FNOFDis	R/W	Frame Number Overflow Disable. 0: Ignore. 1: Disable interrupt generation due to Frame Number Overflow.
4	UNRCEDIs	R/W	Unrecoverable Error Disable. 0: Ignore. 1: Disable interrupt generation due to Unrecoverable Error

Bit	Name	Attribute	Description
3	RSDDis	R/W	Resume Detected Disable. 0: Ignore. 1: Disable interrupt generation due to Resume Detect.
2	SFDis	R/W	Start of Frame Disable. 0: Ignore. 1: Disable interrupt generation due to Start of Frame.
1	WBDHDis	R/W	Write Back Done Head Disable. 0: Ignore. 1: Disable interrupt generation due to HcDoneHead Writeback.
0	SDORDis	R/W	Scheduling Overrun Disable. 0: Ignore. 1: Disable interrupt generation due to Scheduling Overrun.

12.3.5 Memory Pointer Partition

The HC HCCA register contains the physical address of the Host Controller Communication Area. The Host Controller Driver determines the alignment restrictions by writing all 1s to HC HCCA and reading the contents of HC HCCA. The alignment is evaluated by examining the number of zeroes in the lower order bits. The minimum alignment is 256 bytes; therefore, bits 0 through 7 must always return '0' when read. This area is used to hold the control structures and the Interrupt table that are accessed by both the Host Controller and the Host Controller Driver.

Register Offset: 18h
Register Name: HC HCCA Register
Reset Value : 00000000h

31 30 29 28 27 26 25 24 23 22 21 20 19 18 17 16 15 14 13 12 11 10 9 8 7 6 5 4 3 2 1 0

BAHCTC	RSVD
--------	------

Bit	Name	Attribute	Description
31-8	BAHCTC	R/W	This is the base address of the Host Controller Communication Area.
7-0	RSVD	RO	Reserved.

Vortex86EX

32-Bit x86 Micro Processor

The HC Period Current ED Register contains the physical address of the current Isochronous or Interrupt Endpoint Descriptor.

Register Offset: 1Ch
Register Name: HC Period Current ED Register
Reset Value : 00000000h

31 30 29 28 27 26 25 24 23 22 21 20 19 18 17 16 15 14 13 12 11 10 9 8 7 6 5 4 3 2 1 0

PRCRED	RSVD
--------	------

Bit	Name	Attribute	Description
31-4	PRCRED	RO	<p>Period Current ED.</p> <p>This is used by the HC to point to the head of one of the Periodic lists that will be processed in the current Frame. The contents of this register are updated by the HC after a periodic ED has been processed. The HCD may read the contents in determining which ED is currently being processed at the time of reading.</p>
3-0	RSVD	RO	Reserved.

Register Offset: 20h
Register Name: HC Control Head ED Register
Reset Value : 00000000h

31 30 29 28 27 26 25 24 23 22 21 20 19 18 17 16 15 14 13 12 11 10 9 8 7 6 5 4 3 2 1 0

CTHED	RSVD
-------	------

The HC Control Head ED Register contains the physical address of the first Endpoint Descriptor of the Control list.

Bit	Name	Attribute	Description
31-4	CTHED	R/W	<p>Control Head ED.</p> <p>The HC traverses the Control list starting with the HC Control Head ED pointer. The contents are loaded from HCCA during the initialization of the HC.</p>
3-0	RSVD	RO	Reserved.

Vortex86EX

32-Bit x86 Micro Processor

The HC Control Current ED Register contains the physical address of the current Endpoint Descriptor of the Control list.

Register Offset: 24h
Register Name: HC Control Current ED Register
Reset Value : 00000000h

31 30 29 28 27 26 25 24 23 22 21 20 19 18 17 16 15 14 13 12 11 10 9 8 7 6 5 4 3 2 1 0

CTCRED	RSVD
--------	------

Bit	Name	Attribute	Description
31-4	CTCRED	R/W	<p>Control Current ED.</p> <p>This pointer is advanced to the next ED after the present one is served. The HC will continue processing the list from where it left off in the last Frame. When it reaches the end of the Control list, the HC checks CTLF in the HC Command Status Register. If set, it copies the contents of HC Control Head ED to HC Control Current ED and clears the bit. If not set, it does nothing. The HCD is allowed to modify this register only when CTLEn in the HC Control Register is cleared. When set, the HCD only reads the instantaneous value of this register. Initially, this is set to zero to indicate the end of the Control list.</p>
3-0	RSVD	RO	Reserved.

The HC Bulk Head ED Register contains the physical address of the first Endpoint Descriptor of the Bulk list.

Register Offset: 28h
Register Name: HC Bulk Head ED Register
Reset Value : 00000000h

31 30 29 28 27 26 25 24 23 22 21 20 19 18 17 16 15 14 13 12 11 10 9 8 7 6 5 4 3 2 1 0

BHED	RSVD
------	------

Bit	Name	Attribute	Description
31-4	BHED	R/W	<p>Bulk Head ED.</p> <p>The HC traverses the Bulk list starting with the HC Bulk Head ED pointer. The contents are loaded from HCCA during the initialization of the HC.</p>
3-0	RSVD	RO	Reserved.

Vortex86EX

32-Bit x86 Micro Processor

The HC Bulk Current ED Register contains the physical address of the current endpoint of the Bulk list. As the Bulk list will be served in a round-robin fashion, the endpoints will be ordered according to their insertion to the list.

Register Offset: 2Ch
Register Name: HC Bulk Current ED Register
Reset Value : 00000000h

31 30 29 28 27 26 25 24 23 22 21 20 19 18 17 16 15 14 13 12 11 10 9 8 7 6 5 4 3 2 1 0

BHCRD	RSVD
-------	------

Bit	Name	Attribute	Description
31-4	BCRED	R/W	<p>Bulk Current ED.</p> <p>This is advanced to the next ED after the HC has served the present one. The HC continues processing the list from where it left off in the last Frame. When it reaches the end of the Bulk list, the HC checks the ControlListFilled of HcControl. If set, it copies the contents of HC Bulk Head ED to HC Bulk Current ED and clears the bit. If it is not set, it does nothing. The HCD is only allowed to modify this register when BLEn in the HC Control Register is cleared. When set, the HCD only reads the instantaneous value of this register. This is initially set to zero to indicate the end of the Bulk list.</p>
3-0	RSVD	RO	Reserved.

Vortex86EX

32-Bit x86 Micro Processor

The HC Done Head Register contains the physical address of the last completed Transfer Descriptor that was added to the Done queue. In normal operation, the Host Controller Driver should not need to read this register as its contents are periodically written to the HCCA.

Register Offset: 30h
Register Name: HC Done Head ED Register
Reset Value : 00000000h

31 30 29 28 27 26 25 24 23 22 21 20 19 18 17 16 15 14 13 12 11 10 9 8 7 6 5 4 3 2 1 0

DH	RSVD
----	------

Bit	Name	Attribute	Description
31-4	DH	RO	<p>Done Head.</p> <p>When a TD is completed, the HC writes the contents of HC Done Head to the Next TD field of the TD. The HC then overwrites the contents of HcDoneHead with the address of this TD.</p> <p>This is set to zero whenever the HC writes the contents of this register to HCCA. It also sets WBDHS in the HC Interrupt Status Register.</p>
3-0	RSVD	RO	Reserved.

12.3.6 Frame Counter Partition

The HC Fm Interval Register contains a 14-bit value which indicates the bit time interval in a Frame, (i.e., between two consecutive SOFs), and a 15-bit value indicating the Full Speed maximum packet size that the Host Controller may transmit or receive without causing scheduling overrun. The Host Controller Driver may carry out minor adjustments on the FrameInterval by writing a new value over the present one at each SOF. This provides the programmability necessary for the Host Controller to synchronize with an external clocking resource and to adjust any unknown local clock offset.

Register Offset: 34h

Register Name: HC Fm Interval Register

Reset Value : 27782EDFh

31 30 29 28 27 26 25 24 23 22 21 20 19 18 17 16 15 14 13 12 11 10 9 8 7 6 5 4 3 2 1 0

FINTVTG		FSLDP		RSVD		FINTV
---------	--	-------	--	------	--	-------

Bit	Name	Attribute	Description
31	FINTVTG	RW	Frame Interval Toggle. The HCD toggles this bit whenever it loads a new value to FrameInterval.
30-16	FSLDP	RW	FS Largest Data Packet. This field specifies a value that is loaded into the Largest Data Packet Counter at the beginning of each frame. The counter value represents the largest amount of data in bits which can be sent or received by the HC in a single transaction at any given time without causing scheduling overrun. The field value is calculated by the HCD.
15-14	RSVD	RO	Reserved.
13-0	FINTV	RW	Frame Interval. This specifies the interval between two consecutive SOFs in bit times. The nominal value is set to be 11,999. The HCD should store the current value of this field before resetting the HC. By setting the HCTRS field in the HC Command Status Register as this will cause the HC to reset this field to its nominal value. The HCD may choose to restore the stored value upon the completion of the Reset sequence.

Vortex86EX

32-Bit x86 Micro Processor

The HC Fm Remaining Register is a 14-bit down counter showing the bit time remaining in the current Frame.

Register Offset: 38h
Register Name: HC Fm Remaining Register
Reset Value : 00000000h

31 30 29 28 27 26 25 24 23 22 21 20 19 18 17 16 15 14 13 12 11 10 9 8 7 6 5 4 3 2 1 0

FRMTG		RSVD		FRM	
-------	--	------	--	-----	--

Bit	Name	Attribute	Description
31	FRMTG	RO	<p>Frame Remaining Toggle. This bit is loaded from the Frame Interval Toggle field in the HC Fm Interval Register whenever Frame Remaining reaches 0. This bit is used by the HCD for the synchronization between Frame Interval and Frame Remaining.</p>
30-14	RSVD	RO	<p>Reserved.</p>
13-0	FRM	RO	<p>Frame Remaining. This counter is decremented at each bit time. When it reaches zero, it is reset by loading the Frame Interval value specified in the HC Fm Interval Register at the next bit time boundary. When entering the USB Operational state, the HC re-loads the content with the Frame Interval in the HC Fm Interval Register and uses the updated value from the next SOF.</p>

Vortex86EX

32-Bit x86 Micro Processor

The HC Fm Number Register is a 16-bit counter. It provides a timing reference among events occurring in the Host Controller and the Host Controller Driver. The Host Controller Driver may use the 16-bit value specified in this register and generate a 32-bit frame number without requiring frequent access to the register.

Register Offset: 3Ch
Register Name: HC Fm Number Register
Reset Value : 00000000h

31 30 29 28 27 26 25 24 23 22 21 20 19 18 17 16 15 14 13 12 11 10 9 8 7 6 5 4 3 2 1 0

RSVD	FNB
------	-----

Bit	Name	Attribute	Description
31-16	RSVD	RO	Reserved.
15-0	FNB	RO	Frame Number. This is incremented when HcFmRemaining is re-loaded. It will be rolled over to 0h after ffffh. When the USB Operational state is entered, this will be incremented automatically. The contents will be written to HCCA after the HC has incremented the Frame Number at each frame boundary and sent a SOF but before the HC reads the first ED in that Frame. After writing to HCCA, the HC will set the Start of Frame in HC Interrupt Status.

The Hc Periodic Start Register has a 14-bit programmable value that determines the earliest time the HC should start processing the periodic list.

Register Offset: 40h
Register Name: HC Periodic Start Register
Reset Value : 00003E67h

31 30 29 28 27 26 25 24 23 22 21 20 19 18 17 16 15 14 13 12 11 10 9 8 7 6 5 4 3 2 1 0

RSVD	PRS
------	-----

Bit	Name	Attribute	Description
31-14	RSVD	RO	Reserved.
13-0	PRS	R/W	Periodic Start. After a hardware reset, this field is cleared. This is then set by the HCD during the HC initialization. The value is calculated roughly as 10% off from the HC Fm Interval Register. A typical value will be 3E67h. When HC Fm Remaining reaches the value specified, processing of the periodic lists will have priority over Control/Bulk processing. The HC will therefore start processing the Interrupt list after completing the current Control or Bulk transaction that is in progress.

Vortex86EX

32-Bit x86 Micro Processor

The HC LS Threshold register contains an 11-bit value used by the Host Controller to determine whether it is necessary to commit to the transfer of a maximum of 8-byte LS packets before EOF. Neither the Host Controller nor the Host Controller Driver is allowed to change this value.

Register Offset: 44h
Register Name: HC LS Threshold Register
Reset Value : 00000628h

31 30 29 28 27 26 25 24 23 22 21 20 19 18 17 16 15 14 13 12 11 10 9 8 7 6 5 4 3 2 1 0

RSVD	LSTSH
------	-------

Bit	Name	Attribute	Description
31-12	RSVD	RO	Reserved.
11-0	LSTSH	R/W	LS Threshold. This field contains a value that is compared to the Frame Remaining field prior to initiating a Low Speed transaction. The transaction is started only if Frame Remaining , this field. The value is calculated by the HCD with the consideration of transmission and set-up overhead.

12.3.7 Root Hub Partition

All registers included in this partition are dedicated to the USB Root Hub which is an integral part of the Host Controller though still a functionally separate entity. The HCD emulates USB accesses to the Root Hub via a register interface. The HCD maintains many USB-defined hub features that are not required to be supported in hardware. For example, the Hub's Device, Configuration, Interface, and Endpoint Descriptors are maintained only in the HCD as well as some static fields of the Class Descriptor. The HCD also maintains and decodes the Root Hub's device address as well as other trivial operations that are better suited to software than hardware.

The Root Hub register interface is otherwise developed to maintain similarity of bit organization and operation to typical hubs that are found in the system. Below are four register definitions: HC Rh Descriptor A, HC Rh Descriptor B, HC Rh Status, and HC Rh Port Status [5:1]. Each register is read and written as a Dword. These registers are only written during initialization to correspond with the system implementation. The HC Rh Descriptor A and HC Rh Descriptor B registers should be implemented such that they are writable regardless of the HC USB state. HC Rh Status and HC Rh Port Status must be writable during the USB Operational state.

The HC Rh Descriptor A Register is the first register of two describing characteristics of the Root Hub. Reset values are implementation-specific. All other fields are located in the HC Rh Descriptor A and HC Rh Descriptor B registers.

Register Offset: 48h
Register Name: HC Rh Descriptor A Register
Reset Value : 0F000904h

31 30 29 28 27 26 25 24 23 22 21 20 19 18 17 16 15 14 13 12 11 10 9 8 7 6 5 4 3 2 1 0

POPGT	RSVD	NOCRPT	OCRPTM	DVT	NPSW	PSWM	NBDSTP
-------	------	--------	--------	-----	------	------	--------

Bit	Name	Attribute	Description
31-24	POPGT	R/W	Power On to Power Good Time. This byte specifies the duration the HCD has to wait before a powered-on port of the Root Hub is accessed. It is implementation-specific. The unit of time is 2 ms. The duration is calculated as POTPGT * 2 ms.
23-13	RSVD	RO	Reserved.
12	NOCRPT	R/W	No Over Current Protection. This bit describes how the over-current status for the Root Hub ports is reported. When this bit is cleared, the Over Current Protection Mode field specifies global or per-port reporting. 0: Over-current status is reported collectively for all downstream ports. 1: No over-current protection supported.
11	OCRPTM	R/W	Over Current Protection Mode. This bit describes how the over-current status for the Root Hub ports is reported. At reset, this field should reflect the same mode as Power Switching Mode. This field is valid only if the No Over Current Protection field is cleared. 0: Over-current status is reported collectively for all downstream ports. 1: Over-current status is reported on a per-port basis.
10	DVT	RO	Device Type. This bit specifies that the Root Hub is not a compound device. The Root Hub is not permitted to be a compound device. This field should always read/write 0.
9	NPSW	R/W	No Power Switching. These bits are used to specify whether power switching is supported or ports are always powered. USB HC supports global power switching mode. When this bit is cleared, the Power Switching Mode specifies global or per-port switching. 0: Ports are power switched. 1: Ports are always powered on when the HC is powered on.
8	PSWM	R/W	Power Switching Mode. This bit is used to specify how the power switching of the Root Hub ports is

Bit	Name	Attribute	Description
			controlled. USB HC supports global power switching mode. This field is only valid if the No Power Switching field is cleared. 0: all ports are powered at the same time. 1: Each port is powered individually. This mode allows port power to be controlled by either the global switch or per-port switching. If the Port Power Control Mask bit is set, the port responds only to port power commands (Set/Clear Port Power). If the port mask is cleared, the port is controlled only by the global power switch (Set/Clear Global Power).
7-0	NBDSTP	RO	Number Downstream Ports. These bits specify the number of downstream ports supported by the Root Hub. It is implementation-specific. The minimum number of ports is 1. The maximum number of ports supported by OpenHCI is 15.

The HC Rh Descriptor B Register is the second register of two describing the characteristics of the Root Hub. These fields are written during initialization to configure the Root Hub.

Register Offset: 4Ch
Register Name: HC Rh Descriptor B Register
Reset Value : 001E0000h

31 30 29 28 27 26 25 24 23 22 21 20 19 18 17 16 15 14 13 12 11 10 9 8 7 6 5 4 3 2 1 0

PPWCTM	DVRM
--------	------

Bit	Name	Attribute	Description
31-16	PPWCTM	R/W	Port Power Control Mask. Each bit indicates if a port is affected by a global power control command when Power Switching Mode is set. When set, the port's power state is only affected by per-port power control (Set/Clear Port Power). When cleared, the port is controlled by the global power switch (Set/Clear Global Power). If the device is configured to global switching mode (Power Switching Mode=0), this field is not valid. USB HC implements global power switching. bit 0: Reserved bit 1: Ganged-power mask on Port #1 bit 2: Ganged-power mask on Port #2 ... bit15: Ganged-power mask on Port #15
15-0	DVRM	R/W	Device Removable. Each bit is dedicated to a port of the Root Hub. When cleared, the attached device is removable. When set, the attached device is not removable. bit 0: Reserved

Vortex86EX

32-Bit x86 Micro Processor

Bit	Name	Attribute	Description
			bit 1: Device attached to Port #1 bit 2: Device attached to Port #2 ... bit15: Device attached to Port #15

The HC Rh Status Register is divided into two parts. The lower word of a Dword represents the Hub Status field and the upper word represents the Hub Status Change field. Reserved bits should always be written '0'.

Register Offset: 50h

Register Name: HC Rh Status Register

Reset Value : 00000000h

31 30 29 28 27 26 25 24 23 22 21 20 19 18 17 16 15 14 13 12 11 10 9 8 7 6 5 4 3 2 1 0

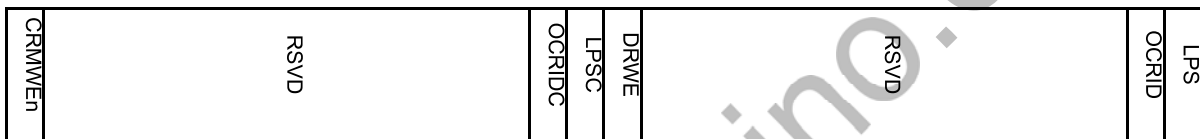

Bit	Name	Attribute	Description
31	CRMWEn	WO	Clear Remote Wakeup Enable (Write). Writing a '1' clears Device Remove Wakeup Enable. Writing a '0' has no effect.
31-18	RSVd	RO	Reserved.
17	OCRIDC	R/W	Over Current Indicator Change. This bit is set by hardware when a change has occurred to the OCI field of this register. The HCD clears this bit by writing a '1'. Writing a '0' has no effect.
16	LPSC	R/W	Local Power Status Change (Read). The Root Hub does not support the local power status feature; thus, this bit is always read as '0'. Set Global Power (Write). In global power mode (Power Switching Mode=0), this bit is written to '1' to turn on power to all ports (clear Port Power Status). In per-port power mode, it sets Port Power Status only on ports whose Port Power Control Mask bit is not set. Writing a '0' has no effect.
15	DRWE	R/W	Device Remote Wakeup Enable (Read). This bit enables a Connect Status Change bit as a resume event, causing an USB Suspend to USB Resume state transition and setting Resume Detected interrupt. 0: Connect Status Change is not a remote wakeup event. 1: Connect Status Change is a remote wakeup event. Set Remote Wakeup Enable (Write). Writing a '1' sets Device Remove Wakeup Enable. Writing a '0' has no effect.

Vortex86EX

32-Bit x86 Micro Processor

Bit	Name	Attribute	Description
14-2	RSVD	RO	Reserved.
1	OCRID	RO	Over Current Indicator. This bit reports over-current conditions when the global reporting is implemented. When set, an over-current condition exists. When cleared, all power operations are normal. If per-port over-current protection is implemented, this bit is always '0'.
0	LPS	R/W	Local Power Status (Read). The Root Hub does not support the local power status feature; thus, this bit is always read as '0'. Clear Global Power (Write). In global power mode (Power Switching Mode=0), This bit is written to '1' to turn off power to all ports (clear Port Power Status). In per-port power mode, it clears Port Power Status only on ports whose Port Power Control Mask bit is not set. Writing a '0' has no effect.

The HC Rh Port Status [3:0] registers are used to control and report port events on a per-port basis. Two HC Rh Port Status registers are implemented in this HC, respectively. The lower word is used to reflect the port status, whereas the upper word reflects the status change bits. Some status bits are implemented with special write behaviour (see below). If a transaction (token through handshake) is in progress when a write to change port status occurs, the resulting port status change must be postponed until the transaction is completed. Reserved bits should always be written as '0'. While the NDP of register 48h is 01h, the register 58 and register 5C will be read as 00000000h. While the NDP of register 48h is 02h, only register 5C is read as 00000000h.

Register Offset: 54h/58h
Register Name: HC Rh Port Status [1:0] Register
Reset Value : 00000000h

31 30 29 28 27 26 25 24 23 22 21 20 19 18 17 16 15 14 13 12 11 10 9 8 7 6 5 4 3 2 1 0

RSVD	PRSC	POCRIDC	PSPSC	PIENSC	CNOSC	RSVD	LSDVA	PPS	RSVD	PRS	POCI	PSS	PES	CCS
------	------	---------	-------	--------	-------	------	-------	-----	------	-----	------	-----	-----	-----

Bit	Name	Attribute	Description
31-21	RSVD	RO	Reserved.
20	PRSC	R/W	Port Reset Status Change. This bit is set at the end of the 10-ms port reset signal. The HCD writes a '1' to clear this bit. Writing a '0' has no effect. 0: port reset is not complete 1: port reset is complete

Bit	Name	Attribute	Description
19	POCRID C	R/W	<p>Port Over Current Indicator Change.</p> <p>This bit is valid only if over-current conditions are reported on a per-port basis. This bit is set when Root Hub changes the Port Over Current Indicator bit. The HCD writes a '1' to clear this bit. Writing a '0' has no effect.</p> <p>0: no change in Port Over Current Indicator 1: Port Over Current Indicator has changed</p>
18	PSPSC	R/W	<p>Port Suspend Status Change.</p> <p>This bit is set when the full resume sequence has been completed. This sequence includes the 20-s resume pulse, LS EOP, and 3-ms resynchronization delay. The HCD writes a '1' to clear this bit. Writing a '0' has no effect. This bit is also cleared when Reset Status Change is set.</p> <p>0: resume is not completed 1: resume completed</p>
17	PEnSC	R/W	<p>Port Enable Status Change.</p> <p>This bit is set when hardware events cause the Port Enable Status bit to be cleared. Changes from the HCD writes do not set this bit. The HCD writes a '1' to clear this bit. Writing a '0' has no effect.</p> <p>0: no change in Port Enable Status 1: change in Port Enable Status</p>
16	CNSC	R/W	<p>Connect Status Change.</p> <p>This bit is set whenever a connect or disconnect event occurs. The HCD writes a '1' to clear this bit. Writing a '0' has no effect. If Current Connect Status is cleared when a Set Port Reset, Set Port Enable, or Set Port Suspend write occurs, this bit is set to force the driver to re-evaluate the connection status since these writes should not occur if the port is disconnected.</p> <p>0: no change in Current Connect Status. 1: change in Current Connect Status.</p> <p>Note: If the Device Removable [NDP] bit is set, this bit is set only after a Root Hub reset to inform the system that the device is attached.</p>
15-10	RSVD	RO	Reserved.
9	LSDVA	R/W	<p>Low Speed Device Attached (Read).</p> <p>This bit indicates the speed of the device attached to this port. When set, a Low-Speed device is attached to this port. When cleared, a Full Speed device is attached to this port. This field is valid only when the Current Connect Status is set.</p> <p>0: full-speed device attached 1: low-speed device attached</p>
8	PPS	R/W	<p>Port Power Status (Read).</p> <p>This bit reflects the port's power status, regardless of the type of power switching implemented. This bit is cleared if an over-current condition is detected. The HCD</p>

Vortex86EX

32-Bit x86 Micro Processor

Bit	Name	Attribute	Description
			<p>sets this bit by writing Set Port Power or Set Global Power. The HCD clears this bit by writing Clear Port Power or Clear Global Power. Which power control switches will be enabled is determined by Power Switching Mode and Port Power Control Mask [NDP]. In global switching mode (Power Switching Mode=0), only Set/Clear Global Power controls this bit. In per-port power switching (Power Switching Mode=1), if the Port Power Control Mask [NDP] bit for the port is set, only Set/ClearPortPower commands are enabled. If the mask is not set, only Set/Clear Global Power commands are enabled. When port power is disabled, Current Connect Status, Port Enable Status, Port Suspend Status, and Port Reset Status should be reset.</p> <p>0: port power is off 1: port power is on</p> <p>Set Port Power (Write) The HCD writes a '1' to set the Port Power Status bit. Writing a '0' has no effect.</p> <p>Note: This bit is always reads '1b' if power switching is not supported.</p>
7-5	RSVD	RO	Reserved.
4	PRS	R/W	<p>Port Reset Status (Read). When this bit is set by a write to Set Port Reset, port reset signaling is asserted. When reset is completed, this bit is cleared when Port Reset Status Change is set. This bit cannot be set if Current Connect Status is cleared.</p> <p>0: port reset signal is not active 1: port reset signal is active</p> <p>Set Port Reset (Write). The HCD sets the port reset signaling by writing a '1' to this bit. Writing a '0' has no effect. If Current Connect Status is cleared, this write does not set Port Reset Status, but instead sets Connect Status Change. This informs the driver that it attempted to reset a disconnected port.</p>
3	POCI	R/W	<p>Port Over Current Indicator (Read). This bit is only valid when the Root Hub is configured in such a way that over-current conditions are reported on a per-port basis. If per-port over-current reporting is not supported, this bit is set to 0. If cleared, all power operations are normal for this port. If set, an over-current condition exists on this port. This bit always reflects the over-current input signal</p> <p>0: no over-current condition. 1: over-current condition detected.</p> <p>Clear Suspend Status (Write). The HCD writes a '1' to initiate a resume. Writing a '0' has no effect. A resume is initiated only if Port Suspend Status is set.</p>
2	PSS	R/W	<p>Port Suspend Status (Read). This bit indicates the port is suspended or in the resume sequence. It is set by a</p>

Bit	Name	Attribute	Description
			<p>Set Suspend State write and cleared when Port Suspend Status Change is set at the end of the resume interval. This bit cannot be set if Current Connect Status is cleared. This bit is also cleared when Port Reset Status Change is set at the end of the port reset or when the HC is placed in the USB Resume state. If an upstream resume is in progress, it should propagate to the HC.</p> <p>0: port is not suspended. 1: port is suspended.</p> <p>Set Port Suspend (Write). The HCD sets the Port Suspend Status bit by writing a '1' to this bit. Writing a '0' has no effect. If Current Connect Status is cleared, this write does not set Port Suspend Status; instead it sets Connect Status Change. This informs the driver that it attempts to suspend a disconnected port.</p>
1	PES	R/W	<p>Port Enable Status (Read). This bit indicates whether the port is enabled or disabled. The Root Hub may clear this bit when an over-current condition, disconnect event, switched-off power, or operational bus error such as babble is detected. This change also causes Port Enabled Status Change to be set. The HCD sets this bit by writing Set Port Enable and clears it by writing Clear Port Enable. This bit cannot be set when Current Connect Status is cleared. This bit is also set, if not already, at the completion of a port reset when Reset Status Change is set or a port suspend when Suspend Status Change is set.</p> <p>0: port is disabled. 1: port is enabled.</p> <p>Set Port Enable (Write). The HCD sets Port Enable Status by writing a '1'. Writing a '0' has no effect. If Current Connect Status is cleared, this write does not set Port Enable Status, but instead sets Connect Status Change. This informs the driver that it attempts to enable a disconnected port.</p>
0	CCS	R/W	<p>Current Connect Status (Read). This bit reflects the current state of the downstream port.</p> <p>0: no device connected. 1: device connected.</p> <p>Clear Port Enable (Write). The HCD writes a '1' to this bit to clear the Port Enable Status bit. Writing a '0' has no effect. Current Connect Status is not affected by any write.</p> <p>Note: This bit is always read as '1b' when the attached device is non-removable (Device Removeable [NDP]).</p>

12.3.8 EHCI Configuration Space

12.3.9 USB2.0 Configurte Space

Register Offset: 01h – 00h
Register Name: Vendor ID Register
Reset Value : 17F3h

15 14 13 12 11 10 9 8 7 6 5 4 3 2 1 0

VID															
-----	--	--	--	--	--	--	--	--	--	--	--	--	--	--	--

Bit	Name	Attribute	Description
15-0	VID	RO	Vendor ID.

Register Offset: 03h – 02h
Register Name: Device ID Register
Reset Value : 6061h

15 14 13 12 11 10 9 8 7 6 5 4 3 2 1 0

DID															
-----	--	--	--	--	--	--	--	--	--	--	--	--	--	--	--

Bit	Name	Attribute	Description
15-0	DID	RO	Device ID.

Register Offset: 05h – 04h
Register Name: Command Register
Reset Value : 0000h

15 14 13 12 11 10 9 8 7 6 5 4 3 2 1 0

RSVD	INTD	BBE	SDE	RSVD	PER	VPS	MWIC	SCE	PME	ME	IOE
------	------	-----	-----	------	-----	-----	------	-----	-----	----	-----

Bit	Name	Attribute	Description
15-11	RSVD	RO	Reserved.
10	INTD	RW	Interrupt Disable. This bit disables the device/function from asserting INTx# . A value of 0 enables the assertion of its INTx# signal. A value of 1 disables the assertion of its INTx# signal. This bit's state after RST# is 0.
9	BBE	RO	Back to Back Enable. USB HC only acts as a master to a single device, so this functionality is not needed.
8	SDE	R/W	SERR_ (Response) Detection Enable bit.

Vortex86EX

32-Bit x86 Micro Processor

Bit	Name	Attribute	Description
			If set to 1, USB HC asserts SERR_ when it detects an address parity error. SERR_ is not asserted if this bit is 0.
7	RSVD	RO	Reserved.
6	PER	R/W	Parity Error Response. This bit controls the device's response to parity errors. When the bit is set, the device must take its normal action when a parity error is detected. When the bit is 0, the device sets its Detected Parity Error status bit (bit 15 in the Status register) when an error is detected, but does not assert PERR# and continues normal operation. This bit's state after RST# is 0.
5	VPS	RO	VGA Palette Snoop. This bit controls how VGA compatible and graphics devices handle accesses to VGA palette registers. This functionality is not needed.
4	MWIC	RO	Memory Write and Invalidate Command Enable. If set to 1, USB HC is enabled to run Memory Write and Invalidate commands. The Memory Write and Invalidate Command will only occur if the cacheline size is set to 32 bytes and the memory write is exactly one cacheline.
3	SCE	RO	Special Cycle Enable. USB HC does not run special cycles on PCI. This bit is always 0.
2	PME	R/W	PCI Master Enable. If set to 1, USB HC is enabled to run PCI master cycles.
1	ME	R/W	Memory Enable. If set to 1, USB HC is enabled to respond as a target to memory cycles.
0	IOE	RO	I/O Enable. If set to 1, USB HC is enabled to respond as a target to I/O cycles.

Register Offset: 07h – 06h
Register Name: Status Register
Reset Value : 0200h

15	14	13	12	11	10	9	8	7	6	5	4	3	2	1	0
DPE	SS	RMAS	RTAS	STAS	DEVSELT	DPRP	FBBC	Reser ved	66C	CL	INTS	RSVD			

Bit	Name	Attribute	Description
15	DPE	WC	Detected Parity Error. This bit is set to 1 whenever USB HC detects a parity error, even if the Parity Error (Response) Detection Enable bit is disabled. Cleared by writing a 1 to it.
14	SS	WC	SERR_ Status. This bit is set to 1 whenever the USB HC detects a PCI address parity error.

Vortex86EX

32-Bit x86 Micro Processor

Bit	Name	Attribute	Description
			Cleared by writing a 1 to it.
13	RMAS	WC	Received Master Abort Status. Set to 1 when USB HC, acting as a PCI master, aborts a PCI bus memory cycle. Cleared by writing a 1 to it.
12	RTAS	WC	Received Target Abort Status. This bit is set to 1 when a USB HC generated PCI cycle (USB HC is the PCI master) is aborted by a PCI target. Cleared by writing a 1 to it.
11	STAS	RO	Signaled Target Abort Status. This bit is set to 1 when USB HC signals target aborts. Cleared by writing a 1 to it.
10-9	DEVSEL T	RO	DEVSEL# timing. Read only bits indicating DEVSEL# timing when a positive decode is performed. Since DEVSEL# is asserted to meet the medium timing, these bits are encoded as 01b.
8	DPRP	WC	Data Parity Reportee. Set to 1 if the Parity Error Response bit is set, and USB HC detects PERR_ asserted while acting as PCI master (whether PERR_ was driven by USB HC or not).
7	FBBC	RO	Fast Back-to-Back Capable. This optional read-only bit indicates whether or not the target is capable of accepting fast back-to-back transactions when the transactions are not to the same agent. This bit can be set to 1 if the device can accept these transactions and must be set to 0 otherwise.
6	RSVD	RO	Reserved.
5	66C	RO	66MHz Capable. This optional read-only bit indicates whether or not this device is capable of running at 66 MHz. A value of zero indicates 33 MHz. A value of 1 indicates that the device is 66 MHz capable.
4	CL	RO	Capabilities List. This optional read-only bit indicates whether or not this device implements the pointer for a New Capabilities linked list at offset 34h. A value of zero indicates that no New Capabilities linked list is available. A value of one indicates that the value read at offset 34h is a pointer in Configuration Space to a linked list of new capabilities.
3	INTS	RO	Interrupt Status. This bit reflects the state of interrupts in the device.
2-0	RSVD	RO	Reserved.

Register Offset: 08h

Vortex86EX

32-Bit x86 Micro Processor

Register Name: Revision ID Register
Reset Value : 07h

7 6 5 4 3 2 1 0



Bit	Name	Attribute	Description
7-0	FTRVL	RO	Functional Revision Level.

Register Offset: 0Bh – 09h
Register Name: Class Code Register
Reset Value : 0C0320h

23 22 21 20 19 18 17 16 15 14 13 12 11 10 9 8 7 6 5 4 3 2 1 0

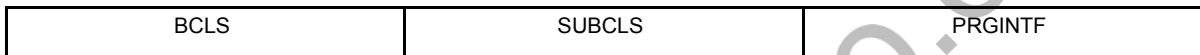

Bit	Name	Attribute	Description
23-16	BCLS	RO	Base Class. The Base Class is 0Ch (Serial Bus Controller).
15-8	SUBCLS	RO	Sub Class. The Sub Class is 03h (Universal Serial Bus).
7-0	PRGINTF	RO	Programming Interface. The Programming Interface is 20h (USB2.0).

Register Offset: 0Ch
Register Name: Cache Line Size Register
Reset Value : 04h

7 6 5 4 3 2 1 0

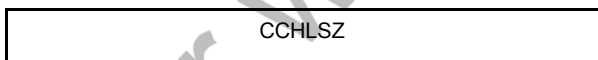

Bit	Name	Attribute	Description
7-0	CCHLSZ	R/W	Cache Line Size This register identifies the system cache line size in units of 32-bit words. USB HC will only store the value of 04h and 08h in this register.

Vortex86EX

32-Bit x86 Micro Processor

Register Offset: 0Dh
Register Name: Latency Timer Register
Reset Value : 00h

7 6 5 4 3 2 1 0

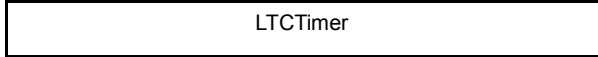

Bit	Name	Attribute	Description
7-0	LTCTimer	RW	Latency Timer. This register identifies the value of the latency timer in PCI clocks for PCI bus master cycles.

Register Offset: 0Eh
Register Name: Header Type Register
Reset Value : 00h

7 6 5 4 3 2 1 0

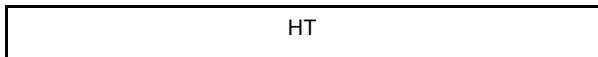

Bit	Name	Attribute	Description
7-0	HT	RO	Header Type Register. This register identifies the type of the predefined header in the configuration space. Since the EHC is a single function device and not a PCI-to-PCI bridge, the byte should be read as 00h.

Register Offset: 13h – 10h
Register Name: Base Address Register
Reset Value : 00000000h

31 30 29 28 27 26 25 24 23 22 21 20 19 18 17 16 15 14 13 12 11 10 9 8 7 6 5 4 3 2 1 0

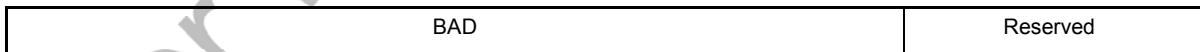

Bit	Name	Attribute	Description
31-8	BAD	RW	Base Address. POST writes the value of the memory base address to this register.
7-0	RSVD	RO	Reserved. These bits are always 0.

Vortex86EX

32-Bit x86 Micro Processor

Register Offset: 2Dh – 2Ch
Register Name: Subsystem Vendor ID Register
Reset Value : 0000h

15 14 13 12 11 10 9 8 7 6 5 4 3 2 1 0

SVID															
------	--	--	--	--	--	--	--	--	--	--	--	--	--	--	--

Bit	Name	Attribute	Description
15	SVID	RO	Subsystem Vendor ID. Set the value in this field to identify the subsystem vendor ID.

Register Offset: 2Fh – 2Eh
Register Name: Subsystem ID Register
Reset Value : 0000h

15 14 13 12 11 10 9 8 7 6 5 4 3 2 1 0

SID															
-----	--	--	--	--	--	--	--	--	--	--	--	--	--	--	--

Bit	Name	Attribute	Description
15	SID	RO	Subsystem ID. Set the value in this field to identify the subsystem ID.

Register Offset: 3Dh – 3Ch
Register Name: Interrupt Control Register
Reset Value: 02FFh

15 14 13 12 11 10 9 8 7 6 5 4 3 2 1 0

INTP								INTL							
------	--	--	--	--	--	--	--	------	--	--	--	--	--	--	--

Bit	Name	Attribute	Description
15-8	INTP	RO	Interrupt Pin. Use INT_B.
7-0	INTL	R/W	Interrupt Line. Index Interrupt Vector.

Vortex86EX

32-Bit x86 Micro Processor

Register Offset: 3Eh
Register Name: Minimun Grant Register
Reset Value : 00h

7 6 5 4 3 2 1 0

MINGNT

Bit	Name	Attribute	Description
7-0	MINGNT	RO	<p>Minimum Grant.</p> <p>This register specifies the desired settings for how long of a burst EHC needs assuming a clock rate of 33 MHz. The value specifies a period of time in units of 1/4 microsecond.</p>

Register Offset: 3Fh
Register Name: Max Latency Register
Reset Value : 00h

7 6 5 4 3 2 1 0

MAXLAT

Bit	Name	Attribute	Description
7-0	MAXLAT	RO	<p>Maximum Latency.</p> <p>This register specifies the desired setting for how often the EHC needs access to the PCI bus assuming a clock rate of 33 MHz. The value specifies a period of time in units of 1/4 microsecond.</p>

Register Offset: 43h – 40h

Register Name: Reserved

Register Offset: 47h – 44h

Register Name: Reserved

12.3.10 EHCI Operational Registers

The base address of these registers is programmable by the memory base address register (EHC PCI configuration register offset 10h – 13h). These registers should be written as DWORD. Bytes access to these registers may have unpredictable effects.

12.3.11 Host Controller Capability Register

Register Offset: 00h

Register Name: Capability Register Length Register

Reset Value : 20h

7 6 5 4 3 2 1 0

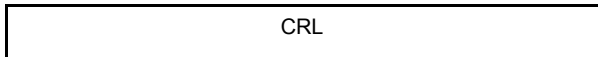

Bit	Name	Attribute	Description
7-0	CRL	RO	Capability Register Length. This register indicates to the length of the host controller capability register.

Register Offset: 03h – 02h

Register Name: Host Controller Interface Version Register

Reset Value : 0100h

15 14 13 12 11 10 9 8 7 6 5 4 3 2 1 0

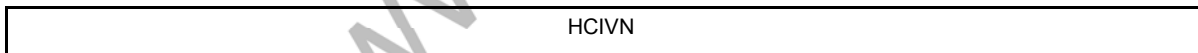

Bit	Name	Attribute	Description
15-0	HCIVN	RO	Host Controller Interface Version Number. This register indicates the EHC supports the EHCI Spec Revision 1.0.

Vortex86EX

32-Bit x86 Micro Processor

Register Offset: 07h – 04h
Register Name: Structural Parameters Register
Reset Value : 00001414h

31 30 29 28 27 26 25 24 23 22 21 20 19 18 17 16 15 14 13 12 11 10 9 8 7 6 5 4 3 2 1 0

RSVD	DPN	RSVD	PI	N_CC	N_PCC	PRR	RSVD	PPC	N_PORTS
------	-----	------	----	------	-------	-----	------	-----	---------

Bit	Name	Attribute	Description						
31-24	RSVD	RO	Reserved. These registers are always 0.						
23-20	DPN	RO	Debug Port Number. This register identifies the first port as the debug port.						
19-17	RSVD	RO	Reserved. These registers are always 0.						
16	PI	RO	Port Indicators (P_INDICATOR). This bit indicates whether the ports support port indicator control. When this bit is a one, the port status and control registers include a read/writable field for controlling the state of the port indicator.						
15-12	N_CC	RO	Number of Companion Controller (N_CC). This field indicates the number of companion controllers associated with this USB2.0 host controller.						
11-8	N_PCC	RO	Number of Ports per Companion Controller (N_PCC). This field indicates the number of ports supported per companion host controller.						
7	PRR	RO	Port Routing Rules. This field indicates the method used by this implementation for how all ports are mapped to companion controllers. The value of this field has the following interpretation: <table style="width: 100%; border-collapse: collapse;"> <thead> <tr> <th style="width: 10%;">Value</th> <th style="width: 90%;">Meaning</th> </tr> </thead> <tbody> <tr> <td style="text-align: center;">0</td> <td>The first <i>N_PCC</i> ports are routed to the lowest numbered function companion host controller, the next <i>N_PCC</i> port are routed to the next lowest function companion controller, and so on.</td> </tr> <tr> <td style="text-align: center;">1</td> <td>The port routing is explicitly enumerated by the first <i>N_PORTS</i> elements of the <i>HCSP-PORTROUTE</i> array.</td> </tr> </tbody> </table>	Value	Meaning	0	The first <i>N_PCC</i> ports are routed to the lowest numbered function companion host controller, the next <i>N_PCC</i> port are routed to the next lowest function companion controller, and so on.	1	The port routing is explicitly enumerated by the first <i>N_PORTS</i> elements of the <i>HCSP-PORTROUTE</i> array.
Value	Meaning								
0	The first <i>N_PCC</i> ports are routed to the lowest numbered function companion host controller, the next <i>N_PCC</i> port are routed to the next lowest function companion controller, and so on.								
1	The port routing is explicitly enumerated by the first <i>N_PORTS</i> elements of the <i>HCSP-PORTROUTE</i> array.								
6-5	RSVD	RO	Reserved. These registers are always 0.						
4	PPC	RO	Port Power Control (PPC). This field indicates whether the host controller implementation includes port power control. A one in this bit indicates the ports have port power switches. A zero in this bit indicates the port do not have port power switches. The value of this field affects the functionality of the <i>Port Power</i> field in each port status and control register.						
3-0	N_PORTS	RO	Number of Ports (N_PORTS). This field indicates the number of ports supported on this host controller.						

Vortex86EX

32-Bit x86 Micro Processor

Register Offset: 0Bh – 08h
Register Name: Capability Parameters Register
Reset Value : 00007006h

31 30 29 28 27 26 25 24 23 22 21 20 19 18 17 16 15 14 13 12 11 10 9 8 7 6 5 4 3 2 1 0

RSVD	EECP	IST	RSVD	ASPC	PFL	RSVD
------	------	-----	------	------	-----	------

Bit	Name	Attribute	Description
31-16	RSVD	RO	Reserved. These registers are always 0.
15-8	EECP	RO	EHCI Extend Capabilities Pointer (EECP). This field indicates the existence of a capability list.
7-4	IST	RO	Isochronous Scheduling Threshold. This field indicates, relative to the current position of the executing host controller, where software can reliably update the isochronous schedule.
3	RSVD	RO	Reserved. This register is always 0.
2	ASOC	RO	Asynchronous Schedule Park Capability. If this bit is set to a one, then the host controller supports the park feature for high-speed queue heads in the Asynchronous Schedule.
1	PFL	RO	Programmable Frame List Flag. If this bit is set to a zero, then system software must use a frame list length of 1024 elements with this host controller. The USBCMD register <i>Frame List Size</i> field is a read-only register and should be set to zero. If set to a one, then system software can specify and use a smaller frame list and configure the host controller via the USBCMD register <i>Frame List Size</i> field. The frame list must always be aligned on a 4K page boundary. This requirement ensures that the frame list is always physically contiguous.
0	RSVD	RO	Reserved. These registers are always 0.

12.3.12 Host Controller Operational Register

Register Offset: 23h – 20h
Register Name: USB2.0 Command Register
Reset Value : 00080B00h

31 30 29 28 27 26 25 24 23 22 21 20 19 18 17 16 15 14 13 12 11 10 9 8 7 6 5 4 3 2 1 0

RSVD	ITC	RSVD	ASPMc	RSVD	ASPMEn	LHCR	INT_AAD	ASEN	PSEn	FLS	HCRESET	RS
------	-----	------	-------	------	--------	------	---------	------	------	-----	---------	----

Bit	Name	Attribute	Description																		
31-24	RSVD	RO	Reserved. These registers are always 0.																		
23-16	ITC	R/W	<p>Interrupt Threshold Control. This field is used by system software to select the maximum rate at which the host controller will issue interrupts. The only valid values are defined below. If software writes an invalid value to this register, the results are undefined.</p> <table style="width: 100%; border-collapse: collapse;"> <tr> <td style="width: 30%;">Value</td> <td>Maximum Interrupt Interval</td> </tr> <tr> <td>00h</td> <td>Reserved</td> </tr> <tr> <td>01h</td> <td>1 micro-frame</td> </tr> <tr> <td>02h</td> <td>2 micro-frames</td> </tr> <tr> <td>04h</td> <td>4 micro-frames</td> </tr> <tr> <td>08h</td> <td>8 micro-frames (default, equates to 1 ms)</td> </tr> <tr> <td>10h</td> <td>16 micro-frames (2 ms)</td> </tr> <tr> <td>20h</td> <td>32 micro-frames (4 ms)</td> </tr> <tr> <td>40h</td> <td>64 micro-frames (8 ms)</td> </tr> </table> <p>Software modifications to this bit while HCHalted bit is equal to zero results in undefined behavior.</p>	Value	Maximum Interrupt Interval	00h	Reserved	01h	1 micro-frame	02h	2 micro-frames	04h	4 micro-frames	08h	8 micro-frames (default, equates to 1 ms)	10h	16 micro-frames (2 ms)	20h	32 micro-frames (4 ms)	40h	64 micro-frames (8 ms)
Value	Maximum Interrupt Interval																				
00h	Reserved																				
01h	1 micro-frame																				
02h	2 micro-frames																				
04h	4 micro-frames																				
08h	8 micro-frames (default, equates to 1 ms)																				
10h	16 micro-frames (2 ms)																				
20h	32 micro-frames (4 ms)																				
40h	64 micro-frames (8 ms)																				
15-12	RSVD	RO	Reserved. These registers are always 0.																		
11	ASPMEn	R/W	Asynchronous Schedule Park Mode Enable. If the Asynchronous Park Capability bit in the HCCPARAMS register is a one, then this bit defaults to a 1h and is R/W. Software uses this bit to enable or disable Park mode.																		
10	RSVD	RO	Reserved. This register is always 0.																		
9-8	ASPMc	R/W	Asynchronous Schedule Park Mode Count. If the Asynchronous Park Capability bit in the HCCPARAMS register is a one, then this bit defaults to a 3h and is R/W. This field contains a count to the number of successive transactions the host controller is allowed to execute from a high-speed queue head on the asynchronous schedule before continuing																		

Vortex86EX

32-Bit x86 Micro Processor

Bit	Name	Attribute	Description
			traversal of the asynchronous schedule.
7	LHCR	R/W	Light Host Controller Reset. It allows the driver to reset the EHCI controller without affecting the state of the ports or the relationship to the companion host controllers.
6	INT_AAD	R/W	Interrupt on Async Advance Doorbell. This bit is used as a doorbell by software to tell the host controller to issue an interrupt the next time it advances asynchronous schedule.
5	ASEn	R/W	Asynchronous Schedule Enable. This bit controls whether the host controller skips processing the Asynchronous Schedule.
4	PSEn	R/W	Periodic Schedule Enable. This bit controls whether the host controller skips processing the Periodic Schedule.
3-2	FLS	R/W	Frame List Size. This field is R/W only if <i>Programmable Frame List Flag</i> in the HCCPARAMS registers is set to a one. This field specifies the size of the frame list. The size the frame list controls which bits in the Frame Index Register should be used for the Frame List Current index. Values mean: 00b 1024 elements (4096 bytes) Default value 01b 512 elements (2048 bytes) 10b 256 elements (1024 bytes) – for resource-constrained environments 11b Reserved
1	HCRESET	R/W	Host Controller Reset (HCRESET). This control bit is used by software to reset the host controller.
0	RS	R/W	Run/Stop (RS) When set to a 1, the host controller proceeds with execution of the schedule.

Register Offset: 27h – 24h
Register Name: USB2.0 Status Register
Reset Value : 00001000h

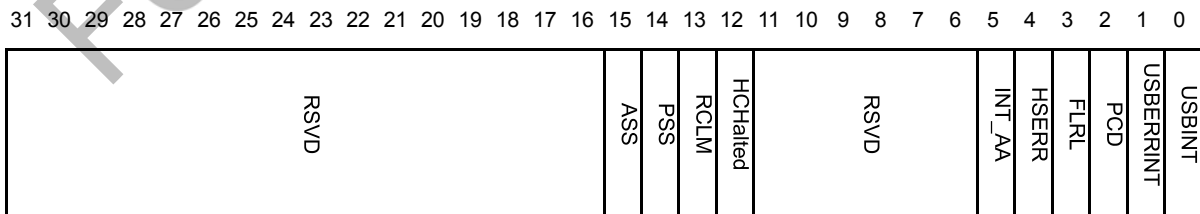

Bit	Name	Attribute	Description
31-16	RSVD	RO	Reserved.
15	ASS	RO	Asynchronous Schedule Status.

Vortex86EX

32-Bit x86 Micro Processor

Bit	Name	Attribute	Description
			This bit reports the current real status of the Asynchronous Schedule. If this bit is a zero then the status of the Asynchronous Schedule is disabled.
14	PSS	RO	Periodic Schedule Status. This bit reports the current real status of the Periodic Schedule. If this bit is a zero then the status of the Periodic Schedule is disabled.
13	RCLM	RO	Reclamation. This bit is used to detect an empty asynchronous schedule.
12	HCHalted	RO	Host Controller Halted (HCHalted). This bit is a zero whenever the Run/Stop bit is a one. The Host Controller sets this bit to one after it has stopped executing as a result of the Run/Stop bit being set to 0, either by software or by the Host Controller hardware.
11-6	RSVD	RO	Reserved.
5	INT_AA	R/WC	Interrupt on Async Advance. System software can force the host controller to issue an interrupt the next time the host controller advances the asynchronous schedule by writing a one to the Interrupt on Async Advance Doorbell bit in the USB2CMD register.
4	HSERR	R/WC	Host System Error. The Host Controller sets this bit to 1 when a serious error occurs during a host system access involving the Host Controller module.
3	FLRL	R/WC	Frame List Rollover. The Host Controller sets this bit to a one when the Frame List Index rolls over from its maximum value to zero.
2	PCD	R/WC	Port Change Detect. The Host Controller sets this bit to a one when any port for which the Port Owner bit is set to zero has a change bit transition from a zero to a one or a Force Port Resume bit transition from a zero to a one as a result of a J-K transaction detected on a suspended port. This bit will also be set as a result of the Connect Status Change being set to a one after system software has relinquished ownership of a connected port by writing a one to a port's Port Owner bit.
1	USBERR INT	R/WC	USB Error Interrupt (USBERRINT). The Host Controller sets this bit to 1 when completion of a USB transaction results in an error condition.
0	USBINT	R/WC	USB Interrupt (USBINT). The Host Controller sets this bit to 1 one the completion of a USB transaction, which result in the retirement of a Transfer Descriptor that had its IOC bit set.

Vortex86EX

32-Bit x86 Micro Processor

Register Offset: 2Bh – 28h
Register Name: USB2.0 Interrupt Enable Register
Reset Value : 00000000h

31 30 29 28 27 26 25 24 23 22 21 20 19 18 17 16 15 14 13 12 11 10 9 8 7 6 5 4 3 2 1 0



Bit	Name	Attribute	Description
31-16	RSVD	RO	Reserved.
5	INT_AAE _n	R/W	Interrupt on Async Advance Enable. When this bit is a one and the Interrupt on the Async Advance bit in the USBSTS register is a one, the host controller will issue an interrupt at the next interrupt threshold. The interrupt is acknowledged by software clearing the Interrupt on the Async Advance bit.
4	HSERREN	R/W	Host System Error Enable. When this bit is a one and the Host System Error Status bit in the USBSTS register is a one, the host controller will issue an interrupt. The interrupt is acknowledged by software clearing the Host System Error bit.
3	FLRLE _n	R/W	Frame List Rollover Enable. When the Rollover bit in the USBSTS register is a one, the host controller will issue an interrupt. The interrupt is acknowledged by software clearing the Frame List Rollover bit.
2	PCDE _n	R/W	Port Change Detect Enable. When this bit is a one and the Port Change Detect bit in the USBSTS register is a one, the host controller will issue an interrupt. The interrupt is acknowledged by software clearing the Port Change Detect bit.
1	USBERRINT _n	R/W	USB Error Interrupt Enable. When this bit is a one, and the USBERRINT bit in the USBSTS register is a one, the host controller will issue an interrupt at the next interrupt threshold. The interrupt is acknowledged by software clearing the USBERRINT bit.
0	USBINT _n	R/W	USB Interrupt Enable. When this bit is a one and the USBINT bit in the USBSTS register is a one, the host controller will issue an interrupt at the next interrupt threshold. The interrupt is acknowledged by software clearing the USBINT bit.

Vortex86EX

32-Bit x86 Micro Processor

Register Offset: 2Fh – 2Ch
Register Name: USB2.0 Frame Index Register
Reset Value : 00000000h

31 30 29 28 27 26 25 24 23 22 21 20 19 18 17 16 15 14 13 12 11 10 9 8 7 6 5 4 3 2 1 0

RSVD	FI
------	----

Bit	Name	Attribute	Description															
31-14	RSVD	RO	Reserved. These registers are always 0.															
13-0	FI	R/W	<p>Frame Index.</p> <p>The value in this register increments at the end of each time frame (e.g. micro-frame). Bits [N:3] are used for the Frame List current index. This means that each location of the frame list is accessed 8 times (frames or micro-frames) before moving to the next index. The following illustrates values of <i>N</i> based on the value of the <i>Frame List Size</i> field in the USBCMD register.</p> <table style="width: 100%; border-collapse: collapse;"> <thead> <tr> <th style="text-align: left;">USBCMD[Frame List Size]</th> <th style="text-align: left;">Number Elements</th> <th style="text-align: left;">N</th> </tr> </thead> <tbody> <tr> <td>00b</td> <td>(1024)</td> <td>12</td> </tr> <tr> <td>01b</td> <td>(512)</td> <td>11</td> </tr> <tr> <td>10b</td> <td>(256)</td> <td>10</td> </tr> <tr> <td>11b</td> <td>Reserved</td> <td></td> </tr> </tbody> </table>	USBCMD[Frame List Size]	Number Elements	N	00b	(1024)	12	01b	(512)	11	10b	(256)	10	11b	Reserved	
USBCMD[Frame List Size]	Number Elements	N																
00b	(1024)	12																
01b	(512)	11																
10b	(256)	10																
11b	Reserved																	

Register Offset: 37h – 34h
Register Name: Periodic Frame List Base Address Register
Reset Value : 00000000h

31 30 29 28 27 26 25 24 23 22 21 20 19 18 17 16 15 14 13 12 11 10 9 8 7 6 5 4 3 2 1 0

BA	RSVD
----	------

Bit	Name	Attribute	Description
31-12	BA	R/W	Base Address. These bits correspond to memory address [31:12].
11-0	RSVD	RO	Reserved. These registers are always 0.

Vortex86EX

32-Bit x86 Micro Processor

Register Offset: 3Bh – 38h
Register Name: Current Asynchronous List Address Register
Reset Value : 00000000h

31 30 29 28 27 26 25 24 23 22 21 20 19 18 17 16 15 14 13 12 11 10 9 8 7 6 5 4 3 2 1 0

LP	RSVD
----	------

Bit	Name	Attribute	Description
31-5	LP	R/W	Link Pointer. These bits correspond to memory address [31:5].
4-0	RSVD	RO	Reserved. These registers are always 0.

Register Offset: 63h – 60h
Register Name: Configured Flag Register
Reset Value : 00000000h

31 30 29 28 27 26 25 24 23 22 21 20 19 18 17 16 15 14 13 12 11 10 9 8 7 6 5 4 3 2 1 0

RSVD	CF
------	----

Bit	Name	Attribute	Description
31-1	RSVD	RO	Reserved. These registers are always 0.
0	CF	R/W	Configure Flag (CF). Host software sets this bit as the last action in its process of configuring the Host Controller. Writing a one to this register will route all ports to this host controller.

Register Offset: 67h – 64h, 6Bh – 68h
Register Name: Port 0 Status and Control Register, Port 1 Status and Control Register
Reset Value : 00002000h

31 30 29 28 27 26 25 24 23 22 21 20 19 18 17 16 15 14 13 12 11 10 9 8 7 6 5 4 3 2 1 0

RSVD	PTC	RSVD	PO	PP	LS	RSVD	PRESET	SSPND	FPRS	OCRC	OCRA	P_EDC	P_ED	CNTSC	CRCNTS
------	-----	------	----	----	----	------	--------	-------	------	------	------	-------	------	-------	--------

Bit	Name	Attribute	Description
31-20	RSVD	RO	Reserved.
19-16	PTC	R/W	Port Test Control. When this field is zero, the port is NOT operating in a test mode. A non-zero value indicates that it is operating in test mode and the specific test mode is indicated by the specific value. The encoding of the test mode bits are (0110b - 1111b are reserved):

Bit	Name	Attribute	Description									
			Bits Test Mode 0000b Test mode not enabled 0001b Test J_STATE 0010b Test K_STATE 0011b Test SE0_NAK 0100b Test Packet 0101b Test FORCE_ENABLE									
15-14	RSVD	RO	Reserved.									
13	PO	R/W	Port Owner. This bit unconditionally goes to a 0b when the Configured bit in the CONFIGFLAG register makes a 0b to 1b transition. This bit unconditionally goes to 1b whenever the Configured bit is zero. Software writes a one to this bit when the attached device is not a high-speed device.									
12	PP	R/W	Port Power (PP). The function of this bit depends on the value of the <i>Port Power Control (PPC)</i> field in the HCSPARAMS register. The behavior is as follows: <table style="margin-left: 20px; border-collapse: collapse;"> <thead> <tr> <th>PPC</th> <th>PP</th> <th>Operation</th> </tr> </thead> <tbody> <tr> <td>0b</td> <td>1b</td> <td>RO Host controller does not have port power control switches. Each port is hard-wired to power.</td> </tr> <tr> <td>1b</td> <td>1b/0b</td> <td>R/W Host controller has port power control switches. This bit represents the current setting of the switch (0 = off, 1 = on). When power is not available on a port (i.e. <i>PP</i> equals a 0), the port is nonfunctional and will not report attaches, detaches, etc.</td> </tr> </tbody> </table> When an over-current condition is detected on a powered port and <i>PPC</i> is a one, the <i>PP</i> bit in each affected port may be transitioned by the host controller from a 1 to 0 (removing power from the port).	PPC	PP	Operation	0b	1b	RO Host controller does not have port power control switches. Each port is hard-wired to power.	1b	1b/0b	R/W Host controller has port power control switches. This bit represents the current setting of the switch (0 = off, 1 = on). When power is not available on a port (i.e. <i>PP</i> equals a 0), the port is nonfunctional and will not report attaches, detaches, etc.
PPC	PP	Operation										
0b	1b	RO Host controller does not have port power control switches. Each port is hard-wired to power.										
1b	1b/0b	R/W Host controller has port power control switches. This bit represents the current setting of the switch (0 = off, 1 = on). When power is not available on a port (i.e. <i>PP</i> equals a 0), the port is nonfunctional and will not report attaches, detaches, etc.										
11-10	LS	RO	Line Status. These bits reflect the current logical levels of the D+ (bit 11) and D- (bit 10) signal lines.									
9	RSVD	RO	Reserved. This bit is always 0.									
8	PRESET	R/W	Port Reset. When software writes a one to this bit, the bus reset sequence as defined in the USB Spec Revision 2.0 is started. Software writes a zero to this bit to terminate the bus reset sequence.									
7	SSPND	R/W	Suspend. Software writes a one to this bit to suspend the downstream port. A write of zero to this bit is ignored by the host controller. The host controller will unconditionally set this bit to a zero when software sets the Force Port Resume from 1 to 0 or sets the Port Reset bit to 1.									

Vortex86EX

32-Bit x86 Micro Processor

Bit	Name	Attribute	Description
6	FPRS	R/W	Force Port Resume. Software sets this bit to a 1 to drive resume signaling. The Host Controller sets this bit to a 1 if a J-to-K transition is detected while the port is in the Suspend state. A write of zero to this bit will force the downstream port to follow the resume sequence defined in the sequence documented in the USB Spec Revision 2.0.
5	OCRC	R/WC	Over-current Change. This bit gets set to a one when there is a change to Over-current Active.
4	OCRA	RO	Over-current Active. 0: This port does not have an over-current condition. 1: This port has an over-current condition.
3	P_EDC	R/WC	Port Enable/Disable Change. For the root hub, this bit gets set to a one only when a port is disabled due to the appropriate conditions existing at the EOF2 pointer.
2	P_ED	R/W	Port Enable/Disabled. Ports can only be enabled by the host controller as a part of the reset and enable. Software cannot enable a port by writing a one to this field. Ports can be disabled by either a fault condition or by host software.
1	CNNTSC	R/WC	Connect Status Change. 1: Change in Current Connect Status. 0: No change.
0	CRCNNT S	RO	Current Connect Status. This value reflects the current connect status of the port.

13. SD/SATA Controller

13.1 Overview

The IDE to SD/SATA controller, which is compatible with the ATA/ATAPI-6 specification. It supports not only a Scatter/Gather DMA mechanism that complies with the Programming Interface for Bus Master IDE Controller Revision 1.0 but also 2 IDE channels and primary channel for SD, secondary for SATA..

13.2 Features

IDE Functions

- Compatible with the ATA/ATAPI-6 specification and supports two IDE channels. (primary channel for SD, secondary for SATA)
- Supports ANSI ATA proposal PIO Modes 0, 1, 2, 3, 4 with flow control, DMA Modes 0, 1, 2 and Ultra DMA modes 0, 1, 2, 3, 4, 5, 6
- Programmable active pulses and recovery time for data port access timing
- 512 bytes FIFO for data transfer per IDE channel
- Supports Scatter/Gather function for DMA/UDMA transfer
- Supports pre-fetch and post-write function for PIO mode per IDE channel

PCI Interface

- Host interface complies with PCI local bus specification revision 2.2
- Supports PCI Power Management v1.1 capability
- Support one Flash/ROM interface for expansion ROM of PCI card

13.3 List of PCI Configuration Registers

31	16	15	00	Index
Device ID (1012h)		Vendor ID (17F3h)		00h-03h
Status (0200h)		Command (0000h)		04h-07h
Base Class Code (01h)	Sub-class code (01h)	Program Interface (8Ah)	Revision ID (03h)	08h-0Bh
Reserved	Header Type (00h)	Latency Timer (00h)	Cache Line Size (08h)	0Ch-0Fh
Primary Channel Command Block Register Base Address (00000001h)				10h-13h
Primary channel Control Block Register Base Address (00000001h) ♦				14h-17h
Secondary Channel Command Block Register Base Address (00000001h)				18h-1Bh
Secondary Channel Control Block Register Base Address (00000001h)				1Ch-1Fh
Bus Master Base Address Register (00000001h)				20h-23h
Reserved				24h-2Bh
Sub-system Device ID (1012h)		Sub-system Vendor ID (17F3h)		2Ch-2Fh
Reserved				30h-3Bh
MAX_LAT (00h)	MIN_GNT (00h)	INTERRUPT PIN (01h)	INTERRUPT LINE (FFh)	3Ch-3Fh
ATA TIMING(Secondary)		ATA TIMING(Primary)		40h-43h
Reserved	Reserved	Reserved	Device 1 ATA Timing(Primary and Secondary)	44h-47h
Ultra DMA Timing Register		Reserved	Ultra DMA Control Register	48h-4Bh
Reserved				4Ch-53h
Reserved		IDE IO Configuration		54h-57h
Reserved				58h-5Fh
Controller Feature Register				60h-63h
Reserved				64h-7Fh
Reserved				80h-83h

Reserved				84h-8Fh
MISC Control Register				90h-93h
SD Control Register				94h-97h
SATA PHY Control Register				98h-9Bh
Reserved				9Ch-9Fh
SATA PHY Control 2 Register				A0h-A3h
Reserved				A4h-A7h
Reserved				A8h-ABh
Low Power Device Timer Enable	Low Power Device Mode Enable	Low Power Device Status	Low Power Device Select	ACh-AFh
Reserved				B0h-FFh

13.4 List of PCI I/O Registers

13.4.1 List of PCI I/O Register - Bus Master IDE I/O Registers

Register Name	R/W	Offset (note)	Default	Register Size
Bus Master IDE Command Register for Primary Channel (BMICRP)	R/W	0x0	00h	8 bits
Bus Master IDE Status Register for Primary Channel (BMISRP)	R/WC	0x2	00h	8 bits
Bus Master Descriptor Table Pointer Register for Primary Channel (BMIDTPRP)	R/W	0x4	00000000h	32 bits
Bus Master IDE Command Register for Secondary Channel (BMICRS)	R/W	0x8	00h	8 bits
Bus Master IDE Status Register for Secondary Channel (BMISRS)	R/WC	0xA	00h	8 bits
Bus Master Descriptor Table Pointer Register for Secondary Channel (BMIDTPRS)	R/W	0xC	00000000h	32 bits

Note: The Base Address depends on Bus Master Base Address Register (BMBA).

13.4.2 IDE Interface and Status Registers from PCI I/O View (PCI IO Space Mapping)

Register Name	R/W	Offset	Default	Register Size
Primary IDE Data Register (VPDR)	R/W	0x0 (Note 1)	0000h	16 bits
Primary IDE Error/Feature Register (VPEFR)	R/W	0x1 (Note 1)	00h	8 bits
Primary IDE Sector Count (Ext) Register (VPSCR)	R/W	0x2 (Note 1, 5)	00h	8 bits
Primary IDE Sector Number (Ext) Register (VPSNR)	R/W	0x3 (Note 1, 5)	00h	8 bits
Primary IDE Cylinder Low (Ext) Register (VPCLR)	R/W	0x4 (Note 1, 5)	00h	8 bits
Primary IDE Cylinder High (Ext) Register (VPCHR)	R/W	0x5 (Note 1, 5)	00h	8 bits
Primary IDE Device/Head Register (VPHDR)	R/W	0x6 (Note 1)	00h	8 bits
Primary IDE Command/Status Register (VPCMR)	R/W	0x7 (Note 1)	00h	8 bits
Primary IDE Device Control/Alternate Status Register (VPSTUR)	R/W	0x6 (Note 2)	--	8 bits
Secondary IDE Data Register (VSDR)	R/W	0x0 (Note 3)	0000h	16 bits
Secondary IDE Error/Feature Register (VSEFR)	R/W	0x1 (Note 3)	00h	8 bits
Secondary IDE Sector Count (Ext) Register (VSSCR)	R/W	0x2 (Note 3, 5)	00h	8 bits
Secondary IDE Sector Number (Ext) Register (VSSNR)	R/W	0x3 (Note 3, 5)	00h	8 bits
Secondary IDE Cylinder Low (Ext) Register (VSCLR)	R/W	0x4 (Note 3, 5)	00h	8 bits
Secondary IDE Cylinder High (Ext) Register (VSCHR)	R/W	0x5 (Note 3, 5)	00h	8 bits
Secondary IDE Device/Head Register (VSHDR)	R/W	0x6 (Note 3)	00h	8 bits
Secondary IDE Command /Status Register (VSCMR)	R/W	0x7 (Note 3)	00h	8 bits

Secondary IDE Device Control/Alternate Status Register (VSSTUR)	R/W	0x6 (Note4)	--	8 bits
---	-----	-------------	----	--------

Definition of R/W Attributes:

RO READ ONLY. If a register is read only, writing will have no effect.

R/W READ/WRITE. A register with this attribute can be read and written.

R/W1 READ/WRITE ONCE. A register with this attribute can be read and write once.

R/WC READ/WRITE CLEAR. A register bit with this attribute can be read and written. However, a write of 1 clears the corresponding bit and a write of 0 will have no effect.

13.5 PCI Configuration Registers Definition

Register Offset: 00h

Register Name: Vendor ID Register

Reset Value : 17F3h

15 14 13 12 11 10 9 8 7 6 5 4 3 2 1 0

VID

Bit	Name	Attribute	Description
15-0	VID	RO	<i>Vendor ID.</i>

Register Offset: 02h

Register Name: Device ID Register

Reset Value : 17F3h

15 14 13 12 11 10 9 8 7 6 5 4 3 2 1 0

DID

Bit	Name	Attribute	Description
15-0	DID	RO	<i>Device ID.</i>

Vortex86EX

32-Bit x86 Micro Processor

Register Offset: 04h
Register Name: Command Register
Reset Value : 0000h

15 14 13 12 11 10 9 8 7 6 5 4 3 2 1 0

RSVD	PER	RSVD	DBME	RSVD	IOAE
------	-----	------	------	------	------

Bit	Name	Attribute	Description
15-7	RSVD	RO	Reserved.
6	PER	RO	Parity Error Response. 1: Enabled 0: Disabled
5-3	RSVD	RO	Reserved.
2	DBME	RW	DMA Bus Master Enable. 1: Enabled 0: Disabled
1	RSVD	RO	Reserved.
0	IOAE	RW	I/O Access Enable. 1: Allow the chip to respond to I/O space accesses. 0: Disable I/O space accesses.

Register Offset: 06h
Register Name: Device Status Register
Reset Value : 630h

15 14 13 12 11 10 9 8 7 6 5 4 3 2 1 0

RSVD	PER	RSVD	DBME	RSVD	IOAE
------	-----	------	------	------	------

Bit	Name	Attribute	Description
15-14	RSVD	RO	Reserved.
13	MAST	RWC	Master Abort Status. This bit is set to high when the IDE Controller acts as a PCI master and has issued a Master-Abort. Write 1 to clear this bit.
12	RTA	RWC	Received Target Abort. This bit is set to high when the IDE controller is a PCI master and the PCI transaction is terminated by receiving a Target-Abort. Write 1 to clear this bit.
11	RSVD	RO	Reserved.
10-9	DEVT[1:0]	RO	DEVSEL Timing. Medium timing is selected for DEVSEL# assertion when the PCI target performs the positive decode.

Vortex86EX

32-Bit x86 Micro Processor

8	RSVD	RO	Reserved.
7	FBC	RO	Fast Back-to-Back Capable. Always read as 0. Not supported.
6	RSVD	RO	Reserved.
5	CAB-66	RO	66 MHz Capable. A "1" indicates that the function supports 66 MHz. A "0" indicates that the function just supports 33 MHz.
4	CAP	RO	Capabilities. This bit indicates whether this function implements a list of extended capabilities such as the PCI power management. When being set, it indicates the presence of capabilities. The value of "0" means that this function does not implement capabilities.
3-0	RSVD	RO	Reserved.

Register Offset: 08h
Register Name: Revision Register
Reset Value: 03h

7 6 5 4 3 2 1 0

RID

Bit	Name	Attribute	Description
7-0	RID	RO	Revision ID. The revision number of the IDE controller.

Vortex86EX

32-Bit x86 Micro Processor

Register Offset: 09h
Register Name: Program Interface
Reset Value: 8A

7 6 5 4 3 2 1 0

CBMO	RSVD	FMOS	MOS	IFMOP	MOP
------	------	------	-----	-------	-----

Bit	Name	Attribute	Description
7	CBMO	RO	Capable of Bus Master Operation. 1: Capable. 0: No Capable
6-4	RSVD	RO	Reserved.
3	IFMOS	RO	Indicate Fixed Mode of Operation for Secondary Channal. 1: Not Fixed Mode 0: Fixed Mode
2	MOS	RW	Mode of Operation for Secondary Channal. 1: PCI-Native Mode 0: Compatibility
1	IFMOP	RO	Indicate Fixed Mode of Operation for Primary Channal. 1: Not Fixed Mode 0: Fixed Mode
0	MOP	RW	Mode of Operation for Primary Channal. 1: PCI-Native Mode 0: Compatibility

Register Offset: 0Ah
Register Name: Sub-class Code Register
Reset Value: 01h

7 6 5 4 3 2 1 0

SCC

Bit	Name	Attribute	Description
7-0	SCC	RO	Sub-class Code. 01h for Standard IDE

Vortex86EX

32-Bit x86 Micro Processor

Register Offset: 0Bh
Register Name: Base Class Code Register
Reset Value: 01h

7 6 5 4 3 2 1 0

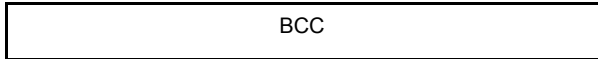

Bit	Name	Attribute	Description
7-0	BCC	RO	Sub-class Code. 01h for Mass storage device.

Register Offset: 0Ch
Register Name: Cache Line Size Register
Reset Value: 08h

7 6 5 4 3 2 1 0

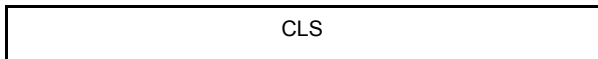

Bit	Name	Attribute	Description
7-0	CLS	RO	Cache Line Size.

Register Offset: 0Dh
Register Name: Master Latency Timer Register
Reset Value: 00h

7 6 5 4 3 2 1 0



Bit	Name	Attribute	Description
7-0	MLT	RO	Master Latency Timer. These bits indicate the PCI Bus master latency timer.

Vortex86EX

32-Bit x86 Micro Processor

Register Offset: 0Eh
Register Name: Header Type Register
Reset Value: 00h

7 6 5 4 3 2 1 0

HEADT

Bit	Name	Attribute	Description
7-0	HEADT	RO	Head Type. These bits Indicate the header type of the device.

Register Offset: 10h
Register Name: Primary Channel Command Block Register Base Address
Reset Value: 00000001h

31 30 29 28 27 26 25 24 23 22 21 20 19 18 17 16 15 14 13 12 11 10 9 8 7 6 5 4 3 2 1 0

RSVD	PCMDBA	RSVD	RT
------	--------	------	----

Bit	Name	Attribute	Description
31-16	RSVD	RO	Reserved.
15-3	PCMDBA	RW	Primary Channel Command Block Base Address (PCMDBA[28:0]). The base address of the command block register of the primary channel.
2-1	RSVD	RO	Reserved.
0	RT	RO	Resource Type (RT) Hardwired to 1 to indicate that the base address field in this register has been mapped to the I/O space.

Note: This register is only used in the "Native-PCI" mode.

Vortex86EX

32-Bit x86 Micro Processor

Register Offset: 14h
Register Name: Primary Channel Control Block Base Address
Reset Value: 00000001h

31 30 29 28 27 26 25 24 23 22 21 20 19 18 17 16 15 14 13 12 11 10 9 8 7 6 5 4 3 2 1 0

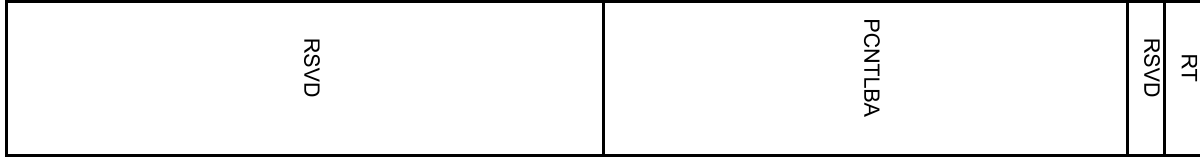

Bit	Name	Attribute	Description
31-16	RSVD	RO	Reserved.
15-2	PCNTLBA	RW	Primary Channel Control Block Base Address (PCNTLBA [29:0]). The base address of the control block register of the primary channel.
1	RSVD	RO	Reserved.
0	RT	RO	Resource Type (RT) Hardwired to 1 to indicate that the base address field in this register has been mapped to the I/O space.

Note: This register is only used in the "Native-PCI" mode.

Register Offset: 18h
Register Name: Secondary Channel Command Block Base Address
Reset Value: 00000001h

31 30 29 28 27 26 25 24 23 22 21 20 19 18 17 16 15 14 13 12 11 10 9 8 7 6 5 4 3 2 1 0



Bit	Name	Attribute	Description
31-16	RSVD	RO	Reserved.
15-3	SCMDBA	RW	Secondary Channel Command Block Base Address (SCMDBA[28:0]). The base address of the command block register of the secondary channel.
2-1	RSVD	RO	Reserved.
0	RT	RO	Resource Type. Hardwired to 1 to indicate that the base address field in this register has been mapped to the I/O space.

Note: This register is only used in the "Native-PCI" mode.

Vortex86EX

32-Bit x86 Micro Processor

Register Offset: 1Ch
Register Name: Secondary Channel Control Block Base Address
Reset Value: 00000001h

31 30 29 28 27 26 25 24 23 22 21 20 19 18 17 16 15 14 13 12 11 10 9 8 7 6 5 4 3 2 1 0

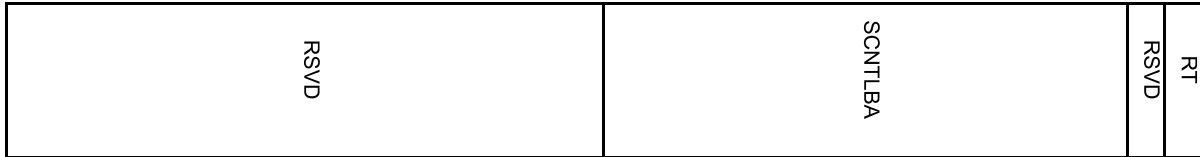

Bit	Name	Attribute	Description
31-16	RSVD	RO	Reserved.
15-2	SCNTLBA	RW	Secondary Channel Control Block Base Address (SCNTLBA[29:0]). The base address of the control block register of the secondary channel.
1	RSVD	RO	Reserved.
0	RT	RO	Resource Type. Hardwired to 1 to indicate that the base address field in this register has been mapped to the I/O space.

Note: This register is only used in the "Native-PCI" mode.

Register Offset: 20h
Register Name: Bus Master Base Address Register
Reset Value: 00000001h

31 30 29 28 27 26 25 24 23 22 21 20 19 18 17 16 15 14 13 12 11 10 9 8 7 6 5 4 3 2 1 0

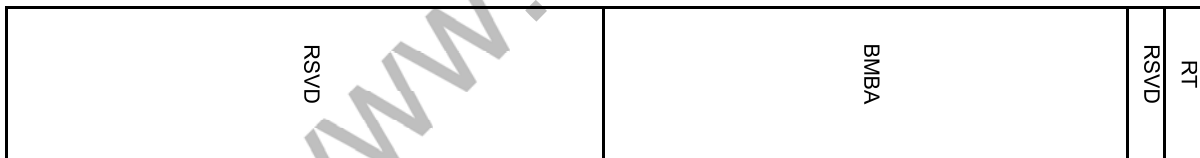

Bit	Name	Attribute	Description
31-16	RSVD	RO	Reserved.
15-4	BMBA	RW	Bus Master Base Address (BMBA [27:0]) These bits provide the base address for the bus master interface register.
3-1	RSVD	RO	Reserved.
0	RT	RO	Resource Type. Hardwired to 1 to indicate that the base address field in this register has been mapped to the I/O space.

Vortex86EX

32-Bit x86 Micro Processor

Register Offset: 2Ch
Register Name: Sub-system Vendor ID Register
Reset Value: 17F3h

15 14 13 12 11 10 9 8 7 6 5 4 3 2 1 0

SVID

Bit	Name	Attribute	Description
15-0	SVID	RW	<i>Sub-system Vendor ID (SVID [15:0]).</i> This register could be written once.

Register Offset: 2Eh
Register Name: Sub-system Device ID Register
Reset Value: 1012h

15 14 13 12 11 10 9 8 7 6 5 4 3 2 1 0

SDID

Bit	Name	Attribute	Description
15-0	SDID	RW	<i>Sub-system Vendor ID (SVID [15:0]).</i> This register could be written once.

Register Offset: 3Ch
Register Name: Interrupt Line Register
Reset Value: FFh

7 6 5 4 3 2 1 0

IL

Bit	Name	Attribute	Description
7-0	IL	RW	<i>Interrupt Line.</i> This is an 8-bit register used to communicate the interrupt line routing information. The value in the register tells which input of the system interrupt controller the device's interrupt pin is connected to.

Vortex86EX

32-Bit x86 Micro Processor

Register Offset: 3Dh
Register Name: Interrupt Pin Register
Reset Value: 01h

7 6 5 4 3 2 1 0



Bit	Name	Attribute	Description
7-0	IP	RO	<i>Interrupt Pin.</i> The register tells which interrupt pin the device uses. The device only uses the INTA#, so the value is 01h.

Register Offset: 3Eh
Register Name: MIN_GNT Register
Reset Value: 00h

7 6 5 4 3 2 1 0

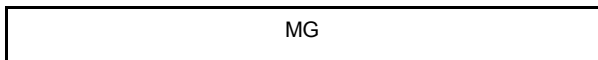

Bit	Name	Attribute	Description
7-0	MG	RO	<i>MIN_GNT.</i> The device has requirements for the setting of Latency Timers.

Register Offset: 3Fh
Register Name: MAX_LAT Register
Reset Value: 00h

7 6 5 4 3 2 1 0



Bit	Name	Attribute	Description
7-0	ML	RO	<i>MAX_LAT.</i> The device has requirements for the setting of Latency Timers.

Vortex86EX

32-Bit x86 Micro Processor

Register Offset: 40h-41h, 42-43

Register Name: Primary ATA Timing Register (PATR), Secondary ATA Timing Register (SATR)

Reset Value: 0000h

15	14	13	12	11	10	9	8	7	6	5	4	3	2	1	0
ATADE	D1ATRE	ISM	RSVD	RM	DTEOS1	AAPDI1	ISPES1	FDTS1	DTEOS0	AAPDI0	ISPES0	FDTS0			

Bit	Name	Attribute	Description
15	ATADE	R/W	ATA Decode Enable. Decode the I/O addressing ranges assigned to this controller. 1: Enabled. 0: Disabled.
14	D1ATRE	R/W	Device 1 ATA Timing Register Enable. 1: Enabled the device 1 ATA timing. 0: Disable the device 1 ATA timing
13-12	ISM	R/W	IORDY Sample Mode. Set the setup time before IORDY are sampled. 00: PIO-0 10: PIO-2, SW-2 10: PIO-3, PIO-4, MW-1, MW-2 11: Reserved
11-10	RSVD	RO	Reserved.
9-8	RM	R/W	Recovery Mode. Set the hold time after IORDY are sampled. 00: PIO-0, PIO-2, SW-2 10: PIO-3, MW-1 10: Reserved 11: PIO-4, MW-2
7	DTEOS1	R/W	DMA Timing Enable Only Select 1. 1: Enabled the device timings for DMA operation for device 1 0: Disable the device timings for DMA operation for device 1
6	AAPDI1	R/W	ATA/ATAPI Device Indicator 1. 1: Indicate presence od an ATA device 0: Indicate presence od an ATAPI device
5	ISPES1	R/W	IORDY Sample Point Enabled Select 1. 1: Enabled IORDY sample for PIO transfers for device 1 0: Disable IORDY sample for PIO transfers for device 1
4	FDTS1	R/W	Fast Drive Timing Select 1. 1: Enabled faster than PIO-0 timing modes for device 1 0: Disable faster than PIO-0 timing modes for device 1

Vortex86EX

32-Bit x86 Micro Processor

3	DTEOS0	R/W	DMA Timing Enable Only Select 0. 1: Enabled the device timings for DMA operation for device 0 0: Disable the device timings for DMA operation for device 0
2	AAPDI0	R/W	ATA/ATAPI Device Indicator 0. 1: Indicate presence od an ATA device 0: Indicate presence od an ATAPI device
1	ISPES0	R/W	IORDY Sample Point Enabled Select 0. 1: Enabled IORDY sample for PIO transfers for device 0 0: Disable IORDY sample for PIO transfers for device 0
0	FDTS0	R/W	Fast Drive Timing Select 0. 1: Enabled faster than PIO-0 timing modes for device 0 0: Disable faster than PIO-0 timing modes for device 0.

Register Offset: 44h
Register Name: Primary and Secondary Device 1 ATA Timing
Reset Value: 00h

7 6 5 4 3 2 1 0

SD1ISM	SD1RM	PD1ISM	PD1RM
--------	-------	--------	-------

Bit	Name	Attribute	Description
7-6	SD1ISM	--	Secondary Device 1 IORDY Sample Mode. Set the setup time before IORDY are sampled. 00: PIO-0 10: PIO-2, SW-2 10: PIO-3, PIO-4, MW-1, MW-2 11: Reserved
5-4	SD1RM	RW	Secondary Device 1 Recovery Mode. Set the hold time after IORDY are sampled. 00: PIO-0, PIO-2, SW-2 10: PIO-3, MW-1 10: Reserved 11: PIO-4, MW-2
3-2	PD1ISM	RW	Primary Device 1 IORDY Sample Mode. Set the setup time before IORDY are sampled. 00: PIO-0 10: PIO-2, SW-2 10: PIO-3, PIO-4, MW-1, MW-2 11: Reserved

Vortex86EX

32-Bit x86 Micro Processor

1-0	PD1RM	RW	<p>Primary Device 1 Recovery Mode. Sets the hold time after IORDY are sampled.</p> <p>00: PIO-0, PIO-2, SW-2</p> <p>10: PIO-3, MW-1</p> <p>10: Reserved</p> <p>11: PIO-4, MW-2</p>
-----	-------	----	---

Register Offset: 48h
Register Name: Ultra DMA Control Register
Reset Value: 00h

7 6 5 4 3 2 1 0

RSVD	UDMESD1	UDMESD0	UDMEPD1	UDMEPD0
------	---------	---------	---------	---------

Bit	Name	Attribute	Description
7-4	RSVD	RO	Reserved.
3	UDMESD1	RW	Ultra DMA Mode Enable for Secondary Device 1. 1: Enabled. 0: Disabled.
2	UDMESD0	RW	Ultra DMA Mode Enable for Secondary Device 0. 1: Enabled. 0: Disabled.
1	UDMEPD1	RW	Ultra DMA Mode Enable for Primary Device 1. 1: Enabled. 0: Disabled.
0	UDMEPD0	RW	Ultra DMA Mode Enable for Primary Device 0. 1: Enabled. 0: Disabled.

Vortex86EX

32-Bit x86 Micro Processor

Register Offset: 4Ah-4Bh
Register Name: Ultra DMA Timing Register
Reset Value: 0000h

15 14 13 12 11 10 9 8 7 6 5 4 3 2 1 0

RSVD	SD1UDCT	RSVD	SD0UDCT	RSVD	PD1UDCT	RSVD	PD0UDCT
------	---------	------	---------	------	---------	------	---------

Bit	Name	Attribute	Description
15-14	RSVD	R/W	Reserved.
13-12	SD1UDCT	R/W	Secondary Device 1 Ultra DMA Cycle Time. SCB1-66 = 0 (and) SCB1-66 = 1 (and) SCB1-66 = X (and) SCB1-100 = 0 SCB1-100 = 0 SCB1-100 = 1 (33MHz base clock) (66MHz base clock) (100MHz base clock) 00: UDMA mode 0 00: Reserved 00: Reserved 01: UDMA mode 1 01: UDMA mode 3 01: UDMA mode 5 10: UDMA mode 2 10: UDMA mode 4 10: Reserved 11: Reserved 11: Reserved 11: Reserved
11-10	RSVD	RO	Reserved.
9-8	SD0UDCT	R/W	Secondary Device 0 Ultra DMA Cycle Time SCB0-66 = 0 (and) SCB0-66 = 1 (and) SCB0-66 = X (and) SCB0-100 = 0 SCB0-100 = 0 SCB0-100 = 1 (33MHz base clock) (66MHz base clock) (100MHz base clock) 00: UDMA mode 0 00: Reserved 00: Reserved 01: UDMA mode 1 01: UDMA mode 3 01: UDMA mode 5 10: UDMA mode 2 10: UDMA mode 4 10: Reserved 11: Reserved 11: Reserved 11: Reserved
7-6	RSVD	R/W	Reserved.
5-4	PD1UDCT	R/W	Primary Device 1 Ultra DMA Cycle Time. PCB1-66 = 0 (and) PCB1-66 = 1 (and) PCB1-66 = X (and) PCB1-100 = 0 PCB1-100 = 0 PCB1-100 = 1 (33MHz base clock) (66MHz base clock) (100MHz base clock) 00: UDMA mode 0 00: Reserved 00: Reserved 01: UDMA mode 1 01: UDMA mode 3 01: UDMA mode 5 10: UDMA mode 2 10: UDMA mode 4 10: Reserved 11: Reserved 11: Reserved 11: Reserved
3-2	RSVD	R/W	Reserved.

Vortex86EX

32-Bit x86 Micro Processor

1-0	PD0UDCT	RW	Primary Device 0 Ultra DMA Cycle Time.		
			PCB0-66 = 0 (and)	PCB0-66 = 1 (and)	PCB0-66 = X (and)
			PCB0-100 = 0	PCB0-100 = 0	PCB0-100 = 1
			(33MHz base clock)	(66MHz base clock)	(100MHz base clock)
			00: UDMA mode 0	00: Reserved	00: Reserved
			01: UDMA mode 1	01: UDMA mode 3	01: UDMA mode 5
			10: UDMA mode 2	10: UDMA mode 4	10: Reserved
			11: Reserved	11: Reserved	11: Reserved

Register Offset: 54h-57h
Register Name: IDE I/O Configuration Registers
Reset Value: 00000000h

31 30 29 28 27 26 25 24 23 22 21 20 19 18 17 16 15 14 13 12 11 10 9 8 7 6 5 4 3 2 1 0

RSVD	SATASM	PATASM	SCB1-100	SCB0-100	PCB1-100	PCB0-100	RSVD	SD1CR	SD0CR	PD1CR	PD0CR	SCB1-66	SCB0-66	PCB1-66	PCB0-66
------	--------	--------	----------	----------	----------	----------	------	-------	-------	-------	-------	---------	---------	---------	---------

Bit	Name	Attribute	Description
31-20	RSVD	RO	Reserved.
19-18	SATASM	RW	Secondary ATA Signal Mode. These bits are used to control mode of the secondary ATA signal pins for mobile swap bay support in mobile implementations. 00: Normal 10: Tri-state 10: Drive low 11: Reserved
17-16	PATASM	RW	Primary ATA Signal Mode. These bits are used to control mode of the primary ATA signal pins for mobile swap bay support in mobile implementations. 00: Normal 10: Tri-state 10: Drive low 11: Reserved
15	SCB1-100	RW	100MHz Base Clock Selection for Secondary Device 1 UDMA Mode. 1: Select the 100MHz clock for UDMA 0: Select the 33/66MHz clock for UDMA

Vortex86EX

32-Bit x86 Micro Processor

14	SCB0-100	RW	100MHz Base Clock Selection for Secondary Device 0 UDMA Mode. 1: Select the 100MHz clock for UDMA 0: Select the 33/66MHz clock for UDMA
13	PCB1-100	RW	100MHz Base Clock Selection for Primary Device 1 UDMA Mode. 1: Select the 100MHz clock for UDMA 0: Select the 33/66MHz clock for UDMA
12	PCB0-100	RW	100MHz Base Clock Selection for Primary Device 0 UDMA Mode. 1: Select the 100MHz clock for UDMA 0: Select the 33/66MHz clock for UDMA
11-8	RSVD	RO	Reserved.
7	SD1CR	RW	Secondary Device 1 Cable Report. BIOS indication flag for reporting the cable type to host software 1: An 80-conductor cable is present 0: A 40-conductor cable is present
6	SD0CR	RW	Secondary Device 0 Cable Report. BIOS indication flag for reporting the cable type to host software 1: An 80-conductor cable is present 0: A 40-conductor cable is present
5	PD1CR	RW	Primary Device 1 Cable Report. BIOS indication flag for reporting the cable type to host software 1: An 80-conductor cable is present 0: A 40-conductor cable is present
4	PD0CR	RW	Primary Device 0 Cable Report. BIOS indication flag for reporting the cable type to host software. 1: An 80-conductor cable is present 0: A 40-conductor cable is present
3	SCB1-66	RW	66MHz Base Clock Selection for Secondary Device 1 UDMA Mode 1: Select the 66MHz clock for UDMA 0: Select the 33MHz clock for UDMA
2	SCB0-66	RW	66MHz Base Clock Selection for Secondary Device 0 UDMA Mode. 1: Select the 66MHz clock for UDMA 0: Select the 33MHz clock for UDMA
1	PCB1-66	RW	66MHz Base Clock Selection for Primary Device 1 UDMA Mode 1: Select the 66MHz clock for UDMA 0: Select the 33MHz clock for UDMA
0	PCB0-66	RW	66MHz Base Clock Selection for Primary Device 0 UDMA Mode. 1: Select the 66MHz clock for UDMA 0: Select the 33MHz clock for UDMA

Register Offset: 60h
Register Name: Controller Feature Register
Reset Value: 0000007h

31 30 29 28 27 26 25 24 23 22 21 20 19 18 17 16 15 14 13 12 11 10 9 8 7 6 5 4 3 2 1 0

31	30	29	28	27	26	25	24	23	22	21	20	19	18	17	16	15	14	13	12	11	10	9	8	7	6	5	4	3	2	1	0
RSVD																LPS	SATAS	RSVD													

Bit	Name	Attribute	Description
31-3	RSVD	RO	<i>Reserved.</i>
2	LPS	RO	<i>Low Power Support.</i>
1	SATAS	RO	<i>SATA Support.</i>
0	RSVD	RO	<i>Reserved.</i>

Register Offset: 80h
Register Name: Reserved

Register Offset: 90h
Register Name: Miscellaneous Control Register
Reset Value: h

31 30 29 28 27 26 25 24 23 22 21 20 19 18 17 16 15 14 13 12 11 10 9 8 7 6 5 4 3 2 1 0

31	30	29	28	27	26	25	24	23	22	21	20	19	18	17	16	15	14	13	12	11	10	9	8	7	6	5	4	3	2	1	0	
RSVD						SCR	PCR	RSVD						SCBLID	PCBLID	RSVD				SCFBS	PCFBS	SCFBSTART	PCFBSTART	RSVD				RIDA	SDIDA	SVIDA	DIDA	VIDA

Bit	Name	Attribute	Description
31-26	RSVD	RO	<i>Reserved.</i>
25	SCR	R/W	<i>Secondary Channel Reset</i>
24	PCR	R/W	<i>Primary Channel Reset</i>
23-18	RSVD	RO	<i>Reserved.</i>
17	SCBLID	RO	<i>SCBLID.</i>
16	PCBLID	RO	<i>PCBLID.</i>
15-12	RSVD	RO	<i>Reserved.</i>
11	SCFBS	R	<i>Secondary Channel FIFO BIST Status.</i>
10	PCFBS	R	<i>Primary Channel FIFO BIST Status</i>
9	SCFBSTART	R/W	<i>Secondary Channel FIFO BIST Start (Clear when finished)</i>
8	PCFBSTART	R/W	<i>Primary Channel FIFO BIST Start (Clear when finished)</i>

Vortex86EX

32-Bit x86 Micro Processor

7-5	RSVD	RO	<i>Reserved.</i>
4	RIDA	R/W	<i>Revision ID Access.</i>
3	SDIDA	R/W	<i>Sub-Device ID Access.</i>
2	SVIDA	R/W	<i>Sub-Vendor ID Access.</i>
1	DIDA	R/W	<i>Device ID Access.</i>
0	VIDA	R/W	<i>Vendor ID Access.</i>

For www.86duino.com

Vortex86EX

32-Bit x86 Micro Processor

Register Offset: 94h
Register Name: SD Control Register
Reset Value: 084000C0h

31 30 29 28 27 26 25 24 23 22 21 20 19 18 17 16 15 14 13 12 11 10 9 8 7 6 5 4 3 2 1 0

SDWT	SDRT	RSVD	MFE	RSVD	SMATM	RSVD	SMCS	RSVD	PCSDM
------	------	------	-----	------	-------	------	------	------	-------

Bit	Name	Attribute	Description
31-24	SDWT	R/W	SD DMA Write Threshold.
23-16	SDRT	R/W	SD DMA Read Threshold.
15-10	RSVD	RO	Reserved.
9	MFE	R/W	MMC Function Enable.
8	RSVD	RO	Reserved.
7	RSVD	RO	Reserved.
6	SMATM	R/W	SD Master Access Test Mode.
5	RSVD	RO	Reserved.
4	SMCS	R/W	SD Master Clock Select
3-1	RSVD	RO	Reserved.
0	PCSDM	R/W	Primary Channel SD Mode.

Register Offset: 98h
Register Name: SATA PHY Control Register
Reset Value: 00000801h

31 30 29 28 27 26 25 24 23 22 21 20 19 18 17 16 15 14 13 12 11 10 9 8 7 6 5 4 3 2 1 0

txAmpCtrl	txPreEmCtrlG1B	txPreEmCtrlG1A	RSVD	D0PSPPEED	BiStErTB	BiStErTA	RSVD	D0PCD	RSVD	D0PHYRDY	RSVD	en3G	RSVD	DOS	D0SP	BiSt	enModel	RSVD	SATAME
-----------	----------------	----------------	------	-----------	----------	----------	------	-------	------	----------	------	------	------	-----	------	------	---------	------	--------

Bit	Name	Attribute	Description
31-30	txAmpCtrl	R/W	txAmpCtrl.
29-27	txPreEmCtrlG1B	R/W	txPreEmCtrlG1B.
26-24	txPreEmCtrlG1A	R/W	txPreEmCtrlG1A.
23	RSVD	R	Reserved.

Vortex86EX

32-Bit x86 Micro Processor

22	D0PSPEED	R	D0 PHY_SPEED. 0:Gen1 1:Gen2
21	BistErrB.	R	BistErrB.
20	BistErrA.	R	BistErrA.
19	RSVD	R	Reserved.
18	D0PCD	R	D0 PHY COMWAKE Detect
17	RSVD	R	Reserved.
16	D0PHYRDY	R	D0 PHYRDY
15-12	RSVD	R	Reserved.
11	en3G	R/W	en3G. 0:Only Gen1. 1:Gen1 and Gen2 Enabled
10-8	RSVD	R/W	Reserved.
7-6	RSVD	R	Reserved.
5	D0S	R/W	D0 Slumber (Manual set SATA PHY in slumber mode)
4	D0SP	R/W	D0 partial (Manual set SATA PHY in partial mode)
3	BIST	R/W	BIST.
2	enModel	R/W	enModel
1	RSVD	R/W	Reserved.
0	SATAME	RO	SATA Mode Enable.

Vortex86EX

32-Bit x86 Micro Processor

Register Offset: A0h
Register Name: SATA PHY Control 2 Register
Reset Value: 1A400000h

31 30 29 28 27 26 25 24 23 22 21 20 19 18 17 16 15 14 13 12 11 10 9 8 7 6 5 4 3 2 1 0

TXDRVCNT	RSVD	TXODCNT	TXOPCNT	RSVD	RXEQCNT	RSVD	P0AIS	RSVD	P0CPE	D0D1	RSVD	P0SBF
----------	------	---------	---------	------	---------	------	-------	------	-------	------	------	-------

Bit	Name	Attribute	Description
31	TXDRVCNT	RW	TXDRVCNT: This signal is De-emphasis control enable 0 => De-emphasis control ON 1 => De-emphasis control OFF
30-29	RSVD	RO	Reserved.
28-24	TXODCNT	RW	TXODCNT: This signal controls amplitude of Transmitter output
23-20	TXOPCNT	RW	TXOPCNT: This signal controls De-emphasis ratio of Transmitter output
19	RSVD	RO	Reserved.
18-16	RXEQCNT	RW	RXEQCNT: This signal controls Equalization ratio of receiver
15-12	RSVD	RO	Reserved.
11-10	P0AIS	RW	Port 0 Align Interval Select. 00 => 256 double words 01 => 128 double words 10 => 64 double words 11 => 32 double words
9	RSVD	RO	Reserved.
8	P0CPE	RW	Port 0 CONT Primitive Enable
7	D0D1	RW	SELECT SATA D0 or D1 to chose TXDRVCNT, TXODCNT, TXOPCNT, and RXEQCNT. 0 => D0, 1=> D1 IMPORTANT: This must be set first then read or write to the corresponding register TXDRVCNT, TXODCNT, TXOPCNT, and RXEQCNT.
6-1	RSVD	RO	Reserved.
0	P0SBF	RW	Port 0 Send BIST FIS

Vortex86EX

32-Bit x86 Micro Processor

Register Offset: A4h
Register Name: IDE Bus Skew Control Register
Reset Value: 40044004h

31 30 29 28 27 26 25 24 23 22 21 20 19 18 17 16 15 14 13 12 11 10 9 8 7 6 5 4 3 2 1 0

SDDID	SDSBD	SHDOD	SHSBD	PDDID	PDSBD	PHDOD	PHSBD
-------	-------	-------	-------	-------	-------	-------	-------

Bit	Name	Attribute	Description
31-28	SDDID	RW	Secondary Channel Device Data Input Delay. These bits are used to control the DD input signal delay time.
27-24	SDSBD	RW	Secondary Channel Device Strobe Delay. These bits are used to control the DSTROBE (DIORDY) input signal delay time.
23-20	SHDOD	RW	Secondary Channel Host Data Out Delay. These bits are used to control the DD output signal delay time.
19-16	SHSBD	RW	Secondary Channel Host Strobe Delay. These bits are used to control the HSTROBE (DIOR) signal delay time.
15-12	PDDID	RW	Primary Channel Device Data Input Delay. These bits are used to control the DD input signal delay time.
11-8	PDSBD	RW	Primary Channel Device Strobe Delay. These bits are used to control the DSTROBE (DIORDY) input signal delay time.
7-4	PHDOD	RW	Primary Channel Host Data Out Delay. These bits are used to control the DD output signal delay time.
3-0	PHSBD	RW	Primary Channel Host Strobe Delay. These bits are used to control the HSTROBE (DIOR) signal delay time.

Vortex86EX

32-Bit x86 Micro Processor

Register Offset: A8h
Register Name: IDE Driving Current Register
Reset Value: 0000001Bh

31 30 29 28 27 26 25 24 23 22 21 20 19 18 17 16 15 14 13 12 11 10 9 8 7 6 5 4 3 2 1 0

SDDID	SDSBD	SHDOD	SHSBD	PDDID	PDSBD	PHDOD	PHSBD
-------	-------	-------	-------	-------	-------	-------	-------

Bit	Name	Attribute	Description
31-6	RSVD	RO	Reserved. These bits are used to control the DD input signal delay time.
5-3	SPC	RW	Secondary Channel PAD Current Control. When SPC[2:0]=000b, the driving current is 2 mA. When SPC[2:0]=001b, the driving current is 4 mA. When SPC[2:0]=010b, the driving current is 6 mA. When SPC[2:0]=011b, the driving current is 8 mA, When SPC[2:0]=100b, the driving current is 6 mA for SDD15-0; 2 mA for others. When SPC[2:0]=101b, the driving current is 8 mA for SDD15-0; 4 mA for others. When SPC[2:0]=110b, the driving current is 10 mA for SDD15-0; 6 mA for others. When SPC[2:0]=111b, the driving current is 12 mA for SDD15-0; 8 mA for others.
2-0	PPC	RW	Primary Channel PAD Current Control. When PPC[2:0]=000b, the driving current is 2 mA. When PPC[2:0]=001b, the driving current is 4 mA. When PPC[2:0]=010b, the driving current is 6 mA. When PPC[2:0]=011b, the driving current is 8 mA, When PPC[2:0]=100b, the driving current is 6 mA for SDD15-0; 2 mA for others. When PPC[2:0]=101b, the driving current is 8 mA for SDD15-0; 4 mA for others. When PPC[2:0]=110b, the driving current is 10 mA for SDD15-0; 6 mA for others. When PPC[2:0]=111b, the driving current is 12 mA for SDD15-0; 8 mA for others.

Vortex86EX

32-Bit x86 Micro Processor

Register Offset: ACh
Register Name: Low Power Device Select Register
Reset Value: 00h

7 6 5 4 3 2 1 0



Bit	Name	Attribute	Description
7-2	RSVD	RO	Reserved.
1-0	LPDSR	RW	00: Select Primary device 0 01: Select Primary device 1 10: Select Secondary device 0 11: Select Secondary device 1

Register Offset: ADh
Register Name: Low Power Device Select Register
Reset Value: 00h

7 6 5 4 3 2 1 0

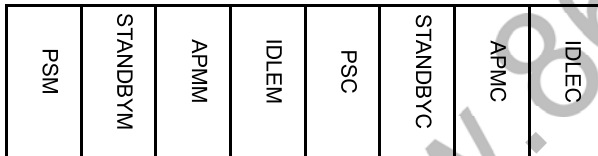

Bit	Name	Attribute	Description
7	PSM	RO	1: Selected device entry Partial/Slumber mode. (For SATA device only)
6	STANDBYM	RO	1: Selected device entry STANDBY mode.
5	APMM	RO	1: Selected device entry APM mode.
4	IDLEM	RO	1: Selected device entry IDLE mode.
3	PSC	RO	1: Selected device reject Partial/Slumber command. (For SATA device only)
2	STANDBYC	RO	1: Selected device reject STANDBY command.
1	APMC	RO	1: Selected device reject APM command.
0	IDLEC	RO	1: Selected device reject IDLE command.

Vortex86EX

32-Bit x86 Micro Processor

Register Offset: AEh
Register Name: Low Power Device Mode Enable Register
Reset Value: 00h

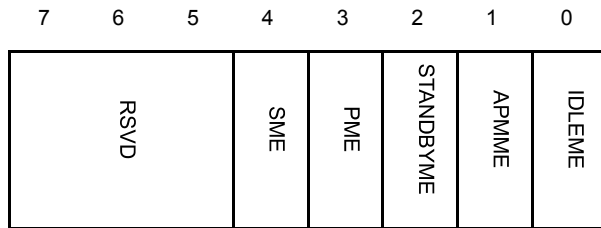

Bit	Name	Attribute	Description
7-5	RSVD	RO	Reserved.
4	SME	RW	1: Selected device Slumber mode enable (For SATA device only)
3	PME	RW	1: Selected device Partial mode enable (For SATA device only)
2	STANDBYME	RW	1: Selected device STANDBY mode enable
1	APMME	RW	1: Selected device APM mode enable
0	IDLEME	RW	1: Selected device IDLE mode enable

Register Offset: AFh
Register Name: Low Power Device Timer Enable Register
Reset Value: 00h



Bit	Name	Attribute	Description
7-2	RSVD	RO	Reserved.
1-0	LPDTER	RW	The entry low power mode timer when device is no access. 00: 10.49 ms 01: 20.97 ms 10: 41.94 ms 11: 83.88 ms

13.6 PCI I/O Register -- Bus Master IDE I/O Registers

Register Offset: 00h, 08h

Register Name: Primary Bus Master IDE Command Registers, Secondary Bus Master IDE Command Registers

Reset Value: 00h

7 6 5 4 3 2 1 0

RSVD	WRC	RSVD	SBM
------	-----	------	-----

Bit	Name	Attribute	Description
7-4	RSVD	RO	Reserved. These bits must return 0h while being read.
3	WRC	RW	Write or Read Control. This bit sets the direction of the bus master transfer. 1: Bus master writes are performed. 0: Bus master reads are performed. This bit must not be changed when the bus master function is active.
2-1	RSVD	RO	Reserved.
0	SBM	RW	Start/Stop Bus Master. Writing a "1" to this bit enables the bus master operation of the controller. A bus master operation begins when the value of this bit has changed from a "0" to a "1". The controller transfers data between the IDE device and the memory only when this bit is set. Writing a "0" to this bit can halt the master operation and all the state information is lost. The master mode operation cannot be stopped and resumed. If this bit is reset while a bus master operation is still active (BMA=1) and the drive has not finished its data transfer (INT=0) yet, the bus master command is aborted, and data transferred from the drive may be discarded before being written to the system memory. This bit shall be reset after the data transfer is completed, as indicated by either BMA being reset or INT being set, or both.

Vortex86EX

32-Bit x86 Micro Processor

Register Offset: 02h, 0Ah

Register Name: Primary Bus Master IDE Command and Status Registers, Secondary Bus Master IDE Command and Status Registers

Reset Value: 00h

7 6 5 4 3 2 1 0

RSVD	D1DMA	D0DMA	RSVD	INT	ERR	BMA
------	-------	-------	------	-----	-----	-----

Bit	Name	Attribute	Description
7	RSVD	RO	Reserved. These bits must return 0h while being read.
6	D1DMA	R/W	Drive 1 DMA Capable. This read/write bit is set by the device's dependent code (BIOS or device driver) to indicate that drive 1 for this channel is capable of DMA transferring, and that the controller has been initialized for optimum performance.
5	D0DMA	R/W	Drive 0 DMA Capable. This read/write bit is set by the device's dependent code (BIOS or device driver) to indicate that drive 0 for this channel is capable of DMA transferring, and that the controller has been initialized for optimum performance.
4-3	RSVD	RO	Reserved. These bits must return 0h when being read..
2	INT	R/WC	Interrupt. This bit is set by the local CPU when an interrupt is required to inform the host. This bit is cleared when a "1" is written to it by host software. Software uses this bit to determine if an IDE device has asserted its interrupt line. When this bit is read as a "1," all data transferred from the drive is visible in the system memory.
1	ERR	R/WC	Error. This bit is set when the controller encounters an error in the process of transferring data to or from the memory. This bit is cleared when a "1" is written to it via software.
0	BMA	RO	Bus Master IDE Active. This bit is set when bit 0 of BMICR register is written by "1". This bit is cleared when the last transfer of the region is performed. EOT for that region is set in the region descriptor. It is also cleared when SBM is cleared. When this bit is read as a "0", all data transferred from the drive during the previous bus master command will be visible in the system memory, unless the bus master command has been aborted.

Vortex86EX

32-Bit x86 Micro Processor

Register Offset: 04h, 0Ch

Register Name: Primary Bus Master IDE Descriptor Table Pointer Registers, Secondary Bus Master IDE Descriptor Table Pointer Registers

Reset Value: 00000000h

31 30 29 28 27 26 25 24 23 22 21 20 19 18 17 16 15 14 13 12 11 10 9 8 7 6 5 4 3 2 1 0

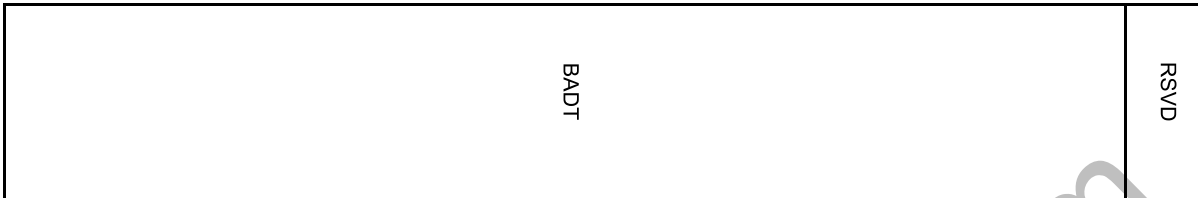

Bit	Name	Attribute	Description
31-2	BADT	RO	Base Address of Descriptor Table. This register provides the base memory address of the Descriptor Table.
1-0	RSVD	RW	Reserved.

13.7 IDE Interface and Status Registers

The following registers are used to control the IDE channel action.

The base address of primary IDE Command Registers (offset 0x0 ~0x7) is defined in PCI Configuration Register 10h~13h (Primary Channel Command Block Register)

The base address of primary IDE Alternate Status/Device Control Register is defined in PCI Configuration Register 14h~17h (Primary Channel Control Block Register)

The base address of the secondary IDE Command Registers (offset 0x0~0x7) is defined in PCI Configuration Register 18h~1Bh (Secondary Channel Command Block Register)

The base address of Secondary IDE Alternate Status/Device Control Register is defined in PCI Configuration Register 1Ch~1Fh (Secondary Channel Control Block Register)

For 13.7.3 ~ 13.7.6 registers, when IDE Device Control Register bit 7 (HOB) is set to 1, these registers are extended for 48-bit address feature setting for ATA-133 spec. The PCI shares the same IO space when HOB is 1 or 0. Please refer to the ATA specification for the detailed register definition.

Register Offset: 00h

Register Name: Primary/Secondary IDE Data Registers- PCI IO Space

Reset Value: 0000h

15 14 13 12 11 10 9 8 7 6 5 4 3 2 1 0

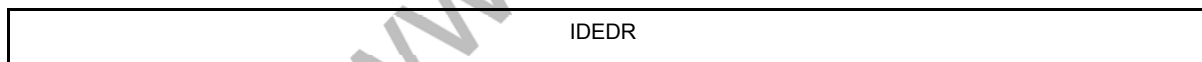

Bit	Name	Attribute	Description
15-0	IDEDR	RW	IDE Data Register. This register is for PIO data access only.

Vortex86EX

32-Bit x86 Micro Processor

This is an IDE Error Register when it is read. It is an IDE Feature Register when being written from the PCI access.

Register Offset: 01h

Register Name: Primary/Secondary IDE Error/Feature Registers- PCI IO Space

Reset Value: 00h

7 6 5 4 3 2 1 0

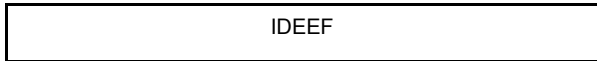

Bit	Name	Attribute	Description
7-0	IDEEF	RW	<p><i>IDE Error/Feature Register.</i></p> <p>When this register is read, it is an IDE Error Register. When this register is written, it is an IDE Feature Register.</p>

Register Offset: 02h

Register Name: Primary/Secondary IDE Sector Count (Ext.) Registers- PCI IO Space

Reset Value: 00h

7 6 5 4 3 2 1 0



Bit	Name	Attribute	Description
7-0	IDESC	RW	<p><i>IDE Sector Count Register.</i></p> <p>The content of this register becomes a command parameter when the Command register is written. The address is the same as Sector Count register in PCI space. If Device Control Register bit 7 HOB is set to 1, this register is Sector Count Ext. Register.</p>

Vortex86EX

32-Bit x86 Micro Processor

Register Offset: 03h

Register Name: Primary/Secondary IDE Sector Number (Ext.) Registers- PCI IO Space

Reset Value: 00h

7 6 5 4 3 2 1 0

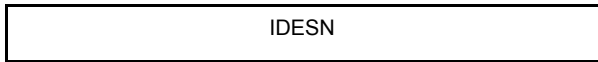

Bit	Name	Attribute	Description
7-0	IDESN	RW	<p><i>IDE Sector Number Register.</i></p> <p>The content of this register becomes a command parameter when the Command register is written. The address is the same as Sector Count register in PCI space. If Device Control Register bit 7 HOB is set to 1, this register is Sector Number Ext. Register.</p>

Register Offset: 04h

Register Name: Primary/Secondary IDE Cylinder Low (Ext.) Registers- PCI IO Space

Reset Value: 00h

7 6 5 4 3 2 1 0

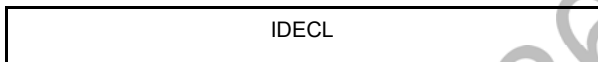

Bit	Name	Attribute	Description
7-0	IDECL	RW	<p><i>IDE Cylinder Low Register.</i></p> <p>The content of this register becomes a command parameter when the Command register is written. The address is the same as Sector Count register in PCI space. If Device Control Register bit 7 HOB is set to 1, this register is Cylinder Low Ext. Register.</p>

Vortex86EX

32-Bit x86 Micro Processor

Register Offset: 05h

Register Name: Primary/Secondary IDE Cylinder High (Ext.) Registers- PCI IO Space

Reset Value: 00h

7 6 5 4 3 2 1 0

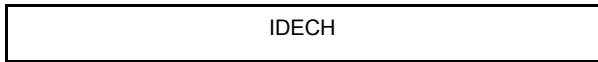

Bit	Name	Attribute	Description
7-0	IDECH	RW	<p><i>IDE Cylinder High Register.</i></p> <p>The content of this register becomes a command parameter when the Command register is written. The address is the same as Sector Count register in PCI space. If Device Control Register bit 7 HOB is set to 1, this register is Cylinder High Ext. Register.</p>

Register Offset: 06h

Register Name: Primary/Secondary IDE Device/Head Registers - PCI IO Space

Reset Value: 00h

7 6 5 4 3 2 1 0

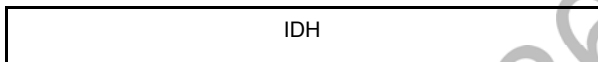

Bit	Name	Attribute	Description
7-0	IDH	RW	<p><i>IDE Device/Head Register.</i></p> <p>Bit 4 DEV in this register selects the device. Other bits in this register are command dependent.</p>

Vortex86EX

32-Bit x86 Micro Processor

This is an IDE Status Register when it is read. It is an IDE Command Register when being written from PCI access.

Register Offset: 07h

Register Name: Primary/Secondary IDE Status/Command Registers - PCI IO Space

Reset Value: 00h

Status Register

7	6	5	4	3	2	1	0
BUSY	DR	RSVD	DREQ	RSVD	RSVD	Error	

Bit	Name	Attribute	Description
7	BUSY	RO	BUSY. When this bit is set to 1, it indicates that the device is busy.
6	DR	RO	Device Ready. When this bit is set to 1, it indicates that the device is ready and can accept and attempt to execute all implemented commands.
5-4	RSVD	--	Reserved.
3	DREQ	RO	Data Request. When this bit is set to 1, it indicates that the device is ready to transfer a word of data between the host and device.
2-1	RSVD	--	Reserved.
0	Error	RO	Error. When this bit is set to 1, it indicates that an error occurred during the execution of the previous command.

Command Register

7	6	5	4	3	2	1	0
CC							

Bit	Name	Attribute	Description
7-0	CC	WO	Command Code. This register contains the command code being sent to the device.

Vortex86EX

32-Bit x86 Micro Processor

The base address of the Primary IDE Alternate Status/Device Control Register is defined in PCI Configuration Register 14h~17h (Primary Channel Control Block Register) and the base address of the Secondary IDE Alternate Status/Device Control Register is defined in PCI Configuration Register 1Ch~1Fh (Secondary Channel Control Block Register). When this register is read, it is Alternate Status Register, which contains the same information as the IDE Status Register. When this register is written, it is Device Control Register.

Register Offset: 06h

Register Name: Primary/Secondary IDE Alternate Status/Device Control Registers- PCI IO Space

Reset Value: --

7 6 5 4 3 2 1 0

--

Bit	Name	Attribute	Description
7	HOB	WO	High Order Byte. This bit is defined by the 48-bit address feature set. If this bit is on, extend register can be accessed.
6-3	RSVD	--	Reserved.
2	SRST	WO	Software Reset. This is a software reset bit. When it is written by 1, a software reset disk interrupt will occur.
1	nIEN	WO	nIEN. This is an enabled bit for the device assertion of interrupt to the host. When it is cleared to 0 and the device is selected, the device interrupt shall be enabled from itself. When it is set to 1 or the device is not selected, the device's interrupt is disabled by itself.
0	RSVD	RW	Reserved. It must be 0.

14. Fast Ethernet Control Unit

14.1 Overview

The Fast Ethernet Control unit provides 32-bit performance, PCI bus master capability, and full compliance with IEEE 802.3u 100Bast-T specifications and IEEE 802.3x Full Duplex Flow Control.

14.2 Features

- ⌘ Integrated Fast Ethernet MAC and Physical chip
 - ⌘ 10Mbps and 100Mbps operation
 - ⌘ Supports 10Mbps and 100 Mbps N-way Auto-negotiation operation
 - ⌘ PCI local bus single-chip Fast Ethernet controller
 - ⌘ Provides PCI bus master data transfers
 - ⌘ PCI memory space or I/O space mapped data transfer of operational registers
 - ⌘ Supports digital and analog loopback capability
 - ⌘ Half/Full duplex capability
 - ⌘ Support Full Duplex Flow Control which compliance with IEEE 802.3x
-

14.3 MAC Block Diagram

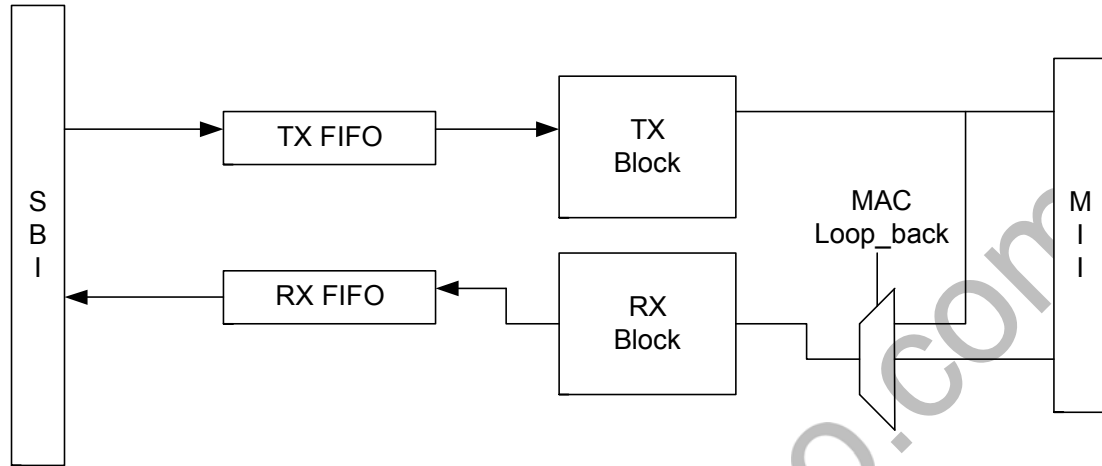

SBI : System Bus Interface
MAC Block Diagram

14.4 MAC PCI Configuration Space Registers

Register Offset: 01h – 00h
Register Name: Vendor ID Register
Reset Value: 17F3h

15 14 13 12 11 10 9 8 7 6 5 4 3 2 1 0

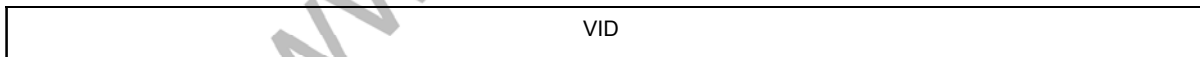

Bit	Name	Attribute	Description
15-0	VID	RO	This register contains a 16-bit value assigned to MAC Vendor ID.

Register Offset: 03h – 02h
Register Name: Device ID Register
Reset Value: 6040h

15 14 13 12 11 10 9 8 7 6 5 4 3 2 1 0

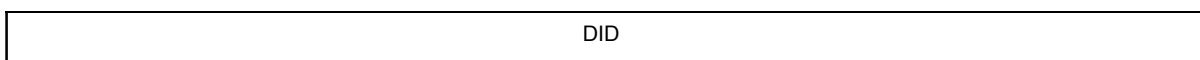

Bit	Name	Attribute	Description
15-0	DID	RO	This register contains a 16-bit value to specify a particular device.

Vortex86EX

32-Bit x86 Micro Processor

Register Offset: 05h – 04h
Register Name: Command Register
Reset Value: 0007h

15	14	13	12	11	10	9	8	7	6	5	4	3	2	1	0
RSVD												PMDC	MSAC	IOSAC	

Bit	Name	Attribute	Description
15-3	RSVD	RO	Reserved. These bits always return '0's.
2	PMDC	R/W	PCI Bus Master Device Control. If it is set to 1, it allows MAC to be enabled for running PCI master cycles.
1	MSAC	R/W	Memory Space Access Control. If it is set to 1, it allows the MAC to respond to memory space access.
0	IOSAC	R/W	I/O Space Access Control. If it is set to 1, it allows the MAC to respond to I/O space access.

Register Offset: 07h – 06h
Register Name: Status Register
Reset Value: 0200h

15	14	13	12	11	10	9	8	7	6	5	4	3	2	1	0
DPE	SS	RMAS	RTAS	STAS	DT	Reserved									

Bit	Name	Attribute	Description
15	DPE	RO	Detected Parity Error. This bit must be set whenever the device detects a parity error. This is a read-only bit and is cleared by writing '1' to it.
14	SS	RO	SERR_ Status. This bit must be set whenever the device asserts SERR_. This is a read-only bit and is cleared by writing '1' to it.
13	RMAS	RO	Receive Master Abort Status when the MAC acts as a master. This bit is set to '1' when the SoC generates a transaction (except for special cycles), and is terminated with master-abort. This is a read-only bit and is cleared by writing '1' to it.
12	RTAS	RO	Receive Target Abort Status when the MAC acts as a master. This bit is set to '1' when the MAC encounters a target abort condition. This is a read-only bit and is cleared by writing a '1' to it.
11	STAS	RO	Signal Target Abort Status when the MAC acts as a slave. The R6040 as a slave never generates a Target abort. This bit is always 0.
10-9	DT	RO	DEVSEL# Timing. The MAC always generates DEVSEL# with low timing. These bits are always '10'.
8-0	RSVD	RO	Reserved. These bits always return '0's.

Vortex86EX

32-Bit x86 Micro Processor

Register Offset: 08h
Register Name: Revision ID Register
Reset Value: 00h

7 6 5 4 3 2 1 0



Bit	Name	Attribute	Description
7-0	RID	R/W	Version number of the R6040 MAC

Register Offset: 0Bh – 09h
Register Name: Class Code Register
Reset Value: 020000h

23 22 21 20 19 18 17 16 15 14 13 12 11 10 9 8 7 6 5 4 3 2 1 0

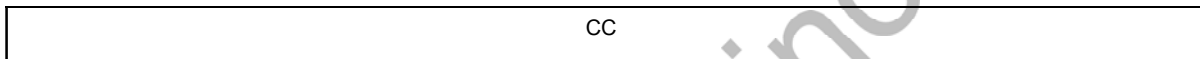

Bit	Name	Attribute	Description
23-0	CC	RO	Class Code of the R6040 FastEthernet Controller.

Register Offset: 0Eh
Register Name: Header Type Register
Reset Value: 00h

7 6 5 4 3 2 1 0



Bit	Name	Attribute	Description
7-0	HT	RO	This register identifies the type of predefined header in the configuration space.

15. USB Device Control Unit

15.1 Overview

The USB Device Control unit is an industry-standard USB interface to a simple read/write interface. It is USB1.1 compliant and supports data transfer at full-speed.

15.2 Features

- ⌘ Compliant fully with Universal Serial Bus Specification Rev. 1.1
- ⌘ Supports data transfer at full-speed (12 Mbit/s)
- ⌘ 3 programmable endpoints and a fixed control IN/OUT endpoint.
- ⌘ Suspend/resume logic provided

15.3 USB Device PCI Configuration Registers Definition

Register Offset: 01h – 00h
Register Name: Vendor ID Register
Reset Value : 17F3h

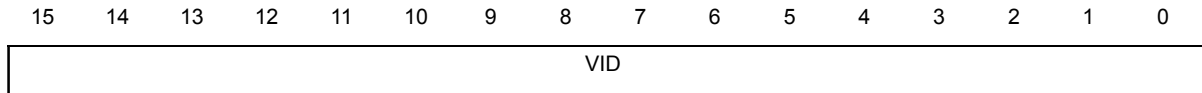

Bit	Name	Attribute	Description
15-0	VID	RO	<i>Vendor ID.</i>

Register Offset: 03h – 02h
Register Name: Device ID Register
Reset Value : 1060h

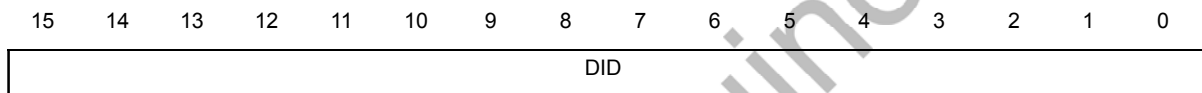

Bit	Name	Attribute	Description
15-0	DID	RO	<i>Device ID.</i>

Register Offset: 05h – 04h
Register Name: Command Register
Reset Value : 0000h

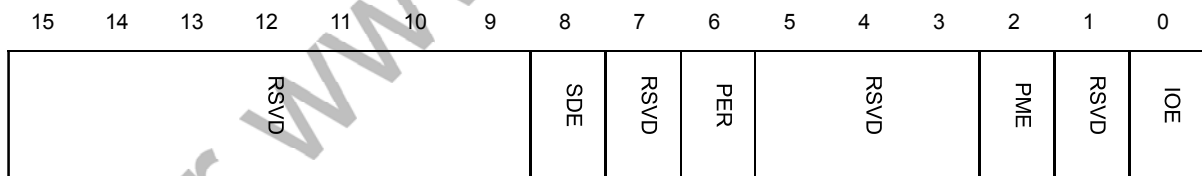

Bit	Name	Attribute	Description
15-9	RSVD	RO	<i>Reserved.</i>
8	SDE	R/W	SERR_ (Response) Detection Enable bit. If set to 1, USB device controller asserts SERR_ when it detects an address parity error. SERR_ is not asserted if this bit is 0.
7	RSVD	RO	<i>Reserved.</i>
6	PER	R/W	Parity Error Response. This bit controls the device's response to parity errors. When the bit is set, the device must take its normal action when a parity error is detected. When the bit is 0, the device sets its Detected Parity Error status bit (bit 15 in the Status register)

Vortex86EX

32-Bit x86 Micro Processor

Bit	Name	Attribute	Description
			when an error is detected, but does not assert PERR# and continues normal operation. This bit's state after RST# is 0.
5-3	RSVD	RO	Reserved.
2	PME	R/W	PCI Master Enable. If set to 1, USB device controller is enabled to run PCI master cycles.
1	RSVD	RO	Reserved.
0	IOE	R/W	I/O Enable. If set to 1, USB device controller is enabled to respond as a target to I/O cycles.

Register Offset: 07h – 06h
Register Name: Status Register
Reset Value : 0200h

15	14	13	12	11	10	9	8	7	6	5	4	3	2	1	0
DPE	SS	RMAS	RTAS	RSVD	DEVSELT	DPRP	RSVD	INTS	RSVD						

Bit	Name	Attribute	Description
15	DPE	WC	Detected Parity Error. This bit is set to 1 whenever USB device controller detects a parity error, even if the Parity Error (Response) Detection Enable bit is disabled. Cleared by writing a 1 to it.
14	SS	WC	SERR Status. This bit is set to 1 whenever the USB device controller detects a PCI address parity error. Cleared by writing a 1 to it.
13	RMAS	WC	Received Master Abort Status. Set to 1 when USB device controller, acting as a PCI master, aborts a PCI bus memory cycle. Cleared by writing a 1 to it.
12	RTAS	WC	Received Target Abort Status. This bit is set to 1 when a USB device controller generated PCI cycle (USB device controller is the PCI master) is aborted by a PCI target. Cleared by writing a 1 to it.
11	RSVD	RO	Reserved.
10-9	DEVSEL T	RO	DEVSEL# Timing. Read only bits indicate DEVSEL# timing when a positive decode is performed. Since DEVSEL# is asserted to meet the medium timing, these bits are encoded as 01b.
8	DPRP	WC	Data Parity Reported.

Vortex86EX

32-Bit x86 Micro Processor

Bit	Name	Attribute	Description
			Set to 1 if the Parity Error Response bit is set, and USB device controller detects PERR_ asserted while acting as PCI master (whether PERR_ was driven by USB HC or not).
7-4	RSVD	RO	Reserved.
3	INTS	RO	Interrupt Status. This bit reflects the state of interrupts in the device.
2-0	RSVD	RO	Reserved.

Register Offset: 08h
Register Name: Revision ID Register
Reset Value : 02h

7 6 5 4 3 2 1 0

FTRVL

Bit	Name	Attribute	Description
7-0	FTRVL	RO	Functional Revision Level.

Register Offset: 0Bh – 09h
Register Name: Class Code Register
Reset Value : 0D0000h

23 22 21 20 19 18 17 16 15 14 13 12 11 10 9 8 7 6 5 4 3 2 1 0

BCLS	SUBCLS	PRGIF
------	--------	-------

Bit	Name	Attribute	Description
23-16	BCLS	RO	Base Class. The Base Class is 0Dh (Reserved).
15-8	SUBCLS	RO	Sub Class. The Sub Class is 00h (Reserved).
7-0	PRGIF	RO	Programming Interface. The Programming Interface is 00h (Reserved).

Vortex86EX

32-Bit x86 Micro Processor

Register Offset: 0Ch
Register Name: Cache Line Size Register
Reset Value : 04h

7 6 5 4 3 2 1 0

CCHLSZ

Bit	Name	Attribute	Description
7-0	CCHLSZ	RO	Cache Line Size. This register identifies the system cache line size in units of 32-bit words. USB device controller will only store the value of 04h in this register.

Register Offset: 0Dh
Register Name: Latency Timer Register
Reset Value : 00h

7 6 5 4 3 2 1 0

LTCTimer

Bit	Name	Attribute	Description
7-0	LTCTimer	R/W	Latency Timer. This register identifies the value of the latency timer in PCI clocks for PCI bus master cycles.

Register Offset: 0Eh
Register Name: Header Type Register
Reset Value : 00h

7 6 5 4 3 2 1 0

HT

Bit	Name	Attribute	Description
7-0	HT	RO	Header Type Register. This register identifies the type of the predefined header in the configuration space.

Vortex86EX

32-Bit x86 Micro Processor

Register Offset: 13h – 10h
Register Name: Base Address Register
Reset Value : 0000001h

31 30 29 28 27 26 25 24 23 22 21 20 19 18 17 16 15 14 13 12 11 10 9 8 7 6 5 4 3 2 1 0

BAD	RSVD	1
-----	------	---

Bit	Name	Attribute	Description
31-7	BAD	RW	Base Address. POST writes the value of the memory base address to this register.
6-0	RSVD	RO	Reserved. These bits are always 1 and it indicates a 128-byte address range is requested.

Register Offset: 2Dh – 2Ch
Register Name: Subsystem Vendor ID Register
Reset Value: 0000h

15 14 13 12 11 10 9 8 7 6 5 4 3 2 1 0

SVID

Bit	Name	Attribute	Description
15-0	SVID	RO	This register contains the subsystem Vendor ID .

Register Offset: 2Fh – 2Eh
Register Name: Subsystem Device ID Register
Reset Value: 0000h

15 14 13 12 11 10 9 8 7 6 5 4 3 2 1 0

SDID

Bit	Name	Attribute	Description
15-0	SDID	RO	This register contains the subsystem Device ID .

Vortex86EX

32-Bit x86 Micro Processor

Register Offset: 3Dh – 3Ch
Register Name: Interrupt Control Register
Reset Value: 01FFh

15 14 13 12 11 10 9 8 7 6 5 4 3 2 1 0



Bit	Name	Attribute	Description
15-8	INTP	RO	Interrupt Pin. Use INT_A.
7-0	INTL	R/W	Interrupt Line. Index Interrupt Vector.

Register Offset: 3Eh
Register Name: Minimum Grant Register
Reset Value : 00h

7 6 5 4 3 2 1 0

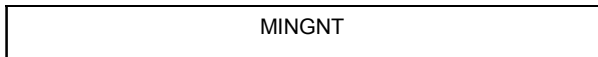

Bit	Name	Attribute	Description
7-0	MINGNT	RO	Minimum Grant.

Register Offset: 3Fh
Register Name: Max Latency Register
Reset Value : 00h

7 6 5 4 3 2 1 0



Bit	Name	Attribute	Description
7-0	MAXLAT	RO	Maximum Latency.

15.4 USB Device Operational Registers

The USB device address register holds the device address assigned by the host. This register initializes to the default address 0 at reset but must be updated by firmware when the host assigns a new address. Only USB data sent to the address contained in this register will be responded to, all others are ignored.

Register Offset: 00h
Register Name: USB device address register
Reset Value: 00h

7	6	5	4	3	2	1	0
DEVEN	DEVADDR[6:0]						

Bit	Name	Attribute	Description
7	DEVEN	R/W	Logic 1 enables the device.
6-0	DEVADDR[6:0]	R/W	This field specifies the USB device address.

Register Offset: 02h
Register Name: Control function register
Reset Value: 00h

7	6	5	4	3	2	1	0
RSVD				SNDRSU	SFRESET	GLINTENA	

Bit	Name	Attribute	Description
7-3	RSVD	RO	Reserved.
2	SNDRSU	R/W	Send Resume: Writing logic 1 will generate an upstream resume signal of 1ms duration. This bit is self-clearing after resume completed. Writing logic 0 has no effect. See Figure15-1-Spend/Resume flow.
1	SFRESET	R/W	Soft Reset: Writing logic 1 to enable a software-initiated reset to the USB device controller. BRST interrupt will then not generate any interrupt request. This bit is self-clearing after reset. Writing logic 0 has no effect. A soft reset is similar to a hardware-initiated reset (via the RESET_ pin).
0	GLINTENA	R/W	Global Interrupt Enable: Logic 1 enables all interrupts. Individual interrupts can be masked by clearing the corresponding bits in the Interrupt Enable register. When this bit is not set, an unmasked interrupt will not generate an interrupt on the interrupt pin. If global interrupt, however, is enabled while there is any pending unmasked interrupt, an interrupt signal will be immediately generated on the interrupt pin.

Figure15-1-Suspend/Resume flow.

Csae 1:

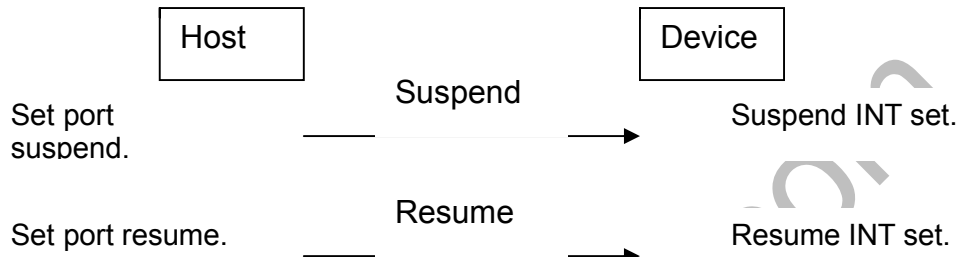

Csae 2:

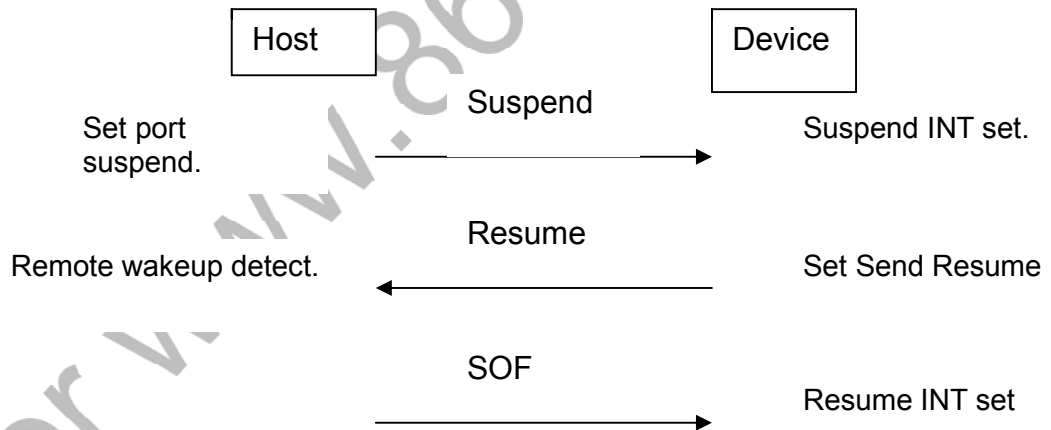

Vortex86EX

32-Bit x86 Micro Processor

Register Offset: 07h –06h
Register Name: Frame number register
Reset Value: 0000h

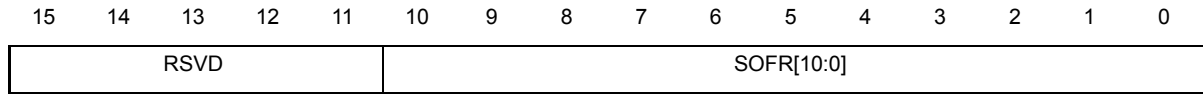

Bit	Name	Attribute	Description
15-11	RSVD	RO	Reserved.
10-0	EPMPS[10:0]	RO	Frame number.

Register Offset: 0Bh – 08h
Register Name: Interrupt enable register
Reset Value : 00000000h

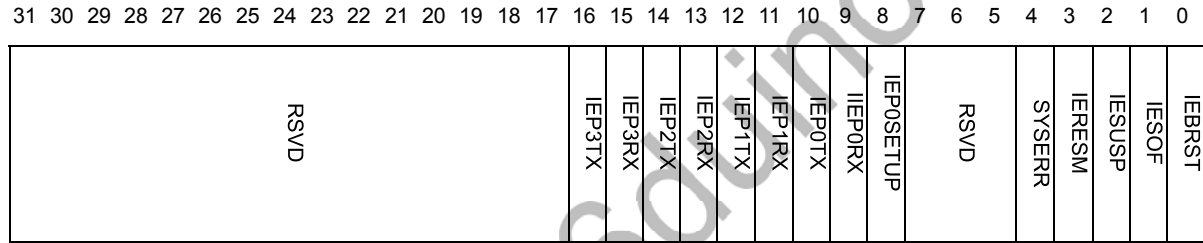

Bit	Name	Attribute	Description
31-17	RSVD	RO	Reserved.
16	IEP3TX	R/W	Logic 1 enables interrupt from the indicated endpoint.
15	IEP3RX	R/W	Logic 1 enables interrupt from the indicated endpoint.
14	IEP2TX	R/W	Logic 1 enables interrupt from the indicated endpoint.
13	IEP2RX	R/W	Logic 1 enables interrupt from the indicated endpoint.
12	IEP1TX	R/W	Logic 1 enables interrupt from the indicated endpoint.
11	IEP1RX	R/W	Logic 1 enables interrupt from the indicated endpoint.
10	IEP0TX	R/W	Logic 1 enables interrupt from the control IN endpoint 0.
9	IEP0RX	R/W	Logic 1 enables interrupt from the control OUT endpoint 0.
8	IEP0SETUP	R/W	Logic 1 enables interrupt for the setup data received on endpoint 0.
7-5	RSVD	RO	Reserved.
4	SYSERR	R/W	Logic 1 enables interrupt on detection of system error state, like FIFO Underrun, FIFO Overrun and PCI error include PCI Parity Error, PCI Master Abort, PCI Target Abort.
3	IERESM	R/W	Logic 1 enables interrupt on detection of a resume state.
2	IESUSP	R/W	Logic 1 enables interrupt on detection of a suspend state.
1	IESOF	R/W	Logic 1 enables interrupt on detection of an SOF.

Vortex86EX

32-Bit x86 Micro Processor

0	IEBRST	RW	Logic 1 enables interrupt on detection of a bus reset.
---	--------	----	--

Register Offset: 0Fh – 0Ch
Register Name: Interrupt status register
Reset Value : 00000000h

31 30 29 28 27 26 25 24 23 22 21 20 19 18 17 16 15 14 13 12 11 10 9 8 7 6 5 4 3 2 1 0

RSVD	EP3TX	EP3RX	EP2TX	EP2RX	EP1TX	EP1RX	EP0TX	EP0RX	IEP0SETUP	RSVD	SYSERR	RESM	SUSP	SOF	BRST
------	-------	-------	-------	-------	-------	-------	-------	-------	-----------	------	--------	------	------	-----	------

Bit	Name	Attribute	Description
31-17	RSVD	RO	Reserved.
16	EP3TX	W1C	Logic 1 indicates the endpoint 3 TX buffer as interrupt source.
15	EP3RX	W1C	Logic 1 indicates the endpoint 3 RX buffer as interrupt source.
14	EP2TX	W1C	Logic 1 indicates the endpoint 2 TX buffer as interrupt source.
13	EP2RX	W1C	Logic 1 indicates the endpoint 2 RX buffer as interrupt source.
12	EP1TX	W1C	Logic 1 indicates the endpoint 1 TX buffer as interrupt source.
11	EP1RX	W1C	Logic 1 indicates the endpoint 1 RX buffer as interrupt source.
10	EP0TX	W1C	Logic 1 indicates the endpoint 0 TX buffer as interrupt source.
9	EP0RX	W1C	Logic 1 indicates the endpoint 0 RX buffer as interrupt source.
8	EP0SETUP	W1C	Logic 1 indicates that a SETUP token was received on endpoint 0.
7-5	RSVD	RO	Reserved.
4	SYSERR	W1C	System error: Logic 1 indicates that detection of system error state, like FIFO Underrun, FIFO Overrun and PCI Error include PCI Parity error, PCI Master Abort, PCI Target Abort.
3	RESM	W1C	Resume status: Logic 1 indicates that a status change from suspend to resume (active) was detected.
2	SUSP	W1C	Suspend status: Logic 1 indicates that a status change from active to suspend was detected on the bus.
1	SOF	W1C	SOF interrupt: Logic 1 indicates that a SOF was received.
0	BRST	W1C	Bus reset: Logic 1 indicates that a USB bus reset was detected. When the device controller detect host drive SE0 state above 1ms and the device controller will issue the bus reset interrupt after the host exit SE0 state.

Vortex86EX

32-Bit x86 Micro Processor

This device controller supports 3 OUT/IN endpoint and endpoint 0 for control transfer. The following registers are endpoint type. The OUT endpoint is used to transmit data from the host to the device while the IN endpoint is used to transmit data from the device to the host.

Table15-1-Endpoint N Type Register

Register Name	Register Offset
Control endpoint 0 type register	10h
OUT endpoint 1 type register	12h
IN endpoint 1 type register	14h
OUT endpoint 2 type register	16h
IN endpoint 2 type register	18h
OUT endpoint 3 type register	1Ah
IN endpoint 3 type register	1Ch

Register Name: Endpoint N type register
Reset Value: 0000h

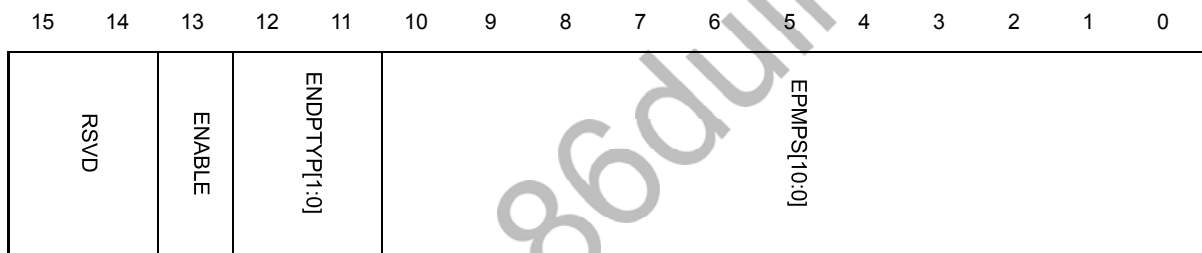

Bit	Name	Attribute	Description
15-14	RSVD	RO	Reserved.
13	ENABLE	R/W	<p>Endpoint Enable: By setting logic 1 to enable read the information of the specified endpoint, ex Endpoint Type, Endpoint MaxPacketSize and Endpoint transaction data buffer start address. When disabled the endpoint, the device controller will not respond to the host.</p> <p>Note: 'Stall'ing a data endpoint will confuse the Data Toggle bit about the stalled endpoint because the internal logic picks up from where it is stalled. Therefore, the Data Toggle bit must be reset by disabling and re-enabling the corresponding endpoint (by setting bit ENABLE to logic 0 and logic 1 in the Endpoint Type register) to reset the PID and it use Data Toggle 0 first.</p>
12-11	ENDPTYP[1:0]	R/W	<p>Endpoint Type: These bits select the endpoint type. For control endpoint 0, this region is reserved.</p> <p>00 — not used 01 — Isochronous 10 — Bulk 11 — Interrupt.</p>

10-0	EPMP5[10:0]	R/W	<p>Endpoint MaxPacketSize: Set the maximum packet size for the endpoint of each transaction. The device controller will have undefined behavior if user set the values that are not defined as following.</p> <p>Isochronous — from 1 to 1023 byte.</p> <p>Interrupt — from 1 to 64 byte.</p> <p>Bulk —8, 16, 32 or 64 byte.</p> <p>Control — 8, 16, 32 or 64 byte.</p> <p>Remark: Setup token is forced to 8 bytes.</p>
------	-------------	-----	--

The Transaction data length register hold the length, status and owner bit. The device controller does not transmit and receive data when the Owner bit is 0 and the device controller will NAK to the host. For OUT endpoint, the firmware sets the Owner bit as 1, and then the device controller receives data from the host. The device controller will set Owner bit as 0, update the status and the LEN field of which data is received from the host. For IN endpoint, the firmware sets the Owner bit=1 and set the LEN field of which data is sent to the host. When data transmission is completed, the device controller will set Owner bit as 0 and update the status.

Note: In normal case, software initialises data buffer and then sets the Owner bit and LEN field. When the device controller is done transfer, it will clear the Owner bit and issue the interrupt. Software does not set the Owner bit then clear it by itself as it maybe have undefined errors.

Table15-2-Endpoint N transaction data length registers

Register Name	Register Offset
Endpoint 0 setup token transaction data length register	20h
Endpoint 0 OUT token transaction data length register	24h
Endpoint 0 IN token transaction data length register	28h
Endpoint 1 OUT token transaction data length register	2Ch
Endpoint 1 IN token transaction data length register	30h
Endpoint 2 OUT token transaction data length register	34h
Endpoint 2 IN token transaction data length register	38h
Endpoint 3 OUT token transaction data length register	3Ch
Endpoint 3 IN token transaction data length register	40h

Vortex86EX

32-Bit x86 Micro Processor

Register Name: Endpoint transaction data length register
Reset Value: 00000000h

31 30 29 28 27 26 25 24 23 22 21 20 19 18 17 16 15 14 13 12 11 10 9 8 7 6 5 4 3 2 1 0



Bit	Name	Attribute	Description
31	O	R/W	Owner bit. Set 1: the USB peripheral controller. Set 0: the CPU.
30	SEP	R/W	Stall Endpoint: Logic 1 stalls the specified endpoint. This bit is not applicable for isochronous transfers. Remark: 'Stall'ing a data endpoint will confuse the Data Toggle bit about the stalled endpoint because the internal logic picks up from where it is stalled. Therefore, the Data Toggle bit must be reset by disabling and re-enabling the corresponding endpoint (by setting bit ENABLE to logic 0 or logic 1 in the Endpoint Type register) to reset the PID.
29	STSACK	R/W	Status Acknowledge: Only applicable for control IN/OUT. This bit controls the generation of ACK or empty packet during the status stage of a SETUP transfer. It will automatically clear when the status stage is completed. No interrupt signal will be generated. 0 — Not at status stage. 1 — Sends an empty packet following the IN token (host-to-peripheral) or ACK following the OUT token (peripheral-to-host). Hardware auto clear to zero.
28-21	RSVD	RSVD	Reserved.
20	TOGERR	RO	The Data Toggle Error bit: It indicates that the hardware detected the toggle error packet. 1: Data toggle error condition occurred 0: Data toggle error condition did not occur
19	DUF	RO	The Data Underflow Flag bit: It indicates that the received data length in the last transaction is lesser than data maximum length specified in the Endpoint of MaxPacketSize register. 1: Underflow condition occurred 0: Underflow condition did not occur
18	DOF	RO	The Data Overflow Flag bit : It indicates that the received data length in the last transaction is exceeded

Vortex86EX

32-Bit x86 Micro Processor

Bit	Name	Attribute	Description
			data maximum length specified in the Endpoint n MaxPacketSize register. 1: Overflow condition occurred 0: Overflow condition did not occur
17	STALL	RO	The Stall Flag bit indicates that a Stall packet was sent to the host. 1: Stall packet was sent to the host 0: Stall packet was not sent
16	ERR	RO	Error bit: The Error Flag bit is set if a USB bus protocol error occurs, include the CRC5, CRC16 error, bit stuffing error, toggle error, PID error or if an incorrect packet type is received. Data Overflow is not considered as errors and will not affect this bit. When the error occurs, the hardware will not respond to the host until the good packet was received. Remark: The device controller will not clear the Owner bit and issue the interrupt immediately when receiving the first error packet. The interrupt will be issued while receiving good packet and the transaction/transfer is completed.
15-13	RSVD	RSVD	Reserved.
12-0	LEN	R/W	Transaction packet length: If this field length is greater than the MaxPacketSize of endpoint, the device controller will issue an interrupt while sending/receiving data of which length is same as this field length or receiving a short packet. This case only supports for Control endpoint 0 and Bulk endpoint. As for Isochronous and Interrupt endpoints, the field value must not be greater than the endpoint MaxPacketSize. OUT endpoint —USB device controller writes back received data length for this transaction. IN endpoint —User sets the length of which data sent to the host.

Table15-3-Endpoint N transaction data buffer start address register

Register Name	Register Offset
Endpoint 0 setup token transaction data buffer start address register	44h
Endpoint 0 OUT token transaction data buffer start address register	48h
Endpoint 0 IN token transaction data buffer start address register	4Ch
Endpoint 1 OUT token transaction data buffer start address register	50h
Endpoint 1 IN token transaction data buffer start address register	54h
Endpoint 2 OUT token transaction data buffer start address register	58h
Endpoint 2 IN token transaction data buffer start address register	5Ch
Endpoint 3 OUT token transaction data buffer start address register	60h
Endpoint 3 IN token transaction data buffer start address register	64h

Register Name: Endpoint transaction data buffer start address register

Reset Value: 00000000h

31 30 29 28 27 26 25 24 23 22 21 20 19 18 17 16 15 14 13 12 11 10 9 8 7 6 5 4 3 2 1 0

EPTDSA

Bit	Name	Attribute	Description
31-0	EPTDSA	RW	<p>Endpoint transaction data buffer start address. It can be BYTE alignment. When the driver is intended to modify this register, it must at the Owner bit=0 condition. It has the undefined error when Owner bit I =1 and software modify this field.</p>

Vortex86EX

32-Bit x86 Micro Processor

Register Offset: 68h
Register Name: Test mode register
Reset Value: 00h

7 6 5 4 3 2 1 0

RSVD	PRBS	KSTA TE	JSTAT E	SE0
------	------	------------	------------	-----

Bit	Name	Attribute	Description
7-4	RSVD	RO	Reserved.
3	PRBS	R/W	logic 1 sets the DP and DM pins to generate the zero length pattern.
2	KSTATE	R/W	logic 1 sets the DP and DM pins to the K state.
1	JSTATE	R/W	logic 1 sets the DP and DM pins to the J state.
0	SE0	R/W	logic 1 sets the DP and DM pins to the SE0 state.

I/O Port: 7Eh
Register Name: Interrupt configuration register
Reset Value: 00h

7 6 5 4 3 2 1 0

RSVD

Bit	Name	Attribute	Description
7-0	RSVD	RO	For internal use.

16. High Definition Audio control Uint

16.1 Overview

This chapter aims to provide the definition and description of High Definition Audio (HD Audio) architecture developed in Vortex86EX platform to bring users the experiences of high quality and high performance audio. As a fact of HD Audio supports the multi-stream, it plays better performance compared with AC'97. The HD Audio architecture is not backward compatible with AC'97 and provides more flexibilities and capabilities than AC'97.

16.2 Features

- ⌘ Support for 1 input and 1 output streams at a time
- ⌘ Supports 6 kHz to 192 kHz sample rate
- ⌘ Support for 8-bit, 16-bit, 20-bit, 24-bit, and 32-bit sample resolution per stream.
- ⌘ For each stream can support up to 16 channels.
- ⌘ For each SDO support 48-Mbps transfer rate
- ⌘ For each SDI support 24-Mbps transfer rate.
- ⌘ Supports audio codecs and codec interrupt generation through Unsolicited Responses.

16.3 HDA PCI Configuration Space Registers

Register Offset: 01h – 00h
Register Name: Vendor ID Register
Reset Value : 17F3h

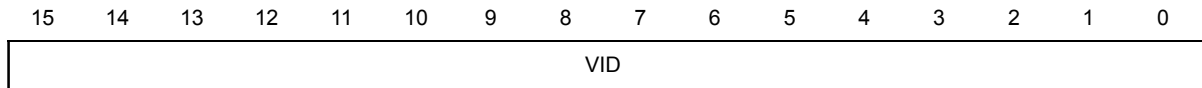

Bit	Name	Attribute	Description
15-0	VID	RO	<i>Vendor ID.</i>

Register Offset: 03h – 02h
Register Name: Device ID Register
Reset Value : 3010h

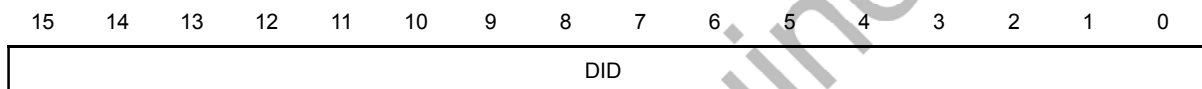

Bit	Name	Attribute	Description
15-0	DID	RO	<i>Device ID.</i>

Register Offset: 05h – 04h
Register Name: Command Register
Reset Value : 0000h

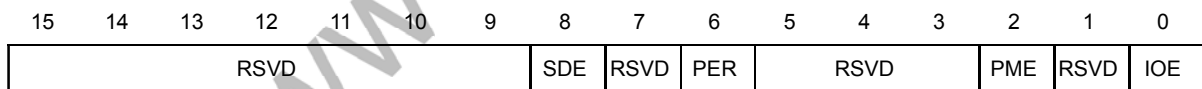

Bit	Name	Attribute	Description
15-9	RSVD	RO	<i>Reserved.</i>
8	SDE	R/W	SERR# (Response) Detection Enable bit. If set to 1, HDA controller asserts SERR# when it detects an address parity error. SERR# is not asserted if this bit is 0.
7	RSVD	RO	<i>Reserved.</i>
6	PER	R/W	Parity Error Response. This bit controls the device's response to parity errors. When the bit is set, the device must take its normal action when a parity error is detected. When the bit is 0, the device sets its Detected Parity Error status bit (bit 15 in the Status register) when an error is detected, but does not assert PERR# and continues normal operation. This bit's state after RST# is 0.

Vortex86EX

32-Bit x86 Micro Processor

5-3	RSVD	RO	Reserved.
2	PME	R/W	PCI Master Enable. If set to 1, HDA controller is enabled to run PCI master cycles.
1	ME	R/W	Memory Enable. If set to 1, HDA controller is enabled to respond as a target to memory cycles.
0	RSVD	RO	Reserved.

Register Offset: 07h – 06h
Register Name: Status Register
Reset Value : 0200h

15	14	13	12	11	10	9	8	7	6	5	4	3	2	1	0
DPE	SS	RMAS	RTAS	RSVD	DEVSEL	DPRP	RSVD				INTS	RSVD			

Bit	Name	Attribute	Description
15	DPE	WC	Detected Parity Error. This bit is set to 1 whenever HDA controller detects a parity error, even if the Parity Error (Response) Detection Enable bit is disabled. Cleared by writing a 1 to it.
14	SS	WC	SERR# Status. This bit is set to 1 whenever the HDA controller detects a PCI address parity error. Cleared by writing a 1 to it.
13	RMAS	WC	Received Master Abort Status. Set to 1 when HDA controller, acting as a PCI master, aborts a PCI bus memory cycle. Cleared by writing a 1 to it.
12	RTAS	WC	Received Target Abort Status. This bit is set to 1 when a HDA controller generated PCI cycle (HDA controller is the PCI master) is aborted by a PCI target. Cleared by writing a 1 to it.
11	RSVD	RO	Reserved.
10-9	DEVSEL T	RO	DEVSEL# Timing. Read only bits indicating DEVSEL# timing when a positive decode is performed. Since DEVSEL# is asserted to meet the medium timing, these bits are encoded as 01b.
8	DPRP	WC	Data Parity Reported. Set to 1 if the Parity Error Response bit is set, and HDA controller detects PERR# asserted while acting as PCI master (whether PERR# was driven by HDA or not).
7-4	RSVD	RO	Reserved.
3	INTS	RO	Interrupt Status. This bit reflects the state of interrupts in the device.
2-0	RSVD	RO	Reserved.

Vortex86EX

32-Bit x86 Micro Processor

Register Offset: 08h
Register Name: Revision ID Register
Reset Value : 02h

7 6 5 4 3 2 1 0



Bit	Name	Attribute	Description
7-0	FTRVL	RO	Functional Revision Level.

Register Offset: 0Bh – 09h
Register Name: Class Code Register
Reset Value : 040300h

23 22 21 20 19 18 17 16 15 14 13 12 11 10 9 8 7 6 5 4 3 2 1 0

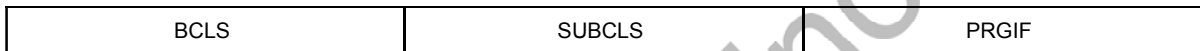

Bit	Name	Attribute	Description
23-16	BCLS	RO	Base Class. The Base Class is 04h.
15-8	SUBCLS	RO	Sub Class. The Sub Class is 03h.
7-0	PRGIF	RO	Programming Interface. The Programming Interface is 00h.

Register Offset: 0Ch
Register Name: Cache Line Size Register
Reset Value : 08h

7 6 5 4 3 2 1 0

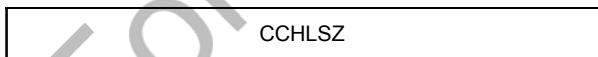

Bit	Name	Attribute	Description
7-0	CCHLSZ	RO	Cache Line Size. This register identifies the system cache line size in units of 32-bit words. HDA controller will only store the value of 04h in this register.

Vortex86EX

32-Bit x86 Micro Processor

Register Offset: 0Dh
Register Name: Latency Timer Register
Reset Value : 00h

7 6 5 4 3 2 1 0

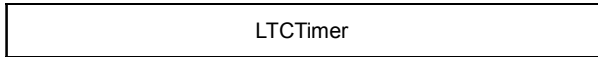

Bit	Name	Attribute	Description
7-0	LTCTimer	R/W	Latency Timer. This register identifies the value of the latency timer in PCI clocks for PCI bus master cycles.

Register Offset: 0Eh
Register Name: Header Type Register
Reset Value : 00h

7 6 5 4 3 2 1 0

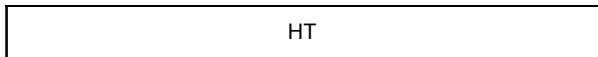

Bit	Name	Attribute	Description
7-0	HT	RO	Header Type Register. This register identifies the type of the predefined header in the configuration space.

Register Offset: 13h – 10h
Register Name: Base Address Register
Reset Value : 00000000h

31 30 29 28 27 26 25 24 23 22 21 20 19 18 17 16 15 14 13 12 11 10 9 8 7 6 5 4 3 2 1 0

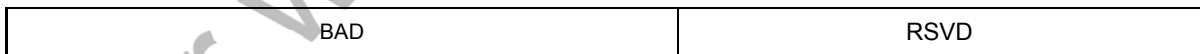

Bit	Name	Attribute	Description
31-12	BAD	R/W	Base Address. POST writes the value of the memory base address to this register.
11-0	RSVD	RO	Indicates a 16K-byte address range is requested.

Vortex86EX

32-Bit x86 Micro Processor

Register Offset: 2Dh – 2Ch
Register Name: Subsystem Vendor ID Register
Reset Value: 17F3h

15 14 13 12 11 10 9 8 7 6 5 4 3 2 1 0

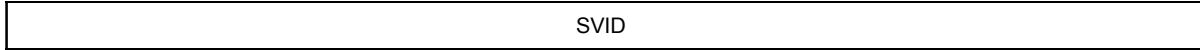

Bit	Name	Attribute	Description
15-0	SVID	R/W1	This register contains the subsystem Vendor ID , can write once

Register Offset: 2Fh – 2Eh
Register Name: Subsystem Device ID Register
Reset Value: 3010h

15 14 13 12 11 10 9 8 7 6 5 4 3 2 1 0

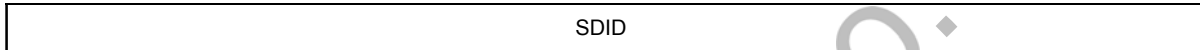

Bit	Name	Attribute	Description
15-0	SDID	R/W1	This register contains the subsystem Device ID , can write once

Register Offset: 3Dh – 3Ch
Register Name: Interrupt Control Register
Reset Value: 0100h

15 14 13 12 11 10 9 8 7 6 5 4 3 2 1 0



Bit	Name	Attribute	Description
15-8	INTP	RO	Interrupt Pin. Use INT_A.
7-0	INTL	R/W	Interrupt Line. Index Interrupt Vector.

Register Offset: 3Eh
Register Name: Minimum Grant Register
Reset Value : 00h

7 6 5 4 3 2 1 0



Bit	Name	Attribute	Description
7-0	MINGNT	RO	Minimum Grant.

Vortex86EX

32-Bit x86 Micro Processor

Register Offset: 3Fh
Register Name: Max Latency Register
Reset Value : 00h

7 6 5 4 3 2 1 0

MAXLAT

Bit	Name	Attribute	Description
7-0	MAXLAT	RO	Maximum Latency.

Register Offset: 40h
Register Name: HDA Control Register
Reset Value : 02h

7 6 5 4 3 2 1 0

RSVD	MBB	MBF	MBO	MBS
------	-----	-----	-----	-----

Bit	Name	Attribute	Description
7-4	RSVD	RO	Reserved.
3	MBB	RO	Memory Bist Busy. 0: Bist is not busy 1: Bist is busy
2	MBF	RO	Memory Bist Finish. 0: Bist is not finish 1: Bist is finish
1	MBO	RO	Memory Bist OK. 0: Bist is fail 1: Bist is pass
0	MBS	R/W	Memory Bist Start. When set to 1, hardware starts bist test.

16.4 HDA Operational Registers

The build-in Audio has signed up High Definition Audio (“Azalia”) Adopters Agreement and been licensed Implementation of the High Definition Audio Specification. The High Definition Audio in Vortex86EX was developed based on the specification, however, there are some parts of the specification remaining unimplemented, shown below:

DMA position lower/upper base address, offset=70h/74h

Wall clock counter alias, offset=2030h

Stream descriptor link position buffer alias, offset=2084h...

force Stream descriptor fifo watermark, offset=8Eh

force Stream descriptor fifo size, offset=90h

64 bit address supported, offset=00h and bit 0

Traffic priority, offset=80h and bit 18

CORB Upper Base Address, offset=44h

RIRB Upper Base Address, offset=54h

Input/Output/Bidirectional Stream Descriptor *n* BDL Pointer Upper Base Address, offset=9Ch

For detailed information of the operation registers, please refer to “High Definition Audio Specification, Revision 1.0”.

17. PCI to PCI Express Bridge Control Unit

17.1 Overview

A PCI-to-PCIE bridge provides a connection path between two independent PCI and PCIE buses. The primary function of the bridge is to allow transactions to occur between a master on one PCI bus and a target on the other PCIE bus. PCI-to-PCIE bridges provide system and add-in card designers the ability to overcome electrical loading limits by creating hierarchical PCI buses.

17.2 Features

Support one Port one Lane

Support PCI Express v1.1

17.3 PCI to PCI Express Bridge PCI Configuration Registers Definition

Register Offset: 01h – 00h
Register Name: Vendor ID Register
Reset Value : 17F3h

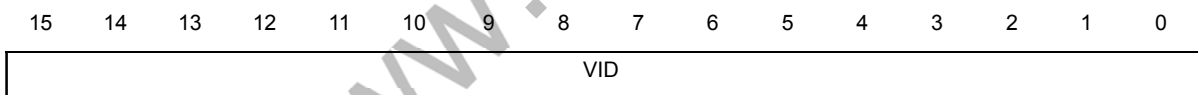

Bit	Name	Attribute	Description
15-0	VID	RO	<i>Vendor ID.</i>

Register Offset: 03h – 02h
Register Name: Device ID Register
Reset Value : 1031h

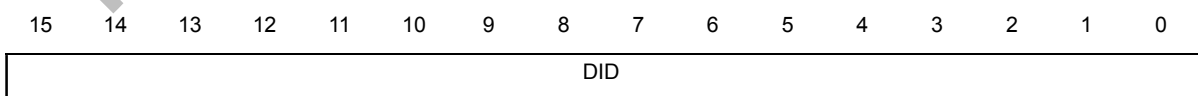

Bit	Name	Attribute	Description
15-0	DID	RO	<i>Device ID.</i>

Vortex86EX

32-Bit x86 Micro Processor

Register Offset: 05h – 04h
Register Name: Command Register
Reset Value : 0000h

15	14	13	12	11	10	9	8	7	6	5	4	3	2	1	0
RSVD				INTD	BBE	SDE	RSVD	PER	VPS	MWIC	SCE	PME	ME	IOE	

Bit	Name	Attribute	Description
15-11	RSVD	RO	Reserved.
10	INTD	R/W	Interrupt Disable. This bit disables the device/function from asserting INTx# . A value of 0 enables the assertion of its INTx# signal. A value of 1 disables the assertion of its INTx# signal. This bit's state after RST# is 0.
9	BBE	RO	Back to Back Enable. Reserved. This bit is always 0.
8	SDE	R/W	SERR_ (Response) Detection Enable bit. 1 : Enable. D1031 asserts SERR_ when it detects an address parity error. SERR_ is not asserted if this bit is 0.
7	RSVD	RO	Reserved. This bit is always 0.
6	PER	R/W	Parity Error Response. This bit controls the device's response to parity errors. When the bit is set, the device must take its normal action when a parity error is detected. When the bit is 0, the device sets its Detected Parity Error status bit (bit 15 in the Status register) when an error is detected, but does not assert PERR# and continues normal operation. This bit's state after RST# is 0.
5	VPS	RO	VGA Palette Snoop. Reserved. This bit is always 0.
4	MWIC	RO	Memory Write and Invalidate Command Enable Reserved. This bit is always 0.
3	SCE	RO	Special Cycle Enable. Reserved. This bit is always 0.
2	PME	R/W	PCI Master Enable. 1 : Enable. Allows master cycles can be forwarded from PCI Express device.
1	ME	R/W	Memory Enable. 1 : Enable. Allows Memory cycles can be forwarded to PCI Express device.
0	IOE	R/W	I/O Enable. 1 : Enable. Allows I/O cycles can be forwarded to PCI Express device.

Vortex86EX

32-Bit x86 Micro Processor

Register Offset: 07h – 06h
Register Name: Status Register
Reset Value : 0230h

15	14	13	12	11	10	9	8	7	6	5	4	3	2	1	0
DPE	SS	RMAS	RTAS	STAS	DEVSELT	DPRP	FBBC	Rvsd	66C	CL	INTS	RSVD			

Bit	Name	Attribute	Description
15	DPE	WC	Detected Parity Error. This bit is set to 1 whenever D1031 detects a parity error, even if the Parity Error (Response) Detection Enable bit is disabled. Cleared by writing a 1 to it.
14	SS	WC	SERR_ Status. This bit is set to 1 whenever the D1031 detects a PCI address parity error. Cleared by writing a 1 to it.
13	RMAS	WC	Received Master Abort Status. Set to 1 when D1031, acting as a PCI master, aborts a PCI bus memory cycle. Cleared by writing a 1 to it.
12	RTAS	WC	Received Target Abort Status. This bit is set to 1 when a D1031 generated PCI cycle is aborted by a PCI target. Cleared by writing a 1 to it.
11	STAS	RO	Signaled Target Abort Status. This bit is set to 1 when D1031 signals target aborts. Cleared by writing a 1 to it.
10-9	DEVSELT	RO	DEVSEL#n Timing. Read only bits indicating DEVSEL# timing when a positive decode is performed. Since DEVSEL# is asserted to meet the medium timing, these bits are encoded as 01b.
8	DPRP	WC	Data Parity Reported. Set to 1 if the Parity Error Response bit is set, and D1031 detects PERR_ asserted while acting as PCI master (whether PERR_ was driven by D1031 or not).
7	FBBC	RO	Fast Back-to-Back Capable. This bit is always 0.
6	RSVD	RO	Reserved. This bit is always 0.
5	66C	RO	66MHz Capable. This bit is always 1
4	CL	RO	Capabilities List. This bit is always 1.
3	INTS	RO	Interrupt Status. This bit is always 0.
2-0	RSVD	RO	Reserved. This bit is always 0.

Vortex86EX

32-Bit x86 Micro Processor

Register Offset: 08h
Register Name: Revision ID Register
Reset Value : 02h

7 6 5 4 3 2 1 0



Bit	Name	Attribute	Description
7-0	FTRVL	RO	Functional Revision Level.

Register Offset: 0Bh – 09h
Register Name: Class Code Register
Reset Value : 060400h

23 22 21 20 19 18 17 16 15 14 13 12 11 10 9 8 7 6 5 4 3 2 1 0

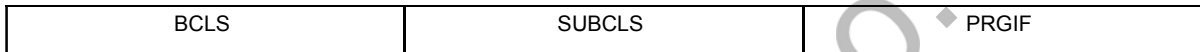

Bit	Name	Attribute	Description
23-16	BCLS	RO	Base Class. The Base Class is 06h.
15-8	SUBCLS	RO	Sub Class. The Sub Class is 04h.
7-0	PRGIF	RO	Programming Interface. The Programming Interface is 00h.

Register Offset: 0Ch
Register Name: Cache Line Size Register
Reset Value : 00h

7 6 5 4 3 2 1 0

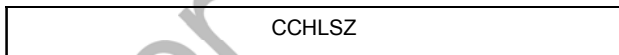

Bit	Name	Attribute	Description
7-0	CCHLSZ	R/W	Cache Line Size. This register identifies the system cache line size in units of 32-bit words. D1031 will only store the value of 08h in this register.

Vortex86EX

32-Bit x86 Micro Processor

Register Offset: 0Dh
Register Name: Latency Timer Register
Reset Value : 00h

7 6 5 4 3 2 1 0

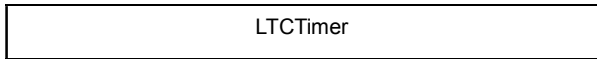

Bit	Name	Attribute	Description
7-3	LTCTimer	R/W	Latency Timer. This register identifies the value of the latency timer in PCI clocks for PCI bus master cycles.
2-0	RSVD	RO	Reserved. This bit is always 0.

Register Offset: 0Eh
Register Name: Header Type Register
Reset Value : 01h

7 6 5 4 3 2 1 0

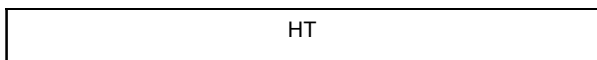

Bit	Name	Attribute	Description
7-0	HT	RO	Header Type Register. This register identifies the type of the predefined header in the configuration space.

Register Offset: 1Ah – 18h
Register Name: Bus Number Register
Reset Value : 000000h

23 22 21 20 19 18 17 16 15 14 13 12 11 10 9 8 7 6 5 4 3 2 1 0

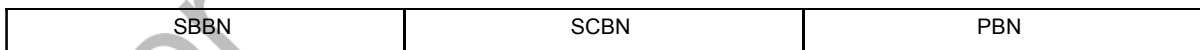

Bit	Name	Attribute	Description
23-16	SBBN	R/W	Subordinate Bus Number. This register indicates the highest bus number below D1031
15-8	SCBN	R/W	Secondary Bus Number. This register indicates D1031's downstream port number
7-0	PBN	R/W	Primary Bus Number. This register indicates D1031's upstream port number

Vortex86EX

32-Bit x86 Micro Processor

Register Offset: 1Bh
Register Name: Secondary Latency Timer Register
Reset Value : 00h

7 6 5 4 3 2 1 0

SLT Timer

Bit	Name	Attribute	Description
7-3	SLT Timer	R/W	Secondary Latency Timer. This register identifies the value of the latency timer in PCI clocks for secondary PCI bus master cycles.

Register Offset: 1Dh – 1Ch
Register Name: IO Base & Limit Register
Reset Value : 0000h

15 14 13 12 11 10 9 8 7 6 5 4 3 2 1 0

IOLA	IOLC	IOBA	IOBC
------	------	------	------

Bit	Name	Attribute	Description
15-12	IOLA	R/W	IO Limit Address.
11-8	IOLC	RO	IO Limit Address cap. 16 bit IO addressing only
7-4	IOBA	R/W	IO Base Address.
3-0	IOBC	RO	IO Base Address cap. 16 bit IO addressing only

Register Offset: 1Fh – 1Eh
Register Name: Secondary Status Register
Reset Value : 0000h

15 14 13 12 11 10 9 8 7 6 5 4 3 2 1 0

DPE	RSE	RMA	RTA	STA	SDTS	DPD	RSVD
-----	-----	-----	-----	-----	------	-----	------

Bit	Name	Attribute	Description
15	DPE	WC	Detected Parity Error. 1 : D1031 received a poisoned TLP from downstream port
14	RSE	WC	Received System Error. 1 : D1031 received some error condition as below Poisoned TLP , CPL timeout , unexpected CPL , unexpected status , FC error....
13	RMA	WC	Received Master Abort. 1 : D1031 received CPL with "Unsupported Request"

Vortex86EX

32-Bit x86 Micro Processor

Bit	Name	Attribute	Description
12	RTA	WC	Received Target Abort. 1 : D1031 received CPL with "Completion Abort"
11	STA	RO	Signaled Target Abort. This bit is always 0.
10-9	SDTS	RO	Secondary DEVSEL# Timing Status. This bit is always 0.
8	DPD	WC	Data Parity Error Detected. 1 : D1031 received a poisoned CPL or write request
7-0	RSVD	RO	Reserved. This bit is always 0.

Register Offset: 23h – 20h
Register Name: Memory Base & Limit Register
Reset Value : 00000000h

31 30 29 28 27 26 25 24 23 22 21 20 19 18 17 16 15 14 13 12 11 10 9 8 7 6 5 4 3 2 1 0

ML	RSVD	MB	RSVD
----	------	----	------

Bit	Name	Attribute	Description
31-20	ML	R/W	Memory Limit.
19-16	RSVD	RO	Reserved. This bit is always 0.
15-4	MB	R/W	Memory Base.
3-0	RSVD	RO	Reserved. This bit is always 0.

Register Offset: 27h – 24h
Register Name: Prefetchable Memory Base & Prefetchable Limit Register
Reset Value : 00000000h

31 30 29 28 27 26 25 24 23 22 21 20 19 18 17 16 15 14 13 12 11 10 9 8 7 6 5 4 3 2 1 0

PML	RSVD	PMB	RSVD
-----	------	-----	------

Bit	Name	Attribute	Description
31-20	ML	R/W	Prefetchable Memory Limit.
19-16	RSVD	RO	Reserved. This bit is always 0.
15-4	MB	R/W	Prefetchable Memory Base.
3-0	RSVD	RO	Reserved. This bit is always 0.

Vortex86EX

32-Bit x86 Micro Processor

Register Offset: 34h
Register Name: Capabilities List Pointer Register
Reset Value : 40h

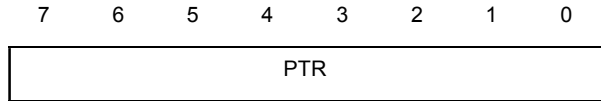

Bit	Name	Attribute	Description
7-0	PTR	RO	Capabilities List Pointer.

Register Offset: 3Dh – 3Ch
Register Name: Interrupt Control Register
Reset Value: 01FFh

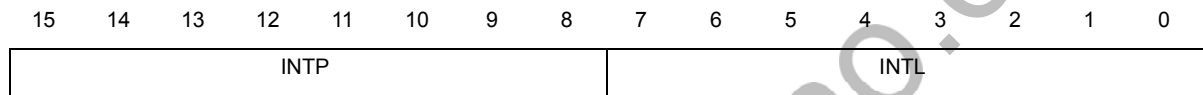

Bit	Name	Attribute	Description
15-8	INTP	RO	Interrupt Pin. Use INT_A.
7-0	INTL	R/W	Interrupt Line. Index Interrupt Vector.

Register Offset: 3Fh – 3Eh
Register Name: Minimum Grant Register
Reset Value : 0000h

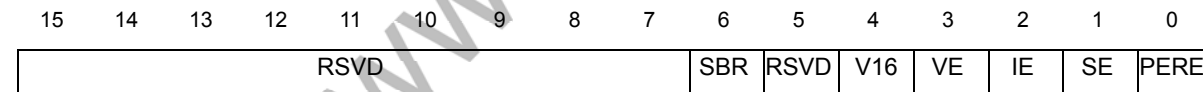

Bit	Name	Attribute	Description
15-7	RSVD	RO	Reserved. This bit is always 0.
6	SBR	R/W	Secondary Bus Reset. 1 : trigger reset on downstream port
5	RSVD	RO	Reserved. This bit is always 0.
4	V16	R/W	VGA 16 bit Decode. 1 : execute 16 bit address decodes on VGA IO accesses
3	VE	R/W	VGA Enable. 1 : forward VGA compatible memory and IO addresses from primary IF to secondary IF
2	IE	RO	Reserved. This bit is always 0
1	SE	R/W	SERR# Enable.
0	PERE	R/W	Parity Error Response Enable.

Vortex86EX

32-Bit x86 Micro Processor

Register Offset: 41h – 40h
Register Name: Capabilities List Register
Reset Value : 8010h

15	14	13	12	11	10	9	8	7	6	5	4	3	2	1	0
NEXT										CID					

Bit	Name	Attribute	Description
15-8	NEXT	RO	Next Capability.
7-0	CID	RO	Capability ID.

Register Offset: 43h – 42h
Register Name: Capabilities List Register
Reset Value : 0181h

15	14	13	12	11	10	9	8	7	6	5	4	3	2	1	0
RSVD							SI	PT			CV				

Bit	Name	Attribute	Description
15-9	RSVD	RO	Reserved. This bit is always 0.
8	SI	R/W	Slot Implemented. 1 : Enabled
7-4	PT	RO	Port Type.
3-0	CV	RO	Capability Version.

Register Offset: 47h – 44h
Register Name: Device Capabilities Register
Reset Value : 00000FC0h

31	30	29	28	27	26	25	24	23	22	21	20	19	18	17	16	15	14	13	12	11	10	9	8	7	6	5	4	3	2	1	0
RSVD											EL1AL	EL0sAL	ETFS	PFS	MPS																

Bit	Name	Attribute	Description
31-12	RSVD	RO	Reserved. This bit is always 0.
11-9	EL1AL	RO	Endpoint L1 Acceptable Latency. 111 : more than 64us
8-6	EL0sAL	RO	Endpoint L0s Acceptable Latency. 111 : more than 4us
5	ETFS	RO	Extended Tag Field supported.

Vortex86EX

32-Bit x86 Micro Processor

Bit	Name	Attribute	Description
			0 : 5-bit Tag field supported
4-3	PFS	RO	Phantom Function supported. 0 : no phantom function supported
2-0	MPS	RO	Max payload Size Supported. 000 : 128B

Register Offset: 49h – 48h
Register Name: Device Control Register
Reset Value : 0000h

15	14	13	12	11	10	9	8	7	6	5	4	3	2	1	0
RSVD	MRRS		ENS	APME	PFE	ETFE	MPS		RSVD	URE	FEE	NFE	CEE		

Bit	Name	Attribute	Description
15	RSVD	RO	Reserved. This bit is always 0.
14-12	MRRS	RO	Max Read Request Size. 000 : 128B
11	ENS	RO	Enable No Snoop. 0 : not supported
10	APME	R/W	Aux Power PM Enable.
9	PFE	RO	Phantom Function Enable. 0 : not supported
8	ETFE	RO	Extended Tag Field Enable. 0 : not supported
7-5	MPS	RO	Max Payload Size. 000 : 128B
4	RSVD	RO	Reserved. This bit is always 0.
3	URE	R/W	Unsupported Request Reporting Enable.
2	FEE	R/W	Fatal Error Reporting Enable.
1	NFE	R/W	Non Fatal Error Reporting Enable.
0	CEE	R/W	Correctable Error Reporting Enable.

Vortex86EX

32-Bit x86 Micro Processor

Register Offset: 4Bh – 4Ah
Register Name: Device Status Register
Reset Value : 0010h

15	14	13	12	11	10	9	8	7	6	5	4	3	2	1	0
RSVD										TDP	APD	URD	FED	NFED	CED

Bit	Name	Attribute	Description
15-6	RSVD	RO	Reserved. This bit is always 0.
5	TDP	RO	Transactions Pending.
4	APD	RO	AUX Power Detected.
3	URD	WC	Unsupported Request Detected.
2	FED	WC	Fatal Error Detected.
1	NFED	WC	Non Fatal Error Detected.
0	CED	WC	Correctable Error Detected.

Register Offset: 4Fh – 4Ch
Register Name: Link Capabilities Register
Reset Value : 0?12DC11h

31	30	29	28	27	26	25	24	23	22	21	20	19	18	17	16	15	14	13	12	11	10	9	8	7	6	5	4	3	2	1	0
PN				RSVD	LAC	RSVD	L1EL	L0EL	APMS	MLW				MLS																	

Bit	Name	Attribute	Description
31-24	PN	R/W	Port Number. By implemented port
23-21	RSVD	RO	Reserved. This bit is always 0.
20	LAC	RO	Link Active Reporting Capable.
19-18	RSVD	RO	Reserved. This bit is always 0.
17-15	L1EL	RO	L1 Exit Latency. 101 : 16us to less than 32us
14-12	L0EL	RO	L0s Exit Latency. 101 : 1us to less than 2us
11-10	APMS	RO	Active State Link PM Support. 11 : L0s and L1 supported
9-4	MLW	RO	Max Link Width. 1 : x1
3-0	MLS	RO	Max Link Speed. 1 : 2.5Gb/s

Vortex86EX

32-Bit x86 Micro Processor

Register Offset: 51h – 50h
Register Name: Link Control Register
Reset Value : 0000h

15	14	13	12	11	10	9	8	7	6	5	4	3	2	1	0	
RSVD										ES	CCC	RL	LD	RCBC	RSVD	APMC

Bit	Name	Attribute	Description
15-8	RSVD	RO	Reserved. This bit is always 0.
7	ES	R/W	Extended Synch. 1 : enable extended FTS ordered set
6	CCC	R/W	Common Clock Configuration. 1 : D1031 and downstream port are operating with common reference clock
5	RL	R/W	Retrain Link. 1 : Enabled
4	LD	R/W	Link Disable. 1 : Disabled
3	RCBC	RO	Read Completion Boundary Control. 0 : 64B
2	RSVD	RO	Reserved. This bit is always 0.
1-0	APMC	R/W	Active State Link PM Control. 00 : Disabled 01 : L0s enabled 10 : L1 enabled 11 : L0s and L1 enabled

Register Offset: 53h – 52h
Register Name: Link Device Status Register
Reset Value : 1011h

15	14	13	12	11	10	9	8	7	6	5	4	3	2	1	0					
RSVD			DLLA	SCC	LT	RSVD					NLW					LS				

Bit	Name	Attribute	Description
15-14	RSVD	RO	Reserved. This bit is always 0.
13	DLLA	RO	Data Link Layer Active.
12	SCC	RO	Slot Clock Configuration. 1 : use the same clock , always 1
11	LT	RO	Link Training.
10	RSVD	RO	Reserved. This bit is always 0.

Vortex86EX

32-Bit x86 Micro Processor

9-4	NLW	RO	Negotiated Link Width. 1 : x1
3-0	LS	RO	Link Speed. 1 : 2.5Gb/s

Register Offset: 57h – 54h
Register Name: Slot Capabilities Register
Reset Value : 00000560h

31 30 29 28 27 26 25 24 23 22 21 20 19 18 17 16 15 14 13 12 11 10 9 8 7 6 5 4 3 2 1 0

PSN	RSVD	SLS	SLV	HPC	HPS	RSVD
-----	------	-----	-----	-----	-----	------

Bit	Name	Attribute	Description
31-19	PSN	R/W	Physical Slot Number.
18-17	RSVD	RO	Reserved. This bit is always 0.
16-15	SLS	R/W	Slot Power Limit Scale. 0 : 1.0x
14-7	SLV	R/W	Slot Power Limit Value.
6	HPC	RO	Hot Plug Capable.
5	HPS	RO	Hot Plug Surprise.
4-0	RSVD	RO	Reserved. This bit is always 0.

Register Offset: 59h – 58h
Register Name: Slot Control Register
Reset Value : 0000h

15 14 13 12 11 10 9 8 7 6 5 4 3 2 1 0

RSVD	LACE	RSVD	PCC	RSVD	HPE	CCE	PDE	MSE	PFD	ABP
------	------	------	-----	------	-----	-----	-----	-----	-----	-----

Bit	Name	Attribute	Description
15-13	RSVD	RO	Reserved. This bit is always 0.
12	LACE	R/W	Link Active Changed Enable.
11	RSVD	RO	Reserved. This bit is always 0.
10	PCC	R/W	Power Controller Control.
9-6	RSVD	RO	Reserved. This bit is always 0.
5	HPE	R/W	Hot Plug Interrupt Enable.
4	CCE	R/W	Command Completed Interrupt Enable.
3	PDE	R/W	Presence Detect Changed Enable.
2	MSE	R/W	MRL Sensor Changed Enable.

Vortex86EX

32-Bit x86 Micro Processor

1	PFD	R/W	Power Fault Detected Enable..
0	ABP	R/W	Attention Button Pressed Enable.

Register Offset: 5Bh – 5Ah
Register Name: Slot Status Register
Reset Value : 0000h

15	14	13	12	11	10	9	8	7	6	5	4	3	2	1	0
RSVD							LASC	RSVD	PDS	RSVD	CC	PDC	RSVD		

Bit	Name	Attribute	Description
15-9	RSVD	RO	Reserved. This bit is always 0.
8	LASC	WC	Link Active State Changed.
7	RSVD	RO	Reserved. This bit is always 0.
6	PDS	RO	Presence Detect State. 1 : slot has device connected
5	RSVD	RO	Reserved. This bit is always 0.
4	CC	WC	Command Completed.
3	PDC	WC	Presence Detect Changed.
2-0	RSVD	RO	Reserved. This bit is always 0.

Register Offset: 5Dh – 5Ch
Register Name: Root Control Register
Reset Value : 0000h

15	14	13	12	11	10	9	8	7	6	5	4	3	2	1	0
RSVD												PIE	SFE	SNE	SCE

Bit	Name	Attribute	Description
15-4	RSVD	RO	Reserved. This bit is always 0.
3	PIE	R/W	PME Interrupt Enable.
2	SFE	R/W	System Error on Fatal Error Enable.
1	SNE	R/W	System Error on Non-Fatal Error Enable.
0	SCE	R/W	System Error on Correctable Error Enable.

Vortex86EX

32-Bit x86 Micro Processor

Register Offset: 63h – 60h
Register Name: Root Status Register
Reset Value : 00000000h

31 30 29 28 27 26 25 24 23 22 21 20 19 18 17 16 15 14 13 12 11 10 9 8 7 6 5 4 3 2 1 0

RSVD	PP	PS	RID
------	----	----	-----

Bit	Name	Attribute	Description
31-18	RSVD	RO	Reserved. This bit is always 0.
17	PP	RO	PME Pending.
16	PS	WC	PME Status.
15-0	RID	RO	PME Requestor ID.

Register Offset: 67h – 64h
Register Name: MISC Register
Reset Value : 05253000h

31 30 29 28 27 26 25 24 23 22 21 20 19 18 17 16 15 14 13 12 11 10 9 8 7 6 5 4 3 2 1 0

confidential	LO	BO	BO	BO	BO	con	BF	BF	BF	BS	BS	BS	RSVD	PO	con	LD
--------------	----	----	----	----	----	-----	----	----	----	----	----	----	------	----	-----	----

Bit	Name	Attribute	Description
31-16		R/W	Confidential. Don't modify
15	LO	RO	Link Ok
14	BOB	RO	RAM BIST OK 1 (need to check BFB)
13	BOR	RO	RAM BIST OK 2 (need to check BFR)
12	BOT	RO	RAM BIST OK 3 (need to check BFT)
11		R/W	Confidential. Don't modify
10	BFB	RO	RAM BIST Finish 1
9	BFR	RO	RAM BIST Finish 2
8	BFT	RO	RAM BIST Finish 3
7	BSB	WO	RAM BIST Start 1
6	BSR	WO	RAM BIST Start 2
5	BST	WO	RAM BIST Start 3
4-3	RSVD	RO	Reserved. This bit is always 0.
2	PO	RO	PHY BIST OK
1		R/W	Confidential. Don't modify
0	LD	R/W	PHY Loopback Enable

Vortex86EX

32-Bit x86 Micro Processor

Register Offset: 6Bh – 68h
Register Name: MISC Register
Reset Value : 00000000h

31 30 29 28 27 26 25 24 23 22 21 20 19 18 17 16 15 14 13 12 11 10 9 8 7 6 5 4 3 2 1 0

confidential

Bit	Name	Attribute	Description
31-0		R/W	Confidential. Don't modify

Register Offset: 6Fh – 6Ch
Register Name: MISC Register
Reset Value : 00000000h

31 30 29 28 27 26 25 24 23 22 21 20 19 18 17 16 15 14 13 12 11 10 9 8 7 6 5 4 3 2 1 0

confidential

Bit	Name	Attribute	Description
31-0		R/W	Confidential. Don't modify

Register Offset: 81h – 80h
Register Name: MSI Capability Register
Reset Value : 9005h

15 14 13 12 11 10 9 8 7 6 5 4 3 2 1 0

NEXT	CID
------	-----

Bit	Name	Attribute	Description
15-8	NEXT	RO	Next Pointer.
7-0	CID	RO	Capability ID is MSI

Register Offset: 83h – 82h
Register Name: MSI Message Control Register
Reset Value : 0000h

15 14 13 12 11 10 9 8 7 6 5 4 3 2 1 0

RSVD	MME	MMC	MSIE
------	-----	-----	------

Bit	Name	Attribute	Description
15-7	RSVD	RO	Reserved. This bit is always 0.
6-4	MME	R/W	Multiple Message Enable.
3-1	MMC	RO	Multiple Message Capable.

Vortex86EX

32-Bit x86 Micro Processor

0	MSIE	R/W	<i>MSI Enable.</i>
---	------	-----	--------------------

Register Offset: 87h – 84h
Register Name: MSI Message Address Register
Reset Value : 00000000h

31 30 29 28 27 26 25 24 23 22 21 20 19 18 17 16 15 14 13 12 11 10 9 8 7 6 5 4 3 2 1 0
ADDR
RSVD

Bit	Name	Attribute	Description
31-2	ADDR	R/W	Address for message address
1-0	RSVD	RO	<i>Reserved.</i> This bit is always 0.

Register Offset: 89h – 88h
Register Name: MSI Message Data Register
Reset Value : 0000h

15 14 13 12 11 10 9 8 7 6 5 4 3 2 1 0
DATA

Bit	Name	Attribute	Description
15-0	DATA	R/W	Programmed by system

Register Offset: 91h – 90h
Register Name: PM Capability Register
Reset Value : 0001h

15 14 13 12 11 10 9 8 7 6 5 4 3 2 1 0	
NEXT	CID

Bit	Name	Attribute	Description
15-8	NEXT	RO	<i>Next Pointer.</i> The last item.
7-0	CID	RO	<i>Capability ID</i> is PM.

Vortex86EX

32-Bit x86 Micro Processor

Register Offset: 93h – 92h
Register Name: PCI PM Capability Register
Reset Value : C802h

15	14	13	12	11	10	9	8	7	6	5	4	3	2	1	0
PMES				RSVD			AC		DSI	RSVD	PMEC	VS			

Bit	Name	Attribute	Description
15-11	PMES	RO	PME_Support.
10-9	RSVD	RO	Reserved. This bit is always 0.
8-6	AC	RO	Aux_Current.
5	DSI	RO	Device Specific Initialization.
4	RSVD	RO	Reserved. This bit is always 0.
3	PMEC	RO	PME Clock.
2-0	VS	RO	Version.

Register Offset: 97h – 94h
Register Name: PCI PM Control & Status Register
Reset Value : 00000000h

31	30	29	28	27	26	25	24	23	22	21	20	19	18	17	16	15	14	13	12	11	10	9	8	7	6	5	4	3	2	1	0
RSVD															PM	RSVD					PM	RSVD					PS				
															ES						EE										

Bit	Name	Attribute	Description
31-16	RSVD	RO	Reserved. This bit is always 0.
15	PMES	RO	PME Status.
14-9	RSVD	RO	Reserved. This bit is always 0.
8	PMEE	R/W	PME Enable.
7-2	RSVD	RO	Reserved. This bit is always 0.
1-0	PS	R/W	Power State. 00 : D0 state 11 : D3 hot state

18. CAN Controller

18.1 Overview

The CAN controller, which is compatible with the CAN2.0A/2.0B specification .It supports 2 CAN Bus channels.

18.2 Features

CAN Functions

- Compatible with the CAN 2.0A/2.0B specification and supports two CAN Bus channels
- Supports speed up to 1MHz.
- Programmable hardware arbitration lost retry function and hardware error retry function

PCI Interface

- Host interface complies with PCI local bus specification revision 2.2
- Supports PCI Power Management v1.1 capability
- Support one Flash/ROM interface for expansion ROM of PCI card

18.3 List of PCI Configuration Registers

31	16	15	00	Index
Device ID (1070h)		Vendor ID (17F3h)		00h-03h
Status (0200h)		Command (0000h)		04h-07h
Base Class Code (0Ch)	Sub-class code (09h)	Program Interface (00h)	Revision ID (00h)	08h-0Bh
Reserved	Header Type (00h)	Latency Timer (00h)	Cache Line Size (00h)	0Ch-0Fh
CAN Bus Control/Status Block Register Base Address (MEMORY SPACE)				10h-13h
CAN Bus Control/Status Block Register Base Address (IO SPACE)				14h-17h
Reserved				18h-2Bh
Sub-system Device ID (1070h)		Sub-system Vendor ID (17F3h)		2Ch-2Fh
Reserved				30h-3Bh
MAX_LAT (00h)	MIN_GNT (00h)	INTERRUPT PIN (01h)	INTERRUPT LINE (ffh)	3Ch-3Fh
Reserved				40h-FFh

18.4 PCI Configuration Registers Definition

Register Offset: 00h
Register Name: PCI PM Capability Register
Reset Value : 17F3h

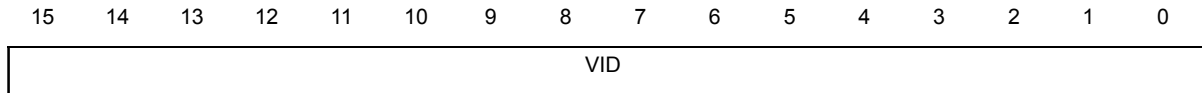

Bit	Name	Attribute	Description
15-0	VID	RO	Vendor ID. This is a 16-bit value assigned to the ITE IDE Controller function.

Register Offset: 02h
Register Name: PCI PM Capability Register
Reset Value : 1070h

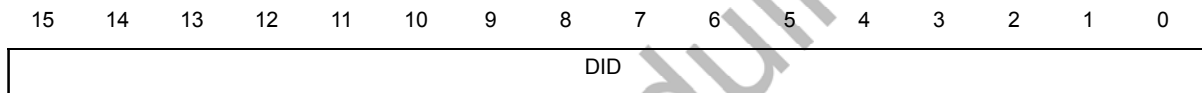

Bit	Name	Attribute	Description
15-0	VID	RO	Device ID. This is a 16-bit value assigned to the ITE IDE Controller function.

Register Offset: 04h
Register Name: Command Register
Reset Value : 0000h

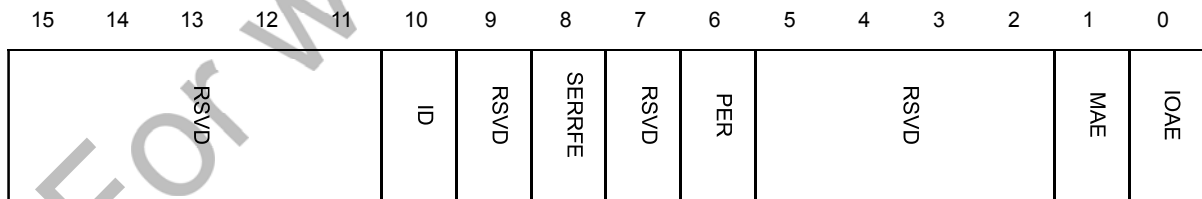

Bit	Name	Attribute	Description
15-11	RSVD	RO	Reserved.
10	ID	R/W	Interrupt Disable. 1: Enabled 0: Disabled
9	RSVD	RO	Reserved.
8	SERRFE	R/W	SERR# Function Enable. 1: Enabled

Vortex86EX

32-Bit x86 Micro Processor

			0: Disabled
7	RSVD	RO	Reserved.
6	PER	RO	Parity Error Response. 1: Enabled 0: Disabled
5-2	RSVD	RO	Reserved.
1	MAE	R/W	Memory Access Enable. 1: Allow the chip to respond to memory space accesses. 0: Disable memory space accesses.
0	IOAE	R/W	IO Access Enable. 1: Allow the chip to respond to io space accesses. 0: Disable io space accesses.

Register Offset: 06h
Register Name: Device Status Register
Reset Value : 0600h

15	14	13	12	11	10	9	8	7	6	5	4	3	2	1	0
DPE	SSE	MAST	RTA	RSVD	DEVT[1:0]	MDPE			RSVD			IS		RSVD	

Bit	Name	Attribute	Description
15	DPE	R/W1C	Detected Parity Error. This bit must be set by the device whenever it detects a parity error, even if parity error handling is disabled. Write 1 to clear this bit.
14	SSE	R/W1C	Signaled System Error. This bit is set whenever the device asserts SERR#. Write 1 to clear this bit.
13	MAST	R/W1C	Master Abort Status. This bit is set to high when the IDE Controller acts as a PCI master and has issued a Master-Abort. Write 1 to clear this bit.
12	RTA	R/W1C	Received Target Abort . This bit is set to high when the IDE controller is a PCI master and the PCI transaction is terminated by receiving a Target-Abort. Write 1 to clear this bit.
11	RSVD	RO	Reserved
10-9	DEVT[1:0]	RO	DEVSEL Timing (DEVT[1:0]) Medium timing is selected for DEVSEL# assertion when the PCI target performs the positive decode.

Vortex86EX

32-Bit x86 Micro Processor

8	MDPE	RW1C	Master Data Parity Error. 0: No data parity error 1: Data parity error occurred
7-4	RSVD	RO	Reserved.
3	IS	RO	Interrupt Status. 0: No Interrupt 1: Interrupt Set
2-0	RSVD	-	Reserved.

Register Offset: 08h
Register Name: Revision Register
Reset Value : 00h

7 6 5 4 3 2 1 0

RID

Bit	Name	Attribute	Description
7-0	VID	RO	Revision ID. The revision number of the IDE controller.

Register Offset: 09h
Register Name: Program Interface Register
Reset Value : 00h

7 6 5 4 3 2 1 0

RSVD

Bit	Name	Attribute	Description
7-0	PIR	RO	Reserved.

Register Offset: 0Ah
Register Name: Sub-class Code Register
Reset Value : 09h

7 6 5 4 3 2 1 0

SCC

Bit	Name	Attribute	Description
7-0	SCC	RO	Sub-class Code. 09h for CAN Bus.

Vortex86EX

32-Bit x86 Micro Processor

Register Offset: 0Bh
Register Name: Base Class Code Register
Reset Value : 0Ch

7 6 5 4 3 2 1 0

BCC

Bit	Name	Attribute	Description
7-0	BCC	RO	Base Class Code. 0Ch for Serial Bus Controller.

Register Offset: 0Ch
Register Name: Cache Line Size Register
Reset Value : 00h

7 6 5 4 3 2 1 0

CLS

Bit	Name	Attribute	Description
7-0	CLS	RO	Cache Line Size.

Register Offset: 0Dh
Register Name: Master Latency Timer Register
Reset Value : 00h

7 6 5 4 3 2 1 0

MLT

Bit	Name	Attribute	Description
7-0	MLT	RW	Master Latency Timer. These bits Indicate the PCI Bus master latency timer.

Register Offset: 0Eh
Register Name: Header Type Register
Reset Value : 00h

7 6 5 4 3 2 1 0

HEADT

Bit	Name	Attribute	Description
7-0	HEADT	RO	Head Type. These bits Indicate the header type of the device.

Vortex86EX

32-Bit x86 Micro Processor

Register Offset: 0Fh
Register Name: Built-in Self Test Register
Reset Value : 00h

7 6 5 4 3 2 1 0

RSVD

Bit	Name	Attribute	Description
7-0	RSVD	RO	Reserved.

Register Offset: 10h
Register Name: CAN Bus Control/Status Block Register Base Address (MEMORY SPACE)
Reset Value : 00000000h

31 30 29 28 27 26 25 24 23 22 21 20 19 18 17 16 15 14 13 12 11 10 9 8 7 6 5 4 3 2 1 0

CANCSB	RSVD	PF	TYPE	RT
--------	------	----	------	----

Bit	Name	Attribute	Description
31-7	CANCSB	RW	CAN Bus Control/Status Block Register Base Address. The base address of the can bus control/status block registers.
6-4	RSVD	RO	Reserved.
3	PF	RO	Prefetchable. Hardwired to 0 to indicate that this memory space is not prefetchable.
2-1	TYPE	RO	Type. Hardwired to 00 to indicate that this memory space is located anywhere in 32-bit access space.
0	RT	RO	Resource Type. Hardwired to 0 to indicate that the base address field in this register has been mapped to the Memory space.

Vortex86EX

32-Bit x86 Micro Processor

Register Offset: 14h
Register Name: CAN Bus Control/Status Block Register Base Address (IO SPACE)
Reset Value : 0000001h

31 30 29 28 27 26 25 24 23 22 21 20 19 18 17 16 15 14 13 12 11 10 9 8 7 6 5 4 3 2 1 0

CANCSB	RSVD	RT
--------	------	----

Bit	Name	Attribute	Description
31-7	CANCSB	RW	CAN Bus Control/Status Block Register Base Address. The base address of the can bus control/status block registers.
6-1	RSVD	RO	Reserved.
0	RT	RO	Resource Type. Hardwired to 1 to indicate that the base address field in this register has been mapped to the IO space.

Register Offset: 2Ch
Register Name: Sub-system Vendor ID Register
Reset Value : 17F3h

15 14 13 12 11 10 9 8 7 6 5 4 3 2 1 0

SVID

Bit	Name	Attribute	Description
15-0	SVID	RO	Sub-system Vendor ID (SVID [15:0]).

Register Offset: 2Eh
Register Name: Sub-system Device ID Register
Reset Value : 1070h

15 14 13 12 11 10 9 8 7 6 5 4 3 2 1 0

SDID

Bit	Name	Attribute	Description
15-0	SDID	RO	Sub-system Device ID (SDID [15:0]).

Vortex86EX

32-Bit x86 Micro Processor

Register Offset: 3Ch
Register Name: Interrupt Line Register
Reset Value : FFh

7 6 5 4 3 2 1 0

IL

Bit	Name	Attribute	Description
7-0	IL	RW	Interrupt Line. This is an 8-bit register used to communicate the interrupt line routing information. The value in the register tells which input of the system interrupt controller the device's interrupt pin is connected to.

Register Offset: 3Dh
Register Name: Interrupt Pin Register
Reset Value : 0h

7 6 5 4 3 2 1 0

IP

Bit	Name	Attribute	Description
7-0	IP	RO	Interrupt Pin. The register tells which interrupt pin the device uses. The device only uses the INTA#, so the value is 01h.

Register Offset: 3Eh
Register Name: MIN_GNT Register
Reset Value : 00h

7 6 5 4 3 2 1 0

MG

Bit	Name	Attribute	Description
7-0	MG	RO	MIN_GNT. The device has requirements for the setting of Latency Timers.

Vortex86EX

32-Bit x86 Micro Processor

Register Offset: 3Fh
Register Name: MIN_GNT Register
Reset Value : 00h

7 6 5 4 3 2 1 0

ML

Bit	Name	Attribute	Description
7-0	ML	RO	MAX_LAT. The device has requirements for the setting of Latency Timers.

For www.86duino.com

18.5 List of CAN Memory Registers

31	16 15	00	Index
Global Control Register			00h-03h
Clock Pre-Scaler			04h-07h
Bus Timing			08h-0Bh
Interrupt Enable			0Ch-0Fh
Interrupt Status			10h-13h
Global Status			14h-17h
Request Register			18h-1Bh
Transmit Status 0			1Ch-1Fh
Transmit Status 1			20h-23h
Transmit Status 2			24h-27h
Receive Status			28h-2Bh
Error Warning Limit Register			2Ch-2Fh
Tx/Rx Error Counter			30h-33h
Identifier Index			34h-37h
Identifier Filter			38h-3Bh
Identifier Mask			3Ch-3Fh
TX Frame Control 0			40h-43h
TX ID 0			44h-47h
TX Data Low 0			48h-4Bh
TX Data High 0			4Ch-4Fh
TX Frame Control 1			50h-53h
TX ID 1			54h-57h
TX Data Low 1			58h-5Bh
TX Data High 1			5Ch-5Fh
TX Frame Control 2			60h-63h
TX ID 2			64h-67h
TX Data Low 2			68h-6Bh

Vortex86EX

32-Bit x86 Micro Processor

TX Data High 2	6Ch-6Fh
RX Frame Type	70h-73h
RX ID	74h-77h
RX Data Low	78h-7Bh
RX Data High	7Ch-7Fh
Reserved	80h-FFh

For www.86duino.com

18.6 List of CAN Memory Register

Register Offset: 00h
Register Name: Global Control Register
Reset Value : 00000000h

31 30 29 28 27 26 25 24 23 22 21 20 19 18 17 16 15 14 13 12 11 10 9 8 7 6 5 4 3 2 1 0

CANCSB	RSVD	RT
--------	------	----

Bit	Name	Attribute	Description
31-25	RSVD	RO	Reserved.
24	PSE	R/W	<p>Power Saving Enable: 0: Disable power saving. 1: Enabled power saving.</p> <p>When this bit is set to 1, the controller will automatically enter the power saving state when it detects that there is no transmit request and no bus activity.</p> <p>When the controller wants to do any transmit request or detects any activity on the bus, it will leave the power saving state into the operation state and start transmitting / receiving messages.</p> <p>At the power saving state, the sampling clock of the controller is stopped.</p>
23-19	RSVD	RO	Reserved.
18	RBF	R/W	<p>identifier filter bypass: 0: disable filter bypass. 1: Enabled filter bypass.</p> <p>If the identifier filter is disabled, this bit is ignored.</p> <p>If filter bypass is enabled and RGF=1, all received messages are stored to Rx Buffer.</p> <p>If filter bypass is disabled and RGF=1, all messages are passed to the identifier filters.</p>
17	RGF	R/W	<p>identifier filter enable 0: disable identifier filter 1: Enabled identifier filter</p> <p>If the identifier filter is disabled, the controller doesn't store any data to Rx Buffer.</p> <p>If the identifier filter is enabled, the controller stores the received data depends on the identifier filters.</p>
16	IRST	R/W1	identifier filter reset:

			<p>1: resetting identifier filter.</p> <p>After finishing the resetting, hardware will clear this bit.</p>
15-10	RSVD	RO	Reserved.
9	ERE	R/W	<p>Error Retry Enable:</p> <p>0: Software controls the retry if transmit error happens.</p> <p>1: Hardware automatically retry if transmit error happens.</p>
8	ARE	R/W	<p>Arbitration Lost Retry Enable:</p> <p>0: Software controls the retry if arbitration lost happens.</p> <p>1: Hardware automatically retry if arbitration lost happens.</p>
7-6	TBP	R/W	<p>Transmit buffer priority:</p> <p>00: Transmit buffer 0 has the highest priority.</p> <p>01: Transmit buffer priority is depended on the identifier field of each transmit buffer.</p> <p>10: Round Robin</p> <p>11: Reserved</p>
5	SR	R/W	<p>Self Reception:</p> <p>0: Normal operation.</p> <p>1: Enabled Self reception.</p> <p>By enabling self reception, a message transmitted form Tx to Rx can be received. The Tx data will be sent to the bus and received by the controller then stored to Rx buffer.</p> <p>This bit only works with loopback.</p>
4	TNAK	R/W	<p>Transmit with no acknowledge:</p> <p>0: Normal operation.</p> <p>1: Enabled TNAK.</p> <p>When transmitting a message with no acknowledge response, the controller treats this transmission as a successful one.</p> <p>This bit should be set when loopback</p>
3	LP	R/W	<p>Loopback:</p> <p>0: Normal operation</p> <p>1: Enabled loopback</p> <p>By Enabling loopback, the controller connects internal Tx and internal Rx.</p>
2	SI	R/W	<p>Silent:</p> <p>0: Normal operation.</p> <p>1: Enabled Silent.</p>

Vortex86EX

32-Bit x86 Micro Processor

			By enabling silent, the controller ignores internal Tx. If Tx is ignored, the controller cannot affect the bus by sending ACK and Error frame.
1	CBA	R/W	<p>CAN bus controller active: 0: CAN controller is not active. 1: CAN controller is active.</p> <p>Writing 1 to enable the controller, so the controller is active. Note that there may be a delay in deactivating or activating the controller due to bus events. The bit status will not read as a zero/one until after the controller has actually been deactivated / activated.</p> <p>If the controller is inactive, the controller's sampling clock is stopped.</p>
0	RST	R/W1	<p>Controller Reset: 1: resetting controller. (software reset)</p> <p>After finishing the reset, hardware will clear this bit. Software cannot terminate the reset process early by writing a zero to this bit. Setting this bit will reset the controller, but not resetting the identifier filter, clock pre-scales and bus timing.</p>

Register Offset: 04h
Register Name: Clock Pre-Scaler Register
Reset Value : 00000000h

31 30 29 28 27 26 25 24 23 22 21 20 19 18 17 16 15 14 13 12 11 10 9 8 7 6 5 4 3 2 1 0

CKSEL	RSVD	CKDIV
-------	------	-------

Bit	Name	Attribute	Description
31	CKSEL	R/W	CAN bus Clock Select: 0: Clock from PCI clock. 1: Clock from external input.
30-6	RSVD	RO	Reserved.
5-0	CKDIV	R/W	CAN bus Clock Divider: 000000: Divide by 2 000001: Divide by 4 000010: Divide by 6

Vortex86EX

32-Bit x86 Micro Processor

			111111: Divide by 128 $TQ = [2 \times (CKDIV+1)] / f(CKSEL)$
--	--	--	---

Note: Clock Pre-Scaler register can be modified only when the controller is not active. (CBA = 0 in Global Control Register.)

Register Offset: 08h
Register Name: Bus Timing Register
Reset Value : 00000220h

31	30	29	28	27	26	25	24	23	22	21	20	19	18	17	16	15	14	13	12	11	10	9	8	7	6	5	4	3	2	1	0
RSVD																SAM	RSVD	SJW	RSVD	PS2	RSVD	PS1	RSVD	PROG							

Bit	Name	Attribute	Description
31-16	RSVD	RO	Reserved.
15	SAM	R/W	Sampling: 0: The bus is sampled once at sample point. 1: The bus is sampled three times prior to the sample point. (low, medium speed bus)
14	RSVD	RO	Reserved.
13-12	SJW	R/W	CAN BUS bit time Synchronization Jump Width 00=1 TQ 01=2 TQ 10=3 TQ 11=4 TQ
11	RSVD	RO	Reserved.
10-8	PS2	R/W	CAN BUS bit time phase segment 2 000=1 TQ 001=2 TQ : 111=8 TQ
7	RSVD	RO	Reserved.
6-4	PS1	R/W	CAN BUS bit time phase segment 1 000=1 TQ 001=2 TQ : 111=8 TQ
3	RSVD	RO	Reserved.
2-0	PROG	R/W	CAN BUS bit time propagation segment 000=1 TQ

Vortex86EX

32-Bit x86 Micro Processor

			001=2 TQ : 111=8 TQ
--	--	--	---------------------------

Note: Bus Timing Register can be modified only when the controller is not active. (CBA = 0 in Global Control Register.)

Register Offset: 0Ch
Register Name: Interrupt Enable Register
Reset Value : 00000000h

31 30 29 28 27 26 25 24 23 22 21 20 19 18 17 16 15 14 13 12 11 10 9 8 7 6 5 4 3 2 1 0

RSVD											XPIE	RBOIE	RBEIE	ALIE	BOIE	EPIE	ECIE	TX2IE	TX1IE	TX0IE	RXIE

Bit	Name	R/W	Description
31-11	RSVD	RO	<i>Reserved.</i>
10	XPIE	RW	<i>Exit power saving interrupt enable.</i>
9	RBOIE	RW	<i>Receive buffer overrun interrupt enable.</i>
8	RBEIE	RW	<i>Receive bus error interrupt enable.</i>
7	ALIE	RW	<i>Arbitration lost interrupt enable.</i>
6	BOIE	RW	<i>Bus Off interrupt enable.</i>
5	EPIE	RW	<i>Error passive interrupt enable.</i>
4	ECIE	RW	<i>Error counter warning interrupt enable.</i>
3	TX2IE	RW	<i>TxBUFFER2 transmit request interrupt enable.</i>
2	TX1IE	RW	<i>TxBUFFER1 transmit request interrupt enable.</i>
1	TX0IE	RW	<i>TxBUFFER0 transmit request interrupt enable.</i>
0	RXIE	RW	<i>Receive interrupt enable:</i>

Vortex86EX

32-Bit x86 Micro Processor

Register Offset: 10h
Register Name: Interrupt Status Register
Reset Value : 00000000h

31 30 29 28 27 26 25 24 23 22 21 20 19 18 17 16 15 14 13 12 11 10 9 8 7 6 5 4 3 2 1 0

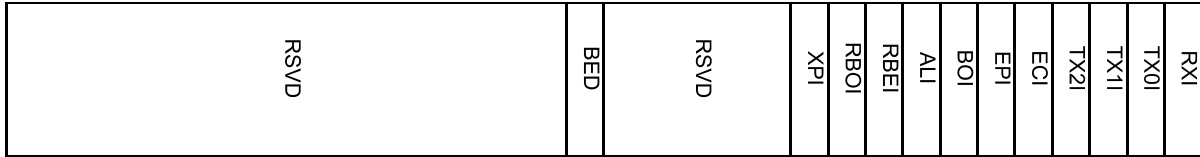

Bit	Name	Attribute	Description
31-17	RSVD	RO	Reserved.
16	BED	RO	Bus Error Direction: 0: Bus error occurs at transmitting. 1: Bus error occurs at receiving.
15-11	RSVD	RO	Reserved.
10	XPI	RW1C	Exit power saving interrupt: 0: the interrupt doesn't occur. 1: The controller leaves the power saving state.
9	RBOI	RW1C	Receive buffer overrun interrupt: 0: the interrupt doesn't occur. 1: Receive buffer is overrun.
8	RBEI	RW1C	Receive Bus error interrupt: 0: the interrupt doesn't occur. 1: Bus receive error occurs.
7	ALI	RW1C	Arbitration lost interrupt: 0: the interrupt doesn't occur. 1: The controller loses arbitration.
6	BOI	RW1C	Bus Off Interrupt: 0: the interrupt doesn't occur. 1: The controller enters bus off.
5	EPI	RW1C	Error passive interrupt: 0: the interrupt doesn't occur. 1: The controller is at the error passive state.
4	ECI	RW1C	Error counter warning interrupt: 0: the interrupt doesn't occur. 1: The error counter value is greater than or equal to the warning limit value.
3	TX2I	RW1C	TxBuffer2 transmit request interrupt: 0: the interrupt doesn't occur. 1: The TB2 request is completed or aborted.
2	TX1I	RW1C	TxBuffer1 transmit request interrupt:

Vortex86EX

32-Bit x86 Micro Processor

			0: the interrupt doesn't occur. 1: The TB1 request is completed or aborted.
1	TX0I	RW1C	TxBuffer0 transmit request interrupt: 0: the interrupt doesn't occur. 1: The TB0 request is completed or aborted.
0	RXI	RW1C	Receive interrupt: 0: the interrupt doesn't occur. 1: there are some messages in the receive buffer.

Register Offset: 14h

Register Name: Controller Status Register

Reset Value : 00000000h

31 30 29 28 27 26 25 24 23 22 21 20 19 18 17 16 15 14 13 12 11 10 9 8 7 6 5 4 3 2 1 0

RSVD	ECW	CEP	CPS	CBO	TIP	RIP
------	-----	-----	-----	-----	-----	-----

Bit	Name	Attribute	Description
31-6	RSVD	RO	Reserved.
5	ECW	RO	Error counter is reach warning limit: 0: Error counter is not reach warning limit 1: Error counter is reach warning limit
4	CEP	RO	Controller is at error passive state: 0: Controller is not at error passive state 1: Controller is at error passive state
3	CPS	RO	Controller is at power saving state: 0: Controller is not at power saving state. 1: Controller is at power saving state.
2	CBO	RO	Controller is at Bus off state: 0: Controller is not at bus off state. 1: Controller is at bus off state.
1	TIP	RO	Transmit is in progress: 0: Controller is not transmitting data. 1: Controller is transmitting data.
0	RIP	RO	Receive is in progress: 0: Controller is not receiving data. 1: Controller is receiving data.

Vortex86EX

32-Bit x86 Micro Processor

Register Offset: 18h
Register Name: Request Register
Reset Value : 00000000h

31 30 29 28 27 26 25 24 23 22 21 20 19 18 17 16 15 14 13 12 11 10 9 8 7 6 5 4 3 2 1 0

RSVD																RRB	RSVD	TBA2	TBR2	TBA1	TBR1	TBA0	TBR0
------	--	--	--	--	--	--	--	--	--	--	--	--	--	--	--	-----	------	------	------	------	------	------	------

Bit	Name	R/W	Description
31-9	RSVD	RO	Reserved.
8	RRB	R/W1	Release the received message. 0: action done 1: release the received message at the top position of the receive buffer. After releasing the received message, the controller can update the receive buffer with the next received message. After releasing current receive buffer, hardware will clear this bit.
7-6	RSVD	RO	Reserved.
5	TBA2	R/W1	Abort Txbuffer2 request: 0: no request 1: Abort Txbuffer2 request. Similar to TBA0
4	TBR2	R/W1	Transmit Txbuffer2 Request: 0: no request 1: request the TB2 transmission. Similar to TBR0
3	TBA1	R/W1	Abort Txbuffer1 request: 0: no request 1: Abort Txbuffer1 request. Similar to TBA0
2	TBR1	R/W1	Transmit Txbuffer1 Request: 0: no request 1: request the TB1 transmission. Similar to TBR0
1	TBA0	R/W1	Abort Txbuffer0 request: 0: no request 1: Abort the TB0 request. After the transmit request is completed or aborted, hardware will clear this bit. Setting this bit has no effect when Txbuffer0 is not requested for the transmission.
0	TBR0	R/W1	Transmit Txbuffer0 Request:

Vortex86EX

32-Bit x86 Micro Processor

			<p>0: no request</p> <p>1: request the TB0 transmission.</p> <p>After the transmit request is completed or aborted, hardware will clear this bit.</p> <p>Hardware will clear TRC0 and TC0 bits in the Transmit status register when setting this bit.</p>
--	--	--	---

Register Offset: 1Ch
Register Name: Transmit Status 0 Register
Reset Value : 00000000h

31	30	29	28	27	26	25	24	23	22	21	20	19	18	17	16	15	14	13	12	11	10	9	8	7	6	5	4	3	2	1	0		
RSVD												BEC0			RSVD												TBBF0	BEO0	ALO0	RSVD	TC0	TA0	TRC0

Bit	Name	R/W	Default	Description
31-19	RSVD	RO	0	Reserved.
18-16	BEC0	RO	0	Bus Error Type: 000: No Error 001: Bit Error 010: Stuff Error 011: CRC Error 100: Form Error 101: Acknowledge Error 110: No Error 111: No Error
15-7	RSVD	RO	0	Reserved.
6	TBBF0	RO	0	Transmit buffer bus off occur 0: 0: Transmit buffer 0 has no error. 1: The Controller's current state is BUS OFF (Clear when TBR0 is set to 1)
5	BEO0	RO	0	Bus error occur 0 0: No bus error 1: An error has occurred during transmitting TX0
4	ALO0	RO	0	Arbitration lost occur 0 0: No arbitration lost 1: Arbitration lost has occurred during transmitting TX0
3	RSVD	RO	0	Reserved
2	TC0	RO	0	Transmission complete for Txbuffer0: 0: Transmission is failed.

Vortex86EX

32-Bit x86 Micro Processor

				1: Transmission is complete. This field will valid when TRC set to 1.
1	TA0	RO	0	Request aborted for Txbuffer0: 0: the Request is not aborted. 1: the Request is aborted. This field will valid when TRC set to 1.
0	TRC0	RO	0	Request completed for Txbuffer0: 0: the Request is in processing. 1: the Request is transmitted or aborted.

Register Offset: 20h
Register Name: Transmit Status 1 Register
Reset Value : 00000000h

31 30 29 28 27 26 25 24 23 22 21 20 19 18 17 16 15 14 13 12 11 10 9 8 7 6 5 4 3 2 1 0

RSVD	BEC1	RSVD	TBBF1	BEO1	ALO1	RSVD	TC1	TA1	TRC1
------	------	------	-------	------	------	------	-----	-----	------

Bit	Name	Attribute	Description
31-19	RSVD	RO	Reserved.
18-16	BEC1	RO	Bus Error Type: 000: No Error 001: Bit Error 010: Stuff Error 011: CRC Error 100: Form Error 101: Acknowledge Error 110: No Error 111: No Error
15-7	RSVD	RO	Reserved.
6	TBBF1	RO	Transmit buffer bus off occur 1: 0: Transmit buffer 0 has no error. 1: The Controller's current state is BUS OFF (Clear when TBR1 is set to 1)
5	BEO1	RO	Bus error occur 1. 0: No bus error 1: An error has occurred during transmitting TX1
4	ALO1	RO	Arbitration lost occur 1. 0: No arbitration lost

Vortex86EX

32-Bit x86 Micro Processor

			1: Arbitration lost has occurred during transmitting TX1
3	RSVD	RO	Reserved.
2	TC1	RO	Transmission complete for Txbuffer1: 0: Transmission is failed. 1: Transmission is complete. This field will valid when TRC set to 1.
1	TA1	RO	Request aborted for Txbuffer1: 0: the Request is not aborted. 1: the Request is aborted. This field will valid when TRC set to 1.
0	TRC1	RO	Request completed for Txbuffer1: 0: the Request is in processing. 1: the Request is transmitted or aborted.

Register Offset: 24h
 Register Name: Transmit Status 2 Register
 Reset Value : 00000000h

31 30 29 28 27 26 25 24 23 22 21 20 19 18 17 16 15 14 13 12 11 10 9 8 7 6 5 4 3 2 1 0

RSVD	BEC2	RSVD	TBBF2	BEO2	ALO2	RSVD	TC2	TA2	TRC21
------	------	------	-------	------	------	------	-----	-----	-------

Bit	Name	Attribute	Description
31-19	RSVD	RO	Reserved.
18-16	BEC2	RO	Bus Error Type: 000: No Error 001: Bit Error 010: Stuff Error 011: CRC Error 100: Form Error 101: Acknowledge Error 110: No Error 111: No Error
15-7	RSVD	RO	Reserved.
6	TBBF2	RO	Transmit buffer bus off occur 2: 0: Transmit buffer 0 has no error. 1: The Controller's current state is BUS OFF (Clear when TBR2 is set to 1)
5	BEO2	RO	Bus error occur 2.

Vortex86EX

32-Bit x86 Micro Processor

			0: No bus error 1: An error has occurred during transmitting TX2
4	ALO2	RO	Arbitration lost occur 2. 0: No arbitration lost 1: Arbitration lost has occurred during transmitting TX2
3	RSVD	RO	Reserved.
2	TC2	RO	Transmission complete for Txbuffer2: 0: Transmission is failed. 1: Transmission is complete. This field will valid when TRC set to 1.
1	TA2	RO	Request aborted for Txbuffer2: 0: the Request is not aborted. 1: the Request is aborted. This field will valid when TRC set to 1.
0	TRC2	RO	Request completed for Txbuffer2: 0: the Request is in processing. 1: the Request is transmitted or aborted.

Register Offset: 28h
Register Name: Receive Status Register
Reset Value : 00000000h

31 30 29 28 27 26 25 24 23 22 21 20 19 18 17 16 15 14 13 12 11 10 9 8 7 6 5 4 3 2 1 0

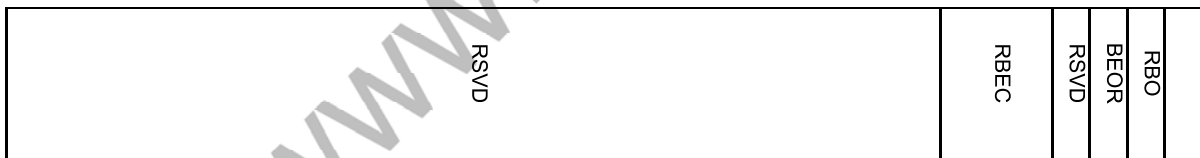

Bit	Name	Attribute	Description
31-7	RSVD	RO	Reserved.
6-4	RBEC	RO	RX Bus error type: 000: No error 001: Bit error 010: Stuff error 011: CRC error 100: Form error 101: Acknowledge error 110~111: No error
3	RSVD	RO	Reserved.
2	BEOR	RO	Bus Error Occur

Vortex86EX

32-Bit x86 Micro Processor

			<p>0: No bus error 1: An Error has occurred during receiving</p>
1	RBO	RO	<p>Receive Buffer Overrun: 0: receive buffer is not overrun. 1: receive buffer is overrun.</p> <p>If the receive buffer is overrun, the incoming message is not stored to the Rx buffer. Software should keep the receive buffer empty by using the Release the received message bit when the controller works.</p>
0	RBS	RO	<p>pending messages: 0: No message in the receive buffer. 1: there are pending messages in the receive buffer.</p> <p>The receive buffer can store two messages. The Release received message bit can drop the first pending message in the buffer, and then the controller updates the RX with the next pending messages.</p>

Register Offset: 2Ch
Register Name: Error Warning Limit Register
Reset Value : 00000060h

31 30 29 28 27 26 25 24 23 22 21 20 19 18 17 16 15 14 13 12 11 10 9 8 7 6 5 4 3 2 1 0

RSVD	EWL
------	-----

Bit	Name	R/W	Default	Description
31-8	RSVD	RO	0	Reserved.
7-0	EWL	R/W	0x60	<p>Error warning limit: If Tx or Rx Error counter is greater than or equal to this value, the controller will issue an interrupt.</p> <p>In general, software initializes it when the controller is inactive.</p>

Vortex86EX

32-Bit x86 Micro Processor

Register Offset: 30h
Register Name: Tx/Rx Error Counter Register
Reset Value : 00000000h

31 30 29 28 27 26 25 24 23 22 21 20 19 18 17 16 15 14 13 12 11 10 9 8 7 6 5 4 3 2 1 0

RSVD	REC	RSVD	TEC
------	-----	------	-----

Bit	Name	Attribute	Description
31-24	RSVD	RO	Reserved.
23-16	REC	R/W	Receive Error Counter: In general, software initializes it when the controller is active.
15-9	RSVD	RO	Reserved.
8-0	TEC	R/W	Transmit Error Counter: In general, software initializes it when the controller is active.

Register Offset: 34h
Register Name: Identifier Index Register
Reset Value : 00000000h

31 30 29 28 27 26 25 24 23 22 21 20 19 18 17 16 15 14 13 12 11 10 9 8 7 6 5 4 3 2 1 0

RSVD	FU	RSVD	IFI
------	----	------	-----

Bit	Name	Attribute	Description
31-9	RSVD	RO	Reserved.
8	IFU	R/W1	Identifier Filter Update. After updating the internal filter buffer specified by filter index, hardware will clear this bit.
7-5	RSVD	RO	Reserved.
4-0	IFI	R/W	Identifier Filter Index: Identifier filter index value from 0x0 ~ 0x1F Before access to any filter through identifier filter reg and mask reg, software should specify filter index number.

Vortex86EX

32-Bit x86 Micro Processor

Register Offset: 38h
Register Name: Identifier Filter Register
Reset Value : 00000000h

31 30 29 28 27 26 25 24 23 22 21 20 19 18 17 16 15 14 13 12 11 10 9 8 7 6 5 4 3 2 1 0



Bit	Name	R/W	Default	Description
31	IFE	R/W	0	Identifier Filter Enable: 0: Disable ID filter. 1: Enabled ID filter.
30	IFM	R/W	0	Identifier Filter Format: 0: This filter is for standard ID (11 bit ID). 1: This filter is for extended ID (29 bit ID).
29	RSVD	RO	0	Reserved.
28-0	IFB	R/W	0	Identifier Filter bit: If IFM is set to 0, bit11~28 will be ignored.

Register Offset: 3Ch
Register Name: Identifier Mask Register
Reset Value : 00000000h

31 30 29 28 27 26 25 24 23 22 21 20 19 18 17 16 15 14 13 12 11 10 9 8 7 6 5 4 3 2 1 0



Bit	Name	Attribute	Description
31-29	RSVD	RO	Reserved.
28-0	IMB	R/W	Identifier Mask bit: If IFM is set to 0, bit 28-11 will be ignored.

Vortex86EX

32-Bit x86 Micro Processor

Register Offset: 48h
 Register Name: TX Data (Low) 0 Register
 Reset Value : 00000000h

31 30 29 28 27 26 25 24 23 22 21 20 19 18 17 16 15 14 13 12 11 10 9 8 7 6 5 4 3 2 1 0



Bit	Name	R/W	Description
31-0	TXDL	R/W	Transmit data low dword: Transmit valid data depends on TDL in TX frame control register.

Register Offset: 4Ch
 Register Name: TX Data (High) 0 Register
 Reset Value : 00000000h

31 30 29 28 27 26 25 24 23 22 21 20 19 18 17 16 15 14 13 12 11 10 9 8 7 6 5 4 3 2 1 0

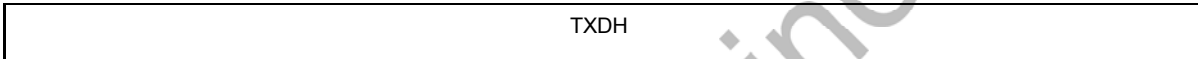

Bit	Name	Attribute	Description
31-0	TXDH	R/W	Transmit data high dword: Transmit valid data depends on TDL in TX frame control register.

Register Offset: 50h
 Register Name: TX Frame Control 1 Register
 Reset Value : 00000000h

31 30 29 28 27 26 25 24 23 22 21 20 19 18 17 16 15 14 13 12 11 10 9 8 7 6 5 4 3 2 1 0



Bit	Name	Attribute	Description
31-8	RSVD	RO	Reserved.
7-4	TDL	R/W	Transmit Data Length Code: 0000-0111 = 0-7 bytes 1xxx = 8 bytes
3-2	RSVD	RO	Reserved.
1	TRTR	R/W	Transmit RTR bit: 0: The frame is a data frame. 1: The frame is a remote frame
0	TFF	R/W	Transmit Frame Format:

Vortex86EX

32-Bit x86 Micro Processor

			0: Standard format has 11 bit IDs 1: Extended format has 29 bit IDs
--	--	--	--

Register Offset: 54h
Register Name: TX ID 1 Register
Reset Value : 00000000h

31 30 29 28 27 26 25 24 23 22 21 20 19 18 17 16 15 14 13 12 11 10 9 8 7 6 5 4 3 2 1 0

RSVD	TID
------	-----

Bit	Name	Attribute	Description
31-29	RSVD	RO	Reserved.
28-0	TID	RW	Transmit frame ID: If TFF is 0 in TX frame control register. The bit28~bit11 will be ignored

Register Offset: 58h
Register Name: Data (Low) 1 Register
Reset Value : 00000000h

31 30 29 28 27 26 25 24 23 22 21 20 19 18 17 16 15 14 13 12 11 10 9 8 7 6 5 4 3 2 1 0

TXDL

Bit	Name	Attribute	Description
31-0	TXDL	R/W	Transmit Data Low Dword: Transmit valid data depends on TDL in TX frame control register.

Register Offset: 5Ch
Register Name: TX Data (High) 1 Register
Reset Value : 00000000h

31 30 29 28 27 26 25 24 23 22 21 20 19 18 17 16 15 14 13 12 11 10 9 8 7 6 5 4 3 2 1 0

TXDH

Bit	Name	Attribute	Description
31-0	TXDH	R/W	Transmit Data High Dword: Transmit valid data depends on TDL in TX frame control register.

Vortex86EX

32-Bit x86 Micro Processor

Register Offset: 60h
Register Name: TX Frame Control 2 Register
Reset Value : 00000000h

31 30 29 28 27 26 25 24 23 22 21 20 19 18 17 16 15 14 13 12 11 10 9 8 7 6 5 4 3 2 1 0

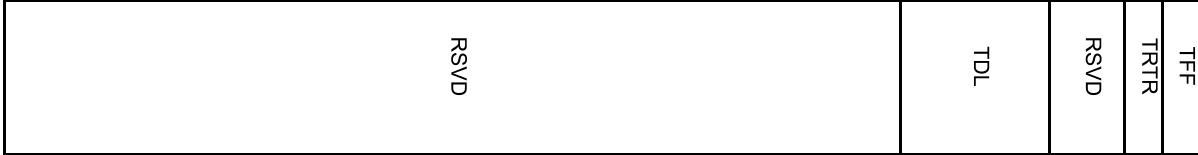

Bit	Name	Attribute	Description
31-8	RSVD	RO	Reserved.
7-4	TDL	R/W	Transmit data length code: 0000-0111 = 0-7 bytes 1xxx = 8 bytes
3-2	RSVD	RO	Reserved.
1	TRTR	R/W	Transmit RTR bit: 0: The frame is a data frame. 1: The frame is a remote frame
0	TFF	R/W	Transmit Frame Format: 0: Standard format has 11 bit IDs 1: Extended format has 29 bit IDs

Register Offset: 64h
Register Name: TX ID 2 Register
Reset Value : 00000000h

31 30 29 28 27 26 25 24 23 22 21 20 19 18 17 16 15 14 13 12 11 10 9 8 7 6 5 4 3 2 1 0

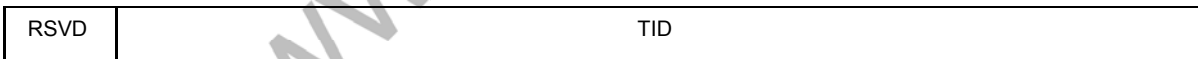

Bit	Name	Attribute	Description
31-29	RSVD	RO	Reserved.
28-0	TID	R/W	Transmit frame ID: If TFF is 0 in TX frame control register. The bit28~bit11 will be ignored

Vortex86EX

32-Bit x86 Micro Processor

Register Offset: 68h
Register Name: TX Data (Low) 2 Register
Reset Value : 00000000h

31 30 29 28 27 26 25 24 23 22 21 20 19 18 17 16 15 14 13 12 11 10 9 8 7 6 5 4 3 2 1 0

TXDL

Bit	Name	Attribute	Description
31-0	TXDL	R/W	Transmit Data Low Dword: Transmit valid data depends on TDL in TX frame control register.

Register Offset: 6Ch
Register Name: TX Data (High) 2 Register
Reset Value : 00000000h

31 30 29 28 27 26 25 24 23 22 21 20 19 18 17 16 15 14 13 12 11 10 9 8 7 6 5 4 3 2 1 0

TXDH

Bit	Name	Attribute	Description
31-0	TXDH	R/W	Transmit Data High Dword: Transmit valid data depends on TDL in TX frame control register.

Register Offset: 70h
Register Name: RX Frame Type Register
Reset Value : 00000000h

31 30 29 28 27 26 25 24 23 22 21 20 19 18 17 16 15 14 13 12 11 10 9 8 7 6 5 4 3 2 1 0

RSVD	RDL	RSVD	RRTR	RFF
------	-----	------	------	-----

Bit	Name	Attribute	Description
31-8	RSVD	RO	Reserved.
7-4	RDL	RO	Receive data length code: 0000-0111 = 0-7 bytes 1xxx = 8 bytes
3-2	RSVD	RO	Reserved.
1	RRTR	RO	Receive RTR bit: 0: The frame is a data frame. 1: The frame is a remote frame
0	RFF	RO	Receive frame format:

Vortex86EX

32-Bit x86 Micro Processor

			0: Standard format has 11 bit IDs 1: Extended format has 29 bit IDs
--	--	--	--

Register Offset: 74h
Register Name: RX ID Register
Reset Value : 00000000h

31 30 29 28 27 26 25 24 23 22 21 20 19 18 17 16 15 14 13 12 11 10 9 8 7 6 5 4 3 2 1 0

RSVD	RID
------	-----

Bit	Name	Attribute	Description
31-29	RSVD	RO	Reserved.
28-0	RID	RO	Receive frame ID: If RFF is 0 in RX frame type register. The bit28~bit11 will be ignored

Register Offset: 78h
Register Name: RX Data (Low) Register
Reset Value : 00000000h

31 30 29 28 27 26 25 24 23 22 21 20 19 18 17 16 15 14 13 12 11 10 9 8 7 6 5 4 3 2 1 0

RXDL

Bit	Name	R/W	Description
31-0	RXDL	RO	Receive Data Low Dword: Receive valid data depends on RDL in RX frame type register.

Register Offset: 7Ch
Register Name: RX Data (High) Register
Reset Value : 00000000h

31 30 29 28 27 26 25 24 23 22 21 20 19 18 17 16 15 14 13 12 11 10 9 8 7 6 5 4 3 2 1 0

RXDH

Bit	Name	R/W	Description
31-0	RXDH	RO	Receive data High Dword: Receive valid data depends on RDL in RX frame type register.

18.7 Procedural Guide

18.7.1 Finding the correct prescaler and bus timing to use: Using an Example

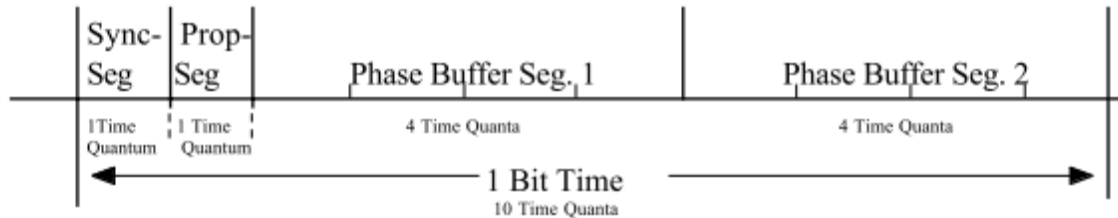

$$\text{Ext_CLK (MHz)} = n \text{ (TQ)} * \text{CKDIV} * \text{BR (MHz)}$$

$$n = 1 \text{ (Sync)} + x \text{ (PROG)} + y \text{ (PS1)} + z \text{ (PS2)} \Rightarrow (1) \text{ Sync Segment is always 1; } (2) 8 \leq n \leq 25$$

Ext_CLK (MHz)	BR (MHz)	CKDIV	n (TQ)	SYNC (TQ)	PROG (TQ)	PS1 (TQ)	PS2 (TQ)
20	1	2	10	1	1	4	4
20	1	2	10	1	3	3	3
20	0.5	4	10	1	1	4	4
20	0.5	4	10	1	3	3	3
20	0.5	2	20	1	3	8	8
20	0.5	2	20	1	5	7	7
20	0.5	2	20	1	7	6	6
20	0.01	250	8	1	1	3	3
20	0.01	250	8	1	3	2	2
20	0.01	250	8	1	4	1	2
20	0.01	250	8	1	5	1	1
20	0.01	100	20	1	3	8	8
20	0.01	100	20	1	5	7	7
20	0.01	100	20	1	7	6	6
20	0.01	80	25	1	8	8	8

For detail on the Time Quanta, please reference CAN Spec 2.0 Part B page 34.

CKDIV (Bit 5 - 0) is in the Clock Pre-Scaler Register (0x04h)

PROG (Bit 2 - 0), PS1 (Bit 6 - 4), and PS2 (Bit 10 - 8) are in the Bus Timing Register (0x08h)

The sampling point for the CAN controller is located at the end of Phase Buffer Seg. 1. So it would be best if this sampling point is positioned around 60% of the length of the Bit Time.

Starting to run the controller:

First we need to reset the controller, either by powering on or setting the RST bit (Bit 0) in the Global

Control Register (0x00h) to one. The controller is already reseted when powered up. If resetting by RST bit, the controller has finished resetting when reading a zero from this RST bit. Importantly, the RST bit will not reset the Identifier Filter that are set. These Identifier Filter settings has to be reset seperately by setting the IRST bit (Bit 16) in the Global Control Register (0x00h).

After resetting and before activating the controller, we will have to set the Clock Pre-Scaler (0x04h) and Bus Timing (0x08h) Registers. It is also recommended to set the Interrupt Enable (0x0Ch) Register at this time too. Although there is really no harm setting the interrupt enables when the controller is active, but still it would be better to set prior to activating.

Prior to activation, you might want to decide to set an error warning limit (Bit 7 : 0) in the Error Warning Limit Register (0x2Ch). This will inform you when the error count has reached this limit. However this might not mean that the controller has entered Passive State if the value was set to be less than d'128. It is just a limit you set to inform yourself. Default is h'60.

Also prior to activation, you would need to consider if this controller acts as an detector that only listens to the bus or as a transceiver that will send and receive datas. If it only works as a detector to simply check if the bus transactions are correct or not, please set the RGF bit (Bit 17) in the Global Control Register (0x00h) to zero. Then set CBA bit (Bit 1) in the Global Control Register (0x00h) to one, by doing so the controller has started to work. If not working as a detector, please set RGF bit (Bit 17) in the Global Control Register (0x00h) to one.

After setting the RGF bit to one, simply setting RBF bit (Bit 18) in the Global Control Register (0x00h) to one. This will let the controller store all the messages, which are not transmiited by this controller. If you want the controller to also store the messages that the controller sent, you could set SR bit (Bit 5) in the Global Control Register (0x00h) to one, or else leave it as zero.

If you want the optional of selective identification message storing, then please set the RBF bit (Bit 18) in the Global Control Register (0x00h) to zero. In this controller, there is a max of 32 identifier filter register blocks that can be used. But by using masking, it would be able to filter a lot more identifiers. Set the Identifier Filter Register (0x38h) and Identifier Mask Register (0x3Ch) according to the register bits. Then set the IFI bits (Bits 4 - 0) in the Identifier Index Register (0x34h) to point this Identifier and its masking to one of the 32 register blocks. Also by setting the IFU bit (Bit 8) in the Identifier Index Register (0x34h) to one will store these info to the pointed register block. When filter is used, it should better start from register block 0.

Filter and mask truth table

Mask bit n	Filter bit n	Message Identifier bit n	Accept or Reject
0	0	0	Accept
		1	Reject
0	1	0	Reject
		1	Accept
1	0	0	Accept
		1	Accept
1	1	0	Accept
		1	Accept

Also prior to activation, you would need to consider if the transmit buffer will transmit the message according to the identifier field priority by setting TBP bit (Bit 6) to one in the Global Control Register (0x00h). If want to transmit message in the order of Transmit Buffer 0,1, and 2 (Transmit Buffer 0 has the highest priority), then set TBP bit to zero, which is the default.

Also prior to activation, you would need to consider when occurring arbitration lost and error will you want the controller to automatically retry the arbitration lost/error message again or not. When coming accross an arbitration lost, if you want the controller to automatically retry, please set ARE bit (Bit 7) in the Global Control Register (0x00h) to one, or else set it as zero. When encountering an error, if you want the controller to automatically retry, please set ERE bit (Bit 8) in the Global Control Register (0x00h) to one, or else set it as zero.

Also prior to activation, you would need to consider if you want the controller to enter power saving mode when there is no activity on the bus. If you want this function to work, please set PSE bit (Bit 24) in the Global Control Register (0x00h) to one, or else set to zero.

After finishing the above settings, you could set the CBA bit (Bit 1) in the Global Control Register (0x00h) to one. This will activate the controller into working mode. If you want to redo any of the above setting, please set the CBA bit back to zero. However setting this bit back to zero doesn't mean it would disactivate immidiately, for that the controller might be transmitting or receiving during the time of the setting to zero. It would need some time to go into disactivate. Please wait until you read back a zero in the CBA bit to confirm for the disactivation. Then simply set to one after finishing new configurations.

18.7.2 Transmitting a message:

If there is no message being sent during the time, store the message to TX Frame Control 0 (0x40h), TX ID 0 (0x44h), and TX Data 0 (0x48h & 0x4Ch). If there is any message that is set for transmission but has not yet finished transmitting, then store it into TX Frame Control 1 (0x50h), TX ID 1 (0x54h),

and TX Data 1 (0x58h & 0x5Ch). If this is also filled then store to TX Frame Control 2 (0x60h), TX ID 2 (0x64h), and TX Data 2 (0x68h & 0x6Ch).

After storing the message, remember to request the transmission by setting TBR0 (Bit 0), TBR1 (Bit 2), or TBR2 (Bit 4) in the Request Register (0x18h) to one according to the former positioning.

If you want to abort any of the requested transmission, you could set the TBA0 (Bit 1), TBA1 (Bit 3), or TBA2 (Bit 5) in the Request Register (0x18h) to one according to the one you want to abort. However, if the corresponding message has started transmitting, it will still finish transmitting and will not be aborted.

If the TX0I bit (Bit 1), TX1I bit (Bit 2), or TX2I bit (Bit 3) in the Interrupt Status Register (0x10h) is set to one, remember to check the corresponding Transmit Status 0 (0x1Ch), Transmit Status 1 (0x20h), or Transmit Status 2 (0x24h) for the information on the condition of the message that has been requested.

If completed without any error, TRC bit (Bit 0) and TC bit (Bit 2) will be set to one and the others are zero.

If completed with error and ERE bit (Bit 8) in the Global Control Register (0x00h) is set to zero, TRC bit (Bit 0) and BEO bit (Bit 5) will be one and the others are zero. If the ERE bit is set to one, then the message will retry until it completes without any error or an abort comes.

If arbitration lost and ARE bit (Bit 7) in the Global Control Register (0x00h) is set to zero, TRC bit (Bit 0) and ALO bit (Bit 4) will be one and the others are zero. If the ARE bit is set to one, then the message will retry and depending on how it finishes it would be completed with error or without error.

18.7.3 Receiving a message:

If the Receive Interrupt bit (Bit 0) in the Interrupt Status Register (0x10h) is one and the RBS bit (Bit 0) in the Receive Status Register (0x28h) is set to one, meaning that there is any pending message waiting to be read.

After reading the message from RX Frame Type (0x70h), RX ID (0x74h), and RX Data (0x78h & 0x7Ch), remember to set RRB bit (Bit 8) in the Request Register (0x18h) to one. This will release the currently pending message and would update newly stored or not yet read message in the controller. If not released, the controller will keep on sending out an interrupt saying that there is an unread message, but in fact the message has already been read.

19. PCI-e Target Register Definition

19.1 Configuration Space Register

31	16	15	00	Offset
Device ID (1210h)		Vendor ID (17F3h)		00h-03h
Status (0200h)		Command (0000h)		04h-07h
Base Class Code (07h)	Sub-class code (00h)	Program Interface (02h)	Revision ID (00h)	08h-0Bh
Built-in Self Test (00h)	Header Type (00h)	Latency Timer (00h)	Cache Line Size (00h)	0Ch-0Fh
Base Address Register (01h)				10h-13h
Reserved				14h-17h
Reserved				18h-2Bh
Sub-system Device ID (1210h)		Sub-system Vendor ID (17F3h)		2Ch-2Fh
Reserved				30h-33h
Reserved			Cap. Pointer (00h)	34h-37h
Reserved				38h-3Bh
MAX_LAT (00h)	MIN_GNT (00h)	Interrupt Pin (03h)	Interrupt Line (00h)	3Ch-3Fh
Reserved				40h-FFh
Reserved				44h-FFh

19.2 PCI Configuration Register

Register Offset: 43h - 40h

Register Name: EX System Status Reg

Reset Value: 00000000h

31 30 29 28 27 26 25 24 23 22 21 20 19 18 17 16 15 14 13 12 11 10 9 8 7 6 5 4 3 2 1 0

RSVD	EXSFS	RSVD	EUIS	EUIE	EXRST
------	-------	------	------	------	-------

Bit	Name	Attribute	Description
31-12	RSVD	RO	Reserved.
11-8	EXSFS	RO	EX Firmware Semaphore Flags. This Flags can be write in EX SB PCI CFG F1 6Ch[7-4].
7-3	RSVD	RO	Reserved.
2	EUIS	RW1C	EXSFS updated Interrupt Status. 0: EXSFS was not updated 1: EXSFS was updated
1	EUIE	R/W	EXSFS updated Interrupt Enable. 0: Disabled 1: Enabled
0	EXRST	RO	EX System Reset Release 0: EX System Reset Finished 1: EX System Reset Not Finished

19.3 IO Mapped Register Format

An output to this register stores a byte into the UART's transmit holding buffer. An input gets a byte from the receive buffer of the UART. These are two separate registers within the UART. To access this register, the Divisor Latch Access Bit (DLAB) must be zero. DLAB is bit 7 in the line control register 3.

I/O Port: Base Address + 0h
Register Name: Transmit/Receive Data Buffer (DLAB=0)
Reset Value: --



Bit	Name	Attribute	Description
7-0	TD/RD	RW	Read: This register holds the received incoming data byte. Write: This register contains the data byte to be transmitted.

The UART contains a programmable baud generator that is capable of taking any clock input from DC to 24 MHz and dividing it by any divisor from 2 to $2^{16}-1$. The output frequency of the baud generator is 16 X the baud [divisor # = (frequency input) / (baud rate X 16)]. Two 8-bit latches store the divisor in a 16-bit binary format. These divisor latches must be loaded during initialization to ensure proper operation of the baud generator. Upon loading either of the divisor latches, a 16-bit baud counter is immediately loaded. The Table listed below provides decimal divisors to use with crystal frequencies of 1.8432 MHz and 24 MHz, respectively. For baud rates of 38400 and below, the error obtained is minimal. The accuracy of the desired baud rate is dependent on the crystal frequency chosen. Using a divisor of zero is not recommended.

I/O Port: Base Address + 0h
Register Name: LSB of Baud Rate Generator Divisor Latches (DLAB=1)
Reset Value: 01h

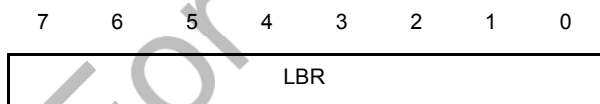

Bit	Name	Attribute	Description
7-0	LBR	R/W	This register contains the LSB (Least Significant Byte) of divisor latches.

Vortex86EX

32-Bit x86 Micro Processor

This register enables the five types of UART interrupts. Each interrupt can individually activate the interrupt (INTR) output signal. It is possible to totally disable the interrupt system by resetting bit 0 through 3 of the Interrupt Enable Register (IER). Similarly, setting bits of the IER register to a logic 1 enables the selected interrupt(s). Disabling an interrupt prevents it from being indicated as active in the IIR and from activating the INTR output signal. All other system functions operate in their normal manner, including the settings of the Line Status and MODEM Status Registers. Table II shows the contents of the IER. Details on each bit are listed as follows.

I/O Port: Base Address + 1h
Register Name: Interrupt Enable Register (DLAB=0)
Reset Value: 00h

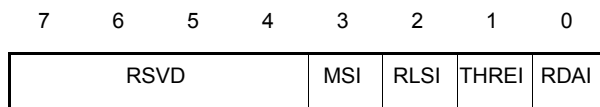

Bit	Name	Attribute	Description
7-4	RSVD	RO	Reserved. Must be always '0'
3	MSI	R/W	Modem Status Interrupt. 0: Disabled 1: Enabled
2	RLSI	R/W	Received Line Status Interrupt. 0: Disabled 1: Enabled
1	THREI	R/W	Transmitter Holding Register Empty Interrupt. 0: Disabled 1: Enabled
0	RDAI	R/W	Received Data Available Interrupt. 0: Disabled 1: Enabled

I/O Port: Base Address + 1h
Register Name: MSB of Baud Rate Generator Divisor Latches (DLAB=1)
Reset Value: 00h

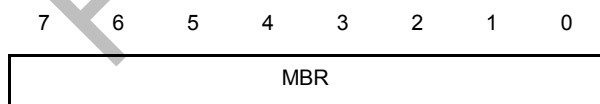

Bit	Name	Attribute	Description
7-0	MBR	R/W	This register contains the MSB (Most Significant Byte) of divisor latches.

In order to provide minimum software overhead during data character transfers, the UART prioritizes interrupts into four levels and records these in the interrupt Identification Register. The four levels of interrupt conditions in order of priority are Receiver Line Status, Received Data Ready, Transmitter Holding Register Empty, and MODEM Status.

When the CPU accesses the IIR, the UART freezes all interrupts and indicates the highest priority pending interrupt to the CPU. While this CPU access is occurring, the UART records new interrupts, but does not change its current indication until the access is complete. Table II shows the contents of the IIR. Details on each bit are listed as follows:

I/O Port: Base Address + 2h
Register Name: Interrupt Identification Register
Reset Value: 01h

7 6 5 4 3 2 1 0

FIFOE	RSVD	FIFOM	PT	IP
-------	------	-------	----	----

Bit	Name	Attribute	Description
7-6	FIFOE	RO	These two bits are set to '1' when the FIFO Control Register bit 0 = '1'.
5-4	RSVD	RO	Reserved. Must be returned all '0's.
3	FIFOM	RO	In non-FIFO Mode This bit is a '0'. In FIFO Mode This bit is set to '1' along with bit 2 when a timeout interrupt is pending
2-1	PT	RO	It indicates the Highest Priority Interrupt Pending. 00: Modem Status Interrupt (Lowest Priority) 01: Transmitter Holding Register Empty Interrupt 10: Received Data Ready Interrupt 11: Receiver Line Status Interrupt (Highest Priority)
0	IP	RO	Interrupt Pending. 0: Interrupt Pending 1: No Interrupt Pending

TABLE Interrupt Control Functions

FIFO Mode Only	Interrupt Identification Register			Interrupt Set and Reset Functions				
	Bit 3	Bit 2	Bit 1	Bit0	Priority Level	Interrupt Type	Interrupt Source	Interrupt Rest Control
	0	0	0	1	-	None	None	-
	0	1	1	0	Highest	received line status	overrun error, parity error, framing error or break Interrupt	reading the line status register
	0	1	0	0	Second	received data available	received data available or trigger level reached	reading the receiver buffer register or the FIFO dropping below the trigger level
	1	1	0	0	Second	character timeout Indication	no characters have been removed from or Input to the RCVR FIFO during the last 4 Characters times and there is at least 1 character in it during this time.	reading the receiver buffer register
	0	0	1	0	Third	transmitter holding register empty	transmitter holding register empty	reading the IIR register (if the source of interrupt is available) or writing into the transmitter holding register
	0	0	0	0	Fourth	MODEM Status	clear to send, data set ready , ring Indicator, or data carrier detect	reading the MODEM Status register

Vortex86EX

32-Bit x86 Micro Processor

This is a write only register at the same location as the IIR (the IIR is a read only register). This register is used to enable the FIFOs, clear the FIFOs, set the RCVR FIFO trigger level, and select the type of DMA signaling.

I/O Port: Base Address + 2h
Register Name: FIFO Control Register
Reset Value: 00h

7 6 5 4 3 2 1 0

TL	RSVD	CTF	CRF	FE
----	------	-----	-----	----

Bit	Name	Attribute	Description
7-6	TL	WO	These two bits are used to set the trigger level (bytes) for Receive FIFO interrupt 00: 1 byte 01: 4 bytes 10: 8 bytes 11: 14 bytes
5-3	RSVD	RO	Reserved.
2	CTF	WO	Writing a '1' to this bit will clear all bytes in transmitted FIFO and reset its counter to 0. The shift register is not cleared
1	CRF	WO	Writing a '1' to this bit will clear all bytes in received FIFO and reset its counter to 0. The shift register is not cleared
0	FE	WO	Setting this bit to a "1" enables both the transmitted and received FIFOs. Clearing this bit to a "0" disables both the transmitted and received FIFOs and clears all bytes from both FIFOs. When changing from FIFO Mode to non-FIFO (16450) mode, data are automatically cleared from the FIFOs. This bit must be a 1 when other bits in this register are written to or they will not be properly programmed.

Vortex86EX

32-Bit x86 Micro Processor

The system programmer specifies the format of the asynchronous data communications exchange and sets the Divisor Latch Access bit via the Line Control Register (LCR). The programmer can also read the contents of the Line Control Register. The read capability simplifies system programming and eliminates the need for separate storage in system memory of the line characteristics. Table II shows the contents of the LCR. Details on each bit are listed as follows:

I/O Port: Base Address + 3h
Register Name: Line Control Register
Reset Value: 00h

7	6	5	4	3	2	1	0
DLAB	BC	SP	EOP	PE	NSB	SCN	

Bit	Name	Attribute	Description
7	DLAB	R/W	Divisor Latch Access Bit (DLAB). It must be set to '1' to access the divisor latch of the baud generator during a Read or Write operation. It must be set to a '0' to access the Receive Buffer, the Transmitter Holding Register or the interrupt Enable Register.
6	BC	R/W	Break Control Bit. It causes a break condition to be transmitted to the receiving UART. 0: Disable the break 1: Force the serial out (SOUT) to the Spacing ('0') State
5	SP	R/W	This bit is the Stick Parity bit. When bits 3, 4 and 5 are logic 1s, the Parity bit is transmitted and checked as a '0'. If bits 3 and 5 are '1's and bit 4 is a '0', the Parity bit is transmitted and checked as a '1'. If bit 5 is a logic 0, Stick Parity is disabled.
4	EOP	R/W	Even/Odd Parity bit selected when parity is enabled 0: Odd parity selected 1: Even parity selected
3	PE	R/W	Parity Enabled/Disabled. 0: Parity disabled 1: Parity enabled When this bit is set to a '1', a parity bit will be generated between the last data word and STOP bit when data is being transmitted, and check the parity bit when data is being received.
2	NSB	R/W	Stop bit. This bit specifies the number of Stop bits transmitted and received in each serial character. Set 0: One Stop bit is generated in the transmitted data. Set 1: One and a half stop bits are generated for a 5-bit word length characters. Two stop bits are generated for either 6-, 7-, or 8-bit word length characters. The receiver checks the first Stop bit only, regardless of the number of Stop bits selected.

Vortex86EX

32-Bit x86 Micro Processor

Bit	Name	Attribute	Description
1-0	SCN	R/W	These two bits specify the number of bits in each transmitted and received serial characters. 00: 5 bits 01: 6 bits 10: 7 bits 11: 8 bits

This register controls the interface with the MODEM or data set (or a peripheral device emulating a MODEM). The contents of the MODEM Control Register are indicated in Table II and are described as below.

I/O Port: Base Address + 4h
Register Name: Modem Control Register
Reset Value: 00h

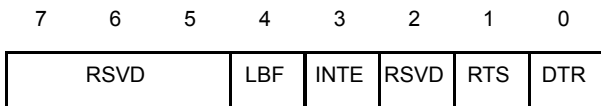

Bit	Name	Attribute	Description
7-5	RSVD	RO	Reserved. Must be all '0's
4	LBF	R/W	<p>This bit provides the loop back feature for diagnostic testing of the Serial Port. When this bit is set to '1', the following occurs:</p> <ol style="list-style-type: none"> 1) The Transmitter serial out (SOUT) is set to the Marking State ('1'). 2) The receiver Serial Input (SIN) is disconnected. 3) The output of the Transmitter Shift Register is "looped back" into the Receiver Shift Register input. 4) All MODEM Control inputs (CTS#, DSR#, RI# and DCD#) are disconnected. 5) The four MODEM Control outputs (DTR#, RTS#, OUT1 and OUT2) are internally connected to the four MODEM Control inputs (CTS#, DSR#, RI# and DCD#). 6) The Modem Control output pins are forced to be inactive high. 7) Data transmitted are immediately received. <p>This feature allows the processor to verify the transmit- and receive-data paths of the Serial Port. In the diagnostic mode, the receiver and the transmitter interrupts are fully operational. The MODEM Control Interrupts are also operational but the interrupts' sources are now the lower four bits of the MODEM Control Register instead of the MODEM Control inputs. The interrupts are still controlled by the Interrupt Enable Register.</p>
3	INTE	R/W	Interrupt Enable. This bit is used to enable a UART interrupt. When OUT2 is a '0', the serial port interrupt output is forced to the high impedance state - disabled. When OUT2 is a '1', the serial port interrupt output is enabled.
2	RSVD	RO	Reserved.

Vortex86EX

32-Bit x86 Micro Processor

Bit	Name	Attribute	Description
1	RTS	R/W	This bit controls the Request To Send (RTS#) output. When this bit is set to a '1', the RTS# output is forced to a '0'. When this bit is a '0', the RTS# output is forced to a '1'.
0	DTR	R/W	This bit controls the Data Terminal Ready (DTR#) output. When this bit is set to a '1', the DTR# output is forced to a '0'. When this bit is a '0', the DTR# output is forced to a '1'.

This register provides status information to the CPU concerning the data transfer.

I/O Port: Base Address + 5h
Register Name: Line Status Register
Reset Value: 60h

7	6	5	4	3	2	1	0
EB	TEMT	THRE	BI	FE	PE	OE	DR

Bit	Name	Attribute	Description
7	EB	R/W	This bit is permanently set to a logic "0" in the 450 mode. In the FIFO mode, this bit is set to a logic "1" when there is at least one parity error, framing error or break indication in the FIFO. This bit is cleared when the LSR is read if there are no subsequent errors in the FIFO.
6	TEMT	R/W	Transmitter Empty (TEMT). This bit is set to a '1' whenever the Transmitter Holding Register (THR) and Transmitter Shift Register (TSR) are both empty. It is reset to a '0' whenever either the THR or TSR contains a data character. This bit is a read only bit. In the FIFO mode, this bit is set whenever the THR and TSR are both empty,
5	THRE	R/W	Transmitter Holding Register Empty (THRE). This bit indicates that the Serial Port is ready to accept a new character for transmission. In addition, this bit causes the Serial Port to issue an interrupt when the Transmitter Holding Register interrupt enable is set high. The THRE bit is set to a '1' when a character is transferred from the Transmitter Holding Register into the Transmitter Shift Register. This bit is reset to '0' whenever the CPU loads the Transmitter Holding Register. In the FIFO mode, this bit is set when the transmit FIFO is empty. It is cleared when at least 1 byte is written to the transmit FIFO. This bit is a read only bit.

Vortex86EX

32-Bit x86 Micro Processor

Bit	Name	Attribute	Description
4	BI	R/W	Break Interrupt (BI) . This bit is set to a '1' whenever the received data input is held in the Spacing state ('0') for longer than a full word transmission time (that is, the total time of the start bit + data bits + parity bits + stop bits). The BI is reset after the CPU reads the contents of the Line Status Register. In the FIFO mode, this error is associated with the particular character in the FIFO it applies to. This error is indicated when the associated character is at the top of the FIFO. When a break occurs, only one zero character is loaded into the FIFO. Restarting after a break is received requires the serial data (RXD) to be '1' for at least 1/2 bit time.
3	FE	R/W	Framing Error (FE) . This bit indicates that the received character does not have a valid stop bit. This bit is set to a '1' whenever the stop bit following the last data bit or parity bit is detected as a zero bit (Spacing level). The FE is reset to a '0' whenever the Line Status Register is read. In the FIFO mode, this error is associated with the particular character in the FIFO it applies to. This error is indicated when the associated character is at the top of the FIFO. The Serial Port will try to resynchronize after a framing error. To do this, it assumes that the framing error was due to the next start bit, so it samples this 'start' bit twice and then takes in the 'data'.
2	PE	R/W	Parity Error (PE) . This bit indicates that the received data character does not have the correct even or odd parity, as selected by the even parity select bit. The PE is set to a '1' upon detection of a parity error and is reset to a '0' whenever the Line Status Register is read. In the FIFO mode, this error is associated with the particular character in the FIFO it applies to. This error is indicated when the associated character is at the top of the FIFO.
1	OE	R/W	Overrun Error (OE) . This bit indicates that the data in the Receiver Buffer Register were not read before the next character was transferred into the register, thereby destroying the previous character. In FIFO mode, an overrun error will occur only when the FIFO is full and the next character has been completely received in the shift register. The character in the shift register is overwritten but not transferred to the FIFO. The OE indicator is set to a '1' immediately upon detection of an overrun condition, and reset whenever the Line Status Register is read.
0	DR	R/W	Data Ready (DR) . It is set to a '1' whenever a complete incoming character has been received and transferred into the Receiver Buffer Register or the FIFO. This bit is reset to a '0' by reading all of the data in the Receiver Buffer Register or the FIFO.

Vortex86EX

32-Bit x86 Micro Processor

This register provides the current state of the control lines from the MODEM (or peripheral device) to the CPU. In addition to this current-state information, four bits of the MODEM Status Register provide change information. These bits are set to logic 1s whenever a control input from the MODEM changes state. They are reset to logic 0s whenever the CPU reads the MODEM Status Register. The contents of the MODEM Status Register are indicated in Table II and described as below.

I/O Port: Base Address + 6h
Register Name: Modem Status Register
Reset Value: x0h

7	6	5	4	3	2	1	0
DCD	RI	DSR	CTS	DDCD	TERI	DDSR	DCTS

Bit	Name	Attribute	Description
7	DCD	RW	This bit is the complement of the Data Carrier Detect (DCD#) input. If bit 4 of the MCR is set to '1', this bit is equivalent to OUT2 in the Modem Control Register.
6	RI	RW	This bit is the complement of the Ring Indicator (RI#) input. If bit 4 of the MCR is set to '1', this bit is equivalent to OUT1 in the Modem Control Register.
5	DSR	RW	This bit is the complement of the Data Set Ready (DSR#) input. If bit 4 of the MCR is set to '1', this bit is equivalent to DTR# in the Modem Control Register.
4	CTS	RW	This bit is the complement of the Clear To Send (CTS#) input. If bit 4 of the MCR is set to '1', this bit is equivalent to RTS# in the Modem Control Register.
3	DDCD	RW	Delta Data Carrier Detect (DDCD). This bit is set to '1' whenever the DCD# input to the chip has changed the state since the last time the MSR (Modem Status Register) was read. It is reset to a '0' whenever the MODEM Status Register is read.
2	TERI	RW	Trailing Edge of Ring Indicator (TERI). This bit is set to '1' whenever the RI# input has been changed from '0' to '1'. It is reset to '0' whenever the MODEM Status Register is read.
1	DDSR	RW	Delta Data Set Ready (DDSR). This bit indicates that the DSR# input to SoC has changed the state since the last time the MSR (Modem Status Register) was read. This bit is set to '1' whenever DSR# input from the MODEM has changed the state. It is reset to '0' whenever the MODEM Status Register is read.
0	DCTS	RW	Delta Clear To Send (DCTS). This bit indicates that the CTS# input to the SoC has changed the state since the last time the MSR (Modem Status Register) was read. This bit is set to '1' whenever CTS# input from the MODEM has changed the state. It is reset to '0' whenever the MODEM Status Register is read.

Note: Whenever bit 0, 1, 2 or 3 is set to a logic "1", a MODEM Status Interrupt is generated.

Vortex86EX

32-Bit x86 Micro Processor

This 8-bit Read/Write Register does not control the UART in any way. It is intended as a scratchpad register used by the programmer to hold data temporarily.

I/O Port: Base Address + 7h
Register Name: Scratchpad Register
Reset Value: --

7 6 5 4 3 2 1 0

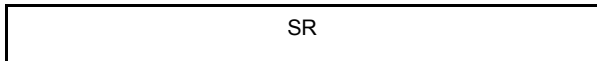

Bit	Name	Attribute	Description
7-0	SR	R/W	This 8-bit read/write register has no effect on the operation of the Serial Port. It is intended as a scratchpad register to be used by the programmer to hold data temporarily.

20. MISC Control Unit

20.1 Overview

A MISC control unit provides Motion Controller and Full-Duplex SPI .

20.2 Features

Support 4 Motion Controllers (Bus 0, Device 16, Function 0)

Support one Full-Duplex SPI (Bus 0, Device 16, Function 1)

20.3 MISC PCI Configuration Registers Definition

20.3.1 Motion Controller Configuration Space Register

31	16	15	00	Offset
Device ID (1331h)		Vendor ID (17F3h)		00h-03h
Status (0200h)		Command (0000h)		04h-07h
Base Class Code (FFh)	Sub-class code (FFh)	Program Interface (00h)	Revision ID (00h)	08h-0Bh
Built-in Self Test (00h)	Header Type (80h)	Latency Timer (00h)	Cache Line Size (00h)	0Ch-0Fh
I/O Base Address Register (01h)				10h-13h
Memory Base Address Register (00h)				14h-17h
Reserved				18h-2Bh
Sub-system Device ID (1330h)		Sub-system Vendor ID (17F3h)		2Ch-2Fh
Reserved				30h-33h
Reserved			Cap. Pointer (00h)	34h-37h
Reserved				38h-3Bh
MAX_LAT (00h)	MIN_GNT (00h)	Interrupt Pin (01h)	Interrupt Line (00h)	3Ch-3Fh
Register R/W Control (00h)	Test Mode Enable (00h)	MC Power Down (0000h)		40h-43h
Reserved	MC Port State Control (000000h)			44h-47h
Reserved				48h-FFh

20.3.2 Full-Duplex SPI Configuration Space Register

31	16	15	00	Offset
Device ID (1710h)		Vendor ID (17F3h)		00h-03h
Status (0200h)		Command (0000h)		04h-07h
Base Class Code (FFh)	Sub-class code (FFh)	Program Interface (00h)	Revision ID (01h)	08h-0Bh
Built-in Self Test (00h)	Header Type (00h)	Latency Timer (00h)	Cache Line Size (00h)	0Ch-0Fh
Base Address Register (01h)				10h-13h
Base Address Register (00h)				14h-17h
Reserved				18h-2Bh
Sub-system Device ID (1710h)		Sub-system Vendor ID (17F3h)		2Ch-2Fh
Reserved				30h-33h
Reserved			Cap. Pointer (00h)	34h-37h
Reserved				38h-3Bh
MAX_LAT (00h)	MIN_GNT (00h)	Interrupt Pin (02h)	Interrupt Line (00h)	3Ch-3Fh
Register R/W Control (00h)	Reserved			40h-FFh

20.4 Full-Duplex SPI Controller

20.4.1 Timing diagram for each mode

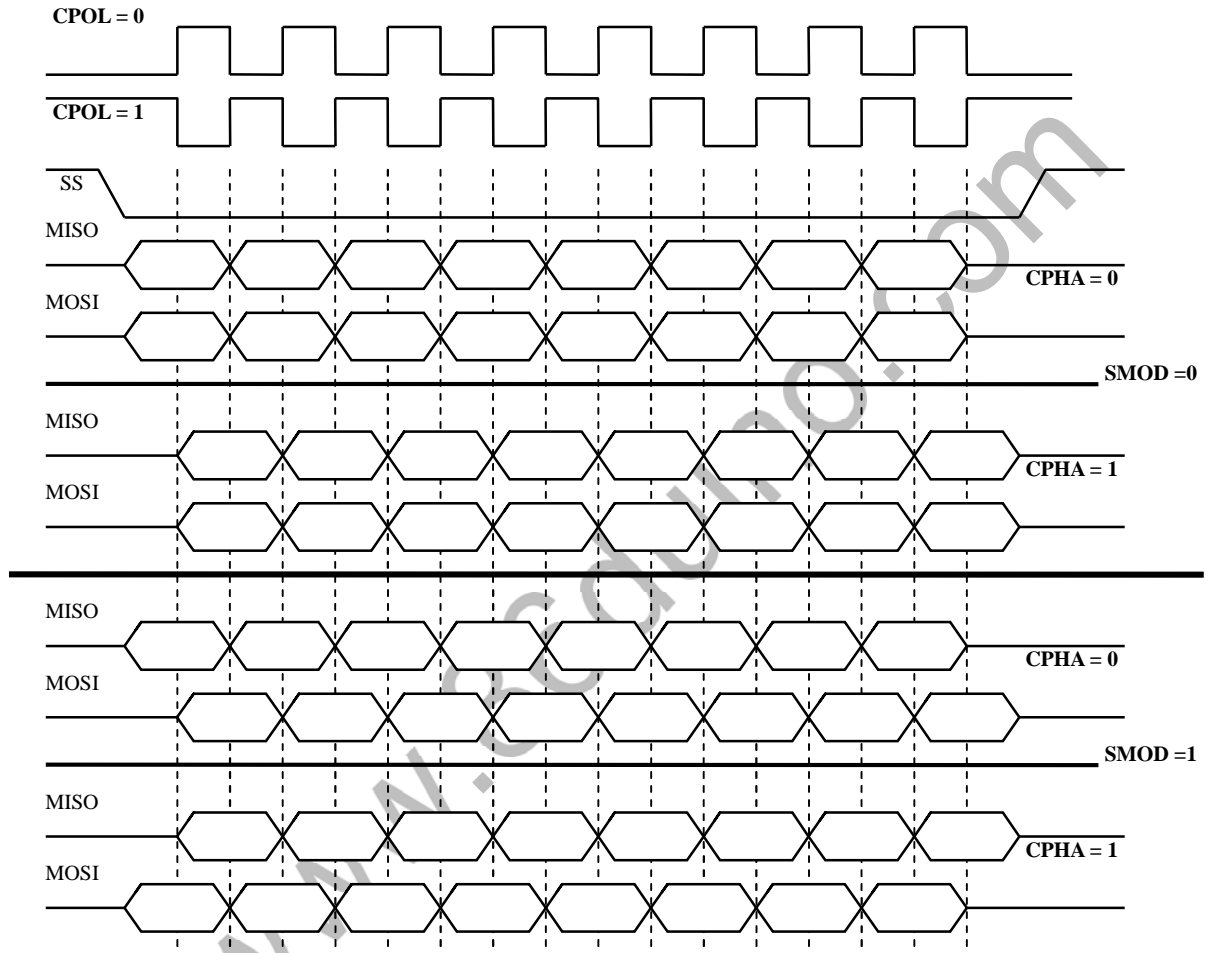

20.4.2 Block diagram

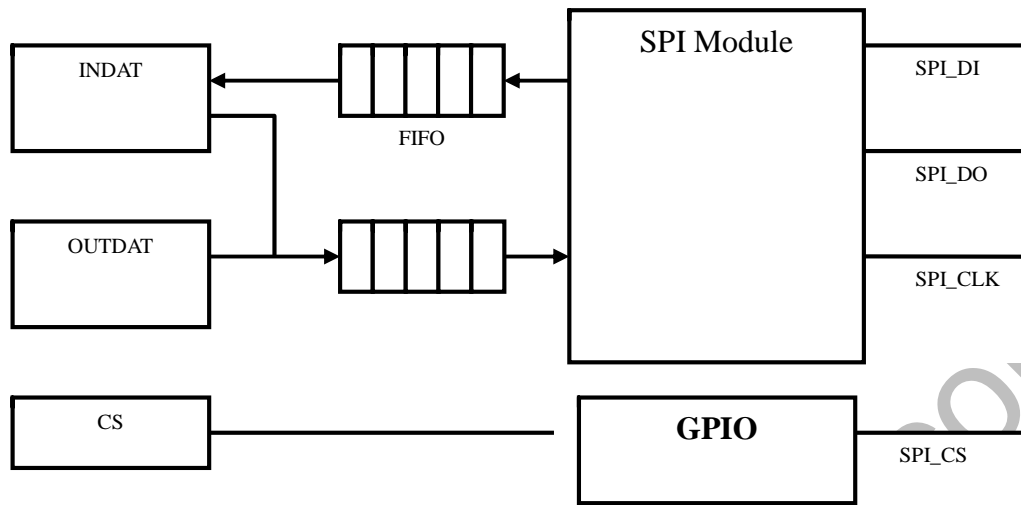

20.4.3 IO/Memory Mapped Registers Definition

Register Offset: BASE_ADDR+00h
Register Name: SPI Output Data Register
Reset Value: --

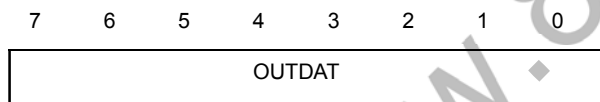

Bit	Name	Attribute	Description
7-0	OUTDAT	WO	Half-duplex mode: Data output to SPI when WRITE. No functioning when READ. Full-duplex mode: Data exchange when WRITE. No functioning when READ.

Register Offset: BASE_ADDR+01h
Register Name: SPI Input Register
Reset Value: FFh

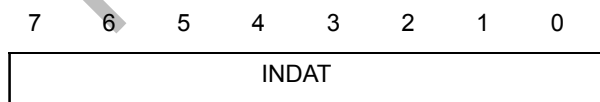

Bit	Name	Attribute	Description
7-0	INDAT	R/W	Half-duplex mode: Data input from SPI when read. Preload data from SPI when write. Full-duplex mode: Data input from SPI when read.

It is not recommended to modify this register when SPI operation.

Register Offset: BASE_ADDR+02h
Register Name: SPI FIFO & Clock Divide Low Byte Register
Reset Value: 12h

7	6	5	4	3	2	1	0
RSVD			FIEN	CKDIV_L			

Bit	Name	Attribute	Description
7-4	RSVD	RO	Reserved.
4	FIEN	R/W	FIFO mode enable when set.
3-0	CKDIV_L	R/W	SPI Clock Divided Low Byte. The SPI clock is SOURCE clock/(2 * SPI clock divided) , 0 is not allowed. H/W will auto change to 1 when CKDIV_H=0, CKDIV_M=0 and CKDIV_L=0 , therefore the programming flow of set SPI clock will be write CKDIV_H and CKDIV_M first then CKDIV_L.

Register Offset: BASE_ADDR+03h
Register Name: SPI Status Register
Reset Value: 18h

7	6	5	4	3	2	1	0
BUSY	OFIFU	IDR	TDC	OFIFE	IFIFU	RSVD	

Bit	Name	Attribute	Description
7	BUSY	RO	SPI controller is BUSY .
6	OFIFU	RO	Output FIFO Full.
5	IDR	RO	FIFO Disabled: Input Data Ready when set FIFO Enabled: Input FIFO not empty when set.
4	TDC	RO	Transmission complete: FIFO disable ħ SPI idle FIFO enable ħ SPI idle + out FIFO empty
3	OFIFE	RO	Output FIFO Empty.
2	IFIFU	RO	Input FIFO Full.
1-0	RSVD	RO	Reserved.

Vortex86EX

32-Bit x86 Micro Processor

Register Offset: BASE_ADDR+04h
Register Name: SPI Chip Select Register
Reset Value: 01h

7 6 5 4 3 2 1 0

RSVD	CS2	CS1
------	-----	-----

Bit	Name	Attribute	Description
7-2	RSVD	RO	Reserved.
1	CS2	R/W	0: SPI CS2# is low, 1: SPI CS2# is high
0	CS1	R/W	0: SPI CS# is low, 1: SPI CS# is high

Register Offset: BASE_ADDR+05h
Register Name: SPI Error Status Register
Reset Value: 00h

7 6 5 4 3 2 1 0

RSVD	WCTE	DOLE	FIURE	FIORE	RVSD
------	------	------	-------	-------	------

Bit	Name	Attribute	Description
7-5	RSVD	RO	Reserved.
4	WCTE	R/WC	Error status 4, Write SPI Control Register when controller is busy. Write 1 to clear.
3	DOLE	R/WC	Error status3, Input data overlap/FIFO over-run . Write 1 to clear.
2	FIORE	R/WC	Error status2, Read a invalid data/Input FIFO under-run . Write 1 to clear.
1	OPIORE	R/WC	Error status1, Output FIFO over-run . Write 1 to clear.
0	RSVD	RO	Reserved.

Register Offset: BASE_ADDR+06h
Register Name: SPI Clock Divide High Byte Register
Reset Value: 00h

It is not recommended to modify this register when SPI operation.

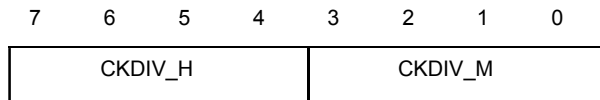

Bit	Name	Attribute	Description
7-4	CKDIV_H	R/W	SPI clock divided high nibble. The SPI clock is SOURCE clock/(2 * SPI clock divided) , 0 is not allowed. H/W will auto change to 1 when CKDIV_H=0, CKDIV_M=0 and CKDIV_L=0 , therefore the programming flow of set SPI clock will be write CKDIV_H and CKDIV_M first then CKDIV_L.
3-0	CKDIV_M	R/W	SPI clock divided middle nibble. The SPI clock is SOURCE clock/(2 * SPI clock divided) , 0 is not allowed. H/W will auto change to 1 when CKDIV_H=0, CKDIV_M=0 and CKDIV_L=0 , therefore the programming flow of set SPI clock will be write CKDIV_H and CKDIV_M first then CKDIV_L.

Register Offset: BASE_ADDR+07h
Register Name: SPI Control Register
Reset Value: 00h

It is not recommended to modify this register when SPI operation.

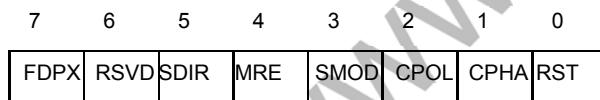

Bit	Name	Attribute	Description
7	FDPX	R/W	Full-Duplex mode 0:Disable full-duplex mode 1:Enable full-duplex mode
6	RSVD	RO	Reserved.
5	SDIR	R/W	Shift Direction 0: MSB is shifted out first. 1: LSB is shifted out first.
4	MRE	R/W	Multi-Read Enable bit, this bit no effect in full-duplex mode 0: SPI will read 1 byte data from slave device after write INDAT register. 1: SPI will read N byte data from slave device after wirt the value N to INDATA register. Before Multi-Read from slave device, please sure FIFO has enough space to store income data.After all the data read into FIFO, the TDC bit of STATUS

Vortex86EX

32-Bit x86 Micro Processor

			<p>register assert.</p> <p>Detail about N please refer to follows:</p> <p>N = 0 : read 1 byte</p> <p>N = 1~16: read 1~16 byte from slave device.</p> <p>N>16: read 1 byte</p>
3	SMOD	R/W	<p>Special Mode.</p> <p>0: Disable(TX & RX on same edge of clock)</p> <p>1: Enabled(TX & RX on different edge of clock)</p>
2	CPOL	R/W	<p>Clock Polarity.</p> <p>0: data is read on the clock's rising edge (low->high transition) and data is changed on a falling edge (high->low clock transition).</p> <p>1: data is read on the clock's falling edge and data is changed on a rising edge.</p>
1	CPHA	R/W	<p>Clock Phase.</p> <p>0:Sample on the leading (first) clock edge</p> <p>1:Sample on the trailing (second) clock edge</p>
0	RST	R/W	<p>Reset bit for the SPI module.</p> <p>0:SPI is out of reset state</p> <p>1:SPI is in reset state</p>

Register Offset: BASE_ADDR+08h
Register Name: SPI INT Enable Register
Reset Value: 00h

7	6	5	4	3	2	1	0
IFURIE	IFORIE	IFUIE	RSVD	OFEIE	OFORIE	OFUIE	ODCIE

Bit	Name	Attribute	Description
7	IFURIE	R/W	Input FIFO Under-run.
6	IFORIE	R/W	Input FIFO Over-run.
5	IFUIE	R/W	Input FIFO Full.
4	RSVD	RO	Reserved.
3	OFEIE	R/W	Output FIFO Empty.
2	OFORIE	R/W	Output FIFO Over-run.
1	OFUIE	R/W	Output FIFO Full.
0	TDCIE	R/W	Transfer Data Complete.

Vortex86EX

32-Bit x86 Micro Processor

Register Offset: BASE_ADDR+09h
Register Name: SPI INT Status Register
Reset Value: 00h

7	6	5	4	3	2	1	0
IFUR	IFOR	IFU	RSVD	OFE	DFOR	OFU	TDC

Bit	Name	Attribute	Description
7	IFUR	RC	<i>Input FIFO Under-run.</i>
6	IFOR	RC	<i>Input FIFO Over-run.</i>
5	IFU	RC	<i>Input FIFO Full.</i>
4	RSVD	RO	<i>Reserved.</i>
3	OFE	RC	<i>Output FIFO Empty</i>
2	DFOR	RC	<i>Output FIFO Over-run.</i>
1	OFU	RC	<i>Output FIFO Full.</i>
0	TDC	RC	<i>Transfer Data Complete/ DMA done.</i>

Register Offset: BASE_ADDR+0Bh
Register Name: SPI Delayed transfer control register
Reset Value: 00h

7	6	5	4	3	2	1	0
DTC							

Bit	Name	Attribute	Description
7-0	DTC	R/W	The DTC register bits (7-0) define the delay between two transfers. The delay is defined in number SPI serial clock cycles.

Register Offset: BASE_ADDR+0Ch
Register Name: SPI Read Write extended register
Reset Value: 00h

31	30	29	28	27	26	25	24	23	22	21	20	19	18	17	16	15	14	13	12	11	10	9	8	7	6	5	4	3	2	1	0
RWEXT																															

Bit	Name	Attribute	Description
31-0	RWEXT	R/W	An extended IN/OUT data register for reduce processor overhead: DWORD size access: Read/write 4 byte from SPI input/output FIFO, before read/write to this register please sure the FIFO has enough data/space. WORD size access: Read/write 2 byte from SPI input/output FIFO, before read/write to this register

			<p>please sure the FIFO has enough data/space.</p> <p>BYTE size access:</p> <p>Read/write 1 byte from SPI input/output FIFO, before read/write to this register</p> <p>please sure the FIFO has enough data/space.</p>
--	--	--	--

For www.86duino.com

21. Electrical Specifications

21.1 Performance Characteristics

Core Voltage	System clock	Core Frequency	Max Power	Typ Power
1.2V (Nominal)	25MHz	400MHz	3 Watt	2 Watt

21.2 Absolute Maximum Ratings

Symbol	Parameter	Min.	Max.	Unit	Conditions
TA	Ambient Temperature	-40	85	°C	Temperature of the surrounding medium
Tstg	Storage Temperature	-40	125	°C	Dry Pack.
VDD12	SB Core power	-0.3	1.26	V	
DIF_VD12IO	Differential PAD	-0.3	1.26	V	
AFE_VCCDL12	Ethernet PHY Digital Logic Cell Core	-0.3	1.26	V	
AVDD_USB12	USB 1.2V Power	-0.3	1.26	V	
AVDD_USBPLL12	USB PLL Power	-0.3	1.26	V	
AVDD_SATA12	SATA PHY: 1.2V Analogue Power	-0.3	1.26	V	
AVDD_SATARX12	SATA PHY: Receiver 1.2V Analogue Power	-0.3	1.26	V	
AVDD_SATAPLL12	SATA PHY: PLL 1.2V Analogue Power	-0.3	1.26	V	
AVDD_PE12	PCIE 1.2V Power	-0.3	1.26	V	
AVDD_PERX12	PCIE Receiver 1.2V Power	-0.3	1.26	V	
VDD18	SB Analogue Power	-0.3	1.89	V	
AFE_VCCABG18	Ethernet PHY Band Gap 1.8V Power	-0.3	1.89	V	
AFE_VCCAPLL18	Ethernet PHY PLL 1.8V Power	-0.3	1.89	V	
AFE_VCCD18	Ethernet PHY 1.8V Power	-0.3	1.89	V	
AFE_RXVCCA18	Ethernet PHY Receiver 1.8V Power	-0.3	1.89	V	

Vortex86EX

32-Bit x86 Micro Processor

VCC18A_TEMP	Temperature Sensor 1.8V Power	-0.3	1.89	V	
VCC18D_TEMP	Temperature Sensor 1.8V Power	-0.3	1.89	V	
VCC18A_PLL5	Internal PLL 1.8V Power	-0.3	1.89	V	
VCC18A_PLL7	Internal PLL 1.8V Power	-0.3	1.89	V	
RTC_VDD33	Battery power for RTC	-0.3	3.6	V	
VDD33	I/O PAD Power	-0.3	3.63	V	
ADC_VCC33A_VREFP	ADC 3.3V Power	-0.3	3.63	V	
ADC_VCC33A	ADC 3.3V Analogue Power	-0.3	3.63	V	
ADC_VCC33D	ADC 3.3V Digital Power	-0.3	3.63	V	
AVDD_USB33	USB 3.3V Power	-0.3	3.63	V	
AVDD_USBBAS33	USB Base Voltage 3.3V Power	-0.3	3.63	V	
AVDD_SATA33	SATA PHY: 3.3V Analogue Power	-0.3	3.63	V	
AVDD_PE33	PCIE 3.3V Power	-0.3	3.63	V	
Vmax	Other digital function pins	-0.3	3.8	V	

21.3 Recommended DC Operating Conditions (T_A)

Symbol	Parameter	Min.	Typ.	Max.	Unit	Conditions
Vil	Input Low Voltage	--	0	0.8	V	
Vih	Input High Voltage	2.5	3.3	--	V	
VDD12	SB Core power	1.14	1.2	1.26	V	
DIF_VD12IO	Differential PAD	1.14	1.2	1.26	V	
AFE_VCCDL12	Ethernet PHY Digital Logic Cell Core	1.14	1.2	1.26	V	
AVDD_USB12	USB 1.2V Power	1.14	1.2	1.26	V	
AVDD_USBPLL12	USB PLL Power	1.14	1.2	1.26	V	
AVDD_SATA12	SATA PHY: 1.2V Analogue Power	1.14	1.2	1.26	V	
AVDD_SATARX12	SATA PHY: Receiver 1.2V Analogue Power	1.14	1.2	1.26	V	
AVDD_SATAPLL12	SATA PHY: PLL 1.2V Analogue Power	1.14	1.2	1.26	V	
AVDD_PE12	PCIE 1.2V Power	1.14	1.2	1.26	V	
AVDD_PERX12	PCIE Receiver 1.2V Power	1.14	1.2	1.26	V	
VDD18	SB Analogue Power	1.71	1.8	1.89	V	
DVDD18	DDR Power	1.71	1.8	1.89	V	
AFE_VCCABG18	Ethernet PHY Band Gap 1.8V Power	1.71	1.8	1.89	V	
AFE_VCCAPLL18	Ethernet PHY PLL 1.8V Power	1.71	1.8	1.89	V	
AFE_VCCD18	Ethernet PHY 1.8V Power	1.71	1.8	1.89	V	
AFE_RXVCCA18	Ethernet PHY Receiver 1.8V Power	1.71	1.8	1.89	V	
VCC18A_TEMP	Temperature Sensor 1.8V Power	1.71	1.8	1.89	V	
VCC18D_TEMP	Temperature Sensor 1.8V Power	1.71	1.8	1.89	V	
VCC18A_PLL5	Internal PLL 1.8V Power	1.71	1.8	1.89	V	
VCC18A_PLL7	Internal PLL 1.8V Power	1.71	1.8	1.89	V	
RTC_VDD33	Battery power for RTC	2.45	3	3.3	V	
VDD33	I/O PAD Power	3.0	3.3	3.6	V	
ADC_VCC33A_VREFP	ADC 3.3V Power	3.0	3.3	3.6	V	
ADC_VCC33A	ADC 3.3V Analogue	3.0	3.3	3.6	V	

Symbol	Parameter	Min.	Typ.	Max.	Unit	Conditions
	Power					
ADC_VCC33D	ADC 3.3V Digital Power	3.0	3.3	3.6	V	
AVDD_USB33	USB 3.3V Power	3.0	3.3	3.6	V	
AVDD_USBBAS33	USB Base Voltage 3.3V Power	3.0	3.3	3.6	V	
AVDD_SATA33	SATA PHY: 3.3V Analogue Power	3.0	3.3	3.6	V	
AVDD_PE33	PCIE 3.3V Power	3.0	3.3	3.6	V	

21.4 DC Characteristics

Symbol	Parameter	Min.	Max.	Unit	Conditions
V _{ol}	Output Low Voltage	--	0.4	V	I _{OL} =5mA
V _{oh}	Output High Voltage	2.4	--	V	I _{OH} =-2Ma
I _{in}	Input leakage current for all input pins (except those with pull up/down resistors)		±10	uA	0 <V _{IN} < VDD33
I _{inp}	Input leakage current for all input pins with pull up/down resistors		±44	uA	0 <V _{IN} < VDD33
C _{pin}	Pin capacitance		3.1	Pf	
I _{bat}	Battery standby current for RTC		2.5	uA	VDD_BAT = 3V

21.5 Temperature

Symbol	Parameter	Typ.	Unit	Conditions
T _{cop}	Case Surface Operating Temperature (case top)	60	°C	Ambient Temperature = 25°C Open case testing. Note 2.
T _A	Ambient Operating Temperature	-40 ~ 85	°C	Temperature of the surrounding medium
T _{stg}	Storage Temperature	-40~125	°C	Dry Pack.

Notes:

- The IC should be mounted on PCB within 7 days after the dry pack is opened. If the IC is out of dry pack more than 7 days, it should be burned in oven (+125°C, > 12 hours) before mounted on PCB.

2. T_{cop} depends on the number of PCB layers, PCB size, system loading, working voltage and running pattern. The condition is for 4-layer A4-size PCB at typical working voltage.

For www.86duino.com

22. AC Electrical Characteristics

22.1 System Reset

22.1.1 Normal System Reset

Symbol	Parameter	Min.	Max.	Unit	Notes
T1	PWRGOOD active to DRAMCLK output stable	256.17		ms	
T2	PWRGOOD active to PCIRST# ready	250		ms	
T3	PWRGOOD active to first code fetch command		252.2	ms	

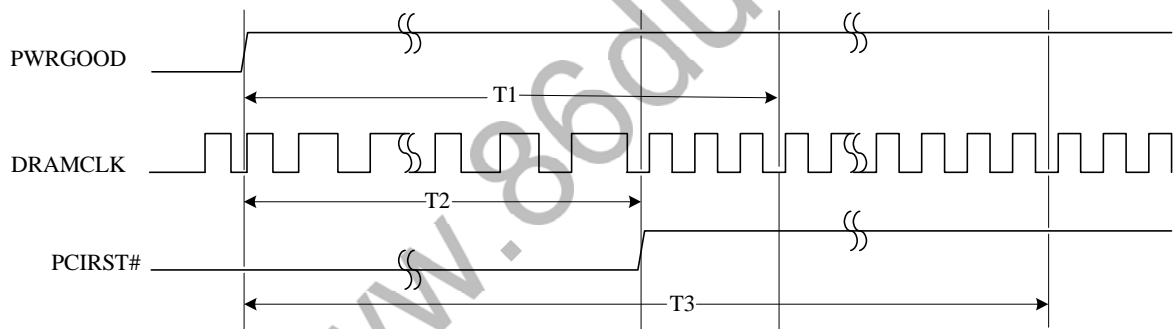

22.1.2 Fast System Reset

Symbol	Parameter	Min.	Max.	Unit	Notes
T1	PWRGOOD active to DRAMCLK output stable	4.97		ms	
T2	PWRGOOD active to PCIRST# ready	2.8		ms	
T3	PWRGOOD active to first code fetch command		5	ms	

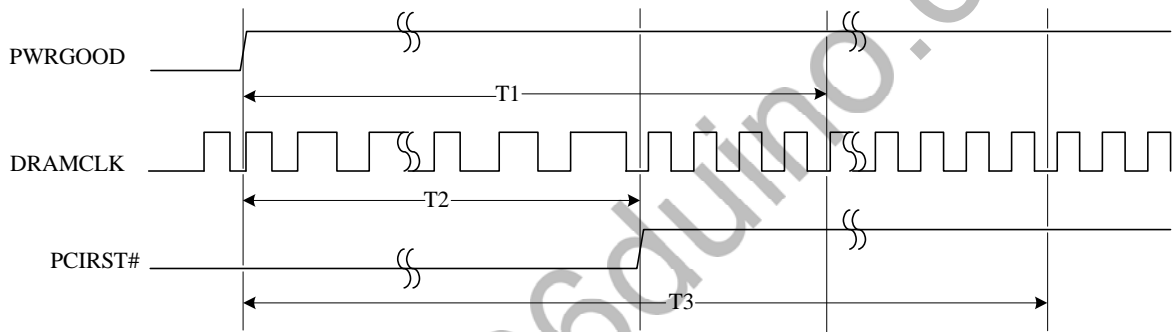

22.2 DDRIII Interface

Read data

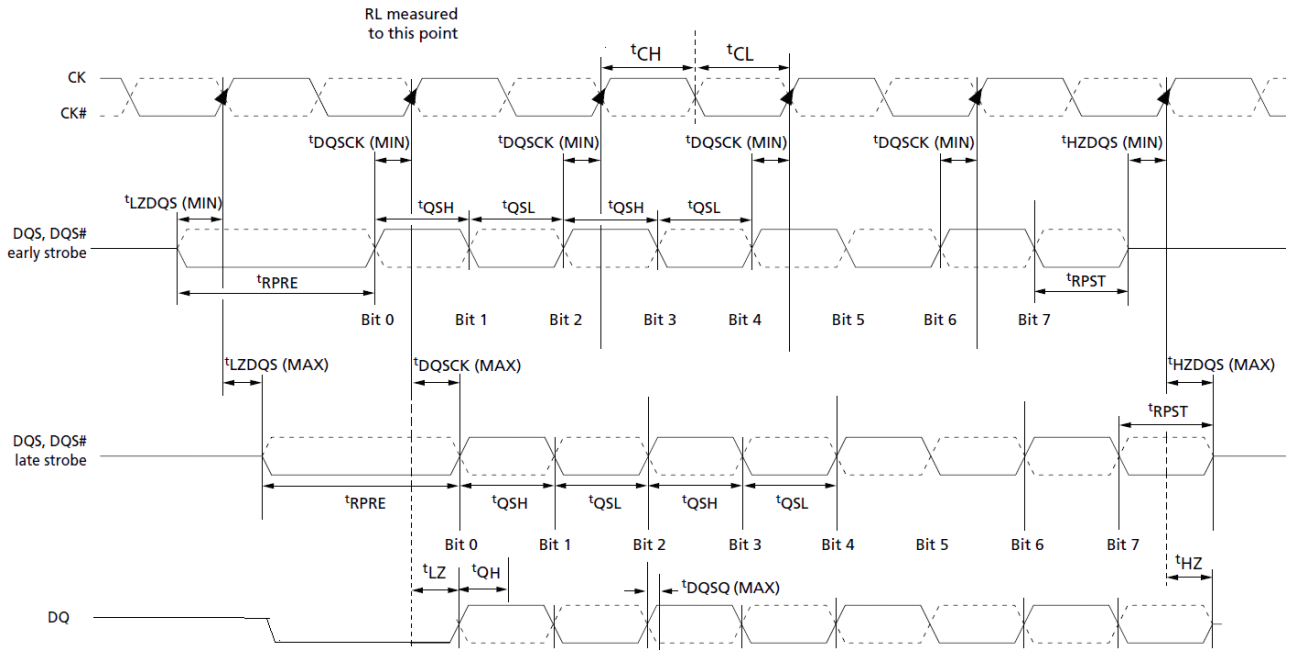

Write data

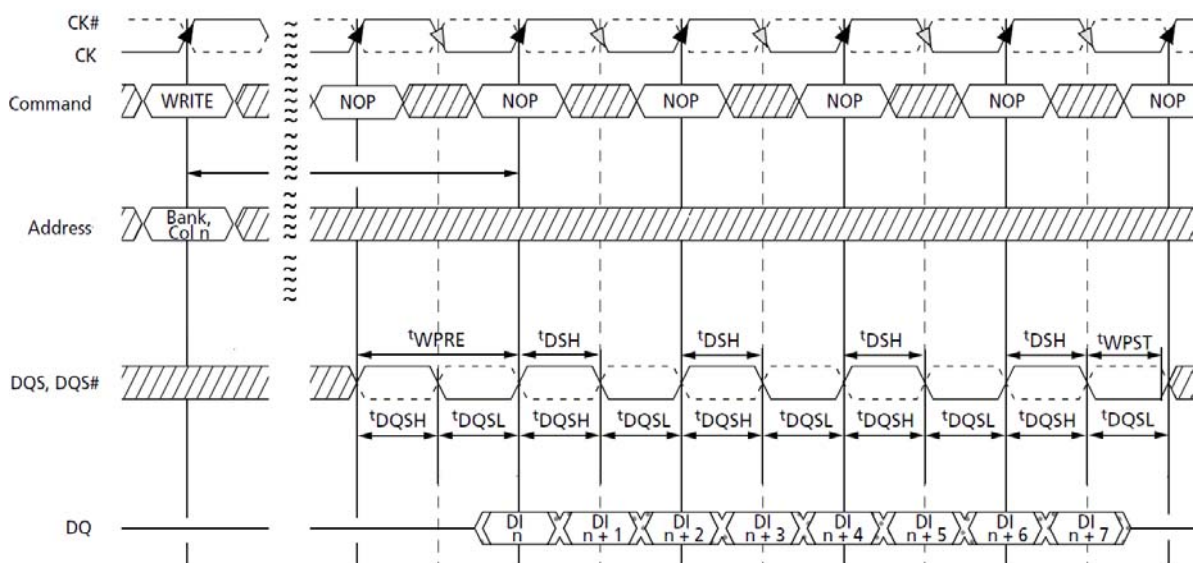

Vortex86EX

32-Bit x86 Micro Processor

Parameter	Symbol	Min	Max	units
CK high-level width	tCH	0.45	0.55	tCK
CK low-level width	tCL	0.45	0.55	tCK
CK half period	tHP	Min(tCL,tCH)	X	ps
DQ access time from CK	tAC	-600	+600	Ps
Data-out high-impedance window from CK/CK#	tHZ		tAC MAX	
Data-out low-impedance window from CK/CK#	tLZ	tAC MIN	tAC MAX	
DQS access time from CK	tDQSCK	-500	+500	ps
DQ and DM hold time	tDH	400	X	Ps
DQ and DM setup time	tDS	400	X	Ps
DQS-DQ skew for DQS and associated DQ signals	tDQSQ	X	350	Ps
DQ hold skew factor	tQHS	X	450	ps
DQ/DQS hold time from DQS	tQH	tHP – tQHS	X	ps
DQS high pulse width	tDQSH	0.35	X	tCK
DQS low pulse width	tDQSL	0.35	X	tCK
Write postamble	tWPST	0.4	0.6	tCK
Write preamble	tWPRE	0.25	X	tCK
Read preamble	tRPRE	0.9	1.1	tCK
Read postamble	tRPST	0.4	0.6	tCK

22.3 ISA Bus Interface

⌘ Read Cycle

T = South Bridge configuration register C0h[31] SB Clock Source Selection, C0h[17] ISA Clock selection or C0h[15:14] High Speed ISA Clock selection

C0h[31]	C0h[17]	C0h[15:14]	PCICLK	ISACK	TW
0	0	XX	33M	8.33M	120ns
0	1	XX	33M	16.67M	60ns
1	X	00	100M	8.33M	120ns
1	X	01	100M	16.67M	60ns
1	X	10	100M	25M	40ns
1	X	11	100M	33M	30ns

W = wait state value is reference the SB C0h

Symbol	Parameter	Min. (ns)	Type (ns)	Max. (ns)	Notes
t _{RC}	Read cycle time	300	120+1.5T+T*W+90		
t _{OEH}	MEMR# hold time	120	120		
t _{RP}	MEMR# pulse width	90	1.5T+T*W		
t _{DS}	Data setup time	10	10		
t _{DH}	Data hold time	0	0		

⌘ Read Cycle Waveforms

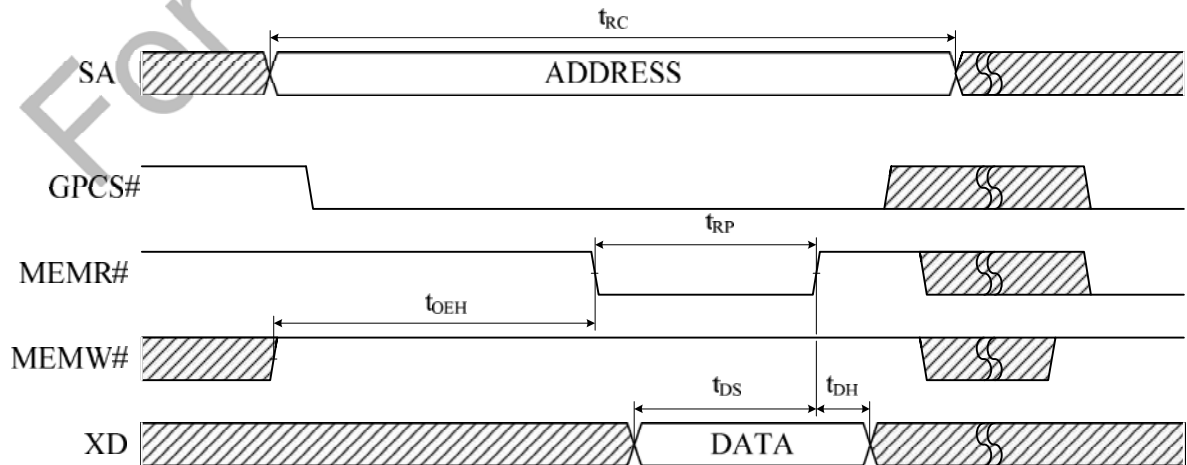

Write Cycle

T = South Bridge configuration register C0h[31] SB Clock Source Selection, C0h[17] ISA Clock selection or C0h[15:14] High Speed ISA Clock selection

C0h[31]	C0h[17]	C0h[15:14]	PCICLK	ISACLK	TW
0	0	XX	33M	8.33M	120ns
0	1	XX	33M	16.67M	60ns
1	X	00	100M	8.33M	120ns
1	X	01	100M	16.67M	60ns
1	X	10	100M	25M	40ns
1	X	11	100M	33M	30ns

W = wait state value is reference the SB C0h

Symbol	Parameter	Min. (ns)	Type (ns)	Max. (ns)	Notes
tAS	Address setup time	120	120		
tAH	Address hold time	1.5T+9 0	1.5T+T*W+9 0		
tCS	MEMW# & GPCS_ setup time	210	210		
tCH	MEMW# & GPCS_ hold time	116	116		
tWP	MEMW# pulse width	1.5T	1.5T+T*W		
tWPH	MEMW# high width	210	210		
tDV	Data valid time	180	210	240	
tDH	Data hold time	120	120		

ε **Write Cycle Waveforms**

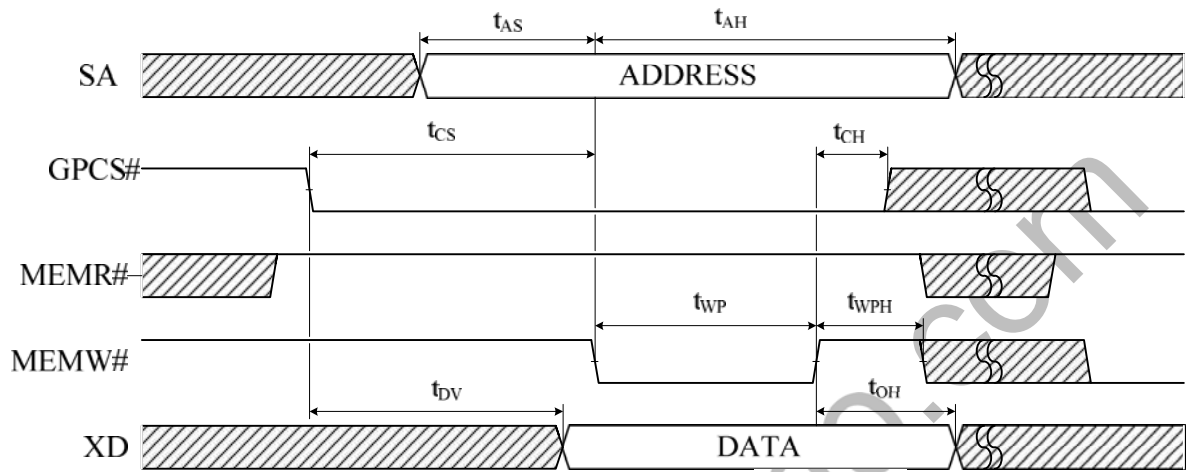

23. Package Information

288LD TFBGA (16 x 16mm)

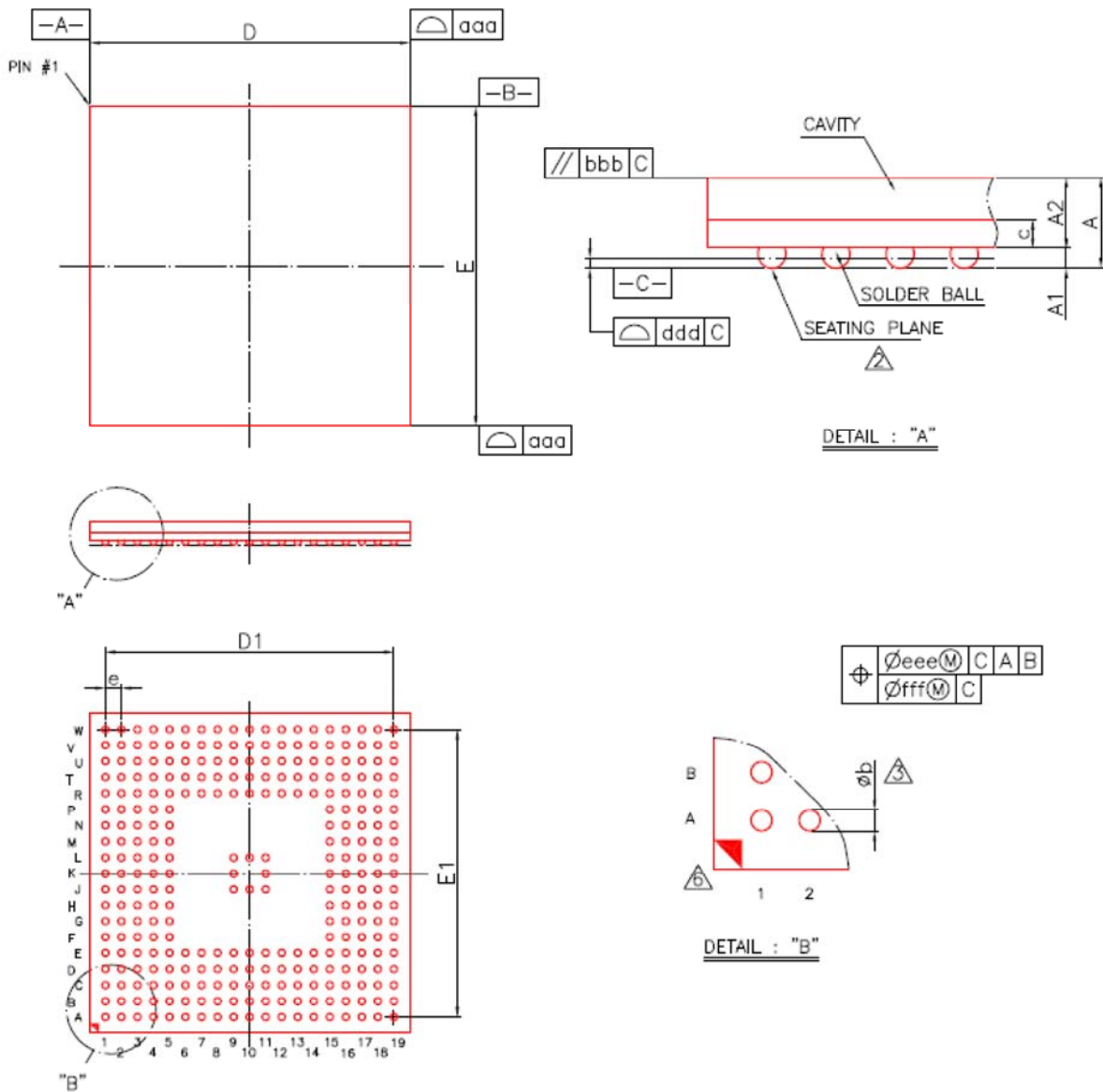

Vortex86EX

32-Bit x86 Micro Processor

Symbol	Dimension in mm			Dimension in inch		
	MIN	NOM	MAX	MIN	NOM	MAX
A	---	---	1.30	---	---	0.051
A1	0.20	0.25	0.30	0.008	0.010	0.012
A2	0.84	0.89	0.94	0.033	0.035	0.037
c	0.32	0.36	0.40	0.013	0.014	0.016
D	15.90	16.00	16.10	0.626	0.630	0.634
E	15.90	16.00	16.10	0.626	0.630	0.634
D1	---	14.40	---	---	0.567	---
E1	---	14.40	---	---	0.567	---
e	---	0.80	---	---	0.031	---
b	0.30	0.35	0.40	0.012	0.014	0.016
aaa		0.10			0.004	
bbb		0.10			0.004	
ddd		0.12			0.005	
eee		0.15			0.006	
fff		0.08			0.003	
MD/ME		19/19			19/19	