

**MC3470**  
**MC3470A**

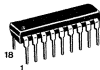
**FLOPPY DISK READ AMPLIFIER**

The MC3470 is a monolithic READ Amplifier System for obtaining digital information from floppy disk storage. It is designed to accept the differential ac signal produced by the magnetic head and produce a digital output pulse that corresponds to each peak of the input signal. The gain stage amplifies the input waveform and applies it to an external filter network, enabling the active differentiator and time domain filter to produce the desired output.

- Combines All the Active Circuitry To Perform the Floppy Disk Read Amplifier Function in One Circuit
- Guaranteed Maximum Peak Shift of 2.0% — MC3470A
- Improved (Positive) Gain  $T_C$  and Tolerance
- Improved Input Common Mode
- See Application Note AN917 for Further Information

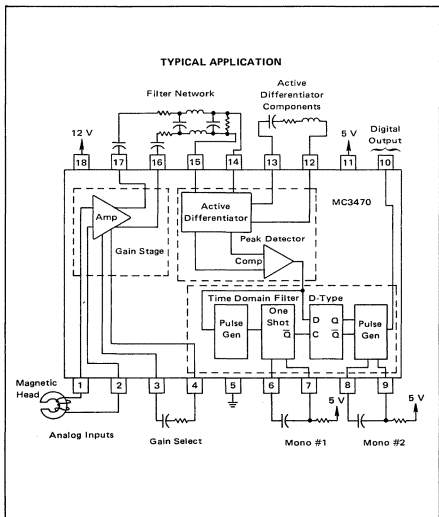
**FLOPPY DISK  
 READ AMPLIFIER SYSTEM**

**SILICON MONOLITHIC  
 INTEGRATED CIRCUIT**

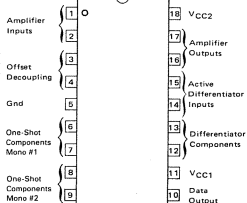


**P SUFFIX**  
 PLASTIC PACKAGE  
 CASE 707

**7**



**PIN CONNECTION**



# MC3470, MC3470A

## MAXIMUM RATINGS (T<sub>A</sub> = 25°C)

Rating	Symbol	Value	Unit
Power Supply Voltage (Pin 11)	V <sub>CC1</sub>	7.0	Vdc
Power Supply Voltage (Pin 18)	V <sub>CC2</sub>	16	Vdc
Input Voltage (Pins 1 and 2)	V <sub>I</sub>	-0.2 to +7.0	Vdc
Output Voltage (Pin 10)	V <sub>O</sub>	-0.2 to +7.0	Vdc
Operating Ambient Temperature	T <sub>A</sub>	0 to +70	°C
Storage Temperature	T <sub>stg</sub>	-65 to +150	°C
Operating Junction Temperature Plastic Package	T <sub>J</sub>	150	°C

## RECOMMENDED OPERATING CONDITIONS

Rating	Symbol	Value	Unit
Power Supply Voltage	V <sub>CC</sub>	V <sub>CC1</sub> + 4.75 to +5.25 V <sub>CC2</sub> +10 to +14	Vdc
Operating Ambient Temperature Range	T <sub>A</sub>	0 to +70	°C

## ELECTRICAL CHARACTERISTICS (T<sub>A</sub> = 0 to +70°C, V<sub>CC1</sub> = 4.75 to 5.25 V, V<sub>CC2</sub> = 10 to 14 V unless otherwise noted)

Characteristic	Figure	Symbol	Min	Typ	Max	Unit
Differential Voltage Gain (f = 200 kHz, V <sub>ID</sub> = 5.0 mV(RMS))	2	A <sub>VD</sub>	80 100	100 110	130 130	V/V
Input Bias Current	3	I <sub>IB</sub>	—	-10	-25	μA
Input Common Mode Range Linear Operation (5% max THD)		v <sub>ICM</sub>	-0.1	—	1.5	V
Differential Input Voltage Linear Operation (5% max THD)		v <sub>ID</sub>	—	—	25	mVp-p
Output Voltage Swing Differential	2	v <sub>oD</sub>	3.0	4.0	—	Vp-p
Output Source Current, Toggled		I <sub>O</sub>	—	8.0	—	mA
Output Sink Current, Pins 16 and 17	4	I <sub>OS</sub>	2.8	4.0	—	mA
Small Signal Input Resistance (T <sub>A</sub> = 25°C)		r <sub>i</sub>	100	250	—	kΩ
Small Signal Output Resistance, Single-Ended (T <sub>A</sub> = 25°C, V <sub>CC1</sub> = 5.0 V, V <sub>CC2</sub> = 12 V)		r <sub>o</sub>	—	15	—	Ω
Bandwidth, -3.0 dB (v <sub>ID</sub> = 2.0 mV(RMS), T <sub>A</sub> = 25°C, V <sub>CC1</sub> = 5.0 V, V <sub>CC2</sub> = 12 V)	2, 17	BW	10	—	—	MHz
Common Mode Rejection Ratio (T <sub>A</sub> = 25°C, f = 100 kHz, A <sub>VD</sub> = 40 dB, v <sub>in</sub> = 200 mVp-p, V <sub>CC1</sub> = 5.0 V, V <sub>CC2</sub> = 12 V)	5	CMRR	50	—	—	dB
V <sub>CC1</sub> Supply Rejection Ratio (T <sub>A</sub> = 25°C, V <sub>CC2</sub> = 12 V, 4.75 ≤ V <sub>CC1</sub> ≤ 5.25 V, A <sub>VD</sub> = 40 dB)		—	50	—	—	dB
V <sub>CC2</sub> Supply Rejection Ratio (T <sub>A</sub> = 25°C, V <sub>CC1</sub> = 5.0 V, 10 V ≤ V <sub>CC2</sub> ≤ 14 V, A <sub>VD</sub> = 40 dB)		—	60	—	—	dB
Differential Output Offset (T <sub>A</sub> = 25°C, v <sub>ID</sub> = v <sub>in</sub> = 0 V)		V <sub>DO</sub>	—	—	0.4	V
Common Mode Output Offset (v <sub>ID</sub> = v <sub>in</sub> = 0 V, Differential and Common Mode)		V <sub>CO</sub>	—	3.0	—	V
Differential Noise Voltage Referred to Input (BW = 10 Hz to 1.0 MHz, T <sub>A</sub> = 25°C)	22	e <sub>n</sub>	—	15	—	μV(RMS)
Supply Currents (V <sub>CC1</sub> = 5.25 V, S <sub>1</sub> to Pin 12 or Pin 13) (V <sub>CC2</sub> = 14 V)	1	I <sub>CC1</sub> I <sub>CC2</sub>	— —	40 4.8	— —	mA

# MC3470, MC3470A

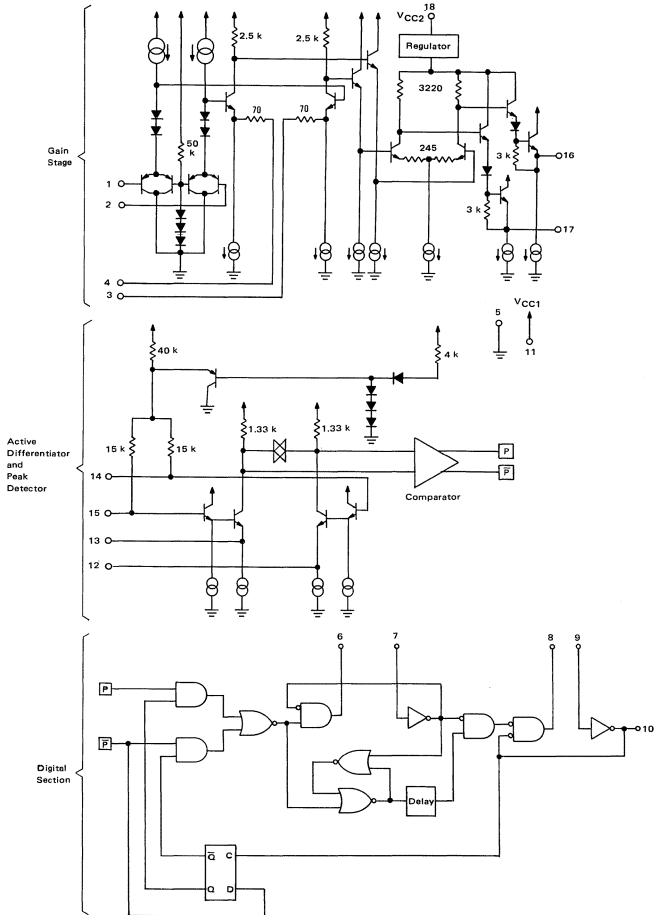
**ELECTRICAL CHARACTERISTICS (continued)** ( $T_A = 0$  to  $+70^\circ\text{C}$ ,  $V_{CC1} = 4.75$  to  $5.25$  V,  $V_{CC2} = 10$  to  $14$  V unless otherwise noted)

Characteristic	Figure	Symbol	Min	Typ	Max	Unit
<b>ACTIVE DIFFERENTIATOR SECTION</b>						
Differentiator Output Sink Current, Pins 12 and 13 ( $V_{OD} = V_{CC1}$ )	6	$I_{OD}$	1.0	1.4	—	mA
Peak Shift ( $f = 250$ kHz, $v_{ID} = 1.0$ Vp-p, $I_{cap} = 500$ $\mu\text{A}$ , where $PS = 1/2 \frac{I_{PS1} - I_{PS2}}{I_{PS1} + I_{PS2}} \times 100\%$ , $V_{CC1} = 5.0$ V, $V_{CC2} = 12$ V)	7, 8	PS	—	—	5.0 2.0	%
Differentiator Input Resistance, Differential		$r_{ID}$	—	30	—	k $\Omega$
Differentiator Output Resistance, Differential ( $T_A = 25^\circ\text{C}$ )		$r_{OD}$	—	40	—	$\Omega$
<b>DIGITAL SECTION</b>						
Output Voltage High Logic Level, Pin 10 ( $V_{CC1} = 4.75$ V, $V_{CC2} = 12$ V, $I_{OH} = -0.4$ mA)	9	$V_{OH}$	2.7	—	—	V
Output Voltage Low Logic Level, Pin 10 ( $V_{CC1} = 4.75$ V, $V_{CC2} = 12$ V, $I_{OL} = 8.0$ mA)	10	$V_{OL}$	—	—	0.5	V
Output Rise Time, Pin 10	11, 12	$t_{TLH}$	—	—	20	ns
Output Fall Time, Pin 10	11, 12	$t_{THL}$	—	—	25	ns
Timing Range Mono #1 ( $t_{1A}$ and $t_{1B}$ )	13	$t_{1A, B}$	500	—	4000	ns
Timing Accuracy Mono #1 ( $t_1 = 1.0$ $\mu\text{s} = 0.625$ R1C1 + 200 ns) (R1 = 6.4 k $\Omega$ , C1 = 200 pF)  Accuracy guaranteed for R1 in the range 1.5 k $\Omega \leq R1 \leq 10$ k $\Omega$ and C1 in the range 150 pF $\leq C1 \leq 680$ pF.  Note: To minimize current transients, C1 should be kept as small as is convenient.	12, 13	$E_{t1}$	85	—	115	%
Timing Range Mono #2	11, 12	$t_2$	150	—	1000	ns
Timing Accuracy Mono #2 ( $t_2 = 200$ ns = 0.625 R2C2) (R2 = 1.6 k $\Omega$ , C2 = 200 pF)  Accuracy guaranteed for 1.5 k $\Omega \leq R2 \leq 10$ k $\Omega$ , 100 pF $\leq C2 \leq 800$ pF	12, 13	$E_{t2}$	85	—	115	%

7

# MC3470, MC3470A

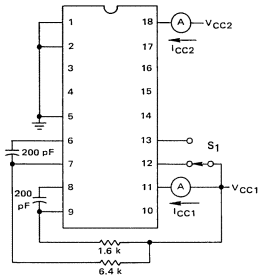
MC3470 CIRCUIT SCHEMATIC



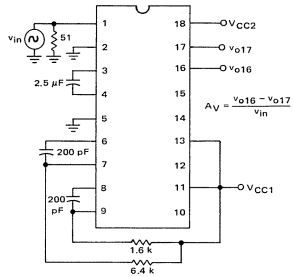
7

# MC3470, MC3470A

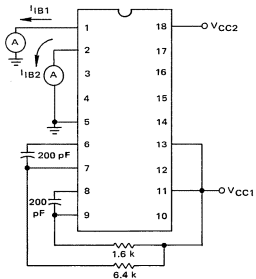
**FIGURE 1 – POWER SUPPLY CURRENTS,  $I_{CC1}$  AND  $I_{CC2}$**



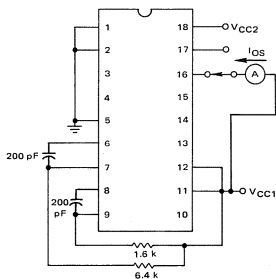
**FIGURE 2 – VOLTAGE GAIN, BANDWIDTH, OUTPUT VOLTAGE SWING**



**FIGURE 3 – AMPLIFIER INPUT BIAS CURRENT,  $I_{IB}$**

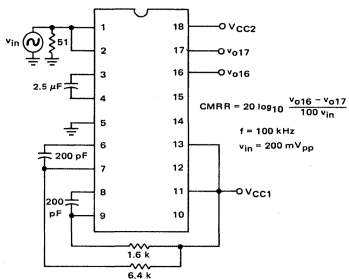


**FIGURE 4 – AMPLIFIER OUTPUT SINK CURRENT, PINS 16 AND 17**



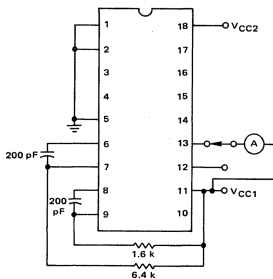
# MC3470, MC3470A

**FIGURE 5 – AMPLIFIER COMMON MODE REJECTION RATIO, CMRR**



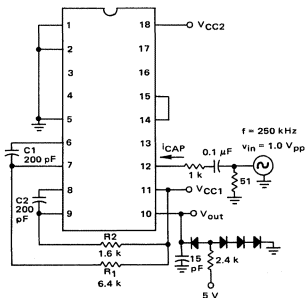
NOTE: Measurements may be made with vector voltmeter hp 8405A or equivalent at 1.0 MHz to guarantee 100 kHz performance.

**FIGURE 6 – DIFFERENTIATOR OUTPUT SINK CURRENT, PINS 12 AND 13**

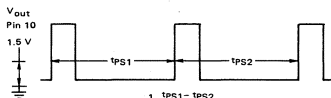


7

**FIGURE 7 – PEAK SHIFT, PS**  
See Figure 8 for Output Waveform



**FIGURE 8 – PEAK SHIFT, PS**  
 $V_{in} = 1.0 V_{pp}$   $f = 250 \text{ kHz}$   
Test schematic on Figure 7



# MC3470, MC3470A

FIGURE 9 – DATA OUTPUT VOLTAGE HIGH, PIN 10

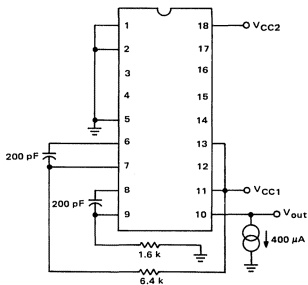


FIGURE 10 – DATA OUTPUT VOLTAGE LOW, PIN 10

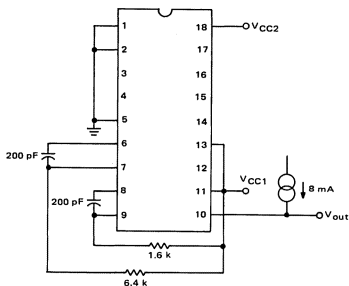


FIGURE 11 – DATA OUTPUT RISE TIME,  $t_{RLH}$   
DATA OUTPUT FALL TIME,  $t_{THL}$   
TIMING ACCURACY MONO #2,  $E_{t2}$

$V_{in}$  is same as shown on Figure 13, test schematic on Figure 12

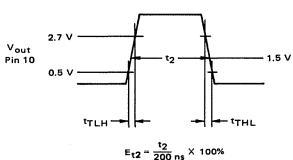
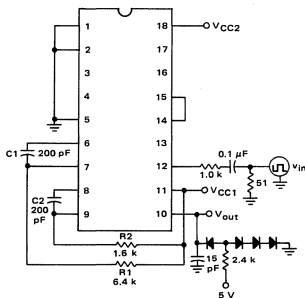


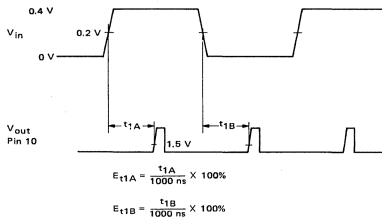
FIGURE 12 – TIMING ACCURACY,  $E_{t1}$  AND  $E_{t2}$   
DATA OUTPUT RISE AND FALL TIMES,  $t_{RLH}$  AND  $t_{THL}$

$V_{in}$  shown on Figure 13

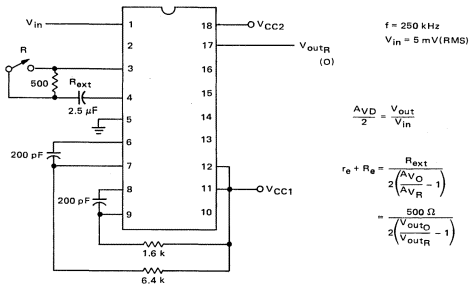


# MC3470, MC3470A

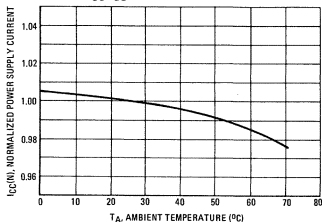
**FIGURE 13 – TIMING ACCURACY MONO #1, E<sub>t1</sub>**  
 $\tau_{TLH} = \tau_{THL} < 10 \text{ ns}$   $f = 250 \text{ kHz}$  50% Duty Cycle  
 Test Schematic on Figure 12



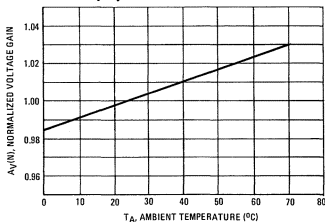
**FIGURE 14 – AMPLIFIER OFFSET DECOUPLING IMPEDANCE, PINS 3 AND 4**  
 $R_e + r_e$  and  $A_V$  with  $R_{ext} = 500 \Omega$



**FIGURE 15 – NORMALIZED POWER SUPPLY CURRENT**  
 $(I_{CC}/I_{CC} 25^\circ\text{C})$  versus TEMPERATURE



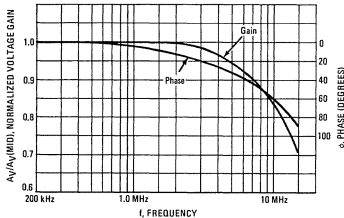
**FIGURE 16 – NORMALIZED VOLTAGE GAIN**  
 $(A_V/A_V 25^\circ\text{C})$  versus TEMPERATURE



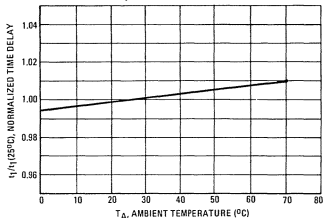


# MC3470, MC3470A

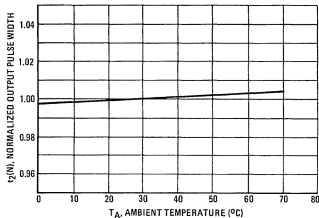
**FIGURE 17 — PHASE AND NORMALIZED VOLTAGE GAIN versus FREQUENCY**



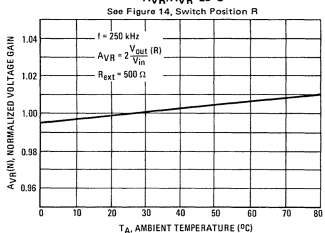
**FIGURE 18 — NORMALIZED TIME DELAY  $t_1$  versus TEMPERATURE**



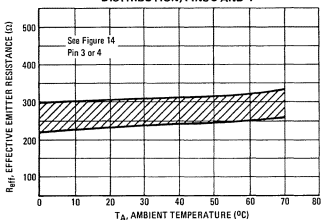
**FIGURE 19 — NORMALIZED OUTPUT PULSE WIDTH,  $t_2/t_2$  25°C**



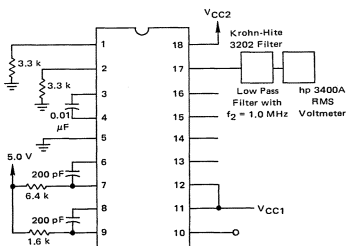
**FIGURE 20 — NORMALIZED VOLTAGE GAIN,  $A_{VR}/A_{VR}$  25°C**



**FIGURE 21 — EFFECTIVE EMITTER RESISTANCE DISTRIBUTION, PINS 3 AND 4**



**FIGURE 22 — DIFFERENTIAL NOISE VOLTAGE**



NOTE: Assume uncorrelated noise sources  
 $e_n$  (differential noise at input) =  $e_{nV} \sqrt{2/100}$

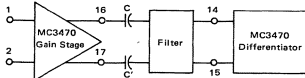
7

# MC3470, MC3470A

## APPLICATION INFORMATION

The MC3470 is designed to accept a differential ac input from the magnetic head of a floppy disk drive and produce a digital output pulse that corresponds to each peak of the ac input. The gain stage amplifies the input waveform and applies it to a filter network (Figure 23a),

**FIGURE 23a – BLOCKING CAPACITORS USED TO ISOLATE THE DIFFERENTIATOR**



enabling the active differentiator and time domain filter to produce the desired output.

### FILTER CONSIDERATIONS

The filter is used to reduce any high frequency noise present on the desired signal. Its characteristics are dictated by the floppy disk system parameters as well as the coupling requirements of the MC3470. The filter design parameters are affected by the read head characteristics, maximum and minimum slew rates, system transient response, system delay distortion, filter center frequency, and other system parameters. This design criteria varies between manufacturers; consequently, the filter configuration also varies. The coupling requirements of the MC3470 are a result of the output structure of the gain stage and the input structure of the differentiator, and must be adhered to regardless of the filter configuration.

The differentiator has an internal biasing network on each input. Therefore, any dc voltage applied to these inputs will perturbate the bias level. Disturbing the bias level does not affect the waveform at the differentiator inputs, but it does cause peak shifting in the digital output (Pin 10). Since the output of the gain stage has an associated dc voltage level, it, as well as any biasing introduced in the filter, must be isolated from the differentiator via series blocking capacitors. The transient response is minimized if the blocking capacitors C and C' are placed before the filter as shown in Figure 23a. The charging and discharging of C and C' is controlled by the filter termination resistor instead of the high input impedance of the differentiator.

The filter design must also include the current-sinking capacity of the amplifier output. The current source in the output structure (see circuit schematic — Pins 16 and 17) is guaranteed to sink a current of 2.8 mA. If the current requirement of the filter exceeds 2.8 mA, the current source will saturate, the output waveform will be distorted, and inaccurate peak detection will occur in the differentiator. Therefore, the total impedance of the

filter must be greater than  $Z_{min}$  as calculated from

$$Z_{min} = \frac{(E_p \Delta V D)_{max}}{2.8 \text{ mA}}$$

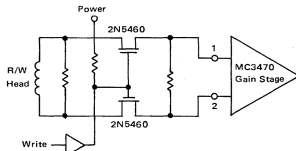
where  $E_p$  is the peak differential input voltage to the MC3470.

### TRANSIENT RESPONSE

The worst-case transient response of the read channel occurs when dc switching at the amplifier input causes its output to be toggled. The dc voltage changes are a consequence of diode switching that takes place when control is transferred from the write channel to the read channel.

If the diode network is balanced, the dc change is a common mode input voltage to the amplifier. The switching of an unbalanced diode network creates a differential input voltage and a corresponding amplified swing in the outputs. The output swing will charge the blocking capacitor resulting in peak shifting in the digital output until the transient has decayed. Eliminating the differential dc changes at the amplifier input by matching the diode network or by coupling the read head to the amplifier via FET switches, as shown in Figure 23b, will minimize the filter transient response.

**FIGURE 23b – FET SWITCHES USED TO COUPLE THE R/W HEAD TO THE MC3470**



Two of the advantages FET switches have over diode switching are:

1. They isolate the read channel from dc voltage changes in the system; therefore, the transient response of the filter does not influence the system transient response.
2. The low voltage drop across the FETs keeps the input signal below the amplifier's internal clamp voltage; whereas, the voltage dropped across a diode switching network adds a dc bias to the input signal which may exceed the clamp voltage.

### AMPLIFIER GAIN

For some floppy systems, it may become necessary to either reduce the gain of the amplifier or reduce the

See Application Note AN917 for further information.

## MC3470, MC3470A

signal at the input to avoid exceeding the output swing capability of the amplifier. The voltage gain of the amplifier can be reduced by putting a resistor in series with the capacitor between Pins 3 and 4 (Figure 14). The relationship between the gain and the external resistor is given by

$$AVR = AVO \cdot \frac{2(r_e + R_e)}{2(r_e + R_e) + R_{ext}}$$

where  $AVO \hat{=}$  voltage gain with the external resistor = 0,

$AVR \hat{=}$  voltage gain with the external resistor in,

$R_{ext} \hat{=}$  the external resistor, and

$r_e + R_e \hat{=}$  the resistance looking into Pin 3 or Pin 4.

Thus,

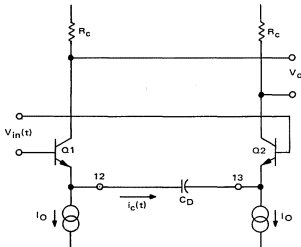
$$R_{ext} = 2 \left( \frac{AVO}{AVR} - 1 \right) (r_e + R_e).$$

A plot of  $(r_e + R_e)$  versus temperature is shown in Figure 21. Figure 20 shows the normalized voltage gain versus temperature with the external resistor equal to 500 ohms.

### ACTIVE DIFFERENTIATOR

The active differentiator in the MC3470 (simplified circuit shown in Figure 24), is implemented by coupling

FIGURE 24 — ACTIVE DIFFERENTIATOR NETWORK



the emitters of a differential amplifier with a capacitor resulting in an output current that will be the derivative of the input voltage,

$$I = Cdv/dt$$

If the output voltage is taken across a resistor through which the collector current is flowing, the resulting voltage will be the derivative of the input voltage.

$$V_O = 2RI_C = 2RC \frac{dv_{in}(t)}{dt}$$

$V_O$  is applied to a comparator which will provide zero

crossing detection of the current waveform. Since the capacitor shifts the current  $90^\circ$  from the input voltage, the comparator performs peak detection of the input voltage.

The following terms will be used in determining the value of C to be used in the differentiator:

$E_p \hat{=}$  peak differential voltage applied to MC3470 amplifier input.

$E_p \sin \omega t \hat{=}$  voltage waveform applied to MC3470 amplifier input (for purposes of discussion, assume a sine wave).

$AV_D \hat{=}$  differential voltage gain of input amplifier.

$v_{in}(t) \hat{=}$  differential voltage waveform applied to the differentiator inputs.

$= E_p AV_D \sin \omega t$  (Note: The filter is assumed to be lossless.)

$i_C(t) \hat{=}$  current through capacitor  $C_D$ .

$R_O \hat{=}$  output resistance of Q1 (Q2) at Pin 12 (13).

If  $v_{in}(t) = E_p AV_D \sin \omega t$ , then the current through the capacitor  $C_D$  is given by

$$i_C(t) = C_D AV_D E_p \omega \cos \omega t$$

$$\text{and } V_O(t) = 2RC_D AV_D E_p \omega \cos \omega t.$$

Accurate zero crossing detection of  $V_O(t)$  [peak detection of  $v_{in}(t)$ ] occurs when the current waveform  $i_C(t)$  crosses through zero in a minimum amount of time. This condition is satisfied by maximizing current slew rate. For a given value of  $\omega$ , the maximum slew rate occurs for the maximum value of  $i_C$  or  $\cos \omega t = 1$ . Therefore,

$$i_C = C_D AV_D E_p \omega$$

The MC3470 current-sourcing capacity will determine the maximum value  $i_C$ ; therefore,  $C_D$  must be chosen such that the maximum  $i_C$  occurs at the maximum  $AV_D E_p \omega$  product.

$$C_D = \frac{i_C \text{max}}{(AV_D E_p \omega) \text{max}} = \frac{1 \text{ mA}}{(120)(E_p \omega) \text{max}}$$

If the peak value specified for  $i_C$  is exceeded, the current source ( $I_O$  in Figure 24) will saturate and distort the waveform at Pins 12 and 13. Consequently, the differentiator will not accurately locate the peaks and peak shifting will occur in the digital output.

The effective output resistance  $R_O$  of Q1 (Q2) will create a pole (as shown in Figure 25) at  $1/2 R_O C_D$ . If this pole is ten times greater than the maximum operating frequency ( $\omega_{max}$ ), the phase shift approaches  $84^\circ$ . Locating the pole at a frequency much greater than  $10 \omega_{max}$  needlessly extends the noise bandwidth thus:

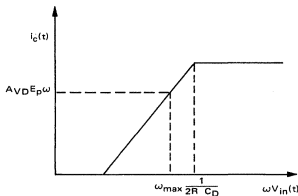
$$2R_O = \frac{1}{C_D 10 \omega_{max}}$$

If  $R_O$  is not large enough to satisfy this condition, a series

7

# MC3470, MC3470A

FIGURE 25 – RESPONSE OF DIFFERENTIATOR USING ONLY  $C_D$

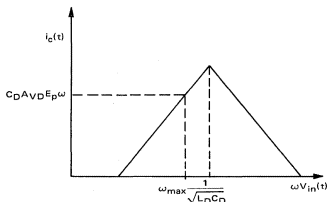


resistor can be added so that

$$R = 2R_D + R_D = \frac{1}{C_D 10 \omega_{\max}}$$

To further reduce the noise bandwidth, a second pole can be added (as shown in Figure 26) by putting an

FIGURE 26 – COMPLETE RESPONSE OF DIFFERENTIATOR



inductor in series with the resistor and the capacitor. The values of  $R$  and  $L$  are determined by choosing the center frequency ( $\omega_0$ ) and the damping ratio ( $\delta$ ) to meet the systems requirements where

$$\omega_0 = \frac{1}{\sqrt{LC_D}}$$

$$\delta = \frac{RC_D}{2\sqrt{LC_D}}$$

$$\omega_0 = 10 \omega_{\max} = \frac{1}{\sqrt{LC_D}}$$

where  $C_D$  is chosen for maximum  $i_c$  as shown previously.

Solving for  $L$  gives:

$$L = \frac{1}{100 C_D (\omega_{\max})^2}$$

Using this value for  $L$  gives:

$$\delta = \frac{RC_D}{\frac{2}{10} \sqrt{\frac{C_D}{C_D (\omega_{\max})^2}}}$$

Solving for  $R$  gives:

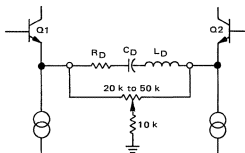
$$R = \frac{\delta}{5 C_D \omega_{\max}}$$

The total resistance ( $R$ ) is the effective output resistance ( $R_O$ ) plus the resistor added in the differentiator ( $R_D$ ). Values of  $\delta$  from 0.3 to 1 produce satisfactory results.

## PEAK SHIFT CONSIDERATIONS

Peak shift, resulting from current imbalance in the differentiator, offset voltage in the comparator, etc., can be eliminated by nulling the current in the emitters of the differentiator with a potentiometer as shown in Figure 27.

FIGURE 27 – PEAK SHIFT COMPENSATION



The potentiometer across the differentiator components is adjusted until a symmetrical digital output cycle is obtained at Pin 10 for a sinusoidal input with the minimum anticipated  $E_P \omega$  product.

## DESIGN EQUATIONS FOR ONE-SHOTS

As shown in Figure 28, the MC3470 input waveform may have distortion at zero crossing, which can result in false triggering of the digital output. The time domain filter in the MC3470 can be used to eliminate the distortion by properly setting the period ( $t_1$ ) of the one-shot timing elements on Pins 6 and 7. The following equation will optimize immunity to this signal distortion at zero crossing of the read head signal.

The timing equation for the time domain filter's one-shot is:

$$t_1 = R_1 C_1 K_1 + T_0$$

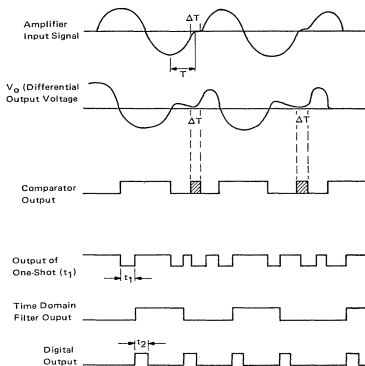
where  $K_1 = 0.625$ ,  $T_0 = 200$  ns.

Actual time will be within  $\pm 15\%$  of  $t_1$  due to variations in the MC3470.

If  $\Delta T$  is the maximum period of distortion (see Figure

## MC3470, MC3470A

FIGURE 28 — WAVEFORMS THROUGH THE READ CIRCUIT



28), then choose  $t_1$  such that

$$\Delta T < t_1 < T - \frac{\Delta T}{2}$$

where  $T = \frac{1}{4f_{(\max)}}$ .

The width of the digital output pulse  $t_2$  (Pin 10) is determined by

$$t_2 = R_2 C_2 K_2$$

where  $K_2 = 0.625$ .

Actual pulse width will be within  $\pm 15\%$  of  $t_2$  due to variations in the MC3470.

To preserve the specified accuracy of the MC3470,  $R_1$ ,  $R_2$ ,  $C_1$ , and  $C_2$  should remain in the ranges shown in the Electrical Characteristics. Also, to minimize current transients, it is important to keep the values of  $C_1$  and  $C_2$  as small as is convenient. For  $t_1 = 1 \mu\text{s}$  and  $t_2 = 200 \text{ ns}$ , suggested good values for the capacitors are

$$C_1 = 250 \text{ pF}$$

$$C_2 = 160 \text{ pF}$$

### BOARD LAYOUT AND TESTING CONSIDERATIONS

An LSI package has many input/output pins in close proximity, some carrying high level signals and others low level signals. As carefully as the on-chip isolation of the devices connected to these pins is implemented by

the manufacturer, the coupling of signals or noise between external wires is under the control of the end-user who designs the integrated circuit into a piece of equipment. The designer should be familiar with the following layout procedures which will optimize the performance of the device. See Figure 29.

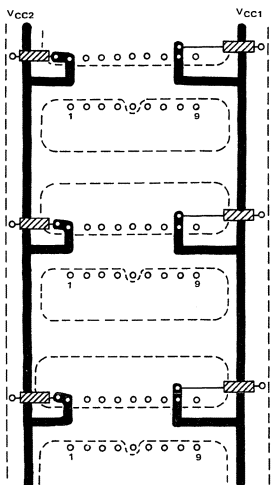
1. Build all circuits on printed circuit boards (including breadboards). Transmission line theory for flat conductors in a plane quite convincingly proves that coupling is far less than for round conductors in three dimensions.
2. Use a ground plane under the IC and over as much of the printed circuit board surface as possible without exceeding practical limits.
3. Avoid signal runs under the IC. Also avoid parallel runs of 1 inch or greater on the opposite or same side of board.
4. Use monolithic ceramic 0.1  $\mu\text{F}$  capacitors for decoupling power supply transients: one from  $V_{CC1}$  to ground and one from  $V_{CC2}$  to ground for each IC package. Keep lead lengths to 1/4 inch or less and place in close proximity to the IC.
5. Keep all signal runs as short as possible.

When evaluating the device for phase jitter and frequency response, a special test jig should be designed to reduce ground loops and coupling caused by instrumentation. Instrumentation test setups must be calibrated

## MC3470, MC3470A

at each test frequency and differential equipment utilized where required. A valid evaluation of the performance of any read amplifier chain requires considerable care and thought.

FIGURE 29 — POWER AND GROUND DISTRIBUTION FOR MC3470 PRINTED CIRCUIT BOARD LAYOUT



NOTE: Dotted line outline ground plane on back side of printed circuit board.