

MURATA ERIE SHORT FORM CATALOG

CATALOG NO. G-01-B



MURATA ERIE NORTH AMERICA

This catalog illustrates the vast array of electronic components manufactured and distributed by Murata Erie North America. With manufacturing facilities located in Rockmart, Georgia and State College, Pennsylvania, Murata Erie is obtaining worldwide recognition for its development and production of highly reliable electronic components. The Company's advanced design engineering and manufacturing technology, combined with automated production and instrumentation systems, provides a high degree of excellence in product quality. The reliability of these components is illustrated by approvals to UL, CSA and Military specifications.

Murata Erie is one of the world's largest manufacturers of fixed and variable ceramic capacitors and also offers a complete line of other electronic components including potentiometers, piezo alarms, resistor networks, posistors, piezo-electric ceramic filters and resonators, crystal filters and oscillators, EMI/RFI filters, high voltage components and hybrid circuits.

Authorized Distributors

Many of the products found in this catalog are available from authorized Murata Erie distributors. This local availability assures the fastest possible delivery and is supported by the Murata Erie distribution centers in Georgia and the Northeast.

Application Assistance

Murata Erie maintains an experienced staff of application engineers at all of its facilities, who are available to provide any technical support that might be required relative to Murata Erie products.

TABLE OF CONTENTS, GENERAL

	<i>Page</i>
Alarms, Piezoelectric	74-76
Antenna, GPS	87-88
Capacitors, See Disc Capacitors	29-45
Capacitors, Fixed Ceramic	
Chip, High Q	20-23
Chip, High Voltage	24-25
Chip, Monolithic	4-15
Chip, Single Layer	27-28
Radial Leaded, Monolithic	16-19
RF Power	26
Disc Capacitors	
General Purpose 50/100/500/1KVDC	33-45
High Temperature 250/500V/1/2/3/6KVDC	40
High Voltage 7.5-4.0KVDC	42-43
Low Voltage/High Capacitance 12/16/25/50V	29-30
Mini. & Conv. 1/2/3/6KV	36-37
Packaging	38-39
Safety Recognized	41
Temperature Compensating 50/100/500/1KVDC	32
Ultra Small 12/16/25/50V	44
Capacitors, Electric Double Layer	44
Capacitors, Trimming	
Ceramic	45-48
Air, Sapphire	49
Connectors	
Miniature, Coaxial	89-90
SMT, Coaxial	91-92
Delay Lines	113

	<i>Page</i>
Design Engineering Kits	114-123
Dielectric Resonator-Based Products	85-86
EMI/RFI Filters	
Block Filters	102
Common Mode Choke Coils	103-104
"D" Connectors	105-107
Disc-Type for PCB Mounting	100-101
Feed-Thru Capacitors	99-100
Feed-Thru Capacitor Chips and Arrays	95, 97
Ferrite Bead Arrays	96
Ferrite Bead Inductors	99
Ferrite Chips	93-94
Filter Chips	95, 98
Filters, Three Terminal	101-102
Noise Filters for AC Line Application	104
Safety Recognized	102
Varistor Capacitor	101
Filters, EMI/RFI See EMI/RFI Filters	93-107
Filters, Piezoelectric	80-81
High Voltage Components	71
Hybrid IC's	108-113
Inductors, Chip	63-65
Microphones	77
Networks, Resistor	66
Oscillators, Crystal	82-84
Potentiometers, Trimming	
Chip	51
Microminiature, Subminiature,	
Carbon, Cermet	52-53
Sealed, Precision, Single-turn, Multi-turn	54-62
Resistors, Positive Temperature Coefficient (Posistors)	67-69
Resonators, Piezoelectric	78-79
Sensors	72-73
Thermistors, Negative Temperature Coefficient	70

TABLE OF CONTENTS, SURFACE MOUNT

	<i>Page</i>
Capacitors, Fixed Ceramic	
High Q	20-23
High Voltage	24-25
Monolithic	4-15
Single Layer	27-28
Capacitors, Trimming	45-46
Connectors, Coaxial	91-92
Delay Lines	113
Dielectric Resonator-Based Products	86
Filters, EMI/RFI	93-98
Inductors	63-65
Potentiometers	51-54
Resonators, Piezoelectric	78

ALPHA NUMERIC SERIES INDEX

SAMPLE KIT INDEX

SERIES	PAGE	SERIES	PAGE
7BB	74	IMD	72
7HB	74	IRA	72
7SB	74	IRB	72
AC	44	LDH	113
AFB	109	LP	73
AFE	109	LQH	64, 65
AFL	109, 110	LQM	64, 65
AFM	109	LQN	63, 64
AFS	109, 110	LQP	63
AFZR	109	LQS	65
ANT	87, 88	M	92
ARC	112	MA	20, 21
ARCL	112	MA40	78
BFA	89, 90	MHF	71
BFU	80	MHR	71
BL	99	MM	89-92
BLA	96	MSC	71
BLM	93, 94	MVM	49
BNP	102	MXSG	91, 92
BNX	102	MXYH	89
BS	73	NFA	97
CCR	91, 92	NFM	95, 98
CFM	81	NFV	101
CFR	81	NTH	70
CFS	81	OC	83, 84
CFU	81	PKB	74
CFW	81	PKD	74
CLA	27, 28	PKM	75, 76
CNT	112	PLA	103
CNTL	112	PLAM	103
CSA	79	PLC	103
CSAC	77	PLCM	103
CSB	79	PLE	103
CSBF	77	PLEM	103
CST	79	PLH	104
CUBL	105	PLI-C	104
CUBM	106, 107	PLT	103
DC	83	POT	54-62
DD	29-35, 38	PTH	67-69
DE	36, 37, 39-41	RPE	16-19
DF	99, 100	RSC	66
DHR	42	RSH	66
DHS	43	RSL	66
DS	100	RVG	50-53
DSR	102	RVX	52
DSS	100, 101	SFE	80, 81
DST	100	SFG	80
DV	48	SFH	80
DVS	48	SFT	80
DVZ	101	SH	84
FKOB	104	TC	82
FR	73	TF	99
GRH	22, 23	TPS	81
GRM	4-15, 24, 25	TRFA	72
GT	49	TRMF	72
H8D	111	TRRA	72
HFE	109	TZ	47
HFP	111	TZBX	45
HFS	110	TZC	46
IMC	72	UFP	26
		VH	82

SERIES	PAGE
BL	123
BLM	123
BNP	123
BNX	123
DCC	119
DD	119, 120
DE	121
DF	123
DHR	119
DHS	118
DS	123
DSR	123
DSS	123
ESR	123
GRM	114-116
LQH	122
LQN	122
MA	117, 118
NFM	123
NFV	123
PLA	123
PLC	123
PLE	123
PLF	123
PLH	123
PLI	123
PLT	123
RPE	118, 119
RVH	122
TZ	121
TZB	121
TZBX	121
TZC	121

CHIPS, MONOLITHIC CERAMIC CAPACITORS

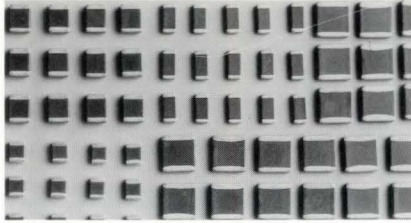

FEATURES

- Miniature size
- Wide capacitance, T.C., voltage and tolerance range
- Industry standard sizes
- 8 mm and 12 mm tape & reel for auto-placement
- Nickel barrier termination standard – highly resistant to metal migration.
- Largest production volume and capacity in the industry

PART NUMBERING SYSTEM

GRM 40 --- X7R 103 K 050 A D

CAPACITOR TYPE AND SIZE
See below and following pages.

3-digit code appears as necessary to indicate special thickness requirements. Please consult your local sales office for details.

TEMPERATURE CHARACTERISTICS
Standard TC's (described herein)
COG=0, ±30ppm (Notes 1 & 2)
X7R=±15%
Z5U=+22, -56%
Y5V=+22, -82%
(See Note 2 below)
P2H=N150±60ppm
R2H=N220±60ppm
S2H=N330±60ppm
T2H=N470±60ppm
U2J=N750±120ppm

CAPACITANCE VALUE
Expressed in picofarads and identified by a three-digit number. First two digits represent significant figures. Last digit specifies the number of zeros to follow. For values below 10pF, the letter "R" is used as the decimal point and the last digit becomes significant.

CAPACITANCE TOLERANCE
(Note 2)
COG: (10pF or less)
B = ±.1pF
★ C = ±.25pF
D = ±.5pF
F = ±1pF for 10pF only (over 10pF)
F = ±1%
G = ±2%
★ J = ±5%
K = ±10%
★ X7R: K = ±10%
M = ±20%
J = ±5% on special request
★ Z5U: M = ±20%
Z = +80, -20%
Y5V: Z = +80, -20%

VOLTAGE
Identified by a three-digit number.
500V available upon request.

MARKING
A=Unmarked
B=EIA Marking
C=Non-standard

PACKAGING

Reel Diameter	EIA-481-A
★ 7" Paper	D
★ 7" Plastic	L
13" Paper	J
13" Plastic	K
Bulk	B

T/R per EIA-481-1

NOTE 1: T.C. Tolerance (COG)

Capacitance (pF)	T.C. Tolerance (ppm)
10 or over	± 30 (G)
4.0-9.9	± 60 (H)
2.1-3.9	± 120 (J)
.4-2.0	± 250 (K)

NOTE 2: Refer to EIA-RS198 for limitations

★ Available as standard through authorized Murata Erie Distributors.

CHIP DIMENSIONS

DIMENSIONS: in. (mm)	Size	EIA Code	L Length	W Width	T Thickness	g Insulation	e Termination
	GRM 39	0603	.060±.006 (1.6±0.15)	.030±.006 (0.8±0.15)	Note 1: Thickness varies with capacitance value. See capacitance charts on following pages for thickness.	.020 (0.5)	.014±.006 (0.35±0.15)
	GRM40	0805	.080±.006 (2.0±0.15)	.050±.006 (1.25±0.15)		.030 (0.75)	.020±.010 (0.5±0.25)
	GRM42-6	1206	.125±.006 (3.2±0.15)	.063±.006 (1.6±0.15)		.040 (1.0)	.020±.010 (0.5±0.25)
	GRM42-2	1210	.125±.006 (3.2±0.15)	.100±.006 (2.5±0.15)		.040 (1.0)	.020±.010 (0.5±0.25)
	GRM43-2	1812	.180±.012 (4.6±0.3)	.125±.008 (3.2±0.2)		.080 (2.0)	.025±.015 (0.63±0.38)
	GRM43-4	1825	.180±.012 (4.6±0.3)	.250±.016 (6.35±0.4)		.080 (2.0)	.025±.015 (0.63±0.38)
	GRM44-1	2220*	.220±.012 (5.6±0.3)	.200±.010-.025 (5.1+0.25-0.5)		.080 (2.0)	.025±.015 (0.63±0.38)
	GRM44	2225*	.220±.012 (5.6±0.3)	.250±.016 (6.35±0.4)		.080 (2.0)	.025±.015 (0.63±0.38)

*Non EIA-Standard Size

CHIP TERMINATION DIAGRAMS

Nickel Barrier Layer (Standard)	Palladium Silver
<p>GRM Series</p> <p>Ceramic Dielectric Inner Electrode Inner Termination (Ag) Nickel Plated Barrier Layer Tin Plating</p>	<p>GR Series</p> <p>Ceramic Dielectric Inner Electrode Outer Electrode End Termination (PdAg)</p>

Note: Other Terminations Available Upon Request. Please Contact Local Sales Office.

DIMENSIONS: in. (mm) TAIL AND LEADER TAPE

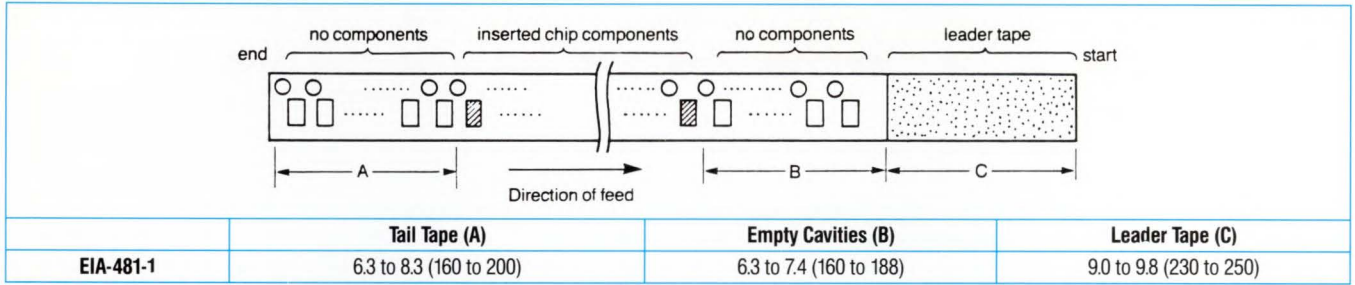

* 20 to 30mm must be unsealed with remaining portion of empty cavities sealed.

8mm PUNCHED (PAPER)	GR(M)39 0603	GR(M)40 0805	GR(M)42-6 1206	GR(M)42-2 1210	
	Tape A max.	.047 (1.2)	.065 (1.65)	.087 (2.2)	.116 (2.95)
	Tape B max.	.079 (2.0)	.095 (2.4)	.150 (3.8)	.144 (3.65)
	Chip T max.	.035 (0.9)	.040 (1.0)	.040 (1.0)	.040 (1.0)
	Tape Pitch: P	.157 ± .004 (4.0 ± 0.1)	.157 ± .004 (4.0 ± 0.1)	.157 ± .004 (4.0 ± 0.1)	.157 ± .004 (4.0 ± 0.1)
8mm EMBOSED (PLASTIC)		GR(M)40 0805	GR(M)42-6 1206	GR(M)42-2 1210	
	Tape A max.	N/A	.061 (1.55)	.079 (2.0)	.114 (2.9)
	Tape B max.	N/A	.093 (2.35)	.142 (3.6)	.142 (3.6)
	Chip T max.	N/A	.053 (1.35)	.060 (1.5)	.060 (1.5)
	Tape Pitch: P	N/A	.157 ± .004 (4.0 ± 0.1)	.157 ± .004 (4.0 ± 0.1)	.157 ± .004 (4.0 ± 0.1)
12mm EMBOSED (PLASTIC)		GR(M)43-2 1812	GR(M)43-4 1825	GR(M)44-1 2220	GR(M)44 2225
	Tape A max.	.146 (3.7)	.197 (5.0)	.209 (5.3)	.264 (6.7)
	Tape B max.	.197 (5.0)	.268 (6.8)	.244 (6.2)	.248 (6.3)
	Chip T max.	.080 (2.0)	.080 (2.0)	.080 (2.0)	.080 (2.0)
	Tape Pitch: P	.320 ± .004 (8 ± 0.1)	.320 ± .004 (8 ± 0.1)	.320 ± .004 (8 ± 0.1)	.320 ± .004 (8 ± 0.1)

CHIP MARKING

- The capacitance value is expressed in pF.
- A two character marking system will be used. The first character will be an alphabetic symbol and it will designate the 1st and 2nd figures of capacitance. The second character will be a numerical digit and it will designate the decimal multiplier of capacitance.
Examples: A1 = $1 \times 10^1 = 10\text{pF}$
J5 = $2.2 \times 10^5 = 0.22\mu\text{F}$
- The marking shall appear in black or legible contrast. The orientation of the marking shall be as illustrated.
- Marking resistance to solvents per EIA-RS 198 method 210

GR39
No Marking



GR42-6, 42-2,
43-2, 44-1, 44



GR40



GR43-4



TC BAR CODE

Where chip marking is required, bar code designations for temperature coefficients (T.C.s) will be provided as listed below.

NPO = □□, N150 = □□, N220 = □□,
N330 = □□, N470 = □□, N750 = □□,
Y5V = □□, Z5U = □□, X7R = □□

Other T.C. Designators are available. Contact your local Murata Erie Sales Office.

T.C. Bar



Base Cap.
Code

Multiplier



CHIP MARKING SPECIFICATIONS

Alphabetic Character	Significant Figures	Alphabetic Character	Significant Figures	Alphabetic Character	Significant Figures	Numeric Character	Decimal Multiplier
A	1.0	L	2.7	W	6.8	0	10 ⁰
B	1.1	M	3.0	X	7.5	1	10 ¹
C	1.2	N	3.3	Y	8.2	2	10 ²
D	1.3	P	3.6	Z	9.1	3	10 ³
E	1.5	Q	3.9	a	2.5	4	10 ⁴
F	1.6	R	4.3	b	3.5	5	10 ⁵
G	1.8	S	4.7	d	4.0	6	10 ⁶
H	2.0	T	5.1	e	4.5	7	10 ⁷
J	2.2	U	5.6	f	5.0	8	10 ⁸
K	2.4	V	6.2	m	6.0	9	10 ⁻¹
				n	7.0		
				t	8.0		
				y	9.0		

MURATA ERIE DESIGNATION	GRM 43-2			GRM 43-4			GRM 44-1			GRM 44		
EIA TYPE DESIGNATION	1812			1825			2220			2225		
WVDC	50	100	200	50	100	200	50	100	200	50	100	200
CAPACITANCE (pF) (NOTE)	1.0											
	10											
(μF) .01	100											
	1000	1000	330 620 1000	1000	1000	560	1000	1000	820	1000	1300	680
		3000	2400			1800 2400			1600			2200
		4700	3900			4700			3600			3000
		.011	.011	.016	.016		.018	.016	.027	.022	.022	
							.036			.033	.033	
	.1											

Note: Capacitance values = EIA 24 Step = 10,11,12,13,15,16,18,20,22,24,27,30,33,36,39,43,47,51,56,62,68,75,82,91
For values under 1.0pF and other values not listed, contact your local Murata Erie Sales Office

STANDARD THICKNESS/PACKAGING SPECIFICATIONS





Dimensions (mm)		Bulk	Tape			
		Pcs/bag (typical)	Pcs/7 inch (178 mm) reel		Pcs/13 inch (330 mm) reel	
		Plastic	Paper	Embossed	Paper	Embossed
	T : 1.25 $\begin{smallmatrix} +0 \\ -0.2 \end{smallmatrix}$	1000	N/A	1000	N/A	5000
	T : 1.5 $\begin{smallmatrix} +0 \\ -0.2 \end{smallmatrix}$	1000	N/A	1000	N/A	5000
	T : 2.0 $\begin{smallmatrix} +0 \\ -0.2 \end{smallmatrix}$	1000	N/A	1000	N/A	4000

HIGH DIELECTRIC CONSTANT TYPE X7R

MURATA ERIE DESIGNATION	GRM 39					GRM 40					GRM 42-6					GRM 42-2				
EIA TYPE DESIGNATION	0603					0805					1206					1210				
WVDC	16	25	50	100	200	16	25	50	100	200	16	25	50	100	200	16	25	50	100	200
CAPACITANCE (pF) 100			220	220	220			220	220	220			220	220	220					
1000					1800		2200			1800					2200					1500
(μF).01		3900		3300				8200	6800	8200										4700
.012	.012		.015			.015	.012	.015	.015			.022	.015	.015	.018			.022		
.027	.022					.027	.022					.033	.027							.027
.047						.047		.056				.047		.039						.047
.1						.1					.1					.1		.068	.1	.1
						.15					.12		.15			.12				
											.33	.22				.22	.18	.22		
																.27	.27			
																.47				
1.0																				

Note: Capacitance values = EIA 12 Step = 10, 12, 15, 18, 22, 27, 33, 39, 47, 56, 68, 82. For values not listed, contact your local Murata Erie Sales Office.

STANDARD THICKNESS/PACKAGING SPECIFICATIONS

DIMENSIONS: mm	Bulk	Tape				
		Pcs/bag (typical)	Pcs/7 inch (178 mm) reel		Pcs/13 inch (330 mm) reel	
			Plastic	Paper	Embossed	Paper
 T: 0.7 ⁺⁰ _{-0.2}	1000	4000	4000	10000	10000	
 T: 0.8 ±0.1	1000	4000	N/A	10000	N/A	
 T: 1.0 ⁺⁰ _{-0.2}	1000	4000	3000	10000	10000	
 T: 1.25 ⁺⁰ _{-0.2} *	1000	N/A	3000	N/A	10000	
 T: 1.5 ⁺⁰ _{-0.2}	1000	N/A	2000	N/A	8000	

*GRM 40 T = 1.25 ± .1

HIGH DIELECTRIC CONSTANT TYPE X7R

MURATA ERIE DESIGNATION	GRM 43-2					GRM 43-4			GRM 44-1				GRM 44		
EIA TYPE DESIGNATION	1812					1825			2220				2225		
WVDC	16	25	50	100	200	50	100	200	25	50	100	200	50	100	200
CAPACITANCE (pF) 100															
1000															
(μF).01			.01	.012	.01										
.1		.1	.12	.15	.082	.047	.033	.033	.056	.056	.056	.022	.082	.056	.033
.1	.39	.27	.39	.47	.1	.39	.33	.27	.47	.33	.27	.27	.68	.39	.33
1.0	.56	.47	.47	.22	1	.56			.47	.39	.47		1.0	.68	
									1.2	1.2			1.5		

Note: Capacitance values = EIA 12 Step = 10, 12, 15, 18, 22, 27, 33, 39, 47, 56, 68, 82. For values not listed, contact your local Murata Erie Sales Office.

STANDARD THICKNESS/PACKAGING SPECIFICATIONS





DIMENSIONS: mm	Bulk	Tape				
		Pcs/bag (typical)	Pcs/7 inch (178 mm) reel		Pcs/13 inch (330 mm) reel	
			Plastic	Paper	Embossed	Paper
T: 1.25 ⁺⁰ / _{-0.2}	1000	N/A	1000	N/A	5000	
T: 1.5 ⁺⁰ / _{-0.2}	1000	N/A	1000	N/A	5000	
T: 2.0 ⁺⁰ / _{-0.2}	1000	N/A	1000	N/A	4000	

HIGH DIELECTRIC CONSTANT TYPE Z5U

MURATA ERIE DESIGNATION	GRM 39			GRM 40			GRM 42-6			GRM 42-2		
EIA TYPE DESIGNATION	0603			0805			1206			1210		
WVDC	50	100	200	50	100	200	50	100	200	50	100	200
CAPACITANCE (pF) 1000						1500						
		3300				3300						
(μF).01	.01		N/A		6800					3300		
					.015					6800		
.1				.022					.022			
				.033					.033			
1.0				.1					.047			
								.1				
								.22				
										.15		
										.33		

Note: Capacitance values = EIA 6 Step = 10, 15, 22, 33, 47, 68. For values not listed, contact your local Murata Erie Sales Office.

STANDARD THICKNESS/PACKAGING SPECIFICATIONS

DIMENSIONS: mm		Bulk	Tape			
		Pcs/bag (typical)	Pcs/7 inch (178 mm) reel		Pcs/13 inch (330 mm) reel	
		Plastic	Paper	Embossed	Paper	Embossed
	T: 0.7 ⁺⁰ _{-0.2}	1000	4000	4000	10000	10000
	T: 0.8 ± 0.1	1000	4000	N/A	10000	N/A
	T: 1.0 ⁺⁰ _{-0.2}	1000	4000	3000	10000	10000
	T: 1.25 ⁺⁰ _{-0.2} *	1000	N/A	3000	N/A	10000
	T: 1.5 ⁺⁰ _{-0.2}	1000	N/A	2000	N/A	8000

*GRM40 T= 1.25 ± .1

HIGH DIELECTRIC CONSTANT TYPE Z5U

MURATA ERIE DESIGNATION	GRM 43-2			GRM 43-4			GRM 44-1			GRM 44		
EIA TYPE DESIGNATION	1812			1825			2220			2225		
WVDC	50	100	200	50	100	200	50	100	200	50	100	200
CAPACITANCE (pF)1000												
(μF) .01			.033									
.1		.068 .1 .12 .22			.1	.047 .068 .1			.1			.1
1.0	.33 .68 1.0			.33	.47			.33	.22		.33 .47	.22
							1.0 1.5			1.0 1.5 2.2		

Note: Capacitance values = EIA 6 Step = 10, 15, 22, 33, 47, 68. For values not listed, contact your local Murata Erie Sales Office.

STANDARD THICKNESS/PACKAGING SPECIFICATIONS





DIMENSIONS: mm		Bulk	Tape			
		Pcs/bag (typical)	Pcs/7 inch (178 mm) reel		Pcs/13 inch (330 mm) reel	
		Plastic	Paper	Embossed	Paper	Embossed
	T : 1.25 $\begin{smallmatrix} +0 \\ -0.2 \end{smallmatrix}$	1000	N/A	1000	N/A	5000
	T : 1.5 $\begin{smallmatrix} +0 \\ -0.2 \end{smallmatrix}$	1000	N/A	1000	N/A	5000
	T : 2.0 $\begin{smallmatrix} +0 \\ -0.2 \end{smallmatrix}$	1000	N/A	1000	N/A	4000

HIGH DIELECTRIC CONSTANT TYPE Y5V

MURATA ERIE DESIGNATION	GRM 39				GRM 40				GRM 42-6				GRM 42-2				
EIA TYPE DESIGNATION	0603				0805				1206				1210				
WVDC	16	25	50	100	16	25	50	100	16	25	50	100	16	25	50	100	
CAPACITANCE (pF) 1000				1200			2200	2200									
(μF).01				4700				6800									
	.033																
			.047				.022	.022									
						.068	.047				.068	.047					.047
.1		.15			.1	.1	.15		.15	.15	.1						.068
	.22				.22	.47			.47	.47							.1
1.0					1.0					1.0				.68	1.0	1.0	.68
									2.2				2.2		1.5		

Note: Capacitance values = EIA 6 Step = 10, 15, 22, 33, 47, 68. For values not listed, contact your local Murata Erie Sales Office.

STANDARD THICKNESS/PACKAGING SPECIFICATIONS

DIMENSIONS: mm	Bulk	Tape				
		Pcs/bag (typical)	Pcs/7 inch (178 mm) reel		Pcs/13 inch (330 mm) reel	
			Plastic	Paper	Embossed	Paper
 T : 0.7 ⁺⁰ _{-0.2}	1000	4000	4000	10000	10000	
 T : 0.8 ± 0.1	1000	4000	N/A	10000	N/A	
 T : 1.0 ⁺⁰ _{-0.2}	1000	4000	3000	10000	10000	
 T : 1.25 ⁺⁰ _{-0.2} *	1000	N/A	3000	N/A	10000	
 T : 1.5 ⁺⁰ _{-0.2}	1000	N/A	2000	N/A	8000	

*GRM40 T = 1.25 ± .1

HIGH DIELECTRIC CONSTANT TYPE Y5V

MURATA ERIE DESIGNATION	GRM 43-2				GRM 43-4		GRM 44-1			GRM 44		
EIA TYPE DESIGNATION	1812				1825		2220			2225		
WVDC	16	25	50	100	50	100	25	50	100	25	50	100
CAPACITANCE (pF) 1000												
(μF).01												
.1				.15 .22	.22	.22 .33 .47				.33 .68	.68	
1.0		1.0	1.0		1.0 1.5		1.0	1.0 1.5	2.2		1.0 1.5	3.3
	2.2							2.2				

Note: Capacitance values = EIA 6 Step = 10, 15, 22, 33, 47, 68. For values not listed, contact your local Murata Erie Sales Office.

STANDARD THICKNESS/PACKAGING SPECIFICATIONS

DIMENSIONS: mm	Tolerance	Bulk	Tape			
		Pcs/bag (typical)	Pcs/7 inch (178 mm) reel		Pcs/13 inch (330 mm) reel	
		Plastic	Paper	Embossed	Paper	Embossed
	T: 1.25 ⁺⁰ _{-0.2}	1000	N/A	1000	N/A	5000
	T: 1.5 ⁺⁰ _{-0.2}	1000	N/A	1000	N/A	5000
	T: 2.0 ⁺⁰ _{-0.2}	1000	N/A	1000	N/A	4000

CHIPS-GRM Series

FOR LOW PROFILE AND SUB-PLCC

HIGH DIELECTRIC CONSTANT TYPE X7R, Y5V

MURATA ERIE DESIGNATION	GRM 40-024						GRM 40-037						GRM 40-026					
EIA TYPE DESIGNATION	0805						0805						0805					
MAX THICKNESS	.020						.026						.028					
WVDC	16		25		50		16		25		50		16		25		50	
TEMPERATURE CHARACTERISTIC	X7R	Y5V	X7R	Y5V	X7R	Y5V	X7R	Y5V	X7R	Y5V	X7R	Y5V	X7R	Y5V	X7R	Y5V	X7R	Y5V
CAPACITANCE (pF) 100					220													
						1000												
			2200	2200														
					6800													
.01(μF)	.01		.01			.01					.01							
	.027								.015			.018				.015		.012
								.022						.022			.015	
	.047		.033				.033				.027		.033					.033
	.1						.056			.056		.047	.047					.047
.1								.15						.15			.1	
								.22										
1.0																		

PACKAGING = Bulk: 1,000 pcs/bag TAPE AND REEL: 4,000 pcs/7" (178mm) Reel, 10,000 pcs/13" (330mm) Reel Paper tape only.

Note: For X7R, Capacitance values = E1A 12 Step = 10, 12, 15, 18, 22, 27, 33, 39, 47, 56, 68, 82.
 For Z5U and Y5V, Capacitance values = E1A 6 Step = 10, 15, 22, 33, 47, 68.
 For values not listed, please contact your local Murata Erie Sales Office.

MURATA ERIE DESIGNATION	GRM 42-625				GRM 42-626		GRM 42-224				GRM 42-225				GRM 42-221			GRM 42-226		
EIA TYPE DESIGNATION	1206				1206		1210				1210				1210			1210		
MAXIMUM THICKNESS	.024				.028		.020				.024				.026			.028		
WVDC	16	25			16	25	16	25			16	25			25			25		
TEMPERATURE CHARACTERISTIC	Y5V	X7R	Z5U	Y5V	Y5V	Y5V	Y5V	X7R	Z5U	Y5V	Y5V	X7R	Z5U	Y5V	X7R	Z5U	Y5V	X7R	Z5U	Y5V
CAPACITANCE (pF) 100																				
	1000																			
.01(μF)																				
.1																				
1.0																				

PACKAGING = Bulk: 1,000 pcs/bag TAPE AND REEL: 4,000 pcs/7" (178mm) Reel, 10,000 pcs/13" (330mm) Reel Paper tape only.

Note: For X7R, Capacitance values = E1A 12 Step = 10, 12, 15, 18, 22, 27, 33, 39, 47, 56, 68, 82.

For Z5U and Y5V, Capacitance values = E1A 6 Step = 10, 15, 22, 33, 47, 68.

For values not listed, please contact your local Murata Erie Sales Office.

MONOLITHIC CERAMIC CAPACITORS

CONFORMAL COATED

RADIAL LEADS

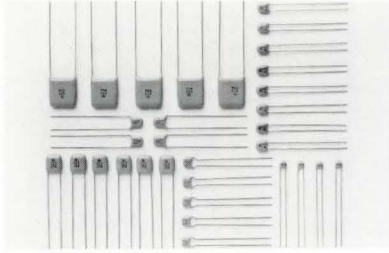

OUTSTANDING CHARACTERISTICS

- Wide capacitance, T.C., voltage and tolerance range
- Industry standard sizes
- Tape and reel available for auto-insertion
- Various lead spacing available
- Marking standard or to customer specification
- Coating material meets UL94V-0

PART NUMBERING SYSTEM

Part Number	RPE 110-XXX	X7R	103	K	050V										
CAPACITOR TYPE AND SIZE	Used only for tape and reel and other variations.														
TEMPERATURE CHARACTERISTICS (Note 3)	COG=0, ±30ppm (Notes 1, 2) X7R=±15% Z5U=+22, -56% Y5V=+22, -82% (See Note 2 below) P2H=N150±60ppm R2H=N220±60ppm S2H=N330±60ppm T2H=N470±60ppm U2J=N750±120ppm														
CAPACITANCE VALUE			Expressed in picofarads and identified by a three-digit number. First two digits represent significant figures. Last digit specifies the number of zeros to follow. For values below 10pF, the letter 'R' is used as the decimal point and the last digit becomes significant.												
CAPACITANCE TOLERANCE (Note 2)					* COG: (10pF or less) * C=± 25pF * D=± 5pF * J=± 5% * K=± 10% * X7R: K=± 10% * M=± 20% * Z5U: M=± 20% * Z=+80, -20% * Y5V: Z=+80, -20%										
VOLTAGE					Identified by a three-digit number. 050 and 100V standard (200V and 500V on special request)										
NOTES:	T.C. Tolerance 1. <table border="1"> <thead> <tr> <th>Capacitance (pF)</th> <th>T.C. Tolerance (ppm)</th> </tr> </thead> <tbody> <tr> <td>10 and over</td> <td>± 30(G)</td> </tr> <tr> <td>4.0-9.9</td> <td>± 60(H)</td> </tr> <tr> <td>2.1-3.9</td> <td>± 120(J)</td> </tr> <tr> <td>.4-2.0</td> <td>± 250(K)</td> </tr> </tbody> </table> Refer to EIA RS-198 for limitations. 2. Refer to EIA RS-198 for limitations. 3. Other T.C.s available on special request.					Capacitance (pF)	T.C. Tolerance (ppm)	10 and over	± 30(G)	4.0-9.9	± 60(H)	2.1-3.9	± 120(J)	.4-2.0	± 250(K)
Capacitance (pF)	T.C. Tolerance (ppm)														
10 and over	± 30(G)														
4.0-9.9	± 60(H)														
2.1-3.9	± 120(J)														
.4-2.0	± 250(K)														

MARKINGS

* Available as standard through authorized Murata Erie Distributors.

Voltage Code
 2=25V, 5=50V,
 1=100V, 6=200V, 9=500V

Temp. Char. Code
 A=COG, P=P2H, R=R2H,
 S=S2H, T=T2H, U=U2J, C=X7R,
 E=Z5U, F=Y5V

RPE 110: Cap. and Tol. only for X7R, Z5U and Y5V materials.

DIMENSIONS: in. (mm)

MURATA ERIE DESIGNATION	RPE 110	RPE 121/RPE122	RPE 123
L	.138 (3.5)	.200 (5.1)	.300 (7.6)
H	.120 (3.1)	.250 (6.4)	.275 (7.0)
T	.100 (2.5)	.125 (3.2)	.125 (3.2)
L.S.	.100 (2.5)	.100 (2.5)/.200 (5.1)	.200 (5.1)

TEMPERATURE CHARACTERISTICS (CHIPS AND RADIAL LEADED DEVICES)

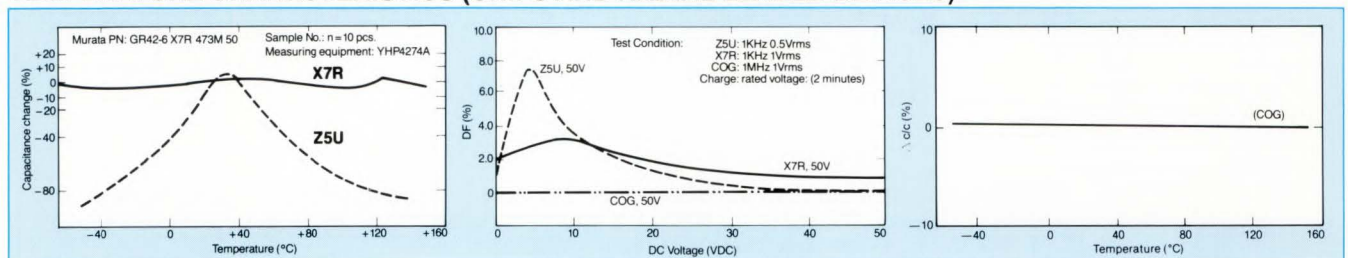

MONOLITHIC CERAMIC CAPACITORS
CONFORMAL COATED
RADIAL LEADS



50-500 VDC

Type	Voltage Rating	Capacitance (pF) (μF)		
		*C0G (NPO) (A)	*X7R (C)	*Z5U (E)
★RPE110	★ 50V	1 - 1,000	220 - .033	1,000 - .068
	★ 100V	1 - 1,000	220 - .012	1,000 - .015
	★ 200V	1 - 130	220 - 5,600	1,000 - 5,600
★RPE121/ 122	★ 50V	1 - 4,300	330 - .15	1,000 - .33
	★ 100V	1 - 3,900	330 - .1	1,000 - .1
	★ 200V	1 - 360	330 - .047	1,000 - .047
	★ 500V	1 - 130	330 - 5,600	1,000 - 5,600
★RPE123	★ 50V	—	—	.47 - 1.0
	★ 100V	—	—	—
	★ 200V ★ 500V	—	—	—
★RPE113	★ 50V	4,300 - .02	.15 - 1.0	.33 - 1.5
	★ 100V	2,000 - .012	.1 - .47	.1 - .68
	★ 200V	360 - 3,900	.047 - .15	.047 - .15
	★ 500V	130 - 1,000	5,600 - 0.33	5,600 - 0.33
★RPE114	★ 50V	.02 - .033	1.0 - 1.8	1.5 - 3.3
	★ 100V	.012 - .027	.47 - 1.0	.68 - 1.0
	★ 200V	3,900 - .01	.15 - .56	.15 - .47
	★ 500V	1,000 - 2,400	.033 - .1	.033 - .1
★RPE117	★ 50V	.033 - .068	1.8 - 2.2	3.3 - 5.6
	★ 100V	.027 - .056	1.0 - 1.5	1.0 - 2.2
	★ 200V	.01 - .027	.56 - 1.0	.47 - 1.0
	★ 500V	2,400 - 6,200	.1 - .22	.1 - .22

TEMPERATURE COMPENSATING 50-100 VDC

Type	Voltage Rating	Capacitance (pF)				
		N150 (P2H) (P)	N220 (R2H) (R)	N330 (S2H) (S)	N470 (T2H) (T)	N750 (U2J) (U)
RPE110	50V	1-360	1-560	1-470	1-390	1-1,800
	100V	1-330	1-510	1-430	1-51	1-960
RPE121/ 122	50V	1-2,400	1-2,700	1-3,300	1-1,200	15-7,500
	100V	1-2,200	1-2,400	1-3,000	1-240	15-4,700

CAPACITANCE TOLERANCE (Note 2)

C0G: (10pF or less) C = ±25pF; D = ±5pF; (over 10pF) J = ±5%; K = ±10%;
 X7R: K = ±10%; M = ±20%
 Z5U: M = ±20%; Z = +80, -20%

TEMPERATURE CHARACTERISTICS

NOTES: T.C. Tolerance

C0G=0±30 ppm (Note 1), -55°C to +125°C
 X7R=±15%, -55°C to +125°C
 Z5U=+22, -56%, +10°C to +85°C
 N150=±60 ppm, -55°C to +125°C
 N220=±60 ppm, -55°C to +125°C
 N330=±60 ppm, -55°C to +125°C
 N470=±60 ppm, -55°C to +125°C
 N750=±120 ppm, -55°C to +125°C

Capacitance (pF)	T.C. Tolerance (ppm)
4-2.0	±250 (K)
2.1-3.9	±120 (J)
4.0-9.9	±60 (H)
10 and over	±30 (G)

Refer to EIA RS198 for limitations.

2. Other T.C.s available on special request.

PREFERRED VALUES

Cap.	Part No. ±5%
C0G (NPO) 50V	
12pF	RPE110C0G120J50V
15	RPE110C0G150J50V
18	RPE110C0G180J50V
20	RPE110C0G200J50V
22	RPE110C0G220J50V
27	RPE110C0G270J50V
33	RPE110C0G330J50V
36	RPE110C0G360J50V
39	RPE110C0G390J50V
47	RPE110C0G470J50V
56	RPE110C0G560J50V
68	RPE110C0G680J50V
82	RPE110C0G820J50V
100	RPE110C0G101J50V
120	RPE110C0G121J50V
150	RPE110C0G151J50V
180	RPE110C0G181J50V
220	RPE110C0G221J50V
270	RPE110C0G271J50V
330	RPE110C0G331J50V
390	RPE110C0G391J50V
470	RPE110C0G471J50V
560	RPE110C0G561J50V
680	RPE110C0G681J50V
820	RPE110C0G821J50V
1000	RPE110C0G102J50V
820	RPE121C0G821J50V
820	RPE122C0G821J50V
1000	RPE121C0G102J50V
1000	RPE122C0G102J50V
1200	RPE121C0G122J50V
1200	RPE122C0G122J50V
1500	RPE121C0G152J50V
1500	RPE122C0G152J50V
1800	RPE121C0G182J50V
1800	RPE122C0G182J50V
2200	RPE121C0G222J50V
2200	RPE122C0G222J50V
2700	RPE121C0G272J50V
2700	RPE122C0G272J50V
3300	RPE121C0G332J50V
3300	RPE122C0G332J50V
3900	RPE122C0G392J50V
4700	RPE123C0G472J50V
5600	RPE123C0G562J50V
6800	RPE113C0G682J50V
8200	RPE113C0G822J50V
.01μF	RPE113C0G103J50V
.012	RPE113C0G123J50V
.015	RPE113C0G153J50V

Cap.	Part No. ±5%
C0G (NPO) 50V	
.018μF	RPE114C0G183J50V
.022	RPE114C0G223J50V
.027	RPE114C0G273J50V
.033	RPE117C0G333J50V
.056	RPE117C0G563J50V
.062	RPE117C0G683J50V
C0G (NPO) 100V	
12pF	RPE110C0G120J100V
15	RPE110C0G150J100V
18	RPE110C0G180J100V
20	RPE110C0G200J100V
22	RPE110C0G220J100V
27	RPE110C0G270J100V
33	RPE110C0G330J100V
36	RPE110C0G360J100V
39	RPE110C0G390J100V
47	RPE110C0G470J100V
56	RPE110C0G560J100V
68	RPE110C0G680J100V
75	RPE110C0G750J100V
82	RPE110C0G820J100V
100	RPE110C0G101J100V
120	RPE110C0G121J100V
150	RPE110C0G151J100V
180	RPE110C0G181J100V
220	RPE110C0G221J100V
270	RPE110C0G271J100V
330	RPE110C0G331J100V
390	RPE110C0G391J100V
470	RPE110C0G471J100V
560	RPE110C0G561J100V
680	RPE110C0G681J100V
560	RPE122C0G561J100V
680	RPE121C0G681J100V
680	RPE122C0G681J100V
750	RPE121C0G751J100V
750	RPE122C0G751J100V
820	RPE121C0G821J100V
820	RPE122C0G821J100V
1000	RPE121C0G102J100V
1000	RPE122C0G102J100V
1200	RPE121C0G122J100V
1200	RPE122C0G122J100V
1200	RPE121C0G122J100V
1500	RPE121C0G152J100V
1500	RPE122C0G152J100V
1800	RPE121C0G182J100V
1800	RPE122C0G182J100V
2200	RPE121C0G222J100V
2200	RPE122C0G222J100V

Cap.	Part No. ±5%
C0G (NPO) 100V	
2700pF	RPE121C0G272J100V
2700	RPE122C0G272J100V
3300	RPE121C0G332J100V
3300	RPE122C0G332J100V
3900	RPE123C0G392J100V
4700	RPE123C0G472J100V
5600	RPE123C0G562J100V
6200	RPE123C0G622J100V
6800	RPE123C0G682J100V
8200	RPE113C0G822J100V
.01μF	RPE113C0G103J100V
.012	RPE113C0G123J100V
.015	RPE114C0G153J100V
.018	RPE114C0G183J100V
.022	RPE114C0G223J100V
.027	RPE114C0G273J100V
.033	RPE114C0G333J100V
.033	RPE117C0G333J100V
.047	RPE117C0G473J100V
.056	RPE117C0G563J100V
X7R 50V ±10%	
220pF	RPE110X7R221K50V
270	RPE110X7R271K50V
330	RPE110X7R331K50V
390	RPE110X7R391K50V
470	RPE110X7R471K50V
560	RPE110X7R561K50V
680	RPE110X7R681K50V
750	RPE110X7R751K50V
820	RPE110X7R821K50V
1000	RPE110X7R102K50V
1000	RPE122X7R102K50V
1200	RPE110X7R122K50V
1500	RPE110X7R152K50V
1800	RPE110X7R182K50V
2200	RPE110X7R222K50V

* All preferred values are available as standard through authorized Murata ERIE Distributors.

PREFERRED VALUES

Cap.	Part No. ±10%
X7R 50V	
2700pF	RPE110X7R272K50V
3300	RPE110X7R332K50V
3300	RPE122X7R332K50V
3600	RPE110X7R362K50V
3900	RPE110X7R392K50V
4700	RPE110X7R472K50V
4700	RPE122X7R472K50V
5600	RPE110X7R562K50V
6200	RPE110X7R622K50V
6800	RPE110X7R682K50V
7500	RPE110X7R752K50V
.01μF	RPE110X7R103K50V
.01	RPE121X7R103K50V
.01	RPE122X7R103K50V
.015	RPE110X7R153K50V
.015	RPE122X7R153K50V
.018	RPE110X7R183K50V
.018	RPE122X7R183K50V
.022	RPE110X7R223K50V
.022	RPE121X7R223K50V
.022	RPE122X7R223K50V
.027	RPE121X7R273K50V
.027	RPE122X7R273K50V
.033	RPE110X7R333K50V
.033	RPE121X7R333K50V
.033	RPE122X7R333K50V
.039	RPE121X7R393K50V
.039	RPE122X7R393K50V
.047	RPE121X7R473K50V
.047	RPE122X7R473K50V
.056	RPE122X7R563K50V
.056	RPE122X7R563K50V
.068	RPE121X7R683K50V
.068	RPE122X7R683K50V
.082	RPE121X7R823K50V
.082	RPE122X7R823K50V
.1	RPE121X7R104K50V
.1	RPE122X7R104K50V
.12	RPE121X7R124K50V
.12	RPE122X7R124K50V
.15	RPE121X7R154K50V
.15	RPE122X7R154K50V
.18	RPE121X7R184K50V
.18	RPE122X7R184K50V
.22	RPE123X7R224K50V
.27	RPE123X7R274K50V
.33	RPE123X7R334K50V
.39	RPE113X7R394K50V
.47	RPE113X7R474K50V
.56	RPE113X7R564K50V
.68	RPE113X7R684K50V
.82	RPE113X7R824K50V
1.0	RPE113X7R105K50V
1.2	RPE114X7R125K50V
1.5	RPE114X7R155K50V
1.8	RPE114X7R185K50V
2.2	RPE117X7R225K50V
X7R 100V	
220pF	RPE110X7R221K100V
270	RPE110X7R271K100V
330	RPE110X7R331K100V
470	RPE110X7R471K100V
560	RPE110X7R561K100V
680	RPE110X7R681K100V
750	RPE110X7R751K100V
820	RPE110X7R821K100V
1000	RPE110X7R102K100V
1500	RPE110X7R152K100V
1800	RPE110X7R182K100V
2200	RPE110X7R222K100V
2700	RPE110X7R272K100V
3300	RPE110X7R332K100V
3600	RPE110X7R362K100V
3900	RPE110X7R392K100V
4700	RPE110X7R472K100V

Cap.	Part No. ±10%
X7R 100V	
5600pF	RPE110X7R562K100V
6800	RPE110X7R682K100V
8200	RPE110X7R822K100V
.01μF	RPE110X7R103K100V
.01	RPE121X7R103K100V
.01	RPE122X7R103K100V
.012	RPE110X7R123K100V
.012	RPE122X7R123K100V
.015	RPE121X7R153K100V
.015	RPE122X7R153K100V
.018	RPE121X7R183K100V
.018	RPE122X7R183K100V
.022	RPE121X7R223K100V
.022	RPE122X7R223K100V
.027	RPE121X7R273K100V
.027	RPE122X7R273K100V
.033	RPE121X7R333K100V
.033	RPE122X7R333K100V
.039	RPE121X7R393K100V
.039	RPE122X7R393K100V
.047	RPE121X7R473K100V
.047	RPE122X7R473K100V
.056	RPE121X7R563K100V
.056	RPE122X7R563K100V
.068	RPE121X7R683K100V
.068	RPE122X7R683K100V
.082	RPE121X7R823K100V
.082	RPE122X7R823K100V
.1	RPE121X7R104K100V
.1	RPE122X7R104K100V
.12	RPE123X7R124K100V
.15	RPE123X7R154K100V
.18	RPE113X7R184K100V
.22	RPE113X7R224K100V
.27	RPE113X7R274K100V
.33	RPE113X7R334K100V
.39	RPE114X7R394K100V
.47	RPE114X7R474K100V
.56	RPE114X7R564K100V
.68	RPE114X7R684K100V
.82	RPE114X7R824K100V
1.0	RPE114X7R105K100V
1.2	RPE117X7R125K100V
Z5U 50V ±20%	
1000pF	RPE110Z5U102M50V
1500	RPE110Z5U152M50V
1800	RPE110Z5U182M50V
2200	RPE110Z5U222M50V
2700	RPE110Z5U272M50V
3300	RPE110Z5U332M50V
3900	RPE110Z5U392M50V
4700	RPE110Z5U472M50V
5600	RPE110Z5U562M50V
6800	RPE110Z5U682M50V
8200	RPE110Z5U822M50V
.01μF	RPE110Z5U103M50V
.01	RPE121Z5U103M50V
.01	RPE122Z5U103M50V
.015	RPE110Z5U153M50V
.015	RPE122Z5U153M50V
.022	RPE110Z5U223M50V
.022	RPE122Z5U223M50V
.033	RPE110Z5U333M50V
.033	RPE122Z5U333M50V
.047	RPE110Z5U473M50V
.047	RPE122Z5U473M50V
.068	RPE110Z5U683M50V
.068	RPE122Z5U683M50V
.1	RPE121Z5U104M50V
.1	RPE122Z5U104M50V
.15	RPE121Z5U154M50V
.15	RPE122Z5U154M50V
.18	RPE121Z5U184M50V
.18	RPE122Z5U184M50V
.22	RPE121Z5U224M50V

Cap.	Part No. ±20%
Z5U 50V	
.22μF	RPE122Z5U224M50V
.27	RPE121Z5U274M50V
.27	RPE122Z5U274M50V
.33	RPE121Z5U334M50V
.33	RPE122Z5U334M50V
.47	RPE123Z5U474M50V
.68	RPE123Z5U684M50V
1.0	RPE123Z5U105M50V
1.5	RPE113Z5U155M50V
2.2	RPE114Z5U225M50V
3.3	RPE114Z5U335M50V
4.7	RPE117Z5U475M50V
5.6	RPE117Z5U565M50V
Z5U 100V	
1000pF	RPE110Z5U102M100V
1500	RPE110Z5U152M100V
1800	RPE110Z5U182M100V
2200	RPE110Z5U222M100V
2700	RPE110Z5U272M100V
3300	RPE110Z5U332M100V
3900	RPE110Z5U392M100V
4700	RPE110Z5U472M100V
5600	RPE110Z5U562M100V
6800	RPE110Z5U682M100V
.01μF	RPE110Z5U103M100V
.01	RPE121Z5U103M100V
.01	RPE122Z5U103M100V
.015	RPE110Z5U153M100V
.015	RPE122Z5U153M100V
.018	RPE121Z5U183M100V
.018	RPE122Z5U183M100V
.022	RPE121Z5U223M100V
.022	RPE122Z5U223M100V
.033	RPE121Z5U333M100V
.033	RPE122Z5U333M100V
.039	RPE121Z5U393M100V
.039	RPE122Z5U393M100V
.047	RPE121Z5U473M100V
.047	RPE122Z5U473M100V
.068	RPE121Z5U683M100V
.068	RPE122Z5U683M100V
.1	RPE121Z5U104M100V
.1	RPE122Z5U104M100V
.12	RPE123Z5U124M100V
.15	RPE123Z5U154M100V
.15	RPE122Z5U154M100V
.18	RPE123Z5U184M100V
.22	RPE113Z5U224M100V
.22	RPE113Z5U334M100V
.47	RPE113Z5U474M100V
.68	RPE114Z5U684M100V
1.0	RPE114Z5U105M100V
1.5	RPE117Z5U155M100V
2.2	RPE117Z5U225M100V

* All preferred values are available as standard through authorized Murata Erie Distributors.

TAPE & REEL FOR AUTO-INSERTION

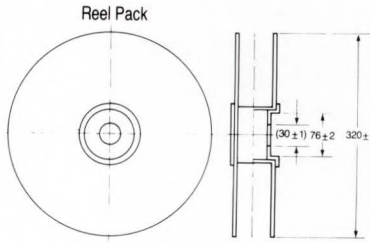

STANDARD QUANTITY PER REEL

	REEL	AMMO
RPE121	2500	2000
RPE122	2500	2000
RPE123	2500	2000
RPE113	2000	2000
RPE114	1500	1500

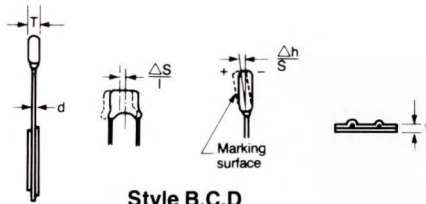

Style B,C,D

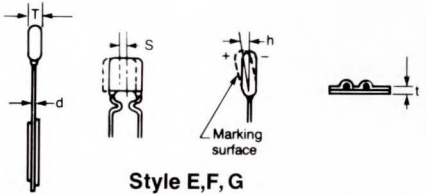

Style E,F,G

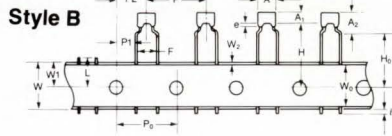

Style B

Fuji—RPE122-901
Panaset—RT-RPE122-905
Avisert, Universal—RPE122-906

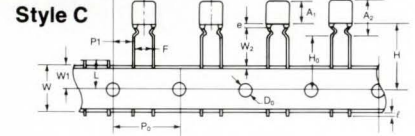

Style C

Fuji—RPE113-901

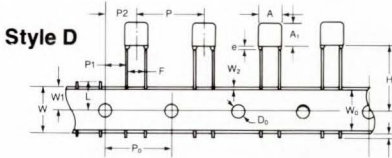

Style D

Fuji, Panaset—RB-RPE113-902
—RPE113-903
Avisert, Universal—RPE113-907

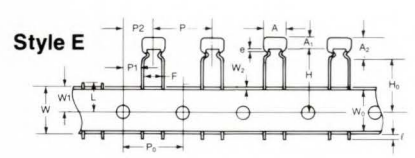

Style E

Fuji—RPE123-951
Avisert, Universal—RPE123-906

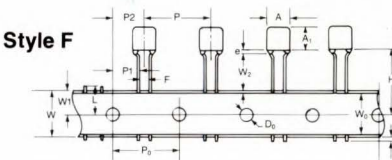

Style F

Fuji, Panaset—RB-RPE114-903
Avisert, Universal—RPE114-907

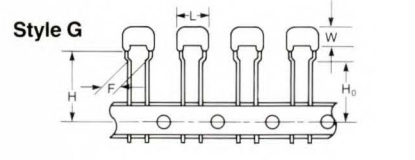

Style G

POSITION		RPE122-901	RPE122-905	RPE122-906	RPE113-901	RPE113-902	RPE113-903	RPE113-907	RPE123-901*	RPE123-906*	RPE114-903	RPE114-907	RPE121-191
STYLE	DIM.	B	B	B	C	D	D	D	E	E	F	F	G
Taping Pitch	P	12.7	12.7	12.7	12.7	12.7	12.7	12.7	12.7	12.7	12.7	12.7	12.7
Feed Hole Pitch	P ₀	12.7±0.2	12.7±0.2	12.7±0.2	12.7±0.2	12.7±0.2	12.7±0.2	12.7±0.2	12.7±0.2	12.7±0.2	12.7±0.2	12.7±0.2	12.7±0.2
Feed Hole Position	P ₂	6.35±1.3	6.35±1.3	6.35±1.3	6.35±1.3	6.35±1.3	6.35±1.3	6.35±1.3	6.35±1.3	6.35±1.3	6.35±1.3	6.35±1.3	6.35±1.3
Feed Hole Position	P ₁	3.85±0.7	3.85±0.7	3.85±0.7	3.85±0.7	3.85±0.7	3.85±0.7	3.85±0.7	3.85±0.7	3.85±0.7	3.85±0.7	3.85±0.7	3.85±0.7
Lead Space	F	5.20±0.4	5.20±0.4	5.20±0.4	5.20±0.4	5.20±0.4	5.20±0.4	5.20±0.4	5.20±0.4	5.08±0.5	5.20±0.4	5.20±0.4	2.5±0.4
Body Width	A	5.0 max	5.0 max	5.0 max	7.5 max	7.5 max	7.5 max	7.5 max	7.5 max	7.5 max	10.0 max	10.0 max	5.0 max
Body Height	A ₁	5.0 max	5.0 max	5.0 max	7.5 max	7.5 max	7.5 max	7.5 max	5.0 max	5.0 max	10.0 max	10.0 max	5.0 max
Body Height	A ₂	6.3 max	8.5 max	6.3 max	10.0 max	—	—	—	6.3 max	6.3 max	13.5 max	—	6.3 max
Body Thickness	T	3.15 max	3.15 max	3.15 max	4.0 max	4.0 max	3.15 max	3.15 max	3.15 max	3.15 max	3.81 max	3.81 max	3.15 max
Deviation Along Tape	ΔS	±2.0	±2.0	±2.0	±2.0	±2.0	±2.0	±2.0	±2.0	±2.0	±2.0	±2.0	±2.0
Width of Tape Carrier	W	18.0±0.5	18.0±0.5	18.0±0.5	18.0±0.5	18.0±0.5	18.0±0.5	18.0±0.5	18.0±0.5	18.0±0.5	18.0±0.5	18.0±0.5	18.0±0.5
Half Width of Tape Carrier	W ₁	9.0 ⁺⁰ _{-0.5}	9.0 ⁺⁰ _{-0.5}	9.0 ⁺⁰ _{-0.5}	9.0 ⁺⁰ _{-0.5}	9.0 ⁺⁰ _{-0.5}	9.0 ⁺⁰ _{-0.5}	9.0 ⁺⁰ _{-0.5}	9.0 ⁺⁰ _{-0.5}	9.0 ⁺⁰ _{-0.5}	9.0 ⁺⁰ _{-0.5}	9.0 ⁺⁰ _{-0.5}	9.0 ⁺⁰ _{-0.5}
Lead Length	H ₀	16.0±0.5	16.0±0.5	20.0±0.5	16.0±0.5	—	—	—	16.0±0.5	20.0±0.5	—	—	16.0±0.5
Lead Length	H	18.0±1.0	20.0±1.0	22.0±1.0	19.0±1.0	16.5±0.5	17.5±0.5	20.0±0.5	18.0±1.0	22.0±1.0	17.5±1.0	20.0±0.5	18.0±1.0
Lead Protrusion	l	+0.5 to -1.0	+0.5 to -1.0	+0.5 to -1.0	+0.5 to -1.0	+0.5 to -1.0	+0.5 to -1.0	+0.5 to -1.0	+0.5 to -1.0	+0.5 to -1.0	+0.5 to -1.0	+0.5 to -1.0	+0.5 to -1.0
Diameter of Feed Hole	D ₀	4.0±0.1	4.0±0.1	4.0±0.1	4.0±0.1	4.0±0.1	4.0±0.1	4.0±0.1	4.0±0.1	4.0±0.1	4.0±0.1	4.0±0.1	4.0±0.1
Lead Wire	d	0.5±0.05	0.5±0.05	0.5±0.05	0.5±0.05	0.5±0.05	0.5±0.05	0.5±0.05	0.5±0.05	0.5±0.05	0.5±0.05	0.5±0.05	0.5±0.05
Total Tape Thickness	t	0.7±0.2	0.7±0.2	0.7±0.2	0.7±0.2	0.7±0.2	0.7±0.2	0.7±0.2	0.7±0.2	0.7±0.2	0.7±0.2	0.7±0.2	0.7±0.2
Deviation Across Tape	Δh	±1.0	±1.0	±1.0	±1.0	±1.0	±1.0	±1.0	±1.0	±1.0	±1.0	±1.0	±1.0
Cutting Position Failure	L	11.0 ⁺⁰ _{-1.0}	11.0 ⁺⁰ _{-1.0}	11.0 ⁺⁰ _{-1.0}	11.0 ⁺⁰ _{-1.0}	11.0 ⁺⁰ _{-1.0}	11.0 ⁺⁰ _{-1.0}	11.0 ⁺⁰ _{-1.0}	11.0 ⁺⁰ _{-1.0}	11.0 ⁺⁰ _{-1.0}	11.0 ⁺⁰ _{-1.0}	11.0 ⁺⁰ _{-1.0}	11.0 ⁺⁰ _{-1.0}
Width of Masking Tape	W ₀	12.5 min	12.5 min	12.5 min	12.5 min	12.5 min	12.5 min	12.5 min	12.5 min	12.5 min	12.5 min	12.5 min	12.5 min
Margin Between Tapes	W ₂	1.5±1.5	1.5±1.5	1.5±1.5	1.5±1.5	1.5±1.5	1.5±1.5	1.5±1.5	1.5±1.5	1.5±1.5	1.5±1.5	1.5±1.5	1.5±1.5
Parts Length	e	1.5 max	1.5 max	1.5 max	1.0 max	1.0 max	1.0 max	1.0 max	1.0 max	1.0 max	1.5 max	1.5 max	1.5 max

*RPE 123 Series — Low Profile — contact your local Murata Erie Sales Office for further information.

PORCELAIN MONOLITHIC CAPACITORS FOR MICROWAVE APPLICATIONS

MA SERIES 18, 58, 28 & 68 SERIES

CONFIGURATIONS AND DIMENSIONS – CASE SIZE 1 AND CASE SIZE 2

Type				Configuration	Dimensions: in. (mm)			Band	Termination
MIL-C-55681	P90±20 ppm/°C	COG±30 ppm/°C	CASE SIZE		Length	W±.010 (.25)	T max.	Y +.010 -.005 (+.25/- .1)	
CDR12	*MA18	MA58	1		.07 max. (1.8 max.)	.055 (1.4)	.055 (1.4)	.010 (.25)	Palladium Silver, Ni Interface & Solder (Sn 62)
CDR14	*MA28	MA68	2		.130 max. (3.3)	.110 (2.8)	.100 (2.5)	.015 (.4)	

PART NUMBERING SYSTEM – CASE SIZE 1

M	A	1	8	101	J
CUBIC MONOLITHIC	A-STD SERIES	DIMENSIONAL AND T.C. CODE 1:P90 Case 1 5:COG Case 1 2:P90 Case 2 6:NPO Case 2	TERMINATION CODE: 8: Pd/Ag, Ni interface, Solder (Sn62) (Preferred)	CAPACITANCE CODE: Expressed in picofarads and identified by a three-digit number. First two digits represent significant figures. Last digit specifies the number of zeros to follow. For values below 10pF, the letter "R" is used as the decimal point and the last digit becomes significant.	TOLERANCES: *B: ±0.1pF *C: ±0.25pF *D: ±0.5pF F: ±1% G: ±2% J: ±5% *Available below 10pF only

SPECIFICATIONS

Quality Factor:	MA 18/28/58/68; Exceeds MIL-C-55681
Temperature Coefficient:	MA 18/28 Series; P90 ± 20ppm/°C, (-55°C to +125°C) MA 58/68 Series; COG (NPO ± 30ppm/°C -55°C to +125°C)
Insulation Resistance:	MA 18/28; 1000K Megohms at +25°C, 100K Megohms at +125°C MA 58/68; 1000K Megohms at +25°C, 100K Megohms at +125°C
Dielectric Test Voltage:	MA 18/28/58/68; 250% of WVDC for 5 seconds
Capacitance Drift:	Meets or Exceeds MIL-C-55681
Aging:	Negligible for MA 18/28/58/68
Environmental Tests:	MIL-STD-202

Shock:	Method 213, Condition J
Vibration:	Method 204, Condition B
Moisture Resistance:	Method 106
Solderability:	Method 208
Immersion:	Method 104, Condition B
Barometric Pressure:	Method 105, Condition B
Resistance to Soldering Heat:	Method 210, Condition B
Thermal Shock:	Method 107, Condition A
Life:	Method 108, Condition F
MARKING:	MA 18/28/58/68; Laser mark Capacitance Code, Tolerance Code, Logo (where space permits)

DIMENSIONS: in. (mm)

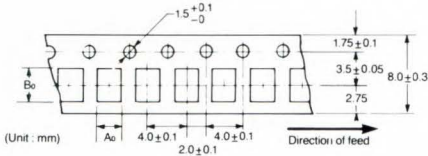

NOTE: 1 A₀ & B₀ ARE DETERMINED BY MAXIMUM SPECIFIED LENGTH AND WIDTH OF COMPONENTS PLUS 0.4±0.2 (0.016±0.008), PLUS THE ADDITIONAL REQUIREMENTS THAT COMPONENTS NOT BE ALLOWED TO ROTATE MORE THAN 20° WITHIN THE CAVITY CLEARANCE OR WHICHEVER CONDITION OCCURS FIRST.

TAPE-AND-REEL PACKAGING

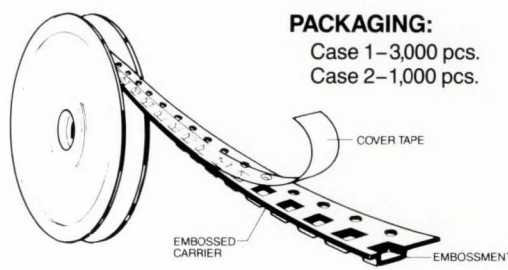

PACKAGING:
Case 1–3,000 pcs.
Case 2–1,000 pcs.

*Available as standard through Murata Ene Distributors.

MA ★ 18 & 58 SERIES, P90 & C0G — CASE SIZE 1

Cap. Code	Cap. pF	Cap. Tol.	WVDC*
OR1	0.1	B	150
OR2	0.2	B	150
OR3	0.3	B,C	150
OR4	0.4	B,C	150
OR5	0.5	B,C,D	150
OR6	0.6	B,C,D	150
OR7	0.7	B,C,D	150
OR8	0.8	B,C,D	150
OR9	0.9	B,C,D	150
*1R0	1.0	B,C,D	150
1R1	1.1	B,C,D	150
*1R2	1.2	B,C,D	150
1R3	1.3	B,C,D	150
1R4	1.4	B,C,D	150
*1R5	1.5	B,C,D	150
1R6	1.6	B,C,D	150
1R7	1.7	B,C,D	150
1R8	1.8	B,C,D	150
1R9	1.9	B,C,D	150
2R0	2.0	B,C,D	150
*2R2	2.2	B,C,D	150
2R4	2.4	B,C,D	150

@125°C

Cap. Code	Cap. pF	Cap. Tol.	WVDC*
2R7	2.7	B,C,D	150
3R0	3.0	B,C,D	150
*3R3	3.3	B,C,D	150
3R6	3.6	B,C,D	150
*3R9	3.9	B,C,D	150
4R3	4.3	B,C,D	150
*4R7	4.7	B,C,D	150
*5R1	5.1	B,C,D	150
*5R6	5.6	B,C,D	150
6R2	6.2	B,C,D	150
*6R8	6.8	B,C,J,K,M	150
*7R5	7.5	B,C,J,K,M	150
*8R2	8.2	B,C,J,K,M	150
9R1	9.1	B,C,J,K,M	150
*100	10	F,G,J,K,M	150
110	11	F,G,J,K,M	150
120	12	F,G,J,K,M	150
130	13	F,G,J,K,M	150
*150	15	F,G,J,K,M	150
*160	16	F,G,J,K,M	150
*180	18	F,G,J,K,M	150

@125°C

Cap. Code	Cap. pF	Cap. Tol.	WVDC*
200	20	F,G,J,K,M	150
*220	22	F,G,J,K,M	150
240	24	F,G,J,K,M	150
*270	27	F,G,J,K,M	150
300	30	F,G,J,K,M	150
330	33	F,G,J,K,M	150
360	36	F,G,J,K,M	150
*390	39	F,G,J,K,M	150
430	43	F,G,J,K,M	150
*470	47	F,G,J,K,M	150
510	51	F,G,J,K,M	150
*560	56	F,G,J,K,M	150
620	62	F,G,J,K,M	150
680	68	F,G,J,K,M	150
750	75	F,G,J,K,M	150
*820	82	F,G,J,K,M	150
910	91	F,G,J,K,M	150
*101	100	F,G,J,K,M	150
111**	110	F,G,J,K,M	150
121**	120	F,G,J,K,M	150
131**	130	F,G,J,K,M	150

@125°C

Cap. Code	Cap. pF	Cap. Tol.	WVDC*
151**	150	F,G,J,K,M	150
161**	160	F,G,J,K,M	150
181**	180	F,G,J,K,M	150
201**	200	F,G,J,K,M	150
221**	220	F,G,J,K,M	150
241**	240	F,G,J,K,M	150
271**	270	F,G,J,K,M	150
301**	300	F,G,J,K,M	150
331**	330	F,G,J,K,M	150
361**	360	F,G,J,K,M	150
391**	390	F,G,J,K,M	150
431**	430	F,G,J,K,M	150
471**	470	F,G,J,K,M	150
511**	510	F,G,J,K,M	150
561**	560	F,G,J,K,M	150
621**	620	F,G,J,K,M	150
681**	680	F,G,J,K,M	150
751**	750	F,G,J,K,M	150
821**	820	F,G,J,K,M	150
911**	910	F,G,J,K,M	150
102**	1000	F,G,J,K,M	150

@125°C

** Extended Cap Range, C0G only

MA ★ 28 & 68, P90 & C0G — CASE SIZE 2 * Available as standard through authorized Murata Erie Distributors — J Tol.

Cap. Code	Cap. pF	Cap. Tol.	WVDC*
OR1	0.1	B	500
OR2	0.2	B	500
OR3	0.3	B,C	500
OR4	0.4	B,C	500
OR5	0.5	B,C,D	500
OR6	0.6	B,C,D	500
OR7	0.7	B,C,D	500
OR8	0.8	B,C,D	500
OR9	0.9	B,C,D	500
*1R0	1.0	B,C,D	500
1R1	1.1	B,C,D	500
1R2	1.2	B,C,D	500
1R3	1.3	B,C,D	500
1R4	1.4	B,C,D	500
*1R5	1.5	B,C,D	500
1R6	1.6	B,C,D	500
1R7	1.7	B,C,D	500
1R8	1.8	B,C,D	500
1R9	1.9	B,C,D	500
2R0	2.0	B,C,D	500
2R1	2.1	B,C,D	500
*2R2	2.2	B,C,D	500
2R4	2.4	B,C,D	500
2R7	2.7	B,C,D	500
*3R0	3.0	B,C,D	500
3R3	3.3	B,C,D	500

@125°C

Cap. Code	Cap. pF	Cap. Tol.	WVDC*
3R6	3.6	B,C,D	500
*3R9	3.9	B,C,D	500
4R3	4.3	B,C,D	500
*4R7	4.7	B,C,D	500
*5R1	5.1	B,C,D	500
*5R6	5.6	B,C,D	500
*6R2	6.2	B,C,D	500
*6R8	6.8	B,C,J,K,M	500
7R5	7.5	B,C,J,K,M	500
*8R2	8.2	B,C,J,K,M	500
*9R1	9.1	B,C,J,K,M	500
*100	10	F,G,J,K,M	500
110	11	F,G,J,K,M	500
*120	12	F,G,J,K,M	500
*130	13	F,G,J,K,M	500
*150	15	F,G,J,K,M	500
160	16	F,G,J,K,M	500
*180	18	F,G,J,K,M	500
*200	20	F,G,J,K,M	500
*220	22	F,G,J,K,M	500
240	24	F,G,J,K,M	500
*270	27	F,G,J,K,M	500
*300	30	F,G,J,K,M	500
*330	33	F,G,J,K,M	500
*360	36	F,G,J,K,M	500
*390	39	F,G,J,K,M	500

@125°C

Cap. Code	Cap. pF	Cap. Tol.	WVDC*
430	43	F,G,J,K,M	500
*470	47	F,G,J,K,M	500
*510	51	F,G,J,K,M	500
*560	56	F,G,J,K,M	500
620	62	F,G,J,K,M	500
*680	68	F,G,J,K,M	500
*750	75	F,G,J,K,M	500
*820	82	F,G,J,K,M	500
910	91	F,G,J,K,M	500
*101	100	F,G,J,K,M	500
*111	110	F,G,J,K,M	300
*121	120	F,G,J,K,M	300
131	130	F,G,J,K,M	300
151	150	F,G,J,K,M	300
161	160	F,G,J,K,M	300
*181	180	F,G,J,K,M	300
*201	200	F,G,J,K,M	300
*221	220	F,G,J,K,M	200
241	240	F,G,J,K,M	200
*271	270	F,G,J,K,M	200
*301	300	F,G,J,K,M	200
*331	330	F,G,J,K,M	200
*361	360	F,G,J,K,M	200
391	390	F,G,J,K,M	200
431	430	F,G,J,K,M	200
*471	470	F,G,J,K,M	200

@125°C

Cap. Code	Cap. pF	Cap. Tol.	WVDC*
*511	510	F,G,J,K,M	100
*561	560	F,G,J,K,M	100
*621	620	F,G,J,K,M	100
*681	680	F,G,J,K,M	50
751	750	F,G,J,K,M	50
821	820	F,G,J,K,M	50
911	910	F,G,J,K,M	50
*102	1000	F,G,J,K,M	50
112**	1100	F,G,J,K,M	50
122**	1200	F,G,J,K,M	50
132**	1300	F,G,J,K,M	50
152**	1500	F,G,J,K,M	50
162**	1600	F,G,J,K,M	50
182**	1800	F,G,J,K,M	50
202**	2000	F,G,J,K,M	50
222**	2200	F,G,J,K,M	50
242**	2400	F,G,J,K,M	50
272**	2700	F,G,J,K,M	50
302**	3000	F,G,J,K,M	50
332**	3300	F,G,J,K,M	50
362**	3600	F,G,J,K,M	50
392**	3900	F,G,J,K,M	50
432**	4300	F,G,J,K,M	50
472**	4700	F,G,J,K,M	50
502**	5000	F,G,J,K,M	50
512**	5100	F,G,J,K,M	50

@125°C

** Extended Cap Range, C0G only

GRH708-710 SERIES

LOW COST HIGH FREQUENCY CHIP CAPACITORS FOR COMMUNICATIONS APPLICATIONS

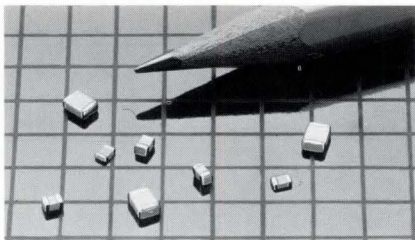

The GRH708-710 Series was designed specifically as an alternative to “cubic” chip capacitors in high-volume applications where low cost is a primary design objective.

FEATURES

- Miniature sizes
- Stable COG temperature coefficient
- Very high Q at high frequencies
- High RF power handling capabilities
- Low noise

DIMENSIONS: in. (mm)

	★ GRH708	★ GRH710
L	.080±.012 (2.0±0.3)	.125±.016 (3.2±0.7)
W	.050±.012 (1.25±0.03)	.100±.012 (2.5±0.3)
T (max.)	.050 (1.25)	.060 (1.5)
g (min.)	.03 (0.7)	.04 (1.0)
e (min.)	.01 (0.25)	.012 (0.3)

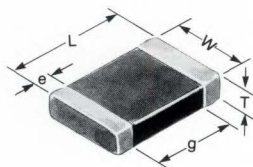

SPECIFICATIONS

Operating Temperature Range	-55 to +125°C
Temperature Coefficient	0±30 ppm/°C
Working Voltage	See table, Page 23.
Dielectric Test Voltage (D.C.)	250% of rated working voltage (except 500 Volt rated @ 200%)
Capacitance Tolerance	C, D, G, J, K Available. Specials on request
Quality Factor (Q)/ESR	Consult your local Murata Erie Sales Office for Q and ESR.
Insulation Resistance	@ 25°C: 1 to 470 pF: 1000K Megohms Min. over 470 pF: 100K Megohms Min. @ 125°C: 0.1 to 470 pF: 100K Megohms Min. over 470 pF: 10K Megohms Min.
Marking:	All capacitors are marked with Logo, Capacitance Code and Tolerance Code (where space permits) ink stamping or laser marking available

PART NUMBERING

GRH708	COG	220	K	100	B	L	PACKAGING
CAPACITOR TYPE AND SIZE GRH=Nickel Barrier layer solder. (Preferred) GR=Palladium/Silver (Non-Preferred)	TEMPERATURE CHARACTERISTIC Standard TC COG=0±30ppm/°C -55°C to +125°C	CAPACITANCE VALUE Expressed in picofarads and identified by a three-digit number. First two digits represent significant figures. Last digit specifies the number of zeros to follow. For values below 10 pF, the letter “R” is used as the decimal point and the last digit becomes significant.	CAPACITANCE TOLERANCE COG: (10pF or less) C=±.25pF D=±.5pF (Over 10pF) G=±2% J=±5% K=±10%	VOLTAGE Identified by a three-digit number.	MARKING A=No Marking B=EIA Marking C=Non-standard	PACKAGING B=Bulk L=7” Reel	

ENVIRONMENTAL

Aging:	Negligible
Environmental Tests:	MIL-STD-202
Shock:	Method 213, Condition J
Vibration:	Method 204, Condition B
Moisture Resistance:	Method 106
Solderability:	Method 208

Immersion:	Method 104, Condition B
Barometric Pressure:	Method 105, Condition B
Resistance to Soldering Heat:	Method 210, Condition B
Thermal Shock:	Method 107, Condition A
Life:	Method 108, Condition F

★ Available as standard through Murata Erie Distributors.

CAPACITANCE VALUES – GRH708

Cap. & Tol. in pF	Max ESR**	Rated VDC
*1.0 ± .25	0.142	200
1.1 ± .25	0.140	200
*1.2 ± .25	0.138	200
1.3 ± .25	0.136	200
1.4 ± .25	0.135	200
*1.5 ± .25	0.134	200
1.6 ± .25	0.133	200
1.7 ± .25	0.133	200
*1.8 ± .25	0.132	200
1.9 ± .25	0.132	200
2.0 ± .25	0.131	200
2.1 ± .25	0.130	200
*2.2 ± .25	0.129	200
2.4 ± .25	0.127	200
*2.7 ± .25	0.125	200
3.0 ± .25	0.123	200
*3.3 ± .25	0.121	200
3.6 ± .25	0.120	200
*3.9 ± .25	0.119	200
4.3 ± .25	0.117	200
4.7 ± .25	0.115	200
5.1 ± .25	0.113	200
*5.6 ± .50	0.111	200
6.2 ± .50	0.110	200
*6.8 ± .50	0.108	200
*7.5 ± .50	0.106	200
*8.2 ± .50	0.104	200
9.1 ± .50	0.102	200
*10 ± .50	0.100	200
11 ± 5%	0.098	200
*12 ± 5%	0.096	200
13 ± 5%	0.094	200
14 ± 5%	0.094	200
*15 ± 5%	0.092	200
16 ± 5%	0.090	200
*18 ± 5%	0.088	200
20 ± 5%	0.087	200
*22 ± 5%	0.085	200
25 ± 5%	0.083	200
24 ± 5%	0.084	200
*27 ± 5%	0.082	200
28 ± 5%	0.081	200
30 ± 5%	0.080	200
32 ± 5%	0.079	200
*33 ± 5%	0.079	200
34 ± 5%	0.078	200
36 ± 5%	0.077	200
*39 ± 5%	0.075	200
43 ± 5%	0.073	200
*47 ± 5%	0.071	200
51 ± 5%	0.070	200
*56 ± 5%	0.068	200
62 ± 5%	0.067	200
*68 ± 5%	0.065	200
75 ± 5%	0.063	200
*82 ± 5%	0.062	200
91 ± 5%	0.060	200
*100 ± 5%	0.058	200
110 ± 5%	0.057	100
*120 ± 5%	0.057	100
130 ± 5%	0.056	100
140 ± 5%	0.056	100
*150 ± 5%	0.056	50
160 ± 5%	0.055	50

GRH710

Cap. & Tol. in pF	Max ESR**	Rated VDC
*3.3 ± .25	0.121	500
3.6 ± .25	0.120	500
*3.9 ± .25	0.119	500
4.3 ± .25	0.117	500
*4.7 ± .25	0.115	500
5.1 ± .25	0.113	500
*5.6 ± .50	0.111	500
6.2 ± .50	0.110	500
*6.8 ± .50	0.108	500
7.5 ± .50	0.106	500
*8.2 ± .50	0.104	500
9.1 ± .50	0.102	500
*10 ± .50	0.100	500
11 ± 5%	0.098	500
*12 ± 5%	0.096	500
13 ± 5%	0.094	500
14 ± 5%	0.094	500
*15 ± 5%	0.092	500
16 ± 5%	0.090	500
*18 ± 5%	0.088	500
20 ± 5%	0.087	500
*22 ± 5%	0.085	500
25 ± 5%	0.083	500
24 ± 5%	0.084	500
*27 ± 5%	0.082	500
28 ± 5%	0.081	500
30 ± 5%	0.080	500
32 ± 5%	0.079	500
*33 ± 5%	0.079	500
34 ± 5%	0.078	500
36 ± 5%	0.077	500
*39 ± 5%	0.075	500
*43 ± 5%	0.073	500
*47 ± 5%	0.071	500
51 ± 5%	0.070	500
*56 ± 5%	0.068	500
62 ± 5%	0.067	500
*68 ± 5%	0.065	500
75 ± 5%	0.063	500
*82 ± 5%	0.062	500
91 ± 5%	0.060	500
*100 ± 5%	0.058	500
110 ± 5%	0.057	500
*120 ± 5%	0.057	500
130 ± 5%	0.056	300
140 ± 5%	0.056	300
*150 ± 5%	0.056	300
160 ± 5%	0.055	200
*180 ± 5%	0.055	200
200 ± 5%	0.055	200
*220 ± 5%	0.055	200
240 ± 5%	0.055	100
*270 ± 5%	0.055	100
300 ± 5%	0.055	100
*330 ± 5%	0.055	100
360 ± 5%	0.055	100
*390 ± 5%	0.055	100
430 ± 5%	0.055	100
*470 ± 5%	0.055	100
510 ± 5%	0.055	50
620 ± 5%	0.055	50
*820 ± 5%	0.055	50
910 ± 5%	0.055	50
*1000 ± 5%	0.055	50

* Available through authorized Murata Erie Distributors: Tol. under 10pF as indicated over 10pF, J.

** Max ESR measured at ¼ wavelength on Booton 34A

500 AND 1000 VOLT RATED MLC CHIP CAPACITORS GRM SERIES

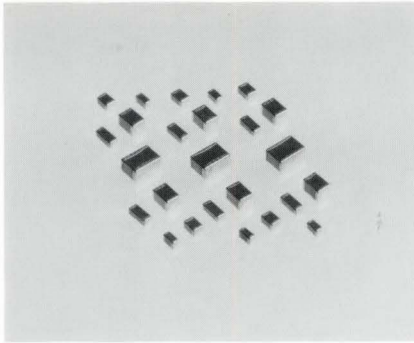

These new surface mount components are designed to meet the growing demand for miniature, reliable chip capacitors, especially where high volume automation is required. Applications include solid state relays, telecom, instrumentation, modems, computer peripherals, and others.

FEATURES

- Standard E.I.A. sizes
- Up to 2 X rated voltage tested
- -55°C to +125°C rated

BENEFITS

- Compatible with SMT equipment
- Improves long term reliability
- Suitable for harsh environments

C0G

*EIA PREFERRED SIZE

MURATA ERIE DESIGNATION	GRM42-6*		GRM42-2*		GRM43		GRM43-2*		GRM43-4*		GRM44-1		GRM44	
EIA TYPE DESIGNATION	1206		1210		1808		1812		1825		2220		2225	
DIMENSIONS: in. (mm)														
L	.125±.008 (3.2±0.2)		.125±.008 (3.2±0.2)		.180±.012 (4.6±0.3)		.180±.012 (4.6±0.3)		.180±.012 (4.6±0.3)		.220±.012 (5.6±0.3)		.220±.012 (5.6±0.3)	
W	.060±.008 (1.5±0.2)		.100±.008 (2.5±0.2)		.080±.008 (2.0±0.2)		.125±.008 (3.2±0.2)		.250±.016 (6.35±0.4)		.200±.010/-0.20 (5.1+0.25/-0.5)		.250±.016 (6.35±0.4)	
T	.065 (1.5)		.100 (1.9)		.100 (1.9)		.110 (2.8)		.110 (2.8)		.110 (2.8)		.110 (2.8)	
max														
g	.040 (1.0)		.040 (1.0)		.080 (2.0)		.080 (2.0)		.080 (2.0)		.080 (2.0)		.080 (2.0)	
min.														
e	.020±.010 (0.5±0.25)		.020±.010 (0.5±0.25)		.020±.010 (0.5±0.25)		.020±.010 (0.5±0.25)		.020±.010 (0.5±0.25)		.020±.010 (0.5±0.25)		.020±.010 (0.5±0.25)	
WVDC	500 1000		500 1000		500 1000		500 1000		500 1000		500 1000		500 1000	
Capacitance														
(pF) 1.0	3.5				10									
10			100				100							
100	470				180 270		330 560		1000 330		1000 330		1000 390	
1000			1000		1200		2700		6800 1500		7500 1500		8200 1800	
(μF) .01														
.1														

PART NUMBERING SYSTEM

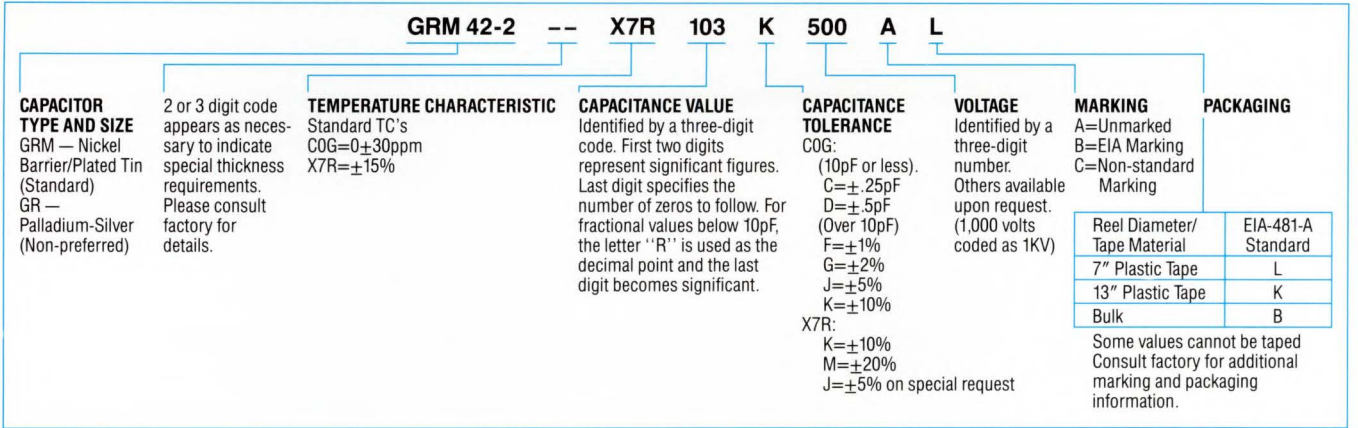

X7R

***EIA PREFERRED SIZE**

MURATA ERIE DESIGNATION	GRM42-6*		GRM42-2*		GRM43		GRM43-2*		GRM43-4*		GRM44-1		GRM44	
EIA TYPE DESIGNATION	1206		1210		1808		1812		1825		2220		2225	
DIMENSIONS: in. (mm)	L		W		T		max		g		min.		e	
	.125±.008 (3.2±0.2)	.125±.008 (3.2±0.2)	.125±.008 (3.2±0.2)	.100±.008 (2.5±0.2)	.080±.008 (2.0±0.2)	.180±.012 (4.6±0.3)	.180±.012 (4.6±0.3)	.180±.012 (4.6±0.3)	.180±.012 (4.6±0.3)	.250±.016 (6.35±0.4)	.220±.012 (5.6±0.3)	.220±.012 (5.6±0.3)	.250±.016 (6.35±0.4)	.250±.016 (6.35±0.4)
	.060±.008 (1.5±0.2)	.100±.008 (2.5±0.2)	.100±.008 (2.5±0.2)	.100±.008 (2.5±0.2)	.100±.008 (2.5±0.2)	.100±.008 (2.5±0.2)	.100±.008 (2.5±0.2)	.100±.008 (2.5±0.2)	.100±.008 (2.5±0.2)	.100±.008 (2.5±0.2)	.100±.008 (2.5±0.2)	.100±.008 (2.5±0.2)	.100±.008 (2.5±0.2)	.100±.008 (2.5±0.2)
	.065 (1.5)	.100 (1.9)	.100 (1.9)	.100 (1.9)	.100 (1.9)	.100 (1.9)	.100 (1.9)	.100 (1.9)	.100 (1.9)	.100 (1.9)	.100 (1.9)	.100 (1.9)	.100 (1.9)	.100 (1.9)
	.040 (1.0)	.040 (1.0)	.040 (1.0)	.040 (1.0)	.040 (1.0)	.040 (1.0)	.040 (1.0)	.040 (1.0)	.040 (1.0)	.040 (1.0)	.040 (1.0)	.040 (1.0)	.040 (1.0)	.040 (1.0)
	.020±.010 (0.5±0.25)	.020±.010 (0.5±0.25)	.020±.010 (0.5±0.25)	.020±.010 (0.5±0.25)	.020±.010 (0.5±0.25)	.020±.010 (0.5±0.25)	.020±.010 (0.5±0.25)	.020±.010 (0.5±0.25)	.020±.010 (0.5±0.25)	.020±.010 (0.5±0.25)	.020±.010 (0.5±0.25)	.020±.010 (0.5±0.25)	.020±.010 (0.5±0.25)	.020±.010 (0.5±0.25)
WVDC	500	1000	500	1000	500	1000	500	1000	500	1000	500	1000	500	1000
Capacitance (pF) 1.0														
1.2														
1.5														
1.8														
2.2														
2.7														
3.3														
3.9														
4.7														
5.6														
6.8														
8.2														
10														
12														
15														
18														
22														
27														
33														
39														
47														
56														
68														
82														
100														
120														
150														
180														
220														
270														
330														
390														
470														
560														
680														
820														
1000														
1200														
1500														
1800														
2200														
2700														
3300														
3900														
4700														
5600														
6800														
8200														
(μF) .01														
.012														
.015														
.022														
.027														
.033														
.039														
.047														
.056														
.068														
.082														
.1														
.12														
.15														
.18														
.22														
.27														
.33														
.39														
.47														
.56														

GLASS ENCAPSULATED MINIATURE RF POWER MULTILAYER CAPACITORS

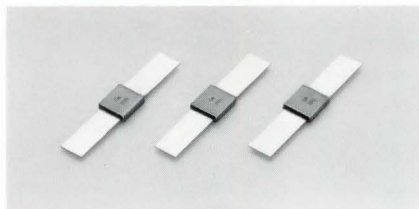

Miniature UFP fixed ceramic capacitors are specifically designed for high voltage and high RF current high frequency applications. They are ideally suited to the latest aerospace and commercial mobile and fixed communication equipment.

Glass encapsulation protects UFP capacitors against corona, contaminants and other environmental factors. Wide, fine silver lead terminations assure minimum inductance and high RF current capabilities. They can withstand temperatures far in excess of soldered units due to solderless lead attachment.

PART NUMBERING SYSTEM

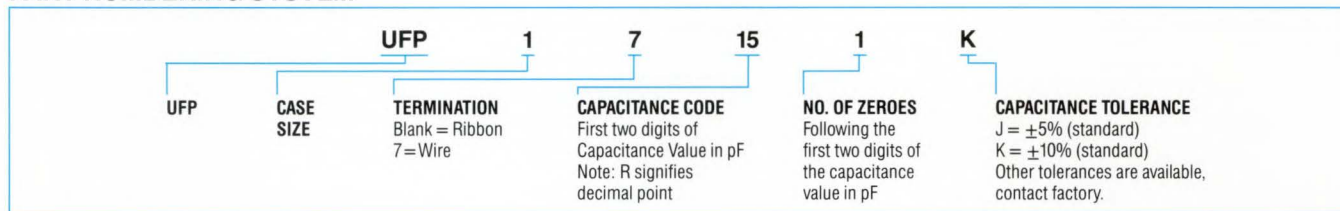

DIMENSIONS: in. (mm)

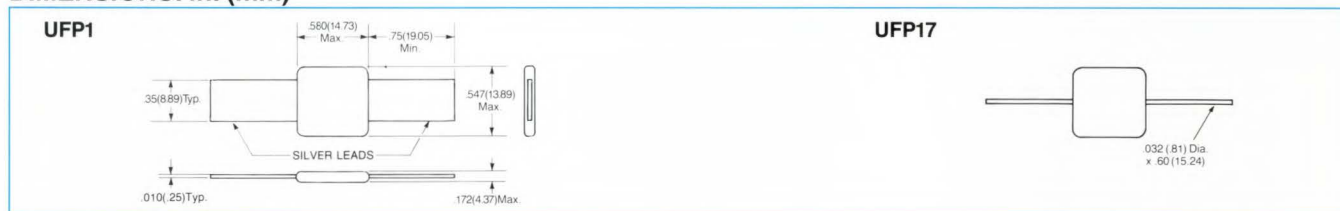

SPECIFICATIONS

Current: 8 amperes at 25°C (Derated for higher temperatures)
Q: 5,000 min. at 1 MHz and 25°C for values 1,000pF and smaller
Tolerances: ±0.5pF for values below 10pF
 ±5%, ±10% for higher values

Power: 12 KVAR at 25°C typical
Voltage: See chart below
***Temperature Coefficient:** +90, ±20ppm/°C at 1 MHz
 (-55°C to +125°C)

*NPOC T.C. also available. Consult your local Murata Erie Sales Office.

Testing: RF tested to rated specifications
Marking: All capacitors stamp marked with company I.D., cap. code and tolerance

Models	Range of Values (pF)	WVDC	Test Voltage DC	RF Current Amps. RMS at +25°C	RF Voltage RMS at +25°C	KVAR* Rating at +25°C	Voltage Limiting Impedance (ohms)	Current Limiting Impedance (ohms)
UFP1	10 to 150	3,600	7,000	8	3,000	12	750	187.5
	160 to 330	2,500	4,500	8	2,000	12	333.3	187.5
	360 to 620	1,200	2,400	8	1,000	6	166.7	93.75
	680 to 1,300	600	1,200	8	500	3	83.3	46.88
	1,500 to 3,000	300	600	8	250	1.5	41.67	23.44

***NOTE**

- When the impedance of the capacitor is higher than the value shown, the limiting factor is the RF voltage shown.
- When the impedance of the capacitor is below the value shown, the limiting factor is the RF current shown.
- Between these two impedance limits, the KVAR rating is the limiting factor. Formulas for voltage and current are:

$$V = (1,000 \times \text{KVAR} \times \text{IMPEDANCE})^{1/2} \quad I = \left(\frac{1,000 \times \text{KVAR}}{\text{IMPEDANCE}} \right)^{1/2}$$

- RF current rating derates 0.4%/°C from +25°C rating at all higher temperatures to +125°C.
- KVAR rating derates 0.5%/°C from +25°C rating at all higher temperatures to +125°C.
- RF voltage derates 0.16%/°C from +25°C rating at all higher temperatures to +125°C.

PREFERRED VALUES

Case Code	Cap. pF	Cap. Code	Tol.
UFP1	10	100*	J,K
	11	110	J,K
	12	120*	J,K
	13	130	J,K
	15	150*	J,K
	16	160	J,K
	18	180	J,K
	20	200*	J,K
	22	220*	J,K
	24	240	J,K
	27	270*	J,K
	30	300*	J,K
	33	330*	J,K
	36	360*	J,K
	39	390	J,K
	43	430	J,K
	47	470*	J,K
51	510	J,K	
56	560*	J,K	
62	620	J,K	
68	680	J,K	
75	750	J,K	

Case Code	Cap. pF	Cap. Code	Tol.
UFP1	82	820	J,K
	91	910*	J,K
	100	101	J,K
	110	111	J,K
	120	121	J,K
	130	131	J,K
	150	151	J,K
	160	161	J,K
	180	181	J,K
	200	201	J,K
	220	221	J,K
	240	241	J,K
	270	271	J,K
	300	301	J,K
	330	331	J,K
	360	361	J,K
	390	391	J,K
430	431	J,K	
470	471	J,K	
510	511	J,K	
560	561	J,K	
620	621	J,K	

Case Code	Cap. pF	Cap. Code	Tol.
UFP1	680	681	J,K
	750	751	J,K
	820	821	J,K
	910	911	J,K
	1,000	102	J,K
	1,100	112	J,K
	1,200	122	J,K
	1,300	132	J,K
	1,500	152	J,K
	1,600	162	J,K
	1,800	182	J,K
	2,000	202	J,K
2,200	222	J,K	
2,400	242	J,K	
2,700	272	J,K	
3,000	302	J,K	

* Available as standard through authorized Murata Erie Distributors: J Tol.

CERAMIC CAPACITORS FOR MICROWAVE INTEGRATED CIRCUITS

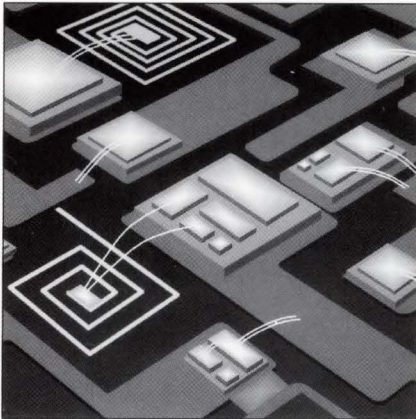

The CLA series of capacitors has been developed to meet the demand for a high reliability capacitor with the ability to withstand high voltages in microwave applications. They are a result of the development of a high density ceramic material and state-of-the-art thin film technology. With CLA single and multi-plate ultra-miniature capacitors, manufacturers of microwave products can improve both production yield and quality. The multi-plate series provides the option of using a single device for varied capacitance requirements, effectively minimizing material preparation while reducing time and cost.

FEATURES

- Operation to over 20GHz.
- Ultra-reliable performance and dielectric strength under high temperature and moisture conditions.
- 100 micro inch minimum, gold plated electrode, provides superior adhesion for die bonding and thermocompression wire bonding.
- Safety margin around plate areas eliminates the possibility of electrical shorts.
- Multi-plate designs (binary-segmented capacitance values on one chip) provide a variety of capacitance values for fine tuning.

PART NUMBERING

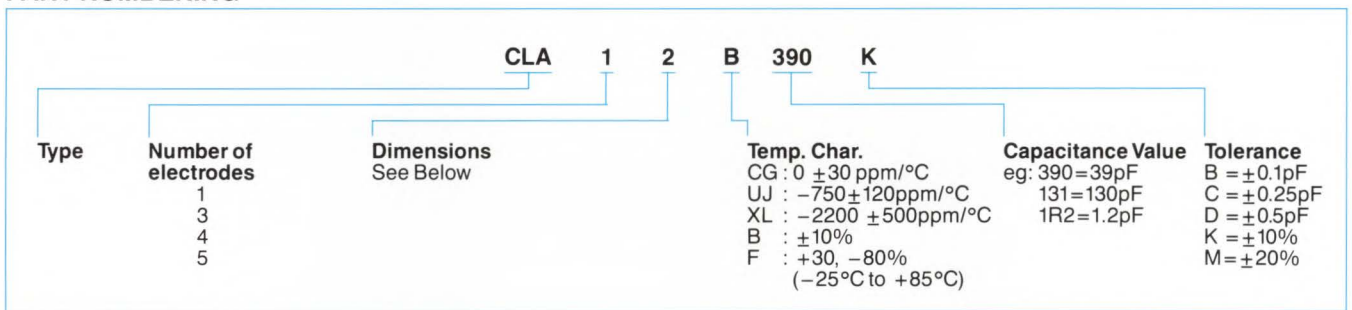

DIMENSIONS: in. (mm)

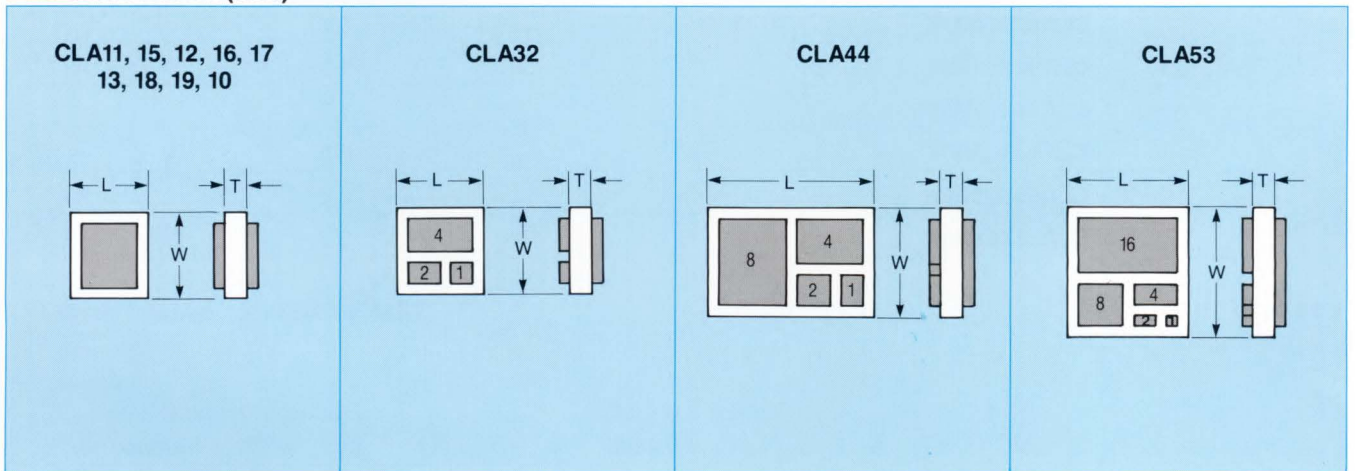

TYPE	L	W	T Max.
CLA11	0.010 (0.25) ± 0.002 (0.05)	0.010 (0.25) ± 0.005 (0.13)	0.007 (0.18)
15	0.015 (0.38) ± 0.002 (0.05)	0.015 (0.38) + 0.015 (0.38), - 0.005 (0.13)	0.008 (0.2)
12	0.020 (0.51) ± 0.002 (0.05)	0.020 (0.51) ± 0.01 (0.25)	0.010 (0.25)
16	0.025 (0.64) ± 0.002 (0.05)	0.025 (0.64) + 0.02 (0.51), - 0.01 (0.25)	0.010 (0.25)
17	0.030 (0.76) ± 0.002 (0.05)	0.030 (0.76) ± 0.015 (0.38)	0.010 (0.25)
13	0.035 (0.90) ± 0.002 (0.05)	0.035 (0.90) + 0.025 (0.64), - 0.015 (0.38)	0.010 (0.25)
18	0.050 (1.27) ± 0.004 (0.10)	0.050 (1.27) + 0.04 (1.02), - 0.02 (0.51)	0.010 (0.25)
19	0.070 (1.78) ± 0.004 (0.10)	0.070 (1.78) + 0.05 (1.27), - 0.03 (0.76)	0.012 (0.3)
10	0.090 (2.29) ± 0.004 (0.10)	0.090 (2.29) + 0.06 (1.52), - 0.04 (1.02)	0.014 (0.35)
32	0.020 (0.51) ± 0.002 (0.05)	0.020 (0.51) ± 0.002 (0.05)	0.010 (0.25)
44	0.035 (0.90) ± 0.002 (0.05)	0.020 (0.51) ± 0.002 (0.05)	0.010 (0.25)
53	0.035 (0.90) ± 0.002 (0.05)	0.035 (0.90) ± 0.002 (0.05)	0.010 (0.25)

SINGLE ELECTRODE

Type		CG	UJ	XL	B	F
CLA11	Cap. Range	0.1-0.2	0.3-0.9	0.6-1.8	1.5-18	20-51
	Tolerance	B, C, D, K	B, C, D, K	B, C, D	C, D, K	K, M
CLA15	Cap. Range	0.2-0.8	0.9- 2.7	1.8-5.6	3.6-56	47-150
	Tolerance	B, C, D	C, D	C, D	D, K, M	K, M
CLA12	Cap. Range	0.3-1.0	1.0- 3.6	2.0-6.2	4.3-68	56-200
	Tolerance	B, C, D	C, D, K	C, D, K	K, M	M
CLA16	Cap. Range	0.3-1.6	2.0- 6.2	3.6-11	7.5-120	100-360
	Tolerance	B, C, D	D, K	D	K, M	M
CLA17	Cap. Range	0.4-2.0	2.7- 7.5	5.6-15	13-130	150-390
	Tolerance	B, C, D	D, K	D, K	K, M	M
CLA13	Cap. Range	0.5-2.7	3.0- 9.1	6.2-18	13-180	160-560
	Tolerance	B, C, D	D, K	K	K, M	M
CLA18	Cap. Range	1.0-5.6	7.5-20	15-39	30-390	330-1300
	Tolerance	C, D	K	K, M	K, M	M
CLA19	Cap. Range	1.8-10.0	13-39	27-75	56-750	680-1800
	Tolerance	C, D, K	K, M	K, M	K, M	M
CLA10	Cap. Range	3.0-16	20-62	39-120	82-1200	1200-3000
	Tolerance	D, K	K, M	K, M	K, M	M

NOTE 1: All Capacitance values in pF

NOTE 2: Capacitance values available within the ranges shown above are in EIA E24 steps as denoted below.

MULTI-ELECTRODE

Part Number	Cap. Value (Largest plate) pF
CLA32UJ0R7K	0.7
CLA32XL1R5K	1.5
CLA44UJ1R5K	1.5
CLA44XL3R0K	3.0
CLA53UJ3R0K	3.0
CLA53XL5R9K	5.9

E24 STEP

1.0	3.3
1.1	3.6
1.2	3.9
1.3	4.3
1.5	4.7
1.6	5.1
1.8	5.6
2.0	6.2
2.2	6.8
2.4	7.5
2.7	8.2
3.0	9.1

TOLERANCE

B: ±0.1 pF
C: ±0.25pF
D: ±0.5 pF
K: ±10%
M: ±20%

TEMPERATURE CHARACTERISTICS

CG: 0 ± 30ppm/°C
UJ: - 750 ± 120ppm/°C
XL: - 2200 ± 500ppm/°C
B: ± 10%
F: + 30, - 80%
(- 25°C to + 85°C)

PART NUMBERING SYSTEM

TYPE DD350	LEADS 950	TEMP. CHAR. Y5P	CAPACITANCE 103	TOL. M	VOLTAGE 50V
CAPACITOR TYPE AND SIZE	LEAD CONFIG. See lead style chart	TEMPERATURE CHARACTERISTICS Temperature Range Y5=-30°C to +85°C MAX. CAP. CHANGE OVER TEMP. RANGE P=±10% U=+22, -56% V=+22, -82%	CAPACITANCE VALUE Expressed in picofarads and identified by a three-digit number. First two digits represent significant figures. Last digit specifies the number of zeros to follow.	CAPACITANCE TOLERANCE M=±20% Z=+80, -20%	VOLTAGE Identified by a two-digit number.

Lead Configuration				AWG	L.S. in. (mm)	Part Number Series											
Availability: A=Available, P=Preferred Standard						DD 340	DD 304	DD 350	DD 305	DD 360	DD 306	DD 380	DD 308	DD 310	DD 312	DD 314	
				24	.100 (2.5)	A	A	A	A								
256 (K10)	27 (K30)			23	.197 (5.0)	P	P	P	P	P	P	P	P	P	P		
*950 (L10)	930 (L30)	63 (L40)	673 (L60)	22	.250 (6.5)	A	A	A	A	A	A	A	A	A	A		
450 (B10)	56 (B30)	71 (B40)	756 (B60)	22	.375 (9.5)										A	A	P
**454 (F10)	57 (F30)	72 (F40)	757 (F60)														

() = Old Code

CAPACITANCE (μF) BY SIZE AND T.C.

TYPE	DIMENSIONS: D max. in. (mm)	12 VOLTS		16 VOLTS		25 VOLTS		50 VOLTS		
		Y5V	Y5P	Y5V	Y5P	Y5V	Y5P	Y5U	Y5V	
*DD340	.197 (5.0)	—	—	—	—	.010	—	—	—	—
*DD304	.197 (5.0)	—	—	—	—	—	.022-.047	—	.010-.022	.022
*DD350	.236 (6.0)	—	.015	—	—	.015	—	.010	—	—
*DD305	.236 (6.0)	.100	—	—	—	—	—	—	—	.033
*DD360	.290 (7.4)	—	.022	—	—	.022	—	.015	—	—
*DD306	.290 (7.4)	—	—	—	—	—	.100	—	.047	.047
*DD380	.350 (9.0)	—	—	—	—	.033/.047	—	.022	—	—
*DD308	.350 (9.0)	.220	—	—	—	—	—	—	.100	.100
*DD310	.433 (11.0)	.330	.068	.220	.068	—	.033/.047	—	—	—
*DD312	.540 (13.7)	.470	.100	—	.100	—	—	.068	—	—
**DD314	.600 (15.2)	—	.150	—	.150	—	—	.100	—	—

* **PREFERRED VALUES (Y5P)** All preferred values are standard through authorized Murata Erie Distributors.

CAP. (μF)	TOL. (%)	PART NUMBER	CAP. (μF)	TOL. (%)	PART NUMBER	CAP. (μF)	TOL. (%)	PART NUMBER
25 VDC			25 VDC (Cont'd)			50 VDC (Cont'd)		
.01	±20	DD340950 Y5P 103M 25V	.068	±20	DD310950 Y5P 683M 25V	.022	±20	DD380950 Y5P 223M 50V
.015	±20	DD350950 Y5P 153M 25V	.1	±20	DD312950 Y5P 104M 25V	.033	±20	DD310950 Y5P 333M 50V
.022	±20	DD360950 Y5P 223M 25V	.15	±20	DD314454 Y5P 154M 25V	.047	±20	DD310950 Y5P 473M 50V
.033	±20	DD380950 Y5P 333M 25V	50 VDC			.068	±20	DD312950 Y5P 683M 50V
.047	±20	DD380950 Y5P 473M 25V	.01	±20	DD350950 Y5P 103M 50V	.1	±20	DD314454 Y5P 104M 50V
			.015	±20	DD360450 Y5P 153M 50V			

* **PREFERRED VALUES (Y5V)**

CAP. (μF)	TOL. (%)	PART NUMBER	CAP. (μF)	TOL. (%)	PART NUMBER	CAP. (μF)	TOL. (%)	PART NUMBER
12VDC			16VDC			50VDC		
.1	+80, -20	DD305950 Y5V 104Z 12V	.22	+80, -20	DD310950 Y5V 224Z 16V	.022	+80, -20	DD304950 Y5V 223Z 50V
.22	+80, -20	DD308950 Y5V 224Z 12V	25VDC			.033	+80, -20	DD305950 Y5V 333Z 50V
.33	+80, -20	DD310950 Y5V 334Z 12V	.047	+80, -20	DD304950 Y5V 473Z 25V	.047	+80, -20	DD306950 Y5V 473Z 50V
.47	+80, -20	DD312950 Y5V 474Z 12V	.1	+80, -20	DD306950 Y5V 104Z 25V	.1	+80, -20	DD308950 Y5V 104Z 50V

NOTE: All capacitors ≤ .492 (12.0) are available on tape and reel for automatic insertion. Consult your local Murata Erie Sales Office for specifications.

* Standard lead configuration available through authorized Murata Erie distributors.

PART NUMBERING SYSTEM

TYPE DD407	LEADS 950	TEMP. CHAR. Y5S	CAPACITANCE 104	TOL. M	VOLTAGE 16V
CAPACITOR TYPE AND SIZE	LEAD CONFIG. See lead style chart	TEMPERATURE CHARACTERISTICS Temperature Range Y5=-30°C to +85°C MAX. CAP. CHANGE OVER TEMP. RANGE S=±22%	CAPACITANCE VALUE Expressed in picofarads and identified by a three-digit number. First two digits represent significant figures. Last digit specifies the number of zeros to follow.	CAPACITANCE TOLERANCE K=±10% M=±20%	VOLTAGE Identified by a two-digit number.

Lead Configuration				AWG	L.S. in. (mm)	Part Number Series							
Availability: A=Available, P=Preferred Standard						DD 404	DD 405	DD 406	DD 407	DD 408	DD 410	DD 412	DD 414
				24	.100 (2.5)	A	A						
256 (K10)	27 (K30)			23	.197 (5.0)	P	P	P	P	P	P	P	
* 950 (L10)	930 (L30)	63 (L40)	673 (L60)	22	.250 (6.5)	A	A	A	A	A	A	A	
** 454 (F10)	57 (F30)	72 (F40)	757 (F60)	22	.375 (9.5)							A	P

()=Old Code

CAPACITANCE (μF) BY SIZE

TYPE	DIMENSIONS:		Y5S		
	D max.		12V	16V	25V
* DD404	.197 (5)		—	.010-.022	.001-.015
* DD405	.236 (6)		—	.027-.047	.018-.022
* DD406	.287 (7.3)		—	.056-.068	.027-.033
* DD407	.315 (8)		—	.082-.1	.039-.047
* DD408	.354 (9.0)		—	—	.056-.068
* DD410	.433 (11)		.22	.15	.082-.1
* DD412	.543 (13.8)		.33	—	—
* DD414	.606 (15.4)		.47	—	—

★ PREFERRED VALUES All preferred values are standard through authorized Murata Erie distributors.

CAP. (μF)	TOL. (%)	PART NUMBER	CAP. (pF)	TOL. (%)	PART NUMBER	CAP. (μF)	TOL. (%)	PART NUMBER
.047	±20	DD405950 Y5S 473M 16V	2700	±20	DD404950 Y5S 272M 25V	.047	±20	DD414454 Y5S 474M 12V
.056	±20	DD406950 Y5S 563M 16V	3300	±20	DD404950 Y5S 332M 25V	.018	±20	DD405950 Y5S 183M 25V
.068	±20	DD406950 Y5S 683M 16V	3900	±20	DD404950 Y5S 392M 25V	.022	±20	DD405950 Y5S 223M 25V
.082	±20	DD407950 Y5S 823M 16V	4700	±20	DD404950 Y5S 472M 25V	.027	±20	DD406950 Y5S 273M 25V
.1	±20	DD407950 Y5S 104M 16V	5600	±20	DD404950 Y5S 562M 25V	.033	±20	DD406950 Y5S 333M 25V
1000pF	±20	DD404950 Y5S 102M 25V	6800	±20	DD404950 Y5S 682M 25V	.039	±20	DD407950 Y5S 393M 25V
1200	±20	DD404950 Y5S 122M 25V	8200	±20	DD404950 Y5S 822M 25V	.047	±20	DD407950 Y5S 473M 25V
1500	±20	DD404950 Y5S 152M 25V	.01 μF	±20	DD404950 Y5S 103M 25V	.056	±20	DD408950 Y5S 563M 25V
1800	±20	DD404950 Y5S 182M 25V	.012	±20	DD404950 Y5S 123M 25V	.068	±20	DD408950 Y5S 683M 25V
2200	±20	DD404950 Y5S 222M 25V	.015	±20	DD404950 Y5S 153M 25V	.082	±20	DD410950 Y5S 823M 25V
			.033	±20	DD412950 Y5S 334M 12V	.1	±20	DD410950 Y5S 104M 25V

NOTE: All capacitors ≤ .492 (12.0) are available on tape and reel for automatic insertion. Consult your local Murata Erie Sales Office for specifications.

*Standard lead configuration available through authorized Murata Erie distributors.

ULTRA SMALL CERAMIC DISC CAPACITORS

E.I.A. CLASS I, II, III & IV



12-50 VDC

DIMENSIONS: in. (mm)

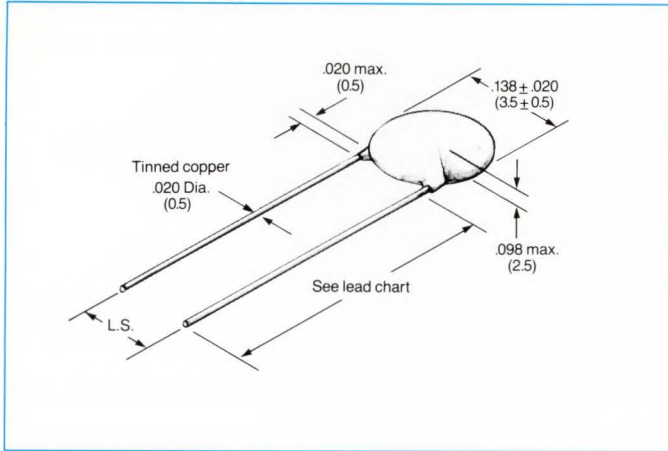

MARKING

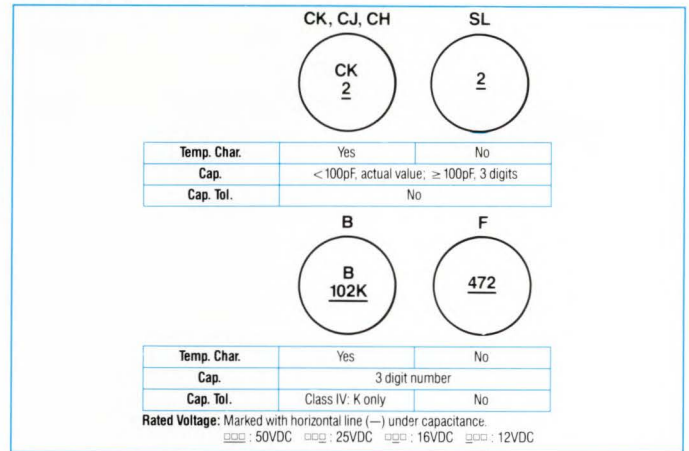

PART NUMBERING SYSTEM

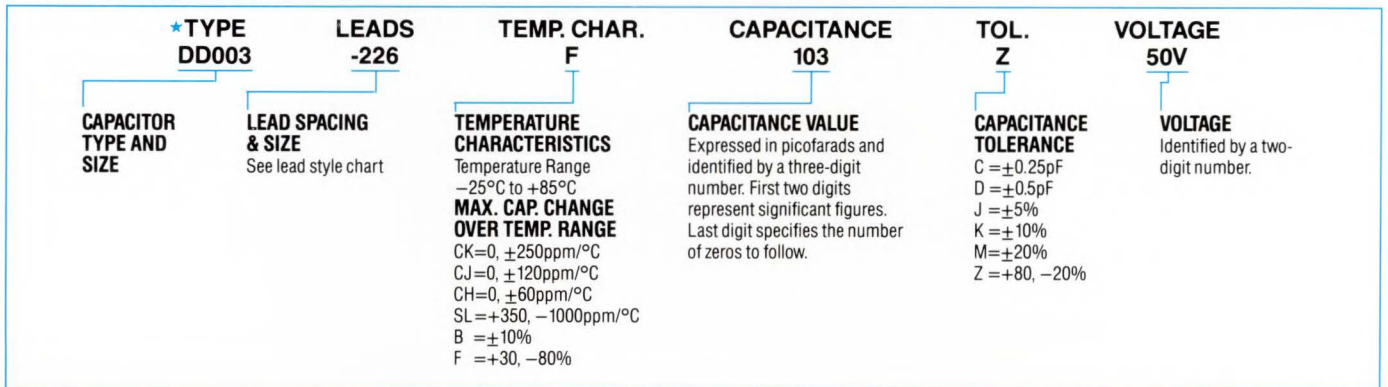

LEAD CONFIGURATIONS

DIMENSIONS: in. (mm)

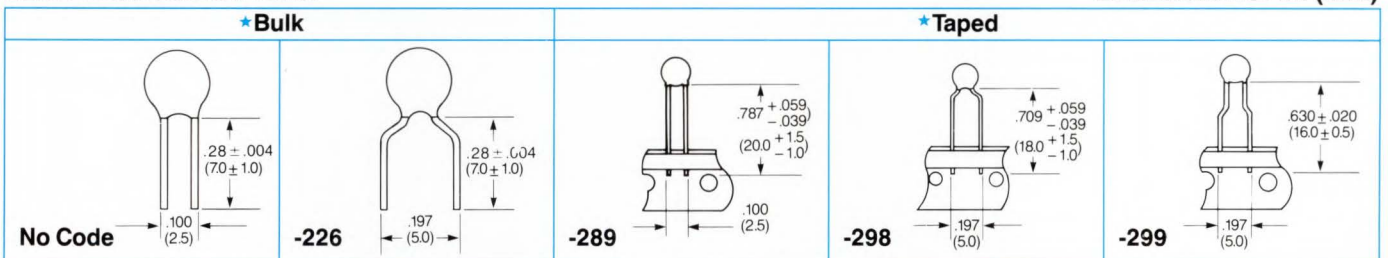

CLASS I

Voltage	Capacitance (pF)			
	CK	CJ	CH	SL
50V	1-2	3	4-47	1-120

CLASS II & III

Voltage	Capacitance (pF)	
	B	F
50V	100-1500	1000-4700

CLASS IV

Voltage	Capacitance (pF)	
	B	F
12V	—	47000
16V	8200-10000	—
25V	2700-6800	—
50V	1800-2200	10000-22000

*Available as standard through authorized Murata Erie Distributors.

TEMPERATURE COMPENSATING CERAMIC DISC CAPACITORS

E.I.A. CLASS I PART NUMBERING SYSTEM

50-100 VDC

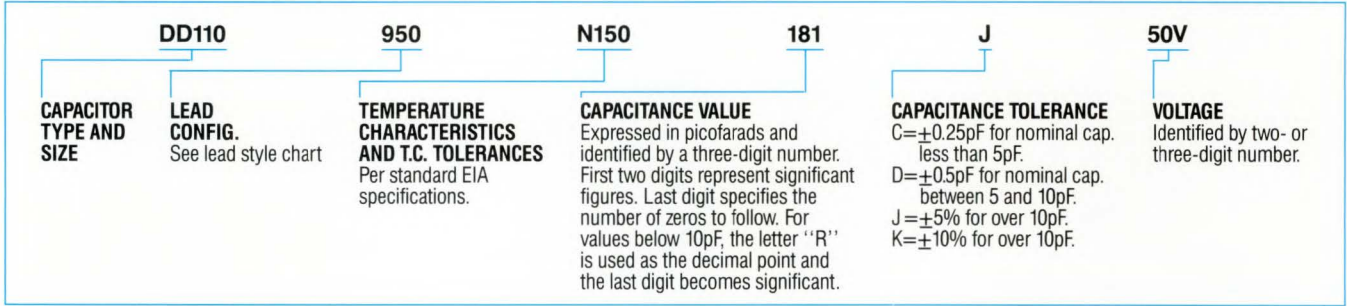

Lead Configuration				AWG	L.S. in. (mm)	Part Number Series														
Availability: A=Available, P=Preferred Standard						DD 104	DD 105	DD 106	DD 107	DD 108	DD 109	DD 110	DD 111	DD 112						
256 (K10)	27 (K30)			24	.100 (2.5)	A	A													
*950 (L10)	930 (L30)	63 (L40)	673 (L60)	23	.197 (5.0)	P	P	P	P	P	P	P	P	P	P	P	P	P	P	P
450 (B10)	56 (B30)	71 (B40)	756 (B60)	22	.250 (6.5)	A	A	A	A	A	A	A	A	A	A	A	A	A	A	A
454 (F10)	57 (F30)	72 (F40)	757 (F60)	22	.375 (9.5)							A	A	A	A	A	A	A	A	A
957 (G10)	931 (G30)	64 (G40)		23	.394 (10.0)							A	A	A	A	A	A	A	A	A

()=Old Code

CAPACITANCE (pF) BY SIZE AND T.C.

TYPE	DIMENSIONS: in. (mm)		CAPACITANCE (pF)							SL* *
	D max.	L.S.	*NPO	N150	N220	N330	N470	N750	N1500	
*DD104	.157 (4)	.118 (3.0) max. over 10pF .156 (4) max. 10pF and under	1-22	1.5-22	1.5-27	2-27	3-33	3-47	12-68	1-82
*DD105	.197 (5)		27-39	24-36	30-43	30-47	36-56	51-75	75-120	91-130
*DD106	.236 (6)		43-62	39-56	47-62	51-68	62-82	82-110	130-160	150-200
*DD107	.295 (7.5)		68-100	62-91	68-100	75-110	91-130	120-180	180-270	220-330
*DD108	.315 (8)		110	100	110-120	120-130	150	200	300	360-390
*DD109	.374 (9.5)		120-160	110-150	130-160	150-180	160-220	220-300	330-470	430-560
*DD110	.413 (10.5)		180-200	160-180	180-200	200-220	240-270	330-360	510-560	620-680
*DD111	.433 (11)		220	200	220	240	300	390	620	750
*DD112	.492 (12.5)		240-270	220-240	240-300	270-330	330-390	430-510	680-820	820-1000

**Note: SL characteristic: P350-N1000

*PREFERRED VALUES All preferred values are standard through authorized Murata Erie distributors.

CAP. (pF)	TOL. (%)	PART NUMBER	CAP. (pF)	TOL. (%)	PART NUMBER	CAP. (pF)	TOL. (%)	PART NUMBER
NPO (C0G)			NPO (C0G)			NPO (C0G)		
1.0	±.25pF	DD104950 NPO 1R0C 100V	15	±5	DD104950 NPO 150J 100V	100	±5	DD107950 NPO 101J 100V
1.5	±.25pF	DD104950 NPO 1R5C 100V	20	±5	DD104950 NPO 200J 100V	120	±5	DD109950 NPO 121J 100V
2.2	±.25pF	DD104950 NPO 2R2C 100V	22	±5	DD104950 NPO 220J 100V	150	±5	DD109950 NPO 151J 100V
3.3	±.25pF	DD104950 NPO 3R3C 100V	27	±5	DD105950 NPO 270J 100V	180	±5	DD110950 NPO 181J 100V
4.7	±.25pF	DD104950 NPO 4R7C 100V	33	±5	DD105950 NPO 330J 100V	220	±5	DD111950 NPO 221J 100V
5.0	±.5pF	DD104950 NPO 5R0D 100V	47	±5	DD106950 NPO 470J 100V	270	+5	DD112950 NPO 271J 100V
5.6	±.5pF	DD104950 NPO 5R6D 100V	56	±5	DD106950 NPO 560J 100V			
6.8	±.5pF	DD104950 NPO 6R8D 100V	68	±5	DD107950 NPO 680J 100V			
8.2	±.5pF	DD104950 NPO 8R2D 100V	75	±5	DD107950 NPO 750J 100V			
10	±5pF	DD104950 NPO 100D 100V	82	±5	DD107950 NPO 820J 100V			

NOTE: All capacitors ≤.492 (12.0) are available on tape for automatic insertion. Consult your local Murata Erie Sales Office for specifications.

*Standard lead configuration available through authorized Murata Erie distributors.

TEMPERATURE COMPENSATING CERAMIC DISC CAPACITORS



E.I.A. CLASS I

PART NUMBERING SYSTEM

500-1K VDC

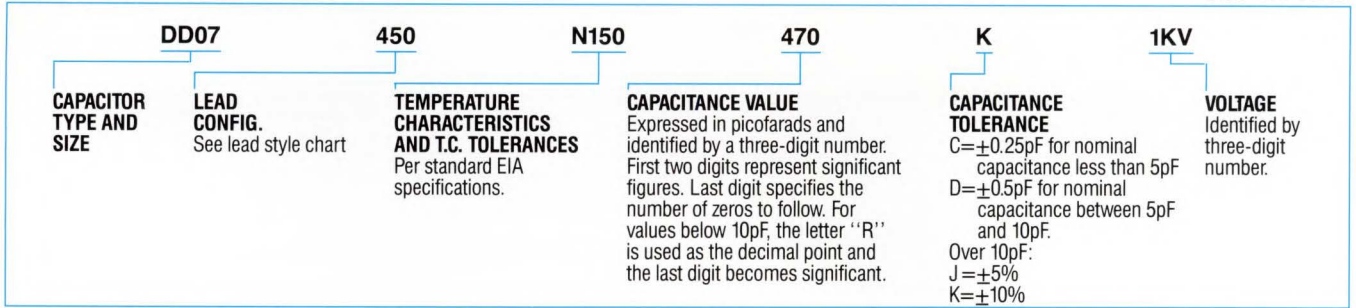

Lead Configuration				AWG	L.S. in. (mm)	Part Number Series									
Availability: A=Available, P=Preferred Standard						DD 05	DD 06	DD 07	DD 08	DD 09	DD 10	DD 11	DD 12	DD 14	DD 16
						23	.197 (5.0)	A	A	A	A	A	A	A	
950 (L10)	930 (L30)	63 (L40)	673 (L60)	22	.250 (6.5)	P	P	P	P	P	P	P			
*450 (B10)	56 (B30)	71 (B40)	756 (B60)	22	.375 (9.5)				A	A	A	A	P	P	
**454 (F10)	57 (F30)	72 (F40)	757 (F60)	23	.394 (10.0)				A	A	A	A	A	A	
957 (G10)	931 (G30)	64 (G40)							A	A	A	A	A	A	

() = Old Code

CAPACITANCE (pF) BY SIZE AND T.C.

TYPE	DIMENSIONS: in. (mm)		CAPACITANCE (pF)							SL* *
	D max.		*NPO	N150	N220	N330	N470	N750	N1500	
*DD05	.197 (5)		1-22	1.5-20	1.5-24	2-24	2-27	3-39	15-56	.5-68
*DD06	.236 (6)		24-30	22-30	27-33	27-36	30-43	43-56	62-88	75-100
*DD07	.295 (7.5)		33-51	33-47	36-56	39-56	47-62	62-91	91-130	110-160
*DD08	.315 (8)		56-62	51-56	62-68	62-75	68-82	100-120	150-180	180-200
*DD09	.374 (9.5)		68-82	62-82	75-91	82-100	91-110	130-160	200-240	220-270
*DD10	.413 (10.5)		91-130	91-120	100-130	110-130	120-160	180-240	270-330	300-430
*DD11	.433 (11)		150-160	130-150	150-180	150-180	180-200	270-300	360-430	470-510
*DD12	.492 (12.5)		180-200	160-200	200-220	200-240	220-270	330-390	470-560	560-620
**DD14	.571 (14.5)		220-270	220-240	240-300	270-300	300-360	430-510	620-750	—
**DD16	.649 (16.5)		—	270	330	330-390	390-470	560-620	820	—

**Note: SL characteristic: P350-N1000

*PREFERRED VALUES All preferred values are standard through authorized Murata Erie distributors.

CAP. (pF)	TOL. (%)	PART NUMBER	CAP. (pF)	TOL. (%)	PART NUMBER	CAP. (pF)	TOL. (%)	PART NUMBER
NPO (C0G)			NPO (C0G)			NPO (C0G)		
1.0	±.25pF	DD05450 NPO 1R0C 1KV	15	±5	DD05450 NPO 150J 1KV	100	±5	DD10450 NPO 101J 1KV
1.5	±.25pF	DD05450 NPO 1R5C 1KV	20	±5	DD05450 NPO 200J 1KV	120	±5	DD10450 NPO 121J 1KV
2.2	±.25pF	DD05450 NPO 2R2C 1KV	22	±5	DD05450 NPO 220J 1KV	150	±5	DD11450 NPO 151J 1KV
3.3	±.25pF	DD05450 NPO 3R3C 1KV	27	±5	DD06450 NPO 270J 1KV	180	±5	DD12450 NPO 181J 1KV
4.7	±.25pF	DD05450 NPO 4R7C 1KV	33	±5	DD07450 NPO 330J 1KV	220	±5	DD14454 NPO 221J 1KV
5.0	±.5pF	DD05450 NPO 5R0D 1KV	47	±5	DD07450 NPO 470J 1KV	270	±5	DD14454 NPO 271J 1KV
5.6	±.5pF	DD05450 NPO 5R6D 1KV	56	±5	DD08450 NPO 560J 1KV			
6.8	±.5pF	DD05450 NPO 6R8D 1KV	68	±5	DD09450 NPO 680J 1KV			
8.2	±.5pF	DD05450 NPO 8R2D 1KV	75	±5	DD09450 NPO 750J 1KV			
10	±5pF	DD05450 NPO 100D 1KV	82	±5	DD09450 NPO 820J 1KV			

NOTE: All capacitors ≤ .492 (12.0) are available on tape for automatic insertion. Consult your local Murata Erie Sales Office for specifications.

*Standard Lead configurations available through authorized Murata Erie Distributors.

MEDIUM TO HIGH K CERAMIC DISC CAPACITORS

E.I.A. CLASS II & CLASS III

PART NUMBERING SYSTEM

50-100 VDC

<p>DD104</p> <p>CAPACITOR TYPE AND SIZE</p>	<p>950</p> <p>LEAD CONFIG. See lead style chart</p>	<p>Y5P</p> <p>TEMPERATURE CHARACTERISTICS Temperature range X5 = -55°C to +85°C Y5 = -30°C to +85°C Z5 = +10°C to +85°C MAX. CAP. CHANGE OVER TEMP. RANGE F = ±7.5% P = ±10% R = ±15% U = +22, -56% V = +22, -82%</p>	<p>221</p> <p>CAPACITANCE VALUE Expressed in picofarads and identified by a three-digit number. First two digits represent significant figures. Last digit specifies the number of zeros to follow.</p>	<p>K</p> <p>CAPACITANCE TOLERANCE K = ±10% M = ±20% Z = +80, -20%</p>	<p>100V</p> <p>VOLTAGE Identified by two- or three-digit number.</p>
---	---	--	---	---	--

Lead Configuration*				AWG	L.S. in. (mm)	Part Number Series												
Availability: A=Available, P=Preferred Standard						DD 104	DD 105	DD 106	DD 107	DD 108	DD 109	DD 110	DD 111	DD 112	DD 113			
256 (K10)	27 (K30)			24	.100 (2.5)	A	A											
*950 (L10)	930 (L30)	63 (L40)	673 (L60)	23	.197 (5.0)	P	P	P	P	P	P	P	P	P	P	P	P	P
450 (B10)	56 (B30)	71 (B40)	756 (B60)	22	.250 (6.5)	A	A	A	A	A	A	A	A	A	A	A	A	A
454 (F10)	57 (F30)	72 (F40)	757 (F60)	22	.375 (9.5)						A	A	A	A	A	A	A	A
957 (G10)	931 (G30)	64 (G40)		23	.394 (10.0)						A	A	A	A	A	A	A	A

() = Old Code

CAPACITANCE (pF) BY SIZE AND T.C.

50-100 VDC

TYPE	DIMENSIONS: in. (mm)		CAPACITANCE (pF)			
	D max.		X5F/Y5F	X5R/*Y5P	*Y5U/Z5U	*Y5V
*DD104	.157 (4)		100-560	100-1,000	1,000-1,500	2,200-4,700
*DD105	.197 (5)		680-1,000	1,200-1,800	2,200-3,300	6,800
*DD106	.236 (6)		1,200-1,500	2,000-2,700	—	10,000
*DD107	.295 (7.5)		1,800-2,200	3,300-3,900	4,700-6,800	20,000
*DD108	.315 (8)		2,700	4,700	—	22,000
*DD109	.374 (9.5)		3,300-3,900	5,600-6,800	10,000	33,000
*DD110	.413 (10.5)		4,700	8,200	—	—
*DD111	.433 (11)		—	—	15,000-22,000	—
*DD112	.492 (12.5)		5,600-6,800	10,000-12,000	—	—
*DD113	.532 (13.5)		8,200	15,000	—	—
STANDARD CAPACITANCE TOLERANCE			±10%(K)	±10%(K)	±20%(M)	+80, -20%(Z)

* **PREFERRED VALUES** All preferred values are standard through authorized Murata Erie distributors.

CAP. (pF)	TOL. (%)	PART NUMBER	CAP. (pF)	TOL. (%)	PART NUMBER	CAP. (pF)	TOL. (%)	PART NUMBER
Y5P			Y5P			Y5V		
100	±10	DD104950 Y5P 101K 100V	5600	±10	DD109950 Y5P 562K 100V	2200pF	+80, -20	DD104950 Y5V 222Z 100V
120	±10	DD104950 Y5P 121K 100V	6800	±10	DD109950 Y5P 682K 100V	3300	+80, -20	DD104950 Y5V 332Z 100V
150	±10	DD104950 Y5P 151K 100V	8200	±10	DD112950 Y5P 822K 100V	4700	+80, -20	DD104950 Y5V 472Z 100V
180	±10	DD104950 Y5P 181K 100V	.01μF	±10	DD112950 Y5P 103K 100V	6800	+80, -20	DD105950 Y5V 682Z 100V
220	±10	DD104950 Y5P 221K 100V	.012	±10	DD112950 Y5P 123K 100V	.01μF	+80, -20	DD106950 Y5V 103Z 100V
270	±10	DD104950 Y5P 271K 100V	.015	±10	DD113950 Y5P 153K 100V	.022	+80, -20	DD108950 Y5V 223Z 100V
330	±10	DD104950 Y5P 331K 100V	Y5U			.033	+80, -20	DD109950 Y5V 333Z 100V
470	±10	DD104950 Y5P 471K 100V	1000	±20	DD104950 Y5U 102M 100V			
560	±10	DD104950 Y5P 561K 100V	1500	±20	DD104950 Y5U 152M 100V			
680	±10	DD104950 Y5P 681K 100V	2200	±20	DD105950 Y5U 222M 100V			
750	±10	DD104950 Y5P 751K 100V	3300	±20	DD105950 Y5U 332M 100V			
820	±10	DD104950 Y5P 821K 100V	4700	±20	DD107950 Y5U 472M 100V			
1000	±10	DD104950 Y5P 102K 100V	6800	±20	DD107950 Y5U 682M 100V			
1200	±10	DD105950 Y5P 122K 100V	6800	+80, -20	DD107950 Y5U 682Z 100V			
1500	±10	DD105950 Y5P 152K 100V	.01μF	±20	DD109950 Y5U 103M 100V			
1800	±10	DD105950 Y5P 182K 100V	.01μF	+80, -20	DD109950 Y5U 103Z 100V			
2200	±10	DD106950 Y5P 222K 100V	.015	±20	DD111950 Y5U 153M 100V			
3300	±10	DD107950 Y5P 332K 100V	.022	±20	DD111950 Y5U 223M 100V			
3900	±10	DD107950 Y5P 392K 100V						
4700	±10	DD108950 Y5P 472K 100V						

NOTE: All capacitors ≤ .492 (12.0) are available on tape for automatic insertion. Consult your local Murata Erie Sales Office for specifications.

* Standard lead configuration available through authorized Murata Erie distributors.

MEDIUM TO HIGH K CERAMIC DISC CAPACITORS



CLASS II & CLASS III

PART NUMBERING SYSTEM

50-1K VDC

DD05	450	Y5F	101	K	1KV
CAPACITOR TYPE AND SIZE	LEAD CONFIG. See lead style chart	TEMPERATURE CHARACTERISTICS Temperature range X5 = -55°C to +85°C Y5 = -30°C to +85°C Z5 = +10°C to +85°C MAX. CAP. CHANGE OVER TEMP. RANGE F = ±7.5% P = ±10% R = ±15% U = +22, -56%	CAPACITANCE VALUE Expressed in picofarads and identified by a three-digit number. First two digits represent significant figures. Last digit specifies the number of zeros to follow.	CAPACITANCE TOLERANCE K = ±10% M = ±20% Z = +80, -20%	VOLTAGE Identified by one- or three-digit number.

Lead Configuration				AWG	L.S. in. (mm)	Part Number Series									
Availability: A=Available, P=Preferred Standard						DD 05	DD 06	DD 07	DD 08	DD 09	DD 10	DD 11	DD 12	DD 14	DD 16
				23	.197 (5.0)	A	A	A	A	A	A	A			
950 (L10)	930 (L30)	63 (L40)	673 (L60)	22	.250 (6.5)	P	P	P	P	P	P	P			
*450 (B10)	56 (B30)	71 (B40)	756 (B60)	22	.375 (9.5)					A	A	A	A	P	P
**454 (F10)	57 (F30)	72 (F40)	757 (F60)	22	.394 (10.0)					A	A	A	A	A	A
957 (G10)	931 (G30)	64 (G40)		23						A	A	A	A	A	A

() = Old Code

CAPACITANCE (pF) BY SIZE AND T.C.

TYPE	DIMENSIONS: in. (mm)		CAPACITANCE (pF)		
	D max.		X5F/Y5F	X5R/ *Y5P	*Y5U/Z5U
*DD05	.197 (5)		100-330	100-560	1,000
*DD06	.236 (6)		390-470	680-820	1,500
*DD07	.295 (7.5)		560-680	1,000-1,200	2,200
*DD08	.315 (8)		820	1,500-1,800	3,300
*DD09	.374 (9.5)		1,000-1,200	2,200	4,700
*DD10	.413 (10.5)		1,500-1,800	2,700	6,800
*DD11	.433 (11)		2,200	3,300-3,900	—
*DD12	.492 (12.5)		2,700	4,700	10,000
*DD14	.571 (14.5)		3,300-3,900	5,600-6,800	20,000
*DD16	.649 (16.5)		4,700	8,200-10,000	—
STANDARD CAPACITANCE TOLERANCES:			±10%(K)	±10%(K)	+80, -20%(Z)

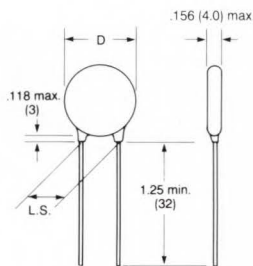

* PREFERRED VALUES

All preferred values are standard through authorized Murata Erie distributors.

CAP. (pF)	TOL. (%)	PART NUMBER	CAP. (pF)	TOL. (%)	PART NUMBER	CAP. (pF)	TOL. (%)	PART NUMBER
Y5P			Y5P			Y5U		
100	±10	DD05450 Y5P 101K 1 KV	1800	±10	DD08450 Y5P 182K 1 KV	1000	±20	DD05450 Y5U 102M 1 KV
120	±10	DD05450 Y5P 121K 1 KV	2200	±10	DD09450 Y5P 222K 1 KV	1500	±20	DD06450 Y5U 152M 1 KV
150	±10	DD05450 Y5P 151K 1 KV	2700	±10	DD10450 Y5P 272K 1 KV	2200	±20	DD07450 Y5U 222M 1 KV
180	±10	DD05450 Y5P 181K 1 KV	3300	±10	DD11450 Y5P 332K 1 KV	3300	±20	DD08450 Y5U 332M 1 KV
220	±10	DD05450 Y5P 221K 1 KV	3900	±10	DD11450 Y5P 392K 1 KV	4700	±20	DD09450 Y5U 472M 1 KV
270	±10	DD05450 Y5P 271K 1 KV	4700	±10	DD12450 Y5P 472K 1 KV	6800	±20	DD10450 Y5U 682M 1 KV
330	±10	DD05450 Y5P 331K 1 KV	5600	±10	DD14454 Y5P 562K 1 KV	.01μF	±20	DD12450 Y5U 103M 1 KV
470	±10	DD05450 Y5P 471K 1 KV	6800	±10	DD14454 Y5P 682K 1 KV	.02μF	±20	DD14454 Y5U 203M 1KV
560	±10	DD05450 Y5P 561K 1 KV	8200	±10	DD16454 Y5P 822K 1 KV			
680	±10	DD06450 Y5P 681K 1 KV	.01μF	±10	DD16454 Y5P 103K 1 KV			
750	±10	DD06450 Y5P 751K 1 KV						
820	±10	DD06450 Y5P 821K 1 KV						
1000	±10	DD07450 Y5P 102K 1 KV						
1200	±10	DD07450 Y5P 122K 1 KV						
1500	±10	DD08450 Y5P 152K 1 KV						

NOTE: All capacitors ≤ .492 (12.0) are available on tape for automatic insertion. Consult your local Murata Erie Sales Office for specifications.

*Standard lead configuration available through authorized Murata Erie distributors.

MINIATURE & CONVENTIONAL CERAMIC DISC CAPACITORS

E.I.A. CLASS I, II & III PART NUMBERING SYSTEM

1-6K VDC

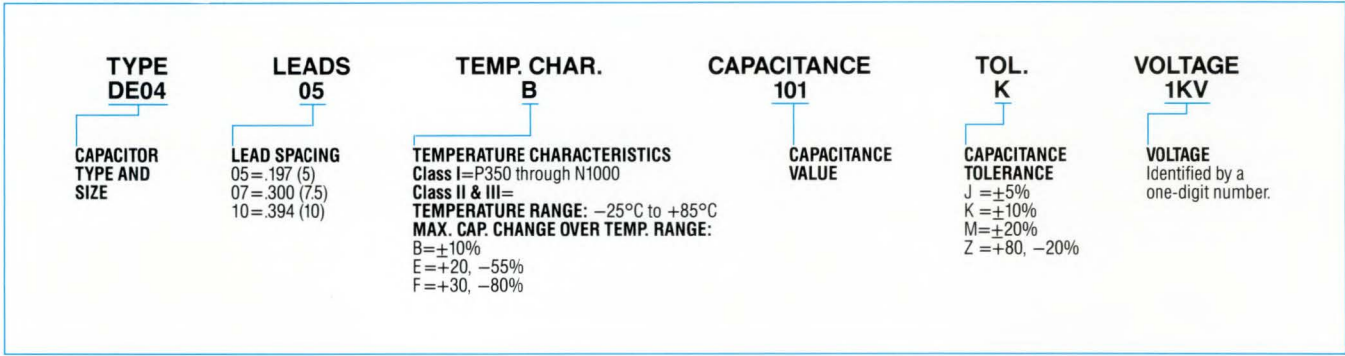

*MINIATURE "SS" SERIES

TYPE	DIMENSIONS: in. (mm)			CAPACITANCE (pF)										
	Lead Space (Tol. ±1mm)			1KV				2KV				3KV		
	D max.	1KV/2KV	3KV	SL	B	E	F	SL	B	E	F	SL	B	E
DE04	.177 (4.5)	.197 (5)	.300 (7.5)	10-47	100-330	—	—	10-33	100-220	—	—	—	—	—
DE05	.197 (5)	.197 (5)	.300 (7.5)	56-68	470	1000	—	39	330	—	1000	10-22	100-220	—
DE06	.236 (6)	.197 (5)	.300 (7.5)	82-120	680-1000	—	2200	47-68	470	1000	—	27-39	330	—
DE07	.276 (7)	.197 (5)	.300 (7.5)	150-180	—	2200	4700	82-100	680	—	2200	47-56	470	1000
DE08	.315 (8)	.197 (5)	.300 (7.5)	220	1500	—	—	120-150	1000	2200	—	68-82	680	—
DE09	.354 (9)	.197 (5)	.300 (7.5)	270	2200	4700	—	180	1500	—	4700	100	1000	—
DE10	.394 (10)	.197 (5)	.300 (7.5)	330-390	3300	—	10000	220	2200	—	—	120	—	2200
DE11	.433 (11)	.197 (5)	.300 (7.5)	470	—	—	—	270	—	4700	—	150-180	1500	—
DE12	.472 (12)	.197 (5)	.300 (7.5)	560	4700	—	—	330	3300	—	10000	220	—	—
DE13	.512 (13)	.300 (7.5)	.300 (7.5)	—	—	10000	—	390	—	—	—	—	2200	4700
DE14	.551 (14)	.394 (10)	.394 (10)	—	—	—	—	470	—	—	—	270	—	—
DE15	.591 (15)	.394 (10)	.394 (10)	—	—	—	—	560	4700	—	—	330	3300	—
DE16	.630 (16)	.394 (10)	.394 (10)	—	—	—	—	—	—	10000	—	390	—	—
Standard Capacitance Tolerance				±5%	±10%	+80, -20%	+80, -20%	±5%	±10%	+80, -20%	+80, -20%	±5%	±10%	+80, -20%

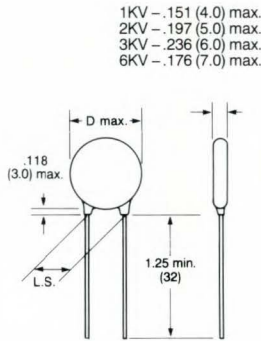

CONVENTIONAL MKV SERIES

TYPE	DIMENSIONS: in. (mm)				CAPACITANCE (pF)								
	Lead Spacing				2KV		3KV		6KV				
	D max.	1KV/2KV	3KV	6KV	N750	N1500	N750	N1500	*N750	*N1500	*B	*E	
DE07	.276 (7)	.197 (5)	.300 (7.5)	.394 (10)	10-82	15-56	10-47	15-39	—	—	—	—	
DE08	.315 (8)	.197 (5)	.300 (7.5)	.394 (10)	100-120	68-82	56-68	47-56	—	15-27	—	—	
DE09	.354 (9)	.197 (5)	.300 (7.5)	.394 (10)	150	100	82	68	22-47	33-39	100-390	—	
DE10	.394 (10)	.197 (5)	.300 (7.5)	.394 (10)	180	120	100	82	56	47-56	470-560	—	
DE11	.433 (11)	.197 (5)	.300 (7.5)	.394 (10)	220	150	120	100	—	68	680	1000	
DE12	.472 (12)	.197 (5)	.300 (7.5)	.394 (10)	270	180	150	120	68-82	82	820	—	
DE13	.512 (13)	.300 (7.5)	.300 (7.5)	.394 (10)	—	220	180	150	100	100	1000	1500	
DE14	.551 (14)	.394 (10)	.394 (10)	.394 (10)	—	270	220	180	120	—	—	—	
DE15	.591 (15)	.394 (10)	.394 (10)	.394 (10)	330	—	—	220	150	120	1200	2200	
DE16	.630 (16)	.394 (10)	.394 (10)	.394 (10)	390	330	270	—	—	150	1500	—	
DE17	.669 (17)	.394 (10)	.394 (10)	.394 (10)	470	390	—	—	—	—	—	—	
Standard Capacitance Tolerance					±5%	±5%	±5%	±5%	±5%	±5%	±5%	±10%	+80, -20%

*Available as standard through authorized Murata Erie Distributors.

★ EIA CLASS I
SL-1, 2 and 3 KVDC PREFERRED VALUES

CAP. (pF)	TOL. (%)	PART NUMBER
1KV		
10	± .5pF	DE0405SL100D1KV
12	±5	DE0405SL120J1KV
15	±5	DE0405SL150J1KV
18	±5	DE0405SL180J1KV
22	±5	DE0405SL220J1KV
27	±5	DE0405SL270J1KV
33	±5	DE0405SL330J1KV
39	±5	DE0405SL390J1KV
47	±5	DE0405SL470J1KV
56	±5	DE0505SL560J1KV
68	±5	DE0505SL680J1KV
82	±5	DE0605SL820J1KV
100	±5	DE0605SL101J1KV
120	±5	DE0605SL121J1KV
150	±5	DE0705SL151J1KV
180	±5	DE0705SL181J1KV
220	±5	DE0805SL221J1KV
270	±5	DE0905SL271J1KV
330	±5	DE1005SL331J1KV
390	±5	DE1005SL391J1KV
470	±5	DE1105SL471J1KV
560	±5	DE1205SL561J1KV

CAP. (pF)	TOL. (%)	PART NUMBER
2KV		
10	± .5pF	DE0405SL100D2KV
12	±5	DE0405SL120J2KV
15	±5	DE0405SL150J2KV
18	±5	DE0405SL180J2KV
22	±5	DE0405SL220J2KV
27	±5	DE0405SL270J2KV
33	±5	DE0405SL330J2KV
39	±5	DE0505SL390J2KV
47	±5	DE0605SL470J2KV
56	±5	DE0605SL560J2KV
68	±5	DE0605SL680J2KV
82	±5	DE0705SL820J2KV
100	±5	DE0705SL101J2KV
120	±5	DE0805SL121J2KV
150	±5	DE0805SL151J2KV
180	±5	DE0905SL181J2KV
220	±5	DE1005SL221J2KV
270	±5	DE1105SL271J2KV
330	±5	DE1205SL331J2KV
390	±5	DE1307SL391J2KV
470	±5	DE1410SL471J2KV
560	±5	DE1510SL561J2KV

CAP. (pF)	TOL. (%)	PART NUMBER
3KV		
10	± .5pF	DE0507SL100D3KV
12	±5	DE0507SL120J3KV
15	±5	DE0507SL150J3KV
18	±5	DE0507SL180J3KV
22	±5	DE0507SL220J3KV
27	±5	DE0607SL270J3KV
33	±5	DE0607SL330J3KV
39	±5	DE0607SL390J3KV
47	±5	DE0707SL470J3KV
56	±5	DE0707SL560J3KV
68	±5	DE0807SL680J3KV
82	±5	DE0807SL820J3KV
100	±5	DE0907SL101J3KV
120	±5	DE1007SL121J3KV
150	±5	DE1107SL151J3KV
180	±5	DE1107SL181J3KV
220	±5	DE1207SL221J3KV
270	±5	DE1410SL271J3KV
330	±5	DE1510SL331J3KV
340	±5	DE1610SL391J3KV

★ EIA CLASS II
B-1, 2 and 3 KVDC PREFERRED VALUES

CAP. (pF)	TOL. (%)	PART NUMBER
1KV		
100	±10	DE0405B101K1KV
150	±10	DE0405B151K1KV
220	±10	DE0405B221K1KV
330	±10	DE0405B331K1KV
470	±10	DE0505B471K1KV
680	±10	DE0605B681K1KV
1000	±10	DE0605B102K1KV
1500	±10	DE0805B152K1KV
2200	±10	DE0905B222K1KV
3300	±10	DE1005B332K1KV
4700	±10	DE1205B472K1KV
6800	±10	DE1510B682K1KV

CAP. (pF)	TOL. (%)	PART NUMBER
2KV		
100	±10	DE0405B101K2KV
150	±10	DE0405B151K2KV
220	±10	DE0405B221K2KV
330	±10	DE0505B331K2KV
470	±10	DE0605B471K2KV
680	±10	DE0705B681K2KV
1000	±10	DE0805B102K2KV
1500	±10	DE0905B152K2KV
2200	±10	DE1005B222K2KV
3300	±10	DE1205B332K2KV
4700	±10	DE1510B472K2KV

CAP. (pF)	TOL. (%)	PART NUMBER
3KV		
100	±10	DE0507B101K3KV
150	±10	DE0507B151K3KV
220	±10	DE0507B221K3KV
330	±10	DE0607B331K3KV
470	±10	DE0707B471K3KV
680	±10	DE0807B681K3KV
1000	±10	DE0907B102K3KV
1500	±10	DE1107B152K3KV
2200	±10	DE1307B222K3KV
3300	±10	DE1510B332K3KV

★ EIA CLASS III
E-1, 2 and 3 KVDC, F-1 and 2 KVDC PREFERRED VALUES

CAP. (pF)	TOL. (%)	PART NUMBER
E-1KV		
1000	+80, -20%	DE0505E102Z1KV
2200	+80, -20%	DE0705E22Z1KV
4700	+80, -20%	DE0905E47Z1KV
.01μF	+80, -20%	DE1307E103Z1KV
E-2KV		
1000	+80, -20%	DE0605E102Z2KV
2200	+80, -20%	DE0805E22Z2KV
4700	+80, -20%	DE1105E47Z2KV
.01μF	+80, -20%	DE1610E103Z2KV

CAP. (pF)	TOL. (%)	PART NUMBER
E-3KV		
1000	+80, -20%	DE0707E102Z3KV
2200	+80, -20%	DE1007E22Z3KV
4700	+80, -20%	DE1307E47Z3KV
F-1KV		
2200	+80, -20%	DE0605F22Z1KV
4700	+80, -20%	DE0705F47Z1KV
.01μF	+80, -20%	DE1005F103Z1KV

CAP. (pF)	TOL. (%)	PART NUMBER
F-2KV		
1000	+80, -20%	DE0505F102Z2KV
2200	+80, -20%	DE0705F22Z2KV
4700	+80, -20%	DE0905F47Z2KV
.01μF	+80, -20%	DE1205F103Z2KV

* All preferred values are standard through authorized Murata Erie Distributors.

TAPED PACKAGING CERAMIC DISC CAPACITORS

Most Murata Erie disc capacitors are available in tape packaging for automatic insertion equipment. Shown on this page are some typical specifications for taped capacitors for general application. The configurations available meet the specifications of

Universal, Panasert® and Avisert® as well as other automatic insertion equipment. Our applications engineers will be happy to work with you to meet your specific requirements.

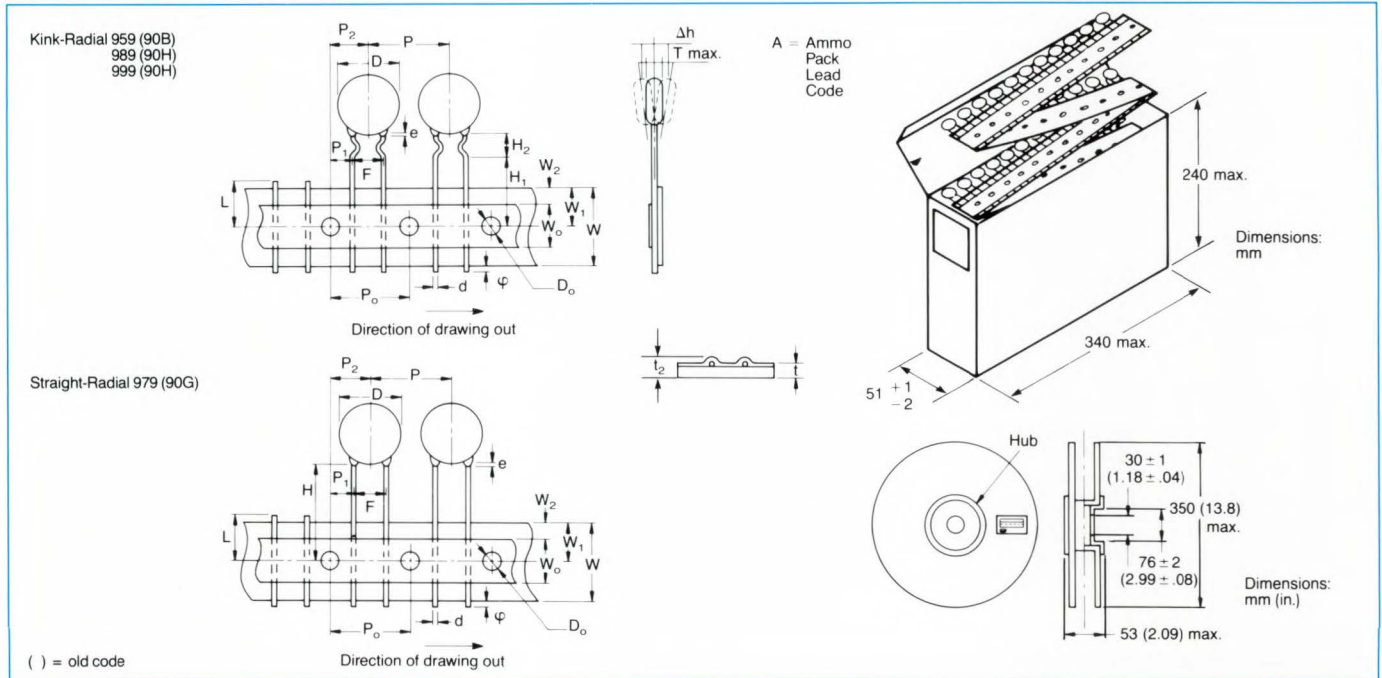

DIMENSIONS: mm

ITEM	CODE	DIMENSIONS	REMARKS	
Taping Pitch	P	12.7		
Guide Pitch	P ₀	12.7 ± 0.2		
Lead Spacing	F	5.2 ± 0.4		
Feed Hole Position	P ₂	6.35 ± 1.3		
Feed Hole Position	P ₁	3.85 ± 0.7		
Diameter of Disc	D	See table		
Width of Base Tape	W	18.0 ± 0.5		
Half of Base Tape Width	W ₁	9.0 ⁺⁰ _{-0.5}		
Lead Length	For Straight Lead Type	H	20.0 ^{+1.5} _{-1.0}	*For taping code 979
	For Kink Lead Type	H ₁	16.0 ± 0.5	For taping code 959, 989, 999
			4.8 max.	*1 For taping code -959
		H ₂	6.0 max.	*2 For taping code -989
		5.0 max.	*3 For taping code -999	
Protruding Length	φ	-1.0 to 3.0		
Diameter of Lead	d	0.6 ^{+0.06} _{-0.05}		
Total Thickness of Tape	t	t ₁ = 0.6 ± 3, t ₂ = 1.5 max.		
Thickness of Capacitor Body	T	See table		
Deviation Across Tape	Δh	0 ± 1.0		
Cutting Position of Failure	L	11.0 ⁺⁰ _{-1.0}		
Width of Adhesive Tape	W ₀	11.5 and over		
Margin Between Both Tapes	W ₂	5.0 min.		
Parts length	e	Up to the center of kink	For taping code 959, 989, 999	
		1.0 mm max.	For taping code 979	
Diameter of Feed Hole	D ₀	4.0 ± 0.1		

★ Available as standard through authorized Murata Erie Distributors.

Disc Capacitor nominal body diameter		Rectangular Capacitor nominal body height	Min. Quantity (pcs.)
Class I, II 50VDC	Class I, II 500VDC & Class III		
Up to *9.5mm	Up to 9.0mm	Up to 7.0mm	2,500 Reel 2,000 Ammo
*9.6mm 12.0mm included	9.1mm 12.0mm included	7.1mm 10.0mm included	2,000 Reel and Ammo

* 1. Applied to DD107-112

DD07-12
DD360-DD310
DD306-DD310
DD406-DD410

* 2. Applied to DD104 & DD105

DD05
DD340
DD304
DD404

* 3. Applied to DD106

DD06
DD350
DD305
DD405

For MKV up to 2KV DC, ≤ 11 mm Dia.
 • 12.7mm pitch/lead spacing 5mm
 (Lead Code: -979)

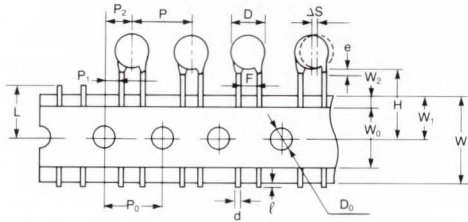

For UP to 13 mm Dia.
 • 15mm pitch/lead spacing 7.5mm
 (Lead Code: -486)

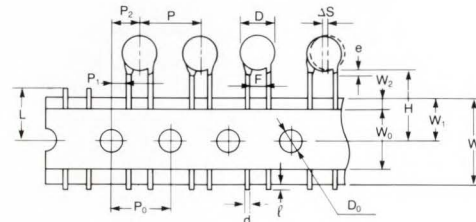

A= Ammo
 Pack
 Lead
 Code

For MKV ≥ 3KV & Safety Caps
 • 30mm pitch/lead spacing 7.5mm
 (Lead Code: -477)

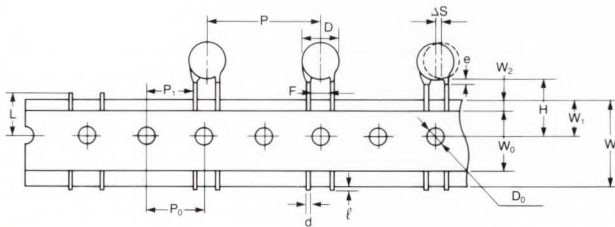

For 10mm Lead Spacing
 • 25.4mm pitch/lead spacing 10.0mm
 (Lead Code: -487)

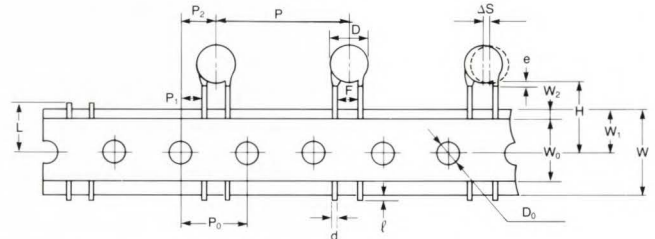

DIMENSIONS: mm

ITEM	CODE	★ -979	★ -486	★ -487	★ -477
Pitch of component	P	12.7	15.0	25.4	30.0
Pitch of sprocket hole	P ₀	12.7 ± 0.3	15.0 ± 0.3	12.7 ± 0.3	15.0 ± 0.3
Lead spacing	F	5.0 ^{+0.8} _{-0.2}	7.5 ± 1.0	10.0 ± 1.0	7.5 ± 1.0
Length from hole center to component center	P ₂	6.35 ± 1.3	7.5 ± 1.5	—	7.5 ± 1.5
Length from hole center to lead	P ₁	3.85 ± 0.7	3.75 ± 1.0	7.7 ± 1.5	3.75 ± 1.0
Body diameter	D	See individual product specifications			
Deviation along tape, left or right	ΔS	0 ± 1.0	0 ± 2.0		
Carrier tape width	W	18.0 ± 0.5			
Position of sprocket hole	W ₁	9.0 ± 0.5			
Lead distance between reference and bottom planes	H	20.0 ± 1.5 -1.0	18.0 ± 2.0 -0		20.0 ± 1.5 -1.0
Protusion length	ℓ	+0.5 / -1.0			
Diameter of sprocket hole	D ₀	4.0 ± 0.1			
Lead Diameter	d	.6 ± 0.05	.65 ± 0.05		
Total tape thickness	t ₁	0.6 ± 0.3			
Total thickness, tape and lead wire	t ₂	1.5 max.			
Portion to cut in case of defect	L	11.0 ⁺⁰ -1.0			
Hold down tape width	W ₀	11.5 min.			
Hold down tape position	W ₂	1.5 ± 1.5			
Coating extension on lead	e	3.0 max.			

★ Available as standard through authorized Murata Erie Distributors.

HR SERIES, HIGH TEMPERATURE (+125°)/ LOW LOSS 3% DISSIPATION FACTOR

E.I.A. CLASS I, II, III
PART NUMBERING SYSTEM

250-6K VDC

TYPE DE07	LEADS 05	TEMP. CHAR. R	CAPACITANCE 221	TOL. K	VOLTAGE 1KV									
CAPACITOR TYPE AND SIZE	LEAD SPACING 5, 05=.197 (5) 7, 07=.300 (75) 10, 10=.394 (10) 16=.630 (16)	TEMPERATURE CHARACTERISTICS -25°C to +125°C MAX. CAP. CHANGE OVER TEMP. RANGE SL=+350-1000 ppm/°C	CAPACITANCE VALUE Expressed in picofarads and identified by a three-digit number. First two digits represent significant figures. Last digit specifies the number of zeros to follow.	CAPACITANCE TOLERANCE J=±5% (Class I only) K=±10%	VOLTAGE Identified by a one, two or three digit number.									
		<table border="1"> <tr> <td></td> <td>-25°C to +85°C</td> <td>+85°C to +125°C</td> </tr> <tr> <td>R=</td> <td>±15%</td> <td>+15, -30%</td> </tr> <tr> <td>C=</td> <td>±20%</td> <td>+15, -30%</td> </tr> </table>		-25°C to +85°C	+85°C to +125°C	R=	±15%	+15, -30%	C=	±20%	+15, -30%			
	-25°C to +85°C	+85°C to +125°C												
R=	±15%	+15, -30%												
C=	±20%	+15, -30%												

★ PREFERRED VALUES 1KV-6KV

TYPE	DIMENSIONS: in. (mm)				CAPACITANCE (pF)								
	D max.	Lead Space (Tol. ±1mm)			250V	500V	1KV		2KV		3KV		6KV
		250V/500V/1KV	2KV/3KV	6KV	R	C	SL	R	SL	R	SL	R	R
DE50-6	.236 (6)	.197 (5)	—	—	220-1000	330-470	—	—	—	—	—	—	—
DE507	.276 (7)	.197 (5)	.300 (7.5)	—	—	—	10-120	—	10-82	—	10-47	—	—
DE50-7	.276 (7)	.197 (5)	—	—	1500	680	—	—	—	—	—	—	—
DE07	.276 (7)	.197 (5)	.300 (7.5)	—	—	—	—	220-470	—	220-270	—	150-270	—
DE508	.315 (8)	.197 (5)	.300 (7.5)	—	—	—	150-180	—	100-120	—	56-68	—	—
DE50-8	.315 (8)	.197 (5)	—	—	2200	1000	—	—	—	—	—	—	—
DE08	.315 (8)	.197 (5)	.300 (7.5)	—	—	—	—	680	—	330-390	—	330	—
DE509	.354 (9)	.197 (5)	.300 (7.5)	—	—	—	220	—	150	—	82	—	—
DE50-9	.354 (9)	.197 (5)	—	—	3300	1500	—	—	—	—	—	—	—
DE09	.354 (9)	.197 (5)	.300 (7.5)	.394 (10)	—	—	—	1000	—	470-560	—	390	220
DE510	.394 (10)	.197 (5)	.300 (7.5)	—	—	—	270	—	180	—	100	—	—
DE51-0	.394 (10)	.197 (5)	—	.394 (10)	4700	2200	—	—	—	—	—	—	—
DE10	.394 (10)	.197 (5)	.300 (7.5)	—	—	—	—	—	—	680	—	470-560	330
DE511	.433 (11)	.197 (5)	.300 (7.5)	—	—	—	330	—	220	—	120	—	—
DE11	.433 (11)	.197 (5)	.300 (7.5)	—	—	—	—	1500	—	820	—	680	—
DE51-2	.472 (12)	.197 (5)	—	—	6800-10000	3300	—	—	—	—	—	—	—
DE12	.472 (12)	.197 (5)	.300 (7.5)	.394 (10)	—	—	—	—	—	1000-1500	—	820	470
DE13	.512 (13)	.394 (10)	.394 (10)	.394 (10)	—	—	—	2200	—	—	—	1000	680
DE51-4	.551 (14)	.394 (10)	—	—	—	4700	—	—	—	—	—	—	—
DE14	.551 (14)	.394 (10)	.394 (10)	—	—	—	—	—	—	1800	—	1200	—
DE15	.591 (15)	.394 (10)	.394 (10)	—	—	—	—	3300	—	2200	—	1500	—
DE16	.630 (16)	.394 (10)	.394 (10)	—	—	—	—	—	—	—	—	1800	—
DE17	.669 (17)	.394 (10)	.394 (10)	.630 (16)	—	—	—	4700	—	2700	—	2200	1000
DE19	.748 (19)	.394 (10)	.394 (10)	.630 (16)	—	—	—	—	—	3300	—	2700	1500
DE20	.787 (20)	.394 (10)	.630 (16)	—	—	—	—	—	—	3900	—	—	—
DE21	.827 (21)	.394 (10)	.394 (10)/ .630 (16)	.630 (16)	—	—	—	—	—	4700	—	—	2200

* All preferred values are standard through authorized Murata Erie distributors.

PART NUMBERING SYSTEM

DE7150	FZ	103	P	VA1	KC/MY	
CAPACITOR TYPE AND SIZE	TEMPERATURE CHARACTERISTICS Temperature Range B = -25°C to +85°C F = -25°C to +85°C FZ = -10°C to +60°C MAX. CAP. CHANGE OVER TEMP. RANGE B = ±10% F = +30%, -80% FZ = +30%, -85%	CAPACITANCE VALUE Expressed in picofarads and identified by a three-digit number. First two digits represent significant figures. Last digit specifies the number of zeros to follow.		CAPACITANCE TOLERANCE K = ±10% M = ±20% P = +100%, -0%	VOLTAGE VA1 = 400 VAC : Europe 250 VAC : (VDE565-1/UL1414) 125 VAC : North America AC125 = 125 VAC : North America Only	LISTED TYPE DESIGNATION

* B, F, FZ are JIS TC codes that are similar to EIA Temperature Characteristics Y5P, Y5V, Z5V.

SPECIFICATIONS

PART NUMBER	DIMENSIONS: in. (mm)		CAPACITANCE (pF) by Value		
	D max.	L.S.	B	F	FZ
★ DE7090 B 101K VA1-KC	.394 (10)	.300 (7.5)	100	—	—
★ DE7090 B 151K VA1-KC	.394 (10)	.300 (7.5)	150	—	—
★ DE7090 B 221K VA1-KC	.394 (10)	.300 (7.5)	220	—	—
★ DE7090 B 331K VA1-KC	.394 (10)	.300 (7.5)	330	—	—
★ DE7090 B 471K VA1-KC	.394 (10)	.300 (7.5)	470	—	—
★ DE7090 B 681K AC125-MY	.394 (10)	.300 (7.5)	680	—	—
★ DE7090 B 102K VA1-KC	.394 (10)	.300 (7.5)	1,000	—	—
★ DE7100 F 222M VA1-KC	.472 (12)	.300 (7.5)	—	2,200	—
★ DE7100 FZ 472P VA1-KC	.472 (12)	.300 (7.5)	—	—	4,700
★ DE7120 F 332M VA1-KC	.551 (14)	.374 (9.5)	—	3,300	—
★ DE7150 F 472M VA1-KC	.669 (17)	.374 (9.5)	—	4,700	—
★ DE7150 FZ 103P VA1-KC	.669 (17)	.374 (9.5)	—	—	10,000
★ DE7150 F 103M VA1-KC	.669 (17)	.374 (9.5)	—	10,000	—

TYPE KC

Part Number	Recognized Standard No.															
	VIDE0560-3 BS415 AS3250		VDE0565-1 — —		SEV1055/SEV1016		SEMKO101/ SS443 04-14		UL 1414	EI E101-82	EI E384/14-82	NEMKO NEMX0661/77 NEMX0132/85		DEMCO Section 201	DEMCO Section 21	CSA C22.2 No. 0 No. 1
	—	X	Y	X	Y	X	Y	X	Y	—	Y	X, Y	X	Y	X, Y	—
DE7090 B 101K VA1-KC	○	○	○	○	○	—	○	○	○	○	○	○	○	○	○	○
DE7090 B 151K VA1-KC	○	○	○	○	○	—	○	○	○	○	○	○	○	○	○	○
DE7090 B 221K VA1-KC	○	○	○	○	○	—	○	○	○	○	○	○	○	○	○	○
DE7090 B 331K VA1-KC	○	○	○	○	○	—	○	○	○	○	○	○	○	○	○	○
DE7090 B 471K VA1-KC	○	○	○	○	○	—	○	○	○	○	○	○	○	○	○	○
DE7090 B 102K VA1-KC	○	○	○	○	○	—	○	○	○	○	○	○	○	○	○	○
DE7090 F 152M VA1-KC	○	○	○	○	○	—	○	○	○	○	○	○	○	○	○	○
DE7100 F 222M VA1-KC	○	○	○	○	○	—	○	○	○	○	○	○	○	○	○	○
DE7120 F 332M VA1-KC	○	○	○	—	○	○	○	○	○	○	○	○	○	○	○	○
DE7120 F 392M VA1-KC	○	○	○	—	○	○	○	○	○	○	○	○	○	○	○	○
DE7150 F 472M VA1-KC	○	○	○	—	○	○	○	○	○	○	○	○	○	○	○	○
DE7100 F 472M VA1-KC	○	○	—	—	○	○	○	○	○	○	○	○	○	○	○	○
DE7150 F 103M VA1-KC	○	○	—	○	○	—	○	○	○	—	○	—	○	—	○	○
DE7100 FZ 472P VA1-KC	○	—	—	—	—	—	○	○	○	○	○	○	○	○	○	○
DE7150 FZ 103P VA1-KC	○	—	—	—	—	—	○	—	○	○	—	○	—	○	—	○
AC Rated Voltage	400	250	400	250	400/250	125/250	400	250	250	250	400	250	400	250	125	

TYPICAL MARKING

1. Capacitance by three-digit code
2. Cap. tolerance by E.I.A. lettercode
3. Safety recognition markings
4. Type Designation
5. Manufacturer's trademark

All safety recognized capacitors are standard through authorized Murata Erie Distributors.

★ Available as standard through authorized Murata Erie Distributors.

HIGH VOLTAGE CERAMIC DISC CAPACITORS

E.I.A. CLASS I, CLASS II & CLASS III

PART NUMBERING SYSTEM

E.I.A. CLASS I

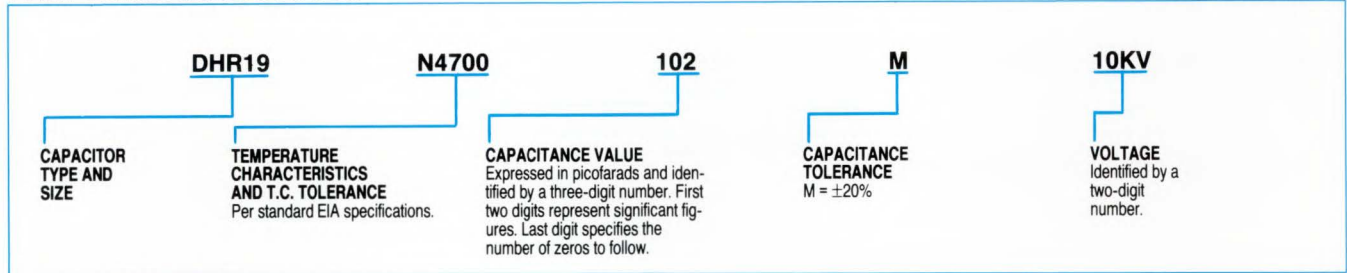

★10 & 15 KVDC PREFERRED VALUES

PART NUMBER	CAPACITANCE (pF)	WORKING VOLTAGE (KVDC)	DIMENSIONS: in. (mm)				
			D max.	H max.	T max.	L.S.	E max.
DHR12 N4700 221M 10KV	220	10	.472 (12)	.512 (13)	.275 (7)	.375 (9.5)	.197 (5)
DHR15 N4700 331M 10KV	330	10	.590 (15)	.630 (16)	.275 (7)	.375 (9.5)	.197 (5)
DHR15 N4700 471M 10KV	470	10	.590 (15)	.630 (16)	.275 (7)	.375 (9.5)	.197 (5)
DHR17 N4700 681M 10KV	680	10	.669 (17)	.700 (17.8)	.275 (7)	.375 (9.5)	.197 (5)
DHR19 N4700 102M 10KV	1,000	10	.748 (19)	.791 (20.1)	.275 (7)	.500 (12.7)	.197 (5)
DHR9 N4700 820M 15KV	82	15	.354 (9)	.394 (10)	.330 (8.4)	.500 (12.7)	.197 (5)
DHR9 N4700 101M 15KV	100	15	.354 (9)	.394 (10)	.330 (8.4)	.500 (12.7)	.197 (5)
DHR12 N4700 151M 15KV	150	15	.472 (12)	.512 (13)	.330 (8.4)	.500 (12.7)	.197 (5)
DHR12 N4700 221M 15KV	220	15	.472 (12)	.512 (13)	.330 (8.4)	.500 (12.7)	.197 (5)
DHR15 N4700 331M 15KV	330	15	.590 (15)	.630 (16)	.330 (8.4)	.500 (12.7)	.197 (5)
DHR17 N4700 471M 15KV	470	15	.669 (17)	.697 (17.7)	.330 (8.4)	.500 (12.7)	.197 (5)
DHR19 N4700 681M 15KV	680	15	.748 (19)	.787 (20)	.330 (8.4)	.500 (12.7)	.197 (5)
DHR22 N4700 102M 15KV	1,000	15	.866 (22)	.909 (23.1)	.330 (8.4)	.500 (12.7)	.197 (5)

PART NUMBERING SYSTEM

E.I.A. CLASS II & III

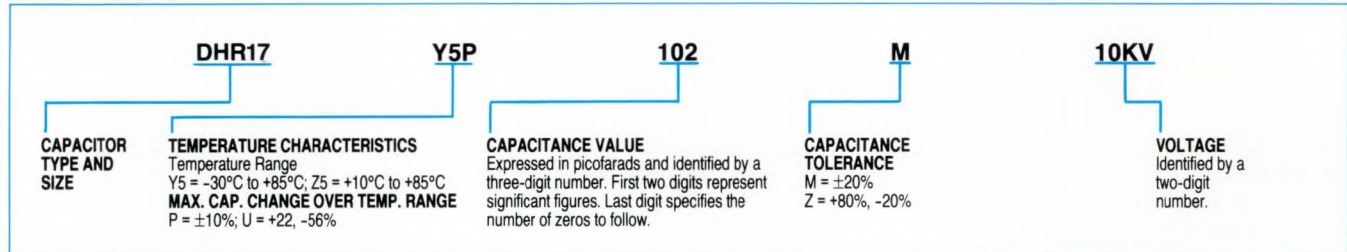

★7.5, 10 & 15 KVDC PREFERRED VALUES

PART NUMBER	CAPACITANCE (pF)	WORKING VOLTAGE (KVDC)	DIMENSIONS: in. (mm)					
			D max.	H max.	T	L.S.	E max.	
DHR9 Y5P 101M 7.5KV	100	7.5	.354 (9)	.394 (10)	.275 (7)	.375 (9.5)	.157 (4)	
DHR9 Y5P 151M 7.5KV	150		.354 (9)	.394 (10)	.275 (7)	.375 (9.5)	.157 (4)	
DHR9 Y5P 221M 7.5KV	220		.354 (9)	.394 (10)	.275 (7)	.375 (9.5)	.157 (4)	
DHR10 Y5P 331M 7.5KV	330		.394 (10)	.433 (11)	.275 (7)	.375 (9.5)	.157 (4)	
DHR12 Y5P 471M 7.5KV	470		.472 (12)	.512 (13)	.275 (7)	.375 (9.5)	.157 (4)	
DHR13 Y5P 681M 7.5KV	680		.512 (13)	.551 (14)	.275 (7)	.375 (9.5)	.157 (4)	
DHR15 Y5P 102M 7.5KV	1,000		.590 (15)	.631 (16)	.275 (7)	.375 (9.5)	.157 (4)	
DHR9 Z5U 471Z 7.5KV	470		.354 (9)	.394 (10)	.275 (7)	.375 (9.5)	.157 (4)	
DHR10 Z5U 681Z 7.5KV	680		.394 (10)	.433 (11)	.275 (7)	.375 (9.5)	.157 (4)	
DHR11 Z5U 102Z 7.5KV	1,000		.433 (11)	.472 (12)	.275 (7)	.375 (9.5)	.157 (4)	
DHR13 Z5U 152Z 7.5KV	1,500		.512 (13)	.551 (14)	.275 (7)	.375 (9.5)	.157 (4)	
DHR15 Z5U 222Z 7.5KV	2,200		.590 (15)	.631 (16)	.275 (7)	.375 (9.5)	.157 (4)	
DHR9 Y5P 151M 10KV	150	10	.354 (9)	.394 (10)	.275 (7)	.375 (9.5)	.197 (5)	
DHR9 Y5P 221M 10KV	220		.354 (9)	.394 (10)	.275 (7)	.375 (9.5)	.197 (5)	
DHR12 Y5P 331M 10KV	330		.472 (12)	.512 (13)	.275 (7)	.375 (9.5)	.197 (5)	
DHR15 Y5P 471M 10KV	470		.590 (15)	.630 (16)	.275 (7)	.375 (9.5)	.197 (5)	
DHR15 Y5P 681M 10KV	680		.590 (15)	.630 (16)	.275 (7)	.375 (9.5)	.197 (5)	
DHR17 Y5P 102M 10KV	1,000		.669 (17)	.700 (17.8)	.275 (7)	.500 (12.7)	.197 (5)	
DHR24 Y5P 202M 10KV	2,000		.945 (24)	.964 (25)	.275 (7)	.622 (15.8)	.197 (5)	
DHR9 Y5P 101M 15KV	100		15	.354 (9)	.394 (10)	.330 (8.4)	.500 (12.7)	.197 (5)
DHR9 Y5P 151M 15KV	150			.354 (9)	.394 (10)	.330 (8.4)	.500 (12.7)	.197 (5)
DHR12 Y5P 221M 15KV	220			.472 (12)	.512 (13)	.330 (8.4)	.500 (12.7)	.197 (5)
DHR12 Y5P 331M 15KV	330			.472 (12)	.512 (13)	.330 (8.4)	.500 (12.7)	.197 (5)
DHR15 Y5P 471M 15KV	470			.590 (15)	.630 (16)	.330 (8.4)	.500 (12.7)	.197 (5)
DHR17 Y5P 681M 15KV	680	.669 (17)		.700 (17.8)	.330 (8.4)	.500 (12.7)	.197 (5)	
DHR20 Y5P 102M 15KV	1,000	.787 (20)		.830 (21.1)	.330 (8.4)	.500 (12.7)	.197 (5)	

★ All preferred values are standard through authorized Murata Erie Distributors.

PART NUMBERING SYSTEM

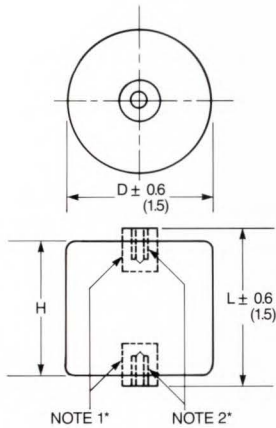
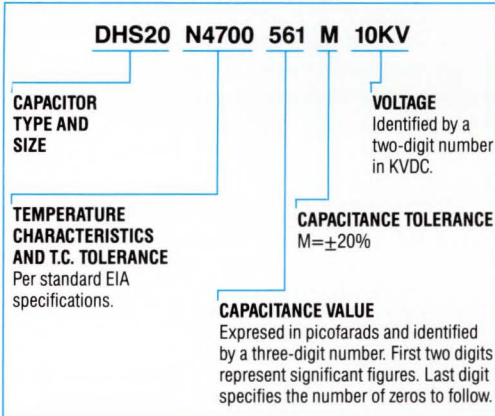

NOTE 1:
This terminal may extend up to 0.100 (2.5) above insulated surface.

NOTE 2:
No. 8-32 NC-28 Tapped holes.

Working Voltage < KVDC >	Depth < Inch (mm) >
10, 15	0.16 (4)
20, 30	0.24 (6)
40	0.31 (8)

PART NUMBERING SYSTEM

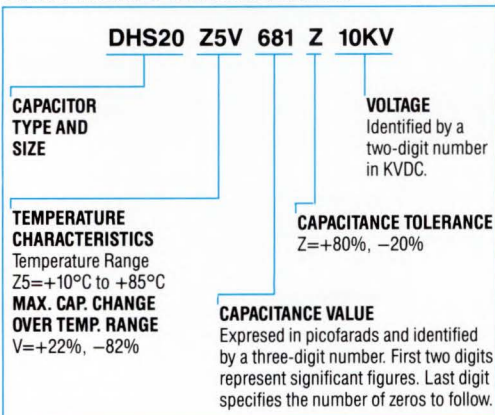

★ E.I.A. CLASS I

10 TO 40 KV DC

PART NUMBER	CAPACITANCE (pF)	WORKING VOLTAGE		TEST VOLTAGE (KVDC)	DIMENSIONS: in. (mm)		
		KVDC	KVAC (60Hz)		D	L	H
DHS20 N4700 561M-10KV	560	10	4	15	.787 (20)	.63 (16)	.47 (12)
DHS30 N4700 122M-10KV	1,200						
DHS30 N4700 182M-10KV	1,800						
DHS38 N4700 282M-10KV	2,800						
DHS52 N4700 502M-10KV	5,000						
DHS60 N4700 802M-10KV	8,000						
DHS20 N4700 371M-15KV	370	15	6	23	.787 (20)	.71 (18)	.55 (14)
DHS30 N4700 801M-15KV	800						
DHS30 N4700 112M-15KV	1,100						
DHS38 N4700 192M-15KV	1,900						
DHS52 N4700 342M-15KV	3,400						
DHS60 N4700 532M-15KV	5,300						
DHS20 N4700 281M-20KV	280	20	8	30	.787 (20)	.95 (24)	.787 (20)
DHS30 N4700 601M-20KV	600						
DHS30 N4700 881M-20KV	880						
DHS38 N4700 142M-20KV	1,400						
DHS52 N4700 252M-20KV	2,500						
DHS60 N4700 402M-20KV	4,000						
DHS20 N4700 191M-30KV	190	30	12	45	.787 (20)	1.10 (28)	.95 (24)
DHS30 N4700 401M-30KV	400						
DHS30 N4700 591M-30KV	590						
DHS38 N4700 941M-30KV	940						
DHS52 N4700 172M-30KV	1,700						
DHS60 N4700 272M-30KV	2,700						
DHS20 N4700 141M-40KV	140	40	16	60	.787 (20)	1.42 (36)	1.26 (32)
DHS30 N4700 301M-40KV	300						
DHS30 N4700 441M-40KV	440						
DHS38 N4700 701M-40KV	700						
DHS52 N4700 132M-40KV	1,300						
DHS60 N4700 202M-40KV	2,000						

★ E.I.A. CLASS III

10 TO 40 KV DC

PART NUMBER	CAPACITANCE (pF)	WORKING VOLTAGE KVDC	TEST VOLTAGE KVDC	DIMENSIONS: in. (mm)		
				D max.	L	H
DHS20 Z5V 681Z-10KV	680	10	15	.787 (20)	.75 (19)	.66 (17)
DHS24 Z5V 122Z-10KV	1,200					
DHS30 Z5V 202Z-10KV	2,000					
DHS38 Z5V 322Z-10KV	3,200					
DHS43 Z5V 472Z-10KV	4,700					
DHS52 Z5V 652Z-10KV	6,500					
DHS57 Z5V 832Z-10KV	8,300	15	23	2.24 (57)	.75 (19)	.66 (17)
DHS60 Z5V 932Z-10KV	9,300					
DHS20 Z5V 471Z-15KV	470					
DHS24 Z5V 801Z-15KV	800					
DHS30 Z5V 132Z-15KV	1,300					
DHS38 Z5V 222Z-15KV	2,200					
DHS43 Z5V 322Z-15KV	3,200	20	30	1.69 (43)	.90 (23)	.82 (21)
DHS52 Z5V 462Z-15KV	4,600					
DHS57 Z5V 582Z-15KV	5,800					
DHS60 Z5V 652Z-15KV	6,500					
DHS20 Z5V 351Z-20KV	350					
DHS24 Z5V 601Z-20KV	600					
DHS30 Z5V 102Z-20KV	1,000	30	45	1.18 (30)	1.02 (26)	.94 (24)
DHS38 Z5V 162Z-20KV	1,600					
DHS43 Z5V 242Z-20KV	2,400					
DHS52 Z5V 332Z-20KV	3,300					
DHS57 Z5V 432Z-20KV	4,300					
DHS60 Z5V 482Z-20KV	4,800					
DHS20 Z5V 261Z-30KV	260	40	60	.787 (20)	1.33 (34)	1.25 (32)
DHS24 Z5V 461Z-30KV	460					
DHS30 Z5V 781Z-30KV	780					
DHS38 Z5V 122Z-30KV	1,200					
DHS43 Z5V 182Z-30KV	1,800					
DHS52 Z5V 252Z-30KV	2,500					
DHS57 Z5V 332Z-30KV	3,300	40	60	2.24 (57)	1.33 (34)	1.25 (32)
DHS60 Z5V 362Z-30KV	3,600					
DHS20 Z5V 181Z-40KV	180					
DHS24 Z5V 341Z-40KV	340					
DHS30 Z5V 571Z-40KV	570					
DHS38 Z5V 921Z-40KV	920					
DHS43 Z5V 132Z-40KV	1,300	40	60	1.69 (43)	1.61 (41)	1.53 (39)
DHS52 Z5V 192Z-40KV	1,900					
DHS57 Z5V 242Z-40KV	2,400					
DHS60 Z5V 272Z-40KV	2,700					
DHS20 Z5V 181Z-40KV	180					
DHS24 Z5V 341Z-40KV	340					
DHS30 Z5V 571Z-40KV	570	40	60	2.04 (52)	1.61 (41)	1.53 (39)
DHS38 Z5V 921Z-40KV	920					
DHS43 Z5V 132Z-40KV	1,300					
DHS52 Z5V 192Z-40KV	1,900					
DHS57 Z5V 242Z-40KV	2,400					
DHS60 Z5V 272Z-40KV	2,700					

★ All high voltage capacitors are standard through authorized Murata Erie Distributors.

ELECTRIC DOUBLE LAYER CAPACITORS ACECAP™

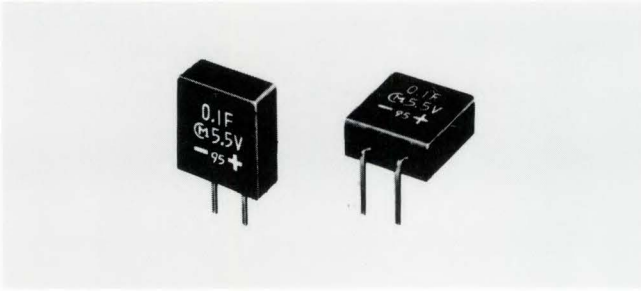

FEATURES

- Tape packaging available.
- Wide capacitance range as low as 0.022F.
- Unrestricted lengthwise and crosswise mounting.
- Compact resin case helps miniaturize and conserve space.
- Waterproof structure facilitates washing.

PART NUMBERING

AC310	301	G	473	Z	5R5
TYPE AC310 : 223Z & 473Z AC312 : 104Z	LEAD SHAPE No code : Standard vertical 301 : Standard horizontal 502 : Flatpacktaped type (H=18.5mm) (223Z, 473Z) 504 : Flatpacktaped type (H=18.5mm) (104Z) 201 : Crimp lead	TEMPERATURE CHARACTERISTICS -25°C to +70°C (+80%, -50%)	CAPACITANCE Code in 3 letters (unit F)	CAPACITANCE TOLERANCE +80%, -20%	RATED VOLTAGE 5.5V DC

DIMENSIONS: in. (mm)

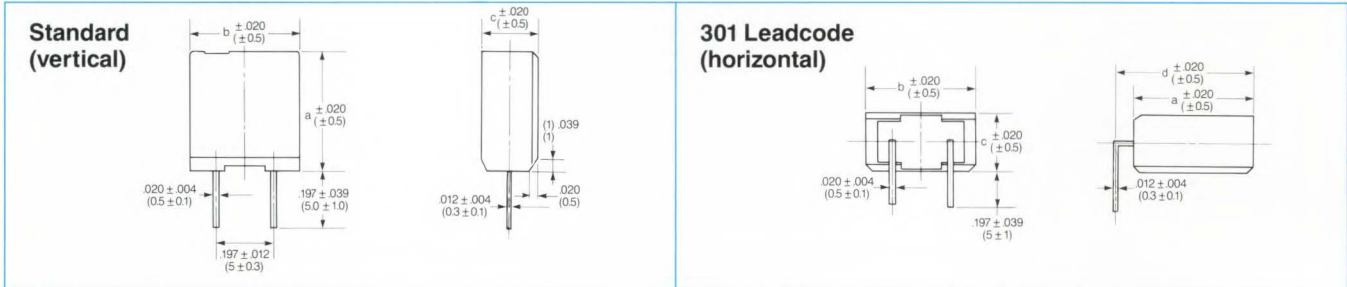

SPECIFICATIONS

Part Number	Rated Voltage (VDC)	Capacitance (F)	Capacitance Tolerance (%)	DIMENSIONS: (mm)				E S R. (Ω)	Leakage* Current (μA)
				a	b	c	d		
★ AC310G223Z5R5	5.5	0.022	+80, -20	10.5	9.5	5.0	12.0	150 max.	50 max.
★ AC310G473Z5R5	5.5	0.047	+80, -20	10.5	9.5	5.0	12.0	60 max.	70 max.
★ AC312G104Z5R5	5.5	0.1	+80, -20	12.5	11.5	5.0	14.0	60 max.	150 max.

(* at 30min)

TAPE SPECIFICATIONS

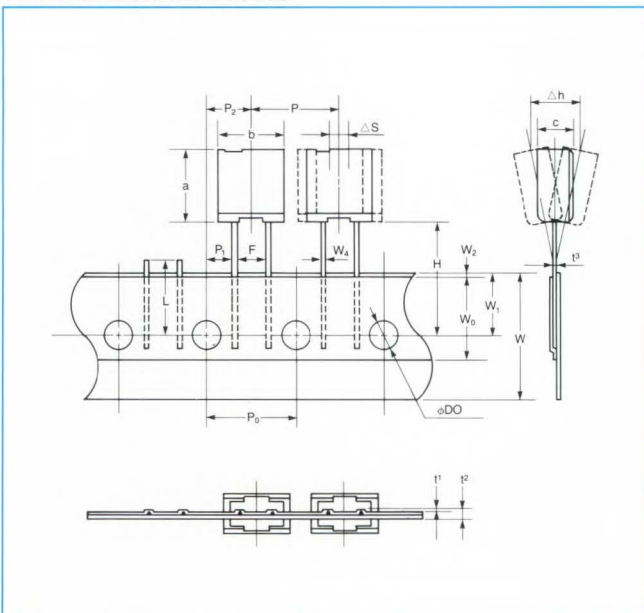

TAPE DIMENSIONS

ITEM	CODE	DIMENSIONS: (mm)	
Pitch of component	P	12.7	
Pitch of sprocket hole	P ₀	12.7±0.2	
Length from hole center to lead	P ₁	3.85±0.7	
Length from hole center to component center	P ₂	6.35±1.3	
Lead spacing	F	5.0 ^{+0.8} _{-0.2}	
Carrier tape width	W	18.0±0.5	
Hold down tape width	W ₀	12.5 max.	
Position of sprocket hole	W ₁	9.0 ^{-0.5} ₀	
Hold down tape position	W ₂	0.5±0.5	
Components bottom plane	H	16.5±0.5	
		18.5±0.5	
Diameter of sprocket hole	D ₀	φ 4.0±0.1	
Portion to cut in case of defect	L	11.0 ^{-0.5} ₀	
Total tape thickness	t ₁	0.6±0.3	
Total thickness, tape and lead wire	t ₂	1.5 max.	
Deviation across tape	Δh ₁	0±1.0	
Deviation along tape, left or right	ΔS	0±0.2	
Lead cross section	Width	W ₄	0.5±0.1
	Thickness	t ₃	0.3±0.1
Body dimension	a	10.5±0.5	*12.5±0.5
	b	9.5±0.5	*11.5±0.5
	c	5.0±0.5	* 5.0±0.5

(* : Dimension of 0.1F)



This washable chip trimmer capacitor has primarily been developed for consumer products such as small radios, pagers, radio communication equipment and audio equipment. Protected by a thermostat resin case, it provides superior resistance to heat.

FEATURES

- Miniature rectangular configuration with dimensions of just 4.0(W) × 4.5(L) × 3.0(H) (mm)
- Ideal for auto-placement
- Can be immersed in flux and solder bath (260°C, 5 sec.)
- Cleaning is possible with organic solvents
- Solderable by solder paste
- Models for conventional insertion are available
- Available on tape and reel for auto-placement
- Can be reflow soldered

PART NUMBERING SYSTEM

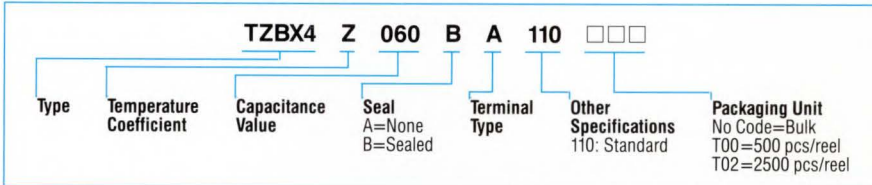

DIMENSIONS: mm

CAUTION: These parts are not available for water washing.

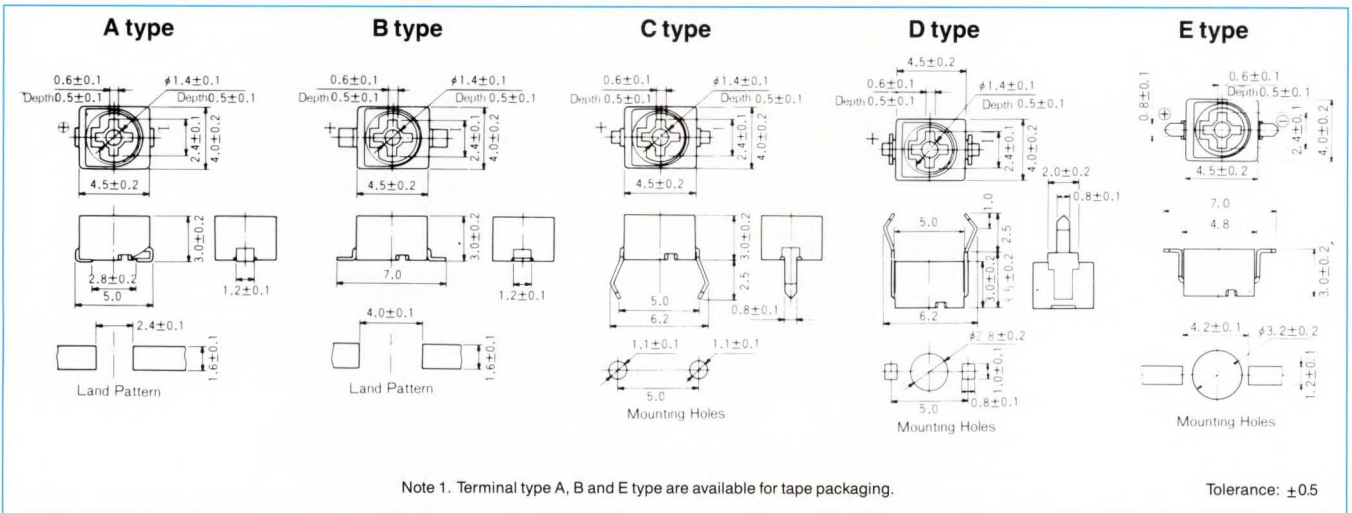

SPECIFICATIONS

Part Number	Capacitance (pF)		Temperature Coefficient (ppm/°C)	Q (Min.) (1MHz, Cmax)	Temperature (°C)	Case Color
	Min.	Max.				
TZBX4Z030□□110	1.4	3.0(+ 50% -0%)	NPO ±200	300	-55 to +85	Brown
TZBX4Z060□□110	2.0	6.0(+ 50% -0%)	NPO ±200	500	-55 to +85	Blue
TZBX4N100□□110	3.0	10.0(+ 50% -0%)	N150 ±300	500	-55 to +85	White
TZBX4R200□□110	4.5	20.0(+ 50% -0%)	N750 ±300	500	-55 to +85	Red
TZBX4P300□□110	6.5	30.0(+ 50% -0%)	N1200±500	300	-55 to +85	Green
TZBX4P400□□110	8.5	40.0(+ 50% -0%)	N1200±500	300	-55 to +85	Yellow
TZBX4Z250□□110	4.0	25.0(+100% -0%)	NPO ±300	300	-55 to +85	Black
TZBX4R500□□110	7.0	50.0(+100% -0%)	N750 ±300	300	-55 to +85	Black

• Rated Voltage...100VDC • Withstanding Voltage...220VDC • Insulation Resistance...10¹⁰MΩ min. • Torque... 15 to 100g·cm 50VDC for Z250, R500.

PACKAGING

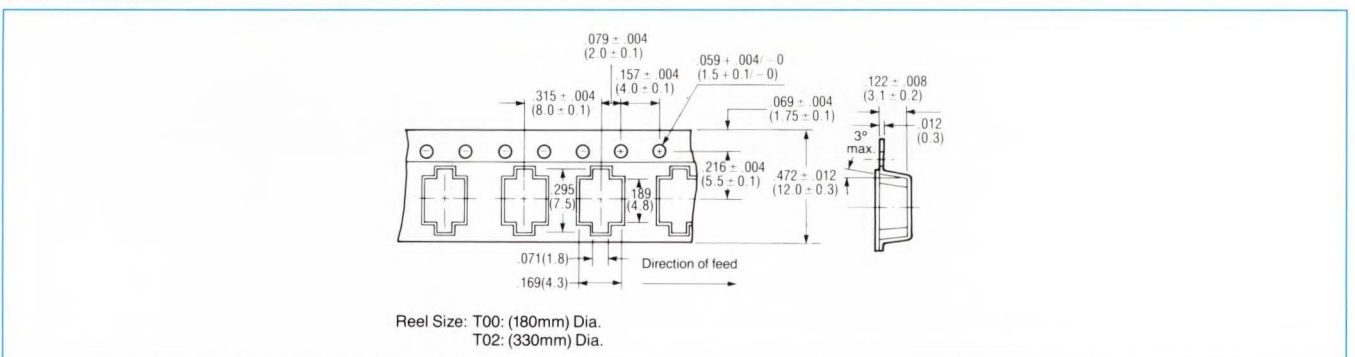

All TZBX4's are available as standard through authorized Murata Erie Distributors.

★ Available as standard through authorized Murata Erie Distributors.

CHIP TRIMMER CAPACITORS TZC03 SERIES



This new low profile chip trimming capacitor is specifically designed to meet the requirements of high density surface mount applications and automated placement equipment.

FEATURES

- Extremely small size—just 3.2 mm × 4.5 mm × 1.6 mm
- Designed for auto-placement in surface mount applications
- Color-coded
- Heat-resistant resin withstands reflow soldering temperatures
- Can be adjusted with standard adjustment tools

CONSTRUCTION

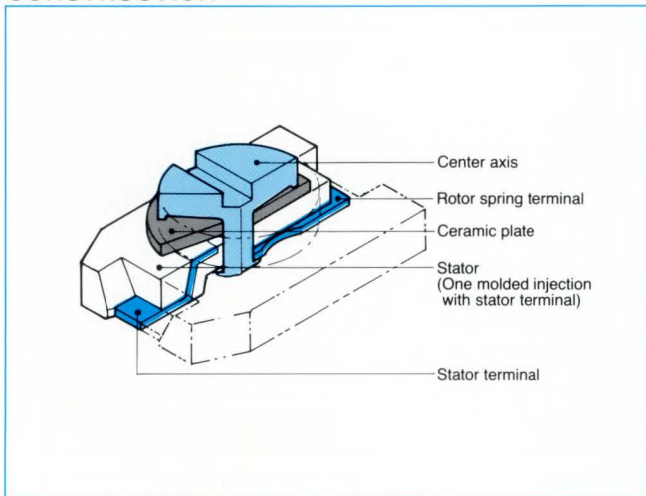

DIMENSIONS: in. (mm)

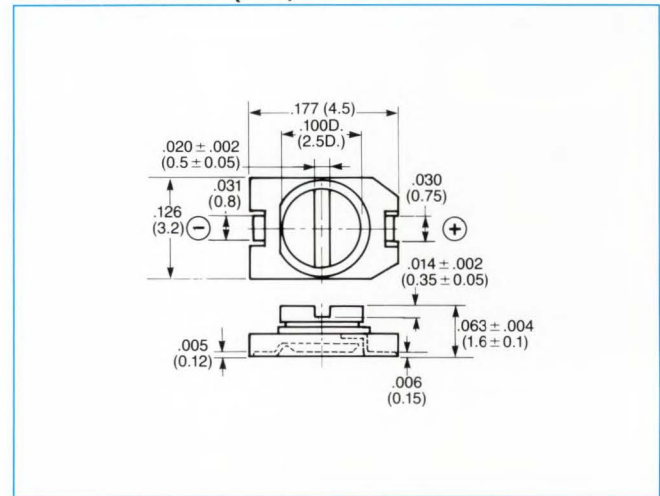

PART NUMBERING SYSTEM

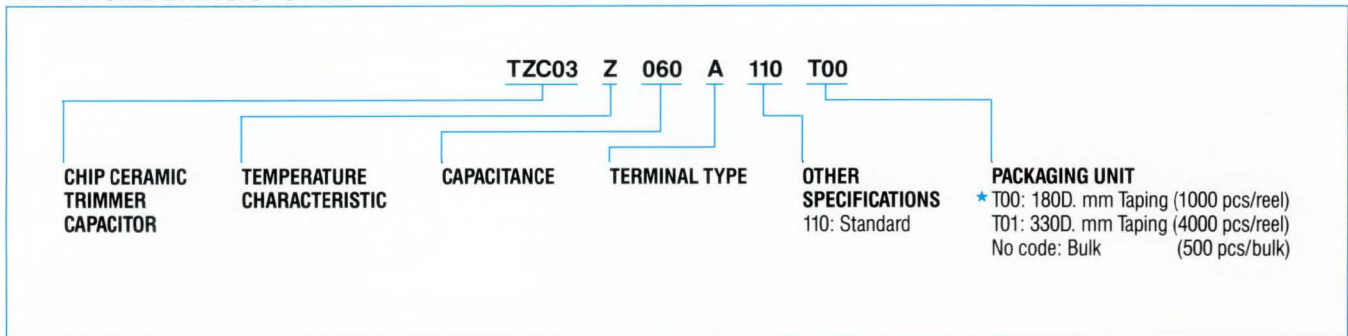

CAUTION: These units are unsealed, therefore avoid washing.

SPECIFICATIONS

Part Number	Capacitance		Temperature Coefficient (ppm/°C)	Q (1MHz, Cmax)	Working Temperature Range (°C)	Stator Color
	Min. (max.)	Max. (+50% -0%)				
* TZC03Z030A110	1.4	3.0	NPO ±300	300 min.	-25 to +85	White
* TZC03Z060A110	2.0	6.0	NPO ±300	500 min.	-25 to +85	Blue
* TZC03R100A110	3.0	10.0	N750 ±300	500 min.	-25 to +85	White
* TZC03P200A110	5.0	20.0	N1200 ±500	300 min.	-25 to +85	Red
* TZC03P300A110	6.5	30.0	N1200 ±500	300 min.	-25 to +85	Green

• Rated voltage...100VDC • Withstand voltage...220VDC • Insulation resistance...10⁴MΩmin. • Torque...15 to 100g-cm

* Available as standard through authorized Murata Erie Distributors.

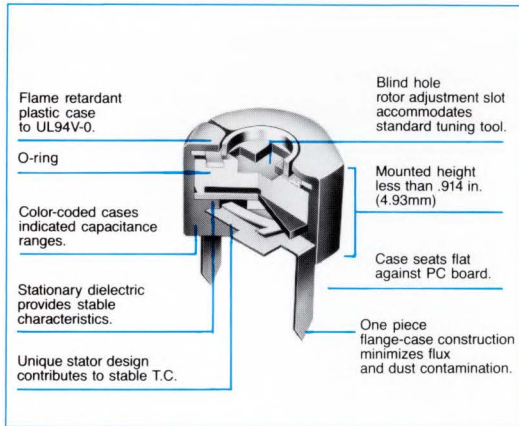

FEATURES

- QPL to MIL-C-81 (CV42)
- Excellent shock and vibration resistance
- Exceptionally linear TC
- Dust and flux resistant construction
- Plastic case meets UL94V-0
- Very adaptable to auto-insertion
- Solvent washable unit featuring "o" ring seal

SPECIFICATIONS

Temperature Range: -55°C to +85°C
Working Voltage: 100 VDC or 50 VDC
Withstanding Voltage: 220 VDC (100V units) or 110 VDC (50V units)
Insulation Resistance: 10⁴MΩ min. (50 VDC)

PART NUMBERING SYSTEM

TZ03 Z 070 ER 169

Type	Temperature Characteristic	Capacitance (pF)	Terminal Configuration	169: Standard/ Solvent Washable 240: Water Washable
------	----------------------------	------------------	------------------------	---

SPECIFICATIONS

Part Number	Capacitance (pF)		Temp. Coeff. (ppm/°C)	Q 1MHz, C max.)	Temperature (°C)	Case Color
	Min.	Max.				
SINGLE CERAMIC PLATE TYPE, 100V SERIES						
★TZ03Z2R3□□169	1.25 max.	2.3 ⁺⁰ / _{-50%}	NPO ±200	300 min.	-55 to +85	Black
★TZ03Z050□□169	1.8 max.	5.0 ⁺⁰ / _{-50%}	NPO ±200	300 min.	-55 to +85	Blue
①★TZ03Z070□□169	2.0 max.	7.0 ⁺⁰ / _{-50%}	NPO ±200	300 min.	-55 to +85	Blue
★TZ03Z100□□169	2.7 max.	10.0 ⁺⁰ / _{-50%}	NPO ±200	500 min.	-55 to +85	Blue
★TZ03N100□□169	2.1 max.	10.0 ⁺⁰ / _{-50%}	N200 ±200	500 min.	-55 to +85	White
①★TZ03T110□□169	3.0 max.	11.0 ⁺⁰ / _{-50%}	N450 ±300	500 min.	-55 to +85	White
①★TZ03T200□□169	4.2 max.	20.0 ⁺⁰ / _{-50%}	N450 ±300	500 min.	-55 to +85	Pink
①★TZ03R200□□169	4.2 max.	20.0 ⁺⁰ / _{-50%}	N750 ±300	500 min.	-55 to +85	Red
①★TZ03R300□□169	5.2 max.	30.0 ⁺⁰ / _{-50%}	N750 ±300	500 min.	-55 to +85	Green
★TZ03P450□□169	6.8 max.	45.0 ⁺⁰ / _{-50%}	N1200 ±500	300 min.	-55 to +85	Yellow
★TZ03P600□□169	9.8 max.	60.0 ⁺⁰ / _{-50%}	N1200 ±500	300 min.	-55 to +85	Brown
★TZ03P700□□169	12.0 max.	70.0 ⁺⁰ / _{-50%}	N1200 ±500	300 min.	-55 to +85	Brown
MONOLITHIC CERAMIC PLATE TYPE, 50V SERIES						
★TZ03Z500□□169	6 max.	50 ⁺⁰ / _{+100%}	NPO ±300	300 min.	-55 to +85	Orange
★TZ03R900□□169	9 max.	90 ⁺⁰ / _{+100%}	N750 ±300	300 min.	-55 to +85	Black
★TZ03R121□□169	10 max.	120 ⁺⁰ / _{+100%}	N750 ±300	300 min.	-55 to +85	Black

□□: Terminal Shape

① QPL approval to MIL-C-81

Stray capacitance for side adjustment (Y type) adaptor is .2pF.

DIMENSIONS: mm

*ER TYPE, TOP ADJUSTMENT

Top view: Driver Hole $\phi 2.5 \pm 0.2$, Depth 0.5min, C max. mark, Mounting Holes $\phi 1.2 \pm 0.1$, Case Color, Ground, hot, 1.0 ± 0.1 , 0.25 ± 0.05 , 0.2 ± 0.05 .

BR TYPE, BOTTOM ADJUSTMENT

Top view: Driver Hole $\phi 2.5 \pm 0.2$, Depth 0.5min, C max. mark, Mounting Holes $\phi 3$, Ground, hot, 1.2 ± 0.1 , 0.25 ± 0.05 , 6.6 , 0.2 , 1.0 ± 0.1 , ± 0.05 , 3.1 , 3.5 , 4.0 , Case Color.

YR TYPE, SIDE ADJUSTMENT

Top view: Driver Hole $\phi 2.5 \pm 0.2$, Depth 0.5min, C max. mark, Trimmer body (Color Case), Socket, 2.5 , 3.2 , 3.7 , 1.2 , 3.5 , 4.5 , 7.5 , Ground, hot, 1.2 , 5 , 7 , Solder, $\phi 1.4 \pm 0.1$, $\phi 1.4 \pm 0.1$, Mounting Holes.

*FR TYPE, SELF-STANDING

Top view: Driver Hole $\phi 2.5 \pm 0.2$, Depth 0.5min, C max. mark, Mounting Holes $\phi 1.2 \pm 0.1$, Case Color, Ground, hot, 1.0 ± 0.1 , 0.25 ± 0.05 , 0.2 ± 0.05 , 6.6 , 4.8 , 3.3 , 3.3 , 5 , $\phi 1.3 \pm 0.1$, $\phi 1.3 \pm 0.1$, Mounting Holes.

NR TYPE, SELF-STANDING, BOTTOM ADJUSTMENT

Top view: Driver Hole $\phi 2.5 \pm 0.2$, Depth 0.5min, C max. mark, Mounting Holes $\phi 3$, Ground, hot, 1.2 ± 0.1 , 0.25 ± 0.05 , 6.4 , 3.4 , 3.4 , 3.0 , 3.0 , 1.0 ± 0.1 , 1.3 ± 0.1 , Case Color.

* Available as standard through authorized Murata Erie Distributors.

CERAMIC TRIMMING CAPACITORS

DVS 3 SERIES

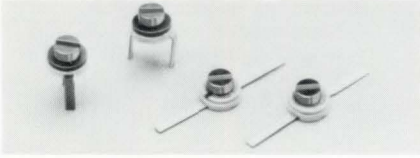

SPECIFICATIONS

Operating Temp. Range:	-55 to +85°C
Working Voltage:	25 VDC
Test Voltage:	50 VDC
"Q" Factor:	500 min. @ 1MHz
Insulation Resistance:	10 ⁴ megohms min.
Tuning Torque:	.2 to 1.5 in.-oz.

DIMENSIONS: in. (mm)

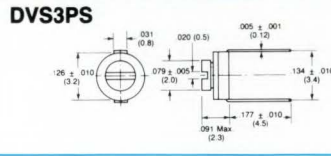

PREFERRED VALUES/ELECTRICAL DATA

Part Number	Cap. Range (pF)	Temp. Coeff. (ppm/°C)	Color Code
*DVS3PS6A	1.5 to 6.0	NPO ±300	Red
*DVS3PS10A	2.0 to 10.0	NPO ±300	Black
*DVS3PS15A	3.0 to 15.0	NPO ±300	Yellow
*DVS3PS20A	5.0 to 20.0	NPO ±300	Violet
*DVS3PS35D	5.0 to 35.0	N750 ±350	—

DVS3A

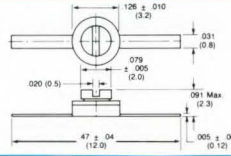

Part Number	Cap. Range (pF)	Temp. Coeff. (ppm/°C)	Color Code
*DVS3A6A	1.5 to 6.0	NPO ±300	Red
*DVS3A10A	2.0 to 10.0	NPO ±300	Black
*DVS3A15A	3.0 to 15.0	NPO ±300	Yellow
*DVS3A20A	5.0 to 20.0	NPO ±300	Violet
*DVS3A35D	5.0 to 35.0	N750 ±350	—

PART NUMBERING SYSTEM (DVS3 and DV6)



DV11 SERIES

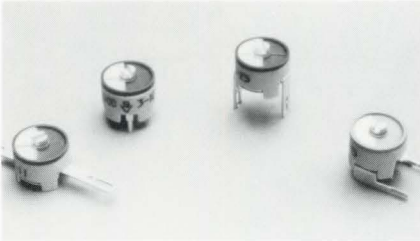

SPECIFICATIONS

Operating Temp. Range:	-55 to +125°C
Working Voltages:	350 VDC for -55 to +85°C 200 VDC for +85 to 125°C Except N650 and N1500 units, 200 VDC for -55 to +85°C 100 VDC for +85 to +125°C
Test Voltage:	500 VDC
"Q" Factor:	500 min. @ 1MHz
Insulation Resistance:	10 ⁴ megohms min.
Tuning Torque:	1 to 16 in.-oz.

DIMENSIONS: in. (mm)

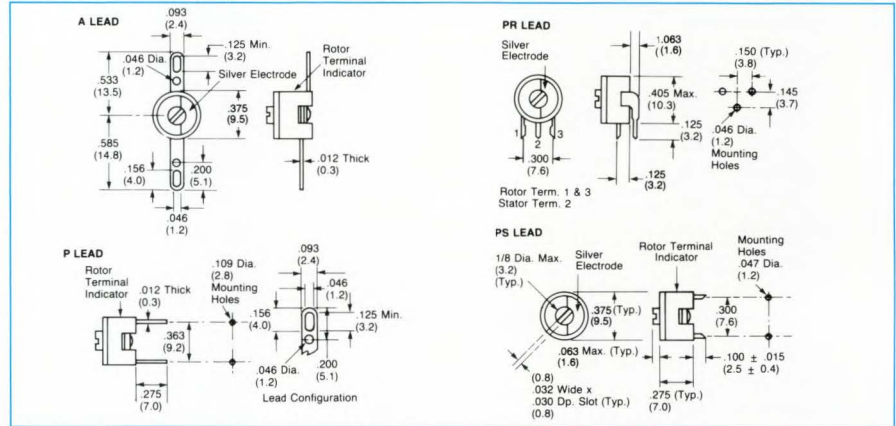

PREFERRED VALUES

DV11 Part Number	Cap. Range		Nominal TC in ppm/°C
	Min.	Max.	
*DV11A8A	2.0	8.0	NPO
DV11A11B	2.5	11.0	N300
DV11A15D	3.0	15.0	N650
*DV11A18A	5.5	18.0	NPO
*DV11A25B	7.0	25.0	N300
*DV11A35D	9.0	35.0	N650
*DV11A60Q	15.0	60.0	N1500
*DV11P8A	2.0	8.0	NPO
*DV11P11B	2.5	11.0	N300
*DV11P15D	3.0	15.0	N650
*DV11P18A	5.5	18.0	NPO
*DV11P25B	7.0	25.0	N300
*DV11P35D	9.0	35.0	N650
*DV11P60Q	15.0	60.0	N1500

PREFERRED VALUES

DV11 Part Number	Cap. Range		Nominal TC in ppm/°C
	Min.	Max.	
*DV11PR8A	2.0	8.0	NPO
*DV11PR11B	2.5	11.0	N300
*DV11PR15D	3.0	15.0	N650
*DV11PR18A	5.5	18.0	NPO
*DV11PR25B	7.0	25.0	N300
*DV11PR35D	9.0	35.0	N650
*DV11PR60Q	15.0	60.0	N1500
*DV11PS8A	2.0	8.0	NPO
*DV11PS11B	2.5	11.0	N300
*DV11PS15D	3.0	15.0	N650
*DV11PS18A	5.5	18.0	NPO
*DV11PS25B	7.0	25.0	N300
*DV11PS35D	9.0	35.0	N650
*DV11PS60Q	15.0	60.0	N1500

PART NUMBERING SYSTEM

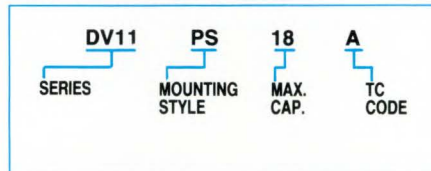

* Available as standard through authorized Murata Erie Distributors.

PRECISION MINIATURE AIR VARIABLE CAPACITORS MVM SERIES

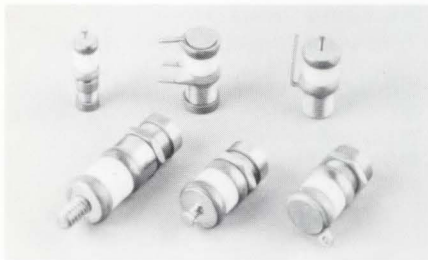

DIMENSIONS: in. (mm)

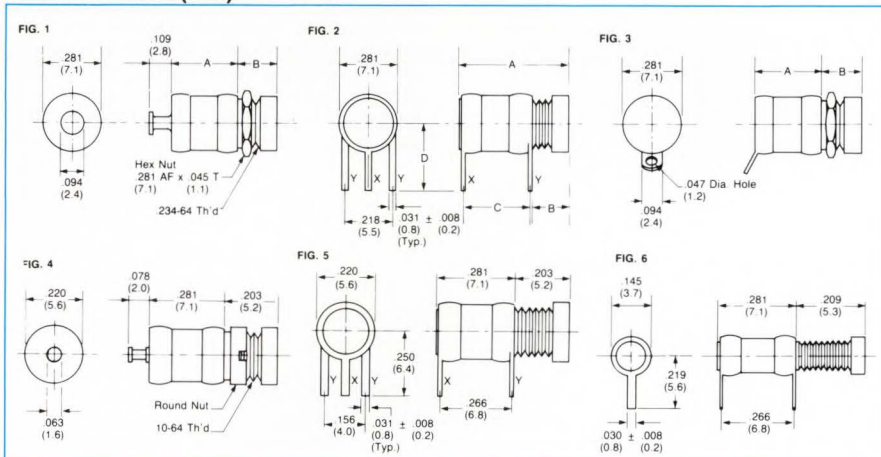

SPECIFICATIONS

Operating Temp. Range:	-65°C to +125°C
Working Voltage:	250 VDC
Test Voltage:	500 VDC
Insulation Resistance:	>10 ⁶ megohms at 250 VDC
Tuning Torque:	0.5 to 5.0 in. oz.

ELECTRICAL DATA/PREFERRED VALUES¹

Part No.	Military Specif. Designation	Capacitance Range (pF)	"Q" Factor @ 100 MHz	Temp. Coeff. (ppm/°C)	Fig. No.	A	B	C	D
*MVM010	PC31J100	0.8 to 10.0	>5000	0±15	1	.288	.196	—	—
*MVM010W	PC26J100	0.8 to 10.0	>5000	0±15	2	.510	.172	.297	.312
*MVM010M	PC25J100	0.8 to 10.0	>5000	0±15	3	.302	.196	—	—
MVM010H	—	0.8 to 10.0	>5000	0±15	*	.288	.196	—	—
*MVM014	PC31J140	1.0 to 14.0	>3000	0±25	1	.288	.196	—	—
*MVM014W**	—	1.0 to 14.0	>3000	0±25	2	.510	.172	.297	.312
MVM014M	PC25J140	1.0 to 14.0	>3000	0±25	3	.302	.196	—	—
*MVM020	PC31J200	1.0 to 20.0	>1500	0±25	1	.500	.242	—	—
*MVM020W**	—	1.0 to 20.0	>1500	0±25	2	.750	.150	.562	.500
*MVM020M	PC25J200	1.0 to 20.0	>1500	0±25	3	.514	.242	—	—
*MVM006	PC31J060	0.4 to 6.0	>10000	0±15	4	—	—	—	—
MVM106	PC29J100	0.8 to 10.0	>7500	0±15	4	—	—	—	—
*MVM006W	—	0.4 to 6.0	>10000	0±15	5	—	—	—	—
*MVM106W	—	0.8 to 10.0	>7500	0±15	5	—	—	—	—
*MVM003W	PC28J3RS	0.35 to 3.5	>10000	0±15	6	—	—	—	—

MECHANICAL DATA

Other styles available. **No slot in seal cap.

*Available as standard through authorized Murata ERIE Distributors.

*Not shown. Same as Figure 1, but with screw turret.

HIGH RESOLUTION MICROMINIATURE SAPPHIRE TRIMMERS FOR MICROWAVE CIRCUITS

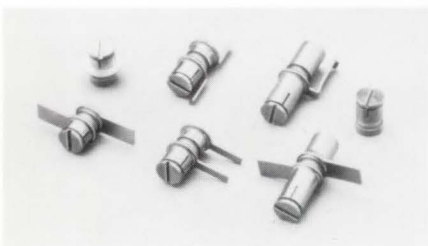

DIMENSIONS: in. (mm)

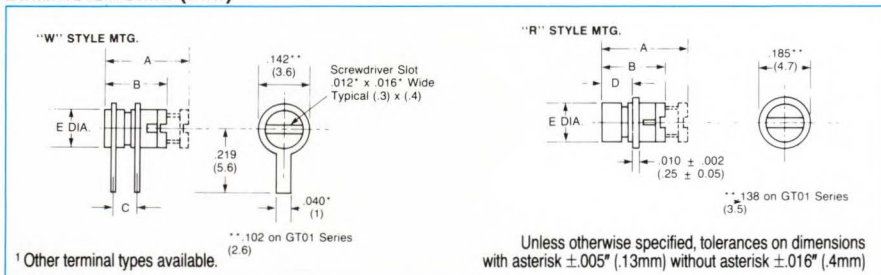

ELECTRICAL DATA/PREFERRED VALUES

Series	Capacitance Range (pF)	"Q" Factor @ 250 MHz
GT 01	0.3 — 1.2	4000
GT 12	0.4 — 2.5	3000
GT 24	0.6 — 4.5	2000
GT 38	0.8 — 8.0	1000

MECHANICAL DATA/PREFERRED VALUES

SERIES	A	B	C	D	E
GT01	.215 (5.5)	.156 (4)	.080 (2)	.083 (2.1)	.075 (1.9)
GT12	.213 (5.4)	.169 (4.3)	.080 (2)	.091 (2.3)	.118 (3)
GT24	.323 (8.2)	.246 (6.3)	.126 (3.2)	.142 (3.6)	.118 (3)
GT38	.571 (14.5)	.413 (10.5)	.250 (6.4)	.250 (6.4)	.118 (3)

PART NUMBERING SYSTEM

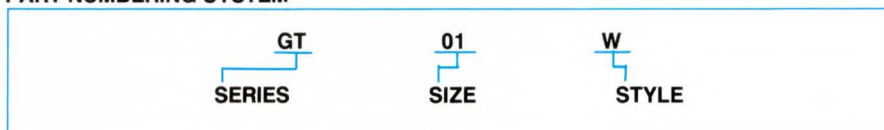

SPECIFICATIONS

Operating Temperature:	-65°C to +125°C
Working Voltage:	500 VDC
Test Voltage:	1000 VDC
Insulation Resistance:	10 ⁴ megohms @ 500 VDC
Temperature Coefficient:	+350 ± 100ppm/°C (+200 ± 100ppm/°C for GT01 series)
Tuning Torque	0.2 to 2.0 in. oz. (0.1 to 1.0 in. oz. for GT01 series)

CHIP, CERMET LOW PROFILE RVG3A



The new SMT RVG3A Series of chip trimming potentiometers features an exceptionally low profile—just 1.5 mm above the PC board—allowing higher component densities than possible before. Its alumina substrate and cermet resistance element provide long term reliability and are designed to withstand the stress of both flow and reflow soldering operations.

FEATURES

- Ultra-low profile—just 1.5 mm H.
- Extremely light weight
- Nickel barrier layer terminations for solderability
- Suitable for both flow and reflow soldering
- Offered on 8 mm tape for auto-placement
- Standard screw driver adjustable
- Suitable for auto-tuning (RVG3A08)

PART NUMBERING SYSTEM

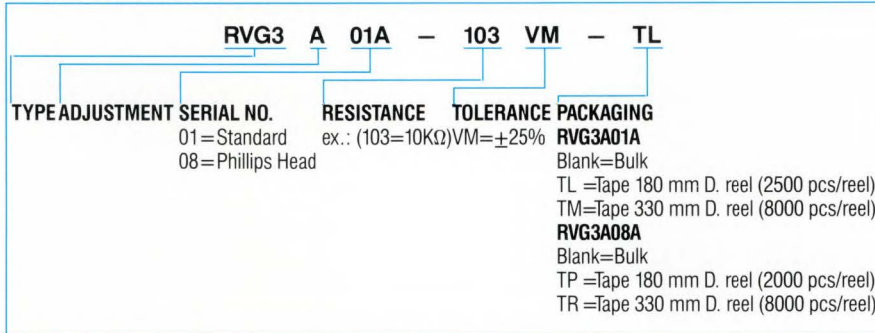

ENVIRONMENTAL CHARACTERISTICS

Humidity Load Life	Res. Change : +3%
Load Life	Res. Change : $\pm 3\%$
Temperature Cycle	Res. Change : $\pm 3\%$
Temperature Coefficient of Resistance	± 250 ppm/°C
Rotational Life (20 Cycle)	Res. Change : $\pm 10\%$

STANDARD RESISTANCES

RES. (ohms)	CODE	RES. (ohms)	CODE
200	201	50K	503
500	501	100K	104
1K	102	200K	204
2K	202	500K	504
5K	502	1M	105
10K	103	2M	205
20K	203		

DIMENSIONS: in. (mm)

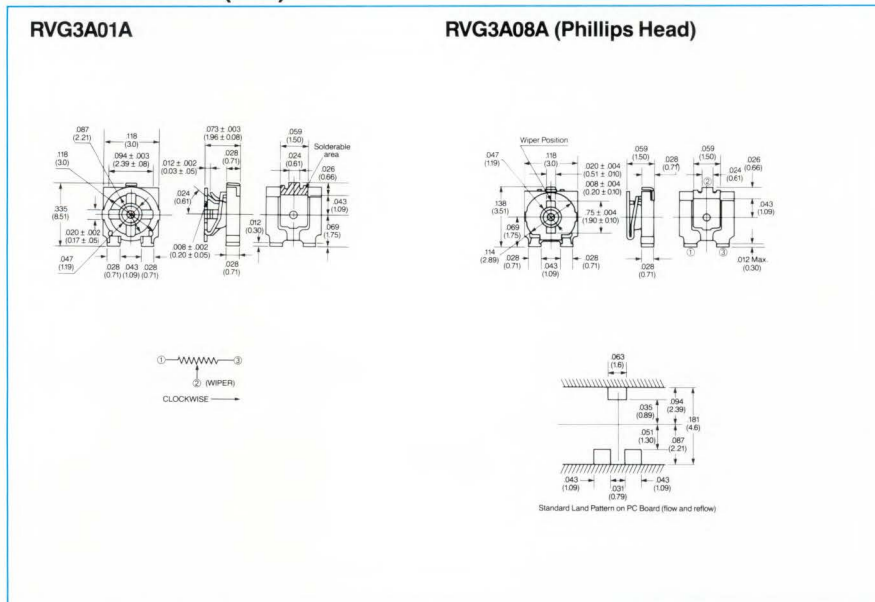

TAPE & REEL

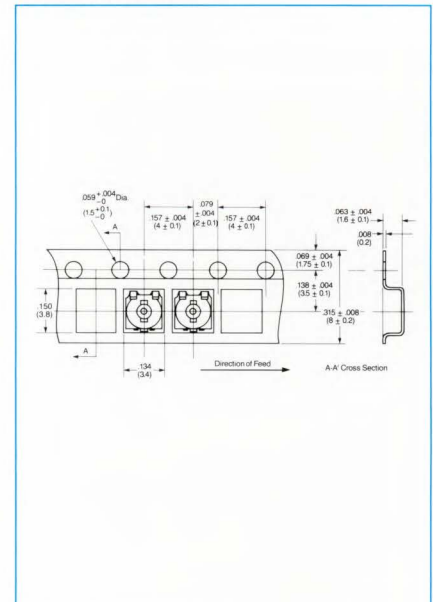

SPECIFICATIONS

Resistance Range	200Ω to 2MΩ
Resistance Tolerance	$\pm 25\%$
Taper	Linear
Power Rating	1/10W at 70°C
Maximum Working Voltage	50V DC
Operating Temperature Range	-55°C to +125°C
Rotational Torque	2.0 to 24.5 mNm
Effective Rotational Angle	270°, $\pm 10^\circ$

All values are standard through authorized Murata Erie Distributors.

CHIP TRIMMING POTENTIOMETERS CERMET

RVG4J, RVG4H, RVG4M



The RVG4 series has presoldered electrodes to facilitate surface mounted auto-placement and reflow soldering. The wide 200° rotational angle improves performance and resistance range.

APPLICATIONS

The RVG4 series are widely applicable for fine circuit adjustments in consumer electronic equipment such as small VTR cameras, TV tuners, portable TV and stereo sets, as well as transceiver communication circuits and industrial motor controllers, photoelectric switches and medical electronic equipment.

FEATURES

- Miniature size—3.8×4.5×2.25(mm) for close component spacing
- Easily adjusts with regular screwdriver
- Large, solid axle not affected by vacuum chuck during auto-placement
- Nickel barrier layer terminals eliminate solder leaching in reflow soldering operation (H type)
- Available on 12mm Tape and Reel for auto-placement

PART NUMBERING SYSTEM

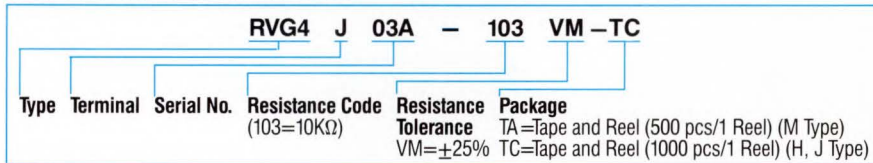

SPECIFICATIONS

Item	RVG4M	RVG4H	RVG4F
Resistance Range		100Ω to 2MΩ	
Tolerance		±25%	
Taper		B (Linear)	
Power Rating		0.1W at 70°C	
Max. Working Voltage		50V DC	
Torque		2.0 to 24.5mNm	
Electrical Rotation		200°±10°	

STANDARD RESISTANCES

RES. (ohms)	CODE	RES. (ohms)	CODE
100	101	20K	203
200	201	30K	303
300	301	50K	503
500	501	100K	104
1K	102	200K	204
2K	202	300K	304
3K	302	500K	504
5K	502	1M	105
10K	103	2M	205

DIMENSIONS: in. (mm)

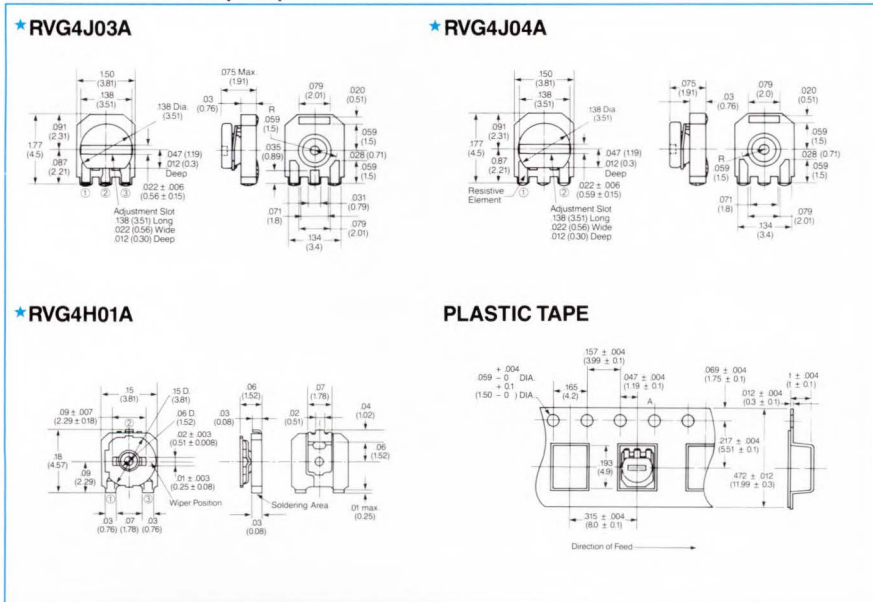

PLASTIC TAPE

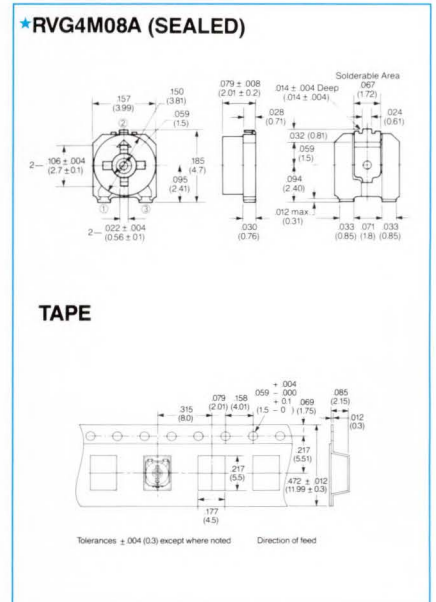
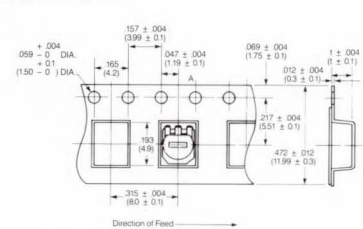

ENVIRONMENTAL SPECIFICATIONS

	Resistance Change	Condition				
Humidity	±3%	500 hrs. at 40°C, 90-95% RH without loading, and 5 hrs. at room temperature.				
Temperature Exposure	±3%	500 hrs., at 70°C without loading, and 1.5 hrs. at room temperature.				
Humidity Load Life	±3%	At 40°C, 90-95% RH rated voltage 1.5 hrs. ON, and 0.5 hrs. OFF for 1000±12 hrs. and 5 hrs. at room temperature.				
Temperature Load Life	±3%	At 70°C, rated voltage 1.5 hrs. ON and 0.5 hrs. OFF for 1000±12 hrs. and 5 hrs. at room temperature.				
Temperature Cycling	±3%	5 cycles				
		Sequence	1	2	3	4
		Temp. (°C)	-55	+25	+125	+25
Temperature Coefficient of Resistance	±250ppm/°C	Sequence	1	2	3	4
		Temp. (°C)	+25	-55	+25	+125
		Time (min.)	30 to 45 each			
Rotational Life	±10%	Continuous 10 cycles without loading				

All values are standard through authorized Murata Erie Distributors.

SUBMINIATURE TRIMMING POTENTIOMETERS

1/5 Watt Carbon, 1/2 Watt Cermet

RVX, RVG



FEATURES

- Diminutive size
- Wide resistance ranges
- Excellent linearity
- Economy
- Non-combustible design
- Extreme resistance to adverse environments
- Excellent humidity resistance

- Alumina-base
- Resistant to flux solvents

CERMET

- All of the features above plus excellent heat dissipation and T.C.
- Low noise

DIMENSIONS in. (mm)

Tol. = ± 0.2

<p>Mounting Hole Pattern</p> <p>Mounting Hole Pattern 059 Dia. (1.5) 100 (2.54) 200 (5.08)</p>	<p>0911H304A</p> <p>Adjustment Slot 157 (5.0) Long 032 (8.1) W 039 (1.0) Deep</p> <p>354 (9.00) 157 (4.00) 016 \pm .004 Thick (.41 \pm .10) 012 \pm .004 Thick (.30 \pm .10) 10 (2.54)</p>	<p>0911H326A</p> <p>04 (1.02) Wide 079 (2.01) Deep</p> <p>Hex. Hole 098 (2.5) Across 138 (3.5) Deep</p> <p>315 (8.0) 217 (5.51) Across 354 (9.0) Dia. 157 (4.0)</p>	<p>0911H308A</p> <p>Hex. Hole 104 (2.64) Across</p> <p>032 (8.1) Wide 039 (1.0) Deep</p> <p>319 (8.1) 354 (9.0) Dia. 324 (8.23) Dia. 274 (6.96) Dia. 098 (2.5) 20 (5.08)</p>	<p>0911H413A</p> <p>Adjustment Slot 032 (8.1) Long 197 (5.0) Wide 028 (.71) Deep</p> <p>126 (3.2) 043 (1.09) 028 (.71) 354 (9.0) Dia. 138 (3.51) Dia.</p>
<p>0911V304A</p> <p>059 Dia. (1.5) Mounting Hole Pattern 400 (10.16) 200 (5.08) Unit = in. Tol. = \pm .02 (.51)</p> <p>018 \pm .004 Thick (.41 \pm .10) 433 (11.0) 40 (10.16) 012 \pm .004 Thick (.30 \pm .10)</p>	<p>0911V326A</p> <p>Window (4 Places) 396 (10.11)</p>	<p>0911V308A</p> <p>402 (10.21)</p>	<p>0911V513A</p> <p>Adjustment Slot 157 (4.0) Long 031 (7.9) Wide 075 (1.91) Deep</p> <p>Mounting Hole Pattern 059 \pm .004 Dia. (3 Holes) (1.5 \pm .10) 157 \pm .004 Dia. (4.0 \pm .10)</p> <p>354 (9.0) Dia. 236 Dia. (6.0) 079 (2.01) Long 031 (7.9) Wide 264 (6.71) 157 (4.0) 205 \pm .004 (5.21 \pm .1) 200 (5.08)</p>	

PART NUMBERING SYSTEM

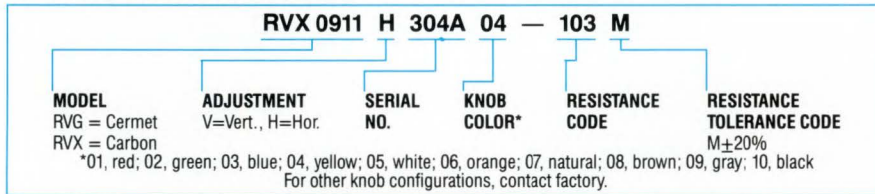

MARKING: Marked with Standard EIA date, resistance and tolerance codes.

SPECIFICATIONS

Characteristic	RVX (Carbon)	RVG (Cermet)
Resistance Range	0911 100— 2 Megohms	0911 200— 1 Megohm
Tolerance	$\pm 20\%$	$\pm 20\%$
Residual Resistance	Less than 500 Ω , 5 Ω max. 500 Ω and up, less than 1% of nominal resistance	
Taper	Linear	Linear
Power Rating**	1/5W (70°C)	1/2W (70°C)
Max. Working Voltage	250 VDC	350 VDC
Torque	0.56 - 4.86 in. oz.	0.56 - 4.86 in. oz.
Terminal Strength	35.27 oz.	35.27 oz.
Effective Rotation	Elec. 240° Mech. 260° \pm 10°	240° 260° \pm 10°
Stop Strength	13.9 in. oz.	

*Derated to 0 watts at 100°C (for Carbon, at 125°C (for Cermet)

PREFERRED TYPES

RVX (CARBON)	
Part Number	Tol. (%)
*RVX0911H304A04-(000)M	± 20
*RVX0911V304A04-(000)M	± 20
RVX0911H326A04-(000)M	± 20
RVX0911V326A04-(000)M	± 20
RVX0911H308A04-(000)M	± 20
RVX0911V308A04-(000)M	± 20
*RVX0911H413A04-(000)M	± 20
*RVX0911V513A04-(000)M	± 20
RVG (CERMET)	
Part Number	Tol. (%)
*RVG0911H304A10-(000)M	± 20
*RVG0911V304A10-(000)M	± 20
RVG0911H326A10-(000)M	± 20
RVG0911V326A10-(000)M	± 20
RVG0911H308A10-(000)M	± 20
RVG0911V308A10-(000)M	± 20
*RVG0911H413A10-(000)M	± 20
*RVG0911V513A10-(000)M	± 20

* STANDARD RESISTANCES

RVX 0911 CARBON					
RES. (ohms)	CODE	RES. (ohms)	CODE	RES. (ohms)	CODE
100	101	3K	302	100K	104
200	201	5K	502	200K	204
300	301	10K	103	300K	304
500	501	20K	203	500K	504
1K	102	30K	303	1M	105
2K	202	50K	503	2M	205

RVG 0911 CERMET					
RES. (ohms)	CODE	RES. (ohms)	CODE	RES. (ohms)	CODE
200	201	5K	502	100K	104
300	301	10K	103	200K	204
500	501	20K	203	300K	304
1K	102	30K	303	500K	504
2K	202	50K	503	1M	105
3K	302				

* All preferred values are available as standard through authorized Murata Erie Distributors.

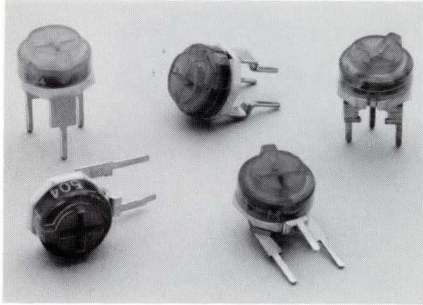

FEATURES

- Excellent humidity characteristics
- Dust-resistant construction
- Non-combustible design
- 1/3 watt power rating
- Economical
- Miniature size
- Wide resistance range

APPLICATIONS

The Murata ERIE Model RVS, RVG 0707 is widely applicable for data processing equipment, for circuit adjustment in portable transceivers, electronic musical instruments, household appliances, (television receivers, radio receivers, tape-recorders), and in many other types of electronic equipment.

DIMENSIONS: in. (mm)

Tol. = ± .02 (.51)

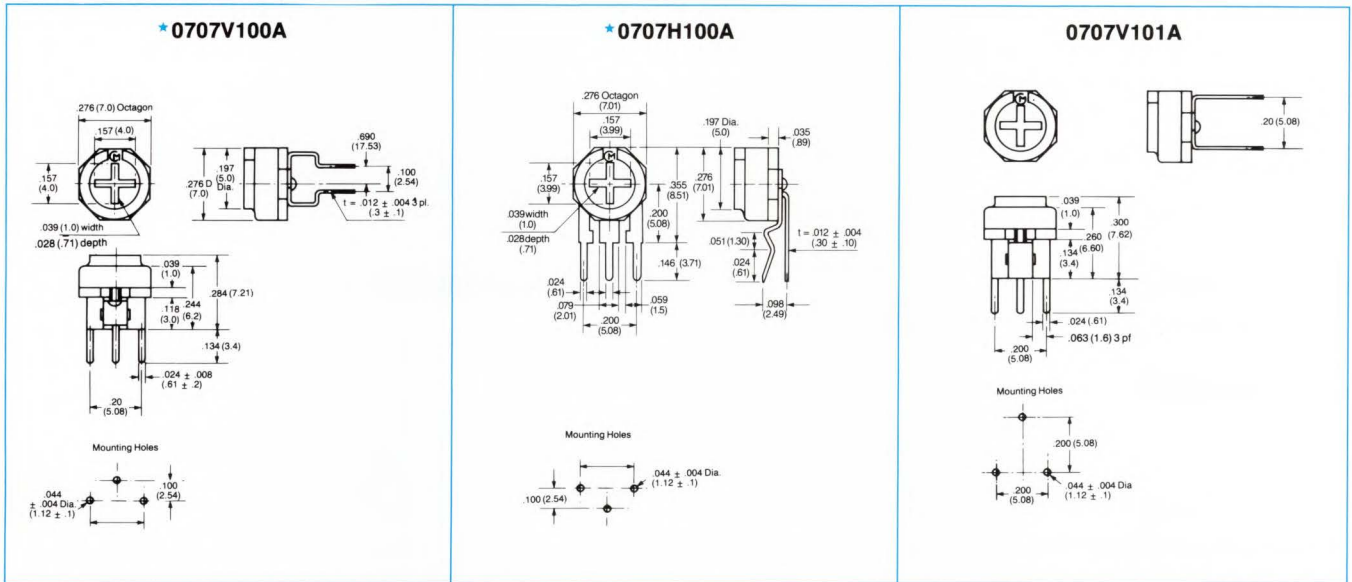

PART NUMBERING SYSTEM

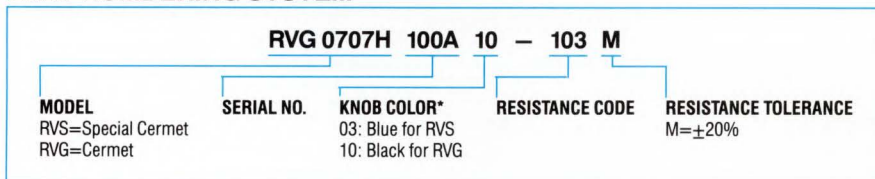

*STANDARD RESISTANCES

RES. (ohms)	CODE
100	101
200	201
300	301
500	501
1K	102
2K	202
3K	302
5K	502
10K	103
20K	203
30K	303
50K	503
100K	104
200K	204
300K	304
500K	504
1M	105

SPECIFICATIONS

Resistance Range	100 ohms to 1 Megohm (RVS), 200 ohms to 1 Megohm (RVG)
Tolerance	±20%
Temperature Coefficient	±100ppm/°C (RVS), ±250ppm/°C (RVG)
Residual Resistance	Less than 500Ω, 5Ω max. 500Ω and up, less than 1% of nominal resistance.
Taper	Linear
Power Rating	1/3W (at 70°C) Derated to 0 watts at 125°C
Max. Working Voltage	100 VDC
Torque	.27 to 2.8 in. oz
Terminal Strength	12.35 oz. when the force is applied in the direction of the axes of the terminal.
Effective Rotation	Elect. 180° Mech. 200°±10°

PREFERRED TYPES

RVG (CERMET)	
PART NUMBER	TOL. (%)
* RVG0707H100A-10-(000)M	±20
* RVG0707V100A-10-(000)M	±20
RVG0707V101A-10-(000)M	±20
RVS (SPECIAL CERMET)	
* RVS0707H100A-03-(000)M	±20
* RVS0707V100A-03-(000)M	±20
RVS0707V101A-03-(000)M	±20

*Available as standard through authorized Murata ERIE Distributors.

MINIATURE 12 TURNED, SEALED, SURFACE MOUNT 1/4" SQUARE

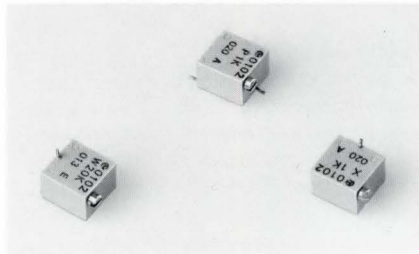

FEATURES:

- Miniature size—.250" x .250" x .169"
- 12-turn
- Will withstand industrial cleaning processes
- Cermet resistance element
- For surface mount applications
- Reflow solderable

POT0102

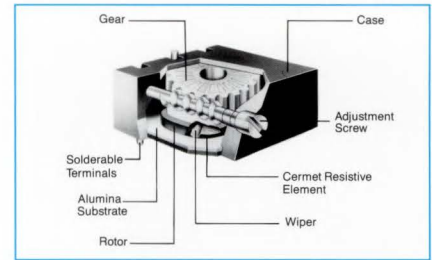

DIMENSIONS in. (mm)

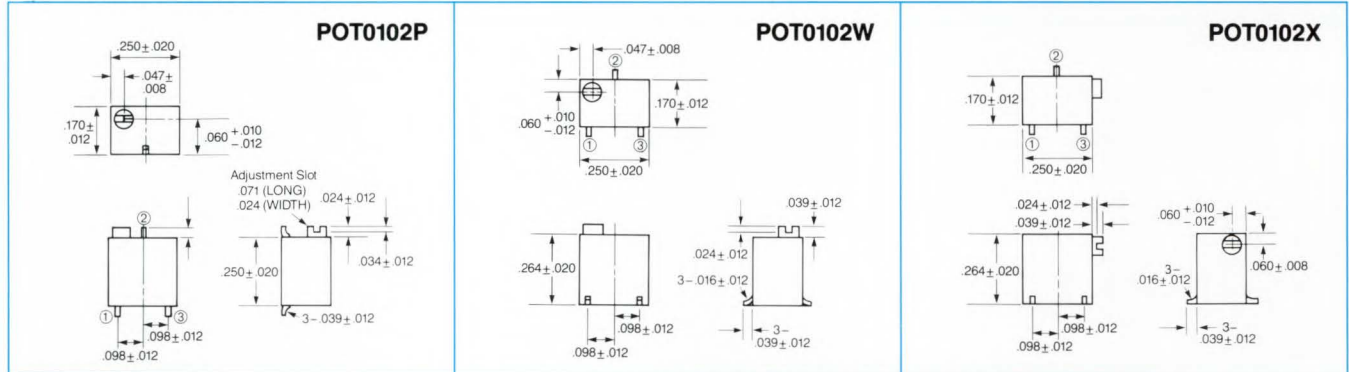

SPECIFICATIONS

Resistance Range	10 ohms to 1 Megohm
Tolerance	±10%
Temperature Coefficient	±100ppm/°C
Residual Resistance	2 ohms max.
Power Rating	0.25W at 85°C. Derated to 0W at +125°C
Working Voltage	200 VDC max.
Operating Temp. Range	-55°C to +125°C
Contact Resistance Variation	3% or 3 ohms max., whichever is greater
Dielectric Strength	600 VAC
Insulation Resistance	1,000 Megohms min. at 500 VDC
Torque	3.0 in.-oz. max.
Effective Electrical Adjust.	12 turns, ±2 turns

ENVIRONMENTAL SPECIFICATIONS

Thermal Shock	±1% total resistance change. ±1% setting stability change.
Humidity	±2% total resistance change. 100 Megohms min. insulation resistance.
Shock	100 G±1% total resistance change. ±1% setting stability change.
Vibration	20 G±1% total resistance change. ±1% setting stability change.
Load Life	1,000 hrs. at 70°C and 0.25W. ±2% total resistance change. ±2% setting stability change.
Low Temperature Operation	24 hrs. at -55°C. ±1% total resistance change. ±1% setting stability change.
High Temperature Exposure	24 hrs. at +125°C. ±2% total resistance change. ±1% setting stability change.
Rotational Life	200 cycles without discontinuity.

PART NUMBERING SYSTEM

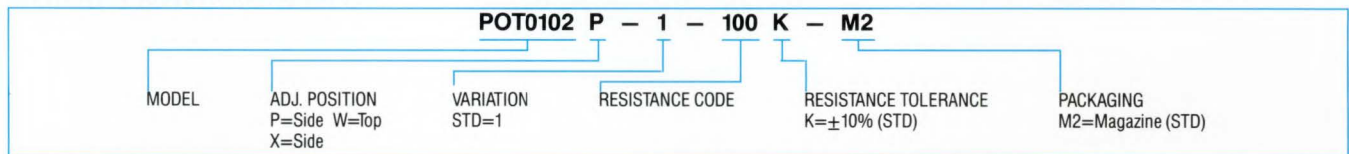

MAGAZINE DIMENSIONS in. (mm)

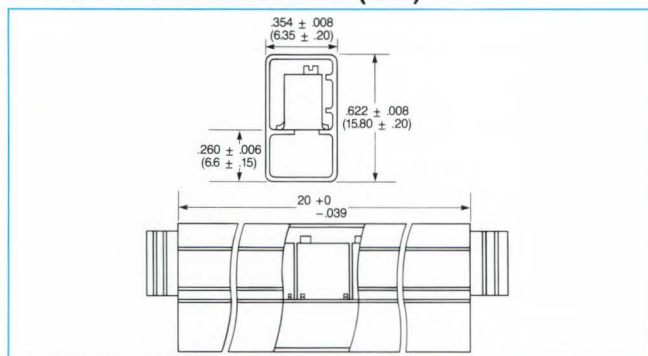

STANDARD LAND PATTERNS

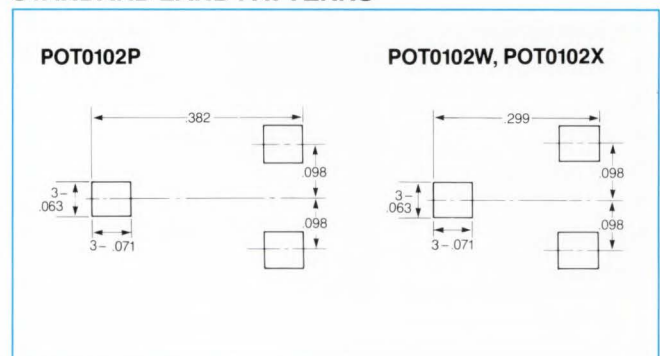

STANDARD RESISTANCES

RES. (ohms)	CODE	RES. (ohms)	CODE	RES. (ohms)	CODE	RES. (ohms)	CODE	RES. (ohms)	CODE	RES. (ohms)	CODE
10	100	100	101	1K	102	10K	103	50K	503	250K	254
20	200	200	201	2K	202	20K	203	100K	104	500K	504
50	500	500	501	5K	502	25K	253	200K	204	1M	105

Available as standard through authorized Murata Erie Distributors.

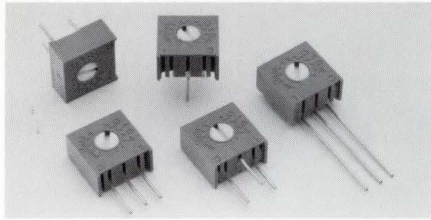

FEATURES

- Very low-cost
- Standard 3/8" square configuration
- Low temperature coefficient — ± 100 ppm/°C from -55°C to +125°C
- Sealed construction. Will withstand industrial cleaning processes.
- Cermet resistance element

DIMENSIONS: in. (mm)

Tol. = $\pm .02$ (.51)

CODE H	X	W	C	S	B	J
<p>Electrical Adjustment Slot 150 (3.81) Long 031 (.79) Wide 039 (1.0) Deep</p>						
CODE F	P	T	R	Y	M	K

PART NUMBERING SYSTEM

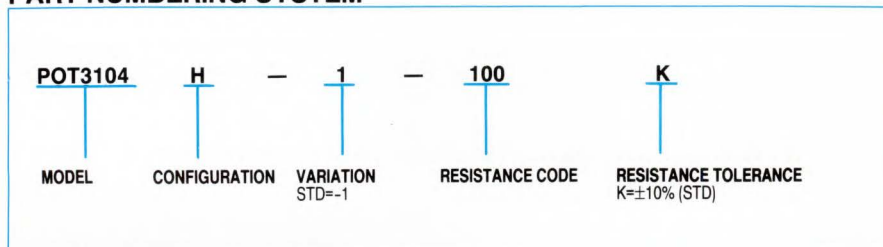

STANDARD RESISTANCES

RES. (ohms)	CODE	RES. (ohms)	CODE
10	100	10K	103
20	200	20K	203
50	500	25K	253
100	101	50K	503
200	201	100K	104
500	501	200K	204
1K	102	250K	254
2K	202	500K	504
5K	502	1M	105
		2M	205

SPECIFICATIONS

Resistance Range	10 ohms to 2 Megohms
Tolerance	±10%
Temperature Coefficient	±100ppm/°C
Residual Resistance	2 ohms max.
Power Rating	0.5W at 70°C. Derated to 0W at +125°C
Working Voltage	300 VDC max.
Operating Temp. Range	-55°C to +125°C
Contact Resistance Variation	1% or 1 ohms max. whichever is greater
Dielectric Strength	900 VAC, room conditions
Insulation Resistance	1,000 Megohms min. at 500 VDC
Torque	5 in.-oz. max.
Effective Electrical Rotation	280° nominal

PREFERRED TYPES

PART NO.	TOL. (%)	CONFIG.
POT3104H-1-(000)K	±10	H
POT3104X-1-(000)K	±10	X
POT3104W-1-(000)K	±10	W
POT3104C-1-(000)K	±10	C
POT3104S-1-(000)K	±10	S
POT3104B-1-(000)K	±10	B
POT3104J-1-(000)K	±10	J
POT3104F-1-(000)K	±10	F
POT3104P-1-(000)K	±10	P
POT3104T-1-(000)K	±10	T
POT3104R-1-(000)K	±10	R
POT3104Y-1-(000)K	±10	Y
POT3104M-1-(000)K	±10	M
POT3104K-1-(000)K	±10	K

NOTE: ALL OHMIC VALUES STANDARD DISTRIBUTOR ITEMS. REPLACE (000) WITH 3 DIGIT OHMIC CODE. EX. 103 = 10K OHMS.

All values are standard through authorized Murata Erie Distributors.

MINIATURE SINGLE-TURN SEALED TRIMMING POTENTIOMETERS

1/4" Diameter

POT3321

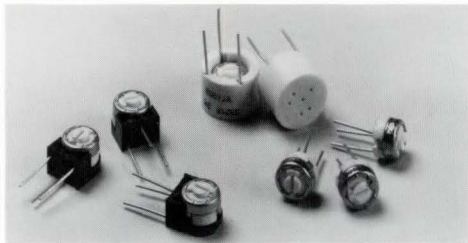

FEATURES

- Flame retardant rotor meets UL94V-0 requirements
- Extremely small size—.260" D. x .181"
- Wide variety of terminal configurations
- Cermet element
- Sealed to withstand wave soldering and immersion cleaning processes.

DIMENSIONS: in. (mm)

Tolerance: ±0.1 (0.25) except where noted

★ POT3321H	★ POT3321P	★ POT3321N	★ POT3321T	★ POT3321S	★ POT3321F

PART NUMBERING SYSTEM

POT3321		H	-	1	-	100	M
MODEL	ADJ. POSITION	VARIATION	RESISTANCE CODE	RESISTANCE TOLERANCE			
	H=Top P=Top N=Side A=Side	1 = Standard 2 = For 10% Tolerance		M = ±20% (K = ±10% also available)			

STANDARD RESISTANCES

RES. (ohms)	CODE	RES. (ohms)	CODE	RES. (ohms)	CODE	RES. (ohms)	CODE
10	100	500	501	10K	103	200K	204
20	200	1K	102	20K	203	500K	504
50	500	2K	202	50K	503	1M	105
100	101	5K	502	100K	104	2M	205
200	201					5M	505

SPECIFICATIONS

Resistance Range	10 ohms to 5 Megohms
Tolerance	± 20% (± 10% available)
Temperature Coefficient	±100ppm/°C
Residual Resistance	2 ohms max.
Power Rating	0.5W at 70°C. Derated to 0W at +150°C
Working Voltage	300 VDC max.
Operating Temp. Range	-55°C to +150°C
Contact Resistance Variation	3% or 3 ohms max. whichever is greater
Dielectric Strength	600 VAC, room conditions
Insulation Resistance	1000 Megohms min. at 500 VDC
Torque	2.8 in.-oz. max.
Effective Electrical Rotation	230° nominal

PREFERRED VALUES

PART NO.	TOL. (%)	CONFIG.
★ POT3321H-1-(000)M	±20	H
★ POT3321P-1-(000)M	±20	P
★ POT3321N-1-(000)M	±20	N
★ POT3321T-1-(000)M	±20	T
★ POT3321S-1-(000)M	±20	S
★ POT3321F-1-(000)M	±20	F

All values are standard through authorized Murata Erie Distributors.

MINIATURE 4-TURN, SEALED TRIMMING POTENTIOMETERS

5/16" Diameter



POT1102

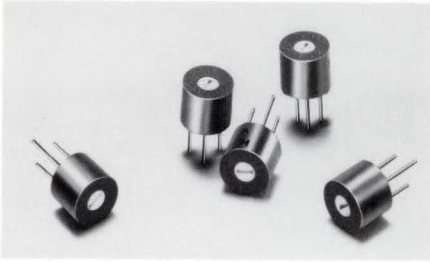

FEATURES

- Unique planetary drive produces the precise setting capability of a multi-turn unit in a small single-turn package.
- Just .300D x .260
- Sealed to withstand wave soldering and immersion cleaning process.

DIMENSIONS: in. (mm)

Tolerance: ± .012 (.3) except where indicated

*POT1102H	*POT1102P	*POT1102T	*POT1102S

PART NUMBERING SYSTEM

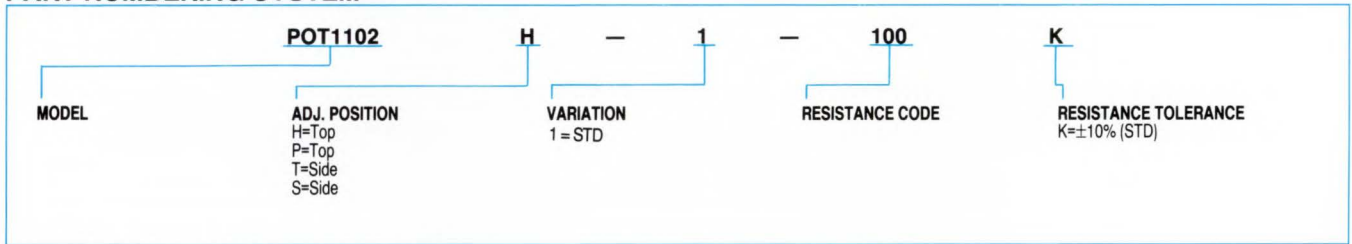

STANDARD RESISTANCES

RES. (ohms)	CODE	RES. (ohms)	CODE	RES. (ohms)	CODE	RES. (ohms)	CODE
10	100	500	501	10K	103	200K	204
20	200	1K	102	20K	203	500K	504
50	500	2K	202	50K	503	1M	105
100	101	5K	502	100K	104	2M	205
200	201						

SPECIFICATIONS

Resistance Range	10 ohms to 2 Megohms
Tolerance	±10%
Temperature Coefficient	±100ppm/°C
Residual Resistance	1% or 2 ohms max. whichever is greater
Power Rating	0.5W at 70°C. Derated to 0W at +125°C
Working Voltage	300 VDC max.
Operating Temp. Range	-55°C to +125°C
Contact Resistance Variation	3% or 3 ohms max. whichever is greater
Dielectric Strength	600 VAC, room conditions
Insulation Resistance	1,000 Megohms min. at 500 VDC.
Torque	2.08 in.-oz. max.
Effective Electrical Adjust.	4 turns nominal

PREFERRED TYPES

PART NO.	TOL. (%)	CONFIG.
*POT1102H-1-(000)K	±10	H
*POT1102P-1-(000)K	±10	P
*POT1102S-1-(000)K	±10	S
*POT1102T-1-(000)K	±10	T

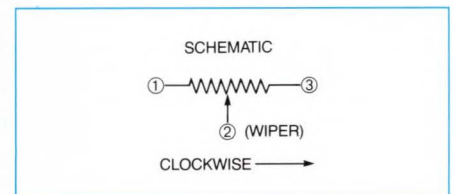

*Available as standard through authorized Murata Erie Distributors.

MINIATURE, SINGLE-TURN TRIMMING POTENTIOMETERS

3/16" Diameter, 1/4 Watt Cermet

POT1103

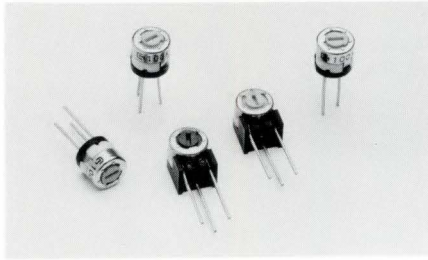

FEATURES

- Extremely small size — .189" Dia. x .181"
- Flame retardant rotor meets UL94V-O requirements.
- Sealed to withstand wave soldering and immersion cleaning processes.

DIMENSIONS: in. (mm)

Tolerance: ± .012 (.3) except where indicated

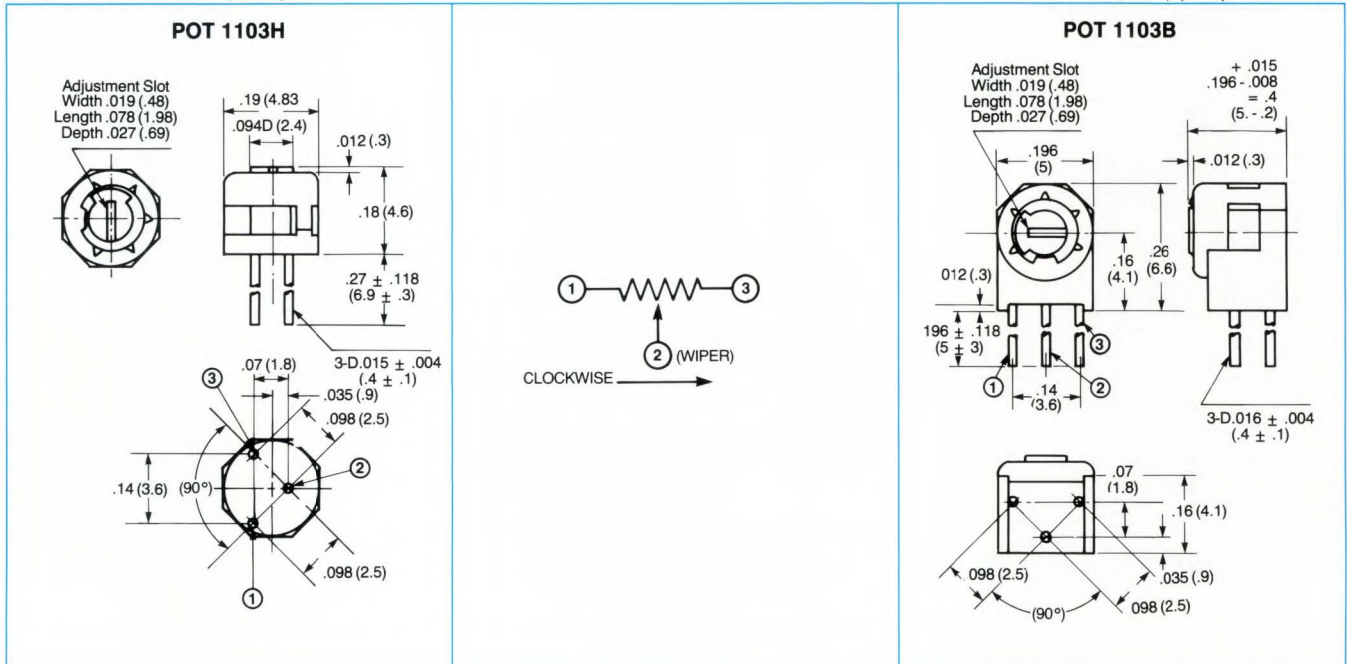

PART NUMBERING SYSTEM

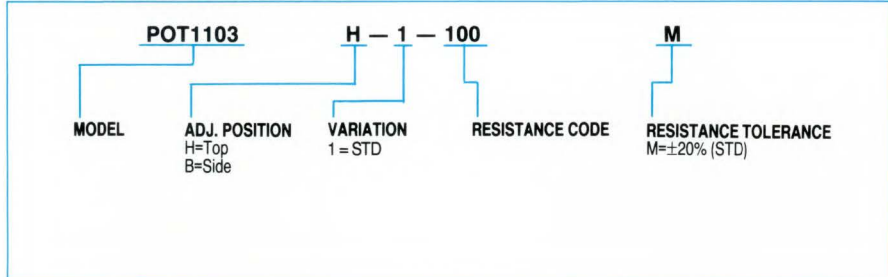

STANDARD RESISTANCES

RES. (ohms)	CODE
10	100
20	200
50	500
100	101
200	201
500	501
1K	102
2K	202
5K	502
10K	103
20K	203
50K	503
100K	104
200K	204
500K	504
1M	105
2M	205

SPECIFICATIONS

Resistance Range	10Ω to 2MΩ
Tolerance	±20%
Temperature Coefficient	± 100ppm/°C (R > 50Ω)
Residual Resistance	1% or 2Ω max., whichever is greater
Power Rating	0.25W at 70° 0W at +125°C
Working Voltage	200 VDC max.
Operating Temp. Range	-55°C to +125°C
Contact Resistance Variation	3% or 3Ω
Dielectric Strength	500 VAC
Insulation Resistance	1,000MΩ min. at 500 VDC.
Torque	1.39 oz. in. max.

PREFERRED TYPES

PART NO.	TOL. (%)	CONFIG.
POT1103H-1-(000)M	±20	H
POT1103B-1-(000)M	±20	B

All values are standard through authorized Murata Erie Distributors.

15-TURN, SEALED TRIMMING POTENTIOMETERS

3/4" Rectangular

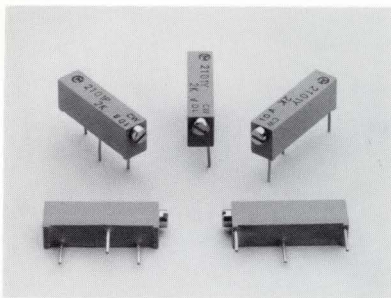

FEATURES

- Small size — .181" x .252" x .752"
- 15-Turn
- Sealed to MIL-R-22097 standards. Will withstand industrial cleaning processes.
- Cermet resistance element

DIMENSIONS: in. (mm)

Tolerance: ± .012 (.3) except where indicated

* POT2103P	* POT2103W	* POT2103Y
<p>Adjustment Slot .093 (2.4) Long .024 (.6) Wide .031 (.8) Deep</p>		

PART NUMBERING SYSTEM

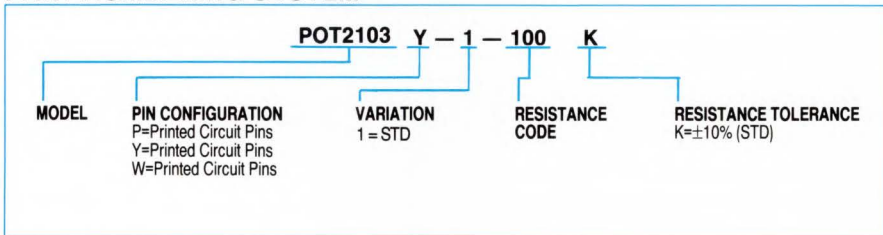

STANDARD RESISTANCES

RES. (ohms)	CODE
10	100
20	200
50	500
100	101
200	201
500	501
1K	102
2K	202
5K	502
10K	103
20K	203
50K	503
100K	104
200K	204
500K	504
1M	105
2M	205

SPECIFICATIONS

Resistance Range	10 ohms to 2 Megohms
Tolerance	±10%
Temperature Coefficient	±100ppm/°C
Residual Resistance	2 ohms max.
Power Rating	0.75W at 70°C. Derated to 0W at +125°C
Working Voltage	300 VDC max.
Operating Temp. Range	-55°C to +125°C
Contact Resistance Variation	3% or 3 ohms max. whichever is greater
Dielectric Strength	1,000 VAC, room conditions
Insulation Resistance	1,000 Megohms min. at 500 VDC.
Torque	2.8 in.-oz. max.
Effective Electrical Adjust.	15 turns nominal

PREFERRED VALUES

PART NO.	TOL. (%)	CONFIG.
POT2103P-1-(000)K	±10	P
POT2103W-1-(000)K	±10	W
POT2103Y-1-(000)K	±10	Y

All values are standard through authorized Murata ERIE Distributors.

22-TURN, SEALED TRIMMING POTENTIOMETERS

1 1/4" Rectangular

POT2102

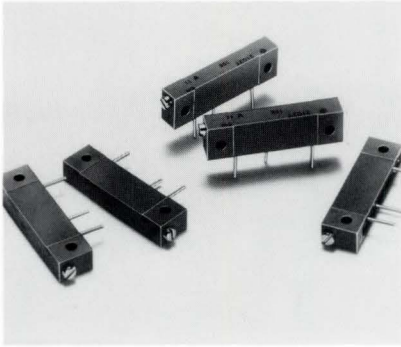

FEATURES

- 22-turn mechanism provides extremely fine adjustment capability
- High power dissipation: 1.0W at 70°C
- Sealed to withstand wave soldering and immersion cleaning

PART NUMBERING SYSTEM

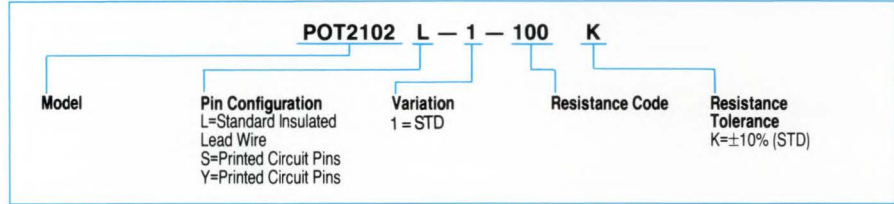

DIMENSIONS: in. (mm)

Tolerance: ± .012 (.3) except where indicated

POT2102L	POT2102S	POT2102Y
<p>.10 ± .008 Dia. (2.54 ± .2) 2 MTG Holes</p> <p>1.25 (31.75)</p> <p>1 ± .008 (25.4 ± .2)</p> <p>.126 ± .008 (3.2 ± .2)</p> <p>.315 ± .016 (8.0 ± .41)</p> <p>.181 (4.6) .75 (1.91)</p> <p>Adjustment Slot .118 (3.0) Long x .024 (.61) Wide x .031 (.79) Deep</p> <p>.236 (6.0)</p> <p>.236 (6.0)</p> <p>.19 ± .008 (4.83 ± .2)</p> <p>.20 (5.08)</p> <p>3 Insulated Leads 30 AWG 6" (152.4) min. Length</p>	<p>16 min. (4.06)</p> <p>.028 ± .004 Dia. (.71 ± .1)</p> <p>.90 (22.9)</p> <p>.70 (17.8)</p> <p>.26 (6.6)</p> <p>① Yellow ② Red ③ Green</p>	<p>.26 (6.6)</p> <p>.70 (17.8)</p> <p>.30 (7.62)</p> <p>.10 (2.54)</p>

STANDARD RESISTANCES

RES. (ohms)	CODE	RES. (ohms)	CODE	RES. (ohms)	CODE	RES. (ohms)	CODE
10	100	500	501	10K	103	500K	504
20	200	1K	102	20K	203	750K	754
50	500	2K	202	50K	503	1M	105
100	101	5K	502	100K	104	2M	205
200	201			200K	204		

SPECIFICATIONS

Resistance Range	10 ohms to 2 Megohms
Tolerance	±10%
Temperature Coefficient	±100ppm/°C
Residual Resistance	2 ohms max.
Power Rating	1W at 70°C. Derated to 0W at +150°C
Max. Working Voltage	300 VDC max.
Operating Temp. Range	-55°C to +150°C
Contact Resistance Variation	3% or 3 ohms max. whichever is greater
Dielectric Strength	1,000 VAC, room conditions
Insulation Resistance	1,000 Megohms min. at 500 VDC
Torque	2.8 in.-oz. max
Effective Electrical Adjust.	22 turns nominal

PREFERRED VALUES

PART NO.	TOL. (%)	CONFIG.
POT2102L-1-(000)K	±10	L
POT2102S-1-(000)K	±10	S
POT2102Y-1-(000)K	±10	Y

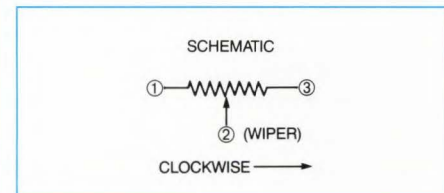

MINIATURE 12-TURN, SEALED TRIMMING POTENTIOMETERS

1/4" Square

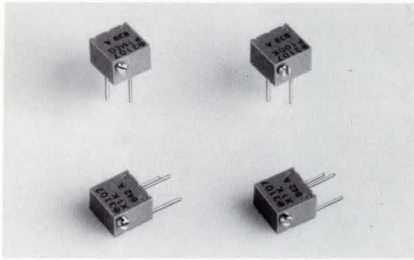

FEATURES

- Miniature size—.250" x .250" x .169"
- 12-Turn
- Sealed to MIL-R-22097 Standards. Will withstand industrial cleaning processes.
- Cermet Resistance Element

DIMENSIONS: in.

Tolerance: ±.012 except where noted

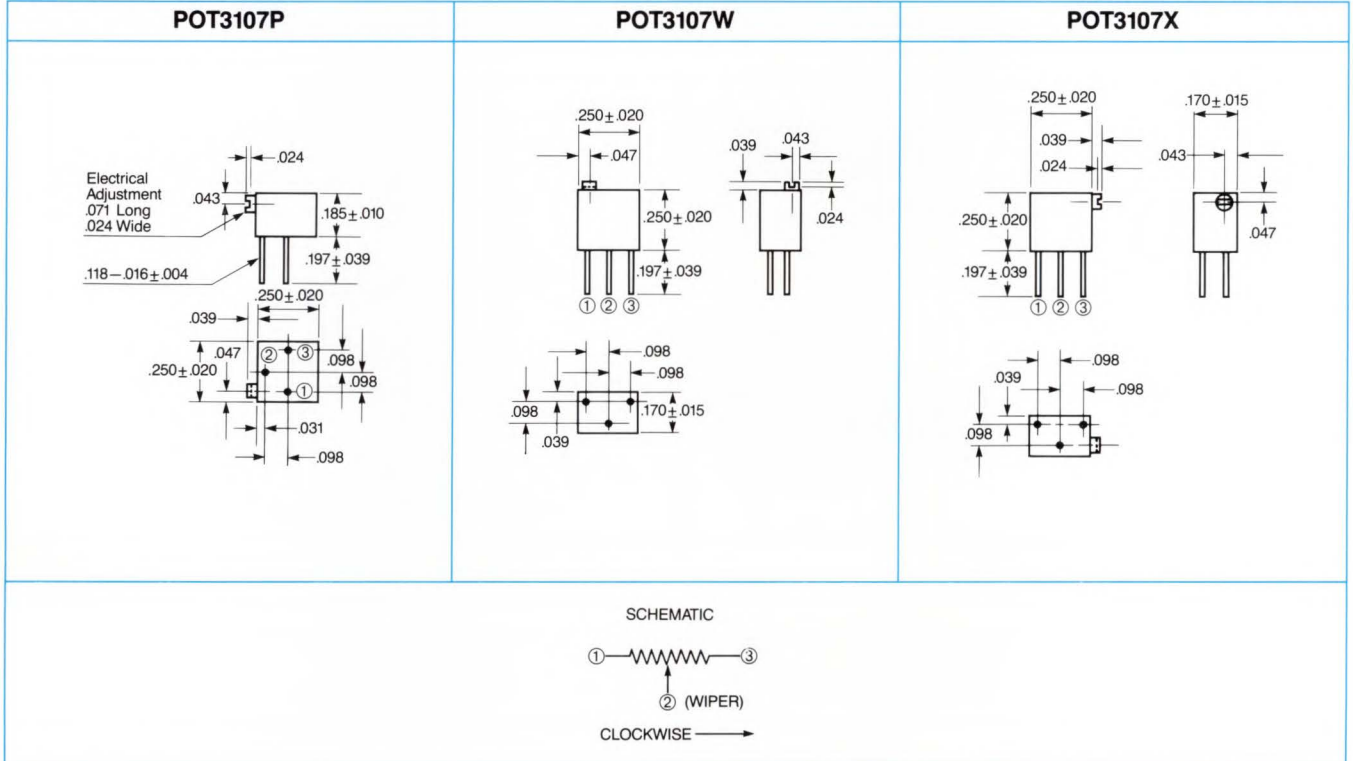

PART NUMBERING SYSTEM

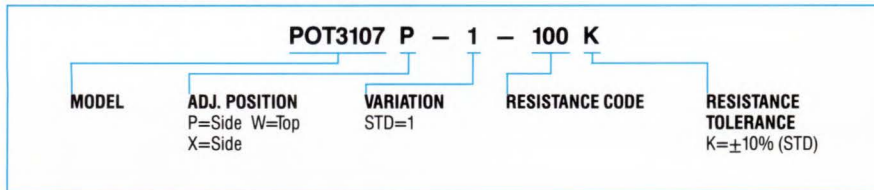

STANDARD RESISTANCES

RES. (ohms)	CODE	RES. (ohms)	CODE
10	100	20K	203
20	200	50K	503
50	500	100K	104
100	101	200K	204
200	201		
500	501	500K	504
1K	102	1M	105
2K	202		
5K	502		
10K	103		

SPECIFICATIONS

Resistance Range	10 ohms to 1 Megohms
Tolerance	±10%
Temperature Coefficient	±100ppm/°C
Residual Resistance	1% or 2 ohms max. whichever is greater
Power Rating	.25W at 70°C. Derated to 0W at +125°C
Working Voltage	200 VDC max.
Operating Temp. Range	-55°C to +125°C
Contact Resistance Variation	3% or 3 ohms max. whichever is greater
Dielectric Strength	600 VAC, room conditions
Insulation Resistance	1,000 Megohms min. at 500 VDC
Torque	3.0 in. oz max.
Effective Electrical Adjust.	12 turns nominal

PREFERRED TYPES

PART NO.	TOL. (%)	CONFIG.
POT3107P-1-(000)K	±10	P
POT3107X-1-(000)K	±10	X
POT3107W-1-(000)K	±10	Y

MINIATURE 25-TURN, SEALED TRIMMING POTENTIOMETERS

3/8" Square

POT3106

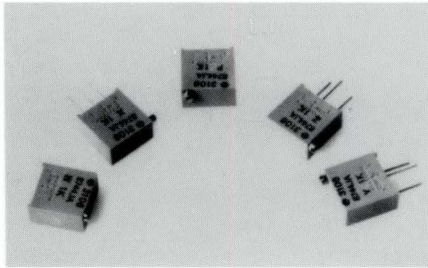

FEATURES

- Low profile—.374" x .394" x .200"
- 25-turn
- Sealed to MIL-R-22097 Standards. Will withstand industrial cleaning processes.
- Cermet resistance element

DIMENSIONS: in. (mm)

Tolerance: ± .012 (0.3) except where noted

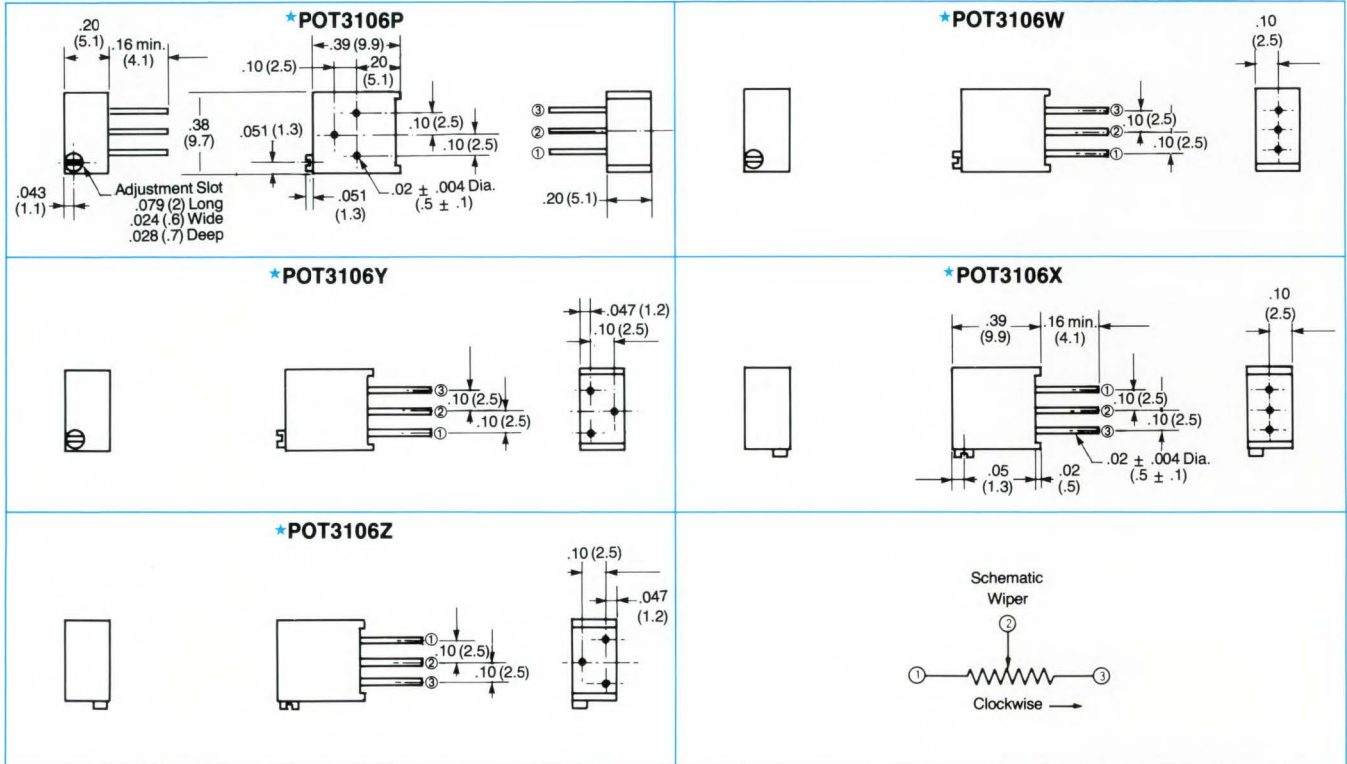

PART NUMBERING SYSTEM

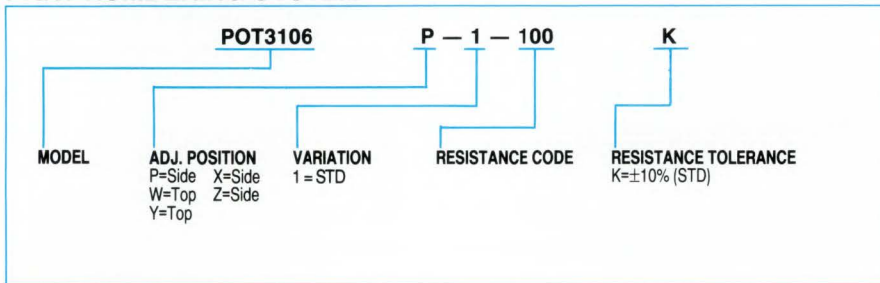

STANDARD RESISTANCES

RES. (ohms)	CODE	RES. (ohms)	CODE
10	100	20K	203
20	200	25K	253
50	500	50K	503
100	101	100K	104
200	201	200K	204
500	501	250K	254
1K	102	500K	504
2K	202	1M	105
5K	502	2M	205
10K	103		

SPECIFICATIONS

Resistance Range	10 ohms to 2 Megohms
Tolerance	±10%
Temperature Coefficient	±100ppm/°C
Residual Resistance	2 ohms max
Power Rating	0.5W at 70°C. Derated to 0W at +125°C
Working Voltage	300 VDC max.
Operating Temp. Range	-55°C to +125°C
Contact Resistance Variation	3% or 3 ohms max., whichever is greater
Dielectric Strength	1,000 VAC, room conditions
Insulation Resistance	1,000 Megohms min. at 500 VDC
Torque	2.08 in. oz. max.
Effective Electrical Adjust.	25 turns nominal

PREFERRED TYPES

PART NO.	TOL. (%)	CONFIG.
POT3106P-1-(000)K	±10	P
POT3106W-1-(000)K	±10	W
POT3106X-1-(000)K	±10	X
POT3106Y-1-(000)K	±10	Y
POT3106Z-1-(000)K	±10	Z

All values are standard through authorized Murata Erie Distributors.

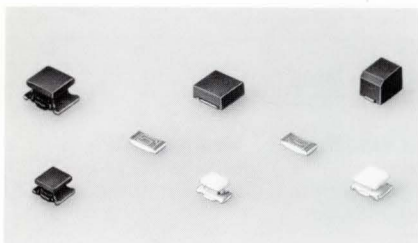

These ultra small, high performance chip inductors feature a low direct current resistance and outstanding high frequency characteristics. Each series has a unique structure specifically designed with a wide range of values suitable for various applications such as CMT, pagers, radio communication equipment and audio equipment.

PACKAGING:

Taped per EIAJ-RC-1009B in plastic tape on a reel in the following quantities:

LQN1A/LQH1N/LQH3N/LQH3C/LQP31A : 2000 pcs/reel (180mm)

LQN2A : 2500 pcs/reel (180mm)

LQH(N)4N : 2500 pcs/reel (330mm)

LQM32C : 1000 pcs/reel (180mm)

LQS33N : 1000 pcs/reel (180mm)

PART NUMBERING

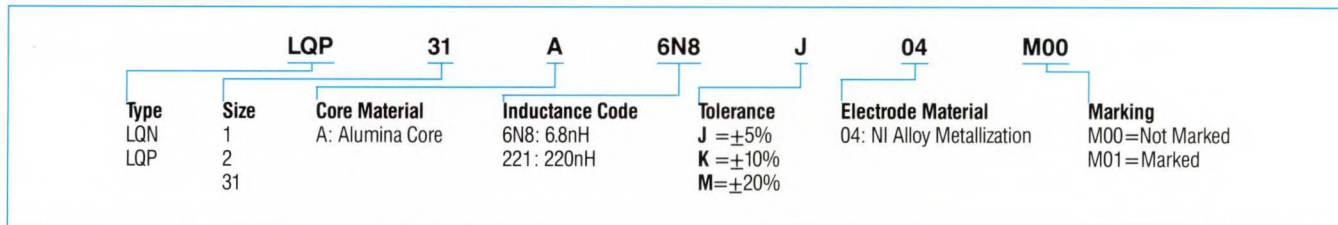

LQN1A/LQN2A SERIES – HIGH Q, FOR HIGH FREQUENCY

DIMENSIONS: in. (mm)

Part Number ^{1,2}	Nominal Inductance		Tolerance ³			Q (Typ.)	DC ⁴ Resistance (Ω) Max.	Self ⁴ Resonance Freq. (MHz) Min.	Allowable ⁴ Current (mA)
	Min.	Max.	J	K	M				
*LQN1A○○○□04M00	0.9nH	100nH	⊙	○		100	0.029±40%	1000	750
*LQN2A○○○□04M00	10nH	82nH			⊙	60	0.25	1000	100
	100nH	220nH		⊙		40	0.40	400	100

1... Inductance code is shown in ○○○ : 4.7nH=4N7, 10nH=10N, 100nH=R10
 2... Tolerance code is shown in □ : ±5%=J, ±10%=K, ±20%=M

3... ⊙ : Standard ○ : Semi Standard.
 4... DC resistance, self-resonant frequency and allowable current are shown with the minimum value of inductance.

LQP31A SERIES – TIGHT TOLERANCE FOR ULTRA HIGH FREQUENCY

Part Number ^{1,2}	Nominal Inductance		Tolerance ³			Q (Typ.)	DC ⁴ Resistance (Ω) Max.	Self ⁴ Resonance Freq. (MHz) Min.	Allowable ⁴ Current (mA)
	Min.	Max.	J	K	M				
LQP31A○○○□04M00	4.7nH	6.8nH		⊙		30	1	2000	230
	10nH	100nH	⊙			30	7	1000	230

1... Inductance code is shown in ○○○○ : 4.7nH=4N7, 10nH=10N, 100nH=R10
 2... Tolerance code is shown in □ : ±5%=J, ±10%=K, ±20%=M

3... ⊙ : Standard ○ : Semi Standard.
 4... DC resistance, self-resonant frequency and allowable current are shown with the minimum value of inductance.

DIMENSIONS OF PLASTIC TAPE: in. (mm)

Part Number	a	b	c
LQN1A	.075 (1.9)	.142 (3.6)	.079 (2.0)
LQN2A	.114±.008 (2.9±0.2)	.142±.008 (3.6±0.2)	.071 (1.8)
LQP31A	.075 (1.9)	.142 (3.6)	.035 (0.9)

PART NUMBERING

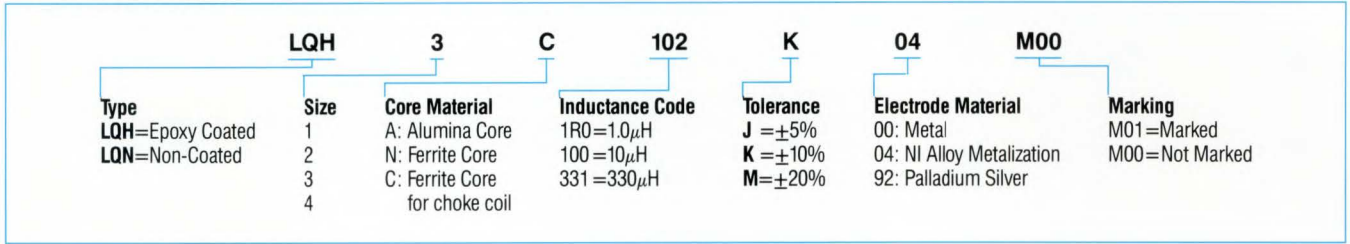

STANDARD TYPE LQH/LQN □ N SERIES

DIMENSIONS: in. (mm)

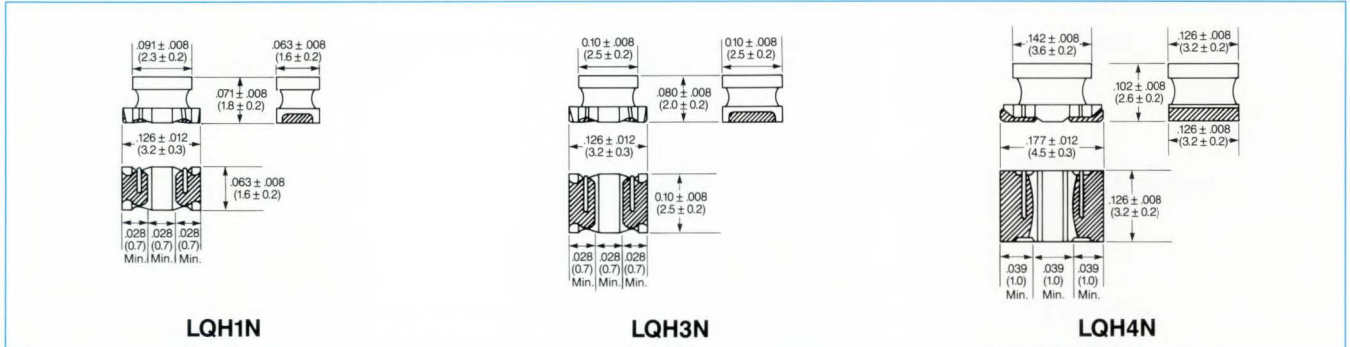

Part Number ^{1,2}	Nominal Inductance		Tolerance ³			Q (Typ.)	DC ⁴ Resistance (Ω) Max.	Self ⁴ Resonance Freq. (MHz) Min.	Allowable ⁴ Current (mA)
	Min.	Max.	J	K	M				
* LQH1N □ □ □ 04M00	0.15 μ H	8.2 μ H		○	◎	50	0.39 \pm 40%	250	250
* LQH3N □ □ □ 92M00	10 μ H	100 μ H	○	◎		60	2.5 \pm 30%	20	100
* LQH3N □ □ □ 04M00	0.1 μ H	0.82 μ H			◎	50	0.25	200	120
* LQH3N □ □ □ 04M00	1.0 μ H	8.2 μ H			◎	50	0.5	100	100
* LQH4N □ □ □ -TA	10 μ H	1.5mH	○	◎		60	1.8	20	50
* LQN4N □ □ □ -TA	10 μ H	1.5mH	○	◎		50	0.56	0.56	400
* LQN4N □ □ □ -TA	1.8mH	2.2mH	○	◎		50	45	45	35

1... Inductance code is shown in □ □ □ : 1.2 μ H=1R2, 10 μ H=100, 100 μ H=101
2... Tolerance code is shown in □ : \pm 5%=J, \pm 10%=K, \pm 20%=M

3... ◎ : Standard ○ : Semi Standard.
4... DC resistance, self-resonant frequency and allowable current are shown with the minimum value of inductance.

LQH □ C / LQM32C SERIES – FOR CHOKE COIL USE, LARGE ALLOWABLE CURRENT, LARGE INDUCTANCE

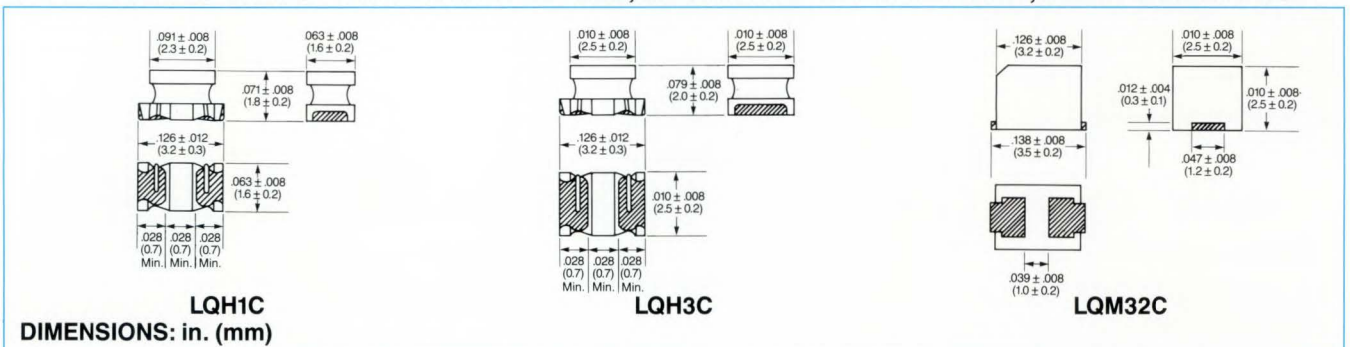

Part Number ^{1,2}	Nominal Inductance		Tolerance ³			Q (Typ.)	DC ⁴ Resistance (Ω) Max.	Self ⁴ Resonance Freq. (MHz) Min.	Allowable ⁴ Current (mA)
	Min.	Max.	J	K	M				
LQH1C □ □ □ □ 04M00	0.12 μ H	4.7 μ H			◎	—	0.08 \pm 40%	250	970
LQH1C □ □ □ □ 04M00	10 μ H	100 μ H		◎		—	1.3 \pm 30%	20	230
LQH3C □ □ □ □ 04M00	1.0 μ H	4.7 μ H			◎	—	0.09 \pm 30%	96	800
LQH3C □ □ □ □ 04M00	10 μ H	330 μ H		◎		—	0.44 \pm 30%	26	300
LQM32C □ □ □ □ 00M00	470 μ H	1000 μ H			◎	—	13 \pm 30%	4.5	80

1... Inductance code is shown in □ □ □ □ : 1.2 μ H=1R2, 10 μ H=100, 100 μ H=101
2... Tolerance code is shown in □ : \pm 5%=J, \pm 10%=K, \pm 20%=M

3... ◎ : Standard ○ : Semi Standard.
4... DC resistance, self-resonant frequency and allowable current are shown with the minimum value of inductance.

LQS33N SERIES – TIGHT TOLERANCE WITH MAGNETIC SHIELD

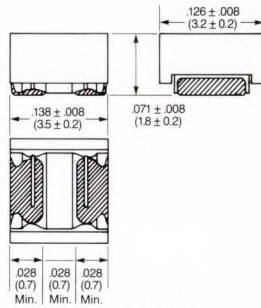

DIMENSIONS: in. (mm)

LQS33N

Part Number ^{1,2}	Nominal Inductance		Tolerance ³			Q (Typ.)	DC ⁴ Resistance (Ω) Max.	Self ⁴ Resonance Freq. (MHz) Min.	Allowable ⁴ Current (mA)
	Min.	Max.	G	J	K				
LQS33N○○○□04M00	1.0μH	100μH	◎	○		100	0.19±30%	120	70

1...Inductance code is shown in ○○○ : 1.2μH=1R2, 10μH=100, 100μH=101
 2...Tolerance code is shown in □ : ±2%=G, ±5%=J, ±10%=K

3...◎ : Standard ○ : Semi Standard.
 4...DC resistance, self-resonant frequency and allowable current are shown with the minimum value of inductance.

DIMENSIONS OF PLASTIC TAPE: in. (mm)

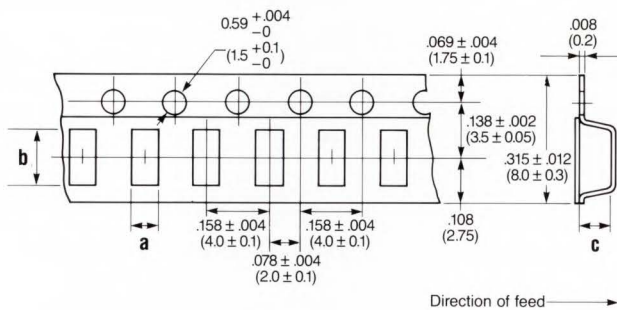

Part Number	a	b	c
LQH1N/LQH1C	.075 (1.9)	.142 (3.6)	.079 (2.0)
LQH3N/LQH3C	.114±.008 (2.9±0.2)	.142±.008 (3.6±0.2)	.087 (2.2)
LQM32C	.114 (2.9)	.157 (4.0)	.110 (2.8)

DIMENSIONS OF PLASTIC TAPE: in. (mm)

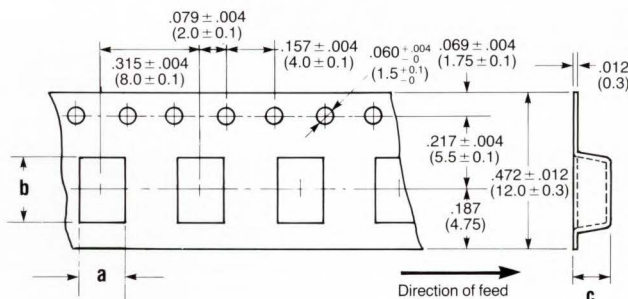

Part Number	a	b	c
LQS33N	0.10 (3.9)	.146 (3.7)	.075 (1.9)
LQH4N/LQN4N	.142 (3.6)	.193 (4.9)	.114 (2.9)

SIP RESISTOR NETWORKS

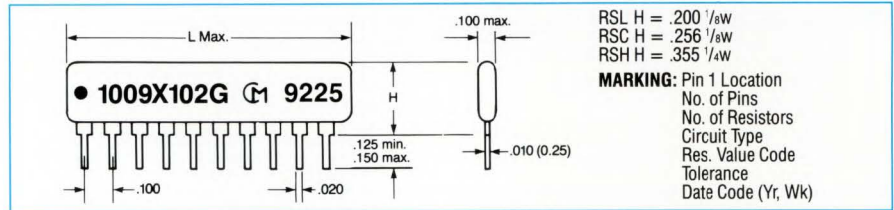
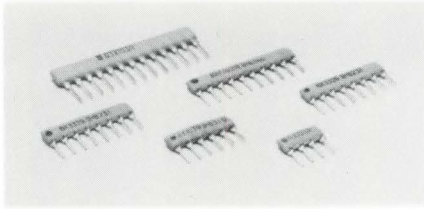

X-CIRCUIT—PARALLEL

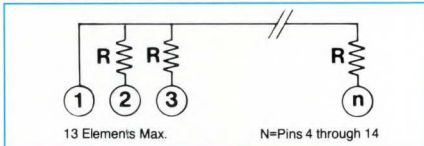

No. Pins	No. of Elements	L
4	3	.398
5	4	.496
*6	5	.594
7	6	.693
*8	7	.795
9	8	.894
*10	9	.996
11	10	1.094
12	11	1.201
13	12	1.299
14	13	1.398

Y-CIRCUIT—DISCRETE

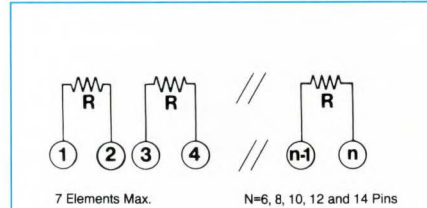

No. Pins	No. of Elements	L
*6	3	.594
*8	4	.795
*10	5	.996
12	6	1.201
14	7	1.398

Z-CIRCUIT—DOUBLE TERMINATION

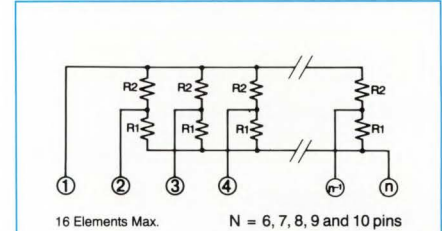

No. Pins	No. of Elements	L
6	8	.594
7	10	.693
8	12	.795
9	14	.894
10	16	.996

PART NUMBERING SYSTEM

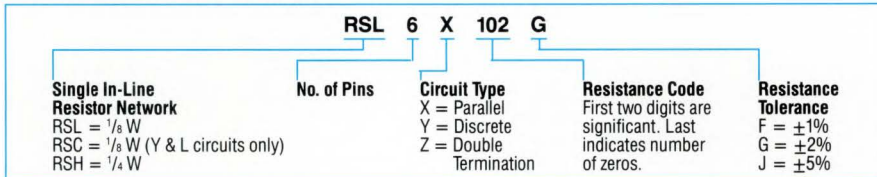

SPECIFICATIONS

Electrical
Temp. Range: -55°C to +125°C
Resistance Range: 22Ω to 1MΩ
Resistance Tolerance: ±1% (F), ±2% (G), ±5% (J)
Temp. Coefficient: ±200 ppm/°C max. (±100 ppm/°C max. on special order)
Power: 100% at 70°C
Maximum ambient temperature at 0 watt is 125°C

Power Derating Characteristics:

Mechanical
Substrate Material: Alumina
Resistor Material: Cermet, thick film
Lead Pull Strength: 2 lbs.
Coating: Meets UL94V-0 standards

Note: Other types and custom designs are also available.

TYPICAL RESISTANCE COMBINATIONS*

R ₁ /R ₂	R ₁ /R ₂	R ₁ /R ₂
160/240	330/390	330/390
180/390	330/470	1.5K/3.3K
220/330	330/680	3K/6.2K

*Note 1: In addition to R₁=R₂ resistance combinations, the typical resistor combinations shown in the chart are available.
2: RC networks are also available. Contact Murata Erie for technical details.

COMMON SIZES/TOLERANCE

Part No.	Tol. (%)	Part No.	Tol. (%)
RSL (Low Profile) 1/8 W		RSH 1/4 W	
*RSL06X(000)G	±2	*RSH06X(000)G	±2
*RSL08X(000)G	±2	*RSH08X(000)G	±2
*RSL10X(000)G	±2	*RSH10X(000)G	±2
RSL06X(000)J	±5	RSH06X(000)J	±5
RSL08X(000)J	±5	RSH08X(000)J	±5
RSL10X(000)J	±5	RSH10X(000)J	±5
RSC 1/8 W		RSC 1/8 W	
*RSL06Y(000)G	±2	*RSC06Y(000)G	±2
*RSL08Y(000)G	±2	*RSC08Y(000)G	±2
*RSL10Y(000)G	±2	*RSC10Y(000)G	±2
RSL06Y(000)J	±5	RSC06Y(000)J	±5
RSL08Y(000)J	±5	RSC08Y(000)J	±5
RSL10Y(000)J	±5	RSC10Y(000)J	±5

*PREFERRED VALUES

Res. (ohms)	Code	Res. (ohms)	Code	Res. (ohms)	Code	Res. (ohms)	Code	Res. (ohms)	Code	Res. (ohms)	Code	Res. (ohms)	Code
22	220	110	111	510	511	2400	242	11000	113	51000	513	240000	244
24	240	120	121	560	561	2700	272	12000	123	56000	563	270000	274
27	270	130	131	620	621	3000	302	13000	133	62000	623	300000	304
30	300	150	151	680	681	3300	332	15000	153	68000	683	330000	334
33	330	160	161	750	751	3600	362	16000	163	75000	753	360000	364
36	360	180	181	820	821	3900	392	18000	183	82000	823	390000	394
39	390	200	201	910	911	4300	432	20000	203	91000	913	430000	434
43	430	220	221	1000	102	4700	472	22000	223	100000	104	470000	474
47	470	240	241	1100	112	5100	512	24000	243	110000	114	510000	514
51	510	270	271	1200	122	5600	562	27000	273	120000	124	560000	564
56	560	300	301	1300	132	6200	622	30000	303	130000	134	620000	624
62	620	330	331	1500	152	6800	682	33000	333	150000	154	680000	684
68	680	360	361	1600	162	7500	752	36000	363	160000	164	750000	754
75	750	390	391	1800	182	8200	822	39000	393	180000	184	820000	824
82	820	430	431	2000	202	9100	912	43000	433	200000	204	910000	914
91	910	470	471	2200	222	10000	103	47000	473	220000	224	1000000	105
100	101												

*Available as standard through authorized Murata Erie Distributors.

Murata Erie Posistors are basically positive temperature coefficient thermistors with a very well defined resistance-temperature “knee” and the unique ability to “switch” relatively large amounts of power. They may also be used as self-regulating heating devices at useful power levels and as control devices for high power heaters. Applications include temperature sensing, over temperature and over current protection and motor starting to name a few.

Products utilizing Posistors are extremely safe and reliable and offer all of the design, manufacturing, repair and sales advantages of solid state technology.

FEATURES

- Compact
- Reduced component count
- Extremely reliable
- “Stepless” temperature control
- Simple repair or replacement
- Long term reliability
- Shock and vibration immunity
- Nonflammable case and insulation available
- No electrical or acoustical noise
- No electrical contacts

VARIETY OF HEATERS

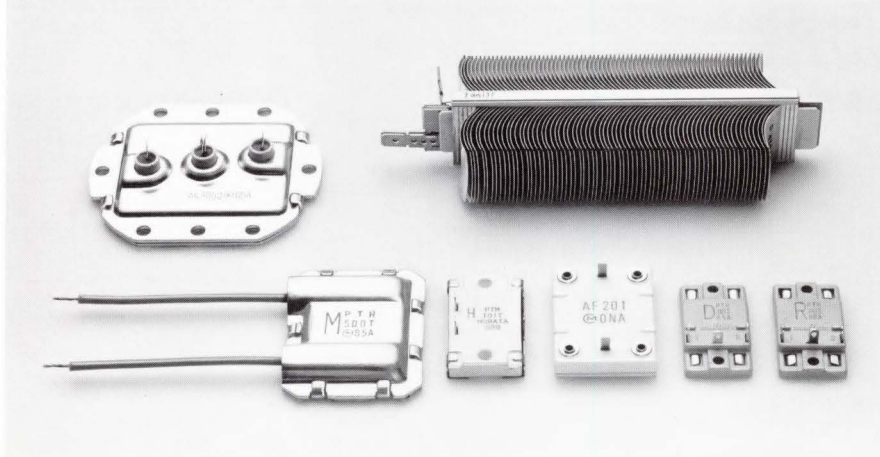

RESISTANCE-TEMPERATURE CHARACTERISTICS

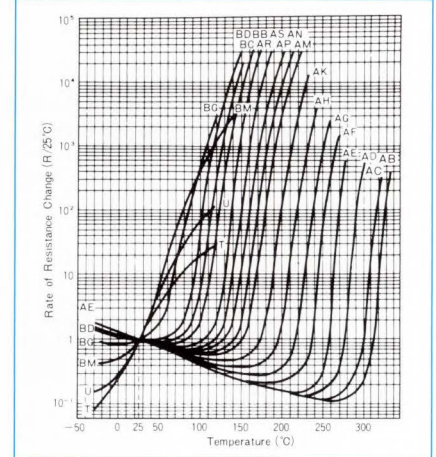

HIGH POWER FLAT HEATERS – PTH497

PTH497A	PTH497B	Part Number	Curie Point	Max. Voltage (Vrms)	Max. Power (Nominal Value) (W)
		PTH497A10BF101Q140	BF (60°C)	140	to 30
		PTH497A10BB101Q140	BB (100°C)		50
		PTH497A10AM101Q140	AM (160°C)	140	100
		PTH497B10BB500Q140	BB (100°C)		100
		PTH497B10AS500Q140	AS (130°C)		120
		PTH497B10AK500Q140	AK (180°C)		250

UL RECOGNIZED (E59464)

CONSTANT TEMPERATURE HEATERS – PTH457/476

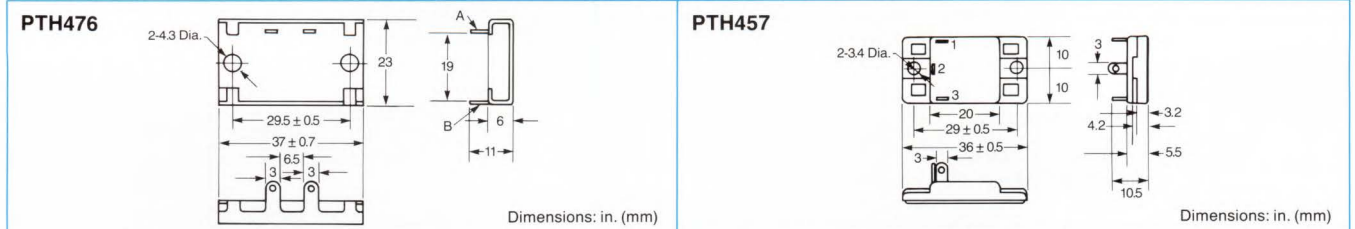

Part Number	Curie Point	Max. Voltage	Nominal Surface Temp.
PTH457 B02 BD 101T 140 (201T 260)	BD (80°C)	140V (260V)	90°C
PTH457 B02 BC 101T 140 (201T 260)	BC (90°C)		100°C
PTH457 B02 BB 101T 140 (201T 260)	BB (100°C)		110°C
PTH457 B02 AR 101T 140 (201T 260)	AR (120°C)		120°C
PTH457 B02 AS 101T 140 (201T 260)	AS (130°C)		130°C
PTH457 F01 AK 101T 140 (201T 260)	AK (180°C)	140V (260V)	160°C
PTH457 F01 AH 101T 140 (201T 260)	AH (200°C)		190°C
PTH457 F01 AG 101T 140 (201T 260)	AG (220°C)		200°C
PTH476 A02 AM 101T 140 (201T 260)	AM (160°C)		155°C
PTH476 A02 AK 101T 140 (201T 260)	AK (180°C)		165°C
PTH476 A02 AH 101T 140 (201T 260)	AH (200°C)	185°C	
PTH476 A02 AG 101T 140 (201T 260)	AG (220°C)	205°C	

POSISTORS® POSITIVE TEMPERATURE COEFFICIENT (PTC) THERMISTORS

To meet specific application requirements for a positive temperature coefficient Posistor for heating, circuit protection or temperature/current regulation, Murata Erie offers a variety of pellets. Our application engineers will provide product design assistance whenever required.

Type	Dimensions (mm)			Rated Voltage	Curie Point Temperature (°C)	Resistance 25°C (Ω)
	A±0.5	B±0.5	T±0.2			
						
PTH420A122AR131N260	6	—	2.5	220	120	130 ± 30%
PTH420A198AG701Q265	8	—	3.2	220	220	700-1500
PTH420A184AN132N260	11	—	2.2	220	150	700-2000
PTH420A127BC102M260	12	—	2.2	220	90	1000 ± 30%
PTH420A008BH651Q260	17	—	2.5	220	40	200-1200
PTH420A208BD220N080	6	—	1.5	12/24	80	22 ± 30%
PTH420A209BD7R0N080	8	—	1.0	12/24	80	7 ± 30%
PTH420A204AK9R0N035	12	—	1.0	12/24	180	9 ± 30%
PTH420A001AR1R7N020	14	—	1.0	12	120	1.7 ± 30%
PTH420A036AR1R0N020	19.5	—	1.0	12	120	1.0 ± 30%
PTH420A168AL1R0P030	20.8	—	1.2	12/24	170	1.5 ± 35%

NOTE: Custom elements are available. Contact Murata Erie for information.

OVERHEAT PROTECTORS — SURFACE MOUNT

Chip PTC Thermistor, PTH9C23 Series, is a SMD Posistor developed for over-heat protection of power transistors, power diodes and power ICs of hybrid circuits as temperature sensors.

FEATURES

- The PTH9C23 Series is a surface mount type, has compact and light design, and is suitable for the miniaturization of circuits.
- Excellent thermal response because of no coating.
- Elements of solid-state construction provides excellent mechanical vibration and impact resistance.
- Contactless operation provides prolonged service life and noiseless operation.

DIMENSIONS: in. (mm)

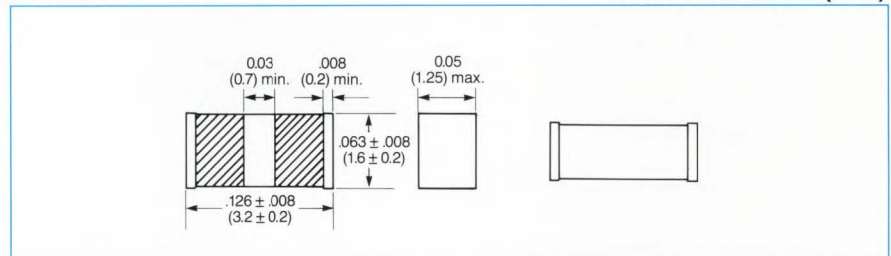

RATINGS

Part Number	Temp. Char. (C.P.) (°C)	Resistance Value (at 25°C)	Temp. (°C) (at 4.7kΩ)	Max. Volt.	Max. Current	Temp. Extent to (°C)
PTH9C23AR471Q-T	AR (120)	470Ω ± 50%	135 ± 10	16V	30mA	-20 to +150°C
PTH9C23BB471Q-T	BB (100)		115 ± 10			-20 to +130°C
PTH9C23BD471Q-T	BD (80)		95 ± 10			-20 to +110°C

-T : Taping (Standard quantity is 2500pcs. per reel)

MOTOR STARTING — U.L. FILE NO. E60216

Murata Erie Posistors are designed to provide a smooth, solid state electronic starting device for single-phase motors utilizing a split-phase starting winding or for PSC motors as a direct replacement for starting capacitors and switches. In certain applications, using a posistor in place of various capacitor/relay starting circuits can increase starting torque.

Type	Resistance (Ω)	Inrush Current (A)	Max. Voltage (V)
PTH490	3.3-33	7-12	160-300
PTH491	3.3-47	7-15	160-500

DIMENSIONS: in. (mm)

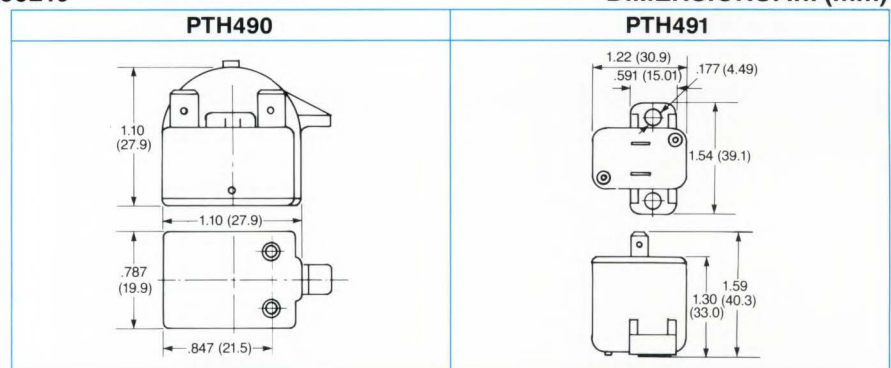

DEGAUSSING FOR COLOR TV AND DATA TERMINAL DISPLAYS

DIMENSIONS: in. (mm)

Part Number	Rated Voltage (V)	Min. Inrush Current (Ap-p)	Max. Steady State Current (mAp-p)	Degauss Coil R (Ω)
PTH451A				
PTH451C				
PTH451A100BG5R0M140	100/120	36Ap-p min.	70mAp-p max.	1
PTH451A103BG8R0M140	100/120	16Ap-p min.	15mAp-p max.	6
PTH451A102BF140M270	220/240	25Ap-p min.	40mAp-p max.	10
PTH451A102BG180N270	220/240	25Ap-p min.	35mAp-p max.	8
PTH451C260BF5R0M140	100/120	35Ap-p min.	15mAp-p max.	1
PTH451C263BG8R0M140	100/120	16Ap-p min.	7mAp-p max.	9
PTH451C262BF140M270	220/240	25Ap-p min.	25mAp-p max.	10
PTH451C262BG180N270	220/240	15Ap-p min.	15mAp-p max.	13

PTH9M/59F SERIES FOR POWER TRANSISTOR OVERHEAT PROTECTION

PTH9M

Dimensions: in. (mm)

Part Number	Resistance			Max. Voltage	Max. Current	Dielectric WSV
	25 (°C)	TS-10 (°C)	TS (°C)			
*PTH9M04□471TS2F333	100 Ω max.	330 Ω max.	470 Ω min.	16V	0.1A	500 VDC for 5 seconds
PTH59F04□471TS						
PTH9M04□222TS2F333	330 Ω max.	1.5 Ω max.	2.2 Ω min.	16V	0.1A	
*PTH59F04□222TS						

□ : BH BG BF BE BD BC BB
TS : 60 70 80 90 100 110 120

PTH59F

Dimensions: in. (mm)

TYPICAL APPLICATION

IC VS. TEMPERATURE

RESISTANCE-TEMPERATURE CHARACTERISTIC

PTH60/61G SERIES FOR IC AND TRANSISTOR CIRCUIT PROTECTION

Dimensions: mm
PTH60: 7.4 max.
PTH61: 9.6 max.

Part Number	Char. (Curie Point)	Resistance (Ω)	Max. Volt. (V)	Max. Current (A)	Non-Operating Current (mA)	Trip Current (mA)
PTH61G30BD2R2N	BD (80°C)	2.2 ± 30%	24	2.0	180	710
PTH61G30BD3R3N		3.3 ± 30%			145	580
PTH61G30BD4R7N		4.7 ± 30%			115	460
PTH60G30BD6R8N		6.8 ± 30%			90	370
PTH60G30BD100N		10 ± 30%			80	320
PTH60G30BD150N		15 ± 30%	32	1.5	60	240
PTH60G30BD220N		22 ± 30%			45	200
PTH60G30BD330N		33 ± 30%			40	170
PTH60G30BD470N		47 ± 30%			30	140
PTH60G30BD680N		68 ± 30%			28	120
PTH60G30BD101N	100 ± 30%	25	100			

PTH60H01-PTH63H02 SERIES FOR LINE VOLTAGE OR TRANSFORMER PROTECTION

Part Number	Char. (Curie Point)	Resistance Range (at 25°C)	Max. Volt.	Max. Current	Non-Operating Current*	Trip Current**	Dimensions: mm			
							D Max.	T Max.	F	d
*PTH60H01AR330M140	AR (120°C)	33Ω ± 20%	140V	0.5A	100mA	230mA	7.4	6.0	5.0	0.5
*PTH61H01AR220M140		22Ω ± 20%		1.0A	140mA	330mA	9.6	6.0	6.5	0.65
*PTH624H01AR150M140		15Ω ± 20%		1.0A	170mA	400mA	11.6	6.0	6.5	0.65
*PTH623H01AR100M140		10Ω ± 20%		1.0A	220mA	510mA	13.0	6.0	9.5	0.65
*PTH622H01AR6R8M140		6.8Ω ± 20%		1.0A	290mA	670mA	14.0	6.0	9.5	0.65
*PTH631H01AR5R6M140		5.6Ω ± 20%		2.0A	340mA	780mA	17.0	6.0	9.5	0.65
*PTH63H01AR4R7M140		4.7Ω ± 20%		2.0A	390mA	900mA	19.0	6.0	9.5	0.65
*PTH59H02AR181M265		180Ω ± 20%	265V	0.3A	29mA	70mA	6.5	6.5	3.5	0.5
*PTH59H02AR121M265		120Ω ± 20%		0.3A	35mA	85mA	6.5	6.5	3.5	0.5
*PTH60H02AR820M265		82Ω ± 20%		0.5A	60mA	150mA	8.2	6.5	5.0	0.5
*PTH60H02AR560M265		56Ω ± 20%		0.8A	80mA	190mA	8.2	6.5	5.0	0.5
*PTH61H02AR390M265		39Ω ± 20%		1.2A	100mA	240mA	10.0	6.5	6.5	0.65
*PTH623H02AR270M265		27Ω ± 20%		1.5A	150mA	360mA	14.0	6.5	9.5	0.65
*PTH62H02AR180M265		18Ω ± 20%		1.8A	180mA	440mA	15.7	6.5	9.5	0.65
*PTH63H02AR120M265	12Ω ± 20%	2.0A	255mA	610mA	19.5	6.5	9.5	0.65		

U.L. Recognized (E78831) * @ +60°C ** @ -10°C
* Available through authorized Murata Erie Distributors.

NTC THERMISTORS

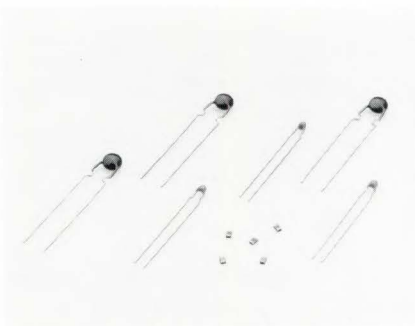

The NTH5D and NTH4G Series of NTC thermistors provides a wide range of resistances and B-constants.

This makes them perfect for use in various applications as devices for temperature sensors and temperature compensation.

NTH5G surface mount device is also available. Call for details.

FEATURES

- Thermally stable with consistent performance
- Very low deviation in temperature index
- Highly reliable
- Specifications and standards can be applied to meet any application and purpose

APPLICATIONS

- Temperature compensation of transistor IC circuits
- Temperature compensation of measuring equipment and various circuits
- Temperature sensor and temperature control for home appliances

DIMENSIONS & SPECIFICATIONS

Dimensions: mm							
Part Number	Resistance 25°C (Ω)	B-Constant 25/50°C (°K)	Resist. Temp. Coeff. 25°C (%/°C)	Part Number	Resistance 25°C (Ω)	B-Constant 25/50°C (°K)	Resist. Temp. Coeff. 25°C (%/°C)
NTH5D221KA	220	3,300	-3.7	NTH5D682KA	6,800	4,100	-4.6
NTH5D331KA	330	3,300	-3.7	NTH5D103KA	10,000	4,100	-4.6
NTH5D471KA	470	3,500	-3.9	NTH5D153KA	15,000	4,100	-4.6
NTH5D681KA	680	3,500	-3.9	NTH5D223KA	22,000	4,200	-4.7
NTH5D102KA	1,000	3,800	-4.3	NTH5D333KA	33,000	4,200	-4.7
NTH5D152KA	1,500	3,800	-4.3	NTH5D473KA	47,000	4,200	-4.7
NTH5D222KA	2,200	3,900	-4.4	NTH5D683KA	68,000	4,400	-4.9
NTH5D332KA	3,300	3,900	-4.4	NTH5D104KA	100,000	4,400	-4.9
NTH5D472KA	4,700	3,900	-4.4	NTH5D154KA	150,000	4,400	-4.9

- B-constant deviation : ±10%
- Thermal dissipation constant : 5.6 mW/°C

- Thermal time constant : 20 sec.
- Operating temp. range : -30 to +125°C

NTC THERMISTOR NTH4G SERIES

Miniature Thermistor for Temperature Sensor – NTH4G series is the world's smallest thermistor that is automatically processed into its radial-leaded form with our advanced production method.

RATINGS

Dimensions: mm		Part Number ¹	Resistance 25°C (KΩ)	B-Constant ² 25/50°C (K)	Thermal Dissipation Constant	Thermal Time Constant	Operating Temperature Range
		NTH4G35A202□02	2.0	3500	2.1 (mW/°C)	1 Sec. Max. (In Liquid)	-40°C to 125°C
		NTH4G37A502□02	5.0	3700			
		NTH4G39A103□02	10.0	3900			
		NTH4G40B203□01	20.0	4050			
		NTH4G41B503□01	50.0	4150			
NTH4G42B104□01	100.0	4250					

*1: Letter denoting the resistance tolerance is entered into the box. (F: ±1%, E: ±3%)

*2: B-Constant Tolerance (±1%) Max. Power 210mW

GLASS ENCAPSULATED NTC THERMISTORS

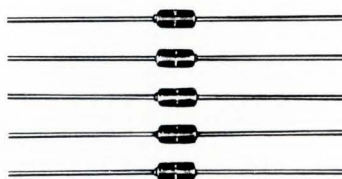

This NTC thermistor Series features chip elements for high accuracy and stability. Encapsulated in glass, these thermistors are suitable for applications demanding high reliability and/or temperature and humidity extremes.

FEATURES

- Stable performance with negligible resistance and B-constant variation
- Glass encapsulation for reliable operation in high humidity-temperature environments
- Compact, light weight, easy to handle
- Custom orders can be produced to meet specific applications

DIMENSIONS & SPECIFICATIONS

Dimensions; mm		Part Number ¹	Resistance (25°C)	B-Constant ²	Thermal Dissipation Constant	Thermal Time Constant	Operating Temperature Range
		NTH300XH502□01	5KΩ	3350K ±3%	2.0mW/°C (Typical)	20 Seconds (Typical)	-40 to +300°C
		NTH300XK103□01	10KΩ	3400K ±3%			
		NTH300XQ103□01	10KΩ	3650K ±3%			
		NTH300XW203□01	20KΩ	3950K ±3%			
		NTH300WA503□01	50KΩ	4000K ±3%			
		NTH300WC104□01	100KΩ	4100K ±3%			
		NTH300WE204□01	200KΩ	4200K ±3%			

*1: Letter denoting the resistance tolerance is entered into the box. (K: ±10%, J: ±5%, E: ±3%)

*2: Denotes the value obtained from the resistance at 25 and 50°C.

HIGH VOLTAGE RESISTOR MHR SERIES

P Type		Part Number	Size W×L(m)	E max (KV)	P max (W)	Δ T (°C)	Part Number	Size W×L(m)	E max (KV)	P max (W)	Δ T (°C)
		MHR0629	6×29	12	1.0	27.4	MHR1538	15×38	25	2.2	19.5
		MHR0643	6×43	20	1.7	24.0	MHR1550	15×50	30	2.5	17.0
		MHR0718	7×18	10	1.0	32.7	MHR1760	17×60	30	2.8	16.6
		MHR0830	8×30	17	1.8	23.8	MHR1839	18×39	25	2.2	18.7
		MHR1220	12×20	15	1.5	27.5	MHR2551	25×51	35	3.0	14.4
		MHR1428	14×28	22	1.7	23.5	MHR2660	26×60	35	3.5	13.3
		MHR1351	13×51	30	2.3	18.1	MHR3458	34×58	35	4.0	12.3

Remarks: 1) $E = \sqrt{PR}$ E: Rated Voltage
 P: Rated Power
 R: Resistance Value
 2) Δ T: Temperature rising per 1 watt (reference value)

PART NUMBERING SYSTEM

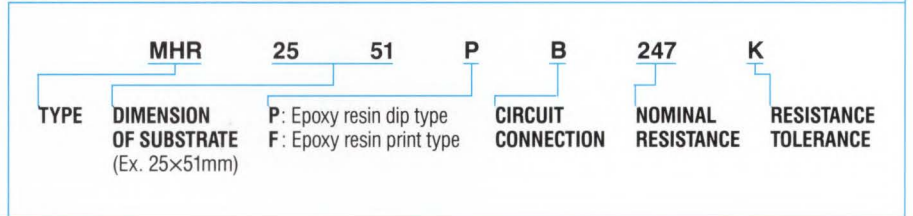

FOCUS ADJUSTING RESISTOR

■ Focus Adjusting Resistor for Color TV-Display

- MHF116 (16KV) for Projection
- MHF045 (6KV) for 4" ~6" CTV
- MHF106 (10KV) for 14" ~CTV
- MHF128 (16KV) for 25" ~CTV
- MHF107 (12KV) for 19" ~CTV
- MHF002 (30KV) for Display
- MHF103 (30KV) for Display (Capacitor Equipped)
- MHF115 (40KV) for Display
- MHF141 (32KV) Double Focus
- MHF138 (12KV) Double Focus

HIGH VOLTAGE CR BLOCK & MULTIPLIER

PART	CIRCUIT	Part Number	Capacitance			Bleeder Resistor	Focus Output
			20KV	30KV	35KV		
MSC63 (for CRT Display) 	 Vmax: 13kVDC Rtotal: 100MΩ ± 20% C ₁ : 330pF ± 20% F ₁ , F ₂ min. ≤ 63.3% S max. ≤ 11.0% F ₁ , F ₂ max. ≥ 89.9% C ₂ : 470pF ± 20%	MSC26, MSC27 MSC32, MSC33	4300pF max.	3000pF max.	—	○	
MSC52-01 (for CRT Display) 	 Vmax: 35kVDC C: 6500pF R ₁ + R ₂ : 400MΩ R ₂ / (R ₁ + R ₂): 1/2000	MSC28, MSC29 MSC34, MSC35			○	—	
		MSC30, MSC31 MSC36, MSC37			—	6000pF max.	○
MSC46-01 (for Dynamic Focus) 	 C : 1000pF Vmax : 15kVDC	MSC52, MSC53	—	6000pF max.	○	—	
		MSC56, MSC57	—	—	—	—	
		MSC63	—	—	—	Dual	
		MSC68, MSC69	—	4500pF max.	4500pF max.	—	Dual

SENSORS PYROELECTRIC INFRARED SENSORS

IRA SERIES

 <p>IRA-E100SZ1 IRA-E100SV1 IRA-E100S1</p> <p>IRA-E009SX1</p>	Part Number	Element Type	Optical Filter	FOV	Operating Temp.
	* IRA-E100SZ1	Dual	7 μ m	51°×51°	-25 to +55°C
	* IRA-E100SV1		1 μ m with AR coat	38°×38°	
	* IRA-E100S1		1 μ m		
* IRA-E009SX	Quad	7 μ m	47°×32°		

CURRENT-MODE INFRARED SENSOR

 <p>IRB-M002SX</p>	Supply Voltage (V _{cc})	5V±0.1V DC
	Sensitivity	1.7×10 ⁶ V/W
	Wave Length Range	7 to 14 μ m
	FVO	$\theta_1=41^\circ, \theta_2=35^\circ$
	Operating Temp.	-25 to +55°C (without condensation)
	Storage Temp.	-30 to +100°C
	Current Consumption	20 μ A (stand by)

INFRARED SENSOR MODULE

 <p>IMC-S7801-02</p> <p>IMD-B101-01</p> <p>IMD-B102-01</p> <p>(Unit: mm)</p>	Part Number	Sensing Distance	FOV	Supply Voltage	Current Consumption	Output
	* IMC-S7801-02	5m	90°×52.5°	3 to 5V	2.5mA	Open collector with timer
	* IMD-B101-01	3.5m (With Fresnel lens IMD-FL01W/G)	104°×30° (With Fresnel lens)	2.6 to 5.5V	0.05mA	Digital & Analog output
	* IMD-B102-01	1.0m (With lens)				Digital output

1. IMD-B102-01 has CdS input terminal which controls its mode on or off in accordance with the ambient darkness.
2. Two fresnel lens models are available for IMD module. IMD-FL01W (White) IMD-FL01G (Grey)

THIN FILM PLATINUM TEMPERATURE SENSOR

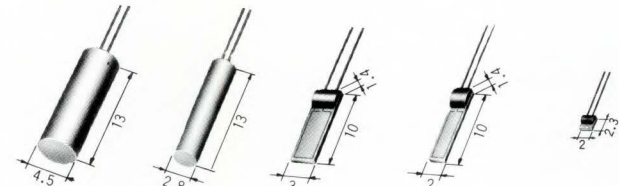
 <p>(Unit: mm)</p>	Part Number			Resistance (0°C)	Temp. Range
	TRFA101□	TRFB101□	TRFC101□	100 Ω	-50 to +600°C
	TRFA501□	TRFB501□		500 Ω	
	TRFA102□	TRFB102□		1K Ω	
	TRRA101□	TRRB101□		100 Ω	
	TRRA501□	TRRB501□		500 Ω	
	TRRA102□	TRRB102□		1K Ω	
□ : Letter denoting the class is entered into the box. (A to D)					
Class	Resistance Tolerance (0°C)	Temp. Coeff. of Resistance (0 to 100°C)			
* A	±0.06%	3850±5ppm/°C			
* B	±0.12%	3850±13ppm/°C			
C	±0.24%	3850±13ppm/°C			
D	±0.60%	3850±65ppm/°C			

*DIN43760, IEC751

TRMF SERIES – AIR FLOW SENSOR MODULE

	Part Number	Velocity	Accuracy	Output	Voltage Supply	Operating Temp.
	TRMF001A	0 to 10m/s	±5 %	Analog non linear output	DC 5±0.5V	0 to 60°C
	TRMF001B		±10%			
	TRMF001C		±20%			

* Available as standard through authorized Murata Erie Distributors.

NON-CONTACT POTENTIOMETER

Part Number	LP06M2F1AA	LP06M3R1AA LP06M4R1AA	LP05D3G1AA
Maximum Rated Voltage (V)	6	6	5
Effective Electrical Travel (*)	±50	±50	±30
Output Sensitivity (mV/deg.)	22(Vin=6V)	22(Vin=6V)	12(Vin=5V)
Independent Linearity (%)	±1.5 max.	±1.5 max.	±1.5 max.
Temperature Characteristic of Output Voltage (%/°C)	-0.4 to -0.15	-0.4 to -0.15	±0.12
Maximum Rotation Torque (gm·cm)	0.5 max.	5 max.	5 max.
Operating Temperature Range (°C)	-10 to +60	-10 to +60	-10 to +60



ROTARY SENSOR

Part Number	Output Type	Rotation Detection	Linear Motion Detection	Module M	Gear Pitch (mm)
FR05CM21AR	Single phase : Analog	△	○	(0.3 to 10.) Applicable	0.7 to 3.1
FR05CM12AL	Twin phase : Analog (with Volta reference terminal)	○	△	0.4	1.3
FR05CM62AF	Twin phase : Analog	○	△	0.4	1.3
FR12AM32AC	Twin phase : Digital	△	○	0.635	2.0
FR05CM14AD	Twin dual phase : Analog	○	△	0.4	1.3



CURRENCY RECOGNITION SENSOR

Part Number	BS05N1HGAA	BS05N1HFAA	BS05i1KFAA	BS05M1HF□□*2
Max. Applied Voltage (V)	5	5	5	5
Output Voltage*1 (mV)	≥ 240	≥ 400	0.3 to 0.8	≥ 250
Sensing Track (mm)	3	3	10	3/1 ch
Operating Temp. Range (°C)	-20 to 60	-20 to 60	-20 to 60	0 to 50



*1. Conforming MURATA measurement.
*2. Multi channel model with order made by each customer.

PIEZOELECTRIC ACOUSTIC ELEMENTS & ALARMS

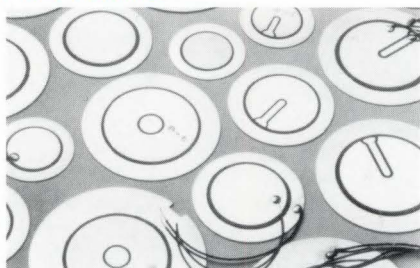

FEATURES

- Extremely clear penetrating sound
- Completely solid state
- One-tenth the power consumption of a comparable electromechanical buzzer
- No electronic noise generation
- Compact size and lightweight
- Variety of models for various tone functions

APPLICATIONS

- Fire alarms
- Gas detectors
- Calculators
- Medical electronics
- Appliances
- Burglar alarms
- Automobiles
- Aircraft
- Clocks
- Watches
- Communications systems
- Data processing
- Instrument and control systems
- Restaurant equipment
- Recreational equipment

EXTERNAL DRIVE (without feedback electrode)

Part Number	Characteristics (*1, *2)			Dimensions: mm				
	Resonant frequency (KHz)	Resonant resistance (Ω)	Capacitance (pF) ±30%	D	a or c	b	T	t
* 7BB-20-6	6.3±0.6	≤350	10000	2.0±0.2	14.0±0.6	12.8±0.2	0.42±0.1	0.20±0.05
* 7BB-27-4	4.6±0.5	≤200	20000	27.0±0.2	19.7±0.6	18.2±0.2	0.54±0.1	0.30±0.05
* 7BB-35-3	2.8±0.5	≤200	10000	35.0±0.2	25.0±0.6	23.0±0.2	0.53±0.1	0.30±0.05
* 7BB-41-2	2.2±0.3	≤250	30000	41.0±0.2	25.0±0.6	23.0±0.2	0.63±0.1	0.40±0.05
7NB-41-25DM-1	.85±.25	≤300	75000	41.0±0.2	25.0±0.5	23.0±0.2	0.21±0.5	0.10±0.03

*1 Insulation resistance 100MΩmin. (at 100VDC)

*2 Maximum applied voltage 30Vp-p

SELF-DRIVEN (with feedback electrode)

Part Number	Characteristics (*1, *2)			Dimensions: mm				
	Resonant frequency (KHz)	Resonant resistance (Ω)	Capacitance (pF) ±30%	D	a	b	T	t
* 7BB-20-6C	6.3±0.6	≤500	8500	20.0±0.2	14.0±0.6	12.8±0.2	0.42±0.1	0.20±0.05
* 7BB-27-4C	4.6±0.5	≤200	18000	27.0±0.2	19.7±0.6	18.2±0.2	0.54±0.1	0.30±0.05
* 7BB-35-3C	2.8±0.5	≤200	24000	35.0±0.2	25.0±0.6	23.0±0.2	0.53±0.1	0.30±0.05
* 7BB-41-2C	2.2±0.3	≤250	24000	41.0±0.2	25.0±0.6	23.0±0.2	0.63±0.1	0.40±0.05
* 7SB-34R7-3C	3.3±0.3	≤150	40000	34.7±0.2	25.0±0.6	23.4±0.2	0.50±0.1	0.25±0.05
* 7SB-34R7-3C2	3.1±0.5	≤160	24000	34.7±0.2	25.0±0.6	23.0±0.2	0.50±0.1	0.25±0.05

To denote lead wire, add "A0" suffix (Ex. 7BB-20-6A0).

ENCASED PIEZO-ALARMS WITH INTERNAL CIRCUITRY

Part Number	*PKB24SPC-3601	*PKB30SPC-2001*	*PKB30SPC-3001	*PKB5-3A0
Sound Pressure Level	90dB@10cm@12V	75dB@1M@12V	75dB@30cm@12V	85dB@30cm@9V
Oscillating Frequency	3.6 ± 0.5KHz	2.0 ± 0.4KHz	2.9 ± 0.5KHz	2.8 ± 0.5KHz
Current	16mA@12V	15mA@12V	15mA@12V	12mA@9V
Operating Voltage	3 to 15V	3 to 15V	3 to 15V	3 to 20V
Operating Temp. Range	-20°C to +70°C	-20°C to +70°C	-20°C to +70°C	-20°C to +60°C
UL Rating	UL-94V0	UL-94V0	UL-94V0	24AWG (UL-1007)
DIMENSIONS: (mm)				

*These parts are also available as washable parts with tape covering the sound emitting hole and epoxy seal at the case bottom.

* Available as standard through authorized Murata Erie Distributors.

ENCASED PIEZO-ALARMS

Part Number	*PKM22EPP-4001	*PKM13EPP-4002	*PKM29-3A0	*PKM24SP-3805	*PKM25-6A0	*PKM37-2A0
Sound Pressure Level	75dB@10cm@3Vp-p	70dB@10cm@3Vp-p	85dB@9V@1M	90dB@12V@10cm	85dB@6.5V@10cm	70dB@12V@1M
Oscillating Frequency	4KHz	4.0KHz	3.4 ± 0.4KHz	3.8 ± 0.4KHz	6.8 ± 0.7KHz	2.0 ± 0.5KHz
Current	1mA@3Vp-p		20mA@9V	12mA@12V	10mA max.	15mA max.
Operating Voltage	3 to 30Vp-p	3 to 25Vp-p	4.5 to 18.0V	3 to 20V	3 to 20V	3 to 20V
Operating Temp. Range	-20°C to +70°C	-20°C to +70°C	-20°C to +70°C	-20°C to +70°C	-20°C to +70°C	-20°C to +70°C
UL Rating	UL-V0	UL-94V0	UL-V0	UL-94HB		
DIMENSIONS: (mm)						

MINIATURE ENCASED PIEZO-ALARMS

Part Number	*PKM35-4A0	*PKM17EPP-4001	*PKM11-4A0	*PKM11-6A0
Sound Pressure Level	75dB@10cm@3Vp-p	72dB@10cm@3Vp-p	75dB@10cm@3Vp-p	75dB@6.5V@10cm
Oscillating Frequency	4KHz	4KHz	4096	6.5 ± 0.7KHz
Current	1mA@3Vp-p	1mA@3Vp-p	1mA max.	8mA@6.5V
Operating Voltage	3 to 25Vp-p	3 to 20Vp-p	3 to 25Vp-p	3 to 15V
Operating Temp. Range	-20°C to +70°C	-20°C to +70°C	-20°C to +60°C	-20°C to +60°C
UL Rating	UL-94HB	UL-94V0	UL-V1	UL-V1
Leads	32AWG (UL-1685)		30AWG (UL-1571)	30AWG (UL-1571)
Dimensions: in (mm)				

★ Available as standard through authorized Murata Erie Distributors.

PIEZOELECTRIC ACOUSTIC ALARMS

PIEZO RINGERS FOR LOW FREQUENCY APPLICATIONS

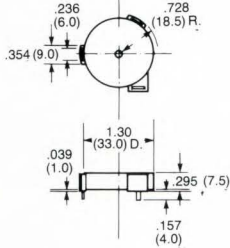
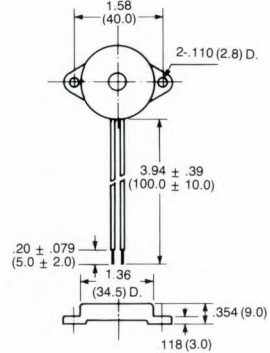
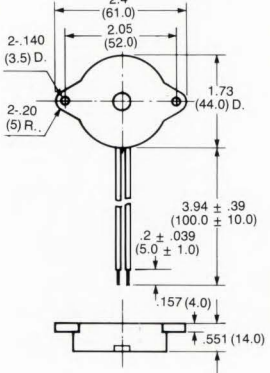
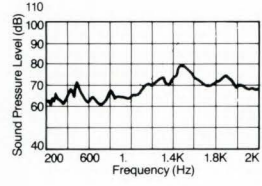
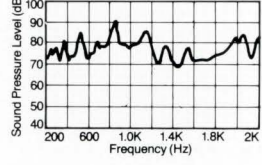
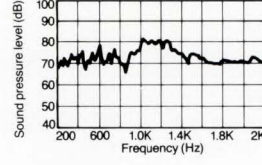
Part Number	*PKM33EP-1001	*PKM34EW-1101C	*PKM44EW-1001D
Sound Pressure Level	70dB min./50cm/20Vp-p square wave at 1.0KHz	70dB min./1m/30Vp-p square wave at 1.1KHz	75dB min./30cm/9Vp-p square wave at 1.0KHz
Allowable Input	30Vp-p max.	40Vp-p max.	30Vp-p max.
Operating Temp. Range	-20°C to +70°C	-20°C to +70°C	-30°C to +70°C
Lead Wire		30 AWG UL-1571	28 AWG UL-1685
DIMENSIONS: in. (mm)			
SOUND PRESSURE LEVEL VS. FREQUENCY CHARACTERISTICS	 <p>Input Voltage: 20.0Vp-p Square Wave Distance: 50.0cm</p>	 <p>Input Voltage: 30.0Vp-p Square Wave Distance: 1m</p>	 <p>Input Voltage: 9.00Vp-p Square Wave Distance: 30.0cm</p>

PIEZO-ALARMS FOR SPECIAL APPLICATIONS

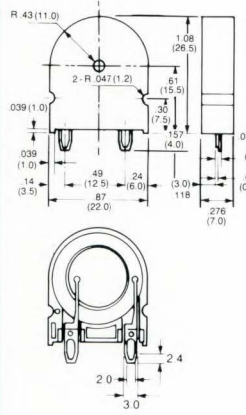
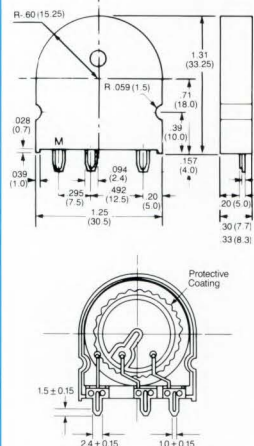
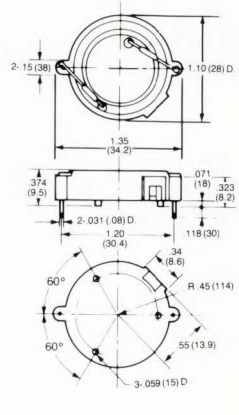
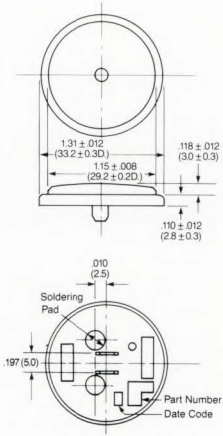
Part Number	*PKM22EPT-2001	*PKM30SPT-2001	*PKM28SEP-2001	*PKD34EP-01R
Sound Pressure Level	70dB@2KHz@10cm@3Vp-p	75dB@10cm@12V	65dB@45.7cm@5Vrms	102±3.5dB (2.5cc coupler)
Oscillating Frequency	2.0KHz	2.0 ± 0.3KHz	2.0KHz	300Hz-3.4KHz
Current		20mA max.		
Operating Voltage	3 to 25Vp-p	3 to 20V	3 to 40Vrms	30 Volt RP
Operating Temp. Range	-20°C to +70°C	-20°C to +70°C	-30°C to +60°C	-20°C to +70°C
UL Rating	UL-94HB	UL-V1	UL-94V0	
DIMENSIONS: in. (mm)				

* Available as standard through authorized Murata Erie Distributors.

**RATING
RECEIVER AND TRANSMITTER**

Part Number	MA23L3-9	*MA40A5R/S	*MA40B5R/S	*MA40E7R/S	*MA40S2R/S	MA40S3R/S
Nominal Frequency (KHz)	23	40				
Sensitivity (dB)	-70 min.	-67 min.	-67 min.	-74 min.	-74 min.	-67 ± 6
Sound Pressure (dB)	(102)	112 min.	112 min.	106 min.	100 min.	111 ± 6
Directivity (deg)	80°	50°	50°	100°	100°	100°
Capacitance (pF)	2800	2000	2000	2200	1600	1600
Allowable Input Voltage (Vrms)	20	20	20	20	10	10
Operating Temperature Range (°C)	-20 to +60	-20 to +85	-20 to +85	-30 to +85	-30 to +85	-30 to +85
Detectable Range (m)	0.2 to 6	0.2 to 6	0.2 to 6	0.2 to 3	0.2 to 4	0.2 to 4
Resolution (mm)	15	9				
Dimension (mm)	24φ × 10.7h	16φ × 12h		18φ × 12h	10φ × 6.8h	10φ × 7.1h
Weight (g)	5.7	2.8	2.3	4.5	0.7	0.6
Feature	Broad-Band	General Use Broad-Band	Black Case	Waterproof	Miniature	Black Case
Figure	1	2	3	4	5	6

Sensitivity: 0dB = 1V/μ bar, Sound Pressured at 30cm, 0dB = 2×10⁻⁴ μ bar

"Operating temperature range," above mentioned, is effective only for actual use. As for temperature characteristics of sound pressure level and sensitivity, and durability, please see specification sheet.

**DIMENSIONS: in. (mm)
RECEIVER AND TRANSMITTER**

*MA23L3-9

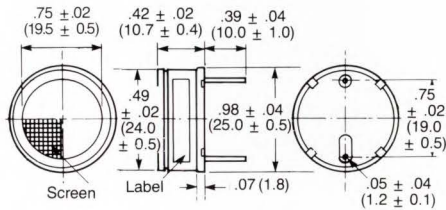

FIG. 1

*MA40E7R/S

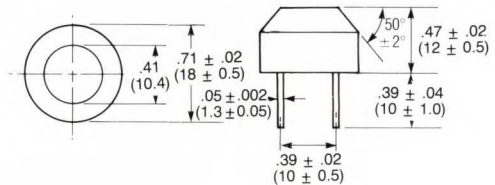

FIG. 4

*MA40A5R/S

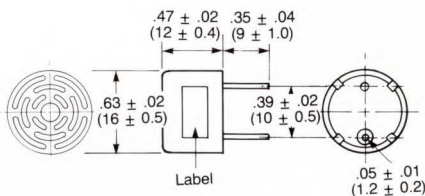

FIG. 2

*MA40S2R/S

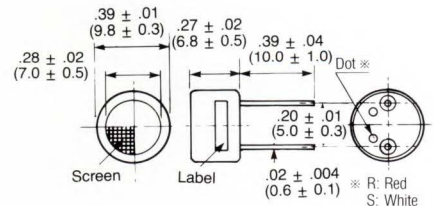

FIG. 5

*MA40B5R/S

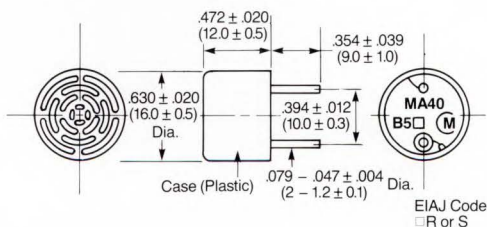

FIG. 3

MA40S3R/S

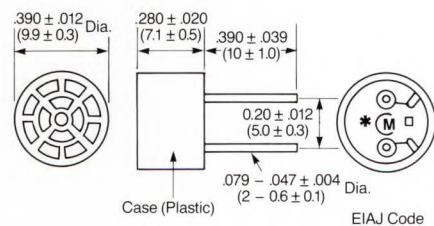
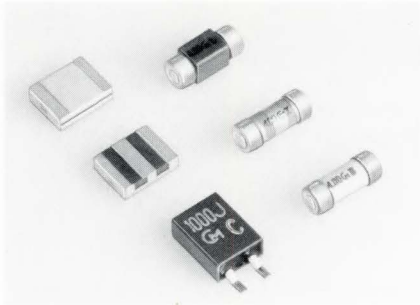

FIG. 6

CERAMIC RESONATORS FOR SURFACE MOUNT

CSBF, CSAC-MGC/MT/MX Series



Increasing demand for size reduction and the economies realized through Surface Mount Technology, have led Murata Erie to develop the new CSBF and CSAC ceramic resonators. The CSBF is a miniaturized leaded unit offering size compatibility with most

commonly available surface mount devices, while the CSAC is a true surface mountable component. Both devices, are available in tape and reel packaging compatible with most auto-placement equipment.

CSBF(J) SERIES – 430 TO 1250KHz

DIMENSIONS: in. (mm)

*Frequency (KHz)	W	H	T	P
430 to 440	.295 ± .012 (7.5 ± 0.3)	.335 ± .012 (8.5 ± 0.3)	.130 ± .012 (3.3 ± 0.3)	.197 ± .008 (5 ± 0.2)
450 to 460	.295 ± .012 (7.5 ± 0.3)	.335 ± .012 (8.5 ± 0.3)	.130 ± .012 (3.3 ± 0.3)	.197 ± .008 (5 ± 0.2)
470 to 480	.295 ± .012 (7.5 ± 0.3)	.335 ± .012 (8.5 ± 0.3)	.130 ± .012 (3.3 ± 0.3)	.197 ± .008 (5 ± 0.2)
490 to 500	.295 ± .012 (7.5 ± 0.3)	.335 ± .012 (8.5 ± 0.3)	.130 ± .012 (3.3 ± 0.3)	.197 ± .008 (5 ± 0.2)
700 to 850	.197 ± .012 (5 ± 0.3)	.256 ± .012 (6.5 ± 0.3)	.091 ± .008 (2.3 ± 0.2)	.197 ± .008 (5 ± 0.2)
910 to 1020	.197 ± .012 (5 ± 0.3)	.256 ± .012 (6.5 ± 0.3)	.091 ± .008 (2.3 ± 0.2)	.197 ± .008 (5 ± 0.2)
1200 to 1250	.197 ± .012 (5 ± 0.3)	.256 ± .012 (6.5 ± 0.3)	.091 ± .008 (2.3 ± 0.2)	.197 ± .008 (5 ± 0.2)

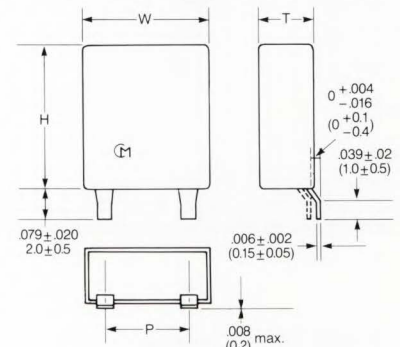

SPECIFICATIONS

Frequency Tolerance	±0.5%
Temperature Stability (–20°C to +80°C)	±0.3%
Aging (room temp., 10 years)	±0.3%
Standard Test Circuit	<p>IC - CD4069UBE (MOS) X - Ceramic Resonator C_{1,1}, C_{1,2} - Loading Capacitance R_d - Damping Resistance</p>

*Note: Only available in frequencies stated in the above chart.

CSAC SERIES – 2.00 TO 32.00MHz DIMENSIONS: in. (mm)

	CSAC □ MGC	CSAC □ MGCM	CSAC □ MT/MX
CSAC □ MGC			
**EIAJ code			

SPECIFICATIONS	CSAC □ MGC/MGCM	CSAC □ MT	CSAC □ MX
Frequency Range	2.00 to 6.00 MHz	6.01 to 13.0 MHz	13.01 to 32.00 MHz
Frequency Tolerance	±0.5%	±0.5%	±0.5%
Storage Temperature Range		–40°C to +85°C	
Temperature Stability	±0.3% (–20°C to +80°C)	±0.5% (–20°C to +80°C)	±0.3% (–20°C to +80°C)
Withstand Voltage		50 VDC max.	

Note: Also available in automotive temp. grades.

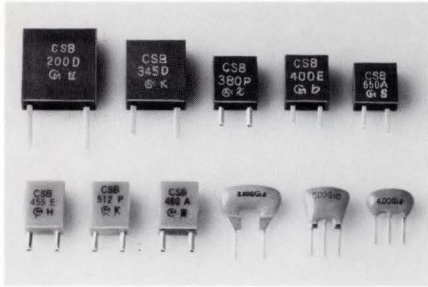

Murata ERIE's ceramic resonators are widely used in clock oscillators for microprocessors, replacing quartz crystals at substantially reduced cost, and in many other applications.

Features of ceramic resonators include low cost, good stability, small size and rugged construction, and a wide frequency range.

AVAILABLE AS STANDARD THROUGH AUTHORIZED MURATA ERIE DISTRIBUTORS

CSA 11.0 MTZ	CSB 480 J
CSA 2.00 MG	CSB 500 J
CSA 3.58 MG	CSB 640 J
CSA 4.00 MG	CSA 1.84 MG
CSA 6.00 MG	CSA 10.0 MTZ
CST 4.00 MGW	CSA 12.0 MTZ
CST 8.00 MTW	CSA 16.00 MXZ040
CST 12.0 MTW	CSA 4.19 MG
CSA 8.00 MTZ	CSA 8.00 MTZ
CSB 400 J	CSB 1000 J
CSB 455 J	CSB 800J

SPECIFICATIONS

TYPE	CSA TYPE	CSB TYPE	CST TYPE
Frequency Range	1.26 to 32 MHz	190 to 1250 KHz	1.80 to 25.99 MHz
Frequency Tolerance	±0.5%	±0.5%	±0.5%
Temperature Stability (-20°C to +80°C)	±0.5%	±0.3%	±0.3%
Time Stability (10 years)	±0.3%	±0.3%	±0.3%

CSA TYPE*

Dimensions: in. (mm)	Dimensions mm	MK	MG	MTZ	MXZ
		1.26 to 1.799 MHz	1.8 to 6.0 MHz	6.01 to 13.0 MHz	13.0 to 32.0 MHz
	W	10.0	10.0 (12.0)**	10.0	10.0
	H	10.0	7.5 (12.0)	10.0	10.0
	T	5.0	5.0 (5.0)	5.0	5.0
	P	5.0	5.0 (5.0)	(5.0)	5.0
	L	5.0	5.0 (5.0)	5.0	5.0
	Capacitance				
CL ₁		30pF			
CL ₂		30pF			

**Dimensions in parentheses () for Freq. Range 2.0 to 2.75 MHz

CSB TYPE*

D : Offset J : In-Line	Dimensions mm	D	D	J	J	J	
		190 to 249 KHz	250 to 374 KHz	375 to 429 KHz	430 to 519 KHz	520 to 699 KHz	700 to 1250 KHz
	W	13.5	10.8	8.0	7.5	5.0	
	H	14.5	12.2	9.0	8.5	7.2	6.0
	T	3.8	3.8	3.3	3.3	2.8	2.2
	P	10.1	7.7	5.0	5.0	5.0	2.5
	L	9.0	6.7	3.5	3.5	3.5	3.5
	Capacitance						
CL ₁		330pF	220pF	120pF	100pF	100pF	100pF
CL ₂		470pF	470pF	470pF	100pF	100pF	100pF

CST TYPE*

Dimensions mm	MG	MTW	MGW	MXW
	1.80 to 2.44 MHz	6.0 to 13.0 MHz	2.45 to 6.0 MHz	13.00 to 25.99 MHz
W	10.0	10.0	10.0	10.0
H	10.0	10.0	5.0	8.0
T	5.0	5.0	5.0	5.0
P	2.5	2.5	2.5	2.5
L	5.0	5.0	5.0	5.0
CL ₁ and CL ₂ (loading capacitors) built-in.				

*For additional information, please refer to Catalog No. P-04-A

PART NUMBERING SYSTEM

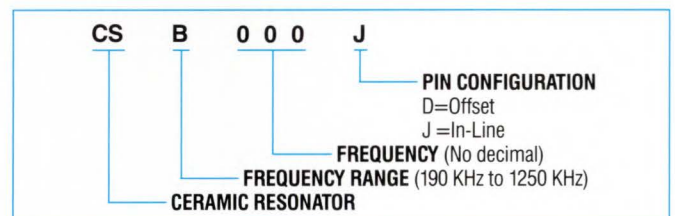
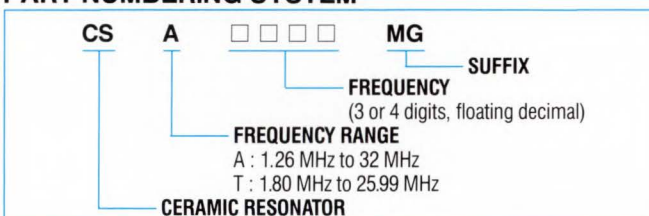

EMITTER BYPASS FILTER

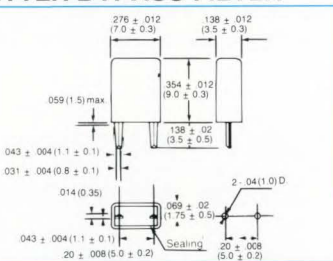

Model	Center Frequency (KHz)	3dB Bandwidth (KHz)	Ripple (dB) max.	Selectivity (dB) min.	Termination Impedance (ohms) max.
BFU455K	455±2	8 (±2KHz)	—	8 @ -9KHz 12 @ +9KHz	30 (15)

Dimensions: (mm)

CERAMIC FILTERS FOR DIGITAL COMMUNICATIONS

SFH

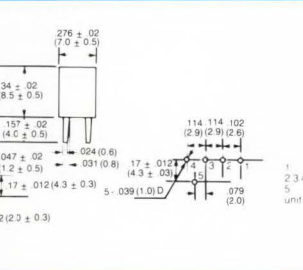

SFG

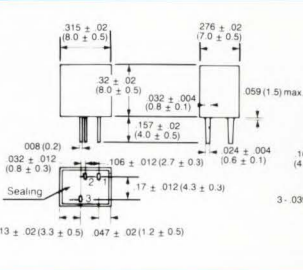

Dimensions: in. (mm)

SPECIFICATIONS

SFG 455 KHz

Part Number	Nominal Center Frequency (KHz)	6dB Bandwidth (KHz) min.	40dB Bandwidth (KHz) max.	Attenuation 455±100 KHz (dB) min.	Insertion Loss (dB) max.	Input/Output Impedance (Ω)	G.D.T. Tolerance Typ. (μsec.)*
*SFG455B	455±1.5	±15	±35	25 (455±80KHz)	5	1500	30 (±15KHz)
*SFG455C	455±1.5	±12.5	±30	25 (455±80KHz)	6	1500	30 (±12.5KHz)
*SFG455D	455±1.0	±10	±25	23	7	1500	30 (±10KHz)
*SFG455E	455±1.0	±7.5	±20	23	8	1500	30 (±7.5KHz)
*SFG455F	455±1.0	±6	±17.5	23	9	2000	20 (±6KHz)
*SFG455G	455±1.0	±4.5	±15	20	10	2000	20 (±4.5KHz)

Part Number	Nominal Center Frequency (KHz)	6dB Bandwidth (KHz) min.	50dB Bandwidth (KHz) max.	Attenuation 455±100 KHz (dB) min.	Insertion Loss (dB) max.	Input/Output Impedance (Ω)	G.D.T. Tolerance Typ. (μsec.)*
*SFH455B	455±1.5	±15	±35	35	6	1500	40 (±15KHz)
*SFH455C	455±1.5	±12.5	±30	35	7	1500	40 (±12.5KHz)
*SFH455D	455±1.0	±10	±25	35	8	1500	40 (±10KHz)
*SFH455E	455±1.0	±7.5	±15	35	9	1500	40 (±7.5KHz)
*SFH455F	455±1.0	±6	±17.5	35	10	2000	40 (±6KHz)
*SFH455G	455±1.0	±4.5	±15	35	13	2000	40 (±4.5KHz)

CERAMIC FILTERS FOR FM RADIOS

SFE Series

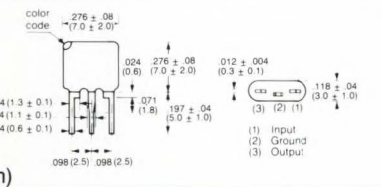

SFT 10.7 Series

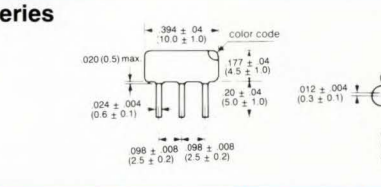

Dimensions: in. (mm)

Model	Center Frequency (MHz, ±30KHz)	3dB Bandwidth (KHz) min.	20dB Bandwidth (KHz) max.	40dB Bandwidth (KHz) max.	Ripple (dB) max.	Spurious Response (8-12MHz) (dB) min.	Insertion Loss (dB) max.	Input/Output Impedance (ohms)	Operating Temperature Range	Withstanding Voltage
*SFE 10.7MA5-A	10.7MHz ±30KHz	280±50	650	—	1.0	30	6	330	-20°C to +80°C	50V DC
*SFE 10.7MS2-A		230±50	570	—	1.0	40	6			
*SFE 10.7MS3-A		180±40	520	—	1.0	40	7			
*SFE 10.7MJA10-A		150±40	380	—	1.0	38	10			
*SFT 10.7MS3-A		180±40	—	550	0.5	(9-12 MHz) 50	7.5			
*SFT 10.7MA5-A		280±50	—	700	0.5	(9-12 MHz) 50	6.0			

*Available as standard through authorized Murata Erie Distributors.

MULTI-ELEMENT LADDER FILTERS FOR HIGH SELECTIVITY

DIMENSIONS: in. (mm)

Model	Center Frequency (KHz)	6dB Bandwidth (KHz) min.	40dB Bandwidth (KHz) min.	Spurious Response (dB) min.	Insertion Loss (dB) max.	Input/Output Impedance (ohms)
*CFU455B2	455 ± 2	± 15	± 30	27	4	1500
*CFU455C2	455 ± 2	± 12.5	± 24	27	4	1500
*CFU455D2	455 ± 1.5	± 10	± 20	27	4	1500
*CFU455E2	455 ± 1.5	± 7.5	± 15	27	6	1500
*CFU455F2	455 ± 1.0	± 6	± 12.5	27	6	2000
*CFU455G2	455 ± 1.0	± 4.5	± 10	25	6	2000
*CFU455H2	455 ± 1.0	± 3	± 9	25	6	2000
*CFU455I2	455 ± 1.0	± 2	± 7.5	25	6	2000

Model	Center Frequency (KHz)	6dB Bandwidth (KHz) min.	50dB Bandwidth (KHz) min.	Spurious Response (dB) min.	Insertion Loss (dB) max.	Input/Output Impedance (ohms)
*CFW455B	455	± 15	± 30	35	4	1500
*CFW455C	455	± 12.5	± 24	35	4	1500
*CFW455D	455	± 10	± 20	35	4	1500
*CFW455E	455	± 7.5	± 15	35	6	1500
*CFW455F	455	± 6	± 12.5	35	6	2000
*CFW455G	455	± 4.5	± 10	35	6	2000
*CFW455H	455	± 3	± 9	35	6	2000
*CFW455I	455	± 2	± 7.5	35	7	2000

Model	Nom. Center Frequency (KHz)	6dB Bandwidth (KHz) min.	50dB Bandwidth (KHz) min.	Ripple (dB) max.	Spurious Response (dB) min.	Insertion Loss (dB) max.	Input/Output Impedance (ohms)
*CFM455A	455	± 17.5	± 30	3dB within 3dB B.W. and 6dB within 6dB B.W.	50	3	1000
CFM455B	455	± 15	± 25		50	3	1000
CFM455C	455	± 13	± 23	50	3	1000	
CFM455D	455	± 10	± 20	50	3	1500	
CFM455E	455	± 8	± 16	45	5	1500	
CFM455F	455	± 6	± 12	45	5	2000	
CFM455G	455	± 4	± 10	*	45	5	2000
CFM455H	455	± 3	± 7.5	*	45	6	2000
CFM455I	455	± 2	± 5	*	45	7	2000

Model	Nom. Center Frequency (KHz)	6dB Bandwidth (KHz) min.	70dB Bandwidth (KHz) min.	Ripple (dB) max.	Spurious Response (dB) min.	Insertion Loss (dB) max.	Input/Output Impedance (ohms)
CFR455A	455	± 17.5	± 30	3dB within 3dB B.W. and 6dB within 6dB B.W.	60	4	1000
CFR455B	455	± 15	± 25		60	4	1000
CFR455C	455	± 13	± 23	60	4	1000	
CFR455D	455	± 10	± 20	60	4	1500	
CFR455E	455	± 8	± 16	55	6	1500	
CFR455F	455	± 6	± 12	55	6	2000	
CFR455G	455	± 4	± 10	*	55	6	2000
CFR455H	455	± 3	± 7.5	*	55	7	2000
CFR455I	455	± 2	± 5	*	55	8	2000
CFR455J	455	± 1.5	± 4.5	*	55	8	2000

Model	Nom. Center Frequency (KHz)	6dB Bandwidth (KHz) min.	70dB Bandwidth (KHz) min.	Ripple (dB) max.	Spurious Response (dB) min.	Insertion Loss (dB) max.	Input/Output Impedance (ohms)
CFS455A	455	± 17.5	± 30	3dB within 3dB B.W. and 6dB within 6dB B.W.	70	4	1500
CFS455B	455	± 15	± 25		70	4	1500
CFS455C	455	± 13	± 23	70	4	1500	
CFS455D	455	± 10	± 20	70	4	1500	
CFS455E	455	± 8	± 15	70	6	1500	
CFS455F	455	± 6	± 12	70	6	2000	
CFS455G	455	± 4	± 9	*	70	6	2000
CFS455H	455	± 3	± 7.5	*	70	7	2000
CFS455I	455	± 2	± 5	*	70	8	2000
CFS455J	455	± 1.5	± 4.5	*	60	8	2000

*3dB Ripple in 6dB B.W.

(Other bandwidths available.)

TV SOUND FILTERS

DIMENSIONS: in. (mm)

Model	Nominal Frequency (MHz)	3dB Bandwidth (KHz) min.	20dB Bandwidth (KHz) max.	Spurious Response (dB) min.	Insertion Loss (dB) max.	Input/Output Impedance (ohms)
*SFE 4.5 MBF	4.5	± 60	530KHz	30dB min. (3.5-4.5MHz) 20dB min. (4.5-5.3MHz)	6	1000

Model	Nominal Frequency (MHz)	30dB Bandwidth (KHz) max.	Min. Attenuation (dB min. at fo)
*TPS 4.5 MB2	4.5	50 min.	35

*Available as standard through authorized Murata Eerie Distributors.

VCXO, MINIATURE HYBRID



DIMENSIONS: in. (mm)

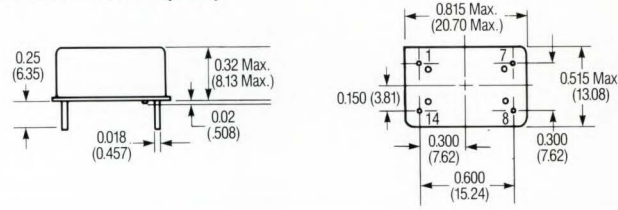

PIN	FUNCTION
1	Voltage Control Input
7	V _{EE} (-5.2V)
8	Output
14	Case & Circuit Ground

SPECIFICATIONS

Model	Features	Frequency Range	Input Voltage & Current	Output Type	Control Voltage and Freq. vs. Voltage Slope	AFC Input Impedance	Linearity	Deviation	Temp. Stability	Temp. Range
VH2340HE	High frequency fundamental crystal	15MHz to 60MHz	-5.2VDC @ 35mA Typ.	ECL "10KH"	0V to -5.0V Negative	10KΩ Min.	±20%	±100ppm	±25ppm	0°C to 70°C

TCXO, STANDARD



DIMENSIONS: in. (mm)

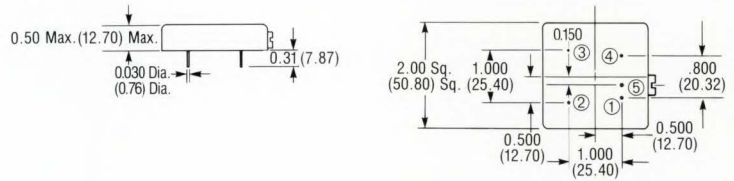

PIN	FUNCTION
1	Output
2	B+
3	Ground
4	N/C
5	Ground

SPECIFICATIONS

Model	Features	Frequency Range	Frequency Stability vs. Temperature Range	Input Voltage & Current	Output Type	Aging Rate	Frequency Adjustment
TC2140DT	High stability Very low aging	6MHz to 20MHz	±0.25ppm 0°C to +50°C	+12VDC @ 15mA max.	TTL Std.	0.2ppm/Yr.	Mechanical 10 Yr. Range Minimum

TCXO, MINIATURE



DIMENSIONS: in. (mm)

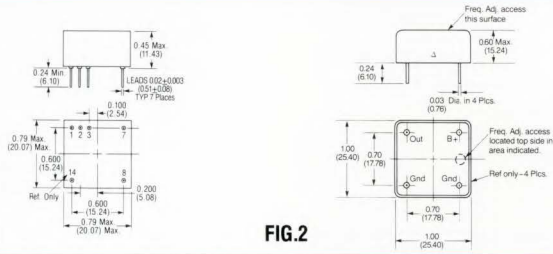

PIN	FUNCTION
1	Ground
2	RF Output
3	+VDC
7	Frequency Adj. V ref.
8	N/C
14	Frequency Adj. input

FIG. 1

FIG. 2

SPECIFICATIONS

Model	Features	Frequency Range	Frequency Stability vs. Temperature Range	Input Voltage & Current	Output Type	Aging Rate	Frequency Adjustment	Figure
TC2100CN	Requires only 0.35 cu. in. Direct replacement for K1516 Series	6MHz to 24MHz	±2ppm -40°C to +85°C	+10VDC @ 15mA max.	Sine, 1Vp-p, 1kΩ Load (Harmonics < -20dBc)	1ppm/Yr.	Electrical via Ext. Pot. or control voltage; 5 Yr. Range Minimum	1
TC2110AH	Low cost unit +5VDC operation	5MHz to 18MHz	±1ppm -20°C to +70°C	+5VDC @ 15mA max.	"HC" CMOS	1ppm/Yr.	Mechanical 10 Yr. Range Minimum	2

TCXO, HIGH FREQUENCY



DIMENSIONS: in. (mm)

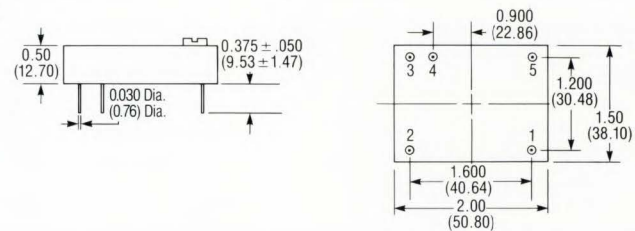

PIN	FUNCTION
1	B+
2	Ground
3	Output
4	Ground
5	Ground

SPECIFICATIONS

Model	Features	Frequency Range	Frequency Stability vs. Temperature Range	Input Voltage & Current	Output Type	Aging Rate	Frequency Adjustment	Figure
TC2170BJ	Small package; Internal freq. multiplier for better stability with fundamental crystal	24MHz to 120MHz	±1ppm -40°C to +70°C	+7.5VDC @ 40mA max.	Sine, +3dBm, 50Ω LOAD	1ppm/Yr.	Mechanical 5 Yr. Range Minimum	3
TC2180BJ	Very small package for UHF TCXO	120MHz to 500MHz	±5ppm -40°C to +70°C	+7.5VDC @ 45mA max.	Sine, +3dBm, 50Ω LOAD	2ppm/Yr.	Mechanical 5 Yr. Range Minimum	3

OCXO, HIGH STABILITY



DIMENSIONS: in. (mm)

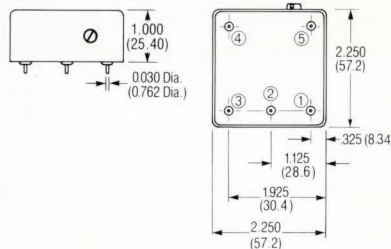

FIG. 1

PIN	FUNCTION
1	Tuning
2	N/C
3	Output
4	Case & Ckt. Gnd.
5	B+

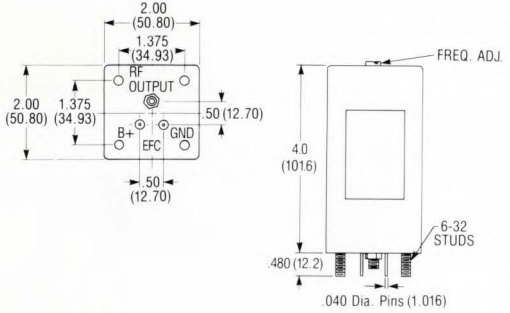
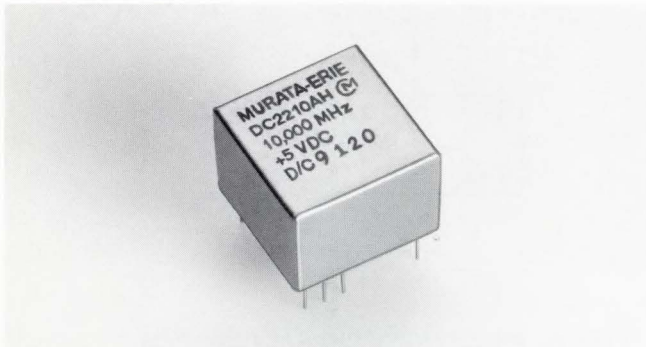

FIG. 2

SPECIFICATIONS

Model	Features	Frequency Range	Input Voltage & Power	Output Type	Electronic Freq. Control and Freq. vs. Voltage Slope	Temperature Stability	Aging	Package	Figure
OC2500ET	Low profile oven	1MHz to 20MHz	+15VDC 1.5W @ 25°C Typ. 4W max. @ turn-on	TTL	±2ppm min. for 0±5v Negative	±1×10 ⁻⁷ -20°C to +70°C	2×10 ⁻⁹ /Day	2.25×2.25×1.00	1
OC2520EK	"SC" or "IT" Cut Crystal For fast warm-up Low phase noise	5MHz to 15MHz	+15VDC 3.0W @ 25°C Typ. 15W max. @ turn-on	+7dBm into 50Ω	±2×10 ⁻⁷ min. for 0±5v Negative	±5×10 ⁻⁹ -40°C to +75°C	5×10 ⁻¹⁰ /Day	2.0×2.0×4.0	2
OC2530EJ	VHF frequency coverage	50MHz to 400MHz	+15VDC 3.0W @ 25°C Typ. 9W max. @ turn-on	+3dBm into 50Ω	±3ppm Mechanical	±1×10 ⁻⁷ -20°C to +70°C	1×10 ⁻⁹ /Day	2.0×2.0×4.0	2

DCXO, SINGLE CHIP



SPECIFICATIONS – MODEL DC221□□□

- Only one active device gives high reliability
- Low parts count for smallest size and best price
- Better stability than any other low cost TCXO

Frequency Range: 6MHz to 25MHz
 Output: "H" ("HC" CMOS)
 Spurious: -60dBc Typ.
 Input Voltage: A Std. (+5VDC)
 Input Current: 20mA Typ.
 Frequency Adjustment:
 To offset at least 10 Yrs. Aging

Frequency Stability: ($\Delta f/f$) vs.:
 Temperature: See Table
 Input Voltage: ±1×10⁻⁸/%
 Load Variation: ±1×10⁻⁸/%
 Time: 1ppm/Yr. Typ.
 Time After Turn-On:
 ±1×10⁻⁷ within 5 sec.
 Short Term (T=1 sec.): 1×10⁻⁹

Model No.	Temp. Range	Max. Freq. Error
DC2210	-40°C to +85°C	±1×10 ⁻⁶
DC2211	-20°C to +75°C	±5×10 ⁻⁷
DC2212	0°C to +70°C	±3×10 ⁻⁷
DC2213	0°C to +50°C	±2×10 ⁻⁷

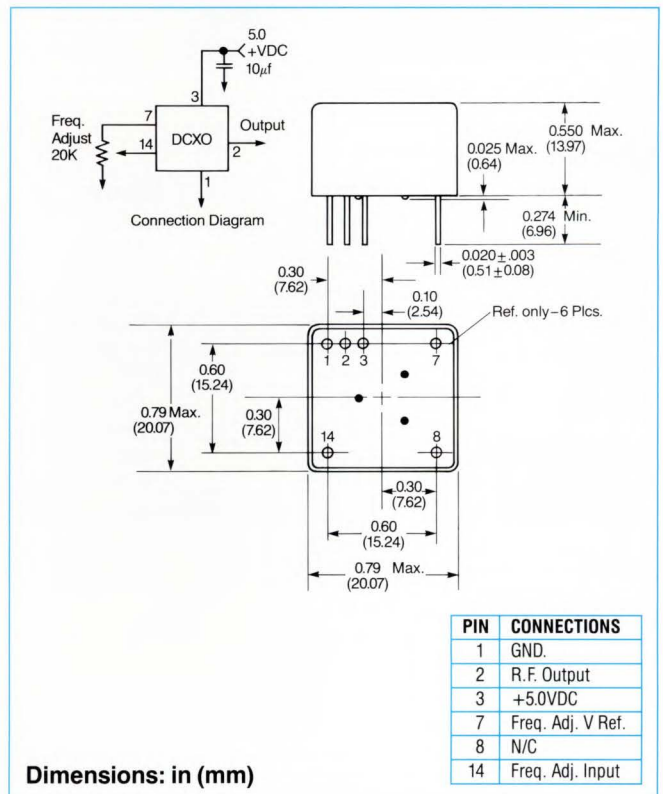

Dimensions: in (mm)

PIN	CONNECTIONS
1	GND.
2	R.F. Output
3	+5.0VDC
7	Freq. Adj. V Ref.
8	N/C
14	Freq. Adj. Input

ECL CLOCK OSCILLATOR

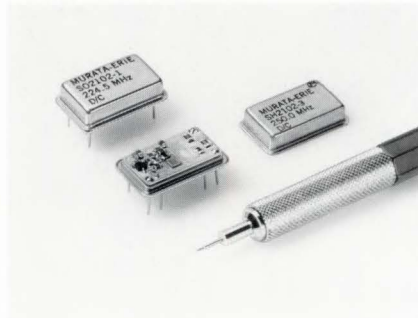

DIMENSIONS: in. (mm)

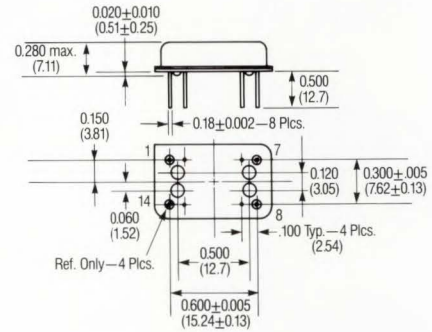
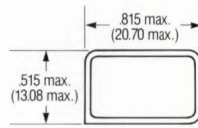

PINS	FUNCTION
1	Output Compliment
7	(Ground) V_{EE}
8	Output
14	+5 V_{CC}
2, 6, 9, 13	Ground

MODEL SH2128AF-1 SPECIFICATIONS

Features	Frequency Range	Frequency Stability vs. Operating Temp. Range	Duty Cycle	Load	Output Level	Input Voltage & Current
High Frequency, Small Package ECL 100K logic compatible High Performance	200MHz to 500MHz	± 250 ppm Max. 0°C to +70°C	50/50 $\pm 10\%$	50 ohms to -2V	ECL "100K"	+5VDC @ 120mA Max. (-5.2VDC Optional)

MINIATURE OXO



SPECIFICATIONS

MODEL	OC2541 DT	OC2545 DT
Features	Very low cost for High stability "SC" cut osc. Low phase noise Small package	Low cost High stability Low phase noise Small package
Frequency Range	5MHz to 20MHz	5MHz to 20MHz
Input Voltage and Power	+12VDC @ 250mA max. (90mA Typ.)	+12VDC @ 250mA max. (90mA Typ.)
Output Type	TTL 50/50 duty cycle	TTL 50/50 duty cycle
Electronic Freq. Control: Freq. vs. Voltage	± 1 ppm min., 0 to +10VDC	± 4 ppm min., 0 to +6VDC
Temperature Stability	± 0.01 ppm Typ., 0°C to +50°C	± 0.05 ppm Typ., 0°C to +50°C
Aging	0.15ppm/Yr.	0.3ppm/Yr.
Package	1.39"x1.06"x1.00"	1.39"x1.06"x1.00"

OC2541, 2545

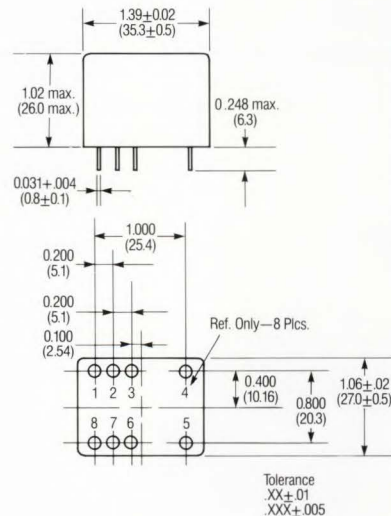

PIN	FUNCTION
1	Output
2	N/C
3	N/C
4	Ground
5	N/C
6	Control Voltage
7	N/C
8	+12V

TYPICAL PHASE NOISE CHARACTERISTICS

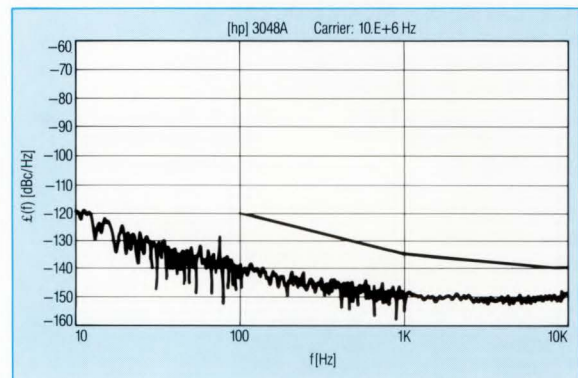

DIELECTRIC RESONATORS (DR)-RESONATORS

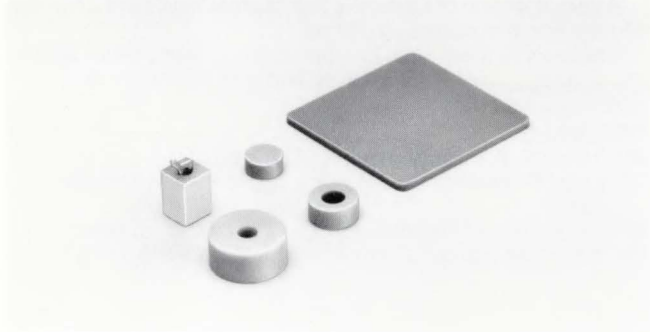

Murata Erie offers a complete line of dielectrics with high permittivity that make excellent resonators for microwave oscillators and filters.

TE mode resonators are offered in both disc and coaxial cylinder configurations while TEM mode units are offered in 1/4 and 1/2 wavelength models. Substrates offer high Q's and dielectric constants making them ideal for applications in Microwave Integrated Circuits (MIC).

FEATURES

- 400 MHz to 30 GHz Frequency Range
- High Unloaded Q
- High Dielectric Constant
- Wide Temperature Coefficient Range: -4 to +10 ppm/°C

DUPLEXERS

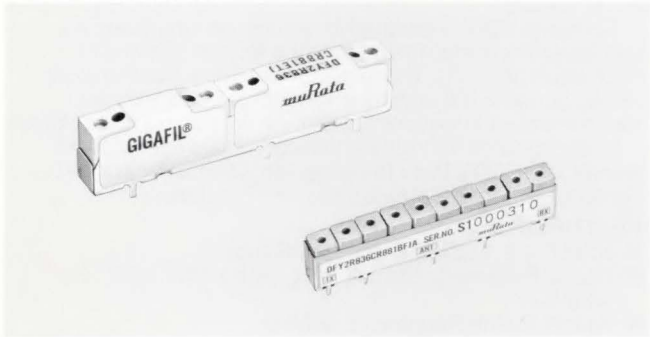

Murata Erie offers a complete selection of dielectric resonator-based Duplexers. Three versions are included—single package, separated pair and separated.

FEATURES

- Low insertion loss through the use of high Q dielectric resonators.
- Small and light.
- Excellent temperature stability through temperature compensated dielectric constant (0 ± 5ppm/°C max.)
- Excellent mechanical stability.
- High power ratings.

DIELECTRIC MICROWAVE FILTER (GIGAFIL®)

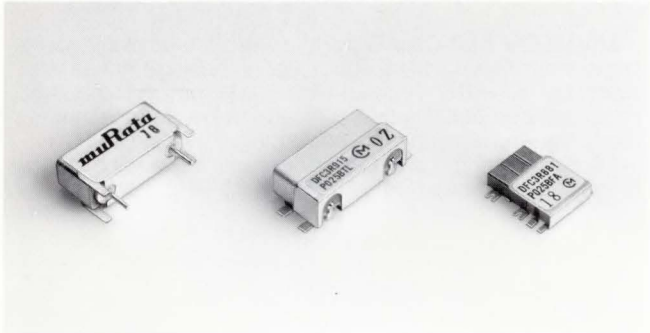

Murata Erie offers a wide selection of dielectric resonator-based filters (Gigafils®) specifically designed for telecommunications applications.

These microwave filters are based on Dielectric Resonator technology and cover the frequency range from 400 MHz to 3 GHz. They offer extremely good temperature stability (± 5 ppm/°C), high selectivity and low insertion loss. Applications include CMT, GPS, Data Transmission, Navigation Systems, Cordless Telephones, Land Mobile Radio (LMR) and Spread Spectrum Systems.

ISOLATORS

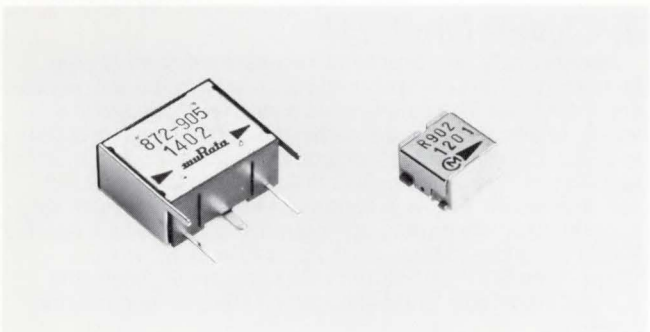

Murata Erie microwave isolators feature small size for surface mounting combined with excellent electrical performance. Typical isolation is 12dB with an insertion loss of 0.9dB. Power ratings 2.5 to 10W depending on model.

These ferrite devices are used as interstage matching devices to absorb antenna mismatching and maintain stable transmission.

Applications include Cellular Mobile Telephone (CMT), Microwave Test Equipment, etc.

FEATURES

- Power Ratings from 2 to 10 Watts
- 15 dB min. Isolation
- Less than 1 dB Insertion Loss
- Sizes Ranging From 6.9 mm × 6.8 mm × 4 mm to 15 mm × 15 mm × 9 mm
- Surface Mount Packages Available

DIELECTRIC RESONATOR OSCILLATORS (DRO)

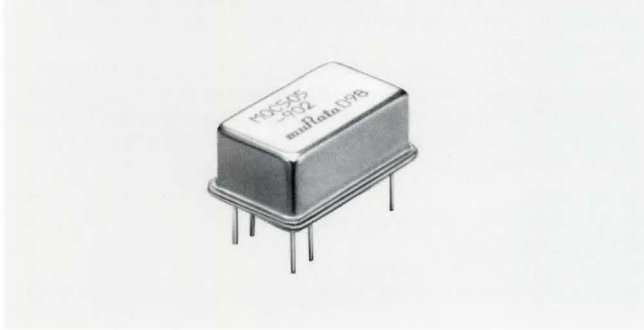

A complete line of Dielectric Resonator Oscillators, utilizing Murata Erie resonators, is offered.

These DRO's are ideal for application in Microwave Communications, DBS, TVRO, CATV, Network Analyzers and Satellite Communications.

FEATURES

- 10 GHz to 11.5 GHz Frequency Range
- Typical Frequency Stability of ± 1 MHz from -40°C to $+60^{\circ}\text{C}$
- Typical Power Output of $+7$ dBm into a 50 Ohm Load
- Case Sizes Ranging from 20 mm \times 12 mm \times 9.5 mm

VOLTAGE CONTROLLED OSCILLATORS (VCO)

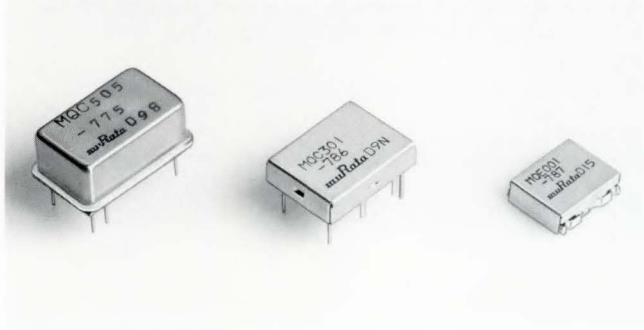

Compact VCO's designed for mobile communications applications are also included in the Murata Erie line of microwave products.

These devices are designed for local oscillator use in the high MHz ranges and offer excellent mechanical and frequency stability in very compact packages.

These devices find wide application in Cellular Mobile Telephone (CMT), Data Transmission, Global Positioning System (GPS) and Spread Spectrum Products.

FEATURES

- 400 MHz to 1.5 GHz Frequency Range
- Typical Frequency Stability of ± 2 MHz from -35°C to $+80^{\circ}\text{C}$
- Typical Tuning Range of ± 12 MHz

MONOLITHIC CHIP LC FILTER

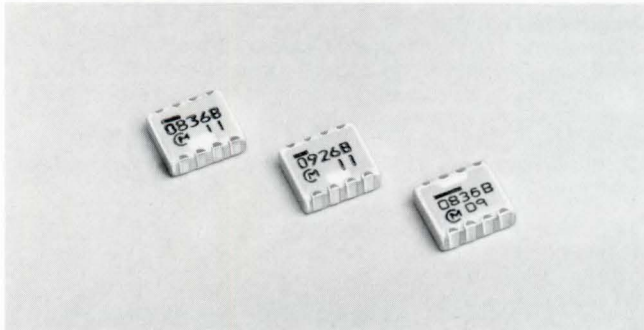

Murata Erie's LC Chip Filter offers an alternative to discrete component filtering. Monolithic layer technology makes the small size, 5.7x5.0x2.2mm and 4.5x3.2x1.5mm, possible. Additional features include integral metal shields, surface mount capability, and tape and reel packaging. The filters are available in bandpass and lowpass responses and cover a range of frequencies from 250 MHz to 3.0 GHz.

MONOLITHIC DIRECTIONAL COUPLER/POWER DIVIDER

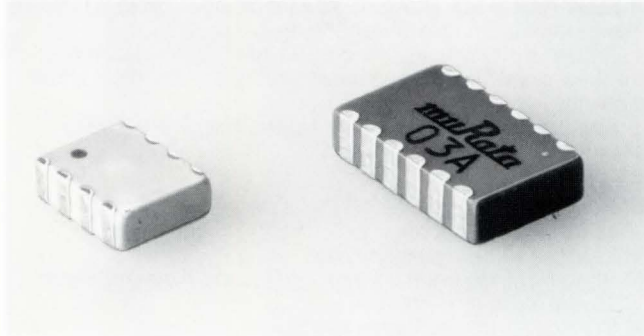

Murata Erie's new directional couplers utilize multi layer technology to reduce the board space associated with conventional couplers. The couplers are available to operate in a variety of frequency ranges within the overall range of 800MHz to 3GHz. Coupling values include 10, 14, and 18dB with other options possible. A 3dB power divider is also available with 90° phase shift. Package options on both these devices vary depending on the power and frequency specifications needed. Package options include 4.5 \times 3.2 \times 2.0mm, 5.0 \times 4.0 \times 2.0mm, and 8.0 \times 5.0 \times 2.1mm. All parts are IR reflowable, surface mountable, and packaged on tape and reel for auto insertion.

**FEATURES**

- Utilizes high dielectric constant ($\epsilon_r =$ approx. 21.4) and high Q magnesium titanate ceramic
- Integral GaAs FET LNA
- Excellent temperature performance
- Small size and low profile
- Wide directivity
- Low cost

ELECTRICAL SPECIFICATIONS* – ANTENNA

Model	ANT0008/ANT0033	ANT0017	ANT0037
Center frequency	1575.42MHz	1580MHz	1575.42MHz
Polarization	R.H.C.P.	R.H.C.P.	R.H.C.P.
Absolute gain	0dBi min. above 20° -5dBi min. for 5° to 20°	0dBi min. above 20° elevation -5dBi min. above 5° elevation	0dBi min. above 20° elevation -5dBi min. above 5° elevation
Axial ratio	3dB max. for 90°	3dB max. at 90° elevation	3dB max. at 90° elevation
VSWR	1.5:1 max.	2:1 max.	1.5:1
Impedance	50Ω	50Ω	50Ω
Bandwidth	2MHz min. (VSWR ≤ 1.5:1)	2MHz min. (VSWR ≤ 2:1)	2MHz min. (VSWR ≤ 1.5:1)

ELECTRICAL SPECIFICATIONS* – LNA

Model	ANT0008/ANT0033	ANT0017	ANT0037
Center frequency	1575.42MHz	1575.42MHz	1575.42MHz
Power gain (P.G.)	20dB min.	20dB min. (except cable loss)	28±3dB
Noise figure	1.5dB max.	1.5dB max. (except cable loss)	2.5dB max.
VSWR	2:1 max.	2:1 max.	2:1 max.
Impedance	50Ω	50Ω	50Ω
Passband width	20MHz min. (P.G. 3dB down)	20MHz min. (N.F. ≤ 1.5dB)	80MHz max. (P.G. 3dB down)
Supply voltage	5±0.5V	5±0.5V	5±0.5V
Current consumption	20mA max.	20mA max.	30mA max.

*At 20°C

SPECIFICATIONS – COMPLETE ASSEMBLY

Overall Dimensions	ANT0008 : 70mm × 70mm × 20mm ANT0033 : 70mm × 70mm × 20.5mm ANT0037 : 70mm × 70mm × 20.5mm	42mm D × 13mm H
Operating Temperature Range	-30°C to +85°C	
Storage Temperature Range	-40°C to +100°C	

**Installed at the center of 90cm × 90cm ground plane

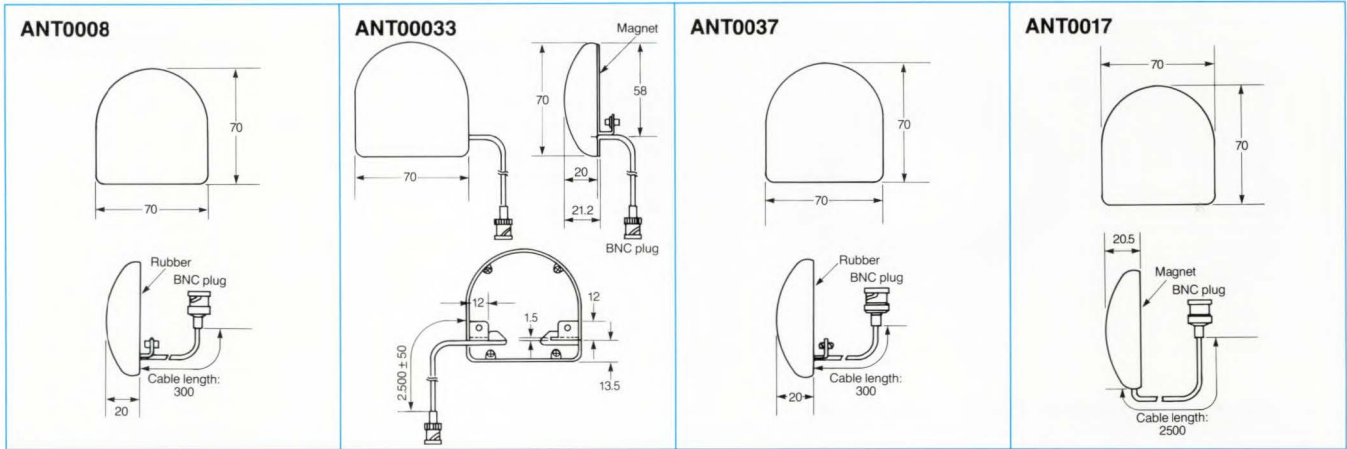

TYPICAL PERFORMANCE

ANT0008
Radiation Pattern (with LNA)

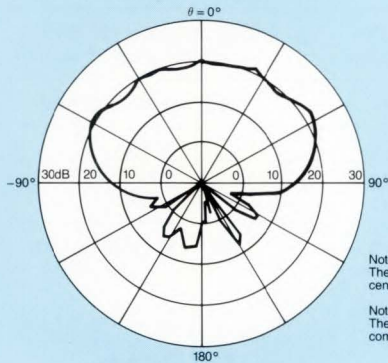

Note 1:
The GPS antenna is installed on the center of 90cm×90cm ground plane.
Note 2:
The GPS antenna gain with a LNA is comparison value with dipole antenna.

Return Loss

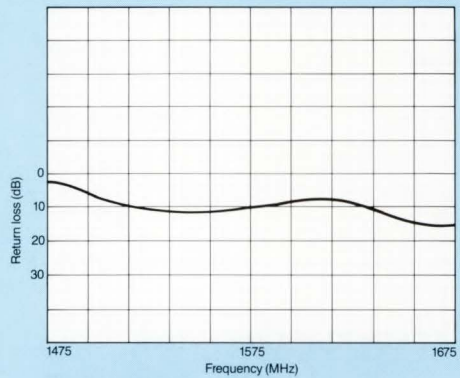

ANT0017
Radiation Pattern (with LNA)

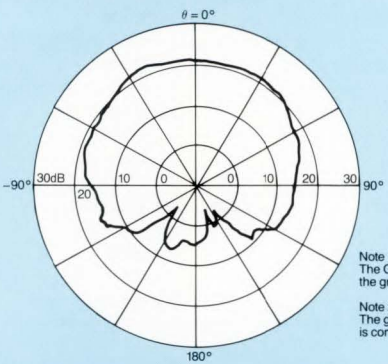

Note 1:
The GPS antenna is not installed around the ground plane.
Note 2:
The gain of GPS antenna unit with a LNA is comparison value with dipole antenna.

Return Loss

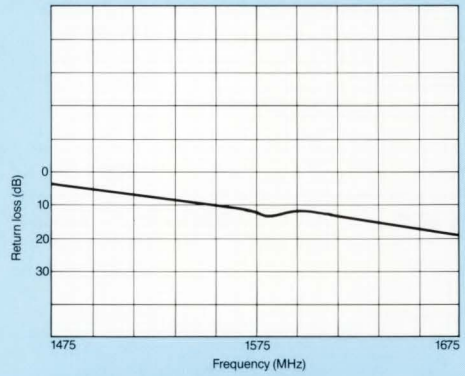

ANT0037
Radiation Pattern (with LNA)

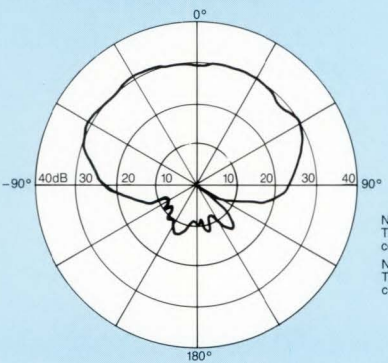

Note 1:
The GPS antenna is installed on the center of 90cm×90cm ground plane.
Note 2:
The GPS antenna gain with a LNA is comparison value with dipole antenna.

Return Loss

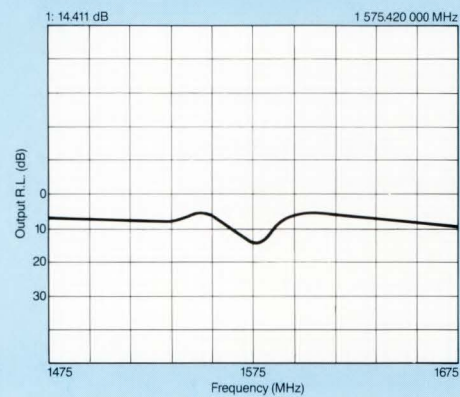

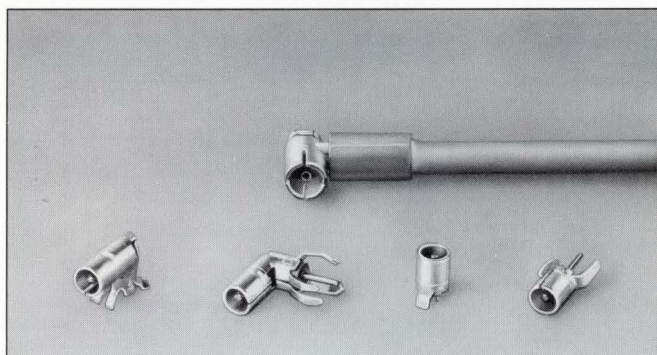

FEATURES

- Micro miniature and low profile
- Low leakage
- High performance at high frequencies
- Low price
- Available cable assembly
- Available for ultra-thin coaxial cables

APPLICATIONS

Portable telephones, mobile telephones, cordless telephones, oscilloscope, GPS, microwave equipment

PART NUMBERING

Part Number	Description
MM3325-2505	Straight jack connector for printed circuits (with male contact)
MM3325-2507	Straight jack connector with insulation spacer for printed circuits (with male contact)
MM3326-2506	Right angle jack connector for printed circuits (with male contact)
MM3327-2514	Straight plug receptacle for use on printed circuit boards — mates with MM3325-2505
MX YH □ □ □ □ □ □ □ □	Right angle plug connector for flexible cables assembly (with female contact) See table on right.

ELECTRICAL SPECIFICATIONS

Item	Rating
Voltage	250V r.m.s.
Frequency	DC to 4GHz
	DC to 2GHz (MM3326-2506 and MM3327-2514 only)
Nominal Impedance	50Ω
Temperature Range	-40°C to +90°C
Insulation Resistance	1000MΩ
Contact Resistance	10mΩ
Withstanding Voltage	300VAC r.m.s.
V.S.W.R.	1.2 Maximum

MATERIALS AND FINISH

Part Name	Materials	Finish
Center Contact	Beryllium copper or Brass	Gold plated
Outer Contact	Phosper bronze	Silver plated or Nickel plated
Insulator	Poly-phenylene sulfide or Poly-butylen terephthalate	None
Outer Sleeve	Brass	Zinc plated

PART NUMBERING FOR CABLE ASSEMBLY

MX
YH
62
XX
200
0

1
2
3
4
5
6

1 Cable assembly
2 4 Cable termination connector code

Number	Connector
YH	MM3621-5901
XX	No Connector

3 Cable number

Number	Cable	Outer Diameter	Outer Conductor	Insulation Mtl.
62	0.8D-QEW	2.5mm	Double Shield	Polyvinylchloride
63	0.8D-QEV	2.0mm	Single Shield	Polyvinylchloride
75	CO-6F-DSB-CX50	1.5mm	Double Shield	FEP High Temp. Res.

5 6 Full length of cable assembly
 Length L (mm) = 5 × 10⁶
 Ex. 100mm = 10⁰ × 100 → 1000
 500mm = 500 × 10⁰ → 5000
 1000mm = 100 × 10¹ → 10001

FULL LENGTH TOLERANCE

Full Length (mm)		Dimensional Tolerance (mm)
Over	Max.	
50	100	± 3
100	500	± 4
500	1000	± 10
1000	—	+2% 0

TYPICAL V.S.W.R.

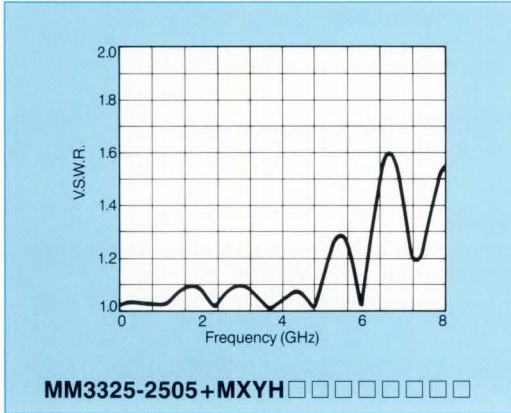

TYPICAL RF LEAKAGE

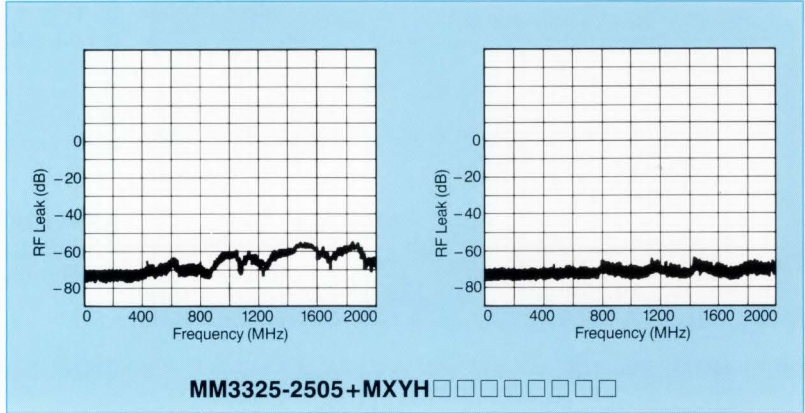

DIMENSIONS: mm

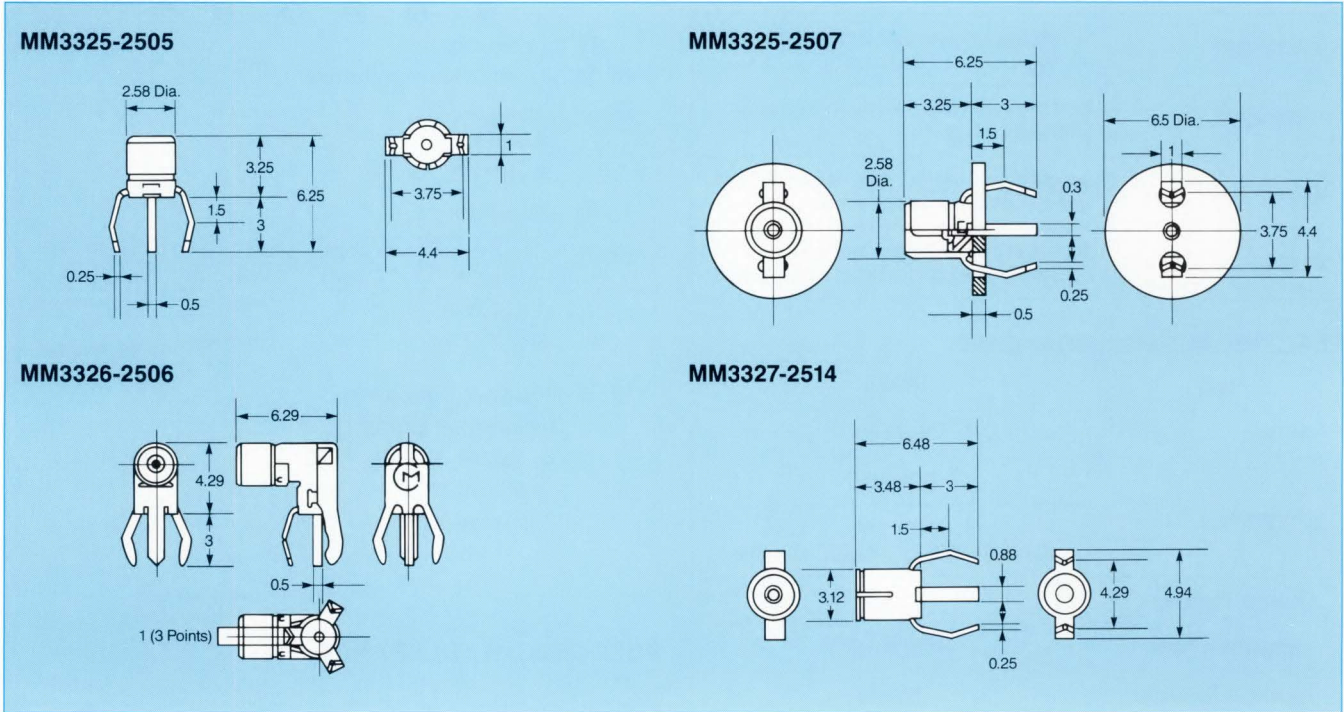

DIMENSIONS: mm

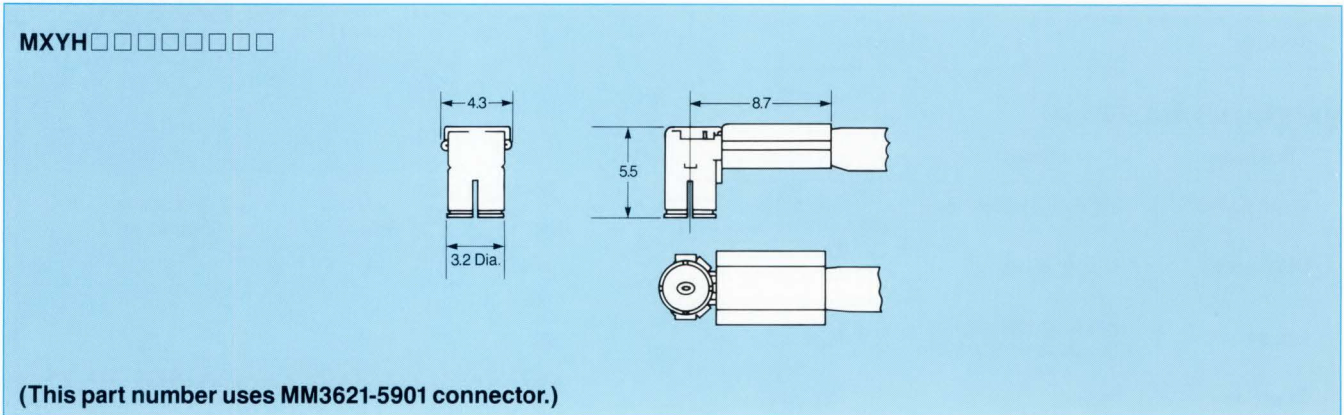

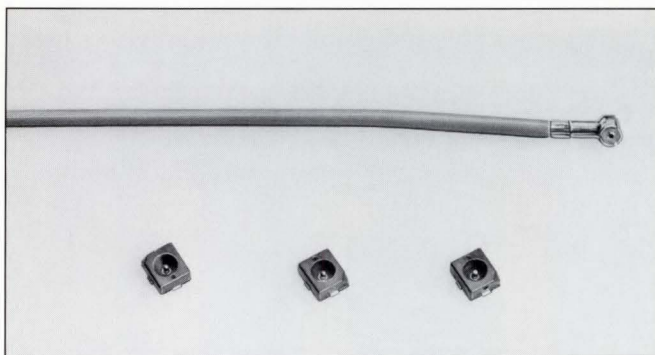

FEATURES

- Micro miniature, low profile (4.2mm max.)
- For SMT and reflow soldering
- Tape and reel available
- High performance (V.S.W.R. 1.2 max. at 2GHz)
- Available for ultra-thin coaxial cables

APPLICATIONS

Portable telephones, mobile telephones, cordless telephones, GPs, other microwave equipment

PART NUMBERING

Part Number	Description	Packaging	Quantity
MM4329-2700	Straight receptacle for printed circuit board. (Center contact shape : Pin)	Bulk package	Free
MM4329-2700TB1		178mm reel	500pcs/reel
MM4329-2700TB2		330mm reel	3000pcs/reel
MXSG63□□□□□□	Right angle cable assembly with flexible cable. (Center contact shape : Socket)		—

ELECTRICAL SPECIFICATIONS

Item	Rating
Voltage	250V r.m.s.
Frequency Rating	DC to 2GHz
Nominal Impedance	50Ω
Temperature Range	-40°C to +90°C
Insulation Resistance	500MΩ Minimum
Contact Resistance	15mΩ Maximum
Withstanding Voltage	300VAC r.m.s.
V.S.W.R.	1.2 Maximum

**MATERIALS AND FINISH
MM4329-2700**

Part Name	Materials	Finish
Center Contact	Stainless Steel	Gold plated
Outer Contact	Stainless Steel	Gold plated
Insulator	Poly-phenylene Sulfide	None

MXSG63□□□□□□

Part Name	Materials	Finish
Center Contact	Beryllium Copper	Gold plated
Outer Contact	Phosphor Bronze	Gold plated and Nickel plated
Insulator	Fiber Reinforced Polypropylene	None

PART NUMBERING FOR CABLE ASSEMBLY

MX
SG
62
XX
200
0

1
2
3
4
5
6

① Cable assembly
② ④ Connector code

Number	Connector
SG	CCR type Plug connector
XX	No Connector

③ Cable number

Number	Cable	Outer Diameter	Outer Conductor Construction	Minimum Bending Radius
63	0.8D-QEV	2.0mm	Single Shield	Polyvinylchloride
75	CO-6F-DSB-CX50	1.5mm	Double Shield	FEP High Temp. Res.

⑤ ⑥ Full length of cable assembly
Length L (mm) = ⑤ × 10^⑥
Ex. 500mm = 500 × 10⁰ → 5000
1000mm = 100 × 10¹ → 10001

FULL LENGTH TOLERANCE

Full Length (mm)*		Dimensional Tolerance (mm)
Over	Max.	
50	100	± 3
100	500	± 4
500	1000	± 10
1000	—	Total Length ⁺² / ₀ %

*L=50mm Min.

DIMENSIONS: mm

MM4329-2700

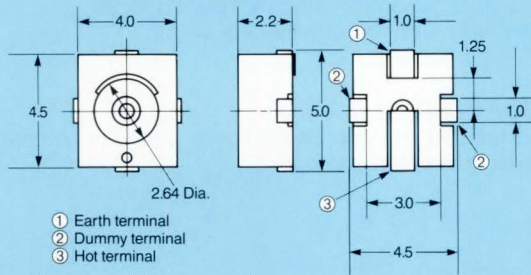

MXSG63 □ □ □ □ □ □

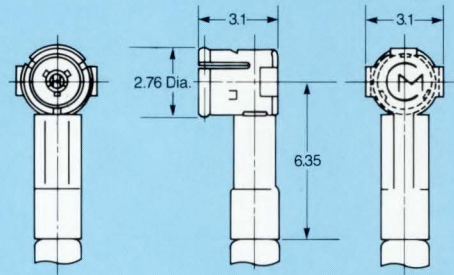

TAPE DIMENSIONS: mm

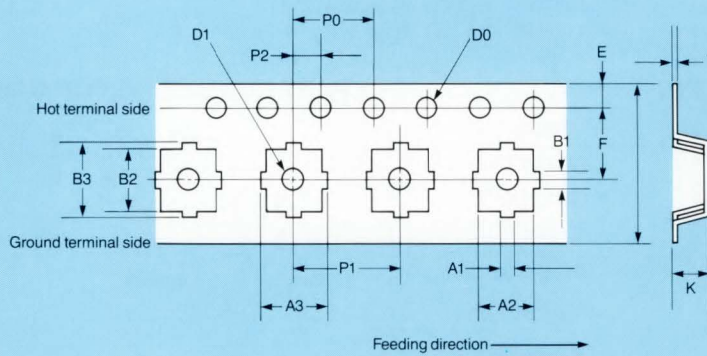

A1	A2	A3	B1	B2	B3	W	D0	D1
1.4	4.2	5.2	1.4	4.7	5.7	12±0.2	φ1.5 ^{+0.1} ₀	1.5MIN.

E	F	K	P0	P1	P2	T
1.75±0.1	5.5±0.1	2.6±0.1	4±0.1	8±0.1	2±0.1	0.3

A1, A2, A3, B1, B2 AND B3 are the bottom dimensions of the cavity.

DISENGAGEMENT TOOL

M17000

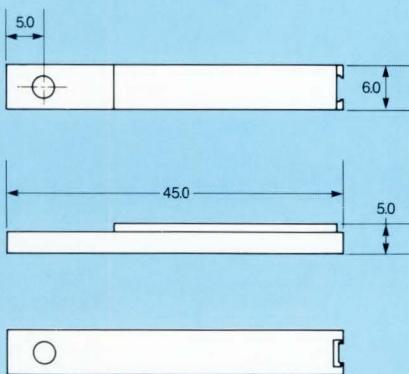

DISENGAGEMENT TOOL APPLICATION

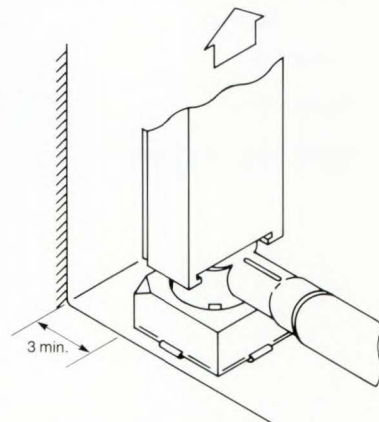

BLM21, BLM31, & BLM41 Series

This new series of solid, ferrite chips for surface mount applications is designed to reduce the possibility of spurious oscillation in high frequency amplifying circuits and operate effectively from several MHz to several hundreds of MHz. Because of their small size, they are mountable on 2.5 mm c-c pitch thus saving considerable PCB space.

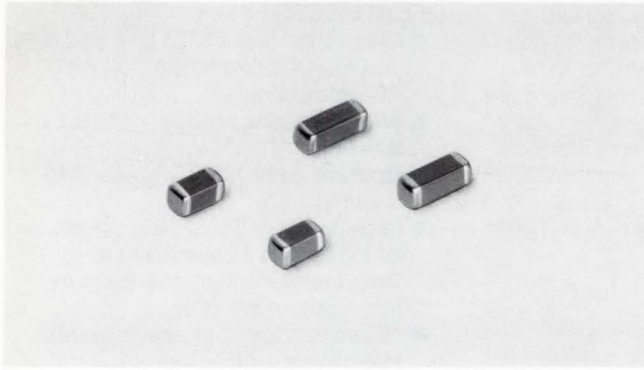

FEATURES

- Surface mountable on 2.5 mm pitch (BLM21 Series 2.0 mm)
- No stray capacitance to 1 GHz
- Wide temperature range: -55°C to $+125^{\circ}\text{C}$
- Effective noise suppression to several hundreds of MHz
- Prevents oscillation in HF amplifiers
- Nickel barrier for solder heat resistance
- Suitable for both flow and reflow soldering applications

DIMENSIONS: in. (mm)

ELECTRICAL CHARACTERISTICS

	Part Number*	Characteristics		
		Impedance (Ω) (Typ.) at 100MHz	Rated Current (mA)	DC Resistance (Ω max.)
0805 	★ BLM21A05	120	200	0.6
	★ BLM21B03	5 (27 @ 1GHz)	500	0.2
	★ BLM21A10	600	200	1.5
1206 	★ BLM31A02	70	200	0.5
1806 	★ BLM41A01	80	500	0.3
	★ BLM41A04	150	200	0.7

Suffix=PB=Bulk, Suffix=PT=Tape & Reel

IMPEDANCE VS. FREQUENCY CHARACTERISTICS

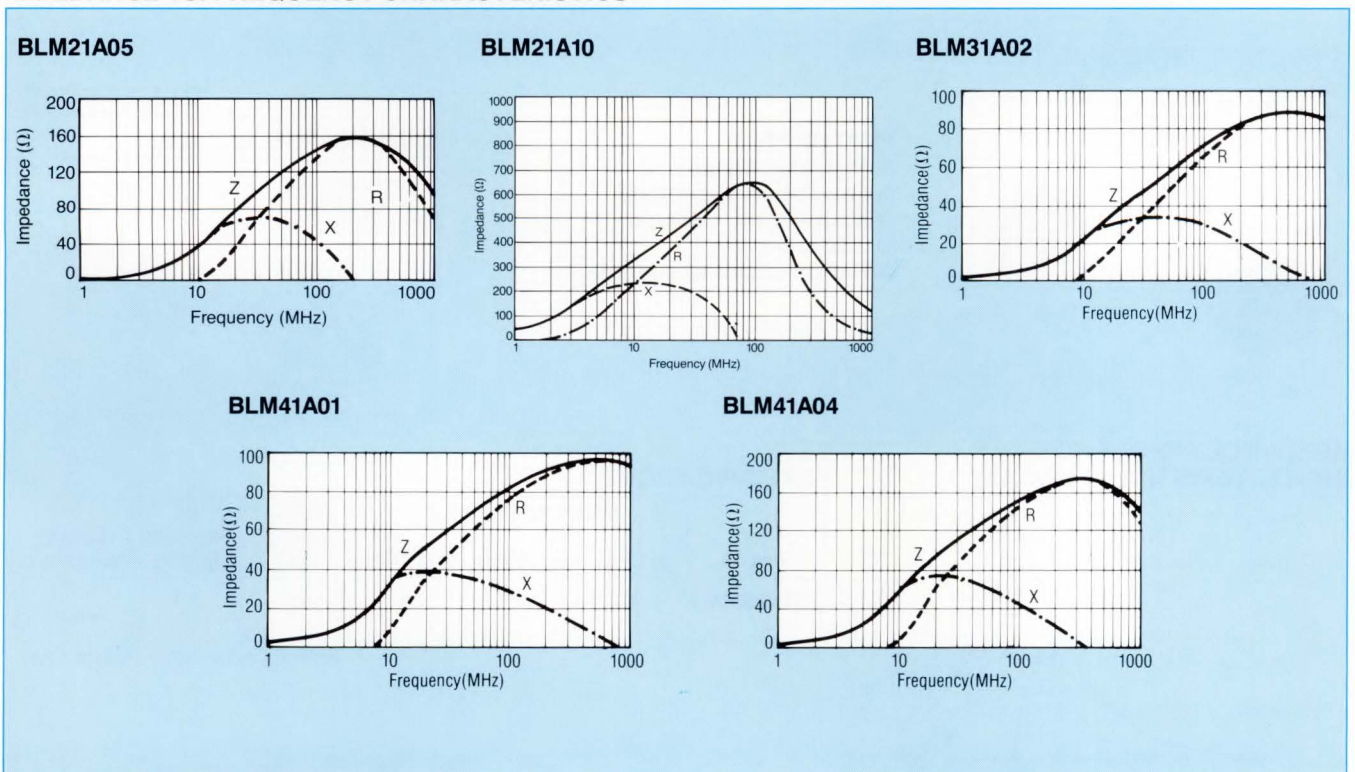

All values are standard through authorized Murata ERIE Distributors.

EMI SUPPRESSION FILTERS SURFACE MOUNT FERRITE CHIPS

BLM32 Series

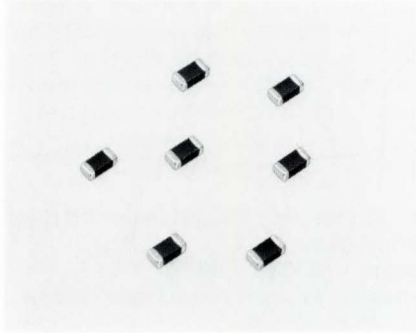

Murata Erie's new BLM32A06 and BLM32A07 are the newest development in the BLM Series of ferrite inductive devices for surface mounting. These new devices can replace inductors in many applications where a series inductor is needed for filtering or RF signal isolation. They provide a very high impedance over the frequency range of from 1 MHz to 500 MHz.

APPLICATIONS

Computers and peripherals, Power supplies, Telephone equipment, Automotive electronics, Consumer electronics.

FEATURES

- **Small size.** Just .126 (3.2) × .063 (1.6) × .043 (1.1) allows .098 (2.5) c-c PCB mounting.
- **Wide frequency range...** 1 MHz to 500 MHz.
- **Operating temperature** -55°C to +125°C.
- **Impedance of BLM32A06 is 6 ohms, BLM32A07 is 40 ohms at 1 MHz. Both feature an impedance over 600 ohms at 100 MHz.**
- **Nickel barrier electrode prevents leaching during soldering.**

DIMENSIONS: in. (mm)

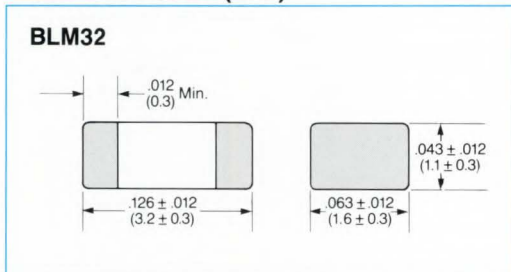

SPECIFICATIONS

Part Number*	Typical Z @ 100 MHz	I (mA)	DC Resistance (Ω) Max.
★ BLM32A06	600	200	1.0
★ BLM32A07	600	200	1.0

Suffix=PB=Bulk, Suffix=PT=Tape & Reel

IMPEDANCE VS. FREQUENCY CHARACTERISTICS

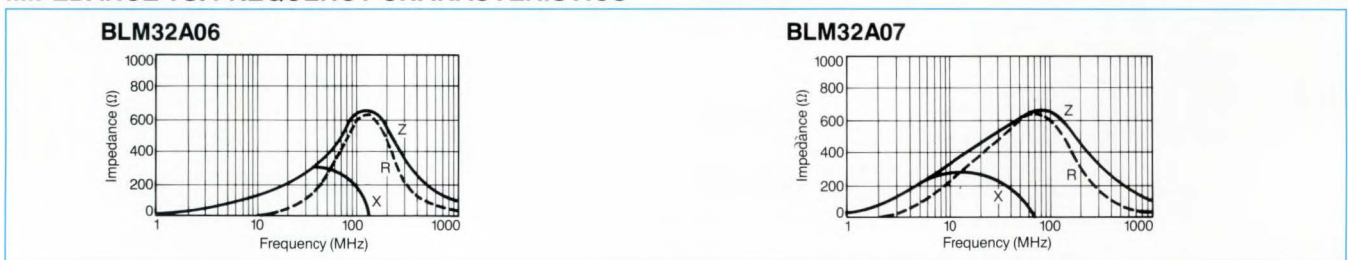

SURFACE MOUNT CHIP INDUCTOR

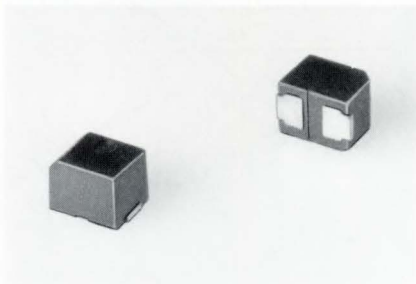

FEATURES

- High impedance
- Low Q/Low distortion
- Magnetically shielded
- 0.5A rating
- High mechanical strength

BLM55OR

DIMENSIONS: in. (mm)

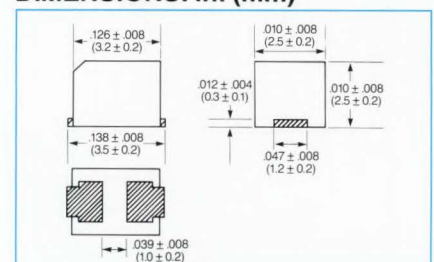

IMPEDANCE FREQUENCY CHARACTERISTICS (TYPICAL)

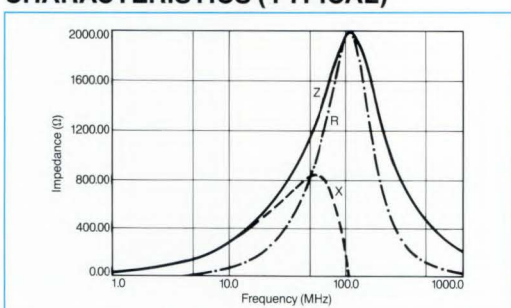

SPECIFICATIONS

Part Number	Impedance (Ω) (Typical)			Rated Current (mA)	DC Resistance (Ω min.)	Operating Temperature
	at 1 MHz	at 100 MHz	at 300 MHz			
★ BLM550RA01	30	2000	800	500	0.7	-25 to +85°C

Suffix=PB=Bulk, Suffix=PT=Tape & Reel

*All values are standard through authorized Murata Erie Distributors: Standard packaging is tape and reel.

NFM41R & NFM61R Series

The new NFM Series of surface mount EMI filters are true feed-thru EMI/RFI filters; the NFM41R providing an SM feed-thru capacitor in various values and the NFM61R providing series ferrite bead inductors, in addition to a capacitor, on both the input and output sides of the filters. Applications for these new filters include filtering of DC power lines in all types of data processing and instrumentation equipment because of their high current capacity.

FEATURES

- Excellent insertion loss characteristics
- Wide frequency range of operation...to several hundred MHz
- Tape and reeled for auto-placement
- High current capability
- High solder heat resistance

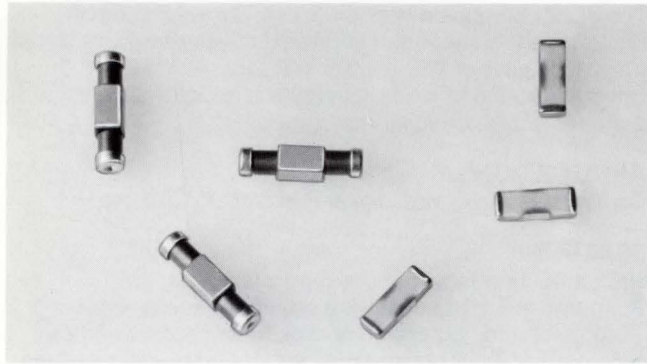

SPECIFICATIONS

DIMENSIONS: in. (mm)	Part Number*	Capacitance	Insulation Resistance	Rated Voltage	Rated Current	DC Resistance	Operating Temp. Range	Temp. Char.
	*NFM41R00C220	22pF ± 50/20%	1000MΩ min.	100V DC	300mA DC	0.3Ω max.	-55°C to +125°C	±15%
	*NFM41R00C470	47pF ± 50/20%						
	*NFM41R00C101	100pF ± 50/20%						
	*NFM41R00C221	220pF ± 50/20%						
	*NFM41R00C471	470pF ± 50/20%						
	*NFM41R10C102	1000pF ± 50/20%						
	*NFM41R10C222	2200pF ± 50/20%	1000MΩ min.	50V DC	2A DC	0.05Ω max.	-25°C to +85°C	±10%
	*NFM41R10C223	22000pF ± 50/20%						
	*NFM61R00T330	33pF ± 30%						
	*NFM61R00T680	68pF ± 30%						
	*NFM61R00T101	100pF ± 30%						
	*NFM61R00T181	180pF ± 30%						
	*NFM61R00T361	360pF ± 20%						
	*NFM61R00T681	680pF ± 30%						
	*NFM61R10T102	1000pF ± 80/20%						
	*NFM61R30T472	4700pF ± 80/20%						

HIGH TEMPERATURE SERIES

Part Number	Capacitance	Insulation Resistance	Rated Voltage	Rated Current	Operating Temp. Range
NFM61RH00T330	33pF ± 30%	1000MΩ min.	100V DC	2A DC	-55°C to +125°C
NFM61RH00T680	68pF ± 30%				
*NFM61RH00T101	100pF ± 30%				
*NFM61RH00T181	180pF ± 30%				
*NFM61RH00T361	360pF ± 20%				
NFM61RH00T681	680pF ± 30%				
*NFM61RH10T102	1000pF ± 80/20%				
NFM61RH20T332	3300pF ± 80/20%				

*Marked items are not standard item.

NFM61RH20T332 is specially adapted for reflow soldering. The flow soldering method should not be used. Suffix=B1=Bulk Suffix=T1=Tape & Reel

EQUIVALENT CIRCUITS



INSERTION LOSS/FREQUENCY CHARACTERISTICS

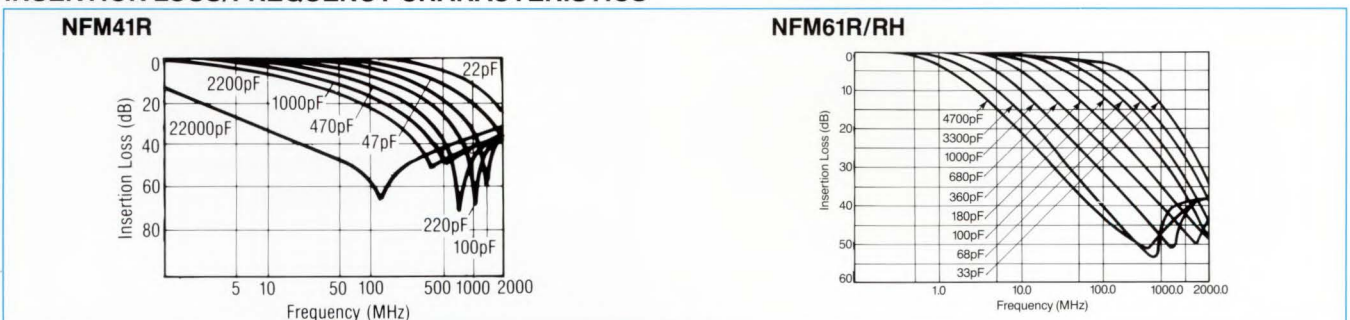

* All values are standard through authorized Murata Erie Distributors: Standard packaging is tape and reel.

EMI SUPPRESSION FILTERS SURFACE MOUNT CHIP FERRITE BEAD ARRAY

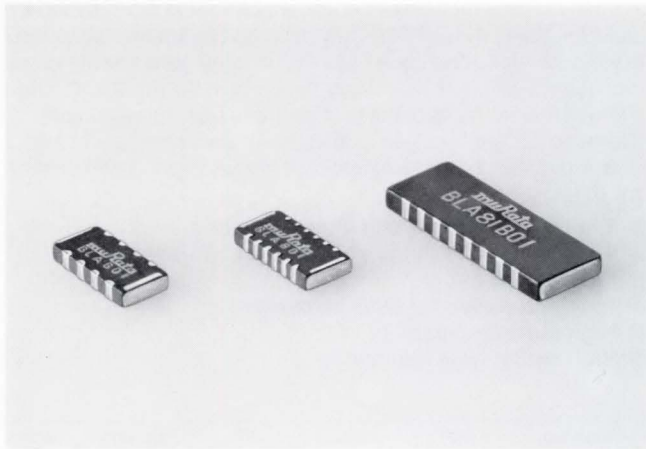

BLA81 Series

The BLA81 Series is a chip ferrite bead array for surface mounting applications and excellent for high-density mounting with a land pitch of .050 (1.27) or .031 (0.8).

It is well suited for noise suppression in digital circuit boards or the I/O cables of digital instruments.

APPLICATIONS

Computers, peripherals, digital TVs, digital VCRs, etc.

FEATURES

- Excellent for high-density mounting.
- Unique electrode structure provides excellent noise suppression and excellent cross-talk characteristics.
- Nickel barrier structure of external electrodes provides excellent solder heat resistance.
- Operating Temperature Range: -55°C to $+125^{\circ}\text{C}$.

SPECIFICATIONS

Part Number	Impedance (Typ.) at 100MHz	Rated Current	Operating Temperature Range
*BLA81B01	70Ω	300 mA	-55 to $+125^{\circ}\text{C}$
*BLA62B01		200 mA	
*BLA41B01		200 mA	

PART NUMBERING

Chip Solid Inductor Array	Number of Circuit and Terminal Pitch	Characteristics	Packaging Code
	81: 8 circuit 1.27mm pitch		T1 = Tape & Reel
	62: 6 circuit 0.80mm pitch		B1 = Bulk
	41: 4 circuit 1.27mm pitch		

DIMENSIONS: in. (mm)

*BLA81

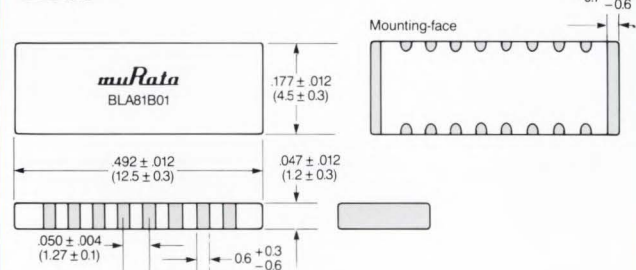

BLA62

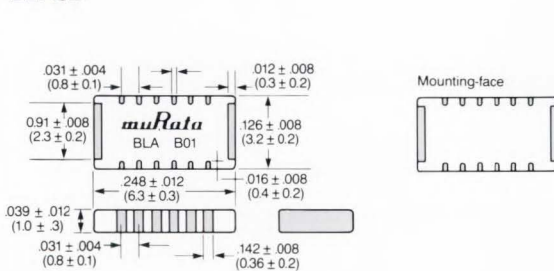

BLA41

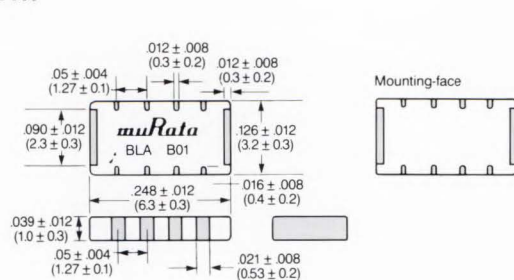

EQUIVALENT CIRCUIT

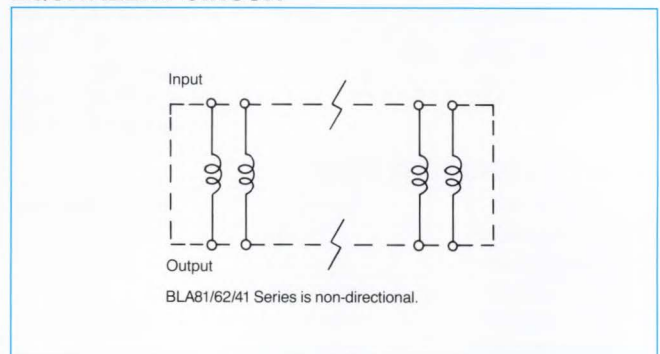

IMPEDANCE VS. FREQUENCY CHARACTERISTICS (TYP.)

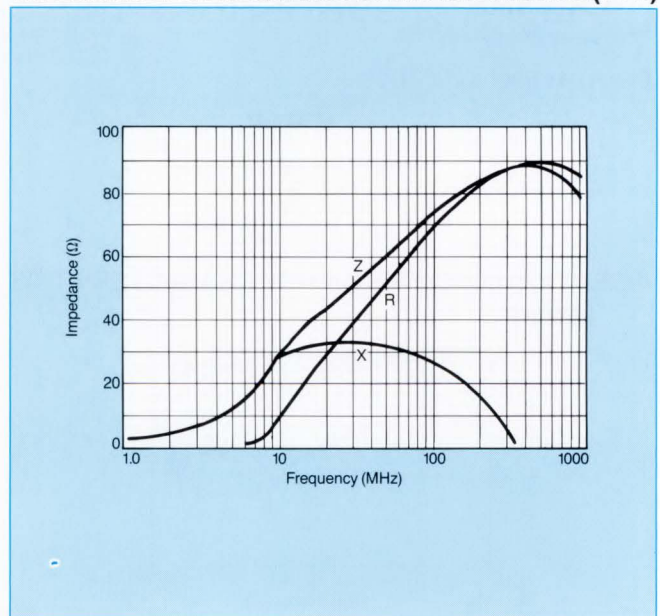

* All values are standard through authorized Murata Erie Distributors: Standard packaging is tape and reel.

EMI SUPPRESSION FILTERS

SURFACE MOUNT

FEED-THRU TYPE



NFA Series

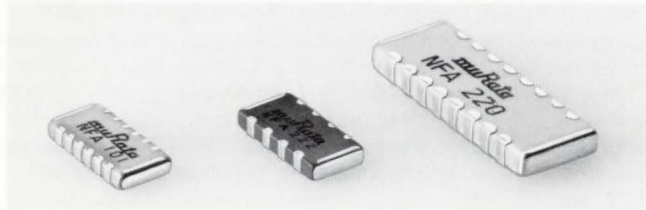

The NFA Series is a chip feed-thru capacitor array filter for surface mounting application and is excellent for high density mounting with a land pitch of .050 (1.27) or .031 (0.8).

It has only two ground terminals for 4 through 8 circuits, therefore making it easy to design a ground pattern.

It is well suited for noise suppression in digital circuit boards or in I/O cables of digital instruments.

FEATURES

- Excellent for high density mounting.
- Unique electrode structure provides excellent noise suppression and excellent cross-talk characteristics.
- Just two ground terminals for all circuits.
- Simple land design makes possible effective EMI suppression with narrow land pitch.
- Nickel barrier structure of external electrodes provides excellent solder heat resistance.
- Wide variety of capacitance values offered.

PART NUMBERING

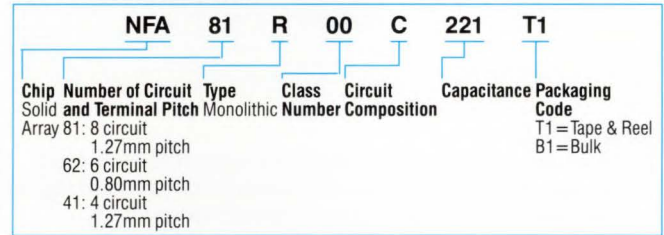

SPECIFICATIONS

Part Number	Capacitance +50, -20%	Rated Voltage	Rated Current	Insulation Resistance	Operating Temp. Range
*NFA81R00C220	22pF	50V DC	300mA DC	1000MΩ min.	-55 to +125°C
*NFA81R00C470	47				
*NFA81R00C101	100				
*NFA81R00C221	220				
*NFA81R00C471	470				
*NFA81R10C102	1000				
*NFA81R10C222	2200				
*NFA81R10C223	22000		200mA DC		
*NFA81R10C223	22000		300mA DC		
NFA62R00C220	22pF	50V DC	200mA DC	1000MΩ min.	-55 to +85°C
NFA62R00C470	47				
NFA62R00C101	100				
NFA62R00C221	220				
NFA62R00C471	470				
NFA62R00C102	1000				
NFA62R10C222	2200				
NFA62R10C223	22000				
NFA41R00C220	22pF	50V DC	200mA DC	1000MΩ min.	-55 to +85°C
NFA41R00C470	47				
NFA41R00C101	100				
NFA41R00C221	220				
NFA41R00C471	470				
NFA41R10C102	1000				
NFA41R10C222	2200				
NFA41R10C223	22000				
NFA41R10C104	100000				

INSERTION LOSS CHARACTERISTICS

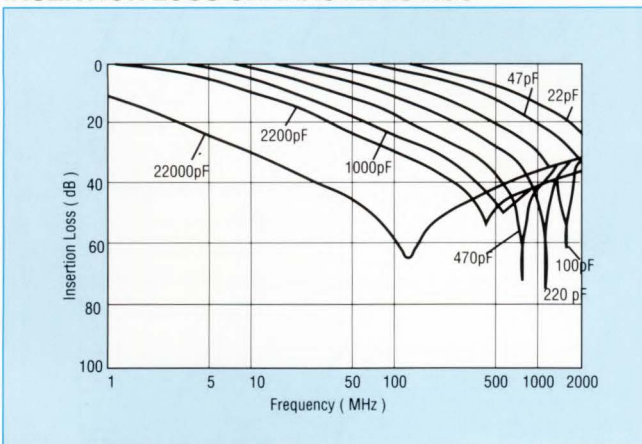

DIMENSIONS: in. (mm)

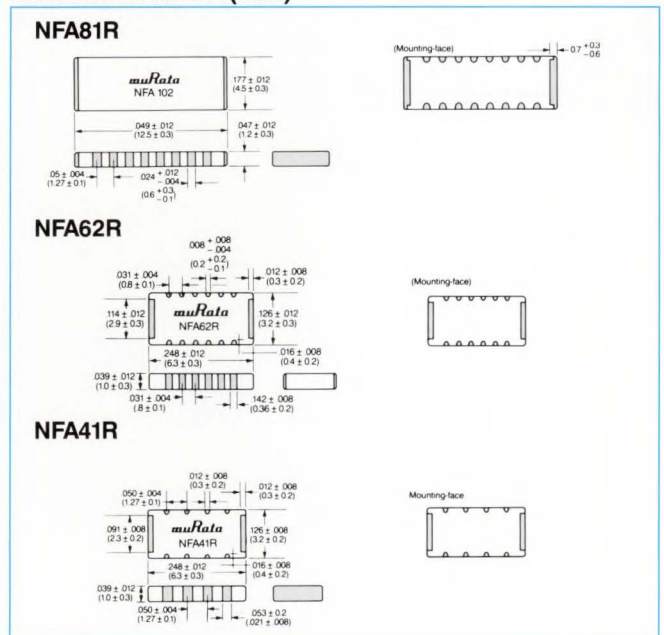

EQUIVALENT CIRCUIT

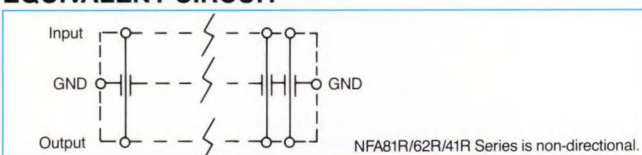

* All values are standard through authorized Murata ERIE Distributors: Standard packaging is tape and reel.

EMI SUPPRESSION FILTERS SURFACE MOUNT CHIP FILTERS



FEATURES

- Step attenuation characteristics make this filter most suitable as a suppressor for unwanted radiation in signal lines without attenuating base-band frequencies.
- Chip configuration is most suitable for noise suppression in compact digital instruments, etc.
- Cut-off frequencies from 10 MHz to 500 MHz.

NFM51 SERIES

Part Number	Cut-off Frequency (MHz)	Minimum Attenuation (dB min.)					Rated Voltage (V)	Rated Current (mA)	Operating Temp. Range
		50 MHz	100 MHz	200 MHz	500 MHz	1 GHz			
*NFM51R00P506	50	*	10	20	30	30	25	200	-40 to +85°C
*NFM51R10P107	100	—	*	5	20	30			
*NFM51R20P207	200	—	—	*	10	30			
*NFM51R30P507	500	—	—	—	*	10			

NFM52 SERIES

Part Number	Cut-off Frequency (MHz)	Minimum Attenuation (dB min.)						Rated Voltage (V)	Rated Current (mA)	Operating Temp. Range
		10 MHz	20 MHz	50 MHz	100 MHz	200 MHz	500 MHz			
*NFM52R00P106	10	*	5	30	30	35	35	50	200	-25 to +85°C
*NFM52R10P206	20	—	*	20	30	35	35			
*NFM52R20P506	50	—	—	*	10	35	35			
*NFM52R30P107	100	—	—	—	*	10	35			

*6dB max.

DIMENSIONS: in. (mm)

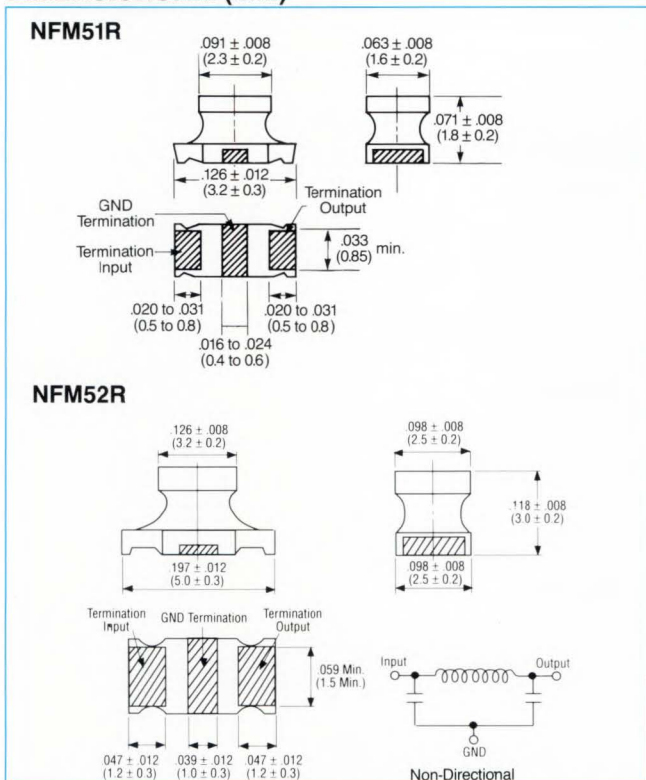

* All values are standard through authorized Murata Erie Distributors: Standard packaging is tape and reel.

NFM51/52 Series

The NFM51/52R Series chip is an efficient signal line noise suppression filter for high-speed digital signal lines where base-band frequencies and noise band frequencies are very close.

Murata Erie has combined its superior ceramic technologies with a unique circuit configuration to realize outstanding noise suppression effect in these applications. The NFM51/52R Series assures noise reduction to meet the specifications of CISPR, FCC, etc.

APPLICATIONS

Noise suppression for compact digital instruments, laptop personal computers, HDTV, EDTV, portable VTR, etc.

PART NUMBERING

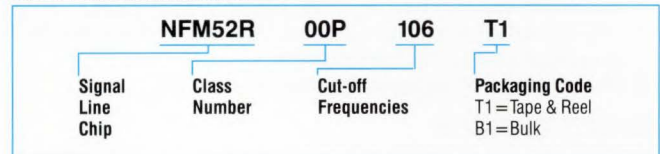

INSERTION LOSS CHARACTERISTICS

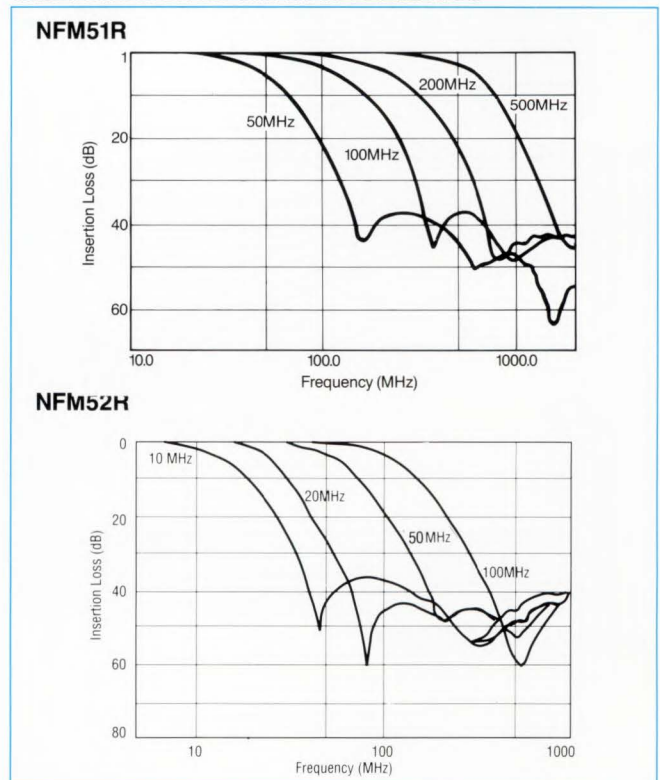

FERRITE BEAD INDUCTORS – BL01/BL02/BL03 SERIES

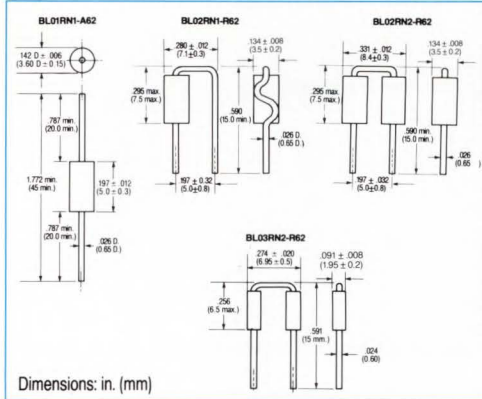

ELECTRICAL CHARACTERISTICS

Item	Characteristics
Permeability	(μ) 550
Saturation Magnetic	(Bs) 3100 (gauss)
Residual Magnetic Flux Density (Brs)	1700 (gauss)
Coercive Force	(Hc) 0.3 (Oe)
Curie Point	(Tc) 130 (°C)
Temp. Coefficient	($\alpha \mu$) 20×10^{-6}
Relative Loss Factor	(DF/ μ) 13×10^{-6}
Resistivity	(ρ) 10^7 (Ω -cm)
Rated Current	BL01 and BL02 (A) 7 A max. BL03 6 A max.

Part Number	Form
*BL01RN1-A62	Axial Single bead
*BL01RN1-A62T5	Axial Single bead, Taped
*BL02RN1-R62	Radial Single bead
*BL02RN2-R62	Radial Double bead
*BL02RN1-R62T2	Radial Single bead, Taped
*BL02RN2-R62T2	Radial Double bead, Taped
*BL03RN2-R62	Radial Double bead
*BL03RN2-R62T2	Radial Double bead, Taped

Environmental: Operating Temperature: -25°C to +85°C

FEED-THRU CAPACITORS – DF220/TF240 SERIES

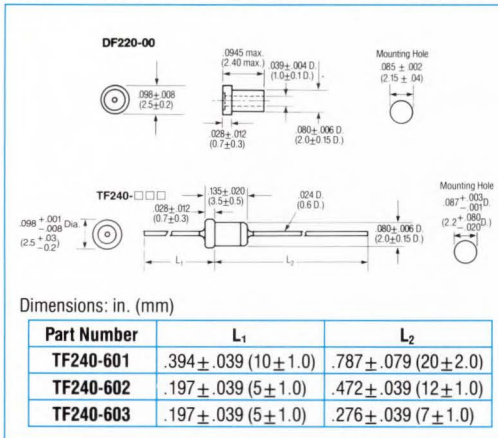

SPECIFICATIONS

Part Number*	Cap. Value	Cap. Tol.	WVDC	DWV	Insertion Loss at 25°C		
					10MHz	100MHz	1GHz
*DF220-00SL020U50	2pF	+0 -100%	50V	125V	—	—	—
*DF220-00B121M50	120pF	±20%	50V	125V	—	3	20
*DF220-00B221M50	220pF	±20%	50V	125V	—	7	25
*DF220-00B471M50	470pF	±20%	50V	125V	—	12	30
*DF220-00E102Z50	1000pF	+80 -20%	50V	125V	3	18	35
*DF220-00SS152GMV50	1500pF	+200 -0%	50V	125V	5	20	40
TF240-□□□SL020D50V	2pF	±0.5pF	50V	125V	—	—	—
TF240-□□□SL220M50V	22pF	±20%	50V	125V	—	—	7
TF240-□□□B331M50V	30pF	±20%	50V	125V	—	10	27
TF240-□□□SS332Z50V	3300pF	+80 -20%	50V	125V	10	25	45

For other capacitance values consult factory.
Operating Temp. Range: -25°C to +85°C
□□□—See DIMENSIONS

Insulation Resistance: 100M Ω min.

FEED-THRU CAPACITORS – TF318/TF418 SERIES

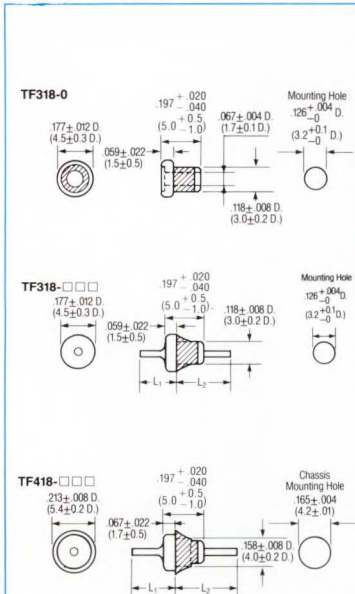

DIMENSIONS: In. (mm)

Type	L ₁	L ₂
*TF318-850	.984 ± .079 (25.0 ± 2.0)	1.18 ± .079 (30.0 ± 2.0)
*TF318-853	.551 ± .040 (14.0 ± 1.0)	.591 ± .040 (15.0 ± 1.0)
*TF318-855	.374 ± .020 (9.5 ± 0.5)	.433 ± .020 (11.0 ± 0.5)
*TF318-053	.433 ± .040 (11.0 ± 1.0)	.650 ± .040 (16.5 ± 1.0)
TF318-055	.276 ± .028 (7.0 ± 0.7)	.244 ± .028 (6.2 ± 0.7)
*TF318-450	.177 ± .030 (4.5 ± 0.8)	.295 ± .040 (7.5 ± 1.0)
*TF318-452	.276 ± .040 (7.0 ± 1.0)	.354 ± .040 (9.0 ± 1.0)
*TF418-452	.283 ± .040 (7.2 ± 1.0)	.347 ± .040 (8.8 ± 1.0)
*TF418-454	.402 ± .040 (10.2 ± 1.0)	.543 ± .040 (13.8 ± 1.0)

SPECIFICATIONS

Part Number	Cap.	Cap. Tol.	Temp. Char.	Rated Volt.
TF318-□□SL100G50V	10pF	±2pF	SL	50VDC
TF318-□□SL220M50V	22pF	±20%	SL	50VDC
TF318-□□SL330M50V	33pF	±20%	SL	50VDC
TF318-□□SL470M50V	47pF	±20%	SL	50VDC
TF318-□YIN101M50V	100pF	±20%	YN	50VDC
TF318-□B271M50V	270pF	±20%	B	50VDC
TF318-□B471M50V	470pF	±20%	B	50VDC
TF318-□E102GMV50V	1000pF	+200%	E	50VDC
TF318-□E152P50V	1500pF	+100%	E	50VDC
TF418-□E102MV300V	1000pF	+200%	E	300VDC
TF418-□E152P300V	1500pF	+100%	E	300VDC

□ Denotes configurations shown above.
Examples:
T318-450B271M50V
T418-452E102GMV300V

PART NUMBERING SYSTEM

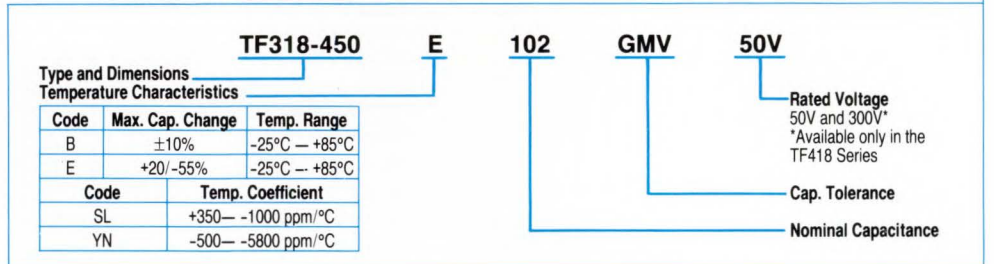

*Available as standard through authorized Murata Erie Distributors.

FEED-THRU CAPACITORS – DF553/DF572 SERIES

DF553 dimensions: 197±.020 (5.0±0.5), 110±.020 (2.8±0.5), 100 max (2.5 max), 433±.040 (11.0±1.0), 906±.075 (23.0±2.0), 156±.020 (4.0±0.5), 040 D (1.0 D), M3.5P x 0.35, Incomplete thread part .040 or less (1.0), Note: Accessory nut & washer supplied.

DF572 dimensions: 284±.012 (7.2±0.3 D), 100 max (2.5 max), 197 max (5.0 max), 063 D (1.6 D), 177±.006 D (4.5±0.2 D), 354±.040 (9.0±1.0), 706±.040 (18.0±1.0).

Dimensions: in. (mm)

SPECIFICATIONS

Part Number	DF553F102P50	DF572-10F102P500
Cap. Value	1000pF	1000pF
Cap. Tolerance	+100/-0%	+100/-0%
Rated Voltage	50VDC	500VDC
Dielectric Strength	125VDC	1250VDC
Insulation Resistance	10000MΩ	10000MΩ
Temp. Characteristic	+30/-80%	+30/-80%
Max. Feed-Thru Current	10A DC	15A DC
Operating Temp. Range	-25°C to +85°C	-25°C to +85°C

EMI SUPPRESSION FILTERS

DS310/DST310/DSS310 SERIES

DS310 TYPE dimensions: 374 max (9.5), 157 max (4.0), 100 max (2.5), 400 max (10.0), 039±.008 (1.0±0.2), 964 min (25.0), 026 D (0.65 D).

DST310 TYPE dimensions: 374 max (9.5), 157 max (4.0), 100 max (2.5), 610 max (15.5), 049±.020 (1.25±0.5), 026 D (0.65 D).

DSS310 TYPE dimensions: 472 max (12.0), 295 max (7.5), 100 max (2.5), 413 max (10.5), 098±.020 (2.5±0.5), 026 D (0.65 D).

Dimensions: in. (mm)

SPECIFICATIONS

Part Number	Rated Current (Between Terminal)	Capacitor			Ferrite Core	Configuration	
		Capacitance	W.V.	T.C.		Dimension	Lead Spacing F ₂
*DS310-55Y5S271M100	7A max.	270pF ± 20%	100V	± 22%	None	Fig. 1	.098 (2.5)
*DS310-55Y5S222M100		2200pF ± 20%	100V				
*DS310-55Y5S223S50		22000pF ± 30%	50V				
*DS310-55D104M16		100,000pF	16V				
*DST310-55Y5S271M100	7A max.	270pF ± 20%	100V	± 22%	Externally Mounted	Fig. 2	.098 (2.5)
*DST310-55Y5S222M100		2200pF ± 20%	100V				
*DST310-55Y5S223S50		22000pF ± 30%	50V				
*DSS310-55Y5S220M100	7A max.	22pF ± 20%	100V	± 22%	Internally Contained	Fig. 3	.098 (2.5)
*DSS310-55Y5S470M100		47pF ± 20%	100V				
*DSS310-55Y5S101M100		100pF ± 20%	100V				
*DSS310-55Y5S271M100		270pF ± 20%	100V				
DSS310-55Y5S222M100		2200pF ± 20%	100V				
DSS310-55Y5S223S50		22000pF ± 30%	50V				

FOR AUDIO CIRCUITS (LOW DISTORTION TYPE)

Part Number	Rated Current (Between Terminals)	Capacitor			Ferrite Core	Configuration	
		Capacitance	W.V.	T.C.		Dimension	Lead Spacing F ₂
DSS310-55BL222M100	7A max.	2200pF ± 20%	100V	± 10%	Internally Contained	Fig. 3	.098 (2.5)
DSS310-55DL223S50		22000pF ± 30%	50V	± 30%			

DS306/DSS306/DST306 SERIES

Fig. 1 dimensions: 276 (7.0) max, 0.1 Max (2.54 Max), 315 (8.0) max, 036±.008 (1.0±0.2), 98 (25.0) min, 024 (0.6), 197±.020 (5.0±0.5), F₁, 098±.020 (2.5±0.5).

Fig. 2 dimensions: 315 (8.0) max, 098 (2.5) max, 276 (7.0) max, 197±.012 (5.0±0.3), 472 (12.0) max, 078±.008 (2.0±0.2), 98 (25.0) min, 024 (0.6), 197±.020 (5.0±0.5), F₁, 098±.020 (2.5±0.5), Ferrite Core.

Fig. 3 dimensions: 315 max (8.0 max), 1.00 max (2.54 max), 276 max (7.0 max), 984 min (25.0 min), 024 (0.6), 197±.02 (5.0±0.5), F₁, 098±.008 (2.5±0.2), Mounting Hole 031-118 (1.08-3.0).

Dimensions: in. (mm)

Part Number	Capacitor			Ferrite Beads	Dimension
	Capacitance	Rated Volt.	Temp. Char.		
*DS306-55Y5S470M100	47pF ± 20%	50VDC	± 22%	None	Fig. 1
*DS306-55Y5S101M100	100pF ± 20%		± 22%		
*DS306-55Y5S271M100	270pF ± 20%		± 22%		
*DS306-55Y5S102M100	1000pF ± 20%		± 22%		
*DS306-55Y5S222M100	2200pF ± 20%		± 22%		
*DS306-55FZ103Z50	10000pF + 80%, -20%		+ 30%, -85%		
*DST306-55Y5S470M50	47pF ± 20%	50VDC	± 22%	Outside	Fig. 2
*DST306-55Y5S101M50	100pF ± 20%		± 22%		
*DST306-55Y5S271M50	270pF ± 20%		± 22%		
*DST306-55Y5S102M50	1000pF ± 20%		± 22%		
*DST306-55Y5S222M50	2200pF ± 20%		± 22%		
*DST306-55FZ103Z50	10000pF + 80%, -20%		+ 30%, -85%		
*DSS306-55Y5S470M100	47pF ± 20%	100VDC	± 22%	Inside	Fig. 3
*DSS306-55Y5S101M100	100pF ± 20%		± 22%		
*DSS306-55Y5S271M100	270pF ± 20%		± 22%		
*DSS306-55Y5S471M100	470pF ± 20%		± 10%		
*DSS306-55Y5S102M100	1000pF ± 20%		± 22%		
*DSS306-55Y5U222Z100	2200pF + 80%, -20%		+ 22%, -56%		
*DSS306-55FZ103N100	10000pF ± 30%		+ 30%, -85%		

• Coating extensions do not exceed the tangent line. Exposed electrode, if any, is covered by soldering, etc.
• Leads with length shorter than standard length are available when required. Contact us for further details.

* Available as standard through authorized Murata Erie Distributors.

NFV610 SERIES

SPECIFICATIONS

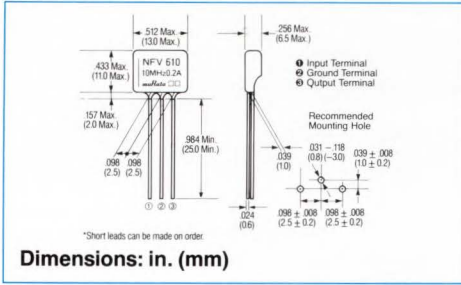

Part No.	Cut-Off Frequency	Minimum Attenuation (dB)					
		10MHz	20MHz	50MHz	100MHz	200MHz	500MHz
*NFV610-655 T2A 106	10MHz	*	3	10	20	35	25
*NFV610-655 T2A 206	20MHz		*	3	10	15	25
*NFV610-655 T2A 506	50MHz			*	3	10	25
*NFV610-655 T2A 107	100MHz				*	3	15

*6dB max

Rated Voltage: 100 VDC, Rated Current: 200mA
Temperature Range: -25°C to +85°C

EMI-GUARD VARISTOR-CAPACITOR DSS706 SERIES

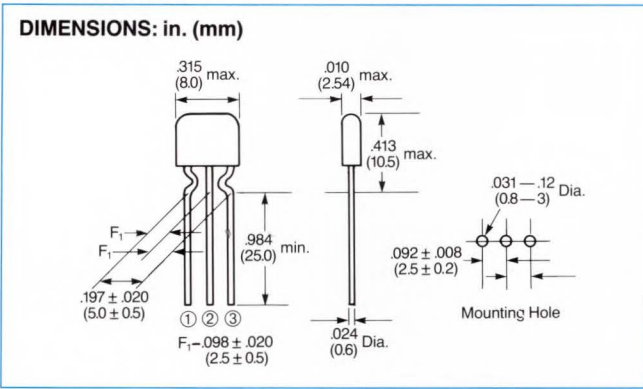

RATINGS

Part No.	DSS706-351D221M25-50
Rated Voltage	25VDC
Varistor voltage	50V
Rated current	6ADC
Operating Temp. Range	-40 to +105°C
Capacitance	220pF±20%
Capacitance Temp. Char.	+20%, -30%
Peak pulse current	100A

DSS710 SERIES

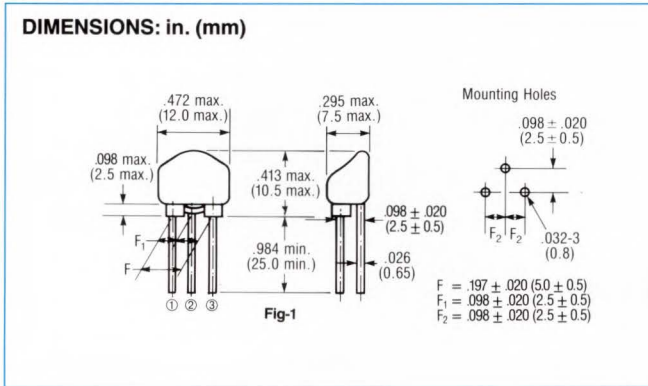

Part No.	DSS710 D 223S 12-22
Capacitance	22000pF +50% -20%
DF	5.0% max.
Insulation Resistance	1 MΩ min.
I _c (max.)	7 A max.
Rated Voltage	12 VDC
Varistor Voltage	22 VDC ± 20%
Voltage Nonlinear Factor	1.25 max. (V10mA/V1mA)
Temperature Characteristics	+20% (-25 to +85°C) -30%
Operating Temperature Range	-40 to +100°C
Inductance	0.8μH × 2 (1 KHz)

VARISTOR-SURGE ABSORBER – DVZ SERIES

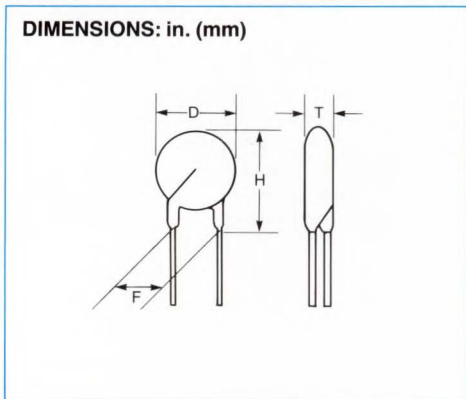

Part No.	Maximum Allowable Voltage		Maximum Clamping Voltage		With-standing Surge Current (A)
	ACrms (V)	DC (V)	V _c (V)	I _p (A)	
DVZ07-551A221 DVZ10-551A221	140	180	360 360	10 25	600 1250
DVZ07-551A431 DVZ10-551A431	275	350	710 710	10 25	600 1250

Do not exceed Max. allowable voltage.
Flux: Use rosin-based flux, but not strong acidic flux (with chlorine content exceeding 0.20wt%).

Size	D	H	T	F
7 type	.354 max. (9.0)	.472 max. (12.0)	.177 max. to .276 max. (4.5) (7.0)	.177±.039 (5.0±1)
10 type	.551 max. (14.0)	.669 max. (17.0)	.197 max. to .295 max. (5.0) (7.5)	.295±.039 (7.5±1)

* Available as standard through Murata Erie Distributors.

EMI SUPPRESSION FILTERS

AC THREE TERMINAL CAPACITOR

Dimensions: (mm)

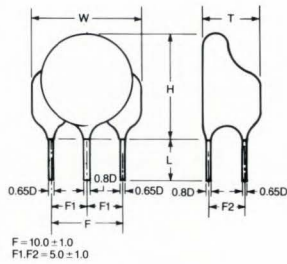

Part No.	W	H	T	L
DSR1100	16.0 max.	15.0 max.	11.0 max.	6.0
DSR1120	16.0 max.	17.0 max.	11.0 max.	
DSR1150	18.0 max.	22.0 max.	11.0 max.	

RATINGS

Item	Ratings
Rated Current	7 A (AC)
Insulation Resistance	10000 MΩ min.
Operating Temperature Range	-25 to +85°C

Part No.	Temp. Char.	Cap. Value (pF)	Cap. Tol (%)	Recognized Standards			Rated Voltage*
				UL 1414	CSA C22.2 No. 1	VDE 565-1	
★ DSR1100-56 E222M VA2-EA	E	2200	±20	£	£	£	VA2
★ DSR1120-56 E302M VA2-EA	E	3000	±20	£	£	£	VA2
★ DSR1150-56 E472M VA2-EA	E	4700	±20	£	£	£	VA2
★ DSR1100-56 FZ472P AC125-EA	E	4700	±100/0	£	£	-	VA2

*VA2: for VDE565-1 SEMKO, BSI . . . 250VAC
for UL1414, CSA C22.2 No. 1 . . . 125VAC

EMI SUPPRESSION FILTERS – 15MHz TO 1GHz – BNP002/004

Dimensions: in. (mm)

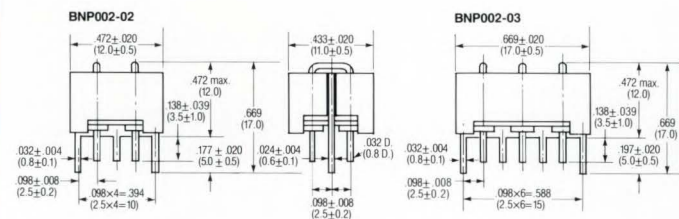

Item	Specifications		
Part Number	★ BNP002-02	★ BNP002-03	★ BNP004-02
Number of Circuits	2	3	2
Circuit Construction	π		
Operating Temperature Range	-50°C to +100°C		
Rated Voltage	50VDC		
Withstand Voltage	300VDC	125VDC	
Maximum Current Capacity	10ADC		
Insulation Resistance	1,000 MΩ min.		
DC Resistance	0.05 Ω max. (20°C to 25°C)		
Insertion Loss	20MHz to 500MHz: 40dB (20°C to 25°C) min.		300MHz to 1GHz 40dB min.

EMI SUPPRESSION FILTERS – 0.5MHz TO 1GHz – BNX002/003

Dimensions: in. (mm)

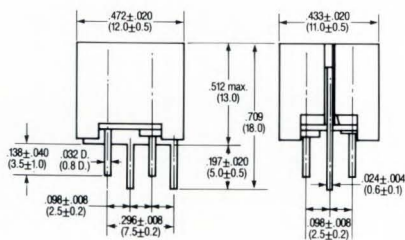

Item	Specifications	
Part Number	★ BNX002-01	★ BNX003-01
Operating Temperature Range	-30°C to +85°C	
Rated Voltage	50VDC	150V
Test Voltage	125VDC	375V
Maximum Current Capacity	10ADC	
Insulation Resistance	100MΩ min.	
Insertion Loss	1MHz to 1GHz: 40dB min. (20°C to 25°C) (line impedance=50Ω)	5MHz to 1GHz 40dB min.

★ Available as standard through authorized Murata Erie Distributors.

**NOISE FILTERS
COMMON MODE CHOKE COIL – Series PLA**

DIMENSIONS: in. (mm)

ELECTRICAL SPECIFICATIONS

Item	Rated Voltage
Rated Voltage	250VAC
Dielectric Strength (between coils)	2000VAC 1
Insulation Resistance	100MΩ min.
Operating Temperature Range	-25°C to +65°C
Temp. Characteristics Inductance	20° +80% (-25°C to +85°C) -40
Special Test	No abnormality against heat cycle, humidity, low temperature and high temperature.
Mechanical Strength	Stand the static load of pin strength 1kg.

SPECIFICATIONS

Type	Inductance (mH) min.	Rated Current (Arms)	DC Resistance (Ω) max.	Self-Resonant Frequency (MHz) Typical
*PLA1021A	1.0	1	0.25	1.0
*PLA2021A	2.0	1	0.30	0.7
*PLA3021A	3.0	1	0.35	0.5
*PLA1022A	1.0	2	0.15	1.0
*PLA1522A	1.5	2	0.20	0.9

* Casing type is shown by the suffix as PLA□□□□C.

**EMI SUPPRESSION FILTERS
COMMON MODE CHOKE COIL – Series PLT**

DIMENSIONS: in. (mm)

TYPES

Part Number	Inductance (μH) min.	Self-Resonant Frequency (MHz)	Code
*PLT0R53C	0.5	1000 min.	B
*PLT1R53C	1.5	250	A
*PLT2003C	20.0	10	C

SPECIFICATIONS

Item	Rating
Rated Voltage	50VDC
Rated Current	3A
Withstand Volt. (between coils)	200VAC 1 min. (between coils)
Operating Temp. Range	-25°C to +60°C

* Available as standard through authorized Murata Erie Distributors.

**NOISE FILTERS
COMMON MODE CHOKE COIL – Series PLC/PLE**

SPECIFICATIONS

Part Number	Inductance (mH) min.	Rated Current (Arms)	DC Resistance (Ω) max.	Self-Resonant Frequency (MHz) Typical
*PLC20HD-7030R5	70	0.5	3.0	0.1
*PLC20HD-3031R	30	1.0	1.0	0.2
*PLC20HD-1131R5	11	1.5	0.4	0.3
*PLC20HD-6522R	6.5	2.0	0.2	0.4
*PLC20HD-3023R	3	3.0	0.1	0.7
*PLC20LD-7030R5	70	0.5	3.0	0.1
*PLC20LD-3031R	30	1.0	1.0	0.2
*PLC20LD-1131R5	11	1.5	0.4	0.3
*PLC20LD-6522R	6.5	2.0	0.2	0.4
*PLC20LD-3023R	3	3.0	0.1	0.7
*PLE25H-3030R5	30	0.5	1.2	0.1
*PLE25H-2230R7	22	0.7	1.0	0.1
*PLE25H-1531R	15	1.0	0.7	0.1
*PLE25H-1131R3	11	1.3	0.6	0.15
*PLE25H-8021R5	8	1.5	0.4	0.2
*PLE25H-3022R	3	2.0	0.2	0.25
*PLE25H-2023R	2	3.0	0.1	0.4

ELECTRICAL RATINGS

Item	Rating
Rated Voltage	250VAC
Withstand Volt. (between coils)	One minute at 2000VAC
Insulation Resistance (between coils: 500VDC)	100MΩ min.
Operating Temp. Range	-25°C to +60°C
Temp. Char. (Inductance)	20°C +80% -50% at the above temp.

DIMENSIONS: in. (mm)

COMMON MODE CHOKE COIL LARGE CURRENTS AND LARGE INDUCTANCE

Part Number	Inductance (mH) min.	Rated Voltage (VAC)	Rated Current (Arms)
PLAM2930R5	29.0	250 (for UL1414, Europe) 125 (for CSA C22.2 No. 1)	0.5
PLAM2230R6	22.0		0.6
PLAM1030R9	10.0		0.9
PLAM4621R3	4.6		1.3
PLAM2321R9	2.3	250 (For Japan, USA, Europe) 125 (For Canada)	1.9
PLEM-3331R0D	33		1.0
PLEM-1431R5D	14		1.5
PLEM-8222R0D	8.2		2.0
PLEM-5422R5D	5.4	250 (For Japan, USA, Europe) 125 (For Canada)	2.5
PLEM-3623R0D	3.6		3.0
PLEM-2024R0D	2.0		4.0
PLCM-5931R0	59		250 (For Japan, USA, Europe) 125 (For Canada)
PLCM-3431R5	34	1.5	
PLCM-1532R0	15	2.0	
PLCM-1132R5	11	2.5	
PLCM-7223R0	7.2	3.0	
PLCM-3024R0	3.0	4.0	

* Operating Temperature Range: -25 to +60°C

DIMENSIONS: (mm)

NOISE FILTERS – PLI-C

Part Number	Circuit Composition		Leakage Current (mA max.)	Insertion Loss (dB)			
	Across-the-line Capacitor	Discharge Resistor		Line to ground (MHz)			
PLI-C1020	inside	none	0.4	14	30	30	20
PLI-C1030			0.5	17	36	30	20
PLI-C1040			0.8	20	40	30	20
PLI-C1050			1.0	23	40	30	20
PLI-C1060			2.0	30	40	30	20

NOISE FILTERS – COMMON MODE CHOKE COIL – Series FKOB

Part Number	Inductance (μH)	RDC (mΩ)	Rated Volt. (V AC)	Rated Current (Arms)	Freq. at Self-Resonance (MHz)	Lead Pitch A/B	Lead Length ℓ
FKOB160MH02	≥ 250	< 50	125 (250)	2.5	5	.315 (8) / .394 (10)	.394 (10)
*FKOB160MH06	≥ 250	< 50	125 (250)	2.5	5	.512 (13) / .394 (10)	.177 (4.5)
FKOB160MH25	≥ 600	< 80	125 (250)	2.5	4	.315 (8) / .394 (10)	.394 (10)
FKOB160MH13	≥ 600	< 80	125 (250)	2.5	4	.512 (13) / .394 (10)	.177 (4.5)
FKOB160MH23	≥ 800	< 80	125 (250)	2.5	3.5	.315 (8) / .394 (10)	.394 (10)
FKOB160MH14	≥ 800	< 80	125 (250)	2.5	3.5	.512 (13) / .394 (10)	.177 (4.5)
FKOB160MH26	≥ 1000	< 100	125 (250)	1.5	2.5	.315 (8) / .394 (10)	.394 (10)
FKOB160MH16	≥ 1000	< 100	125 (250)	1.5	2.5	.512 (13) / .394 (10)	.177 (4.5)
FKOB160MH24	≥ 1500	< 120	125 (250)	1.5	1.5	.315 (8) / .394 (10)	.394 (10)
FKOB160MH15	≥ 1500	< 120	125 (250)	1.5	1.5	.512 (13) / .394 (10)	.177 (4.5)

*Standard units

COMMON MODE CHOKE COILS

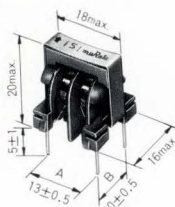
PLH11L Series	Part Number	Inductance (μH)	RDC (Ω)	Rated Volt. (V. AC)	Rated Current (Arms)
	PLH11L-1811R2	≥ 180	< 0.15	250	1.2
	PLH11L-1511R5	≥ 150	< 0.10		1.5
	PLH11L-8002R2	≥ 80	< 0.07		2.2
	PLH11L-6003R3	≥ 60	< 0.05		3.3

WIDE BAND FREQUENCY TYPE

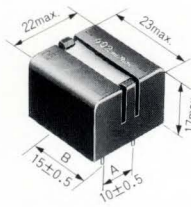
PLH14H Series	Part Number	Inductance (mH)	RDC (Ω)	Rated Volt. (V. AC)	Rated Current (Arms)
	PLH14H-4020R5	4.0	< 3.0	250	0.5
	PLH14H-2420R8	2.4	< 1.0		0.8
	PLH14H-8011R7	0.8	< 0.5		1.7
	PLH14H-4013R0	0.4	< 0.1		3.0

WIDE BAND FREQUENCY TYPE

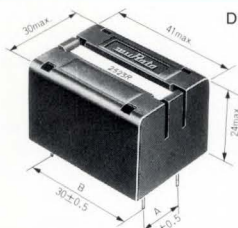
PLH20H Series	Part Number	Inductance (mH)	RDC (Ω)	Rated Volt. (V. AC)	Rated Current (Arms)
	*PLH20H/20HM-9021R0	≥ 9.0	< 1.0	250	1.0
	*PLH20H/20HM-4622R0	≥ 4.6	< 0.3		2.0
	*PLH20H/20HM-2523R0	≥ 2.5	< 0.1		3.0
	*PLH20H/20HM-8016R0	≥ 0.8	< 0.1		6.0

PLH20HM Series (SHIELDED)

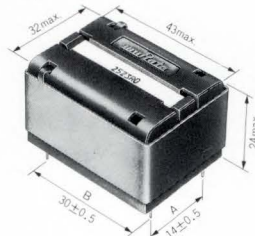

* Available as standard through authorized Murata Erie Distributors.

EMI SUPPRESSION D-CONNECTORS (Low Cost Type) – (CUBL09 SERIES) Dimensions: mm

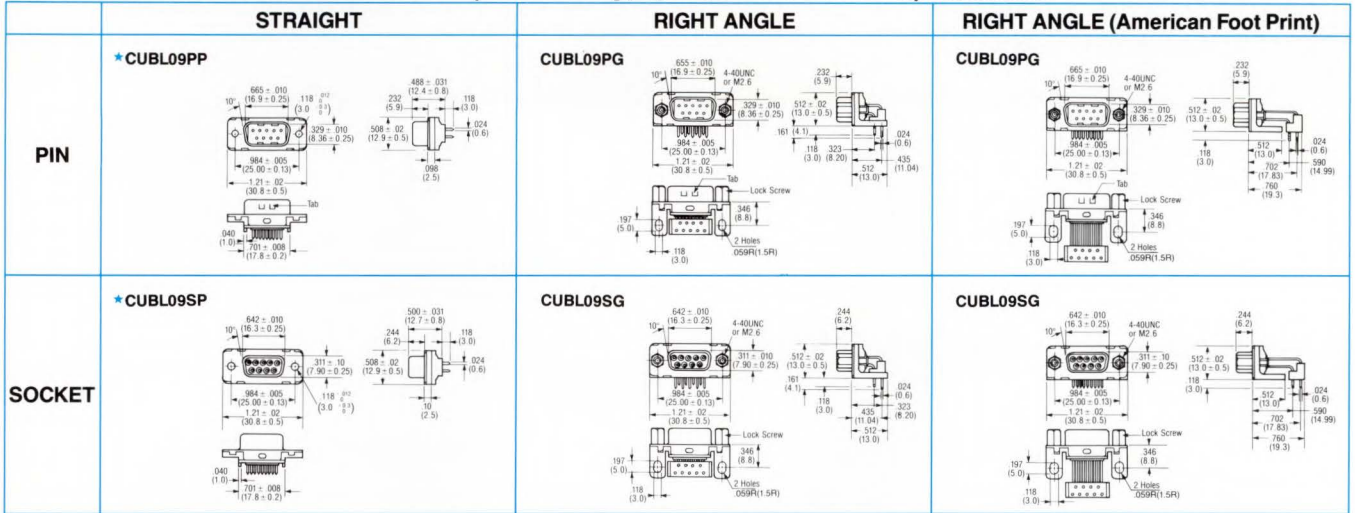

SPECIFICATIONS

Number of Lines	9
Operating Temp.	-25°C to +85°C
Rated Voltage	100VDC
Test Voltage	250VDC
Rated Current	5A max.
Insulation Resistance	1000MΩ min.
Insertion Loss	30dB/100MHz (2000pF) * min.
D.F.	5% max.

*Other capacitance, 1000pF, 500pF and 250pF lower than 2000pF is also available.

PART NUMBERING SYSTEM

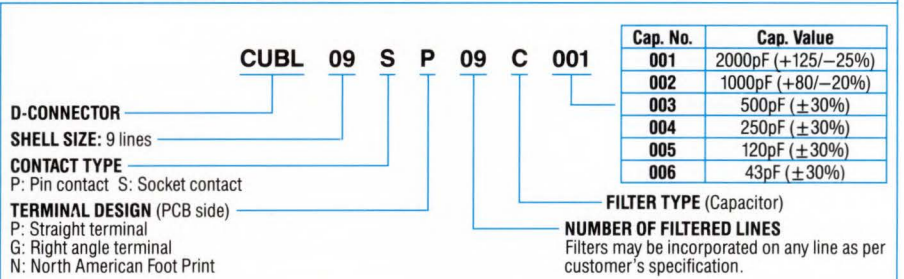

EMI SUPPRESSION D-CONNECTOR CUBL25 SERIES

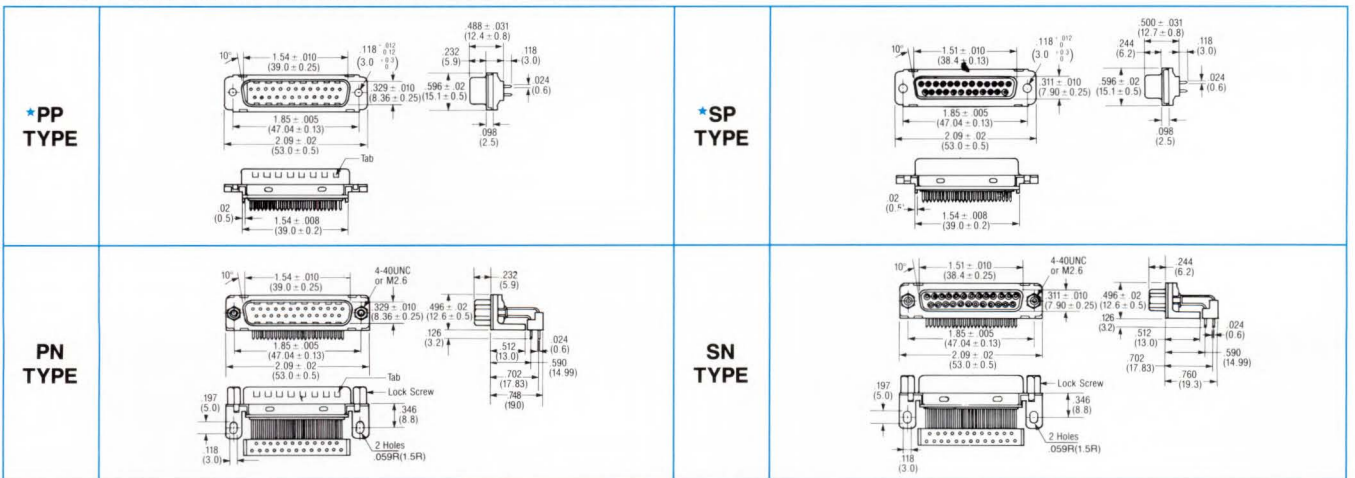

SPECIFICATIONS

Number of Lines	25
Operating Temp.	-25°C to +85°C
Rated Voltage	100VDC
Test Voltage	250VDC
Rated Current	5A max.
Insulation Resistance	1000MΩ min.

PART NUMBERING SYSTEM

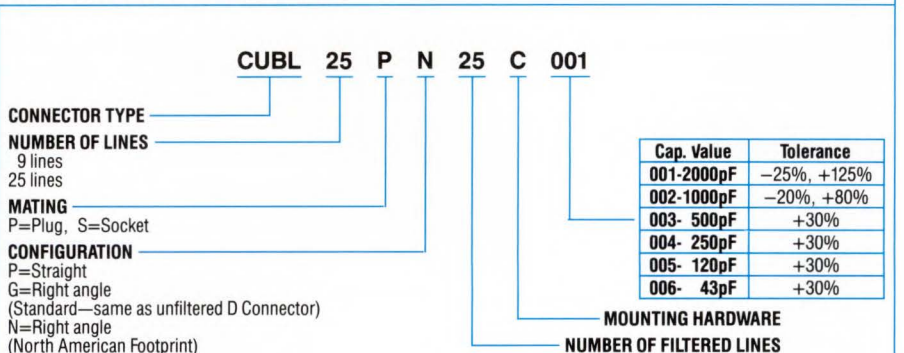

DIMENSIONS: in. (mm)

PIN		SOCKET	
RIGHT ANGLE (STANDARD)		RIGHT ANGLE (STANDARD)	
<p>*CUBM09PG</p> <p>655 ± 0.10 (16.9 ± 0.25) 329 ± 0.10 (8.36 ± 0.25) 512 ± 0.2 (13.0 ± 0.5) 232 (5.9) 161 (4.1) 118 (3.0) 323 (8.20) 024 (0.6) 435 (11.04) 512 (13.0) 984 ± 0.05 (25.00 ± 0.13) 1.21 ± 0.2 (30.8 ± 0.5) Tab Lock Screw 346 (8.8) 197 (5.0) 118 (3.0) 2 Holes .059R(1.5R)</p>	<p>*CUBM09SG</p> <p>642 ± 0.10 (16.3 ± 0.25) 311 ± 0.10 (7.90 ± 0.25) 512 ± 0.2 (13.0 ± 0.5) 244 (6.2) 161 (4.1) 118 (3.0) 323 (8.20) 024 (0.6) 435 (11.04) 512 (13.0) 984 ± 0.05 (25.00 ± 0.13) 1.21 ± 0.2 (30.8 ± 0.5) Tab Lock Screw 346 (8.8) 197 (5.0) 118 (3.0) 2 Holes .059R(1.5R)</p>		
RIGHT ANGLE (NORTH AMERICAN FOOTPRINT)		RIGHT ANGLE (NORTH AMERICAN FOOTPRINT)	
<p>CUBM09PN</p> <p>665 ± 0.10 (16.9 ± 0.25) 329 ± 0.10 (8.36 ± 0.25) 512 ± 0.2 (13.0 ± 0.5) 232 (5.9) 118 (3.0) 323 (8.20) 024 (0.6) 590 (14.99) 760 (19.3) 984 ± 0.05 (25.00 ± 0.13) 1.21 ± 0.2 (30.8 ± 0.5) Tab Lock Screw 346 (8.8) 197 (5.0) 118 (3.0) 2 Holes .059R(1.5R)</p>	<p>*CUBM09SN</p> <p>642 ± 0.10 (16.3 ± 0.25) 311 ± 0.10 (7.90 ± 0.25) 512 ± 0.2 (13.0 ± 0.5) 244 (6.2) 118 (3.0) 323 (8.20) 024 (0.6) 590 (14.99) 760 (19.3) 984 ± 0.05 (25.00 ± 0.13) 1.21 ± 0.2 (30.8 ± 0.5) Tab Lock Screw 346 (8.8) 197 (5.0) 118 (3.0) 2 Holes .059R(1.5R)</p>		
RIGHT ANGLE (STANDARD)		RIGHT ANGLE (STANDARD)	
<p>*CUBM25PG</p> <p>1.54 ± 0.10 (39.0 ± 0.25) 329 ± 0.10 (8.36 ± 0.25) 496 ± 0.2 (12.6 ± 0.5) 232 (5.9) 169 (4.3) 126 (3.2) 024 (0.6) 435 (11.04) 512 (13.0) 984 ± 0.05 (25.00 ± 0.13) 2.09 ± 0.2 (53.0 ± 0.5) Tab Lock Screw 346 (8.8) 197 (5.0) 118 (3.0) 2 Holes .059R(1.5R)</p>	<p>*CUBM25SG</p> <p>1.51 ± 0.10 (38.4 ± 0.25) 311 ± 0.10 (7.90 ± 0.25) 496 ± 0.2 (12.6 ± 0.5) 244 (6.2) 169 (4.3) 126 (3.2) 024 (0.6) 435 (11.04) 512 (13.0) 984 ± 0.05 (25.00 ± 0.13) 2.09 ± 0.2 (53.0 ± 0.5) Tab Lock Screw 346 (8.8) 197 (5.0) 118 (3.0) 2 Holes .059R(1.5R)</p>		
RIGHT ANGLE (NORTH AMERICAN FOOTPRINT)		RIGHT ANGLE (NORTH AMERICAN FOOTPRINT)	
<p>CUBM25PN</p> <p>1.54 ± 0.10 (39.0 ± 0.25) 329 ± 0.10 (8.36 ± 0.25) 496 ± 0.2 (12.6 ± 0.5) 232 (5.9) 126 (3.2) 024 (0.6) 590 (14.99) 760 (19.3) 984 ± 0.05 (25.00 ± 0.13) 2.09 ± 0.2 (53.0 ± 0.5) Tab Lock Screw 346 (8.8) 197 (5.0) 118 (3.0) 2 Holes .059R(1.5R)</p>	<p>*CUBM25SN</p> <p>1.51 ± 0.10 (38.4 ± 0.25) 311 ± 0.10 (7.90 ± 0.25) 496 ± 0.2 (12.6 ± 0.5) 244 (6.2) 126 (3.2) 024 (0.6) 590 (14.99) 760 (19.3) 984 ± 0.05 (25.00 ± 0.13) 2.09 ± 0.2 (53.0 ± 0.5) Tab Lock Screw 346 (8.8) 197 (5.0) 118 (3.0) 2 Holes .059R(1.5R)</p>		

PART NUMBERING SYSTEM

CUBM 25 P N 25 C 002 NC

Connector Type: CUBM
Number of Lines: 25
Mating: P
Configuration: N
Number of Filtered Lines: 25
Filter Type: C
Capacitance Value: 002
Tolerance: NC

Mounting Hardware

Male Thread: 484 (12.3)
Female Thread: 197 (5.0)
Jackscrew

Available in Right Angle Configuration

Jackscrew	Male Thread	Female Thread	L in. (mm)
Blank	M2.6	M2.6	.248 (6.3)
D	4-40 UNC	4-40 UNC	.248 (6.3)
E	M2.6	M2.6	.189 (4.8)
NA	Without Lockscrew, Rear Shell M2.6 Female Thread		
NC	Without Lockscrew, Rear Shell 4-40 UNC Female Thread		

Capacitance Value	Tolerance
001—2000 pF	-25%, +125%
002—1000 pF	-20%, +80%
003—500 pF	±30%
004—250 pF	±30%
005—120 pF	±30%
006—43 pF	±30%

SPECIFICATIONS

Number of Lines	9, 15, 25
Operating Temperature	-25°C to +85°C
Rated Voltage	100VDC
Test Voltage	250VDC
Rated Current	5A max.
Insulation Resistance	1000MΩ min.

* Available as standard through authorized Murata Erie Distributors.

DIMENSIONS: in. (mm)

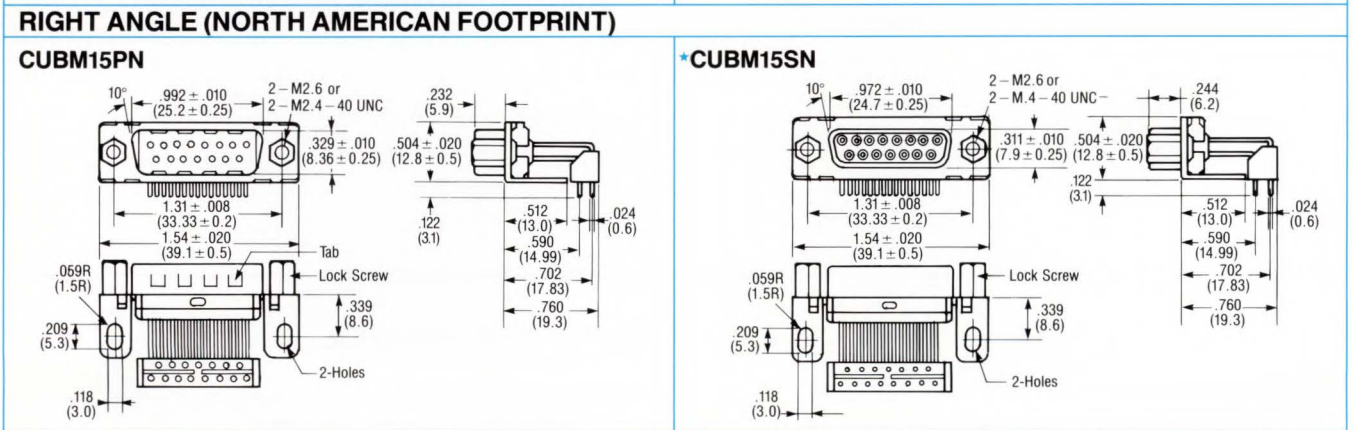
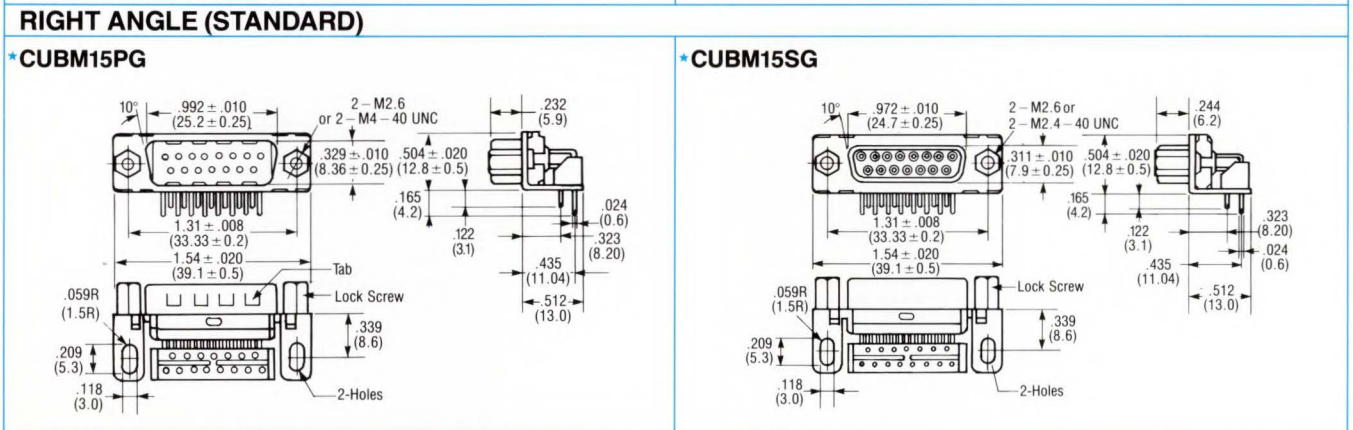
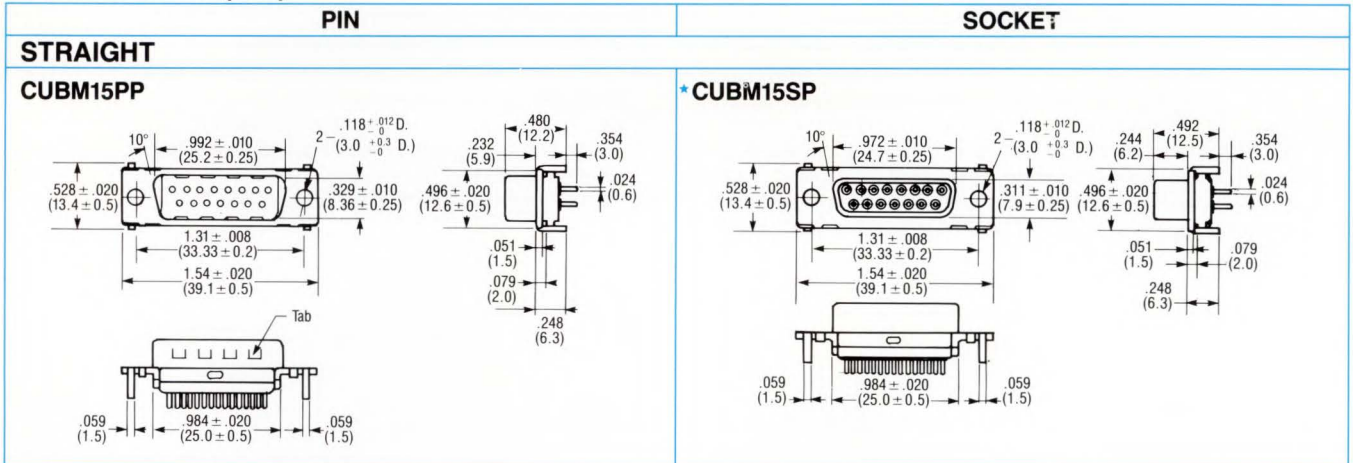

RECOMMENDED PC BOARD MOUNTING HOLES DIMENSIONS

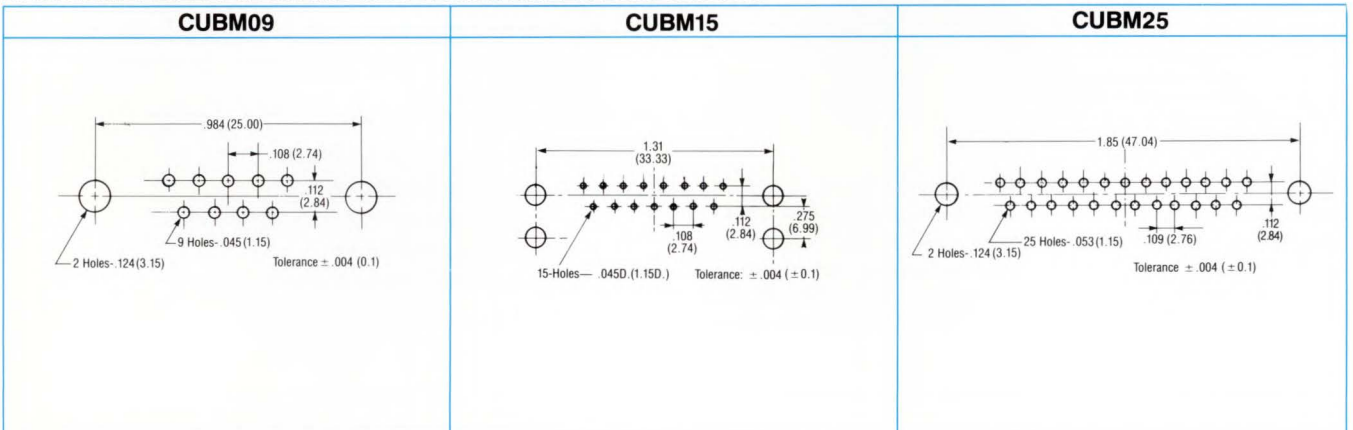

★ Available as standard through authorized Murata Erie Distributors.

CIRCUIT MODULE (Hybrid IC)

WHAT IS A HYBRID IC?

Hybrid ICs (Hybrid Integrated Circuit) incorporate electronic circuitry which combine such components as semiconductors, passive components, and printed elements on a ceramic substrate. There are basically two types of Hybrid ICs. Thin Film and Thick Film Technology. Murata Erie Hybrid IC technology is primarily Thick Film technology. Over 45 years of component experience, and over 20 years of Thick Film experience has allowed Murata Erie to offer a Total Hybrid System. Please contact our Murata Erie Circuit Module Design Group for Engineering consultation.

FEATURES:

- Reduce PCB complexity.
- Reduce Assembly and Testing time.
- Increase flexibility of REDESIGN and NEXT GENERATION DESIGN.
- Shipped as 100% fully tested module.
- Good High Frequency and Heat dissipation characteristics.
- Can greatly reduce "TIME TO MARKET."

MARKETS	END EQUIPMENT APPLICATIONS	CIRCUIT MODULE CLASSIFICATIONS					
		Active Filters	RC/C Modules	Functional Modules			Custom Modules
				SCSI Terminators	DC-DC Converters	Current Detectors	
COMPUTER	PC, Mini, Super, Notebook	○	○	○	○		○
	FDD, HDD, CD-ROM		○	○			○
	I/O, Interface, SCSI		○	○			○
	FA, NCU, Controller		○	○	○		○
	Data Acquisition/Instr.	○	○		○		○
	CD-Interactive, Multimedia	○	○	○			○
COMMUNICATIONS	TDMA/GSM/PCN/GPS	○					○
	PBX/ISDN/LAN/WAN	○	○		○		○
	FAX/PC FAX Boards	○	○			○	○
	Handheld Systems	○	○		○		○
AUTOMOTIVE	Engine Control Systems		○				○
	Multiplexing Systems		○				○
	Car Audio Systems	○	○		○		○
	Car Alarms/Controls		○				○
CONSUMER	Digital Audio/Pro	○					
	Home/Portable Audio	○	○				
	DBS Tuners	○	○				○
	Electronic Appliances		○				○

CUSTOM CIRCUIT MODULE DESIGN (Hybrid ICs)

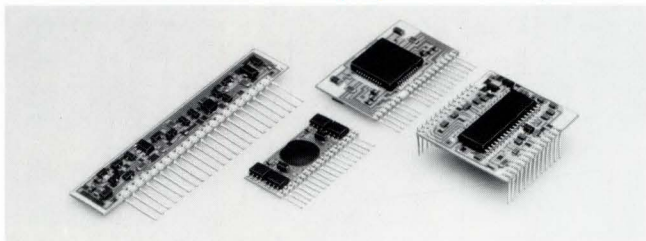

Murata Erie offers custom Thick Film Circuit Module design engineering and production capabilities. Our advanced computer aided design and manufacturing (CAD/CAM) systems allow us to respond to your various needs with quality and speed. If you have an application that could use our established Thick Film Technology, please contact us for engineering consultation.

ORDERING INFORMATION

Please provide the following information when inquiring about custom modules:

- Functional description of circuit
- Application
- Resistor and capacitor values and tolerance if known
- Manufacturer and part number of all active devices (Semiconductors)
- Package type preferred (SIP or DIP or SMD)
- Package dimensions (LxWxH)
- Your target cost for module
- Your development schedule requirements
- Your production schedule
- Expected annual usage (EAU)

ACTIVE FILTERS (TYPICAL EXAMPLES)

FACSIMILE/MODEM

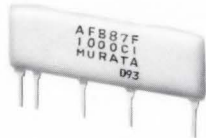
AFB87F1000C1	Part Number	Function	Dimensions (mm)		
			L	H	T
	AFC92F011A2	Cable equalizer (4dB/8dB)	23.0	12.0	6.5
	AFM94F400C12	Dial tone detector (fo=400Hz)	48.0	15.0	6.5
	AFL110F3700M5	Transmit LPF (tc=3700Hz with GDT compensation)	24.0	11.0	6.5
	AFB87F1000C1	Receive BPF (Japan, North America, Europe)	33.0	12.0	6.5
	AFE36F1800E1	Link equalizer (1 link equalizer)	33.0	13.5	6.5
	AFM94F2100C14	2100Hz tonal detector	47.0	15.0	6.5

CAR AUDIO

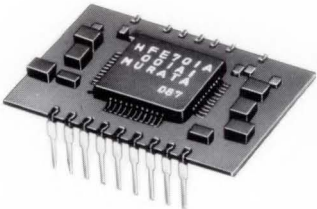
HFE701A001A1	Part Number	Application	Function	Type	Dimensions (mm)			Remarks
					L	H	T	
	HFE701A001A1	Electronic Volume System	Includes TC-9188	DIP	38.0	26.5	6.5	
	HFE701F008A1	Electronic Volume System	Includes TC-9222	SIP	35.0	22.0	8.0	
	AFE436F001B1	Graphic Equalizer	9ch Stereo, ±12dB	SIP	56.0	15.0	6.5	fo=60, 125, 250, 500 1K, 2K, 4K, 8K, 10KHz
	AFE428F001G1	Graphic Equalizer	7ch Stereo, ±12dB	SIP	47.5	16.0	6.5	fo=60, 125, 250, 500 1K, 3.5K, 10KHz
	AFS712F001A1	AM/FM Stereo	25, 10K, 19KHz Beat Eliminate	SIP	36.5	15.0	7.0	
	HFE110F002A1	FM antenna filter	BPF+AGC	SIP	22.0	7.5	5.5	
	AFZR74E9000A2	AM Stereo	9KHz Beat Eliminate	SIP	17.0	7.5	3.5	
	HFE210F001A1	ROS module	LA2231, LC7071, BPF	SIP	44.5	14.0	8.5	

DIGITAL/PCM/PRO AUDIO & DATA ACQUISITION SYSTEMS:

AFS16F40000B1											
Part Number	Pass Band (Hz)	Filter Order	Filter Response	T.H.D. (%)	Over Sampling	De-emphasis	Aperture Compensation	Dimensions (mm)			Note
								L	H	T	
AFS16F40000B1	20 to 22K	3	Butterworth × 2	0.0015	4Fs			17.0	9.5	5.0	
AFS16F36000C1	20 to 20K	3	Butterworth × 2	0.0015	4Fs	○		21.0	9.5	5.0	
AFL75F20000C1	20 to 20K	5	Butterworth with poles	0.003	2Fs			28.0	13.0	6.5	
AFL77F20000A1	20 to 20K	7	Butterworth with poles	0.003	2Fs			33.0	15.0	6.5	
AFL87F20000E1	20 to 20K	7	Tcheb. with poles	0.003	1Fs			33.0	15.0	6.5	
AFL87F20000S1	20 to 20K	7	Tcheb. with poles	0.003	1Fs			27.0	11.0	5.0	
AFL87F20000H4	20 to 20K	7	Tcheb. with poles	0.003	1Fs	○	○	33.0	19.0	5.5	
AFS814F20000A1	20 to 20K	7	Tcheb. with poles × 2	0.003	1Fs			55.0	14.0	6.5	
AFL89F22000D1	20 to 22K	9	Tcheb. with poles	0.003	1Fs			38.0	17.0	5.5	
AFL89WB20000C5	20 to 20K	9	Tcheb. with poles	0.003	1Fs			37.0	16.0	5.0	Metal Case
AFL811WF22000B3	20 to 22K	11	Tcheb. with poles	0.003	1Fs			53.0	17.0	5.0	Metal Case

CELLULAR/TWO WAY COMMUNICATIONS

AFL25F3000S15	Part Number	Application	Dimensions (mm)		
			L	H	T
	AFC98F003A1	Data/SAT Filter for US Cellular	27.5	10.0	7.0
	AFL24F3120A14	Splatter Filter for Radio Transceivers	16.5	11.5	5.0
	AFL25F3000S15	Splatter Filter for US Cellular & UK-TACS	15.0	9.0	6.5
	AFH85F300B1	Audio Filter for Land Mobile	25.0	12.5	5.5
	AFL85F210C11	Data Filter for Land Mobile	24.0	12.0	8.0
	AFB27F1000E1	Transmitting unit BPF for US Cellular/UK-TACS	22.0	9.0	7.0

We offer custom design support and variations to above products. Please contact our Circuit Module Group to discuss.

(TYPICAL EXAMPLES)

DBS TUNER: (DBS=DIRECT BROADCAST SYSTEM)

Part Number	Pass Band (Hz)	Filter Order	Filter Response	T.H.D. (%)	Over Sampling	De-emphasis	Aperture Compensation	Dimensions (mm)			Note
								L	H	T	
AFS28F20000B1	20 to 20K	3	Tcheb. $\times 2$	0.0015	4Fs	○		19.5	10.0	4.5	DBS only
AFS810F20000D1	20 to 20K	5	Tcheb. with poles $\times 2$	0.0007	2Fs	○		53.0	15.0	6.5	DBS only

SURROUND PROCESSOR

Part Number	Filter Order	Distortion Rate (%)	Noise Level (μV)	Dimensions (mm)			Analog Filter	Digital Filter		De-emphasis	Aperture Compensation
				L	H	T		2Fs	4Fs		
AFL89F8000D1	9	0.003	8	38.0	17.0	5.0	○				
AFL85F8000E1	5	0.003	32	23.0	15.0	5.5	○			○	

CD-i: (CD INTERACTIVE)

AFL87F17000E1

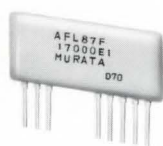

AFL87F001A1

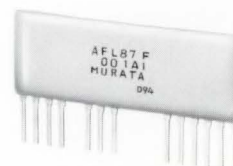

Part Number	Filter Order	Distortion Rate (%)	Noise Level (μV)	Dimensions (mm)			Analog Filter	Digital Filter		De-emphasis	Aperture Compensation
				L	H	T		2Fs	4Fs		
AFL87F17000E1	7	0.003	8	33.0	15.0	5.5	○				
AFL87F001A1	7	0.004	60	44.5	18.0	5.5	○			○	

- Distortion rate is the typical value at 1 KHz, 2Vms.
- Noise level is the typical value.
- Filter order $\times 2$: Stereo.
- Custom-made types are available upon request.

CURRENT DETECTORS FOR FACSIMILE/MODEM/NCU

HFS113F001A1



HFS113F002A1

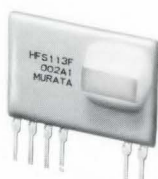

FEATURES

- These are the high sensitive type of current detection modules.
- These are suitable modules for detecting on-hook and off-hook in the FAX receiver.

Part Number	Working Current (mA)	Input Impedance (Ω)	Isolation Voltage (kVAC)
HFS113F001A1	$\pm 5/\pm 15$	9 max.	3.75
HFS113F002A1	$0/\pm 10$	9 max.	3.75
HFS113F015A1	$0/\pm 15$	9 max.	1.5

We offer custom design support and variations to above products. Please contact our Circuit Module Group to discuss.

SCSI SWITCHING TERMINATORS

<p>H8D2392C 9 Circuit SIL Type</p>		<p>H8D2469 18 Circuit SMD Type</p>		
Part Number	Application/Rating*	Dimensions (mm)		
		L	H	T
H8D2392C	9 Line "Single Ended" Passive SIP	32.5	10.0	5.0
H8LS118SA1 (H8D2469)	18 Line "Single Ended" Passive SMD	20.5	3.5	10.7
H8D2459	9 Line "Single Ended" Active SIP	37.0	11.0	6.0
H8D2508	9 Line "Differential" SIP	41.0	13.0	6.0

*Reference ANSI SCSI 2 Standards.

DC-DC CONVERTERS NOTEBOOK/PORTABLE COMPUTER

<p>HFP126A003A1</p>		<p>HFP111F003A1</p>			
Part Number	Application	Input Voltage (V)	Output Voltage (V)	Max. Current Load (A)	Dimensions HxWxL
HFP-083 (Assumed)	Main Power Supply	8 to 15.4	4.75 to 5.25, -22.0	2.2	12.0x22.0x8.0
HFP126A003A1	LCD DRIVE IC POWER SUPPLY	4.5 to 5.5	-22.5 to -20.5	0.032	6.0x30.0x10.2
HFP111F003A1	BACKING UP RAM BATTERY	5.5 to 16.0	4.75 to 5.25	0.15	12.0x8.0x22.0

PAGER AND BATTERY OPERATED DEVICES

<p>HFP101A014A1</p>	Part Number	Input Voltage (V)	Output Voltage (V)	Max. Current Load (mA)
	HFP101A005A1	0.9 to 1.7	1.8 to 2.8	10
	HFP101A018A1	1.0 to 1.7	2.80 to 3.05	1
	HFP101A019A1	0.9 to 1.7	2.95 to 3.35	0.1
	HFP101A013A1	1.0 to 1.7	4.6 to 5.3	6
	HFP101A014A1	1.0 to 1.7	4.7 to 5.2	6
	HFP101A017A1	1.8 to 3.4	4.7 to 5.5	4

PCB MOUNTED APPLICATIONS (COMPUTER, PBX, ISDN, LAN)

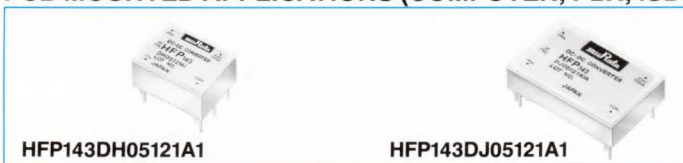

FOR COMMUNICATIONS

- Input Voltage is 5V, 24V, 48V.
- There are seven output voltages: 5V, 12V, 15V, ±12V and ±15V.
- Isolation between input and output signals.
- These use Murata Erie's large ceramic capacitor.
- As Tantalum electrolytic capacitors are not used, increasing reliability.
- 1 million Hrs. MTBF

Power (W)	Number of Output	Part Number	Input Voltage (V)	Output Voltage (V)	Max. Current Load (mA)	Dimensions HxWxL(mm)	Weight (g)
1.5	1	HFP143DH05051A1	5	5	300	10.5x20.5x25.5	12
		HFP143DH05121A1	5	12	120		
		HFP143DH05151A1	5	15	100		
		HFP143DH24051A1	24	5	300		
	2	HFP143DH48051A1	48	5	300		
		HFP143DH05122A1	5	±12	Each 60		
		HFP143DH05152A1	5	±15	Each 50		
3.0	1	HFP143DJ05121A1	5	12	250	8.5x26.0x42.0	20
		HFP143DJ05151A1	5	15	200		
		HFP143DJ48051A1	48	5	600		
	2	HFP143DJ05122A1	5	±12	Each 120		
		HFP143DJ05152A1	5	±15	Each 100		

We offer custom design support and variations to above products. Please contact our Circuit Module Group to discuss.

CIRCUIT MODULE (Hybrid IC) (RC/C MODULE)

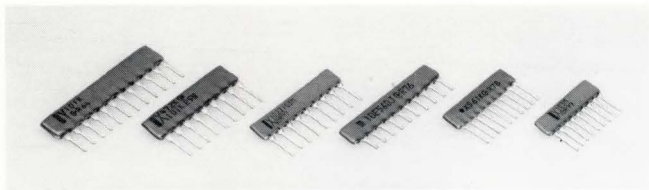

These products represent our most standard Hybrid line. Consisting of standard Resistor/Capacitor and Capacitor network circuit configurations, the customer decides the individual component values. Once a customer determines the ideal values of capacitor and resistor, Murata Erie can provide these products in mass production quantities.

FOR PART NUMBERS NOT SHOWN BELOW, CONTACT MURATA ERIE CIRCUIT MODULE GROUP FOR DESIGN OPTIONS.

PART NUMBERING SYSTEM (RC-MODULE)

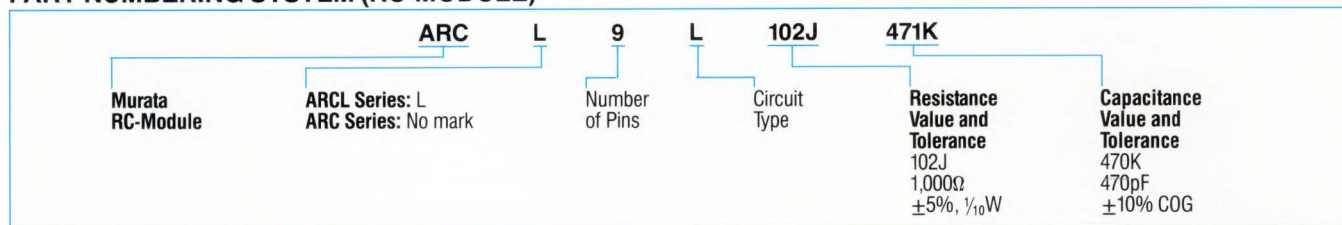

SPECIFICATIONS/ARC SERIES

Prefix	Circuit Type	Circuit	Configuration		Dimensions: (mm)	
ARCL	L		Number of Pins	9	ARCL 	
			Number of Components	R: 4, C: 4		
			Length (mm)	.965(24.5)		
ARCL	S		Number of Pins	6, 10	ARC 	
			Number of Components	R: 4, C: 4, 8		
			Length (mm)	.689(17.5), 1.083(27.5)		
ARCL	X		Number of Pins	5, 9	ARC 	
			Number of Components	R: 4, C: 4, 8		
			Length (mm)	.571(14.5), .965(24.5)		
ARC	I		Number of Pins	10	ARC 	
			Number of Components	R: 9, C: 9		
			Length (mm)	1.083(27.5)		
ARC	8E		Number of Pins	8	ARC 	
			Number of Components	R: 6, C: 1		
			Length (mm)	.866(22)		
ARC	10E		Number of Pins	10	ARC 	
			Number of Components	R: 6, C: 2		
			Length (mm)	1.063(27)		

MOST COMMON RESISTOR/CAPACITOR MODULES: (ARC SERIES)

L	S	X	E
ARCL9L471J101K ARCL9L471J471K ARCL9L102J101K ARCL9L102J471K	ARCL6S102J101K ARCL6S102J471K ARCL6S103J101K ARCL6S103J471K ARCL10S102J101K ARCL10S102J221K	ARCL10S103J470K ARCL10S103J101K ARCL10S103J471K ARCL10S103J102M ARCL10S473J470K ARCL10S473J101K	ARCL5X103J102M ARCL5X103J103M ARCL9X103J101K ARCL9X103J221K ARCL9X473J101K ARCL9X473J221K

CNT SERIES DIMENSIONS: In. (mm)

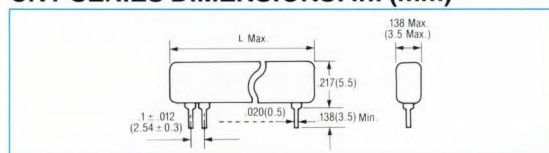

PART NUMBERING SYSTEM

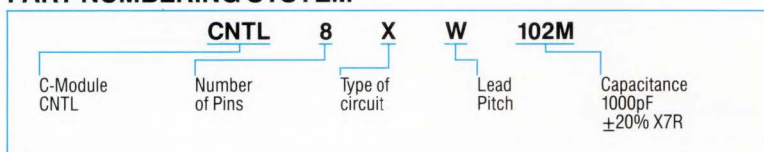

MOST COMMON CAPACITOR MODULES: (CNT SERIES)

Circuit	Capacitance /1 Element	Cap. Rating	Cap. Tol. (%)	Temp. Char.	Part Number	Part Number	Part Number	Part Number	
	47pF	50VDC	10	COG	—	—	CNTL9XW470K	—	
	100pF	50VDC	10	COG	CNTL5XW101K	CNTL8XW101K	CNTL9XW101K	CNTL10XW101K	
	470pF	50VDC	10	COG	CTNL5XW471K	—	CNTL9XW471K	—	
	1000pF	50VDC	20	X7R	—	CNTL8XW102M	CNTL9XW102M	CNTL10XW102M	
	10000pF	25VDC	20	X7R	—	CNTL8XW103M	CNTL9XW103M	CNTL10XW103M	
	1μF	16VDC	-20,+80	Y5V	—	CNTL8XW104Z	CNTL9XW104Z	CNTL10XW104Z	
	# of Pins					5	8	9	10
	# of Elements					4	7	8	9
	Length					.571 (14.5)	.866 (22.0)	.965 (24.5)	1.063 (27.0)
	Top Tstg.					-35°C to +85°C			
Tstg.					-40°C to +85°C				

We offer custom design support and variations to above products. Please contact our Circuit Module Group to discuss.

DELAY LINE CHIP MONOLITHIC, 200 MHz to 2 GHz



This delay line has been developed by applying chip multilayer and through hole technology. It consists of copper line and temperature compensated dielectric and incorporates metal shields. LD series are very small and provide excellent signal matching.

FEATURES

- High stability at high frequency (200MHz to 2GHz).
- This product is small, thin, light and highly reliable and utilizes multilayer construction.
- Metal shield is built into the chip.
- Reflow soldering ability is standard.
- Supplied on tape & reel and bulk packaging.

APPLICATIONS

- Optical interface equipment.
- Fiber optic tele-communications.
- High speed super computers.
- Test and measurement equipment.

DIMENSIONS : mm

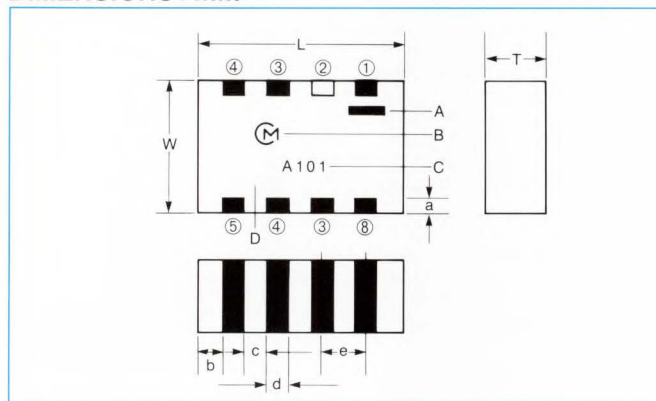

CODE	LDH36	LDH46 TYP
L	6.3±0.3	10.0±0.3
W	5.0±0.3	6.3±0.3
T	2.5 max	4.0 max
a	0.4±0.3	0.4±0.3
b	0.64 min	0.49 min
c	0.3 min	1.3 min
d	0.6 min	0.8 min
e	1.27±0.2	2.54±0.2

TERMINAL

PIN No.	NAME	PIN No.	NAME
1	IN / OUT	5	IN / OUT
2	GND	6	GND
3	GND	7	GND
4	GND	8	GND

ELECTRICAL CHARACTER TABLE

LDH36 TYPE							
Part Numbers	Delay Time (DT) (ns)	*Impedance	Rising Time	D.C. Resistance (Ω) MAX)	Insulation Resistance	Rated Power	Operating Temperature Range
LDH36-01A101AB	0.1±0.05	50Ω±10%	0.1nS max.	0.2	100MΩ min	1/4W	-25 to +85°C
LDH36-01A201AB	0.2±0.05			0.4			
LDH36-01A301AB	0.3±0.05			0.6			
LDH36-01A401AB	0.4±0.05		0.8				
LDH36-01A501AB	0.5±0.05		1.0				
LDH36-01A601BB	0.6±0.1		1.2				
LDH36-01A701BB	0.7±0.1		1.4				
LDH36-01A801BB	0.8±0.1		1.6				
LDH36-01A901BB	0.9±0.1		1.8				
LDH36-01A102BB	1.0±0.1		2.0				
LDH46 TYPE							
LDH46-01A152BA	1.5±0.1	50Ω±10%	0.3nS max.	3.0	100MΩ min	1/4W	-25 to +85°C
LDH46-01A202BA	2.0±0.1			4.0			
LDH46-01A252BA	2.5±0.1			5.0			
LDH46-01A302BA	3.0±0.1		6.0				
LDH46-01A402BA	4.0±0.1		8.0				
LDH46-01A502BA	5.0±0.1		10.0				
LDH46-01A602CA	6.0±0.2		12.0				
LDH46-01A702CA	7.0±0.2		14.0				
LDH46-01A802CA	8.0±0.2		16.0				
LDH46-01A902CA	9.0±0.2		18.0				
LDH46-01A103CA	10.0±0.2	20.0					

We offer custom design support and variations to above products. Please contact our Circuit Module Group to discuss.

CAPACITORS— CHIP, MONOLITHIC

- Miniature size
- Wide capacitance, TC, voltage and tolerance range
- Industry standard sizes
- 8mm and 12mm tape and reel for auto-placements
- Barrier layer termination systems for wave, reflow or vapor phase solder
- Largest production volume and capacity in the industry

★ KIT-GRM36

Part No.	Cap.	Tol.
COG 50V, 100 each value		
GRM36COG0R5C50AB	0.5pF	± .25pF
GRM36COG010C50AB	1	± .25
GRM36COG020C50AB	2	± .25
GRM36COG030C50AB	3	± .25
GRM36COG040C50AB	4	± .25
GRM36COG050C50AB	5	± .25
GRM36COG060D50AB	6	± .5
GRM36COG070D50AB	7	± .5
GRM36COG080D50AB	8	± .5
GRM36COG090D50AB	9	± .5
GRM36COG100D50AB	10	± .5
GRM36COG120J50AB	12	±5 %
GRM36COG150J50AB	15	±5
GRM36COG180J50AB	18	±5
GRM36COG220J50AB	22	±5
GRM36COG270J50AB	27	±5
GRM36COG330J50AB	33	±5
GRM36COG390J50AB	39	±5
GRM36COG470J50AB	47	±5
GRM36COG560J50AB	56	±5
GRM36COG680J50AB	68	±5
GRM36COG820J50AB	82	±5
GRM36COG101J50AB	100	±5
GRM36COG121J50AB	120	±5
GRM36COG151J50AB	150	±5
X7R 50V, 200 each value		
GRM36X7R221K50AB	220 pF	±10%
GRM36X7R271K50AB	270	±10
GRM36X7R331K50AB	330	±10
GRM36X7R391K50AB	390	±10
GRM36X7R471K50AB	470	±10
GRM36X7R561K50AB	560	±10
GRM36X7R681K50AB	680	±10
GRM36X7R821K50AB	820	±10
GRM36X7R102K50AB	1000	±10
GRM36X7R122K50AB	1200	±10
GRM36X7R152K50AB	1500	±10
GRM36X7R182K50AB	1800	±10
GRM36X7R222K50AB	2200	±10
GRM36X7R272K50AB	2700	±10
GRM36X7R332K50AB	3300	±10
GRM36X7R392K50AB	3900	±10
GRM36X7R472K25AB	4700	±10
GRM36X7R562K25AB	5600	±10
GRM36X7R682K25AB	6800	±10
GRM36X7R822K16AB	8200	±10
GRM36X7R103K16AB	.01μF	±10
Y5V 50V, 200 each value		
GRM36Y5V102Z50AB	1000 pF	+80, -20%
GRM36Y5V222Z50AB	2200	+80, -20
GRM36Y5V332Z50AB	3300	+80, -20
GRM36Y5V472Z50AB	4700	+80, -20
GRM36Y5V103Z50AB	.01 μF	+80, -20
GRM36Y5V153Z25AB	.015	+80, -20
GRM36Y5V223Z25AB	.022	+80, -20
GRM36Y5V333Z16AB	.033	+80, -20

★ STANDARD DISTRIBUTOR ITEMS

★ KIT-GRM39

Part No.	Cap.	Tol.
COG 100V, 50 each value		
GRM39COG010B100AB	1 pF	± .1 pF
GRM39COG1R5B100AB	1.5	± .1
GRM39COG2R2B100AB	2.2	± .1
GRM39COG3R3B100AB	3.3	± .1
GRM39COG4R7B100AB	4.7	± .1
GRM39COG6R8C100AB	6.8	± .25
GRM39COG100D100AB	10	± .5
GRM39COG150J100AB	15	±5 %
GRM39COG220J100AB	22	±5
GRM39COG330J100AB	33	±5
GRM39COG470J100AB	47	±5
GRM39COG680J100AB	68	±5
GRM39COG101J100AB	100	±5
COG 50V, 50 each value		
GRM39COG010B050AB	1 pF	± .1 pF
GRM39COG1R5B050AB	1.5	± .1
GRM39COG2R2B050AB	2.2	± .1
GRM39COG3R3B050AB	3.3	± .1
GRM39COG4R7B050AB	4.7	± .1
GRM39COG6R8C050AB	6.8	± .25
GRM39COG100D050AB	10	± .5
GRM39COG150J050AB	15	±5 %
GRM39COG220J050AB	22	±5
GRM39COG330J050AB	33	±5
GRM39COG470J050AB	47	±5
GRM39COG680J050AB	68	±5
GRM39COG101J050AB	100	±5
GRM39COG151J050AB	150	±5
GRM39COG221J050AB	220	±5
X7R 50V, 50 each value		
GRM39X7R221K050AB	220pF	±10%
GRM39X7R331K050AB	330	±10
GRM39X7R471K050AB	470	±10
GRM39X7R681K050AB	680	±10
GRM39X7R102K050AB	1000	±10
GRM39X7R152K050AB	1500	±10
GRM39X7R222K050AB	2200	±10
GRM39X7R332K050AB	3300	±10
GRM39X7R472K050AB	4700	±10
GRM39X7R682K050AB	6800	±10
GRM39X7R103K050AB	.01μF	±10
X7R 25V, 50 each value		
GRM39X7R472K025AB	4700pF	±10%
GRM39X7R682K025AB	6200	±10
GRM39X7R103K025AB	.01μF	±10
X7R 16V, 50 each value		
GRM39X7R153K016AB	.015μF	±10%
GRM39X7R223K016AB	.022	±10
GRM39X7R333K016AB	.033	±10
Y5V 50V, 50 each value		
GRM39Y5V152Z050AB	1500pF	+80, -20%
GRM39Y5V222Z050AB	2200	+80, -20
GRM39Y5V332Z050AB	3300	+80, -20
GRM39Y5V472Z050AB	4700	+80, -20
GRM39Y5V682Z050AB	6800	+80, -20
GRM39Y5V103Z050AB	.01 μF	+80, -20%
GRM39Y5V153Z050AB	.015	+80, -20
GRM39Y5V223Z050AB	.022	+80, -20
Y5V 25V, 50 each value		
GRM39Y5V152Z025AB	1500pF	+80, -20%
GRM39Y5V222Z025AB	2200	+80, -20
GRM39Y5V332Z025AB	3300	+80, -20
GRM39Y5V472Z025AB	4700	+80, -20
GRM39Y5V682Z025AB	6800	+80, -20
GRM39Y5V103Z025AB	.01 μF	+80, -20
GRM39Y5V153Z025AB	.015	+80, -20
GRM39Y5V223Z025AB	.022	+80, -20
GRM39Y5V333Z025AB	.033	+80, -20
GRM39Y5V473Z025AB	.047	+80, -20
Y5V 16V, 50 each value		
GRM39Y5V333Z016AB	.033μF	+80, -20%
GRM39Y5V473Z016AB	.047	+80, -20
GRM39Y5V683Z016AB	.068	+80, -20
GRM39Y5V104Z016AB	.1	+80, -20

CAPACITORS— CHIP, MONOLITHIC (continued)

★ KIT-GRM40

Part No.	Cap.	Tol.
COG 50V, 50 each value		
GRM40COG010C050AB	1pF	± .25pF
GRM40COG020C050AB	2	± .25
GRM40COG030C050AB	3	± .25
GRM40COG040C050AB	4	± .25
GRM40COG050D050AB	5	± .5
GRM40COG060D050AB	6	± .5
GRM40COG070D050AB	7	± .5
GRM40COG080D050AB	8	± .5
GRM40COG090D050AB	9	± .5
GRM40COG100D050AB	10	± .5
GRM40COG120J050AB	12	± 5 %
GRM40COG150J050AB	15	± 5
GRM40COG180J050AB	18	± 5
GRM40COG220J050AB	22	± 5
GRM40COG330J050AB	33	± 5
GRM40COG390J050AB	39	± 5
GRM40COG470J050AB	47	± 5
GRM40COG560J050AB	56	± 5
GRM40COG680J050AB	68	± 5
GRM40COG820J050AB	82	± 5
GRM40COG101J050AB	100	± 5
GRM40COG121J050AB	120	± 5
GRM40COG151J050AB	150	± 5
GRM40COG181J050AB	180	± 5
GRM40COG221J050AB	220	± 5
GRM40COG271J050AB	270	± 5
GRM40COG331J050AB	330	± 5
GRM40COG391J050AB	390	± 5
GRM40COG471J050AB	470	± 5
X7R 50V, 100 each value		
GRM40X7R391K050AB	390pF	± 10%
GRM40X7R471K050AB	470	± 10
GRM40X7R561K050AB	560	± 10
GRM40X7R681K050AB	680	± 10
GRM40X7R821K050AB	820	± 10
GRM40X7R102K050AB	1000	± 10
GRM40X7R122K050AB	1200	± 10
GRM40X7R152K050AB	1500	± 10
GRM40X7R182K050AB	1800	± 10
GRM40X7R222K050AB	2200	± 10
GRM40X7R272K050AB	2700	± 10
GRM40X7R332K050AB	3300	± 10
GRM40X7R392K050AB	3900	± 10
GRM40X7R472K050AB	4700	± 10
GRM40X7R562K050AB	5600	± 10
GRM40X7R682K050AB	6800	± 10
GRM40X7R822K050AB	8200	± 10
GRM40X7R103K050AB	.01 μF	± 10
GRM40X7R123K050AB	.012	± 10
GRM40X7R153K050AB	.015	± 10
GRM40X7R183K050AB	.018	± 10
GRM40X7R223K050AB	.022	± 10
Z5U 50V, 100 each value		
GRM40Z5U103M050AB	.01 μF	± 20%
GRM40Z5U123M050AB	.012	± 20
GRM40Z5U183M050AB	.018	± 20
GRM40Z5U223M050AB	.022	± 20
GRM40Z5U333M050AB	.033	± 20
GRM40Z5U473M050AB	.047	± 20
Y5V, 25V, 100 each value		
GRM40Y5V104Z25V	.1 μF	+80, -20%

★ STANDARD DISTRIBUTOR ITEMS

★ KIT-GRM42-6

Part No.	Cap.	Tol.
COG 50V, 50 each value		
GRM42-6COG100D050AB	10pF	± .5pF
GRM42-6COG120J050AB	12	± 5 %
GRM42-6COG150J050AB	15	± 5
GRM42-6COG180J050AB	18	± 5
GRM42-6COG220J050AB	22	± 5
GRM42-6COG330J050AB	33	± 5
GRM42-6COG390J050AB	39	± 5
GRM42-6COG470J050AB	47	± 5
GRM42-6COG560J050AB	56	± 5
GRM42-6COG680J050AB	68	± 5
GRM42-6COG820J050AB	82	± 5
GRM42-6COG101J050AB	100	± 5
GRM42-6COG121J050AB	120	± 5
GRM42-6COG151J050AB	150	± 5
GRM42-6COG181J050AB	180	± 5
GRM42-6COG221J050AB	220	± 5
GRM42-6COG271J050AB	270	± 5
GRM42-6COG331J050AB	330	± 5
GRM42-6COG391J050AB	390	± 5
GRM42-6COG471J050AB	470	± 5
GRM42-6COG561J050AB	560	± 5
GRM42-6COG681J050AB	680	± 5
GRM42-6COG821J050AB	820	± 5
GRM42-6COG102J050AB	1000	± 5
X7R 50V, 100 each value		
GRM42-6X7R331K050AB	330pF	± 10%
GRM42-6X7R391K050AB	390	± 10
GRM42-6X7R471K050AB	470	± 10
GRM42-6X7R561K050AB	560	± 10
GRM42-6X7R681K050AB	680	± 10
GRM42-6X7R821K050AB	820	± 10
GRM42-6X7R102K050AB	1000	± 10
GRM42-6X7R122K050AB	1200	± 10
GRM42-6X7R152K050AB	1500	± 10
GRM42-6X7R182K050AB	1800	± 10
GRM42-6X7R222K050AB	2200	± 10
GRM42-6X7R272K050AB	2700	± 10
GRM42-6X7R332K050AB	3300	± 10
GRM42-6X7R392K050AB	3900	± 10
GRM42-6X7R472K050AB	4700	± 10
GRM42-6X7R562K050AB	5600	± 10
GRM42-6X7R682K050AB	6800	± 10
GRM42-6X7R822K050AB	8200	± 10
GRM42-6X7R103K050AB	.01 μF	± 10
GRM42-6X7R123K050AB	.012	± 10
GRM42-6X7R153K050AB	.015	± 10
GRM42-6X7R183K050AB	.018	± 10
GRM42-6X7R223K050AB	.022	± 10
GRM42-6X7R333K050AB	.033	± 10
GRM42-6X7R393K050AB	.039	± 10
GRM42-6X7R473K050AB	.047	± 10
GRM42-6X7R563K050AB	.056	± 10
GRM42-6X7R683K050AB	.068	± 10
GRM42-6X7R823K050AB	.082	± 10
GRM42-6X7R104K050AB	.1	± 10
Z5U 50V, 100 each value		
GRM42-6Z5U473M050AB	.047 μF	± 20%
GRM42-6Z5U563M050AB	.056	± 20
GRM42-6Z5U683M050AB	.068	± 20
GRM42-6Z5U823M050AB	.082	± 20
GRM42-6Z5U104M050AB	.1	± 20

CAPACITORS— CHIP, MONOLITHIC (continued)

KIT-GRM40-TC

Temperature compensating

Values below in each of these T.C.'s: P2H, R2H, S2H, T2H, U2J

Part No.	Cap.	Tol.
50V, 50 each value		
GRM40□□□010B050AB	1 pF	± .1 pF
GRM40□□□1R5B050AB	1.5	± .1
GRM40□□□2R2B050AB	2.2	± .1
GRM40□□□3R3B050AB	3.3	± .1
GRM40□□□4R7B050AB	4.7	± .1
GRM40□□□6R8C050AB	6.8	± .25
GRM40□□□100D050AB	10	± .5
GRM40□□□150J050AB	15	±5 %
GRM40□□□220J050AB	22	±5
GRM40□□□330J050AB	33	±5
GRM40□□□470J050AB	47	±5
GRM40□□□680J050AB	68	±5
GRM40□□□101J050AB	100	±5
GRM40□□□151J050AB	150	±5
GRM40□□□221J050AB	220	±5
GRM40□□□331J050AB	330	±5
GRM40□□□471J050AB	470	±5
GRM40□□□681J050AB	680	±5
GRM40□□□102J050AB	1000*	±5
GRM40□□□152J050AB	1500*	±5

*T2H and U2J only

KIT-GRM42-6-TC

Temperature compensating

Values below in each of these T.C.'s: P2H, R2H, S2H, T2H, U2J

Part No.	Cap.	Tol.
50V, 50 each value		
GRM42-6□□□010B050AB	1 pF	± .1 pF
GRM42-6□□□1R5B050AB	1.5	± .1
GRM42-6□□□2R2B050AB	2.2	± .1
GRM42-6□□□3R3B050AB	3.3	± .1
GRM42-6□□□4R7B050AB	4.7	± .1
GRM42-6□□□6R8C050AB	6.8	± .25
GRM42-6□□□100D050AB	10	± .5
GRM42-6□□□150J050AB	15	±5 %
GRM42-6□□□220J050AB	22	±5
GRM42-6□□□330J050AB	33	±5
GRM42-6□□□470J050AB	47	±5
GRM42-6□□□680J050AB	68	±5
GRM42-6□□□101J050AB	100	±5
GRM42-6□□□151J050AB	150	±5
GRM42-6□□□221J050AB	220	±5
GRM42-6□□□331J050AB	330	±5
GRM42-6□□□471J050AB	470	±5
GRM42-6□□□681J050AB	680	±5
GRM42-6□□□102J050AB	1000*	±5
GRM42-6□□□152J050AB	1500*	±5

*T2H and U2J only

★ STANDARD DISTRIBUTOR ITEMS

CAPACITORS— CHIP, MONOLITHIC, ELECTROLYTICS REPLACEMENTS

KIT-GRM-TA

Tantalum Alternative

Part No.	Cap.	Tol.
X7R 16V, 25 each value, *10 each value		
GRM39X7R153K016AB	.015 μ F	±10%
GRM39X7R223K016AB	.022	±10
GRM39X7R333K016AB	.033	±10
GRM40X7R153K016AB	.015	±10
GRM40X7R223K016AB	.022	±10
GRM40X7R333K016AB	.033	±10
GRM40X7R473K016AB	.047	±10
GRM40X7R683K016AB	.068	±10
GRM40X7R104K016AB	.1	±10
GRM40X7R154K016AB	.15	±10
GRM42-6X7R104K016AB	.1	±10
GRM42-6X7R154K016AB	.15	±10
GRM42-6X7R224K016AB	.22	±10
GRM42-6X7R334K016AB	.33	±10
*GRM42-2X7R154K016AB	.15	±10
*GRM42-2X7R224K016AB	.22	±10
*GRM42-2X7R334K016AB	.33	±10
*GRM42-2X7R474K016AB	.47	±10
*GRM43-2X7R474K016AB	.47	±10
Y5V 16V, 25 each value, *10 each value		
GRM39Y5V333Z016AB	.033 μ F	+80, -20%
GRM39Y5V473Z016AB	.047	+80, -20
GRM39Y5V683Z016AB	.068	+80, -20
GRM39Y5V104Z016AB	.1	+80, -20
GRM40Y5V333Z016AB	.033	+80, -20
GRM40Y5V473Z016AB	.047	+80, -20
GRM40Y5V683Z016AB	.068	+80, -20
GRM40Y5V104Z016AB	.1	+80, -20
GRM40Y5V154Z016AB	.15	+80, -20
GRM40Y5V224Z016AB	.22	+80, -20
GRM40Y5V334Z016AB	.33	+80, -20
GRM40Y5V474Z016AB	.47	+80, -20
GRM42-6Y5V154Z016AB	.15	+80, -20
GRM42-6Y5V224Z016AB	.22	+80, -20
GRM42-6Y5V334Z016AB	.33	+80, -20
GRM42-6Y5V474Z016AB	.47	+80, -20
GRM42-6Y5V684Z016AB	.68	+80, -20
GRM42-6Y5V105Z016AB	1.0	+80, -20
GRM42-6Y5V155Z016AB	1.5	+80, -20
*GRM42-2Y5V684Z016AB	.68	+80, -20
*GRM42-2Y5V105Z016AB	1.0	+80, -20
*GRM42-2Y5V155Z016AB	1.5	+80, -20
*GRM42-2Y5V225Z016AB	2.2	+80, -20
*GRM43-2Y5V225Z016AB	2.2	+80, -20

CAPACITORS— CHIP MONOLITHIC, MICROWAVE

- Miniature sizes
- Very high Q at high frequencies
- High RF power capabilities
- Impervious to adverse environmental conditions
- Low dissipation factors
- Perfect retrace capability
- High temperature stability
- Low noise

★ KIT-MA18-001 (Evaluation Kit)

Part No.	Cap.	Tol.
P90 150V, 5 each value		
MA181R0B	1.0pF	± .1 pF
MA181R8C	1.8	± .25
MA182R7D	2.7	± .5
MA183R3D	3.3	± .5
MA184R7D	4.7	± .5
MA185R7D	5.6	± .5
MA188R2K	8.2	± 10 %
MA18100K	10	± 10
MA18120K	12	± 10
MA18150K	15	± 10
MA18220K	22	± 10
MA18360K	36	± 10
MA18470K	47	± 10
MA18560K	56	± 10
MA18820K	82	± 10

★ KIT-MA18-002 (Tune Kit)

Part No.	Cap.	Tol.
P90 150V, 5 each value		
MA180R3B	0.3pF	± .1 pF
MA180R4B	0.4	± .1
MA180R5B	0.5	± .1
MA180R6B	0.6	± .1
MA180R7B	0.7	± .1
MA180R8B	0.8	± .1
MA180R9B	0.9	± .1
MA181R0B	1.0	± .1
MA181R2B	1.2	± .1
MA181R4B	1.4	± .1
MA181R5B	1.5	± .1
MA181R6B	1.6	± .1
MA181R8B	1.8	± .1
MA181R9B	1.9	± .1
MA182R0B	2.0	± .1
MA182R1B	2.1	± .1
MA182R2B	2.2	± .1
MA182R4B	2.4	± .1
MA182R7B	2.7	± .1
MA183R0B	3.0	± .1
MA183R6C	3.6	± .25
MA183R9C	3.9	± .25
MA184R7C	4.7	± .25
MA185R1C	5.1	± .25
MA185R6C	5.6	± .25
MA186R2C	6.2	± .25 %
MA186R8J	6.8	± 5 %
MA188R2J	8.2	± 5
MA189R1J	9.1	± 5
MA18100J	10	± 5

★ STANDARD DISTRIBUTOR ITEMS

★ KIT-MA18-003 (Designer Kit)

Part No.	Cap.	Tol.
P90 150V, 5 each value		
MA181R0B	1.0pF	± .1 pF
MA181R3B	1.3	± .1
MA181R6B	1.6	± .1
MA181R9B	1.9	± .1
MA182R1B	2.1	± .1
MA182R7C	2.7	± .25
MA183R3C	3.3	± .25
MA183R9C	3.9	± .25
MA184R7C	4.7	± .25
MA185R6C	5.6	± .25
MA186R8J	6.8	± 5 %
MA187R5J	7.5	± 5
MA188R5J	8.2	± 5
MA189R1J	9.1	± 5
MA18100J	10	± 5
MA18120J	12	± 5
MA18150J	15	± 5
MA18180J	18	± 5
MA18220J	22	± 5
MA18240J	24	± 5
MA18270J	27	± 5
MA18330J	33	± 5
MA18360J	36	± 5
MA18390J	39	± 5
MA18470J	47	± 5
MA18560J	56	± 5
MA18680K	68	± 10
MA18750K	75	± 10
MA18820K	82	± 10
MA18910K	91	± 10

★ KIT-MA28-001 (1) (Evaluation Kit)

Part No.	Cap.	Tol.
P90 500V, 5 each value		
MA281R0C	1.0pF	± .25pF
MA282R2D	2.2	± .5
MA283R6D	3.6	± .5
MA285R6D	5.6	± .5
MA287R5D	7.5	± .5
MA28110J	11	± 5 %
MA28160J	16	± 5
MA28240J	24	± 5
MA28360J	36	± 5
MA28510J	51	± 5
MA28750J	75	± 5
MA28101J	100	± 5
MA28201J	200*	± 5
MA28471M	470*	± 20
MA28621M	620**	± 20

*300VDC **200VDC

★ KIT-MA28-002 (1) (Tune Kit)

Part No.	Cap.	Tol.
P90 500V, 5 each value		
MA280R3B	0.3pF	± .1pF
MA280R4B	0.4	± .1
MA280R5B	0.5	± .1
MA280R6B	0.6	± .1
MA280R7B	0.7	± .1
MA280R8B	0.8	± .1
MA280R9B	0.9	± .1
MA281R0B	1.0	± .1
MA281R2B	1.2	± .1
MA281R4B	1.4	± .1

DESIGN ENGINEERING KITS

CAPACITORS— CHIP MONOLITHIC, MICROWAVE (continued)

★ KIT-MA28-002 (1) (continued) (Tune Kit)

Part No.	Cap.	Tol.
P90 500V, 5 each value (continued)		
MA281R5B	1.5pF	± .1 pF
MA281R6B	1.6	± .1
MA281R8B	1.8	± .1
MA281R9B	1.9	± .1
MA282R0B	2.0	± .1
MA282R1B	2.1	± .1
MA282R2B	2.2	± .1
MA282R4B	2.4	± .1
MA282R7B	2.7	± .1
MA283R0B	3.0	± .1
MA283R6C	3.6	± .25
MA283R9C	3.9	± .25
MA284R7C	4.7	± .25
MA285R1C	5.1	± .25
MA285R6C	5.6	± .25
MA286R2C	6.2	± .25
MA286R8J	6.8	± 5 %
MA288R2J	8.2	± 5
MA289R1J	9.1	± 5
MA28100J	10	± 5

★ KIT-MA28-003 (1) (Designer Kit)

Part No.	Cap.	Tol.
P90 500V, 5 each value		
MA280R3B	0.3pF	± .1 pF
MA280R4B	0.4	± .1
MA280R5B	0.5	± .1
MA280R6B	0.6	± .1
MA280R7B	0.7	± .1
MA280R8B	0.8	± .1
MA280R9B	0.9	± .1
MA281R2B	1.2	± .1
MA281R5C	1.5	± .25
MA281R8C	1.8	± .25
MA282R2C	2.2	± .25
MA282R7C	2.7	± .25
MA283R0C	3.0	± .25
MA283R3C	3.3	± .25
MA283R6C	3.6	± .25
MA284R3C	4.3	± .25
MA285R6C	5.6	± .25
MA286R2C	6.2	± .25
MA286R8J	6.8	± 5 %
MA287R5J	7.5	± 5
MA288R2J	8.2	± 5
MA289R1J	9.1	± 5
MA28100J	10	± 5
MA28110J	11	± 5
MA28130J	13	± 5
MA28160J	16	± 5
MA28180J	18	± 5
MA28240J	24	± 5
MA28270J	27	± 5
MA28300J	30	± 5
MA28330J	33	± 5
MA28360J	36	± 5
MA28430J	43	± 5
MA28470J	47	± 5
MA28560K	56	± 10
MA28620K	62	± 10
MA28680K	68	± 10
MA28910K	91	± 10
MA28131K	130*	± 10
MA28161K	160*	± 10

★ STANDARD DISTRIBUTOR ITEMS

★ KIT-MA28-003 (1) ★ KIT-MA22-003MS (2) (Designer Kit)

Part No.	Cap.	Tol.
P90 150V, 5 each value		
MA28181K	180* pF	± 10%
MA28201K	200**	± 10
MA28221K	220**	± 10
MA28241K	240**	± 10
MA28301K	300**	± 10
MA28361M	360**	± 20
MA28431M	430**	± 20
MA28471M	470**	± 20
MA28511M	510**	± 20
MA28561M	560**	± 20
MA28621M	620**	± 20

*300VDC **200VDC

(1) Termination-Palladium silver, nickel interface, solder (SN62)
(2) Termination-Microstrip leads

CAPACITORS— RADIAL LEADED, MONOLITHIC

- Wide capacitance, T.C., voltage and tolerance range
- Industry standard sizes
- Tape and Reel available for auto insertion
- Various lead spacing available
- Marking standard or to customer specification

★ KIT-RPE

Part No.	Cap.	Tol.
COG 100V, 50 each value		
RPE110COG1R0C100V	1 pF	± .25pF
RPE110COG2R2C100V	2.2	± .25
RPE110COG4R7C100V	4.7	± .25
RPE110COG8R2D100V	8.2	± .25
RPE110COG100D100V	10	± 5 %
RPE110COG180J100V	18	± 5
RPE110COG220J100V	22	± 5
RPE110COG330J100V	33	± 5
RPE110COG470J100V	47	± 5
RPE110COG680J100V	68	± 5
RPE110COG820J100V	82	± 5
RPE122COG101J100V	100	± 5
RPE122COG221J100V	220	± 5
RPE122COG331J100V	330	± 5
RPE122COG471J100V	470	± 5
RPE122COG821J100V	820	± 5
X7R 100V, 50 each value		
RPE122X7R102K100V	1,000pF	± 10%
RPE122X7R222K100V	2,200	± 10
RPE122X7R472K100V	4,700	± 10
RPE122X7R103K100V	10,000	± 10
RPE122X7R223K100V	22,000	± 10
RPE122X7R333K100V	33,000	± 10
RPE122X7R473K100V	47,000	± 10
RPE122X7R104K100V	100,000	± 10
Z5U 50V, 50 each value		
RPE122Z5U224M050V	220,000pF	± 20%
RPE122Z5U334M050V	330,000	± 20
RPE123Z5U474M050V	470,000	± 20
RPE123Z5U105M050V	1,000,000	± 20

CAPACITORS— RADIAL LEADED, MONOLITHIC (continued)

★ KIT-RPE-TR*

Part No.	Cap.	Tol.
COG 100V, 50 each value		
RPE122COG1R0C100V	1 pF	± .25pF
RPE122COG2R2C100V	2.2	± .25
RPE122COG4R7C100V	4.7	± .25
RPE122COG8R2D100V	8.2	± .25
RPE122COG100D100V	10	± 5 %
RPE122COG180J100V	18	± 5
RPE122COG220J100V	22	± 5
RPE122COG330J100V	33	± 5
RPE122COG470J100V	47	± 5
RPE122COG680J100V	68	± 5
RPE122COG820J100V	82	± 5
RPE122COG101J100V	100	± 5
RPE122COG221J100V	220	± 5
RPE122COG331J100V	330	± 5
RPE122COG471J100V	470	± 5
RPE122COG821J100V	820	± 5
X7R 100V, 50 each value		
RPE122X7R102K100V	1,000pF	± 10%
RPE122X7R222K100V	2,200	± 10
RPE122X7R472K100V	4,700	± 10
RPE122X7R103K100V	10,000	± 10
RPE122X7R223K100V	22,000	± 10
RPE122X7R333K100V	33,000	± 10
RPE122X7R473K100V	47,000	± 10
RPE122X7R104K100V	100,000	± 10
Z5U 100V, 50 each value		
RPE122Z5U103M100V	10,000pF	± 20%
RPE122Z5U104M100V	100,000	± 20
Z5U 50V, 50 each value		
RPE122Z5U224M050V	220,000pF	± 20%
RPE122Z5U334M050V	330,000	± 20
RPE123Z5U474M050V	470,000	± 20
RPE123Z5U105M050V	1,000,000	± 20

*Supplied with typical Tape & Reel lead forms.

CAPACITORS— HIGH VOLTAGE

- Epoxy resin encapsulated
- Small size
- Highly reliable internal construction
- Wide selection of values
- Up to 40 KVDC working voltage

★ KIT-HIGH VOLTAGE

Part No.	Cap.	KV	Tol.	Qty.
DHR12Y5P471M7.5KV	470pF	7.5	± 20%	25
DHR15Y5P120M7.5KV	1,000	7.5	± 20	25
DHR17Y5P102M10KV	1,000	10	± 20	25
DHR9Y5P101M15KV	100	15	± 20	25
DHR15Y5P471M15KV	470	15	± 20	25
DHR20Y5P102M15KV	1,000	15	± 20	25
DHS30N4700122M10KV	1,200	10	± 20	5
DHS38N4700192M15KV	1,900	15	± 20	5
DHS24Z5V461Z30KV	460	30	+80, -20	5
DHS30N4700591M30KV	590	30	± 20	5
DHS60Z5V272Z40KV	2,700	40	+80, -20	5
DCC510N750101K	100	7.5	± 10	1
DCC507N750101K	100	15	± 10	1

★ STANDARD DISTRIBUTOR ITEMS

CAPACITORS— DISC

- Wide capacitance range, T.C., voltage and tolerance range
- Industry standard capacitance values
- Available for auto insertion
- Various lead spacing available
- Safety capacitors are U.L., CSA, VDE, etc. listed

★ KIT-DISC-1 (EIA Class I)

Part No.	Cap.	Tol.
COG 1KV, 25 each value		
DD05-450NP01R0C1KV	1.0pF	± .25pF
DD05-450NP01R2C1KV	1.2	± .25
DD05-450NP01R5C1KV	1.5	± .25
DD05-450NP01R8C1KV	1.8	± .25
DD05-450NP02R2C1KV	2.2	± .25
DD05-450NP02R7C1KV	2.7	± .25
DD05-450NP03R3C1KV	3.3	± .25
DD05-450NP03R9C1KV	3.9	± .25
DD05-450NP04R7C1KV	4.7	± .25
DD05-450NP05R6D1KV	5.6	± .50
DD05-450NP06R8D1KV	6.8	± .50
DD05-450NP08R2D1KV	8.2	± .50
DD05-450NP0100D1KV	10	± .50
DD05-450NP0120J1KV	12	± 5 %
DD05-450NP0150J1KV	15	± 5
DD05-450NP0180J1KV	18	± 5
DD05-450NP0220J1KV	22	± 5
DD06-450NP0270J1KV	27	± 5
DD07-450NP0330J1KV	33	± 5
DD07-450NP0390J1KV	39	± 5
DD07-450NP0470J1KV	47	± 5
DD08-450NP0560J1KV	56	± 5
DD09-450NP0680J1KV	68	± 5
DD09-450NP0820J1KV	82	± 5
DD10-450NP0101J1KV	100	± 5
DD10-450NP0121J1KV	120	± 5
DD11-450NP0151J1KV	150	± 5
DD12-450NP0181J1KV	180	± 5
DD14-454NP0221J1KV	220	± 5
DD14-454NP0271J1KV	270	± 5
COG 100V, 25 each value		
DD104-950NP01R0C100V	1.0pF	± .25pF
DD104-950NP01R2C100V	1.2	± .25
DD104-950NP01R5C100V	1.5	± .25
DD104-950NP01R8C100V	1.8	± .25
DD104-950NP02R2C100V	2.2	± .25
DD104-950NP02R7C100V	2.7	± .25
DD104-950NP03R3C100V	3.3	± .25
DD104-950NP03R9C100V	3.9	± .25
DD104-950NP04R7C100V	4.7	± .25
DD104-950NP05R6D100V	5.6	± .50
DD104-950NP06R8D100V	6.8	± .50
DD104-950NP08R2D100V	8.2	± .50
DD104-950NP0100D100V	10	± .50
DD104-950NP0120J100V	12	± 5 %
DD104-950NP0150J100V	15	± 5
DD104-950NP0180J100V	18	± 5
DD104-950NP0220J100V	22	± 5
DD105-950NP0270J100V	27	± 5
DD105-950NP0330J100V	33	± 5
DD105-950NP0390J100V	39	± 5
DD106-950NP0470J100V	7	± 5
DD106-950NP0560J100V	56	± 5
DD107-950NP0680J100V	68	± 5
DD107-950NP0820J100V	82	± 5
DD107-950NP0101J100V	100	± 5
DD109-950NP0121J100V	120	± 5
DD109-950NP0151J100V	150	± 5
DD110-950NP0181J100V	180	± 5
DD111-950NP0221J100V	220	± 5
DD112-950NP0271J100V	270	± 5

DESIGN ENGINEERING KITS

CAPACITORS— DISC (continued)

★ KIT-DISC-1 (continued)

Part No.	Cap.	Tol.
COG 50V, 25 each value		
DD003CK010C50V	1.0pF	± .25pF
DD003SL1R5C50V	1.5	± .25
DD003CH100D50V	10	± .50
DD003CH120J50V	12	± 5 %
DD003CH150J50V	15	± 5
DD003CH180J50V	18	± 5
DD003CH220J50V	22	± 5
DD003CH270J50V	27	± 5
DD003CH330J50V	33	± 5
DD003CH390J50V	39	± 5
DD003CH470J50V	47	± 5
DD003SL560J50V	56	± 5
DD003SL680J50V	68	± 5
DD003SL820J50V	82	± 5
DD003SL101J50V	100	± 5
DD003SL121J50V	120	± 5

★ KIT-DISC-2

(EIA Class II & III)

Part No.	Cap.	Tol.
Y5P, Y5U 1KV, 25 each value		
DD05-450Y5P101K1KV	100pF	± 10%
DD05-450Y5P121K1KV	120	± 10
DD05-450Y5P151K1KV	150	± 10
DD05-450Y5P181K1KV	180	± 10
DD05-450Y5P221K1KV	220	± 10
DD05-450Y5P271K1KV	270	± 10
DD05-450Y5P331K1KV	330	± 10
DD05-450Y5P391K1KV	390	± 10
DD05-450Y5P471K1KV	470	± 10
DD05-450Y5P561K1KV	560	± 10
DD06-450Y5P681K1KV	680	± 10
DD06-450Y5P821K1KV	820	± 10
DD07-450Y5P102K1KV	1,000	± 10
DD07-450Y5P122K1KV	1,200	± 10
DD08-450Y5P152K1KV	1,500	± 10
DD08-450Y5P182K1KV	1,800	± 10
DD09-450Y5P222K1KV	2,200	± 10
DD10-450Y5P272K1KV	2,700	± 10
DD11-450Y5P332K1KV	3,300	± 10
DD11-450Y5P392K1KV	3,900	± 10
DD09-450Y5U472M1KV	4,700	± 20
DD14-454Y5P562K1KV	5,600	± 10
DD10-450Y5U682M1KV	6,800	± 20
DD12-450Y5U103M1KV	10,000	± 20
DD16-454Y5P103K1KV	10,000	± 10
DD16-454Y5U203M1KV	20,000	± 20

Y5P, Y5U, Y5V 100V, 25 each value

DD104-950Y5P101K100V	100pF	± 10%
DD104-950Y5P121K100V	120	± 10
DD104-950Y5P151K100V	150	± 10
DD104-950Y5P181K100V	180	± 10
DD104-950Y5P221K100V	220	± 10
DD104-950Y5P271K100V	270	± 10
DD104-950Y5P331K100V	330	± 10
DD104-950Y5P391K100V	390	± 10
DD104-950Y5P471K100V	470	± 10
DD104-950Y5P561K100V	560	± 10
DD104-950Y5P681K200V	680	± 10
DD104-950Y5P821K100V	820	± 10
DD104-950Y5P102K100V	1,000	± 10
DD105-950Y5P122K100V	1,200	± 10
DD105-950Y5P152K100V	1,500	± 10
DD105-950Y5P182K100V	1,800	± 10
DD106-950Y5P222K100V	2,200	± 10
DD106-950Y5P272K100V	2,700	± 10
DD107-950Y5P332K100V	3,300	± 10
DD107-950Y5P392K100V	3,900	± 10
DD108-950Y5P472K100V	4,700	± 10
DD109-950Y5P562K100V	5,600	± 10
DD105-950Y5V682Z100V	6,800	+80, -20
DD106-950Y5V103Z100V	10,000	+80, -20

★ KIT-DISC-2 (continued)

Part No.	Cap.	Tol.
Y5P, Y5U, Y5V 100V, 25 each value (continued)		
DD109-950Y5U103M100V	10,000pF	± 20%
DD112-950Y5P103K100V	10,000	± 10
DD107-950Y5V203Z100V	20,000	+80, -20
DD108-950Y5V223Z100V	22,000	+80, -20
DD109-950Y5V333Z100V	33,000	+80, -20
B, F 50V, 25 each value		
DD003B101K50V	100pF	± 10%
DD003B151K50V	150	± 10
DD003B181K50V	180	± 10
DD003B221K50V	220	± 10
DD003B271K50V	270	± 10
DD003B331K50V	330	± 10
DD003B391K50V	390	± 10
DD003B471K50V	470	± 10
DD003B561K50V	560	± 10
DD003B681K50V	680	± 10
DD003B821K50V	820	± 10
DD003B102K50V	1,000	± 10
DD003B122K50V	1,200	± 10
DD003B152K50V	1,500	± 10
DD003F472Z50V	4,700	+80, -20

★ KIT-DISC-3

(EIA Class IV)

Part No.	Cap.	Tol.
Y5P, Y5U, Y5V 50, 25, 12V 25 each value		
DD340-950Y5P103M25V	.01 μ F	± 20%
DD304-950Y5U103Z50V	.01	+80, -20
DD350-950Y5P103M50V	.01	± 20
DD350-950Y5P153M25V	.015	± 20
DD304-950Y5U153Z50V	.015	+80, -20
DD360-950Y5P153M50V	.015	± 20
DD360-950Y5P223M25V	.022	± 20
DD304-950Y5V223Z50V	.022	+80, -20
DD380-950Y5P223M50V	.022	± 20
DD304-950Y5V333Z25V	.033	+80, -20
DD305-950Y5V333Z50V	.033	+80, -20
DD304-950Y5V473Z25V	.047	+80, -20
DD380-950Y5P473M25V	.047	± 20
DD306-950Y5V473Z50V	.047	+80, -20
DD310-950Y5P473M50V	.047	± 20
DD310-950Y5P683M25V	.068	± 20
DD312-950Y5P683M50V	.068	± 20
DD306-950Y5V104Z25V	.10	+80, -20
DD312-950Y5P104M25V	.10	± 20
DD308-950Y5V104Z50V	.10	+80, -20
DD314-454Y5P104M50V	.10	± 20
DD314-454Y5P154M25V	.15	± 20
DD308-950Y5V224Z12V	.22	+80, -20
DD310-950Y5V334Z12V	.33	+80, -20
DD312-950Y5V474Z12V	.47	+80, -20

Y5S 25, 16, 12V 25 each value

DD404-256Y5S103K25V	.01 μ F	± 10%
DD404-256Y5S153K25V	.015	± 10
DD404-256Y5S223K16V	.022	± 10
DD405-950Y5S223K25V	.022	± 10
DD405-950Y5S333K16V	.033	± 10
DD406-950Y5S333K25V	.033	± 10
DD405-950Y5S473K16V	.047	± 10
DD407-950Y5S473K25V	.047	± 10
DD406-950Y5S683K16V	.068	± 10
DD408-950Y5S683K25V	.068	± 10
DD407-950Y5S104K16V	.10	± 10
DD410-950Y5S104K25V	.10	± 10
DD410-950Y5S154K16V	.15	± 10
DD410-950Y5S224K12V	.22	± 10
DD412-950Y5S334K12V	.33	± 10
DD414-454Y5S474K12V	.47	± 10

B,F 50, 16, 12V 25 each value

DD003B103M16V	.01 μ F	± 20%
DD003F453Z50V	.01	+80, -20
DD003F223Z50V	.022	+80, -20
DD003F473Z12V	.047	+80, -20

★ STANDARD DISTRIBUTOR ITEMS

CAPACITORS— DISC, SAFETY

★ KIT-SAFETY-CAPACITOR

Meet UL, CSA, SEV, VDE, etc. standards

Part No.	Cap.	Tol.
400, 250, 125VAC 25 each value		
DE7090B101KVA1-KC	100pF	± 10%
DE7090B151KVA1-KC	150	± 10
DE7090B221KVA1-KC	220	± 10
DE7090B331KVA1-KC	330	± 10
DE7090B471KVA1-KC	470	± 10
DE7090B102KVA1-KC	1,000	± 10
DE7100F222MVA1-KC	2,200	± 20
DE7120F332MVA1-KC	3,300	± 20
DE7150F472MVA1-KC	4,700	± 20
DE7100FZ472PVA1-KC	4,700	+100, -0
DE7150F103MVA1-KC	10,000	± 20
DE7150FZ103PVA1-KC	10,000	+100, -0
DE2110F682MAC125-MX	6,800	± 20
DE1910E472MACT4K-KD	4,700	± 20
DE1410E222MACT4K-KD	2,200	± 20

CAPACITORS— CHIP TRIMMING

- Miniature size
- Designed for auto-placement
- Can be immersed in flux and solder bath
- Can be cleaned with organic solvents

★ KIT-TZSBOX-1

Part No.	Min. Cap.	Max. Cap.	T.C.
TZ03, 8 each value			
TZ03Z2R3FR169	1.25pF	2.3pF	COG
TZ03Z050FR169	1.8	5.0	COG
TZ03Z070FR169	2.0	7.0	COG
TZ03Z100FR169	2.7	10.0	COG
TZ03N100FR169	2.1	10.0	N220
TZ03T110FR169	3.0	11.0	N450
TZ03T200FR169	4.2	20.0	N450
TZ03R200FR169	4.2	20	N750
TZ03R300FR169	5.2	30	N750
TZ03P450FR169	6.8	45	N1200
TZ03P600FR169	9.8	60	N1200
TZ03Z500FR169	6	50	COG
TZ03R900FR169	9	90	N750
TZBX4, 10 each value			
TZBX4Z030BC110	1.4pF	3.0pF	COG
TZBX4Z060BC110	2.0	6.0	COG
TZBX4N100BC110	3.0	10.0	N150
TZBX4R200BC110	4.5	20.0	N750
TZBX4P300BC110	6.5	30.0	N1200
TZBX4P400BC110	9.0	40.0	N1200
TZBX4Z250BC110	4.0	25.0	COG
TZBX4R500BC110	7.0	50.0	N750

★ KIT-TZSBOX-2

Part No.	Min. Cap.	Max. Cap.	T.C.
TZBX4, 10 each value			
TZBX4Z030BA110	1.4pF	3.0pF	COG
TZBX4Z060BA110	2.0	6.0	COG
TZBX4N100BA110	3.0	10.0	N150
TZBX4R200BA110	4.5	20.0	N750
TZBX4P300BA110	6.5	30.0	N1200
TZBX4P400BA110	9.0	40.0	N1200
TZBX4Z250BA110	4.0	25.0	COG
TZBX4R500BA110	7.0	50.0	N750
TZBX4Z060BB110	2.0	6.0	COG
TZBX4N100BB110	3.0	10.0	N150

★ STANDARD DISTRIBUTOR ITEMS

★ KIT-TZSBOX-2 (continued)

Part No.	Min. Cap.	Max. Cap.	T.C.
TZBX4, 10 each value (continued)			
TZBX4R200BB110	4.5pF	20.0pF	N750
TZBX4P300BB110	6.5	30.0	N1200
TZBX4Z060BE110	2.0	6.0	COG
TZBX4N100BE110	3.0	10.0	N150
TZBX4R200BE110	4.5	20.0	N750
TZBX4P400BE110	9.0	40.0	N1200
TZC03, 10 each value			
TZC03Z030A110	1.4	3.0	COG
TZC03Z060A110	2.0pF	6.0pF	COG
TZC03R100A110	3.0	10.0	N750
TZC03P200A110	5.0	20.0	N1200
TZC03P300A110	6.5	30.0	N1200

★ KIT-TZSBOX-3

Part No.	Min. Cap.	Max. Cap.	T.C.
TZBX4, 10 each value			
TZBX4Z030BA110	1.4pF	3.0pF	COG
TZBX4Z060BA110	2.0	6.0	COG
TZBX4N100BA110	3.0	10.0	N150
TZBX4R200BA110	4.5	20.0	N750
TZBX4P300BA110	6.5	30.0	N1200
TZBX4P400BA110	9.0	40.0	N1200
TZBX4Z250BA110	4.0	25.0	COG
TZBX4R500BA110	7.0	50.0	N750
TZBX4R200BB110	4.5	20.0	N750
TZBX4P300BB110	6.5	30.0	N1200
TZBX4Z060BB110	2.0	6.0	COG
TZBX4N100BB110	3.0	10.0	N150
TZBX4R200BC110	4.5	20.0	N750
TZBX4Z060BD110	2.0	6.0	COG
TZBX4N100BD110	3.0	10.0	N150
TZBX4R200BD110	4.5	20.0	N750
TZBX4Z060BE110	2.0	6.0	COG
TZBX4N100BE110	3.0	10.0	N150
TZBX4R200BE110	4.5	20.0	N750
TZBX4Z060BB110	2.0	6.0	COG
TZBX4N100BB110	3.0	10.0	N150

★ KIT-TZSBOX-4

Part No.	Min. Cap.	Max. Cap.	T.C.
TZ03, 8 each value			
TZ03Z070FR169	2.0pF	7.0pF	COG
TZ03Z100FR169	2.7	10.0	COG
TZ03T110FR169	3.0	11.0	N450
TZ03T200FR169	4.2	20.0	N450
TZ03R200FR169	4.2	20.0	N750
TZ03R300FR169	5.2	30.0	N750
TZ03P450FR169	6.8	45.0	N1200
TZ03Z500FR169	6.0	50.0	COG
TZBX4, 10 each value			
TZBX4Z030BA110	1.4pF	3.0pF	COG
TZBX4Z060BA110	2.0	6.0	COG
TZBX4N100BA110	3.0	10.0	N150
TZBX4R200BA110	4.5	20.0	N750
TZBX4P300BA110	6.5	30.0	N1200
TZBX4P400BA110	9.0	40.0	N1200
TZBX4Z250BA110	4.0	25.0	COG
TZBX4R500BA110	7.0	50	N750
TZC03, 10 each value			
TZC03Z030A110			
TZC03Z060A110	2.0pF	6.0pF	COG
TZC03F100A110	3.0	10.0	N750
TZC03P200A110	5.0	20.0	N1200
TZC03P300A110			

POTENTIOMETERS— CHIP, TRIMMING

- Miniature size
- RVG4 Series, open frame
- Easily adjustable with regular screwdrivers
- Large, solid axle not affected by vacuum chuck during auto-placement
- Solder coated terminals eliminate solder leaching in reflow solder operations
- RVG4J and H Series available on 12mm tape and reel for auto-placement
- RVG4J and H Series available on 12mm tape and reel for auto-placement
- RVG3A08A Series available for automatic adjustment
- RVG3A Series available on 8mm tape & reel for auto-placement

★ KIT-RVG3 BOX

(Open)

Part No.	Res.
RVG3A01A, 20 each value	
RVG3A01A-501VM	500 ohms
RVG3A01A-102VM	1K
RVG3A01A-302VM	3K
RVG3A01A-502VM	5K
RVG3A01A-103VM	10K
RVG3A01A-203VM	20K
RVG3A01A-303VM	30K
RVG3A01A-503VM	50K
RVG3A01A-104VM	100K
RVG3A01A-204VM	200K
RVG3A01A-105VM	1M
RVG3A08A, 20 each value	
RVG3A08A-501VM	500 ohms
RVG3A08A-102VM	1K
RVG3A08A-302VM	3K
RVG3A08A-502VM	5K
RVG3A08A-103VM	10K
RVG3A08A-203VM	20K
RVG3A08A-303VM	30K
RVG3A08A-503VM	50K
RVG3A08A-104VM	100K
RVG3A08A-204VM	200K
RVG3A08A-105VM	1M

★ KIT-RVG4 BOX

(Open)

Part No.	Res.
RVG4J03A, 20 each value	
RVG4J03A-102VM	1K
RVG4J03A-502VM	5K
RVG4J03A-103VM	10K
RVG4J03A-503VM	50K
RVG4J03A-104VM	100K
RVG4J04A, 20 each value	
RVG4J04A-102VM	1K
RVG4J04A-502VM	5K
RVG4J04A-103VM	10K
RVG4J04A-503VM	50K
RVG4J04A-104VM	100K
RVG4H01A, 20 each value	
RVG4H01A-501VM	500 ohms
RVG4H01A-102VM	1K
RVG4H01A-302VM	3K
RVG4H01A-502VM	5K
RVG4H01A-103VM	10K
RVG4H01A-203VM	20K
RVG4H01A-303VM	30K
RVG4H01A-503VM	50K
RVG4H01A-104VM	100K
RVG4H01A-504VM	500K
RVG4H01A-105VM	1M

INDUCTORS—CHIP

- Miniature size
- Available in ferrite and ceramic cores
- Wide standard inductance range—10nH to 2200 μ H
- High Q at frequencies to 100MHz for ferrite cores and to 1GHz for ceramic core

★ KIT-L-CHIP

Part No.	Nom. Value	Tol.
LQN2A CERAMIC CORE, 25 each value		
LQN2A10NM04M00	10nH	$\pm 20\%$
LQN2A18NM04M00	18	± 20
LQN2A22NM04M00	22	± 20
LQN2A33NM04M00	33	± 20
LQN2A39NM04M00	39	± 20
LQN2A47NM04M00	47	± 20
LQN2A56NM04M00	56	± 20
LQN2A68NM04M00	68	± 20
LQN2A82NM04M00	82	± 20
LQN2AR10K04M00	100	± 10
LQN2AR12K04M00	120	± 10
LQN2AR15K04M00	150	± 10
LQN2AR18K04M00	180	± 10
LQN2AR22K04M00	220	± 10
LQH3N FERRITE CORE, 25 each value		
LQH3NR27M92M00	0.27 μ H	$\pm 20\%$
LQH3NR39M92M00	0.39	± 20
LQH3NR56M92M00	0.56	± 20
LQH3NR68M92M00	0.68	± 20
LQH3NR82M92M00	0.82	± 20
LQH3N1R0M04M00	1.0	± 20
LQH3N1R2M04M00	1.2	± 20
LQH3N1R5M04M00	1.5	± 20
LQH3N1R8M04M00	1.8	± 20
LQH3N2R2M04M00	2.2	± 20
LQH3N2R7M04M00	2.7	± 20
LQH3N3R3M04M00	3.3	± 20
LQH3N3R9M04M00	3.9	± 20
LQH3N4R7M04M00	4.7	± 20
LQH3N5R6M04M00	5.6	± 20
LQH3N6R8M04M00	6.8	± 20
LQH3N8R2M04M00	8.2	± 20
LQH3N100K04M00	10	± 10
LQH3N120K04M00	12	± 10
LQH3N150K04M00	15	± 10
LQH3N180K04M00	18	± 10
LQH3N220K04M00	22	± 10
LQH3N270K04M00	27	± 10
LQH3N330K04M00	33	± 10
LQH3N390K04M00	39	± 10
LQH3N470K04M00	47	± 10
LQH3N680K04M00	68	± 10
LQH3N101K04M00	100	± 10
LQH3N151K04M00	150	± 10
LQH3N221K04M00	220	± 10
LQH3N331K04M00	330	± 10
LQH3C FERRITE CORE, 25 each value		
LQH3C1R0M04M00	1.0 μ H	$\pm 20\%$
LQH3C2R2M04M00	2.2	± 20
LQH3C4R7M04M00	4.7	± 20
LQH3C100K04M00	10.0	± 10
LQH3C220K04M00	22.0	± 10
LQH3C470K04M00	47.0	± 10
LQH3C101K04M00	100.0	± 10
LQH3C221K04M00	220.0	± 10
LQH3C331K04M00	330.0	± 10
LQH4N FERRITE CORE, 25 each value		
LQH4N391K-TA	390 μ H	$\pm 10\%$
LQH4N471K-TA	470	± 10
LQH4N561K-TA	560	± 10
LQH4N681K-TA	680	± 10
LQH4N821K-TA	820	± 10
LQH4N102K-TA	1000	± 10

EMI/RFI FILTERS— CHIPS

- For surface mount applications
- Extremely small size
- For DC and sequel applications

KIT-EK115A

Part No.	Qty.	Type
BLM21B03	20	Chip Solid Inductor
BLM21A05	100	
BLM31A02		
BLM32A06		
BLM32A07		
BLM41A01		
NFM41R00C220	40	Chip EMI Suppression Filter Solid type
NFM41R00C470		
NFM41R00C101		
NFM41R00C221	40	Chip EMI Suppression Filter Solid type
NFM41R00C471		
NFM41R10C102		
NFM41R10C222		
NFM41R10C223		
NFM61R00T361	20	Chip EMI Suppression Filter
NFM61R10T102		
NFM61R30T472		

EMI/RFI FILTERS— POWERLINE

- For AC power line filtering
- Small size
- Wide selection of attenuation characteristics

KIT-EK025B

Part No.	Qty.	Type	
PLA1022A	2	Compact Common Mode Choke Coil, Non-Case Type	
PLA3021A	2		
PLA5021A	2		
PLA8021C	2	Case-Type	
PLH11L-6003R3	2	High Frequency	
PLA1511R5	2	Common Mode Choke Coil	
PLE25H-1531R	1	Common Mode Choke Coil	
PLE25H-2023R	1		
PLC20LD-3031R	1		
PLC20HD-7030R5	1		
ESR1100-56E222M VA2-EA	10		Safety Standard Recognized EMIFIL® For AC Power Supplies
DSR1120-56 E302M VA2-EA	10		
DSR1150-56 E472M VA2-EA	10		
DSR1100-56 FZ472P VA2-EA	10		
PLI-A0302	1	Noise Filter For AC Line Applications	
PLI-C1030	1		
PLI-D0303	1		
PLI-E0303	1		
PLI-S0303	1		
PLF-C1030	1		
PLT1R53C	5		Common Mode Choke Coil
BNX002-01	5		DC Power Line Filter
BL02RN2-R62	50	Ferrite Bead	

★ STANDARD DISTRIBUTOR ITEMS

EMI/RFI FILTERS— COMPUTING DEVICES

- For PCB application
- For DC signal line filtering
- Wide selection of values

★ KIT-EK015C

Part No.	Qty.	Type
BNX002-01	3	DC Powerline Filter
BNP002-03	3	Signal Line Filter
DF221-601SS152GMV50	30	Subminiature Semiconductor
BL01RN1-A62	50	Ferrite Bead Inductors
BL02RN2-R62	50	
BL03RN2-R62	50	
BLM31A02	20	Chip Ferrite Bead
BLM41A04	20	
DS306-55Y5S470M	50V	3 Lead Disc Filter
DS306-55Y5S101M	50V	
DS306-55Y5S271M	50V	
DS306-55Y5S102M	50V	
DS306-55Y5S222M	50V	
DS306-55FZ103Z	50V	
DSS306-55Y5S220M	100V	3 Lead Disc Filter With Ferrites
DSS306-55Y5S470M	100V	
DSS306-55Y5S101M	100V	
DSS306-55Y5S221M	100V	3 Lead Disc Filter With Ferrites
DSS306-55Y5S471M	100V	
DSS306-55Y5S102M	100V	
DSS306-55Y5U222Z	100V	
DSS306-55FZ103N	100V	
DSS306-55FZ223Z	16V	3 Lead Disc Filter
DS310-55Y5S223S	50V	
DS310-55Y5S104M	16V	3 Lead Disc Filter With Ferrites
DSS310-55Y5S2220M	100V	
DSS310-55Y5S470M	100V	
DSS310-55Y5S101M	100V	
DSS310-55Y5S271M	100V	
DSS310-55Y5S222M	100V	
DSS310-55Y5S223S	100V	
DSS710-D223S12-22	5	
NFV610-655T2A106	100V	Noise Suppression Filter
NFV610-655T2A206	100V	
NFV610-655T2A506	100V	
NFV610-655T2A107	100V	



Marketing Communications
2200 Lake Park Drive
Smyrna, Georgia 30080
Telex: 26-1301
Panafax: 404-436-3030

For Further Information, Call 1-800-831-9172