

Data Transmission Lines and Their Characteristics

National Semiconductor
Application Note 806
Kenneth M. True
April 1992



OVERVIEW

This application note discusses the general characteristics of transmission lines and their derivations. Here, using a transmission line model, the important parameters of characteristics impedance and propagation delay are developed in terms of their physical and electrical parameters. This application note is a revised reprint of section two of the Fairchild Line Driver and Receiver Handbook. This application note, the first of a three part series (see AN-807 and AN-808), covers the following topics:

- Transmission Line Model
- Input Impedance of a Transmission Line
- Phase Shift and Propagation Velocity for the Transmission Line
- Summary — Characteristics Impedance and Propagation Delay

INTRODUCTION

A data transmission line is composed of two or more conductors transmitting electrical signals from one location to another. A parallel transmission line is shown in *Figure 1*. To show how the signals (voltages and currents) on the line relate to as yet undefined parameters, a transmission line model is needed.

TRANSMISSION LINE MODEL

Because the wires A and B could not be ideal conductors, they therefore must have some finite resistance. This resistance/conductivity is determined by length and cross-sectional area. Any line model, then, should possess some series resistance representing the finite conductivity of the wires. It is convenient to establish this resistance as a per-unit-length parameter.

Similarly, the insulating medium separating the two conductors could not be a perfect insulator because some small leakage current is always present. These currents and dielectric losses can be represented as a shunt conductance per unit length of line. To facilitate development of later equations, conductance is the chosen term instead of resistance.

If the voltage between conductors A and B is *not variable* with time, any voltage present indicates a static electric field between the conductors. From electrostatic theory it is known that the voltage V produced by a static electric field E is given by

$$V = \int E \cdot dl \quad (1)$$

This static electric field between the wires can only exist if there are free charges of equal and opposite polarity on both wires as described by Coulomb's law.

$$E = \frac{q}{4\pi\epsilon r^2} \quad (2)$$

where E is the electric field in volts per meter, q is the charge in Coulombs, ϵ is the dielectric constant, and r is the distance in meters. These free charges, accompanied by a voltage, represent a capacitance ($C = q/V$); so the line model must include a shunt capacitive component. Since total capacitance is dependent upon line length, it should be expressed in a capacitance per-unit-length value.

It is known that a current flow in the conductors induces a magnetic field or flux. This is determined by either Ampere's law

$$\int H \cdot dl = I \quad (3)$$

or the Biot-Savart law

$$dB = \frac{\mu dl \times r}{4\pi r^3} \quad (4)$$

where r = radius vector (meters)

ℓ = length vector (meters)

I = current (amps)

B = magnetic flux density (Webers per meter)

H = magnetic field (amps per meter)

μ = permeability

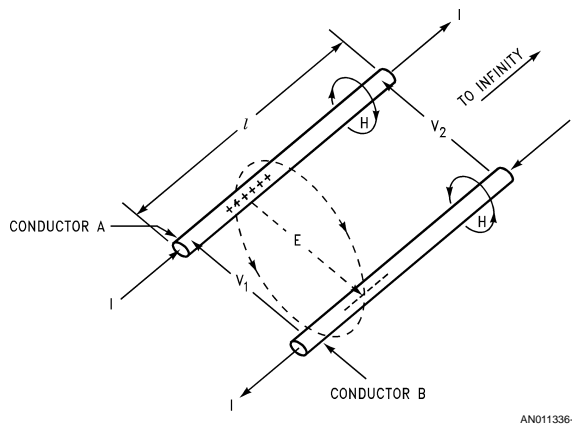

AN011336-1

FIGURE 1. Infinite Length Parallel Wire Transmission Line

If the magnetic flux (ϕ) linking the two wires is variable with time, then according to Faraday's law

$$V = \frac{d\phi}{dt} \tag{5}$$

A small line section can exhibit a voltage drop—in addition to a resistive drop—due to the changing magnetic flux (ϕ) within the section loop. This voltage drop is the result of an inductance given as

$$V = L \frac{di}{dt} \tag{6}$$

Therefore, the line model should include a series inductance per-unit-length term. In summary, it is determined that the model of a transmission line section can be represented by two series terms of resistance and inductance and two shunt terms of capacitance and conductance.

From a circuit analysis point of view, the terms can be considered in any order, since an *equivalent* circuit is being generated. Figure 2 shows three possible arrangements of circuit elements.

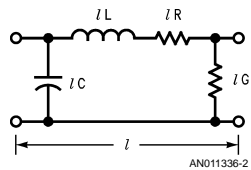

a

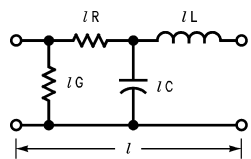

b

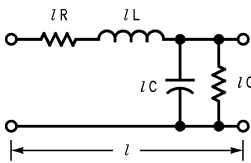

c

FIGURE 2. Circuit Elements

For consistency, the circuit shown in *Figure 2* will be used throughout the remainder of this application note. *Figure 3* shows how a transmission line model is constructed by series connecting the short sections into a ladder network.

Before examining the pertinent properties of the model, some comments are necessary on applicability and limitations. A *real* transmission line does not consist of an infinite number of small lumped sections — rather, it is a distributed network. For the lumped model to accurately represent the transmission line (see *Figure 3*), the section length must be quite small in comparison with the shortest wavelengths (highest frequencies) to be used in analysis of the model. Within these limits, as differentials are taken, the section length will approach zero and the model should exhibit the same (or at least very similar) characteristics as the actual distributed parameter transmission line. The model in *Figure 3* does not include second order terms such as the increase in resistance due to skin effect or loss terms resulting from non-linear dielectrics. These terms and effects are discussed in the references rather than in this application note, since they tend to obscure the basic principles under consideration. For the present, assume that the signals applied to the line have their minimum wavelengths a great deal longer than the section length of the model and ignore the second order terms.

INPUT IMPEDANCE OF A TRANSMISSION LINE

The purpose of this section is to determine the input impedance of a transmission line; i.e., what amount of input current I_{IN} is needed to produce a given voltage V_{IN} across the line as a function of the LRCG parameters in the transmission line, (see *Figure 4*).

Combining the series terms IR and IL together simplifies calculation of the series impedance (Z_s) as follows

$$Z_s = \ell(R + j\omega L) \tag{7}$$

Likewise, combining IC and IG produces a parallel impedance Z_p represented by

$$Z_p = \frac{1}{Y_p} = \frac{1}{j(\omega C + G)} \tag{8}$$

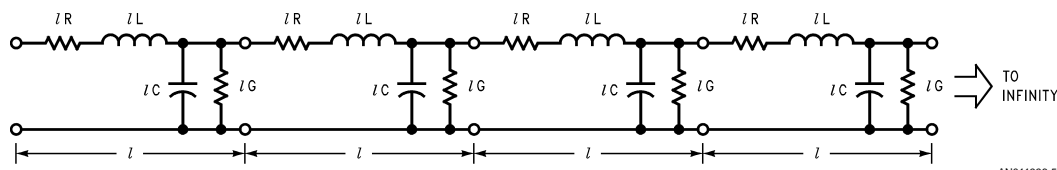

FIGURE 3. A Transmission Line Model Composed of Short, Series Connected Sections

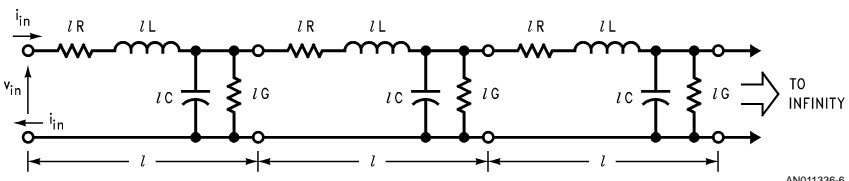

FIGURE 4. Series Connected Sections to Approximate a Distributed Transmission Line

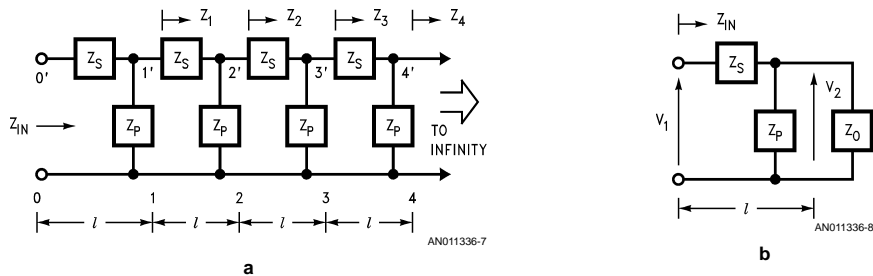

FIGURE 5. Cascaded Network to Model Transmission Line

Since it is assumed that the line model in *Figure 5* is infinite in length, the impedance looking into any cross section should be equal, that is $Z_1 = Z_2 = Z_3$, etc. So *Figure 5* can be simplified to the network in *Figure 5* where Z_0 is the characteristic impedance of the line and Z_{in} must equal this impedance ($Z_{in} = Z_0$). From *Figure 5*,

$$Z_{in} = Z_s + \frac{Z_0 Z_p}{Z_0 + Z_p} = Z_0 \quad (9)$$

Multiplying through both sides by $(Z_0 + Z_p)$ and collecting terms yields

$$Z_0^2 - Z_s Z_0 - Z_s Z_p = 0 \quad (10)$$

which may be solved by using the quadratic formula to give

$$Z_0 = \frac{Z_s \pm \sqrt{Z_s^2 + 4Z_s Z_p}}{2} \quad (11)$$

Substituting in the definition of Z_s and Z_p from *Equation (7)* and *Equation (8)*, *Equation (11)* now appears as

$$Z_0 = \frac{l(R + j\omega L)}{2} \pm \frac{1}{2} \sqrt{l^2 (R + j\omega L)^2 + 4 \frac{R + j\omega L}{G + j\omega C}} \quad (12)$$

Now, as the section length is reduced, all the parameters (R , L , G , and C) decrease in the same proportion. This is because the per-unit-length line parameters R , L , G , and C are constants for a given line. By sufficiently reducing l , the terms in *Equation (12)* which contain l as multipliers will become negligible when compared to the last term

$$\frac{R + j\omega L}{G + j\omega C}$$

which remains constant during the reduction process. Thus *Equation (12)* can be rewritten as

$$Z_0 = \sqrt{\frac{R + j\omega L}{G + j\omega C}} = \sqrt{Z_s Z_p} \quad (13)$$

particularly when the section length l is taken to be very small. Similarly, if a high enough frequency is assumed,

$$\frac{\omega}{2\pi} > 100 \text{ kHz}$$

such that the ωL and ωC terms are much larger respectively than the R and G terms, $Z_s = j\omega L$ and $Z_p = 1/j\omega C$ can be used to arrive at a lossless line value of

$$Z_0 = \sqrt{\frac{L}{C}} \quad (14)$$

In the lower frequency range,

$$\frac{\omega}{2\pi} \cong 1 \text{ kHz}$$

the R and G terms dominate the impedance giving

$$Z_0 = \sqrt{\frac{R}{G}} \quad (15)$$

A typical twisted pair would show an impedance versus applied frequency curve similar to that shown in *Figure 6*. The Z_0 becomes constant above 100 kHz, since this is the region where the ωL and ωC terms dominate and *Equation (13)* reduces to *Equation (14)*. This region above 100 kHz is of primary interest, since the frequency spectrum of the fast rise/fall time pulses sent over the transmission line have a fundamental frequency in the 1-to-50 MHz area with harmonics extending upward in frequency. The expressions for Z_0 in *Equation (13)*, *Equation (14)* and *Equation (15)* do not contain any reference to line length, so using *Equation (14)* as the normal characteristic impedance expression, allows the line to be replaced with a resistor of $R_0 = Z_0 \Omega$ neglecting any small reactance. This is true when calculating the initial voltage step produced on the line in response to an input current step, or an initial current step in response to an input voltage step.

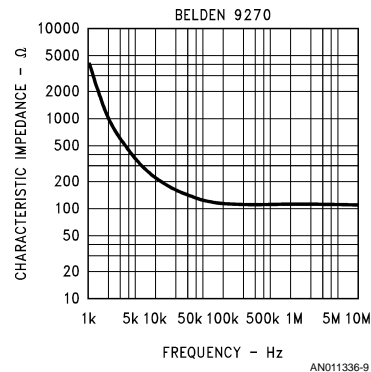

FIGURE 6. Characteristics Impedance versus Frequency

Figure 7 shows a 2V input step into a 96Ω transmission line (top trace) and the input current required for line lengths of 150, 300, 450, 1050, 2100, and 3750 feet, respectively (second set of traces). The lower traces show the output voltage waveform for the various line lengths. As can be seen, maxi-

imum input current is the same for all the different line lengths, and depends only upon the input voltage and the characteristic resistance of the line. Since $R_0 = 96\Omega$ and $V_{IN} = 2V$, then $I_{IN} = V_{IN}/R_0 \cong 20$ mA as shown by Figure 7.

A popular method for estimating the input current into a line in response to an input voltage is the formula

$$C(dv/dt) = i$$

where C is the total capacitance of the line ($C = C$ per foot x length of line) and dv/dt is the slew rate of the input signal. If the 3750-foot line, with a characteristic capacitance per unit length of 16 pF/ft is used, the formula $C_{total} = (C \times \ell)$ would yield a total lumped capacitance of 0.06 μ F. Using this $C(dv/dt) = i$ formula with $(dv/dt = 2V/10$ ns) as in the scope photo would yield

$$i = \frac{2V}{10 \text{ ns}} \times 0.06 \mu\text{F} = 12A$$

This is clearly not the case! Actually, since the line impedance is approximately 100Ω , 20 mA are required to produce 2V across the line. If a signal with a rise time long enough to encompass the time delay of the line is used ($t_r \gg \tau$), then

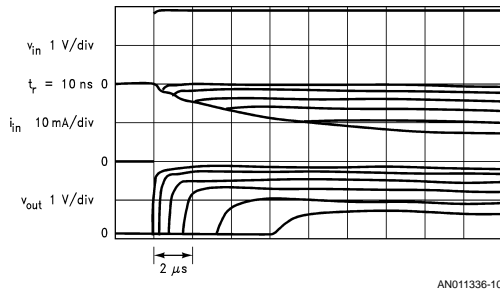

FIGURE 7. Input Current Into a 96Ω Transmission Line for a 2V Input Step for Various Line Lengths

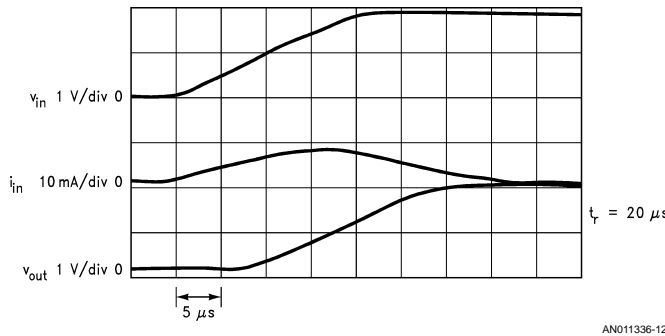

FIGURE 8. Input Current Into Line with Controlled Rise Time $t_r > 2\pi$

Using Figure 5, v_2 can be expressed as

$$v_2 = v_1 \frac{Z_p Z_0}{Z_p + Z_0} \frac{1}{Z_s + Z_p Z_0 / (Z_p + Z_0)} \quad (16)$$

or

$$\frac{v_1}{v_2} = \frac{Z_s(Z_p + Z_0) + Z_p Z_0}{Z_p Z_0} \quad (17)$$

the $C(dv/dt) = i$ formula will yield a reasonable estimate of the peak input current required. In the example, if the dv/dt is $2V/20 \mu\text{s}$ ($t_r = 20 \mu\text{s} > \tau = 6 \mu\text{s}$), then $i = 2V/20 \mu\text{s} \times 0.06 \mu\text{F} = 6$ mA, which is verified by Figure 8.

Figure 8 shows that $C(dv/dt) = i$ only when the rise time is greater than the time delay of the line ($t_r \gg \tau$). The maximum input current requirement will be with a fast rise time step, but the line is essentially resistive, so $V_{IN}/I_{IN} = R_0 = Z_0$ will give the actual drive current needed. These effects will be discussed later in Application Note 807.

PHASE SHIFT AND PROPAGATION VELOCITY FOR THE TRANSMISSION LINE

There will probably be some phase shift and loss of signal v_2 with respect to v_1 because of the reactive and resistive parts of Z_s and Z_p in the model (Figure 5). Each small section of the line (ℓ) will contribute to the total phase shift and amplitude reduction if a number of sections are cascaded as in Figure 5. So, it is important to determine the phase shift and signal amplitude loss contributed by each section.

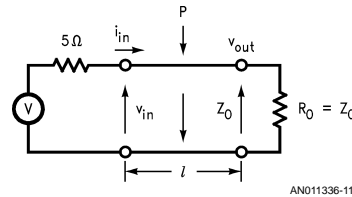

$\ell = 150, 300, 450, 1050, 2100, 3750$ ft.
24 AWG TWISTED PAIR $R_0 \cong 96\Omega$

AN011336-11

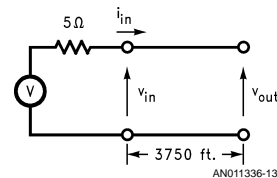

$R_0 = 96\Omega, \delta = 1.6 \text{ ns/ft.}$

AN011336-13

AN011336-12

and further simplification yields

$$\frac{v_1}{v_2} = 1 + Z_s \left[\frac{1}{Z_0} + \frac{1}{Z_p} \right] \quad (18)$$

Remember that a per-unit-length constant, normally called γ is needed. This shows the reduction in amplitude and the change in the phase per unit length of the sections.

$$\gamma_\ell = \alpha_\ell = j\beta_\ell \quad (19)$$

Since

$$v_2 = v_1^{-\gamma \ell} = v_1^{-\alpha \ell} + v_1^{-j\beta \ell} \quad (20)$$

where $v_1^{-\alpha \ell}$ is a signal attenuation and $v_1^{-j\beta \ell}$ is the change in phase from v_1 to v_2 ,

$$\ln \left[\frac{v_1}{v_2} \right] = \ln (\alpha \ell + j\beta \ell) = \alpha \ell + j\beta \ell = \gamma \ell \quad (21)$$

Thus, taking the natural log of both sides of Equation (18)

$$\ln \left[\frac{v_1}{v_2} \right] = \ln \left[1 + Z_s \left(\frac{1}{Z_0} + \frac{1}{Z_p} \right) \right] \quad (22)$$

Substituting Equation (13) for Z_0 and Y_p for ℓ/Z_p

$$\gamma \ell = \ln \left[1 + Z_s \left(\sqrt{\frac{Y_p}{Z_s}} + Y_p \right) \right] \quad (23)$$

Now when allowing the section length ℓ to become small,

$$Y_p = \ell(G + j\omega C)$$

will be very small compared to the constant

$$\sqrt{Y_p/Z_s} = 1/Z_0,$$

since the expression for Z_0 does not contain a reference to the section length ℓ . So Equation (23) can be rewritten as

$$\gamma \ell = \ln \left(1 + Z_s \sqrt{\frac{Y_p}{Z_s}} \right) = \ln (1 + \sqrt{Y_p Z_s}) \quad (24)$$

By using the series expansion for the natural log:

$$\ln (1 + \zeta) = \zeta - \frac{\zeta^2}{2} + \frac{\zeta^3}{3} \dots \text{etc.} \quad (25)$$

and keeping in mind the

$$\sqrt{Z_s Y_p}$$

value will be much less than one because the section length is allowed to become very small, the higher order expansion terms can be neglected, thereby reducing Equation (24) to

$$\gamma \ell = \sqrt{Z_s Y_p} = \ell \sqrt{(R + j\omega L)(G + j\omega C)} \quad (26)$$

If Equation (26) is divided by the section length,

$$\gamma = \frac{\gamma \ell}{\ell} = \sqrt{(R + j\omega L)(G + j\omega C)} \quad (27)$$

the propagation constant per unit length is obtained. If the resistive components R and G are further neglected by assuming the line is reasonably short, Equation (26) can be reduced to read

$$\gamma \ell = j\beta \ell = j\omega \ell \sqrt{LC} \quad (28)$$

Equation (28) shows that the lossless transmission line has one very important property: signals introduced on the line have a constant phase shift per unit length with no change in amplitude. This progressive phase shift along the line actually represents a wave traveling down the line with a velocity equal to the inverse of the phase shift per section. This velocity is

$$v = \frac{\omega}{\beta} = \frac{1}{\sqrt{LC}} \quad (29)$$

for lossless lines. Because the LRCG parameters of the line are independent of frequency except for those upper fre-

quency constraints previously discussed, the signal velocity given by Equation (29) is also independent of signal frequency. In the practical world with long lines, there is in fact a frequency dependence of the signal velocity. This causes sharp edged pulses to become rounded and distorted. More on these long line effects will be discussed in Application Note 807.

SUMMARY — Characteristic Impedance and Propagation Delay

Every transmission line has a characteristic impedance Z_0 , and both voltage and current at any point on the line are related by the formula

$$Z_0 = \frac{v}{i}$$

In terms of the per-unit-length parameters LRCG,

$$Z_0 = \sqrt{\frac{R + j\omega L}{G + j\omega C}}$$

Since $R \ll j\omega L$ and $G \ll j\omega C$ for most lines at frequencies above 100 kHz, the characteristic impedance is best approximated by the lossless line expression

$$Z_0 \cong \sqrt{\frac{L}{C}}$$

The propagation constant, γ , shows that signals exhibit an amplitude loss and phase shift with the latter actually a velocity of propagation of the signal down the line. For lossless lines, where the attenuation is zero, the phase shift per unit length is

$$\beta = \frac{\beta \ell}{\ell} = \omega \sqrt{LC}$$

This really represents a signal traveling down the line with a velocity

$$v = \frac{\omega}{\beta} = \frac{1}{\sqrt{LC}}$$

This velocity is independent of the applied frequency.

The larger the LC product of the line, the slower the signal will propagate down the line. A time delay per unit length can also be defined as the inverse of v

$$\delta = \frac{1}{v} = \sqrt{LC} \quad (30)$$

and a total propagation delay for a line of length ℓ as

$$\tau = \ell \delta = \ell \sqrt{LC} \quad (31)$$

For a more detailed discussion of characteristic impedances and propagation constants, the reader is referred to the references below.

REFERENCES

- Hamsher, D.H. (editor); *Communications System Engineering Handbook*; Chapter 11, McGraw-Hill, New York, 1967.
- Reference Data for Radio Engineers*, fifth edition; Chapter 22; Howard T. Sams Co., New York, 1970.
- Matrick, R.F.; *Transmission Lines for Digital and Communications Networks*; McGraw-Hill, New York, 1969.
- Metzger, G. and Vabre, J.P.; *Transmission Lines with Pulse Excitation*; Academic Press, New York, 1969.

LIFE SUPPORT POLICY

NATIONAL'S PRODUCTS ARE NOT AUTHORIZED FOR USE AS CRITICAL COMPONENTS IN LIFE SUPPORT DEVICES OR SYSTEMS WITHOUT THE EXPRESS WRITTEN APPROVAL OF THE PRESIDENT OF NATIONAL SEMICONDUCTOR CORPORATION. As used herein:

1. Life support devices or systems are devices or systems which, (a) are intended for surgical implant into the body, or (b) support or sustain life, and whose failure to perform when properly used in accordance with instructions for use provided in the labeling, can be reasonably expected to result in a significant injury to the user.
2. A critical component in any component of a life support device or system whose failure to perform can be reasonably expected to cause the failure of the life support device or system, or to affect its safety or effectiveness.



National Semiconductor Corporation
Americas
Tel: 1-800-272-9959
Fax: 1-800-737-7018
Email: support@nsc.com

www.national.com

National Semiconductor Europe
Fax: +49 (0) 1 80-530 85 86
Email: europe.support@nsc.com
Deutsch Tel: +49 (0) 1 80-530 85 85
English Tel: +49 (0) 1 80-532 78 32
Français Tel: +49 (0) 1 80-532 93 58
Italiano Tel: +49 (0) 1 80-534 16 80

National Semiconductor Asia Pacific Customer Response Group
Tel: 65-2544466
Fax: 65-2504466
Email: sea.support@nsc.com

National Semiconductor Japan Ltd.
Tel: 81-3-5620-6175
Fax: 81-3-5620-6179