

RCD COMPONENTS INC.



**RESISTORS
CAPACITORS
COILS
DELAY LINES**



Quality by design.

W E L C O M E

RCD's goal, since our founding over a third of a century ago, has been to be a growing and profitable organization that provides the highest quality passive components and services to our customers. If you're not already buying from us, give RCD a try. You'll see that we have the right solutions, at the right pricing & delivery.

RCD is a no-nonsense quality-oriented company. We define quality as 100% customer satisfaction. This goes well beyond failure-free product and focuses also on service, delivery performance and pricing.



One thing that we seem to do differently from many firms is to *listen*. As a result of this and being a customer-driven company, we offer over 100 customized product options (such as increased voltage capability, gold plated lead wires, custom marking, non-standard values, military screening, etc.) to readily fulfill the specific design requirements of each customer. And to fulfill customer delivery requirements, we offer one of the industry's largest inventories of finished goods, short lead times, and unique SWIFT™ service.

We're a big small company. Big enough to know the market and to take on our largest competitors. Yet small enough to care immensely about our customers, vendors, and employees, to whom we extend our sincere appreciation, without whom we wouldn't exist. To potential customers, we extend an invitation for an opportunity to lock-in with a reliable, dependable, and cost-effective passive component manufacturer, ready to demonstrate the benefits of doing business with our company.

Louis M. Arcidy,
President

Product index on pages 7 - 10

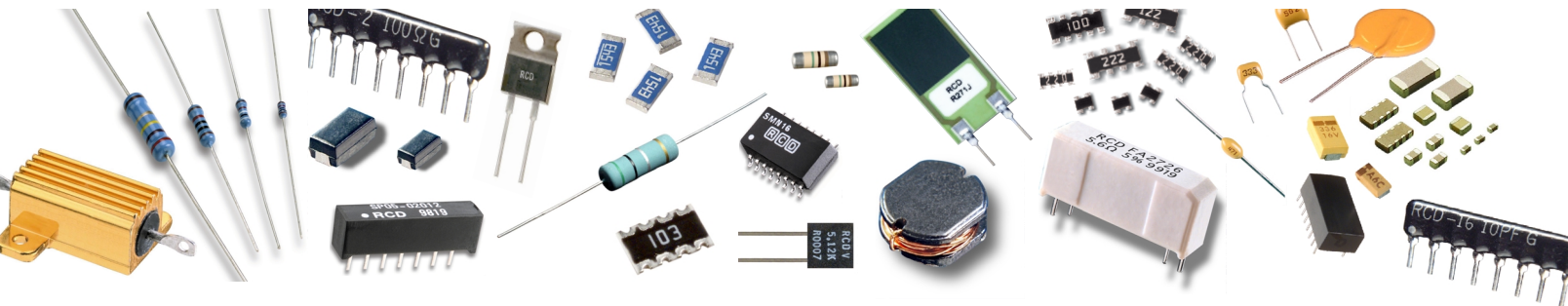

H I S T O R Y

RCD began as an idea in 1969 when Louis Arcidy decided to leave his position as Vice President of a major components manufacturer and start his own firm, a firm that he vowed would remain unencumbered by short term goals and quality tradeoffs. Arcidy purchased The Ronel Corporation of Goleta California, a specialty manufacturer of precision and power military-grade wirewound resistors, inductors and delay lines. After moving Ronel across the country, Arcidy along with his sons and a team of engineers, started business in a historic mill building in Manchester, New Hampshire.



Throughout the 1950's & 60's, Louis Arcidy and his team had made many advancements in resistive technology. His greatest technological innovation was in developing a method to eliminate most of the degrading effects of temperature, humidity, and other environmental factors on resistor performance, thereby achieving the world's greatest level of precision and stability. Arcidy's developments were critical to defense, medical, and aerospace applications (particularly the Mercury, Saturn, Gemini, and Apollo missions), garnering him the nickname "Mister Resistor" in 1962, the same year that John Glenn, another NH resident, became the first person to orbit the earth.

Arcidy's reputation for engineering excellence resulted in rapid success. Some of RCD's first customers were other resistor firms interested in expanding their product line to include precision and specialty models, a practice that continues today. In order to increase capacity and reduce costs, RCD began offshore production plants in Haiti (1975) and St. Lucia (1980). RCD also developed a unique quick-delivery production department, named the *SWIFT*[™] program. The *SWIFT*[™] program guaranteed production of almost any resistor within 2 days (i.e. Ship WithIn Fifty Two hours). The service was an instant hit and continues to help many hundreds of customers out of delivery jams every year.



Since the first year of production, RCD has grown over 100-fold, including multiple acquisitions and partnerships, with combined employment of nearly 600 dedicated people in the USA, Caribbean, and Asia. Many millions of resistors, capacitors, coils, and delay lines are produced every day. RCD continues to operate as a privately-held corporation, owned and managed by the Arcidy family. Many employees from the 1970's still remain, as do many of its original customers, a testament to Mr. Arcidy's vision and never-ending quest for utmost quality and customer service.

Louis J. Arcidy
Founder and Continued Inspiration



RCD's Manchester NH Production Plant

T H E D I F F

Worldwide Manufacturing

Our New Hampshire factory serves as headquarters for our manufacturing operations. Sales, Engineering, Manufacturing, Final QC, Inventory and Reliability functions are conducted here. The N.H. plant manufactures primarily smaller quantities and *SWIFT*™ orders, as well as precision, custom, and military devices. Additional products are produced in Europe, while low-cost volume efficiency is attained at the Caribbean and Asian facilities.

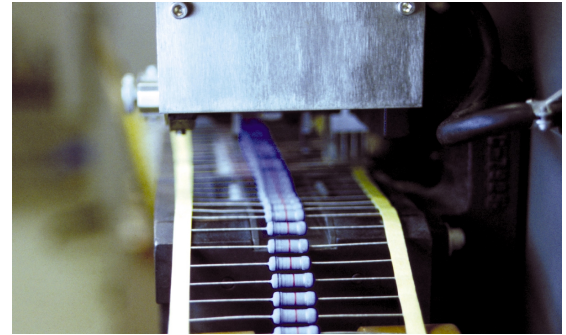

Product Quality & Performance

Our award-winning ABZED™ program is achieving six sigma PPM quality levels, and even PPB (parts per billion) on some products. Our goal though, is nothing short of abzed quality (absolute zero defects). It's RCD's sincere dedication to quality throughout the design, development, test, and production processes that differentiates us from others. Some customers never realize our performance advantages until performing side-by-side testing. Component preconditioning coupled with highest grade materials ensures superior performance. Our QA system and products meet various EIA and Military specifications, as well as the following standards (as applicable)...

- ISO9001 (Reg.# 19.3094)
- QS9000, TS16949 Compliant
- MIL-I-45208 Quality, MIL-STD-790 Reliability
- ANSI/NCSL Z540-1, ISO-10012-1 Calibration
- Defense Supplier under FSCM 56637
- GIDEP Participant
- DLSC Certification 0016723
- UL File E48042
- IQ Net (Reg. # IQM3101)
- AEC-Q200 Automotive Components

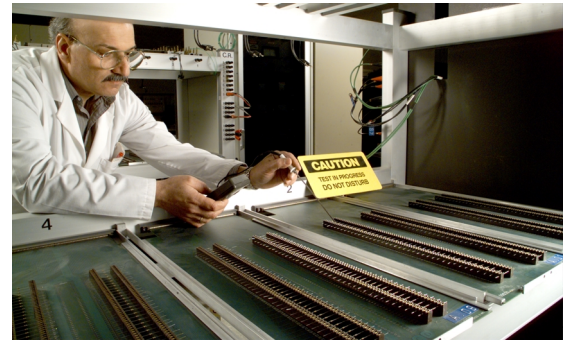

SWIFT™ Delivery

We're serious about prompt and on-time delivery. RCD maintains one of the largest inventories in the industry. Our multi-billion piece inventory doesn't just include the most popular items, but includes a wide range of styles, values, tolerances and sizes not normally stocked by other firms. And if unavailable from stock, our exclusive *SWIFT*™ service is available on most products, enabling production in as little as 3 days (moderate premium charge applies, lead time depends on type and quantity). Available on leaded and SM precision and power resistors, metal film, fusible, low-ohm, surge and temp-sensitive resistors, as well as custom networks, shunts, capacitors, inductors jumpers and delay lines.



Breadth of Line

RCD offers one of the widest range of passives in the world! For instance, we offer resistors from 0.0001Ω to $2 \times 10^{14}\Omega$, tolerances to .0005%, voltages to 300KV, operating frequencies from DC to GHz, TC's from 0.25ppm to +7000ppm, from components the size of the period at the end of this sentence to those over 3 feet long. And everything in between. But it's not just the selection of product families that sets us apart, it's the range within each product family. If you compare one of our products with an "equivalent" one from a competitor, you'll notice that in just about every instance, we offer a much wider range of values, sizes, and options.



E R E N C E

RoHS

RCD has been active in environmental causes for decades (it's no coincidence that our logo is green). All products are available in RoHS-compliant version (termination "W"). Most are also available with SnPb plating (termination "Q"). Refer to RCD's website for additional details.



Industry's lowest prices

RCD's reputation for unsurpassed quality sometimes gives the impression that we're a "pricey" company... not true. Our exceptional process-quality results in low manufacturing costs since we rarely have scrap or rework. Our pricing is generally quite attractive compared to competitors (including importers with little or no quality control). All things considered, our company is an excellent choice for any company interested in lowering its overall passive component procurement costs. Although RCD's unit prices are typically 10% to 30% below competitors, when considering the hidden costs of late delivery, discrepant product, and poor service, RCD offers even far larger advantages. The best components at the best prices, period.

Award Winning Engineering

Advancements in materials and manufacturing processes have resulted in many performance and pricing breakthroughs. Extreme conditions are probed to determine optimum designs for highest stability and reliability. Electronic Products magazine awarded RCD 'Product of the Month' on two occasions for space-saving inductor and power resistor designs, as well as the coveted 'Product of the Year' award for TO220 heat sink resistors, the only resistor product awarded in over 25 years! On-site design and machine shop capabilities enable quick tooling of new products at minimal expense. Since our inception, RCD's forte has been in customized products. While other firms force customers into their standard catalog products, RCD offers dozens of design variations (many of which are not listed on data sheets) to ensure that each item is optimized for the specific application, often with little or no extra cost.



MIL-Spec Screening

RCD offers a full gamut of Lab testing for critical-use applications such as military, medical, aerospace. These hi-rel components are available with burn-in, Group A/B screening and a host of stress tests...

Temp. Cycling/Thermal Shock	Shock/ Vibration
Humidity/Moisture Resistance	Dielectric Strength
Burn-In/ Life Cycling	Insulation Resistance
Noise/ Distortion	Solvent Resistance
Temperature Coefficient	Extreme Temp. Exposure
Pulse & Overload Capability	Solderability
Scanning Electron Microscope	X-Ray Analysis

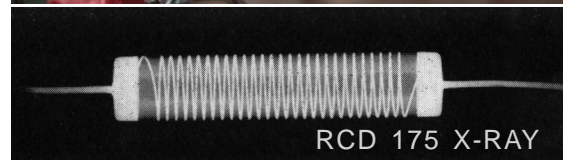

"RCD" = Real Customer Dedication

Our customer service team wants to do more than meet your expectations... we want you to be delighted! Among the many factors distinguishing RCD from other manufacturers are our service-related qualities such as JIT delivery, overall flexibility, and ironclad warranty. We firmly believe in PIE (partners in excellence) principals, and are most interested in joining with our customers and vendors in building long term relationships and mutually beneficial partnerships, striving for 100% customer satisfaction. Contact our Customer Satisfaction (Sales) team or Field reps and find out for yourself just how: RCD MAKES THE DIFFERENCE.

I N V E N T O R Y

Listing of RCD's most popular stock items, numerous additional items and values are available (refer to page 14 for EIA values)

SERIES MC THICK FILM CHIP RESISTORS, p. 16



MC0402	1Ω - 1 Meg, 1% (E-96 values) 10Ω - 1 Meg, 5% (E-24 values)
MC0603	10Ω - 1 Meg, 1% (E-96 values) 10Ω - 1 Meg, 5% (E-24 values)
MC0805	10Ω - 1 Meg, 1% (E-96 values) 10Ω - 1 Meg, 5% (E-24 values)
MC1206	10Ω - 1 Meg, 1% (E-96 values) 10Ω - 1 Meg, 5% (E-24 values)

SERIES BLU PRECISION CHIP RESISTORS, p. 18



BLU0402	10Ω to 100K, 0.1%
BLU0603	10Ω to 100K, 0.01% & 0.1%
BLU0805	10Ω to 1 Meg, 0.01% & 0.1%
BLU1206	10Ω to 1 Meg, 0.01% & 0.1%

SERIES CN CHIP RESISTOR ARRAYS, p. 31



CN1206A	10Ω to 10K 5% (E-24 values)
---------	-----------------------------

SERIES GP METAL FILM RESISTORS 1%, p. 63



GP50, 1/8W, 1%	10Ω to 1 Meg (E-96 values)
GP55, 1/4W, 1%	10Ω to 1 Meg (E-96 values)
GP55S, 1/2W, 1%	10Ω to 1 Meg (E-96 values)

SERIES CF CARBON FILM RESISTORS 5%, p. 66

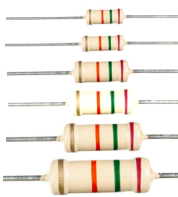

CF12, 1/8W	1Ω to 1 Meg (E-24 values)
CF22, 1/4W mini	1Ω to 1 Meg (E-24 values)
CF25, 1/4W	1Ω to 22 Meg (E-24 values)
CF50S, 1/2W	1Ω to 10 Meg (E-24 values)
CF100, 1W	1Ω to 10 Meg (E-12 values)
CF200S, 2W	1Ω to 10 Meg (E-24 values)

SERIES RSF POWER OXIDE RESISTORS, p. 64

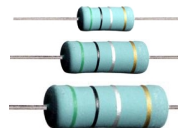

RSF1A, 1W	0.1Ω to 100K (E-24 values)
RSF2B, 2W-3W	0.1Ω to 100K (E-24 values)
RSF3B, 5W	0.2Ω to 100K (E-24 values)

SERIES RMF MINI POWER OXIDE RESISTORS, p. 64

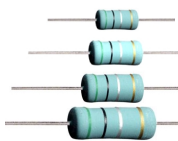

RMF1/2, 1/2W	0.1Ω to 470K, 1% & 5%
RMF1, 1W	0.08Ω to 120K, 1% & 5%
RMF2, 2W	0.1Ω to 100K, 1% & 5%
RMF3, 3W	0.1Ω to 200K, 1% & 5%

SERIES 100 WIREWOUND RESISTORS 1% & 5%, p. 43



125, 1W	0.1Ω to 1K (E-24 values)
135, 3W	0.01Ω to 10K (E-24 values)
160, 5W	0.05Ω to 10K (E-24 values)
175, 10W	0.1Ω to 1K (E-24 values)

SERIES 600 HEAT-SINK WW RESISTORS 1% & 5%, p. 46



615, 25W	0.05Ω to 1K (E12 values)
620, 50W	0.05Ω to 10K (E12 values)

ZERO-OHM JUMPERS, SMD & THRU-HOLE

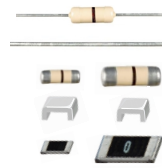

ZJ1, ZJ2, ZJ3	Zero-ohm axial jumper p.57
Z22	Zero-ohm uninsulated jumper p.57
ZCF12, ZCF25S	Zero-ohm MELF jumper p.21
ZJ1206	Zero-ohm high current SMD p.57
ZC0402, 0603, 0805, 1206, 1210	Zero-ohm chip jumper p.16

SERIES PW & PV POWER RESISTORS 5%, p. 47 & 48

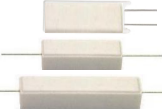

PV5, 5W	0.01Ω -100K, 5%
PW5, 5W	0.01Ω -100K, 5% & 10%
PW10, 10W	0.01Ω -100K, 5% & 10%

SERIES RG HIGH MEG OHM RESISTORS, p. 69



RG1/4, 500V	1M to 1000M, 1% & 5%
RG1/2, 1KV	1M to 1000M, 1% & 5%

SERIES CC CARBON COMPOSITION RESISTORS, p. 74

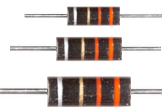

CC1/4, 1/4W	1Ω -22M, 5% & 10%
CC1/2, 1/2W	1Ω -6.8M, 5% & 10%
CC1, 1W	2.2Ω -1M, 10%

SERIES CL SIP RESISTOR NETWORKS, p. 37

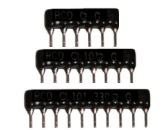

CL06, Config. 1&2	33Ω to 1 Meg (E-6 values)
CL08, Config. 1&2	10Ω to 1 Meg (E-6 values)
CL10, Config. 1&2	10Ω to 1 Meg (E-6 values)

SERIES CE CERAMIC CHIP CAPACITORS, p. 88



CE0402	0.47pF - 0.1uF, C0G, X7R, Y5V
CE0603	10pF - 1uF, C0G, X7R, Y5V
CE0805	10pF - 10uF, C0G, X7R, Y5V
CE1206	10pF - 10uF, C0G, X7R, Y5V

SERIES TS TANTALUM CHIP CAPACITORS, p. 91



TSA (1206)	0.1 uF to 22uF
TSB (1411)	1uF to 47uF
TSC (2412)	10uF to 100uF
TSD (2917)	10uF to 100uF

SERIES MCI CHIP INDUCTORS, p. 93, 94



CI0603	0.01uH to 0.1uH (E12 values)
CI0805	0.01uH to 1uH (E12 values)
CI1008	0.01uH to 10uH (E12 values)
MCI1210	0.01μH to 330μH (E-6 values)
MCI1812	0.1μH to 1000μH (E12 values)

SERIES AL, P & PF INDUCTORS, p. 100-102



AL02, 10%	0.1μH to 470μH (E-6 values)
AL03, 10%	0.1μH to 470μH (E-6 values)
AL05, 10%	0.1μH to 2200μH (E-6 values)
P0206, 10%	0.1μH - 1000μH, molded (E-12)
PF0410, 10%	0.22 -10,000μH, shielded (E-12)

ACTIVE & PASSIVE DELAY LINES, p. 109, 111



A1405 Active	5-tap, 25nS to 300nS
P1410 Passive	10-tap, 100nS to 500nS

C U S T O M

In addition to our catalog products, RCD offers hundreds of design variations as well as a wide range of fully customized components. While some other component manufacturers prefer to produce only their standard product line, RCD has been a "specialty" manufacturer for over 3 decades. We don't mind custom and/or difficult items. In fact, we love a challenge so don't hesitate to inquire. Single piece quantities to millions of pieces. If you need a resistor that will operate at cryogenic temperatures, in an acidic atmosphere, at frequencies over 100GHz, etc., contact RCD's engineering department.

CUSTOM RESISTIVE PRODUCTS

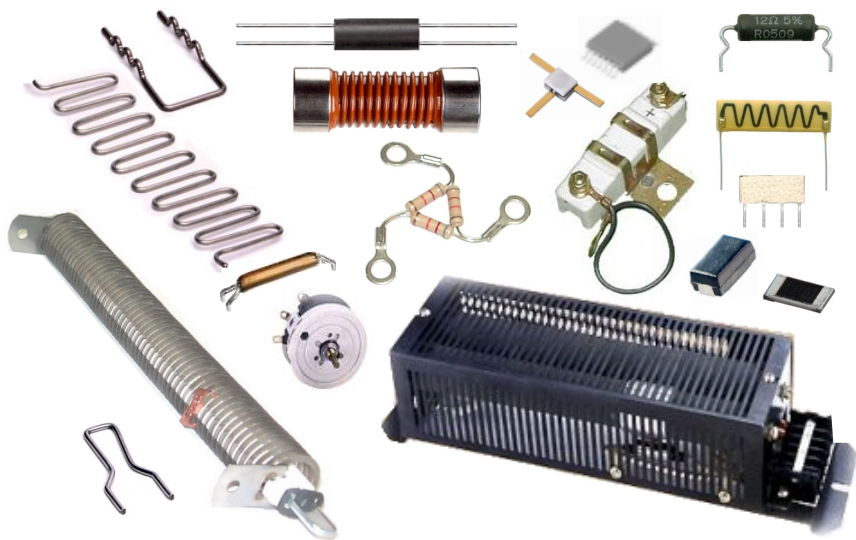

- ❑ Wirewound, film, composition, & foil technologies
- ❑ Ratings to 300KV, 15KA, 150KJoule
- ❑ Various heat-sink & water-cooled designs
- ❑ Microwave frequencies (up to 112GHz)
- ❑ Variable resistors/rheostats
- ❑ Shunts & current sense resistors, SM and leaded
- ❑ Load box & grid resistors
- ❑ Capacitor-mount charging resistors
- ❑ Ballast resistors, thermistors, varistors
- ❑ Edgewound & dynamic braking resistors
- ❑ Harsh atmosphere (oil, sulphur, salt water, etc.)
- ❑ Embedded Resistors, Polymer Circuits, IPC's
- ❑ Networks, hybrids, attenuators, LTCC circuits
- ❑ Temperature-sensitive resistors, RTD's
- ❑ Low distortion audio resistors
- ❑ Fusible resistors (single shot and resettable)
- ❑ Matched pairs, sets, networks
- ❑ Thick film on steel (resistors/circuits/networks)
- ❑ Micro-resistors (axial, radial, SM, wirebond)
- ❑ Custom lead forming & extensions, fast-on terminals
- ❑ High vibration, shock, and aerospace applications

CUSTOM CAPACITIVE PRODUCTS

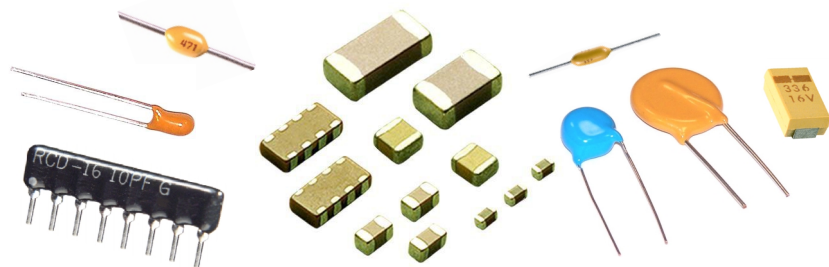

- ❑ Tantalum and ceramic (single & multilayer)
- ❑ Resistor/Capacitor snubbers, networks, arrays
- ❑ High voltage (to 40KV)
- ❑ Low ESR
- ❑ High RF power
- ❑ High Q, low dissipation factor
- ❑ Low profile
- ❑ Microwave frequencies up to 100GHz
- ❑ Micro-resistors (axial, radial, SM, wirebond)

CUSTOM INDUCTIVE PRODUCTS

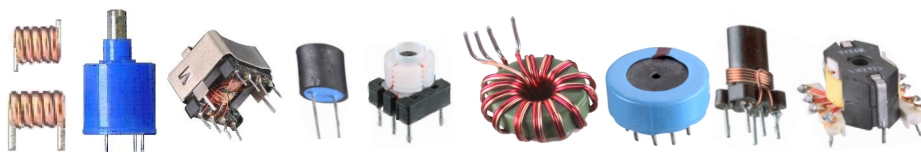

- ❑ Air coils (round & flat wire, leaded or SMD)
- ❑ Spark coil transformers
- ❑ High value inductors (1.0mH to 2H)
- ❑ Toroids (1/8" to 2" dia.)
- ❑ Wide band chokes and bead cores
- ❑ Variable coils (shielded, unshielded, smd)
- ❑ Pot core assemblies
- ❑ Pulse and miniature transformers
- ❑ Hash chokes, bobbin-wound coils
- ❑ Trigger and telecom transformers

CUSTOM DELAY LINES & FILTERS









- ❑ Active or passive technologies
- ❑ Programmable DL's (3bit to 8 bit)
- ❑ High bandwidth frequency
- ❑ Customized circuits with non-linear taps
- ❑ Leading and trailing edge design
- ❑ High Td/Tr ratio, fast rise time
- ❑ Industrial and military temperature range
- ❑ Wide choice of DL logic (Schottky TTL, LSTTL, FAST TTL, ASTTL, 10K ECL, 10KH ECL, 100K ECL, HCMOS, & FACT CMOS)
- ❑ Ceramic filters up to 5GHz



C O N T E N T S

RCD Surface Mount Components



Film Resistors

 Thick-film chip, general purpose (MC Series).....	16
 Thick-film chip, Military-grade (MCT Series).....	17
 Precision chip resistor (BLU Series).....	18
 Power film MELF resistor (MPF Series).....	19
 Metal film MELF resistor (MGP, MHM Series).....	20
 Carbon film MELF resistor (MCF Series).....	21



Wirewound Resistors

 Wirewound MELF resistor (MW Series).....	22
 Molded wirewound resistor (MWM Series).....	23
 Precision gullwing WW resistor (PC451G).....	42





Current Sense Resistors & Shunts

 Molded plate resistor (MWM-L Series).....	23
 Current sensing chip resistor (ML Series).....	24
 Current sensing 4-terminal resistor (SF Series).....	25



High Voltage/ High Megohm Resistors

 High megohm chip resistor (HR Series).....	26
 High voltage chip resistor (SRH Series).....	27
 High megohm gullwing resistor (BC-G Series).....	71

Networks, Arrays, Hybrids, IPC's

 Chip array, concave terminations (CN Series).....	31
 Chip array, convex terminations (SMN Series).....	32
 Thick film molded networks (SMN16 Series).....	33
 Custom networks & IPC's (DLN Series).....	36
 Custom hybrids & LTCC, thick- & thin-film.....	41



Composition & Surge Resistors

 Pulse tolerant molded resistor (PRM Series).....	28
 Pulse withstanding resistor design, Option 'P'.....	77

Zero-Ohm Jumpers

 Zero-ohm chip jumper (ZC Series).....	16
 Zero-ohm MELF jumper (ZCF Series).....	21
 Chip jumper array (ZN,ZMN).....	31, 32
 Jumper, high current (Z1206 Series).....	57



Fusible Resistors

 Fusing flat chip resistor (FC Series).....	29
 Fusing MELF resistor (MBW Series).....	81



Heat Sink Resistors

 TO-style power film resistor (MPD, MP-G).....	78
---	----





Temperature Sensitive Resistors & RTD's

 Linear PTC chip resistor (FLP Series).....	30
 Linear PTC MELF resistor (MLP Series).....	84





Capacitors

 Multilayer ceramic chip capacitor (CE Series).....	88
 Tantalum chip capacitor (TS Series).....	91
 Tantalum chip cap, low ESR (TSE Series).....	91



Inductors, Transformers, Choke Coils

 Ceramic core, open wound chip inductor (CI).....	93
 Molded wirewound chip inductor (MCI Series).....	94
 Shielded WW chip inductor (MSI Series).....	95
 Multilayer ceramic chip inductor, high freq. (MHI).....	96
 Multilayer shielded ferrite chip inductor (MLI).....	97
 Power inductor (HI Series).....	98
 Power chip inductors (PIC Series).....	99
 Custom inductive products.....	105

Delay Lines

 Programmable, TTL & ECL, 3-8 Bit (TT, EC Series)...	106
 Active DL, single/dual/triple/quad output (A0).....	108
 Active DL, 5- & 10-Tap (A08, A14, SMA14).....	109
 Passive, single (SMP01S, P01AG, P0801AG).....	110
 Passive, 5/10/20tap (SMP, P1410AG, P2420AG)...	111

Miscellaneous

 ZZ surface mount lead forming.....	34
 Chip resistor kits, thick- and thin-film.....	35

continued on next page →

RCD Through-Hole Components (page 1 of 2)

Networks, Arrays, Hybrids, IPC's

	Custom networks & IPC's (DSN, DDN).....36
	Precision thin film SIP networks (CP Series).....37
	Thick film SIP networks (C, CL Series).....38
	Resistor/Capacitor SIP networks (RC Series)....39
	Current Sensing SIP Networks (CSS Series)....40
	Voltage Dividers (VDS Series).....40
	Custom hybrids & LTCC, thick- & thin film.....41

Wirewound Resistors

	Precision, axial & radial (SA, MA, PC, Q Series)....42
	Precision power, silicone coated (100 Series)....43
	Miniature power, silicone coated (200 Series)....44
	General purpose power WW (RW Series).....45
	Aluminum housed wirewound (600 Series).....46
	Ceramic case, axial lead (PW Series).....47
	Ceramic case, vertical mount (PV, PVH).....48
	Ceramic case, vertical bracket (PWV Series)....48
	Ceramic case, radial leads (PWLL Series).....49
	Ceramic case, lug terminals & bracket (PWH).....49
	Industrial power, tubular WW (T Series).....50
	Edgewound, high power (EW Series).....51
	Industrial power, flat WW (FW, FWE Series).....52

Current Sense Resistors & Shunts

	Ceramic case, vertical, 2&4 terminal (PV, PVH)...48
	Ceramic case, axial lead, 2 terminal (ULV).....53
	Ceramic case, 4 terminal (LVF, LVH).....54
	Metal plate shunt, 2 & 4 terminal (LOR).....55
	Molded low-ohm plate resistor (LV3 Series)....55
	Open-air, low value shunt resistor (OA Series)...56
	DC shunts, 50 to 5000A (SPM, SVM, SHM).....113

Zero-Ohm Jumpers

	Jumper Networks (CJ Series).....40
	Zero-ohm jumper, axial lead (ZJ, Z Series).....57

Resistance Standards

	Ultra-precision, metal encased (A1 Series).....58
	Precision, molded case (A2 Series).....58

Film and Foil Resistors

	Power film, ceramic case, axial (PW-M).....47
	Power film, ceramic case, vertical (PV-M).....48
	Power film, vertical bracket-mount (PWV-M).....48
	Metal foil, epoxy or hermetic seal, radial (HP).....59
	Metal film, hermetic-sealed, axial (HM).....60
	Metal film, ultra-precise, radial (VS Series)....59
	Metal film, ultra-precision, axial (PMF Series)....61
	Metal film, precision, axial lead (MF Series).....62
	Metal film, general purpose (GP/GPS).....63
	Metal film, flameproof, axial lead (FP/FPS).....63
	Metal oxide, flameproof, axial (RSF, RMF).....64
	Miniature power film resistor (MG, FS).....65
	Carbon film resistor (CF Series).....66
	Sub-miniature axial lead resistor (MFA).....67
	Planar thick film power resistor, ceramic (TP)...68
	Thick film power resistor on steel (TPS).....68

High Voltage/ High Megohm Resistors

	High voltage axial lead resistor (RG, RH, RP)....69
	High power, high voltage tubular (SR).....70
	High megohm radial lead resistor (BC Series)...71
	High megohm / high voltage resistors & voltage dividers, axial lead or screw terminations (UHV Series).....72

Composition & Surge Resistors















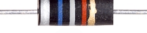

















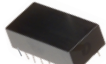



	High surge axial lead resistor (PR Series).....73
	Carbon composition resistor, axial (CC).....74
	High pulse voltage, carbon resistor (CFZ).....75
	High surge non-inductive composition, tubular clip-mount and axial lead (PCN).....76

Custom Resistive Products

	Water cooled, microwave, low distortion, etc...6
--	--

TABLE OF CONTENTS, Continued

RCD Through-Hole Components (page 2 of 2)

	Heat Sink Resistors			Inductors, Transformers, Coils
	Aluminum housed wirewound (600 Series).....	46		General purpose inductor choke (AL).....
	TO-style power film resistor (MP Series).....	78		Molded inductor, axial lead (P Series).....
	Power thick film on steel resistor (HDP Series).....	79		Shielded inductor, axial lead (PF Series).....
	Fusible Resistors			Flat inductor, radial lead (FRL Series).....
	Fuse resistor, general purpose, WW (RW-FF).....	45		High current power chokes (HL Series).....
	Fuse resistor, power, ceramic case (PW-FF).....	47		High current filter chokes, axial lead (CA)....
	Fuse resistor, custom precision (FR Series).....	80		High current filter chokes, radial (CH).....
	Fuse resistor, general purpose, film (BW).....	81		High current filter chokes, vertical (CV).....
	Thermal fuse resistor, axial lead (TF).....	82		Isolation LAN-Ethernet transformers (LE)....
	Thermal fuse resistor, radial lead (TFV).....	82		Pulse transformers (ST Series).....
	Thermal fuse line feed resistor, SIP (LF2).....	83		Custom inductive products.....
	Temperature Sensors & RTD's			
	Linear PTC film resistors, axial (LP, LPT).....	84		Delay Lines
	Linear PTC WW resistors, axial & radial (ATB, PTB, ATS Series).....	85		Programmable, TTL & ECL, 3-8 Bit (TT, EC)...
	RTD elements (PTC Series).....	86		Active ECL10K & ECL100K (E10, E100).....
	RTD probes, stainless steel, ceramic, or epoxy encased (PTS Series).....	86		Active, single/dual/triple/quad output (A0).....
	Platinum thin-film sensors, RTD elements (PT).....	87		Active DL, 5 and 10 Tap, DIP & SIP (A08, A14, SA08 Series).....
	Capacitors			Passive DL, Single Output, DIP & SIP (P01, S01 Series).....
	Custom capacitors (high voltage, etc).....	6		Passive DL, 10 & 20 Tap, DIP (P1410, P2420 Series).....
	Capacitor SIP networks (RC Series).....	39		Passive DL, 5-Tap & 10-Tap, SIP (SP05, SP10 Series).....
	Multilayer ceramic capacitor, axial (CEA).....	89		
	Multilayer ceramic capacitor, radial (CER).....	90		
	Tantalum capacitor, radial (TR Series).....	92		
	Miscellaneous			
	RCD History.....	2		Military Specifications.....
	SWIFT™ Program.....	3		Useful Formulas and Information.....
	Military Screening.....	4		General Notes, Terms & Conditions.....
	RoHS Program.....	4		Standard EIA Values & Color Code Chart.....
	Standard Stock Items / Inventory.....	5		Tape & reel packaging, horizontal, vertical, SM.....
	Custom Components.....	6		Pulse withstanding resistor design, Option 'P'.....
	Alphabetical Index.....	10		Assembly Services.....

ALPHABETICAL INDEX



RESISTORS • CAPACITORS • COILS • DELAY LINES

SERIES	DESCRIPTION	PG	SERIES	DESCRIPTION	PG
100	Precision power, silicone coated resistor.....	43	MPF	Power film MELF resistor.....	19
200	Miniature power, silicone coated resistor.....	44	MSI	Shielded wirewound chip inductor.....	95
600	Aluminum housed wirewound resistor.....	46	MW	Wirewound MELF resistor.....	22
A01-A04	Active delay line, single, double, triple, quad DIP.....	108	MWM	Molded wirewound resistor, surface mount.....	23
A08, A14	Active delay line, 5- and 10-Tap, DIP & SM.....	109	MWM-L	Molded plate resistor shunt, surface mount.....	23
A1, A2	Resistance standards, precision & ultra precision.....	58	OA	Open-air, low value shunt resistor, axial & radial.....	56
AL	General purpose inductor choke, axial-lead.....	100	P	Molded inductor, axial lead.....	101
ASSEMBLY	Assembly services.....	114	P01, P0801	Passive delay line, Single Output, DIP & SM.....	110
ATB, ATS	Linear PTC WW resistors, axial-lead.....	85	P1410, P2420	Passive delay line, 10- & 20-Tap, DIP & SM.....	111
BC	High megohm radial-lead resistor.....	71	PC	Precision wirewound resistor, radial lead.....	42
BC-G	High megohm gullwing SM resistor.....	71	PC451G	Precision gullwing WW resistor, SM.....	42
BLU	Precision chip resistor.....	18	PCN	High surge non-inductive composition resistor.....	76
BW	Fuse resistor, general purpose, film.....	81	PF	Molded shielded inductor, axial-lead.....	102
C	Thick film resistor network, SIP.....	38	PIC	Power chip inductor.....	99
CA	High current filter chokes, axial-lead.....	105	PMF	Metal film resistor, ultra-precision, axial-lead.....	61
CC	Carbon composition resistor, axial-lead.....	74	PR	High surge axial-lead resistor.....	73
CE	Multilayer ceramic chip capacitor.....	88	PRM	Pulse tolerant molded surface mount resistor.....	28
CEA	Multilayer ceramic capacitor, axial-lead.....	89	PT	Platinum thin-film sensors, RTD elements.....	87
CER	Multilayer ceramic capacitor, radial-lead.....	90	PTB	Linear PTC wirewound resistor, radial-lead.....	85
CF	Carbon film resistor.....	66	PTC	RTD element, economical.....	86
CFZ	High pulse voltage, carbon resistor.....	75	PTS	RTD probes, stainless steel, encased.....	86
CH	High current filter chokes, radial-lead.....	105	PV, PVH	Ceramic encased resistor, vertical, 2- & 4-terminal.....	48
CI	Ceramic core, open wound chip inductor.....	93	PV-M	Power film resistor, ceramic case, vertical.....	48
CJ	Jumper networks.....	40	PW	Ceramic encased resistor, axial-lead.....	47
CL	Thick film SIP resistor network.....	38	PW-FF	Fuse resistor, power, ceramic case.....	47
CN	Chip resistor array, concave terminations.....	31	PWH	Ceramic encased resistor, lug terminals/bracket mount.....	49
CP	Precision thin film resistor networks, SIP.....	37	PWLL	Ceramic encased resistor, radial spade terminals.....	49
CSS	Current sensing resistor networks, SIP.....	40	PW-M	Power film resistor, ceramic encased, axial.....	47
CUSTOM	Custom resistive, capacitive, inductive, DL products.....	6	PWV	Ceramic encased resistor, vertical, bracket-mount.....	48
CV	High current filter choke, vertical.....	105	PWV-M	Power film resistor, vertical bracket-mount.....	48
DDN	Custom networks & IPC's, DIP.....	36	Q	Precision WW resistor, axial, metal film replacement.....	42
DLN	Custom networks & IPC's, surface mount.....	36	RC	Resistor/Capacitor SIP network.....	39
DSN	Custom networks & IPC's, SIP.....	36	RG	High voltage axial lead resistor.....	69
E10, E100	Active Delay Line ECL10K & ECL100K.....	107	RH	High voltage axial lead resistor, precision.....	69
EC	Programmable Delay Line, ECL, 3-8 Bit.....	106	RMF	Metal oxide, flameproof, axial, miniature size.....	64
EIA	EIA standard values.....	14	RP	High voltage axial lead resistor, professional.....	69
EW	Edgewound, high power resistor.....	51	RSF	Metal oxide resistor, flameproof, axial-lead.....	64
FC	Fusible flat chip resistor.....	29	RW	General purpose power wirewound resistor.....	45
FLP	Linear PTC chip resistor.....	30	RW-FF	Fuse resistor, general purpose, wirewound.....	45
FP/FPS	Metal film, flameproof, axial lead resistor.....	63	S01	Passive delay line, single output, SIP.....	110
FR	Fuse resistor, custom precision.....	80	SA	Precision wirewound resistor, axial lead.....	42
FRL	Flat inductor, radial lead.....	103	SA08	Active delay line, 5-Tap 8-Pin SIP.....	109
FS	Miniature power film resistor.....	65	SF,SFG	Current sensing 4-terminal surface mount resistor.....	25
FW, FWE	Industrial power, flat wirewound.....	52	SHM	DC shunts, 300 to 5000A, horizontal mount.....	113
GP/GPS	Metal film, general purpose.....	63	SMA14	Active delay line, 5-Tap surface mount DIP.....	109
HDP	Power thick film on steel resistor.....	79	SMN	Chip resistor array, convex terminations.....	32
HI	Power inductor, SM, shielded & non-shielded.....	98	SMN16	Thick film molded resistor networks.....	33
HL	High current power choke.....	104	SMP1410,1610	Passive delay line, 10-Tap surface mount DIP.....	111
HM	Metal film resistor, hermetic-sealed, axial-lead.....	60	SMP01S	Passive delay line, Single Output SM DIP.....	110
HP	Metal foil resistor, epoxy or hermetic seal, radial-lead.....	59	SP05, SP10	Passive delay line, 5-Tap & 10-Tap, SIP.....	112
HR	High megohm chip resistor.....	26	SPM	DC shunts, 50 to 75A, panel mount.....	113
HYBRIDS	Hybrid circuits, thick- or thin-film.....	41	SR	High power, high voltage resistor, tubular.....	70
KITS	Chip Resistor & Chip Capacitor Kits.....	35	SRH	High voltage chip resistor.....	27
LE	Isolation LAN-Ethernet transformer.....	106	ST	Pulse transformer.....	106
LF2	Thermal fuse line feed resistor, SIP.....	83	SWIFT	SWIFT™ delivery program.....	3
LOR	Metal plate shunt, low value resistor, 2 & 4 terminal.....	55	SVM	DC shunts, 50 to 500A, vertical mount.....	113
LP, LPT	Linear PTC film resistors, axial-lead.....	84	T	Industrial power, tubular wirewound resistor.....	50
LV3	Molded low-ohm plate resistor, axial-lead.....	55	TAPE & REEL	Tape & Reel packaging specifications.....	15
LVF, LVH	Ceramic case resistor, 4-terminal.....	54	TF, TFV	Thermal fuse resistor, axial or radial lead.....	82
MA	Precision wirewound resistor, miniature, axial.....	42	TP	Planar thick film power resistor, ceramic.....	68
MC	Thick-film chip resistor, general purpose.....	16	TPS	Thick film power resistor on steel.....	68
MBW	Fusible MELF resistor.....	81	TR	Tantalum capacitor, radial.....	92
MCF	Carbon film MELF resistor.....	21	TS	Tantalum chip capacitor.....	91
MCI	Molded wirewound chip inductor.....	94	TSE	Tantalum chip cap, low ESR.....	91
MCT	Thick-film chip resistor, Military-grade.....	17	TT	Programmable delay line, TTL, 3-8 Bit.....	106
MF	Metal film resistor, precision, axial lead.....	62	UHV	High-voltage megohm resistor.....	72
MFA	Sub-miniature axial lead resistor.....	67	ULV	Ceramic case, low value resistor 2-terminal, axial.....	53
MG	Miniature power film resistor.....	65	VDS	Voltage Divider.....	40
MGP	Metal film MELF resistor.....	20	VS	Metal film resistor, ultra-precision, radial-lead.....	59
MHI	Multilayer ceramic chip inductor, high frequency.....	96	Z1206	Jumper, high current.....	57
MHM	Metal film MELF resistor, hermetic seal.....	20	ZC	Zero-ohm chip jumper.....	16
ML	Current sensing low value chip resistor.....	24	ZCF	Zero-ohm MELF jumper.....	21
MLI	Multilayer shielded ferrite chip inductor.....	97	ZJ, Z	Zero-ohm jumper, axial lead.....	57
MLP	Linear PTC MELF resistor.....	84	ZN,ZMN	Chip jumper array, convex or concave.....	31, 32
MP,MPD,MP-G	TO-style power film resistor, SM & thru-hole.....	78	ZZ	Surface mount lead forming.....	34

MIL-Spec Resistors and Capacitors

Prior to ordering any MIL equivalent parts, please check whether MIL qualification is required. RCD warrants much of its product line to meet applicable MIL specifications, but this does not imply qualification.

MIL-R-11 RC07GF252K (RCD CC series) Resistor, Composition							
RC07 Styles RC05 - RC42	GF G = 70° Max. ambient temp. for full-load operation. F = temp. coefficient, which varies with resistance from 625ppm to ±3100ppm/°C	252 Resistance, first 2 digits are significant, 3rd digit is number of zeros. 252 = 2500 ohms	K Tolerance J = 5% K = 10% M = 20%				
MIL-PRF-22684 RL07S103J (RCD GP series) Resistor, General Purpose, Color-Banded, Axial Lead							
RLR07 Styles RL07 - RLR42	S Terminal (Lead) S = Solderable	103 Resistance, first 2 digits are significant, 3rd digit is number of zeros. 103 = 10,000 ohms	J Tolerance G = 2% J = 5%				
MIL-R-10509 RN55D1002F (RCD MF & PMF series) Resistor, Metal Film, High Stability, Axial Lead							
RN55 Styles RN50-RN80	D Temperature Coefficient C = 50ppm D = -500ppm to +200ppm E = 25ppm	1002 Resistance, first 3 digits are significant, 4th digit is number of zeros. For values below 100 ohms use R as decimal point. 1002 = 10,000 ohms	F Tolerance B = 0.1% C = 0.25% D = 0.5% F = 1%				
MIL-PRF-26 RW74U49R9F (RCD 100 series) Resistor, Power Wirewound, Axial Lead							
RW74 Styles RW10 - RW81 Fixed Wirewound Resistor, Power Type	U Max. "hot spot" derating temp. U = 275°C V = 350°C N = 350°C (Non-inductive)	49R9 Resistance, first 3 digits are significant, 4th digit is number of zeros. For values below 100 ohms use R as decimal point. 49R9 = 49.9 ohms	F Tolerance B = 0.1%, D = 0.5%, F = 1% (Tolerance code is only used on Char. U resistors. Char. V is ±5% on values 1Ω or above, ±10% below 1Ω.)				
MIL-PRF-18546 RE60G1650F (RCD 600 series) Resistor, Power Wirewound, Chassis Mounted							
RE60 Styles RE60 - RE80	F Inductance characteristics G = inductive N = non-inductive	1650 Resistance, first 3 digits are significant, 4th digit is number of zeros. For values below 100 ohms use R as decimal point. 1650 = 165 ohms	F Tolerance F = 1% (Always 1%)				
MIL-R-93 RB52CE12701FR (RCD SA, PC series) Resistor, Wirewound, Precision							
RB52 Styles RB08 - RB73	C Terminal C = Solderable W = Weldable	E Temperature Coefficient 90ppm below 1Ω 50ppm, 1Ω to 9.9Ω 20ppm 10Ω & up	12701 Resistance, first 4 digits are significant, 5th digit is number of zeros. For values below 1000 ohms use R as decimal point. 12701 = 12,700 ohms	F Tolerance A = 0.05% B = 0.1% D = 0.5% F = 1.0%			
MIL-PRF-55365 CWR BC225JBB (RCD TS series) Tantalum Chip Capacitors							
CWR06 Styles CWR03- CWR29	B Voltage A=2V B=3V C=4V D=6V E=8V F=10V G=12V H=15V J=20V K=25V L=30V M=35V N=50V	C Termination B = Gold C = Hot Solder dip H = Solder Plated K = Solder Fused	225 Capacitance (pF), first 2 digits are significant, 3rd digit is number of zeros	J Tolerance J = 5% K = 10% M = 20%	B Failure Rate A = Non-ER B = 0.1% C = 0.01% D = 0.001%	B Surge Current Option	
MIL-PRF-914 M914C01H1002FAS (RCD SMN, SMTF series) Surface Mount Networks							
M914	C Termination C = Gold F = Tin/Lead J = Hot Solder dip	01 Package Size	H Characteristic R = 25ppm C = 50ppm, hermetic H = 50ppm, non-hermetic K = 100ppm M = 300ppm	1002 Resistance, first 3 digits are significant, 4th digit is number of zeros. R is decimal point under 100Ω. 1002 = 10,000Ω	F Tolerance B=0.1% D = 0.5% F = 1% G = 2% J = 5%	A Schematic	B Failure Rate C = Non-ER M = 1% P = 0.1% R = 0.01% S = 0.001%
MIL-PRF-55681 CDR01 BX 100AKSM (RCD CE series) Ceramic Chip Capacitors							
CDR01 Styles CDR01 - CDR35	BX Dielectric BP = 30ppm BX = 15%	100 Capacitance (pF), first 2 digits are significant, 3rd digit is number of zeros. R is decimal point below 10pF.	A Voltage A=50V B=100V C=200V D=300V E=500V K=150V F=1KV G=2KV H=3KV J=4KV	K Tolerance B = 0.1pF G = 2% C = .25pF J = 5% D = .5pF K = 10% F = 1% M = 20%	S Termination M = PdAg S = SnPb coated Y = Tin Plated Ni Z = SnPb plated Ni	M Failure Rate C = Non-ER M = 1% P = 0.1% R = 0.01% S = .001%	
MIL-PRF-83401 M8340101H1002JA (RCD C, CL, RC, DDN Series) Resistor & Resistor Capacitor Networks							
M83401 M=Burn-in C=Non-Burn-in	01 Package size	H Characteristic Y = 5ppm, hermetic C = 50ppm, hermetic H = 50ppm, non-hermetic K = 100ppm, non-hermetic M = 300ppm, non-hermetic R = 25ppm, non-hermetic	1002 Resistance, first 3 digits are significant, 4th digit is number of zeros. R is decimal point. 1002 = 10,000Ω	J Tolerance V = 0.005% D = 0.5% T = 0.01% F = 1% A = 0.05% G = 2% B = 0.1% J = 5%	A Schematic		

MIL-R-39008 RCR07G153JS (RCD CC series with option 37) Resistor, Composition					
RCR07 Styles RCR05 - RCR42	G G = 70° Max. ambient temp. for full-load operation and TC of ±625ppm to ±1900ppm/°C	153 Resistance, first 2 digits are significant, 3rd digit is number of zeros. 153 = 15,000 ohms	J Tolerance J = 5% K = 10%	R Failure Rate M = 1.0% P = 0.1% R = 0.01% S = 0.001%	
MIL-PRF-39017 RLR071502GR (RCD MF series) Resistor, General Purpose, Alpha-numeric marking					
RLR07 Styles RLR05 - RLR62	C Terminal C = Solderable/Weldable	1502 Resistance, first 3 digits are significant, 4th digit is number of zeros. 1502 = 15,000 ohms	G Tolerance F = 1% G = 2% J = 5% K = 10%	R Failure Rate C = Non-ER M = 1.0% P = 0.1% R = 0.01% S = 0.001%	
MIL-PRF-55182 RNR60H1003FS (RCD MF, PMF, HM series) Resistor, Precision Film					
RNR60 RNR = Solderable leads RNC = Solderable/Weldable RNN = Weldable Styles RNR50-RNC90	H C = 50ppm, hermetic sealed H = 50ppm, non-hermetic E = 25ppm, hermetic sealed J = 25ppm, non-hermetic K = 100ppm, non-hermetic	1003 Resistance, first 3 digits are significant, 4th digit is number of zeros. For values below 100 ohms use R as decimal point. 1003 = 100,000 ohms	F Tolerance B = 0.1% D = 0.5% F = 1%	S Failure Rate C = Non-ER M = 1.0% P = 0.1% R = 0.01% S = 0.001% T = Space level	
MIL-PRF-39007 RWR74S49R9FR (RCD 100 series) Resistor, Power Wirewound, Axial Lead					
RWR74 Styles RWR71 - RWR82	S Terminal S = Solderable W = Weldable Z = Weldable, non-inductive N = Solderable, non-inductive	49R9 Resistance, first 3 digits are significant, 4th digit is number of zeros. For values below 100 ohms use R as decimal point. 49R9 = 49.9 ohms	F Tolerance B = 0.1% D = 0.5% F = 1%	R Failure Rate C = Non-ER M = 1.0% P = 0.1% R = 0.01% S = 0.001% T = Space level	
MIL-PRF-39009 RER60F1650R (RCD 600 series) Resistor, Power Wirewound, Chassis Mounted					
RER60 Styles RER40 - RER75	F Tolerance F = 1% (Always 1%)	1650 Resistance, first 3 digits are significant, 4th digit is number of zeros. For values below 100 ohms use R as decimal point. 1650 = 165 ohms	R Failure Rate C = Non-ER M = 1.0% P = 0.1% R = 0.01% S = 0.001%		
MIL-PRF-39005 RBR52L12601FR (RCD SA, PC series) Resistor, Wirewound, Precision					
RBR52 Styles RBR52 - RBR81	L Terminal L = Solderable U = Weldable	12601 Resistance, first 4 digits are significant, 5th digit is number of zeros. For values below 1000 ohms use R as decimal point. 12601 = 12,600 ohms	F Tolerance T = 0.01% Q = 0.02% A = 0.05% B = 0.1% F = 1%	R Failure Rate C = Non-ER M = 1.0% P = 0.1% R = .01% S = .001% T = Space level	
MIL-PRF-55342 M55342H01B1E00M (RCD BLU & MCT series) Resistor, Chip					
M55342	H Temperature Characteristic E = 25ppm H = 50ppm K = 100ppm M = 300ppm	01 Style RM0302 - RM2512	B Termination Material B = Solder coated, nickel barrier, wraparound G = Gold wraparound C = Palladium silver, wraparound D = Palladium silver, single-sided	1E00 Resistor Value and Tolerance Code	M Failure Rate C = Non-ER M = 1.0% P = 0.1% R = 0.01% S = 0.001%
MIL-PRF-49465 M4946501TR0100F (RCD LOR & ULV series are similar) Resistor, Low Ohmic, Metal Element					
M4946501T Styles RLV10 - RLV31	R0100 Resistance			F Tolerance F = 1% H = 3% J = 5%	
MIL-PRF-49462 M4946201AA100KF (RCD RG, RH, RP series) Resistor, High Voltage, Film					
M4946201AA Styles RHV30 - RHV35	100K Resistance, first 3 significant digits followed by multiplier (K = Kohm, M = Megohm, G = Gigohm)			F Tolerance F = 1% G = 2% J = 5%	
MIL-PRF-29 MFC504 (RCD SR & T series) Resistor, High Voltage Wirewound or Film, Ferrule Terminal					
MFC Styles MFA - MFF	504 Resistance, first 2 digits are significant, 3rd digit is number of zeros 504 = 500,000Ω (±0.5%)				

USEFUL FORMULAS AND INFORMATION



RESISTORS • CAPACITORS • COILS • DELAY LINES

OHM'S LAW	
$E = IR$	$E = \text{Voltage (Volts)}$
$R = E/I$	$R = \text{Resistance (Ohms)}$
$I = E/R$	$I = \text{Current (Amperes)}$
$P = EI$	$P = \text{Power (Watts)}$
$P = E^2/R$	
$P = I^2R$	

ENERGY CONVERSION	
$J = Pt$	$J = \text{Energy} = \text{Watt-seconds} = \text{Joules}$
$J^* = \frac{CE^2}{2}$	$C = \text{Capacitance (Farads)}$
	$t = \text{Time (Seconds)}$
	$E = \text{Voltage (Volts)}$
	$P = \text{Power (Watts)}$

*Capacitor discharge circuit

RESISTORS IN SERIES
$R_s = R_1 + R_2 + R_3 \dots + R_n$

RESISTORS IN PARALLEL
$R_p = \frac{1}{1/R_1 + 1/R_2 + 1/R_3 \dots + 1/R_n}$

ELECTRICAL CHARACTERISTICS		
Quality	Symbol	Basic unit
Current	I	Ampere (A)
Charge	Q	Coulomb (C)
Power	P	Watt (W)
Voltage	V	Volt (V)
Resistance	R	Ohm (Ω)
Reactance	X	Ohm (Ω)
Impedance	Z	Ohm (Ω)
Conductance	G	Siemens (S)
Capacitance	C	Farad (F)
Inductance	L	Henry (H)
Frequency	f	Hertz (Hz)
Period	t	Second (S)

TEMPERATURE CONVERSION
$T_c = 5/9 (T_f - 32^\circ)$
$T_f = 9/5 (T_c) + 32^\circ$

PPM CONVERSION						
1ppm	10ppm	25ppm	50ppm	100ppm	1000ppm	10,000ppm
.0001%	.001%	.0025%	.005%	.01%	0.1%	1%

Value	MULTIPLES & SUBMULTIPLES OF UNITS		Example
	Prefix	Symbol	
1,000,000,000,000 = 10^{12}	tera	T	$T\Omega = 10^{12}\Omega$
1,000,000,000 = 10^9	giga	G	$G\Omega = 10^9\Omega$
1,000,000 = 10^6	mega	M	$M\Omega = 10^6\Omega$
1,000 = 10^3	kilo	K	$KV = 10^3V$
0.1 = 10^{-1}	deci	d	$dm = 10^{-1}m$
0.01 = 10^{-2}	centi	c	$cm = 10^{-2}m$
0.001 = 10^{-3}	milli	m	$mA = 10^{-3}A$
0.000 001 = 10^{-6}	micro	μ^*	$\mu V = 10^{-6}V$
0.000 000 001 = 10^{-9}	nano	n	$ns = 10^{-9}s$
0.000 000 000 001 = 10^{-12}	pico	p	$pF = 10^{-12}F$

* "M" is often used to designate " μ " (micro)

GENERAL NOTES

OVER/UNDER SHIPMENT POLICY

RCD reserves the right to ship $\pm 3\%$ (or 1 piece, whichever is greater) of the quantity ordered ($\pm 6\%$ on **SWIFT™** orders). Please order accordingly.

90-DAY NO HASSLE RETURN POLICY

Standard stock items can be returned for any reason less a 30% restocking charge (\$25 minimum) as long as the goods are packaged in the original RCD containers and remain in "new" condition (material discrepancies resulting from RCD's error are returnable for full credit). The maximum returnable quantity must not exceed RCD's normal stock level. All returns require a Return Material Authorization (RMA) number. Shipping charges are to be paid by customer.

CUSTOM MADE ORDERS POLICY

All non-stock items are manufactured on a NCNR (no cancellation, no return) basis for each particular customer's requirement. The customer is liable for full costs applicable at the time of any changes.

SALES TERMS

All orders are subject to RCD's Terms and Conditions as detailed in Form GF061. All specifications are subject to change without notice.

STANDARD EIA DECADE VALUES



RESISTORS • CAPACITORS • COILS • DELAY LINES

Each number represents a series of values, determined by multiplying or dividing the number by powers of 10. For example, the number 22 represents the following ohm values: 0.22Ω, 2.2Ω, 22Ω, 220Ω, 2.2KΩ, etc. Consult the data sheet on each product to determine the available range.

Have it Your Way! The tables below are provided for standardization purposes but as a custom component specialist for nearly 40 years, please realize that we also offer a full range of intermediate values on most products (often at little or no extra charge). So if you specifically want a 12345.6789Ω resistor, don't settle for less.

E-6 Series (±20%)

10	15	22	33	47	68
----	----	----	----	----	----

E-12 Series (±10%)

10	12	15	18	22	27	33	39	47	56	68	82
----	----	----	----	----	----	----	----	----	----	----	----

E-24 Series (±5%, ±2%)

10	11	12	13	15	16	18	20	22	24	27	30
33	36	39	43	47	51	56	62	68	75	82	91

E-96 Series (±1%)

100	102	105	107	110	113	115	118	121	124	127	130
133	137	140	143	147	150	154	158	162	165	169	174
178	182	187	191	196	200	205	210	215	221	226	232
237	243	249	255	261	267	274	280	287	294	301	309
316	324	332	340	348	357	365	374	383	392	402	412
422	432	442	453	464	475	487	499	511	523	536	549
562	576	590	604	619	634	649	665	681	698	715	732
750	768	787	806	825	845	866	887	909	931	953	976

E-192 Series (±0.1%, 0.25%, 0.5%)

100	101	102	104	105	106	107	109	110	111	113	114
115	117	118	120	121	123	124	126	127	129	130	132
133	135	137	138	140	142	143	145	147	149	150	152
154	156	158	160	162	164	165	167	169	172	174	176
178	180	182	184	187	189	191	193	196	198	200	203
205	208	210	213	215	218	221	223	226	229	232	234
237	240	243	246	249	252	255	258	261	264	267	271
274	277	280	284	287	291	294	298	301	305	309	312
316	320	324	328	332	336	340	344	348	352	357	361
365	370	374	379	383	388	392	397	402	407	412	417
422	427	432	437	442	448	453	459	464	470	475	481
487	493	499	505	511	517	523	530	536	542	549	556
562	569	576	583	590	597	604	612	619	626	634	642
649	657	665	673	681	690	698	706	715	723	732	741
750	759	768	777	787	796	806	816	825	835	845	856
866	876	887	898	909	920	931	942	953	965	976	988

COLOR CODE EXAMPLES

0.1Ω 5%	BRN-BLK-SILV-GOLD
1Ω 5%	BRN-BLK-GOLD-GOLD
10Ω 5%	BRN-BLK-BLK-GOLD
100Ω 5%	BRN-BLK-BRN-GOLD
1KΩ 5%	BRN-BLK-RED-GOLD
10KΩ 5%	BRN-BLK-ORN-GOLD
100KΩ 5%	BRN-BLK-YLW-GOLD
1MΩ 5%	BRN-BLK-GRN-GOLD
10MΩ 5%	BRN-BLK-BLU-GOLD
100MΩ 5%	BRN-BLK-VIOL-GOLD
1GΩ 5%	BRN-BLK-GRAY-GOLD
1Ω 1%	BRN-BLK-BLK-SILV-BRN
10Ω 1%	BRN-BLK-BLK-GOLD-BRN
100Ω 1%	BRN-BLK-BLK-BLK-BRN
1KΩ 1%	BRN-BLK-BLK-BRN-BRN
10KΩ 1%	BRN-BLK-BLK-RED-BRN
100KΩ 1%	BRN-BLK-BLK-ORN-BRN
1MΩ 1%	BRN-BLK-BLK-YLW-BRN
10MΩ 1%	BRN-BLK-BLK-GRN-BRN
100MΩ 1%	BRN-BLK-BLK-BLU-BRN
1GΩ 1%	BRN-BLK-BLK-VIOL-BRN

STANDARD EIA COLOR CODE TABLE (4 Bands if tolerance ≥2%, 5 bands if ≤1%)



COLOR	No. 1	No. 2	Multiplier	Tol.
BLACK	0	0	10 ⁰ (1)	-
BROWN	1	1	10 ¹ (10)	-
RED	2	2	10 ² (100)	±2% (G)
ORANGE	3	3	10 ³ (1000)	-
YELLOW	4	4	10 ⁴ (10,000)	-
GREEN	5	5	10 ⁵ (100,000)	-
BLUE	6	6	10 ⁶ (1,000,000)	-
VIOLET	7	7	10 ⁷ (10,000,000)	-
GRAY	8	8	10 ⁸ (100,000,000)	-
WHITE	9	9	10 ⁹ (1,000,000,000)	-
GOLD	-	-	10 ⁻¹ (0.1)	±5% (J)
SILVER	-	-	10 ⁻² (0.01)	±10% (K)



COLOR	No. 1	No. 2	No. 3	Multiplier	Tol.
BLACK	0	0	0	10 ⁰ (1)	-
BROWN	1	1	1	10 ¹ (10)	±1% (F)
RED	2	2	2	10 ² (100)	-
ORANGE	3	3	3	10 ³ (1000)	-
YELLOW	4	4	4	10 ⁴ (10,000)	-
GREEN	5	5	5	10 ⁵ (100,000)	±0.5% (D)
BLUE	6	6	6	10 ⁶ (1,000,000)	±0.25% (C)
VIOLET	7	7	7	10 ⁷ (10,000,000)	±0.1% (B)
GRAY	8	8	8	10 ⁸ (100,000,000)	-
WHITE	9	9	9	10 ⁹ (1,000,000,000)	-
GOLD	-	-	-	10 ⁻¹ (0.1)	-
SILVER	-	-	-	10 ⁻² (0.01)	-

TAPE & REEL PACKAGING



RESISTORS • CAPACITORS • COILS • DELAY LINES

Taped components typically have trimmed leads. The data sheet "bulk" lead length dimensions therefore do not apply. For RCD's standard tape & reel packaging, specify code "T". For custom T&R, select from options below (TX, TF, TPN, etc). For ammo-pack (tape & boxed), specify code "A" instead of "T" (A, AX, AF, APN, etc). All dimensions in mm.

HORIZONTAL TAPING (per EIA RS296D)

The component pitch depends on body diameter, tape spacing depends on body length. RCD's standard spacing provides a 20mm min lead length.

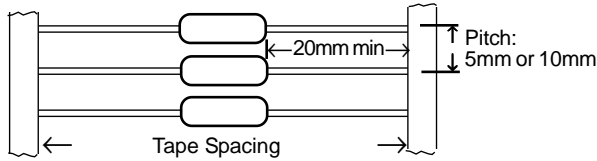

Specify packaging code "T" for RCD's standard tape spacing and pitch. For custom taping, specify code TX for 52.4mm spacing & 5mm pitch, TF= 52.4mm spacing & 10mm pitch, TU= 63.5mm spacing & 5mm pitch, TT= 63.5mm spacing & 10mm pitch, TJ=73mm spacing & 5mm pitch, TN=73mm spacing & 10mm pitch. Various other taping options available.

SIP NETWORK TAPING: Packaging code = A3 (Ammo pack)

SIP's with 4 or 5 pins have pins 2-4 taped, SIP's with 6 or 7 pins have pins 3-5 taped, SIP's with 8, 9, or 10 pins have pins 4-6 taped

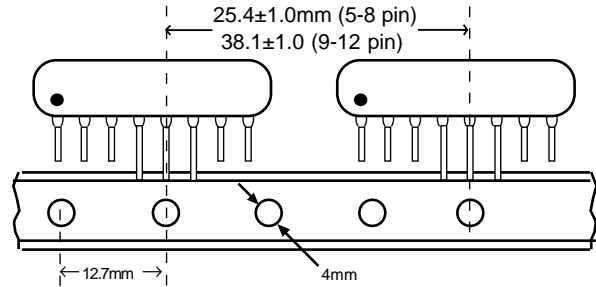

RADIAL LEAD AND VERTICAL TAPING

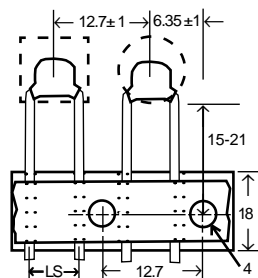

Standard Radial Taping
Resistors & Caps (Code T)

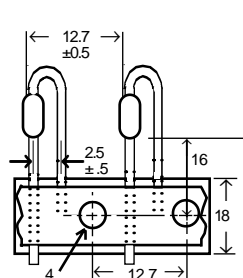

High Density (Code THD)
1/8 & mini-1/4W body sizes

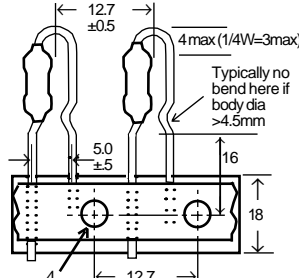

Panasert (Code TPN)
1/4W ~3W body sizes

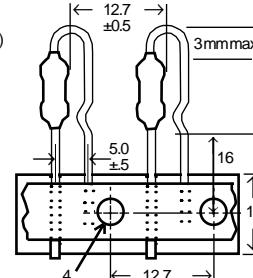

Avisert (Code TAV)
1/4 ~1/2W body sizes

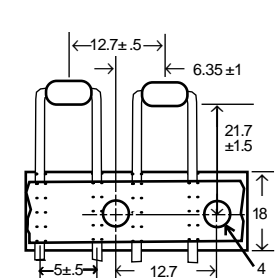

Horiz. Preform (Code THP)
1/8 & mini-1/4W body sizes

EIA 481 SURFACE MOUNT TAPING: Code T (if heat sealed cover tape is required instead of pressure sensitive adhesive, specify code TH)

PART	TYP. QTY	WIDTH
BC630G	*	*
BC632G	1000	24mm
BC633G	1000	24mm
BLU0201	10000	8mm
BLU0402	10000	8mm
BLU0603	5000	8mm
BLU0805	5000	8mm
BLU1206	5000	8mm
BLU1210	5000	8mm
BLU2010	4000	12mm
BLU2512	4000	12mm
CE0201	10000	8mm
CE0402	10000	8mm
CE0603	4000	8mm
CE0805	4000	8mm
CE1206	4000	8mm
CE1210	2K/2.5K	8mm
CE1812	1000	12mm
CE2225	1000	12mm
CE3035	*	*
CI0402	4000	8mm
CI0603	3000	8mm
CI0805	2000	8mm
CI1008	2000	8mm
CN0606	5000	8mm
CN0804	5000	8mm
CN1206	5000	8mm
CN1608	4000	12mm
CN2012	4000	12mm
CN2512	4000	12mm
FC0402	10000	8mm
FC0603	5000	8mm
FC0805	5000	8mm
FC1206	5000	8mm
FC1210	5000	8mm
FC2010	4000	12mm
FC2512	4000	12mm
FLP0805	5000	8mm
FLP1206	5000	8mm
HI330	500/1K	24mm
HI330S	500/1K	24mm
HI500	250	32mm
HI500S	250	32mm
HP7GW	*	*
HR0402	10000	8mm
HR0503	*	*
HR0603	5000	8mm
HR0805	5000	8mm
HR1206	5000	8mm
HR1210	5000	8mm

PART	TYP. QTY	WIDTH
HR2010	4000	12mm
HR2512	4000	12mm
MBW1/4F	2500	12mm
MBW1/2F	2000	16mm
MBW1/2FS	2500	12mm
MBW1FS	2000	16mm
MBW2F	1500	16mm
MBW3F	*	*
MC0201	10000	8mm
MC0402	10000	8mm
MC0603	5000	8mm
MC0805	5000	8mm
MC1206	5000	8mm
MC1210	5000	8mm
MC2010	4000	12mm
MC2040	5000	16mm
MC2512	4000	12mm
MCF10	3000	8mm
MCF12	3000	8mm
MCF22	3000	8mm
MCF25	2000	12mm
MCF25S	2000	12mm
MCI1008	2000	8mm
MCI1210	2000	8mm
MCI1812	500	12mm
MCT0402	10000	8mm
MCT0505	*	*
MCT0603	5000	8mm
MCT0805	5000	8mm
MCT1005	*	*
MCT1206	5000	8mm
MCT1210	5000	8mm
MCT1505	4000	8mm
MCT2010	4000	12mm
MCT2512	4000	12mm
MGP45	3000	8mm
MGP50	3000	8mm
MGP50S	3000	8mm
MGP55	2000	12mm
MGP55S	2000	12mm
MHI0201	10000	8mm
MHI0402	10000	8mm
MHI0603	4000	8mm
MHI0805	4000	8mm
ML0402	10000	8mm
ML0603	5000	8mm
ML0805	5000	8mm
ML1206	5000	8mm
ML2010	4000	12mm
ML2512	4000	12mm

PART	TYP. QTY	WIDTH
MLB2512	2000	12mm
MLI0603	4000	8mm
MLI0805	4000	8mm
MLI1008	2000	8mm
MLI1206	2500	8mm
MLP12	3000	8mm
MLP25	2000	12mm
MP126G	500	24mm
MP220G, GB	*	*
MPD220	500	24mm
MPF1	2500	12mm
MPF2	1500	24mm
MPF2S	2000	16mm
MPF3	*	*
MPF3S	1500	24mm
MSI1210	2000	8mm
MSI1812	500	12mm
MW12	2000	12mm
MW1	2000	12mm
MW2	500/2K	16mm
MW25	1500	24mm
MW3	*	*
MW35	1500	24mm
MW5	*	*
MWM1/2	2.5K/5K	12mm
MWM1/2L	2.5K/5K	12mm
MWM1	2500	12mm
MWM1L	3000	12mm
MWM2	1000	24mm
MWM27	1000	24mm
MWM2L	2000	24mm
MWM2LS	2000	12mm
MWM2S	2000	16mm
MWM3	750	44mm
MWM3S	800	32mm
MWM5	750	44mm
PC451G	*	*
PCN1/4M	1000	24mm
PCN1/2M	800	32MM
PCN1M	750	44mm
PIC1	2000	12mm
PIC2	1500	16mm
PIC3	1000	16mm
PIC4	1000	16mm
PIC5	1000	24mm
PIC6	500	24mm
PIC7	500	24mm
PRM1/8	2.5K/5K	12mm
PRM1/4	2500	12mm
PRM1/2	1000	24mm

PART	TYP. QTY	WIDTH
PRM1	750	44mm
SF1	1500	16mm
SFG2	700	44mm
SMA1405	1000	24mm
SMN0404	10000	8mm
SMN0606	5000	8mm
SMN0804	10000	8mm
SMN1206	5000	8mm
SMN1506	5000	8mm
SMN16	2000	24mm
SMN2010	4000	12mm
SMN2012	4000	12mm
SMNN1206	5000	8mm
SMP01S	*	*
SMP1410	1000	24mm
SMP1610	1000	24mm
SRH1020	*	*
SRH1206	5000	8mm
SRH2512	4000	12mm
SRH4020S	1000	16mm
SRH5020	1000	24mm
SRH7020	*	*
TSA	2000	8mm
TSB	2000	8mm
TSC	500	12mm
TSD	500	12mm
TSE	400	12mm
TSS	2500	8mm
VS1GW	*	*
VS15GW	1000	24mm
VS16GW	1000	24mm
VS2GW	*	*
Z1206	1000	8mm
ZC0201	10000	8mm
ZC0402	10000	8mm
ZC0603	5000	8mm
ZC0805	5000	8mm
ZC1206	5000	8mm
ZC1210	4000	8mm
ZC2010	4000	12mm
ZC2512	4000	12mm
ZCF10	3000	8mm
ZCF12	3000	8mm
ZCF22	3000	8mm
ZCF25	2000	12mm
ZCF25S	2000	12mm
ZZ SMALL	800	32mm
ZZ MED.	750	44mm
ZZ LARGE	*	*

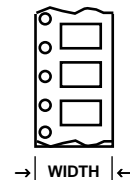

- NOTES:**
- Quantity of CE, MHI, MLI, HI, PIC, and MLB depend on chip thickness.
 - Quantities listed are typical and subject to change. Notify RCD if specific quantity/reel is required, or any other special taping/labeling requirements.
 - Tape & Reel packaging is standard for many items and therefore RCD reserves the right to supply parts on tape, even when "bulk packaging" is ordered.

*Consult factory

THICK FILM CHIP RESISTORS AND JUMPERS

MC SERIES 50mW (0201) to 3W (2040) ZC SERIES Zero-ohm chip (1A - 25A)



Term.W is
RoHS
compliant
& 260°C
compatible

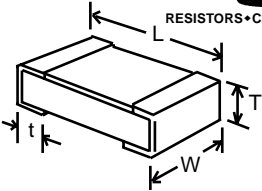

- Industry's widest selection & lowest prices-
0.1Ω to 22M, 50mW to 3W, 0.25% to 5%, TC's to 50ppm
- 0402, 0603, 0805, 1206 sizes heavily stocked in 1% & 5%
(other sizes available from stock in many popular values)
- Option V: +175° operating temperature
- Option U: User-trimmable chips
- Option P: Increased pulse capability
- Military screening, custom values & TC, microwave design, etc.

RCD's Series MC resistors utilize precision thick film technology offering inherently low inductance, exceptional reliability and superior performance. Heavy plating with *NO LEACH™* nickel barrier assures superb solderability and long shelf life. State-of-the-art production line enables the industry's most precise accuracies (0.25% & 50ppm!) thereby replacing more costly thin-film chips in many applications. RCD offers low cost offshore assembly of SM and leaded PCB's (refer to RCD's Assembly Services p.114 for more information).

RCD Type MC, ZC	Wattage Rating ¹	Std TC ² ppm/°C, typ.	Resis. Range ±0.5% Tol ²	Standard Resis. Range ±1% Tol ²	Standard Resis. Range ±5% Tol ²	MC Voltage Rating ²	TYPE ZC Jumper ³	Dimensions Inch [mm]				
								L	W	T	t	
0201	.05W	100		10Ω to 22KΩ		25V	1 Amp Max. 50mΩ Max.	.024±.002	.012±.002	.010±.002	.006±.002	
		200		22.1K to 1MΩ				10Ω to 1MΩ	[0.6±.03]	[.3±.03]	[.25±.03]	[.15±.05]
		400						1- 9.1Ω ,1.1M- 2.2M				
0402 Stock item	.063W	100		10Ω to 1MΩ		50V	1 Amp Max. 50mΩ Max.	.040±.004	.020±.004	.014±.004	.010±.004	
		200						10Ω to 1MΩ	[1.00±.1]	[.5±.1]	[.35±.1]	[.25±.1]
		400		1Ω to 9.76Ω				1- 9.1Ω ,1.1M- 4.7M				
0603 Stock item	.1W	100	10Ω to 1M	10Ω to 1MΩ		50V	1.5 Amp Max. 50mΩ Max.	.061±.005	.031±.004	.016±.006	.010±.006	
		200						10Ω to 1MΩ	[1.55±.12]	[.8±.1]	[.40±.15]	[.25±.15]
		400		1Ω to 9.76Ω				1- 9.1Ω ,1.1M- 10M				
0805 Stock item	.125W	100	10Ω to 1M	10Ω to 1MΩ		150V	2 Amp Max. 50mΩ Max.	.079±.005	.050±.006	.020±.006	.016±.008	
		200						10Ω to 1MΩ	[2.0±.15]	[1.25±.15]	[.50±.15]	[.4±.2]
		400		0.1-9.76Ω, 1.02M-10M				0.1-9.1Ω, 1.1M-20M				
1206 Stock item 1206B	.25W .50W	100	10Ω to 1M	10Ω to 1MΩ		200V	2 Amp Max. 50mΩ Max.	.126±.008	.061±.006	.024±.006	.020±.008	
		200		1.02M to 5.6M				10Ω to 5.6MΩ	[3.2±.2]	[1.55±.15]	[.61±.15]	[.51±.2]
		400		0.1-9.76Ω, 5.62M-10M				0.1-9.1Ω, 6.2M-22M				
1210	.33W	100	10Ω to 1M	10Ω to 1MΩ		200V	3 Amp Max. 50mΩ Max.	.126±.008	.098±.008	.024±.008	.020±.010	
		200		1.02M to 5.6M				10Ω to 5.6MΩ	[3.2±.2]	[2.5±.2]	[.6±.2]	[.5±.25]
		400		0.1-9.76Ω, 5.62M-10M				0.1-9.1Ω, 6.2M-22M				
2010	.75W	100	10Ω to 1M	10Ω to 1MΩ		200V (250V Opt. P)	3 Amp Max. 50mΩ Max.	.197±.008	.102±.008	.024±.008	.020±.010	
		200		1.02M to 5.6M				10Ω to 5.6MΩ	[5.0±.2]	[2.6±.2]	[.6±.2]	[.50±.25]
		400		0.1-9.76Ω, 5.62M-10M				0.1-9.1Ω, 6.2M-22M				
2512 2512B	1.0W 2.0W	100	10Ω to 1M	10Ω to 1MΩ		250V (350V Opt. P)	4 Amp Max. 50mΩ Max.	.250±.01	.125±.010	.024±.008	.026±.012	
		200		1.02M to 5.6M				10Ω to 5.6MΩ	[6.35±.25]	[3.2±.25]	[.6±.2]	[.65±.3] ⁴
		400		0.1-9.76Ω, 5.62M-10M				0.1-9.1Ω, 6.2M-22M				
2040	2.0/3.0*	100		10Ω to 1MΩ		350V	N/A	.201±.008	.402±.008	.024±.008	.055±.018	
		200						10Ω to 1MΩ	[5.1±.2]	[10.2±.2]	[.6±.2]	[1.4±.46]
		400						1- 9.1Ω				

¹ Operation at or near full rated power (especially >1W) involves consideration of mounting geometry (solder pad and trace area/thickness, etc.). Request FA2623 for suggested mounting pad layouts.

² Extended resistance range available. Most sizes available down to 0.01Ω 1%. ³ Up to 25A available. ⁴ Dim. t on MC2512B is .094[2.4] maximum.

TYPICAL PERFORMANCE

Thermal Shock (-55° to +125°C)	0.2% ΔR
Overload (2.5x W, 5S, NTE 2x rated V)	1% ΔR
Low Temp. Operation (-55°C)	0.2% ΔR
High Temp. Exposure (125°C, 100hrs)	0.5% ΔR
Resistance to Solder Heat	0.2% ΔR
Moisture Resistance	0.5% ΔR
Load Life(1000 hrs.)	1.0% ΔR
Operating Temp. (+175°C Opt. V)	-55 to +155°C
Derating (above 70°C)	Derate W & V by 1.18%/°C

P/N DESIGNATION:

RCD Type: MC or ZC

Chip Size: 0201 to 2040

Options: U, P, etc. (leave blank if std)

Resis. Code 0.25% to 1% Tol: 3 signif. digits & multiplier
(R100=.1Ω, 1R00=1Ω, 10R0=10Ω, 1000=100Ω, 1001=1KΩ)
5% Tol: 2 signif. digits & multiplier (R10=.1Ω, 1R0=1Ω, 100=10Ω,
101=100Ω, 102=1KΩ). Leave blank on ZC zero-ohm chips.

Tolerance: J=5%, F=1%, D=0.5%, C=0.25% Leave blank on ZC
zero-ohm chips. Opt.U trimmable chips W=±15%, M=±20%, U=0 to -30%.

Packaging: B=Bulk, T=Tape & Reel

Optional TC: 50=50ppm, 101=100ppm, 201=200ppm (leave blank if std)

Termination: W= Lead-free, Q= Tin/Lead (leave blank if either is acceptable)

MC 1206 - 2210 - F T W

PULSE WITHSTAND CHART (increased pulse levels avail.)

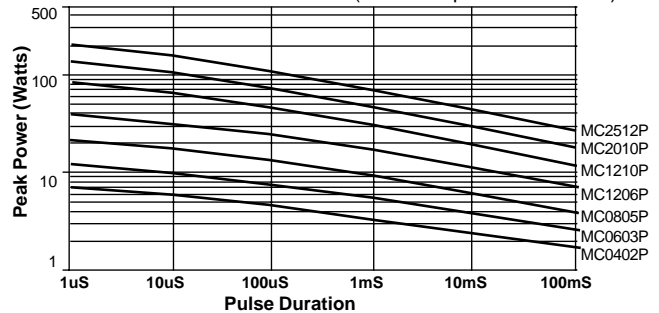

Pulse capability is dependent on res. value, waveform, repetition, etc. Chart is a general guide for Opt. P version, single or infrequent pulses, with peak voltage levels not exceeding 150V for 0402 & 0603 size, 300V for 0805, 400V for 1206 & 1210, 450V for 2010 & 2512. Max pulse wattage for standard parts (w/o Opt.P) is 50% less, max pulse voltage is 50V less. Increased pulse levels available. For improved performance and reliability, pulse derating factor is recommended (30-50% typ., refer to #R-42). Verify selection by evaluating under worst-case conditions.

THICK FILM PRECISION CHIP RESISTORS

MILITARY GRADE

MCT SERIES



Term. W is
RoHS
compliant
& 260°C
compatible

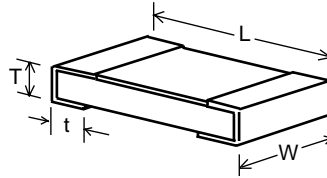

Wraparound Termination (standard)

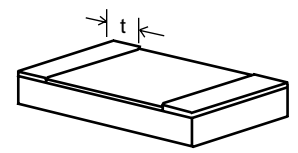

Single Face Termination (Opt. S)

- Choice of termination materials: 100% tin plated nickel barrier is standard (palladium silver, gold, or tin-lead solder is available)
- Wraparound termination is standard, single sided termination is available (Option 'S')
- Wide resistance range: 0.1Ω to 100MΩ
- 100% Group A screening per MIL-R-55342 available
- Wide design flexibility for use with hybrid or smd circuitry
- Custom sizes, high surge, untrimmed chips available
- Backside metalization available

Precision performance to 0.1% 50ppm/°C!

RCD series MCT chip resistors are designed to meet applicable performance requirements of MIL-PRF-55342¹. Variety of sizes and termination materials allows wide design flexibility. Palladium silver terminations are recommended for use with conductive epoxy, gold is recommended for wire bonding, and tin plated nickel for soldering.

SPECIFICATIONS

RCD Type	Wattage @ 70°C**	Voltage Rating	Resistance Range	L* ±.008 [0.2]	W ±.008 [0.2]	t ²	T*
MCT0402	50MW	30V	10Ω - 1M	.039 [1.0]	.020 [.51]	.012±.005 [.3±.13]	.014±.006 [.35±.15]
MCT0505	100MW	50V	1Ω - 10M	.050 [1.27]	.050 [1.27]	.014±.007 [.35±.18]	.018±.006 [.45±.15]
MCT0603	100MW	40V	0.1Ω - 100M	.060 [1.53]	.030 [.76]	.012±.006 [.3±.15]	.018±.006 [.45±.15]
MCT0805	150MW	70V	0.1Ω - 100M	.075 [1.91]	.050 [1.27]	.016±.008 [.4±.2]	.018±.006 [.50±.15]
MCT1005	200MW	100V	1Ω - 20M	.100 [2.54]	.050 [1.27]	.018±.008 [.45±.2]	.020±.006 [.50±.15]
MCT1206	250MW	125V	0.1Ω - 100M	.124 [3.15]	.061 [1.55]	.020±.008 [.5±.2]	.020±.006 [.50±.15]
MCT1505	250MW	125V	1Ω - 10M	.150 [3.81]	.050 [1.27]	.020±.010 [.5±.25]	.020±.006 [.50±.15]
MCT1210	500MW	150V	0.1Ω - 100M	.124 [3.15]	.100 [2.54]	.020±.010 [.5±.25]	.020±.006 [.50±.15]
MCT2010	800MW	150V	0.1Ω - 100M	.196 [5.0]	.100 [2.54]	.020±.010 [.5±.25]	.020±.006 [.50±.15]
MCT2512	1000MW	200V	0.1Ω - 100M	.248 [6.3]	.125 [3.18]	.020±.010 [.5±.25]	.020±.006 [.50±.15]

* Dimension given is for single face termination. Add .004" [1mm] for wraparound termination. ** Wattage based on mounting to ceramic substrate, derate by 25% if mounted to a glass epoxy P.C.B.

¹ Military p/n's are given for reference only and do not imply qualification or exact interchangeability. ² Dimension "t" (underside termination width) applies only to termination type W

TYPICAL PERFORMANCE CHARACTERISTICS

Characteristic	10Ω to 1MΩ range			<10Ω, >1MΩ
	±300 ppm (standard)	±100ppm (opt.)	±50ppm (opt.)	±400ppm (standard)
Temp. Coefficient	±300 ppm (standard)	±100ppm (opt.)	±50ppm (opt.)	±400ppm (standard)
Thermal Shock	0.5%	0.5%	0.5%	0.75%
Short Time Overload	0.5%	0.25%	0.25%	1%
High Temp. Exposure	0.5%	0.5%	0.5%	0.75%
Moisture Resistance	0.5%	0.5%	0.5%	1.5%
Load Life	1.0%	0.5%	0.5%	1.5%

DERATING

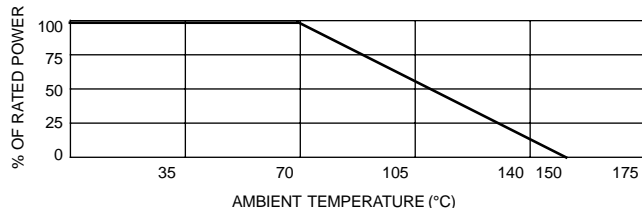

PART NUMBER DESIGNATION:

MCT0805 □ - **1001** - **F T** **101 W**

RCD Type

Options: S = single sided termination (leave blank for wraparound termination)

Res. Value: 4 digit code if tol. is 0.1% to 1% (R100=0.1Ω, 1R00=1Ω, 10R0=10Ω, 1000=100Ω, 1001=1KΩ, 1002=10K, 1003=100K, 1004=1MΩ)
3 digit code if ≥2% (R10=0.1Ω, 1R0=1Ω, 100= 10Ω, 101=100Ω, 102=1KΩ, 103=10K, 104=100K, 105=1MΩ)

Tolerance Code: B=0.1%, C=0.25%, D=0.5%, F=1%, G=2%, J=5%, K=10%, M=20%

Packaging: B=bulk, T=tape&reel, W=waffle tray

Optional TC Characteristic: 50 = 50ppm, 101 = 100ppm, 201= 200ppm, etc. (leave blank if standard)

Termination Material: Standard = W (lead-free 100% Tin with Nickel barrier). Optional = Q (Tin-Lead solder with Ni barrier), P= untinned Palladium Silver, G=Gold

ULTRA PRECISION CHIP RESISTORS

BLU SERIES



RESISTORS • CAPACITORS • COILS • DELAY LINES

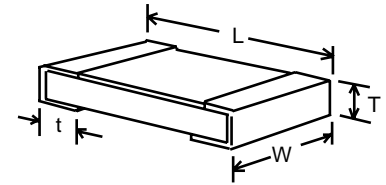

- Industry's widest range of precision chip resistors!
- Tolerance to $\pm 0.01\%$, TCR to 5 ppm/ $^{\circ}\text{C}$

CUSTOM OPTIONS

- Option P: Pulse resistant design
- Option ER: Burn-In for Hi-Rel applications
- Option V: +200 $^{\circ}$ operating temperature
- Option A: Marking of resis. code in 3 or 4 digits (not available on BLU0201 or BLU0402)
- Matched sets and TC's to 2ppm available (limited range)

'Blu-Chip' performance at an economical price!

RCD's expertise in the field of ultra-precision resistors since 1973, combined with the latest in automated chip resistor production equipment, enables precision chip resistors at prices comparable to lower grade devices. The BLU-chip design features excellent stability levels. Intermediate and extended-range values are available on custom basis. Popular values are available from stock.

RCD Type	Power @ 70 $^{\circ}\text{C}$	Max. Working Voltage*	TCR (PPM/ $^{\circ}\text{C}$)	Standard Resistance Range ¹				Dimensions			
				0.01%	.02%, .05%	0.1%, 0.25%	0.5%, 1%	L	W	T	t
BLU0201	.05W	15V	10, 15	N/A	N/A	100 Ω - 10K	100 Ω - 10K	.020 \pm .004	.01 \pm .002	.014 \pm .004	01 \pm .005
			25,50	N/A	N/A	100 Ω - 10K	33 Ω - 22K				
			100	N/A	N/A	100 Ω - 10K	10 Ω - 22K				
BLU0402	.062W	25V	5	50 Ω -2K	50 Ω -2K	51 Ω -2K	50 Ω -2K	.040 \pm .004	.020 \pm .002	.014 \pm .004	.01 \pm .005
			10, 15	50 Ω -12K	50 Ω -12K	51 Ω -12K	25 Ω -12K				
			25	50 Ω -12K	50 Ω -12K	10 Ω - 100K	10 Ω - 100K				
			50,100	50 Ω -12K	50 Ω -12K	10 Ω - 100K	10 Ω - 1M				
BLU0603	.1W	75V	5	50 Ω -8K	50 Ω -8K	50 Ω -8K	50 Ω -8K	.063 \pm .008	.031 \pm .006	.018 \pm .006	.012 \pm .008
			10, 15	25 Ω -100K	25 Ω -100K	10 Ω -402K	25 Ω -100K				
			25	25 Ω -100K	4.7 Ω -150K	4.7 Ω -402K	2 Ω -402K				
			50,100	25 Ω -100K	4.7 Ω -150K	4.7 Ω -402K	2 Ω - 1M				
BLU0805	.125W	100V	5	50 Ω -16K	50 Ω -16K	50 Ω -16K	50 Ω -16K	.079 \pm .006	.050 \pm .006	.018 \pm .006	.014 \pm .008
			10, 15	25 Ω -200K	25 Ω -200K	10 Ω -499K	25 Ω -200K				
			25,50,100	25 Ω -200K	4.7 Ω -500K	4.7 Ω - 1M	1 Ω - 1M				
BLU1206	.25W	150V	5	50 Ω -30K	50 Ω -30K	50 Ω -30K	50 Ω -30K	.126 \pm .006	.063 \pm .006	.020 \pm .006	.020 \pm .010
			10, 15	25 Ω -500K	25 Ω -500K	10 Ω -1M	25 Ω -500K				
			25,50,100	25 Ω -500K	4.7 Ω - 1M	4.7 Ω - 1M	1 Ω - 2M				
BLU1210	.33W	150V	5, 10	100 Ω -30K	100 Ω -330K	100 Ω -330K	100 Ω -330K	.126 \pm .006	.098 \pm .008	.024 \pm .008	.020 \pm .010
			25	51 Ω -500K	51 Ω - 2M	51 Ω - 2M	51 Ω - 2M				
			50,100	51 Ω -500K	51 Ω - 2M	51 Ω - 2M	10 Ω - 4.7M				
BLU2010	.5W	150V	5	50 Ω -30K	50 Ω -30K	50 Ω -30K	50 Ω -30K	.197 \pm .008	.098 \pm .008	.024 \pm .008	.024 \pm .008
			10, 15	25 Ω -500K	25 Ω -500K	10 Ω -1M	25 Ω -500K				
			25,50,100	25 Ω -500K	4.7 Ω - 1M	4.7 Ω - 1M	1 Ω - 2M				
BLU2512	1W	200V	5	50 Ω -50K	50 Ω -50K	50 Ω -50K	50 Ω -50K	.248 \pm .008	.126 \pm .008	.024 \pm .008	.024 \pm .008
			10, 15	25 Ω -500K	25 Ω -500K	10 Ω -1M	25 Ω -500K				
			25,50,100	25 Ω -500K	4.7 Ω - 1M	4.7 Ω - 1M	1 Ω - 2M				

*Maximum working voltage determined by $E = \sqrt{PR}$, E should not exceed value listed. Increased voltage ratings available. ¹ Extended range available, consult factory.

TYPICAL PERFORMANCE CHARACTERISTICS

Requirements	Characteristics (5-25ppm)*	Test Method
Short Time Overload, 5 Sec.	$\pm 0.1\%$ ΔR	Rated W x 2.5, nte 2x Max..Voltage
Resistance to Solder Heat	$\pm 0.05\%$ ΔR	260 \pm 5 $^{\circ}\text{C}$, 3 seconds
High Temperature Exposure	$\pm 0.1\%$ ΔR	100 hours @ +125 $^{\circ}\text{C}$
Thermal Shock	$\pm 0.1\%$ ΔR	-55 $^{\circ}\text{C}$ to +125 $^{\circ}\text{C}$, 0.5 hrs, 5 cycles
Moisture Resistance	$\pm 0.2\%$ ΔR	MIL-STD-202 M103 95% RH 1000hrs
Load Life (1000 hours)	$\pm 0.1\%$ ($\pm .25\%$ 10,000 hrs)	Rated W, Mil-PRF-55342 4.8.11.1
Solderability	95% (Min.)	MIL-Std-202, Method 208
Shelf Life	100 ppm/year (Max.)	Room Temp. & Humidity, No-Load
Dielectric Withstand Voltage	250V (100V 0402 & 0603)	60 Seconds, terminal to ceramic

* The typical ΔR of chips with 50-100ppm TC is double that of chips with 5 to 25ppm TC

CONSTRUCTION

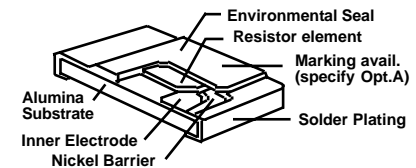

To ensure utmost reliability, care should be taken to avoid potential sources of ionic contamination.

P/N DESIGNATION: BLU1206 - 1002 - B T 25 W

RCD Type BLU1206 - 1002 - B T 25 W

Options: P, ER, A (leave blank if standard)

4-Digit Resistance Code: 3 signif. digits & multiplier (10R0=10 Ω , 1000=100 Ω , 1001=1K Ω)

Tolerance Code: F=1%, D=0.5%, C=0.25%, B=0.1%, A=0.05% Q=0.02%, T=0.01%

Packaging: B = Bulk, T = Tape & Reel

TC: 5=5ppm, 10=10ppm, 15=15ppm, 25=25ppm, 50=50ppm, 101=100ppm

Termination: W= Lead-free, Q= Tin/Lead (leave blank if either is acceptable)

DERATING CURVE

Resistors may be operated up to full rated power with consideration of mounting density, pad geometry, PCB material, and ambient temperature.

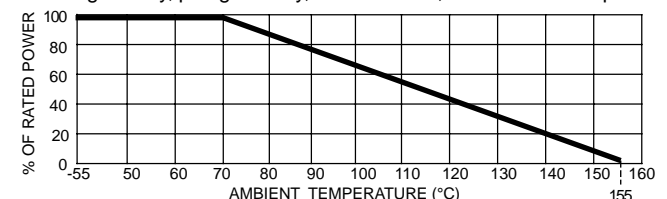

ECONOMICAL 1 WATT TO 3 WATT POWER FILM MELF RESISTORS MPF SERIES



RESISTORS • CAPACITORS • COILS • DELAY LINES



Term. W is
RoHS
compliant
& 260°C
compatible

FEATURES

- High power in small body size
- Low cost MELF design
- Wide resistance range: 0.1Ω to 10MΩ
- Standard tolerance: ±5% (available to ±0.1%)
- Inherent low inductance power film performance

RCD's MPF Series utilize special filming processes and highest grade materials to achieve high power density, yet the economical MELF package enables pricing well below rectangular counterparts. The multilayer coating offers excellent environmental protection and dielectric strength, and is resistant to industrial solvents, steam and humidity.

OPTIONS

- Option P: Increased Pulse Capability
- Option 37: Group A Screening per Mil-R-39008
- Numerous design modifications are available (special marking, matched sets, increased temperature, etc.)

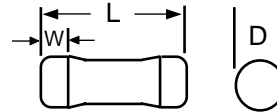

SPECIFICATIONS

Inch [mm]

RCD Type	Wattage Rating	Voltage Rating ¹	Resistance Range ²	L Max.	D Max.	W (Min.)
MPF1	1W	300V	0.1Ω to 1MΩ	.256 [6.5]	.106 [2.7]	.036 [.9]
MPF2S	2W	350V	0.1Ω to 4.7MΩ	.375 [9.5]	.146 [3.7]	.047 [1.2]
MPF2	2W	400V	0.1Ω to 6.8MΩ	.453 [11.5]	.185 [4.7]	.056 [1.4]
MPF3S	3W	400V	0.1Ω to 6.8MΩ	.453 [11.5]	.185 [4.7]	.056 [1.4]
MPF3	3W	400V	0.1Ω to 10MΩ	.602 [15.3]	.201 [5.1]	.064 [1.6]

¹ Not to exceed \sqrt{PxR} , increased working voltages available. ² Extended range available

TYPICAL PERFORMANCE CHARACTERISTICS

Temperature Coefficient	200ppm/°C ≤1M, 350ppm 1M-6.8M, 500ppm >6.8M)
Operating Temperature	-55 to +165°C
MPF1, 2, 3 Power Derating: MPF2S, 3S Power Derating:	1.053%/°C >70°C .714%/°C >25°C
Dielectric Strength	500V
Insulation Resistance	10,000Meg ohm
Solderability	95% Min.
Short Time Overload (2.5xW 5S, not to exceed 2x volt rating)	0.5% MPF1,2,3; 1% MPF2S, 3S
Voltage Coefficient	25ppm/V
Resistance to Solder Heat (245°C,5S)	0.3%
Temperature Cycling	1%
Moisture Resistance	2%
Load Life (1000 hours at rated W)	2% MPF1,2,3; 4% MPF2S, 3S

PULSE CAPABILITY

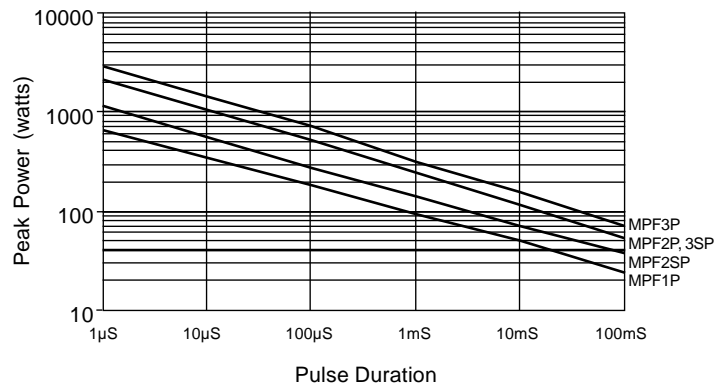

Pulse capability is dependent on res. value, waveform, repetition rate, current, etc. Chart is a general guide for Opt. P pulse resistant version, single pulse, with peak voltage levels not exceeding 1KV MPF1, 1.5KV MPF2S, 2KV MPF2, 2.5KV MPF3S, 3KV MPF3. Max pulse capability for standard parts (w/o Opt.P) is 50% less. For improved performance and reliability, a 30-50% pulse derating factor is recommended, or larger for frequent pulses, high values, etc. (refer to #R-42). Verify selection by testing under worst-case conditions. Increased pulse levels available.

P/N DESIGNATION:

RCD Type MPF2S □ - 102 - J T W

Options: P, 37 (leave blank if standard)

Resis. Code: **≤1%**: 3 signif. figures & multiplier, e.g. R100= 0.1Ω, 1R00= 1Ω, 1000= 100Ω, 1001= 1KΩ.

Resis. Code **2% - 10%**: 2 signif. figures & multiplier, e.g. R10= 1Ω, R15= .15Ω, 1R0= 1Ω, 100= 10Ω, 102= 1K, 103= 10KΩ

Tolerance : J= 5% (std), D=0.5%, F=1%, G=2%, K=10%

Packaging : B = Bulk, T = Tape & Reel

Termination: W= Lead-free, Q= Tin/Lead (leave blank if either is acceptable, in which case RCD will select based on lowest price and quickest delivery)

APPLICATION NOTE

The temp. rise of SM resistors depends largely on heat conduction through the end terminations, which can vary significantly depending on PCB material and layout (i.e. pad size, trace area, copper thickness, air convection, etc). Typical temperature rise at full rated power is 100°C for MPF1,2,3 and 150°C for MPF2S & 3S (based on DIN44050 PCB material with 500 sq. mil circuit traces MPF1, 2, 2S and 1000 sq. mil MPF3,3S). It is recommended to evaluate product in actual use conditions to ensure the proper component and PCB layout is utilized.



METAL FILM MELF RESISTORS

MGP SERIES - Conformal Coated

MHM SERIES - Hermetic Sealed



- Industry's widest selection of metal film MELF resistors-.1W to .5W, 0.1Ω to 22MΩ, 0.1% to 5%, 10ppm to 100ppm/°C
- Low cost, quick delivery (available on **SWIFT™** program)
- Precision performance, excellent environmental stability
- Series MHM hermetic sealed is an industry first!

OPTIONS

- Option S: Increased power (refer to chart below)
- Option P: Increased pulse capability
- Option F: Flameproof coating (per UL94V0)
- Dozens of additional options are available... burn-in, special marking, non-standard values, high frequency designs, matched sets, temp. sensitive, zero-ohm jumpers, etc. Customized components are an RCD specialty!

Metal film performance, economical price!

RCD Series MGP melf* resistors utilize precision film technology which is inherently low inductance, low noise, and high stability even after extended periods. Heavy solder plating assures excellent solderability and long shelf life. Series MHM offers hermetically sealed environmental protection and utmost reliability. MGP series parts are color banded, MHM are alphanumerically marked with resistance and tolerance. *Melf = metal electrode face-bonded (cylindrical component).

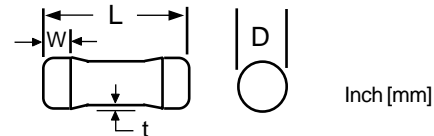

SPECIFICATIONS

RCD Type	Wattage (Std)	Wattage (Opt. 'S')	Voltage Rating ^{1,2}	Resistance Range ²	Dielectric Strength ²	L±.012 [.3]	D±.008 [.2]	W (Min.)	t (Max) ²
MGP45	.1W	.15W	100V	1Ω to 1M	200V	.079 [2.0]	.044 [1.12]	.012 [.3]	.003 [.076]
MGP50	.125W	.25W	200V	0.18Ω to 10M	250V	.135 [3.4]	.057 [1.45]	.02 [5]	.004 [.1]
MGP55	.25W	.5W	250V	0.1Ω to 22M	350V	.232 [5.9]	.085 [2.15]	.024 [6]	.006 [.15]
MHM55 ³	.125W	.25W	250V	10Ω to 200K	350V	.275 [7.0]	.120 [3.05]	.050 [1.27]	.006 [.15]

¹ Max working voltage determined E=√(PxR), not to exceed the value listed.

² Consult factory for non-standard range

³ Preliminary

PERFORMANCE

	MGP Series*	MHM Series*
TCR (10 & 15ppm avail on custom basis)	100ppm/°C std, 25&50ppm avail	100ppm/°C std, 25&50ppm avail
Operating Temperature Range	-55 to +155°C	-65 to +175°C
Power Derating above 70°C	1.18%/°C	.95%/°C
Solderability (5 sec @ 230°C)	95% coverage	95% coverage
Insulation Resistance(Dry)	10,000MΩ	10,000MΩ
Short-Time Overload (5 sec. @ 2.5x power not to exceed 2x voltage rating)	0.25% (0.5% Opt.S)	.025% (.05% Opt.S)
Resis. to Solder Heat (260°C, 5 sec.)	0.2%	.02%
Temperature Cycling (-50°C + 120°C)	0.5%	.02%
Moisture (Mil-Std202 M106 & Mil-R-55342)	0.5%**	.05%**
Load Life (1000 hours rated power)	0.5%(1%Opt.S)	.1% (.2% Opt.S)

* Typical performance levels listed are for standard products from 10Ω to 1M. Consult factory for performance levels of extended range and modified designs.
 ** To ensure utmost reliability, care should be taken to avoid potential sources of ionic contamination

APPLICATION NOTE #1: Temperature Rise (T_{HS})

The T_{HS} of SM resistors depends largely on heat conduction through the end terminations, which can vary significantly depending on PCB material and layout (i.e. pad size, trace area, copper thickness, air flow, etc.). Typical temp. rise at full rated power is 30-50°C (Opt.S=50-70°C).

APPLICATION NOTE #2: Resistor Selection

MGP resistors are ideal for semi-precision SM applications and are generally more economical than thin film rectangular chips. For less critical applications, consider low cost MCF carbon film melf resistors. For increased performance, especially in high humidity applications (such as Naval or tropical environments), consider MHM series. If flat chips are preferred, consider BLU series (precision) or MC series (semi-precision/general purpose). For higher power, consider MPF series.

PULSE WITHSTAND CHART (increased pulse levels avail.)

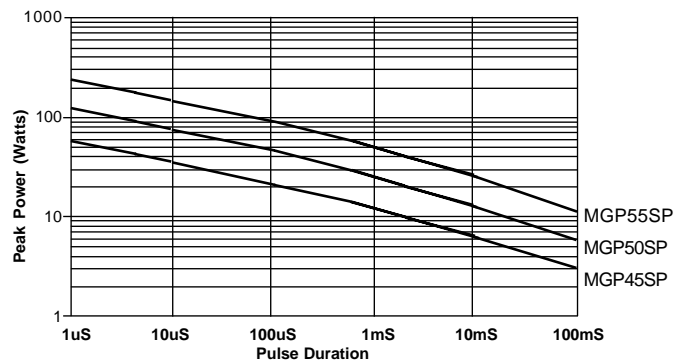

Pulse capability is dependent on res. value, waveform, repetition rate, current, etc. Chart is a general guide for Opt. P pulse resistant version, single pulse, with peak voltage levels not exceeding 1KV for MGP55SP, 700V MGP50SP, and 350V MGP45SP. Max pulse capability for standard parts (w/o Opt.P) is 60% less. For improved performance and reliability, a 30-50% pulse derating factor is recommended (or larger for frequent pulses, high values, etc). Consult RCD for application assistance. Verify selection by evaluating under worst-case conditions.

P/N DESIGNATION:

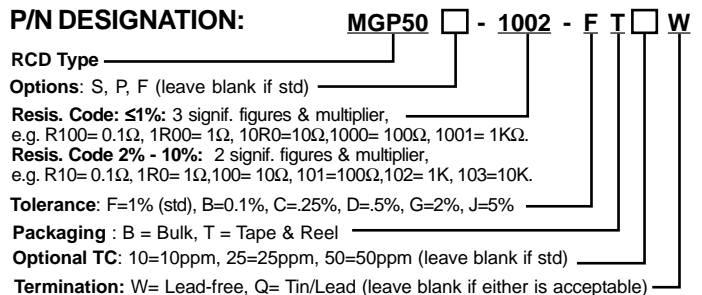

COMMERCIAL 1/10 to 1/2 WATT CARBON FILM MELF RESISTORS

MCF SERIES



- Economy-grade pricing!
- Wide resistance range (up to 22MegΩ available)
- Standard tolerance: ±5% (±2% available)
- Series ZCF zero-ohm jumpers available, .02Ω maximum. Type ZCF10 is rated at 2A, ZCF12, 3A, and ZCF25 at 5A. ZCF Series marked with a single black band.

Low cost, carbon film MELF's! Pulse voltage to 3KV!
Quality levels are unsurpassed due to stringent process controls. Automated Far East production results in low prices. RCD offers the industry's widest range of sizes and options including zero ohm jumpers and high pulse voltage versions.

OPTIONS

- Option Z - high pulse voltage to 3KV
- Option 37 - Group A screening per Mil-R-39008

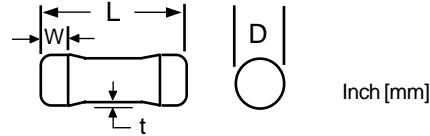

SPECIFICATIONS

RCD Type	Wattage at 70°C	Series MCF Voltage Rating			Series MCFZ Voltage Rating			L ±.008 [.2]	D ±.008 [.2]	W (Min.)	t (Max.)
		Voltage Rating ¹	Max. Pulse Voltage ²	Resis. Range ³	Voltage Rating ¹	Max. Pulse Voltage ²	Resis. Range ³				
MCF10	.10	100V	200V	1Ω - 1MΩ	n/a	n/a	1KΩ - 1MΩ	.079 [2.0]	.044 [1.12]	.012 [.3]	.006 [.15]
MCF12	.125	200V	400V	1Ω - 1MΩ	250V	2KV	1KΩ - 1MΩ	.135 [3.4]	.057 [1.45]	.012 [.3]	.006 [.15]
MCF22	.25	250V	400V	1Ω - 1MΩ	n/a	n/a	1KΩ - 1MΩ	.135 [3.4]	.057 [1.45]	.012 [.3]	.006 [.15]
MCF25	.25	250V	600V	1Ω - 2.2MΩ	300V	3KV	1KΩ - 2.2M	.232 [5.9]	.085 [2.15]	.020 [.5]	.008 [.2]
MCF25S	.50	250V	600V	1Ω - 2.2MΩ	n/a	n/a	1KΩ - 2.2M	.232 [5.9]	.085 [2.15]	.020 [.5]	.008 [.2]

¹ Maximum working voltage determined by $E = \sqrt{PR}$, E should not exceed value listed in column above. Dielectric strength is rated the same as the maximum working voltage.
² Peak pulse voltage is highly dependent on pulse waveform and resistance value. Voltage levels given indicate maximum levels for the series. These levels are not attainable for all values and pulse waveforms. Consult factory for application assistance.
³ Consult factory for resistance values outside of standard range (0.1Ω to 22 Meg available).

DERATING

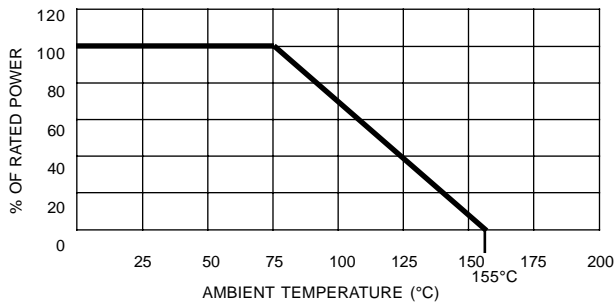

TEMPERATURE COEFFICIENT (Typ.)

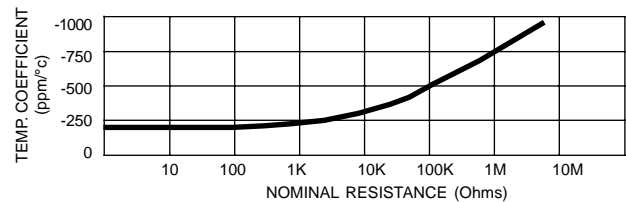

CURRENT NOISE (Typ.)

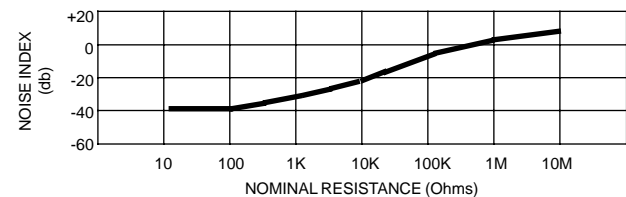

PERFORMANCE CHARACTERISTICS

Operating Temperature Range	-55 to +155°C
Solderability (5 sec. @ 230°C)	95% coverage
Insulation Resistance (Dry)	10,000 MegΩ
Short-Time Overload (5 sec. @ 2.5x power not to exceed 2x voltage rating)	0.5%* + .05Ω
Resistance to Solder Heat (260°C, 5 sec.)	0.5% + .05Ω
Temperature Cycling (-50°C + 120°C)	1.0% + .05Ω
Moisture Resis. (MIL-Std-202, Method 106)	5.0% + .05Ω
Load Life (1000 hours rated power)	2.5%* + .05Ω

* Multiply by 2 for MCF22 and MCF25S Series.

P/N DESIGNATION:

MCF25 - 102 - J T W

RCD Type _____

3-Digit Resis. Code: 2 signif. digits & multiplier
 1R0=1Ω, 100=100Ω, 101=100Ω, 102=1KΩ, 103=10K, 104=1M, 105=10M, etc.

Tolerance: J = 5% (standard), K = 10%, G = 2%

Packaging: B = Bulk, T = Tape & Reel

Termination: W = Lead-free, Q = Tin/Lead (leave blank if either is acceptable, in which case RCD will select based on lowest price and quickest delivery)

RCD Components Inc., 520 E. Industrial Park Dr., Manchester, NH, USA 03109

Tel: (603) 669-0054 Fax: (603) 669-5455 E-mail: sales@rcdcomponents.com www.rcdcomponents.com

SURFACE MOUNT WIREWOUND RESISTORS

MELF AND GULLWING DESIGNS, 1/2 TO 5 WATT

MW SERIES



- Inherent wirewound stability and overload capability
- Resistance range: 0.005Ω to 50KΩ
- Excellent T.C. stability (available to ±5ppm/°C)
- Standard tolerance: ±1% or ±5% (available to 0.01%)
- Available on exclusive **SWIFT™** delivery program!

OPTIONS

- Option X:** Non-inductive
- Option T:** PTC Temp. Sensitive (+80 to +6000ppm/°C)
- Option P:** Increased Pulse Capability
- Option F:** Flameproof (UL94V-0)
- Option ER:** 100 Hour Burn-In
- Numerous options avail.: special marking, matched sets, Hi-Rel screening, low thermal EMF, etc. Consult factory

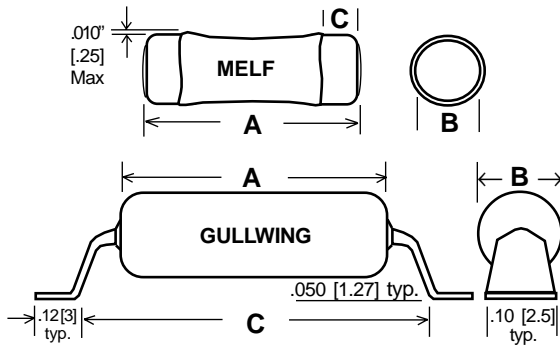

RCD Series MW provide a cost-effective solution for demanding applications. Advantages include superior surge capability, improved temperature stability, moisture resistance, noise, and a significant space and cost savings over molded models. MW3 & MW5 feature compliant gullwing terminals, which act as standoffs to reduce PCB temperature and help minimize TCE stress (utilize compliant terminals in applications with wide temperature gradients).

TYPICAL PERFORMANCE CHARACTERISTICS

Load Life (1000 hours)	±0.5%
Moisture Resistance	±0.2%
Temperature Cycling	±0.2%
Short Time Overload	5x rated W, 5Sec
Resistance to Solder Heat (260°C, 5S)	±0.1%
Thermal Shock (gullwing only)	±0.2%
Solderability (<.032" from PCB)	95% coverage
Inductance: standard	1uH to 10uH typ.
Inductance: Option X ≤50Ω	0.2uH max*
Inductance: Option X >50Ω	0.37uH max*
Operating Temperature Range	-55°C to +155°C (275°C avail.)

* specify Opt.75 for inductance levels 50% that of Opt.X, or Opt.76 for 33% that of Opt.X

RCD Type	Package Style	Wattage @ 25°C	Wattage Derating above 25°C	Maximum Voltage ¹	Dielectric Strength ²	Resistance Range ²	DIMENSIONS Inch [mm]		
							A	B	C
MW1/2	MELF	0.5W	3.85mW/°C	30V	200V	0.5Ω- 500Ω	.180 ±.02 [4.57 ±.5]	.060 ±.008 [1.52 ±.2]	.020 [.5] Min.
MW1	MELF	1W	7.7mW/°C	40V	250V	0.05Ω -1K	.250±.02 [6.35 ±.5]	.085 ±.008 [2.16 ±.2]	.020 [.5] Min.
MW2	MELF	2W	15.4mW/°C	60V	250V	0.05Ω -2K	.350 ±.02 [8.89 ±.5]	.125 ±.008 [3.18 ±.2]	.024 [.6] Min.
MW25	MELF	2.5W	19.2mW/°C	100V	300V	0.05Ω -5K	.415 ±.02 [10.54 ±.5]	.144 ±.008 [3.66 ±.2]	.032 [.8] Min.
MW35	MELF	3W	23.1mW/°C	200V	400V	0.05Ω -10K	.500 ±.024 [12.7±.6]	.169 ±.010 [4.3 ±.25]	.040 [1] Min.
MW3	GULLWING	3W	23.1mW/°C	200V	500V	0.005Ω -25K	.485 ±.04 [12.3 ±1]	.165 ±.030 [4.19 ±.76]	.650 ± .04 [16.5 ± 1]
MW5	GULLWING	5W	37mW/°C	250V	500V	0.005Ω -50K	.530 ±.06 [13.5±1.5]	.180 ± .035 [4.57 ± .89]	.715 ± .04 [18.2 ± 1]

¹Voltage determined by E = √PR, E not to exceed maximum voltage rating. Increased ratings available. Multiply by 0.7 for Opt. X. ² Increased range available

SPECIFICATIONS

Resistance Range	Available Tolerances	Temp. Coef. (ppm/°C)	
		Standard	Optional
R005-R0099	1% to 10%	900	600, 300
R010-R049	0.5% to 10%	600	300, 200
R050-R099	0.1% to 10%	300	200, 100, 50
R100-R990	0.05% to 10%	100	50, 30, 20
1R00-9R90	0.02% to 10%	50	30, 20, 10
10R0 and above	0.01% to 10%	30	20, 10, 5

P/N DESIGNATION:

MW2 - **1001** - **F** **T** **W**

RCD Type _____

Options: X, T, P, F, ER (leave blank for std)

Resis.Code 0.01%-1%: 3 signif. figures & multiplier, (R010=0.01Ω, 1R00=1Ω, 10R0=10Ω, 1000=100Ω, 1001=1K, etc.)

Resis.Code 2%-10%: 2 signif. figures & multiplier, (R01=0.01Ω, 1R0=1Ω, 100=10Ω, 101=100Ω, 102=1K, 103=10K, etc.)

Tolerance Code: K=10%, J=5%, H=3%, G=2%, F=1%, D=0.5%, C=0.25%, B=0.1%, A=0.05%, Q=0.02%, T=0.01%

Packaging: B = Bulk, T = Tape & Reel (melf only)

Temp. Coef. (leave blank for standard): 5 = 5ppm, 10 = 10ppm; 100ppm & above, use 3 digit code: 101=100ppm, 201=200ppm, etc.

Termination: W= Lead-free, Q= Tin/Lead (leave blank if either is acceptable, in which case RCD will select based on lowest price and quickest delivery)

SM POWER RESISTORS, 1/2W - 5W, .0005Ω - 1MΩ WIREWOUND, FILM, & METAL PLATE



MWM SERIES



- Widest selection in the industry!
- Tolerance to ±0.01%, T.C. to ±5ppm/°C
- Available on exclusive **SWIFT™** delivery program!

OPTIONS

- Option X: Non-inductive (refer to application note below)
- Option P: Increased Pulse Capability
- Option M: Power metal film element
- Option L: Low profile non-inductive metal plate design
- Option E: Low thermal EMF design
- Special marking, high current, flame retardant, fusible, temp.sensitive, hi-rel screening/burn-in, fusible, SnPb, etc.

Exceptional performance and reliability is achieved via highest grade materials and processing. An all-welded wirewound construction is standard, featuring premium-grade wire for superior stability and surge capability. Opt. L low profile models feature a non-inductive metal plate element. The power film version (Opt.M) achieves values as high as 1MΩ and is inherently low inductance thereby enabling stable operation at high frequencies.

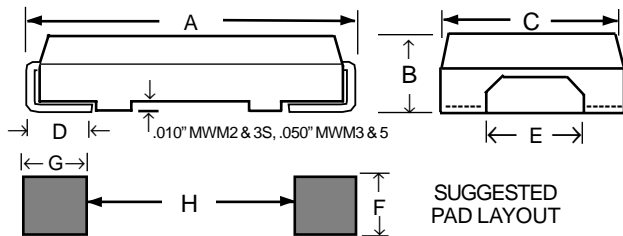

PERFORMANCE (Typ)	WW & Opt. L Metal Plate	Opt. M Film Element
Load Life (1000 hrs)	±1% (MWM2S,3S,27=2%)	±1%
Moisture Resistance	±0.25%	0.5%
Temperature Cycling	±0.2%	0.5%
Short Time Overload	5 x rated W for 5 Sec	5 x rated W for .5 Sec
Temp. Coefficient	Standard Optional	Standard Optional
R0005-R024	400ppm 100, 200	n/a n/a
R025-R049	300ppm 100, 200	n/a n/a
R050-R099	200ppm 50, 100	n/a n/a
R100-R990	90ppm 20,30,50	350ppm 200
1R00-9R90	50ppm 10,20,30	200ppm 100
10R0 & above	30ppm 5,10,20	100ppm 25,50
Dielectric Strength ¹	500V Min. ¹ , 1KV avail.	500V Min. (1KV avail.)
Solderability ²	95% coverage	95% coverage
Operating Temp.	-55 to +175°C(+275° avail)	-55°C to +175°C
Available Resis. Tol.	0.01% to 10%	0.5% to 5%

¹ Dielectric strength for low profile Opt. L is 100V (300V avail) ² Tested within .032" [.8mm] of pcb surface

RCD TYPE	Wattage Rating	Max Voltage* [Current]	Std Resis Range	Opt M Resis Range	Opt M Max Voltage	DIMENSIONS Inch [mm]							
						A	B (Max)	C	D (Min)	E	F	G	H
MWM1/2	0.5W	33V [10A]	.01Ω - 2K	5Ω - 1M	200V*	.204±.02 [5.2 ± .5]	.111 [2.82]	.125±.01 [3.2±.25]	.025 [.63]	.045±.015 [1.14±.4]	.080 [2.0]	.100 [2.5]	.08 [2]
MWM1	1W	58V [20A]	.001Ω-10K	.1Ω - 1M	200V*	.258±.02 [6.55±.5]	.125 [3.17]	.150±.015 [3.8±.4]	.032 [0.8]	.060±.015 [1.50±.4]	.100 [2.5]	.125 [3.2]	.12 [3]
MWM2	2W	120V [30A]	.002Ω-25K	.1Ω - 1M	250V*	.449±.032 [11.4±.8]	.208 [5.28]	.225±.015 [5.7±.4]	.060 [1.5]	.070±.020 [1.78±.5]	.160 [4.0]	.157 [4.0]	.20 [5]
MWM2S	2W	80V [25A]	.1Ω- 200Ω	1Ω - 1M	250V*	.297 ± .020 [7.5 ± .5]	.165 [4.19]	.150±.015 [3.8±.4]	.044 [1.1]	.050±.016 [1.27±.4]	.100 [2.5]	.125 [3.2]	.14 [3.6]
MWM27	2.7W	180V [30A]	.005Ω-20K	1Ω - 1M	250V*	.480±.032 [12.2±.8]	.230 [5.84]	.228±.016 [5.8±.4]	.05 [1.27]	.070±.020 [1.78±.5]	.160 [4.0]	.18 [4.57]	.20 [5]
MWM3S	3W	200V [30A]	.005Ω-25K	1Ω - 1M	300V*	.625±.032 [15.9±.8]	.270 [6.86]	.275±.015 [7±.38]	.05 [1.27]	.085±.016 [2.16±.4]	.160 [4.0]	.175 [4.5]	.40 [10]
MWM3	3.5W	250V [30A]	.005Ω-50K	1Ω - 1M	350V*	.811±.020 [20.6±.5]	.295 [7.49]	.273±.02 [6.9 ± .5]	.063 [1.6]	.102±.028 [2.6 ± .7]	.200 [5.0]	.200 [5.0]	.60 [15]
MWM5	5W	300V [32A]	.005Ω-100K	n/a	n/a	.811±.020 [20.6±.5]	.295 [7.49]	.273±.02 [6.9 ± .5]	.063 [1.6]	.102±.028 [2.6 ± .7]	.250 [6.4]	.250 [6.4]	.60 [15]

LOW PROFILE METAL PLATE MODELS

RCD TYPE	Wattage Rating	Max Voltage* [Current]	Std Resis Range	Opt M Resis Range	Opt M Max Voltage	A	B (Max)	C	D (Min)	E	F	G	H
MWM1/2L	0.5W	√(PR) [12A]	.003Ω-.05Ω	n/a	n/a	.200 ± .012 [5.1 ± .3]	.053 [1.35]	.100±.01 [2.54±.25]	.025 [.63]	.060 [1.5] min	.080 [2.0]	.100 [2.5]	.08 [2]
MWM1L	1W	√(PR) [25A]	.001Ω-0.1Ω	n/a	n/a	.250 ± .012 [6.3 ± .3]	.057 [1.45]	.126 ± .012 [3.2 ± .3]	.025 [.63]	.070 [1.8] min	.150 [3.8]	.125 [3.2]	.120 [3]
MWM2L	2W	√(PR) [30A]	.002Ω-0.2Ω	n/a	n/a	.330±.012 [8.38±.3]	.057 [1.45]	.157 ± .012 [4.0 ± .3]	.032 [0.8]	.100 [2.5] min	.197 [5.0]	.157 [4.0]	.157 [4]
MWM2LS	2W	√(PR) [45A]	.0005 - .005Ω	n/a	n/a	.250 ± .012 [6.3 ± .3]	.079 [2.0]	.126 ± .012 [3.2 ± .3]	.032 [0.8]	.080[.20] min	.150[3.8]	.125[3.2]	.120[3]

*Voltage determined by E = √PR, E not to exceed maximum voltage rating. Increased ratings available. Multiply by 0.7 for Opt. X

APPLICATION NOTES:

- Power Rating:** Resistors may be operated up to full rated power with consideration of mounting density, pad & trace geometry, PCB material, and ambient temperature. Standard parts should be derated (W&V) by .67%/°C when ambient exceeds 25°C, low profile parts by 1%/°C above 70 °C
- Inductance:** Standard wound parts are 1 - 20uH typ. For "non-inductive" design, specify Opt.X (0.2uH max ≤50Ω, .37uH >50Ω, 50nH avail). Opt. L (metal plate element) and Opt.M (power film element) are inherently low inductance (1 to 10nH typ). Consult factory for assistance.
- Pulse Capability:** standard MWM (wirewound) and Opt. L (metal plate) offer excellent overload capability greatly exceeding that of film resistors. The overload level can often be economically enhanced by a factor of 50% or more via special processing (Opt.P). Pulse capability is highly dependent on size & resistance (available up to 50 joules). Consult factory for assistance.

P/N DESIGNATION:

MWM2 □ - **1001** - **E** **T** □ **W**

RCD Type _____

Options: X,P,M,L,F,E (leave blank if std)

Resis.Code .01%-1%: 3 signif. figures & multiplier, e.g. R010=0.01Ω, R100=0.1Ω, 1R00=1Ω, 1000=100Ω, 1001=1K.

Resis.Code 2%-10%: 2 signif. figures & multiplier, R01=0.01Ω, R10=0.1Ω, 1R0=1Ω, 100=10Ω, 101=100Ω, 102=1K. Use extra digits as needed: R005, R0075, R012, etc.

Tolerance Code: K=10%, J=5%, H=3%, G=2%, F=1%, D=0.5%, C=0.25%, B=0.1%, A=0.05%, Q=0.02%, T=0.01%

Packaging: B = Bulk, T = Tape & Reel

TC (leave blank if standard): 5 = 5ppm, 10 = 10ppm, 20=20ppm, 30=30ppm,50=50ppm, 101=100ppm, 201=200ppm, 301=300ppm

Termination: W= Lead-free, Q= Tin/Lead. Leave blank if either is acceptable (RCD will select based on lowest price and quickest delivery).

LOW-OHM CHIP RESISTORS, 0.1W TO 3W

ML SERIES

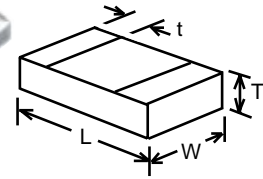

RESISTORS • CAPACITORS • COILS • DELAY LINES

- Industry's widest range and lowest cost!
Values as low as 0.0005Ω, current ratings to 60 Amp
- High power to size ratio
- Non-inductive

OPTIONS

- Option V: 170°C operating temperature range
- Option EK: Group A screening per MIL-R-10509
- Option EL: Group A & B screening per MIL-R-10509

RCD's ML series offers cost-effective solutions for low resistance applications and are particularly ideal for various types of current sensing, voltage dividing, battery and pulse circuits, including linear and switching power supplies, power amplifiers, consumer electronics, etc. The resistance element is thick film or metal plate, and is coated with high temperature insulation for exceptional environmental protection.

RCD Type	Max. Wattage * (70°C)	Max. Current * (70°C)	Resistance Range	Typical TC (ppm/°C)	Optional TC (ppm/°C)	L	W	T	t
ML0402	0.1W	3A	0.02Ω TO 0.049Ω	400	200, 100	.040 ± .004 [1.00 ± .1]	.020 ± .004 [.5 ± .1]	.014 ± .004 [.35 ± .1]	.010 ± .004 [.25 ± .1]
			0.050Ω TO 0.099Ω	300	200, 100				
			0.100Ω TO 1.0Ω	200	100				
ML0603	0.125W	3.5A	0.01Ω TO 0.049Ω	400	200, 100	.061 ± .005 [1.55 ± .12]	.031 ± .004 [.8 ± .1]	.016 ± .006 [.40 ± .15]	.012 ± .008 [.3 ± .2]
			0.050Ω TO 0.099Ω	300	200, 100				
			0.100Ω TO 1.0Ω	200	100				
ML0805	0.25W	5A	0.01Ω TO 0.049Ω	400	200, 100	.079 ± .008 [2.0 ± 0.2]	.050 ± .008 [1.25 ± 0.2]	.020 ± .006 [0.5 ± .15]	.024 ± .008 [0.6 ± 0.2]
			0.050Ω TO 0.099Ω	300	200, 100				
			0.100Ω TO 1.0Ω	200	100				
ML1206	0.5W	7A	0.01Ω TO 0.049Ω	400	200, 100	.126 ± .008 [3.2 ± 0.2]	.063 ± .008 [1.6 ± 0.2]	.020 ± .006 [0.5 ± .15]	.030 ± .018 [0.76 ± .46]
			0.050Ω TO 0.099Ω	300	200, 100				
			0.100Ω TO 1.0Ω	200	100				
ML2010	1W	14A	0.01Ω TO 0.049Ω	400	200, 100	.197 ± .008 [5.0 ± 0.2]	.098 ± .008 [2.5 ± 0.2]	.020 ± .006 [0.5 ± .15]	.032 ± .020 [0.8 ± 0.5]
			0.050Ω TO 0.099Ω	300	200, 100				
			0.100Ω TO 1.0Ω	200	100				
ML2512	2W	20A	0.01Ω TO 0.049Ω	400	200, 100	.250 ± 0.01 [6.35 ± 0.25]	.126 ± .012 [3.2 ± 0.3]	.024 ± .008 [0.6 ± .2]	.040 ± .020 [1 ± 0.5]
			0.050Ω TO 0.099Ω	300	200, 100				
			0.100Ω TO 1.0Ω	200	100				
MLB2512	2W/ 3W *	60A	0.0005Ω	350	200, 100	.250 ± 0.01 [6.35 ± 0.25]	.126 ± .012 [3.2 ± 0.3]	.020~.063** [0.5 ~ 1.6]	.040~.106** [1.0 ~ 2.7]
			0.00075Ω, 0.001Ω, 0.0015Ω, 0.002Ω	200	100, 50				
			0.0025Ω TO 0.01Ω	150	100, 50				

* In order to operate at maximum wattage and current ratings, a suitable substrate or PCB design is required to carry the current and drain the heat. Heavy Cu, large pads and traces, and/or multilayer PC boards are recommended. MLB2512 has a 3W rating when used with 300mm² x .0056 Cu pads

** Varies with resistance value (lower values typically have thicker bodies and wider termination pads for increased current carrying capability)

TYPICAL PERFORMANCE CHARACTERISTICS

Characteristics	Δ R
Thermal Shock (-55° to +155°C)	±1%
Short Time Overload (2x [PxR] ^{1/2} , 5 sec.)	±2%
Low Temp. Operation (-55°C)	±1%
High Temp. Exposure (125°C, 100 hrs.)	±1%
Resistance to Solder Heat	±0.5%
Moisture Resistance	±1%
Load Life(1000 hrs.)	±2%
Operating Temperature Range	-55 to +155°C
Derating of Wattage & Current	1.177%/°C above 70°C
Solderability	95% Min. Coverage
Terminal Adhesion	15 Grams Min.

P/N DESIGNATION:

ML2010 - **R01** - **J** **T** **W**

RCD Type

Options: V, EK, EL (leave blank if standard)

Resis. Code: for 1% tol. use R as decimal point and 3 digits, e.g. R100= 0.1Ω, R200=.2Ω; for 2%-10% use R and 2 digits, e.g. R10= 0.1Ω, R20= .2Ω, etc. except if necessary, use additional (significant) digits, e.g. R005 for 0.005Ω, R0075 for 0.0075Ω in any tolerance

Tolerance Code: F=1%, G=2%, J=5%

Packaging: B=Bulk, T=Tape & Reel

Optional TC: 50=50ppm, 101=100ppm, 201=200ppm

Termination: W= Lead-free, Q= Tin/Lead (leave blank if either is acceptable)

4-TERMINAL SURFACE MOUNT

SF SERIES



Term.W is
RoHS
compliant
& 260°C
compatible

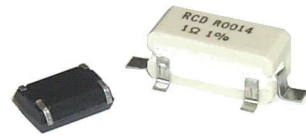

- Industry's widest range! Values from .001Ω-5KΩ, tolerances to ±0.01%, TC's to 5ppm, 1W to 3W
- Excellent for current sensing applications
- Available on exclusive **SWIFT™** delivery program!

OPTIONS

- Option X: Low inductance design
- Option P: Increased pulse capability
- Option E: Low thermal EMF design
- Also available: burn-in, leaded version, custom-marking, increased current rating, matched sets, etc.

RCD's Series SF resistors feature an all-welded "Kelvin" 4-terminal design in a surface mount package, reducing the effects of lead resistance. High-temperature case provides excellent environmental protection. Series SF utilizes the same technology as our popular Series LVF leaded resistors with over 30 years of proven experience.

Resistance (ohms)	Available Tolerances	Standard Temp Coef. (Optional TC)
.001 - .0049	1% - 10%	600ppm/°C (300, 200, 100, 50ppm)
.005 - .0099	.5% - 10%	600ppm/°C (200, 100, 50, 25ppm)
.01 - .024	.25% - 10%	200ppm/°C (100, 50, 25ppm)
.025 - .049	.1% - 10%	150ppm/°C (100, 50, 25ppm)
.05 - .099	.05 - 10%	90ppm/°C (50, 25, 15ppm)
.1 - .99	.02% - 10%	50ppm/°C (25, 15, 10ppm)
1 Ohm and above	.01% - 10%	30ppm/°C (20, 10, 5ppm)

RCD Type	Wattage @ 25°C	Max. Current	Resistance Range
SF1	1W	10A	.001 to 4K
SFG2	2W - 3W*	15A	.001 to 5K

* SFG2 capable of 3W dissipation with consideration of pcb layout and pad geometry

TYPICAL PERFORMANCE SPECIFICATIONS

Operating Temp.	-55° to +175° C
Dielectric Strength	250V Min.
Short-time Overload	5x rated W, 5 Sec
Moisture Resistance	.5%
High Temp. Exposure	.2%
Load Life (1000 hours)	1%
Temperature Cycling	.5%
Shock and Vibration	.1%

SF1

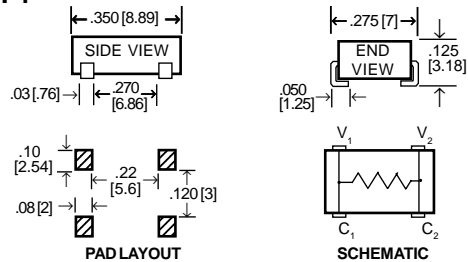

SFG2

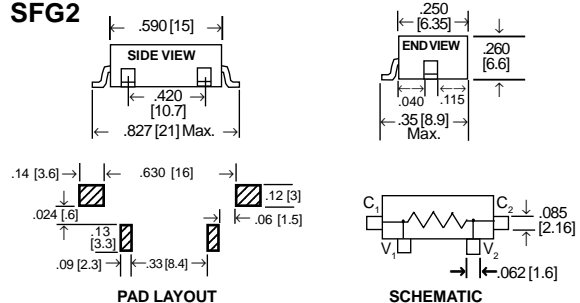

DERATING CURVE

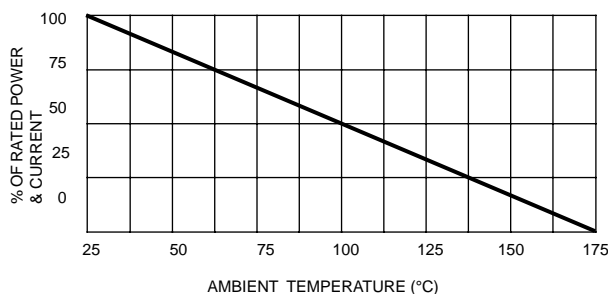

P/N DESIGNATION:

SF1 - **R001** - **J** **T** **W**

RCD Type (SF1 or SFG2) _____

Options: X, E, etc (leave blank if standard) _____

Resis. Code .01% -1%: 3 signif. figures & multiplier, R001=.001Ω, R010=.01Ω, R100=.1Ω, 1R00=1Ω, 10R0=10Ω, 1000=100Ω, 1001=1K

Resis. Code 2% - 10%: 2 signif. figures & multiplier, R001=.001Ω, R01=.01Ω, R10=0.1Ω, 1R0=1Ω, 100=10Ω, 101=100Ω, 102=1KΩ. Use extra digits as needed (R0125, R0075, etc).

Tolerance Code: K=10%, J=5%, H=3%, G=2%, F=1%, D=0.5%, C=0.25%, B=0.1%, A=0.05%, Q=0.02%, T=0.01%

Packaging: B = Bulk, T = Tape & Reel _____

Optional TC (leave blank for std): 5=5ppm, 10=10ppm, 20 = 20ppm, etc; 100ppm and above use 3-digit code: 101=100ppm, 201=200ppm, etc.

Termination: W= Lead-free, Q= Tin/Lead (leave blank if either is acceptable, in which case RCD will select based on lowest price and quickest delivery)

HIGH MEGOHM CHIP RESISTORS

HR SERIES



RESISTORS • CAPACITORS • COILS • DELAY LINES

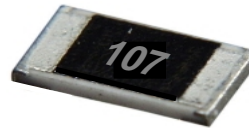

- Resistance Range: 1MΩ to 1TΩ (10¹²Ω)
- Standard Tol: ±5% up to 500MΩ, ±10/20/50% >500MΩ
- Choice of terminations: lead-free, tin/lead, or gold
- Low cost, popular models available from stock
- Excellent thermal, voltage, and environmental stability

HR SERIES - Industry's Highest Value Chip Resistors!

RCD's HR Series offers excellent stability for applications requiring high ohmic values such as X-Ray equipment, photomultipliers, ionization detectors and other circuits which involve low signal detection or amplification. The excellent performance of the HR Series also makes them ideal as an input resistor in many high impedance voltage dividers.

SPECIFICATIONS

RCD Type	Wattage	Max. Working Voltage	Termination Type	Resistance Range ¹	Dimensions			
					A ± .01 [2.54]	B ± .01 [2.54]	H Max.	t Typ.
HR0402	.063W	50V	W	1M - 470M	.02 [.51]	.04 [1.02]	.018 [.45]	.01 [.25]
HR0503	.03W	50V	S	1M - 100M	.025 [.64]	.05 [1.27]	.024 [.6]	.012 [.3]
HR0603	.1W	50V	W	1M - 10G	.031 [1.3]	.061 [1.55]	.022 [.55]	.012 [0.3]
HR0805	.125W	150V	W	1M - 1T	.05 [1.25]	.079 [2.0]	.026 [.66]	.012 [0.3]
HR1206	.25W	200V	W	1M - 1T	.062 [1.6]	.126 [3.2]	.026 [.66]	.016 [0.4]
HR1210	.33W	200V	W	1M - 470M	.098 [2.5]	.126 [3.2]	.026 [.66]	.02 [0.5]
HR2010	.5W	200V	W	1M - 470M	.102 [2.6]	.197 [5.0]	.026 [.66]	.02 [0.5]
HR2512	1W	250V	W	1M - 1G	.125 [3.2]	.25 [6.35]	.028 [.7]	.02 [0.5]

¹ Consult factory for resistance values outside of the standard range

TYPICAL PERFORMANCE CHARACTERISTICS

Voltage Coef. 5V-15V*	.01%/V up to 10 ⁸ Ω, .05%/V 10 ⁹ Ω, .2%/V 10 ¹⁰ Ω, 1%/V 10 ¹¹ Ω.
Temperature Coef. (25-125°C)	300ppm < 10 ⁷ Ω, 500ppm 10 ⁷ - 10 ⁹ Ω, 1000ppm > 10 ⁹ - 10 ¹⁰ Ω, 2000ppm > 10 ¹⁰ - 10 ¹¹ Ω, 2500ppm > 10 ¹¹ - 10 ¹² Ω
Thermal Shock (-55° to +125°C)	0.5% ΔR
Short Time Overload (2 x Max V, 5S)	1% ΔR
Low Temp. Operation (-55°C, 1 hr)	0.5% ΔR
High Temp. Exposure (125°C, 100 hrs)	0.5% ΔR
Resistance to Solder Heat	0.25% ΔR
Moisture Resistance	0.5% ΔR
Load Life(1000 hrs.)	1.0% ΔR
DC Resistance	within tol. @ 50V 25°C

* VC is based on HR1206 and larger (smaller sizes have higher VC's)

DERATING CURVE

Resistors may be operated up to full rated power & voltage, with consideration of mounting layout and environmental conditions

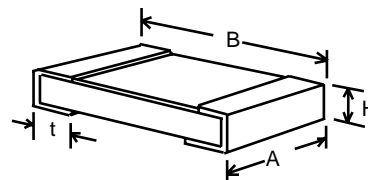
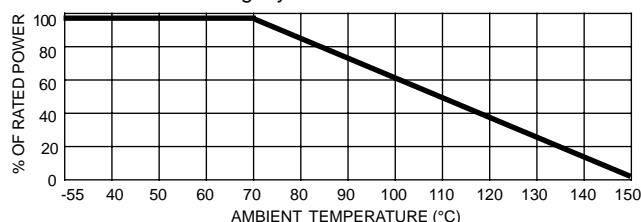

Termination Type W: Wraparound (standard on all sizes except HR0503)

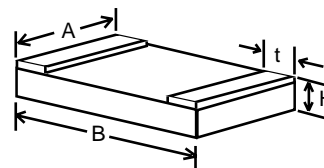

Termination Type S: Single Sided (HR0503)

P/N DESIGNATION:

HR0805 - 107 - J T

RCD Type _____

Resis.Code: 2 digits & multiplier (105=1M, 106=10M, 107=100M, 1G0=1G, 10G=10G, 100G=100G, 1T0=1T)

Tolerance Code: N=50%, M=20%, K=10%, J=5%

Packaging: B = Bulk, T = Tape & Reel

Termination: W= Lead-free (Tin-plated), Q= Tin/Lead, G= Gold plated

PRECISION HIGH VOLTAGE/ HIGH VALUE CHIP RESISTORS

SRH SERIES



RESISTORS • CAPACITORS • COILS • DELAY LINES

FEATURES

- Industry's highest precision hi-voltage SM resistors!
- Voltage ratings up to 7KV, resistance values to 1TΩ (10¹²Ω)
- Tolerances to 0.1%, TC's to 25ppm/°C, VC's to 0.5ppm/V

OPTIONS

- Opt. H: increased voltage (5% & 10% tol.)
- Mil-spec screening/burn-in, special marking, high pulse, custom values/TC/VC, high frequency designs, etc. Customized resistors have been an RCD specialty for over 30 years!
- Opt. V: 250° Operating Temperature

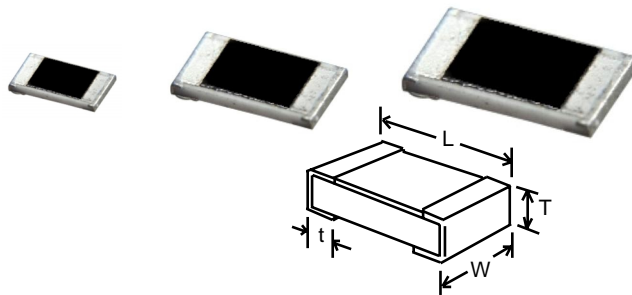

DERATING CURVE

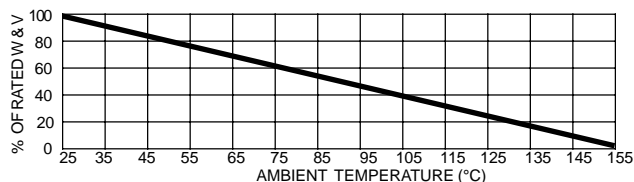

DIMENSIONS

RCD Type	L±.01 [.25]	W±.014 [.35]	T±.008 [.2]	t ±.015 [.38]
SRH1206	.126 [3.2]	.061 [1.55]	.024 [.6]	.020 [.51]
SRH2512	.250 [6.4]	.132 [3.35]	.024 [.6]	.025 [.63]
SRH4020S	.400 [10.2]	.200 [5.1]	.024 [.6]	.035 [.90]
SRH5020	.500 [12.7]	.200 [5.08]	.031 [.8]	.079 [2.0]
SRH7020	.710 [18]	.200 [5.08]	.031 [.8]	.079 [2.0]
SRH1020	1.000 [25.4]	.200 [5.08]	.031 [.8]	.079 [2.0]

RCD Type	Rated Power	Rated Voltage	Option 'H' Voltage Rating ¹	Resistance Range ²		
				0.1%, 0.25%, 0.5%	1%, 2%	5%, 10%
SRH1206	.25W	400V ³	600V	100K to 100M	100K to 100M	100K to 1T
SRH2512	1W	1000V	2000V ⁴	100K to 100M	100K to 1000M	100K to 1T
SRH4020S	1.5W	4000V	6000V	100K to 100M	100K to 1000M	100K to 1T
SRH5020	2W	2500V	3500V	100K to 100M	100K to 500M	100K to 1000M
SRH7020	3W	3500V	5000V	100K to 100M	100K to 500M	100K to 1000M
SRH1020	4W	5000V	7000V	100K to 100M	100K to 500M	100K to 1000M

¹ Opt. H available in 5% and 10% tolerance ² Expanded resistance range available
³ Values above 10M rated at 300V ⁴ Special construction available for 3KV capacitor peak voltage discharge

PERFORMANCE CHARACTERISTICS ¹

Operating Temp. Range	-55 °C to +155°C	
Pulse Capability	1.0%	2x rated voltage, 1.2 x 50uS
Thermal Shock	0.5%	-55°C to +125C, 0.5 hours, 5 cycles
Low Temp. Storage	0.5%	24 hrs @ -55°C
High Temp. Exposure	0.5%	100 hours @ +125°C
Resistance to Solder Heat	0.1%	260 ± 5°C, 3 seconds
Moisture Resistance	0.5%	Mil-STD-202 M.103 95% RH 1000 hours
Load Life(1000 hrs.)	1.0%	Rated Wor V per Mil-PRF-55342 4.8.11.1

¹ Characteristics are typical for resistance range up to 1GΩ, consult factory concerning higher values

TC AND VOLTAGE COEFFICIENT CHARACTERISTICS

Res.Range	Characteristic	1206	2512	4020	5020	7020	1020
10MΩ to 100M	VCppm/V, typ	50	10	4	3	1	0.5
	TC ppm/°C (opt. TC)	100 (25,50)	100 (25,50)	100 (25,50)	100 (25,50)	100 (25,50)	100 (25,50)
>100M to 500M	VCppm/V, typ	100	15	7	5	2	1
	TCppm/°C (opt. TC)	250 (50,100)	100 (25,50)	100 (25,50)	100 (25,50)	100 (25,50)	100 (25,50)
>500M to 1G	VCppm/V, typ	250	20	10	7	3	2
	TCppm/°C (opt. TC)	250 (100)	250 (100)	100 (25,50)	100 (25,50)	100 (25,50)	100 (25,50)
>1G to 10G	VCppm/V, typ	800	80	20	-	-	-
	TCppm/°C (opt. TC)	1000 (500)	500 (250)	100 (50)	-	-	-
>10G to 100G	VCppm/V, typ	1500	200	80	-	-	-
	TCppm/°C (opt. TC)	2000 (1000)	500 (250)	250 (100)	-	-	-
>100G to 1T	VCppm/V, typ	4000	400	200	-	-	-
	TCppm/°C (opt. TC)	3000 (n/a)	1000 (500)	500 (250)	-	-	-

P/N DESIGNATION:

SRH2512 - 1006 - F B 101 W

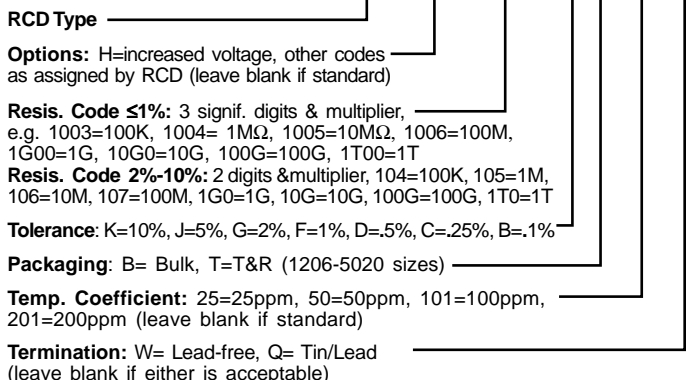

PULSE RESISTORS, SURFACE MOUNT

PRM SERIES

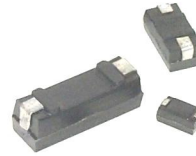
 Term. W
is Pb-free
and RoHS
compliant

- High voltage/ high surge capability
- Cost effective surface mount package
- Available on RCD's exclusive **SWIFT™** program

OPTIONS

- Option ER: Group A Screening per MIL-R-39008 RCR
- Option B: Increased power
- Option X: Non-inductive

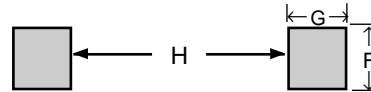
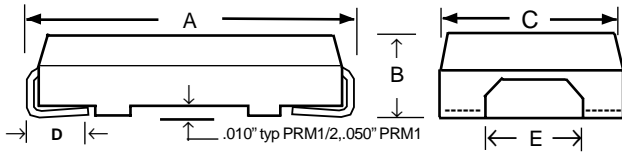
 SUGGESTED
PAD LAYOUT

Pulse tolerant surface mount resistors!

Series PRM withstand high energy pulses, and are superior to conventional film & wirewound types. The heavy duty construction features a ceramic core, enabling improved thermal transfer and long term stability. Elements are protected by flame-retardant molding for excellent environmental performance. Alpha-numeric marking is standard. PRM resistors are cost effective in a wide variety of pulse applications including telecom line feed resistors, snubber circuits, in-rush currents, capacitor charge/discharge circuits, lightning surges, etc.

SPECIFICATIONS

RCD Type	Wattage Rating Std	Wattage Rating Opt B	Max. Voltage ^{1,3,4}	Max. Peak Pulse Voltage ^{2,4}	Resistance Range	DIMENSIONS Inch [mm]							
						A	B	C	D	E	F	G	H
PRM1/8	.125W	.5W	150V	2KV	0.1Ω - 2K	.200 ± .02 [5.1 ± .5]	.096 ± .015 [2.44 ± .38]	.120 ± .01 [3.18 ± .25]	.025 Min. [.63]	.045 ± .015 [1.14 ± .38]	.080 [2.0]	.100 [2.5]	.08 [2.0]
PRM1/4	.25W	1W	250V	3.5KV	0.1Ω - 10K	.258 ± .02 [6.55 ± .5]	.110 ± .015 [2.79 ± .38]	.150 ± .015 [3.81 ± .38]	.032 Min. [.8]	.060 ± .015 [1.5 ± .38]	.100 [2.5]	.125 [3.2]	.120 [3.0]
PRM1/2	.5W	2W	350V	5KV	0.1Ω - 24K	.472 ± .024 [12 ± .6]	.208 ± .02 [5.3 ± .5]	.228 ± .016 [5.8 ± .4]	.050 Min. [1.27]	.070 ± .02 [1.78 ± .5]	.160 [4.0]	.180 [4.57]	.200 [5.0]
PRM1	1W	4W	500V	10KV	0.1Ω - 100K	.811 ± .020 [20.6 ± .5]	.275 ± .020 [6.99 ± .5]	.273 ± .020 [6.93 ± .5]	.063 Min. [1.6]	.102 ± .028 [2.6 ± .7]	.200 [5.0]	.200 [5.0]	.600 [15.2]

¹Rated continuous voltage = $\sqrt{P \times R}$, nte value listed. ²Pulse voltage capability is dependent on res. value, waveform, & repetition rate. ³Expanded range available ⁴Multiply by 0.7 on Opt.X parts

SURGE CAPABILITY

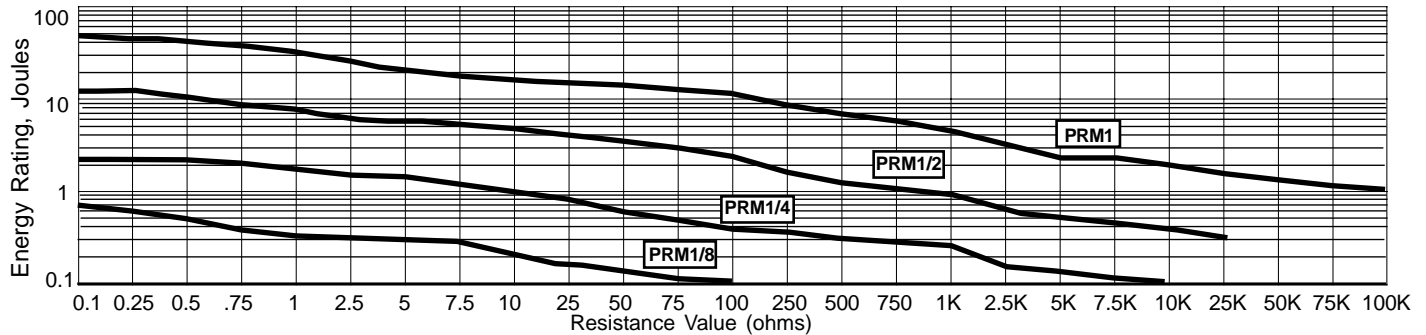

TYPICAL PERFORMANCE CHARACTERISTICS

Wattage Derating	1.25%/°C >70°C (Opt. B to be derated 0.8%/°C >25°C)
Max. Induc*: Opt. X ≤ 50Ω	0.2uH PRM1/8-1/2, .3uH PRM1
Max. Induc*: Opt. X > 50Ω	0.37uH PRM1/8-1/2, .6uH PRM1
Short-time Overload	±0.5%
Temperature Cycling	±0.5%
TCR (20ppm avail.)	±120ppm/°C (<0.2Ω=200ppm)
Moisture Resistance	±1%
Shock and Vibration	±0.2%
Effect of Soldering	±0.2%
Voltage Coefficient	±0.005%/V
Load Life	±0.5% Std, ±1% Opt.B
Operating Temp Range	-55 to +150°C, +275°C avail.
Dielectric Strength	500V (1KV avail.)

* specify Opt.75 for induc levels 50% that of Opt.X, or Opt.76 for 33% that of Opt.X

APPLICATION NOTE

Use chart above to select model to meet desired surge level. Pulse not to exceed peak V & j ratings (derate 30% for Opt.X), and average power during repetitive pulses nte rated W. 30% safety factor is recommended for infrequent pulses, 50% typ. for repetitive pulses (request Note R42 for derating factors attributable to pulse width, rep. rate, temp., altitude, humidity). Verify by evaluating under worst-case conditions. Depending on specifics, PR series can often satisfy the surge requirements of UL-217, -268, -294, -497, -508, -913, -943, -991, -1459, -1971, ANSI/IEEE C62.41, CCITT (Rec. K17), Bellcore TR-NWT-001089 & TR-TSY-000057, CSA C22.2-225, IEC 664, IEC 801.5, IEEE587, Can.Doc. CS-03, FCC Part 68., etc. Consult factory for assistance.

P/N DESIGNATION:

PRM1 - **102** - **K** **T** **W**

RCD Type _____

Options: X, ER, B (leave blank if std)

Resis. Code 1% tol: 3 signif. figures & multiplier, e.g. R100=0.1Ω, 1R00=1Ω, 10R0=10Ω, 1000=100Ω, 1001=1K. 2%-10%: 2 signif. fig. & multiplier (R10=0.1Ω, 1R0=1Ω, 100=10Ω, 102=1K)

Tolerance: J=5% (standard), F=1%, G=2%, K=10%

Packaging: B = bulk, T = Tape & Reel

Optional TC: 20 = 20ppm, 50 = 50ppm (leave blank if standard)

Termination: W = Lead-free, Q = Tin/Lead (leave blank if either is acceptable, in which case RCD will select based on lowest price and quickest delivery)

FUSIBLE CHIP RESISTORS

FC SERIES



RESISTORS • CAPACITORS • COILS • DELAY LINES

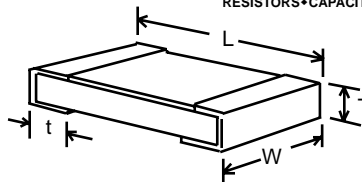

- Industry's broadest range of fusible chip resistors- 7 standard sizes from 0402 to 2512, widest resistance range- 1Ω to 10K standard
- Perform like conventional chip resistors under normal conditions but fuse when subject to overloads
- Standard tolerance: ±5%, 10% (1%, 2% available)
- See MBW Series for additional SM fuse resistors (1/4W-3W)

Surface Mount Circuit Protection!

RCD Series FC resistors offer a low cost approach to circuit protection in case of overload or component failure. The resistor is designed to act as a conventional resistor under normal operating conditions, but will quickly open when subjected to suitable continuous overload. Standard fusing characteristics can be altered to customer requirements.

OPTIONS

- Option ER: Group A screening per Mil-PRF-55342
- Customized fusing time and/or fusing power level

RCD Type	Wattage Rating	Max. Hold-Off Voltage	Resistance Range	DIMENSIONS			
				L	W	T	t
FC0402	.10W	50V ¹	1Ω to 1KΩ ²	.040±.004 [1.0±.10]	.020 ± .002 [0.5 ± .05]	.014 ± .004 [.35 ± .15]	.010 ± .005 [.25 ± .12]
FC0603	.125W	100V ¹	1Ω to 1.8KΩ ²	.063 ± .008 [1.6 ± .20]	.031 ± .005 [0.8 ± .13]	.018 ± .006 [.45 ± .15]	.012 ± .008 [.30 ± .20]
FC0805	.15W	150V ¹	1Ω to 3KΩ ²	.079 ± .008 [2.0 ± .20]	.050 ± .006 [1.25 ± .15]	.018 ± .006 [.45 ± .15]	.014 ± .008 [.35 ± .20]
FC1206	.25W	200V ¹	1Ω to 5.1KΩ ²	.126 ± .008 [3.2 ± .20]	.063 ± .008 [1.6 ± .20]	.020 ± .006 [.50 ± .15]	.020 ± .010 [.51 ± .25]
FC1210	.50W	250V ¹	1Ω to 6.2KΩ ²	.126 ± .008 [3.2 ± .20]	.098 ± .008 [2.5 ± .20]	.024 ± .008 [.61 ± .20]	.020 ± .010 [.51 ± .25]
FC2010	.75W	300V ¹	1Ω to 7.5KΩ ²	.197 ± .008 [5.0 ± .20]	.100 ± .008 [2.6 ± .20]	.024 ± .008 [.61 ± .20]	.020 ± .010 [.51 ± .25]
FC2512	1.0W	400V ¹	1Ω to 10KΩ ²	.248 ± .008 [6.3 ± .20]	.124 ± .010 [3.2 ± .25]	.024 ± .008 [.61 ± .20]	.030 ± .018 [.75 ± .46]

¹Open circuit voltage (consult factory for increased voltage rating) ²Extended resistance range available

TYPICAL PERFORMANCE CHARACTERISTICS

REQUIREMENTS	CHARACTERISTICS	TEST METHOD
Min. Fusing Power	FC0402 <30 sec at 2.5W FC0603 <30 sec at 3W FC0805 <30 sec at 3.25W FC1206 <30 sec at 5W FC1210 <30 sec at 7.5W FC2010 <30 sec at 11.25W FC2512 <30 sec at 15W	Unmounted, 25°C, residual resistance to be a minimum of 100X the original value.
Temperature Coefficient	200ppm/°C (<5Ω=250ppm)	25°C to +125°C
Resistance to Soldering Heat	± 0.25%	260 ± 5°C, 3 seconds
High Temperature Exposure	± 0.5%	100 hours @ +125°C
Low Temp. Operation	± 0.5%	-55°C, 1 hour
Moisture Resistance	± 1.5%	Mil-PRF-55342
Load Life (1000 hours)	± 5%	Rated W per Mil-PRF-55342 4.8.11.1
Thermal Shock	± 0.5%	-55°C to +125°C, 0.5 hours, 5 cycles
Solderability	95% (Min.)	MIL-Std-202, Method 208
Dielectric Withstanding Voltage	250V (100V 0402 & 0603)	60 Seconds, terminal to ceramic
Operating Temp. Range	-55°C to +125°C	
Derating (above 70°C)	derate W & V by 1.18%/°C	

CONSTRUCTION

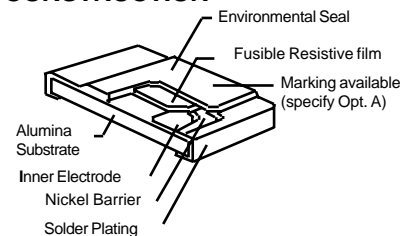

APPLICATION NOTES:

- 1) Fault level must be suitable to safely open the resistor. If insufficient the resistor may reach elevated temp. For this reason, the fusing load must be relatively large compared to rated W, 30-60x is common for most circuits, and should be at least equal to the minimum fusing power listed in Performance Chart. Fusing may still occur at W levels below these but not as consistently (fast-blow models available).
- 2) Don't exceed volt rating or 200x W rating, whichever is less. Customers should evaluate product for suitability under all possible overload scenarios. Customized fusing characteristics are available. Fusing times vary depending on the amount of "heat sinking" involved, i.e. PCB material, pad size, trace thickness, etc.
- 3) Customers should evaluate fusing in actual-use conditions. Exercise care when testing fuse resistors.

P/N DESIGNATION:

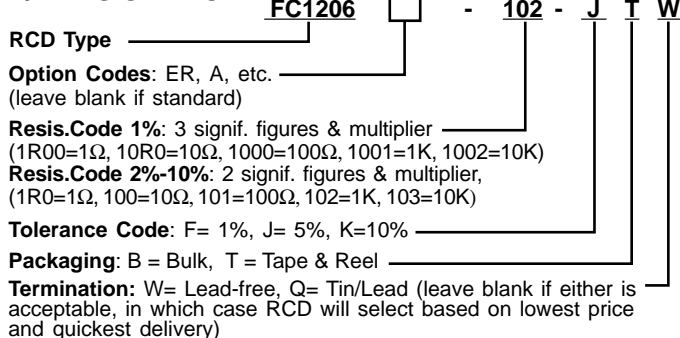

TEMPERATURE SENSITIVE CHIP RESISTORS

FLP SERIES



- Excellent stability and PTC linearity
- Economically priced
- Fast response time
- Operating temp. -65°C to +150°C
- Standard tolerance: ±1%, ±2%, ±5%
- Refer to MLP Series for additional SM PTC resistor selection from (1.5Ω to 100K, +150 to +4500ppm)

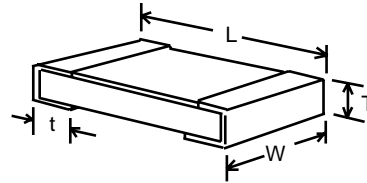

Available TCR*	TCR Tolerance
+3000 ppm/°C	5%
+3300 ppm/°C	5%
+3600 ppm/°C	5%
+4000 ppm/°C	5%
+4500 ppm/°C	5%
+5000 ppm/°C	5%

*Standard T.C.R.'s shown; additional T.C.R.'s available upon request.

DERATING

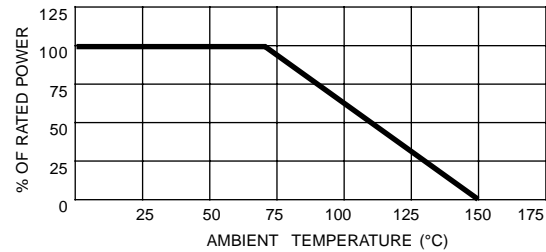

SPECIFICATIONS

RCD Type	Wattage Rating @70°C	Resistance Range *	Thermal Dissipation	Response Time	L ±.008 [.2]	W ±.006 [.2]	T ±.006 [.15]	t ± .008 [.2]
FLP0805	.125W	50Ω to 2KΩ	8.2mW/°C	4 Sec.	.079 [2.0]	.050 [1.25]	.018 [.4]	.016 [.4]
FLP1206	.25W	50Ω to 10KΩ	9mW/°C	6.5 Sec.	.126 [3.2]	.061 [1.55]	.024 [.6]	.020 [.5]

*Consult factory for resistance values outside the standard range. Entire resistance range isn't available in each TC, consult factory for availability.

RESISTANCE/TEMPERATURE CURVE

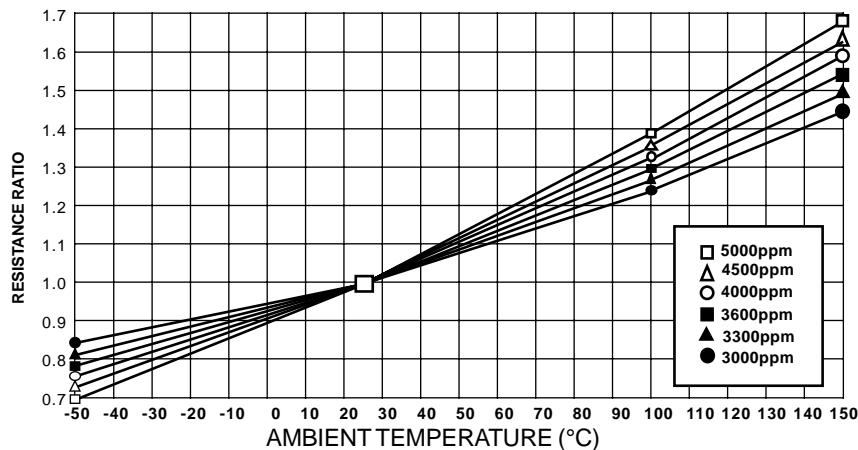

THERMAL RESPONSE TIME

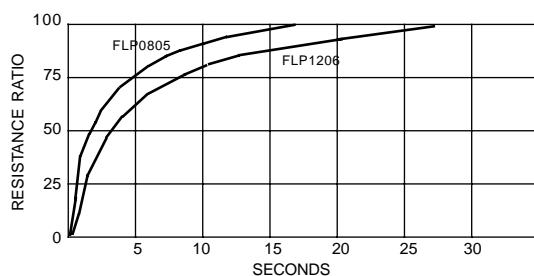

P/N DESIGNATION:

FLP1206 - 102 - J T 332 W
RCD Type _____
Resis. Code 1%: 3 signif. figures & multiplier (10R0=10Ω, 1000=100Ω, 1001=1KΩ, 1002=10KΩ, etc.)
Resis. Code 2%-10%: 2 signif. digits & multiplier (100=10Ω, 101=100Ω, 102=1KΩ, 103=10K, etc.)
Tolerance: G= ±2%, J= ±5%, K=±10%
Packaging: B = Bulk, T = Tape & Reel
Temperature Coefficient in 3-Digit Code: 302=3000ppm, 452=4500ppm, 502=5000ppm
Termination: W= Lead-free, Q= Tin/Lead (leave blank if either is acceptable)

THICK FILM CONCAVE CHIP ARRAYS

CN SERIES Resistor Arrays ZN SERIES Jumper Arrays

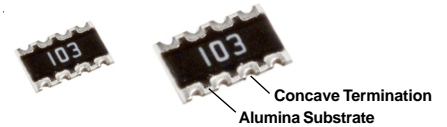

- Popular self-aligning concave termination pads (convex termination style also available, see SMN series)
- Industry's widest selection and lowest cost!
- 1Ω to 10MΩ, 1% to 5%, 6 sizes, 5 circuit schematics
- 2 to 8 resistors per array reduces mounting costs
- ZN Series zero ohm jumpers are 1Amp, 50mΩ max

RCD's Series CN resistor and ZN jumper chip arrays not only enable significant pcb space savings, but a sizeable cost savings over the use of individual components. The savings in assembly cost, by placing a single chip instead of multiple chips, more than pays for the cost of these components. Circuits comprised of multiple values are available on a custom basis.

4 PIN: CN0606

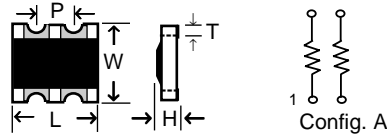

10 PIN MINI: CN1608

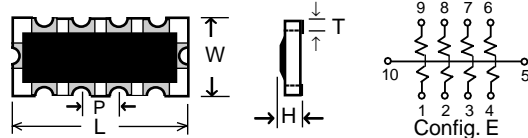

8 PIN: CN0804, CN1206, CN2012

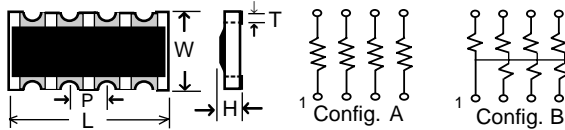

10 PIN STANDARD: CN2512

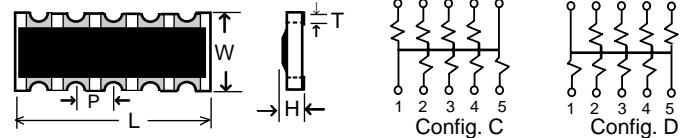

RCD Type	Config	Rated Power*	Working Voltage	TC (ppm/°C)	Res. Range 1% Tol	Res. Range 2 & 5% Tol	L ±.01 [.25]	W ±.008 [.2]	P ±.008 [.2]	H ±.006 [.15]	T typ.
CN0606	A	62mW	50V	200ppm	1Ω - 1M	1Ω - 10M	.063 [1.6]	.063 [1.6]	.0315 [.8]	.022 [.55]	.012 [.3]
CN0804	A	62mW	25V	200ppm	1Ω - 1M	1Ω - 1M	.079 [2]	.039 [1]	.02 [.5]	.016 [.4]	.010 [.25]
CN1206	A	62mW	50V	200ppm	1Ω - 1M	1Ω - 10M	.126 [3.2]	.063 [1.6]	.0315 [.8]	.022 [.55]	.016 [.4]
CN1608	E	62mW	25V	200ppm	**	22Ω - 1M	.157 [4]	.083 [2.1]	.0315 [.8]	.024 [.6]	.016 [.4]
CN2012	A	125mW	50V	200ppm	**	10Ω - 1M	.200 [5.08]	.126 [3.2]	.050 [1.27]	.024 [.6]	.022 [.56]
CN2012	B**	62mW	50V	200ppm	**	10Ω - 1M	.200 [5.08]	.126 [3.2]	.050 [1.27]	.024 [.6]	.022 [.56]
CN2512	C	62mW	50V	200ppm	**	22Ω - 1M	.252 [6.4]	.126 [3.2]	.050 [1.27]	.024 [.6]	.018 [.45]
CN2512	D	62mW	50V	200ppm	**	22Ω - 1M	.252 [6.4]	.126 [3.2]	.050 [1.27]	.024 [.6]	.018 [.45]

* Rated power is per resistor element at 70°C ** Consult factory for availability

DERATING

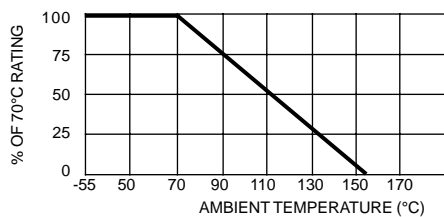

SUGGESTED PAD LAYOUT

RCD Type	Fig.	A	B	C	D
CN0606 (4-pin)	1	.016 [.4]	.016 [.4]	.032 [.8]	.036 [.9]
CN0804 (8-pin)	1	.012 [.3]	.008 [.2]	.024 [.6]	.020 [.5]
CN1206 (8-pin)	1	.016 [.4]	.016 [.4]	.032 [.8]	.036 [.9]
CN1608 (10-pin)	2	.016 [.4]	.016 [.4]	.040 [1]	.040 [1]
CN2012 (8-pin)	1	.034 [.87]	.016 [.4]	.040 [1]	.080 [2]
CN2512 (10-pin)	1	.031 [.79]	.019 [.48]	.045 [1.1]	.094 [2.4]

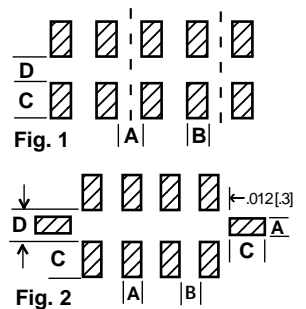

TYPICAL PERFORMANCE CHARACTERISTICS

Operating Temp. Range	-55°C to +155°C
Short time Overload (2.5X rated W, 5 sec)	±2%+0.1Ω max.
Resistance to Solder Heat (260°C, 10 sec)	±1%+0.1Ω max.
Moisture Res. (90-95% RH, 40°C, 100 hrs)	±3%+0.1Ω max.
High Temp. Exposure (125°C, 100 hrs)	±1%+0.1Ω max.
Load Life (1000 hrs at rated W)	±3%+0.1Ω max.
Insulation Resistance	10,000 Megohm
Dielectric Withstanding Voltage	400V

P/N DESIGNATION: CN 1206 A - 102 - J T W

Type (CN, ZN) _____
 Chip Size _____
 Circuit Configuration: A, B, C, D, E _____
 Resis.Code 1%: 3 signif. figures & multiplier, e.g. 1R00=1Ω, 10R0=10Ω, 1000=100Ω, 1001=1KΩ, etc.
 Resis.Code 2%-5%: 2 signif. figures & multiplier, e.g. 1R0=1Ω, 100=10Ω, 101=100Ω, 102=1KΩ, etc.
 Leave blank on ZN zero-ohm jumper arrays (.05Ω max)
 Tolerance Code: J=5%(std), G=2%, F=1%
 Leave blank on ZN zero-ohm jumper arrays
 Packaging: B = Bulk, T = Tape & Reel
 Termination: W= Lead-free (standard), Q= Tin/Lead (leave blank if either is acceptable)

THICK FILM CONVEX CHIP ARRAYS



RESISTORS•CAPACITORS•COILS•DELAY LINES

SMN SERIES Resistor Arrays ZMN SERIES Jumper Arrays



Term. W is Pb-free and RoHS compliant

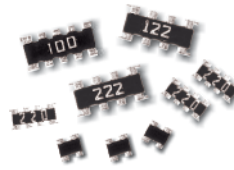

- ☐ Internationally popular convex termination pads
- ☐ Industry's widest selection and lowest cost!
- ☐ 1Ω to 10MΩ, 0.5% to 5%, 8 sizes, 3 circuit schematics
- ☐ 2 to 9 resistors per array reduces mounting costs
- ☐ ZMN Series zero ohm jumpers are 1Amp, 50mΩ max
- ☐ Scalloped edge design available

RCD's Series SMN resistor and ZMN jumper chip arrays not only enable significant pcb space savings, but a sizeable cost savings over the use of individual components. The savings in assembly cost, by placing a single chip instead of multiple chips, more than pays for the cost of these components. SMN/ZMN feature convex terminations, concave available (see CN Series).

4 PIN: SMN0404, SMN0606

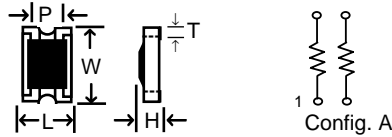

10 PIN: SMN2010, SMNN1206 (SMNN1206 avail. in Config. D only)

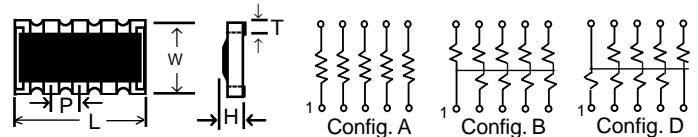

8 PIN: SMN0804, SMN1206, SMN2012

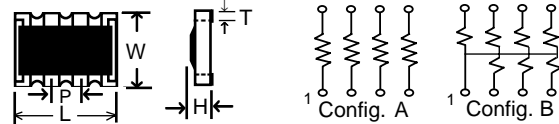

16 PIN: SMN1506

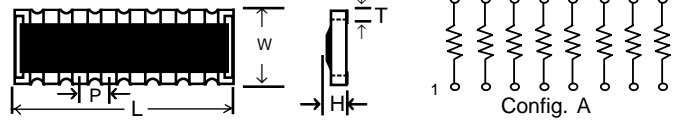

RCD Type	Config	Rated Power*	Working Voltage	TC (ppm/°C)	Res. Range 0.5% Tol	Res. Range 1% Tol	Res. Range 2 & 5% Tol	L ±.01 [.25]	W ±.008 [.2]	P ±.008 [.2]	H ±.006 [.15]	T typ.
SMN0404	A	62mW	25V	250ppm	**	**	10Ω - 1M	.039 [1]	.039 [1]	.025 [.65]	.016 [.4]	.010 [.25]
SMN0606	A	62mW	50V	200ppm	**	**	1Ω - 10M	.063 [1.6]	.063 [1.6]	.0315 [.8]	.022 [.55]	.012 [.3]
SMN0804	A	62mW	25V	250ppm	**	**	10Ω - 1M	.079 [2]	.039 [1]	.02 [.5]	.016 [.4]	.010 [.25]
SMN1206	A	62mW	50V	200ppm	22Ω-470K	1Ω - 10M	1Ω - 10M	.126 [3.2]	.063 [1.6]	.0315 [.8]	.022 [.55]	.010 [.25]
SMNN1206	D	31mW	25V	200ppm	**	**	10Ω - 1M	.126 [3.2]	.063 [1.6]	.025 [.64]	.022 [.55]	.010 [.25]
SMN1506	A	62mW***	25V	200ppm	**	**	10Ω - 1M	.154 [3.9]	.063 [1.6]	.02 [.5]	.018 [.45]	.012 [.3]
SMN2010	A	100mW	50V	200ppm	**	**	10Ω - 1M	.200 [5.08]	.100 [2.54]	.040 [1.0]	.024 [.6]	.010 [.25]
SMN2010	B	55mW	50V	200ppm	**	**	10Ω - 1M	.200 [5.08]	.100 [2.54]	.040 [1.0]	.024 [.6]	.010 [.25]
SMN2012	A	125mW	50V	200ppm	**	**	22Ω - 1M	.200 [5.08]	.122 [3.10]	.050 [1.27]	.024 [.6]	.012 [.30]
SMN2012	B**	62mW	50V	200ppm	**	**	10Ω - 1M	.200 [5.08]	.122 [3.10]	.050 [1.27]	.024 [.6]	.012 [.30]

* Rated power is per resistor element at 70°C ** Consult factory for availability *** SMN1506 package power rating is .25W

DERATING

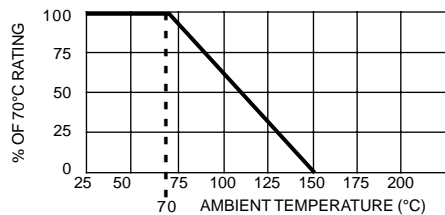

SUGGESTED PAD LAYOUT

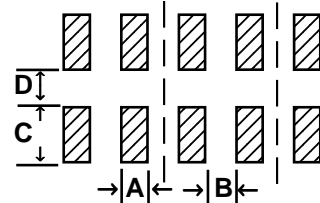

RCD Type	A	B	C	D
SMN0404 (4-pin)	.014 [.36]	.011 [.28]	.020 [.5]	.020 [.5]
SMN0606 (4-pin)	.016 [.4]	.016 [.4]	.032 [.8]	.036 [.9]
SMN0804 (8-pin)	.012 [.3]	.008 [.2]	.020 [.5]	.020 [.5]
SMN1206 (8-pin)	.018 [.45]	.014 [.36]	.032 [.8]	.036 [.9]
SMNN1206 (10-pin)	.014 [.36]	.011 [.28]	.032 [.8]	.036 [.9]
SMN1506 (16-pin)	.012 [.3]	.008 [.2]	.032 [.8]	.039 [.9]
SMN2010 (10-pin)	.022 [.55]	.018 [.45]	.040 [1]	.060 [1.5]
SMN2012 (8-pin)	.032 [.82]	.018 [.45]	.045 [1.1]	.080 [2]

TYPICAL PERFORMANCE CHARACTERISTICS

Operating Temp. Range	-55°C to +150°C
Short time Overload (2.5X rated W, 5 sec)	±2%+0.1Ω max.
Resistance to Solder Heat (260°C, 10 sec)	±1%+0.1Ω max.
Moisture Res. (90-95% RH, 40°C, 100 hrs)	±3%+0.1Ω max.
High Temp. Exposure (125°C, 100 hrs)	±1%+0.1Ω max.
Load Life (1000 hrs at rated W)	±3%+0.1Ω max.
Insulation Resistance	10,000 Megohm
Dielectric Withstanding Voltage	400V

P/N DESIGNATION: SMN 2010 A - 102 - J T W

Type (SMN, SMNN or ZMN)
 Chip Size
 Circuit Configuration: A, B, D
 Resis.Code 1%: 3 signif. figures & multiplier, e.g. 1R00=1Ω, 10R0=10Ω, 1000=100Ω, 1001=1KΩ, etc.
 Resis.Code 2%-5%: 2 signif. figures & multiplier, e.g. 1R0=1Ω, 100=10Ω, 101=100Ω, 102=1KΩ, etc.
 Leave blank on ZMN zero-ohm jumper arrays (.05Ω max)
 Tolerance Code: J=5%(std), G=2%, F=1%, D=0.5%
 Leave blank on ZMN zero-ohm jumper arrays
 Packaging: B = Bulk, T = Tape & Reel
 Termination: W= Lead-free (standard), Q= Tin/Lead (leave blank if either is acceptable)

THICK FILM SURFACE MOUNT NETWORKS SMALL OUTLINE MOLDED DIP

SMN16 SERIES



Choice of gull-wing or J-lead styles!

RCD's SMN series feature SOIC-type packaging with gull-wing leads, or SOJ type with leads formed under the body for even greater space savings. The molded construction results in excellent moisture resistance, and compliant leads prevent solder joint fatigue under vibration and thermal shock conditions.

- Epoxy-molded for excellent environmental performance
- Standard tolerance: $\pm 5\%$ (1%, 2% available)
- Temperature coefficient: $\pm 100\text{ppm}/^\circ\text{C}$ typical
- Available on 24mm embossed plastic tape or magazine tube

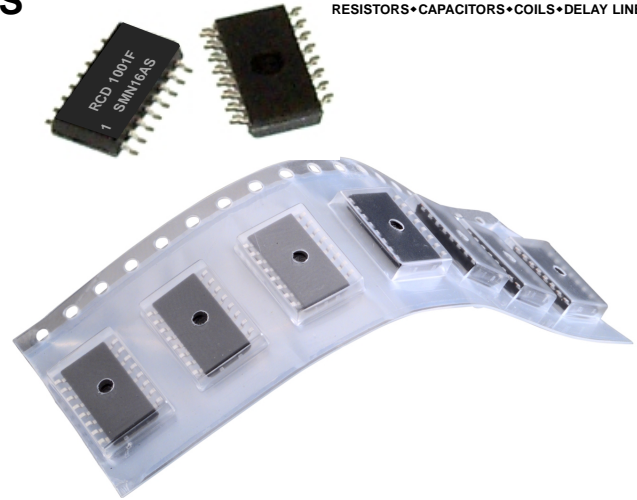

POWER RATING

Config. Type	Single Resistor		Package	
	@ 25°C	@ 70°C	@ 25°C	@ 70°C
A	.25W	.16W	.75W	.5W
B	.125W	.08W	.75W	.5W

DERATING

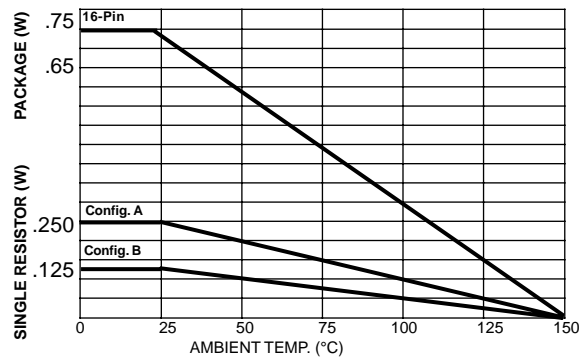

STANDARD CONFIGURATIONS

(Custom circuits available.)

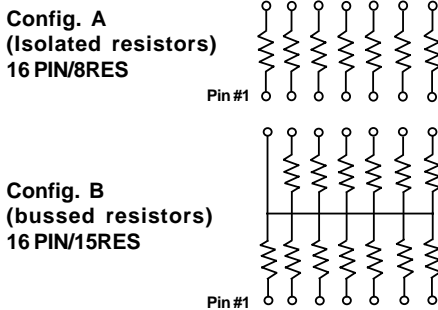

S Type (SOIC)

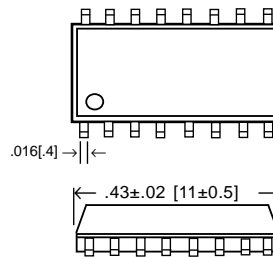

J Type (SOJ)

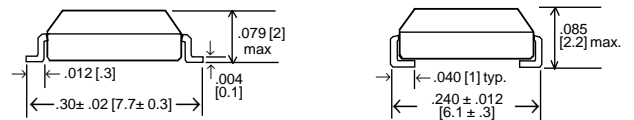
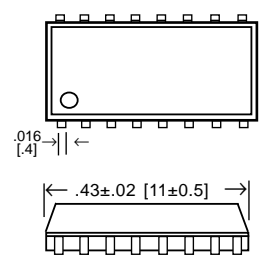

SPECIFICATIONS, TYPICAL

Resistance Range	33Ω to 3.3 Meg
Resistance Tolerance	$\pm 1, 2, 5, 10\%$
Voltage Rating	25VDC or $\sqrt{\text{PR}}$ (whichever is less)
Temperature Range	-55 to +150°C
Temperature Coefficient	$\pm 200\text{ppm}/^\circ\text{C}$
T.C. Tracking	50ppm/°C
Voltage Coefficient	<50 ppm/ V Typ.
Thermal Shock	$\pm 0.5\% + .05\Omega$
Short-Time Overload	$\pm .25\% + .05\Omega$
Resistance to Solder Heat	$\pm .25\% + .05\Omega$
Moisture Resistance	$\pm 0.5\% + .05\Omega$
Load Life (1000 hours)	$\pm 1.0\% + .05\Omega$
Dielectric Strength	200V Min.

P/N DESIGNATION:

SMN 16 A S - 102 - J B W

RCD Type: SMN 16 A S - 102 - J B W

Number of Pins (16 is standard)

Configuration: A=Isolated, B=Bussed

Package Style: S= SOIC, J= SOJ

Resis.Code 1%: 3 signif. figures & multiplier (10R0=10Ω, 1000=100Ω, 1001=1K, 1002=10K, 1003=100K, 1004=1M)

Resis.Code 2%-5%: 2 signif. figures & multiplier (100=10Ω, 101=100Ω, 102=1KΩ, 103=10K, 104=100K, 105=1M, etc.)

Tolerance: J=5% (standard), G=2%, F=1%

Packaging: B = Bulk, M = Magazine, T = Plastic Tape

Termination: W= Lead-free, Q= Tin/Lead (leave blank if either is acceptable)

Option ZZ Lead Forming



Available on RCD's axial-lead resistor and inductor models from 1/2W to 5W body sizes (up to 50W available on custom basis).

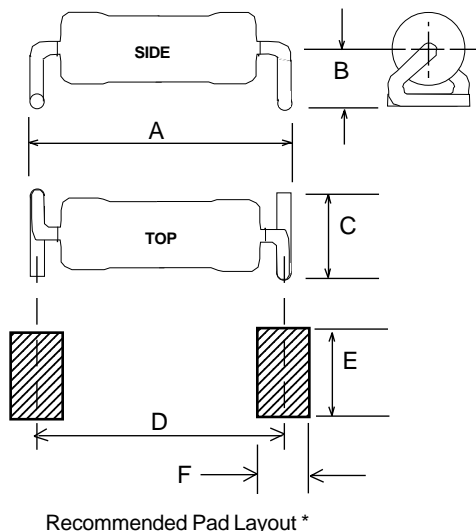

RCD TYPE	A	B	C	D	E	F
SMALL (RCD type 133, 135, 232, AL05, ATB206, BW2F, CC1/2, CF100, CF100S, CFZ75, CFZ100, F2S, GP65, FP65, MA206, MF60, PCN1S, PF0410, PMF1/8, PMF1/4S, P0410, PR1/2, RG1S, RH1/2, RMF2, RSF1B, RW1, & RW2)	.625 ± .024 [15.88 ± .6]	.165 ± .032 [4.19 ± .8]	.260 ± .032 [6.6 ± .8]	.598 [15.2]	.315 [8]	.157 [4]
MEDIUM (RCD type 140, 150, 155, 235, 255, BW3F, CC1, CF200S, CFZ200, F3S, FP70, GP70, HM65, MF65, PCN2S, PMF1/4, PR1, RG1, RH1, RMF3, RSF2B, & RW3)	.825 ± .032 [20.95 ± .8]	.165 ± .036 [4.19 ± .9]	.300 ± .032 [7.6 ± .8]	.793 [20.1]	.355 [9]	.157 [4]
LARGE (RCD type 156, 160, ATS160, CF300, CFZ300, HM70, MF70, PCN2, PMF1/2, PR2, Q70, RMF5S, RW5, & SA102)	1.07 ± .04 [27.18 ± 1.0]	.200 ± .04 [5.1 ± 1]	.260 ± .032 [6.6 ± .8]	1.035 [26.3]	.315 [8]	.157 [4]

* **Application Note:** Give due consideration to PCB layout, ambient temperature, and air convection to ensure that the component body, solder joints, and PCB surface do not exceed respective temperature ratings. Most resistor products, especially miniature body sizes and power types are designed to run fairly hot at full rated power. Traditionally these through-hole parts would be raised well above the circuit board to prevent PCB charring or solder joint fatigue. Use of shorter lead lengths and reduced PCB clearance associated with Option ZZ forming may require power derating. It is generally advisable to increase mounting pad dimensions to act as heat sinks in the event that applied power exceeds 60% of rating.

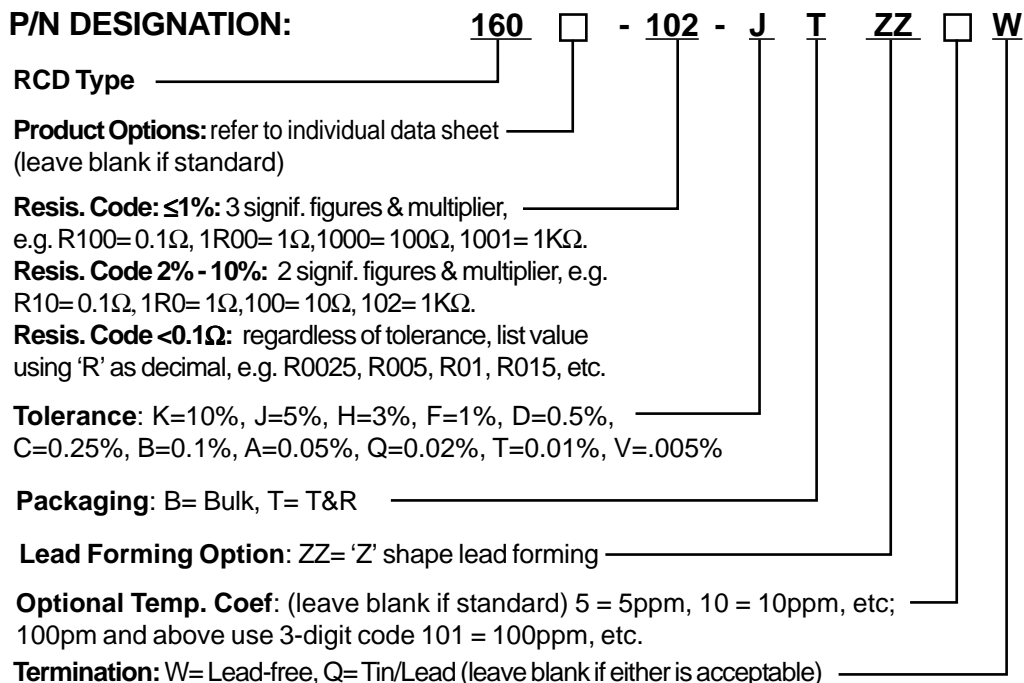

RESISTOR AND CAPACITOR KITS LAB KITS

- ❑ Low cost - prices start at \$19.95! Most Popular models are highlighted below (consult factory for full range of kits)
- ❑ Thick- and thin-film resistors, ceramic & tantalum capacitors
- ❑ Great for engineering labs and prototyping. Refills available
- ❑ Packaged in compartmentalized containers or looseleaf binders
- ❑ Lead-free RoHS kits available (add 'W' to end of p/n)
- ❑ Custom kits including non-standard values available
- ❑ **New!** 0201, 0402 & 0603 resistor chip kits available (contact factory)



0805 1/8W 5% Thick Film Resistor

P/N MC0805-KIT-J10: 10 pieces each, MC0805, 122 values, 10Ω-1M, 200ppm, includes zero-ohm, 1220 pcs total. ("J" Kit includes all standard E-24 values and zero ohm).

P/N MC0805-KIT-J50: same as MC0805-KIT-J10 except 50 pieces each, 6100 pcs total. ("J" Kit includes all standard E-24 values and zero ohm).

0805 1% Thick Film Resistor

P/N MC0805-KIT-F10: 10 pieces each, MC0805, 72 values (see table), 10Ω-1M, 100ppm, 720 pcs total.

P/N MC0805-KIT-F50: same as MC0805-KIT-F10 except 50 pieces each, 3600 pcs total.



0402 Ceramic Capacitor NPO/X7R/Y5V Assortment

P/N CE0402-KIT-A10: 18 popular values, 0402 size, 50V, 10 pcs each (180pcs total). For 25pcs (450pcs total) change "10" at end of P/N to "25"; for 50pcs (900 total) change to "50", for 100pcs (1800 total) change to "100".
 NPO ±.25pF: 1pF, 2.2pF, 3.3pF, 4.7pF, 6.8pF
 NPO ±5%: 10pF, 22pF, 33pF, 47pF, 68pF, 100pF, 220pF
 X7R ±10%: 470pF, 1000pF, 2200pF, 3300pF, 4700pF,
 Y5V ±20%: 0.01uF

0603 Ceramic Capacitor NPO/X7R/Y5V Assortment

P/N CE0603-KIT-A10: 20 popular values, 0603 size, 50V, 10 pcs each (200pcs total). For 25pcs (500pcs total) change "10" at end of P/N to "25"; for 50pcs (1000 total) change to "50", for 100pcs (2000 total) change to 100.
 NPO ±.25pF: 1pF, 2.2pF, 3.3pF, 4.7pF, 6.8pF
 NPO ±5%: 10pF, 22pF, 33pF, 47pF, 68pF, 100pF, 220pF, 470pF, 1000pF
 X7R ±10%: 2200pF, 3300pF, 4700pF, 0.01uF
 Y5V ±20%: , 0.1uF, 1uF

0805 Ceramic Capacitor NPO/X7R/Y5V Assortment

P/N CE0805-KIT-A10: 20 popular values, 0805 size, 50V, 10 pcs each (200 pcs total). For 25pcs (500pcs total) change "10" at end of P/N to "25"; for 50pcs (1000 total) change to "50", for 100pcs (2000 total) change to 100.
 NPO ±.25pF: 1pF, 2.2pF, 3.3pF, 4.7pF, 6.8pF
 NPO ±5%: 10pF, 22pF, 33pF, 47pF, 68pF, 100pF, 220pF, 470pF, 1000pF
 X7R ±10%: 2200pF, 3300pF, 4700pF, 0.01uF
 Y5V ±20%: , 0.1uF, 1uF

1206 1/4W 5% Thick Film Resistor

P/N MC1206KIT-C10: 10 pieces each, MC1206, 24 values (0, 10, 47, 100, 150, 470, 680, 1K, 1.5K, 2.2K, 3.3K, 4.7K, 6.8K, 10K, 15K, 22K, 33K, 47K, 68K, 100K, 150K, 470K, 680K, 1M), 240 pcs total.

P/N MC1206-KIT-J10: 10 pieces each, MC1206, 122 values 10Ω-1M, 200ppm, includes zero-ohm, 1220 pcs total. For this same kit except 50 pcs each, 6100 pcs total, specify MC1206-KIT-J50.

1206 1/4W 1% Thick Film Resistor

P/N MC1206-KIT-F10: 10 pieces each, MC1206, 72 values (see table), 10Ω-1M, 100ppm, 720 pcs total.

MC1206-KIT-F50: same as MC1206-KIT-F10 except 50 pieces each, 3600 pcs total.

0805 1/8W 0.5% Thin Film Resistor

BLU0805-KIT-D100: 100 pcs each, BLU-0805, 97 values, all standard E24 values 10Ω-100K, 9700 pcs total. TC=25ppm above 100Ω.

1206 1/4W 1% Thin Film Resistor

P/N BLU1206-KIT-F100: 100 pieces each, BLU-1206, 106 values, all standard E24 values 10Ω-240K, 10,600 pcs total. TC=25ppm above 100Ω.

72 Values included in 1% MC Kits (MC0805-KIT-F10 & -F50, MC1206-KIT-F10 & -F50)

10	40.2	130	464	2K	10K	36.5K	110K
12.1	47.5	150	499	2.37K	10.7K	40.2K	150K
15	49.9	200	511	3.01K	12.1K	47.5K	162K
20	51.1	221	523	4.32K	15K	49.9K	200K
21.5	56.2	274	562	4.75K	20K	56.2K	301K
22.1	64.9	280	619	4.99K	22.1K	75K	332K
24.3	75	324	750	5.11K	29.4K	82.5K	499K
30.1	100	332	1K	5.62K	30.1K	90.9K	750K
39.2	121	432	1.5K	7.5K	33.2K	100K	1M



Tantalum Capacitor Assortment

P/N TS-KIT-A10: Assortment of the 12 most popular values, 1 uH to 100uH, ±10%, 6 VDC to 50 VDC, 10 pieces each (120 pieces total). For 25 pcs each (300 pcs total) change "10" at end of P/N to "25"; for 50 pcs each (600 pcs total) change to "50", for 100 pcs each (1200 total) change to "100".

- 6 VDC 100 uF case D (7343)
- 10 VDC 6.8 uF case B (3528)
- 10 VDC 15 uF case C (6032)
- 16 VDC 4.7 uF case B (3528)
- 16 VDC 6.8 uF case C (6032)
- 16 VDC 10 uF case C (6032)
- 16 VDC 33 uF case D (7343)
- 16 VDC 47 uF case D (7343)
- 25 VDC 1.5 uF case B (3528)
- 35 VDC 1.0 uF case B (3528)
- 35 VDC 1.5 uF case C (6032)
- 35 VDC 4.7 uF case D (7343)
- 50 VDC 1.0 uF case C (6032)

CUSTOM NETWORKS

DSN SERIES - SIP Networks

DDN SERIES - DIP Networks

DLN SERIES - SM Networks



RESISTORS • CAPACITORS • COILS • DELAY LINES



Term.W is Pb-free and RoHS compliant



- Industry's widest range of custom networks!
 - Available on exclusive **SWIFT™** delivery program
 - Very economical in any volume
 - SIP package sizes: 3 to 12-pin std., (2 to 40-pin avail.)
 - DIP package sizes: 14 & 16-pin std., (4 to 40-pin avail.)
 - Resistor matching to .005% 1PPM TC
 - Wide range of custom and low-profile sizes available.
- Custom circuits are designed to the specific application utilizing virtually any combination of R/L/C/D components.

Custom R/L/C/D networks with little or no tooling charge!

RCD's custom networks are a cost effective approach for numerous applications. Networks can be comprised solely of resistors, capacitors, inductors, diodes, or any combination. Depending on the requirements, custom networks are produced via monolithic (single substrate) or discrete construction. Discrete networks utilize various chip or leaded components welded or soldered into a circuit, then encapsulated into a molded epoxy case. Discrete networks provide wide design flexibility, fast delivery, and low set-up costs. Monolithic networks are conformal coated and generally enable lowest cost in medium to higher volumes.

SERIES DSN SIP DIMENSIONS

Odd pin counts also available

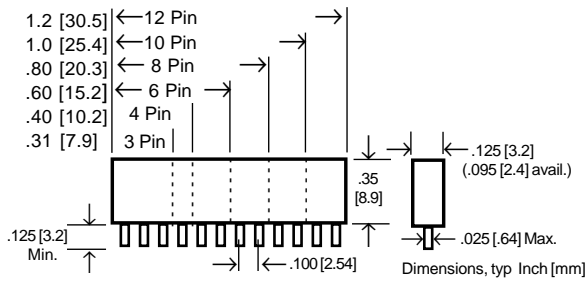

SERIES DDN DIP

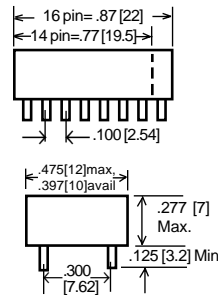

SERIES DLN SURFACE MOUNT

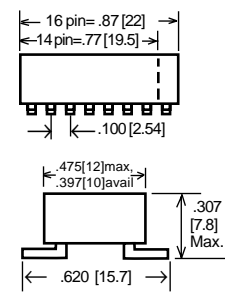

DSN STANDARD CONFIGURATIONS

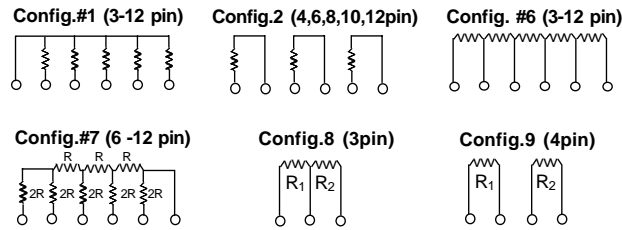

Standard configurations have single resistance value per package except Config's 7, 8, & 9.

DDN & DLN STANDARD CONFIGURATIONS

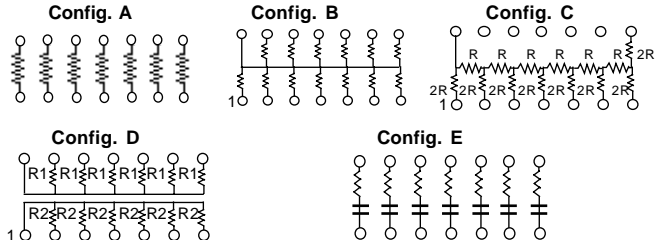

TYPICAL CUSTOM CONFIGURATIONS: (part numbers are assigned by factory)

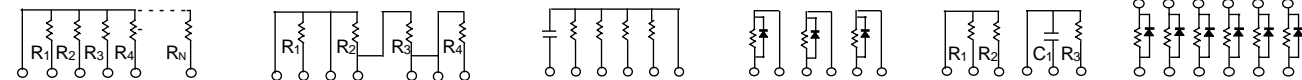

SPECIFICATIONS:

Resistors (thick-film, thin-film, wirewound, foil, composition): 0.005Ω to 4000Meg, ±0.005% to 5%, ±2 to 200ppm, .125W is standard (available up to 1W)

Capacitors (ceramic or tantalum):
 NPO: 0.47pf - 0.1pf, ±0.5% to ±10%
 X7R: 100pf - 2.2μf, ±2% to ±20%
 X5R: 100pf - 10μf, ±2% to ±20%
 Z5U/Y5V: 1000pf-10μf, ±10% to +80-20%
 Tantalum: 0.1uF - 220uF, ±1% to ±20%

Diodes: fast speed diodes such as 1N3595, 1N4148, 1N4150, etc., Schottky, Germanium, etc.

Inductors (thick-film, thin-film, wirewound): 1nH to 1000uH, ±10% (±1% to ±20% avail)

P/N DESIGNATION: (consult factory for non-std circuits)

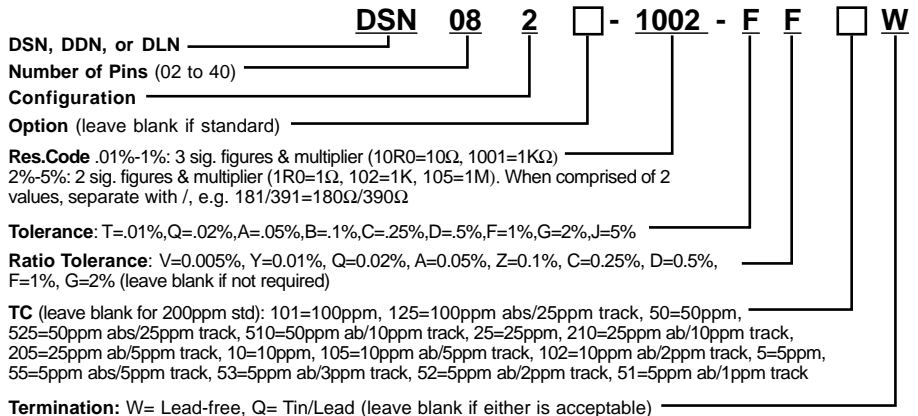

PRECISION THIN FILM SIP NETWORKS

CP SERIES



- Ultra-precision performance and environmental stability
- Tolerances to 0.1%, matching to 0.05%
- Temperature coefficients to ± 5 ppm, TC tracking to ± 1 ppm
- Custom configurations available
- For tighter tolerances, mixed values, custom circuits, etc., refer to DSN Series

Unsurpassed performance levels!

RCD's CP Series conformal coated SIPs were developed to offer performance levels unattainable in thick film networks. Series CP networks meet the need for ultra-precision requirements when product reliability is a must. Pricing remains competitive due to automated production.

DERATING

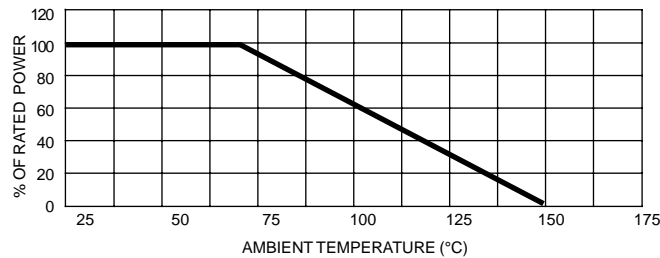

DIMENSIONS

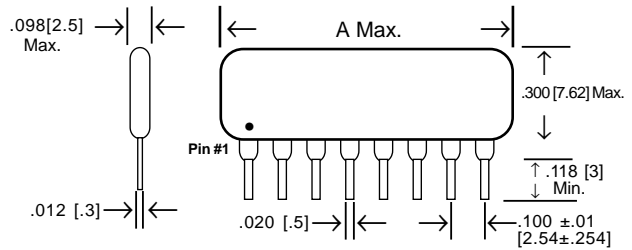

RESISTANCE RANGE

Configuration Number	Resistance Range		
	15ppm*	25ppm	50ppm
1	1K Ω to 10K Ω	100 Ω to 30K Ω	50 Ω to 50K Ω
2	1K Ω to 30K Ω	100 Ω to 75K Ω	50 Ω to 100K Ω

* 5 and 10ppm available, consult factory.

Number of Pins	Dimension 'A'
5	0.550 [14.0]
6	0.650 [16.5]
7	0.750 [19.0]
8	0.850 [21.6]
9	0.950 [24.1]
10	1.050 [26.7]

POWER RATINGS

Circuit Type	Single Resis.	Package Power					
		5 Pin	6 Pin	7 Pin	8 Pin	9 Pin	10 Pin
Config. 1	0.12W	.4W	0.5W	0.6W	0.7W	0.8W	0.9W
Config. 2	0.15W	-	0.3W	-	0.4W	-	0.5W

STANDARD CONFIGURATIONS

(Custom configurations available.)

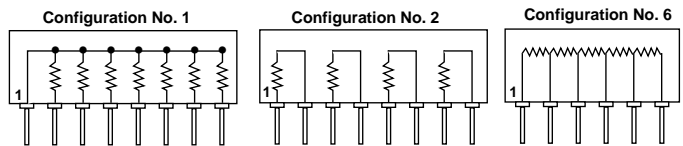

PERFORMANCE SPECIFICATIONS, Typical

Operating Temperature	-55°C to +150°C
Maximum Voltage	100V
Insulation Resistance	10,000 M Ω
Temperature Cycling	$\pm 0.1\%$ Max.
Short-Time Overload	$\pm 0.1\%$ Max.
Resistance to Solder Heat	$\pm 0.1\%$ Max.
Moisture Resistance	$\pm 0.25\%$ Max.
Load Life	$\pm 0.25\%$ Max.
Vibration	$\pm 0.1\%$ Max.

P/N DESIGNATION:

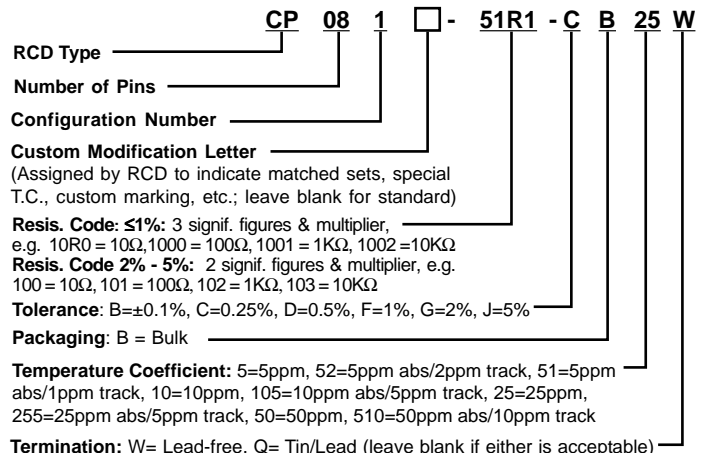

THICK FILM SIP NETWORKS

CL SERIES - Low Profile

C SERIES - High Power

- ☐ Low cost! Widest selection in the industry!
- ☐ Low profile CL Series available from stock (config.1 & 2, 6-pin,8-pin, and 10-pin)
- ☐ Wide resistance range: 10Ω to 3MΩ
- ☐ Available on tape & reel
- ☐ 4-pin through 14-pin standard (2 through 20-pin available)
- ☐ R/2R Ladder Networks (Config. 7) offer 1/2LSB accuracy from 4 to 10 bits



Term.W is Pb-free and RoHS compliant

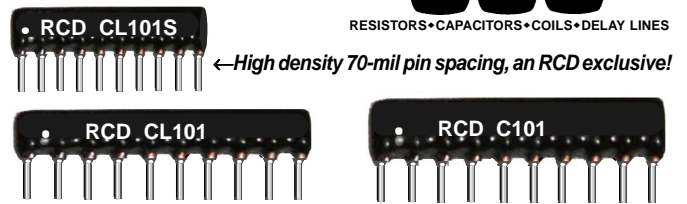

- ☐ **OPTION V** - +200°C temperature Range
- ☐ **OPTION S** - Super high density (.070" pin spacing)
- ☐ **OPTION P** - Pulse tolerant design
- ☐ **OPTION N** - Narrowline design (.070" thick)
- ☐ **OPTION F** - Flameproof coating
- ☐ **OPTION C** - Copper alloy terminals
- ☐ Available in custom circuits with multiple values/capacitors/diodes, increased power & voltage, tolerance & TC matching, longer pins, special marking, military screening, resis. values 1Ω to 1000M, etc.

STANDARD CONFIGURATIONS

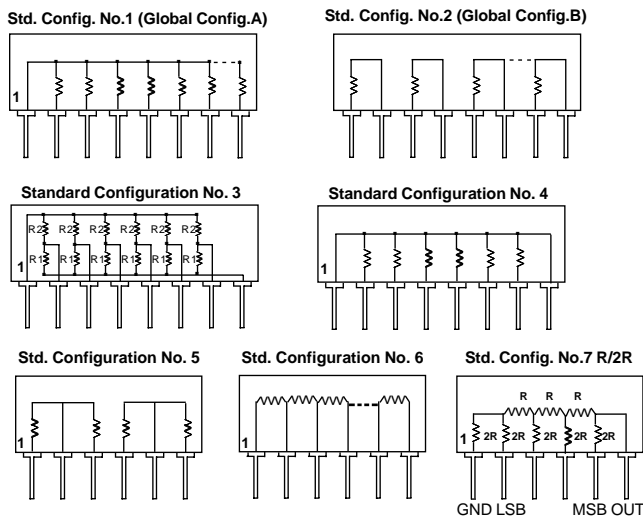

STANDARD VALUES- Config. 1, 2, 4, 5, 6:

22Ω to 1M* in E-24 values (preferred values in bold type)-
10, 11, 12, 13, 15, 16, 18, 20, 22, 24, 27, 30, 33, 36, 39, 43, 47,
 51, **56, 62, 68, 75, 82, 91** *non-standard values 10Ω to 3M avail.

STANDARD VALUES - Config. 3, Dual Terminator, R₁/R₂ :

81/130	160/260	220/270	330/470
120/195	162/260	220/330	330/680
121/195	180/390	330/390	3K/6.2K

R/2R LADDER NETWORKS (Config.7): 4Bit/6-pin, 5Bit/7-pin, 6Bit/8-pin, 7Bit/9-pin, 8Bit/10-pin, 9Bit/11-pin, and 10Bit/12-pin. Available in Series C (low profile Series CL n/a). Linearity accuracy is 1/2LSB. Standard values are 5KΩ, 10KΩ, 25KΩ, 50KΩ, & 100KΩ ±2%.

P/N DESIGNATION:

CL 08 2 **- 102 - G B** **W**

CL= low profile (std), C= high power
 Number of Pins
 Configuration Number
 Options: V,S,P,N,F,C (leave blank if std)
 Resis.Code 1%: 3 signif. figures & multiplier, (e.g. 10R0=10Ω, 1000=100Ω, 1001=1K, 1004=1M)
 Resis.Code 2%-5%: 2 signif. figures & multiplier, (e.g. 100=10Ω, 101=100Ω, 102=1K, 103=10K, 104=100K, 105=1M)
 When comprised of 2 res.values (config.3&7) separate with /, e.g. 181/391=180Ω/390Ω
 Tolerance Code: G=2% (standard), F=1%, J=5%
 Packaging: B=Bulk, A3=3 pin taping Ammo pack, M=Magazine Tube
 Opt. TC: 50=50ppm, 101=100ppm (leave blank if standard)
 Termination: W= RoHS compliant, Q= Tin/Lead (leave blank if both acceptable)

DIMENSIONS

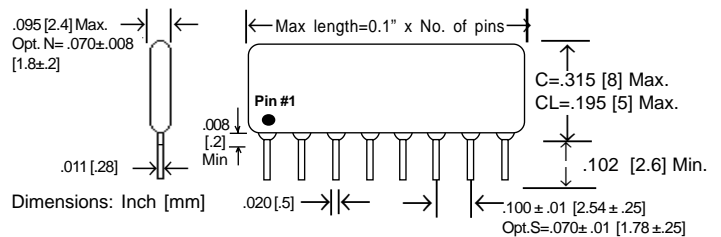

RCD Type	SINGLE RESISTOR POWER RATING*			PACKAGE POWER RATING*						
	Config. 1,3,4,5,6	Config. 2	Config. 3, 7	4-Pin	6-Pin	7-Pin	8-Pin	9-Pin	10-Pin	12-Pin
C	.3W	.5W	.17W	1W	1.5W	1.75W	2W	2.25W	2.5W	3W
CL	.2W	.3W	.125W**	.5W	1W	1.25W	1.5W	1.75W	2W	2.5W

* 25 deg C. Reduce wattage ratings by 1/3 for Opt.S **Config. 7 n/a in CL Series

DERATING (Series C and CL)

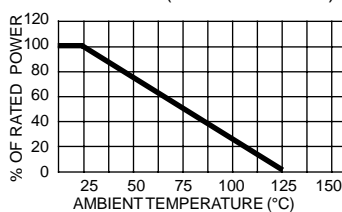

DERATING (Option V)

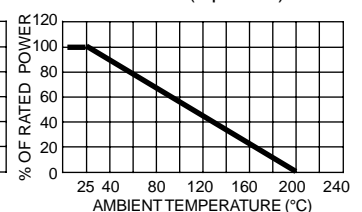

TYPICAL PERFORMANCE SPECIFICATIONS

Standard Tolerance	2% >=100Ω, 5% <100Ω (1% avail.)
Temperature Coefficient	±100ppm typ (±250ppm <50Ω & >2.2M)
TCR Tracking	50PPM typical
Operating Temperature	-55°C to +125°C (+200°C Opt.V)
Max. Working Voltage	200V Series C, 100V Series CL & Opt.S
Short Time Overload	±0.5% (2.5x rated V, 5S, nte 2xW)
Resistance to Solder Heat	±0.25% (350°C, 5S)
Moisture Resistance	±1%
Terminal Strength	±0.25%
Thermal Shock	±0.5%
Load Life (1000 hours)	±1.0%
Temperature Cycling	±0.5%
Shock and Vibration	±0.25%
Lead Solderability	Meets MIL-R-83401
Marking*	Pin #1 ID, resis value, & tol as minimum*
Terminals	Solder plated steel typ., copper alloy avail**

*Parts may be marked with Std or Global configuration code
 ** RCD recommends use of copper alloy terminals (opt. C) in aqueous cleaning systems

CAPACITOR AND RESISTOR/CAPACITOR NETWORKS

RC SERIES



- ☐ Widest selection in the industry!
- ☐ Low cost resulting from automated production
- ☐ PCB space savings over discrete components
- ☐ Custom circuits available
- ☐ Exclusive **SWIFT™** delivery available (refer to DSN series)
- ☐ Options include voltage ratings to 2KV, multiple values, custom marking, low profile & narrow profile designs, diodes, etc.

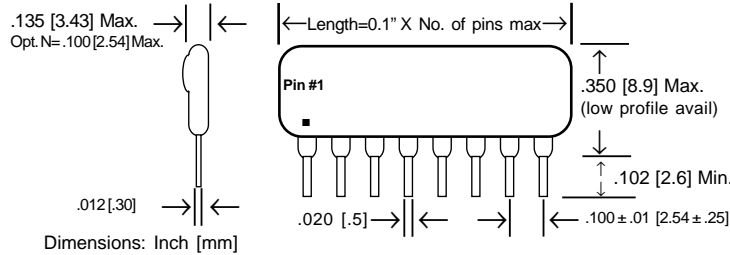

STANDARD SCHEMATICS (Custom circuits available)

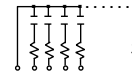

RC-01
(4, 5, 6, 7, 8, 9, 10, 11, 12, 13, 14 pin)

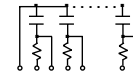

RC-02
(5, 7, 9, 11, 13 pin)

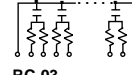

RC-03
(5, 7, 9, 11, 13 pin)

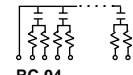

RC-04
(5, 7, 9, 11, 13 pin)

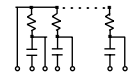

RC-05
(5, 7, 9, 11, 13 pin)

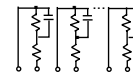

RC-06
(4, 6, 8, 10, 12, 14 pin)

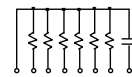

RC-07
(8 pin)

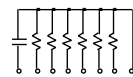

RC-08
(8 pin)

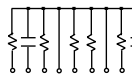

RC-09
(10 pin)

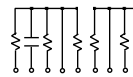

RC-10
(10 pin)

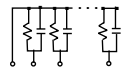

RC-11
(4, 5, 6, 7, 8, 9, 10, 11, 12, 13, 14 pin)

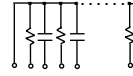

RC-12
(5, 7, 9, 11, 13 pin)

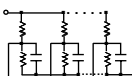

RC-13
(4, 5, 6, 7, 8, 9, 10, 11, 12, 13, 14 pin)

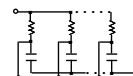

RC-14
(4, 5, 6, 7, 8, 9, 10, 11, 12, 13, 14 pin)

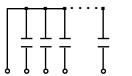

RC-15
(4, 5, 6, 7, 8, 9, 10, 11, 12, 13, 14 pin)

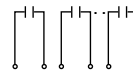

RC-16
(4, 6, 8, 10, 12, 14 pin)

SPECIFICATIONS

RESISTORS

Resistance Range: 22Ω to 1MΩ standard, 1Ω to 100M avail.
 Tolerance: ±5% standard, ±2% and ±1% available
 Temp. Coefficient: ±100ppm typ (±250ppm <50Ω & >2.2M)
 Voltage rating: 50V (up to 1KV available)
 Operating Temp: -55° C to +125°C
 Power Rating: .2W @25°C (package power = .125W/pin)

CAPACITORS

Capacitance Range: 10pF to 0.1μF standard, 0.5pF to 10μF avail.
 Voltage rating: 50V standard, 6.3V to 2KV available
 Dielectric: COG(NPO), X7R, X5R, Y5V, Z5U*
 Standard capacitance values & dielectrics: refer to table below (most popular models listed in bold). Any combination of chips from RCD's CE Series can be utilized on a custom basis.

P/N CODE	CAP. VALUE	TOL.	TYPE	VOLTAGE
100KG	10pF	10%	NPO/COG	50V
220KG	22pF	10%	NPO/COG	50V
330KG	33pF	10%	NPO/COG	50V
470KG	47pF	10%	NPO/COG	50V
560KG	56pF	10%	NPO/COG	50V
680KG	68pF	10%	NPO/COG	50V
101KG	100pF	10%	NPO/COG	50V
151KG	150pF	10%	NPO/COG	50V
221KG	220pF	10%	NPO/COG	50V
331KG	330pF	10%	NPO/COG	50V
471KG	470pF	10%	NPO/COG	50V
561KG	560pF	10%	NPO/COG	50V
681KG	680pF	10%	NPO/COG	50V
102MR	1000pF	20%	X7R	50V
222MR	2200pF	20%	X7R	50V
472MR	4700pF	20%	X7R	50V
103MR	.01μF	20%	X7R	50V
223ZV	.022μF	+80%/-20%	Y5V*	50V
333ZV	.033μF	+80%/-20%	Y5V*	50V
473ZV	.047μF	+80%/-20%	Y5V*	50V
683ZV	.068μF	+80%/-20%	Y5V*	50V
104ZV	0.1μF	+80%/-20%	Y5V*	50V

* Y5V is standard, Z5U is available (Y5V & Z5U are considered interchangeable)

P/N DESIGNATION: RC 08 01 - 102 J 561 K G W

Type (RC Series) _____
 Number of Pins (4 -14 std, 2 -20 avail) _____
 Configuration Number _____
 Options: assigned by RCD, leave blank if std _____
 Resis.Code (Ω) 2 signif. figures & multiplier, (e.g. 100=10Ω, 101=100Ω, 102=1K, 105=1M) _____
 Resistor Tol. Code: J=5% (standard), G=2% _____
 Capac. value (pF) 2 signif. figures & multiplier, e.g. 100=10pF, 101=100pF, 102=1000pF, 104=100000pF (.1uF) _____
 Capac. Tol. Code: J=5%, K=10%, M=20%, Z=+80%/-20% _____
 Cap. Voltage (if other than std 50V): 006=6.3V, 010=10V, 016=16V, 025=25V, 101=100V, 201=200V, 501=500V, 102=1KV, 202=2KV. _____
 Cap. Dielectric: G=COG(NPO), R=X7R, X=X5R, U=Z5U, V=Y5V _____
 Termination: W= Lead-free, Q= Tin/Lead (leave blank if either is acceptable) _____

SPECIAL PURPOSE NETWORKS & VOLTAGE DIVIDERS

VDS SERIES Voltage Dividers



Term. W is Pb-free and RoHS compliant

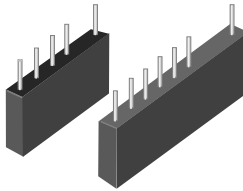

- 2 through 7-decade voltage dividers with ratios from 1:1 to 1,000,000:1
- 1200 & 1500V models standard (up to 20KV available)
- Ratio accuracy to $\pm 0.01\%$, 2ppm TC
- Temp. Range: -55 to +125°C

RCD Type	Resistance Values					
	R1	R2	R3	R4	R5	R6
V5A91	9Meg	900K	90K	9K	1k	-
V5A99	9Meg	900K	90K	9K	900	-
V5A11	10Meg	1.1111M	101.01K	10.01K	1.001K	-
V5B91	9Meg	900K	90K	9K	1k	-
V5B99	9Meg	900K	90K	9K	900	-
V5B11	10Meg	1.1111M	101.01K	10.01K	1.001K	-
V5C91	9Meg	900K	90K	9K	1k	-
V5C99	9Meg	900K	90K	9K	900	-
V5C11	10Meg	1.1111M	101.01K	10.01K	1.001K	-
V6A91	9Meg	900K	90K	9K	900	100
V6A99	9Meg	900K	90K	9K	900	90

P/N DESIGNATION (standard models): **V5A91 B A 50 / 10 W**

RCD Type **V5A91**

Tolerance: Q=.02%, A=.05%, B=.1%, C=.25%, D=.5%, F=1%

Ratio Tol: Y=.01%, Q=.02%, A=.05%, Z=.1%, C=.25%, D=.5% (leave blank if not req'd)

TC: 5=5ppm/°C, 10=10ppm 15=15ppm, 25=25ppm, 50=50ppm

TC Track: 3=3ppm/°C, 5, 10, 15, 25, 50 (leave blank if not required)

Termination: W= Lead-free, Q= SnPb (leave blank if either is acceptable)

P/N FA2779 - Our most popular model (available from stock)

High precision enables universal application at a price comparable to lower grade models.

- TCR: 25ppm absolute
- TC Track: 2.5ppm (R6=5ppm)
- Resis. Tol: $\pm 0.1\%$ absolute
- Ratio Tol: $\pm 0.03\%$
- Working Voltage: 1200V

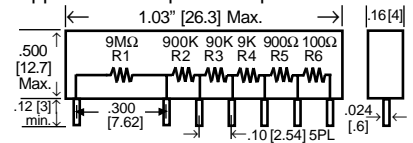

Standard models

(numerous custom models are also available from 2 through 7 decades):

P/N V5A 5-Decade 1200V

- TCR: $\pm 5, 10, 15, 25,$ or 50ppm
 TC Track: 3, 5, 10, 25, 50ppm
 Res. Tol: $\pm 0.05, .1\%, .25\%, .5\%$
 Ratio Tol: $\pm 0.03\%$ to 0.5%

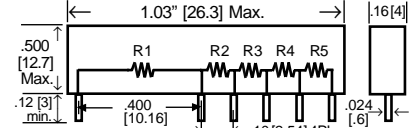

P/N V5B 5-Decade 1200V

- TCR: $\pm 5, 10, 15, 25,$ or 50ppm
 TC Track: 3, 5, 10, 25, 50ppm
 Res. Tol: $\pm 0.05, .1\%, .25\%, .5\%$
 Ratio Tol: $\pm 0.03\%$ to 0.5%

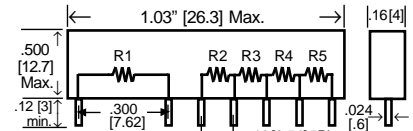

P/N V5B 5-Decade 1500V

- TCR: $\pm 5, 10, 15, 25,$ or 50ppm
 TC Track: 3, 5, 10, 25, 50ppm
 Res. Tol: $\pm 0.05, .1\%, .25\%, .5\%$
 Ratio Tol: $\pm 0.03\%$ to 0.5%

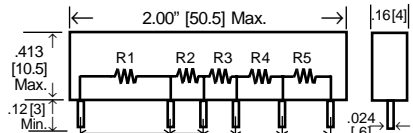

P/N V6A 6-Decade 1200V

- TCR: $\pm 5, 10, 15, 25,$ or 50ppm
 TC Track: 3, 5, 10, 25, 50ppm
 Res. Tol: $\pm 0.05, .1\%, .25\%, .5\%$
 Ratio Tol: $\pm 0.03\%$ to 0.5%

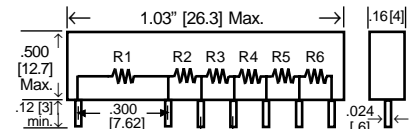

CSS SERIES Current Sensing



Term. W is Pb-free and RoHS compliant

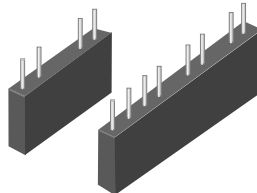

- 4-terminal Kelvin configuration
- Wide variety of single & multi-resistor models
- Current ratings up to 5 amps available
- Resistance range: 0.01Ω to 1 Meg
- Tolerances to $\pm 0.01\%$ ($\pm 0.1\% < 1\Omega$)
- TC's to $\pm 3\text{ppm}/\text{C}$ ($\pm 30\text{ppm} < 1\Omega$)
- Available on exclusive **SWIFT™** delivery program
- Custom configurations available
- Standard sizes: 6, 8, 10, 12 pin SIP's

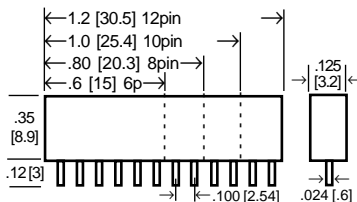
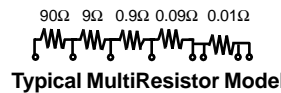
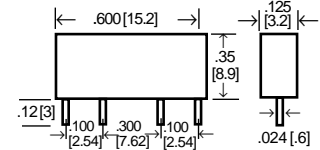
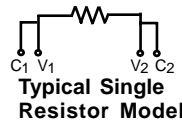

CJ SERIES Jumper Circuits



Term. W is Pb-free and RoHS compliant

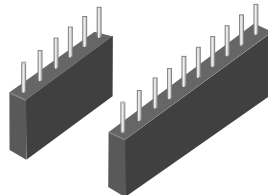

- Custom designed to customer requirement
- 2 amp rating is standard (3, 5, 10 amp available)
- 0.02Ω maximum resistance (0.005Ω available)
- Eliminates costly DIP switches in permanently-fixed circuits
- Available on exclusive **SWIFT™** delivery program
- Available in 6, 8, 10, 12-pin SIP or 14 & 16-pin DIP (custom sizes available). For SM chip jumper arrays, see ZN & ZMN series.

TYPICAL CIRCUITS:

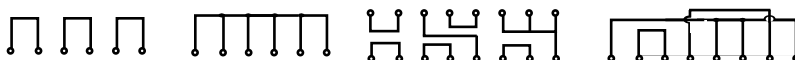

CJS SERIES SIP PACKAGE

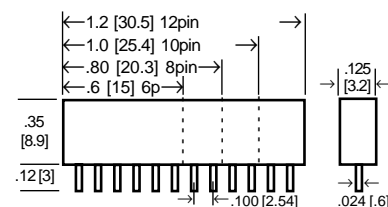

CJD SERIES DIP PACKAGE

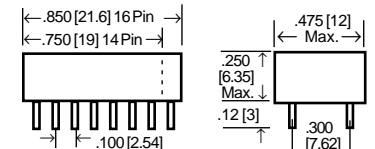

CUSTOM HYBRID PRODUCTS

(Request RCD Hybrid Catalog for complete information)

FEATURES

- Choice of thick-film or thin-film
- High volume specialist!
- SIP, DIP, or LCC packages
- Single or multilayer circuits
- Precision pattern accuracy to .005" line width and spacing
- Crossovers and through hole conductors available
- Surface Mount soldered or wire bonded
- Hermetic sealed construction available
- Wide choice of active and passive components
- Active or passive laser-trim capability



Over 30 years of hybrid experience!

As a thick film specialist, RCD had been supplying premetallized substrates to hybrid manufacturers for years. These substrates typically included all resistors as well as conductor paths and pads, ready for post assembly of additional active or passive components. RCD expanded its capability to include these post assembly operations and began offering completed hybrids in 1979. Typical savings up to 25% have been realized due to RCD's high volume automated production line. Our highly automated European and Far East affiliated factories, can offer the highest quality standards at the most economical price in the industry.

SPECIFICATIONS

Substrate: 96% Alumina (thick film circuits)
99% Alumina (thin film circuits)
FR-4 Glass Epoxy P.C. boards
Insulated Steel (thick film circuits)

Packaging: Conformal Coated
Epoxy Encapsulated
Hermetic Sealed
Ceramic Package

Resistors: Thin Film - 10 Ω to 1 Meg
Tolerances to 0.1%
TCR's to ± 5 ppm/ $^{\circ}$ C
Tracking to 2 ppm/ $^{\circ}$ C

Resistors: Thick Film - 0.5 Ω to 100 Gig (10¹¹ Ω)
Tolerances to 0.5%
TCR's to ± 50 ppm/ $^{\circ}$ C
Tracking to 25 ppm/ $^{\circ}$ C

Conductor: Material - Palladium Silver
Platinum Silver
Palladium Gold
Platinum Gold
Gold
Silver

Components: Active - Transistors
Diodes
Linear IC's
Digital IC's

Components: Passive - Capacitors
(Tantalum, Ceramic)
Inductors
Trimmers

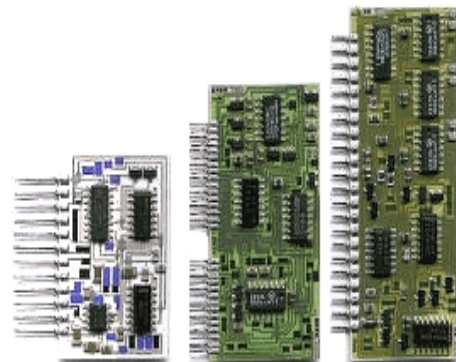
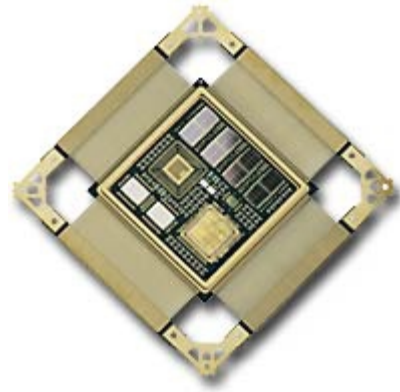

SURFACE MOUNT SUBCONTRACT ASSEMBLY AVAILABLE!

ULTRA PRECISION WIREWOUND RESISTORS

SA, MA, PC, & Q SERIES



RESISTORS • CAPACITORS • COILS • DELAY LINES

- Industry's widest range: 0.1Ω to 25MΩ, tolerances to ±0.005%, TC's to 2PPM
- All-welded, negligible noise, low thermal emf
- Available on RCD's exclusive **SWIFT™** delivery program!



Term. W is Pb-free and RoHS compliant

Series SA (standard), MA (mini), PC (radial), and Q (economy) are designed for precision circuits (DC⁵ and low frequency AC). The standard construction features well-proven wirewound technology. Customized WW and NiCr film designs are available for high-frequency operation. All models are preconditioned thereby enabling excellent stability/reliability.

OPTIONS

- Option P: Increased pulse/overload capability
- Option M: Low reactance NiCr film design
- Option HS: High speed/fast rise time
- Option ER: 100-hr stabilization burn-in⁴
- Matched tolerances, T.C. tracking to 1ppm/°C
- Dozens of additional modifications are available... special marking, positive TC, hermetic seal, 4-terminal, low inductance, etc. Custom designs are RCD's specialty!

Performance (Opt ER, typ)	SA/MA/PC	Q Series
Load Life	±.03%	±.05%
Short Time Overload	±.005%	±.02%
High Temp Exposure	±.05%	±.1%
Moisture	±.02%	±.03%
Operating Temp	-55 to +145°C	-55 to +160°C
Shelf Life Stability	±.002%/year	±.004%/year
Temp Coef ≥10Ω	20ppm (2,3,5,10 avail)	20ppm (2,3,5,10 avail)
1 - 9.9Ω	30ppm (5,10,20 avail)	30ppm (5,10,20 avail)
<1Ω	90ppm (10,20,30 avail)	90ppm (10,20,30avail)

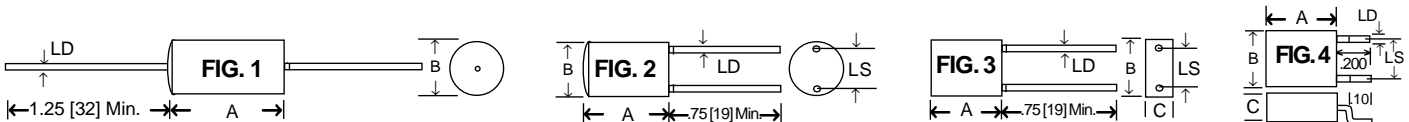

RCD TYPE	FIG.	MIL TYPE ¹	Wattage Rating		Maximum Voltage ^{2,3}	Res. Range 0.1Ω to ~	A		LD	LS	C (Max)
			RCD ^{2,4}	MIL ⁴			±.062 [1.6]	±.025 [.64]			
SA100	1	RB/RBR56	.25	.125	200	1.2 Meg	.350 [8.9]	.250 [6.35]	.032 [.81]	-	-
SA101	1	RB/RBR55	.33	.150	400	2.0 Meg	.500 [12.7]	.250 [6.35]	.032 [.81]	-	-
SA102	1	RB/RBR54	.50	.250	400	4.0 Meg	.750 [19.1]	.250 [6.35]	.032 [.81]	-	-
SA103	1	-	.75	-	500	5.0 Meg	1.00 [25.4]	.250 [6.35]	.032 [.81]	-	-
SA104	1	RB/RBR53	.60	.33	400	6.0 Meg	.750 [19.1]	.375 [9.52]	.032 [.81]	-	-
SA105	1	RB/RBR52	1.00	.50	600	10.0 Meg	1.00 [25.4]	.375 [9.52]	.032 [.81]	-	-
SA106	1	-	.60	-	400	6.0 Meg	.675 [17.1]	.437 [11.1]	.032 [.81]	-	-
SA107	1	-	1.25	-	700	12.0 Meg	1.00 [25.4]	.437 [11.1]	.032 [.81]	-	-
SA108	1	-	.60	-	400	7.0 Meg	.675 [17.1]	.500 [12.7]	.032 [.81]	-	-
SA109	1	RB/RBR57	1.25	.75	800	15.0 Meg	1.00 [25.4]	.500 [12.7]	.032 [.81]	-	-
SA110	1	RB/RBR58	1.50	1.00	900	20.0 Meg	1.50 [38.1]	.500 [12.7]	.032 [.81]	-	-
SA111	1	RB/RBR59	2.00	1.25	1000	25.0 Meg	2.00 [50.8]	.500 [12.7]	.032 [.81]	-	-
MA200	1	-	.05	-	100	200K	.250 [6.35]	.100 [2.54]	.020 [.51]	-	-
MA201	1	-	.05	-	100	250K	.300 [7.62]	.100 [2.54]	.020 [.51]	-	-
MA202	1	-	.10	-	100	300K	.250 [6.35]	.125 [3.18]	.023 [.58]	-	-
MA203	1	-	.10	-	100	400K	.312 [7.92]	.125 [3.18]	.023 [.58]	-	-
MA204	1	-	.12	-	150	800K	.380 [9.65]	.142 [3.61]	.023 [.58]	-	-
MA205	1	-	.125	-	200	900K	.500 [12.7]	.160 [4.06]	.023 [.58]	-	-
MA206	1	-	.15	-	200	900K	.380 [9.65]	.187 [4.75]	.025 [.64]	-	-
MA207	1	-	.2	-	200	1.2 Meg	.500 [12.7]	.187 [4.75]	.025 [.64]	-	-
Q55	1	RN/RNR55	.125	.125	200	100K	.250 [6.35]	.105 [2.67]	.023 [.58]	-	-
Q60	1	RN/RNR60	.250	.250	300	150K	.380 [9.65]	.142 [3.61]	.023 [.58]	-	-
Q65	1	RN/RNR65	.500	.500	350	200K	.520 [13.20]	.188 [4.78]	.025 [.64]	-	-
Q70	1	RN/RNR70	.750	.750	500	300K	.750 [19.10]	.250 [6.35]	.032 [.81]	-	-
Q75	1	RN/RNR75	1.00	1.00	600	500K	1.02 [25.9]	.375 [9.53]	.032 [.81]	-	-
PC400	2	-	.15	-	200	500K	.250 [6.35]	.250 [6.35]	.023 [.58]	.200 [5.08]	-
PC401	2	RB/RBR71	.25	.125	400	750K	.312 [7.29]	.250 [6.35]	.023 [.58]	.200 [5.08]	-
PC402	2	-	.25	-	400	1 Meg	.375 [9.52]	.250 [6.35]	.023 [.58]	.200 [5.08]	-
PC404	2	-	.30	-	400	1 Meg	.500 [12.7]	.250 [6.35]	.023 [.58]	.200 [5.08]	-
PC405	2	-	.33	-	400	1 Meg	.375 [9.52]	.375 [9.52]	.023 [.58]	.200 [5.08]	-
PC406	2	RB70	.33	.250	400	2 Meg	.500 [12.7]	.375 [9.52]	.032 [.81]	.200 [5.08]	-
PC407	2	-	.50	-	400	2 Meg	.500 [12.7]	.500 [12.7]	.032 [.81]	.300 [7.62]	-
PC408	2	-	.63	-	400	2 Meg	.625 [15.9]	.500 [12.7]	.032 [.81]	.300 [7.62]	-
PC451	3	RNC90	0.3	0.3	300	1 Meg	.336 [8.5] max	.320 [8.1] max	.023 [.58]	.150 [3.81]	.120
PC452	3	-	1.0	-	350	25K	.370 [9.4] max	.610 [15.5] max	.023 [.58]	.500 [12.7]	.135
PC454	3	-	2.0	-	500	100K	.390 [9.9] max	1.12 [28.4] max	.028 ±.004	.900 [22.9]	.260
PC451G	4	-	0.3	-	300	1 Meg	.336 [8.5] max	.320 [8.1] max	.023 [.58]	.150 [3.81]	.120

¹Military p/n's are given for reference only and do not imply qualification or exact interchangeability. ²Increased ratings avail. ³Max. voltage determined by E=(PR)^{1/2}. E not to exceed value listed. ⁴Option ER burn-in is performed at Mil-power rating and 25°C ambient. Additional burn-in and Mil-screening options available. ⁵Standard reactance levels are quite high limiting use to DC or AC circuits <50KHz typ. (depending on size and resistance value). Specialty designs available for use at high frequencies, consult factory.

P/N DESIGNATION: MA207 - 1003 - A B W

RCD Type MA207

Options: P, M, HS, ER (leave blank if standard)

Resis. Code: 3 digits & multiplier (R100= .1Ω, 1R00= 1Ω, 1000= 100Ω, 1001= 1KΩ, 1002= 10K, 1003= 100K, 1004= 1M)

Tolerance Code: F=1%, D=0.5%, C=0.25%, B=0.1%, A=0.05% Q=0.02%, T=0.01%, V=0.005%

Packaging: B = bulk, T = Tape & Reel

Optional Temp. Coefficient - leave blank for standard (2 = ±2ppm/°C, 3 = ±3ppm, 5 = ±5ppm, 10 = ±10ppm, 20 = ±20ppm)

Termination: W= Pb-free, Q= Sn/Pb (leave blank if either is acceptable)

POWER DERATING: Series SA/MA/PC40 resistors shall be derated according to Curve A; Series Q & PC45 per Curve B (resistors with 0.1% or tighter tolerance to be derated 50% per Mil-Std-199).

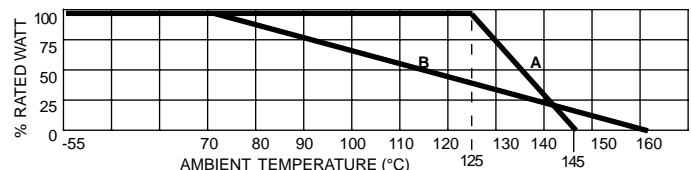

PRECISION POWER WIREWOUND RESISTORS SILICONE COATED 1/2 WATT TO 50 WATT



RESISTORS • CAPACITORS • COILS • DELAY LINES

100 SERIES



Term. W is Pb-free and RoHS compliant

RCD 160F
10KΩ 5%

- World's widest range of axial lead WW resistors! 0.005Ω to 2MΩ, tolerances to ±0.005%, 1/2W to 50W, numerous design options
- Low cost! Available on exclusive **SWIFT™** delivery program

OPTIONS

- Option X: Low Inductance
- Option P: Increased Pulse Capability
- Option F: Flameproof Coating
- Option ER: 100-Hour Burn-In
- Option B: Increased Power
- Radial leads (opt.R), low thermal emf (opt.E), matched sets, special marking, cut & formed leads, hi-rel screening, non-standard values, high voltage, etc. Customized components are RCD's speciality!

DERATING (derate W/V/A ratings when ambient temp. exceeds 25°C): Char. U is the max. power for ±0.5% typ. load life stability & 275°C hotspot, Char. V is max. power for ±3% stability & 350°C hotspot

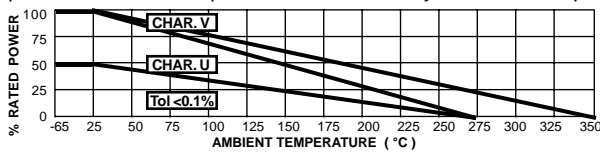

Series 100 resistors offer exceptional performance at an economical cost. Superior stability results from welded construction and windings of premium grade resistance wire on thermally conductive ceramic cores. Hi-temp coating provides excellent environmental protection and solvent resistance. Tin (or SnPb) coated copper or copperweld leads offer excellent solderability and extended shelf life.

PULSE CAPABILITY: Excellent pulse capability results from wirewound construction. The pulse/overload capability can often be economically enhanced by a factor of 50% or more via special Option P processing. Pulse capability is highly dependent on size and resistance value, consult factory (available up to 500 joules).

INDUCTANCE: small sizes have inductance of 1- 50uH typ. Larger sizes and higher values typically have greater levels. For non-inductive design, specify Opt. X. The max. series inductance for Opt.X resistors at 0.5MHz is listed in table (per MIL-R-39007). Specialty constructions are available for even lower inductance levels (Opt.75 inductance = 50% of Opt.X, Opt.76 = 33% of Opt.X).

RCD Type	≤ 50Ω	> 50Ω
102X-140X	0.2μH	0.37μH
145X-160X	0.3μH	0.6μH
165X-178X	0.65μH	1.2μH

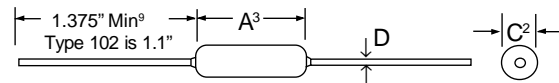

RCD Type	MIL Type ⁵	Std. Wattage Ratings		Opt.B Wattage Ratings		Resistance Range ^{6,7}	Maximum Voltage Rating ^{1,6}	DIMENSIONS [Numbers in brackets are mm]					
		Char.U	Char.V	Char.U	Char.V			A ³		C ²		D ⁸ ± .003 [.08]	
								± .062	[1.58]	± .032	[.81]	Std.	Optional
102	-	0.5	0.8	0.8	1.0	.01Ω - 2K	30V	.16 ±.03	[4±.8]	.07±.02	[1.8±.5]	.020	-
110	RW81 (110B)	0.8	1.0	1.5	2.0	.01Ω - 8K	40V	.24 ±.03	[6±.8]	.085	[2.16]	.020	.024 (opt. 22)
115	-	1.0	1.2	1.5	2.0	.01Ω - 12K	45V	.312	[7.92]	.085	[2.16]	.020	.024 (opt. 22)
120	-	1.0	1.2	-	-	.01Ω - 15K	50V	.344	[8.74]	.093	[2.36]	.020	.024 (opt. 22)
Stock 125	RW70 (125B RW80)	1.5	1.8	2.0	2.5	.01Ω - 20K	55V	.406	[10.3]	.093	[2.36]	.020	.024 (opt. 22)
130	-	1.6	2.0	-	-	.01Ω - 22K	65V	.530	[13.5]	.093	[2.36]	.020	.024 (opt. 22)
Stock 133	-	2.0	3.0	3.0	4.0	.005Ω - 20K	80V	.355	[9.00]	.156	[3.96]	.032	.024 (opt. 22)
Stock 135	RW69	3.0	4.0	4.0	5.0	.005Ω - 40K	140V	.500	[12.7]	.188	[4.78]	.032	.024(22), .040(18)
140	RW79	3.0	4.0	4.0	5.0	.005Ω - 50K	140V	.550	[14.2]	.188	[4.78]	.032	.040 (opt. 18)
145	-	3.5	4.5	4.5	6.5	.005Ω - 60K	180V	.770	[19.6]	.188	[4.78]	.032	.040 (opt. 18)
150	-	3.5	4.5	5.0	7.0	.005Ω - 60K	150V	.500	[12.7]	.225	[5.72]	.040	.032 (opt. 20)
155	-	4.0	5.0	6.0	8.0	.005Ω - 100K	210V	.625	[15.9]	.225	[5.72]	.040	.032 (opt. 20)
156	-	5.0	6.0	-	-	.005Ω - 150K	300V	.800	[20.3]	.250	[6.35]	.040	.032 (opt. 20)
Stock 160	RW74	5.0	7.0	7.0	10	.005Ω - 200K	400V	.875	[22.2]	.312	[7.92]	.040	.032 (opt. 20)
165	RW67	6.0	7.5	-	-	.005Ω - 220K	450V	1.000	[25.4]	.312	[7.92]	.040	.032 (opt. 20)
170	-	7.0	9.0	10	12	.005Ω - 300K	550V	1.200	[30.9]	.312	[7.92]	.040	.032 (opt. 20)
171	-	7.0	8.5	-	-	.005Ω - 250K	700V	1.660	[42.2]	.208	[5.28]	.032	.040 (opt. 18)
172	-	8.5	10	-	-	.005Ω - 400K	900V	2.100	[53.3]	.225	[5.72]	.032	.040 (opt. 18)
173	-	9.0	11	12	14	.005Ω - 400K	650V	1.550	[39.4]	.300	[7.62]	.040	.032 (opt. 20)
Stock 175 ⁴	RW68, 78	10	13	15	18	.005Ω - 500K	900V	1.720 ⁴	[43.7]	.350 ⁴	[8.89]	.040	.032 (opt. 20)
176	-	10	12	-	-	.005Ω - 500K	800V	1.875	[47.6]	.300	[7.62]	.040	.032 (opt. 20)
178	-	13	15	-	-	.01Ω - 750K	1150V	2.410	[61.2]	.350	[8.89]	.040	.032 (opt. 20)
180	RW56	14	16	16	20	.01Ω - 800K	1000V	2.100	[53.3]	.500	[12.7]	.040	-
185	-	20	25	-	-	.015Ω - 1M	1350V	2.800	[71.1]	.500	[12.7]	.040	-
186	-	25	30	-	-	.010Ω - 1M	1400V	4.060	[103]	.350	[8.89]	.040	.032 (opt. 20)
190	-	40	50	-	-	.025Ω - 2M	1500V	5.000	[127]	.500	[12.7]	.040	-

¹ Working voltage = (PR)^{1/2}, not to exceed max rating (multiply by 0.7 for Opt.X). ² Allow .032" additional for Opt X or values <1Ω ³ Coating overflow onto each lead ≤2xD ⁴ Until existing inventory is depleted, type 175 may be .397" [10mm] dia x 1.81 [46] long with 1.31 [33] lead length ⁵ Military p/n's are given for reference only and do not imply qualification or exact interchangeability. ⁶ Increased range avail. ⁷ Resis. value measured at 3/8" ±1/16" from each end of body ⁸ Heavier lead gauge option is recommended on low values to enable lower leadwire resis., increased current, and improved TC ⁹ Lead length applies to bulk packaged units (taped parts may be shorter, refer to taping spec.) ¹⁰ Dependent on value, options, etc

TYPICAL PERFORMANCE¹⁰

Load Life (Char.U)	±0.5% (±1% on sizes >10W)
Thermal Shock	±0.2%
Moisture Resistance	±0.2%
Shock and Vibration	±0.1%
Overload, 5 Sec	5x rated W 102-156, 10x W 160-190
Dielectric Strength	500V (for 1KV specify opt.33)
Max. Current (not to exceed wattage or voltage rating)	Resistors with .020" dia leads = 11A, .024" = 15A, .032" = 22A, .040" = 30A
TC (ppm/°C) ≥10Ω	20ppm (5 & 10ppm avail.)
1Ω - 9.9Ω	50ppm (10, 20, 30ppm avail.)
0.1Ω - .99Ω	90ppm (20, 30, 50 ppm avail.)
.05Ω - .099Ω	300ppm (50, 100, 200ppm avail.)
.01Ω - .049Ω	600ppm (100, 200, 300ppm avail.)

P/N DESIGNATION:

RCD Type 135 - 102 - J B W

Options: X, R, V, P, F, ER, E, B, 76, 75, 22, 20, 18 (leave blank if standard)

Resis. Code 1% & tighter tols: 3 signif. digits & multiplier, e.g. R100=0.1Ω, 1R00=1Ω, 1000=100Ω, 1001=1KΩ. 2%-10%: 2digits & multiplier (R10=.1Ω, 1R0=1Ω, 100=10Ω, 102=1K) Use extra digits as needed: R005, R0075, R012, etc.

Tolerance: K=10%, J=5%, H=3%, G=2%, F=1%, D=0.5%, C=0.25%, B=0.1%, A=0.05%, Q=0.02%, T=0.01%, V=0.005%

Packaging: B= Bulk, T= T&R (avail. on type 102 to 176)

Optional TC: 5= 5ppm, 10= 10ppm, 20= 20ppm, 30= 30ppm, 50= 50ppm, 101= 100ppm, 201=200ppm (leave blank if std)

Termination: W= Lead-free, Q= Tin/Lead (leave blank if either is acceptable)

MINIATURE WIREWOUND RESISTORS

1 WATT to 10 WATT

200 SERIES



RESISTORS • CAPACITORS • COILS • DELAY LINES

- Significant space savings!
- Tolerance to $\pm 0.01\%$, TCR to 5ppm/°C
- Wide resistance range: 0.005Ω to 250K
- Available on exclusive SWIFT™ delivery program
- All sizes available on Tape & Reel

OPTIONS

- Option X: Low Inductance
- Option P: Increased Pulse Capability
- Option F: Flameproof Coating
- Option ER: 100-Hour Burn-In
- Also available: low thermal emf (opt.E), matched sets, cut & formed leads, special marking, 4-terminal, hi-rel screening, hermetic seal, non-standard values, increased voltage, etc. Customized components are an RCD speciality!

TYPICAL SIZE COMPARISON

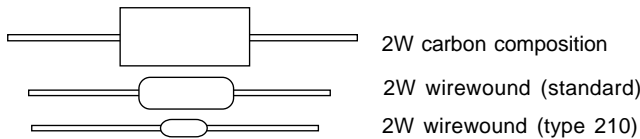

Typically half the size of conventional resistors! Type 202 is world's smallest wirewound resistor! Series 200 resistors offer the same MIL-grade construction as Series 100 resistors except utilize proprietary materials and processing, enabling significant size reductions. Series 200 resistors are ideal when PCB real estate is at a premium! Highest grade materials enable excellent stability and environmental performance.

DERATING: Power resistors reach elevated temperatures when operated near full wattage, and therefore should be mounted off the PCB and derated according to required stability levels.

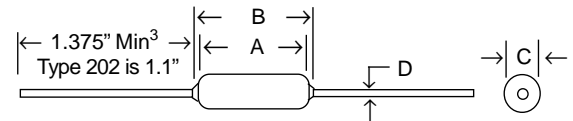
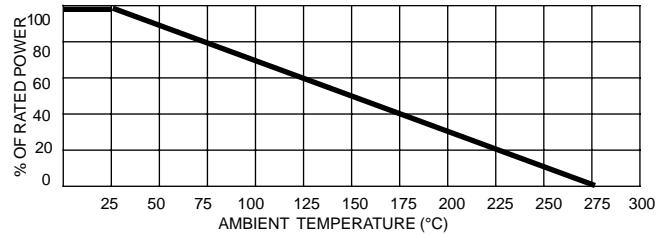

RCD Type	Wattage Rating	Maximum Voltage ¹	Resistance Range	DIMENSIONS Inch [mm]				
				A	B (Max)	C ²	D (Nominal Diameter)	
							Standard	Optional
202	1.0W	30V	.01Ω to 2K	.150 ±.032 [3.81 ± .8]	.200 [5.08]	.064 ±.02 [1.63 ± .5]	.020 [0.5]	N/A
210	2.0W	40V	.01Ω to 10K	.250 ±.040 [6.35 ±1]	.300 [7.62]	.093 ±.025 [2.36 ± .6]	.020 [0.5]	.024 (Opt."22") [0.6]
232	3.0W	60V	.005Ω to 20K	.350 ±.040 [8.9 ±1]	.480 [12.2]	.140 ±.032 [3.56 ± .8]	.031 [0.8]	N/A
235	5.0W	157V	.005Ω to 40K	.500 ±.040 [12.7 ±1]	.595 [15.1]	.188 ±.032 [4.78 ± .8]	.031 [0.8]	.040 (Opt."18") [1.0]
255	7.0W	210V	.005Ω to 80K	.625 ±.040 [15.9 ±1]	.765 [19.4]	.232 ±.032 [5.89 ± .8]	.040 [1.0]	N/A
272	10W	600V	.005Ω to 250K	1.040 ±.048 [26.4 ±1.2]	1.125 [28.6]	.350 ±.032 [8.89 ± .8]	.040 [1.0]	N/A

¹ Volt rating determined by $E = \sqrt{PR}$, E not to exceed max. rating. Increased ratings available. Multiply by 0.7 for Opt. X

² Allow .032" additional for Option X and values below 1.0Ω

³ Lead length applies to bulk packaged parts units, parts supplied on tape may be shorter (refer to taping specification)

SPECIFICATIONS:

Temperature Coefficient typ. (Consult factory for TC on opt. P)	.005 - .0099Ω: 600ppm std (200, 300ppm opt.) .01 - .049Ω: 300ppm std (100, 200ppm opt.) .05 - .099Ω: 200ppm std (50, 100ppm opt.) .1 - .99Ω: 90ppm std (10, 20, 30, 50ppm opt.) 1 - 9.9Ω: 50ppm std (10, 20, 30ppm opt.) 10Ω & above: 20ppm std (5, 10ppm opt.)								
Inductance, Standard	1 to 50μH typical, depends on size & resistance value. Specify Opt. X for non-inductive performance (see below).								
Inductance, Opt.X (levels as low as 20nH avail.)	<table border="0"> <tr> <td>≤ 50Ω</td> <td>> 50Ω</td> </tr> <tr> <td>Type 202X-235X: 0.2μH Max</td> <td>0.37μH Max</td> </tr> <tr> <td>Type 255X: 0.3μH Max</td> <td>0.6μH Max</td> </tr> <tr> <td>Type 272X: 0.6μH Max</td> <td>1.0μH Max</td> </tr> </table>	≤ 50Ω	> 50Ω	Type 202X-235X: 0.2μH Max	0.37μH Max	Type 255X: 0.3μH Max	0.6μH Max	Type 272X: 0.6μH Max	1.0μH Max
≤ 50Ω	> 50Ω								
Type 202X-235X: 0.2μH Max	0.37μH Max								
Type 255X: 0.3μH Max	0.6μH Max								
Type 272X: 0.6μH Max	1.0μH Max								
Dielectric Strength	500V (300V Type 202), 1KV available (Opt. 33)								
Overload, 5 Sec.	5X rated W 202-235, 10X rated W 255-272								

P/N DESIGNATION:

210 - **1001** - **F** **B** **W**

RCD Type _____

Options: X, P, F, ER, E, 22, 18 (leave blank if standard)

Resis. Code: ≤1%: 3 signif. figures & multiplier, e.g. R100=0.1Ω, 1R00=1Ω, 1000=100Ω, 1001=1KΩ.
Resis. Code 2% - 10%: 2 signif. figures & multiplier, e.g. R10=0.1Ω, 1R0=1Ω, 100=10Ω, 101=100Ω, 102=1KΩ.
 Use extra digits as needed: e.g. R005, R0075, R012

Tolerance: K=10%, J=5%, H=3%, F=1%, D=0.5%, C=0.25%, B=0.1%, A=0.05%, Q=0.02%, T=0.01%

Packaging: B = Bulk, T = T&R

Optional TC: 5= 5ppm, 10= 10ppm, etc., if 100ppm & above use 3-digit code: 101 = 100ppm, 201= 200ppm, etc. (leave blank if standard)

Termination: W= Lead-free, Q= Tin/Lead (leave blank if either is acceptable, in which case RCD will select based on lowest price and quickest delivery)

ECONOMY WIREWOUND RESISTORS

1 WATT to 10 WATT

RW SERIES



RESISTORS • CAPACITORS • COILS • DELAY LINES



- Excellent performance at economy prices
- Wide resistance range: 0.01Ω to 25KΩ
- Standard tolerance is 5% (1%, 2% and 10% available)
- Available on exclusive **SWIFT™** delivery program
- Choice of standard bulk pack, horizontally taped (available on all sizes), or vertically taped (1W/2W/3W sizes only)

OPTIONS

- Option X: Low Inductance
- Option P: Increased Pulse Capability
- Option FF: Flameproof Fusible (see application guide below)
- Option E: Low Thermal EMF
- Option F: Flameproof Coating
- Also available: cut & formed leads (horizontal and vertical), increased voltage, special marking, etc. Customized components are an RCD specialty!

DERATING

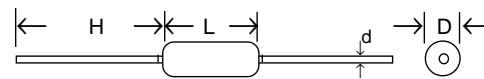
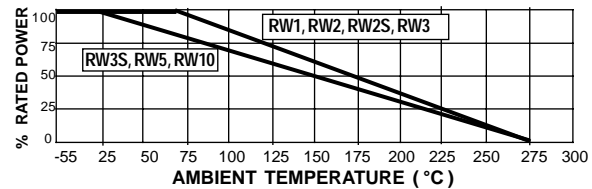

SPECIFICATIONS

RCD Type	Wattage	Voltage Rating	Resistance Range	L (Max. Body Length)	D ¹ ±.032 [.8]	d ±.005 [.13]	H Min. ²
RW1	1	60V	0.01Ω-2.4K	.390 [9.9]	.140 [3.56] ¹	.027 [.69]	0.96 [24]
RW2	2	100V	0.01Ω-10K	.500 [12.7]	.180 [4.6] ¹	.028 [.71]	1.16 [30]
RW2S	2	100V	0.01Ω-9.1K	.457 [11.6]	.170 [4.32] ¹	.028 [.71]	1.16 [30]
RW3	3	140V	0.01Ω-20K	.638 [16.2]	.220 [5.6] ¹	.031 [.8] ³	1.16 [30]
RW3S	3	120V	0.01Ω-10K	.500 [12.7]	.180 [4.6] ¹	.028 [.71]	1.16 [30]
RW5	5	210V	0.05Ω-25K	.74 [18.8]	.256 [6.5] ¹	.031 [.8] ³	1.25 [32]
RW10	10	700V	0.1Ω-25K	1.7 [43.2]	.325 [8.26] ¹	.031 [.8] ³	1.25 [32]

¹ Allow .032" [0.8mm] additional for Opt.X or values <1Ω ² 0.040" [1mm] lead dia. available, specify option "18" ³ The lead length of parts supplied on tape may be shorter

TYPICAL PERFORMANCE CHARACTERISTICS

Temperature Range	-55°C to +275°C
Temperature Coefficient	1Ω and above: 100ppm/°C 0.05 to 0.99Ω : 300ppm/°C Below 0.05Ω : 600ppm/°C
Insulation Resistance	1000 Megohms
Marking	Color band or digitally marked with res.value & tol as min
Moisture Resistance	± 2% Δ R
Thermal Shock	± 1% Δ R
Dielectric Strength	500V
Load Life	RW1,RW2,RW3= 2% ΔR RW2S,RW3S,RW5,RW10= 3%ΔR Option FF= 3% ΔR
Overload	5 x rated W, 5 Sec. (Option FF = 2xW, 5S)

OPTION FF FUSE RESISTOR APPLICATION GUIDE

1. Opt. FF fusible version is available from 0.1Ω - 2.4K (RW1=1.2K max)
2. Fault level must be suitable to safely open the resistor. Option FF parts are designed to blow within 20S at 15x rated power if ≥1Ω, 20x if <1Ω (preferable if fault level is double this level to ensure quick fusing time).
3. Maximum fault must not exceed 200x W rating, or voltage rating, whichever is less (increased levels avail).
4. For customized fusing, complete RCD's fuse questionnaire, or advise the desired fusing wattage/current, min/max blow times, continuous power, surge reqts, ambient temp, physical constraints, fault voltage, inductance, etc.
5. Fuse types shouldn't be mounted in contact with other components or PCB.
6. Residual resistance is ≥100x initial value after fusing.
7. Verify selection by evaluating under the full range of fault conditions. Place resistors inside a protective case when testing under overload.

P/N DESIGNATION:

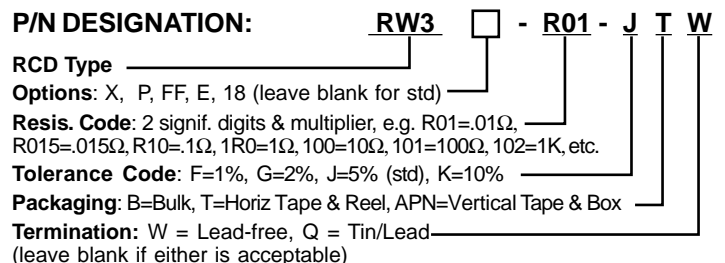

ALUMINUM HOUSED RESISTORS

600 SERIES



RESISTORS • CAPACITORS • COILS • DELAY LINES

- Widest selection in the industry! 5 to 1000 Watt
- 0.005Ω to 1MΩ, tolerance to .01%, TC to 5ppm
- High power and high pulse capacity in compact size
- Welded wirewound construction, low noise
- Available on exclusive **SWIFT™** delivery program!
- **Option X:** Non-inductive
- **Option P:** Increased pulse capability
- **Option ER:** 100 hour burn-in per MIL-PRF-39009
- **Option B:** Increased power
- Additional modifications: unanodized cases, custom marking, increased dielectric/creepage & working voltage, low thermal emf (opt.E), etc. Customized components are an RCD Specialty!

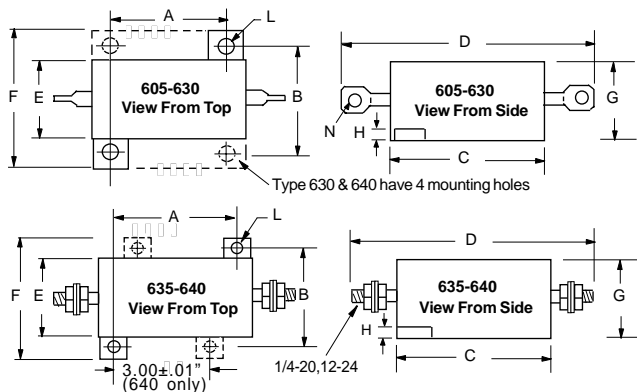

Standard units feature lug terminals (605 - 630) or threaded terminals (635 & 640).

Option L (605-625): Insulated stranded wires embedded into the case. Black TFE 18awg x 12" L with 1/4" strip is standard (16awg TFE & 14awg PVC avail). Also available with 4 insulated lead wires (Opt.4L), and with a wide variety of terminals... quick-connect male (Opt. LM=.25x.032); female (Opt. LF=.25x.032", LFS=.187x.020); ring terminal (Opt. LR=.145" I.D., LRR=.25" I.D.).

Option 2T & 4T (605-625): Straight leadwires. 2T is 2-terminal design, 4T is 4-terminal. Each have 18awg x 1" min lead length. 16awg x 1" and 12AWG x .5" also available (12 AWG not avail in Opt 4T).

Option 4R (605-630): 4-terminal design. 16AWG lug terminals are welded to standard terminals.

Option Q (605-630): .187x.020" male fast-on terminal; Opt. Q2 (610-625) is .250x.032" male terminal. Opt. Q & Q2 add 0.9 ± 0.125" to Dim. D.

SPECIFICATIONS: Consult factory for dimensions on liquid cooled design up to 1000 Watt

RCD Type	MIL Type ¹	Wattage, Mounted			Resis. Range (Ω)	Voltage Rating ²	A ±.005	B ±.005	C ±.062	D ±.062	E ±.031	F ±.031	G ±.031	H ±.010	L ±.005	N ±.005	Mtg Screw
		Std	Opt.B	MIL													
605	RE/RER60	7.5	15	5	.005-20K	160	.444 [11.3]	.490 [12.5]	.600 [15.2]	1.125 [28.6]	.334 [8.5]	.646 [16.4]	.320 [8.2]	.065 [1.6]	.093 [2.4]	.050 [1.3]	#2 [M2]
610	RE/RER65	12.5	20	10	.005-100K	265	.562 [14.3]	.625 [15.9]	.750 [19.0]	1.375 [35.0]	.420 [10.8]	.800 [20.3]	.405 [10.3]	.075 [1.9]	.093 [2.4]	.086 [2.2]	#2 [M2]
615	RE/RER70	25	35	20	.005-200K	550	.719 [18.3]	.781 [19.8]	1.062 [27.0]	1.938 [49.3]	.531 [13.5]	1.080 [27.4]	.546 [13.9]	.088 [2.2]	.125 [3.2]	.086 [2.2]	#4 [M2.5]
620	RE/RER75	50	60	30	.005-400K	1250	1.563 [39.7]	.844 [21.5]	1.968 [50.0]	2.781 [70.6]	.609 [15.6]	1.140 [28.8]	.610 [15.5]	.088 [2.2]	.125 [3.2]	.086 [2.2]	#4 [M2.5]
625	-	75	-	-	.01-500K	1900	1.563 [39.7]	.844 [21.5]	2.850 [72.4]	3.663 [93.0]	.609 [15.6]	1.140 [28.8]	.610 [15.5]	.088 [2.2]	.125 [3.2]	.086 [2.2]	#4 [M2.5]
630	-	100	-	-	0.1-100K	1900	1.377±.01 [35.0]	1.457±.01 [37.0]	2.579 [65.5]	3.38±.09 [85.9]	1.053 [26.7]	1.839 [46.7]	.960±.05 [24.4]	.138±.03 [3.5]	.173±.01 [4.4]	.086 Min [2.2]	#8 [M4]
635	RE77	100	150	75	0.1-600K	1900	2.75±.01 [69.85]	2.25±.01 [57.15]	3.50 [88.9]	5.48±.09 [139.14]	1.812 [46.0]	2.812 [71.42]	1.75 [44.45]	.188±.03 [4.78]	.188±.01 [4.78]	n/a	#8 [M4]
640	RE80	250	300	120	0.1-1M	2300	3.875±.01 [98.42]	2.50±.01 [63.5]	4.50 [114.3]	7.00±.09 [177.8]	2.125 [53.98]	3.00 [76.2]	2.188 [55.58]	.250±.03 [6.35]	.188±.01 [4.78]	n/a	#8 [M4]

¹ Military part numbers are for reference only and do not imply qualification. ² Max. voltage = (PR)^{1/2}, not to exceed the value listed (increased ratings avail). Multiply by 0.7 for Opt.X.

TYPICAL PERFORMANCE CHARACTERISTICS:

Temp. Coefficient	.005 - .0099Ω: 600ppm std (200, 300ppm opt.) .01 - .049Ω: 300ppm std (100, 200ppm opt.) .05 - .099Ω: 200ppm std (50, 100ppm opt.) .1 - .99Ω: 90ppm std (10, 20, 30, 50ppm opt) 1 - 9.9Ω: 50ppm std (10, 20, 30ppm opt.) 10Ω & above: 20ppm std (5, 10ppm opt.)
Dielectric (DWV)	Standard³ 605, 610 1KV 615, 620, 625 2KV 630, 635, 640 2.5KV Optional 2KV (Opt.36), 2.5KV (Opt.34) 2.5KV (Opt.34), 3KV (Opt.41) 3KV (Opt.41), 4KV (Opt.65)
Inductance, Opt.X	≤50Ω 605 0.2uH Max 610, 615 0.3uH Max 620, 625 0.65uH Max 630, 635, 640 1.5uH Max >50Ω 0.37uH Max 0.6uH Max 1.2uH Max 3.0uH Max
Load Life (1000 hrs)	±1% (±2% for 625-640, and ±3% Opt.B)
Moisture Resistance	±0.5%
Overload	5x rated W, 5 Sec (V not to exceed DWV)
Terminal Strength	10-lb pull test
Operating Temp.	-55°C to +250°C

³ The dielectric strength on Opt. L resistors is 50% of standard (available up to 3KV)

DERATING: Power rating is based on the use of a suitable heat sink and thermal compound to limit case temp. to 200°C. Derate wattage 0.44%/°C above 25°C. Recommended aluminum chassis area is 64in² x.040" thick for type 605 and 610, 83in² x.040" thick for type 615, 144in² x.060" thick for type 620, and 144in² x .125" for types 625 through 640. Without a heat sink, derate wattage rating by 60%.

P/N DESIGNATION:

610 - 1001 - F B W

RCD Type _____

Options: X, Q2, Q, P, LRR, LR, LM, LFS, LF, L, ER, E, B, 65, 41, 36, 34, 16, 14, 4T, 4R, 4L (leave blank if std)

Resis. Code: ≤1%: 3 signif. figures & multiplier, e.g. R010=0.01Ω, R100=0.1Ω, 1R00=1Ω, 1000=100Ω, 1001=1KΩ

Resis. Code 2% - 10%: 2 signif. figures & multiplier, e.g. R01=0.01Ω, R10=0.1Ω, 1R0=1Ω, 100=10Ω, 102=1KΩ

Tolerance: K=10%, J=5%, H=3%, G=2%, F=1%, D=0.5%, C=0.25%, B=0.1%, A=0.05%, Q=0.02%, T=0.01%

Packaging: B = standard

Non-std lead length for option L (inches): (12" = std) 4", 16", etc.

Optional TC (leave blank if std): 5=5ppm, 10=10ppm; 20=20ppm; 30=30ppm; 50=50ppm; 101=100ppm, 201=200ppm, 301=300ppm)

Termination: W= Lead-free, Q= Tin/Lead (leave blank if either is acceptable)

GENERAL PURPOSE 1W TO 25W CERAMIC-ENCASED RESISTORS

PW SERIES



- Low cost and the industry's broadest selection!
- Available from stock in popular sizes (5W & 10W, 0.1Ω to 5K) and selected values in other sizes; non-stock items are available on exclusive **SWIFT™** delivery program
- Tolerance to ±0.05%, TCR to ±5 ppm/°C
- Wide resistance range: .05Ω to 1MegΩ
- Tape & Reel available up to 10W size (Opt.A not avail. on T&R)

OPTIONS

- Option X: Non-inductive (PW5X & smaller: ≤50Ω=0.2uH max, >50Ω=0.37uH max; PW7X & larger: ≤50Ω=0.3uH max, >50Ω=0.6uH max). Reduced inductance levels available
- Option T: Temp. sensitive (up to +6000ppm/°C)
- Option P: Increased pulse capability
- Option FF: Fuse within 10S at 30x rated W⁴ and within 45S at 20x rated W (1Ω to 1K). Custom fusing characteristics avail.
- Option B: Increased power
- Option A: Standoffs built into ceramic case
- Additional options available... burn-in, special marking, non-standard values, increased voltage, longer or heavier gauge leads, specialty lead wire material/plating/insulation, cut & formed leads, etc. Customized components are an RCD specialty!

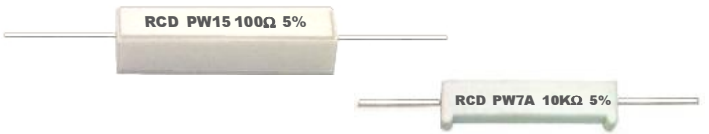

PW resistors are designed for general purpose and semi-precision power applications. The fireproof ceramic construction provides excellent thermal conductivity and resistance to moisture & solvents. Typical marking is 'RCD', value, tol. & wattage (or type). The resistance element is wirewound on lower values, & power film on higher values depending on options (opt. P & T parts are always WW). If a specific construction is preferred, specify opt.WW or M (not avail. in all values).

APPLICATION NOTE #1: Resistor Comparison

Series PW resistors offer moderate performance levels at prices below that of other WW or film technologies. Other choices for medium power applications are Series PV resistors (2W to 10W, similar to PW in vertical package); Series 100 military grade WW (1/2W to 50W, offers improved performance, pulse capability, and reliability); Series RW (1W to 5W WW, offers space savings); and Series RSF/RMF power film (1/2W to 9W, offers reduced inductance).

APPLICATION NOTE #2: Temperature Rise

Power resistors reach elevated temperatures (typically 125° to 250°C) when operated at full wattage, so when utilizing above 50% power rating, the bodies should be mounted off the PCB with adequate clearance from heat sensitive components. Opt. A standoffs are helpful in preventing heat transfer to PCB.

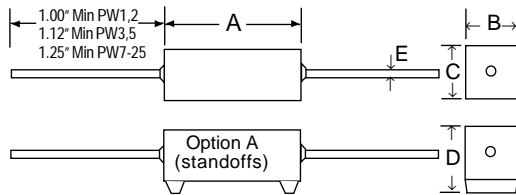

RCD Type	Wattage		Resis. Range (0.05Ω -)	Rated Continuous Working Voltage ¹	DIMENSIONS Inch [mm]				
	Std.	Opt. B			A (Max.)	B ±.032 [.81]	C ±.05 [1.3]	D Max.	E ±.004 [.1]
PW1	1	2	1M	100 ²	.62 [15.8]	.25 [6.4]	.25 [6.4]	N/A	.028 [.7]
PW2	2	3	1M	100 ²	.72 [18.3]	.27 [6.8]	.27 [6.8]	.39 [4.9]	.028 [.7]
PW3	3	5	1M	150 ²	.91 [23.1]	.31 [7.9]	.31 [7.9]	.43 [10.9]	.031 [.8] ³
PW5	5	7	1M	200 ²	.91 [23.1]	.38 [9.7]	.35 [8.9]	.47 [11.9]	.031 [.8] ³
PW7	7	10	1M	350	1.42 [36]	.38 [9.7]	.35 [8.9]	.52 [13.2]	.031 [.8] ³
PW10	10	-	1M	500	1.96 [50]	.38 [9.7]	.38 [9.7]	.52 [13.2]	.031 [.8] ³
PW15	15	-	30K	540	1.96 [50]	.50 [12.7]	.50 [12.7]	.68 [17.2]	.031 [.8] ³
PW20	20	-	40K	600	2.55 [65]	.58 [14.7] max	.50 [12.7]	.70 [17.8]	.031 [.8] ³
PW22	22	-	40K	650	2.55 [65]	.58 [14.7] max	.50 [12.7]	.70 [17.8]	.031 [.8] ³
PW25	25	-	40K	700	2.55 [65]	.58 [14.7] max	.50 [12.7]	.70 [17.8]	.031 [.8] ³

DERATING CURVE:

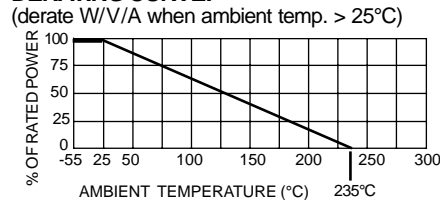

¹ Maximum voltage rating is determined by $E = \sqrt{PR}$, E should not exceed value listed.
² Specify opt. 59 for double voltage rating. ³ Specify opt.18 for 18AWG (.040") diameter leads.

TYPICAL PERFORMANCE FOR SERIES PW

Temperature Coef _{T25-T100}	1Ω and above	100ppm/°C typ., 300ppm max. ¹
	0.05Ω to 1Ω	200ppm/°C typ., 600ppm max. ¹
Operating Temp.	-55° to +235° C ²	
Terminal Strength	5 lbs. minimum	
Dielectric Strength	1000V	
5 Sec. overload (≤1.5x max V)	3X rated wattage (Opt. WW = 5X)	
Moisture Resistance	3.0% ³	
High Temp. Exposure	1.0% ³	
Load Life (1000 hours)	3.0% ³	
Temperature Cycling	2.0% ³	
Shock and Vibration	1.0% ³	

¹ TC to 5ppm available >10Ω, 10ppm 1-10Ω, 20ppm 0.1-1Ω ² 275°C avail ³ Tightened performance avail ⁴ Opt FF max fault nte 1.5x RCWW or 200x W rating

P/N DESIGNATION:

PW10 □ - **100** - **J** **B** □ **W**

RCD Type _____

Options: X, WW, T, P, M, FF, B, A, 59, 18 (Leave blank if standard)

Resis.Code .05%-1%: 3 signif. figures & multiplier, R100=0.1Ω, 1R00=1Ω, 10R0=10Ω, 1000=100Ω, 1001=1K.

Resis.Code 2%-10%: 2 signif. figures & multiplier, R10=0.1Ω, 1R0=1Ω, 100=10Ω, 101=100Ω, 102=1K.

If necessary, use additional (significant) digits, e.g. R005 for 0.005Ω, R0075 for 0.0075Ω in any tolerance.

Tolerance: K=10%, J=5% (std), H=3%, G=2%, F=1%, D=0.5%, C=0.25%, B=0.1%

Packaging: B=Bulk (standard), T= Tape & Reel

Temp. Coefficient (leave blank for standard TC): 5=5ppm, 10=10ppm, 20=20ppm, 50=50ppm, 101=100ppm, 201=200ppm

Termination: W= Lead-free, Q= Tin/Lead (leave blank if either is acceptable, in which case RCD will select based on lowest price and quickest delivery)

2W TO 25 WATT VERTICAL MOUNT RESISTORS

PV SERIES - 2 Terminal PVH SERIES - 4 Terminal PWV SERIES - Bracket Mount



Term.W is Pb-free and RoHS compliant

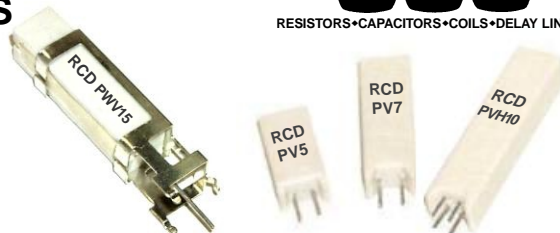

- Industry's widest range! 1mΩ-1M, to ±.05% 10ppm!
- Built-in standoffs minimize heat transfer to P.C.B.
- Available on exclusive **SWIFT™** delivery program!

OPTIONS

- Option X - Non-Inductive
- Option WW or M (wirewound or film element)
- Option P - Increased pulse capability
- Option FF- Fuse within 10S @50x rated W (custom avail)
- Option E - Low thermal EMF design
- Option B - Increased power (refer to chart below)
- Numerous modifications avail: custom marking, TC's to +6000ppm, various lead wire sizes, burn-in, etc.

Significant space savings compared to axial-lead types!

PV, PVH, and PWV resistors are designed for power applications where space is at a premium. The PV series offers lowest cost for medium power applications. PVH series are similar except in 4-terminal Kelvin design (to cancel lead wire effect). PWV bracketed resistors enable higher power levels and superior performance in applications involving shock and vibration. The ceramic construction is fireproof and resistant to moisture & solvents. The internal element is wirewound on lower values, power film on higher values (depending on options, e.g. opt. P parts are always WW). If a specific construction is preferred, specify opt.'WW' for wirewound, opt.'M' for power film (not available in all values).

SERIES	Wattage	Max. Voltage*	Max. Current*	Std Resis Range	A ±.04 [1.0]	B ±.04 [1.0]	C ±.062 [1.6]	D ±.04 [1]	E ±.005[.12]	F (Nom)
PV2	2W (3W)	80V	14A	.005Ω to 1M	.450 [11.4]	.300 [7.6]	.800 [20.3]	.197 [5]	.028 [.7]	.036 [.9]
PV3	3W (4W)	150V	17A	.005Ω to 1M	.475 [12.1]	.350 [8.9]	.980 [24.9]	.197 [5]	.031 [.8]	.040 [1]
PV5	5W (6W)	250V	22A	.005Ω to 1M	.500 [12.7]	.360 [9.2]	1.00 [25.4]	.197 [5]	.031 [.8]	.040 [1]
PV7	7W (10W)	350V	26A	.005Ω to 1M	.500 [12.7]	.400 [10]	1.52 [38.6]	.197 [5]	.031 [.8]	.040 [1]
PV10	10W (12W)	500V	32A	.005Ω to 1M	.500 [12.7]	.400 [10]	2.02 [51.3]	.197 [5]	.031 [.8]	.040 [1]
PV10S	10W (12W)	400V	32A	.005Ω to 1M	.625 [15.9]	.500 [12.7]	1.38 [35.0]	.290 [7.4]	.036 [.9]	.048 [1.2]
PV10A	10W (12W)	400V	32A	.005Ω to 1M	.625 [15.9]	.500 [12.7]	1.38 [35.0]	.197 [5]	.036 [.9]	.048 [1.2]

SERIES	Wattage	Max. Voltage*	Max Current* Std (Opt.B)	Std Resis Range	A ±.04 [1.0]	B ±.04 [1.0]	C ±.062 [1.6]	D ±.04 [1]	E ±.024[.6]	F ±.003" Std (Opt.B)
PVH2	2W (3W)	80V	14A (17A)	.001Ω to 10K	.450 [11.4]	.300 [7.6]	.800 [20.3]	.197 [5]	.075 [1.91]	.032 (.040)
PVH3	3W (5W)	150V	17A (22A)	.001Ω to 25K	.475 [12.1]	.350 [8.9]	.980 [24.9]	.197 [5]	.100 [2.54]	.032 (.040)
PVH5	5W (7W)	250V	22A (26A)	.001Ω to 30K	.500 [12.7]	.400 [10]	1.00 [25.4]	.197 [5]	.100 [2.54]	.032 (.040)
PVH7	7W (10W)	350V	26A (32A)	.001Ω to 50K	.500 [12.7]	.400 [10]	1.52 [38.6]	.197 [5]	.100 [2.54]	.032 (.040)
PVH10	10W (12W)	500V	32A (40A)	.001Ω to 250K	.500 [12.7]	.400 [10]	2.02 [51.3]	.197 [5]	.100 [2.54]	.032 (.040)
PVH10S	10W (12W)	400V	32A (40A)	.001Ω to 250K	.625 [15.9]	.500 [12.7]	1.38 [35.0]	.290 [7.4]	.125 [3.18]	.032 (.040)
PVH10A	10W (12W)	400V	32A (40A)	.001Ω to 250K	.625 [15.9]	.500 [12.7]	1.38 [35.0]	.197 [5]	.125 [3.18]	.032 (.040)

SERIES	Wattage	Max. Voltage*	Max Current*	Std Resis Range	A Max	B ±.04 [1.0]	C ±.04 [1.0]	D ±.02 [0.5]	E ±.06 [1.5]	F ±.06 [1.5]
PWV5	5	200V	22A	.01Ω to 1M	1.40 [35.6]	.400 [10]	.400 [10]	.060 [1.5]	.200 [5]	.200 [5]
PWV7	7	350V	26A	.01Ω to 1M	1.86 [47.3]	.400 [10]	.400 [10]	.060 [1.5]	.200 [5]	.200 [5]
PWV10	10	500V	32A	.01Ω to 1M	2.46 [62.5]	.400 [10]	.400 [10]	.060 [1.5]	.200 [5]	.200 [5]
PWV15	15	540V	32A	.01Ω to 150K	2.46 [62.5]	.500 [12.7]	.530 [13.5]	.100 [2.5]	.265 [6.7]	.265 [6.7]
PWV20	20	600V	32A	.01Ω to 150K	3.02 [76.7]	.500 [12.7]	.580 [14.7]	.100 [2.5]	.275 [7.0]	.295 [7.5]
PWV25	25	600V	32A	.01Ω to 150K	3.02 [76.7]	.500 [12.7]	.580 [14.7]	.100 [2.5]	.275 [7.0]	.295 [7.5]

* Units not to exceed wattage, voltage, or current rating, whichever is less. Voltage determined by $E = \sqrt{PR}$, E not to exceed max voltage rating. Multiply voltage rating by 0.7 for Opt. X. Increased voltage & current ratings available (up to 1KV, 100A).

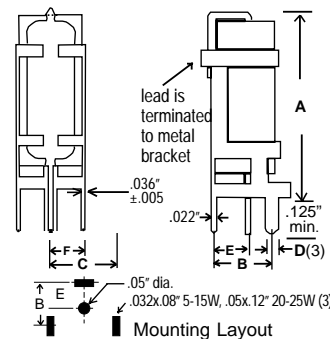
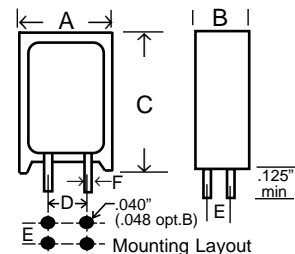
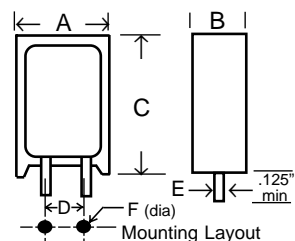

TYPICAL PERFORMANCE CHARACTERISTICS

Temp. Coef. PPM/°C (25 - 100/°C)	Res. Range	PV & PWV Std (Best)	PVH Std (Best)
	.001-.0049Ω	N/A	1200ppm (50ppm)
	.005-.0099Ω	800ppm (50ppm)	600ppm (25ppm)
	.01-.024Ω	600ppm (50ppm)	200ppm (25ppm)
	.025-.049Ω	500ppm (30ppm)	150ppm (25ppm)
	.05-.099Ω	400ppm (20ppm)	90ppm (10ppm)
.1 - .99Ω	350ppm (20ppm)	50ppm (10ppm)	
1Ω & above	200ppm (10ppm)	20ppm (5ppm)	
Operating Temp.	-55° to +220° C (275° C avail)		
Dielectric Strength	1000V		
5 Sec. overload (≤1.5x max V)	3X rated wattage (Opt. WW = 5X)		
Moisture Resistance	3.0%		
High Temp. Exposure	1.0%		
Load Life (1000 hours)	3.0%		
Opt X Inductance (reduced inductance levels avail. to 67nH)	Opt.X ≤5W: ≤50Ω=2uH max, >50Ω=.37uH max Opt.X ≥7W: ≤50Ω=.3uH max, >50Ω=.6uH max		
Temperature Rise	125 to 220°C typ at full rated power		
Derating (W, V, A)	Derate by .513%/°C above 25° C		

P/N DESIGNATION:

RCD Type **PV10** - **100** - **J** **B** **W**

Options: X, WW, P, M, FF, E, B (Leave blank if standard)

Resis.Code .05%-1%: 3 signif. figures & multiplier, e.g. R001=.001Ω, R010=.01Ω, R100=.1Ω, 1R00=1Ω, 10R0=10Ω, 1000=100Ω, 1001=1K.

Resis.Code 2%-10%: 2 signif. figures & multiplier, e.g. R001=.001Ω, R01=0.01Ω, R10=0.1Ω, 1R0=1Ω, 100=10Ω, 101=100Ω, 102=1K.

Tolerance: A=0.05%, B=0.1%, C=0.25%, D=0.5%, F=1%, G=2%, J=5% (std), K=10%

Packaging: B=bulk (standard)

Optional TC: 10=10ppm, 20=20ppm, 50=50ppm, 101=100ppm, 201=200ppm, etc. (leave blank if standard)

Termination: W= Lead-free, Q= Tin/Lead (leave blank if either is acceptable, in which case RCD will select based on lowest price and quickest delivery)

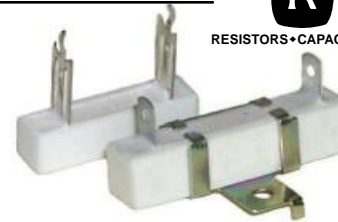

5W TO 50 WATT POWER RESISTORS CERAMIC ENCASED, RADIAL LEADS

PWLL & PWH SERIES

- ☐ Low cost, fireproof construction
- ☐ 0.1Ω to 150KΩ, ±5% is standard (0.5% to 10% avail.)

OPTIONS

- ☐ Option X: Non-Inductive
- ☐ Option P: Increased pulse capability
- ☐ Option G: 1/4x.032" male fast-on terminals (PWH & PWHM15-50)

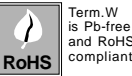

PWLL and PWH resistors are designed for general purpose and semi-precision power applications. The ceramic construction is fireproof and resistant to moisture & solvents. The internal element is wirewound on lower values, power film on higher values (depending on options, e.g. opt. P parts are always WW). If a specific construction is preferred, specify opt.'WW' for wirewound, opt.'M' for power film (not available in all values).

RCD Type	Wattage (25°C)	Resis. Range	Max.Cont. Working Voltage ¹	DIMENSIONS: Inch (mm)						
				L (max)	W (max)	H (max)	LS	P1	P2	P3 ±.06 [1.5]
PWLL5	5	.1Ω-50K	350	1.10 [28]	.413 [10.5]	.413 [10.5]	.59±.06 [15±1.5]	.055±.01[1.4±.25]	.11 [2.8] min	.413 [10.5] ³
PWLL7	7	.1Ω-100K	500	1.42 [36]	.413 [10.5]	.413 [10.5]	.89±.06[22.5±1.5]	.055±.01[1.4±.25]	.11 [2.8] min	.413 [10.5] ³
PWLL10	10	.2Ω-100K	700	1.93 [49]	.413 [10.5]	.413 [10.5]	1.26±.06 ⁴ [32±1.5]	.055±.01[1.4±.25]	.11 [2.8] min	.413 [10.5] ³
PWLL15	15	.5Ω-100K	750	1.95 [49.5]	.532 [13.5]	.532 [13.5]	1.26±.08 [32±2]	.108±.012[2.75±.3]	.15 [3.8] min	.591 [15] ³
PWLL25	25	.5Ω-100K	1000	2.54 [64.5]	.591 [15]	.591 [15]	1.77±.08 [45±2]	.108±.012[2.75±.3]	.15 [3.8] min	.591 [15] ³
PWH10, PWHM10	10 ²	.5Ω-50K	700	1.97 [50]	.433 [11.0]	.473 [12.5]	1.30±.08 [33±2]	.470 ± .04 [12 ± 1]	.22 ±.04 [5.5±1]	.275 [7]
PWH15, PWHM15	15 ²	.5Ω-150K	750	1.97 [50]	.531 [13.5]	.572 [14.5]	1.30±.08 [33±2]	.470 ± .04 [12 ± 1]	.24 ±.04 [6 ± 1]	.315 [8]
PWH25, PWHM25	25 ²	.5Ω-150K	1000	2.56 [65]	.598 [15.2]	.591 [15]	1.77±.12 [45±3]	.470 ± .04 [12 ± 1]	.24 ±.04 [6 ± 1]	.315 [8]
PWH40, PWHM40	40 ²	1Ω-2K	1000	3.03 [77]	.787 [20.0]	.847 [21.5]	2.17±.08 [55±3]	.69 ±.04 [17.5 ± 1]	.28 ±.06 [7±1.5]	.394 [10]
PWH50, PWHM50	50 ²	1Ω-2K	1000	3.62 [92]	.787 [20.0]	.847 [21.5]	2.72±.12 [69±3]	.69 ±.04 [17.5 ± 1]	.28 ±.06 [7±1.5]	.394 [10]

¹ Max voltage determined by E=(PR)^{1/2}, E not to exceed MCWV (increased voltage levels avail.)

² When mounted on suitable heatsink, PWHM wattage may be increased by 25% (use thermal grease)

³ PW5LL,7LL,10LL also avail. with 15 or 25mm standoff terminals (specify opt.15 or 25); PW15LL & 25LL avail. with 10.5mm or 30mm, specify options 10 or 30.

⁴ 1.39"[35mm] avail., specify opt. 35

PWLL

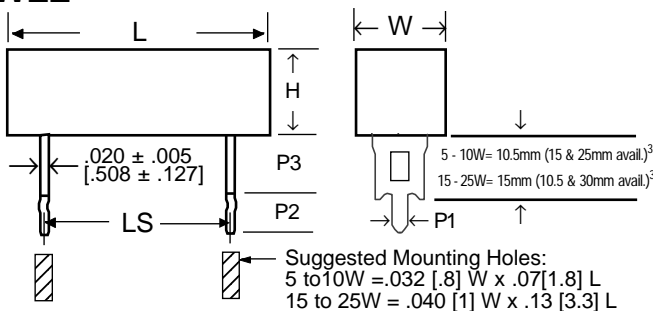

PWH

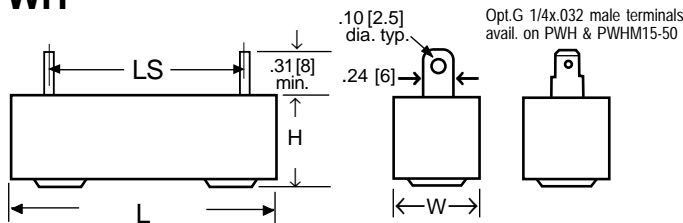

PWHM (PWH with metal mounting bracket)

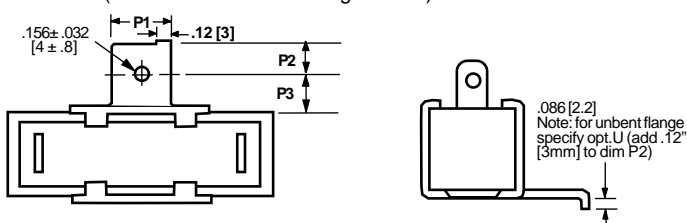

PERFORMANCE (typ.)

Temperature Coef _{T25 to T100}	1Ω & above	100ppm/°C typ., 300ppm max *
	Below 1Ω	200ppm/°C typ., 600ppm max. *
Operating Temp.	-55° to +235° C (275° C avail)	
Terminal Strength	5 lbs. minimum	
Dielectric Strength	1000V	
5 Sec. overload (≤1.5x max V)	3X rated wattage (Opt. WW = 5X)	
Moisture Resistance	3.0%	
High Temp. Exposure	1.0%	
Load Life (1000 hours)	3.0%	
Temperature Cycling	2.0%	
Shock and Vibration	1.0%	
Inductance (standard parts are inductive, specify opt.X for low inductance version)	Opt.X 25W & smaller: ≤50Ω=0.3uH max, >50Ω= 0.6uH max. Opt. X 30W & larger: ≤50Ω=1uH max, >50Ω= 2uH max). Reduced induc. avail.	
Temperature Rise	100 to 140°C typ at 50% rated power, 200 to 250°C typ at full rated power	
Derating	Derate wattage and voltage by .48%/°C above 25° C	

* Tightened TC's available, consult factory

P/N DESIGNATION:

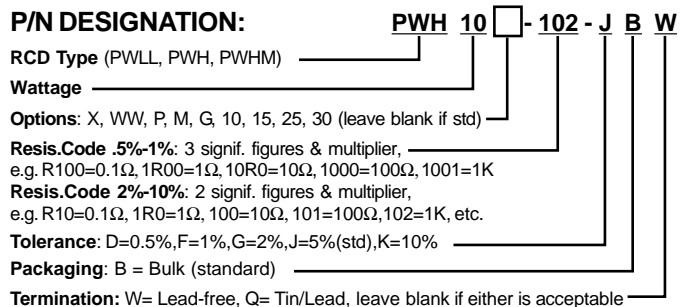

TUBULAR WIREWOUND RESISTORS

12 WATT to 1300 WATT



RESISTORS • CAPACITORS • COILS • DELAY LINES

T SERIES



Term. W is
RoHS
compliant
& 260°C
compatible

- ☐ Widest range in the industry!
- ☐ High performance for low cost
- ☐ Tolerances to $\pm 0.1\%$, an RCD exclusive!
- ☐ Low inductance version available (specify opt. 'X')
- ☐ For improved stability & reliability, T Series is available with 24 hour burn-in (specify opt. 'EQ')

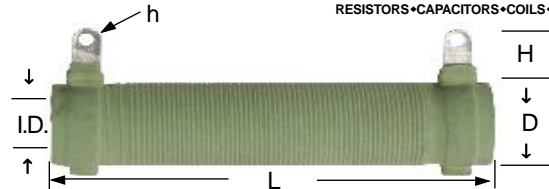

Standard Series T: Tubular design enables high power at low cost. Specialty high-temp flame resistant silicone ceramic coating holds wire securely against ceramic core providing optimum heat transfer and precision performance (enabling resistance tolerances to 0.1%).

OPTIONAL STYLES:

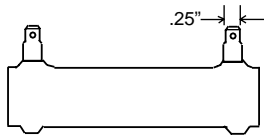

Option G: Male Quick-Connect
1/4 x .031" thick [6 x .8mm] male tab

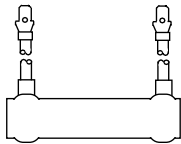

Option L: Insulated Leads
Stranded wire is soldered to lug terminals and insulated with shrink tubing. Also available ring terminal (Opt LR), quick-connect male (LM), female (LF), and various others.

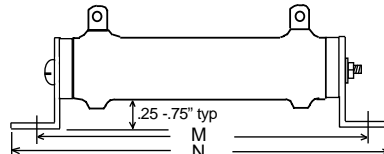

Opt. M: Assembled with Thru-Bolt Brackets
Small models are mounted $\approx 1/4$ " above mounting plane, medium $\approx 1/2$ ", large $\approx 3/4$ ". Mounting kit (2 slotted brackets, insulators, threaded rod, nuts & washers) may be purchased separately, specify T50-BRACKET, T80-BRACKET, etc.

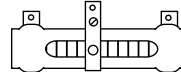

Option V: Adjustable
Exposed winding enables adjustment of resistance value. Slider divides wattage rating proportionally. Available on edgewound and standard winding. Do not over-tighten.



Option T: Tapped
Single or multi-tapped units avail. Power rating is reduced by 10% per tap. Indicate resistance value and wattage required per section when ordering.

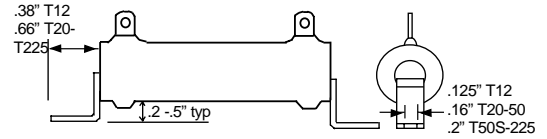

Option J: Push-In Bracket (12W - 225W)
Units are supplied with pre-assembled push-in slotted brackets. Brackets may be purchased separately, specify T50-PIB, T80-PIB, etc. (order 2 brackets for each resistor)

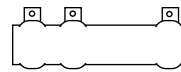

Opt. A: Axial Lead (illustrated)
Opt. R: Radial Lead
Lead wires are attached to lug terminals to enable soldering direct to PCB. The resistor body can be supported by leads up to 25W size.

RCD Type	Wattage Rating	Resistance Range*		Dimensions Inch[mm], typical					Option M (Mounting Bracket)		
		Standard	Adjustable (Opt.V)	L	D	I.D. (min)	H	h (min)	M	N	P
T12	12	0.1Ω - 10K	0.1Ω - 3K	1.76 [45]	.55 [14]	.2 [5]	.4 [10]	.08 [2]	2.15 [55]	2.6 [65]	.12 [3]
T20S	20	0.1Ω - 15K	0.1Ω - 4K	2.0 [50]	.55 [14]	.2 [5]	.4 [10]	.08 [2]	2.6 [65]	3.0 [76]	.12 [3]
T25	25	0.1Ω - 20K	0.1Ω - 6K	2.0 [50]	.7 [18]	.3 [8]	.48 [12]	.08 [2]	2.68 [68]	3.2 [80]	.16 [4]
T50	50	0.1Ω - 40K	0.1Ω - 12K	4.0 [102]	.7 [18]	.3 [8]	.48 [12]	.08 [2]	4.72 [120]	5.2 [132]	.16 [4]
T50S	50	0.1Ω - 40K	0.1Ω - 12K	3.55 [90]	1.1 [28]	.5 [13]	.67 [17]	.16 [4.0]	5.12 [130]	5.8 [147]	.22 [5.5]
T75	75	0.1Ω - 50K	0.1Ω - 16K	6.0 [152.4]	.7 [18]	.3 [8]	.48 [12]	.08 [2]	6.69 [170]	7.2 [182]	.16 [4]
T80	80	0.1Ω - 60K	0.1Ω - 18K	4.35 [110]	1.1 [28]	.5 [13]	.67 [17]	.16 [4.0]	5.90 [150]	6.7 [171]	.22 [5.5]
T100	100	0.1Ω - 100K	0.1Ω - 30K	6.4 [163]	1.1 [28]	.5 [13]	.67 [17]	.16 [4.0]	8.00 [202]	8.5 [216]	.22 [5.5]
T150	150	0.1Ω - 130K	0.1Ω - 40K	7.7 [195]	1.2 [30]	.63 [16]	.75 [19]	.16 [4.0]	9.25 [235]	10 [254]	.22 [5.5]
T175	175	0.13Ω - 150K	0.13Ω - 45K	8.5 [215]	1.2 [30]	.63 [16]	.75 [19]	.16 [4.0]	10 [254]	10.6 [269]	.24 [6]
T225	225	0.16Ω - 165K	0.16Ω - 50K	10.5 [267]	1.2 [30]	.63 [16]	.75 [19]	.16 [4.0]	12 [305]	12.6 [321]	.24 [6]
T300	300	0.4Ω - 220K	0.4Ω - 66K	10.2 [259]	1.7 [43]	0.9 [23]	1.0 [25]	.18 [4.5]	11.8 [300]	12.8 [325]	.31 [8]
T500	500	0.5Ω - 250K	0.5Ω - 75K	13 [330]	2.1 [53]	1.2 [30]	1.0 [25]	.18 [4.5]	15.0 [380]	15.8 [402]	.35 [9]
T600	600	0.8Ω - 300K	0.8Ω - 90K	15.7 [399]	2.1 [53]	1.2 [30]	1.0 [25]	.18 [4.5]	17.7 [450]	18.5 [470]	.35 [9]
T750	750	0.8Ω - 400K	0.8Ω - 120K	18.1 [460]	2.1 [53]	1.2 [30]	1.0 [25]	.18 [4.5]	20.1 [510]	21.1 [535]	.35 [9]
T1000	1KW	1Ω - 500K	1Ω - 150K	21.3 [540]	2.5 [63]	1.4 [35]	1.15 [30]	.22 [5.5]	23.4 [595]	24.2 [615]	.35 [9]
T1300	1.3KW	1Ω - 750K	1Ω - 200K	25.6 [650]	2.7 [69]	1.4 [35]	1.15 [30]	.22 [5.5]	27.6 [702]	28.5 [722]	.35 [9]

* Extended range available

SPECIFICATIONS

Standard Tolerance	1Ω and above: $\pm 5\%$ (avail. to $\pm 0.1\%$), Below 1Ω: $\pm 10\%$ (avail. to $\pm 1\%$)
Temp. Coefficient (avail. to 20ppm)	260ppm/°C 1Ω and above, 400ppm/°C 0.1Ω to 0.99Ω
Dielectric Strength	1000 VAC (terminal to mounting bracket)
Overload	10x rated power for 5 sec.
Operating Temp.	-55°C to +350°C
Derating	.31%/°C above 25°C
Temperature Rise	$\approx 250 - 325^\circ\text{C}$ @full rated W

P/N DESIGNATION:

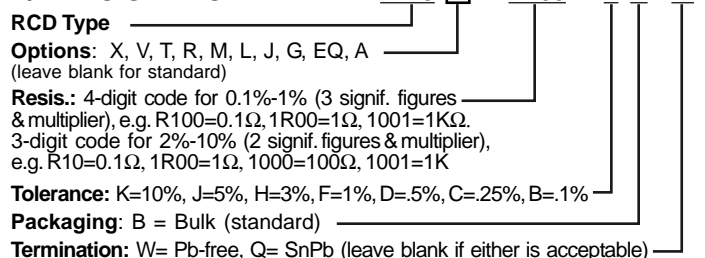

HIGH POWER EDGEWOUND RESISTORS

TUBULAR, 75 WATT to 2000 WATT

EW SERIES



- Widest range in the industry!
- High thermal capacity & power-to-size ratio
- Highest power performance for low cost
- Flameproof silicone coating
- Custom sizes and terminations available

OPTIONS

- Option X: Non-inductive
- Option ER: 100 hour burn-in
- Option M: Thru-bolt brackets
- Option T: Single or multi-tapped design

High power edgewound construction, economical price!

RCD Series EW is designed to meet heavy-duty requirements where space is at a premium. Unique ribbon element is edgewound onto a ceramic tube offering the industry's highest power ratings at a low cost. Inductance levels are lower than conventional round-wire designs. Series EW is ideally suited for load testing, power distribution, high power instrumentation, etc.

SPECIFICATIONS

RCD Type	Wattage @ 25°C	Resistance Range* Ω	A	B	C	E	F	G	H	I	J	K	L
EW75	75W	0.1 - 8	4.33[110]	.984[25]	.63 [16]	.32[8]	5.9[150]	.197[5]	.71[18]	.236[6]	6.53[166]	2.28[58]	.047[1.2]
EW100	100W	0.1 - 9	3.54[90]	1.10[28]	.708[18]	.32[8]	5.12[130]	.197[5]	.71[18]	.236[6]	5.75[146]	2.36[60]	.047[1.2]
EW120	120W	0.1 - 12	4.33[110]	1.10[28]	.708[18]	.32[8]	5.90[150]	.197[5]	.71[18]	.236[6]	6.53[166]	2.36[60]	.047[1.2]
EW150	150W	0.1 - 15	5.51[140]	1.10[28]	.708[18]	.32[8]	7.08[180]	.197[5]	.71[18]	.236[6]	7.71[196]	2.36[60]	.047[1.2]
EW180	180W	0.1 - 18	6.3[160]	1.10[28]	.708[18]	.32[8]	7.87[200]	.197[5]	.71[18]	.236[6]	8.50[216]	2.36[60]	.047[1.2]
EW225	225W	0.1 - 23	7.67[195]	1.10[28]	.708[18]	.32[8]	9.25[235]	.197[5]	.71[18]	.236[6]	9.88[251]	2.36[60]	.047[1.2]
EW240	240W	0.1 - 24	7.28[185]	1.38[35]	.945[24]	.36[9]	8.86[225]	.197[5]	.748[19]	.315[8]	9.64[245]	2.99[76]	.063[1.6]
EW300	300W	0.3 - 30	8.27[210]	1.38[35]	.945[24]	.36[9]	9.84[250]	.197[5]	.748[19]	.315[8]	10.78[274]	2.99[76]	.063[1.6]
EW375	375W	0.3 - 38	8.27[210]	1.57[40]	.984[25]	.44[11]	9.84[250]	.197[5]	.748[19]	.315[8]	10.78[274]	3.07[78]	.063[1.6]
EW450	450W	0.3 - 45	10.23[260]	1.57[40]	.984[25]	.44[11]	11.81[300]	.197[5]	.748[19]	.315[8]	12.6[320]	3.07[78]	.063[1.6]
EW600	600W	0.3 - 60	12.99[330]	1.57[40]	.984[25]	.44[11]	14.56[370]	.197[5]	.748[19]	.315[8]	15.55[395]	3.07[78]	.063[1.6]
EW750	750W	0.3 - 75	12.99[330]	1.97[50]	1.38[35]	.47[12]	14.96[380]	.236[6]	.984[25]	.354[9]	15.75[400]	4.13[105]	.063[1.6]
EW900	900W	0.3 - 90	15.75[400]	1.97[50]	1.38[35]	.47[12]	17.72[450]	.236[6]	.984[25]	.354[9]	18.5[470]	4.13[105]	.063[1.6]
EW1000	1000W	0.5 - 100	18.11[460]	1.97[50]	1.38[35]	.47[12]	20.07[510]	.236[6]	.984[25]	.354[9]	21.0[533]	4.13[105]	.063[1.6]
EW1200	1200W	0.5 - 120	18.11[460]	2.36[60]	1.57[40]	.59[15]	20.27[515]	.236[6]	1.18[30]	.393[10]	21.06[535]	4.41[112]	.063[1.6]
EW1500	1500W	0.5 - 150	21.26[540]	2.36[60]	1.57[40]	.59[15]	23.42[595]	.236[6]	1.18[30]	.393[10]	24.21[615]	4.41[112]	.063[1.6]
EW2000	2000W	0.5 - 200	25.59[650]	2.56[60]	1.65[28]	.59[15]	27.63[702]	.238[6]	1.18[30]	.393[10]	28.42[722]	4.72[120]	.063[1.6]

* Available as low as 0.05Ω on special order.

Option M - thru-bolt mounting brackets for secured mounting

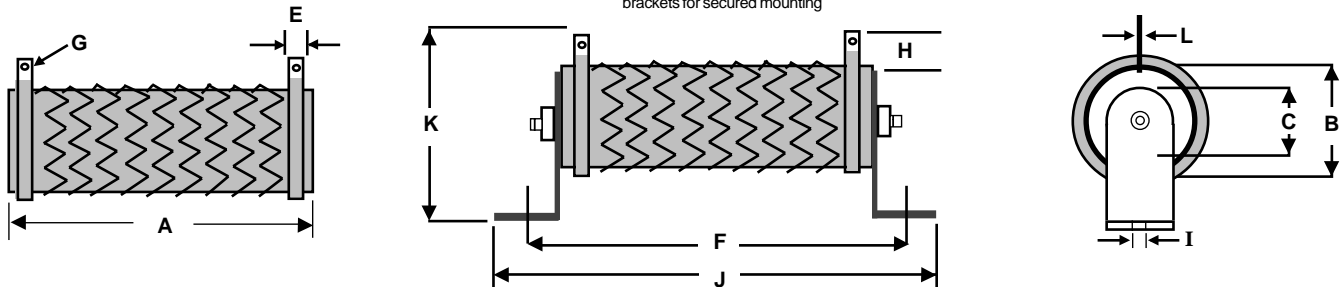

PERFORMANCE CHARACTERISTICS

Tolerance	±5% is standard 1Ω and above, ±10% below 1Ω (avail. to ±1%)
Temperature Coefficient	400ppm/°C Typ. (available to 50 ppm)
Dielectric Strength*	1000 VAC: terminal to mounting bracket 0 VAC: terminal to resistor body
Overload	10x rated power for 5 sec.
Derating	Full power @ 25°C to zero power @ 350°C

* Increased dielectric strength available.

P/N DESIGNATION:

EW750 - **1R5** - **J** **B** **W**

RCD Type: _____

Options: X, ER, M (Leave blank if standard)

Resis.Code 1%: 3 signif. figures & multiplier, (R100=1Ω, 1R00=1Ω, 10R0=10Ω, 1000=100Ω)

Resis.Code 2%-10%: 2 signif. figures & multiplier, (R10=0.1Ω, 1R0=1Ω, 100=10Ω, 101=100Ω, 102=1K)

Tolerance: K=10% (std <1Ω), J=5% (std 1Ω & above), G=2%, F=1%

Packaging: B = Bulk (only)

Termination: W= Lead-free, Q= Tin/Lead (leave blank if either is acceptable)

FLAT POWER WIREWOUND RESISTORS, 40 - 450 WATT

FW SERIES - Wirewound FWE SERIES - Edgewound



Term.W is
RoHS
compliant
& 260°C
compatible



- Widest range in the industry!
- Stackable, low profile design
- High power-to-size ratio
- Flameproof silicone coating (UL-94V0)
- Tapped versions, custom sizes and terminations avail.

OPTIONS

- Option X: Non-inductive
- Option EQ: 24-hour burn-in at full rated power
- Option 22: 22mm stand-off height

High power flat wound construction, low cost!

Unique oval-shaped ceramic core construction offers a low profile body for minimal height installation. Available in a wide range of power ratings from 40W to 450W. Feature all-welded construction and integral mounting brackets, allows stackable mounting configurations for increased power ratings. Series FWE (edgewound) offers highest size-to-power ratio making it ideally suited for load testing, power distribution, high power instrumentation, etc.

FW SERIES

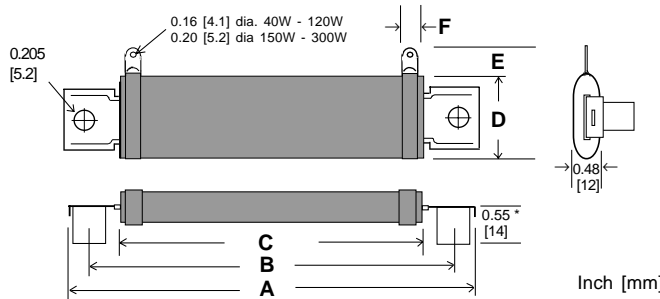

FWE SERIES (EDGEWOUND VERSION)

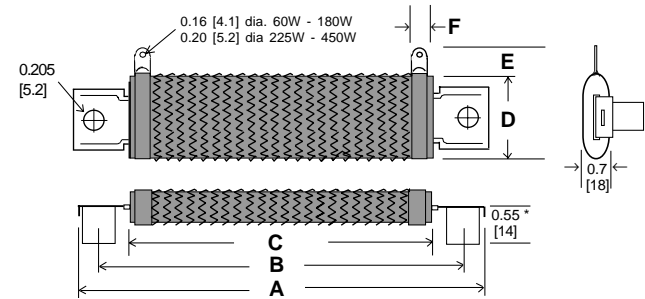

*For 22mm (.87") stand-off height instead of standard 14mm, specify option 22

SPECIFICATIONS

RCD Type	Wattage @ 25°C	Resistance Range ¹ (Ω)	A	B	C	D	E	F
FW40	40W	0.1 - 5K	3.26 [83]	2.75 [70]	1.97 [50]	1.14 [29]	.5 [12.7]	.27 [7]
FW55	55W	0.1 - 6K	4.84 [123]	4.33 [110]	3.54 [90]	1.14 [29]	.5 [12.7]	.27 [7]
FW70	70W	0.1 - 7K	6.0 [153]	5.5 [140]	4.72 [120]	1.14 [29]	.5 [12.7]	.27 [7]
FW95	95W	0.1 - 10K	7.2 [183]	6.69 [170]	5.9 [150]	1.14 [29]	.5 [12.7]	.27 [7]
FW120	120W	0.1 - 15K	8.58 [218]	8.07 [205]	7.28 [185]	1.14 [29]	.5 [12.7]	.27 [7]
FW150	150W	0.1 - 18K	8.58 [218]	8.07 [205]	7.28 [185]	1.42 [36]	.53 [13.5]	.35 [9]
FW200	200W	0.1 - 25K	9.56 [243]	9.05 [230]	8.26 [210]	1.42 [36]	.53 [13.5]	.35 [9]
FW250	250W	0.1 - 30K	11.29 [287]	10.78 [274]	10.0 [254]	1.42 [36]	.53 [13.5]	.35 [9]
FW300	300W	0.1 - 35K	13.11 [333]	12.6 [320]	11.8 [300]	1.42 [36]	.53 [13.5]	.35 [9]
FWE60	60W	1.0 - 4.0	3.26 [83]	2.75 [70]	1.97 [50]	1.14 [29]	.5 [12.7]	.27 [7]
FWE80	80W	1.0 - 5.0	4.84 [123]	4.33 [110]	3.54 [90]	1.14 [29]	.5 [12.7]	.27 [7]
FWE100	100W	1.0 - 7.0	6.0 [153]	5.5 [140]	4.72 [120]	1.14 [29]	.5 [12.7]	.27 [7]
FWE140	140W	1.0 - 9.0	7.2 [183]	6.69 [170]	5.9 [150]	1.14 [29]	.5 [12.7]	.27 [7]
FWE180	180W	1.0 - 12.0	8.58 [218]	8.07 [205]	7.28 [185]	1.14 [29]	.5 [12.7]	.27 [7]
FWE225	225W	1.0 - 15.0	8.58 [218]	8.07 [205]	7.28 [185]	1.42 [36]	.53 [13.5]	.35 [9]
FWE300	300W	1.0 - 20.0	9.56 [243]	9.05 [230]	8.26 [210]	1.42 [36]	.53 [13.5]	.35 [9]
FWE375	375W	1.0 - 25.0	11.29 [287]	10.78 [274]	10.0 [254]	1.42 [36]	.53 [13.5]	.35 [9]
FWE450	450W	1.0 - 30.0	13.11 [333]	12.6 [320]	11.81 [300]	1.42 [36]	.53 [13.5]	.35 [9]

¹ Available as low as 0.05Ω on special order.

Tolerance	±5% is standard 1Ω and above, ±10% below 1Ω (avail. to ±1%)
Temperature Coefficient*	260ppm/°C Typ. 21Ω and above, 400ppm/°C 0.1Ω to 20Ω
Dielectric Strength**	1000 VAC: terminal to mounting bracket 0 VAC: terminal to resistor body
Overload	10x rated power for 5 sec.
Derating	Full power @ 25°C to zero power @ 350°C

*TC's to 50ppm available **Increased dielectric strength available

P/N DESIGNATION:

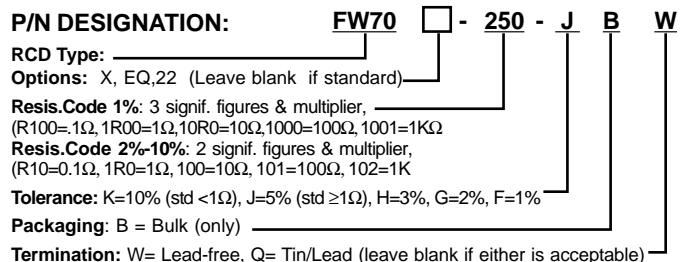

ULTRA-LOW OHM, 2 WATT to 20 WATT

ULV SERIES

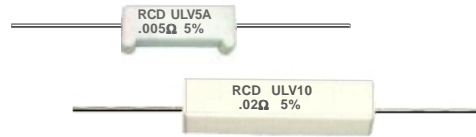

FEATURES

- Values from 0.002Ω to 0.05Ω, tolerances to ±0.5%
- Ceramic body results in a fireproof construction
- Welded construction, low-inductance
- Excellent overload capability
- Available on RCD's exclusive **SWIFT™** delivery program!

OPTIONS

- Option X: Non-inductive design (<0.1uH)
- Option A: Built-in standoffs available
- Option E: Low thermal EMF design

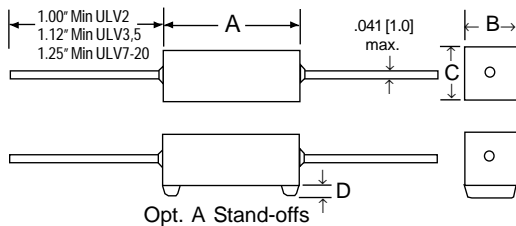

Ultra Low Value, 2-Terminal

When ordering low value resistors please note that the lead resistance can be a contributing factor. RCD measures the resistance value at 3/8 ±1/32" from each end of the body (per MIL-R-49465). If in actual use, a different span from the resistor body to the PCB will be required, please advise at the time of ordering.

TYPICAL PERFORMANCE

TC _{T25 to T100}	.025Ω to 0.05Ω	200ppm/°C typ., 50 & 100ppm avail.
	.01Ω to 0.0249Ω	400ppm/°C typ., 200 & 100ppm avail.
	.005Ω to 0.0099Ω	800ppm/°C typ., 400 & 200ppm avail.
	.002Ω to 0.0049Ω	1600ppm/°C typ., 800 & 400ppm avail.
Operating Temp.	-55° to +275° C	
Terminal Strength	5 lbs. minimum	
Dielectric Strength	1000V	
Short Time Overload	5x rated W, 5 Sec., nte 1.5x max A	
Moisture Resistance	1.0%	
Temp. Cycle (-40/+125°C)	1.0%	
Load Life (1000 hours)	1.0%	
Shock and Vibration	0.2%	

RCD Type	Wattage Rating ¹ @ 25°C	Current Rating ¹ @ 25°C	MIL Type ²	Resis. Range ¹ (Ω)	DIMENSIONS [Numbers in brackets are mm.]			
					A ±.04 [1.0]	B ±.032 [.81]	C ±.05 [1.3]	D Typ. (Opt. A only)
ULV2	2W	20A	-	.002 - .05	.70 [17.8]	.27 [6.8]	.27 [6.8]	.06 [1.5]
ULV3	3W	25A	-	.002 - .05	.88 [22.4]	.31 [7.9]	.31 [7.9]	.06 [1.5]
ULV5	5W	30A	RLV41	.002 - .05	.88 [22.4]	.38 [9.7]	.35 [8.9]	.06 [1.5]
ULV7	7W	35A	RLV42	.0025 - .05	1.42 [36] max.	.38 [9.7]	.35 [8.9]	.10 [2.5]
ULV10	10W	40A	RLV43	.003 - .05	1.96 [50] max.	.38 [9.7]	.38 [9.7]	.10 [2.5]
ULV15	15W	40A	-	.003 - .05	1.96 [50] max.	.50 [12.7]	.50 [12.7]	.10 [2.5]
ULV20	20W	40A	-	.005 - .05	2.55 [65] max.	.56 [14.2] max.	.50 [12.7]	.10 [2.5]

¹ Increased rating available, consult factory

² Military part numbers are for references only and do not imply qualification.

P/N DESIGNATION:

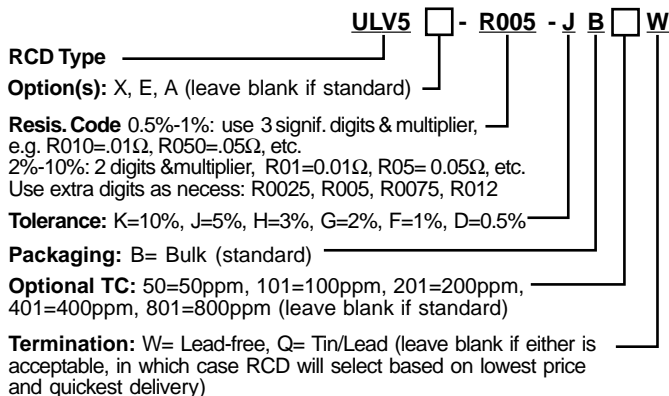

DERATING:

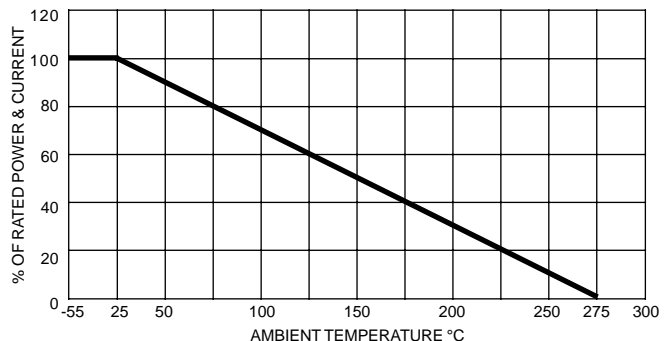

PRECISION 4-TERMINAL RESISTORS, 2- TO 20-WATT CERAMIC ENCASED LVF & LVH SERIES



Term. W
is Pb-free
and RoHS
compliant

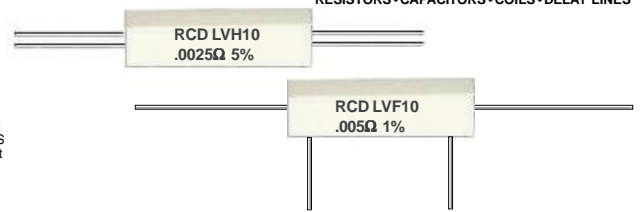

FEATURES:

- Industry's widest range of 4-terminal power resistors!
- Standard tolerances to 0.1%, TC's to 5ppm
- Welded & fireproof construction
- Available on exclusive **SWIFT™** delivery program!
- 4-terminal "Kelvin" design eliminates contributing error due to lead resistance
- Standard current ratings to 40A (up to 100A on custom basis)
- For surface mount design up to 3W see SF series

OPTIONS:

- Option X: Non-inductive design
- Option E: Low thermal EMF design
- Numerous other options available including custom marking, lead forming, lead diameter, burn-in, etc.

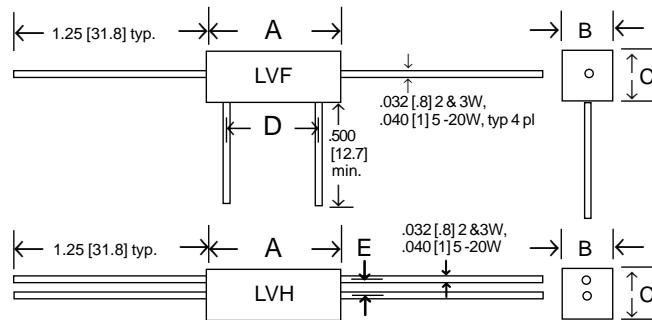

Four-Terminal Current Sensing as low as 0.0005Ω

RCD's Series LVF resistors feature a 4-terminal "Kelvin" design to eliminate the effects of lead resistance. Precision resistive element is potted inside a ceramic case for excellent durability and environmental protection. Series LVF resistors are well-suited for current sensing applications including test instrumentation, power supplies, and power amplifiers. Specify option E when circuits require low thermal EMF.

TEMPERATURE COEFFICIENT

Resis. Range	Standard TC (ppm/°C, typ)	Optional TC
.0005 to .0049Ω	600 ppm	200, 100, 50
.005 to .0249Ω	200 ppm	100, 50, 30
.025 to .99Ω	100 ppm	50, 30, 20
1 to 9.9Ω	50 ppm	30, 20, 10
10Ω and up	30 ppm	20, 10, 5

DERATING:

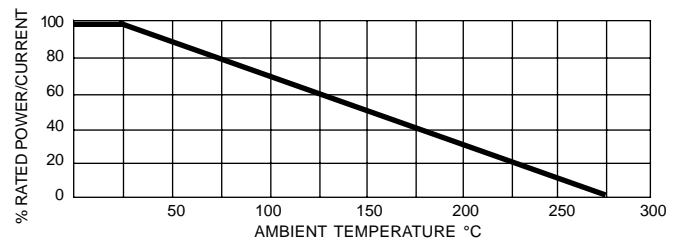

RCD Type	Wattage Rating ¹	Max. Working Voltage ^{1,2}	Max. Current ^{1,3}	Resistance Range (Ω)	DIMENSIONS [Numbers in brackets are mm]				
					A ±.04 [1.0]	B ±.032 [.81]	C ±.032 [.8]	D (LVF only) ±.12 [3]	E (LVH only) ±.032 [.8]
LVF2S, LVH2S	2	100V	15A	.0005 - 10K	.59 [15]	.25 [6.35]	.25 [6.35]	.45 [11.43]	.075 [1.9]
LVF2, LVH2	2	100V	20A	.0005 - 15K	.70 [17.58]	.27 [6.8]	.27 [6.8]	.50 [12.7]	.075 [1.9]
LVF3, LVH3	3	150V	25A	.001 - 25K	.88 [22.4]	.31 [7.9]	.31 [7.9]	.56 [14.2]	.10 [2.54]
LVF5, LVH5	5	200V	30A	.001 - 30K	.88 [22.4]	.38 [9.7]	.35 [8.9]	.56 [14.2]	.10 [2.54]
LVF7, LVH7	7	350V	35A	.001 - 50K	1.42 [36] Max	.38 [9.7]	.35 [8.9]	1.00 [25.4]	.10 [2.54]
LVF10, LVH10	10	500V	40A	.001 - 100K	1.96 [50] Max	.38 [9.7]	.38 [9.7]	1.38 [35.0]	.10 [2.54]
LVF15, LVH15	15	540V	40A	.001 - 100K	1.96 [50] Max	.50 [12.7]	.50 [12.7]	1.38 [35.0]	.125 [3.17]
LV20F, LVH20	20	600V	40A	.002 - 200K	2.55 [65] Max	.50 [12.7]	.50 [12.7]	2.00 [50.8]	.125 [3.17]

¹ Consult factory for increased ratings ² Working Voltage = (PR)^{1/2}, voltage not to exceed the maximum value listed ³ Units not to exceed wattage, current, or voltage rating, whichever is less

P/N DESIGNATION:

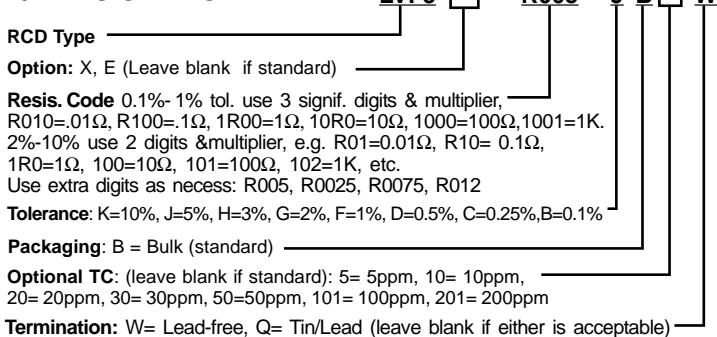

SUGGESTED MOUNTING

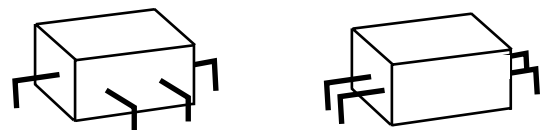

Bend leads approximately 1/8" from body. If operating at or near rated power, standoff is suggested to prevent overheating of the PCB. Utilize heavy duty copper traces adequate for intended current levels.

PRECISION LOW-OHM METAL PLATE RESISTORS

LOR SERIES 2-Terminal & 4-Terminal

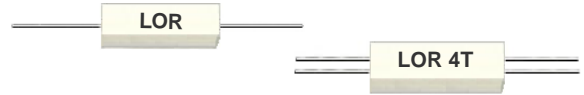

- Ideal for current sense applications
- 0.0025Ω to .25Ω, 0.1% to 10%
- Low TC, high pulse capability
- Non-inductive metal element
- Available on RCD's exclusive **SWIFT™** delivery program!



OPTIONS

- Option 4T: 4 Terminal
- Option E: Low thermal emf design
- Non-std resistance values, custom marking, burn-in, etc.

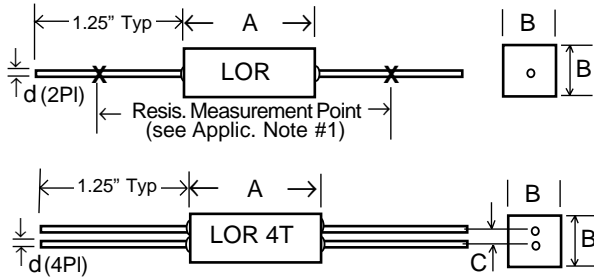

STANDARD RESISTANCE VALUES AND CODES

(Non-standard values available, most popular values listed in bold)
 .0025Ω (R0025), .003Ω (R003), **.005Ω** (R005), .0068Ω (R0068), .0075Ω (R0075),
 .0082Ω (R0082), **.01Ω** (R010 if ≤1%, R01 if ≥2%), .012Ω (R012), **.015Ω** (R015),
.02Ω (R020 if ≤1%, R02 if ≥2%), .022Ω (R022), **.025Ω** (R025), **.03Ω** (R030 if
 ≤1%, R03 if ≥2%), .033Ω (R033), **.04Ω** (R040 ≤1%, R04 ≥2%), **.05Ω** (R050 ≤1%,
 R05 ≥2%), .068Ω (R068), **.07Ω** (R070 if ≤1%, R07 if ≥2%), .075Ω (R075),
.08Ω (R080 if ≤1%, R08 ≥2%), **.1Ω** (R100 if ≤1%, R10 ≥2%), .15Ω (R150 if
 ≤1%, R15 ≥2%), .2Ω (R200 if ≤1%, R20 ≥2%), .25Ω (R250 if ≤1%, R25 ≥2%).

RCD TYPE	WATTAGE @25°C	MAX CURRENT RATING ¹	RESISTANCE RANGE (OHMS)	RESISTANCE MEASUREMENT POINT ±.062 [1.6]	DIMENSIONS			
					A ±.04 [1]	B ±.032 [.8]	d ±.002 [.05]	C ² ±.032 [.8]
LOR3	3W	25A	.0025 to .25	1.310 [33.3]	.551 [14]	.256 [6.5]	.032 [.8] ³	.075 [1.9]
LOR4	4W	32A	.0025 to .25	1.310 [33.3]	.551 [14]	.256 [6.5]	.040 [1] ⁴	.075 [1.9]
LOR5	5W	40A	.0025 to .25	1.670 [42.4]	.880 [22.35]	.320 [8.13]	.040 [1]	.100 [2.54]

¹ I = (P/R)^{1/2}, not to exceed max current rating (increased levels avail). ² Dim. C applies to Opt.4T ³ Specify opt.18 for .040 [1mm] lead dia ⁴ Specify opt.20 for .032 [0.8mm] lead dia

PERFORMANCE CHARACTERISTICS

Test Parameter	Performance, Typ.
Load Life	0.5% +5mΩ
Vibration	0.05% +5mΩ
Overload	5 Sec, 5X rated W (NTE Current Rating)
Temp. Coefficient	(per chart, 4wire conn. at body)
Temp. Range	-55° to +275°C
Dielectric Strength	1000 VAC
Insulation Res.	10,000MΩ min dry
Terminal Strength	10 lb. min.
Solderability	per Mil-STD-202, m.208
Inductance	non-inductive (3nH to 20nH typ)

POWER DERATING

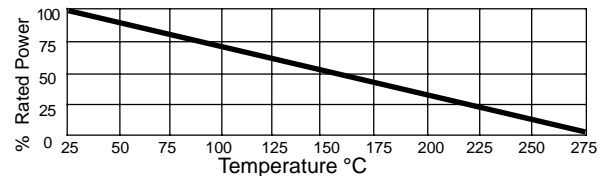

TEMPERATURE COEFFICIENT (typ.)

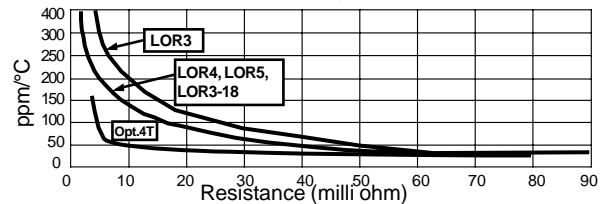

APPLICATION NOTES:

- LOR3 & 4 parts have resistance measured at 1.31" [33.3mm], LOR5 at 1.67" [42.4mm]. Also available per customer requirement.
- 18AWG (.040" dia) leads are standard on LOR4 & 5 and available on LOR3 by specifying opt.18. RCD recommends .040" leads, since the heavier gauge results in lower lead resistance, improved heat transfer, and lower in-circuit TCR (.032" leadwires have resistivity of ~1mΩ/in., 0.04" dia. ~0.6mΩ/in). An extra inch of .032" leadwire in the circuit will increase the TC of a 10mΩ resistor by roughly 350ppm. Keep leadwires short for best TC stability.
- To achieve utmost precision in current sense or shunt applications, RCD offers LOR3 & LOR5 in 4-terminal version, specify opt.4T (eliminates lead resistance when utilized in Kelvin configuration). Request App. note #R31 for performance comparison of 2- vs. 4-terminal.

P/N DESIGNATION:

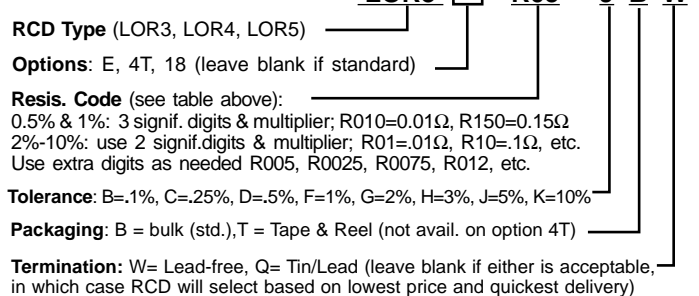

OPEN-AIR LOW VALUE CURRENT SHUNT RESISTORS

0.001Ω to 0.15Ω, 1 WATT to 5 WATT

OA SERIES



Term. W is Pb-free and RoHS compliant



RESISTORS • CAPACITORS • COILS • DELAY LINES



← New narrow profile design offers significant space savings!

- Industry's widest range and lowest cost!
- Tolerances to ±0.5%, TC's to ±20ppm
- Available on exclusive **SWIFT™** delivery program!
- Option S: Axial lead (unformed element)
- Option E: Low Thermal EMF
- Option A: Stand-offs formed into lead wires
- Optional pin diameters and pin spacing

RCD's OA series offers cost-effective performance for a wide range of current shunt/sense applications. The non-insulated open-air design features non-inductive performance and excellent stability/overload capacity. Numerous design modifications and custom styles are available... current ratings up to 100A, surface mount designs, military screening/burn-in, marking, insulation, intermediate values, etc. Custom shunts have been an RCD specialty over 30 years! Contact factory for assistance.

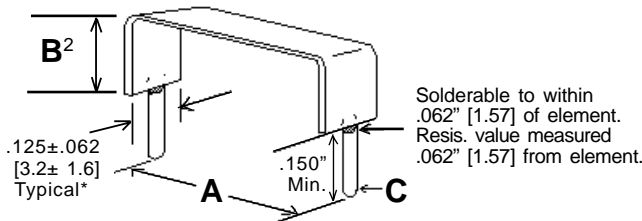

Typical shape depicted--actual shape may vary within envelope given. Overall length not to exceed Dim.A +.12" [3]. Dimensions in inches [mm]. * Most values are .125 [3.2] wide, lowest 2W-5W are .187 [4.75] wide, highest 1W-2W values are .062 [1.6] wide

Option 'A' Stand-offs:

For stand-off, specify Opt. A (e.g. OA2BA, OA5AA). Resis. value is measured at bottom of stand-off.

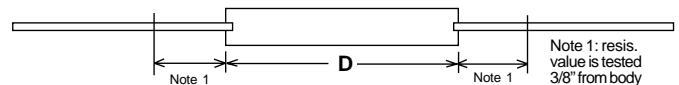
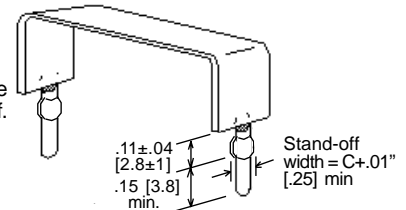

Option 'S' Straight Axial Lead Design (lead length = 1.25" [31.8] min)

SPECIFICATIONS

RCD Type	Power Rating ¹	Current Rating ¹		Resistance Range	A (lead spacing) ±.040 [1]		B Max. ²	C (lead diameter)		D Max.
		With Std. Lead	With Opt. Lead		Standard	Optional ²		Standard	Optional	
OA1A	1W	14A	17A	.001Ω-.08Ω	.40 [10.5]	.2" [5], .275" [7]	.35 [8.9] ²	20AWG	18AWG (Opt. 18)	1.20 [30.5]
OA1B	1W	17A	14A	.001Ω-.08Ω	.45 [11.4]	.2" [5], .275" [7]	.30 [7.6] ²	18AWG	20AWG (Opt. 20)	1.20 [30.5]
OA2A	2W	22A	24A	.001Ω-.1Ω	.40 [10.5]	.2" [5], .275" [7]	.70 [17.8] ²	20AWG	18AWG (Opt. 18)	1.95 [49.5]
OA2B	2W	24A	22A	.001Ω-.1Ω	.60 [15.2]	.2" [5], .275" [7]	.60 [15.2] ²	18AWG	20AWG (Opt. 20)	1.95 [49.5]
OA3A	3W	26A	24A	.001Ω-.12Ω	.60 [15.2]	.2" [5], .275" [7]	.90 [22.9] ²	18AWG	20AWG (Opt. 20)	2.50 [63.5]
OA5A	5W	32A	40A	.0025Ω-.15Ω	.80 [20.3]	.2" [5], .275" [7]	1.0 [25.4] ²	18AWG	16AWG (Opt. 16)	2.94 [74.7]

¹Units not to exceed wattage or current rating, whichever is less. Current rating is based on standard lead diameter, increased ratings available.
²Dim.B applies only to parts formed to the standard lead spacing (increase accordingly for options 80 & 27). Custom pin spacings are available.

STANDARD RESISTANCE VALUES AND CODES

Intermediate values available, most popular values listed in bold:
 .001Ω (R001), .0015Ω (R0015), .002Ω (R002), .0025Ω (R0025), .003Ω (R003), **.005Ω** (R005), .0068Ω (R0068), .0075Ω (R0075), .0082Ω (R0082), **.01Ω** (R010 if ≤1%, R01 ≥2%), .012Ω (R012), **.015Ω** (R015), **.02Ω** (R020 if ≤1%, R02 ≥2%), .022Ω (R022), **.025Ω** (R025), **.03Ω** (R030 if ≤1%, R03 ≥2%), .033Ω (R033), **.04Ω** (R040 if ≤1%, R04 ≥2%), **.05Ω** (R050 ≤1%, R05 ≥2%), .068Ω (R068), **.07Ω** (R070 if ≤1%, R07 ≥2%), .075Ω (R075), **.08Ω** (R080 if ≤1%, R08 ≥2%), **.1Ω** (R100 if ≤1%, R10 ≥2%).

TYPICAL OPERATING CHARACTERISTICS:

TEMPERATURE RANGE: -55 to +275°C
 DERATING: derate power & current rating by 0.4%/°C above 25°C
 OVERLOAD: 5 x rated power for 5 seconds
 LOAD LIFE @ 25°C (1000 hrs): 1% ΔR
 MOISTURE No Load (1000 hrs): 1% ΔR
 INDUCTANCE: <10nH
 TEMP. CYCLING -40°C to +125°C (1000 cycles): 1% ΔR

TOLERANCE AND T.C. OPTIONS

Resistance Range	Tol. Range	Temp. Coef. (ppm/°C)	
		Typical	Best Avail.*
.001 to .0049Ω (OA5A=.0025 to .005Ω)	3% to 10%	900ppm	200ppm
.005 to .0099Ω (OA5A=.006 to .015Ω)	1% to 10%	600ppm	100ppm
.010 to .024Ω (OA5A=.016 to .025Ω)	1% to 10%	200ppm	50ppm
.025 to .049Ω	1% to 10%	100ppm	30ppm
.05 to .10Ω	1% to 10%	50ppm	20ppm

* TC options vary depending on size and value (consult factory for availability)

P/N DESIGNATION: OA2A □ □ □ - R001 - J B □ W

RCD Type _____
 Design Options: S=unformed, E= low thermal EMF, A=standoffs. Leave blank if std.
 Lead Spacing Option: 80=.2" [5mm], 27=.275" [7mm]. Leave blank if std.
 Lead Diameter Option: 20=20AWG, 18=18AWG, 16=16AWG. Leave blank if standard.
 Resis. Code (see table): R01, R010, R100, etc.
 Tolerance Code: D=0.5%, F=1%, G=2%, H=3%, J=5%, K=10%
 Packaging: B = bulk (standard)
 TC (see table for options): 20=20ppm, 30=30ppm, 50=50ppm, 101=100ppm, 201=200ppm, 301=300ppm. (leave blank if standard)
 Termination: W=Lead-free, Q=Tin/Lead (leave blank if either is acceptable)

ZERO-OHM JUMPERS, 2A to 25A

ZJ SERIES - INSULATED Z SERIES - UNINSULATED

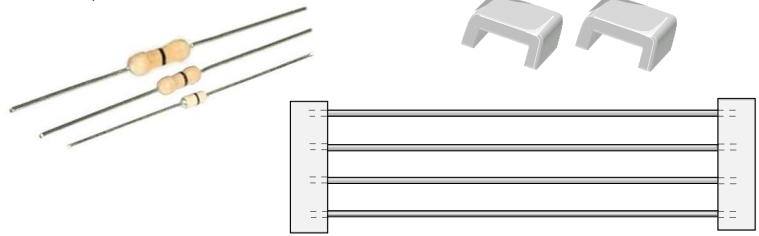

- Industry's widest range of zero-ohm jumpers
- Low cost, delivery from stock
- Commercial & military applications
- 3 standard styles- insulated, uninsulated, & surface mount (also refer to ZC Series for thick-film chip jumpers and ZCF for cylindrical MELF)
- Horizontal and vertical tape & reel available
- Custom models to 50A available

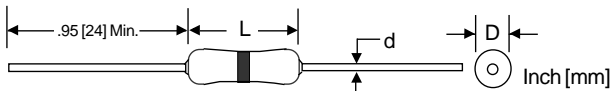

RCD "zero-ohm" jumpers were developed for use as interconnection devices between points on a PCB when separated by circuit paths, or when the pcb layout has been changed requiring new point connections. Specify ZJ Series (insulated bodies) when jumpers are in close proximity with conductor paths. Specify Z Series (uninsulated tin plated copper) for circuits involving higher current levels. In addition to the 4 standard wire sizes listed (18-22 awg), Series Z is available in a wide range of custom sizes (12-26awg). RCD's Z1206 SM jumper achieves the industry's highest current rating in a 1206-size due to the heavy duty tin plated copper element. The ultra low resistance of type Z1206 (.00012Ω) is 25-400 times better than conventional models! Z1206 is formed into a U-shape to provide 500V isolation clearance.

SERIES ZJ INSULATED JUMPER SPECIFICATIONS

RCD Type	Military Type	L ±.015 [.4]	D ±.012 [.3]	d ±.003 [.08]	Maximum Resistance	Amp. Rating @70°C*	Dielectric Strength	Operating Temp. Range	Qty per Reel, Typ.
ZJ1		.145 [3.4]	.061 [1.55]	.020 [5]	.02Ω	2A	300V	-55 to +155°C	5000
ZJ1B	AA55502	.145 [3.4]	.061 [1.55]	.020 [5]	.01Ω	5A	300V	-55 to +155°C	5000
ZJ2		.250 [6.4]	.090 [2.3]	.024 [6]	.02Ω	3A	500V	-55 to +155°C	5000
ZJ2B	AA55501	.250 [6.4]	.090 [2.3]	.024 [6]	.01Ω	10A	500V	-55 to +155°C	5000
ZJ3		.335 [8.5]	.110 [2.8]	.025 [.63]	.02Ω	5A	500V	-55 to +155°C	4000

* Increased current ratings available

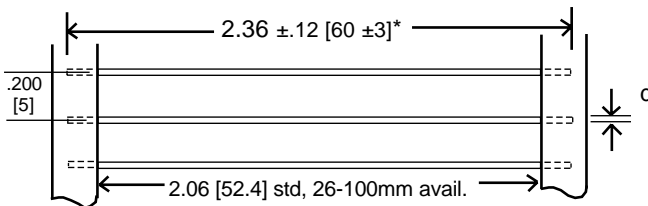

* Lengths from 0.2" to 6" [5 to 152mm] are avail.

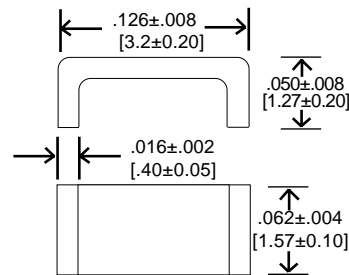

SERIES Z UNINSULATED JUMPER SPECIFICATIONS

RCD Type	d ±.003 [.08]	≈Wire Gauge	Resistance (Ω / inch)	Max. Amp Rating 25°C	Qty per Reel, Typ.
Z22	.024 [.6]	22 AWG	≈.0015Ω	10A	10,000
Z21	.028 [.7]	21 AWG	≈.0011Ω	15A	8,000
Z20	.031 [.8]	20 AWG	≈.0009Ω	20A	8,000
Z18	.040 [1]	18 AWG	≈.0006Ω	25A	5,000

SERIES Z1206 SM JUMPER SPECIFICATIONS

Resistance (25°C, no load)	120uS (0.00012S)
Current Rating †	25A at 25°C
Inductance	5nH
Isolation Voltage	500V
Soldering Temp.	260°C 10 Sec
Operating Temp. Range	-55°C to +175°C
Amperage Derating	Derate .667%/deg>25°C

† Requires suitably heavy-duty conductor paths to carry high currents

SERIES Z and ZJ Cut & Form Options

Most popular sizes are listed below but any W & H dimension from 0.2 to 1" [5 to 25mm] is available. Custom forming with standoffs also available.

C&F Code	W	H
C2	.200 [5]	.250 [6.3]
C12	.25 [6.3]	.250 [6.3]
C25	.30 [7.6]	.250 [6.3]
C4	.40 [10]	.250 [6.3]
C5	.50 [12.7]	.250 [6.3]

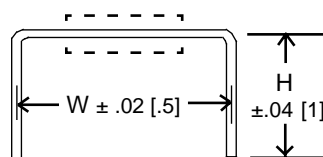

P/N DESIGNATION:

ZJ2 - T □ W

RCD Type

Packaging: B = Bulk, T = Tape & Reel

Optional Cut & Form Codes: C2 - C25, per table. Leave blank if no forming (not applicable to Z1206 which are formed as standard)

Termination: W= Lead-free, Q= Tin/Lead (leave blank if either is acceptable)

RESISTANCE STANDARDS ULTRA STABLE

A SERIES



Dimensions
Inch [mm]

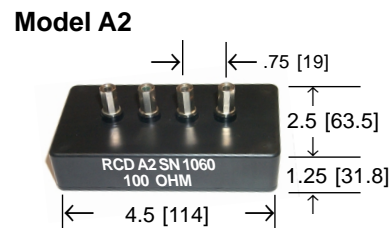

- Designed for use as DC Resistance Standards in industrial, research, and metrology laboratories
- Standards are individually tested and certified to the National Institute of Standards and Technology
- Accuracies to $\pm 0.0005\%$!
- Choice of models: A1 offers utmost precision and stability for 'primary standard' applications, A2 offers economical 'secondary standard' performance
- Values from 0.01Ω to $1M\Omega$ are standard (any decade or intermediate value can be offered on a custom basis from 0.001Ω to $10^{13}\Omega$, consult factory)
- Low thermal EMF and voltage coefficients
- RCD standards lab offers recalibration services
- Low temperature coefficient (approx. $10\text{ppm}/^\circ\text{C}$)
- Operating temperature: 0°C to $+40^\circ\text{C}$
- Low cost 2-terminal banana plug standards avail.

RCD - The standard by which others are measured!

RCD has been manufacturing precision resistors for more than 30 years, which have evolved into some of the most precise and stable standards available worldwide, up to 10 times more accurate than competitive models!

Series A1: Made of premium resistance wire, wound on insulated brass spools for precise matching of TCE, and pre-conditioned to assure utmost stability. The element is immersed in moisture-free oil inside a sealed metal container. Available in two grades, A1A to $\pm 0.0005\%$ and A1B to $\pm 0.001\%$. A1A standards are not only traceable to the NIST, but also include a computerized TC chart giving corrections for every 0.01°C from 18 to 30°C . Series A1 are provided with a thermometer well at the center of the standard. As an option, a 100 Ω platinum RTD element (RCD type PTF1 accurate to 0.1°C) can be imbedded in the midst of the resistance windings. Heavy duty leads enable series/parallel connections without compromising the guaranteed limit of error.

Series A2: Precision resistors with 4-terminal brass binding posts designed for less critical applications such as secondary reference standards. Molded low-profile case with flexible internal insulation protects the resistance element from damage even when exposed to non-laboratory environments, such as production or R&D departments. Gold plated binding posts available.

A1 SPECIFICATIONS

Resistance Value	Nom. Tolerance		Measured Value Resolution	Accuracy of Measured Value*		Wattage Rating	Current Rating	Long Term Stability**		Power Coef.* (ppm/mW)	
	A1A	A1B		A1A	A1B			A1A	A1B	A1A	A1B
0.1 Ω	$\pm 0.005\%$	$\pm 0.05\%$ (.01% avail)	0.0000001 Ω	5ppm	10ppm	1.0W	3.2A	1-5ppm	2-10ppm	.002	.010
1.0 Ω	$\pm 0.0005\%$	$\pm 0.003\%$ (.001% avail)	0.000001 Ω	3ppm	10ppm	1.0W	1.0A	0.5-3ppm	1-5ppm	.001	.005
10 Ω	$\pm 0.0005\%$	$\pm 0.003\%$ (.001% avail)	0.00001 Ω	4ppm	10ppm	1.0W	.32A	0.5-3ppm	1-5ppm	.001	.005
50 Ω	N/A	$\pm 0.003\%$ (.001% avail)	0.00001 Ω	-	10ppm	1.0W	.14A	N/A	1-5ppm	N/A	.005
100 Ω	$\pm 0.0005\%$	$\pm 0.003\%$ (.001% avail)	0.0001 Ω	4ppm	10ppm	1.0W	.1A	0.5-3ppm	1-5ppm	.001	.005
400 Ω	N/A	$\pm 0.003\%$ (.001% avail)	0.0001 Ω	-	10ppm	1.0W	.05A	N/A	1-5ppm	N/A	.005
1K Ω	$\pm 0.0005\%$	$\pm 0.003\%$ (.001% avail)	0.001 Ω	5ppm	10ppm	1.0W	.032A	0.5-3ppm	1-5ppm	.001	.005
10K Ω	$\pm 0.0005\%$	$\pm 0.003\%$ (.001% avail)	0.01 Ω	7ppm	10ppm	1.0W	.01A	0.5-3ppm	1-5ppm	.001	.005

A2 SPECIFICATIONS

Resistance Value	Nominal Tolerance	Measured Value Resolution	Accuracy of Meas. Value*	Wattage Rating	Current Rating	Long Term Stability**	Power Coef. (ppm/mW) *
0.01 Ω	$\pm 0.05\%$ (.01% avail)	0.000001 Ω	200ppm	1.0W	10A	20-100ppm	0.5
0.1 Ω	$\pm 0.03\%$ (.01% avail)	0.00001 Ω	50ppm	1.0W	3.2A	10-50ppm	0.3
1.0 Ω	$\pm 0.01\%$ (.005% avail)	0.0001 Ω	20ppm	1.0W	1A	5-25ppm	0.3
10 Ω	$\pm 0.01\%$ (.005% avail)	0.001 Ω	20ppm	1.0W	.32A	5-25ppm	0.1
50 Ω	$\pm 0.01\%$ (.005% avail)	0.001 Ω	20ppm	1.0W	.14A	5-25ppm	0.1
100 Ω	$\pm 0.01\%$ (.005% avail)	0.001 Ω	20ppm	1.0W	.1A	5-25ppm	0.1
400 Ω	$\pm 0.01\%$ (.005% avail)	0.001 Ω	20ppm	1.0W	.05A	5-25ppm	0.1
1K Ω	$\pm 0.01\%$ (.005% avail)	0.01 Ω	20ppm	1.0W	.032A	5-25ppm	0.1
10K Ω	$\pm 0.01\%$ (.005% avail)	0.1 Ω	20ppm	1.0W	.01A	5-25ppm	0.1
100K Ω	$\pm 0.01\%$ (.005% avail)	1.0 Ω	50ppm	1.0W	.0032A	5-25ppm	0.1
1M Ω	$\pm 0.01\%$ (.005% avail)	10.0 Ω	200ppm	1.0W	.001A	10-50ppm	0.1

HOW TO ORDER:

Standards can be ordered as complete sets or individually. SET-A1A has six A1A standards (0.1 Ω , 1 Ω , 10 Ω , 100 Ω , 1K, 10K). SET-A1B has eight A1B standards (0.1 Ω , 1 Ω , 10 Ω , 50 Ω , 100 Ω , 400 Ω , 1K, 10K). SET-A2 has eleven A2 standards (0.01 Ω , 0.1 Ω , 1 Ω , 10 Ω , 50 Ω , 100 Ω , 400 Ω , 1K, 10K, 100K, 1M). Order individual standards by denoting the model number and value, e.g. "A1A - 1 OHM", "A1B - 10K", "A2 - 1M". Indicate non-standard tolerances, e.g. "A2 - 1 OHM .005%". Lead-free RoHS-compliant design is available by adding "W" to end of p/n. Custom values are available.

* Tested at $25 \pm 0.05^\circ\text{C}$ in a well stirred oil bath at $<100\text{mW}$ (5ppm=.0005%, 10ppm=.001%, etc.)
 **Typical stability under conditions of normal use over 1 year period.

ULTRA PRECISION RESISTORS TO 0.001% 0.25PPM

HP SERIES- Metal Foil VS SERIES- Thin Film



Term.W is RoHS compliant & 260°C compatible

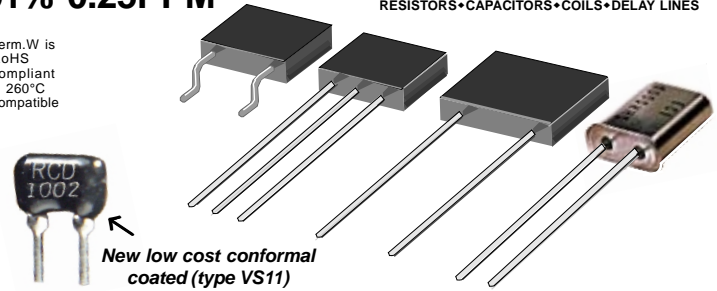

New low cost conformal coated (type VS11)

- Industry's widest range and highest precision
- Low inductance, capacitance, noise and thermal EMF
- Through-hole and SM designs
- VS16 is a dual resistor design (TC tracking to 1ppm avail.)
- Available on exclusive **SWIFT™** delivery program!

OPTIONS

- Option GW: gullwing SM lead forming (avail. on 24mm T&R)
- Option EQ: 24 hour burn in (or ER -100 hour burn in)
- Numerous additional options available including custom marking, matched sets, military screening, etc.

Nichrosil™ Metal Foil - Unsurpassed Performance

Series HP resistors feature a metal foil construction for the most demanding applications. Series VS feature a thin film construction which enables excellent performance across a wide range of values, offering a viable alternative to precision wirewound resistors. Superlow TC's, up to 20x better than Mil p/n RNC90Y requirements, provide new opportunities for design engineers. HP10 is hermetically sealed in a metal case, all others are epoxy encased or coated.

SPECIFICATIONS

RCD Type	Power Rating @70°C	Volt Rating	Resis. Range ¹	FIG	A Max.	B Max.	C Max.	D ±.01
VS1	.25W	250V	10Ω -500K	1,5	.320	.345	.120	.150
VS11	.25W	250V	10Ω -150K	4	.240	.354	.100	.100
VS15	.3W	300V	10Ω -3M	1,5	.305	.305	.105	.200
VS16	.15W ²	300V	10Ω -1.5M	3,5	.305	.305	.105	.100
VS2	.6W	300V	10Ω -1M	1,5	.320	.345	.120	.150
VS3	.7W	300V	30Ω -3M	1	.610	.365	.160	.400
VS4	1.0W	350V	30Ω -5M	1	.585	.545	.160	.400
VS5	1.5W	350V	50Ω -7M	1	.820	.545	.160	.650
VS55	1W	400V	10Ω -10M	1	1.120	.400	.260	.900
VS6	2.0W	500V	100Ω -10M	1	1.120	.400	.260	.900
HP7	.3W	300V	10Ω -25K	1,5	.320	.400	.120	.150
HP10	.6W	300V	10Ω-60K	2	.455	.530	.200	.150

¹ Consult factory for resistance values as low as 1Ω or as high as 100MΩ.
² VS16 wattage rating is per resistor, package power rating is 0.3W

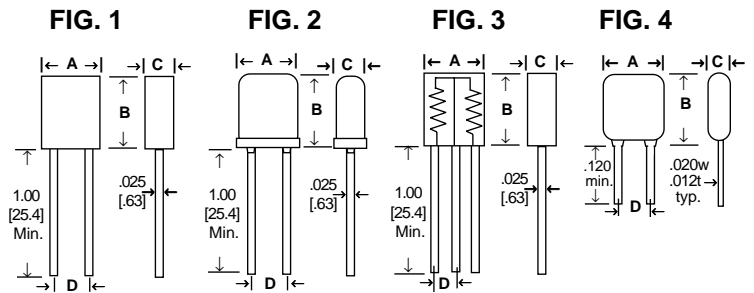
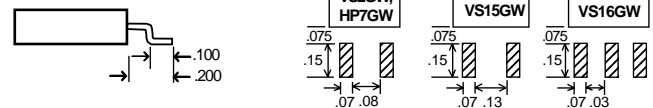

FIG. 5 Option GW (GULLWING)

Available on VS1, VS2, VS15, VS16, & HP7



PERFORMANCE CHARACTERISTICS

Condition	HP10 Max.	HP7 & VS Series**	MIL RNC90Y
TC (ppm/°C)***	.25/.5/1/3/5	1/2/3/5/10/25/50	5ppm
Resistance Tol.	.001% to .1%	.005% to 1%	.005% to 1%
2000hr Load 125°C	±.02%	±.05%	±.05%
Overload	±.01%	±.01%	±.05%
Moisture Resistance	±.01%	±.03%	±.05%
Shock, Vibration	±.01%	±.01%	±.01%, ±.02%
Voltage Coefficient	.1ppm/V	2ppm/V	5ppm/V
Shelf Life (1 year)	5ppm	25ppm	-
Thermal EMF	.05μV/°C	0.1μV/°C	-
Rise Time	1nS	1nS	-
Inductance	.1μH	.1μH	-
Capacitance	1.0pF	1.0pF	-
Current Noise	-30dB	-30dB	-
Derating	Derate W & V ratings by .909%/°C from 70 to 125°C, and 1%/°C from 125° to 175°C (full rated wattage @ 70°C, half wattage @ 125°C, zero wattage @ 175°C)		

* Per MIL-R-55182/9 100Ω to 100KΩ (Consult factory if outside this range.)
** Data is typical for all VS sizes except VS1 which meets MIL-R10509 Char E.
***TC is measured -55°C to +125°C for TC's > 5ppm, -20°C to +85°C for TC's 0.5 to 5ppm, and 20°C to +60°C for 0.25ppm.

COMPARISON	RCD Series VS & HP Film & Foil Resistors	RCD PC451 Wirewound
Inductance	Very Low	High*
Capacitance	Very Low	High*
Rise Time	Very Fast	Slow*
Stability	Excellent	Excellent
High Frequency	Excellent	Poor*
Cost Advantage	High values, high volume, high frequency circuits	Low values, small volume

* Largely dependent on resistance value (non-inductive and high-speed winding available.)

P/N DESIGNATION:

HP10 - **1001** - **F** **T** **5** **W**

RCD Type

Options: P, H, GW, ER, EQ (leave blank if std)

Resis. Code: 3 signif. figures & multiplier (10R0= 10Ω, 1000= 100Ω, 1001=1KΩ, 1002=10K, 1003=100K). When VS16 contains 2 different values, separate with / (e.g. 903/103)

Tolerance Code: F=1%, D=0.5%, C=0.25%, B=0.1%, A=0.05%, Q=0.02%, T=0.01%, V=.005%, S=.001%

Ratio Tolerance (VS16 only): V=0.005%, Y=0.01%, Q=0.02%, A=0.05%, Z=.1%, C=.25%, D=.5%, F=1%, G=2% (leave blank if not req'd)

Packaging: B = Bulk, T = Tape & Reel

TC: .25=0.25ppm, .5=0.5ppm, 2=2ppm, 5=5ppm, 10=10ppm, 25=25ppm, TC Tracking (VS16 only): 210=25ppm abs/10ppm track, 205=25ppm abs/5ppm track, 105=10ppm abs/5ppm track, 102=10ppm abs/2ppm track, 53=5ppm abs/3ppm track, 52=5ppm abs/2ppm track, 51=5ppm abs/1ppm track.

Termination: W= Lead-free, Q= Tin/Lead (leave blank if either is acceptable). Gold plated leads also available on most sizes (specify code G)

HERMETIC SEALED PRECISION METAL FILM RESISTORS HM SERIES



- Industry's widest range!
- Tolerances to $\pm 0.01\%$, TC's to $\pm 5\text{ppm}$!
- Hermetic enclosure enables exceptional environmental stability and physical protection
- Power levels are above equivalent military ratings!
- Available on exclusive **SWIFT™** delivery program!
- Extremely low noise, thermal EMF, and voltage coefficient

RCD Series HM hermetically sealed precision metal film resistors are designed for demanding applications including high humidity, salt atmosphere, and other hostile environments. The improved environmental stability is achieved by hermetically sealing the resistor element within the external insulated tube.

The wide choice of resistance values, tolerances, and temperature coefficients exceeds the military range of MIL-PRF-55182, enabling new opportunities for circuit designers.

OPTIONS

- OPTION EK : Group A screening per Mil-R-10509
- OPTION EL: Group A & B screening per Mil-R-10509
- A variety of options are available including custom sizes, formed leads, matched sets, non-standard values, special lab testing/burn-in, increased power/voltage/pulse capability, etc. Customized components are RCD's specialty!

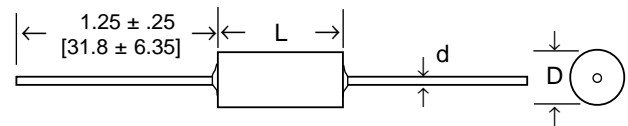

SPECIFICATIONS

RCD Type	MIL Type ¹	Standard Wattage Rating		Military Wattage Rating		Max. Working Voltage ²	Resistance Range ²	Dimensions		
		70°C	125°C	70°C	125°C			L	D	d
HM55	RNC55 RNR55 RNN55	.2W	.1W	.125W	.1W	200V	10Ω - 1M	.272 ± .024 [6.9 ± .6]	.123 ± .02 [3.1 ± .6]	.024 ± .002 [.6 ± .05]
HM60	RNC60 RNR60 RNN60	.25W	.125W	.25W	.125W	250V	10Ω - 2M	.287 ± .024 [7.3 ± .6]	.134 ± .024 [3.4 ± .6]	.024 ± .002 [.6 ± .05]
HM65	RNC65 RNR65 RNN65	.5W	.25W	.5W	.25W	300V	10Ω - 10M	.630 ± .05 [16 ± 1.2]	.236 ± .032 [6 ± 0.8]	.025 ± .002 [.635 ± .05]
HM70	RNC70 RNR70 RNN70	1.0W	.5W	.75W	.5W	350V	10Ω - 10M	.680 ± .062 [17.3 ± 1.57]	.250 ± .032 [6.35 ± 0.8]	.032 ± .002 [.8 ± .05]
HM75	RNC75 RNR75 RNN75	2.0W	1.0W	2.0W	1.0W	500V	10Ω - 10M	1.102 ± .062 [28 ± 1.57]	.395 ± .04 [10 ± 1]	.032 ± .002 [.8 ± .05]

¹ MIL type given for reference only and does not imply MIL qualification or exact interchangeability. ² Increased range available, consult factory

PERFORMANCE CHARACTERISTICS*

Condition	RCD Typ.	MIL-PRF-55182 Max.
TC (ppm/°C) **	5, 10, 15, 25, 50	25, 50ppm
Resistance Tolerance	.01%, .02%, .05%, .1%, .25%, .5%, 1%	.1%, .5%, 1%
Operating Temp. Range	-65° to +175°C	-65° to +175°C
Moisture Resistance	.03%	.2%
2000 Hour Load Life*	.1%	.5%
Thermal Shock/Overload	.02%	.2%
Low Temp. Operation	.05%	.15%
Terminal Strength	.02%	.2%
Dielectric Withstanding	.02%	.15%
Resis. to Solder Heat	.02%	.1%
Shock	.03%	.2%
Vibration	.02%	.2%
High Temp. Exposure	.2%	.5%

* Tested in accordance with MIL-PRF-55182 at applicable MIL power ratings.

** TC is measured +25 to +85°C, expanded range available

DERATING

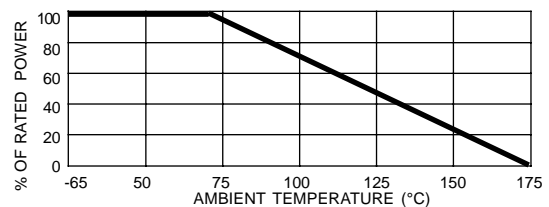

P/N DESIGNATION: HM55 - 1001 - F T 10 W

RCD Type _____
Options: EK, EL (leave blank for std) _____
Resis. Code: 3 signif. figures & multiplier, e.g. 1R00= 1Ω, 10R0=10Ω, 1000= 100Ω, 1001= 1KΩ, etc. _____
Tolerance Code: F=1%, D=0.5%, C=0.25%, B=0.1%, A=0.05%, Q=0.02%, T=0.01% _____
Packaging: B = Bulk, T = Tape & Reel _____
Temp. Coef: 5=5ppm, 10=10ppm, 15=15ppm, 25=25ppm, 50=50ppm _____
Termination: W= Lead-free, Q= Tin/Lead (leave blank if either is acceptable) _____

ULTRA PRECISION METAL FILM RESISTORS



RESISTORS • CAPACITORS • COILS • DELAY LINES

PMF SERIES



- Tolerances to $\pm 0.01\%$, TC's to $\pm 3\text{ppm}/^\circ\text{C}$
- Exceptional performance levels
- Extremely low noise, reactance, voltage coefficient
- All sizes available on Tape & Reel

OPTIONS

- Option S: miniature size
- Option ER: 100 hour burn-in (full rated $W_{25^\circ\text{C}}$)
- Also available: matched sets, axial and vertical cut & formed leads, hi-rel screening, special marking, hermetic seal, non-standard values, increased power & voltage, etc. Customized components are an RCD speciality!

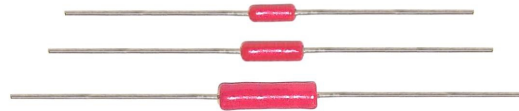

RCD's PMF Series meets the need for ultra-precision performance when product reliability is a must. Stability levels (comparable to those of precision wirewound resistors), coupled with the excellent high-frequency performance of film resistors, makes the PMF Series the universal choice. State-of-the-art deposition and trim equipment enables the industry's widest resistance range. The exceptional performance of this series provides new opportunities for circuit designers to obtain the utmost in long term reliability without the need for post circuit trimming.

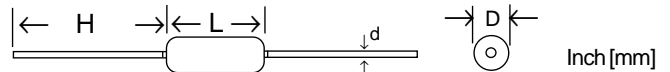

DERATING:

Derate W and V per graph when ambient temp exceeds 85°C

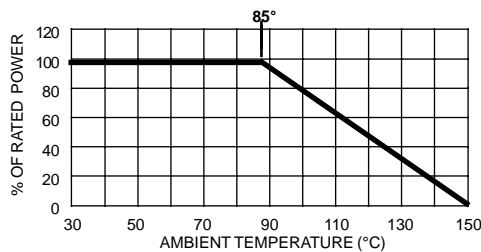

DIMENSIONS

RCD Type	L $\pm .032$ [.8]	D $\pm .025$ [.6]	d $\pm .003$ [.08]	H (Min.)
PMF1/20	.150 [3.8]	.065 [1.7]	.018 [.45]	.94 [24]
PMF1/10	.280 [7.1]	.105 [2.7]	.025 [.6]	1.1 [28]
PMF1/8S	.280 [7.1]	.105 [2.7]	.025 [.6]	1.1 [28]
PMF1/8	.380 [9.6]	.140 [3.5]	.025 [.6]	1.16 [29.5]
PMF1/4S	.380 [9.6]	.140 [3.5]	.025 [.6]	1.16 [29.5]
PMF1/4	.578 [14.7]	.189 [4.8]	.025 [.6]	1.16 [29.5]
PMF1/2	.736 [18.7]	.250 [6.35]	.031 [.8]	1.16 [29.5]
PMF1	.79 [20] Max	.315 [8] Max	.031 [.8]	1.30 [33]

TYPICAL PERFORMANCE

Temp.Coefficient (-20 to $+85^\circ\text{C}$, Ref 25°C)	25ppm/ $^\circ\text{C}$ (std), 15ppm, 10ppm, 5ppm, 3ppm
Thermal Shock (-55~ $+85^\circ\text{C}$, 5cyc 1/2hr)	0.02%
Moisture Resist.* (MIL-STD-202, M.106)	0.08%
Resistance to Solder Heat (260°C , 10S)	0.02%
Short Time Overload (2.5x RCWV, 5S, NTE 1.5xVR)	0.01% (.02% Opt.S)
Life (1000 hrs., full power)	0.02% (.05% Opt.S)
Shelf Life (Max. per year)	50 PPM
Dielectric Strength	500V (300V PMF1/20)
Operating Temperature	-55 to $+150^\circ\text{C}$

* To ensure utmost reliability, care should be taken to avoid potential sources of ionic contamination.

SPECIFICATIONS

RCD Type	Wattage @ 85°C	Voltage Rating*	Resistance Range
PMF1/20	1/20	200	10Ω to 604K
PMF1/10	1/10	250	10Ω to 1.5Meg
PMF1/8S	1/8	250	10Ω to 1.5Meg
PMF1/8	1/8	300	10Ω to 2 Meg
PMF1/4S	1/4	300	10Ω to 2 Meg
PMF1/4	1/4	350	10Ω to 5 Meg
PMF1/2	1/2	400	10Ω to 10 Meg
PMF1	1	500	10Ω to 15 Meg

* Maximum working voltage determined by $E = (PR)^{1/2}$, E not to exceed value listed in column above.

MATCHED SETS AND NETWORKS

RCD's experience in matching resistors for sets and networks can result in an economical solution for many circuits. Cost savings up to 50% can be achieved by allowing relatively loose absolute tolerances but tight matching requirements by pair or set. Resistance matching is available to 0.01% and T.C. tracking to $\pm 1\text{ppm}/^\circ\text{C}$.

P/N DESIGNATION: PMF1/10 - 1001 - Q B 5 W

RCD Type _____
 Options: S, ER, etc. (leave blank if standard) _____
 Resis. Code: 3 signif. figures & multiplier, e.g. 1R00= 1Ω , 10R0= 10Ω , 1000= 100Ω , 1001= $1K\Omega$, 1002= $10K\Omega$, 1003= $100K\Omega$, 1004= $1M\Omega$, 1005= $10M\Omega$ _____
 Tol. Code: F=1%, D=.5%, C=.25%, B=.1%, A=.05%, Q=.02%, T=.01% _____
 Packaging: B = Bulk, T = Tape & Reel _____
 Temp. Coefficient: (5=5ppm, 10=10ppm, 25=25ppm, etc.) _____
 Termination: W= Lead-free, Q= Tin/Lead (leave blank if either is acceptable) _____

PRECISION METAL FILM RESISTORS

MF SERIES



- Wide resistance range: 1.0Ω to 22.1 Meg
- TC ±25 to ±100ppm standard, matching to 10ppm
- Precision quality, excellent stability, low cost
- Meets performance requirements of MIL-R-10509 and EIA RS-460 (screening per Mil-PRF-55182 available)
- Extremely low noise, reactance, voltage coefficient
- Available on exclusive **SWIFT™** delivery program!
- All sizes available on Tape & Reel

OPTIONS

Custom marking, formed leads, matched sets, burn-in, increased power/voltage/pulse capability, flameproof, etc.

DERATING

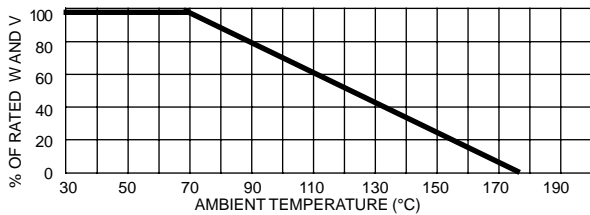

Military-grade performance at commercial grade price!

RCD MF Series metal film resistors have been designed to meet or surpass the performance levels of MIL-R-10509 characteristics D, C, and E. The film is a nickel-chrome alloy, evaporated onto a high grade substrate using a high vacuum process to ensure low TC's and superb stability. The resistors are coated or encased with a high-temp epoxy to ensure utmost moisture and solvent protection. Stringent controls are used in each step of production to ensure 'built-in' reliability and consistent quality. Resistors are available with alpha-numeric or color band marking.

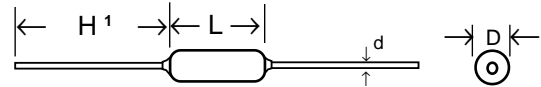

RCD Type	L (Max.)	D (Max.)	d (Max.)	H ¹ (Min.)
MF50	.168 [4.3]	.075 [1.9]	.020 [5]	1.00 [25]
MF55	.285 [7.2]	.102 [2.6]	.026 [66]	1.00 [25]
MF60	.404 [10.3]	.160 [4.06]	.026 [66]	1.10 [28]
MF65	.598 [15.2]	.211 [5.36]	.028 [7]	1.16 [29.5]
MF70	.724 [18.4]	.264 [6.7]	.033 [85]	1.16 [29.5]
MF75	1.114 [28.3]	.409 [10.4]	.033 [85]	1.16 [29.5]

¹ Longer leads available

RCD Type	MIL TYPE ¹	Wattage Rating @ 70°C	Maximum Working Voltage ²	TCR PPM/°C ³	Standard Resistance Range	
					1%	.5%, .25%, .1%
MF50	RN50	1/8W	200V	100, 50, 25	10Ω to 1.0MΩ	10Ω to 562K
MF55	RN55	1/4W	250V	100, 50	1.0Ω to 22.1MΩ	10Ω to 1.2MΩ
				25	10Ω to 1.0MΩ	10Ω to 1.2MΩ
MF60	RN60	1/2W	300V	100, 50	2.5Ω to 5.1MΩ	10Ω to 1.5MΩ
				25	10Ω to 1.0MΩ	10Ω to 1.5MΩ
MF65	RN65	3/4W	350V	100, 50	10Ω to 10MΩ	20Ω to 5.1MΩ
				25	20Ω to 5.1MΩ	20Ω to 5.1MΩ
MF70	RN70	1W	400V	100, 50	10Ω to 15MΩ	20Ω to 10MΩ
				25	20Ω to 10MΩ	20Ω to 10MΩ
MF75	RN75	2W	500V	100, 50	20Ω to 15MΩ	20Ω to 10MΩ
				25	20Ω to 10MΩ	20Ω to 10MΩ

¹ MIL type given for reference only and does not imply MIL qualification or exact interchangeability. ² Rated voltage = (PR)^{1/2} or Max. Voltage Rating, whichever is less.

³ TC is measured at -20 to +85°C, referenced to 25°C. TC's to 10ppm available.

PERFORMANCE CHARACTERISTICS*

Load Life (1000 hrs, full Mil equiv power @25°C)	0.10%
Short Time Overload (2.5x RCWV, 5 Sec, NTE 1.5x VR)	0.05%
Temp. Cycling (-55 to +85°C, 5 cycles, 1/2 hr)	0.10%
Moisture Resistance** (MIL-STD-202, M.106)	0.10%
Effect of Solder (260°C, 10 Sec)	0.02%
Low Temperature Operation (-65°, 1 hr)	0.02%
Shock, Vibration (per MIL-PRF-55182)	0.01%
Dielectric Strength (up to 1KV available)	500V (MF50=300V)
Operating Temperature Range	-65 to +175°C

* Data is representative of typical performance levels from 10Ω–100K (consult factory for performance data outside this range).

**To ensure utmost reliability, care should be taken to avoid potential sources of ionic contamination.

P/N DESIGNATION:

MF55 - **1002** - **B** **T** **25** **W**

RCD Type MF55

Option Code: assigned by RCD (leave blank if standard)

Resis. Code: 3 signif. digits & multiplier, e.g. R100=0.1Ω, 1R00=1Ω, 10R0=10Ω, 1000=100Ω, 1001=1K, 1002=10K, 1003=100K, 1004=1M, 1005=10M

Tolerance Code: F= 1%, D= 0.5%, C= 0.25%, B= 0.1%

Packaging: B = Bulk, T = Tape & Reel

Temperature Coefficient: 25= 25ppm, 50= 50ppm, 101= 100ppm

Termination: W= Lead-free, Q= Tin/Lead (leave blank if either is acceptable, in which case RCD will select based on lowest price and quickest delivery)

METAL FILM RESISTORS

GP SERIES - Standard GPS SERIES - Small Size FP/FPS SERIES - Flameproof



Term.W is
RoHS
compliant
& 260°C
compatible

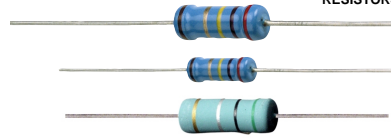

- Industry's widest range! 10 models, 1/8W to 2W, 1Ω to 22.1MΩ, 0.1% to 5%, 25ppm to 100ppm
- Miniature GPS Series enables significant space savings
- Flameproof FP & FPS version meet UL94V-0
- Wide selection available from stock

OPTIONS

- Option P: Pulse tolerant design
- Option ER: 100-hour burn-in (full rated $W_{25^{\circ}}$)
- Option 48: Short-time overload screening
- Numerous design modifications are available - matched sets, TCR tracking, cut & formed leads, increased voltage and temperature ratings, non-magnetic construction, etc.

Precision performance, industry's lowest price!

RCD's GP metal film resistors and FP flameproof version are designed to provide high performance and reliability at low costs. Improved performance over industry standard is achieved via the use of high grade materials combined with stringent process controls. Unlike other manufacturers that lock users into a limited range of "standard products", RCD offers the industry's widest choice of design options, including non-standard resistance values.

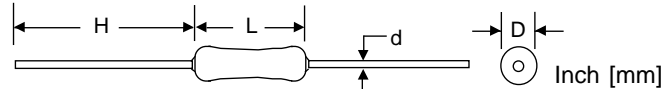

SERIES GP & FP SPECIFICATIONS

RCD Type	Watt Rating (70°C)	Max Working Voltage ¹	TC ppm/°C	Standard Resis. Range (custom avail.)			L ± .020 [5]*	D ± .016 [4]*	d ± .003 [08]	H (Min)**	Std. Reel Quantity
				.1% & .25%	0.5%	1% -5%					
GP50, FP50	.125W	200V	25 50 100	100Ω-1M 30Ω-1M 20Ω-1M	50Ω-1M 10Ω-1M 10Ω-1M	40Ω-1M 10Ω-1M 5Ω-10M	.134 [3.4]	.067 [1.7]	.018 [45]	.98 [25]	5000
GP55, FP55	.25W	250V	25 50 100	51.1Ω-1M 10Ω-1M 1Ω-5.1M	30Ω-1M 10Ω-1M 10Ω-1M	30Ω-1M 10Ω-1M 1Ω-22.1M	.248 [6.3]	.090 [2.3]	.024 [60]	.98 [25]	5000
GP60, FP60	.50W	350V	25 50 100	100Ω-1M 10Ω-1M 10Ω-1M	50Ω-1M 10Ω-2.2M 10Ω-2.2M	40Ω-1M 10Ω-5M 10Ω-10M	.353 [9.0]	.138 [3.5]	.026 [65]	.98 [25]	2500
GP65, FP65	1.0W	400V	25 50 100	100Ω-1M 10Ω-1M 10Ω-1M	50Ω-1M 10Ω-3M 10Ω-3M	50Ω-1M 10Ω-3M 10Ω-3M	.455 [11.5]*	.177 [4.5]*	.030 [75]	1.26 [32]	2000
GP70, FP70	2.0W	500V	25 50 100	100Ω-1M 10Ω-1M 10Ω-1M	50Ω-1M 10Ω-5M 10Ω-5M	50Ω-1M 10Ω-5M 10Ω-5M	.590 [15]*	.195 [5.0]*	.031 [8]	1.26 [32]	1000

SERIES GPS & FPS SPECIFICATIONS

RCD Type	Watt Rating (70°C)	Max Working Voltage ¹	TC ppm/°C	Standard Resis. Range (custom avail.)			L ± .020 [5]*	D ± .016 [4]*	d ± .003 [08]	H (Min)**	Std. Reel Quantity
				.1% & .25%	0.5%	1% -5%					
GP50S, FP50S	.25W	200V	25 50 100	100Ω-1M 30Ω-1M 20Ω-1M	50Ω-1M 10Ω-1M 10Ω-1M	40Ω-1M 10Ω-1M 5Ω-10M	.134 [3.4]	.067 [1.7]	.018 [45]	.98 [25]	5000
GP52S, FP52S	.4W	200V	25 50 100	100Ω-1M 30Ω-1M 20Ω-1M	50Ω-1M 10Ω-1M 10Ω-1M	40Ω-1M 10Ω-1M 10Ω-2.4M	.134 [3.4]	.067 [1.7]	.020 [5]	.98 [25]	5000
GP55S, FP55S	.5W	250V	25 50 100	51.1Ω-1M 10Ω-1M 1Ω-5.1M	30Ω-1M 10Ω-1M 10Ω-1M	30Ω-1M 10Ω-1M 1Ω-22.1M	.248 [6.3]	.090 [2.3]	.024 [60]	.98 [25]	5000
GP56S, FP56S	.6W	250V	25 50 100	51.1Ω-1M 10Ω-1M 1Ω-5.1M	30Ω-1M 10Ω-1M 10Ω-1M	30Ω-1M 10Ω-1M 1Ω-22.1M	.248 [6.3]	.090 [2.3]	.024 [60]	.98 [25]	5000
GP60S, FP60S	1W	350V	25 50 100	100Ω-1M 10Ω-1M 10Ω-1M	50Ω-1M 10Ω-2.2M 10Ω-2.2M	40Ω-1M 10Ω-5M 10Ω-10M	.353 [9.0]	.138 [3.5]*	.028 [7]	.98 [25]	2500

¹ Working voltage = (PR)^{1/2}, voltage level not to exceed the maximum value listed. Increased ratings available

* Tolerance is ±.032 [8] on GP65, FP65, GP70, FP70 length, ±.024 [6] on GP65, FP65, GP70, FP70, GP60S, FP60S body diameter

**Lead length dimensions are for bulk packaged parts, taped parts may be shorter (refer to taping spec)

TYPICAL PERFORMANCE CHARACTERISTICS

Environmental Test	GP/FP (Standard)	GPS /FPS (Mini)
Short Time Overload	0.25%	0.5%
Resis. to Solder Heat	0.05%	0.05%
Moisture Resistance*	0.3% (FP=0.6%)	0.3% (FPS=0.6%)
1000 Hour Load Life	0.5%	1%
Temperature Cycling	0.2%	0.2%
Low Temp Operation	0.1%	0.1%
Noise	0.1uV/V	
Voltage Coefficient	5ppm/V	
Derating	Derate W and V by 1.11%/°C above 70°C	
Operating Temperature	-55°C to +160°C	
Flame Retardancy	GP&GPS = UL94V-1, FP&FPS = UL94V-0	
Dielectric Strength	500V (GP & FP50/50S/52S=300V)	

* To ensure utmost reliability, care should be taken to avoid potential sources of ionic contamination.

P/N DESIGNATION:

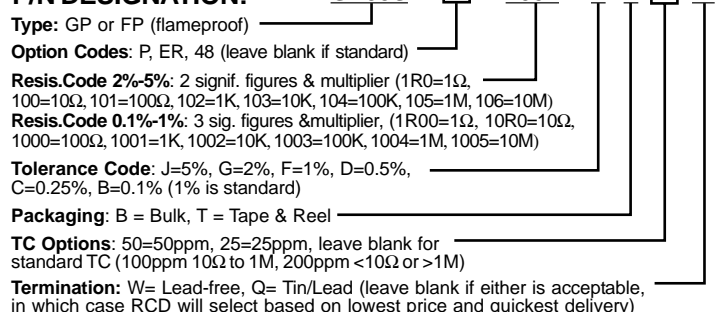

METAL OXIDE RESISTORS, 1/2W to 9W

RSF SERIES- Standard RMF SERIES- Miniature



- Low cost! Delivery from stock (standard E-24 values, 5%)
- Flameproof construction (UL94V-0)
- 0.1Ω to 1 Meg, standard tolerances: ±1%, ±2%, ±5%
- All sizes avail. on horizontal tape, ½-3W avail. on vertical tape
- Options include increased voltages, custom marking, cut & formed leads, Sn-Pb solder leads (Opt. Q), high pulse (Opt. P), etc.

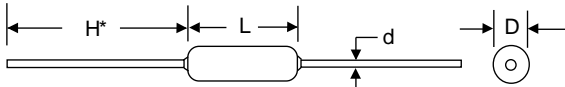

* Dim. H is for bulk pack, taped leads may be shorter (refer to taping spec). Non-std lengths and cut&form avail

RCD's oxide film resistors are ideally suited for medium-power applications. Surge levels exceed that of other film constructions. A thick complex-oxide material is deposited on a ceramic core for optimum heat dissipation, low inductance, and high stability even after extended periods. Series RMF (mini version) utilizes highest grade cores and special processing for increased power density. Flameproof coating offers excellent environmental protection and is resistant to solvents and humidity. Available bulk or T&R (5Kpcs/reel RMF1/2, 2.5Kpcs RSF1A, 2Kpcs RSF1B & RMF1, 1Kpcs RSF2B & RMF3, 500pcs RSF3B-7B & RMF5-7).

Stock	SERIES RSF	Wattage		Max. Voltage Rating ¹	Opt. P Peak Pulse Voltage ²	Standard Resistance Range	L±.032 [8]	D±.025 [6]	d±.004 [1]	H* (Min.)
		25°C	70°C							
Stock	RSF1A	1.0W	0.7W	300V	2KV	0.1Ω to 1M	.354 [9]	.135 [3.4]	.025 [65]	.945 [24]
Stock	RSF1B	1.5W	1.0W	350V	2.5KV	0.1Ω to 1M	.433 [11]	.165 [4.2]	.031 [8]	.945 [24]
Stock	RSF2B	3.0W	2.0W	350V	3KV	0.1Ω to 1M	.590 [15]	.212 [5.4]	.031 [8]	1.06 [27]
Stock	RSF3B	5.0W	3.0W	500V	4.5KV	0.47Ω to 1M	.950 [24.1]	.320 [8.1]	.031 [8]	1.25 [31.7]
	RSF5B	7.0W	5.0W	750V	6KV	0.5Ω to 240K	1.585 [40.3]	.320 [8.1]	.031 [8]	1.375 [35]
	RSF7B	9.0W	7.0W	800V	8KV	2.0Ω to 510K	2.080 [52.8]	.320 [8.1]	.031 [8]	1.375 [35]

Stock	SERIES RMF	Wattage Rating	Max Voltage Rating ¹	Opt. P Peak Pulse Voltage ²	Standard Resistance Range	L±.032 [8]	D±.025 [6]	d±.004 [1]	H* (Min.)
	RMF1/2	.5W @70°C	250V	2KV	0.1Ω -510K	.250 [6.35]	.090 [2.3]	.024 [6]	.945 [24]
	RMF1	1W @70°C	300V	2.5KV	0.1Ω -1M	.375 [9.53]	.135 [3.4]	.024 [6]	.945 [24]
	RMF2	2W @70°C	350V	3KV	0.1Ω -1M	.450 [11.4]	.162 [4.1]	.031 [8]	.945 [24]
	RMF3	3W @70°C	350V	3.5KV	0.1Ω -1M	.598 [15.2]	.213 [5.4]	.031 [8]	1.25 [31.7]
	RMF5	5W @70°C	500V	5KV	0.47Ω -1M	.950 [24.1]	.335 [8.5]	.031 [8]	1.375 [35]
	RMF5S	5W @25°C	500V	4KV	0.47Ω -1M	.695 [17.6]	.250 [6.4]	.031 [8]	1.25 [31.7]
	RMF7	7W @25°C	500V	5KV	0.47Ω -1M	.950 [24.1]	.335 [8.5]	.031 [8]	1.375 [35]

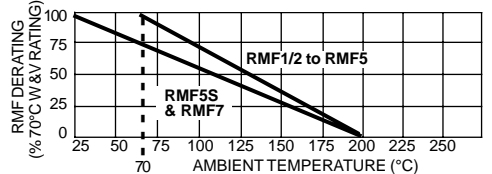
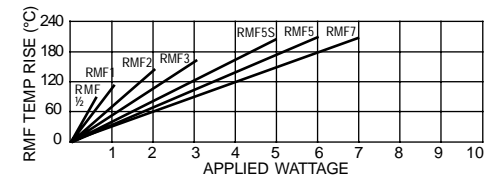
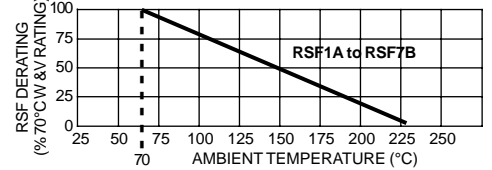
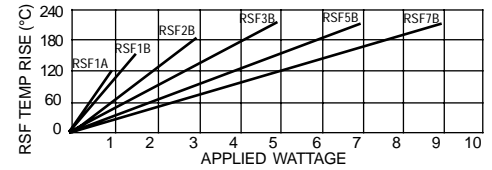

TYPICAL PERFORMANCE CHARACTERISTICS

Temperature Coefficient	±100ppm Typ., ±200 Max.
Insulation Resistance	10,000 MΩ Min.
Load Life (1000 hours)	±2% RSF ₇₀ , ±3% RSF ₂₅ , ±3% RMF
Short-Time Overload	2.5x rated W, 5S, nte 2x rated V
Temperature Cycling	±1.0%
Moisture Resistance	±2.0%
Shock and Vibration	±0.2%
Effect of Soldering	±0.5%
Voltage Coefficient	.001%/V
Current Noise	<.1μV/ V/decade
Dielectric Strength	500V (350V sizes <2W)
Standard Marking (custom marking avail)	Color banded or stamped with resis.value & tol as minimum
Terminal Strength	5 pound pull (minimum)
Operating Temp Range	-55 to +235°C (+200°C RMF)

¹ Rated continuous working voltage determined by $E=(PR)^{1/2}$, E not to exceed max voltage rating. Increased ratings avail.

² Peak voltage is for Opt.P (derate 50% for std parts), single & infrequent pulses (derate 30-50% for frequent pulses), based on 1μS pulse duration (derate 10-30% for longer pulses). Pulse to be ≤ peak wattage and ≤ peak voltage rating. Average pulse power to be ≤ watt rating. Consult factory for assistance, verify samples.

OPTION P PULSE CAPABILITY (single or infrequent pulse)²

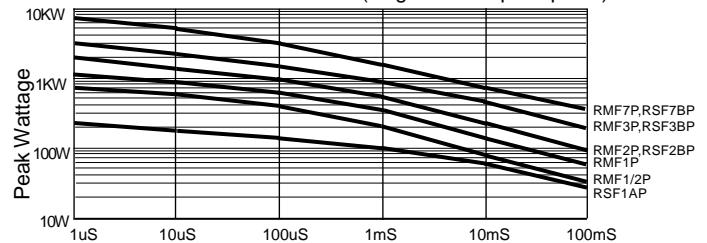

P/N DESIGNATION:

RSF2B □ - 101 - J T W

RCD Type

Option Codes: leave blank if standard

Resis.Code 1%: 3 signif. figures & multiplier, (R100=1Ω, 1R00=1Ω, 10R0=10Ω, 1000=100Ω, 1001=1K, 1004=1M)

Resis.Code 2%-10%: 2 signif. figures & multiplier, (R10=0.1Ω, 1R0=1Ω, 100=10Ω, 101=100Ω, 102=1K, 105=1M)

Tolerance Code: J=5% (std), G=2%, F=1%

Packaging: B = Bulk, T = Horizontal Tape & Reel, APN=Vertical Tape & Box (available up to 3W size)

Termination: W= Lead-free, Q= Tin/Lead (leave blank if either is acceptable)

MINIATURE POWER FILM RESISTORS



RESISTORS • CAPACITORS • COILS • DELAY LINES

MG SERIES - 1/2W & 1W FS SERIES - 1W, 2W, 3W



Term. W is
RoHS
compliant
& 260°C
compatible



FEATURES

- Miniature sizes enable significant space savings
- Replaces wirewound types at reduced cost
- 0.1Ω to 1 Meg, standard tolerances: ±1%, ±2%, ±5% (Series MG available to 0.1%)
- All sizes available on horizontal or vertical tape

OPTIONS

- Options include increased voltages, custom marking, cut & formed leads, high pulse (Opt. P), molded version (Opt. 49), TC's to 25ppm, Sn-Pb terminations, Military screening, etc.

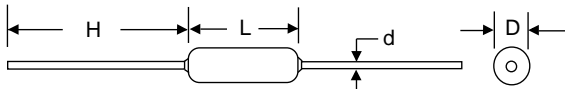

Industry's smallest power film resistors!

Increased power is achieved by a special film process and high grade alumina cores. The unique structure of these materials also achieves increased working voltages and superior pulse capability compared to typical film resistors. The low inductance inherent in film construction enables use at high frequencies thereby fulfilling a wider range of applications compared to wirewound resistors. Series MG are designed for precision and semi-precision applications, with tolerances available to 0.1% and TC's available to 25ppm. Series FS are designed for semi-precision and general purpose 1% to 5% applications (1% to 5% tolerance with typical TC stability of 100ppm). Series FS resistors also feature a flameproof coating as standard (optional on MG series). Marking is stamped or color banded.

SPECIFICATIONS

RCD Type	Wattage	Resistance Range	Max Voltage Rating*	Dielectric Strength	L ± .025 [.8]	D ± .025 [.6]	d ± .003 [.08]	H (Min.)**
MG1/2	1/2W @ 25°C	1Ω to 1M	200V	250V	.150 [3.81]	.066 [1.68]	.018 [.45]	.945 [24]
MG1	1W @ 25°C	0.1Ω to 1M	250V	500V	.250 [6.35]	.090 [2.3]	.024 [.6]	.945 [24]
F1S	1W @ 70°C	0.1Ω to 1M	350V	350V	.250 [6.35]	.090 [2.3]	.024 [.6]	.945 [24]
F2S	2W @ 70°C	0.1Ω to 1M	400V	500V	.420 [10.67]	.159 [4.0]	.031 [.8]	1.25 [31.7]
F3S	3W @ 70°C	0.1Ω to 1M	500V	500V	.580 [14.7]	.200 [5.08]	.031 [.8]	1.25 [31.7]

* Working voltage determined by $E = (PR)^{1/2}$, E not to exceed Max Voltage Rating. Consult factory for short time overload or surge voltage capability.

** Lead length dimension is for bulk packaged parts, consult Taping specifications for parts supplied on Tape&Reel

TYPICAL PERFORMANCE

Specifications (1Ω-100K)	MG Series	FS Series
Temperature Coefficient	±100ppm/°C typ., 25&50ppm avail.	±100ppm/°C typ.
Insulation Resis. (min.)	10,000 MΩ	10,000 MΩ
Load Life (1000 hours)	±1%	±5%
Short-time Overload	±0.5%	±0.5%
Temperature Cycling	±0.5%	±1%
Moisture Resistance	±1%	±2%
Shock and Vibration	±0.2%	±0.2%
Effect of Soldering	±0.5%	±0.5%
Voltage Coefficient	< .001%/V	< .001%/V
Operating Temp. Range	-55°C to +175C	-55°C to +200°C

DERATING

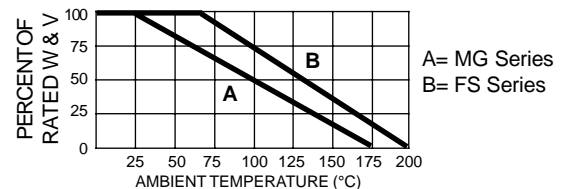

P/N DESIGNATION:

RCD Type _____ **F1S** □ - **102** - **J** **T** □ **W**

Option Codes: Q, P, etc. (leave blank if std)

Resis.Code 0.1% - 1%: 3 signif. digits & multiplier (R100=0.1Ω, 1R00=1Ω, 10R0=10Ω, 1000=100Ω, 1001=1K, 1002=10K, 1003=100K, 1004=1M)

Resis.Code 2%-5%: 2 signif. figures & multiplier (R10=0.1Ω, 1R0=1Ω, 100=10Ω, 101=100Ω, 102=1K, 105=1M)

Tolerance Code: J=5%, G=2%, F=1%. In addition, tolerances of 0.5%(D), 0.25%(C), and 0.1%(B) are available on MG Series

Packaging: B = Bulk, T = Tape & Reel

Optional Temp. Coefficient: 25=25ppm, 50=50ppm, 101=100ppm, 201=200ppm (leave blank for standard)

Termination: W= Lead-free, Q= Tin/Lead (leave blank if either is acceptable)

CARBON FILM RESISTORS, 1/8 to 3 WATT

CF SERIES



RESISTORS • CAPACITORS • COILS • DELAY LINES



- Industry's lowest cost and widest selection!
- **Delivery from stock in bulk or tape/reel**
- Excellent long-term stability, exceeds MIL-R-11
- Mini 1/4W, 1/2W, 1W models
- Standard tolerance: ±5% up to 10M (±2%, ±10% avail.)
- Flameproof coating available (Series CFF)
- Available on axial or vertical Tape & Reel
- Available with axial or vertical cut & formed leads

Widest range in the industry!

RCD Series CF resistors are designed for general purpose applications. Multilayer coating and color band markings are resistant to industrial solvents and humidity. New miniature sizes enable significant space savings due to optimization of thermally conductive materials. CF22 is 1/4W in 1/8W size and is designed for mounting spans as small as 0.200" [5mm]. CF50A is 1/2W in 1/4W size, CF100S is 1W in 1/2W size. Manufactured in Far East.

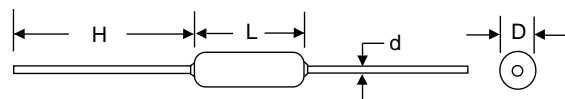

DERATING: W and V to be derated per graph A when ambient temp exceeds 70°C (40°C for CF100S & CF300 per graph B).

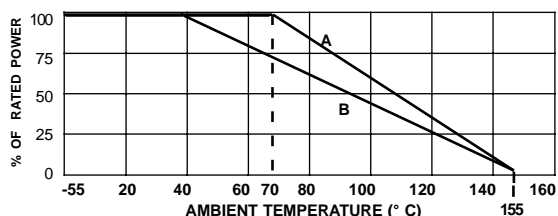

TEMPERATURE COEFFICIENT (Typ.)

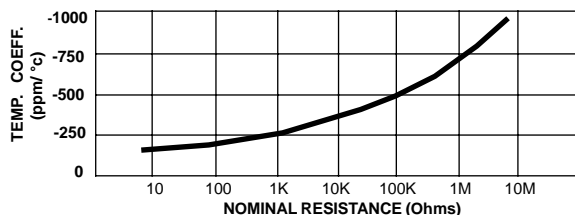

CURRENT NOISE (Typ.)

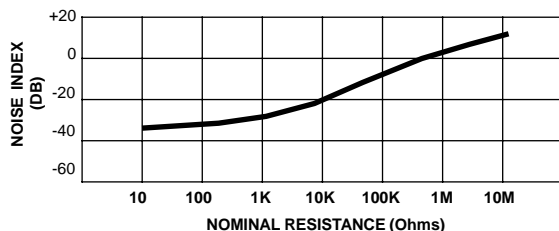

TYPICAL PERFORMANCE

Load Life 1000 hours	±1% std, ±2% mini
Shelf Life at 25°C (1 year)	±1.0%
Effect of Solder	±0.3%
CF (standard) Moisture Resis:	±2% <100K, ±3% >100K
CFF (flameproof) Moisture Resis:	±3% <100K, ±5% >100K
Short-Time Overload	±0.5% std, ±1% mini
Shock and Vibration	±0.2%
Terminal Strength	±0.2%
Temperature Cycling	±0.5%
Insulation Resistance	10,000 Megohms Min
Voltage Coefficient	10 PPM/Volt
Dielectric Strength	500V (300V CF12 & CF22)

DIMENSIONS Inch [mm]

TYPE	L±.032[.8]	D±.020[.5]	d±.003[.08]	H(MIN)*	Reel Size
CF12	.145 [3.7]	.062 [1.5]	.020 [5]	1.0 [25]	5000
CF22	.134 [3.4]	.067 [1.7]	.020 [5]	1.0 [25]	5000
CF25	.250 [6.4]	.090 [2.3]	.024 [6]	1.0 [25]	5000
CF50S	.354 [9.0]	.125 [3.2]	.025 [6.3]	1.0 [25]	4000
CF50A	.250 [6.4]	.090 [2.3]	.024 [6]	1.0 [25]	5000
CF100S	.354 [9.0]	.148 [3.7]	.028 [7]	1.0 [25]	2500
CF100	.470±.05 [11.9±1.3]	.180±.032 [4.6±.8]	.031 [8]	1.0 [25]	2000
CF200S	.63±.08 [16.0±2.0]	.210±.05 [5.3±1.3]	.031 [8]	1.06 [27]	1000
CF300	.71±.08 [18.0±2.0]	.250±.05 [6.4±1.3]	.031 [8]	1.25 [32]	1000

Mini 1/4W

Mini 1/2W

Mini 1W

* Lead length is for bulk packaged parts, taped parts may be shorter. Non-standard lengths and cut & formed leads available

SPECIFICATIONS

TYPE	Wattage	Max. Working Voltage*	Max. Overload Voltage	Resistance Range	
				±2% (G)	±5% (J)
CF12	1/8W	200V	400V	10Ω-220K	1Ω-10M
CF22	1/4W	250V	500V	10Ω-1M	1Ω-10M
CF25	1/4W	250V	500V	10Ω-1M	1Ω-22M**
CF50A CF50S	1/2W	350V	700V	10Ω-1M	1Ω-10M
CF100S	1W	400V	800V	10Ω-1M	1Ω-10M
CF100	1W	500V	1000V	10Ω-1M	1Ω-10M
CF200S	2W	600V	1100V	10Ω-1M	1Ω-10M
CF300	3W	650V	1200V	10Ω-1M	1Ω-10M

*Max working voltage determined by $E = \sqrt{VPR}$, E not to exceed value listed in column above.

** CF25 available up to 100 MegΩ in 10% tolerance.

P/N DESIGNATION:

CF50S - 102 - J T W

RCD Type: CF (std) or CFF (flameproof)

3-Digit Resis. Code: 2 signif. digits & multiplier (1R0=1Ω, 100=10Ω, 101=100Ω, 102=1KΩ, 103=10K, 104=100K, 105=1M, 106=10M, 107=100M)

Tolerance: G= 2%, J= 5%(std up to 10M), K=10%(std ≥ 10M)

Packaging: B=Bulk, T=Tape&Reel, A=Ammo Pack (Tape & Box), TAV = Avisert T&R, TPN = Panasert T&R, C=cut reel

Termination: W= Lead-free, Q= Tin/Lead (leave blank if either is acceptable, in which case RCD will select based on lowest price and quickest delivery)

MICRO-MINIATURE FILM RESISTORS



RESISTORS • CAPACITORS • COILS • DELAY LINES

MFA SERIES



FEATURES

- ❑ Subminiature size results in significant space savings, enabling high density circuits
- ❑ Wide resistance range: 1Ω to 10MΩ
- ❑ Standard tolerances: ±1%, 2%, 5%, 10% (±0.5% available)
- ❑ Excellent high frequency performance
- ❑ Excellent environmental performance
- ❑ Available with cut & formed leads

World's smallest axial-lead resistors!

RCD Series MFA resistors were originally developed for use in aerospace requirements but have found numerous uses in industrial and medical applications, including hearing aids and high-frequency circuits. MFA1/10 & MFA1/20 are color banded, MFA1/16 is stamped with 3-digit resistance code.

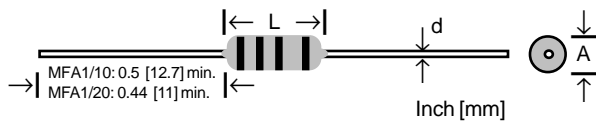
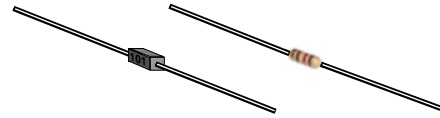

Figure 1: MFA1/10 & MFA1/20

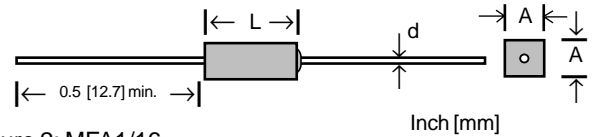

Figure 2: MFA1/16

DIMENSIONS & ELECTRICAL RATINGS

RCD Type	Figure	Wattage Rating	Max. Voltage	Resistance Range				L ± .024 [.6]	A ± .008 [.2]	d ± .002 [.05]
				1% Tol.	2% Tol.	5% Tol.	10% Tol.			
MFA1/20	1	.05W @40°C	60V	100Ω - 1M	100Ω - 1M	1Ω - 10M	1Ω - 10M	.090 [2.3]	.030 [.76]	.008 [.2]
MFA1/16	2	.063W@70°C	50V	-	-	10Ω - 2.4M	2Ω - 10M	.075 [1.9]	.036 [.91]	.008 [.2]
MFA1/10	1	.10W@40°C	100V	-	51Ω - 390K	10Ω - 1M	1Ω - 4.7M	.130 [3.3]	.044[1.1]	.012 [.3]

TYPICAL PERFORMANCE

Thermal Shock (-55° to +125°C)	0.2% ΔR
Short Time Overload (2.5x W, 5S, NTE 2x rated V)	1% ΔR
Low Temp. Operation (-55°C, 100 Hrs)	0.5% ΔR
High Temp. Exposure (125°C, 100hrs)	0.5% ΔR
Temperature Coefficient	250ppm/°C (available to 25ppm)
Resistance to Solder Heat	0.2% ΔR
Moisture Resistance	2% ΔR
Load Life(1000 hrs.)	1.0% ΔR, 5% Max.
Operating Temperature	-55 to +125°C
Dielectric Strength	200V
Voltage Coefficient	10ppm/volt
Insulation Resistance	100Mohm

DERATING

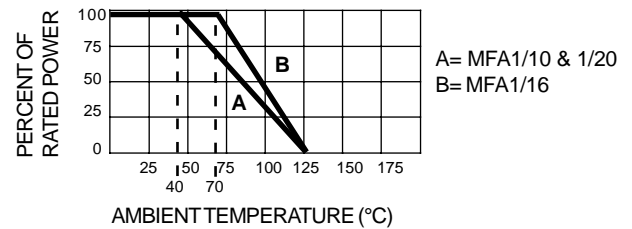

P/N DESIGNATION:

MFA1/20 - 1001 - F B W

RCD Type _____

Resis. Value: 4 digit code if tol. is 0.5% or 1%
(1R00=1Ω, 10R0=10Ω, 1000=100Ω, 1001=1KΩ)
3 digit code if tol. is 2% or greater (1R0=1Ω, 100=10Ω, 101=100Ω, 102=1KΩ, 103=10K, 104=100K, 105=1M)

Tolerance: D=0.5%, F=1%, G=2%, J=5%

Packaging: B=Bulk, T=T&R (MFA1/10 only)

Termination: W= Lead-free, Q= Tin/Lead (leave blank if either is acceptable)

HIGH POWER PLANAR RESISTORS, 5W to 100W

TP SERIES CERAMIC SUBSTRATE TPS SERIES STEEL SUBSTRATE



Term.W is
RoHS
compliant
& 260°C
compatible

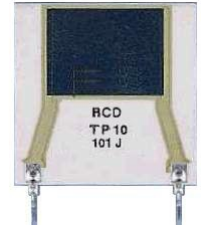
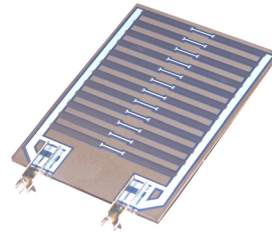

- Space saving flame retardant design
- High power density
- Thin profile, and lightweight
- Low Inductance: 50nh typ at 1MHz
- Wide resistance range: 0.5Ω to 1MΩ
- Excellent transient withstanding capabilities
- Standard tolerances: as tight as ±0.5%

OPTIONS

- Special marking, extended value range, custom sizes and shapes, burn-in and military screening, insulated leads, quick-disconnect terminals, multiple resistor circuits, etc. Consult factory for assistance.

SPACE SAVING THICK FILM PLANAR RESISTORS!

Series TP/TPS offer high power density in a lightweight design. Designed for switch mode power supplies, snubber circuits, heaters, in-rush limiters, dynamic braking, and other power applications, the planar construction offers significant PCB real estate savings over conventional resistors, especially in forced air applications. The unique design enables very low inductance and excellent surge capabilities. Series TP utilize alumina substrates for excellent heat dissipation. Series TPS utilize stainless steel substrates for even greater dissipation and durability. A special hi-temp/hi-voltage dielectric insulates the resistor and terminals from the metal substrate, enabling greater voltage and insulation compared to porcelain enameled models.

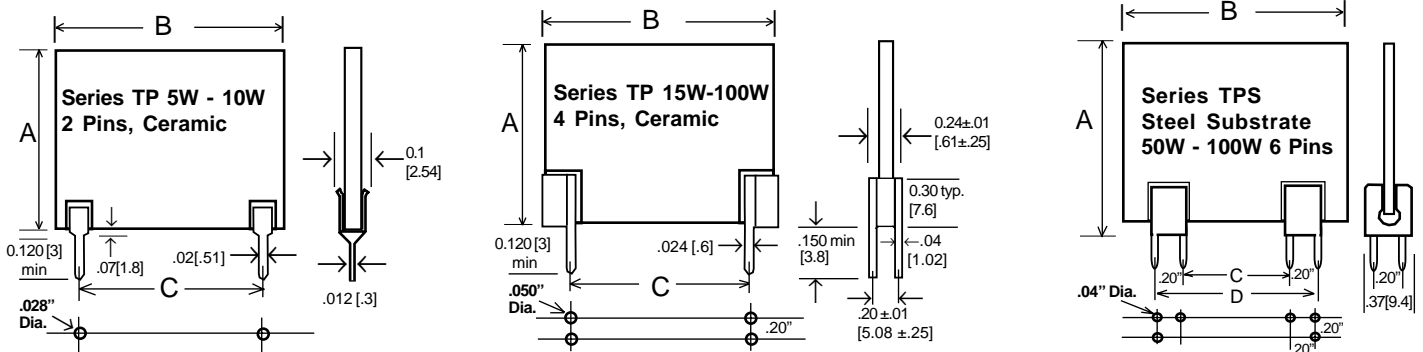

RCD Type	Wattage @ 25°C	Max. Voltage Rating ¹	Standard Resistance Range ²	DIMENSIONS Inch [mm]			
				A Max	B Max	C	D
TP05	5W	500V	1Ω to 200K	1.015 [25.8]	.512 [13]	.200±.01 ³ [5.08±.25] ³	-
TP07 ⁵	7.5W	500V	1Ω to 200K	1.015 [25.8]	.765 [19.4]	.500±.01 ^{3,4} [12.7±.25]	-
TP10	10W	500V	1Ω to 300K	1.015 [25.8]	1.015 [25.8]	.800±.01 ³ [20.3±.25]	-
TP15 ⁵	15W	500V	1Ω to 1MΩ	1.22 [31]	1.27 [32.26]	1.00±.02 [25.4±.5]	-
TP25 ⁵	25W	500V	1Ω to 1MΩ	1.18 [30]	2.22 [56.39]	1.90±.02 [48.26±.5]	-
TP50 ⁵	50W	500V	1Ω to 1MΩ	2.27 [57.66]	2.22 [56.39]	1.90±.02 [48.26±.5]	-
TPS50	50W	250V	0.5Ω to 10KΩ	2.80 [71.1]	1.77 [44.96]	1.00±.02 [25.4±.5]	1.40±.02 [35.56±.5]
TPS100	100W	300V	0.5Ω to 20KΩ	3.65 [92.7]	2.59 [65.8]	1.30±.02 [33.02±.5]	1.70±.02 [43.18±.5]

¹ Maximum Operating Voltage is DC or AC peak ² Expanded range available ³ Available with 0.300" [7.62mm] pin spacing, specify opt.78 ⁴ Available with 0.200" [5.08mm] pin spacing, specify opt.80

⁵ Preliminary information

TYPICAL PERFORMANCE CHARACTERISTICS

Load Life (1000 hours)	±2%
Moisture Resistance	±1%
Temperature Cycling	±1%
Overload (not to exceed max voltage)	5x rated W, 200mS
Dielectric Strength	500VDC (750V avail)
Resistance to Solder Heat (260°C, 5 sec)	±0.5%
Temperature Coefficient (ppm/°C)	100ppm/°C (≥2%=200ppm)
Operating Temperature	TP = -55°C to 170°C TPS = -55°C to 275°C
Power Derating	TP = 1%/°C > 70°C TPS = 0.4%/°C > 25°C

P/N DESIGNATION:

TP05 □ - **102** - **J** **B** **W**

RCD Type ——— □

Options: assigned by RCD (leave blank for standard)

Resis.Code 0.5%, 1%: 3 signif. figures & multiplier, e.g. 1R00=1Ω, 10R0=10Ω, 1000=100Ω, 1001=1K, etc.

Resis.Code 2%-10%: 2 signif. figures & multiplier, e.g. R50=5Ω, 1R0=1Ω, 100=10Ω, 101=100Ω, 102=1K, etc.

Tol. Code: D=0.5%, F=1%, G=2%, J=5%, K=10%, M=20%

Packaging: B = Bulk ———

Termination: W= Lead-free, Q= Tin/Lead (leave blank if either is acceptable)

HIGH VALUE & HIGH VOLTAGE CYLINDRICAL RESISTORS

RG SERIES - General Purpose RH SERIES - High Precision RP SERIES - Professional Grade



Term.W is RoHS compliant & 260°C compatible

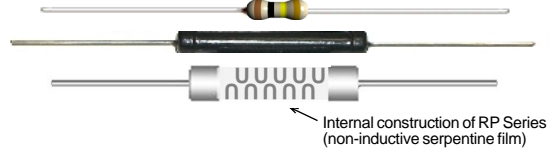

- Industry's widest range of high value/ high voltage resistors- 1/8 ~ 20W, 1KΩ~ 10¹³Ω, 300V~ 90KV, TC's to ±15ppm, ±0.05%~ 10%
- Available on Tape & Reel (sizes <2.5" long)

OPTIONS

Options include formed leads, matched sets, custom marking, burn-in, vacuum/space operation, custom sizes, etc. Opt. P = high pulse design, Opt.H = increased voltage, Opt.B = increased power, Opt.58 = hermetic seal.

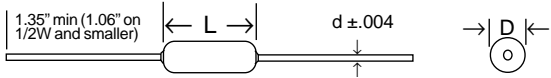

RCD's high voltage thick-film resistors represent the most advanced technology in the industry. Series RG is designed for semi-precision applications, offering a low cost solution up to 15KV. Series RH features a special composition and processing to achieve improved tolerance, TC, & voltage (60KV). Series RP utilize highest grade materials enabling tightest tolerances, lowest VC's, TC's to 15ppm, and superior power/temp/voltage levels (90KV). RP utilize serpentine film pattern for lowest inductance. Units are printed or banded with resistance value and tolerance as minimum.

The ruggedness of these models enables superior long term reliability, especially in demanding applications such as military, space, and medical equipment, as well as electron microscopes, high impedance amplifiers, electrometer, radiation testers, etc.

RG Series	Wattage @ 25°C	Voltage Rating*	Dielectric Strength	Dimensions Inch [mm]			Standard Resistance Range** (K=10 ³ , M=10 ⁶ , G=10 ⁹)					
				L	D	d	25ppm	50ppm	100ppm	200ppm	350ppm	
RG1/8	1/8W	300V	500V	.134 ±.04 [3.4±1.0]	.067 ±.025 [1.7 ± 0.64]	.020 [5]	N/A	1M-10M	1M-300M	1M-300M	1M-300M	1M-300M
RG1/4	1/4W	500V	500V	.256 ±.04 [6.5±1.0]	.098 ±.025 [2.5 ± 0.64]	.024 [6]	N/A	100K-50M	100K-3G	100K-3G	100K-3G	100K-3G
RG1/2	1/2W	1KV	500V	.368 ±.04 [9.4±1.0]	.134 ±.032 [3.4 ± 0.81]	.025 [6.4]	N/A	100K-50M	100K-3G	100K-3G	100K-3G	100K-3G
RG1S	1W	1.5KV	500V	.472 ±.05 [12.0±1.3]	.158 ±.032 [4.0 ± 0.81]	.028 [7]	N/A	200K-50M	200K-100M	200K-300M	200K-300M	200K-300M
RG1	1W	2KV	1KV	.581 ±.05 [14.8±1.3]	.216 ±.032 [5.5 ± 0.81]	.031 [8]	N/A	200K-50M	200K-100M	200K-500M	200K-500M	200K-500M
RG2	2W	5KV	1KV	1.06 ±.062 [26.9±1.6]	.275 ±.032 [7.0 ± 0.81]	.031 [8]	N/A	N/A	**	**	**	1M-1.5G
RG3	3W	10KV	1KV	1.67 ±.062 [42.4±1.6]	.275 ±.032 [7.0 ± 0.81]	.031 [8]	N/A	N/A	**	**	**	1M-1.5G
RG4	4W	15KV	1KV	2.05 ±.062 [52.1±1.6]	.335 ±.032 [8.5 ± 1.02]	.040 [1]	N/A	N/A	**	**	**	1M-1.5G

RH Series	Wattage @ 25°C	Voltage Rating*	Dielectric Strength	Dimensions Inch [mm]			Standard Resistance Range** (K=10 ³ , M=10 ⁶ , G=10 ⁹ , T=10 ¹²)				
				L	D	d	25ppm	50ppm	100ppm	200ppm	≥400ppm
RH1/8	1/8W	500V	500V	.240±.04 [6.1±1.0]	.085±.025 [2.16±0.6]	0.024 [6]	100K-50M	50K-100M	10K-100M	10K-500M	500M-4G
RH1/4	1/4W	750V	500V	.354±.04 [9.0±1.0]	.118±.04 [3.00±1.0]	0.024 [6]	100K-100M	100K-100M	10K-300M	10K-1G	1G-5G
RH1/2	1/2W	1500V	500V	.500±.04 [12.7±1.0]	.180±.04 [4.57±1.0]	0.031 [8]	100K-100M	100K-100M	100K-1G	100K-5G	1G-5G
RH1	1W	2000V	1KV	.571±.04 [14.5±1.0]	.180±.04 [4.57±1.0]	0.031 [8]	100K-100M	100K-500M	100K-2G	100K-15G	15G-50G
RH2	2W	5000V	1KV	1.00±.08 [25.4±2.0]	.265±.05 [6.73±1.3]	.031/0.04 [8/1]	100K-100M	100K-500M	100K-2G	100K-100G	100G-3T ¹
RH3	3W	10KV	1KV	1.65±.08 [41.9±2.0]	.265±.05 [6.73±1.3]	.031/0.04 [8/1]	100K-100M	100K-500M	100K-2G	100K-100G	100G-10T ²
RH4	4W	15KV	1KV	2.05±.08 [52.1±2.0]	.320±.05 [8.13±1.3]	.031/0.04 [8/1]	-	100K-500M	100K-2G	100K-10G	-
RH6	6W	20KV	1KV	3.03±.08 [77.2±2.0]	.320±.05 [8.13±1.3]	.031/0.04 [8/1]	-	500K-500M	500K-2G	100K-10G	-
RH10	10W	35KV	1KV	4.70±.12 [119.4±3.1]	.320±.05 [8.13±1.3]	.031/0.04 [8/1]	-	1M-500M	1M-2G	100K-10G	-
RH16	16W	60KV	1KV	7.48±.12 [190±3.1]	.320±.05 [8.13±1.3]	0.04 [1.0]	-	1M-500M	1M-2G	100K-10G	-

¹ RH2 is available in 400ppm TCR from 100G to 300G, 300G-600G is 1000ppm, 600G-3T is 1500ppm ² RH3 is available in 400ppm TCR from 100G-600G, 600G-1T is 1000ppm, 1T-10T is 1500ppm

RP Series	Wattage @ 40°C	Voltage Rating*	Dielectric Strength	Dimensions Inch [mm]			Standard Resistance Range** (K=10 ³ , M=10 ⁶ , G=10 ⁹)				
				L	D	d	15ppm	25ppm	50ppm	100ppm	200ppm
RP4	3.8W	15KV	1KV	1.063±.04 [27.0±1.0]	.315 ±.025 [8.0±.64]	.031 [7.9]	1K - 1G	1K - 10G	1K - 10G	1K - 10G	1K - 10G
RP5	5W	21KV	1KV	1.457±.04 [37.0±1.0]	.315 ±.025 [8.0±.64]	.031 [7.9]	1K - 1G	1K - 15G	1K - 15G	1K - 15G	1K - 15G
RP8	7.5W	30KV	1KV	2.047±.05 [52.0±1.3]	.315 ±.025 [8.0±.64]	.031 [7.9]	1K - 1G	1K - 20G	1K - 20G	1K - 20G	1K - 20G
RP10	10W	45KV	1KV	3.071±.06 [78.0±1.5]	.315 ±.025 [8.0±.64]	.031 [7.9]	1K - 1G	1K - 30G	1K - 30G	1K - 30G	1K - 30G
RP14	13.5W	60KV	1KV	4.000±.06 [101.6±1.5]	.315 ±.025 [8.0±.64]	.031 [7.9]	1K - 1G	1K - 40G	1K - 40G	1K - 40G	1K - 40G
RP16	16W	72KV	1KV	4.800±.06 [121.9±1.5]	.315 ±.025 [8.0±.64]	.031 [7.9]	1K - 1G	1K - 50G	1K - 50G	1K - 50G	1K - 50G
RP20	20W	90KV	1KV	5.984±.06 [152.0±1.5]	.315 ±.025 [8.0±.64]	.031 [7.9]	1K - 1G	1K - 60G	1K - 60G	1K - 60G	1K - 60G

* Maximum working voltage is DC or AC RMS (50-60Hz sinusoidal) and is determined by E=(PR)^{1/2}, E, N not to exceed value listed in column above. ** Consult factory for res. values outside the standard range

CUSTOM DESIGNS

Increased Ratings - increased power and voltage ratings are available with special processing. By specifying Opt.H on RG series, voltage ratings are increased by 100% (by 50% on sizes 2W-4W).

Matched Sets and Networks - cost savings up to 50% can often be achieved by specifying tight matching requirements instead of tight tol. and TC rets. Resistance matching to 0.02% and TC tracking to 5ppm is available.

Threaded Terminations - resistors are available with tapped end caps for series combination into virtually any voltage or resis. value.

Hermetic-Sealed Construction (Opt. 58) - Available on RH1, RH2, & RH3 for use in harshest environments. Add .08" to dia. & .18" to length.

P/N DESIGNATION:

RCD Type **RH2** **□** - **1005 - F T 50 W**

Options: P, H, B, 58, etc. (leave blank if std)

4-Digit Resis. Code 0.1%-1%: 1001=1K, 1002=10K, 1003=100K, 1004=1M, 1005=10M, 1006=100M, 1G00=1GΩ, 10G0=10G, 100G=100G, 1T00=1TΩ, 10T0=10T

3-Digit Resis. Code 2%-10%: 102=1K, 103=10K, 104=100K, 105=1M, 106=10M, 107=100M, 1G0=1G, 10G=10G, 100G=100G, 1T0=1TΩ, 10T=10T

Tolerance: J=5%, G=2%, F=1%, D=.5%, C=.25%, B=.1%, A=.05%

Packaging: B = Bulk, T = Tape & Reel

TC: 15=15ppm, 25=25ppm, 50=50ppm, 80=80ppm, 101=100ppm, 201=200ppm, 351=350ppm, 401=400ppm, 102=1000ppm, 152=1500ppm

Termination: W= Lead-free, Q= Tin/Lead (leave blank if either is acceptable)

SPECIFICATIONS (Typ.)

	RG Series	RH Series	RP Series
Operating Temp. Range	-55 to +155°C*	-55 to +155°C*	-55 to +225°C*
Tolerances	1%-10%, 0.1% avail	0.1%-5%	0.05%-5%
Coating	Epoxy	Epoxy	Silicone
Inductance	Low	Low	Non-Inductive
Overload (1.5xW, 5S, nte 1.5xV)	±1% ΔR	±0.5% ΔR	±0.25% ΔR
Load Life (1000 hours)	±2% ΔR	±0.5% ΔR	±0.4% ΔR
Moisture Resistance	±2% ΔR	±0.5% ΔR	±0.25% ΔR
Voltage Coefficient (VC = ppm/V)	<1GΩ	-10ppm/V	-5ppm/V
	1GΩ - 10GΩ	-30ppm/V	-20ppm/V
	10G - 7TΩ	N/A	-100ppm/V

* Extended temperature range available ** Tinned copper leads avail. on Series RP (specify Opt.25)

DERATING

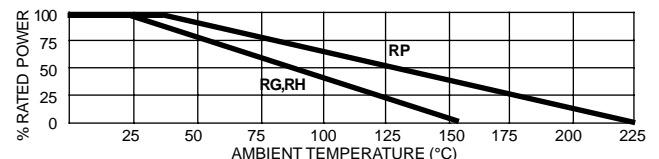

HIGH POWER & HIGH VOLTAGE RESISTORS

2 WATT to 250 WATT, 15KV to 300KV



RESISTORS • CAPACITORS • COILS • DELAY LINES

SR SERIES



Term. W is
RoHS
compliant
& 260°C
compatible



- Power ratings to 250 watts, voltages to 300KV
- Wide resistance range: 50KΩ to 5000MΩ
- Standard Tolerances: ±2, 5, 10, 20%
- Excellent temperature stability
- Excellent resistance to voltage pulses
- Ferrule terminals for clip mounting

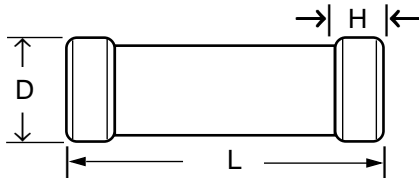

Industry's highest power film resistors!

RCD's SR Series is designed for high voltage and/or high power applications. Film construction has extremely low reactance enabling superior high-frequency performance. Insulation is resistant to moisture, solvents, and oil mediums.

The combination of high power and high voltage provides new opportunities for design engineers to obtain the utmost in performance, without the need to assemble chains of resistors in series. Applications include X-ray equipment, electron microscopes, and TWT amplifiers.

RCD Type	Max. Working Voltage*	Wattage @ 70°C**	Critical Resistance	Resistance Range	Dimensions Inch [mm]		
					L	D	H
SR15	15KV	2.0	112MΩ	50KΩ to 500M	2.05 ± .08 [52.1 ± 2]	.512±.02 [13.0±.51]	.275±.04 [7.0±1.01]
SR20	20KV	3.0	133MΩ	50KΩ to 1000M	3.23 ± .08 [82 ± 2]	.512±.02 [13.0±.51]	.275±.04 [7.0±1.01]
SR30	30KV	5.0	180MΩ	50KΩ to 2000M	3.94 ± .08 [100 ± 2]	.748±.02 [19.0±.51]	.394±.05 [10.0±1.27]
SR60	60KV	10	360MΩ	50KΩ to 5000M	7.87 ± .08 [200 ± 2]	.906±.02 [23.0±.51]	.590±.05 [14.0±1.27]
SR90	90KV	25	324MΩ	50KΩ to 5000M	11.02 ± .08 [280 ± 2]	1.18±.02 [30.0±.51]	.787±.06 [20.0±1.52]
SR120	120KV	50	288MΩ	50KΩ to 5000M	14.57 ± .08 [370 ± 2]	1.81±.02 [46.0±.51]	.787±.06 [20.0±1.52]
SR150	150KV	100	225MΩ	50KΩ to 5000M	18.50 ± .08 [470 ± 2]	1.81±.02 [46.0±.51]	.984±.06 [25.0±1.52]
SR200	200KV	150	267MΩ	100KΩ to 5000M	23.62 ± .12 [600 ± 3]	1.81±.02 [46.0±.51]	.984±.06 [25.0±1.52]
SR250	250KV	200	312MΩ	100KΩ to 5000M	31.50 ± .12 [800 ± 3]	2.12±.02 [53.8±.51]	1.26±.08 [32.0±1.52]
SR300	300KV	250	360MΩ	100KΩ to 5000M	39.37 ± .12 [1000 ± 3]	2.12±.02 [53.8±.51]	1.26±.08 [32.0±1.52]

* Maximum working voltage determined by $E = \sqrt{PR}$ below the critical resistance value.

** Increased wattage ratings up to double the standard are available, consult factory.

PERFORMANCE CHARACTERISTICS

Wattage Derating (linear)	Full power @ 70°C to zero @ 125°C
Temperature Range	-25°C to +125°C
Temperature Coefficient	300 ppm/°C Typ.
Short-Time Overload*	±2.5% Max. ΔR
1000 Hour Load Life (in oil)	±5.0% Max. ΔR
Dielectric Strength	±1.0% Max. ΔR

* 2.5x rated wattage (not to exceed 1.5x max. working voltage) for 5 seconds.

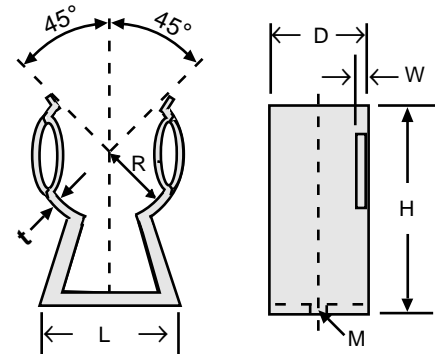

MOUNTING CLIPS

(Dimensions given are nominal in inches)

P/N DESIGNATION:

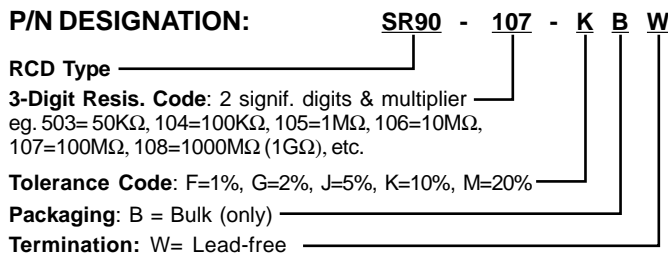

For use on Type	R	D	L	H	M	t	W
SR15, SR20	.24	.24	.51	.67	.125	.02	.04
SR30	.36	.40	.63	1.00	.165	.03	.06
SR60	.44	.59	.71	1.25	.165	.04	.06
SR90	.57	.71	.95	1.54	.256	.04	.06
SR120, SR150, SR200	.89	.79	1.42	2.36	.256	.06	.08
SR250, SR300	1.04	.98	1.77	2.75	.256	.06	.08

RADIAL LEAD MEGOHM RESISTORS

BC SERIES

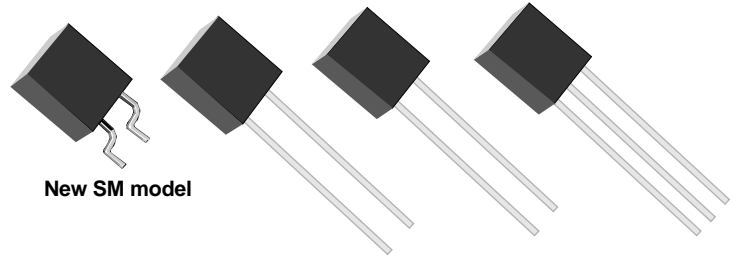
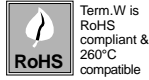

New SM model

- Wide resistance range up to 1000 MegOhm
- TC's as low as ± 25 ppm available
- Standard tolerance is $\pm 1\%$; 0.1% available
- Significant space savings over axial lead resistors
- Available on Tape & Reel
- Economically priced
- Precision quality, excellent stability, low inductance

OPTIONS

- Option P: increased pulse capability
- Option H: increased voltage rating
- Option G: gullwing SM lead forming (avail. on 24mm T&R)
- Option EQ: 24 hour burn in (or ER -100 hour burn in)
- Numerous additional options available including custom marking, matched sets, military screening, etc.

Space-saving megohm resistors!

RCD Series BC resistors are designed for precision high-megohm requirements where space is at a premium. Operating temperature range is -55°C to $+175^{\circ}\text{C}$. Type BC632 features the smallest body size. Type BC630 features an increased voltage rating, wider resistance range, and the lowest cost. BC633 features two resistors within single package. Units are epoxy encapsulated for superior environmental protection.

SPECIFICATIONS

RCD Type	Wattage	Max. Voltage*	Dielectric Strength**	Resistance Range***	A ± 0.015 [.38]	B ± 0.015 [.38]	C ± 0.01 [.25]	D ± 0.002 [.05]	E ± 0.015 [.38]
BC630	.75W	500V	400V	300K to 1000M	.310 [7.87]	.330 [8.38]	.118 [3.0]	.024 [.6]	.150 [3.81]
BC632	.75W	400V	400V	300K to 100M	.290 [7.37]	.290 [7.37]	.095 [2.41]	.024 [.6]	.200 [5.08]
BC633	.25W per resis.	400V per resis.	400V	300K to 100M	.290 [7.37]	.290 [7.37]	.095 [2.41]	.024 [.6]	.100 [5.08]

* Maximum working voltage is determined by $E \sqrt{PR}$, E should not exceed value listed. ** Increased dielectric strength available *** Lower and higher values available on custom basis, consult factory.

TYPICAL PERFORMANCE CHARACTERISTICS

Overload (1.5x rated voltage, 5 sec)	$\pm 0.5\%$ ΔR	
Load Life (1000 hours)	$\pm 0.5\%$ ΔR	
Dielectric Strength	400V AC	
Resistance to Solder Heat	$\pm 0.1\%$ ΔR	
Moisture Resistance	$\pm 0.5\%$ ΔR	
Insulation Resistance (dry)	10,000 Megohms Min.	
Operating Temperature Range	-55°C to 175°C	
Shelf Life at 25°C	$\pm 0.2\%$ ΔR (1 Yr.)	
Temperature Coefficient	300K -100M Ω	100ppm/ $^{\circ}\text{C}$ std (25, 50, 80ppm avail)
	>100M Ω	350ppm/ $^{\circ}\text{C}$ std (100,200ppm avail)
Voltage Coefficient (tightened VC levels available)	300K - 1M Ω	-20ppm/ V Typ.
	1M Ω - 100M Ω	-30ppm/ V Typ.
	100M - 500M Ω	-50ppm/ V Typ.
	500M - 1G Ω	-80ppm/ V Typ.

BC630 & BC632 (single resistor) BC633 (dual resistor)

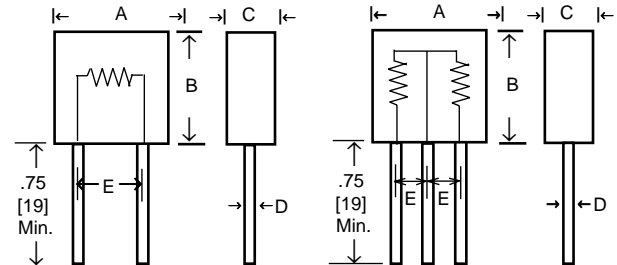

OPT. G GULLWING DESIGN

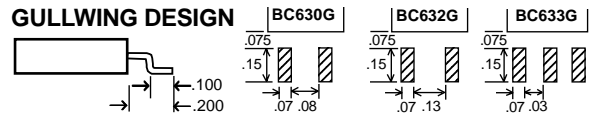

P/N DESIGNATION: BC630 - 1005 - F B 101 W

RCD Type _____
 Options: P, H, G, ER, EQ (leave blank if std) _____
Resis. Code 0.1%-1%: 3 signif. figures & multiplier, (e.g. 3003=300K Ω , 1004=1M Ω , 1006=100M Ω)
Resis. Code 2%-5%: 2 signif. figures & multiplier, (e.g. 304=300K Ω , 105=1M Ω , 107=100M Ω).
 When BC633 is comprised of 2 values, separate with /, e.g. 905/105
Tol. Code: J=5%, G=2%, F=1%, D=0.5%, C=0.25%, B=0.1%
Packaging: B = Bulk, T = Tape & Reel _____
Temp. Coefficient: 25 = 25ppm, 50 = 50ppm, 80 = 80ppm, 101 = 100ppm, 201=200ppm, 351=350ppm
Termination: W= Lead-free, Q= Tin/Lead (leave blank if either is acceptable, in which case RCD will select based on lowest price and quickest delivery)

DERATING

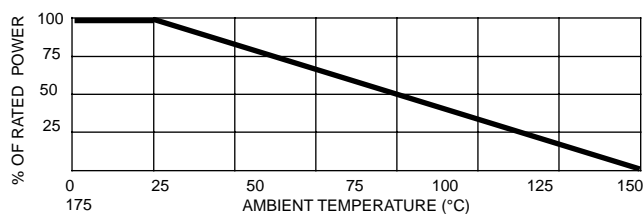

HIGH VOLTAGE AND HIGH VALUE RESISTORS

UHV SERIES



- Resistance values up to 200TΩ (2x10¹⁴Ω), tolerances to 1%!
- Voltage rating to 14KV. Pulse voltage to 50KV avail.
- Low noise & voltage coefficient
- Industry's best TCR, as low as ±25ppm/°C

SPECIAL MODIFICATIONS

- Screw terminations available
- Resistance tolerances to ±0.2%, matching to 0.1%
- Voltage or resistance ratios up to 1000 : 1±1.0%
- Increased power, voltage, and operating frequency levels

DERATING

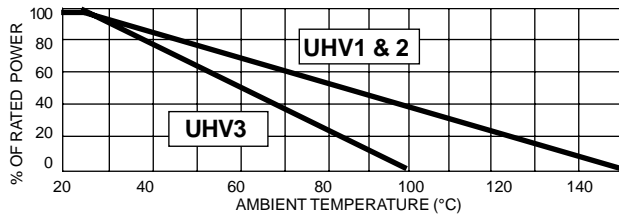

World's highest resistance range!

RCD Type UHV resistors are suited for all high value applications from general purpose bleed chains to highest reliability X-ray systems and TWT amplifiers. RCD's exclusive complex oxide film features state-of-the-art performance and extended life stability. The unique molecular structure of the resistive element offers exceptional insensitivity to high voltage and thermal shock. The protective insulation provides a high dielectric voltage, and insulation resistance. Series UHV3 is hermetically sealed in a glass or ceramic case, minimizing the effects of moisture or contamination.

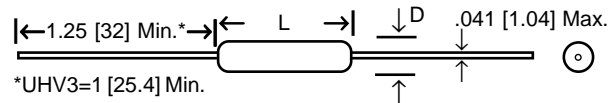

RCD Type	L (Max.)	D
UHV1	1.102 [28.0]	.315 ±.040 [8.0±1]
UHV2	1.875 [47.6]	.315 ±.040 [8.0±1]
UHV3	2.00 [50.8]	.264 [6.7] Max.

RCD TYPE	Wattage @ 25°C	Working Voltage*	Avail. TCR (ppm/°C)	RESISTANCE RANGE**		
				1%	2%	5%, 10%
UHV1	1.0W	4000V	25	1K to 100M	1K to 100M	1K to 100M
			50	100Ω to 100M	100Ω to 100M	100Ω to 100M
			100	10Ω to 1G	5Ω to 1G	5Ω to 1G
			250	1.1G to 10G	1.1G to 10G	1.1G to 10G
			-2000	2M to 10G	2M to 50G	2M to 100G
UHV2	2.0W	14,000V	25	1K to 100M	1K to 100M	1K to 100M
			50	100Ω to 100M	100Ω to 100M	100Ω to 100M
			100	100K to 1G	100K to 1G	100K to 1G
			250	1.1G to 50G	1.1G to 50G	1.1G to 50G
			-2000	2M to 50G	2M to 100G	2M to 150G
UHV3	1.0W	1000V	-2000	100M to 1G	100M to 1G	100M to 1G
			-2500	1G to 1T	1G to 1T	1G to 1T
			-3500	1T to 5T	1T to 10T	1T to 200T

* Maximum DC or AC_{RMS} working voltage determined by E=√PR below the critical resistance value. Voltage rating is doubled in warm oil. Increased voltage ratings available. **increased range available.

PERFORMANCE CHARACTERISTICS¹

Temperature Range	UHV1&2 = -55°C to +150°C UHV3 = -40°C to +100°C
Voltage Coefficient ²	1 - 20ppm typ. UHV1 & UHV2 10 to 80ppm UHV3
Insulation Resistance (500V)	10 ¹³ Ω
Load Life (1000 hours, typ.)	0.5%
Shelf Life (12 months, typ.)	0.5%
Noise (per freq. decade, typ.)	2.0μV/V

¹ Characteristics are typical for resistance range up to 1GΩ, consult factory concerning higher values
² Measured between 100V and 500V on values above 100M (tighter VC's available)

APPLICATION NOTES

- Due to possible surface condensation, high voltages should not be applied in conditions of high humidity. The end caps of UHV1&2 are uninsulated and need to be mounted an adequate distance from conductors to ensure adequate isolation voltage.
- Type UHV3 is coated with silicone to reduce condensation on the glass case and minimize shunt resistance. The coating must not be damaged or subjected to solvents; handle by terminations. UHV3 >100G are supplied with a guard band to minimize leakage current.
- Resistance measurements on values over 1 Meg are made at 100V.
- Resistors are available with screw terminations & tapped end caps to provide virtually any voltage or resistance value by combining in series.

RESISTANCE CODE

Resistance Value	Scientific Notation	Resis. Code	
		1%	2%-10%
1KΩ	1x10 ³ Ω	1001	102
1MΩ	1x10 ⁶ Ω	1004	105
10MΩ	1x10 ⁷ Ω	1005	106
100MΩ	1x10 ⁸ Ω	1006	107
1GΩ	1x10 ⁹ Ω	1G00	1G0
10GΩ	1x10 ¹⁰ Ω	10G0	10G
100GΩ	1x10 ¹¹ Ω	100G	100G
1TΩ	1x10 ¹² Ω	1T00	1T0
10TΩ	1x10 ¹³ Ω	10T0	10T
100TΩ	1x10 ¹⁴ Ω	100T	100T

P/N DESIGNATION:

RCD Type UHV3 □ - 1T50 - F B 101 W

Option Codes assigned by RCD (leave blank if std)

Resis. Code 1% Tol: 3 signif. figures & multiplier (1001=1KΩ, 1004=1MΩ, 1006=100MΩ, 1G00=1GΩ, 1T50=1.5T, etc.)

Resis. Code 2% - 10%: 2 signif. figures & multiplier (105=1MΩ, 107=100M, 1G5=1.5GΩ, 15T=15TΩ). Refer to Resis. Code table

Tolerance Code: K=10%, J=5%, G=2%, F=1%

Packaging: B =Bulk, T= Tape & Reel

Temp. Coefficient (PPM/°C): 25=25ppm, 50=50ppm, 101=100ppm, 102=1000ppm, 202=2000ppm, 252=2500ppm, 352=3500ppm

Termination: W= Lead-free, Q= Tin/Lead (leave blank if either is acceptable)

HIGH SURGE RESISTORS, 1/8W to 12W

PR SERIES



Term. W
is Pb-free
and RoHS
compliant



RESISTORS • CAPACITORS • COILS • DELAY LINES

RCD PR2
10K 5%

- Cost effective high-voltage surge resistors to 200 joules
- Available on RCD's exclusive **SWIFT™** program
- Molded surface mount version available ([PRM series](#))

OPTIONS

- Opt. ER: Group A Screening per MIL-R-39008 RCR
- Opt. S: Group A & 24-hr burn-in at 1.5X rated W@25°C⁷
- Opt. F: Flameproof coating
- Opt. B: Increased power (see Specifications chart)
- Opt. X: Non-inductive (see Performance Char. table)

Excellent Low Cost Replacement for Composition Resistors

Series PR pulse resistors withstand higher energy pulses than conventional film & wirewound types, without the performance disadvantages of carbon comp resistors. The heavy duty construction features a high thermal conductivity core and coating, enabling improved thermal transfer, long term stability, and environmental performance. Series PR satisfy a wide variety of pulse applications including lightning, snubber, in-rush current, capacitor charge, etc.

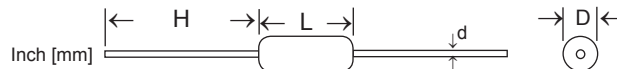

SPECIFICATIONS

RCD Type	Wattage Rating		Max. Continuous Voltage ^{1,5,8}	Max. Peak Pulse Voltage ^{2,5,8}	Resistance Range ⁵	L (Body Length)	D ⁶ (Body Dia.)	d±.004 [.1]	H ⁴ (min)
	Standard	Option B							
PR1/8	1/8W	1/2W	150V	2KV	0.1Ω-2K	.145±.025 [3.69±.64]	.062±.015 [1.6±.38]	.018 [.46]	1.0 [25.4]
PR1/4	1/4W	1W	250V	3.5KV	0.1Ω-10K	.240±.032 [6.1±.8]	.085±.025 [2.16±.64]	.022 [.56]	1.375 [35]
PR1/2	1/2W	2W	350V	5KV	0.1Ω-24K	.375±.040 [9.2±1]	.156±.025 [3.96±.64]	.028 [.7]	1.375 [35]
PR1	1W	4W	500V	10KV	0.1Ω-100K	.600±.040 [15.2±1]	.225±.032 [5.72±.8]	.032 [.8] ³	1.375 [35]
PR2	2W	5W	750V	15KV	0.1Ω-200K	.875±.062 [22.2±1.6]	.312±.032 [7.92±.8]	.040 [1] ³	1.375 [35]
PR5	5W	7W	800V	18KV	0.1Ω-220K	1.05±.062 [26.7± 1.6]	.350±.032 [8.89±.8]	.040 [1]	1.375 [35]
PR10	10W	12W	1000V	25KV	0.1Ω-300K	1.72±.062 [43.7±1.6]	.350±.032 [8.89±.8]	.040 [1]	1.375 [35]

¹ Max voltage = √(PxR), not to exceed value listed. ² Pulse voltage & energy capability is dependent on res. value, waveform, repetition rate, & environmental conditions (refer to R-42 for derating factors). ³ .040" (1mm) lead dia. is available on PR1 (specify PR1-18), .032" [.8mm] lead dia. is available on PR2 (specify PR2-20) ⁴Lead length is for bulk packaging, taped parts may be shorter (consult taping dimensions). ⁵ Expanded range avail. ⁶Allow .024" [.6mm] additional for Opt.X or values <1Ω ⁷PR1/8 - PR2 with Opt. S receive burn-in at 150% rated W, PR5 - PR10 & Opt.B at 100% rated W. ⁸Multiply by 0.7 on Opt.X parts.

SURGE CAPABILITY

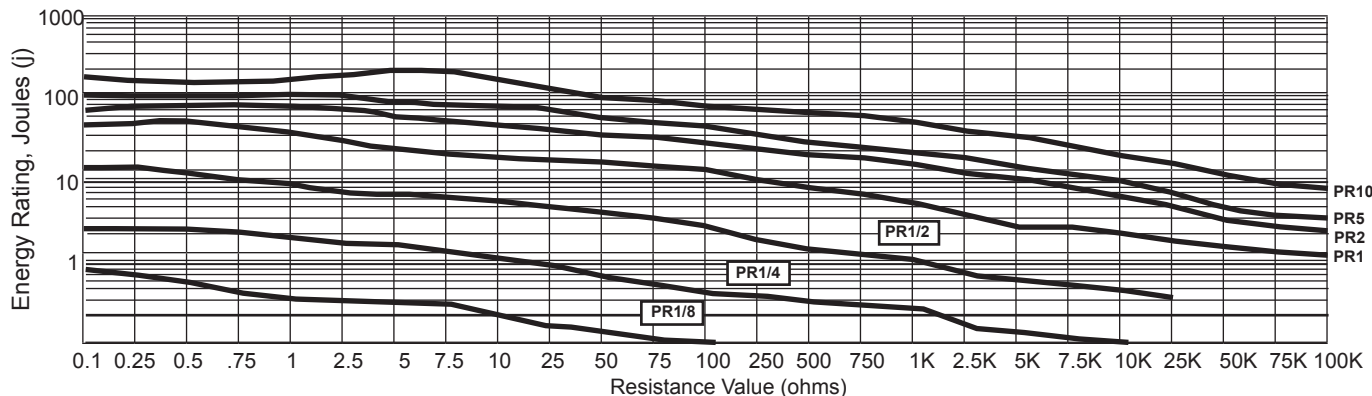

PERFORMANCE CHARACTERISTICS, Typ.

Derating, Wattage & Voltage	PR1/8-PR2 1.25%/°C >70°C, PR5-PR10 & Opt. B to be derated 0.8%/°C >25°C
Max. Induc*: Opt. X≤50Ω	0.2uH PR1/8X-PR1/2X, 0.3uH PR1X-PR2X, 0.7uH PR5X-PR10X
Max. Induc*: Opt. X>50Ω	0.37uH PR1/8X-PR1/2X, 0.6uH PR1X-PR2X, 1.4uH PR5X-PR10X
Short-time Overload	±0.5%
Temperature Cycling	±0.5%
TCR (20 & 50ppm avail.)	±100ppm/°C (<0.2Ω=200ppm)
Moisture Resistance	±1%
Shock and Vibration	±0.2%
Effect of Soldering	±0.2%
Voltage Coefficient	±0.005%/V
Load Life	±0.5% Std, ±1% Opt.B
Operating Temp Range	-55 to +150°C, +275°C avail.
Dielectric Strength	500V (1KV avail.)

* specify Opt.75 for induc levels 50% that of Opt.X, or Opt.76 for 33% that of Opt.X

APPLICATION NOTE

Use chart above to select model to meet desired surge level. Pulse not to exceed peak V & j ratings (derate 30% for Opt.X), and average power during repetitive pulses nte rated W. 30% safety factor is recommended for infrequent pulses, 50% typ. for repetitive pulses (refer to Note R42 for derating factors attributable to pulse width, rep. rate, temp., altitude, humidity). Verify by evaluating under worst-case conditions. Depending on specifics, PR series can often satisfy the surge requirements of UL-217, -268, -294, -497, -508, -913, -943, -991, -1459, -1971, ANSI/IEEE C62.41, CCITT (Rec. K17), Bellcore TR-NWT-001089 & TR-TSY-000057, CSA C22.2-225, IEC 664, IEC 801.5, IEEE587, Can.Doc. CS-03, FCC Part 68., etc. Consult factory for assistance.

P/N DESIGNATION:

PR1/2 - **102** - **K** **T** **W**

RCD Type _____

Options: X, S, F, ER, B (leave blank if std) _____

Resis. Code 1% tol: 3 signif. figures & multiplier, e.g. R100=0.1Ω, 1R00=1Ω, 10R0=10Ω, 1000=100Ω, 1001=1K, 2%-10%: 2 signif.fig. & multiplier (R10=0.1Ω, 1R0=1Ω, 100=10Ω, 102=1K)

Tolerance: J=5% (standard), F=1%, G=2%, K=10% _____

Packaging: B = bulk, T = Tape & Reel _____

Optional TC: 20 =20ppm, 50= 50ppm (leave blank if standard) _____

Termination: W= Lead-free, Q= Tin/Lead (leave blank if either is acceptable) _____

CARBON COMPOSITION RESISTORS

1/4 WATT TO 1 WATT HIGH SURGE

CC SERIES



Term. W
is Pb-free
and RoHS
compliant



RESISTORS • CAPACITORS • COILS • DELAY LINES

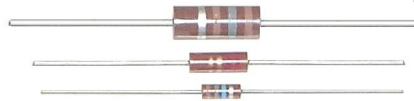

- High surge/high pulse capability
- Low inductance/high frequency performance
- Rugged hot molded construction
- 1/8W and 2W sizes in development
- Surface mount styles in development

OPTIONS

- Option 37: Group A screening per Mil-R-39008
- Numerous modifications are available... custom marking, cut & formed leads, increased voltages, hot solder dipped leads, etc. Customized components are an RCD specialty!

Now available to 1% tolerance, an industry first!

Carbon composition resistors are considered as perhaps the most reliable of all electronic components. There are no windings or film, resulting in a truly non-inductive resistor with excellent pulse-withstanding capability. Hi-Rel Group A Screening per Mil-R-39008 is available (specify option 37). Recent manufacturing improvements have achieved tolerances as tight as 1%, now enabling carbon comp reliability for semi-precision circuits. Note: composition construction isn't as stable as other types especially in humid conditions, and therefore isn't suitable for precision applications (refer to RCD's PR Series for improved environmental performance).

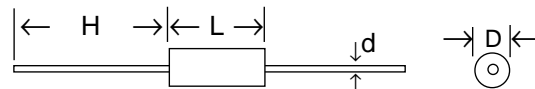

RCD Type	Wattage at 70° C ¹	Max Voltage ²	Peak Pulse Voltage ^{3,4}	Joule Rating ^{3,4}	Dielectric Strength	Resistance Range	Dimensions Inch [mm]			
							L±.032 [.8]	D±.012 [.3]	d±.002 [.05]	H (typ.)
CC1/4	0.25W	250V	6KV	1.8j	500V	1Ω - 22M (E24)	.250 [6.35]	.090 [2.3]	.024 [.61]	1.0 [25.4]
CC1/2	0.5W	350V	10KV	6.4j	700V	1Ω - 22M (E24)	.375 [9.53]	.140 [3.56]	.028 [.71]	1.0 [25.4]
CC1	1W	500V	14KV	20j	1000V	2Ω - 1.2M (E12)	.562 [14.27]	.225 [5.72]	.036 [.91]	1.0 [25.4]

¹ Derate wattage by 1.25%/°C above 70°C ² Rated continuous voltage determined by E = (PR)^{1/2}, E not to exceed the value listed. ³ Increased levels available ⁴ Peak pulse (rupture) voltage and joule ratings are dependent on resistance value, pulse wave form and repetition rate. Derate 25-50% for repetitive pulses and improved stability/reliability. Repetitive pulse average power not to exceed wattage rating. Verify selection by evaluating under worst case conditions. Consult factory for assistance.

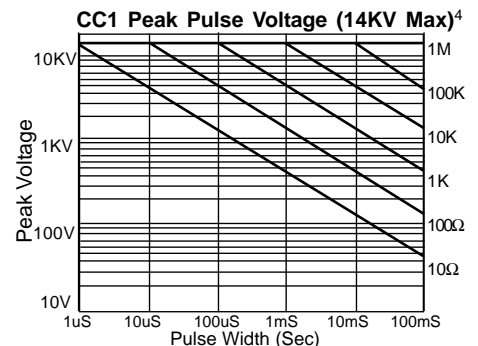
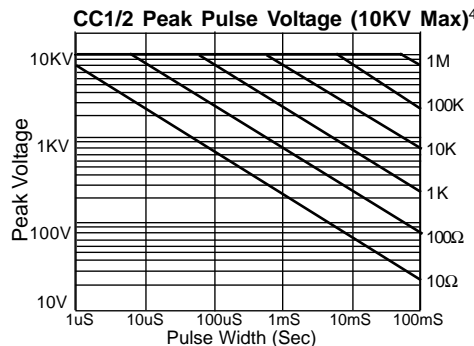
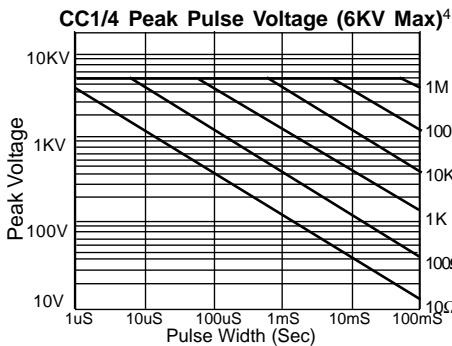

TYPICAL PERFORMANCE CHARACTERISTICS

Short-time Overload	±2.5%
Temperature Cycling	±2%
Temperature Coefficient	±0.15%/°C
Moisture Resistance	±5%
Shock and Vibration	±1%
Load Life	±10%
Voltage Coefficient	±0.03%/V
Operating Temp. Range	-55° C to + 150° C

APPLICATIONS

Typical applications include snubber circuits, lightning surge, grounding resistors, RFI suppression, dummy loads, etc. Depending on the application, CC resistors can often satisfy requirements of UL217, 268, 294, 497A, 508, 913, 1459, & 1971; IEEE587, C37.90, & C62.41; IEC552, 801, & 1000-4; AAMI EC11; Bellcore TR 357 & 1089; EN 61000-4, 60601, & 50082.

TEMPERATURE RISE

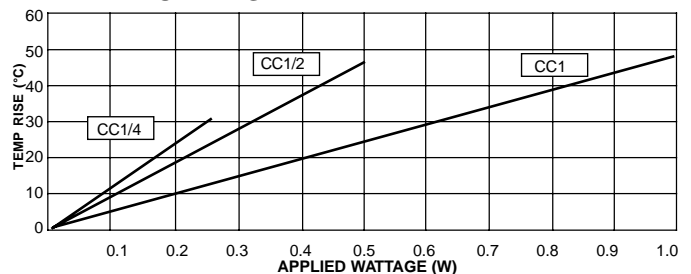

P/N DESIGNATION: **CC1/2** - **101** - **J** **T** **W**
RCD Type CC1/2
Options: 37, etc (leave blank if standard)
3-Digit Resis Code: 2 signif. digits & multiplier (1R0=1Ω, 100=10Ω, 101=100Ω, etc)
Tol Code: J=5% (std on CC1/4 & 1/2), K=10% (std CC1), 1% (F) and 2% (G) available
Packaging: B = bulk, T = Tape & Reel A = Ammo Pack
Termination: W=Lead-free, Q=Tin/Lead (leave blank if either is acceptable)

HIGH VOLTAGE CARBON RESISTORS

1/8 WATT to 3 WATT

CFZ SERIES



RESISTORS • CAPACITORS • COILS • DELAY LINES



- High pulse voltage capability
- Low cost, prompt delivery
- Standard resistance range: 1K - 22MΩ
- Surface Mount version available!
- Inherently low inductance

Type CFZ was developed as a low-cost alternative to high voltage thick film and carbon composition resistors. Carbonized film processing enables pulse capabilities to 12KV! Elements are protected by moisture resistant epoxy coating for excellent environmental performance. Application assistance available.

OPTIONS

- Option 25 - Hot solder dipped leads
- Option 37 - Group A screening per Mil-R-39008
- Numerous design modifications are available (custom marking, uninsulated, specialty non-inductive/ high frequency design, cut & formed leads, etc.)

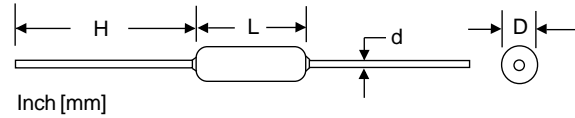

RCD Type	Wattage	Max Working Voltage ¹	Peak Pulse Voltage ²	L	D	d ±.003 [.08]	H ³
CFZ12	.125W	250V	2KV	.145±.032 [3.68±.8]	.062±.02 [1.57±.51]	.020 [.51]	1.06±.08 [27±2]
CFZ25	.25W	300V	3KV	.250±.032 [6.35 ±.8]	.090±.02 [2.2 ±.51]	.024 [.61]	1.06±.08 [27±2]
CFZ50S	.5W	400V	5KV	.354±.032 [8.99±.8]	.125±.02 [3.18±.51]	.028 [.71]	1.06±.08 [27±2]
CFZ75	.75W	500V	6KV	.354±.032 [8.99±.8]	.148±.02 [3.76±.51]	.031 [.79]	.980 [25] Min
CFZ100	1.0W	600V	7KV	.470±.050 [11.9±1.3]	.180±.025 [4.57±.64]	.031 [.79]	1.06 [27] Min
CFZ200	2.0W	700V	10KV	.600±.050 [15.2±1.3]	.200±.025 [5.08±.64]	.031 [.79]	1.06 [27] Min
CFZ300	3.0W	800V	12KV	.710±.080 [18.0±2.0]	.250±.050 [6.35±1.27]	.031 [.79]	1.26 [32] Min

¹ Maximum working voltage = (PR)^{1/2}, voltage not to exceed the value listed. Increased voltage ratings available

² Peak pulse voltage is highly dependent on pulse waveform and resistance value. Voltage levels given indicate the maximum levels for the series. These levels are not attainable for all values and pulse waveforms. Consult factory for application assistance.

³ Lead length is for bulk packaged parts, taped parts may be shorter. Non standard lengths and cut&formed leads available)

DERATING

RCD CFZ12 through CFZ200 power ratings must be derated above 70°C, derate CFZ300 above 40°C.

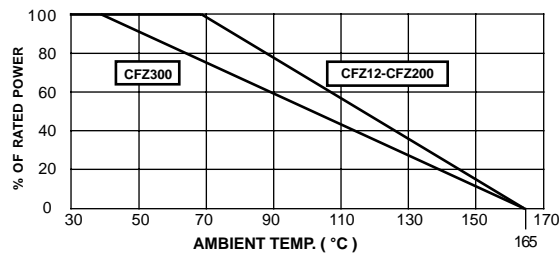

SPECIFICATIONS

Resistance Range	1K to 22MΩ†
Standard Tolerance	±5% (2%, 10% avail)
Operating Temp. Range	-55° to +165°C†
Dielectric Strength	CFZ12 =400V, CFZ25-75 = 500V, CFZ100-300=1000V
Temp.Coef.1K-100K	0.05%/°C typ.
100K-1M	0.1%/°C typ.
1M -10M	0.15%/°C typ.

† Expanded range available, consult factory.

TYPICAL PERFORMANCE CHARACTERISTICS

Load Life	±3%
Shelf Life	±1%/yr
Short Time Overload	±1%
Solder Heat	±0.3%
Moisture	±2%
Temperature Cycling	±0.5%
Insulation Resistance	10,000MΩ

PART NUMBER DESIGNATION:

CFZ25 - **101** - **J** **T** **W**

RCD Type _____

Options: 37, 25 (leave blank if standard) _____

3-Digit Resis.Code: 2 signif. digits & multiplier _____
(102=1KΩ, 103=10K, 104=100K, 105=1M, 106=10M)

Tolerance Code: J=5% (std), G=2%, K=10% _____

Packaging: B = Bulk, T = Tape & Reel _____

Termination: W= Lead-free, Q= Tin/Lead (leave blank if either is acceptable, in which case RCD will select based on lowest price and quickest delivery)

HIGH SURGE NON-INDUCTIVE COMPOSITION RESISTORS

UP TO 400 WATT, 160KV & 150,000 JOULES

PCN SERIES



RESISTORS • CAPACITORS • COILS • DELAY LINES



Term. W is RoHS compliant & 260°C compatible



- Industry's widest range of composition resistors!
- High energy and voltage capability, non-inductive
- Standard tolerances of 10% & 20% (5% avail.)

OPTIONS

- Option HC: special coating for oil immersion (+175°C max)
- Option 37: Group A screening per Mil-R-39008
- Custom rod and disk sizes, expanded resistance range, custom metallization, increased voltage/dielectric/joule ratings avail. End caps, lug terminals, & mounting clips avail.

Type PCN resistors are manufactured from carbon and ceramic granules into a solid bulk composition enabling pulse capabilities unmatched by wirewound or film resistors. Marking is alpha-numeric or color band. Flexible manufacturing process enables customized rod or disk sizes up to 5" diameter and 18" long. Typical applications include snubber circuits, lightning surge, grounding resistors, RFI suppression, dummy loads, etc. Depending on the application, PCN resistors can often satisfy requirements of UL217, 268, 294, 497A, 508, 913, 943, 991, 1459, & 1971; IEEE587, C37.90, & Bellcore TR357 & 1089; EN61000-4, 60601, & 50082.

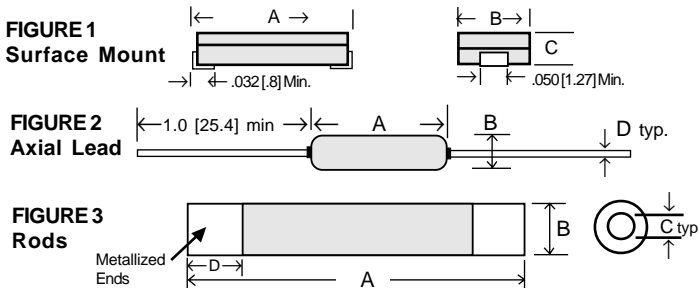

DERATING

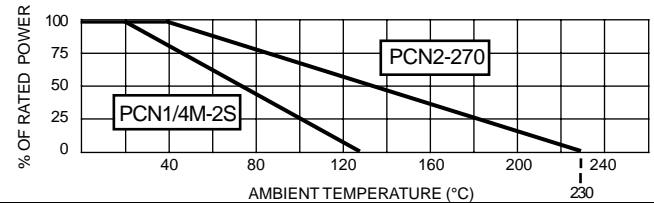

RCD Type	Fig.	Wattage	Max Working Voltage ¹	Pulse Voltage ²	Joule Rating ³	Resistance Range ⁴	A	B	C	D
PCN1/4M	1	.25W	250V	2KV	2	1Ω - 10M	.450±.032 [11.4±0.8]	.225±.015 [5.7±.38]	.180 ±.020 [4.6±.50]	-
PCN1/2M	1	.5W	350V	2.5KV	7	1Ω - 10M	.625±.032 [15.9±0.8]	.276±.015 [7.0±.38]	.245±.025 [6.22±.64]	-
PCN1M	1	1W	500V	3KV	18	2Ω - 1M	.811±.020 [20.6±0.5]	.283±.025 [7.2±.63]	.283 ±.025 [7.2±.63]	-
PCN1/2S	2	.5W	250V	2KV	2	1Ω - 10M	.250 ±.024 [6.5 ±.60]	.100±.028 [2.5±.70]	-	.025 [6.4]
PCN1S	2	1W	350V	2.5KV	7	1Ω - 10M	.394 ±.032 [10 ±.80]	.140±.028 [3.6±.70]	-	.032 [8.1]
PCN2S	2	2W	500V	8KV	16	2Ω - 1M	.610±.06 [15.5±1.5]	.220±.04 [5.59±1.0]	-	.034 [8.6]
PCN2	2	2W	500V	4KV	25	5.6Ω to 51K	.775 ±.06 [19.7±1.5]	.225±.05 [5.72±1.27]	-	.032 [8.1]
PCN3	2	3W	600V	5KV	96	10Ω to 20K	1.00±.05 [25.4±1.27]	.339±.05 [8.61±1.27]	-	.032 [8.1]
PCN5	2	5W	700V	10KV	160	10Ω to 30K	1.58±.05 [40.1±1.27]	.339±.05 [8.61±1.27]	-	.032 [8.1]
PCN10	3	10W	800V	20KV	370	18Ω to 23K	2.36 ±.05 [60 ±1.27]	.551±.05 [14±1.27]	.31 [8]	.4 [10]
PCN20	3	20W	900V	30KV	560	26Ω to 28K	3.15 ±.05 [80 ±1.27]	.551±.05 [14±1.27]	.31 [8]	.4 [10]
PCN30	3	30W	1000V	35KV	1060	21Ω to 23K	3.94±.05 [100±1.27]	.788±.05 [20±1.27]	.55 [14]	.5 [13]
PCN30S	3	30W	1200V	50KV	10,000	10Ω to 45K	5.0 ±.062 [127±1.57]	.750±.05 [19±1.27]	std=solid, opt.T=.24 [6]	.6 [15]
PCN50	3	50W	1700V	70KV	2450	45Ω to 58K	7.87±.08 [200 ± 2]	.788±.05 [20±1.27]	.55 [14]	.6 [15]
PCN50S	3	50W	1700V	60KV	20,000	5.6Ω to 30K	6.0 ±.062 [152±1.57]	1.0 ±.05 [25.4±1.27]	std=solid, opt.T=.48[12]	.5 [13]
PCN75S	3	75W	1800V	80KV	30,000	8Ω to 41K	8.0 ±.062 [203±1.57]	1.0 ±.05 [25.4±1.27]	std=solid, opt.T=.48[12]	.87 [22]
PCN80	3	80W	2000V	80KV	4360	45Ω to 50K	9.84±.08 [250 ± 2]	.985±.05 [25±1.27]	.71 [18]	.87 [22]
PCN100	3	100W	2400V	100KV	5430	55Ω to 100K	11.81±.08 [300 ± 2]	.985±.05 [25±1.27]	.71 [18]	.87 [22]
PCN100S	3	100W	2400V	120KV	40,000	12Ω to 60K	12.0 ±.062 [305±1.6]	1.0 ±.05 [25.4±1.27]	std=solid, opt.T=.48[12]	.87 [22]
PCN150	3	150W	2500V	100KV	14,760	26Ω to 28K	11.81±.08 [300 ± 2]	1.575±.06 [40±1.52]	1.10 [28]	.87 [22]
PCN150S	3	150W	2500V	160KV	60,000	15Ω to 80K	16.0 ±.062 [406±1.6]	1.0 ±.05 [25.4±1.27]	std=solid, opt.T=.48[12]	.87 [22]
PCN270	3	270W	2600V	160KV	30,000	21Ω to 23K	17.72±.08 [450 ± 2]	1.969±.06 [50±1.52]	1.50 [38]	1.0 [25]
PCN400S	3	400W	2600V	160KV	150,000	6Ω to 30K	16.0 ±.062 [406±1.6]	1.63±.06 [41.4±1.52]	std=solid, opt.T=.48[12]	.87 [22]

¹ Max. continuous voltage is determined by E= (PR)^{1/2}, E not to exceed the Max. Working Voltage. ² Peak pulse voltage is dependent on resistance and pulse waveform. Levels listed are based on 10X160 nS pulse, 10KΩ. Increased voltage available. Consult factory on each application. ³ Joule rating is dependent on resis. value, pulse duration, and repetition rate. Levels listed are based on 10ms pulse width X 20,000 cycles, 150Ω, full cooling between pulses. Increased joule ratings available. Consult factory on each application. ⁴ Expanded resistance range available.

PERFORMANCE*

Specification	PCN1/4M-PCN2S	PCN2- PCN400S
Temperature Cycling	1%	1%
Temperature Coefficient	.15%/°C Max.	.15%/°C Max.
Moisture Resistance	5%	5%
Load Life (500 hrs)	±10%	±5%
Operating Temp. Range	-55 to +125°C	-55 to +230°C
Dielectric Strength (V-block)	500V, 60S	0V**
Overload (nte 2.5xRCWV)	3x Rated W, 5S	10x Rated W, 5S
Derating (W, V, & E)	.952%/°C >20°C	.526%/°C >40°C

*Typical performance 10Ω to 1MΩ (consult factory for requirements outside this range)
 ** Specify Opt. HC for 500V dielectric or Opt.33 for 1KV (derate pulse voltage 50% & max temp to +175°C)

P/N DESIGNATION: PCN30 - 102 - K B W

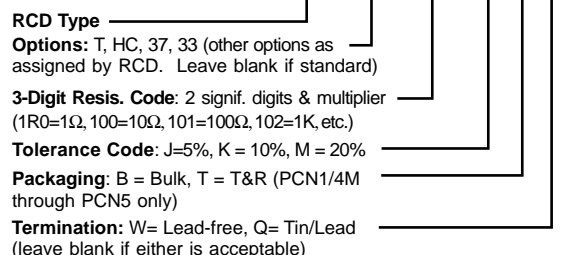

OPTION P



RESISTORS • CAPACITORS • COILS • DELAY LINES

PULSE WITHSTANDING PROTECTIVE RESISTORS

FUSIBLE RESISTORS: All of RCD's failsafe resistors (Series BW, FR, RWFF, PWFF, LF and TF), are available with a pulse resistant construction which enables the resistor to remain stable under very short pulses (such as lightning surge or capacitor discharge) but will open circuit under longer overloads. There are direct tradeoffs between the fusing and surge characteristics in fuse resistors (except TF & LF series), wherein a higher pulse energy will result in a higher fusing current and/or slower fusing time. The following charts offer a guideline as to RCD's capability but all fusible resistors with pulse withstanding requirements are custom designed and therefore require engineering consultation. Please advise the pulse waveshape, peak voltage, number of pulses, allowable resistance shift, maximum body size, and power-cross conditions if required.

NON-FUSIBLE RESISTORS: Surge resistant construction is also available on standard wirewound, power oxide, carbon film, and surface mount resistors (RCD Series 100, 200, RW, 600, PW, PV, PWV, RSF, RMF, CF, MW, MWM, etc.). Resistors with option P construction are typically rated for energy levels up to double those of standard parts, (depending on product, resistance value, etc.). Consult factory for assistance.

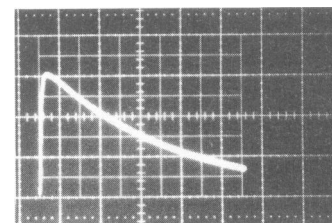

Typical pulse waveshape as depicted on an oscilloscope

TELECOM SURGE STANDARDS

FCC (Docket 19528-68)
 REA (PE60)
 CCITT (Rec. K17)
 BELLCORE (TR-TSY-000057)
 UL1459
 TR1089, GR1089

AC POWER LINE SURGE STANDARDS

IEEE587
 UL943, UL217, UL268
 IEC664
 ANSI/IEEE C62.41-1980

AC POWER CROSS STANDARDS

UL497

TYPICAL LIGHTNING PULSE WAVEFORMS

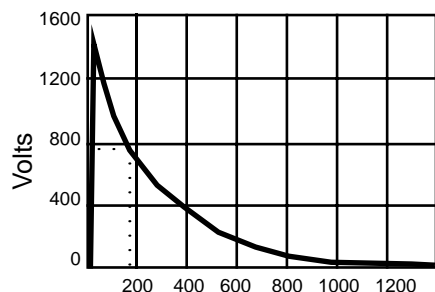

10 by 160 – 1500 Volts
 FCC – Longitudinal Surge

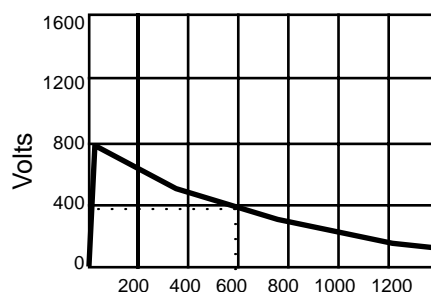

10 by 560 – 800 Volts
 FCC – Metallic Surge

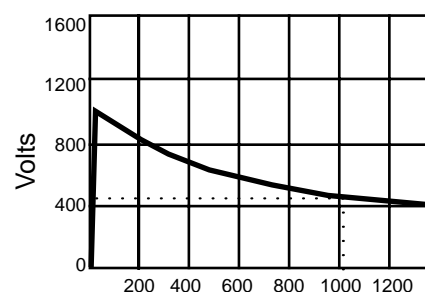

10 by 1000 – 1000 Volts
 REA – Current Surge

MAXIMUM AVAILABLE PULSE WITHSTANDING VOLTAGE

10μS by 1000μS waveform* (To be used as a guide only; consult factory for details).

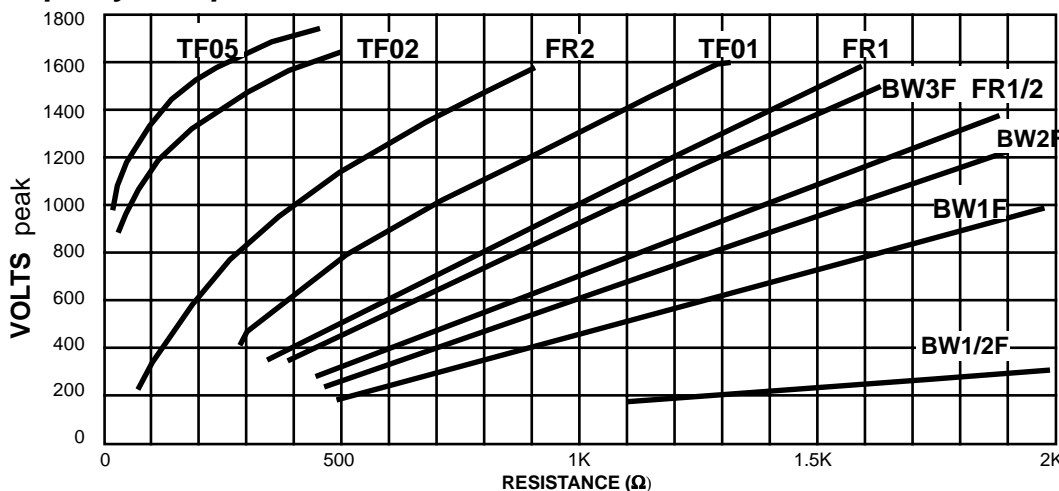

Example: A BW2F 1KΩ fuse resistor can be designed to withstand a 600V (10/1000) lightning surge; however, this increased surge capability may result in a slower fusing time.

*10μS rise time to peak voltage, 1000μS decay to half voltage.

Minimum resistance capable of withstanding 10 X 1000, 1000V* 10 Pulses	
RCD Type	Resistance
BW1/4F	20K
BW1/2F	10K
BW1F	2K
BW2F	1.5K
BW3F	1 K
FR-1/2	1.3K
FR-1	900Ω
FR-2	300Ω
TF01	300Ω
TF02	30Ω
TF04	5.6Ω
TF05	5.0Ω
TF07	4.0Ω
TFV2	30Ω
TFV3	5.0Ω

POWER FILM RESISTORS TO 140 WATT

MP SERIES



Term.W is
RoHS
compliant
& 260°C
compatible

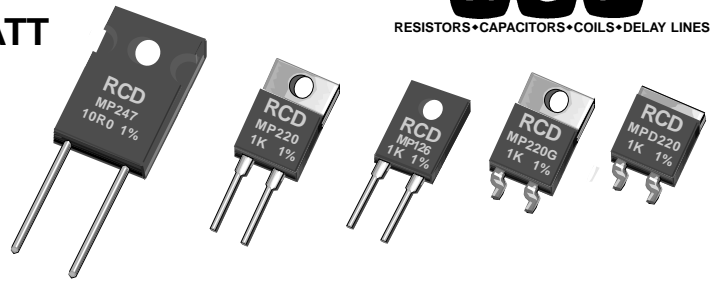

- Industry's widest range of TO-style power resistors!
- Standard resistance range: 0.01Ω to 56KΩ
- Standard tolerance: ±1%, ±2%, ±5% (available to 0.025%)
- Non-Inductive performance
- Resistor is electrically isolated from the mounting surface

OPTIONS

- Option P: Increased pulse capability
- Option G: Gull-wing lead formation for surface mounting
- Option B: Increased power design
- Numerous design modifications are available (special marking, custom lead wires, burn-in, etc).

High Performance Molded Heat-Sink Resistors

RCD's MP series feature power film resistor elements designed for excellent environmental stability as well as superior high-frequency performance (custom designs up to 1GHz avail.). All sizes feature metal base plate for optimum heat transfer. The resistor is electrically isolated from the metal tab, and molded into various package styles with high-temp flame retardant epoxy. **MP126 and MP220 in reduced wattage ratings now available in tighter TCs and tolerances from 10Ω to 49.9K: MP126 (5W) to 0.025% and 2ppm, MP220 (10W) to 0.05% and 5ppm.**

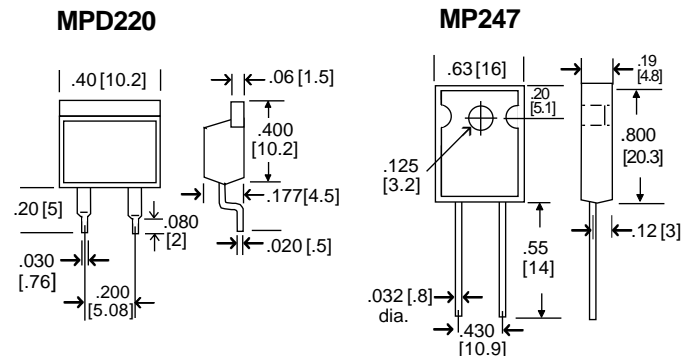
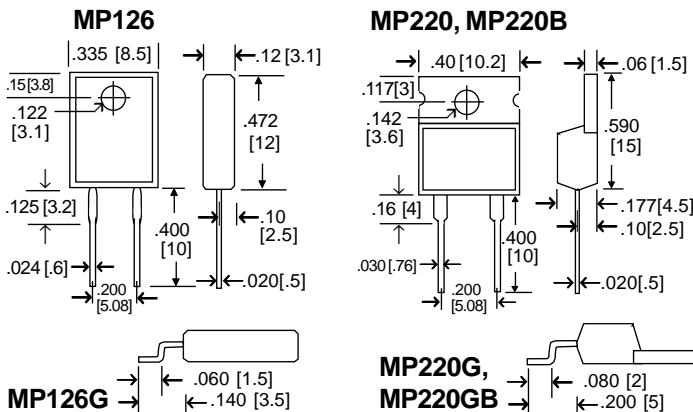

SPECIFICATIONS

RCD Type	Max. Power with Heat Sink (25°C)		Max Power ¹ w/o Heat Sink (25°C)	Thermal Resist. ²	Max. Voltage ^{3,4}	Resistance Range (Ω) ⁴
	<240Ω	≥240Ω				
MP126	20W	10W	1.25W	<6°C/W	300V	.01 - 56K
MP126G	20W	10W	1.25W	<6°C/W	300V	.01 - 56K
MP220	35W	20W	2.25W	<4°C/W	500V	.01 - 56K
MP220G	25W	20W	2.00W	<4°C/W	500V	.01 - 56K
MPD220	30W	20W	2.25W	<4°C/W	500V	.01 - 56K
MP220B	50W	30W	2.25W	<2.5°C/W	500V	.1 - 56K
MP220GB	45W	30W	2.25W	<2.5°C/W	500V	.1 - 56K
MP247	100W	n/a	3.5W	<1.5°C/W	√(PR)	.1 - 240
MP247B	140W	n/a	3.5W	<1°C/W	√(PR)	.1 - 240

¹ Power rating without heat sink is based on unit being mounted on double-sided 2oz 1" x 1" x .063" PCB.
² R_{θJC} Film (J) to Case (C) ³ Voltage determined by E= (PR)^{1/2}, not to exceed the Max. Voltage Rating
⁴ Extended range available, consult factory.

POWER RATING

Power rating is based on the resistor being tightly screwed to a suitable heat sink (with thermal compound) to limit hot spot case temperature to 155°C. Derate W, V, A by .77%/°C above 25°C (as depicted in chart below). Mounting torque not to exceed 8 in-lbs. Refer to Applic. Guide R-34 for additional detail concerning heat-sink resistor mounting guidelines.

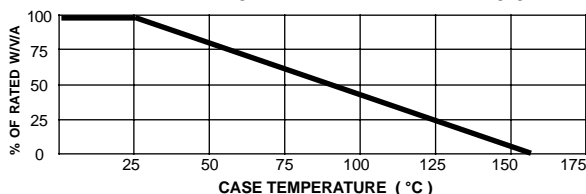

TYPICAL PERFORMANCE CHARACTERISTICS

Standard Temperature Coefficient (Typ, +25°C to +125°C)	50ppm ≥10Ω (2ppm avail) 100ppm 0.1 - 9.9Ω 250ppm 0.01 - 0.99Ω
Operating Temperature Range	-55 to +155°C
Std. Resistance Tol. (0.025%-5% avail)	±1% ≥.05Ω, ±5% <.05Ω
Dielectric Strength	1500VAC
Current Rating	30A max.
Insulation Resistance	10,000 MΩ min.
Load Life Stability	±1%
Overload	1.5x W, 5S, nte 1.5x Max V
Thermal Shock (Mil-Std-202 M107C)	±0.25%
Soldering Stability	±0.1%
Moisture Res (Mil-STD-202, M106)	±0.5%

P/N DESIGNATION: MP220 □ - 1001 - F B □ W

RCD Type _____
Options: P, G, B, etc (leave blank for std) _____
Resis. Code 0.025%-1%: 3 digits & multiplier (R010=.01Ω, R100=.1Ω, 1R00=1Ω, 10R0=10Ω, 1000=100Ω, 1001=1K, etc)
Resis. Code 2%-10%: 2 digits & multiplier (R01=.01Ω, R10=0.1Ω, 1R0=1Ω, 100=10Ω, 101=100Ω, 102=1K, etc.)
Tolerance Code: J=5%, G=2%, F=1%, D=0.5%, C=0.25%, B=0.1%, A=0.05%, X=0.025%
Packaging: B = Bulk, T = Taped (bulk is standard) _____
Optional Temp. Coefficient: 25=25ppm, 50=50ppm, 25=25ppm, 10=10ppm, 5=5ppm, 2=2ppm (leave blank for std) _____
Termination: W= Pb-free, Q= Sn/Pb. Leave blank if either is acceptable (RCD will select based on lowest price and quickest delivery)

POWER THICK FILM ON STEEL RESISTORS TO126, TO220, and TO247, 25 to 100 WATT

HDP SERIES



Term.W
is Pb-free
and RoHS
compliant

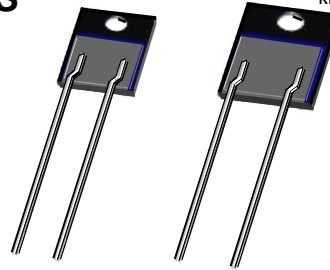

FEATURES

- Industry's most economical TO-style power resistors!
- Standard resistance range: 0.05Ω to 10KΩ
- Standard tolerance: ±1%, ±2%, ±5% (available to 0.1%)
- Flame resistant construction
- Non-Inductive performance
- Resistor is electrically isolated from the mounting surface

OPTIONS

- Option P: Increased pulse capability
- Option EQ: 24-hour burn-in at full rated wattage (free air)
- Option 33: 1KV Dielectric Stength
- Numerous design modifications are available (special marking, custom lead wires, hi-rel screening, etc). Customized components are an RCD specialty!

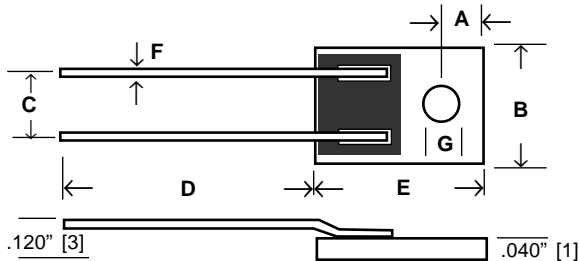

Award winning design! High power density at low prices!

RCD Series HDP resistors were designed to offer precision performance in TO-126, TO-220 and TO-247 style packages. The cost effective design features an oxidized stainless steel carrier which is insulated with a proprietary hi-temp dielectric upon which the resistive film and solder pads are deposited. This enables reduced thermal resistance over conventional ceramic or ceramic/copper sandwich designs, resulting in increased power and overload capability (pulse graph available). The resistive film is insulated with a specialty flame resistant coating offering superior environmental protection.

TYPICAL PERFORMANCE CHARACTERISTICS

Load Life	±1%
Moisture Res.(Mil-Std-202 M106)	±0.5%
Thermal Shock (Mil-Std-202, Method 107 Cond.C)	±0.3%
Overload (2x W, 1Sec, nte1.5x Max V)	±0.3%
Terminal Pull Strength	5 lbs direct, 2 lbs peel
Temp.Coefficient 0.5Ω & above 0.05Ω 0.49Ω	100ppm (50& 80ppm opt.) 200ppm (100ppm opt.)
Dielectric Strength ¹	750V Std. (Opt.33= 1KV)
Insulation Resis. ¹	1000M min.
Operating Temperature Range	-55°C to +200°C

¹Between two terminals and mounting surface, DCV

SPECIFICATIONS

RCD Type	Wattage @ 25°C	Max. Voltage	Resistance Range	DIMENSIONS Inch [mm]						
				A	B	C	D	E	F Typ.	G Typ.
HDP126	25W (2W free air)	300V ³	0.05Ω - 10K ³	.091±.01 [2.3±.25]	.323±.012 [8.2±.3]	.200±.012 [5.08±.3]	.940 Min. [24]	.465±.012 [11.8±.3]	.031 [.8]	.098 [2.5]
HDP220S ²	40W (2.5W free air)	300V ³	0.05Ω - 10K ³	.117±.01 [3±.25]	.400±.012 [10.16±.3]	.200±.012 [5.08±.3]	0.5 Min. [12.7]	.600±.012 [15.24±.3]	.031 [.8]	.142 [3.6]
HDP220	50W (3W free air)	300V ³	0.05Ω - 10K ³	.117±.01 [3±.25]	.425±.012 [10.8±.3]	.200±.012 [5.08±.3]	.940 Min. [24]	.650±.012 [16.5±.3]	.031 [.8]	.118 [3]
HDP247	100W (5W free air)	350V ³	0.05Ω - 10K ³	.156±.01 [4±.25]	.630±.012 [16.0±.3]	.400±.012 [10.16±.3]	.940 Min. [24]	.820±.012 [20.8±.3]	.031 [.8]	.142 [3.6]

² Information on HDP220S is preliminary ³ Extended range available

POWER RATING

Power rating is based on the resistor being tightly screwed to a suitable heat sink (with thermal compound) to limit hot spot case temperature to 200°C. Derate wattage by .57%/°C above 25°C (as depicted in chart below). Mounting torque not to exceed 8 in-lbs. Request Applic.Guide R-34 for additional information concerning heat-sink resistor mounting guidelines.

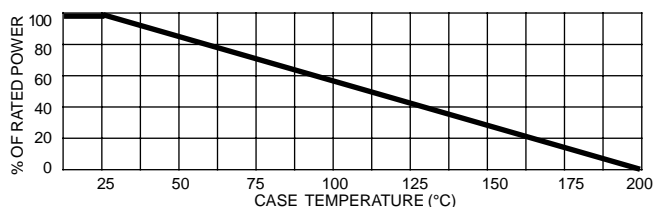

P/N DESIGNATION:

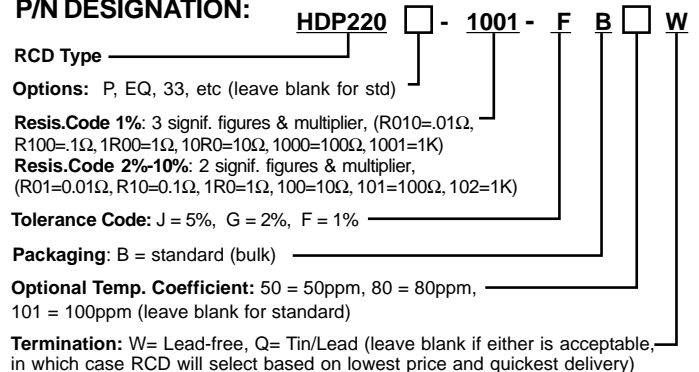

FAILSAFE FUSE RESISTORS

1/2 WATT to 50 WATT

FR SERIES



RCD

- Precision performance, flameproof design per UL94V-0
- Fusing-to-Operating current ratios as low as 3:1!
- Fusing times available from 1 millisecond to 30 seconds
- Available on exclusive *SWIFT™* delivery program
- Custom design available for increased surge capability (specify Option P)
- Also available: Hi-Rel screening, burn-in, custom marking, etc.

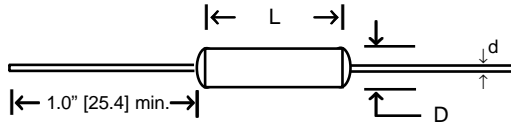

SPECIFICATIONS

RCD Type*	Wattage @25°C(W ₂₅)	Resistance Range	L ±.04 [1]	D±.02 [.5]	d typ
FR1/2	0.5	.06Ω to 500Ω	.29 [7.4]	.125 [3.2]	.020 [.5]
FR1	1.0	0.1Ω to 1.5K	.60 [15.2]	.130 [3.3]	.020 [.5]
FR2	2.0	0.1Ω to 2K	.69 [17.5]	.170 [4.3]	.032 [.8]
FR3	3.5	0.1Ω to 3K	.58 [14.7]	.230 [5.8]	.032 [.8]
FR5	5.5	0.1Ω to 5K	.984 [25]	.323 [8.2]	.032 [.8]

* Other sizes available up to 50 Watt on a custom basis.

Precision Grade Fuse Resistors!

RCD's FR Series was designed to obtain the best from two devices. It combines the performance of a precision grade resistor with precisely controlled fusing characteristics. Typical applications include protection for zener diodes and other semiconductor components, emitter resistors for current sharing transistors, Squib circuits, and/or other circuits that require precision fusing characteristics unobtainable with traditional fuses.

Please note that due to the inherent compromise involved between resistive vs. fusing performance it is recommended that prior consultation be made with RCD's engineering department to obtain the optimum design. Parts intended for high-reliability applications are available with burn-in (opt. ER) and/or military screening.

PERFORMANCE CHARACTERISTICS

Tolerance	5% standard, 0.1-10% available
Temperature Coefficient (typ)	±100ppm 0.1-9Ω, ±50ppm 1Ω & up, available to ±10ppm
Dielectric Strength	750 VAC
Insulation Resistance	1,000 megohms min. (dry)
Derating	Derate linearly from full rated power @ 25°C to zero power @ 175°C (.67%/°C)

FUSING CHARACTERISTICS: Standard FR resistors are designed to fuse within 10 seconds as follows:

FR1/2 to FR2 ≥1Ω = 20 x W₂₅ (20 times the 25°C wattage rating), <1Ω = 40 x W₂₅. FR3 & FR5 ≥5Ω = 25 x W₂₅, <5Ω = 50 x W₂₅.

Faster fusing is available. Max. fault condition not to exceed 300x W₂₅. Following chart depicts custom design capabilities.

Fusing Current (Amperes)	Minimum Resistance Value to Fuse in 1 Sec. or Less					Minimum Resistance Value to Fuse in 5 Sec. or Less				
	FR1/2	FR1	FR2	FR3	FR5	FR1/2	FR1	FR2	FR3	FR5
0.15	360Ω	720Ω	1.44K	2.88K	5.76K	180Ω	360Ω	720Ω	1.44K	2.88K
0.25	120Ω	240Ω	480Ω	960Ω	1920Ω	60Ω	120Ω	240Ω	480Ω	960Ω
0.5	30Ω	60Ω	120Ω	240Ω	480Ω	15Ω	30Ω	60Ω	120Ω	240Ω
1.0	7.5Ω	15Ω	30Ω	60Ω	120Ω	3.8Ω	7.5Ω	15Ω	30Ω	60Ω
1.5	3.3Ω	7Ω	13Ω	26Ω	53Ω	1.7Ω	3.3Ω	7Ω	13Ω	26Ω
2.0	2.0Ω	4Ω	8Ω	16Ω	32Ω	1.0Ω	2Ω	4Ω	8Ω	16Ω
3.0	1.0Ω	2Ω	4Ω	8Ω	16Ω	0.5Ω	1Ω	2Ω	4Ω	8Ω
5.0	0.5Ω	1Ω	2Ω	4Ω	8Ω	.25Ω	.5Ω	1Ω	2Ω	4Ω
10	0.25Ω	.5Ω	1Ω	2Ω	4Ω	.13Ω	.25Ω	.5Ω	1Ω	2Ω
15	0.15Ω	.3Ω	.6Ω	1.2Ω	2.4Ω	.08Ω	.15Ω	.3Ω	.6Ω	1.2Ω
20	0.1Ω	.2Ω	.4Ω	.8Ω	1.6Ω	.06Ω	.10Ω	.2Ω	.4Ω	.8Ω

APPLICATION & DESIGN NOTES:

- Fusing current should be ≥ 4 times the continuous current for best performance.
- Resistors reach elevated temperatures prior to opening- elevate body above the PCB.
- Exercise care when testing fuse resistors.
- RCD can custom manufacture fuse resistors from 1/8W to 50W per customer req't. Design objectives are achieved by element material (wirewound or film), insulation (silicone, ceramic, epoxy), and process (alloy & resistor geometry).
- Thermal fuses are also available and are designed to "blow" when the resistor body or the ambient temperature reaches preset temperature (110°C to 240°C).
- Custom surge-tolerant fuses are designed not to "blow" due to short term voltage transients, lightning surges, or capacitor discharges, but will fuse under longer term overloads. Consult factory for details.
- Please include the following information when customized design is required: Continuous wattage or current; ambient temperature; fusing wattage or current; minimum and maximum "blow" times; resistance value & tolerance; max. size; voltage level, AC or DC, wave form, & frequency; and a general description of the application. Include info as to any pulse or overload conditions that the resistor must withstand.

P/N DESIGNATION:

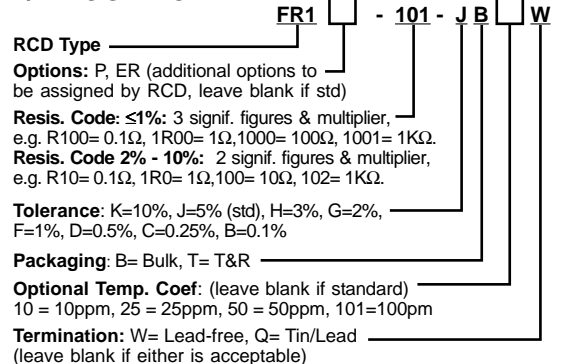

FUSIBLE FILM RESISTORS, GENERAL PURPOSE 1/8 WATT to 3 WATT

BW/MBW SERIES



RESISTORS • CAPACITORS • COILS • DELAY LINES

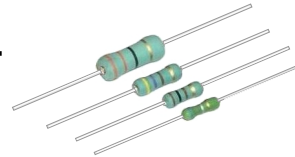

BW Series - Axial Lead



MBW Series - SM MELF

- Industry's widest selection of fusible film resistors -
1/8W to 3W, .1Ω to 24KΩ, 1% to 5%, leaded & surface mount
- Low cost, quick delivery (available on **SWIFT™** program)
- Flameproof (UL94V0), surface-mount versions available

OPTIONS

- Modified fusing characteristics (fast blow, slow blow, etc.)
- Increased pulse capability (Option P)
- Dozens of additional options are available...
Mil-spec screening/burn-in, special marking, non-standard values, custom lead forming, increased power or voltage, etc. Customized components are an RCD specialty!

Low Cost Circuit Protection!

RCD pioneered fusible film resistors in the early 1970's as a low cost approach to circuit protection in case of overload or component failure. The component is designed to act as a conventional resistor under normal operating conditions, but open quickly under fault conditions. Series BW meets the requirements of EIA RS-325 and can be useful in eliminating circuit board damage and fire hazards. Standard fusing characteristics can be altered to customer requirements.

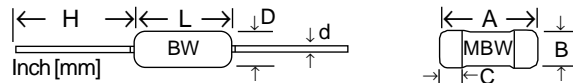

RCD Type	Wattage Rating ¹	Resistance Range ¹	Voltage Rating ^{1,2}	Dimensions BW Series (Axial Lead)				Dimensions MBW (MELF)		
				L ± .032 [.8]	D ± .024 [.6]	d ±.003 [.07]	H (Min.)	A ± .012[.3]	B (Max.)	C (Min.)
BW1/8F	1/8W	1Ω to 10K	200V	.145 [3.7]	.067 [1.7]	.020 [.5]	1.00 [25]	N/A		
BW1/4F, MBW1/4F	1/4W	0.1Ω to 10K	200V	.250 [6.4]	.090 [2.3]	.022 [.55]	1.02 [26]	.256 [6.5]	.118 [3]	.040 [1]
BW1/2F, MBW1/2F	1/2W	0.1Ω to 24K	250V	.354 [9.0]	.128 [3.3]	.025 [.6]	1.02 [26]	.374 [9.5]	.154 [3.9]	.060 [1.5]
BW1/2FS, MBW1/2FS	1/2W	0.2Ω to 20K	250V	.250 [6.4]	.090 [2.3]	.022 [.55]	1.02 [26]	.256 [6.5]	.118 [3]	.040 [1]
BW1F, MBW1FS	1.0W	0.1Ω to 24K	300V	.375 [9.5]	.135 [3.4]	.026 [.65]	1.02 [26]	.374 [9.5]	.154 [3.9]	.060 [1.5]
BW2F, MBW2F	2.0W	0.1Ω to 24K	300V	.450 [11.4]	.162 [4.1]	.031 [.8]	1.02 [26]	.441 [11.2]	.197 [5]	.080 [2]
BW3F, MBW3F	3.0W	0.1Ω to 24K	350V	.60±.062[15.2±1.6]	.22±.032[5.6±.8]	.031 [.8]	1.37 [35]	.598 [15.2]	.220 [5.6]	.080 [2]

¹ Expanded range available ² Maximum working voltage is determined by E = (PR)^{1/2}, E should not exceed value listed.

FUSING CHARACTERISTICS

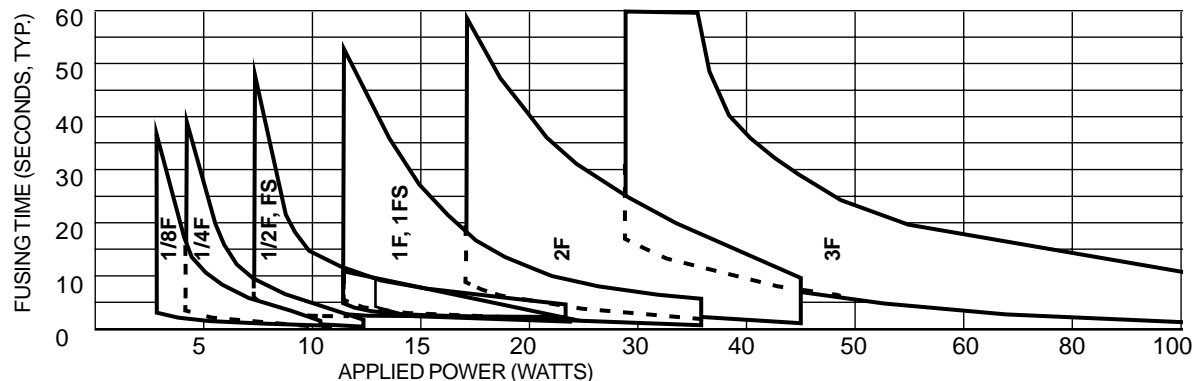

APPLICATION NOTES:

1. Fault level must be suitable to safely open the resistor quickly, especially surface mount MBW models. If insufficient, the resistor may reach elevated temp. For this reason, the fusing overload must be relatively large compared to rated W, 20 to 50x is common for most axial-lead applications, 40 to 100x for most SM circuits. SM fusing times vary due to mounting geometry/materials, so each application needs to be evaluated by user. The fault condition must be at least equal to the minimum W indicated in each of the above curves, and preferably double for SM applications. Fusing may still occur at W levels below the levels graphed above but not consistently (fast-blow models available). Don't exceed volt rating or 200x W rating, whichever is less (increased levels available).
2. For customized models, complete RCD's Fuse Questionnaire or advise the desired fusing wattage or current, min. & max. blow time, continuous wattage, ambient temp., pulse conditions, physical constraints, voltage to be interrupted, frequency, etc.
3. Maintain clearance from any heat-sensitive or flammable materials.
4. Fusing times vary depending on resistance value. Typical fusing times are given above for 1Ω - 3.9K. Low values tend to fuse slower. Consult factory for assistance.
5. Residual resis. is ≥50x initial value after fusing at 20x rated W (30x for BW1/8F & MBW)
6. Verify selection by evaluating under the full range of fault conditions. Place resistors inside a protective case when testing.

TYPICAL PERFORMANCE

Temperature Coefficient	200ppm/°C
Load Life Stability	5%
Operating Temp. Range	-55 to +165°C
Power Derating	0.71%/°C >25°C
Dielectric Strength	500V (300V BW1/8F)

P/N DESIGNATION: BW1F □ - 101 J T W

RCD Type BW1F □
Options (leave blank if standard)
Resis.Code 1%: 3 signif. figures & multiplier, (R100=1Ω, 1R00=1Ω, 10R0=10Ω, 1000=100Ω, etc.)
Resis.Code 2%-10%: 2 signif. figures & multiplier, (R10=0.1Ω, 1R0=1Ω, 100=10Ω, 101=100Ω, etc.)
Tolerance: J=5% (std.), G=2%, F=1%
Packaging: B=Bulk, T=Tape & Reel
Termination: W = Lead-free, Q = Tin/Lead (leave blank if either acceptable)

THERMAL FUSE RESISTORS, 1/2W to 60W PERMANENT OR REPLACEABLE FUSE



RESISTORS • CAPACITORS • COILS • DELAY LINES

TF SERIES



Term.W is
RoHS
compliant
& 260°C
compatible

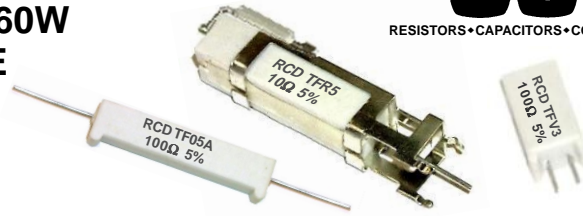

- ☐ Meets UL, FCC, REA, and EIA requirements
- ☐ Fusing-to-operating current ratio as low as 1.25:1!
- ☐ Fusing times can be custom tailored
- ☐ Precision tolerance to $\pm 0.1\%$, TC's to 5ppm available
- ☐ Available on exclusive **SWIFT™** delivery program

OPTIONS

- ☐ Option X: Low inductance design
- ☐ Option P: high pulse design (consult factory for assistance)
- ☐ Option A: ceramic case with standoffs (standard on TFV)
- ☐ Customized fuse time/temp, Hi-rel screening & burn-in, increased V & W, aluminum-housed heat sink design, etc.

RCD's TF Series construction consists of a thermal fuse welded in series with a resistor element. The assembly is potted inside a ceramic case (model TFR fuse is mounted externally in order to provide field-replaceability of the fuse). Under overload conditions, the thermal fuse "senses" the temperature rise of the resistor element and opens upon reaching a predetermined temperature. Devices can be custom tailored to specific fault conditions and do not require the large power overloads necessary with other fuse resistors to achieve proper fusing. Thus, the TF Series offers great safety, since high temperatures are not involved to achieve fusing. Typical applications include telecom line cards, repeaters, trunk carrier systems, RFI suppression, power supply, medical, and automotive circuits.

TF Series

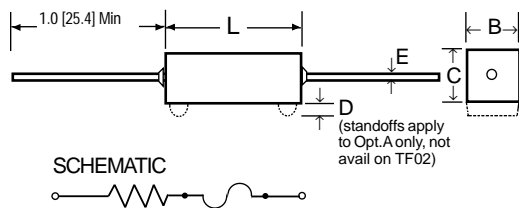

TFV Series

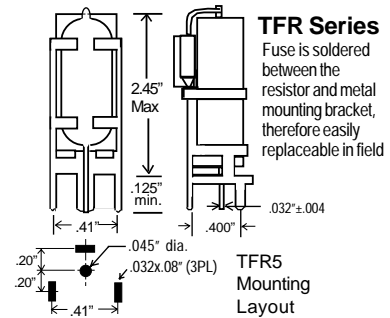
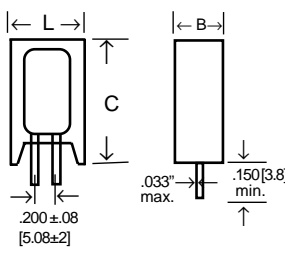

RCD Type ¹	Wattage @ 25°C ²	Min/Max Fusing Range ³	Voltage Rating ⁴	Resistance Range (Std.) ⁵	L \pm .032 [.81]	B \pm .032 [.81]	C \pm .032 [.81]	D \pm .032 [.81]
TF01S	1W	3W to 100W	40V	.05Ω to 1KΩ	.70 [17.8]	.26 [6.6]	.26 [6.6]	.06 [1.5]
TF01	1W	5W to 100W	50V	.05Ω to 4KΩ	.88 [22.4]	.31 [7.9]	.31 [7.9]	.06 [1.5]
TF02	2W	7W to 200W	100V	.05Ω to 10K	.95 [24.1]	.28 [7.1]	.28 [7.1]	N/A
TF04	4W	10W to 400W	150V	.05Ω to 25K	1.39 [35.3]	.38 [9.7]	.35 [8.9]	.12 [3.0]
TF05	5W	15W to 500W	200V	.05Ω to 40K	1.88 [47.8]	.38 [9.7]	.38 [9.7]	.12 [3.0]
TF07	7W	20W to 700W	250V	.05Ω to 60K	1.88 [47.8]	.50 [12.7]	.50 [12.7]	.12 [3.0]
TFV2	2W	4W to 200W	100V	.05Ω to 10K	.435 [11.0]	.30 [7.6]	.80 [20.3]	N/A
TFV3	3W	6W to 300W	150V	.05Ω to 20K	.515 [13.0]	.40 [10]	1.00 [25.4]	N/A
TFV5	5W	8W to 500W	200V	.05Ω to 25K	.500 [12.7]	.40 [10]	1.52 [38.6]	N/A
TFV7	7W	12W to 700W	250V	.05Ω to 40K	.500 [12.7]	.40 [10]	2.02 [51.3]	N/A
TFR5	5W	7W to 500W	200V	.05Ω to 40K	See illustration above			

¹ Other sizes available from 1/2W to 60W. ² Wattage rating based on 167°C fuse, deduct 24% for 133°C and 40% for 110°C. ³ Expanded range available ⁴ Maximum resistor working voltage determined by $E = (PR)^{1/2}$, E not exceed value listed ⁵ Resistance range from .005Ω to 1MΩ available. ⁶ Opt.A standoffs are available on TF1/2 - TF07 (not available on TF02)

SPECIFICATIONS (133°C fuse design)

Tolerance	0.1% to 10% available
Temperature Coefficient	± 100 ppm standard, T.C.'s to ± 5 ppm/avail.
Dielectric Strength	500 VAC
Insulation Resistance	10,000 megohms min. (dry)
Operating Temp. Range	-55 to +120°C (up to 225°C avail.)
Derating	1%/°C above 20°C
Fuse Rating ($\pm 5^\circ\text{C}$)	Standard = 133°C 2A 250V. Other popular models are 110°C, 167°C and 187°C (72°C to +240°C available, 0.5A to 25A)
Standard FuseTime: TFV Series shall fuse within 30S at 20x rated power, TF and TFR shall fuse within 30S@30x rated W. Refer to chart for approx. fuse curves (custom fusing available).	

P/N DESIGNATION:

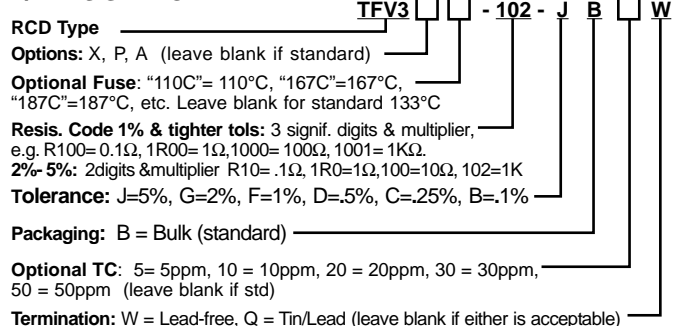

If a custom model is required, please advise the continuous wattage rating, ambient temperature, fusing wattage or current, min/max blow time, resistance value & tolerance, maximum size, pulse voltage & waveform, and a general description of the application.

FAILSAFE FUSIBLE WIREWOUND RESISTORS

LF2 SERIES

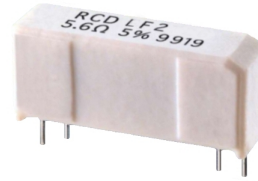

FEATURES

- ☐ Industry's widest range!
- ☐ Withstands lightning surges and power crosses
- ☐ Resistance range: 0.01Ω to 10KΩ
- ☐ LF2 1Ω to 1.6K meets UL497A, Bellcore GR1089, ITU-T K.20
- ☐ LF2A meets Bellcore TR1089 specifications
- ☐ Standard tolerance: ±1% or ±5% (available to ±0.01%)
- ☐ Available on RCD's exclusive **SWIFT™** delivery program!

OPTIONS

- ☐ Option A: TR1089 performance
- ☐ Option X: Non-inductive (0.2μH max ≤50Ω, 0.37μH >50Ω)
- ☐ Option ER: 100 Hour Burn-In
- ☐ Customized fusing characteristics
- ☐ Matched pairs or groups

RCD type LF2 is designed to provide circuit protection for telecom applications, such as line feed, ADSL, HDSL, and switching networks, as well as snubber circuits, switching regulators, power faults, etc. The LF2 is a combination power resistor and isolated thermal fuse housed in a ceramic case. The combination enables the device to withstand short-time overloads (various lightning surges, AC power crosses, inrush currents, and ESD pulses), yet open safely under extended overload conditions. The all-welded internal construction combined with highest grade materials ensures utmost performance and reliability. For even greater protection under power cross conditions, as required by TR1089, specify LF2A.

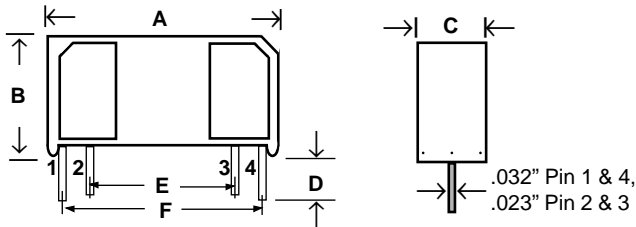

HOW TO USE LF2

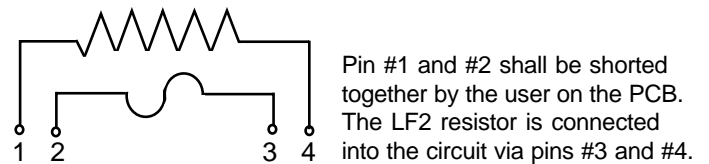

RCD Type	Wattage @ 25°C	Resistance Range	DIMENSIONS Inch [mm]					
			A	B	C	D	E	F
LF2	2.0 W	0.01Ω - 10KΩ*	1.045±.02 [26.5±.5]	.450±.02 [11.43±.5]	.265±.02 [6.73±.5]	.125 Min. [3.17±.5]	.700±.015 [17.78±.4]	.900±.015 [22.86±.4]

* LF2A resistance range is 1.8Ω to 100Ω

TYPICAL PERFORMANCE CHARACTERISTICS

Wattage Derating	21mW/°C >25°C
Load Life (1000 hours)	±0.5%
Moisture Resistance	±1%
Temperature Cycling	±0.5% (-55 to +120°C)
Short Time Overload	±0.2%(10W, 5 Sec)
Lightning Surge Capability LF2 5.6Ω -10K LF2A 1.8 -100Ω	10μSx1000μS 1KV/100A peak, 10Ω source, 50 pulses x 60S rep (peak voltages up to 10KV avail.)
Temperature Coefficient .10Ω to .99Ω 1Ω and above	Standard 90ppm Optional 10,20,30,50 50ppm 10,20,30
Operating Temperature	-55°C to +120°C std (may be higher or lower on custom designs depending on fuse rating)
Flammability	UL 94V-0, EC 695-2-2
Fusing Characteristics	<p>Power (Watts) vs LF2 Fusing Range (Seconds, Typ.)</p>

APPLICATION NOTES:

Failsafe surge resistors are often tailored to particular customer requirements. Consultation with RCD's Engineering department is recommended on all applications to ensure optimum performance at the most cost-effective price. Depending on the application, Series LF2 or LF2A can often satisfy the requirements of UL497A, UL1950, UL1459, FCC Part 68, REA 397 & PE60, Bellcore GR1089 & TR1089, ITU-T K.20 & K.21, VDE 0750, IEC 1000-4, CCITT K17, IEEE 472 & 587, ANSI C37.90 & C62.41, SAE J1113, MIL-STD-704, MIL-STD-1399, & MIL-STD-1275.

P/N DESIGNATION: LF2 - 1001 - F B W

RCD Type LF2
Options: X, ER, A (leave blank for standard)
Resis.Code 1%: 3 signif. figures & multiplier, (R100=.1Ω, 1R00=1Ω, 10R0=10Ω, 1000=100Ω, 1001=1K, etc)
Resis.Code 2%-10%: 2 signif. figures & multiplier, (R10=0.1Ω, 1R0=1Ω, 100=10Ω, 101=100Ω, 102=1K, etc)
Tolerance Code: J=5%, H=3%, G=2%, F=1%
Packaging: B = Bulk (standard)
Optional Temp. Coefficient (leave blank for standard): 5=5ppm, 10 = 10ppm, 20 = 20ppm, etc.
Termination: W=Pb-free, Q=Sn/Pb (leave blank if either is acceptable)

TEMPERATURE SENSITIVE METAL FILM RESISTORS

TC'S FROM +150 TO +7000 PPM

MLP SERIES +155°C MELF

LP SERIES +155°C AXIAL

LPT SERIES +300°C AXIAL



FEATURES

- Economically priced PTC sensors
- Wide resistance range: 1.5Ω - 100K
- High stability, excellent linearity
- Standard tolerance: ±5% (1%, 2%, 10% available)
- Marked with color bands or alpha-numeric
- Resistance value is measured at 25°C (0°C available)
- Flat chip available, refer to FLP series



STANDARD TEMPERATURE COEFFICIENTS

(Boldfaced items indicate most popular TC's)

TCR* (ppm/°C)	TCR* Tolerance	Standard Resistance Range	
		LP12 & MLP12	LP25 & MLP25
150	±50 ppm/°C	51Ω - 51KΩ	100Ω - 100KΩ
250		51Ω - 51KΩ	100Ω - 100KΩ
350		51Ω - 51KΩ	100Ω - 100KΩ
450		51Ω - 51KΩ	100Ω - 100KΩ
550		51Ω - 51KΩ	100Ω - 100KΩ
650	±10%	51Ω - 43KΩ	100Ω - 82KΩ
750		51Ω - 43KΩ	100Ω - 82KΩ
850		51Ω - 43KΩ	100Ω - 82KΩ
950		51Ω - 43KΩ	100Ω - 82KΩ
1000		51Ω - 27KΩ	100Ω - 51KΩ
1200		51Ω - 27KΩ	100Ω - 51KΩ
1400		51Ω - 27KΩ	100Ω - 51KΩ
1600		51Ω - 10KΩ	100Ω - 27KΩ
1800		51Ω - 10KΩ	100Ω - 27KΩ
2000		51Ω - 9.1KΩ	100Ω - 22KΩ
2200	51Ω - 9.1KΩ	100Ω - 22KΩ	
2500	±5%	51Ω - 9.1KΩ	100Ω - 22KΩ
3000		10Ω - 5.1KΩ	20Ω - 10KΩ
3300		10Ω - 5.1KΩ	20Ω - 10KΩ
3600		10Ω - 5.1KΩ	1.5Ω - 10KΩ
4000		10Ω - 3.3KΩ	1.5Ω - 10KΩ
4500	10Ω - 680Ω	10Ω - 10KΩ	
5000	10Ω - 680Ω	10Ω - 10KΩ	
7000**	±10%	10Ω - 10KΩ	10Ω - 10KΩ

¹ 1% tol avail in limited resis.range

² LPT resis. may also be specified at 0°C (e.g. "101@0", "1001@0")

* T.C. measured at 25°C and 65°C.

** 7000 ppm parts are marked alphanumerically. Operating temp. range is -65 to +125°C, resis. tol. is 5% or 10%, hermetically sealed silicon

Linear positive temperature coefficients:

LP & MLP temperature sensitive resistors feature linear positive T.C.'s in a wide range of R/T slopes. The series was developed as a low cost substitute for wirewound sensors. Various temperature coefficients are obtained by adjusting the film composition. LPT features platinum film for improved linearity, interchangeability and +300°C operating temp. Small sizes result in fast response times, typically 6 seconds for LP/MLP12 & LPT, 9 seconds for LP/MLP25 (in still air).

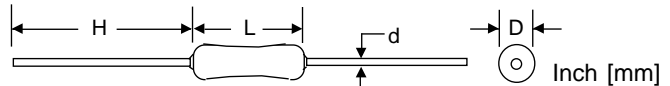

TYPE	L ±.031 [.8]	D ± .02 [.5]	d ± .003 [.08]	H Min.
LP12	.140 [3.56]	.064 [1.6]	.020 [.5]	1.00 [25.4]
LP25	.270 [6.86]	.090 [2.3]	.024 [.6]	1.18 [30]
LPT	.157 [4]	.064 [1.6]	.018 [.46]	1.00 [25.4]

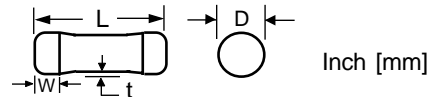

TYPE	L±.01 [.25]	D±.008 [.2]	W (Min.)	t (Max.)
MLP12	.135 [3.4]	.057 [1.45]	.012 [.3]	.006 [.15]
MLP25	.225 [5.7]	.085 [2.15]	.020 [.5]	.008 [.2]

PERFORMANCE

	LP12 & MLP12	LP25 & MLP25	LPT
TC (25 - 65°C)	+150~ +5000ppm/°C	+150~ +5000ppm/°C	+3500ppm/°C
Resis. Range	10 ohm to 51K	1.5 ohm to 100K	10 to 500 ohm
Wattage @25°C	1/8W	1/4W	1/16W
Voltage Rating	150V	250V	150V
Operating Temp.	-55°C to +155°C	-55°C to +155°C	-55°C to +300°C
Derating >25°C	.77%/°C (W&V)	.77%/°C (W&V)	.364%/°C (W&V)
Thermal Diss.	2.5 mW/°C	4.5mW/°C	2mW/°C
1000-hr Load Life	1.0% Max.	1.0% Max.	0.5% Max.
1 Year Shelf Life	0.3% Max.	0.3% Max.	0.2% Max.
High Temp. Exposure	±1% after 1000hrs@125°C	±1% after 1000hrs@125°C	±0.5% after 1000hrs@150°C
Linearity	±0.5% 0~100°C ±1.5% -50~150°C	±0.5% 0~100°C ±1.5% -50~150°C	±0.2% 0~100°C ±0.5% -50~150°C ±1.5% -50~300°C

P/N DESIGNATION:

RCD Type (LP12, MLP12, LP25, MLP25, LPT) — **LP25 - 101 - J T 151 W**

Resis. @25°C²: If ≥2% tol. use 2 signif. figures & multiplier, (1R0=1Ω, 100=10Ω, 101=100Ω, 102=1K, 103=10K, etc.); If ≤1% tol. use 3 signif. digits & multiplier (1R00=1Ω, 10R0=10Ω, 1000=100Ω, 1001=1K, 1002=10K, 1003=100K)

Tolerance: F=1%, G= 2%, J= 5% (std), K=10%

Packaging: B = Bulk, T = Tape & Reel

TC: Use 3-digit code (151=150ppm, 102=1000ppm, 452=4500ppm)

Termination: W=Pb-free, Q=SnPb (leave blank if either is acceptable)

TEMPERATURE SENSITIVE PRECISION WIREWOUND RESISTORS TCR'S FROM +80 TO +6000 PPM



ATB SERIES- AXIAL LEAD, EPOXY ATS SERIES- AXIAL LEAD, SILICONE PTB SERIES- RADIAL LEAD, EPOXY

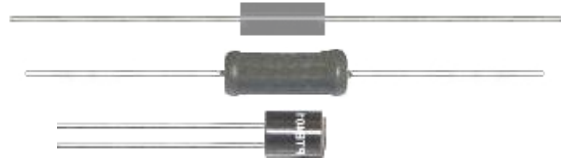

- Industry's widest range of positive TCR resistors!
- Available on exclusive **SWIFT™** delivery program!
- Additional sizes available--most popular shown below
- Choice of 15 standard temperature coefficients per Table 1

RCD's AT and PT Series resistors offer inherent wirewound reliability and precision performance in all types of temperature sensing or compensating circuits. Sensors are wound with various alloys to achieve wide range of temperature sensitivity.

ATS SERIES 350°C RATING

RCD ATS Series offer precision wirewound resistor performance at economical pricing. Ceramic core and silicone coating provide high operating temperature. The coating ensures maximum protection from environmental and mechanical damage (envir. performance per MIL-PRF-26).

ATB SERIES 175°C RATING

RCD ATB Series are typically multi-layer bobbin-wound enabling higher resistance values. Encapsulated in moisture-proof epoxy, Series ATB meets the environmental requirements of MIL-R-93. Operating temperature range is -55°C to +175°C. Standard tolerances are ±0.1%, ±0.25%, ±0.5%, ±1%.



RCD Type	Body Length ±.031 [.8]	Body Diameter ±.015 [.4]	Lead Diameter (typ)	Wattage @ 25°C	4500ppm Resis. Range
ATS110	.250 [6.35]	.093 [2.36]	.020 [.51]	.5	1Ω - 300Ω
ATS125	.406 [10.3]	.093 [2.36]	.020 [.51]	1.0	1Ω - 1KΩ
ATS135	.500 [12.7]	.188 [4.78]	.032 [.81]	3.0	1Ω - 1.5K
ATS145	.812 [20.6]	.188 [4.78]	.032 [.81]	3.5	1Ω - 3K
ATS150	.500 [12.7]	.218 [5.54]	.040 [1.02]	3.5	1Ω - 2K
ATS155	.625 [15.9]	.250 [6.35]	.040 [1.02]	4.0	1Ω - 3K
ATS160	.875 [22.2]	.312 [7.92]	.040 [1.02]	5.0	1Ω - 4K
ATS170	1.220 [31.0]	.312 [7.92]	.040 [1.02]	7.0	1Ω - 5K
ATS175	1.780 [45.2]	.375 [9.53]	.040 [1.02]	10.0	1Ω - 10K



RCD Type	Body Length ±.031 [.8]	Body Diameter ±.015 [.4]	Lead Diameter (typ)	Wattage @ 25°C	4500ppm Resis. Range
ATB200	.250 [6.35]	.100 [2.54]	.020 [.51]	.05	1Ω - 3K
ATB202	.250 [6.35]	.125 [3.18]	.025 [.635]	.10	1Ω - 5K
ATB204	.375 [9.53]	.142 [3.60]	.025 [.635]	.12	1Ω - 8K
ATB206	.375 [9.53]	.187 [4.75]	.025 [.635]	.15	1Ω - 15K
ATB100	.350 [8.89]	.250 [6.35]	.032 [.81]	.25	1Ω - 20K
ATB101	.500 [12.7]	.250 [6.35]	.032 [.81]	.33	1Ω - 30K
ATB102	.750 [19.1]	.250 [6.35]	.032 [.81]	.50	1Ω - 76K
ATB104	.750 [19.1]	.375 [9.53]	.032 [.81]	.60	1Ω - 114K

PTB SERIES 175°C RATING

RCD PTB Series offer the same reliability and precision performance as the ATB series except in a radial lead design.



RCD Type	Body Length ±.031 [.8]	Body Dia. ±.015 [.4]	Lead Diameter (typ.)	Lead Spacing ±.015 [.4]	Watts @ 25°C	4500ppm Resis. Range
PTB401	.312 [7.92]	.250 [6.35]	.025 [.64]	.200 [5.08]	.25	1Ω - 15K
PTB406	.500 [12.7]	.375 [9.53]	.032 [.81]	.200 [5.08]	.33	1Ω - 40K

TABLE 1. SERIES ATB, ATS, ATB RESISTANCE RANGE

Temp. Coef. (ppm/°C)	T.C. Tolerance (ppm/°C)	Resis. Range Multiplier (x 4500ppm Res. Range)	In order to determine the available resistance range for each TC, use the multiplier times the 4500 ppm resistance range. Example: a resistor with a TC of +3200 ppm can be manufactured with a resistance value twice as high as the same resistor with a TC of 4500 ppm. A resistor with a TC of +6000 ppm can only reach a third of the resistance value available with 4500 ppm wire.
+80	±20	5.3	
+100	±20	5.3	
+140	±40	5.0	
+180	±40	2.0	
+400	±40	4.5	
+650	±50	2.0	
+1000	±100	3.0	
+1400	±200	3.2	
+2600	±200	3.3	
+3200	±200	2.0	
+3500	±300	2.7	
+3850 (Pt)	±80	.4	
+3900 (Cu)	±300	.083	
+4500 (NiFe)	±300	1.00	
+6000 (Ni)	±400	.33	

P/N DESIGNATION: **ATS135 - 1000 - F B 452 W**

RCD Type —————

Resis. Code ≤1%: 3 signif. figures & multiplier, (1R00=1Ω, 10R0=10Ω, 1000=100Ω, 1001=1K, etc.)
Resis. Code 2%-10%: 2 signif. figures & multiplier, (1R0=1Ω, 100=10Ω, 101=100Ω, 102=1K, etc.)

Tolerance @ 25°C: J=5%, H=3%, G=2%, F=1%, D=0.5%, C=0.25%, B=0.1%

Packaging: B = Bulk, T = Tape & Reel (axial lead only)

Temperature Coefficient: 80 = 80ppm; 100ppm and higher, use 3 digit code: 101 = 100ppm, 452 = 4500 ppm, etc.

Termination W= lead-free, Q= tin/lead (leave blank if either is acceptable, in which case RCD will select based on lowest price and quickest delivery)

PLATINUM, NICKEL, NICKEL IRON RTD's TEMPERATURE RATING UP TO 500°C



PTC SERIES- Ceramic Case PTS SERIES- Stainless Steel

- Inherent wirewound stability
- Resistance range: 1Ω to 1000Ω
- Tolerance available to ±0.1%
- Wide selection of TC's (+3850 to +6720ppm)
- Excellent linearity and thermal response time

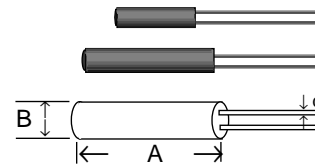

RCD's Resistance Temperature Detectors are designed for tough industrial applications, and are utilized to sense or regulate air (PTC) or liquid (PTS) environments. Series PTC feature an all-welded wirewound construction for increased durability under stress and vibration, and exceptional stability. PTS probes are encased in a stainless steel sheath and are available with WW or film elements.

RCD Type	Resistance Wire	TCR 0° to 100°C	TC 3-digit code	Resistance Range (Ω)	A ±.060 [1.5]	B ±.01 [.25]	C* Typ. [.05]
PTC100PT	Platinum	3850ppm	392	1 - 200	.575 [14.6]	.096 [2.44]	.016 [.4] Lead Length 0.5 [12.7] min.
PTC100CPN	Chem. Pure Nickel	6720ppm	672	1 - 120			
PTC100N	Nickel 270	6000ppm	603	1 - 120			
PTC100NF	Nickel Iron	5150ppm	522	1 - 500			
PTC150PT	Platinum	3850ppm	392	1 - 400	.575 [14.6]	.125 [3.18]	.016 [.4] Lead Length 0.5 [12.7] min.
PTC150CPN	Chem. Pure Nickel	6720ppm	672	1 - 200			
PTC150N	Nickel 270	6000ppm	603	1 - 200			
PTC50NF	Nickel Iron	5150ppm	522	1 - 1000			
PTC200PT	Platinum	3850ppm	392	1 - 400	.675 [17.1]	.170 [4.32]	.020 [.5] Lead Length 1.0 [25.4] min
PTC200CPN	Chem. Pure Nickel	6720ppm	672	1 - 200			
PTC200N	Nickel 270	6000ppm	603	1 - 200			
PTC200NF	Nickel Iron	5150ppm	522	1 - 1000			

* Lead material is nickel for minimal oxidation at high temperature on platinum elements, tinned copperweld is standard on others.

LINEARITY

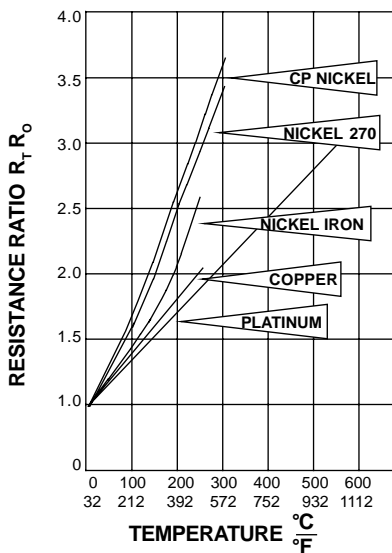

WIRE COMPARISON

Wire Alloy	Cost	Temp. Range	Linearity	R/T Curve Repeatability
Platinum	Medium	-55 to +500°C	Excellent	Excellent
CP Nickel	High	-55 to +300°C	Fair	Good
Nickel 270	Low	-55 to +300°C	Fair	Fair
Nickel Iron	Low	-55 to +260°C	Fair	Good

THERMAL RESPONSE (TIME CONSTANT) varies with different element sizes, resistance values, and wire alloy. Typical time constant for PTC 150 PT 100 ohm is 2.2 seconds in water moving 3ft./sec. Consult factory for details.

SELF-HEATING is contingent upon resistance value, alloy, and element size. Typical self-heating for PTC 150 PT 100 ohm is 65 mW/°C in water moving at 3ft./sec. Consult factory for particular specifications.

INTERCHANGEABILITY - The strain-free design of RCD sensors insures maximum repeatability. This characteristic is degraded by lot-to-lot inconsistencies of the various wire alloys. Platinum being extremely consistent allows the best interchangeability characteristics. Consult factory for specific data based on particular alloy and tolerance.

SHOCK AND VIBRATION - PTC elements withstand 100 G's sinewave shock for 3 cycles at 10 milliseconds, and withstand vibration 10Hz to 2200Hz at 20 G's.

P/N DESIGNATION:

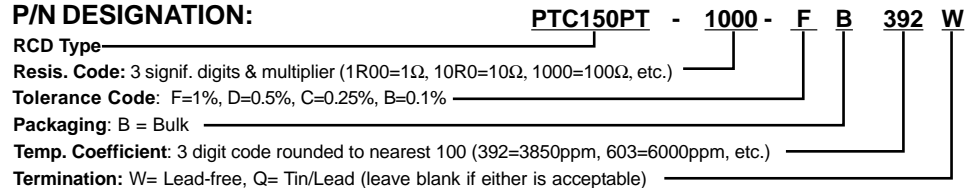

RTD PROBES, TEMPERATURE RATING UP TO 500°C

PTS SERIES

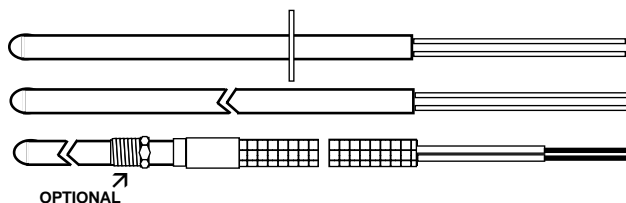

Series PTC (wirewound) and PT (thin-film) RTD elements can be assembled into stainless steel sheaths for severe environmental requirements. These probes (PTS Series) are moistureproof and pressure tight and in many instances may be directly inserted into process lines or thermowells for precise temperature readings. Series PTS is available in any standard PTC resistance value and temperature coefficient, in .125" [3.18], .187 [4.75], .250 [6.35] diameters. Teflon insulated leads are standard (other insulations available). 2-terminal, 3-terminal, or 4-terminal configurations available. Probe lengths available from 0.5" [12.7] to 18" [457]. **Consult factory for list of standard probe styles including surface measurement, flange mount, screw mount, etc.**

THIN-FILM PLATINUM TEMPERATURE SENSOR

PT SERIES



- Industry's lowest cost and widest selection!
- Precision performance, excellent stability, fast response
- Wide resistance range: 100Ω, 500Ω, 1000Ω
- Dual sensors available in a single package (Type PTD)
- Meets DIN 43760 and IEC 751
- Choice of temperature ratings (up to +640°C)

SPECIAL MODIFICATIONS (Consult Factory)

- Non-standard resistance values up to 2000Ω
- Surface Mount chip elements
- Insulated extension wires
- Assembly into stainless steel probes (PTS Series)
- MIL-Spec Group A & B environmental testing

TYPE PTF - FLAT ELEMENT

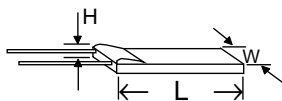

TYPE PTR - CYLINDRICAL (ceramic encased)

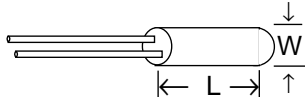

TYPE PTA - AXIAL LEAD (ceramic encased)

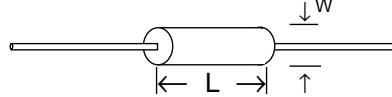

TYPE PTD - DUAL ELEMENT (ceramic encased)

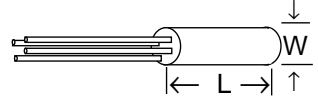

RCD Type	Dimensions			Standard Resistance Values	Typical Response Time (sec.)				Self Heating Air 1m/s (°C/mW)
	W ±.016 [.4]	L ±.02 [.5]	H Max.		Water 0.2 m/s		Air 1 m/s		
					50%	90%	50%	90%	
NEW → PTF1/2	.062 [1.6]	.125 [3.2]	.047 [1.2]	100	.08	.25	4	11	.17
PTF1	.080 [2]	.400 [10]	.055 [1.4]	100,500,1000	.2	.5	5	13	.17
PTF4	.080 [2]	.100 [2.5]	.047 [1.2]	100	.07	.2	3	10	.30
PTF5	.080 [2]	.200 [5]	.055 [1.4]	100, 500, 1000	.1	.3	5	15	.25
PTR1	.125 [3.2]	.530±.062	N/A	100,500,1000	1.5	6	20	66	.12
PTR2	.120 [3]	.250±.031	N/A	100	1.3	5	15	50	.16
PTA1	.125 [3.2]	.600±.04	N/A	100,500,1000	1.5	6	20	66	.12
PTA2	.120 [3]	.250±.031	N/A	100	1.3	5	15	50	.16
PTD1	.170 [4.3]	.675±.062	N/A	2x100, 2x500, 2x1000	2	8	25	80	.12

SPECIFICATIONS

Operating Temperature Range	Type L: -50 to +200°C (low temp, economy) Type H: -50 to +500°C (high temp, industrial) Type T: -50 to +640°C (highest temp, specialty)
TCR (0°C to 100°C)	+3850ppm/°C
Stability	<0.1°C typ. drift after 1000 hours at Max Temp
Insulation	10MΩ Min. @ 25°C, 1 MΩ Min. @ Max. Temp.
Capacitance (1 KHz)	<10 pF
Inductance	Essentially non-inductive (<0.1μH)

RESISTANCE AND INTERCHANGEABILITY

°C	Resistance	Tolerance			
		.5 DIN	DIN	1.5 DIN	2 DIN
-50	.803	±.25°C	±.55°C	±.85°C	±1.1°C
0	1.000	±.15°C	±.3°C	±.45°C	±.6°C
+100	1.385	±.35°C	±.8°C	±1.2°C	±1.6°C
+200	1.758	±.55°C	±1.3°C	±2.0°C	±2.6°C
+300	2.120	±.75°C	±1.8°C	±2.7°C	±3.6°C
+400	2.470	±.95°C	±2.3°C	±3.5°C	±4.6°C
+500	2.809	±1.15°C	±2.8°C	±4.2°C	±5.6°C

TOLERANCES (B is standard)

DIN 43760	Letter Code	Resistance Tolerance (@ 0°C)	Temperature Tolerance (@ 0°C)
.5 DIN	A	.06%	.15°C
DIN	B	.12%	.3°C
1.5 DIN	L	.2%	.5°C
2 DIN	C	.25%	.6°C
4 DIN	D	.5%	1.3°C
5 DIN	E	.6%	1.5°C

P/N DESIGNATION: PTF2 H □ - 1001 - D T W

RCD Type _____

Temperature Rating: L, H, or T _____

Option Codes: (leave blank if standard) _____

4-Digit Resis. Code (at 0° C): 3 signif. digits & multiplier (1000=100Ω, 5000=500Ω, 1001=1KΩ)

Tolerance @0°C: See tolerance table for codes ("B" is std) _____

Packaging: B = Bulk (standard) _____

Termination: W = Lead-free, Q = Tin/Lead (leave blank if either is acceptable)

MULTILAYER CERAMIC CHIP (MLCC) CAPACITORS



RESISTORS • CAPACITORS • COILS • DELAY LINES

CE SERIES



Term.W is Pb-free and RoHS compliant

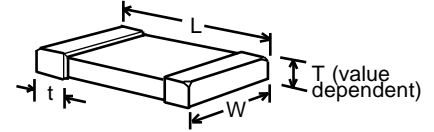

- Industry's widest range and lowest prices: 0201 to 3035 size, .47pF to 100uF, 6.3V to 4KV (up to 20KV custom available)
- New X5R high-capacitance dielectric offers lower impedance and ESR (especially at higher frequencies), at lower cost & smaller size than tantalum, aluminum, and film styles
- Quick delivery, wide selection available from stock!
- Lead-free tin plating is standard
- Precision matching to 0.1% available

RCD Type	Max Voltage	Capacitance Range (E-12 Values) ^{1,3}			
		COG (NPO) ¹	X7R ¹	X5R ¹	Y5V (Z5U) ²
CE0201 NEW!	6.3			.01uF	.01uF - .047uF
	10	82pF-100pF		1200pF-.01uF	
	16	43pF-100pF	560pF-3300pF	3300pF-4700pF	1000pF-.01uF
	25	.47pF-100pF	180pF-1000pF	100pF-2200pF	1000pF
	50	.47pF-22pF	39pF-470pF		
CE0402	6.3			.1uF-1uF	
	10		.039uF - 0.1uF	.012uF-.1uF	.10uF- 1uF
	16	270pF-470pF	100pF-.047uF	.012uF-.047uF	1000pF-.1uF
	25	1pF-470pF	100pF-.022uF		1000pF-.047uF
	50	.47pF-330pF	100pF-470pF		1000pF-.022uF
CE0603	6.3			.27uF-4.7uF	
	10		.15uF- 1uF	.27uF-2.2uF	.68uF-2.2uF
	16	1800-3300pF	.033uF-.22uF	.12uF-1uF	.12uF-1uF
	25	.47pF-2200pF	100pF-.15uF	.056uF-.18uF	2200pF-.47uF
	50	.47pF-2200pF	100pF-.1uF		2200pF-.22uF
	100	.47pF-820pF	100pF-4700pF		
	200	.47pF-330pF			
CE0805	6.3			1.5uF-22uF	
	10		.33uF-2.2uF	1uF-10uF	2.2uF-10uF
	16		.047uF-1uF	.33uF-4.7uF	.47uF-4.7uF
	25	.47pF-.01uF	330pF-.47uF	1uF-4.7uF	.01uF-2.2uF
	50	.47pF-.01uF	100pF-.33uF	.22uF	.01uF-1uF
	100	.47pF-1500pF	100pF-.039uF		.01uF-.22uF
	200	.47pF-820pF	180pF-.015uF		
	500	.47pF-470pF	2200pF-.012uF		
CE1206	6.3		10uF	4.7uF-47uF	
	10		1uF-4.7uF	2.2uF-10uF	1uF-22uF
	16		.27uF-3.3uF	1.2uF-10uF	1uF-10uF
	25	.47pF-.033uF	1000pF-2.2uF	.56uF-10uF	.01uF-10uF
	50	.47pF-.033uF	150pF-.47uF		.01uF-2.2uF
	100	.47pF-6800pF	150pF-.15uF		
	200	.47pF-1500pF	220pF-.033uF		
	500	.47pF-820pF	220pF-.022uF		
CE1210	6.3			4.7uF-100uF	47uF-100uF
	10		2.2uF-10uF	4.7uF-22uF	22uF
	16		.68uF-4.7uF	1uF-10uF	10uF-22uF
	25	560pF-.01uF	1000pF-3.3uF	2.2uF-10uF	.1uF-10uF
	50	100pF-.01uF	1000pF-1uF	1uF	.1uF-4.7uF
	100	100pF-6800pF	1000pF-.15uF		.1uF-1uF
	200	100pF-4700pF	1000pF-.068uF		
	500	100pF-2200pF	2200pF-.047uF		
CE1812	25	1000pF-.018uF	.01uF- 1uF	10uF	.15uF-3.3uF
	50	100pF-.018uF	.01uF- 1uF		.15uF-2.2uF
	100	100pF-.01uF	.01uF-.47uF		.1uF-1uF
	200	100pF-6800pF	6800pF-.1uF		
	500	150pF-5600pF	4700pF-.12uF		
	1000	150pF-4700pF	2200pF-.027uF		
	2000	150pF-2200pF	330pF-3300pF		
	3000	100pF-1000pF			
CE2225	25	1500pF-6800pF	.01uF-5.6uF		.68uF-4.7uF
	50	100pF-.056uF	.01uF-3.3uF		.68uF-3.3uF
	100	100pF-.047uF	.01uF-1.5uF		
	200	1000pF-8200pF	.015uF-.42uF		
	500	1000pF-5600pF	.018uF-.39uF		
	1000	1000pF-3300pF	8200pF-.1uF		
	2000	1000pF-2200pF	1200pF-.01uF		
	3000	220pF-2200pF			
CE3035	25	1000pF-.1uF	.01uF-2.2uF		1uF-10uF
	50	1000pF-.047uF	.01uF-2.2uF		1uF-6.8uF
	100	1000pF-.033uF	.01uF-1uF		
	200	1000pF-.022uF	.01uF-1uF		
	500	1000pF-.018uF	6800pF-1uF		
	2000	1000pF-3300pF			

SIZE	L	W	T (Max)	t
0201	.024±.0016 [6±.04]	.012±.001 [3±.03]	.016 [4]	.006±.003 [.15±.07]
0402	.039±.003 [1±.07]	.020±.002 [5±.05]	.024 [6]	.01±.006 [.25±.15]
0603	.063±.004 [1.6±.1]	.031±.004 [8±.0.1]	.036 [9]	.014±.006 [.35±.15]
0805	.079±.008 [2.0±.2]	.049±.008 [1.25±.2]	.061 [1.55]	.02±.01 [.5±.25]
1206	.126±.012 [3.2±.3]	.063±.008 [1.6±.2]	.065 [1.65]	.02±.01 [.5±.25]
1210	.126±.012 [3.2±.3]	.098±.012 [2.5±.3]	.098 [2.5]	.024±.012 [.6±.3]
1812	.177±.016 [4.5±.4]	.126±.012 [3.2±.3]	.098 [2.5]	.030±.02 [.75±.5]
2225	.224±.02 [5.7±.5]	.251±.02 [6.4±.5]	.098 [2.5]	.030±.02 [.75±.5]
3035	.299±.02 [7.6±.5]	.354±.02 [9.0±.5]	.118 [3.0]	.030±.02 [.75±.5]

DIELECTRIC CHARACTERISTICS

ITEM	COG (NPO)	X7R	X5R	Z5U /Y5V*
Available Tolerances	<10pF: ±1pF, .25pF, ±5pF; ≥10pF: ±1%, 2%, 5% (std), 10%	5%, 10% (std), 20%	5%, 10% (std), 20%	±20% (std), +80/-20%
Operating Temperature	-55° to +125°C	-55° to +125°C	-55°C to +85°C	-30 to +85°C
Temperature Characteristic	±30ppm/°C	±15% max. over Oper. Temp.Range	±15% max. over Oper. Temp.Range	Z5U: +22/-56% Y5V: +22/-82%
Aging (cap loss/decade hr)	0%	2% Max.	2.5% Max.	7% Max.
Voltage Coef (ΔC@ maxV)	negligible	-50% to +10% typ	-50% to +10% typ	-80% to +20% typ
Dissipation Factor	0.1% Max.	2.5% Max. 50V & 100V, 3% 25V, 3.5% 16V	3% Max 25V, 3.5% 16V, 5% 10V	Z5U: 4% Max. Y5V: 5% ≥50V, 7% 16-25V
Insul. Resis. 25°C (min)	100GΩ or 1GΩ·μF whichever is less	100GΩ or 1GΩ·μF whichever is less	100GΩ or 500MΩ·μF whichever less	10GΩ or 1GΩ·μF whichever is less
Dielectric Strength	2.5x rated VDC	2.5x rated VDC	2.5x rated VDC	2.5x rated VDC
Test Parameters (25°C, 1Vrms)	≤1000pF=1MHz >1000pF=1KHz	1KHz	1KHz	Z5U: 1KHz .5Vrms Y5V: 1KHz 1Vrms
Marking	Typically unmarked, marking available (specify Opt. A)			

* Y5V is standard, Z5U is available (Y5V & Z5U are considered interchangeable)

STANDARD PACKAGING QUANTITY*

SIZE	T (7" reel)	C (Cartridge)	B (Bulk)
0201	15000	**	2000
0402	10000	20000	2000
0603	4000	15000	2000
0805	4000	10000	2000
1206	4000	5000	2000
1210	2000*	**	500
1812	1000	**	500
2225	1000	**	500
3035	**	**	500

*Typical quantity, varies with chip thickness (13" reels avail.)

**Consult factory for availability

P/N DESIGNATION: CE1206 [] - 103 - K 201 R T W

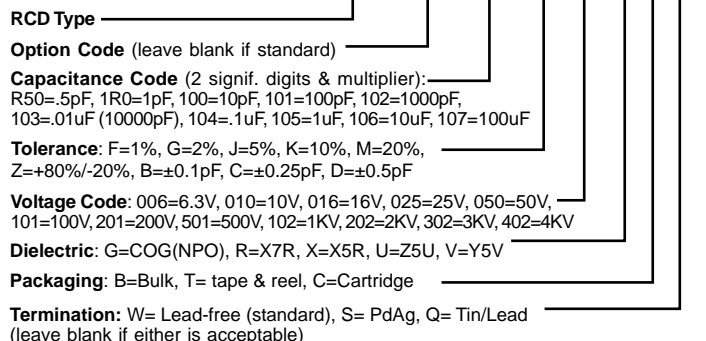

¹ Expanded range available. ² Range applies to Y5V, consult factory for Z5U range
³ Not all combinations of voltage & dielectric are available in all E-12 values

AXIAL LEAD CERAMIC CAPACITORS MULTILAYER CERAGOLD™ CONSTRUCTION

CEA SERIES



- ☐ Conformal coated, miniature sizes, 0.3pF - 2.2uF
- ☐ Wide range of capacitance, tolerance, TC, and voltage
- ☐ COG (NPO), X7R, Z5U and Y5V temperature coefficients
- ☐ Popular values available from stock

RCD's CEA Series features *Ceragold™* high-density multi-layer construction enabling an expanded range of values. Bodies are insulated with a proprietary flame retardant epoxy coating for superior environmental protection and dielectric strength. Non-standard values, increased voltage ratings, custom marking, military screening, cut & formed leads, etc., are available. Matched sets and networks also available. Custom components are an RCD specialty!

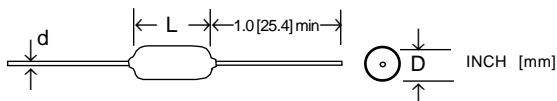

SPECIFICATIONS

RCD Type	WVDC ¹	CAPACITANCE RANGE			L (Body Length, Max)	D (Body Diameter, Max)	d (Lead Dia)
		COG (NPO)	X7R	Z5U/Y5V ²			
CEA05	25	0.3 - 1000pF	100pF - 0.15uF	1000pF - 1.0uF	0.150 [3.8]	.100 [2.54]	.018 ±.003 [0.45 ±.08]
	50	0.3 - 1000pF	100pF- 0.10uF	1000pF - 0.47uF			
	100	0.5 - 820pF	100pF- 0.01uF	1000pF- 0.068uF			
CEA10	25	0.5 - 2700pF	100pF - 0.22uF	1000pF - 1.2uF	0.170 [4.32]	.100 [2.54]	.018 ±.003 [0.45 ±.08]
	50	0.5 - 2200pF	100pF- 0.10uF	1000pF - 1.0uF			
	100	0.5 - 1000pF	100pF- 0.033uF	1000pF- 0.10uF			
CEA12	25	0.5 - 5600pF	100pF - 1.0uF	1000pF - 2.2uF	0.200 [5.1]	.118 [3.0]	.018 ± .003 [0.45 ± .08]
	50	0.5 - 4700pF	100pF- 0.47uF	1000pF - 1.0uF			
	100	0.5 - 3300pF	100pF- 0.10uF	1000pF- 0.10uF			

DIELECTRIC CHARACTERISTICS (typical)

ITEM	COG (NPO)	X7R	Y5V (Z5U) ²
Cap. Range, E12 values	0.3 pF- 5,600 pF	100 pF - 1uF	1,000 pF - 2.2uF
Capacitance Tolerance	<10pF: ±1pF, .25pF, .5pF (std) ≥10pF: ±1%, ±2%, ±5%(std), ±10%	±5%, ±10% (std), ±20%	±20% (std), +80/- 20%
Operating Temperature Range	-55°C to +125°C	-55°C to +125°C	-30°C to +85°C
Temperature Characteristics	0 ± 30ppm/°C ³	±15% max over op.temp range	+22%/-82% (+22%/-56%) max over operating temp range
Aging (cap loss/decade hr)	negligible	2%	7%
Voltage Coef (ΔC@ max V)	negligible	-50% to+10% typ	-80% to+20% typ
Dissipation Factor (1KHz)	0.15% (+25°C & +125°C) 1.0VRMS, 1MHz for values<1000pF	2.5% Max., 1VRMS	4.0% Max. 0.5 VRMS
Insulation Resistance 25°C (MIL-STD-202-METHOD-302)	100GΩ or 1000MΩ-uF whichever is less	100GΩ or 1000MΩ-uF whichever is less	10GΩ or 1000MΩ-uF whichever is less
Dielectric Strength	2.5x rated VDC	2.5x rated VDC	2.5x rated VDC
Life Test (1000 hours)	2x rated voltage @+125°C ΔC<3% or 0.25pF wig	2x rated voltage at +125°C ΔC<20%	1.5x rated voltage at +85°C ΔC<30%

Cut & Forming

Wide range of styles and sizes available... horizontal, vertical mount, snap-in kinks, etc. Consult factory.

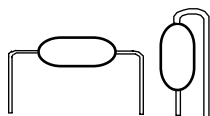

Footnotes:

- ¹ Expanded range available, consult factory
- ² Y5V is standard, Z5U is avail. (Y5V & Z5U are considered interchangeable)
- ³ ±60ppm <10pF

P/N DESIGNATION: CEA10 - 102 - J 101 G T W

RCD Type CEA10
Option Code: (leave blank if standard)
Capacitance Code 2 significant digits & multiplier:
 R5=0.5pF, 1R0=1pF, 100=10pF, 101=100pF, 102=1000pF,
 103=.01uF (10,000pF), 104=.1uF(100,000pF), 105=1uF
Tolerance: F=1%, G=2%, J=5%, K=10%, M=20%,
 Z=+80%/-20%, B=±0.1pF, C=±0.25pF, D=±0.5pF
Voltage Code: 025=25V, 050=50V, 101=100V, 201=200V
Dielectric: G=COG(NPO), R=X7R, V=Y5V (U=Z5U)
Packaging: B=Bulk, A=Ammo, T=Tape & Reel (5K pcs/reel typ)
Termination: W= Lead-free, Q= Tin/Lead
 (leave blank if either is acceptable)

RADIAL LEAD CERAMIC CAPACITORS MULTILAYER CERAGOLD™ CONSTRUCTION CER SERIES



Term. W is
RoHS
compliant
& 260°C
compatible



- ☐ Industry's widest range- 0.47pF to 10uF, tolerances to 1%
- ☐ Space-saving radial lead design
- ☐ COG (NPO), X7R, Z5U and Y5V temperature coefficients
- ☐ Tape and reel packaging available
- ☐ Standard industry sizes
- ☐ High voltage models available
- ☐ Cut and formed leads available

RCD's *Ceragold™* high-density multilayer construction enables superior performance and capacitance range. Proprietary flame retardant epoxy coating ensures optimum environmental protection and dielectric strength. Non-standard values, increased voltage ratings, custom marking, military screening, cut & formed leads, etc., are available. Matched sets and networks also available. Custom components are an RCD specialty!

DIMENSIONS

RCD Type	L Max.	H Max.	T Max.*	LS ±.024 [0.6]
CER15	.165 [4.2]	.150 [3.81]	.150 [3.81]	.100 [2.5]
CER17	.150 [3.81]	.150 [3.81]	.150 [3.81]	.200 [5.0]
CER20	.200 [5.08]	.200 [5.08]	.150 [3.81]	.100 [2.5]
CER22	.200 [5.08]	.200 [5.08]	.150 [3.81]	.200 [5.0]
CER30	.300 [7.62]	.217 [5.5]	.150 [3.80]	.200 [5.0]
CER40	.413 [10.5]	.394 [10]	.165 [4.2]	.217 [5.5]
CER50	.492 [12.5]	.433 [11]	.165 [4.2]	.295 [7.5]

*Body thickness varies with capacitance value

BODY STYLE (additional styles available)

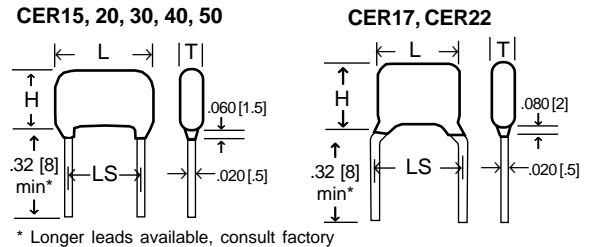

DIELECTRIC CHARACTERISTICS (typical)

ITEM	COG (NPO)	X7R	Y5V (Z5U) ²
Cap. Range, E12 values	0.47 pF- 0.1uF	330 pF - 1uF	1,000 pF -10uF
Capacitance Tolerance	<10pF: ±.1pF, .25pF, .5pF (std) ≥10pF: ±1%, ±2%, ±5%(std), ±10%	±5%, ±10% (std), ±20%	±20% (std), +80/- 20%
Operating Temperature Range	-55°C to +125°C	-55°C to +125°C	-30°C to +85°C
Temperature Characteristics	0 ± 30ppm/°C ³	±15% max over op.temp range	+22%/ -82% (+22%/ -56%) max over operating temp range
Aging (cap loss/decade hr)	negligible	2%	7%
Voltage Coef (ΔC@ max V)	negligible	-50% to +10% typ	-80% to +20% typ
Dissipation Factor (1KHz, 25°C)	0.15% (+25°C & +125°C) 1.0VRMS, 1MHz for values <1000pF	2.5% Max., 1VRMS	4.0% Max. 0.5 VRMS
Insulation Resistance 25°C (MIL-STD-202-METHOD-302)	100GΩ or 1000MΩ-uF whichever is less	100GΩ or 1000MΩ-uF whichever is less	10GΩ or 1000MΩ-uF whichever is less
Dielectric Strength	3x rated VDC	3x rated VDC	3x rated VDC
Life Test (1000 hours)	2x rated voltage @+125°C ΔC<3% or 0.25pF wig	2x rated voltage at +125°C ΔC<20%	1.5x rated voltage at +85°C ΔC<30%

CAPACITANCE RANGE

RCD TYPE	WVDC ¹	STANDARD CAPACITANCE RANGE ¹		
		COG (NPO) Std. tol. = 5%	X7R Std. tol. = 10%	Y5V(Z5U) ² Std. tol. = 20%
CER15, CER17	25	0.47 - 3300pF	100pF - 0.22uF	.01uF - 1.2uF
	50	0.47 - 2200pF	100pF - 0.1uF	.01uF - 1uF
	100	0.47 - 1000pF	100pF - 0.047uF	1000pF - 0.1uF
CER20, CER22	25	0.47 - 6800pF	100pF - 1uF	.01uF - 1.2uF
	50	0.47 - 4700pF	100pF - 0.47uF	.01uF - 1uF
	100	0.47 - 3900pF	100pF - 0.1uF	.01uF - 0.33uF
CER30	25	10 - 10,000pF	470pF - 1uF	.01uF - 1.5uF
	50	10 - 7500pF	470pF - 1uF	.01uF - 1.5uF
	100	5 - 4700pF	100pF - 0.22uF	.01uF - 1.0uF
CER40	25	10 - 47,000pF	1000pF - 1uF	.68uF - 4.7uF
	50	10 - 27,000pF	1000pF - 1uF	.68uF - 3.3uF
	100	5 - 22,000pF	100pF - 0.47uF	.68uF - 2.2uF
CER50	25	1000pF - 0.1uF	.01uF - 2.2uF	1uF - 10uF
	50	1000pF - 0.047uF	.01uF - 2.2uF	1uF - 6.8uF
	100	1000pF - 0.033uF	.01uF - 1uF	1uF - 2.2uF

¹ Expanded range available, consult factory

² Y5V is standard, Z5U is avail. (Y5V & Z5U are considered interchangeable)

³ ±60ppm <10pF

P/N DESIGNATION: CER15 - 102 - K 050 R B W

RCD Type — CER15 —
Option Code (leave blank if standard) —
Capacitance Code (pF) 2 signif. digits & multiplier: R47=0.47pF, 1R0=1pF, 100=10pF, 101=100pF, 102=1000pF, 103=.01uF(10,000pF), 104=.1uF(100,000pF), 105=1uF, 106=10uF
Tolerance: F=1%, G=2%, J=5%, K=10%, M=20%, Z=+80%/-20%, B=±0.1pF, C=±0.25pF, D=±0.5pF
Voltage Code: 025=25V, 050=50V, 101=100V, 201=200V
Dielectric: G=COG (NPO), R=X7R, V=Y5V (U=Z5U)
Packaging: B=Bulk(poly bag), A=Ammo, T=Tape & Reel (typical quantities are 500-1000 pcs/bag, 2500 per Ammo box, and 4000/Reel)
Termination: W=lead-free, Q=tin/lead (leave blank if either is acceptable)

TANTALUM CHIP TANGOLD™ CAPACITORS

TS SERIES- General Purpose TSE SERIES- Low ESR



New! Mini 0805 case size



- Epoxy molded, UL94V-0 Flame Retardant
- Excellent humidity and surge performance
- Low leakage current
- -55° to +125°C operating temperature range
- Extended capacitance range and low profile designs available

RCD's **Tangold™** construction provides superior performance and wide capacitance range as a result of a solid slug of high-gain tantalum powders sintered under vacuum. The flame retardant epoxy molding ensures optimum environmental protection and dielectric strength. Non-standard values, low-profile packages, custom marking, military screening, fusible, etc., are available.

DIMENSIONS (low profile version also available)

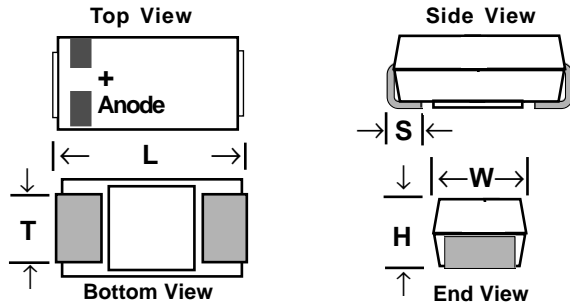

Case Size	L	W	H	T	S
S (0805) [2012]	.079±.008 [2 ±0.2]	.049±.008 [1.25±0.2]	.047±.008 [1.2±0.2]	.043±.008 [1.1 ±0.2]	.020±.012 [.5±0.3]
A (1206) [3216]	.126±.008 [3.2±0.2]	.063±.008 [1.6±0.2]	.063±.008 [1.6±0.2]	.047±.008 [1.2±0.2]	.031±.012 [0.8±0.3]
B (1411) [3528]	.138±.008 [3.5±0.2]	.110±.008 [2.8±0.2]	.075±.008 [1.9±0.2]	.087±.008 [2.2±0.2]	.031±.012 [0.8±0.3]
C (2412) [6032]	.236±.012 [6.0±0.3]	.126±.012 [3.2±0.3]	.098±.012 [2.5±0.3]	.087±.008 [2.2±0.2]	.051±.012 [1.3±0.3]
D (2917) [7343]	.287±.012 [7.3±0.3]	.169±.012 [4.3±0.3]	.110±.012 [2.8±0.3]	.094±.008 [2.4±0.2]	.051±.012 [1.3±0.3]
E (2917H) [7343H]	.287±.012 [7.3±0.3]	.169±.012 [4.3±0.3]	.162±.012 [4.1±0.3]	.094±.008 [2.4±0.2]	.051±.012 [1.3±0.3]

STANDARD CAPACITANCE AND ESR (Ω) VALUES (extended value range available in each size, ESR is typ.)

Volt Rating 85°C ²	4VDC (5V Surge)			6.3VDC (8V Surge)			10VDC (13V Surge)			16VDC (20V Surge)			20VDC (26V Surge)			25VDC (33V Surge)			35VDC (46V Surge)			50VDC (65V Surge)				
	uF	Code	Case Size	'TS' ESR	'TSE' ESR	Case Size	'TS' ESR	'TSE' ESR	Case Size	'TS' ESR	'TSE' ESR	Case Size	'TS' ESR	'TSE' ESR	Case Size	'TS' ESR	'TSE' ESR	Case Size	'TS' ESR	'TSE' ESR	Case Size	'TS' ESR	'TSE' ESR			
0.1	104																									
.15	154																									
.22	224																									
.33	334																									
.47	474																									
.68	684																									
1.0	105				A/S	14/25			A/S	13/25		A/S	11/20	6/NA	A	9	5.5	B/A	7/8	2/4	B	6.5	2	C	5.5	1.6
1.5	155	S	30		A/S	12/25			A/S	10	6/NA	A/S	8/12	6/NA	B/A	5/6.5	NA/4.5	B	5	1.5	C/B	4.5/5.2	2.5/3	D/C	4/4.5	1/1.5
2.2	225	S	25		A/S	9/20	6/NA	A/S	7	6/NA	B/A	5.5/6.5	NA/4	B/A	3.5/5.3	1.5/4	B	4.5	2.2	C	3.5	1.5	D/C	2.5	.8/1.5	
3.3	335	A/S	9/20	4/NA	A/S	7/12	6/NA	B/A	5/5.5	NA/4	B/A	4.5/5	2/4	C/B	2.5/3	NA/1.3	C	2.8	1.2	D/C	2.0/2.5	NA/8	D	2.0	.8	
4.7	475	A/S	7.5/14	3.5/NA	B/A	5/6	NA/3.5	B/A	4/5	1.5/3	B/A	3.5/4	1.5/3	D/C	2.5/2.8	NA/6	C	2.4	.6	D/C	1.5/2.2	.7/7	D/E	1.4/9	.6	
6.8	685	B/A	6/6.5	NA/3	B/A	4/5	1.2/2	B/A	3/4	1.2/3	C/B	2.5/3.5	.8/1.2	D/C	1.8/2	NA/6	D/C	1.4/2	NA/6	D	1.3	.5	E	.9	.5	
10	106	B/A	4/6	1.2/2	B/A	3/4	1/2	B/A	2.5/3	.8/2	C/B	2/2.8	.6/8	D	1.3	NA/5	D/C	1.2/1.8	4/6	D	1	.4	E	.9		
15	156	B/A	3.5/4	1.2/2	C/B	2.5/3.2	.6/7	C/B	2.2/2.8	.5/7	C	1.8	.4	D	1.1	.35	D	1	.4	E	.9	.3	E	.9		
22	226	C/B	2.5/3.2	.5/6	C/B	2/2.5	.5/6	C/B	1.8/2.4	.4/7	D/C	1.1/1.6	.25/35	D	.9	.3	D	.9	.4	E	.9	.3	E	.9		
33	336	C/B	2.2/2.8	.5/5	D/C	1.3/1.8	NA/3	D/C	1.1/1.6	.25/3	D/C	.9/1.5	.25/3	D	.9	.25	E	.9	.3	E		.3				
47	476	D/C	1.3/1.8	NA/5	D/C	1.1/1.6	.22/25	D/C	.9/1.2	.22/3	D/C	.9/1.4	.2/3	E/D	.9/9	NA/2	E	.9	.3							
68	686	D/C	1.1/1.6	.2/25	D/C	.9/1.6	.2/2	D	.9	.2	D	.9	.15	E	.9	.2	E	.9								
100	107	D/C	.9/1.3	.2/2	D/C	.9/1.4	.15/3	D	.9	.15	D/E	.9	.15/15	E	.9	.15	E	.9								
150	157	D/C	.7/1.0	.15/3	D	1	.15	E	1	.15	E	.9	.15													
220	227	D	.9	.15	E	1	.15	E	.9	.15	E	.9														
330	337	E	.9	.15	E	.9	.15	E	.9	.1	E	.9														
470	477	E	.9	.15	E	.9	.1	E	.9		E	.9														
680	687	E	.9	.1	E	.5	.1	E	.9		E	.9														

¹ Leakage current = 0.01C_{μF} V (or 0.5μA, whichever is greater)

² Derate voltage rating by .825%/°C above 85°C

SPECIFICATIONS

CAPACITANCE (120Hz)	ΔC FROM INITIAL @20°C			DISSIPATION FACTOR, TYP.			
	-55°C	+85°C	+125°C	-55°C	+20°C	+85°C	+125°C
<1.0μF	-10%	+10%	+12%	6%	4%	5%	6%
1.5 to 68μF				10%	6%	8%	10%
100 to 220μF				12%	8%	10%	12%
330 to 680μF				16%	12%	14%	16%

STANDARD PACKAGING

Case Size	7" Reel Qty, typ.	Tape Width
S	0805 [2012]	2500
A	1206 [3216]	2000
B	1411 [3528]	2000
C	2412 [6032]	500
D	2917 [7343]	500
E	2917H [7343H]	400

P/N DESIGNATION:

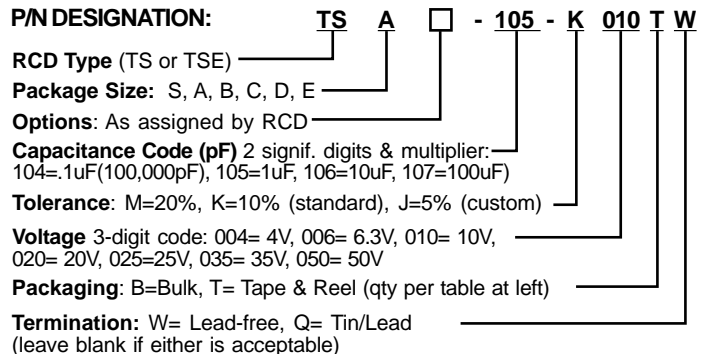

RADIAL LEAD TANGOLD™ CAPACITORS

EPOXY RESIN COATED, TANTALUM

TR SERIES



- Epoxy resin dipped, UL94V-0 Flame Retardant
- Low leakage current and impedance
- Excellent humidity and heat resistance
- Laser marked capacitor body
- Several lead-wire forms available

STANDARD LEAD STYLES

Style 10 (.100" lead spacing) Style 20 (.200" lead spacing)

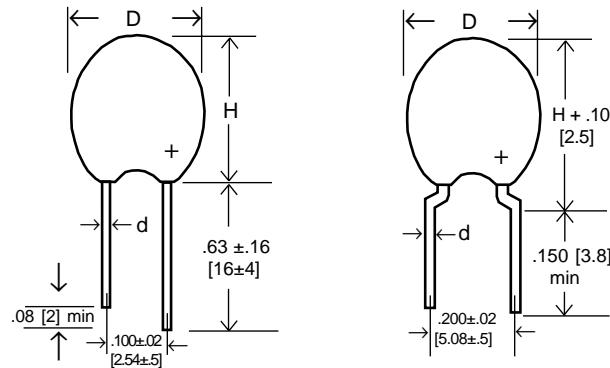

OPTIONAL LEAD STYLES (additional styles available)

Style 25 (.250" lead spacing) Style 10K (.100" LS with kink)

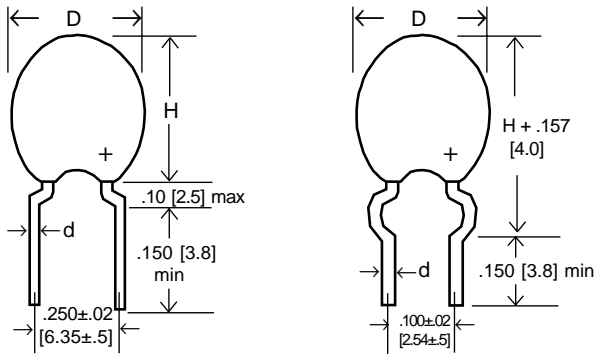

P/N DESIGNATION:

TR A 10 □ - 105 - K 020 A W

RCD Type _____

Case Code: A, B, C, D, E, F _____

Lead Style: 10, 20, 25, 10K, etc. _____

Option Code(s): Leave blank if standard _____

Capacitance Code (pF): 2 significant digits & multiplier
103=10,000pF or 0.01uF, 104=100,000pF or 0.1uF, 105 = 1uF, 106= 10uF, 107=100uF

Tolerance: Standard=K (10%). J (5%) & M (20%) also avail. _____

Voltage: 3 digit code (003=3V, 004=4V, 006=6.3V, 010=10V, 016=16V, 020=20V, 025=25V, 035=35V, 050=50V) _____

Packaging: B=Bulk, A = Ammo (tape & box) _____

Termination: W= Lead-free (std), Q= Tin/Lead (leave blank if either is acceptable) _____

DIMENSIONS

Case Size	D(Max)	H (Max)	d ± .002 [.05]
A	.177 [4.5]	0.28 [7.1]	.020 [0.50]
B	.196 [5.0]	.315 [8.0]	.020 [0.50]
C	.217 [5.5]	.375 [9.5]	.020 [0.50]
D	.256 [6.5]	.433 [11.0]	.020 [0.50]
E	.335 [8.5]	.512 [13.0]	.020 [0.50]
F	.375 [9.5]	.650 [16.5]	.020 [0.50]

RATED VOLTAGE, NOMINAL CAPACITANCE AND CASE SIZES									
Rated DC Voltage(85°C)	3	4	6.3	10	16	20	25	35	50
Rated DC Voltage(125°C)	2	2.5	4	6.3	10	13	16	20	32
Short-time Overload Voltage (30Sec)	4	5.2	8	13	20	26	33	46	65
Capacitance (µF)	Code								
	Case Code								
0.047	473							A	A
0.068	683							A	A
0.1	104							A	A
0.15	154							A	A
0.22	224							A	A
0.33	334							A	A
0.47	474							A	A
0.68	684							A	A
1.0	105				A	A	A	A	B
1.5	155				A	A	A	A	C
2.2	225			A	A	A	A	B	C
3.3	335			A	A	A	B	B	D
4.7	475	A	A	A	A	B	B	B	D
6.8	685	A	A	A	B	B	C	C	D
10	106	A	A	B	B	B	C	C	E
15	156	A	A	B	C	C	D	D	F
22	226	B	B	C	C	C	D	D	F
33	336	B	B	C	D	D	E	E	F
47	476	C	C	D	D	D	E	E	F
68	686	D	D	D	D	E	F	F	
100	107	D	D	E	E	E	F	F	
150	157	D	E	E	E	F			
220	227	E	E	E	F				
330	337	E	F	F					
470	477	F							
680	687	F							

SPECIFICATIONS

CAPACITANCE (µF)	ΔC FROM INITIAL LIMIT			DISSIPATION FACTOR (25°C, 120Hz)			
	-55°C	+85°C	+125°C	-55°C	+25°C	+85°C	+125°C
<1.0				6%	4%	6%	6%
1.5 to 68	±10%	±15%	±25%	10%	6%	10%	10%
100 to 680				12%	8%	12%	12%

CERAMIC CORE WIREWOUND CHIP INDUCTORS

CI SERIES

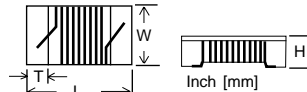

- Industry's widest range! 1nH to 10uH, 1%-10%, 0402-1008 sizes
- Non-magnetic ceramic-core design for HF operation
- Customized versions available with non-standard values, increased Q & SRF, marking of induct. value, etc.
- Ferrite core available for expanded inductance range & low DCR (Opt.F)

RCD Type	L± .01 [.25]	W±.01[.254]	H Max.	T±.006[.15]
CI0402	.044 [1.12]	.024 [6]	.028 [.7]	.012 [.3]
CI0603	.060 [1.5]	.035 [.89]	.040 [1]	.013 [.33]
CI0805	.080 [2.0]	.058 [1.47]	.060 [1.52]	.020 [.5]
CI1008	.105 [2.67]	.090 [2.29]	.090 [2.29]	.022 [.55]

INDUC. VALUE	CI0402					CI0603					CI0805					CI1008					
	Q (min)	Test Freq MHz	SRF, MHz	DCR, max.Ω	Rated DC Current(mA)	Q (min)	Test Freq MHz	SRF, MHz	DCR, max. Ω	Rated DC Current(mA)	Q (min)	Test Freq MHz	SRF, MHz	DCR, max.Ω	Rated DC Current(mA)	Q (min)	Test Freq MHz	SRF, MHz	DCR, max. Ω	Rated DC Current(mA)	
1nH	16	250	6000	.045	1360																
2nH	16	250	6000	.07	1040																
2.2nH	19	250	6000	.07	960						40	1500	>6G	.05	600						
3.3nH	19	250	6000	.066	840						30	1500	>6G	.08	600						
3.9nH	19	250	5800	.066	840	20	250	>6G	.08	700											
5.6nH	20	250	5800	.083	760																
6.8nH						25	250	5800	.11	700	50	1000	5000	.11	600						
7.5nH	22	250	5800	.104	680																
8.2nH	22	250	4400	.104	680																
10nH						30	250	4800	.13	700	50	1000	4800	.19	600	55	50	4100	.08	1000	
12nH	24	250	3600	.12	640	30	250	4000	.13	700	50	500	4100	.15	600	65	50	3400	.09	1000	
15nH	24	250	3280	.172	560	30	250	4000	.17	700	50	500	3900	.17	600	55	50	2600	.13	1000	
18nH						30	250	3200	.17	700	50	500	3300	.20	600	60	50	2600	.11	1000	
19nH	24	250	3040	.202	480																
22nH						35	250	3000	.19	700	55	500	2600	.22	500	60	50	2400	.12	1000	
23nH	24	250	2720	.214	400																
27nH	24	250	2480	.298	400	35	250	2800	.22	600	60	500	2500	.25	500	60	50	1700	.13	1000	
33nH						35	250	2300	.22	600	60	500	2200	.27	500	70	50	1700	.14	1000	
36nH	24	250	2320	.403	320																
39nH						35	250	2200	.25	600	60	500	2100	.29	500	70	50	1600	.15	1000	
47nH						35	200	2100	.28	600	60	500	1750	.31	500	70	50	1600	.16	1000	
56nH						35	200	2000	.31	600	60	500	1650	.32	500	70	50	1400	.18	1000	
68nH						35	200	1850	.34	600	60	500	1500	.38	500	65	50	1200	.21	1000	
82nH						35	150	1700	.54	400	60	500	1400	.42	400	65	50	1000	.22	1000	
.1uH						35	150	1500	.71	400	60	500	1200	.46	400	60	25	1000	.56	650	
.12uH						35	150	1350	.79	300	50	250	1200	.51	400	60	25	1000	.63	650	
.15uH						28	150	1200	.92	280	50	250	1000	.56	400	50	25	850	.62	580	
.18uH						25	100	1100	1.25	240	50	250	950	.64	400	50	25	800	.70	620	
.22uH						25	100	1000	1.50	200	45	250	850	.70	400	50	25	700	.80	500	
.27uH						25	100	860	1.80	170	40	250	680	1.0	350	50	25	700	.91	500	
.33uH						25	100	600	2.00	150	40	250	660	1.4	310	50	25	600	1.05	450	
.39uH						25	100	460	2.10	120	35	250	560	1.5	290	50	25	500	1.12	470	
.47uH											33	100	430	1.7	250	50	25	500	1.19	470	
.56uH											23	50	350	1.9	230	50	25	450	1.33	400	
.68uH											23	50	300	2.0	190	50	25	375	1.47	400	
.75uH											23	50	280	2.1	180	45	25	360	1.54	360	
.82uH											23	50	250	2.3	180	45	25	350	1.61	400	
1uH											20	50	200	2.5	150	35	25	290	1.75	370	
1.2uH																35	7.9	250	2.0	310	
1.5uH																28	7.9	200	2.3	330	
1.8uH																28	7.9	160	2.6	300	
2.2uH																28	7.9	160	2.8	280	
2.7uH																22	7.9	140	3.2	290	
3.3uH																22	7.9	110	3.4	290	
3.9uH																20	7.9	100	3.6	260	
4.7uH																20	7.9	90	4.0	260	
5.6uH																20	7.9	80	5.7	240	
6.8uH																20	7.9	70	7.7	200	
8.2uH																20	7.9	60	10.7	150	
8.2uH*																37	7.9	65	2.6	220	
10uH*																38	7.9	60	2.9	210	

* Option 'F' Ferrite Core Design

SPECIFICATIONS

Temperature Range	-40°C to +125°C
T.C. of Inductance	+100ppm/°C typ.
Thermal Shock	MIL-STD-202, M. 107
Dielectric Strength	50V DC Min.

DESIGN NOTE: A method to achieve a higher self-resonant frequency is to use two inductors in series (each to be half of the required value).

P/N DESIGNATION:

CI1008 - **101** - **K T W**

RCD Type _____
 Option Codes: F= ferrite core (leave blank if std)
 Induc. Code (uH): 2 signif. figures and multiplier
 R01=10nH (.01uH), R10=100nH (.1uH), 1R0=1uH. Values below 10nH (.01uH) use 'N' to indicate nH 1N0=1nH, 4N7=4.7nH, etc.
 Tolerance: F= 1%, G= 2%, J= 5%, K= 10%
 Packaging: B = Bulk, T = Tape & Reel
 Termination: W= Lead-free, Q= Tin/Lead (leave blank if either is acceptable)

MOLDED WIREWOUND CHIP INDUCTORS

MCI SERIES

 Term. W
is Pb-free
and RoHS
compliant

- Molded construction, excellent environmental performance
- 1210 and 1812 sizes available from stock
- Ferrite core, wirewound construction
- Intermediate values, increased current, Q, & SRF available

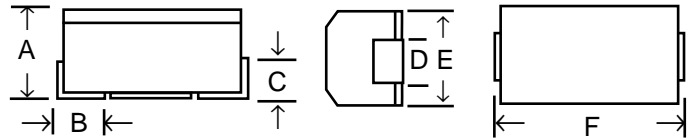

TYPE MCI1008

Induc. (µH)	Standard Tolerance	Q (Min.)	Test Freq. (MHz)	SRF Min. (MHz)	Max. DCR (ohm)	Rated* DC Current (mA)
.12	±10%	30	25.2	600	.37	420
.15	±10%	30	25.2	550	.42	380
.22	±10%	30	25.2	450	.52	330
.33	±10%	30	25.2	400	.60	300
.47	±10%	30	25.2	350	.68	250
.68	±10%	30	25.2	270	.85	220
.82	±10%	30	25.2	250	1.0	200
1.0	±10%	30	7.96	220	1.1	195
1.5	±10%	30	7.96	135	1.3	190
2.2	±10%	30	7.96	75	1.55	180
3.3	±10%	30	7.96	48	1.9	170
4.7	±10%	30	7.96	40	2.3	165
6.8	±10%	25	7.96	33	2.7	160
8.2	±10%	25	7.96	30	3.1	155
10	±10%	25	2.52	27	3.5	150
15	±10%	25	2.52	20	4.4	140
22	±10%	25	2.52	17	5.5	125
33	±10%	25	2.52	15	7.1	110
47	±10%	20	2.52	13	11	80
68	±10%	20	2.52	11	16.6	70
82	±10%	20	2.52	10	19	65
100	±10%	15	.796	9	21	60

Dim.	MCI1008	MCI1210	MCI1812
A	.067 ±.012 [1.7 ±.3]	.087 ±.008 [2.21 ±.2]	.126 ±.008 [3.2 ±.2]
B	.016 ±.008 [.4 ±.2]	.027 ±.012 [.686 ±.3]	.027 ±.012 [.686 ±.3]
C	.016 [.4] Min.	.02 [.51] Min.	.02 [.51] Min.
D	.040 [1.0] Min.	.040 [1.0] Min.	.044 [1.1] Min.
E	.079 ±.008 [2.0 ±.2]	.098 ±.01 [2.49 ±.25]	.125 ±.01 [3.2 ±.25]
F	.100 ±.01 [2.54 ±.26]	.126 ±.01 [3.2 ±.25]	.177 ±.012 [4.5 ±.3]

TYPE MCI1210

Induc. (µH)	Standard Tolerance	Q (Min.)	Test Freq. (MHz)	SRF Min. (MHz)	Max. DCR (ohm)	Rated* DC Current (mA)
.01	±20%	15	100	2500	.13	520
.015	±20%	19	100	2100	.16	500
.022	±20%	23	100	1700	.20	480
.033	±20%	25	100	1400	.24	470
.047	±20%	26	100	1200	.30	460
.068	±20%	27	100	1000	.36	450
.10	±20%	28	100	700	.44	450
.15	±20%	30	25.2	450	.25	450
.22	±20%	30	25.2	350	.32	450
.33	±20%	30	25.2	300	.40	450
.47	±20%	30	25.2	220	.50	450
.68	±20%	30	25.2	160	.60	450
1.0	±10%	30	7.96	120	.70	400
1.5	±10%	30	7.96	85	.85	370
2.2	±10%	30	7.96	75	1.0	320
3.3	±10%	30	7.96	60	1.2	260
4.7	±10%	30	7.96	50	1.5	220
6.8	±10%	30	7.96	40	1.8	180
10	±10%	30	2.52	30	2.1	150
15	±10%	30	2.52	20	2.8	130
22	±10%	30	2.52	20	3.7	110
33	±10%	30	2.52	17	5.6	70
47	±10%	30	2.52	15	7.0	60
68	±10%	30	2.52	12	9.0	50
100	±10%	20	.796	10	11	40
150	±10%	20	.796	8	15	65
220	±10%	20	.796	7	21	50
330	±10%	20	.796	5	34	40

TYPE MCI1812

Induc. (µH)	Standard Tolerance	Q (Min.)	Test Freq. (MHz)	SRF Min. (MHz)	DC Resis. (Ω @20°C)	Rated* DC Current (mA)
0.10	20%	28	25.2	600	.28	540
0.12	20%	30	25.2	500	.22	520
0.15	20%	30	25.2	400	.25	500
0.18	20%	30	25.2	300	.28	490
0.22	20%	30	25.2	200	.30	480
0.27	20%	30	25.2	200	.32	460
0.33	20%	30	25.2	180	.34	450
0.39	20%	30	25.2	180	.38	450
0.47	20%	30	25.2	165	.42	450
0.56	20%	30	25.2	150	.46	450
0.68	20%	30	25.2	150	.51	450
0.82	20%	30	25.2	140	.55	450
1.0	10%	50	7.96	100	.50	450
1.2	10%	50	7.96	80	.55	430
1.5	10%	50	7.96	70	.60	410
1.8	10%	50	7.96	60	.65	390
2.2	10%	50	7.96	55	.70	380
2.7	10%	50	7.96	50	.75	370
3.3	10%	50	7.96	45	.80	355
3.9	10%	50	7.96	40	.90	330
4.7	10%	50	7.96	35	1.0	315
5.6	10%	50	7.96	33	1.1	300
6.8	10%	50	7.96	27	1.2	285
8.2	10%	50	7.96	25	1.4	270
10	10%	50	7.96	20	1.6	250
12	10%	50	2.52	18	2.0	225
15	10%	50	2.52	17	2.5	200
18	10%	50	2.52	15	2.8	190
22	10%	50	2.52	13	3.2	180
27	10%	50	2.52	12	3.6	170
33	10%	50	2.52	11	4.0	160
39	10%	50	2.52	11	4.5	150
47	10%	50	2.52	10	5.0	140
56	10%	50	2.52	9.0	5.5	135
68	10%	50	2.52	9.0	6.0	130
82	10%	50	2.52	8.0	7.0	120
100	10%	40	2.52	8.0	8.0	110
120	10%	40	.79	6.0	8.0	110
150	10%	40	.79	5.0	9.0	105
180	10%	40	.79	4.5	9.5	102
220	10%	40	.79	4.3	12	100
270	10%	40	.79	4.0	18	92
330	10%	40	.79	3.5	20	85
390	10%	40	.79	3.0	23	80
470	10%	30	.79	3.0	26	62
560	10%	30	.79	3.0	30	50
680	10%	30	.79	3.0	39	50
820	10%	30	.79	2.5	45	40
1000	10%	20	.79	2.5	50	30

SPECIFICATIONS

Temperature Range	-40°C to +105°C
T.C. of Inductance	+50 to +150ppm/°C typ.
Resis. to Soldering Heat	260°C, 10 seconds
Resis. to Solvents	per MIL-STD-202, m215
DC Current	10% Max ΔL at full current

* Current rating is based on 85°C max ambient, derate 5%/°C above 85°C

P/N DESIGNATION:

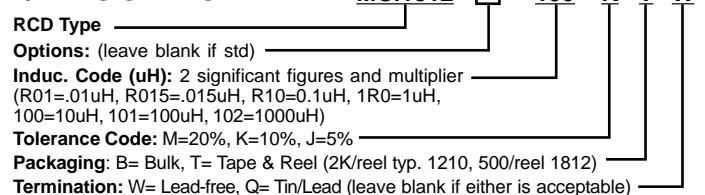

SHIELDED WIREWOUND INDUCTORS

MSI SERIES



RESISTORS • CAPACITORS • COILS • DELAY LINES



FEATURES

- New design features lower DC resistance and increased current ratings
- Electromagnetic shield results in minimal coupling
- Epoxy molding provides superior moisture protection
- Compatible with flow and reflow soldering
- Standard values from 1uH to 1000uH (intermediate values are available)
- Mini 1008 size in development

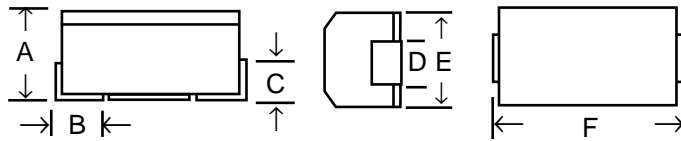

RCD's MSI Series is ideally suited for telecom, auto, audio, and power supply line applications. The magnetic shield reduces cross talk and suppresses radiation. High temperature internal construction ensures optimum heat durability compatible with lead-free processes (260°C, 10 Sec.).

DIMENSIONS

Dim.	MSI1210	MSI1812
A	.087 ± .008 [2.21 ± .2]	.126 ± .008 [3.2 ± .2]
B	.024 ± .012 [.6 ± .3]	.024 ± .012 [.6 ± .3]
C	.02 [.5] Min.	.02 [.5] Min.
D	.040 [1.0] Min.	.063 [1.6] Min.
E	.098 ± .01 [2.49 ± .25]	.125 ± .01 [3.2 ± .25]
F	.126 ± .01 [3.2 ± .25]	.177 ± .012 [4.5 ± .3]

MSI1210

Induc. (μH)	Induc. Code	Std. Tol.	Q (Ref)	Test Freq. (MHz)	SRF Min. (MHz)	Max. DCR (ohm)	Rated Current* (mA) DC
1.0	1R0	20%	5	7.96	100	0.08	500
1.5	1R5	20%	5	7.96	80	0.11	400
2.2	2R2	20%	5	7.96	68	0.12	340
3.3	3R3	20%	5	7.96	54	0.15	270
4.7	4R7	20%	5	7.96	46	0.17	240
6.8	6R8	20%	5	7.96	38	0.23	195
10	100	10%	10	2.52	30	0.34	165
15	150	10%	10	2.52	26	0.42	145
22	220	10%	10	2.52	21	0.65	115
33	330	10%	10	2.52	17	0.98	95
47	470	10%	10	2.52	14	1.3	85
68	680	10%	10	2.52	12	2.0	70
100	101	10%	10	.796	10	3.3	55
150	151	10%	10	.796	8	4.2	45
220	221	10%	10	.796	7	7.1	35
330	331	10%	10	.796	5	9.1	30
470	471	10%	10	.796	4	21	25
680	681	10%	10	.796	3	26	20
1000	102	10%	10	.252	2.4	32	15

MSI1812 (consult factory for extended value range)

Induc. (μH)	Induc. Code	Std. Tol.	Q (ref)	Test Freq. (MHz)	SRF Min. (MHz)	Max. DCR (ohm)	Rated Current* (mA) DC
1.0	1R0	20%	10	7.96	200	0.07	800
1.5	1R5	20%	10	7.96	130	0.08	700
2.2	2R2	20%	10	7.96	80	.10	600
3.3	3R3	20%	10	7.96	45	.12	460
4.7	4R7	20%	10	7.96	35	.13	400
6.8	6R8	20%	10	7.96	28	.19	300
10	100	10%	10	2.52	22	.28	250
15	150	10%	10	2.52	20	.39	200
22	220	10%	10	2.52	18	.60	170
33	330	10%	10	2.52	14	.82	140
47	470	10%	10	2.52	11.5	1.2	120
68	680	10%	10	2.52	10	1.6	100
100	101	10%	10	.796	8	2.3	90
150	151	10%	10	.796	7	3.0	65
220	221	10%	10	.796	5.5	5.0	55
330	331	10%	10	.796	4	7.8	45

* Rated current is equal to the current that results in a temperature rise of 20°C or inductance drop of 10%, whichever is smaller

SPECIFICATIONS

Resistance to Soldering Heat	260°C, 10 seconds
Resistance to Solvents	per MIL-STD-202
Coupling (1mm apart)	2% Max 1 uH to 100uH 5% Max > 100uH
Test Equipment	HP4342A Q Meter, HP4191A RF Analyzer, Wheatstone Bridge
Operating Temperature Range	-40°C to +105°C (including self temperature rise)
Current Rating	per table at 85°C or below
Derating	Derate current by 5%/°C above 85°C
Marking	3 digit inductance code, as minimum

P/N DESIGNATION

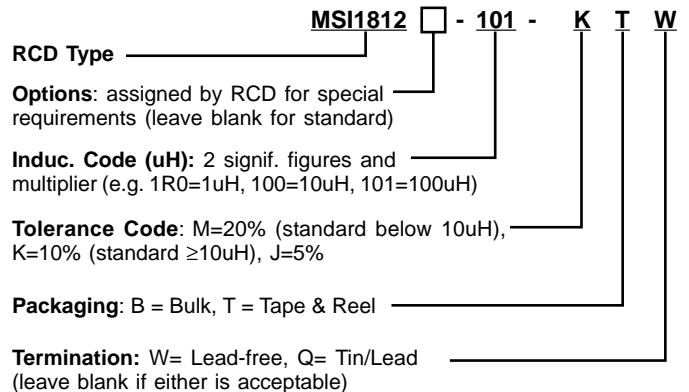

MULTILAYER CERAMIC CHIP INDUCTORS

HIGH FREQUENCY PERFORMANCE

MHI SERIES

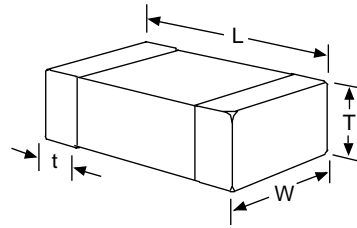

- Wide range - 0.6nH to 470nH, up to 10GHz 420mA
- Advanced monolithic construction especially suited for high frequency applications
- Excellent Q and SRF characteristics
- Operating temperature range: -55°C to +125°C
- Standard tolerance: ±5% (±0.3nH on values <6.8nH)

RCD Type MHI0201 is the world's smallest chip inductor!

Ind. (nH)	Ind. Code	Test Freq. (MHz)	MHI 0201*				MHI 0402				MHI 0603				MHI 0805			
			Q Min. @100 MHz	SRF Min. (MHz)	DCR Max. (Ω)	Rated Current (mA,DC)	Q Typ. @100 MHz	SRF Min. (MHz)	DCR Max. (Ω)	Rated Current (mA,DC)	Q Typ. @100 MHz	SRF Min. (MHz)	DCR Max. (Ω)	Rated Current (mA,DC)	Q Typ. @100 MHz	SRF Min. (MHz)	DCR Max. (Ω)	Rated Current (mA,DC)
0.6	N60	100	11	>6,000	0.08	420	-	-	-	-	-	-	-	-	-	-	-	-
0.8	N80	100	11	>6,000	0.09	410	-	-	-	-	-	-	-	-	-	-	-	-
1.0	1N0	100	11	>6,000	0.10	400	11	10,000	.09	300	14	10,000	0.05	300	-	-	-	-
1.2	1N2	100	11	>6,000	0.13	280	11	10,000	.09	300	14	10,000	0.05	300	-	-	-	-
1.5	1N5	100	11	>6,000	0.16	280	11	6,000	.12	300	14	6,000	0.10	300	21	4000	0.10	300
1.8	1N8	100	11	>6,000	0.16	275	11	6,000	.12	300	10	6,000	0.10	300	18	4000	0.10	300
2.2	2N2	100	11	>6,000	0.18	220	10	6,000	.14	300	12	6,000	0.10	300	18	4000	0.10	300
2.7	2N7	100	11	>6,000	0.21	220	10	6,000	.14	300	13	6,000	0.10	300	19	4000	0.10	300
3.3	3N3	100	11	>6,000	0.30	190	10	6,000	.16	300	14	6,000	0.12	300	16	4000	0.13	300
3.9	3N9	100	11	>6,000	0.45	170	10	4,000	.19	300	13	6,000	0.14	300	18	4000	0.15	300
4.7	4N7	100	11	>6,000	0.55	160	10	4,000	.21	300	13	4,000	0.16	300	18	3500	0.20	300
5.6	5N6	100	11	>6,000	0.68	140	10	4,000	.23	300	14	4,000	0.18	300	20	3200	0.23	300
6.8	6N8	100	11	>6,000	0.75	130	10	3,900	.25	300	14	4,000	0.22	300	20	2800	0.25	300
8.2	8N2	100	11	5,500	0.86	110	10	3,600	.28	300	14	3,500	0.24	300	21	2400	0.28	300
10	10N	100	11	4,500	1.10	100	10	3,200	.31	300	14	3,400	0.26	300	20	2100	0.30	300
12	12N	100	11	3,700	1.25	90	11	2,700	.40	300	14	2,600	0.28	300	21	1900	0.35	300
15	15N	100	11	3,300	1.50	90	11	2,300	.50	300	15	2,300	0.32	300	22	1600	0.40	300
18	18N	100	-	-	-	-	11	2,100	.55	300	15	2,000	0.35	300	24	1500	0.45	300
22	22N	100	-	-	-	-	11	1,900	.60	300	16	1,600	0.40	300	23	1400	0.50	300
27	27N	100	-	-	-	-	11	1,600	.70	300	16	1,400	0.45	300	23	1300	0.55	300
33	33N	100	-	-	-	-	11	1,300	.80	300	17	1,200	0.55	300	24	1200	0.60	300
39	39N	100	-	-	-	-	11	1,200	1.0	200	18	1,100	0.60	300	23	1000	0.65	300
47	47N	100	-	-	-	-	11	1000	1.2	200	17	900	0.70	300	23	900	0.70	300
56	56N	100	-	-	-	-	11	750	1.3	200	17	900	0.75	300	23	800	0.75	300
68	68N	100	-	-	-	-	11	750	2.0	180	18	700	0.85	300	25	700	0.80	300
82	82N	100	-	-	-	-	10	600	2.2	150	18	600	0.95	300	24	600	0.90	300
100	R10	100	-	-	-	-	10	600	2.5	150	18	600	1.00	300	23	600	0.90	300
120	R12	100	-	-	-	-	10	600	2.7	150	16	500	1.2	300	22	500	0.95	300
150	R15	100	-	-	-	-	-	-	-	-	13	500	1.2	300	22	500	1.00	300
180	R18	100	-	-	-	-	-	-	-	-	13	400	1.3	300	23	400	1.10	300
220	R22	100	-	-	-	-	-	-	-	-	12	400	1.5	300	20	350	1.20	300
270	R27	50	-	-	-	-	-	-	-	-	14	300	1.9	150	20	300	1.30	300
330	R33	50	-	-	-	-	-	-	-	-	-	-	-	-	22	250	1.40	300
390	R39	50	-	-	-	-	-	-	-	-	-	-	-	-	17	250	1.30	300
470	R47	50	-	-	-	-	-	-	-	-	-	-	-	-	17	200	1.50	300

* 0201 chips are single layer construction utilizing RCD's proprietary film technology.

DIMENSIONS

Type MHI	L (Length)	W (Width)	T Max. (Thickness)	t (Term. Width)
0201	.022 ±.003 [0.55 ±.075]	.011 ±.002 [0.28 ±.05]	.012 [0.3]	.006 ±.002 [0.15 ±.05]
0402	.039 ±.004 [1.00 ±.10]	.020 ±.004 [0.5 ±.1]	.022 [0.55]	.010 ±.004 [0.25 ±.10]
0603	.063 ±.006 [1.6 ±.15]	.031 ±.006 [0.8 ±.15]	.037 [0.95]	.012 ±.008 [0.3 ±.2]
0805	.079 ±.008 [2.0 ±.2]	.049 ±.008 [1.25 ±.2]	.057 [1.45]	.020 ±.012 [0.5 ±.3]

P/N DESIGNATION:

MHI0402 - 22N - J T W

RCD Type _____
 Induc. Code: per above table _____
 Tolerance: J= ±5% (std ≥6.8nH),
 S= ±0.3nH (std <6.8nH), K= ±10%
 Packaging: B=Bulk, T=Tape&Reel in qtls of 10Kpcs/reel
 0201 & 0402, 4K pcs 0603 & 0805 (3K pcs 0805 if ≥47nH)
 Termination: W= Lead-free (100% Sn) _____

MULTILAYER SHIELDED FERRITE CHIP INDUCTORS

MLI SERIES



- Magnetically self-shielded, eliminates crosstalk & coupling between conductors. Excellent for high density placement.
- Suitable for either flow or reflow soldering
- 0.047uH to 33uH, 5mA to 450mA, 13MHz to 680MHz SRF
- Economical space-saving design
- Standard inductance tolerance is ±10% (20% if <0.1uH)
- Mini 0402 & 0201 sizes in development

RCD's MLI inductors feature a monolithic multilayer construction. The structure involves no windings/welds/solder joints, ensuring highest reliability and performance levels over a wide temperature and humidity range. Operating temperature is -55° to +125°C (derate current by 2.5%/°C above 85°C). Applications include noise/EMI elimination for I/O lines in a wide range of computer, telecom, medical, and audio applications.

Ind. (µH)	MLI 0603					MLI 0805					MLI1008					MLI 1206				
	Test Freq. (MHz)	Q Min.	SRF Min. (MHz)	DCR Max. (Ω)	Rated Current (mA,DC)	Test Freq. (MHz)	Q Min.	SRF Min. (MHz)	DCR Max. (Ω)	Rated Current (mA,DC)	Test Freq. (MHz)	Q Min.	SRF Min. (MHz)	DCR Max. (Ω)	Rated Current (mA,DC)	Test Freq. (MHz)	Q Min.	SRF Min. (MHz)	DCR Max. (Ω)	Rated Current (mA,DC)
0.047	50	10	260	0.30	50	50	15	320	0.20	300	-	-	-	-	-	50	20	320	0.15	300
0.068	50	10	250	0.30	50	50	15	280	0.20	300	-	-	-	-	-	50	20	280	0.25	300
0.082	50	10	245	0.30	50	50	15	255	0.20	300	-	-	-	-	-	-	-	-	-	-
0.10	25	15	240	0.50	50	25	20	235	0.30	250	25.2	30	680	0.21	450	25	20	235	0.25	250
0.12	25	15	205	0.50	50	25	20	220	0.30	250	25.2	30	650	0.22	400	25	20	220	0.30	250
0.15	25	15	180	0.60	50	25	20	200	0.40	250	25.2	30	530	0.25	400	25	20	200	0.30	250
0.18	25	15	165	0.60	50	25	20	185	0.40	250	25.2	30	520	0.29	370	25	20	185	0.40	250
0.22	25	15	150	0.80	50	25	20	170	0.50	250	25.2	30	390	0.30	370	25	20	170	0.40	250
0.27	25	15	136	0.80	50	25	20	150	0.50	250	25.2	30	330	0.33	350	25	20	150	0.50	250
0.33	25	15	125	0.85	35	25	20	145	0.55	250	25.2	30	310	0.39	350	25	20	145	0.50	250
0.39	25	15	110	1.0	35	25	25	135	0.65	200	25.2	30	290	0.40	320	25	25	135	0.60	250
0.47	25	15	105	1.35	35	25	25	125	0.65	200	25.2	30	260	0.44	300	25	25	125	0.60	200
0.56	25	15	95	1.55	35	25	25	115	0.75	150	25.2	30	230	0.49	250	25	25	115	0.70	200
0.68	25	15	80	1.70	35	25	25	105	0.80	150	25.2	30	200	0.52	250	25	25	105	0.80	150
0.82	25	15	75	2.10	35	25	25	100	1.00	150	25.2	30	180	0.61	200	25	25	100	0.90	150
1.0	10	30	70	0.60	25	10	45	75	0.40	50	7.96	30	150	0.75	150	10	45	75	0.40	100
1.2	10	30	60	0.80	25	10	45	65	0.50	50	7.96	30	140	0.87	120	10	45	65	0.50	100
1.5	10	30	55	0.80	25	10	45	60	0.50	50	7.96	30	130	1.00	110	10	45	60	0.50	50
1.8	10	30	50	0.95	25	10	45	55	0.60	50	7.96	30	120	1.10	100	10	45	55	0.50	50
2.2	10	30	45	1.15	15	10	45	50	0.65	30	7.96	30	105	1.30	100	10	45	50	0.60	50
2.7	10	30	40	1.35	15	10	45	45	0.75	30	7.96	30	90	1.40	100	10	45	45	0.60	50
3.3	10	30	38	1.55	15	10	45	41	0.80	30	7.96	30	80	1.60	80	10	45	41	0.70	50
3.9	10	30	36	1.70	15	10	45	38	0.90	30	7.96	30	75	1.70	80	10	45	38	0.80	50
4.7	10	30	33	2.10	15	10	45	35	1.00	30	7.96	30	70	1.90	80	10	45	35	0.90	50
5.6	4.0	30	22	1.55	15	4.0	45	32	0.90	15	7.96	30	60	2.20	80	4.0	50	32	0.70	25
6.8	4.0	30	20	1.70	15	4.0	45	29	1.00	15	7.96	30	55	2.40	70	4.0	50	29	0.80	25
8.2	4.0	30	18	2.10	15	4.0	45	26	1.10	15	7.96	30	50	2.60	50	4.0	50	26	0.90	25
10	2.0	30	17	2.55	15	2.0	45	24	1.15	15	2.52	25	30	2.20	30	2.0	50	24	1.0	25
12	2.0	30	15	2.75	15	2.0	45	22	1.25	15	2.52	25	27	2.50	20	2.0	50	22	1.05	15
15	1.0	20	14	1.70	15	1.0	30	19	0.80	5	2.52	25	23	2.80	20	1.0	35	19	0.70	5.0
18	1.0	20	13	1.85	15	1.0	30	18	0.90	5	2.52	25	22	3.20	20	1.0	35	18	0.70	5.0
22	1.0	-	-	-	-	1.0	30	16	1.10	5	2.52	25	21	3.60	20	1.0	35	16	0.90	5.0
27	1.0	-	-	-	-	1.0	30	14	1.15	5	2.52	25	19	4.30	15	1.0	35	14	0.90	5.0
33	0.4	-	-	-	-	0.4	30	13	1.25	5	2.52	25	17	4.70	15	0.4	35	13	1.05	5.0

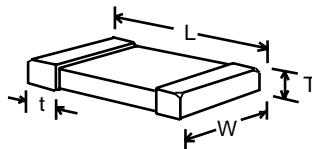

DIMENSIONS

Type MLI	L (Length)	W (Width)	T Max. (Thickness)	t (Term. Width)
0603	.063 ±.006 [1.6 ±.15]	.031±.006 [0.8 ±.15]	.037 [0.95]	.012 ±.008 [0.3 ±.2]
0805	.079 ±.008 [2.0 ±.2]	.049 ±.008 [1.25 ±.2]	.057 [1.45]	.020 ±.012 [0.5 ±.3]
1008	.098 ±.008 [2.5 ±.2]	.079 ±.008 [2.0 ±.2]	.073 [1.9]	.020 ±.012 [0.5 ±.3]
1206	.126 ±.008 [3.2 ±.2]	.063 ±.008 [1.6 ±.2]	.055 [1.4]	.020 ±.012 [0.5 ±.3]

P/N DESIGNATION:

MLI1206 - 220 - K T W

RCD Type

Induc. Code (uH): 2 signif. figures and multiplier (R10=0.1uH, 1R0=1uH, 100=10uH, 101=100uH). Below 0.1uH, use 'R' as decimal point (R01, R068, etc.)

Tolerance Code: M=20% (std<0.1uH), K=10% (std ≥.1uH), J=5%, S=±0.3nH

Packaging: B=Bulk, T=Tape & Reel (4K pcs/7" reel 0603 & 0805, 2K 1008, and 3K 1206, 10Kpc 13" reels also avail.)

Termination: W= Lead-free (100% Sn)

POWER SM INDUCTORS, UP TO 20 AMPS SHIELDED AND NON-SHIELDED



RESISTORS • CAPACITORS • COILS • DELAY LINES

HI SERIES



Term.W
is Pb-free
and RoHS
compliant



- High current in small SM package
- Cost effective
- Low DC resistance, high power-to-size ratio

OPTIONS

- Option S: electro-magnetic shield
- Military screening, intermediate values, testing at operating frequency, expanded inductance range, etc.

RCD's HI Series represents the ultimate in low cost power inductors. Constructed from high-performance materials optimized for power surface mount applications, and designed to satisfy a wide variety of applications including board mounted DC-DC converters, mini power supplies, voltage multiplying circuits, and a host of power applications where space is at a premium. A wide range of made-to-order sizes are available in shielded and non-shielded versions including super low-profile models (HI330 & HI500 are the most popular sizes).

HI330 & HI330S DIMENSIONS

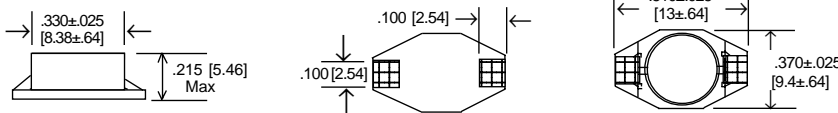

Suggested Mounting

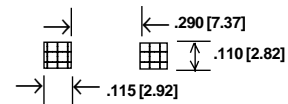

HI500 & HI500S DIMENSIONS

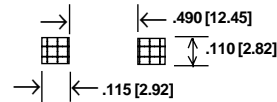
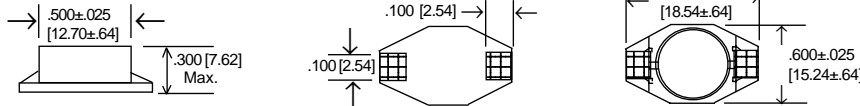

HI330 SPECIFICATIONS

RCD P/N	Inductance (μH)	DCR (Ω , typ)	SRF (MHz typ)	Isat (A)	Irms (A)
HI330-1R0	1.0	.008	130	9.0	6.8
HI330-1R5	1.5	.009	90	8.0	6.4
HI330-2R2	2.2	.010	65	7.0	6.1
HI330-3R3	3.3	.013	50	6.4	5.4
HI330-4R7	4.7	.016	45	5.4	4.8
HI330-6R8	6.8	.019	35	4.6	4.4
HI330-100	10	.025	35	3.8	3.9
HI330-150	15	.040	23	3.0	3.1
HI330-220	22	.050	18	2.6	2.7
HI330-330	33	.088	15	2.0	2.1
HI330-470	47	.12	12	1.6	1.8
HI330-680	68	.16	10	1.4	1.5
HI330-101	100	.23	8	1.2	1.3
HI330-151	150	.33	6	1.0	1.0
HI330-221	220	.53	5	.8	.8
HI330-331	330	.81	4	.6	.6
HI330-471	470	1.1	3.5	.5	.5
HI330-681	680	1.6	3	.4	.4
HI330-102	1000	2.15	2	.3	.3

HI500 SPECIFICATIONS

RCD P/N	Inductance (μH)	DCR (Ω , typ)	SRF (MHz typ)	Isat (A)	Irms (A)
HI500-1R0	1.0	.007	80	20	8.6
HI500-2R2	2.2	.009	80	16	7.1
HI500-3R3	3.3	.011	60	14	6.2
HI500-6R8	6.8	.016	40	12	5.3
HI500-100	10	.025	30	10	4.3
HI500-150	15	.035	22	8	4.0
HI500-220	22	.047	20	7	3.5
HI500-330	33	.066	15	5.5	3.0
HI500-470	47	.086	9	4.5	2.6
HI500-680	68	.13	8	3.5	2.3
HI500-101	100	.19	7	3	1.8
HI500-151	150	.25	6	2.6	1.5
HI500-221	220	.38	5	2.4	1.2
HI500-331	330	.56	4	1.9	1.0
HI500-471	470	.85	3	1.4	.82
HI500-681	680	1.1	2.5	1.2	.72
HI500-102	1000	1.8	2	1.0	.56

HI330S SHIELDED SPECIFICATIONS

RCD P/N	Inductance (μH)	DCR (Ω , typ)	SRF (MHz typ)	Isat (A)	Irms (A)
HI330S-1R0	1.0	.011	140	5.6	5.0
HI330S-1R5	1.5	.016	120	5.2	4.5
HI330S-2R2	2.2	.024	80	5.0	3.8
HI330S-3R3	3.3	.034	70	3.9	3.3
HI330S-4R7	4.7	.044	40	3.2	2.7
HI330S-6R8	6.8	.068	38	2.8	2.2
HI330S-100	10	.091	35	2.4	2.0
HI330S-150	15	.150	25	2.0	1.5
HI330S-220	22	.207	19	1.6	1.3
HI330S-330	33	.334	15	1.4	1.1
HI330S-470	47	.472	13	1.0	0.8

HI500S SHIELDED SPECIFICATIONS

RCD P/N	Inductance (μH)	DCR (Ω , typ)	SRF (MHz typ)	Isat (A)	Irms (A)
HI500S-100	10.0	.040	30	8.0	3.9
HI500S-150	15.0	.048	20	7.0	3.4
HI500S-220	22.0	.059	18	6.0	3.1
HI500S-330	33.0	.075	14	5.0	2.8
HI500S-470	47.0	.097	10	4.0	2.4
HI500S-680	68.0	.138	9	3.0	2.0
HI500S-101	100	.207	7	2.4	1.7
HI500S-151	150	.293	6	2.1	1.3
HI500S-221	220	.470	5	1.9	1.1
HI500S-331	330	.780	4	1.1	0.86
HI500S-471	470	1.08	3	1.1	0.73
HI500S-681	680	1.40	2.5	0.96	0.64
HI500S-102	1000	2.01	2	0.80	0.53

TYPICAL PERFORMANCE CHARACTERISTICS

Temperature Rise	40°C at I _{rms}
Rated Current (Isat)	-10% Typ.
Operating Temp. Range	-40°C to +125°C
Current Derating	2.5%/°C above 85°C
Resistance to Solder Heat	260°C, 10 Seconds
Test Condition	25°C, 100KHz, 0.1Vrms

P/N DESIGNATION:

HI330 □ - **101** - **M** **T** **W**
RCD Type _____
Options: S= Shielded (leave blank if standard) _____
3-Digit Inductance Value Code: (2 signif. digits & multiplier) 1R0= 1μH, 100=10μH, 101=100μH, 102=1000μH
Tolerance: M=20%, K=10% _____
Packaging: B=Bulk, T=Tape & Reel _____
Termination: W= Lead-free, Q= Tin/Lead (leave blank if either is acceptable) _____

SURFACE MOUNT POWER INDUCTORS

PIC SERIES



Term.W is
RoHS
compliant
& 260°C
compatible



RESISTORS+CAPACITORS+COILS+DELAY LINES

- Industry's widest range and lowest cost!
- 0.68μH to 2200μH, 0.18A to 3.5A

OPTIONS

- Option ER¹: Military Screening
- Numerous design modifications are available including high frequency testing, shielded, increased current and temperature ratings, non-standard inductance values, custom marking, etc.

Series PIC inductors were developed to provide high current capability in an economical surface mount design. The cylindrical geometry enables a wide range of values with excellent high frequency performance. Construction is wirewound and utilizes a ferrite core. Units are marked with inductance value. Applications include noise filtering, DC/DC converters, telecom, power supplies, switching regulators, etc. Custom models available.

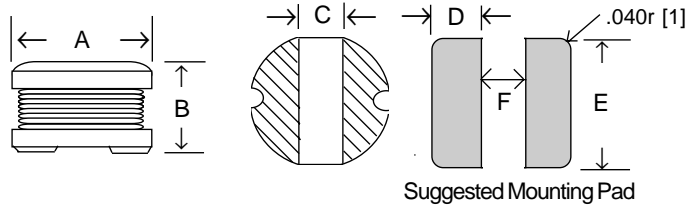

Type	A (Max)	B (Max)	C (Typ)	D	E	F
PIC1	.189 [4.8]	.138 [3.5]	.060 [1.5]	.070 [1.75]	.177 [4.5]	.060 [1.5]
PIC2	.240 [6.1]	.193 [4.9]	.070 [1.8]	.085 [2.15]	.225 [5.7]	.067 [1.7]
PIC3	.319 [8.1]	.157 [4.0]	.083 [2.1]	.120 [3.0]	.307 [7.8]	.080 [2]
PIC4	.319 [8.1]	.216 [5.5]	.083 [2.1]	.120 [3.0]	.307 [7.8]	.080 [2]
PIC5	.405 [10.3]	.177 [4.5]	.083 [2.1]	.150 [3.75]	.394 [10]	.100 [2.5]
PIC6	.409 [10.4]	.228 [5.8]	.083 [2.1]	.150 [3.75]	.394 [10]	.100 [2.5]
PIC7 ²	.433 [11]	.295 [7.5]	.083 [2.1]	.160 [4.0]	.420 [10.7]	.110 [2.8]

Induc. Value (μH) & Std. Tol.	PIC1 Current Rating/DC Max. Resis	PIC2 Current Rating/DC Max. Resis	PIC3 Current Rating/DC Max. Resis	PIC4 Current Rating/DC Max. Resis	PIC5 Current Rating/DC Max. Resis	PIC6 Current Rating/DC Max. Resis	PIC7 ² Current Rating/DC Max. Resis
.68 ±20%	2.60A/ .045Ω	Consult RCD	Consult RCD	Consult RCD	Consult RCD	Consult RCD	Consult RCD
1.0 ±20%	2.56A/ .049Ω	"	"	"	"	"	"
1.4 ±20%	2.52A/ .057Ω	"	"	"	"	"	"
1.8 ±20%	1.95A/ .064Ω	"	"	"	"	"	"
2.2 ±20%	1.75A/ .072Ω	2.20A/ .054Ω	"	"	"	"	"
2.7 ±20%	1.58A/ .079Ω	2.10A/ .057Ω	"	"	"	"	"
3.3 ±20%	1.44A/ .087Ω	2.00A/ .060Ω	"	"	"	"	"
3.9 ±20%	1.33A/ .094Ω	1.90A/ .065Ω	"	"	"	"	"
4.7 ±20%	1.15A/ .109Ω	1.80A/ .070Ω	1.78A/ .054Ω	"	"	"	"
5.6 ±20%	1.10A/ .126Ω	1.70A/ .075Ω	1.68A/ .060Ω	"	"	"	"
6.8 ±20%	1.08A/ .132Ω	1.60A/ .080Ω	1.58A/ .067Ω	2.7A/ 0.05Ω	"	"	"
8.2 ±20%	1.05A/ .147Ω	1.50A/ .090Ω	1.48A/ .074Ω	2.5A/ 0.06Ω	2.60A/ 0.04Ω	"	"
10 ±20%	1.04A/ .182Ω	1.45A/ 0.10Ω	1.44A/ 0.08Ω	2.3A/ 0.07Ω	2.38A/ 0.05Ω	2.60A/ 0.06Ω	3.50A/ 0.06Ω
12 ±20%	0.97A/ .210Ω	1.40A/ 0.12Ω	1.39A/ 0.09Ω	2.0A/ 0.08Ω	2.13A/ 0.06Ω	2.45A/ 0.07Ω	3.40A/ 0.07Ω
15 ±20%	0.85A/ .235Ω	1.30A/ 0.14Ω	1.24A/ 0.10Ω	1.8A/ 0.09Ω	1.87A/ 0.07Ω	2.27A/ 0.08Ω	3.10A/ 0.08Ω
18 ±20%	0.74A/ .338Ω	1.25A/ 0.15Ω	1.12A/ 0.11Ω	1.6A/ 0.10Ω	1.73A/ 0.08Ω	2.15A/ 0.09Ω	3.00A/ 0.09Ω
22 ±20%	0.68A/ .378Ω	1.11A/ 0.19Ω	1.07A/ 0.13Ω	1.5A/ 0.11Ω	1.60A/ 0.09Ω	1.95A/ 0.10Ω	2.60A/ 0.10Ω
27 ±20%	0.62A/ .52Ω	1.00A/ .22Ω	0.94A/ .15Ω	1.3A/ .12Ω	1.44A/ .10Ω	1.76A/ .11Ω	2.40A/ .11Ω
33 ±10%	0.56A/ .54Ω	0.88A/ .25Ω	0.85A/ .17Ω	1.2A/ .14Ω	1.26A/ .12Ω	1.50A/ .12Ω	2.30A/ .12Ω
39 ±10%	0.52A/ .59Ω	0.80A/ .32Ω	0.74A/ .22Ω	1.1A/ .16Ω	1.20A/ .15Ω	1.37A/ .14Ω	2.10A/ .14Ω
47 ±10%	0.44A/ .84Ω	0.72A/ .37Ω	0.68A/ .25Ω	1.0A/ .20Ω	1.10A/ .17Ω	1.28A/ .17Ω	1.95A/ .17Ω
56 ±10%	0.42A/ .94Ω	0.68A/ .42Ω	0.64A/ .28Ω	.94A/ .24Ω	1.00A/ .20Ω	1.17A/ .19Ω	1.85A/ .19Ω
68 ±10%	0.37A/ 1.12Ω	0.62A/ .52Ω	0.59A/ .33Ω	.85A/ .28Ω	.91A/ .22Ω	1.11A/ .22Ω	1.65A/ .22Ω
82 ±10%	0.33A/ 1.37Ω	0.58A/ .60Ω	0.54A/ .41Ω	.78A/ .37Ω	.85A/ .25Ω	1.00A/ .25Ω	1.50A/ .25Ω
100 ±10%	0.30A/ 1.66Ω	0.52A/ .70Ω	0.51A/ .48Ω	.72A/ .45Ω	.74A/ .34Ω	.97A/ .35Ω	1.40A/ .35Ω
120 ±10%	Consult RCD	0.49A/ .93Ω	0.48A/ .54Ω	.66A/ .48Ω	.69A/ .40Ω	.89A/ .40Ω	1.30A/ .40Ω
150 ±10%	"	0.41A/ 1.1Ω	0.40A/ .75Ω	.58A/ .68Ω	.61A/ .54Ω	.78A/ .47Ω	1.20A/ .47Ω
180 ±10%	"	0.38A/ 1.37Ω	0.36A/ 1.02Ω	.51A/ .77Ω	.56A/ .62Ω	.72A/ .63Ω	1.00A/ .63Ω
220 ±10%	"	0.35A/ 1.57Ω	0.31A/ 1.20Ω	.49A/ .96Ω	.53A/ .72Ω	.66A/ .73Ω	.95A/ .73Ω
270 ±10%	"	0.31A/ 1.87Ω	0.29A/ 1.31Ω	.42A/ 1.11Ω	.45A/ .95Ω	.57A/ .97Ω	.90A/ .97Ω
330 ±10%	"	0.28A/ 2.30Ω	0.28A/ 1.50Ω	.40A/ 1.26Ω	.42A/ 1.10Ω	.52A/ 1.16Ω	.80A/ 1.16Ω
390 ±10%	"	0.23A/ 3.40Ω	0.22A/ 2.47Ω	.36A/ 1.77Ω	.38A/ 1.24Ω	.48A/ 1.30Ω	.75A/ 1.30Ω
470 ±10%	"	0.20A/ 4.50Ω	0.20A/ 3.00Ω	.34A/ 1.96Ω	.35A/ 1.53Ω	.42A/ 1.48Ω	.65A/ 1.48Ω
560 ±10%	"	Consult RCD	Consult RCD	.30A/ 2.22Ω	.32A/ 1.90Ω	.33A/ 1.90Ω	.60A/ 1.90Ω
680 ±10%	"	"	"	.26A/ 2.96Ω	.25A/ 3.12Ω	.28A/ 2.25Ω	.50A/ 2.45Ω
820 ±10%	"	"	"	Consult RCD	.22A/ 4.00Ω	.24A/ 2.55Ω	.48A/ 2.55Ω
1000 ±10%	"	"	"	"	.18A/ 5.96Ω	.20A/ 3.75Ω	.46A/ 3.00Ω
1200 ±10%	"	"	"	"	Consult RCD	Consult RCD	.35A/ 3.50Ω
1500 ±10%	"	"	"	"	"	"	.32A/ 4.18Ω
2200 ±10%	"	"	"	"	"	"	.28A/ 5.46Ω

¹ Option ER Military Screening: per Mil-C-15305 (Thermal Shock -25/+85°C, DCR, Inductance, Vis./Mechanical Insp) ² Information on PIC7 is preliminary

SPECIFICATIONS

Standard Tol.: ≤27uH ±20% (10% avail), >27uH ±10% (5% avail)
 Inductance Test Frequency: 1KHz (high freq. testing avail.)
 Temperature Range: -40 to +105°C
 Temperature Rise: 20°C typical at rated current
 Derating: derate current rating by 5%/°C above 85°C
 Resistance to Soldering Heat: 260°C for 10 Sec
 Rated Current lowers inductance approximately 10%

P/N DESIGNATION:

PIC1 - **1R8** - **M** **T** **W**
 RCD Type _____
 Option Codes: ER, 63, etc (leave blank if std) _____
 Inductance (uH): 2 signif. digits & multiplier _____
 (R68=.68uH, 1R0=1uH, 100=100uH, 101=100uH, 102=1000uH)
 Tolerance Code: M=20%, W=15% K=10%, J=5% _____
 Packaging: T= Tape & Reel _____
 Termination: W= Pb-free (std), Q= SnPb (leave blank if either is acceptable) _____

MOLDED SHIELDED INDUCTORS

PF SERIES



FEATURES

- MIL-grade performance at commercial grade prices due to automated production
- Electromagnetic shield
- Performance per MIL-C15305!
- Delivery from stock**
- Tape & Reel packaging available.
- Standard inductance tolerance is $\pm 10\%$ (available to $\pm 3\%$)
- Marking is color banded or alpha numeric.

MILITARY EQUIVALENTS

MIL part numbers are given for reference only and do not imply QPL

Inductance Range	Grade	Class	MIL Standard
0.22 μ H - 0.82 μ H	1	A	MS-75087
1.0 μ H - 12 μ H	1	A	MS-75088
15 μ H - 10,000 μ H	1	A	MS-75089

DIMENSIONS

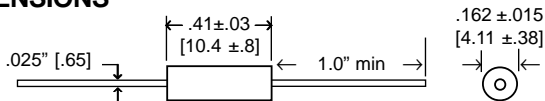

SPECIFICATIONS

Shielding	Less than 3% coupling
Temperature Range	-55 to +125°C
Insulation Resistance	1000 Megohm Min.
Dielectric Strength	1000 VAC Min.
Solderability	Per MIL-STD-202, M.208
Moisture Resistance	Per MIL-STD-202, M.106
Temp. Coef. of Inductance	+50 to +150ppm/°C Typ.
Terminal Strength	5 lb. Pull, Axial
Vibration	Per MIL-STD-202, M.204
Shock	Per-MIL-STD-202, M.205

P/N DESIGNATION:

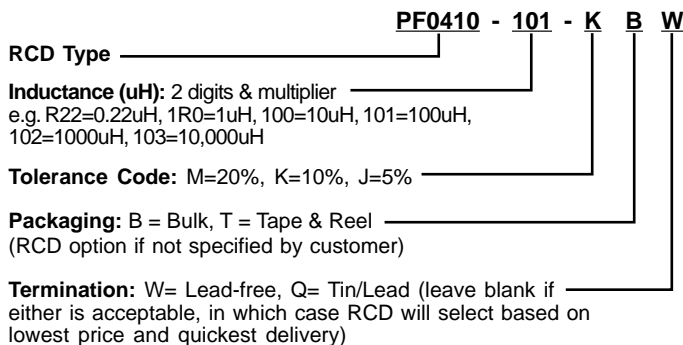

Induc. (μ H)	Q (Min.)	Test Freq. (MHz)	SRF Min. (MHz)	DCR Max. (ohm)	Rated Current (mA, DC)
0.22	49	25	250	.067	1100
0.27	47	25	250	.11	855
0.33	46	25	250	.13	780
0.39	44	25	250	.18	670
0.47	44	25	235	.25	565
0.56	43	25	210	.33	490
0.68	42	25	190	.45	420
0.82	40	25	180	.59	370
1.0	44	25	140	.07	1070
1.2	44	7.9	130	.10	895
1.5	44	7.9	115	.12	815
1.8	44	7.9	105	.14	775
2.2	44	7.9	100	.19	650
2.7	44	7.9	92	.28	535
3.3	44	7.9	85	.35	480
3.9	44	7.9	75	.40	450
4.7	44	7.9	70	.55	380
5.6	44	7.9	65	.72	335
6.8	50	7.9	55	1.02	280
8.2	50	7.9	50	1.32	250
10	50	7.9	46	1.62	220
12	55	2.5	44	2.0	200
15	45	2.5	49	.8	315
18	45	2.5	45	.89	300
22	45	2.5	41	.96	290
27	45	2.5	38	1.19	260
33	45	2.5	34	1.37	240
39	45	2.5	29	1.93	205
47	50	2.5	27	2.11	195
56	50	2.5	25	2.23	190
68	50	2.5	21	2.70	170
82	50	2.5	10.5	2.44	180
100	50	2.5	10	3.12	160
120	55	.79	9.7	3.60	150
150	55	.79	8.5	4.10	140
180	55	.79	8.0	4.40	135
220	55	.79	7.5	5.00	125
270	55	.79	7.0	5.80	115
330	55	.79	6.5	6.40	110
390	60	.79	6.2	7.40	105
470	60	.79	5.7	9.50	92
560	60	.79	4.7	10.5	90
680	60	.79	4.5	11.8	80
820	60	.79	4.2	13.0	80
1000	60	.79	3.8	17.5	70
1200	45	.25	1.5	22.1	60
1500	45	.25	1.2	26.5	55
1800	45	.25	1.0	29.9	50
2200	45	.25	.97	33.8	50
2700	45	.25	.92	47.3	40
3300	45	.25	.84	53.0	40
3900	45	.25	.80	73.8	35
4700	45	.25	.74	81.6	31
5600	44	.25	.73	96.9	28
6800	40	.25	.66	111	27
8200	40	.25	.54	119	26
10,000	40	.25	.47	137	24

*Consult factory for non-standard values from 0.1 μ H to 100mH

FLAT RADIAL LEAD INDUCTOR COILS

FRL SERIES



- Narrow size for densely populated boards
- Low cost
- High Q, high current
- 0.82μH to 10mH

OPTIONS

- Option ER: Military Screening: per MIL-C-15305 (Thermal Shock -25/+85°, DCR, Inductance, Vis/Mech Insp)
- Option A: units marked with inductance value
- Option 55: 1KHz Test Frequency
- Non-standard values, increased current, increased temp.
- Encapsulated version



RCD's FRL Series is an economical inductor with a space-saving flat coil design. The unique characteristics of the rectangular geometry enable a wide range of inductance and high Q levels for use at high frequencies. Construction is open-frame wirewound utilizing a ferrite core.

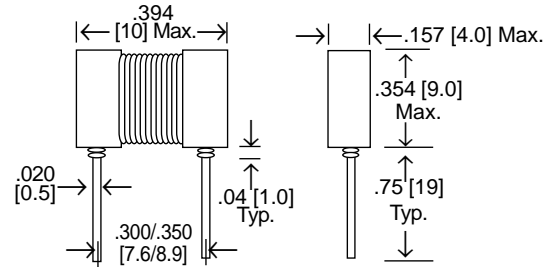

Inductance Value (μH)	Test Frequency (MHz)	Q (Min.)	DCR Max. (Ω)	Rated DC Current (Amp)
0.82	25	37	.010	7.4
1.0	7.9	40	.011	7.0
1.2	7.9	39	.012	6.0
1.5	7.9	33	.014	5.0
1.8	7.9	37	.020	4.8
2.2	7.9	38	.025	4.4
2.5	7.9	40	.030	4.1
2.7	7.9	43	.028	4.0
3.3	7.9	35	.036	3.7
3.9	7.9	37	.048	3.4
4.7	7.9	37	.053	3.2
5.0	7.9	40	.080	2.9
5.6	7.9	35	.092	2.8
6.8	7.9	29	.113	2.6
7.5	7.9	30	.114	2.5
8.2	7.9	32	.116	2.2
10	7.9	40	.160	2.1
12	2.5	40	.140	2.0
15	2.5	40	.158	1.6
18	2.5	40	.180	1.5
22	2.5	40	.230	1.4
27	2.5	50	.285	1.3
33	2.5	45	.346	1.2
39	2.5	45	.371	1.1
47	2.5	45	.502	1.0
56	2.5	40	.687	.95
68	2.5	40	.888	.90
75	2.5	40	1.19	.86
82	2.5	50	1.20	.85

Inductance Value (μH)	Test Frequency (MHz)	Q (Min.)	DCR Max. (Ω)	Rated DC Current (Amp)
100	2.5	60	1.60	.75
120	.79	70	1.72	.65
150	.79	60	1.95	.60
180	.79	70	2.07	.58
220	.79	50	2.18	.49
250	.79	40	2.70	.49
270	.79	50	2.53	.45
330	.79	50	3.33	.41
390	.79	45	3.45	.39
470	.79	40	5.20	.35
500	.79	35	5.30	.34
560	.79	40	5.40	.32
680	.79	45	5.90	.29
750	.79	30	6.00	.28
820	.79	40	6.32	.27
1000	.79	40	8.60	.22
1200	.25	70	10.0	.21
1500	.25	62	14.3	.19
1800	.25	62	15.8	.17
2200	.25	60	17.7	.15
2500	.25	60	18.0	.14
2700	.25	60	19.3	.14
3300	.25	50	21.7	.13
3900	.25	50	26.0	.12
4700	.25	50	29.9	.11
5000	.25	45	31.0	.10
6000	.25	35	41.0	.09
7500	.25	25	50.0	.08
10000	.25	25	70.0	.07

SPECIFICATIONS

Tolerance: ±10% standard (±5% and ±20% available)
 Temperature Range: -40 to +105° C
 Temperature Rise: 20° C typ. at full rated current

APPLICATIONS: Typical applications include noise filtering, DC/DC converters, switching regulators, audio equipment, telecom, RF circuits, audio filters, hash filters, power supplies, power amplifiers, etc. Customized models available for specific applications (consult factory).

P/N DESIGNATION:

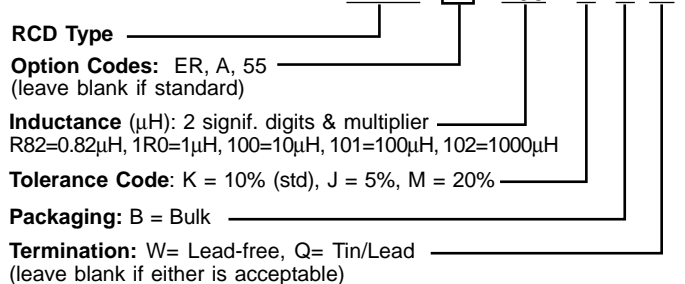

HIGH CURRENT POWER CHOKES

HL SERIES



- Low price, wide selection, 2.7μH to 100,000μH, up to 15.5A
- Option ER Military Screening: per MIL-PRF-15305 Grp.A
- Non-standard values & sizes, increased current & temp., inductance measured at high freq., cut & formed leads, etc.

HL chokes are specifically designed for high current applications. The use of high saturation cores and flame retardant shrink tubing makes them ideal for switching power supply circuits.

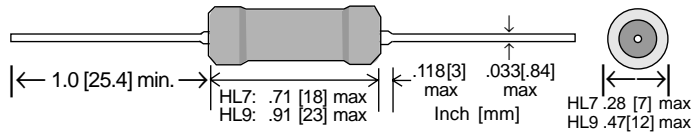

SERIES HL7

Inductance Value (μH)	DCR (Max@20°C)	DC Saturation Current (A)	Rated Current (A)	SRF (MHz, Typ)
2.7	.016	7.9	1.6	39
3.9	.019	7.3	1.3	32
4.7	.022	6.3	1.3	36
5.6	.024	5.6	1.3	25
6.8	.026	5.3	1.3	25
8.2	.028	4.5	1.3	21
10	.033	4.1	1.3	17
12	.037	3.6	1.3	15
15	.040	3.3	1.3	12
18	.044	3.0	1.3	11
22	.050	2.7	1.3	10
27	.058	2.5	1.3	7
33	.075	2.2	1.0	6.8
39	.094	2.0	.80	5.7
47	.10	1.8	.80	4.8
56	.13	1.7	.80	4.4
68	.14	1.5	.80	3.8
82	.15	1.4	.80	3.7
100	.21	1.2	.63	3.0
120	.28	1.1	.50	2.9
150	.34	1.0	.50	2.5
180	.36	.95	.50	2.4
220	.43	.86	.50	2.1
270	.56	.77	.40	1.9
330	.67	.70	.40	1.8
390	.77	.64	.40	1.4
470	1.2	.59	.31	1.4
560	1.3	.54	.31	1.0
680	1.6	.49	.25	1.0
820	2.0	.44	.20	1.0
1000	2.3	.40	.20	.90
1200	2.7	.35	.20	.77
1500	3.5	.33	.15	.76
1800	4.0	.29	.15	.64
2200	4.5	.27	.15	.51
2700	5.4	.24	.12	.51
3300	6.6	.22	.12	.48
3900	8.6	.20	.10	.45
4700	9.7	.18	.10	.42
5600	14	.16	.08	.32
6800	16	.15	.08	.30
8200	21	.13	.06	.28
10000	26	.12	.05	.26
12,000	30	.11	.05	.23
15,000	43	.10	.039	.18
18,000	48	.09	.03	.18

SERIES HL9

Inductance Value (μH)	DCR (Max@20°C)	DC Saturation Current (A)	Rated Current (A)	SRF (MHz, Typ)
3.9	.007	15.5	4	34
4.7	.008	13.9	4	31
5.6	.011	12.6	4	29
6.8	.011	11.6	4	26
8.2	.013	9.89	4	23
10	.017	8.70	4	20
12	.019	8.21	4	17
15	.022	7.34	4	14
18	.023	6.64	4	11
22	.026	6.07	4	10
27	.027	5.36	4	9
33	.032	4.82	4	9
39	.033	4.36	4	8
47	.035	3.98	4	7
56	.037	3.66	3.2	6
68	.047	3.31	2.5	5
82	.060	3.10	2.0	4
100	.09	2.8	1.6	3
120	.11	2.5	1.6	3
150	.13	2.2	1.6	3
180	.15	2.0	1.6	2
220	.16	1.9	1.6	2
270	.20	1.6	1.6	2
330	.21	1.5	1.6	2
390	.28	1.4	1.6	2
470	.38	1.2	1.2	1
560	.42	1.2	1.0	1
680	.55	1.0	1.0	1
820	.66	.97	0.8	1
1000	.84	.87	0.8	1
1200	1.0	.79	0.6	1
1500	1.2	.70	0.6	.75
1800	1.6	.64	0.6	.72
2200	2.0	.58	0.5	.70
2700	2.1	.53	0.4	.65
3300	2.5	.47	0.4	.60
3900	2.7	.43	0.4	.55
4700	3.2	.39	0.4	.50
5600	3.9	.36	.32	.40
6800	5.7	.32	.25	.35
8200	6.3	.29	.25	.30
10000	7.3	.27	.25	.30
12,000	9.2	.24	.20	.30
15,000	10.5	.21	.20	.30
18,000	14.8	.20	.16	.20
22,000	21.8	.18	.13	.20
27,000	22.7	.16	.13	.15
33,000	25.7	.15	.13	.15
39,000	31.8	.14	.10	.15
47,000	36.1	.12	.10	.10
56,000	40.9	.11	.10	.10
68,000	57.3	.10	.08	.10
82,000	79.3	.09	.07	.10
100,000	89.7	.08	.07	.10

SPECIFICATIONS

Test Frequency: 1KHz @0DCA
 Tolerance: ±10% standard (±5%, ±15% and ±20% available)
 Temperature Rise: 20°C typ. at full rated current
 Temp.Range: -55°C to +125°C (no load), +100°C max at rated A
 Saturation Current: lowers inductance approx. 5% (10% max)

APPLICATIONS: Typical applications include buck/boost, noise filtering, DC/DC converters, SCR & triac controls, EMI suppression, switching power circuits, audio equipment, telecom, filters, power amplifiers, etc. Designed for use with Linear Tech LT1073 & LT1173, National Semi LM2574, Unitrode UC2575. Customized models available.

P/N DESIGNATION:

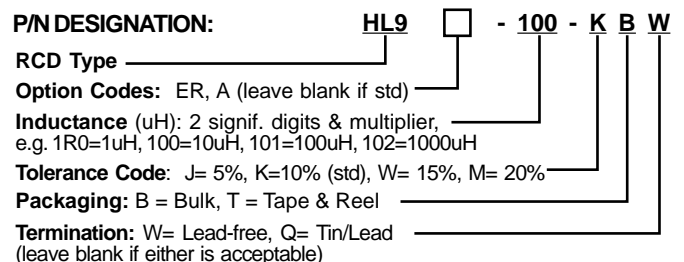

FILTER CHOKES, 1 to 25 AMP CA, CH, CV SERIES



RESISTORS • CAPACITORS • COILS • DELAY LINES

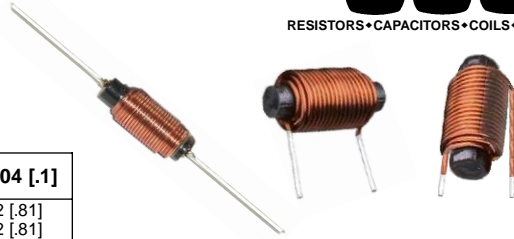

SERIES CA AXIAL LEAD SPECIFICATIONS

RCD Type	Induc. (1 KHz)	Rated DC Current	DCR, max Ω	SRF MHz, min	A (Max.)	B (Max.)	W ± 0.04 [1]
CA1	27 μ H	1A	.13	5	.400 [10.2]	.875 [22.2]	.032 [.81]
	50 μ H	1A	.17	4	.400 [10.2]	1.125 [28.6]	.032 [.81]
	100 μ H	1A	.25	2	.475 [12.1]	.875 [22.2]	.032 [.81]
	270 μ H	1A	.50	1	.475 [12.1]	.875 [22.2]	.032 [.81]
	470 μ H	1A	.56	.8	.550 [14.0]	1.125 [28.6]	.032 [.81]
680 μ H	1A	.74	.7	.550 [14.0]	1.125 [28.6]	.032 [.81]	
CA2	27 μ H	2A	.085	5.5	.475 [12.1]	1.05 [26.7]	.032 [.81]
	50 μ H	2A	.135	4	.550 [14.0]	1.125 [28.6]	.032 [.81]
	100 μ H	2A	.155	2	.550 [14.0]	1.125 [28.6]	.032 [.81]
	270 μ H	2A	.300	1	.550 [14.0]	1.125 [28.6]	.032 [.81]
CA3	5 μ H	3A	.02	25	.475 [12.1]	.875 [22.2]	.032 [.81]
	10 μ H	3A	.035	20	.475 [12.1]	.875 [22.2]	.032 [.81]
	27 μ H	3A	.07	6	.550 [14.0]	1.125 [28.6]	.032 [.81]
	50 μ H	3A	.075	4	.550 [14.0]	1.125 [28.6]	.032 [.81]
	100 μ H	3A	.125	2	.550 [14.0]	1.125 [28.6]	.032 [.81]

- Low cost 1 to 25 Amp rod-core chokes
- Non-standard values and sizes available
- Varnish or shrink tube insulation available

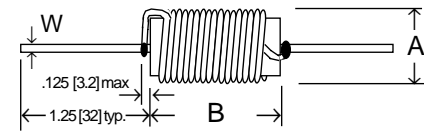

CA SERIES

SERIES CH RADIAL LEAD SPECIFICATIONS (up to 25A sizes available)

Type	Induc. (1KHz)	Rated DC Current	DCR, max Ω	SRF MHz, min	A (Max.)	B (Max.)	LS ± 0.062 [1.6]	W ± 0.04 [1]
CH3	5 μ H	3A	.015	40	.625 [15.9]	.875 [22.2]	.500 [12.7]	.040 [1]
	10 μ H	3A	.018	25	.625 [15.9]	1.125 [28.6]	.687 [17.4]	.040 [1]
	27 μ H	3A	.035	8	.812 [20.6]	.875 [22.2]	.437 [11.1]	.040 [1]
	50 μ H	3A	.050	5	.812 [20.6]	1.125 [28.6]	.750 [19.1]	.040 [1]
	100 μ H	3A	.065	2.5	.812 [20.6]	1.375 [34.9]	.937 [23.8]	.040 [1]
	150 μ H	3A	.075	2	.812 [20.6]	1.375 [34.9]	1.062 [27]	.040 [1]
	270 μ H	3A	.095	1	.812 [20.6]	1.625 [41.3]	1.312 [33.3]	.040 [1]
CH5	5 μ H	5A	.012	30	.640 [16.3]	.875 [22.2]	.750 [19.1]	.054 [1.4]
	10 μ H	5A	.015	20	.640 [16.3]	1.125 [28.6]	1.000 [25.4]	.054 [1.4]
	27 μ H	5A	.025	7	.640 [16.3]	.875 [22.2]	.562 [14.3]	.054 [1.4]
	50 μ H	5A	.030	4	.875 [22.2]	1.125 [28.6]	.750 [19.1]	.054 [1.4]
	68 μ H	5A	.035	3.5	.875 [22.2]	1.125 [28.6]	.875 [22.2]	.054 [1.4]
	100 μ H	5A	.050	2.5	.875 [22.2]	1.375 [34.9]	1.000 [25.4]	.054 [1.4]
	150 μ H	5A	.060	2	.875 [22.2]	1.625 [41.3]	1.250 [31.8]	.054 [1.4]

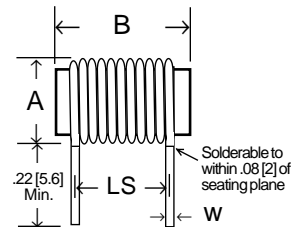

CH SERIES

SERIES CV SPECIFICATIONS

Type	Induc. (1KHz)	I SAT & IRMS (Amps)	DCR Max. (ohm)	DIMENSIONS			
				A (Max.)	B (Max.)	LS ± 0.062 [1.6]	W ± 0.04 [1]
CV10-1R0	1 μ H	10A	.003	.50 [12.7]	.75 [19.1]	.42 [10.7]	.054 [1.37]
CV25-1R0	1 μ H	25A	.002	.60 [15.2]	.68 [17.3]	.42 [10.7]	.068 [1.73]
CV10-3R3	3.3 μ H	10A	.005	.50 [12.7]	1.0 [25.4]	.42 [10.7]	.054 [1.37]
CV3-4R7	4.7 μ H	3A	.021	.51 [13.0]	.75 [19.1]	.42 [10.7]	.035 [0.89]
CV5-4R7	4.7 μ H	5A	.012	.50 [12.7]	.75 [19.1]	.42 [10.7]	.042 [1.07]
CV10-4R7	4.7 μ H	10A	.012	.50 [12.7]	1.0 [25.4]	.42 [10.7]	.054 [1.37]
CV20-4R7	4.7 μ H	20A	.004	.53 [13.5]	1.2 [30.5]	.42 [10.7]	.068 [1.73]
CV3-100	10 μ H	3A	.023	.50 [12.7]	.75 [19.1]	.42 [10.7]	.035 [0.89]
CV5-100	10 μ H	5A	.017	.50 [12.7]	.75 [19.1]	.42 [10.7]	.042 [1.07]
CV10-100	10 μ H	10A	.015	.52 [13.2]	1.0 [25.4]	.42 [10.7]	.054 [1.37]
CV20-100	10 μ H	20A	.006	.75 [19.1]	1.8 [45.7]	.60 [15.2]	.075 [1.91]
CV3-150	15 μ H	3A	.025	.50 [12.7]	1.0 [25.4]	.42 [10.7]	.035 [0.89]
CV10-150	15 μ H	10A	.020	.52 [13.2]	1.0 [25.4]	.42 [10.7]	.054 [1.37]
CV3-220	22 μ H	3A	.035	.50 [12.7]	1.0 [25.4]	.42 [10.7]	.035 [0.89]
CV5-220	22 μ H	5A	.023	.50 [12.7]	1.0 [25.4]	.42 [10.7]	.042 [1.07]
CV10-220	22 μ H	10A	.015	.66 [16.8]	1.3 [33.0]	.42 [10.7]	.060 [1.52]
CV5-270	27 μ H	5A	.024	.50 [12.7]	1.0 [25.4]	.49 [12.5]	.042 [1.07]
CV12-330	33 μ H	12A	.017	.70 [17.8]	1.3 [33.0]	.55 [14.0]	.060 [1.52]
CV3-470	47 μ H	3A	.050	.55 [14.0]	1.0 [25.4]	.42 [10.7]	.035 [0.89]
CV5-470	47 μ H	5A	.035	.65 [16.5]	1.1 [28.0]	.70 [17.8]	.042 [1.07]
CV10-470	47 μ H	10A	.022	.85 [21.6]	1.3 [33.0]	.70 [17.8]	.060 [1.52]
CV3-820	82 μ H	3A	.110	.50 [12.7]	.65 [16.5]	.375 [9.5]	.028 [0.71]
CV3-101	100 μ H	3A	.072	.55 [14.0]	1.2 [30.5]	.70 [17.8]	.035 [0.89]
CV5-101	100 μ H	5A	.055	.65 [16.5]	1.3 [33.0]	.70 [17.8]	.042 [1.07]
CV3-151	150 μ H	3A	.140	.60 [15.2]	1.2 [30.5]	.43 [10.9]	.028 [0.71]
CV5-151	150 μ H	5A	.065	.65 [16.5]	1.3 [33.0]	.70 [17.8]	.042 [1.07]
CV3-221	220 μ H	3A	.210	.55 [14.0]	1.2 [30.5]	.42 [10.7]	.025 [0.64]
CV10-271	270 μ H	10A	.160	1.1 [28.0]	1.0 [25.4]	.72 [18.3]	.038 [0.97]
CV3-391	390 μ H	3A	.250	1.1 [28.0]	1.0 [25.4]	.72 [18.3]	.035 [0.89]
CV5-391	390 μ H	5A	.190	1.1 [28.0]	1.0 [25.4]	.72 [18.3]	.038 [0.97]

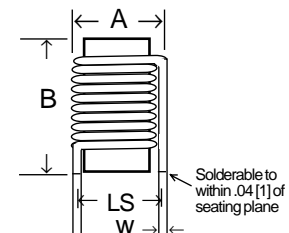

CV SERIES

P/N DESIGNATION: CA3 - 101 - K B W

- RCD Type** CA3
- Inductance (uH)** 101 (2 signif. figures & multiplier (5R0=5uH, 100=10uH, 271=270uH, etc.))
- Tolerance Code:** K=10% (std), 5% (J) avail.
- Packaging:** B = Bulk
- Termination:** W = Lead-free (standard), Q = Tin/Lead (leave blank if either is acceptable)

CUSTOM INDUCTIVE PRODUCTS

Exceptional cost savings resulting from automated offshore production!

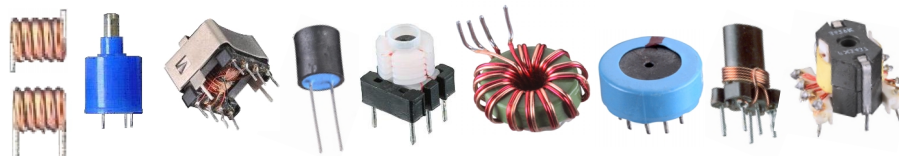

- Air coils (round & flat wire, leaded or SMD)
- Spark Coil Transformers
- High value inductors (1.0mH to 2H)
- Toroids (1/8" to 2" dia.)
- Wide band chokes and bead cores
- Variable coils (shielded, unshielded, smd)
- Pot core assemblies
- Pulse and miniature transformers
- Hash chokes, Bobbin-wound coils
- Trigger and Telecom transformers

ISOLATION TRANSFORMERS

SERIES 'LE' LAN-ETHERNET APPLICATIONS

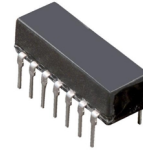

- Economical
- Low leakage inductance and interwinding capacitance
- Fast rise time: 3nSec typical
- Low profile 16-pin DIP (14-pin available)
- Surface mount design available
- Choice of turns ratio, 1:1 or 2:1

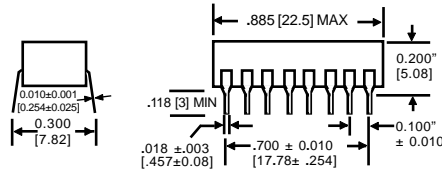
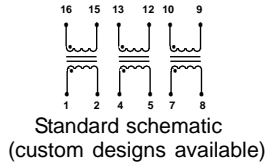

RCD Type	Turns Ratio (±5%)	Primary Induc. (±20%)	Primary ET Constant (V-µS Min.)	DCR (Max.)	
				PRI	SEC
LE1-20	1:1	20µH	1:5	0.3Ω	0.3Ω
LE1-35	1:1	35µH	2:1	0.3Ω	0.3Ω
LE1-50	1:1	50µH	2:1	0.3Ω	0.3Ω
LE1-75	1:1	75µH	2:1	0.3Ω	0.3Ω
LE1-100	1:1	100µH	2:1	0.35Ω	0.35Ω
LE1-200	1:1	200µH	3:0	0.45Ω	0.45Ω
LE2-20	2:1	20µH	1:5	0.3Ω	0.15Ω
LE2-50	2:1	50µH	2:1	0.3Ω	0.15Ω
LE2-100	2:1	100µH	2:5	0.35Ω	0.18Ω
LE2-200	2:1	200µH	3:0	0.45Ω	0.23Ω

SERIES 'ST' PULSE-TRANSFORMERS

- Low cost
- Industry's widest selection
- Excellent for providing interfacing for starlan configurations, digital and data processing, line coupling matching, and Token Ring isolation
- Custom schematics available
- Wide inductance range: 10µH to 5000µH
- Wide choice of Turns Ratio: 1:1, 2:1, 1:1:1, 2:1:1, 3:1:1, 4:2:1, etc.

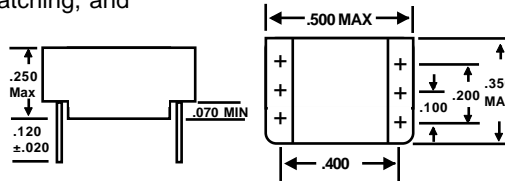

STANDARD CONFIGURATIONS

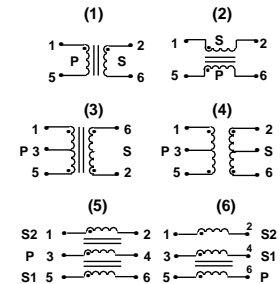

PROGRAMMABLE DELAY LINES

(Consult factory for detailed data sheets)

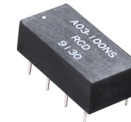

SERIES 'TT' TTL PROGRAMMABLE

TT3 3 BIT

- Total delay times from 14nS to 287nS
- Incremental delays of 1nS to 40nS
- 7nS zero step delay
- 16-pin DIP package

TT4 4 BIT

- Total delay times from 30nS to 165nS
- Incremental delays of 1nS to 10nS
- 15nS zero step delay
- 32-pin DIP package

TT6 6 BIT

- Total delay times from 83nS to 650nS.
- Incremental delays of 1nS to 10nS.
- 20nS zero step delay
- 48-pin DIP package

TT8 8 BIT

- Total delay times from 275nS to 1040nS
- Incremental delays of 1nS to 4nS
- 20nS zero step delay
- 64-pin DIP package

SERIES 'EC' ECL 10K PROGRAMMABLE

EC3 3 BIT

- Total delay times from 7nS to 70nS
- Incremental delays of 1nS to 10nS
- 3nS zero step delay
- 16-pin DIP package

EC4 4 BIT

- Total delay times from 15nS to 150nS
- Incremental delays of 1nS to 10nS
- 10nS zero step delay
- 32-pin DIP package

EC6 6 BIT

- Total delay times from 63nS to 323nS
- Incremental delays of 1nS to 5nS
- 8nS zero step delay
- 48-pin DIP package

EC8 8 BIT

- Total delay times from 255nS to 127nS
- Incremental delays of 1nS to 5nS
- 12nS zero step delay
- 64-pin DIP package

ECL DIGITAL DELAY LINES

E10 SERIES - ECL10K INTERFACED

E100 SERIES - ECL100K INTERFACED

- Industry's widest selection! 5nS - 200nS (500nS avail.)
- Economical cost, prompt delivery
- Fast 2nSec rise time typical
- Standard 16 pin DIP on ECL 10K, 24 pin DIP on ECL 100K
- Surface mount design available
- Delay Line Application Guide available
- High-speed CMOS design available



RESISTORS • CAPACITORS • COILS • DELAY LINES



Term.W is Pb-free and RoHS compliant



TEST CONDITIONS @ 25°C

Pulse Width	2X Total Delay
Pulse Spacing	5X Total Delay
Pulse Amplitude	-1.0V provided by open emitter ECL 10K gate
Supply Voltage (VEE)	5.2 VDC ECL10K, -4.5 VDC ECL 100K
Ground (VCC)	0V

ECL10K (ECL100K) outputs connected to external pull down 100Ω (50Ω) resistor to -2V. Total Delay and Tap tolerance: ±5% or ±1nS, whichever is greater.

TYPE E105 - ECL 10K 5 TAP

Total Delay (nS)	Tap Delay (nS)
10	2
15	3
20	4
25	5
30	6
40	8
50	10
60	12
80	16
100	20

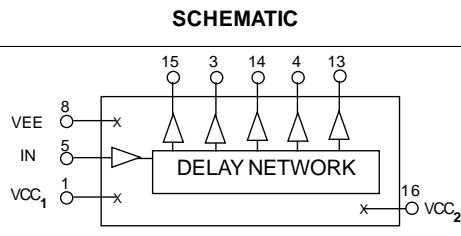

TYPE E1008 - ECL 100K 8 TAP

Total Delay (nS)	Tap Delay (nS)
8	1
16	2
24	3
32	4
40	5
48	6
56	7
64	8
72	9
80	10
160	20
200	25

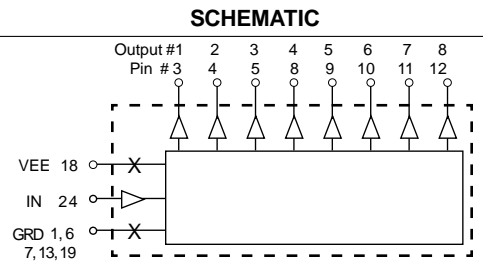

TYPE E101 - ECL 10K SINGLE OUTPUT

Delay (nS)
5
10
15
20
25
50
75
100

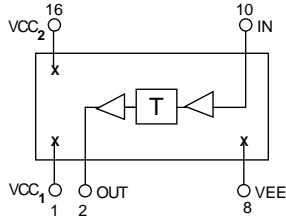

TYPE E1001 - ECL 100K SINGLE OUTPUT

Delay (nS)
5
10
15
20
25
50
75
100
150
200

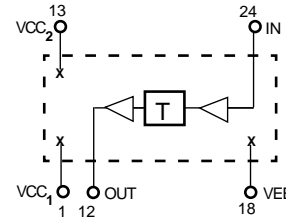

TYPE E103 - ECL10K 3 INDEPENDENT DELAYS*

Delay(nS)
5
10
15
20
25
50

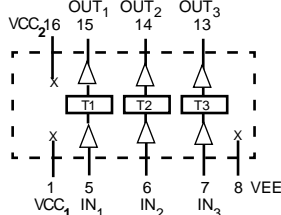

*Also available in a double delay output

TYPE E1004 - ECL100K 4 INDEPENDENT DELAYS

Delay (nS)
5
10
15
20
25
50
75
100

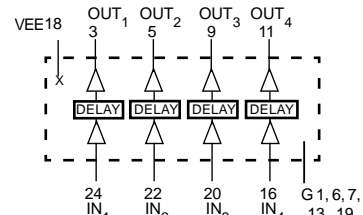

10K ECL DIMENSIONS

(unused pins may be removed)

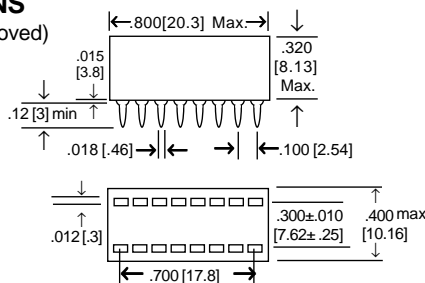

100K ECL DIMENSIONS

(unused pins may be removed)

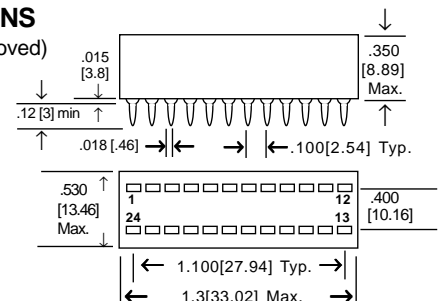

ACTIVE (DIGITAL) DELAY LINES

SINGLE, DUAL, TRIPLE, QUAD DELAYS

A0 SERIES



RESISTORS • CAPACITORS • COILS • DELAY LINES



- Economical cost, prompt delivery!
- Wide range of values, 5nS to 500nS
- TTL Schottky interfaced

OPTIONS

- Opt.T= trailing edge design
- Opt. F =fast TTL, H =HCMOS, C =FACT
- Opt.A = auto-insertable design
- Opt.39 = -40 to +85°C operating temp.
- Tighter tolerances, faster rise times
- Low power design
- Military screening

STANDARD DELAY TIMES

5nS, 10nS, 15nS, 20nS, 25nS, 50nS, 75nS, 100nS, 250nS, 500nS

Intermediate values available on special order.

SPECIFICATIONS

Operating Temp: 0 to 70°C

Delay Tol: $\pm 2nS$ or $\pm 5\%$, whichever greater

Rise Time: 4nS

Peak Soldering Temp: +230°C

CHARACTERISTICS

RCD Type	Independent Delays	Package Style	Circuit
A01	Single	14P	A
A01S	Single	8P	B
A01AG	Single	14SM	A
A01SAG	Single	8SM	B
A02A	Dual	14P	C
A02SA	Dual	8P	D
A02AG	Dual	14SM	C
A02SAG	Dual	8SM	D
A03	Triple	14P	E
A03S	Triple	8P	F
A03AG	Triple	14SM	E
A03SAG	Triple	8SM	F
A04	Quadruple	14P	G
A04AG	Quadruple	14SM	G

TEST CONDITIONS @25°C

- 1.) Input test pulse voltage: 3.2V
- 2.) Input pulse width: 50nS or 1.2x the total delay (whichever is greater)
- 3.) Input rise time: 2.0nS (0.75V to 2.4V)
- 4.) Delay measured at 1.5V on leading edge only with no loads on output (specify opt. T for trailing edge design)
- 5.) Supply Voltage (Vcc): 5V
- 6.) Pulse spacing: 2x pulse width minimum

Low cost solution for multiple timing delays in a single package!

RCD's digital delay lines have been designed to provide precise fixed delays with all the necessary drive and pick-off circuitry. All inputs and outputs are Schottky-type and require no additional components to achieve specified delays. Designed to meet the applicable environmental requirements of MIL-D-23859. Type A01 features a single fixed delay, type A02 features two isolated delays, A03 features three delays, and A04 features 4 delays (single delay SIP available). Application Guide available.

PACKAGE STYLES

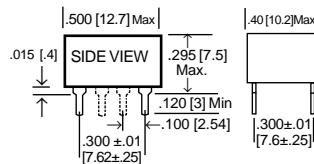

PACKAGE STYLE 8P (8-Pin DIP)

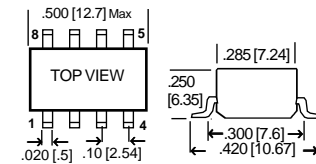

PACKAGE STYLE 8SM (8-Pin SM DIP)

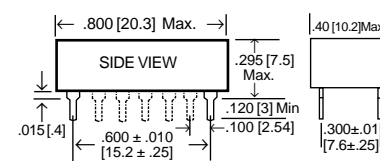

PACKAGE STYLE 14P (14-Pin DIP)

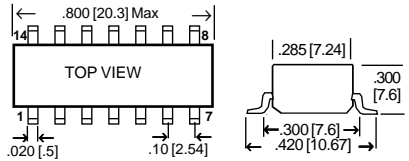

PACKAGE STYLE 14SM (14-Pin SM DIP)

CIRCUIT SCHEMATICS

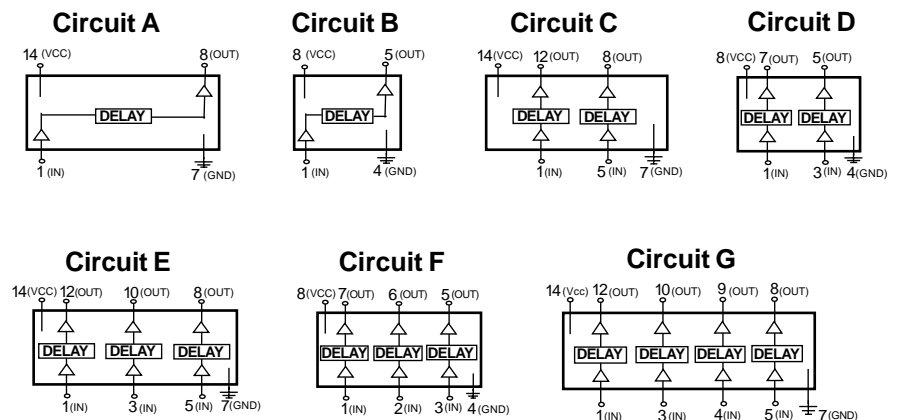

P/N DESIGNATION:

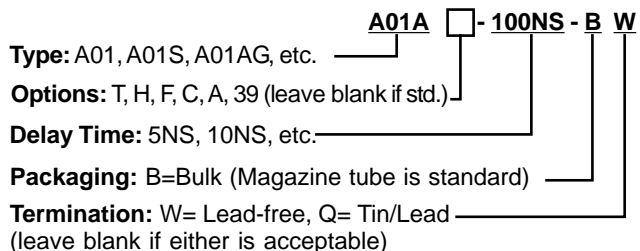

ACTIVE DELAY LINES, 5-TAP & 10-TAP THROUGH-HOLE & SURFACE MOUNT

A08 SERIES: 8-Pin DIP A14 SERIES: 14-Pin DIP SA08 SERIES: 8-Pin SIP SMA14 SERIES: 14-Pin SO



Term.W is Pb-free and RoHS compliant



- Economical cost
- A1405 popular values from stock!
- Wide selection, 20 - 1000nS
- Choice of 5 or 10 equally spaced taps
- TTL Schottky interfaced, TTL&DTL compatible

RCD's active delay lines have been designed to provide precise tap delays with all the necessary drive and pick-off circuitry. All inputs/outputs are schottky-type, requiring no additional components to achieve specified delays. Units are 100% inspected. Excellent for applications requiring high delay stability, fast rise times and no jitter, such as memory boards, disk drives, and signal processing. Application Guide available.

OPTIONS

- Opt.T= trailing edge design
- Opt.F =fast TTL, H=HCMOS, C=FACT
- Opt.A = auto-insertable design
- Opt.ER = -55 to +125°C operating temp.
- Opt.39 = -40 to +85°C operating temp.
- Tighter tolerances, faster rise times
- Military screening

TOTAL-DELAY TIMES (T_D)

20nS, **25nS**, 30nS, 40nS, **45nS**, **50nS**, **60nS**, **75nS**, **100nS**, **125nS**, **150nS**, **200nS**, **250nS**, **300nS**, 350nS, 400nS, 450nS, **500nS**, 750nS, **1000nS**

(popular values listed in bold. Intermediate and extended range values available on special order).

SPECIFICATIONS

Operating Temp: 0 to 70°C (opt.39= -40 to +85°C, opt.ER= -55 to +125°C)

Rise Time: 4nS max.

Delay Tol: ±2nS or ±5%, whichever greater

Tap Tol: ±2nS or 5%, whichever greater

Peak Soldering Temp: +230°C

CHARACTERISTICS

RCD Type	Delay Range	No. of Taps	Delay per Tap
A0805	20nS - 500nS	5	20% TD
A0805AG	20nS - 500nS	5	20% TD
A1405	20nS -1000nS	5	20% TD
A1405AG	20nS -1000nS	5	20% TD
A1410	50nS -1000nS	10	10% TD
A1410AG	50nS -1000nS	10	10% TD
SA0805	20nS - 500nS	5	20% TD
SMA1405	20nS - 250nS	5	20% TD

Most popular models are listed in boldface. A1405AG is most popular SM model, A1405 is most popular thru-hole.

TEST CONDITIONS @25°C

- 1.) Input test pulse voltage: 3.2V
- 2.) Input pulse width: 50nS or 1.2x the total delay (whichever is greater)
- 3.) Input rise time: 2.0nS (0.75V to 2.4V)
- 4.) Delay measured at 1.5V on leading edge only with no loads on output (specify opt. T for trailing edge design)
- 5.) Supply Voltage (Vcc): 5V
- 6.) Pulse spacing: 2x pulse width min.

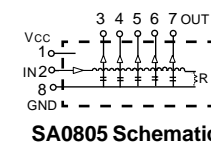
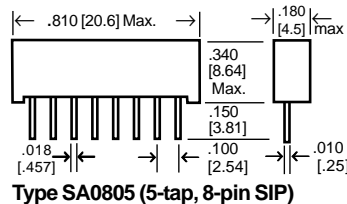
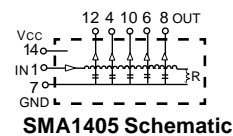
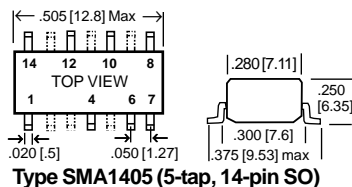
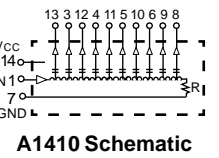
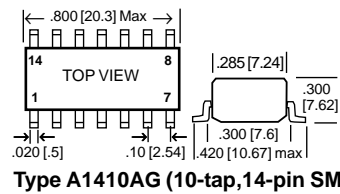
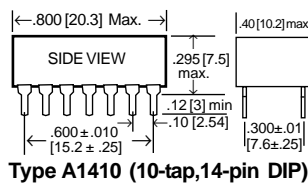
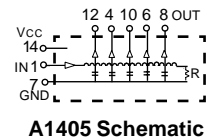
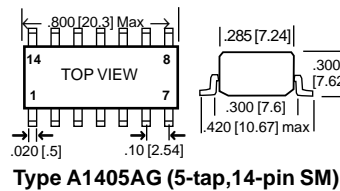
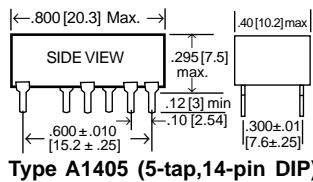
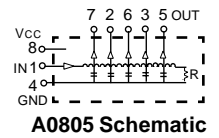
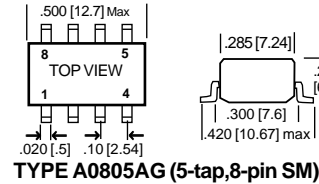
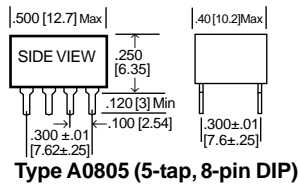

P/N DESIGNATION:

Type: A0805, A0805AG, A1405, A1405AG, A1410, A1410AG, SMA1405, SA0805

Options: T, H, F, ER, C, A, 39 (leave blank if std.)

Delay Time: 20NS, 25NS, 100NS, etc.

Packaging: B=Bulk (magazine tube std), T=Tape & Reel (SM1405 only)

Termination: W=Lead-free, Q=Tin/Lead (leave blank if either is acceptable)

A0805 - **100NS** - **B** **W**

PASSIVE SIP DELAY LINES, SINGLE OUTPUT



RESISTORS • CAPACITORS • COILS • DELAY LINES

SMP01S - 4 PIN SM

P01S - 4 PIN DIP

P01 - 14 PIN DIP & SM

S01 - 3 PIN SIP



Term. W
is Pb-free
and RoHS
compliant

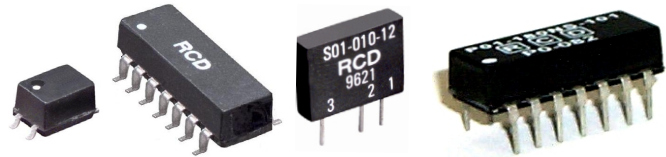

- Industry's widest range: 0.1nS to 1000nS
- Low cost, prompt delivery!
- Wide range of package styles
- Detailed application handbook available

OPTIONS

- Custom circuits, delay and/or impedance values
- MIL-D-23859 screening
- Increased operating temperature range
- Low profile package (Type P01 only)
- Tighter tolerance or temperature coefficient
- Faster rise times

RCD's passive delay lines are a lumped constant design, incorporating high-performance inductors and multilayer capacitors in a molded case ensuring stable transmission, low temperature coefficient, and excellent environmental performance.

Total Delay Tolerance	S01: $\pm 5\%$ or $\pm 0.2\text{nS}$ (whichever is greater) P01: $\pm 5\%$ or $\pm 2\text{nS}$ (whichever is greater) P01S/SMP01S: $\pm 20\%$
Temperature Coefficient	$\pm 100\text{ppm}/^\circ\text{C}$ Max.
Insulation Resistance	1000M Ω Min.
Dielectric Strength	100VDC
Distortion	$\pm 10\%$ Max.
Operating Temp. Range	0 to 70°C (Opt.39= -40 to 85°C, ER= -55 to 125°C)
Operating Freq. (BW)	BW (MHz)=.35/(Tr nS x 1000)
Attenuation: (dependent on impedance, low values have lower attenuation)	S01: 2% P01: 10nS-300nS 10% , >300nS 20% P01S/SMP01S: 20%

RCD Type	Delay Time, T _D (nS)	Max. Rise Time, T _R * (nS)	Available Impedance Values ($\pm 10\%$)
P01S & SMP01S	0.1	2.0	50 Ω or 75 Ω
	0.2	2.0	50 Ω or 75 Ω
	0.3	2.0	50 Ω or 75 Ω
	0.4	2.0	50 Ω or 75 Ω
	0.5	2.0	50 Ω or 75 Ω
	0.6	2.0	50 Ω or 75 Ω
	0.7	2.0	50 Ω or 75 Ω
	0.8	2.0	50 Ω or 75 Ω
	0.9	2.0	50 Ω or 75 Ω
	1.0	2.0	50 Ω or 75 Ω
S01	0.5	1.6	55 Ω , 93 Ω or 100 Ω
	1.0	1.6	55 Ω , 93 Ω or 100 Ω
	2.0	1.6	55 Ω , 93 Ω or 100 Ω
	3.0	1.7	55 Ω , 93 Ω or 100 Ω
	4.0	1.7	55 Ω , 93 Ω or 100 Ω
	5.0	1.8	55 Ω , 93 Ω or 100 Ω
	6.0	2.0	55 Ω , 93 Ω or 100 Ω
	7.0	2.2	55 Ω , 93 Ω or 100 Ω
	8.0	2.4	55 Ω , 93 Ω or 100 Ω
	9.0	2.6	55 Ω , 93 Ω or 100 Ω
10.0	2.8	55 Ω , 93 Ω or 100 Ω	
P01, P01A, P01G, P01AG	10	3.5	100 Ω
	20	5.5	50 Ω , 100 Ω , 200 Ω
	30	6.5	50 Ω , 100 Ω , 200 Ω
	40	8	50 Ω , 100 Ω , 200 Ω , 300 Ω
	50	10	50 Ω , 100 Ω , 200 Ω , 300 Ω , 500 Ω
	60	12	50 Ω , 100 Ω , 200 Ω , 300 Ω , 500 Ω
	75	15	50 Ω , 100 Ω , 200 Ω , 300 Ω , 500 Ω
	100	20	50 Ω , 100 Ω , 200 Ω , 300 Ω , 500 Ω
	120	24	50 Ω , 100 Ω , 200 Ω , 300 Ω , 500 Ω
	150	30	50 Ω , 100 Ω , 200 Ω , 300 Ω , 500 Ω
	180	36	50 Ω , 100 Ω , 200 Ω , 300 Ω , 500 Ω
	200	40	50 Ω , 100 Ω , 200 Ω , 300 Ω , 500 Ω
	220	44	50 Ω , 100 Ω , 200 Ω , 300 Ω , 500 Ω
	250	50	50 Ω , 100 Ω , 200 Ω , 300 Ω , 500 Ω
	300	60	50 Ω , 100 Ω , 200 Ω , 300 Ω , 500 Ω
	375	75	50 Ω , 100 Ω , 200 Ω , 300 Ω , 500 Ω
	500	100	50 Ω , 100 Ω , 200 Ω , 300 Ω , 500 Ω
600	120	50 Ω , 100 Ω , 200 Ω , 300 Ω , 500 Ω	
750	150	50 Ω , 100 Ω , 200 Ω , 300 Ω , 500 Ω	
1000	200	50 Ω , 100 Ω , 200 Ω , 300 Ω , 500 Ω	

* Faster rise times available on some models

Type P01S 4-Pin DIP, Type SMP01S 4-Pin Surface Mount

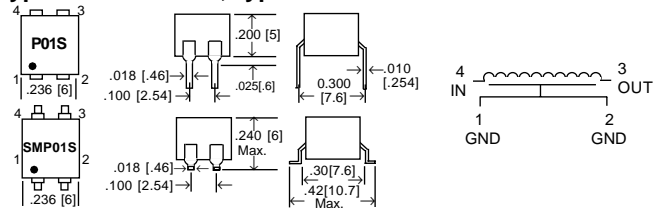

Type S01 3-Pin SIP

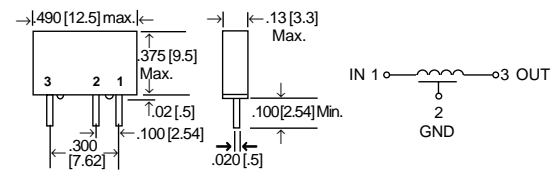

Type P01 (.300" Profile) & P01A (.200") 14-Pin DIP

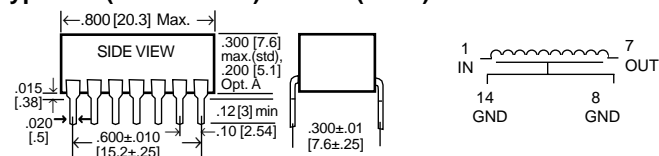

Type P01G (.300" Profile) & P01AG (.200") 14-Pin Surface Mount

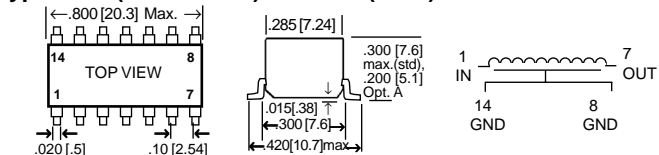

TEST CONDITIONS: Pulse width at 3x total delay, pulse input at 2.5V, delay measured at 25°C on leading edge with no loads on output. Rise time measured at 10% to 90% points.

P/N DESIGNATION:

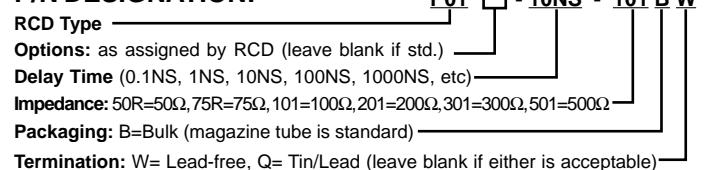

PASSIVE DELAY LINES, TAPPED, SIP PACKAGE

SP05 SERIES - 7 PIN, 5 TAP

SP10 SERIES - 14 PIN, 10 TAP



RESISTORS • CAPACITORS • COILS • DELAY LINES



Term.W is Pb-free and RoHS compliant



- Low cost, prompt delivery!
- Wide variety of values, 5nS to 750nS
- Fast rise times
- Detailed application handbook available

OPTIONS

- Custom circuits available
- Non-standard delay times & impedance values
- Tighter tolerance or temperature coefficient
- Faster rise times
- MIL-D-23859 screening
- Increased operating temperature range

RCD's SP05 and SP10 passive delay line series are a lumped constant design per applicable portions of MIL-D-23859. The units incorporate high performance inductors and multi-layer capacitors, ensuring stable transmission, low temperature coefficient, and excellent environmental performance in space-saving SIP design.

Total Delay Tolerance	±5% or ±0.5nS (whichever is greater)
Tap Delay Tolerance	±5% or ±0.5nS (whichever is greater)
Temperature Coefficient	100ppm/°C Max.
Insulation Resistance	1000MΩ min.
Dielectric Strength	100VDC
Distortion	±10% Max.
Operating Temp. Range	0 to 70°C (Opt.39= -40 to 85°C, ER= -55 to 125°C)
Operating Freq. (BW)	BW (MHz)=.35/(TR nS x 1000)
Attenuation: (dependent on impedance, low values have lower attenuation)	SP05= 2-5%, SP10=2.5-4% @50Ω, 5-8% @100Ω, 5-10% @200Ω, 5-15% @300Ω, 7-20% @500Ω

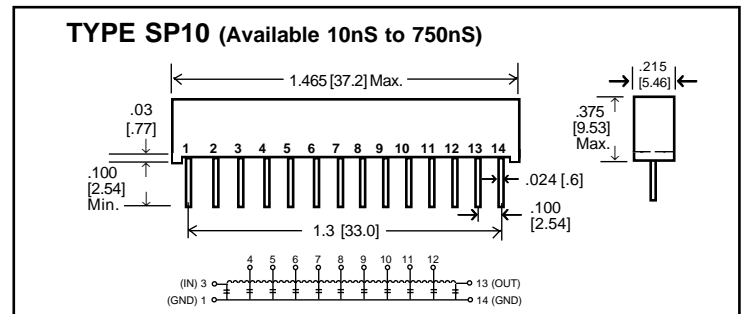
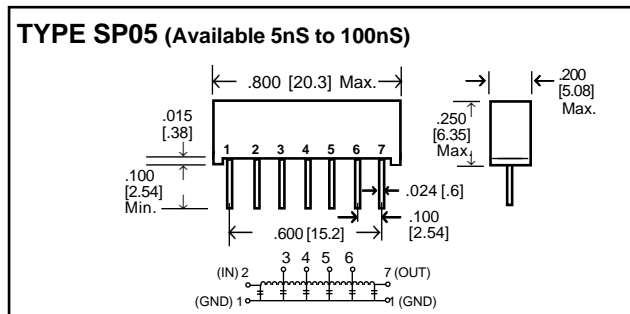

TYPE SP05, 7 PIN 5 TAPS

Total Delay, T _D (nS)	Max. Rise Time, T _R (nS)	Delay per TAP (nS)	Available Impedance Values (±10%)
5	2.0	1.0 ± .3	50Ω, 100Ω
10	3.3	2.0 ± .4	50Ω, 100Ω
20	6.0	4.0 ± .6	50Ω, 100Ω
25	7.8	5.0 ± 1	50Ω, 100Ω
30	9.0	6.0 ± 1	50Ω, 100Ω
40	12	8 ± 1.5	50Ω, 100Ω
50	15	10 ± 1.8	50Ω, 100Ω
60	18	12 ± 2	50Ω
70	22	14 ± 2	50Ω
75	23	15 ± 3	50Ω
80	24	16 ± 3	50Ω
90	27	18 ± 3	50Ω
100	28	20 ± 3	50Ω

TYPE SP10, 14 PIN 10 TAPS

Total Delay, T _D (nS)	Max. Rise Time, T _R (nS)	Delay per TAP (nS)	Available Impedance Values (±10%)
10	3	1.0 ± .5	100Ω
20	5.5	2.0 ± .75	50Ω, 100Ω, 200Ω
30	6.5	3.0 ± 1	50Ω, 100Ω, 200Ω
40	8	4.0 ± 2	50Ω, 100Ω, 200Ω, 300Ω
50	10	5.0 ± 2	50Ω, 100Ω, 200Ω, 300Ω, 500Ω
60	12	6.0 ± 2	50Ω, 100Ω, 200Ω, 300Ω, 500Ω
75	15	7.5 ± 2	50Ω, 100Ω, 200Ω, 300Ω, 500Ω
100	20	10 ± 2	50Ω, 100Ω, 200Ω, 300Ω, 500Ω
120	24	12 ± 2	50Ω, 100Ω, 200Ω, 300Ω, 500Ω
150	30	15 ± 2	50Ω, 100Ω, 200Ω, 300Ω, 500Ω
200	40	20 ± 2	50Ω, 100Ω, 200Ω, 300Ω, 500Ω
250	50	25 ± 2	50Ω, 100Ω, 200Ω, 300Ω, 500Ω
300	60	30 ± 2	100Ω, 200Ω, 300Ω, 500Ω, 100Ω,
500	100	50 ± 2.5	200Ω, 300Ω, 500Ω
600	120	60 ± 3	300Ω, 500Ω
750	150	75 ± 3.75	300Ω, 500Ω

P/N DESIGNATION:

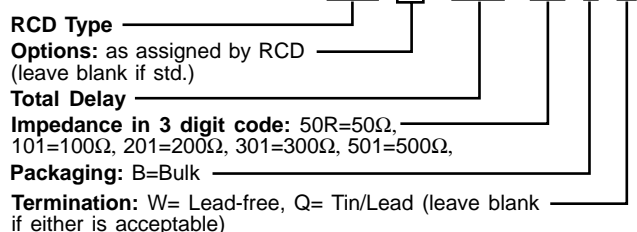

TEST CONDITIONS @25°C

- 1.) Input test pulse shall have a pulse amplitude of 2.5 volts, rise time of 2nS, and pulse width of 5X total delay.
- 2.) Delay line to be terminated to within 1% of its characteristic impedance.
- 3.) Delay time measured from 50% of input pulse to 50% of output pulse on leading edge with no loads on output.
- 4.) Rise time measured from 10% to 90% of output pulse.

DC Meter Shunts 50A to 15000A



Term.W is RoHS compliant & 260°C process compatible



RESISTORS • CAPACITORS • COILS • DELAY LINES

- Low cost and broad selection! Nearly 100 models of standard and mini-shunts available (most popular models listed below). Custom models are our specialty: 10μΩ to 10mΩ, 10mV to 1V, up to 15KAmp
- Standard models are 50 to 5000 Amp, 50mV & 100mV
- Available on **SWIFT™** delivery program
- Heavy duty brass terminal blocks
- Low TC and low thermal EMF Manganin element
- Uniform current distribution
- Stamped with current and voltage

RCD Type	Drop	Rating	Fig.	Dim. A	Dim. B	Dim. C
SPM5050	50mV	50A	1	1.18 [30]	4.72 [120]	5.12 [130]
SPM5060	50mV	60A	1	1.18 [30]	4.72 [120]	5.12 [130]
SPM5075	50mV	75A	1	1.18 [30]	4.72 [120]	5.12 [130]
SVM5050	50mV	50A	2	0.80 [20]	3.15 [80]	3.94 [100]
SVM5060	50mV	60A	2	0.80 [20]	3.15 [80]	3.94 [100]
SVM5075	50mV	75A	2	0.80 [20]	3.15 [80]	3.94 [100]
SVM50100	50mV	100A	2	1.17 [30]	3.15 [80]	3.94 [100]
SVM50150	50mV	150A	2	1.17 [30]	3.15 [80]	3.94 [100]
SVM50200	50mV	200A	2	1.17 [30]	3.15 [80]	3.94 [100]
SVM100300	100mV	300A	3	1.00 [25.4]	4.13 [105]	5.24 [133]
SVM100500	100mV	500A	3	1.75 [44.5]	4.13 [105]	5.24 [133]
SHM50300	50mV	300A	4	1.00 [25.4]	3.54 [90]	4.65 [118]
SHM50400	50mV	400A	4	1.34 [34]	3.54 [90]	4.65 [118]
SHM50500	50mV	500A	4	1.73 [44]	3.54 [90]	4.65 [118]
SHM50600	50mV	600A	4	2.12 [54]	3.54 [90]	4.65 [118]
SHM50800	50mV	800A	5	2.91 [74]	3.54 [90]	4.65 [118]
SHM501000	50mV	1000A	5	3.46 [88]	3.54 [90]	4.65 [118]
SHM501500	50mV	1500A	5	3.15 [80]	5.90 [150]	7.09 [180]
SHM502000	50mV	2000A	5	3.15 [80]	5.90 [150]	7.09 [180]
SHM503000	50mV	3000A	5	6.30 [160]	5.90 [150]	7.09 [180]
SHM504000	50mV	4000A	5	6.30 [160]	5.90 [150]	7.09 [180]
SHM505000	50mV	5000A	5	7.87 [200]	5.90 [150]	7.87 [200]

Typical Performance

Accuracy: 0.5% Std, 0.25% available

TCR: 15ppm/°C

Dielectric Strength (Fig.1 only): base panel = 1KV

Application Notes:

- 1) For reduced temperature rise, mount units with multiple resistance blades in vertical position so that the heat rises between the blades.
- 2) Number of resistance blades shown is for illustration purposes only. Actual parts may have more or less blades depending on current rating and voltage drop.
- 3) Hot spot of shunt should be maintained below 100°C via use of suitable bus bar size, positioning, and air flow. The parts should never be allowed to exceed 145°C as this would cause permanent resistance shift.
- 4) Shunts may be connected in parallel for increased current capacity (requires separate pair of millivolt leads connecting each shunt to the instrument terminals).

P/N Designation:

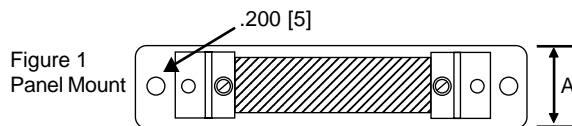
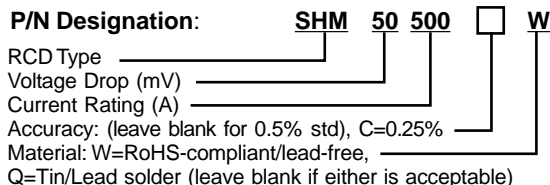

Figure 1
Panel Mount

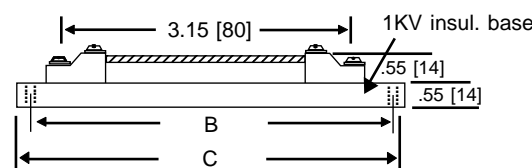

Figure 2
Vertical Mount

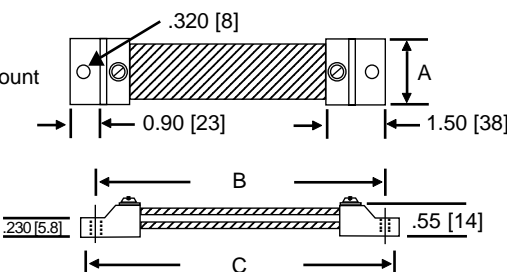

Figure 3
Vertical Mount
High Current

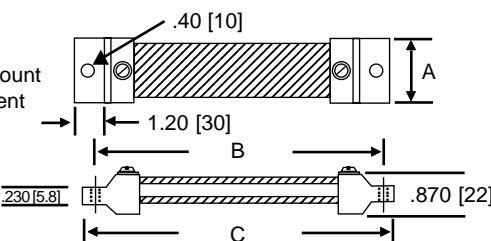

Figure 4
Horizontal Mount

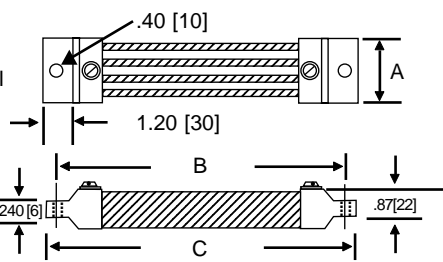

Figure 5
Horizontal Mount,
High Current

4 mounting holes, 0.40 [10] dia. on 800A & 1KA
4 mounting holes, 0.47 [12] dia. on 1500A & 2KA
6 mounting holes, 0.47 [12] dia. on 3KA & 4KA
8 mounting holes, 0.63 [16] dia. on 5KA

.87 [22] 800-1000A
3.07 [78] 1.5K-4KA
3.78 [96] 5000A

A S S E M B L Y S E R V I C E S



Low Cost Subcontract Assembly Services

RCD began offering subcontract assembly services nearly 30 years ago, long before “outsourcing” became a household word. The service started at the request of a few customers who had visited our offshore resistor plants. Upon learning of our cost advantages, they asked if we’d consider assembling their products. Since that time, we’ve been involved in contract assembly as an important value-added service to our customers. Over half of our assembly projects are specialty items, those that don’t quite “fit” with the major CEM’s, so don’t hesitate asking us to quote on uncommon projects.

Advantages

Our assembly services offer significant cost savings without the problems often associated with subcontract ventures and Maquiladoras. Projects are handled by the N.H. facility as if we were an extension of your own production plant. Our experience offers obvious advantages over the typical subcontractor...

-Engineering: our staff can assist in the design, test & troubleshooting phase of development

-Quality: Your assemblies will be given the same commitment to detail that has earned RCD an enviable reputation for highest quality products.

-Local Support: RCD’s N.H. subcontract specialists are available to coordinate the design, training, scheduling, testing, shipping, regulatory audits, customs clearance, etc. We’re immediately available in the event of a design change or quality concern.

-Manufacturing Capability: Our expertise results in a high degree of skill in areas such as high density PCB’s, micro-miniature assemblies, microwave products, cable harnesses, etc.

-Cost: With consideration of offshore labor rates and zero-defect quality, it is certain that the value of RCD’s professional service is more than competitive.

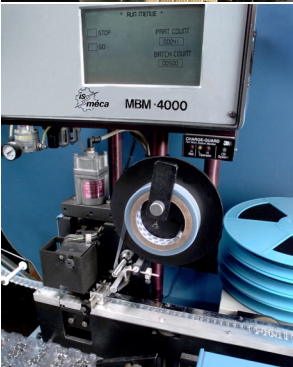

Electro-Mechanical and PCB Assembly

Offers fast entry to market with components and materials sourced by RCD (or customer supplied). Surface mount, through-hole, or mixed technologies, RoHS compatible, aqueous or vapor cleaning, CAD-design, Mil-883 QC inspection and processing.

General Assembly, Component Prep and Taping Services

Consider RCD for your component prep services including axial/radial/SM taping, lead forming, marking, and hot-solder dipping. We also provide general assembly services such as hand soldering, welding, conformal coating, potting, and encapsulation.

Laser Trimming Services

Laser trimming is available in passive or active processing, thick or thin-film resistor networks, hybrids and chips. Date coding and chip carrier scribing is also available. Statistical analysis and hard copy data provided upon request.

Custom Coil and Transformer Winding

RCD offers single layer, multilayer, perfect layer, and toroidal winding capabilities from 12 to 52 AWG. Bobbin assembly, custom marking and inspection are also available.



QUALITY SUBCONTRACT ASSEMBLY

RCD Components Inc., 520 E. Industrial Park Dr., Manchester, NH, USA 03109
Tel: 603-669-0054 Fax:603-669-5455 Email:sales@rcdcomponents.com www.rcdcomponents.com