

Digital Video Encoder

Description

The CXD1910AQ is a digital video encoder designed for set top box, digital VCRs and other digital video applications. The device accepts ITU-R601 compatible Y, Cb, Cr data, and the data are encoded to analog composite video and Y/C video (S-Video) signal.

Features

- NTSC and PAL encoding mode
- Composite video and separate Y/C video (S-Video) outputs
- Y, U, and V outputs
- 8/16-bit pixel data input mode
- 13.5 Mpps pixel rate
- 10-bit 3 channels DACs
- Supports I²C bus (400kHz) and SONY SIO
- Closed Caption (Line 21, Line 284) encoding
- Macrovision Pay-Per-View copy protection system* Rev. 6.1
- Monolithic CMOS single 5.0V power supply
- 64-pin plastic QFP package

* This device is protected by U.S. patent numbers 4631603, 4577216 and 4819098 and other intellectual property rights. Use of the Macrovision anticopy process in the device is licensed by Macrovision for non-commercial home use only. Reverse engineering or disassembly is prohibited.

64 pin QFP (Plastic)

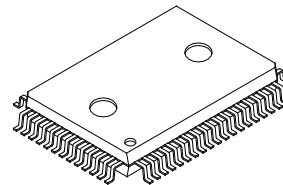

Absolute Maximum Ratings

• Supply voltage	V _{DD}	-0.3 to +7.0	V
• Input voltage	V _I	-0.3 to +7.0	V
• Output voltage	V _O	-0.3 to +7.0	V
• Operating temperature	T _{opr}	-20 to +75	°C
• Storage temperature	T _{stg}	-40 to +125	°C

(V_{SS} = 0V)

Recommended Operating Conditions

• Supply voltage	V _{DD}	4.75 to 5.25	V
• Input voltage	V _{IN}	V _{SS} to V _{DD}	V
• Operating temperature	T _{opr}	0 to +70	°C

I/O Capacitance

• Input pin	C _I	11 (Max.)	pF
• Output pin	C _O	11 (Max.)	pF

Note) Test conditions: V_{DD} = V_I = 0V
f_M = 1MHz

Sony reserves the right to change products and specifications without prior notice. This information does not convey any license by any implication or otherwise under any patents or other right. Application circuits shown, if any, are typical examples illustrating the operation of the devices. Sony cannot assume responsibility for any problems arising out of the use of these circuits.

Block Diagram

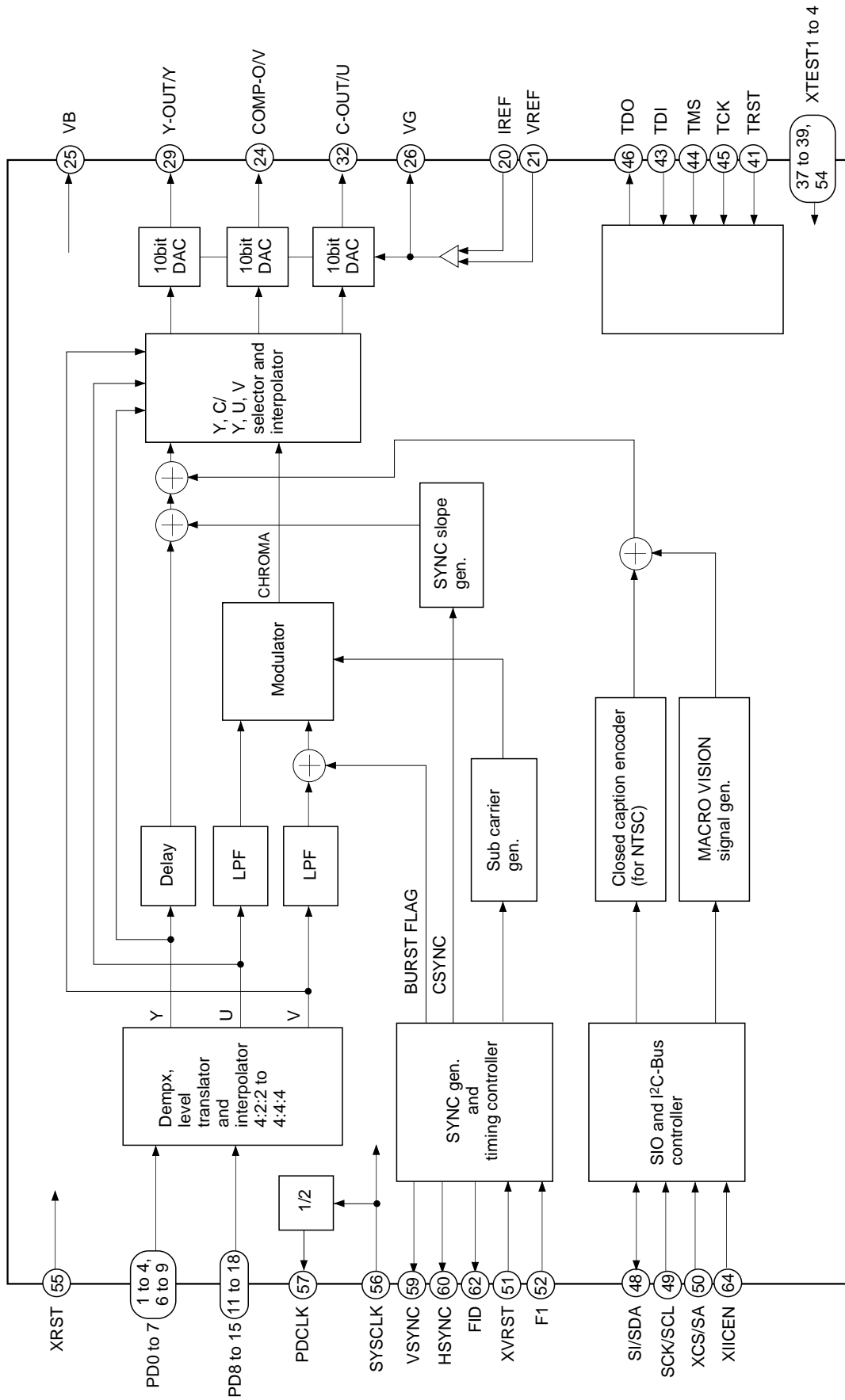

Pin Description

Pin No.	Symbol	I/O	Description
1	PD7	I	8-bit pixel data input pins (PD0 to 7). When control register bit "PIF MODE" = "0": These are inputs for multiplexed Y, Cb, and Cr signal. When control register bit "PIF MODE" = "1": These are inputs for Y signal.
2	PD6	I	
3	PD5	I	
4	PD4	I	
5	V _{SS}	—	Digital ground
6	PD3	I	8-bit pixel data input pins (PD0 to 7). When control register bit "PIF MODE" = "0": These are inputs for multiplexed Y, Cb, and Cr signal. When control register bit "PIF MODE" = "1": These are inputs for Y signal.
7	PD2	I	
8	PD1	I	
9	PD0	I	
10	V _{DD}	—	Digital power supply
11	PD15/TD7	I/O	8-bit pixel data input pins / Test data bus. When control register bit "PIF MODE" = "0": These inputs are not used. When control register bit "PIF MODE" = "1": These are inputs for multiplexed Cb and Cr signal. When test mode, it's used for internal circuit test data bus. Test mode is available only for device bender.
12	PD14/TD6	I/O	
13	PD13/TD5	I/O	
14	PD12/TD4	I/O	
15	PD11/TD3	I/O	
16	PD10/TD2	I/O	
17	PD9/TD1	I/O	
18	PD8/TD0	I/O	
19	V _{SS}	—	Digital ground
20	IREF	O	The reference current output pin. Connect resistance "16R" which is 16 times output resistance "R".
21	VREF	I	The voltage reference input pin. Sets output full scale value.
22	AV _{DD1}	—	Analog power supply
23	AV _{SS1}	—	Analog ground
24	COMP-O/V	O	This is the output of 10-bit D/A converter. When control register bit "YC/YUV" = "1": This pin outputs composite signal. When control register bit "YC/YUV" = "0": This pin outputs color difference (V) signal.
25	VB	O	Connect to V _{SS} with a capacitor of approximately 0.1μF.
26	VG	I	Connect to AV _{DD} with a capacitor of approximately 0.1μF.
27	AV _{DD2}	—	Analog power supply
28	AV _{SS2}	—	Analog ground
29	Y-OUT/Y	O	This is the output of 10-bit D/A converter. This pin outputs luminance (Y) signal.

Pin No.	Symbol	I/O	Description
30	AV _{DD3}	—	Analog power supply
31	AV _{SS3}	—	Analog ground
32	C-OUT/U	O	This is the output of 10-bit D/A converter. When control register bit "YC/YUV" = "1": This pin outputs chroma (C) signal. When control register bit "YC/YUV" = "0": This pin outputs color difference (U) signal.
33	TD10	I/O	Test data bus. This pin should be open. When test mode, it's used for internal circuit test data bus. Test mode is available only for device bender.
34	V _{DD}	—	Digital power supply
35	TD9	I/O	Test data bus. These pins should be open.
36	TD8	I/O	When test mode, it's used for internal circuit test data bus. Test mode is available only for device bender.
37	XTEST1	I	Test mode control input pins. These pins are pulled up. When these pins are "H", the CXD1910AQ is not test mode. Test mode is available only for device bender.
38	XTEST2	I	
39	XTEST3	I	
40	V _{SS}	—	Digital ground
41	TRST	I	Test mode reset input pins. When power on reset, set "L" for more than 40 clocks (SYSCLK).
42	V _{DD}	—	Digital power supply
43	TDI	I	Test mode control input pins. This pin is pulled up.
44	TMS	I	Test mode control input pins. This pin is pulled up.
45	TCK	I	Test mode control input pins. This pin should be "H" input.
46	TDO	O	Test data bus. This pin should be open.
47	V _{SS}	—	Digital ground
48	SI/SDA	I	This pin's function is selected by XIICEN (Pin 64). When XIICEN = "H", this pin is SONY SIO mode; SI serial data input. When XIICEN = "L", this pin is I ² C-BUS mode; SDA input/output.
49	SCK/SCL	I	This pin's function is selected by XIICEN (Pin 64). When XIICEN = "H", this pin is SONY SIO mode; SCK serial clock input. When XIICEN = "L", this pin is I ² C-BUS mode; SCL input.
50	XCS/SA	I	This pin's function is selected by XIICEN (Pin 64). When XIICEN = "H", this pin is SONY SIO mode; XCS chip select input. When XIICEN = "L", this pin is I ² C-BUS mode; SA slave address select input signal which selects I ² C-BUS slave address.
51	XVRST	I	Vertical sync reset input pin in active low. This pin is pulled up. This is used to synchronize external vertical sync and internal vertical sync. When XVRST is "L", internal digital sync generator is reset according to F1 status.

Pin No.	Symbol	I/O	Function
52	F1	I	Field ID input. For external synchronization with XVRST signal, the field for resetting is determined by the main signal. "H" indicates 1st field. "L" indicates 2nd field.
53	V _{DD}	—	Digital power supply
54	XTEST4	I	Test mode control input pin. This pin is pulled up. When this pin is "H", the CXD1910AQ is not test mode. Test mode is available only for device bender.
55	XRST	I	System reset input pin in active low. When power on reset, set "L" for more than 40 clocks (SYSCLK).
56	SYSCLK	I	System clock input pin. To generate correct subcarrier frequency, precise 27MHz is required.
57	PDCLK	O	Pixel data clock output pin for 13.5MHz. This clock is divided from SYSCLK. This is used when 16-bit pixel data mode.
58	V _{SS}	—	Digital ground
59	VSYNC	O	Vertical sync signal output pin.
60	HSYNC	O	Horizontal sync signal output pin.
61	SO	O	This pin's function is selected by XIICEN (Pin 64). When XIICEN = "H", this pin is SONY SIO mode; SO serial out output pin. When XIICEN = "L", this pin is not used and output is high impedance.
62	FID	O	Field ID output pin. When control register bit "FIDS" = "1": "L" indicates 1st field, "H" indicates 2nd field. When control register bit "FIDS" = "0": "H" indicates 1st field, "L" indicates 2nd field.
63	V _{DD}	—	Digital power supply
64	XIICEN	I	Serial interface mode select input pin. This pin is pulled up. When XIICEN = "L", Pins 48 to 50 and 61 are I ² C-BUS mode. When XIICEN = "H", Pins 48 to 50 and 61 are SONY SIO mode.

Electrical Characteristics

DC characteristics

(Ta = 0 to +70°C, Vss = 0V)

Item	Symbol	Conditions	Min.	Typ.	Max.	Unit	Pins
Input high voltage	V _{IH}	V _{DD} = 5.0V ± 5%	2.2			V	*1
Input low voltage	V _{IL}	V _{DD} = 5.0V ± 5%			0.8	V	*1
Output high voltage	V _{OH1}	I _{OH} = -2.4mA V _{DD} = 4.75 to 5.25V	V _{DD} -0.8			V	*2
Output low voltage	V _{OL1}	I _{OL} = 4.8mA V _{DD} = 4.75 to 5.25V			0.4	V	*2
Output high voltage	V _{OH2}	I _{OH} = -1.2mA V _{DD} = 4.75 to 5.25V	V _{DD} -0.8			V	*3
Output low voltage	V _{OL2}	I _{OL} = 2.4mA V _{DD} = 4.75 to 5.25V			0.4	V	*3
Input leak current	I _{I1}	V _I = 0 to 5.25V V _{DD} = 4.75 to 5.25V	-10		10	μA	*4
Input leak current	I _{I2}	V _I = 0V V _{DD} = 5.0V ± 5%	-40	-100	-240	μA	*5
Supply current	I _{DD}	V _{DD} = 5.0V ± 5%			70*6	mA	

*1 PD0 to 15, TD8 to 10, XTEST1 to 4, TRST, TDI, TCK, SI/SDA, SCK/SCL, XCS/SA, XVRST, F1, XRST, SYSCLK, XIICEN

*2 PDCLK, VSYNC, HSYNC, FID, SO

*3 TDO, TD0 to 10

*4 PD0 to 15, TD8 to 10, TCK, SI/SDA, SCK/SCL, F1, XRST, SYSCLK

*5 XTEST1 to 4, TRST, TDI, TMS, XCS/SA, XVRST, XIICEN

*6 Not include analog supply current

DAC characteristics 1

(AV_{DD} = 5V, R = 200Ω, V_{REF} = 1.35V, Ta = 25°C)

Item	Symbol	Measurement conditions	Min.	Typ.	Max.	Unit
Resolution	n			10		bit
Linearity error	E _L		-2.5		2.5	LSB
Differential linearity error	E _D		-1.5		1.5	LSB
Output full-scale current	I _{FS}		6.25	6.75	7.25	mA
Output offset voltage	V _{OS}				1	mV
Output full-scale voltage	V _{FS}		1.25	1.35	1.45	V
Precision guaranteed output voltage range	V _{OC}		1.25	1.35	1.45	V

DAC characteristics 2

($V_{DD} = 5V$, $R = 200\Omega$, $V_{REF} = 2.0V$, $T_a = 25^\circ C$)

Item	Symbol	Measurement conditions	Min.	Typ.	Max.	Unit
Resolution	n			10		bit
Linearity error	E_L		-2.0		2.0	LSB
Differential linearity error	E_D		-1.0		1.0	LSB
Output full-scale current	I_{FS}		9.5	10.0	10.5	mA
Output offset voltage	V_{OS}				1	mV
Output full-scale voltage	V_{FS}		1.9	2.0	2.1	V
Precision guaranteed output voltage range	V_{OC}		1.9	2.0	2.1	V

AC characteristics

1. Pixel Data Interface

(1) 8-bit mode

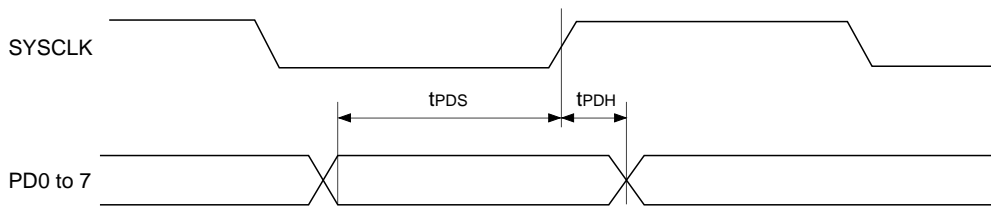

($T_a = 0$ to $+70^\circ C$, $V_{DD} = 4.25$ to $5.25V$, $V_{SS} = 0V$)

Item	Symbol	Min.	Typ.	Max.	Unit
Pixel data setup time to SYSCLK	t_{PDS}	10			ns
Pixel data hold time to SYSCLK	t_{PDH}	3			ns

(2) 16-bit mode

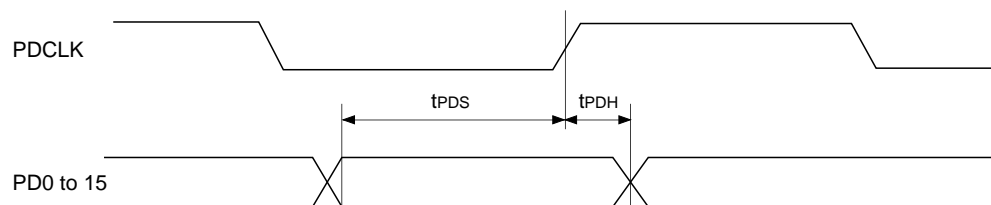

($T_a = 0$ to $+70^\circ C$, $V_{DD} = 4.75$ to $5.25V$, $V_{SS} = 0V$)

Item	Symbol	Min.	Typ.	Max.	Unit
Pixel data setup time to PDCLK	t_{PDS}	20			ns
Pixel data hold time to PDCLK	t_{PDH}	0			ns

2. Serial Port Interface

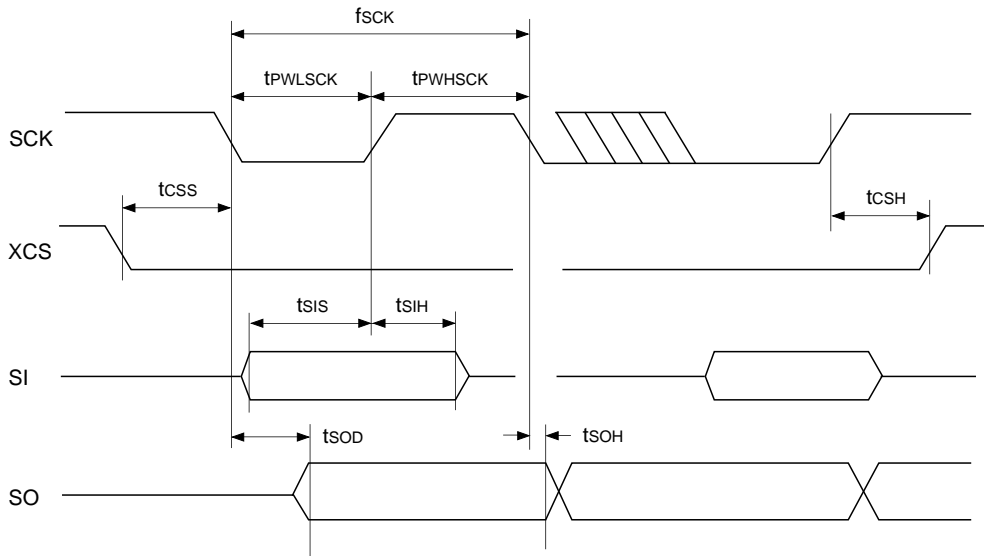

($T_a = 0$ to $+70^\circ\text{C}$, $V_{DD} = 4.75$ to 5.25V , $V_{SS} = 0\text{V}$)

Item	Symbol	Min.	Typ.	Max.	Unit
SCK clock rate	f_{sck}	DC		3	MHz
SCK pulse width Low	t_{pWLsck}	100			ns
SCK pulse width High	t_{pWHsck}	100			ns
Chip select setup time to SCK	t_{css}	150			ns
Chip select hold time to SCK	t_{csh}	150			ns
Serial input setup time to SCK	t_{sis}	50			ns
Serial input hold time to SCK	t_{sih}	10			ns
Serial output delay time from SCK	t_{sod}			30	ns
Serial output hold time from SCK	t_{soh}	3			ns

3. XVRST, F1

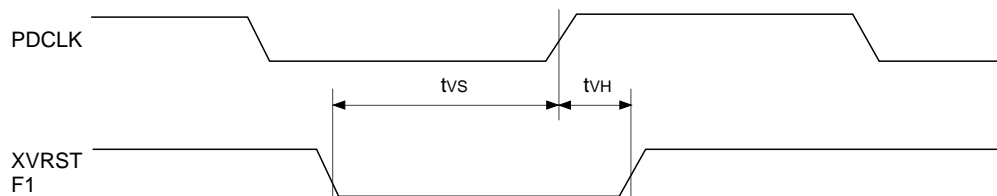

($T_a = 0$ to $+70^\circ\text{C}$, $V_{DD} = 4.75$ to 5.25V , $V_{SS} = 0\text{V}$)

Item	Symbol	Min.	Typ.	Max.	Unit
XVRST, F1 setup time to PDCLK	t_{vs}	20			ns
XVRST, F1 hold time to PDCLK	t_{vh}	0			ns

4. SYSCLK, PDCLK, VSYNC, HSYNC, FID

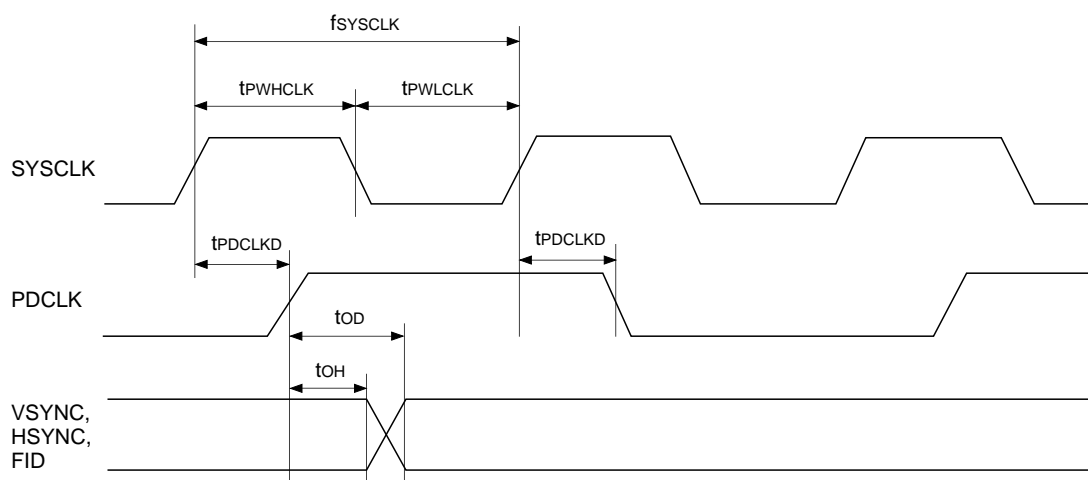

($T_a = 0$ to $+70^{\circ}\text{C}$, $V_{DD} = 4.75$ to 5.25V , $V_{SS} = 0\text{V}$)

Item	Symbol	Min.	Typ.	Max.	Unit
SYSCLK clock rate	f_{SYSCLK}		27		MHz
SYSCLK pulse width Low	t_{PWLCLK}	11			ns
SYSCLK pulse width High	t_{PWHCLK}	11			ns
PDCLK delay time from SYSCLK	t_{PDCLKD}			20	ns
Control output delay time from SYSCLK	t_{COD}			25	ns
Control output hold time from SYSCLK	t_{COH}	3			ns

Description of Functions

The CXD1910AQ converts digital parallel data (ITU-R601 Y, Cb, Cr) into analog TV signals in NTSC (RS170A) or PAL (ITU-R624; B, G, H, I) format.

The CXD1910AQ first receives image data in 8-bit parallel form (multiplexed Y, Cb, and Cr data), or in 16-bit parallel form (8-bit Y and 8-bit multiplexed Cb and Cr data). After demultiplexing, it converts Cb and Cr signals into U and V signals respectively, interpolates 4:2:2 to 4:4:4, and modulates the signals with the subcarrier generated by digital subcarrier generator.

Y signal and modulated chroma signal are oversampled (at double) to reduce $\sin(x)/(x)$ rolloff.

10-bit DACs are used for converting digital composite and Y/C signals into analog signals.

1. Pixel Input Format

Pixel input format is determined by bit 4 (PIF MODE) of control register address 01H, as shown in Table 1-1.

When PIF MODE is "0", the image data (Y, Cb, Cr) input from PD0 to PD7 is sampled at the rising edge of SYSCLK.

When PIF MODE is "1", Y data is input into PD0 to 7, multiplexed Cb and Cr data are input into PD8 to 15, and these respective data are sampled at the rising edge of PDCLK.

PIF MODE	PD15 to 8	PD7 to 0
0 (8-bit mode)	NA	Y/Cb/Cr
1 (16-bit mode)	Cb/Cr	Y

Table 1-1

Pixel Data Input Timing

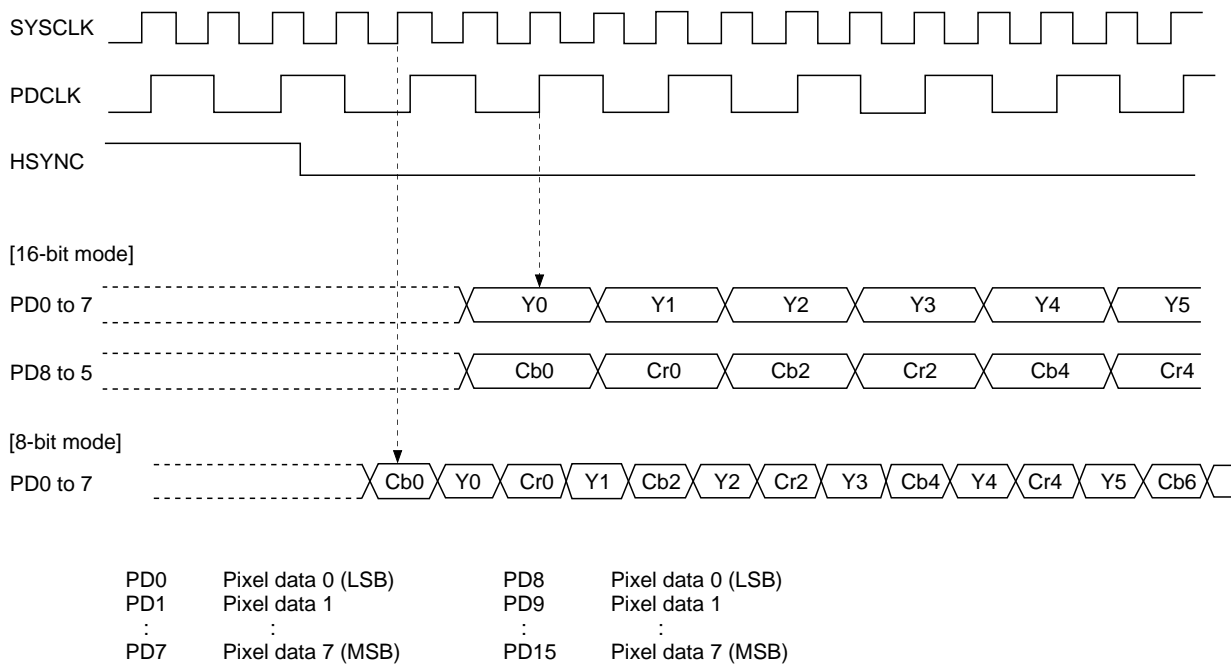

2. Serial Interface

The CXD1910AQ supports both I²C-BUS (high-speed mode) and SONY's serial interface. These modes can be selected by XIICEN input pin as shown in Table 2-1 below.

XIICEN	H	L
	SONY SIO mode	I ² C mode
SI/SDA	SI	SDA
SCK/SCL	SCK	SCL
XCS/SA	XCS	SA
SO	SO	High-Z

Table 2-1

2-1. I²C-BUS interface

The CXD1910AQ becomes a slave transceiver of I²C-BUS, and supports the 7-bit slave address and the high-speed mode (400K bit/s).

2-1-1. Slave address

Two kinds of slave address (88H, 8CH) are selectable by the SA signal, as shown in Table 2-2 below.

A6	A5	A4	A3	A2	A1	A0	R/W
1	0	0	0	1	SA	0	X

Table 2-2

2-1-2. Write cycle

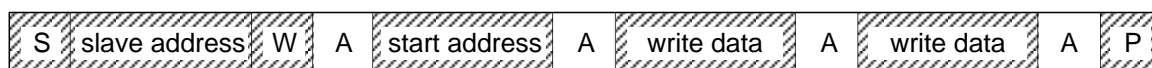

"0"

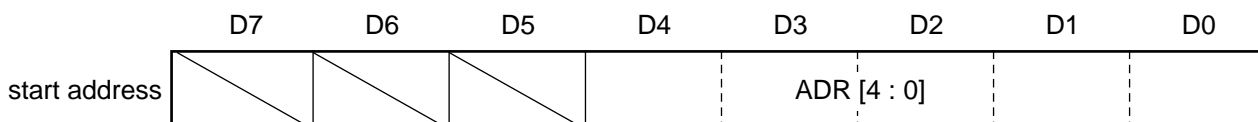
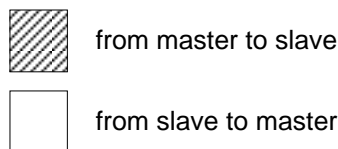

After the slave address is supplied from the master, the data in the next transfer cycle is set up inside the start address register of this IC as start address of the control register. In subsequent cycles, the data supplied from the master is written in the addresses indicated by the control register address. The set control register address is automatically incremented with the completed transfer of each byte of data.

2-1-3. Read cycle

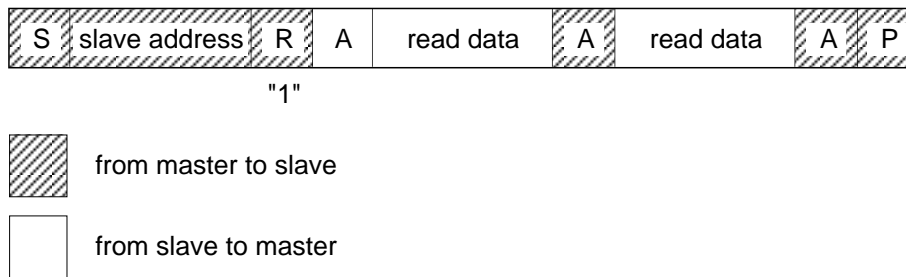

After the slave address is supplied from the master, subsequent cycles change immediately to read cycles and only ID code (address 09H, 0AH) is read out. During the read cycle, the start address is automatically set to 09H.

Note) In the SONY SIO mode, addresses from 00H to 0AH can be read out.

2-1-4. Handling of general call address (00H)

General call address is neglected and there is no ACK response.

2-2. SONY serial interface

SONY serial interface uses SCK, XCS, SI and SO signals.

Serial interface is activated when XCS signal is “Low”, and samples serial input data at the rising edge of SCK. The first one byte after XCS activation is set up as a serial control command. The data includes a start control register address and direction of the serial interface. The control register address is automatically incremented with the transfer of each byte of data. In the write mode, the data of second byte and after are written in the addresses indicated by the address generated by the address generator of the CXD1910AQ. In the read mode, the serial input data is neglected and writing is not done.

Serial Interface Timing

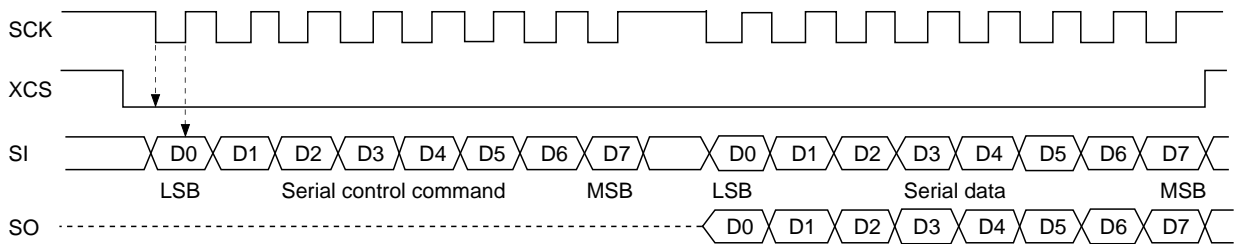

Serial Interface Sequence

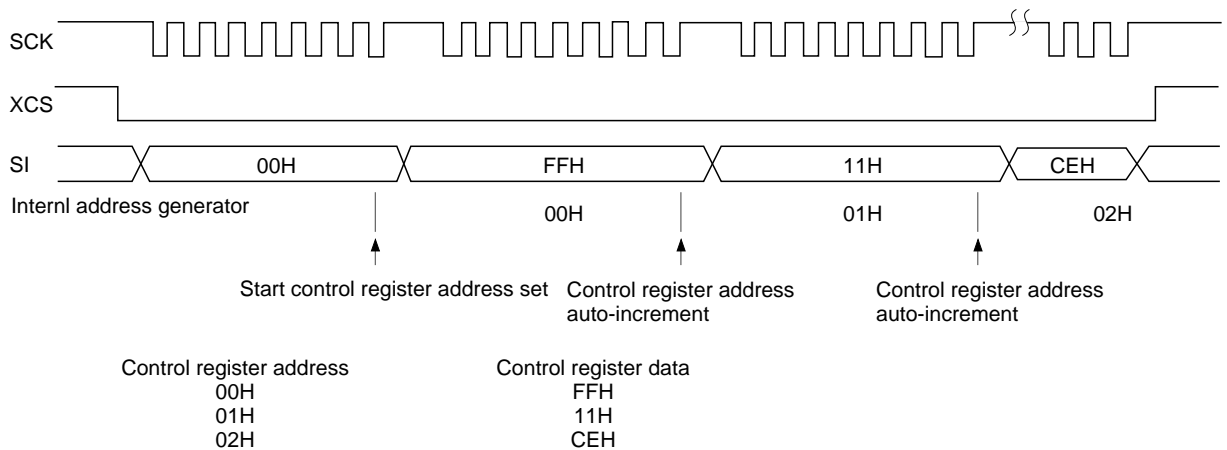

2-1. Serial control command format

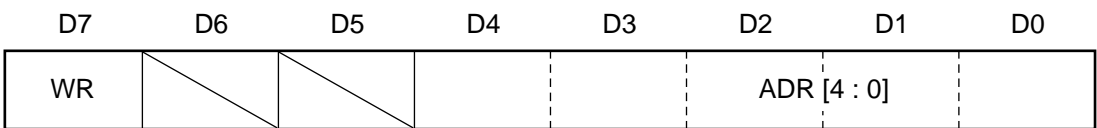

WR : Direction for serial interface
 When this bit is “1”:
 The serial interface is write mode.
 Incoming serial data is set up inside the control register according to the control register address.
 When this bit is “0”:
 The serial interface is read mode.
 The control register data is output to SO according to the control register address.

ADR [4 : 0] : Start control register address

3. XVRST, F1

XVRST and F1 signals are used to synchronize with external V. sync.

XVRST and F1 signals are sampled at the rising edge of PDCLK, and F1 signal is sampled when XVRST is Low. When F1 is High, the internal sync generator is reset to the 1st field, and when F1 is Low, it is reset to the 2nd field. When XVRST is set at High, digital sync generator starts operation, and the sequence of 1st or 2nd field starts.

XVRST Timing (1st Field)

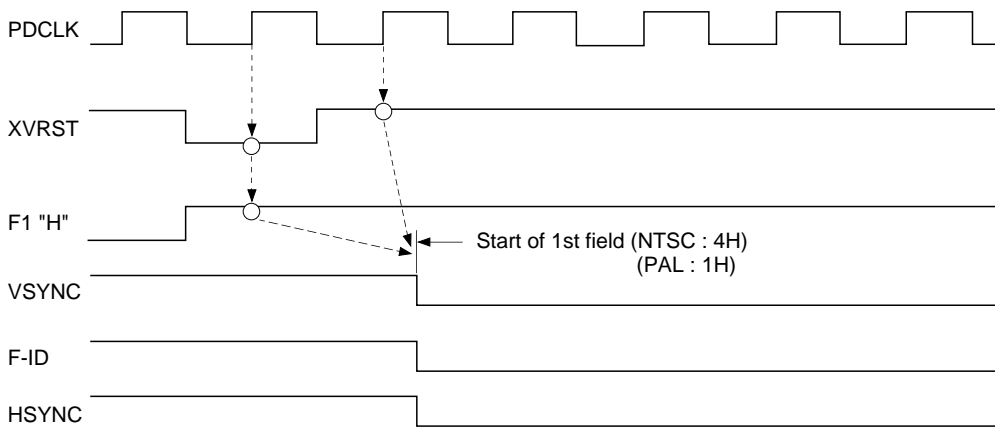

XVRST Timing (2nd Field)

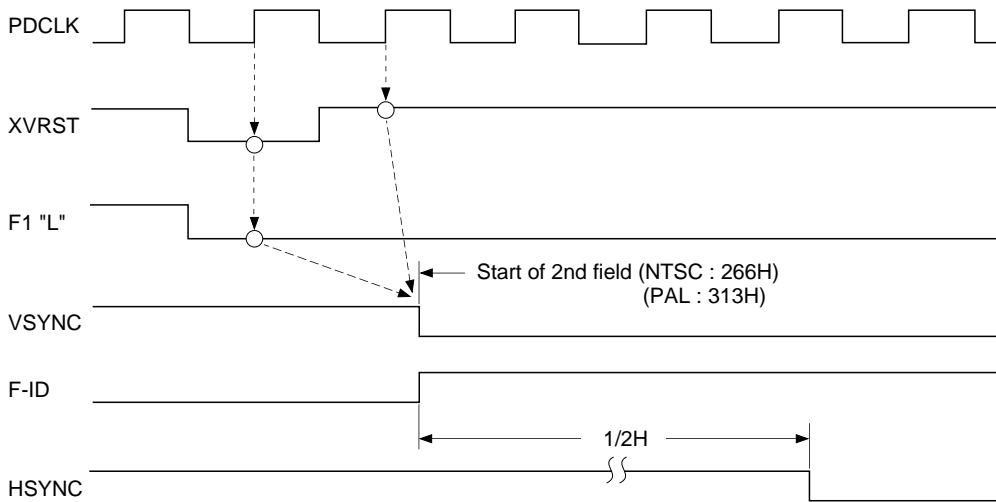

4. Closed Caption

The CXD1910AQ supports closed caption encoding.

ASCII data for closed caption encodes line 21 and line 284 by adding parity bit to ASCII data (data #1 and data #2 for line 21, data #1 and data #2 for line 284) which is set up for control registers 03H, 04H, 05H and 06H. Control registers 03H to 06H are double-buffered and ASCII data which is set up by serial interface is synchronized with VSYNC.

Double Buffer for Closed Caption

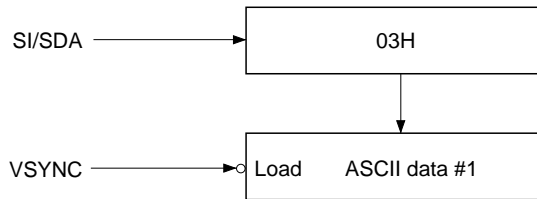

Closed Caption Data Renewal Timing

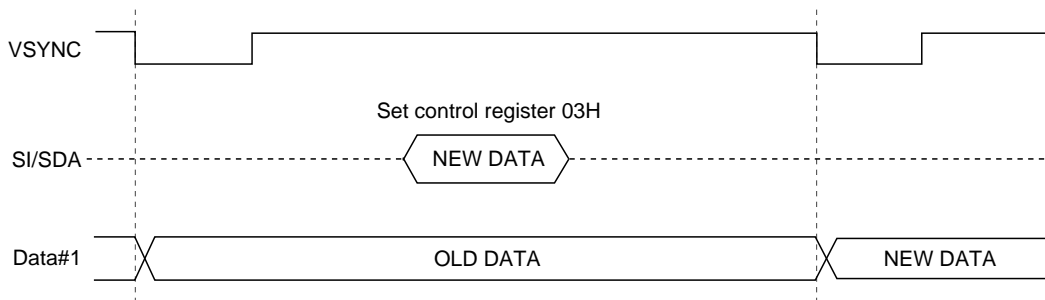

Closed Caption Signal Waveform

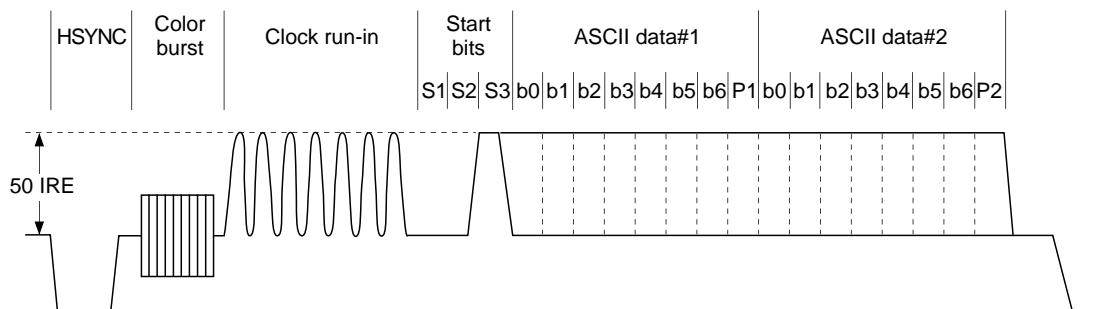

NTSC Vertical Interval

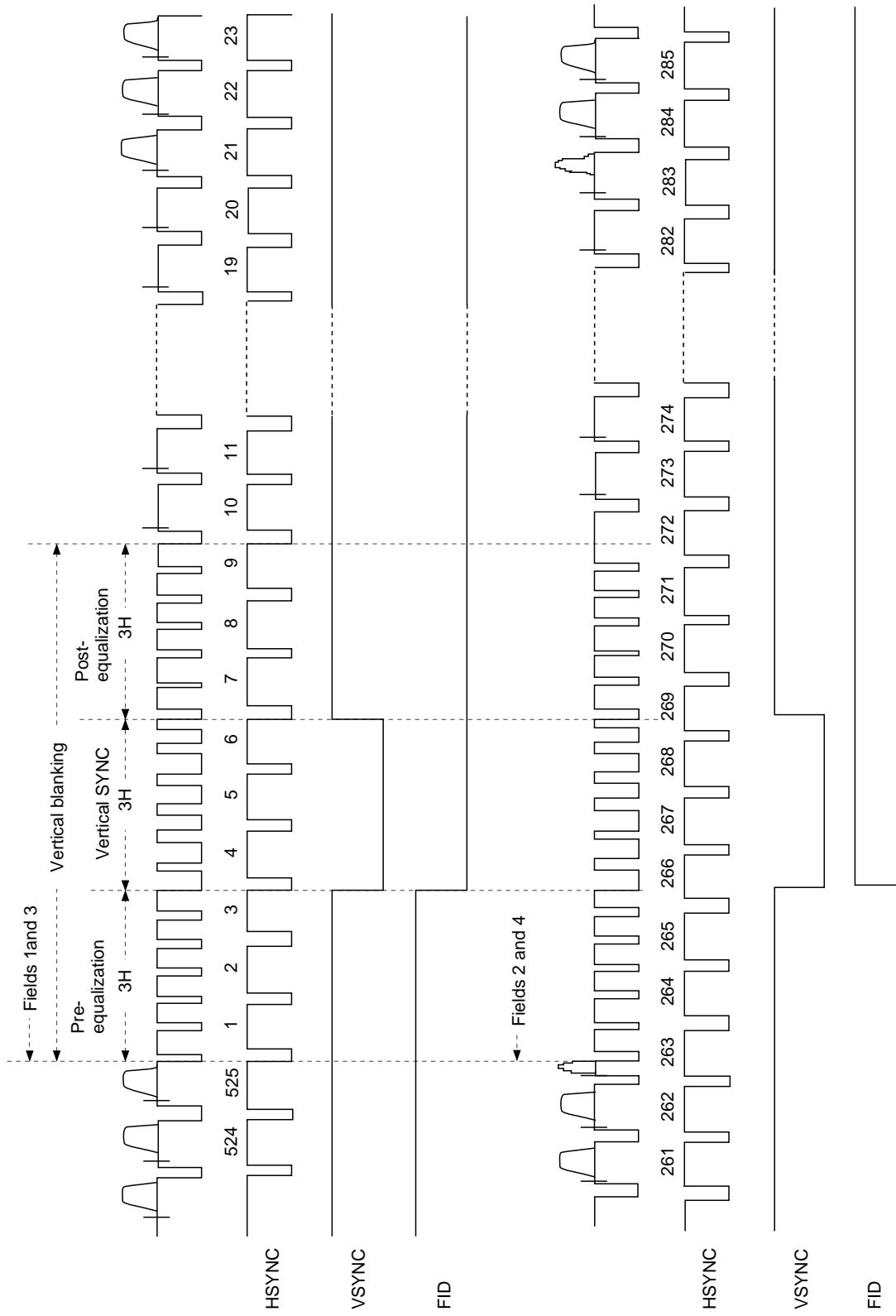

PAL Vertical Interval

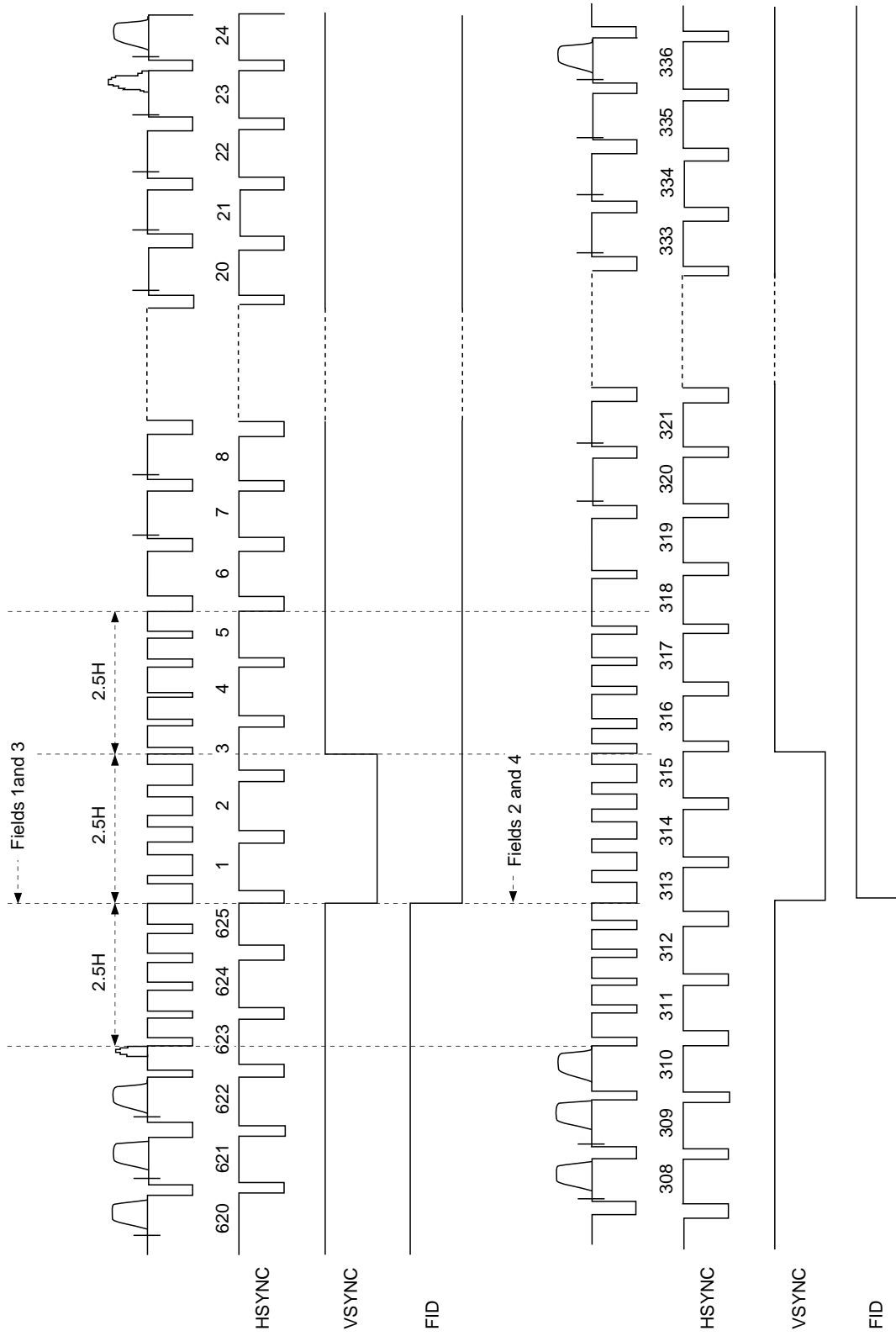

Vertical Synchronization Timing

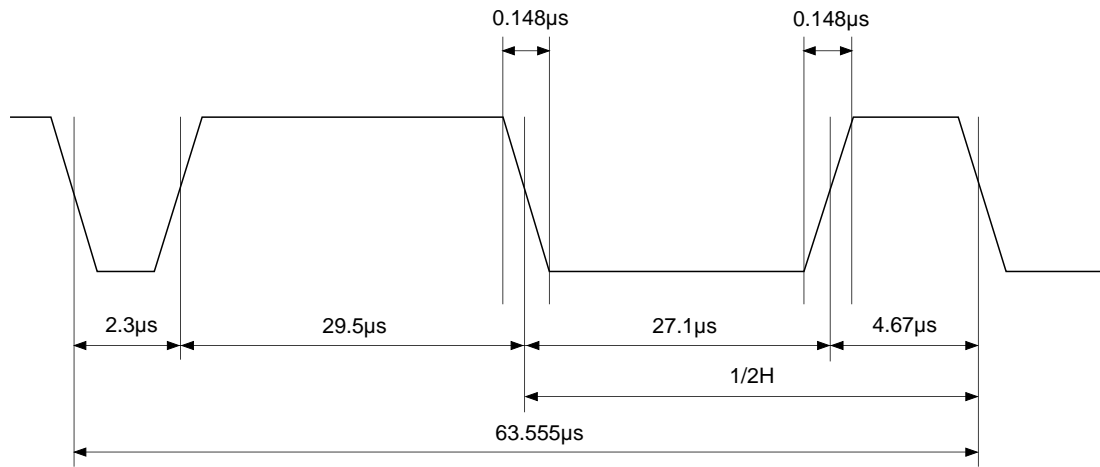

NTSC Equalizing & Synchronizing Pulses

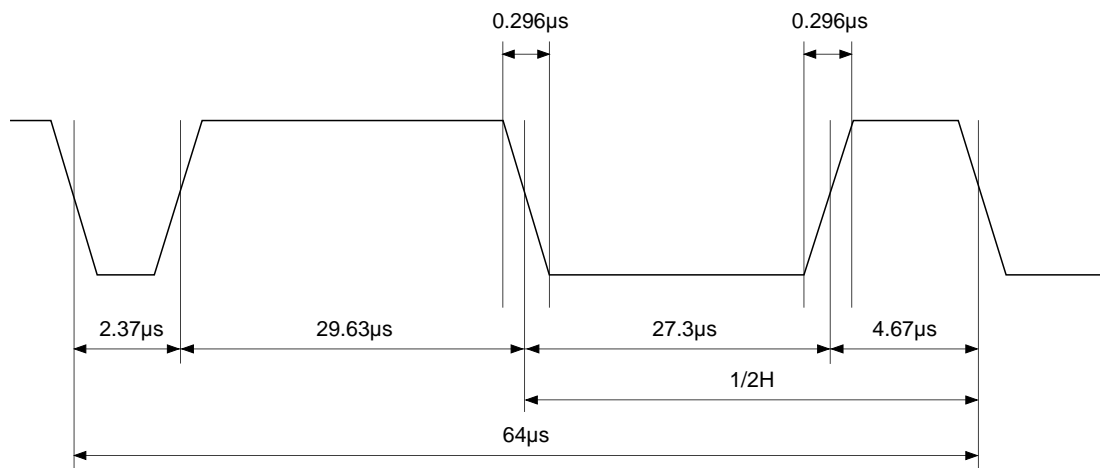

PAL Equalizing & Synchronizing Pulses

Control Register Map

Note) For the bit which is not assigned, use it by setting “0”.

		BIT								
		7	6	5	4	3	2	1	0	
Address 00H		FIDS	MASK EN	PIX EN	YC/YUV	BF	SET UP	/	ENC MODE	R/W

- ENC MODE** Encoding mode
 0 : PAL encoding mode
 1 : NTSC encoding mode (Default)

- SET UP** Set up enable
 0 : Non set up level, black = blanking level
 1 : 7.5 IRE set up level insertion (Default)

- BF** Burst flag enable
 0 : Disable burst flag
 1 : Enable burst flag (Default)

Color burst exists or not can be selected.

- YC/YUV** DAC output function select
 0 : Y, U, V output mode
 1 : Video signal (Comp, Y, C) output mode (Default)

- PIX EN** Pixel data enable
 0 : Disable input pixel data
 1 : Enable input pixel data (Default)

When input pixel data is disabled, output becomes blanking level or black level regardless of input PD0 to PD15.

- MASK EN** Mask enable
 0 : When V-blanking, pixel data through
 1 : When V-blanking, pixel data reject (Default)

When MASK EN = “0”, input pixel data during V-blanking interval are valid, and output obeys input pixel data.
 When MASK EN = “1”, input pixel data during V-blanking interval are all invalid, and output becomes blanking level.
 As for this mode, input pixel data under 16 (0 to 16) is limited to 16; input pixel data more than 235 (235 to 255) is limited to 235.

- FIDS** FID polarity select
 0 : 1st field “H”, 2nd field “L”
 1 : 1st field “L”, 2nd field “H” (Default)

BIT

Function Selection #2

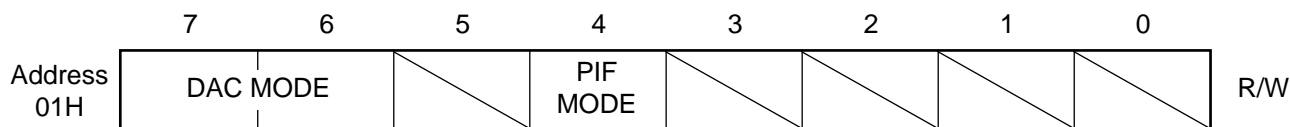

PIF MODE Pixel input format
 0 0 : 8-bit mode Multiplexed Y, Cb, Cr (4:2:2) (Default)
 1 1 : 16-bit mode Y and multiplexed Cb, Cr

DAC MODE DAC output activity
 0 0 : Non-active
 0 1 : Y-OUT and C-OUT active
 1 0 : Comp-out active
 1 1 : Both active (Default)

BIT

Function Selection #3

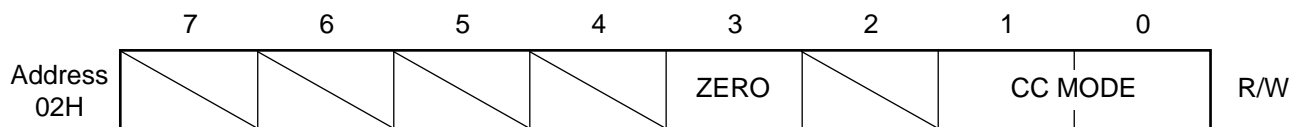

CC MODE Closed caption encoding mode
 0 0 : Disable closed caption encoding (Default)
 0 1 : Enable encoding in 1st field (Line 21)
 1 0 : Enable encoding in 2nd field (Line 284)
 1 1 : Enable encoding in both fields

ZERO Use it by setting "0".

BIT

Closed Caption Character #1 for 21H

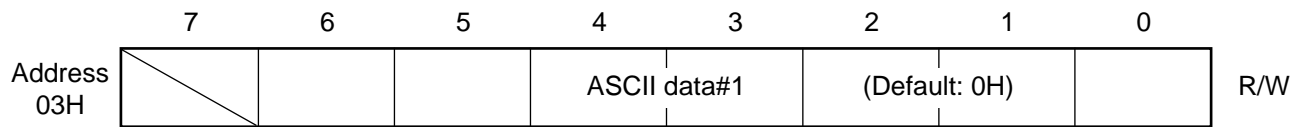

Closed Caption Character #2 for 21H

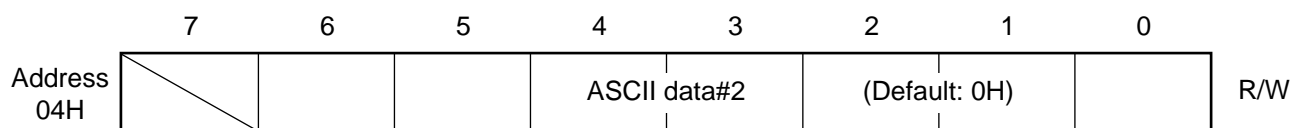

Closed Caption Character #1 for 284H

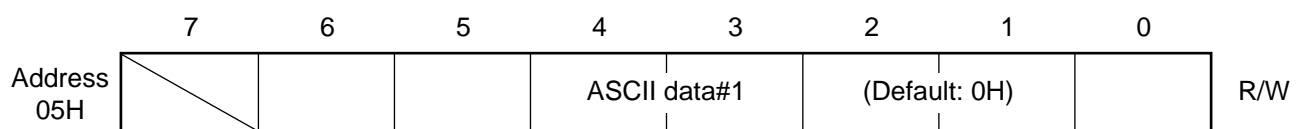

Closed Caption Character #2 for 284H

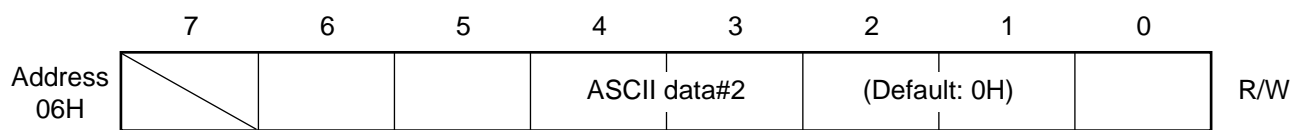

Video Timing

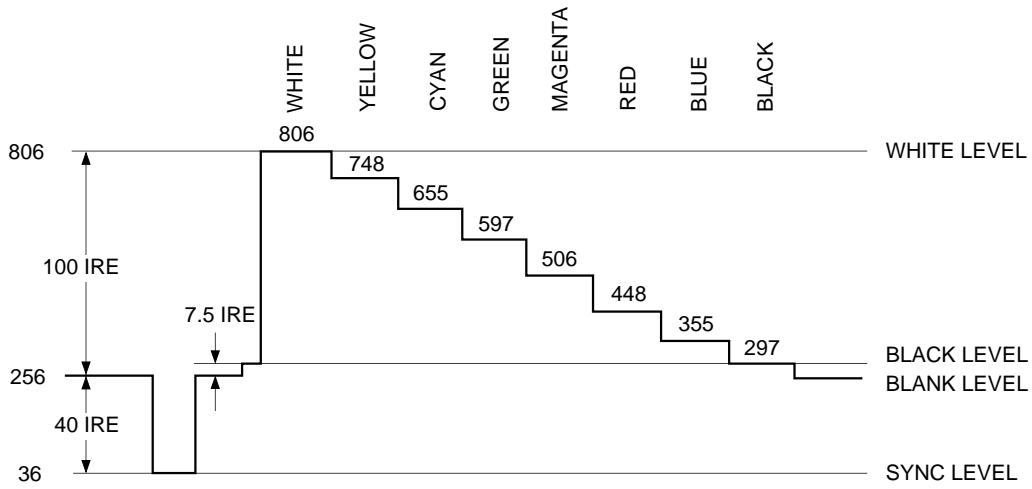

NTSC Y (Luminance) Video Output Waveform
7.5 IRE SETUP

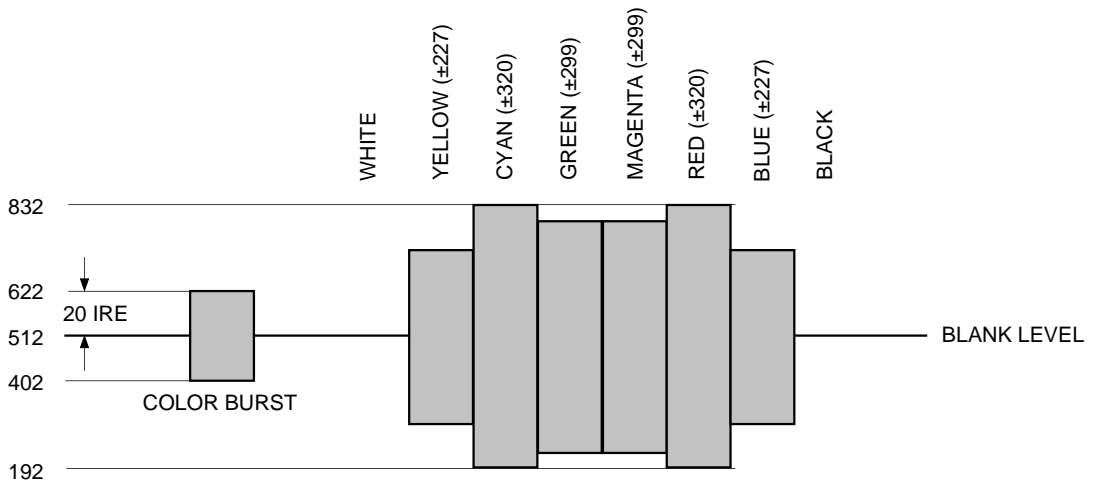

NTSC C (Chroma) Video Output Waveform
7.5 IRE SETUP

Video Timing

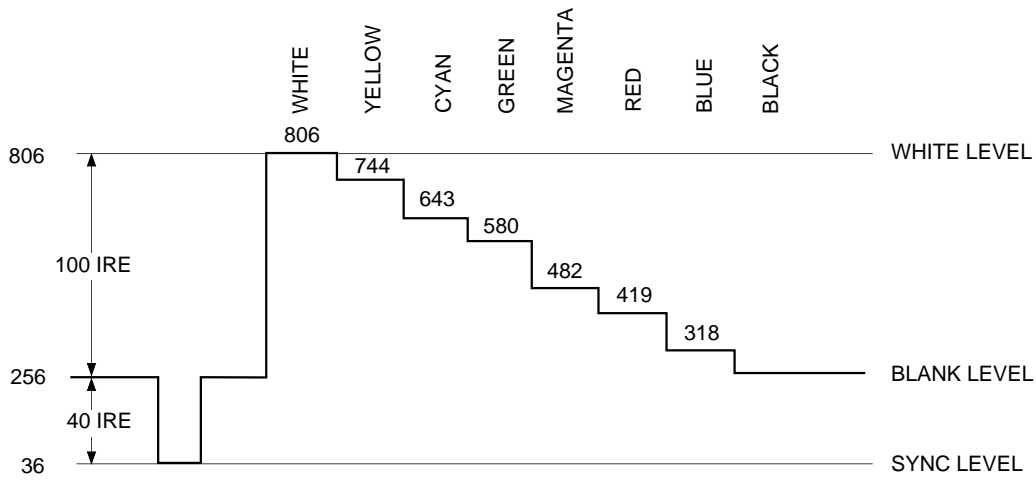

NTSC Y (Luminance) Video Output Waveform
No SETUP

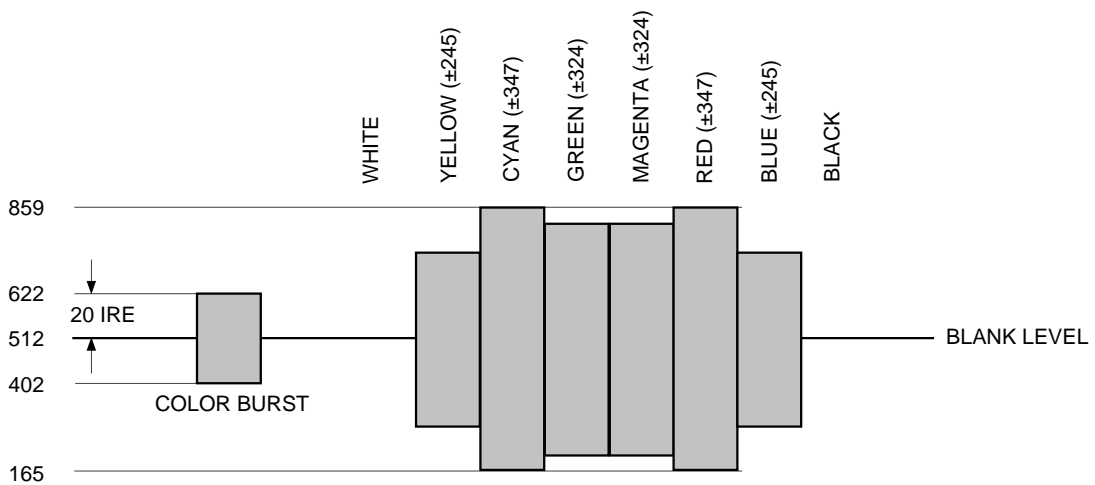

NTSC C (Chroma) Video Output Waveform
No SETUP

Video Timing

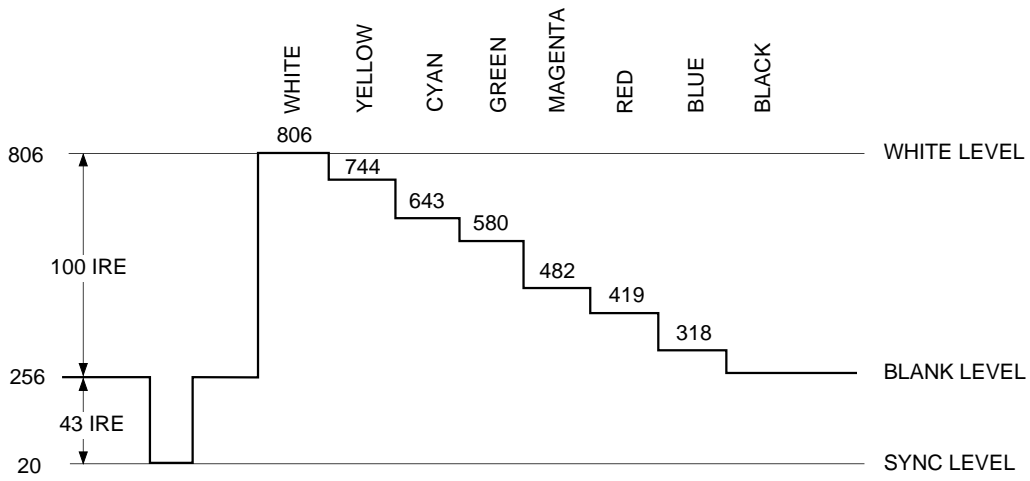

PAL Y (Luminance) Video Output Waveform

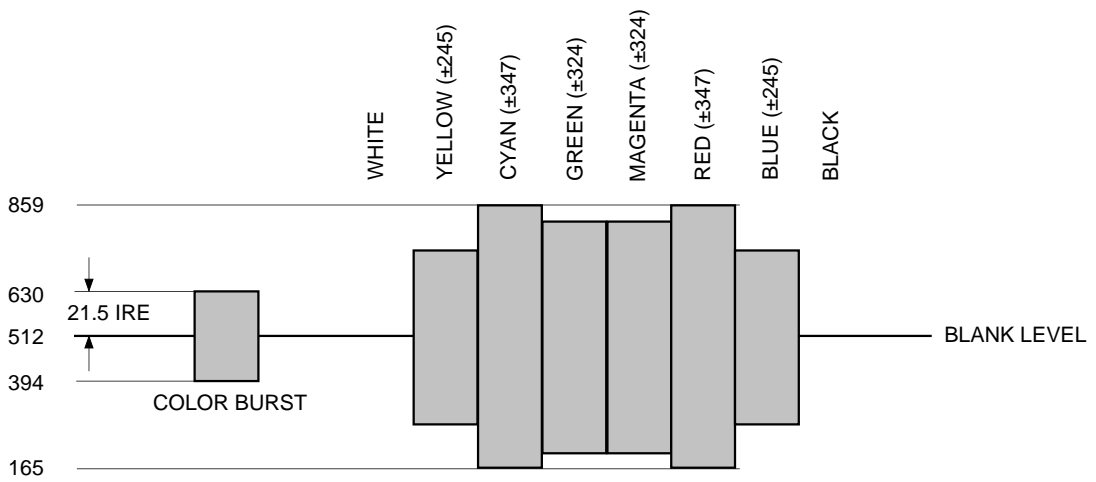

PAL C (Chroma) Video Output Waveform

Video Timing

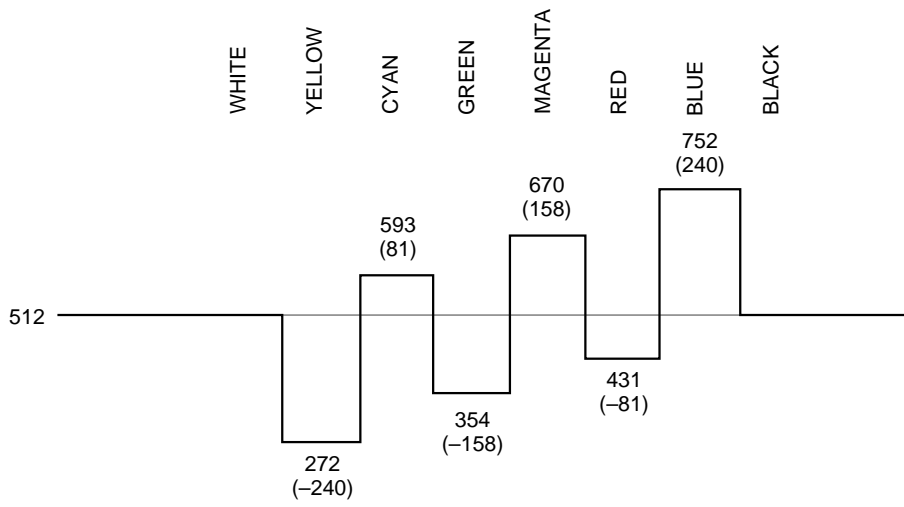

Color Difference (U) Video Output Waveform

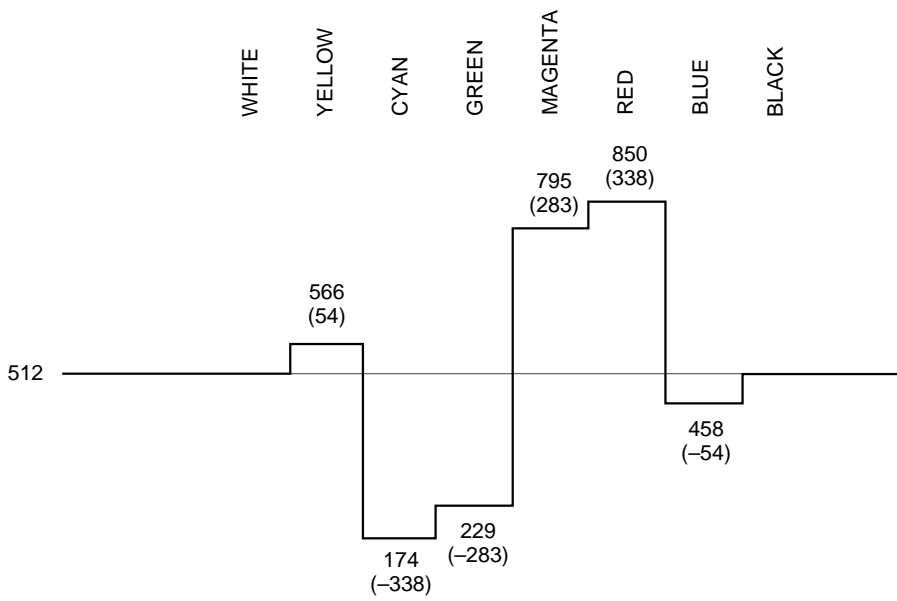

Color Difference (V) Video Output Waveform

Internal Filter Characteristics

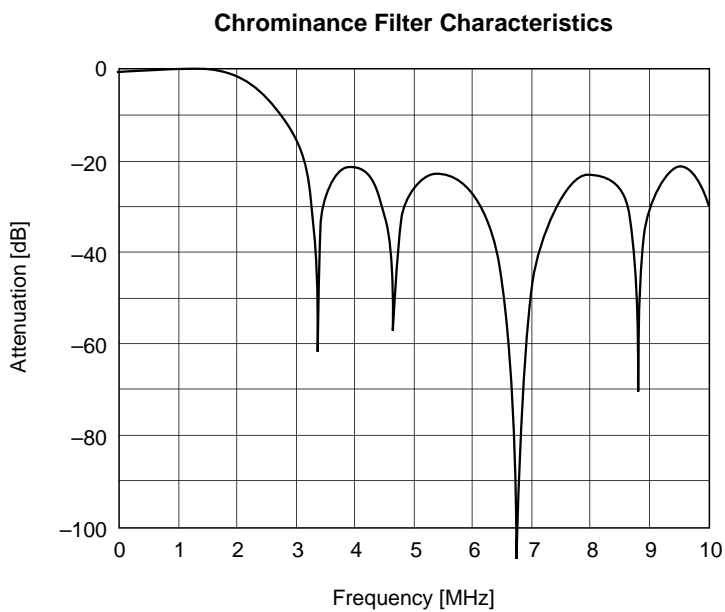
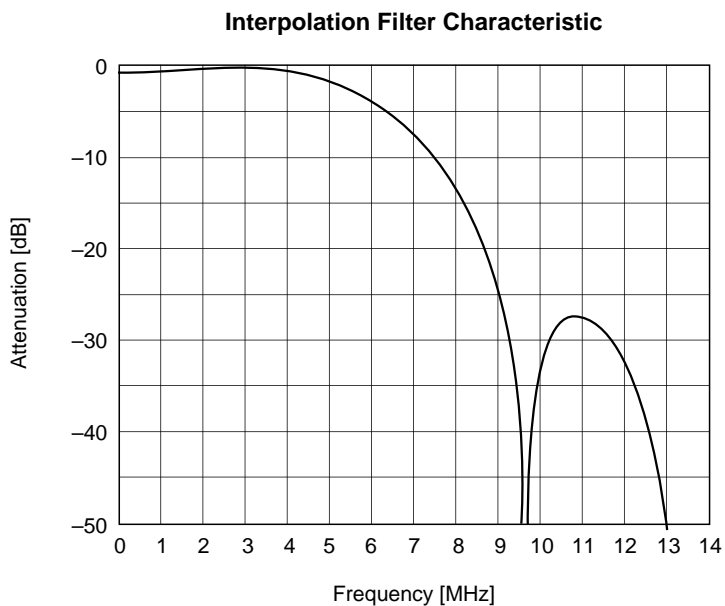

Application Circuit 1

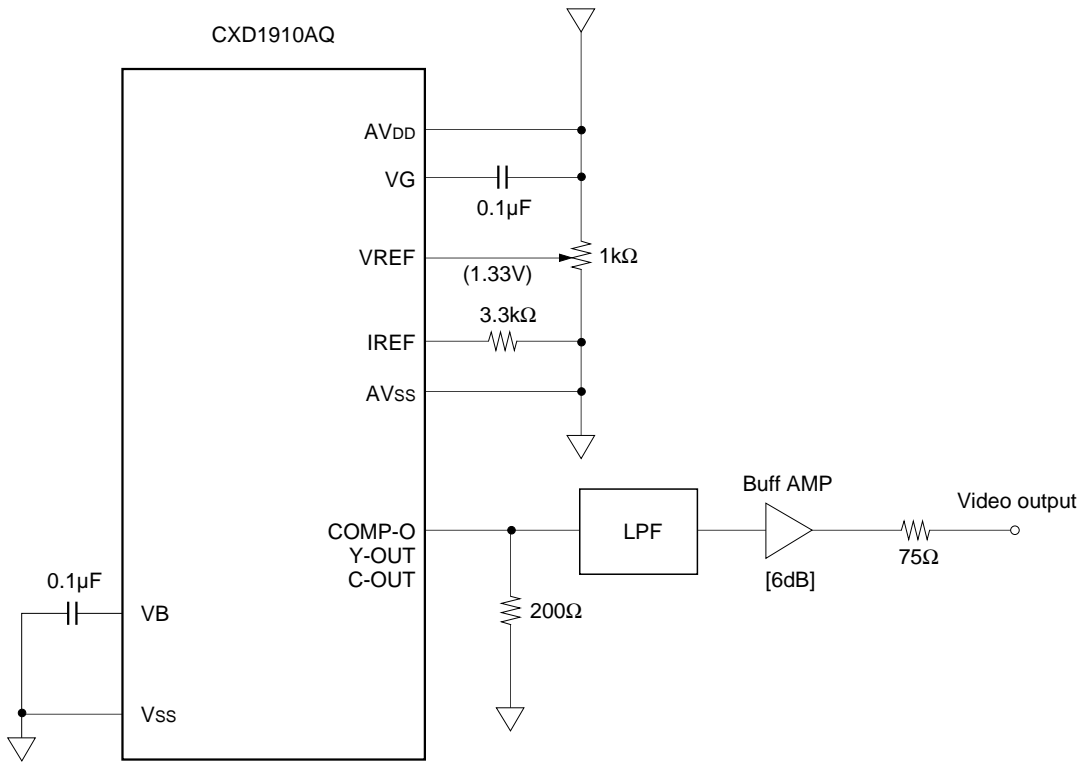

Application Circuit 2

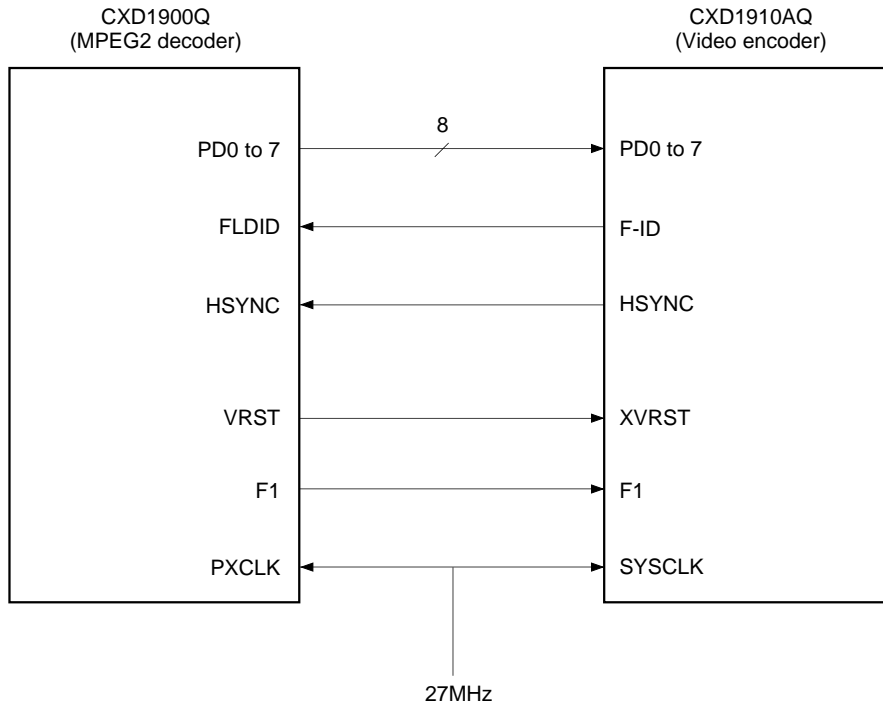

Application circuits shown are typical examples illustrating the operation of the devices. Sony cannot assume responsibility for any problems arising out of the use of these circuits or for any infringement of third party patent and other right due to same.

Package Outline Unit: mm

64PIN QFP(PLASTIC)

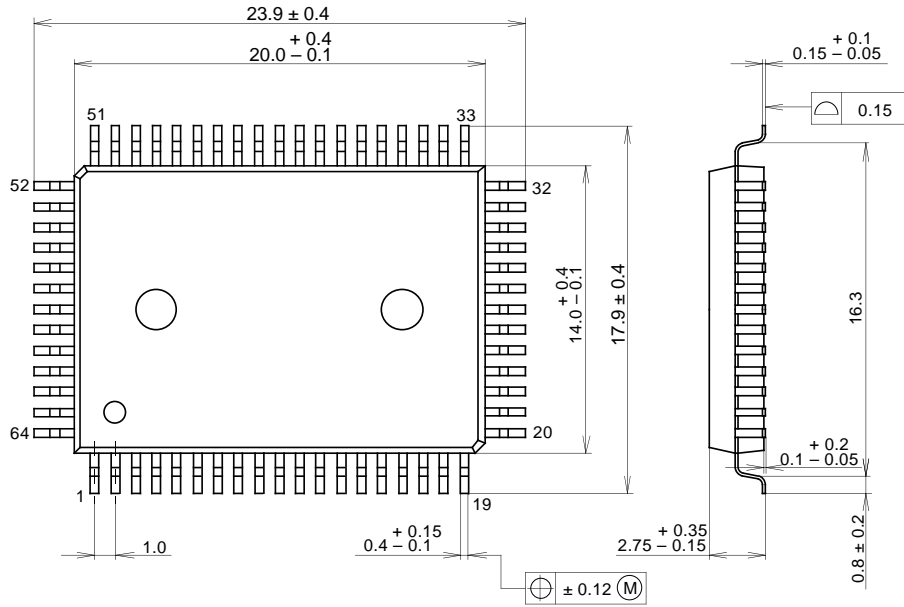

SONY CODE	QFP-64P-L01
EIAJ CODE	*QFP064-P-1420
JEDEC CODE	_____

PACKAGE STRUCTURE

PACKAGE MATERIAL	EPOXY RESIN
LEAD TREATMENT	SOLDER/PALLADIUM PLATING
LEAD MATERIAL	COPPER /42 ALLOY
PACKAGE WEIGHT	1.5g