

computers and automation

MOLECULAR
ELECTRONICS

PERT

Cybernation:
The Silent
Conquest

MARCH
1962

Vol. XI — No. 3

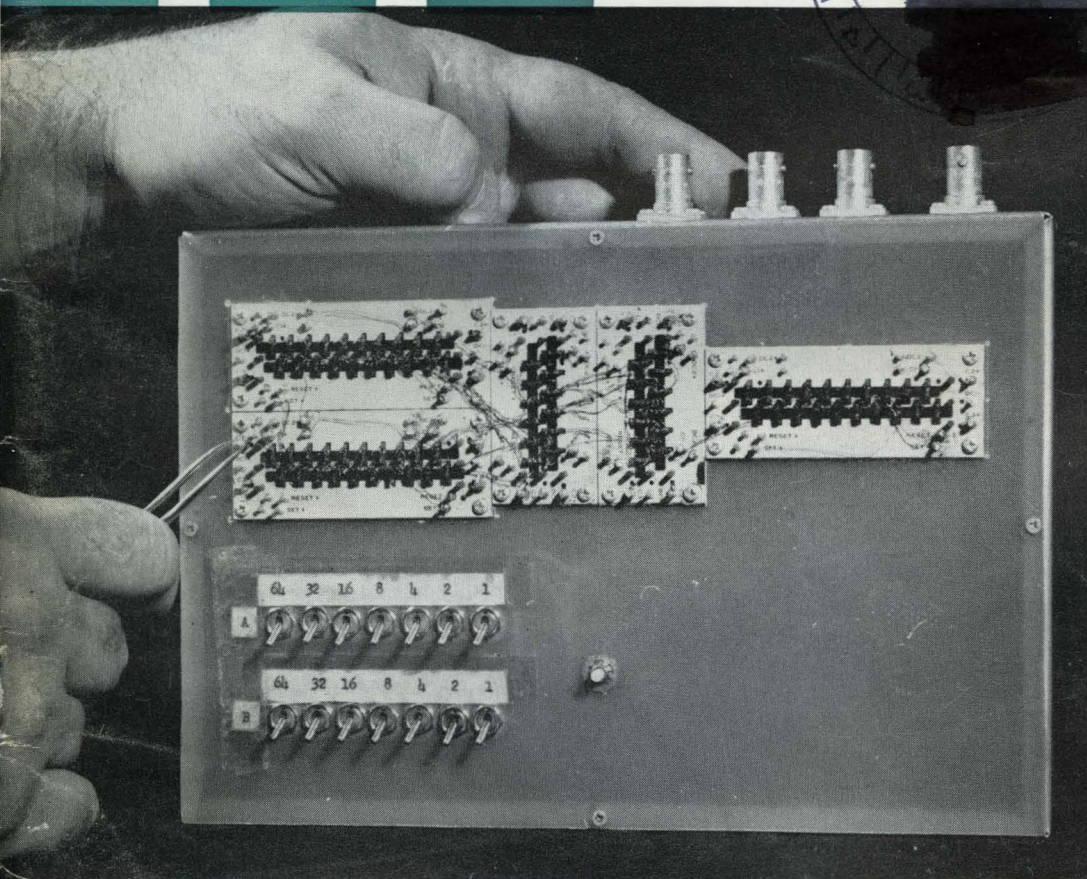

Say "Good-bye" to Tension

GET RESULTS AND RELAXATION

... DIVIDENDS FROM

STATISTICAL'S

DATA PROCESSING

Experience

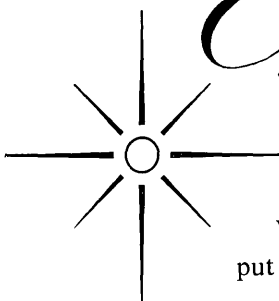

When data-processing problems put the pressure on you, you'll find the "safety valve" you need at STATISTICAL. A wealth of experience is always ready to go to work for you here. Behind every assignment is a searching understanding of management problems and solutions . . . gained in serving America's top companies since 1933.

From this experience comes the consistently-high quality service you would expect from America's oldest and largest independent data-processing and computer service. Sophisticated methods.

Responsible personnel. The latest electronic equipment. Coast-to-coast facilities. Advantages like these add up to "know-how" and "show-how" that can not be acquired overnight.

This experience-in-depth service is available to you day or night. A call to our nearest data-processing and computer center will bring you the results you want . . . and relaxation.

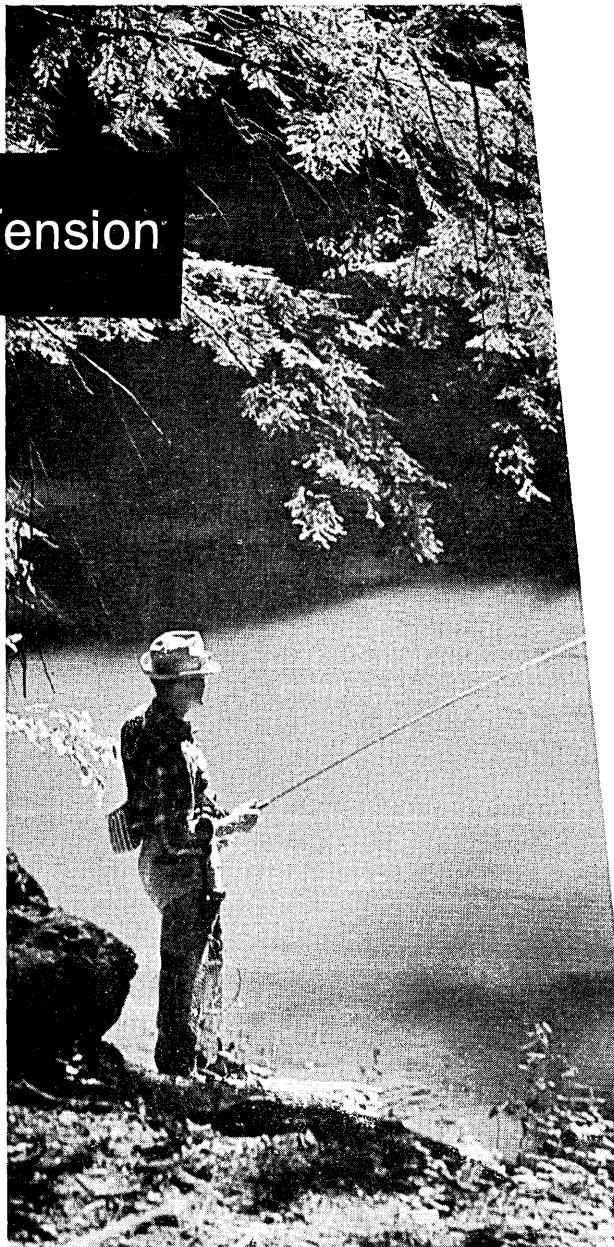

Established 1933

Statistical

TABULATING CORPORATION

NATIONAL HEADQUARTERS

104 South Michigan Avenue - Chicago 3, Illinois

OFFICES IN PRINCIPAL CITIES — COAST TO COAST



THE STATISTICAL MARK OF EXCELLENCE

Now you can transmit your business data by telephone!

You do it with DATA-PHONE service—the dramatic, new Bell System development that lets business machines talk over telephone lines.

Great volumes of data—You can send production figures, payrolls, inventories, sales orders—from punched cards, paper tape or magnetic tape such as shown below.

At high speed—up to 2500 words per minute when regular telephone lines are used. When DATA-PHONE service is used with leased private lines, speeds many times this rate can be obtained.

Accurately. Data is received in the same punched-card or tape form that it was in originally.

Economically. DATA-PHONE transmission goes over regular telephone lines at regular telephone rates. Some firms accumulate a day's data, then send it after hours, when rates are lowest.

Let one of our Communications Consultants show you how DATA-PHONE service can put more speed, accuracy, economy and profit into your data handling. Just call your Bell Telephone Business Office and ask for him.

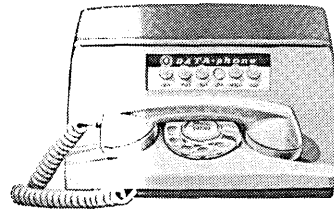

BELL TELEPHONE SYSTEM

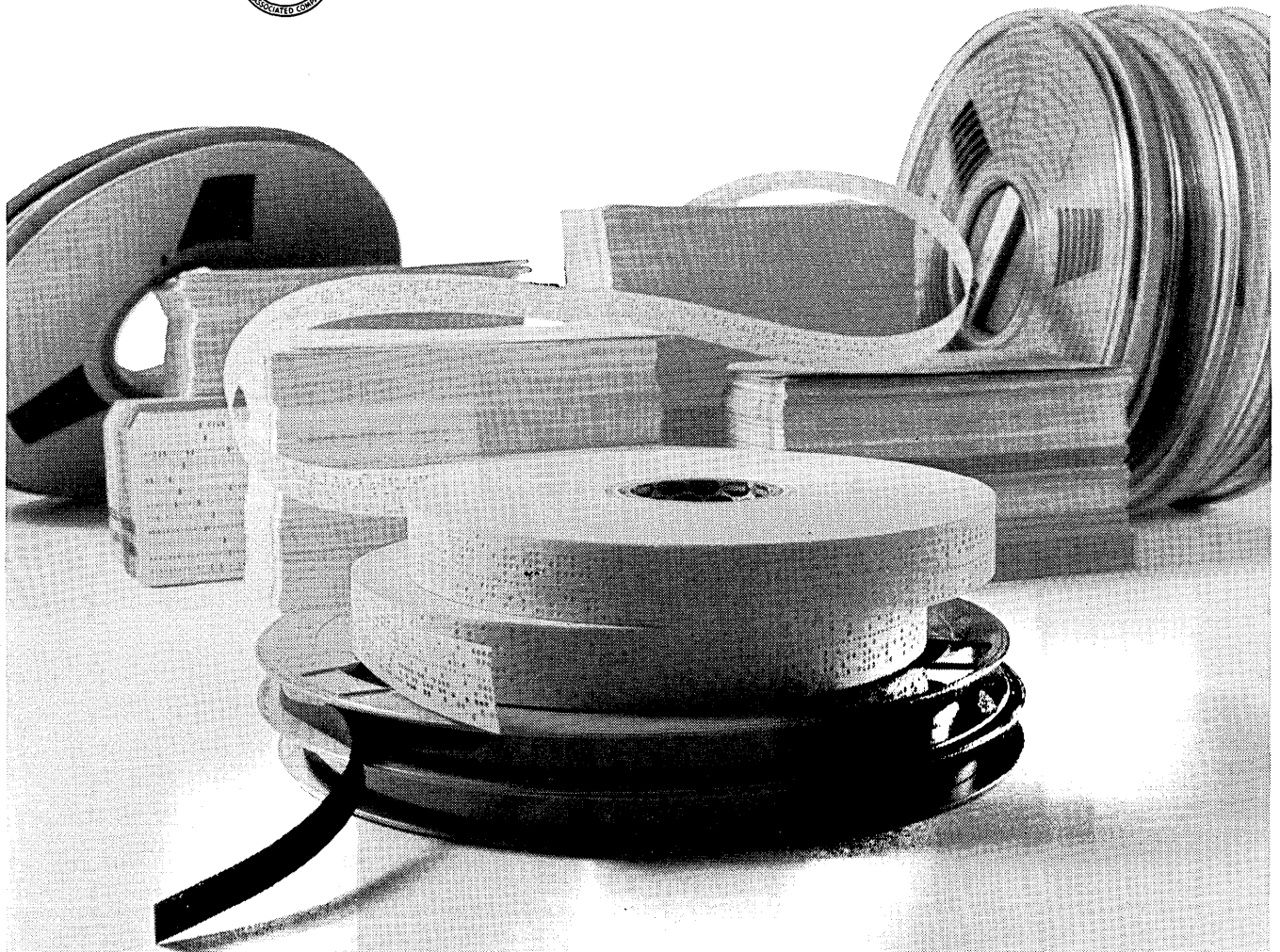

rs'
nal
m-
he
ess
to
ur
re

or
ial
ed
m-
rm
es,
co-
on
rs.
ed
nd
me

ur
cal

N
on

Pky.,
ws &

Park,

Div.,
e 9 /

19 /

view,

46 /

Uni-
& As-

Chi-

tion,
es 24

COMPUTERS and AUTOMATION

COMPUTERS AND DATA PROCESSORS, AND THEIR CONSTRUCTION,
APPLICATIONS, AND IMPLICATIONS, INCLUDING AUTOMATION

Volume XI
Number 3

MARCH, 1962

Established
September, 1951

EDMUND C. BERKELEY *Editor*
PATRICK J. MCGOVERN *Assistant Editor*
MOSES M. BERLIN *Assistant Editor*
NEIL D. MACDONALD *Assistant Editor*
SYDNEY STARR *Art Director*

CONTRIBUTING EDITORS

ANDREW D. BOOTH
JOHN W. CARR, III
PETER KUGEL
NED CHAPIN
ALSTON S. HOUSEHOLDER

ADVISORY COMMITTEE

MORTON M. ASTRAHAN
GEORGE E. FORSYTHE
ALSTON S. HOUSEHOLDER
HOWARD T. ENGSTROM
RICHARD W. HAMMING
HERBERT F. MITCHELL, JR.

SALES AND SERVICE DIRECTOR

PATRICK J. MCGOVERN
815 Washington St.
Newtonville 60, Mass.
DEcatur 2-5453

ADVERTISING REPRESENTATIVES

Los Angeles 5 WENTWORTH F. GREEN
439 So. Western Ave. DUnkirk 7-8135
San Francisco 5 A. S. BABCOCK
605 Market St. YUkon 2-3954
Elsewhere PATRICK J. MCGOVERN
815 Washington St. DEcatur 2-5453
Newtonville 60, Mass.

COMPUTERS and AUTOMATION is published monthly at 815 Washington St., Newtonville 60, Mass., by Berkeley Enterprises, Inc. Printed in U.S.A.

SUBSCRIPTION RATES: United States, \$15.00 for 1 year, \$29.00 for 2 years, including the June Directory issue; Canada, add 50c a year for postage; foreign, add \$1.50 a year for postage. Address all Editorial and Subscription Mail to Berkeley Enterprises, Inc., 815 Washington St., Newtonville 60, Mass.

ENTERED AS SECOND CLASS MATTER at the Post Office at Boston, Mass.

POSTMASTER: Please send all Forms 3579 to Berkeley Enterprises, Inc., 815 Washington St., Newtonville 60, Mass.

Copyright, 1962, by Berkeley Enterprises, Inc.

CHANGE of ADDRESS: If your address changes, please send us both your new address and your old address (as it appears on the magazine address imprint), and allow three weeks for the change to be made.

Some Novel Applications of Computers

1B to 9B
(inserted between pages 24 and 25)

FRONT COVER

Long-Lived Computer for Space 1, 6

ARTICLES

Molecular Electronics—An Introduction,
by WESTINGHOUSE ELECTRIC CORP. 10
PERT (Program Evaluation and Review Technique)—
A Control Concept using Computers,
by JOHN JODKA 16
Cybernation: The Silent Conquest,
by DONALD N. MICHAELS 26

ACROSS THE EDITOR'S DESK 10B to 20B
(inserted between pages 24 and 25)

READERS' AND EDITOR'S FORUM

Call for Papers for WESCON, Los Angeles,
Aug. 21-24, 1962 6
"Dues" from Automation Machines for Aiding Adjust-
ments of Displaced Workers 6
Summer Research Training Institute in Heuristic Pro-
gramming, by PAUL ARMER 7
Association for Computing Machinery National Confer-
ence, 1962—Call for Papers 7
Programmed Assistance 7
Calendar of Coming Events 20

REFERENCE INFORMATION

Books and Other Publications, by MOSES M. BERLIN 21
Who's Who in the Computer Field (Supplement) . . . 42
New Patents, by RAYMOND R. SKOLNICK 44

INDEX OF NOTICES

Advertising Index 46
Computer Directory and Buyers' Guide 23
Glossary of Computer Terms 23
Manuscripts 18
Reference and Survey Information 23
Who's Who Entry Form 42

3,017,0
Mas
A n
3,017,0
N.
Yor
syste
3,017,0
Flav
I.B.
gran
essin
3,017,0
Eng
Ont
N.
elec
3,017,0
Schv
dig,
mul
3,017,0
Cal
/ A
3,017,0
N.
alle
3,017,0
Va.
A a
3,017,0
Eng
An
chir
3,017,0
Cal
Day
cuit
3,017,0
Cal
Inc.
sign
3,017,0
Eve
kin,
Yor
stad
pro
3,017,0
D.
Wa
para
3,017,0
Squ
A r
3,017,0
N.
neti
3,017,0
fiel
sear
for
3,018,0
fiel
data
3,018,0
Com
Cor
latir
3,018,0
N.
put
3,018,0
pan
chir
inte
3,018,0
Tow
liam
Tel
/ A
COM

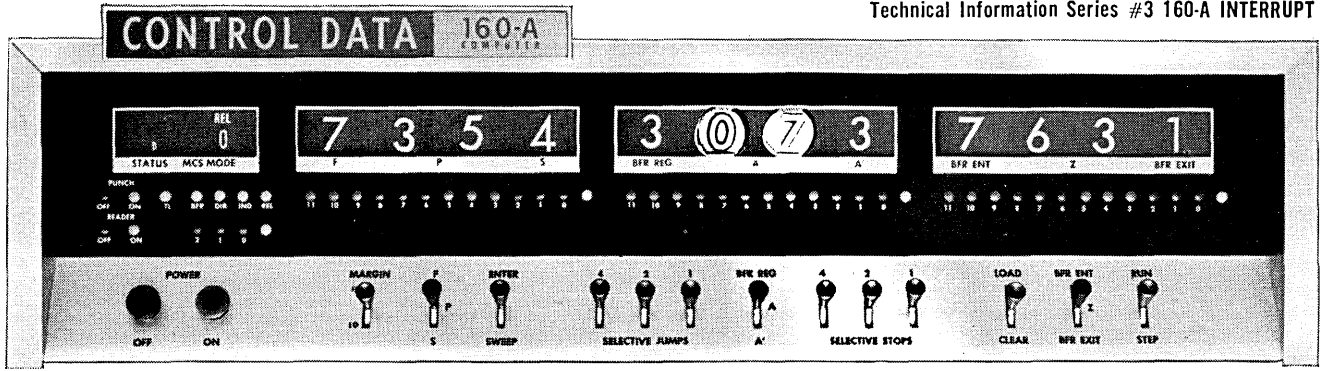

GREEN LIGHTS INDICATE INTERRUPT STATUS.

NEW CONTROL DATA 160-A COMPUTER

Desk-Size Computer with Large Computer Capabilities

In evaluating desk-size computers, the flexibility and capability of the computer to perform interrupt functions is of great importance. Similar to the interrupt feature employed in many advanced, large-scale computers, the 160-A Program Interrupt allows the normal program sequence to be interrupted by various external conditions . . . such as a peripheral equipment completing its function, operator action, and end-of-buffer sequence. Few desk-size computers on the market today have this capability.

The 160-A has four interrupt lines: two internal and two external. When an interrupt signal occurs on one of these lines, the computer executes a special RETURN JUMP instruction to one of four fixed memory locations, depending upon the line generating the interrupt.

For example, the operator can activate Interrupt Line 10 by momentarily depressing any combination of a Selective Stop Switch and a Selective Jump Switch, which are located on the 160-A console display panel. Interrupt Line 20 is activated each time a buffer operation is completed. Finally, Interrupt Lines 30 and 40 are external lines and may be activated by any peripheral device designed to provide an interrupt signal. In all cases where an interrupt occurs, the

160-A executes a special RETURN JUMP instruction to a fixed memory location.

Interrupt signals are recognized in a priority sequence, the lower-numbered lines being recognized first. Thus, where an interrupt occurs simultaneously on Lines 10 and 20, Line 10 will be recognized first. Once an interrupt signal is placed on a line, it remains until recognized or until a console MASTER CLEAR instruction is executed.

A desk-size computer, the Control Data 160-A has the speed, capability, and flexibility of many large-scale computers. For more detailed information about the 160-A Program Interrupt and other standard features, write for Publication #B12-61.

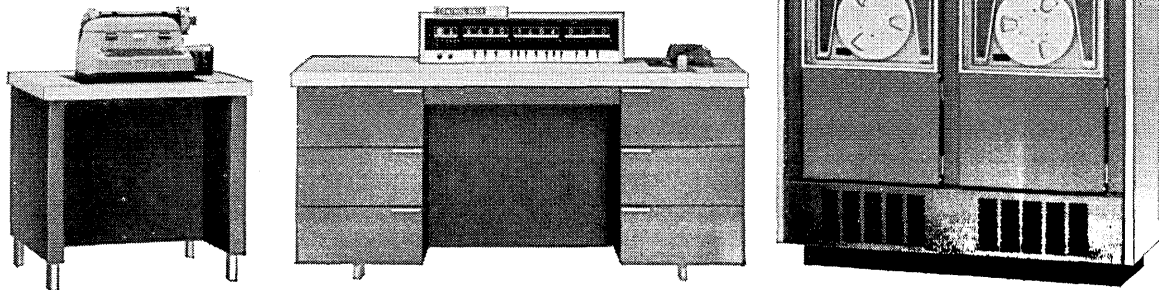

CONTROL DATA CORPORATION
 COMPUTER DIVISION
 501 PARK AVENUE, MINNEAPOLIS 15, MINNESOTA

Readers' and Editor's Forum

FRONT COVER: LONG-LIVED COMPUTER FOR SPACE

The front cover shows a prototype, ferrite-core, really a *revived kind* of miniaturized computer under development, which will run for years in outer space without maintenance.

The prototype shown is in operation at the research laboratories of Lockheed Missiles & Space Company, Sunnyvale, Calif. It uses ordinary copper wire and rugged, ceramic-like ferrite cores in place of transistors. The design promises to have far-reaching implications for spacecraft and electronics generally.

Only the set of five cards containing multi-aperture ferrite cores (to which tweezers are pointing) are computer elements; the base to which the cards are attached is lab equipment. A typical computer would have about 30 times as much circuitry as shown here; it could perform the same computations as a standard computer. The double row of switches at the lower left serves as controls for the demonstration model.

The magnetic core computer is from 10 to 100 times more reliable than computers using transistors. In space vehicles computers perform most of the guidance, data collection, data processing, and data transmission. Both the copper wire and the ferrites are extremely tough. Virtually the only place where failure can occur is where the wires of one circuit are joined to those of another. But magnetic-core computers process information about 200 times more slowly than transistorized computers—but still at the rate of 5000 pulses per second.

CALL FOR PAPERS FOR WESCON, LOS ANGELES, AUGUST 21-24, 1962

Papers to be contributed to the 1962 Western Electronic Show and Convention in Los Angeles, August 21-24, 1962, should be submitted in the following way:

Abstracts of 100 to 200 words, and summaries of 500 words, should be sent before April 15, to Dr. David Langmuir, c/o Wescon, 1435 So. La Cienega Blvd., Los Angeles 35, Calif.

"DUES" FROM AUTOMATION MACHINES FOR AIDING ADJUSTMENTS OF DISPLACED WORKERS

One manufacturer of automation equipment announced in February that its automation machines will pay "dues" to be used to develop ways to ease automation's impact on displaced workers.

John I. Snyder, Jr., President and Chairman of U. S. Industries, Inc., said that the dues will be calculated upon the sale or lease price for each automated USI machine. These payments will continue monthly for one year from the date of sale or lease. He estimated that the dues will range in annual amounts from \$25 to \$1,000 per machine.

"Such dues are to be paid to a labor-management foundation now being created, which will be charged with the specific responsibility of administering the funds thus collected for the benefit of employees affected by automation advances," he said.

"The rapid growth of automation and the problems created by this growth are matters of increasingly serious concern to government as well as to labor and management. It is our belief that those companies actively engaged in the production of automation equipment must also hasten to shoulder their proper share of the clear responsibilities imposed on us all by our technological achievements in this field. Automation is inevitable and its use is rapidly increasing. Positive, affirmative steps by the makers of machines must be taken now to preserve human values in today's changing times."

U. S. Industries consists of 15 divisions engaged in the manufacture of products for use in metal fabricating, transmission of oil, water and gas, petroleum production, aircraft and missiles, the dairy industry, and other fields. The USI Automation Division, Silver Spring, Md., produces a machine called TransfeRobot 200, a low-cost automation device used mainly in assembly line operations. The company's Production Machine Division in Chicago also produces automated press lines and other large automated production machines.

Mr. Snyder said that the labor-management foundation chosen to administer the funds resulting from its new policy is now being established under the joint sponsorship of USI and the International Association of Machinists. It will take the form of a non-profit foundation created for the sole purpose of establishing and administering a program that will effectively aid in the transitional adjustments of workers affected by automation.

Studies for methods of effective retraining are expected to receive priority in the foundation's planning.

USI and the International Association of Machinists have worked closely together in the past as joint sponsors of the Foundation on Employee Health, Medical Care and Welfare, Inc., which was established in 1956 to aid and assist companies and unions in the health and welfare field.

Muller
Gene
ville,
lumb
Newma
BRA
—, '5
pater
Oxford
Com
Corp
Hou
to th
Sout
merc
Paden,
pany
ABP
West
Patton
sear
City
Har
data
Payne,
Corp
USN
Payne,
Airc
/ A
'56,
Peters
Dep
vent
triev
BE
Petrie,
Prel
/ '2
prg
Rice,
Cash
Pro
Yor
Bro
Yor
anal
Salsbu
Corp
End
Mic
Simme
DH
vive
P /
prg
Simp
Com
pita
Arb
'31,
res
Siquel
lins
ter,
Bea
eval
sup
Street
som
US
'37,
VanW
lin
St,
life
in
tion
Walk
ren
DE
Yates,
Ana
ton

PROFIT ENGINEERED

The Bendix G-20 computing system—an integrated, advance-design hardware-software package—is profit engineered to bring you maximum results per dollar invested. ■ Designed concurrently, G-20 hardware and software blend into a system which allows you to simultaneously process engineering and business programs. Under executive program control, program priorities are automatically established. Automatic too is memory allocation and the assignment of high-speed communications channels and input-output devices. This means that your G-20 always represents the maximum-efficiency operational configuration for the jobs at hand ...without reprogramming or manual intervention. ■ The G-20 was designed for maximum uptime and ease of operation, too. Seeing that you take full advantage of G-20 speed and power is a large staff of automatic programming specialists and a nationwide team of application experts. Complete physical system support—from pre-installation planning through installation and continuing maintenance—is provided by Bendix Computer service specialists. ■ It all adds up to maximum results per dollar invested. Investigate the proven, installed G-20 at once...see how this profit engineered system can help you effectively reduce your data processing costs. Call your nearest Bendix Computer office or write: Bendix Computer Division, 5630 Arbor Vitae Street, Los Angeles 45, California. Dept. D-38.

Bendix Computer Division



THE BENDIX G-20 COMPUTING SYSTEM

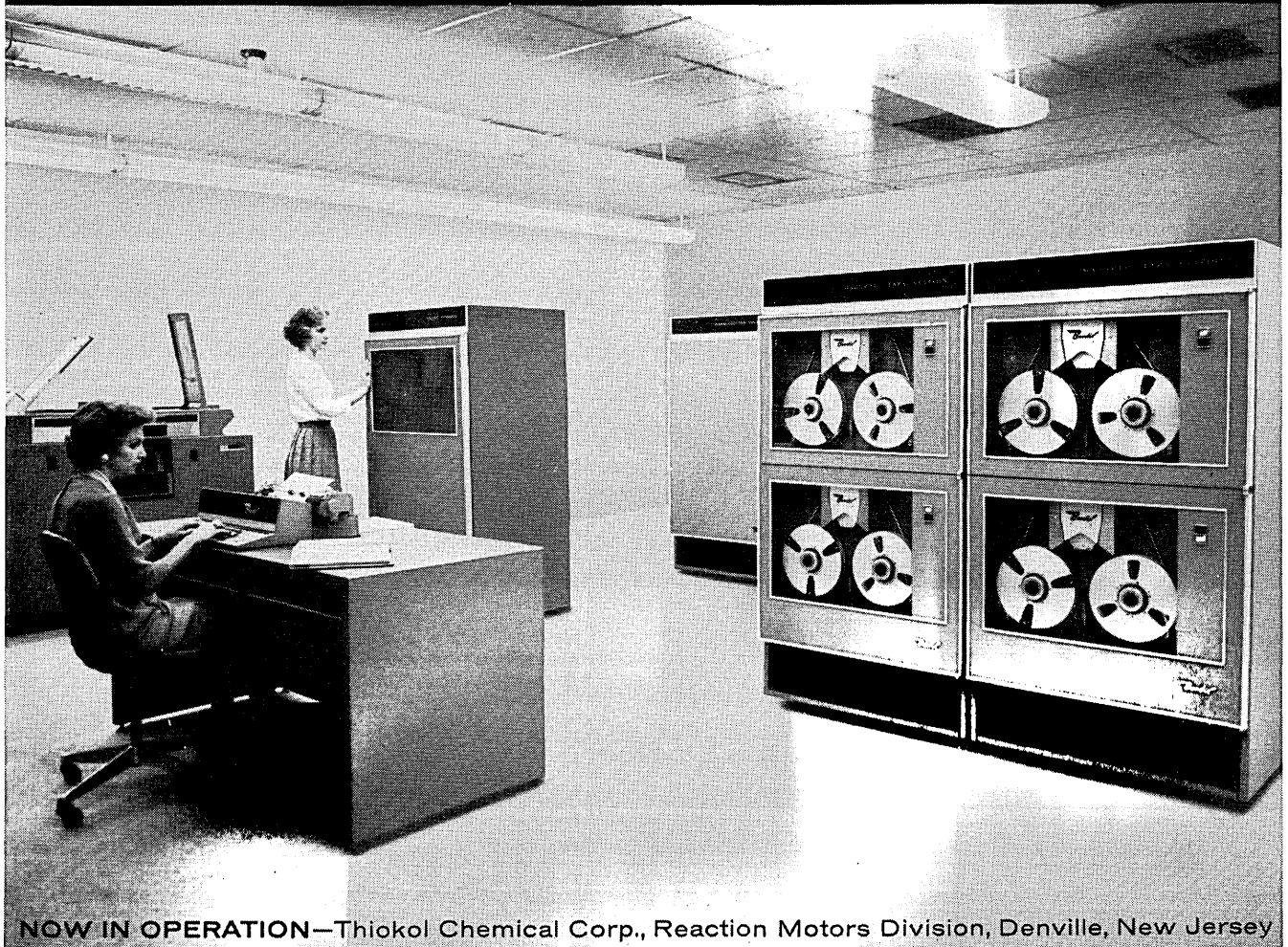

NOW IN OPERATION—Thiokol Chemical Corp., Reaction Motors Division, Denville, New Jersey

The committee expects to review an anticipated 400 contributed papers in preparing the final program.

SUMMER RESEARCH TRAINING INSTITUTE IN HEURISTIC PROGRAMMING

Paul Armer
Head, Computer Sciences Dept.
The Rand Corporation
Santa Monica, Calif.

Applications are invited from academic personnel for participation in a Research Training Institute on Heuristic Programming, to be held at The RAND Corporation, Santa Monica, California, June 18—July 27, 1962. The Institute will cover techniques in the programming of digital computers to solve complex problems using some of the methods observed in human problem-solving. Participants will be expected to hold doctoral degrees although exceptionally qualified advanced candidates for the doctorate will be considered. Experience in computer programming will be a prerequisite. Stipends and travel allowance will be offered. Deadline for applications is March 30, 1962. For further information write to Dr. Bert F. Green, Jr., Computer Sciences Department, The RAND Corporation, Santa Monica, California.

ASSOCIATION FOR COMPUTING MACHINERY NATIONAL CONFERENCE 1962 — CALL FOR PAPERS

The 1962 ACM National Conference will be held September 4-7 at the Hotel Syracuse and the War Memorial Auditorium in Syracuse, New York.

The conference will include contributed papers on the areas and suggested topics detailed below:

1. Scientific Information Processing: Numerical Analysis and Mathematical Applications; Applications in the Physical Sciences; Engineering Analysis, Simulation and Synthesis.
2. Automatic Programming and Computer Languages: Compilers and Assemblers; Monitor Systems; ALGOL, COBOL, etc.
3. Business Information Processing: Business and Management Control Systems; Automated Clerical Systems; Operations Research and Management Simulation.
4. Information Retrieval: Memory Devices; Automatic Abstracting; Indexing Methods.
5. Language Translation: Natural Languages (English, French, Russian, etc.); Artificial Languages.
6. Education: Use of Computers in Education; Education of Computer Personnel.
7. Real-Time Information Processing: Programming Real-Time Computers; Simulation of Real-Time Processes.
8. Social Aspects and Philosophies: Responsibilities of Computer Personnel; Social Problems of Today; Predictions for the Future.

Papers representing original contributions in these and related fields are invited. For any such paper,

there should be sent, on or before May 1, 1962, to Technical Program Co-chairman, R. W. Beckwith, 7614 Hunt Lane, Fayetteville, N. Y., the following (in quadruplicate): an 800 to 1000 word illustrated summary (about 4 pages); and a 35-word abstract.

Both the summary and abstract should highlight the nature of the contribution, its significance in the art, and theoretical and experimental results. Accompanied by key drawings or photos, or both, the manuscripts should be submitted on single-side, black on white, double-spaced typewritten form, with the author's name, affiliation, address, and telephone contact on the first page, and author's name and abbreviated paper title on subsequent pages. On papers with multiple authorship, the name of the speaker who will deliver the paper should also be noted.

The 35-word abstract will be published in an advance program.

An innovation at ACM 62 will be a specially-prepared letterpress edition of a *Digest of Technical Papers*. To be distributed at the meeting, the book, with about 180 pages, will include illustrated condensations of all papers.

The program will also include a number of invited papers, round-table discussions, and "Halls of Discussion." Suggestions for topics for the discussions will be welcome.

General chairman of the conference is R. S. Jones, Sylvania Electric Products, Inc., Camillus, N. Y.

PROGRAMMED ASSISTANCE



"I think I know where he's getting all of the suggestions the company has been paying him for."

busi
ling,
of na
patit
agem

In t
the
can b
prob
popu
most
cyber
will
nucle
realn
the i
even
will
the
they,
puter

TH
peop
cyber
with
avera
can
nucle
schol
know
relat
prob
will

Som
tively
chind
of in
nate
what
large
the c
and
nate
woul
with

Ev
all th
after
more
posi
will
short
fulfil
has e
activ
most
will
to th
to th

OB
respo
we sh
gap
feren

COM

ACHPHENOMENON

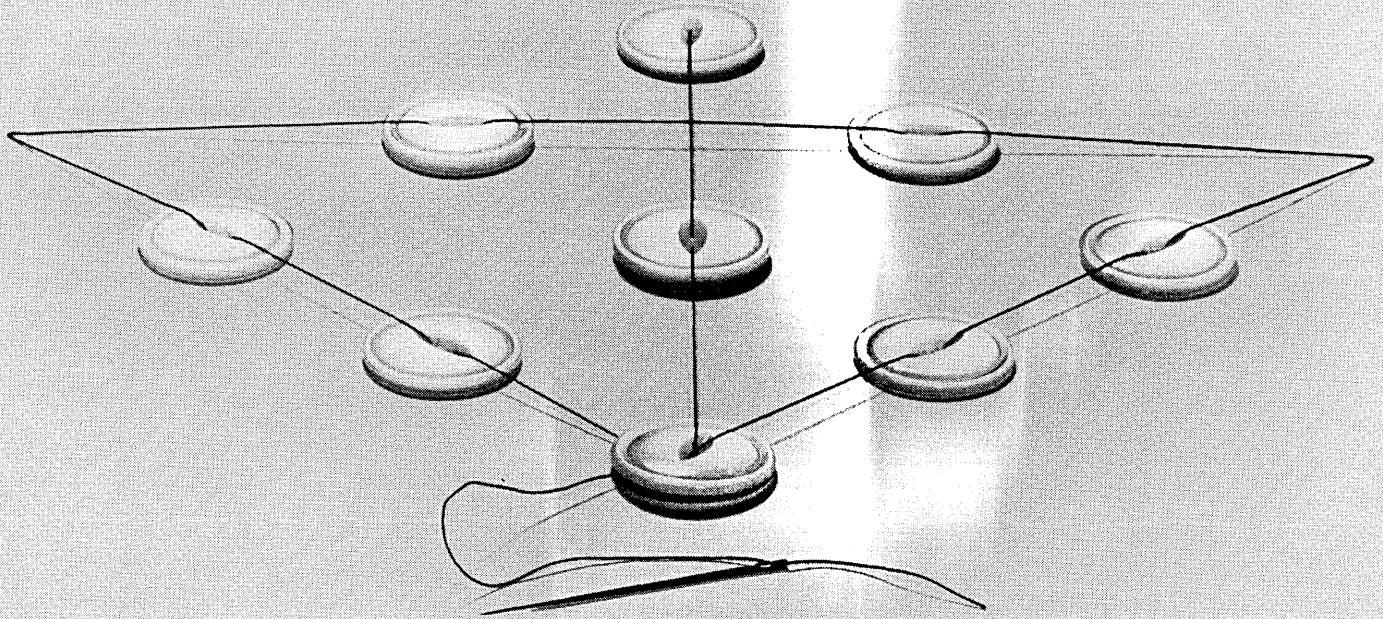

For the first moment, the elements are seen separately. Then suddenly, insight arrives. The structure is seen as a whole. With just four straight lines it is possible to bisect all nine dots, the pencil never leaving the paper. What happened? A Flash Experience. Aha! Achphenomenon.

The courage to go outside the confines of the original pattern resulted in an optimal solution. This talent to think in new directions is a quality we look for in engineers. If you're sometimes dissatisfied with traditional concepts and look for a chance to exercise your creative impulses, send a resume to Mr. Nick B. Pagan, Manager Professional and Scientific Staffing. Expect a prompt reply.



LITTON SYSTEMS, INC.

GUIDANCE AND CONTROL SYSTEMS DIVISION

5500 CANOGA AVENUE, WOODLAND HILLS, CALIF.

Guidance Systems • Control Systems • Computers • Computer Components

An Equal Opportunity Employer

MOLECULAR ELECTRONICS — AN INTRODUCTION

Westinghouse Electric Corp.
Pittsburgh 30, Pa.

Electronics began with the invention and early development of the vacuum tube. Vacuum tubes are incorporated into electronic circuits by connecting them into the proper array of other components such as resistors, capacitors and inductors. Such circuits are capable of performing a variety of basic electronic functions—amplification, oscillation, AC to DC conversion, frequency selection and the like. An assembly of circuits forms an electronic system, for example, the electronic system of a home radio or television set, or the guidance system of a rocket. The great percentage of today's electronic systems are still put together in this traditional fashion—the assembly of individual components into circuits (or subsystems) which perform a given function, and thence into systems that will accomplish the over-all effect desired.

The Goal of Molecular Electronics

Molecular electronics is a new concept of electronic systems. Basically, it seeks to integrate into a solid block of material the functions performed by electronic circuits or even whole systems. Its goal is to rearrange the internal physical properties of the solid in such a way that phenomena occurring within or between domains of molecules will perform a function ordinarily achieved through the use of an assembly of electronic components.

Molecular electronics is the most forward-looking of several modern approaches to the development of small, reliable, efficient electronic systems. Almost all attempt to perform the required electronic functions in solid semiconductor-type materials. Molecular electronics, however, is unique in its goal of doing away with the traditional concept of circuit components. Should this goal be fully realized, or even partially so, it would extend the capabilities of electronic systems well beyond that which can be achieved today. In addition to lowering size and weight, increasing reliability and reducing power requirements, molecular blocks could make possible the execution of tasks now too complex to be performed economically by conventional methods and permit the performance of electronic functions which cannot be achieved at all with lumped components.

Reliability of Electronic Systems

With the growth in complexity of electronic systems, perhaps the most crucial problem to be faced, and one particularly critical in military applications, is that of reliability.

The probability that any complete electronic system will function as intended is found by multiplying

together the probabilities of the individual components and connections making up the system. Indeed, with the present state of development of reliable electronic devices, the soldered connections in a system—which outnumber the components many times over—are probably more of a collective hazard than are the components themselves.

As a simple numerical example, suppose a system is composed of only seven components and connections, each having a probability of survival of 90 per cent. Connected together, these seven probabilities give an average probability of survival for the entire system of less than 50 per cent. ($0.9 \times 0.9 \times 0.9 \times 0.9 \times 0.9 \times 0.9 \times 0.9 = 0.48$)

Of course, in practice, the individual probabilities will be higher than 90 per cent. But when the calculation is extended to the thousands of components and tens of thousands of soldered joints composing the electronic systems of modern aircraft or missiles, it is obvious that these individual probabilities must be extremely high if the entire system is to have any real chance of carrying out its intended function. Some idea of the magnitude of the problem can be gained from this comparison: the B-17 or B-29 of World War II used some 2,000 individual electronic components; today, the B-58 requires nearly 100,000 in systems of much greater complexity.

In recent years, therefore, a great deal of attention has been given to this problem of increasing the reliability of electronic components and circuit construction. However, the probability formula shows that a reduction in the number of components and connections raises the over-all probability of system survival much faster than does improvement in the probabilities of the individual parts of the system. For this reason, modern electronics research has as one of its major objectives a reduction in the number of components and connections required to perform a given function. In this respect, molecular electronics is particularly attractive. If a given function is performed within a single, solid block of material, interconnections are eliminated completely.

Principles Underlying Semiconductor Devices

Molecular electronics, as well as other modern approaches to electronic systems, in large measure rests upon a body of scientific knowledge which has accumulated in little more than a decade. Semiconductors, and the startling innovations they have brought about, date only from the invention of the transistor in 1948. Since an elementary understanding of semi-

conductors is essential to an understanding of the construction and behavior of molecular electronic systems, some basic concepts of semiconductors will be discussed.

Semiconductor devices are almost exclusively of a type known as "junction" devices. The simplest such device consists essentially of a small sliver of germanium, silicon or other semiconductor material having two regions which differ electrically.

One region, called n-type material, is so prepared chemically that it has an excess number of electrons associated with some of its atoms. For example, a few atoms (comparatively) of arsenic or antimony introduced into pure germanium or silicon will supply the "free" electrons required of n-type material and make it capable of conducting electricity. Similarly, about one in 100 million atoms of aluminum or indium introduced into germanium or silicon will cause a shortage of electrons in the material, giving rise to vacancies, or "holes," in the crystal's electronic structure and creating p-type material. Such material also conducts electricity when electrons move through the crystal by jumping from one vacancy to the next. Thus, in effect, the electronic deficiency, or "hole," is moving. Electrons and holes often are collectively referred to as charge carriers.

The boundary, or interface, between p-type and n-type regions within the crystal is called a junction. A device which contains a single junction is usually referred to as a diode. It is a two-terminal device (one connection to each region) having high resistivity in one direction and lower resistivity in the other. This permits the device to act as a rectifier.

If a second junction is properly built into the semiconductor crystal, the diode becomes a transistor—a three-terminal device having one type of material sandwiched between two layers of the opposite variety. Transistors can be p-n-p or n-p-n types depending upon the starting base material, which is designated by the center letter.

Basically, the transistor can be considered as two diodes back to back, close enough to influence each other, and biased in opposite directions (Fig. 1). They have a common connection to the base material. Charge carriers injected into one diode (the emitter circuit) affect the resistivity, and hence the current flow, in the other diode (the collector circuit).

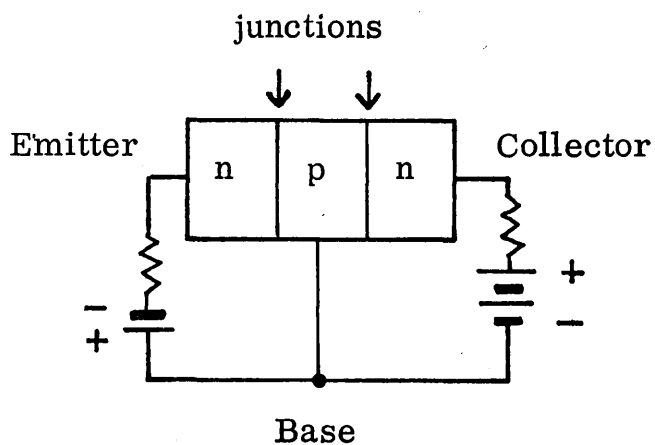

Fig. 1. Basic transistor circuit

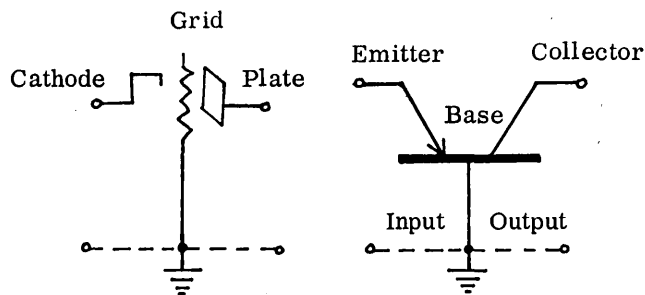

Fig. 2. Basic comparison of transistor and three-element vacuum tube

Through this action the transistor becomes an amplifier and exhibits perhaps the most important phenomenon in electronics—the use of a small electrical signal to control a large one. In this respect it duplicates the behavior of a three-element vacuum tube in which the grid controls the flow of electrons from cathode to plate (Fig. 2).

The introduction of impurity atoms into a semiconductor material is called doping. An n-type or p-type base material is prepared by adding the proper type and concentration (about 1 in 10^8) of impurity atoms when the material is made. Then, the region of opposite type is formed by exposing the base material to the vapor of the impurity element, which diffuses down through the crystal to a depth determined by such controllable factors as time, temperature and concentration. It also can be done by alloying the impurity metal onto the surface of the base material or by other techniques. In any case, the boundary between the two types of material is the all-important semiconductor junction.

The invention of the transistor, the development of junction-type devices, and a rapidly expanding basic research effort in semiconductor materials thus form the basis of molecular electronics and other present-day approaches to microcircuitry and solid-state electronic systems. These approaches appear to mark the beginning of a modern revolution in electronics, which will have profound effect upon its philosophy, its technology, its capability and its impact upon human affairs.

Modern Approaches to Solid-State Electronic Systems

Many specific techniques have been devised to take advantage of modern semiconductor technology in the construction of solid-state microcircuitry. They can, however, be classed into three main approaches.* In increasing order of "newness" and level of sophistication these are: (1) Microcomponent assembly, (2) Two-dimensional microminiaturization, and (3) Functional electronic blocks—the "building blocks" of molecular electronics.

1) *Microcomponent assembly*: Significant progress toward microcircuitry has been achieved through the construction of micromodules from microcomponents. This approach is a logical extension of the trend toward miniaturized electronic components. One of its advantages is the speed and ease with which it

*S. W. Herwald and S. J. Angello, "Integration of Circuit Functions Into Solids," *Science*, October 21, 1960.

can be achieved, because of the availability of more-or-less standard components and the existence of a backlog of experience with conventional circuitry. Thus, the problems associated with the approach perhaps are more technological than they are scientific. It is a standard approach in many research and development projects associated with computers, solid-state control systems, solid-state displays, telemetry systems and other advanced electronic devices, particularly those of interest to the military.

Although microcomponent modules have the advantages of small size, light weight and ruggedness, they do not represent any particular advantage over conventional circuits in the required number of parts and soldered connections. In fact, the tiny components and hair-like wire connections make assembly of the modules difficult and particularly critical if the customary hazards of soldered joints are to be avoided.

2) *Two-dimensional (2-D) microminiaturization*: 2-D microminiaturization seeks to eliminate the thickness dimension in electronic circuitry by forming the active and passive circuit elements directly upon a thin insulating wafer, or substrate. Thus, capacitors, resistors and other components are processed along with their interconnections upon an insulating ceramic wafer, usually by a film depositing technique such as evaporation or sputtering. This approach virtually eliminates the assembly of individual components into a given system or subsystem and does away with a considerable number of interconnections. 2-D microminiaturization is expected to become increasingly significant in electronic systems as a step beyond microcomponent assembly, but it still suffers from the limitations imposed by the traditional concept of separate circuit components connected together to obtain the function desired. Only with the distinctive approach of molecular electronics has this basic concept been abandoned.

3) *Functional electronic blocks*: Molecular electronics might be thought of as an approach in which the simple and familiar block diagram of electronics takes the place of the detailed circuit diagram, or schematic, as the working blueprint for constructing an electronic system. Each functional electronic block is a subsystem that takes on the function of an entire block in the block diagram. These subsystems then go together with a minimum number of connections to form the total system. If the system is not too complicated, its entire function conceivably could be executed within a single block.

Current Status of Molecular Electronics

Under a contract with the Wright Air Development Divisions, USAF, this company has developed a variety of simple functional electronic blocks which are capable of performing such functions as audio and video amplification, oscillation, multivibrator behavior, phase shifting, switching and frequency discrimination. Currently, work is under way to assemble such blocks into more complex electronic systems which cannot, at the present state of the art, be integrated into a single functional block. A radio receiver,

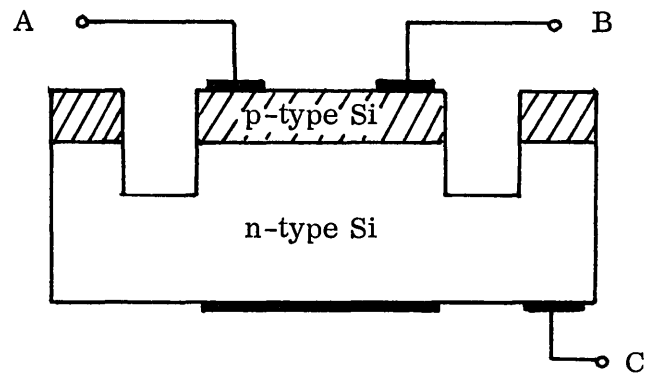

Fig. 3. Cross-section of notch filter functional electronic block

operating in the standard broadcast band, already has been assembled using six functional blocks.

Because of the advanced state of semiconductor technology, semiconductor materials, particularly germanium and silicon, have been the starting materials for the construction of functional blocks. However, other types of materials are expected to be useful as soon as the appropriate technology develops. The techniques employed in the fabrication of standard semiconductor devices are also the ones used in functional block construction. Junction fabrication, etching, plating, alloying, cutting, masking, film deposition and various other methods are employed to form the appropriate regions and interfaces in the block.

A functional block, typical of several that have been developed commercially, is the so-called "notch filter,"* shown in cross section in Figure 3.

Such a notch filter, also called a "distributed bridged-T," attenuates a narrow band of radio frequencies and passes all other frequencies it receives. In addition, it can be tuned to reject different frequencies by adjusting the voltage across it. Thus, the block achieves frequency selection—ordinarily attained by coil-capacitor components—and makes possible a tunable functional block amplifier. This single block replaces a circuit having at least six resistors and capacitors and their soldered interconnections.

The notch filter block is made by starting with a base of lightly doped, high resistivity, n-type silicon. An impurity is diffused into its upper surface to form a heavily doped, relatively low-resistivity skin of p-type silicon and a p-n junction at its interface with the base material. Slots cut through the p-type material isolate it, and also the junction, into three parts. Thin metal films then are deposited on the areas shown in the

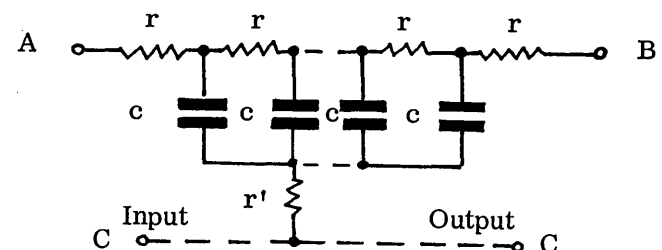
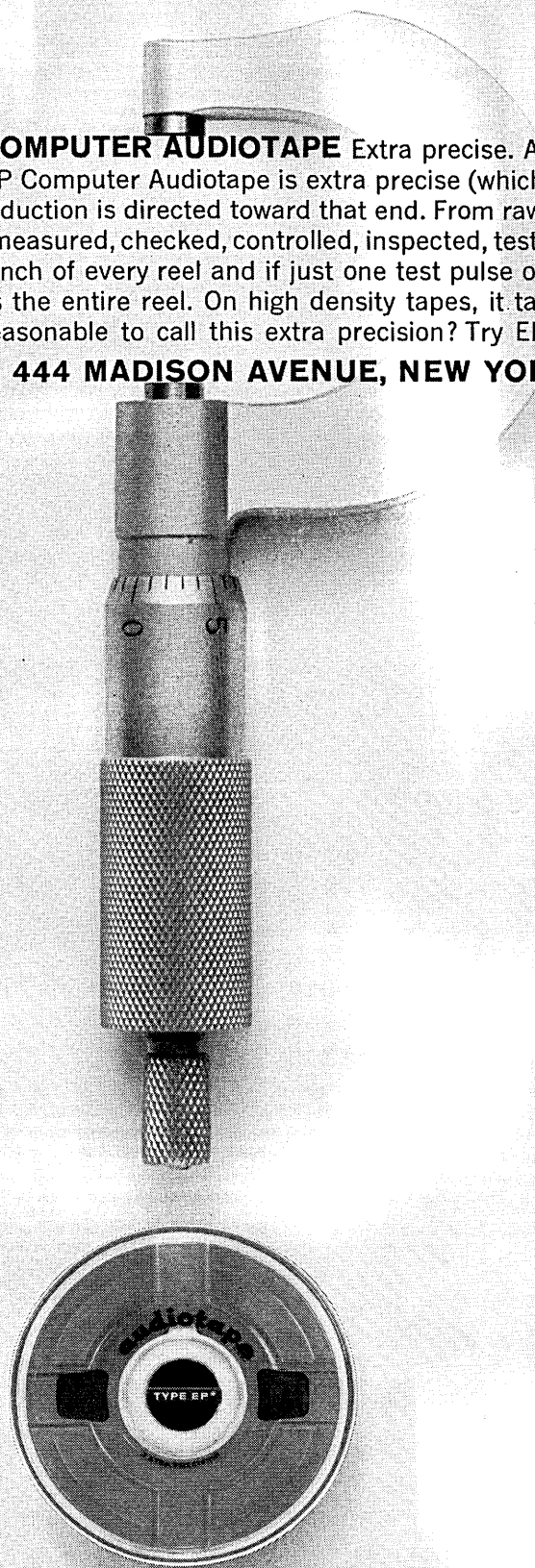

Fig. 4. Circuit analog of notch filter

*W. M. Kaufman, "Theory of a Monolithic Null Device and Some Novel Circuits," Proceedings of the IRE, September, 1960.

HOW PRECISE IS EP COMPUTER AUDIOTAPE Extra precise. An unscientific term but an accurate one. We know EP Computer Audiotape is extra precise (which is what EP stands for) because every step in its production is directed toward that end. From raw material to sealed container, this computer tape is measured, checked, controlled, inspected, tested. Automatic Certifiers record and play back every inch of every reel and if just one test pulse out of 40 million doesn't reproduce properly out goes the entire reel. On high density tapes, it takes 112 million perfect pulses to qualify. Is it unreasonable to call this extra precision? Try EP Computer Audiotape.

AUDIO DEVICES INC., 444 MADISON AVENUE, NEW YORK 22, NEW YORK



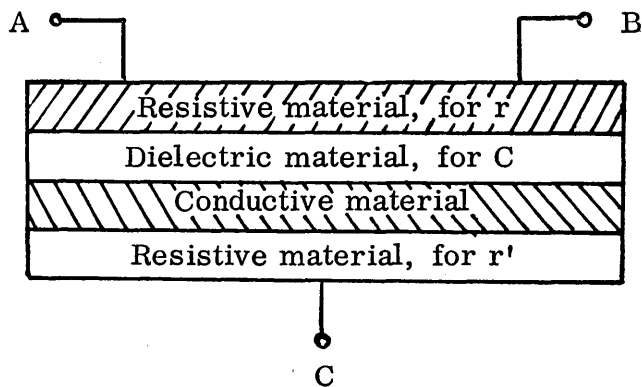

Fig. 5. Idealized structure of notch filter in solid materials

diagram, and three external leads, A, B, C, are attached to two of these films. The entire block is about one-fourth of an inch long, one-eighth of an inch wide, and five-thousandths of an inch thick.

Prepared from conventional components, the notch filter would consist of a network of series resistors (r) and shunt capacitors (c) connected to a resistor (r'), as shown in Figure 4. An idealized form of solid block structure with corresponding characteristics is shown in Figure 5. It consists of a four-layer sandwich. Between terminals A and B, the top layer of high-resistance material corresponds to the series resistors, r , between the equivalent points in Figure 4. The dielectric layer forms the shunt capacitors, c , which, by means of the layer of good-conducting material, are connected directly to a bottom resistive layer that is a "built-in" version of r' in Figure 4.

An idealized version of the notch filter as constructed from a block of semiconductor material is shown in Figure 6. Here, the p-type layer has high resistance, and capacitance is obtained from the p-n junction by applying a bias voltage, E , in the reverse direction. Again the bottom layer replaces resistor r' in Figure 4.

Translated into its practical form as a functional electronic block, the idealized notch filter of Figure 6 assumes the form shown in Figure 3. The main difference is the addition of the thin metallic areas, which make connection to the capacitive region of the

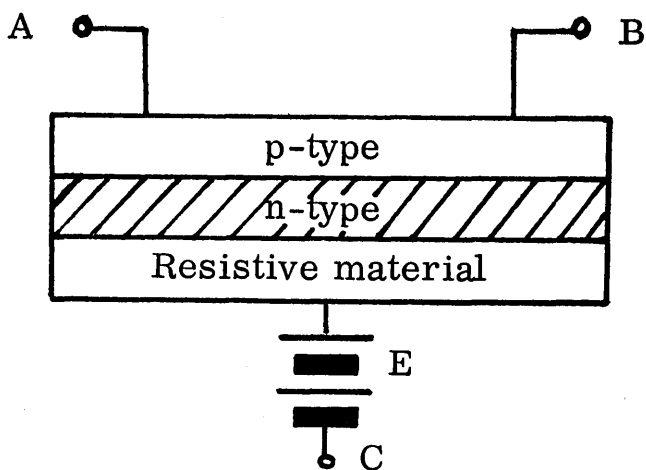

Fig. 6. Idealized structure of notch filter in semiconductor material

block. The block's capacitance, as well as the resistance across it, varies with the voltage applied across the block, thus changing its frequency response, or tuning it. Because the resistance and capacitance are distributed throughout the block—not lumped at specific locations in it—the performance of the notch filter functional block cannot be exactly duplicated in a circuit constructed from ordinary components. Thus, in this sense, it performs a new electronic function, not attainable heretofore with conventional circuitry.

Future of Molecular Electronics

The technology of molecular electronics has progressed to the point that functional electronic blocks of several different types are being made available commercially for experiment and evaluation. At present, their cost is high, but there seems to be no reason why they cannot ultimately be produced in large quantity at less cost than the equivalent circuitry.

Success in molecular electronics rests heavily upon a basic understanding of the innate properties of materials and, because of this, upon the ability to modify and exploit them in useful form. Therefore, progress in this new approach to electronic systems will be largely conditioned by progress in two areas—materials and processing techniques.

A major step toward the more perfect, more uniform semiconductor materials required in molecular systems was recently achieved by scientists at the Westinghouse Research Laboratories with the development of the "dendritic growth" of germanium and silicon crystals. In contrast to conventional techniques, the new process grows these semiconductor materials in the form of long, thin, optically flat, perfectly surfaced strips which need no intermediate processing to make them suitable for finished semiconductor devices. In later experiments, "multi-zone" dendrites with "built-in" p and n regions have been grown and have been made into simple semiconductor devices simply through the attachment of the proper leads. Improvements in the dendritic growth process can be expected to have broad implications for molecular electronics and for conventional semiconductor device fabrication as well.

A second materials development of consequence to molecular electronics is the "epitaxial growth" by vapor deposition of layers of silicon upon a silicon substrate. This technique will provide the multiple junctions required by the more complicated types of functional blocks.

Progress is being reported, too, in the development of new processing techniques for the fabrication of functional blocks. Electron beam cutting and welding, photoetching, vapor deposition and the like are processes already in use. A major research effort is under way to perfect existing materials and techniques, discover new ones, and develop a technology which will provide, with reasonable economy, reproducible functional blocks of high performance.

As such materials and techniques become available, molecular electronics will fulfill the promise it now demonstrates as a major advance in the electronics art.

IBM extends the range of programming

Are you interested in exploring the capabilities of the computer?

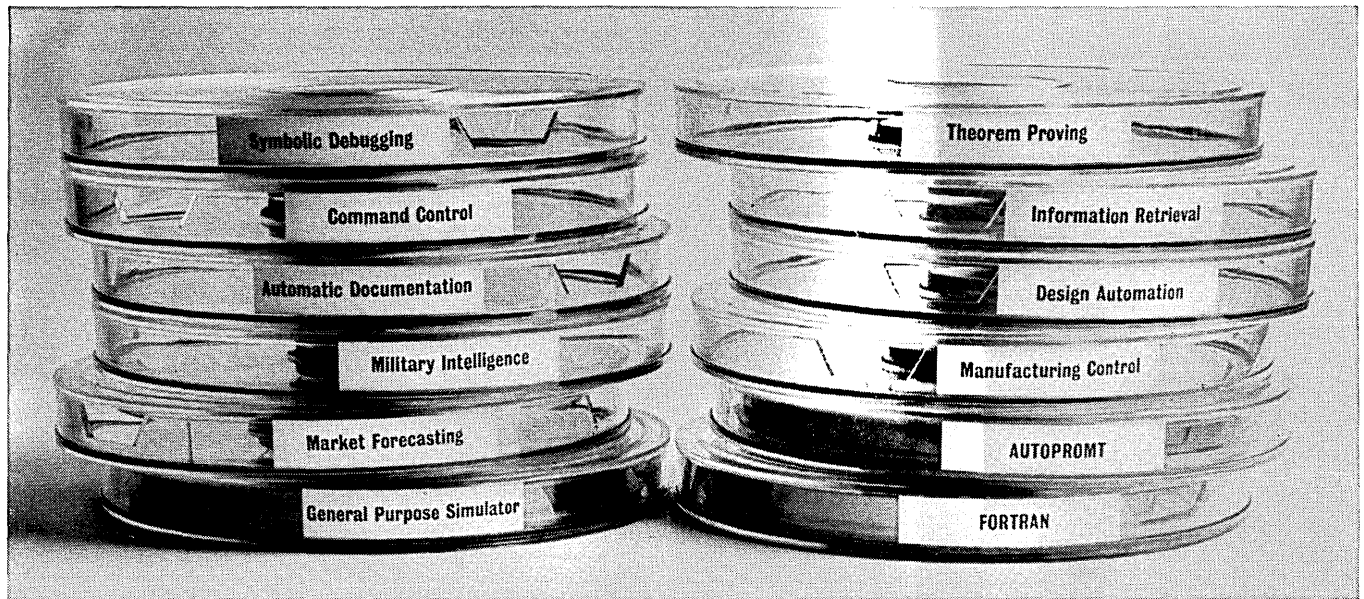

Some of the most important programming developments are taking place now at IBM.

The broad scope of work underway at IBM offers important advantages to members of our professional programming staff. They have the opportunity to work on projects taken from the broad range of programming. They are face to face with the frontiers of applied, scientific and administrative programming. For example, what advanced programming techniques interest you the most: multiprogramming systems . . . compilers . . . problem-oriented languages and processors? Programmers at IBM are exploring these techniques and many more.

Here are some other areas you might work in if you were a programmer at IBM: theory of computing . . . artificial intelligence . . . simulation systems . . . scheduling methodology . . . communications control systems . . . space systems . . . and the design of total computer systems.

At IBM, you would find yourself in the kind of atmosphere that encourages accomplishment. You would help to design new hardware systems. You would work side by side with men of eminent professional stature: scientists, engineers and mathematicians who pioneer in the

research and development that make new computing systems possible.

What's more, you would be able to give your projects the time they deserve. Time for thinking. Time for achievement.

The scope of programming at IBM stimulates professional growth. It offers possibilities which merit serious consideration whether you are a master of the skills of programming or a relative newcomer to the field. Salaries and benefits at IBM are excellent. If you have experience in scientific or commercial programming, we would like to acquaint you with the wide range of responsible positions on our programming staff.

Programming facilities are located in San Jose, Calif.; Washington, D. C., area; Lexington, Kentucky; Rochester, Minnesota; Omaha, Nebraska; and New York, Endicott, Kingston, Owego, Poughkeepsie and Yorktown Heights, New York. IBM is an Equal Opportunity Employer.

For further details, please write, outlining your background and interests, to: Manager of Professional Employment, IBM Corporation, Dept. 539P, 590 Madison Ave., New York 22, N.Y.

PERT (Program Evaluation and Review Technique) —A CONTROL CONCEPT USING COMPUTERS

John Jodka

Cost Accounting Supervisor
General Dynamics Convair
San Diego, Calif.

The concept presented here is no substitute for judgment, and indeed the concept relies heavily on it, but it is a control "breakthrough" which should revolutionize controllership methods. Although this technique has been pioneered in the defense industry, the same principle can be adopted as a tool of financial management in any industry. As to the companies in the aerospace industry, they must adjust to this new type of management control or find themselves wanting when defense contracts are awarded. This new concept, Program Evaluation and Review Technique, is called PERT by the Navy Special Project Office. The same technique is called PEP by the Air Force, standing for Program Evaluation Procedure.

The evaluation method to check actual progress to schedule was begun by the Navy Special Project Office in December 1959, using consultants from the firm of Booz, Allen and Hamilton in the planning phase. The method was so successful that, as is apparent from the instructions to bidders on major government contracts, the PERT/PEP method will be a requirement for most major defense contracts let in the future.

It is also virtually certain that the prime contractors will be forced to demand PERT type techniques down to all tiers of the supply line because the very workability of the system depends on the interrelationships of all parts of the whole, especially in regard to producing the first end article of a system or program. Therefore, anyone doing business with the Armed Services or with any prime contractor who does such business is well advised to get acquainted with the method.

How Does PERT Work?

The common denominator of *time* is used for all planning, measurements of progress to schedule, evaluating changes to schedule and forecasting future progress. The interrelationships of each identifiable event and the activities required to reach that point, are planned, programmed and iteratively reported on. For a large project, this continuous and frequent reporting, to be timely, usually requires the clerical help that a data computer of some kind can provide. The reports merely show trouble spots or potential trouble spots. The system is the epitome of the "management by exception" theory because it highlights the critical path to the end objective. However, be-

cause it also reports repetitively and frequently on all activities, there is little chance of a potential problem spot being overlooked.

Before proceeding further, it might be well to define a few words and phrases which have special meanings when used in connection with the subject under discussion. An *event* is a specific, recognizable point in time when there is an occurrence where accomplishment is definite. An *activity* is the work that must be accomplished to get from one event to another. The *critical path* is the one which from the beginning of the project to the end objective takes the longest period of time. A *network* is a chart which portrays in tinkertoy fashion all the events and the activities which must be accomplished to reach the end objective and which reflects all the ramifications and interrelationships of the constraints. *Slack* is the amount of time which an activity may have over and above the minimum time required to accomplish the activity which is permissible and still meets schedule; this slack is usually termed *positive* slack, because it is possible to have *negative* slack representing the lack of time according to latest planning to meet a contractually fixed schedule date.

Constructing Control Charts and "Networks"

The typical schedule control chart is a bar chart or a Gantt chart as shown in Exhibit 1. Naturally there can be many sub-charts to portray more specific milestones within each of these general areas with a great variety of symbols designating various milestones. However, the basic flaw of these charts is that they fail to show the interplay and effect of one activity on the other activities.

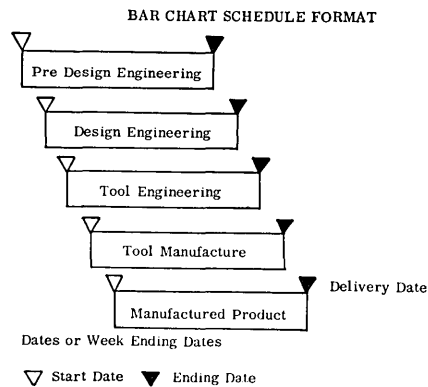

Exhibit 1

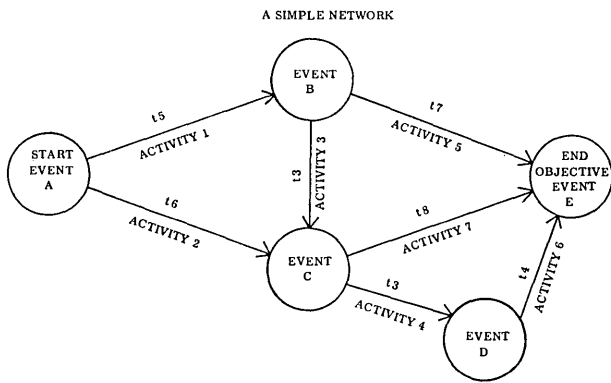

Exhibit 2

A network portrays the interdependence of all preceding activities and succeeding events as shown in Exhibit 2. Each activity is stated in a common unit of time, be it hours, days or weeks, and each event is one that is unmistakable and recognizable. Obviously, for example, the accomplishment of Event C is a constraint on beginning Activity 4, and any delay in reaching Event C will delay Event D and the end objective Event E. This kind of analysis can be made for a simple project without the use of a computer. Hence, it becomes feasible to require all tiers of suppliers to use PERT methods.

Noted above each activity is the time factor, shown as t5 for Activity 1, for example, and representative of 5 time units. The critical path then becomes that path which requires the greatest number of time units. In Exhibit 2 it goes from A to B to C to E for an expenditure of 16 time units. Testing any other path will prove that no other way takes as many time units. If the start date is such that the 15 time units results in an end objective date beyond the contractually scheduled date, then the path is said to have "negative slack." If it exactly hits the scheduled date, it has "zero" slack. All other paths have "positive slack," because more than the allowed time can elapse in their accomplishment, without jeopardy to the end objective.

In order that a network be meaningful, the input must be accurate and valid. Each activity must be planned by the personnel in the organization most experienced in the accomplishment of that type of activity and who can best estimate the time and manpower requirements for accomplishment based on available resources.

Use of the Technique

If, in the initial construction, there is negative slack, the critical path is determined and added manpower or resources allotted where feasible to reduce the time span, so that the end date will be met. Ob-

viously, personnel assigned to "positive slack" areas can be temporarily assigned to the critical area.

Changes in plan are always difficult to handle in evaluating the effect on specific activities and then relating that to the whole schedule. The PERT technique shows where "the shoe pinches," and the successful result depends on normal good management methods. These changes in plan are sometimes described "PERTurbations," an apt label in many ways.

The table below depicts a typical PERT report showing event identifications prior and subsequent to the activity described, the department responsible to carry out the activity, the expected completion date, the scheduled completion date and an indication of the amount of slack time.

One method of getting a more probable expected date is the use of three time estimates for each activity indicating: (a) optimistic estimate, (b) most likely time and (c) pessimistic estimate. By using probability factors and making inputs for standard deviations expected, it is possible to develop an expected time and a measure of its potential variability. Although such techniques are rather advanced and not in general use, they have been required on some contracts.

Organization to Support the Concept

The writer's company has studied the PERT concept and planned the organizational and procedural steps needed to make the system work on any newly initiated project. Exhibit 3 is a graphic presentation of such an organization for a major project. Parts of the organization, as required, would be set up for any minor project. In all cases, there would be a project leader or project manager who would be primarily responsible for the success of the project and who would report directly to the company manager. Exhibit 3 reads from left to right, beginning with the basic definition of work to be done and ending with the top man, the project leader in control.

Work is defined at a level of detail necessary for individual job assignments and supervisory work control. Detail schedules are developed on work sheets from the detail work plans, with identification cross-indexed to the control documents. Worksheet data are processed through a computer to establish the schedule and make up the "network" against which actual work accomplishment will be reported.

Work accomplishments are monitored in established recording centers where reports of actual time spent are introduced into the detail reporting system. Predictions of schedule problem areas are generated at the first-line supervisory level and processed through a computer to update the detail reports.

TABLE

Event		Activity description	Department responsible	Date		
Prior	Subsequent			Expected	Scheduled	Slack
0001	0006	Issued procedural design charts	Engineering	11/1/61	10/29/61	+3
0167	0198	Prepare mockup model	Factory	12/24/61	12/22/61	-2

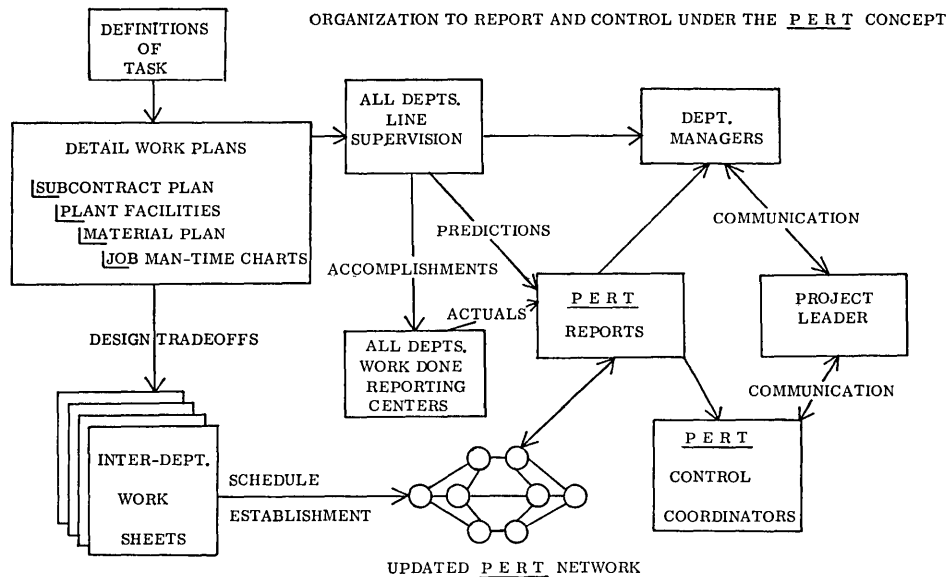

Exhibit 3

Schedule progress is monitored by control coordinators. They are directly responsible to the project leader and not to the supervision of the work areas over which they exercise control, so that the project leader has an eyewitness who is familiar with the physical work area and who can advise him when steps must be taken to take corrective action or to realign plans and schedules to effect changes rapidly with the least detriment to the end schedule.

The Need for Cost Reporting

It is apparent from the discussion above that the control is on scheduled tasks with time as the common control factor. While it is very true that time is money and that if a project is under good physical control then dollar control can hardly be inadequate, it is equally true that both contractors and customers, in the final analysis, will settle in payment for services rendered in terms of dollars. Therefore, the accounting profession must devise new methods of recording costs and keeping track of dollars that are compatible with the PERT schedule control concepts. It is obvious that if the customer is geared to thinking in terms of a physical schedule, he will also be desirous of attaching dollar costs to the same physical event. Any attempt to identify common costs, applicable to the entire program, to a specific physical occurrence is undoubtedly difficult.

Each separate item has its own peculiar quantity-cost relationship. To reflect such a relationship for each of the activities in a PERT network and to keep them updated for changes in the objectives of a program by way of acceleration, quantity change, method change, etc., is obviously a tremendous task and one for which there are no "generally accepted practices." It is apparent that there is a point beyond which the addition of extra resources (money) will not greatly affect quantity. This is the sort of thing a project leader will expect the accountant to tell him, so that if a schedule slippage is preferable to an exorbitant outlay of money, the customer can be so notified.

The Controller's Role

Whether or not accountants solve the problem of relating costs to PERT schedule control, it is still of utmost importance that they be familiar with these techniques. The controller and his organization will have to take a big part in any control technique which the Government requires of industry, and it is evident that the PERT method will definitely be a requirement when dealing with the Defense Department.

(Reprinted with permission from N.A.A. BULLETIN, vol. 43, no. 5, January 1962, published by the NATIONAL ASSOCIATION OF ACCOUNTANTS, New York, N. Y.)

MANUSCRIPTS

WE ARE interested in articles, papers, reference information, and discussion relating to computers and automation. To be considered for any particular issue, the manuscript should be in our hands by the first of the preceding month.

ARTICLES: We desire to publish articles that are factual, useful, understandable, and interesting to many kinds of people engaged in one part or another of the field of computers and automation. In

this audience are many people who have expert knowledge of some part of the field, but who are laymen in other parts of it.

We look particularly for articles that explore ideas in the field of computers and automation, and their applications and implications. An article may certainly be controversial if the subject is discussed reasonably. Ordinarily, the length should be 1000 to 3000 words. A suggestion for an article should be submitted to us before too much work is done.

NEWS AND DISCUSSION: We desire to

print news, brief discussions, arguments, announcements, letters, etc., anything, in fact, if it is likely to be of substantial interest to computer people.

PAYMENTS: In many cases, we make small token payments for articles, if the author wishes to be paid. The rate is ordinarily 1/2¢ a word, the maximum is \$15, and both depend on length in words, whether printed before, etc.

All suggestions, manuscripts, and inquiries about editorial material should be addressed to: *The Editor, COMPUTERS and AUTOMATION, 815 Washington Street, Newtonville 60, Mass.*

is in
0 in
rvice
nt of
r ex-
s vol-
) per

oduc-
te to
abri-
f the
g it.
ainly
e do-
com-
ed by
iring
gn is
ents:
tion-
ch as
unit.
nt is
uters
utine
shoot
ance
, but
is re-
ome-

ervice
mode
checked
(per-
limi-
ssing
lers).
s not
l not

oney
there
e way
per-
e, of
than
com-
work-
neap?
ough
l try,
e the
more
jobs
aving
oney.
ning,
p to
izing.
e the
nnel

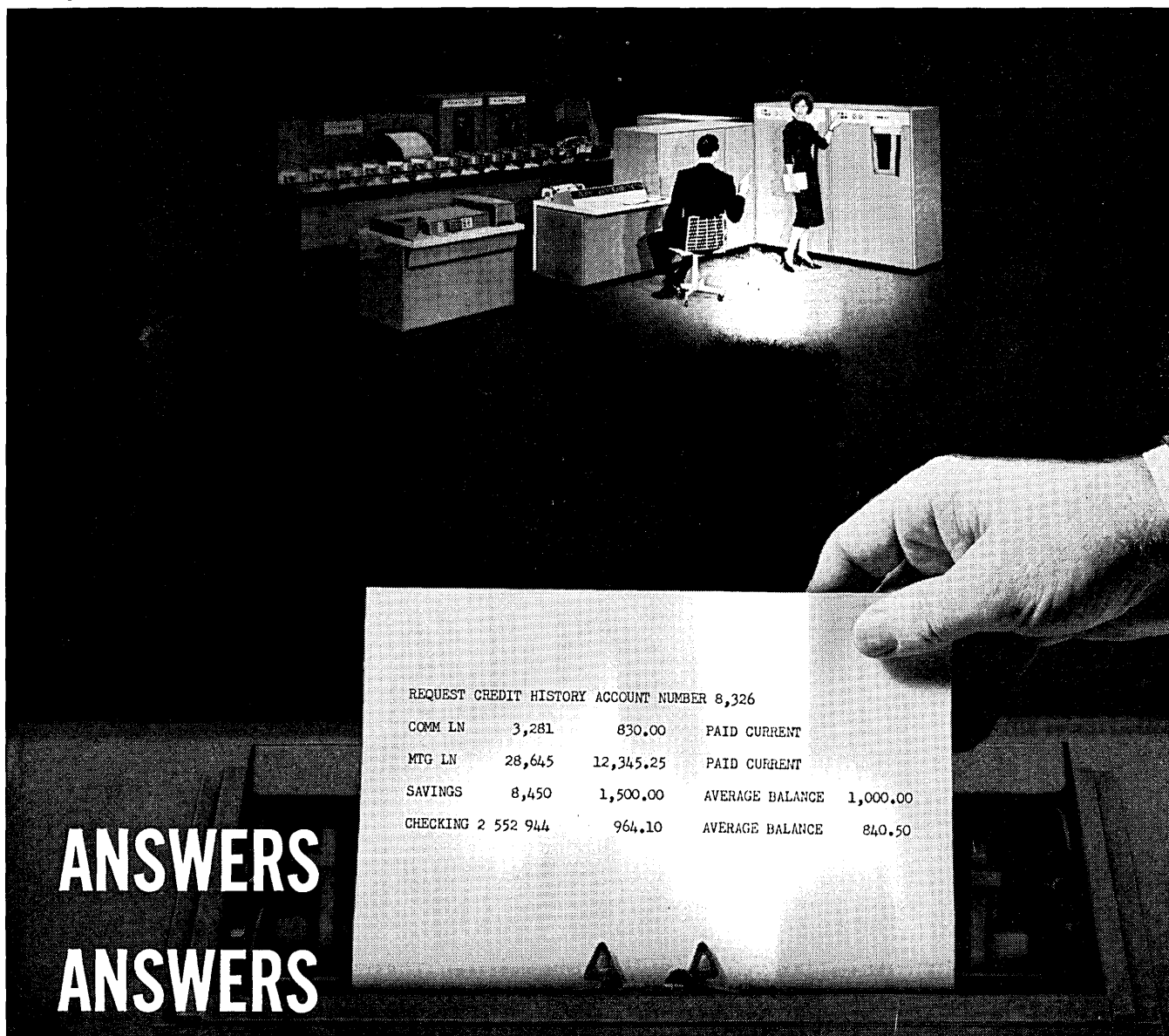

ANSWERS
ANSWERS

ANSWERS...with CRAM and Remote Inquiry

*provided by
the NCR 315
Computer System*

The NCR 315 CRAM (Card Random Access Memory) Computer System is more than just another back-office electronic accounting machine... it is a vital electronic tool which contributes to a higher-quality of management and personnel effectiveness.

For example: in a bank, Inquiry Units placed in the various departments enable authorized personnel to interrogate the computer files at will... to promptly answer requests for balances... to quickly obtain valuable credit information... to obtain current, up-to-the-minute reports on investments, trusts, loans, and other essential data.

In industry, Inquiry Units can be located at dozens of remote locations, en-

abling people to communicate with the computer files... even from hundreds of miles away. With the NCR 315 you will be able to keep a "current-finger" on the pulse of your business... to get immediate answers to questions about inventories, production, sales... and a host of other timely facts people must have to effectively manage... and to act while the "iron is hot."

The NCR 315 CRAM System provides many exclusive advantages for Remote Inquiry, Data Processing, On-Line Accounting, Operations Research, Engineering and Scientific Applications. For more information, call your nearby NCR representative or write to Data Processing Systems and Sales, Dayton 9, Ohio.

NCR PROVIDES TOTAL SYSTEMS—FROM ORIGINAL ENTRY TO FINAL REPORT—through Accounting Machines, Cash Registers or Adding Machines, and Data Processing The National Cash Register Company—1039 Offices in 121 Countries—78 Years of Helping Business Save Money

NCR

CALENDAR OF COMING EVENTS

- Mar. 8-10, 1962: 10th Annual Scientific Meeting of the Houston Neurological Society, Symposium on Information Storage and Neural Control, Texas Medical Center, Houston, Tex.; contact William S. Fields, M.D., Symposium Chairman, Houston Neurological Society, 1200 M. D. Anderson Blvd., Houston 25, Tex.
- Mar. 13-15, 1962: Symposium on Application of Statistics and Computer to Fuels and Lubricants Research Programs (Unclassified), Granada Hotel, San Antonio, Tex.; contact Roy Quillian, Southwest Research Inst., Box 2296, San Antonio 6, Tex.
- Mar. 22-23, 1962: Third Meeting of Honeywell 800 Users' Association, Biltmore Hotel, Los Angeles, Calif.; contact Bert L. Neff, Metropolitan Life Insurance Co., 1 Madison Ave., New York 10, N. Y.
- Mar. 24, 1962: 6th Annual Symposium on Recent Advances in Computer Technology, Ohio State University, Columbus, Ohio; contact R. K. Kissinger, Publicity Chairman, c/o Nationwide Insurance Companies, 246 No. High St., Columbus, Ohio
- Mar. 26-29, 1962: IRE International Convention, Coliseum & Waldorf-Astoria Hotel, New York, N. Y.; contact E. K. Gannett, IRE Headquarters, 1 E. 79 St., New York 21, N. Y.
- April 2-5, 1962: Annual Meeting of POOL (LGP-30, RPC-4000, and RPC-9000 Electronic Computer Users Group), Penn-Sheraton Hotel, Philadelphia, Pa.; contact Dr. Henry J. Bowlden, Union Carbide Corp., P. O. Box 6116, Cleveland 1, Ohio
- April 4-6, 1962: Univac Users Association and Univac Scientific Exchange Organization, Leamington Hotel, Minneapolis, Minn.; contact David D. Johnson, Sec'y, Univac Users Association, Ethyl Corp., P. O. Box 341, Baton Rouge, La.
- April 9-11, 1962: Meeting of the 304 Association (Users of NCR 304 Data Processor), Minute Maid Co., Orlando, Florida; contact L. J. Rushbrook, The 304 Association, National Cash Register Co., Main & K Streets, Dayton 9, Ohio.
- April 9-13, 1962: Business Equipment Exposition, McCormick Place, Chicago, Ill.; contact G. H. Gutekunst, Jr., Mgr., Press Information, Business Equipment Manufacturers Exhibits, Inc., 235 E. 42 St., New York 17, N. Y.
- April 11-13, 1962: SWIRECO (S. W. IRE Conference and Electronics Show), Rice Hotel, Houston, Tex.; contact Prof. Martin Graham, Rice Univ. Computer Project, Houston 1, Tex.
- April 16-18, 1962: Symposium in Applied Mathematics on "Interactions Between Mathematical Research and High-Speed Computing," at American Mathematical Society and Association for Computing Machinery Symposium, Atlantic City, N. J.; contact Mrs. Robert Drew-Bear, Head Special Projects Dept., American Mathematical Society, 190 Hope St., Providence 8, R. I.
- April 18-20, 1962: Conference on Information Retrieval in Action, Cleveland, Ohio; contact Center for Documentation and Communication Research Conference, Western Reserve Univ., 10831 Magnolia Dr., Cleveland 6, Ohio
- April 24-26, 1962: 12th Annual International Polytechnic Symposium, devoted to "The Mathematical Theory of Automata," United Engineering Center, 345 E. 47 St., New York, N. Y.; contact Symposium Committee, Polytechnic Inst. of Brooklyn, 55 Johnson St., Brooklyn 1, N. Y.
- April 25-27, 1962: National Microfilm Association Convention, Mayflower Hotel, Washington, D. C.; contact Vernon D. Tate, Exec. Secretary, National Microfilm Association, P. O. Box 386, Annapolis, Md.
- April 30-June 8, 1962: Seminar in Search Strategy, Graduate School of Library Science, Drexel Institute of Tech., Phila. 4, Pa.; contact Seminar in Search Strategy, Graduate School of Library Science, Drexel Inst. of Tech., Phila. 4, Pa., Att: Mrs. M. H. Davis
- May 1-3, 1962: Spring Joint Computer Conference, Fairmont Hotel, San Francisco, Calif.; contact Richard I. Tanaka, Lockheed Missile & Space Div., Dept. 58-51, Palo Alto, Calif.
- May 7-8, 1962: Fifth Annual Conference of the Association of Records Executives and Administrators, Waldorf-Astoria Hotel, New York City; contact Miss Judith Gordon, AREA Conference publicity chairman, Metal & Thermit Corp., Rahway, N. J.
- May 8-10, 1962: Electronic Components Conference, Marriott Twin Bridges Hotel, Washington, D. C.; contact Henry A. Stone, Bell Tel. Lab., Murray Hill, N. J.
- May 9-11, 1962: Operations Research Society of America, Tenth Anniversary Meeting, Shoreham Hotel, Washington, D. C.; contact Harold O. Davidson, Operations Research Inc., 8605 Cameron St., Silver Spring, Md.
- May 14-16, 1962: National Aerospace Electronics Conference, Biltmore Hotel, Dayton, Ohio; contact George A. Langston, 4725 Rean Meadow Dr., Dayton, Ohio
- May 21-25, 1962: Institute on Electronic Information Display Systems, The American University, Washington, D. C.; contact Dr. Lowell H. Hattery, Director, Center for Technology and Administration, The American University, 1901 F St., N.W., Washington 6, D. C.
- May 22-24, 1962: Conference on Self-Organizing Systems, Museum of Science and Industry, Chicago, Ill.; contact Mr. George T. Jacobi, COSOS Conference Sec'y, Armour Research Foundation, 10 W. 35 St., Chicago 16, Ill.
- May 28-June 1, 1962: Colloquium on Modern Computation Techniques in Industrial Automatic Control, Paris, France; contact French Association of Automatic Control (AFRA), 19, Rue Blanche, Paris 9, France.
- June 4-14, 1962: Mathematical Techniques of Optimization (10-Day Short Course on Operations Research), Purdue University, Lafayette, Ind.; contact Div. of Adult Education, Purdue University, Lafayette, Ind.
- June 11-July 20, 1962: Summer Institute on Advanced Topics in the Computer Sciences, Computation Center, University of North Carolina, Chapel Hill, N. C.; contact Dr. John W. Carr, III, Computation Center, University of North Carolina, P. O. Box 929, Chapel Hill, N. C.
- June 18-Sept. 14, 1962: Engineering Summer Conference Courses, Univ. of Mich., Ann Arbor, Mich.; contact Raymond E. Carroll, Univ. of Mich., 126 West Engineering Bldg., Ann Arbor, Mich.
- June 19-21, 1962: Fourth Joint Automatic Control Conference, Univ. of Texas, Austin, Tex.; contact Prof. Otis L. Updike, Dept. of Chemical Engineering, Univ. of Va., Charlottesville, Va.
- June 19-21, 1962: Second Annual San Diego BioMedical Engineering Symposium and Exhibit, Stardust Motor Hotel, San Diego, Calif.; contact The Program Committee, Inter-Science, Inc., 8484 La Jolla Shores Dr., La Jolla, Calif.

- July 17-18, 1962: Rochester Conference on Data Acquisition and Processing in Medicine and Biology, University of Rochester Medical Center, Rochester, N. Y.; contact Mr. Kurt Enslein, University of Rochester, Rochester 20, N. Y.
- June 19-22, 1962: National Machine Accountants Association International Conference, Hotel Statler, New York, N. Y.; contact R. Calvin Elliott, Exec. Dir., NMAA, 524 Busse Highway, Park Ridge, Ill.
- June 27-28, 1962: 9th Annual Symposium on Computers and Data Processing, Elkhorn Lodge, Estes Park, Colo.; contact W. H. Eichelberger, Denver Research Inst., Univ. of Denver, Denver 10, Colo.
- June 27-29, 1962: Joint Automatic Control Conference, New York Univ., New York, N. Y.; contact Dr. H. J. Hornfeck, Bailey Meter Co., 1050 Ivanhoe Rd., Cleveland 10, Ohio.
- July 18-19, 1962: Data Acquisition & Processing in Medicine & Biology, Whipple Auditorium, Strong Memorial Hospital, Rochester, N. Y.; contact Kurt Enslein, Brooks, Inc., 499 W. Comm. St., P. O. Box 271, E. Rochester, N. Y.
- August 9-11, 1962: Northwest Computing Association Annual Conference, Seattle, Wash.; contact Robert Smith, Conference Director, Box 836, Seahurst, Wash.
- Aug. 21-24, 1962: 1962 Western Electronic Show and Convention, California Memorial Sports Arena and Statler-Hilton Hotel, Los Angeles, Calif.; contact Wescon Business Office, c/o Technical Program Chairman, 1435 S. La Cienega Blvd., Los Angeles 35, Calif.
- Aug. 27-Sept. 1, 1962: 2nd International Conference on Information Processing, Munich, Germany; contact Mr. Charles W. Adams, Charles W. Adams Associates, Inc., 142 the Great Road, Bedford, Mass.
- Sept. 3-7, 1962: International Symp. on Information

- Theory, Brussels, Belgium; contact Bruce B. Barrow, Postbus 174, Den Haag, Netherlands
- Sept. 3-8, 1962: First International Congress on Chemical Machinery, Chemical Engineering and Automation, Brno, Czechoslovakia; contact Organizing Committee for the First International Congress on Chemical Machinery, Engineering and Automation, Vystaviste 1, Brno, Czechoslovakia.
- Sept. 19-20, 1962: 11th Annual Industrial Electronics Symposium, Chicago, Ill.; contact Ed. A. Roberts, Comptometer Corp., 5600 Jarvis Ave., Chicago 48, Ill.
- Oct. 2-4, 1962: National Symposium on Space Elec. & Telemetry, Fountainbleu Hotel, Miami Beach, Fla.; contact Dr. Arthur Rudolph, Army Ballistic Missile Agency, R & D Op. Bldg. 4488, Redstone Arsenal, Ala.
- Oct. 8-10, 1962: National Electronics Conference, Exposition Hall, Chicago, Ill.; contact National Elec. Conf., 228 N. LaSalle, Chicago, Ill.
- October 15-18, 1962: Conference on Signal Recording on Moving Magnetic Media, The Hungarian Society for Optics, Acoustics and Cinetechnics, Budapest, Hungary; contact Optikai, Akusztikai, es Filmtechnikai Egyesulet, Szabadsag ter 17, Budapest V, Hungary
- Oct. 30-31, 1962: Conference on Eng. Tech. in Missile & Spaceborne Computers, Disneyland Hotel, Anaheim, Calif.; contact William Gunning, EPSCO-West, 240 E. Palais Rd., Anaheim, Calif.
- Nov. 5-7, 1962: 15th Annual Conf. on Elec. Tech. in Medicine and Biology, Conrad Hilton Hotel, Chicago, Ill.; contact Dr. J. E. Jacobs, 624 Lincoln Ave., Evanston, Ill.
- Nov. 13-15, 1962: NEREM (Northeast Res. & Engineering Meeting), Boston, Mass.; contact NEREM-IRE Boston Office, 313 Washington St., Newton, Mass.
- Dec. 4-5, 1962: Eastern Joint Computer Conference, Bellevue-Stratford Hotel, Philadelphia, Pa.

BOOKS AND OTHER PUBLICATIONS

Moses M. Berlin
Allston, Mass.

We publish here citations and brief reviews of books and other publications which have a significant relation to computers, data processing, and automation, and which have come to our attention. We shall be glad to report other information in future lists if a review copy is sent to us. The plan of each entry is: author or editor / title / publisher or issuer / date, publication process, number of pages, price or its equivalent / comments. If you write to a publisher or issuer, we would appreciate your mentioning **Computers and Automation**.

Tomer, Robert B. / **Industrial Transistor & Semiconductor Handbook** / Howard W. Sams & Co., Inc., 3334 Sutherland Ave., Indianapolis 6, Ind. / August, 1961, printed, 254 pp, \$4.95

The operating characteristics, circuit-design procedures, and typical applications of many types of semiconductors are here discussed. In twelve chapters the author covers "Semiconductor Physics," "Circuit

Fundamentals," "Industrial Control Using Semiconductors," "Thermoelectricity in Solar-Energy Conversion," "The Future of Semiconductors," etc. Two appendices discuss "Thermal Stability" and list "Transistor Parameter Symbols and Definitions." Index.

Holland, James G., and B. F. Skinner / **The Analysis of Behavior** / McGraw-Hill Book Co., Inc., 330 West 42 St., New York 36, N. Y. / 1961, printed, 377 pp, \$3.50

This text is arranged so that the student "should be able to instruct himself in [the] part of psychology which deals with . . . the explicit prediction and control of the behavior of people." The authors, Professors of Psychology at Harvard University, have constructed a programmed textbook—in lieu of a teaching machine—with the subject matter presented from fundamentals to involved applications of theory. Fourteen parts including fifty-three sets comprise the book. Following each group of parts, reviews and tests are given.

Pierce, J. R. / **Symbols, Signals and Noise: The Nature and Process of Communication** (Harper Modern Science Series) / Harper & Bros., 39 East 33 St., New York 16, N. Y. / 1961, printed, 305 pp, \$6.50

Communication theory is discussed from a mathematical point of view, with theorems concerning communication following

from fundamental hypotheses. The author, Director of Research in Communications Principles at the Bell Telephone Labs., introduces the subject in the chapter, "The World and Theories." Speech, physical uses of numbers and some basic theorems are discussed. The remaining thirteen chapters include: "The Origins of Information Theory," "Encoding and Binary Digits," "Cybernetics," "Information Theory and Psychology," and the final chapter, "Back to Communication Theory." An appendix, "On Mathematical Notation," a glossary and an index are included.

Reistad, Dale L. / **Banking Automation and the Magnetic Ink Character Recognition Program** / Detroit Research Institute, 12 East Hancock, Detroit 1, Mich. / 1961, printed, 180 pp, \$7.50

This book contains two almost equal parts, the first consisting of an introduction to the techniques of magnetic ink character recognition, the second, of papers on current applications. In seven chapters the author, Consultant to Booz, Allen and Hamilton, discusses banking automation, character codes, document filing, specialized computers which perform recognition, and preparing for automation. The papers, which form the second part of the book, include: "A Case Study of a Bank Now Preparing to Handle MICR Items," "The Future Role of Computers in Banking," and "Printing of Documents."

Make over 200 Small Computing
and Reasoning Machines with . . .

BRAINIAC

ELECTRIC BRAIN CONSTRUCTION KIT

WHAT COMES WITH YOUR BRAINIAC® KIT? All 33 experiments from our original kit (1955), with exact wiring templates for each one. All 13 experiments from the former Tyniac kit. 156 entirely new experiments with their solutions. Over 600 parts, as follows: 6 Multiple Switch Discs; Mounting Panel; 10 Flashlight Bulbs; 2 Multiple Socket Parts, each holding 5 bulbs; 116 Wipers, for making good electrical contact (novel design, patented, no. 2848568); 70 Jumpers, for transfer contacts; 50 feet of Insulated Wire; Flashlight Battery; Battery Box; nuts, bolts, sponge rubber washers, hard washers, screwdriver, spintite blade, etc. ALSO: 256 page book, "Brainiacs" by Edmund C. Berkeley, including chapters on: an introduction to Boolean Algebra for designing circuits; "How to go from Brainiacs and Geniacs® to Automatic Computers"; complete descriptions of 201 experiments and machines; over 160 circuit diagrams; list of references to computer literature.

This kit is an up-to-the-minute introduction to the design of arithmetical, logical, reasoning, computing, puzzle-solving, and game-playing circuits—for boys, students, schools, colleges, designers. It is simple enough for intelligent boys to assemble, and yet it is instructive even to engineers because it shows how many kinds of computing and reasoning circuits can be made from simple components. This kit is the outcome of 11 years of design and development work with small electric brains and small robots by Berkeley Enterprises, Inc. With this kit and manual you can easily make over 200 small electric brain machines that display intelligent behavior and teach understanding first-hand. Each one runs on one flashlight battery; all connections with nuts and bolts; no soldering required. (Returnable for full refund if not satisfactory.) . . . Price \$18.95.

WHAT CAN YOU MAKE WITH A BRAINIAC KIT?

LOGIC MACHINES

Syllogism Prover
James McCarty's Logic Machine
AND, OR, NOT, OR ELSE, IF . . . THEN, IF AND
ONLY IF, NEITHER . . . NOR Machines
A Simple Kalin-Burkhart Logical Truth Calculator
The Magazine Editor's Argument
The Rule About Semicolons and Commas
The Farnsworth Car Pool

GAME-PLAYING MACHINES

Tit-Tat-Toe
Black Match
Nim
Sundorra 21
Frank McChesney's Wheeled Bandit

COMPUTERS—to add, subtract, multiply, divide, . . . ,
using decimal or binary numbers.
—to convert from decimal to other scales of notation
and vice versa, etc.

Operating with Infinity
Adding Indefinite Quantities
Factoring Any Number from 45 to 60
Prime Number Indicator for Numbers 1 to 100
Thirty Days Hath September
Three Day Weekend for Christmas
Calendar Good for Forty Years 1950 to 1989
Money Changing Machine
Four by Four Magic Square
Character of Roots of a Quadratic
Ten Basic Formulas of Integration

PUZZLE-SOLVING MACHINES

The Missionaries and the Cannibals
The Daisy Petal Machine
Calvin's Eenie Meenie Minie Moe Machine
The Cider Pouring Problem
The Mysterious Multiples of 76923, of 369, etc.
Bruce Campbell's Will
The Fox, Hen, Corn, and Hired Man
The Uranium Shipment and the Space Pirates
General Alarm at the Fortress of Dreadeerie
The Two Suspicious Husbands at Great North Bay

The Submarine Rescue Chamber Squalux
The Three Monkeys who Spurned Evil
Signals on the Mango Blossom Special
The Automatic Elevator in Hoboken
Timothy's Mink Traps
Josephine's Man Trap
Douglas Macdonald's Will
Word Puzzle with TRICK

QUIZ MACHINES

The Waxing and the Waning Moon
Intelligence Test
Guessing Helen's Age
Geography Quiz
Mr. Hardstone's Grammar Test
Solving Right Triangles

SIGNALING MACHINES

The Jiminy Soap Advertising Sign
The Sign that Spells Alice
Tom, Dick, and Harry's Private Signaling Channels
Jim's and Ed's Intercom

CRYPTOGRAPHIC MACHINES

Secret Coder
Secret Decoder
Lock with 65,000 Combinations
Lock with 15,000,000 Combinations
The General Combination Lock
Leonard's Two-Way Coding Machine

. . . AND MANY MORE

MAIL THIS REQUEST or a copy of it
Berkeley Enterprises, Inc.
815 Washington Street, R107, Newtonville 60, Mass.

Please send me BRAINIAC KIT K18, including manual,
instructions, over 600 parts, templates, circuit diagrams,
etc.

I enclose \$18.95 for the kit plus . . . for handling and
shipping (30c, east of Mississippi; 80c, west of Missis-
sippi; \$1.80, outside U.S.). I understand the kit is return-
able in seven days for full refund if not satisfactory (if
in good condition).

My name and address are attached.

Kibbee, Joel M., Clifford J. Craft, and Burt Nanus / Management Games: A New Technique for Executive Development / Reinhold Publ. Corp., 430 Park Ave., New York 22, N. Y. / 1961, printed, 347 pp, \$10.00

The construction and utilization of games which find application to actual business experiences are here discussed. Many recent applications of the games are given. The book's four parts are: Background, Theory and Practice, Administration, Game Design, and Case Studies. Seventeen chapters are included. The final section, Reference, includes a useful directory of management games (and where to write for further information), a bibliography, and an index.

Russell, J. K. / Symbolic Address-Symbolic Optimum Program for a Drum-Memory Computer, PB 151999 / U. S. Dept. of Commerce, Office of Technical Services, Washington 25, D. C. / 1961, printed, 39 pp, \$1.25

This report presents an attempt to time-optimize a computer program for the LGP-30. It is found that although the program is lengthened, it can be made to run faster. The report discusses techniques for optimization and explains, with examples of usage, the symbolic language employed.

Peterson, E. L. / Statistical Analysis and Optimization of Systems / John Wiley & Sons, Inc., 440 Park Ave. South, New York 16, N. Y. / 1961, printed, 190 pp, \$9.75

The theory and methods of analyzing a system before and during the design stage to produce optimization of the system are discussed by describing problems and their solutions. Nine chapters include: "Linear System Theory," "Statistics of Random Variables," "Systems Analysis and Design," "Applications in Optimal Synthesis" and "Optimizing Inputs for Specified Linear Systems." The first of four appendices discusses "General Stability Considerations." "The Variational Problem of Mayer" is covered in the fourth appendix. References and index.

Alt, Franz L., Editor / Advances in Computers, volume II / Academic Press Inc., 111 Fifth Ave., New York 3, N. Y. / 1961, printed, 434 pp, \$14.00.

Five papers by six authors on subjects relating to computation and data processing are here presented. The titles are: "A Survey of Numerical Methods for Parabolic Differential Equations," "Advances in Orthogonalizing Computation," "Microelectronics Using Electron-Beam-Activated Machining Techniques," "Recent Developments in Linear Programming," and "The Theory of Automata, A Survey." Each paper includes references. Author and subject indices.

Williams, Theodore J., and Verlin A. Lauher / Automatic Control of Chemical and Petroleum Processes / Gulf Pub. Co., Book Div., 3301 Buffalo Drive, Houston 1, Tex. / 1961, printed, 336 pp, \$10.50.

The application of automation to chemical and petroleum processes is discussed, citing examples from industry. The book's nine chapters include: "Automatic Control—A Definition of the Mathematics Involved," "The Nyquist Diagram—How It Is Used," "Nonlinear Aspects of Process Control Analysis," and "Special Topics in Process Control." An appendix explains symbols used in the text. Author and subject indices.

Computers in Control, S-132 / American Institute of Electrical Engineers, 345 East 47 St., New York 17, N. Y. / 1961, offset (without retyping), 250 pp, \$5.00.

Twenty-four papers presented at the

1960 and 1961 AIEE Control Computer Sessions are here presented. The emphasis in most of the papers is on applications to chemical processes and on special purpose computers. Among the titles: "Chemical Process Selection for Computer Control," "Brief Introduction to the D. D. A. Computer," "A Variable Increment Computer," "A Generalized Chemical Processing Model for the Investigation of Computer Control," "Hybrid Computers for Process Control," and "Dynamic Optimization and Control of a Stirred-Tank Chemical Reactor." No bibliography or index.

Johnson, Walter E. / Data Reduction Instrumentation for Radio Propagation Research, PB 161612 / U. S. Dept. of Commerce, Office of Technical Services, Washington 25, D. C. / 1961, printed, 32 pp, \$1.00.

This paper discusses an approach to the over-all problem of data reduction instrumentation for a project under investigation by the Boulder Laboratories, National Bureau of Standards. It is emphasized that early coordination between those responsible for the "data taking, data analysis and data reporting" is essential to successful implementation. Three special purpose computers are described; a spectrum analyzer, a distribution analysis system, and a correlation computer. Also, three computation aids for reduction of data not recorded on magnetic tape are described.

Charnes, A., and W. W. Cooper / Management Models and Industrial Applications of Linear Programming, vol. II / John Wiley & Sons, Inc., 440 Park Ave. South, New York 16, N. Y. / 1961, printed, 863 pp, \$11.75.

This book is for those interested in managerial applications of linear programming, and bases most of its information on research conducted on actual managerial problems. Eight chapters include: The Modified Simplex and Dual Methods, and the Revised Simplex Code for Electronic Calculators, Transportation-type Models, Some Relations between the Theory of Games and Linear Programming, and Game Theory: Extensions and Applications. A chapter is devoted to miscellaneous topics. Four appendices include, "The Double-Reverse Methods," "Mixing Routines for a Class of Coupled Models," and "Some Further Aspects of Saddle Points and Min-Max Operators." Bibliography and index.

Current Research and Development in Scientific Documentation, no. 9, NSF-61-76 / Superintendent of Documents, U. S. Government Printing Office, Washington 25, D. C. / 1961, printed, 270 pp, \$1.25.

This ninth in a series of reports on research and development in the field describes activities in the U. S. and where possible, in foreign countries. The reports include names and addresses of the researchers (and/or sponsors) and brief descriptions of the work and its status. The five headings under which the reports are grouped: Information Needs and Uses, Information Storage and Retrieval, Mechanical Translation, Equipment, and Potentially Related Research, including pattern recognition, artificial intelligence, and linguistic and lexicographic research. References to the work being reported accompany many of the reports.

Proceedings, 2nd Management Symposium of the Association of Data Processing Service Organizations / A. of D. P. S. O., 1000 Highland Ave., Abington, Pa. / 1961, printed, 38 pp, \$5.00.

The proceedings of the conference held in St. Louis on May 5, 1961 are here published. Included are the four papers: "Cost Elements in Service Center Operation," "The Service Center and the Professions,"

"Work Scheduling in the Service Center," "COBOL and the Service Bureau—A Panel," and discussions following each presentation. Membership eligibility and roster, committees, and attendees are stated. No index.

Pavlik, Ernst, and Bruno Machei / A Combined Control System for the Process Industries: Principle, Components and Instruments of the TELEPERM-TELEPERNEU System / D. Van Nostrand Co., Inc., Princeton, N. J. / 1962, printed, 197 pp, \$6.00.

The standardization of control systems has led to the design of modular electric and pneumatic systems. This book, translated from the German, discusses the principles of a system for designing instruments, methods for making the instruments compatible and their applications. The book concentrates on pneumatic and electro-pneumatic components of the system. The four sections, which include numerous chapters, are: Automation in the Process Industries, Structural Elements, Pneumatic Instruments, and Electropneumatic Instruments.

Riordan, John / Stochastic Service Systems / John Wiley & Sons, Inc., 440 Park Ave. South, New York 16, N. Y. / 1962, printed, 139 pp, \$6.75.

This book provides a comprehensive summary of progress in the field of stochastic service systems—systems in which the demands for service have a probabilistic nature. The author, addressing his presentation to applied mathematicians, uses familiar mathematical notations and "tools" in discussing applications of the theory. Following an introductory chapter, the titles are: "The Simplest Traffic System," "Single-Server Systems," "Traffic Input and Service Distributions," "Many-Server Systems," and "Traffic Measurements." References and index.

Automatizace and Telemeknika, Tom 22, no. 11 / University Nauk, Moscow, U. S. S. R. / 1961, printed, 134 pp, cost ?

This issue of the Russian language publication includes fifteen articles on topics relating to computers, data processing and mathematics. In addition, a discussion of "Automatization and Communism" is included. Among the topics: "Application of Methods of Statistic Dynamics to Design of Characteristics of Some Automation Objects," "On Investigation of Automatic Systems by means of Matrix Transformations," and "Electro-Magnetic Control Elements." A Scientific Seminar on Pneumo-Hydraulic Automation is included.

Automatika and Telemeknika, Tom 22, no. 12 / University Nauk, Moscow, U. S. S. R. / 1961, printed, 171 pp, cost ?

This issue of the Russian language publication includes seventeen articles on topics related to data processing and mathematics. Among the titles: "Some Approximate Methods for Solving Problems of Optimum Control of Distributed Parameter Systems," "Use of Invariance Principle under Non-linear Action of Disturbance," and "Method of Solution of Multi-Loop Pulse System Equations."

Murray, Albert E. / Phase I Report: Perceptron Applicability to Photointerpretation, PB 171832 / Office of Technical Services, U. S. Dept. of Commerce, Washington 25, D. C. / 1961, offset, 60 pp, \$1.50.

This report discusses applications of perceptrons to the interpretation of aerial photographs and cites results obtained with the Mark I perceptron, a 400-sensory unit perceptron. The pattern-recognition problems of photographic interpretation are illustrated by examples of recent experiments. Photographs accompany the text. References.

**Get Your Reference and
Survey Information
in the Computer Field from**

COMPUTERS and AUTOMATION

DATA PROCESSORS • APPLICATIONS • IMPLICATIONS

Keep This List for Handy Reference

Computers and Automation now publishes more than 25 kinds of reference and survey information. Here is our latest inventory, of kind of information and issues when published. . . . Subscribe to **Computers and Automation** and have this information at your elbow!

Roster of Organizations:

- Organizations in the Computer Field (June 1961)
- Consulting Services (June 1961)
- Computing Services (June 1961)
- School, College, and University Computer Centers (June 1961)
- Computer Users' Groups (June 1961)
- Robot Makers (June 1961)
- Organizations in Teaching Machines and Programmed Learning (Feb. 1962)

Computers and Data Processors:

- Descriptions of Digital Computers (June 1961)
- Survey of Commercial Analog Computers (June 1961)
- Survey of Special Purpose Computers and Data Processors (June 1961)
- Types of Automatic Computing Machinery (June 1961)
- Computer Census (July 1960)

Products and Services in the Computer Field:

- Roster of Products and Services: Buyers' Guide to the Computer Field (June 1961)
- Classes of Products and Services (June 1961)
- Types of Components of Automatic Computing Machinery (June 1961)
- Survey of Robots (June 1961)

Applications:

- Over 500 Areas of Application of Computers (June 1961)
- Novel Applications of Computers (Mar. 1958, 1959, 1962)
- Important Applications of Computers (Oct. 1958-59-60, Nov. 1961)
- Application Programs Available (June 1961)

Markets:

- Computer Market Survey (Sept. 1959)
- The Market for Computers in Banking (Sept. 1957)
- The Market for Computers in the Oil and Natural Gas Industry (Nov. 1957)

People:

- Who's Who in the Computer Field (various issues)

Pictorial Reports:

- Annual Pictorial Reports on the Computer Field (Dec. 1958, Dec. 1959, Dec. 1960, Dec. 1961)
- A Pictorial Manual on Computers (Dec. 1957, Jan. 1958) (reprint available)

Words and Terms:

Glossary of Terms and Expressions in the Computer Field, 5th edition, sold separately, \$3.95 (over 870 terms defined)

Information and Publications:

- Books and Other Publications (many issues)
- New Patents (many issues)
- Survey of Recent Articles (many issues)

With the ever-increasing expansion of the field of automatic handling of information, it is easy to predict that more and more reference information of these and other kinds will need to be published; and this we shall do. For it is a fact that reference information of the kind here described is not computable from automatic computing machinery—instead, it comes from collecting observations and reports about the real world. This is our job.

Start Your Subscription Now So That You Will Be Sure to Have the Next Issue!

..... MAIL THIS COUPON (or a copy of it)

To: **COMPUTERS and AUTOMATION**
815 Washington St., R107
Newtonville 60, Mass.

1. () Please enter my subscription to **Computers and Automation** including **The Computer Directory and Buyers' Guide**
I enclose () \$15.00 for one year,
() \$29.00 for two years,
—for U.S.A. (add 50 cents a year for Canada; \$1.00 a year elsewhere)

2. () Please send me the following back copies:
.....
.....
I enclose \$1.50 for each one, except the June Computer Directory issues, \$12 (1961, 156 pages), \$4 (prior years).

I understand any of these are returnable in 7 days if not satisfactory for full refund (if in good condition).

Name

Title

Organization

Address

SK
IN

PULS
WID
MOD
INPU
COM

What
the di
cuitry
incre
comp
gyro
cal da
face
engin

Sever
pated
earlier
the d
strong
safe
appro
system
requir
they p
accur
Some
requir
volum
nary i
schem
pound



DATA

COMP

SOME

NOVEL APPLICATIONS OF COMPUTERS

NOVEL MEDICAL APPLICATIONS OF ELECTRONIC DATA PROCESSING

Moses M. Berlin

Assistant Editor, Computers and Automation

Electronics data processing has been applied notably to medical research and diagnosis. Special purpose devices, instruments, and large data-processing systems serve as tools of the physician and the medical researcher. Some examples of applications are here described.

Microscopic Particles

1. Electronics is being used to aid in the study of microscopic particles in biological specimens. The problem is to avoid the effects of the intense light needed to illuminate the specimens under the visual microscope because heat accompanies the light. The solution is to use closed-circuit television attached to the microscope. The television system transmits the microscope's findings to remote areas where adequate lighting will not interfere with the specimen. Two such systems currently in use are manufactured by the Sylvania Electric Co. and the Allen B. Dumont Laboratories.

Telephone Transmission of Electrocardiograms

2. Electrocardiograms are transmissible via telephone, allowing for long-distance consultation between cardiologists. Currently, a system developed by Mnemotron Corp. and Electronic Medical Systems, which uses acoustical transmission, is operating and also a Bell Telephone system using direct electrical coupling, are in use.

Radio-Electrocardiograph

3. A device has been manufactured which can be used to help predict heart attacks. The radio-electrocardiograph, RKG-100, has been produced by Telemedics, Inc. It allows cardiologists to obtain electrocardiograms from patients in motion, under stress conditions. The device weighs 10 ounces, and broadcasts to a small receiver located up to 500 feet away. Also, the device can record outputs on magnetic tape for later analysis.

Electronic Simulated Ear

4. An electrical analog of the human ear has been constructed by the Applied Research Laboratory of the University of Arizona. The analog device directly models the human outer, middle, and inner ear, and is used to analyze speech and interpret psycho-physical phenomena.

Controlled Artificial Hand

5. An artificial hand controlled by a computer and equipped with sensory devices has been designed by Dr. Henrich A. Ernst, a graduate researcher at Mass. Inst. of Technology, Cambridge, Mass. The mechanical hand can manipulate objects; it is equipped with thirty sensory devices, and in searching for an object, gropes about, exploring carefully all of the area in front of it. The hand can discriminate between objects of different sizes and can "feel" its way around objects. It is controlled by a unit which is linked to the TX-0 computer at M. I. T.

Automatically Controlled Radiation Therapy

6. Electronic equipment is being used for cancer therapy. An example of a recent appli-

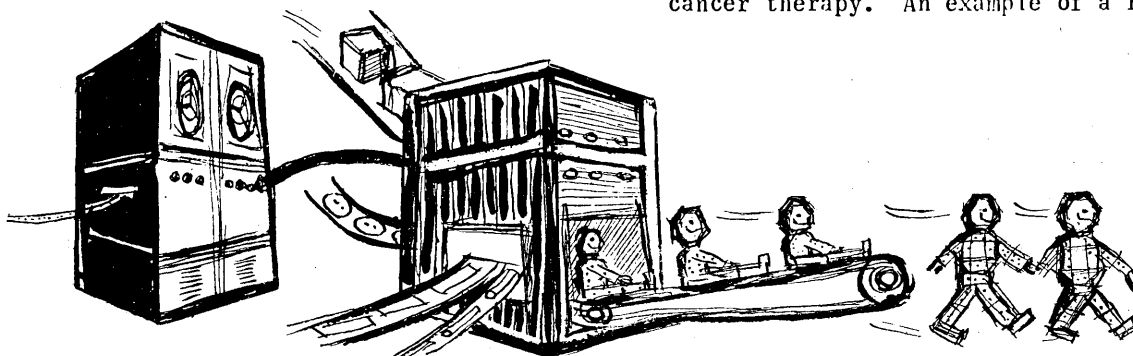

cation is the 6 million electron volt device called a "Medical LINAC" developed by High Voltage Engineering Corp. The equipment, in current use at U. S. hospitals, provides radiation therapy with automatic dose control. In addition to therapeutic use, the equipment is being used for medical research since it can sterilize bone and tissue.

Collation of Hospital Patient Records

7. The records of 2,500,000 hospital patients are to be processed and analyzed by a Honeywell 400 computer system. The system will be located at Ann Arbor, Mich. Clinical records of discharged patients, including age, sex, diagnosis, treatment, medication, and duration of confinement, will serve as input. The computer will collate the information and produce reports on patient care and treatment. Eventually, the number of participating hospitals will increase, and the findings of the computer are likely to help improve hospital care in many parts of the country.

Electrochemical Simulation of Nervous System

8. Experiments are being made with electrochemical waves, tending toward a machine which can "match" the human nervous system in versatility and compactness. The PAL-L system, designed at the Applied Research Laboratory of Space-General Corp., is capable of learning by trial and error, any one of over 16 million different behavior patterns. In a similar application, the IBM 7090 is being used for experiments in pattern recognition and concept formation.

Fetal Heart Beat Recorder

9. An electronic device has been designed which isolates and records the fetal heart beat. The device aids in distinguishing the fetal heart beat from that of the mother, and also indicates to the obstetrician whether an unborn child is suffering from a disease which will require immediate attention upon birth.

Electronic Pill for Diagnosis

10. An electronic device that can be swallowed like a pill is being used for internal diagnosis. The pill allows physicians to receive information about an internal organ without introducing objects which might alter the condition of the organ. The "electronic pill" measures and records temperatures, pressures, and similar physiological data.

Computers and Medicine in the USSR

11. In the U.S.S.R. large computer systems are being applied to medical and biolog-

cal research. The machines are being made available to medical centers, and medical students are being trained in mathematics and computer programming.

MAKING AND UP-DATING APPRAISALS FOR INSURANCE PURPOSES

One of the country's biggest appraisal firms has begun keeping appraisal figures current by use of computers. The work is handled by the data processing and computer center of Statistical Tabulating Corporation, in New York, using an IBM 1400-series system. Current appraisals are reported to customers two to three months faster.

An appraisal provides up-to-date figures on replacement cost, depreciation, sound value, replacement insurance value, and sound insurance value, of land, buildings, equipment, stocks, bonds, promissory notes, accounts receivable, good will and other intangibles, and so forth.

The appraising service is used by insurance brokers and by owners of industrial, commercial, and institutional properties, and others, to determine fair market value, insurability, tax liability, and other essential information. Government bodies also use the information in condemnation proceedings.

Starting initially with "observed appraisal values," the computer program uses factors that reflect changes in replacement costs of buildings and other property, changing economic conditions, accrual of depreciation, etc., to maintain up-to-date figures on replacement cost, depreciation, and sound insurable value. Also included in the program are adjustments for additions and deletions of property.

The number of properties appraised in a typical month using the computer ranges from 100 to 200. Previously, two clerks used to be employed full time to bring the figures up to date, and their work required considerable time of one supervisor. Now the two clerks are no longer required, and the supervisor's work, for this operation, has been reduced to inspection of results.

This clerical saving has been realized so far by only one office. But the service is being extended to operations in other metropolitan cities and will be extended ultimately to all operations across the country.

tion
for t
chair
gross
servi
Unite
compa
1960.

ber 3
amount
net e
\$168,

faste
1962,
ing a
is ex
\$200

renta
in 19
opera
tion
data
in 19
hope
withi

appro
-- mo
eers
and d
to da
to ma
fense
our w
elect
capab
if an
This
and w
role

cessi

THE UNIVAC PLAYS BRIDGE

Thomas A. Throop
International Business Machines Corp.
Yorktown Heights, N.Y.

This report describes the status of what is, to the author's best knowledge, the first computer program for playing bridge. The program, which has been written for the UNIVAC 1 computer, first "deals" the cards to the four hands and then proceeds to bid one or more of the hands for one round of bidding.

The UNIVAC always bids the South hand, and may or may not bid the West, North, and East hands, which may be bid by human players. The cards for a hand to be bid by such a player are typed out by the UNIVAC unityper for the player to see. When it is his turn to bid, he decides on a bid and this is then entered into the machine at the console. Thus, the UNIVAC may bid all four of the hands or a lesser number against human competition.

The author is aware of an existing program which is able to play as declarer three or four specific hands. In contrast, it should be noted that the program described in this article is playing bridge in a general sense, since the computer is bidding randomly dealt hands.

Dealing

First, let us consider the method of dealing the cards. To do this, the program employs a formula for generating random numbers. An initial eleven digit number is chosen and typed in at the UNIVAC console. Successive eleven digit numbers are generated by the computer program until all fifty-two cards have been generated.

Each successive pair of random numbers is translated into one of the possible fifty-two cards. The rank of the card is derived from five of the digits of the first number of each pair. The suit of the card is derived from two of the digits of the second number of each pair. This card is the next one to be dealt if it has not been generated by a previous pair of random numbers. Eventually, all of the fifty-two cards are dealt in this manner. Two of the digits of the initial random number are used to derive the North-South and East-West vulnerability.

It should be noted that any hand of particular interest may always be dealt as many times as wished simply by typing in the same initial number at the UNIVAC console. In other words, any particular hand may be asso-

ciated with the initial eleven digit number which led to its generation.

The first thirteen cards generated are assigned to the hand of the dealer, the second thirteen cards to the second hand, and so forth, this assignment of the cards being as random as any other. The program then arranges the cards by suit and rank within the suit for each of the four hands in the usual newspaper bridge column format. The computer is now ready to bid the dealer's hand and any of the others not to be bid by human players.

Bidding

For each hand it is to bid, the computer counts the high card points and distributional points according to the familiar Goren point-count system. For each suit the computer also determines what we may call the "suit value". The suit value is equal to the high card points plus the number of cards in the suit. For example, the suit value of KQ52 is 5 for the high card points plus 4 for the number of cards which totals 9 for the suit value. The suit value is a measure of the strength of the suit for no-trump play.

Taking into account several factors, including high card points, additional distributional points, suit values, the vulnerability, and any preceding bids by the other hands, the computer decides what it considers to be the best bid for the hand. The program is aware of many of the modern-day tournament conventions such as 5 card majors in first or second position, weak jump overcalls, and the Stayman and Gerber conventions.

Sample Hands

Let us now consider a few of the hands which were dealt and bid by the UNIVAC. The first hand is as follows:

		<u>North</u>				<u>East</u>	
		S	A 4			S	J 8 7 3
		H	K 6 5			H	7 3
		D	J 10 5 4			D	Q 7 6 3
		C	A J 5 3			C	Q 7 2
		<u>West</u>				<u>South</u>	
S	10 6 5			S	K Q 9 2		
H	A 9 8 2			H	Q J 10 4		
D	K 8 2			D	A 9		
C	K 9 6			C	10 8 4		

Dealer: South

Vulnerability: Neither side vulnerable

The bidding:

<u>South</u>	<u>West</u>	<u>North</u>	<u>East</u>
1C	Pass	2NT	Pass

South is the dealer with neither side vulnerable. As South, the computer opens 1 club with its thirteen-point hand rather than 1 spade or 1 heart since it does not open a major suit in first or second position without 5 cards in the suit. As West, the computer passes. With the North hand, the computer bids 2 no-trump, having thirteen high card points with balanced distribution. As East, the computer passes. On a second round of bidding the computer, as South, would bid 3 no-trump which is the correct final contract.

The following hand is of interest:

<u>North</u>	
S	K 8 7 4 3
H	----
D	A Q 9 8 6 3
C	Q 8

<u>West</u>	<u>East</u>
S A 6	S Q J 2
H Q 3	H 10 7 6 5
D 10 7 4 2	D J 5
C A K 10 7 5	C J 4 3 2

<u>South</u>	
S	10 9 5
H	A K J 9 8 4 2
D	K
C	9 6

Dealer: South

Vulnerability: East-West vulnerable

The bidding:

<u>South</u>	<u>West</u>	<u>North</u>	<u>East</u>
4H	Pass	Pass	Pass

South is the dealer with East-West vulnerable. As South, the computer correctly preempts 4 hearts, having only 5 or 6 losers and non-vulnerable against vulnerable opponents. This is the final contract as the computer passes with each of the other hands.

Here is one final hand:

North

S	J 9 2
H	A
D	K Q 6 5 4
C	Q J 7 4

West

S	K 10 5 4
H	K Q 10 7 6 5 2
D	J 10
C	----

East

S	A Q 8 3
H	J 4 3
D	A 3
C	A 6 3 2

South

S	7 6
H	9 8
D	9 8 7 2
C	K 10 9 8 5

Dealer: South

Vulnerability: Neither side vulnerable

The bidding:

<u>South</u>	<u>West</u>	<u>North</u>	<u>East</u>
Pass	1H	Double	Redouble

South is the dealer with neither side vulnerable. As South, the computer passes. As West, the computer opens 1 heart. With the North hand, the computer makes a take-out double, having fourteen or more points and at least three spades. That is, a take-out double of one major suit promises at least three cards in the other major suit. As East, the computer redoubles to show ten or more points.

Program and Comments

The description of the above three hands has indicated a few of the factors involved in the selection of a bid. At present the program consists of 25 UNIVAC blocks (comprising approximately 3000 instructions); three are for dealing the cards and 22 are for bidding the hands.

Finally, it is interesting to consider one possible use of a program for completely bidding and playing the hand. There are numerous bidding systems employed by American players and still others are used by the Italians, the French, and the British. American bridge teams have not won a world's championship in the last eight years of international competition against these teams. Are

the American players not as good, or are the American bidding systems simply inferior? To answer this question it is necessary only to codify each system in question and then provide for computer "battles" between the various American and foreign systems.

Assume that the same program is used for the play of the four hands, but that the computer is programmed to bid the North-South cards according to one system and to bid the East-West cards according to a second system. In a few hours, several thousand hands may be dealt and played by the computer and the results scored. Then, the same hands are regenerated and played again with North-South holding the previous East-West cards and vice-versa. For each "pair" the total score for the second set of results is added to the first total score. The system played by the pair emerging with the net positive score would then be judged the superior bidding system. In effect, this scheme constitutes a team-of-four match between two teams of precisely equal playing ability but employing two different bidding systems.

The scheme described above would make it possible to conduct computer battles between the various American, Italian, French, and British bidding systems. In forthcoming international tournaments our top-ranking teams would then be in a position to employ whichever bidding system was judged by the computer's results to be superior. Perhaps our teams then might recapture the world's bridge championship!

STOCK CONTROL ON 30,000 ITEMS FOR AN ELECTRONICS DISTRIBUTOR

Activity in more than 30,000 items handled by a leading electronics distributor is reported continuously by the data processing and computer center of Statistical Tabulating Corporation in New York. A complete picture of the inventory status, obtained with an IBM 1401 computer in less than one hour, ensures that the client will avoid being out of stock on any item. The initial purpose in putting inventory control on the computer was to speed delivery to customers, as well as to maintain minimum inventory, but faster turnover is expected to generate a substantial increase in earnings. The client expects that the savings will amount to more than \$25,000 "if we increase it by one turn a year".

The activity for each item is posted daily as 500 to 600 orders are processed. The order point is also adjusted daily on the basis of the activity in each item. There is also a daily activity report breakdown by the customer.

The status of each item is adjusted continuously by sales, orders, deliveries, and incoming shipments. In the determination of order point, which keeps fluctuating with all these factors, trends are evaluated on the basis of the data for the reporting month to date, year to date, previous month, and second previous month.

The sales curve for each item is projected to permit the client's management to make intelligent marketing decisions.

SCORING THE 1964 OLYMPIC WINTER GAMES

The Organizing Committee of the IX Olympic Winter Games has asked the International Business Machines Corporation to solve a major problem facing it by providing a system for the rapid collection, processing and reporting of scoring information throughout the area of the 1964 Winter Games in and around Innsbruck, Austria.

IBM has agreed to provide such a system, and will furnish the men and machines without charge.

The system, called "Tele-Processing", which combines communications and computers, will shrink the distances between the event sites and provide the fastest computing and reporting of Olympic results in history.

Most winter events are run from different sites where the athletes compete one at a time, making it difficult to ascertain which country is winning.

At Innsbruck, the various events will be spread out over a 200-square-kilometer area -- approximately ten times greater than the 1960 Squaw Valley area -- with some sites as far as 40 kilometers apart. It is estimated that 15 million characters of scoring information will have to be speedily transmitted and processed during the course of the Games.

The center of the "Olympic Results Network" will be two IBM 1401/RAMAC computers, centrally located in the Olympic Data Center adjoining the main Press Center at Innsbruck University. The computers for the Olympics will be produced at IBM World Trade Corporation's plant at Sindelfingen, Germany.

During an estimated 30 man-months of preparation, IBM technicians will compile the rules of the winter events and translate them into language the machines can understand. Approximately 50,000 separate instructions will be written and stored in the computers' magnetic memory units. Any of the stored information can be recalled from memory in less than a second.

As each athlete completes his event and data is flashed to the Center, the computers will automatically refer to the stored instructions and rules of that event, and use them in making the scoring computation. While the event is still in progress, the computer will automatically compare and sort the times of the ten top competitors, and print out the standings in sequence.

MONTHLY REPORT OF 350 BUSINESS CYCLE INDICATORS

In late 1961, the Census Bureau made public its Monthly Report on Current Business Cycle Developments, which had been going confidentially to top government officials for the past four years. The Administration decided to make the report generally available in the belief that it would prove useful to business forecasters.

The publication consists mainly of a long series of tables showing the movement of about 350 economic indicators over the business cycle. The figures are prepared on Census Bureau computers in the five days immediately preceding publication -- about the 20th of each month.

BEARING CALCULATIONS

Fafnir Bearing Co.
New Britain, Conn.

In order to predict bearing performance which will enable the designer to specify the right bearing for a given application, it is necessary to know precisely how the rolling elements in the bearing share the load. The problem is made difficult by the fact that a rolling-element bearing is what engineers call a statically-indeterminate, non-linear spring system. In addition, the motions of the rolling elements themselves give rise to centrifugal and gyroscopic forces, which must be considered when operating speeds are high. The deflections of the shaft and supporting structure under load also add to the complexity of the problem.

Engineers are now able to express all these factors in mathematical language. The solution of this problem has been made possible by Fafnir's chief research engineer, Mr. A. B. Jones, who has spent more than a quarter of a century in the development of rolling-element bearing theory.

The simple formulae which bearing engineers have been using for many years (often still used) are simplified cases of the new general theory. This theory was originally programmed for the IBM-704 computer. Recent-

ly, the theory was reprogrammed for the IBM-7090 computer which, in this instance, is about six times faster than the 704.

The large-scale digital computer provides a means of solving problems in a matter of minutes or even seconds, although the theory is too complex for manual solution.

The instructions to the computer are contained in a single deck of punched cards called the object deck. It spells out to the computer the exact steps to take in solving any problem put to it.

Individual problems are prepared for the computer by punching the bearing design characteristics, the load and speed conditions, and other pertinent data, on a second set of cards. Only a few punched cards are needed to describe an entire bearing system; their preparation takes but a few minutes. The second set of cards is placed behind the object deck and the complete package is then fed to the computer. Any number of separate problems can be stacked behind the object deck.

The computer performs the necessary calculations at electronic speed and prints the results at 800 lines per minute. The varying effects of different design parameters can be studied and the optimum bearing installation selected for any application.

Fafnir has developed other programs for specialized bearing applications. One such program evaluates the effects of elastic distortion of the bearing rings themselves as, for example, the effect on bearing life of the distortions of the outer ring of a helicopter planetary transmission idler gear bearing under the tooth loads.

Another program enabled a prominent manufacturer of inertial guidance instruments to design a phenomenally accurate gyro by matching the deflection characteristics of the spin-axis bearings to the elastic characteristics of the spin-motor and gimbal structures and thus minimize the anisoelastic drift of the guidance system.

The new methods of analysis are particularly useful in predicting the performance of very high-speed bearing installations where centrifugal and gyroscopic loading of the rolling elements affect bearing operation and life. Jet engine thrust bearings and bearings used in high-speed turbo-machinery require analyses such as only the computer can supply.

inst:
meet
gradu
This
be us
IBM
fell
State
istra

avail
stude
in th
a do
ate
ing.

STATI

insta
San F
cente
offic
IBM
past
are p
of th

\$465
the P
were
of P
sign
to be

mated
tem
and
Defen
Reser
figur

COM

ANALYSIS OF PIPING FLEXIBILITY

Service Bureau Corp.
425 Park Ave.
New York 22, N.Y.

Over 350,000 feet of intricate plant piping have been analyzed in the past year using this company's computer program for analysis of piping flexibility.

The piping flexibility program took two and one-half years to develop. The investment in such a program is justified because it can be offered as a packaged computer data processing service.

The service has been used for nuclear power plants, conventional power plants, ship-board power plants, missile systems, cryogenic systems, chemical processes, and the petrochemical and petroleum industries.

One user of the piping flexibility analysis is Commonwealth Associates, Inc., an engineering consulting firm of Jackson, Mich. Commonwealth, which doesn't have a computer, made use of this company's computer program to analyze 25,000 feet of intricate plant piping for the Enrico Fermi Atomic Power Plant, which will supply power to Detroit Edison Company.

Commonwealth mails data sheets describing the piping system to be analyzed, along with an isometric drawing, to SBC's data processing center in New York. There the information is fed into an IBM 704 computer along with the piping program. The data is processed and a complete report is then mailed back to Commonwealth in 24 to 48 hours.

Reports produced by the program give: anchor and restraint reactions; forces, moments, and stresses at all intermediate points; displacements and rotations. The program will accept tangents, bends, and closed loops in any combination and having any orientation.

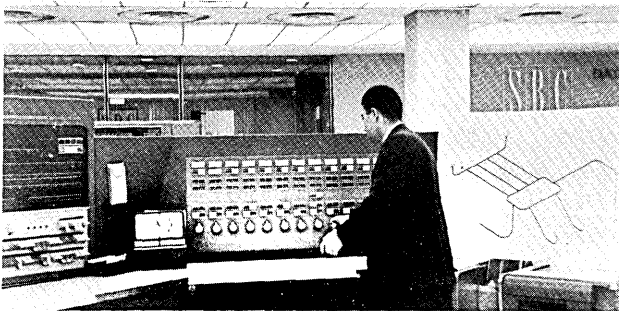

UNIVERSITY OF MIAMI COMPUTER HANDLES STUDENT REGISTRATION, BUDGET ACCOUNTING, MEDICAL STATISTICS, FISHERIES DATA, ETC.

Radio Corp. of America
30 Rockefeller Plaza
New York 20, N.Y.

An RCA 301 electronic data processing system that can run the performance gamut from student registration and accounting to medical statistics and up-to-the-minute information on commercial fishing in Florida waters is being installed at the University of Miami, Florida.

The system will lead to tighter budget control and faster processing of reports of 13,000 students attending the University's four yearly semesters.

It will be used by a Department of Biometry and Statistics to be established by the Medical School. Studies will be made on gynecology, tumors, epidemiology, neurology, polio and other medical subjects. Voluminous statistics on patients in the university hospital will be analyzed by the computer.

The computer will be used in psychological testing conducted by the university's Guidance Center in student counselling and placement work.

An analysis of commercial fishing statistics will be made for the State Department of Fisheries. Information will be produced at regular intervals on the types and quantities of fish brought in by fishermen of the various counties, the type and amount of gear used, numbers of fishermen per boat, how long the boat is out, and other factors of value for industry reports, evaluation, and projections.

ELECTRONIC DIFFERENTIAL ANALYZER BEING USED IN INERTIAL GUIDANCE AND NAVIGATION SYSTEM DESIGN

Astro Space Laboratories, Huntsville, Ala., a subsidiary of Belock Instrument Corp., is using an electronic differential analyzer from Applied Dynamics, Inc., Ann Arbor, Mich., for the design and development of the networks and closed-loop servo systems associated with inertial guidance and navigation systems. The AD-1 computer is being used to determine and study the overall dynamic response of the closed-loop servo systems, and to design individual components in the loop.

SOCIAL SECURITY COMMUNICATIONS NETWORK

A new installation for the Social Security Administration by the Bell Telephone System and Digitronics Corporation, Albertson, N.Y., enables the SSA to transmit data instantly and directly between machines throughout the country over the regular telephone network. This data transmission system can include any combination of types of terminals, with no restrictions as to number or type of media.

The system uses the Dial-o-verter System, made by Digitronics and the Bell System Data-Phone dataset, to transmit data at high speed over regular dial exchange telephone lines, leased lines, and broadband or microwave facilities.

Data can be transmitted between 600 district offices and the SSA computer center in Baltimore at speeds up to 1500 words per minute.

The new electronic data communications network was designed as part of a long range plan to speed up the processing and issuance of benefit payments, and to cope with what has been termed "the world's most colossal bookkeeping job".

SPACE AND MOON EXPLORATION

The Recomp III computer, made by the Autonetics division of North American Aviation, Inc., is being used to interpret the incoming tracking data for the current Ranger Lunar Exploratory Series of experiments. Operating at Jet Propulsion Laboratory, Pasadena, Calif., the computer receives inputs from five Deep Space Instrumentation Facility tracking stations, located throughout the world. It presents these data in graph form for evaluation in approximately three minutes.

The Ranger series of experiments is an exploratory program of nine shots planned by the National Aeronautics and Space Administration. Its purpose is to prepare for a "soft landing" on the moon with scientific instruments and equipment. Throughout the series, precise records are kept to provide immediate and complete information on space shot results for evaluation by JPL scientists. During the firings, data from the tracking stations is fed into the computer by direct teletype line. It is interpreted by the computer and superimposed over charts of predicted course, speeds, trajectory, etc. Variations between predicted and actual performance are used to correct tracking coordinates.

AUTOMATION IN RETAILING

An automatic merchandising control system called Uni-Tote is said to have completed a successful field installation test through the two-month Christmas season at Robinson's Department Store in Glen Burnie, Maryland. The operation showed a saving of personnel time, faster and more accurate recording and compilation of store data, and an improvement in credit operations. During the test run, the Glen Burnie store was visited by representatives of 85 stores and store chains.

The Uni-tote system, developed by the American Totalisator Company, a Division of Universal Controls, Inc., is a series of machines, linked by wire and cable. The system performs sales check calculating and imprinting, accounting, billing, credit checking, and inventory control. The key unit in the system is a point-of-sale register. The keyset panel on the register, linked to the central control unit, records method of payment, time and method of delivery, data on merchandise items concerned, taxes, and all essential information for each transaction. The central control unit, through which all data from the point-of-sale register is fed, provides instantaneous store-total reports. The sales journal records each sale in readable form and makes a one line permanent record of every transaction.

NEW YORK TIMES TO TRANSMIT NEWSPAPER DAILY TO LOS ANGELES BY ELECTRONIC TRANSMISSION

The New York Times is scheduled to start this year transmitting news matter from New York to Los Angeles using the Dial-o-verter System of Digitronics Corp., Albertson, N.Y.

The complete weekday edition of The Times, less local news and advertising, will be sent daily over ordinary telephone lines to Dial-o-verter terminals in Los Angeles. Using paper tape terminals, the system will operate at 1,000 words per minute. Two Dial-o-verter terminals will be located in New York, and two more terminals will be in Los Angeles. A special switching arrangement is provided at each point, in case there is malfunctioning of a terminal. New York will send about 96,000 words daily to the Los Angeles terminals. The paper tape will be fed into eleven line-casters. Each line-caster sets type at 66 words per minute. The 96,000 words thus can be set in type in 133 minutes, as compared with two full business days if previously available equipment were used. A full month of testing the facilities resulted in zero transmission errors.

tra
pun
lin
set
tem
com
com
the
ope
uni
on
pri
duce

ava

IBM

the
sci
pro
fast
iste
peri
arit

32,
conf
can
dev
Syst
cust
repr

put
to
have
chan
dist
mem
the
log
tra
div

COM

PROCESSING COLLEGE ENTRANCE AND OTHER EXAMINATIONS

Educational Testing Service, Princeton, N.J., is using a computer to facilitate the reporting and interpretation of test results on the College Board examinations administered six times a year throughout the world.

An RCA 501 computer, used in conjunction with an electronic scoring and data transcription machine, enables the testing service to provide schools and colleges information about individual applying students, -- more information, faster, and more easily than ever before.

Records of student candidates, which previously occupied extensive storage space in file cabinets, can now be stored on magnetic tape and can be located, updated and processed much more easily.

The testing service can then keep cumulative records on individual students and provide comprehensive reports to schools and colleges covering student performance. The new computer can also handle details of administrative tasks associated with large scale testing programs such as assigning students to test centers and printing tickets of admission.

The computer will permit the testing service to deal with the steadily growing number of students who are taking tests and will enable the organization to provide valuable new services without delaying critical reporting dates.

The RCA computer system, working with ETS's electronic scoring and transcribing machine, has the capability of processing 6000 test papers an hour. In addition to the main computer unit, the RCA 501 system includes a high-speed memory containing more than 32,000 characters. There are seven magnetic-tape memory units, each storing 10 million characters. Reports are produced on a high-speed printer capable of printing ten 120-character lines per second.

FREIGHT CAR IDENTIFYING

American Brake Shoe Company, New York, and Transdata, Inc., San Diego, Calif., have agreed to cooperate in the engineering, testing, manufacture and marketing of an automatic freight car identification system for the railroads.

The Microwave Identification Railroad Encoding Reflector System is known as MIRROR. It consists of a special tag to be mounted on each railroad car, and a trackside scanner

which reads the tag at speeds of one to 60 miles per hour. The tag is readable by humans as well as by the scanner. It carries the code of the owning railroad and the number of the car. Other data can be included if desired.

Microwave reflections from the tag are translated into a teletype code output signal. This signal may be used to send train car listings to control centers, can be transmitted to hump towers to assist in switching operations, and has applications in automating the inter-railroad per diem charges for cars.

MACHINE TOOL FOR CONTOUR TAPE-CONTROLLED MILLING

Thompson Ramo Wooldridge, Michigan City, Ind., is building the numerical control system for contour milling for the new Wilson milling machine, which was designed and built by The H. & H. Wilson Company of Bell, Calif. This machine is a ram-type, tape-controlled, 4-spindle, 12-speed, contour-milling machine, with all motions capable of moving 200 inches per minute simultaneously.

The TRW numerical control is a solid-state system for continuous path control of three axes, simultaneously. It includes a 400-character-per-second photo-electric tape reader to accept the standard 1-2-4-8 binary code from one-inch 8-level punched tape. The system has internal feed-rate override, command multiply, and a word-address tape format. The system also includes an optional stop control, manual data input and full data display and servo error detection for each axis.

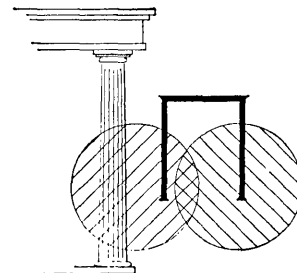
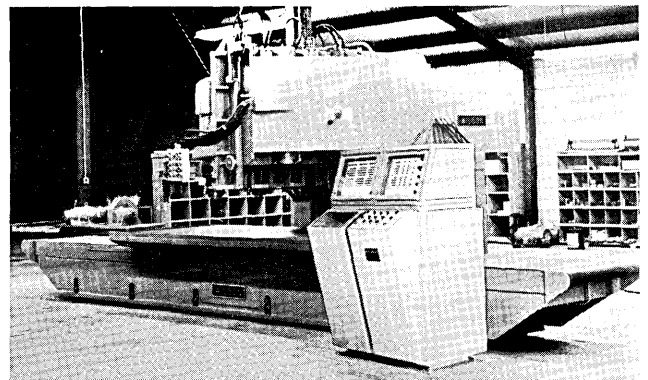

ACROSS THE EDITOR'S DESK

News of Computers and Data Processors

New Computing Centers

TACTICAL AIR OPERATIONS CENTER

The first Tactical Air Operations Center of the advanced Marine Corps Tactical Data System, developed by the Data Systems Division of Litton Systems, Inc., Canoga Park, Calif., is in operation for field evaluation at the Marine Corps Air Facility at Santa Ana, Calif.

The center is installed in a complex of helicopter-transportable huts. The system can also be moved by transport aircraft or truck. The equipment, which includes high-speed digital computers, permits the establishment of integrated air defense, close air support, enroute air traffic control, and control of surface-to-air missiles -- all within a few hours from starting to set up in a new location.

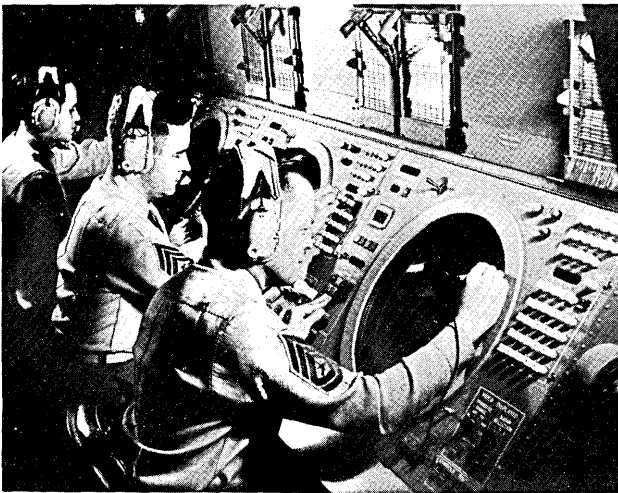

Tactical Air Operations Center brings advanced data processing and display facilities to the Marines' traditional role of amphibious assault. The helicopter portable display hut shown is linked to computer and communications huts.

C-E-I-R ANNOUNCES NEW CHICAGO CENTER

A new research and electronic data processing service center is planned for Chicago in September, 1962, by C-E-I-R, Inc. This will be C-E-I-R's eighth in the United States; they also operate centers in Paris, London and Mexico City.

COMPUTERMAT II "DO-IT-YOURSELF" COMPUTER CENTER

ComputerMat, Inc. has opened its second self-service computer center at 14827 Ventura Blvd., San Fernando Valley, Calif. This new center includes an IBM 1620 Data Processing System and is patterned after the company's first center located in Los Angeles.

The service is offered to many engineering, scientific, and commercial firms which need the advantages of a computer but are too small to justify a system of their own. The necessary equipment is provided and the customer is allowed to do his own work. An experienced staff is provided to assist clients in the preparation of programs and machine operation if such assistance is desired.

OPTICAL CHARACTER READING INTO COMPUTING EQUIPMENT

The Pennsylvania Power & Light Company, Philadelphia, Pa., has exhibited its new IBM 1418 Optical Character Reader.

The machine "reads" conventional printed or typed information somewhat like the human eye and "writes" results on magnetic tape. Information is taken from meter reading sheets by the Optical Character Reader and recorded on tape. This information next goes to the IBM 7070 which computes the customer's bill. The company reports it can process 22,000 bills a day in the new center.

puter
The l
puter
solid
puter
line
autom
desig
steel
close
high
forme

are r
on th
modul
fit t
arran
the p
compu
gram
probl

termi
to 90
velop
is ca
opera
to co
with
This
and a
compu

asyn
prepa
modul
wave
ceivi
recov
data
Contr
and c
trans
repla
termi

COMPE

NEW PRODUCTS

MULTIPURPOSE ANALOG COMPUTER TO CONTROL PROCESSES

Electronic Associates, Inc.
Long Branch, N.J.

A new line of multi-purpose analog computers has been developed by this company. The line is known as the Multi-Purpose Computer PC-12 line and is assembled from stock, solid-state modular components. These computers are produced in various sizes for on-line control of industrial processes and for automatic data processing. They have been designed to meet requirements of chemical, steel and other industrial processes for closed-loop control or for applications where high speed on-line computation must be performed on constantly changing data.

In the PC-12 the permanent connections are replaced by a system of patching modules on the rear of the computer chassis. The modules are interconnected by patch cords to fit the requirements of the problem. This arrangement eliminates the need for disturbing the program configuration when replacing a computing module. It also permits the program to be readily modified to meet changing problem requirements.

NEW SWIFT DATA COMMUNICATION SYSTEM

General Electric Company
Communication Products Dept.
Lynchburg, Va.

A new transistorized data communications terminal which is capable of transmitting up to 90,000 characters per second has been developed by this company. This new equipment is called the TDS-90. It enables large, fast-operating computers in major computer centers to converse directly in computer language with smaller devices in satellite locations. This lessens down-time at the central location and affords maximum utilization of the larger computers, making the center more productive.

The TDS-90 transmitting equipment accepts asynchronous signals from a magnetic tape unit, prepares these signals for transmission, and modulates them onto the base band of a microwave beam or coaxial cable. The TDS-90 receiving equipment demodulates the signals, recovers signal energy, and shapes it into data suitable for transfer to the computer. Control signals, necessary for the operation and control of a tape unit, are encoded and transmitted via the data channel. A TDS-90 replaces a single tape unit at each computer termination.

PHOTOCELL PUNCHED TAPE READER

Rheem Manufacturing Co.
Electronics Division
5200 W. 104th St.
Los Angeles, Calif.

A new high-speed photocell punched-tape reader, the RR-1000, is being produced by this company. It handles 1000 characters per second; it has completely transistorized circuits, photovoltaic sensing cells, and two-speed motor drives.

DIGIT-MATIC CALCULATORS

Victor Business Machines Co.
Division of Victor Comptometer Corp.
3900 North Rockwell St.
Chicago 18, Ill.

The picture below shows a solenoid actuated Digit-Matic Calculator with the cover removed. Serial entry units have solenoid-operated numerical keys, addition, subtraction, multiplication, and division keys.

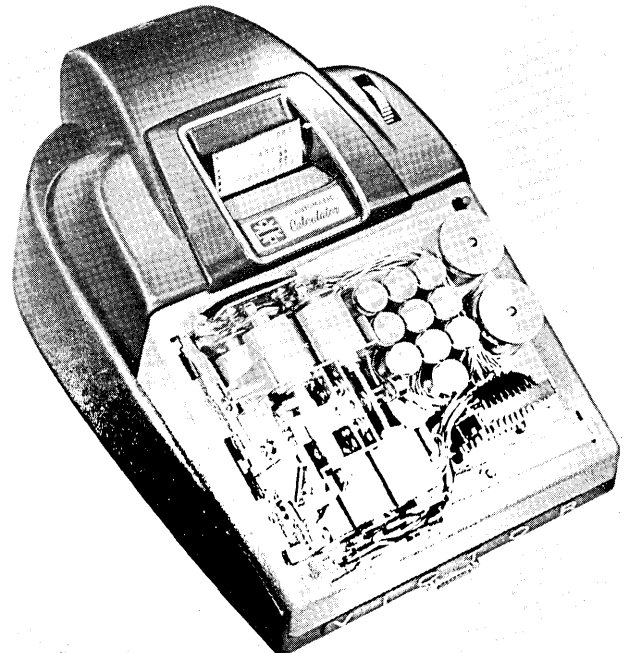

The calculators perform both basic and complex math. Some applications are: computation of density, area, velocity, temperature, force, pressure and flow rate.

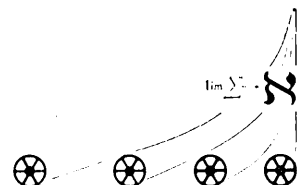

WRITTEN MESSAGES BY TELEPHONE

Written messages may now be sent over regular telephone lines by simply dialing and connecting in the normal way. TELautograph Co., New York, has developed the PHONE-writer which is used in connection with Bell Telephone's DATAPHONE service. The user can either talk, write, or do both with a single call. Written messages may also be sent to unattended receivers. Anyone can transmit handwritten or sketched information instantaneously from one location to another. Carbon copies may also be provided by the device.

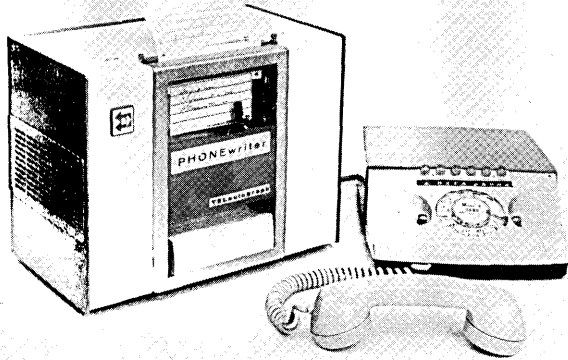
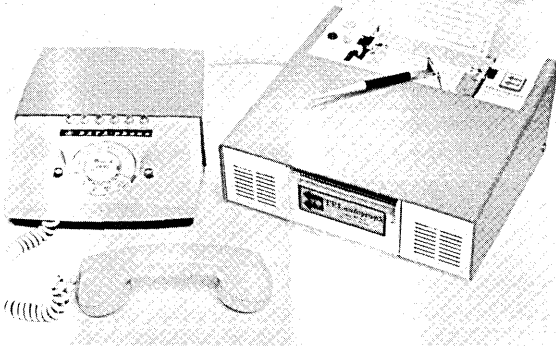

In the top picture is shown the PHONE-writer transmitter; in the bottom picture, the PHONE-writer receiver.

NEW UNIVAC OPTICAL SCANNING PUNCH

Remington Rand Univac
315 Park Avenue South
New York 10, N.Y.

Information indicated by pencil marks on source-document cards can be read and punched at a rate of 150 cards per minute with the Univac 5440 Optical Scanning Punch, developed by this company.

It is possible to sort according to types defined by marks on the card itself. An enlarged card-stacking area, redesigned card receivers, and the inclusion of misfeed stopping devices, permit the machine to function without constant attention from an operator. The type 5440 has a mark scanning capacity of forty columns. Its 90-column punching capacity makes it compatible with all elements in 90-column systems.

DIGITAL COMPUTER TEACHING DEVICE

Dynatech Corporation
471 N.E. 79th St.
Miami 38, Fla.

This company is producing an inexpensive, fundamental teaching device for digital computers.

The self-contained flip-flop lucite cards hold two binary read-out lights and additional circuit components. The digital computer teaching device can accomplish addition, multiplication, subtraction, and division up to the number 31, in binary 11111.

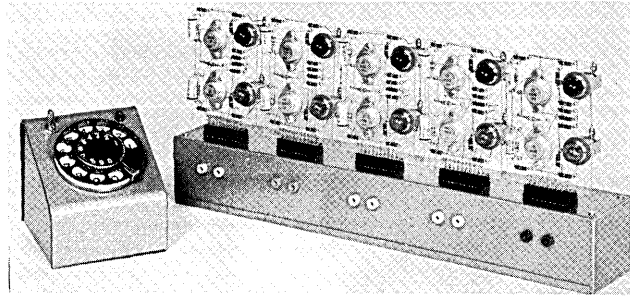

ANALOG UNIT TO ESTIMATE SCHEDULE COSTS

Mauchly Associates, Inc.
Fort Washington, Pa.

An analog computer that will enable a company to determine the most economical method of meeting various schedules for a project has been developed by this company.

The computer, called SkeduFlo Model MCX-30, is operated by setting up the job sequences by pinboard. Possible project durations are scanned automatically, and an output curve is automatically plotted during the scan. The project coordinator or supervisor is able to determine what schedules are feasible and what jobs are critical in any possible schedule. The name "MCX-30" stands for minimum-cost expediting computer with capability of handling up to 30 jobs.

COMPUTER-LINOFILM CONVERTER

Mergenthaler Linotype Company
29 Ryerson St.
Brooklyn 5, N.Y.

This company has developed a device to transpose computer-output information into punched tape. The converter will act as a link between large computers and the type-setting unit of Mergenthaler's Linofilm system for photocomposition. The data-processing computer will produce magnetic tape which the computer-Linofilm converter accepts. It is then transposed into punched paper tape to operate the Linofilm Photo Unit. The photo unit output is right-reading positive type on film or photographic paper from which printed pages of textbook quality can be produced.

The converter will be made commercially available in mid-1962.

IBM 7094, POWERFUL NEW SOLID-STATE COMPUTER

International Business Machines Corp.
Data Processing Division
112 East Post Road
White Plains, N.Y.

The IBM 7094 data processing system is the most powerful of the company's solid-state scientific computers. Increased speed and processing power of the 7094 are provided by faster adding circuits, additional index registers and instructions, and facility for performing double-precision floating point arithmetic.

The new system has a storage capacity of 32,768 words. A variety of input and output configurations are available. The machine can be linked to various IBM Tele-processing devices for full data-transmission ability. System compatibility makes it possible for a customer with a 7090 to use the 7094 with no reprogramming.

The magnetic tape unit enables the computer to accept and record data at speeds up to 170,000 characters a second. The 7094 can have instantaneous access to up to 279 million characters of information stored on magnetic disks in IBM 1301 disk storage units. With a memory reference speed of 2.00 microseconds, the 7094 can in one second perform 500,000 logical decisions, 250,000 additions or subtractions, 100,000 multiplications or 62,500 divisions.

NEW LONG-LENGTH DELAY LINE

Deltime Inc.
608 Fayette Ave.
Mamaroneck, N.Y.

A long-length delay line of the magnetostrictive design has been developed by this company. It is suitable for data storage functions in computer systems at increased frequencies. The Deltime 197 delay line provides a 5 millisecond delay with a pulse repetition rate of one megacycle with a return-to-zero operation.

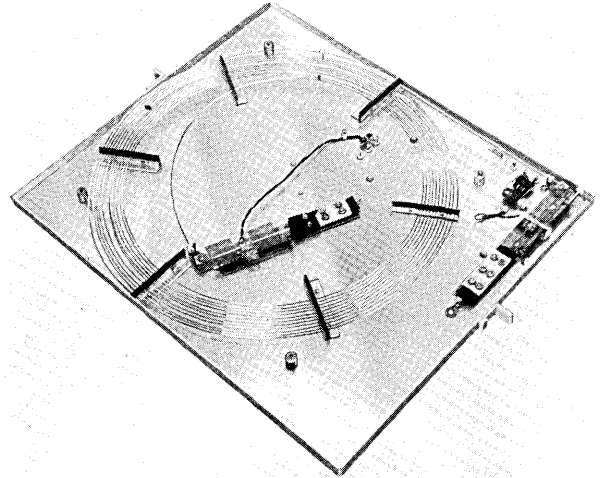

SOLID CERAMIC CIRCUITS

Radio Corporation of America
30 Rockefeller Plaza
New York 20, N.Y.

This company has developed a solid-ceramic circuit one-third the size of an aspirin tablet. The developmental device can perform all conventional circuit functions from amplification to computer switching. The circuits include both active and passive materials. They are fully compatible with the RCA Micromodule Program -- a U.S. Army sponsored effort to develop miniature tactical communications systems and computers using circuits no bigger than an ordinary sugar cube. They also can be used with all other forms of micro-circuitry from multi-element assemblies to integrated and molecular devices.

Pilot production of the units is scheduled to begin before the end of 1962.

NEW INSTALLATIONS

ILLINOIS BLUE CROSS-BLUE SHIELD INSTALLS HONEYWELL 800

A Honeywell 800 electronic computer has been installed by Illinois Blue Cross-Blue Shield in Chicago as part of a program to maintain low operating costs and to further improve service to its subscribers, hospitals and physicians.



Contract data concerning the nearly 5 million members of Illinois Blue Cross-Blue Shield will be contained in 13 magnetic tape reels like those shown at the left and held by Pat Tielbar, electronics department employee, in the picture above. The new machine is capable of performing more than 40,000 operations a second, such as additions and subtractions. The entire file can be reviewed by the computer in about one hour each day, posting an average of 20,000 transactions and changes in membership status. The Honeywell 800 is expected to handle almost all of the bookkeeping for the organization.

IBM COMPUTER FOR LONG ISLAND BANK

The Franklin National Bank of Long Island, New York, is converting to a high speed IBM 1401 computer for handling much of the record-keeping functions.

Over 75,000 school children are members of the bank's Junior Savings plan and will be among the first depositors handled by the computer. Over \$10 million has been deposited by the young people using this plan.

Annual interest calculations necessary to keep these accounts up to date each year formerly took on punched card equipment 21 hours each quarter to calculate. The job is now completed in 21 minutes with the IBM 1401.

The computer will also work on accounting, personal loans, mortgages, and corporate stock records.

ARKANSAS AND TEXAS IN THE NEXT ROOM TO CONNECTICUT

By using telephone lines to link a computer at its Middlebury, Conn., headquarters with plants 1500 miles away. The U.S. Time Corporation is now processing product schedules, payrolls, and shipping invoices as efficiently as if all the facilities were in the same office. The company is the world's largest manufacturer of watches and producers of gyroscopes.

The new installation, the IBM 1401 Data Processing System, transmits the data from punched cards bearing wage and hour data for each employee over telephone lines from Little Rock, Ark., to Middlebury, Conn. through an IBM transmitting-receiving device called a "data transceiver".

Daily production figures are similarly transmitted from the Little Rock and Abilene, Texas, plants to Connecticut, where they are balanced against pending orders. The computer processes the orders and transmits the pertinent data back to Little Rock as printed shipping documents and invoices.

In addition, the data transmitted to the computing center is recorded in the 1401 for use in sales forecasts and analyses, cost and production control reports, accounts receivable, billings, and other accounting documents.

The company is planning to have a tele-processing connection between its European and its American offices.

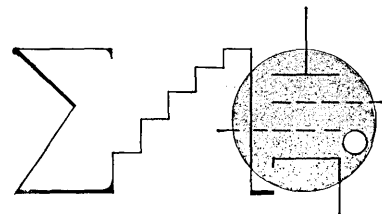

IBM 7074 SYSTEM FOR PENN STATE

The Pennsylvania State University has installed an IBM 7074 computing system to meet the growing needs of its faculty and graduate students for computational services. This will be the first system of this type to be used in purely academic applications. The IBM 7074 is replacing an IBM 650 system which fell short of the University's needs. Penn State also operates an IBM 7070 as an administrative machine.

The Computation Center at Penn State is available to all faculty members and graduate students who have need of computer services in their research or instruction. A staff of a dozen specialists assist faculty and graduate students in programming and problem solving.

STATISTICAL TABULATING CORP. IN SAN FRANCISCO INSTALLS IBM 1400 SYSTEMS

Statistical Tabulating Corporation has installed an IBM 1400 system in the firm's San Francisco data processing and computer center at 417 Market Street. STC has 14 offices across the country and has put the IBM 1400 system into seven centers in the past year. Seven additional 1400 systems are planned for delivery in the first quarter of this year.

NEW CONTRACTS

POLARIS PRINTER CONTRACTS AWARDED TO POTTER INSTRUMENT COMPANY

Three separate contracts totalling over \$465,000 from three of the major suppliers on the POLARIS Fleet Ballistic Missile program were awarded to Potter Instrument Company, Inc. of Plainview, N.Y. The contracts are for design and production of high-speed line printers to be used in POLARIS-equipped submarines.

CONTRACT TO OPERATIONS RESEARCH INC.

A contract for the provision of an automated management information and control system (PERT), standing for Programmed Evaluation and Review Technique, for the national Civil Defense program has been awarded to Operations Research, Santa Monica, Calif. No dollar figure was disclosed.

CONTROL DATA RECEIVES CONTRACT INCREASE

Control Data Corporation of Minneapolis, Minn., has now received production contracts for eleven fire control computers totaling in excess of \$5 million, to be delivered in 1962 and 1963. The earlier research and development prime contract, to develop the geoballistic fire control computers, was also in excess of \$5 million.

The purpose of the Polaris Mark 84 Fire Control computer, designed and built by Control Data, is to receive position data from the Ship's Inertial Navigation System (SINS), and to calculate trajectories to the assigned targets prior to the time the missiles are fired, currently loading trajectory information to the computers in the Polaris missiles up to the moment the missile is fired. The fire control system can prepare missiles for launch at the rate of one per minute. Missiles are guided in flight by their own inertial guidance systems.

SYLVANIA RECEIVES "ZMAR" \$28 MILLION CONTRACT

Sylvania Electronic Systems, a subsidiary of General Telephone & Electronics, received the ZMAR (Zeus multi-function array radar) award from Bell Telephone Laboratories. ZMAR, is for use in the U.S. Army's Nike-Zeus anti-missile missile system. This system is being developed to provide a defense of the continental United States against the threat of intercontinental ballistic missiles. Bell Telephone Laboratories is responsible for the design and development of the Nike-Zeus system. Western Electric Company is prime contractor for the Nike-Zeus program.

ANELEX RECEIVES CONTRACT FOR OVER \$2 MILLION

Anelex Corporation has been awarded a contract in excess of \$2,000,000 by International Electric Corp., an ITT subsidiary, for special purpose, militarized printer systems. These printer systems are for use in SAC's Project 465L, a completely integrated command control system. The system, designed by IEC, will provide the Strategic Air Command with instantaneous information and positive control of its forces by means of a high speed data acquisition, processing and display system.

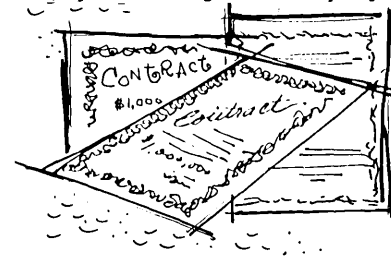

\$15 MILLION AWARDED SPERRY
FOR POLARIS SUB NAVIGATION

The Sperry Gyroscope Company has received \$15 million from the U. S. Navy for design, production, and installation of navigation equipment aboard ten new Polaris submarines.

The submarines to be equipped with the navigation aids will be ships of the Lafayette class. They will be capable of carrying 2500-mile, nuclear-tipped Polaris missiles -- weapons that will be able to reach a target anywhere on earth. (Five Polaris submarines equipped with 1200-mile-range missiles are now on station at sea.) The new ships are scheduled to be in service with the fleet by the end of 1964.

AIRLINE RESERVATION SYSTEM FOR OZARK AIR LINES

Ozark Air Lines, St. Louis, Mo., has entered into a contract with the Univac Division of Remington Rand for equipment to process passenger reservations between Ozark and all other airlines.

About 65% of Ozark passengers use the services of another airline to complete their journey. This requires the processing of reservations between two or more airlines. The Univac-Unicall equipment will reduce the time for this type of reservation to a matter of seconds and practically eliminate errors. The basic equipment consists of a large Univac electronic brain located in Chicago, and an electronic device at each Ozark station known as Unicall.

Remington Rand is installing a nationwide Airline Interline Development (AID) system in which all airlines are expected to participate. In operation, the schedules of all airlines for months in advance are fed into the electronic memory machine. Availability of seats on each flight is kept current by each airline. To obtain the information in the electronic brain, a reservation agent at any Ozark station merely sets the levers on his Unicall to the proper inquiry, picks up his telephone and the computer returns a voice reply reporting whether it is able or not able to confirm the reservation. When AID is in full operation, space on any flight operating in the United States can be secured through the device, permitting almost instant confirmation of return reservations.

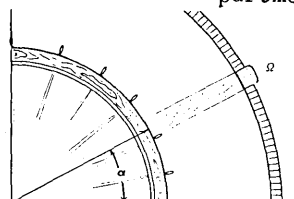

POTTER RECEIVES OVER \$1,000,000 CONTRACT

Potter Instrument Company, Inc. has received a contract of over \$1,000,000 from RCA for development and production of special magnetic tape transport systems. These systems are to be used in the U.S. Air Force COMLOGNET (Communication Logistic Network).

OVER \$1 MILLION CONTRACT FOR BECKMAN

The Systems Division of Beckman Instruments, Inc., has received a contract from AETRON-Covina Plant, a Division of Aerojet-General Corporation for more than \$1 million. The equipment, two data acquisition systems, is for use in the NASA Saturn space vehicle program and will be used in test of rocket engines. The systems will record performance data from tests of the rocket engines at speeds up to 5,000 samples a second. The equipment will edit, correct, and tabulate the information and record it on magnetic tape for evaluation by digital computers.

CONTROL CENTERS FOR DEPARTMENT OF DEFENSE
TO BE EQUIPPED BY IBM FEDERAL SYSTEMS DIVISION

IBM's Federal Systems Division, Rockville, Maryland, has received a contract from the Defense Communications Agency to install four advanced information-handling systems. These systems will be installed at Defense Department Area Communications Control Centers in Europe, Alaska, Hawaii and Colorado. These centers currently are manually operated.

A solid-state IBM 1410 Data Processing System at each center will receive status reports from DCS operating stations in its geographical area. From these reports, the 1410 will plot the area status on electronic wall displays in each center and at the Defense National Communications Control Center near Washington, D.C. The computer systems will help the Department of Defense keep important military messages moving through its global Defense Communications System -- under almost all emergency conditions.

The Defense Communications System comprises 6300 circuits spread through 73 countries around the world. It consists mainly of government owned or leased long-haul point-to-point circuits of the three military departments and other DOD facilities.

the
Amc
ans
cod
vid
ous

the
put
car
Eas
In
dea
sul
era
ing
ver
the
fir
pai
wou
sys
a t
cisi
difi

pos:
the
Brit
term
woul
ever
er's
team
chan

by a
port
comp
por
the
140
that
on
inv
del
min
pec
ear
wil
cre

dai
The
bas
als
cus

PEOPLE OF NOTE

DIRECTOR OF BEMA DATA PROCESSING GROUP

34 AWARDS TO IBM STAFF INVENTORS

Ronald D. Dodge, Leon E. Palmer and George A. Walker, engineers at IBM's Lexington, Ky., electric typewriter laboratory, jointly developed a wear compensator for the company's new "Selectric" typewriter. A \$30,000 cash award was presented to them by the company for their joint invention.

The presentation was made at a dinner honoring 34 award winners under the company's Invention Award Plan. The group, representing seven IBM divisions, research laboratories, and the IBM World Trade Corporation, was credited with twenty inventions rated "outstanding" by the company. In addition to the \$30,000 award, a \$10,000 award, and two \$5,000 awards, each of the 34 engineers honored had previously been awarded \$1,000.

The award plan was inaugurated a year ago to encourage employee inventions and to give recognition to employee inventors who contribute significantly to the company's technological progress.

DR. LOUIS G. DUNN SUCCEEDS GENERAL DOOLITTLE

General J. H. Doolittle, Chairman of the Board of Thompson Ramo Wooldridge Inc.'s Subsidiary, Space Technology Laboratories, Inc. has retired upon reaching STL's normal retirement age of 65. General Doolittle will continue as a member of the Board of Directors of both companies and as an STL consultant.

Dr. Louis G. Dunn, who has been President of STL since 1958 will succeed General Doolittle as Chairman of the Board of STL. Dr. Ruben F. Mettler, who has been STL's Executive Vice President since 1958, has been elected to succeed Dr. Dunn as President and Chief Executive officer of STL.

NEW LIBRASCOPE VICE PRESIDENT

Myron R. Prevatte has been elected a vice president of Librascope. Previously he was manager of the Washington office. He will continue to direct operations of the division's Washington, D.C. customer relations office.

Prevatte joined Librascope in 1955 and was responsible for development of computer control systems for the Navy's ASROC weapon system and for weapon systems aboard Fleet Rehabilitation and Modernization destroyers.



Charles A. Phillips has been named director of the Data Processing Group of the Business Equipment Manufacturers Association.

Mr. Phillips is credited with initiating the COBOL (Common Business Oriented Language) method of programming by giving general direction to an organization of computer users and manufacturers called the Conference on Data Systems Language (CODASYL).

In January, 1957, Mr. Phillips was named Director, Data Systems Research Staff, in the Department of Defense. He has had extensive experience and responsibilities in data processing ever since he joined the government in 1935.

ELECTRONIC DATA PROCESSING ADVISORY PANEL

An EDP Advisory Panel to stimulate the interchange of ideas and technology between educational institutions and industry has been formed by Minneapolis-Honeywell's Electronic Data Processing Division.

The academic members of the panel include Dr. Maurice Wilkes, director of the Mathematical Laboratory, University of Cambridge (England); Dr. Philip Morse, professor of physics and director of the Computation Center at Massachusetts Institute of Technology; Dr. G. D. McCann, head of the electrical engineering department and director of the Computation Center at California Institute of Technology; Dr. Nicholas Metropolis, director of the Institute for the Study of Computers, University of Chicago, and Dr. Norman R. Scott, professor of electrical engineering and editor of IRE Transactions, University of Michigan.

Honeywell panel members are: Dr. J. Ernest Smith, vice president, EDP Division (panel chairman); John W. Anderson, the division's vice president in charge of engineering, and Richard M. Bloch, director of product planning. Dr. Ronald J. McFarlan, past president of IRE and consultant to Honeywell's EDP Division, is secretary of the panel.

Meetings will be held several times a year. The first meeting was held January 22-23 in Wellesley, Mass.

SOFTWARE NEWS

PERT SYSTEM FOR IBM 1401 AND 7070

EASY, HONEYWELL 400 PROGRAMMING AID

EASY, the major automatic programming aid for the Honeywell 400 computer, was introduced as an operational system at a series of demonstrations at Honeywell Electronic Data Processing Division, Wellesley, Mass. This assembly system already is assembling computer programs at customer installations of the Honeywell 400.

EASY includes sort and collate generators and a program-tape file-maintenance routine. It allows instructions to be written in elementary, three-character, mnemonic operation codes and symbolic location tags. It provides simple techniques for incorporating thoroughly tested problem solutions, such as sort routines, into a program. Any number of programs may be assembled for processing without operator interruption, and stored on magnetic tape for future use.

LINEAR PROGRAMMING NOW AVAILABLE WITH G-20

Bendix Corporation's Computer Division reports that linear programming is now available with the G-20 system. They say that the G-20 linear programming routine can handle problems ranging from the smallest to those twice the capacity of any known linear programming routine.

The mathematical method used is a composite computational algorithm. All arithmetic is performed in double-precision floating point with the working matrix up-dated in each iteration. Input to the program for data and control is punched cards. Only non-zero elements need be entered. Corrections to the program may be made by entering a single card without restarting the program. An optional feature allows input data to be listed on the line printer for verification.

CINCH

Packard Bell Computer Corporation's interpretive routine for the PB250 computer called CINCH has been modified to simplify its use by personnel not familiar with computer programming techniques. The new CINCH routine is compatible with the original routine and with the software now available for the PB250.

Modification of CINCH includes provisions for: easy correction of programming errors; simplification of coding; and extension of the routine for use with a PB250 of any memory size. The routine facilitates rapid programming of engineering and scientific problems.

Telecomputing Services, Inc., subsidiary of Telecomputing Corporation of Los Angeles, Calif., has developed a basic PERT scheduling system for the IBM 1401 and 7070.

TSI's computer program arranges PERT network data topologically so that network event nodes can be numbered at random. Up to 99 networks containing up to 2500 activities each can be scheduled for each computer run. The system has restart capabilities, error diagnostics, and disallowance of cyclic networks.

The new PERT program is used by the firm's Los Angeles Data Center.

NEOPHYTES WIN COBOL RACE

The first fully checked out COBOL-61 compiler by a computer manufacturer was submitted to the Defense Dept. in January. A team of five neophyte computer programmers from International Business Machines Corporation's General Products Division at Endicott, N.Y. won for IBM an industrywide race: S.V. Codella, T.J. Worosz, Jr., L.R. O'Leary, P. Pecukonis, F.M. Quigley.

The first version of COBOL, (which stands for Common Business Oriented Language) known as COBOL-60, was published two years ago. A revised version, published last June, is called COBOL-61. The government put industry on notice that it will not purchase equipment incapable of using COBOL automatic programming; so a race developed to get the revised and more final version into the hands of the government and commercial customers.

The first computer to cross the line came as a surprise to industry, the Defense Dept., and in some degree to IBM itself: the IBM 1410. The programming team that brought about this feat ranges in age from 23 to 32, and none of the five had much programming experience before June, 1960.

The method the men used to write the complex computer program in record time is significant. It seemed logical to use a short-cut automatic programming technique to develop a new automatic computer program. The group were taught a kind of automatic programming language called XTRAN. XTRAN is a computer language that is capable of talking about languages and logic. With their knowledge of XTRAN, the group put together the complex COBOL-61 master program for the 1410 computer.

This experiment was stimulated half by conviction that a new approach to program writing would work, and half by the problem of not having enough experienced programmers; it worked.

is,
com
pro
l c
fou
mor

and
East
The
play
for
to k
ente
Thus
hand
peti

gram
or f
shou
this
sens
deal

deal
emph
bers
chos
Succ
by th
card

is t
two
from
of ea
rived
numb
one
by a
tual
in th
itia
North

ticu
time
init
other

BUSINESS NEWS

IBM DECLARES INCOME FIGURES

International Business Machines Corporation has announced its preliminary results for the year 1961. Thomas J. Watson, Jr., chairman of the board, reported that IBM's gross income for the year 1961 from the sale, service, and rental of its products in the United States amounted to \$1,694,295,547, compared with \$1,436,053,085 in the year 1960.

Net earnings for the year ended December 31, 1961, after U.S. federal income taxes amounted to \$207,227,597. This compares with net earnings after taxes for the year 1960 of \$168,180,880.

THE CURRENT STATUS OF RCA ELECTRONIC DATA PROCESSING

David Sarnoff
Chairman of the Board
Radio Corp. of America
New York, N. Y.

Data processing has become one of the fastest growing major businesses of RCA. In 1962, gross income from all RCA data processing activities, both commercial and military, is expected to be substantially in excess of \$200 million dollars.

Our commercial data processing sales and rental income alone should increase 2½ times in 1962. Through this increase, and improved operating procedures, we anticipate a reduction of approximately 50 per cent in our 1962 data processing costs. We expect the costs in 1963 to be reduced by half again and we hope to realize a profit in data processing within 2 to 3 years from now.

To support our growth plans, we now have approximately 2,000 scientists and engineers -- more than 25% of all scientists and engineers employed by RCA -- engaged in research and development on various projects related to data processing, from minute components to major systems for both industry and defense. The combination of their efforts and our wide-ranging technological background in electronics and communications gives us a capability in many computer areas that few, if any, other companies can hope to match. This is a young, rapidly-changing technology and we are determined to play an important role in its development.

At the end of 1961, 125 RCA data processing systems had been installed, and the

first delivery of the RCA 601 is expected soon. The number of firm bookings for equipment to be delivered within 18 months is more than double the total of current installations. Bookings in 1961 were double the 1960 figure. Deliveries last year were 2½ times greater than the preceding twelve months. In a three-year period, RCA has moved into a strong position in the computer field. We are recognized as an important competitive factor.

CONTROL DATA CORPORATION REPORTS INCREASED SALES AND PROFITS

William C. Norris, President of Control Data Corporation, has reported that for the six months' period ended December 31, 1961, the Company's sales, rentals and service income was \$17,308,142, as compared with \$8,543,126 for the same period in 1960. Net earnings for the six months period were \$636,990, compared with \$403,722 for the previous year.

Norris also reported that the Company's backlog of orders continues to increase. As of December 31, 1961, 29 large-scale Control Data 1604 electronic digital computers were installed, and 124 Control Data 160 and 160-A electronic digital computers were delivered.

Norris reported that a second large computing center has been put into operation by the Company at Stanford Industrial Park, Palo Alto, California. This computing center utilizes both the 1604 and 160 computers, and is now available on a service bureau basis. A similar computing center has been in operation for over one year at the Company's home office at Minneapolis.

A number of programming systems are under development as a part of the Company's efforts in the business data processing market. Implementation of COBOL for the 1604 computer is now nearly complete and a version of this program is also being planned for the 160 and 160-A computers.

HONEYWELL REPORTS SALES GAINS

Sales of Minneapolis-Honeywell Regulator Co. increased to a record \$470,205,941 in 1961, as compared with \$426,183,310 a year ago.

Paul B. Wishart, chairman of the board, said all major phases of the company's business in 1961 showed increases in sales over last year, the largest being in military and space activities and in electronic data processing. At the year's end, new EDP systems with a sales value of \$46-million had been installed, and the year-end backlog exceeded that figure.

New Firms, Divisions, and Mergers

FOUR NEW VICTOR COMPTOMETER DIVISIONS

Victor Comptometer Corporation of Chicago, Ill., has established four independent operating divisions to handle its activities outside the business machines industry -- three in recreation products and one in electronic systems and manufacturing.

The new electronic systems and manufacturing division, Victor Electronic Systems Co., has been assigned responsibility for electronic data processing devices, advanced scientific products, including infra-red detection systems, and special defense contract work. The division will consolidate previous electronic activities of both Victor Adding Machine and Comptometer.

TWO ELECTRONIC COMPANIES TO COMBINE

Plans for a combination of Anadex Instruments Inc. and Infonetics Corp., both of Van Nuys, Calif., will be submitted to stockholders of both companies for approval.

Anadex Instruments Inc., organized in 1957, manufactures precision analog and digital instruments. Infonetics Corp. organized in 1961, manufactures electro-mechanical data processing equipment.

The new company will retain the name, Anadex Instruments Inc.

TWO PHILADELPHIA DATA PROCESSING FIRMS MERGE

A new firm, Electronic Processing Center Inc., has been formed as the result of a merger between Electronic Data Processing Corp. and Punch Card Data Processing. Both firms had headquarters in Philadelphia.

The newly formed company specializes in data processing projects of all sizes and types. Offices are located at the Southeast corner of Broad and Vine Sts., Philadelphia, Pa.

SUIT AGAINST COMPUTER DYNAMICS CORPORATION DISMISSED

Dismissal of the suit by C-E-I-R, Inc., to join the Computer Dynamics Corp. from seeking to do business with its former or prospective clients was granted by Judge

Kathryn Lawlor Shook of Montgomery County Circuit Court, Maryland.

In ruling on the motion to dismiss, filed by attorneys for Computer Dynamics Corp. of Silver Spring, Md., after a week of testimony by C-E-I-R, Inc. of Arlington, Va., Judge Shook ruled that the former employees of the corporation "took no knowledge with them that was the employer's property", and "no secret methods or formula" and that C-E-I-R had "no proprietary rights in business from the United States Government".

THE STANDARD REGISTER CO. -- RAYTHEON CO.

Standard Register Co., Dayton, Ohio, and Raytheon Company's Equipment Division, Waltham, Mass., have agreed that Standard Register will be the sales and service organization for data communications equipment manufactured by Raytheon.

The Communications and Data Processing Operation of the Equipment Division of Raytheon will supply design and production. Standard Register will provide distribution and marketing know-how. Raytheon also will supply design and assembly for installations that are partially custom-built by use of Raytheon's line of off-the-shelf digital building blocks.

NEW NATIONWIDE NETWORK OF EDP CENTERS

Automated Procedures Corp., New York, has begun a nation-wide network of electronic data processing centers by acquiring a California firm, Automaton Business Machine Service. The new west coast subsidiary will be called A.D.P. Sales & Service Corp. It was obtained through an exchange of stock; no cash was involved; the amount of stock was not disclosed.

A.P.C. plans to set up or purchase EDP centers in San Francisco, Seattle, Dallas, St. Louis, Chicago, Boston, and Atlanta during 1962 and 1963.

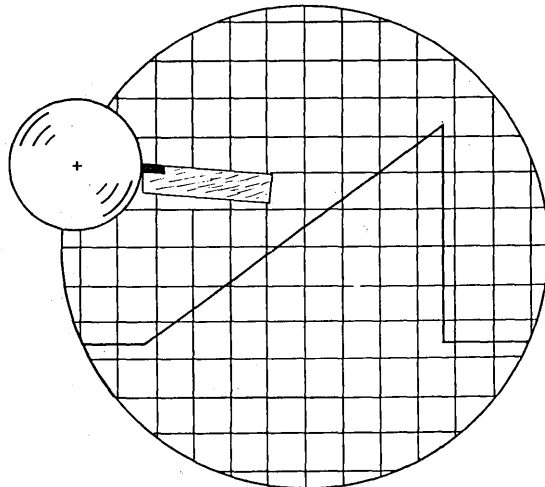

SKIRMISH OVER A COMPUTER-TO-INERTIAL-PLATFORM INTERPRETER

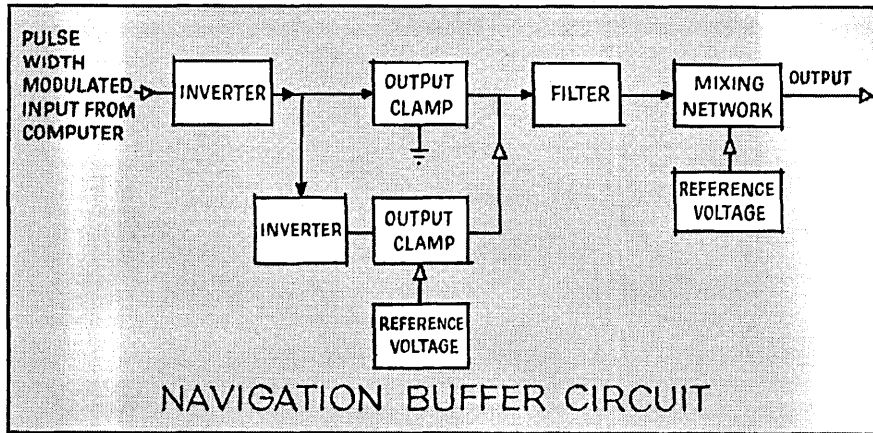

What is the best way to implement the digital-to-analog conversion circuitry required to convert binary incremental signals from a digital computer to precise d.c. voltages for gyro torquing in an airborne tactical data system? This was a problem faced by Litton data systems engineers.

Several engineers who had participated in the development of an earlier navigation buffer employing the digital servo technique were strongly inclined towards playing it safe by adopting an identical approach. To permit the navigation system to sustain the longer flights required under the new program, they proposed engineering greater accuracy into the existing buffer. Somehow, they felt, the additional requirements for lesser weight and volume could also be met. Preliminary investigation revealed that this scheme would require at least 20 pounds of hardware.

Feeling that a better way could be found, other engineers studied alternate approaches and finally proposed a scheme for generating d.c. gyro torquing voltages scaled according to width-modulated pulses linearly related to computer word length. This approach appeared to hold promise of an accuracy of at least 1 part in 4000 (0.025%), which was specified for two of the required eight signals (six for the inertial subsystem; two for the cockpit display system). The pulse width modulation/demodulation method also appeared to require far less hardware than would the digital servo technique because of the elimination of heavy electromechanical components.

Skeptics were quick to point out that the specified precision would be impossible to obtain in view of errors inherent in pulse-width modulation, delays and rise times in the precision switch, switch offset volt-

age, reference supply voltage, filter capacitor leakage and stability, filter lags, drum speed variation, and signal line ground currents.

Undaunted, the advocates of the new method pressed ahead, conducted detailed studies and laboratory investigations to nullify all objections and verified the complete feasibility of their proposed scheme.

Now functioning as part of a tactical data system installed in a carrier-based aircraft, this eight-signal navigation buffer is packaged on five 3" x 3" cards and two small assemblies. Weight and volume are about one-fifth of that required for a digital servo type of buffer. More recently, new packaging techniques have enabled reduction of the buffer unit by an additional 40% to two cards and two assemblies without degrading accuracy.

Litton management recognizes the value of results stimulated by healthy controversy. Security and proprietary restrictions preclude our discussing current activities, but new programs offering many new technical challenges are now being conducted. And Litton continues to encourage an environment in which engineers can propose and pursue other than safe approaches to problems. If you've been frustrated in your attempts to follow through on new approaches to digital data handling and display functions, try writing H. Laur, Litton Systems, Inc., Data Systems Division, 6700 Eton Avenue, Canoga Park, California; or telephone DIamond 6-4040.

An Equal Opportunity Employer

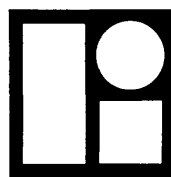
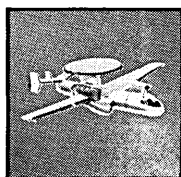

DATA SYSTEMS DIVISION
LITTON SYSTEMS, INC.

A DIVISION OF LITTON INDUSTRIES

DATA HANDLING & DISPLAY SYSTEMS • COMPUTER SYSTEMS • MODULAR DISPERSED CONTROL SYSTEMS

CYBERNATION: THE SILENT CONQUEST

Donald N. Michaels

Washington, D. C.

Introduction

Both optimists and pessimists often claim that automation is simply the latest stage in the evolution of technological means for removing the burdens of work. The assertion is misleading. There is a very good possibility that automation is so different in degree as to be a profound difference in kind, and that it will pose unique problems for society, challenging our basic values and the ways in which we express and enforce them.*

In order to understand what both the differences and the problems are and, even more, will be, we have to know something of the nature and use of automation and computers. There are two important classes of devices. One class, usually referred to when one speaks of "automation," is made up of devices that automatically perform sensing and motor tasks, replacing or improving on human capacities for performing these functions. The second class, usually referred to when one speaks of "computers," is composed of devices that perform, very rapidly, routine or complex logical and decision-making tasks, replacing or improving on human capacities for performing these functions.

Using these machines does not merely involve replacing men by having machines do tasks that men did before. It is, as John Diebold says, a way of "thinking as much as it is a way of doing. . . . It is no longer necessary to think in terms of individual machines, or even in terms of groups of machines; instead, for the first time, it is practical to look at an entire production or information-handling process as an integrated system and not as a series of individual steps."¹ For example, if the building trades were to be automated, it would not mean inventing machines to do the various tasks now done by men; rather, buildings would be redesigned so that they could be built by machines. One might invent an automatic bricklayer, but it is more likely that housing would be designed so that bricks would not be laid. Automation of the electronics industry was not brought

*This paper makes the following assumptions in looking on the next twenty years or so: 1) international relations will derive from the same general conditions that pertain today; 2) the weapons systems industries will continue to support a major share of our economy; 3) major discoveries will be made and applied in other technologies, including psychology and medicine; 4) trends in megalopolis living and in population growth will continue; 5) no major shifts in underlying social attitudes and in public and private goals will take place.

It is not often that a report is published on computers and automation (combined into the one word "cybernation") that is promptly mentioned and discussed in a number of newspapers, and treated by an editorial in the "New York Times" entitled "Is Man Obsolete?" (Jan. 30, 1962)

But the Center for the Study of Democratic Institutions, Santa Barbara, Calif. (an activity of the Fund for the Republic), has published "Cybernation: The Silent Conquest," a report to it by Donald N. Michaels. He is director of planning and programs of the Peace Research Institute, Washington, D. C., and was formerly a consultant to UNESCO, the Department of Defense, and the National Aeronautics and Space Administration. And the report has received widespread attention and comment.

The report is interesting and important, and relates to computers. The editors of "Computers and Automation" do not by any means agree with all the statements made in the report. But we do believe it is highly desirable that its ideas be considered and argued, and so we reprint it—in full rather than in part.

about through the invention of automatic means for wiring circuits but through the invention of essentially wireless—*i.e.*, printed—circuits (though today there are automatic circuit wirers as well).

The two classes of devices overlap. At one pole are the automatic producers of material objects and, at the other, the sophisticated analyzers and interpreters of complex data. In the middle zone are the mixed systems, in which computers control complicated processes, such as the operations of an oil refinery, on the basis of interpretations that they make of data automatically fed to them about the environment. Also in this middle zone are those routine, automatic, data-processing activities which provide men with the bases for controlling, or at least understanding, what is happening to a particular environment. Processing of social security data and making straight-

Kibb
Na
Te
Rel
Ne
pp
Th
whic
exper
cent
The
Theo
Desig
ters a
erenc
agem
furth
an in
Russe
Op
Co
Co
Wa
pp
Th
optim
LGP-
gram
faster
optim
of us
Peter
Op
So
Yo
\$9.
Th
system
to pr
discu
soluti
System
Varia
"App
"Opti
System
cusses
"The
cover
ences
Alt, 1
put
111
196
Fiv
lating
are h
vcy o
Differ
thom
tronic
chinn
in Li
of A
clude
dices.
Willi
Lau
and
Bo
I,
Th
ical a
citing
nine
trol—
volve
Is U
Cont
Proce
syml
ject i
Comp
Ins
47
set
Tw
COM

CONTENTS

INTRODUCTION
THE ADVANTAGES OF CYBERNATION
THE PROBLEMS OF CYBERNATION
UNEMPLOYMENT AND EMPLOYMENT
Blue-Collar Adults
Service Industries
Middle Management
Overworked Professionals
Untrained Adolescents
Some Proposed Solutions
ADDITIONAL LEISURE
Leisure Class One
Leisure Class Two
Leisure Class Three
Leisure Class Four
DECISIONS AND PUBLIC OPINION
Privileged Information
The Inevitability of Ignorance
Personnel and Personalities
Mass vs. the Individual
Decisions for Business
THE CONTROL OF CYBERNATION
TIME AND PLANNING
EDUCATION: OCCUPATIONS AND ATTITUDES
A MORATORIUM ON CYBERNATION?
CONTROL: PUBLIC OR PRIVATE?
AFTER THE TAKE-OVER

forward tabulations of census information are examples of these activities.*

Cybernated systems perform with a precision and a rapidity unmatched in humans. They also perform in ways that would be impractical or impossible for humans to duplicate. They can be built to detect and correct errors in their own performance and to indicate to men which of their components are producing the error. They can make judgments on the basis of instructions programmed into them. They can remember and search their memories for appropriate data, which either has been programmed into them along with their instructions or has been acquired in the process of manipulating new data. Thus, they can learn on the basis of past experience with their environment. They can receive information in more codes and sensory modes than men can. They are beginning to perceive and to recognize.

As a result of these characteristics, automation is being used to make and roll steel, mine coal, manufacture engine blocks, weave cloth, sort and grade everything from oranges to bank checks. More versatile automatic fabricators are becoming available, too:

"U. S. Industries announced . . . that it had developed what was termed the first general-purpose automation machine available to manufacturers

*In order to eliminate the awkwardness of repeating the words "automation" and "computers" each time we wish to refer to both at the same time, and in order to avoid the semantic difficulties involved in using one term or the other to mean both ends of the continuum, we invent the term "cybernation" to refer to *both* automation and computers. The word is legitimate at least to the extent that it derives from "cybernetics," a term invented by Norbert Wiener to mean the processes of communication and control in man and machines. He derived it from the Greek word for "steersman." The theory and practice of cybernetics underlie all systematic design and application of automation and computers.

*as standard 'off-the-shelf' hardware. . . . The new machine, called a TransfeRobot, sells for \$2,500. . . . The Westclox Company of La Salle, Ill., has been using a TransfeRobot to oil clock assemblies as they pass on a conveyor belt. The machine oils eight precision bearings simultaneously in a second. At the Underwood Corporation typewriter plant in Hartford, the robot picks up, transfers and places a small typewriter component into a close-fitting nest for an automatic machine operation. In an automobile plant, the device seeds partly fabricated parts of a steering assembly to a trimming press and controls the press. The device consists basically of an arm and actuator that can be fitted with many types of fingers and jaws. All are controlled by a self-contained electronic brain."*²

At the other end of the continuum, computers are being used rather regularly to analyze market portfolios for brokers; compute the best combination of crops and livestock for given farm conditions; design and "fly" under typical and extreme conditions rockets and airplanes before they are built; design, in terms of costs and traffic-flow characteristics, the appropriate angles and grades for complex traffic interchanges; keep up-to-date inventory records and print new stock orders as automatically computed rates of sales and inventory status indicate. Computers have also been programmed to write mediocre TV dramas (by manipulating segments of the plot), write music, translate tolerably if not perfectly from one language to another, and simulate some logical brain processes (so that the machine goes about solving puzzles—and making mistakes in the process—in the ways people do). Also, computers are programmed to play elaborate "games" by themselves or in collaboration with human beings. Among other reasons, these games are played to understand and plan more efficiently for the conduct of wars and the procedures for industrial and business aggrandizement. Through such games, involving a vast number of variables, and contingencies within which these variables act and interact, the best or most likely solutions to complex problems are obtained.

The utility and the applicability of computers are being continually enhanced. For example, after a few hours of training, non-specialists can operate the smaller computers without the aid of programmers simply by plugging in pre-recorded instruction tapes that tell the computer how to do specific tasks. Instruction-tape libraries can supply pre-programmed computer directions for everything from finding the cube root of a number to designing a bridge. When the machine is through with one task, its circuits can be easily cleared so that a new set of pre-programmed instructions can be plugged in by its businessman operator.

But the capabilities of computers already extend well beyond even these applications. Much successful work has been done on computers that can program themselves. For example, they are beginning to operate the way man appears to when he is exploring ways of solving a novel problem. That is, they apply and then modify, as appropriate, previous experiences with and methods of solution for what appear to be related problems. Some of the machines show origi-

nality and unpredictability. To take one example from a recent paper of Norbert Wiener:

*"The present level of these learning machines is that they play a fair amateur game at chess but that in checkers they can show a marked superiority to the player who has programmed them after from 10 to 20 playing hours of working and indoctrination. They thus most definitely escape from the completely effective control of the man who has made them. Rigid as the repertory of factors may be which they are in a position to take into consideration, they do unquestionably—and so say those who have played with them—show originality, not merely in their tactics, which may be quite unforeseen, but even in the detailed weighting of their strategy."*³

Another example of a machine the behavior of which is not completely controllable or predictable is the Perceptron, designed by Dr. Frank Rosenblatt. This machine can learn to recognize what it has seen before and to teach itself generalizations about what it recognizes. It can also learn to discriminate, and thereby to identify shapes similar to those it has seen before. Future versions will hear as well as see. It is not possible to predict the degree and quality of recognition that the machine will display as it is learning. It is designed to learn and discriminate in the same way that it is believed man may learn and discriminate; it has its own pace and style of learning, of refining its discriminations, and of making mistakes in the process.

It is no fantasy, then, to be concerned with the implications of the thinking machines. There is every reason to believe that within the next two decades machines will be available outside the laboratory that will do a credible job of original thinking, certainly as good thinking as that expected of most middle-level people who are supposed to "use their minds." There is no basis for knowing where this process will stop, nor, as Wiener has pointed out, is there any comfort in the assertion that, since man built the machine, he will always be smarter or more capable than it is.

*"It may be seen that the result of a programming technique of (cybernation) is to remove from the mind of the designer and operator an effective understanding of many of the stages by which the machine comes to its conclusions and of what the real tactical intentions of many of its operations may be. This is highly relevant to the problem of our being able to foresee undesired consequences outside the frame of the strategy of the game while the machine is still in action and while intervention on our part may prevent the occurrence of these consequences. Here it is necessary to realize that human action is a feedback action. To avoid a disastrous consequence, it is not enough that some action on our part should be sufficient to change the course of the machine, because it is quite possible that we lack information on which to base consideration of such an action."*⁴

The capabilities and potentialities of these devices are unlimited. They contain extraordinary implications for the emancipation and enslavement of mankind.

The opportunities for man's enhancement through the benefits of cybernation are generally more evident and more expected, especially in view of our proclivity to equate technological advances with progress and happiness. In the words of the National Association of Manufacturers:

*"For the expanding, dynamic economy of America, the sky is indeed the limit. Now more than ever we must have confidence in America's capacity to grow. Guided by electronics, powered by atomic energy, geared to the smooth, effortless workings of automation, the magic carpet of our free economy heads for distant and undreamed horizons. Just going along for the ride will be the biggest thrill on earth!"*⁵

But the somber and complex difficulties produced by cybernation, which already are beginning to plague some aspects of our society and economy, are only beginning to be recognized. Thus, although this paper will describe, first, the advantages of cybernation, which make its ever expanding application so compelling, it will, on the whole, emphasize the less obvious, sometimes acutely uncomfortable aspects of this development with which we must successfully contend if we are to enjoy the benefits of both cybernation and democracy.

The Advantages of Cybernation

In recent years deteriorating sales prospects, rising production costs, increased foreign competition, and lower profits have led business management to turn to our national talent for technological invention as the most plausible means of reducing costs and increasing productivity, whether the product is an engine block or tables of sales figures. And the government, faced with the need to process and understand rapidly increasing masses of numerical facts about the state of the nation and the world, is already using 524 computers and is the major customer for more of them.

What are the advantages of cybernated systems that make government and private enterprise turn to them to solve problems?

In the first place, in a competitive society a successfully cybernated organization often has economic advantages over a competitor using people instead of machines. As *U. S. News and World Report* says:

*"In one line of business after another, the trend is the same. Companies are spending millions of dollars to mechanize their operations, boost output and cut costs. . . . Says an official of a big electrical company: 'It is no longer a question of whether or not to automate, but rather it is how far to go and how fast to proceed. If you don't, your competition will.'"*⁶

Not only must many organizations automate to compete, but the same principle probably holds for competing nations. We are by no means the only semi-cybernated society. Europe and Russia are well under way, and their machines and products compete with ours here and in the world market. The U.S.S.R. is making an all-out effort to cybernate as much of its planning-economic-industrial operation as it can.

In the second place, reducing the number of personnel in an organization reduces the magnitude

July
qu
ve
co
Ro
June
ci
Yo
N
June
an
co
Ur
June
No
Ho
lar
July
cin
Ho
Br
Ro
Aug
An
Sn
Aug
Co
St
co
14
Aug
In
CL
14
Sept.
W
brief
publ
cant
proc
whic
We
form
copy
entr
publ
catic
prio
If y
suer
men
mati
Tom
&
W.
Av
196
Th
sign
of m
discu
cover
COM

of management's human relations tasks, whether these be coping with over-long coffee breaks, union negotiations, human errors, or indifference.

In the third place, cybernation permits much greater rationalization of managerial activities. The computers can produce information about what is happening now, as well as continuously up-dated information about what will be the probable consequences of specific decisions based on present and extrapolated circumstances. The results are available in a multitude of detailed or simplified displays in the form of words, tables of figures, patterns of light, growth and decay curves, dial readings, etc. In many situations, built-in feedback monitors the developing situation and deals with routine changes, errors, and needs with little or no intervention by human beings. This frees management for attention to more basic duties. There is, for example,

*"... an automatic lathe . . . which gauges each part as it is produced and automatically resets the cutting tools to compensate for tool wear. In addition, when the cutting tools have been worn down to a certain predetermined limit, the machine automatically replaces them with sharp tools. The parts are automatically loaded onto the machine and are automatically unloaded as they are finished. These lathes can be operated for 5 to 8 hours without attention, except for an occasional check to make sure that parts are being delivered to the loading mechanism."*⁷

Another example, combining built-in feedback with a display capability, adds further illumination:

"The Grayson-Robinson apparel chain, which has more than 100 stores throughout the country, receives print-punch tags daily from its stores and converts them to full-size punchcards. The complete merchandise and inventory control function is then handled on a computer. What styles are to be processed first are determined at the computer center. During any given week about 60 per cent of the sales data are received and summarized. On the following Monday morning the remaining 40 per cent of the sales data are received. The computer can then begin running style reports immediately after the tickets have been converted to cards. By this time the company can run up style reports by departments and price lines in order to obtain the necessary merchandising information. The entire reporting job is completed by Wednesday afternoon of each week, including reports on

Freeing management from petty distractions in these ways permits more precise and better substantiated decisions, whether they have to do with business strategy, government economic policy, equipment system planning, or military strategy and tactics. Thus, management in business or government can have much better control both over the system as it operates and over the introduction of changes into future operations. Indeed, the changes themselves may be planned in conformity with, and guided by, a strategy that is derived from a computer analysis of the future environment.

In the fourth place, cybernation allows government and industry much greater freedom in locating their

facilities efficiently in relation to the accessibility of raw products, markets, transportation, and needed (or cheaper) human and material resources. Distance is no longer a barrier to control and coordination. The computers that control automated processes need not be near the factories nor the data-processing computers near their sources of information or users if other considerations are more pressing. Widely dispersed installations can be coordinated and controlled from still another place, and the dispersed units can interact with each other and affect one another's performance as easily, in many cases, as if they were all in the same place.

In the fifth place, some degree of cybernation is necessary to meet the needs of our larger population and to maintain or increase the rate of growth of the Gross National Product. An estimated 80,000,000 persons will be added to our population in the next twenty years. Beyond increases in productivity per man hour to be expected from the projected 20 per cent growth in the labor force during the same period, productive growth will have to be provided by machines.

If the criteria are control, understanding, and profits, there are strong reasons why government and business should want to, and indeed would have to, expand cybernation as rapidly as they can. The versatility of computers and automation is becoming better understood all the time by those who use them, even though, as with the human brain, most present users are far from applying their full potential. Cheap and general purpose computers or modular components applicable to many types of automatic production and decision-making are now being manufactured. In good part, they are cheap because they themselves are produced by automated methods. Techniques for gathering the field data that serves as the "inputs" to the machines are being refined and themselves automated or semi-automated. For example, a large shoe distributor is planning to attach a pre-punched IBM card to each shoe box. When a sale is made, the card is returned to a central facility to guide inventory adjustment, reordering, and sales recording and analysis. Techniques for quickly implementing the "outputs" from the machines are also being invented. Methods are being developed for systematically establishing the precise kind and degree of cybernation required in specific situations as well as the changes needed in the rest of the institution or organization using cybernation.

These are the advantages for management, for government, and for those parts of the work force whose status has been enhanced because of cybernation. But as cybernation advances, new and profound problems will arise for our society and its values. Cybernation presages changes in the social system so vast and so different from those with which we have traditionally wrestled that it will challenge to their roots our current perceptions about the viability of our way of life. If our democratic system has a chance to survive at all, we shall need far more understanding of the consequences of cybernation. Even the job of simply preserving a *going* society will take a level of planning far exceeding any of our previous experiences with centralized control.

The balance of this paper will point out some of the implications of cybernation that we must recognize in our task of developing a society and institutions in which man may be allowed to reach his full capacities.

The Problems of Cybernation

Unemployment and Employment

BLUE-COLLAR ADULTS *"In the highly automated chemical industry, the number of production jobs has fallen 3% since 1956 while output has soared 27%. Though steel capacity has increased 20% since 1955, the number of men needed to operate the industry's plants—even at full capacity—has dropped 17,000. Auto employment slid from a peak of 746,000 in boom 1955 to 614,000 in November. . . . Since the meat industry's 1956 employment peak, 28,000 workers have lost their jobs despite a production increase of 3%. Bakery jobs have been in a steady decline from 174,000 in 1954 to 163,000 last year. On the farm one man can grow enough to feed 24 people; back in 1949 he could feed only 15."*

Further insight into the problem of declining employment for the blue-collar worker comes from union statements to the effect that the number of these employees in manufacturing has been reduced by 1,500,000 in the last six years. As one example from the service industries, automatic elevators have already displaced 40,000 operators in New York.

Another disturbing aspect of the blue-collar displacement problem is its impact on employment opportunities for Negroes. There is already an increasingly lopsided Negro-to-white unemployment ratio as the dock, factory, and mine operations where Negroes have hitherto found their steadiest employment are cybernated. This, plus the handicaps of bias in hiring and lack of educational opportunity, leaves Negroes very few chances to gain new skills and new jobs. Continued widespread and disproportionate firings of Negroes, if accompanied by ineffectual re-employment methods, may well produce a situation that will increase disenchantment abroad and encourage discontent and violence here.

SERVICE INDUSTRIES It is commonly argued that, with the growth of population, there will always be more need for people in the service industries. The assumption is that these industries will be able to absorb and displace, retrained blue-collar labor force; that automation will not seriously displace people who perform service functions; and that the demand for engineers and scientists will be so great as to provide employment for any number of the young people who graduate with engineering training. (Indeed, some of this demand is expected to arise from the needs of cybernetic systems themselves.)

It is all very well to speak glowingly of the coming growth in the service industries and the vast opportunities for well-paid jobs and job-upgrading that these activities will provide as blue-collar opportunities diminish. But is the future as bright and as simple as this speculation implies? In the first place, service activities will also tend to displace workers by becoming self-service, by becoming cybernated, and by being eliminated. Consider the following data: The U. S.

Census Bureau was able to use fifty statisticians in 1960 to do the tabulations that required 4,100 in 1950. Even where people are not being fired, service industries can now carry on a vastly greater amount of business without hiring additional personnel; for example, a 50 per cent increase in the Bell System's volume of calls in the last ten years with only a 10 per cent increase in personnel.

Automation frequently permits the mass production of both cheap items and items of adequate to superior quality. It frequently uses methods of fabrication that makes replacement of part or all of the item more efficient or less bother than repairing it. As automation results in more leisure time, certainly some of this time will be used by more and more do-it-yourselfers to replace worn-out or faulty components in home appliances that are now repaired by paid service personnel. Nor is it clear that repairing computers will be big business. Computer design is in the direction of microminiaturized components: when there is a failure in the system, the malfunctioning part is simply unplugged or pulled out, much as a drawer from a bureau, and replaced by a new unit. Routine procedures determine which component is malfunctioning, so routine that the larger computers now indicate where their own troubles are, so routine that small computers could be built to troubleshoot others. This does not mean that clever maintenance and repair people will be completely unnecessary, but it does mean that a much more careful estimate is required of the probable need for these skills in home-repair work or in computer-repair work.

Drip-dry clothes, synthetic fabrics, plus self-service dry and wet cleaning facilities, probably will outmode this type of service activity.

Identification by fingerprints, instantly checked against an up-to-date nation-wide credit rating (performed by a central computer facility), could eliminate all service activities associated with processing based on identification (for example, bank tellers). A computer that can identify fingerprints does not yet exist, but there is no reason to believe it will not be invented in the next two decades.

If people cost more than machines—either in money or because of the managerial effort involved—there will be growing incentives to replace them in one way or another in most service activities where they perform routine, predefined tasks. It is possible, of course, that eventually people will not cost more than machines, because there may be so many of them competing for jobs, including a growing number of working women. But will service people be this cheap? As union strength is weakened or threatened through reductions in blue-collar membership, unions will try, as they have already begun to do, to organize the white-collar worker and other service personnel more completely in order to help them to protect their jobs from managements willing to hire those who, having no other work to turn to, would work for less money. Former blue-collar workers who, through retraining, will join the ranks of the service group may help to produce an atmosphere conducive to such unionizing. But how many service organizations will accept the complications of union negotiations, strikes, personnel

services, and higher wages in preference to investing in cybernation?

It is possible that as automation and computers are applied more widely an attitude of indifference to personalized service will gradually develop. People will not demand it and organizations will not provide it. The family doctor is disappearing; clerks of all sorts in stores of all sorts are disappearing as well. For example:

*"The R. H. Macy Co. is trying out its first electronic sales girl. This machine is smart enough to dispense 36 different items in 10 separate styles and sizes. It accepts one- and five-dollar bills in addition to coins and returns the correct change plus rejecting counterfeit currency."*¹⁰

People either get used to this or, as in the case of the self-service supermarket, seem to prefer it.

It is already the rare sales clerk who knows the "real" differences between functionally similar items; indeed, in most stores, sales clerks as such are rare. Thus, the customer is almost forced to do much of his own selecting and to know at least as much about or to be at least as casual about the differences between competing items as the clerk. As automation increases, the utility of the sales clerk will further diminish. With some products, automation will permit extensive variation in design and utility. With others, especially if our society follows its present course, automation will encourage the endless proliferation of items only marginally different from one other. In either event there is no reason to believe that the clerk or salesman will become more knowledgeable about an even larger variety of competing items. Finally, it is obvious that the remaining tasks of the clerk, such as recording the sale and insuring that the item is paid for, can be cybernated without difficulty.

The greater the indifference to personalized service by both buyers and sellers, the greater the opportunity, of course, to remove human judgments from the system. Cybernation may well encourage acceptance to such depersonalization, and this, in turn, would encourage further reductions in opportunities for service jobs.

MIDDLE MANAGEMENT The blue-collar worker and the relatively menial service worker will not be the only employment victims of cybernation.

"... Broadly, our prognostications are along the following lines:

"(1) Information technology should move the boundary between planning and performance upward. Just as planning was taken from the hourly worker and given to the industrial engineer, we now expect it to be taken from a number of middle managers and given to as yet largely nonexistent specialists: 'operation researchers,' perhaps, or 'organizational analysts.' Jobs at today's middle-management level will become highly structured. Much more of the work will be programmed, i.e., covered by sets of operating rules governing the day-to-day decisions that are made.

"(2) Correlatively, we predict that large industrial organizations will recentralize, that top managers will take on an ever larger proportion of the innovating, planning, and other 'creative' functions than they have now.

"(3) A radical reorganization of middle-management levels should occur with certain classes of middle-management jobs moving downward in status and compensation (because they will require less autonomy and skill), while other classes move upward into the top-management group.

"(4) We suggest, too, that the line separating the top from the middle of the organization will be drawn more clearly and impenetrably than ever, much like the line drawn in the last few decades between hourly workers and first-line supervisors.

*". . . Information technology promises to allow fewer people to do more work. The more it can reduce the number of middle managers, the more top managers will be willing to try it. . . . One can imagine major psychological problems arising from the depersonalization of relationships within management and the greater distance between people at different levels. . . . In particular, we may have to reappraise our traditional notions about the worth of the individual as opposed to the organization, and about the mobility rights of young men on the make. This kind of inquiry may be painfully difficult, but will be increasingly necessary."*¹¹

As cybernation moves into the areas now dominated by middle management in government and in business—and this move is already beginning—growing numbers of middle managers will find themselves displaced. Perhaps the bulk of displaced members of the blue-collar and service work force might be trained "up" or "over" to other jobs with, generally speaking, little or no decline in status. But the middle manager presents a special and poignant problem. Where can he go? To firms that are not as yet assigning routine liaison, analysis, and minor executive tasks to machines? This may take care of some of the best of the displaced managers and junior executives, but if these firms are to have a future, the chances are that they will have to computerize eventually in order to compete. To the government? Again, some could join it, but the style and format of governmental operations may require readjustments that many junior executives would be unable to make. And, in any case, government too, as we have seen, is turning to computers, and it is entirely possible that much of the work of its middle management will also be absorbed by the computers. Up into top management? A few, of course, but necessarily only a few. Into the service end of the organization, such as sales? Some here, certainly, if they have the talent for such work. If computers and automation lead to an even greater efflorescence of marginally differentiated articles and services, there will be a correspondingly greater emphasis on sales in an effort to compete successfully. But can this be an outlet for a truly significant portion of the displaced? And at what salary? Overseas appointments in nations not yet using cybernation at the management level? Again, for a few, but only for those with the special ability to fit into a different culture at the corresponding level from which they came.

Middle management is the group in the society with the most intensive emotional drive for success and status. Their family and social life is molded by these needs, as the endless literature on life in subur-

bia and exurbia demonstrate. They stand to be deeply disturbed by the threat and fact of their replacement by machines. One wonders what the threat will do to the ambitions of those who will still be students and who, as followers of one of the pervasive American dreams, will have aspired to the role of middle manager "on the way up."

With the demise or downgrading of this group, changes in advertising, or at least changes in the be expected. These people, although they are not the only consumers of products of the sort advertised in *The New Yorker*, *Holiday*, and the like, are certainly among the largest of such consumers. They are the style-setters, the innovators, and the experimenters with new, quality products. With their loss of status and the loss of their buying power, one can imagine changes in advertising, or at least changes in the "taste" that this advertising tries to generate. It is possible that the new middle elite, the engineers, operations researchers, and systems analysts, will simply absorb the standards of the group they will have replaced. But they may be different enough in outlook and motives to have different styles in consumption.

OVERWORKED PROFESSIONALS There are service jobs, of course, that require judgments about people by people. (We are not including here the "personalized service" type of salesmanship.) The shortage of people with these talents is evidenced by the 60-hour and more work-weeks of many professionals. But these people are the products of special education, special motives, and special attitudes that are not shared to any great degree by those who turn to blue-collar or routine service tasks. Increasing the proportion of citizens with this sort of professional competence would require systematic changes in attitudes, motives, and levels of education, not to mention more teachers, a professional service already in short supply. Alterations of this magnitude cannot be carried out overnight or by casual advertising campaigns or minor government appropriations. It is doubtful indeed, in our present operating context, that they can be done fast enough to make a significant difference in the employment picture for professional services in the next decade or two. Values become imbedded early in life. They are subject to change, to be sure, but we are not, as a democratic society, adept at or inclined to change them deliberately and systematically.

Even if the teachers and the appropriate attitudes already existed, service needs at the professional level might not be great enough to absorb a large share of the potentially unemployed. Much of the work that now takes up the time of many professionals, such as doctors and lawyers, could be done by computers—just as much of the time of teachers is now taken up by teaching what could be done as well by machines.

The development of procedures for medical diagnosis by machine is proceeding well. A completely automatic analysis of data can produce just as good a diagnosis of brain malfunction as that done by a highly trained doctor. Cybernated diagnosis will be used in conjunction with improved multi-purpose antibiotics and with microminiaturized, highly sensitive, and accurate telemetering equipment (which can be swallowed, imbedded in the body, or affixed to it) in order to detect, perhaps at a distance, signifi-

cant symptoms.¹² All of these developments are likely to change the nature of a doctor's time-consuming tasks. In the field of law successful codification, so that searches and evaluations can be automatic, as well as changes in legal procedures, will probably make the lawyer's work substantially different from what it is today, at least in terms of how he allocates his time.

Computers probably will perform tasks like these because the shortage of professionals will be more acute at the time the computers acquire the necessary capabilities. By then, speeded-up data processing and interpretation will be necessary if professional services are to be rendered with any adequacy. Once the computers are in operation, the need for additional professional people may be only moderate, and those who are needed will have to be of very high calibre indeed. Probably only a small percentage of the population will have the natural endowments to meet such high requirements. A tour of the strongholds of science and engineering and conversations with productive scientists and engineers already lead to the conclusion that much of what now appears to be creative, barrier-breaking "research and development" is in fact routine work done by mediocre scientists and engineers. We lost sight of the fact that not everybody with dirty hands or a white coat is an Einstein or a Steinmetz. Many first-class scientists in universities will testify that one consequence of the increasingly large federal funds for research is that many more mediocre scientists doing mediocre work are being supported. No doubt for some time to come good use can be made by good professionals of battalions of mediocre professionals. But battalions are not armies. And sooner or later one general of science or engineering will be able to fight this war for knowledge more effectively with more push-butons than with more intellectual foot-soldiers.

UNTRAINED ADOLESCENTS *"Altogether the United States will need 13,500,000 more jobs in the Sixties merely to keep abreast of the expected growth in the labor force. This means an average of 25,000 new jobs each week, on top of those required to drain the reservoir of present unemployment and to replace jobs made superfluous by improved technology. In the last year, despite the slackness of employment opportunities, 2,500,000 more people came into the job scramble than left it through death, age, sickness or voluntary withdrawal. This was more than double the 835,000 average annual growth in the working population in the last ten years. By the end of this decade, 3,000,000 youngsters will be starting their quest for jobs each year, as against 2,000,000 now. This almost automatically guarantees trouble in getting the over-all unemployment rate down to 4 per cent because the proportion of idleness among teen-age workers is always far higher than it is among their elders."*¹³

The Labor Department estimates that 26,000,000 adolescents will seek work in the Sixties. If present performance is any indicator, in the decade ahead 30 per cent of adolescents will continue to drop out before completing high school and many who could go to college won't. The unemployment rate for such drop-outs is about 30 per cent now. Robert E. Hfert, of the Department of Health, Education, and Wel-

fare, concluded in a 1958 study that approximately one-fourth of the students who enter college leave after their freshman year never to return. Figures compiled since then lead him to conclude that there has been no significant change, in spite of the National Defense Education Act, which was supposed to help reduce this figure.¹⁴

If some figures recently given by James B. Conant turn out to be typical, at least one situation is much more serious than the average would imply. He found that in one of our largest cities, in an almost exclusively Negro slum of 125,000, 70 per cent of the boys and girls between 16 and 21 were out of school and unemployed. In another city, in an almost exclusively Negro slum, in the same age group, 48 per cent of the high school graduates were unemployed and 63 per cent of the high school drop-outs were unemployed.¹⁵ These adolescents would in the normal course join the untrained or poorly trained work force, a work force that will be more and more the repository of untrainable or untrained people displaced from their jobs by cybernation. These adolescents will have the following choices: they can stay in school, for which they are unsuited either by motivation or by intelligence; they can seek training that will raise them out of the untrained work force; they can compete in the growing manpower pool of those seeking relatively unskilled jobs; or they can loaf.

If they loaf, almost inevitably they are going to become delinquent. Thus, without adequate occupational outlets for these youths, cybernation may contribute substantially to further social disruption.

Threatened institutions often try forcibly to repress groups demanding changes in the *status quo*. Imagine the incentives to use force that would exist in a nation beset by national and international frustrations and bedeviled by anarchic unemployed-youth movements. Imagine, too, the incentives to use force in view of the reserves of volunteer "police" made up of adults who can vent their own unemployment-based hostility in a socially approved way by punishing or disciplining these "children."

A constructive alternative, of course, is to provide appropriate training for these young people in tasks that are not about to be automated. But this implies an elaborate, costly program of research and planning to recruit teachers, to apply advanced teaching machine methods as a supplement to teachers, and to stimulate presently unmotivated youngsters to learn. The program would also require intensive cooperation among business, labor, education, local social service agencies, and the government. And all this must begin *now* in order for it to be ready when it will be needed.

None of this is easily met. Persuading drop-outs to stay in school will not be easy. Teachers will not be easy to recruit unless they are well paid. There is already a shortage of teachers. And let no one suggest that an easy source of teachers would be displaced workers. There is no reason to believe that they have the verbal and social facility to teach, and most of them would have nothing to teach but skills that have become obsolete. Some, of course, might be taught to teach, though this would add obvious complications to the whole effort.

Knowing what to teach will depend on knowing what types of jobs are likely to exist when the student finishes his training. This will require knowledge about the trends and plans of local industry, if that is where the youths are to work (and if that is where industry plans to stay!), and of industries in other localities, if the youths are willing to move. Such knowledge often does not exist in a rapidly changing world or, if it exists, may not be forthcoming from businesses more concerned with competition than with the frustrated "delinquents" of their community. As of now, in the words of Dr. Conant, "unemployment of youth is literally nobody's affair."

SOME PROPOSED SOLUTIONS Retraining is often proposed as if it were also the cure-all for coping with adults displaced by cybernation as well as young people. In some circumstances it has worked well for some people, especially with office personnel who have been displaced by data-processing computers and have learned other office jobs, including servicing the computers. But in other cases, especially with poorly educated blue-collar workers, retraining has not always been successful, nor have new jobs based on that retraining been available. Max Horton, Michigan's Director of Employment Security, says:

*"I suppose that is as good as any way for getting rid of the unemployed—just keeping them in retraining. But how retrainable are the mass of these unskilled and semi-skilled unemployed? Two-thirds of them have less than a high school education. Are they interested in retraining? But most important, is there a job waiting for them when they have been retrained?" The new California Smith-Collier Act retraining program drew only 100 applicants in six months.*¹⁶

A. H. Raskin's survey of the situation leads him to conclude:

*"The upgrading task will be a difficult, and perhaps impossible, one for those whose education and general background do not fit them for skilled work. The outlook is especially bleak for miners, laborers and other unskilled workers over 40, who already make up such a big chunk of the hard core of joblessness."*¹⁷

Moreover, management has not always been willing to institute retraining programs. People are either fired outright in some cases or, more often, simply are not rehired after a layoff.

"Labor and management have been slow to face the problem over the bargaining table. Harry Bridges' West Coast longshoremen's union recently agreed to give shippers a free hand to mechanize cargo handling—in exchange for a guarantee of present jobs, plus early retirement and liberal death benefits. In Chicago this week, President Clark Kerr of the University of California, one of the top labor economists, will preside over a company-union committee meeting at Armour & Co. to draw up a plan for the rapidly automating meat industry. A similar committee is at work at Kaiser Steel Co. But many authorities think such efforts are far too few, that management must do more. E. C. Schulze, acting area director of Ohio's state employment service, says: 'I've yet to see an employer's group willing to take a look at this prob-

lem and seek solutions. They refuse to recognize their responsibility. They talk about long-term trends—but nobody talks about the immediate problem of jobless, needy people.’”¹⁸

The problem of retraining blue-collar workers is formidable enough. But, in view of the coming role of cybernation in the service industries, the retraining problem for service personnel seems insuperable. No one has seriously proposed what service tasks this working group could be retrained *for*—to say nothing of training them for jobs that would pay high enough wages to make them good consumers of the cornucopia of products manufactured by automation.

Another proposal for coping with the unemployment-via-cybernation problem is shorter hours for the same pay. This approach is intended to maintain the ability of workers to consume the products of cybernation and, in the case of blue-collar workers, to maintain the strength of unions. This would retain the consumer purchasing capacity for x workers in those situations where the nature of the cybernation process is such that x men would do essentially the same work as x plus y men used to do. But when the task itself is eliminated or new tasks are developed that need different talents, shorter shifts clearly will not solve the problem. The latter conditions are the more likely ones as cybernation becomes more sophisticated.

Proponents of cybernation claim that it should reduce the price of products by removing much of the cost of labor and increasing consumer demand. Whether the price of beef, or milk, or rent will be reduced in phase with the displaced worker's lowered paycheck remains to be seen. So far this has not happened. Whether the price of TV sets, cars, refrigerators, etc., will be reduced substantially depends in part on how much product cost goes into larger advertising budgets aimed at differentiating the product from the essentially same one produced last year or from the practically identical one produced on some other firm's automated production line.

An obvious solution to unemployment is a public works program. If our understanding of the direction of cybernation is correct, the government will probably be faced for the indefinite future with the need to support part of the population through public works. There is no dearth of public work to be done, and it is not impossible that so much would continue to be needed that an appropriately organized public works program could stimulate the economy to the point that a substantial portion of the work force could be re-absorbed into the private sector. That is, although the proportion of workers needed for any particular task will be reduced through the use of cybernation, the total number of tasks that need to be done could equal or exceed the absolute number of people available to do them. It is not known whether this situation would obtain for enough tasks in enough places so that the portion of the population working on public projects would be relatively small. However, if it should turn out that this felicitous state of affairs could be realized in principle, clearly it could only be realized and sustained if there were to be considerable and continuous centralized planning and control over financing, the

choice of public projects, and the places where they were to be done. If, for whatever reasons, this situation could not be achieved, the public works payroll would remain very large indeed.

What would be the effects on the attitudes and aspirations of a society, and particularly of its leadership, when a significant part of it is overtly supported by governmental public works programs? (“Overtly” is used because much of the aerospace industry in particular and of the weapons systems industry in general is subsidized by the government right now: they literally live off cost plus fixed fee contracts, and there is no other comparable market for their products.) Whatever else the attitudes might be, they certainly would not be conducive to maintaining the spirit of a capitalistic economy. This shift in perspective may or may not be desirable, but those who think it would be undesirable should realize that encouraging the extension of cybernation, in the interests of free enterprise and better profits, may be self-defeating.

The inherent flexibility of cybernated systems, which permits great latitude in their geographic location, is the inspiration for the proposal that if jobs are lost through cybernation, the unemployed could be moved to another area where jobs exist. It is said that a governmental agency similar to the Agricultural Resettlement Administration, which moved farmers from the Dust Bowl to cities, could be used. However, two important differences between that situation and this one would complicate this effort: the contemporary cause of the unemployment would not be the result of an act of God; and it is not immediately evident that these unemployed people could find jobs in other areas, which might be suffering from a similar plethora of useless workers.

Herbert Striner has suggested that a more extreme approach would be to export blue-collar and white-collar workers and their families to nations needing their talents. The problem of whether or how the salary differential might be made up is one of several difficulties with this proposal. Yet, if such emigration could be carried out, it might be a better solution than letting the workers atrophy here. The economic history of former colonial powers and their colonization techniques indicate that “dumping” of excess personnel into foreign lands would not be a radically new innovation.

Another possible long-run approach might be curtailment of the birth rate. In times of depression the rate falls off naturally—which may be the way the process would be accomplished here if enough people become unemployed or marginally employed (although the effects of the lowered birth rate would only follow after the economic and social changes had been made). Of course, the government could encourage birth control by reducing the income tax dependency deduction or by other tax means.

Finally, there is the proposal to reduce the working population by increasing the incentives for early retirement. Government could do this by reducing the retirement age for social security, and unions and management could use their collective ingenuity to provide special retirement incentives. Naturally, this would increase the already large percentage of retired

I
A
th
Som
velo
The
offer
prof
oppo
broa
face
adm
wha
est y
com
proc
thes
Her
you
puti
syste
mur
...
At
atin
You
tem
emi
nec
COM

elderly people. Along with the other familiar problems associated with this group is the poignant one we shall face in more general form in the next section: how are all these people to be kept happily occupied in their leisure?

Whether any of these proposed solutions is adequate to the challenge of unemployment is not known to us or, we gather, to those who have proposed one solution or another. But even if, in principle, some combination of them would be adequate, in order to put them into effect a considerable change would be necessary in the attitudes and voting behavior of Congress and our tax-paying citizens. Preconceptions about the virtues and vices of work, inflation, the national debt, and government control run deep and shift slowly.

Not all of these dire threats would come to pass, of course, if cybernation reduced consumer buying power through unemployment and, thereby, the financial capability of industry and business to introduce or profit from cybernation. In this way we might all be saved from the adverse effects of unemployment from this source. But the economy would still be faced with those threats to its well-being which, as were pointed out earlier, make the need to cybernate so compelling.

Cybernation is by nature the sort of process that will be introduced selectively by organization, industry, and locality. The ill-effects will be felt at first only locally and, as a result, will not be recognized by those who introduce it—and perhaps not even by the government—as a *national* problem with many serious implications for the whole social system. Also, because one of the chief effects of cybernation on employment is not to hire rather than to fire, the economic-social consequences will be delayed and will at any time be exacerbated or ameliorated by other economic and social factors such as the condition of our foreign markets, which also are being changed and challenged by European and Russian cybernation. By the time the adverse effects of cybernation are sufficiently noticeable to be ascribed to cybernation, the equipment will be in and operating.

Once this happens, the costs of backtracking may be too great for private enterprise to sustain. For, in addition to the costs of removing the equipment, there will be the costs of building a pre-cybernation system of operations. But which firms will voluntarily undertake such a job if they are unsure whether their competitors are suffering the same setback—or indeed if their competitors are going to decybernate at all? And, if not voluntarily, how would the government enforce, control, and pay for the change-over?

Additional Leisure

It is generally recognized that sooner or later automation and computers will mean shorter working hours and greater leisure for most if not all of the American people. It is also generally, if vaguely, recognized that there probably are problems connected with the use of leisure that will take time to work out.

Two stages need to be distinguished: the state of leisure over the next decade or two, when our soci-

ety will still be in transition to a way of life based on the widespread application of cybernation; and the relatively stable state some time in the future when supposedly everybody will have more leisure time than today and enough security to enjoy it. The transitional stage is our chief concern, for the end is far enough off to make more than some general speculations about it footless. At this later time people's behavior and attitudes will be conditioned as much by presently unforeseeable social and technological developments as by the character and impact of cybernation itself.

During the transition there will be four different "leisure" classes: 1) the unemployed, 2) the low-salaried employees working short hours, 3) the adequately paid to high-salaried group working short hours, and 4) those with no more leisure than they now have—which in the case of many professionals means very few hours of leisure indeed.

LEISURE CLASS ONE Today, most of the unemployed are from low educational backgrounds where leisure has always been simply a respite from labor. No particular aspirations to or positive attitudes about the creative use of leisure characterize this group. Since their main concern is finding work and security, what they do with their leisure is a gratuitous question; whatever they do, it will hardly contribute to someone else's profits.

It is worth speculating that one thing they might do is to participate in radical organizations through which they could vent their hostility over being made insecure and useless. Another thing they could do, if so motivated and if the opportunity were available, would be to learn a skill not likely to be cybernated in the near future, although, as we have seen, the question arises of what this would be. Another thing would be to move to areas where there is still a demand for them. But breaking community ties is always difficult, especially during periods of threat when the familiar social group is the chief symbol of security. And who would pay for their move and who would guarantee a job when they got where they were going?¹⁰

As cybernation expands its domain, the unemployed "leisure" class will not consist only of blue-collar workers. The displaced service worker will also swell the ranks of the unemployed, as well as the relatively well-trained white-collar workers until they can find jobs or displace from jobs the less well-trained or less presentable, like the college graduate filling-station attendant of not so many years ago. It is doubtful that during their unemployed period these people will look upon that time as "leisure" time. For the poorly educated, watching television, gossiping, and puttering around the house will be low-cost time-fillers between unemployment checks; for the better educated, efforts at systematic self-improvement, perhaps, as well as reading, television, and gossip; for many, it will be time spent in making the agonizing shift in style of living required of the unemployed. These will be more or less individual tragedies representing at any given time a small portion of the work force of the nation, statistically speaking. They will be spread over the cities and suburbs of the nation, reflecting the consequences of actions taken

by particular firms. If the spirit of the day grows more statistical than individualistic, as this paper suggests later that it well might, there is a real question of our capacity to make the necessary organized effort in order to anticipate and cope with these "individual" cases.

The free time of some men will be used to care for their children while their wives, in an effort to replace lost income, work at service jobs. But this arrangement is incompatible with our image of what properly constitutes man's role and man's work. The effects of this use of "leisure" on all family members will be corrosive rather than constructive and will contribute to disruption of the family circle. "Leisure" for this group of people may well acquire a connotation that will discourage for a long time to come any real desire to achieve it or any effort to learn how to use it creatively.

One wonders, too, what women, with their growing tendency to work—to combat boredom as well as for money—will do as the barriers to work become higher, as menial white-collar jobs disappear under the impact of cybernation, and as the competition increases for the remaining jobs. If there are jobs, 6,000,000 more women are expected to be in the labor force in 1970 than were in it in 1960. Out of a total labor force of 87,000,000 at that time, 30,000,000 would be women. To the extent that women who want jobs to combat boredom will not be able to get them, there will be a growing leisure class that will be untrained for and does not want the added leisure. As for those women who have a source of adequate income but want jobs because they are bored, they will have less and less to do at home as automated procedures further routinize domestic chores.

LEISURE CLASS TWO A different kind of leisure problem will exist for the low-income group working shorter hours. This group will be composed of people with the attitudes and behavior traditionally associated with this class, as well as some others who will have drifted into the group as a result of having been displaced by cybernation. What evidence there is indicates that now and probably for years to come, when members of this group have leisure time as a result of fewer working hours, the tendency will be to take another job.²⁰ It is reasonable to believe that the general insecurity inevitably arising from changing work arrangements and the over-all threat of automation would encourage "moonlighting" rather than the use of free time for recreation. If these people cannot find second jobs, it is hard to imagine their doing anything different with their free time from what they do now, since they will not have the money, the motives, or the knowledge to search out different activities.

If the shorter hours are of the order of four eight-hour days, potentially serious social problems will arise. For example, a father will be working fewer hours than his children do in school. What he will do "around the house" and what adjustments he, his wife, and children will have to make to each other will certainly add very real difficulties to the already inadequate, ambiguous, and frustrating personal re-

lationships that typify much of middle-class family life.

LEISURE CLASS THREE Workers with good or adequate income employed for shorter hours are the group usually thought of when one talks about the positive opportunities for using extra leisure in a cybernated world. Its members for the most part will be the professional, semi-professional, or skilled workers who will contribute enough in their social role to command a good salary but who will not be so rare as to be needed for 40 hours a week. These people already value learning and learning to learn. Given knowledge about, money for, and access to new leisure-time activities, they are likely to make use of them. They could help to do various desirable social service tasks in the community, tasks for which there is not enough money to attract paid personnel of high enough quality. They could help to teach, and, by virtue of their own intimate experiences with cybernation, they would be able to pass on the attitudes and knowledge that will be needed to live effectively in a cybernated world. It is likely, too, that this group will be the chief repository of creative, skilled manual talents. In a nation living off mass-produced, automatically produced products, there may be a real if limited demand for hand-made articles. (We may become again in part a nation of small shopkeepers and craftsmen.) In general, this group of people will probably produce and consume most of its own leisure-time activities.

LEISURE CLASS FOUR The fourth group consists of those who probably will have little or no more leisure time than they now have except to the extent permitted by additions to their ranks and by the services of cybernation. But extrapolations for the foreseeable future indicate insufficient increases in the class of presently overworked professionals and executives. Computers should be able to remove many of the more tedious aspects of their work in another few years, but for some time to come these people will continue to be overburdened. Some of this relatively small proportion of the population may manage to get down to a 40-hour week, and these lucky few should find no difficulty in using their leisure as productively and creatively as those in the third group.

Thus, during the transition period, it is the second group, the low-salaried workers who cannot or will not find another job, that presents the true leisure problem, as distinct from the unemployment problem. Here is where the multiple problems connected with private and public make-play efforts may prove very difficult indeed. We have some knowledge about relatively low-income workers who become voluntarily interested in adult education and adult play sessions, but we have had no real experience with the problems of how to stimulate the interests and change the attitudes of a large population that is forced to work shorter hours but is used to equating work and security, that will be bombarded with an advertising *geist* praising consumption and glamorous leisure, that will be bounded closely on one side by the unemployed and on the other by a relatively well-to-do community to which it cannot hope to

aspire. Boredom may drive these people to seek new leisure-time activities if they are provided and do not cost much. But boredom combined with other factors may also make for frustration and aggression and all the social and political problems these qualities imply.

Decisions and Public Opinion

PRIVILEGED INFORMATION The government must turn to computers to handle many of its major problems simply because the data involved are so massive and the factors so complex that only machines can handle the material fast enough to allow timely action based on understanding of the facts. In the nature of the situation, the decisions made by the government with the help of computers would be based in good part on computers that have been programmed with more or less confidential information—and privileged access to information, at the time it is needed, is a sufficient if not always necessary condition for attaining and maintaining power. There may not be any easy way to insure that decisions based on computers could not become a threat to democratic government.

Most of the necessary inputs for the government's computer systems are available only to the government, because it is the only institution with sufficiently extensive facilities for massive surveys (whether they be photographic, observational, paper and pencil, or electronic in nature). Also, the costs of these facilities and their computer installations are so great that buying and maintaining such a system is sensible only if one has the decision-making needs of a government and the data required to feed the machines. Other organizations, with other purposes, would not need this kind of installation. These machines can provide more potent information than merely rapidly produced summaries and tabulations of data. They can quickly provide information on relationships among data, which may be appreciated as significant only by those already having privileged information based on a simpler level of analysis or on other non-quantified intelligence to which the user is privy.²¹ Computers can also provide information in the form of extrapolations of the consequences of specific strategies and the probabilities that these consequences will arise. This information can be based on exceedingly complex contingencies. The utility and applicability of these extrapolations will be fully understandable only to those knowing the particular assumptions that went into the programming of the machines.

THE INEVITABILITY OF IGNORANCE It may be impossible to allow much of the government, to say nothing of the public, access to the kind of information we have been discussing here. But let us assume that somehow the operation of the government has been reorganized so that procedures are enforced to permit competing political parties and other private organizations to have access to the government's raw data, to have parallel systems for the processing of data as well as to have access to the government's computer programs. Even then, most people will be incapable of judging the validity of one contending computer program compared to another, or whether the policies based on them are appropriate.

This condition exists today about military postures. These are derived in good part from computer analyses and computer-based games that produce probabilities based on programmed assumptions about weapon systems and our and the enemy's behavior. Here the intellectual ineffectualness of the layman is obscured by the secrecy that keeps him from finding out what he probably would not be able to understand anyway. If this sounds condescending, it only needs to be pointed out that there are large areas of misunderstanding and misinterpretation among the military too. At any given time, some of these people do not fully appreciate the relationships between the programs used in the computers and the real world in which the consequences are supposed to follow. As it is now, the average intelligent man has little basis for judging the differing opinions of economists about the state of the economy or even about the reasons for a past state. He also has little basis for appraising the conflicting opinions among scientists and engineers about the costs and results of complex scientific developments such as man in space. In both examples, computers play important roles in the esoteric arguments involved.

Thus, even if people may have more leisure time to attend more closely to politics, they may not have the ability to contribute to the formulation of policy. Some observers feel that the middle class does not now take a strong interest in voting and is alienated in its responsibility for the conduct of government. Leisure may not change this trend, especially when government becomes in large part the complex computer operation that it must necessarily become.

Significant public opinion may come from only a relatively small portion of the public: a) those who are able to follow the battles of the computers and to understand the implications of their programs; and b) those who are concerned with government policy but who are outside of or unfamiliar with the computer environment.

For this segment of the voting population, differences over decisions that are made or should be made might become more intense and more irreconcilable. Already there is a difference of opinion among intelligent men about the problem of the proper roles in American foreign policy of military weapons, arms control, and various levels of disarmament. One side accuses its opponents of naïveté or ignorance about the "facts" (computer-based), and the other side objects to the immorality or political insensibilities of its opponents. Many aspects of the problem involve incommensurables; most are too complex to stand simplification in order to appeal to the larger public or to an unsophisticated Congressman. Yet the arguments are simplified for these purposes and the result is fantastic confusion. The ensuing frustration leads to further efforts to make the case black or white and to further efforts by one contingent to provide ever more impressive computer-based analyses and by the other side to demonstrate that they are beside the point.

This is only one example of the problems that will arise from the existence of sophisticated computers. Will the problems create greater chasms between the

sophisticated voter and the general public, and within the sophisticated voting group itself?

PERSONNEL AND PERSONALITIES As for the selection of the men who are to plan or make policy, a computerized government will require different training from that which executive personnel in most governmental agencies has today. Certainly, without such training (and perhaps with it) there is bound to be a deepening of the split between politics and facts. For example, it is evident that the attitudes of many Congressmen toward space activities are motivated more by politics and conventional interpretations of reality than by engineering facts or the realities of international relations.

The same schisms will be compounded as computers are used more and more to plan programs in the Department of Health, Education, and Welfare, urban development, communications, transportation, foreign aid, and the analysis of intelligence data of all sorts.

In business and industry the shift has already begun toward recruiting top management from the cadre of engineering and laboratory administration, for these are the people who understand the possibilities of and are sympathetic to computer-based thinking. In government the trend has not been as clear-cut, but it is noteworthy that the scientist, as high-level adviser, is a recent innovation and one clearly here to stay. Sometimes unhappily and sometimes enthusiastically, the scientist, scientist-administrator, and engineer acknowledge that their role of adviser is frequently confused with that of policy-maker. As people with this training come more to influence policy and those chosen to make it, changes in the character and attitudes of the men responsible for the conduct of government will inevitably occur.

For reasons of personality as well as professional perspective, many operations researchers and systems analysts have great difficulty in coping with the more ambiguous and less "logical" aspects of society.²² Their temperaments, training, and sympathies may not incline them to indulge the slow, ponderous, illogical, and emotional tendencies of democratic processes. Or they may ignore the extra-logical nature of man. Emphasis on "logic," in association with the other factors we have mentioned, may encourage a trend toward the recruitment of authoritarian personalities. There is no necessary correlation between the desire to apply scientific logic to problems and the desire to apply democratic principles to daily, or even to professional scientific, life.

MASS VS. THE INDIVIDUAL The psychological influence of computers is overwhelming: they symbolize and reenforce the potency of America's belief in the utility of science and technology. There is a sense of security in nicely worked-up curves and complex displays of information which are the products of almost unimaginably intricate and elegant machinery. In general, the influence of computers will continue to be enhanced if those who use them attend chiefly to those components of reality which can be put into a computer and processed by it, and the important values will become those which are compatible with this approach to analyzing and manipulating the world. For example, the influence of computers has

already been sufficiently strong to seduce military planners and civil defense planners away from those aspects of their problems which are not now subject to data processing. Most of the planning for survival following nuclear attack has to do with those parts of the situation which can be studied by computers. Crucial aspects of psychological and social reorganization have been pushed into the background simply because they cannot be handled statistically with convenience or with the demonstrated "expertness" of the specialist in computers. Thus, the nature of the postattack situation is argued learnedly but spuriously by those who have the attention of leadership, an attention stimulated by the glamor of computers, the prestige of their scientist-keepers, and the comfort of their "hard facts."

Computers are especially useful for dealing with social situations that pertain to people in the mass, such as traffic control, financial transactions, mass-demand consumer goods, allocation of resources, etc. They are so useful in these areas that they undoubtedly will help to seduce planners into inventing a society with goals that can be dealt with in the mass rather than in terms of the individual. In fact, the whole trend toward cybernation can be seen as an effort to remove the variabilities in man's on-the-job behavior and off-the-job needs which, because of their non-statistical nature, complicate production and consumption. Thus, somewhere along the line, the idea of the individual may be completely swallowed up in statistics. The planner and those he plans for may become divorced from one another, and the alienation of the individual from his government and individual from individual within government may grow ever greater.

Computers will inevitably be used to plan employment for those displaced by cybernation. This may lead to a more rationalized society than could otherwise be invented, with a more adequate allocation of jobs. But one wonders whether it will not also lead, on a national scale, to an attitude in the planner of relative indifference to the individual, an indifference similar to that shown by many managers of large self-service institutions who find an occasional complaint too much trouble to cope with individually because the influence of the individual on the operation of the system is too negligible to warrant attention.

What will be the consequences for our relations with underdeveloped nations of a government that sees the world through computers? With our general public alienated from its own productive and governmental processes and our leadership seemingly successful through its use of computer-based planning and control, our government may well become more and more incapable of recognizing the differences between the needs, aspirations, and customs of these nations and those of our own country. In these nations, productive and governmental processes will still be very human activities, with all the non-statistical variabilities that implies. Our decision to race the U.S.S.R. to the moon is an initial indication of our incapacity as an advanced technological nation to appreciate what our acts look like to other nations with different attitudes.

cond
const
system
be di
Ser
type
devic
num
two r
Or
chem
assoc
atom
duce
the "
make
about
dium
a sho
vacar
ture
condu
crysta
Thust
movin
refer
Th
n-typ
A de
refer
(one
in or
This
If
cond
a thr
sand
Trans
the st
cente
Ba
diode
other
have
Char
circu
rent

Emi

On the other hand, the emphasis on human behavior as a statistical reality may encourage revisions in the temporal scale of government planning and programs. Time is a statistical property in cybernated systems: it takes time for variables to average out, to rise or fall in their effects, and the time period usually is not a fiscal year or some small multiple thereof. Thus, perhaps we can hope for more sensible long-range planning in government as a result of the computer's need for long time periods in which to make its statistical models work out. If this should come about, of course, it will require vast changes in the conduct of government and in the devices that government, and especially the Congress, uses for controlling its activities. It may also result in extending the present trend of turning over governmental policy-planning and, in effect, policy-making responsibilities to private organizations and their human and machine computers such as RAND. For unless the rules for Congressional elections are also changed, some of the responsibility that Congressmen now take for programs, when they vote relatively short-term appropriations, will no doubt be transferred to the machines that invented the plans if Congressmen should be faced with passing on appropriations and programs that would extend far beyond the time of their incumbencies.

DECISIONS FOR BUSINESS The implications of the concentration of decision-making within business firms as a result of cybernation are not as clear-cut as the effects for government. In principle, both big and small business will be able to know much more about the nature of their markets and of their organizational operations through cybernation. Whether or not this will help both big and small proportionately is far from clear. Big business will undoubtedly have better facilities for information and decisions, but small business may be able to get what it needs by buying it from service organizations that will come into existence for this purpose. Big organizations will be able to afford high-priced personnel for doing the thinking beyond that done by the machines. If quality of thinking is always related to price, the big organizations will be able to put their small competitors out of business. But the big organizations, precisely because of their size, may have relatively little maneuverability, and some of the best minds may find the little organizations a more exciting game. Whether the little organizations could stay afloat is moot, but one can anticipate some exciting entrepreneurial maneuvers among the small firms while they last.

One thing is clear: among the small organizations, and probably among the big ones too, we can expect disastrous mistakes as a result of poor machine programming or inaccurate interpretations of the directives of the machines. These will be greatest during the early period when it will be faddish to plan via machine and when few organizations will have the brainpower and organization to do so intelligently. Thus, added to the unemployment ranks in the decade or so ahead will be those who have been put out of jobs because their firms have misused computers.

The Control of Cybernation

Time and Planning

Time is crucial in any plan to cope with cybernation. Ways of ameliorating its adverse effects require thinking farther ahead than we ever do. In a society in the process of becoming cybernated, education and training for work as well as education and training for leisure must begin early in life. Shifts in behavior, attitudes, and aspirations take a long time to mature. It will be extraordinarily difficult to produce appropriate "culture-bearers," both parents and teachers, in sufficient numbers, distribution, and quality in the relatively brief time available. It is hard to see, for example, how Congress, composed in good part of older men acting from traditional perspectives and operating by seniority, could recognize soon enough and then legislate well enough to produce the fundamental shifts needed to meet the complexities of cybernation. It is hard to see how our style of pragmatic making-do and frantic crash programs can radically change in the next few years. This is especially hard to visualize when the whole cybernation situation is such that we find it impossible to determine the consequences of cybernation even in the medium long run. The differences expressed in the public statements of business and labor demonstrate that any reconciliation of interests will be a very long-range effort indeed. "Drastic" actions to forestall or eliminate the ill-effects of cybernation will not be taken in time unless we change our operating style drastically.

Education: Occupations and Attitudes

Among the many factors contributing to the stability of a social system are two intimately intertwined ones: the types of tasks that are performed; and the nature of the relationship between the attitudes of the members of the society toward these tasks and their opinions about the proper goals of the individual members of the society and the right ways of reaching them.

The long-range stability of the social system depends on a population of young people properly educated to enter the adult world of tasks and attitudes. Once, the pace of change was slow enough to permit a comfortable margin of compatibility between the adult world and the one children were trained to expect. This compatibility no longer exists. Now we have to ask: What should be the education of a population more and more enveloped in cybernation? What are the appropriate attitudes toward and training for participation in government, the use of leisure, standards of consumption, particular occupations?

Education must cope with the transitional period when the disruption among different socio-economic and occupational groups will be the greatest; and the later, relatively stable period, if it ever comes to exist, when most people would have adequate income and shorter working hours. The problem involves looking ahead five, ten, twenty years to see what are likely to be the occupational and social needs and attitudes of those future periods; planning the intellectual and social education of each age group in the numbers needed; motivating young people to seek certain types of jobs and to adopt the desirable and

necessary attitudes; providing enough suitable teachers; being able to alter all of these as the actualities in society and technology indicate; and directing the pattern of cybernation so that it fits with the expected kinds and distribution of abilities and attitudes produced by home and school.

To what extent education and technology can be coordinated is not at all clear, if only because we do not know, even for today's world, the criteria for judging the consonance or dissonance in our educational, attitudinal, and occupational systems. We think that parts of the social system are badly out of phase with other parts and that, as a whole, the system is progressively less capable of coping with the problems it produces. But there is little consensus on the "causes" and even less on what can be done about them. All we have at present is the hope that most people can be educated for significant participation in such a world as we have foreseen here—we have no evidence that it can be done.

If we do not find the answers to these questions soon, we will have a population in the next ten to twenty years more and more out of touch with national and international realities, ever more the victims of insecurity on the one hand and ennui on the other, and more and more mismatched to the occupational needs of the day. If we fail to find the answers, we can bumble along, very probably heading into disaster, or we can restrict the extension of cybernation, permitting it only where necessary for the national interest. But judging the national interest and distinguishing it from private interests would confront us with most of the problems that have been outlined in this paper.

Perhaps time has already run out. Even if our style somehow should shift to long-range planning, it would not eliminate the inadequate training and inadequate values of much of our present adolescent and pre-adolescent population, as well as of those adults who will be displaced or remain unhired as a result of cybernation in the next decade. Only a partial solution exists in this case: Begin now a program of economic and social first aid for these people.

A Moratorium on Cybernation?

Can we control the effects of cybernation by making it illegal or unprofitable to develop cybernation technology? No, not without virtually stopping the development of almost all of new technology and a good part of the general development of scientific knowledge. The accumulation of knowledge in many areas of science depends on computers. To refine computers and make them more versatile requires research in almost every scientific area. It also requires the development of a technology, usually automated, to produce the articles needed to build new computers. As long as we choose to compete with other parts of the world, we shall have to develop new products and new means for producing them better. Cybernation is the only way to do it on a significant scale. As long as we choose to live in a world guided by science and its technology we have no choice but to encourage the development of cybernation. If we insist on this framework, the answers to coping with

its effects must be found elsewhere than in a moratorium on its development.

Control: Public or Private?

There has always been tension between big industry, with its concern for profit and market control, and government, with its concern for the national interest. The tension has increased as big business has become so large as to be quasi-governmental in its influence and as government has had to turn to and even subsidize parts of business in order to meet parts of the national interest within a free-enterprise framework. Under these circumstances we can expect strong differences between government and business as to when and where it is socially legitimate to introduce automation.

Sufficient governmental control over who can cybernate, when, and where would not come easily. In the first place, decisions about control would have to be based on the intentions of local business and industry as well as on the national picture. For example, the effects on Congressional seating of shifts in populations as a result of cybernation-based industrial relocation would presumably enter the calculations. Longer-run consequences would have to be balanced against short-run profits or social dislocations. Implications for our military posture and for international trade would be significant. Moreover, it would be difficult for the government to make a case for control of private organizations on the basis of ambiguous estimates of the effects of automation on hiring policy. In any particular case, it becomes clear only well after the fact of cybernation whether increases or changes in production resulted in a corresponding increase in man-hours of work sufficient to compensate the economy for the jobs lost or the people unhired.

Finally, it must be kept in mind that the power of some of the largest unions is seriously threatened by automation. In a relatively short time they may not have the leverage they now have. Thus, a crucial counterbalance to the pressures from business may be absent when it is most needed. It is possible that the crisis that will arouse the government to exert control will not be evident until the blue-collar work force has been so eroded as to have weakened the unions irreparably.

Yet some sort of control is going to be necessary. There are, of course, the federal regulatory agencies. However, they have never been distinguished for applying their powers with the vigor sometimes allowed by their mandates, and there is no reason to suppose that their traditional weaknesses would suddenly disappear and that an agency created to cope with cybernation would be effective. Nor is there any reason to believe that an agency with the very wide-ranging powers that it would need would be approved before the crisis that it was supposed to avert was upon us.

In theory, control could be exercised by private enterprise. But in the unlikely case that competitors could see their mutual interests clearly enough to join forces, the very act of cooperative control would be incompatible with our anti-trust laws. Whether the government or some alter-government comprised of

business, labor, and industry were to do the controlling, either group would have to undertake a degree of national planning and control thoroughly incompatible with the way in which we look upon the management of our economic and social system today.

After the Take-Over

In twenty years, other things being equal, most of the routine blue-collar and white-collar tasks that can be done by cybernation will be. Our schools will probably be turning out a larger proportion of the population better educated than they are today, but most of our citizens will be unable to understand the cybernated world in which they live. Perhaps they will understand the rudiments of calculus, biology, nuclear physics, and the humanities. But the research realm of scientists, the problems of government, and the interplay between them will be beyond the ken even of our college graduates. Besides, most people will have had to recognize that, when it comes to logic, the machines by and large can think better than they, for in that time reasonably good thinking computers should be operating on a large scale.

There will be a small, almost separate, society of people in rapport with the advanced computers. These cyberneticians will have established a relationship with their machines that cannot be shared with the average man any more than the average man today can understand the problems of molecular biology, nuclear physics, or neuropsychiatry. Indeed, many scholars will not have the capacity to share their knowledge or feeling about this new man-machine relationship. Those with the talent for the work probably will have to develop it from childhood and will be trained as intensively as the classical ballerina.

Some of the remaining population will be productively engaged in human-to-human or human-to-machine activities requiring judgment and a high level of intelligence and training. But the rest, whose innate intelligence or training is not of the highest, what will they do? We can foresee a nation with a large portion of its people doing, directly or indirectly, the endless public tasks that the welfare state needs and that the government will not allow to be cybernated because of the serious unemployment that would result. These people will work short hours, with much time for the pursuit of leisure activities.

Even with a college education, what will they do all their long lives, day after day, four-day week-end after week-end, vacation after vacation, in a more and more crowded world? (There is a population explosion to face in another ten to thirty years.) What will they believe in and aspire to as they work their shorter hours and, on the outside, pursue their "self-fulfilling" activities, whatever they may be? No one has ever seriously envisioned what characteristics these activities might have in order to be able to engross most men and women most of their adult lives. What will be the relationship of these people to government, to the "upper intellectuals," to the rest of the world, to themselves?

Obviously, attitudes toward work, play, and social responsibility will have changed greatly. Somehow we shall have had to cope emotionally with the vast gap in living standards that will then typify the difference between us and the have-not nations. We

shall presumably have found some way to give meaning to the consumption of mass leisure. It would seem that a life oriented to private recreation might carry with it an attitude of relative indifference to public responsibility. This indifference, plus the centralization of authority, would seem to imply a governing élite and a popular acceptance of such an élite.

If this world is to exist as a coherent society, it will have to have its own "logic," so that it will make sense to its inhabitants. Today, for most of our population, our society makes sense, even though some other eyes hardly see us as logical in the formal sense of the word and the eyes of some of our own people look on us as a more or less pointless society. We make and solve our problems chiefly by other than mathematical-logical standards, and so must the cybernated generations. What these standards might be, we do not know. But if they are inadequate, the frustration and pointlessness that they produce may well evoke, in turn, a war of desperation—ostensibly against some external enemy but, in fact, a war to make the world safe for human beings by destroying most of society's sophisticated technological base. One thing is clear: if the new "logic" is to resolve the problems raised here, it will have to generate beliefs, behavior, and goals far different from those which we have held now and which are driving us more and more inexorably into a contradictory world run by (and for?) ever more intelligent, ever more versatile slaves.

FOOTNOTES

1. John Diebold, *Automation: Its Impact on Business and Labor*, National Planning Association, Planning Pamphlet No. 106, Washington, D. C., May, 1959, p. 3.
2. "Multi-Purpose Automation Unit is Sold 'Off the Shelf,'" *New York Times*, June 23, 1961, p. 44.
3. Norbert Wiener, "Some Moral and Technical Consequences of Automation," *Science*, Vol. 131, No. 3410, May 6, 1960, p. 1356.
4. *Ibid.*, p. 1357.
5. *Calling All Jobs*, National Association of Manufacturers, New York, October, 1957, p. 21.
6. "When Machines Have Jobs—and Workers Do Not," *U. S. News and World Report*, Vol. 50, No. 6, February 6, 1961, p. 76.
7. From statement by Walter Reuther before the Subcommittee on Economic Stabilization of the Joint Committee on the Economic Report, U. S. Congress; *Automation and Technological Change*, 84th Congress, First Session, USGPO, 1955, p. 99.
8. From statement of James A. Suffridge, President, Retail Clerks International Association before the Subcommittee on Automation and Energy Resources of the Joint Economic Committee, U. S. Congress; *New Views on Automation*, 86th Congress, Second Session, USGPO, 1960, p. 591.
9. "The Automation Jobless . . . Not Fired, Just Not Hired," *Time*, Vol. 77, No. 9, February 24, 1961, p. 69.
10. From statement by Howard Coughlin, President, Office Employees International Union, AFL-CIO, before the Subcommittee on Automation and Energy Resources of the Joint Economic Committee, U. S. Congress; *New Views on Automation*, 86th Congress, Second Session, USGPO, 1960, p. 513.
11. Harold J. Leavitt and Thomas L. Whisler, "Management in the 1980's," *Harvard Business Review*, Nov.-Dec. 1958, pp. 41-8.
12. See, for example, Howard Rusk, "New Tools in Medicine," *New York Times*, July 23, 1961.
13. A. H. Raskin, "Hard-Core Unemployment a Rising National Problem," *New York Times*, April 6, 1961, p. 18.
14. In conversation with Mr. Iffert. See also Robert E. Iffert, *Retention and Withdrawal of College Students*, Bulletin No. 1, Department of Health, Education, and Welfare, 1958.
15. James B. Conant, "Social Dynamite in Our Large Cities," *Vital Speeches*, No. 18, July 1, 1961, p. 554 ff.
16. "The Automation Jobless . . . Not Fired, Just Not Hired," *Time*, Vol. 77, No. 9, February 24, 1961, p. 69.
17. A. H. Raskin, "Fears About Automation Overshadowing Its Boons," *New York Times*, April 7, 1961, p. 16.

(Concluded on Next Page)

Who's Who in the Computer Field

(Supplement)

A full entry in the "Who's Who in the Computer Field" consists of: name / title, organization, address / interests (the capital letters of the abbreviations are the initial letters of Applications, Business, Construction, Design, Electronics, Logic, Mathematics, Programming, Sales) / year of birth, college or last school (background), year of entering the computer field, occupation / other information such as distinctions, publications, etc. An absence of information is indicated by — (dash). Other abbreviations are used which may be easily guessed like those in the telephone book.

- Davenport, John H / Secy, Integrand Corp, 1 Bond St, Westbury, N Y / AP / '20, Univ of Mich Grad Schl, —, —
- DeCruccio, John F / Compr Sys Coordinator, Western Electric Co, Inc, 100 Central Ave, Kearny, N J / ABP / '33, Lehigh Univ (BSIE), '57, ind engr
- DeLassen, Jan / Pgrmr, Mobil Oil Co, Caracas, Venezuela / ALMP / '34, Texas A & M, '59, prgrmr
- De Nicola, Robert / Pgrmr, Port of N Y Authority, 111-8th Ave, N Y 11, N Y / P / '14, CCONY, '61, prgrmr
- Dickinson, William R / Compr Consltn, Data Processing Consultants Co., First Nat'l Bank Bldg, 1580 Sherman, Evanston, Ill / A / '24, Northwestern, '58, compr conslnt
- Edmiston, Walter / Dig Compr Adm, Phila Naval Shipyard, Phila, Pa / ABP, gen admn / '16, Drexel Inst, Temple Univ, '55, — / Secy Univac User Assoc
- Effros, Alan L / Mbr Elecnc Products Dept, Recordak Corp, 1 Wanamaker Place, New York 3, N Y / ABDEMPS / '29, Adelphi Coll, '55, sys & prod plng / techl papers on info procg and retrieval
- Ferrari, Reynold / Mgr Comm Appl, Bendix Computer Div, 205 E 42nd St, New York 17, N Y / ABLPS / '26, St. John's Univ, '56, accountant
- Fonseca, John / Head, Banking, Ins & Real Estate Dept, Mohawk Valley Technical Inst, Utica, N Y / B / '25, Harvard Law Schl, '59, coll adm / "Impact of Automation on Insurance College Courses and Administration"
- Grossman, George / Chmn of Mathematics, William Howard Taft High Schl, Board

of Education of the City of New York, N Y 57, N Y; Instructor in Computers and Math at Columbia Univ, Schl of Engrg, N Y 27, N Y / ALMP, teaching / '14, CCONY and Columbia Univ, '57, chmn of high schl math dept / article in 2/61 Mathematics Teacher discussing how programming is taught to high schl students

- Hardy, Norman / Vice Pres, Rabinow Engrg Co, Inc, 1025 Research Blvd, Rockville, Md / AS / '17, CCONY, '51, apln engr
- Holmes, James D J / Assoc Prof of Accountancy, Univ of Miss, Schl of Commerce and Bus Admr, University, Miss / teaching / '30, Univ of Alabama (BS, MS), '58, teacher / "An Introductory Course in the Field of Electronic Data Processing"
- Johnson, Gilbert I / Sr EDP Pgrmr, General Dynamics, Fort Worth, Tex / BP / '29, North Texas State, Texas Christian U, '51, prgrmr
- Keenan, John A / Sr Engr, Sylvania Data Systems, 1210 VFW Parkway, W Roxbury, Mass / DE / '30, Univ of Wisc, '57, engr
- Kerr, J L / Devt Engr, Electronic Switching System, 6200 East Broad, Columbus 13, Ohio / AP / '37, Washington U, '60, —
- Lemus, F / Scientist, SHAPE Air Defence Technl Centre, P O Box 174, The Hague, Netherlands / ABMP / '26, Iowa State Univ, '57, statistician / "A Mixed Model Factorial in Testing Electrical Connectors," "Reliability Evaluation of a Power Supply System"
- Lewis, Albert D M / Assoc Prof of Structural Engrg, Purdue Univ, Civil Engrg Bldg, Lafayette, Ind / AEP / '20, Purdue Univ, '54, civil engr
- Lowe, Stephen / Aero Space Technologist, National Aeronautics and Space Administration, Box 273, Edwards, Calif / ALMP / '36, Univ of Utah, '61, prgrmr
- Luckie, Robert Ross, III / Mathn, HRB-Singer, Inc, P O Box 60, Science Pk, State College, Pa / ADEL, info retrieval, military aplns / '34, Pennsylvania State Univ, '60, compr sys dsgn
- Marshall, Harold J / Elecnc Systms Analyst, New England Mutual Life Ins Co, 501 Boylston St, Boston, Mass / ABP / —, Boston Univ, '56, compr pgrmr and sys anlyst
- McCall, Dr Jerry C / Asst to the Dir, George C Marshall Space Flight Center, Nat'l Aeronautics and Space Admn, Huntsville, Ala / AP / '27, Univ of Miss (BA, MA), Univ of Ill (MS, PhD), '54, —

WHO'S WHO IN THE COMPUTER FIELD — CUMULATIVE EDITION, 1962

Computers and Automation will publish this spring a cumulative edition of "Who's Who in the Computer Field." The closing date for receiving entries is Mar. 25, 1962. If you are interested in computers, please fill in the following Who's Who entry form (which may be copied on any piece of paper) and send it to us for your free listing. If you have friends in the computer field, please call their attention to sending us their Who's Who entries. The cumulative edition will include only the entries of persons who send us their Who's Who information.

Name? (please print)

Your Address?

Your Organization?

Its Address?

Your Title?

Your Main Computer Interests?

() Applications

() Business

() Construction

() Design

() Electronics

() Logic

() Mathematics

() Programming

() Sales

() Other (specify):

Year of birth?

College or last school?

Year entered the computer field?

Occupation?

Anything else? (publications, distinctions, etc.)

.....

.....

.....

When you have filled in this entry form please send it to: Who's Who Editor, **Computers and Automation**, 815 Washington Street, Newtonville 60, Mass.

18. "The Automation Jobless . . . Not Fired, Just Not Hired," *Time*, Vol. 77, No. 9, February 24, 1961, p. 69.

19. Perhaps an indication of things to come is to be found in the recent Federal Court ruling that employees have an "earned and vested right" of seniority and that this cannot be "denied unilaterally" or affected by a change in the location of their employer. "Court Bars Firing in Plant Move," *Washington Post*, July 7, 1961.

20. Harvey Swados, "Less Work—Less Leisure," *Mass Leisure*, ed. Eric Larrabee and Rolf Meyersohn, The Free Press, Glencoe, Ill., 1958, p. 353.

21. Lawrence E. Davies, "Data Retriever to Help the CIA. Finds One Page in Millions in Only a Few Seconds," *New York Times*, July 12, 1961.

22. Donald N. Michael, "Some Factors Tending to Limit the Utility of the Social Scientist in Military Systems Analysis," *Operations Research*, Vol. 5, No. 1, February, 1957, pp. 90-96.

Muller, Elizabeth M / Sr Staff Mathn, General Precision, GPL Div, Pleasantville, N Y / AD, new systms / -, Columbia, '51, sys analyst

Newman, Sam / Mathn, NAFEC, FAA/BRAD, Atlantic City, N J / M / '19, -, '57, mathn / various papers and publs, patent

Oxford, Desmond de Villiers / Proj Mgr Compr Investigation, Anglo American Corporation Limited, Leslie Pollak House, Kitwe, Northern Rhodesia / Aplns to the mining industry / '16, Univ of South Africa, '60, mining engr / numerous published articles

Paden, John K / Pres, John K Paden Company, 2624 Shelby St, Dallas 19, Tex / ABPS / '24, US Military Academy at West Point, '56, elecnc data prog constnt

Patton, Peter C / Assoc Engr, Midwest Research Inst, 425 Volker Blvd, Kansas City 10, Mo / AMP, info retrieval / '35, Harvard (AB), Kansas Univ (MA), '57, data prog sys anlyst

Payne, R / Supv Compr Lab, Worthington Corp, Harrison, N J / AMP / '12, USNA, '57, engr

Payne, W H / Admn Sys Specl, Lockheed Aircraft Corp, Box 551, Burbank, Calif / ABMP, compr sys evaluation / '27, -, '56, data prog plng

Peterson, Norman D / Mgm Analyst, US Dept of Interior, Portland, Ore / P, inventory and prodtn ctrl, info retrieval / -, Washington State Univ (MS, BED), '55, mathn

Petrie, H Philip / Engrg Speclst, The Air Preheater Corp, Wellsville, N Y / AMP / '26, St. Bonaventure Univ, '57, compr prgmng

Rice, Sidney E / Sr Prgmr, The National Cash Register Company, National Data Processing Center, 660 Madison Ave, New York 21, N Y / AP, systems / '28, Brooklyn Coll, New London Jr Coll, New York Community Coll, '57, compr sys analyst and prgmr

Salsbury, Robert G / Staff Mathn, IBM Corp, General Product Development Lab, Endicott, N Y / ADLP / '22, Univ of Mich (MA), '57, prgmr-analyst

Simmons, Maryhelen / Dig Compr Prgmr, DHEW, SSA, Bureau of Old Age & Survivors Insurance, Woodlawn 35, Md / P / '23, Coll of Notre Dame of Md, '55, prgmr

Simpson, Charles H / Mgr, Data Prog, Commission on Professional and Hospital Activities, First National Bldg, Ann Arbor, Mich / ABP, medical data res / '31, Mich State Univ, '60, medical data res

Siqueland, Torger A / Bus Sys Anlyst, Collins Radio Co., Information Science Center, 19700 San Joaquin Rd, Newport Beach, Calif / ABCP, eqpm and sys evaluations / '29, St Olaf Coll, '59, admr supv

Street, Lt David L / Data Sys Anlyst, Personnel Systems Development Office, USAF, Bolling 25, D C / P, sys dsgn / '37, U of Colo, '60, sys anlyst and prgmr

VanWinkle, Richard L / Chf Prgmr, Franklin Life Insurance Company, 800 So 6th St, Springfield, Ill / AP / '31, -, '52, life ins acctg / co-authored life ins chpt in Handbook of Automation Computation and Control

Walker, Robert M / Elecnc Engr, Lawrence Radiation Lab, Livermore, Calif / DEL / '35, Univ of Calif, '57, engr

Yates, D J / Sec-Treas, National Computer Analysts, Inc, Route 206 Center, Princeton, N J /

DERIVING majority logic NETWORKS

FUND THM:

$$f(X, Y, Z) \equiv (X \# Y \# f_{xy}) \# (\bar{X} \# \bar{Y} \# f_{\bar{x}\bar{y}}) \# f_{xy}$$

DEFINITIONS:

$$X \# Y \# Z \equiv \text{Maj}(X, Y, Z); f_{xy} \equiv f(X, X, Z); f_{\bar{x}\bar{y}} \equiv f(X, \bar{X}, Z)$$

DERIVATION:

Let $f(X, Y, Z)$ be even-parity function P .

Then $f_{xy} \equiv \bar{Z}$ and $f_{\bar{x}\bar{y}} \equiv Z$ so

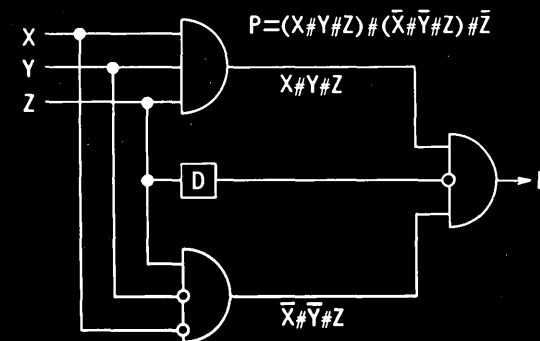

The fundamental theorem of majority-decision logic, a typical product of Univac's Mathematics and Logic Research Department, has practical as well as theoretical interest. The even-parity checker derived above from the fundamental theorem can be used to determine the parity of 3^n bits in 2^n logical levels using only $\frac{3}{2}(3^n - 1)$ three-input majority gates.

Qualified applicants will find at Remington Rand Univac a scientific climate tuned to the intellectual curiosity of the professional man. The opportunity and the incentive for advancement are waiting for you in highly significant positions at Univac. You are invited to investigate them immediately.

■ SYSTEMS ANALYSTS ■ APPLICATIONS ANALYSTS ■ ENGINEER WRITERS ■ LOGICAL DESIGNERS ■ PROGRAMMERS

Contact the office of your choice:

R. K. PATTERSON
REMINGTON RAND UNIVAC
Univac Park
St. Paul 16, Minnesota

WILLIAM LOWE
REMINGTON RAND UNIVAC
P.O. Box 6068
San Diego 6, California

REMINGTON RAND
UNIVAC

DIVISION OF SPERRY RAND CORPORATION

There are also immediate openings in all areas of digital computer development at our other laboratories. Inquiries should be addressed to:

T. M. McCABE
Rem. Rand Univac
P.O. Box 500
Blue Bell, Penn.

D. CLAVELIUS
Rem. Rand Univac
Wilson Avenue
So. Norwalk, Conn.

(An equal opportunities employer)

NEW PATENTS

Raymond R. Skolnick

Reg. Patent Agent

Ford Inst. Co.

Div. of Sperry Rand Corp.

Long Island City 1, New York

The following is a compilation of patents pertaining to computer and associated equipment from the "Official Gazette of the U. S. Patent Office," dates of issue as indicated. Each entry consists of patent number / inventor(s) / assignee / invention. Printed copies of patents may be obtained from the Commissioner of Patents, Washington 25, D. C., at a cost of 25 cents each.

December 12, 1961 (Cont'd)

- 3,012,725 / Frederic C. Williams, Romiley, Tom Kilburn, Davyhulme, Manchester, and Geoffrey C. Tootill, Hawley, Camberley, Eng. / I. B. M. Corp., New York, N. Y. / An electronic digital computing device.
- 3,012,726 / Frederic C. Williams, Romiley, Tom Kilburn, Davyhulme, Manchester, Geoffrey C. Tootill, Hawley, Camberley, and Arthur A. Robinson, Hazel Grove, Eng. / I. B. M. Corp., New York, N. Y. / An electronic digital computing device.
- 3,012,727 / Frederic C. Williams, Romiley, and Tom Kilburn, Davyhulme, Manchester, Eng. / I. B. M. Corp., New York, N. Y. / An electronic digital computing device.
- 3,013,120 / Esmond P. Wright, London, Eng. / International Standard Elect. Corp., New York, N. Y. / A data processing system.
- 3,013,251 / Esmond P. Wright, London, Eng. / International Standard Elect. Corp., New York, N. Y. / Data processing equipment.
- 3,013,252 / Frederick T. Andrews, Jr., Berkeley Heights, N. J. / Bell Telephone Lab., Inc., New York, N. Y. / A magnetic core shift register circuit.
- 3,013,254 / Robert K. Walker, New Hartford, N. Y. / General Electric Co., a corp. of N. Y. / An information storage apparatus.

December 19, 1961

- 3,014,180 / John G. Leming, Niagara Falls, N. Y. / U. S. A. as represented by the Sec. of the Air Force / An electronic pulse coder.
- 3,014,202 / Lorenz Hanewinkel, Neukirchen, Germany / Zuse KG., Neukirchen, Germany / A selector for selecting channels.
- 3,014,203 / Louis D. Stevens, San Jose, Calif. / I. B. M. Corp., New York, N. Y. / An information storage matrix.
- 3,014,204 / Arthur W. Lo, Fords, N. J., and Hewitt D. Crane, Palo Alto, Calif. / R. C. A., a corp. of Del. / A magnetic circuit.

December 26, 1961

- 3,014,652 / Alfred Zarouni, Brooklyn, N. Y. / Bell Telephone Lab., Inc., New York, N. Y. / An automatic data reader.

- 3,014,654 / Raymond E. Wilser, U. S. Army, and Harry M. Lawrence, Ware Neck P. O., Va. / I. B. M. Corp., New York, N. Y. / A random storage input device.
- 3,014,659 / Arthur H. Dickinson, Greenwich, Conn. / I. B. M. Corp., New York, N. Y. / An electronic integrating means for continuous variable quantities.
- 3,014,662 / Charles R. Borders, Alpine, N. J. / I. B. M. Corp., New York, N. Y. / Counters with serially connected delay units.
- 3,014,663 / John W. Horton and Arthur G. Anderson, New York, N. Y. / I. B. M. Corp., New York, N. Y. / A binary full adder.
- 3,015,040 / Gerald A. Maley, Poughkeepsie, and William W. Boyle, La Grangeville, N. Y. / I. B. M. Corp., New York, N. Y. / A binary trigger circuit.
- 3,015,042 / Balthasar H. Pinckaers, Edina, Minn. / Minneapolis-Honeywell Regulator Co., Minneapolis, Minn. / A pulse responsive circuit with storage means.
- 3,015,089 / Philip N. Armstrong, Santa Monica, Calif. / Hughes Aircraft Co., Culver City, Calif. / A minimal storage sorter.
- 3,015,091 / James J. Nyberg, Torrance, and Alfred D. Scarbrough, Palos Verdes Estates, Calif. / Thompson Ramo Wooldridge, Inc., Cleveland, Ohio / A memory matrix control device.

January 2, 1962

- 3,015,441 / Edward F. Rent, Vestal, and Flavious M. Powell, Johnson City, N. Y. / I. B. M. Corp., New York, N. Y. / An indexing system for a stored program calculator.
- 3,015,442 / Arthur H. Dickinson, Greenwich, Conn. / I. B. M. Corp., New York, N. Y. / An electronic multiplier.
- 3,015,443 / Wendell S. Miller, 1341 Comstock Ave., Los Angeles, Calif. / An electronic computer.
- 3,015,444 / Herbert A. Schneider, Coytesville, N. J. / Bell Telephone Lab., Inc., New York, N. Y. / A digital data generator circuit for computer testing.
- 3,015,445 / Toshio Kashio, Musashino, Japan / Uchida Yoko Co., Lim., Toyko, Japan / A relay type bi-quinary adder apparatus.
- 3,015,694 / Freddy David, Rochester, N. Y. / General Dynamics Corp., Rochester, N. Y. / A solid state binary code demultiplexing and demultiplexing device.
- 3,015,708 / Warren P. Mason, West Orange, N. J. / Bell Telephone Lab., Inc., New York, N. Y. / A combined memory storage and switching arrangement.
- 3,015,732 / Harry C. Kuntzleman, Newark Valley, and John G. Simek, Endicott, N. Y. / I. B. M. Corp., New York, N. Y. / A delayed coincidence circuit.
- 3,015,783 / Joseph P. Vignos, Binghamton, N. Y., and Donald P. Shoultes, Charleston, S. C. / I. B. M. Corp., New York, N. Y. / A bipolar switching ring.

- 3,015,734 / John P. Jones, Jr., Pottstown, Pa. / Navigation Computer Corp., a corp. of Penn. / A transistor computer circuit.
- 3,015,807 / Arthur V. Pohm, White Bear Lake, Earl N. Mitchell, St. Paul, and Thomas D. Rossing, Northfield, Minn. / Sperry Rand Corp., New York, N. Y. / A non-destructive sensing of a magnetic core.
- 3,015,808 / Nicolaas C. De Troye, Eindhoven, Netherlands / North American Philips Co., Inc., New York, N. Y. / A matrix-memory arrangement.
- 3,015,809 / Peter B. Myers, Millington, N. J. / Bell Telephone Lab., Inc., New York, N. Y. / A magnetic memory matrix.

January 9, 1962

- 3,016,008 / Ralph Berger, Wellesley, and Hugh E. Harlow, Reading, Mass. / Analex Corp., Boston, Mass. / A data processing apparatus.
- 3,016,195 / Arthur Hambrun, Endicott, N. Y. / I. B. M. Corp., New York, N. Y. / A binary multiplier.
- 3,016,196 / Paul Mallery, Murray Hill, N. J. / Bell Telephone Lab., Inc., New York, N. Y. / An arithmetic carry generator.
- 3,016,466 / Richard K. Richards, Old Troy Road, Wappingers Falls, N. Y. / ——— / A logical circuit.
- 3,016,470 / Gilbert A. Van Dine, Madison, N. J. / Bell Telephone Lab., Inc., New York, N. Y. / A shift register.
- 3,016,516 / Charles H. Doersam, Jr., 24 Winthrop Rd., Port Washington, N. Y. / ——— / A pulse code multiplexing system.
- 3,016,517 / Burton R. Saltzberg, New Providence, N. J. / Bell Telephone Lab., Inc., New York, N. Y. / A redundant logic circuitry.
- 3,016,521 / John H. McGuigan, New Providence, N. J. / Bell Telephone Lab., Inc., New York, N. Y. / A magnetic core memory matrix.
- 3,016,522 / Norman M. Lourie, Watertown, and Kenneth E. Perry, Newton, Mass. / Minneapolis-Honeywell Regulator Co., Minneapolis, Minn. / An information storage apparatus using a record medium.
- 3,016,523 / John J. Sharp, Stevenage, Eng. / International Computers and Tabulators, Lim., London, Eng. / An information storage system.
- 3,016,524 / Arthur G. Edmunds, 69 Warwick Ave., Edgware, Eng. / ——— / An information storage system.
- 3,016,527 / Edgar N. Gilbert, Whippany, and Edward F. Moore, Chatham, N. J. / Bell Telephone Lab., Inc., New York, N. Y. / An apparatus for utilizing variable length alphabetized codes.

January 16, 1962

- 3,017,082 / Reginald L. Riddiford, Birmingham, and Frank Salisbury, Coventry, Eng. / General Electric Co., Lim., London, Eng. / A device for sensing punched cards, tapes or other members.

- 3,017,084 / Sadia S. Guternam, Dorchester, Mass. / Raytheon Co., a corp. of Del. / A magnetic core shift register.
- 3,017,091 / Werner Ulrich, New York, N. Y. / Bell Telephone Lab., Inc., New York, N. Y. / A digital error correcting system.
- 3,017,092 / Edward F. Rent, Vestal, and Flavious M. Powell, Johnson City, N. Y. I.B.M. Corp., New York, N. Y. / A program control for data storage and processing machine.
- 3,017,094 / Christopher Strachey, London, Eng., and Donald B. Gillies, Toronto, Ontario, Can. / I.B.M. Corp., New York, N. Y. / An order control arrangement for electronic digital computers.
- 3,017,095 / Martin Hebel and Gunther Schweitzer, Nurnberg, Ger. / Max Grundig, Furth, Bavaria, Ger. / An electric multiplying arrangement.
- 3,017,098 / John W. Haanstra, San Jose, Calif. / I.B.M. Corp., New York, N. Y. / An adding device.
- 3,017,099 / Grant W. Booth, Collingswood, N. J. / R.C.A., a corp. of Del. / A parallel binary adder.
- 3,017,100 / Bennett Housman, Arlington, Va. / I.B.M. Corp., New York, N. Y. / A adder circuit.
- 3,017,101 / Charles E. Owen, Stanmore, Eng. / I.B.M. Corp., New York, N. Y. / An electronic digital computing machine.
- 3,017,102 / Ladimer J. Andrews, Gardena, Calif. / The National Cash Register Co., Dayton, Ohio / A digital indicator circuitry.
- 3,017,109 / Vernon R. Briggs, Los Angeles, Calif. / Thompson Ramo Wooldridge Inc., Cleveland, Ohio / A pulse width signal multiplying system.
- 3,017,610 / Albert A. Auerbach, Hollis, Evelyn Berezin, New York, Samuel Lubkin, Bayside, and Robert F. Shaw, New York, N. Y. / Curtiss-Wright Corp., Carlstadt, N. J. / An electronic data file processor.
- 3,017,612 / Jerome R. Singer, Washington, D. C. / National Scientific Lab., Inc., Washington, D. C. / A method and apparatus for storing information.
- 3,017,613 / James C. Miller, Hamilton Square, N. J. / R.C.A., a corp. of Del. / A negative resistance diode memory.
- 3,017,614 / Jan A. Rajchman, Princeton, N. J. / R.C.A., a corp. of Del. / A magnetic storage device.
- 3,017,616 / Raymond A. Runyan, Ridgefield, Conn. / Electro-Mechanical Research, Inc., Ridgefield, Conn. / A system for processing recorded information.

January 23, 1962

- 3,018,042 / David L. Nettleton, Haddonfield, N. J. / R.C.A., a corp. of Del. / A data input system.
- 3,018,045 / William L. Poland, Bethel, Conn. / Schlumberger Well Surveying Corp., Houston, Tex. / A signal translating system.
- 3,018,046 / Arthur W. Vance, Cranbury, N. J. / R.C.A., a corp. of Del. / A computing device.
- 3,018,047 / Richard J. LaManna, Whippary, N. J. / Munroe Calculating Machine Co., Orange, N. J. / A binary integer divider.
- 3,018,048 / Gustav A. Backman, Franklin Township, Somerset County, and William C. Ortel, Summit, N. J. / Bell Telephone Lab., Inc., New York, N. Y. / A gated accumulator.

at **AUTONETICS**

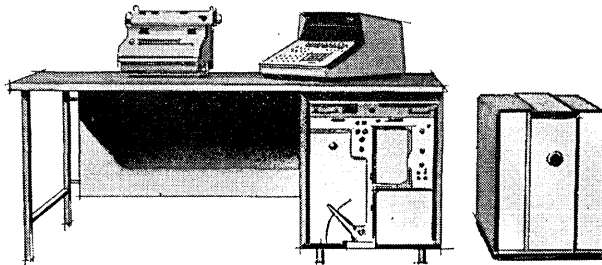

**they chose
tape transports...**

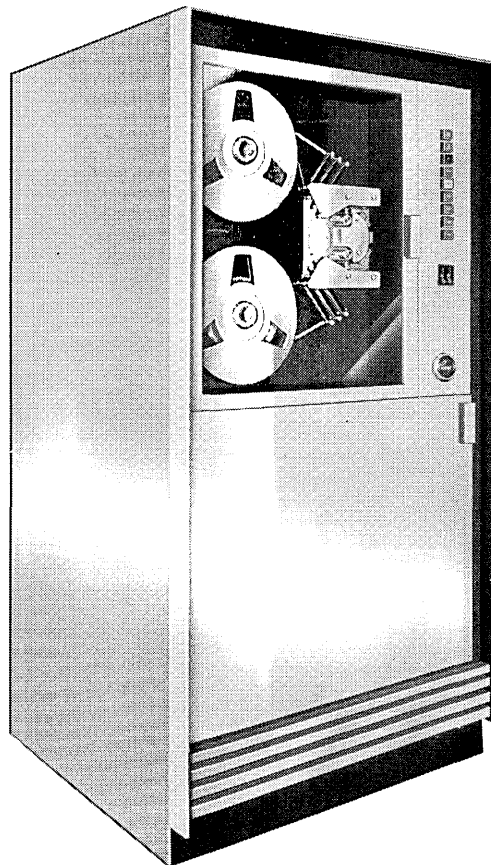

**for the Recomp II
computer system**

This system offers the user a magnetic tape memory unit with a capacity of over 600,000 words—and four of these units can be coupled to permit a total memory capacity of over 2,500,000 words.

Key to this highly reliable memory system is the Potter Model 910 Digital Magnetic Tape Transport. This solid-state unit provides data transfer rates to 22,500 per second on 1/2-inch tape or 40,000 characters per second on 1-inch tape at tape speeds up to 75 inches per second. In Recomp II, the Model 910 is teamed with the transistorized Model 921A Read-Write Amplifier system, which provides flexibility to match virtually any digital tape application.

To learn more about Potter Digital Magnetic Tape Transports write today.



PLAINVIEW, NEW YORK

GUIDE TO TABLES IN MATHEMATICAL STATISTICS

By J. Arthur Greenwood
and H. O. Hartley

This first book exclusively devoted to tables of mathematical statistics catalogues an enormous selection of such tables originally published between 1900 and 1960 but heretofore available in scattered sources only. It fills an important need for those engaged in the computational side of mathematical statistics, for the professional computer faced with a statistical problem, and for the statistician called upon to compute.

\$8.50 at your bookstore



Princeton University Press
Princeton, N. J.

- 3,018,049 / David J. Green, Pacific Palisades, Calif. / Lear, Inc., Santa Monica, Calif. / A probability curve and error limit computer.
- 3,018,051 / Harold S. Hemstreet, Binghamton, N. Y. / General Precision Inc., a corp. of Del. / An analog computer apparatus.
- 3,018,384 / William E. Zrubek, Glen Burnie, Md. / U. S. A. as represented by the Sec. of the Navy / A transistor circuit for converting pulse information into bistable information.
- 3,018,388 / William D. Rowe, Snyder, N. Y. / Westinghouse Electric Corp., East Pittsburgh, Pa. / A binary counter with isolation means between flip-flop stages.
- 3,018,389 / Marvin B. Herscher, Philadelphia, Pa. / R.C.A., a corp. of Del. / A delay circuit using magnetic cores and transistor storage devices.

January 30, 1962

- 3,018,954 / Joseph J. Eachus, Cambridge, Mass. / Minneapolis-Honeywell Regulator Co., Minneapolis, Minn. / An error checking device employing tristable elements.
- 3,018,955 / Myron J. Mendelson, Los Angeles, Calif. / United Aircraft Corp., East Hartford, Conn. / An apparatus for performing arithmetic operations.
- 3,018,956 / William A. Hosier and Thomas A. Puorro, Stoneham, Mass. / Research Corp., New York, N. Y. / A computing apparatus.
- 3,018,957 / Byron L. Havens, Closter, N. J. / I.B.M. Corp., New York, N. Y. / An electronic multiplier-divider.
- 3,018,958 / Robert M. Walker, Closter, N. J., and Arthur G. Anderson, New York, and Donald E. Rosenheim, Long Beach, N. Y. / I.B.M. Corp., New York, N. Y. / A very high frequency computing circuit.

ADVANCED SYSTEMS DEVELOPMENT

Emerging now from three years' intensive effort at International Electric is a computer-based communication system that equals the state-of-the-art. Future progress will depend upon our ability to advance the state-of-the-art in our design and development of future systems.

Research Specialists are needed for original contributions in *Artificial Intelligence*, to result in advanced techniques in man/machine communications. They will perform studies in such fields as linguistics, philology, learning theory, automatic programming, information retrieval, simulation and compilers.

Programming Specialists are needed for advanced program analysis and development for large, real time digital systems.

For consideration, send your resume to Manager of Technical Staffing, Dept. CA.

INTERNATIONAL ELECTRIC CORPORATION

An Associate of International
Telephone and Telegraph Corporation

Rte. 17 & Garden State Pky.
Paramus, New Jersey

An equal opportunity employer.

ADVERTISING INDEX

Following is the index of advertisements. Each item contains: Name and address of the advertiser / page number where the advertisement appears / name of agency if any.

American Telephone & Telegraph Co., 195 Broadway, New York 7, N. Y. / Page 3 / N. W. Ayer & Son, Inc.

Audio Devices, Inc., 444 Madison Ave., New York 22, N. Y. / Page 13 / Charles W. Hoyt Co.

Bendix Computer Div., 5630 Arbor Vitae St., Los Angeles 45, Calif. / Page 7 / Shaw Advertising, Inc.

Computron, Inc., 122 Calvary St., Waltham, Mass. / Page 48 / Larcom Randall Advertising, Inc.

Control Data Corp., 501 Park Ave., Minneapolis 15, Minn. / Page 5 / —

Electronic Associates, Inc., Long Branch, N. J. / Page 47 / Gaynor & Ducas, Inc.

International Business Machines Corp., 590 Madison Ave., New York 22, N. Y. / Page 15 / Benton & Bowles, Inc.

International Electric Corp., Rte. 17 & Garden State Pky., Paramus, N. J. / Page 46 / Carpenter, Matthews & Stewart, Inc.

Litton Systems, Inc., Data Systems Div., Canoga Park, Calif. / Page 25 / Compton Advertising, Inc.

Litton Systems, Inc., Guidance and Control Systems Div., 5500 Canoga Ave., Woodland Hills, Calif. / Page 9 / Compton Advertising, Inc.

National Cash Register Co., Dayton 9, Ohio / Page 19 / McCann-Erickson, Inc.

Potter Instrument Co., Inc., Sunnyside Blvd., Plainview, N. Y. / Page 45 / Gamut Inc. Advertising

Princeton University Press, Princeton, N. J. / Page 46 / Franklin Spier, Inc.

Remington Rand Univac, Div. of Sperry Rand Corp., Univac Park, St. Paul 16, Minn. / Page 43 / Mullen & Associates, Inc.

Statistical Tabulating Corp., 104 So. Michigan Ave., Chicago 3, Ill. / Page 2 / Fred H. Ebersold, Inc.

NOTICE: This March 1962 issue of **Computers and Automation** contains 68 pages: the regular section, pages 1 to 48; and the last-minute section (which closed Feb. 20) pages 1B to 20B, inserted between pages 24 and 25.

PLOT YOUR DIGITAL DATA FOR GRAPHIC RESULTS

... WITH ACCURATE, LOW COST EAI SERIES 3100 DATAPLOTTER

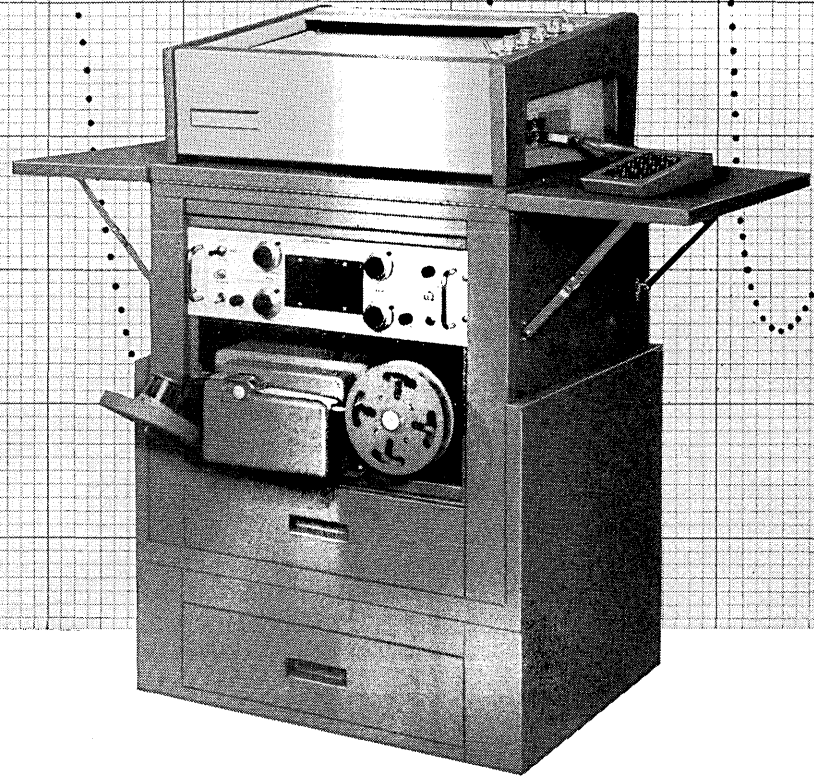

Outstanding Features of the EAI Series 3100 DATAPLOTTER include:

- System accuracy up to 0.175% of full scale.
- Punched card, tape or keyboard input.
- Plotting speeds up to 80 points per minute.
- Provisions for "off-board" origin.
- Compact, self-contained single cabinet design. Punched card reader external.
- Adaptable to any computer system.
- Accepts analog as well as digital inputs.
- Automatic off-scale point rejection.

The full potential usefulness of digital computer calculations is seldom fully realized. Because of the excessive cost of hand plotting, the benefits of graphic displays of digital data are usually sacrificed. Now, with the DATAPLOTTER 3100, this lost dividend can be recovered.

The quickest and easiest way to analyze the voluminous output of digital computers is in the form of easy-to-read x-y charts. With graphs plotted on the EAI Series 3100 [11"x 17"] DATAPLOTTER, digital information achieves new accessibility and convenience for computer data users. This new low-cost digital plotter enables project groups to set up independent data interpretation operations utilizing information obtained from central computer services. Experience shows that this equipment will deliver plots more rapidly and accurately and free valuable man-hours for engineering and management.

Some of the applications in which the EAI Series 3100 DATAPLOTTER is extremely valuable include Frequency Response Curves • Fluid Flow Charts • Stress Analysis • Aerodynamic Studies • Chemical Reaction Rates • Missile Trajectories and Orbits • Thrust Studies • Flight Data • Sales and Market Analyses.

EAI Series 3100 DATAPLOTTER® can save you money and improve your engineering and computer services. For information on this new equipment, write to Department CA-22.

EAI

ELECTRONIC ASSOCIATES, INC. Long Branch, New Jersey

Computape, you never change a bit.

Penelope, you're exactly right. One can't change a bit if one expects to run around with computers all day. That's why I'm guaranteed to deliver 556 or 800 bits per inch with no dropouts in severest computer applications.

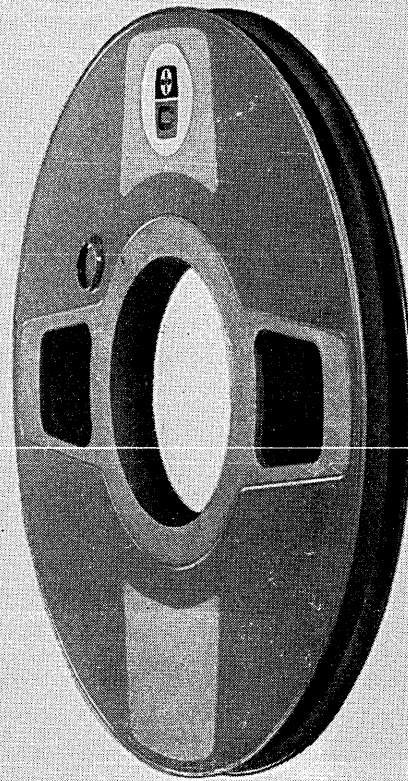

P. S. Computape doesn't really talk, of course. But in a computer, Computape *reliability* will deliver its own message. New COMPUTAPE, the premium quality computer and instrumentation tape, is the product of the only company devoted exclusively to the manufacture of quality tapes for data processing and instrumentation. *Investigate new Computape today. Better still, immediately.*



COMPUTRON INC.
122 Calvary Street, Waltham, Massachusetts