

dup  
C.5

IT & RADIATION  
F CALIFOR  
X B  
ERM CALIF

May, 1965

# computers and automation

~~AMERICAN~~  
~~PUBLIC LIBRARY~~

MAY 25 1965  
TECHNICAL LIBRARY  
UNIVERSITY OF CALIFORNIA

Guiding "Early Bird" at Comsat's Control Center



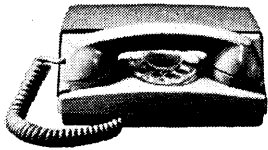

**Navajo Freight Lines takes the shortest route to faster billing**

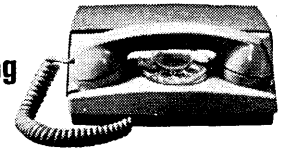

Navajo Freight Lines, Inc., uses Bell System Data-Phone\* service to speed some 4000 bills a day.

At originating terminals, freight bills are cut on 35 ASR teletypewriter machines. Copies of the bills and an 8-channel by-product tape are produced simultaneously.

The tape is then transmitted over telephone lines at 1050 words per minute (or a bill every 3 seconds) to destination terminals and to Navajo headquarters in Denver.

At the destination terminals, tapes are inserted in 35 ASR teletypewriters which produce delivery copies of the freight bills.

At the same time in Denver, tapes are processed through a magnetic tape converter direct to computers which check for accuracy and produce copies of bills for preaudit.

This operation has made substantial savings for Navajo Freight. Billing steps have been reduced from 10 to 4. Accounting now takes just 2 days instead of 8. Current revenue figures are always available to Navajo management within 24 hours.

Find out how Data-Phone service can work for your data systems by talking with one of our Communications Consultants. Just call your Bell Telephone Business Office and ask for his services.

\*Service mark of the Bell System



**Bell System**

American Telephone and Telegraph Co. and Associated Companies

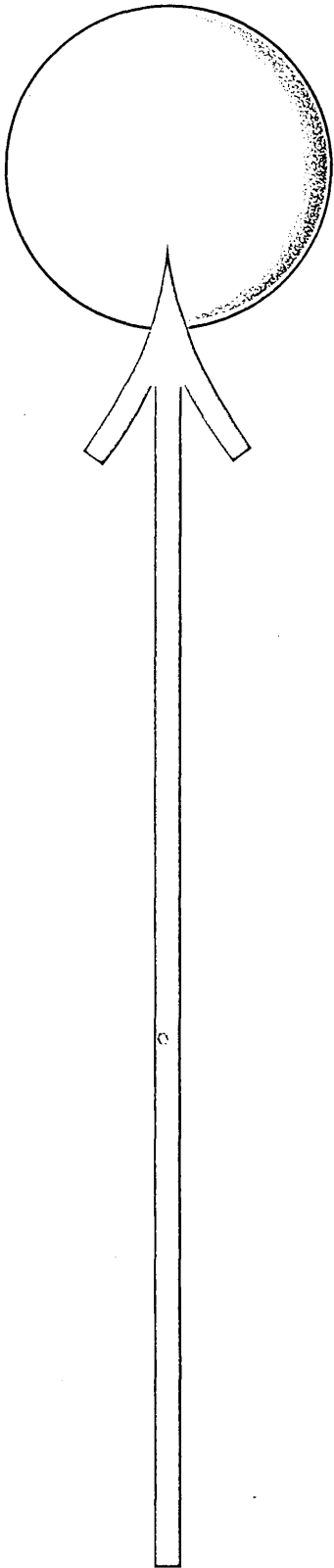

Activities at NASA's Manned Space Center in Houston, Texas, represent both a challenge and a promise. Project Apollo will be watched by responsible persons everywhere. **Wolf Research and Development Corp.** is playing a key role in this massive undertaking. **Would you like to join us?**

**SCIENTIFIC PROGRAMMERS** — Our biggest need right now is for Senior, Junior and Support Programmers for compilation, analysis and evaluation of information vital to NASA in Houston. A minimum of two years' programming experience with large-scale computers and a BS or BA in Math, Physics or Engineering are required. Write.

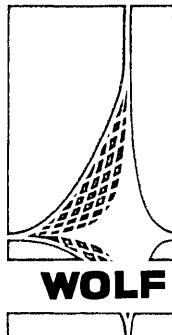

**WOLF RESEARCH AND DEVELOPMENT CORPORATION**  
BOX 36 K • BAKER AVENUE • WEST CONCORD • MASS. 01781

*an equal-opportunity employer*  
Circle No. 20 on Readers Service Card

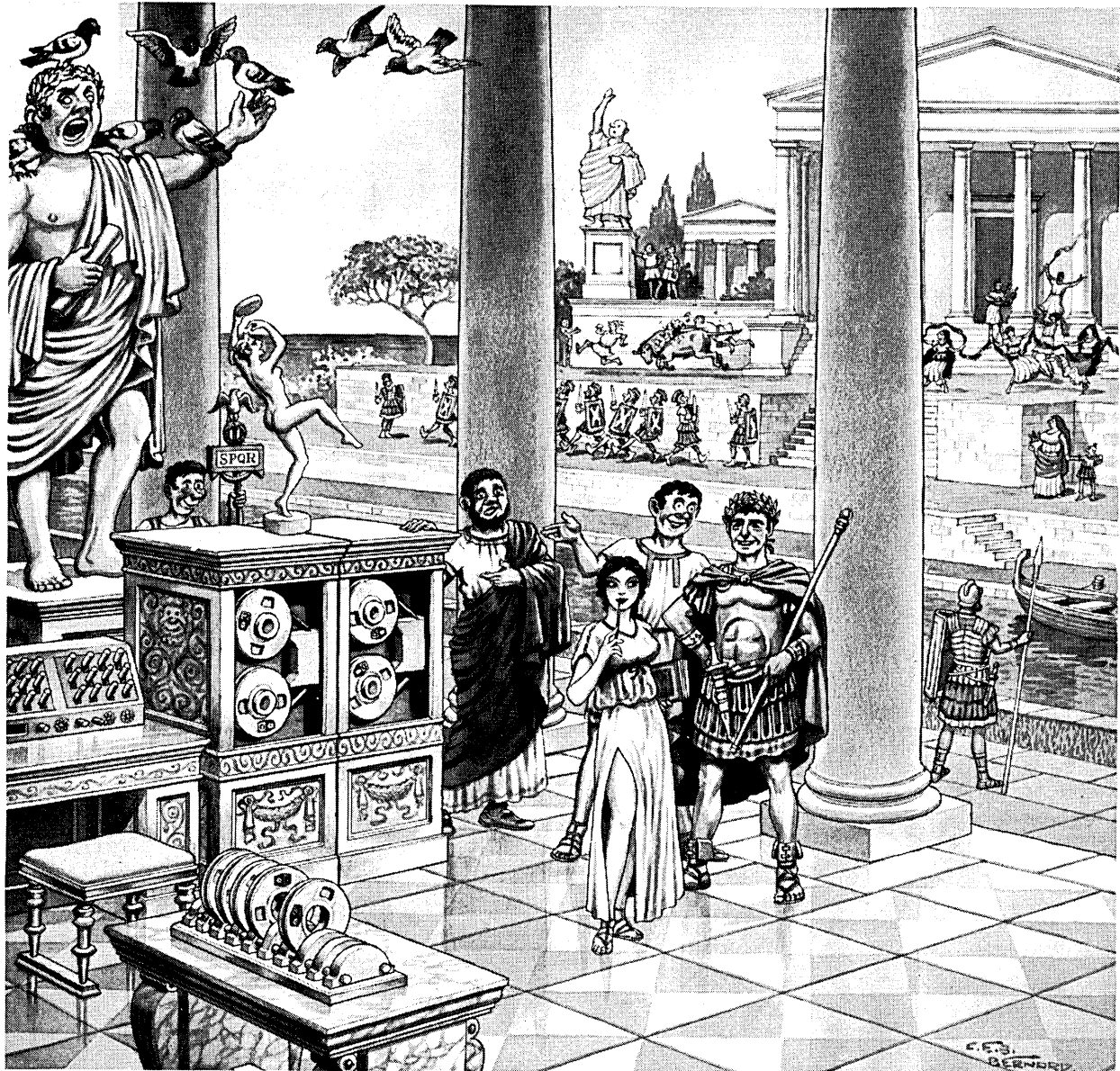

© Computron Inc. 1965

Pompey the Great, who considered himself a great innovator in the art of warfare, often boasted that he had introduced the use of pigeons as airborne messengers.

(Actually, he had borrowed the idea from a cashiered Chinese general named Ho Ming — which explains why they are known by that name and not as Pompey Pigeons.)

"You can have your new-fangled computers," he would scoff at Caesar. "Pigeons are the last word in modern communications!"

"Want to bet?" Caesar asked him one day.

"Name the stakes!" said Pompey.

Answered Caesar: "How about the Roman Empire?"

"You're on!" Pompey shouted.

And so the great struggle between the two took place, with Rome itself as the prize.

If you remember your Gibbon, you know what hap-

pened. Caesar's legions and his data processing equipment triumphed, and Pompey's boast came home to roost. After the crushing victory of the pro-processing forces over the pro-pigeon wing, Caesar dramatically celebrated his triumph by installing his computers directly at the base of Pompey's statue — as if to demonstrate to all the world which of the two had been right, and which had been for the birds.

This fascinating bit of tape history, incidentally, is presented for your edification by Computape, and the moral of the whole bit is crystal clear:

Computape is heavy-duty tape so carefully made that it delivers 556, or 800, or (if you want) 1,000 bits per inch — with no dropout.

Now — if Computape can write that kind of computer tape history — shouldn't you be using it?

\*Reg. T.M. Computron Inc



**COMPUTRON INC.**

MEMBER OF THE **BASF** GROUP

122 CALVARY STREET, WALTHAM, MASSACHUSETTS

COMPUTAPE — product of the first company to manufacture magnetic tape for computers and instrumentation, exclusively.

Circle No. 2 on Readers Service Card

As the Early Bird satellite goes up,  
the control staff of Commercial Satellite Corporation  
analyzes calculations produced by computer  
describing the satellite's precise position in space.  
See more information on page 49.



# computers and automation

MAY, 1965 Vol. 14, No. 5

editor and publisher  
EDMUND C. BERKELEY

assistant editors  
MOSES M. BERLIN  
LINDA LADD LOVETT  
NEIL D. MACDONALD

contributing editors  
ANDREW D. BOOTH  
DICK H. BRANDON  
JOHN W. CARR, III  
NED CHAPIN  
ALSTON S. HOUSEHOLDER  
PETER KUGEL

advisory committee  
T. E. CHEATHAM, JR.  
JAMES J. CRYAN  
GEORGE E. FORSYTHE  
RICHARD W. HAMMING  
ALSTON S. HOUSEHOLDER  
HERBERT F. MITCHELL, JR.  
VICTOR PASCHKIS

associate publisher  
PATRICK J. MCGOVERN

production manager  
ANN B. BAKER

art director  
RAY W. HASS

fulfilment manager  
WILLIAM J. MCMILLAN, 815 Washington St.  
Newtonville, Mass. 02160, 617-DEcatur 2-5453

advertising representatives  
New York 10018, BERNARD LANE  
37 West 39 St., 212-BRYant 9-7281  
Chicago 60611, COLE, MASON AND DEMING  
737 N. Michigan Ave., 312-SU 7-6558  
Los Angeles 90005, WENTWORTH F. GREEN  
300 S. Kenmore Ave., 213-DUnkirk 7-8135  
San Francisco 94105, A. S. BABCOCK  
605 Market St., 415-YUKon 2-3954  
Elsewhere, THE PUBLISHER  
815 Washington St., 617-DEcatur 2-5453  
Newtonville, Mass. 02160

computers and data processors:  
the design, applications,  
and implications of  
information processing systems.

## In This Issue

- 17 THE INTERNATIONAL IMPACT OF COMPUTERS AND AUTOMATION  
by Edmund C. Berkeley
- 19 SMALL COMPUTERS: A BILLION DOLLAR MARKET BY 1970?  
by Rudy C. Stiefel
- 22 THE FUTURE OF COMPUTERS IN THE FEDERAL GOVERNMENT  
by James P. Titus
- 27 REAL TIME SYSTEMS: A COMPLEXITY CHECK LIST  
by Robert V. Head
- 32 STEREOGRAPHIC PROJECTIONS BY DIGITAL COMPUTER  
by A. Michael Noll

## In Every Issue

- across the editor's desk
- 49 COMPUTING AND DATA PROCESSING NEWSLETTER
- editorial
- 7 The Barrels and the Elephant: Crackpot Vs. Pioneer
- market report
- 9 The European Computer Market
- throughput
- 45 Computers and Automation in Israel
- readers' and editor's forum
- 11 Regarding a National Computer Facility
- 11 Comments on "Decomposition — 7 League Boots for Linear Program-  
ming"
- 11 Computer Art Contest
- 12 More Comments on "Computers and the Public Sector of the Economy"
- 12 Notice Re the "Computer Directory and Buyers' Guide"
- 38 Calendar of Coming Events
- 42 Washington Report: \$250 Million Annual Savings in the Federal Govern-  
ment's Use of Computers
- 70 Automatic Carriage Operation
- 70 Sensitive Maintenance Conditions
- reference information
- 68 Computer Census
- 73 New Patents, by Raymond R. Skolnick
- index of notices
- 78 Advertising Index
- 78 Classified Advertisements
- 2B Computer Directory
- 76 Who's Who in the Computer Field

\*D ON YOUR ADDRESS IMPRINT  
MEANS THAT YOUR SUBSCRIP-  
TION INCLUDES THE COMPUTER  
DIRECTORY. \*N MEANS THAT  
YOUR PRESENT SUBSCRIPTION  
DOES NOT INCLUDE THE COM-  
PUTER DIRECTORY.  
SEE PAGE 2B FOR SPECIAL  
PREPUBLICATION OFFERS  
FOR \*N SUBSCRIBERS.



COMPUTERS AND AUTOMATION IS PUBLISHED MONTHLY AT 815 WASHINGTON ST., NEWTONVILLE, MASS. 02160, BY BERKELEY ENTERPRISES, INC. ADDITIONAL OFFICE OF PUBLICATION: 1657 WASHINGTON ST., HOLLISTON, MASS. PRINTED IN U.S.A. SUBSCRIPTION RATES: UNITED STATES, \$15.00 FOR 1 YEAR, \$29.00 FOR 2 YEARS, INCLUDING THE JUNE DIRECTORY ISSUE; CANADA, ADD 50¢ A YEAR FOR POSTAGE; FOREIGN, ADD \$3.50 A YEAR FOR POSTAGE. ADDRESS ALL EDITORIAL AND SUBSCRIPTION MAIL TO BERKELEY ENTERPRISES, INC., 815 WASHINGTON ST., NEWTONVILLE, MASS., 02160. SECOND CLASS POSTAGE PAID AT HOLLISTON, MASS.

POSTMASTER: PLEASE SEND ALL FORMS 3579 TO BERKELEY ENTERPRISES, INC., 815 WASHINGTON ST., NEWTONVILLE, MASS. 02160. © COPYRIGHT, 1965, BY BERKELEY ENTERPRISES, INC. CHANGE OF ADDRESS: IF YOUR ADDRESS CHANGES, PLEASE SEND US BOTH YOUR NEW ADDRESS AND YOUR OLD ADDRESS (AS IT APPEARS ON THE MAGAZINE ADDRESS IMPRINT), AND ALLOW THREE WEEKS FOR THE CHANGE TO BE MADE.

# Digital's software is complete, carefully documented, and easy to use.

## Even elegant.

With the delivery of a Digital Equipment Corporation PDP computer, you get complete software, exhaustively tested at DEC. Software that you can read like a novel. The package includes:

On-line debugging routine (DDT). It gives the user dynamic printed program status information. He can monitor the execution of single instructions or subsections. Change instructions or data in any format.

Symbolic Editor (SED). SED lets the user add, delete, or change or insert single lines or sections of his symbolic program. The output is a complete program ready for assembly or compilation.

Symbolic assemblers, including FORTRAN, that give the programmer a diagnostic printout during compilation and let him add, delete, or change statements before continuing to compile. He can correct mistakes at the console teleprinter and continue compiling.

Other PDP software includes macro assemblers (on the PDP-6 and PDP-8), utility programs (mode conversion, dump routines, etc.), elementary subroutines, and diagnostic and maintenance programs.

Digital's program documentation is in keeping with the quality of PDP hardware itself. It is complete, rigorous, rational, and easy to use.

And PDP users exchange information through DECUS—Digital Equipment Computer Users Society, an active association comprising many important organizations.

For information about our software, the PDP-8 (the new \$18K 1.6  $\mu$ sec cycle time computer), the PDP-7 (the new medium-sized computer), and the large-scale PDP-6, call any Digital Equipment office or the main office: DIGITAL EQUIPMENT CORPORATION, Maynard, Massachusetts 01754. Telephone: 617 897-8821. TWX: 710 347-0212. Telex: 092-027. Cable: DIGITAL MAYN.

MAYNARD, MASSACHUSETTS • Washington, D.C. • Parsippany, N.J. • Los Angeles • Palo Alto • Chicago • Ann Arbor • Pittsburgh • Huntsville • Orlando • Carleton Place, Ont. • Reading, England • Munich, W. Germany • Sydney, Australia

**digital**  
EQUIPMENT CORPORATION

Circle No. 4 on Readers Service Card

## The Barrels and the Elephant: Crackpot Vs. Pioneer

---

There was once, it is said, a manufacturer in Pittsburgh, whose factory made good strong steel barrels; and he wanted to increase his sales. So he consulted his advertising agency, and together they worked out a dramatic advertisement showing how strong his barrels were, using a photograph of an elephant standing on one of the barrels, and the slogan "barrels strong enough to support an elephant." But sales fell off. So the manufacturer and the advertising agency investigated, and they found out that no one believed that barrels could be strong enough to support an elephant, and the audience thought that the advertising showed a fake picture.

This story is a good example of the difference between truth and believability. It happens often that something is believable and true, or believable and not true, but some of the time something is true yet not believable.

The moral of this story is that if you want to convince an audience, you have to find out what the audience already thinks, and work forward from that area. And if you want to say something to an audience that it will not believe, you might just as well save your breath to cool your porridge. Now there are conditions where this is not true; for example, the persons who desire to convince people of some unbelievable information may have a tight grip on communications like radio or television; and the technique of the big lie told often enough is likely to produce much belief or at least conformity. But for most of us, our task is usually to persuade people, by evidence of reason and by appeal to emotion.

The problem of the manufacturer with his barrels is a problem that many computer people have. The great power of computers to solve problems is in many cases true yet unbelievable. These powers have limitations of course; there are quite a few things that computers cannot do. But there are other things, no matter how surprising they may be at first glance, which computers can do, and can do remarkably well.

The truth teller who is far ahead of what is believable in his time has a rough road; if you like him, he is a pioneer, and, if you don't like him, he is a crackpot. The first of these eminent persons in the computer field is without doubt Charles Babbage. As a professor of mathematics in Cambridge, England, in 1822 he launched his argument for a difference engine. For more than 20 years he tried to bring his idea to fruition, without success. During the rest of the

1800's, people called him a crackpot. Today we call him a pioneer.

Another old argument in the computer field is whether or not a computer can think. By the time the champion chess-player of the world is a computer program, probably it will be generally agreed that a computer can think; and all those persons who previously have been called crackpots for saying that a computer thinks, will graduate to being called pioneers.

Even today there are still fantastic possibilities in the computer field; and computer people may be classified as crackpots or pioneers in regard to what they say about these ideas. One such possibility is the "growth" of powerful computers by chemical processes, resembling the growth of the human brain. The steady development of microelectronics makes this possibility seem to many computer people quite plausible. And of course we have the example of the growth of the human brain for a model. What Nature can do repeatedly, it is quite likely that man can do also eventually—if not in the same way, then in a roughly equivalent way. For example, both birds and men fly, though the processes used so far are conspicuously different.

In the meantime, some of our readers may desire to explain "true" ideas to audiences who are not prepared to believe them. People are averse to believing in strange things until they have some good evidence, and until the idea seems to be emotionally appealing.

Probably a good way to argue for some of these ideas is to begin with a soft-sell approach, something like this:

"Now let's use our imagination, and think of one of the possibilities that lies ahead: . . .

This idea which we shall now discuss may seem a bit fanciful, but just the same the possibility is an interesting one; and some computer people even think that it will surely happen, for the following reasons among others . . ."

Such a procedure may save some computer people from being called crackpots when they are really pioneers!

*Edmund C. Berkeley*  
EDITOR

---

DO YOU HAVE A **SIGNAL PROCESSING** PROBLEM?  
**AMBILOG 200** IS DESIGNED TO SOLVE IT!

---

Using the best of both analog and digital techniques, the AMBILOG 200™ Stored Program Signal Processor is designed from the ground up to handle the "floods of data" generated in test and research programs. Although such programs cover many fields — biomedical monitoring, geophysical research, test stand instrumentation, automatic weapons checkout, speech analysis — all require complex *signal processing*: multiple input acquisition and output distribution, monitoring, editing, arithmetic, analysis, recording and display. Because of its high processing speed and extensive input/output for both analog and digital data, AMBILOG 200 is ideally suited for such tasks. Here are some examples.

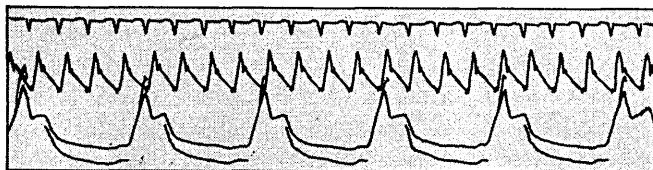

---

**Real Time Waveform Measurement**

Peak values, axis crossings, ratios of successive differences, and other characteristics of analog signals are measured in real time. Incoming signals are monitored for events of interest, using complex programmed detection criteria. In a typical biomedical application, the result is a 100-to-1 reduction in the bulk of magnetic tape output records.

---

$$A(n,w) = \int_0^T W(t)F(n,t) \cos(wt)dt$$
$$B(n,w) = \int_0^T W(t)F(n,t) \sin(wt)dt$$

---

**Spectrum Analysis**

Parallel hybrid multiplication and summing, 2 microsecond 30-bit digital storage, and a flexible instruction format providing efficient list processing combine to make the AMBILOG 200 powerful in statistical signal analysis techniques such as Fourier transformation, auto and cross correlation, power spectrum density analysis, and generation of histograms of amplitude spectra.

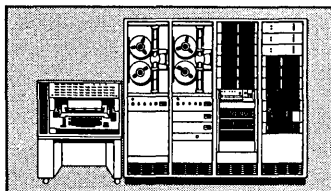

---

**Digitizing and Recording**

Multiple inputs, from up to several hundred sources, are routed through a multiplexer switch array under stored program control. At no penalty in sampling rates over conventional systems, the AMBILOG 200 converts incoming data to engineering units for recording or monitoring. An analog-to-digital converter performs a complete 15-bit conversion in 4 microseconds for digital storage, recording or outputting.

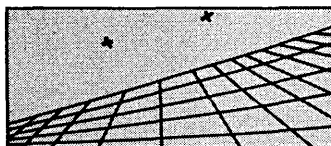

---

**Display Generation**

Multiple analog outputs facilitate close man-machine relationships in systems involving visual displays. Points of an image stored in memory are rotated through three space angles and projected on a CRT at a 50 Kc rate. Co-ordinate transformation is accomplished simultaneously with digital-to-analog conversion.

---

For technical reports describing in detail these and similar AMBILOG 200 applications, write I. R. Schwartz, Vice President.

*Adage*  
INC.

1079 Commonwealth Avenue,  
Boston, Massachusetts 02215



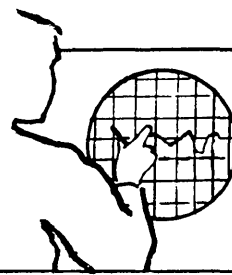

## THE EUROPEAN COMPUTER MARKET

The number of digital computers installed in Western Europe increased nearly 50% during 1964, from 3919 installed at the end of 1963, to 5889 computers installed at the end of 1964, according to a comprehensive market report recently released. The report, entitled "European Computer Survey, 1965", was prepared by Computer Consultants Ltd., a leading British consulting firm.

During the same period, existing orders for computer systems in Western Europe also increased by nearly 50%, from 2335 to 3485. These remarkable increases make Western Europe the fastest growing major market for computer systems in the world today. Although the number of computers in Western Europe is about 30% of the estimated 18,000 computers in the United States (about 28% by value), experts predict that at the European market's current growth rate, it should equal the U. S. market in number of computers installed by 1970.

American technology and marketing skill have captured the major share of the European computer market. This is clearly evidenced by the fact that 25% of the computers now installed in Western Europe were manufactured in the United States and another 54% were manufactured in Western Europe by American firms or American licensees. Only 21% of Western Europe's current computing power has been manufactured by independent European concerns.

The statistics on computer systems on order in Western Europe show that American firms are planning

to build a larger share of the computers they'll supply to Western Europe in Western Europe. Of these computers on order, only 17% are expected to be manufactured in the United States while 61% will be manufactured in Western Europe, a change from the 25%-54% ratio previously mentioned. Only 22% of the computers currently on order in Western Europe are to be built by independent European firms.

This on order situation is of course subject to change as countries vary their import allowances and requirements (e. g. Britain's recent 15% surcharge on imports of equipment such as computers). However outside of Great Britain, which currently supplies 54% of its own computer needs, the other countries of Western Europe do not have a very developed indigenous computer manufacturing capability. For example, French firms have built only 16% of the computers France uses and German firms have built only 9% of Germany's installed computers. So it is difficult to envision how many Western European countries will be able to supply a major share of their own computer needs in the near future. Hopefully this unbalance will lead to greater international cooperation in the design and development of advanced computer systems.

The chart below gives a breakdown of computers installed by country at the end of 1963 and 1964, as well as the value of computers installed at the end of 1964. The figures are taken from the "European Computer Survey, 1965" prepared by Computer Consultants Ltd. of England and available in the United States from the International Data Corporation, 355 Walnut St., Newton, Mass.

### COMPUTERS INSTALLED

### COMPUTERS ON ORDER

<u>COUNTRY</u>	<u>COMPUTERS INSTALLED</u>			<u>COMPUTERS ON ORDER</u>		
	<u>NUMBER</u> <u>(END OF 1963)</u>	<u>NUMBER</u> <u>(END OF 1964)</u>	<u>VALUE</u> <u>(END OF 1964)</u> <u>(\$MILLIONS)</u>	<u>NUMBER</u> <u>(END OF 1963)</u>	<u>NUMBER</u> <u>(END OF 1964)</u>	<u>VALUE</u> <u>(END OF 1964)</u> <u>(\$MILLIONS)</u>
Austria	66	108	23.4	50	68	15.8
Belgium	142	232	53.2	105	127	34.8
Denmark	74	95	23.3	30	57	15.8
Finland	19	54	12.5	35	59	12.5
France	791	1084	345.6	406	526	125.0
Germany	993	1413	394.8	455	867	191.6
Gr. Britain	626	948	296.1	381	754	230.0
Greece	50	67	17.8	20	47	10.5
Irish Rep.	10	41	11.1	39	37	6.9
Italy	592	882	278.5	339	295	95.3
Netherlands	156	275	81.1	134	188	75.7
Norway	54	109	22.7	71	78	14.9
Portugal	16	29	11.2	29	37	7.6
Spain	23	38	10.1	19	78	16.1
Sweden	147	257	76.6	121	120	37.4
Switzerland	160	257	76.9	101	147	40.1
<u>TOTALS</u>	<u>3,919</u>	<u>5,889</u>	<u>1,734.9</u>	<u>2,335</u>	<u>3,485</u>	<u>930.0</u>

# CALCOMP DIGITAL PLOTTING SYSTEMS ARE CONVERTIBLE

As a customer's plotting requirements become more complex, Calcomp 700 Systems can be converted upward from one model to another.

Today's Model 750 can become tomorrow's Model 780 by adding or substituting appropriate modules. In between are Models 760 and 770, bridging the gap between the basic and the ultimate.

## COMPATIBLE WITH COMPUTING SYSTEMS

*"Modular Design" of the 700 Systems makes them compatible with most major computing systems, including the IBM/360.*

*They also are compatible with the current industry trend toward in-the-field upgrading of data processing systems. As computing systems are upgraded to meet changing customer requirements, 700 Systems can be converted simultaneously, as required.*

## ECONOMICAL TO CONVERT

The cost of upgrading one model to another amounts to the difference in list price, plus the cost of a service call. Conversion can be accomplished in the field by Calcomp service representatives.

## HOW PLOTTING SYSTEMS ARE USED

*Calcomp plotting systems are used to present digital computer output as annotated charts, graphs, maps or drawings. The systems consist of magnetic tape units connected to Calcomp plotters.*

*Model 750 drives 500 series plotters and provides display and search features.*

*Model 760 also drives 500 series plotters, provides display and search, and employs tape format which reduces computer time required to prepare tape for plotting.*

*Model 770 works with high speed 700 series plotters and introduces variable step sizes (.005 and/or .01 inches) and ZIP MODE® capabilities which permit finer plotting resolution at advanced speeds.*

*Model 780 provides all of the features of the 770 plus the ability to read higher density tape, and increases computer efficiency by packing more data per inch of tape.*

*For additional features of the "700 Systems," their advantages over other digital systems, and their capabilities — one compared with another — write "Marketing."*

BOOTH 24  
IFIPS • May 24-28  
New York HILTON



CALIFORNIA COMPUTER PRODUCTS, INC. 305 Muller Avenue, Anaheim, California (714) 774-9141

Circle No. 6 on Readers Service Card

**REGARDING A NATIONAL  
 COMPUTER FACILITY**

**I. From E. L. Harder, Chairman**

**Board of Governors  
 American Federation of Information Processing Societies  
 New York, N. Y. 10017**

In regard to your suggestion in the January, 1965 *Computers and Automation* editorial, that AFIPS initiate the planning studies for a national computer facility, I have discussed this with the heads of the AFIPS societies, and offer the following comment:

A national computer facility certainly appears desirable and necessary. However, the dimensions of this project are such that actual "planning" for such a facility would require the active participation and support of the Federal Government. I believe the proper role of the professional societies at the moment is to attempt to define the nature of the problem and to serve as a catalyst to encourage the Government to take the necessary starting steps for establishment of this facility.

**II. From the Editor**

We are delighted that the "professional societies" may "serve as a catalyst to encourage the government to take the necessary starting steps for establishment of this facility."

If we at *Computers and Automation* can help, please ask us.

**COMMENTS ON "DECOMPOSITION—  
 7 LEAGUE BOOTS FOR LINEAR  
 PROGRAMMING"**

**John S. Bonner**

**Bonner and Moore Associates, Inc.  
 Houston 2, Texas**

This letter is in reply to some points raised by Dr. Jack Moshman in his article "Decomposition—7 League Boots for Linear Programming" appearing in the February, 1965 issue of *Computers and Automation*.

Dr. Moshman implies that, until the recent availability of the CEIR Decomposition program, the problem-solving capabilities of the Decomposition principle could not be used. The Bonner & Moore Decomposition LP system for the IBM 7094 (incidentally, the first such system to apply the acronym DECOMP) was released in the first quarter of 1962, more than three years ago.

Dr. Moshman repeatedly implies that the principal value

**COMPUTER ART CONTEST**

In our August issue, we shall publish the results of a competition which we run each year in art produced by a computer.

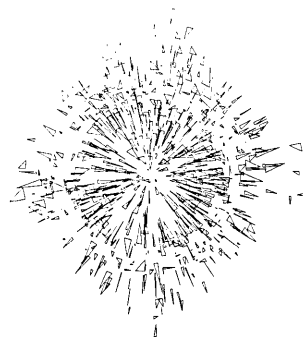

We invite entries from anyone interested. A letter should accompany the art, explain what problem led to it, and in a few sentences how the computer produced the result. There are no other formalities. The closing date for receipt of entries in our office is Monday, July 5, 1965.

The art winning the contest will become the front cover for our August issue.

Next to these words appear the winners of the computer art contests in our last two August issues.

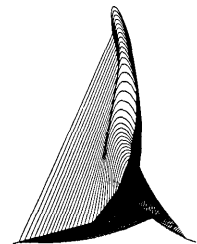

of Decomposition is in permitting the solution of bigger and better LP problems. This attitude completely overlooks what may well be a far more valuable ability, that of permitting the application of different computational techniques to different segments of the problem. The Bonner & Moore system, for example, permits both linear programming and distribution subproblems. This latter type permits individual subproblems with as many as five thousand equivalent equations, and over a half million variables within a single subproblem, provided that certain stylized requirements of subproblem structure are met. These requirements are characteristic of a large and important group of industrial problems, those involving supply and distribution networks. The important characteristic of the Decomposition principle which Dr. Moshman appears to overlook is that it is possible to include these specialized structures in the same problem with conventional LP structures (and possibly other specialized techniques) and utilize for each a specialized calculation procedure.

Finally, there appears to be something of a contradiction between the first two paragraphs of the article. In the first paragraph, Dr. Moshman implies that the application of linear programming has been restricted in the past to large companies involved in complex industrial processes, with the further implication that a large, untapped source of application among smaller, less sophisticated users exist. The balance of the article is devoted to a description of a method of permitting the solution of still larger and more complex problems.

## MORE COMMENTS ON "COMPUTERS AND THE PUBLIC SECTOR OF THE ECONOMY"

### I. From Elton Ray

Los Angeles, Calif.

Your excellent February editorial "Computers and the Public Sector of the Economy" called much needed attention to the vivid contrast between the public and private sectors of the economy.

Yugoslavia, which has found ways to effectively "privatize"—introduce competition and profit motivation into previously public industries—with substantial increases in efficiency and quality, may point the way to an easy, simple, and permanent solution to the deplorable state of the public sector of America: "Transfer" as many fields of endeavor as possible from the public to the private sector.

Subways and roads inherently pose a difficult "problem" of management, no matter who owns and operates them, because they are "natural monopolies" for reasons of topology. But there is no intrinsic reason why schools, libraries, and many other presently public services cannot be largely if not entirely, transferred to the private sector. Indications are that education, for example, would vastly benefit—witness the fact that a very large percentage of innovations in education have come from the small fraction of schools that operate in the private sector. The *Liberal Innovator* (Box 34718, Los Angeles) has published some rather interesting and novel ideas along these lines.

To privatize previously public sectors will, in many cases, require imaginative new approaches in organization. And data processing and automatic control will certainly find many new applications.

### II. From Morris C. Matson

Fort Worth, Texas

For the past several years your magazine has provided me with what I considered to be good, factual, up-to-date information about the computer field. Having some awareness of your professional stature in the computer industry I always felt safe in accepting information presented in your publication.

Several times I have had reservations about your editorial page. My associates have suggested on occasion that your thinking was not too good in some non-computer areas and that we should cancel our subscription. I have always maintained that they misunderstood your position. Today, however, I find myself in complete agreement with them.

What a tragedy it is for a professional man in a technical field to consider himself qualified to speak in the areas of physiology, politics, sociology, economics, the construction of subways, and national defense. For example, I don't think I have ever read a more ridiculous statement than "Certainly there is nothing magical or supernatural about the brain of a man; and certainly once the process of chemically growing brains is understood, much better materials than protoplasm can be found for making them." If there is nothing supernatural about the brain then there is nothing super-

## NOTICE RE THE COMPUTER DIRECTORY AND BUYERS' GUIDE, THE REGULAR JUNE ISSUE OF COMPUTERS AND AUTOMATION

The next issue of "Computers and Automation", the regular June issue, is our "1965 Annual Computer Directory and Buyers' Guide".

We have two kinds of subscribers: directory subscribers, and non-directory subscribers. Non-directory subscribers do not receive the June issue as part of their subscription. To find out which you are, look at the address label on the cover: if it has \*D, you receive the directory; if it has \*N, you do not receive the directory.

For information about receiving the directory or changing from a non-directory to a directory subscription, please see the information on page 2B.

natural about the human being so why not grow a better man rather than limit yourself to the brain alone.

The significance of your statement that "Many persons would eagerly engage in part-time work if they could do so conveniently," escapes me. What relationship does this have to the fact that the 5% unemployment rate is fiction? Do you mean that because I am willing to accept consulting work on a "moonlight" basis that I really ought to be counted among the unemployed?

Your statement that society must make sure that every human being has a decent job and/or a decent income is meaningless. May I ask you what is a decent job or a decent income or for that matter, what or who is society? Who can make those decisions for another person? You can't determine what is decent for me and I can't determine what is decent for you. Please don't try.

As one of your many loyal readers may I respectfully request that in your editorials you stick to a field in which you are proficient. If you want to preach, then use some other medium for your platform. Your magazine's status as a professional journal will be destroyed by a few more editorials about New York subways and the fiction in unemployment figures.

### III. From the Editor

Thank you for your letter of March 30 in which in a courteous and friendly way you express strong disagreement with some of the views recently expressed in my editorials.

I am enclosing, from the April issue which you may not yet have received, some comments and some rebuttal which deal with the discussion. Also, when you next come to the Boston area, please consider yourself invited to have lunch with me; for, to respond to all the points in your letter would take pages and pages. However I want particularly to reply now to one of the remarks in your letter: "what a tragedy it is for a professional man in a technical field to consider himself qualified to speak in the areas of physiology, politics, sociology, economics, the construction of subways, and national defense."

There are important answers to this remark of yours.

First, it seems to me that the basic purpose of editorials in any magazine is to help the readers of a magazine get out of ruts, old ways of thinking and behaving. The world around us nowadays is full of change and demands fresh

thinking. The more stimulation, the more discussion, the more argument, the more thought, we who edit **Computers and Automation** can stir up with the editorials I write and check with the other editors—the more ferment there will be in the field of computers and automation, and the more good is likely to be produced from that ferment. I believe the editorials you take issue with stir up ferment.

Second, this particular professional man (myself) has had a very broad education lasting many years, which has included: (1) an A.B. degree from Harvard College in 1930, summa cum laude, after a four-year liberal arts course that included economics, history, and many other subjects; (2) another degree (F.S.A.) from the Society of Actuaries, representing the passing of 12 professional actuarial examinations (1931-41) including such subjects as investments, economics, etc.; (3) much travel outside of the United States, including visiting over 20 countries of this small planet including the Soviet Union, India, Australia, etc.; (4) the rough and tumble of owning, operating, and managing a small business from 1948 on, which has stayed solvent and met every payroll for more than 16 years, which is far beyond the average lifetime for small businesses in the United States (about 5 years); etc. Therefore, I believe I am to a small degree qualified to speak up to some extent in many more fields than just one, computers.

Third, even if a person is not at all professionally trained in a Subject X, it may well be that Subject X has impinged on his own personal experiences, and therefore he has firsthand, important information. A mother who has taken thalidomide on the advice of her doctor and found her baby born deformed, has had important experience about the worth of the advice from her doctor and the effectiveness of thalidomide; she can make a proper judgment about it from her own experience, and has a qualification for speaking up. A person who has traveled in the subways of New York, Chicago, Philadelphia, London, Paris, Moscow, and Sydney, and has looked around him and observed with his own eyes can make certain judgments about subways from his own experience, and has a qualification for speaking up.

Of course, there is always a tendency for professionals to try to be too authoritative; ordinary people must speak up to counteract this. If the streets of Boston are less well paved than the streets of London, it is proper for me as an ordinary person to speak up.

It simply is not true that a man who is a professional in one field is thereby to be barred from speaking up in another field—to a sensible extent and based on evidence that he can cite. In this connection, I would like to recommend highly to you the book "A Nation of Sheep" by former Navy Captain William J. Lederer, published 1961 by W. W. Norton & Co., in which he talks about how far Americans have become sheep in their tendency to shut out their own assessments and judgments when they should be assessing and judging for themselves.

Finally, the computer field is really a very strange and unusual field, if one compares it with many other fields of science and engineering. The computer field is strange and unusual because it penetrates into all other fields, like applied mathematics. In fact, computer methods are like mathematical methods, able to apply in countless places and with extraordinary advantage all over the spectrum of human affairs.

Consequently, the computer field requires that persons who desire to be real experts in computers should have broad knowledge, cultivated minds, hungry, avid intellects, and a tendency to speak up, so that they can see better into all kinds of problems and see ways in which computer techniques can benefit their solution. Computer people are basically information engineers, persons who are seeking to engineer information in our world so as to solve problems.

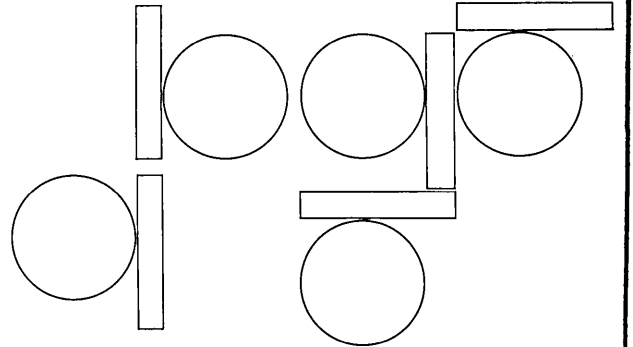

## **BRANDON** **APPLIED SYSTEMS, INC.**

### and **computers** and automation

are pleased to offer the third series (Spring, 1965) of

#### **TECHNICAL SEMINARS IN DATA PROCESSING**

— conducted by Brandon Applied Systems, Inc.

— sponsored by Computers and Automation

The remaining Seminars are:

##### **"Management Standards for Data Processing"**

a 2-day course for managers and senior personnel on management control and standards. This course is based in part on the book of the same name, by Dick H. Brandon. (D. Van Nostrand Company, Inc., Princeton, N.J. 1963.)

**New York, N.Y. — May 19, 20**

##### **"Computer Selection and Characteristics Analysis"**

a 2-day course on techniques used in equipment selection and the various characteristics of hardware, software and the manufacturers of current equipment. The course is designed for management personnel with responsibility for equipment selection.

**New York, N.Y. — June 9, 10**

##### **"Computer Systems Analysis Techniques"**

a new 2-day technical course on the techniques of systems analysis and computer feasibility study. This course is designed for experienced analysts and supervisory personnel. One seminar:

**New York, N.Y. — June 16, 17**

These courses are also given in London, Stockholm, and Tel Aviv.

For the Spring 1965 course catalog write or phone or mail coupon:

#### **BRANDON APPLIED SYSTEMS, INC.**

30 East 42nd Street, New York, N.Y. 10017  
212-YUkon 6-1518

TO: **Brandon Applied Systems**  
**30 East 42 St.,**  
**New York, N.Y. 10017**

Please send me the Spring 1965 course catalog.  
My name and address are attached.

Circle No. 9 on Readers Service Card

# FREE

Any one of these outstanding works (VALUE TO \$25.00)  
to mark your membership in  
**THE LIBRARY OF COMPUTER AND INFORMATION SCIENCES**

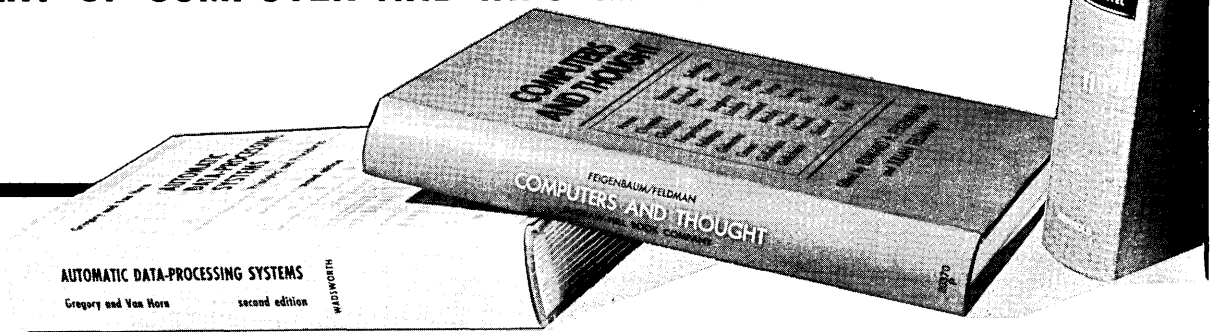

Will you accept—as a gift—a copy of any one of the superb reference works described above? We are making this offer to demonstrate the advantages of membership in THE LIBRARY OF COMPUTER AND INFORMATION SCIENCES, the unique program designed to serve the leaders in this rapidly expanding, vitally important field.

Real-time responses, market simulation, stochastic systems control, programming languages—these are only a few of the exciting new developments in the computer sciences that have brought about a vast amount of published materials. How can you cut through this maze of materials to pinpoint the approaches that will be most *directly useful* to you?

Here is where THE LIBRARY OF COMPUTER AND INFORMATION SCIENCES will be most valuable. Under the direction of a distinguished Editorial Advisory Board (below), the LIBRARY carefully screens the large number of books in the field. It then selects the most important, most authoritative

volumes and offers them to you—each month—at substantial discounts up to 40%. As a member, you need accept as few as four books during the next twelve months, and you will receive a *free* Bonus Book of your choice after every fourth Selection.

Selections of THE LIBRARY OF COMPUTER AND INFORMATION SCIENCES range widely over the field, covering such topics as: *Operations Research* • *Systems Design* • *Mathematical Models* • *Data Processing Equipment* • *Information Retrieval* • *Simulation* • *Management Information Systems* and many others.

By participating in this program, you build an impressive library of timely, crucial books in a field of the greatest significance. And you keep abreast of developments in the computer sciences in the most economical and convenient way.

To join, all you need to do is fill in the coupon on the next page, indicating your choice of a Membership Gift (with value to \$25.00), plus your first Selection at the reduced Mem-

ber's Price. If you join immediately, you will also receive a *free* copy of the new Reference Diary of THE LIBRARY OF COMPUTER AND INFORMATION SCIENCES (a \$3.95 value), an appointment diary containing much useful data and information on the field.

**Begin membership  
with one of these fine  
books at reduced  
member's prices**

### Programming and Coding Digital Computers

By Philip M. Sherman

A systematic introduction to the most important aspect of computer operation. Covers the development of the program and the entire cycle of practical tasks—from problem analysis to program debugging—which are involved in planning for and implementing computer application. Many worked examples, practice problems.

List Price \$11.00 Member's Price \$7.95

### An Introduction to Automatic Computers

By Ned Chapin

A detailed study of what computers can do, how they operate, what their demands are, and how results can be achieved. Of-

## The Library of Computer and Information Sciences

### Editorial Advisory Board

**Chairman**  
ISAAC L. AUERBACH  
President and  
Technical Director,  
Auerbach Corporation

**Editorial Director**  
EDMUND C. BERKELEY  
Secretary, Association  
for Computing  
Machinery (1947-53)

**Members**  
JACK BELZER  
Professor and Director of  
the Knowledge Availability  
Systems Center,  
University of Pittsburgh

JOHN W. CARR, III  
Professor, Moore School  
of Electrical Engineering,

NED CHAPIN  
Data Processing Consultant

ALSTON S. HOUSEHOLDER  
Director, Mathematics  
Division, Oak Ridge  
National Laboratory

ANDREW D. BOOTH  
Dean of Engineering,  
University of  
Saskatchewan

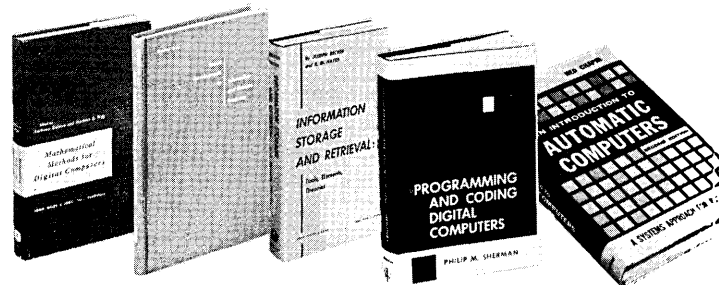

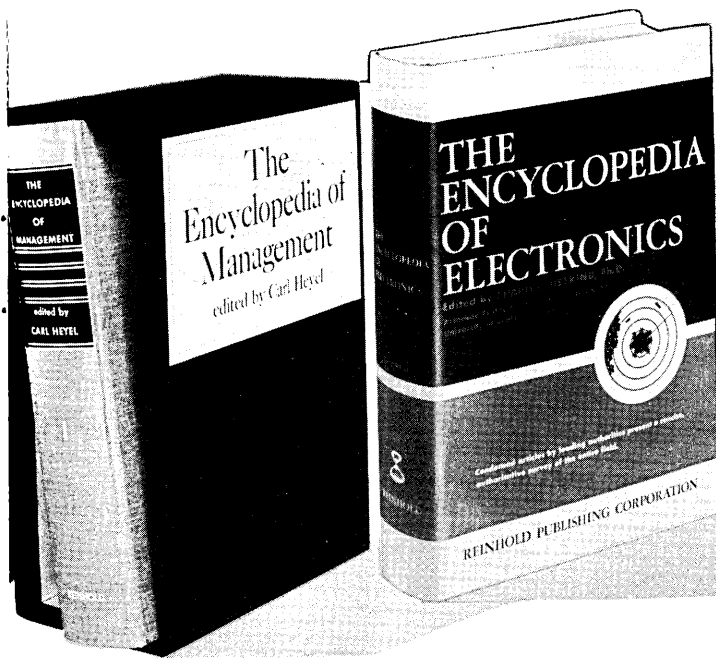

### ENCYCLOPEDIA OF ELECTRONICS

Edited by Charles Susskind. The most authoritative survey of electronic science now available. Written by 405 leading specialists. 420 illustrations. 996 oversize pages. Published at \$22.50.

### ENCYCLOPEDIA OF MANAGEMENT

Edited by Carl Heyel. Remarkable reference with over 300 authoritative articles on all areas of management. Over 200 outstanding contributors. Many charts, tables, graphs. Two volumes, boxed. 1084 pages. Published at \$25.00.

### TWO IMPORTANT COMPUTER VOLUMES

**Automatic Data-Processing Systems**, by Gregory and Van Horn, on all aspects of business data flow and control — plus **Computers and Thought**, edited by Feigenbaum and Feldman, on machines that think and their value to science and industry. A \$22.30 value.

fers illuminating discussion of systems analysis and design, the operational aspects of designing and using efficient systems of data handling, much more.  
List Price \$9.75 Member's Price \$7.75

#### Information Storage and Retrieval

By Joseph Becker and R. M. Hayes  
Well-documented and amply illustrated overview of the entire field of the information sciences. Analyzes the overall problems of optimal use of present systems and proposes mathematical methods of quantifying material from diverse sources.  
List Price \$11.95 Member's Price \$8.75

#### The Language of Computers

By Bernard A. Galler  
A cogent and thoughtful overview of the basic character, design, and operation of a computer language, emphasizing its problem-solving utility and function. Discusses such techniques as: the generation and use of random digits; a program to produce programs; and many others.  
List Price \$8.95 Member's Price \$6.50

#### Recent Developments In Information and Decision Processes

Edited by Robert Machol & Paul Gray  
Wiener, Bellman, Diamond and 13 other leaders in the field report on optimal decision-making techniques such as dynamic programming. Bayesian formulations, ergodic theorem, self-organizing systems.  
List Price \$8.00 Member's Price \$5.95

#### Mathematical Methods for Digital Computers

Edited by Anthony Ralston & Herbert S. Wilf

An illuminating exposition of the most useful techniques of numerical analysis for solving mathematical and physical problems on the digital computer. A book for all those who intend to do any serious work on a digital computer.  
List Price \$9.00 Member's Price \$6.95

#### International Dictionary of Applied Mathematics

Massive new reference that covers all important concepts of applied mathematics . . . of 81 basic branches of physics and engineering. 1177 oversize pages; over 8,000 entries; addendum of foreign terms.  
List Price \$25.00 Member's Price \$14.95

#### Business Data Processing and Programming

By Robert H. Gregory & Richard L. Van Horn  
For the operating executive or systems specialist — a complete survey of equipment, processing, and programming in the flow of business information. With 60 easy-to-follow illustrations.  
List Price \$9.25 Member's Price \$6.95

Special FREE GIFT if you join now!

### The REFERENCE DIARY

of the Library of Computer & Information Sciences

A combination appointment diary and reference guide, this convenient book contains a checklist of key ideas in computers and data processing; a list of over 700 areas to which computers can be applied; a detailed summary of the characteristics of digital computers; a summary of binary arithmetic and related number systems—and much more.

A \$3.95 Value FREE with membership

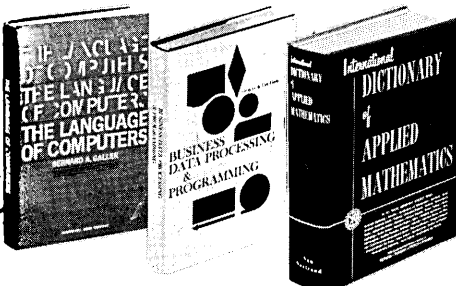
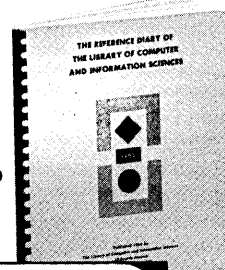

#### MEMBERSHIP FORM

C5.

Library of Computer & Information Sciences  
59 Fourth Avenue,  
New York, N. Y. 10003

Please enroll me as a member and send me—as a Membership Gift—the work checked at right, plus my free copy of The Reference Diary. Also send me the Selection listed at right at the reduced member's price. I need accept only as few as four Selections in the next 12 months, and I will receive a free Bonus Book of my choice after every fourth Selection.

- Encyclopedia of Electronics
- Two Computer Volumes
- Encyclopedia of Management

First Selection \_\_\_\_\_

NAME \_\_\_\_\_

ADDRESS \_\_\_\_\_

CITY \_\_\_\_\_ STATE \_\_\_\_\_ ZIP CODE# \_\_\_\_\_

Please be sure to indicate zip code clearly.

Payment enclosed. (We pay postage and handling charges.)

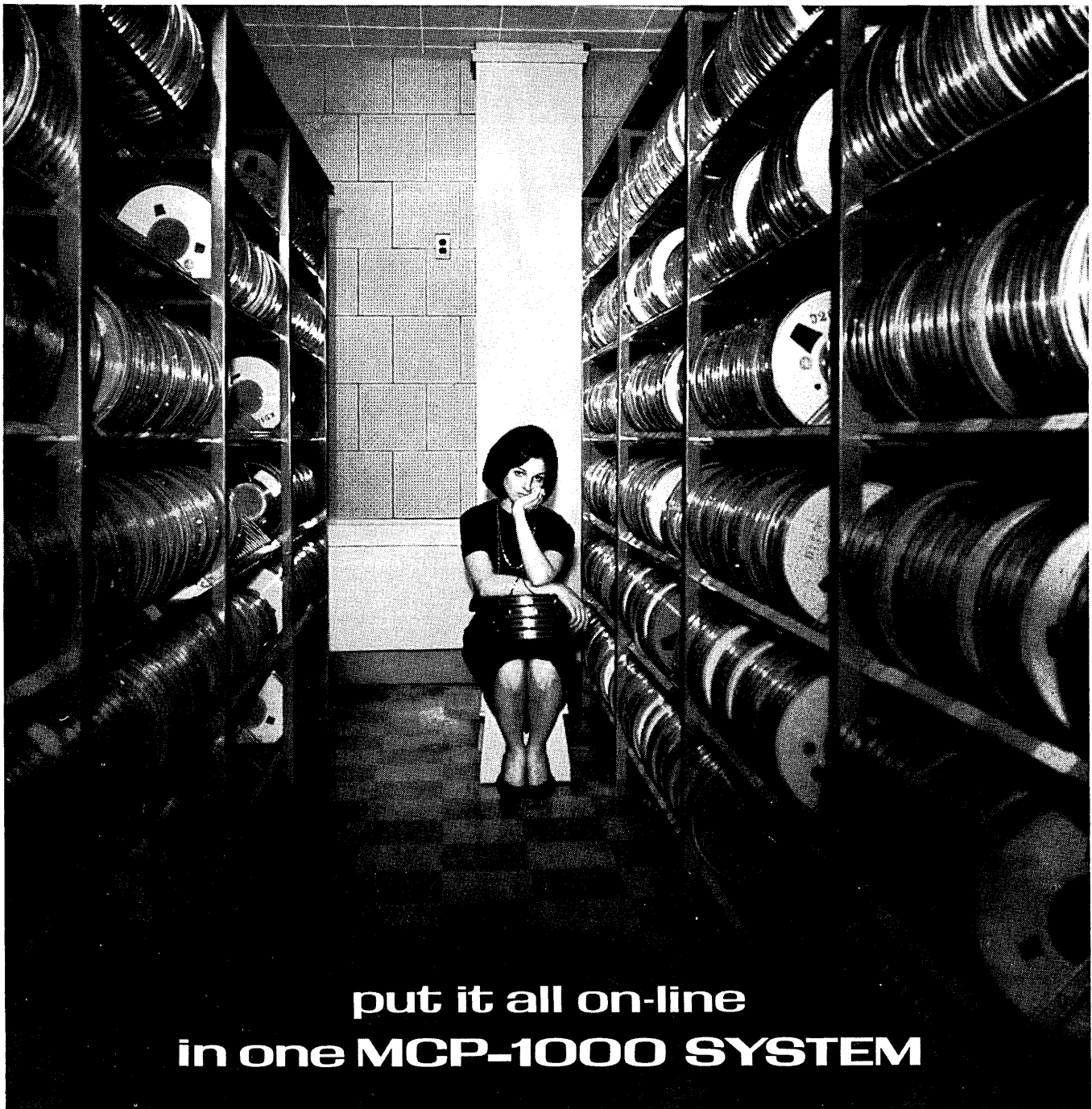

**put it all on-line  
in one MCP-1000 SYSTEM**

Up to 156 billion characters,  
or the equivalent of 15,000  
reels of tape . . . with four  
megacycle readout rate . . .

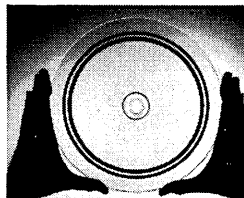

**Photostore Disc**

Available as an auxiliary mem-  
ory or free-standing with the  
MCP-1 Memory Centered  
Processor . . .

People with tapes only get in the way of Itek's new data processing system — the Memory Centered Processor. It offers 100 times more mass random storage capacity than ordinary memory systems. Unique photo-discs store so much data that your entire storehouse of magnetic tapes can be placed ON-LINE in one MCP Digital Library Unit. Each disc holds information equivalent to two reels of tape (25 million characters), and once in reading position offers 15 millisecond average random access. The serial readout rate is four million bits per second. The MCP System

delivers any record in a trillion-bit file in 2.5 seconds maximum, and any queued ("look-ahead") record in 250 milliseconds. You will soon be able to see units of the MCP System store, search, compare, translate, extract, and edit information at Itek's New York Information Processing Center. To visit the Center or to obtain information about our lease/purchase plan for auxiliary mass memories or the MCP System, write



**Itek Corp., Digital Data Systems Division, 10 Maguire Road, Lexington, Massachusetts 02173, Tel. 617-862-6200**

Circle No. 7 on Readers Service Card



# THE INTERNATIONAL IMPACT OF COMPUTERS AND AUTOMATION

*Edmund C. Berkeley*  
*Editor, Computers and Automation*

As the Third Congress of the International Federation for Information Processing opens in May 1965 in New York, it may be worthwhile to reflect on the force and direction of computers and automation all over the world, both now and in the probable future.

## **Magnitude of the Force**

In the twenty years since 1945, the total number of large-scale sequence-controlled calculators (1944 language) or automatic computers (1965 language) installed and operating has gone from two or three to more than 25,000. The computers made to date represent probably an investment on the order of fifty billion dollars. The number of computers will soon be more than 50,000, and is likely to rise continually for many years.

In fact it is not unreasonable to draw an analogy with the rise and development of the automobile, which amplifies the traveling power of man's body, and contrast that with the computer which amplifies the thinking power of man's mind. In an advanced industrial country the number of cars is probably between 10 and 30 per hundred persons. It is reasonable to expect that eventually the number of computers will be in about the same range, between 10 and 30 per 100 persons.

## **Directions of the Force**

When we look at the directions of the force of the computer revolution, they seem to be in almost all directions at once, like an explosion. For the computer is a universal instrument, like language, writing, or books.

An inventory of applications of computers is published in the Computer Directory issue of *Computers and Automation* in June of each year. The 1964 list enumerated more than 700 applications, and in 1965, the list will enumerate more than 800 applications of computers. But in years to come it may appear foolish to publish such a list, since it

will go without saying that computers like books will apply anywhere!

## **Why?**

Thirty years ago who would have forecast that such a revolutionary development as the automatic computer (and its application to guide automatic machines, which may be called automation) would have taken place?

Why has this happened, and why has it happened in this century?

Looking backward, it seems clear that all the necessary ingredients were present: punch card calculating machines; electronics for radio and radar; the analytical engine concepts of Charles Babbage and others; the early calculating machines like the planimeter and differential analyzer; and the pressing need for large quantities of calculation. The electronic computer ENIAC built at Moore School of Electrical Engineering in Philadelphia grew out of these ingredients.

The revolution was enabled to take off and rocket upwards because of the level of engineering in this century. This achieved great reliability, great speed, and great capacity.

And so most of the time now, people do not need to put up with arm-chair solutions to difficult problems: instead the answers can be calculated. We are traveling swiftly towards the point where most of the language of thought will be calculable like mathematics.

## **A Million Times Faster than Previously**

It may be argued that computers "can do nothing that we cannot do ourselves." This argument has been well answered in an article "Impact of Computers" in the *American Mathematical Monthly* for February 1965. In it, Richard W. Hamming of Bell Telephone Laboratories, a former president of the Association for Computing Machinery, says:

"Another argument . . . that (computing) machines can do nothing that we cannot do ourselves . . . is true, but also false. It is like the statement that, regarded solely as a form of transportation, modern automobiles and aeroplanes are no different from walking. . . . The reason the statement is false is that it ignores the order of magnitude change between the three modes of transportation: we can walk at speeds of around 4 miles per hour, automobiles travel typically around 40 miles per hour, while modern jet planes travel at around 400 miles per hour. Thus a jet plane is around two orders of magnitude faster than unaided human transportation, while modern computers are around six orders of magnitude faster than hand computation. It is common knowledge that a change by a single order of magnitude may produce fundamentally new effects in most fields of technology; thus the change by six orders of magnitude in computing has produced many fundamentally new effects . . . that are being simply ignored when the statement is made that computers can only do what we could do for ourselves if we wished to take the time."

### **Future Trends**

The changes that have already happened because of the computer revolution are relatively few as compared with the changes that almost certainly will take place in the future. These changes will result from present visible and conspicuous trends in the field of computers and automation. Among these trends (besides those mentioned already) are:

1. The cost of computers will decrease greatly, yet their power will increase.
2. Direct communication among computers will increase greatly.
3. The difficulty of programming computers will decrease greatly.
4. Automatic machines equipped with guiding computers (automation) will increase very greatly.
5. The input/output channels of computers will become much more varied and flexible than they are today.

These trends can be relied upon to keep operating because of big advantages to be gained and the intense forces of competition in the computer field. Eventually, limitations from natural laws will operate for some of these trends. For example, the speed of transmission of information inside a computer is limited by the speed of light. But we are still a long way from being stopped by these limitations.

### **The Application of Computers to Projects Crossing National Boundaries**

An obvious world-wide area in which computers can be expected to make great contributions is in the solving of engineering and environmental problems which affect two or more nations.

For example, at the present time, a joint development program involving the Mekong Delta in South East Asia is being pushed. Four countries are affected, Cambodia, Laos, Viet Nam, and Thailand. Since this is an engineering problem, and there is basic scientific agreement on what needs to be done, here is an application for computer calculations.

Another world-wide area in which automatic computers will make a contribution is the control of the weather. Of course, control of the weather has happened so far in only a limited way, for example, with silver iodide smoke generators. But as scientific understanding of the weather and computing capacity increase, this achievement ought to become possible; and the advantages of permanently curing droughts and floods, providing the right amount of rain at the right times, are so vast that it is likely that nations will agree to delegate part of their sovereignty in order to produce these good results.

Many more problems involving two or more nations and the allocation of resources in equitable ways will be resolved by solutions produced by computers. The application of complicated formulas with great quantities of data is one of the particular types of problems made to order for a computer.

### **The International Flow of Skills**

Already technical treatises written in one country enable persons in other countries to learn and profit from the technical information contained. Similarly, but with an important added gain, computer programs written in one country and incorporating novel skills can spread to other countries, enabling the same new skills to be used there also without human learning. We can predict amazingly quick progress in the use of new skills, as the magnetic tapes expressing them pass from one country to another.

### **Libraries and Information**

We can expect a great development of communicating facilities between persons who want certain information and resources which contain the information. Libraries everywhere will become electrically accessible via computer and communication links. Such transfer of information will be both national and international. The international pooling of information and literature can eventually become very large and very useful.

### **International Economic Planning**

Computers can also apply usefully in economic planning between nations, for example, in a trading group such as the Common Market or the European Free Trading Association. Through computer calculations using techniques such as input/output analysis, the countries can decide which resources and goods they should import and export and which they should strive to produce or manufacture for themselves as efficiently as possible.

When this kind of economic planning later becomes extended on a world-wide basis, one can envision a world-wide trade association helping to guide and increase world-wide trade with the aid of computers. This would lead towards a degree of economic planning and allocation of resources and manufacturing power among national and private interests, so that economic prosperity would be increased for all, and presently less developed nations would much more rapidly achieve higher standards of living for their people.

### **The Reconciling of Conflicts**

It seems to me, however, that one of the largest contributions that can occur from the use of computers in the international field is in the reconciling of conflicts. Conflicts mean waste, destruction, and often death. They have two basic sources: reason and emotion. Emotion stars in the old proverb: "there are none so blind as those that will not see"; and reason stars in the old proverb: "where there is a will, there is a way." There comes a time in many conflicts when emotion like a flame dies down and starts to go out; a desire to settle the conflict and get on with other business develops; and the stage is then set for reason. Each contender then often finds that the information that he has been using is woefully different from the information that the other contender has been using; they should be able to call on computers to put together an acceptable joint basis of factual information, and a variety of proposals for settlement of the conflict. It would be highly desirable that the negotiations and treaties that end conflicts should be as good as possible, so that they do not, if possible, lead to more conflicts in the future. Such a requirement means a thorough

(Please turn to page 21)

# SMALL COMPUTERS: A BILLION DOLLAR MARKET BY 1970?

*Rudy C. Stiefel*  
President  
Infotran, Inc.  
New York, N. Y. 10021

During the last two decades, computers have become larger and faster. Some of the top manufacturers fight for the honor of having the "fastest" or the "largest" computer in the world.

The trend is now reversing quietly. More and more, customers ask, "How small a computer can do my job?" This partly reflects the much-heralded miniaturization of electronic components but also, and more fundamentally, the transition of the computer industry from a pioneering status to one with a sound economic basis where profitability and low cost are paramount. It also represents the transition from "centralized," high-priced units to "decentralized" computers and systems—thus opening a potential mass market.

What accounts for the advance in small computers? Primarily it is the trend toward automated circuitry lowering production costs of logical components and their connections, and the resulting ability to mass-produce entire arithmetic functions and units.

While previously an arithmetic unit was a major investment and everything had to be designed around it—due to its complexity and expense—it is now usually overshadowed in business applications by the input and output considerations. Now it is possible to economically produce multiple arithmetic units allowing individual computations to be done in parallel and in different locations.

## **How Small Will Computers Become?**

There is no definite limit in sight at this moment to how

small computers will become. In computer technology, small currents are usually sufficient to produce correct and useful information; and smallness often implies economy. Computers are already small enough to become a part of such mundane devices as cash registers, time clocks, typewriters, and other mass-produced machines.

Computer circuitry will eventually be a part of so many devices that people will often be unaware of its presence. However, the dimensions of computer circuits will not diminish continuously. While there are good reasons to decrease the dimensions between components or their "deposited" equivalents as computing speeds increase, optimum dimensions will eventually evolve which will allow reasonable speeds while still providing efficiency in production, checking and maintenance. Also, for thermal reasons, a decrease in dimensions is usually accompanied with a decrease in computing power, thus decreasing signal-to-noise ratios. While some of the "noise" is "home-made" within the computer, a limit eventually will be reached below which it is not economical any more to shield the minute signals from outside interference.

Considering all the pros and cons regarding miniaturization, the circuitry will probably settle on flat configurations of sufficient size to be easily handled with simple, common tools and to be readily recognizable by the unaided eye. The flat, "two-dimensional" shape maintains minimum volume, yet allows ample and effective space for connections.

## How Slow Will Computers Become?

Until recently most manufacturers of computers were concerned with how fast a computer could work. The bulk of future users, however, could hardly care less about the internal computing speed. All they are concerned with is the question: Can the device or the system do my job more efficiently and economically than it is being done now? The answer must naturally include the consideration whether the data processor can keep up with the problem or not. However, most systems are expected to be input/output limited, and the presently current computing speeds appear more than ample to cover future mass-use requirements.

The computer industry will probably gravitate toward a most economical speed range somewhere around 10 megacycles. This avoids most of the problems created by the "finite" speed of transmission (speed of light) and the fact that at higher frequencies, the signal energy radiates increasingly from the prescribed path, rather than traveling along it. While the former may be good for broadcast communication purposes, it is diametrically opposed to the very idea of a "logic machine." High computing speeds will also be achieved increasingly by paralleling "slow" units as the cost of mass-produced hardware decreases.

## The Automobile and the Computer

It may be interesting to draw an analogy between the development of the automobile at the beginning of this century and the computer industry today. Early in the century, it was still thought that the faster a car could go, the better it was. The later years showed however that high speed capability, while desirable, was neither significant nor did it determine who was to survive in the automobile industry and whose name would be only of antique value. But, more importantly, while top speed became relatively unimportant in the subsequent development of the auto industry, the introduction of a mass-produced car that everyone could own and operate signaled the start of one of the biggest industries to date.

## The Role of Data Communications

"What good is a wealth of information if you don't tell it to someone who can use it?"

This well-known rule taught in many human relations classes also applies to computers. It is a rare case that the information which a computer provides is useful right at the computer. Maybe it has to go only to another room or department but, increasingly, computer output is used in several places, some of them at a great distance.

The same is true for the input information on which the computer bases its operation. It, too, is likely to come from many and distant sources. Therefore data communications and data processing will have to develop closely together. For small computers, the increasing availability of data communications will be a vital lifeline that will make decentralized computing possible and advantageous.

In connection with this, it may be useful to point out the significance that satellite communications will have for data processing and computers. In the past, the limited frequency spectrum available for long-range communication was always a spectre hanging heavily over the prospects of future expansion of data communication. With satellite communication almost a certainty in the next few years, this basic limitation has been all but removed. With its narrow beams and very high carrier frequency and straight-line transmission not being a disadvantage anymore but an advantage, there seems to be no limitation in sight to the amount and speed with which computers, small and large, may be able to talk to each other in the future.

## How Much Programming?

Some experts believe that within ten years the sales volume of special-purpose small computers will exceed that of the large general-purpose machines, since the market for the small data processing devices is much larger than for the multi-million dollar machines. The key to the mass market includes the ability of the computer to be operated directly by personnel with not more than a few hours' instructions and, by implication: A great reduction in programming effort.

Not all manufacturers agree with this expectation. Some feel that the versatility achieved by the stored programs of the larger machines will lead to systems so capable and so fast that they can handle all requirements, particularly with the aid of "super-programming" and data communications. But the cost of programming is likely to remain high and data communications will always remain a high-priced item in data processing.

Another vital ingredient of the small computer for the "small business" must be the ability to "see what you are doing" while it is being done—not only after it has been done. Increased visibility of the results immediately after, and perhaps during, each operation, with the opportunity to introduce choices and changes, will be vital to the important non-professional future user of these computers. The trend will therefore be toward easier programming—not requiring a professional or highly-trained person. Such computers will therefore be more specialized, and will have fewer programming (software) choices. However, manufacturers may continue to avail themselves of many of the hardware and software means of furnishing different computers based on the same production lines.

## Expansion in Both Directions

While the efforts towards making computers more capable, faster, and often larger, will continue, the trend in the opposite direction, namely, to make computers smaller, will become of increasing importance.

Many manufacturers are working on small computers to be ready for the mass market. IBM, for example, is attacking the problem from both ends by making larger computers smaller and—by making their electric typewriters more intelligent, such as in the IBM 632. The IBM 6400 for small business use and the IBM 1130 for engineering and scientific applications represent efforts in the direction of smaller computers penetrating a new market. Also, Friden, a maker of desk calculators of long standing, has announced all-electronic desk model computers.

Litton's Monroe Division, strengthened by the newly-merged Royal McBee Company, is also making desk-size computer systems. Smith Corona offers a low-priced, versatile data processor. Digital Equipment Corporation, as well as several smaller companies—including some foreign ones—offer computers in the "below \$5000" range or have designs for such computers in the making.

## "Common Carrier Computers," or "Local" Computers?

Much attention is being given now to the possibilities of using powerful, central computers in "utility type" arrangements, similar to the organization of electric power and communications companies, or common transportation systems. The well-known advantages of common carriers in these fields are: Improved usage and availability of equipment based on statistical considerations and higher-grade service which specialized companies can give over that of the occasional user. While the widespread "Service Bureaus" make use of these advantages, it is not likely that "electronic access" to these central facilities will prove equally economical or practical.

There are basic differences between "computer utilities" and "power utilities" providing communications, transportation, etc. The latter are based on much larger investments in equipment and real estate than even a large computer represents. Computer hardware rarely requires more than a few million dollars in purchase cost, can usually be conveniently rented, and is relatively easy to move and to establish at any location. Furthermore, the price of the actual computer hardware is going down and will decline much further as automated circuitry will be used more extensively. In addition, the present power utilities do not simply sell the use of their equipment, but furnish the necessary "transportation" of a commodity—be it power, people, materials, or information. Computation, as such is not necessarily connected with long-distance transportation, though when it is, it usually uses a common communications carrier for this purpose.

Since the price of communications will remain relatively high, the mere saving of the computer purchase price and the training of the operators can generally not make up for the difference. In addition, the facilities for time sharing, multiplexing and switching which are required to give multiple access to a computer, are additional costs not necessary in "local" computers. Furthermore, local computers often allow "on line" operation, thus reducing intermediate storage and generally simplifying the planning and logistics of computer usage.

As a result, it can be expected that local computers will prevail when no communication problem is connected with a computer. An exception will be the occasional user of technical or business computation, who cannot justify acquiring his own facilities. For him the new IBM 1130 with the "quick exchange" disc cartridge file is a distinct advance.

Other applications for central facilities are: automated libraries; credit and financial data centers; and other "pools" of information—which, due to the nature of the stored information, will work better in centralized fashion with public or semi-public access.

### What Will the Future Look Like?

The main growth in the computer field to date has been in general purpose computers, which allowed manufacturers to concentrate on a few types of computers. Also, traditionally, the first computers were used for scientific purposes, with the emphasis on complex and lengthy mathematical operations, which were difficult to solve "by hand."

However, the greatest future potential market for computer-type machines, it seems, will be in special purpose "information devices." In these machines the ability to calculate is secondary and is overshadowed by the ability of information machines to memorize, read, write and transfer data from one position to another. Such systems as production and inventory control, hospital supervision, library systems, census taking, national voting systems, and executive control systems, still await effective instrumentation. These computer systems frequently obtain their inputs or furnish their outputs through data communication channels. General purpose computers are often poorly equipped for this, sometimes requiring an extra "computer" as a buffer and "switchboard."

In the past, it was not generally economical or practical to build such specialized devices because components were not perfected and packaged to be readily usable for this purpose. This situation is gradually changing; in the near future, highly adaptable and self-contained solid-state units will become readily and economically available, opening up a new market for automated information devices. These machines will exhibit less customer-programmed "software" in contrast to factory-built "wares" which can be mass-produced.

### New Applications

Among challenging computer applications that we can look forward to in the near future are:

- Tie-ins between computerized time clocks and payroll machines that enable automatic calculation and recording of hours worked, and the preparation of payroll checks or credit vouchers. The cost of these machines should compare favorably with a bookkeeper's annual salary.

- Cash registers used in conjunction with computers that maintain a perpetual inventory and prepare requisitions for replacing merchandise. Such units will be economical enough even for small businesses.

- Computer devices for "home" use. These may be somewhat further away, but are, nevertheless, as sure to come as did the dial telephone. As a matter of fact, most computing devices at home will start as clusters around the telephone and other communications systems, such as radio, TV, teletype and Facsimile. Some of these devices require wide transmission spectra; their use will be facilitated by the increased communication capabilities that will become available through satellite communication. "Subscription TV" is only one of the more sophisticated services of the future, such as electronically-transmitted newspapers, automatic billing and crediting, banking and buying with instant, written confirmation.

Voting and polling will be done conveniently, frequently and yet securely from the home, thus allowing a citizen to exercise his right and duty to make his opinions known—and be counted. This should take the guesswork out of the present "fan mail" counting and put polling on a more reliable and useful basis.

In the area of communications, computerized teleprinters can store messages until the lines are clear and therefore expedite as well as reduce the cost of current methods. Telephone companies now use computer devices of all "sizes" to make their switchboards more "intelligent." Small computers will find increasing use in brokerage houses, as well as in such advanced areas as Communication Satellite Systems.

The era is therefore near when computing devices will be as common as electric motors, thus making the pioneer scientist's Norbert Wiener's prediction come true: What the motor is to the human muscle, the computer will be to the human brain.

---

## THE INTERNATIONAL IMPACT OF COMPUTERS AND AUTOMATION

(Continued from page 18)

survey of a great number of alternatives, and displaying before the negotiators a variety of impartial and equitable compromises, with their evaluation.

When the heat has died down, this situation is something like the presentation and evaluation of plans before a board of directors. In this area it seems to me that computers can make a steadily more useful contribution in world affairs.

Secretary General U Thant of the United Nations said not long ago "It is no longer resources that limit decisions—it is decisions that limit resources." The computer is becoming our preeminent tool for considering, evaluating, and choosing between decisions.

It would be highly desirable that a committee of distinguished representatives of the computer profession, perhaps selected by IFIP, and a committee of the United Nations should meet together and set up channels by means of which the computer revolution can be made particularly helpful to the countries of the world and the functioning of the United Nations.

# THE FUTURE OF COMPUTERS IN THE FEDERAL GOVERNMENT

*James P. Titus*  
*Washington, D. C.*

In less than a dozen years, the computer population in the Federal Government has jumped from 10 systems to 5,400. Directly, or through its contractors, the Government now finances 30 per cent of all computers in this country at an annual cost of \$3 billion, and this figure does not include military and classified systems.

Such an increase has brought about many problems in the management of computers. Some have been resolved, others are being looked at in Congress and the Executive branch, and still others are yet to be taken up.

Hearings held in the House of Representatives in 1963 and again this year focused attention on the problems of acquisition and use of computers. They precipitated an extensive study by the Bureau of the Budget of the computer structure in Government. This study will have a lasting effect.

In addition to pinpointing problems, the study revealed that there has been considerable improvement in Government computer matters during the last few years. Agencies are choosing computers better; policies have been established for equal and fair consideration of all manufacturers; standards are being developed; sharing of government computers has begun in many cities; and more consideration is given to the relative merits of purchasing and renting computers.

## **How is a Computer to be Defined?**

But much is still to be done, according to the Bureau of the Budget. One problem is how to define computers. The dearth of new equipment in hundreds of configurations, the disappearing line between "scientific" and "business" computers, increased applications—these have all ruled out computer classification by type or cost. Instead, the Bureau of the Budget (BOB) will now use a system that looks at the environment in which the computer operates and the response in time it is required to make (the figure shows these classifications by environment and response with

specific computers shown in the matrix). These classifications will be used for developing policy, guidelines, and criteria.

## **How Should Computers be Used?**

Unused machine capacity is a wide-open invitation to find additional uses for a computer. This happens in the Government, and it has brought about an excess of marginal applications, which are uneconomical, difficult to eliminate, and sometimes the cause of procurement of additional equipment.

The Budget Bureau believes that the decision on uses to be made of computers should be made by agency management—those responsible for mission accomplishment—rather than by equipment or systems specialists. It recommends that management review computer uses to determine if the benefits anticipated in the cost/benefit analysis made before acquisition are being realized and to determine the priority of each application so that marginal applications, if present, are removed.

## **Meeting Requirements for Computer Capacity**

Some of the computer capacity that is excess could be used for sharing purposes. According to BOB, there were 170,000 hours of machine time in 1964 that could have been considered for sharing, although it admitted that not all of it could have been used practically. Despite this excess, agencies spent \$18.3 million in 1964 on machine time and related services from outside contractors.

Organizations that provide these services include non-profit firms, research institutions, educational institutions, consulting firms, firms specializing in equipment operation or systems design and programming, and equipment manufacturers themselves. These firms are usually called on when peak workloads arise and it is to the agencies' advantage to secure outside help instead of enlarging its own work force for a short time; or when the needed talents are

Environment Category:

	I Professional Support	II Central Computing Services	III Integrated Operations	IV Real-Time Operations	V Research and Development	VI Special Operations
Response Class A — Priority:	Remote-console time-shared systems		•High-Response Inventory Control •High-Response Information Retrieval	•Command and Control Communications •Network Control •Airline Reservations	•Time-Sharing Computations •Engineering Design Modification and Interfacing for:	• Military Systems involving: • Guidance computers • Range Finding Computations • Other "Single Purpose" Uses, with equipment designed and built to meet special conditions
B — Time Critical:	• Experimental and Development Projects	• Engineering and Scientific Data Processing • Digital Simulation	• Off-line Inventory Control and Information Retrieval • Weather Predictions	• Dynamic Simulation • Missile Checkout	• Communications • Display Control • Data Reduction • Increased processing capacity and capability	
C — Scheduled:	• Engineering and Design Computations	• Data Reduction • Scientific Computations • Business and Management Data Processing	• Management and Business Systems	• Range Safety Process Control		

COMPUTER CLASSIFICATION CHART

not available in the Government. The latter case usually arises in systems development and programming.

Several problems are present in the use of contractor organizations, the Budget Bureau said. The services and products produced by a contractor for one agency might often meet the needs of another agency that is contracting for the same thing; some effective means for exchange of information is needed. Potential conflicts are present when manufacturers of equipment develop systems under contract and then bid on another contract to furnish the equipment; some means for objectivity is needed here.

Three recommendations are made to solve these problems:

1. Establishment of an interagency group to study and develop cost principles to be applied by agencies in establishing prices for shared computer time and services.
2. Evaluation of the service center concept by the Bureau of the Budget to determine a proper course of action to be taken.
3. A study of the problems associated with use of contractor organizations with the aim of developing guidelines.

### Selecting Proper Equipment

The study on which BOB's report is based included discussions with both manufacturers and agencies about the complex task of selecting computers. There are two methods used in the Government: in-house evaluations based on examination of EDP literature; and submission of proposals by manufacturers in response to systems specifications laid down by agencies. The latter method is more widely used.

The report lists several disadvantages to manufacturers in the proposal method. Preparing detailed proposals is costly. Agencies allow too little time for response to proposals. Selection is often made without telling the "losing" manufacturers why their equipment was not selected. However, selections on the basis of manufacturers' responses is called sound. Here are the reasons:

It provides the best means for each manufacturer to

present his case on an equal basis with all other manufacturers; the inclusion of system specifications in the request for proposal properly places the emphasis upon the system, rather than upon a simple comparison of hardware; and it helps to prevent biased selections that may be unfair to the manufacturers. While the practice may cause some delay in improving operations, any costs that might be incurred on this account are considered to be outweighed by the checks and balances that this practice provides against what otherwise might be hasty, ill-conceived actions. . . .

Nevertheless, the need to simplify the proposals required of manufacturers is recognized. The preparation of systems specifications on a more uniform basis by Government agencies, and the more effective use of bench-mark problems that are representative of the data processing requirements would benefit the supplier in preparing a proposal, as well as the Government in evaluating the proposals.

Further, the development and eventual use of standard; machine-independent, program languages will greatly facilitate the comparative evaluation of proposals from the standpoint of the manufacturer's total product, including both equipment performance and related programming support. This emphasizes the importance of adequate Federal support of the program of the American Standards Association.

To improve the selection of computers, the report lists three recommendations:

1. The Budget Bureau will publish regulations covering five phases of EDP equipment selection: preparation of system specifications—including bench-mark problems—to be furnished to equipment suppliers in requests for proposals; evaluation of suppliers' proposals; compatibility considerations; consideration of excess and surplus equipment; distinctions between additions, replacements, and modifications when selection policies are applied, and interagency

sharing of experiences in the selection and performance of equipment.

2. The General Services Administration (GSA) should maintain current data on the characteristics and performance capabilities of all items of commercially available, general-purpose equipment that is in place in the Government, available from suppliers, or scheduled to become available. Based on this data, GSA would provide comparative information to agencies.

3. GSA should make available to agencies information on the performance of firms that supply EDP equipment and programming aids—that is: Do they deliver what they are supposed to? Is it delivered on time?

### **Purchase or Rental of Computers**

It has been recommended repeatedly by the General Accounting Office that the Government purchase more computers than it presently does. According to this report, the soundness of this recommendation depends on the ability of the Government to find second and third uses for purchased computers.

The Budget Bureau, as well as other agencies, have two objections. First, it said that there is little chance that equipment could be used "as is" at a second or third installation, because a computer varies substantially within a given model through use of optional features and modifications. Second, it said that most of the computers that could be used again could probably not be released by the current user at the time they are needed by the second user. In fact, it said, most of the computers that the Government has already purchased (an estimated 46 per cent of the total at June 1965) will not be usable again and will have to be junked. Consequently, it recommends against purchasing others solely in anticipation of eventual re-use.

The Budget Bureau is not against computer purchasing, but it said that costs associated with purchase must be proven less than rental costs before a computer should be purchased.

It believes that present policy on purchase and lease should continue, except that interest on loans should be included as a factor in cost comparisons. Provision should also be made for a general suspension of purchase activity on certain computer models when it becomes evident that superior equipment is about to become available, or when potential excesses of Government-owned equipment warrant only temporary rental of equipment, pending the availability of such excesses.

To avoid use of equipment beyond the point of economic advantage, the report said that GSA should develop guidelines on the replacement of equipment. It also said that GSA should study the problem of excess equipment and the problem of maintenance—should the Government maintain its purchased computers or have someone else do it?

### **Contracting for Procurement of Equipment**

General Services Administration annually negotiates with manufacturers for purchase, rental, and maintenance of computing equipment. The Budget Bureau said that this system is not satisfactory to either party. Sometimes the computer manufacturer must "finance" the Government's continued use of rented equipment because the agency is waiting for the manufacturer to submit his offer on the next fiscal year's contract, or GSA is bogged down with EDP contract work. The Government gets no advantages as a volume purchaser even though multiple procurements are made under one contract. Extra use charges for computer rentals cause many contract delays. Both sides become involved in "tactics" over contract negotiations, which causes further delays.

The entire contract system needs tightening, and the Budget Bureau recommends these specific steps:

- All contracts for the fiscal year should be executed and in effect by the beginning of the fiscal year—July 1.

- The time between July 1 and Sept. 15 should serve as a period in which agencies develop and submit to GSA recommendations on changes in the existing contract.

- By Oct. 15, GSA should make available to the manufacturers the proposed changes for the following fiscal year.

- Manufacturers should be required to submit their offers for the coming fiscal year on or before Dec. 15.

- Negotiation of contracts with all manufacturers should be completed by April 30, at which time authorization would be given to all manufacturers for printing and distributing copies of their contracts. Between April 30 and May 31, GSA should develop and distribute to all agencies formulas to be used in computing rental or maintenance payments.

- If a manufacturer fails to submit a contract offer by Dec. 15, agencies would not solicit proposals from him for any equipment to be procured after the following July 1. This would become effective on July 1 and remain so for 60 days plus the number of days after April 30 until a contract is executed (some persons in Washington feel this would have little effect on manufacturers).

- GSA should convene an advisory committee of the major users of EDP equipment in the Government to review any conflicts existing between the negotiators.

- GSA should continue to seek contract improvements, especially with regard to discounts on quantity procurements and optional use periods, including unlimited use.

### **Standardization of Equipment and Techniques**

Differences in computer designs and programming techniques cause numerous problems in the Government. To name but a few: difficulty in making sharing arrangements; restricted placement of excess equipment; limited sharing of computer programs among Government installations.

A related problem, although existing much longer than computers, is the lack of standardization of data elements in common use and the codes used to represent them. Data elements are such things as an item of supply or a person's birth date; codes are alphabetical or numerical representations. If they were standard throughout the Government, the high cost of data conversion would be greatly reduced.

In Government, an immediate goal will be compatibility among computer systems by concentrating first on programming languages and other utilization techniques. Government support of the American Standards Assn. will be increased and the National Bureau of Standards will get more people to test proposed standards and provide guidance in standards development.

The closest Bureau of Budget comes to recommending equipment standards is that it would like to see magnetic tapes standardized with respect to width, speed, recording density, number of channels, and size of the reel.

### **Research and Development in Computer Sciences**

Further research and development efforts are needed from the National Bureau of Standards in computer systems, programs, and computation, the report said. The Budget Bureau would like to see computer-evaluation programs developed and criteria established for evaluation of programming languages.

It said there is about \$135 million spent annually on computer R&D, but the program needs to be coordinated by the Office of Science and Technology.

### **Government-Contractor Relationships**

Contractors, in this sense, are those who use computers in cost-reimbursement contracts, mostly with the Department



of Defense, National Aeronautics & Space Administration, and Atomic Energy Commission. The report said they use as many computers as the Government does and the Government pays for them either directly or indirectly. There has been little attempt to develop policies for equipment used by these contractors, except by individual agencies.

One of the latter is the Department of Defense, which recently proposed an amendment to the Armed Services Procurement Regulations to limit the amount of rental costs chargeable to a contract. Under this proposal, the contractor would be free to either purchase or rent, but if the purchase method were shown to be to the Government's economic advantage, EDP charges would be limited to the amount that the contractor would receive if the equipment was purchased. The report recommends that both DOD and NASA adopt this proposed regulation and that agencies should include equipment operated by contractors in intra-agency sharing plans.

#### **EDP Management Information System**

One of the Government's largest problems in managing computers is that it has not had enough information to know exactly what it is dealing with. There is currently a Government-wide reporting system that requires agencies to submit annual reports on their use of EDP equipment, but this is basically an annual "status report."

The Budget Bureau said that the information system is a matter of high priority and should contain the following information:

- Manufacturers' performance with respect to equipment engineering, maintenance, and program support.
- Productive and unproductive equipment time.
- Operating costs for common Government applications.
- Use of EDP personnel.
- Extent to which the Government uses commercial sources for ADP.
- Contract negotiation and administration.
- EDP equipment used by cost-reimbursement contractors.
- Benefits derived from use of computers.

#### **Organization and Legislation**

When something grows as fast in the Government as computers have, it is bound to shake the organization; the Budget Bureau believes that legislation should be drafted that will remove doubts about who is authorized to do what. Specifically, it has asked for the following:

1. Legislation for joint use of EDP equipment. This would set up a revolving fund for service centers, equipment pools and time-sharing.
2. Legislation to improve compatibility in EDP by implementing Federal standards for equipment and techniques and Federal standard data elements and codes.
3. Legislation to establish a research center on computer sciences in the National Bureau of Standards and to provide advisory and consulting services to agencies on computer systems development and related problems.

This legislation is either in Congress in one form or another, or it is shortly coming. Congress is increasingly interested in what the Government is doing with its computers and it is investigating more facets in each session. This investigation is expected to continue as long as the computer industry displays its remarkable growth and new computing equipment keeps overshadowing the old. Eventually, the Government will learn how to effectively manage its computers, no matter what their make-up or application to the Federal environment. Until then, change will be a way of life for those responsible for computers in the Government. They won't be required to run to keep in place; they'll have to sprint to stay ahead.



## **Couple Your Skills in Real Time Systems System & Compiler Programming Operations Research Computer Languages**

... with a desire to accomplish, through design automation, important technical and business objectives.

Significant new positions are being created at Texas Instruments for those with Ph.D. level skills in electrical engineering, mathematics, communication science, etc. and with three or more years' experience accumulating the required skills. Successful candidates for these positions must be able to direct efforts of highly competent groups with similar skills. Specific duties include:

1. Definition of areas for exploiting the information sciences in process control, process and product optimization, real time process scheduling in the semiconductor manufacturing area.
2. Definition of design problems in the broad area extending from components to systems which can be economically performed on remote-station time-shared computing facilities.
3. Operations research methods in real time for the semiconductor and equipment manufacturing areas.

Please send confidential resume to R. W. Olson, vice president, Special Projects office, dept. C-148

**TEXAS  
INSTRUMENTS**  
INCORPORATED

P. O. Box 5474 • Dallas, Texas 75222

*An Equal Opportunity Employer*

Circle No. 8 on Readers Service Card

# BRYANT

# Model-2

Series 4000

## DISC FILES

See for yourself . . . at the International Federation of Information Processing Congress May 24 through 29—New York Hilton Hotel.

*new programming flexibility!*  
*new Dual/Rapid random access!*  
*new environmental independence!*  
*new on-line maintainability!*  
*new long-term reliability!*  
*new lower cost per bit!\**

\*By "lower" we mean the lowest yet — as low as 0.0075 cent per bit!

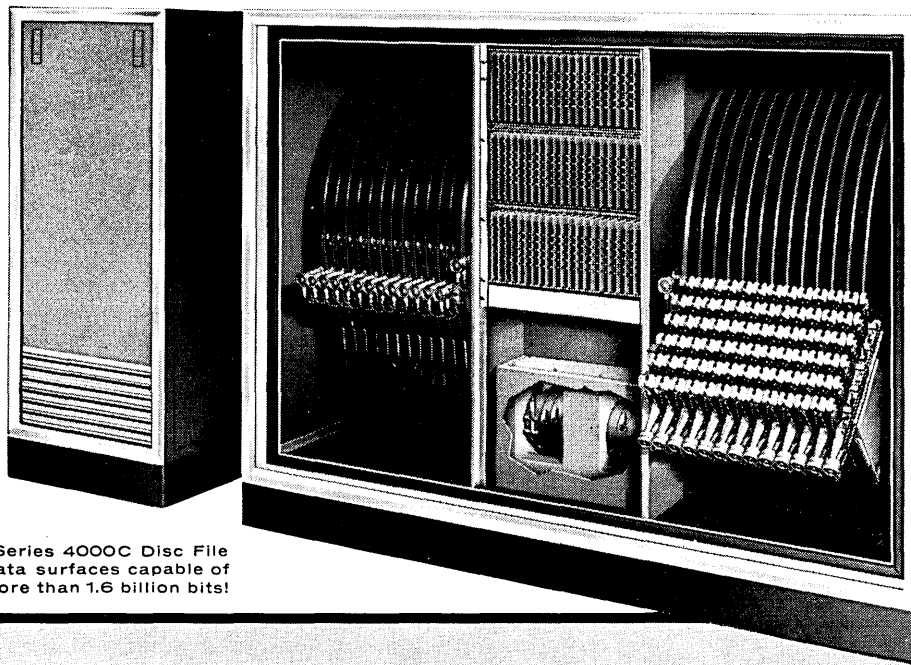

Model 2 Series 4000C Disc File has 50 data surfaces capable of storing more than 1.6 billion bits!

### *More of everything you need and want in a random-access mass memory . . .*

That's what Bryant engineers have built into new Model-2 Series 4000 disc files. And that's what you'll get when you use them with your computer and data processing systems.

For they incorporate all the proven operating principles of their predecessors—the original Bryant Series 4000 random-access mass memories now serving in more than 150 key installations throughout the world—plus a host of advanced new features and options designed to minimize maintenance, extend MTBF, and increase programming flexibility. Specifically, major improvements include:

New Dual/Rapid random access head positioning system that permits independent operation of the two file modules, greatly increases programming flexibility, and can also be used to reduce total access time by as much as 50%.

New self-contained environmental control that maintains both disc file modules at proper operating temperature, cleans circulating air, assures positive internal pressurization, permits unrestricted on-line maintainability.

New electronic interface with all optional read, write and head select circuit modules packaged together in a hinged card rack as close to the magnetic heads as possible.

New fact-filled brochure contains details—want your copy?

## BRYANT

### COMPUTER PRODUCTS

*A Division of EX-CELL-O Corporation*

850 Ladd Road • Walled Lake, Michigan 48088

# REAL TIME SYSTEMS: A COMPLEXITY CHECK LIST

*Robert V. Head  
Vice President  
Security First National Bank  
Los Angeles, Calif.*

## **Early Real-Time Data Processing Systems**

Most of the early real-time data processing systems, which appeared in the mid 1950's, were developed to satisfy military needs and as a class were much larger than the off-line or batch processing systems in operation at the time. One can at present find numerous examples of these large-scale systems applied to military and paramilitary applications. One of the best known is SAGE with its specially engineered equipment devoted to air defense. The BMEWS system for ballistic missile early warning and the Project Mercury system to monitor the astronaut's flights, both of these employing duplexed IBM 7090 computers, provide other examples. These data processing systems had equipment costs in the tens of millions and required program steps in the hundreds of thousands.

Because of the advanced nature of these military systems and their tremendous capacity for generating data immediately useful to the system operators, great interest was aroused within the commercial data processing field in real-time systems. Among the pioneer businesses to adapt real-time technology to their data processing needs were the airlines. There are today several airline reservation systems in being. Although these are not as large as their predecessors devoted to military work, they are generally larger in terms of hardware cost than any data processing systems previously existing within the air transportation industry.

## **Commercial Real-Time Systems**

With the successful adaptation of real-time capability to commercial data processing, it appears that the era of real-

time systems has truly arrived. Encouraged by announcements of new equipment well-suited to real-time needs, such as the IBM 7740 and the GE Datanet 30 communications multiplexors, many companies are now taking a serious look at the possible role to be played by a real-time system in their organizations. Savings institutions, insurance companies, railroads, and brokerage houses are representative of the kinds of companies now either installing or seriously contemplating real-time systems.

Many of the systems being developed today are much smaller than either the military or the airline reservation systems which led the way. For example, the very smallest stored-program processor in IBM's product line, the 1440, is, along with 1060 teller terminals and 1311 disk packs, being widely proposed to handle on-line savings accounting in banks and savings and loan associations. It would seem that the field of real-time system development is rapidly maturing to the point where the applications can utilize the gamut of the manufacturers' product lines—all the way from an IBM 1440 for a savings bank to an IBM 7090 system for airline reservations for a major carrier.

## **System Size and System Complexity**

In light of this expansion, can we say that there is a direct relationship between system size and system complexity, such that the smaller real-time systems will be less difficult to design and install than the larger systems which preceded them?

Unfortunately this is not the case. For there are many factors other than size, whether measured by capacity of the

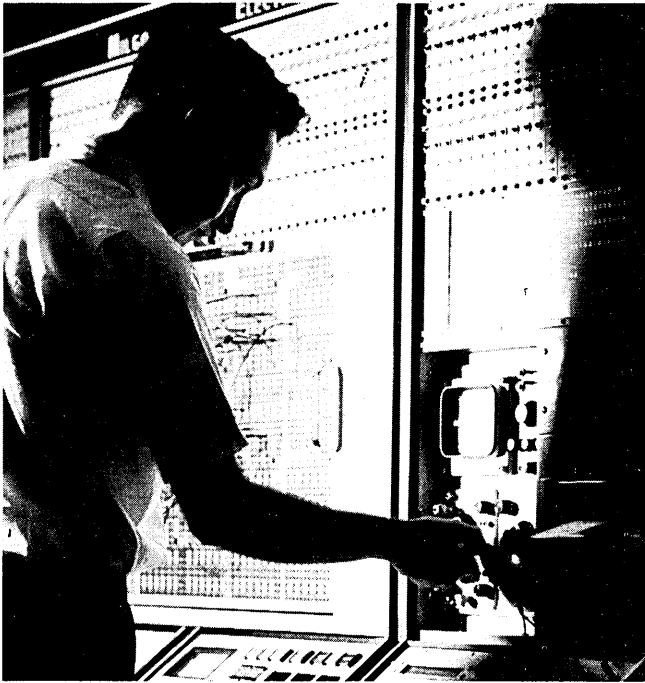

## Your solution may be in better EQUIPMENT

... and the superior performance of Milgo equipment may be your most effective solution. Dependable accuracy is an integral part of all Milgo equipment, and offers you specific advantages in the following areas:

### COMPUTER SYSTEMS . . .

analog, hybrid

### DATA DISPLAY . . .

digital plotters,  
X-Y Recorders  
precision CRT displays

### DATA CONVERSION . . .

analog to digital  
digital to analog

The superiority of Milgo equipment is assured in use by the support of qualified specialists in applications and analysis through the facilities of Control Technology, Inc., a subsidiary firm. This combination of unexcelled hardware and superior software is available to fit your specific need. Write for the full story.

## MILGO ELECTRONIC CORPORATION

7620 N. W. 36th Avenue • Miami, Florida  
Phone (305) 691-1220

Circle No. 14 on Readers Service Card

central processing unit or number of instructions required, which must be considered in determining the complexity of a real-time system. It is important that these factors be fully understood by the prospective user of such a system. Only then can he predict with some confidence the amount of developmental time and effort required to convert his application to a real-time data processing environment.

To illustrate, anyone conversant with programming for real-time systems would agree that a multiprogrammed medium-size system is likely to be more costly to program and take longer to install than a large-scale system that processes its transactions one-by-one. Even though the equipment cost and the total number of instructions required may be greater in the large-scale system, the more complex nature of multiprogramming the medium-size system requires significantly more programming effort over a longer period. A greater investment in programming may be demanded because each individual programmer produces fewer instructions when working in the multiprogrammed milieu. And more time may be needed to develop the system because of the greater complexity of testing in a multiprogrammed environment in which there may be several transactions in varying stages of completion within the central computer, rather than queued up outside the computer as in the case of the sequential processing system.

### The Spectrum of System Complexity

It is evident that system complexity, and consequently system development cost, cannot be determined by size alone, regardless of whether measured by hardware size, program length, transaction volume or similar criteria. A number of specific questions must be answered before a particular system may be placed in its proper position on any spectrum of system complexity.

Following is a set of questions about real-time systems, presented in checklist form. The more "yes" answers which the prospective user of such system can supply, the more complex his system is going to turn out to be, and the more demanding of time and manpower to make it a reality.

#### 1. System Availability

This set of complexity questions has to do with the extent to which the system must make itself available to its users. Questions about system availability relate to reliability of the equipment, its error-checking ability, and its over-all capacity for performing the application processing in a prompt and satisfactory way throughout the period in which processing is required.

- Is a lengthy period of sustained operation required, such as 24 hours a day, 7 days a week, 52 weeks a year?
- Must elaborate error detection and correction features be engineered or programmed into the system?
- Must a method of protecting vital file records be developed so that such records will continue to be available in the event of system malfunction?
- Can a degraded level of service be tolerated in case of partial system unavailability?
- What are the consequences of the system going down:
  1. Is it easy to revert to a manual or semi-automatic system?
  2. Can operations be resumed immediately when the system becomes available, or must there be a special recovery mode to update records, reactivate files, etc.?

#### 2. System Variability

Under this heading are questions about the nature of the application being placed on the real-time data processing

system. Some systems will exhibit little volatility once they are converted; but most will require modification and expansion that should, insofar as possible, be anticipated when the system is first designed.

- Is the application unique; i.e., is this the first system of its kind or the first one utilizing new equipment or programming solutions?
- Can the application be expected to grow significantly in volume over the projected life of the system?
- Is the application highly susceptible to changes in government regulations, industry standards, company policy, or competitive practices?
- Are there other applications that management may wish to add to the system?
- Can additional equipment, programs, or capacity be added to the system in a non-disruptive fashion?

### 3. Input/Output Characteristics

There is great variety in the kinds of input/output\* devices available today. General-purpose terminals with numeric and alphanumeric ability, special-purpose terminals, punched-card and paper and magnetic tape transmitters, and devices for transmitting analog signals are some general types of real-time input/output equipment. And there is even greater variety in the way in which this equipment can be employed in various systems. There are, for example, "conversational" modes, in which an operator makes an entry from a terminal, then awaits the computer response before taking further action. At the opposite extreme is the closed-loop approach in which data is obtained and processed automatically by the system, largely bypassing the operator in the decision-making process. Many questions need to be answered in determining system complexity in terms of its input/output.

- Are the messages or signals variable in length?
- Are the incoming messages or signals generated asynchronously rather than upon some dependable cycle or schedule; i.e., based upon the arrival of customers at a counter or some similarly uncontrollable terminal environment?
- Must the system accept all input as it is generated or can the receipt of input be controlled by such means as polling?
- If human operators are the source of the input, does the system permit great latitude in the format and syntax of the input submitted?
- Must the input be thoroughly edited and validated by the computer prior to processing?
- Are there stringent response-time requirements, if this is the kind of system where each input elicits a response?
- Does the system generate unsolicited output to the terminals; i.e., does it produce messages that are not responses to inquiries and that may be of a priority which necessitates interruption of work in progress at a particular terminal?

### 4. Communication Characteristics

This group of complexity questions is closely related to the preceding one of input/output, but focuses more upon the difficulties of delivering the data from source to processor and back to source again if need be.

- Is the system geographically dispersed with remote ter-

\* Most real-time systems people refer, as a matter of convention, to "input" as data generated at a terminal and "output" as data generated by the computer.

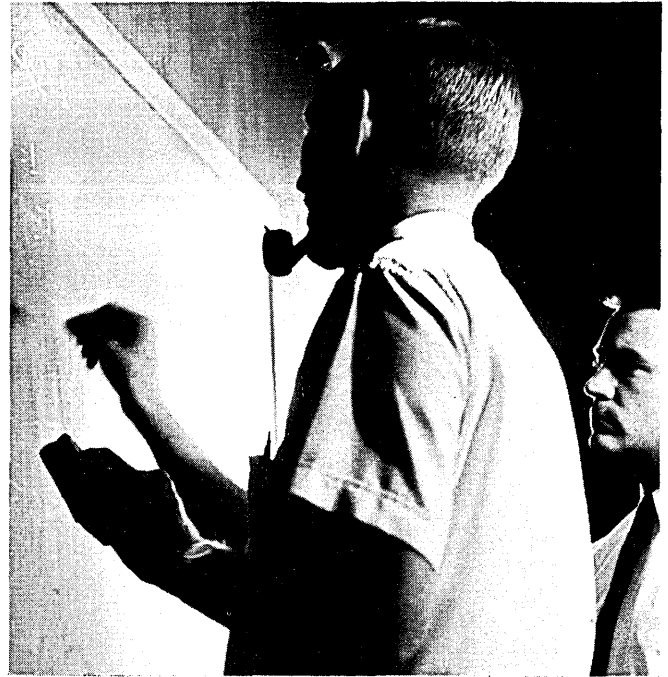

## Your solution may be in better ANALYSIS

... and systems analysis by CTI specialists may offer the most direct solution. Their evaluation can provide you with a sound, logical base for technical decision. The CTI technical staff combines the skills of highly qualified specialists in mathematics, physics and engineering, with extensive experience in the following areas:

**COMPUTER APPLICATIONS . . .**  
analog, digital, hybrid

**CONTROL THEORY . . .**  
research and applications

**PROGRAMMING**

**SYSTEMS ANALYSIS AND SIMULATION**

**TECHNICAL EDUCATION**

This experience can help assure the on-time completion of your project. CTI's computation centers are equipped to provide modern facilities for your occasional or peak demand.

For further information write or call: Dr. Albert Jackson,

## CONTROL TECHNOLOGY, INC.

Long Beach, California.

Phone (213) 433-3360

(a subsidiary of Milgo Electronic Corporation)

Circle No. 18 on Readers Service Card

minals or possibly even interconnected processors remote from each other?

- Are there peaks and cycles in the communication volume that must be smoothed out by queuing data at the central processor or multiplexor?
- Are there differing transmission speeds for various parts of the system?
- Does the system include a large number of terminals?
- Are there several different kinds of terminals in the system?

## 5. Processing Equipment Features

In this category are collected questions pertaining to the complexity of the equipment in the system, and more especially the equipment at the central processing site. The fact that multiplexors are employed in a system or that a duplex or other interconnected configuration is proposed certainly should not be felt to constitute an indictment of the system as a poorly designed one. It is necessary, however, to recognize that such a proliferation of equipment is contributing to system complexity.

- Is much of the equipment newly designed for this application?
- Are there extensive modifications required in existing equipment?
- Are there interconnected computers?
- Is there a stored program communication multiplexor?
- Is this a duplex system; i.e., one possessing both an on-line and a standby computer?
- Are there random access storage devices attached to the system?
- Is there more than one type of storage device?
- Is a large volume of storage needed by the system?
- Is this a system in which two computers share a single file?

## 6. Programming Features

The real-time programs must actually be weighed for complexity of two kinds: (1) developmental complexity and (2) operational complexity. Developmental complexity is the result of performance requirements and equipment features which add to the difficulty of planning, writing, and testing the programs. Operational complexity describes those programming features of a system that, once operational status has been achieved, contribute to the cost and difficulty of running the system. However, since most programming features must be classified in both of these categories, the questions below do not make a distinction.

- Is the system multiprogrammed; i.e., will there be several transactions in varying stages of processing inside the system at any one time?
- Can all programs be kept in the computer memory or must some be called in from file storage upon demand?
- Are there processing priorities to be controlled by the programs?
- Is fallback to a degraded level of service programmed in whole or in part?
- Is recovery from fallback programmed in whole or in part?
- Must a special programming language be developed for the system or an existing one modified?
- Must the programming staff learn how to program more than one computer?
- Are there many restrictions on program preparation, such as length of program, efficiency of program, etc.?

## An Example of Comparison of Two Real-Time Systems

Keeping these complexity questions in mind, it may prove instructive to contrast two types of real-time systems

currently receiving considerable attention. We shall see how the answers to certain key questions serve to differentiate these systems in terms of their complexity. Let us consider a typical airline reservation system and a typical savings bank system:

1. The airline system must operate 24 hours a day or on some schedule almost this demanding. The savings bank system need operate only one shift five days a week.

2. It is more difficult to revert to manual operation in the reservation system when the central computer is down. In the savings bank system the teller terminals can be used as off-line window machines and operations can continue—at least for a while—without great disruption while the computer is unavailable.

3. Input is less controllable in the airline reservation system, which typically possesses typewriter input/output capability as part of each terminal device. This gives the reservation agent the opportunity to send alphanumeric messages to the computer which must then be assembled and edited. In contrast, the entry format on messages from a teller terminal is more restricted and controlled because the data is numeric only.

4. The airline reservation system is widely dispersed, with terminals in some systems distributed on a nation-wide or even a world-wide basis. The typical savings bank system may not even require a communications network, with all its equipment (both terminals and central computer) housed under one roof and cable-connected.

5. The airline reservation system usually has to communicate with and control hundreds of terminals—one for each agent position in each city served. The savings bank system normally has to poll and otherwise control only two or three dozen teller terminals.

6. Because the airline reservation system must achieve a sustained level of performance, a duplex equipment configuration is often provided (two of everything at the processing center, with one set of equipment standing by in the event of malfunction of the on-line equipment). The savings bank system, which does not have to be available for as long and which can more easily revert to manual procedures when the computer is down, does not require duplex equipment, and consequently avoids the complexities of planning and programming for switchover as well as the substantial equipment costs.

7. The throughput level (number of entries within a given period of time) in an airline reservation system is such that multiprogramming must be undertaken to permit the processing of one entry while another is waiting for a record to be accessed from file storage. The savings bank system, serving fewer terminals, can permit one entry to be processed through to completion, even though this may mean that the computer sits idle while a needed record is being brought in from file to complete processing of the current entry.

There are, of course, exceptions to the points of comparison just cited. Several savings bank systems, for example, possess a duplex equipment configuration and at least one airline reservation system is not multiprogrammed. But in the main these differences are valid. They are presented here, along with the complexity factors upon which they are based, to suggest the importance of making distinctions among real-time applications, instead of assuming that all such installations must be highly complex or that there is a necessary conjunction between size and complexity.

## Reference

"Real-Time Business Systems" by Robert V. Head, published by Holt Reinhart and Winston, New York, N. Y., 1965, 384 pp.

When the job is too big for this...

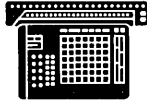

and this is too big for the job

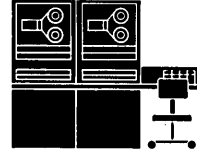

**The WYLE Scientific**  
**More than a calculator – Almost a computer**  
**... with unlimited, externally-stored**  
**automatic input,**  
**\$4350**

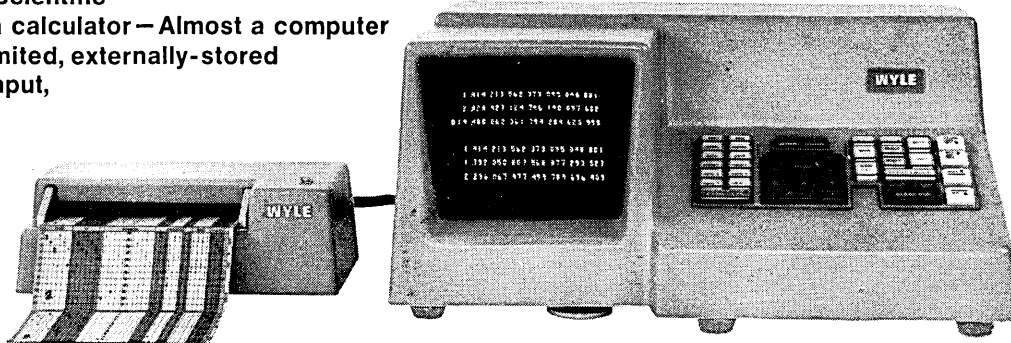

WORLD'S MOST ADVANCED DESK-TOP COMPUTATIONAL CENTER, the WYLE *Scientific* offers almost unlimited application in the solution of complex scientific, engineering, and statistical problems. Yet it is easier to operate than a calculator; takes up about the same desk space as an electric typewriter; solves problems with speed approaching that of a computer; operates with the quiet, and reliability of all-solid-state electronics. And its cost amortizes over a three-year period at less than \$1 per working hour.

THE ONLY DESK-TOP MACHINE WITH UNLIMITED STORED-PROGRAM AUTOMATIC INPUT, it eliminates all the wasted time of multi-step repetitive problem solving. It can be programmed with a ballpoint pen to perform all your recurrent computations automatically, regardless of length, through its card reader. Typical calculations you can program include the development of any trigonometric functions; any exponential functions; statistical analysis;  $\log_e x$  and  $\log_{10} x$ ; antilog  $x$ ; radix conversion; cube root; polynomial evaluation. For *any* program, you simply punch in your instructions by hand on a Wyle stored program card, which has the *Scientific* keyboard reproduced on it, and enter the variables through the manual keyboard. No computer training, "language," or special equipment is needed to develop a complete library covering your repetitive formulas. Any number of cards can be taped together to feed continuously into the reader the lengthiest computations. And preprogrammed Wyle cards are available covering a wide area of problem solutions.

The *Scientific* can be very effectively used for computer program formulation and checkout. It is particularly valuable when determining the requirement for double precision programming.

**NEVER BEFORE CAPABILITIES LIKE THESE**

The contents of all registers are displayed, on an eight-inch cathode ray tube, as indicated in the following diagram.

0 000 000 000 000 000 495 582 441	Multiplier-Quotient Register
000 000 004 512 000 000 000 000	Entry Register
000 000 000 000 000 495 582 441	Accumulator Register
000 000 000 001 414 213 562 373	Storage Register 1
000 000 000 001 732 050 807 568	Storage Register 2
000 000 000 002 236 067 977 499	Storage Register 3

All parts of a problem are visible. The contents not only of the three active arith-

metic registers, but also of the three storage registers are displayed at all times. Numbers entered from the keyboard are seen as they are entered and can be verified before use.

Transcription errors are eliminated through complete versatility of transfer from any register to any other without loss of desired data.

All registers handle 24-digit numbers to provide extreme numerical precision.

Decimal points are entered as they occur in the numbers, using an eleventh key, and all input and answers are correctly aligned with decimal point on the output display.

Automatic square root is provided, as is single entry squaring.

These capabilities, combined with stored program automatic entry, for the first time fill the technical and economic gap between calculators and computers.

\$4350 complete with automatic input (PAC)

\$3950 for basic calculator (You can add automatic input later)

For further information, write Dept. T, Wyle *Scientific* Sales, 339 So. Isis Ave., Inglewood, Calif. Or phone OR 8-5671.

**THE WYLE Scientific**

a product of **WYLE LABORATORIES**

Circle No. 16 on Readers Service Card

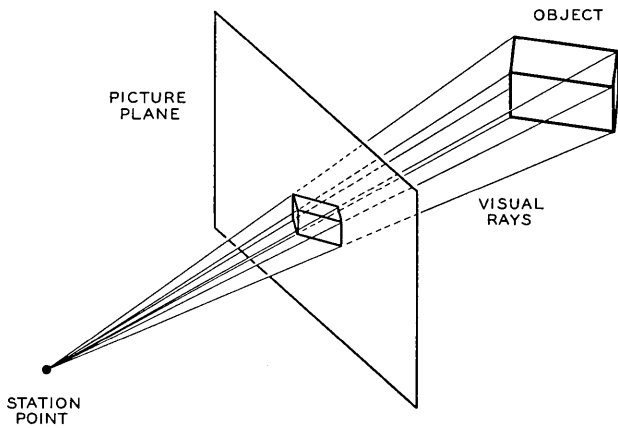

Fig. 1. Perspective projection of an object.

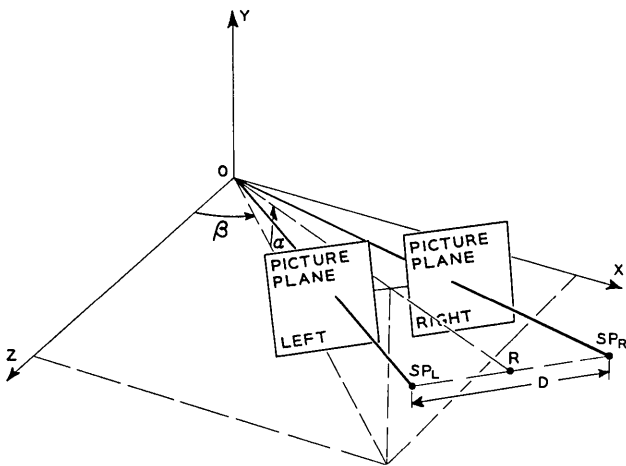

Fig. 2. Pictorial representation of stereographic projection including rotation and inclination of the station points.

The human eye is the receptory organ of an extremely complex vision system. This system has the ability to perceive a brightness range from 10,000 millilamberts to 0.00001 millilambert—a ratio of one billion to one.<sup>1</sup> The images focused upon the retina of each eye are each slightly different, and the brain, by some presently unknown method, translates these differences into an effect which we call depth.

Our depth-perceptive abilities yield much information about our three-dimensional environment. When added to photographs, the illusion of depth becomes a source of considerable realism and excitement; so exciting are these prospects that LOOK magazine sponsored 13 years of research to produce one such picture in mass quantities.<sup>2</sup> However, the illusion of depth also has important applications in the visualization of scientific data. A physics textbook, for example, has used two perspective drawings side-by-side so that a three-dimensional effect is obtained when viewed properly, and anaglyphs have been used in a Hungarian descriptive-geometry text.<sup>3, 4</sup>

A few years ago, psychological research into depth perception was initiated using random patterns that depicted surfaces when viewed stereoptically.<sup>5, 6</sup> These patterns were produced by a digital computer programmed to calculate and automatically plot the stereoscopic projections. The technique depicted only surfaces however, and so was not applicable to the presentation of scientific curves and figures.

The obvious next step was to use the digital computer to calculate and plot stereographic projections of general-purpose scientific data. A computer has been so programmed, and the results are reported in this article. The

# STEREOGRAPHIC PROJECTIONS BY DIGITAL COMPUTER

*A. Michael Noll  
Bell Telephone Laboratories  
Murray Hill, N. J.*

aviation industry has also been interested in computer stereographic techniques, and the results of its efforts have been described.<sup>7, 8</sup>

## Stereographic Projection

The basic technique for producing a three-dimensional drawing is the technique of stereographic projection. This technique consists of producing two perspective drawings corresponding to the images seen by the left and right eyes. Usually the drawing of such perspectives is quite tedious, and in practice various approximations such as isometric, one vanishing point, and two vanishing point projections are used.<sup>9</sup> However, the digital computer is so adept at performing "tedious" calculations that straight-forward methods for producing a perspective can be utilized.

To produce a perspective drawing of an object, it is first necessary to choose some point (representing the eye) from which the object is viewed (see Fig. 1). In descriptive-geometry terminology, this point is called a station point.<sup>11</sup> A plane, more specifically called a picture plane, is inserted between the object and the station point. Projection lines (actually visual rays) are then drawn from the object to the station point, and their points of intersection with the picture plane are connected to complete the perspective drawing.

Since two perspectives are required to produce a stereographic drawing, two station points (one for each eye) and two picture planes must be chosen. The object can be viewed from any angle if an angle of inclination and an angle of rotation of the station points are introduced. Assuming that the object is specified in a rectangular co-



ordinate system, the stereographic scheme can be depicted as in Fig. 2. The left and right picture planes, the left and right station points, and the angles of inclination and rotation are shown. If an object were to be projected stereographically, lines would be drawn from it to the station points. The intersections of these lines with the picture planes produce two slightly different perspectives, corresponding to the left and right-eye images. When viewed stereoscopically, these two perspectives create the illusion of depth. Of course, the computer does not have the ability to physically draw lines from the object to the station points, and so an analytic treatment of stereographic techniques is required.

The derivation of the projection formulas is straightforward, and the formulas will be supplied upon request to the author.

### Stereographic Projection by Computer

If the rectangular coordinates of some point are known, then the corresponding left and right perspectives can be easily computed. The introduction of angles of inclination and rotation of the viewing point makes the computations only slightly more complex. The projection technique is thus reduced to equations that can be evaluated by a digital computer. It is only necessary to represent the object to be projected by straight lines connecting points. These points are given to the computer, along with parameters, and the computer then computes the corresponding coordinates of the points in the left and right picture planes.

The remaining problem is to plot the projected points and to then connect lines between them thereby producing the left and right perspectives. This is a job far too tedious to do by hand; fortunately, an elaborate device manufactured by the Stromberg Carlson division of General Dynamics is available for plotting digital data.

The Stromberg-Carlson SC-4020 microfilm plotter consists primarily of a cathode ray tube and a 35-mm camera for taking pictures of the information displayed on the face of the tube. Instructions for the SC-4020 are written on magnetic tape; the tape is then decoded by the SC-4020 and used to generate commands for opening and closing the shutter of the camera, for advancing the film, and for deflecting the beam of the cathode ray tube. Development of the film produces a 35-mm microfilm transparency which consists of lines connecting points, drawn, in effect, directly under the control of a digital computer. In this manner, the perspective points computed by an IBM 7094 digital computer are used as the input to an off-line SC-4020 microfilm plotter through an intermediate magnetic-tape storage. After photographic development, the microfilm can then be viewed directly in a stereoscope, and the final result is an illusion of depth created by a completely computerized technique as diagrammed in Fig. 3.

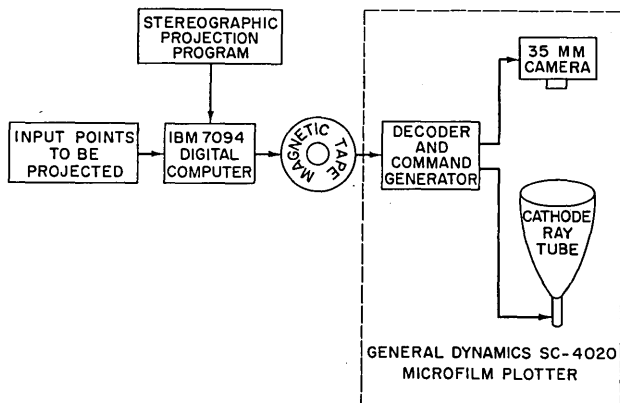

Fig. 3. Block diagram of computer technique for producing stereographic projections.

### Stereographic Projection Program

The preceding paragraphs have indicated that the computer requires only the coordinates of the end points of lines to compute the stereographic projections. The projected points are then used as the input to an off-line microfilm plotter which actually draws lines between them. The command structure of the microfilm plotter has been designed to draw either a single line between two points or a sequence of connected line segments between a set of points. Thus, if all the points are stored in one master array for programming convenience, when they are to be plotted, the proper sets must be unpacked from the projected master array. This can be done conveniently with two subroutines, one to store and pack the coordinates of the points of each set, and a second to actually compute the stereographic projections, unpack them, and instruct the plotter to draw on microfilm the left and right images. Thus, the first subroutine is called repeatedly until all the sets of points to be projected have been packed together.

The functions of the stereographic computing subroutines are indicated in Fig. 4. ARRAY is called to store the coordinates of the points of each set. After all the sets of points have been called, a call to PLOT computes the stereographic projections, using the previously-derived equations. The argument of PLOT specifies the distance to the origin, the interfocus distance, and the angles of inclination and rotation.

Since the size of the microfilm frame is restricted, it is important that the perspectives be centered and scaled in size to adequately fill each frame. Accordingly, PLOT searches for the maximum and minimum of the arrays. The maximum and minimum are used to determine the shifting required to center each perspective in its frame. A scaling factor is also computed and used to scale the perspectives in size to assure that they are neither too big nor too little. PLOT then instructs the microfilm plotter to draw lines between the points specified in the shifted and scaled arrays.

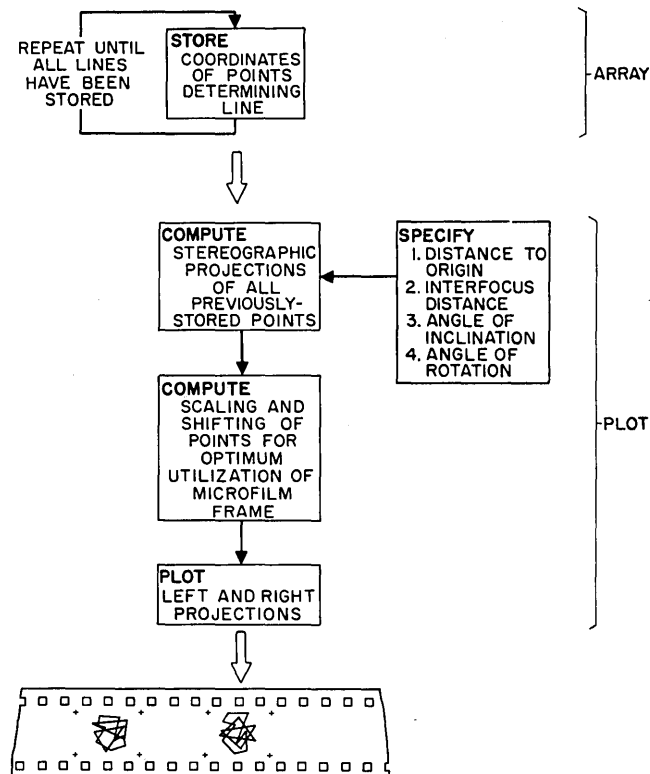

Fig. 4. Basic flow chart of stereographic-projection subroutines.

## Four Examples

Several examples of stereoscopic drawings produced by the computer are here given. In order to see them, as printed here, it is necessary to decouple one's eyes sufficiently to produce double images. The left and right perspectives are presented next to each other. The trick in looking at them is to decouple the eyes sufficiently to produce a third image centered between the left and right

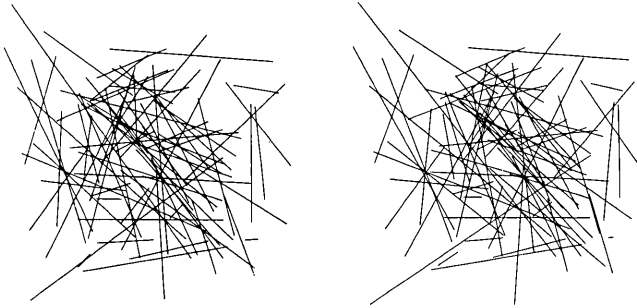

Fig. 5. Random pattern of straight lines.

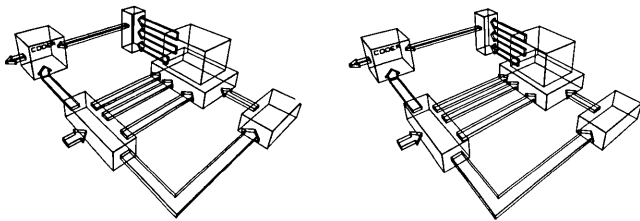

Fig. 7. Block diagram.

perspective. This task is made easier by first gazing beyond the page and then dropping the eyes to the page without refocusing; a piece of paper placed between and perpendicular to the two perspectives may also be held to produce the third image. The third image, when and if obtained, is in depth but is at first blurred. If one continues to look at it for a while, it will become clear, and look remarkably solid.

One of the major disadvantages of stereographic projection of scientific data is that a stereoscope is usually necessary for viewing them. This reason plus the tedious drafting work required to prepare the projections are two reasons why stereographic presentations have not been used more frequently. However, considerable research is being devoted to solving the first problem; and the computer techniques described in this article almost eliminate the second.

Figure 5 shows a three-dimensional bundle of lines whose end points have been determined at random. This type of pattern is excellent for demonstrating depth, since each perspective by itself contains no monocular perspective clues. Speech spectrograms have been plotted in Figure 6. The frequency in cycles per second is plotted to the right; the vertical distance measures the log amplitude of each spectral component, and each spectral slice is separated in time by 15 milliseconds. The educational possibilities of stereographic projections by computer are exemplified by the flow diagram shown in Fig. 7. An electrical engineering application is given by the transfer function plotted in Fig. 8.

## Discussion

The examples given in the preceding paragraphs are representative only of a few of the many provocative visual

presentations using depth made possible by the computer technique described in this article. The most obvious use is in the presentation of curves and functions of three variables. When visualized in true depth, many important trends in data become quite evident, as, for example, the formant structure of the speech spectra shown previously. Here is a method for presenting stress diagrams, the construction of beams and bridges, the structure of molecules,

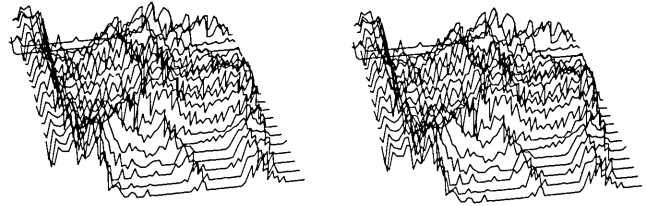

Fig. 6. Three-dimensional speech spectrogram.

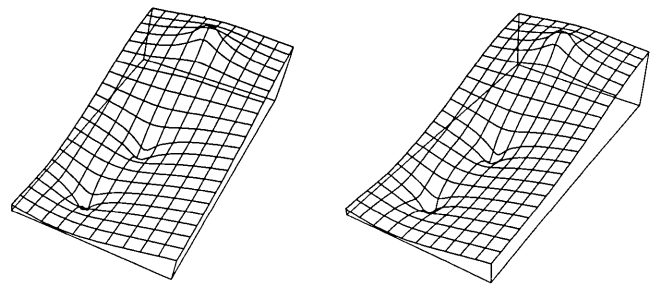

Fig. 8. Contour plot of electrical transfer function.

functions of a complex variable, and much more—all viewed from any angle and any distance. It is apparent that further applications are limited by only the imagination of the prospective user.

The three-dimensional examples were contributed by R. M. Golden, H. M. Kalish, and J. C. Noll, and are gratefully acknowledged.

## References

1. Lawrence J. Fogel, *Biotechnology: Concepts and Applications*, Prentice-Hall, Inc., Englewood Cliffs, 1963, p. 93.
2. *LOOK*, February 25, 1964, pp. 102-105.
3. Philip M. Morse and Herman Feshbach, *Methods of Theoretical Physics*, McGraw-Hill Book Company, Inc., New York, 1953.
4. Imre Pal, *Descriptive Geometry With Three-Dimensional Figures*, Hungarian Technical Publishers, Budapest, 1962.
5. Bela Julesz, "Binocular Depth Perception of Computer-Generated Patterns," *Bell System Technical Journal*, Vol. 39, September, 1960, pp. 1125-1162.
6. Bela Julesz and Joan E. Miller, "Automatic Stereoscopic Presentation of Functions of Two Variables," *Bell System Technical Journal*, Vol. 41, March 1962, pp. 663-676.
7. Gary A. McCue, "Visualization of Functions by Stereographic Techniques," North American Aviation, Inc., SID63-170, January 20, 1963.
8. H. R. Puckett, "Computer Method for Perspective Drawing," *Journal of Spacecraft and Rockets*, Vol. 1, No. 1, January, 1964, pp. 44-48.
9. E. G. Paré, R. O. Loving and I. L. Hill, *Descriptive Geometry*. The MacMillan Company, New York, 1959.

# CAREERS WITH CONTROL DATA



*"Only an individual person . . . not manpower in the mass sense of the word . . . makes a discovery, conceives a product or inspires other individuals."*

This philosophy has taken Control Data Corporation a long way since its formation in July of 1957. The combination of perceptive management and extraordinary technical skills has molded one of the most successful enterprises in modern electronics.

Today CONTROL DATA develops, manufactures and markets a complete line of advanced, high-speed computing systems for application in science, manufacturing, business and research. As a world-wide organization, CONTROL DATA ranks third in revenue from data processing equipment and has become the leader in the production of computer systems for scientific use.

If you believe in the development of the individual as a basis for corporate progress, CONTROL DATA invites you to investigate these positions. Nationwide assignments are available.

**Programmer Analysts ■ Systems Applications Analysts ■ Systems Installation ■ Systems and Procedures Analysts ■ Site Planning and Installation Engineers ■ Software Documentation ■ Systems Evaluation ■ Data Center Salesmen.**

**TECHNICAL APPLICATIONS:** Positions exist in research and development at the Ph.D. level. Requires a minimum of three years' linear programming or numerical analysis experience, including matrix algebra and theory of approximation. Minimum education requirement: MS degree. MINNEAPOLIS location.

**ENGINEERING SOFTWARE:** Diagnostic and Acceptance Test Programming—Develop software capable of detecting logic faults and marginal operation in equipment. Mechanized or Automated Design—Develop software to aid the design process and to produce the necessary manufacturing documentation. Hardware/Software Analysis—Develop software to evaluate systems performance. Familiarity with benchmark problems, instruction mixes, compilers and monitors. MINNEAPOLIS location.

**ADVANCED DESIGN:** BSEE required with a minimum of 5 year's

related experience. These assignments are on state-of-the-art development projects within the Advanced Design Department in: (1) High Speed Digital Circuits; (2) Extremely High Performance Core Memories. These projects will determine the operating characteristics of FUTURE Control Data general purpose computers. Successful performance of assignment manage complex technical activities. MINNEAPOLIS locations.

**PROGRAMMING ANALYSTS/PROMOTIONAL:** Opportunity in the Software Promotion Group for a digital computer specialist with these qualifications: programming background, imagination, demonstrable writing ability, marketing orientation, effective coordinator and ambition. An individual with the proper combination of the above qualities will shape the position for himself. A knowledge of publications/procedures would be helpful. PALO ALTO location.

**Employment Centers in New York ■ Washington, D.C. ■ Minneapolis ■ Palo Alto ■ Los Angeles will promptly review your qualifications and interests.**

Send resume indicating positions of interest to: William D. Rowe  
Employment Dept. 1L,  
4201 Lexington Ave. No.  
St. Paul, Minnesota

**IFIP Conference:** If you will be in New York during the IFIP Conference, plan to discuss these and other career opportunities with Control Data employment representative.

For other opportunities at CONTROL DATA, write R. O. Brostrom, 8100 34th Ave. So., Minneapolis, Minnesota.

**CONTROL DATA**  
**CORPORATION**

*An Equal Opportunity Employer*

Circle No. 17 on Readers Service Card

# SEL MAKES

## SEL 600 SERIES DATA ACQUISITION SYSTEMS

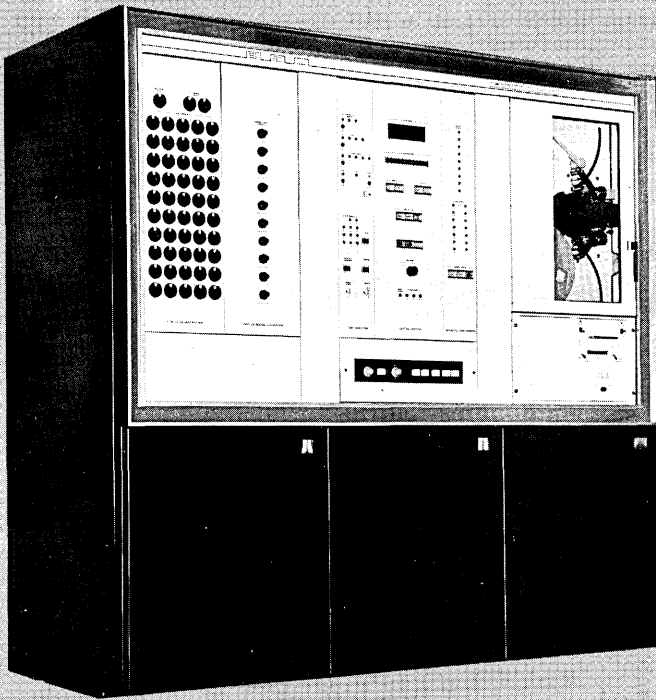

- HIGH SPEED DATA ACQUISITION TO 220,000 SAMPLES/SECOND
- SLOW SPEED DATA LOGGING FOR LARGE INPUT CHANNEL CAPACITY
- DIRECT LOW LEVEL OR HIGH LEVEL INPUTS
- COMPUTER CONTROLLED RANDOM ACCESS SAMPLING

### SEL 600 BASIC SYSTEM SPECIFICATIONS

NUMBER OF CHANNELS .....1 to thousands  
INPUT VOLTAGES FULL SCALE ..... $\pm 4$  MV to  $\pm 100$  volts  
ACCURACY .....to  $\pm 0.05\% \pm \frac{1}{2}$  bit  
RESOLUTION .....to 14 bits binary or 17 bits BCD  
SYSTEM SAMPLING RATES .....to 220,000 samples per second

### SEL 600 OPTIONS

On-line reduction with SEL 800 computers  
Computer programmable channel sampling  
Computer addressable gain and offset  
Quick-look displays  
Auto self-test features

**NOW YOU CAN PURCHASE TOTAL SYSTEM CAPABILITY FROM ONE SOURCE — COMPATIBLE ACQUISITION AND COMPUTER SYSTEMS REPRESENT THE ULTIMATE IN AN ENGINEERED APPROACH TO YOUR REQUIREMENTS FOR .....**

#### FOR MORE INFORMATION WRITE FOR THESE BULLETINS

9032 — SEL 810 General Purpose Digital Computer  
9042 — SEL 600 Data Acquisition Systems  
9056 — SEL 840 Scientific Digital Computer

#### IMMEDIATE OPENINGS FOR LOGIC DESIGN ENGINEERS

SEL is an equal opportunity employer

# BOTH .....

## SEL 800 SERIES GENERAL PURPOSE DIGITAL COMPUTERS

- ALL SILICON MONOLITHIC INTEGRATED DIGITAL CIRCUITS
- HIGHEST THROUGHPUT RATE OF ANY MACHINES IN THEIR SIZE OR PRICE CLASS
- 1.75  $\mu$ SECOND — FULL CYCLE TIME — FULLY PARALLEL OPERATION
- HARDWARE MULTIPLY, DIVIDE AND FLOATING POINT CAPABILITY

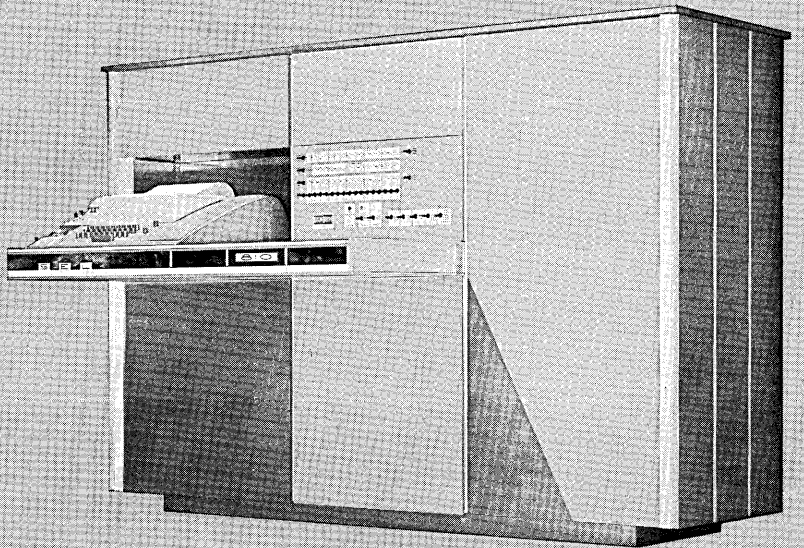

BASIC CHARACTERISTICS		810 AND 840 OPTIONS
<b>SEL 810 COMPUTER</b>	<b>SEL 840 COMPUTER</b>	To 32,768 word core in main frame—all directly addressable External drum or disc storage Up to 8 I/O channels Up to 6 direct memory access channels Any standard peripherals
WORD SIZE .....16 bits STORAGE .....4096 words Hardware multiply included Two independent I/O channels Typewriter, tape reader and punch Hardware index register and program counter Complete software package for real-time applications FORTRAN package for off-line scientific computation	WORD SIZE .....24 bits STORAGE .....4096 words Hardware multiply and divide included	

- REAL TIME DATA READOUT IN ENGINEERING UNITS
- CLOSED LOOP DIRECT DIGITAL CONTROL
- INDUSTRIAL PROCESS PRESET CONTROL
- OFF-LINE GENERAL PURPOSE COMPUTATION

**SEL**

SYSTEMS ENGINEERING LABORATORIES, INCORPORATED

P. O. BOX 9148 / FORT LAUDERDALE, FLA. 33310 / AREA CODE 305 / 587-2900

Circle No. 12 on Readers Service Card

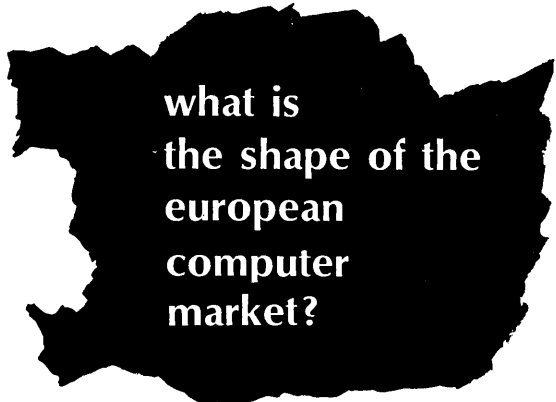

what is  
the shape of the  
european  
computer  
market?

A comprehensive survey of the European computer market is available now. Prepared by Computer Consultants Limited of Great Britain, **EUROPEAN COMPUTER SURVEY, 1965** has comprehensive information for each of the following countries:

Austria	Germany	Norway
Belgium	Great Britain	Portugal
Denmark	Greece	Spain
Finland	Holland	Sweden
France	Irish Republic	Switzerland
	Italy	

Listed individually for each country is:

1. Economic information.
2. List of computer installations by name of user up to December 1964.
3. Table of installations up to December 1964 by user categories and price group.
4. Table of estimate of new installations for 1965 by user categories and price group.
5. Estimate of new installations for 1966 by user categories and price group.
6. Estimate of future installations by user categories and price group from 1967 to 1970 inclusive.

Also included are:

- Grand summary of installations, showing number installed, home built and import value; number on order, home built and import value; total population, working population and number of people capable of being helped by a computer.
- Tables of value of computers installed and on order showing home built and import value.
- Table of individual countries export of computers.
- Notes on the computers currently installed in European countries.
- Names and addresses of the manufacturers of the computers installed in Europe.
- European manufacturing locations, if any, of the computers installed in Europe.

Is this the data you need to understand and benefit from the rapidly expanding European Computer Market?

To order your copy of the **European Computer Survey, 1965** send your check or purchase order to the International Data Corporation, P.O. Box 1, Newtonville, Mass. 02160. Price is \$285. Additional copies for the same organization may be ordered for \$95 each.

The International Data Corporation is the exclusive North American distributor for the **European Computer Survey, 1965**.

**I | D | C** International Data Corporation  
P.O. Box 1  
Newtonville, Massachusetts 02160

Circle No. 11 on Readers Service Card

# CALENDAR OF COMING EVENTS

May 18-21, 1965: **GUIDE International User Organization Meeting (Users of Large Scale IBM EDP Machines)**, Statler-Hilton Hotel, Detroit, Mich.; contact Lois E. Mecham, Secretary, **GUIDE International**, c/o United Services Automobile Association, 4119 Broadway, San Antonio, Tex. 78215

May 18, 1965: **SWAP Conference**, Marriott Motor Hotel, Twin Bridges, Washington, D. C.; contact Gordon V. Wise, Control Data Corp., 8100 34th Ave. So., Minneapolis, Minn. 55420.

May 19-21, 1965: **15th CO-OP Conference**, Marriott Motor Hotel, Twin Bridges, Washington, D. C.; contact Gordon V. Wise, Control Data Corp., 8100 34th Ave. So., Minneapolis, Minn. 55420.

May 19-21, 1965: **Power Industry Computer App. Conference (PICA)**, Jack Tar Hotel, Clearwater, Fla.; contact G. W. Stagg, American Elec. Power Serv. Corp., 2 Broadway, New York, N. Y. 10008.

May 20-21, 1965: **Spring Technical Meeting of the Digital Equipment Computer Users Society (DECUS)**, William James Hall, Harvard University, Cambridge, Mass.; contact DECUS, Maynard, Mass. 01754

May 21, 1965: **Computing Conference on Advances in Computing**, State University of N. Y., Stony Brook, L. I., N. Y.; contact John Moran, State University of N. Y., Stony Brook, L. I., N. Y.

May 21-22, 1965: **Meeting of the Interim Users Committee of 6600 Users**, N. Y. University's Courant Institute of Mathematical Sciences, 251 Mercer St., New York, N. Y.; contact Gordon V. Wise, Control Data Corp., 8100 34th Ave. So., Minneapolis, Minn. 55420

May 24-29, 1965: **IFIP Congress '65**, New York Hilton Hotel, New York, N. Y.; contact Evan Herbert, Conover Mast Publ., 205 E. 42 St., New York 17, N. Y.

May 28-29, 1965: **SDS Users Group**, Americana Hotel, New York, N. Y.; contact Ed Wattenbarger, Ext. 230, Scientific Data Systems, 1649 Seventeenth St., Santa Monica, Calif.

June, 1965: **Automatic Control in the Peaceful Uses of Space**, Oslo, Norway; contact Dr. John A. Aseltine, Aerospace Corp., P. O. Box 95085, Los Angeles 45, Calif.

June 1, 1965: **1965 Annual Meeting and Seminar of the Computing & Data Processing Society of Canada**, Walper Hotel, Kitchener, Canada; contact Computing and Data Processing Society of Canada, Ottawa, Ontario, Canada

June 1-3, 1965: **ACM Reprogramming Conference**, Nassau Inn, Princeton, N. J.; Mrs. L. R. Becker, ACM Reprogramming Conference, c/o Applied Data Research, Inc., Route 206 Center, Princeton, N. J. 08540

June 8-16, 1965: **International Seminar on ADP for Top Management in Public Administration**, Amsterdam, Holland; contact The Netherlands Automatic Information Processing Research Centre, 6 Stadhouderskade, Amsterdam, The Netherlands

June 10-12, 1965: Annual Southeastern Regional Conference of Association of Computing Machinery, Palm Beach Towers, Palm Beach, Fla.; contact Donald J. Beutenmuller, Gen. Chairman, 243 Russlyn Dr., W. Palm Beach, Fla.

June 17-18, 1965: 3rd Annual Conference of The Computer Personnel Research Group, Washington University, St. Louis, Mo.; contact Prof. Malcolm H. Götterer, Program Chairman, 120 Boucke Bldg., Pennsylvania State University, University Park, Pa. 16802

June 21-25, 1965: Information Sciences Institute, Seminar I: Image Processing, Univ. of Maryland, Computer Science Center and University College, College Park, Md.; contact Div. of Institutes, Center of Adult Education, Univ. of Md., College Park, Md. 20742

June 21-25, 1965: San Diego Symp. for Biomedical Engineering, San Diego, Calif.; contact Dean L. Franklin, Scripps Clinic & Res Found., La Jolla, Calif.

June 22-25, 1965: 2nd Annual SHARE Design Automation Committee Workshop, Chalfonte Haddon Hall, Atlantic City, N. J.; contact J. Behar, IBM Corp., Mathematics and Applications Dept., 590 Madison Ave., New York, N. Y. 10022

June 22-25, 1965: 1965 Joint Automatic Control Conference, Rensselaer Polytechnic Institute, Troy, N. Y.; contact Prof. C. N. Shen, Rensselaer Polytechnic Institute, Troy, N. Y.

June 28-July 1, 1965: Information Sciences Institute, Seminar II: Pattern Recognition, Univ. of Maryland, Computer Science Center and University College, College Park, Md.; contact Div. of Institutes, Center of Adult Education, Univ. of Md., College Park, Md. 20742

June 29-July 2, 1965: Data Processing Management Association 1965 International Data Processing Conference and Business Exposition, Benjamin Franklin Hotel and Convention Hall, Philadelphia, Pa.; contact Data Processing Management Association, 524 Busse Highway, Park Ridge, Ill.

Aug. 14-Sept. 6, 1965: National Science Foundation Conference on Digital Computers for College Teachers of Science, Mathematics and Engineering, Univ. of Southwestern Louisiana, Lafayette, La.; contact Dr. James R. Oliver, Director, USL Computing Center, Box 133, USL Station, Lafayette, La. 70506

Aug. 23-27, 1965: 6th International Conference on Medical Elec. & Biological Engineering, Tokyo, Japan; contact Dr. L. E. Flory, RCA Labs., Princeton, N. J.

Aug. 24-26, 1965: Association for Computing Machinery, 20th National Meeting, Sheraton-Cleveland Hotel, Cleveland, Ohio; contact Lewis Winner, 152 W. 42 St., New York, N. Y. 10036

Aug. 24-27, 1965: WESCON, Cow Palace, San Francisco, Calif.; contact IEEE L. A. Office, 3600 Wilshire Blvd., Los Angeles, Calif.

Sept. 8-10, 1965: Industrial Electronics & Control Instrumentation Conference, Sheraton Hotel, Philadelphia, Pa.; contact Lewis Winner, 152 W. 42 St., New York, N. Y. 10036

Sept. 20-23, 1965: Second Systems Engineering Conference & Exposition, McCormick Place, Chicago, Ill.; contact Clapp & Poliak, Inc., 341 Madison Ave., New York, N. Y. 10017.

Oct., 1965: International Symposium on Economics of Automatic Data Processing, Rome, Italy; contact Symposium on Economics of ADP, International Computation Centre, Casella Postale No. 10053, Rome, Italy

# opinionated

Two months before Spectra 70 announcement!

September 28, 1964

RCA SETS TO  
ANNOUNCE NEW  
COMPUTER SERIES  
DESIGNED TO BE  
PROGRAM COMPATIBLE  
WITH SYSTEM/360

**EDIP**  
**INDUSTRY AND  
MARKET REPORT**

A SEMI-MONTHLY NEWSLETTER FOR EXECUTIVES  
IN THE ELECTRONIC DATA PROCESSING INDUSTRY  
AND THE FINANCIAL COMMUNITY

First report on this important large-scale computer order!

July 15, 1964

GENERAL ELECTRIC  
OBTAINS ADVANCED  
POSITION IN  
COMPUTER TIME-  
SHARING FIELD  
BY WINNING MIT  
PROJECT MAC AWARD

**EDIP**  
**INDUSTRY AND  
MARKET REPORT**

A SEMI-MONTHLY NEWSLETTER FOR EXECUTIVES  
IN THE ELECTRONIC DATA PROCESSING INDUSTRY  
AND THE FINANCIAL COMMUNITY

Over six months before Model 20 announcement!

April 30, 1964

IBM PONDERES  
INTRODUCTION OF  
MODEL 20  
PROCESSOR: 7000  
SERIES PROGRAM  
CONVERSION

**EDIP**  
**INDUSTRY AND  
MARKET REPORT**

A SEMI-MONTHLY NEWSLETTER FOR EXECUTIVES  
IN THE ELECTRONIC DATA PROCESSING INDUSTRY  
AND THE FINANCIAL COMMUNITY

**EDP INDUSTRY AND MARKET REPORT** is a semi-monthly newsletter that gives an unclouded view of the developments in the fast-moving computer industry. Unbiased reporting. Timely analysis. Straight-from-the-shoulder opinion. The REPORT is management information for the EDP industry executive and the advanced computer user.

**EDP INDUSTRY AND MARKET REPORT** is industrial intelligence at its best. Well-researched. To the point. How is the EDP market changing? What new equipment will be significant? From which companies are these products coming? Who is merging with whom? And what do the answers to these questions mean for EDP companies and for the industry?

The **EDP INDUSTRY AND MARKET REPORT** is edited by a staff of computer industry experts who bring more than a dozen years of computer industry editorial experience to the job. Editorial contributions are gathered from the top industry authorities. The REPORT is backed by the full research facilities of the International Data Corporation whose research studies include an installation by installation analysis of over 80% of all computers installed and on order in the U.S.

**EDP INDUSTRY AND MARKET REPORT** subscriptions are \$49. per year; \$29. for six months. To enter a subscription or request a sample copy write to International Data Corporation, P.O. Box 1, Newtonville, Mass. 02160.

**IDC** International Data Corporation  
P.O. Box 1  
Newtonville, Massachusetts 02160

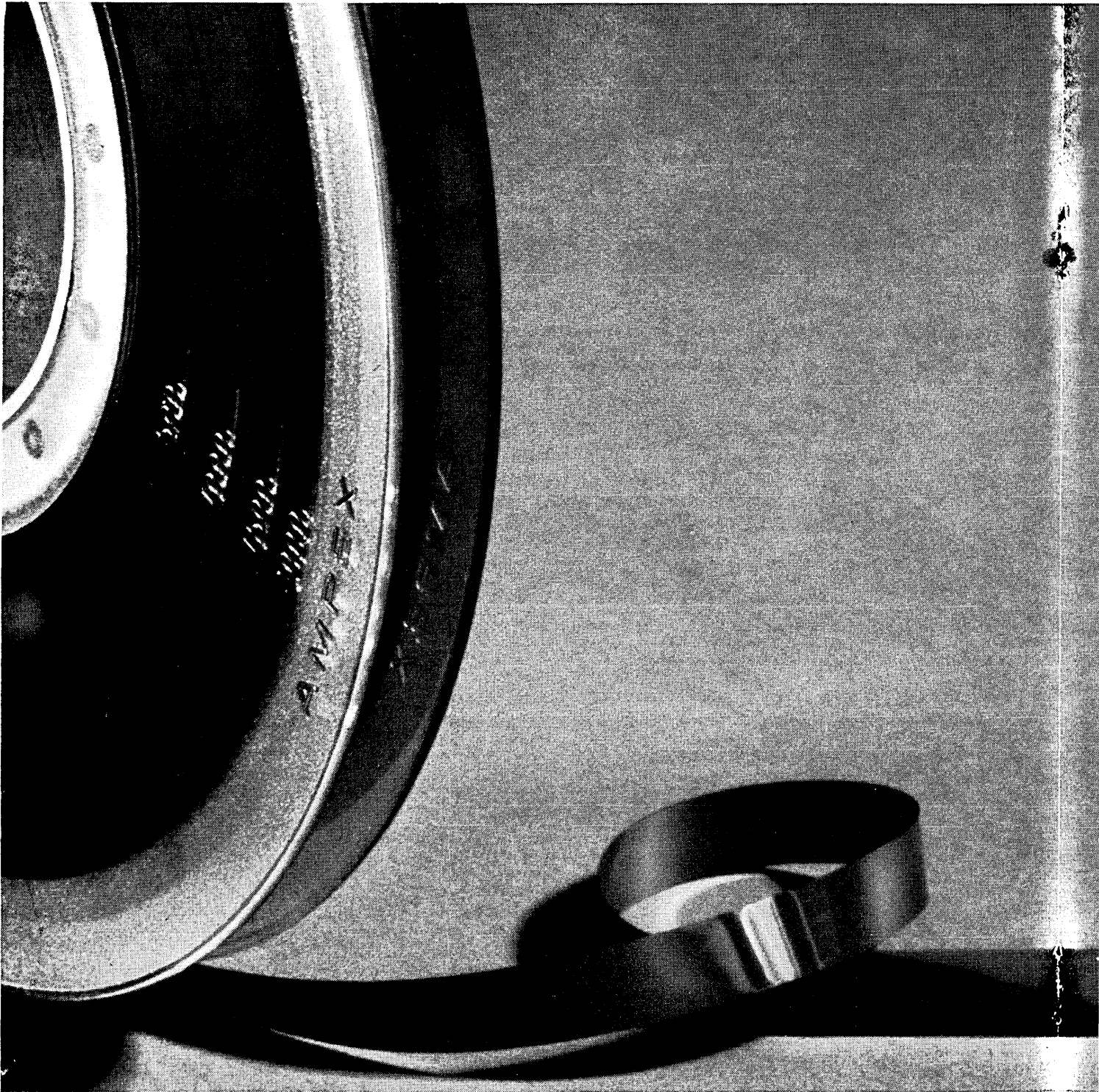

Two entirely new, long-wear, heavy-duty Ampex computer tapes are now available. The two (Ampex 838 for 800 bpi applications and 832 for 556 bpi applications) are the result of an intensive 2 year development program. Using an advanced oxide formulation, these new tapes feature a mirror-smooth surface that consistently gives the cleanest, most reliable performance ever possible. The proof of the new formulation is in the using: no other tape on the market does as much to reduce 'temporary errors' and static build-up. Even the reel is new: IBM compatible configurations are available on solid



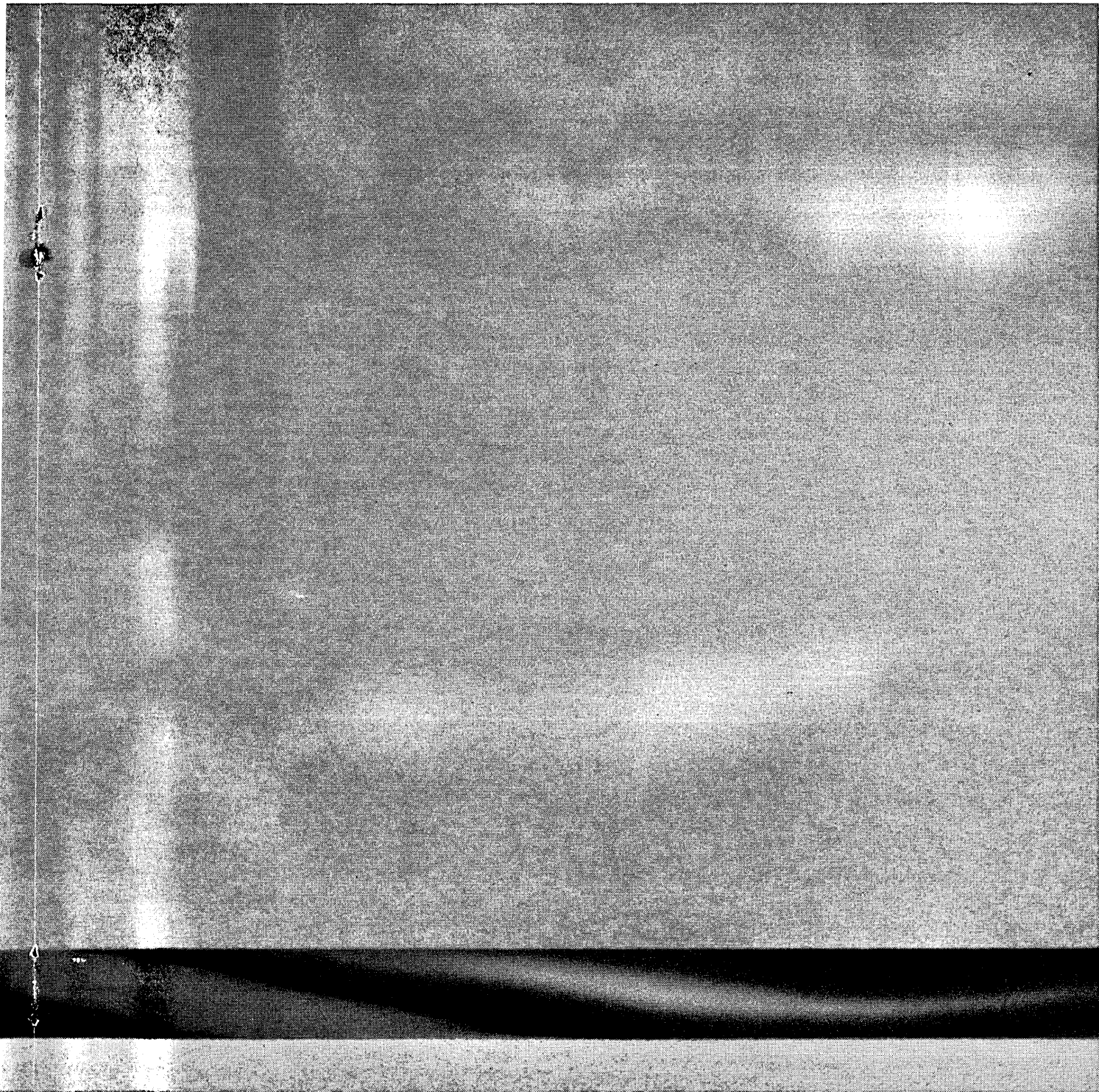

**Announcing:  
the most important advance  
in computer tape in four years.**

flanged plastic reels with new aluminum hubs. Who benefits from this remarkable new tape? Anyone who uses IBM (including full width tested), IBM compatible, RCA 301, and most Univac computer systems. Try it. Test it. Use it. We think that you'll agree that the time spent in developing this remarkable new tape was time well spent. For a demonstration, call your Ampex representative, or write the only company providing recorders, tape and core memory devices for every application: Ampex Corp., 401 Broadway, Redwood City, California.

**AMPEX**

---

**\$250 MILLION ANNUAL SAVINGS IN THE  
FEDERAL GOVERNMENT'S  
USE OF COMPUTERS**

**Government Activities Subcommittee  
Committee on Government Operations  
House of Representatives  
Congress of the United States  
Washington, D. C.**

A quarter of a billion dollars a year in savings to the government can be realized under a proposal by Southeast Texas Congressman Jack Brooks (D-Texas) to coordinate government acquisition and use of automatic data processing (ADP) equipment, a House efficiency subcommittee has been informed.

The bill, H. R. 4845, was endorsed by a number of witnesses who appeared before the House Government Activities Subcommittee.

Joseph Campbell, the Comptroller General of the United States, told the subcommittee, ". . . the Government will continue to incur substantial amounts of unnecessary costs until more effective centralized management and control" of computers, a "high cost area of government operations," are achieved.

The General Accounting Office, which Campbell heads, has conducted studies of automatic data processing equipment used by the federal government and the estimated savings are based on these studies.

Lawson B. Knott, Jr., Acting Administrator of General Services, told the subcommittee, ". . . there is a clear need for the enactment of legislation which would assist in improving the acquisition and utilization of ADP equipment in the Government."

Knott continued:

". . . The use of automatic data processing equipment in government has grown phenomenally during the past 13 years. In 1954, there were only 10 computers in use by the federal government. By the end of 1964, the usage had increased to 1,767. The current estimate is that there will be 2,150 computers in federal use by the end of fiscal year 1966. In 1964, federal agencies spent \$1.1 billion for the purchase, rental and operation of data processing equipment for all types of use by 2,068 organizational units within 44 federal agencies. Current estimates indicate that on a nationwide basis by 1970, the number of computer systems and annual costs in connection therewith will triple."

In outlining the bill's provisions, Brooks, who is chairman of the subcommittee, said that at present "each agency

operates independently in the acquisition and utilization of ADP equipment with only Bureau of the Budget guidelines to follow."

But, he said, furnishing the agencies with guidelines "has not, in turn, provided the Bureau of the Budget with the data necessary to determine agency compliance with existing policies." He added, "Nor does the bureau have information sufficient to recognize new problems as they arise or to establish new policies as they are needed."

The bill would set up a revolving fund for use in acquisition of ADP equipment as needed and in setting up equipment sharing pools and computer service centers. Each agency would determine its own ADP needs and the use made of the equipment. The Administrator of General Services would act as coordinator for government acquisition and use of ADP equipment. Along with the revolving fund, the General Services Administration would maintain a continuous inventory of ADP equipment in use by the government and government contractors.

Equipment used only part of the time by one agency or contractor might well be operated the rest of the time by another user. And when an agency or contractor is finished with a computer, a check would be made to see if any other government function could use the equipment rather than purchasing a new computer.

"With a minimum of \$12 million wasted for each month that implementation of this legislation is delayed—and I believe this to be an extremely conservative figure—prompt action must be taken on H. R. 4845," Congressman Brooks said.

The Congressman introduced similar legislation two years ago which was approved by the House of Representatives but the Senate did not act before the Congress ended.

Others scheduled to appear at the hearings were Elmer B. Staats, Deputy Director of the Bureau of the Budget; Edmond C. Buckley, Director, Office of Tracking and Data Acquisition, National Aeronautics and Space Administration; John P. Abadessa, Controller, Atomic Energy Commission; and Dr. William Eaton, Deputy Assistant Secretary for Science and Technology, Department of Commerce.

The members of the Subcommittee are Congressman William S. Moorhead (D-Pa.), David S. King (D-Utah), Dante B. Fascell (D-Fla.), Ogden R. Reid (R-N. Y.), and Edward J. Gurney (R-Fla.).

The Subcommittee is part of the House Government Operations Committee, which is headed by Congressman William L. Dawson (D-Ill.).

The Adley Express Company of New Haven, Conn. has three iron-bound rules of operation; service, efficiency and speed—a philosophy which dictated FORMSCARDS as the continuous tabulating cards for Adley's accounts payable and payroll.

FORMSCARDS are unique; they don't have medial waste strips between the cards. So you don't waste money shipping useless medial strips around. You don't waste space storing medial strips. You don't waste time running them across your processing equipment. You don't waste time bursting them. And finally, you don't wind up with a truck-load of medial strips to throw out.

(See why those little strips between cards are called "waste strips?")

Isn't it time you followed the route Adley took to faster, waste-free tabulating card operations? There's a FORMSCARD system to fit your every need. Let us tell you all about the time, trouble and money you could be saving with FORMSCARDS; drop us a line and we'll send you our brochure telling the whole amazing FORMSCARD story. Or, if there's a rush, give us a call. Phone: Oldfield 9-4000 Area code 215.

**Forms inc.**  
WILLOW GROVE, PENNA.

# Adley Express saves a truckload of time with Formscards

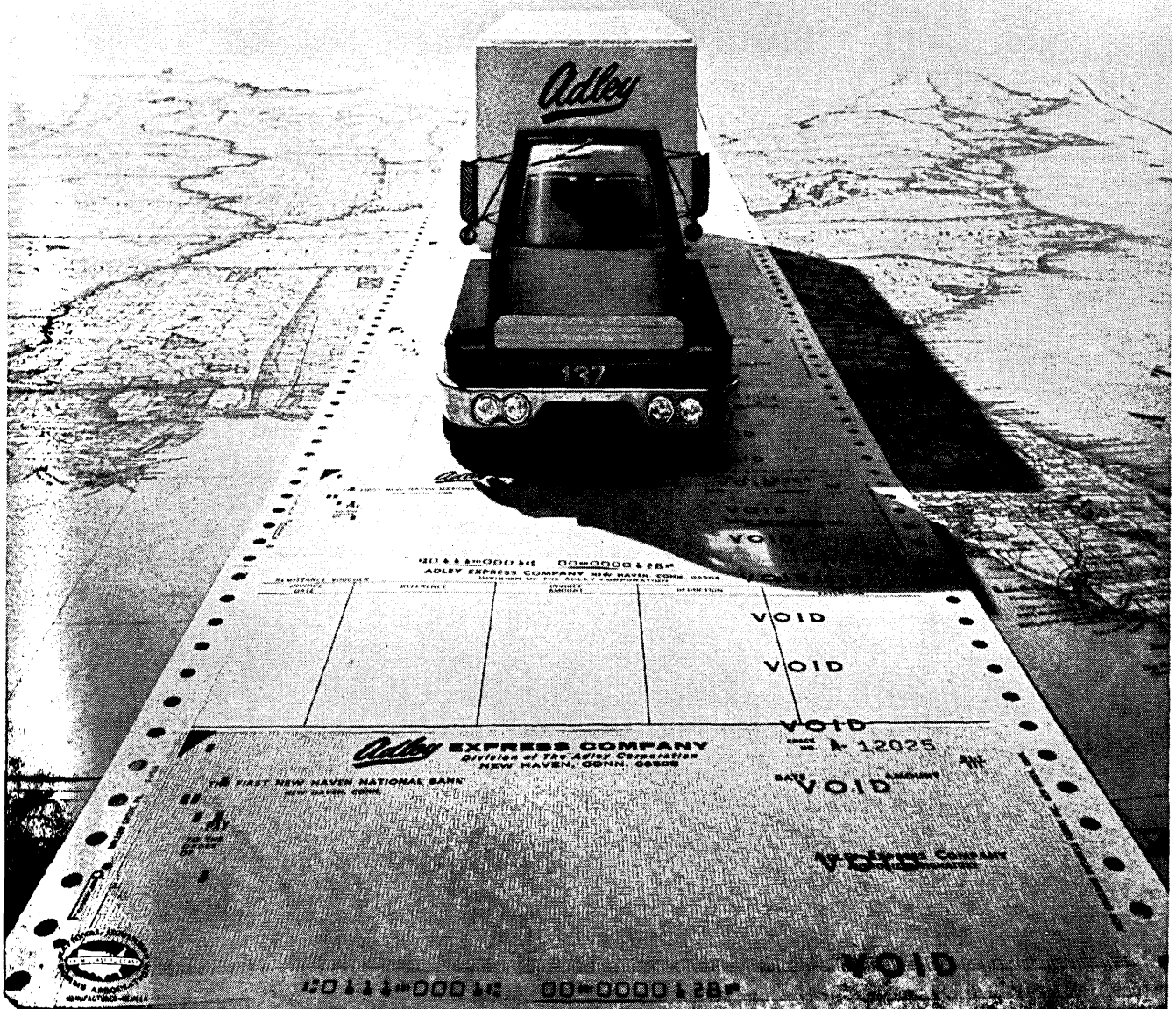

Circle No. 19 on Readers Service Card

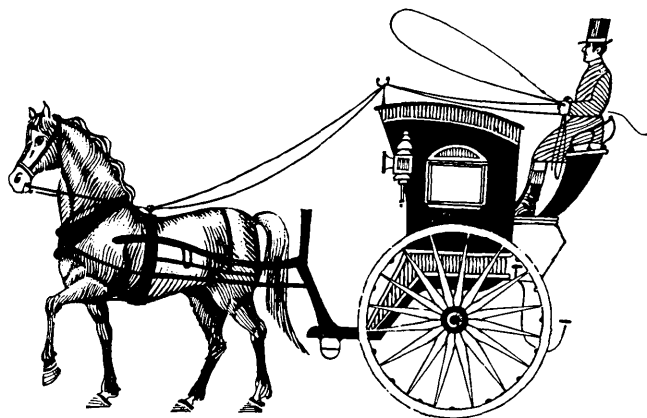

**IS YOUR TAPE CONVERSION STILL WORKING AT HORSE AND BUGGY SPEEDS?**

**THINK AHEAD...THE NEW KLEINSCHMIDT 321 ADS CONVERTS TAPE TO HARD COPY AT 400 WORDS PER MINUTE!...TODAY**

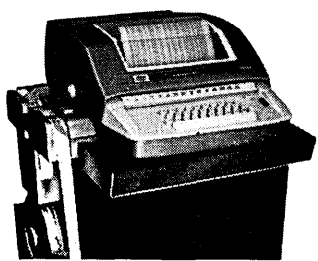

Think of tape conversion four times faster than you may be getting now. Think of less tape backup. Think of the Kleinschmidt™ 321™ ADS. Whether it's used "on line" or "off line," the 321 ADS gives you complete and reliable facilities for tape preparation, tape duplication and hard-copy print-out. For further information on the

efficiency of the 321 ADS and other Kleinschmidt Electronic Data Communications equipment, write: KLEINSCHMIDT, Division of SCM Corporation, Lake Cook Road, Deerfield, Illinois.

THINK AHEAD  
... THINK SCM



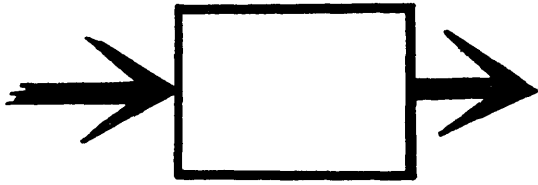

## Computers and Automation in Israel

When examining the use of computers in various parts of the world, one finds some notable gaps—South America, Asia, the Middle East, Africa. The extended use of computers in the United States, Europe, Russia, and Australia represents a strong contrast.

One surprising exception is Israel, a nation only 17 years old. Surrounded by hostile Arab countries with limited technical competence, Israel has developed, partly in defence, a strong capability in computers. At a recent meeting of the Israel Data Processing Association (an IFIPS member), over 400 technical people attended a two-day symposium with extensive technical sessions titled comparably to our own activities. The entire symposium was in Hebrew, conducted by Israeli experts, with only two exceptions: a session on computer languages by the noted Dutch Professor Van Wyngaarden, and a session by myself on real-time systems. Interestingly enough, there is no substantial language problem: Israeli data processing technicians are almost completely bilingual and are often fluent in French or German as well.

The country has developed rapidly, and is beginning to realize the tremendous potential of data processing in this expansion. With a population of less than three million, it is smaller than the Republic of Ireland, but its computer population is already large, by comparison. The total of computers installed today is 26 and an additional 30 are on order from various manufacturers.

Vendor representation is handicapped to a limited extent by the Arab boycott. Univac, for example, has no representation. Principal vendors today are IBM and NCR, each of whom has a staff of over 200 in sales and service. The installation lineup is approximately as follows:

IBM — 14 computers—principally 1401 and 1460, including three service centers.

NCR — four 315 computers, including one service center

Philco — 5 computers (two 212's and three 1000's) in one military installation, without sales or service representation.

Control — 2 computers (a 1604 and a 160A), both at the Data Weizmann Institute. (A service center is planned during the second quarter of 1965 with a CDC 3100.)

Elliott — 1 computer at Technion

In addition, the country has two native computers, the GOLEM (robot) at the Weizmann Institute and the SABRAC (sabra is a native cactus) at the Scientific Department of the Ministry of Defense.

The data processing problems of Israel are not very different from those in the United States. The personnel problems are comparable, heightened by the fact that all workers belong to the union. Thus, programmer selection

is sometimes complicated. Scheduling problems are the same, and documentation is equally well ignored in Hebrew. There is a bit of a language problem in data presentation; Hebrew is required on many documents so that interchangeable-type printers are needed. In addition, the Hebrew alphabet is not the same as ours, causing punching problems; and serial printers, typewriters, and bookkeeping machines have to travel from right to left as well as from left to right.

Israel also has its supply of consultants, most of whom are Israeli-born, although many are trained in the United States. Not many American firms can afford to compete in Israel; the salary structures are the same as ours, but the currency value is one-third. In addition, the air fare of \$800 prevents most United States firms from establishing Israeli facilities. Local service bureaus appear and disappear like mushrooms, as in the United States, with similar problems of quality and performance. However, since the country is small and isolated, the data processing community is aware of the problems and recognizes possible solutions.

Data transmission is still in its infancy in Israel. The military system provides reasonable transmission, but the public telephone system is of insufficient quality to permit extensive and reliable transmission. Making a phone call in Israel can be risky and time-consuming; even getting a phone installed requires three to four years. (It is rumored that the local CDC representative, in setting up the new facility, stopped looking for an office; he said he would find a phone around which he could then build an office.) Anyway, data communication networks will have to wait for improved telephone service.

The data processing community in Israel has a tremendous respect for United States technology. American magazines, books and other literature are virtually the only training materials. As a result, experienced Americans are welcomed and placed in high regard. American technical support in any form is put to good use. It is hoped that we will live up to these expectations of Israel, so that we can continue to contribute to the growth and development of that country.

Dick H. Brandon  
Contributing Editor

now available

# TELETYPEWRITER FUNDAMENTALS HANDBOOK

By Wm. D. Rexroad

... IN HANDY POCKET-SIZE BOOKLET FORM PUBLISHED  
BY COMPUTER DESIGN PUBLISHING CORPORATION

The Handbook is based on an article that appeared in the November issue of COMPUTER DESIGN. The demand for reprints of the article was so overwhelming that it has now been expanded, giving more details on some of the topics previously-covered, and adding up-to-date information on 8-level codes, the standard code adopted by the ASCII, frequency shift keying systems, radio teletypewriter techniques, and descriptions of the latest in teletypewriter machinery.

**IDEAL FOR:** REFERENCE BOOK • TRAINING PROGRAMS • SALES AIDS  
FOR SWITCHING COMPUTER MFGRS. • LIBRARIES • EMPLOYEE  
EDUCATION • CUSTOMER INDOCTRINATION

**MAJOR TOPICS:** BASIC PRINCIPLES OF TELETYPEWRITERS  
HOW THEY OPERATE • Signal Generation & Reception • Baudot  
Code & Eight Level Codes • Teletypewriter Distortion  
HOW THEY ARE USED • Simplex, Half-Duplex, Full Duplex •  
Neutral & Polar Circuits • FSK & RTTY  
GLOSSARY OF TELETYPEWRITER TERMINOLOGY  
DESCRIPTIONS & PHOTOS OF TELETYPEWRITER MACHINES

PRICE: only \$1.50 per copy  
Quantity prices available on request  
To order your copy, simply fill out coupon below, enclose  
\$1.50 per copy, and mail to: COMPUTER DESIGN PUBLISH-  
ING CORPORATION, BAKER AVE., W. CONCORD, MASS.  
01781



.....  
COMPUTER DESIGN PUBLISHING CORP.  
BAKER AVE., W. CONCORD, MASS. 01781

GENTLEMEN:  
Enclosed is \$..... for ..... copy(ies) of  
TELETYPEWRITER FUNDAMENTALS HANDBOOK.

SEND HANDBOOK(S) TO:

NAME .....  
COMPANY .....  
ADDRESS .....  
CITY ..... STATE .....

at  
Honeywell,  
programmers  
are ■ ■ ■

promoted, paid, perfected, pushed, puzzled,  
pooled, paired, pampered, propelled, pacified,  
persuaded, publicized, perplexed, proved,  
patronized, pleased, progressed...even pitied,

...but never ignored

The industry-wide impact of LIBERATOR and numerous other software products developed by Honeywell has created a wide range of opportunities at our Programming Systems Division in suburban Boston.

Positions exist for programmers and analysts who have experience in software development, with emphasis on

**Operating Systems**  
**Conversion Techniques**  
**COBOL Compilers**  
**FORTRAN Compilers**  
**Software Support**  
**Sort Generators**  
**Peripheral Systems**  
**LIBERATOR Translators**  
**Random Access**  
**Math Routines**  
**Technical Writing**

*Qualified candidates should  
forward their resumes to  
Mr. Frederick S. Bartlett  
Personnel Manager  
Technical Divisions*

**Honeywell**  
**ELECTRONIC DATA PROCESSING**

151 NEEDHAM ST., DEPT. 10, NEWTON, MASS.

*An Equal Opportunity Employer*

# SOME THINGS ARE BETTER DONE OFF LINE —

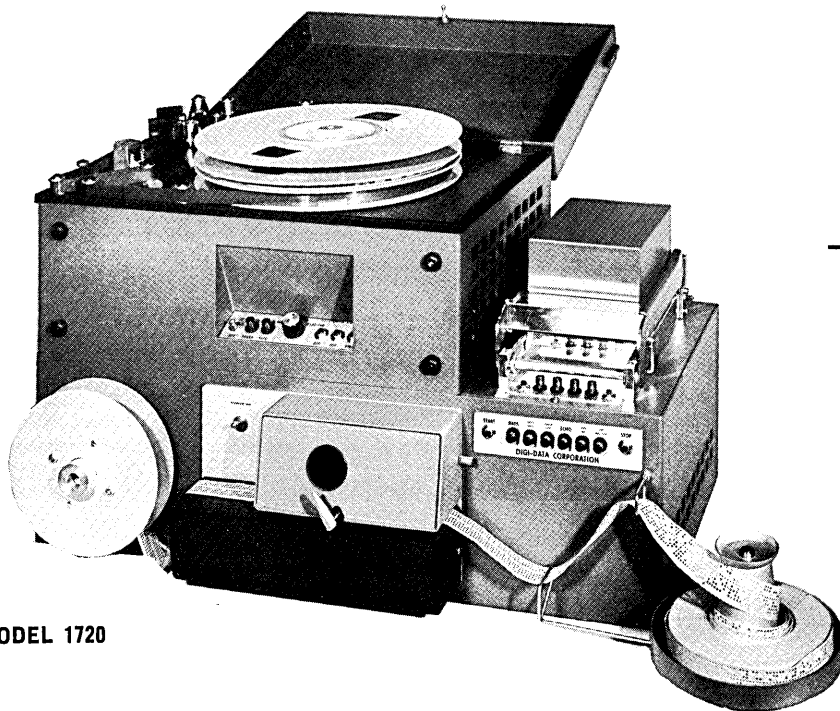

MODEL 1720

— Paper Tape to  
Magnetic Tape  
Conversion  
for example;

- Virtually any paper tape reader will limit the speed of your computer, but now your computer can run at full speed.
- The Model 1720 uses center tape unwind for simplest possible tape loading and handling.
- Performs error and validity checks.
- Low cost.
- Minimizes computer scheduling problems.
- Broad programming capability handles virtually all code conversion or format conversion requirements.
- Minimal space required; any table or desk will serve the purpose.
- Easy on tape—mangled tapes are unheard of.
- Nationwide service.



— Low-cost Data Transmission;

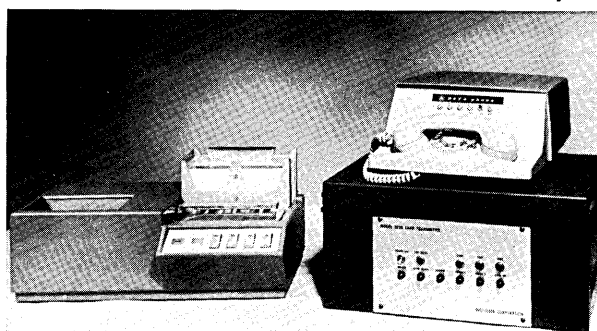

In addition to our line of converters, Digi-Data Corporation manufactures card and paper tape Data-Phone® transmission units such as the Model 2120 Magnetic Tape Receiver and the 2020 Card Transmitter shown here.

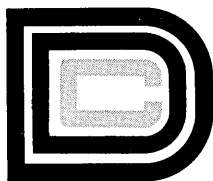

**DIGI-DATA CORPORATION** .....

DIGITAL STEPPING RECORDERS ■ DIGITAL DATA HANDLING EQUIPMENT

4315 Baltimore Avenue • Bladensburg, Maryland 20710 • Telephone (301) 277-9378

WESTERN REGIONAL OFFICE:  
4341 West Commonwealth Avenue  
Fullerton, California 92633  
Telephone (213) 941-3182



# "ACROSS THE EDITOR'S DESK"

## Computing and Data Processing Newsletter

### TABLE OF CONTENTS

Applications . . . . .	49	New Literature . . . . .	63
New Contracts . . . . .	52	Jobs and Opportunities . . . . .	63
New Installations . . . . .	53	Meeting News . . . . .	64
Computing Centers . . . . .	55	Business News . . . . .	64
New Products . . . . .	56	Computer Census . . . . .	68

### APPLICATIONS

#### COMSAT'S CONTROL CENTER GUIDES EARLY BIRD INTO SYNCHRONOUS ORBIT

Early Bird, the world's first commercial communications satellite, was launched on April 6 from launch pad 17A at Cape Kennedy by the National Aeronautics and Space Administration (NASA) for the Communications Satellite Corporation (Comsat). On April 9, it was parked in a "near letter perfect" orbit over the Equator.

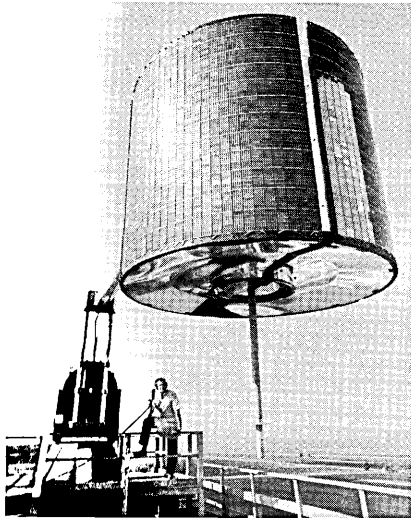

— Early Bird undergoing tests at the Hughes Aircraft Company in Los Angeles before it was shipped to Cape Kennedy for launching.

The Communications Satellite Corporation took organizational form in March, 1963 (under the

Communications Satellite Act which became law on August 31, 1962). One of its early activities with the Department of State was to start exploratory talks with major communications countries. These established a clear desire among many countries to become partners in the unique venture.

This was formalized on August 20, 1964, in a pair of agreements — the first dealing primarily with the organizational principles for the joint venture (governments) and a second dealing primarily with the commercial, financial and operating aspects of the global communications system (communications entities). Representatives of eleven countries, including the United States, and the communications entities of the countries, including Comsat, signed the agreements.

Under provisions of the agreement, Comsat acts as manager in the design, development, establishment, operation and maintenance of the space segment of the global system.

Although the agreements initially were signed only by a small number of countries, they were left open for signing by all countries which are members of the International Telecommunication Union (ITU). (The ITU is a specialized agency of the United Nations, to which 122 nations belong.) Today 45 countries belong to the commercial communications satellite venture.

Following Early Bird's launch from Cape Kennedy, attention

was focused on Comsat's new control center in downtown Washington, D.C. Here, after studying calculations produced by an IBM computer, space experts decided precisely when to fire the motor which kicked the satellite out of its original path into synchronous orbit 22,300 miles above the equator.

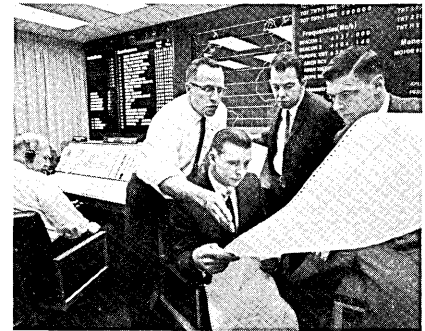

— Shown at Comsat's control center are: Dr. Spencer Spaulding, Manager of System Analysis, holding list of computer calculations; James D. Rinehart, Department Head, Systems Simulation, standing in back of Spaulding; Martin Votaw, Early Bird Project Manager; and George Dill, a member of the Command and Control staff. Responsibility for the precise moment to fire the motor of the satellite rested with these men.

The key sections of the control center include: a control console table and a floor-to-ceiling display board, created by Blair, Inc., Baileys Crossroads,

## Newsletter

Va.; a communications unit; and an IBM 7040 computer complex.

The 20-foot long display board was the means of viewing the entire project as a whole. The control center chief sat at the control console table coordinating the communications and updated the display board as events occurred. The operations director viewed the display data and directed the overall operation.

The Early Bird satellite was first put into a "transfer" orbit by the three-stage firing of the Thrust-Augmented-Delta launch vehicle. This ideal orbit is elliptical, with an apogee of 22,950 miles and a perigee of 830 miles.

As the satellite went up, information about it was received at the center from the Goddard Space Flight Center and other points and, after 12 hours, from the United States earth station at Andover, Maine. The information was automatically punched into cards and tape.

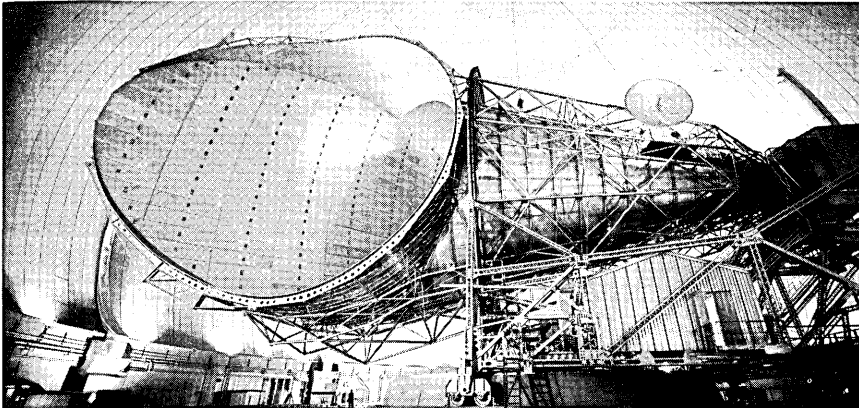

— The 14-foot dish antenna at the earth station at Andover, Maine, sent the first command to turn on Early Bird's transmitting equipment.

The cards were read by the center's computer which used a variety of mathematical techniques to determine the six orbital elements that described the satellite's precise position in space. Reports were printed automatically, defining this position and its projected path.

Space experts analyzed these reports to determine what options were open to them in controlling the satellite. Commands were given to affect various maneuvers and to position the satellite. At the fourth apogee of the transfer orbit, approximately 40 hours after launch, the command fired a small solid propellant motor in Early

Bird which kept it in its apogee orbit. Following the apogee motor firing the satellite was moved over to its position at approximately 27.5 degrees West Longitude.

Another important function of the control center was to instruct tracking centers to position their antenna. These instructions, calculated by the computer, were sent to the stations where the positioning was performed automatically. Ultimately scheduling and antenna pointing data will flow from the center to all participating earth stations.

In North America, the Andover, Maine station (which has been leased by Comsat from the American Telephone and Telegraph Company) was modified for the task of positioning the satellite and acting as a link for service. In Canada, an earth station at Mill Village, Nova Scotia, is under construction to go into service later on.

Early Bird will be capable of transmitting 240 two-way voice channels for telephone use, high speed data, or telegraph or television.

### INTERNAL REVENUE REPORTS RESULTS OF COMPUTER USE

Internal Revenue Service has reported that use of computers to process Federal income tax returns in 1964 resulted in approximately \$52.5 million in additional revenue, and off-set \$16.7 million in potential refunds to business and

individual taxpayers who owed taxes for previous years.

Business returns were processed in 1964 by computers in four Internal Revenue regions covering half the nation. Automatic data processing of individual returns began in the seven-state Southeast Region in 1963.

These are the highlights of the third year of operation of Internal Revenue's ADP system contained in a report by Commissioner of Internal Revenue, Sheldon S. Cohen.

In addition, individual taxpayers in the U. S. reported \$2 billion more in interest income on returns filed in 1964 than they did on returns filed in the previous year. The amount of interest income reported rose 28 percent in 1964. The number of returns from taxpayers reporting interest income was up 45 percent.

The amount of dividend income reported in 1964 was up \$690,000, an increase of 6 percent over 1963. The number of returns reporting dividend income was up 20 percent.

The Commissioner credited automatic data processing and the public's awareness of ADP's capabilities for most of the increase in interest and dividend income reporting. "After three years of operation, results show the ADP system is a success. It is coming to be an increasingly efficient tool in reshaping our tax system to enable it to cope with a rapidly increasing workload," Mr. Cohen said.

The Internal Revenue ADP schedule calls for a region entering the system to start by processing business returns. After two years, the region then begins processing individual returns. Internal Revenue's ADP system began on a pilot basis with business returns processing in the Southeast Region in 1962. All business returns filed in the U.S. now are being processed by ADP.

In the Southeast Region, where individual returns were processed for the first time by ADP in 1964, tax assessments were up 25 percent. This compares with a 9 percent increase in assessments reported for the rest of the nation in 1964.

Eight million individual returns and declarations of estimated tax were subjected to expanded

mathematical verification made possible by ADP. The net yield in additional revenue realized through mathematical verification in the Southeast Region was \$14.8 million. Of this amount approximately \$5 million can be credited to expanded mathematical verification under the ADP system.

In addition, the system identified some 300,000 possible non-filers of income tax returns. The identification resulted from use of the individual master file of taxpayers incorporated in the Southeast Region's operations in 1964. Notices are being sent to each. Those who fail to respond or who give unsatisfactory explanations will be investigated.

In addition to the Southeast Region, the Mid-Atlantic Region now is processing individual returns by ADP. The Central and Southwest Regions will start individual returns processing under the system in 1966. The balance of individual returns in the three remaining regions — North-Atlantic, Midwest and Western — will be included in the system by 1967.

All individual taxpayers with previous filing records already are listed in the National Identity File, however. The National Identity File, completed in January 1964, was the first nationwide application of Internal Revenue's ADP system.

The File, a listing of taxpayers by name and social security number, provides an effective basis for identifying and locating taxpayers when they move from one location to another. It helps in detecting taxpayers who fail to file tax returns, those who file more than one return in order to receive multiple refunds, as well as detecting erroneous social security numbers and other discrepancies.

The business master and individual master files are the heart of the basic ADP system and contain detailed records of business and individual taxpayers. Consolidated tax accounts for all business taxpayers in the nation will be completed by the end of this year. Completion of individual accounts is scheduled for 1967 when the ADP system will be in full operation nationwide.

### **CAR-DISPLAY, COMPUTER-FED TELEVISION**

Alfred E. Perlman, president of the New York Central System, has inaugurated a new customer service utilizing computer-fed television sets to provide instantaneous freight car information. "This is the world's first commercial use of television to display both words and numbers supplied by computers," Mr. Perlman said.

The new system, called Car-Display, is connected to the railroad's huge Transportation Computer Center which maintains a constant record of 125,000 freight cars. The Center includes an IBM 1710 computer equipped with IBM 1301 disc files and performs customer freight car tracing, car distribution and car utilization functions. Car reporting messages, originating at 234 points along the railroad's 10,000 miles of track are its primary source of data.

The computer-fed television device enables Central to tell customers immediately the present location of their freight car as well as the history of its movements on the railroad. As a customer gives his car identification, the tracing center clerk types the number on the Car-Display set's keyboard.



— Car-Display device enables clerk to instantaneously provide freight car information. Both words and numbers are supplied by computers.

Total reply, indicating the car's movements and location, appears on the screen immediately after the last letter or number is registered. Central's Transportation Computer requires only one hundred-forty milliseconds to feed the total information picture. If necessary, the reply can be

recorded by an automatic, high-speed typewriter integrated in the television unit.

The railroad now has five Car-Display units (built by Data Display, Inc., St. Paul, Minn.) at its New York City Tracing center.

### **CARBONLESS PAPER, SMALL COMPUTERS, SPEED HOSPITAL'S PAYROLL, BILLING OPERATIONS**

Rolls of carbonless paper and a small computer used in two different business office applications are simplifying payroll and patient billing operations for the Louis A. Weiss Memorial Hospital in Chicago, Ill. In both cases, the roll of carbonless paper is used as a second sheet to record all information transcribed by the computer on employee checks, earnings ledger cards and patient ledger cards.

Each day — seven days a week and 52 weeks a year — a girl is kept busy posting charges to some 250 patient ledger cards, according to Douglas N. Contos, hospital business manager. She does her posting on the computer. Four magnetic stripes on each card act as the memory device on which the computer stores its information. When a patient enters the hospital, certain fixed data is encoded in the magnetic ledger card. This includes the patient's hospital number, room number, room rate, type of insurance, etc.

Each day's charges are then posted to the ledger card until the patient is ready to check out. Since all the information from each day is being recorded in the ledger card's magnetic memory stripe, all that is necessary to figure the total bill is to insert the ledger card into the computer and read out the information. The machine totals all columns and then breaks out what is covered by insurance and what is to be paid by the patient.

All this information being added to the computer's vast store of knowledge also is being recorded for hospital balancing and cross-checking purposes on the backup roll of "Action" Brand Carbonless Paper. This paper, manufactured by the 3M Company, has the ink built in and is imaged by the simple strike of the accounting machine key. At the end of each day, the "Action" Paper record is used as an audit trail to verify all charges on the patient's account.

## Newsletter

"This provides us with an easy means of checking," Mr. Contos explained. He said that the "Action" paper gives a clear, smudge-proof image. Also, it saves reloading time because rolls are longer than other carbonless or carbon-interleafed papers and either side of the paper can be inserted into the machine.

The same method and the same tools employed in the patient billing process are utilized in getting out 350 employee checks one day each week. In this application,



— Helen Cone feeds variable information into the computer to figure payroll checks.

the backup roll of "Action" paper is stored for five years and is used primarily as a record of disbursements for bank reconciliation and audit purposes. Complete journals are filed in a binder.

The computer and "Action" paper are used at the end of each quarter and at year end to prepare the 941 report and the W-2 Statement of Earnings for all employees. All that is required is to insert the magnetic ledger card in the machine and the computer will analyze the stripe and print out the desired information which has been accumulated over the year. All the information is recorded on the backup roll of "Action" paper. (For more information, designate #41 on the Readers Service Card.)

### COMPUTER TECHNIQUE FOR PLOTTING HIGHWAY ROUTES

Two University of Miami researchers have developed an improved computer technique for plotting highway routes at the least possible construction cost. Dr. Bernard E. Howard, a mathematician, and Zacarias Bramnick, a civil engineer, have been perfecting the method, which applies the

so-called calculus of variations, over the past two years.

First announcement of their work was made at the recent First Latin American Congress on Electronic Computation in Mexico City. Latin American nations building roads through impenetrable or unexplored regions should find the method particularly valuable, the researchers predict.

"The shortest distance between two points may be a straight line," Dr. Howard observes. "But it may not be the cheapest. In the case of a highway, the straight line may be over a mountain or through a swamp."

The researchers devised a set of computer programs which, given pertinent data about a planned highway, will plot the cheapest route — virtually acre by acre. In the case of a mythical 20-mile highway through a section of south Dade County, the route the computer recommended saved an average of \$10,000 per mile over the straight line cost. Although the method would be equally applicable to U.S. roads, the UM team believes its most urgent application to be in Latin America.

The projected "Carretera Bolivariana", an international highway linking five nations, would stretch from Colombia to Bolivia. The road must run through the Amazon River Basin, probably the least explored jungle of the world. Conventional field tests are impossible.

Using the Bramnick-Howard method, the road would be routed by teaming aerial surveys with computer computation. Initial local cost estimates could be made from the air, then fed into the computer. Later, engineering teams could be dropped in specific doubtful areas for further tests that would allow the computer to refine the route. Where speed is essential, the researchers visualize a truck-borne computer (probably of the hybrid type) to plot routes in the field.

The computer method has not yet been refined to include such special considerations as river crossings. "We are sure different mathematical techniques can be integrated into the programs to deal with more complex problems," Howard says. "The real test will come when our method is used on a real highway."

## NEW CONTRACTS

### SIEMENS & HALSKE OF GERMANY PLACES MAJOR ORDER FOR 26 RCA SPECTRA 70 SYSTEMS

Siemens & Halske A.G. of Germany, one of the top 10 industrial firms of Western Europe, has ordered 26 RCA Spectra 70 computer systems valued at more than \$9 million. This is the first major overseas order for Spectra 70 systems and is the initial transaction under the sales agreement signed by Siemens & Halske and RCA in December, according to Arnold K. Weber, Vice President and General Manager, RCA Electronic Data Processing.

The Siemens & Halske order includes a combination of 70/15, 70/25, and third generation 70/45 and 70/55 computer systems and peripheral equipment. Mr. Weber said the systems are for the German firm's internal use and for filling its customer orders. The computer configurations purchased from RCA under the sales agreement will be marketed and serviced by Siemens & Halske through its world-wide sales and maintenance organization. Deliveries of the Spectra 70 electronic data processing systems will begin this year.

### SDS AWARDED \$1.3 MILLION NASA CONTRACT

NASA's Marshall Space Flight Center, Huntsville, Ala., has awarded a \$1.3 million contract to Scientific Data Systems, Santa Monica, Calif., for three DEE-6 Digital Events Evaluators. The DEE-6's (built around an SDS 930 general purpose computer) will be used at Huntsville and at Cape Kennedy to perform automatic checkouts on Saturn rocket stages.

The Saturn family of rockets are the primary launch vehicles for the Apollo Manned Lunar Landing program. During Saturn checkout, each DEE-6 automatically will monitor the status of 3000 information lines every two thousandths of a second and report on the status of the space vehicle and ground support equipment.

Five other DEE-6's and 17 DEE-3's (a similar system using an SDS 910) have been ordered by NASA under previous contracts.

## CONTRACT FOR H610 TO BE INSTALLED AT GRAND COULEE DAM

Honeywell Inc.'s Special Systems division has been awarded a contract by the U.S. Department of Interior's Bureau of Reclamation for installation of a digital computer "watchdog" system at Grand Coulee dam in Washington.

The system, a Honeywell 610, initially will scan and alarm approximately 200 temperature and 30 pressure variables, logging these at periodic intervals, and sequence-monitor 420 digital contacts, including all major relaying and circuit-breaker operations in the two plants and at substations.

The system also will monitor the Grand Coulee pumping plant which at present has six 65,000-horsepower pumps lifting water 350 feet from the reservoir for use in irrigating lands on the Columbia river basin reclamation project.

The Honeywell system is scheduled for delivery in the fourth quarter of 1965. It is designed to permit on-line control in the future.

## BRANIFF GIVES \$1.5 MILLION CONTRACT FOR BUNKER-RAMO SYSTEM

An advanced management information computer system will be produced and maintained by The Bunker-Ramo Corporation under a \$1,500,000 five-year contract for Braniff International Airways. The network tying in the computers and communications devices is scheduled to be in full operation by November, and is designed to take care of reservations requirements into the 1970's.

The new Braniff network will use a combination of high-speed voice circuits and economical telegraph circuits to tie the 30 major cities to the two Bunker-Ramo 335 real-time computers at Dallas, Tex. The 335's initially will be programmed by Bunker-Ramo to make reservations data accessible to Braniff personnel around the clock. With additional programming, the airline also can use them for general purpose data processing.

Braniff's original system, installed in 1957 by Bunker-Ramo (then The Teleregister Corp.) on an eight-year contract, will be

phased out when the new network goes into service in November, having established a reliability record of 99.98 per cent up time.

## SEVEN DDP-224 COMPUTERS FOR SATURN V DISPLAY SYSTEMS

In a contract totaling over one million dollars, Computer Control Company, Inc., Framingham, Mass., has received an order from Sanders Associates, Inc., for seven DDP-224 general purpose digital computers. The DDP-24's will be the digital computer portion of seven Saturn V operational display systems Sanders is building for NASA. The display systems are an integral part of the automated acceptance checkout equipment for the launch vehicle (ACE/LV).

The DDP-224's will collect data, format information, and distribute critical booster measurements to associated displays. The display systems will interface with the Saturn V operational computer to establish the communications link between personnel and the vehicle under test and will provide real-time monitoring, command and emergency control capability.

Four display systems, each including a DDP-224, will be installed at the NASA Kennedy Space Center, Fla., for final checkout of the fully assembled Saturn V vehicles. Three systems will be installed at the NASA Marshall Space Flight Center, Huntsville, Ala.

## DIGITAL MAPPING CONTRACT AWARDED TO ITEK

Itek Corporation, Lexington, Mass., has received a \$2.4 million incentive contract from the U.S. Army for the study and implementation of a Digital Mapping System. The award was made by the U.S. Army Geodesy, Intelligence and Mapping Research and Development Agency (GIMRADA). GIMRADA operates within the structure of the U.S. Army Corps of Engineers.

The award calls for a research program designed to further the state-of-the-art in automatic map making. The program is expected to complete one of the steps necessary for a digital mapping system which will automatically produce accurate maps from aerial photographs.

## NEW INSTALLATIONS

### CONTROL DATA 6600 INSTALLED AT NYU

A Control Data 6600 computer has been installed at New York University's Courant Institute of Mathematical Sciences. Installation of Courant's 6600 — the first on the East Coast — was made at the Institute's recently dedicated Warren Weaver Hall, located at the University's Washington Square Center. The Institute will use the 6600 to develop methods for using very high-speed computers for applied mathematics and mathematical physics through numerical and non-numerical techniques.

### LUFTHANSA INSTALLS COMPUTER SYSTEM TO SPEED RESERVATIONS

The first foreign airline in North America to have started operations of an electronic reservations control system is Lufthansa German Airlines. At the airlines New York headquarters, an IBM 1440 computer system has been installed which enables the airline to maintain a complete booking inventory control for a full year in advance. It automatically provides a daily flight status report for transmittal to all 50 division sales offices. The system also will be used for accounting and payroll processing.

The IBM 1440 computer, as adapted for Lufthansa, consists basically of three disk storage devices; a processor; a card read-punch device; a printer and the main control console. In addition, a paper tape punch is used to transmit manifests to airports and status reports and recaps to sales offices.

### PHILCO 212 SYSTEM INSTALLED FOR FORD SCIENTISTS AND ENGINEERS

Ford scientists and engineers are using a new computer system at the Ford Research and Engineering Center, Dearborn, Mich. The new system was installed by the Communications and Electronics Division of Philco, a Ford subsidiary.

The heart of the system — called the Philco 212 Electronic

## **Newsletter**

Data Processing System — is an advanced scientific computer of high speed, precision, and reliability. Its processing capability is equivalent to about four large scientific computers of the type it replaces, and is 15 to 20 times faster, according to Robert A. Roggenbuck, a Ford computer applications manager.

Ford scientists use the computer and its related equipment to investigate a wide range of problems in pure and applied sciences and manufacturing processes. Ford engineers use the system to analyze and optimize new product designs for future cars and trucks.

### **GREEN GIANT INSTALLS GE-415**

The Green Giant Co., LeSeuer, Minn., one of the nation's largest food processors, is installing a General Electric 415 computer system this month. The \$400,000 magnetic tape system will be used to process orders, handle inventory control and product shipments, and perform routine data processing activities. The new computer will keep tabs on all inventory by product, label, variety, quality, can size, grade, where produced and where stocked.

### **FIRST JAPANESE H-200 INSTALLED BY TOKYO BANK**

The first Japanese-produced Honeywell 200 data processing system has been installed in the Tokyo Business Center of Sumitomo Bank, one of Japan's largest banks. The Sumitomo Bank will use the system for processing consumer and pension loan financing and for general accounting tasks.

The system, which is manufactured in Japan by Nippon Electric Company under terms of a licensing agreement signed in 1962, is one of more than 50 H-200's ordered by Japanese companies since its introduction there last year, according to Nippon Electric Company officials. Nippon Electric markets the Honeywell 200 as the NEAC 2200. It also manufactures and markets Honeywell's entire Series 200 computer line.

### **PDP-7'S SELECTED FOR SEISMIC STUDY**

Lincoln Laboratory of Massachusetts Institute of Technology has ordered three general-purpose PDP-7 computers from Digital Equipment Corporation of Maynard, Mass. Each computer will include 8192 words of core memory, an extended arithmetic element, a data interrupt multiplexer, automatic magnetic tape control, and two tape transports.

The computers will be used by the laboratory's Division 6 for a real-time seismic data processing application. Two will be used in the field in connection with a large seismic array. The third will remain at the laboratory for checkout and program development uses.

The laboratory conducts research in selected areas of advanced electronics, with responsibility for applications to problems of national defense and space exploration. Delivery will be in June, July, and August.

### **ZIPPO LIGHTER MANUFACTURER INSTALLS COMPUTER SYSTEM**

A new computer system has been placed in use by the Zippo Manufacturing Company, Bradford, Pa., according to George G. Blaisdell, president. The Zippo accounting system is built around a National Cash Register 315 CRAM computer with paper tape input.

Some of the larger current operations are: order entry, sales analysis, commissions, stock status availability, etc. Eventually the company expects to arrive at a "total system" in which every information processing step, from original accounting entries to final management reports, is monitored by the computer and its peripheral equipment.

Zippo's NCR 315 data system includes a central processor, high-speed printer, card reader, paper tape reader and punch, and two CRAM (Card Random Access Memory) devices.

### **UNIVAC 490 DELIVERED TO ALCOA'S DAVENPORT WORKS**

A Univac 490 Real-Time Computing System has been delivered to the Davenport Works (Iowa) of

the Aluminum Company of America by the Sperry Rand Corporation's UNIVAC Division. Peripheral equipment includes two Univac 1004 processing systems, a bank of magnetic tape systems and two FASTRAND mass data storage devices.

The new computing system will be used by Alcoa for processing order receipts, production scheduling and central inventory control, financial and cost accounting, maintenance control and other similar applications. Alcoa's Davenport Works produces aluminum plate, sheet and foil.

### **SDS COMPUTER ORDERED BY AEC**

Scientific Data Systems, Santa Monica, Calif., has received an order for an SDS 930 computer system by the Atomic Energy Commission for the University of Washington Nuclear Physics Laboratory. The computer system will be used in conjunction with the new three-stage tandem Van de Graaff accelerator which is currently being installed at the laboratory for experiments in nuclear physics.

Included in the SDS system are an SDS 930 computer with 8192 words of core memory, keyboard/printer, paper tape reader and punch, card reader and punch, line printer, two tape transports and two 21-inch oscilloscope displays.

### **IBM SYSTEM/360 ORDERED BY CINCINNATI BANK**

The Buckeye Savings Association, Cincinnati, Ohio, has placed an order with IBM Corporation for several special "on-line" teller window machines and a new computer, the IBM System/360, according to Hilary H. Evers, Jr., President of the bank.

Mr. Evers stated that the system will provide thousands of Buckeye customers with the fastest financial service available anywhere. The system also will be valuable as a management tool. Other firms in the area have indicated an interest in leasing the services of the new system for their accounting departments via telephone lines. No commitments have been made, but the equipment could handle all of the bank's work plus that of a number of other firms simultaneously.

## RESEARCH CALCULATIONS CONVERTS TO HONEYWELL 200

Research Calculations, Inc., an eastern computer service bureau serving both commercial and scientific organizations, has installed a Honeywell 200 electronic data processing system in its Newton, Mass., headquarters.

The system includes a central processor with 8192 characters of main memory; four magnetic tape units; a high-speed printer; and reader and punch units for both punched paper tape and tabulating cards.

The H-200, which replaces an older 1401 computer, will be used by the firm to process data for its New England customers, with applications ranging from payroll and sales analysis on the commercial level to satellite data analysis on the scientific level.

## FIRST INSTALLATION OF DIGIAC 3080

Installation of the first DIGIAC 3080 educational computer (see Computers and Automation, November 1964, p.43) at the Nassau County Technical and Trade Training Center in Westbury, N.Y., has been announced by the manufacturer, Digital Electronics Inc., Long Island, N.Y. The Center is operated by the Nassau County Vocational Education and Extension Board, Mineola, N.Y., under the direction of Mr. Charles R. Wallendorf. The Westbury school was organized to train computer technicians in all aspects of digital systems.

## SOUTHWEST FOOD CHAIN TO INSTALL NCR 315

Shop Rite Foods, Inc., Albuquerque, N.M., — which operates 80 supermarkets in New Mexico, Texas and Oklahoma — will install a National Cash Register 315 computer system this month. The equipment will handle payroll, accounts payable, vendor records and general ledger, and also will provide various sales, depreciation and other management reports.

In addition to the 315 central processor, the installation will consist of two CRAM (Card Random Access Memory) devices, a high-speed printer and a paper tape reader.

## COMPUTING CENTERS

### AUTOMATED LITERATURE SEARCHING SERVICE FOR INDIVIDUAL SCIENTISTS

Usually when you think of a profile, you think of a biographical sketch or of a human head represented in a side view. To the Institute for Scientific Information, Philadelphia, Pa., a "profile" is a special bibliography reflecting the current interests of any scientist in any discipline anywhere in the world. This "interest profile" is submitted to ISI by the scientist for a highly individualized scientific and technical literature searching service that notifies him promptly each week of current items of specific interest to him. This automated alerting service is called ASCA.

ASCA (Automatic Subject Citation Alert) was developed by the Institute after ten years of research and is a refinement of citation indexing...custom designed to make it both economically and conceptually possible for every individual scientist to get exactly what he wants extracted from the growing literature.

This is how ASCA works. Each scientist constructs his own profile — a bibliography of question citations. A citation is a code for any specific article, patent, review or any other publication which defines the scientist's current area of interest. From then on, the computer system takes over.

As fast as it appears, newly-published literature is screened and matched against each individual profile for answers to the questions asked by each scientist. A computer report is mailed to the scientist, each week, of those articles, communications, reviews, etc., that have cited any — one or more — of the question citations specified in his profile. Any current item that cites any profile entry will be listed in bibliographic form on the report. The weekly ASCA report that is mailed to the scientist contains full bibliographic data including full article title and all co-authors; if a U.S. patent cites any item in the profile, all inventors and assignees, as well as title and classification number are included. Even if none of

his profile items are cited in a given week, the subscriber receives a report to assure him that his "interest profile" has been serviced, and each week he can use his report form to add new questions to his profile.

ASCA is electronically processing more than 1000 U.S. and foreign scientific and technical journals and all of the 50,000 U.S. patents issued each year. Journals from all the disciplines will be added continually throughout the year. The institute estimates that the bibliographies of the items in these journals and patents yield about 60,000 reference citations each week. This means that within one year, each separate profile question will be matched against approximately 3 million potential answers.

The effectiveness of ASCA is attributed to the concept of citation indexing. Since the scientist expresses his subject interests in citations rather than words, the semantic problems usually associated with complex nomenclature or descriptors are avoided. ASCA's approach through citation linkage effectively pulls together related material from all branches of science and technology, calling attention to current, pertinent but often-elusive material. (For more information, designate #43 on the Readers Service Card.)

### COMPUSTAT — NEW SERVICE FOR FINANCIAL ANALYSTS

A cooperative agreement between The Service Bureau Corporation (SBC) and Standard Statistics Company, Inc., will enable financial analysts to use electronic computers as a routine tool for appraising common stocks and investment portfolios. Standard Statistics, a subsidiary of Standard & Poor's Corporation, will provide SBC's New York Data Processing Center with Compustat magnetic tapes, containing 20 years and/or 20 quarters of financial data on utilities and industrials.

The new service — called Compustat — will be offered to banks, brokerage houses, mutual funds, insurance companies, savings associations, corporate financial analysts and investment counselors.

Users may request data on as many as 100 utilities, 900 industrials or a combination of each.

## Newsletter

The Compustat tapes are processed on specially designed IBM 1401 and 7094 computer programs which provide a variety of financial reports.

To use the new system, which will be marketed initially by SBC's New York Data Processing Center, a customer may request any of the studies already programmed, or may desire a specific study to meet particular requirements. Some of the areas now available in SBC's statistical computing library include: a selection of those companies which meet specific criteria stated by the financial analyst; a financial history of a corporation for any consecutive ten-year period after 1946; a set of ratios describing a company's financial performance compared with industry ratios; growth and stability factors for a company, along with its industry's net income and net sales; and comparison of market information on several companies.

Tapes will be updated about ten times a year for industrials, and somewhat less frequently for utilities.  
(For more information, designate #42 on the Readers Service Card.)

---

### NEW PRODUCTS

---

---

#### Digital

---

#### MINIATURIZED SYLVANIA PROCESSOR

A miniaturized computer, weighing less than 200 pounds and occupying only four cubic feet of space has been introduced by Sylvania Electric Products Inc., (a subsidiary of General Telephone & Electronics Corp.), New York, N.Y.

The MSP-24 (Miniaturized Sylvania Processor) is designed to perform the large-scale high-speed computations of conventional computers. It uses 3500 integrated circuits which contain the equivalent of 24 components such as transistors, diodes and resistors. The computer, modular in construction, can be expanded by adding more modules.

Integrated circuits are a form of microelectronics in which microscopic components and circuits are

constructed on tiny chips of silicon and encased in glass. The tiny circuits permit a drastic reduction in computer size and also provide a high degree of reliability.



— Integrated circuits for three computers fit into a thimble.

The MSP-24 was designed by Sylvania Electronic Systems, a division of the company. The integrated circuits were designed and manufactured by Sylvania's Semiconductor Division.  
(For more information, designate #44 on the Readers Service Card.)

#### DES-30 (DIGITAL EXPANSION SYSTEM)

A low-cost, general-purpose digital logic system that adds hybrid capabilities to small analog computers has been announced by Electronic Associates, Inc., Long Branch, N.J. This new system, the DES-30 (Digital Expansion System) may be linked to any general-purpose analog or digital computer, or may be used autonomously as an aid to digital instruction or design.

When used with EAI's TR-48 Analog Computer, the DES-30 makes possible the solution of problems of far greater complexity than those solvable by the TR-48 alone. For example, the hybrid system can provide economic solutions to advanced problems such as statistical calculations, Fourier analysis, transport delay simulation, incremental and iterative computations. It also provides facilities for storage and playback.

In the DES-30, digital operations are performed by modular building blocks designed to relieve the programmer of details of timing, loading, and other circuit considerations associated with digital logic systems. All facilities are designed to provide the necessary interface or features to enhance hybrid problem set-up with a minimum of programming and "debugging" efforts.

All outputs are buffered to provide maximum noise immunity and fan out. Inputs and outputs to the components, as well as control signals, are terminated at a plug-in patch-bay which permits the interconnecting of digital circuits with patch cords and plugs much like that of an analog computer. Pre-programmed patch panels are used to shorten time "on-computer" and for program repeat.

Other features of the self-contained DES-30 include: synchronous logic, internal clock and provisions for external signal triggering, a 540-hold removable patch panel, and one type of flip-flop module which can serve as a shift register, counter or as four individual flip flops. Operations can be as slow as 1 cps; single step operation for debugging procedures is accomplished by push button. System expansion is achieved by plugging in additional modules.  
(For more information, designate #46 on the Readers Service Card.)

#### DIGITAL COMPUTER CHECKS AUTHENTICITY OF INTER-BANK TRANSACTIONS

A new low-cost digital computer which instantly checks the authenticity of messages in inter-bank transactions is now available from Digital Electronics, Inc., Long Island, N.Y. Known as CO-DIT, the new system permits the bank to handle a greater number of messages within a specified period of time and with fewer people.

In present day practice, most large financial institutions with branch offices or correspondent banks have special code arrangements between each other for checking the authenticity of messages involving transfer of funds and other important banking matters. Each message must be individually checked by bank personnel using various non-automated methods before the transaction or message is forwarded to the proper department for action.



With the new CO-DIT system, the operator merely enters certain data directly from the message into the computer. The computer automatically deciphers this information, combines it with pre-set information and displays a code word or number on the control panel display. The message is accepted only if the code word on the computer display agrees with the test word sent with the message.

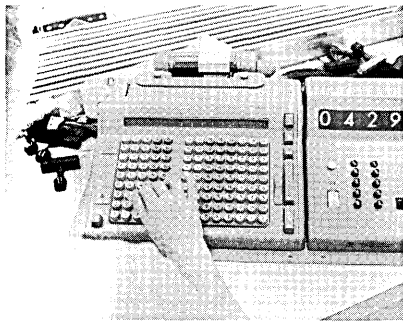

In order to facilitate faster processing and provide additional security, the proper codes are pre-wired into the computer. In addition, the system also may be pre-set to handle different codes from other banks or institutions. The bank uses CO-DIT to prepare outgoing messages in the same manner as incoming messages.

The present CO-DIT computer can index up to 999 different identification numbers for member or correspondent banks. Provisions have also been made for the handling of transactions in currency other than dollars.

The CO-DIT system includes a special purpose solid state digital computer, a modified adding machine and an illuminated control/display device. The entire system is smaller in size than a standard office desk and requires no special wiring or air conditioning.

The equipment can be operated by an unskilled operator after only a few minutes of training. An average operator can perform the entire "checking operation" in less than ten seconds.  
(For more information, designate #45 on the Readers Service Card.)

## IBM ADDS TWO TIME-SHARING COMPUTERS TO SYSTEM/360

The IBM System/360 Model 64 and Model 66, designed specifically for time-sharing applications, have been announced by IBM Corporation, White Plains, N.Y. The

computers, able to handle a number of different jobs at once, will provide the equivalent of large-scale scientific computing facilities to engineers and scientists working at a variety of terminals remote from the computer itself.

The central computer will operate in a "conversational" way with each terminal, acknowledging data entry and automatically checking for clerical or logical errors. In addition to operating in a "conversational" time-sharing way, the new models also can be performing standard data processing calculations. To do these jobs effectively, Models 64 and 66 combine several major advances in computer circuit design and programming.

Key differences between the new computers and previously announced IBM System/360 equipment include channel controllers (which permit flexible interconnection of processors, memories and input-output equipment) and dynamic relocation of memory. Dynamic relocation refers to a method of using memory space efficiently when programs and data are being moved frequently in and out of the system. This method makes use of new electronic circuitry known as associative memory, and frees the computer user of the need to keep track of exactly where information is located during the actual processing.

Models 64 and 66 use the full set of System/360 programming instructions plus extra instructions to direct the time-sharing features. Programs prepared on the two new machines can be recompiled for use on other System/360 equipment.

System/360 Models 64 and 66 will be available in a wide variety of configurations. In a single configuration up to four computer processors, eight memories and four channel controllers can be linked together. With the channel controllers, up to four central processors can share a pool of main memory devices capable of storing up to two million characters.

Memory cycle time for the Model 64 is two microseconds for eight characters of information; cycle time for the Model 66 is one microsecond.  
(For more information, designate #47 on the Readers Service Card.)

## Analog

### PORTABLE ANALOG COMPUTER FOR SCHOOLS AND COLLEGES

A portable, low-cost analog computer, designed to provide students with an introduction to analog computation, is being manufactured by System Computers Limited of England. The device, System Computers Analogue Tutor Mk2, is believed to be the first computer of its kind built specifically for tutorial purposes.

The equipment, in addition to demonstrating the basic principles of analog computation, can be used to show how system investigation and behavior analysis can be applied to such subjects as biology, chemistry and physics.

The computer is self-contained with plug-in characteristics. It measures 19½" long, 12" high and 14" deep and weighs only 57½ pounds, easily portable between classrooms or laboratories. Two or more computers can be linked to provide an increased computing capacity, with one instrument acting as the master.

All metering instruments and controls are arranged on the front of the console. The front panel assembly of the computer is removable to allow study of the inside structure.

Six operational amplifiers are provided, mounted in pairs to form plug-in modules. Four of these can be used either as summers or integrators and the remainder as summers only. Provision is made for the addition of an electronic multiplier as a standard extra. Circuit elements are shown symbolically on the patch panel.

The computing components, feedback resistors and capacitors, input resistors, diodes etc., are plugged directly into the face of the patch panel. Thus components of any value or tolerance can be used, depending on requirements. The standard selection of components has 1% tolerance. Closer tolerance components can be supplied.

(For more information, designate #49 on the Readers Service Card.)

### PROCESS CONTROL SIMULATOR TRAINS ENGINEERS

A process control simulator, designed specifically to teach control engineers, has been developed by a British firm, Feedback Ltd. of England, to serve as an electrical analog of a process and its controller.

It can be used both for demonstrations of process control methods and for quantitative experimental work. Advantages include reduction of teaching time, elimination of hazard to processes, immediate results and flexibility.

The equipment is capable of simulating a three-term controller operating a three-capacity process. Effect of load and supply perturbations to the process can be measured on an oscilloscope and recorded.

The simulator is an assembly of transfer function units and amplifiers. Each of the three channels is independent and the summed output is free from interaction between the components. Each channel contains an assembly of two amplifiers. For the proportional term the second of the two cascade amplifiers is switched to -1. This gives a convenient means of proportional control using the calibrated gain control of the first amplifier.

A wide variety of components is available, accurate within 1 percent of nominal values. Dimensions are 21 3/4" x 13 1/4" x 21 1/2". Weight is 85 pounds.

The Process Control Simulator is particularly useful for accelerated training of operators and engineers. A wide range of experiments are included in the Instruction Book supplied with the equipment. Markets are chiefly universities, technical colleges and large manufacturing companies operating their own staff training programs. (For more information, designate #48 on the Readers Service Card.)

#### CORRECTION

On page 50 of the April issue of "Computers and Automation", the address of Digi-Data Corp. is incorrectly listed as Bladensburg, Va. in "Model 2020 Card Transmitter". The correct address is Bladensburg, Maryland.

### Memories

#### MASS MEMORY STORAGE FILES ADDED TO SERIES 200 LINE

Honeywell Inc. has announced development of a line of fast, high-density mass memory file units. The company said it will market three models of the memory device with its new Series 200 computers and to other original equipment manufacturers in the EDP industry.

The three memory files span a range from 15 million characters of storage capacity to more than two billion characters. They are priced to compete in the smallest to the largest random mass memory markets.

The basic storage medium for the mass memory files is a magnetic tape strip approximately the size of a punched card. A single cartridge containing 512 magnetic tape strips is approximately the size of a small shoe-box and weighs less than five pounds.

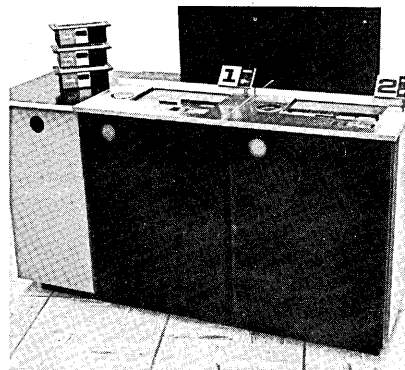

— Honeywell's Mass  
Memory File

In the smallest file, Model 251, a single cartridge has a storage capacity of 15 million six-bit characters. Record access time is 95 milliseconds. In the larger files, Models 252 and 253, each cartridge has a capacity of 60 million six-bit characters, accessible at speeds of 150 and 225 milliseconds, respectively.

The Model 252 file permits a maximum of one cartridge on-line at one time; Model 253, however, allows up to five cartridges to operate simultaneously for a maximum on-line storage capacity of 300 million characters. In addition, up to eight files can be attached to a single control

unit, thereby increasing the maximum effective storage capacity of Model 253 to a total of 2.4 billion characters.

Cartridges are loaded easily and quickly through a sliding glass port in the top of the memory transport. Once in position, a series of selection rods are automatically inserted through notches in the top of each tape strip in the 512-strip deck. Combinations of selection rods are turned, on command from the computer, from the "hold" position to a "release" position, permitting a single strip to be selected from the deck. The computer commands are analogous to combinations used to open a safe. Each tape strip in the cartridge requires a different combination. The strip is moved to the read-write drum, which can search and read or write in a 16.7 millisecond revolution. A strip is returned randomly to the deck along a raceway that carries it to a pick-up pedestal for reinsertion into the deck, where it is held until called for again.

Any number of cartridges can be used to store mass volumes of data in an off-line status. Each cartridge is contained in a dust-proof container that can be stored on office shelving when not in use.

Costs of the files are "the lowest on a cost-per-bit basis in the industry," Claude H. Smith, marketing vice president of Honeywell's EDP division, stated. He said the company anticipated major markets would be in insurance, banking, manufacturing and retailing fields, where the demands for accessing large files of data quickly and randomly are "most acute".

(For more information, designate #50 on the Readers Service Card.)

#### DUPLEX RAM<sup>®</sup> INTRODUCED BY POTTER

A new, twin-cartridge tape random access memory has been announced by Potter Instrument Company, Inc., Plainview, N.Y. The Duplex RAM<sup>®</sup>, as the twin-cartridge model is called, has the same on-line capacity and all of the performance capabilities intrinsic in the basic RAM, but provides important operational flexibility. Since the machine is equipped with two Tape Pack cartridges, it is now possible to copy partial or entire data content from one cartridge to the other. This eliminates the

necessity for two machines where the on-line capacity of one is adequate.

The RAM memory system has a unique drive system which permits the use of high-density magnetic tape loops as the storage medium. The use of magnetic tape loops gives the RAM simplicity of design and flexibility of operation.



— Duplex RAM®

Each cartridge comprises two rows of four magnetic tape loops. The machine provides 50.2 million bits of on-line capacity equally divided between the two cartridges. Information is recorded serially at a packing density of 1000 bits/inch and any information may be written or read at random by transmitting address information to the unit with an appropriate command signal. All head assemblies are mounted on a common head post having 28 positions, resulting in 112 addressable tracks per tape loop. Reliability is better than one bit in  $10^{10}$  transient error rate. Head positioning time is less than 65 milliseconds, and a check-read operation is completed in less than 500 microseconds after writing. Average access time is less than 90 milliseconds, including both head positioning and average latency time. Data transfer rate is 600 KC/S. Cartridge loading time is less than 15 seconds; cartridge weight is less than 13 pounds.

Comparisons between the RAM and other machines is said to show typical operations being accomplished in half the usual time — and cost per bit reduced to one-fourth.

(For more information, designate #69 on the Readers Service Card.)

## Information Retrieval

### DOCUMENT RETRIEVAL AND DISPLAY FILE

The Mosler Safe Company, New York, N.Y., will demonstrate for the first time, its entry in the automated document retrieval and display field, at the National Microfilm Association Convention, at the Sheraton-Cleveland Hotel, Cleveland, Ohio, May 11-13. The Mosler system initially was developed for use by the U.S. Navy and the Air Force.

With this system, documents up to 18" x 24" are reduced to microimages and filed at random on aperture cards. By entering the number of the filed document on a keyboard, any one of thousands of documents can be automatically selected and projected onto a

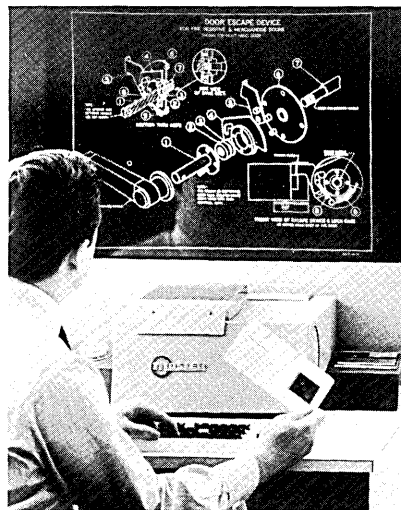

viewing screen. This retrieval cycle can be performed in ten seconds. Prints can be made at the press of a button.

Heart of the system is a retrieval device which selects the desired card, elevates it on a column of air for projection on the viewing screen, and refiles it. The device, 32" wide x 50" deep, takes up only 11 square feet of floor space.

In addition to providing immediate access to filed engineering drawings, maps, and detailed specification sheets, the Mosler system prevents loss and damage to the filed documents. The master image always remains inside the unit and, once filed, is never touched. The column of air which

raises the card, also serves to protect the microfilm surface from damage.

The Mosler Safe Company stated that the first document retrieval models will be available to private industry late this year and other models early in 1966.

(For more information, designate #51 on the Readers Service Card.)

### CARD (COMPACT AUTOMATIC RETRIEVAL DEVICE)

Houston Fearless Corporation of Los Angeles, Calif., has developed a new system which is easily adaptable to almost any retrieval or display problem needing a readily accessible library of information. Designated CARD (Compact Automatic Retrieval Device), it is a storage retrieval device for rapid random access to large quantities of film slides or cards.

CARD can be tailored for self-contained reference viewers with front or rear projection systems. It may also be integrated as a peripheral device with computers for data and image storage. CARD modules are versatile enough for almost any application requiring from  $1\frac{1}{2}$  to  $2\frac{1}{2}$  seconds average access time.

CARD is based on the proven edge notched card principle of selection, but Houston Fearless has greatly simplified the mechanics through new innovations (patent pending). The process entails mounting the film slides in a metal holder with edges notched in a binary coded pattern. Stored between magnets, each slide is magnetically suspended in a "floating store", permitting slide retrieval without touching adjacent slides.

The desired slide is identified and selected by selector bars running the full length of the slide storage module. As the selector assembly moves toward the stored slides, only that slide matching the setting of the selector bars will be retrieved. Since the pattern is different for each slide or category, all but the one desired remain outside the grasping range of a picker assembly.

Selected slides are then carried to one end of the selector directly into the film (projection) gate. When a new slide is desired, the last slide selected is pushed

## Newsletter

back into the store and a new slide is withdrawn in a single cycle.

A prototype CARD unit in one configuration (see picture below) uses a self-contained dual viewing screen. A telephone information

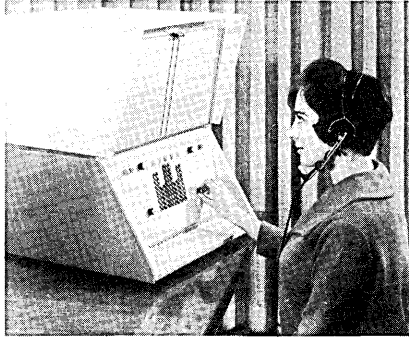

operator is shown providing new numbers or old at the touch of a button in less than 1/2 of the time it now takes. This full unit is only thirty inches tall.

Single module CARD units with capacities of 128, 256, 512 and 1024 slides may be obtained for both 35 or 70mm film sizes, with larger film sizes accommodated on special order. By adding more modules, the total library size may be expanded. (For more information, designate #52 on the Readers Service Card.)

---

### Input-Output

---

#### SC-1150, EDP TAPE TRANSPORT SYSTEM

At the INTERDATA Congress in New York City May 24, Potter Instrument Company, Inc. (Plainview, N.Y.), will introduce a new, high-performance tape transport announced as "the industry's highest performing and world's most advanced digital magnetic tape transport system".

The new transport, Model SC-1150, is a high-speed, single-capstan digital tape transport which operates at bidirectional tape speeds to 150 ips at 800 bpi with no program restrictions. The SC-1150 is 7- or 9-channel (System 360 or ASCII) compatible and can be adapted to all major computer formats.

A new tape drive design utilizes a single capstan to pass the tape through a low friction tape

path. Tape loading is easier than ever before. Tape is threaded directly from the supply reel to the take-up reel. From this point, loading is accomplished automatically at the touch of a button.

The oxide side of tape touches no surface except the read/write head, greatly increasing tape life and data reliability. The read/write head is retractable and does not contact the tape during rewind.

Control of the tape path is maintained by a precision trough guide system. A low inertia drive permits rapid linear acceleration while maintaining tape contact with the capstan at all times. No restricting pinch rollers, valves, guide rollers, or air guides are used. Complicated mechanical adjustments are eliminated. Constant vacuum results in uniform tape pressure on the reels. The capstan drive system is synchronous motor controlled to give long motor life and maintenance-free operation. Highly reliable photoelectric sensors, long-life lamps and all solid-state servo controls are used. Other features include EOT/BOT load point sensing, Potter's IBM-compatible QUICK-LOCK® hubs, and a new custom-styled cabinet. (For more information, designate #70 on the Readers Service Card.)

#### 2201 FLEXOWRITER INTRODUCED

A completely new Flexowriter automatic writing machine has been introduced by Friden, Inc., San Leandro, Calif. (a subsidiary of The Singer Company). The new 2201 Flexowriter® automatic writing machine, Programatic model, has fast operation at a low sound level, and programming versatility as a guarantee against obsolescence.

Program flexibility for various applications is achieved by a removable control panel. To change a program, the operator simply plugs in a new program panel. Optional input and output units add increased versatility.

A special desk is the central feature of the modular arrangement housing the 2201 and related pieces of equipment. The modular styling allows auxiliary units to be plugged into the stand rather than the machine, thus eliminating an unsightly tangle of cables.

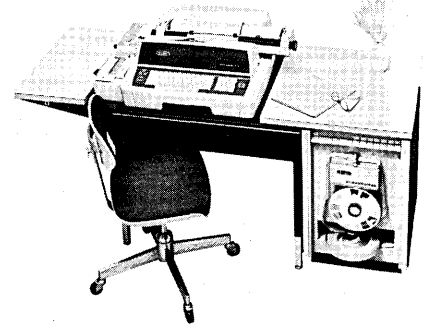

— 2201 Flexowriter®

The Friden machine is activated by punched tape or cards and, as an automatic by-product of the basic operation, simultaneously punches tapes or cards for use as source data for other documents. Auxiliary devices include the 2212 auxiliary tape reader, the 2214 Selectadata selective reader and the 2215 auxiliary tape punch. (For more information, designate #57 on the Readers Service Card.)

#### "BRITE-WALL" — A NEW FLIGHT INFORMATION SYSTEM

A new flight information system called "Brite-Wall" for use in public areas of airline terminals, has been developed by the Bunker-Ramo Corporation, Stamford, Conn. The Brite-Wall System displays flight information in milliseconds on a bank of cathode ray tubes ranging in size from 6 to 27 inches on a wall display as large as 8 feet by 24 feet. Adaptable to the demands of individual airlines, the smallest tube can display 1 to 3 alpha, numeric, or symbolic characters approximately 3/4 inches high, while the largest tube can display up to 12 lines of 32 smaller characters per line.

Its modular construction permits the system to be as large or as small as requirements dictate. Depending on specific requirements systems can be designed utilizing various combinations of screen size. High light output CRT tubes enable displayed information to be readily seen across a terminal floor. The system may be manually controlled or it may be operated from a customer's present computer system.

An unusual feature of Brite-Wall is its ability to electronically bring information up-to-the-second by rapid changes to a single character, a word, or a complete line. Mistakes by operators or

information changes are easily handled without the necessity of having to re-do the entire message. (For more information, designate #58 on the Readers Service Card.)

## IBM VOTOMATIC

A briefcase-size, inexpensive voting device, which uses punched cards in conjunction with a printed ballot is now being marketed by IBM Corporation. The company has announced the incorporation into its product line of a vote recorder developed by Dr. Joseph P. Harris, professor emeritus of the political science department at the University of California. The device, weighing approximately six pounds, will be known as the IBM Votomatic and is priced at \$185.

The voter registers his choices by using a pen-like stylus to punch holes in a specially designed data processing card. The voter slips the card into the voting device so that it positions itself precisely underneath the printed ballot (see photo below) which can be several pages in length.

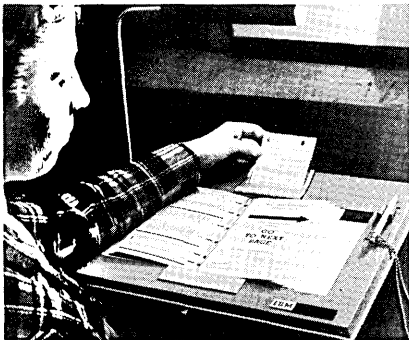

As the voter turns each page of the ballot, additional voting issues and punching positions are exposed. The pre-scored punching positions are immediately opposite the ballot page and are indicated by arrows from the candidate's name or the "yes" or "no" choices in a referendum. After a page has been turned, the issues already voted upon and the holes already punched in the card are covered and others are exposed, making it easy for the voter to concentrate on only a few issues at a time.

Election officials who tested the system last November said it not only proved simpler for the public, but also was less expensive than other voting methods. The punched card ballot can be entered directly into general pur-

pose data processing equipment for automatic counting at high speeds. Computer tabulation of the punched card ballots averages less than a half cent per vote.

There are up to 240 response positions available on a single punched card ballot. (The largest paper ballot in the 1964 elections required 236 voting positions.) Thus, many varied and complex recording situations can be handled on the new device.

Additional applications of the vote recording principle would enable interviewers, survey takers, salesmen, doctors, educators, inspectors, researchers, and others to capture data directly on punched cards, saving time and labor and eliminating delays and errors connected with transcribing written records. (For more information, designate #54 on the Readers Service Card.)

## DATASTROBE INTRODUCED BY RAYTHEON COMPONENTS

Datastrobe, a new standard line of electronic readout devices, was introduced by Raytheon Company's Components Division, Lexington, Mass., at the annual conference of the Institute of Electrical and Electronics Engineers (IEEE) in New York, March 22.

Stroboscopic techniques are employed to project multicharacter presentations with a steady, bright illumination. Specialized symbols and alphabetical and numerical characters of any font, type face, or language can be specified in a Datastrobe system.

Datastrobe offers in-line, in-plane readout; well-defined, nonsegmented characters; wide angle viewing; and a fail safe display feature. Characters have the conventional shape and optimum width-to-height ratios necessary for quick and accurate visual recognition.

The Datastrobe readout system may be used with computers; digital test equipment; range radar, digital control, and air and sea navigation systems; and remote readouts for displays of space launch countdown clocks, air line arrival and departure information, and stock market quotations. Cost of the new readouts will vary according to the application requirements and the accessories. (For more information, designate #53 on the Readers Service Card.)

## NEW MAGNETIC TAPE UNITS FOR NCR 315 SERIES

The National Cash Register Company, Dayton, Ohio, has announced the addition of three new magnetic tape handlers to its line of 315 computer equipment.

The three new units are the Class 333-102 with 83.4 KC transfer rate; the Class 334-131 with controller; and Class 334-132 without controller, both of the latter having a transfer rate of 33.3 KC. When using the 33.3 KC magnetic tape units, the first unit must be a Class 334-131 with controller which will control up to four additional Class 334-132 units.

The devices are compatible with the recording density of several other magnetic tape models in the NCR 315 line, operating at either 556 bits per inch density at both odd and even parity or 200 BPI at odd parity. (For more information, designate #56 on the Readers Service Card.)

## OPTICAL PRINTING SALES REGISTER

A new Monroe Sweda series 4500 optical printing sales register has been introduced by the Monroe Sweda Sales Register Systems, division of Litton Industries, Orange, N.J. The optical font register produces a paper tape on which numeric data is visibly recorded, permitting electronic "reading" of sales information by optically sensitive computer devices at greatly increased speeds, according to Charles S. Adams, division vice-president. The new optical font — a special imprinting type face — conforms to proposed standards of the American Standards Association for data processing equipment. (For more information, designate #55 on the Readers Service Card.)

---

## Components

---

## MICROELECTRONIC DEVICE REPLACES 21 COMPUTER CIRCUITS

General Instrument Corporation recently has introduced to the computer-data processing industry a first-of-its kind microelectronic circuit which replaces 21 individual basic circuits used by the

hundreds and thousands in all forms of digital computing and data processing equipment. One microscopic wafer measures only 70/1000 inch long and 60/1000 inch wide. Each of the new microcircuits costs less than \$75, compared with a total of \$136.50 for the 21 it replaces.

Developed by the Company's Microelectronics Division at Hicksville, N.Y., the computer microcircuit, known as a "21-bit shift register", contains 110 transistors and 48 resistors built into the silicon wafer in a complex pattern virtually invisible to the naked eye. It performs the functions of 21 separate "flipflops", which are the basic switching and "counting" elements in digital computers.

The new device, according to the company, is capable of handling more bits of information than any microcircuit yet available commercially. Each shift register handles 21 bits simultaneously (or in groups of 16, 4 and 1 bits, so as to give the storage and processing performance of three separate shift registers).

The unique microelectronic device makes possible significant reductions in size, as well as cost, of computer memory systems and can be used to immediate advantage in small computers, space information systems, industrial automation controls, and a wide range of commercial data processing equipment.

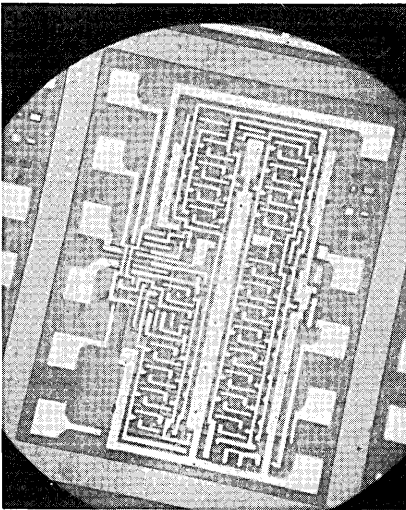

— Microphotograph of MOS 21-bit shift register

The new integrated microcircuits will be available in large quantities to the electronics industry by mid-June. (For more information, designate #60 on the Readers Service Card.)

### SSE-1100 MEMORY EXERCISER

Computer Test Corporation, Cherry Hill, N.J., has announced industry's first commercially-available automatic test system employing off-the-shelf integrated circuits to perform all the logic, timing and error checking functions for the entire system. Model SSE-1100 Memory Exerciser is designed to generate predetermined digital data and store it in a magnetic memory system under test, address by address, recall the data on command and then compare it with the original information. If a defective address is detected, the Exerciser will count the error as it occurs while the memory system is being cycled, or it will stop automatically and display the memory address and the bit location of the error.

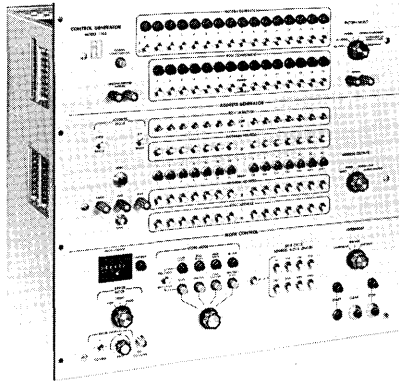

— Shown above is a system module which contains three functional sections to the Exerciser: (1) Pattern Generator - programs the desired pulse pattern for the memory under test; (2) Address Generator - sets the minimum and maximum memory locations through which the Exerciser cycles; (3) Mode Control - sets the mode of operation for type of cycling and for error detection.

The SSE-1100 is capable of testing systems with memory capacities of up to 16,384 words with word lengths of up to 64 bits per word. (Word length capacity can be expanded by 16 bit increments to accommodate the larger memory sizes without major modifications.) The full cycle time of the Exerciser can be varied over the range of 1 to 200  $\mu$ sec so that different speed systems can be tested. The total testing time required by the Exerciser to perform the data comparison check for errors is less than 0.2  $\mu$ sec, which permits the

checking of memory systems with relatively long data access times.

The Exerciser uses eight different types of MECL (Motorola Emitter Coupled Logic) 30 mc Integrated Circuits in the system logic, in the timing circuits and in the error checking circuitry. The use of integrated circuits has made possible significant expansion in the logical design of the Exerciser permitting much greater programming flexibility without a corresponding increase in the physical size of the system. The packing density of the integrated circuits has resulted also in minimum wiring and cabling distances. (For more information, designate #62 on the Readers Service Card.)

### INTEGRATED CIRCUIT MODULES FROM COMPUTER CONTROL

Computer Control Company, Inc., Framingham, Mass., has introduced  $\mu$ -PACS, a broad line of fully integrated circuit modules. The new 3C PAC module line consists of monolithic integrated circuit modules supplemented by some integrated/discrete hybrid modules and a few discrete component modules.

$\mu$ -PACS, with a typical noise rejection margin of 1.35 volts, are integrated circuits mounted on etched glass-impregnated epoxy cards. They permit easy design and design modification and simplified procedures for check-out and maintenance. All important circuit inputs and outputs are available at connector pins, which makes possible traditional systems design. Design changes or system expansion are achieved simply by changing or adding modules or wires.

$\mu$ -PAC circuits, operating from DC to 5 mc, utilize the NAND function.  $\mu$ -PACS can be used also to directly implement the NOR function for negative logic, or AND-OR logic. All  $\mu$ -PACS use static logic.

Auxiliary equipment includes BLOCS for accepting wire wraps or taper pin connectors, power supplies, cooling units, module extractors, extender PACS, manuals, and logic sticker kits. (For more information, designate #61 on the Readers Service Card.)

## NEW LITERATURE

### ENGLISH TRANSLATION OF RUSSIAN JOURNAL

Scientific Information Consultants Ltd., 661 Finchley Road, London NW2, recently has begun to publish an English translation of the Theoretical Cybernetics Section of the Russian "Referativnyy zhurnal, Matematika", under the heading "Theoretical Cybernetics Abstracts". This is a cover-to-cover translation and is published within about three months of receiving the Russian original. The annual subscription is \$135.

### MERCHANDISE MANAGEMENT

A total system concept for merchandise management in retail stores is described in a 28-page brochure available from The National Cash Register Company. The brochure, "Merchandise Management, A Total System", highlights system objectives, data generation, electronic data processing, and significance of "action" documents and reports as a modern management tool.

(For more information, designate #63 on the Readers Service Card.)

### H20 DIGITAL CONTROL SYSTEM BROCHURE AVAILABLE

Typical process applications that can be performed by the new Honeywell 20 digital control system are outlined in a 16-page brochure recently published by the automatic control company's Special Systems Division. The brochure, oriented toward process engineers, describes with accompanying block diagrams how the low-cost computer system can be used for monitoring and data logging, supervisory control, direct digital control, high-speed data acquisition, batch processing, and production control. (For more information, designate #64 on the Readers Service Card.)

### LINE PRINTER INFORMATION MANUAL

A new 24-page booklet contains all general and operating data for Data Products Corporation's high speed dp/p 4000 Series

Line/Printers. Special emphasis is given to simplicity of operation, loading, interfacing and maintenance. The print hammer design, paper drive system and modular plug-in electronics also are illustrated and described. Complete specifications for 360, 600 and 1,000 (48-characters) lines per minute models within the Series are also included. (For more information, designate #65 on the Readers Service Card.)

### AUTOMATIC MULTIPROGRAMMING IN THE 600 FAMILY

A new 12-page brochure has been released by General Electric which describes how advanced automatic multiprogramming is accomplished in the 600 family. The five key software modules comprising GECOS — General Comprehensive Operating Supervisor executive program — are described. Associated hardware features are pictured.

(For more information, designate #66 on the Readers Service Card.)

### INCREMENTAL DIGITAL TAPE RECORDERS

Precision Instrument Company has published new literature that details the one-step production of computer compatible magnetic tapes from randomly acquired data by the use of incremental digital tape recorders.

The new literature includes an eight-page brochure describing Precision's three series of incremental recorders, with specifications on 200 and 556-bit per inch packing density models, write only and read/write versions, and portable or rack-mounted configurations.

The technical material also contains circuit diagrams for interfacing the digital recorders with common data sources. (For more information, designate #67 on the Readers Service Card.)

## JOBS & OPPORTUNITIES

### COMPUTERIZED JOB FINDING IS OFFERED TO EXECUTIVES

A computerized system that matches the job with the job-seeker has been developed by Career-Ways System Inc., of Princeton, N.J.

For a fee of \$24 a year, an executive or professional man may have his name and qualifications placed on a coded card. An employer engaged in a talent search sends his job profile to Career-Ways. It is fed into a computer which then chooses the cards of all individual members that fit the job qualifications. A staff of consultants and advisers do a further screening job and the contenders then are notified of the opening. Up to this point, the job candidate's only identification has been a number on a card.

If the candidate is interested, he gives Career-Ways written authorization to notify the employer. Because Career-Ways is not a conventional employment service, there is no further charge to either party if employment is finalized.

The Princeton company's service at present is limited to professional and executive talent. Individual members have complete anonymity through the use of the computerized system. Clients, both individual and corporate, are located in all 50 states and 11 foreign countries. The majority of company clients are among the nation's top 500 firms.

The firm's executive director, Gordon G. Sikes, contends the computerized system has the advantages of better communication between employer and job-seeker; complete anonymity while the search is on; and a fast, efficient and economical way of bringing the right man and the right job together. (For more information, designate #68 on the Readers Service Card.)

# NEW

## DREXAMATIC

# PUNCHED CARD PROGRAMMER

*For reference control  
and data entry . . .*

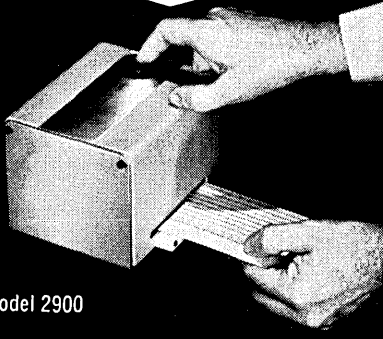

Model 2900

### APPLICATIONS INCLUDE . . .

- Remote data entry
- Machine dispensing
- Material weighing
- and all digital or analog automated systems

This new punched card programmer gives you . . .

- ✓ Potentiometer reference control
- ✓ Current reference control
- ✓ Time control
- ✓ Count control

### CUSTOM ACCESSORIES

Drexel will custom design to your specifications, various card programmer accessories including sequence timers, potentiometers, current references and counters.

For complete information or to arrange a demonstration, write to:



(215) 672-2200

HORSHAM, PENNA., Suburban Philadelphia

Circle No. 25 on Readers Service Card

## Newsletter

### MEETING NEWS

#### EDUCATORS IN ELECTRICAL ENGINEERING MEET AT BERKELEY CAMPUS

The impact of computers on engineering, science, business, and many other domains of human activity recently provided a backdrop for a special invitational conference of over sixty leading educators in electrical engineering, representing forty engineering colleges in the United States and Canada.

The conference was held at the Berkeley campus of the University of California and was called on the initiative of Profs. M. E. Van Valkenburg (University of Illinois) and L. A. Zadeh (University of California). Present among the attendees were representatives of the Engineering Council for Professional Development and of the National Science Foundation.

A primary aim of the conference was to reexamine the role of electrical engineering in computer sciences. Since modern digital computers are essentially large-scale electronic systems, electrical engineers have always played a central role in their design and construction. However, the rapid growth in the use of computers has brought about a shift in emphasis from design to utilization. As a consequence, electrical engineering departments are now finding it necessary to provide training in subjects such as natural and artificial languages, automata theory, artificial intelligence, and other fields in which the accent is on abstract symbol manipulation rather than electronic circuit synthesis.

One conclusion that emerged from discussions at the conference was that within the next few years, computer sciences would very likely come to occupy an important and perhaps a central position in electrical engineering, with computer-science majors constituting a large fraction of students in electrical engineering departments.

#### 1965 DPMA INTERNATIONAL DATA PROCESSING CONFERENCE AND BUSINESS EXPOSITION

The city of Philadelphia (Pa.) will host the 1965 DPMA International Data Processing Conference

and Business Exposition June 29-July 2. The Ben Franklin Hotel has been chosen as the Conference Hotel, but most events will take place in Convention Hall.

The Business Exhibit will be set up in the Convention Hall — Exhibit Floor. General sessions and seminars will take place at the Convention Hall — Center Building.

This year's Conference theme is "Education, Keystone of Management". All seminar categories fall under the "Advancement" realm of things and include the following topics: I. Advances in Management Information Systems; II. Advances in Data Processing Management; III. Advances in Data Processing Education; IV. Advances in Hardware; and V. Advances in Software.

More information concerning the Conference program, registration and reservations may be obtained by contacting Data Processing Management Association, 524 Busse Highway, Park Ridge, Ill.

### BUSINESS NEWS

#### DATA COMMUNICATIONS UP STRONGLY IN 1964

Use of data communications services in business operations continued strong in 1964, with new developments in the field indicating growth in the years ahead, the Bell System reports.

"Increasing interest in advanced communications is related directly to the expanded use of computers and related electronic facilities in business today," reports Edgar C. Gentle, Jr., AT&T administrator of data communications planning.

"With more and more business functions becoming oriented to automatic data processing, companies are meeting the need to convey information with greater speed and efficiency. Traditional communications methods are being supplemented by newer communication systems," Mr. Gentle says.

"The number of data communications systems established by businesses during 1964 is running well ahead of the previous year,"



reports Frank A. Robinson, AT&T sales projects administrator. "Particularly noteworthy in this growth is the mounting number of small as well as large companies now introducing advanced communications facilities to their operations."

Of particular interest to business in 1964 was Data-Phone data communications service, the Bell System's facility for enabling machine-to-machine communication over the regular telephone network. A substantial increase in the types of applications to which Data-Phone service is applied occurred during the year.

"Industries most clearly reflecting the condition of the economy showed particularly strong interest in Data-Phone service during the past year," Mr. Robinson reports. "Credit bureaus and other firms directly related to consumer buying are a notable case. Confronting the need to handle steadily increasing amounts of information, arising from mounting business volume, a number of these organizations established or expanded data communications systems during the year, some of which are now speeding information from coast to coast."

Similarly, the banking industry continued as a pacesetter in the use of advanced information systems. Particularly notable during 1964 has been the number of banks that are offering data processing services to professional and business customers, as well as to correspondent banks, through data communications.

The trend toward automated purchasing through data communications between suppliers and buyers, which began developing in 1963, came on strong during the past year, penetrating many segments of business. "Because of the remarkable cost-cutting and operational advantages that these automated ordering systems are producing, this development is expected to continue," Mr. Robinson says.

A specialized use of Data-Phone service in the medical field also advanced during 1964. Using Data-Phone service permitting the transmission of heartbeat readings over regular phone lines, a number of medical centers have established data links to remote hospitals, clinics and doctors' offices.

In these systems, doctors are transmitting a patient's electro-

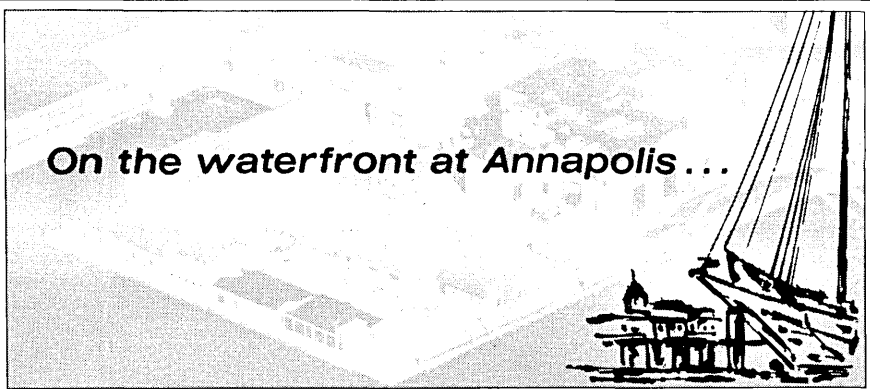

## Opportunities for Analysis into Ship & Submarine Systems

The U.S. Navy Marine Engineering Laboratory conducts RDT&E in naval shipboard and submarine machinery & auxiliary systems (electrical, propulsion, control, etc.). In addition to developing basic improvements in performance and reliability, the Laboratory concentrates on ship silencing, new concepts in energy conversion and control, ways to minimize friction and wear, special operating machinery for deep-diving vessels; and tough, resistant naval alloys to meet all ocean environmental conditions.

The Laboratory buildings—now more than 50 of them—house some of the finest research, experimental and evaluation equipments of their kind... such as high-speed computers, electric power generators, vibration and shock test stands, metals composition analysis instruments, cryogenic storage and handling facilities, physics and chemistry labs, and complex instrumentation for measuring strain, stress, pressure, acceleration, velocity, performance, and reliability. The Laboratory grounds resemble a modern industrial park, and include special facilities for in-field experimentation.

And the locale is ideal. Washington, Baltimore, and the ocean resorts are no more than one hour's drive. Annapolis itself is the state capital, and offers small-city living with metropolitan accessibility.

Because of a sharply increased workload involving urgent new projects, there are key openings for qualified professionals in every MEL division... Electrical Systems, Machinery Systems, Ship Silencing, Friction & Wear, Naval Alloys, and Special Projects. A few representative positions are listed below, but there are many more... all with strong growth potential.

- 2/ **ELECTRONIC INSTRUMENTATION ENGINEER (\$10,250 to start\*)** R&D in feedback analysis automatic control systems, analog computers, simulation, and familiarity with digital computers.
- 3/ **ELECTRICAL SHIPBOARD SYSTEMS ENGINEER (\$12,075 to start\*)** To apply formal reliability techniques to electrical/electronic aspects of ship machinery and control (pumps, compressors, controls, actuators, etc.)... and to use electrical reliability parameters in the system mathematical models.
- 5/ **PERT - GRADUATE ENGINEER (\$10,250 to start\*)** Experienced in edp systems and procedures, R&D and contractor software, coordination and liaison on systems development.

- 7/ **SYSTEMS MANAGEMENT ENGINEER (\$10,250 to \$12,075 to start\*)** Technical interface coordination and compatibility control of hull, propulsion, sensors, navigation or integrated controls of deep-submergence craft. Includes related drawings, systems designs and sequence diagrams... design data sheets, defense RFP analyses... performance evaluation, test & instrumentation... proposal evaluation and coordination.

- 8/ **SYSTEMS ENGINEER—PhD preferred (\$12,075 to \$13,335 to start\*)** Mechanical and electrical or electronic systems engineering on the staff of the Associate Technical Director for Research. Should be a recognized technical research specialist.

- 25/ **APPLIED MATHEMATICIAN—PhD level only (\$13,335 to start\*)** In the general area of math, theoretical physics and engineering theory, to conduct technical reviews in cooperation with other Research Coordinators in order to investigate the extent of analytical progress throughout the Lab... and to guide project engineers to make best possible use of math methods. Also conduct Operations Research studies, and advise the technical divisions on results.

- 27/ **COMPUTER MATHEMATICIANS (\$8,650 to \$12,075 to start\*)** Management programming operations, plus solution of engineering problems by model construction; reduction of mathematics to computer format... and other computer activities.

- 30/ **OPERATIONS RESEARCH ANALYST (\$10,250 or \$12,075\*)** Operations research technique as applied to a long-range planning program involving functional planning matrices.

\*Every position—and there are more—is listed at the starting level, and offers the complete benefits of Career Civil Service PLUS regular salary increases in grade. Applicants must be college graduates (advance degrees preferred where so indicated), and all selections will be made on an equal opportunity basis. Relocation expenses will be paid.

If you are interested in applying your experience and capabilities to the vital and growing business of improving ship and submarine performance, write to Mr. W. M. Siesko, Head-Employment Branch (Code:162-M). When possible, please indicate by number which position you are interested in. All replies will be promptly acknowledged and speedily processed.

**U.S. Navy Marine Engineering Laboratory** Annapolis, Maryland 21402

Circle No. 26 on Readers Service Card

## WANTED FOR CASH USED I.B.M. COMPUTER SYSTEMS AND PERIPHERALS

WE WILL PURCHASE FOR CASH THE FOLLOWING USED IBM COMPUTER SYSTEMS, YOU MAY HAVE FOR SALE, AT PRESENT, OR WITHIN THE NEXT 12 MONTHS:

MODEL # 1401, 1403, 1405, 1440, 1620, 1621, 7070, 7601, 7608, 7094. TAPE DRIVES # 727, 729, 7330. SORTERS, KEY PUNCHES, REPRODUCERS, VERIFIERS, COLLATORS, TABULATORS. 024, 026, 044, 046, 047, 056, 063, 077, 082, 083, 085, 088, 403, 407, 514, 519, 602A.

ADVISE COMPLETE CONFIGURATIONS, MODELS AND SERIAL NUMBERS FOR OUR QUOTATIONS.

### FOR SALE

#402, #403, #407, #7061 ARITHMETIC AND PROGRAM CONTROL UNIT FOR 7070 SYSTEM, UNIVAC SS 90, NCR 390, IBM #650, RAMAC #305, CDC #G15D AND 2 TAPE DRIVES.

**L. A. PEARL CO.**

801 SECOND AVE. NEW YORK, N.Y. 10017  
PHONE: 212 OREGON 9-6535

Circle No. 27 on Readers Service Card

## Your Most Complete Source for Punched Tape Handling Equipment

Since its founding in 1948, Cycle Equipment Company has developed a unit to fit your every need for automatic handling of punched paper tape up to 1" wide, at speeds up to 50" per second.

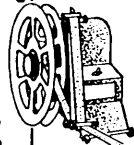

The line now includes:  
CYCLE UNIVERSAL and  
STANDARD TAPE MINDERS.

Model 500 Series DRIVE UNIT  
providing up to 160 variations  
to wind or feed tape.

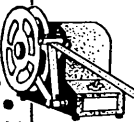

NAB REEL MOUNT to receive any  
manufacturer's conventional NAB  
reels to 1" width.

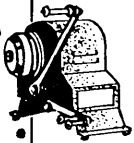

UNIVERSAL REELS in all sizes,  
with or without NAB HUB.

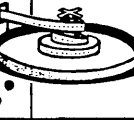

UNWINDERS adaptable to any  
positioning.

PANEL TAPE MINDERS and TAPE  
TRANSPORTS for any relay rack  
panel.

PLUS many other innovations.  
Write today for descriptive litera-  
ture, #CA-5.

DEALER INQUIRIES INVITED

**CYCLE EQUIPMENT COMPANY**  
17480 SHELburnE WAY  
LOS GATOS, CALIFORNIA



Circle No. 28 on Readers Service Card

cardiogram, while it is being taken, to a medical center, in many instances hundreds of miles away. At the center the information can be immediately analyzed by a specialist who can then verbally consult with the administering physician over the Data-Phone service arrangement.

"Strongly increased activity in this area is expected in the coming years," Mr. Robinson says, "for it offers the medical profession the opportunity to extend the range of its services considerably. Moreover, medical technology is now looking to Data-Phone service in anticipation of similar systems enabling the transmission of encephalograms (brainwave readings) as well as other critical medical data."

Also foreseen is a steady increase in the business field in the use of on-line, real-time systems in which information is relayed from the point of origin directly to data processing facilities and then back to the originator or to a specified destination without delay.

"Technical developments and equipment innovations, occurring at a very rapid rate, are leading in the race between 'hardware' designers and the systems planners who incorporate these achievements into systems applications. In effect, the systems designers have really been unable to keep up with these new techniques, and this is really the most formidable challenge facing the automation industry today," Mr. Gentle emphasizes.

"In this regard, integration of communications services and data processing facilities is necessary to make optimum use of both," Mr. Gentle remarks. "Many businesses, airlines, financial firms and some manufacturers have already made substantial progress in this direction and others are now showing increased interest in this arrangement.

"In fact," Mr. Gentle continues, "it is apparent that communications is emerging as the vital link in data processing systems today. This is evidenced not only by the growing number of data communications facilities coming into use, but by the recent activities on the part of major computer manufacturers. Several have recently announced the development of small units designed to function as satellites linked, via communications facilities, to larger central computers.

## EAI ACHIEVES RECORD SALES

Electronic Associates received orders for \$37,520,000 in fiscal 1964, ending January 1, 1965, compared to the previous record of \$32,301,000 set in 1963. Net sales (completed contracts) rose to \$33,853,375, the sixth consecutive increase, from \$28,758,093 in 1963. Net Income of \$1,863,601 was the second highest in EAI's history, but was moderately below the preceding year's record income of \$2,198,820 because of the very sizable investment in the largest new product development and introduction program ever undertaken by the company.

During 1964, EAI increased expenditures for R&D by over 40 percent and introduced several major new products. The EAI 8400 digital computer put EAI directly into the rapidly expanding scientific computer market. The EAI 8800 analog computer represents a step forward in analog computer development.

EAI reports that customer interest in the two new computers has been high and a number of orders have been received. The first customer deliveries will begin in mid-1965, and both will be in volume production by the end of the year.

## C-E-I-R INCREASES SALES, PROFITS IN 1ST QTR.

C-E-I-R, Inc., international applied research and computer services company, has reported sales of \$4,632,700 in the first quarter of fiscal 1965 ended December 31, up 14% over \$4,068,100 for the same period last year.

Operating profit of current operations before taxes was \$225,500, up from \$22,900 for the same quarter of fiscal 1964. The latter figure excludes operating profits of \$41,700 from C-E-I-R's British affiliate, C-E-I-R, Ltd., 60% of which was sold to the British Petroleum Co., Ltd., on March 31, 1964.

Results for the first quarter do not reflect the acquisition by C-E-I-R of RCA's Washington, D.C., data processing center, which was purchased January 1, 1965.

**CAI ACHIEVES  
123% EARNINGS JUMP**

A 123% jump in net earnings after taxes and a near-doubling in sales are reported for 1964 by Computer Applications Incorporated, a computer programming, analytical service and data processing concern.

Total consolidated revenues for the year ended last September 30 climbed to \$4,879,644 compared to \$2,775,749 in the previous year, John A. DeVries, president, reported to stockholders. The 1964 figure, he said, does not include the operations of Computer Concepts, Incorporated which was acquired last October 1.

"The greatest portion of the Company's growth during Fiscal 1964 came from internal expansion," Mr. DeVries explained, with CAI's own professional staff more than doubling.

The firm's progress was further accelerated, he said, by acquisition of three companies during the year. These were Orchard-Hays & Company, Inc., Silver Spring, Md.; Suburban Data Processing Center, Inc., Fairfield, N.J., and the data processing activities of Conroy-Smith and Company of New Jersey, which has since been consolidated with Suburban.

On October 1, 1964, the company completed acquisition of Tape Converter Services, Inc., physically consolidated with Suburban Data Processing, and Computer Concepts, Inc., located in Silver Spring, Md. Last month, the company announced plans to acquire EMAC Data Processing Corporation of Woodside, N.Y., which will be consolidated with Electronic Business Services Corporation, CAI's rapidly growing New York City data processing unit.

# New Computer Books For Your Reference Bookshelf

All available on 10-Day examination

• NEW IN APRIL •

## NUMERICAL ANALYSIS

By CARL-ERIK FROBERG, *University of Lund, Sweden*

Requiring a background of elementary calculus and differential equations, this text is intended for introductory courses in numerical analysis. Stress is placed on modern and efficient methods. Consistent with this emphasis, a brief account of the theory of matrices is presented, while applications of matrix methods have been treated in considerable detail.

c. 327 pp, (1965) \$8.95

## COMPUTING METHODS, Volumes I and II

By I. S. BEREZIN and N. P. ZHIDKOV, *Moscow State University*

This translation presents a broad and systematic treatment of the basic ideas underlying the most important numerical methods. The first volume deals with approximation; the second treats the solution of equations. The two-volume work is intended as a survey for the final year of undergraduate study for students specializing in computational mathematics.

Vol. I c. 447 pp (1965) \$15.00  
Vol. II c. 553 pp (1965) \$15.00

## PRINCIPLES OF COMPUTATION

By PETER CALINGAERT, *International Business Machines Development Laboratory*

This text, which requires a knowledge of elementary calculus, is intended for introductory courses dealing with computation, computers, or programming. Designed primarily for students of mathematics, engineering, the physical and natural sciences, and the quantitative social sciences, it presents a basic introduction to the principles of computation — both digital and analog, both automatic and manual.

c. 256 pp, 81 illus. (1965) \$7.75

• ALSO •

## SEQUENTIAL MACHINES: Selected Papers

EDITED BY EDWARD F. MOORE, *Bell Telephone Laboratories, Inc.*

This book contains the original published form of much of the most important work in the field of sequential machines. Two of the papers are translations from the Russian and appear here for the first time in English. All of the papers, with the exception of one included for historical interest, contain ideas of current research interest.

272 pp, 90 illus. (1964) \$7.50

## AN INTRODUCTION TO MATHEMATICAL MACHINE THEORY

By SEYMOUR GINSBURG, *System Development Corporation*

Intended primarily for mathematicians, programmers and logical designers, this book offers a treatment of selected topics on the behavior of mathematical machines, considered from the terminal characteristics point of view. Attention is focused on complete and incomplete sequential machines, abstract machines, and tape recognition devices. In addition, the automaton and various extensions of it are also discussed.

148 pp. 113 illus. (1962) \$8.75

## A FORTRAN PRIMER

By E. I. ORGANICK, *University of Houston*

Intended as an introduction to computing techniques using FORTRAN, this text is directly applicable for use with many types of digital computers for which FORTRAN processors are available. It provides several hundred drill exercises and seven programming assignments with complete solutions.

186 pp. 207 illus. (1963) \$3.95

Please send for my inspection and approval, a copy of each book I have checked. (I understand that I can return the books in ten days if I decide not to keep them.)

<input type="checkbox"/>	Froberg, NUMERICAL ANALYSIS	\$8.95
<input type="checkbox"/>	Berezin-Zhidkov, COMPUTING METHODS	
	Vol. I	\$15.00
	Vol. II	\$15.00
<input type="checkbox"/>	Calingaert, PRINCIPLES OF COMPUTATION	\$7.75
<input type="checkbox"/>	Moore, SEQUENTIAL MACHINES	\$7.50
<input type="checkbox"/>	Ginsburg, AN INTRODUCTION TO MATHEMATICAL	
	MACHINE THEORY	\$8.75
<input type="checkbox"/>	Organick, A FORTRAN PRIMER	\$3.95



**ADDISON-WESLEY  
PUBLISHING COMPANY, INC.**

Dept. A-36479  
Reading, Massachusetts

Name ..... Title .....

Affiliation .....

Address .....

City ..... State ..... Zip Code .....

Please extend College Professor's Discount

Payment Enclosed. (We pay postage if you enclose check — same inspection privilege) 36479

Circle No. 29 on Readers Service Card

# MONTHLY COMPUTER CENSUS

The number of electronic computers installed or in production at any one time has been increasing at a bewildering pace in the past several years. New vendors have come into the computer market, and familiar machines have gone out of production. Some new machines have been received with open arms by users — others have been given the cold shoulder.

To aid our readers in keeping up with this mushrooming activity, the editors of COMPUTERS AND AUTOMATION present this monthly report on the number of general purpose electronic computers of American-based companies which are installed or on order as of the preceding month. These figures included installations and orders outside the United States. We update this computer census monthly, so that it will serve as a "box-score"

of progress for readers interested in following the growth of the American computer industry, and of the computing power it builds.

In general, manufacturers in the computer field do not officially release installation and on order figures. The figures in this census are developed through a continuing market survey conducted by associates of our magazine. This market research program develops a documented data file which now covers over 80% of the computer installations in the United States. A similar program is conducted for overseas installations.

Any additions, or corrections, from informed readers will be welcomed.

AS OF APRIL 10, 1965

NAME OF MANUFACTURER	NAME OF COMPUTER	SOLID STATE?	AVERAGE MONTHLY RENTAL	DATE OF FIRST INSTALLATION	NUMBER OF INSTALLATIONS	NUMBER OF UNFULFILLED ORDERS
Addressograph-Multigraph Corporation	EDP 900 system	Y	\$7500	2/61	11	1
Advanced Scientific Instruments	AST 210	Y	\$2850	4/62	22	2
	ASI 2100	Y	\$3000	12/63	6	0
	ASI 6020	Y	\$2200	4/65	0	4
	ASI 6040	Y	\$2800	7/65	0	4
	ASI 6050	Y	\$3000	10/65	0	0
	ASI 6070	Y	\$3500	10/65	0	0
	ASI 6080	Y	\$4000	1/66	0	0
Autonetics	RECOMP II	Y	\$2495	11/58	57	X
	RECOMP III	Y	\$1495	6/61	15	X
Bunker-Ramo Corp.	BR-230	Y	\$2680	8/63	13	1
	BR-300	Y	\$3000	3/59	40	X
	BR-330	Y	\$4000	12/60	35	X
	BR-340	Y	\$7000	12/63	18	5
	BR-530	Y	\$6000	8/61	15	X
Burroughs	205	N	\$4600	1/54	58	X
	220	N	\$14,000	10/58	44	X
	E101-103	N	\$875	1/56	169	X
	B100	Y	\$2800	8/64	33	35
	B250	Y	\$4200	11/61	96	10
	B260	Y	\$3750	11/62	145	120
	B270	Y	\$7000	7/62	130	25
	B280	Y	\$6500	7/62	65	25
	B370	Y	\$8400	7/65	0	18
	B5000/B5500	Y	\$20,000	3/63	35	13
Clary	DE-60/DE-60M	Y	\$525	2/60	305	3
Computer Control Co.	DDP-19	Y	\$2800	6/61	3	X
	DDP-24	Y	\$2500	5/63	55	18
	DDP-116	Y	\$900	4/65	1	32
	DDP-224	Y	\$3300	3/65	2	30
Control Data Corporation	G-15	N	\$1000	7/55	325	X
	G-20	Y	\$15,500	4/61	28	X
	160*/160A/160G	Y	\$1750/\$3400/\$12,000	5/60;7/61;3/64	422	5
	924/924A	Y	\$11,000	8/61	28	1
	1604/1604A	Y	\$38,000	1/60	60	X
	3100	Y	\$7350	12/64	10	25
	3200	Y	\$12,000	5/64	37	25
	3300	Y	\$15,000	7/65	0	33
	3400	Y	\$25,000	11/64	5	17
	3600	Y	\$58,000	6/63	38	15
	3800	Y	\$60,000	5/65	0	17
	6400	Y	\$40,000	12/65	0	2
	6600	Y	\$110,000	8/64	4	5
	6800	Y	\$140,000	4/67	0	1
Digital Equipment Corp.	PDP-1	Y	\$3400	11/60	60	2
	PDP-4	Y	\$1700	8/62	55	6
	PDP-5	Y	\$900	9/63	103	5
	PDP-6	Y	\$10,000	10/64	5	8
	PDP-7	Y	\$1300	11/64	10	30
	PDP-8	Y	\$525	4/65	0	120
El-tronics, Inc.	ALWAC IIIE	N	\$1820	2/54	24	X
Electronic Associates, Inc.	8400	Y	\$9000	6/65	0	6
Friden	6010	Y	\$600	6/63	200	140
General Electric	115	Y	\$1375	12/65	0	45
	205	Y	\$2900	6/64	16	15
	210	Y	\$16,000	7/59	56	X
	215	Y	\$6000	9/63	44	5
	225	Y	\$8000	4/61	138	4
	235	Y	\$10,900	4/64	38	12
	415	Y	\$7300	5/64	40	85
	425	Y	\$9600	6/64	20	50
	435	Y	\$14,000	10/64	7	22
	625	Y	\$41,000	12/64	2	16
	635	Y	\$45,000	12/64	2	18
General Precision	LGP-21	Y	\$725	12/62	143	X
	LGP-30	semi	\$1300	9/56	430	X
	RPC-4000	Y	\$1875	1/61	98	X
Honeywell Electronic Data Processing	H-120	Y	\$2600	12/65	0	150
	H-200	Y	\$4500	3/64	370	380

NAME OF MANUFACTURER	NAME OF COMPUTER	SOLID STATE?	AVERAGE MONTHLY RENTALS	DATE OF FIRST INSTALLATION	NUMBER OF INSTALLATIONS	NUMBER OF UNFULFILLED ORDERS	
Honeywell (cont'd.)	H-400	Y	\$8500	12/61	110	3	
	H-800	Y	\$22,000	12/60	75	11	
	H-1200	Y	\$6500	2/66	0	18	
	H-1400	Y	\$14,000	1/64	9	2	
	H-1800	Y	\$30,000	1/64	5	8	
	H-2200	Y	\$11,000	10/65	0	30	
	H-4200	Y	\$16,800	2/66	0	4	
	DATAmatic 1000	N	\$40,000	12/57	3	X	
IBM	305	N	\$3600	12/57	185	X	
	360/20	Y	\$1800	12/65	0	2000	
	360/30	Y	\$4800	4/65	0	2300	
	360/40	Y	\$9600	4/65	0	590	
	360/50	Y	\$18,000	7/65	0	270	
	360/60	Y	\$35,000	8/65	0	55	
	360/62	Y	\$50,000	9/65	0	22	
	360/70	Y	\$80,000	10/65	0	65	
	650-card	N	\$4000	11/54	270	X	
	650-RAMAC	N	\$9000	11/54	50	X	
	1130	Y	\$900	11/65	0	440	
	1401	Y	\$4500	9/60	8250	550	
	1401-G	Y	\$1900	5/64	800	100	
	1410	Y	\$12,000	11/61	780	100	
	1440	Y	\$3500	4/63	1500	700	
	1460	Y	\$9800	10/63	1100	150	
	1620 I, II	Y	\$2500	9/60	1700	30	
	1800	Y	\$6500	2/66	0	55	
	701	N	\$5000	4/53	1	X	
	7010	Y	\$19,175	10/63	68	25	
	702	N	\$6900	2/55	8	X	
	7030	Y	\$160,000	5/61	6	X	
	704	N	\$32,000	12/55	47	X	
	7040	Y	\$14,000	6/63	93	45	
	7044	Y	\$26,000	6/63	45	10	
	705	N	\$30,000	11/55	64	X	
	7070, 2, 4	Y	\$24,000	3/60	365	12	
	7080	Y	\$55,000	8/61	71	2	
	709	N	\$40,000	8/58	11	X	
	7090	Y	\$64,000	11/59	75	5	
	7094	Y	\$70,000	9/62	140	20	
	7094 II	Y	\$76,000	4/64	55	30	
	ITT	7300 ADX	Y	\$18,000	9/61	9	5
Monroe Calculating Machine Co.	Monrobot IX	N	Sold only - \$5800	3/58	155	X	
	Monrobot XI	Y	\$700	12/60	520	150	
National Cash Register Co.	NCR - 304	Y	\$14,000	1/60	26	X	
	NCR - 310	Y	\$2000	5/61	46	1	
	NCR - 315	Y	\$8500	5/62	300	60	
	NCR - 315-RMC	Y	\$12,000	9/65	0	50	
	NCR - 390	Y	\$1850	5/61	850	90	
	NCR - 500	Y	\$1500	9/65	0	150	
Philco	1000	Y	\$7010	6/63	16	2	
	2000-210, 211	Y	\$40,000	10/58	21	2	
	2000-212	Y	\$52,000	1/63	8	3	
	2000-213	Y	\$68,000	6/65	0	1	
Radio Corp. of America	Bizmac	N	\$100,000	-/56	3	X	
	RCA 301	Y	\$6000	2/61	575	30	
	RCA 3301	Y	\$11,500	7/64	21	26	
	RCA 501	Y	\$14,000	6/59	98	2	
	RCA 601	Y	\$35,000	11/62	4	1	
	Spectra 70/15	Y	\$2600	11/65	0	60	
	Spectra 70/25	Y	\$5000	11/65	0	40	
	Spectra 70/45	Y	\$9000	3/66	0	50	
Spectra 70/55	Y	\$14,000	5/66	0	15		
Raytheon	250	Y	\$1200	12/60	170	10	
	440	Y	\$3500	3/64	10	10	
Scientific Data Systems Inc.	SDS-92	Y	\$900	4/65	1	35	
	SDS-910	Y	\$2000	8/62	120	20	
	SDS-920	Y	\$2700	9/62	78	8	
	SDS-925	Y	\$2500	12/64	1	25	
	SDS-930	Y	\$4000	6/64	31	20	
	SDS-9300	Y	\$7000	11/64	9	7	
	UNIVAC	I & II	N	\$25,000	3/51 & 11/57	30	X
III		Y	\$20,000	8/62	88	5	
File Computers		N	\$15,000	8/56	22	X	
Solid-State 80 I, II, 90 I, II & Step		Y	\$8000	8/58	340	X	
418		Y	\$11,000	6/63	15	10	
490		Y	\$26,000	12/61	42	15	
1004		Y	\$1900	2/63	2200	250	
1050		Y	\$8000	9/63	145	195	
1100 Series (except 1107)		N	\$35,000	12/50	13	X	
1107		Y	\$45,000	10/62	25	3	
1108		Y	\$50,000	7/65	0	17	
LARC		Y	\$135,000	5/60	2	X	
TOTALS					26,071	10,631	

X = no longer in production.

\* To avoid double counting, note that the Control Data 160 serves as the central processor of the NCR 310. Also, many of the orders for the IBM 7044, 7074, and 7094 I and II's are not for new machines but for conversions from existing 7040, 7070 and 7090 computers respectively.

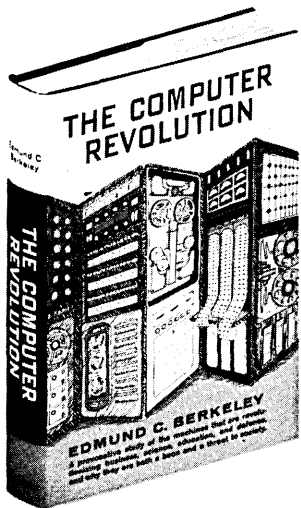

# THE COMPUTER REVOLUTION

by  
Edmund C. Berkeley

—Editor of *Computers and Automation*

—Secretary of the Association for Computing Machinery, 1947-53

"The revolution that Berkeley is talking about is not something that might happen in the future. It is happening right now, not somewhere else, but here in the world we live in. . . . An excellent . . . introduction to the nature and capabilities of present day data processing machines" — John W. Mauchly, *Science*

An important account of computers and their revolutionary implications — including a report on "conversations with a computer" that happened, and explanations of how intelligent discussion with a computer has been and may be programmed.

## CONTENTS

### PART I. Where We Are

1. THE REVOLUTION IN THE HANDLING OF INFORMATION
2. WHAT IS AN AUTOMATIC COMPUTER?  
The Machine That Can Be "Educated" and Will "Think"
3. HOW DID IT HAPPEN?  
A Short History of Computers
4. HOW MUCH POWER HAS MAN GRASPED?  
The Powers of Present-Day Computers
5. HOW IS THIS POWER BEING USED?  
Some Significant Applications of Computers to Date
6. HOW DOES AN AUTOMATIC COMPUTER ACTUALLY WORK?

### PART II. The Discussing Computer

7. CONVERSATION WITH A COMPUTER  
Some Demonstrations
8. COMPUTER CONVERSATION COMPARED WITH HUMAN CONVERSATION  
Some Demonstrations
9. IDEAS AND THEIR HANDLING BY A COMPUTER  
All the Language of Thought becoming Calculable Like Mathematics
10. THE SPECIFIC IDEAS THAT THE DISCUSSING COMPUTER MUST DEAL WITH  
Brick-Words, Cement-Words, and Frameworks of Statements

### PART III. Where We Are Headed

11. WAR AND COMPUTERS
12. PEACE AND COMPUTERS
13. EMPLOYMENT AND COMPUTERS
14. SOCIETY AND COMPUTERS  
PART IV. The Social Responsibilities of Computer People
15. DANGERS FROM COMPUTERS
16. DISCUSSION AND ARGUMENT
17. ACTIONS RELATED TO THE SOCIAL RESPONSIBILITIES OF COMPUTER PEOPLE

### Appendices

- Over 500 Areas of Application of Computers
- Can You Tell the Computer's Responses from the People's Responses?
- The Common Everyday Context, and Cement Words
- Report to the Council of the Association for Computing Machinery by the Committee on the Social Responsibilities of Computer People
- Essential Special Terms in Computers and Data Processing
- Bibliography
- Index

TO: COMPUTERS AND AUTOMATION  
815 Washington St., Newtonville, Mass. 02160

( ) Please send me "The Computer Revolution" by E. C. Berkeley.

( ) I enclose \$4.50. ( ) Please bill me.

Returnable in seven days for full refund (in salable condition).  
My name and address are attached.

## AUTOMATIC CARRIAGE OPERATION

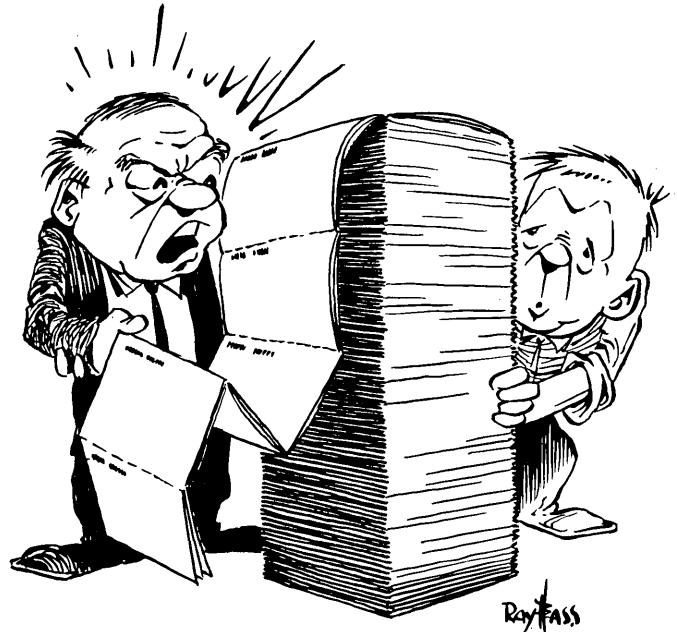

"Whats-a-matter — you got a romance with a page-skip routine?"

## SENSITIVE MAINTENANCE CONDITIONS

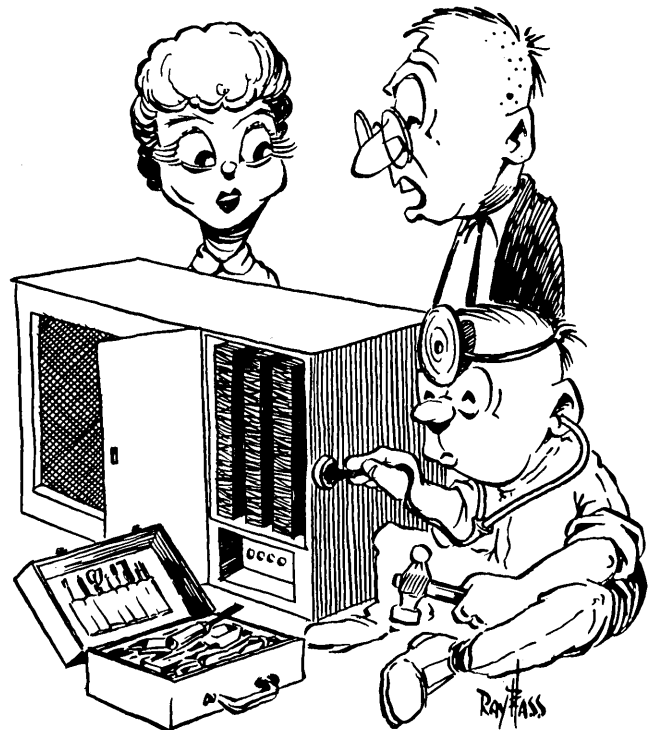

"The maintenance policy, Miss Calvin — and you'd better bring along our medical policy too!"

# How good are NCR Computers?

## Ask the man who has acquired 174 more of them.

Take flight pay, overseas pay, time-in-grade, allotments, and some 50 other factors. Multiply by 800,000 men. You now have an idea of how complicated the U.S. Air Force payroll is. You also have an inkling of why Uncle Sam has acquired 174 NCR 390 Computers.

NCR Total Systems:  
no one else serves so many lines  
of business so completely.

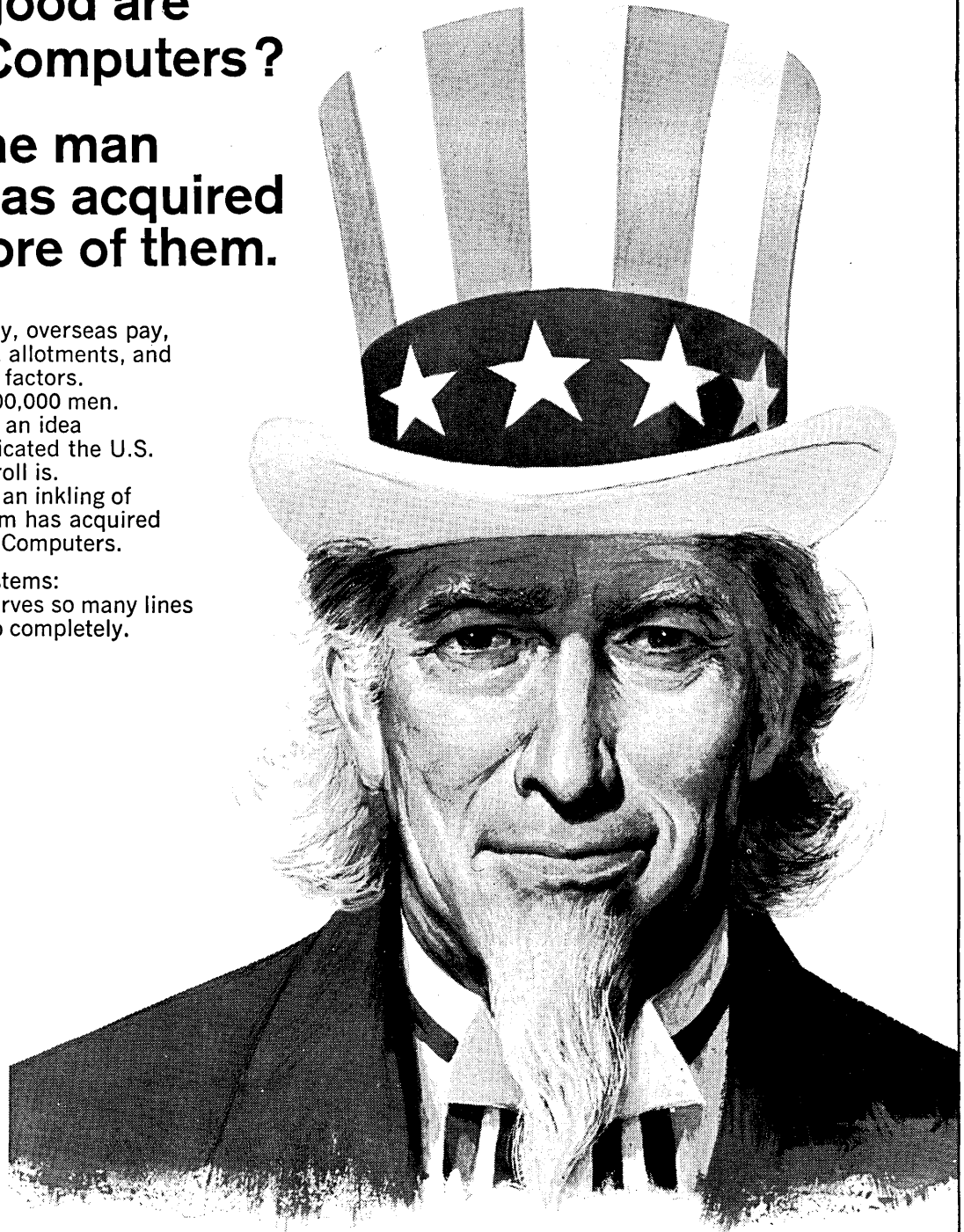

# N

# C

# R

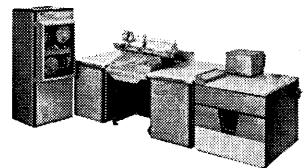

VISIT THE NCR PAVILION AT THE N. Y. WORLD'S FAIR

THE NATIONAL CASH REGISTER CO. ®

Circle No. 30 on Readers Service Card

OPPORTUNITIES IN LOS ANGELES AND  
HOUSTON WITH TRW SPACE TECHNOLOGY  
LABORATORIES FOR MATHEMATICIANS,  
ENGINEERS AND PHYSICISTS IN SCIENTIFIC  
AND BUSINESS PROGRAMMING

TRW Space Technology Laboratories has openings for Scientific and Business Programmers at its Computation and Data Reduction Centers (CDRC) at TRW Space Technology Center in Redondo Beach, California, and in its new Manned Spaceflight Department in Houston, Texas.

In Redondo Beach near Los Angeles International Airport, you will be working with over 200 programmers and scientists who are applying their background in mathematics, engineering and the physical sciences to resolve problems of the aerospace environment, and to further advance the capability of computers and the computer sciences. Here, their responsibilities include space mission analysis, statistical analysis, data analysis, spacecraft environmental simulation, interpretive computer simulation, automated plotting, business data processing, real-time operations, list processing, and computer system applications.

In Houston in new facilities adjacent to NASA's Manned Space Flight Center, you will be a vital part of the Apollo Program. TRW Space Technology Laboratories has responsibility to NASA for Apollo mission planning, mission analysis and real-time program development. STL's task, in broad terms, consists of "building a computer highway to the moon." STL Programmers will chart the path the Apollo craft must follow and the functions and maneuvers which will be required to remain on that path for manned landing on the lunar surface in 1969.

With this challenging assignment, STL in Houston has ground-floor opportunities that may never be available again. For these exceptional openings, STL requires BS or MS degrees in Aeronautical Engineering, Physics, Applied Math or Astronomy, with experience or training in these areas:

**MISSION ANALYSIS:** *Strong analytical ability and technical originality with broad background in flight mechanics, astronautics, missile guidance and mission performance.*

**TRAJECTORY ANALYSIS:** *Familiarity with the use of digital computation, analytically inclined, with background in space mechanics.*

**ASTRODYNAMICS:** *Theoretical background in celestial mechanics, orbit determination and/or related fields of math, physics or astronomy.*

**GUIDANCE ANALYSIS:** *Familiarity with techniques for missile guidance and experience in orbital mechanics, random processes and statistics.*

**SCIENTIFIC PROGRAMMING:** *Background in high speed digital computers. Will assist in the solution of problems arising in missile and space vehicle engineering, with responsibility for direction, programming, debugging and analysis of computer solutions.*

**ACT NOW!** Forward your resume immediately to R. J. Brown, TRW Professional Placement, One Space Park, Department CA -5, Redondo Beach, California. TRW is an equal opportunity employer.

**TRW SPACE TECHNOLOGY LABORATORIES**

THOMPSON RAMO WOOLDRIDGE INC.



# NEW PATENTS

**RAYMOND R. SKOLNICK**

Reg. Patent Agent

Ford Inst. Co., Div. of Sperry Rand Corp., Long Island City 1, New York

The following is a compilation of patents pertaining to computer and associated equipment from the "Official Gazette of the U. S. Patent Office," dates of issue as indicated. Each entry consists of patent number / inventor(s) / assignee / invention. Printed copies of patents may be obtained from the U. S. Commissioner of Patents, Washington 25, D. C., at a cost of 25 cents each.

## March 2, 1965

- 3,171,894 / Maxime G. Kaufman, Camp Springs, Md. and Francis X. Downey, Annandale, Va. / U.S.A. as represented by Secretary of the Navy / Data Transmission System.
- 3,171,970 / Wallace J. Dunnet, Fayville and Alvin G. Lemack, West Roxbury, Mass. / Sylvania Electric Products, Inc. / Magnetic Logic Device.
- 3,171,972 / John R. Wilkinson, Allendale, N. J. / Sperry Rand Corp. / Clocking of Logic Circuits.
- 3,171,980 / Ralph J. Colao, White Plains and Paul M. Levy, New Rochelle, N. Y. / General Precision, Inc. / Dynamic Memory Circuit.
- 3,172,086 / Frank S. Wendt, Princeton, N. J. / RCA / Cryoelectric Memory Employing a Conductive Sense Plane.
- 3,172,088 / Robert D. Kodis, Brookline and Sadia S. Guterman, Boston, Mass. / Di / An Controls, Inc. / Drive Circuit For Magnetic Core Memory.
- 3,172,090 / Charles R. Fisher, Jr., Pittsford, N. Y. / General Dynamics Corp. / Magnetic Data Handling System.

## March 9, 1965

- 3,173,126 / Jacob Rabinow, Takoma Park and Arthur W. Holt, Silver Spring, Md. / by mesme assignments to Control Data Corp. / Reading Machine With Core Matrix.
- 3,173,129 / Robert M. Hayes, Sherman Oaks and Joseph E. Stalder, Manhattan Beach, Calif. / The Magnavox Co. / Card Processing System.
- 3,173,130 / Terrell N. Lowry, Boonton, N. J. / Bell Telephone Labs., Inc. / Memory Circuit.
- 3,173,132 / Andrew H. Bobeck, Chatham, N. J. / Bell Telephone Labs, Inc. / Magnetic Memory Circuits.

## March 16, 1965

- 3,174,106 / Roger A. Urban, St. Paul, Minn. / Sperry Rand Corp. / Shift Register Employing Rows of Flip Flops Having Serial Input and Output but with Parallel Shifting Between Rows.
- 3,174,133 / Irvin A. Kunzman, Jr., Norristown and Wallace B. Jakacki, Chalfont,

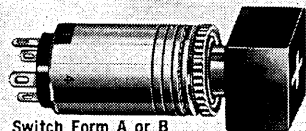

Switch Form A or B with 3/4" sq. cap

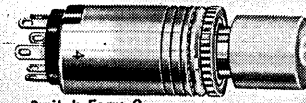

Switch Form C with 1/2" rnd. cap

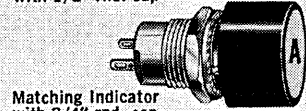

Matching Indicator with 3/4" rnd. cap

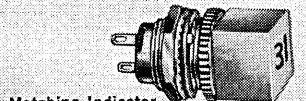

Matching Indicator with 1/2" sq. cap



For complete data, request current Catalog.

Illust. approx. 75% actual size

## Subminiature ILLUMINATED PUSH BUTTON SWITCHES and matching Indicator Lights

DIALCO Switches and Indicator Lights provide almost limitless applications—are flexible in arrangement—economical in price—and feature high reliability.

Switches are the silent, momentary type—requiring 24 oz. (approx.) operating force. Contact arrangements are: S.P.S.T., normally open or normally closed; S.P.D.T. two circuit (one normally open, one normally closed). Ratings: 3 amps, 125V A.C.; 3 amps, 30V D.C. (non-inductive). The switch is completely enclosed and independent of the lamp circuit. The light source is the T-1 3/4 incandescent lamp, available in voltages from 1.35 to 28V. Units are made for single hole (keyed) mounting in panels up to 3/16" thick and mount from back of panel in 1/2" clearance hole. Switch forms for dry circuits are also available.

Other features include: 1/2" or 3/4" interchangeable caps, round or square, rotatable or non-rotatable, in a choice of 7 color combinations.

FOREMOST MANUFACTURER OF PILOT LIGHTS

**DIALIGHT** CORPORATION

60 STEWART AVENUE, BROOKLYN, N.Y. 11237 212 HYACINTH 7-7600

**DIALCO**<sup>®</sup>

Circle No. 32 on Readers Service Card

- Pa. / Leeds and Northrup Co. / Actuation of On-Off Outputs From Electronic Digital Computer Device.
- 3,174,135 / Hans-Joachim Dreyer, Korntal, Rolf Basten, Stuttgart-Zuffenhausen and Gottfried Porst, Stuttgart-Weil im Dorf, Germany / International Standard Electric Corp. / Program Controlled Electronic Data Processing System.
- 3,174,136 / Jacques Georges Lucien Hannicq, Bagnolet and Yves-Jean Francois Brette, Sevres, France / Compagnie des Machines Bull (Societe Anonyme), Paris, France / Apparatus for Coordinating the Operations of Various Sections of Data Processing Systems.
- 3,174,137 / Moiz B. Khambaty, Cambridge and Walter Strohmeier, Newton Highlands, Mass. / Honeywell Inc. / Electric Gating Apparatus.
- 3,174,138 / Thomas J. Matcovich, Abington and William E. Flannery, Norristown, Pa. / Sperry Rand Corp. / Memory Elements Using Variable Axis Anisotropic Magnetic Thin Film.

- 3,175,202 / John J. King, Great Neck, N. Y. / Sperry Rand Corp. / Core Memory Apparatus.
- 3,175,203 / William O. Rice, Los Angeles, Calif. / by mesme assignments to Control Data Corp. / Magnetic Core Driving System.
- 3,175,204 / Duncan N. MacDonald, Arcadia, Calif. / Burroughs Corp. / Magnetic Card Random Access Memory.

## March 30, 1965

## March 23, 1965

- 3,175,197 / Raymond E. Miller, Yorktown Heights and John Paul Roth, Ossining, N. Y. / IBM / Inhibitor Logic Arrays.
- 3,175,201 / John C. Slonszewski, Katonah, N. Y. / IBM / Magnetic Storage Elements.

- 3,176,275 / Maurice Woolmer Gribble, Romiley, Stockport and Ronald Naylor, Cheadle Hulme, Cheadle, England / Ferranti, Ltd., Lancashire, England / Information Storage Devices.
- 3,176,276 / Donald O. Smith, Lexington, Mass. / M.I.T., Cambridge, Mass. / Magnetic Domain-Wall Storage and Logic.
- 3,176,277 / Robert S. Weisz, Pacific Palisades, Salvatore J. Zuccaro, Santa Monica and Mario Semeraro, Sherman Oaks, Calif. / Ampex Corp. / Nondestructive Readout Memory.
- 3,176,280 / Charles R. Fisher, Jr., Pittsford, N. Y. / General Dynamics Corp. / Data Handling System.
- 3,176,281 / Robert E. Pattison, San Jose, Calif. / IBM / Portable Memory for Data Processing Machine.
- 3,176,287 / Charles R. Fisher, Jr., Pittsford, N. Y. / General Dynamics Corp. / Data Handling System.

# Your existing IBM 1401 computer programs will run without change on IBM SYSTEM/360.

Look at these remarkable test results!

Application	1401 Time	SYSTEM/360 Time	How much faster?
Freight reconciliation	9.4 minutes	4.5 minutes	<b>2.0 times faster</b>
Matrix inversion	9.5 minutes	3.2 minutes	<b>2.9 times faster</b>
COBOL compile	22.0 minutes	5.1 minutes	<b>4.3 times faster</b>
FORTRAN compile & go	28.0 minutes	6.5 minutes	<b>4.3 times faster</b>
Cash distribution	20.0 minutes	7.9 minutes	<b>2.5 times faster</b>
Manufacturing: production program	42.0 minutes	18.0 minutes	<b>2.3 times faster</b>
Inventory analysis	45.0 minutes	15.3 minutes	<b>2.9 times faster</b>
Tax reporting	1.8 minutes	0.8 minutes	<b>2.2 times faster</b>
Inventory update	37.0 minutes	16.1 minutes	<b>2.3 times faster</b>

Emulators—special hardware devices we have developed—enable SYSTEM/360 to use your existing computer programs without costly reprogramming.

We invited customers to bring their 1401 programs to us and test them on a SYSTEM/360.

And they came—more than 125 of them—from as far away as Sweden.

They came with card programs and tape programs...with payroll programs and inventory programs...with COBOL and FORTRAN programs...with scientific and mathematical problems. They

came with programs they had written, programs they had been using successfully on IBM 1401 systems.

We ran all these programs on SYSTEM/360 without changing any of them.

And they ran faster—sometimes three times faster...sometimes four times faster...sometimes only 20% faster—but, on the average, about twice as fast.

Programs that are written for IBM 1620, 1410, 1460, 1440 and all 7000 series computers also will work on SYSTEM/360 as long as you choose to use them.

Eventually, you will want to reprogram to take full advantage of SYSTEM/360 speed and versatility. But you don't have to do it right away. You can convert a program at a time, any time you choose.

SYSTEM/360 is ready to start working for you the day it moves in. It's ready to go like 65 right now—1965—with your 1960 programs.

Imagine what great things it will do when you reprogram!

**SYSTEM/360—The Computer with a Future.**

**IBM**

Circle No. 36 on Readers Service Card

# 5000 POINTS PER SECOND

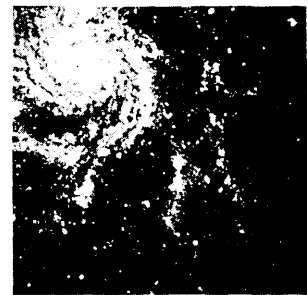
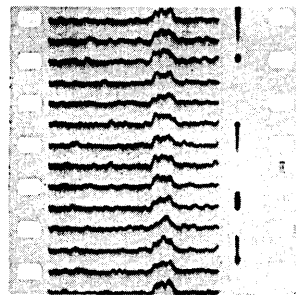
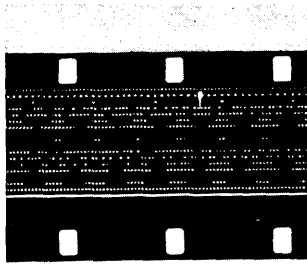

Information International, Inc., Cambridge, Mass., has developed a fully automatic Programmable Film Reader to read scientific or engineering data recorded on photographic film, paper, or similar media. Readout can be had on IBM-compatible magnetic tape, or in the form of numerical print-outs, graphs or plots, or visual CRT displays. This article describes the system and its applications.

**THE FILM READING SYSTEM** Using 16 or 35 mm. film as a medium for recording scientific data has many advantages. Because of the small input power and limited storage space that are required, it is particularly suitable for recording data produced by recording devices in space vehicles or aircraft; by wind and current measuring devices; and by other devices of similar nature.

However, reading or transcribing the data from film once it has been recorded has presented many problems in the past. It has generally been necessary for an analyst or researcher to read the data visually from the film and transcribe it by hand. This has been found to be a time-consuming, laborious and relatively expensive operation. In some cases, semi-automatic film reading devices are available. However, these can read only about 5000 points per day and require a human operator.

Information International, Inc., of Cambridge, Mass., has now developed a completely automatic computer film reading system which can read film at the rate of approximately 5000 points per second. Scientific data recorded on 16 or 35 mm film can be read completely automatically and printed out in the form of numerical listings or recorded on magnetic tape for further processing and analysis. The film reading system is based on three major elements: A general purpose digital computer, together with a visual display scope; a film reading device; and computer programs for using the computer and film reader.

**THE FILM READING PROCESS** The film reading process involves the scanning of film by a rapidly moving light point on the visual display scope. The output of this scanning operation is detected by a photo-sensitive device in the film reader and relayed to the digital computer for further processing and analysis. In addition to translating the data itself into a more desirable format, the film reading system can also furnish additional summaries and analyses of the data as may be required.

**EXTREMELY FLEXIBLE SYSTEM** The flexibility of the film reading system in two respects should be emphasized. First, almost any format of data on film can be read, with appropriate modifications to the basic computer program. This includes data represented in the form of lines, graphs (e.g., radar pulses), points, and other similar forms of data. Second, almost any type of desired output may be obtained once the basic data is obtained from the film. Forms of output which are available include the following:

- (i) A print-out or listing of data on paper.
- (ii) A record of the data on magnetic tape.
- (iii) Visual representations of data. These may take the form of a continuous graph (using a digital x-y plotting device). Or they may take the form of photographs — still or motion — of scope displays.

In addition to data recorded on film, data recorded on paper can also be read by means of the film reading system.

## SYSTEM APPLICATIONS

- (i) Analysis of data produced by oscillographs or other types of graphic recorders
- (ii) Tracking and analysis of objects for which motion pictures are available (e.g., missile tracking studies)
- (iii) Reading of astronomical or astrophysical data recorded on film (e.g., analysis of stellar configurations)
- (iv) Reading photographs of cloud chambers, bubble chambers, and spark chambers
- (v) Counting of particles (such as blood cells or bacteria) in photographs
- (vi) Character recognition

To the best of our knowledge, Information International is the only commercial firm supplying fully automatic computer film reading systems. We do essentially two things. We develop and manufacture film reading systems for clients to use at their own facilities (as, for example, in the case of radar film reading systems we have developed for Lincoln Laboratory and the U. S. Air Force). And we furnish services for reading films which are sent to us for processing (as in the case of oceanographic current meter film).

III is able to supply equipment to satisfy a variety of customer needs. Customer options include transmittive or reflective input media, binary density decision, multiple level density measurement, local contrast measurement, and various degrees of system resolution.

We can supply a completely set-up, ready-to-run "turnkey" film reading system (including a medium price, general purpose computer). Or we can provide the basic film reading device, appropriate computer programs, or technical consulting to those planning to develop their own film reading systems. The film reading device itself may be used with specialized film reading computer programs, such as those we have developed, which make use of highly sophisticated filtering techniques to minimize the effect of "noise" (dirt, scratches, general illegibility) on the film. As a result, the film reading system is capable of reading film in relatively poor condition. Or, where the quantity of data on film is not great enough to justify investment in a film reading system, I.I.I. can furnish services for reading film and transcribing data on a production basis. A brochure describing the film reader and film reading systems we have developed is available on request.

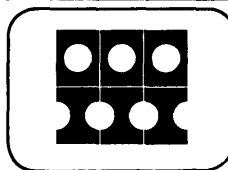

**INFORMATION  
INTERNATIONAL  
INCORPORATED**  
200 SIXTH ST., CAMBRIDGE, MASS.

Circle No. 35 on Readers Service Card

here it is!

# who's who in the computer field - '63/'64

A new comprehensive edition of the WHO'S WHO IN THE COMPUTER FIELD is available. This is the first edition in over five years. All entries are complete and accurate as of January, 1963. This handsome, clothbound book is the standard biographical reference on over 5000 leaders in computer applications/ design/ education/ logic/ mathematics/ marketing/ programming/ systems analysis

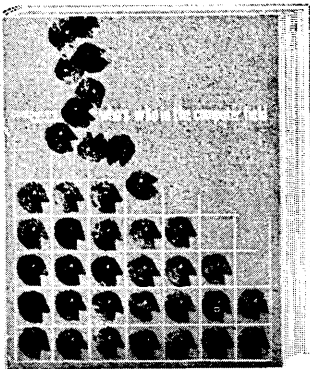

This is the answer book for such questions as:  
Where did he get his degree?  
How do you spell his name?  
What is his home address?  
Where is he working?  
What is his job title?  
What are his interests in the computer field?  
What papers has he given?  
What books has he written or edited?  
To what societies does he belong?  
In what year was he born?

Regular price: \$24.95. Price to subscribers to Computers and Automation: \$18.75. Full refund within ten days if not completely satisfied with the usefulness of this volume. To order your copy, send a check or purchase order to:

Who's Who in the Computer Field, Attn: Order Section  
815 Washington Street, Newtonville 60, Mass.

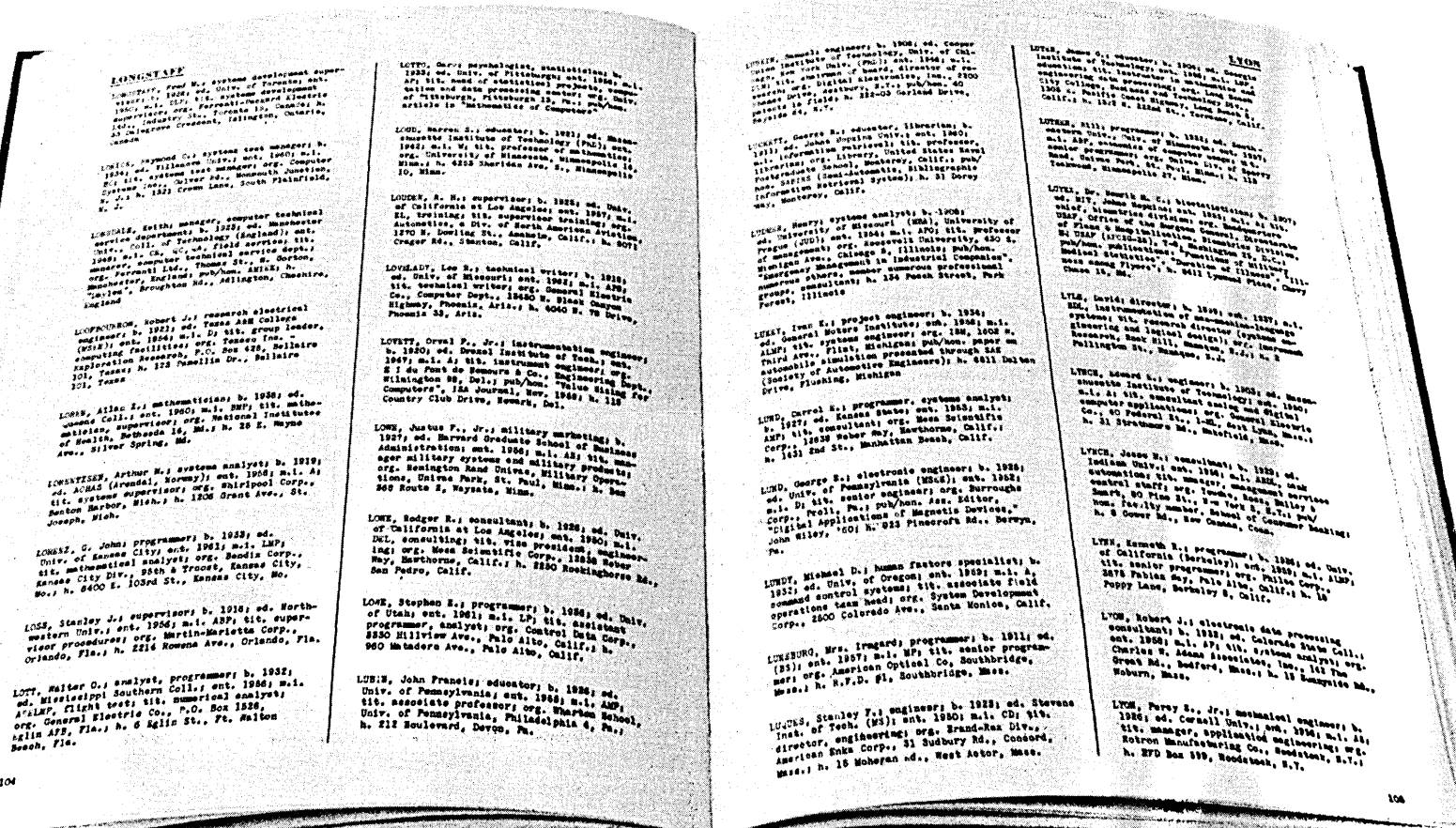

On-line or off-line.  
2,000 cards. Collated. 1 minute.



If you use the new UNIVAC® 1001 Card Controller for nothing but collating, you can still easily justify your investment.

It's an alphanumeric collator that's at least 50% faster than any collator you can buy or rent.

18 common collating functions are pre-wired on a Multi-Program Panel. A flick of the appropriate switch and you're ready to roll.

And selection of control fields is a simple matter of re-arranging pins on the pinboard attached to the panel.

Two card-feeds operate at 1000 cpm each. And it can compare 64 alphanumeric characters and symbols, and compare and sequence-check on 64 columns.

But if the 1001 was nothing more than

an extremely fast collator, we wouldn't have called it a Card Controller.

It's a multi-purpose machine that's perfect for card-editing and proving, columnar sorting, merge sorting, group sorting and even statistical sorting and counting. (In 80 or 90 column models.)

It can compare, add, subtract and do programmed multiplication.

It can do combined operations such as editing/accumulating while merging. (Functions previously done by different machines or in separate runs.)

Off-line, the 1001 is the workhorse of any EDP or tab installation.

On-line with a UNIVAC® 1004 Card Processor, the two machines become a multi-file system with dual processing

capabilities. An exclusive Advance File Search feature permits you to look ahead in the master file while processing, punching and printing are going on. Or, both machines can operate independently. The 1001's two separate card-feeds provide input at the rate of 2000 cpm. Input files can be merged and selected during processing. The 1004 provides still a 3rd input of 615 cpm.

Naturally, the cost- and time-saving value of the 1001 is inherent in its capabilities. The more applications you use it for, the more you save.

For details on the 1001 get in touch with your local Univac representative.

**THE UNIVAC® 1001 CARD CONTROLLER**

**UNIVAC®**

A DIVISION OF SPERRY RAND CORPORATION

Circle No. 33 on Readers Service Card

# ADVERTISING INDEX

Following is the index of advertisements. Each item contains: Name and address of the advertiser / page number where the advertisement appears / name of agency if any.

Adage, Inc., 292 Main St., Cambridge, Mass. 02142 / Page 8 / Fuller & Smith & Ross Inc.  
Addison-Wesley Publishing Co., Reading, Mass. / Page 67 / L. K. Frank Co.  
American Telephone & Telegraph Co., 195 Broadway, New York 17, N. Y. / Page 2 / N. W. Ayer & Son  
Amplex Corporation, 401 Broadway, Redwood City, Calif. / Pages 40, 41 / Cunningham & Walsh Inc.  
Benson-Lehner Corp., 14761 Califa St., Van Nuys, Calif. / Page 79 / Leonard Daniels Advertising  
Brandon Applied Systems, Inc., 30 E. 42 St., New York, N. Y. 10017 / Page 13 / —  
Bryant Computer Products, 850 Ladd Rd., Walled Lake, Mich. 48088 / Page 26 / Watkins, Rogers, Inc.  
California Computer Products, Anaheim, Calif. / Page 10 / Advertisers Production Agency  
Career Center, 770 Lexington Ave., New York, N. Y. 10021 / Page 80 / Mohr & Co., Inc.  
Computer Design, Baker Ave., West Concord, Mass. / Page 46 / —  
Computers and Automation, 815 Washington St., Newtonville, Mass. 02160 / Page 70 / —  
Computron Inc., 122 Calvary St., Waltham, Mass. / Page 4 / Tech/Reps  
Control Data Corp., 8100 34th Ave. So., Minneapolis 20, Minn. / Page 35 / Erwin Wasey, Inc.  
Control Technology, Inc., a subsidiary of Milgo Electronic Corp., Long Beach, Calif. / Page 29 / McClellan Associates, Inc.  
Cycle Equipment Co., 17480 Shelburne Way, Los Gatos, Calif. / Page 66 / Benét Hanau & Associates  
Dialight Corp., 60 Stewart Ave., Brooklyn, N. Y. 11237 / Page 73 / H. J. Gold Co.  
Digi-Data Corp., 4315 Baltimore Ave., Bladensburg, Md. / Page 48 / —  
Digital Equipment Corp., Maynard, Mass. 01754 / Page 6 / The Rumrill Co., Inc.  
Drexel Dynamics Corp., Horsham, Pa. / Page 64 / Benn Associates  
Forms, Inc., Willow Grove, Pa. / Page 43 / Elkman Advertising Co., Inc.  
Honeywell Electronic Data Processing Div., 151 Needham St., Newton, Mass. / Page 47 / Allied Advertising Agency Inc.  
Information International, Inc., 200 Sixth St., Cambridge, Mass. 02142 / Page 75 / —  
International Business Machines Corp., Data Processing Div., White Plains, N. Y. / Page 74 / Marsteller Inc.  
International Data Corp., P. O. Box 1, Newtonville, Mass. 02160 / Pages 38, 39 / —  
Itek Corporation, 10 Maguire Rd., Lexington 73, Mass. / Page 16 / Allied Advertising Agency Inc.  
Kleinschmidt, Div. of SCM Corp., Lake Cook Rd., Deerfield, Ill. / Page 44 / Batten, Barton, Durstine & Osborn, Inc.  
Library of Computer and Information Sciences, 59 Fourth Ave., New York 11, N. Y. / Pages 14, 15 / —  
Memorex Corporation, 1180 Shulman Ave., Santa Clara, Calif. / Page 2A / Hal Lawrence Inc.

Milgo Electronic Corp., 7620 N. W. 36th Ave., Miami, Fla. 33147 / Page 28 / McClellan Associates, Inc.  
National Cash Register Co., Main & K Sts., Dayton 9, Ohio / Page 71 / McCann-Erickson, Inc.  
Navy Marine Engineering Laboratory, Annapolis, Md. 21402 / Page 65 / GLM Associates, Inc.  
L. A. Pearl Co., 801 Second Ave., New York, N. Y. 10017 / Page 66 / —  
Systems Engineering Laboratories, Inc., P. O. Box 9004, Ft. Lauderdale, Fla. / Pages 36, 37 / Tech Ad Service  
Texas Instruments Inc., P. O. Box 5474, Dallas, Tex. 75222 / Page 25 / McCarty Company/Rice, Inc.  
TRW/Space Technology Laboratories, One Space Park, Redondo Beach, Calif. / Page 72 / Fuller & Smith & Ross Inc.  
Univac, Div. of Sperry Rand, 1290 Avenue of the Americas, New York, N. Y. 10019 / Page 77 / Daniel and Charles, Inc. Advertising  
Wolf Research and Development Corp., P. O. Box 36W, Baker Ave., W. Concord, Mass. 01781 / Page 3 / de Garmo-Boston, Inc.  
Wyle Laboratories, 339 So. Isis Ave., Inglewood, Calif. / Page 31 / Norman Rose & Associates

---

## C&A CLASSIFIED COLUMN

Use economical C&A Classified Ads to buy or sell your computer and data processing equipment, to offer services to the industry, to offer new business opportunities, to seek new positions or to fill job vacancies, etc.

Rates for Classified Ads: 90¢ per word — minimum, 20 words. First line all capitals — no charge.

Blind Ads: Box Numbers acceptable at \$4.00 additional to cover costs of handling and postage.

Send copy to: Computers and Automation, 815 Washington Street, Newtonville, Mass. 02160. Telephone: 617-332-5453.

Deadline for Classified Ads is the 10th of the month preceding issue.

7070 CARD/TAPE SYSTEM FOR SALE: 5K, five 729 II's. January 1966 delivery. Write Box 103, Computers and Automation, 815 Washington Street, Newtonville, Mass. 02160.

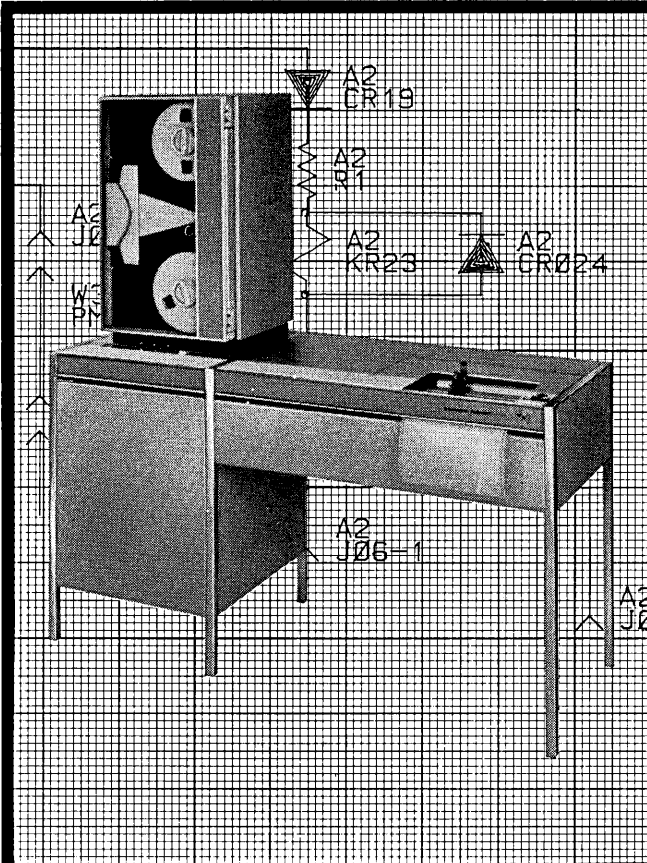

# DIGITAL PLOTTING

*Is  
The  
Difference*

There is a great deal of difference in digital plotting when you consider the dramatic advantages found only in Benson-Lehner's new 30-inch DRAFTOMATIC System.

1. Dual density (200 and 556 bpi) tape handling capability
  2. High speed (300 steps/sec.)
  3. High resolution (.005 inches)
  4. Modular construction
  5. Wide range of flexibility
  6. Compatible with all digital computers
  7. On-line/off-line operation
  8. Capital outlay is drastically reduced
  9. 120 ft. paper roll capability\*
- \* 30 inch plotting paper is available with any desired pre-printed grid, or, if more economical, 12-inch plotting paper can also be used.

Many computer sub-routines are available in our library for your use. Programming assistance is readily available.

Our warranty service is backed by the nation's largest field service organization specializing in computer-graphic equipment.

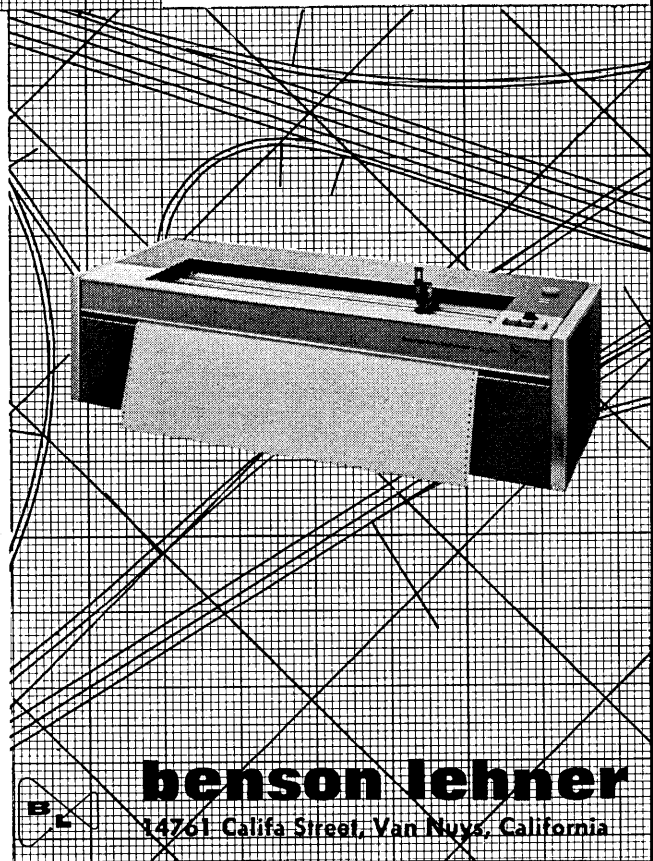

**benson lehner**

14761 Califa Street, Van Nuys, California

**From May 24-27  
you have  
Two Big  
Opportunities  
to advance your  
professional future**

**OPPORTUNITY ONE: ATTEND IFIP CONGRESS 65 at the NEW YORK HILTON, 6th Avenue and 53rd Street**

Make a point to join 5000 engineers and scientists at the largest international meeting ever held in the information sciences. You'll get a rarely-available international view of information-processing sciences and technology and, even more important, be able to meet and exchange ideas with the men and companies in the forefront of this work.

**OPPORTUNITY TWO: ATTEND THE CAREER CENTER, CITY SQUIRE MOTOR INN, 51st Street and Broadway**

And make a point to register now to meet top representatives of many of the companies attending IFIP, who are also sponsoring employers of the Career Center. They have immediate, pressing and crucial openings to fill, and may be able to offer you greater challenge and opportunity and a better future and income in the information-processing industry. ■ One phone call can put you in touch with them and start the entire process of registration, review of your qualifications, and interviews with mutually interested employers. All the while, you remain totally anonymous, identified only by a code number. ■ Career Center will arrange interview appointments at a time convenient for you during IFIP. In addition, your qualifications will also be distributed (anonymously, again) to other members of our national network of employer-sponsors who may not be attending IFIP. ■ The Career Center is not an employment agency, and there are never any fees or charges of any kind.



NOTE: If you are not planning to attend IFIP, you can still contact these Career Center sponsoring employers. Forward your resume to Career Center, 770 Lexington Avenue, New York, N. Y. 10021, for processing. Your anonymity is assured. Interviews with employers who express interest in your experience and background will then be arranged in an area convenient to your city.

**PHONE TODAY PLAZA 9-1085 / OR WRITE CAREER CENTER, 770 LEXINGTON AVE., NEW YORK, N. Y. 10021**