

DATA MATION⁷⁴®

May



\$ALARY

\$URVEY

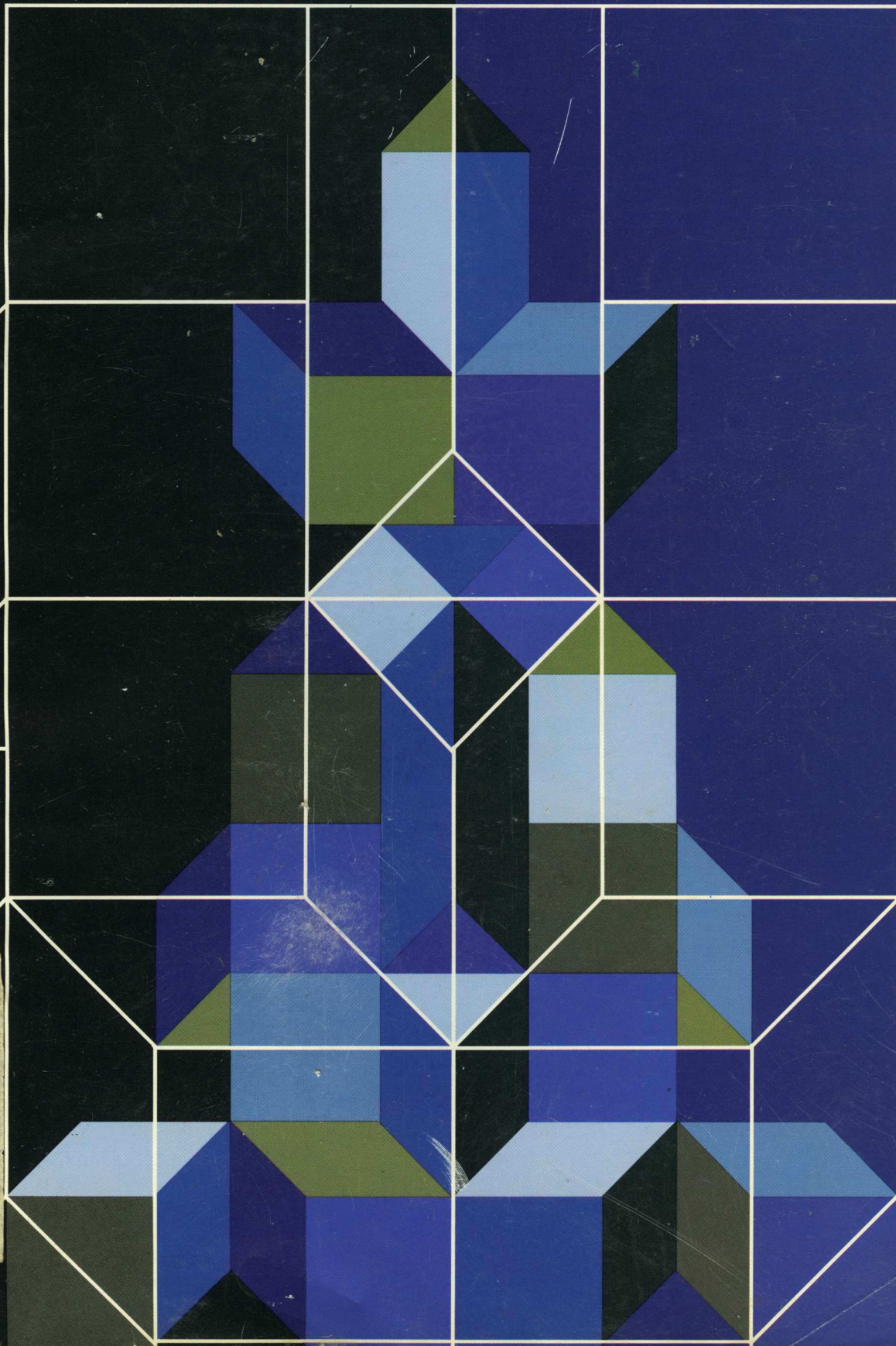

ALSO: HIRING, CITY MODELING,
SOFTWARE PROJECTS, AND
NETWORK CONFERRING

How the ADM-1 Terminal became the American Dream Machine

As an OEM or end user, what would you want in the ultimate display terminal? All the standard cliches—low cost, reliability, performance, compactness?

Affirmative?

So we put the dream

together. By designing the entire circuit on a *single board*—not 3 or 33 separate boards. We used quick-service socketed IC's. Components that provide 5000 hours of mean-time-between-

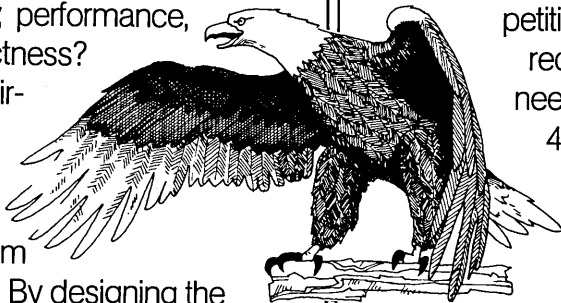

failures (250% better than the pack). A microcontroller with a 600 nsec cycle time—a full generation ahead of competition. Spare parts requirements engineered down to just 4 packages.

So the dream became reality. Priced down in

the under \$2000 range.* With a full 53-key TTY keyboard, 960 or 1920 characters on a 12" screen. Baud rates from 110 to 9600. Full

editing. Dual intensity protect mode. And it's 100% American made.

So dream a little. With the Lear Siegler ADM-1, you can afford twice the terminal capacity.

*OEM Pricing Available

LEAR
SIEGLER,
INC.



ELECTRONIC
INSTRUMENTATION
DIVISION

714 N. Brookhurst St.
Anaheim, Calif. 92803
(714) 774-1010

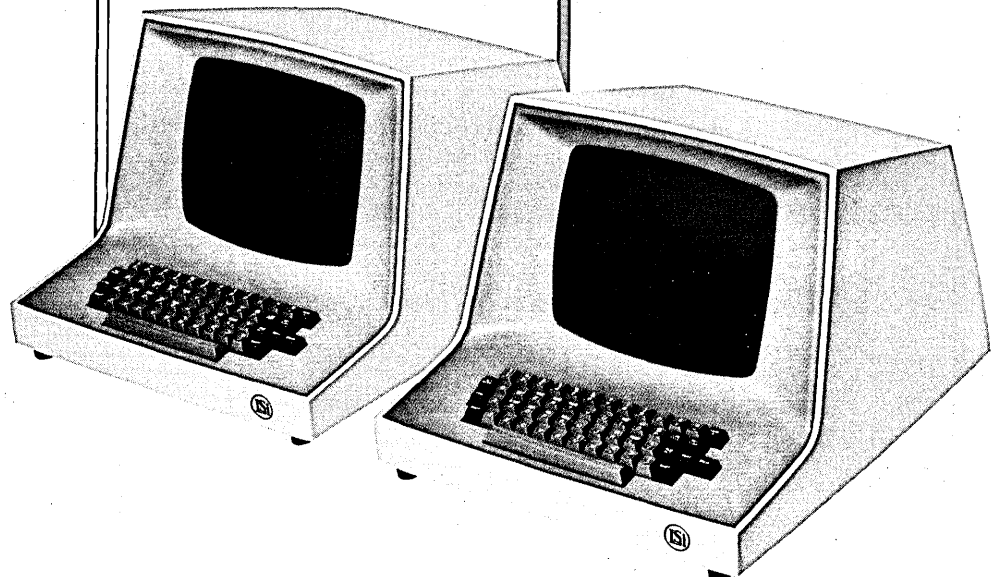

TALLY DATASCRIBE & PRINTER

Still the best buy in your search for cost effective terminals.



Put a Tally Datascribe next to a Tally Printer and you have a terminal unmatched in cost effectiveness and performance.

Tally's Datascribe, with its unique data compression feature, can transmit magnetic tape data at speeds equivalent to 3000 to 4000 Baud using a 1200 Baud 202C data set. Tally's Printer, in 125, 200, or 600 line per minute versions, offers optimum print speeds for remote terminal requirements. Monthly rental for this dynamic duo starts at a low, low \$600 a month.

A truly sensible buy.

Datascribe increases your throughput and decreases line charges. You can actually triple your 1200 Baud rate without changing modems. A printer matched to your data volume—125 lpm, 200 lpm, or 600 lpm. No wasted capacity. Liberates your computer for other tasks. Only Tally gives you all these features and benefits plus field tested hardware reliability.

It's a proven and popular combination.

We can proudly point to a long list of contented customers. And to support these installations, we can point to an expanded field service organization. We're committed to service what we sell. We're in the data communications and terminal business for the long haul. We have a solid 25 year track record.

We plan to build on it in the future by continually offering better solutions to your data processing problems. Solutions like our hardwired Datascribe data compression that requires no computer time, no software—a truly unique approach to data communications.

Features include unattended operation for both send and receive functions. Full 2400 foot tape reel. English language display for ease of key entry.

In actual benchmark tests, these average throughputs were obtained using 200 character records. 150 records per minute with 1200 Baud modems. 300 records per minute with 3600 Baud modems. 400 records per minute with 4800 Baud modems. Plus, Datascribe offers four kinds of error checking features during transmission to assure dependable data.

If you need even more evidence about this cost performance terminal package, we invite your inquiry. Contact your local Tally man and let him demonstrate the advantages to you.

In Boston (617) 742-9558, Chicago (312) 298-6710, New York (201) 671-4636, San Francisco (415) 632-4280. Or contact us direct, Tally Corporation, 8301 So. 180th Street, Kent, Washington 98031, Phone (206) 251-5500.

TALLY®

See us at the NCC,
Booths 322-328

If you're a small user with a small data center, or a big user with small, satellite data centers, look at our new 4- to 12-keystation System 1200.

It has the muscle to let small operations think big. Data purification and reformatting, plus complete range and error checking. And verification, accumulation and editing. All so you'll send clean and accurate data to your mainframe.

And you get your pick of up to 256 different formats. Even RJE communications, when you want to call home.

It's all wrapped up in a single, economical package. Disk, processor and tape drive are included in the compact control unit.

The keystations are the same ones proven for over two years now in our larger System 2400 key-to-disk.

The 1200 has a lot to offer your small data center. A call to your nearby MDS office, or to our headquarters at (315) 792-2424, will bring you the full story.

Find out for yourself why data-entry products like our Data Recorders, our powerful system 2400's and our new compact System 1200 have made our user list the second largest in the industry. Mohawk Data Sciences Corp., Utica, N.Y. 13503.

MDS

Mohawk Data Sciences

CIRCLE 33 ON READER CARD

See MDS systems in action—
booth 551, NCC.

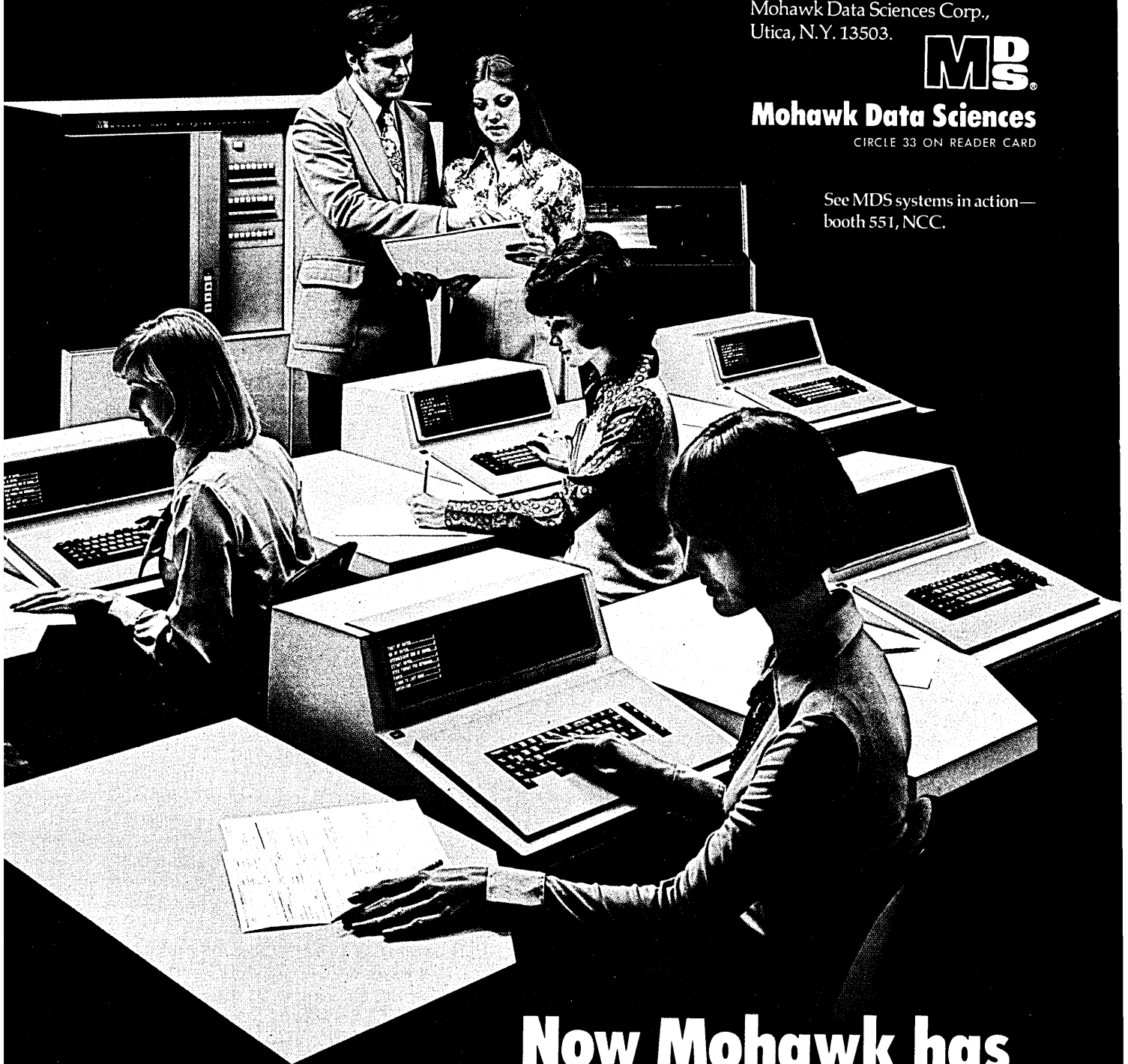

**Now Mohawk has
a powerful key-to-disk
everybody can afford.**

DATA MATION⁷⁴®

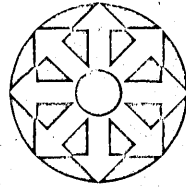

MAY, 1974
volume 20 number 5
This issue 117,500 copies

50 Edp Salary Survey

RICHARD A. MC LAUGHLIN. Can you qualify for the big numbers?

57 A Structured Approach to Hiring

TREVOR J. SWANSON and JOHN J. DEVORE. The faint of heart need not apply.

64 The Planner's Computer

DAVID A. GULLEY and WILLIAM G. KANE. Comprehensive models don't work; these do.

71 Programmer Productivity and the Delphi Technique

RANDALL F. SCOTT and DICK B. SIMMONS. Structured Programming isn't very important.

78 How to Prepare Functional Specifications

JOSEPH T. RIGO. Users have been told more than they want to know about how the software operates, not enough about how they fit in.

85 Network Conferencing

JACQUES VALLEE. The number of participants and their various locations can be virtually limitless.

96 Israel's Computer Scene

ANGELINE PANTAGES. Intellectual and economic infusions help this young nation develop its computing industry in spite of war and limited resources.

105 News in Perspective

COMPANIES	105	RETAILING	111
TECHNOLOGY	108	SOCIETIES	113
PERSONNEL	109	COMMUNICATIONS	114
		BENCHMARKS	118

164 The Forum

FRANK ENGEL, JR. FORTRAN wasn't built in a day.

JOHN A. N. LEE. Standards committees must admit to the existence of error.

departments

Calendar	9	Look Ahead	17
Letters to the Editor	27	Hardware	128
Editor's Readout	49	Literature	150
News in Perspective	105	Books	158
Software & Services	142	The Forum	164
People	153		
Index to Advertisers	161		

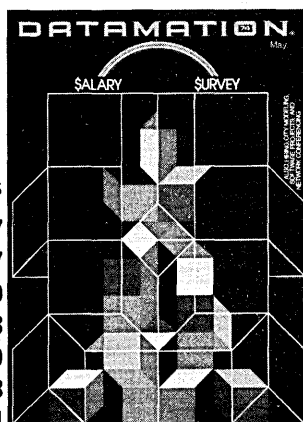

about the cover

A concentrated look at the structures we build to the pot of gold. Whether your concerns lie with how to divide it up or what moves to make to get it, our pattern is a soberly colored symbolic look at the facts and figures revealed in our survey in this issue. Design is by our art director.

Communications Updates for Data Managers.

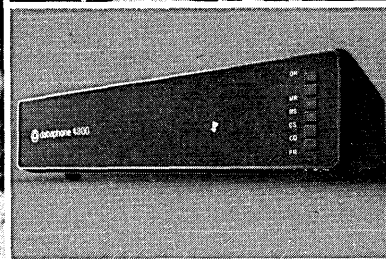
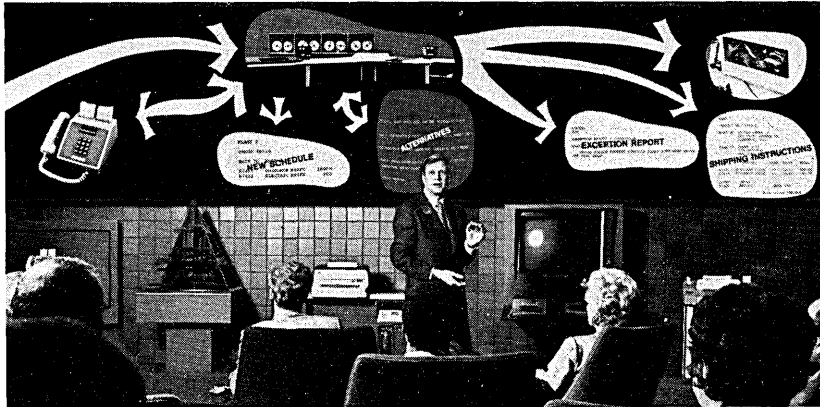

Because the Bell System wants to provide the best possible communications service for American data users, we have a standing invitation to data processing and systems managers. Come to a Bell seminar and learn of the latest communications services and concepts. See how others are solving their com-

munications problems. Exchange ideas with other people in the data field, both in discussion sessions and informally at lunch.

The seminars are offered in six cities, at no charge. Call the Bell System Communications Consultant who works with your organization. Or mail the coupon.

Bell System Seminar, Dept. F 1, 866 Third Avenue, New York, N.Y. 10022
I am interested in your Communications Seminars for Data Managers.

- Please have a representative call me.
 Please send a brochure and schedule.

The location I would prefer is:

- Atlanta Sacramento
 Denver San Francisco
 New York Seattle

Name _____ Title _____
Company _____ Telephone _____
Street _____ City _____ State _____ Zip _____

We hear you. 

DATAMATION.

EDITORIAL STAFF

Editor John L. Kirkley
Articles Editor Richard A. McLaughlin
International Editor Angeline Pantages
Communications Editor Phil Hirsch
Industry Editor W. David Gardner
Products Editor Michael William Cashman
Copy Editor Merrill Press Cherlin
Calendar Editor Carol A. Constantian
Letters Editor Angela V. Smith
News Editor Tom McCusker

Bureau Managers

San Francisco Edward K. Yasaki
Los Angeles Edith D. Myers
Washington, D.C. Phil Hirsch
New York Angeline Pantages
New England W. David Gardner

Correspondents

Minneapolis James K. Johnson
Southwest Robert F. Alexander
Europe Pearce Wright
Australia Frederick A. Bland
Editorial Advisor Robert L. Patrick
Technical Advisor Lowell Amdahl
Contributing Editors Paul Armer, Howard Bromberg, Philip H. Dorn, Louis B. Marienthal, Ray W. Sanders, Milton R. Wessel, F. G. Withington

EDITORIAL OFFICES

Headquarters: 1801 S. La Cienega Blvd., Los Angeles, CA 90035. Phone (213) 559-5111. **Eastern:** 35 Mason St., Greenwich, CT 06830, (203) 661-5400. Lakeside Office Park, 599 North Avenue, Wakefield, Mass. 01880, (617) 246-2121, 9805 Singleton Dr., Bethesda, MD 20034, (301) 530-7271. **Southwestern:** 2711 Cedar Springs, Dallas, TX 75201, (214) 744-0161. **Western:** 2680 Bayshore Frontage Rd., Suite 401, Mountain View, CA 94043, (415) 965-8222. **Foreign:** 65, Hill Road, Chelmsford, Essex, England, 64/90 Blues Point Rd., McMahon's Point, NSW 2060, Australia.

GRAPHIC DESIGN & PRODUCTION

Art & Production Director Cleve Marie Boutell

Production Manager Marilee Pitman

CIRCULATION

35 Mason Street, Greenwich, CT 06830

Circulation Director Suzanne A. Ryan

Marketing Research Director Douglas De Carlo

Publisher James M. Morris

Circulation audited by Business Publications Audit



Member



American Business Press, Inc.



DATAMATION is published monthly on or about the first day of every month by Technical Publishing Company, 1301 South Grove Ave., Barrington, Illinois 60010; Arthur L. Rice, Jr., Chairman of the Board; James B. Tafel, President; Gardner F. Landon, Executive Vice President.

Executive, Circulation and Advertising offices, 35 Mason Street, Greenwich, CT 06830, (203) 661-5400. Editorial offices, 1801 S. La Cienega Blvd., Los Angeles, CA 90035. Published at Chicago, Ill.

DATAMATION is circulated without charge by name and title to certain qualified individuals who are employed by companies involved with automatic information handling equipment. Available to others by subscription at the rate of \$18 annually in the U.S. and Canada. Reduced rate for qualified students. Foreign subscriptions are available for £12.50 or for the equivalent of \$30 U.S. in most West European currencies. Sole agent for all subscriptions outside the U.S.A. and Canada is J. B. Tratsart, Ltd. 154 A Greenford Road, Harrow, Middlesex HA13QT, England. No subscription agency is authorized by us to solicit or take orders for subscriptions. Controlled circulation paid at Columbus, OH and Form 3579 to be sent to Technical Publishing Company, P.O. Box 2000, Greenwich, CT 06830. Copyright 1974, Technical Publishing Company. Microfilm copies of **DATAMATION** may be obtained from University Microfilms, A Xerox Company, 300 No. Zeeb Road, Ann Arbor, Michigan 48106. Printed by Beslow Associates, Inc.

DATAMATION

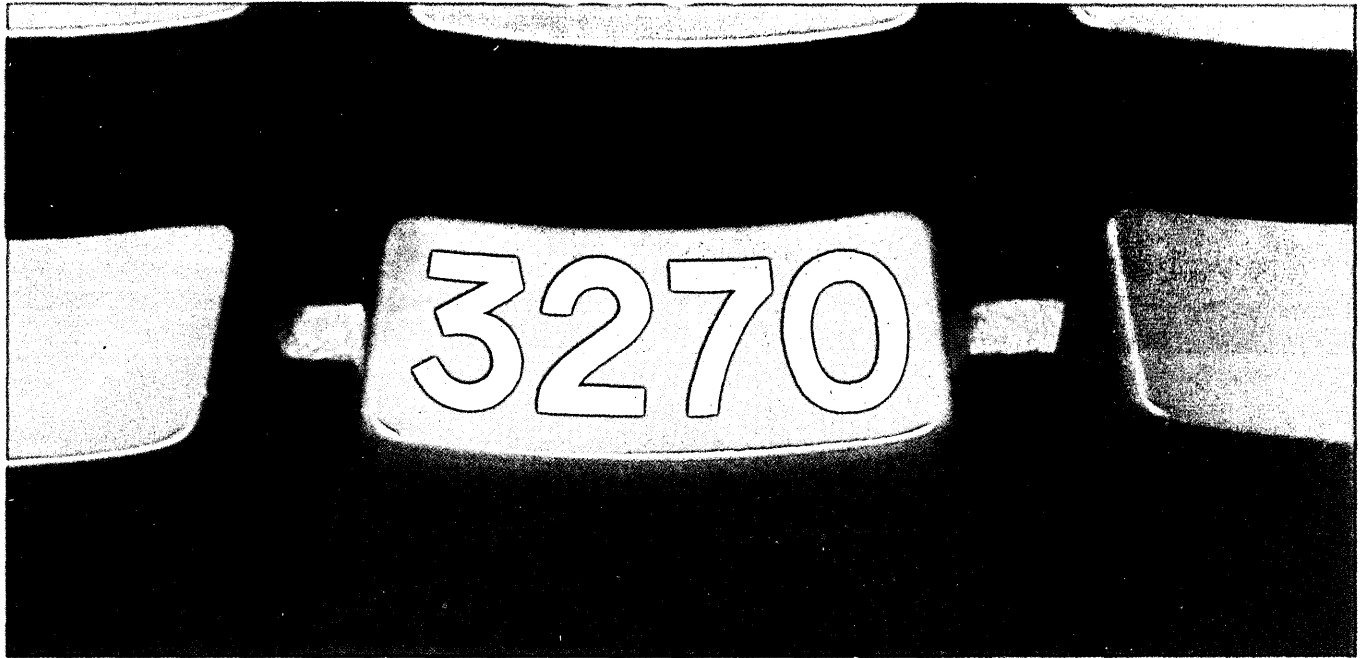

INCOTERM® PUNCHES IN

Our 3270 Gives You More Choices.

Their 3270 Sells For Twice as Much.

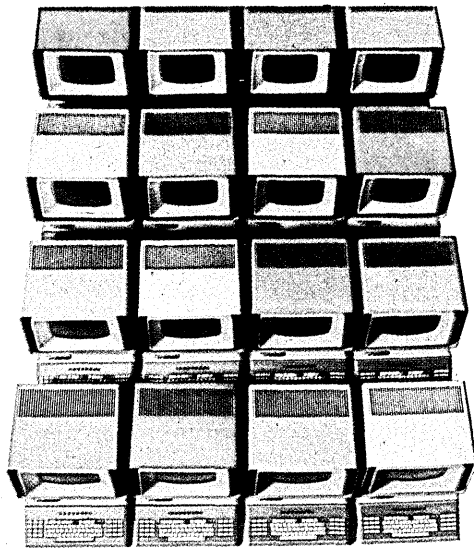

INCOTERM punches in with an intelligent 3270 —at less than half the purchase cost of the system it emulates—and with a number of pluses the original never got around to. For example:

THREE SCREEN SIZES include 80 characters by 24 lines, 80 by 12 and 40 by 12.

INCOTERM Sales Offices:

Atlanta (404) 294-7588 • Boston (617) 655-6100 • Chicago (312) 593-2230 • Dallas (214) 634-2600 • Los Angeles (213) 640-0328
New York (212) 541-5780 • Orlando (305) 894-2605 • Pittsburgh (412) 921-4667 • San Francisco (415) 697-3643
Seattle (206) 682-7597 • Washington, D.C. (703) 524-8610 • Uxbridge, U.K. 31913-4, or London, U.K. 01-841-85-25

A NUMERIC PAD is featured in the typewriter keyboard for greater ease of data entry.

FIELD BLINK under attribute control provides attention getting capability for data errors and operator instructions.

INTERCHANGEABILITY at data communication speeds from 1200 to 9600 bits per second without any modification, or concern for device configuration.

EXTENSIBILITY: the SPD® 320 video terminals are capable of being reconfigured for full duplex SDLC operation to continue IBM compatibility.

WIDELY DISTRIBUTED INTELLIGENCE, even in a large group of terminals, greatly increases system reliability. It also reduces expensive line time and permits better line balancing.

Isn't it time you punched in? Call or write:

 **INCOTERM**
CORPORATION

6 Strathmore Road • Natick, Massachusetts 01760 • (617) 655-6100

TermiNet 300 SP
Split-Platen Printer

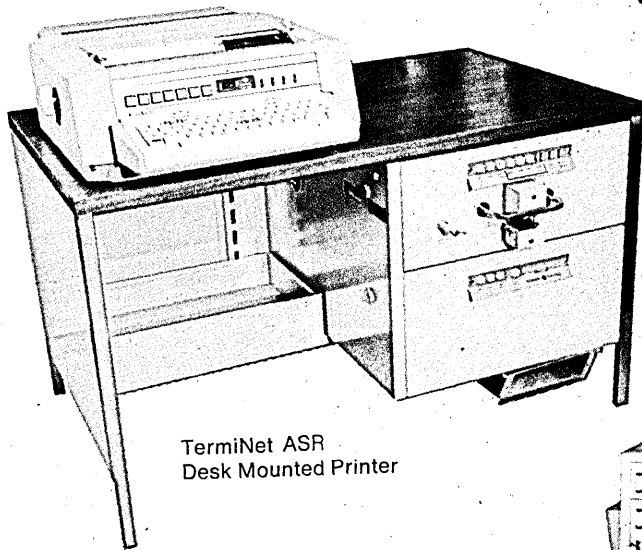
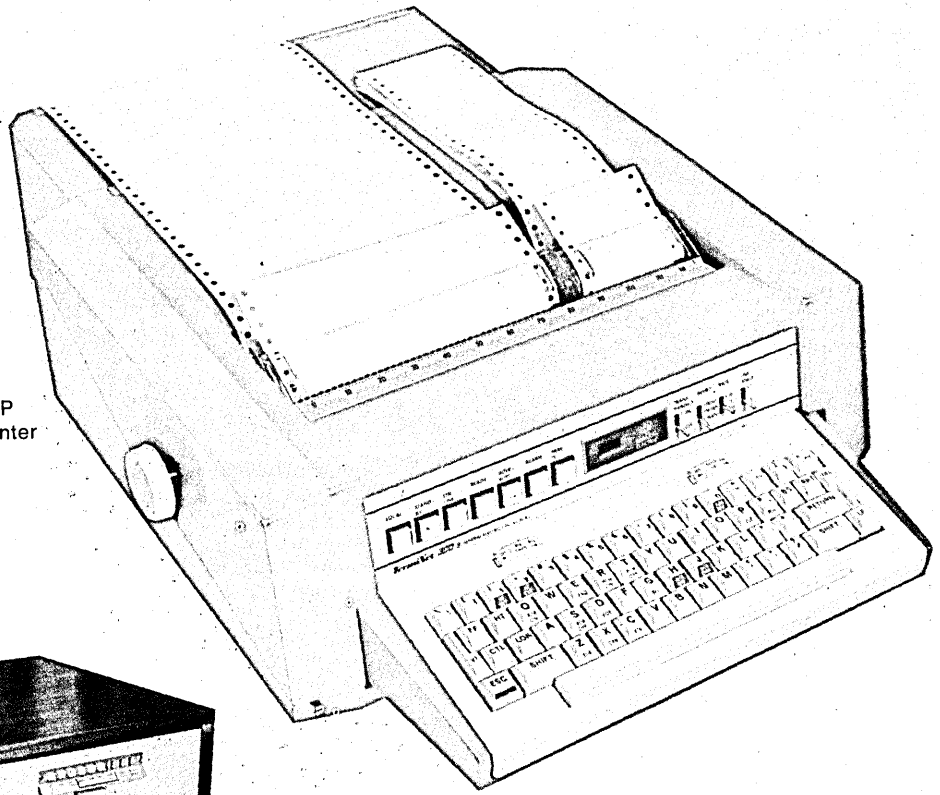

TermiNet ASR
Desk Mounted Printer

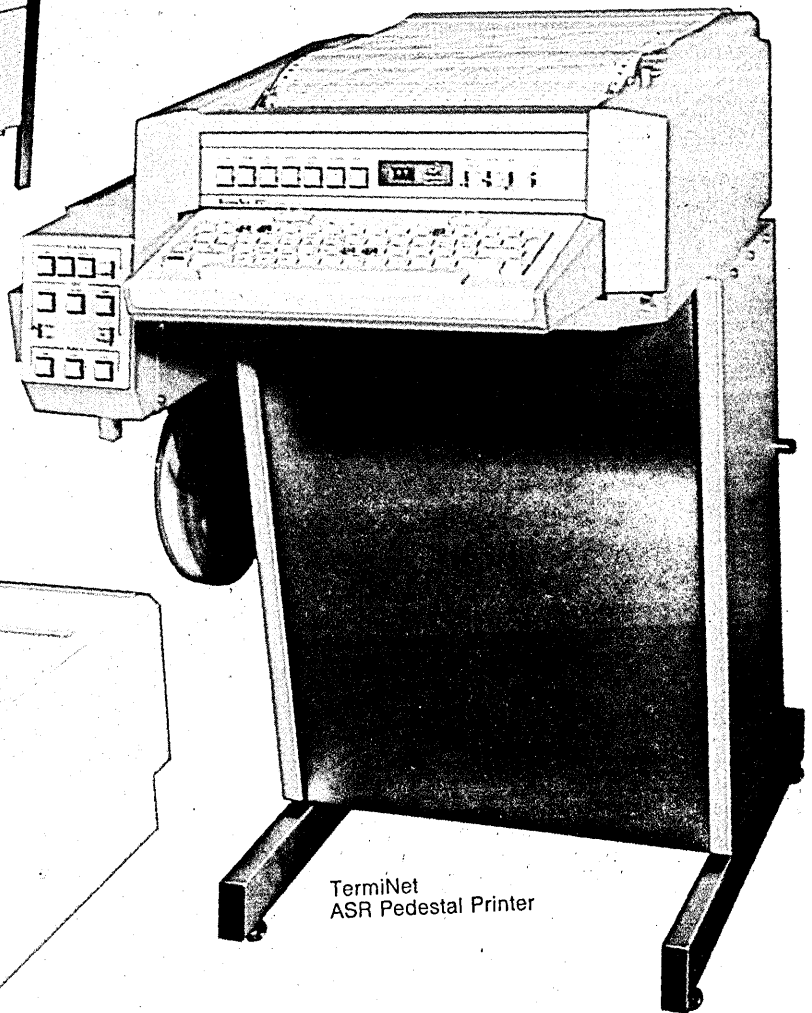

TermiNet
ASR Pedestal Printer

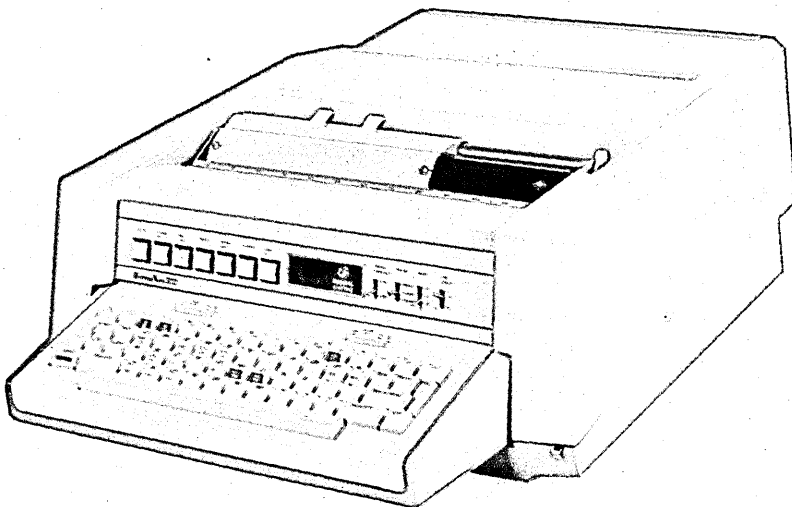

TermiNet 300 Printer

Terminet
Receive Only Printer

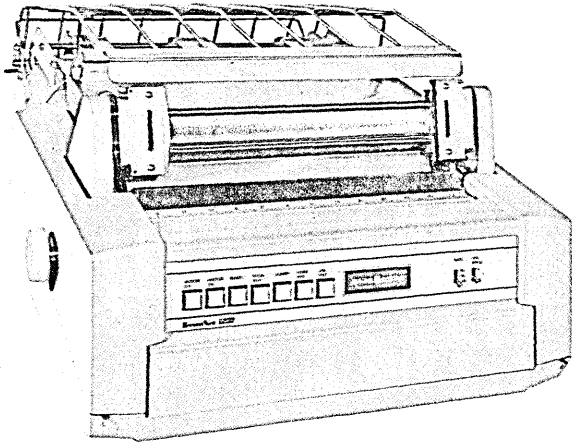

Terminal requirements in your data communication systems take on all kinds of sizes and shapes. There are different data distribution patterns. Volume changes from one application to another. Speed, function and configuration requirements are seldom the same. That's why General Electric will continue to expand its line of quiet, high-speed printers and options. Our objective: Offer you diversified products with commonality of components from a single source to meet an ever increasing variety of data communication objectives and eliminate retraining.

Terminet 300 Printer — 10, 15, 30 CPS. Quieter than a typewriter. The work horse of the line. Designed to give maximum reliable operation.

Terminet 1200 Printer — 10, 30, 120 CPS. Designed to handle high volume traffic economically. Up to 1200 baud transmission rate optimizes use of public and private lines.

Terminet 300 Split-Platen Printer — 10, 15, 30 CPS. Two platens operate independently. For any system requiring hard copies for parallel but dissimilar information.

Terminet Receive Only Printer —

A receive only version of the Terminet 300, 300 SP, and 1200 printers are available for printing of received data.

Terminet Pedestal — Available for the Terminet 300, 300 SP and 1200 printers. Compact and accessible units offer major savings on premium floor space.

As your needs diversify—So do GE Terminet® printers

Terminet Desk Mounted Printer — Convenient work station providing reader and punch operator controls with built-in power supply.

Numerous options are available to match your exact needs of today and your changing needs of tomorrow. Most can be added or deleted by simply inserting an optional plug-in module: 1200 Baud Magnetic Tape Cassette, Numeric Cluster, Answer Back, Horizontal Tabulation, Form Feed and Vertical Tabulation, Parity Error Detection, External Paper Handler, Transparency Switch, Selective Addressing, Automatic Motor Control, Line Control, Form Tray and Restacking Shelf, 1200 Baud Rate Switch, 300 Baud Integral Modem, Current Interface (DATI)

For more information on any one GE Terminet printer or the complete line, write on your letterhead to Section 794-11, P. O. Box 4197, Lynchburg, Virginia 24502, or let us help you match the right GE Terminet with your specific data objective, call us collect — (703) 942-8161.

Terminet 1200 Printer

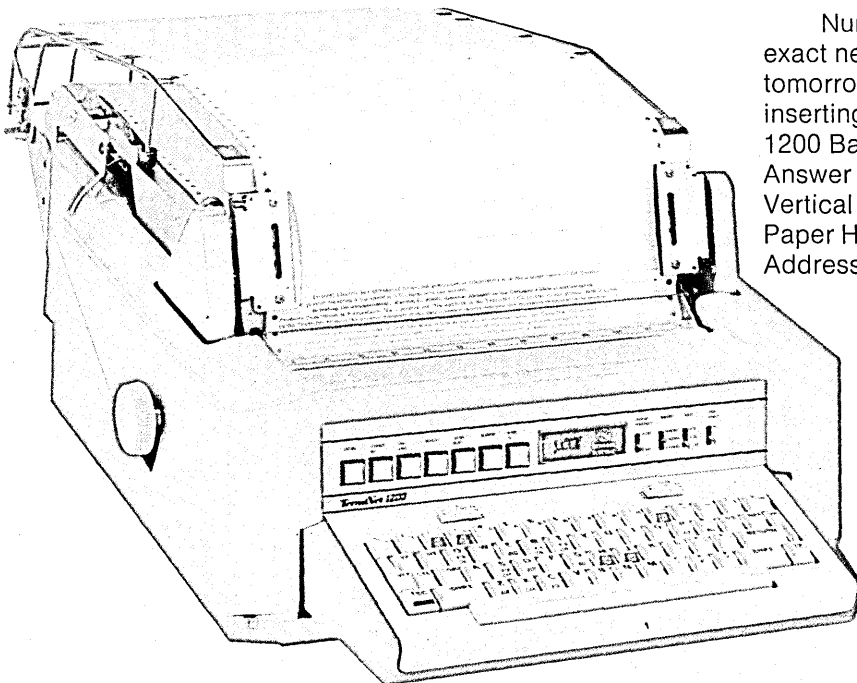

**GE Terminet printers
Fast·Quiet·Reliable**

GENERAL  ELECTRIC

CIRCLE 29 ON READER CARD

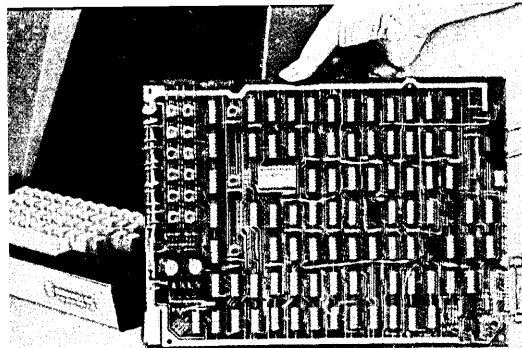

The whole works on one single PC board with every chip a plug-in!

LOWEST COST
 LOWEST COST
 LOWEST COST
 HIGHEST UPTIME
 HIGHEST UPTIME

Large, double-size characters available for super-readability!



Plug in to a TTY or any RS232 printer for hard copy when you need it!

OUR CRT HAS LESS GUTS ... AND FEWER BELLIES

Telera users call it the **Uptime Terminal** because it rarely gets sick. If it ever does, the cure is simple. We replace *one single plug-in board* that contains **ALL** logic, character generation, drives, interface, the works. Just about anything that can go wrong is on that board and is plug-in replaceable, *right down to every chip*. Telera is so quickly and easily repaired, you can do it yourself with our easy-to-understand service manual — or we'll do it for you. MSI circuitry and top-grade components have drastically

cut down the number of Telera parts that can go wrong, and that brings down your cost, too. Our price is competitive, but we're different on the inside . . . we're "healthier."

FEATURES

- o RS232-C, TTL, 20 ma current loop signal connections
- o ASCII coding; 98 characters generated, 64 displayed
- o Data rates to 2400 baud
- o Displays of 960, 1728 or 1920 characters
- o Full or half duplex, switch selectable
- o Local or remote modes, switch selectable

- o Non-contacting solid-state keyboard (read-only if you want)
- o Direct TTY replacement without interface or software changes

OPTIONS

- o Switchable baud rates
- o Switchable line formats
- o Numeric keypad adapter
- o RS232 output to any printer
- o 50/60 Hz, 115/230 VAC power
- o Remote keyboard
- o Slave up to 5 video repeaters

Call collect (612) 941-3300 and ask for Telera! It's a "gutless wonder"! (We have a warranty that's different, too!)

TELERAY 3300

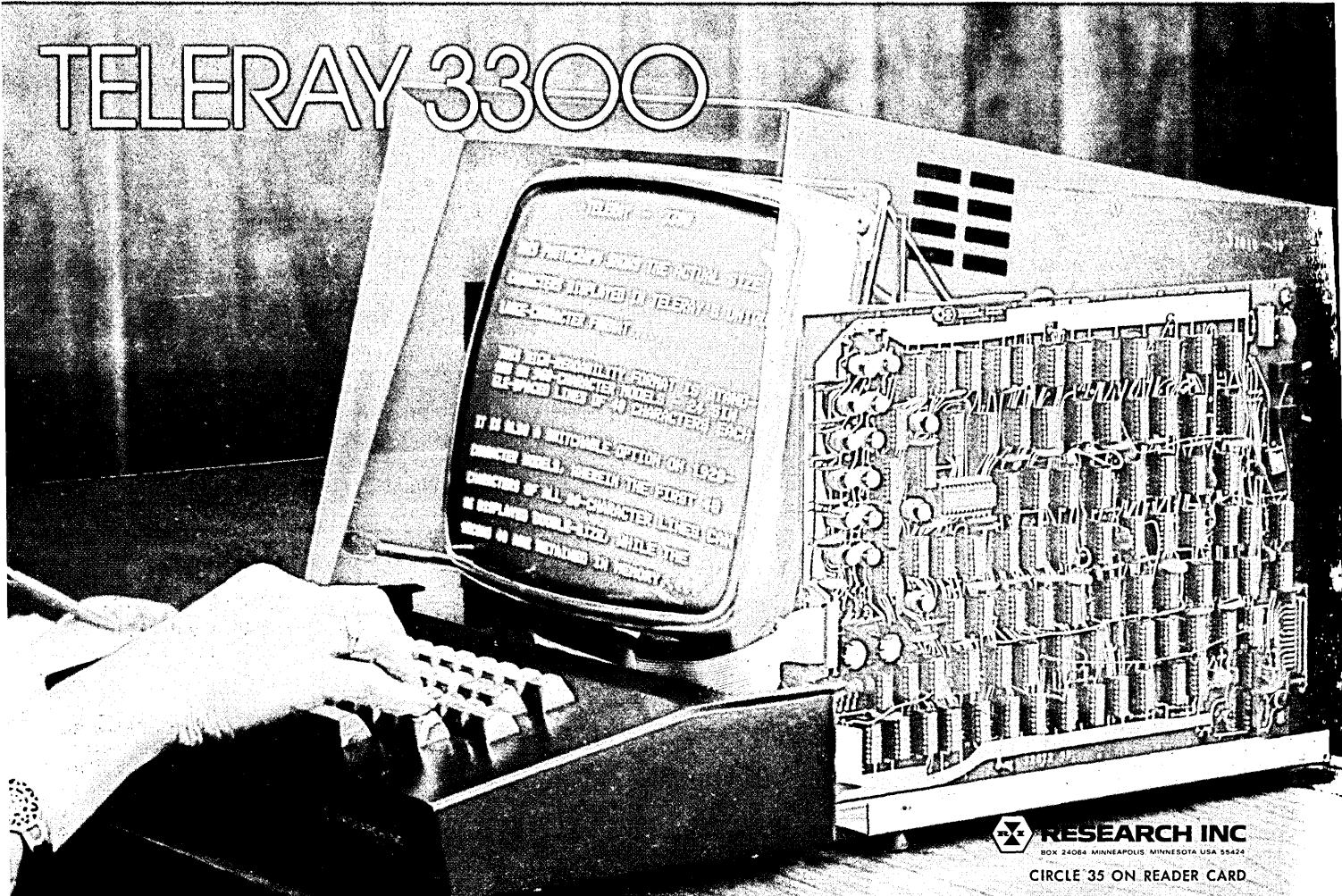

RESEARCH INC
 BOX 24084 MINNEAPOLIS, MINNESOTA USA 55424

CIRCLE 35 ON READER CARD

Calendar

JUNE

Second Annual Symposium on the Simulation of Computer Systems, June 4-6, Gaithersburg, Md. Sponsored by the National Bureau of Standards and the ACM Special Interest Group on Simulation, this conference will consist of technical sessions and a series of parallel tutorials on the simulation of computer systems as applied to the computer use and procurement cycle. Presentations will cover the use of computer simulation at IBM, CDC, Univac, Hughes Aircraft, TRW, the Navy, and the Air Force, among other places. Fee: not yet established, about \$40. Contact: Deanna J. Nelson, Dept. of Defense Computer Institute, Washington Navy Yard, Washington, DC 20390.

Thirteenth Semiannual International ICES Users Group Conference, June 13-14, San Francisco. ICES (the Integrated Civil Engineering System) is a computer system, developed by MIT, which supports a comprehensive collection of engineering computer programs relating to such areas as structural analysis and design, roadway design, coordinate geometry calculations, project management, and soil analysis. The user group, with a membership of about 500 firms, was formed to provide a forum on the use and modification of these programs. Fee: \$40; \$30 extra for pre-conference learning sessions (June 12) for which pre-registration by June 5 is required. Contact: Roy A. Imbsen, Office of Structures, Dept. of Transportation, P.O. Box 1499, Sacramento, CA 95807.

ICC '74—IEEE International Conference on Communications, June 17-19, Minneapolis. Sponsored by the Communications Society and IEEE (Twin Cities section), this program will include: a tutorial session on communications satellites; a technical program of 200 papers on satellite communications and on data and voice transmission connected with wire, radio, and computer-oriented communications in both theoretical and practical applications; and an exhibition of technical products in the telecommunications field. Advance fee (before June 1): \$40, IEEE members; \$50, others; at conference, add \$10. Contact: Marilou E. Thomas, Northwestern Bell Telephone Co., 70 W. Fourth St., St. Paul, MN 55102.

Eleventh Annual Design Automation Workshop, June 17-19, Denver. The goal of this workshop, sponsored by the ACM Special Interest Group on Design Automation and the IEEE Computer Society, is to improve and expand the quality and quantity of developments in the field of "design automation," defined by organizers of the event as "the use of computers as tools which aid the design process . . . often extended to include areas such as testing, simulation, and certain portions of manufacturing." Advance fee: \$50, ACM or IEEE members; \$60, others; at workshop, add \$10. Contact: J. Michael Galey, IBM Corp., Dept H90, Bldg. 124, Monterey and Cottle Rds., San Jose, CA 95193.

International Symposium on Fault-Tolerant Computing, June 19-21, Champaign, Ill. Sponsored by the Technical Committee on Fault-Tolerant Computing of the IEEE Computer Society in cooperation with the Coordinated Science Laboratory of the Univ. of Illinois, this conference consists of sessions on: fault analysis and location, reliability modeling and redundant systems, diagnosis and testing, fault-

tolerant systems and design techniques, and system maintenance and software testing. Advance fee: \$55, IEEE members; \$70, others; at conference, add \$10. Contact: Prof. Gernot Metzger, Coordinated Science Laboratory, Univ. of Illinois, Urbana, IL 61801.

DPMA 1974 INFO/EXPO, June 23-26, Minneapolis. The 22nd annual DPMA conference and business exposition will include: six three-quarter-day programs on microfilm and microfiche, data entry systems, point-of-sale systems, minicomputers, small and medium-scale systems, and virtual memory; a presentation on the IBM data security studies and one on the future of dp; eight "personal growth sessions"; and a series of idea exchange meetings. Fee: \$150, members; \$190, others. Contact: John A. Guerrieri, Jr., DPMA, 505 Busse Hwy., Park Ridge, IL 60068.

Fifth Conference on Computers in the Undergraduate Curricula, June 24-26, Pullman, Wash. The fifth in a series of conferences on applications of computers in undergraduate education will be held this year at Washington State Univ. Described as "the sole national conference designed to provide a multidisciplinary forum for disseminating information about the educational uses of computers," the conference will include papers, panel discussions, demonstrations, and exhibits. Advance fee: not yet available, about \$45 for members of the academic community, \$75 for others; at conference, add \$10. Contact: Dr. Ottis W. Rechard, Computer Science Dept., Washington State Univ., Pullman, WA 99163.

Syntopican II—Third International Conference and Exposition of the International Word Processing Assn., June 26-28, Atlanta. This year's conference will be devoted primarily to small workshop sessions, for both novices and experienced users, on such topics as: administrative support programs, computer word processing, work measurement, dictation systems, measuring the usage of systems, and environmental concerns. There will be an exhibit of word processing equipment, supplies, and services. Fee: \$100 for members of IWP, Administrative Management Society, and Office Microfilm Management Assn.; \$125, others. Contact: Linda Zangrilli, IWP, AMS Bldg., Maryland Rd., Willow Grove, PA 19090.

JULY

Second Jerusalem Conference on Information Technology, July 29-August 1, Jerusalem. The objective of this conference is to arouse interest among governments and international and national organizations, as well as individuals, in the role of the computer in economic and social developments; sessions on topics within the areas of "computers in an operational environment," "planning, forecasting, and modeling," and "workshops on technology utilization" are planned. There will also be an exhibit of equipment. The first Jerusalem conference, in summer 1971, attracted 1,500 participants from 40 countries. Fee: \$70. Contact: ILTAM, P.O. Box 7170, Jerusalem, Israel.

Conferences are generally listed only once. Please check recent issues of DATAMATION for additional meetings scheduled during these months.

Today, more than 100 of the best known and respected computer companies use Documation readers and punches.

Our family of card handling equipment may tell you why.

Documation makes a complete line of card readers and punches to meet your changing needs. On this page are only a few of the many configurations we have created for the computer industry around the world. Ask your computer representative for more details about how we are responding to your requirements.

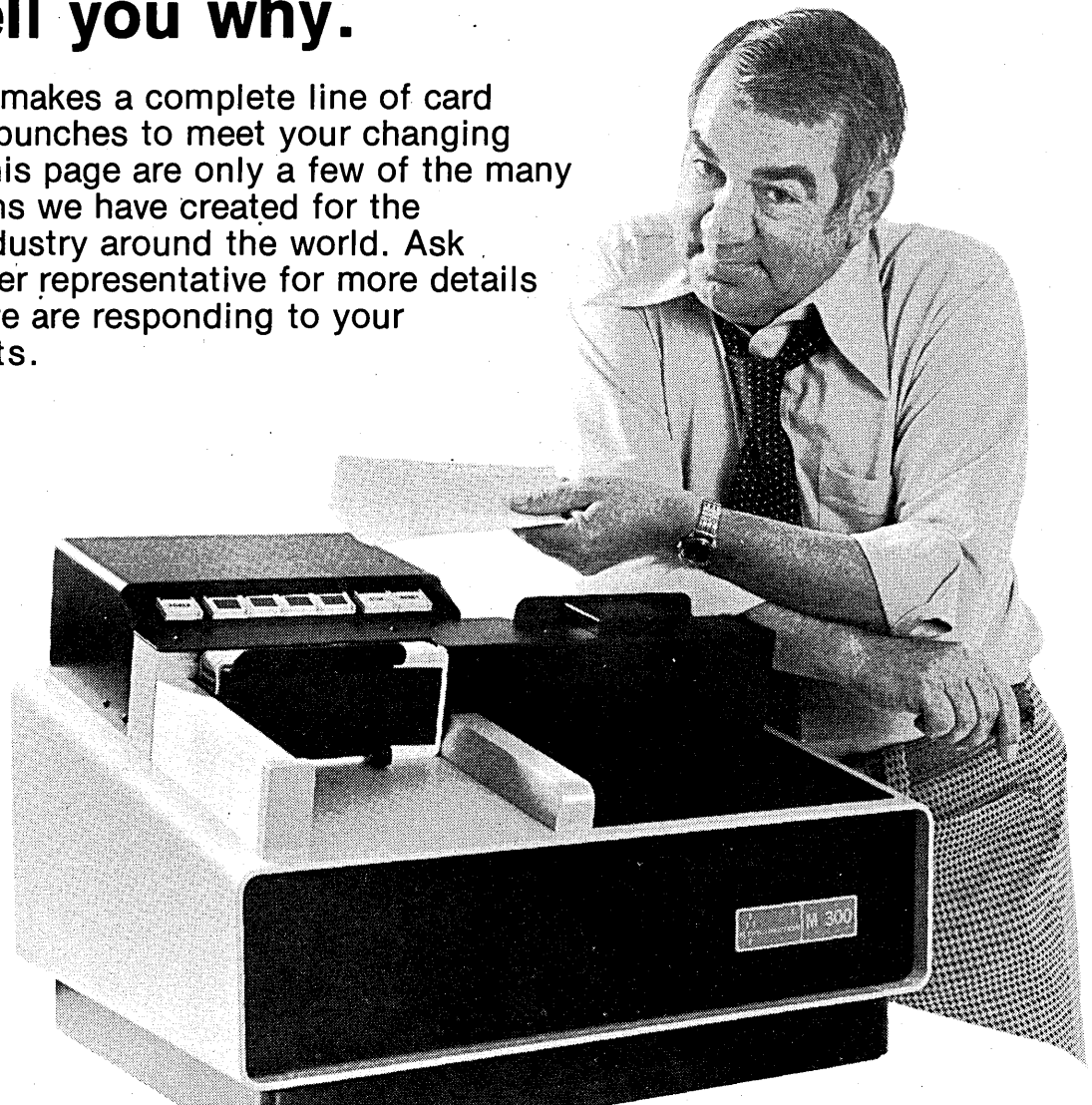

Slant Top Card Readers

Card rate; 300, 600, or 1000 cards per minute. Card Type: Standard 80-column or optical mark. Hopper/stacker: 1000 card capacity



M 1200 Card Reader
 Card rate: 1200 cards per minute
 Card type: Standard 80-column
 or Optical mark
 Hopper/stacker: 2250 cards

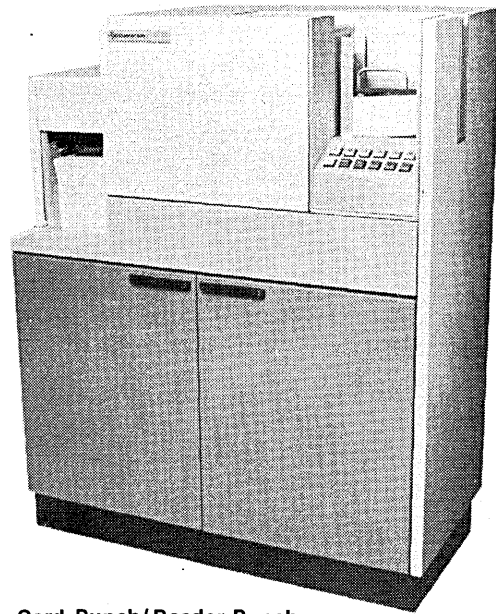

Card Punch/Reader-Punch
 Punch mode: 100 to 285 cards per minute
 Read only mode: 400 cards per minute
 Card type: Standard 80-column
 Hopper/stacker: 1000 cards

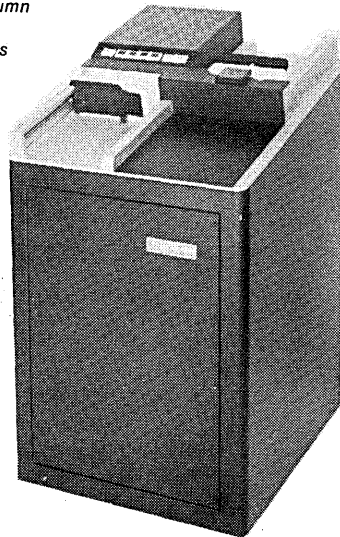

Console Card Readers
 Card rate: 600 or 1000 cards per minute
 Card type: Standard 80-column or optical mark
 Hopper/stacker: 1500 cards

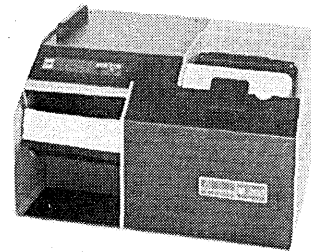

M 200 Card Reader
 Card rate: 285 cards per minute
 Card type: Standard 80-column or optical mark
 Hopper/stacker: 550 cards

Twin Head Card Readers
 All Documation card readers with reading speeds from 285 to 1200 cards per minute are available to read both standard 80-column and optical mark cards.

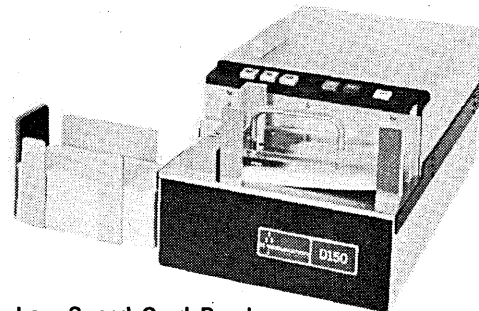

Low Speed Card Readers
 Card rate: 220 cards per minute
 Card type: Standard 80-column or optical mark
 Hopper/stacker: 400 cards



DOCUMATION
 INCORPORATED
 POST OFFICE BOX 1240
 MELBOURNE, FLORIDA 32901
 TELEPHONE (305) 724-1111
 TWX 510-959-6286

How'd you like to cut your air freight costs in half? Simple.

United's "Daylight Savings"

SHIP 3,000 POUNDS FOR THE
COST OF 1,500 POUNDS.

Here's all you do. Load your shipment
in one of our wide-body containers
(like our LD-3). Get it to us between
4 a.m. and 4 p.m. Now you've
qualified for our "Daylight Savings"
rate—our discount for shipping
when we're least busy, on our
wide-body passenger jets. Your
cost per hundred pounds
can be cut in half.



SEE HOW YOU SAVE!

This chart shows
the savings possible
with our LD-3 container.
You can save even more with
the larger LD-11 and LD-7
containers. Call United for the
facts about our big containers...
and our big "Daylight Savings."

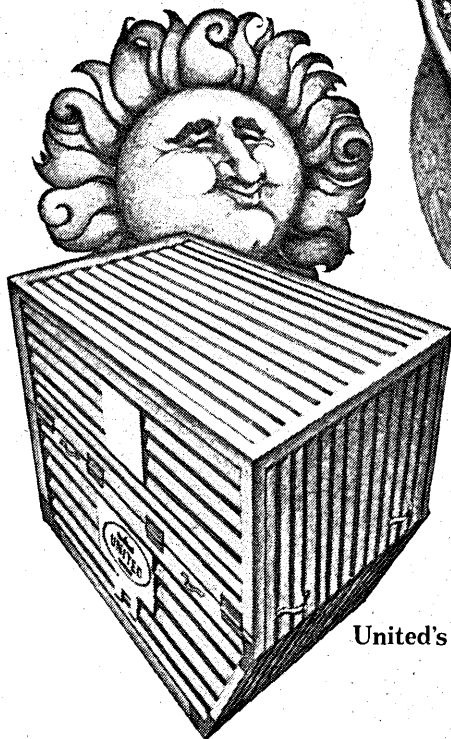

United's LD-3

United's "Daylight Savings" from New York City, for example:

Weight of LD-3 contents (lbs.)	1500	2100	2700	3000	(max.) 3160	
Density (lbs. per cubic foot)	10	14	18	20	21	
To:	flat charge*	Cost per 100 pounds				
Chicago	\$102	\$ 6.80	\$ 4.86	\$ 3.78	\$ 3.40	\$3.23
San Francisco	303	20.20	14.43	11.22	10.10	9.59
Los Angeles	289	19.27	13.76	10.70	9.63	9.15

*Based on airport-to-airport Time of Tender "Daylight Savings" rates. These rates were effective February 18, 1974, and are subject to change.

United Air Lines Jet Freight

No. 1 in the U.S. sky

Industrial designers like the way they look. Engineers like the way they work.

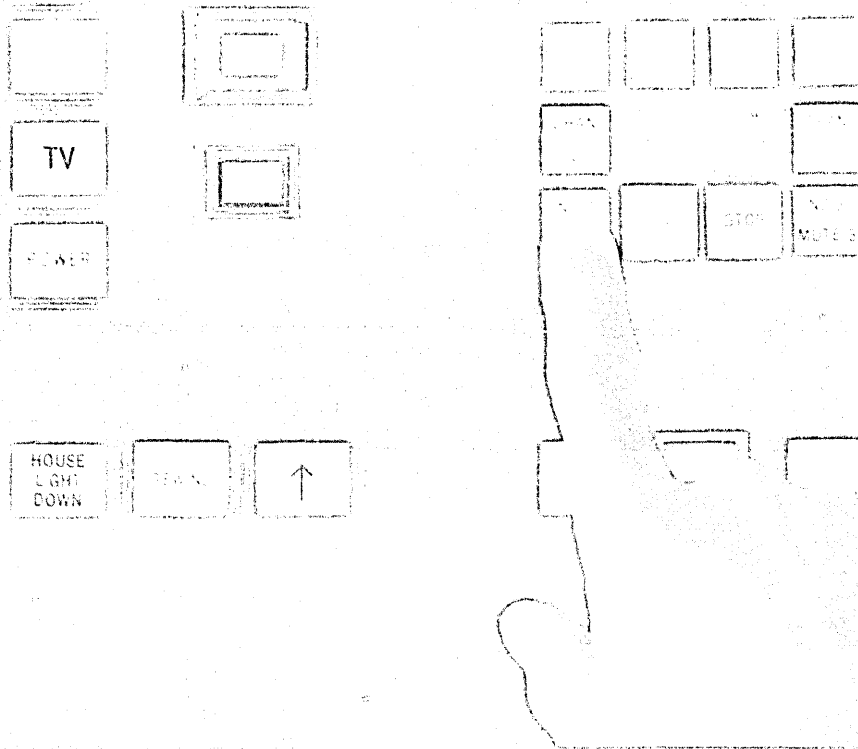

Micro Switches
Series 1 (left) and Series 2 (right)

- Series 1 (left)** - Series 1 (left) features over all three energy levels - momentary contact.
- Series 2 (right)** - Series 2 (right) includes stop, reset, and other symbols and a variety of button shapes.
- Series 3 (right)** - Series 3 (right) features momentary contact and other features.
- Series 4 (right)** - Series 4 (right) features momentary contact and other features.

If you've got a particular idea about what a lighted push-button should look like, we've got four important members for you: Series 1, 2, 3 and 4.

They represent one of the biggest selections of lighted push-buttons in the world.

So you get to choose from a long list of options, representing every size and shape you select. Like buttons available in popular, brightly fluorescent colors. Either translucent or protected. Representing includes thin stems, engraved or film inserts, with an optional indirect legend available. Buttons and housings come in a choice of colors. Lighting is single or multiple frame. Mounting either single unit, snap or screw. You can also choose between round or square configurations, and most of them offer front-of-panel mounting, without tools.

But your choice doesn't end at the front of the panel. In back of the button, there are three energy levels available - solid-state, low-energy and power. You can choose among solder, quick-connect, P.C. board mount or screw terminals. They're all U.L. and C.S.A. listed, with military listed variations available. Circuitry can be single-pole, single-throw through four-pole, double-throw. With momentary or alternate action.

And even though each of the four Series has its own particular advantages, they all have one thing in common: the kind of reliability you'd expect from the company that pioneered lighted push-button switches.

If you'd like more information on any or all of the MICRO SWITCH lighted push-buttons, call toll-free (800) 425-9200 (in N.Y. 516/291-0900, collect) for the name of your nearest Branch Office or Authorized Distributor.

MICRO SWITCH products are available worldwide through International

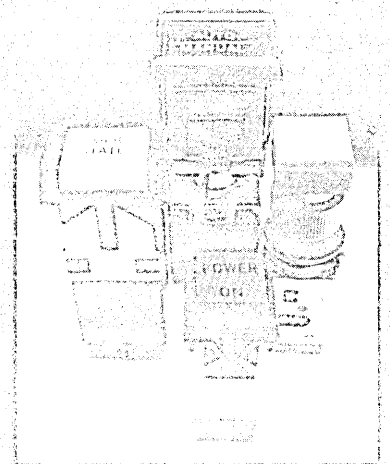

MICRO SWITCH

MEMBER OF THE MICRO SWITCH GROUP
A DIVISION OF THE BRONXVILLE

CIRCLE 26 ON READER CARD

Ask about keyboard. Ask about scanning. And cost justification.
Ask about multimedia. And software.

Ask about
the nuts and bolts
and how many bytes...

before you decide on
the Cummins KeyScan[™]
Data Entry System.

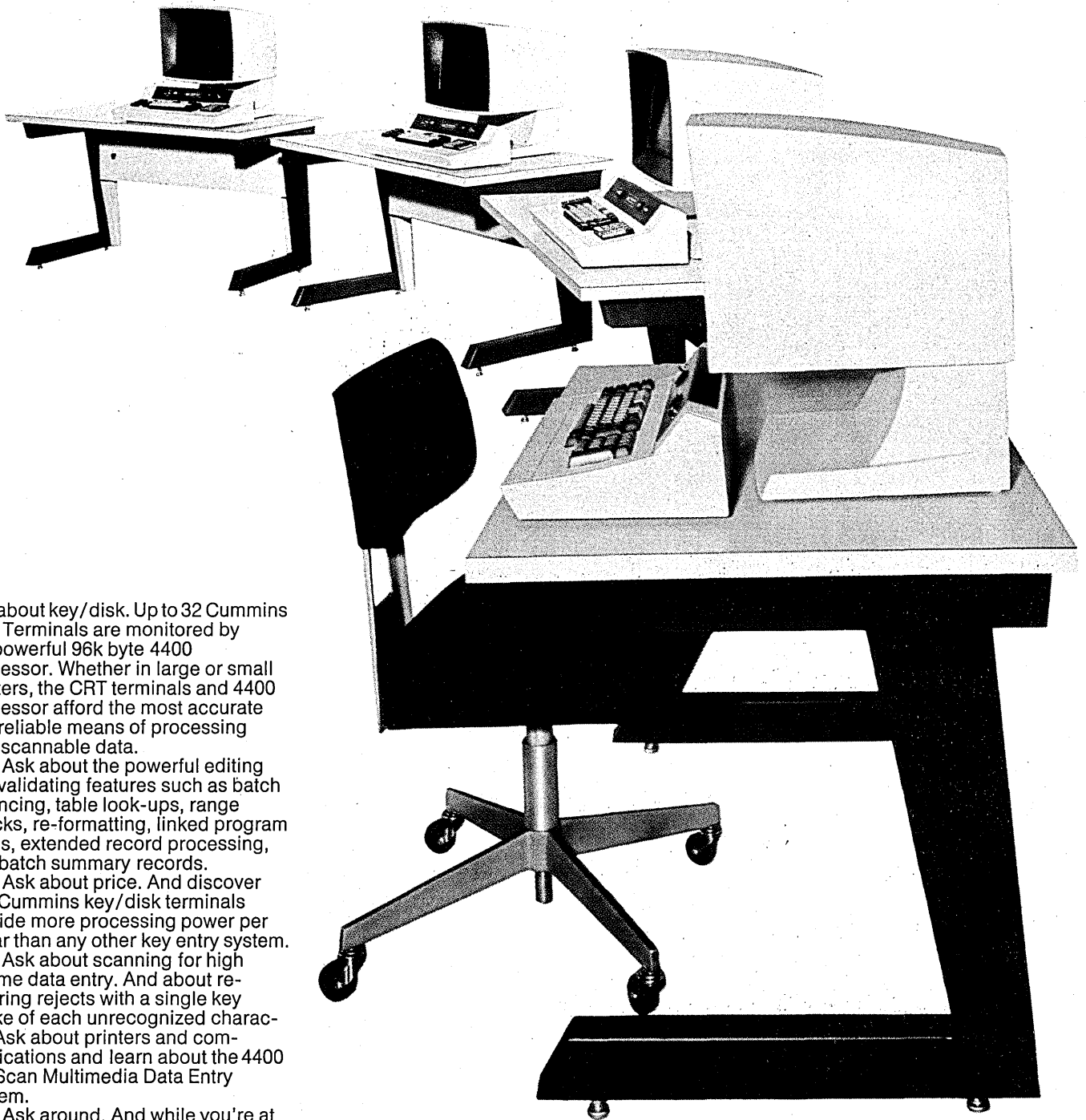

Ask about key/disk. Up to 32 Cummins CRT Terminals are monitored by the powerful 96k byte 4400 Processor. Whether in large or small clusters, the CRT terminals and 4400 Processor afford the most accurate and reliable means of processing non-scannable data.

Ask about the powerful editing and validating features such as batch balancing, table look-ups, range checks, re-formatting, linked program levels, extended record processing, and batch summary records.

Ask about price. And discover that Cummins key/disk terminals provide more processing power per dollar than any other key entry system.

Ask about scanning for high volume data entry. And about re-entering rejects with a single key stroke of each unrecognized character. Ask about printers and communications and learn about the 4400 KeyScan Multimedia Data Entry System.

Ask around. And while you're at it ask about Cummins, a company with over 45 branch sales and service offices located across the country. Send for the 4400 KeyScan System brochure. Write: 836 Waukegan Rd., Glenview, IL 60025. Or ask the operator to dial 312/724-8000 and make an appointment to visit our demonstration facilities.

Ask about the KeyScan Data Entry System. Then ask about other systems and you decide which is best.

 **CUMMINS**
CUMMINS-ALLISON CORP.

4400

KeyScan Multimedia Data Entry System

Datacraft® SLASH 4 Virtual Memory
Computer System.

Delivers power, economy, flexibility and
versatility. All you'll ever want. Or need. For concurrent
multi-batch processing. Critical real-time. Remote job entry.
Time sharing.

Whatever your application, the SLASH 4 VM's
750 nanosecond cycle time, automatic program relocation,
re-entrant processors, and effective memory utilization,
deliver higher throughput for you. Big single programs... up
to 256K... are handled with ease in a multi-task oriented
architecture that virtually eliminates costly software penalties.

That's Efficiency.
That's Money Saved.

You'll be amazed at what you get. And how
much you can do. Contact us for all the facts. Datacraft,
1200 Gateway Drive, Fort Lauderdale, Florida 33309,
Telephone (305) 974-1700. For international inquiries write:
Techmaton N.V. Gebouw 105/106, Schiphol-Oost, Holland.

Datacraft®

SUBSIDIARY OF HARRIS-INTERTYPE CORPORATION



SLASH 4 VM COMPUTER SYSTEMS

CIRCLE 10 ON READER CARD



LOOK AHEAD

MONOPOLY GAME

Judge Earl R. Larson's findings in Minneapolis federal court that IBM once entered into a secret "technological merger" with Sperry Rand could be a critical argument in current antitrust actions by a number of IBM competitors. California Computer Products, a peripherals manufacturer seeking \$3 billion in damages against IBM, has asked that IBM refute or confirm "paragraph by paragraph" the judge's findings that the agreement was an attempt by IBM and Sperry Rand to "strengthen or solidify their monopoly in the edp industry" (see Jan., p. 78).

The suits brought against IBM by Calcomp and others (see April, p. 142) essentially are based on Judge A. Sherman Christensen's ruling against IBM last year in the Telex case in Tulsa, which IBM is appealing in Denver. But legal experts say that if the Telex judgment is not upheld in appeals court, then the Larson findings will be a key alternate argument for competitors in their charges that IBM damaged them by violating anti-monopoly laws.

HONEYWELL ANNOUNCEMENTS: READY FOR FS

Gertrude Stein proclaimed the "lost generation," but it may have been left to Honeywell to proclaim the "last generation" when it announced its Series 60 in late April. Users have been growing weary of all those hardware buzzwords in recent years, particularly when the flashy new equipment and subsystems didn't work. So Honeywell "unveiled" its GCOS operating system. And what could be more tried and true?

Lurking in the background, of course, is IBM's Future System (FS). Honeywell's Clarence W. Spangle says FS has been on their minds, but like everyone else in the industry—including IBM maybe—no one knows what FS will look like. So Honeywell opted for a highly flexible series.

The indication is that there will be a constant flow of hardware and software enhancements for the Series 60, which in itself is something of a product orgy. For instance, when 4K MOS memories become available, they'll be easy to design into the Honeywell equipment. The development thrust at Honeywell, then, will be in software. Indeed, the only tantalizing technological hardware product to emerge from the Honeywell Series 60 announcement is its high speed non-impact page printing system. Initially, the printing system will be offered solely to Honeywell customers. But we're guessing that the system just might be configured for outsiders at some later date. The price—starting at \$162K—is important. IBM is said to have a similar model in the works, and if it is significantly more expensive, as expected, that could push Honeywell to offer it to others. In fact, there are those who think that Honeywell just could be joining IBM and Xerox in the office copying business, with Honeywell starting at the high end.

POS FOR THE LITTLE GUY

The Bank of America seeks four to 100 small retailers, doing \$500,000 to \$2 million a year in business, on which to test a point-of-sale package it will offer through its business services div. The stores selected for the pilot test, which will run through calendar year '75, will be in Los Angeles or San Francisco. In mid-April the bank said Los Angeles had the edge. The retailers will be offered terminals,

LOOK AHEAD

either on-line to the bank's computer center or standalone with cassette storage, and a total accounting service including receivables, payables, general ledger, payroll, commission calculation and analysis, and inventory control. They can opt to acquire their own terminals, but the bank plans to offer economies of large-scale buying from "a couple of vendors." At writing Singer, NCR, and IBM were front runners. In 1976, said William Lechmanski of the bank's product development div., "we'll go out for competitive bid and settle for one vendor." The bank will test both OCR and magnetics for data entry in the test period and hopes to settle on one before this is over. By the end of 1977, Lechmanski said, "we will be going full speed throughout California."

MEMORY HOUSES AIM AT S/3 MARKET

Memory houses are eyeing the huge IBM System/3 add-on market. Latest to enter is Standard Memories, Ft. Lauderdale, which plans to offer users savings of 30-40%. Prototypes which fit into the cpu are operating and installations should begin this summer.

The company will be up against three other key suppliers--Business Technology Systems, CFI Memories, and Fabri-Tek--in its effort to penetrate a market that is huge (20,000 installations in North America) but also scattered among small users who are tough to reach profitably. And many buy in such small quantities as 4-8K on a monthly rental basis. But there also are buyers seeking up to 56K add-ons, say sources at Group/3, an organization of System/3 users.

A PROBLEM IN OREGON: A JOB IN PHOENIX

Bill Fellingner, a student at Oregon State Univ., feels strongly about computer security. He was asked to resign his position on the network planning staff of the Oregon Dept. of Higher Education when he took control of a Dept. of Motor Vehicles 370/158 and crashed the system to show what could happen if a proposed multi-college student network piggybacked on the system, as had been suggested by some state officials. But he's not through with concern for data security. He's accepted a position with Honeywell and, following his graduation in June, will go to Phoenix to work on Multics.

FREE...FOR A PRICE

Stanford Research Institute has distributed 3,000 copies of a 131-page report on Computer Abuse since the results of its National Science Foundation-sponsored study first were offered last fall. Some subscribers are angry that the report comes with a computer-generated invoice for \$3 after it was offered free in press releases. The author, SRI's Donn B. Parker, says the \$38,000 funding covered the printing of only 2,000 copies, but admits he erred in not advising subscribers of the charge before billing them. SRI now is referring requests for copies to the Commerce Dept.'s National Technical Information Service in Springfield, Va., which will print the report and sell it for \$4.75.

THE FLOWERS THAT BLOOM IN THE SPRING...

Veteran computer entrepreneurs are blossoming out this spring with new ventures. Time-sharing pioneer Joseph T. Hootman, who six years ago founded Remote Computer Corp. of Los Angeles, emerges as a partner in Network Management Assoc., Inc. of Los Angeles and Saratoga, Calif. Hootman and partner Einar Stefferud, a computer management consultant, have contracts from the Air Force, NASA, and Rand Corp. to assist

(Continued on page 122)

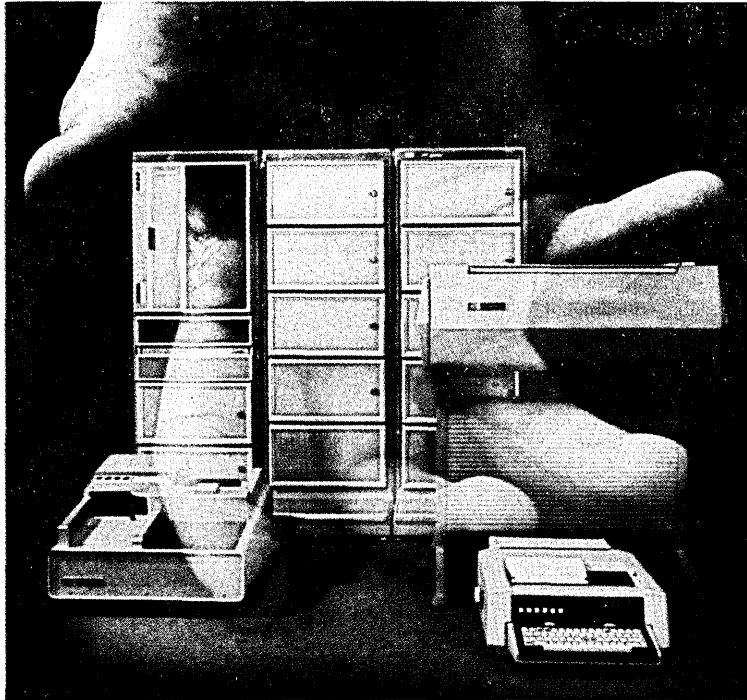

This \$170,000* system gives you more computer access than any \$300,000 system in existence.

HP's 3000 Minicomputer System gives you four languages: COBOL; BASIC; FORTRAN and HP's System Programming Language. A powerful Editor and File Manager. And concurrent accessibility from both terminals and batch peripherals.

This innovation works for a living.

If you do, call us.

HP minicomputers. They work for a living.

HEWLETT *hp* PACKARD

Sales and service from 172 offices in 65 countries.
1501 Page Mill Road, Palo Alto, California 94304

*Domestic USA prices.

22412

May, 1974

CIRCLE 18 ON READER CARD

19

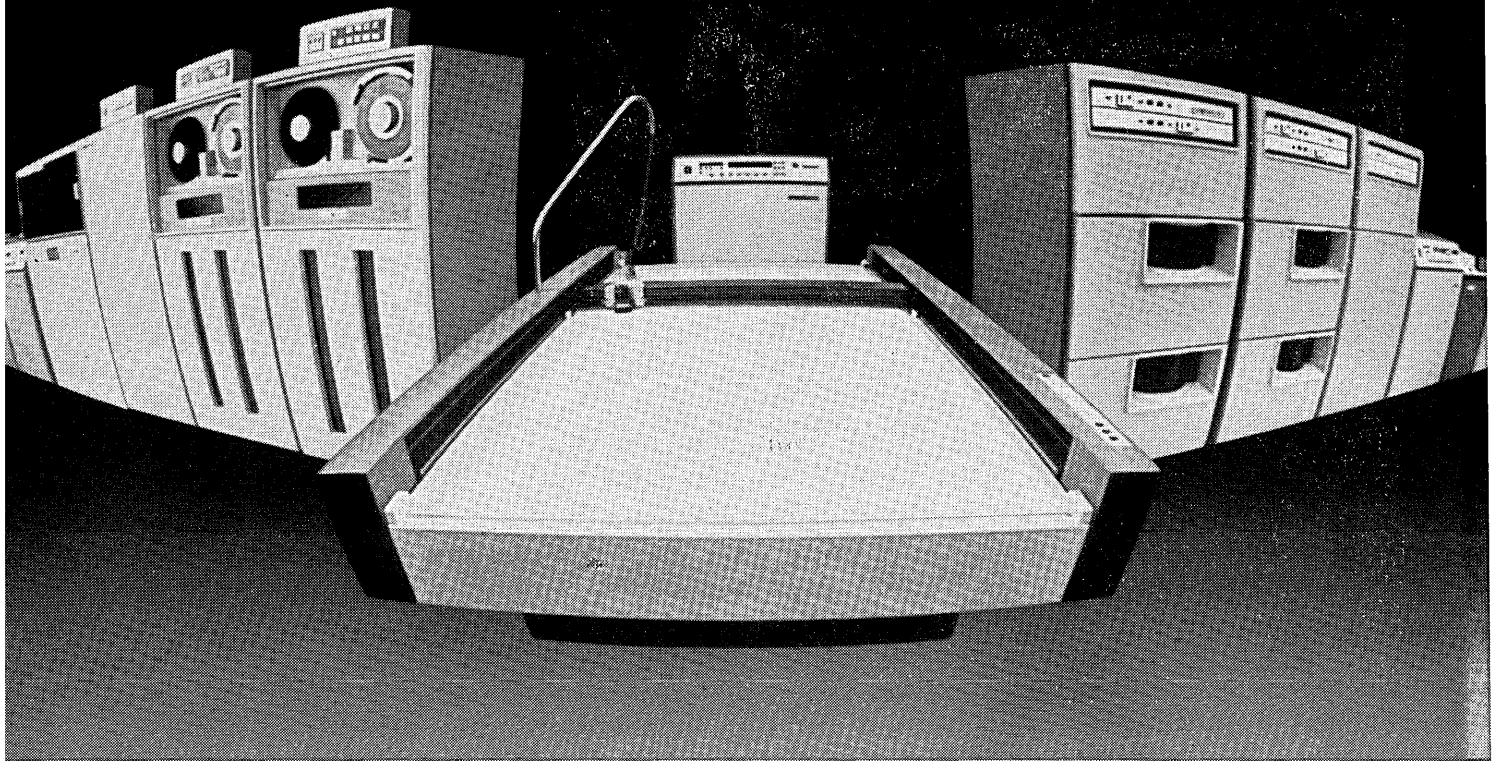

Peripheral vision.

From the beginning, we have preferred concentration to diversification. We don't supply everything that attaches to your computer. But the things we do supply are the best.

What do we supply?

Drum plotters. We're the world's leading supplier of both hardware and software.

Flatbed plotters. Several years ago, we saw a need and an opportunity to expand the plotter's uses. The flatbed plotter allows a variety of materials to be substituted for paper, and it has expanded the

market for computer graphics, as well.

Microfilm plotters. Here, we got bigger by getting smaller. With microfilm. Our 1675 COM plotter/printer and our 2100 COM printer deliver the best price/performance in the industry.

Disk memory equipment. This was our second area of concentration. In a remarkably short time, we have become the leading independent supplier.

Tape systems. We've recently begun to concentrate on tape. The result is that

our new 1040 Tape Drive combines the features of others with our own experience. We intend to be a leader in this field.

The point is we have not grown by accident. Thirteen years after our beginning, we have become a leader in computer peripherals.

For information on peripheral products, call your local CalComp office, or contact California Computer Products, Inc., DM-M5-74, 2411 West La Palma Avenue, Anaheim, California 92801 (714) 821-2011

CALCOMP

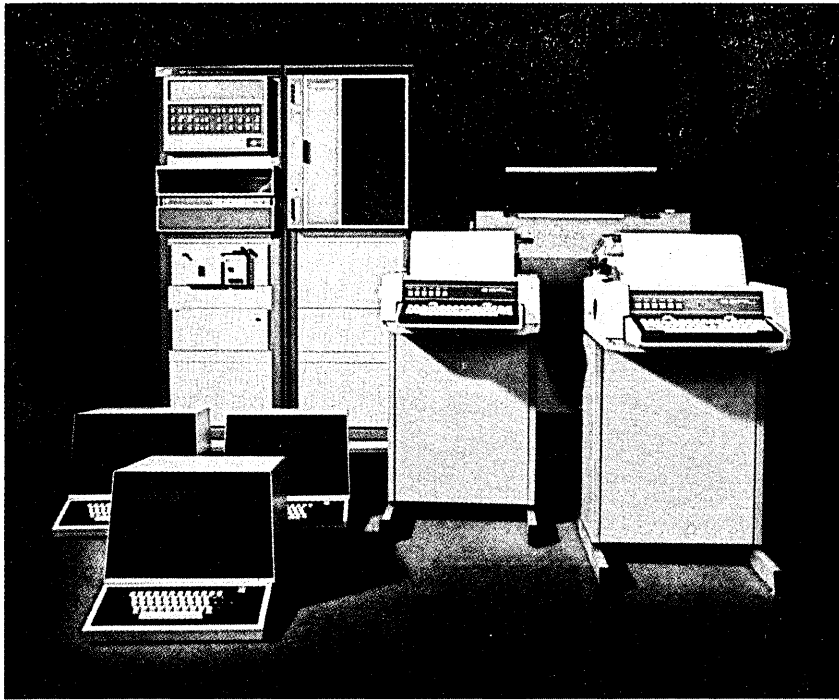

Processing 18,000 business transactions per hour is nothing new. A minicomputer that does it for \$80,000* is!

HP's Management 230 System lets you enter, edit, update and process transactions on as many as 32 remote terminals.

With no interim handling. And without overloading the resources of your central system.

This innovation works for a living.

If you do, call us.

HP minicomputers. They work for a living.

HEWLETT *hp* PACKARD

Sales and service from 172 offices in 65 countries.
1501 Page Mill Road, Palo Alto, California 94304

*Domestic USA prices.

22413

May, 1974

CIRCLE 70 ON READER CARD

21

SYCOR INTRODUCES THE SPEED READER.



When it comes to fast data access, our Sycor 340 intelligent terminal with its new Flexible Disk* option has the fastest draw in the West—or anywhere else.

And still costs less than the comparable IBM offering.

Like most models, our new option uses IBM-compatible diskettes. But the similarity ends there. Our Flexible Disk's positioning time leaves the others standing still.

For example, it moves to the center of the diskette (40 tracks) in 117 msec. Ask our competitors for their times.

And because it holds two diskettes and either one or two cassettes, our Sycor 340 is the ideal intelligent terminal for order entry applications involving small to medium size customer, salesman and product price files.

It allows you to manage your own mini-database.

Best of all, it can be combined with a host of optional features, including three speeds of printers, a card reader, magnetic tape drives and both asynchronous and binary synchronous communications.

Ask your Sycor representative about our intelligent terminal and its new Flexible Disk option.

The speed reader.

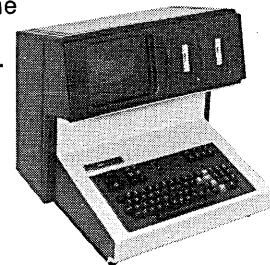

SYCOR

S[®]
SYCOR INC

Corporate Offices: Ann Arbor, Michigan 48104 (313) 971-0900. **District Sales Offices:** Atlanta (404) 457-1166 • Boston (617) 890-7290 • Chicago (312) 297-5200 • Cleveland (216) 831-8625 • Columbus (614) 888-8657 • Dallas (214) 521-6710 • Denver (303) 458-0794 • Detroit (313) 355-5770 • Greensboro, N.C. (919) 274-2964 • Hartford (203) 529-1100 • Houston (713) 688-5224 • Indianapolis (317) 784-6779 • Kansas City, Mo. (816) 842-7799 • Los Angeles (213) 640-0120 • Miami (305) 592-1533 • Minneapolis (612) 854-2309 • New York (212) 371-9050 • Philadelphia (609) 665-1170 • Pittsburgh (412) 922-3350 • Portland, Ore. (503) 227-5672 • San Francisco (415) 349-6626 • St. Louis (314) 878-0090 • Washington (703) 527-0200. **Service Centers in 80 cities.** **Canada:** Sycor International Ltd., Toronto (416) 429-0883.

See the Sycor 340 with Flexible Disk option at the National Computer Conference.

*Patents applied for

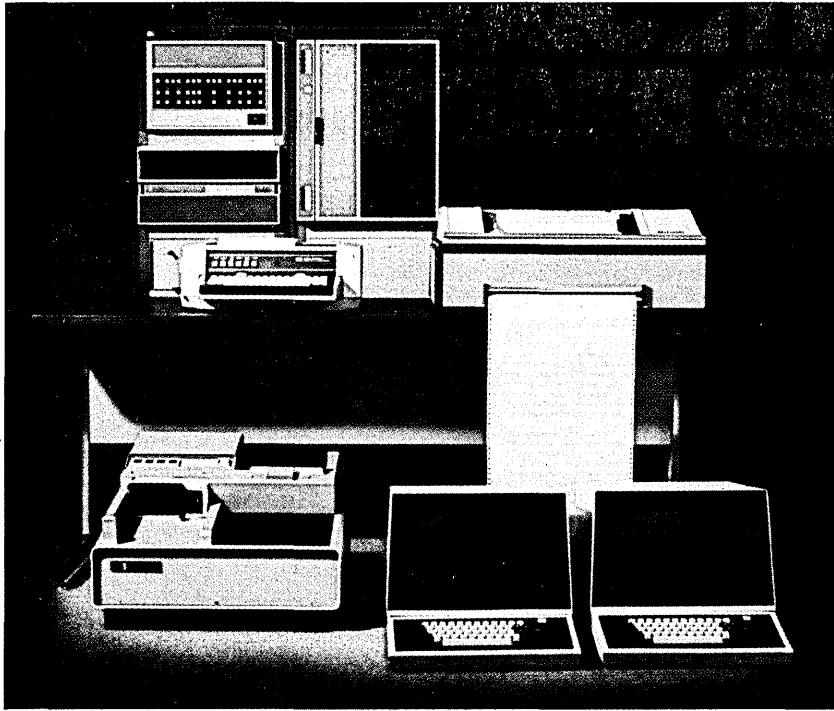

This minicomputer gives you
the data base management
you'd expect on a \$1,000,000 computer.
It costs \$78,000*.

HP's Management 260 System lets you
keep from 5 million to 94 million
bytes of data instantly active . . . on-line.
Make application programs data independent.
Eliminate data redundancy and insure data privacy.

This innovation works for a living.

If you do, call us.

HP minicomputers.
They work for a living.

HEWLETT  PACKARD

Sales and service from 172 offices in 65 countries.
1501 Page Mill Road, Palo Alto, California 94304

*Domestic USA prices.

22414

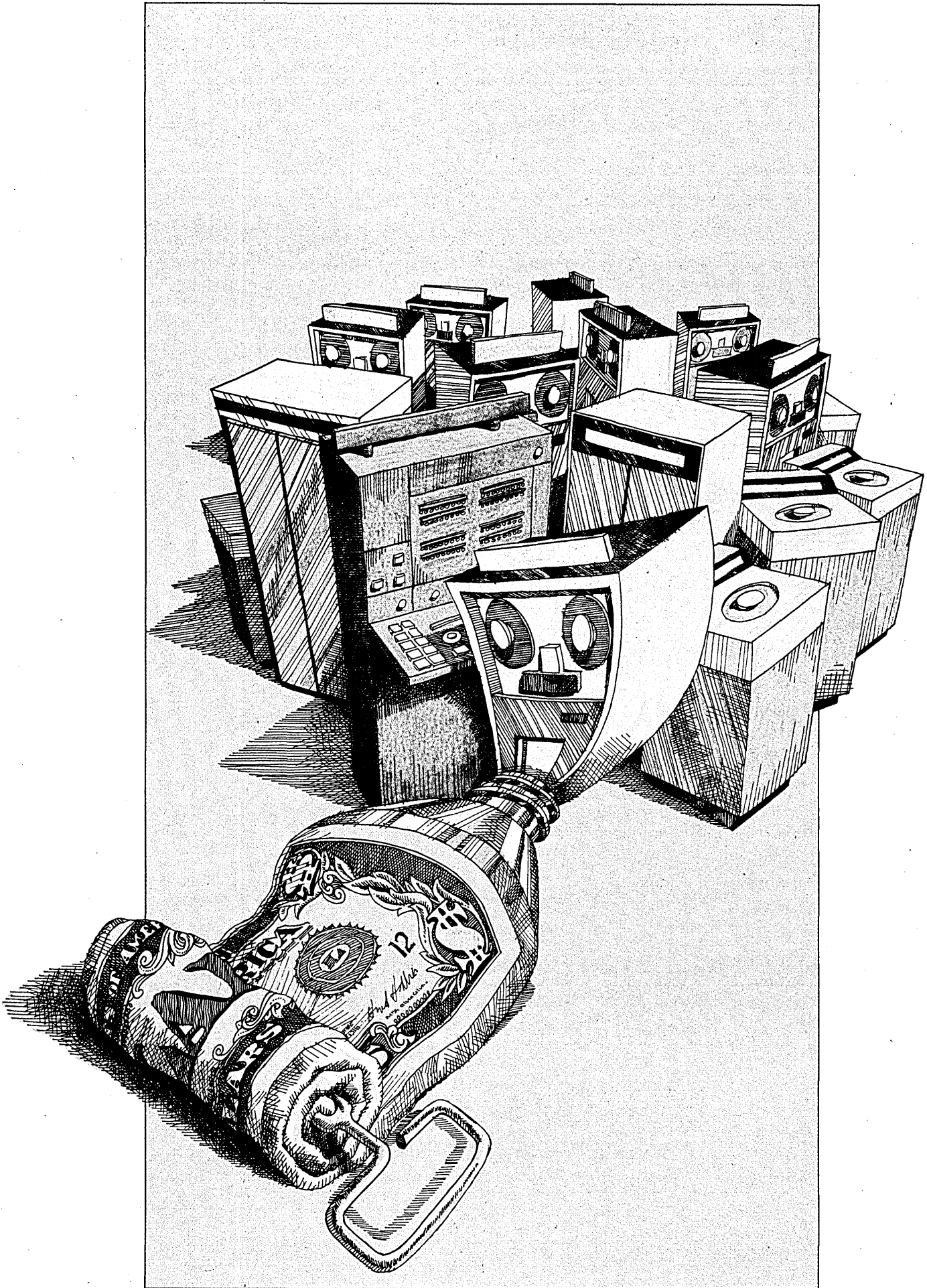

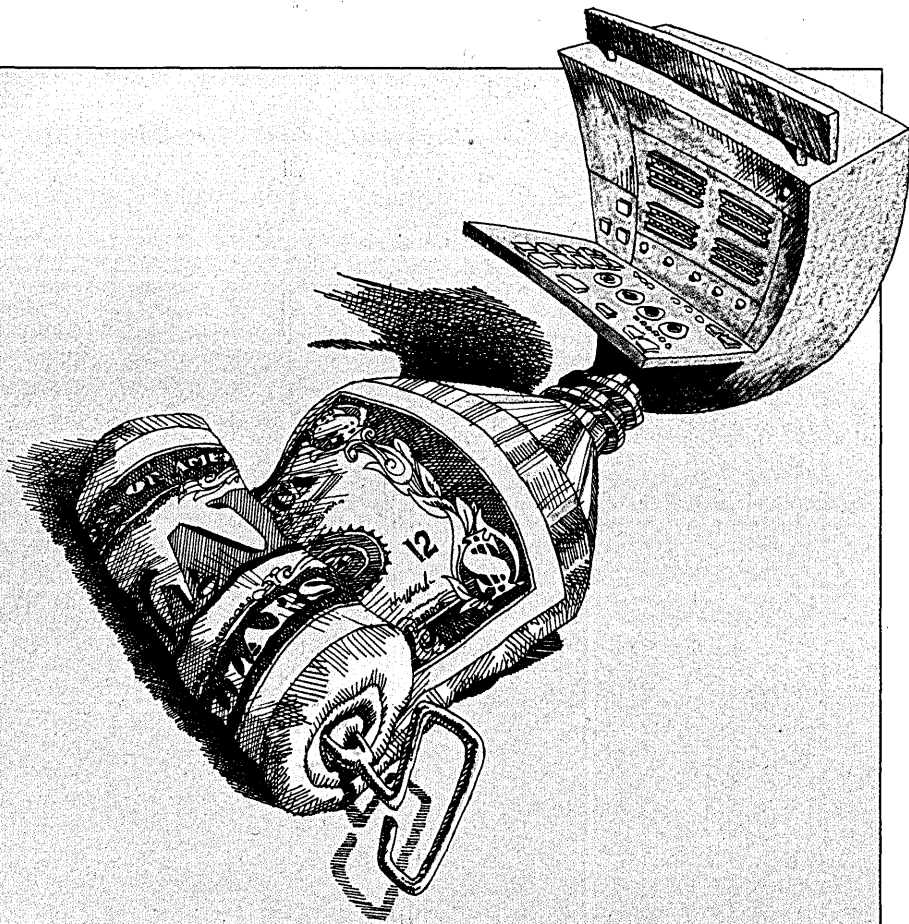

ITEL squeezes more out of your computer dollar than Brand X.

Now you can get a whole computer system from ITEL for less than what IBM charges for just a central processing unit.

The numbers speak for themselves:

For \$51,238 a month, IBM rents you a single 370/158 CPU (includes two extra shifts). But for \$48,406, ITEL leases you that same 370 CPU with ITEL Monolithic Memory, 24 ITEL disk drives plus their controllers, as well as 24 ITEL tape drives with their controllers.

To put it another way, if you were to rent a comparable system from IBM, it would cost you \$81,846 a month. Almost double our price.

Furthermore, we'll lease any kind of 370 computer package at proportional savings. And we'll make sure that all terms and provisions are custom-tailored to meet your exact financial objectives.

At ITEL, we couldn't have acquired over half a billion dollars in IBM computer leasing experience without doing more for your money.

Your financial alternative.

ITEL
CORPORATION
DATA PRODUCTS GROUP

One Embarcadero Center, San Francisco, California 94111, Phone: (415) 983-0000



**This
\$4,000,000 baby
is not paid to
lie around.**

Insist on ACE-SIL® rubber battery separators.

When a \$4,000,000 computer "goofs-off" you've got problems. People scream. Everything backs up. And the cost of downtime can keep you awake at night. Sure, some computers are backed up by fail-safe standby systems. But, unfortunately, a standby system is only as good as its batteries. And a battery is only as good as its separator.

That's why most premium battery-makers choose Ace-Sil microporous rubber separators for critical applications. Their highly uniform microporous structure permits freer flow of acid ions

between plates. Electrical resistance is consistently low. The separators function efficiently over wide temperature ranges and variations in acid concentration. And short circuits are forestalled because the separators are shock-proof and abrasion-resistant. How long do these properties last? Throughout the longest possible battery life.

Wouldn't it be silly to have a \$4,000,000 computer lie down on the job because of a 40¢ separator? If you're concerned about your "fail-safe" system write us now for full information. Ace-Sil. Performance-tested for over 20 years.



**MICROPOROUS
PRODUCTS DIVISION**

Amerace Corporation
Microporous Products Division, Ace Road, Butler, N. J. 07405

CIRCLE 24 ON READER CARD

Letters

Berated benchmark

Mr. R. Fred Littrell's article on "Economies of Scale in the IBM 360 and 370" (March, p. 83) was most interesting. The conclusion and approach clearly support the position that small-scale computers in the IBM line are more cost-effective than the large-scale computers for business data processing applications.

Mr. Littrell prefaces his empirical analysis with the following statement: "The results and inferences reported in this study are statistical in nature, based upon sets of comparisons. Obviously, as most vendors and many users know, benchmarks can be designed around any specific computer system configuration to 'prove' practically any point."

Then he proceeds to do just that.

The study would have been more convincing if supported in more depth in two areas:

1. What was the exact make-up of the multi-programming environment under which the study was conducted?
2. How was the benchmark structured?

If one does not accept the benchmark, one cannot accept the conclusion . . .

T. E. SHAUGHNESSY

*Manager, Supply Data Systems
PPG Industries, Inc.*

Pittsburgh, Pennsylvania

Mr. Littrell replies: I did not design the benchmarks. They were reported by IBM to have been designed to assess the relative performance of 360s and 370s.

Mr. Littrell's article on economies of scale is both misleading and dangerous. His conclusions are exactly contrary to real-world experience.

Littrell concluded that economies of scale exist in scientific computing but not in commercial computing. The reason that such an erroneous conclusion was reached is that he utilized benchmark data and employed the length of a benchmark run as the variable for performance and concluded, in error, that the most economical IBM computer for commercial dp is the IBM 360 model 30.

This happens because a commercial benchmark run is generally limited by the speed of the peripherals. Moving such a benchmark run to a faster computer without improving the peripherals only provides a more expensive run, which Littrell uses as his bad data.

The real question here is not how long one benchmark runs, but how efficiently a company's or institution's

entire workload can be run. Littrell's data could only hold for a firm which has overinvested in computing: if there is a small amount of work for a large computer.

But what is not recognized is that if a commercial system is heavily loaded, expanding it is far superior to adding another small machine. If this were not true, General Motors would employ 32,768 IBM 360 model 30s (or maybe more).

On the other hand, it is in the scientific field that very small computers (HP-35, TI-20, PDP-8, etc.) are finding homes. This is because many types of scientific computation can utilize minimum function. Almost any commer-

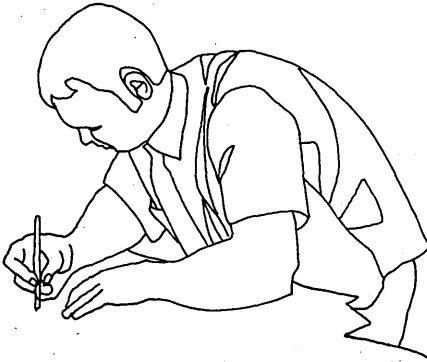

cial application, however, requires rather sizable file space.

So once again, benchmark data can be used to demonstrate anything, including conclusions which are contrary to fact.

MARTIN B. SOLOMON

*Director, Computing Center
University of Kentucky
Lexington, Kentucky*

Mr. Littrell replies: The design of the computer architecture is of prime importance in increasing I/O rates; if you use the cpu to manage character and buffer I/O to and from a single-ported memory, faster I/O peripherals will tend to degrade the system further. I have seen performance monitor reports for OS/VS1 systems in which 70% of the cpu cycles were used to manage the I/O and operating system. A separate I/O processor is cheaper than a faster cpu. As for expanding a heavily loaded commercial system, I suggest rereading my comments on the effects of memory expansion.

It takes time

The sources quoted in your March DATAMATION article "Does SDLC Stack

DATAMATION welcomes correspondence about the computer industry and its effect on society, as well as comments on the contents of this publication. Letters should be typed and limited in length to 250 words, if possible. We reserve the right to edit or select excerpts from letters submitted to us. Write to 1801 S. La Cienega Blvd., Los Angeles, CA 90035.

the Deck for IBM?" (p. 121) give a grossly unfair picture of IBM's motives.

Our responsibility when we make technical contributions to the standards community is to help develop the best possible standards for the data processing industry and its users.

In the case of data link control, as early as 1971 we proposed a technical approach different to that under consideration by the committees. What your sources characterize as delay arose from our submission of subsequent contributions outlining the benefits offered by this approach.

We appreciate that this takes time, but not to make such contributions would be to shirk our responsibility to propose the best technical approach as we see it.

L. JOHN RANKINE

IBM Standards

Armonk, New York

Advice

I want to thank DATAMATION for the kind words in the January story (p. 82) about my departure and the glowing obituary written by Angie Pantages in the March International Edition (p. 130A).

Each, however, includes a small, critical error. I am not now, nor have I ever been, an advisor or consultant to DATAMATION.

As a publication concerned with being frequently accurate, I know that you will want to straighten the record. ROBERT B. FOREST

*Performance Communications International
Neuilly-sur-Seine
France*

Better nets

Your coverage of computer networks in the March issue was most enjoyable. However, I must take issue with your inclusion of the article on the Texas A&M computing facility as an example of networking. While that may very well be a particularly successful university computer center, I find nothing about their operation which is substantially different than most other university or service bureau facilities. I believe a much more informative article covering the Univ. of Hawaii's networking technique, the Carnegie-Mellon multi-minicomputer network, or many other such systems would have been more relevant to the issue topic of computer networks.

WALTER M. LAMIA

2 Lt., USAF

Keesler AFB, Mississippi

Give Ma a fighting chance

Your contributing editor, Philip H. Dorn, seems to have gotten some things garbled in his Editor's Readout (March, p. 53). Speaking only for my-

"The more programmers we hire, the further we fall behind..."

LET "PEOPLE" OPTIMIZE YOUR HUMAN RESOURCES.



Solve your data processing personnel problems the way many of the largest corporations in the country have done. By calling in The Berton Group. To assist your company in developing a more efficient EDP manpower utilization and recruiting program.

We're personnel science consultants who are also computermen. Our program is "PEOPLE"—Personnel Evaluation, Organization, Career Pathing, Planning and Education. It's a scientific approach to manpower management, based on objective criteria and defined individual and corporate commitments. A program which your EDP professionals and managers can accept, live with, and grow with.

"PEOPLE" is basic... and proven. It gets to the roots of your problems, beginning with a rational organizational structure, including career pathing and position descriptions. Defining each job by skill and performance norms, not title. Our proprietary skills matrix lets you measure the level of proficiency, the degree of timeliness, and the degree of necessity of every employee's professional attainments. So that you can effectively assign resources through knowledge of existing skills and capabilities. And gain objectivity in your hiring, manpower utilization and performance evaluation.

This approach also lets you motivate your people with a clearly defined career ladder, showing each employee where and how far he can advance. With lots of alternatives for mobility. And with progressive skills acquisition by targeted education and job exposure from automated sources.

Want to reduce turnover and improve productivity? Just give us a call. We'll be glad to review your situation with your corporate and data processing management. Without obligation, of course.

THE BERTON GROUP, INC.
747 Third Avenue
New York, New York 10017
(212) 754-0700
*Personnel Science Consultants
to the Data Processing Community*

CIRCLE 85 ON READER CARD

letters

self and not for my company, I resent some of his distortions.

The long-standing Bell System practice of nationwide average pricing has made it possible for users of all types of communications services in smaller areas to have access to a truly nationwide network. If we as a nation are to abandon that philosophy by opening up selective routes to "competition," simple justice demands that we go the whole route and allow all competing companies (including AT&T) to set prices on each route that fairly reflect the cost of providing the service on that route. Mr. Dorn's suggestion that users outside major metropolitan areas will subsidize the Bell System's "competitive" routes simply is not true; but these users will no longer receive the subsidy they themselves are presently getting from high-volume routes.

I agree with Mr. Dorn that a strong statement of American telecommunications policy is needed. I disagree most strongly, however, with his assertion that a technical background is important to participation in that decision. Every person who ever uses a telephone has a vital stake in how our nation handles the questions facing us. He says AT&T is "aggressive." I am amazed that they have not yet mounted a national campaign to inform the public that there is a move afoot to let big special interest users pay lower rates, leaving the little guy, the communicating public, to pay the bill.

ERIC R. ZIEMER
Systems Analyst

Illinois Bell Telephone Co.

Mr. Dorn replies: Mr. Ziemer is trying to hypnotize us into believing that the Bell System loves widows and orphans living on isolated farms, the little guy. In fact the Bell System has always given a special rate to the large user and any other special interest group that can bring pressure at the expense of the individual user. Consider WATS, Telpak, etc.

The real point regarding competition is that it will develop naturally whenever a monopoly vendor is not providing the required services. When Bell moved far too slowly in providing data-oriented services and equipments, a whole industry sprung up to fill the vacuum. Bell failed in its responsibilities and now is complaining bitterly about having to be competitive. If Bell had been on target and properly read the developing market place, this issue would not exist. The Trans-Canada Digital Data Network (operational April 1973) is a case in point. There is no need for customer-supplied modems because the network's management provides almost all classes of service a user might desire.

The new Bell System Digital Data System is right on target, just about five years too late. DDS is a strong

reaction to competitive pressure and proves again that Bell has first-rate technical resources when it finally begins to move.

CAI in the boondocks

... The article "CAI—Boon or Boondoggle?" in your March issue (p. 90) would leave a naive reader with the impression that its two authors were the first to come up with an efficient solution to the CAI software production problem. In fact, CAI lessons have been produced at Stony Brook for the past six years by means of an authoring system which SCHOLAR/TEACH is only now attempting to approximate in its proposed next phase.

When CAI was still in its infancy, it was already apparent that the cost of hardware would soon prove to be the least expensive part of the package. One of the first "lesson generating" programs was designed at Stony Brook by Bruce Burley and his colleagues at IBM. This was an early (1966) and limited endeavor to provide non-pro-

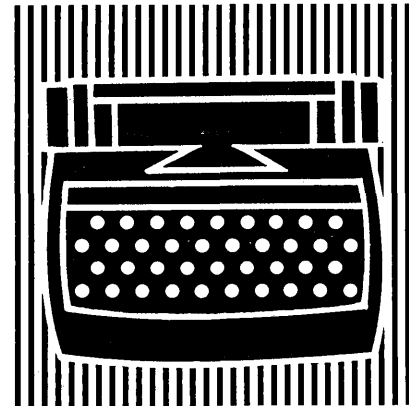

grammer users with a means of access to the system, and was subsequently absorbed into our modular, general-purpose authoring system. This system allows the user to create CAI course material in either one of two modes—on-line with prompts, or batch mode. Since material for different disciplines, or levels of learning, often requires different response processing and curriculum management strategies, the user is offered a broad choice of validated options in these areas as well as the opportunity to specify the textual material itself. However, the default system permits the author to keep his specifications to the bare minimum if he desires.

We welcome what appears to be an increasing interest in the non-programmer author, and would be happy to share our experiences and production cost figures with others.

BETTY WENESER

Director, CAI

BEVERLY SIEGEL

*Manager of Instructional Programming
State University of New York
Stony Brook, New York* □

***“Choosing a
data communications
vendor is
as important as
choosing a
data processing
vendor”***

Harold E. O'Kelley,
President of Datapoint Corporation

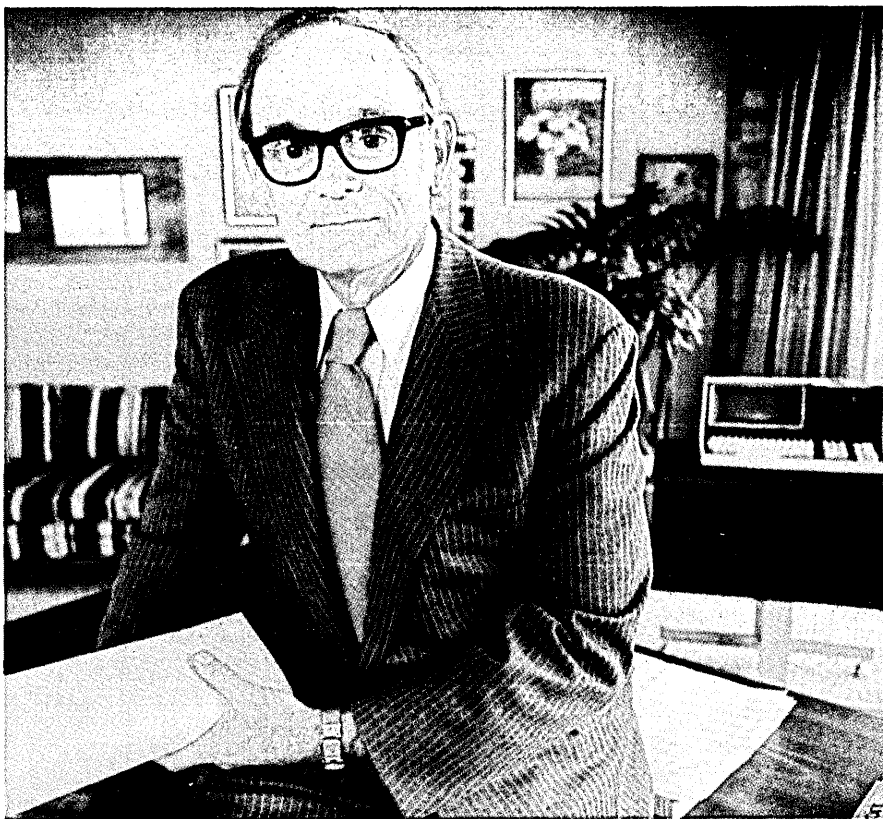

Today the typical company spends more to collect and move business data than to process it. Probably you already know how to select an equipment vendor for your computer room. But how about the equally important selection of a vendor for equipment to collect and “massage” data at your field office locations and move it to and from your central computer—what we call Dispersed Data Processing.

The most critical consideration in selecting a vendor for Dispersed Data Processing equipment is the ability to support ALL your present field data collection and communication requirements, and as your business grows, to support your EXPANDED needs swiftly and economically. Much of the dispersed processing equipment currently available is impractical to upgrade without a major new investment in equipment, software and training. The wrong choice here could cost you more than your original investment, since replacing equipment at multiple field locations is more complex even than replacing a central computer.

With Datapoint equipment, the problem is avoided. We offer three upward compatible dispersed processors, the 1100, 2200 and 5500, which provide progressively increased power and work productivity. Their upward compatibility makes system upgrades a simple, pain-

less transition, without the wastefulness of multiple Dispersed Data Processing vendors. No other vendor now offers such a trio of compatible processors. No other dispersed processing equipment offers as many operating advantages.

What else should you look for in a data communications vendor? Since this is a dynamic new area of the technology, you will likely be dealing with one of a dozen young, innovative companies. STABILITY, therefore, is a key consideration. It is indicated by a vendor's growth as well as by number of installations, financial resources, and reference customers. Datapoint is maintaining an annual growth rate in excess of 60% in an industry expected to reach a \$1 billion annual shipment level by 1980. With over 4,000 2200 systems installed in some of the largest and most prestigious companies in the world, Datapoint is a clear leader in the Dispersed Data Processing industry.

You should also look for vendor COMMITMENT. Indicators of commitment to the Dispersed Data Processing Business are willingness to lease, percentage of total revenue derived from Dispersed Data Processing, availability of operating software, vendor supplied field maintenance support, and the level of on-going product development activity. In all these categories, Datapoint ranks at the top.

Since 40% of all units shipped by Datapoint are on lease, Datapoint has a major interest in development programs which extend the useful life of existing products by maintaining their competitive advantages. Similarly, Datapoint assumes contractual liability for the maintenance of its own equipment in over 700 cities from 34 strategically located customer service centers, further illustrating commitment to product reliability.

These are a few of the reasons why the leader in Dispersed Data Processing is DATAPOINT. We'd welcome the opportunity to discuss your company's data communications and dispersed data processing needs personally. For information on the company and our dispersed processors, write or call the sales office nearest you or contact Datapoint Corporation, San Antonio, Texas 78284.

Datapoint

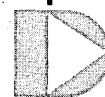

Home Office: 9725 Datapoint Drive/San Antonio, Texas 78284/(512) 696-4520 • **Sales Offices:** Atlanta/(404) 458-6423 • Boston/(617) 890-0440 • Chicago/(312) 671-5310 • Cincinnati/(513) 421-6122 • Cleveland/(216) 921-9200 • Dallas/(214) 630-1342 • Detroit/(313) 557-6092 • Greensboro/(919) 299-8401 • Houston/(713) 688-5791 • Los Angeles/(213) 645-5400 • Minneapolis/(612) 854-4054 • New York/(212) 759-4656 • Philadelphia/(215) 643-5767 • Phoenix/(602) 265-3909 • Pittsburgh/(412) 931-3663 • San Francisco/(415) 968-7020 • Seattle/(206) 455-2044 • Washington, D.C.//(703) 790-0555 • **International:** TRW Electronics—International/Los Angeles, California, TELEX 674593 • TRW Communications/Toronto, Canada (416) 481-7288 • North Sydney, Australia/922-2207 • Brussels/76 20 30 • Toronto/(416) 438-9800 • Copenhagen/(01) 105 366 • London/(01) 965 8722 • Helsinki/90554 415 • Paris/581 12 70 • Hanover, Germany/(0511) 634 011 • Rotterdam/(010) 216244 • Ramat Aviv, Israel/(03) 417170 • Milan/316.333 • Tokyo/(236) 3211 • Oslo/15 34 90 • Johannesburg/725 1226 • Stockholm/(08) 188295 • Lyss/Berne/(032) 844 240.

Don't buy a computer for where you are. Buy it for where you're going.

Let's face it, there's really no such thing as a cheap computer. A brain with any capacity at all represents a lot of bucks.

So if you're about to lay down a good piece of cash for a computer that can do the job you've got now, why not spend a little more for a computer that can do the jobs you'll have later.

The Xerox 530 computer.

No dead-ender, this. The Xerox 530 is a high-performance, 16-bit, multi-use computer system. Right out of the box, the 530 can do real-time work and batch work simultaneously.

And as your needs get bigger, the Xerox 530 gets bigger, too. Its memory is expandable. You can add input and output channels as you need them. You can add special purpose peripherals. You can add central processor options.

And using HASP protocol, you can even plug your Xerox 530 into a big computer.

So don't buy yourself short. Look into the Xerox 530. The little computer with a big future.

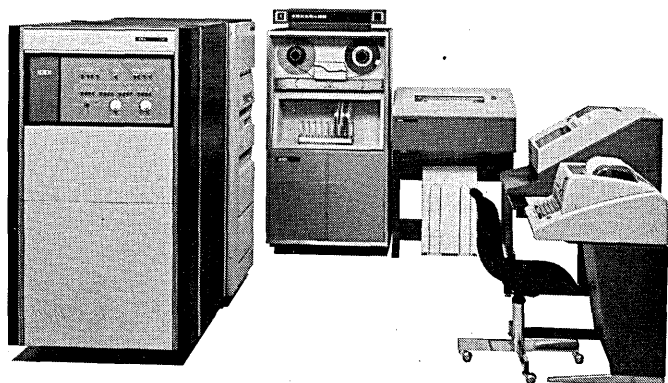

**The Xerox 530 Computer.
Looks small. Thinks big.**

XEROX

XEROX® and 530 are trademarks of XEROX CORPORATION.

Find the misfiled tape!

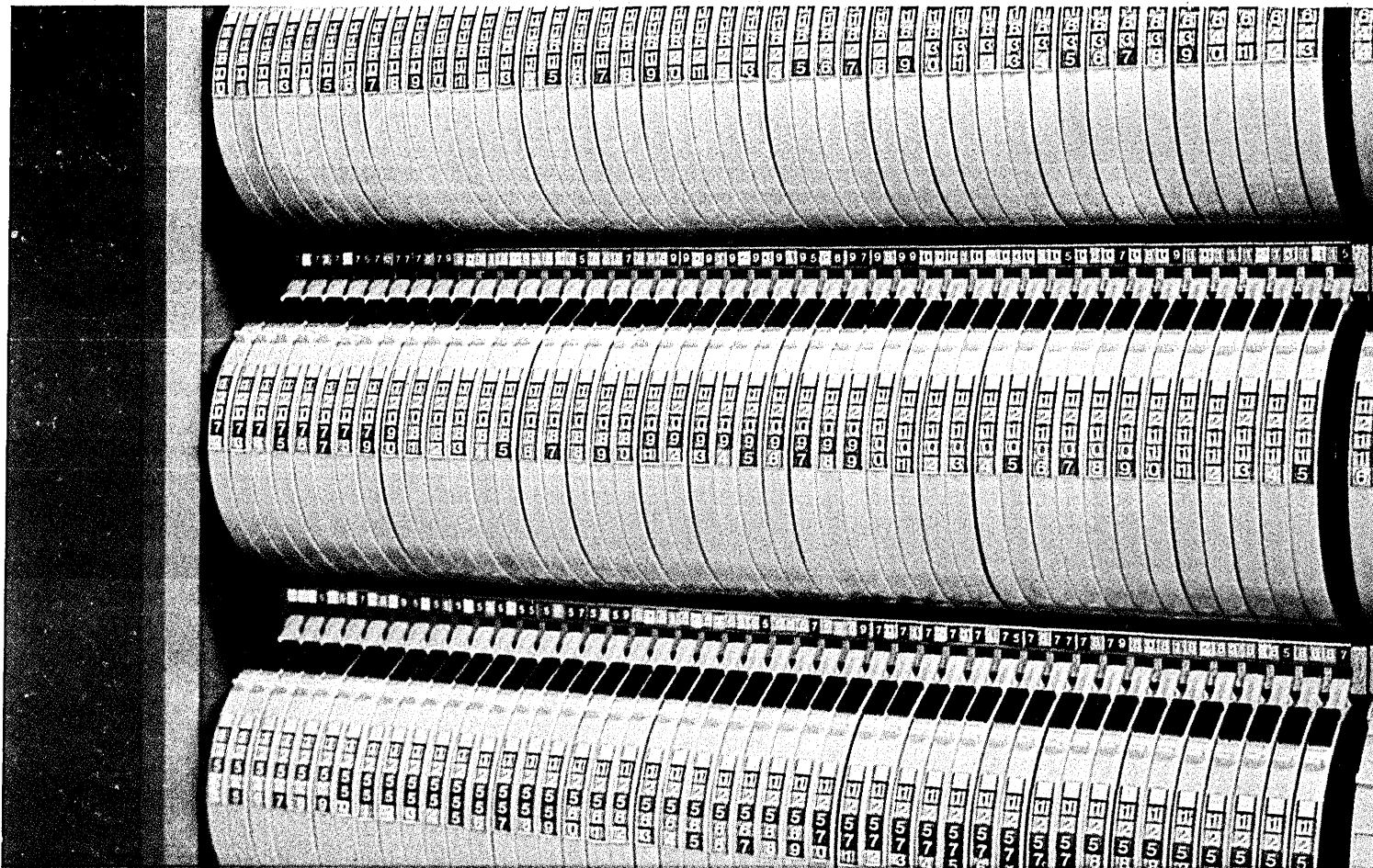

Win a free test pack of new Tab CompuColor tape ID system

At last, a proven color-coded filing system to eliminate costly magnetic tape misfiles. Tab CompuColor Tape ID is a proven computer-generated color-coded filing system used in numeric file installations. It combines your numeric filing with our patented color coding to bring you a 70% increase in filing efficiency and virtual elimination of misfiles. Speed is the key:

colors don't have to be memorized; they provide an instant sight check to numbers that are read directly. New Tab CompuColor Tape ID system provides a complete labeling system designed for all fixed position reel containers. So what are you waiting for? Try to win a free test pack, or call your local Tab Products representative for a full product presentation.

(Offer limited to one test pack per library. Packs will be delivered by your local Tab representative.)

Tab Products Company 2690 Hanover Street Palo Alto, California 94304		I FOUND IT! The mistake is (circle the error in the ad and mail it to us)
Name _____		
Company _____		
Address _____		
City _____ State _____ Zip _____		

TAB
PRODUCTS CO

CIG 145 Memory:

Top Line Features. Bottom Line Price.

1 PLUG-IN UPGRADES

Need more memory? Plug it in. Each of the eight Basic Storage Modules (BSM's) of the CIG system can accept up to 256K bytes of plug-in semi-conductor memory. So when you need more memory, you'll get it. Fast.

2 DOUBLE CAPACITY

IBM: One meg
CIG: Two meg's
The CIG/145 has dual gates each of which contains up to a full megabyte of main memory. Up to 2,048K bytes in one compact unit. CIG's double capacity. Twice the memory IBM can give you.

3 MODEL CHANGES

Every CIG/145 memory system includes the proper model change required to upgrade your 145 CPU to its new storage capacity. So you save twice. Once on the memory system. Once on the model change. Both from CIG.

4 REALLOCATION

The CIG/145 will reallocate any segment of main memory in 128K increments. So if you do have a problem, you move it where it hurts you least. In fact, your CIG/145 system will even cover-up for failing IBM memory. All under operator control.

5 INVISIBLE MEMORY

Throw a switch and we'll disappear. Really! CIG's on-line/off-line switch will make your 145 think its CIG memory was never there. So if IBM has a problem, they can't point at us, 'cause they can't find us. We're invisible!

6 ECCL

CIG's Error Checking and Correction Logic. It keeps your system up even if the chips are down. In fact, the CIG/145 can continue to operate with an entire 32K bit memory card out. Because each card contributes only one bit per word. And our ECCL automatically corrects all single bit errors.

7 FOUR LEVEL DIAGNOSTICS

The CIG/145 allows four levels of integrated diagnostic support: 1) Off-line operation from the integral test panel. 2) Execution of CIG stand alone diagnostics. 3) IBM and CIG microdiagnostics executed from the 3145's microinstruction processor. 4) IBM on-line diagnostics such as OLTEP (Online Test Executive Program) and ASCP (Automatic System Checkout Program).

IBM offers only the last two levels of diagnostic support, both of which require use of the central processor to execute.

Which means your operations stop when IBM's diagnostics start.

8 SERVICE

We're memory specialists. So if your CIG memory system ever does require service, you get a CIG memory expert. Not a generalist like IBM might send. Your CIG memory spares are on-site, too. Not at some remote depot. That's one of the ways we keep 650 CIG memory customers happy.

9 PACKAGE LEASING

CIG not only gives you 145 memory, we can lease you the mainframe and all your disc and tape peripherals to boot. That way you get everything from one source. All the equipment. And all the savings.

10 CIG/145. ITS BEST FEATURE IS US.

As we said before, you don't keep 650 memory customers happy by being charming. You keep them happy with innovative products backed by solid performance and service.

CIG is the world's leading independent memory supplier with sales, service, and systems engineering support available throughout the United States, Canada and Europe.

In addition to our 360/370 and Univac memory systems, other CIG products and services include 360/370 package leasing, plug-compatible block multiplexer and selector channels, and IBM plug-compatible disc and tape I/O sub-systems. What we've done for other people, we know we can do for you. Check us out. And call us in.

CIG CIG COMPUTER PRODUCTS, INC.

A Subsidiary of Computer Investors Group, Inc.
11351 Washington Blvd., Stamford, Conn. 06902

Dear CIG,

I'd like to check your prices. Have your rep call me at _____

Send a copy of "Add on Memory for the 370/145;"

Send info on other CIG Memory for the 360/_____, 370/_____

Name _____ Title _____

Company _____

Street _____

City _____ State _____ Zip _____

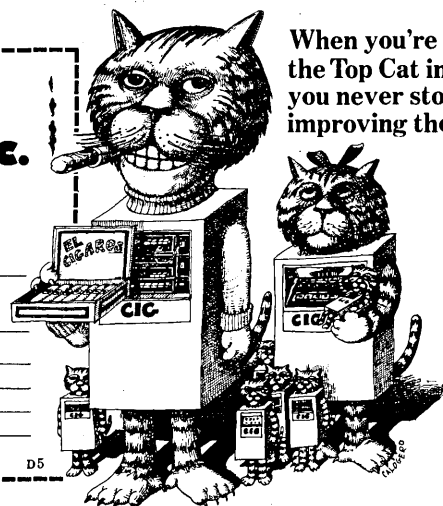

When you're
the Top Cat in Add-On Memory,
you never stop
improving the breed.

D5

Our 30 c.p.s. terminals could cost a lot less than the 10 c.p.s. terminals you're using now.

The more data you transmit, the more your 10 c.p.s. terminals start costing you in telephone line and computer time charges.

At some point, it pays to upgrade to 30 c.p.s. You'll move a lot more data a lot faster and save enough in transmission charges to cover your costs many times over. You'll also free up some of your telephone facilities for other uses.

Our systems planning experts can help you decide when it's time to upgrade. They'll figure out how much you can save in remote batch or time sharing costs. And they'll recommend the right equipment.

With our 31 different EDT-300 terminal models in KSR, ASR or MSR modes, you can choose the exact paper tape, mag tape cassette, acoustic coupling, Data-Phone*

or data access arrangements you need.

Leasing, which starts as low as \$110 a month, also gets you Termicare®, the only centralized diagnostic maintenance and support service available. We'll use Termicare to help set up your system, and we will test it out under natural environmental conditions. If a problem should arise, Termicare's centralized service lets us focus all of our resources on solving it quickly.

To get more information, write Z. V. Zakarian, Western Union Data Services Company, 70 McKee Drive, Mahwah, N.J. 07430. Or call him at 800-631-7050 (N.J. 201-529-1170).

"When it's time to speed up,
we've got 31 different ways
to do it." Z. V. Zakarian



*Registered Trademark
of AT&T.



data services company

The graphics terminal that's best alone.

If your graphics terminal application requires a single terminal or small quantities at a given location, the AG-60™ is your best buy because it's...

best in APPEARANCE.

- 512 X 512 dot matrix gas discharge display (plasma panel)
- 60 dots per inch resolution
- Bright, even in modern office lighting
- No dimming, distortion, flicker, or jitter
- Never needs focusing

best in PERFORMANCE.

- Up to 9600 baud serial address rate, 50K baud optional interface available
- Alpha-numerics with variable character font available
- Graphics capability with hardware vector generator
- Full range of support software immediately available.
- Selective erase (point by point and vector erase)
- Full panel erase in 20 microseconds
- Self-contained memory, no excessive loading of CPU

best in SIZE.

- Modular design (separate keyboard, display, and control pack)
- Compact — easy to work with, instead of around
- Display module only 7" deep

best in PRICE.

- No refresh circuitry or expensive support hardware needed
- Ready to use, nothing extra to buy (EIA RS 232 interface)
- Prices start at less than \$5000 in unit quantities

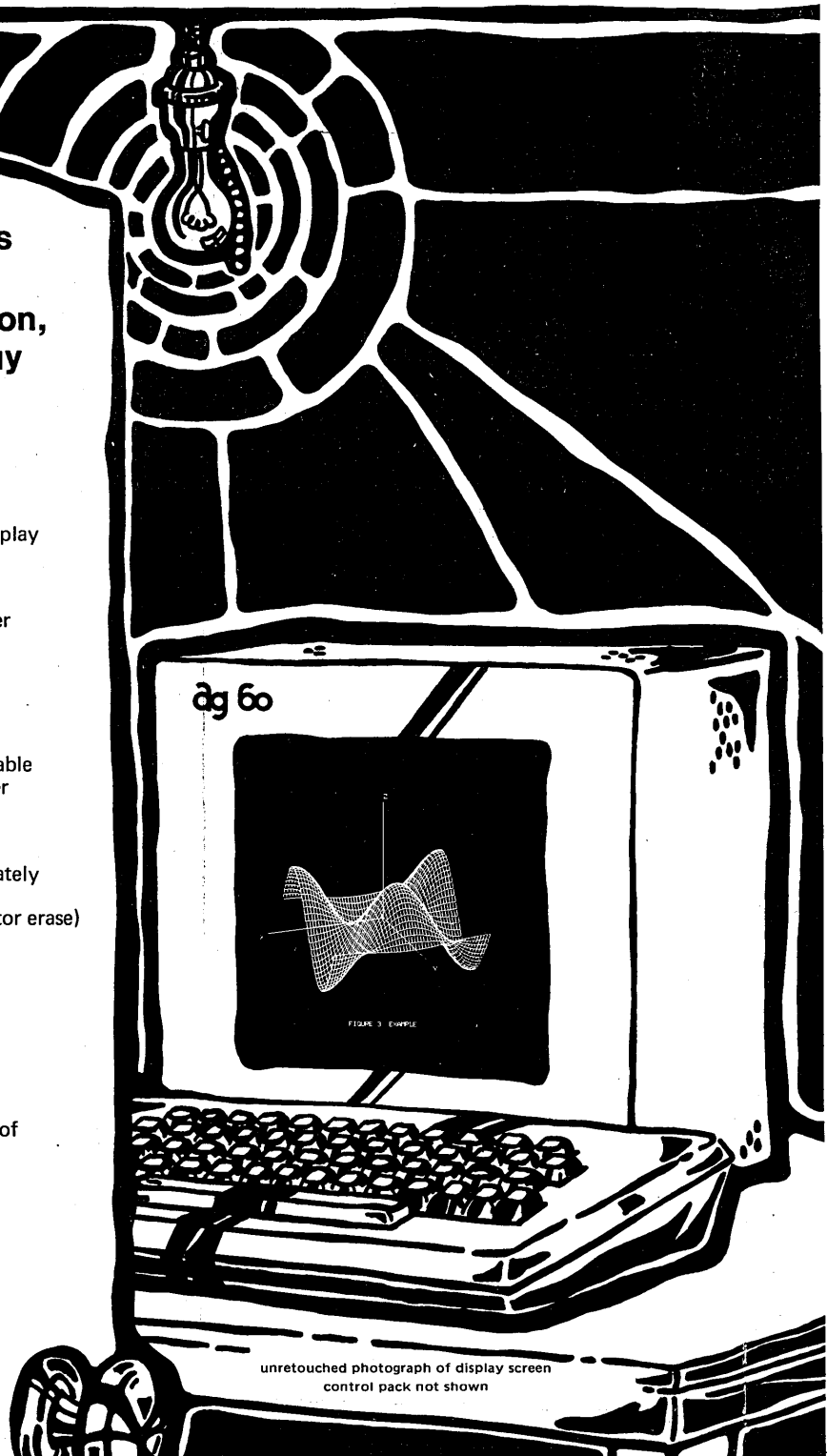

The AG-60 graphics terminal is best when you need just one
...or two...or three...or...

APPLICATIONS GROUP, INC., P.O. Box 444 A, Maumee, Ohio 43537

Introducing: The Honeywell Information System

It's our family of people,
products, and services.
It includes new computer
systems we call Series 60.



It's a family that will keep our customers purring.

The Honeywell Information System represents a dedication of Honeywell people to helping our customers achieve the goals they've set for their computer operations.

It signifies a re-emphasis in our product and service offerings on results-oriented, cost-effective performance.

It symbolizes our way of doing business in the information systems arena.

It's our way of summarizing Honeywell capability, commitment and continuity in response to customer needs.

It's a family with Capability:

We've just introduced Series 60.

Series 60 makes the promise of the future a reality now.

Series 60 has been designed to make it significantly easier to tap the power of the computer for results on the spot.

Series 60 offers new Honeywell advances in data base technology, information networking, and transaction processing—capabilities that will play a dominant role in computer operations of the next decade.

Series 60 complements Honeywell's already extensive product offerings. It includes seven computer models of advanced design, plus a variety of new peripherals.

With Series 60 we've enhanced our proven GCOS executive system and made it the basis for a graduated set of software capabilities tailored to match different levels of hardware performance.



Plus we're taking a number of other steps to provide users— regardless of their present systems— with a smooth and evolutionary path to increased performance.

So now, more than ever before, Honeywell has the capability you need for the results you expect.

If you're ready for your first or second computer, The Honeywell Information System is easy to understand, easy to install, and easy to use.

If you're an experienced user who is outdistancing the capability of your present equipment, The Honeywell Information System is the logical next step to increased performance.

And if you're a large user, The Honeywell Information System can provide superior efficiency in managed distribution of your company's information. Through use of Honeywell minicomputers, you can handle a complex information network operating in a variety of processing dimensions.

It's a family with a Commitment:

Honeywell's dedication to customers is the cornerstone of The Honeywell Information System.

With the development of Series 60, we've provided for the protection of our customers' current investment in hardware, software, and programming. Series 60 lets you continue with your current Honeywell equipment for as long as you want. And when you're ready to move to increased performance, you can make the move easily and with your application investment intact.

For example, our medium and large Series 60 systems have a compatibility mode which not only allows you to run existing programs written for your current hardware, but also lets you mix these programs with new ones written expressly for the new system.

It's a family with Continuity:

All kinds of changes affect the future of your computer operations: changes in your business, changes in your information structure, changes in computer technology and processing techniques.

With this in mind, as we introduce and continue to expand the capabilities of The Honeywell Information System, we're building a unique ability for Honeywell users to manage these changes and be prepared for the future.

We're doing this by evolving toward standard software and operational procedures that interface between the computer and your business. So as your processing needs grow or change in character, you'll be able to adjust easily. The way you go about operating your system will remain the same.



The new Model 62/60 is a low-cost first step into Honeywell's new Series 60 family. It has the potential for easy and unlimited growth.

The power you want for the results you deserve.

New high-performance hardware.

As you would expect from systems that initiate a new Honeywell family, our Series 60 represents the latest evolutionary step in computer design. For example, we've incorporated a number of advances based on our Multics System development.

But this is not technology to dazzle. It's technology designed to serve the user... to make a system more powerful, easier to use, and more reliable.

Features offered include multi-

programming systems architecture, large-scale integrated circuitry, solid-state memory, data privacy provisions, and extensive use of firmware.

Reliability was a major design objective for Series 60. Many features have been built into the systems to run continual checks on their accuracy.

If part of the system needs service, a fail-soft feature allows reconfiguration of system resources so processing can continue without interruption. The result is unexcelled availability of the system.



Model 66/80, a new large-scale system featuring Honeywell's famous GCOS executive software with advanced information networking, data base management, and transaction processing capabilities.

New high-speed printing efficiency

Honeywell's new Page Printing System operates offline to handle a complete printing function. Every sheet is an original of superior quality.

The system is designed to reduce overall printing costs, improve turnaround time, and operate with output tapes generated by systems of any manufacturer.

The system employs a quiet, nonimpact electrographic process delivering 140 to 210 pages per minute (12,000 to 18,000 lines per minute).

Capabilities include the preparation of 132-column reports in 11" by 8½" format, the printing of forms as well as data, the cutting of forms to lengths specified by the user, and the collating and stacking of output automatically.

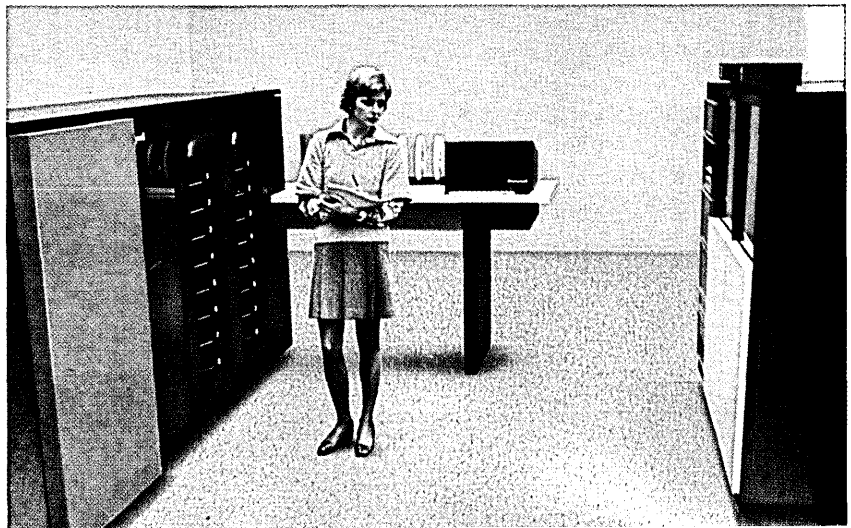

GCOS is King.

For several years, Honeywell's General Comprehensive Operating Supervisor (GCOS) for our Series 6000 computers has been one of the most versatile and respected executive systems in the industry.

With this kind of success for encouragement, we've enhanced GCOS and made it the software standard for Series 60. We've made it available in several different levels of performance. And we have compatibility features to make the growth path to GCOS an easier one, regardless of a user's current hardware.

The reputation GCOS enjoys comes both from its superior ability to manage a computer system efficiently and from its reliability.

In addition to being a leading operating system, GCOS is also a leader in data base management and information networking and is rapidly becoming

a leader in transaction processing. These are the capabilities which make it much easier for users to access computer resources, and which are sure to play a major role in computer operations during the next decade.

With Honeywell's GCOS software, these capabilities are not just a promise for the future, but a reality now.

Flexible multidimensional capability

The full range of GCOS capability offers proven multiprogramming, multiprocessing, local and remote batch processing, plus the latest concepts of file system design, communications and time sharing.

The dimensions of batch processing, remote access processing, transaction processing, and time sharing are integrated, thus providing a level of effectiveness beyond that attainable with multiple-system installations.

This merging of processing dimensions in concurrent operation permits the tailoring of the processing mix to individual installation requirements, including dynamic variation throughout the processing day.

Data base management efficiency

The organization, processing, and timely availability of data affecting the state of your business are obviously of first priority. All else—hardware, software, programming languages—supports the need to get at and use such data.

For a fast-growing number of companies today, this means one central information source available to every part of the organization. A common data base lets you define real-world situations and relationships as they occur. It also eliminates redundancies.

Honeywell makes all this possible with a powerful data base management capability. And it provides these benefits without loss of confidentiality or security.

Series 60 offers enhanced capabilities for assembling larger data bases, sharing files, and modifying existing data bases more readily. Honeywell is also playing a leading role in helping to establish industry standards for data base management.

Transaction processing convenience

Transaction processing offers the convenience of online data processing to a wide range of industries such as banking, health care, insurance, brokerage, distribution, government, transportation and manufacturing.

It's a technique that gets the computer involved in mainstream operations as they occur by allowing the processing, filing, or reference of up-to-date information from online communication terminals. The transaction processing terminals are used by sales clerks, bank tellers, factory workers, and others as a regular part of their job.

Honeywell's Series 60 with its GCOS transaction processing capability for larger users makes online transaction processing practical for many companies where before the complexity and cost of such systems were prohibitive.

To simplify system use, only data is entered at the terminal. Terminal users do not enter a program, control cards, or even program control statements. They don't even need to know that computer programs exist. For example, when a bank's customer makes a deposit, the teller immediately enters a transaction describing the deposit. The customer's bank record is updated right at the teller window.

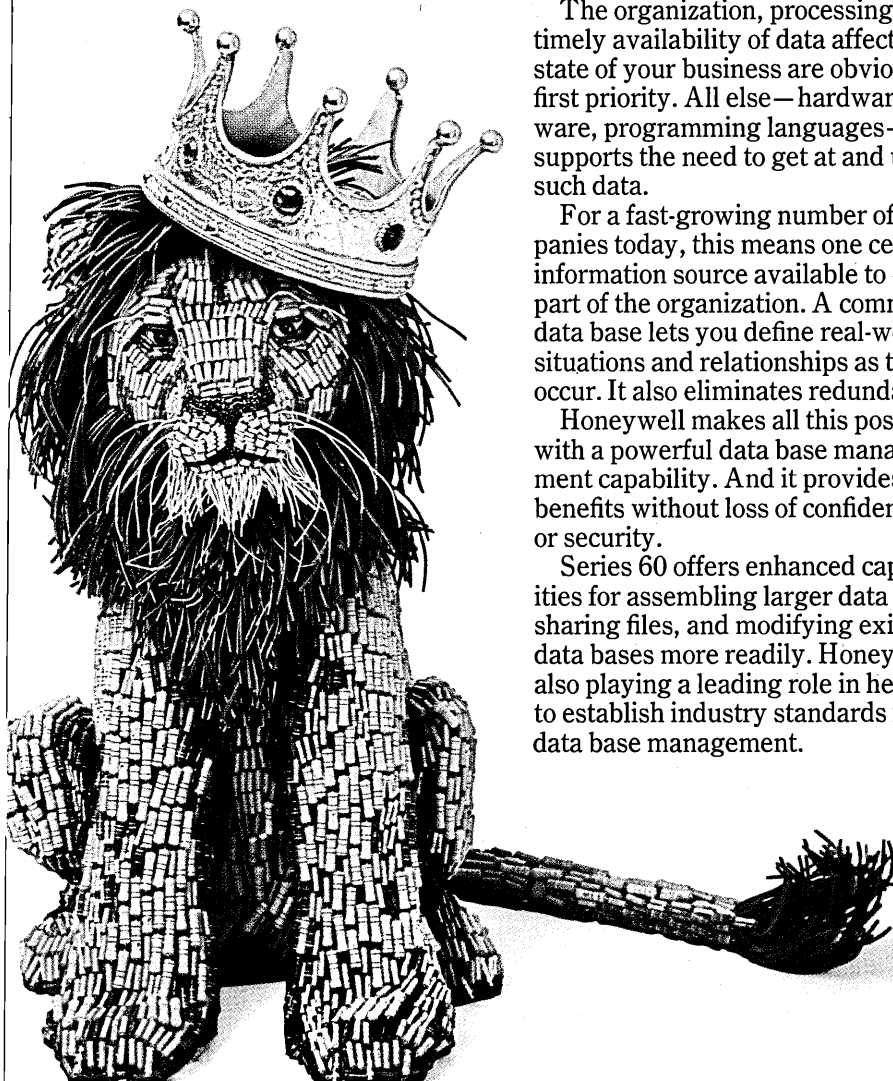

Data communications to unify your business.



The Honeywell Information System is by definition an integral and vital part of a business operation—the channel for timely information flow and processing to aid decision making.

Therefore, Honeywell has placed special emphasis on data communications, developing efficient ways to distribute information throughout your company... including to and from remote locations such as branch offices, warehouses, and factories.

We call this highly refined technique "information networking." It can be a key to giving your business the timely intelligence and response capability needed to react to business changes and opportunities. Information networking can help you improve your customer service, tighten up your inventory, get faster financial information, spot developing business trends faster and more accurately.

In short, information networking can provide the information to improve management effectiveness and increase your company's ability to compete in a very competitive world.

How we help you build this capability

Larger Series 60 systems have been designed to permit the sharing of a common data base, as well as the sharing of peripheral resources, by multiple

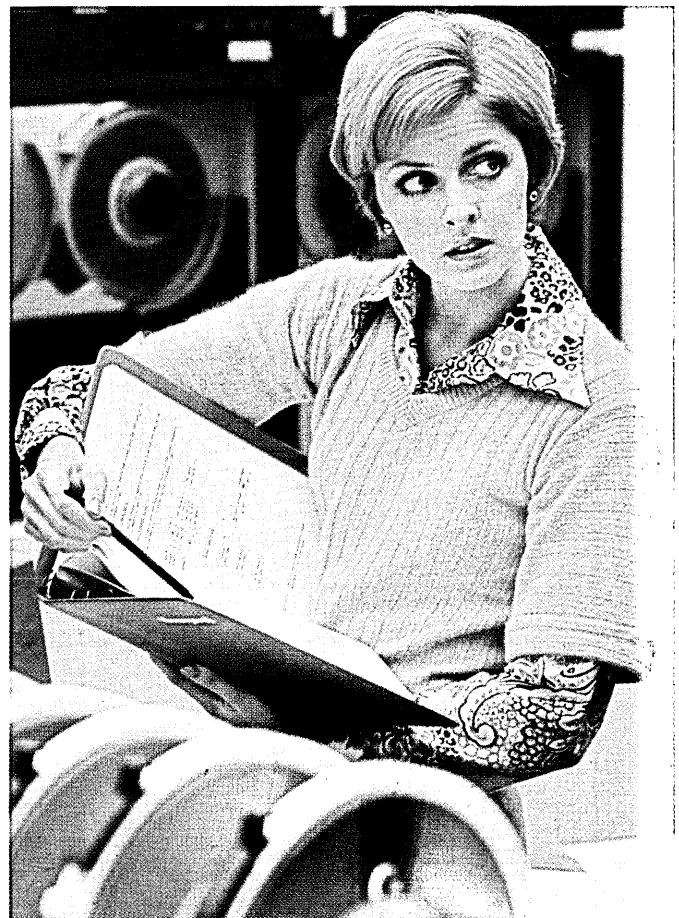

processors. This capability means increased flexibility and efficiency in information networking operations.

Our DATANET front-end network processors handle communications without tying up the host central processor. (Honeywell has been an industry leader with this approach.) And our DATANET remote network processor performs chores such as remote job entry, remote batch processing, and line concentration to further improve data handling and reduce data transmission costs.

Our new integrated communications processors offer small- and medium-system users an advanced and powerful entry into data communications at a low cost. They can handle multiple lines and support a wide range of terminals.

Our Network Processing Supervisor (NPS) has established a new industry standard for data communications efficiency and control. NPS software supports not only transaction processing, but also all other modes of remote

access: remote batch, time sharing, direct program access, data allocation and distribution, plus store-and-forward message switching.

Advanced NPS features include data and system integrity protection, including error detection/correction, automatic restart/recovery and support of fail-soft operation in a dual configuration. Supervisory control functions monitor events in the network and exert control over these events when necessary. Statistical recording and reporting features provide detailed and summary information reflecting network operation, and customization features meet individual network requirements.

Our terminals provide additional efficiencies in line utilization to further reduce communications costs. This they achieve by means of built-in microprocessor controllers plus highly sophisticated control disciplines. Other advantages provided by these new terminals include connection flexibility and ease of operation.



The model 64/20 offers a new level of performance for medium-scale users. It includes a compatibility mode for easy transition from Honeywell Series 200/2000 systems.

Major help for key industry specific needs.

The Honeywell Information System includes an extensive library of application software—system designs and modular, precoded packages specific to your industry. Whether installed as supplied or modified prior to use, they help produce quick business results, keeping your development costs down and increasing the return on your investment.

Manufacturing: Honeywell's Factor, a management information system for manufacturers, includes critical applications such as Bill of Materials Processor, Inventory Management, Material Requirements Planning, Production Scheduling and Control, Purchasing Management, Numerical Control, and Management Science techniques. Many of these tools can be efficiently brought together in a data base environment for increased control and productivity.

Education: Honeywell offers application programs in the areas of both administration (SCRIBE) and instruction (EDINET). SCRIBE programs handle tasks such as Attendance Accounting, Grade Reporting, and Class Scheduling. EDINET programs range from Resource Retrieval to Individualized Math Instruction and College Selection. Honeywell time sharing capabilities, running under the control of either GCOS or the Dartmouth Time Sharing System, are popular with both schools and colleges.

Banking: Honeywell supports a full array of banking peripherals and terminals, including extensive MICR capabilities and a high-performance

teller terminal. Honeywell banking packages plus data communications and Central Information File (CIF) capabilities can dramatically increase a bank's information processing and customer service capacity.

Distribution: Honeywell's MI-DIS is a system design for total control of all distribution functions, including Order Processing, Inventory Management, Vehicle Scheduling, Sales Analysis and Financial Management.

Health Care: Honeywell is deeply involved in and committed to the health care industry. Capabilities range from Patient Accounting and Hospital Financial Management to Clinical Laboratory, Catheterization Laboratory, and Intrahospital Communications applications.

Government: A large selection of customer-developed applications are available. For states, they include Employment Security Processing, Social Services, Revenue System, Motor Vehicle Registration, Driver's Licenses, Liquor Store Control, and Legislative System. And for cities or counties, applications range from Utility Accounting to Revenue Collection and Law Enforcement.

That's The Honeywell Information System story... The Pride of Honeywell... and yet it's only the beginning. We'd like to tell you a lot more. So why not call our local sales office. Or check the reader service card. Or drop us a note. Honeywell Information Systems (MS 061), 200 Smith Street, Waltham, Massachusetts 02154.

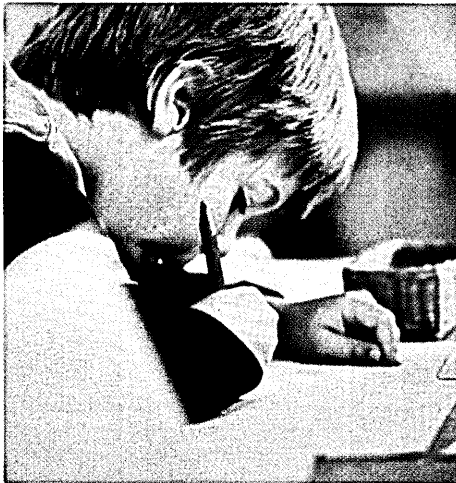

The Other Computer Company: **Honeywell**

The Pride of Honeywell.



Single-source computer service is a put-up or shut-up business.

We're putting up.

We have a world-wide network of service facilities, staffed with well-trained and experienced service technicians. And backed up with logistics and technical support that would make any service organization envious.

We've put together an operation that is specifically intended to cure the perennial service headache of mix'n'match systems. Raytheon Service Company will provide leasing companies, users, and owners with a single source for competent service at any EDP installation, anywhere in the free world. And we'll give any manufacturer good reason to think twice before he takes on the effort and expense of building an internal service organization. Raytheon Service Company. One source for great service — in North and South America, Europe, the Far East — or wherever your equipment might be. We *are* putting up. Try us. Call or write Mike Salter, Commercial Marketing Manager, Raytheon Service Company, 12 Second Avenue, Burlington, Mass. 01803. 

CIRCLE 71 ON READER CARD

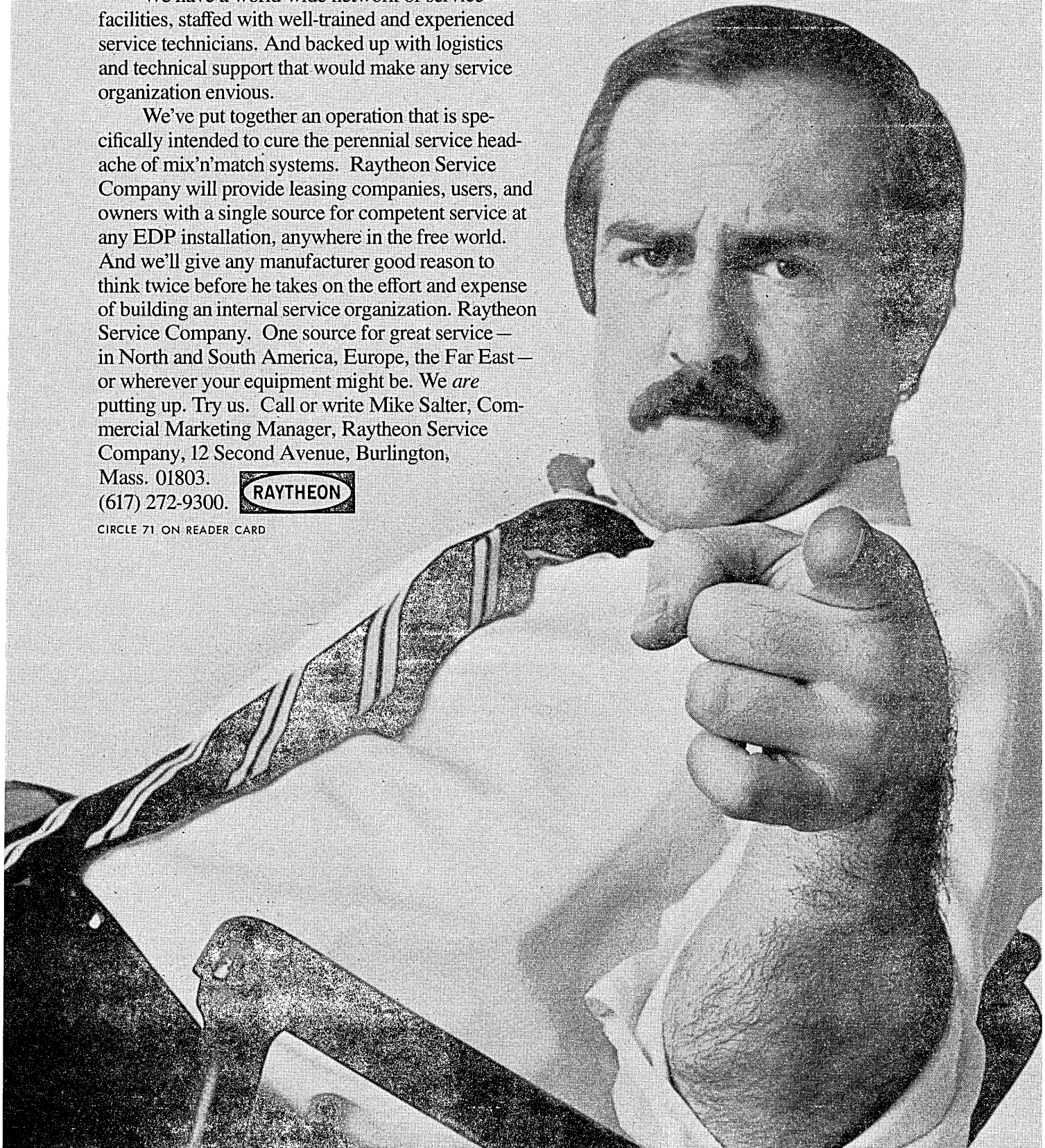

We make CRT terminals that solve problems. If you need a glass-Teletype® that's more than a glass-Teletype®, ADDS' Consul 580 is the solution.

The most reliable TTY compatible terminal around, it comes complete with printer interface, numeric pad, cursor addressing and 24 lines instead of 16. And at a cost that's reasonable instead of cheap. \$1795.

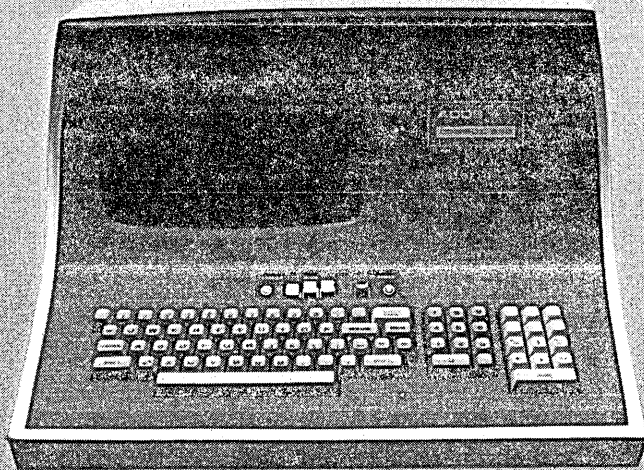

Consul 880 could be called our feature attraction. Its features include data entry, formatting, blinking, video output and 3 operating modes. Plus you can opt for our unique \$200 graphics option, our cassette, and our printer. 880's so beautiful it has to be seen in person.



Nobody makes more solutions

Consul 880A is ADDS' desktop CRT designed to operate in a polled environment. Up to 96 of these feature-laden terminals can be daisy-chained together on a single telephone line without a cluster controller.

Our rack-mountable version of the same terminal is called the 780A. Another beautiful solution.



Envoy is ADDS' sleek, portable CRT terminal. If you don't need paper, the Paperless Portable is for you.

We packed it with all the features of our desktop CRTs, including formatting and an edit sub-mode especially for programmers. At 28 pounds, it's better than heavy. And it's a whole lot better than paper.



than ADDS. Nobody.

ADDS Applied Digital Data Systems 100 Marcus Blvd.
Hauppauge, New York 11787 (516) 231-5400.

CIRCLE 72 ON READER CARD

There's no substitute for intelligence...

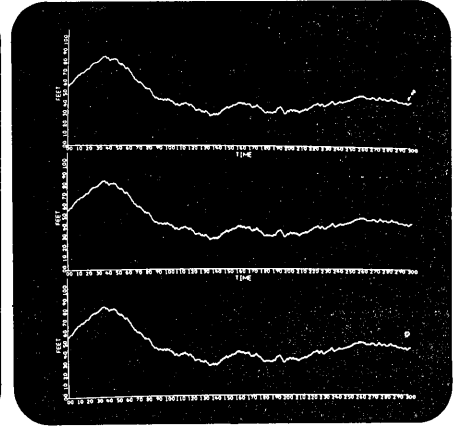
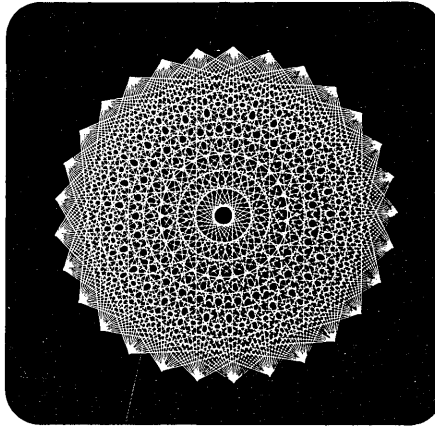
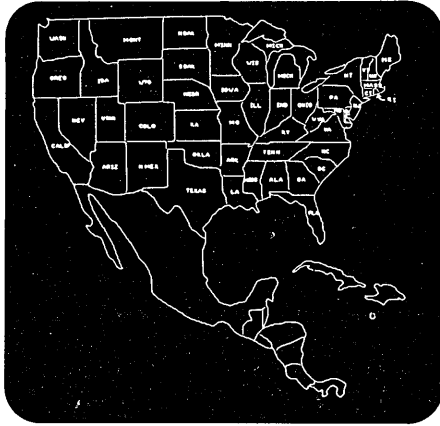

especially when it comes with a Display-oriented FORTRAN IV package

Because the IMLAC PDS-4 is an intelligent computer graphics system, it has always been easy to interact with. Now, it's easier than ever thanks to our specially designed FORTRAN Graphics Package. Designed to support the display as well as the minicomputer, it provides capabilities which let you use the Keyboard and Display as logical FORTRAN devices. The compiler recognizes display variables which allow easy manipulation of display information by use of normal FORTRAN commands. And, with significant enhancement of display support, it still provides extended ANSI FORTRAN IV capabilities. To facilitate mathematical computation and complement FORTRAN, we offer a hardware Floating Point Arithmetic Module with 16, 32-bit floating point registers.

FLEXIBLE SYSTEM CONFIGURATION is assured with the PDS-4 because it offers a full line of digital peripherals including: Removable Pack Disc for as much storage as you require, Graphic Hard Copy Device

to document your results, Magnetic Tape Cassette, Direct Memory Access Channel, Paper Tape Reader/Punch and many others. Flexibility also means the PDS-4 will function on a Stand-Alone basis or with any computer that supports remote terminal operation.

INTERACTIVE DEVICES include Light Pen, Data Tablet, Joystick, Trackball, Mouse and Keyset plus separate Function Keyboards with lighted or unlighted keys.

POWERFUL GRAPHICS CAPABILITY means that you can display more than 3,000 flicker-free characters (refreshed at 40 fps) on the standard 17" CRT. Draw up to 2,000 inches of vector with 1024 x 1024 resolution. And Fast Data Plotting provides Auto-incrementing in either X or Y direction. Standard features include: Hardware Blink, Character Rotation/Re-

flection, Scaling, 16 Levels of Gray Scale, 4 Vector Drawing Modes and Scissoring.

EXTENSIVE SOFTWARE SUPPORT includes: FORTRAN IV Compiler, Macro Assembler, Disc Operating System, Interactive Display-oriented Debugger, Text Editor, Intelligent Terminal Graphics Control Program, Host Computer FORTRAN Callable Subroutines, etc. And we'd be happy to tell you about the creative and productive uses to which hundreds of IMLAC users are putting this interactive system. Also, how you can have a powerful, fully functional computer graphics system for a basic price of less than \$15,000.

For complete information contact any IMLAC Sales Office or call or write: IMLAC CORPORATION, 150 A Street, Needham, Massachusetts 02194 (Tel: (617) 449-4600).



INTERACTIVE INTELLIGENCE

**PDS-4
MINICOMPUTER BASED
INTERACTIVE GRAPHICS
SYSTEM**

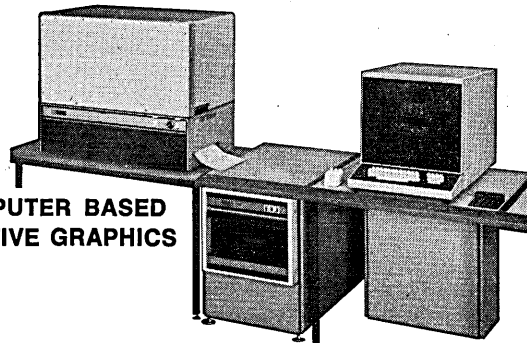

BOSTON (617) 449-4600 NEW YORK (516) 466-8890 WASHINGTON, D.C. (301) 277-6127 CHICAGO (312) 437-3122 DAYTON (513) 254-0992 LOS ANGELES (213) 990-4244 SAN FRANCISCO (408) 245-9291 LONDON, ENGLAND (01) 903-7362



WHY PAY FOR COM, WHEN ALL YOU NEED IS INTER/COM™?

The Bell & Howell Inter/COM microfilm recorder gives your operation many of the benefits of computer output on microfilm at a cost that's a lot less than COM.

It microfilms continuous fanfold data print-out sheets at 5,000 lines a minute.

Whether or not you already have a COM unit, you still print some computer reports on paper. And every time you use the computer as a printer to produce more paper copies, you're wasting valuable computer time, scarce paper and money.

Instead, why not let our Inter/COM unit take care of your microfilm requirements and let your computer take care of your computer requirements?

Just mail in the coupon to find out how economical Inter/COM can be. Or call your local Bell & Howell representative.

©1974 Bell & HOWELL COMPANY. All Rights Reserved.
Bell & Howell and Inter/COM are trademarks of Bell & Howell Company.

BUSINESS EQUIPMENT GROUP



BELL & HOWELL

Products that cut the cost of doing business.

CIRCLE 9 ON READER CARD

**Bell & Howell
Business Equipment Group
6800 McCormick Road
Chicago, Illinois 60645**

Please send me more information on how I can save with Bell & Howell's Inter/COM Microfilm Recorder.

Name _____

Company _____

Street _____

City _____

State _____

Zip _____

Need additional memory for your minicomputer?

FABRI-TEK can supply it.

Fabri-Tek has the add-on system that's made for your mini . . . ready for off-the-shelf delivery. Plus, you're assured of unquestioned reliability and guaranteed availability through the use of high volume "field proven" core memory.

CHECK THESE PRICES* —

PDP-8 Series	24k words/\$5200	ea.	@ qty. 1
PDP-11 Series	16k words/\$4180	ea.	@ qty. 1
	64k words/\$12,560	ea.	@ qty. 1
PDP-12 Series	24k words/\$5200	ea.	@ qty. 1
Nova 1200 Series	32k words/\$6825	ea.	@ qty. 10
HP 2114 & 2100 Series	24k words/\$6060	ea.	@ qty. 1

Another plus is our on-site or factory service capability by a highly trained professional staff.

More new models. And ease of interface, too. Because all of Fabri-Tek's Add-On Memories are plug compatible and contained in an external enclosure with power supply.

This approach features the following:

1. Ability to utilize a core memory with a "track record" because the form factor or design doesn't have to change with each introduction of a new mini add-on.
2. No more than one card slot is used within the CPU to configure the maximum amount of core memory.
3. No additional power drain on your CPU power supply.

They're all available in 8k word increments to larger than the maximum allowable word size for some models.

Also . . . we're not new in the core memory business. For over a decade our product line has consisted of a wide range of cores, planes, stacks, and core memory systems.

Who could ask for anything more?

You, we hope. For more information, write or call:

*Prices subject to change without notice. U.S. prices shown.

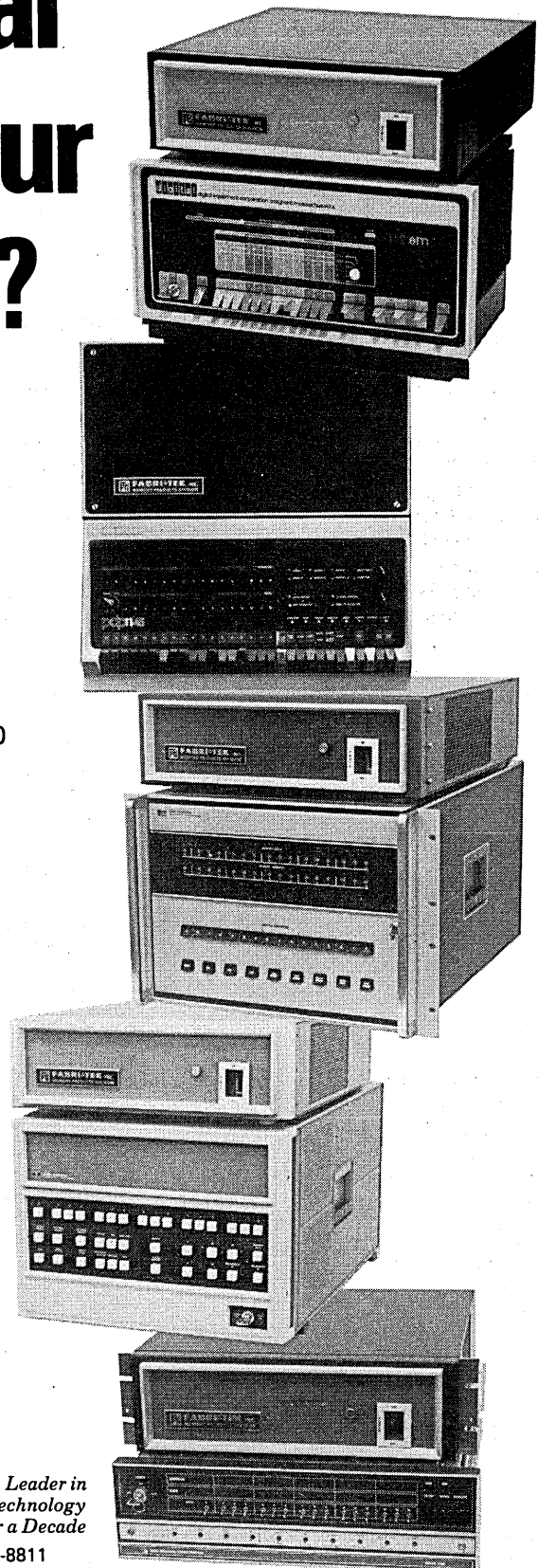

FABRI-TEK INC.
COMPUTER SYSTEMS

*Leader in
Memory Technology
for Over a Decade*

5901 South County Road 18 • Minneapolis, MN 55436 • (612) 935-8811

SALES OFFICES IN:

Boston (617) 969-5077	Dallas (214) 661-3155	Long Beach (213) 420-2493	Orlando (305) 857-1050	Sunnyvale (408) 739-4780	Hong Kong K-331383	Tokyo (03) 432-6901
Chicago (312) 437-4116	Denver (303) 753-0631	New Jersey (201) 964-4770	Phoenix (602) 266-4448	Toledo (419) 865-6693	Munich 089-755-8298	United Kingdom Maidenhead 37321-4

Editor's Readout

A PLEA FOR PRIVACY

Congress is off on one of its legislative binges.

In April there were 102 privacy bills, spawned by 207 sponsors and cosponsors, floating around the House. In the Senate, 62 lawmakers were sponsoring similar legislation. And that's not all. Out there in the state capitols, legislators—like Assemblyman William Bagley of California—were zealously touting their versions of how to control the use of automated personal data systems.

On the surface, all this concern sounds very healthy. But once the bandwagon moves on and a new, burning issue claims the attention of our lawmakers (especially those up for reelection), who cleans up the litter that's left behind?

Obviously the lawyers and the courts . . . a time-consuming and expensive process. And while they're untangling the many laws, the data banks will continue to grow and interconnect, and many of the clever protective techniques signed into law will have been circumvented by new and even more clever techniques. Legislating "techniques" is an exercise in futility. If the motivation is strong enough—whether a desire for power, profit, or even efficiency—a way will be found around the law and a new statute will have to be drafted to plug the loophole.

Instead of more bills, we need a coherent plan of attack.

Our concern should be with all data banks, manual or automated, shared by two or more users—thereby excluding, for example, the local retailer with a 3x5 card file on his customers or a large corporation's internal personnel file.

We ought to be able to systematically and rapidly modify our regulatory methods to keep pace with technological and cultural change.

We'll need funding. And to make it all work, there have to be enforcement procedures complete with large, sharp, punitive teeth. Finally, whatever we do, we had better be quick about it.

Too many large information systems that are badly flawed already exist.

One of the most comprehensive and thoughtful studies of this problem is the HEW report on *Records, Computers and the Rights of Citizens*. Although it offers guidelines and does not pretend to be a legal document, legislators are lifting passages verbatim and attempting to write them into law. (Willis Ware, chairman of the advisory committee that authored the report, is not at all happy about this.) And, once such a privacy law is on the books, it will be up to the wronged individual to prosecute and plea for justice. Unfortunately, that too often means justice for the wealthy, for the influential, and for the well-informed, highly motivated individual with the available time and money. The little guy?—well, he's out of luck.

Another alternative is to establish a new federal agency, similar to Sam Ervin's Information Systems Board (but with a scope broad enough to cover all data banks). It would have to be very large and, because of the constantly growing number and variety of data banks, practically omnipresent. It would be, in short, unwieldy, expensive, and liable to create more problems than it would solve.

There is a third way to go. Instead of relying solely on the courts, or creating a new federal bureaucracy, we might consider a hybrid system. One part would be a nonprofit corporation chartered by Congress to set standards and certify systems. The other part would be an agency to enforce the law. The seeds of such an agency are already germinating in Sen. Ervin's bill (S2963).

There's plenty of precedent for federally chartered nonprofit enterprises: Chemical Abstracts, a central data bank and distribution agency for the world of chemical knowledge, is a venerable example, having received its charter in 1933.

The job of this new corporation would be to create, maintain, and up-

date standards governing the collection and dissemination of shared data banks containing personal information. The standards would form the basis for mandatory certification of both public and private data bases.

We'd leave the creation of generalized guidelines concerning the right to privacy to the legislators; the new nonprofit corporation would set standards and certify against them; devising the specific technologies to meet the certification standards would be up to the owners of the data base.

Funding for the new organization would initially come from the federal government—perhaps through the National Science Foundation. By charging a fee for each certification examination, the corporation could become largely self-sufficient.

What's missing are the big, sharp, shiny teeth. Enforcement would be up to the other half of the hybrid—the intramural board or agency established by Congress. Title III of Sen. Ervin's bill seeks to establish a Federal Information Systems Board made up of representatives from federal and state government as well as "private citizens well versed in the law of privacy, constitutional law, and information systems technology." A good mix, one that could easily be expanded into the proposed enforcement agency. (The agency would also function as an advisory board to the corporation.)

Whatever direction the search for privacy safeguards takes, there should be a moratorium on the introduction of privacy bills while a coherent approach is established. That approach must address policy, detail standards, certification, enforcement, handling of complaints, and financing. It should have participation from bureaucrats, technocrats, and the public at large.

And it had better recognize the complexity and rapidly changing nature of the technology, or it won't be successful.

—John L. Kirkley

Used with proper care, salary data can help a dp professional plot his career path to the bigger figures on the charts, but not necessarily to a "better" job

edp SALARY

Salary data is nearly always confidential. Data processing managers and salary administrators who need such information are usually forced to call a few friends and arrange a trade. This kind of trading has been done for several years on a very large scale by a group of 1,265 U.S. firms which cooperate in the yearly reconstruction of a salary data base. Through a special arrangement with the administrator of that data base,¹ DATAMATION has been given access to salary information pertaining to just over 93,000 dp employees.

Once compiled, this information has at least four uses. It can be checked against a firm's salary scale to ensure that the firm is competitive in bidding for employees. It can be used to ensure that dp salaries are internally equitable—that a keypunch supervisor is being paid a reasonable amount more than other keypunchers, for instance. It can be used by an individual in determining whether his rate of pay is reasonable for his position, and in choosing among career paths open to him. Before the information can be used for any of these purposes, it must be calibrated.

Salary surveys are useful, interest-

ing, and fun to read, but they can lead to discomfort and indigestion if not taken as prescribed. Proper calibration requires that the effects of industry, geography, and size of installation be taken into account. Even more important, an installation's set of jobs and their associated responsibilities must be made to correspond with those presented in the survey data.

Some other factors have been considered important in determining salaries, including an employee's age and how old his degree is. As far as we have been able to determine, neither of these is particularly important to our profession.

Effects of geography

Some strange disparities exist in dp salaries across the country. There can be as much as a \$200/week difference in average top paying jobs in two cities. Some of this can be explained by differences in the cost of living, in how desirable a city is to live in, and in the "averages" used (an "average" dp installation in New York City may be much larger than an "average" installation in Fargo, North Dakota). These factors do not readily explain why a dp manager in Newark is likely to make \$628/week while his New York City counterpart makes only \$556. Is Newark really that bad a place to live? Or why is a dp manager in St. Paul paid \$50 more per week than one in its supposedly twin city, Minneapolis?

If any valid generalization can be made about edp pay scales in different geographic regions, it is that the more densely populated areas pay more. New York and some neighboring New Jersey cities are among the top paying (despite the difference between Newark and New York). Similarly, people are paid more for working in Los Angeles than in neighboring Orange County. Madison and Milwaukee, though not too far apart, also have two different labor pools. Low paying cities are apt to be not only smaller but also more isolated, like Fargo, Laramie, and Lincoln.

Geographic differences do not make the averages useless, only more difficult to use appropriately. Somehow the averages must be keyed to each region. If you have no other way of doing this, the Bureau of Labor Statistics keeps some local statistics for a few key dp positions. Using the Bureau's numbers will help peg any variation in pricing in your neighborhood.

Effects of industry

Perhaps because they have more sophisticated applications, or because their business often requires them to locate in high-paying cities, or because their "average" installations are larger, some industries pay better dp salaries than others. A.S. Hansen breaks out its data base according to 10 broad industry categories. We attempted to compare the average salaries in them.

¹The data was provided by the Philip H. Weber Salary Administration Services Section of A. S. Hansen, inc., publisher of "The Weber Salary Survey Report on Data Processing Positions in the United States." The data base was reconstituted in late 1973, therefore 1974 increases are not reflected. (Late 1974 figures, after midsummer reviews are included, are expected to be up about 5% over the figures on the chart.)

SURVEY

by Richard A. McLaughlin, Associate Editor

To minimize the effects of geography, we looked at a slice of the data that represented one level of pay. That is, a large number of cities are alike or nearly alike in their dp pay scales. We took the data that corresponded to a set of similar cities, including Los Angeles, Chicago, Cleveland, Fort Worth, Miami, Phoenix, Tulsa, and Washington, D.C.

No self-respecting statistician would ever admit to our methods, but we produced our numbers by averaging the weekly pay for job positions in one family (like "programming") in one industry, then averaging the averages by industry. (For those who like to keep track of such things, by the way, the average pay of all dp employees in all industries in those cities is \$245/week or \$12,750/year.)

According to this ungodly method, the Transportation industry is the best to be in. In order of pay, the industries were: Transportation (13.1% over "average"), Communications (+11.0%), Utilities (+10.2%), Manufacturing (+2.9%), Government (3.3% under "average"), Wholesale Trade (-3.7%), Retail Trade (-4.5%), Finance & Insurance (-6.9%), Services (-9.0%), and Construction (-9.8%).

Job classifications

The job titles and descriptions listed below correspond to those that ap-

peared on the questionnaires used to gather data for the study. Participants in the study were not asked "what do you pay your lead programmers?" Instead they were asked to read the job descriptions, figure out which of their people fit them, then fill in the salary information. The charts should be read with the same care.

Using these descriptions, large computer departments should be able to fit all of their employees into the structure. Smaller computer departments will not have this many jobs or this many levels, but still should be able to classify their employees and use the salary charts.

Smaller computer departments will very likely have some jobs that are less specialized and which combine several classifications into one job. In such cases, employees should be classified according to how they spend the majority of their time. If the job is so varied that this cannot be done, they should be classed according to the highest classification that represents a *significant* portion of their time, *providing* that the majority of their total time can be accounted for by other classifications in the same job family.

The job classifications are not the ones we "suggest" for the ideal shop. Certainly they do not represent the newest kind of organization. There is no reflection of chief programmer teams, not even a mention of a data

base administrator. The categories given are those on which the 1,265 involved firms could agree. And they work pretty well.

Manager of Data Processing

Plans, organizes and controls the overall activities of the data processing department, including systems analysis, programming, and computer operation. Consults with, advises, and coordinates between his groups and other departments. Reports to corporate management on data processing plans, projects, performance, and related matters.

Assistant Manager of Data Processing

Assists the manager in planning, organizing, and controlling the sections of the department. Usually has line responsibility but in certain instances may have only staff responsibility. Participates in research and procedural studies. Develops analyses of existing and newly developed equipment and techniques. Consults with and advises other departments with regard to feasibility studies, systems and procedures, and records control.

Technical Assistant to the Manager

Provides technical assistance for plan-

SALARY SURVEY

ning and directing the installation, modification, and operation of dp systems. Analyzes proposed and existing dp applications in terms of machine capabilities, costs, and man and machine hours. Usually has only departmental staff responsibility. Plans and recommends machine modifications or additional equipment. Directs the compilation of records and reports concerning production, machine malfunctions, and maintenance.

Coordinator of Data Processing

Coordinates activities of the dp operation with the company's other departments. Usually has only departmental staff responsibility. Assists in establishing systems analysis, programming, and computer operations priorities. Recommends standard policies and procedures.

Work Process Scheduler

Schedules operating time of the overall dp activities. Responsible for keeping idle time to a minimum. Schedules preventive maintenance.

Manager of Systems Programming

Plans and directs all activities of the Systems Programming Section. Projects software and hardware requirements in conjunction with other managers within the department and with corporate management. Develops standards for all systems software and works to design and implement systems required. Directs the interfacing of systems software with the hardware configuration and the applications systems. Provides technical guidance relating to the operating system to all members of the dp staff. Reports to either the Manager of Data Processing or to the Manager of Systems Analysis or to the Manager of Programming.

Lead Systems Programmer

Assists in scheduling systems programming projects and in assigning personnel to those projects. May act as a project manager for major systems applications and as the manager of the department in his absence. Usually assumes the responsibility for coordinating the activities of systems programming with the other dp sections.

Senior Systems Programmer

Develops specifications for extremely complex systems programming applications. May define the logic, perform the coding, testing, and debugging or may provide technical direction to lower classifications performing these

operations. Usually is responsible for applications dealing with the overall operating system or with complex subsystems such as sophisticated file management routines, large telecommunications networks, or advanced mathematical/scientific software packages.

Systems Programmer A

Works from specifications to develop or modify programs to improve the efficiency of the operating system. Develops logic, codes, tests and debugs software defined by higher level categories. Modifies, tests and debugs vendor-supplied utilities, application packages and engineering releases. Assists in developing and modifying relatively complex software, such as routines supporting multiprogramming, telecommunications and file management.

Systems Programmer B

Assists in defining and programming

moderately complex software such as utilities, job control language, macros and subroutines. May assist in the coding of benchmarks, job accounting and control modules developed internally by the firm. May assist with relatively complex software such as compilers, link editors, and assemblers.

Systems Programmer C

Assists in coding and maintaining utilities, job control language, and i/o programs, as well as other systems software of moderate complexity. May assist in maintaining the program libraries and technical manuals and in installing new vendor-supplied engineering releases. Assignments are generally under the technical direction of a higher level systems programmer. Usually possesses some background in applications programming and has a working knowledge of at least one assembler language.

JOB FAMILIES

The jobs have been grouped into a number of "families." The families range from "Manager" or "Supervisor" to "Trainee." There are two important things to know about the families. First, the levels in each category were *derived*, not arbitrarily set. A histogram was constructed for all people in "programming" by plotting "number of people" vs. "sal-

ary." If there were five "bumps" or clusters in the histogram, five levels of programmer were defined. These levels were worked back onto the questionnaire. Over a period of years, the listed classifications have evolved.

Second, the classifications have these general qualifying characteristics:

Manager (or Supervisor)	Usually in full charge of all activities of a section or department. May personally supervise the operations of his staff or direct the operation through subordinates.
Lead	Usually considered the assistant manager or supervisor in families where an "assistant manager" title does not appear. Instead may be a line supervisor with full technical knowledge but added duties of assigning, instructing and checking other section members.
Senior	Usually competent to work at the highest technical level of all phases of the activity. Works on his own most of the time. May give some direction to lower classifications.
A	Works under general supervision. Usually can work on his own in most phases of the activity. Requires only some general direction for the other phases.
B	Works under direct supervision. Usually fairly competent to work on several phases of the activities with only general directions, but needs some instruction and guidance for the other phases.
C	Works under immediate supervision, generally on only one activity. The work is carefully checked.
Trainee	Usually a probationary employee who has no previous experience.

Manager of Systems Analysis

Responsible for feasibility studies for new applications, and for systems design. Assigns and directs personnel. Consults with and advises other departments on systems and procedures. Reports to the Manager of Data Processing.

Lead Systems Analyst

Assists in planning, organizing, and controlling the activities of the section. Assists in scheduling the work of the section and assigning personnel to projects. May act as systems projects manager. May coordinate the activities of the section with other sections and departments.

Senior Systems Analyst

Confers with officials, scientists, and engineers to define business or scientific/engineering dp problems. Formulates statements of those problems and devises dp solutions. Prepares block diagrams illustrating the solutions and may assist in or supervise the preparation of flowcharts from those diagrams.

Systems Analyst A

Defines the applications problem, determines system specifications, recommends equipment changes, and designs dp procedures. Devises data verification methods. Prepares block diagrams and record layouts from which programming prepares flowcharts. May assist in or supervise the preparation of flowcharts.

Systems Analyst B

Assists in devising computer system specifications and record layouts. Prepares systems flowcharts to describe existing and proposed operations. Prepares comprehensive block diagrams in accordance with instructions from higher classifications. May assist in the preparation of flowcharts. Analyzes existing office procedures as assigned.

Systems Analyst C

Carries out analyses of a less complex nature. Prepares functional process charts to describe existing and proposed operations. Designs detailed record and form layouts. Details block diagrams to reflect specific computer procedures. May assist in the preparation of flowcharts.

Manager of Applications Programming

Plans, organizes, and controls the preparation of application programs. Assigns, outlines and coordinates the work of the programming staff. Establishes standards for block diagram-

ming, flowcharting, and coding. May write and debug complex programs. Collaborates with systems analysts and other technical personnel in scheduling equipment analyses, feasibility studies, and applications systems planning. Reports to the Manager of Data Processing.

Lead Applications Programmer

Assists in scheduling programming projects. Coordinates the activities of the programming section with other sections of the computer department. May act as programming project manager.

Senior Applications Programmer

Analyzes problems outlined by systems analysts in terms of detailed equipment requirements. Designs detailed flowcharts. Verifies program logic by preparing test data for trial runs. Tests

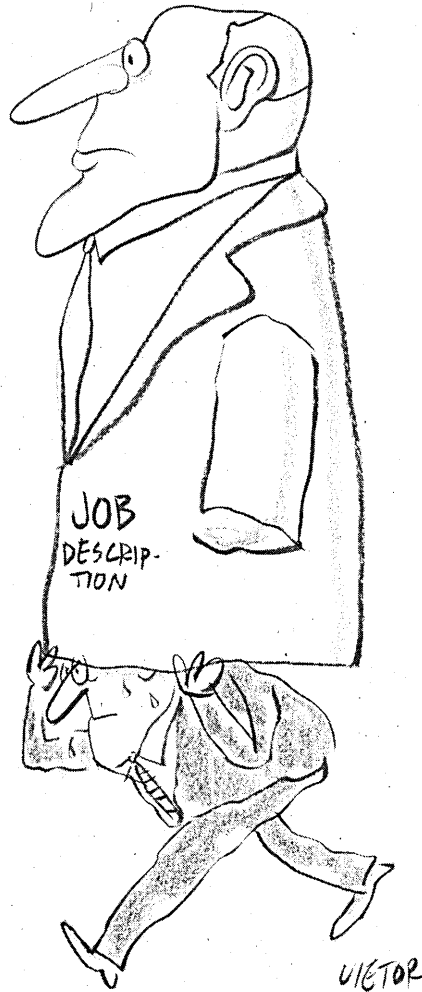

and debugs programs. Prepares run sheets for routine programs. May do coding from flowcharts. May assist in determining the causes of computer or program malfunctions. May confer with technical personnel in systems analysis and application planning.

Applications Programmer A
Conducts detailed analyses of defined systems specifications and develops all levels of block diagrams and flowcharts. Codes, prepares test data, tests and debugs programs; revises and refines programs and documents all procedures used in finished programs. Evaluates and modifies existing programs to take into account changes in system requirements or equipment configurations.

Applications Programmer B
Assists in coding and in analyzing previously defined system specifications. Assists in—and in some cases carries out on his own—the preparation of all levels of block diagrams and flowcharts. Codes; assists in preparing test data and in testing and debugging programs. Assists in the documentation of all procedures used in the system.

Applications Programmer C Trainee

Assists in the analysis of system specifications and coding. Performs all work under close supervision.

Manager of Systems Analysis and Programming

Responsible for feasibility studies, systems design and programming. Assigns personnel to projects and directs their activities. Coordinates section activities with other sections and departments. Reports to Data Processing Manager or to Corporate Management.

Lead Systems Analyst/Programmer

Assists in planning, organizing and controlling the activities of the section. Assists in scheduling and assigning personnel. May act as systems/programming project manager. May coordinate the activities of the section with other sections and departments.

Senior Systems Analyst/Programmer

Confers with managers, scientists, and engineers to define business or scientific/engineering dp problems. Formulates statements of those problems and devises dp solutions. Prepares block diagrams illustrating the solutions and may assist in or supervise the preparation of flowcharts from those diagrams. Analyzes existing system and program logic and makes revisions.

Systems Analyst/Programmer A

Confers with dp personnel to determine the problem and type of data to be processed. Defines the applications problem, determines system specifica-

SURVEY OF WEEKLY SALARIES

Job Title	Nationwide Averages					Number in Survey	Normal Salary Ranges vs. Installation Size Determined by Monthly Hardware Rental				
	Low	1st	Avg	3rd	High		to \$6K	to \$12K	to \$25K	to \$50K	over \$50K
<u>Conventional Organization Reporting Through DP Manager</u>											
<u>Department Management</u>											
Manager	214	382	477	548	938	1,024	208-574	266-559	271-690	296-809	279-844
Assistant Manager	184	329	410	471	807	319	178-494	229-480	232-593	254-696	239-726
Technical Assistant	171	306	382	438	750	226	166-459	213-447	216-552	237-647	223-675
Coordinator	150	267	334	383	656	174	145-402	186-391	189-483	207-566	195-591
Scheduler	96	172	214	246	422	208	93-258	119-251	121-310	133-364	125-380
<u>Systems Programming</u>											
Manager	231	341	382	419	585	127		202-250	287-446	277-514	278-550
Lead Programmer	200	297	332	365	509	156		176-218	250-388	241-447	242-479
Senior Programmer	185	273	305	336	468	404		162-200	230-357	205-411	223-440
Programmer A	161	239	267	294	409	437		142-175	201-312	193-360	195-385
Programmer B	138	204	229	251	351	265		121-150	172-267	166-308	167-330
Programmer C	120	177	198	218	304	57		105-130	149-232	143-267	144-286
<u>Applications Programming</u>											
Manager	169	314	357	398	620	538	215-483	225-445	215-527	212-519	238-603
Lead Programmer	145	269	307	342	533	785	185-416	193-383	185-453	182-447	204-519
Senior Programmer	127	235	268	298	465	2,853	161-363	168-334	161-395	159-389	178-452
Programmer A	110	203	232	258	403	4,267	139-314	146-289	140-342	137-337	154-392
Programmer B	94	175	199	222	347	3,335	120-271	125-249	120-295	118-282	133-373
Programmer C	82	153	175	194	304	1,748	105-237	110-218	105-258	103-254	116-295
<u>Systems Analysis</u>											
Manager	211	347	389	429	643	570	289-514	253-461	247-530	252-561	249-622
Lead Analyst	183	302	338	373	559	962	252-447	220-401	215-461	219-488	217-541
Senior Analyst	169	277	311	343	514	2,123	231-411	202-369	197-423	201-449	199-497
Analyst A	148	243	272	300	450	2,036	205-360	177-323	173-371	176-392	174-435
Analyst B	126	208	233	257	385	1,149	173-308	152-276	148-317	151-336	149-373
Analyst C	110	180	202	223	334	343	150-267	131-239	128-275	131-291	129-323
<u>Combined Systems Analysis & Applications Programming</u>											
Manager	210	356	397	437	636	513	265-506	248-438	258-482	272-544	241-627
Lead Analyst/Programmer	183	310	345	380	553	929	230-440	216-381	224-419	236-474	210-546
Senior Analyst/Programmer	157	267	298	327	477	1,593	199-379	186-329	193-361	203-408	181-470
Analyst/Programmer A	136	232	258	284	413	2,374	172-329	161-284	167-313	176-354	157-408
Analyst/Programmer B	117	199	222	244	356	1,691	148-283	139-245	144-270	152-305	135-351
Analyst/Programmer C	102	174	194	214	311	699	129-247	121-214	126-236	133-266	118-307
<u>Computer Operations</u>											
Manager	142	245	281	312	540	1,140	169-366	164-365	156-407	178-424	172-501
Lead Computer Operator	115	198	228	253	437	1,689	137-297	133-296	126-329	144-343	139-406
Senior Computer Operator	90	171	200	222	333	1,000	105-237	110-218	105-258	103-254	116-295

Computer Operator A	86	149	171	190	329	5,714	103-223	100-248	108-248	108-258	104-319
Computer Operator B	74	127	146	162	280	3,421	88-190	85-190	85-211	92-220	89-260
Computer Operator C	69	120	137	153	264	1,949	82-179	80-179	76-199	87-207	84-245
<u>Tab Operations</u>											
Supervisor	124	188	216	238	363	311	155-252	165-283	141-277	157-292	147-363
Lead Tab Operator	107	162	185	204	312	393	133-217	142-243	131-239	135-250	156-312
Tab Operator A	93	141	161	178	272	1,304	116-189	124-212	106-208	118-218	110-272
Tab Operator B	81	122	140	154	236	1,105	100-164	107-183	91-180	102-189	95-236
Tab Operator C	69	105	120	133	203	466	86-141	92-158	79-155	87-163	79-203
Trainee	65	100	114	126	192	167	82-133	87-150	74-147	83-154	69-192
<u>Keypunching</u>											
Supervisor	104	159	182	200	318	1,348	123-221	116-249	112-260	117-272	120-304
Lead Key Punch Operator	91	138	158	174	277	1,654	106-192	101-216	98-226	102-237	104-264
Keypunch Operator A	78	119	136	150	239	9,141	92-166	87-187	84-195	88-204	90-228
Keypunch Operator B	67	103	118	130	207	11,884	79-143	75-162	73-169	76-177	77-197
Keypunch Operator C	63	97	111	122	194	2,963	74-135	70-152	68-158	71-166	73-185
Trainee	55	84	96	106	168	1,301	64-117	61-132	59-137	62-144	63-160
<u>Other Operations Staff</u>											
Tape Librarian	82	116	144	167	268	1,029	103-173	99-170	85-202	82-217	85-252
Controls Clerk/Scheduler	77	108	134	155	248	1,668	95-161	92-158	79-188	87-202	88-234

Organization Reporting
Through Separate Managers

Data Processing Management

Manager	217	299	376	435	697	245	287-355	252-395	245-520	265-555	248-640
Assistant Manager	163	225	282	326	523	113	215-266	189-296	184-390	199-416	186-480
Technical Assistant	152	209	263	304	488	71	200-248	176-277	171-364	101-388	173-448
Coordinator	141	194	245	283	453	119	186-230	164-257	159-338	172-360	161-416
Scheduler	113	155	195	226	362	187	149-183	131-205	127-270	137-288	128-333

Systems Analysis

Manager	235	359	410	452	622	68	224-516	350-407	325-489	299-524	294-590
Lead Analyst	205	312	356	393	541	141	195-449	304-354	283-425	260-456	256-513
Senior Analyst	176	269	307	339	467	415	168-387	262-305	244-367	224-392	220-442
Analyst A	153	233	266	294	404	574	146-336	227-265	211-318	194-340	191-383
Analyst B	141	215	245	271	373	411	134-310	209-244	195-293	179-314	176-354
Analyst C	122	186	213	235	323	83	116-268	181-211	169-254	155-272	153-306

Applications Programming

Manager	192	283	325	361	516	71	211-374	259-332	239-419	229-433	230-495
Lead Programmer	167	246	282	314	449	147	184-326	225-289	208-364	199-377	200-431
Senior Programmer	144	212	244	271	387	577	158-280	194-249	179-314	172-325	172-371
Programmer A	124	184	211	234	335	768	137-243	168-216	155-272	148-281	149-321
Programmer B	115	170	195	216	309	633	127-224	155-199	146-251	137-260	138-297
Programmer C	99	147	169	187	268	307	110-194	134-172	124-217	118-225	119-257

SALARY SURVEY

tions, recommends equipment changes, designs dp procedures and block diagrams. May prepare flowcharts and codes. Devises data verification methods and standard systems procedures.

Systems Analyst/ Programmer B

Assists in devising system and program specifications and record layouts. Prepares flowcharts and logic diagrams for existing and proposed operations. Codes. Prepares comprehensive block diagrams in accordance with instructions from higher classifications. May assist in the preparation of flowcharts. Analyzes existing office procedures as assigned.

Systems Analyst/ Programmer C Trainee

Carries out analyses and programming of a less complex nature as assigned and instructed. Usually works only on one activity under very close direction with the work being closely checked. Prepares functional process charts to describe existing and proposed operations. Designs detailed record and form layouts. Detail block diagrams to reflect specific procedures. May assist in the preparation of flowcharts.

Manager of Computer Operations

Plans, organizes and controls the Computer Operations Section. Establishes detailed schedules for the use of equipment. Assigns personnel and instructs them where necessary. Reviews equipment logs and reports to the Manager of Data Processing on operating efficiency.

Lead Computer Operator

Assists in scheduling the operations and in assigning personnel. Coordinates activities of the section with other sections in the data processing department. May act as shift supervisor.

Senior Computer Operator

Usually operates the central console. May give some direction to lower level classifications. Studies run sheets. Re-runs job steps to recover from machine error or program error, consulting with technical staff where necessary. Maintains machine performance and production records.

Computer Operator A

Assists in running the machines and maintaining records. May assist in error recovery.

Computer Operator B

Assists in operating the computer and peripherals. May keep records regarding output units and use of supplies.

Computer Operator C

Carries out minor duties in accordance with detailed instructions. Usually works on only one activity under very close direction with the work being carefully checked.

Tape Librarian

Maintains library of magnetic and paper tape. Classifies, catalogs and stores reels. Maintains charge-out records. Inspects tape for wear or damage.

Data Examination Clerk (Controls Clerk/Scheduler)

Maintains the accuracy of processing by comparing source materials with reports, documents or other output. Maintains a schedule of work in the input queue.

Data Conversion Machine Operator

Operates any of several types of machines for converting source documents to paper tape, paper tape to cards, etc.

Reading the charts

Five salaries are reported for each position in the chart of nationwide averages. The first is "Average Low," which is the numerical average of the lowest salary rates reported for that position. "First Quartile" is the rate at which 25% of the number of reported salaries are lower and 75% higher. "Average" is the numeric average of all rates reported by all companies. "Third Quartile" is the counterpart of first; 75% of all reported salaries are lower. "Average High" is the counterpart of "Average Low." The actual highest and lowest figures reported do not appear on the charts.

There are actually two different kinds of shops represented in the data: shops where a single dp manager controls analysis, programming and operations; and shops where the dp manager, manager of programming, and manager of analysis report individually to a higher authority. The positions for the shops with equal level managers for the three functions are separated on the charts from those in the more conventional arrangement.

There are five installation sizes reported, split out by monthly hardware rental charges. The "up to \$6,000/month" category would include machines up to the size of the average IBM 360/22. For up to \$12,000/month, 360/30s, HIS 1015s, and Burroughs 2700s can be acquired. 360/40s, Spectra 70/45s, and Sigma 7s usually run under \$25K. For up to \$50K you can have 370/155s (if you don't load them

too heavily with options), CDC 3600s or B6500s. It takes over that amount to rent an average B7700, CDC 6600, or 370/168. A. S. Hansen considers installation size to be a less important factor than city or industry, and therefore does not normally break down the salary structure in that manner. We have derived the salary ranges listed under the "installation size" headings from Hansen's other reports.

One other note about the charts: the data in the chart makes nice even jumps from level to level within families of jobs. The real world should work that way, but doesn't always. To make the data behave, A.S. Hansen, inc. has smoothed it in a fashion something like a first-order linear regression. This curve-fitting has made the data more useful for salary administration, especially for establishing internal equity.

Conclusions

This is a seven-page article. It takes only two pages of the seven to show the salaries for 66 jobs in five different sizes of installations. It takes the other five pages to describe how to use that one page. That's how tough it is to use the information presented.

With the proper effort, a dp manager or salary administrator can use the charts to balance a dp organization. He may see that he has been paying level "B" programmers less than level "C" systems analysts, contrary to the consensus of what the skills are worth on the open market. With the proper preparation in assembling industry and geographic data, he may use the survey to argue for higher pay for all the dp staff. The job descriptions alone may be valuable to a firm that has not developed formal definitions; those given here have taken years to develop and are worth adopting.

An individual using the charts must invest enough time to be certain he is comparing his true job description against its salary allotment. He must also check the industry and location effects. Once appropriately prepared, he is then faced with some self-scrutiny. If he is fully convinced that he is being underpaid for his level of skill, he might choose to lobby for more money or to move. His move can take two directions. He can change jobs within his firm, if his company is agreeable, to enter a job stream (no pun intended) which tops out at a higher salary. Or, obviously, he can change companies, cities, or even industries. Since all measures of the "goodness" of a job are not in money, this survey can provide only a portion of his decision-making input. The rest must come from introspection. □

A highly organized and precise procedure for hiring programmers provides the maximum in objectivity, efficiency, speed, and hopefully success

A STRUCTURED APPROACH TO HIRING

by Trevor J. Swanson and John J. Devore

The need to hire two Programmer II's (a classified position defined by the State of Kansas) for the Kansas State Univ. computing center resulted in the adoption of a very structured approach to fill the positions. It was hoped a structured approach would elicit the greatest amount of information to base a decision upon and, thus, lead to a more objective decision.

Pressure to make an objective and reliable choice of candidates to fill the positions came primarily from two sources. There was a wealth of well-qualified people to choose from and affirmative action guidelines had to be strictly followed. Further, because the need for help was critical, we hoped to find, interview, evaluate, and hire in the space of two weeks. Names of candidates for Programmer II positions at KSU are supplied by the state of Kansas in the form of a list of five eligible candidates per position. The state determines eligibility by candidates' scores on a test similar to IBM's Programming Aptitude Test (PAT). Those familiar with PAT know that this method of evaluating programmers, or programming potential, ranks right beside divination in its reliability. So we needed information more significant than the PAT score about each person on the list of eligible candidates.

The general rule-of-thumb for meeting affirmative action guidelines is that a minority candidate is hired if all else

between two candidates appears equal. Obviously, technical and experiential equality is a difficult condition to judge in an objective manner, and objective judgments are not only hard to justify but frequently less than exceptional in quality. Trying to make this judgment in an objective manner resulted in the inclusion of technical, structured questions in the actual interview process.

It may be useful to define our concept of structured hiring before dealing with the individual steps in detail. By "structured" we mean highly organized. There was an overall organization to the procedure: creating position descriptions, scheduling the interviews, specific steps in the actual interview, a post interview process, an evaluation, and a specific format for notifi-



"Not only do we have a great retirement plan, but also our employees age more quickly."

© DATAMATION®

HIRING

cation of candidates. Since time was short, we planned to complete the process within a week and a half (and we almost succeeded). There was also a structured approach to the actual interviews which had specific preliminary steps, a particular format for the physical setting, and an organized recording of information about candidates. Further, the interview questions were common for all interviewees and structured according to information sought.

Creating position descriptions was the first step in the overall procedure (see box for a description of one of the two positions). As far as possible, the descriptions reflected the true nature of the work to be performed. Thus, the most carefully contrived part of the description was that dealing with job duties. The exercise of creating the description had the additional advantage of compelling both a thorough examination of the nature of the work presently constituting the duties for the Programmer II, and also a careful look at what future work should be.

The second, and major, part of the process was to conduct the actual interviews. An hour and a half was allowed for each candidate. This generally broke down to 15 minutes of preparatory work, an hour of questioning, and a 15-minute individual post-interview analysis. All of the candidates were interviewed through a two-day period.

During the 15 minutes spent in pre-interview planning, each candidate, located in another office, was asked to fill out or update a very brief employment form. The pre-interview time can be varied for each candidate depending upon the length of time it was anticipated he/she would need to complete the form. The candidate was also given the detailed position descriptions to study prior to being questioned.

Two interviewers and a recorder (secretary) were present during the interview. An attempt was made to have all concerned sit *around* a desk so that the questioning would seem less like an inquisition. A tape recording of each interview was also made to facilitate the interviewers' occasional reconstruction of questions and answers. (Only one tape was reviewed. One candidate failed to adequately answer a technical question, and the recording was used to determine if the question was clearly stated by the interviewers. It had been.) Each candidate was asked at the outset of the interview if the recording would be a bother. Although currently an act of ill repute on the national scene, none of the candidates objected to being taped. Each

Name of Interviewee: _____

Interviewer: _____

Date: _____

Interviewer

1. What courses have you taken in computer science? Describe the kind of computer science work and the breadth of the total academic work.
2. What paid work experience do you have? What kind of interaction with people did you have in these work experiences? Responsibility? Authority?
3. What kind of service have you provided to others—community or other service in high school or college? Leadership positions held?
4. Do you have ideas about the form that continued professional development should take? Do you have specific plans to continue your formal education?
5. Have you made a technical presentation to more than 20 persons? What experience have you had writing?
6. How do you go about creating internal documentation for a source program? Describe the user documentation and the technical program documentation necessary for a program or system.
7. Have you had experience doing consulting work? Please describe this experience. Have you had experience doing programming work, significant programming projects in the classroom, or any computer-related experience for which pay was gained?
8. If you were given the task of copying one tape to another, how would you do it? What is the extent of your use of library programs?
9. What operating system language experience, experience with file systems, tape, or disc have you had?
10. What do you do when you begin to debug your output?
11. If a wrong result is obtained from a program without any diagnostic errors, what advice would you give to proceed?
12. Describe the debugging aids of various languages you know.
13. When would you advise a rerun without changing the program?
14. Under what conditions would you advise getting an object deck as opposed to a load module?
15. What are the relative merits of modular code as opposed to in-line coding?

In which positions are you interested?

Perform appropriate set(s) of questions

Information services applicants only

1. What is your statistical experience? Course work? What is: a dependent variable; an independent variable; an observation?
2. An individual who has data with missing values is in need of advice. What advice would you give him?
3. What experience do you have in numerical analysis? Course work?
4. What sources of applications software do you know of?
5. What do you know about program library organization schemes (manual and machine oriented)?
6. What is your experience with program, subroutines, and procedure libraries?
7. What experience do you have with CAI, CMI and other uses of the computer for instructional purposes?

General questions

16. What is the basic principle of structured programming?
17. What is the basic principle of top-down coding?
18. Indicate the structure of a large general-purpose third generation computer.
19. Indicate the purpose of a paging algorithm.
20. What is a virtual machine?
21. What do you think you can contribute to the computing center?

Interview Questions.

interviewer would ask three or four logically interconnected questions in a row, although either would interrupt at any time in order to ask the candidate to enlarge upon a particular question.

Upon encountering questions which pertained strictly to one or the other position, the candidate was allowed to express his/her inclination to apply for both positions, or one of the two. At this time, the candidates were also asked if they had further questions about either of the two positions or duties thereof. Since the managers of the involved sections were doing the interviewing, they individually asked the questions pertaining to their positions.

The questions were of two major kinds: general questions eliciting background and career plans, and technical questions. Of the general questions, there were a certain number of the mom and apple pie variety:

"What do you think you can contribute to the Kansas State Univ. computing center?"

"Will you be involved in community service activities of any kind as a permanent resident of this area?"

"How does this job fit into your overall career plans?"

This kind of question was generally asked toward the end of the interview.

Candidates were asked general information questions at the beginning of the interview. Some of these questions were:

"What courses have you taken in computer science?"

"What degrees do you now hold?"

"What is your overall grade point average for these degrees?"

"What paid programming experience do you have?"

This kind of question was asked at the beginning to allow the candidate to become familiar with the situation while answering direct, obvious questions which had just been encountered on the employment form; i.e., these questions were designed to relax the candidate while he/she adjusted to the interview process and the interviewers.

Technical questions, both "situational" and "informational," were also

asked. An example of a situational question for the information services position was:

"Given the situation that a graduate student approaches you, indicating that his advisor has sent him over to have the computer analyze his data, what steps would you take to handle the situation?"

Another was:

"How would you handle a situation where a user asked your opinion of the best library routine to handle a particular analysis? Assume you are aware of the routines available in

your library and several available across the country."

One technical information question took the form of asking the candidate to write a short deck listing program. This was prefaced by the questions:

"What programming languages are you familiar with? In what special languages or systems are you proficient? Examples: ECAP, minicomputers, COGO, EISPACK."

The interviewer then requested:

"In the language you feel most comfortable using, write a complete program to read records from the card

Programmer II
Information Services
 Full time, permanent
 Shift: 8 a.m.-12 Noon, 1 p.m.-5 p.m.
 Starting date—December 15-January 1

Percentage of time	Duties
40-50%	Program Set-up, Execution, and Verification: Performs the necessary programming, scheduling, and verification of computing activities for center users primarily using library routines. Involves working with packaged statistical systems such as Statistical Package for the Social Sciences (SPSS) and the BMD series.
25-30%	User Interaction: Assists the manager of information services in the interaction with computing center users concerning the availability, selection, and recommendation of library routines. In specific areas of expertise, independent interaction with users will be performed. Provide assistance with technical problems concerning the use of library programs. Special emphasis is given to statistical and mathematical analysis and test scoring and grade book analysis. Other useful knowledge includes computer aided instruction course preparation, numerical analysis, and mapping.
10-15%	System Evaluation and Recommendation: Participates in the evaluation of the computing center's needs for library program modification and acquisition. Performs detailed technical and financial analyses necessary for support of recommendations concerning library programs. Perceptive to user problems which cause difficulties because of library documentation facilities, procedures, or administrative practice.
10-15%	Development and Maintenance of the Machine-readable Libraries: In particular, development of analytical tools to measure library use and effectiveness, testing of library programs, correcting or updating library routines, providing user aids in the form of keyword indices, and providing other retrieval aids.
5-10%	Technical Writing: Participation in the preparation and editing of the Users Guide and the Newsletter, user oriented descriptions of library routines and user guidelines to technical procedures, and program logic documentation.

Programmer II position description.

	Tech- nical	Commu- nication ability	Experience		Course work	Degrees	GPA	Apparent attitude	Maturity	Documen- tation experience	Recom- menda- tions	Career plans	List deck program
			kind	depth									
Ms. Gamine													
Mr. Blatherskite													
Ms. Seraphic													
Mr. Galoot													
Mr. Ambspace													
Ms. Brandex													

Fig. 1. Candidate/quality grid.

HIRING

reader and print those records on a printer."

Both interviewers had room on their pre-typed list of questions to briefly note answers given by the candidate.

Immediately after each interview, a brief evaluation was made while particular answers were still fresh in our minds. To facilitate this process a grid sheet (Fig. 1, page 59) was used with a score of 1 (low) to 5 (high) given for each candidate/quality. Although the qualities were discussed by the interviewers, each had a grid sheet in which to record an independent judgment. If it had been subsequently discovered that a wide gap existed in the scores given by the two interviewers, the tapes could have been used to arbitrate differences.

After all the actual interviews had been conducted, the most subjective part of the hiring process had to be accomplished; one candidate had to be selected for each position. Obviously the numbers on the grid sheet could not simply be added, as this would be analogous to adding apples, oranges, and elephants; the result would be meaningless. A suitable formula with proper weighting for different candidate qualities could be derived, but this is not only a questionable process in dealing with humans but also one that is probably unnecessary.

Selection was easily narrowed to two or three candidates for each position on the basis of interview answers and technical background considerations. Candidates were finally selected by eliminating equivalent qualities from consideration and carefully analyzing the available information on the remaining qualities of each candidate. This selection process was formalized by having the manager of each section involved send a justification for his selection, in the form of a memo, to the associate director of the computing center.

After the selected candidates were offered and had accepted the positions via telephone, others were notified that they had not been selected. This was done by phone so that they could consider other opportunities at the earliest possible time. In addition, formal letters of notification were mailed soon after the phone calls.

Several random observations about this structured hiring process might be made. First, there was a surprising degree of agreement between the interviewers regarding the relative qualities of individual candidates. Second, we learned that the questions should be even more structured than they were. For instance, it was rather devastating for candidates to be asked for definitions of an "independent variable" and

a "dependent variable" after they had revealed no knowledge of statistics. Lower level questions should be skipped if the preceding level question reveals no knowledge of a subject. Merely outlining the questions with appropriate indentions would be a considerable help in alleviating this problem.

The structured approach to hiring enabled us to swiftly, reasonably objectively, and successfully fill vacancies where the need was critical. We are now in the process of hiring a Computer Operator Trainee and a Programmer I using the same procedure. Further, the administrative data processing dept. on campus has adopted the procedure in order to hire four Programmer I's. The final success of this structured approach to hiring will be revealed by the success of selected candidates in their respective positions. Only time will tell whether the choices were wise, but the reaction of those involved, including applicants, indicates that the success of the method will exceed our initial expectations. □



Dr. Swanson is manager of information services at the Kansas State Univ. computing center, and is an instructor of computer science there. Previously with the Univ. of California at Irvine, he has a PhD from Southern Illinois Univ.



Mr. Devore is manager of programming services at the Kansas State Univ. computing center. He has been in the computer field since 1968, and his past experience includes systems programming and user consulting.



Local maintenance force.

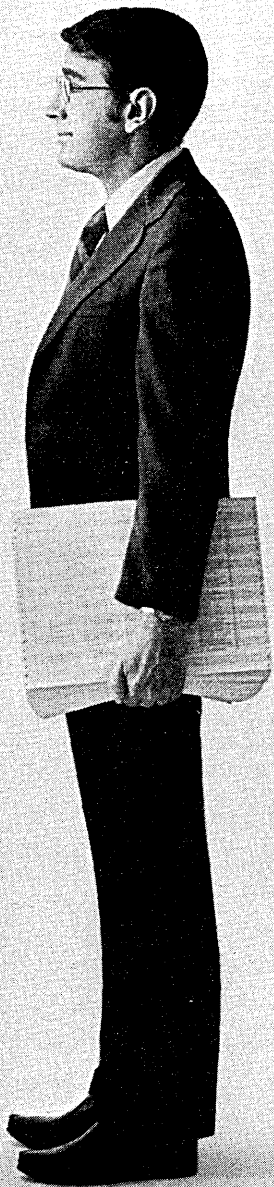

2

Data experts at
your Bell headquarters.

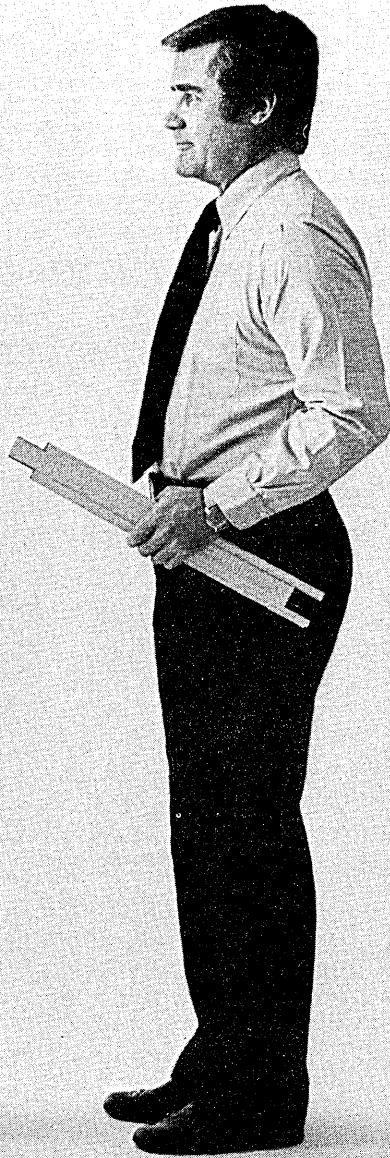

3

Design engineers.

3 steps up to cut downtime.

Bell System engineers pioneered modern data communications in the mid-fifties. Our long experience means our data equipment has unmatched dependability and reliability. And our maintenance force has expertise unequalled anywhere.

Our local maintenance people promptly solve most of your data problems.

For those rare stumpers, they are backed by our Data Technical Support Plan (DATEC), a program that enables them to get help quickly from all levels of the Bell System.

A really difficult problem may even be referred to the engineers at Bell Laboratories and Western Electric who designed the equipment involved.

At AT&T and your Bell Company, we know that when your data communications operation is down, you need help in a hurry.

We hear you.



**Another Varian first. A
HASP based system that
turns your 360/370 into
a network.**

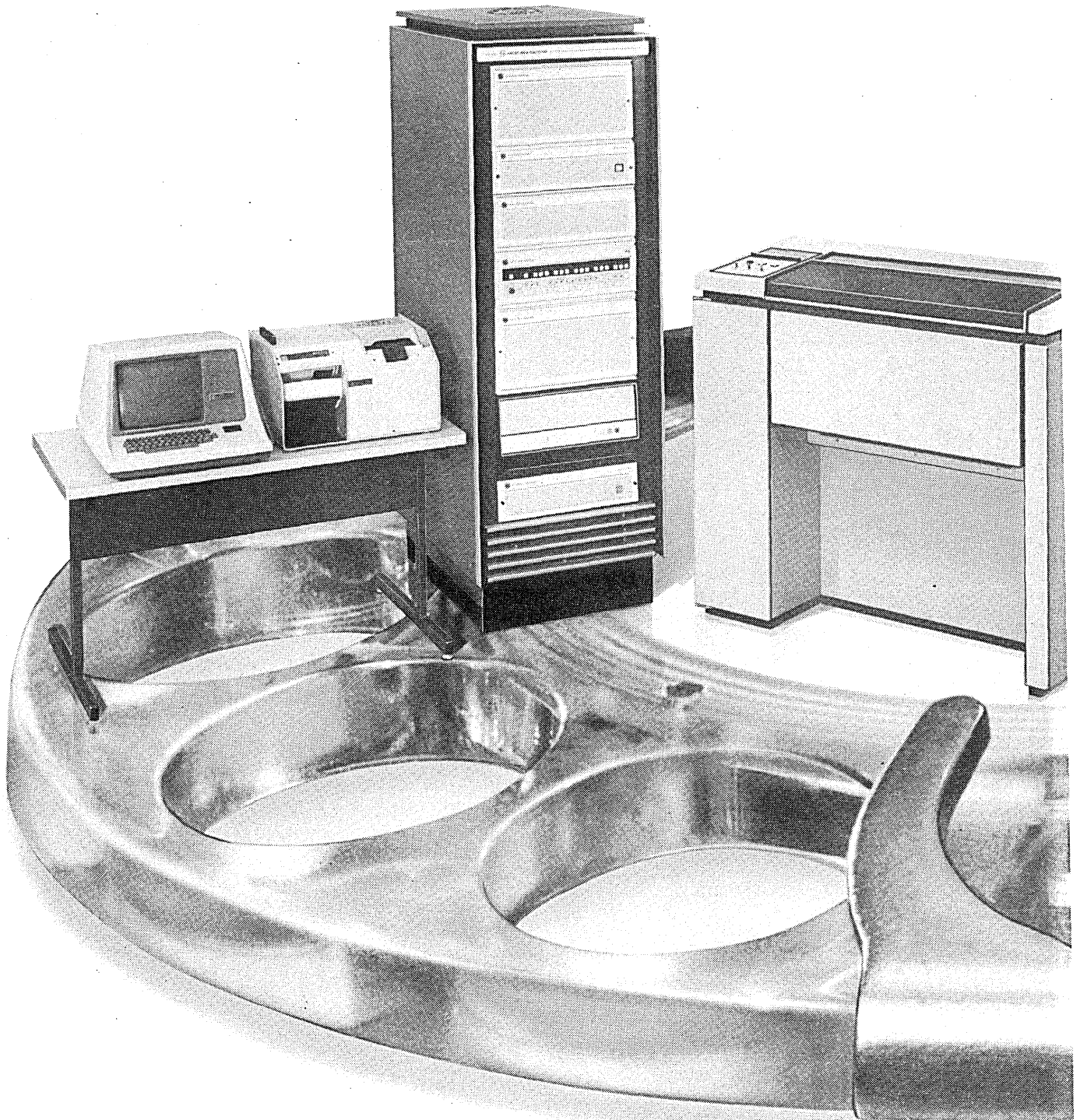

And gives you quite a cost/performance break. Interface the 360/370 with one of the Varian family of remote processing systems. You'll not only get a more powerful network. But you can put the power where you need it most.

With this extra distributed computing, perform your real-time or batch jobs at the local level. And at the same time, submit payroll

and inventory jobs to your central system. It's the Varian software that does it. HASP/RJE with our powerful VORTEX/VTAM operating system. And the Varian V-70 family of flexible data processing systems.

The result is a hardware/software combination that gives you network capabilities no one else can touch. Add a HASP based Varian system

and give your IBM 360/370 a break. As well as your profit and loss statement.

For detailed information on how our remote processing system can greatly enhance the capability of your network, write for our comprehensive brochure. Varian Data Machines, 2722 Michelson Drive, Irvine, California 92664.

Or call (714) 833-2400.



**The mini killers
varian data machines**

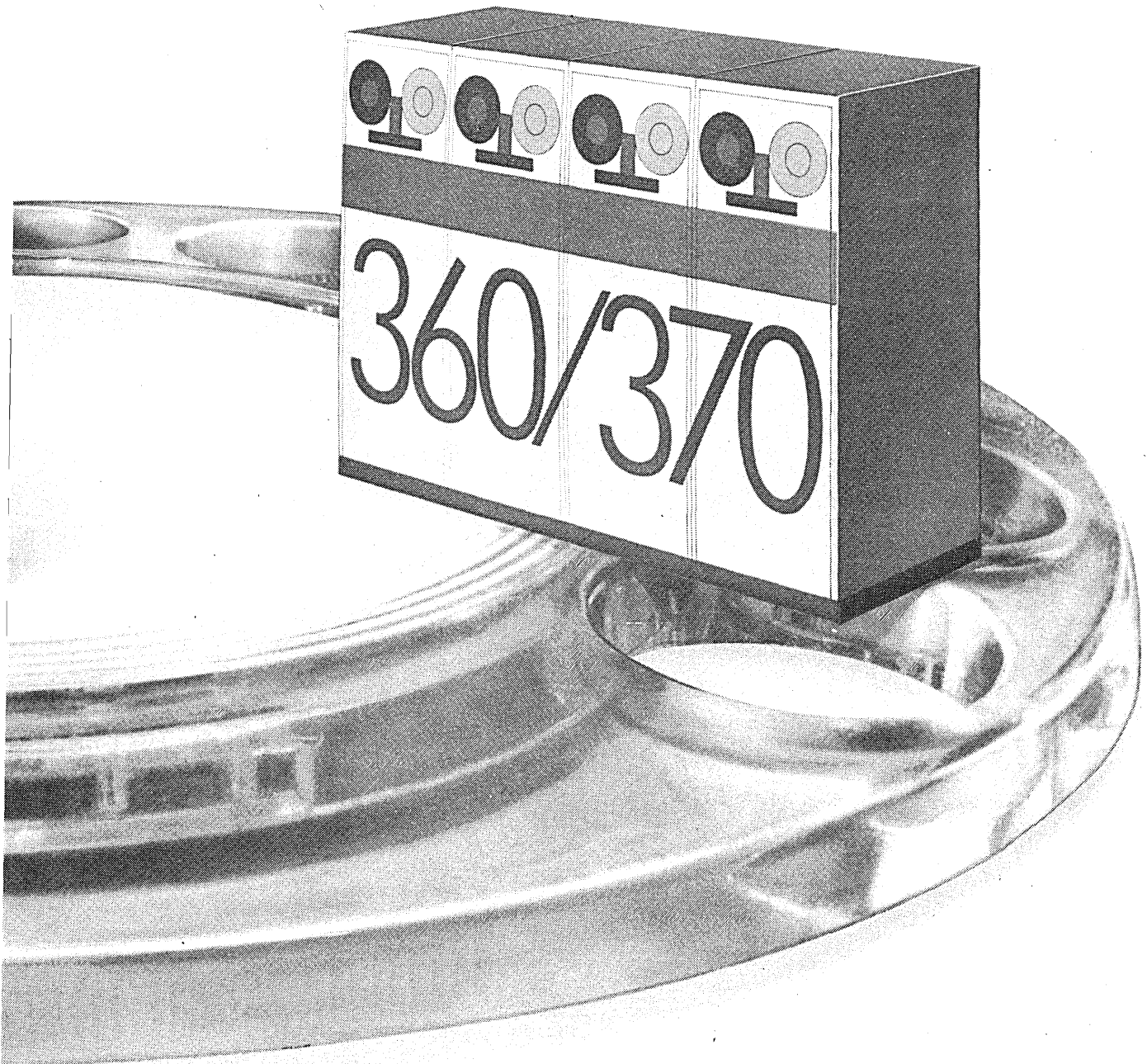

Effective regional planning can become a continuous process incorporated into day-to-day governing and decision-making

THE PLANNER'S COMPUTER

by David A. Gulley and William G. Kane

The process of planning, whether for broad long-term strategy or detailed operations, is basically the process of developing and analyzing various alternatives. Put together, these alternatives lead to the creation of a process working model. Computer-aided model building and simulation are now accepted and widely used processes for some kinds of planning. However, computer-aided modeling for urban and regional planning remains a controversial issue.

The planning departments of Larimer and Weld Counties in Colorado are currently involved in a Regional Economic Study that will provide vital answers about the development of local economy. The experiences gained by this planning group indicate that computer-aided modeling can generate valid community models that answer specific questions vital to the community's economy. Considering the present urban and environmental crisis, many more problems demanding rigorous analytical treatment will arise in the future. Although the computer is not a panacea, the planner's need for computer power will continuously increase as he faces these new problems.

End-state vs. process planning

The city planning process has been plagued by the illusory and ineffective concept of the "comprehensive plan." By devoting itself to the prediction of a distant future, planning has typically:

1. Relegated the tough day-to-day decisions to insolubility and insignificance.
2. Constructed long-range plans on a data base which has been suppositional and therefore not strong enough for the broad consensual framework needed to make a plan work.

In effect, planning has cyclically adopted short-range, product-oriented goals. Melville G. Branch* has called this "end-state" planning, or planning which stops at the publication of the comprehensive plan. The form of

growth in a community is affected by zoning, land value, human values, the political system, taxation and lending policies, constantly shifting markets, and more. The traditional attempt has been to freeze these infinitely dynamic processes into the static, two-dimensional, technicolor comprehensive planning map. The map's value as a guide for action is lost due to the adverse decisions which inevitably result after the completion of the comprehensive planning study. Generally, after several years' accumulation of unguided decisions by public officials, public indignation reaches a critical level, an exorbitant planning budget is scraped together and the ritual of the comprehensive plan is reinvented.

A new approach to planning is evolving in response to this dreary and frustrating cycle. It has a variety of names: process planning, impact planning, ongoing planning, or even continuous planning. Regardless of name, this new planning strategy reflects three important considerations:

1. Planning involves many processes and services with different planning time scales. For example, most utilities require a sufficient public investment and population base to put their planning on the 20 to 25 year time scale, while the matter of a desirable housing mix can be decided on a monthly basis in response to key market indicators. Therefore, it is inadequate to plan for all processes on the same time scale.
2. Planning has taken, on a quantitative bias. Long-range comprehensive planning has been far enough removed from reality to give its conception a certain artistic flavor. Key design elements have been more important than the daily formulation of public policy. Traditional design elements are now being supplemented with such essential community indicators as income, land value, geography, condition of housing, and a plan for pat-

terns of land use in mathematically derived optimal patterns.

3. Planning is adapting itself to provide better solutions for the day-to-day problems through the creation and maintenance of key data files. The planning process is moving closer to daily city administration, bringing more data to bear on current city dilemmas. This is largely because the comprehensive planning process, even under the most favorable circumstances, has had little impact on urban growth. The years of accumulation of daily decisions explain the form of cities and it is upon these decisions that this new planning technology is brought to bear.

The implications of this new planning

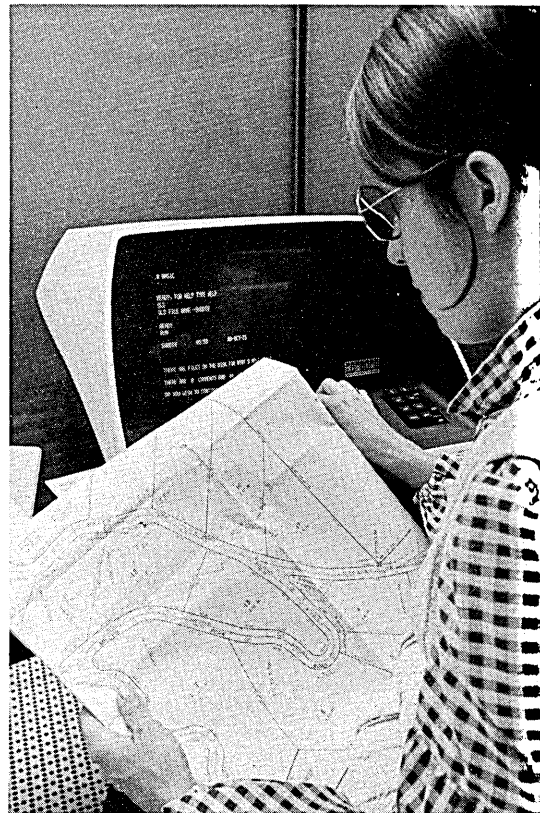

Statistical data and reporting methods now developed will be used for analysis of crime probabilities and police resource allocation.

*M. G. Branch, *City Planning and Aerial Information*, Harvard Univ. Press, Cambridge, Mass., 1971.

strategy are enormous. As the new concept of planning moves closer to present and future community needs, planning itself will assume a more significant role in local government. To the dp man, this means the planner will become one of his most demanding and sophisticated customers.

The Larimer County-Fort Collins System

In 1971, the city's new director of systems and information began talking to the manager of the county's computer installation. They recognized that the pooling of city and county dp resources would be feasible, effective, and economically desirable. A general review of inter-agency functions showed that mutual needs for the same data existed. By establishing uniform files and data flow, the available information could be used by many departments. The primary objective of merging the dp operations was to exploit this.

Larimer County has been involved in data processing for about five years, having started with an IBM 407, then a System/3. Fort Collins established a staff-level Dept. of Systems and Information, supported by outside services, about three years ago.

The joint installation now runs a Digital Equipment Corp. DEC system-10 with 480K bytes of core, two discs,



The DECsystem-10 is augmented by a Houston Instruments DP-7 flatbed plotter and a Tektronix graphics display tube. Land-line property mapping, surface approximation, and contouring software was supplied by Computer Research Corp. The programs convert metes-and-bounds legal descriptions into latitude and longitude, and provide slope information for use in mountain developments.

four tapes, and a communications controller with 16 ports. The center provides services to many departments of the city (1970 population: 43,368) and county (1970 population: 89,900). Among these services are:

1. Utility billing for Fort Collins (approximately 25,000 accounts), which includes the capability to store and provide on-line access not only to billing data (account status, charges, meter reading, etc.), but also to engineering data such as primary and secondary servicing substations, transformers and/or phase line identifications and locations, kilowatt usage evaluations, rate structure analysis, etc.
2. The revenue accounting system that handles all monies received in Fort Collins on a daily basis to provide dynamic fund controls and a daily evaluation of monetary status to better judge investment possibilities.
3. A police reporting system, now available to the Fort Collins Police and Larimer County Sheriff's Office. The system fulfills all FBI report requirements in addition to comprehensive local statistical analysis, including area offense analysis, arrest, incident, and accident arrays.
4. A water hydraulics system to assist the engineers in analysis of trapezoidal water flow. It incorporates many variables and constraints such as pitch, water flow, capacity, structure (i.e., material), run-off, etc.
5. Programs for the verification and analysis of traffic flow for the traffic engineers of Fort Collins (this system has been interfaced with the police system to provide information on motor vehicle accidents and moving violations to further analyze selected locations).

As a planner's tool, the DEC system-10 provides these capabilities:

1. It is a high-speed adding ("number crunching") machine.
2. It is a versatile data source with a very attractive built-in potential for merging different data files.
3. It is a fast turnaround analytical tool permitting study of alternate planning strategies.

Number-cruncher

The most basic application of any computer system is, of course, in number-crunching. By number-crunching, we refer to sorting and elementary computations, particularly when done on a routine basis. Planning agencies

have less need for such work than some other departments, but several such applications exist in our agencies. When the present DEC system-10 was installed, our field engineer developed a comprehensive plot-closure program, whereby all subdivision plots, annexations to the city, etc. could be calculated for closure by boundary, block, lot, street easements, cul-de-sacs, etc.—from the highest to the lowest survey mapping. This conversational program has been used extensively by the county planning dept.

Statistical analysis is a magnificent tool for probing for associations and debunking myths about a community, but its practicality is limited without a computer's speed. In Larimer County, the increased use of such methods has led to several conversational programs: a program to compute mean and standard deviation; a polynomial curve-fitting program for first-, second-, and third-order polynomial fits to a single independent variable; a program to compute correlation coefficients; and a stepwise multiple regression program for up to 20 independent variables, with nine variable transforms and built-in "lead-lag" capability.

The value of such programs can be illustrated by a problem which recently arose—estimating the per-capita cost of providing certain types of government services. One could always divide last year's budget by total population served, and come up with an average value. However, such a figure isn't particularly meaningful in terms of projecting increased costs corresponding to a specific population increase. An alternate procedure was employed. Budget figures for those services and total population were developed for Larimer County and for selected similar counties, based on certain criteria (e.g., percentage of population that is urban). A polynomial was fit to the data points, and the X coefficient was used to estimate the *marginal* per-capita increase in providing services. The fit was extremely good, and the resulting value is much more defensible than a mere average value would be.

Data source

The topic of file integration is of major interest to data processors these days, since as we all know (Euclid to the contrary) "the whole is considerably greater than the sum of its parts." State and local governments routinely collect enormous amounts of information about a community's ever-changing status. The idea that this data should be collated and shared would seem obvious, were it not for the fact that this so seldom happens.

PLANNER'S COMPUTER

We presently have several information systems that can spin off data to our planning agencies. The county tax assessor's files contain parcel numbers (geographic locators), value of land and improvements, a rough land use code, and legal descriptions. The county motor vehicle system under development will contain the number and types of vehicles plus the owner's address.

The City Police-County Sheriff reporting system reports motor vehicle accidents, and should prove useful in transportation planning and impact zoning analysis. The city sales tax file yields monthly data on retail sales by location. These files are all of some use to planners, but the "star" information system is the Fort Collins housing file.

In the spring of 1972 the Fort Collins Planning Office undertook an inventory of land use and housing in the Fort Collins area. This program was put together for arranging a definitive survey of the housing stock in an updatable format.

Traditional housing and land use surveys have been guilty of the flaws inherent in end-state or product planning. Housing inventories have been viewed as final products and as such have had little enduring value beyond their day of completion. The Fort Collins study was structured to put a complete inventory of land use, housing and housing conditions in a format capable of weekly updating.

The housing study was initiated with a complete air photo coverage of the study site (213 square miles) at scales of 1" to 200' and 1" to 600'. A housing inventory and survey form was then prepared for gathering data on taxes, land use and housing condition criteria. The survey form and consequent data records were designed so that the need for good housing data could be balanced against the necessity of having a manageable data file. Cooperation between the planning dept. and systems and information dept. resulted in a one-sheet survey form. Essential to the creation of the survey form was the use of keys to allow matching and merging with existing files. In our case, certain data fields were created with the intention of picking them from the existing assessor's file. As it stands now, our files can be matched and merged using two basic keys: the 10-digit county assessor's parcel number (a geographic code which includes township, range, section number, quarter section number and a sequential parcel number) and street address.

To date, roughly 17,000 structures and parcels have been mapped, surveyed and keypunched into final file form. This includes about a three-mile

radius beyond the city limits. Estimated cost is \$25,000 for surveyors' salaries, air photos, programming costs, keypunching, and professional staff time. This does not include monthly operating costs for machine rental or periodic programming assistance.

Analytical tool

As a planning tool, this survey gives us the best basis available for housing market analyses. We have a tabulation of housing mix for the city as a whole and focus to the quarter section or neighborhood level in seconds (especially since the data is keyed that way). Such a survey, when contrasted with socio-economic data from the census records, allows local government to express values in the type and cost range of housing to be built. When combined with current planning techniques of development impact zoning, this data permits planning the construction of housing that more closely fits the existing need while minimizing impacts on the municipal and school district budgets. The survey gives a feel for the gaps in our housing supply and a basis for direction in local and federal housing programs.

The data provides us with a basis to do local level statistical investigations into such questions as the determinants of urban land value. The survey puts the whole matrix of zoning, building codes, access, taxation, age of structures and location at our fingertips for better understanding of their interrelationships. Simple and multiple regression is presently being considered for the generation of hypotheses through the use of factor analysis.

On a day-to-day basis the survey will permit us to:

1. Better understand the potential impacts of planning proposals on existing neighborhoods.
2. Provide the basis for demographic analysis at the neighborhood level.
3. Save costly hours each month in properly notifying property owners of zoning changes (the process is currently done manually by flipping through large assessors numbers files). The survey file will permit us to key in parcel numbers and have owners names and addresses printed directly on labels.
4. Provide housing-related data for various citizen commissions.
5. Supply data on old structures for the Historic Landmarks Commission.
6. Output site data for the local housing authority.
7. Eventually make various data

available for the private sector for aiding in market determinations.

Updating will be done on a weekly basis. Building inspector receipts will be sent to the planning office to be coded, keypunched and merged with the files. Continued use of the housing and land use file requires fast and accurate graphic updating. The problem is complex since the complete study involves over 100 square miles (sections) and 100 individual property ownership maps. With each parcel being tied to a legal metes and bounds description, a future plotting system that can draw each section will be a useful asset.

The housing file will shortly become a cornerstone in an important addition to our data bank capabilities, the "regional growth monitoring system," which is presently on the drawing boards. The purpose of the growth monitoring system is to pool the data collection efforts of a number of different jurisdictions (three municipalities, two counties, and several state agencies), so that growth may be monitored by geographical area (traffic zones). Starting with base year data (1971), the system will keep track of changing land use patterns, population, employment, and vehicle ownership. This data has extremely important potential use in transportation, land use, economic studies, and other areas.

The regional economic study

Larimer and Weld Counties form a region in northcentral Colorado which is presently experiencing a dramatic rate of growth that shows no sign of slacking off. If anything, growth may be accelerating due to the two county seats reaching a "takeoff point" in size and economic development. The Larimer-Weld region historically has been a predominantly agricultural area. Rapid growth can cause severe problems in an urban area. In the Larimer-Weld region, the impact of growth might be even more acute, for the growth is causing a qualitative shift from a rural to an urban community. For these reasons, a Regional Economic Study was formed to deal with these matters.

In analyzing economic growth, the study attempts to answer several specific questions about the local economy:

1. What is the present structure of the economy, and how did it get that way?
2. What is the "ideal" structure of the economy, and how will probable future growth affect

- the difference between "real" and "ideal" structures?
3. What, precisely, is the relationship between growth in employment and growth in population?
 4. How would growth or decline in an economic activity, or the establishment of a new industry, affect the rest of the economy?
 5. How does industrial and residential expansion affect the cost and revenue patterns of local government?

We think it goes without saying that answering these questions requires more than colored maps or interviews with local authorities.

The foundation of the Regional Economic Study is a linear model that economists call an input-output table. All of the economic units in a community—manufacturing plants, households, supermarkets, farming, department stores, and so on—are interdependent. The input-output table is essentially a form of double-entry book-keeping that tracks this interdependence. Each row of the table indicates the volume of *sales* of a sector (to other local sectors, to local final demand—for example, households and government—and "exports" to the rest of the nation). Each column of the table displays a sector's *purchases* (from local sectors and households, and from the rest of the country).

The completed input-output table is a detailed description of the local economy. The table can be used to derive several sets of equations for answering the questions listed above. These equations indicate the amount and type of purchases each sector must make per dollar of output, and per dollar of output delivered to final demand. To see how this information may be useful, suppose that one of the major local firms, Amalgamated Octopus, has announced an expansion program. Physical expansion will stimulate the local construction industry. New workers added to AO's payroll will spend paychecks throughout the economy. And as the level of Octopus's output climbs, so will its demand for the goods and services produced by AO's local suppliers. The growth in the local economy, induced in several different ways by the expansion of Amalgamated Octopus, can be predicted (though not perfectly, of course) by the equations developed from the input-output table.

Local economic growth can in turn be related to immediate concerns of planners—population influx, changing land use needs, water consumption, even increases in air and water pollution and solid waste, if the data can be uncovered. Another interesting use of

the input-output equation lies in contrasting the present economy with an "ideal" economy that represents optimum amounts of different types of employment. Given the input-output data and a linear programming code, such an ideal economy is easily defined. More significantly, such a model can accommodate both those who seek a stronger "export base" and those who prefer some other index of well-being, such as per-capita income or "cleaner" industry.

Program tools

A number of analytical tools are needed in so ambitious a project, and some of them definitely require access to a scientific-language computer. In our case, the availability of a time-shared computer also has helped remove the study from the end-state or report-oriented category. Conversational software is being developed for estimating the economic impact of further growth or decline. Furthermore, the growth monitoring system mentioned above will provide continuous updates of some of the data needed for the study.

The Public Sector Impact Model (PSIM), used for estimating fiscal impact of residential expansion on local government, is an excellent example of the ripple effect of the new planning strategy. The mathematical form of the model is quite straightforward. The physical description of a subdivision is translated into demand placed on physical facilities and local government programs; costs and revenues are thereby computed and contrasted. PSIM was designed to require the least amount of input data possible (some simple information about the housing mix, nearby roads, the school district, and average property value), and can be operated by clerical personnel. About three man-months of data gathering were required for a county school district model.

In the process of collecting the data for this model, several things became clear. For one thing, nobody had a grasp of how much it would cost to build, widen, or maintain a road. It also became apparent that to estimate a subdivision's impact, one needed criteria indicating when roads require expanding. This insight has led to the design of some new data gathering into the routine process of analyzing proposed subdivisions.

We call the use of "what if" models such as PSIM and GEIM (general economic impact model) "contingency planning" since they allow planners to immediately weigh the consequences of newly-arisen conditions—something no comprehensive plan can do. We feel

this reliance on computer software, rather than impressive-looking but quickly-outdated bound reports, makes the Regional Economic Study a portent of the future of local planning.

Conclusion

Earlier we noted that planning is taking on a quantitative bias. Much spirited debate about the usefulness of urban and regional models is currently in evidence, and we have no intention of muddying the water any further. Our viewpoint is that it is possible to build valid models of a community that are designed to answer *specific* questions. We have much less faith in any model that purports to simulate all of the complex interactions of a community.

Modeling may provide answers, but it has such an arcane reputation that many wonder if this scientific approach to planning is feasible for the small planning agency. We feel our current experiences with such an approach indicate that it is very much a possibility. □



Mr. Gulley is director of systems engineering for Larimer County, Colo., responsible for economic, statistical, and optimization studies related to management and planning. He has a master's degree in operations research and has taught management at Metropolitan State College of Colorado.

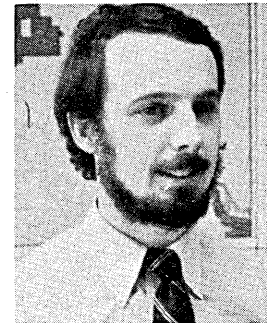

Mr. Kane is planning director for Fort Collins, Colo. He has a master's degree in regional planning from the Univ. of Pennsylvania, and has taught land use and planning at Colorado State Univ.

**INTERDATA
ANNOUNCES
THE INDUSTRY'S
FIRST \$3200
MINICOMPUTER
TO CHALLENGE
THE NOVA.**

PDP-11 PERFORMANCE AT A NOVA 2 PRICE.

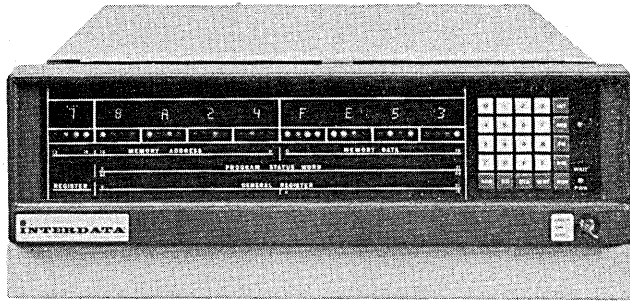

Minicomputer myths you can live without:

1. There is no such thing as a high-performance, low-cost minicomputer.
2. You have to choose between two extremes – pay a ton for a machine like the PDP-11 and save on software costs, or buy a cheapie like the Nova 2 and pay the price later.

All wrong.

Because now there's the Interdata 7/16 – an extremely flexible 16-bit OEM minicomputer that combines the best of both worlds.

It's easier to program than the PDP-11 because it has 16 hardware registers, up to 64K bytes of directly addressable main memory, 255 I/O interrupts with automatic vectoring to service routines and a comprehensive set of more than 100 instructions. That's a lot of muscle.

It's completely modular in design – plug-in options can be installed in the field to meet your specific application requirements.

Options like multiply/divide, programmers' console with hexidecimal display, power fail/auto restart, memory protect and a high-speed Arithmetic Logic Unit that includes floating point hardware. In fact, you can expand the low-cost 7/16 all the way up to the 32-bit Interdata 7/32.

Yet it costs as little as \$3200. Just like the machines that give you the barest minimum. And quantity discounts can reduce that low price by as much as 40%.

Performance	7/16	Nova 2/4	PDP-11/05
Data word length (bits)	4, 8, 16	16	1, 8, 16
Instruction word length (bits)	16, 32	16	16, 32, 48
General-purpose registers	16	4	8
Hardware index registers	15	2	8
Maximum memory available (K-bytes)	64	64	64
Directly addressable memory (K-bytes)	64	2	64
Automatic interrupt vectoring	Standard	Not available	Standard
Parity	Optional	Not available	Special order
Cycle time (usec.)	1.0 or 0.75	1.0 or 0.8	0.9
Available I/O slots	4	2	2

Price	7/16	Nova 2/4	PDP-11/05
8 KB processor	\$3,200	\$3,200	\$4,795
16 KB processor	3,700	3,700	6,495
32 KB processor	5,300	5,300	10,895
Multiply/Divide option	\$950	\$1,600	\$1,800
Floating Point option	\$4,900	\$4,000 plus \$1,000 for 2/10 configuration	Not available

Source: Data General Price List, Copyright 1973, and addendum dated 5/15/73. Nova 2/4 bulletin 012-000060, 1973. DEC OEM & Product Services Catalog, 1972. Auerbach Minicomputer Characteristic Digest, June, 1973. "How to use Nova Computers", 1973.

So you no longer have to make the painful choice between good performance and good price. Or between hardware economy and software efficiency. Now you have a minicomputer that gives you both.

The Interdata 7/16.

We put our muscle where their myth is.

INTERDATA®

2 Crescent Place, Oceanport, New Jersey 07757 (201) 229-4040.
 Boston – (617) 890-0557. Washington – (703) 525-4806. Philadelphia – (215) 436-5579.
 Orlando – (305) 851-6962. Chicago – (312) 437-5120. Detroit – (313) 356-5515.
 Dayton – (513) 434-4193. Kansas City – (913) 384-1606. Houston – (713) 783-3060.
 Dallas – (214) 238-9656. Denver – (303) 758-0474. Los Angeles – (213) 640-0451.
 Phoenix – (602) 968-2477. San Diego – (714) 565-0602. San Francisco – (415) 969-1180.
 Seattle – (206) 455-0680. Toronto – (416) 677-8990. Tokyo – (270) 7711.
 Sydney – 439-8400. London – Uxbridge 52441. Munich – 0811-8543887.

Why Remex is the cat's pajamas in punched tape systems

- You get the fit you need
- We tailor systems for you
- And they don't cost all that much

Remex works with you to provide the right punched tape capabilities for the job to be done. And the price is low.

Take the reliable Remex 2000, 6000 and 7000 Series punched tape readers and reader/spoolers. They're fast, accurate and adaptable, with speeds of 150, 300 and 500 cps. Plus an advanced reading system which can read highly transparent tapes without adjustments. Plus a low cost, high performance servo system tailored to your specific job. All this with one common, easy-to-use interface.

Or take the Remex Series 6375 combo and 1075 Series perforator which gives you a 75 cps punch at the price of some 60 cps units.

Whatever you need in P/T, what you get is proven reliability, outstanding price/performance and cooperation you can't buy elsewhere at any price. It's what you'd expect from a long-established, major-factor-in-the-business company.

MAKIN' WHOOPIE. In new product development, Remex is here with bells on. Such as with our new floppy disk drives and systems, and our compatible digital cassette systems that can turn any punched tape system into a real performance tiger.

For information, contact Remex, 1733 Alton St., Santa Ana, California 92705 (714) 557-6860. In Europe and the U.K., contact S.p.A., Microtecnica, Torino, Italy.

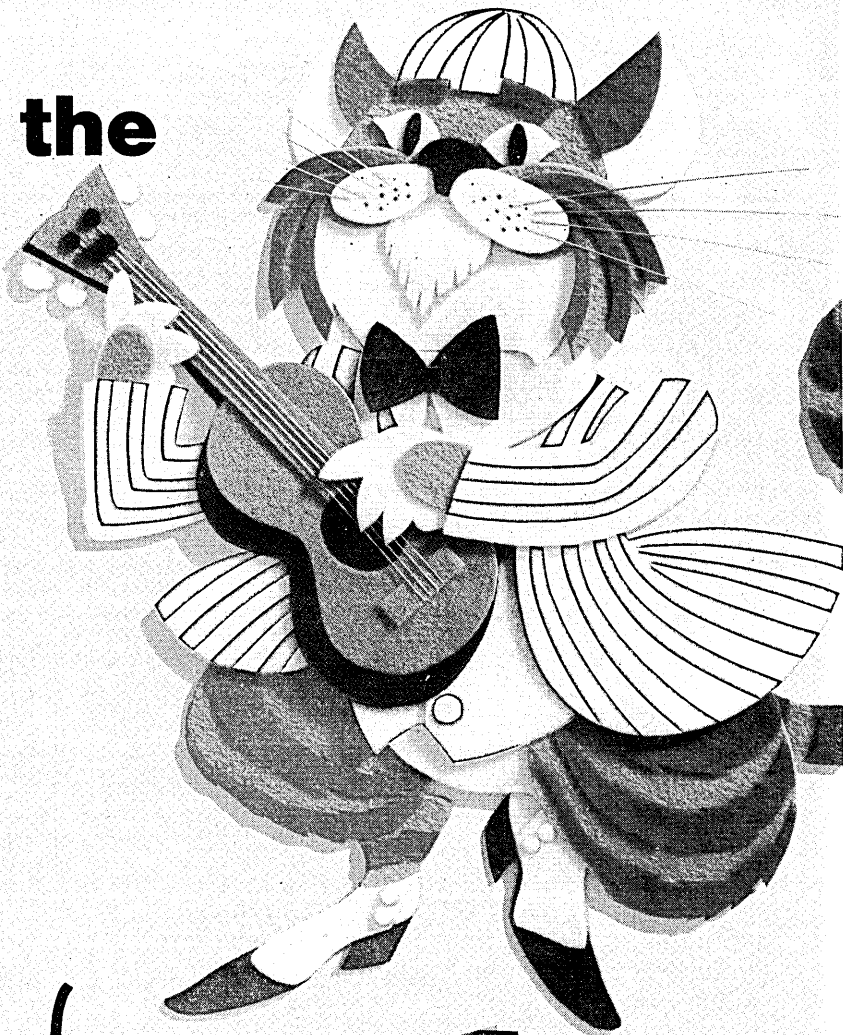

RRS-6500 Reader with advanced photoelectric reading system

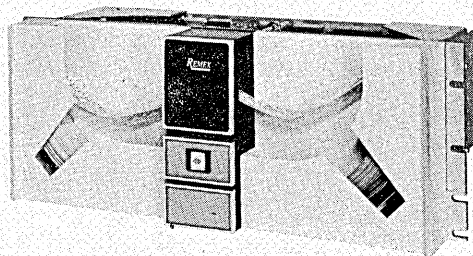
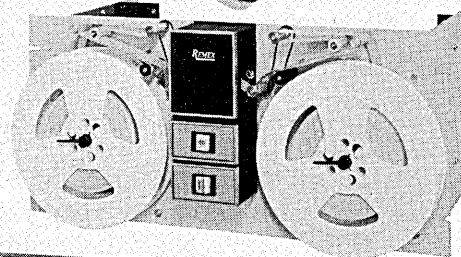

RRF-6300 bidirectional fanfold tape reader, reads to 300 characters per second

RAF-6375 Perforator/Reader combines 75 characters/second perforating, 300 characters/second reading, in a single low-cost system

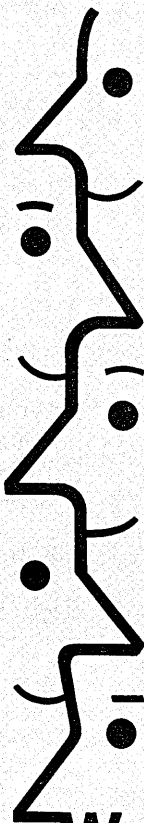

We work with you!

REMEX



Ex-Cell-O Corporation

According to this panel, the use of structured or GOTO-less programming is far less important than good documentation, programming tools, and experience

PROGRAMMER PRODUCTIVITY AND THE DELPHI TECHNIQUE

by Randall F. Scott and Dick B. Simmons

The cost of software development has now become the most expensive part of a computer application. The software-to-hardware cost ratio will grow further apart as personnel costs increase and hardware computing power becomes less expensive. The cost of software in the U.S. has now reached \$10 billion, which is over 1% of the gross national product.¹ Since it is unlikely that the personnel costs will decline, methods to improve productivity become more and more important.

A review of programming management literature shows much commentary but very little research on programmer productivity. Of course, the primary reason for this situation is the difficulty in performing this kind of research. Consequently, there is a lot of talk, but little action.

There are three major ways that you would expect research into programmer productivity to be approached: analysis of historical data, observation during program development, and simulation. Each method, when used to study programmer productivity, presents many problems.

There is no current, generally available historical data to permit a meaningful analysis. System Development Corp. and Planning Research Corp. performed significant historical data collection and analysis² 5-10 years ago. The data is applicable to second generation system development, and the analysis was oriented toward prediction rather than productivity.

1. Barry W. Boehm, "Software and Its Impact: A Quantitative Assessment," *Datamation*, May 1973, p. 48.

2. A. M. Pietrasanta, "Two Empirical Studies of Program Production," *IFIP Proceedings*, 1968.

Neither collection was designed to represent the population of computer programs (because no one knows this population); therefore, the results cannot be safely extended.

Observation of programs being developed, while possible, is impractical because of the time and expense. The development of a programming project may take days, months, or even years. Obtaining access to the development programmers and observing enough projects to draw inferences are also problems of observation.

Simulation offers hope as a method of obtaining insight into programmer productivity; only recently has it been used to study computer programming.^{3,4} Of course, the use of simulation implies a knowledge of the active project variables and their interrelationships.

Before beginning any programmer productivity research, it would be helpful to have a conference with some practicing managers and project management experts, although this would be both difficult to arrange and expensive. Even better results can be obtained using an inexpensive iterative method called Delphi.

Delphi is a technological forecasting procedure developed at the Rand Corp. by Norman Dalkey and Olaf Helmer.⁵ It was developed in the early

3. Otis A. Thomas, "A Computer Programming Shop Simulation Model: A Managerial Decision Tool," 3rd International Conference on Computer Management, 1972.

4. Randall F. Scott, "A Programmer Productivity Prediction Model," unpublished doct. dissertation, Texas A&M Univ., 1973.

5. Norman Dalkey and Olaf Helmer, "An Experimental Application of the Delphi Method to the Use of Experts," *Management Science*, April 1963.

'50s as an attempt to improve upon the forecasting ability of a single expert. The procedure has three essential features: anonymous response, iteration and controlled feedback, and statistical group response. The features are designed to minimize the biasing effects of dominant individuals, of irrelevant communications, and of group pressure toward conformity.⁶

The members of a typical Delphi panel never meet each other. This eliminates the possibility of a small vocal minority swaying the responses of other members. Reputations are neutralized by the anonymous feature of the survey.

Controlled feedback is a method of reducing noise. Participants in the exercise are provided information on the distribution of the group response from the previous survey round. If the response differs from the consensus, panel members are then asked to either support their original estimates or to change them.

The statistical group response feature provides for recognition that the exact answer is unknown and the value of all final responses should be maintained. This type of response helps reduce group pressure.⁷

By using almanac-style information (e.g., the population of N.Y. in 1880) researchers at Rand have validated that the use of iteration, with the median and upper and lower quartiles as feedback, results in convergence toward the true answer.

The Delphi survey technique has

6. Norman Dalkey, *The Delphi Method: An Experimental Study of Group Opinion*, Rand Corp., June 1969.

7. Robert M. Fulmer, "Forecasting the Brave New World of 1984," *Manage*, March 1971.

**You want
MULTIPLE,
INDEPENDENT
KEYBOARD
DISPLAYS
FOR PDP11?
— WITH DIRECT
MEMORY
ACCESS?**

**Well Sir — It's /
in the
cards!!!**

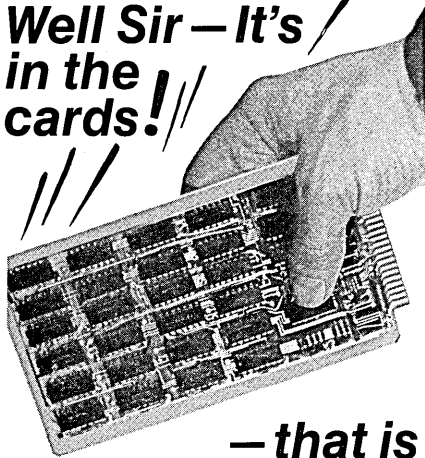

— that is

Leigh's fast (DMA) Display Controller Cards that plug directly into a DEC expander box

THEY FEATURE:

- 64 ASCII Character set
- Full page (2000 character) update in 63 msec
- 12 editing functions
- No new software

There are many more features but you're gonna hafta write in so we can tell you about em

LEIGH

**LEIGH INSTRUMENTS LIMITED
AVIONICS DIVISION**

P.O. Box 820 Carleton Place, Ontario,
Canada, K0A 1J0

Tel: (613) 257-3883 • Telex: 053-4148

L74-1C

PROGRAMMER PRODUCTIVITY

been applied to a wide variety of problems. In addition to its original purpose of technological forecasting, Delphi has been employed for regional planning, medical forecasting, and educational planning.

This application of Delphi does not have an exact parallel. Delphi was used as a strictly non-analytical tool to determine what programming project variables have the greatest impact on programmer productivity. Information of this kind is necessary before important variables can be identified for historical data collection, before data can be collected by observation, or before a simulation model can be developed.

Instead of future events, the Delphi statements were defined as variables (see Table 1). The panel members were asked to correlate each variable

of programmers assigned" was rated plus seven, an increase in the number of programmers assigned would be an extremely important factor in improving the productivity of individual programmers. For a minus seven rating, an increase in the number of programmers assigned would be an extremely important factor in reducing individual programmer productivity. Many of the variables are not easily quantified. "Increasing" the variable in some cases is more of a concept than a reality.

Variables were included in an attempt to define the milieu of a programming project. The last five variables were added after round one because they were suggested by the panel members, so only round two results were obtained for these new variables. The original 30 were composed by the

1. Complexity of application
2. Number of implemented locations
3. Complexity of input (volume, device types, data fields, formats)
4. Complexity of output (volume, device types, data fields, formats)
5. Program size
6. Response time of application being developed (from batch to real-time)
7. Central hardware (processor capability, internal storage size, internal storage speed, word size)
8. Peripheral hardware (external storage speed, external storage size, number of devices)
9. Interfaces with other computer systems
10. Programming language (consider a continuum from basic assembly language to language designed for a particular application)
11. Availability of programmer tools (system utilities, trace programs, dump routines, etc.)
12. Development turnaround time of test facilities (batch to interactive)
13. Quality of external documentation (documentation generated prior to programmer task assignment)
14. Quality of internal documentation (documentation generated during program development)
15. Shop environment (closed to open)
16. Programmer experience in functional area
17. Programmer experience in data processing
18. Personnel turnover rate (low to high)
19. Complexity of operating-system/programmer interface
20. Stability of initial design (from static to dynamic)
21. Characteristics of data base (structure, size, complexity)
22. Definition of "independent" modules for individual programmer task assignment
23. Effectiveness of project communications (completeness of programmer task assignment)
24. Number of programmers assigned
25. Number of agencies concurring in the design
26. Customer adp experience
27. Appropriate documentation standards
28. Availability of documentation aids
29. Well-defined programming practices
30. Total elapsed time required for development
31. Number of unconditional transfer statements in source program
32. Use of structured programming
33. Programmer participation in setting project goals
34. Programming management experience of the project manager
35. Level of coordination required among programming groups

Table 1. Delphi survey variables

Round 1 Sent	Round 1 Received	Round 2 Sent	Round 2 Received
43	39	39	34

Table 2. Delphi response rate

with programmer productivity, which was defined as implemented object instructions generated per unit of time. The panel members were asked to correlate, on a scale from minus seven to plus seven, the effect on programmer productivity of increasing the magnitude of each variable. A rating of zero implied no relationship, a rating of plus or minus four was moderately important, and plus or minus seven applied to extremely important factors. For example, if the variable "number

authors.

The panel members were selected either because they were currently managing programming projects or, because of research and past experience, they were considered experts in the management of programming projects. A broad range of applications and types of organizations was included. There were panel members representing the following organizations: Air Force, American Oil Co., Bell Telephone Laboratories, Army,

IBM, NASA, National Bureau of Standards, Navy, Pennsylvania State Univ., Shell Oil, Southern Railways, and Univac. Some of these organizations had panel members from different functional areas and locations. The high percentage of participation (Table 2) reflects the interest and desire for information on this subject.

The feedback provided the panel members after round one was the median, upper quartile and lower quartile. These were used, since research indicated that there was no known form of feedback that had proven more effective.⁸

The degree of consensus on round one varied considerably among the variables. Some were almost unanimous while others evidenced a range from plus seven to minus seven. The variables

of four to imply significance, there are eight consensus variables which have an important influence on productivity. All results for round one and two are from the 34 members who participated in the complete survey. The outcome of round two showed a definite convergence toward the median.

Although one goal of Delphi is consensus, much can be learned even where there is no evidence of any consensus of opinion. Delphi studies can be used to discover differences of opinion within a constituency. It can be important to know what areas are controversial prior to making decisions.⁹ For the purpose of this study, a lower to upper quartile range of five or more is used to identify controversial variables. Table 5 contains the variables which remain controversial as to their

and operating system complexity, and open or closed programming shop did not receive high ratings.

Another revealing result was variable 31 (number of unconditional transfer statements in the source program). There was a consensus of opinion since the range was one; but the median was zero. From this result it is obvious that this panel of experts does not feel the controversy on the importance of unconditional transfer statements ("GO TO" controversy) is worthwhile in its effect on programmer productivity.

The Delphi procedure provided a useful tool in this analysis of programmer productivity. The level of voluntary participation and degree of convergence definitely made the survey successful. There are variables which experts more or less agree are more important than other variables in their effect on programmer productivity. There also exists a significant amount of controversy concerning the effect of some other variables which are present in all program development projects. □

Variable	Median
Quality of external documentation	6
Availability of programmer tools	5
Programmer data processing experience	5
Programmer functional area experience	4
Independent modules for task assignment	4
Complexity of application	1
Number of installations	0
Shop environment (open or closed shop)	0

Table 3. Round 1 consensus

Variable	Median
Quality of external documentation	6
Programming language	5
Availability of programming tools	5
Programmer experience in data processing	5
Programmer experience in functional area	5
Effect of project communications	5
Independent modules for task assignment	4
Well-defined programming practices	4
Central hardware	3
Quality of internal documentation	3
Personnel turnover rate	3
Complexity of operating-system/programmer interface	1
Customer adp experience	1
Appropriate documentation standards	1
Availability of documentation aids	1
Peripheral hardware	1
Use of structured programming	1
Programmer participation in setting goals	1
Complexity of application	0
Number of installations	0
Shop environment (open or closed shop)	0
Number of unconditional transfer statements in the source program	0

Table 4. Round 2 consensus

Variable	Lower Quart	Median	Upper Quart
Program size	-4	-2	1
Response time of application	-3	0	1
Stability of initial design	-3	-2	2
Level of coordination required	-3	-2	2

Table 5. Round 2 controversial variables

with the most consensus after round one are listed in Table 3. Consensus was defined as a lower to upper quartile range of less than three. The round one variable with the most impact on programmer productivity was the "quality of external documentation" which had a median of six.

Table 4 includes 22 variables on which there was a consensus of opinion after round two. Using a median

importance to programmer productivity.

These results clearly point up the importance that programming project managers place on providing the working programmer with a well-documented, thoroughly defined, independent task. Experienced programmers working in high level languages were also considered very important. Environmental factors such as hardware

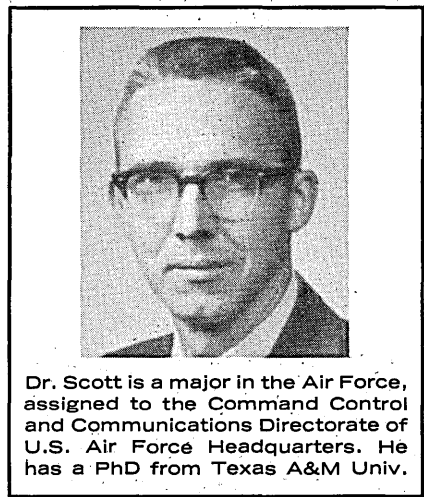

Dr. Scott is a major in the Air Force, assigned to the Command Control and Communications Directorate of U.S. Air Force Headquarters. He has a PhD from Texas A&M Univ.

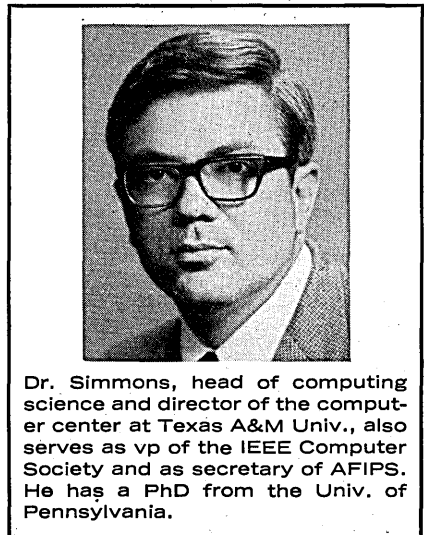

Dr. Simmons, head of computing science and director of the computer center at Texas A&M Univ., also serves as vp of the IEEE Computer Society and as secretary of AFIPS. He has a PhD from the Univ. of Pennsylvania.

8. Norman Dalkey, et al., *The Delphi Method IV: Effect of Percentile Feedback and Feeding of Relevant Facts*, Rand Corp., March 1970.

9. Robert C. Judd, "Use of Delphi Methods in Higher Education," *Technological Forecasting and Social Change*, Vol. 4, No. 3, 1972.

It's everything you've ever wanted in a peripheral for your mini. With a price/performance ratio superior to every other electrostatic printer/plotter on the market.

In fact, the Gould 5000 gives you 1600 lines per minute — and that's more than any other electrostatic printer/plotter on the market.

That means you get high speed for improved mini throughput efficiency. Low cost for economic justification. And, of course, high reliability backed by Gould's reputation for quality.

But you also get a lot more. Resolution of 100 dots per inch. Full alphanumeric and graphic capabilities. 132 characters per line. A 64 ASCII character set. Fan fold and roll paper. 8 bit wide data path.

Optional features? The Gould 5000 is loaded. 96 ASCII character set, upper and lower case. 128 ASCII character set custom designed to your requirements. On-line mini-computer and off-line magnetic tape interfaces.

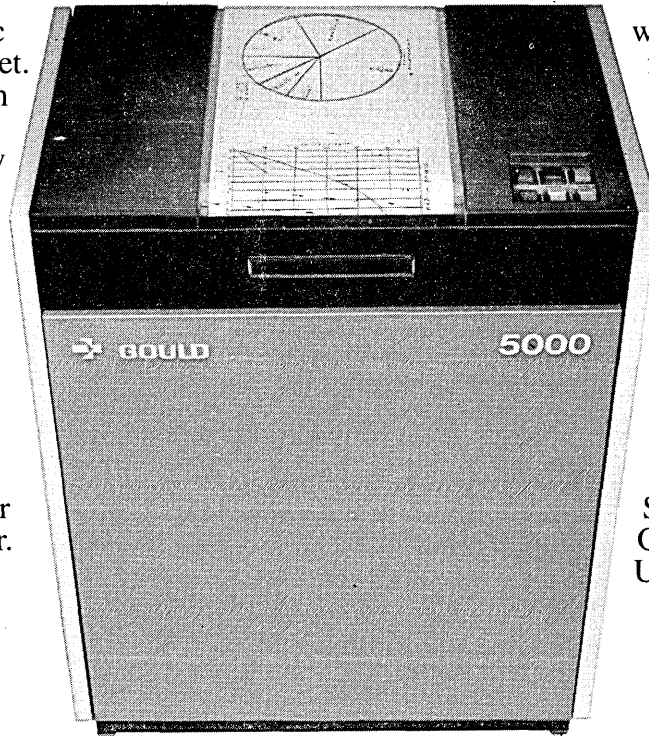

What's more, Gould software is the most efficient and flexible available anywhere. It lets your mini print and plot considerably faster than competitive units.

We say that the new Gould 5000 is the best buy on the market, with the best features of any mini-computer printer/plotter. And our Pete Highberg or Bill Koepf can prove it to you. Get in touch with them now at Dept. D-5, Gould Inc., Data Systems Division, 20 Ossipee Road, Newton Upper Falls, Mass. 02164.

The new Gould 5000. It's the fastest printer/plotter ever designed for mini-computers.

Stability Age Beauty

TEC has profitably manufactured information display and control products for computer-oriented industries since 1958—that's "stability." Since 1963 we've produced crt terminals called DATA-SCREEN™ Terminals—that's "age" in a young industry. Our carefully styled terminals are compatible in any application, match any decor—that's "beauty."

WHY OEM'S SPECIFY THIS DATA-SCREEN™ TERMINAL

... availability

... reliability

... more standard features

... \$1810*



When systems OEM's compare this new terminal with others they find that it's available, *now*. They find that it's part of a family of terminals that have recorded hundreds of thousands of hours of proved, on-the-job reliability in computer communications. And they find that its low price includes many options that must be added to the cost of other brands.

These serial, buffered and conversational mode DATA-SCREEN™ Terminals—Models 450, 455, 456—include a host of important, often used display, data entry and interface options that can be set to customize the terminal when it is installed. A very few features do cost more: exclusive DATA•PANEL® fixed message display; automatic answer back; printer interfaces; and special function keyboards.

For information about these and 15 other DATA-SCREEN™ Terminals offering parallel, serial and teletypewriter replacement interfaces and priced from \$995* contact:

TEC, Incorporated, 9800
North Oracle Road,
Tucson, Arizona 85704,
(602) 297-1111. In Europe:

TEC, Incorporated, 25
Piper Rd., Kingston Upon
Thames, Surrey, UK,
01-549-1920.



CIRCLE 31 ON READER CARD

*Complete with keyboard
in OEM quantities



"White Dove of the Desert"
Mission San Xavier del Bac

CINCINNATI

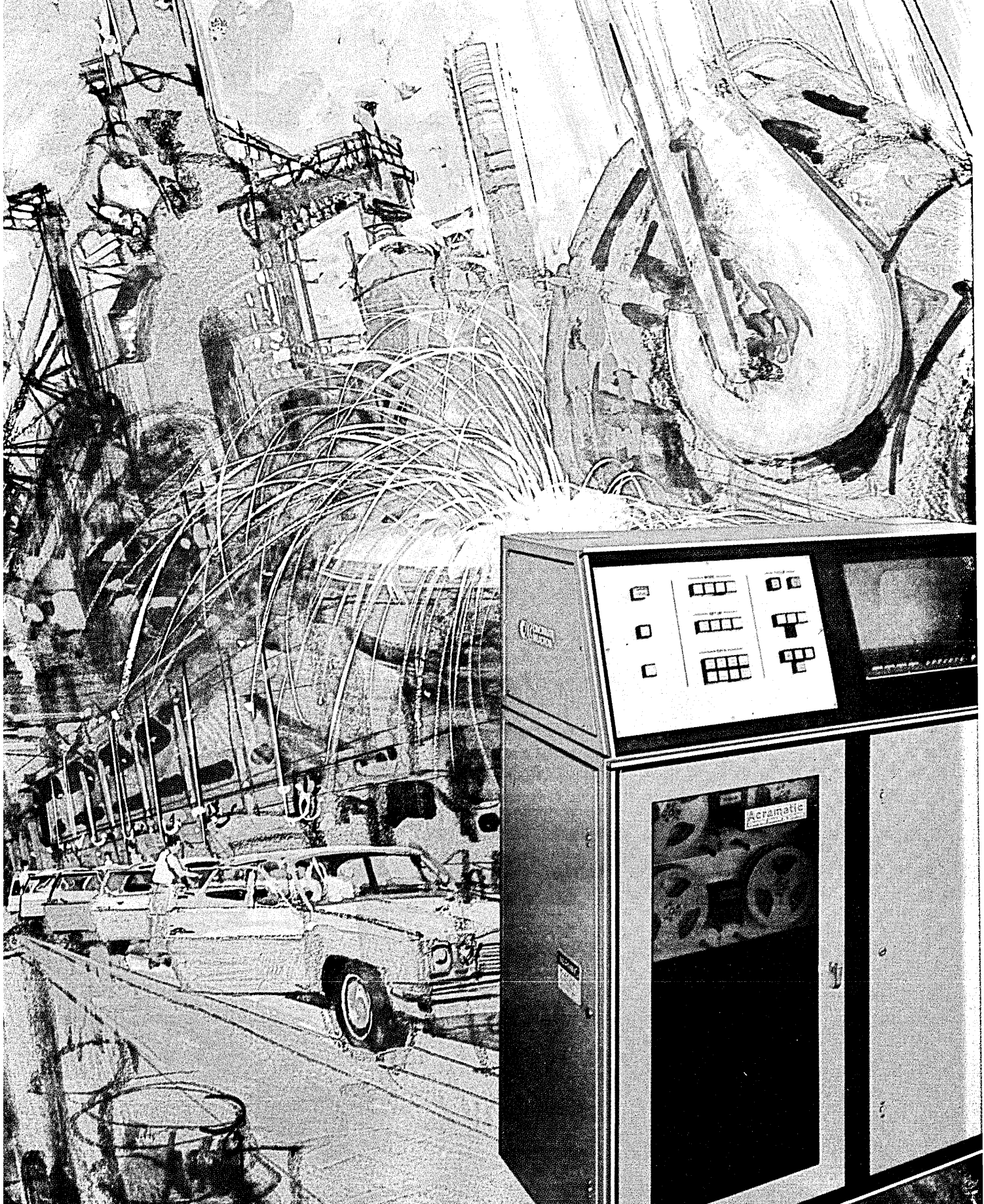

MILACRON has a plan

FOR COMPUTERIZED MANUFACTURING

Write today for your personal copy of this plan. It is available to help you develop your computer aided manufacturing project, machine tool control, N/C data management, inventory control, parts management or any other manufacturing process you may be considering. This plan will aid any manufacturer who is concerned with optimizing his process for improved R.O.I.

Whatever computerization your company requires, we can show you the planning approach that will save you time and money in getting the process on line. We'll be there to help you plan your application and decide how much control to select, what hardware and peripherals are best, how to implement the software, whether to lease from us or buy . . . in short the complete picture for you.

Cincinnati Milacron, a Fortune 500 Company, has been a manufacturer since 1884, solving process problems that are fundamentally the same throughout manufacturing. We've learned a lot. Process Controls Division has over the years participated in the developments in controls, from tubes, to transistors, to IC's to computers on a chip. The same type of long range continuity and graceful transition through planning is available to you.

Computerization doesn't have to be difficult. Our plan shows you how and why. Write for a copy of the Milacron plan today on your letterhead to Mr. Joseph Mount, Director of Marketing, Process Controls Division, Cincinnati Milacron, Lebanon, Ohio 45036.

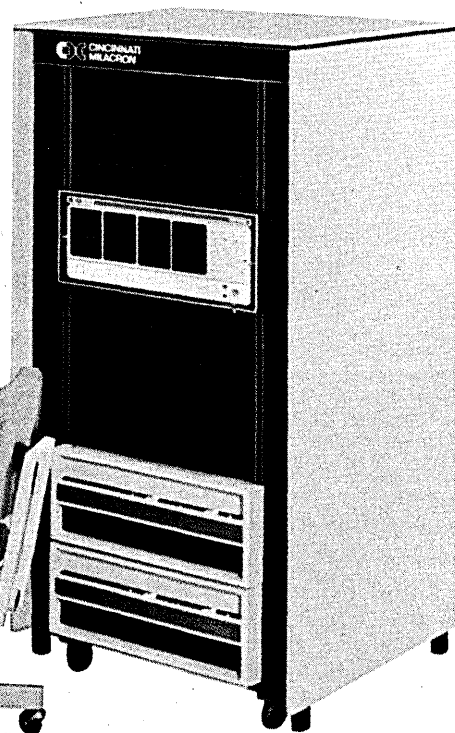

minicomputers
**CINCINNATI
MILACRON**

Machine Tools
Process Controls
Chemicals
Plastics
Plastics Processing Machinery
Abrasives

CIRCLE 22 ON READER CARD

Functional specifications, which show the user how people interact with the machine, should be written before software specifications. When done correctly, they are much like a contract.

HOW TO PREPARE FUNCTIONAL SPECIFICATIONS

This essay is about designing and preparing functional specifications for a proposed computer system. So let's start off with a working definition.

By functional specifications, I mean a set of documents that describe a computer system as it will appear to the user. These documents describe the "user system" as opposed to the software system. The user system includes human actions as well as machine operations. The design must provide for these as well as for other non-computer functions such as the distribution of output. Functional specifications are, in many ways, a contract. The users agree to accept a system that will permit them to function in the manner described.

In contrast, system specifications, which are prepared later, describe the software system needed to make the user system work. System specifications are derived from functional specifications, but their emphasis is on different matters and they are intended for a technical audience. Users may be interested in seeing them, but they should not have to understand the intricacies of computer programming to find out what is going to happen to them when their system goes operational.

The users may be bankers, manufacturers, professors, or even computer programmers. From a systems development standpoint, they have a few things in common:

1. They work for a large organization. It is so large that oral communication is no longer adequate. Things have to be written down and circulated.
2. Their interest in computer systems is very limited, but while it exists, it is intense. That is, they are very concerned about the ways that it will affect them, but probably couldn't care less about the rest of it. This may be

equated with the average programmer's interest in his company's payroll system. Unless he is actually working on the system, his attention is apt to be focused on the timeliness, content, and format of output.

3. The users, quite properly, think they know more about their needs than any hot shot from the systems dept. This doesn't mean they expect him to simply take notes and come back later with what they asked for. But they do want to be involved. They are going to have to live with the new system, and they want a hand in its development.

Failure to provide for this last point in particular causes all sorts of strange things to happen to the project. Users are determined to have some influence over their futures. If the development process does not provide an adequate,

They don't want to have to look in six different places to follow the flow of a single item . . .

orderly mechanism, they will force their views into consideration whenever they feel it is necessary.

For one thing, they make frequent requests for changes after the specifications supposedly have been frozen. Some of these are inevitable. Everyone has a few bright ideas late in the game. But if the preponderance of user contributions doesn't begin flowing until coding has started, it is because the users are only beginning to realize what is happening to them. As they get increasingly familiar with the design, they develop more and more requirements for changes. It is far less expensive and frustrating to get these things out of the way early in the game.

Second, it becomes difficult to get decisions from user management. Still

by Joseph T. Rigo

worse, it isn't even possible to get a rational explanation for the delay. This happens when the user isn't convinced that the project team members really know what they are doing. The situation has been presented so poorly that the user manager doesn't even know what questions to ask. So he stalls. He doesn't want to turn the project off because it may take five years to get it restarted. So he waits. In time the more immediate problems clear up a bit, and the project advances another baby step.

Third, unending parallels. The new system is getting its final tests, and the lower echelons of the user staff are getting into the act. For the first time, they are finding out how they will be doing business in the future, and they don't like it. They want changes, and they get them. One by one. And the company pays the cost of operating under two systems at the same time.

Fourth, members of the project team are adopted into the user family. They would prefer to get on with their glamorous new on-line project, but they keep getting these phone calls. The user needs to know what he must do to get his monthly report run. All the instructions were put into a user manual, but it lies buried in a forgotten desk drawer. It is easier for the user to call someone from the old project team for his answers, and human nature, like water, always flows along the easiest course.

Finally, the system never lives up to the expectations for it. The day after it is installed, the users begin speculating about what they really would like.

Of course, no set of functional specifications is going to solve all these problems. Good management and thorough systems analysis are essential. But it is difficult to have either of these without good written communications. This may be the electronic age, but it is still possible to circulate the written

word to people who can't fit into a room for an oral presentation. It is still possible to stare at a written spec until you figure out what is bugging you. Once the problems are discovered, they can be ironed out in face to face meetings.

Lots of people in this business spend enormous amounts of time writing. Yet they still seem to have problems communicating with their users. It is possible to generalize about some of the reasons, and, in good tech writer fashion, I have ordered them into another list.

Too much computer jargon. This is the most easily remedied problem. Users don't understand programmerese, and they resent being forced to learn it. By the time they reach the recommendation at the end of the document, they may be visibly angry. This doesn't help anyone's sales pitch. Interestingly, it is not particularly difficult to get programmers and analysts to write in English. All they need is a good example to follow and a little encouragement.

Too much computer and management information. Users are not particularly interested in hardware configurations that they will never see, blocking factors, disc cylinders, or HASP. They may be willing to learn a little bit about data base, but not much. They just want to know how they will be able to get their work done. Where will the terminals go? What will the reports look like?

Technical specifications normally should not even be included in the same document as functional material. If the technical material is there, readers will feel that they have to understand it in order to grasp the information they really want. They can't, of course, and their ability to cooperate with the project is affected.

Similarly, only a limited portion of the user staff is seriously interested in project costs and schedules. This management information should also be communicated separately.

Information that is of concern to the users doesn't get included. Project teams spend enormous amounts of time trying to explain OS JCL, but don't bother nailing down report formats until the programming specs are written. Terminal response times are discussed in detail, but there is nothing about how the work will get done when the power fails. The user wants information about proofs and controls so that he can be sure that all his operations—inside and outside the computer—are going properly. The head of the key-punch section wants to know how its workload will be affected. Dozens of

other people want to know where they will find the information they need once the card files disappear.

Not enough documents. Many small documents are better than saving everything for one massive package that can't be read and reviewed in less than five weeks. Each document can be geared for a particular segment of the user audience. Each can be reviewed, revised, reviewed again, and finalized while other project work goes on. One of these may provide a brief overview of the entire proposed user system so that each person will be able to find his place in the grand scheme. All of them can be bound together for the user manager's display shelf at the end of a phase. But at key decision points, formal review and approval should be perfunctory. All the real problems should have already been solved. In small documents for specialized audiences, errors and omissions stand out better. Misunderstandings can be clarified, and it is possible to identify and resolve small problems that otherwise might slip through while attention was focused on major issues.

Poor organization. There is a tendency when doing this sort of work to orient the specifications around the organization of the proposed software system or of the project team. If the team is divided into groups for technical purposes, each contributes a section for the functional specs.

This is similar to organizing a FORTRAN programmers' guide around the phases of the compiler. But most programmers don't really care about what happens in the parse phase. They only want to know the rules for using

... after it is installed, the users begin speculating about what they would really like.

an IF statement, and they want all the relevant information in one place, not split among five.

Users are interested in the processing of their business transactions. They don't want to have to look in six different places to follow the flow of a single item of business.

Functional specs should be organized around staff jobs in the user organization. They provide the information a person will need to know to perform his work, which may be to punch a card, read a report, or manage a department. They may assume that a keypuncher knows how to key-punch and the manager knows how to manage, but they cannot assume that everyone knows all the deadlines and shifted responsibilities that will be in-

troduced with the new system.

It is not necessary, of course, to write specifications for every staff job or even for most of them. Determining exactly what needs to be written down is still a matter of professional judgment. The main guideline would probably be the degree that the job is being affected by the new system. In any case, few project managers are accused of providing too much of this information.

The exact nature of a set of functional specifications also depends upon the needs of the individual project and user. Or, as they said in the Army, the answer varies according to the situation and the terrain. Nevertheless, the following basic elements or documents may be considered:

Run description. One of these may be prepared for every computer run in a batch system. A run may be defined here as everything that happens from the time a user sends input to the computer center until he gets output back. The question of whether the run requires execution of one program or 50 should not be important to him.

The audience for this document is the head of the group that will be responsible for getting the run. This is not necessarily the same person who prepares the input or uses the output, although both may flow through his hands. This document provides:

- The English and technical names of the computer operation so that the user and the computer operators can talk to each other.
- A brief statement of the purpose of the run. This will help the user communicate with other users.
- Prerequisite runs.
- What other runs will depend upon the execution of this one?
- Deadlines. When must input be submitted? When will output be available?
- Input. No details, but list everything that will be sent to the computer center, including run request forms.
- Output. What will come back? Again, no details at this point.
- Verification information. This section contains information about how the user will be able to ensure that everything ran properly. Possible error messages may be listed, along with an indication of corrective action required. This should be just enough so that the user will know when to hold up distribution of the output because of conditions requiring a rerun.
- Detailed instructions for filling out any forms that are needed. Other information relevant to this

FUNCTIONAL SPECIFICATIONS

run may be included. General information about dealing with the computer center, securing re-runs, solving disputes, etc., would usually be documented separately. Such information is subject to change independently of system changes, and it should be possible to make such changes without having to revise every outstanding run description.

Input descriptions. One of these is prepared for each item of input for a batch system. The audience might be a keypunch operator or the head of a keypunch section. If this is the same section that communicates with the computer center, this might simply be an attachment to its corresponding run description. It need not be treated as a separate document unless it has a separate audience.

Alternatively, this document may describe how to fill out a form that will be handed to a keypunch operator. The only real difference is that a copy of the form would be attached with sample entries filled in.

If the input item is a card, this document identifies every entry, one by one, generally by card column. It identifies exactly what gets punched. If the person must make a decision, it indicates what the options are and the rules that apply. All codes are explained.

In some cases, it may be desirable to identify the source of each item of information going into the card. Where will the data come from, what does it mean, and how will it be used? The audience for this type of information is clearly someone other than the head of the keypunch section, but this type of document might still be a convenient means for presenting it.

Report descriptions. One of these would be prepared for each report to be produced by the system. It is intended for the people who will be using that particular report. It contains the following data:

- Name of the report.
- Purpose and use of the report. This can be done in one paragraph; it is not intended to be a job description.
- Identification of the computer program that will produce the report. This is essential for cross reference and communication between the users and the development team.
- Who in the user organization will be responsible for producing the report?
- Schedules and deadlines. How often is it produced, and what deadlines apply?
- Anticipated volume. This pro-

vides guidelines for determining how big the report will be: e.g., one page for every 20 accounts.

- Distribution plans. Who will get copies, how long must they be retained, and are they simply thrown out later or must they be filed?
- Illustrations of planned page formats.
- Derivation of data elements. This explains each item of data that will appear in the report. It will identify the source of the data, what happened to it during processing, and what it means in its current state. All codes must be explained, as well as abbreviations and user jargon.

Clerical task description. One of these may be prepared for each key staff job under the new system. In particular, it may describe how to use the computer output to perform other work. For example, if the organization has to fill out a government report, it may indicate where a staff member will be able to find the necessary information once the current sources have been converted to disc files.

On a more elaborate basis, a terminal user's guide prepared at this stage may serve as an excellent design specification for an on-line system. It would indicate all operator actions and the computer's responses. The goal of the project team would then be to build a system to function as described.

Management information. One of these might be prepared for each user manager who will be affected by the new system, although the level of detail required for each would vary. It indicates how the general flow of work through the manager's organization will be affected. It defines any changes of responsibilities between his and other organizations. It describes plans for keeping the organization in business if the computer goes down for an extended period. And it indicates what work must get priority if large numbers of staff members are absent because of a flu epidemic or whatever.

This may be supplemented by documented agreements on items of particular interest. Bankers, for example, are very concerned about the formulas to be used for calculating interest. The agreement that is worked out may be attached as a separate document to the management specification for the appropriate organization. In matters like this, the format is not particularly important. The real problem is in figuring out what has to be said and securing agreement.

Other documents may be added as necessary. The above list, for example,

makes no provision for telling the user what data will be contained in the electronic files. This has to be done somehow and may be treated as one more special small document to be attached to a management information specification.

Issues of security and privacy may be discussed as well as provisions for handling confidential information. By documenting them in this manner, as part of the formal functional specifications, they are included in the "contract" between the user and the project team. Yet their circulation is easily restricted to those with a need to know.

Clearly, this approach to functional specifications involves a lot of paper, and no one project is going to be so complex as to warrant all of it. Nevertheless, it is a possible way of doing things, and any one of these small documents may be a solution to a problem. It is not necessary to buy the whole package. Only one report in a whole system may be so sensitive that it requires a full scale report description document. If the problem does come up, though, it is good to know of a way of tackling it, and to have samples on hand of how the format was used in other situations.

Equally clear, I hope, is that complete functional specifications make excellent source material for other activities, notably for user staff training and for preparation of final user documentation. To serve such purposes, updating is necessary as the project goes on. But the major conceptual work will have been done. For user instruction and reference documents, illustrations of actual forms, machines, and output can be added. And the only remaining step is to bind each of them in a bright cover so that it can be quickly spotted in a pile of papers when it is needed. □

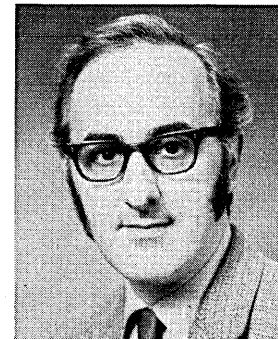

Mr. Rigo majored in journalism at the Univ. of Maine, and subsequently wrote weather reports for the Associated Press and programming manuals for IBM. He is currently assistant vice president at Bankers Trust Co. in New York.

DP DIALOG

Notes and observations from IBM which may prove of interest to data processing professionals.

DP DIALOG appears regularly in these pages. As its name suggests, we hope DP DIALOG will be a two-way medium for DP professionals. We'd like to hear from you. Just write: Editor, DP DIALOG, IBM Data Processing Division, White Plains, N.Y. 10604.



Dr. Alec Broers examines an X-ray image-forming device with the new low-loss scanning electron microscope.

Exploring An Invisible Realm

With their incredible densities, computer components are rapidly approaching dimensions no longer visible with even the best of optical microscopes. Now, two IBM scientists have made a major advance in electron optics, a key to further technological progress. Dr. Oliver Wells and Dr. Alec Broers have developed a new method for operating the scanning electron microscope which may allow research-

ers to see surface details as small as 10 angstroms—or a few atoms wide—on many objects.

Among the samples being examined are specimens ranging from blood cells to minute electronic components to the experimental X-ray image-forming device pictured above, a development being pursued by Michael Hatcakis and Dr. David Sayre, also members of the Thomas J. Watson Research Center in

Yorktown Heights, N.Y.

Whatever the eventual applications of their development, both Drs. Wells and Broers agree that, in areas from medicine to metallurgy, "This new low-loss electron method gives us a chance to examine the world around us, to discover what was perhaps unknown before."

In a conventional surface scanning microscope, now a standard research
(Continued on Page 3)

How Data Entry is Working for the Tappan Company

To meet the need for timely sales and production information, the Tappan Company is using teleprocessing to home in on the ranges. Key elements in the network, which also provides data on other products in the firm's Appliance Group: a System/370 Model 145 at Tappan's Mansfield, Ohio headquarters and IBM 3740 data entry systems at 12 major distribution and manufacturing centers across the country.

The Appliance Group initially used communication terminals to link remote facilities with the central computer. "The terminals served our purpose in getting the program underway," says Don Jenkins, Data Processing Operations Manager, "but they don't compare with the 3740's speed, ease of operation and user acceptance. The 3740 offers much higher data transmission rates, has a faster printer, and the visual CRT verification reduces operator error."

With the communication terminals, operators keyed order information into batch buffers. These were later polled by the central computer, and during the evening this data was fed into the Appliance Group's comprehensive finished goods system.

Early the following morning, headquarters returned data files to the dis-

tribution and manufacturing sites, where the required shipping information, in-transit reports, orders, invoices,



For Tappan's Appliance Group, the 3740 data entry system is a key element in a teleprocessing network that links the company's headquarters with major distribution and manufacturing facilities.

manufacturing schedules, current inventory status and exception reports were generated.

Recently, Tappan installed a 3741 dual data station and 3713 printer at each remote location. Operators now enter order data onto the 3740 diskette.

"Originally, it took time to educate our personnel at the remote sites to do things differently," Jenkins explains. The similarity between the old and new procedures, and the operator features of the 3740, made installation of the new equipment "very easy, almost an evolution," he adds.

The Appliance Group has also moved to 3742 dual data stations to meet its headquarters data entry needs. And, in several instances, central machines and data entry personnel have been moved directly into user departments.

"This has proved to be a real asset," Jenkins notes. "Data entry operators are finding short-cuts, redundancies we never would have found centrally, and they're gaining a real identification with users, and a better understanding of what the business is about."

"The 3740 has resulted in decidedly greater productivity," Jenkins says. "Our operators like it better—and their work clearly shows it." **IBM**

System/360: A Decade Later.

Just over ten years ago, on April 7, 1964, IBM introduced System/360 at meetings of more than 150,000 people in nearly 100 countries around the world. "In the annals of major product changes," observed one leading business magazine at the time, it was like the "switch from the Model T to the Model A." The announcement was, indeed, dramatic in scope and far-reaching in its effect.

A decade later, System/360 spans nearly half the history of computing, a history that stretches from the ENIAC and Whirlwind I to virtual systems. It provides a benchmark against which to measure an industry's startling growth and a perspective on how much the computer's capabilities have expanded.

Take growth, for example. One estimate puts the total number of systems in use in 1964 at about 20,000. By 1971, when the first System/370 was delivered, that figure had quadrupled to over 80,000. Today, the total is estimated at well over 100,000.

Growth in the computer's capabilities has more than kept pace. System/360 was introduced as a compatible family in 19 combinations of speed and memory size—the largest 50 times more powerful than the smallest.

It offered a two-fold improvement in price/performance and a system architecture able to accommodate both scientific and commercial applications. Even in an industry which moves in seven-league strides, these were bold and dramatic departures.

Today, System/360's integrated circuitry has been overtaken by the monolithics and MOSFETs of System/370; the operating system has made the quantum jump to the virtual system; the promise of teleprocessing and management information systems has become the reality of data base/data communications networks.

Ten years ago, the smallest, least expensive System/360 was the Model 30. Now, a similarly configured System/370 Model 125 would cost less, have twice the real memory, double the on-line direct access storage with fewer spindles, five times the direct access data transfer rate and more room for writing instructions than even the largest System/360—up to 16 million characters of virtual storage. That kind of progress is characteristic of data processing. It may be worth recalling that a significant share of it began on April 7, 1964. It was quite a day. Quite a debut. Quite a decade. **IBM**

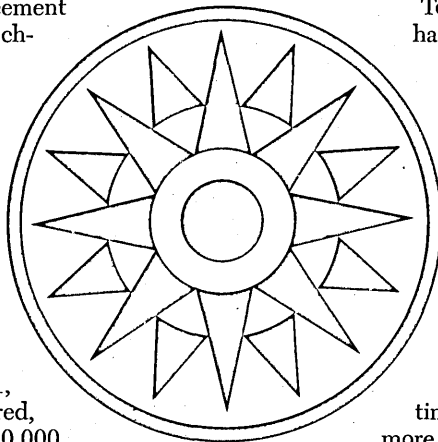

Sidelines

New Aid to Medicine

At the Texas Institute for Rehabilitation and Research in Houston, scientists are using an IBM computer to produce highly accurate, three-dimensional measurements of the human body for studies ranging from spinal deformities in children to weight loss in astronauts.

Overlapping photographs of the body are taken simultaneously. Then a plotting device, like the type used in aerial mapping, identifies reference points common to each photo to create a three dimensional image. These ref-

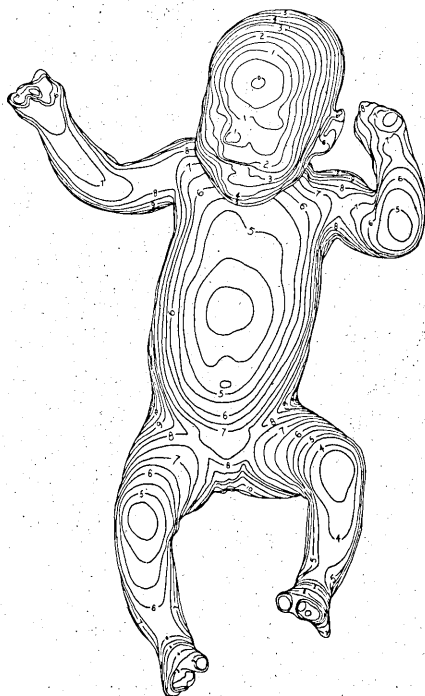

erence points, which can number over 40,000, are fed into the computer to produce precise measurements of the entire body or any part of it. With a computer driven plotter, such measurements can be shown in a number of ways—the contour map of the body pictured above, or cross sections of the body, or graphs showing how body volume is distributed from head to foot—to assist doctors in their diagnosis and treatment of a wide variety of medical disorders.

Energy Conservation

With the double-edged problem of uncertain fuel supplies and spiraling power costs, more and more businesses and large institutions are seeking new ways to conserve energy. In Jacksonville, Florida, the Gulf Life Insurance Company is meeting both

problems in its 27-story home office building with the help of an IBM System/7. Operating under IBM's Power Monitoring and Control program, the system checks the entire structure's power demand every 30 seconds. As demand approaches a pre-determined limit, the computer begins to systematically cut back on power consumption without appreciably affecting the comfort of building occupants.

Company officials estimate the System/7 will help reduce Gulf Life's use of electric power by better than 18% a year. They also expect to see net savings of more than \$75,000 annually in power costs.

Streamlined Data Entry from Remote Locations

For computer users whose business information is dispersed over multiple locations—like insurance companies and distribution firms—the recently-announced IBM 3790 Communications System can provide new remote processing capabilities and streamline the flow of information to the central computer.

In processing an application for an automobile policy, for example, an insurance agent need only key in data at his remote location. The 3790 can immediately check the format and accuracy of the data, scan appropriate rate tables, determine the proper premiums and even calculate the agent's commission.

In addition to this stand-alone feature and ability to process and store data for later batch transmission, the 3790 will also interact with most virtual storage models of System/370, giving remote offices direct access to master records and the additional processing power of larger host computers.

Key to the 3790 system is the programmable controller. Also available are display units, keyboard printers, communication terminals, line printers and an optional auxiliary control unit.



Invisible Realm...

(Continued from first page)

tool, a beam of electrons scans a specimen. Secondary electrons are ejected from each point on the surface as the beam moves back and forth. At the same time, a spot is scanned across a

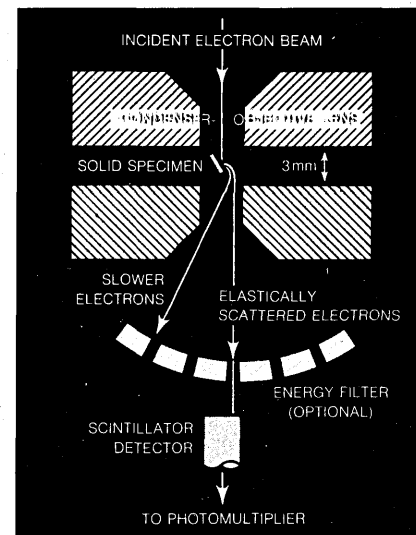

Resolution is higher in the low-loss scanning microscope because a shorter focal-length lens can be used.

cathode ray tube. The strength of the ejected electron signal controls the brightness of the CRT beam, resulting in a picture of the surface under study.

The microscope's resolution, or ability to clearly distinguish smaller features, is limited because the specimen must be focused as much as a centimeter from the electromagnetic lens to collect electrons efficiently.

In another type of standard microscope—called a transmission microscope—objects can be placed as close as a tenth of a centimeter to the lens. But because in this case the electrons pass right through the specimen to form the picture, only thinly-sliced samples can be examined.

Drs. Wells and Broers have combined the two techniques so that the surface of solid samples can be seen with extremely high resolution. While the sample is placed in the same position as in the transmission microscope, the key difference in their development is the use of low-loss electrons—original electrons from the beam that lose very little energy on striking a solid surface. Low-loss electrons which bounce off the sample surface are pulled back by the lower half of the lens and are collected to provide the output signal.

The new electron microscope has been in its present form since the Spring of 1973, although it had gone through several stages of development before that time. It is currently capable of useful magnification up to 300,000 times.

Cheese, Music, Puzzles Result in Tailor-made Curriculum

Nearly half of all college students never graduate. But one college in Michigan has cut its dropout rate to 20% by using a computer to help show teachers what makes their students tick.

Dr. Joseph E. Hill, after becoming president of Oakland Community College in the suburb of Detroit, adopted a new technique which tests a student's ability to understand the world around him. The way individual students respond helps the faculty determine what the best learning environment is for each one—whether it be a classroom, individual study with programmed materials, informal conferences with classmates or a combination of all these approaches.

Instead of the standard battery of diagnostic tests which most students undertake, Oakland asks them to participate in such diverse activities as tasting cheese, listening to music or assembling puzzles.

Dr. Hill says: "In one test for example, we ask the students to walk a line—but we put a chair in the way. What they do tells us whether they're likely to follow instructions to the letter or go their own way."

"We know everybody is different. Some feel and see and

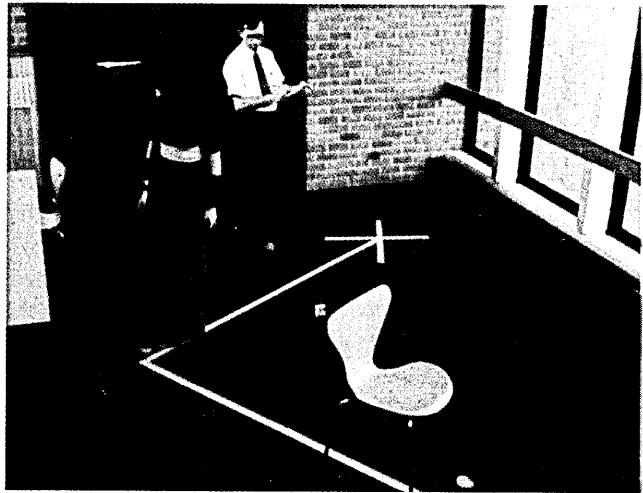

What this student does with the chair in her path will indicate how prone she is to following instructions to the letter or just going her own way.



Cheese tasting tests a student's differentiation powers through taste, smell and sight.

hear things that others don't. Some reason logically, others impulsively. To pull together all these variables we have programmed an IBM computer to process tests results and produce a 'map' of each individual's style of learning—his cognitive style. With these maps we can personalize study programs and put each student in a learning situation which is best for him."

The study program does not rule out the traditional classroom and lecture hall method, but offers alternatives to students who are geared to learning better in other ways.

In 1973 over half the 15,000 students at Oakland took the cognitive style tests. By 1975 Dr. Hill hopes to have facilities for at least 60%.

He first used computer analysis to process results of cognitive style mapping while serving as consultant to Detroit's federally funded Urban Adult Education project in the mid-Sixties. In the early stages of his research Dr. Hill worked out cognitive style maps by hand but he says "it wasn't practical. The variables for any one individual's development process are so great you need a computer to

process them. In fact, from pre-school to the second year of graduate school more than 1,000,000 profiles are possible. There are more than 3,000 possible profiles at a given level of educational development, although between five and seven hundred are most commonly found."

While cognitive style mapping has already gained acceptance at many other colleges and secondary schools throughout the United States and Canada, Dr. Hill hopes eventually this new testing procedure will become even



This student tests his motor skills by passing a wire loop over an undulating electric "eel" without touching the surface.

more widely accepted. "It's about time we adjusted our teaching styles to the learning styles of each student. We should begin to teach students as though they would pass, not as if they would fail."

IBM®

DATAMATION

The FORUM system enables a distributed community to share ideas, exchange data, and make group decisions through a computer network

NETWORK CONFERENCING

A scientist returning from a stay at his remote vacation cabin on the shore of a lake in Canada once told me of his conversation with his only neighbor there, a retired philosophy professor.

The scientist had spent some time building a walkie-talkie set with his teen-age son, and after this effort they were gratified to find that the system was working perfectly. My friend immediately informed the philosopher of his achievement: "I have talked with my son who was over a mile away in the forest. Isn't that wonderful?"

"I don't know," said the old man. "What did you talk about?"

We might put the same question to the builders of computer networks, and the people who design software to run on them: How much of the communication on such networks is meaningful, stimulating, and usable by human beings? And how much of it is trivia, only made necessary by the awkwardness of the command languages, the constraints of the file structures, and the inadequacy of the hardware? When will the impact of computer networks begin to be felt in the communication of information among groups of people?

The answer is that until very recent-

ly the computers that were playing a great role in processing data were not used at all in exchanging ideas about them. During the '60s very few projects were aimed at producing and demonstrating conferencing software. (Convenient terminals, it is true, were



In 1929, science-fiction writer Hugo Gernsback hypothesized a communication medium that would couple the ability to send text messages to another person with that of actually seeing that person on a special screen. Current developments in terminal technology and time-sharing software bring his concept close to economic feasibility.

by Jacques Vallee*

an expensive luxury.) Turoff's work¹ is notable among early projects that explored techniques enabling more than two groups of users to conduct computer conferences.

A primitive form of information exchange among users of PDP-10 computers on the ARPA network is the "link" mechanism of the TENEX operating system. It enables a user to communicate with another terminal by typing a message string that is transmitted one character at a time. This mechanism can be extended to several users, but the interaction soon becomes garbled as the number of participants increases.

There is also a message distribution system that is in wide use around the network. It relies on a "mailbox" mechanism that enables any user to place the text of a message into another user's file space at another network site. Although the program allows multiple copies of the text to be distributed, it does not permit conferencing in the sense of several users sharing a common file space.

A third approach to the support of community information needs is found in the work of the Augmentation Research Center at Stanford Research Institute, where a complex text-editing language is available to create documents that can be "journalized." These documents are assigned sequential numbers to facilitate retrieval and they become available to all members of the

*This research is supported by the National Science Foundation under Grant GJ-35 326X and the Advanced Research Projects Agency under contract no. DAHC 15 72 C 0165.

¹Murray Turoff, "Human Communication via Data Networks," *Computer Decisions*, January, 1973.

NETWORK CONFERENCING

user group to which they are sent. Both the journal mechanism and the message system are asynchronous in the sense that participants do not interact through the medium in real-time.

Forum on ARPANET

Our own effort has centered on the development of a different approach to network conferencing, aimed at providing a spectrum of possible meeting structures under which any number of participants (limited only by the number of available ports) could exchange ideas and information, make real-world decisions, or even elicit forecasts.

The program development described in this article has resulted in the introduction of a system named FORUM that shows promise of improved interaction among experts. One of its peculiarities is the fact that—in contradiction to most interactive systems on the network—it does not require training in the use of a particular language. As a matter of fact, a participant can go through an entire conference without learning a single command, and no special or control character is used.

Oddly enough, the research that led to the design of FORUM was not initially aimed at supporting a better way of linking people in free-form discussions. Instead, it originated with the observation that current techniques for opinion elicitation and the use of experts in such situations as technological forecasting, education, and decision-making had severe shortcomings. The use of the computer both as a communication medium and as an information-handling tool appeared as a promising direction for improving the flow of ideas and data among experts at a time when many organizations relied increasingly on such expert knowledge to conduct their day-to-day business and to plan their long-term development. An effort was begun at the Institute for the Future with the hypothesis that a computer-conferencing network might have a range of applicability extending beyond the extreme case of the structured questionnaire.

FORUM has the ability to administer hundreds of questionnaires simultaneously but it also allows a completely open, unstructured conferencing style. An experimental version of the program began to be used on the ARPA network in June 1973 with the release of the participants' program to the Automatic Programming group at the Univ. of Southern California (USC-ISI), and with the release of a version including the conference set-up program to the Advanced Research Projects Agency the following month.

The set-up program performs three major functions. First, it guides the chairman of an inquiry in setting up, in advance, the files necessary for conducting the inquiry. When the set-up process is complete, these files contain highly structured information about the group of intended participants, the agenda of topics and questions to be treated, and the specific information elicitation, processing, and feedback activities to be undertaken. Second, the program performs the routine functions of administering the inquiry: providing instructions to inquiry participants, leading them through the agenda, posing questions, storing and processing answers, and presenting summaries of results—all according to the chairman's specifications. And third, the program allows inquiry participants to interrupt their activities and call for special functions such as review of instructions or substantive background, communication with other participants, deviation from the agenda, and monitoring of both the accumulated data and the status of participants.

In its specific features, FORUM is characterized by its interrupt capability, adaptive instructions, message handling, loss-of-carrier response, editing of text input, and synchronous conversational capability. Several other key features have been added to the control program which were not anticipated in the earlier stages. These include the use of linked-allocation "tree" indexes in most of the files, improved handling of unexpected or faulty user input, and an extended command repertoire for the conferee and chairman.

Experiments with data bases

During May 1973 our project made arrangements to link the three main administrative centers of the U.S. Geological Survey (USGS) in a series of teleconferences using FORUM. The reasons for this choice of user community were the following:

1. The USGS is an organization with widely disseminated centers that provides a typical environment in which to explore such applications of teleconferencing as joint planning and policy formulation.
2. The USGS has wide experience in the handling of information and is currently facing a problem of central planning for its data bases. In this environment the capability to link information retrieval centers through a teleconferencing network could be demonstrated and explored.
3. Experience with time-sharing

systems at several levels already existed within the survey, and terminal equipment was available on the premises at all three sites in Washington, D.C. (Office of Resource Analysis), Denver, Colo. (Branch of Computations), and Menlo Park, Calif.

One session was a demonstration of teleconferencing in concert with mineral resource data bases (see Fig. 1, p. 91).

In Denver, one of the participants operated a terminal linked to an oil and gas information system resident in INFONET's computer in Los Angeles. In Menlo Park, another geologist was operating the DIRAC-2 interactive retrieval system running on the Stanford Univ. IBM 360/67 computer. Under DIRAC-2 a data base of Alaska mineral resources was maintained.²

The following is a sample of the interaction as it developed in the environment described (the names of the participants have been replaced by single letters):

B (geologist in Washington):

To all participants: Please ask your requests relative to the variable listed at the beginning of the session. At this time, I'd like to ask you all to submit the first round of questions (i.e., retrieval criteria).

A (geologist in California):

To R: How about a list of counties?
C (California):

To B: Let's do a retrieval on pools in Colorado which have a production of greater than 2000 bbls in 1969 and produce from a Type "A" sand.

C:
To B: Retrieval criteria production > 2000 producing rock type "A" sand.

A:
To R: Did you get our request for a list of counties included in the file?
R (Denver):

To A: Yes we have the request in the system.

IFF (Institute for the Future):

I wonder if you can fill this request. Can you give me the percentage of unused oil and gas resources still in the ground (compared to total resources) in your sample data base?

B:
To IFF: We will give you the total reserves for oil and gas, and also the total production. The difference is your answer.

R:
To B: Here is a list of county names: Baca, Bent, Boulder, Cheyenne, Delta, Elbert, Fremont, Gar-

²Vallee and Askevold, "Information Organization for Interactive Use: Design Implications in Data-Base Systems," *Journal of ASIS*, July/August, 1973.

Cluster type layout for programmers includes Reference File for hanging storage of loose print-out in Wright Line Hanging Print-Out Folders.

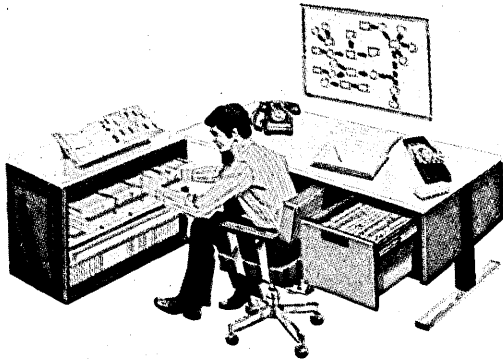

Programmers work station has specialized storage for cards, loose print-out in hanging folders and other documents. Portable key punch and Magnetic Visual Display Board are also shown.

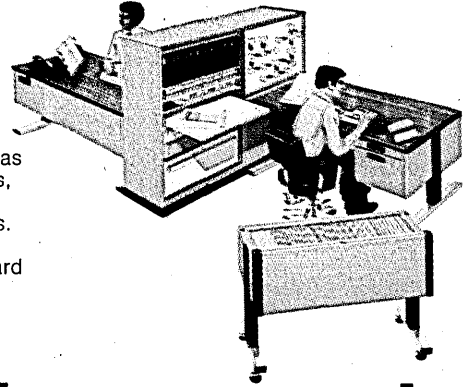

systems and programming work environments

Systems analysts and programmers have needs that cannot be properly met with conventional office furniture. Wright Line's specialized Systems and Programmers equipment meets these needs in work stations that are efficient, aesthetically pleasing and compact from the standpoint of floor space requirements.

Our new brochure shows typical work environments and specialized equipment. For a copy, circle the readers' service number or write to Wright Line, a Division of Barry Wright Corporation, 160 Gold Star Boulevard, Worcester, Massachusetts 01606.

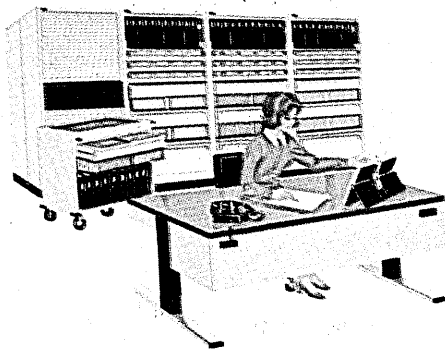

Systems and Programming library designed to store and access mixed media includes Optimedia Reference Stand, Optimedia Cabinets and Truck.

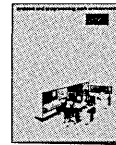

Highly compact work environment for systems analysts includes work surface, completely flexible storage arrangement and magnetic visual display boards for PERT or flow charting.

Application and Professional Services



Engineering Services

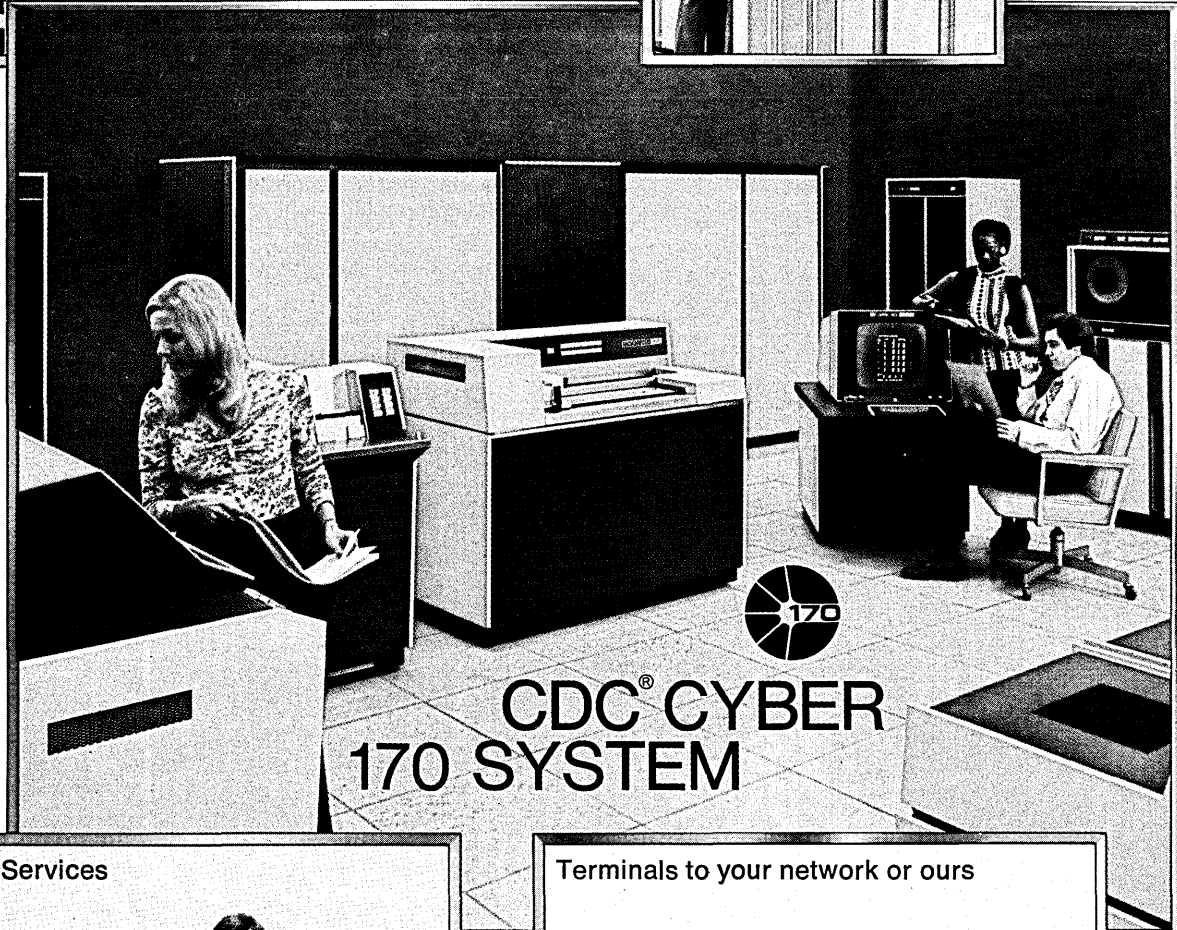
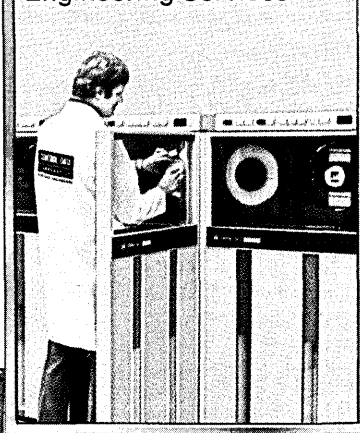

CDC[®] CYBER 170 SYSTEM

Education Services



Terminals to your network or ours

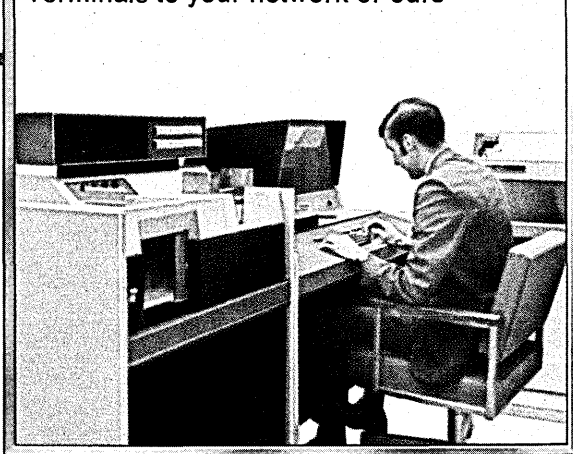

Control Data Corporation Announces

The CDC[®] CYBER 170 System

A versatile new computer system
from the Total Services Computer Company.

- A computer system that performs scientific, engineering, and business data processing . . . in timesharing, batch, remote batch, and transaction modes.
- New and improved software, high performance peripherals, plus new data communication systems for network processing.
- Separate element pricing to let you buy just what you need.
- Total services support worldwide, including . . .
 - engineering and architectural
 - applications development
 - education and training
 - systems analysis
 - maintenance
 - consulting
 - financing
 - CYBERNET[®] Data Services to supplement your own system when needed.

Find out how this reliable and versatile new computer system — using proven computer architecture and advanced technologies — can improve your company's data processing efficiency.

Contact your local CDC sales office . . . or dial our Hot Line collect* (612/853-3535) . . . or write to Control Data, D-54, Box 1980, Airport Station, Minneapolis, Minnesota 55111.

*U.S.A. only

CONTROL DATA

CORPORATION

IS THIS HOW YOUR VIDEO TERMINAL OPERATORS SEE THINGS BY THE END OF THE DAY?

Clear things up with a clustered video terminal system from Quotron Systems. Our terminals were designed for a room full of people.

Besides the standard green phosphor and anti-reflectant screens, Quotron Systems adds a unique dimension for display resolution — a 16x22 bar mosaic matrix for character patterns. You get 352 tiny rectangles for resolution compared with the 35 dots of the conventional 5x7 dot matrix display. Because of a more flexible pattern and no

voids between display elements for the eye to fill in, Quotron Systems gives you characters with print-like quality.

Our 16x22 matrix is a very revealing dimension when used for forming lower-case letters, single position fractions, double-letter symbols, graphs and underscoring.

Avoid a roomful of problems. Give Quotron quality to your eye weary operators. Quotron's Intelligent Terminal Systems provide powerful solutions along with resolution.

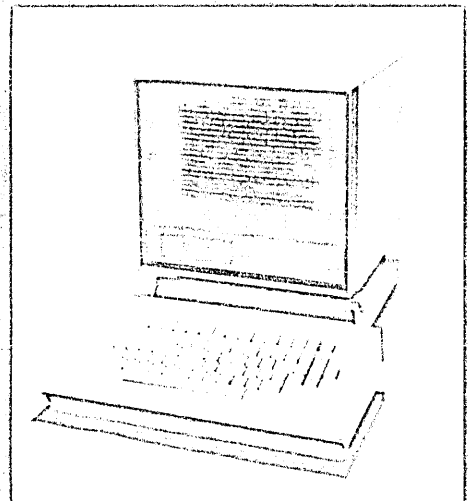

QUOTRON SYSTEMS, INC.

Systems Marketing • 5454 Beethoven Street • Los Angeles, California 90066 • Telephone: (213) 398-2761

NETWORK CONFERENCING

field, Jackson, Jefferson, and Kiowa.

B:

To all: Please try and stick to the variables listed in the beginning of the session.

To R: For IFF use variable L1A and L1C for reserves.

R:

Nine records were found which had annual production of crude in 1969 greater than 2000 bbls.

A:

Okay. R: How about a list of all the oil fields in Cheyenne County and their annual production for 1970?

B:

To A: Remember that Roger has to type in the output from the search.

To all: Remember, we can tabulate numeric variables.

A:

We are now asking questions of the Alaska file asked by interested visitors.

C:

To A: Can you give us an idea of what is going on?

B:

To A: There is one pool in the county. The pool name is Mississippian. The production for 1970 was 22,180 bbls. The associated gas production was 800 MCF.

A:

We are showing Ed and Pauline how the file works. So far they have asked things like: How many properties contain gold and silver?

Chairman:

To A: What is the nature of the data in the Alaska file?

A:

To all: We have names of the prop-

erties, where they are located, whether they are metallic or non-metallic, and all references containing additional data. We do not have production data.

A:

To R: Thanks much.

C:

It is obvious to me that so far this morning we have been able to demonstrate a capability that the Survey has an immediate need for. We have also answered at least 5 letters that normally cross the 5th floor.

A:

To C: There are no entries with W but we found two that contain silver.

A:

To C: We are following up on your request.

R:

To IFF: There are two records in the file with the data for crude originally in place. These two records each show 9,500,000 bbls originally in place and the cum. production thru 1970 was 2,293,336 bbls for one and 184,831 bbls for the other.

A:

To C: Both are occurrences for which we have no reserve data. Neither has significant economic potential.

The last part of the third session was a structured questionnaire. In this mode, each participant was asked to independently respond to a series of questions prepared by the chairman.

After these on-line sessions the participants held a conference call by telephone. The call was recorded and it is our plan to consistently use this tech-

nique in the future to compare participation and linguistic behavior under the two media.

The ability (found in FORUM) to link together the resources of several information centers, possibly operating different computer networks, was seen by all participants as a concept of interest.

The tests that we have conducted with FORUM (outside of the cooperative study with the USGS) fall into two groups: 1. in-house sessions intended for specific use of the system in situations such as expert opinion elicitation, staff meetings, etc., and 2. sessions conducted in cooperation with other groups and institutions, on an informal basis, to gain a better understanding of the degree to which the medium is suited to particular environments. The system exhibited no degradation of performance and response time even with twelve terminals in the on-line discussion.

For a number of reasons we are beginning to use FORUM in our own work and find it quite useful. First, it is the very purpose of our Institute to organize, structure and, as far as possible, improve the collective work of groups of experts. The probability elicitation and forecasting features of FORUM have been used for several months in the real-life environment of in-house projects dealing with future trends in communications regulations, with the chemical industry, and with the telephone industry. In the analysis included in Project AWARE, a multi-client study of future corporate environments, the panelists were called upon to make projections of a number of trends, and all probability estimates were processed using the capabilities of FORUM subroutines (although no on-line teleconferencing actually took place at that time).

The probability density assigned by each respondent was corrected according to his estimating ability and weighted according to his degree of expertise in order to arrive at a group estimate.

Another application of the FORUM system in open discussion mode was found in maintaining contact with staff members during periods of travel away from the Institute. One of our researchers, who formally joined the staff in July, actually participated in a number of "meetings" and made valuable contributions to the analysis of the group interaction during May and June while he was still residing in another part of the country.

Of special interest in such "staff meeting" situations is the fact that management decisions regarding cur-

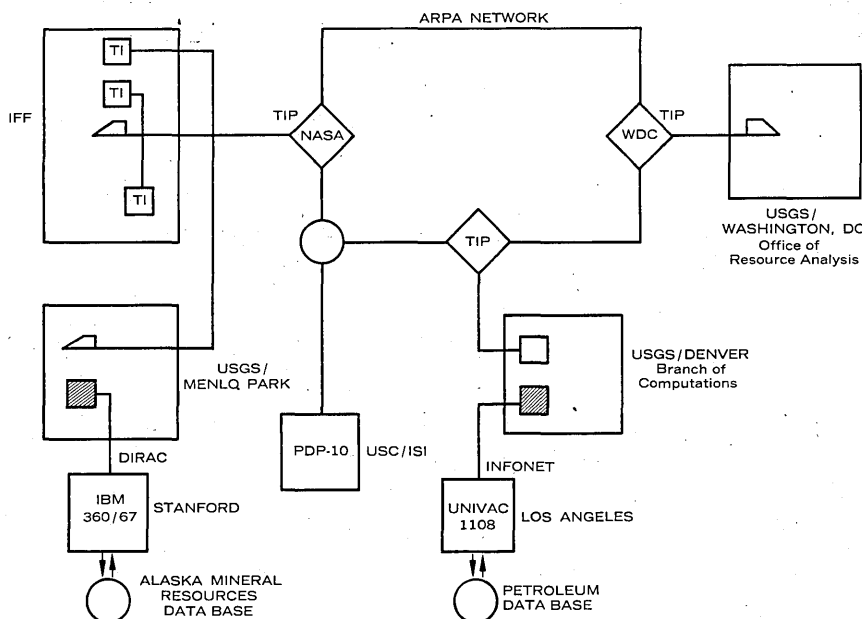

Fig. 1. FORUM experiment on ARPANET with information retrieval coupling through INFONET and DIRAC (June 7, 1973)

Your computer is only as good as its cassette.



Introducing the Maxell DC-300.

Don't blame your computer for dropouts, read-errors or write-errors. Blame the cassette.

Or, better still, replace it with a Maxell DC-300.

We subjected the DC-300 to a comprehensive inspection on the working tracks on all reels, one-by-one, according to standard specifications.

The results: The DC-300 proved to be completely free of read-errors and write-errors over an extended testing period.

Maxell also developed a special binder for the DC-300 that has resulted in a radical decrease in drop-outs. And by finishing the binder to a mirror-like surface the tape is now in closer contact with the head.

Another feature of the DC-300 that will upgrade your computer system is the enhanced recording density of the magnetic tape.

In addition, we created a cassette shell that is stronger and more durable than any other on the market. Four carbon-impregnated guide rollers—instead of two of ordinary plastic—reduce torque for tension and static-free operation at high speeds. Forget about having your tape jamming or becoming ripped and inoperative.

In other words, the new Maxell DC-300 is the finest data cassette on the market today...and tomorrow.

And if you don't believe us, ask your computer.
Or write us for technical data.

maxell[®]

The answer to all your tape needs.

Maxell Corporation of America, 130 West Commercial Ave., Moonachie, New Jersey 07074
CIRCLE 76 ON READER CARD

NETWORK

rent and future plans, schedules, and assignments can be kept for future reference in the context of the discussion in which these decisions were made. The ability to later refer back to such a transcript is invaluable.

A final comment on the in-house use of FORUM concerns the change in life style that such a medium makes possible; better use of personnel and computer time, and ability to extend the range of environments in which an individual staff member may work without losing contact with the team, are some of the advantages that point to the feasibility of applying this concept in the business environment.

Several special experiments have been conducted by giving other institutions access to the system. Although less formal and less carefully controlled than the IFF/USGS sessions, these experiments allowed us to observe the behavior of users who were approaching the system for the first time.

Of special significance was the observation that FORUM enabled groups of individuals (administrators, researchers, and technical personnel as well as "experts") to conduct extended conferences lasting several days rather than hours. They could participate as their own schedules permitted, without concern for time zones. In this sense it became clear that we must explore further the use of the system not simply as a way to link groups of selected individuals in specific discussions, but as the *supportive medium for continued communication among disseminated communities*. And the next time a philosopher points his finger at the computer and communication hardware and asks what we talked about, we think that we will have some very substantive results to show him. □

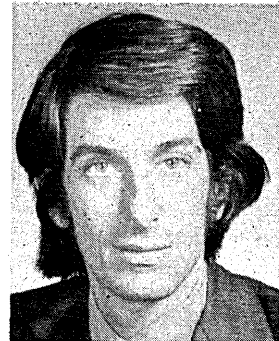

Dr. Vallee is a research fellow at the Institute for the Future, where he leads the design and implementation of a computer conferencing system. He was previously associated with information network research at Stanford Univ. and Stanford Research Institute. He is a graduate of the Sorbonne, and has a PhD from Northwestern Univ.

The honeymoon is over.



(Time to get serious about uninterruptible power sources.)

America's romance with energy is cooling off. We're running out of steam, out of water falls, out of electricity from any source. And as our power becomes less available, brownouts and blackouts become more likely. (Just ask your computer.) Fortunately, there's still time to install an Elgar Uninterruptible Power Source. It will protect your computer system against voltage dips and brownouts (regulation to $\pm 2\%$), up to 40 dB line transient reduction, and give 10 minutes of backup power in the event of a blackout. Write or call for details today... while you still have the energy.

Elgard Uninterruptible Power Sources are available in 500 VA to 15kVA models. They supply up to ten minutes of instantaneous reserve in case of power failure; and they have self-contained, maintenance-free batteries. Ideal for IBM Systems 3 and 7, DEC PDP Series, Burroughs Banking Systems, and Litton/Sweda P.O.S. Systems. Priced from \$1,595.

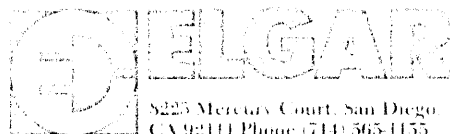

8225 Mercury Court, San Diego
CA 92111 Phone (714) 565-1155

Oh, sure, our GTE IS/1500 key-to-disc systems are competitive in price. But we feature some other things that put us way above most other systems:

A brilliant 12" screen (not the usual 9").

Card reader and high-speed printer capability (which most competitors don't offer).

Up to 32 terminals per system (twice what you'll get with most others).

And, if operator comfort means more data on the disc, we think nothing touches our stations. From the wrap-around modesty panel to doubly-backed-up

error alert, everything's designed to keep things moving fast and accurately.

But the biggest extra you get from us is our software package. It's a whole bundle of add-ons at no added price...

Reformatting capability (with one competitor, it costs \$50 a month; another doesn't offer it at all).

Plus tape-in capability. Batch balancing (including data validation). Operator statistics. Multiple format levels (up to 8 levels with intermediate level tab stops).

Our key-to-disc system has a lot

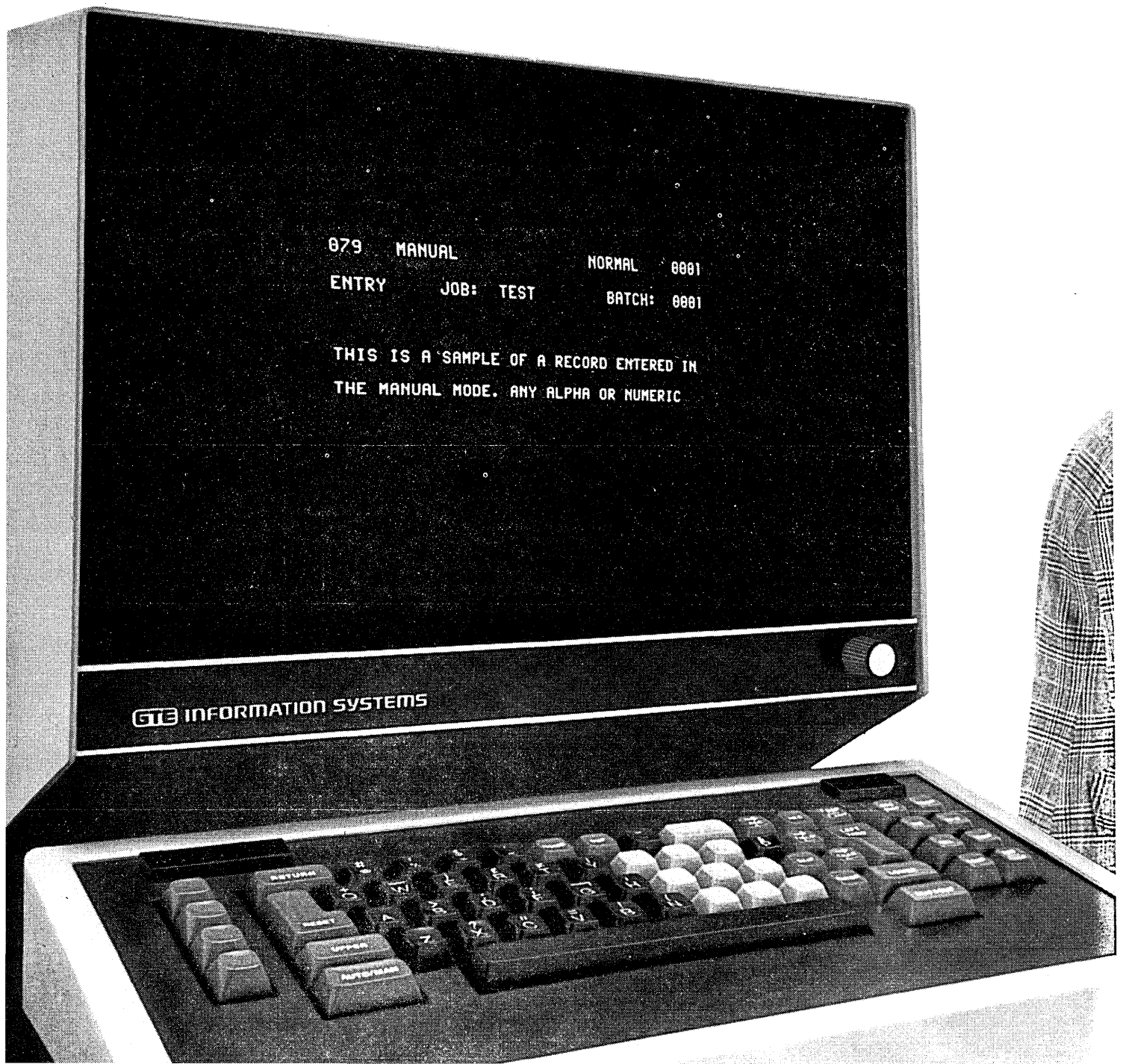

All this would cost you hundreds of dollars a month from someone else. From us, it's part of the deal.

And here's something nobody else can offer you at any price: the unmatched GTE service organization, with more than 700 people at key locations around the country.

When you want an updated data-entry system, look at more than just price.

Now, more than ever, GTE Information Systems belongs between you and your computer.



GTE Information Systems: One Stamford Forum, Stamford, Conn. 06904. **Atlanta**, 404-688-1670; **Boston**, 617-237-5222; **Chicago**, 312-332-7800; **Cleveland**, 216-771-8455; **Dallas**, 214-741-4361; **Detroit**, 313-353-5494; **Hartford**, 203-563-3767; **Houston**, 713-626-1713; **Los Angeles**, 213-380-2309; **Minneapolis**, 612-854-2898; **New York**, 212-486-3290; **Philadelphia**, 215-649-7410; **Pittsburgh**, 412-391-4170; **St. Louis**, 314-863-0330; **San Francisco**, 415-349-2600; **Seattle**, 206-283-3103; **Washington**, 202-293-2800, **Montreal**, 514-866-9324; **GTE/IS Europe S.A.**, 412 Ave. de Tervuren, 1150 Brussels, Belgium.

CIRCLE 73 ON READER CARD

more to offer than just price.



Israel is a developing nation with developed ideas in computing.

ISRAEL'S COMPUTER SCENE

While the shelling continued on the Golan Heights, precious few kilometers away the Israelis continued to conduct their government in Jerusalem, run their commerce and industry in the bustling cities of Tel Aviv and Haifa, and hawk their wares to an almost unabated tourist flow in the fascinating Old City in Jerusalem. The ancient churches, mosques, temples, palaces, and fortresses loomed undisturbed in the atmosphere of jumbled, centuries-old arguments about who shall hold sway over the land they occupy. And everywhere you looked, new buildings were being set into the hills or stacked ever higher on the flatlands. It was March, warm and sunny, in strikingly beautiful Israel.

The deceptively peaceful, "life-as-usual" atmosphere was contradicted by the sight of hitchhiking soldiers and by concerns being voiced everywhere—concerns that the people are more subdued, that the young are worried about their future in this land their parents came to for refuge and in pursuit of an ideal, and concerns that needed skilled and unskilled labor will not continue to emigrate to Israel. Taxes are high, inflation is getting worse, and the budget has been decimated by an unexpected war. Too, the newspapers are full of Israel's own Watergate investigation—not like Watergate in specific issues, but in the question of responsibility. Who is finally to blame for government failures in preparedness for war?

In this setting, we looked at some of Israel's efforts in computing. We found the country is enormously aware of data processing's importance to national development, and has formal, centralized structures designed to ease the implementation of dp systems and

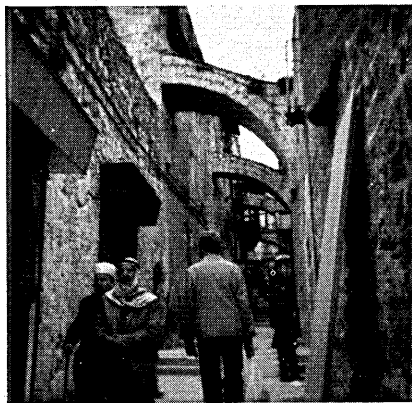

Jerusalem's Old City stands in striking contrast to the modernization of Israel going on outside its walls.

to encourage the growth of an indigenous computer export industry. We found that, as a country with a worldwide Jewish "citizenry," Israel has well-established lines to computer experts everywhere. Many experts from the U.S., Europe, and Latin America offer their time year-round on computer committees which review and

by Angeline Pantages,
International Editor

advise on national dp plans. And we found this dp community of 4,000 professionals suffering from some nearly universal computing problems.

Liaison agency

Our host was Aharon Gertz, director general of Iltam, coordinating agency for all computing in Israel. Mr. Gertz (who at 65 smilingly proclaims himself the "oldest computer man in Israel") put Iltam into perspective for us. The agency is an independent corporation which acts as liaison among the country's four computing sectors: national government, local government, labor, and the private sector. It reports to the overseer Ministry of Commerce and Industry. It is supervisor, promoter, coordinator, policy-maker—a structure, says Gertz proudly, that is close to the new Japanese system of coordination. "All ways are leading to Iltam."

In other words, through Iltam go all requests to the government from the other sectors for funds in the form of grants, loans, etc. Requests to import computers (95% are imported) go through it. Iltam will negotiate with the government on behalf of computer buyers to get the best terms of payment of the stiff 40% duty on these imports. It helps both vendors and government in efforts to export, and mediates in arguments and establishes new policies to help resolve them. (For example, software companies are arguing that the government should not try to do all

development work internally, service bureaus are arguing about the competition from bureaus in the government.)

Iltam is also the coordinator of the Israeli and worldwide computer committees. These committees were formed under the Joint Economic Conference, a structure aimed at encouraging economic and intellectual infusions from abroad into all its industries. (In addition to studies, reports, and seminar development, these committees are also the sponsors of a triennial international conference, the Jerusalem Conference on Information Technology. The second of these conferences is coming up, July 29-Aug. 1, and rather than act as a forum for Israeli computing, it will emphasize the "role of the computer in social and economic developments." It is seeking the statute of a major worldwide meeting and hopes to attract 2,000, half from abroad.)

The overview

During our week's stay in Israel, we were able to touch on some of the activities in the public and private sectors and visit with service and manufacturing companies. For security reasons, we were not able to see the most advanced and largest single user of computing, the Army.

As a nation of just over three million people, and 20,000 square kilometers of land, the small inventory of 383 systems estimated to be installed at the end of 1973 is not surprising. Nor is the fact that two-thirds of them are systems costing \$2,000 per month or less. Still, the nation had only 100 systems in 1968. The computer population is rapidly increasing as current expenditures are more than \$100 million annually and are expected to triple in the next five to seven years.

Another way of looking at its number of computers is by population (a high ratio of one system per 3,500 population), and by what is at the top end in size. Israel has more than 35 systems costing \$18,000/month or more, even several IBM 370/158s and 168s, and CDC 6600s. These behemoths are, of course, mostly in the duty-free sectors—government and universities. (All seven universities have computers.)

In expenditure by sector, in 1972 the government accounted for 37% of the \$100 million spent, industry for 14.6%, education for 12%, and banking and insurance, 11%. Most of the money was spent with IBM and CDC, followed by NCR and Burroughs.

In applications, Israel is in "stage one and a half," IBM's director David Cohen generalized. It is past using computers for clerical work alone and is currently in the middle of produc-

tion control, process control, and planning developments. "The depth of utilization is three to five years behind the U.S." Further, data transmission is somewhat in its infancy, although we note that the closeness of cities makes data communication less necessary in many applications (e.g., Jerusalem is a 45-minute ride from Tel Aviv).

A recent interim report by the Ministry of Communications revealed 45 lines "serving about twice as many terminals," currently in use for data communications (the maximum rate available is 4800 bps). Another 58 lines are on order. It says that by 1980, lines will be increased to 1,700 and terminals to 2,500.

But these simple figures and generalizations belie the sophistication of many current operations and systems in development. There is remote control of the national irrigation system, an on-line system for handling the scheduling and movement of the citrus crops from the groves to the port of Haifa for export, systems in banks for automatic payments and collections, El Al's reservation system (advice: book well in advance), large scale application of linear programming for farm and industry planning of the kibbutzim, and on-going development of a standard population registry which will be available to all government departments.

What strikes us most about a small advancing country like Israel is that its size permits centralization, efficiency in management, and rather strong control

of dp-based systems. It doesn't guarantee it, but allows it. The Israelis weren't too aware of this in the '60s, but they are now.

Government systems

The government (excluding the military) operates about 50 of the country's computers, the majority of which are medium- and large-scale machines. This indicates considerable computing power and a certain amount of human weakness. Aharon Gertz wistfully talks about the fact that he founded the Office Mechanization Centre, the main government service bureau, in 1953, and dreamed that all computing for the government would be done in this bureau. As in all governments we know of, the dream was eroded—for some practical reasons, some political—as each ministry hankered for its own systems.

The result was uncontrolled proliferation of systems and, in absence of a central authority, the traditional problems of lack of standardization, system sharing or data exchange. "Economies of scale" were ignored; installations suffered from too much or too little work. There were too few professionals and insufficient funds to meet the demands.

More than two years ago, with strong encouragement from its international committees, the government instituted the central authority and advisory support it needed to correct the situation. The core of this is the Automation and Systems Management



The Israelis may be three to five years behind the U.S. in terms of the depth of applications, but not in terms of technology, due in part to the country's international "citizenry."

**Before we wrote the only
Computer User Plan, we built
today's best planned computer.
The Prime 300.**

**The Prime
Computer User Plan.**

PRIME

PRIME 300

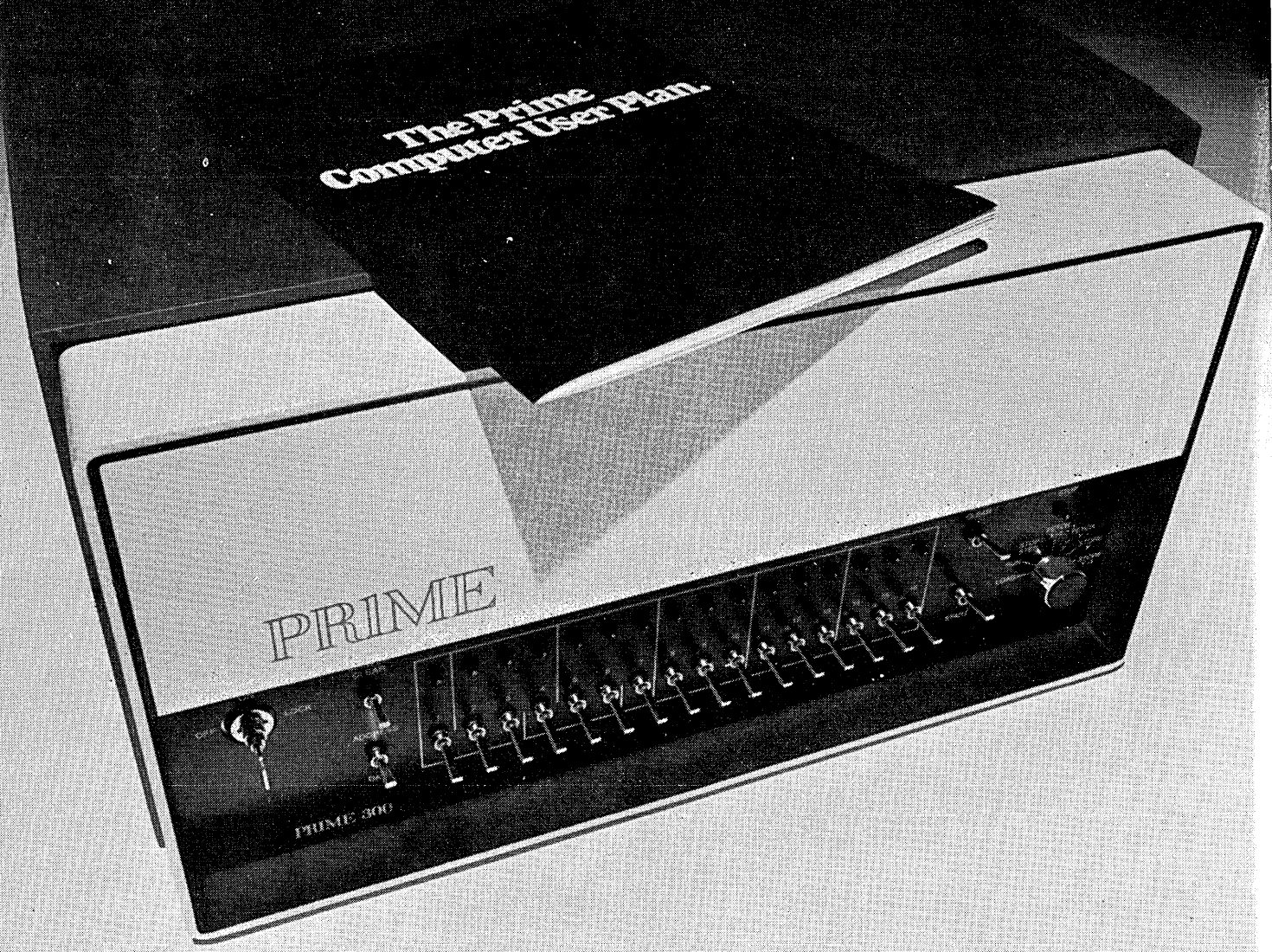

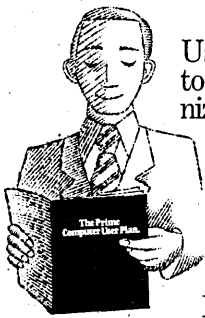

The Prime Computer User Plan brings common sense to buying a computer. It recognizes the simple fact that your needs might change someday.

The Plan introduces the first two-year guaranteed trade-in policy. It details the upward and downward compatibility features only Prime offers. In short, it gives every assurance you can always put a Prime system to use.

We consider The Plan a new way to buy, use and upgrade computer systems. We also give you the systems to consider: The Prime 100, 200 or 300. The chart below is a preview of what to expect in each.

Standard Processor Features	
Prime 300 Central Processor (1 board)	<ul style="list-style-type: none"> • Virtual Memory—automatic paging, mapped address translation to 256K words, restricted execution mode, and memory protect. • Stack Procedure Instructions • Micro Verification Routines** • Hardware Multiply/Divide and Double Precision Arith.* • DMC/DMT Capability* • Automatic Program Load From Input Devices (PTR, TTY, CR, MT, Disk)*
Prime 200 Central Processor (1 board)	<ul style="list-style-type: none"> • Memory Byte Parity • Processor Byte Parity • Full Addressing Modes—direct, indirect, and indexed in both sectored and relative modes • Virtual Instruction Package (VIP)—automatic trapping of unimplemented instructions and substitution of functionally equivalent software subroutines.
Prime 100 Central Processor (1 board)	<ul style="list-style-type: none"> • 8-Channel Programmable DMA • 4 Channel Full Duplex Asynchronous Serial Interface • Multi-level Vectored Priority Interrupt System

* Optionally available on Prime 100 and 200
**Optionally available on Prime 200

The chart suggests there's a little 300 in every Prime computer. Naturally, we planned it that way. Our 300 is just the reverse of the big box with a little computer inside.

Other 300 features will tell you just how big it is. For instance, there's high-speed MOS memory with 32K words per board. Up to 256K words per system. There's floating point arithmetic and writable control store, too. In short, there's everything you'll need in the computer you can plan with. Work out a multi-function system or plan a multi-user arrangement. The diagram that follows is just one way to go.

The Prime 300 supports a multi-user, virtual memory Disk Operating System (DOS VM) and a foreground/background Real Time Operating System (RTOS VM).

A Prime 300 with virtual memory easily accommodates over a dozen users. What's more, each is guaranteed 64K words of virtual memory available to program in FORTRAN, BASIC, Macro Assembler and Micro Assembler.

The system files and paging space are all provided by cartridge disk. Our new diskettes offer low cost storage for personal user files.

A Prime 300 is good. How good can best be seen in The Plan. It shows how to upgrade from the 100 right on to the 300. In the process, you don't change software. The time and expense of reprogramming are gone. You can also use the 300 as a software development system. The software will run on 100's or 200's without modification. The Plan guarantees this kind of system compatibility.

The Plan also goes into system integrity features. Memory Byte Parity and Processor Byte Parity are standard in the Prime 300. Micro-verification routines (also standard) and controller loop-back allow you to isolate faults to a single board.

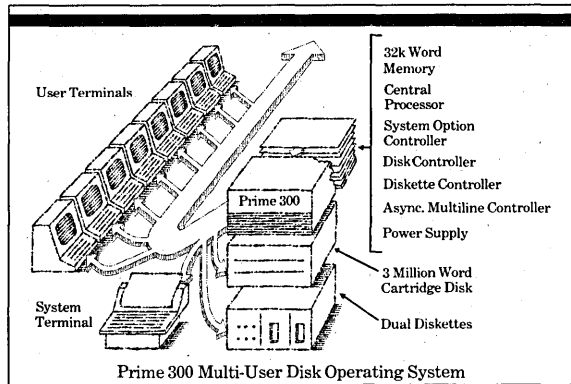

The Plan then spells out our total service options. They run from comprehensive on-call service contracts to Prime's unique Air Spare System. With Air Spare, we'll air express, for a minimal charge, any backup boards you may need from our nearest service center. We'll make repairs on faulty boards and have them back in no time. Meanwhile, you'll be operating full-time thanks to Prime.

There's more to The Plan. The best way to discover how much is to have your own. Send for it. The coupon below, like the Prime 300, will make it all possible.

To: Prime Computer, Inc.
23 Strathmore Rd.
Natick, Ma. 01760

- Send The Plan
 Send the Planner
(He'll call for an appointment.)

Name

Title

Company

Address

City

State

Zip

PRIME

ISRAEL'S COMPUTER SCENE

team in the Bureau of the Budget of the Ministry of Finance. We interviewed Rami Guzman, manager of the ASM team. Guzman explained that his operation embodies the computing functions of three U.S. agencies, the budget management office, General Services Administration, and the National Bureau of Standards. This means it controls procurement, resource allocation, and system development. The emphasis is on the latter, embodying everything from standardization to helping ministries develop individual systems, to developing systems to be shared by the ministries.

Guzman talked about long-range planning and the early implementation of data base techniques. He echoed a popular cry: "Programming development looked at in the short range won't result in an open system, adjustable to changing demands." He underscored the need to put data processing near the top in the organizational charts and has instituted a policy requiring each ministry to have a system group reporting directly to the heads of departments.

Guzman also pointed out the need for standard, integrated systems shared by the departments. ASM is now in the process of establishing a scheme for the interchange of population data among the government ministries. Although there is a standard identity number for all citizens, Guzman's group found that the ministries had entered this number in their files in 38 different ways. A "cornerstone" population registry with basic data will be stored in the Office Mechanization Centre systems, accessible by any department for its own files. (For those who do not choose to standardize according to the ASM scheme, there will be conversion programs to allow access to this continually updated file.)

Among other shared files planned or in operation are a land registry system to be used by 15 government units, a foreign trade information system that 12 departments will use, and a vehicle and driver information system for seven departments' use. ASM will also help to combine the police department's now separate communication and information file systems into one large network, using a CDC 1700 for message switching, linked to an IBM 370/145. In the coming year, ASM has plans to develop an ARPA-like network connecting four big centers and on-line branches. We should also note that among its many new policies, Israel's government has followed the U.S. lead by decreeing third-party peripherals and memories when they offer the best buy.

The Ministry of Interior doesn't

have its own computer (though it seems it is not wisdom but politics that prevents it), but it has established a rather unique system. Along with the Union of Local Authorities, it established a separate company to do all the computing for the 200 municipal governments. Chevrah le'Automatzia was started in 1966 and currently has a 370/145 and 135 and 80 people to do such tasks as municipal payrolls, water bills, tax assessment, financial reports, land use classifications, and budgeting. It is scheduling more applications aimed at manpower and resource planning. Assured that it has been a successful effort, we note another example of the potential of small nations to surpass the giants in efficiency of government management.

The kibbutzim

Interesting to note was that several of the country's cooperative communities, or kibbutzim, have jumped on the computer bandwagon, obtaining systems like the System/3 to do their own business processing and planning. This development is a result not only of the growing complexity of running a kibbutz, which may have both farming and industrial enterprises, but also of the desire to offer people more job opportunities.

A man who does not favor such a trend is Dr. Yaaqov Goldschmidt, director of the Inter-Kibbutz Economic Advisory Unit, a cooperative association under the Kibbutz Federations. His unit sells many services to the kibbutzim, including consulting and data processing for farm and production management. This organization has been lauded for its work in the large-scale application of linear programming to farm planning, used today by 150 kibbutzim. It has developed a system for analyzing the economic success and development of a kibbutz over time and in relation to other kibbutzim. And a third major service is a "fully integrated computerized information system for budgeting and control, finance and cost accounting, sales and inventory management and billing."

All this was developed under a man who says, "I don't care for the computer." A graduate of business administration at Cornell Univ., Goldschmidt only wants to use it to serve the kibbutz and management aspects. His group does not have a computer and doesn't want one. "There is ample hardware around already." Goldschmidt is using a government bureau, but is shopping around for the best deal. His expenditures amount to what the bureau charges, plus one driver with one car to make deliveries and

pickups. He feels kibbutzim don't need their own computers and none could afford one that could process his sophisticated systems. "What one kibbutz is paying IBM about \$3,000/month to do, it could be paying us \$600 a month to do. They (the kibbutzim) are primarily just using the computer to punch cards all day," he remarked cynically. "There is already so much overcapacity in this country." The kibbutzim are producing 30% of Israel's agricultural output, and Goldschmidt is saying that one 75-man group that rents time can help them optimize that output.

Learning from war

The suddenness of the Yom Kippur War, although it left the country smarting economically and shaken emotionally, proved several things about data processing. Without it, Israel would have been "in a mess," noted IBM's David Cohen. Because of it, the country continued to operate—payrolls were met, food was supplied, checks were processed, factories were producing, the fields were irrigated.

But the sudden mobilization of the citizenry left companies without as much as 80-90% (worst case) of their staff. One day everyone calmly left "their pencils and half-empty coffee cups on their desks" to go home for the holiday and didn't return for months. One service bureau had a single operator left, a woman who kept the computer room going by working long shifts. Software companies, their single asset being people, were badly hit. Minicomputer maker Elbit was caught right at the beginning of production of mini's for CDC's System 17 and its backlog of 500 systems was not much reduced for some time.

The country came to the realization that computing had been overlooked as a "critical industry" in the war plans. There were no general exemptions from call-up among its male professionals who fall between the ages of 18 and 49. The government did make exemptions to allow some firms to meet commitments there and abroad, but it knows now that isn't enough, and will develop a specific plan. The country also realized that more women, older people, the handicapped, and draft-ineligible foreigners should be recruited into positions critical to a company's ability to operate.

The costliness of the war also underscored the already evident need to increase exports and foreign investment in Israel. In a later issue we will discuss this need, the manpower problem, and the indigenous computer industry. □

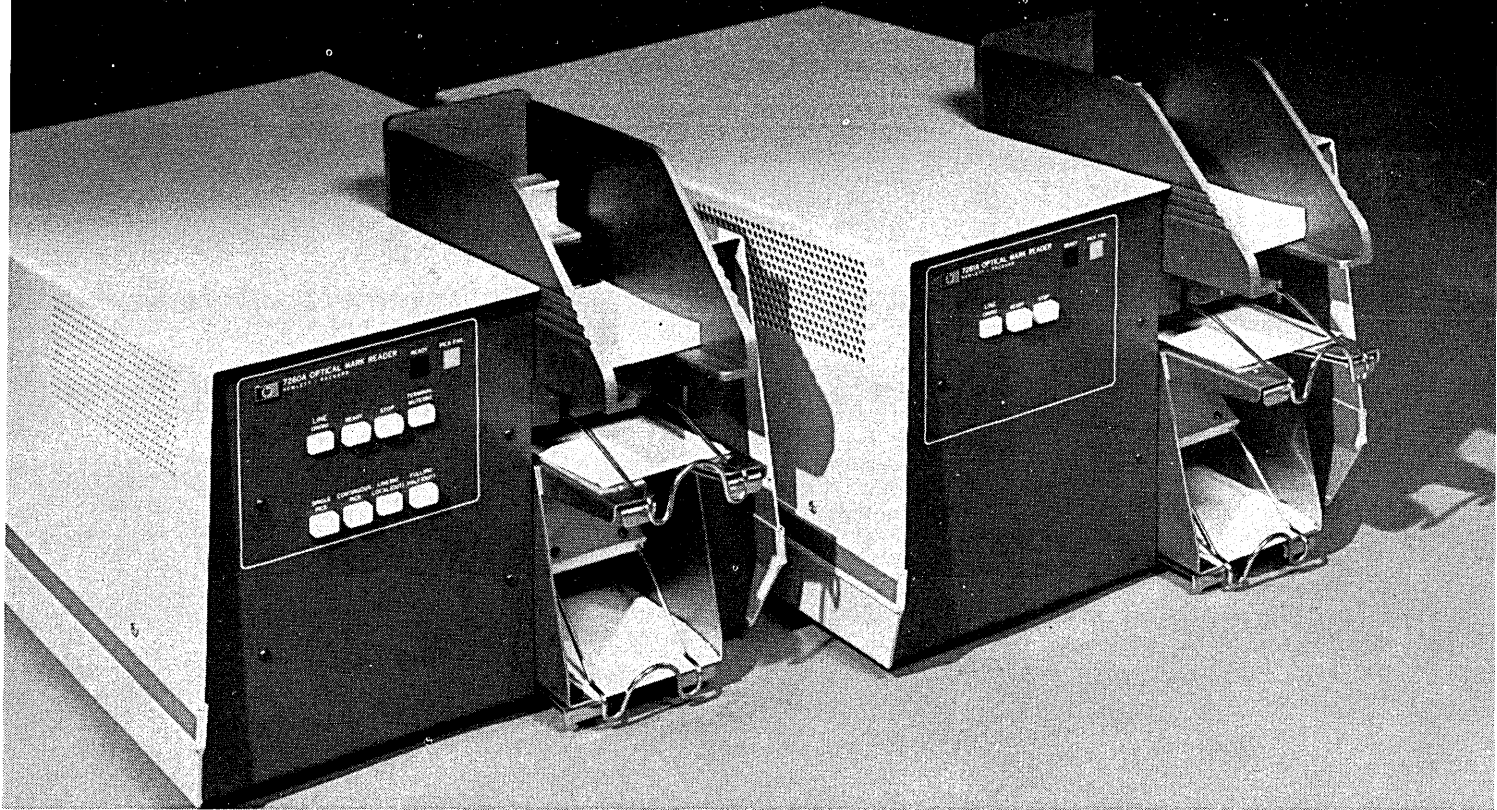

The new Optical Mark Readers from Hewlett-Packard.

We put a lot more into our hardware,
so you can get a lot more
out of your cards.

A pencil marked card is the simplest possible device for both data preparation and entry. For timekeeping, stock control, sales reports, test results or whatever.

And now Hewlett-Packard has two new Optical Mark Readers that let you get the greatest possible flexibility from your marked card system. They let you use cards with or without clock marks, with any combination of pencil marks and prepunched holes, printed instructions and even tear off stubs.

Since HP's Readers accept cards with both punches and marks, you save time and money. And you can use standard size tab-cards or cards up

to 11 $\frac{1}{8}$ inches long to accommodate up to 96 columns of data.

Choose from two Readers with standard interfaces for your particular system. One has a parallel output for computers, smart terminals or calculators. The other gives you a serial (RS 232) output for applications where remote data entry is important. Both handle cards at speeds up to 300 cpm. An optional select hopper is available that even lets you sort cards from the deck.

With a serial output reader, you get the versatility of switchable baud rates from 110 to 2400. Internal buffering insures that data transmission rate will be optimized to your special

requirements. Buffering also allows retransmission of data to aid in data comparison and identification of transmission errors.

Hewlett-Packard's Optical Mark Readers have the features and flexibility to give you the widest possible latitude in designing card forms for your special application. All your people do is mark information on the card with an ordinary soft pencil.

You'll get more out of your cards, because we put more into our hardware. OEM discounts are available. For details, write Hewlett-Packard, 1501 Page Mill Road, Palo Alto, California 94304.

11405

HEWLETT  PACKARD

Sales and service from 172 offices in 65 countries.
1501 Page Mill Road, Palo Alto, California 94304



SAME WINNING AMPEX

This season the Ampex championship team of data and information processing equipment experts is taking to the field in two new sets of uniforms.

From Marina del Rey, California, it's the Ampex Memory Products Division. They're winning all the plays in the core memory game because they have

better products. TIN and lithium core technology for even performance in all climates and advanced stack and module designs mean extra winning margins. This is the team that can field as few as 8K or as many as a million words of capacity and still keep the admission price low enough for the most pinched budget.

AMPEX

AMPEX MEMORY PRODUCTS DIVISION
13031 W. Jefferson Blvd., Marina del Rey, CA 90291
(213) 821-8933

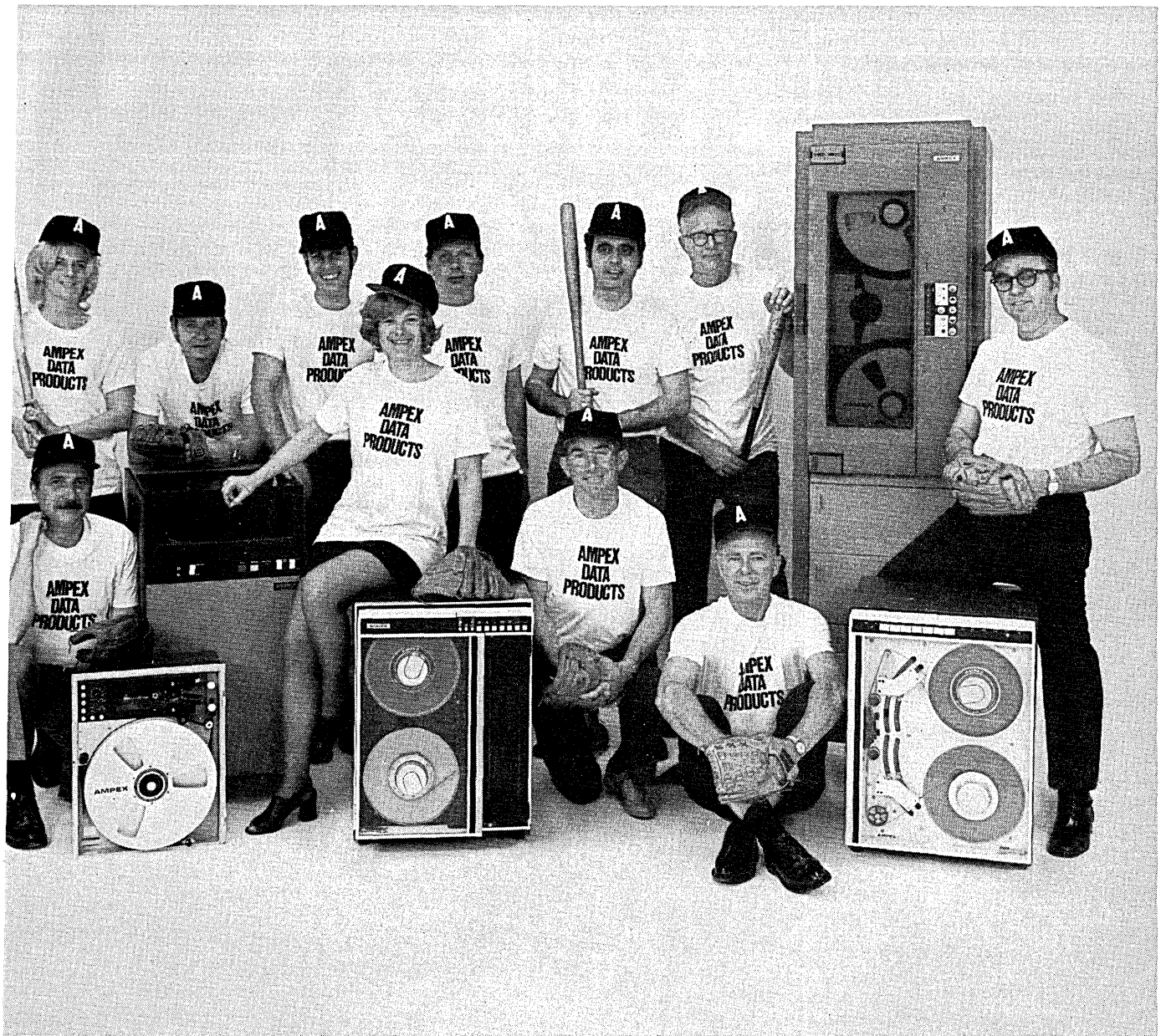

TEAM; NEW UNIFORMS.

From Redwood City, California, it's the Ampex Data Products Division. These experts in tape and disk technology are out to make a clean sweep of the competition, and they have a whole locker room full of equipment for every situation. Data Products picked up even more strength when they drafted all the players from the Ampex Instrumentation Division,

including all the experts in both digital and analog data recording.

No matter what sort of peripheral support your system needs, get Ampex into the game. Call your nearest Ampex sales office today and ask for an inning on your own home field. You'll quickly become one of our most loyal fans.

AMPEX

AMPEX DATA PRODUCTS DIVISION
401 Broadway, Redwood City, California 94063
(415) 367-3943

Can't afford computer output microfilm? Sure you can.

You don't have to buy a computer output microfilmer or even rent one. Just call on a service bureau equipped with a Kodak Kom microfilmer.

Using a service bureau is similar to time-sharing. You get all the savings of computer output microfilming. Without a big investment.

The service bureau can handle all the details for you. It will convert your tape data to microfilm, process the film, and get it back to you fast.

Take your pick of microforms. Depending on your application requirements, you can instruct the service bureau to microfilm in roll or fiche formats. You can even have your business forms superimposed on the microfilm images.

When you select a service bureau equipped with a Kodak Kom microfilmer, you can do so with confidence. Kodak backup makes the difference. Full software support. Kodak



service. Information management know-how. Everything that's needed to make the most of COM.

Get all the facts.

For more information on computer output microfilming, please write us. Eastman Kodak Company, Business Systems Markets Division, Dept. DP584, Rochester, N. Y. 14650.

For better information management.



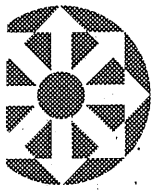

NEWS IN PERSPECTIVE

Companies

Meet Jacques Maisonrouge, page 106, the man whom author Nancy Foy describes as "an effective voice for the growing influence of Europe in IBM's corporate headquarters." With the recent reorganization of IBM's mightily profitable World Trade organization, Maisonrouge finds himself again in Paris, where much of the decision making in IBM's overseas operations will be centered . . .

Technologists talk of bubble memories and charge-coupled devices as faster-access replacements for disc memories. But what about an older idea—the electron beam memory—whose "time has come," according to one organization that has delivered one? page 108 . . .

Are labor unions penetrating data processing installations? Do people, worried about job security, bad working hours, and fringe benefits, "are coming to us now," says one union official in a report on page 109 . . .

The National Retail Merchants Assn. is close to fixing on a standard for the technology for reading merchandise tickets on electronic point-of-sale devices, page 111 . . .

Electronics, brawling infant of the '60s, is growing up, reports computer practitioner Philip Dorn, who recently toured the annual meeting and exhibit of the giant Institute of Electrical and Electronic Engineers in New York, page 113 . . .

There are many bargains in the new digital data services tariffs filed this spring by AT&T and Datran, page 114.

IBM's New World Trade: The Change Is Symbolic

And There's the Benefit of Executive Health

IBM's latest international reorganization brings virtually no changes in the company's reporting structure in Europe. Everyone still reports to IBM Europe in Paris where Frank Cumiskey remains president and Kap Cassani his second-in-command. Cumiskey still reports to Jacques Maisonrouge, who still reports to IBM World Trade chairman Gilbert Jones.

The main physical difference is that Maisonrouge will be spending only 25% of his time in New York, instead of 50%.

The symbolic difference is important. It marks a major decentralization that actually has been going on with IBM's typical gradualness for several years.

The Maisonrouge that Frank Cumiskey reports to is not the president of IBM World Trade Corp. (though Maisonrouge retains that hat); he is the chairman of a new Delaware corporation, IBM World Trade Europe/Middle East/Africa Corp. (which IBMers have already shortened to E/ME/A or 'Emma'). And even more important in hierarchical terms, the Jones that Maisonrouge reports to is not the chairman of World Trade (though Jones retains that hat); he is the vice chairman of IBM Corporation (another hat Jones already wore since the appointment of John Opel to the presidency of IBM earlier this year).

In practical terms, IBM World Trade Corp. ceases to be the controlling element of IBM's international operations. Instead Emma and the new Americas/Far East company (A/FE or 'Ah-fee'

for short) take on greater importance, each with the same presidents as before, but each with a powerful new chairman reporting to the parent corporation at Armonk. The addition of Maisonrouge to Emma and Ralph Pfeiffer (who previously headed the powerful U.S. Data Processing Division) to Ah-fee gives credibility to IBM's claims that it is pushing more decision-making power out close to the market-place. As IBM chairman Frank Cary said in his announcement of the changes: "We are making these changes to strengthen our responsiveness in the marketplace—the marketplace not of today, where we are doing well with an old structure, but the marketplace of tomorrow, where we hope to do even better with a new one."

Both Ah-fee and Emma report to Gilbert Jones in the Corporate Office. So does World Trade, which will continue to "provide corporate support" to the country organizations for accounting, the treasurer functions, legal counsel and information systems, the mechanism by which IBM manages its global R&D and continental manufacturing facilities.

Decisions in Paris

Although the announcement said that headquarters for World Trade and for the new corporations would be "in the New York area" (that means they will occupy the new Mount Pleasant building around the end of the year), the important physical change is that Jacques

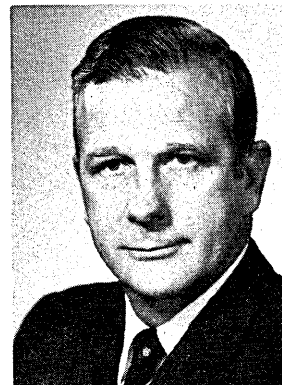

REORGANIZATION: Frank J. Cumiskey, right, is president of IBM's new World Trade Europe/Middle East/Africa Corp. and Gordon R. Williamson, center, is president of the Americas/Far East Corp. At left is Gilbert E. Jones, World Trade chairman and vice-chairman of the IBM board.

Maisonrouge is finally coming home to Paris.

IBM-Emma's new chairman cites executive health as one benefit of the reorganization. "It's much better to travel north-south or south-north than east-west or west-east," he said. "You stay in the same time zones. I must say that I have found, going around the world several times a year, it's extremely tiring. This will be much easier."

The real logic for the change is the size of the business though, and in that sense, he sees no demotion for Maisonrouge, and important promotion for IBM Europe. His lonely existence as a symbol of "the foreigner in a top-level

job" may have clouded the issue. Discussing his own status in Paris, he said cheerfully: "Well, you know, it depends on how you look at hierarchies, and the importance of an individual. If you measure my importance by the amount of gross income, then I am less important today than I was before, because the gross income I watch over is two-thirds what it was. But if you compare it with two years ago, we have as much gross income in Europe today as we had in the entire World Trade organization two years ago. If you measure importance by the reporting levels, I am at the same level I was before. There is no question, though, that some people will interpret

this move as a lessening of responsibility."

This probably will be the last major reorganization for a while. Maisonrouge commented: "Nothing is definitive in a large company. We continue to grow. If this helps us to grow faster, then there may be other changes in five or 10 years to make the units manageable. But the logic of having a corporation which has basically three units—the United States, Europe, and the rest of the world—is pretty strong. This should last us some time. Our last major reorganization was ten years ago. You don't reorganize too often because of the impact on people."

The reorganization does not change planning for plants and investment. "The facilities that we need are completely dependent on the market, not

Jacques Maisonrouge: The Multinational Man

How do you develop a multinational man? You get to him early, says IBM's Jacques Maisonrouge.

"If you start very early in life to adapt yourself to foreign environments, it is easier," he said during an interview in Paris in April. "When I graduated from university 25 years ago, the first working experience I had was in the United States—I had a scholarship to study there." He did technical work with IBM from 1948 to 1949, then returned to Paris to IBM World Trade marketing and management assignments, returning to New York as vice president of World Trade from 1962 to 1964, then returning once again to Paris, this time as president of IBM World Trade Europe Corp., a company chartered in France.

This company, somewhat overshadowed by the new Emma, elected Maisonrouge chairman at its late April meeting this year. In late 1967, Maisonrouge became president and director of World Trade and a vice president of IBM Corp. itself, returning for the third time to New York.

The most difficult

"My last move was the most difficult," he recalled. His children were farther along in school, and the disruption to the family was characteristically more severe. Even so, in a DATAMATION interview in late 1972 he cited his five children as important reasons to stay in the U.S. His oldest girl had become a doctor at the age of 22 and was doing her residency in Montreal. The second was in her third year of a Ph.D. biology program at Columbia, while the third was preparing a Ph.D. in mathematics at New York Univ. The younger children were absolutely fluent in French and English. "My children just love America," he said in 1972. In 1974 the Maisonrouges had already found a

home in Paris; his eldest daughter had married and had been in France for a year; the second was studying at INSEAD outside Paris; and the son was planning to return to France in 1975. One daughter was marrying in the U.S., but the family's center of gravity had clearly shifted to Paris—along with that of IBM World Trade.

This dovetailing of personal and corporate needs is characteristic of IBM. In 1972, denying rumors that he would go



JACQUES MAISONROUGE

Comfortable anywhere, especially in Paris

back to France to take a political job, Maisonrouge said: "I don't have political aspirations. Most French people who know me assume that eventually I am going to go back to France. In typical French fashion they think it is impossible to have occupied the post I have here, and then accept a 'lower' post with IBM there. But in our American thinking, it is not impossible at all."

Common language

Maisonrouge continued to put his energies behind the quiet campaign to beef up the Paris organization, not for personal reasons but because he felt it was best for IBM and for Europe. In the meantime he was an effective voice for the growing influence of Europe in cor-

porate headquarters. Most Maisonrouge speeches contained some reference to his Frenchness. (At one London speech last year he suggested with a barely straight face that French should be the language of the Common Market.) He and Gilbert Jones testified to the United Nations on the contributions of the multinationals. The man who was quoted in the 'white negroism' chapter of Christopher Tugendhat's book *The Multinationals* continued to work patiently, from within, to make the company more truly multinational. In this sense, the new European organization is both his achievement and his reward, though Maisonrouge would be the first to give credit to Jones, Arthur (Dick) Watson and other IBM people who have encouraged the decentralization.

He downplays the importance of the reorganization. "One characteristic of a dynamic organization is that reorganizations happen very often," he says. Discussing the gradual transfer of functions such as customer engineering and sales from New York to Paris, he says: "This present step is just a normal evolution of this trend towards decentralization into geographical areas . . . We have done it this way essentially because of the growth of the company. It is very difficult for a single management team in New York to manage the worldwide operations. Thus by having two corporations, one for the Americas and the Far East, the other for the European continent, we could give better management to the two groups."

IBM's concept of Europe transcends that of De Gaulle, which spread from the Atlantic to the Ural mountains. "We go from Iceland to South Africa, and from Ireland to Vladivostok," said Maisonrouge. "We even reach the Pacific Ocean because Russia is in our sphere of activity."

—N. F.

the organization," said Maisonrouge. *Emma* and *Ah-fee* still will have to have corporate approval for large investments, such as the new plant that is going into Spain. Maisonrouge identifies countries like Spain and Brazil, shifting from "developing" to "industrialized" as the fastest growing markets for IBM products. "Our policy has always been and will remain to have manufacturing facilities where we have our markets," he said.

Who is split?

The World Trade of 1972 had about 115,000 employees. The organization that Maisonrouge and Pfeiffer split in April had grown to 122,000; 87,000 of these are in *Emma* (up from about 83,000 in 1972) and the other 35,000 are in *Ah-fee*. Thus, though *Emma* represents about 69% of World Trade's gross revenues (or \$3.55 of its \$5.14 billion), it has siphoned off about 71% of its people. This slight imbalance is also likely to show up internally in comparisons between the two, since the most highly developed markets (and thus the main manufacturing facilities) are in *Emma*. On a country-by-country basis, IBM accountants wash out the inter-company business before they total up internal accounts, but even so the pure sales companies always come out looking a bit more profitable, mainly because they don't have the same administrative overheads and complexities as country organizations that also manufacture. Most of the population growth in IBM Europe in the past two years seems to have been in the smaller countries like Spain, while Germany, France and the U.K. have kept employment levels essentially stationary.

Of the 127 countries in which IBM has at least branch office organizations (that's 126 from World Trade plus the U.S.), 91 are now headed by "nationals." Of the remaining 35 (countries where IBM has not yet been able to hire and train local managers), all but 11 are headed by non-Americans (often British, French, Swedes or Canadians), called "third-country nationals" in IBM-ese.

Maisonrouge no longer has to make a point of looking for the foreigners first for any job opening. He proudly proclaims that he just looks for the best man available, regardless of nationality; though he admits it is still more difficult to persuade European country organizations to part with their star performers on short notice while American executives will let a good employee interview for a different job in the company, even though it inconveniences them.

A survey of Maisonrouge's many hats shows why he will go on commuting east-west and west-east. He remains a senior vice president of IBM Corporation, and president of IBM World

Trade, which will go on as a convenient accounting, control, and coordination mechanism, even though it seems less important. As chairman of *Emma*, the Delaware corporation, Maisonrouge has a board of directors currently leaning toward insiders from the old World Trade board—including Frank Cumiskey and Kap Cassani from the Paris office, Billy Christensen who will be *Emma's* man in New York, and *Emma's* boss Gilbert Jones. ("On this board, he works for me now!" quipped the Frenchman who has been second-in-command to Jones for about 15 years.) IBM Europe S. A., the French company, also continues, with a board that includes Cumiskey, Cassani, and some eminent inside and outside people from the IBM France board, including



NEW DP CHIEF: John F. Akers, left, was named president of IBM's huge Data Processing Div., replacing Ralph A. Pfeiffer, Jr., named chairman of IBM's new World Trade Americas/Far East Corp. Jacques Maisonrouge is Pfeiffer's counterpart at the Europe/Middle East/Africa Corp. (see accompanying story).

Baron Christian de Waldner, who retired as chairman of IBM France last year.

Maisonrouge also discussed the building in Mount Pleasant, New York. This was heralded very recently as the new World Trade headquarters, after ten years of internal discussions and surveys about whether to move out of Manhattan. Although two-thirds of World Trade's power seemingly already has moved to Paris—as symbolized by the move of a single Frenchman—the Mount Pleasant building will be fully occupied when it opens at the end of the year. *Ah-fee* will be headquartered there—with a rapidly increasing central staff (due to double in size as *Ah-fee* gets its own product line management, product sales specialists, and other perquisites which *Emma* has been building up for years). The World Trade "services" in legal, accounting and information systems will move. And *Emma* will have a full-time U.S. staff of its own, rotating to and from Europe to some extent to keep communications lines open and informal systems working. Those people, under Billy Christensen, will also be in the Mount Pleasant building.

—Nancy Foy

Turnaround Will Be Slow, No Miracles

"I have no deadline," asserted Alexander E. Patterson, Jr., new president of GTE Information Systems, Inc. Appointed last September, the ex-IBM executive has been trying to solve some of the problems that caused a \$19.9 million loss on \$80 million revenues in 1973. But he is not trying to achieve a "miracle turnaround" and parent GTE hasn't demanded it, although it's known to have invested more than \$200 million in the subsidiary.

Anyone who has watched large companies enter the computer field and exit gracefully looks for telltale signs of trouble in firms—the destructively rapid management changes of a General Electric, the blatant assurances of support from an RCA secretly divided about its commitment, even the seemingly inspired recruitment of ex-IBMers who, it turns out, had never held profit and loss responsibility.

Patterson replaces another ex-IBM-er, Len Muller. Muller's lack of true top-level profit experience at IBM is said to have hampered him at GTE/IS. The same cannot be predicted for Patterson. He was with IBM from 1949-68, which included eight years of top posts at World Trade Corp. as assistant general manager for IBM Europe, and vp of operations and vp of marketing of WTC. He also served within GTE as vp of business development (manufacturing group) of the Service Corp. And if first impressions are an indication, he exudes all those good executive qualities—quietly commanding, candid-yet-diplomatic, charming.

From initial indications, he is trying to wield a scalpel rather than a cleaver in changing this long-aborning data communications company. Our interview with him was dotted with phrases like "walk rather than run," "go slowly," and "low profile." In the last eight months, with GTE's blessings, he has brought in an almost completely new corporate management team, but he has not made any wholesale cutbacks in the staff. It has stayed at the 3,000 level. He has not chopped out any of the product line, although he has replaced two of three plant managers and two of three engineering managers. He has also added reliability managers.

Part of the problem, explains Patterson, was that "the company ran very fast at times and got itself into trouble. At times it was more marketing oriented than engineering or product oriented." GTE's chairman, Leslie Warner, had explained GTE/IS losses as being due to "adverse economic conditions in the securities industry, cost overruns on new installations of several complex data communications systems, and the rede-

termination of the value of certain revenue-producing equipment. . . .” What Warner refers to as a problem of “cost overruns” and Patterson refers to as being “more marketing oriented” probably contributed most to the downfall of the previous management.

Fast delivery

It is best exemplified by a Social Security Administration contract. In April of 1973, GTE/IS was chosen to install a complete communications network of terminals, printers and controllers connecting 460 offices to the SSA center—by January 1974! Patterson came on the scene in the middle of this. “I was stunned that they had taken it.” The contract was full of “onerous penalties,” and “if we’d blown it, we would have been in hot water.”

And it would have been a big splash, since the system and its deadlines were



ALEXANDER E. PATTERSON JR.
He wields a scalpel at GTE/IS

legislated by Congress. Starting in January, welfare recipients were supposed to be able to walk into an SSA office and collect hardship funds immediately. SSA people had to have the ability to confirm their eligibility and the fact that they had not already collected funds at another office. If the system hadn't been operational, it would have been a chaotic and costly situation for everyone.

Obviously relieved, Patterson noted they made it (and even a “little money”). “We proved we had the people and products to do it.” But enthusiastic marketeers won't have the chance to bid a contract and the round-the-clock toil of the staff that way again. George Erickson, the technical leader who managed the gigantic project, has been made GTE/IS director of system programs, reporting directly to Patterson. (Erickson, formerly with Bunker Ramo, has more than a dozen years experience with data communications systems, such as NASDAQ and the Sheraton Hotels network.)

Patterson's top management changes have resulted in the exodus of almost

all the presidents of the companies GTE bought to form its subsidiary. Looking back, GTE/IS seems to have gone through a fairly common evolution for a firm created by acquisition. It came into being in late 1970, the result of buying several companies during the three previous years: Ultronic Systems Corp. (display terminals and financial services and terminals), Novar Corp. (hard copy terminals), Tempo Computers Inc. (communications processors), and Programming Methods Inc. (specialist in data communications software system development). Over these companies and a few internal operations, GTE superimposed a management from its own and IBM's ranks. The idea was, and continues to be, to create a company specializing in all elements of a data communications system up to the central computer room.

What about presidents?

The inherent difficulties of such an agglomeration must be obvious. Once-autonomous presidents and executives have to be subordinated, elevated, rearranged. The lower levels have to find out who they are working for, where they get their approval to do anything. The organizational layers have to be thinned out. Identity, image, must be established. (GTE/IS is said to have spent considerable time on this problem. The question initially was, how do you shorten “Novar, division of General Telephone and Electronics Information Systems Inc., subsidiary of General Telephone and Electronics”?)

And then there are the reorganizations and re-reorganizations. In 1972, Patterson explained, GTE/IS was reorganized functionally. All marketing was smashed together, directed by ex-IBM Jack De Labry. Also, the financial, service, and manufacturing and engineering functions were removed from control of the various companies and each put under one manager. The former presidents had gradually been moved into the corporate staff: Bill Bennett, Novar, became assistant to the president; J. T. Lawson, Ultronic, became vice president of corporate development; and J. E. McAteer, Tempo, was vice president of operations.

“Some of it worked, some didn't,” said Patterson. The marketing consolidation proved most cumbersome, and under Patterson it has been redivided into the brokerage and data communications divisions. Data communications now has a special force of 20-30 people dedicated to total systems sales and support. This has the support of Programming Methods Inc., which continues to be run by president George Langnas. With the exception of Lang-

nas, all the presidents are gone, as are all of Muller's team but the legal counsel.

GTE/IS also bought a European company in 1973, EDP Resources, which now markets some of the product line, as well as software services and packages. Patterson eliminated the international vice president's post in the U.S., preferring to work directly with Kurt Hackl, who heads the operation in Brussels and worked for Patterson at IBM World Trade. “They are very excited about our product line to complement their software capability,” said Patterson. But he returned to his general mood: “We want to be extremely careful how they do that. They should walk before they run.”

In the meantime, GTE/IS continues to announce new products—such as the 7801 crt terminal (IBM 3270-like), the 1511/14 key-to-disc system, and the 5700 hard copy terminal, all announced in 1973. It also has supplemented its data entry capability through the acquisition of Logic Corp., Cherry Hill, N.J.

—Angeline Pantages

Technology

An Old Idea Whose Time Has Come?

At a number of locations, an experimental random access memory suitable as a swapping store is under development. The electron beam memory has an access time slower than that of main memory but faster than drums and discs. “It's an old idea whose time has come,” says Ivor Brodie, manager of the physical electronics group in the engineering sciences lab at Stanford Research Institute, Menlo Park, Calif.

An experimental memory module with a capacity of 65K bits and an access time of three microseconds recently was delivered by SRI to the Avionics Lab at Wright-Patterson AFB in Dayton, Ohio. John Kelly, who heads the SRI memory program, says its main advantages over rotating memory are a 1,000-fold decrease in access time and the elimination of all mechanical motion. He adds that now that it's been shown to work (the module had no errors in two billion cycles, each of which carried a bit in or out), the capacity could be enlarged substantially, like to a billion bits or more, and the access time can be cut. In production, the price could be on the order of 0.02 cents per bit.

Price comparisons with competing memory technologies are difficult at best, meaningless at worst. But a recently published study by a group at Mitre Corp. shows projections of 0.1 cent/bit in 1975 for bubble memories and for charge coupled devices (CCD's). For disc files, others use as a rough guide

0.05 cents/bit for a fixed-head file and 0.005 for a movable-head file. The latter, of course, have slower access times than are generally ascribed to bubble, CCD, and electron beam memories.

As in a crt, an analogy the developers dislike, SRI's electron beam addressed memory consists of an electron beam and a beam deflector sealed in a two-inch-diameter stainless steel tube. And it operates in a vacuum. Also inside is the storage medium, a silicon chip measuring less than an inch square on which four million bits can be stored in a 2K x 2K array.

The bits are stored in "microcapacitors" in tiny cavities on the surface of the chip. Each cavity in the lab model has a diameter of six microns. The developers believe this can be reduced to one-micron-diameter holes and think they can achieve a density of 600 million bits per square inch.

Nondestructive

Because information is stored as an electrostatic charge, this is a nonvolatile memory. Even when there is a loss of power, the data remains in the microcapacitor for any length of time from a day to a week. The useful life of a bit in its little cavity is a function of both time and usage, deteriorating a little with each readout. In normal use it

would require refreshing perhaps once an hour. Thus the SRI memory can be considered a nondestructive readout memory.

Although one has not yet been delivered to a customer, a similar system is under development at Micro Bit Corp., Lexington, Mass. It reportedly differs in the storage "target," consisting not of a semiconductor but rather of a homogeneous film, explains Dr. Dennis Speliotis, manager of systems development at Micro Bit. He refuses to say much more about the medium. The speed, price-per-bit, and access time do not differ materially from those cited by SRI.

The access time, says SRI's Brodie, is determined by an analog-to-digital converter's settling time. As advances are made in the technology of this device, which is also the single most costly component, he feels the access time can be shortened to something like a half-microsecond.

Since few people are interested in accessing a bit at a time, these systems are organized with several tubes operating in parallel. Packaged together, the tubes share a common shield against radiation, common control electronics, and power supply. The people at SRI say that such a unit, with a storage capacity of 64 million bits, would occupy a space measuring two to three cubic feet. The system would have a data rate of 10 megabits/tube, or 160 megabits in the block-oriented mode.

New enough?

The electron beam memory, however, is not without its critics. One observer noted that it's necessary for a new device to be a hundred times better than an existing technology because by the

time you've made your device manufacturable, the competitive technology could simultaneously have improved its price/performance by a hundredfold. "This tends to make people rather skeptical of new and developing technologies," it was said.

This certainly applies to a vacuum tube device ("Looks like we're back to the Williams tube," one pundit observed), which people fear would be unreliable. To this, Micro Bit's Speliotis says, "Our answer is, 'Don't you use oscilloscopes, displays?'" He admits that if something does go wrong there's not much one can do at the user site but to replace one tube with another (each is enclosed in its own vacuum). "We have guns that have been running at the plant for about three years," he adds. "We've had no problems as far as the target or the guns," which are the two most vulnerable components. But the tube can be repaired at the plant at a fraction of the cost of a new one.

A projected manufacturing cost of about \$100 for that tube is also being questioned. Its complexity is compared with that of a color tv tube, production of which is counted in the millions, much greater than the demand could be for memory tubes. And yet the color tube costs about \$65, it is said.

But if the read-write electron beam addressed memory is difficult to believe, Micro Bit claims to have in its lab a read-only model with a capacity of 10^{14} bits. In production, they say, its price could be 10^{-7} cents per bit, lower than anything else that exists. The company currently seeks outside funding to pursue this elusive devil.

—Edward K. Yasaki

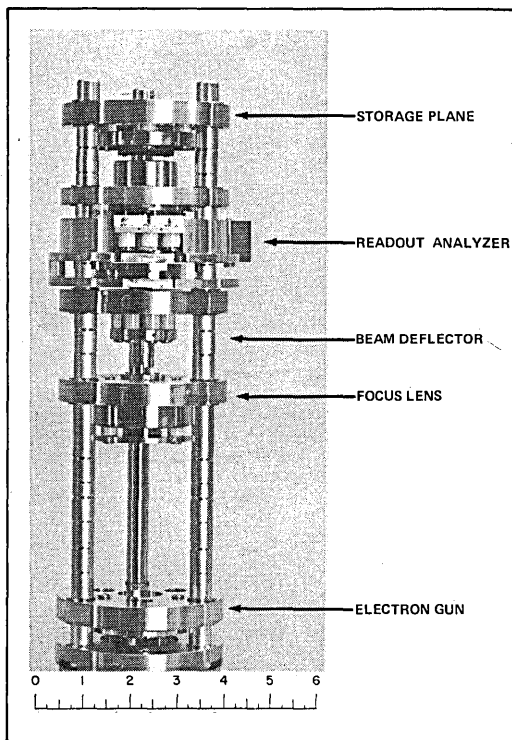

Electron gun (or tube) runs up center, supported by three steel columns. When ganged with other guns to operate in parallel, not all of the supporting structure for each gun is needed. Full name is electron beam addressed memory. Scale at bottom is in inches. This is the one-gun memory with 65K bits that was shipped to the Air Force.

Personnel

Even Baby-sitters Have to Eat

"Work is the same everywhere, even if it's baby-sitting a computer. It's the working conditions that create unions."

This from Lee White of the Communications Workers of America, one of a long list of unions which count data processing personnel among their membership and probably the one most actively working to increase its penetration in the data processing field.

Work may well be the same everywhere, but data processing as a class of work is unique in its position vis-a-vis union organizing efforts. For one thing, according to the Commerce Dept.'s SIC code, there is no computer industry and, for this reason, the Dept. of Labor's industrial relations section is unable to break out the number of dp people in organized unions.

For another, data processing is more

than just a target of union organizers. It's ammunition for organization of other types of workers, those whose jobs the organizers believe are threatened by the advance of automation. It's an ominous threat to those who paint way-out pictures of what could happen in a massive strike of those who run the "nerve centers" of society and industry.

It can have its nuisance value as in the case of three on-strike computer maintenance technicians (Honeywell) who activated a field office data collection system at Metropolitan Life Insurance Co. by prerecorded messages via telephone. The instructions, not to rewind paper tape, caused the next read command to read blank tape endlessly. The involved technicians were discharged and indicted under an obscene telephone call law.

A TWO-YEAR WARRANTY? ON CARD READERS??

YES!!! Only by Peripheral Dynamics Inc.

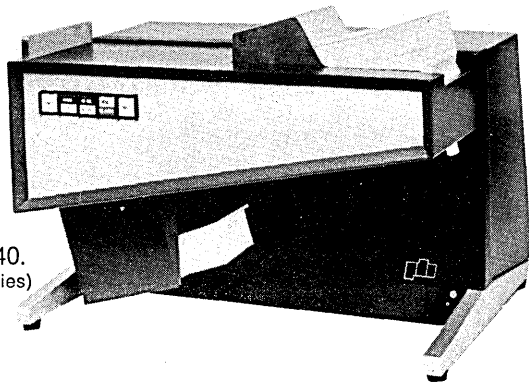

Proven performance starts at \$1040. (in OEM quantities)

The revolutionary warranty that speaks for itself in reliability and maintainability.

The Peripheral Dynamics Inc. Card Reader Family. The best darn little card pickin' reader this side of your minicomputer or remote terminal. From the people who've made card readers a good business.

PERIPHERAL DYNAMICS INC.

1030 W. Germantown Pike/Norristown, Pa. 19401 215/539/5500

CIRCLE 80 ON READER CARD

Data Center Problems ?

- HOT SPOTS
- DUST
- PROCESSING GIBBERISH
- Equipment Failure
- CARD JAMS
- CONDENSATION
- HEAD-TO-DISK INTERFERENCE
- Low Air Quantity
- SAFETY SHUTDOWN
- HUMIDITY
- Temperature Variations
- PAPER STICKING
- STATIC ELECTRICITY
- Silver Migration
- HEAD CRASH
- Read-write Errors
- Tape Deterioration

Free Handbook Has Answers

"Process Cooling for the Data Center Environment," published by the world's leading manufacturer of computer cooling equipment, is now in its third printing. Covers such subjects as problems caused by wrong environment, economics of the proper system, and design criteria. Get a copy free from your local EDPAC sales representative, or by writing direct to AC MANUFACTURING COMPANY, Old Cuthbert & Deer Roads, Cherry Hill, N.J. 08034. Phone: 609-428-9800.

EDPAC

PROCESS COOLING FOR COMPUTERS

47

CIRCLE 89 ON READER CARD

news in perspective

No union lays claim to a corner on data processing organizing, but at least three see data processing personnel as specifically falling within their charter and many others pull in data processing people as part of vertical industry bargaining units, as the United Auto Workers has done in the auto industry.

Target for three

The three which see dp people as a natural target for them are the CWA, the Office and Professional Employees International Union (OPEIU), and the Marine Engineers Beneficial Assn. (MEBA).

CWA's White sees data processing as a natural adjunct to communications. "It's (organizing dp people) part of our program. We're interested and we're working." He said CWA is interested in organizing all types of data processing installations, not just those essentially in the communications industry.

But, if another union is in "we'll stay out," says White. A case in point is the CWA's own data processing installation which is organized by the OPEIU.

A sometime problem is the breaking out of computer personnel as a separate bargaining unit. OPEIU, which has dp members in units in some half dozen Blue Cross and Blue Shield organizations, was approached by dp personnel of Blue Cross in New York City. "When we went to the National Labor Relations Board to ask for permission to hold an election," said Arthur Lewandowski, an OPEIU organizer, "they said we had to take everybody. We tried. The computer people wanted us but we were frustrated in our attempts to organize the overall unit so we walked away." Subsequently, said Lewandowski, the International Brotherhood of Electrical Workers "tried our route and even tried the strike bit but it didn't work."

Henry Dooley, an MEBA organizer in San Francisco, believes that "most of the time" it is possible to "carve out a unit" of dp personnel. The MEBA has been successful in doing this with the city of San Francisco, the city of South San Francisco, and the computer groups of American President Lines and Pacific Far East Lines.

Sometimes they lose

Dooley, like CWA's White, feels the problems that unions face in organizing dp workers are like those with workers in all other lines of work with one occasional exception. "Sometimes programmers think they're professionals and that can cause you to lose an election once in awhile."

At OPEIU it's potential loss of jobs to

automation that is a big concern right now. "We've kind of riffled in on automated banking," said Lewandowski. "Automation is to bank employees what the bulldozer was to laborers in the construction field."

OPEIU has been playing up the threat of automated banking in its publication, *White Collar*, urging workers whose jobs could be eliminated by automation to "upgrade your jobs and do it now." Lewandowski said two national columnists have agreed to do interviews on the subject but "because of Watergate that's

been few and management seems to have survived those that have occurred. During the Blue Cross, New York City strike, management people "with some knowledge" managed to keep things going to a point where the union wasn't able to gain a foothold.

In San Francisco, an on-line system serving, among others, the police and courts remained operating during a nine-day municipal employees strike that crippled many of the city's operations. Dp chief Henry Nanjo did concede there were some 40 hours of back-

at an annual 12% to 15% clip."

Again the money looms largest. Inflation could prove to be the biggest boon to union organizers in dp or any other field. The cost of living affects everybody, even those who baby-sit computers.

—Edith Myers

Retailing

Scanning Standard Due Before Summer

Retailers are close to adopting standards for reading merchandise tickets on electronic point-of-sale devices. Irv Solomon, a vice president of the National Retail Merchants Assn. (NRMA) thinks that by the end of May, "our standards effort will be at a point where many merchandise retailers should be ready to place equipment orders."

The association last fall announced it favored OCR as a reading technology, and early this spring the association and a manufacturers' liaison group began working on: a character font and code format for OCR-scannable merchandise tickets; and a data layout for the ticket, with the printing specifications needed to make the data "wandable"—readable by hand-held devices called wands.

Within NRMA, a group known as the systems specifications working committee has been set up with authority to adopt proposed standards on behalf of the NRMA membership.

Solomon thinks a final decision would lead to the placement of more equipment orders by merchandise retailers he claims have been reluctant to install POS devices because of a lack of standards.

Fixed on font

It's generally agreed that one task force recommendation will be to adopt OCR-A1 as the character font. Beyond that, it is considered likely the association will approve two basic merchandise ticket formats; one will consist of an eight-digit "short" stockkeeping unit (SKU) number, a five-digit price, and a human-readable but non-scannable merchandise color code. This information will be designed for pin tickets and adhesive labels that are already in wide use by retailers. A store using this format will need an in-house POS system with look-up capability or an outside service bureau system. The short SKU will be a pointer for accessing size, style, color, and other information stored in computer memory.

The other technology likely to emerge from NRMA's deliberations will be designed for the "hanging" tickets which stores use on such items as apparel and furniture. This format provides room

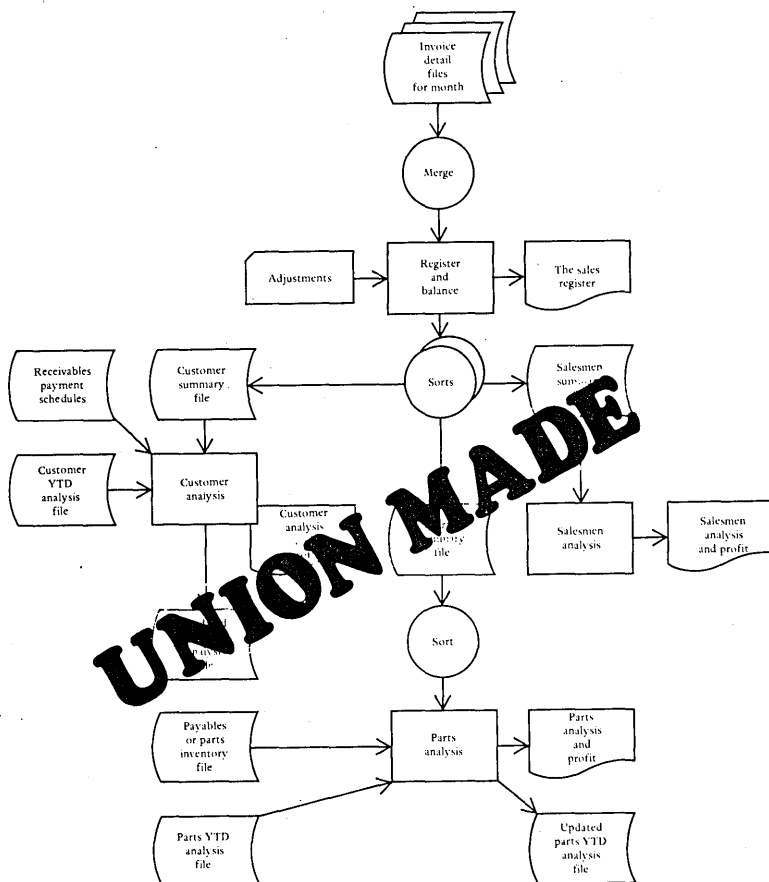

The Wave of the Future?

on the middle burner for now."

Union organizers generally agree that data processing personnel are receptive to and ripe for organizing. "They can't name their own price any more. Some are even being laid off. They're worried about job security, arbitrary assignment of bad shifts, and fringe benefits," said one, "but most of all they're concerned about money. They see union groups getting increases that approximate the cost of living increase while theirs fall many percentage points below. They're coming to us now."

And interest in unions among computer people isn't unique to the U.S. The U.K.'s Assn. of Scientific Technical and Managerial Staffs (ASTMS) claims some 15,000 to 20,000 dp people among its membership and it's pushing hard for more.

So far strikes by dp personnel have

log for well-rested keypunchers when the strike was ended.

In Los Angeles in mid-April L.A. County dp chief Tom Kidwell was ready with a strike plan, which he didn't want to detail, for a strike threatened for April 29 by county employees including a "goodly percentage" of his staff. "We're concerned but we're prepared," said Kidwell as a consortium of Los Angeles County employee organizations continued negotiations mainly aimed at a higher-than-offered cost of living increase. At writing, the county had come up from 2% to 4% and the employee groups had come down from a demand of 12% to one for 9%.

In setting the April 29 strike deadline spokesmen for the employees called the 2% offer "unparalleled cynicism and contempt for county employees in face of an inflation which is rocketing along

for either a short SKU or a long one (23-30 digits) and, in the latter case, eliminates the need for system look-up capability.

All numeric

It is understood that the SKU, whether short or long, will be an all-numeric code, although an alpha option will be offered. One reason for this plan is that adding alpha capability increases the cost of the terminal by as much as \$240

for circuit cards.

The prospective NRMA standard will make it possible, hopefully, for a merchandise retailer to scan the grocery industry's UPC code with the same terminal. Many general merchandise stores require this capability because they sell items offered by food supermarkets. NRMA's Solomon says, "We're willing to accept the UPC data format for these 'overlap' items." He says the decision of the supermarketiers last March to modify their code slightly eliminates another

source of incompatibility. A 10-digit numeric code, which had been placed under the UPC bar code, has been moved downward, Solomon said. This makes it readable by the wands which the retailers plan to use (supermarkets are employing a scanner embedded in the checkout counter).

But some problems remain to be resolved. Standard start/stop codes have to be added to the UPC numeric block to make it "wandable." Another difficulty is that UPC numbers are printed in OCR-B, while NRMA probably will settle on OCR-A1. This problem seems likely to be settled by developing a wand capable of reading either font. It will be attached to a terminal which has been designed to scan OCR-A1. Three extra circuit cards, costing a total of about \$300, will be needed to sense and interpret the UPC's B numerics. These cards will be housed in a small module attached to the terminal. Solomon says NCR, Singer, Regitel, and IBM all have agreed to offer this type of system to general merchandisers.

While none of these details have been finalized yet, several retailers and manufacturers have jumped the gun and started testing POS systems for department stores that use wand-type scanners and merchandise tickets coded in OCR-A. One test began last month at a J. C. Penney store in Harrisburg, Pa. It involves 110 NCR 280 terminals equipped with REI wands. The tickets are being produced on an IBM printer, as well as on Monarch and Soabar ticket-making equipment. Sears began a test earlier, at stores in Tennessee and Ohio, using Singer and NCR equipment. Reportedly, the company is using REI and Unicom ticket makers.

Meanwhile, Belk's, a large variety store chain, is in the second year of a test designed primarily to determine the feasibility of POS for small- and medium-volume merchandisers. This one is going on at several stores in and around Charlotte, N.C. Each sale is registered in the conventional way, and the tickets, after being sent to a back office, are batch fed into a Data Source scanner. Belk's is using Cummins, Dennison, Kimball, and Monarch equipment to prepare the tickets. The company is also testing a hand-held labeling machine that permits price changes to be made on the sales floor. The labeler, made by Primark, produces a gummed strip that covers the price area of the original ticket. The price information is printed in a font called OCR-M, but reportedly it can be read by an OCR-A scanner. The adhesive is specially designed to discourage customers from removing it and thereby purchasing marked-up merchandise at marked-down prices. Penney's is understood to have decided to test the same labeler.

—P. H.

If you've been waiting for something special in a Software Design Opportunity . . .

Your wait is over! If you have experience with real time systems or command and control systems, we can offer you the fast track to major project responsibility with one of the nation's largest equipment and systems innovators. It's a long-term career opportunity in vital defense software programs. Your background could include systems programming or real-time software design or systems engineering; project management; new business acquisition or micro programming systems. If you have successful experience in some of these areas, these positions could offer immediate rewards and an excellent career opportunity. Let's talk, in confidence, of course. Write:

LRC

ASSOCIATES

12004 Aintree Lane, Reston, Virginia 22091.

Representing an Equal Opportunity Employer M/F



CIRCLE 46 ON READER CARD

Electronics: Getting Down to Business

Electronics, brawling infant of the '60s, is acquiring an air of stability and importance. This was evident this Spring at INTERCON '74, annual meeting and exhibit of the 30,000 member Institute of Electrical and Electronic Engineers (IEEE) in New York, where many of the subjects sounded like the *Harvard Business Review* or the American Management Assn.

While there were the usual intense groups huddled arguing about the number of circuits on the head of a pin, more and more of the engineers seemed to be turning to the show's theme, "getting down to business in electronics in 1974."

This was particularly noticeable at the technical sessions. Of the 40 scheduled, some 15 were devoted to matters dealing with marketing and consumer electronics. The traditional military playthings have given way to such items as anti-skid devices, fuel injection systems, watches, cable tv, point-of-sale devices, and, of course, hand-held calculators.

Electronics is a \$40 billion a year business—10% earmarked for overseas business—and economist Rosemary Mazon of the Export-Import Bank noted at the conference that it will grow to \$85 billion by the end of the decade. But the cost of entry has risen sharply. Venture capitalist Frank Driscoll, New Court Securities, said the factory that could have been acquired and equipped for \$1 million a few years ago now costs nearly \$5 million.

Double standard

One of the program's high points was a slashing attack on the international trade double standard by A.R. Schroter of Rockwell International. Schroter charged heatedly that while everybody is free to come to the U.S. and build a plant or acquire a company, reciprocity doesn't exist. He noted that the Japanese are building a steel mill near New York, Gimbels is owned by a U.K. corporation, and even the Good Humor man has gone overseas to learn to speak Dutch. At the same time an American company trying to open up in Japan can be blackballed by any single Japanese company in the same market, and foreign majority control is prohibited in more than three-fourths of the Japanese market.

While admitting that direct foreign investment in the U.S. is still small in comparison with U.S. investment abroad (although the data is so bad that nobody really knows for sure the extent of the penetration), Schroter did suggest that

it is time the balance be redressed. In his prepared remarks he made it very clear that he is not afraid of competition here but does want equal access to protected home markets, particularly in prosperous Japan and Germany. With a new round of GATT (General Agreement on Tariffs and Trade) talks scheduled soon, he suggested it is high time

for American industry to insist as a matter of policy on equal opportunity and a fair fight in highly developed industrialized markets.

A political person

In his first talk since taking office, former Connecticut Congressman Emilio Q. Daddario, director of the Congressional Office of Technology Assessment, suggested that his operation is another step toward realigning the balance of power within government. Daddario's OTA will permit the Congress to be better informed on technological matters than their executive branch counterparts. Only in operation four



This is the electronic "key" that can be a photo ID badge. It can open a door...selectively, control your parking, automate your payroll, control off-hour elevators...and printout a record of who went where...and when.

This is the RUSCARD

For full information, phone toll free (800) 423-4194, ask for Mr. Martin.

RUSCO ELECTRONIC SYSTEMS Box 2848D, Pasadena, Calif. 91105



FREE! Sample RUSCARD and the new Ruscards Security Access Control guide.

name and position

company

address

months after a long struggle for funding, they are already launching studies on the energy crisis, materials, health care, and ocean sciences. OTA exists to serve the Congress, to provide better information for making trade-off decisions between technological progress and the quality of national life. Daddario, by his own words a "political person," appears to enjoy high respect within the Congress, which will give him the leverage an outsider could not attain.

Although the OTA methodology is still under development, it appears to be leaning toward the use of outside con-

Verma of Bell of Canada, a lengthy discussion of Ma Bell's new Digital Data System by L.R. Pamm, and a look ahead at the plans for a packet-switched, value-added network by Dr. Ralph Alter of Packet Communications. These public networks were contrasted with the shared network for remote computing being provided by CDC and described by R. F. Mayer. Since the Bell system had only filed the DDS tariffs the previous week, interest in their five city network ran high. The Canadians, already in business with 18 cities across Canada linked via Dataroute, received acclaim for getting there far earlier than their southern neighbors.

Devil's advocate

Earl Joseph, staff scientist at Univac, played devil's advocate in a technology session by reminding the audience that the user community really doesn't care about technology, just cost, usability, and performance. One of the more interesting figures he cited was that the cost of programming an instruction is now 100 million times the cost of executing it. Joseph predicts smart memories, logic closely integrated to the memory with the independent processing unit eventually disappearing, a greater ability for remote processing, and increasingly larger memories available. He foresees the number of large computers continuing to drop while the mini-explosion continues to grow. Joseph contends that the paperless society isn't far off and represents a vital growth opportunity for electronics. As the cost of delivering a printed page begins to ascend dramatically, the same amount of data may be far cheaper to deliver electronically.

The exhibitions, five minutes north

by subway but a long 20 minutes by traffic-stalled buses, were compressed into two floors of the Coliseum. Noteworthy was the foreign invasion—displays from Germany, Japan, Trinidad & Tobago, the U.K. and, for the first time, the USSR, mixed with a reduced number of U.S. companies. Among the mainframe houses, only Burroughs with its panel components and DEC with logic circuits were present. Systems houses were equally scarce. More than one observer thought calculators were the hit of the show. Attendees jammed the Hewlett-Packard booth to try out the new programmable model. Computer Design Corp.'s Alpha 325 and Beta 326 seemed to have bridged the computer-calculator gap.

Sharing a hotel with the Boston Bruins and the touring Women of the Professional Tennis world created some wild lobby confusion. Youthful autograph hunters couldn't tell Bobby Orr from an engineer. The usual IEEE quarters, the Americana, had been acquired by a medical convention and a certain amount of grumbling about the elderly Statler was heard. Fortunately the weather held until a departure day snowstorm left late departing exhibitors strewn all over the East.

The IEEE affair has fundamental problems. Technical papers are often of limited interest except to researchers while the exhibits are aimed at working engineers looking for off-the-shelf solutions. The split leads to strange breakdowns in communications and, in the past, a technical program totally unrelated to the show: The 1974 renewal came closer to closing the gap than its predecessors, but the physical separation across town still keeps the salesmen in one place and the technicians in another. Being under one roof would help.

—Philip H. Dorn



DOWN TO BUSINESS: Some 25,000 persons inspected the wares of the world's electronic industries at the New York exhibit of the Institute of Electrical and Electronic Engineers (IEEE).

sultants and subcontractors to do the work under the direction of permanent staff members. His 1974 budget calls for spending 75% of his authorized \$2 million on outside contracts. Answering a reporter's question, Daddario indicated that it will be important to develop information systems capability so that the data will be on tap when needed, but that it would have to be done in such a way as to protect the proprietary rights of individual and corporate contributors.

In a jam-packed steam room (among its other deficiencies the Statler-Hilton appears to regard fresh air with disdain), a data network session featured an overview of the Canadian Digital Data Network by D.J. Horton and P.K.

Communications

Digital Networks: Big Bargains Are Offered

Significant price reductions and considerable advances in reliability are offered in digital data service tariffs filed this spring by AT&T and the Wyly Corp.'s Datran subsidiary.

Datran's tariff became effective April 4. Service is offered between Houston, St. Louis, and four intermediate cities. Commercial start-up of AT&T's Digital Dataphone Service (DDS) was delayed until at least July 18 to give competing specialized carriers time to file objections to the phone company's rate structure. An additional delay of up to 90 days is possible. AT&T initially planned

to offer DDS to Boston, New York, Philadelphia, Washington, D.C., and Chicago.

Both carriers plan rapid expansion of their networks. AT&T said it hopes to have 24 cities on-line by the end of this year and to be operating nationwide by 1976. Datran said it will be in business between Houston and Chicago by next September. By February '75, it will be operating between the East and West Coasts (using Southern Pacific's microwave network between Houston and San Francisco).

DDS is offered at 2.4, 4.8, 9.6, and 56

**WHAT WOULD
YOU SAY TO A
UNIVERSAL DIGITAL
DATA IN/DATA OUT
TERMINAL THAT WAS**

Kbs. For an intercity 2.4 Kbs. channel, AT&T proposes to charge \$20/month plus 40 cents/airline mile. Intercity channels for the other three speeds are priced as follows: 4.8 Kbs., \$40 and 60 cents/mile; 9.6 Kbs., \$60 and 90 cents; 56 Kbs., \$125 and \$4.

Some local charges

AT&T's digital service customers also will have to pay at least two other kinds of charges: one is for a local distribution channel, connecting the user's terminal to a phone company central office. Bell calls this a "digital access line" (DAL). The other charge is for the interface, or "digital service unit" (DSU), between the DAL and the user's terminal.

If a customer is within five miles of "a principal telephone company central office," he qualifies for a Type 1 digital access line. The charge is \$65 to \$200/month, depending on transmission speed ordered, plus a \$100 one-time installation charge. Customers farther away must use a Type 2 DAL, costing \$90 to 250/month plus 60 cents to \$6/mile. In addition, there is a \$100 installation charge.

The interface at the user's end of the DAL actually consists of two units—the digital service unit and a "customer service unit" (csu), but the latter is provided as part of the access line, at no additional charge. The DSU will cost \$15-20/month, plus \$25 for installation. There will also be an additional charge for "off-net extensions"—i.e., access to DDS through analog local loops. Off-net extension service is promised for next year. The additional charges haven't been announced.

Higher speeds 'available'

Datran is offering tariffed service at 2.4, 4.8, and 9.6 Kbs. Higher speeds—56 Kbs. and 1.344 Mbs. were mentioned specifically—are also "available," al-

though they weren't included in the company's recent tariff filing. Datran's intercity channel charges are: 75 cents/airline mile/month for 2.4 or 4.8 Kbs. service, and 90 cents/mile/month for 9.6 Kbs. service. Local distribution channels "within the serving city's metropolitan area and environs" are \$70 each. The channel, in some cases, terminates in a "connecting arrangement" costing \$5/month; in other cases, the user must lease a "digital communications console" (DCC), which costs \$80 to \$180/month, depending on transmission speed, plus \$150-200 for installation.

A significant difference between the two networks is that AT&T provides all-digital service end-to-end. Datran, by comparison, offers access to its system through analog local loops leased from the phone company. This latter arrangement may produce some service degradation compared to an all-digital system. On the other hand, it means economies for the user. If he supplies his own modems (and they are accepted by Datran), he doesn't need a digital communications console. He interfaces through the \$5/month connecting arrangement. Also, there is no extra charge for an "off-net extension."

AT&T allows its DDS customers to provide their own DSU's, but a company spokesman indicates that no independent manufacturers are likely to market this hardware for some time.

Credit for errors

Possibly the most interesting feature of Datran's filing is its quality of service guarantee, under which the customer gets a credit on his bill if the service is less than 99.95% error-free. This percentage is based on seconds of transmission rather than number of bits. Also, the tariff, while specifying that the errors must be due to Datran-provided

facilities, rather than those provided by the customer or another carrier, doesn't describe a procedure for determining who's at fault. Nevertheless, the guarantee appears to be a significant improvement over what Bell is offering. The phone company says its "objective" is to provide 199 error-free seconds in every 200 transmitted. This standard allows about 10 times as many errors, on the average, as Datran's guarantee.

Both carriers permit the customer to furnish his own channel subdividing equipment, to share a terminal and access channel with other users; and to combine carrier-provided and independently made station hardware.

Rate comparisons are difficult because of all the variables involved and the fact that, as of now, the two networks encompass different geographic areas. However, according to one analysis, Datran's rates are higher than AT&T's at the lower speeds, and approximately equal at 9.6 Kbs. In both cases, the new rates are considerably lower than existing ones. For example, the current monthly charge for a 9.6 Kbs. analog private-line circuit between Houston and St. Louis is \$969. Under Datran's tariff, a digital channel operating at the same speed, with much greater reliability, costs \$747.50.

—Phil Hirsch

Bell Loses Ground On Two Fronts

In its ongoing battles with specialized common carriers on the one hand and the interconnect industry on the other, AT&T last month lost a little ground on both fronts.

The Federal Communications Commission was about to tell Bell it would have to provide local loop facilities ordered by MCI Communications Corp. This after a federal appeals court in Philadelphia lifted an injunction against AT&T compelling the phone company to rent the connections to MCI. The injunction had been granted by a lower court in February.

On the interconnect front, the Calif. Supreme Court told the state's Public Utilities Commission to take another look at the evidence before deciding that foreign attachment users must lease connecting arrangements from the phone company. The order was the result of a suit filed against the PUC by Phonetele, Inc., manufacturers of the Phonemaster, a device enabling users to limit outgoing calls to specified exchange prefixes and/or area codes. Phonetele objected to an "interim decision" by the PUC under which its customers had to continue leasing connecting arrangements from phone companies while the commission considered a

Switched Digital Service in 1975

The Wylly Corp.'s Datran subsidiary was about to file a tariff offering 56 Kbs. service at \$4.50/mile/month, its president Glen Penisten said at a recent talk in Chicago.

Penisten also said the company will offer switched service "beginning in 1975." He said "switched service will be offered at 4.8, 9.6, and multiples of 4.8 and 56 Kbs. Our production switch, to be delivered in mid-1974, is designed to service more than 10,000 customers and will handle up to 80,000 calls per hour."

Establishing each call will require "only a few hundred milliseconds, permitting a minimum billing time of six

seconds," Penisten said. He said automatic dialing and answering will be standard features, as will automatic camp-on and abbreviated dialing. The prices for switched services are still under study, but Penisten said "we see switched transmission across the country at 4,800 bps for .15 cents/minute." He said such a capability, along with digital facsimile equipment, "will begin to make electronic mail practical."

AT&T has said it plans to offer switched service also, but it hasn't announced when the service could begin.

THIS VERSATILE

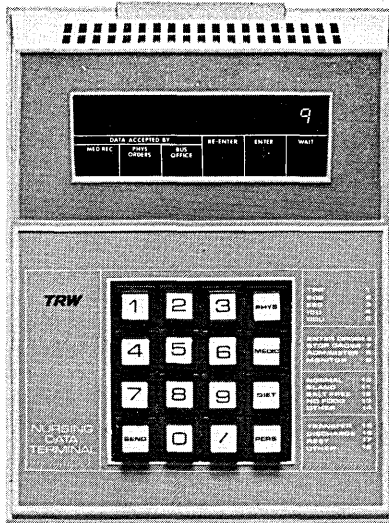

Nursing Station

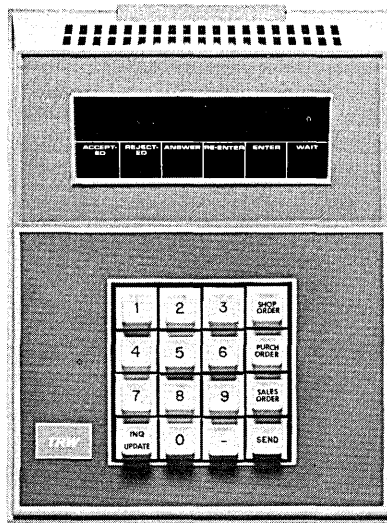

Shop Control

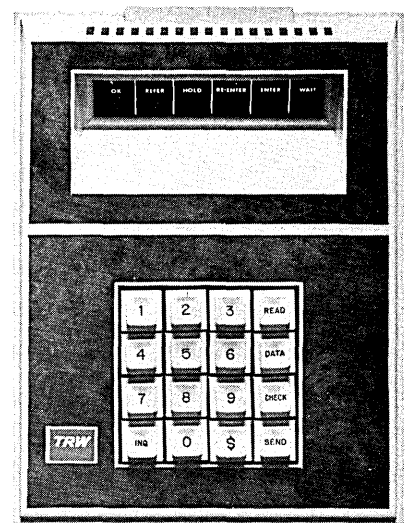

Credit Verification

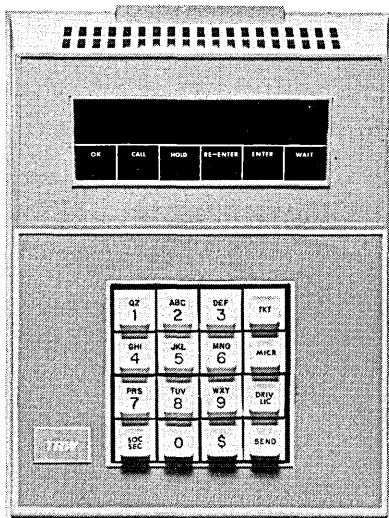

Ticket & Check Control

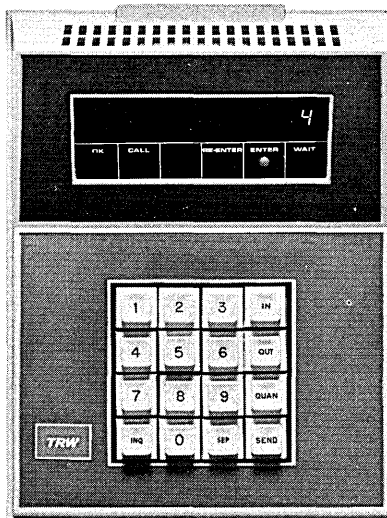

Inventory Control

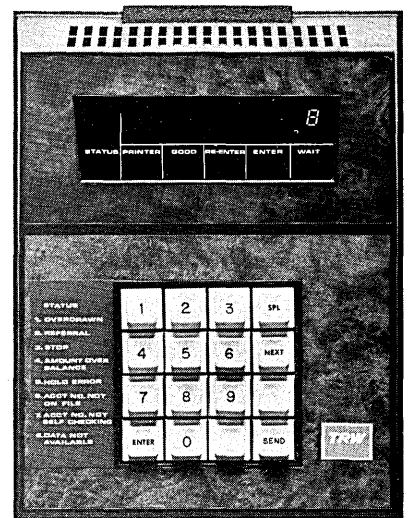

Banking: Teller Station

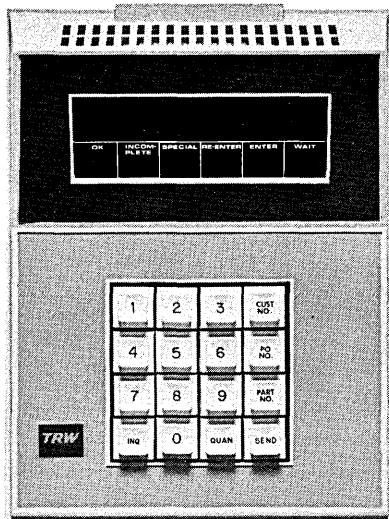

Order Entry

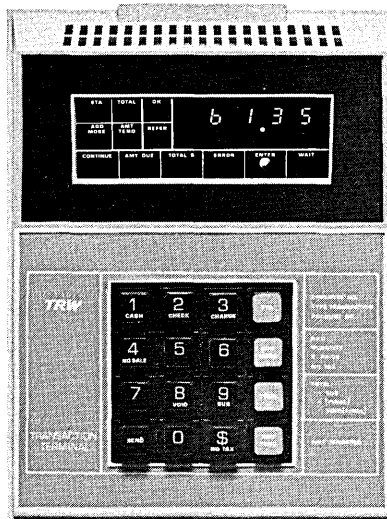

Sales Data Entry

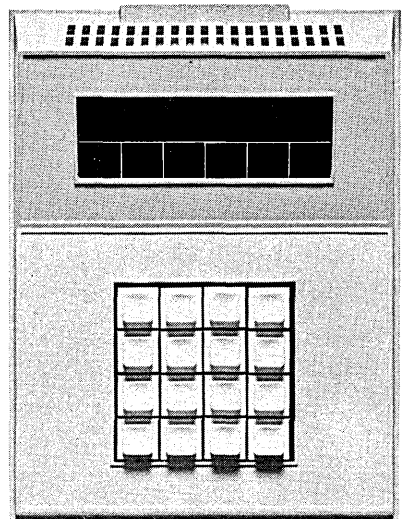

Name your own application

plan for certifying foreign attachments that could be connected directly.

Both the five-year-old struggle with the interconnect industry and the four-year-old joust with the specialized carriers are a long way from being over for AT&T.

Started with Carterfone

The interconnect battle started in June '68 with the Carterfone decision which said AT&T couldn't continue prohibiting attachment of customer-provided terminal equipment to the dial-up network.

In December '68, the Commission accepted (but didn't approve) an AT&T amendment to its dial-up tariff which allowed the use of customer-provided terminals, provided they were attached to the network through protective connecting arrangements leased from the phone company.

In 1969 the National Academy of Sciences was asked to evaluate the need for connecting arrangements. A year later, NAS concluded that: a) network protection is necessary; b) the connecting arrangement is one feasible way of providing it; and c) development of a program for certifying the safety of independently-made equipment is another feasible way.

The Academy suggested formation of manufacturer-carrier technical advisory committees to explore the certification idea. In 1971, a group was organized to develop a certification scheme for customer-provided PBX equipment. Early in '72, a certification study group for automatic dialing/answering equipment was assembled. And in June '72, the FCC began a formal proceeding to determine whether there was a "need to go beyond Carterfone" and adopt rules permitting greater use of foreign attachments. A joint board of federal and state regulators was set up to consider the question first. It was directed to evaluate recommendations of the advisory committees and to suggest ways of implementing a certification program if it determined there was a need to go beyond Carterfone.

The National Assn. of Regulatory Utility Commissioners (NARUC) insisted this charter wasn't broad enough. It had to include the economic impact of interconnection on the telephone companies and their subscribers.

"My deep concern," said Edward P. Larkin, a NARUC member and a member of the New York Public Service Commission, "is the consequence of the diversion of large blocks of essential revenues from a well-functioning, regulated, natural monopoly and the promotion of . . . interconnect . . . suppliers, all in the name of competition."

Another inquiry

Early last month the FCC responded to NARUC by launching a new inquiry into the economic impact of allowing phone company customers to use foreign attachments. Related matters also will be covered, including the economic impact of the newly-emerging specialized carriers on the long-established ones.

How this new inquiry will affect the joint board proceedings wasn't stated. Conceivably, the board could come up with a certification scheme for foreign attachments before the FCC determines the economic impact of such a scheme.

As the North American Telephone Assn., the interconnect industry's chief trade association, put it in a recent statement to the FCC, "the attempt to develop certification procedures has been jogging ponderously uphill to a rule-making that may never materialize."

The only tangible progress from all the maneuvering, as far as interconnect suppliers and users are concerned, is that the Rochester, N.Y. Telephone Co. now allows foreign attachments to be connected to the dial-up circuits through a connecting arrangement that is simpler than the one required by Bell. But this device too must be acquired from the phone company.

Also, Utah's public utilities commission has proposed a certification scheme under which independently-made terminals could be attached directly, but hearings on this proposal don't begin until July 1.

Last summer, the North Carolina public utilities commission proposed a ban on the use of customer-provided terminal devices for intrastate dial-up service. This ban also would apply to interstate service since the two are connected. Similar restrictions were proposed in Minnesota, Nebraska, and Oklahoma. Soon after North Carolina acted, interconnect suppliers and user groups asked the FCC to rule on whether a state could unilaterally bar foreign attachments. Late last January, the commission said, in effect, "no." The FCC, it said, "has primacy in authority over the terms and conditions governing the interconnection of customer-provided equipment to the nationwide telephone network . . . No state regulation can oust this commission for its clear jurisdiction."

The North Carolina PUC quickly appealed this decision by filing in the Fourth Circuit Court of Appeals, Richmond, Va. Other appeals, including one by the Bell System, have been filed in Washington, D.C. and New York. All the cases are being consolidated in Richmond where Bill Borhgesani, Jr., telecommunications counsel for the Na-

tional Retail Merchants Assn., sees "an all-out battle" shaping up. He hopes for a decision before the end of the year.

Other challenges

And, as California's PUC follows up on the Supreme Court instructions it received, other court challenges to AT&T's foreign attachment restrictions are pending in other courts and/or at the FCC.

The specialized common carrier issues are in the courts too. MCI and AT&T recently filed suits against one another, charging violations of antitrust laws.

AT&T's struggle with specialized common carriers started in 1969 when the FCC authorized the first one, MCI, to offer service. In May 1971 the commission opened the floodgates with a decision effectively establishing the data communication services business as a competitive one.

On the local loops issue, the FCC last October ordered the phone company to file interstate tariffs covering local loops leased to other carriers. AT&T did so under protest and the new tariffs are considerably higher than state tariffs and don't encompass the same services. The commission has launched a new proceeding to look into justification for the higher rates. The FCC also issued a show cause order to AT&T asking why it shouldn't cease and desist from delaying interconnections of the type in dispute (local loops).

The Justice Dept. has become involved on both fronts of the phone company's war. The department is investigating AT&T's efforts to frustrate both the specialized carriers and the interconnect manufacturers. Bell has supplied the feds with specified documents, which antitrust attorneys are now perusing behind tightly-closed doors. And a Senate antitrust subcommittee, headed by Phil Hart of Michigan, is getting ready to hold hearings on AT&T's competitive maneuvers, particularly in regard to interconnect equipment.

Benchmarks

Not So Uncertain: With the exception of Control Data, which expected a slight dip in earnings, computer mainframers had a spectacular first quarter of what many expected to be an "uncertain" year. CDC attributed its problem to higher interest costs and said it expected all of 1974 to show an improvement.

Burroughs earnings rose 31% to \$21.4 million, a record and a gain of \$5 million over last year's \$16.3 million. Its revenue also was a record \$322.8 million, up 18% over the same period last year. Honeywell's income rose by \$2 million to \$18.2 million on revenues in

THIS BIG

(Actual Size)

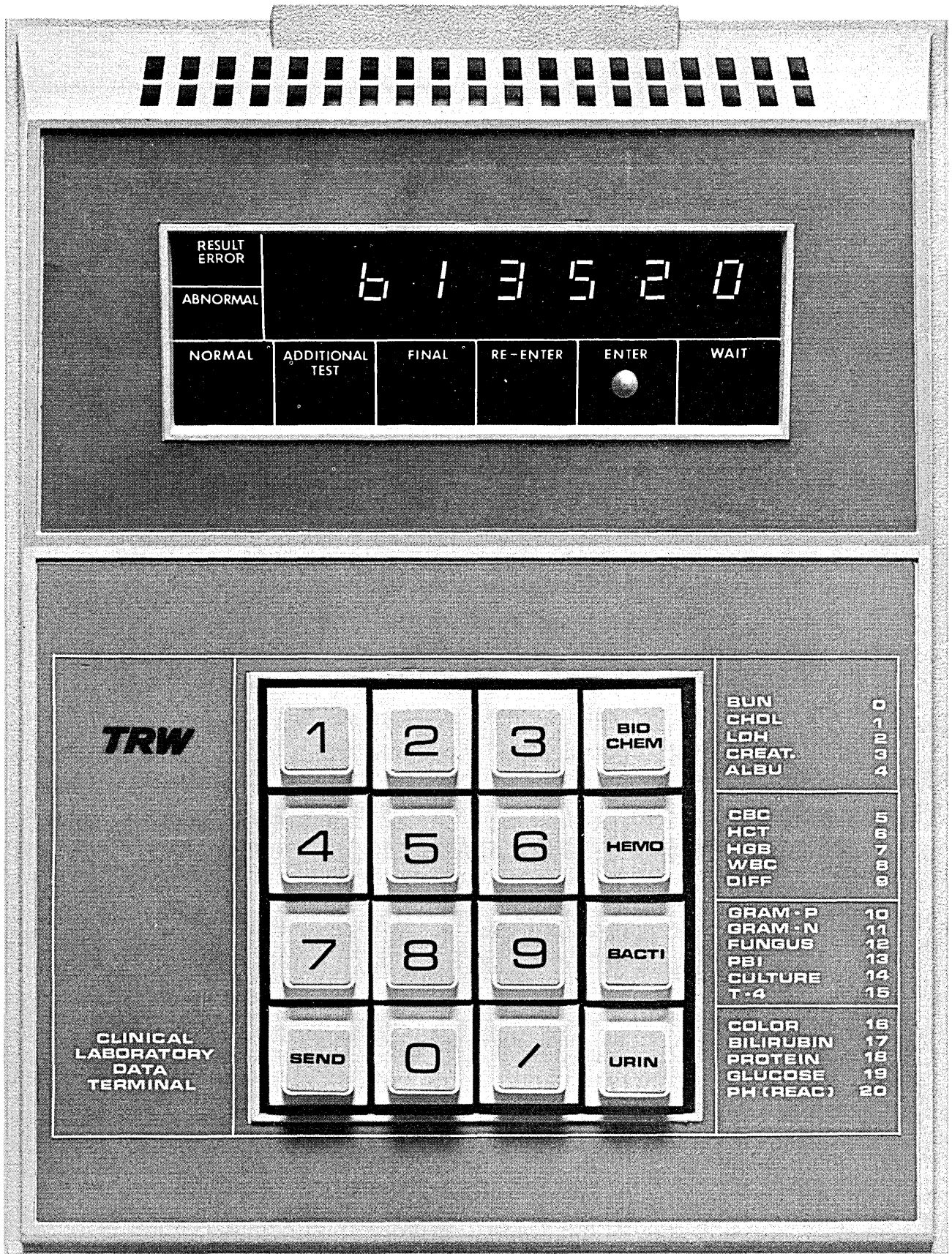

the first quarter of \$585 million. NCR Corp. said its first quarter earnings of \$12.1 million were a 62% increase over the year before. The company's revenues rose by a comparatively smaller 5.4%. It attributed the higher earnings gain to continued cost cutting in domestic operations. Stockholders at the annual meeting changed the company's name from National Cash Register Co. to the firm's initials, NCR Corp.

IBM said a high rate of equipment was purchased in the first quarter, contributing "significantly" to a 22% rise in revenue to \$3 billion from \$2.4 billion in the first quarter of 1973. Its net rose 27% to \$431.3 million.

Electronics Is Healthy: WEMA, a trade association of electronics and information technology industries, said its membership has soared 10% to 714 companies within the last nine months, "reflecting continued good health in the electronics industry." The association recently issued its annual directory of its member companies and their officers and products, which is sold for \$26.50. It takes orders for the directory at P.O. Box 11036, Station A, Palo Alto, CA 94306.

New Man at Memorex: The man who led Collins Radio Co. into the black during its troubled times in 1972-73 left the presidency of the Dallas company to succeed Laurence L. Spitters as president of troubled Memorex Corp. Robert C. Wilson, 54, faces another serious challenge with the Santa Clara company, which announced a \$119.1 million loss on 1973 sales of \$177 million.

Sales Abroad for Jobs Here: William R. Hewlett, president of Hewlett-Packard Co., representing WEMA before a Senate Finance Committee hearing on the proposed Trade Reform Act of 1973, reported results of a survey of WEMA companies to which 189 firms responded. He said the respondents indicated that 27% of their 1973 sales came from the export of U.S. manufactured products. A number of these companies, including his own, he said, view international business as a way of providing more jobs for U.S. employees as well as a way of increasing profits. Both Hewlett and his co-WEMA representative at the hearing, Dr. C. Lester Hogan, president of Fairchild Camera and Instrument Corp., urged passage of trade legislation which would further open the door to international markets for U.S. high technology products and would assist companies pursuing these markets to compete effectively with foreign manufacturers of similar products.

Dr. Hogan, in his testimony, argued for the continuance of Tariff Items 806.30 and 807.00, regulations which allow American manufacturers to produce parts domestically, ship them abroad for assembly or processing, and then reimport finished products with duty paid only on the value added by offshore assembly. "Most semiconductor products cannot be marketed anywhere if they are assembled with domestic labor at U.S. wage rates. The cost of our products would increase substantially and would undoubtedly price them out of the market."

The New Certifiers: The Data Processing Management Assn. (DPMA) turned over the control and administration of its professional certification program to the recently formed Institute for Certification of Computer Professionals



(ICCP), an organization representing eight professional societies. The new group will administer the DPMA's Certificate in Data Processing and Registered Business Programmer examination programs. Shown in photo when the program was turned over are from left: William S. Eick, ICCP treasurer; James B. Sutton, DPMA president; Donn W. Sanford, DPMA executive director; John K. Swearingen, ICCP president; and Paul M. Pair, ICCP secretary.

It's Finally Happened: The Data Processing Management Assn. (DPMA) has applied for membership in the American Federation of Information Processing Societies (AFIPS). The DPMA executive council approved the move last month following discussion of the various points investigated by a special AFIPS study committee which had been considering the matter for several months. James B. Sutton, DPMA president, said the association had received preliminary unofficial assurance that DPMA would become a partner in the

National Computer Conference (NCC), now operated jointly by AFIPS, the Assn. for Computing Machinery (ACM), the IEEE Computer Society, and the Society for Computer Simulation. "This in no way should indicate, however, that DPMA will abandon its own independent international conference (INFO/EXPO)," said Sutton. "We'll just be looking at different dates to avoid unnecessary conflicts with the NCC schedule."

For Bigger and Better POS: General Instrument Corp. completed its acquisition of American Regitel from Motorola Inc., and will meld the San Carlos, Calif. point-of-sale equipment manufacturer with its UniTote div., considered the grandfather of POS. The new UniTote/Regitel division will be part of the parent company's Data Systems and Services Group. Evan Ragland, president of American Regitel, becomes vice president and general manager of UniTote/Regitel. In the acquisition, holders of American Regitel's 576,205 common shares received 124,810 shares of General Instrument common stock. In addition, Motorola received 5,000 shares of General Instrument common for its 1,212,710 shares of Regitel Class A common.

Thanks for the Memory: Somebody will go away from the National Computer Conference with reason to say this. He or she will be the winner of Ampex Corp.'s "The DEC Shuffle." Prize in the giveaway, aimed at helping Ampex assemble profiles of customer systems in use, is \$23,000 worth of free core from the firm's memory products div. The prize can be taken in one of three options: a complete 32K memory expansion core for the MD-10 memory for the Digital Equipment Corp. PDP-10; a \$23,000 credit against the purchase of an Ampex equivalent to the MD-10 memory with a capacity of either 32K or 64K words; or a \$23,000 credit against the purchase of a 256K word capacity Ampex ARM-10 memory. All it will take to enter the competition will be answers to 14 questions and a company name and address. The drawing will be at 2 p.m. May 9.

Bucking the Trend: Pocket calculators continue to buck the trend of spiraling prices by taking the opposite direction. Latest price decrease was announced by Hewlett-Packard for two of its pocket-sized scientific calculators, the HP-35, reduced from \$295 to \$225, and the HP-45, down to \$325 from \$395. "Lower manufacturing costs achieved through specific cost reduction programs and high volume led to the lower prices," said William E. Terry, H-P vice president. □

AND THIS SMALL

\$308⁰⁰

Introducing Digidata™ for the OEM. The TRW series 9000, low cost universal digital input-output terminal for any system requiring rapid, reliable communication of digital data.

Use alpha terminals or any other peripherals where you need them in your system. But why pay those big, extra dollars for the many places where Digidata does it all?

Fully buffered, the standard, four digit display model is \$308. But even the most complex Digidata model is inexpensive, and of course OEM pricing is even more attractive.

Communications interface units, cluster controllers, and other communications products are all available from TRW to get you on-line rapidly, reliably with the lowest cost comprehensive system in your field.

TRW terminals have proven themselves in the consumer credit field. Write for our Literature Package and see how these versatile low cost terminals can help you offer your customers a whole lot more capability for a lot less cost.

TRW DATA SYSTEMS
12911 Simms Avenue
Hawthorne, California
90250 (213) 535-3891

TRW®

WRITE ON!

TRW DATA SYSTEMS

OEM Marketing
12911 Simms Avenue
Hawthorne, California 90250

I like the idea of a truly reliable, low cost digital terminal. Send me the OEM Series 9000 Literature Package.

My interest is in systems for _____ and my potential need is _____ terminals.

Name _____

Title _____ Company _____

Street _____ City _____

State _____ Zip _____ Phone _____

LOOK AHEAD

(Continued from page 18)

their clients in managing the use of computer network facilities.

In Minneapolis, Gary A. Stoltz, who for five years helped direct Data 100 Corp. through the complexities of lease financing (see Dec. '73, p. 164), is raising \$15 million to form a computer equipment rental company, as yet unnamed. Stoltz, who left Data 100 last fall to form a consulting company, expects to be in business before June.

THE LAST OF VIATRON

For the nostalgia fans we bring the latest news on Viatron Computer System Corp.: the company has been struggling through various stages of bankruptcy and at this writing appeared about to dissolve as a corporation.

However, a young Boston area firm, Portidat, Inc., was preparing to take over the company's business with the idea of supervising the servicing of some 2,000 Viatron terminals that have been delivered. It's also reported that there still is a "sufficient amount" of Viatron machines to be marketed and that Portidat will do the selling. In fact, one customer is interested in taking 25 Viatron terminals:

Robert Dockser and Thomas Murray, the ex-IBMers who were operating Viatron in bankruptcy, have left; but the attorney-trustee of Viatron, Robert Popeo, still remains in that post.

MAKING WAY FOR THE SUN

The data processing div. of the city of Anaheim, Calif. has been replaced by the World Football League, specifically the California Sun and, more specifically, in Anaheim stadium, home of baseball's California Angels. The city dp department vacated 5,000 sq. ft. of office space it had occupied in the stadium for four years. Said space is now headquarters for the California Sun, a WFL franchise owned by the city of Anaheim. And the department is only a few miles away from the Sun and the Angels in 11,000 sq. ft. of office space it shares, along with a 370/145, with the San Gabriel Valley Municipal Data System, a joint dp service for 16 smaller California cities. The Anaheim dp'ers gave up their space to the Sun with a lot less reluctance than the NFL is displaying in giving up players..

RUMORS AND RAW RANDOM DATA

Since writing "The French Fad," an article on metric system conversion controversies to be published next month in Datamation, author Chet Cohen has been traveling in England, from where he reports "it may take a century" for all England to be metric, though he once thought it would take only 10 years. "Although children are learning metric in schools, visible evidence of the 'french fad' is scarce"... Qantas, the Australian airline, has dropped IBM and Honeywell maintenance of its four 360/65s and six Honeywell front-enders because neither vendor wanted to service the other's equipment and Qantas was tired of calling up both. It's given the new maintenance contract to DPCE, a subsidiary of Dier, a Sydney computer leasing company... Also down under, IBM put together an international team of experts from Australia, France, Germany, and Canada to land an order for 215 terminals for Western Australia's computerized betting system...At UCLA, where a four million byte 360/91 is being used for the first time this year for on-line course enrollment of some 28,000 students, a student hurrying across campus was overheard telling another who hailed him: "Can't stop now, gotta go talk to the computer."



1. Liquid fuel poured for demonstration.



2. Fuel ignited.

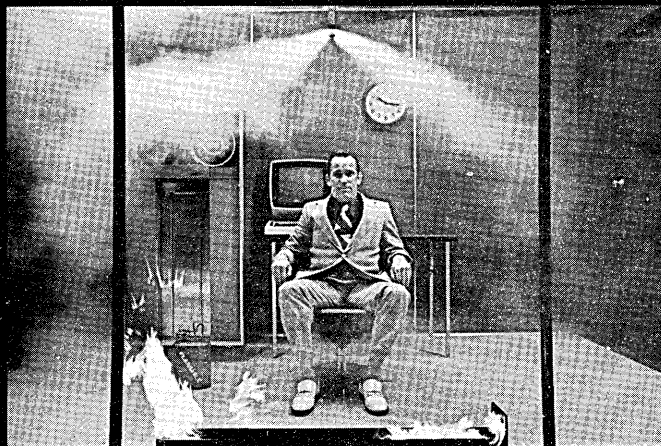

3. Halon 1301 released.



4. Fire out. Man safe. No residue.

In the time it takes to read this sentence, Halon 1301 extinguished this fire with no harm to man or equipment.

It's protection you need
against damage, downtime
and loss of records.

If you can't afford to be without your data processing equipment or records, you can't afford to be without Du Pont Halon 1301 protection.

A total flooding system using Halon 1301 works fast and can be released fast—while people are in the area, because exposure to usual extinguishing concentrations for up to five minutes is not harmful. The National Fire Protection Association has approved a standard for the use of Halon 1301 (Standard 12A).

Halon 1301 is the ideal extinguishant

for protecting electronic equipment. It is a chemical vapor that can penetrate cabinets, above ceilings and under floors. Yet it doesn't leave residue or cause thermal shock damage to equipment. It's electrically non-conductive and non-corrosive. And systems using Halon 1301 are economically competitive with other gaseous fire protection systems.

For more information on automatic total flooding systems using Halon 1301 fire extinguishant, write or call Du Pont Company, Room 23891-A, Wilmington, DE 19898. 302-774-7381.

Total flooding systems using Halon 1301, with UL and/or FM approval, are manufactured by:
The Ansul Co. Walter Kidde & Co., Inc.
Cardox Div. of Norris Industries
Chemetron Corp. Safety First Products
Fenwal, Inc.

CIRCLE 100 ON READER CARD





**The more you ask about data communications,
the more the answer is minicomputers.**

**And the more you ask about minicomputers,
the more the answer is Digital.**

There's a revolution going on in data communications. And Digital's leading the way.

Digital's putting minis to work in data concentration, front end processing, message switching, remote

systems for RJE and local processing, and in network applications around the world.

Today that revolution moves forward. With Digital's leading PDP-11 family of minicomputers, the highly

sophisticated DEC system-10 time sharing system, and a full range of tools, including peripherals, interfaces and software.

If you have questions on where the revolution's going next, now's

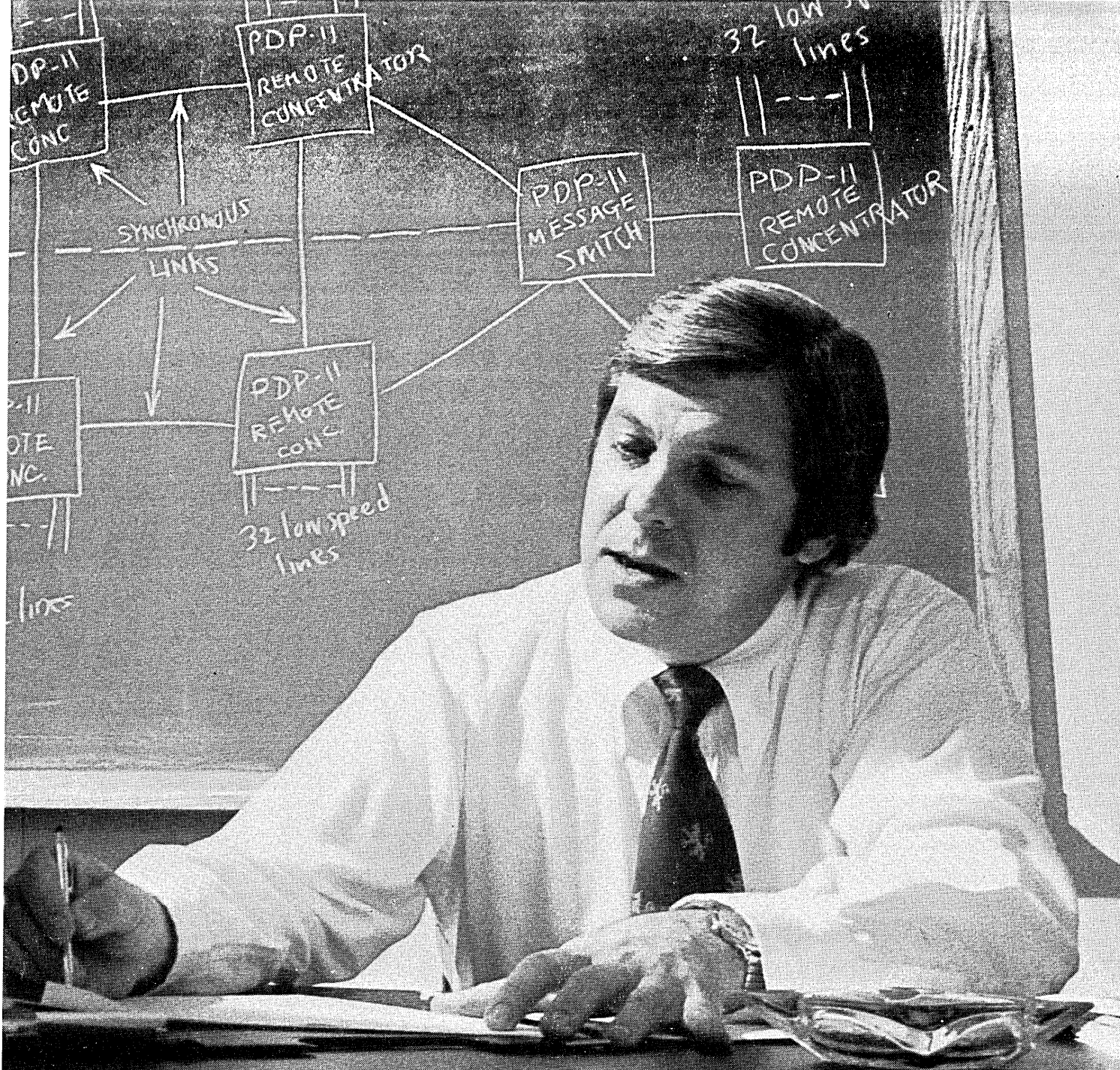

the time to get the answers. Ask Digital's DECcomm group. The specialists who made the world's leader in minicomputers the world's best source of new thinking in data communications.

Call or write, the DECcomm Group, Digital Equipment Corporation, Maynard, Mass. 01754. (617) 897-5111, European headquarters: 81 route de l'Aire, 1211 Geneva 26. Tel: 42 79 50. Digital Equipment of

Canada Ltd., P.O. Box 11500, Ottawa, Ontario K2H 8K8. (613) 592-5111.

digital

CIRCLE 50 ON READER CARD

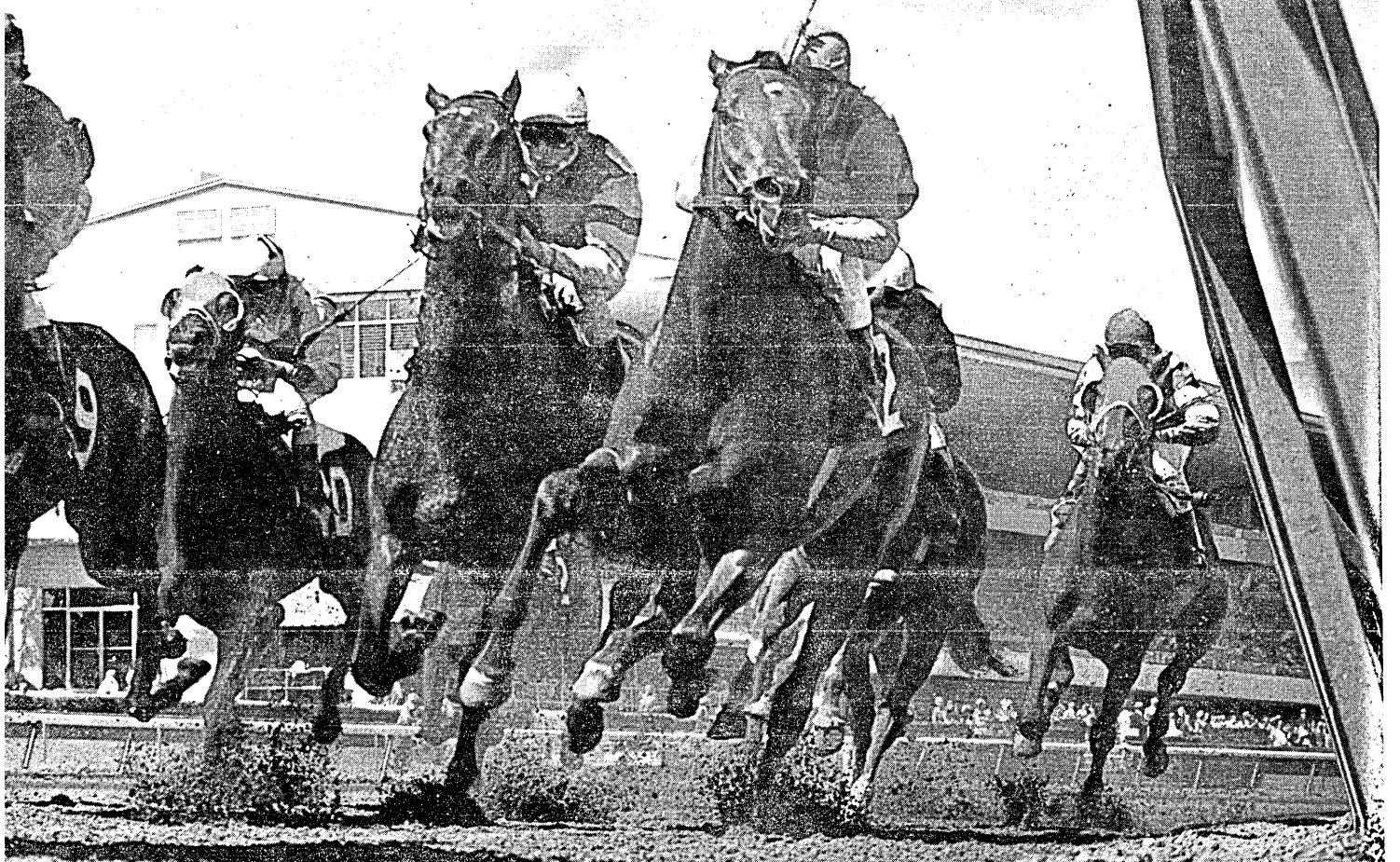

WE'RE MOVING UP ON THE INSIDE.

Some big-name front runners in the computer sweepstakes are looking back over their shoulders. And finding a gutsy four-year-old sneaking up and beating them to the finish line more times than they like to admit.

The fact is, we're beating the hide off them. With a stable of computer thoroughbreds from MODCOMP I to our newest champion, MODCOMP IV, first computer to offer the computing power of traditional 32-bit machines at a 16-bit price. With 1,024 address mapping registers, complete context switching in 3 microseconds, 240 general purpose registers and up to 512K bytes of memory. All harnessed to a complete set of working software that gets it off and running while other contenders are still waiting to get saddled up.

Get in touch with us for more facts and figures. And find out why we're making losers out of a lot of one-time big winners.

Put your money on the winner.

MODCOMP

✦ MODULAR/COMPUTER SYSTEMS INC. 1650 West McNab Road / Ft. Lauderdale, Florida 33309
Telephone: (305) 974-1380 TWX 510-955-9820

European Marketing Headquarters: 103 Mytchett Road, Mytchett, Surrey, England
Telephone: Farnborough Hants 514-251 Telex: 85631

CIRCLE 63 ON READER CARD

A completely new concept in data communications

The first VIRTUAL TERMINAL SYSTEM



INPUT/OUTPUT DEVICES AVAILABLE WITH THE BRAEGEN VIRTUAL TERMINAL SYSTEM

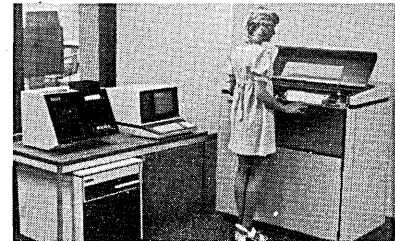
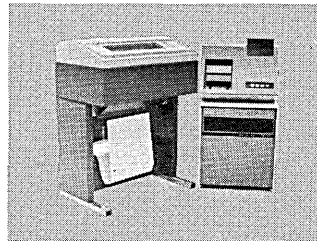
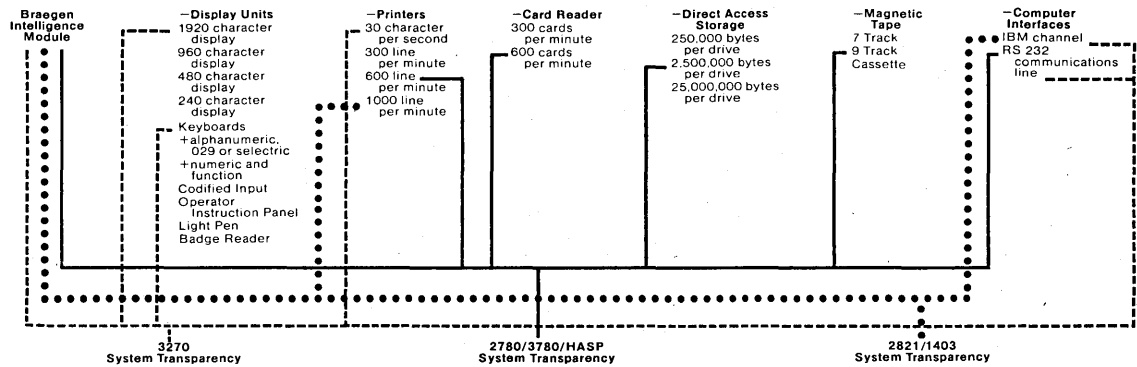

Braegen invented the Virtual Terminal System. A completely new concept in data communications that goes all the way from 360/370 channel interface to full communications line configuration to stand-alone processing capability.

Virtual Terminal System refers to a hardware/software breakthrough that eliminates the entire spectrum of dedicated controllers and rigid peripheral configurations. If you want it to, Braegen's VTS can look like an IBM 3270, a 2780/3780, or a 2821/1403 system. Or it can take on the personality of any other popular system. And you can work in any one of these modes at any time, or you can put everything together in a full cluster without reprogramming or reloading.

With the Braegen VTS, you can assemble a peripheral lineup that combines video terminals, line printers, card readers, mag or paper tape, single or stacked discs, batch or on-line operations, and truly interactive routines. And you can utilize any combination while working from a single, low-cost communications processor. This is the perfect interface solution for just about any OEM system.

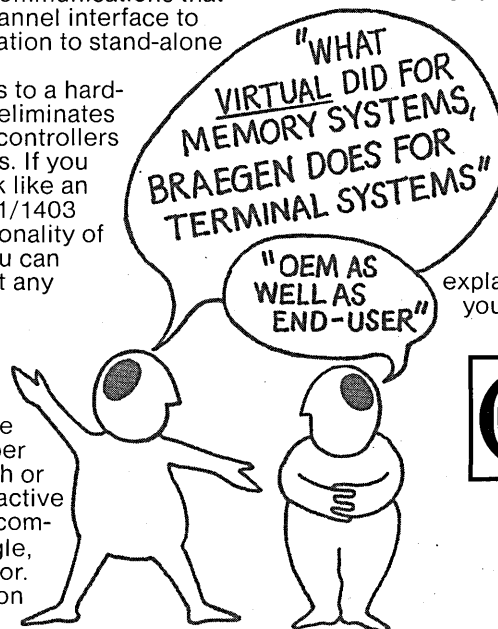

VTS saves money three ways. As a replacement for one of the popular IBM controller systems, it does more and costs less. As a growth step in expanding EDP systems to an interactive level, it sidesteps the need to get locked-in to an inflexible future. And as a first step in building an information system, the Braegen Universal Controller can serve as both host CPU and a terminal processor, saving a fortune in surplus mainframe capacity.

Virtual Terminal System power is explained in a new brochure we'll send when you write or call us. Use VTS power to save money and extend capability.



BRAEGEN

The BRAEGEN Corporation
 927 Thompson Place
 Sunnyvale, California 94086
 (408) 738-0900

Hardware

Off-line

It's just possible that the familiar punched card will die before paper tape does—at least in Europe—according to a recent survey of more than 1,000 installations conducted by EDP Europa Report. While most planners expect to still be using cards in two more years, the percentage of those who will use them as their primary source of input is predicted to drop from 65% to 15%. Where will the input be coming from? According to EDP Europa, 31% will come from remote terminals (compared to 2% now), 24% from key-to-disc systems (up from 7%), and 9% from OCR devices (versus 1%).

Nostalgia lovers will appreciate knowing that a Williams tube memory has been donated to the Smithsonian Institution by the Ferranti organization of Manchester, England. The device, which used a cathode ray tube for storing information, was a big advancement in memory technology, particularly in terms of speed, over the acoustical delay lines in use during the early fifties. IBM licensed the technology between 1953 and 1956 for use on the 701 and, briefly, on the 702 machines, until a radical new technology called core memory was perfected. Ferranti, one of the most innovative manufacturers of early computers, sold its data processing interests to International Computers Ltd. in 1963, but continues to build special-purpose systems.

Some of the spirit of foolishness in our April issue unfortunately spread to places where it shouldn't have. The photo of Computer-Link Corp.'s model 1700 tape evaluator/cleaner appears in the middle of the product description for Randomex on p. 62. Randomex's disc cartridge cleaner really doesn't look like that at all.

An upcoming issue of Datamation will feature a comprehensive survey of the rapidly expanding mini- and microcomputer fields. If your firm manufactures these products, please send for a questionnaire so we can include them. Write to: Datamation, 1801 S. La Cienega Blvd., Los Angeles, Calif. 90035, Attn: Minicomputer Survey.

Hand-held Computer

The Alpha 325 and Beta 326 are either the most interesting computers announced since the Burroughs B1700, or the most exciting calculators announced since Hewlett-Packard came out with the HP-35. We'll let you be the judge after reading what they can do. The Beta 326 could easily be held in your hand, except that it comes *standard* with a Philips-type cassette drive attached to a short plug-in cable,

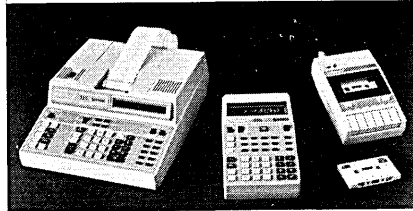

so you'll probably want to put it down. Over 100,000 program steps or 9,000 data values can be stored on a single 1½-ounce cassette. It's just not very hard to imagine the 326 as *the* computer in many small, professional businesses; and what the models can't handle, they can communicate through a modem (optional) to a distant computer, tty, or crt terminal. Programmable in algebraic notation from the keyboard, the 326 accepts blocks of programs in 160-step increments (dare we say pages?) with program segments capable of automatically calling and storing data from the cassette! Register arithmetic may be performed on data into or out of all 12 internal storage registers, with entries and results appearing with 13-digit accuracy in a gas discharge display. The dynamic range for computations is 10^{-98} to 10^{99} .

If you need hard copy records, that's where the Alpha 325 comes in. It is a slightly larger desktop unit that incorporates a 10-column journal tape printer. The inside of the 326 is organized a little differently; it accepts 416-statement chunks from the cassette, and can handle a program of 150,000 statements. Both products have over 100 built-in calculating functions, compared to 51 in the HP-65. The good news doesn't stop before the price tags, either, with the 326 retailing for \$1,195 and the 325 desktop version with printer initially set for \$1,795. First deliveries will take place before July. COMPUTER DESIGN CORP., Los Angeles, Calif.

FOR DATA CIRCLE 341 ON READER CARD

370 Disc Storage

IBM has come up with an interesting variation on the 3340 (Winchester) disc drive that might potentially speed

up processing on virtual memory 370 models ranging from the 135 to the 168. The model 70F data module retains "a number" of movable read/write heads for access of up to 69.3 megabytes of data, but 30 fixed heads have been placed inside for reading a half-megabyte of data that can be accessed in a very quick 10.1 msec. All the heads have to do is wait for the 2,900 RPM to rotate the five logical storage cylinders under them, so it's really only latency time. The transfer rate remains 885 KB/second.

The new data module operates on any two-drive 3340 equipped with a fixed-head modification (\$40/month on a two-year contract), and the packs seem very expensive at \$4,400 purchase, or \$140/month on the same extended term plan. Still, users willing to change their shop's JCL decks to allocate paging tables, partitioned data set directories, job queues, data management and access methods files, work areas, or other information critical to the machine's throughput might be able to realize a substantial throughput increase which might come close to negating the cost of the packs. First units go to the field during the fourth quarter. IBM CORP., White Plains, N.Y.

FOR DATA CIRCLE 342 ON READER CARD

Radioed Data

The Air Force is planning to broadcast entire data bases into the sky for military applications — something that seemed pretty far out six months ago — but this firm has developed a capability for users needing short-haul transmission to do the same thing, though on a much smaller scale. An ultra-high frequency radio has been developed capable of transmitting at

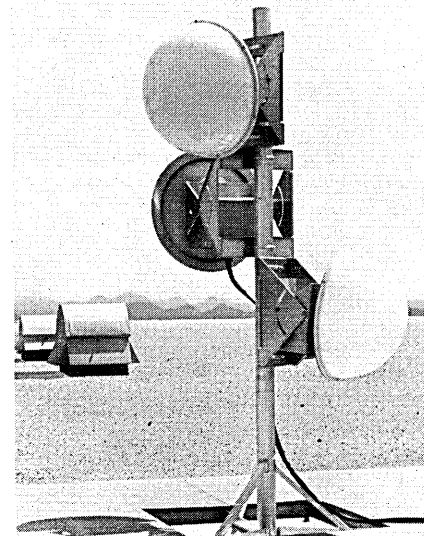

DATAMATION

The ADDS/500. Graphics unlimited, with economy.

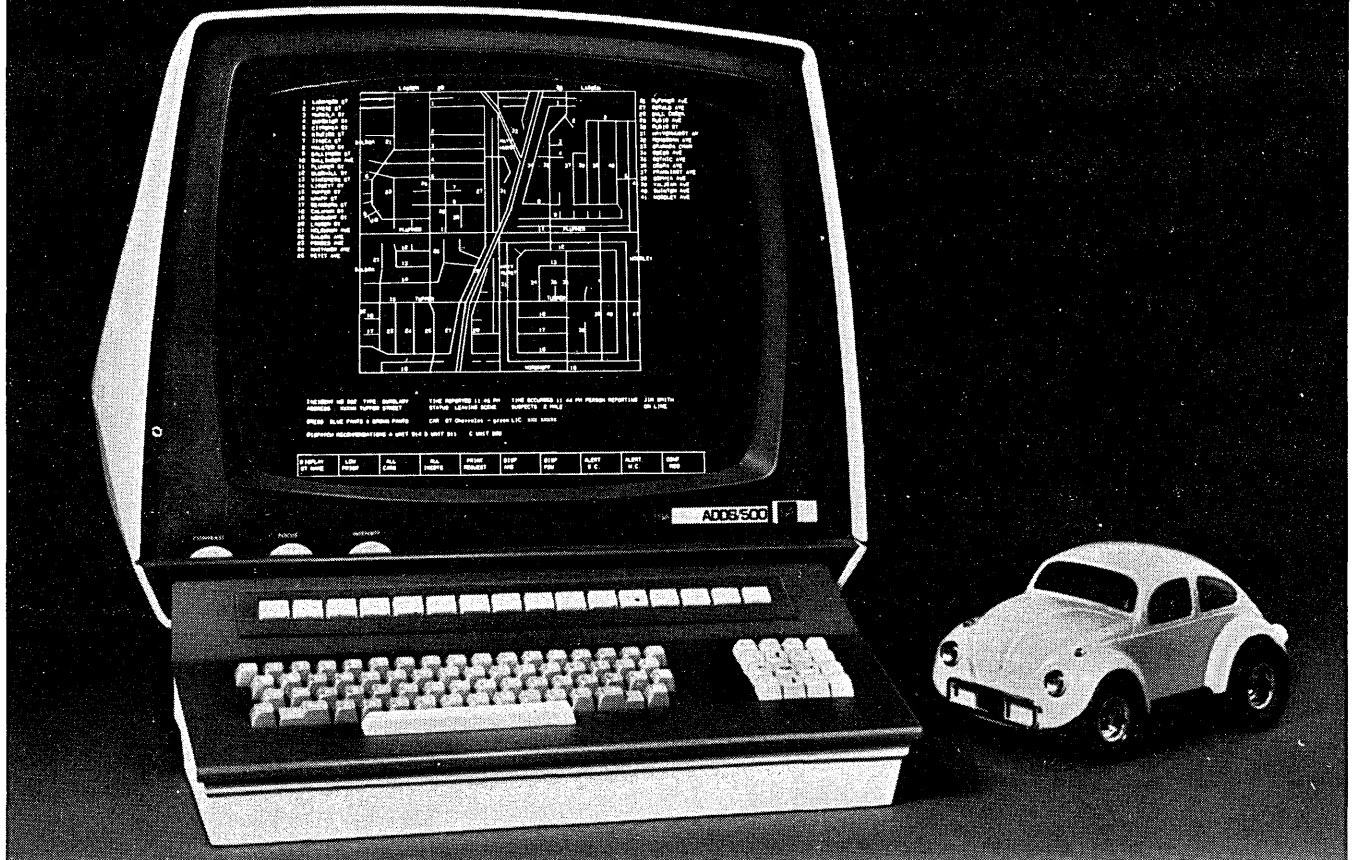

Sanders' ADDS/500 graphic display system offers state-of-the-art technology and performance you'd associate with high cost. Contrary to expectation, you can buy the basic system, complete with minicomputer, to suit your budget.

The ADDS/500 graphics display is an interactive, computer-driven system that functions on-line or stand-alone. Its "building block" components, including up to four display terminals, can be configured off-the-shelf to achieve custom designs. And it interfaces with general-purpose digital computers.

Applications? Unlimited: LSI mask making, automated flight testing, simulation and training, pattern layout, land-use management and broad creation of computer-aided designs.



There's much more. Get the full story from Sanders Data Systems, Inc., Graphic Systems Marketing, Daniel Webster Highway-South, Nashua, N. H. 03060. Call (603) 885-5280.

Sanders...the intelligent answer

European Sales Offices: Sanders Data Systems, Ltd., 51/53 Brick Street, London W1Y 7DU, England;
Sanders Data Systems, GmbH, 6000 Frankfurt/Main, Rennbahnstrasse 72/74, West Germany.

ONE WAY OF COPING WITH YOUR IBM 1130:

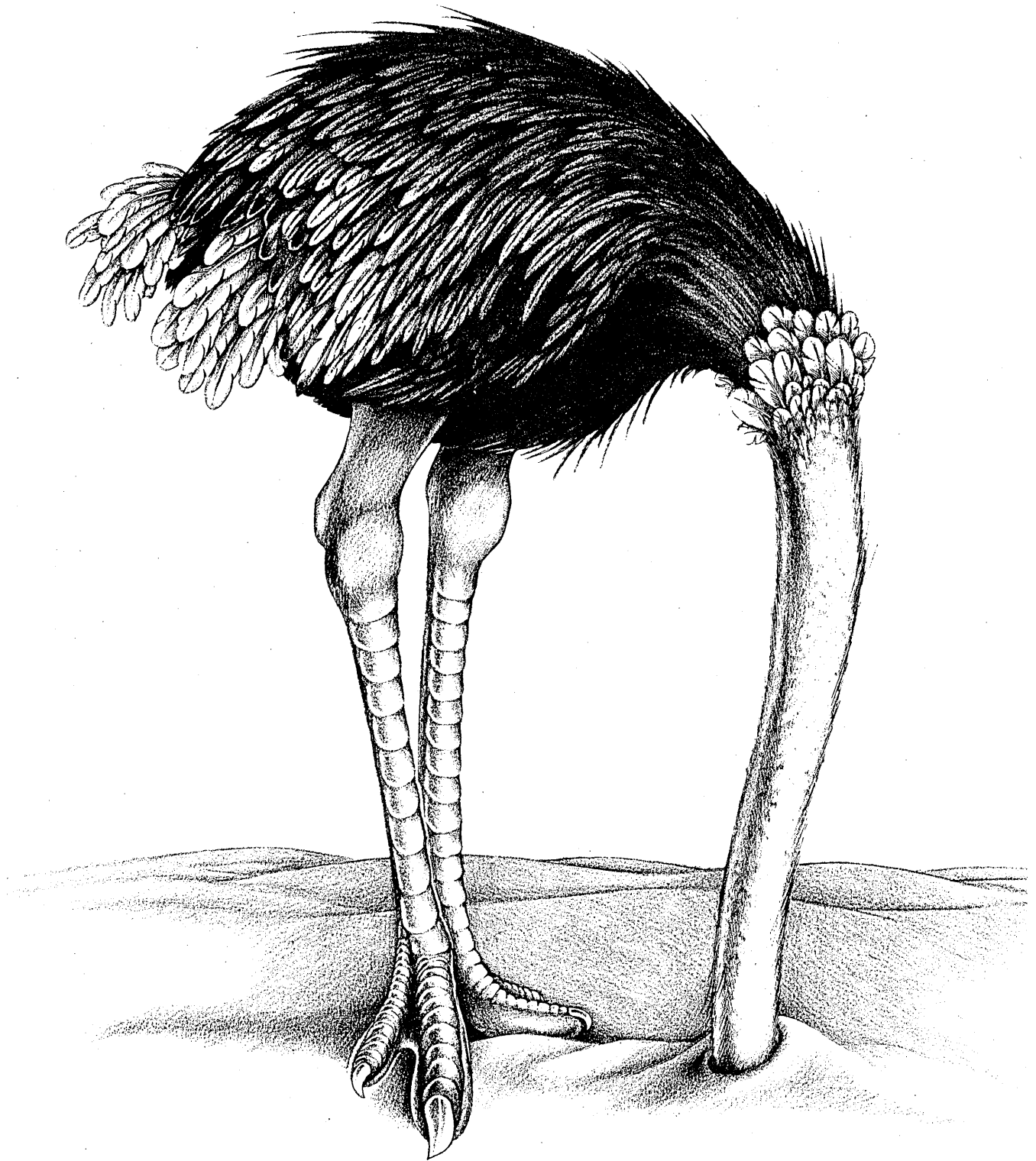

THE OTHER:

Face it. The 1130 has been discontinued.

That may not bug you now, but sooner or later you're going to be up a creek.

And the only solution IBM can offer is moving you up to a bigger, more expensive computer with all new software to write.

General Automation has a solution that's simpler.

The DMS.

Even if you think you're happy with your 1130 now, we can replace it with our basic DMS at a monthly cost savings of about 40%.

As your needs grow, our system can grow with you. In fact, we can give you up to ten times the throughput of an 1130. Just add what you need when you need it.

You can even add real-time capability. With a choice of two new operating systems: DPS or CMS.

But you'll never pay more for our DMS than you're paying right now for the 1130. And you can run more than 95% of your existing software without change.

Our specialists are

constantly developing more peripherals and software for you. Our user group is constantly trading information on how to get the most from the system.

Now you can see why our DMS has replaced more than three hundred 1130's. Four times more than anyone.

We believe a system that can do all this for you is a much prettier sight than what you're looking at now.

I want to know more about the DMS and why it's the number one replacement for the IBM 1130.

Forget it. I still want to keep my head in the sand.

Name _____

Company _____

Address _____

City _____

State _____ Zip _____

Mail to General Automation,
1055 South East Street,
Anaheim, California 92805. Or
call us at (714) 778-4800.

**DMS SYSTEMS BY
GENERAL AUTOMATION**

HOT

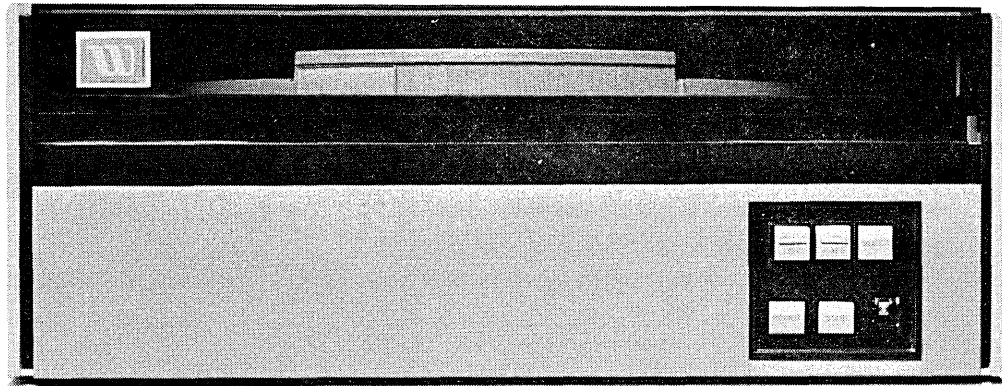

AND

COLD

WANGCO 200 TPI DISC DRIVES BRING BACK THE DATA... EVERY BIT!

When you pick your 200 TPI disc drives, the challenge is to find a drive that will operate reliably under a wide range of temperatures. Sometimes the drive is warm and the cartridge is cold. Sometimes it's the other way around. And there are infinite combinations in between.

But to a WANGCO 200 TPI disc drive it doesn't matter. WANGCO's active electronic temperature compensation system really works. And WANGCO 200 TPI drives were designed as 200 TPI drives from the start. They are *not* 100 TPI drives warmed over for higher performance.

The design of the precision cast frame is based on the critical demands of 200 TPI. These same frames, incidentally, are used to give our 100 TPI drives their exceptional reliability.

Even the voice-coil positioner, and its optical sensing system and associated control logic, the DC drive motor... every assembly and component, has been designed specifically for 200 TPI performance and 200 TPI reliability.

WANGCO front and top loading disc drives are only 7 inches high, yet both offer 100 TPI and 200 TPI capability in the same size, with capacities to 100 megabits.

Performance, reliability and low cost... we're setting a hot pace, and the prices are cool.

For more information call the WANGCO office nearest you, or write for our new disc drive literature package. WANGCO Incorporated, 5404 Jandy Place, Los Angeles, Calif. 90066 - (213) 390-8081, TWX-910/343 6246.

WANGCO INCORPORATED - SETTING THE PACE IN PERIPHERALS

New York, N.Y. 516/294-0893 • Boston, Mass. 617/444-9264 • Washington, D.C. 301/937-2215 • Huntsville, Ala. 205/881-7836 • Chicago, Ill. 312/336-1555
Houston, Tex. 713/785-0581 • Dallas, Tex. 214/620-1551 • Denver, Colo. 303/355-3521 • San Francisco, Calif. 408/732-6210 • Seattle, Wash. 206/632-0710
In Europe: WANGCO Incorporated, Radix House, Staines, Middlesex, England

hardware

either 39 or 22 gigahertz (GHz), yielding a transmission range of approximately three miles. The radio only accepts an incoming data rate of 1.5 MHz, so it has to be tied to either a multiplexor or a data channel clocked at that rate. But what this will allow users to do is transmit data in short-distance situations *not* within a line of sight. One of the firm's subsidiaries can even supply terminals to use in conjunction with the radio. The high-frequency transmission is said to be very reliable except in extremely heavy rain. A complete radio/antenna set sells for \$8,250, and two are required to make a data link. NORDEN TELECOMMUNICATION PRODUCTS, Norwalk, Conn. FOR DATA CIRCLE 343 ON READER CARD

Terminal System

The Virtual Terminal System is yet another very powerful terminal system with a *soft* controller programmable to accept an almost endless combination of peripheral devices. It's a sound concept—probably pioneered by Datapoint—and since adopted by a number of manufacturers, including IBM, CDC, and Incoterm.

The VTS can be programmed to be an alternative 3780 HASP work station, 3270 network, 2780 batch terminal, 3735 keyboard/printer/disc, or its big brother the 3790 with multiple terminals and greater capacity. The VTS controller can even perform some of these functions simultaneously, given its (up to) 256K memory size. Peripherals offered with the system include video displays ranging from 240-1,920 characters; printers ranging from 30-cps serial units to 1,000-lpm line printers; 300- and 600-cpm 80-column readers; floppy disc drives; and magnetic tape drives, including cassettes. The first configurations to go out the door this month are 16-terminal 3270-compatible display systems for \$1,895/month, and 2780-compatible batch terminals for \$795/month. Both functions combined rent for \$2,475. THE BRAEGEN CORP., Sunnyvale, Calif. FOR DATA CIRCLE 357 ON READER CARD

DEC's Microprocessors

It isn't the first, and it isn't announcing any technological breakthrough, but the mere fact that minicomputer giant Digital Equipment Corp. is entering the nebulous microcomputer market is very significant. DEC obviously believes there is a market segment that wasn't being covered by its products, and to whatever extent minicomputer orders will be affected by the microprocessor phenomenon, DEC wants to be sure it

has alternative products to show customers. The chips for the eight-bit MPS (microprocessor series), and 12-bit medium-scale integration PDP-8 equivalent PDP-8/A, will initially come from microcomputer chip king Intel Corp., but that could change if DEC realizes large sales volumes from the products. All things considered, it seems a cautious way for DEC to enter the market, giving one the feeling that the company isn't nearly as much at ease in this market as it was in the early days of minis.

The MPS consists of five modules: an eight-bit cpu capable of addressing up to 16K of memory; a semiconductor read/write memory module expandable from 1K to 4K eight-bit words; a programmable ROM, expandable from 256 to 4K words; an external event detection module to monitor low voltage or to implement priority interrupt schemes; and a monitor con-

trol panel serving as a diagnostic checkout and program entry device. A 1K RAM and cpu sells for \$445 in 1,000 unit quantities, or \$745 each.

The PDP-8/A seems like an even better buy. For only \$150 in additional price (unit quantity), one gets 12-bit addressing for up to 32K of 1.5 usec memory. Another big plus is that it is fully compatible with all of the PDP-8's software and peripheral products, a fact that will count heavily with oem's. The PDP-8/A will be available in December; the MPS in June. DIGITAL EQUIPMENT CORP., Maynard, Mass.

FOR DATA CIRCLE 344 ON READER CARD

Terminal Printer

This company apparently had the original idea of combining the Diablo print mechanism with the Intel microprocessor, and claims to have sold 160 units to date. The microprocessor is responsible for storing characters transmitted

product spotlight

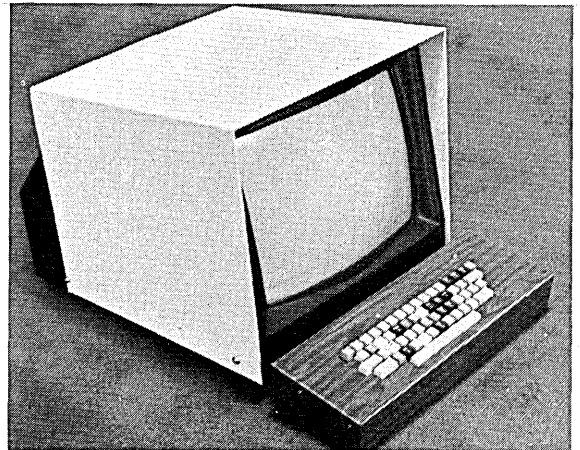

Color Intelligent Terminal

It's becoming increasingly apparent that having crt operators search a screen containing 2,000 letters and numbers of information—all displayed in black and white—isn't the ideal way to do things. Recent studies have shown that it's approximately three times easier for eyes to discriminate color data from a screen, causing fewer errors. This new firm's first product is an eight-color intelligent terminal using the ubiquitous Intel 8008 microcomputer set (for which there's a reasonable amount of software already in existence) and capable of operating at speeds ranging from 110 to 4,800 baud. The firm's principals claim not to be neophytes in the field, having participated in the design of such successful crt's as the original Datapoint terminal and others.

The Intecolor 8000 consists of a 17-inch crt, keyboard, microcomputer, and full cabinetry. For \$7,200 users get 4K of RAM (which is used to refresh memory), programmable read-only memories, four i/o ports, and the

keyboard. Up to 2,000 characters are displayed on the screen, arranged as 25 rows of 80 ASCII characters. The standard character is a 5x7 dot matrix, with an optional 32 programmable graphic symbols displayed in a 6x8 pattern to cut down refresh memory requirements (and cost). Also optional is a plot mode for doing curves and graphs. The standard i/o interface is an asynchronous transmitter/receiver with a tty interface. Options for the 8000 abound, including cassette drives, printers, reverse and protected field, additional characters, etc. Software will have to be written by the oem's or end users, but it's claimed that with the standard ASCII interface, that won't be hard to do. In support of that, cross-assemblers and other types of software development products are appearing on the market for the Intel microprocessors. Deliveries are being quoted as less than 90 days for the initial units. INTELLIGENT SYSTEMS CO., Norcross, Ga.

FOR DATA CIRCLE 340 ON READER CARD

hardware

during carriage-return times, analyzing the content, and making a decision on what to do with the carriage when it has returned, e.g., tab over 20 columns to position the print head. They have

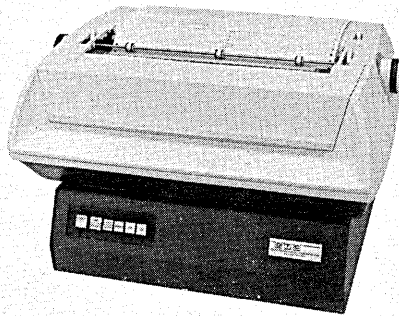

just announced a receive-only version of the original terminal (which had a keyboard). It operates at 10, 15, and 30 cps with full upper- and lower-case character sets, which are easily interchanged. The standard interface is an RS232 or tty loop, with built-in modem optional. The price for the unit is \$3,100; subtract \$1,000 if you don't want the microprocessor controller. DATA TERMINALS & COMMUNICATIONS, Palo Alto, Calif.

FOR DATA CIRCLE 345 ON READER CARD

Data Entry/Remote Batch

Since Data 100 was in the remote batch terminal business before it was in the data entry business, think of the KEYBATCH system as a batch terminal having a cluster of up to nine data entry stations that can edit and store up to 5 megabytes of data on a disc for eventual transmission to a central



mainframe in batch mode. The system is compatible with virtually any line discipline available, starting with IBM's 2780, 3780, and HASP protocols; Univac; CDC; Honeywell's 100 series; and even the ICL 7020. The functions of batch transmission and data entry can be done either simultaneously or separately.

Editing on the 256-character crt's can be expanded to include cross-field interdependency with logical operators and branching; single- and two-dimensional table look-up; 14-digit floating

point arithmetic; range and value checking; zero balancing and cross-footing; COBOL-like editing of numeric fields; output reformatting; and an optional customer-specified check digit modulus. A typical configuration, either standalone or used with an existing model 78 batch terminal, and consisting of eight key stations, a data entry control unit, a 2.4 megabyte disc and a tape drive, sells for \$40,824, or rents for \$1,176/month on a one-year lease, including maintenance. DATA 100 CORP., Minneapolis, Minn.

FOR DATA CIRCLE 346 ON READER CARD

Portable Terminal

The 260-5 is a portable data terminal featuring thermal printing at 30 cps across 80-column lines. Weighing only 30 pounds, the terminal is used by simply plugging it into a wall socket, inserting a telephone receiver into the acoustic coupler, and dialing the appropriate number. The unit can trans-



mit its 94-character ASCII repertoire bit serially at any speed up to 300 baud. A 10-key numeric pad is superimposed on the standard keyboard. Two of the nicer features of the 260-5 include the almost noiseless thermal printing technique (but no multiple copies—which isn't such a detriment to remote applications) and a MTBF figure of 4,000 hours. Priced at \$2,795, the 260-5 can be rented for \$110/month on a three-year lease. Deliveries begin before July does. NCR, Dayton, Ohio.

FOR DATA CIRCLE 347 ON READER CARD

Modem Eliminator

Any installation with two synchronous modems within 50 feet of each other (on the same link) might be able to save a lot of money by using the ME-8A modem eliminator. It is essentially a transposition of interface leads—no modulation is involved. The unit can operate in a full-duplex environment at speeds up to 20 kilobaud, and plug-in clocks can be inserted by the user to select the speed. The unit also supplies clear-to-send, data set ready, and data terminal ready signals. One \$160 unit is needed to replace two modems.

Clocks cost \$25 for each speed required. SPECTRON CORP., Moorestown, N.J.

FOR DATA CIRCLE 348 ON READER CARD

Minicomputer

The 4K MOS random-access memory chip has apparently matured to the point that Hewlett-Packard felt safe in designing a new minicomputer family around it. For those not familiar with the advantages of technology down at the chip level, the big advantages of the 4K chip are faster memory speed, less power consumption, smaller size and weight, lower cost, and a mean-time-between-failure (MTBF) rate from two to fifteen times better than core-based systems.

Two models debut. Both are user-programmable using an internal 24-bit processor, with memory parity, power-fail, and extended arithmetic unit standard on each. The 2105A can contain up to 32K 16-bit words within its 5¼-inch chassis, complete with four I/O channels. The larger 2108A has nine I/O channels and a 32K memory that can be expanded to 64K before the end of this year. The machines emulate the earlier 2100 series, and in addition have 42 new instructions, including 28 index register commands, bit and byte manipulation mnemonics, move and compare firmware, and floating point hardware (optional on the 2105A, standard on the 2108A). As many as four ROM-stored programs can be loaded from the front panel.

Initial versions of both models will be restricted to purchasers ordering five or more, but it would seem that the new minis will show up in H-P's user systems before long (but perhaps with

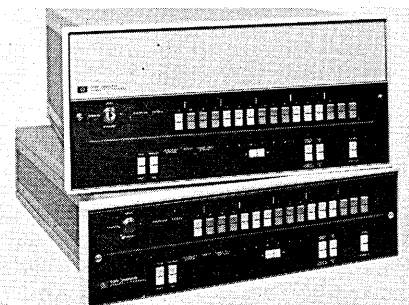

different model designations). With 16K of memory the 2105A sells for \$7,400; \$11K with 32K of storage. Add \$1K to the 2108A for the additional I/O channels and floating-point hardware. First units will be available next month. HEWLETT-PACKARD CO., Palo Alto, Calif.

FOR DATA CIRCLE 349 ON READER CARD

Disc Storage

The 33302 is a large-scale disc storage system designed to be a totally transparent alternative to IBM's 3330 dou-



Announcing “take-along” computer power.



That's right, now you can have access to your central computer wherever you go. You can be on-line from the plant across the street or from a hotel room across the country. Weighing just 30 lbs., the portable NCR 260 KSR Thermal Printer Terminal is as easy to transport as your attache case.

Besides portability, the NCR 260 KSR Thermal Printer provides all the functions required to send and receive numeric and alphanumeric data. Included is an integrated modem with an acoustic coupler, a thermal printer, and an alphanumeric keyboard with an imbedded numeric pad. And even the cabinet is functional. It opens and becomes a nesting place for the terminal.

Equipped with a 30-character per second printing rate and non-impact printing mechanism, the NCR 260 KSR is the quicker, quieter way to transmit and receive data.

Portability remains the key, though. This advantage provides you with much more efficient use of computer time. And increased efficiency adds up to a better return on your computer dollar.

As with all NCR products, the NCR 260 KSR thermal printer is backed by the entire network of NCR support systems. With more than 7000 field engineers in more than 480 field offices, you are assured of fast, complete service when needed.

The portable NCR 260 KSR is a terminal you'll want to know more about. To get additional information just contact your local NCR representative. Or write to NCR, Dayton, Ohio 45479.

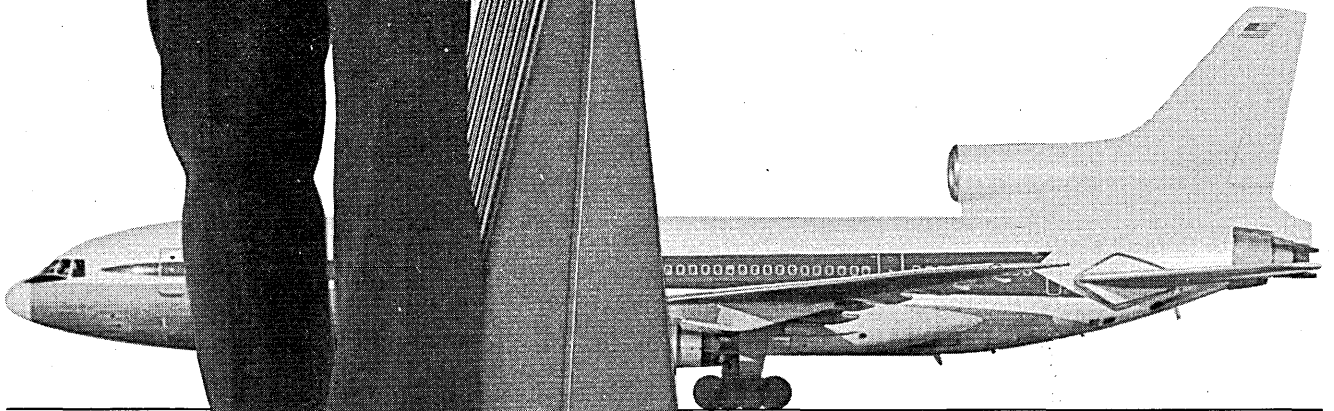

NCR
Complete Computer Systems

To enter data is human.
To ENTIREX it, divine.

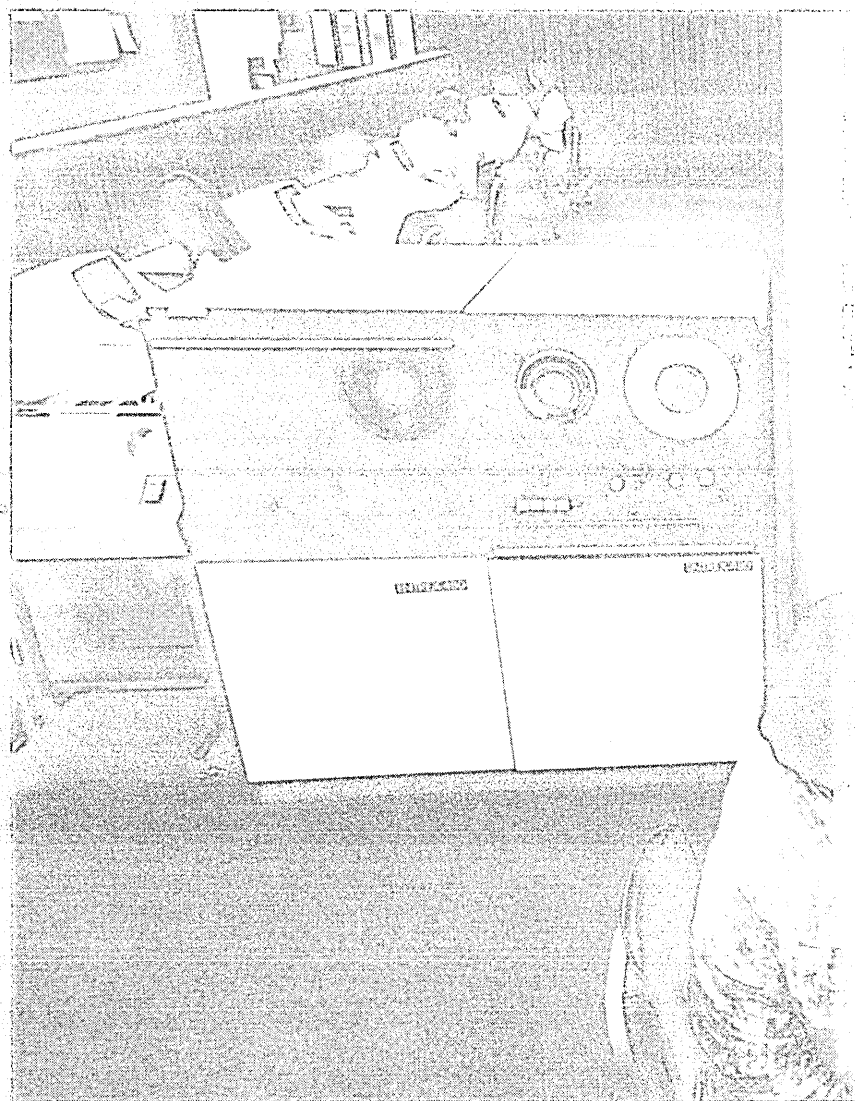

The big difference is pre-processing in System 480's batch edit and output edit software — simultaneous with data entry.

No other key-to-disk system gives you so much control over the quality of your output, so much independence from the main frame, so much versatility in managing the data while you have it.

Files can be sorted, merged, and collated. Error message files can be created. Partial outputs can be examined. Virtually anything you could do in a tab room you can do on System 480, only much faster and much quieter.

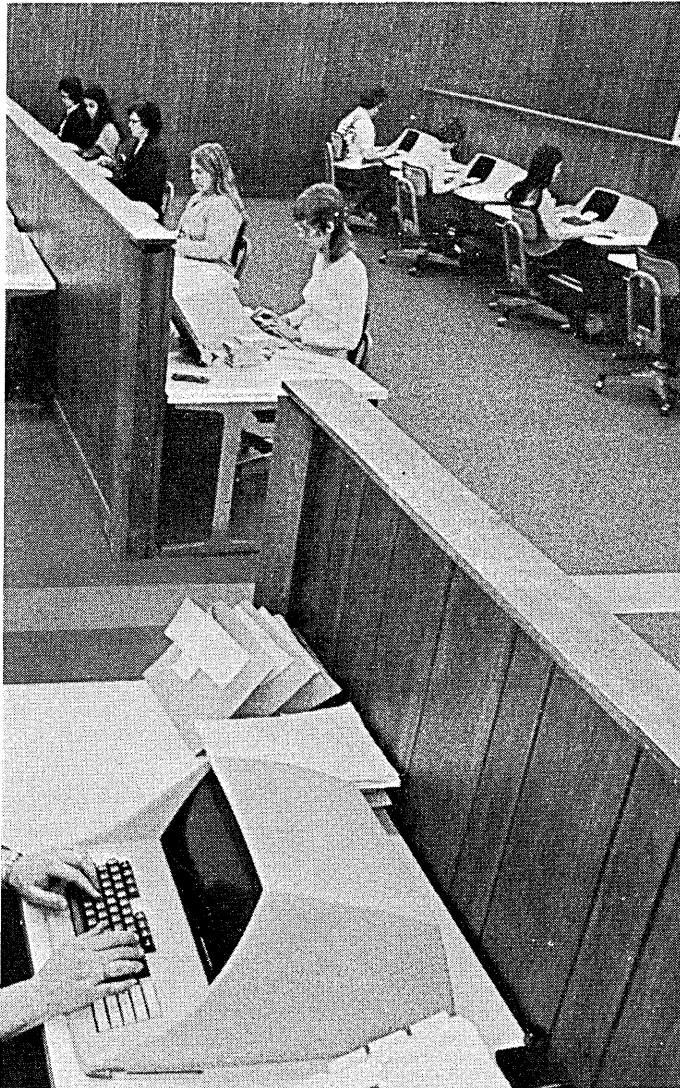

As for data entry, both System 480 and our lower priced System 280 are unsurpassed in programmed helpfulness to the operator: Formatted, full record display; interactive English language messages; over 40 checks, flags, tables, and other software features (including our exclusive HELP button) for easy, error-free entry. Operators and supervisors love the ENTREX key station.

Highlights of System 480

Key stations Up to 32
029 and typewriter
Display 480 characters
Disk 2.4M bytes or more
Tape unit 7 or 9 track, 556, 800, or 1600 bpi
10.5-in. 2400 ft.

Highlights of System 280

Key stations Up to 12
029 or typewriter
Display 360 characters
Disk 1.8M bytes or more
Tape unit 9 track, 800 or 1600 bpi
8.5-in. 1200 ft.

While you're thinking about clean data, we suggest that you validate our batch of claims. A contact with somebody you know at one of the more than 200 ENTREX installations would be human. A call to one of our representatives would be divine. ENTREX, Inc., 168 Middlesex Turnpike, Burlington, Mass. 01803. (617) 273-0480. **ENTREX**

Atlanta, Georgia 404-634-6391, Burlington, Massachusetts 617-273-0480, Chicago, Illinois 312-782-5427, Columbia, Maryland 301-997-3310, 3311, Columbus, Ohio 614-451-1058, Dallas, Texas 214-741-1140, Houston, Texas 713-777-2341, King of Prussia, Pennsylvania 215-265-2270, Los Angeles, California 213-475-0480, Louisville, Kentucky 812-283-1169, Madison, Wisconsin 608-221-3378, Madison Heights, Michigan 313-583-1760, Miami, Florida 305-949-4544, New Orleans, Louisiana 504-588-4308, New York, New York 212-682-2130, San Francisco, California 415-989-6580 X324, Wethersfield, Connecticut 203-563-3866, Montreal, Quebec Canada 514-866-5841, Willowdale, Ontario Canada 416-493-9333.

the centronics phenomenon!

a reliable 132 column teleprinter at 120 char/sec.

cutting telephone line costs is just the beginning!

The Centronics 508. Our new 120 cps, 132 column interactive hard copy terminal is destined to solve many headaches for the communications people, for the minis and for the small business gang, too!

Price/performance—Centronics' calling card. Reduce telephone line costs by printing 4 to 12 times faster. Now Centronics' low priced 132 column incremental keyboard printer is ready to take on a world of exciting applications. From simple teleprinter duties to sophisticated message switching and timesharing systems. As an input/output device, the 508 is also a natural for the demanding needs of small business systems. Indeed, the applications for the 508 are limited only by the imagination of its users.

First cousin to the popular 308. Every feature of the versatile new 508 is also available in our popular 80 column teleprinter, the Centronics 308. And whether you purchase or lease, prompt service is available nationwide from over 40 locations.

The 308 or the new 508?
It depends on how wide you want to save!

CENTRONICS

centronics data computer corp.

hudson, n. h. 03051

telephone (603) 883-0111

eastern region: (617) 646-7200

philadelphia: (609) 234-6111

washington, d.c.: (703) 450-5071

central region: (513) 294-0070 (ohio)

chicago: (312) 398-4500

western region: (714) 979-6650 (s. calif.)

san francisco: (408) 733-9530

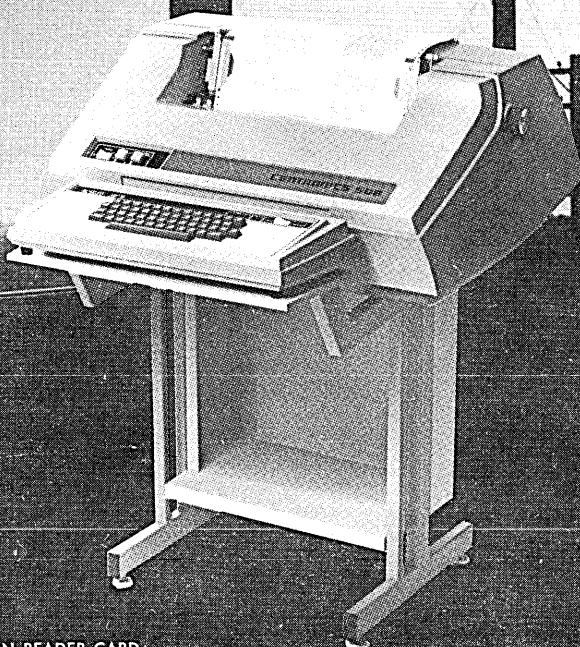

CIRCLE 88 ON READER CARD

hardware

ble-density storage system. Up to four strings of eight drives each can be attached to the system control unit using the four-channel and spring switch options, yielding a maximum capacity of 6.4 billion bytes. Each drive holds a 200-megabyte pack, just like IBM's. Other features include rotational position sensing and error correction up to 11 bits in length on a single track. The 33302 even has microprogrammed diagnostics stored on—what else—floppy discs. These can be loaded into the controller for functional diagnostic routines without affecting on-line operation of the system. An eight-pack system with controller sells for \$252K, and various lease plans are available. First units go to the field in June. CONTROL DATA CORP., Minneapolis, Minn.

FOR DATA CIRCLE 351 ON READER CARD

Color Graphics

There's a color crt intended for business applications elsewhere in this section, and here's a color product oriented toward graphics tasks. The AS103 is a vector-programmed crt terminal that provides high-speed graphics in up to 64 colors. Plug-in function generators are available for vectors,

characters, and circles. The unit can be interfaced directly to a mini, using the mini's memory for screen refresh; or a list processor can be supplied to provide local refresh buffer and data formatting capabilities. The 10 x 8-inch screen holds 1K x 1K addressable points. Interfaces are offered for many popular minis.

The slewing speed is 1 usec/inch,

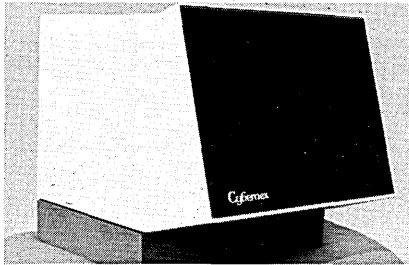

with the drawing rate of 20 usec/inch (average for 5" vectors). A 64-character ASCII set is displayed as 5x7 dot-matrix images. Basic system prices start at \$5,120, excluding mini interface. CYBERNEX CORP., Palo Alto, Calif.

FOR DATA CIRCLE 350 ON READER CARD

OCR System

The System 410 is a high-speed optical character recognition system primarily oriented toward high-volume, turn-around document applications. It can

accommodate documents ranging in size from 3 x 2 1/4 inches to 6 x 9 inches, with any number of lines and characters placed on documents within a quarter-inch of the edges. With a scanning speed of up to 2,000 cps, the 410 can thus process upwards of 500 multiple-line documents per minute. The choice of fonts includes ocr-A, handprint (the standard 0-9 numerals, plus and minus, as well as letters C, S, T, X, and Z), 407-1, Gothic, 1428, ocr-B, 12L, and OMR.

The heart of the 410 is a new image-dissection scanner that is said to do a better job of reading all the ocr fonts even if they are of less than optimum quality, with a resulting decrease in error rates. The basic package includes

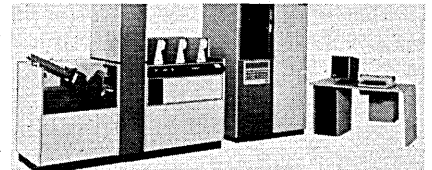

the scanner, multiple font capability, an 8K 16-bit mini, magnetic tape controller, drive, and i/o console. This system rents for \$3,300/month on a one-year lease, including maintenance. The programmable mini can be set up to select certain documents and drop them into one of the 410's three output hoppers. In operation, the basic 410

How to implement a security control system without installation costs.

GBC PHOTO IDENTIFICATION SYSTEM

Now you can make instant security checks upon entry or in any department at any time.

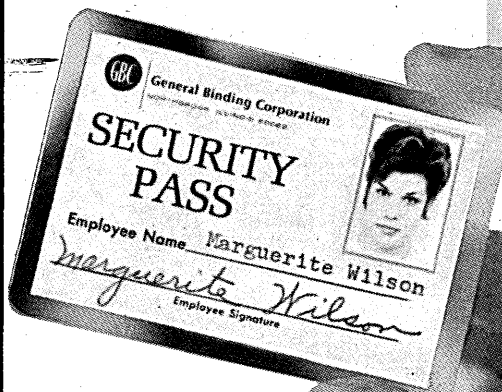

That unfamiliar face could be an employee, a visiting guest or an uninvited stranger intent on thievery, vandalism or industrial espionage. You'll know at a glance... with a GBC Photo Identification System.

Everything you need to produce your own instant pictures, trim them to size and permanently seal them in plastic on any regular or computer coded card is provided in this one low cost GBC kit. There's no installation because there's nothing to install. Just set the camera, die-cutter and laminator on a desk and you're ready to start. Mail coupon for details.



General Binding Corporation
NORTHBROOK, ILLINOIS 60062

The "How To" People.

General Binding Corporation D-574
Northbrook, Illinois 60062

Tell me more about your Photo ID System. Also include free Paper Communications Idea Handbook.

Name _____

Organization _____

Address _____

City _____

State _____ Zip _____

hardware

system provides for on-line character insertion, and 90° scan rotation. Options that include additional memory for the mini, additional tape drives (up to four), printers, and additional font capability can raise rental prices to over \$10K per month. Three systems have already gone to the field, one to GTE, one to *Reader's Digest*, and the other to Japan. SCAN-OPTICS, INC., East Hartford, Conn.

FOR DATA CIRCLE 355 ON READER CARD

Peripheral Processor

The i5x is a communications-oriented minicomputer that has been given the task of emulating the IBM 2821 card reader/line printer controller, permitting 360 and 370 users to assemble low-cost heterogeneous configurations. Almost any imaginable peripheral can be put into either a local or remote environment, with all code/command translation accomplished by the i5x. No modifications to the 360 or 370 software are required, so the system seems to be yet another alternative to products supplied by Paradyne and Computer Transmission Corp. The i5x has the advantage of requiring only one system in the configuration, rather

than one at each end of a link. Turn-key systems should be available within approximately six months, and excluding the peripherals, will be priced at \$18-28K depending on what emulation packages are required. INTERCOMPUTER COMMUNICATIONS CORP., Phoenix, Ariz.

FOR DATA CIRCLE 354 ON READER CARD

Remote Batch

The model 734 remote batch terminal's biggest feature is its ability to talk to either Control Data 3000, 6000, or CYBER 70 series, or to IBM mainframes



that can accept 2780 protocol. The 734 will also be marketed with only CDC or IBM logic and will be called the 734 or the 27801, respectively. The basic configuration includes a 16K byte controller, card reader/printer adapter, operator panel, keyboard/display, and 200 User Terminal emula-

tion code. The user can choose from 300 or 600 cpm readers, and from 300 or 600 lpm 136-column line printers. A terminal with the lower-speed peripherals is priced under \$27K, or \$750/month on a one-year lease, excluding maintenance. The 2780 compatibility feature is priced at \$1,500, or \$23/month on the same length lease. CONTROL DATA CORP., Minneapolis, Minn.

FOR DATA CIRCLE 353 ON READER CARD

Oem Business System

The Opus III uses this manufacturer's 16-bit minicomputer, a three-drive Philips cassette unit, and an IBM Selectric typewriter, all packaged in a desk enclosure. The price of \$21K includes 16K of mos memory and any package in the company's software library. These include an accounting program, accounts receivable program, and others oriented toward such vertical industries as trucking and cattle raising. No service organization exists to support the Opus III, however, since it is intended to be marketed to firms willing to develop other software packages and vertical end-user market segments. Machines are generally available within 30 days. COMPUTER DEVELOPMENT INC., Concord, Calif.

FOR DATA CIRCLE 356 ON READER CARD



★★★★
**Elect
FDR
and
DSF**

Vote for Fast Dump Restore and Data Set Functions for the biggest savings in time, money and resources! FDR dumps disk packs to tape 2 to 5 times faster than the standard OS utility.

FDR restores disks faster than it dumps them. DSF provides selective dump and restore by data set name or track addresses and the restored space can be allocated to different physical locations. If you think FDR is fast, wait 'til you see DSF in action! Send for your free 30-day trial, more information and your Timesavers Button; and elect FDR and DSF, **THE TIMESAVERS!**

**INNOVATION
DATA PROCESSING**

925 Clifton Avenue, Clifton, NJ 07013
201-777-1940

CIRCLE 92 ON READER CARD

FLOPPY DISK SYSTEM

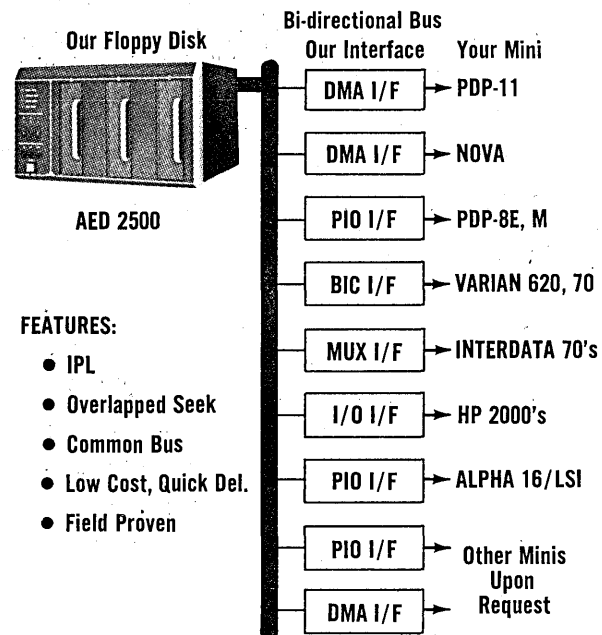

FEATURES:

- IPL
- Overlapped Seek
- Common Bus
- Low Cost, Quick Del.
- Field Proven

Call Jerry Kennedy:

ADVANCED ELECTRONICS DESIGN, INC.

3197 PARK BOULEVARD • PALO ALTO, CALIFORNIA 94306
(415) 493-4914

CIRCLE 64 ON READER CARD

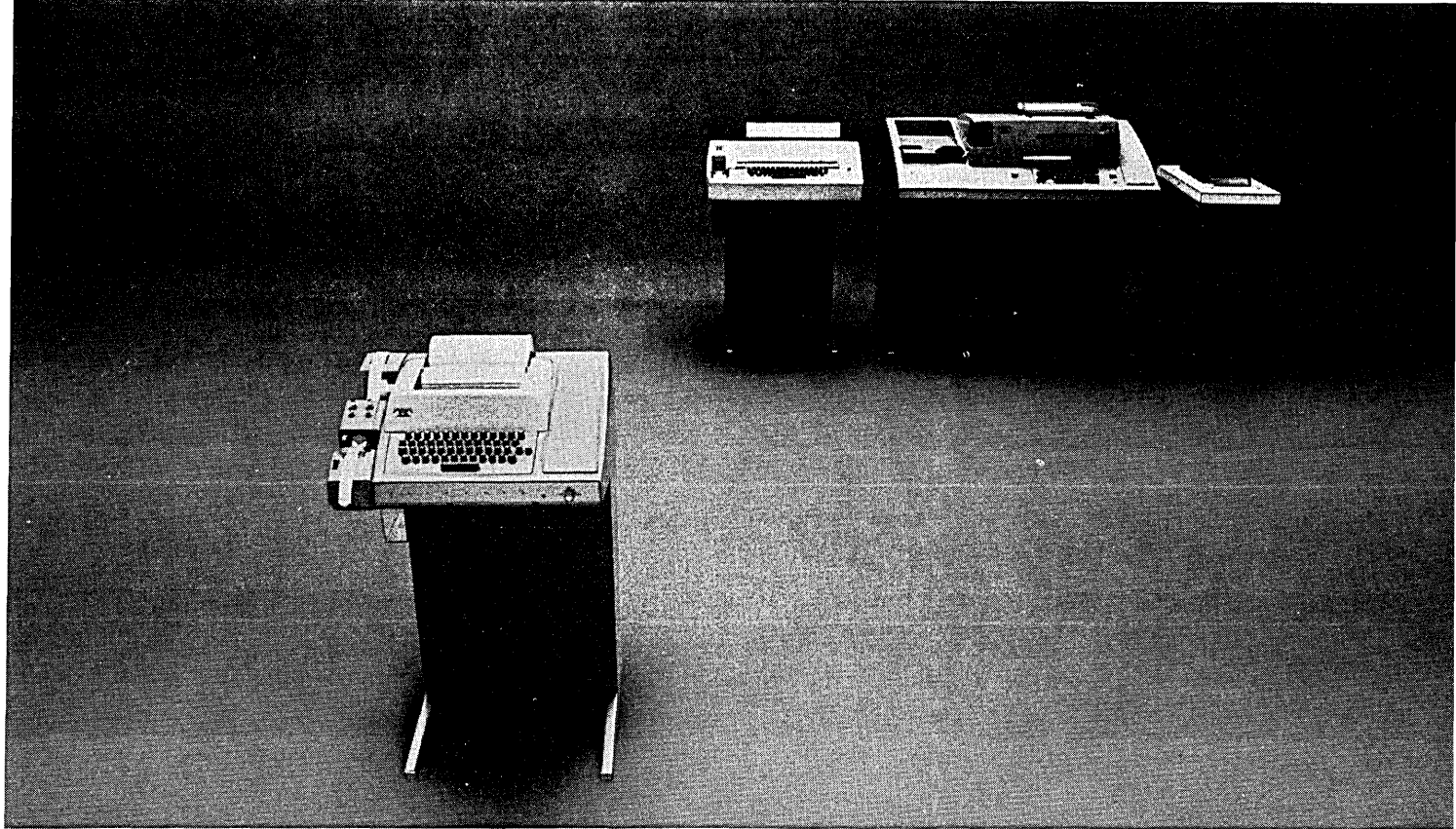

**As good as the
model 33 is, we're aware
that for some people
it's not enough.**

Our model 33 is the standard of the data communications business for three very good reasons. Economy, reliability and versatility.

Yet we realize some applications require a little more. That's why the model 33 isn't an orphan.

Some of our customers want everything the model 33 offers, but they want it in a wide-platen configuration to accept standard computer fan-folded forms. For them, we make the model 38.

Some customers may have applications requiring an extremely rugged terminal. A

machine that can operate day and night for months on end with little maintenance. For them, we make our heavy-duty model 35.

Still others need a unit that can give them greater speed. For them we build our 4210 magnetic tape terminal. The 4210 is compatible with all our other terminals and can move data on-line at speeds up to 2400 wpm.

Our data terminals are offered in various configurations: models 33, 35 and 38 can be ordered as ASR, KSR and RO units.

It takes more than manufacturing facilities to build the terminals Teletype® Corporation offers. It also takes commitment. From people who think service is as important as sales. In terminals for computers and point-to-point communications.



The computercations people.

Software & Services

Updates

The director of communications for the second largest facilities management firm specializing in banks and financial institutions made some interesting comments recently before the American Management Assn.'s System Management Conference. Bruce Wright of Little Rock, Ark.-based Systematics referred to a recent survey showing that 2,500 U.S. executives feel that technicians, not managers, are setting the goals for this country's dp operations. Wright thinks the outlook for facilities management is excellent, and that its 45% increase in revenues since 1969 may be dwarfed by increases to \$1 billion in 1975 and to as much as \$2.5 billion by 1985.

Gerald Larsen, president of Unicorn Systems, Los Angeles, has come up with an idea we think should be copied. It's a "forever" warranty on the custom software his firm develops, with only three small catches to it: Unicorn must be allowed to make all enhancements; if the system bombs because of customer changes, Unicorn will get it running again (and charge you separately for it); Unicorn is released from legal responsibility for how the system is used. Larsen feels that "best efforts" contracts have retarded the growth of the independent software industry. Along with Larry Welke's recently announced service for storing program source decks in a bank vault to salve customer concerns about "what if you go out of business and we're left with only the object decks," it's clear that solutions are being found for some of the software industry's major problems.

Cincom's TOTAL, one of the first and most successful data base management systems, has been translated into NEAT/3, NCR's proprietary English-like programming language. The DBMS will initially be offered on the two largest Century series machines, the 300 and the 251, and possibly on one or more models slated to be announced before the middle of the year.

Data Base Management

DBMILOAD and DBMILIST are two products that can probably eliminate the need to write "quick and dirty" programs to load and examine data bases. Their vendor says they are a lot quicker and cleaner than most of the programs seen in most 360 IMS shops. DBMILOAD builds a DL/I data base from a sequential input data set that contains all the segments the user wishes to load. The user codes a control card defining the usage of each of the fields that will be input. Data is then transformed into packed, binary, hexadecimal, or display formats. After the data base has been built, the module gives statistics on how many segments were loaded, complete with segment name identification.

DBMILIST can list an entire DL/I data base, selectively list specific roots, or list portions of a data base, all under the control of parameters and keywords supplied on cards. The assembler language modules are priced at \$2K each or \$3K for both. All that's needed to use the programs is to link them to a particular library and specify i/o files. For that reason, only the object deck is supplied. Documentation accompanies the packages. DATA BASE MANAGEMENT, INC., Vernon, Conn.
FOR DATA CIRCLE 321 ON READER CARD

Educational Administration

The Terminal Oriented Administrative Data System (TOADS) software package is Hewlett-Packard's entry into the highly competitive educational systems market, where its developers hope it will gain a leg up over such worthy competitors as Digital Equipment and IBM. Three software packages are the initial members of TOADS and are oriented toward small- to medium-sized school districts and small community colleges. It's claimed that the only similar software on the market is IBM's EPIC package, which is not terminal oriented and must be run on System/3 and 370 computers.

The first member is called Student Information System (sis), for use with H-P's 3000 system in elementary and secondary schools. sis provides capabilities for building a student data base, attendance accounting, and grade reporting. The integrated data base has linkages that point back and forth to other files, typically a grades file, home/parents/health file, etc. This allows use of mark sense equipment for reporting attendance, grades, and class schedules. All programs are written in COBOL to facilitate modification of report formats. sis is priced at \$7,500 and will be available in August.

The College Information System (CIS) is used on H-P's 2000F time-sharing system, which can support up to 32 terminals simultaneously, we're told. It, too, has an integrated data base of student records, permits on-line student registration, allows monitoring of how many students have signed up for specific courses, and produces class lists. Additionally, CIS allows grade reporting from terminals, with subsequent production of report cards and transcripts. A general-purpose file query system permits examination of various student attributes, which can be as complex as "how many students of a particular ancestry, sex, and age are attending from a specific town." CIS is available now for \$7,500 and is being checked out at a local college.

ADMIN 2000, for use on the twin-mini 2000F system, is for small community colleges and smaller school districts. The terminal-oriented system handles financial and budgeting chores and does payroll (which we're told is a more complicated task than for a multi-division corporation). Priced at \$8K, ADMIN 2000 is available now. HEWLETT-PACKARD CO., Cupertino, Calif.
FOR DATA CIRCLE 322 ON READER CARD

Birth Announcement

Here's a novel way to announce the arrival of a new little streaker in your household. The birth announcement program generates the silhouette of the newborn out of descriptive records that can be up to 160 characters long; the records are repeated throughout the design. The program is written in PL/1 and require a minimum of 74K bytes of storage. Three data cards appended to the program deck control



the number of copies to be generated and the content of the 160-character message. The program is priced at \$25. SPECIALTY SOFTWARE CO., Athens, Ga.

FOR DATA CIRCLE 324 ON READER CARD

CICS Enhancements

Two small subroutines have been developed for IBM's CICS (Customer Inquiry and Control System) that would seem to be applicable to most users of the data base transaction monitor. MOD permits up to 512 bytes of information to be modified in a given file per in-

No other software
can do all the things
MARK IV does!
With quality products
experience
counts...



20,000 Users Trained

More than 20,000 persons have been trained to use MARK IV; 25 classes a month teach users in our advanced, intermediate and basic courses.

2,200 System User-Years

More than 700 satisfied users in 36 countries. Their cumulative use of MARK IV Systems totaled more than 2,200 user-years of experience in March, 1974.

693 Man-Years Support Experience

This Field Staff experience is available to all current and prospective MARK IV users from 84 experienced technicians in 14 offices today.

468 Man-Years Development Experience

The full time effort of our current Development and Headquarters Staff of 40 technicians provides 468 man-years DP experience with more than 200 man-years devoted to MARK IV alone.

No other firm can match this product dedication and experience today.

If you program Business Applications—complete systems or retrieval and reporting systems—MARK IV provides more power with less programming than any other language.

MARK IV is a general purpose information processing system for IBM 360/370, Univac Series 70, 90, 9400, and Siemens 4004 computers. On-Line versions are available for in-house use or on nationwide time sharing networks.

informatics inc
MARK IV Systems Company



North American Headquarters

MARK IV Systems Co.
21050 Vanowen Street
Canoga Park, California 91304
Telephone (213) 887-9121

Offices:

- Chicago (312) 648-0280
- Dallas (214) 233-6861
- New York (201) 488-2700
- Washington D.C. (301) 770-5951
- Toronto, Canada (416) 493-9616

International Offices

Informatics S.A.
18 Rue Camille Martin
1203 Genève, Suisse
Téléphone 022/45 22 00

London • Paris • Copenhagen
Rome • Dusseldorf • Mannheim

and
Computer Applications Co., Ltd.
2-3-1 Hitotsubashi, Shogakukan Bldg.
Chiyoda-ku, Tokyo, Japan
Telephone 263-7241

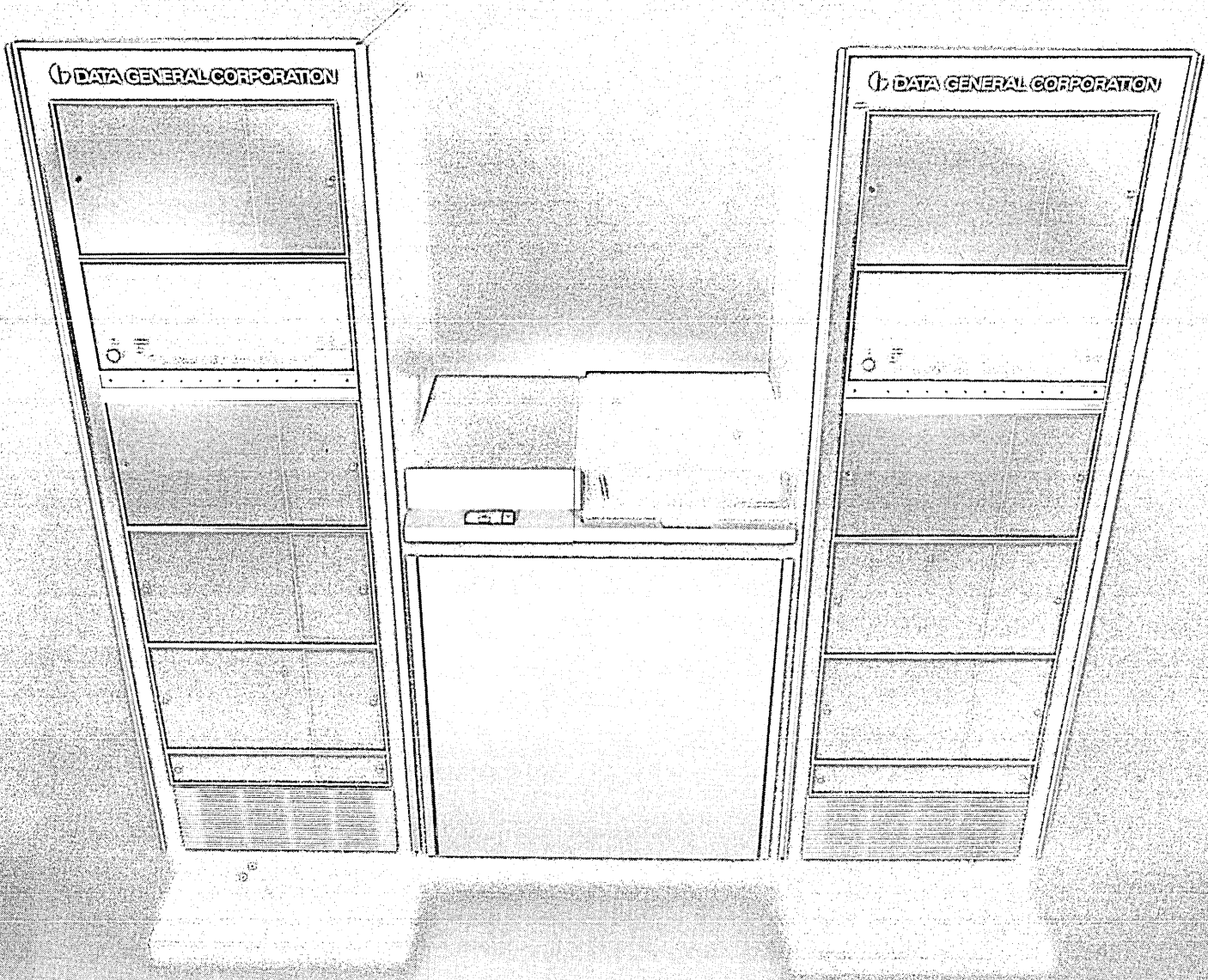

Data General introduces the first stereo computer system.

This computer not only looks like a music system.
It works in stereo.

Two separate computers play off the same disc.
It's called the Dual Nova.

The Dual Nova is a standard off-the-shelf product. Which means it's fully supported by the operating system. You just plug it in and go to work.

Which is the first time you've been able to do that on a small dual processor system.

If you want to do load sharing, the disc gives you a huge storage area that both computers can use. So both computers can share the same datafiles and programs.

And if you want to use the Dual Nova as a redundant system, the backup computer won't just sit there. You can put it to work on computation, data reduction, or what have you.

And if one of the computers happens to go down, the other one will keep going. One can't hurt the other. Because they're totally separated. Electrically. Mechanically. And physically.

There's three discs to choose from: the quick access Novadisc, a cartridge disc, or big capacity disc pack.

You can use any two computers made by Data General.

And as it turns out, every Dual Nova computer has a foreground to do one thing. And a background to do something else.

Just in case you want to go quad.

DataGeneral

The computer company you can understand.

• Data General Corporation Southboro, Massachusetts 01772, (617) 485-9100.
Datagen of Canada Ltd., Hull, Quebec (819) 770-2030/Data General Europe, Paris, France 504-23-44.

YOUR EDUCATION REPRESENTS
AN IMPORTANT
PERSONAL INVESTMENT--

**WHAT HAVE YOU
DONE WITH IT
SO FAR?**



"Got a job" isn't quite the full answer, is it? You're *you*. And there's more to life than just "a job" — or should be.

What could you expect if you joined us? A quality of life that means the difference between "a job" and a way of living.

We design and manufacture complete electronic systems of various kinds for business, industry and government. It is our practice to hire very able people and then put them to work doing what they most like to do.

Because we are a large company, we offer a total career growth-potential that is as big as we are. And because we work in relatively small product-oriented divisions, your abilities and contributions are highly visible from the time you join us, with prompt recognition of superior performance.

Whether you work for us in California, New York,

Ohio, Florida, Kansas or Delaware, you'll find yourself looking forward to coming to work in the morning. And your technology won't become obsolescent in 5 or 10 years, because, to remain a leader, we must continue to work on the far edge of the current state of the art.

Professional involvement . . . continuing development as an engineer . . . an environment of individual responsibility that encourages new ideas and rewards initiative. These are *good* dividends on the personal investment you've already made on your education!

If you're not realizing them now, write:

**NCR Worldwide Headquarters, Dept. D-5
Corporate Executive &
Professional Placement
Dayton, Ohio 45479**

An Equal Opportunity Employer M/F

NCR

software & services

quiry. The changes can be in either hexadecimal or display format, which can reduce the need to recompile application programs when changes or file modifications must be made. A companion to MOD called EJCL allows job control language to be entered into the job stream from crt screens, stored sequential files, ISAM files, or a program data set. This routine is priced at \$275. SOFTWARE MODULE MARKETING, Sacramento, Calif.

FOR DATA CIRCLE 323 ON READER CARD

S/3 Remote Job Entry

Many IBM System/3 computers are used as satellites in larger data processing environments, and their maker has just announced two new system control packages that make it easier to ship programs too large or too complex for the S/3 to 370s. The models 6 and 10 disc systems can now function as multi-leaving remote job entry work stations for submission of jobs to central 370s operating under vs1 or vs2. Input can come through the S/3's card reader (either 80- or 96-column unit), and additionally model 10s can send the programs from tape or disc files. Writer output to the S/3 can be directed to the card punch, or printer, and to tape and disc units on the model 10. The programs are available now at no charge. IBM CORP., White Plains, N.Y.

FOR DATA CIRCLE 325 ON READER CARD

TSO Enhancements

A number of commands are available for IBM's Time-Sharing Option (TSO) submonitor that might gladden the hearts of users who spend a large amount of time editing data. The COPY, MOVE, and DUP subcommands are available for all TSO-supported terminals, and a full screen editor subcommand is available for 3275-2, 3277-2, or equivalent terminals.

With the copy, move, and duplicate commands, a line or group of lines can be copied or moved in the edit data set, and a line may be duplicated any number of times. All data set types are supported. The price for the three commands is \$330.

The Full Screen Editor (FSE) displays 22 lines of the edit data set in card image format, with all 80 characters displayed. FSE features forward and backward paging capability and editing of any or all lines displayed. The price is \$660 (all prices apply to installations and not to individual cpu's). A number of customers have been using the TSO commands for some time, among them Exxon Corp.,

Hughes Aircraft Co., and Dow Chemical. XONICS, Arlington, Va.

FOR DATA CIRCLE 326 ON READER CARD

Time-sharing Sort

The Integrated CMS Sort System (ICS) is compatible with IBM's OS sort, but is implemented in the time-sharing environment under the CMS time-sharing submonitor on IBM 370 systems

equipped with VM/370. The sort can be used as a stand-alone utility or as support for the COBOL sort verb, or may be called from assembler language or PL/1 routines. All control statement types used by the OS Sort/Merge are recognized by the ICS package, and it has the same control field definitions, formats, and restrictions.

Perhaps the best features of ICS are

software spotlight

Data Set Examination

VERIFY is intended to be the "last resort" in finding out why some tape or disc data sets are unreadable by IBM's OS monitor. Consequently, almost every conceivable facility for handling fixed-length records has been built into the package, including the counting of blocks in the data set, determination of maximum and minimum block size, checking for the existence of a permanent input error or zero-length block and location of that error in terms of block count, determination of the actual size of an input block instead of relying on the BLKSIZE subparameter in the JCL that formed it and its label,

and much, much more. The developers have even been able to use VERIFY in order to reconstruct a portion of a data set so that it will at least process (though it may have incorrect data).

VERIFY is written in PL/1 and reads input data sets as consisting of blocks of an undefined length up to 32,760 characters. It is distributed in two versions: one for the PL/1 optimizing compiler, and the other for the PL/1 (F) compiler. Both source and object modules are supplied for \$100. The program requires approximately 70K of storage, plus buffer space. The timing of the program "seems" to be in the ratio of one unit of cpu time for each eight units of input time, degrading as the number of options elected by the user increases. UNIV. OF NORTH CAROLINA, Chapel Hill, N.C.

FOR DATA CIRCLE 320 ON READER CARD

ASI-ST

THE APPROACH TO DATA MANAGEMENT

ASI-ST HIGHLIGHTS:

- The dominant user language with IMS and TOTAL
- Easy for programmers and non-programmers to use
- Conversational versions under IMS DB/DC, TSO and CICS teleprocessing environments
- Optimized virtual (VS, VS1, VS2), OS and DOS support
- Unparalleled processing efficiency, exceeding all other languages — including BAL!

for details on the ASI-ST approach contact:

Applications Software Inc., 21515 Hawthorne Blvd., Torrance, CA 90503
Phone (213) 542-4381 • Telex 653-563 . . . offices in Boston, Tokyo



THE Software Manufacturer

CIRCLE 84 ON READER CARD

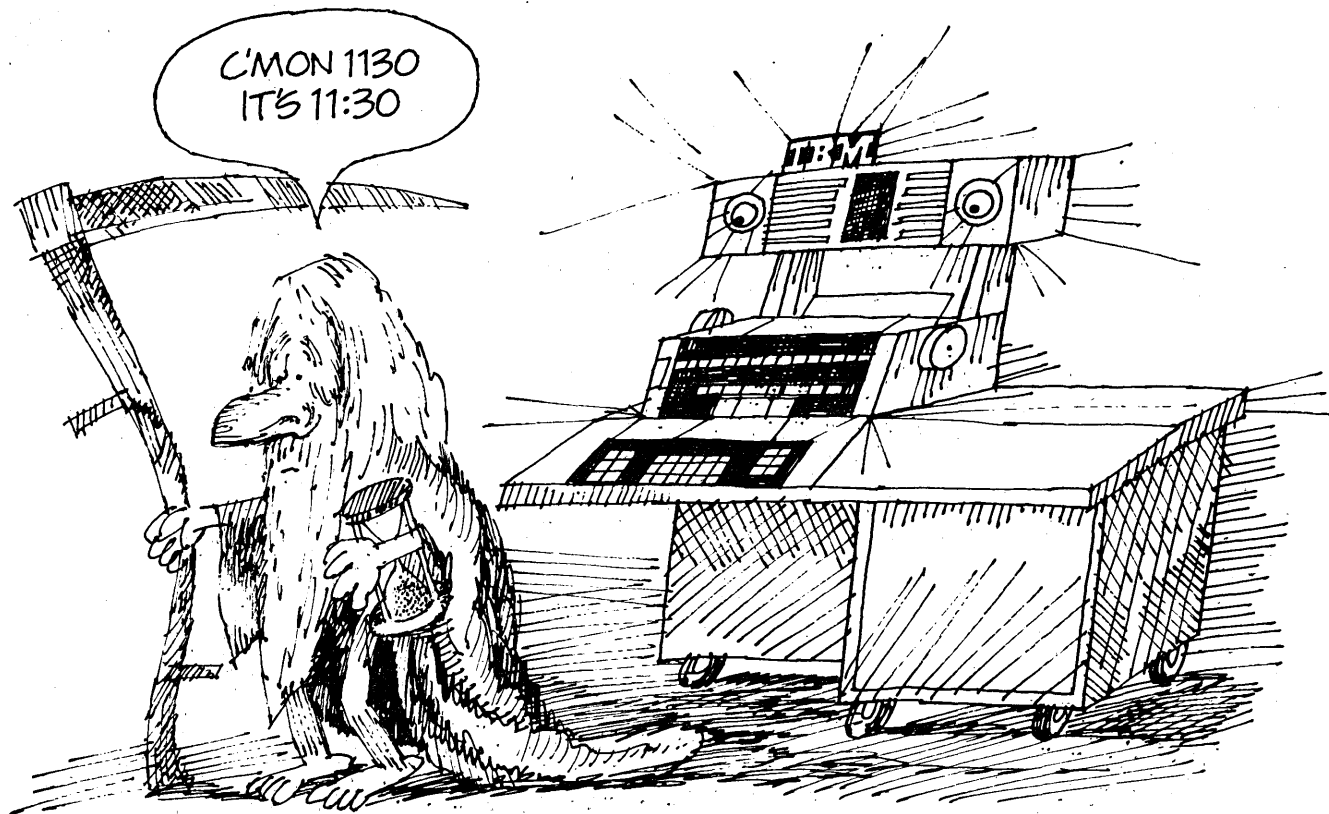

The 1130 was a fine idea for its time. Time's up.

Introducing the Computer Hardware Inc. CHI-2130. A 16-bit, general purpose central processor with a basic cycle time of 800 nsec. Everything that the 1130 was, plus a heck of a lot more at three to six times faster. It also costs less.

Suppose you now have an 1130 on the floor. Pack it up and send it back. Every scrap of software in your house will run on the CHI-2130 without modification. That includes applications, diagnostics, the whole works. The only difference is speed — you'll be able to do more than twice as much work with the CHI-2130 as you were doing with your old 1130.

Suppose you're interested in communications. With the 2130's internal speed, supporting multiple high speed terminal, on-line order entry, remote batch, and interactive systems are all possible on the CHI-2130.

When you call in a representative from Computer Hardware Inc., you're going to be talking about savings of tens of thousands of dollars. And the sooner you and we get together, the sooner you'll begin saving. Start with our CHI-2130 brochure. It gives you all the facts in a straightforward way that any penny-pinching systems analyst can understand. Turn an ordinary year into something special. Make this the year of the CHI-2130.

**X CHI COMPUTER
HARDWARE INC.**

CHI Field Offices: New York, NY (212) 759-8885; Oak Brook, IL (312) 986-0141; Fullerton, CA (714) 871-2030; Tacoma, WA (206) 473-0505; Houston, TX (713) 665-7741; Anchorage, AK (907) 272-7074.

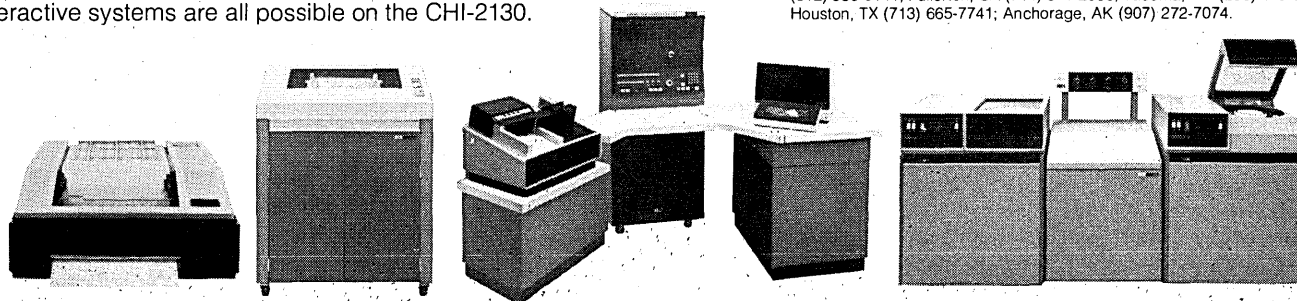

P.O. Box 4496, Sacramento, California 95825, (916) 929-8731

DECISION HAS MADE ITS MARK IN THE MEDICAL FIELD

If you're planning to develop computerized educational systems for such applications as 60-second test grading, admission, record-keeping, etc., we have a new, low-cost Optical Mark Reader for you.

The Decision OMR 6500, capable of both off-line and on-line operation, utilizes new techniques in optical scanning and automated form handling. The 6500 solves data entry problems in areas which were previously infeasible. The high performance and broad-range potential of this new mark reader lends itself to many applications in medicine, education, business, industry and government.

Operating under complete program control, the OMR 6500 employs a unique scanning mechanism which moves the optics while the page or document remains in its original stationary position. Programmable error detection is performed before the paper is advanced.

Contact us: DECISION, INC., 5601 College Avenue, Oakland, Calif. 94618; telephone (415) 654-8626.

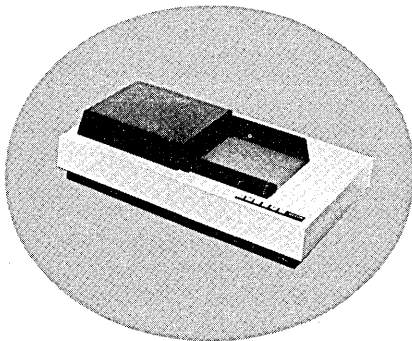

DECISION

CIRCLE 39 ON READER CARD

May, 1974

software & services

its abilities to handle both ascending and descending record organizations of various lengths, as well as packed decimal, floating-point and alpha fields, etc. There may not be another disc-based sort on the market that competes with IBM's core sort. Depending on the size of virtual memory, the number of records to be sorted, and the sort key, actual sort times for ICS are said to be two to twelve times faster than the standard IBM sort. ICS is priced at \$11,500 and can also be leased or rented. Users get access to the assembler language source code. STANDARD DATA CORP., New York, N.Y.

FOR DATA CIRCLE 327 ON READER CARD

360/370 Accounting

Boole & Babbage has made some substantial changes in its SMS/CAS computer accounting system to make it more flexible. Two of the three modules comprising SMS/CAS remain relatively unaffected: an edit module that examines SMF data to insure that invalid data is not processed, and a statistics module that generates performance reports. But the third module, billing, has been scrapped completely in favor of a new accounting module that allows for entry of off-line charges, credits, and budget figures on monthly billing and year-to-date summaries. Flexible billing rates are allowed on cpu time, voluntary wait time, main and auxiliary core residence, spooling, EXCP and occupancy charge by device, mounting operations, priority and/or shift charges, and TSO connect time. The product is written in COBOL (instead of the original PL/1), and priced at \$7,500. It can also be leased. BOOLE & BABBAGE, Sunnyvale, Calif.

FOR DATA CIRCLE 328 ON READER CARD

COBOL Optimization

STAGE III is a source code analysis and optimization tool oriented toward the IBM OS/DOS/VS environment. After reading in COBOL programs as large as 28,000 source statements, STAGE III produces a diagnostic listing and a new source module containing transparent changes to the target program. The result of these changes is typically a 10-20% reduction in execution time or storage requirements. Efforts by an optimizing analyst can increase these reductions by an additional 5-15%, it's claimed. STAGE III is available on a license agreement for \$5K plus a nominal monthly charge. The package is currently undergoing beta testing and should be out by summer. TESDATA SYSTEMS CORP., McLean, Va.

FOR DATA CIRCLE 329 ON READER CARD

The Floating Floors® System



A better way to raise the floor

Floating Floors, Inc., provides Infinite Access Air Plenum Floors in either lightweight die-cast aluminum, or economical steel panels. Both support up to 1,000 lbs. on one square inch with less than .080" deflection. Aluminum panels are available with static-control carpeting that's held firmly on all sides by a plastic lip to prevent unraveling.

and control the air

U.L. Listed Site Environment System (SES®) Units automatically maintain temperature within $\pm 2^\circ$ and humidity within $\pm 5\%$. Dual compressor/condensers offer longer life, reliable service.

send for detailed information

Write for the newly revised Infinite Access Air Plenum Floors and Precise Environment Control brochures to: Floating Floors, Inc., Subsidiary of N L Industries, Inc., 5400 North Detroit Ave., Toledo, Ohio 43612. (419) 476-0721.

NL FLOATING
INDUSTRIES FLOORS, INC.

CIRCLE 96 ON READER CARD

Literature

Edp Salary Survey

This 44-page pamphlet surveys salaries of 200 different edp job classifications, comparing six different regions of the U.S. and nine different industries (advertising/publishing, financial services, distribution, government, health services, heavy manufacturing, light manufacturing, services, and utilities/transportation). In addition, each job classification is described with regard to responsibilities, duties, interaction, and required knowledge and skills. Cost: \$12.50. AUERBACH PUBLISHERS, INC., Dept. SS, 121 N. Broad St., Philadelphia, PA 19107.

Buying a Software Package

A pamphlet entitled "Make or Buy" —An Important Management Decision discusses the advantages of buying a proven software package and tailoring it to specific needs, rather than developing one's own program. It describes the ideal package, gives a cost comparison, and lists a set of guidelines for shopping for a package in a section by L. A. Welke, *ICP Quarterly* editor and publisher. SOFTWARE INTERNATIONAL CORP., Andover, Mass.
FOR COPY CIRCLE 302 ON READER CARD

Retail Automation Report

A monthly newsletter begun in February will report on retail automation, presenting in each issue a case study of a major installation, product reviews, market trends, and industry news. Until June 15 there will be an introductory one-year subscription fee of \$54; the regular rate will be \$60/year. The introductory issue is available free through the reader service number. CREATIVE STRATEGIES INC., Palo Alto, Calif.

FOR COPY CIRCLE 301 ON READER CARD

Datapro Reports

Three reports recently added to *DATAPRO 70*, an edp reference and information service, are: a 62-page report on the IBM System 370, a 40-page report on optical readers, and a 38-page report on small accounting computers. The report on the System 370, costing \$15, gives the results of in-depth interviews with 20 users, as well as descriptions and analyses of all the current System 370 equipment and software. The report on optical readers gives detailed comparison charts on 104 commercially available readers from 46 manufacturers, ratings based on the experiences of 116 users, and advice on assessing the pros and cons

of optical input techniques and selecting a suitable reader. In the report on small accounting computers, there are charts comparing characteristics and prices of 118 low-cost business dp systems supplied by 38 vendors, an analysis of experiences of 80 users, and guidelines for selecting and applying these systems. The optical reader report and the small accounting computer report cost \$10 each. DATAPRO RESEARCH CORP., 1805 Underwood Blvd., Delran, NJ 08075.

IEEE Catalog

The IEEE Computer Society's publications catalog for spring-summer 1974 lists publications in the categories of communications, Compcon, fault-tolerant computing, switching and auto-

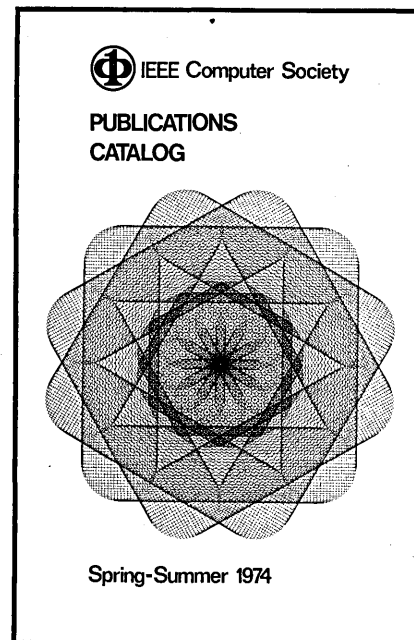

mata, design automation, pattern recognition, applications, minicomputers, computer architecture, memory technology, programming and software, and archives. IEEE COMPUTER SOCIETY, Long Beach, Calif.

FOR COPY CIRCLE 300 ON READER CARD

Government Data Files

The 1974 *Directory of Computerized Data Files and Related Software* is the first annual government-wide guide to machine-readable federal data files, data bases, and related software, covering more than 500 data files from 60 major government agencies. Descriptions of the data files include abstracts, generating agencies, file titles, time frames of data, data sources, technical descriptions, and availability. All data files are cross-referenced in a generat-

ing agency index, subject index, and catalog reference number index. Cost: \$60. NATIONAL TECHNICAL INFORMATION SERVICE, U.S. Dept. of Commerce, P.O. Box 1553, Springfield, VA 22151.

Computer Contracts

Understanding Computer Contracts —Syntax-Legal Analysis of Standard Commercial Computer Purchase and Lease Contracts analyzes purchase and lease contracts in depth, paragraph by paragraph. The booklet, discussing 28 major contract provisions of five major manufacturers of computer equipment, is directed at lawyers, law students, business students and professors, dp managers, bankers, libraries, insurance companies, hardware and software manufacturers, and anyone else who plans to rent, lease, or buy a computer. Cost: \$6.50 for DPMA members, \$9.50 for others. DATA PROCESSING MANAGEMENT ASSN., 505 Busse Hwy., Park Ridge, IL 60068.

Communications Rate Reference

The expanded 1974 edition of *The Guide to Communications Services*, now issued in a pocket-size loose-leaf binder to accommodate the monthly revisions, monitors the more than 5,000 pages of tariffed telecommunication services of the interstate and international communications common carriers. The rate-reference standard, this year doubled in size, aims to give accurate, unbiased data on all telecommunication services of all licensed communications common carriers. In addition, the guide contains such reference material as: a subject cross-reference index, glossary of terms, common carrier directory, tariff cross-reference directory, area code directory, frequently used telecommunication planning formulas and abbreviations, and rate calculators. It is offered only on a subscription basis at \$75 a year. CENTER FOR COMMUNICATIONS MANAGEMENT, INC., P.O. Box 324, Ramsey, NJ 07446.

DATAMATION Subject Index

There are still some copies of the 20-page subject index of 1973 *DATAMATION*, Vol. 19, Nos. 1-12, which includes references to feature articles, conference reports, book reviews, News in Perspective, Editor's Readout, and The Forum. *DATAMATION*, Los Angeles, Calif.

FOR COPY CIRCLE 307 ON READER CARD



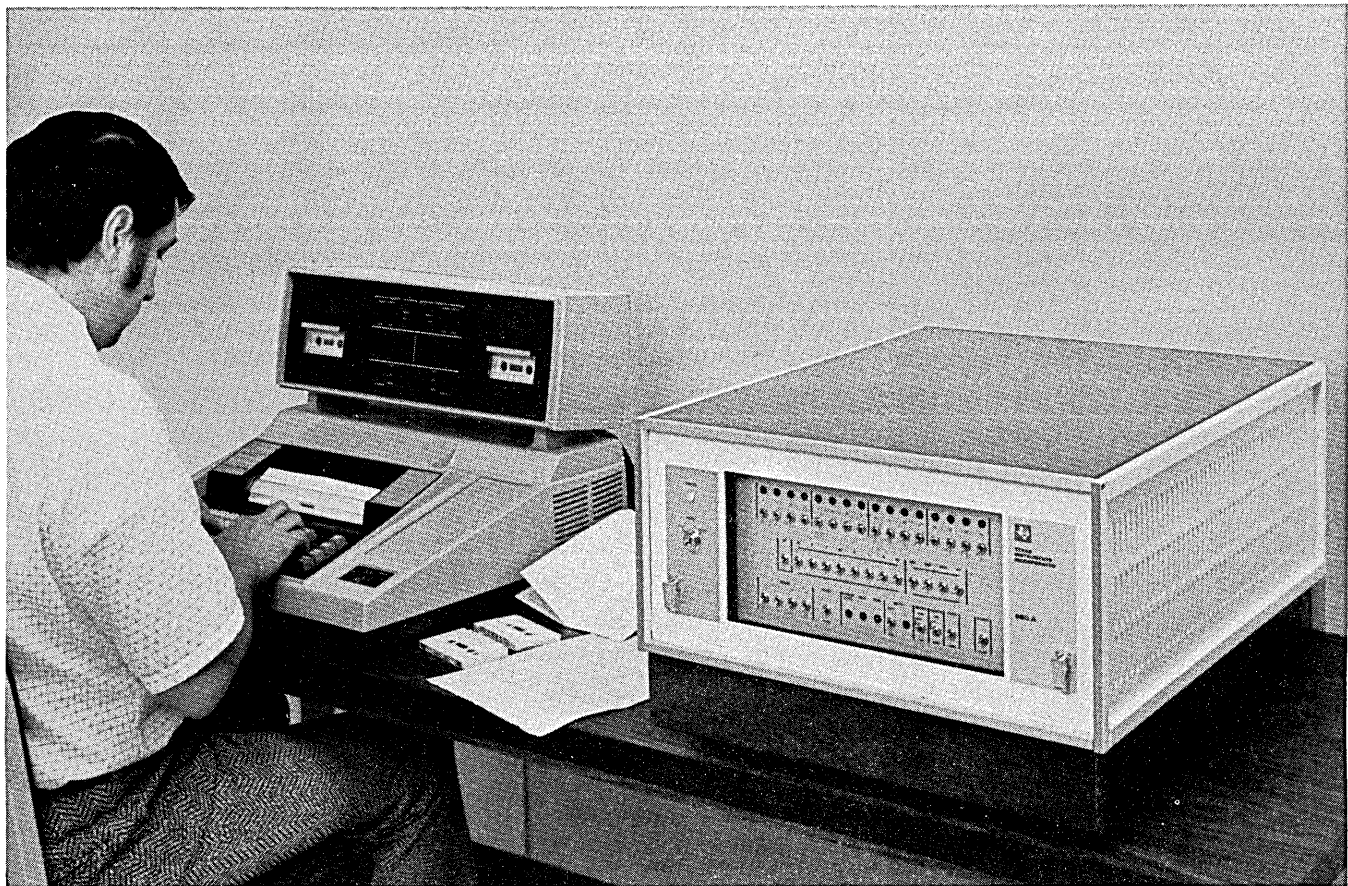

\$9225 buys this complete high-performance computer system from Texas Instruments

Combine a *Silent 700** Model 733 twin-cassette ASR data terminal and a 980A minicomputer with 8K of memory. You have a fast, powerful computer system, including a cassette operating system, for much less than you would normally expect to pay.

And delivery is only 30 days.

This system is useful for such applications as business data processing and batch data retrieval. Add more *Silent 700* terminals and

do multiple terminal data entry. Or run multi-user BASIC. With 16K of memory, run high-level languages like FORTRAN IV.

By adding a disc, you can run the powerful DX980 operating system. This way, for less than \$25,000, you get a system that is substantially equivalent to other systems with price tags of \$35,000 or more.

With *Silent 700* ASR terminals, you get the speed, quietness and

reliability that have made them a standard of comparison. And, the convenience of tape cassettes and non-impact printing make the *Silent 700* terminals a powerful alternative to conventional paper-tape teletypewriters.

Want more information? Call the nearest TI office listed below or contact Texas Instruments Incorporated, P.O. Box 1444, Houston, Texas, 77001.



*Trademark of Texas Instruments Incorporated

Arlington, Va. (703) 527-2800 • Atlanta, Ga. (404) 458-7791 • Boston, Mass. (617) 890-7400 • Chicago, Ill. (312) 671-0300 • Clark, N.J. (201) 574-9800 • Cleveland, Oh. (216) 464-1192 • Dallas, Tx. (214) 238-5318 • Dayton, Oh. (513) 253-6128 • Denver, Co. (303) 758-5536 • Detroit, Mich. (313) 353-0830 • Hamden, Conn. (203) 281-0074 • Houston, Tx. (713) 777-1623 • Huntsville, Ala. (206) 837-7510 • Indianapolis, Ind. (317) 248-8555 • Milwaukee, Wis. (414) 475-1690 • Minneapolis, Minn. (612) 835-5711 • New York, N.Y. (212) 541-9540 • Orange, Ca. (714) 547-9221 • Orlando, Fla. (305) 644-3535 • Philadelphia, Pa. (215) 643-6450 • Phoenix, Az. (602) 249-1313 • Rochester, N.Y. (716) 461-1800 • San Francisco, Ca. (408) 732-1840 • Seattle, Wash. (206) 455-1711 • St. Louis, Mo. (314) 993-4546 • Amstelveen, Holland 020-456256 • Bedford, England 58701 • Copenhagen, Denmark (01) 917400 • Frankfurt, Germany 0611/39 9061 • Manchester, England 33411 • Milano, Italy 6888051 • Montreal, Canada (514) 332-3552 • Paris, France (1) 630-2343 • Stockholm, Sweden 67 98 35 • Sydney, S. Australia 837-015 • Toronto, Canada (416) 889-7373 • Tokyo, Japan 402-6181

TEXAS INSTRUMENTS
INCORPORATED



The day the new habits arrived at St. Theresa's.

It could have been the program and it could have been a faulty tape. Heaven only knows. But you'll find no peace on earth when an error is raising the devil with your orders.

What you need to find is a way of narrowing your possibility of error. And the easiest place to start is in your selection of computer tape. How? By specifying BASF.

At BASF, we produce tapes

that are a lot better than they have to be. For example, our special coating technique provides a more even dispersion of oxide particles in the binder, so no matter what your packing density, you get improved bit-to-bit uniformity and fewer sins of omission.

One more point. Our tapes don't cost any more than the competition's. You're already paying for BASF quality . . . you might as well

have it. Write today for the complete story of how BASF computer tapes stack up against the competition. Remember, nobody makes better tape than the people who invented it. BASF Systems, Crosby Drive, Bedford, Mass. 01730.

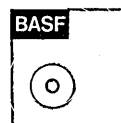

When it's BASF...you know it's not the tape that goofed.

PEOPLE PEOPLE PEOPLE PEOPLE

THE BIGGEST, BUT NOT THAT BIG

The IBM user organizations SHARE and GUIDE have been criticized in recent years for their decreasing influence on IBM's marketing strategies. But a former SHARE president, James D. Babcock of General Electric's information services div.,



James D. Babcock

Rockville, Md., gives the organizations high marks on another ground: as the focal point for helping users cope with the complexities of today's systems and applications.

"Maybe the influence of SHARE/GUIDE—I don't differentiate between them—is not as great as it used to be, but they still are needed simply to keep people abreast of change."

Babcock, who recently joined the GE division as manager of its IBM Services Program (it soon will add a 370/158 to the Honeywell-based international network) was the president of SHARE in 1965, the year he left Rand Corp. to form Allen-Babcock Computing, Inc., a Los Angeles time-sharing company. Unlike the old days when SHARE pressure "paved the way for IBM to start thinking about data base management systems and teleprocessing," Babcock thinks the organizations should now address themselves to more of a "tutorial function." He notes that "while they used to trade programs, today they trade ideas and applications."

Computer ideas and applications have been the concern of the 44-year-old mathematician/entrepre-

neur ever since he graduated from the Univ. of Michigan with a B.S. in mathematics and joined Rand in 1954 as a scientific programmer doing nuclear-related studies for the Atomic Energy Commission. His first involvement with time-sharing was as an innovator, as part of a team selecting hardware to replace Rand's JONNIAC time-sharing system. His first contract at the head of Allen-Babcock was with IBM to design and implement a time-sharing software system, based on PL/1, for commercial service. His company later used the product of the study: a system called RUSH (Remote Use of Shared Hardware) which first was offered on a 360/50, later enhanced with remote job entry capability, and more recently is for use under virtual machine concepts on a 370/158.

Babcock left Allen-Babcock when its business was acquired late last year by International Time Sharing Co. of Minneapolis.

Of the future, Babcock thinks teleprocessing will achieve its full value when computers will be able to share very wide bandwidths, transmitting at 50KB and up. As head of Allen-Babcock and as a member of a National Academy of Science group studying problems

of computer communications interconnections, Babcock became widely quoted as an opponent of AT&T's policies that limited computer connections to communications lines and equipment. "The regulation problems are fierce," he said in a recent interview.

Babcock also gained a reputation among associates for a unique ability to converse equally well with top technical personnel and top management people on his favorite subject, on-line computing. "I think it began the day I sent a programmer over to help a customer with a problem and the customer called up and asked, 'why did you send that guy over, I can't understand what he's talking about.' It's important to be able to communicate on all levels; but it isn't tried by many people. Look how few general practitioners are left in medicine."

Asked for his feeling about leaving a small organization for a huge corporation like GE, Babcock explains, "I was at that point in my career to go with a big company. So I looked around, and I couldn't see anyone bigger than GE." But he qualifies this: "This is a small division of GE, about 1,200-1,300 people. It's not big like IBM. I picked it for that reason."

HAVING TOO MUCH FUN

Lockheed Electronics Co.'s new general manager, data management systems, charged with marketing, marketing support, finance, manufacturing, and customer engineering for the firm's full line of shared processor data entry systems, foresees "a tremendous future" for the data entry market and says Lockheed will grow from key-to-disc, which it has been in since last May, "into the whole data entry field." Alexander Greenfield says he plans to relate intelligent terminals and communications to Lockheed's existing line and to tie in OCR (optical character recognition) and MICR (magnetic ink character recognition).

"I'm hiring people I know to do this the way I know is right . . . people who made the mistakes I did growing with this. . . ." Greenfield's background includes extensive work



Alexander Greenfield

with on-line systems and intelligent terminals. He lays claim to having designed the first on-line reservations system while with Teleregister Corp. (subsequently acquired by Bunker-Ramo) some ten years ago and to having been involved in the design of the first on-line banking system. While at Teleregister, he

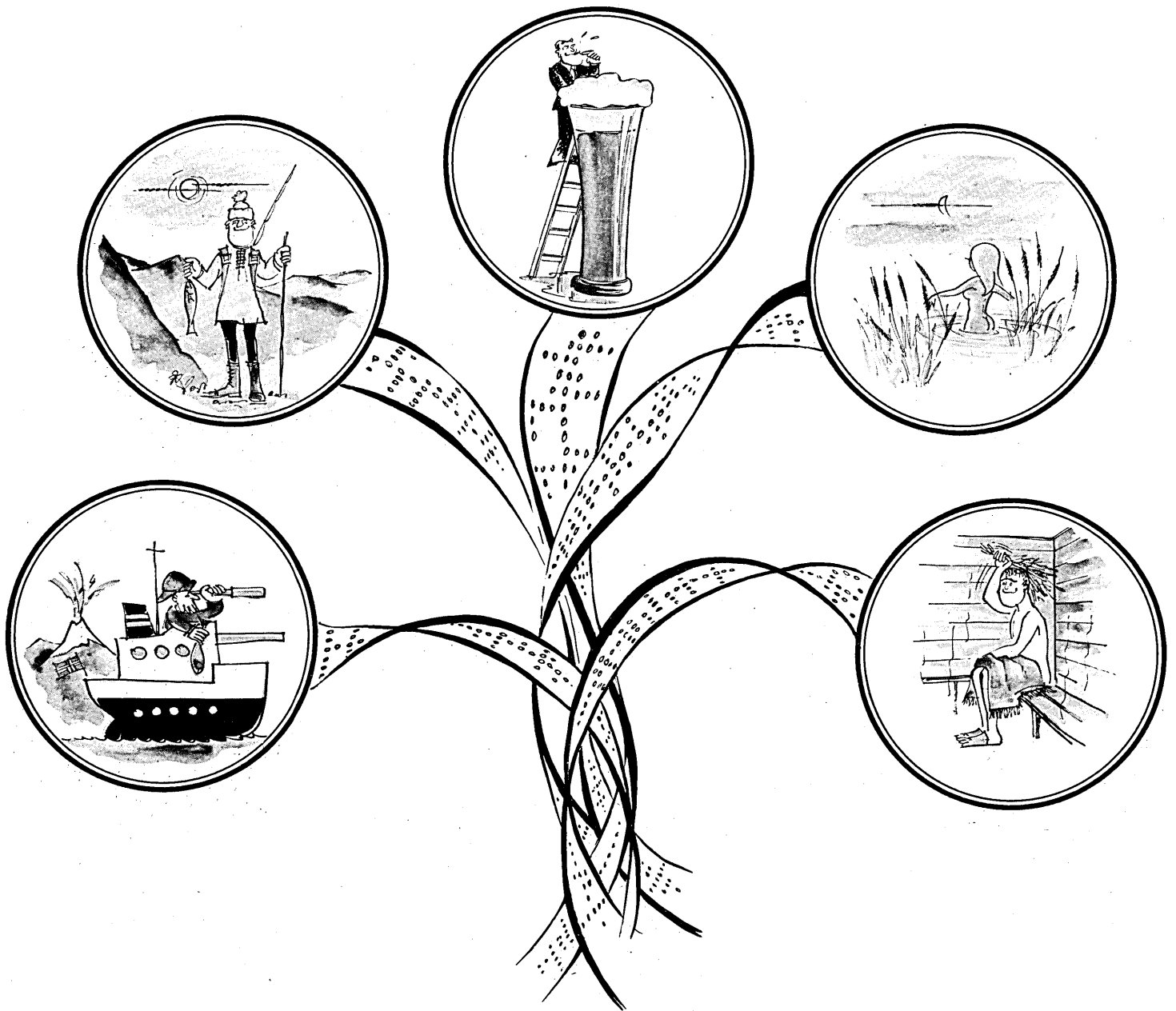

You may associate Denmark with beer, Finland with sauna, Iceland with hot springs and cod war, Norway with the midnight sun and Sweden with midnight sin. So you may be surprised to learn that the Scandinavian countries are also spending some effort on Information Processing. You are possibly not even aware of the fact that there is a Scandinavian Computer Journal, »data«, which reaches 90–95 % of all computer installations in Scandinavia and brings you in contact with a prosperous market.

»data« was started in 1971 by the Nordic user associations and has had a strong growth during the past three years.

We shall be pleased to furnish you with further relevant information on our Journal and how you will be able to use it in your marketing plans in the Nordic countries.

We will also gladly let you know how you can use »data« to form contact with the whole data world, viz. the 5,000 participants in the IFIP Congress at Stockholm this August.

Being the official Journal of the Congress, participants will receive »data«, No. 5/74. This issue will be in English only.

data

- Bredgade 58
- DK-1260 Copenhagen K
- DENMARK

INTRODUCING STATOS BI-SCAN.*

It blows other hard copy right off the map.

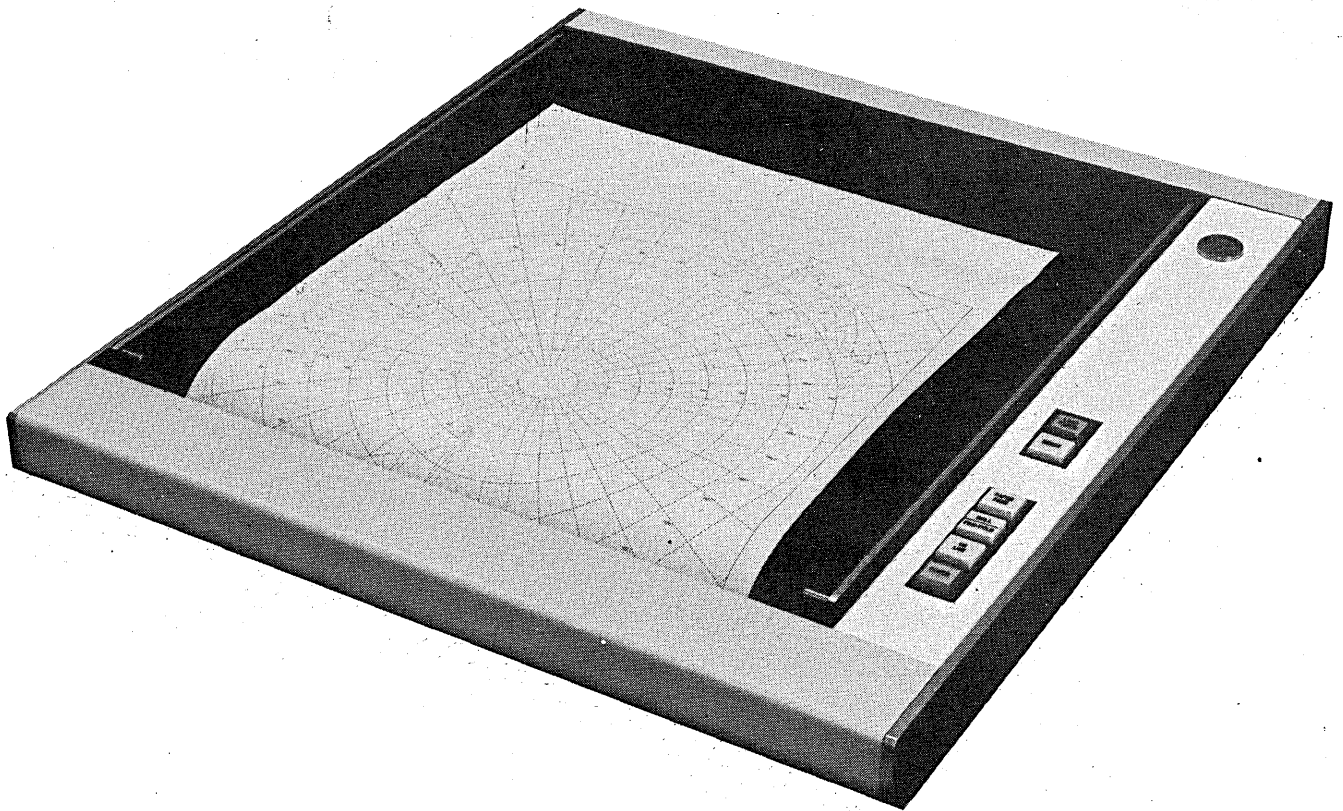

The new Bi-Scan™ writing head in Statos 33 family of printer/plotters gives you sharper hard copy output than any standard electrostatic computer peripheral in the business.

In fact, a 250% improvement in contrast. It does this with a simple but unique staggered-styli design. Each stylus is 60% larger in diameter so that the dots actually touch to produce extremely clear printing or plotting.

But Bi-Scan is just one of the exclusive features that makes the Statos 33 family of printer/plotters the best

cost/performance buy around.

Other features you'll like include automatic control electronics to simplify interfacing, make programming easy, and take a big load off the computer. A dynamic toning system to guarantee even toning at all operating speeds. And a choice of four widths: 8-1/2 inch, 11 inch, 15 inch, and the super wide 22 inch (ideal for

weather maps, seismic charts, or D-size drawings).

Whatever your requirements—alphanumerics in any language (even Chinese), graphics, or graphics interspersed with words—there's a Statos printer/plotter for you. And they're priced right.

For details on how Statos 33 units relate to your application, call Dave Sloan (415) 493-4000. Or write Varian Data Machines, 611 Hansen Way, Palo Alto, CA 94303.

 **varian
data machines**

*Bi-Scan Patent Pending

PEOPLE

also participated in development of the first voice-response on-line system and in early work on what was to become Bunker Ramo's NASDAQ (National Assn. of Securities Dealers' Automated Quotation system). It was an exciting time to be involved with on-line systems, he says. "All the people you hear about today worked under me."

Before joining Teleregister, Greenfield was with Univac and was a designer of the Univac 120. After Teleregister, he went to Pitney-Bowes, serving first as a consultant and later as general manager of the computer div. From Pitney-Bowes, he went to Compat Corp. of New York as president—"they took me on when they were in trouble." During his four years with Compat the firm changed from a supplier of electronic components to a manufacturer of intelligent batch terminals. Greenfield said Compat designed the first intelligent batch

terminal. The company subsequently was acquired by Data 100, which still is selling the Compat terminal "very successfully."

Greenfield's next venture was the founding of a firm called Chronotel, which developed a device to reduce telephone bills by monitoring all calls digitally. Chronotel currently is "in the legalistic phase of being sold out to a very large corporation."

A holder of 17 patents in the computer and instrumentation

fields, Greenfield is a licensed professional engineer in the state of New York and received a bachelor's degree in electrical engineering from Pratt Institute and a master's in the same field from New York Univ. He has earned an additional 130 credits toward a doctorate at NYU and the Univ. of Michigan but hasn't found time to put in the year of residency required for the higher degree. "I'm having too much fun working in industry."

IT'S THE 51% THAT COUNTS

"I'm a two jobber," says Wilson R. Cooper, new president of Informatics Inc.'s Western Systems Co. And that's kind of rare in the job hopping dp business, which Cooper's been in since 1961. But he hasn't been standing still. Informatics, which he joined in 1964, is Cooper's second employer. Since he joined the firm he's made geographic

moves 10 times.

He joined Informatics as a "classical systems programmer." He was a part of the design team for the company's MARK IV file management system and has spent varied periods of time for the firm in New York and Seattle. He was in Sacramento for Informatics for a year and three months as project manager

JON S. GOULD was appointed vice president for systems and software development for Interdata, Inc., Oceanport, N.J. . . . DR. THOMAS B. MARTIN, a vice president and a founder of Threshold Technology, Inc., Cinnaminson, N.J., has been elected executive vice pres-

ident . . . JOHN P. SINGLETON was named vice president and manager of the systems and data processing div. of California-based Great Western Financial Corp.

CLEAN DISC CARTRIDGES

... quickly, safely and completely

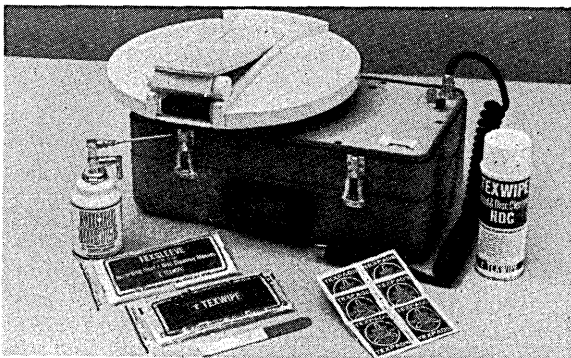

Data loss is insidious . . . the ordinary day-to-day use of disc cartridges actually leads to steady deterioration. Even carefully controlled environments produce harmful contaminating effects. However, it is now possible to protect both System 3 (5440) and type 2315 disc cartridges, and the data they contain with the new Texwipe System 315, off-line motorized cartridge cleaner. The average cost to clean a cartridge is 15¢. The System 315 sells for only \$950. For information on S/315, and the complete line of Texwipe disc pack cleaning and inspection instruments, write today.

TEXWIPE
Hillsdale, New Jersey 07642

Save time...money...trouble...

Lease your Teletype* equipment from RCA...

Model 33ASR (with tape perforator and reader) **\$55 per month.**

Model 33KSR (send/receive) **\$40 per month.**

- Immediate delivery in any quantity.
- Includes nationwide maintenance service by RCA's own technicians.

Call or write nearest office: RCA Service Company
A Division of RCA, Technical Services

Bldg. 204-2
Camden, N.J. 08101
Phone: (609) 779-4129

3310 South 20th Street
Philadelphia, Pa. 19145
Phone: (215) HO 7-3300 (Pa.)
(609) WO 3-2043 (N.J.)

1778 Marietta Blvd., N.W.
Atlanta, Ga. 30318
Phone: (404) 355-6110

20338 Progress Drive
Strongsville, Ohio 44136
Phone: (216) 238-9555

43 Edward J. Hart Rd.
Liberty Industrial Park
Jersey City, N.J. 07305
Phone: (201) 451-2222 (N.J.)
(212) 267-1550 (N.Y.)

7620 Gross Point Road
Skokie, Ill. 60076
Phone: (312) 965-7550

2711 Irving Blvd.
Dallas, Texas 75207
Phone: (214) ME 1-8770

1501 Beach Street
Montebello, Calif. 90640
Phone: (213) 685-3069

RCA

* Registered trademark of Teletype Corp.

er for CLETS (California Law Enforcement Transmission System). In 1967 he opened Informatics' Northern California office and spent five happy years there until 1972 when he was brought "kicking and screaming" back to Los Angeles to become general manager of what then was the Western Division.

Subsequently he was named vice president, Western Division, and when the division became Western Systems Co. last March, he was named its president. The new company has three main activities: marketing PRODUCTION IV, a manufacturing management system, in conjunction with a newly acquired European company, Parsons & Williams AG of Switzerland; mail-order sales of software and hardware products for System/3 users through its Group/3 division, also newly ac-

quired; and custom programming and software services, including MARK IV applications.



Wilson R. Cooper

Before joining Informatics, Cooper was head of the systems programming section, Pacific Missile Range, where he was responsible for automatic programming systems for the organization's large-

scale IBM and Univac computers. A John Motley Morehead Scholar and a member of Phi Beta Kappa, he received a B.S. degree in mathematics from the Univ. of North Carolina and an M.S. degree in math from the Univ. of Washington as a Woodrow Wilson Fellow. He got into data processing the way many other 1961 math graduates did: "you go to programming school, right?" He's questioned the choice "49% of the time" since then, "but as long as it seems okay 51%, that's what counts."

As a Southern Californian, Cooper spends his spare time backpacking, woodworking, and in an occasional game of tennis. He's a one-time skier, but "when you've lived in Sacramento and Seattle where you can get to good skiing in an hour. . . ." But he doesn't want to move again.

DANIEL L. DUDAS was appointed president of a newly formed subsidiary of System Development Corp., Santa Monica, Calif., sdc Development Corp., and will be involved with data management systems for banks, financial institutions, and industrial organizations . . . C. G. HATFIELD was appointed vice president, engineering services, for Xerox Computer Services, Marina del Rey, Calif. . . . RICHARD BOUCHER was named

assistant president for Electronic Arrays, Mountain View, Calif. . . . W. WILLIAM ACKER assumed the new position of vice president of Cambridge operations for ADL Systems, Inc., a subsidiary of Arthur D. Little, Inc. . . . JOHN R. WALKER was named vice president, project management, at Datapoint Corp., San Antonio, Texas. □

HOT
TOPIC!

Check out these books on
**STRUCTURED
PROGRAMMING**

AN INTRODUCTION TO PROGRAMMING: A Structured Approach Using PL/1 and PL/C

By Richard Conway and David Gries, both of Cornell University. One of the leading introductions to structural programming, this book emphasizes the systematic development of algorithms. Conway and Gries provide complete, explicit details about structure, and stress the importance of correctness and testing of programs. 1973, 460 pp., paper \$8.95; cloth \$11.95

For more information, write:
Richard Marran, Winthrop Publishers, Inc., 17 Dunster Street,
Cambridge, Massachusetts
02138



**WINTHROP
PUBLISHERS, INC.**

SYSTEMATIC PROGRAMMING: An Introduction

By Niklaus Wirth, Eidgenössische Technische Hochschule, Zurich. Explains digital computers' essential properties, which are necessary to programming in general. Stresses a systematic approach to the development of algorithms: stepwise refinement of its parts and gradual decomposition of a problem into subproblems. 1973, 169 pp., \$10.50

For more information, write:
Robert Jordan, Dept. J-933,
College Division, Prentice-Hall,
Englewood Cliffs, N.J. 07632

**From
PRENTICE-HALL**

Bright new ideas for OEM designers:

Magnetic Tape Drives from Bright

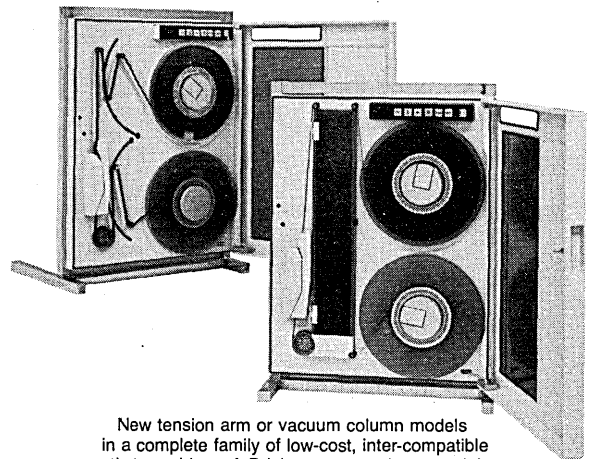

New tension arm or vacuum column models in a complete family of low-cost, inter-compatible magnetic tape drives. A Bright vacuum column model costs only 10.75% more than the competitively priced Bright tension arm model. Write or call today for a free brochure.

We'll give you a Bright idea.



That's Bright!

A subsidiary of Data Disc Incorporated.

683 West Maude Avenue, Sunnyvale, California 94086 (408) 735-9868

Regional sales offices: Los Angeles, CA—(213) 883-8413; Cleveland, OH—(216) 228-0624; Orlando, FL—(305) 644-5550; Elmsford, NY—(914) 592-8658; Buffalo, NY—(716) 839-5020; Ottawa, Ontario, Canada — (613) 234-4797.

CIRCLE 81 ON READER CARD

CIRCLE 94 ON READER CARD

Books

The Elements of Programming Style
by Brian W. Kernighan and
P. J. Plauger
McGraw-Hill, 1974
147 pp. \$3.00

In the computing business, we have grown familiar with "add-ons" that can be attached to hardware or software systems to enhance performance. This little book represents a new invention—you add-on to your programming course, regardless of the text used, and double your educational performance!

As the title portends, the concept of the book is heavily influenced by the classic work on English writing, *The Elements of Style*, by Strunk and White (which, by the way, wouldn't be a bad addition to a programming course itself). But let the first words of the preface speak for the authors:

"Good programming cannot be taught by preaching generalities. The way to learn to program well is by seeing, over and over, how real programs can be improved by the application of a few principles of good practice and a little common sense. Practice in critical reading leads to skill in rewriting, which in turn leads to better writing."

Since this was the approach advo-

cated in *The Psychology of Computer Programming* (Weinberg's own book—a plug . . . ed.), I couldn't help but applaud even a feeble first attempt to teach critical reading of computer programs—but there's nothing feeble about this little killer.

I suppose one could criticize one thing about the book—it was a bit like shooting fish in a barrel. Instead of choosing "real" programs, Kernighan and Plauger selected most of their examples from among 33 programming texts, many of which—as is obvious from the text—contain programs which had never been close enough to a computer to be cooled by the air-conditioning. But then, these are the very texts that introduce the Youth of America to that ultimate addiction—computer programming. Who would condemn those who attack the Corrupters of Youth? It needed doing, and after this cleansing fresh wind, who among us would dare to write a programming text without proving each and every program in the real fire of battle with the giant brain—and with a few puny readers' brains as well?

Not all the texts are such easy marks, yet none escape the practiced eye of the authors. One of my own books is there, and even though all examples were machine tested and carefully read, Kernighan and Plauger

pick four (ouch) examples which will certainly be educational to the reader since they were to me, the author. (Kernighan and Plauger, in typical Bell System graciousness, omit identification of each source. Readers may wish to play the game of trying to identify which uglies came from their favorite text. Authors may want to kill themselves.)

In short, if you are now writing, have ever written, or ever intend to write a computer program, you should have a copy of *The Elements of Programming Style*. And when your copy arrives, just start it—you won't be able to put it down.

—G. M. Weinberg

Computer-Communication Network
N. Abramson and K. Kuo, ed.
Prentice Hall, Inc., 1973
525 pp. \$22.50

This text consists of a series of 14 well-edited chapters by individual authors. While there is some inconsistency in the quality of the various chapters, most are good and some are excellent. The book is designed for the engineering student or for the computer professional who has been around communication systems for several years, but has never had the opportunity to think about those systems.

There are two chapters of definitions, an excellent chapter on the common carrier network, a good chapter on how to interface a computer with that network, a rather frank chapter on regulatory policy and the future, and a good chapter on communications economics. Three chapters are devoted to computer network case studies covering Dartmouth, ARPA, and the Aloha System. The chapter on file allocation in a computer network is a little weak, and those of you who have forgotten most of your differential equations will ponder a bit over the queuing chapter. The text is basically non-mathematical and most of it can be easily read and understood by most computer professionals.

Many companies are blindly using communications nets to pump data to and from remote locations servicing a variety of terminals. Some companies are beginning to understand that those communications nets are woven into the fabric of the company and its information processing system, and hence are beginning to wish they understood those nets better. If such a company were to appoint a digital communications manager and assign him at least half time to communications matters, this text would be an excellent point of departure and could possibly provide him with sufficient material for a series of local lectures to the remainder of the professional staff.

—R. L. Patrick

Try it first. Send for a free sample.

Tempilabel^o

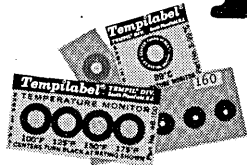

Temperature Indicating Labels

The center spot on a Tempilabel^o turns black when the surface to which it is affixed reaches the specified temperature (from 100° to 600°F).

Tempilabels^o are available with single spots, or with multiple spots for monitoring safe operating temperatures. They provide permanent temperature records, and are thus useful in designing components and selecting materials.

If you are not now using Tempilabels^o, fill in the coupon. We'll be glad to send you a sample that you can try in your own plant or laboratory.

Tempilabel^o

Division, Big Three Industries, Inc.
Hamilton Blvd., South Plainfield, N.J. 07080
Phone: 201 • 757-8300 • Telex: 138662

Send sample of Tempilabel^o.

For use at _____ temperature.

Name _____

Title _____

Company _____

Street _____ City _____

State _____ Zip _____

Can you spot your limitations?

CIRCLE 75 ON READER CARD

Kybe digital cassettes: 100 million to 1 says they're the best.

Kybe digital cassettes have a read error rate of less than one character in 100 million. Not just when they're new, but over twice the life of ordinary digital cassettes.

If this sounds surprising, it shouldn't. Kybe's #1



position in tape certifying and testing systems has made us the world's #1 experts on improving tape performance. The result: the ultimate in data reliability at no increase in cost. For details on what makes Kybe your best digital cassette buy, call or write:



CIRCLE 58 ON READER CARD

EXECUPORT: Terminals and Peripherals

Shown is the Execuport 320 Portable Data Terminal. Plugs in anywhere, communicates via telephone with built-in acoustic coupler. Quiet and highly reliable.

Features include:

- Upper and lower case
- Three RS232 connectors
- Keyboard isolate switch
- Illuminated print area
- Single and double spacing
- Teletype or numeric cluster keyboard
- Integral carrying case
- Data access jack
- Print position counter
- Many other features and options

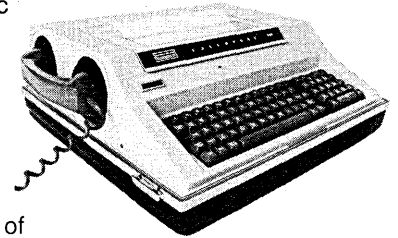

Ask about the full line of EXECUPORT terminals and peripherals, including paper and magnetic tape units. Use the reader service card or phone or write.

EXECUPORT: The tougher terminal.



Computer Transceiver Systems Inc.
East 66 Midland Ave., Paramus, N. J. 07652
(201) 261-6800 • TELEX: 138-707

CIRCLE 87 ON READER CARD

Managing the Computer Resource July 28-August 9, 1974

This intensive program focuses on the management of corporate computer activities. It is designed for men and women with responsibilities in computer-based information systems management, either senior management to whom the computer resource reports, or the management of the computer resource itself. The orientation of the course is toward management, not technology.

Course topics will include:

- Information Systems Planning
- Information Systems Organization
- EDP Administration and Management
- EDP Audits
- Design of Information Systems
- Incorporation of Data-Based Technology
- Computer Privacy
- Management of the Computer Utility Network

The seminar is based on intensive research and course development by its faculty: Professors Cyrus Gibson, Robert Gilbertson, Warren McFarlan, James McKenney, and Richard Nolan.

The all-inclusive fee is \$1200.

For further information write or call:

Administrative Director
Managing the Computer Resource Program
Sherman 4
Harvard Business School
Boston, Mass. 02163
Telephone: (617) 495-6226



AN EXECUTIVE EDUCATION PROGRAM OF THE

Harvard Business School

to \$25,000 COMMUNICATIONS

Data Systems Sales

Progressive systems engineering firm located in desirable Middle Atlantic city requires a marketing representative to assist in the market identification and sales of voice and data communications requirements, concept definition analyses, and system design studies, to commercial & non-defense government clients. Applicant must be able to make sales presentations to high level corporate officials, actively participate in the preparation of proposals and close contracts for communications consulting services. Fees paid. Please rush resume and salary history.

PERSONNEL RESOURCES
INTERNATIONAL, INC.

342 Madison Ave., N.Y.C. 10017
Suite 1234 212-MU 2-2030



CIRCLE 106 ON READER CARD

systems analysts

Our client is a large international corporation, with several responsible positions for professionals. You will be engaged in the analysis and design of large-scale IBM systems. Qualifications include a working knowledge of the IBM full operating system, plus 3 or more years' experience in systems analysis and design. Programming background is a must. We invite you to submit a full resume, including your salary history to Data Processing Department.

M.L. GRANT ASSOCIATES

919 Third Avenue

New York, N.Y. 10022

COMMUNICATIONS SYSTEMS ANALYSIS & DESIGN

We are a leading suburban Chicago manufacturer of computer, mechanical and electronic equipment, currently seeking an aggressive, creative individual able to assume a career position highly oriented toward professional growth.

The individual selected will have had previous senior level programming experience, familiarity with data communications, and the ability to assume management responsibilities. Knowledge of communications emulator packages for such terminal devices as 2780, 2968, DCT-2000, UT-200, etc. is a definite plus.

Responsibilities will include the design and implementation of a variety of communications software packages for a mini-computer based product line.

We are also seeking several staff-level Systems Programmers.

We offer an excellent salary, comprehensive benefits package and a professional working environment. Please submit resume, including salary history and current requirements, in confidence to:

MR. RONALD L. WESTROM
Assistant Personnel Director

An Equal Opportunity Employer M/F

CA CUMMINS
CUMMINS-ALLISON CORP.
800 Waukegan Road Glenview IL 60025

CIRCLE 112 ON READER CARD

American Management Associations'

info74

**NEW YORK COLISEUM
SEPTEMBER 9-12, 1974**

CLAPP & POLIAK, INC.
Exposition Management
245 Park Avenue
New York, N.Y. 10017

Please send me complete details on INFO 74.

Name _____

Title _____

Company _____

Street _____

City _____ State _____ Zip _____

- I am interested in visitor's information
 I am interested in exhibitor's information

info74 IS DIFFERENT...

**INFO 74 is an information systems
Exposition for Management**

**INFO 74 is an information systems
Exposition for EDP Management**

**INFO 74 is an information systems
Conference for Management**

**INFO 74 is an information systems
Conference for EDP Management**

INFO 74 is an *applications* show, not a technical show. The emphasis is on what information systems can do for management—not how it does it. (But the technology is available for those who need to know it.)

INFO 74 will show Management how to use the computer and other information systems in new and different applications, how to work with EDP Management in developing these new applications.

INFO 74 will have over 200 exhibits by the leading manufacturers of information systems equipment and suppliers of information services. (Over 115 companies have already signed up for space.)

For complete information, just send coupon.

Advertisers' Index

AC Manufacturing Company	110	Elgar	93
Adage, Incorporated	168	Entrex, Inc.	136, 137
Advanced Electronics Design, Inc.	140	Fabri-Tek Inc.	48
American Telephone and Telegraph Company	4, 60, 61	Floating Floors, Inc., Subsidiary of N L Industries, Inc.	149
Ampex Corporation	102, 103	General Automation	130, 131
Applications Group, Inc.	34	General Binding Corporation	139
Applications Software Inc.	147	General Electric	6, 7, 167
Applied Digital Data Systems	44, 45	Gould Inc., Data Systems Division	74
BASF Systems	152	M. L. Grant Associates	160
Bell & Howell, Business Equipment Group	47	GTE Information Systems	94, 95
The Berton Group Inc.	28	Robert Half Personnel Agencies	161
The Braegen Corporation	127	Harvard Business School	159
Bright Industries Inc, A Subsidiary of Data Disc Incorporated	157	Hewlett-Packard	19, 21, 23, 101
Brussels Universities Computer Centre	162	Honeywell	35-42
Cadillac Associates, Inc.	166	IBM	81, 82, 83, 84
California Computer Products, Inc.	20	IMLAC Corporation	46
Centronics Data Computer Corp.	138	Incoterm Corporation	5
CIG Computer Products, Inc.	32	Info 74	160
Cincinnati Milacron, Process Controls Division	76, 77	Informatics Inc.	143
Computer Hardware Inc.	148	Innovation Data Processing	140
Computer Transceiver Systems, Inc.	159	Interdata	68, 69
Computer Transmission Corporation	165	Intel Corporation	24, 25
Control Data Corporation	88, 89	Kybe Corporation	159
Cummins-Allison Corp.	14, 15, 160	Lear Siegler, Inc., Electronic Instrumentation Division	Cover 2
Data	154	Leigh Instruments Limited	158
Data General Corporation	144, 145	LRK Associates	112
Datacraft Corporation	16	Manpower	162
Datapoint Corporation	29	Maxell Corporation of America	92
Datapro Research Corporation	169	Micro Switch, A Division of Honeywell	13
Decision, Inc.	149	Microporous Products Division Amerace Corporation	26
Digital Equipment Corporation	124, 125, 166	Modular Computer Systems	126
Documation Incorporated	10, 11	Mohawk Data Sciences Corp.	2
Du Pont Company	123	NCR	135, 146
Eastman Kodak Company, Business Systems Markets Division	104	Network Analysis Corporation	170

We know the ropes

In Financial and EDP Occupations.

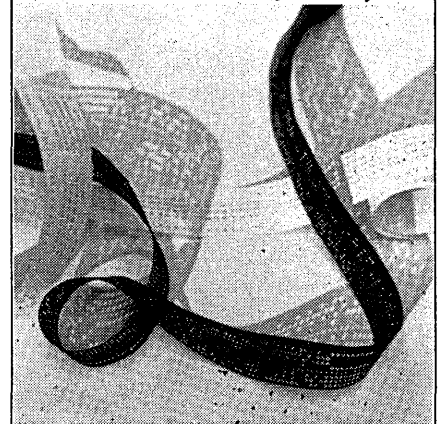

Assuring you the right person for the job *and* the right job for the person.

We have specialized in Financial and Data Processing employment for over a quarter of a century, and frankly, *we're good at it.*

World's largest Financial & EDP
Personnel Specialists

Alexandria, Va., 5001 Seminary Road	(703) 931-3600
Allentown, Hotel Traylor Bldg.	(215) 439-1506
Atlanta, 3379 Peachtree Road N.E.	(404) 233-2416
Baltimore, The Quadrangle-Cross Keys	(301) 323-7770
Boston, 140 Federal St.	(617) 423-6440
Charlotte, 4801 E. Independence Blvd.	(704) 535-3370
Chicago, 333 N. Michigan Ave.	(312) 782-6930
Cincinnati, 606 Terrace Hilton	(513) 621-7711
Cleveland, 1367 E. 6th St.	(216) 621-0670
Dallas, 2001 Bryan Tower	(214) 742-9171
Denver, 1612 Court Place	(303) 244-2925
Detroit, 670 Honeywell Center, Southfield	(313) 559-1212
Hartford, 111 Pearl St.	(203) 278-7170
Houston, 1200 Central Nat'l Bank Bldg.	(713) 228-0056
Indianapolis, 9 North Illinois St.	(317) 636-5441
Kansas City, Mo., 127 West 10th St.	(816) 474-4583
Lancaster, Pa., 8 North Queen St.	(717) 299-5621
Long Island, 420 Jericho Turnpike, Jericho	(516) 822-8080
Los Angeles, 3600 Wilshire Blvd.	(213) 386-6805
Louisville, 680 South 4th St.	(502) 589-6657
Memphis, 12 S. Main St.	(901) 523-8950
Miami, 1190 N.E. 163 St., No. Miami Beach	(305) 947-0684
Milwaukee, 777 East Wisconsin Ave.	(414) 271-9380
Minneapolis, 80 South 8th St.	(612) 336-8636
Newark, 1180 Raymond Blvd.	(201) 623-3661
New York, 330 Madison Ave.	(212) 986-1300
Omaha, 7101 Mercy Road	(402) 397-8107
Orange, Cal., 500 South Main St.	(714) 835-4103
Philadelphia, 2 Penn Center Plaza	(215) 568-4580
Phoenix, 1517 Del Webb TowneHouse	(602) 279-1688
Pittsburgh, Gateway Towers	(412) 471-5946
Portland, Or., 610 S.W. Alder St.	(503) 222-9778
Providence, 400 Turks Head Bldg.	(401) 274-8700
St. Louis, 7733 Forsyth Blvd., Clayton	(314) 727-1535
San Francisco, 111 Pine St.	(415) 434-1900
San Jose, 675 North First St.	(408) 293-9040
Seattle, 1215 Fourth Ave.	(206) 624-9000
Stamford, Ct., 111 Prospect St.	(203) 325-4158
Tampa, 1311 N. Westshore Blvd.	(813) 876-4191
Washington, D.C., 7316 Wisconsin N.W.	(301) 652-1960
Wilmington, 1102 West St.	(302) 652-3244

London, England, 17 Finsbury Square	01-638-4394
Toronto, Canada, 15 Toronto St.	(416) 868-1314
Vancouver, B.C., 535 Thurlow St.	(604) 688-7726

ROBERT HALF
PERSONNEL AGENCIES

CIRCLE 113 ON READER CARD

Even Webster's Knows About QUEST

QUEST (kwĕst). v. 1. To make a search; to go on a quest.

QUEST SYSTEMS, INC. n. 1. A corporation founded in 1968. 2. The largest professional recruitment firm in the U.S. functioning solely in the computer sciences; its client companies pay all employment fees, interviewing and relocation expenses. Quest is known for its deep personal commitment to relate to each candidate as an individual with individual goals. 3. Its professional staff averages over 6 years of experience in EDP recruiting (additionally, staff members have direct hands-on experience in programming, systems, hardware sales, etc.) 4. Quest is presently searching for degreed programmers and analysts (commercial, scientific, systems software) for over 3,500 client companies in the U.S. *Quest has openings in over 700 U.S. towns and cities.* 5. Methodology — see Questsystem.

QUESTSYSTEM (kwĕst sis'tĕm). n. 1. Discussing with a man what he would like to be doing in light of what he has been doing. 2. Analyzing the realities of his objectives as they relate to the current job marketplace. 3. Contacting client companies and other Quest staff personnel to identify positions of possible interest. 4. Introducing the job candidate to his prospective employers by providing complete details to each about the other, ensuring the efficacious use of everyone's time. 5. Arranging interviews. 6. If employment offers are extended, Quest assists in evaluating the responsibilities, compensation and opportunities (and relates those to the initially stated objectives). The Questsystem has been working for thousands of professionals at no expense, whatsoever. Ask your friends of their past dealings with Quest. Then, put the Questsystem to work for you. For additional information on this subject, please inquire directly to Quest Systems, Inc. (All inquiries/resumes received will be responded to immediately and in confidence).

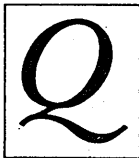

QUEST SYSTEMS INC.®

6400 Goldsboro Road

Washington, D. C. 20034 (301) 229-4200

Baltimore: (301) 265-1177 • Philadelphia: (215) 667-3322

CIRCLE 109 ON READER CARD

FREE EMPLOYMENT SERVICE FOR PROGRAMMERS AND ANALYSTS

Serving Northeast, Southeast and Midwest U.S.



RSVP will provide free employment counselling and develop and selectively distribute your resume.

Our openings include scientific and commercial applications, telecommunications, control systems, software development and systems programming utilizing most languages, computers and operating systems. We also serve engineering and market-

ing personnel in the computer field.

Call or send resume or rough notes of objectives, salary, location restrictions, education and experience (including computers, models, operating systems and languages) to any one of our offices. Or check the reader service card for a free sample resume and typical job descriptions. We will answer all correspondence from U.S. citizens and permanent residents and will guarantee our best efforts in a professional and ethical manner to all qualified applicants. Our client companies pay all of our fees.

- RSVP SERVICES, Dept. M., Suite 700, One Cherry Hill Mall, Cherry Hill, New Jersey 08034 (609) 667-4488
- RSVP SERVICES, Dept. M., Suite 104, Towle Bldg., 1777 Walton Road, Blue Bell, Penna., 19422 (215) 643-5550
- RSVP SERVICES, Dept. M., 1651 Old Meadow Road, McLean, Va. 22101 (703) 790-5166

RSVP SERVICES

Employment Agency for Computer Professionals

CIRCLE 111 ON READER CARD

Why make a project out of a special project?

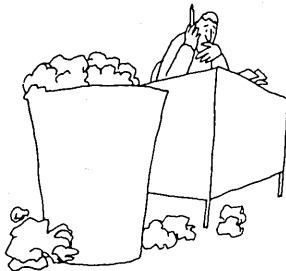

Special projects have a way of fouling up an entire operation. They waste too much time, tie up too many people.

Instead, why not call Manpower. We'll get those special projects completed quickly, reliably and professionally. No matter what you're up against. Just give us a call.

MANPOWER®

TEMPORARY SERVICES

DATAPOWER SERVICES

We'll give you all the help you need.

Key punch Operators. Tab Operators. Computer Operators. Edit Clerks. Systems Analysts. Coding Clerks. Computer Programmers.

CIRCLE 107 ON READER CARD

The Brussels Universities Computer Centre, equipped with a CONTROL DATA 6500 has an immediate opening for an experienced systems analyst to be hired as systems group leader.

The successful candidate will be motivated for that kind of job, have organisational talents and leadership, and a good internal knowledge of SCOPE or KRONOS.

Terms are subject to negotiation and will match talent and experience.

Send curriculum vitae and salary requirements to:

COMPUTER CENTRE U.L.B.-V.U.B.

To the attention of the Director

avenue F.D. Roosevelt, 50

1050 Brussels

CIRCLE 114 ON READER CARD

ADVERTISERS' INDEX

Omron Systems, Inc.	Cover 3
Peripheral Dynamics Inc.	110
Personnel Resources International, Inc.	159
Prentice-Hall	157
Prime Computer Inc.	98, 99
Quest Systems Inc.	162
Quotron Systems, Inc.	90
Raytheon Service Company	43
RCA Service Company, A Division of RCA, Technical Services	156
Remex, Ex-Cell-O Corporation	70
Research Inc.	8
Romac & Associates	166
RSVP Services	162
Rusco Electronic Systems, A Rusco Industries Company	113
Sanders Data Systems, Inc.	129
Source EDP	163
Sycor Inc.	22
Tab Products Co.	31
Tally Corporation	1
TEC Incorporated	75
Teletype Corporation	141, Cover 4
Tempil Division, Big Three Industries, Inc.	158
Texas Instruments Incorporated, Digital Systems Division	151
Texwipe	156
TRW Data Systems .	115, 117, 119, 121
United Air Lines	12
Varian Data Machines	62, 63, 155
Wangco Incorporated	132
Western Union Data Services Company	33
Wright Line, A Division of Barry Wright Corporation	87
Xerox	30

May, 1974

Technical Publishing Company

Arthur L. Rice, Jr., Chairman of the Board
 James B. Tafel, President
 Gardner F. Landon, Exec. Vice President
 Calverd F. Jacobson, Financial Vice President
 Edwin C. Prouty, Jr., Secretary and Director of Data Processing

Advertising Offices

Sales Manager and Vice President
John Brennan: Greenwich, Ct. 06830
 35 Mason St. (203) 661-5400
 Cable: DATAMATION,
 Greenwich, Connecticut

Eastern District Managers
A. Treat Walker,
Warren A. Tibbetts: Greenwich, Ct. 06830
 35 Mason St. (203) 661-5400

New England District Manager & Vice President
Warren A. Tibbetts: Manchester, N.H. 03104
 112 W. Haven Rd.
 (603) 625-9498

Midwest District Manager
John M. Gleason: Chicago, Ill. 60606
 205 W. Wacker Drive
 (312) 346-1026

Western Manager and Senior Vice President
Hamilton S. Styron: Los Angeles, Calif. 90035
 1801 S. La Cienega Blvd.
 (213) 559-5111

District Manager
Alan Balté, Jr.: Los Angeles, Calif. 90035
 1801 S. La Cienega Blvd.
 (213) 559-5111

Western District Manager
James E. Filiatrault: Mountain View, CA 94043
 2680 Bayshore Frontage Rd.
 Suite 101
 (415) 965-8222

U.K., Scandinavia, Benelux, Germany
Intergroup Communications, Inc.
Wallace K. Ponder, European Director
 31 Lyncroft Avenue
 Pinner, Middx. HA5 1JU
 England
 Tel: (01) 868 9289
 Cables: PACOM, Pinner

France, Switzerland, Italy, Spain
Gerard Lasfargues
 32 rue Desbordes Valmore
 75016 Paris
 France
 Tel: (1) 288 90 22

Germany
Bohn International KG
 6000 Frankfurt/Main 1
 Hansaallee 7
 Germany
 Tel: 0611/55 80 77

Other Magazines

Plant Engineering Pollution Engineering
 Power Engineering Purchasing World
 Research/Development

**Beat the Big One...
 Heart Attack
 Give Heart Fund**



Just out! 1974 computer salary survey Yours free

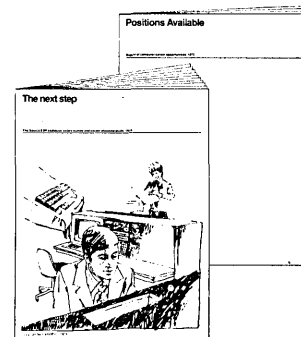

Do you know how much money your colleagues made last year for doing the work you do? Do you know which computing skills are the most lucrative? Do you know how to get a better position?

Source Edp does. And we'll share what we know with you. Our eighth annual salary survey and career planning guide, "The Next Step," compiles salary data received from the 11,000 professionals who consulted us last year. We add to that advice developed over our twelve years of recruiting computer people: danger signals that mean you should start looking for a new position, mistakes to avoid. A periodic supplement lists positions currently available.

Source Edp is the largest nationwide recruiting firm devoted exclusively to computer professionals. We print "The Next Step" as a service to people like you. Fill out the reader reply card, and we'll send you one absolutely free.

Corporate headquarters:
 100 South Wacker Drive
 Chicago, Illinois 60606
 (312) 782-0857

Regional offices:
Atlanta
 11 Corporate Square, 30329, (404) 634-5127
Chicago
 100 S. Wacker Drive, 60606, (312) 782-0857
 903 Commerce Drive, Oak Brook IL 60521,
 (312) 323-8980
 550 Frontage Road, Northfield IL 60093,
 (312) 446-6395
Dallas
 7701 Stemmons Freeway, 75247, (214) 638-4080
Detroit
 26555 Evergreen, 48076
 (313) 352-6520
Houston
 4635 Southwest Freeway, 77027, (713) 626-8705
Kansas City, MO
 20 W. Ninth Street, 64105, (816) 474-3393
Los Angeles
 3550 Wilshire Boulevard, 90010, (213) 386-5500
 2081 Business Center Drive, Irvine CA 92664,
 (714) 833-1730
Minneapolis
 801 Nicollet Mall, 55402, (612) 332-8735
New York
 600 Third Avenue, 10016, (212) 682-1160
Palo Alto
 525 University Avenue, 94301, (415) 328-7155
Philadelphia
 1700 Market Street, 19103, (215) 665-1717
San Francisco
 111 Pine Street, 94111, (415) 434-2410
St. Louis
 130 S. Bemiston Avenue, Clayton MO 63105,
 (314) 862-3800
Union, N J
 2400 Morris Avenue, 07083, (201) 667-8700

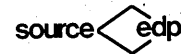

This forum is offered for readers who want to express their opinion on any aspect of information processing. Your contributions are invited.

The Forum

REVISE STANDARD FORTRAN?

American National Standard (ANS) X3.9-1966 FORTRAN and ANS X3.10-1966 Basic FORTRAN were the first such national standards for a programming language to be adopted. The individuals who pioneered in their development are worthy of our commendation and gratitude for a job well done. The tremendous success of X3.9 FORTRAN is indeed a tribute to those past efforts of X3.4.3, the predecessor of X3J3. However, the American National Standards Institute (ANSI) requires that every standard must be reaffirmed, revised or withdrawn within five years of its issue date. It is the responsibility of X3J3 to recommend appropriate action with respect to the disposition of ANS X3.9-1966 and ANS X3.10-1966. As early as 1967, just one year after their adoption, questions of interpretation of the standards were raised, which X3J3 sought to resolve. Two clarification reports have been published, but after three years of intensive effort, X3J3 concluded that some of the questions could not be resolved without extending the language beyond the descriptions contained in the standard, and that it was necessary to revise ANS X3.9 FORTRAN rather than simply reaffirm the existing standard. At the same time, it became evident that ANS X3.10 Basic FORTRAN was used little, and that there was little support for its reaffirmation.

Having recognized that revision was necessary in order to clarify and correct known deficiencies in ANS X3.9-1966 FORTRAN, X3J3 was then confronted with the question of how far to go in modifying the language. Two alternatives were presented immediately. The first was to make no changes in the FORTRAN language itself, and to make only those changes to the standard document which were necessary to correct the known deficiencies in it. No new features would be introduced, nor would any of the existing features of the language be changed materially. This course of action ideally would protect the status of both existing standard conforming processors and existing standard conforming programs, with the possible exception of minor changes occasioned by misinterpretations of ambiguous descriptions in ANS X3.9-1966. It would ignore all interim language developments since the standard was drafted, as well as the many features which have become available in existing standard conforming processors as extensions to the FORTRAN language. It would not provide any additional capability to extend the application area of the standard FORTRAN language, nor would it do anything to enhance significantly the primary purpose of the standard, to facilitate the interchange of programs for use on a number of processors.

The second alternative was to develop a new language based on ANS X3.9-1966 FORTRAN, but without restriction as to the retention or modification of existing features, the purpose being to create a "better" FORTRAN by eliminating mistakes of the past and introducing new features which have been found desirable. This would be in the tradition of the past evolutionary development which led successively from FORTRAN I to FORTRAN II to FORTRAN IV, and now might give us FORTRAN VIII (Since Univac and Computer Sciences, among others, have pre-empted the name FOR-

TRAN V for their versions of extended FORTRAN, one would be obliged to give the new language some other name to avoid the obvious implications). As a result of following this alternative, one would expect that both existing standard conforming processors and existing standard conforming programs would be invalidated; that new processors would have to be built; and that existing applications programs, together with their data, would require conversion in order to be run on processors conforming to the new standard. Because of this, consideration should be given to the possibility of providing a SIFT-like translator to assist in the conversion of programs and their data, although experience with the SHARE Internal FORTRAN Translator in conversion of FORTRAN II to FORTRAN IV programs was not encouraging. Still, the ability to effect a mechanical translation from the old to the new would influence the design of the new language. Presumably by a judicious choice of new features to be included in the language, the application area of the standard language could be expanded significantly, which in turn would enhance the interchange of standard conforming programs. Accomplishing significant improvements in the language hopefully would make it attractive to the user to convert to the new language, and attractive to the implementor to provide processors for it in order to retain the user's business.

Neither of these courses of action are attractive in the context of revision of the FORTRAN standard. To ignore the developments which have been implemented in FORTRAN processors since FORTRAN IV was created over 10 years ago would be a serious mistake, and to ignore as well the demonstrated need to further expand the application area of FORTRAN as shown by those implemented extensions would be unresponsive to the needs of the using community. On the other hand, to develop a new FORTRAN language would be to embark once again upon the route of ALGOL and PL/1. Even if such a course of action should be deemed within the charter of X3J3, it must be recognized that X3J3 has neither the resources needed to tackle such a task, nor the assurance that another attempt would be any more successful in defining a successor to FORTRAN. X3J3 rejected both of these extremes in favor of the more pragmatic endeavor of making modest extensions to the language within the framework of X3.9-1966 FORTRAN, while preserving the validity of existing standard conforming programs. Existing standard conforming processors might be invalidated, but since processors must change to adapt to any revisions of the language, conversion of processors was assumed to be inevitable. The growth and development of the FORTRAN language envisioned by the framers of the present standard would be reflected in the features to be added to the standard language.

The principal criteria used in developing ANS X3.9-1966 FORTRAN were (in approximate order of priority):

- (1) Interchangeability of FORTRAN programs between processors.

It's not nice to fool IBM.

But we had to simplify the communications tangle.

It's certainly not IBM's fault that datacomm was designed for teletypewriter I/O. The "dataset-line-dataset" standard of the telegraph business was adopted by the computer industry because everybody thought voice-grade speeds would be more than enough. That serial standard was incompatible with the computer's operation, so the communications controller and its high-overhead software were invented. Until now, that's how computer systems have had to live with the limitations of communications technology.

TRAN's M4000 High Speed Remote Processing System fools your IBM mainframe into thinking its remote devices aren't remote. M4000 effectively adapts communications to the high speed needs of your computer system by making both IBM and non-IBM remote peripherals and terminals totally transparent to the central computer.

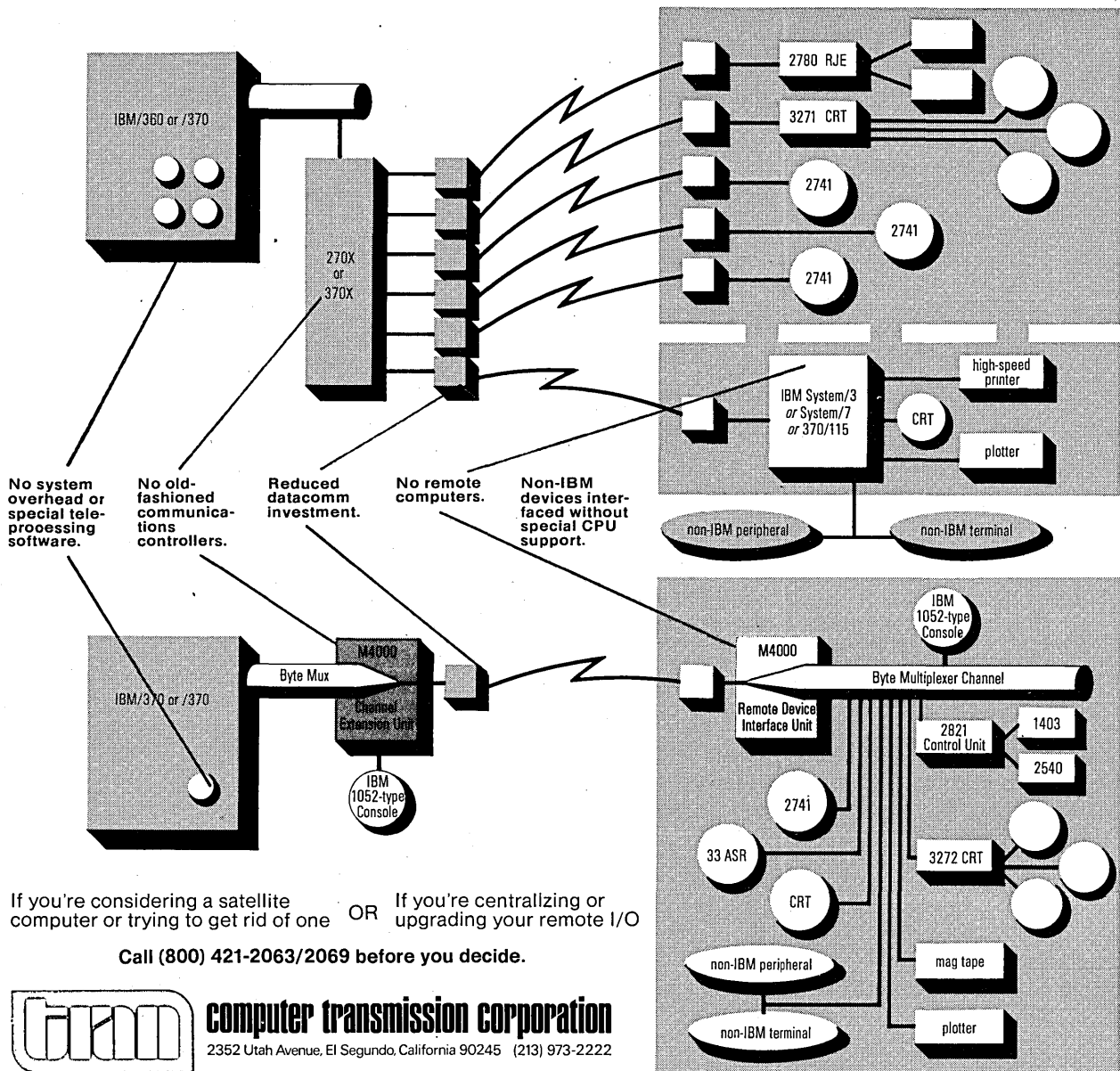

If you're considering a satellite computer or trying to get rid of one OR If you're centralizing or upgrading your remote I/O

Call (800) 421-2063/2069 before you decide.



computer transmission corporation

2352 Utah Avenue, El Segundo, California 90245 (213) 973-2222

And your IBM computer will never know the difference.

WHAT IS YOUR TRUE WORTH?

FREE JOB OPPORTUNITIES BULLETIN

Cadillac Associates represents the nation's largest and most respected professional placement service. Our close relationship with the nation's finest firms generates continuous career opportunity information and allows us to confidentially present your qualifications to those at "decision-making" levels.

Our bulletin, published quarterly, listing available opportunities in the Systems & Data Processing field is available free of charge and will be mailed to your home upon your request.

For your free bulletin, without any obligation, circle reader service card #115. Please USE HOME ADDRESS ONLY!

FREE CONFIDENTIAL PLACEMENT SERVICE

If you desire immediate assistance in locating an opportunity consistent with your objectives (professional/financial/geographic), CALL OR WRITE TODAY. A member of our staff of SYSTEMS & EDP SPECIALISTS will reach you by telephone to discuss your objectives and how we might help you satisfy them. A resume, or some details of background, will be appreciated.

Remember: Our client firms are located from coast to coast and assume all expenses (agency fee, interviewing & relocation).



E. W. MOORE
Executive Vice President
CADILLAC ASSOCIATES, INC.*
32 West Randolph St. Chicago, Ill. 60601
Financial 6-9400

*"Where More Executives Find Their Positions Than Anywhere Else in The World."

CIRCLE 115 ON READER CARD

EDP offers they couldn't refuse.

Thousands of bright ambitious EDP professionals...particular and concerned about their careers...have come to Romac in total confidence to discuss their futures. We know their business. We listen. We screen in depth. And we present appropriate fee paid opportunities.

Many of these opportunities develop through Romac's effective inter-office system...a network of partners from Portland to Atlanta.

Contact Romac...you may find an offer you can't refuse:



ROMAC...bringing the "right people" together in Data Processing, Accounting and Banking.

ROMAC

& ASSOCIATES/Personnel Consultants

Contact ROMAC & Associates, 200 Boylston St., Chestnut Hill, MA., 02167 (617)969-4010 for immediate transmission to our network of Partners in: Portland, Hartford, New Haven, Stamford, Rhode Island, Buffalo, Rochester, Syracuse, Chestnut Hill, Ma., Boston, Washington, D.C., Charlotte and Atlanta. Or write or call direct.

DO IT ALL

Develop Advise Perform

Disk and Tape Support Engineers

Digital, the world leader in minicomputer technology, is currently seeking several, highly-motivated individuals to participate in a ground floor opportunity involving new product development.

As an important member of our Disk and Tape Support team, you'll have a chance to do it all. Develop and coordinate field service maintenance strategy. Review and advise in the area of reliability/maintainability. And perform field-related study as well as technical and administrative support.

To qualify you should have a solid technical background and, ideally, a year's experience in corporate Field Service Support of disk or magnetic tape systems. Some administrative potential or experience is required, and you should have excellent communication skills.

If you have a BSEE, or you're a Technical

School graduate or Field Service Specialist with equivalent experience, get in touch with us.

Some travel may be required.

Please direct your resume to Ken Trend, Digital Equipment Corporation, 110 E. Main Street, Maynard, Mass. 01754

digital

digital equipment corporation

The above positions are open for application to men and women regardless of race, national origin, age, religion or creed.

- (2) Compatibility with existing practice.
- (3) Consistency and simplicity to the user preparing FORTRAN programs.
- (4) Suitability for efficient processor operation for a wide range of computing equipment of varying structure and power.
- (5) Allowance for future growth in the language.

These are still the principal criteria guiding X3J3 in developing the proposed revision of the FORTRAN standards. However, in considering new features to be added to the language and modifications to existing features, there are additional constraints affecting the committee's actions. The dominant consideration is that the new standard must provide the same interpretation as ANS X3.9-1966 for any existing standard conforming program. X3J3 has thus far been inclined to a strict interpretation of this guideline, such that no change has been adopted which provides a different interpretation from that provided by ANS X3.9-1966, regardless of whether or not there exist any standard conforming programs which would be affected by the changed interpretation. X3J3 has avoided the less stringent position which would accept such a change to the language, provided that the number of existing standard conforming programs affected by the change would be insignificantly small. There is also a very strong feeling that FORTRAN should remain FORTRAN, and that no change should be accepted which is inconsistent with the FORTRAN philosophy. No change should be made to the language which does not expand the application area or significantly improve the utility of the language for the user. Change merely for the sake of change, or to provide an alternate form for an existing capability must be avoided.

As a practical consideration, the amount of time and talent available imposes a limitation on what can be included in the revised standard. X3J3 is a voluntary activity. Many of the individual members are making substantial personal contributions to the work of the committee beyond that supported by their sponsors. However, there will be some desirable features which will not be included in the next revision of the standard simply because the resources necessary to incorporate them in the standard were not available, even though there was strong sentiment in favor of them. A binary data type is one such omitted feature, which I personally have advocated. It will not be included because no one has completed an adequate description of it within the context of the proposed new standard document. Finally, in determining which features to include in the new standard, consideration must be given to the cost associated with each feature. The implementation cost of processors must be kept within reasonable bounds in order that implementors will continue to make standard conforming FORTRAN processors widely available on a broad spectrum of data processing systems. The language must remain such that it is reasonable to expect that processors will produce good object program efficiency, and that processing times will be attractive to the user. The benefits accruing from its use must exceed the cost to the user of making the transition to the new standard language in terms of documentation, training, conversion of existing programs and their data (including those which do not conform to ANS X3.9-1966 FORTRAN specifications), etc., otherwise the new language will not be widely accepted. In summary, these are the concomitant constraints which, in my opinion, govern the revision of the FORTRAN standard:

- (1) Effect on standard conforming programs.
- (2) Consistency with FORTRAN philosophy.
- (3) Expected impact in expanding the capability of the language.

THE MOST RELIABLE STANDBY POWER SYSTEMS HAVE



A HEART OF GOLD.

**GENERAL ELECTRIC GOLDTOP® BATTERIES
... THE MAINTENANCE-FREE POWER SOURCE
FOR LONG LIFE DEPENDABILITY IN YOUR
STANDBY POWER APPLICATION**

In addition to maintenance-free dependability and long life, Goldtop rechargeable nickel-cadmium batteries offer you:

- Convenient small size for mounting anywhere in any position. Ideal for those hard-to-get-to applications.
- High temperature capability for hot ambient locations.
- High current discharge capability. This small battery does a big job.
- A sealed battery to eliminate venting of corrosive gases.
- Simple constant current charging. No voltage cutoff circuitry required.

These are just a few reasons why you should put a heart of gold into your next standby power system. For more information circle the reader service card, or write General Electric Company, Section 452-05, Schenectady, N. Y. 12345

GENERAL  ELECTRIC

CIRCLE 90 ON READER CARD

Look who's into low-cost graphics!

Adage, always out front in quality, now brings you the Adage/400 . . . today's lowest-cost full capability graphics system with character, vector, and refreshed CRT.

The Adage/400 is the best system ever. Thanks to its digital MSI, LSI microprocessor controller, you get: an extensive graphics command set . . . increased speed (0.75 in./ μ sec for lines and 6.5 μ sec for characters) . . . reduced host computer load . . . built-in microdiagnostics for greater reliability and maintainability.

Plug the Adage/400 into your computer for as little as \$42.9K. Color CRT, large digitizer, and hard-copy unit are available as options.

For a total system, there's the Adage/300: the Adage processor plus Adage/400 graphics. It outperforms the big Adage/100, but costs less.

In hardware, software, applications, operations, and service . . . whether it's CAD/CAM, simulation, or any other graphics application, talk to us. Phone, write, or use the Readers Service Card.

No one knows Computer Graphics like Adage.

adage

Adage, Incorporated
1079 Commonwealth Avenue
Boston, Massachusetts 02215
Telephone (617) 783-1100

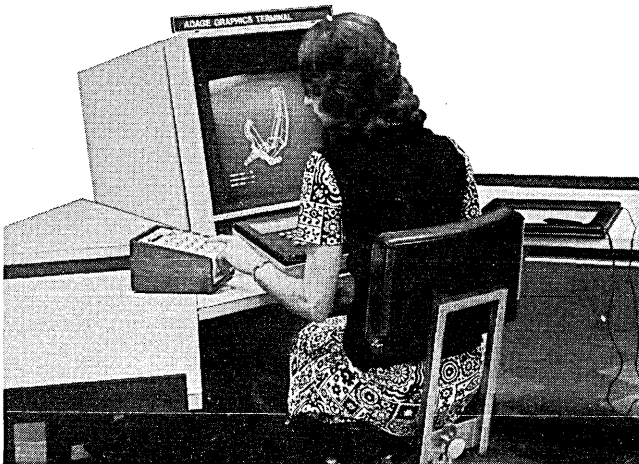

CIRCLE 83 ON READER CARD

the forum

- (4) Effort needed to incorporate the feature into the standard.
- (5) Effect upon cost of implementation.
- (6) Effect upon cost to the user.
- (7) Effect upon processing time.

There has long been a divergence of opinion as to whether standards should reflect only existing practice, or anticipate and lead the way in new directions. It is not my desire to resolve that issue here. Waiting to follow technology leads to the necessity of choosing one of several competing forms, each differing slightly from the others, or of compromising between them. In either event, someone is almost certain to be adversely affected regardless of which choice is made. Innovating, on the other hand, is fraught with the possibility of missing the boat and going in the wrong direction. The trouble with many FORTRAN innovations which have been implemented in existing processors in the past is that they were conceived and implemented in a low cost environment, where a quick and dirty approach was taken which was advantageous for a particular processor. The resultant feature is not always in the best interests of all users, nor in a form which is desirable for all systems and consistent with other new developments. One must weigh these factors as well in his judgment of each of the things done in revising the FORTRAN standard.

The specific actions taken by X3J3 in the course of the development of the revised standard have been discussed on several occasions. The references cited below may give the interested reader an insight into the sort of modifications most likely to appear, although one cannot state with absolute certainty until its final approval exactly what changes will be incorporated in the revised standard FORTRAN. A draft of the proposed American National Standard X3.9-1977 FORTRAN (revised) should be available for public review and comment in 1975. Inquiries concerning its publication should be made to the Director of Standards, CBEMA, 1828 L Street NW, Washington, DC 20036.

I cannot resist making one final personal observation concerning FORTRAN and its continued existence. Way back in the dim, dark days of the first generation, when the International Algebraic Language (IAL) broke upon the scene, we declared a moratorium on FORTRAN developments and pushed all out for ALGOL 58 as our standard programming language. Alas, along came ALGOL 60, upsetting our hopes for a universal programming language. We acceded to the pragmatists who had kept the faith with FORTRAN, and moved on to FMS and FORTRAN IV for our second generation large scale computing systems. Then, when we heard that a new computer system was in the offing, we jumped in to define a new language to rectify all the mistakes of the past and to supersede FORTRAN, COBOL and assembly languages as well, we hoped. Thus PL/1 (nee NPL) was born, to be the end of all diverse programming languages. With the new family of machines, the third generation, we could make a clean break with the past, get away from FORTRAN, COBOL, etc. with all their imperfections, and have just one language to learn, to teach, to maintain, to support and to use!

So, once again the moratorium; no more changes to FORTRAN, which coincidentally was then going through the standardization process. Get on with the wave of the future. And, once again, came disillusionment. PL/1 was late, so that if one wanted to get work done and out of the new system, he very well had better stick with FORTRAN. When PL/1 finally did arrive, it was big and ponderous, expensive to use, difficult to teach, and defective. Users in droves did not abandon good old FORTRAN and surge to the new, in spite of the tremendous pressures to do so. Some of us then reluctantly returned to FORTRAN, and wondered if some

modest improvements might not be in order. My own favorite FORTRAN deficiencies over the years have been the lack of character and boolean data types, a viable error recovery procedure, and means for parallel processing of different program units and of synchronizing their interactions.

In 1967, when I came to X3.4.3 urging consideration of these changes, I was summarily castigated and squelched: "We've just arrived at a standard, so don't rock the boat now." Over two years later, when X3J3 finally recognized the need for revision as cited above, it was already too late to meet the ANSI deadline. There were others, too, who had their own pet features to suggest: Direct Access I/O, ENCODE/DECODE, List Directed I/O, Multiple Entry, etc., each aimed at some deficiency in the language. These individuals were also motivated to join the standardization effort, not to invent a new programming language, but to improve FORTRAN without losing the basic characteristics which have established it so securely. Many other FORTRAN users and implementors, while not becoming active members of the committee, have communicated to X3J3 their ideas for improvement of the language, and have lent their support to revising the standard.

Thus it is that we, the members of X3J3, have the temerity to recommend to ANSI a revision of the FORTRAN standards. To those who hold that "the world has a lot to learn from the structured programming school of Dijkstra, Floyd, Burstall, et al," I would only point out that in the meantime the world still has a lot of work to get done which pragmatic FORTRAN will continue to accomplish.

—Frank Engel, Jr.

Mr. Engel is the chairman of the American National Standards Institute Committee X3J3 and is an independent consultant.

THE STANDARDIZATION OF DIAGNOSTIC AND ERROR MESSAGES

A fundamental problem must be resolved: the explicit recognition that errors can occur in programs must be accepted by standardization committees. Only when we have accomplished that, is it useful to consider the problems of which messages will be issued. In the preparation of a candidate standard for fundamental BASIC,¹ which also could form the basis for procurement documentation, I believe it is imperative that the existence of errors be communicated to the user of the program. These errors can be classified in two groups: 1) those syntactic errors of language which are implicitly acknowledged in the standard by the fact that the standard allows only the valid syntactic forms of the language, and 2) errors of operation which are not acknowledged by the standards, but rather are ignored since only the effects of "valid" programs are specified.

The major objection expressed to me against the standardization of error conditions is that their very existence stifles further language development. That is, a statement of the form: "Where the syntactic form of the program does not conform to the valid forms specified herein, the program shall be said to be in error and the user shall be informed of the variances between the program and the anticipated language form," explicitly states that all language extensions are invalid. However, current work in syntactic analysis² shows that an analyzer can be constructed so that it is capable of discriminating between

¹ Lee, J.A.N., Beckhardt, S.R., and Karshmer, A.I., "A Candidate Standard for Fundamental BASIC," National Bureau of Standards, Report NBS-GRC 73-17, July 1973.

² Graham, S.L., and Rhodes, S.P., "Practical Error Recovery in Compilers," Proc. ACM Symp. on Principle of Programming Languages, Boston, Oct. 1973.

400 EDP REPORTS

Datapro Research Corporation will send you 400 objective evaluations of more than 2000 EDP products for just \$10. The evaluations include product specifications, pricing, users' experiences, and company backgrounds. A partial list of the product categories covered is shown on the right.

\$10
60-day
subscription
offer

The 400 reports are part of DATAPRO 70, the world's most widely used EDP information service. Over 8000 EDP professionals currently subscribe to DATAPRO 70 on an annual subscription basis. In order to introduce you to DATAPRO 70 and to help you evaluate it, we are making this unbelievable offer: for \$10 you will receive 400 reports, housed in three handsome looseleaf binders, on a special 60-day mini-subscription basis. You have no obligations beyond the \$10 charge and the promise to return the books after 60 days should you decide not to continue your subscription. It's that simple. Offer void after May 30, 1974.

CRT Displays
Minicomputers
Software
Key-to-disk
Modems
Vendors
Card Readers
Printers
Card Punches
Disk Drives
Tape Drives
Optical Readers
COM
Mainframes
Multiplexors
Concentrators
Time-sharing
Add-on Memory
Key-to-tape
Accounting
Computers
Typewriter
Terminals
Voice Response
PaperTape Units
RJE Terminals

datapro

DATAPRO RESEARCH CORPORATION
1805 Underwood Boulevard
Delran, New Jersey 08075
609/764/0100

YES, send me DATAPRO 70 for my 60-day mini-subscription.

name _____ title _____
company _____
address _____
city _____ state _____ zip _____
telephone _____

Check enclosed. Bill me \$10, adding \$2 shipping & handling

The Problem Solvers

(#2 in a series)



Lynn Hopewell

As the computer communications environment becomes more complicated there is rising concern about the future of existing systems.

Aetna Life and Casualty, for instance, experienced difficulties in plans for major expansions in their large nationwide teleprocessing network.

NAC was commissioned to help improve Aetna's data communications advanced planning activities. According to NAC's Lynn Hopewell, who directed the studies, "Our main goal was to help Aetna plan more efficiently, not to do the planning ourselves.

"We tackled problems of organizational design, technical planning methodology, systems engineering and procurement strategies for the computer communications areas. We also evaluated alternative data communications network architectural strategies to make long range planning decisions under conditions of uncertainty.

"As a result of our successful contribution, we are presently working with Aetna in the design of new networks with several thousand terminals."

If you would like to insure your company against future telecommunication uncertainties, write or call us collect.

nac

NETWORK ANALYSIS CORPORATION

Beechwood, Old Tappan Road, Glen Cove, N.Y. 11542 (516) 671-9580

CIRCLE 77 ON READER CARD

the forum

various sentential forms of the language being analyzed even when the presented forms are not precisely as anticipated. Hence, it should be no great effort to discriminate between those forms which are in the standard and those which are "local" extensions. At this level of analysis, the "forgiving" compiler should be required (by the standard) to communicate with the user, indicating what it thought was meant and what actions were taken to correct the assumed situation.

At the level of program execution there are a number of situations of which the user should be made aware; the cases of arithmetic overflow and underflow, for example, are typical of these situations. Then add to that the fact that the remedial action taken by the host system has not been standardized either. In one instance, overflow may be considered a fatal error, while in another, overflow is one of the bounds on arithmetic operations which is well defined and of which the user should be well aware. In this latter case, it is assumed that the responsibility for the necessary remedial action is in the hands of the user. In this type of situation, the language or the host system can provide facilities by which the remedial action is specified by the user, but failing that the least the system must provide is an indication of what happened *and* what action was taken. Such actions should be a part of the standard.

In surveying many BASIC implementations for the preparation of the candidate standard, it was discovered that remedial actions are not common among the implementations. For example, after arithmetic overflow, one system substituted machine infinity as the result (one of the more common actions), while in another the representation of zero was inserted. Obviously, the same program executed on the two machines could have widely differing results.

Another major source of difference between systems related to errors is the action taken when the operations are not fully defined. For example, in FORTRAN the default action taken when the value of the index on a computed GOTO is out of range was not specified in the 1966 standard; as a result there exist several different implementations, all of which do not contravene the standard! Fortunately, the proposed FORTRAN standard³ has seen this problem and has closed the door on the variety of default conditions.

In my opinion, the standardizing committees are doing a disservice to the community by not admitting to the existence of invalid programs, or at least some recognizable subset of the universe of programs about which the standard can tell us something—even the fact that they are incorrect. To ignore the forgiving compiler while permitting the parasitic extension of the language through defaulting conditions is no longer a position which a computer professional can support.

I remember from my high school physics classes the statement: "Nature abhors a vacuum." If nature is a synonym for implementer, and vacuum represents the holes left by the standardizers, it is obvious why the so-called standard implementations of a language contain so many uncommon features and dangerous extensions which lead the user toward implementation dependency.

The problems of language extension vs. standardization mainly accrue when the invalid forms of the original language elements are made valid in the extension, or where the meaning of the original elements is altered by the extension. Let us agree to work towards closing the holes and providing for an orderly extension of the language.

—John A. N. Lee

Dr. Lee is professor of computer science at the University of Massachusetts.

³ Engel, F., "Future FORTRAN Development," *SIGPLAN Notices*, Vol. 8, No. 3.

Take a peripheral... an Omron peripheral

Add a cassette,
Or, add a dual cassette.
Or, add a printer.
It's up to you.

One of the major advantages of the Omron 8025 CRT Microprocessor System is the ability of the system to accept field pluggable changes or additions.

It matters little whether you initially order your system with a cassette and/or a printer. At any time your needs dictate, you can add these peripherals at your installation. Cassette System—single or dual. Printer—it's your option.

And there's more to come.

The Omron 8025 CRT System is without a doubt, the industry's most flexible system.

We do it with cards not mirrors.
Simple, field plug-in cards.

If that sounds easy—it is.

Contact us for additional information about other variable, expandable configurations. They make very interesting reading.



The terminal with
"Variable I.Q."

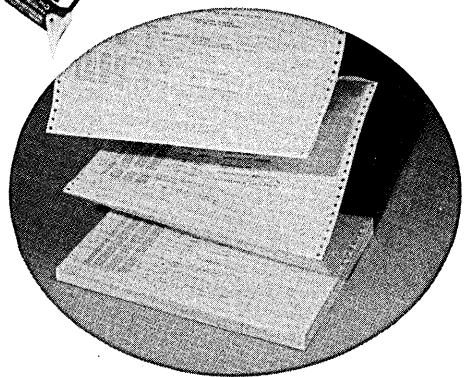
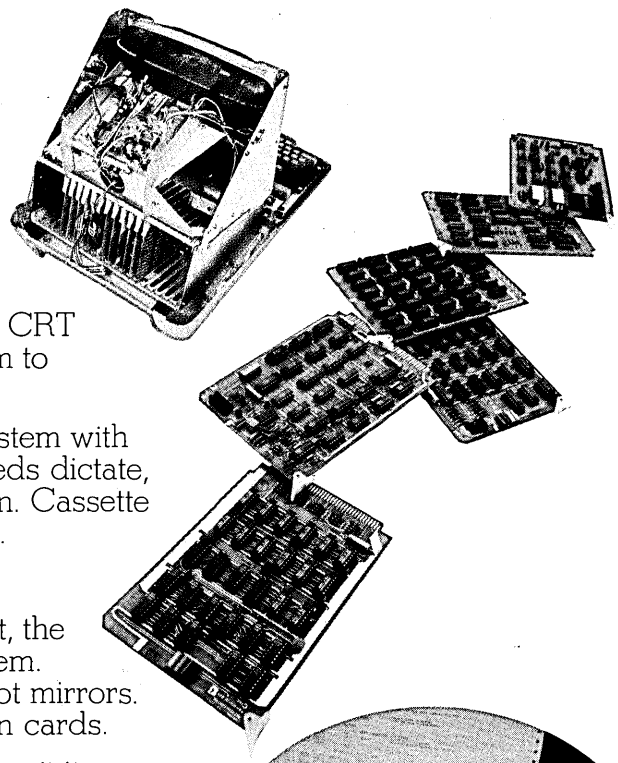
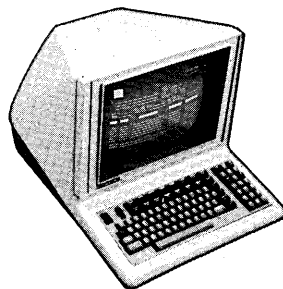

Information
Products
Division

432 Toyoma Drive
Sunnyvale, California 94086
Telephone: (408) 734-8400

See us at NCC Booth 821

CIRCLE 2 ON READER CARD

The 4210. We call it our "moonlighter."

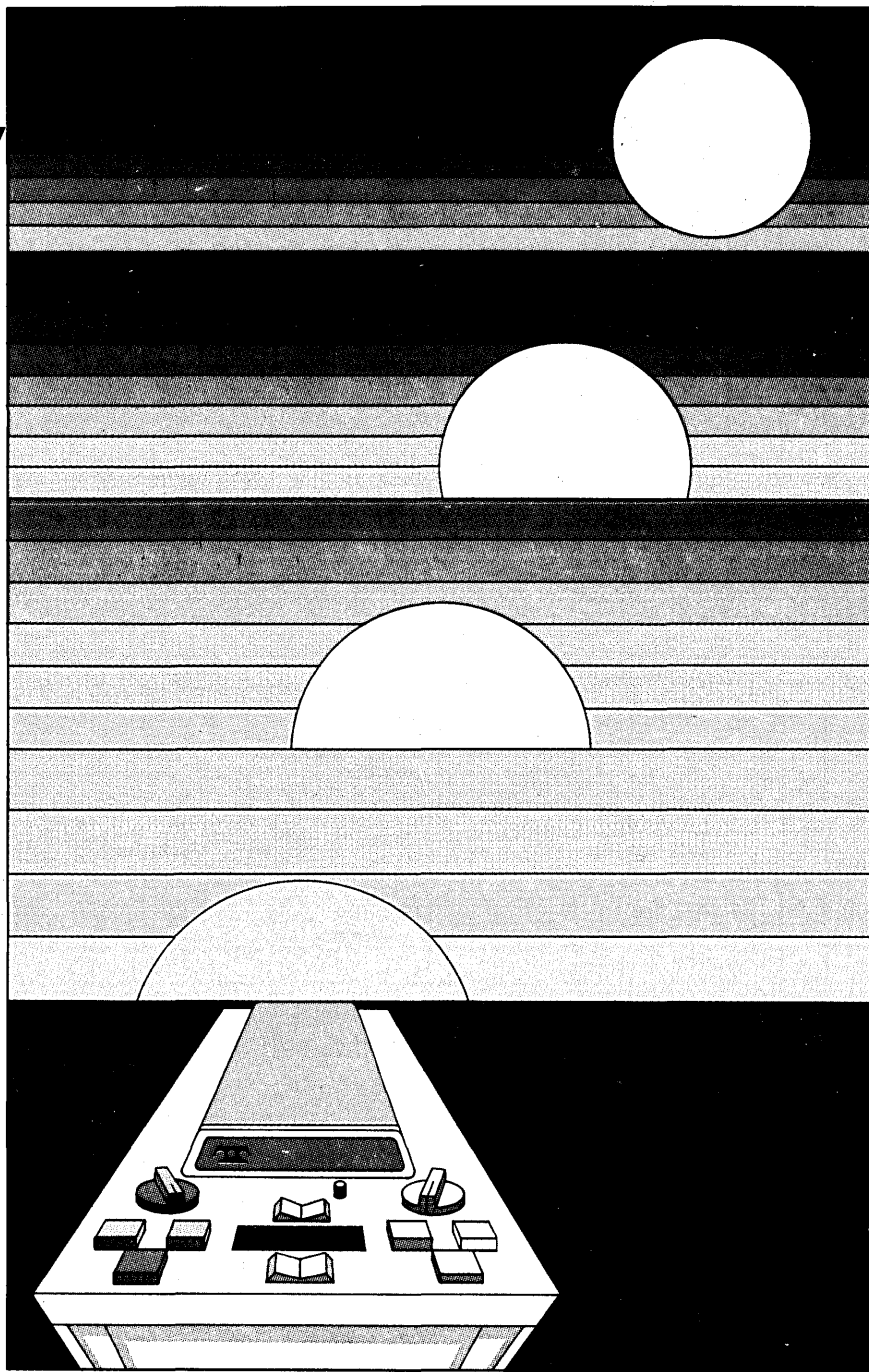

Teletype is a trademark registered in the United States Patent Office.

Because after you work our 4210 magnetic tape data terminal all day, it's ready to work all night.

For example, with the 4210 set in the local receive mode, your operator can prepare tapes during the day simply by typing them out on a standard keyboard terminal—like a Teletype® model 33, 35, 37 or 38. Then at the end of the day, the operator switches the 4210 to the on-line automatic mode. So data goes out at night when transmission rates are lower or unused capacity is

available. At up to 2400 baud for efficient utilization of voice grade channels.

Not only does the 4210 send out previously prepared tapes while everyone is at home relaxing, the unit also receives new data. And if time is critical, the automatic rewind and local print-out option allows data to be recorded and printed out.

Completely unattended.

So when everyone shows up in the morning, the data received during the night is there, waiting. And the machine is ready to start its daytime job as a data preparation terminal.

It takes more than manufacturing facilities to build this kind of versatility into the machines Teletype Corporation offers. It also takes commitment. From people who think service is as important as sales. In terminals for message communications and computers.

That's why we invented a new name for who we are and what we make. The computercations people.

TELETYPE



The computercations people.

For more information about any Teletype product, write or call: TERMINAL CENTRAL, Teletype Corporation, Dept. 81Q, 5555 Touhy Avenue, Skokie, Illinois 60076. Phone 312/982-2500.