



PIAKE 80

ROADBLOCKS TO WORLDWIDE SITES

ALSO:
THE REAL COSTS OF DDP
PROBING PRODUCTIVITY
IN FOCUS: ALVIN TOFFLER

A Marriage of Convenience— for PDP and LSI users!

It's a marriage made in heaven—for DEC PDP-11 and LSI-11 owners who would like a low-cost, quick-to-install, high-density data storage system.

The union consists of Kennedy's Series 5300 fixed media, Winchester technology disk drives and Kennedy emulation controllers. The controllers, which use standard DEC PDP-11 operating systems and diagnostic software, are embedded inside the computer, allowing the Series 5300 to be easily attached to both PDP-11 and LSI-11 minis! In one sweet, short

ceremony, Series 5300, with its one, two or three platter versions and unformatted data capacity of 70M bytes and

track density of 300 TPI can be joined with the KSC11 unibus disk controller for the PDP-11; and the KSC01, for use with the LSI-11. And no software changes or other alterations are required. Kennedy Series 5300, controllers and your PDP-11 or LSI-11—put them together, plug them in and you have a winning system.

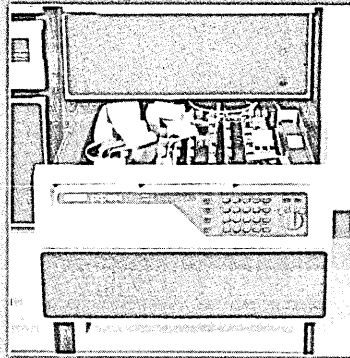

KENNEDY

Subsidiary, Magnetics & Electronics Inc.

1600 Shamrock Ave., Monrovia, CA 91016
(213) 857-8831 FAX: 910-385-3249

JUST MARRIED

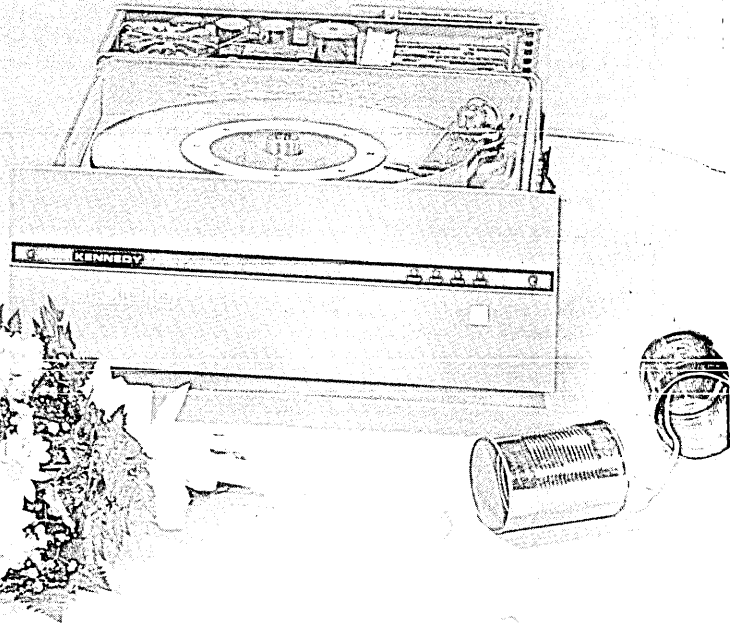

SINGLE BOARD PDP-11* TAPE CONTROLLER

FIRST AGAIN ★ FROM THE NUMBER ONE CONTROLLER COMPANY

- ★ PE & NRZ on one standard hex board.
- ★ All classic control features plus many new ones.
- ★ Integral LED self-test.
- ★ Embeds in all PDP-11's.

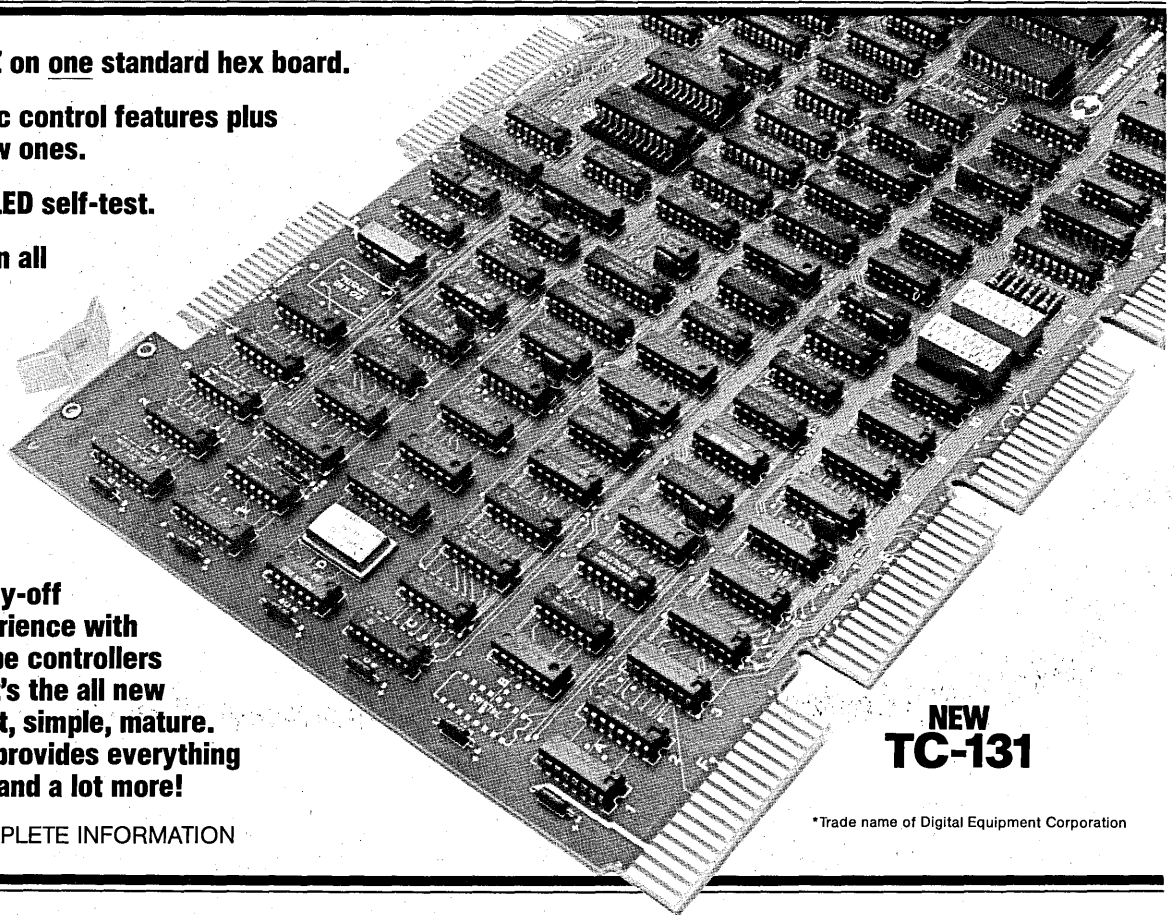

Here's your pay-off from our experience with over 4,000 tape controllers for PDP-11's. It's the all new TC-131. Elegant, simple, mature. A new star, it provides everything you expect...and a lot more!

SEND FOR COMPLETE INFORMATION

**NEW
TC-131**

*Trade name of Digital Equipment Corporation

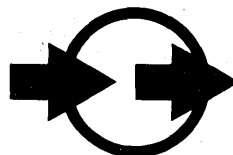

14321 Myford Rd., Tustin, CA 92680

western peripherals

Division of WESPERCORP.
714/730-6250 - TWX 910-595-1775

Cable WESPER

CIRCLE 4 ON READER CARD

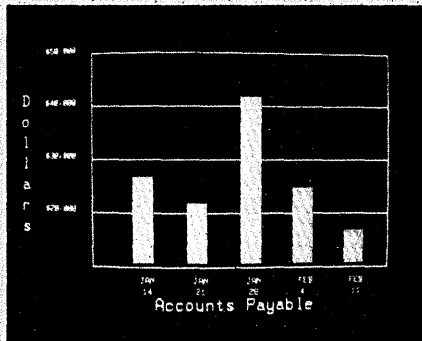

Management Information Display

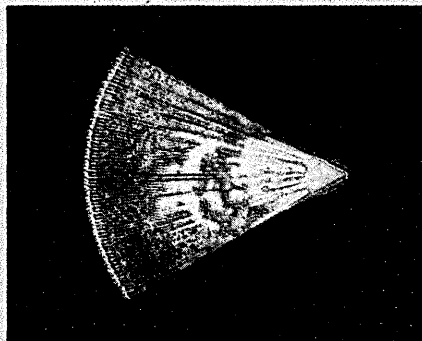

Ultrasonic heart sector scan

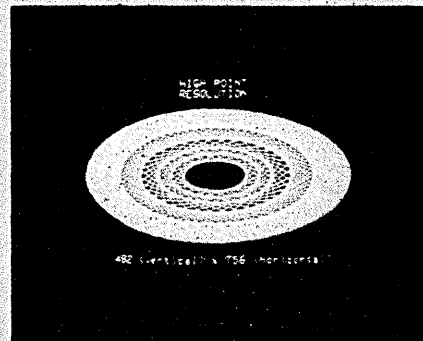

High-resolution display with alphanumerics

Get the professional color display that has BASIC/FORTRAN simplicity

LOW-PRICED, TOO

Here's a color display that has everything: professional-level resolution, enormous color range, easy software, NTSC conformance, and low price.

Basically, this new Cromemco Model SDI* is a two-board interface that plugs into any Cromemco computer.

The SDI then maps computer display memory content onto a convenient color monitor to give high-quality, high-resolution displays (756 H x 482 V pixels).

When we say the SDI results in a high-quality professional display, we mean you can't get higher resolution than this system offers in an NTSC-conforming display.

The resolution surpasses that of a color TV picture.

BASIC/FORTRAN programming

Besides its high resolution and low price, the new SDI lets you control with optional Cromemco software packages that use simple BASIC- and FORTRAN-like commands.

Pick any of 16 colors (from a 4096-color palette) with instructions like DEFCLR (c, R, G, B). Or obtain a circle of specified size, location, and color with XCIRC (x, y, r, c).

*U.S. Pat. No. 4121283

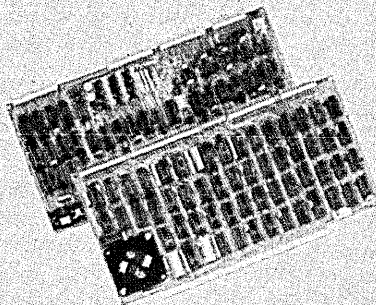

Model SDI High-Resolution Color Graphics Interface

HIGH RESOLUTION

The SDI's high resolution gives a professional-quality display that strictly meets NTSC requirements. You get 756 pixels on every visible line of the NTSC standard display of 482 image lines. Vertical line spacing is 1 pixel.

To achieve the high-quality display, a separate output signal is produced for each of the three component colors (red, green, blue). This yields a sharper image than is possible using an NTSC-composite video signal and color TV set. Full image quality is readily realized with our high-quality RGB Monitor or any conventional red/green/blue monitor common in TV work.



Model SDI plugs into Z-2H 11-megabyte hard disk computer or any Cromemco computer

DISPLAY MEMORY

Along with the SDI we also offer an optional fast and novel two-port memory that gives independent high-speed access to the computer memory. The two-port memory stores one full display, permitting fast computer operation even during display.

CONTACT YOUR REP NOW

The Model SDI has been used in scientific work, engineering, business, TV, color graphics, and other areas. It's a good example of how Cromemco keeps computers in the field up to date, since it turns any Cromemco computer into an up-to-date color display computer.

The SDI has still more features that you should be informed about. So contact your Cromemco representative now and see all that the SDI will do for you.

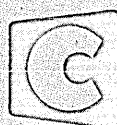

Cromemco
i n c o r p o r a t e d

280 BERNARDO AVE., MOUNTAIN VIEW, CA 94040 • (415) 964-7400
Tomorrow's computers today

CIRCLE 5 ON READER CARD

DATA⁸⁰MATION[®]

SEPTEMBER 1980/\$4.00 U.S.A.
VOLUME 26 NUMBER 9
This issue, 165,415 copies

FEATURES

36 IN FOCUS

Becky Barna

Author Alvin Toffler has a few more future shocks.

130 GOING GLOBAL

Managers of corporate information systems run into a variety of roadblocks when they set up worldwide sites.

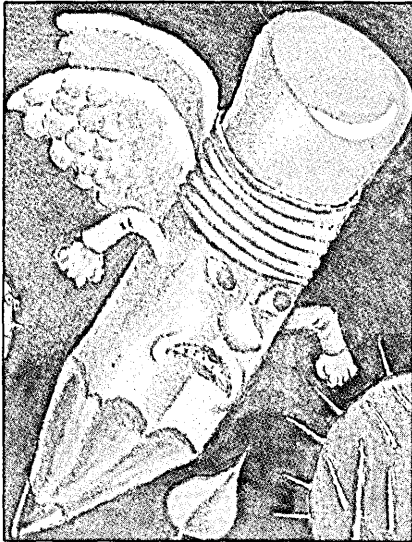

149 LOOSENING THE TELECOM LINK

Oswald H. Ganley

Canada wants its share of the information revolution's production and employment.

157 CURRENT TRENDS IN THE EUROPEAN COMPUTER MARKET

Frank Halpern

It's still a dynamic, rapidly growing dp equipment market.

164 RETRIEVING INFORMATION

V. A. J. Maller

Multiple search jobs can be done concurrently at very high rates with CAFS.

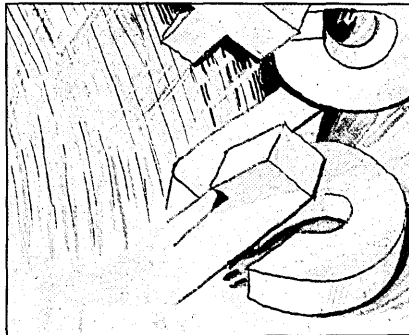

177 ZBB FITS DP TO A TEE

Thomas J. Francl, W. Thomas Lin, and Miklos A. Vasarhelyi

Zero-base budgeting helps reevaluate programs and expenditures in terms of cost-benefit.

184 MARRIAGE: DP STYLE

Merrill Cherlin

Is there a relationship between data processing and divorce?

192 DOES DISTRIBUTED PROCESSING PAY OFF?

Kenneth M. Sullivan

Although ddp may be fashionable, what are its real costs?

201 THE ARCHITECTS OF SYSTEM DESIGN

Dionysios Tsihritzis

Using principles of architecture to bolster those of engineering.

207 PROBING PRODUCTIVITY

Robert L. Patrick

For overall productivity improvement, make this survey.

217 FIRE-FIGHTING MINI

Donald N.H. Chi and Henry E. Perlee

Explosion, combustion, fire, and coal mine research facilities use a Bureau of Mines computer network.

NEWS IN PERSPECTIVE

47 FINANCIAL

A look at venture capital.

48 COMPANIES

New name, new game. Uphill fight for Sanders.

58 COMMUNICATIONS

Datacom bonanza forecast.

64 STRATEGIES

IBM hold in Europe slipping. Japan's amicable alliance.

82 COMPUTER CRIME

Motives for theft.

88 SOFTWARE

Of birds, IBM, and software.

96 MAINFRAMES

Power in a pinch.

98 PERIPHERALS

Big drive for backup.

106 EDUCATION

Institute born of gratitude.

114 LEGISLATION

R&D bills on front burner.

118 COMPUTER GRAPHICS

CPA sour on dp graphics.

120 MEETINGS

It's a small world. Progress on the-TDF front.

128 BENCHMARKS

Deregulate; Home time-sharing; NCR to make more chips; Over a billion a year; Millions for INMOS; Com bill stands still.

DEPARTMENTS

- 8 LOOKING BACK
- 13 LOOK AHEAD
- 18 CALENDAR
- 23 LETTERS
- 33 EDITOR'S READOUT
- 224 PEOPLE
- 228 HARDWARE
- 240 SOFTWARE & SERVICES



- 249 SOURCE DATA
- 261 READERS' FORUM
- 276 MARKETPLACE
- 280 ADVERTISERS' INDEX

COVER ILLUSTRATION BY STEPHEN DURKE

The Associative File Processor. AFP.

A Special Purpose Hardware System for Retrieving Textual Information.

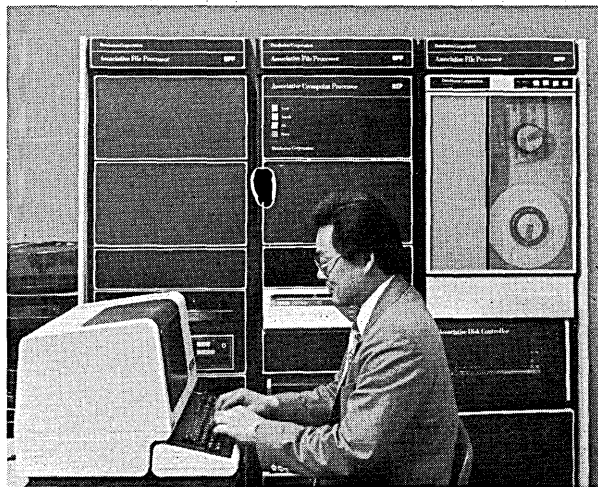

Full Text Retrieval. Finds relevant information in large free text files (typically 300 million characters or more) that match queries.

Unrestricted Queries. Unrestricted query vocabulary with boolean AND, OR, NOT and proximity key word logic.

Simple Configuration. AFP[®] runs on a PDP11 host mini-computer and includes all necessary user software.

Real Time Data Input. New data may be input and searched as it is received, if necessary.

Special Associative Hardware. The processing power is made possible by the special AXP[®] hardware effectively having the capability of 1200 cpu's.

Affordable. Now you can afford full text retrieval costing only a few pennies per search.

Available in Three Configurations. The AXP100 attaches to an existing PDP11 computer; the AXP200 is self contained with a communication interface to a network or another host computer; the AXP300 is a turn key system including CRT terminals and a line printer.

Application Areas Include:

Military and Intelligence	Technical Report Retrieval
Law Enforcement	Generic Record Keeping
Library Search	Current Awareness Bulletin
Word Processing Support	Laboratory Testing and Retrieval
Abstract Search	Journal Abstracting and Control
Title and Property Search	Pharmaceutical Literature Retrieval
Trial Transcripts	Product Bibliographies
Patent Search	Chemical Compound Retrieval
Litigation Support	Historical Records and Archives



Call (213) 887-9523 or write for a detailed brochure.

Datafusion Corporation

5115 Douglas Fir Road, Calabasas, California 91302

DATAMATION.

Editor John L. Kirkley
Articles Editor Wendy Reid Crisp
News Editor Becky Barna
International Editor Linda Runyan
Managing Editor, Europe Andrew Lloyd
Products Editor Bill Musgrave
Copy Editor Florence Lazar
Assistant Editor Sarah Rolph
Editorial Assistants Deborah Sojka,
 Don Rosenthal

Bureau Managers

San Francisco Edward K. Yasaki
Los Angeles Edith D. Myers
Boston Vin McLellan
New York Ralph Emmett
Technology Editor, Europe Fred Lamond

Correspondents

Washington Willie Schatz
London Malcolm Peltu
Sydney, Australia Norman Kemp
Telecommunications Editor Ronald Frank
Editorial Advisor Robert L. Patrick
Technical Advisor Lowell Amdahl
Contributing Editors Ralph G. Berglund,
 Howard Bromberg, Philip H. Dorn, John M.
 Eger, David Hebditch, Angeline Pantages,
 Russell Pipe, Carl Reynolds, F. G.
 Withington, Amy D. Wohl.

EDITORIAL OFFICES

Headquarters: 666 Fifth Ave., New York, NY 10103.
 Phone (212) 489-2588. **New England:** 161 High St., Boston, MA 02110, (617) 482-4606. **Eastern:** 1531 Inlet Ct., Reston, VA 22090, (703) 435-3206. **Western:** 1801 S. La Cienega Blvd., Los Angeles, CA 90035, (213) 559-5111; 2680 Bayshore Frontage Rd., Suite 401, Mountain View, CA 94043, (415) 965-8222. **International:** 6605 Burlington Pl., Springfield, VA 22152, (703) 569-3383. **Foreign:** 221 Blvd. Raspail, 75014 Paris, France, (331) 322-7956. **New York, N.Y. TELEX 640-229.**

Art Director Kenneth Surabian
Production Manager Robert Gaydos
Art/Production Coordinator Susan M. Rasco

CIRCULATION

666 Fifth Avenue, New York, NY 10103
Circulation Manager Joseph J. Zaccaria
Director of Marketing Deborah Dwellley
Publisher James M. Morris

Technical Publishing

DB a company of
 The Dun & Bradstreet Corporation

BPA Circulation audited
 by Business Publications Audit

ABP Member American Business Press, Inc.

DATAMATION (USPS 508-290) Magazine is issued monthly on or about the first day of every month, with the exception of Nov., which is semimonthly. Published by Technical Publishing, a company of the Dun and Bradstreet Corporation, 1301 South Grove Ave., Barrington, IL 60010; James B. Tafel, Chairman; John K. Abely, President. Executive, advertising, editorial offices, and subscription department, 666 Fifth Ave., New York, NY 10103. Published at East Greenville, Pa. Subscription rates: \$36 (U.S. and Possessions); \$45 (Canadian). Reduced rate for qualified U.S. students: \$18. Foreign subscriptions: £38. Additional charge for airmail: £32. Japan, Australia and New Zealand: £42 (air-shipped). Sole agent for all subscriptions outside the U.S.A. and Canada is J. B. Tratsart, Ltd. 154 A Greenford Road, Harrow, Middlesex HA13QT, England, (01)422-8295 or 422-2456. No subscription agency is authorized by us to solicit or take orders for subscriptions. Controlled circulation postage paid at Bethlehem, PA 18016. Copyright 1980 by Technical Publishing Company, a Division of Dun-Donnelley Publishing Corporation. All rights reserved. * "Datamation" registered trademark of Technical Publishing Company. Microfilm copies of DATAMATION may be obtained from University Microfilms, A Xerox Company, 300 No. Zeeb Road, Ann Arbor, Michigan 48106. Printed by Brown Printing Co., Inc. POSTMASTER: Form 3579 to be sent to Technical Publishing Company Circulation Office: 666 Fifth Avenue, New York, NY 10103. ISSN: 0011-6963. Single copy: \$4.00 in U.S.A.

Word Processing

Data Processing

Electronic
Message Service

Voice and Data
Communications Management

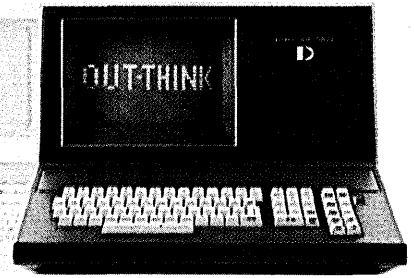

Now Datapoint combines all four capabilities into one integrated system using a common database. And every function is available at each 3800 workstation.

Watch productivity soar as four office functions are integrated in one system



This is the only system which handles *all* the basic business media — data, words, messages, and telephone communications.

By combining all the basic business media, Datapoint's Integrated Electronic Office gives you increased productivity, improved cost efficiency, and tighter management control.

Here are five more benefits.

Pick the size you need.

 1 MB + *Single User*
\$325/month

 *Multi-User*
20 MB + \$1930/month 

3-year lease prices shown do not include printers (many types available), maintenance, installation or training charges.

1. It's the multifunction system you can't outgrow. You can add workstations, increase processing power, expand peripherals, broaden the common database—virtually without limit. All because of Datapoint's exclusive ARC™ system architecture.

No matter how large the system, responsive performance is provided at every Datapoint workstation.

2. It gives you word processing with new search power. Save valuable WP time with Datapoint's exclusive retrieval system, AIM (Associative Index Method). It searches for facts and documents by *content*. You needn't enter titles or index numbers, just words or phrases from the document you wish to retrieve.

3. It cuts long-distance telephone bills up to 40 percent. Datapoint's Long Distance Control System reduces long-distance costs by a combination of least-cost routing for all calls, queuing, and call buffering. It even prints out traffic data to give you greater control of costs. And it works with existing PBX or CENTREX exchanges.

4. It sends messages in a flash — essentially for free. Documents can be stored, retrieved, and transmitted automatically from one Datapoint processor to another — across the hall or across the country. By using the excess capacity of your flat-rate voice communications lines

during nonpeak hours, the Datapoint Electronic Message System gives your interoffice correspondence a free ride. With EMS you can even downline load file updates and programs to all your remote Datapoint processors.

5. It gives you a unified approach to office integration. With Datapoint's Integrated Electronic Office, anything goes. Enter data. Compute and store. Retrieve and incorporate in text. Transmit messages interleaved with voice. Receive confirmations of messages automatically. And more.

Let us help you apply the power of the Integrated Electronic Office to your organization now. Call (512) 699-7151 for the number of the nearest Datapoint office. Or write: Datapoint, Corporate Communications, DM-K05, 9725 Datapoint Drive, San Antonio, TX 78284.

DATAPOINT

CIRCLE 7 ON READER CARD

The Graphics

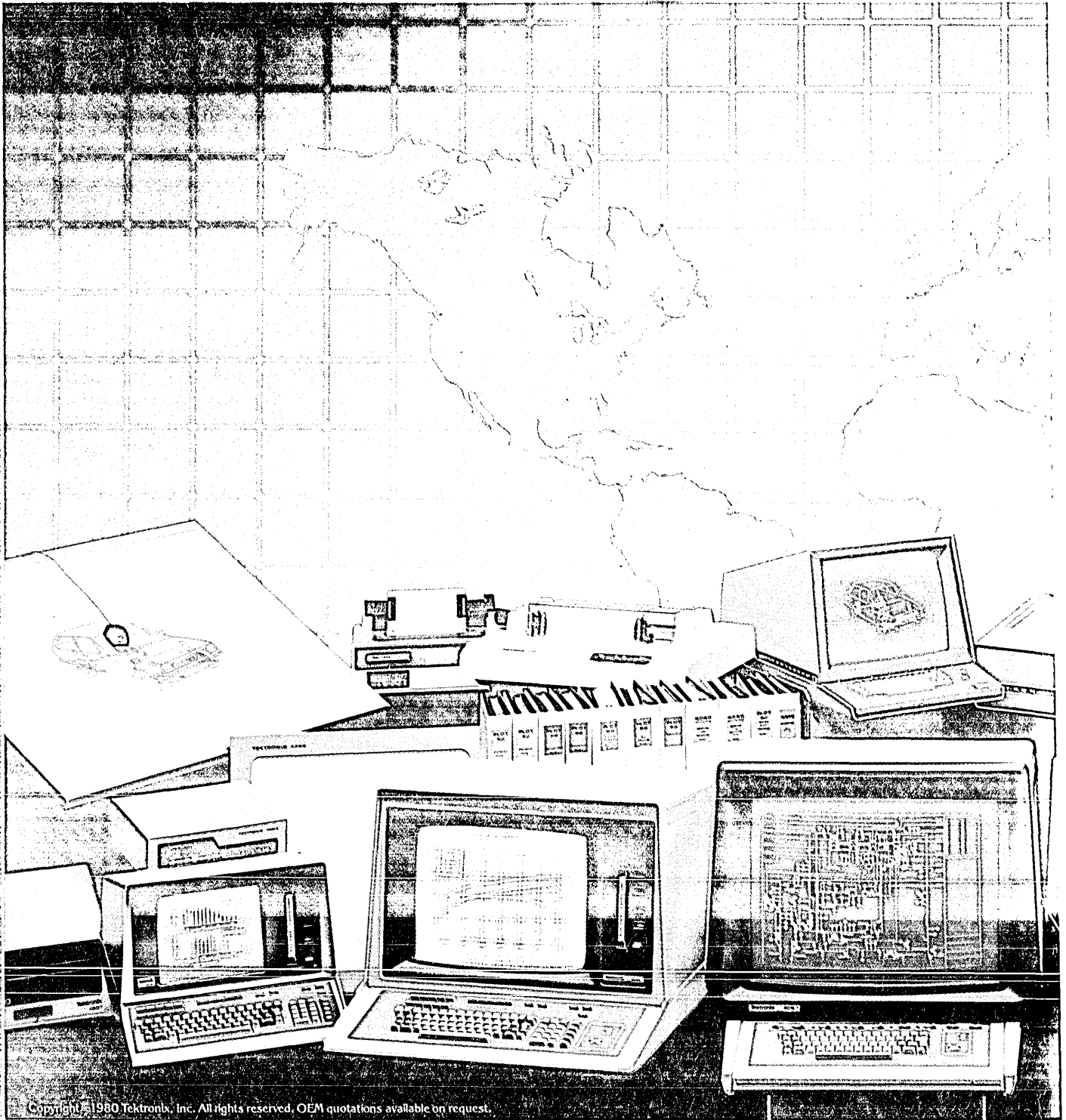

Copyright © 1980 Tektronix, Inc. All rights reserved. OEM quotations available on request.

Standard

Graphics, the true universal language.

For 12 years, Tektronix has set the standards by which graphics information is measured:

In resolution.
Size. Software.
Service.
Reliability.
Compatibility.
And breadth of product line.

Whatever your own standards of productivity and graphics performance, you can turn to Tektronix.

We'll measure up.

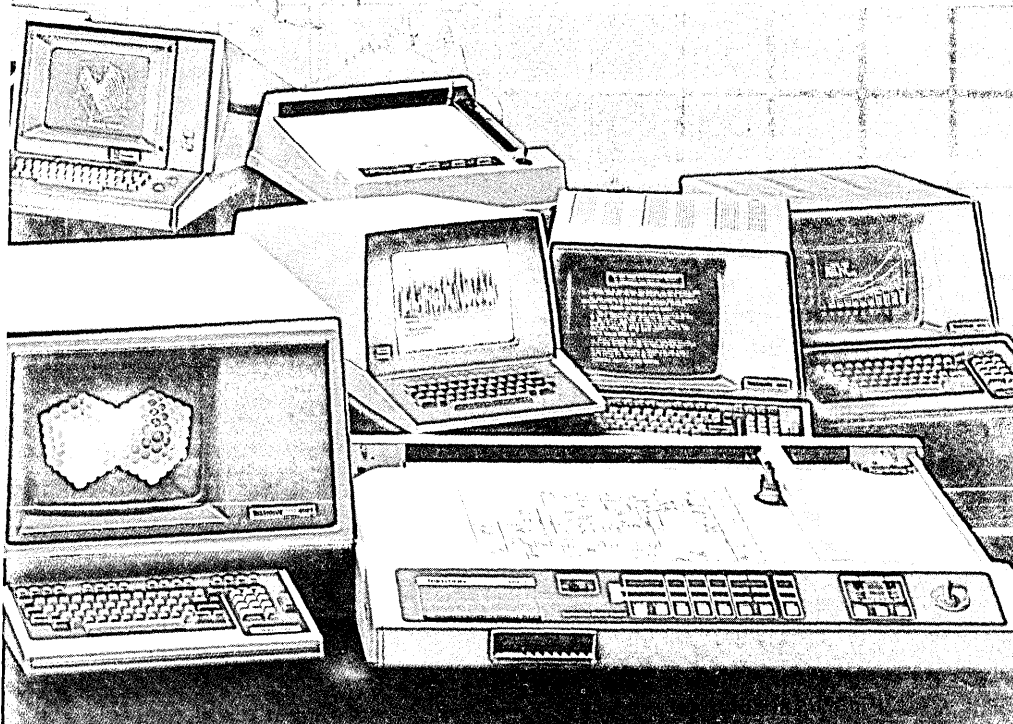

For more information,
contact your local Tektronix
sales office or call toll free,
1-800-527-5151 (in Oregon,
644-0511 collect).

Tektronix, Inc.
Information Display Division
P.O. Box 1700
Beaverton, OR 97075

Tektronix International, Inc.
European Marketing Centre
Post Box 627
1180 AA Vinstevan
The Netherlands

Tektronix

COMMITTED TO EXCELLENCE

CIRCLE ONE READER CARD

promacs® lets you show everyone just how productive a programmer can be!

PROMACS will change the way you've thought software development had to be. For the better. Much better. By enhancing programmer creativity. Increasing productivity. Reducing testing costs and maintenance costs. Trimming software development time by as much as 75%. And by improving the software staff's image among management and users.

EARN YOUR BADGE IN PROGRAMMER PRODUCTIVITY



Get a badge, free, from MACS.

Programmer productivity and more. From PROMACS — the new free-form, high-level programming language that's similar to COBOL, but easier to use to create COBOL programs, from the simplest to the most complex. And it does it by the innovative use of powerful macros that generate a structured COBOL program which you complete and execute. Allowing you to create in a few statements what COBOL requires pages and pages of coding to accomplish.

PROMACS...from MACS, the people who've been delivering software excellence for over 10 years (in products such as DATAMACS, the world's best-selling automatic test data generator.

macs

management and computer services, inc.
great valley corporate center valley forge, pa 19482 215-648-0730

CIRCLE 9 ON READER CARD

macs

great valley corporate center, valley forge, pa. 19482

I WANT TO BE A SOFTWARE HERO!

- Tell me more about PROMACS and the free 30-day trial offer.
- Send more information...and a SOFTWARE HERO badge.
- Would you believe I see no need for improved software productivity, but would like a SOFTWARE HERO badge.

Name _____

Title _____

Company _____

Address _____

City _____ State _____ Zip _____

Phone _____ CPU/Op.Sys. _____

DM980

Twenty Years Ago/Ten Years Ago

LOOKING BACK

SEPTEMBER/OCTOBER 1960

Twenty years ago, the industry heralded the debut of the starlets of consultancy: "An interesting development is noted in New York. The Lone Wolf of Ossining, Daniel D. McCracken, has incorporated himself. McCracken is the first of a new, revitalized crop of freewheeling, freelance computer consultants. These hardy souls have decided that their talents as computer programmers and equipment experts can best be utilized if they are unhampered by regular paychecks. They usually accept anything from one-shot assignments to long-term contracts and are distinguished by the fact that they might have several jobs going at widely scattered points in the U.S.

"For a while, McCracken had the whole country to himself. Then, about a year ago, Robert Patrick set up shop in the Los Angeles area. During 1960, Bob Barton, Jackson Granholm and Gene Amdahl have also established themselves in L.A. and Herbert R. J. Grosch has returned to full time consulting in New York City. It will be interesting to watch the fortunes (or lack of same) of these bold, rugged individuals."

SEPTEMBER 1970

The new firm, Computer General, Inc., a subsidiary of Marchuk and Metcalf Associates, promised first deliveries of a laser-based computer by April of 1971. The computer featured a trillion-bit electro-optical memory, and reportedly had a full access time of 20 nsec. Dr. Frank Marchuk, president, released a few details on the processors, but no information on the buyers. However, he did say the first eight of 40 units ordered by three buyers would be delivered in April without memory, priced at \$350,000 each. The price for a mainframe with a trillion bits was \$500,000, and for an additional \$100,000, the buyer got 10 trillion bits.

Xerox Data Systems had remote maintenance up its sleeve for 1971. Sigma Series users would be connected to a diagnostic laboratory at XDS headquarters in El Segundo, Calif., and maintenance-by-telephone service would be available to these users. Data from diagnostic tests on computers and peripherals at a user's site would be transmitted to El Segundo via telephone, and analyzed by XDS systems service people

who would then send back step-by-step repair instructions. XDS spokesmen said pilot tests at 28 installations were 100% successful in finding the source of malfunctions, but the average time for locating the problem was five hours. The spokesmen also stated XDS was trying to cut down on the amount of time needed for telephone repairs. IBM promised a similar service for 370 users, called RETAIN (Remote Technical Assistance and Information Network) for 1971.

The FCC was edging toward opening new specialized communications systems to new carriers, especially those planning data transmission networks. After lengthy debates, the commission decided to seek comments on a staff paper that concluded the market potential was sufficient to support more than one applicant in an area, and that users deserved a wider choice. The paper also found that new entries would disperse risks and initiatives as well as stimulate technical innovation, and it saw no merit in the claims of existing common carriers that applicants for new systems were trying to "skim the cream" off the most profitable markets. Commissioner Nicholas Johnson called the action "timid," and said it was "simply a prelude to interminable delay."

Dittberner Associates, a Bethesda, Md., consulting firm specializing in telecommunications, was hired by the FCC to suggest ways of implementing the recommendations made during the summer by a panel from the National Academy of Sciences. The panel recommended that a "terminal standardization certification program controlled by the FCC could provide adequate technical protection—but almost in the same breath said the present setup was feasible. Under the present setup, terminal interfaces are supplied exclusively by the carriers. If the FCC agrees with Dittberner, the telephone terminal market would be opened to independent suppliers."

Dittberner Associates also stated the commission should presume that independently made terminals, interfaces, and communication systems posed no threat to the performance of the telephone network and these should be certified unless the carriers could prove otherwise.

—Deborah Sojka

Pick An Interface. Any Interface.

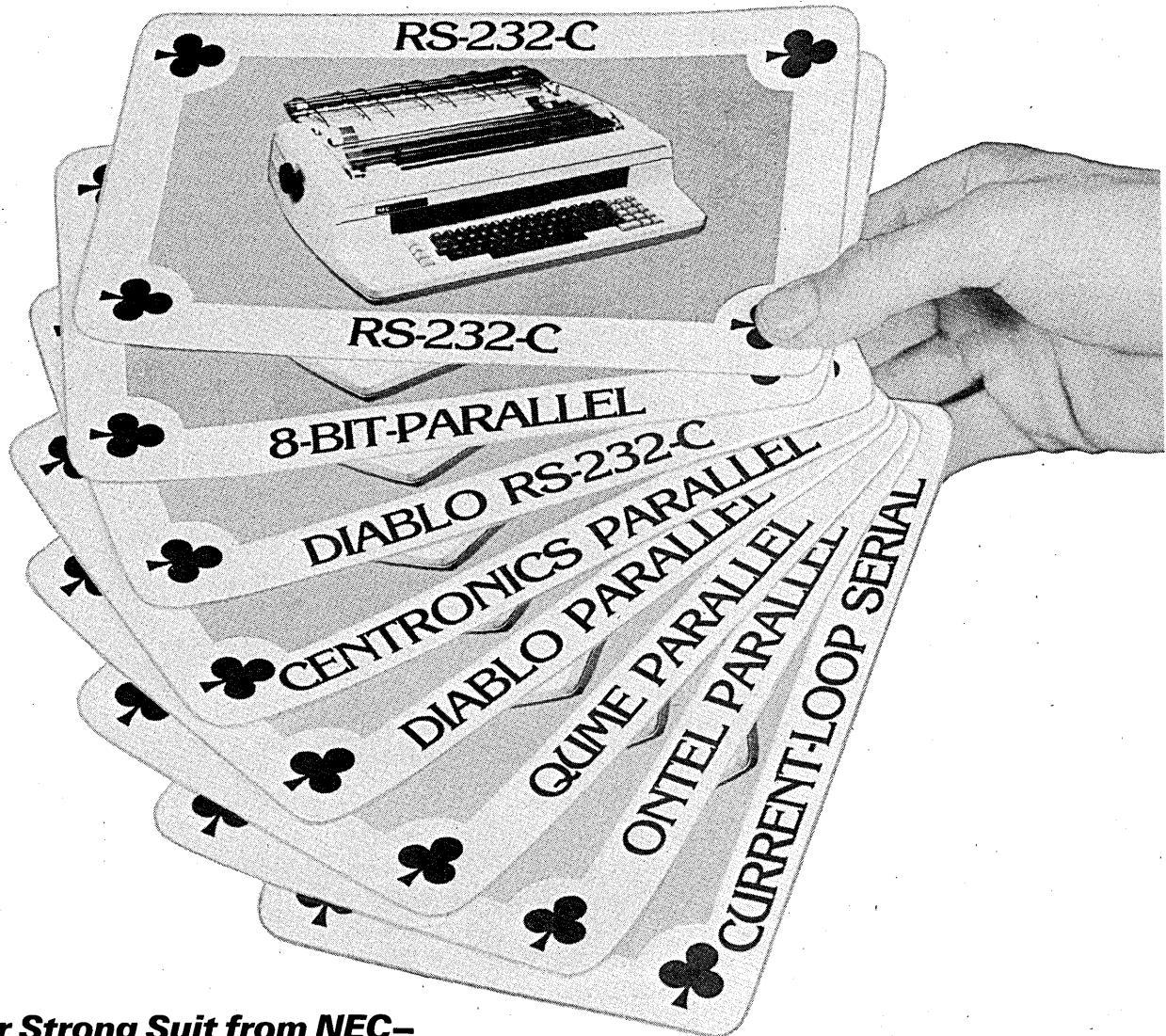

Another Strong Suit from NEC— Eight Standard Spinwriter Interfaces.

When it comes to selecting that perfect printer, an interface problem is the last thing that should stand between you and a winning system. That's why NEC offers 8 industry standard interfaces for its printers.

Why? So you can add Spinwriters to your system right now, or replace any printer you're now using with any one of nine Spinwriter Models. So you can have the industry's finest character printers. Just plug them in.

NEC Spinwriters are designed so that interface firmware resides on the same board as our microprocessor CPU. For you, that means a truly simple and clean interconnect: a sure bet.

Go ahead... call us. We'll show you our winning hand of printer interfaces. No matter what you're using now, regardless of your *former* interface limitations, you can have the best. Spinwriters, from NEC.

For information, call your nearest NEC sales office.

NEC. Going after the perfect printer.

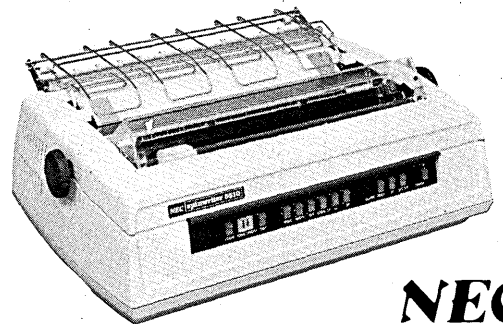

NEC

NEC Information Systems, Inc.

Home Office: 5 Militia Drive, Lexington, MA 02173, (617) 862-3120
Eastern Office: 36 Washington Street, Wellesley, MA 02181, (617) 431-1140
Central Office: 3400 South Dixie Drive, Dayton, OH 45439, (513) 294-6254
West Coast Office: 8939 S. Sepulveda Blvd., Los Angeles, CA 90045 (213) 670-7346
Southern Office: 2945 Flowers Road South, Atlanta, GA 30341 (404) 458-7014

CIRCLE 10 ON READER CARD



Key to Success

Intel's integrated dictionary unlocks data management solutions.

Programmer productivity. Application development. Data base design. Project management. Programming standards. Maintenance. Data security, accuracy, integrity. Optimization of resources. Controlled growth.

All of these are priority issues among forward-thinking organizations today. But these are just a few of the issues addressed—and solved—by Intel's Information Resource Management product family.

The key is in Intel's Integrated Data Dictionary, IDD.

Get the big picture.

The IDD gives you a detailed, panoramic view of what's happening in your data base environment. By continually monitoring and tracking information (ranging from data items all the way up to entire application systems with multiple programs), Intel's dictionary puts reports on who, what, where, how, and when at your fingertips. Most importantly, you won't need a crystal ball to forecast the impact of change. Impact reports are standard, too.

Streamline application development.

With a wealth of vital information in hand, you can simplify the task of building and fine-tuning new applications. And because the dictionary works intimately with SYSTEM 2000®/80, Intel's powerful data base management system, designers are given extensive data modeling and application prototyping capabilities. Moreover, data items, records, and definitions are easily added, deleted, or modified even after a data base is in full production. And, like all IDD

functions, this can be handled on-line or in batch mode.

Enforce standards, communicate, and cut redundancy.

Intel's data dictionary quickly tells you and anyone else involved in data base and application development, what already exists (and

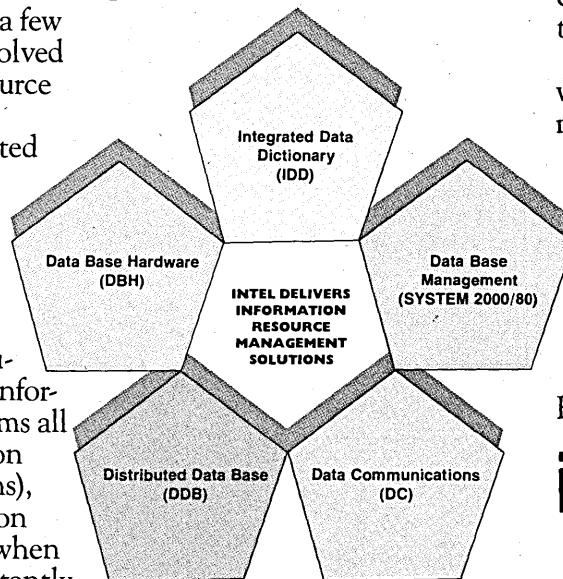

in what form it exists) in your environment. Additionally, the dictionary applies editing, error detection, and correction functions.

Guarantee data security.

Watchdog of your data is IDD's sophisticated security system. With passwords which protect data as far down as the item level, you can be confident that your data remains "clean." You can be confident that unauthorized personnel will not accidentally alter or view sensitive information.

Implement successful solutions.

Intel's Integrated Data Dictionary is an application design aid, a documentation vehicle, a way to enforce standards and procedures, a master reference for determining the impact of change, a tool for controlling growth today and tomorrow.

To examine your key to success with Intel's IDD and other Information Resource Management products, clip the coupon below or call our Market Information Office at 512/258-5171.

We'll respond with descriptive brochures, success stories about our customers, plus an invitation to our complimentary seminars on Information Resource Management.

intel delivers solutions.

Europe: Intel Semiconductor (Nederland) B.V., Commercial Systems Division, Oranjestraat 1, 3441 Ax Woerden, The Netherlands, 31/3480-11264, Telex 47970 CSD NL
Canada: Intel Semiconductor of Canada, Ltd., 201 Consumers Fd., Suite 200, Willowdale, Ontario M2J 4G8, 416/494-6831

Please forward literature on Intel's Integrated Data Dictionary and other IRM products.

Name _____

Company _____

Mailing address _____

City, State, Zip _____

Telephone () _____

Mainframe(s) installed: IBM (compatible)

_____, CDC _____, Univac _____;

Operating system _____

Return to: Intel Commercial Systems Division
P.O. Box 9968; Austin, Texas 78766
ATTN: Market Information Office

CIRCLE 11 ON READER CARD

Introducing The entire BTI family of 32-bit multiprocessor systems.

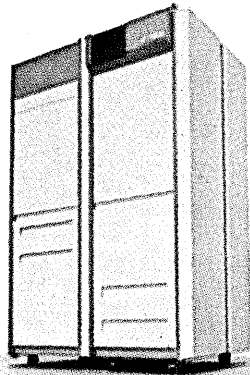

Finally, there's a computer system that lets you grow by plugging in resources, instead of by changing models — the BTI 8000.

Our family secret is Variable Resource Architecture (VRA): a flexible mix of hardware resources controlled by a single, self-regulating operating system. The result is mainframe level performance at substantially lower costs, plus unequalled flexibility.

You can tailor the BTI 8000 to serve over 200 on-line, interactive users. Or to handle large batch loads. Or to do some of each. And, you can

vary system performance **over a tenfold range** by merely adding or deleting hardware modules.

Additionally, built-in growth potential allows you to respond to changing requirements easily and quickly — without modifying either the operating system or your applications software.

As for reliability and support, they're established family traditions, proven by over 2,500 other BTI computers operating in the U.S., Canada and Europe. For full details about the BTI 8000, contact the BTI office nearest you.



Corporate Offices: 870 West Maude Avenue, Sunnyvale, CA (408) 733-1122 Regional Offices: Piscataway, NJ (201) 457-0600;
Palatine, IL (312) 397-9190; Dallas, TX (214) 630-2431; Sunnyvale, CA (408) 733-1122. Sales Offices in major U.S. cities.
In the United Kingdom: Birmingham (021)-477-3846

CIRCLE 12 ON READER CARD

LOOK AHEAD

NASCO FINDS "H" IN HITACHI

New West Coast whispers are that Nasco (National Advanced Systems Co.) is getting ready to offer a 10 MIPS machine from Hitachi in response to the expected first quarter "H" announcement from IBM.

ANAT IN THE U.S. MARKET

Nixdorf Computer AG has signed with Israeli minicomputer company, Elbit, to offer the Israelis' IBM-compatible ANAT series computers exclusively in Germany, and nonexclusively throughout Europe. What's more, the ANAT models will soon be marketed to volume oem buyers in the U.S.

The Israeli ANAT comes in three models -- the I, III, and V, roughly comparable to the IBM 370/125-2, 4331, and 370/148 respectively. Nixdorf has already received the first ANAT/III deliveries. In the U.S. market, the ANAT/III, 4331-compatible with 512 kilobytes of main memory and integrated internal peripheral controllers, will be oem priced at \$43,000. The typical 256 kilobyte ANAT/I will sell oem for about \$35,000, and the full-megabyte ANAT/V will be oem priced at about \$63,000.

ROBOTS RUMOR

A new IBM division may soon be unveiled out of GSD in Boca Raton. Project White Cloud, IBM's internal development group for industrial robots of the sort used to assemble crts in Raleigh, has reportedly been reorganized as the General Robotics Division. Scuttlebutt is the new division marks a major commitment by IBM in an emerging marketplace. For now, a small GRD sales force will sell only internally to IBM.

ROBIN HOOD IN DISGUISE

Honeywell is apparently transferring veteran field engineers from its large and medium cpu support staff and retraining them to service the popular new Level 6 small computer -- leading some large users to fear that HIS policy may again slight its virtually captive installed base. "The older equipment needs TLC," notes one industry consultant, "and they are stripping talent out of the field to assign them to Level 6 customers."

AMDAHL TO DIVERSIFY

Look for Amdahl Corp. to diversify its product line. The maker of IBM software-compatible mainframes has finalized its acquisition of Tran and should be coming up with new communications products. One area is communications front-ends. Without any fanfare, a deal has been made with

LOOK AHEAD

Fujitsu for its IBM-compatible 4705 front-end. The imported communications box has already been installed at one or two selected customer sites for evaluation, and other potential users are being sounded out. Although Amdahl itself has little communications software expertise, Tran might assist in developing independent software for the 4705.

And, can disk drives be far behind? The company is rumored to have approached the financial community for the funds necessary to begin making its own DASDs. But David Morgenthaler says Amdahl's immediate interests lie less in the drives, more in storage hierarchy management or a higher performance version of the disk controller "because the bigger machines are bottlenecked by today's controllers."

GTE GROUP GETS
NASTY. EDICT

We hear the brass at GTE has told its newly formed Communications Network Systems Group to shape up by October -- or else. The group, formed last December following GTE's acquisition of Telenet Corp. (the packet switching organization) and Cambridge Telecommunications Inc. (which makes software and processors for connecting terminal systems to packet switching networks), lost \$25 million in its last quarter. Sources who talk of the edict don't know exactly what "or else" means.

XTEN LOOKING
FOR HELP?

We're told that Xerox may go outside for the technology needed to put together its proposed Xten service. Siemens is considered by former insiders as a possible source. The operation, now housed in Long Island, has left only two of the technical people -- both relatively junior -- who worked on the project in Woodland Hills, Calif. "We all prepared written reports on our work," says one technical person involved in the project. "It's not impossible for them to proceed on their own; it's just unlikely."

DÉJÀ VU

About to make the plug-compatible mainframe plunge a second time around, Gene Amdahl resigned his chairman emeritus position in Amdahl Corp. last month to set up a new company in the PCM field he helped pioneer. Dr. Amdahl's would-be accountants are plugging for the new venture to be incorporated in Bermuda; Amdahl himself says such details are unimportant. Instead, he's pinning his hopes, as well as a considerable amount of money, on being able to deliver in three to three and a half years a product that beats IBM on price/performance points. Some

(continued on page 45)



How can a Programming Manager go home at 5 o'clock?

These days it's easy.

There's a new version of MARK IV, our famous application development system, designed to get your applications up and running quickly.

You get productivity benefits only a non-procedural tool like MARK IV can offer. It's like adding programmers to your staff.

Sophisticated interfaces for IMS (DL/I) reduce your need for data base expertise. And a TP report writing language gets you out from under the backlog of user requests.

MARK IV frees your programmers from routine jobs to work on critical applications. And best of all, it's priced with your budget in mind.

If changes in your company are keeping you busy half the night, take heart.

Complete the coupon, or call and ask about MARK IV. Once you've tried MARK IV, you'll wonder how you ever went home without it.

Informatics Inc., 21050 Vanowen Street, Canoga Park, CA 91304
 Ron Mullenau, Product Manager
 (213) 887-9121

Send me complete details on MARK IV
 Have Sales Rep call me.

informatics inc. 

Name _____ Title _____
 Company _____
 Address _____
 City _____ State _____ Zip _____
 Telephone _____
 Computer _____ Operating System _____
 Teleprocessing System _____ Data Base Manager _____ M-D-980

MARK IV[®] by Informatics[®]

CIRCLE 13 ON READER CARD

The Information Management Company.

WE SAW THE 32-BITS. AND

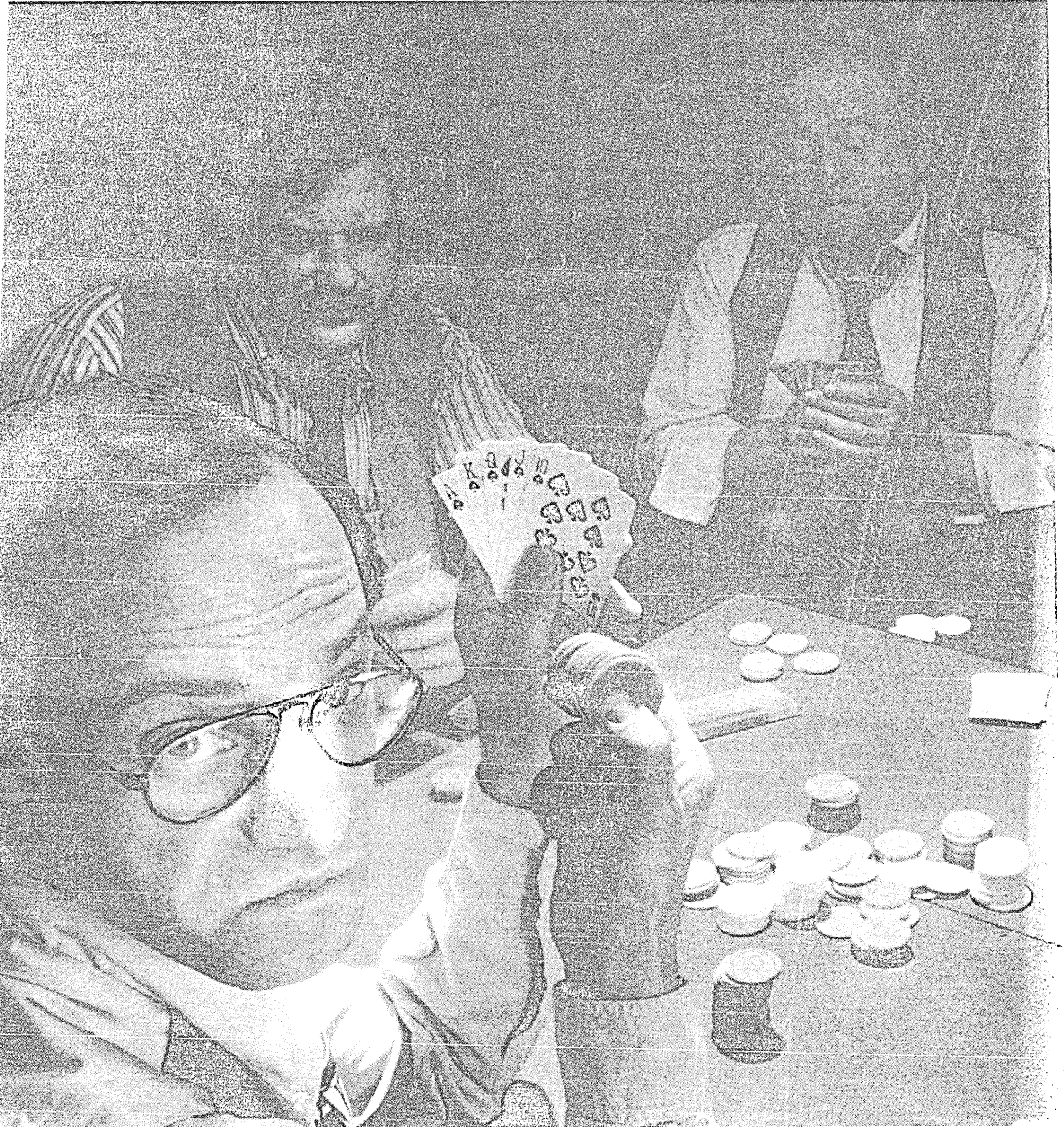

INDUSTRY'S RAISED 'EM.

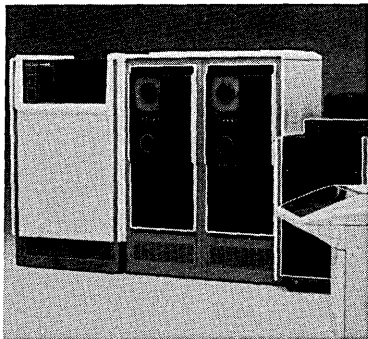

INTRODUCING ECLIPSE® MV/8000, the fast new processor that gives you high throughput, high performance, and unmatched reliability, and the most compatible 32-bit computer system in the industry.

You need a 32-bit system that thinks fast. MV/8000's 36.4 MB/sec. memory bandwidth is two-to four-times faster than its nearest competitor. And it features a unique three-level I/O system using independent processors that drive high-speed busses and as many as 128 terminals.

Need hot architecture? MV/8000 gives you one of the industry's most advanced virtual memory management techniques, plus 4 gigabytes of logical address space, 6.6 gigabytes of on-line storage, and user programs as large as 512 megabytes – that's 6 times larger than the competition's.

Your MV/8000 also has unmatched reliability and maintainability. It comes with its own independent microNOVA™-based System Control Processor that continuously monitors a diagnostic bus, and identifies hardware faults right down to the field-replaceable unit. Plus, you get enhanced maintainability with a totally alterable control store – the first ever on a 32-bit mini-mainframe.

How about system security? MV/8000 gives you an 8-ring security system that divides the address space into eight imbedded protection areas, each with a unique privilege level. That secures system resources and user's privileged routines.

You need a 32-bit computer that speaks your language. MV/8000 speaks just about all of them, based on its new, ultra-sophisticated AOS/VS operating system that's compatible with our time-tested AOS (Advanced Operating System). AOS/VS has optimized micro-code for high-level languages like ANSI FORTRAN 77, ANSI BASIC, and ANSI PL/I. What's more, AOS/VS can run COBOL, DG/L, DG/DBMS, TPMS, INFOS II, AZ-TEXT™ word processing, RCX70 (3270) and RJE (2780/3780).

Compatibility? Forget about emulation, mode bits or rewrites. Along with its new 32-bit applications, MV/8000 executes all existing AOS-based ECLIPSE programs. You don't have to change programs, peripherals, interfacing, documentation, or people.

MV/8000, new from Data General. From now on we hold all the cards in 32-bit systems. Bet on it. And win.

Data General Corporation, Westboro, MA 01580, (617) 366-8911. ECLIPSE is a registered trademark and microNOVA & AZ-TEXT are trademarks of Data General. © Data General Corporation, 1980.

CIRCLE 14 ON READER CARD

Data General

Mail to: Data General Corporation, Westboro, MA 01580
 Your MV/8000 sounds like a winner. Send complete info. Deal me in now. Send a sales rep.

Name _____
Title _____
Company _____
Address _____
City _____
State _____
Zip _____

Tel. _____

D980

CALENDAR

SEPTEMBER

SICOB '80, September 17-26, and Convention Informatique, September 15-19, Paris, France.

These back-to-back exhibitions and conferences cover personal computing to office equipment, and constitute the largest French international show. Contact Pierre Wagner, International Trade Shows in France, 1350 Sixth Ave., New York, NY 10019, (212) 582-4960.

Federal Computer Conference, September 22-24, Washington.

Cosponsored by DATAMATION. Will address the management of change in the 1980s for federal dp users. Contact Ms. Lynn Green, P.O. Box 368, Wayland, MA 01778, (617) 358-5181.

OCTOBER

IFIP Congress '80, October 6-9, Tokyo, Japan, and October 14-17, Melbourne, Australia.

Challenges of a computer presence is the theme of the Eighth World Computer Congress. Contact AFIPS, 815 North Lynn Street, Suite 800, Arlington, VA 22209.

INFO '80, October 6-9, New York City.

Returning to the New York Coliseum is the Information Management Exposition and Conference. Contact Clapp & Poliak, Inc., 245 Park Ave., New York, NY 10017, (212) 661-8410.

Fourth Annual Conference Seminar of the Data Processing Librarians and Documentation Managers Association, October 15-17, Boston.

The conference theme will be "Managing Computer Based Information," encompassing documentation, multimedia library, word processing, etc. Contact Robert Archibald, Commercial Union Assurance Companies, MIS-33, One Beacon St., Boston, MA. 02108.

DPMA's International Data Processing Conference and Business Exposition, October 26-29, Philadelphia.

The conference takes a close look at the dp and operational management user markets. Contact Conference Coordinator, 505 Busse Highway, Park Ridge, IL 60068, (312) 825-8124.

Canadian DP Education Conference, October 27-28, Toronto, Ontario.

"The DP Educator: A Professional" is the topic. Contact Jim Lowe, Shell Canada, Ltd., P.O. Box 400, Terminal "A," Toronto, Ontario, M5W 1E1, (416) 597-7025.

ACM 1980 Annual Conference, October 27-29, Nashville.

Dr. Alvin Weinberg will keynote this conference, speaking on "The Interaction Between Information and Energy Systems." More than 45 technical sessions will be featured, with the 11th ACM

North American Chess Championship and many other special sessions and exhibits. Contact Charles L. Bradshaw, ACM '80 Conference Chairman, Box 1980, Station B, Nashville, TN, 37235, (615) 322-2951.

National Small Computer Show, October 30-November 1, New York City.

The fourth annual show features thirty 50-minute lecture presentations, and numerous hardware and software displays. Contact Ralph Ianuzzi, 110 Charlotte Pl., Englewood Cliffs, NJ, (201) 569-8542.

NOVEMBER

Federal Office Automation Conference, November 4-6, Washington, D.C.

This annual conference debuts with a special Office Automation Institute on its first day (Nov. 4), and continues with various sessions and workshops to create a well-rounded program for both novices and seasoned veterans. Contact Federal Office Automation Conference, P.O. Box E, Wayland, MA 01778, (617) 358-5119.

CAM-I 9th Annual Meeting, November 11-13, Dallas.

Also called by its theme name, "Man and Computers: Partners in Manufacturing," the meeting will feature papers on the "Human Side of CAD/CAM," and "Application of CAD/CAM in the Electronics Industry." Contact Rhonda Gerganess, CAM-I, Inc., 611 Ryan Plaza Dr., Suite 1107, Arlington, TX 76011, (817) 265-5328.

Pacific '80 Conference on Distributed Processing, November 11-14, San Francisco.

Cosponsored by the ACM and its chapters of the Pacific region, the conference will hold tutorials on Nov. 11, with conference meetings on the 12th through the 14th. Contact Robin Williams, IBM, K55-282, 5600 Cottle Rd., San Jose, CA 95193.

Western Educational Computing Conference, November 20-21, San Diego.

Conference will feature the use of computing in education for instruction, administration, and research. Luncheon speeches will be given by Grace Hopper and Bernard Luscombe. Contact Ron Langley, Director, Computer Center, California State University, Long Beach, 1250 Bellflower Blvd., Long Beach, CA 90840, (213) 498-5459.

DECEMBER

Fourth International Online Information Meeting, December 9-11, London, England.

The conference will offer a varied program, addressing current problems and opportunities that arise when providing information to business, industry, government, and academic institutions. Contact Organising Secretary, Online Review, Learned Information, (Europe) Ltd., Besselsleigh Rd., Abingdon, Oxford OX13 6EF, England.

A whole world. Because our parent company, C. Itoh Co., Ltd. (pronounced "C. Eetoe") is a multinational organization with resources and subsidiaries located in every corner of the globe.

As C. Itoh Electronics, Inc., we're fortunate to be part of this international network. It lets us seek out quality materials and technologies wherever they can be found. And for a company that specializes in computer peripherals for the OEM, that's just as important as price or the capability to deliver.

Today, we're offering the latest designs in dot matrix and daisy wheel printers, card readers, CRT monitors, floppy disk drives, and a lot more.

We're also seeing to it that our OEM customers get all the support they need. The engineering support to solve their system integration problems. Plus complete documentation and a service network that oper-

ates repair and refurbishment stations nationwide.

So when you deal with us, you can be sure you're doing business with people who are dedicated to the OEM. And a company whose parent organization has been around since 1858.

Our goal? To become the best OEM peripheral source in the country. Because with all our international connections, we haven't forgotten what our motto promises: One world of quality.

For information on our product lines for the OEM computer systems manufacturer, contact C. Itoh Electronics, Inc., 5301 Beethoven St., Los Angeles, CA 90066, Tel. (213) 390-7778; Midwestern Regional

Office: 240 East Lake St., Suite 301-A, Addison, Illinois 60101, Tel. (312) 941-1310; Eastern Regional Office: 666 Third Avenue, New York, NY 10017; Tel. (212) 682-0420.

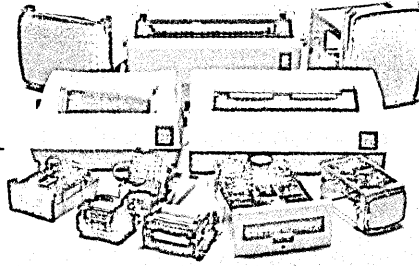

A world of quality.



 **C. Itoh Electronics, Inc.**
One world of quality

CIRCLE 15 ON READER CARD

TANDEM NonStop™ PATHWAY NOW ON-LINE'S AS EASY TO PROGRAM

On-Line Programming—25 to 50% cheaper. User developed on-line applications packages just got a whole lot easier. And better. Not to mention 25 to 50% cheaper. We've eliminated all the time-consuming grief of dealing with terminal handling characteristics for one. And not incidentally, there's even greater protection in data base integrity, too.

PATHWAY has all the programs, procedures and structures you need to get your applications up and running, in NonStop™ operation, in record time. Inexpensively.

Terminal Independent Applications. By taking the on-line programming task on in component parts rather than attacking it as an all-encompassing, monolithic whole, PATHWAY software makes the transaction processing system job relatively simple, and frees the application programmer from concern over terminal characteristics.

PATHWAY handles four of the critical operations in transaction processing applications as modular, inter-connectable elements: Terminal Interface handles multi-terminal I/O; Field Validation performs

data consistency checks; Data Mapping controls data conversion and formatting; and Transaction Control covers application and transaction flow. Each resource is partitioned, with well-defined interfaces between them. This is the secret to a modular systems' success. It allows optimized utilization of all the resources and permits additional resources to be dovetailed into the system as needed—without rewrite, without redesign and without degrading system performance.

We Speak Your Language. When it's time for the fifth operation—interaction with the data base—a Data Base Application Program can communicate in any of the languages available on the Tandem NonStop™ System: industry standard COBOL, FORTRAN, MUMPS, or our own transaction-oriented language, TAL, all facilitated by Tandem ENSCRIBE to interact with the Data Base management capabilities.

The Things You Can Forget. The PATHWAY Transaction Processing System capabilities include an Interactive Screen Builder which builds the screens interactively at a terminal, independent of the application

program which serves it; a Screen COBOL Pseudo Code Compiler; a Terminal Control

PATHWAY
FIELD
VALIDATION

Program to interpret the pseudo code library and

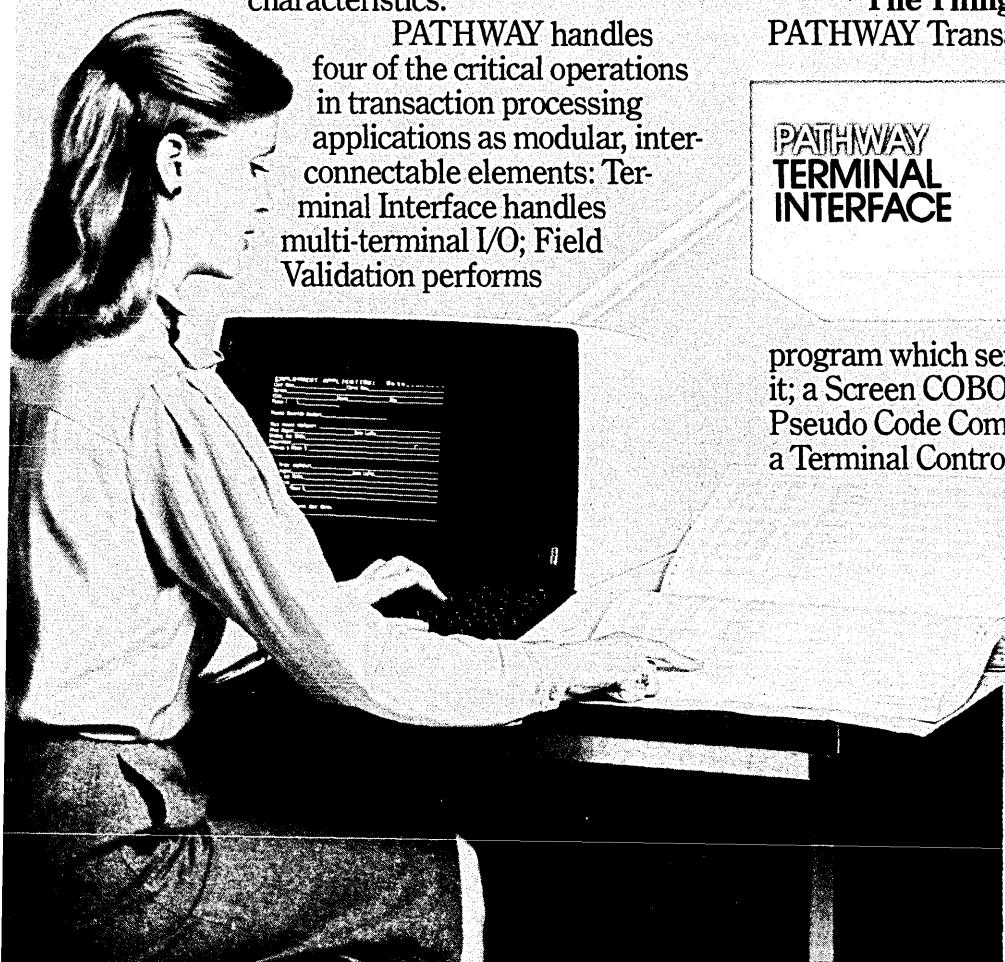

PATHWAY
TERMINAL
INTERFACE

AS BATCH.

check the flow and content internally; the Applications Monitor which has power to create, track and alter the application run time environment; and finally the Application Monitor Control Language which lets an operator communicate with an active Application Monitor. It's a powerful system, easy to use and inexpensive. With everything you need to get your on-line transaction applications up and running, with all the benefits of a NonStop™ System, in record time.

Dynamic Load Balancing. It comes from taking logical advantage of the multi-processor environment. There is no need for the programmer to consider load balancing with the PATHWAY Transaction Processing System. It's handled automatically; with additional copies of PATHWAY applications started in designated CPUs as needed. And deleted when no longer required. Dynamic load balancing—built into the system's resource management capabilities.

And PATHWAY software also takes full advantage of the unique multi-page storage capabilities built into our new 6520 terminal.

PATHWAY DATA MAPPING

Because terminal mapping translates physical into logical characteristics, programmers can forget about code signal conversions and call on terminals by name. And there's one more major advantage of the PATHWAY Transaction Processing System: one

PATHWAY TRANS- ACTION CONTROL

system can be used for convenient development, testing and production of application packages.

The Tandem NonStop™ System. Even when it wasn't this easy, it was miles ahead in the on-line world. With immediately available alternatives in all hardware and software elements, the NonStop™ System can go right around any failed element and never skip a beat. Even when a failure occurs in a processor, an I/O Channel, a disc, or a disc controller. Remarkable.

This is the one system in the world which lets you start with only the computing power you need right now and add as your needs grow, in low cost modular elements. From an entry level two processor system, you can go to sixteen processors with thousands of terminals and not lose one cent on your original investment.

Protection From Loss. Because of its unique parallel operation at all critical points, no transaction in process is ever lost or duplicated.

The data base and programs in operation can be readily duplicated, hence completely protected from damage or destruction.

RECORD IN RECORD OUT DATA BASE SERVICE

For Complete Information. Call or write for a demonstration of our unique capabilities, and for the name and address of your local Tandem sales and service representatives, domestic and international.



TANDEM

Worldwide Headquarters: Tandem Computers, Inc.,
19333 Vallco Parkway, Cupertino, California 95014
TOLL FREE 800-538-3107 or (408) 725-6000 in California.

CIRCLE 16 ON READER CARD

Introducing the Prime 250. The computer for anyone with big plans and a small budget.

If the kind of performance you're looking for in a computer doesn't relate to the kind of money you have in your budget, we have a solution.

It's called the Prime 250.

And for the first time, you can have mainframe capability for just \$59,500; not much more than you'd pay for a mere low-end minicomputer.

The 250 can support up to sixteen simultaneous users. It has 32-bit architecture, up to one million-byte main memory, and can run programs as large as 32 million bytes.

It supports industry-standard languages like FORTRAN, COBOL, RPG II, PL/I and BASIC. And it features a range of remote job entry software products, and PRIMENET™ networking software which allows the 250 to communicate with virtually any computer, no matter where it's located.

But perhaps the most meaningful feature of this remarkable computer is its total compatibility with other Prime 50 Series computers.

You see, the 250 is just one member of a very large, very versatile family that uses the same operating system, the same file system, and the same communication network. So as your plans get bigger and your hardware grows, your application software will still be applicable. And that's something you just won't get from any other computer company.

If you'd like to know more about the Prime 250, contact any Prime office, or write to our Advertising Dept., 3 Newton Executive Pk., Newton, MA 02162.

PRIME Computer

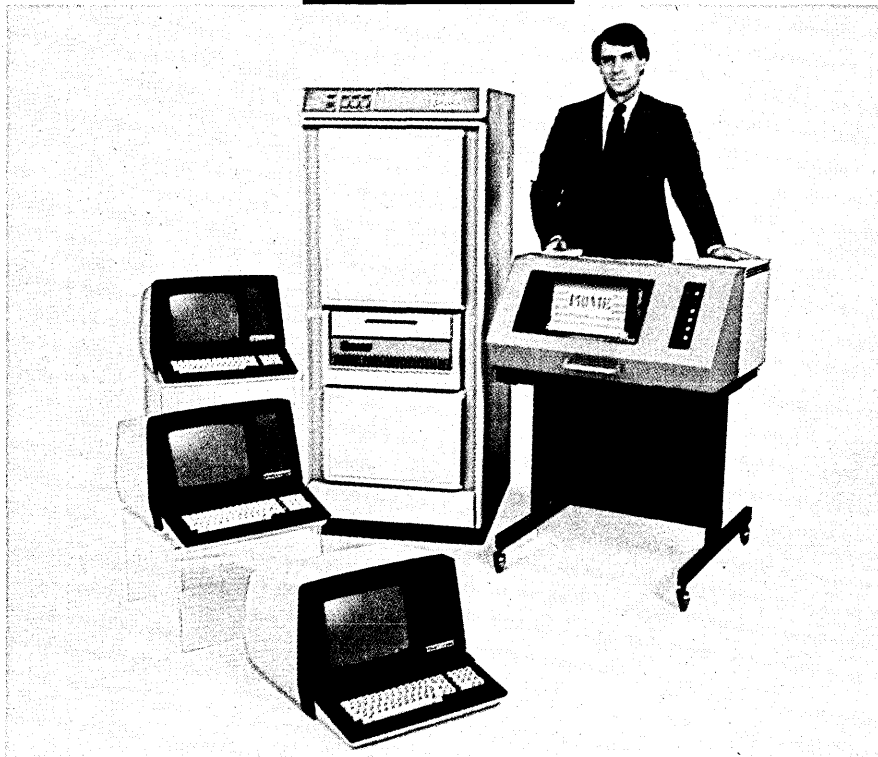

LETTERS

THEY SHALL NOT BE MOVED

Re: "Look Ahead" (June, p. 18), please accept these facts in order to relieve readers of the speculation contained in this piece.

ICL specifically and categorically denies that it has any intention of transferring its Utica manufacturing operation from the U.S. Operations continue and we expect will grow satisfactorily.

The new "group of execs" as you call them are senior managers around the world who have participated in the normal way in management information flows relative to such a group. This is normal for any major company operating worldwide.

ICL's commitment to the U.S. market is producing steady growth under planned conditions, and we expect that you will notice this more and more in the future.

ALAN A. BENJAMIN

Director, Corporate Communications
International Computer Limited
Putney Bridge, London

We stand by our story—ed.

AS THE WORLD TURNS

Re: "A Hospital's CARES" (June, p. 156), Mr. Spaziano states "... two 516s make available 48 hours a day batch processing time." Somehow I don't think the number of computers one has affects the rotation of the earth. There are still only 24 hours in a day.

NEAL FULLER

Management Consulting Services
Ernst & Whinney
Houston, Texas

ANOTHER ENTRY

Re: datacom manufacturers survey (June, p. 112), I was somewhat disappointed our company was not mentioned. Our 1979 revenues were almost \$2 million; 1980 will approach \$2.5 million; and our line of data communications test equipment includes line monitors, tape units, multifunction error rate testers, hard-copy diagnostic printer units, and a complete tech control series.

WILLIAM R. ADAMS

Chairman and Ceo
Epicom, Inc.
Altamonte Springs, Florida

FUNNY BUSINESS

Re: "Focus" (July, p. 37), several photographs depict some of the "goings on" at the recent National Computer Conference. I didn't attend; however, judging from the pictures presented it must have resembled a circus more than a business conference. Is this the way we do business today?

The photographs showed a Trojan warrior about to impale a smiling attendee with his sword. Next, two lovely ladies dressed more for cheerleading on a football field than any other activity I can think of, and a mime doing his thing, and, finally, a man dressed up for a country hoedown discussing a computer console with an interested party.

I have a question. What has all this to do with computers and the computing industry? The article said the conference was "A gathering place for the movers and shakers in this industry." After looking at the pictures, I am wondering what these people are trying to move and shake. Could any of this actually convince anyone to buy a computer—and if so, why?

WILLIAM A. DELANEY

President
Analysis & Computer Systems, Inc.
Bedford, Massachusetts

ORCHIDS

Re: "Letters" (June, p. 31), Mr. Huff makes two remarks that are so outrageously subjective that I am sure my reply will be only one of hundreds that will, a little less subjectively, refute them.

Firstly, DATAMATION is not declining in quality anymore than policemen are getting younger, stairs are getting steeper or the daughter's boyfriend is getting uglier.

Times are changing and DATAMATION is moving with them, within reason. In the light of a changing world, why should Mr. Huff expect anything to stay the same old way. For a less subjective opinion on whether the change is for better or worse, please consult the circulation figures.

Secondly, on the original point of his letter, please continue to include works of a satirical or even fictional nature. They should help remind a lot of readers that computers are part of a very real world and

are not a means for the self-serving ego trip that some computer "experts" appear to be on.

R. D. BARTON

European Advertising Manager
Tektronix
Amsterdam, The Netherlands

SURVEY CENSURE

Re: "Salary Survey" (April, p. 110), the Office of Personnel Management has received several Congressional inquiries concerning the federal salary figures for computer occupations. After reviewing the article, we have concerns with the federal salaries cited, with the survey methodology, and with the conclusion that federal salaries seem to be unjustifiably higher than those in the private sector.

The federal government sets pay rates on the basis of comparability with jobs in private industry through an annual review, the *National Survey of Professional, Administrative, and Clerical Pay* (PATC survey). Based on PATC results, in 3,000 to 4,000 firms, the Office of Personnel Management, the Office of Management and Budget, and the Labor Department (who, acting jointly, comprise the President's pay agent) formulate a recommendation to the President on the pay adjustment required to achieve comparability with the private sector. Since the survey provides actual private industry pay data on only 22 white-collar occupations, one of which is computer operator, rates for the more than 400 other federal occupations, including other computer jobs, are derived through a rather complicated and lengthy process. Although we don't currently compare federal/private sector rates for a range of computer jobs, we are embarking on a "long-range" effort to add more computer occupations to the PATC survey so that direct pay comparisons can be made.

The actual average federal salaries are significantly lower for some occupational categories than those published in your article. For example, a GS-4 "trainee" computer operator in the federal service has an average salary of \$11,106, not \$14,500. Also, "leads," typically at GS-6, 7, or 8 depending on the actual federal work situation, earn less than \$28,411; workers at

LETTERS

GS-8 have an average salary of \$17,564. We are unable to compare the salary figures for systems analysts, programmer analysts, and programmers because the federal computer specialist job group contains all of these specializations. The mean salary for all federal employees in this job series, however, is \$26,800, significantly lower than many of the salary figures cited in the article.

We appreciate that a comprehensive survey of a wide range of computer jobs is quite complicated. However, we feel that the survey approach and representation may contribute to the overall impression that federal salaries are too high.

It would also have been helpful if the survey had addressed differences in occupational difficulty and the level of responsibility for computer jobs in different environments. Data processing jobs vary tremendously by industry, purpose of the organization, and type of application, either scientific or commercial. Higher level jobs are typically the most variable and difficult to compare in a meaningful way without detailed information on the duties and responsibilities of each job. Comparisons by job title and short functional statements alone can result in tenuous conclusions.

For example, some jobs such as data processing managers or systems analysts may be very different in scientific, research, and other development settings than in business and commercial environments. The federal counterpart to data communications/telecommunications manager (job title 33) probably is in charge of a very expensive, complex, and large government operation in which the work is pushing the state of the art. Government data processing work frequently involves scientific applica-

tions, contrasted to business/commercial applications, and highly qualified, very experienced workers are very often required. Therefore, comparisons to banks and retail or other establishments, where the applications are typically simpler, should ideally reflect and discuss these differences.

JEROME D. JULIUS
Assistant Director for Pay Programs
U.S. Office of Personnel Management
Washington, D.C.

SURVEY SURVEYED

Re: The Top 100 (July, p. 87), we are mightily impressed with the survey on the industry leaders. However, we urgently request a completion of this in-depth effort with additional "ranking" of these same "leaders." For example:

- 1) Ranking as to *income per employee*.
- 2) Ranking as to *profitability*.
- 3) Ranking as to *computer*, only. (We note that some companies included sales of unlike goods, such as addressing equipment, or standalone embossers.)
- 4) Ranking *number of systems (cpus) sold*.

These are more significant figures for the dealer/distributor/user to use in a total picture of the computer market.

The real survivors in the marketplace will be the companies who can show great productivity. Total dollars earned are not really as important as are the dollars earned per each employee and versus costs.

Thank you for such a valiant effort.

MARJ NICKUM
Marketing
Total Business Equipment and
Systems Co.
Denver, Colorado

DP + WP = IP

Re: "Editor's Readout" (June, p. 37) and Amy Wohl's "Replacing the Pad and Pencil" (June, p. 169), I thought I might share an idea. It's not very novel, but nobody's mentioning it.

I suggest that the images of dp and wp have become stereotyped by IBM's definitions of a decade ago separating the terms for marketing convenience. A new term, "information processing" (IP), embodies both disciplines and might unlock some thought cabinets.

The micro is a key ingredient in IP. It's a user to the dp mainframe—a front-end to the executive crt, where the IPer screens and cues the exec, determines hardcopy or no (a word processor, of course) and capable of some very defined examination of the stacks of printout that now arrive on the exec desk—and finally, it readily interfaces with existing technology.

If IPer in a large organization form a "quality circle" in the Japanese management style, dp has the necessary user interaction to deliver what the organization needs—DBMS access or some helpful software on the micro. Too long have dp folks felt the exec was the user—with communications problems that are legend. A trained IPer becomes a valuable resource, now and for the future.

Considering the simplicity of the concept, IP is an answer that will work. For those who think secretaries are not smart enough, compare their salaries to entry-level programmers. For those who think micros are expensive, compare a loaded 16 bit machine with the better dedicated word processors. For those who doubt the Japanese management style, run a comparison in consumer products like cars or hi-fis (and read Peter Drucker). For those who wonder about software for micros, a visit to the neighborhood computer store will have you studying quality, not availability or price.

STEPHEN A. ANDERSON
Merrill MacNamee, Anderson
& Associates Inc.
Chicago, Illinois

DAP DELINEATED

Re: "ICL Hopes DAP Will Zap U.S." (May, p. 104), I would like to comment on certain statements regarding computer development projects at Goodyear Aerospace.

The term "DAP" is ICL's name for its specific parallel processing system. It is not a generic term, synonymous with all parallel computer architectures. Therefore, the statement that the STARAN program "failed to produce a DAP (or parallel processor)" is very misleading. Goodyear had been involved in the design and production of parallel computing architectures of many types for over 15 years. Our STARAN program to develop a production parallel computing system was quite successful. STARAN processors are currently installed and opera-

CARTOON BY TOM MASON

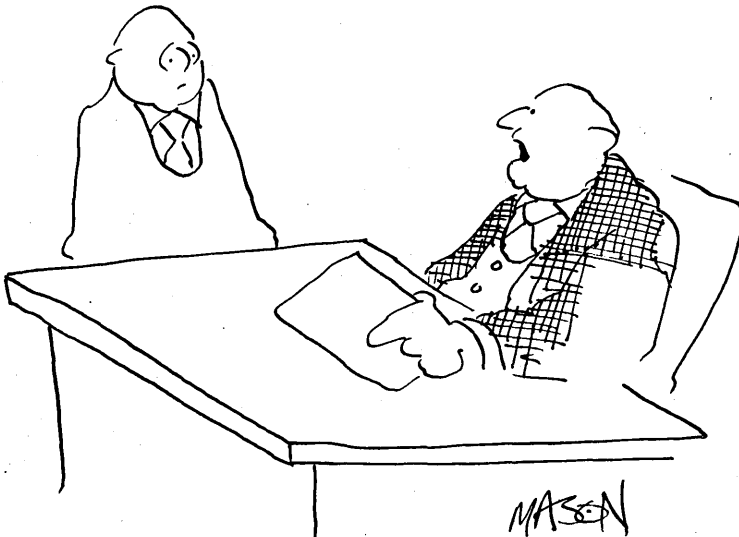

"Harris, I'm afraid you've missed the brass ring."

© DATAMATION

The future of word processing is in your hands.

At NBI, we've designed a system that can show you the future.

The future of word processing, information processing and communications.

It's the NBI System 3000, the word processing system designed to cope with what the future holds for offices everywhere —paperwork and declining productivity.

The NBI System 3000 is document oriented. So when you make one change the entire document automatically shifts to print out correctly as altered.

NBI also gives you the most totally

automatic outlining, indexing, footnoting, sorting and equation typing capabilities available. Capabilities that save hours of expensive human effort. Capabilities that no other system makes so easy.

The NBI System 3000 takes the common, tedious problems that slow office workers down and solves them, automatically.

Take the future in your own two hands.

Call NBI. 1695 38th St., Boulder, CO 80301, 800/525-0844. In Colorado, call 303/825-8403. **CIRCLE 18 ON READER CARD**

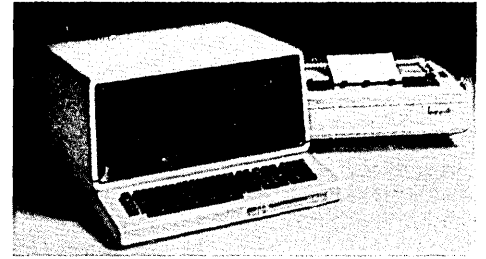

Lifting America from under the paper weight.



Now you can watch your four favorite programs...

The new HP 2626 display station will give you a view of your computer system you've never seen before.

It lets you divide the screen into as many as four separate "frames," each attached to a different workspace in the terminal's memory. You can check a program listing in one frame and access a file in another. Fill out a form in one workspace while the computer loads the next form into another. Or do text preparation and editing in adjacent frames. Right before your eyes.

That's not all. The HP 2626 has two data communications ports instead of the usual one, so you can use the split screen capability to talk to two computers at the same time. Or log onto the same computer twice for simultaneous batch and interactive jobs.

More than meets the eye.

A high resolution character cell and a glare-reducing screen coating give the HP 2626 the sharpest, clearest display of any of our terminals. And that's saying a lot.

What's more, you can set line lengths of up to 160 characters in any workspace. Then scroll horizontally to get the entire picture. (The built-in thermal printer includes a compressed mode to print up to 132 characters per line.) Scroll vertically, too, or change the size of the frame at the touch of a key.

An interactive forms drawing module makes it easy to design forms, including drawing

horizontal or vertical lines with just a single keystroke. You can even program the terminal for audio tones to cue your operator to critical or non-critical errors, or other conditions within a program.

Split decisions.

Hook up the HP 2626 to two computers (or the same one twice) and it's like getting a multi-tasking capability right in the terminal. Your systems designer can now compile, execute, monitor and edit programs as if two stations were available.

While your user is filling out a form, the terminal can be sending data from the previous form to a computer. And down-loading the next form into an adjacent workspace. By smoothing out the "type and wait" of data entry, you can take advantage of less expensive, low-speed transmis-

...same time,

sion lines without sacrificing the efficiency of your operator. The result? You'll get more out of the entire system.

If you'd like to watch a program on the new HP 2626 display station, or any of our terminals, just call your local HP sales office listed in the White Pages. You can also write for more information to Hewlett-Packard, Attn: Ed Hayes, Dept. 471, 19400 Homestead Road, Cupertino CA 94015. Or just return the coupon.

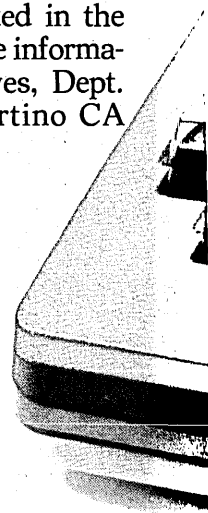

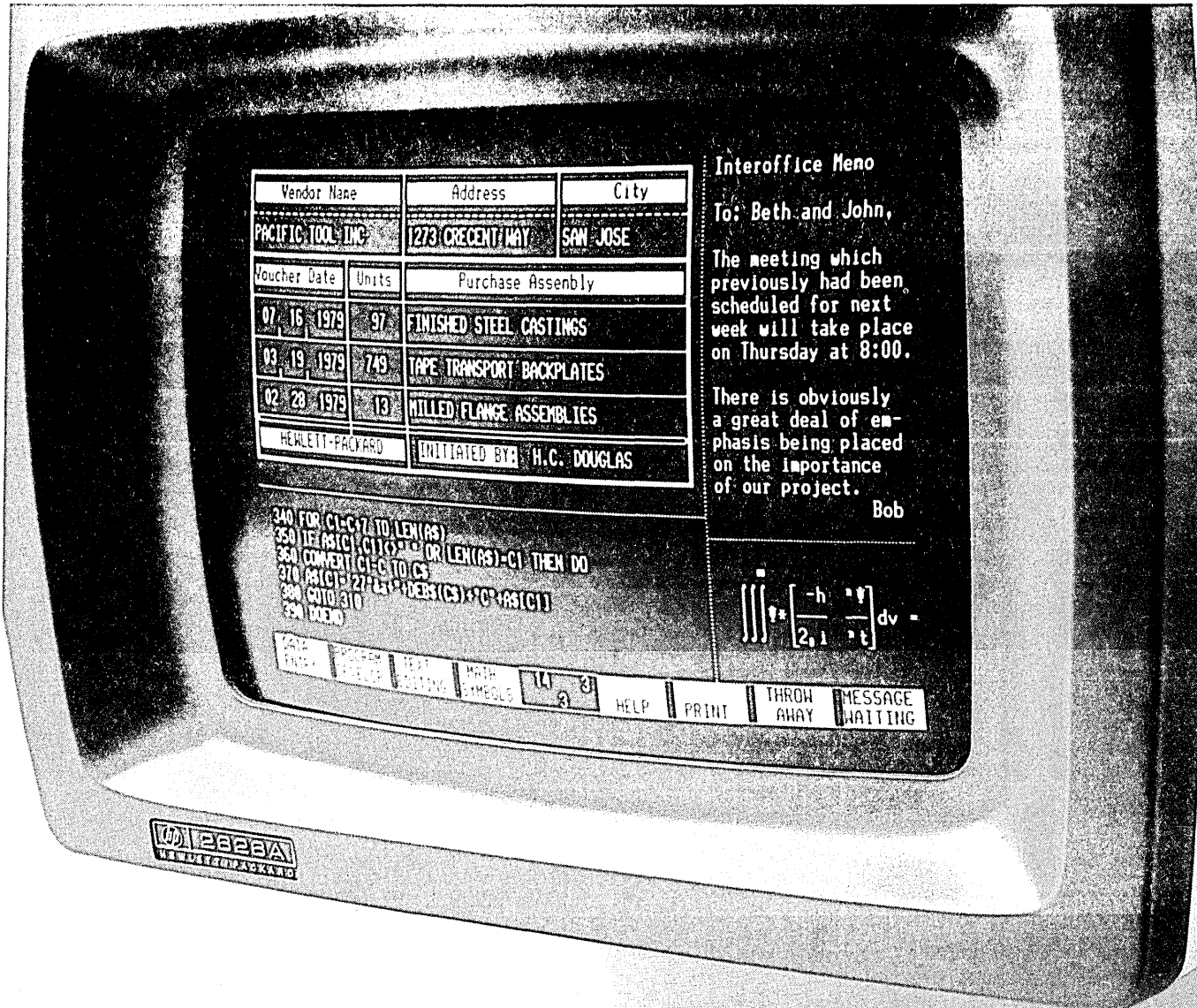

Vendor Name	Address	City
PACIFIC TOOL INC	1273 CRECENT WAY	SAN JOSE
Voucher Date	Units	Purchase Assembly
07 16 1979	97	FINISHED STEEL CASTINGS
03 19 1979	749	TAPE TRANSPORT BACKPLATES
02 28 1979	13	MILLED FLANGE ASSEMBLIES
HEWLETT-PACKARD		INITIATED BY H.C. DOUGLAS

Interoffice Memo
 To: Beth and John,
 The meeting which previously had been scheduled for next week will take place on Thursday at 8:00.
 There is obviously a great deal of emphasis being placed on the importance of our project.
 Bob

340 FOR C1-C17 TO LEN(AS)
 350 DELAST(C1) OR LEN(AS)-C1 THEN DO
 360 COMMENT C1 TO CS
 370 AS(C1) 27 45 45 45 45 45 45 45 45 45
 380 GOTO 310
 390 END

$$\int \int \int \frac{-h}{2,1} \frac{v}{t} dv$$

HELP
 PRINT
 THROW AWAY
 MESSAGE WAITING

HP 2626A
 HEWLETT-PACKARD

same station.

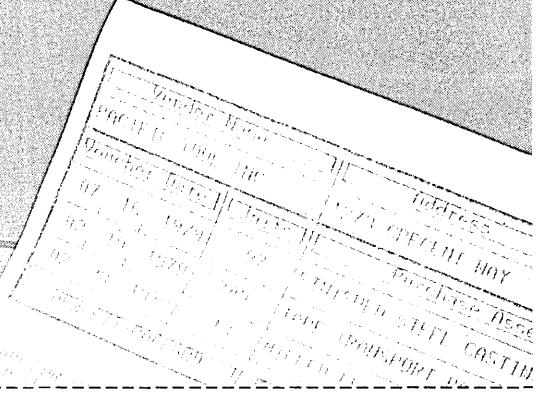
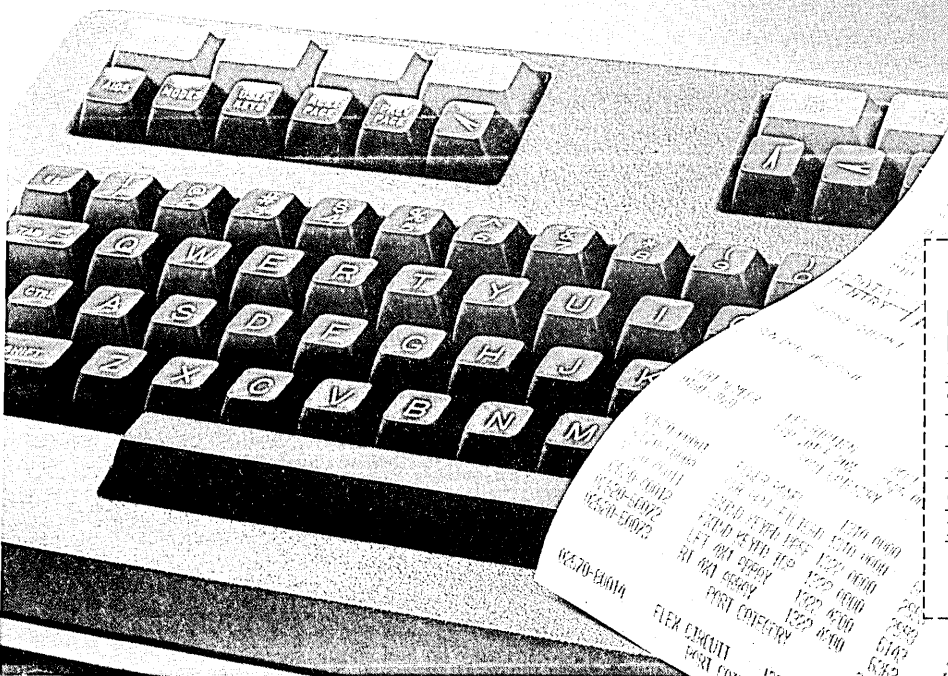

Yes! I'd like to find out more about the HP 2626 display station. Please send me your brochure.

I'd like more information on HP's family of data terminals.
 Please have a representative call me.

Name _____
 Title _____
 Company _____
 Address _____
 City/State/Zip _____
 Phone _____

Mail to: Hewlett-Packard, Attn: Ed Hayes,
 Dept. 471, 19400 Homestead Rd., Cupertino, CA 94015.

CIRCLE 19 ON READER CARD

LETTERS

tional at five locations throughout the U.S. Furthermore, as a direct outgrowth of our STARAN program, Goodyear had recently been awarded a multimillion dollar contract from Grumman to develop a miniaturized, mil-qualified version of the STARAN architecture for use in the U.S. Navy/Grumman E-2C and Control aircraft.

The statement that Goodyear was "chosen to develop a DAP for NASA/Goddard Space Flight Center" is equally misleading. We are currently under contract to NASA/Goddard to develop the Massive Parallel Processor (MPP), a different parallel processing architecture than the DAP. Goodyear won the competitive MPP program by proposing a system based on a NASA-developed design approach but employing a GAC-proprietary processing element.

The implication that Goodyear's latest designs are based on ICL's DAP is not true. Both the airborne processor and the MPP are based on our earlier STARAN systems. Finally, there is no basis for the statement that ICL's DAP is the "world's first processor to be based on a matrix of distributed microprocessors, or processing elements, clustered together in what is known as an 'array.'" Besides Goodyear's STARAN (demonstrated in 1972), there are a number of other systems which predate the

ICL DAP. The SOLOMON computer described at the 1962 FICC by Slotnick et al is an example of one such system.

SHERWIN RUBEN
Manager, Digital Systems Marketing
Goodyear Aerospace Corporation
Akron, Ohio

PROGRAMMING PERSONALS

Re: "A Modern Aladdin's Lamp" (March, p. 272), Dorothy A. Walsh seems to be saying that trivial programming isn't what programming is all about. Fine, but there is a lot of software running on "personals" that is sufficiently untrivial to have required the professional programming techniques she espouses: abstraction, analysis, synthesis, organization, formal testing, etc. On the other hand, there is a lot of software running on mainframes that's trivial.

As for which machines are best to use for learning how to program, a dedicated TRS-80 is far from superior to a dumb terminal hooked up to a mainframe (unless coping with unnecessarily complex operating systems and waiting in line for cpu time are considered part of professional programming). The dedicated personal gives the novice the chance to explore machine operation at the bit level . . . a hard opportunity to come by with a mainframe, and an

experience invaluable to the professional programmer who needs to be aware of potential inefficiencies posed by humanized machine-human interfaces. . . .

A bunch of programming novices presuming to be capable of making important dp management decisions . . . can hardly be as dangerous as the dp decision-makers who have never programmed at all (and there are still plenty of them around). Even with trivial programming, it doesn't take the beginner long to experience the frustrations resulting from disorganized, hasty software development, and this person is quickly taught the value of the time and effort spent up front before charging into coding and testing.

As to the Piper-jumbo analogy, if the Piper is instrumented for all-weather flying, and the private pilot becomes proficient at flying under instrument flight rules, he ought to be able to make the transition to jumbo flying quite well.

RICHARD C. VANDERBURGH
Dayton, Ohio

CORRECTION

In the "DATAMATION 100" ranking (July, p. 99), the number of Sperry Rand employees should have been listed as 47,000, not 90,000. *

COMPUTERS—TERMINALS—MODEMS!

NEW!
From Perkin-Elmer
1250 Super Owl

\$1799

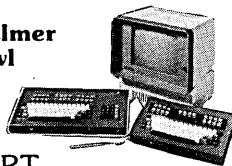

Intelligent CRT
Incredibly powerful and flexible

- 24 fully programmable function keys
- Full screen editing capabilities
- RAM memory for down line loading by host computer
- Built-in printer port
- Full polling capabilities
- Detachable keyboard
- Optional light pen
- Much more!

Perkin-Elmer Bantam 550 CRT



\$749

- Transparent mode
- Addressable cursor
- Editing functions
- Upper/lower case
- Compact

**Perkin-Elmer 650/655
CRT Page Printer**

- 100 CPS
- Quiet
- Compact
- RS232
- Can be added to any CRT with our interface option.

\$999



The printer designed to give you rapid, reliable, hard copy of your CRT screen display.

Penril 300/1200 Modem

- 1200 Baud—Bell 212A
- 300 Baud
- Originate/Auto answer
- Full duplex
- RS232
- 1 year warranty

\$799



Direct connection to the phone lines via RJ11C standard extension phone jack

Connect any computer or terminal to the phone lines.

The Phone-Link Acoustic Modem

NEW! \$179



- Sleek, low profile
- 0:300 Baud
- Originate/Answer modes
- Half/Full duplex
- Self test

- RS232—Will work with any RS232 computer or terminal
- LED displays of all functions
- 1 year warranty
- At your computer store now!

Microterm Mime IIA CRT \$819
Microterm ACT VA \$779
USR-330 Originate/Auto-Answer Modem . \$339

Write or call for information on our business and scientific computer systems.

**Teletype
Model 43 KSR
\$1049**



- 110 or 300 Baud
- RS232C/ASCII
- Pin feed/8½"H x 11"W paper is perfect for filing and copying

- 132 columns
- Upper/lower/case, true descenders
- Dot matrix impact printing

DEC LA34

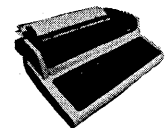

- Teletype 43 plug compatible
- Variable character sizes
- Full width paper
- Many more features
- Write for print sample

\$995



U.S. ROBOTICS INC.
203 N. WABASH SUITE 1718 CHICAGO, ILL. 60601

CIRCLE 20 ON READER CARD

We offer full service, on-site maintenance plans on all equipment. Any product may be returned within 10 days for a full refund.

SALES
GENERAL OFFICES
SERVICE

(312) 346-5650
(312) 346-5651
(312) 733-0497

Avery invents the label.

Again.

Avery announces self-adhesive labels now available for the IBM 3800 printing subsystem. A major breakthrough in label technology!

Avery invented the self-adhesive label in 1935. The data processing label in 1954.

Always first with the solution to your label problem. Again and Again.

Our commitment to innovation, problem solving and superior performance has made Avery the world's largest label producer.

For the distributor in your area contact:
Avery Label, Business Systems Division,
P.O. Box R, Azusa, CA 91702. (213) 357-7031



Avery Label

An Avery International Company

**There can only be
one leader.**

CIRCLE 21 ON READER CARD

38 **delivers**

**The productivity advances of IBM's
new System/38 are being
confirmed in early installations.**

IBM has started delivering System/38's to customers.

And customers have started delivering comments like these to IBM.

"I created a special equipment report in 15 minutes flat. Before, it would have taken a day and a half of programming,"—Chuck Petter, Data Processing Manager, Road Machinery and Supplies Company, Minneapolis.

"We've developed an online order entry system with one-third the effort... and the application is much more polished. We're very pleased."—Larry Brenner, Director, Corporate Information Services, United Merchants and Manufacturers, New York City.

"The System/38 significantly reduced the amount of code necessary to write a program and the time and effort required to move into new applications. We're extremely enthusiastic."—Larry Petterson, Director of Data Processing, St. Olaf College, Northfield, Minnesota.

And we're enthusiastic, too.

Because the IBM General Systems Division's versatile new System/38 is a compact system with

many large computer features. Such as distributed online work stations so users don't have to go to the computer; a central data base that makes information easier to retrieve, revise and use; the Control Program Facility, which automatically monitors and manages the flow and processing of data; online program testing, so programs can now be debugged as normal processing continues.

And System/38 has advanced features rarely found in any computer, large or small. Like Single Level Storage, which treats all storage as a single unit and automatically keeps track of it.

And thanks to System/38's streamlined architecture, many functions that previously required programmers' time have been absorbed into the system itself.

The result of these IBM innovations? A computer that lets you do much more, much more simply.

We're pleased that System/38 is already helping business function with greater cost-efficiency, productivity and profitability.

In short, System/38 delivers. And it can deliver for you.

For more information call your IBM General Systems Division representative or write us at P.O. Box 2068, Atlanta, GA 30301.



IBM
General Systems Division

CIRCLE 22 ON READER CARD

Data/Switch builds peripheral switches for today's IBM computer systems

*** (Even with IBM's newly announced 3814)**

Only Data/Switch System 1000 has all these features ... Today!

- Matrix sizes to 16 x 24 (one system incorporates the function of several 3814's)
- State-of-the-art semi-conductor switching
- Nanosecond switch speeds
- Inter-active remote controls (up to 400')
- Continuous configuration display
- Redundant controls
- On-the-fly/"immediate" switching
- Channel data display
- Self diagnostics
- Data streaming support
- Redundant power
- 90-day availability
- Price/performance

System 1000 is operating today in computer rooms around the world in automotive, aerospace, transportation, banking and government facilities. Write us for more information and a reference list, and find out about the company we keep.

CIRCLE 23 ON READER CARD

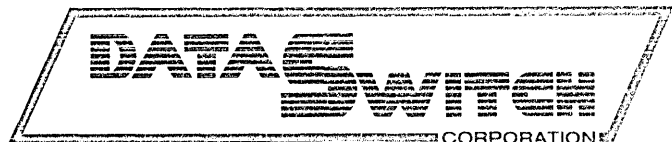

Corporate Headquarters: Landmark Square, Norwalk, CT 06851 (203) 853-3330 • TWX 710-468-3210
• Regional Offices: Western (714) 781-7780 • Mid-West (312) 986-1997 • Eastern (203) 853-3330
• England: PCML, Ltd., Cobham (09326) 7111 Telex 269415

EDITOR'S READOUT

STING LIKE A BEE

It's never easy being second best, especially when you're accustomed to being first.

There's a certain poignancy, a sense of irretrievable loss—it's the spectacle of the aging boxer, the butterfly that has lost its float, the bee that has lost its sting.

In individuals it's a function of time, the inevitable wearing away of the mechanism, the slackening of the sinews, the feeling that compels an author like Annie Dillard in *Pilgrim at Tinker's Creek* to write "I am a frayed and nibbled survivor in a fallen world, and I am getting along."

And like people, stars, butterflies, mountains, and nations all have their life cycles, each one moving past its prime and inexorably fading.

But there's something tricky about this business of doing a slow fade. It's the ability to distinguish between the start of that downhill slide and a serious but transitory dip in the organism's cycle, one that can be corrected by a resurgence of will.

We have to ask these questions about our nation: are we becoming a second-rate country, are we moving into an inevitable decline after only 200 years of vigorous life, are our shortcomings both at home and abroad a clear sign of fatal fraying? Or are we suffering a serious but temporary setback? Will happy days be here again?

We know that our economic position in the world has eroded. We've watched the television industry being swept from under us and all the finger-pointing about our shortsightedness or Japan's "unscrupulous" tactics in the worldwide marketplace won't bring that back in a hurry. Detroit is a disaster area. Our antiquated steel mills can no longer compete and shipbuilding has long since sailed over the horizon. Not a very bright picture.

And what of the computer industry?

Even a cursory glance at the pages of this magazine, the business or general



press, reveals overseas competitive activity at a fever pitch. Japan, Inc., is moving strongly to develop very large scale integration, and its mainframers are finally beginning to make their moves into the U.S. The French software industry is in high gear; they are looking at our enormous market with greedy Gallic eyes. And the efficient Germans, like everyone else, are actively seeking to capitalize on the huge potential of the small business and office automation markets.

But, say some, the U.S.'s ability to pull through in a crunch, coupled with our technological ingeniousness, will see us through. The same spirit that engendered the cotton gin is giving us the microprocessor and the Winchester disk drive. The demon of labor intensivity will force us to produce the technology that will bring us back to the top of the heap.

Yes, but. And it's a big but. We can develop the jazziest technology in the world, but unless we can market our products *worldwide* on a competitive basis with those feisty foreigners, we might as well pull up the rocking chair and spend the rest of our downhill days watching the light fade. It is time for our U.S. industry and our government to begin working together and

to get tough in the international marketplace. After all, it is a worldwide market; restricting cash flow through economic isolationism is sheer suicide.

Almost every other nation's government in the world helps its indigenous industries through financial backing, protective tariffs, two-tier pricing, and vigorous participation in the rough and tumble of international trade negotiations.

Our government, on the other hand, seems intent on hindering rather than helping our corporations in their quest for overseas markets. That hindrance ranges from the overt, through absurd antitrust laws preventing cooperative ventures, to a not-so-benign neglect that finds us acquiescing to the chauvinistic procurement policies of our chief competitors.

We don't think this country is second-rate nor is it ready for an early retirement. We'll probably make our comeback in spite of our government's mindless bureaucratic roadblocks and ineptness. But it sure as hell would speed up the process if the government would do a little floating and a little stinging on behalf of U.S. business in the international arena. It's a rough world out there and we need all the help we can get. *

IF FAST CHANGING ARE SLOWING YOUR YOU REALLY NEED

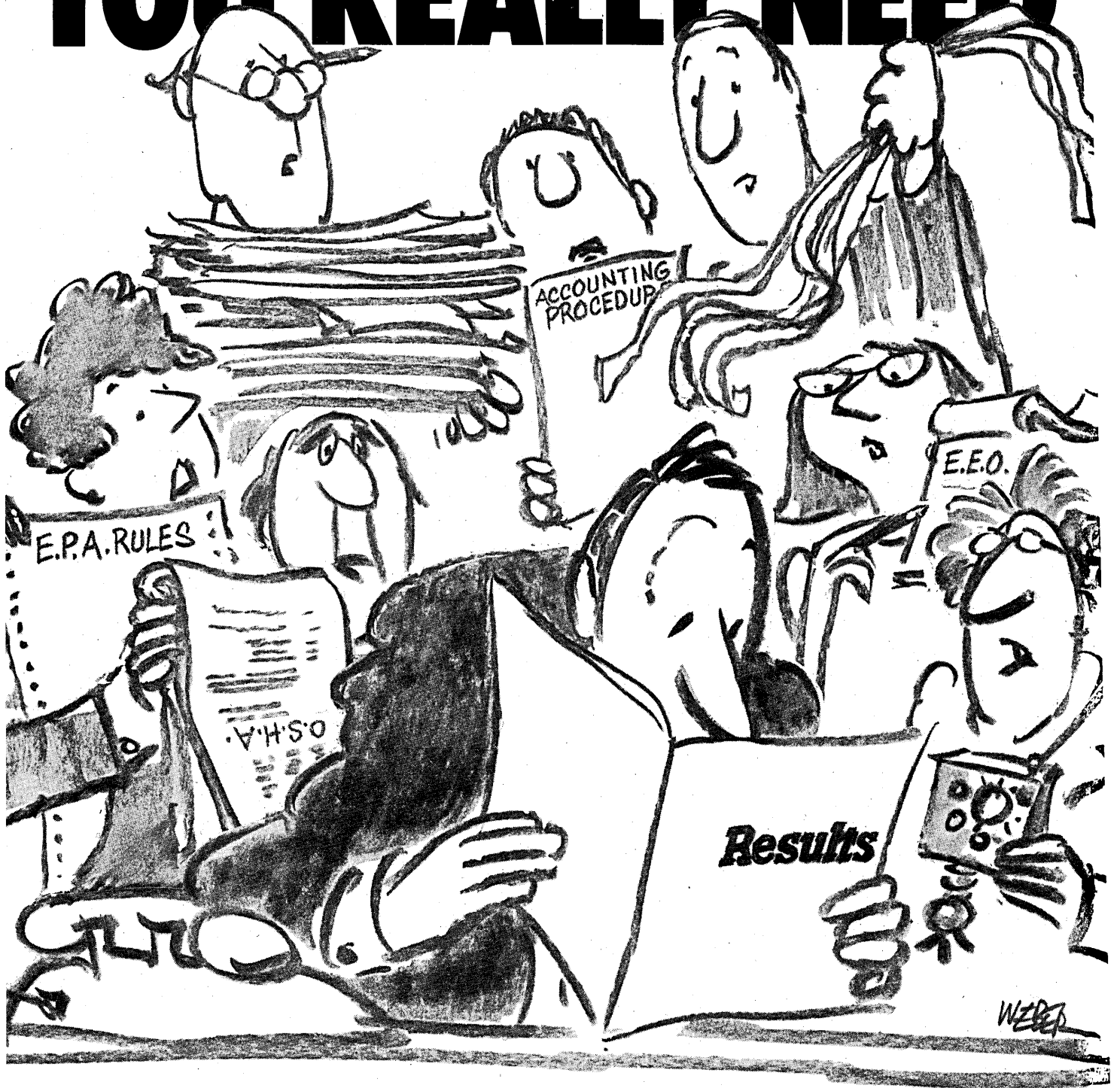

FACTS PRODUCTIVITY, RESULTS.

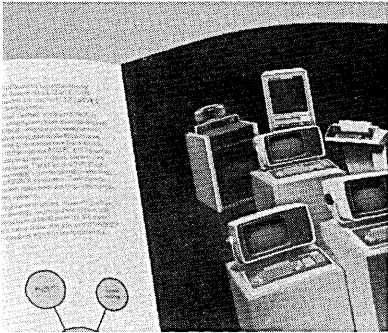

**THE NEXT STEP IN DATA BASE
MANAGEMENT IS HERE.**

And to help you get them, Data General announces DG/DBMS, a brand new, results-oriented database management system for ECLIPSE® distributed data processing systems.

DG/DBMS is a sophisticated CODASYL-based DBMS. And it's described in detail in a booklet every productivity-minded data processing manager ought to read. The title? Appropriately enough, it's called "Results."

We designed DG/DBMS to let you change as fast as the facts change. Company expansion and diversification plans, plus frequent changes in accounting regulations, EEO rules, EPA laws, privacy laws, all dictate the need to respond fast when changes occur.

Our DBMS begins saving you time and money right in the computer room. DG/DBMS is designed for ease-of-use so programmers can be more productive. One user, in fact, reported productivity gains of twenty-five percent. Beyond the computer room, our DG/DBMS interactive query facility provides fast data inquiry and report generation in user departments. That's why our DBMS is more cost-effective, reliable, and more manageable than any other. Put it together with our new XODIAC™ Network Management System, our new AZ-TEXT™ word processing, our RCX70 emulation software, and all our other fully compatible AOS-based ECLIPSE software tools and processors, and sophisticated languages. You'll have all the data processing power and growth you'll need to take care of business through the 1980's and beyond.

Find out about our new DG/DBMS and ECLIPSE Data Systems. Send for our brochure: RESULTS.

Data General Corporation, Westboro,
MA 01580 (617) 366-8911
ECLIPSE is a registered trademark
and XODIAC and AZ-TEXT are
trademarks of Data General.
©Data General
Corporation, 1980

CIRCLE 24 ON READER CARD

Data General

Mail to: Data General Corporation, Westboro, MA 01580
 I want Results. Get that booklet in the mail now!
 I demand Results. Get a sales rep in here ASAP!

Name _____
Title _____
Company _____
Address _____
City _____ State _____ Zip _____

Tel. _____

D980

TOFFLER TALKS OF TOMORROW

This is a story about Alvin Toffler and the future. Both are complex subjects.

On a sweltering July afternoon, a black van pulls up to a reclamation project on the lower West Side of Manhattan. Among the people who pile out is one who stands taller than the rest against the backdrop of New York's World Trade Towers.

"I must say, this is a new experience for me."

This formidable figure and an entourage of photographers, artists, and editors traipse across the hot sand to desolate looking dunes, an unlikely sight within the bustling city. As the camera starts clicking away, our subject says with an easy smile, "When this photo is published, please tell [my wife] Heidi that I was indeed in New York and not the Sahara."

Alvin Toffler thrives on new experiences. The sultry trip to the landfill may not go on record as one of his more memorable excursions, but still you could almost see his mental camera at work juxtaposing images of wasteland and metropolis.

"I don't believe in technological determinism."

I first met Alvin Toffler in another magnificent city. We talked in June in his hotel suite high above the sights of San Francisco. The author of *Future Shock* talked at length about his latest best-seller, *The Third Wave*. And he talked of much, much more.

"Despite the fact that I'm usually regarded as a techno-freak, I don't believe that the system is driven by technology; I don't believe in technological determinism. We have the power to shape technology, and technology affords the potential for different societies to develop in quite different ways. But ecology, population, culture, and other forces have just as much impact on the directions of change as the technology itself; they are all part of an interleaved system. Yet there is very little effort to synthesize, to look at the interactions of all these changes simultaneously. That's basically what I try to do."

It is this synthesis—and one on a grand scale indeed—that Toffler tackles in *The Third Wave*. First, the futurist takes us back briefly through past eras in human history. Toffler identifies First

Wave civilization as the agricultural era, a period that began almost 10,000 years ago. Then, sometime between 1650 and 1750 a new civilization began to take hold; the Industrial Revolution swept in as Second Wave civilization. Its reign was much shorter, of course, lasting no more than 300 years.

Today, we are already well into what Toffler terms the Third Wave, a strange and complex new civilization that

"Chrysler is a beautiful case in point of the collapse of Second Wave industry."

emerged about 1955. That was the year, he points out, when blue collar workers were for the first time outnumbered by white collar and service workers. "This was the same decade," he says in his book, "that saw the widespread introduction of the computer, commercial jet travel, the birth control pill, and many other high-impact innovations."

And if you think for a minute that those innovations were unrelated, you need only read his book to find the synergies. For Toffler looks at changes in politics, economies, family structures, cultures, and life itself—and discusses them in what he calls a "wholistic" (as opposed to "halfistic") fashion to determine just where this new tidal wave is taking us.

The follow-up to *Future Shock* indeed holds a few shockers of its own. In *The Third Wave* Toffler talks of a new do-it-yourself movement; of new and advanced manufacturing methods that will spell the demise of factory automation lines; of the blurring distinction between producers and consumers, leading to a new breed of "prosumers"; of the movement of audio, video, computing and communications gear into the home, where more and more employees will remain in these "electronic cottages" to do their day's work; of the disintegration of the nation state as we now know it; of a major face-lift for corporations of the future; of a shift from a world of synchronization, centralization, and mass production to one of individualism and "de-massification."

The changes are devastating, and Toffler eyes them with utter optimism. While he sees signs of a better world in

the long run, he admits that the next few years of transition may be tough, particularly as people try to hold onto patterns of the past.

"Chrysler is a beautiful case in point of the collapse of Second Wave industry," Toffler contends. "There's a classic case where jobs of hundreds of thousands of workers are threatened because of the stupidity and arrogance of their managers over the past couple of decades. The response when a badly managed industry like that gets in trouble is to ask Uncle Sam to bail them out. That's socialism for the rich in the name of preserving jobs for the poor."

"We want a compassionate social policy, we don't want the brunt of change to be unfairly borne, and we don't want ordinary American working people to suffer the impact of this transition. But none of that's possible if we try to hold on to yesterday's industries."

How would Toffler tackle the situation? "I would have said, 'Yes, we will help Chrysler, but make that help contingent upon a transition out of the auto industry.' They could take their technological resources, their human resources, their skills and plan for a conversion to some socially desirable and intelligent forms of production. Instead, we say, 'O.K., here's a loan guarantee;

"I believe in convergences. Novel juxtapositions are the crux of creativity."

go ahead and make cars forever.'"

He smiles, knowing that his next comment will strike a responsive chord in me. "And some major companies in the computer business should take a careful look at Chrysler. Without transition planning, heads will roll there too."

Toffler says the world's movement away from centralization is as true in computing as it is elsewhere. Fewer and fewer big number-crunchers will be bought, and those that are will be for more and more specific applications. What's really exciting now, he says, is the home computer business—"a key piece of computing that's falling into place." But more important than mere computing, he adds, is the combination of computing, voice, video, telecommunications, etc. "I believe in conver-

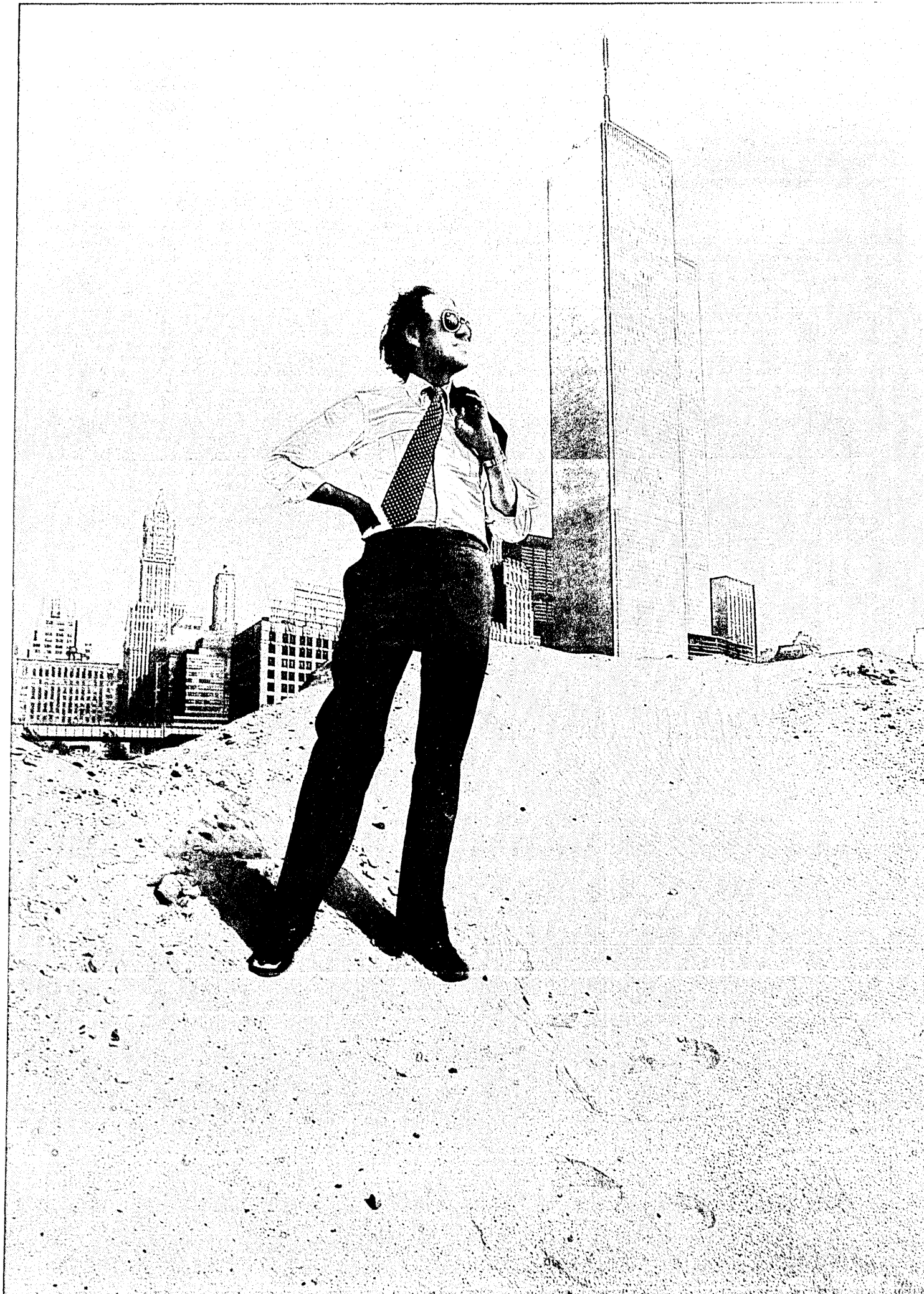

FOCUS

gences. Novel juxtapositions are the crux of creativity, and that's where the breakthroughs are."

Because the computer played a major role in bringing about this revolution, Toffler thinks that industry should also take on much of the responsibility for easing the transition to the Third Wave. "Perhaps the computer industry, the electronics industry, the information

"I would also like to see more black and brown and female faces when I go to meetings [in this industry]."

industry in general should begin lobbying for the electronic cottage," he suggests, "with a goal for a shift of 20% of American jobs into the home by 1990.

"Now that's a technologically based change that clearly has implications far beyond technology; it involves energy savings, changes in family life, a restructuring of the suburbs, and a whole lot of other things. And it seems not unreasona-

ble to me to ask the computer industry to put up some dough to study the impact of work at home. The only group I know of that currently collects information on work at home is the IRS—and that's clearly for different purposes."

There are other areas the industry needs to study, such as employment. Will computers cause job displacement? "And in a data drenched society, what do we do with the computer illiterate?" Toffler asks. "We desperately need a breakthrough in natural languages so the common man can communicate with computers. The industry needs to worry about these problems and not shrug them off."

Then, too, Toffler points to considerations about "the rest of the world" and such concerns as data protectionism and data barriers. "The global neural network is spreading. There's a gap between rich and poor nations, and not just an economic and cultural gap, but a computer gap as well.

"So far, computers have been for the rich. The computer shouldn't loom

over the world as the rich man's toy and tool."

Realizing he's beginning to launch a tirade on the trade, Toffler settles back and sums up. "O.K., here's my editorial: the computer industry is going to face continued resistance and even terrorist attacks, as is true in Europe, as long as the computer is seen as cold, metallic, and the servant—the tool—of the rich and powerful. And the smartest thing this industry could do to reduce social resistance to the spread of the computer is one, to warm it up and make it more friendly, and two, to squarely face these social questions of work at home, unemployment, etc. Whatever positions the industry takes, it should take some positions, and not just make believe the problems will go away."

Then, just as he was about to go on to other topics, Toffler couldn't resist adding one more gripe to a growing list. "I would also like to see more black and brown and female faces when I go to meetings [in this industry]."

Toffler occasionally speaks at IBM meetings, and he says he's always amazed that the audience is still 99% male—"a sea of white shirts and white faces." He tells of a discussion he once had with an organizer of an IBM meeting.

"Now there is a big discussion of what's being called 'reindustrialization'—a most unfortunate term."

After surveying the audience and finding it to be all male, he asked the program organizer why the company hadn't invited the wives, at least to attend the talk. He found the answer amusing: "Well, you don't understand the troubles we have. Do we invite just wives? Do we invite spouses? Do we invite friends, and what if the friends are of the same sex? So we made the decision to invite only employees."

"The easy way out," Toffler chides. And another hanger-on to Second Wave ideas.

The information industry is hardly the only group to come under fire from this social critic. Every major American institution gets its fair share. And the U.S. government is certainly no exception.

"A major problem in the United States is that it has historically been anti-thetic to anything that smacks of planning. Our government is not as sophisticated about certain social and political problems as Japan, Germany, France, and other Western countries. There, they talk about plans for a transition to the information society; they are conscious of it. Whether their strategy is right or wrong, at least it is a strategy."

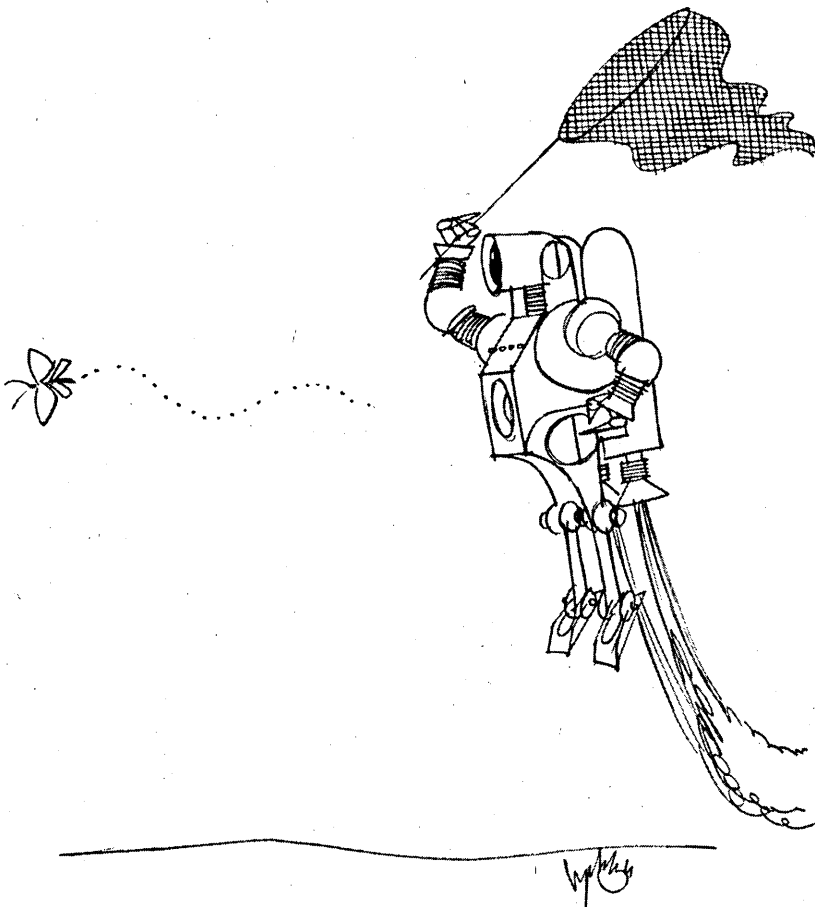

© DATAMATION

CARTOON BY W. HARBAUGH

Why Datacorp's COM Service is more dependable than any other source.

Even your own.

Experience.

At Datacorp, we've been producing Computer Output Microfilm for more than ten years. Today, we're the world's largest COM Service organization. Over the years we've helped thousands of companies make the paper-to-COM transition with our convenient, cost-effective, dependable service.

Last year alone we produced 12.6 billion pages of COM for more than 2,000 Datacorp customers. Customers that range from some of the largest Fortune 500 companies, to medium and small companies in all fields.

Our experience has taught us a lot about producing COM, and about providing the on-time delivery companies like yours demand.

Track Record.

We've established a near-perfect record for meeting our delivery commitments. A record of dependable, on-time delivery that's better than other service organizations, and even better than many in-house COM operations.

How? First, our large volume allows us to use the most advanced, most reliable production equipment available. Second, the Datacorp people who operate our centers possess more experience and expertise than any group of COM specialists

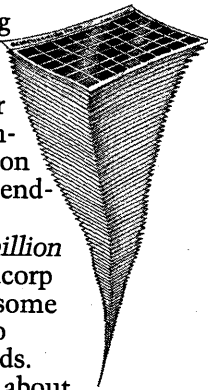

anywhere. Expertise that can only come from producing nearly 35 million frames of COM every day.

Systems, Equipment, Supplies and more.

Datacorp is the only single source for all your COM needs. Besides service, we offer the full range of major brand COM Equipment and Supplies, from viewers to film and chemistry. And, we're the only service company that offers U-COM — a convenient turn-key path to your own in-house COM center.

Local Service Across the U.S.

We reduce the distance your data must travel with full service and production capability in each of our 40 centers. This enables us to provide faster turnaround and the responsive, dependable service you demand.

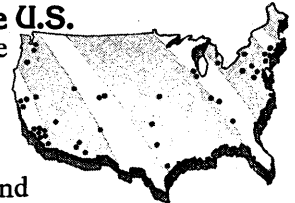

To learn more about Datacorp COM Service, in-house COM systems, or COM equipment and supplies, give us a call. The Datacorp Service center in your area is in the yellow pages under Microfilm. Or, for a listing of all Datacorp locations and complete information on your most dependable COM source, use the reader service card or write:

DATACORP

A DSI Corp Subsidiary

5075 S.W. Griffith Drive, P.O. Box 2000,
Beaverton, Oregon 97075, (503) 641-7400

CIRCLE 25 ON READER CARD

FOCUS

Toffler says that until very recently he knew of no one in Washington who was even thinking about a transition strategy. "But now there is a big discussion of what's being called

"I'd rather go through life as a writer than as a tourist."

'reindustrialization'—a most unfortunate term. Reindustrialization implies going back rather than breaking ground. Now that may be a comfortable way to deal with things, but in many ways it's

wrongheaded and deceptive.

"I think there is the beginning of a consciousness in Washington. But as yet there is no coherent overall understanding that what's involved is more than technology, more than competing with Japan or Germany, more than jobs or international competition. We tend to frame things in a very conventional and 'non-wholistic' fashion. And it won't get us very far that way."

But how does a product of Second Wave society talk in Third Wave terms, I ask Toffler. His answer comes quickly.



Emerson ends the computer power struggle

Introducing Emerson's 50 KVA 60 Hz

Answer For Computer Power Supplying clean, trouble-free power to your computer operations can be a struggle. The problems associated with 60 Hz utility supplied power are legendary. Not only are blackouts and brownouts commonplace, but there are a continuing series of utility voltage fluctuations occurring during the day.

You can end the struggle for clean power because Emerson is now supplying a 50 KVA version of its world renowned 60 Hz uninterruptible power system (UPS). With more than 200,000 KVA installed worldwide, Emerson has been the leader in UPS for large-scale computer systems. Now, this same tradition of quality and reliability is available in a 50 KVA version to handle virtually any size computer operation.

An Emerson UPS system gives you reliable,

trouble-free power. Your computer operation never sees the "hits" and "glitches" that are a daily part of utility supplied power. And, in the event of a blackout or other serious power disruption, Emerson's battery backup gives you ample time to switch over to an emergency power supply or provide for an orderly shutdown.

If you want to end the computer power struggle, call or write Emerson today.

The Power Behind Every Great Computer



Emerson Electric Co.
Industrial Controls Division
3300 South Standard Street
Santa Ana, California 92702
(714) 545-5581 Telex 67-8460
Emerson Electric Industrial Controls, Ltd.
Elgin Drive
Swindon, SN2 6DX, Wilts, England
0793 24121 Telex 449101

"Let's take a practical application," he begins. "For example, what is Third Wave architecture? When we talk about 'advanced contemporary architecture' what we really come up with is Bauhaus modified with a little imagination, a little surrealism, a little of this, and a little of that. It is very hard, given certain structural constraints, the nature of materials, the previous training of architects, etc., etc., to conceptualize something other than Second Wave architecture.

"I don't think anyone is truly a Third Wave thinker. I don't think anyone could be. All one can hope to do is glimpse the edges, perhaps mistake them, probably package them in Second Wave ways. But at least we're branching out."

Alvin Toffler is never at a loss for words. No question stumps him; no question gives him cause to pause. It isn't as if he doesn't think about the answers. It's as if he's already thought about them.

"I have done a bit of thinking about thinking," Toffler says. "No matter how strongly I can commit myself to a point of view, I'm forced to recognize that there are totally other ways of look-

"I don't think anyone is truly a Third Wave thinker. I don't think anyone could be."

ing at the same phenomenon. Different modes of apprehending reality are useful for different purposes. Some are good for making a buck, some are good for engineering, some are good for social relationships, some are good for other purposes. I guess what I believe is that we need to go from what I would call single metaphor thinking to multiple metaphor thinking.

"It is no accident that my book is called *The Third Wave*. If I look back at *Future Shock*, that book is divided into three basic divisions. I didn't set out with that in mind, but then I have to ask myself, 'Why does my thinking naturally fall into threesies when other people work in twosies?' To most people the world is black and white; I just see another dimension."

He has a good laugh at himself and at his thoughts on thinking.

A couple of years ago, in an autobiographical sketch, Toffler had this to say: "It sounds presumptuous, but I want to change the world, and, despite the difficulties in that, it's why I write . . . I'd rather go through life as a writer than as a tourist."

Who knows? Someday his writings may mention that trip to the desolate dunes in the midst of Manhattan. For Alvin Toffler, nothing is an accident, only insight.

—Becky Barna

CIRCLE 26 ON READER CARD

Most installations have a 2-3 year backlog of unimplemented applications

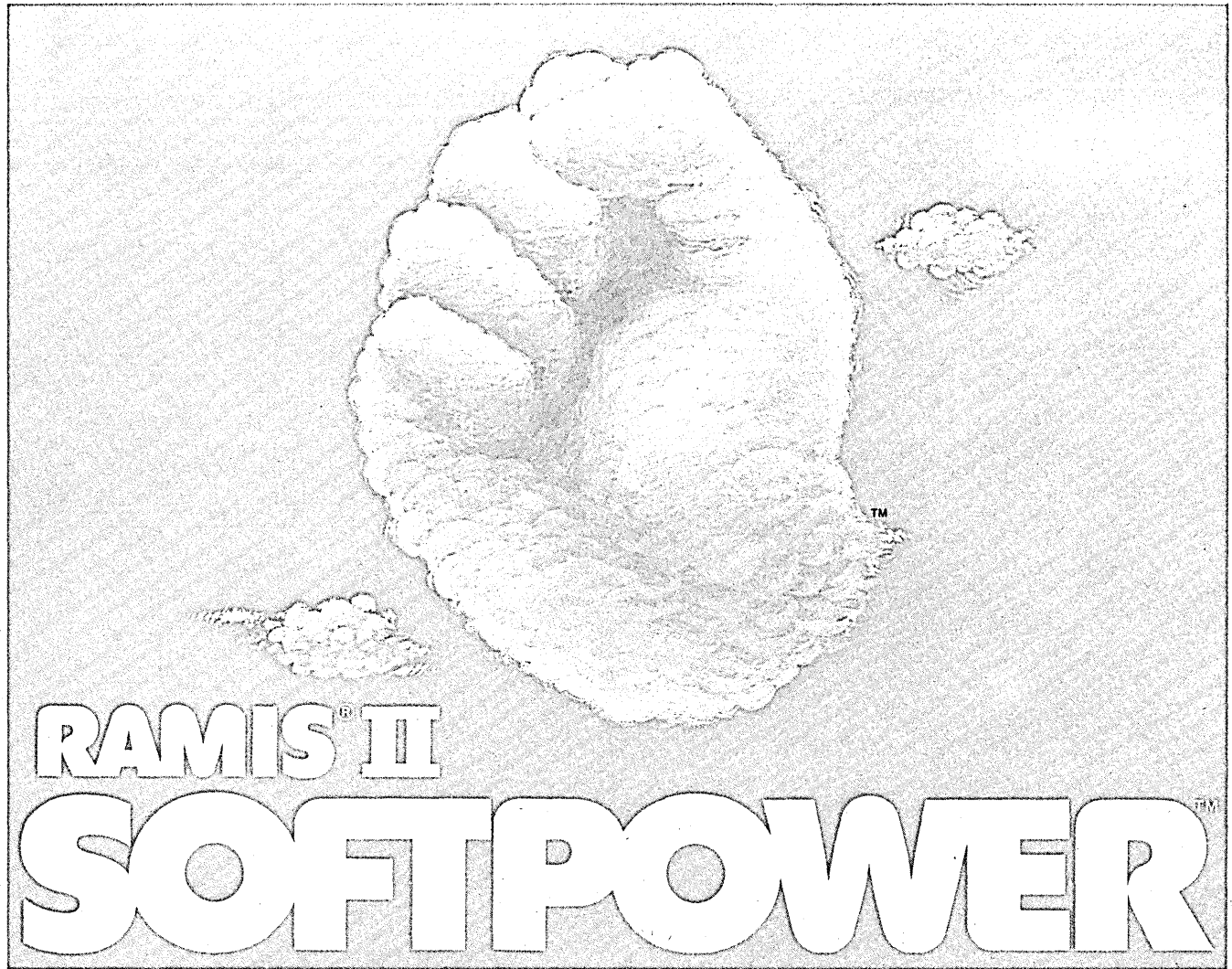

Turns backlogs into applications

RAMIS II is a complete information management system. It integrates an English-like nonprocedural language with a flexible DBMS. The DBMS permits the easy integration of data from a variety of sources, while the nonprocedural language lets you tell the computer what you want done without having to say how to do it.

Users report that RAMIS II systems can be implemented in 1/5 the time it takes using procedural languages such as Cobol or PL/1. This translates into a productivity gain of 400%!

Because RAMIS II systems are simple to set up and modify, there is no need to develop elaborate specifications in advance. In fact, users report that basic requirements can be agreed upon and a prototype implemented in 1/3 the time it normally takes just to develop the specs. The data structures and reports may then be modified and enhanced in an

evolutionary manner until the system is fully operational.

Eliminating programming also eliminates the need to talk about programming. This frees the user and dp staff to concentrate on the problem rather than the code—which results in both better communications and a better system.

In business, to stand still is to fall behind. More cost effective hardware, an increasing demand for computerized applications, and the decreasing availability of applications programmers means even bigger backlogs unless more powerful, more productive software is used.

For more information call or write today for a free RAMIS II factbook.

Name _____

Title _____

Company _____

Address _____

City _____

State _____ Zip _____

Phone _____

Mail to: Mathematica Products Group
P.O. Box 2392, Princeton, NJ 08540

RAMIS II SOFTPOWER

SOFTWARE THAT UNLOCKS THE POWER OF YOUR HARDWARE

MATHEMATICA 14 Washington Road • Princeton, NJ 08540 • (609) 799-2600

CIRCLE 27 ON READER CARD

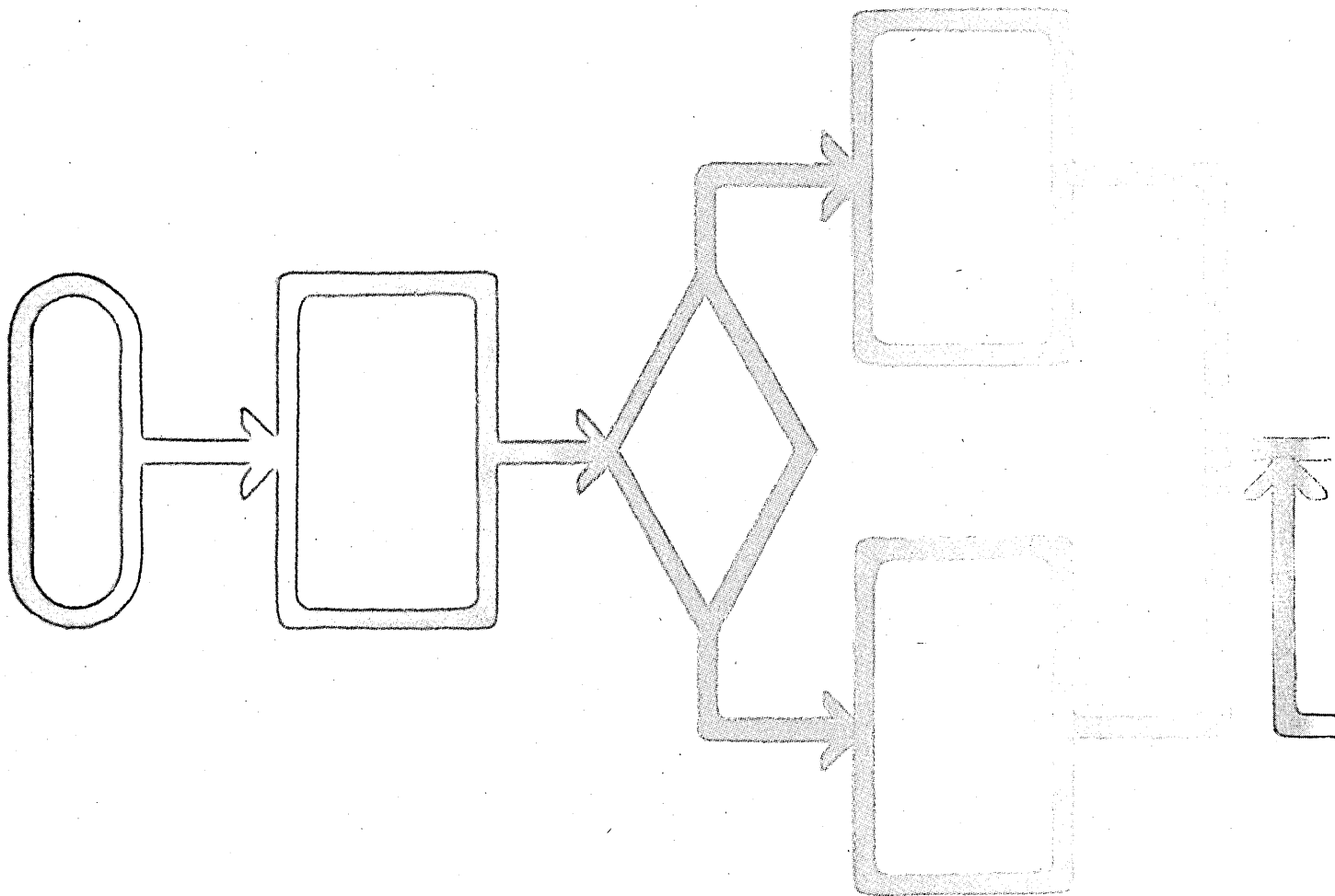

Logical designs for information management.

○ From discoveries as fundamental as floating point arithmetic and the use of subroutines to the latest advances in bubble memory and laser technologies, Bell is an experienced innovator.

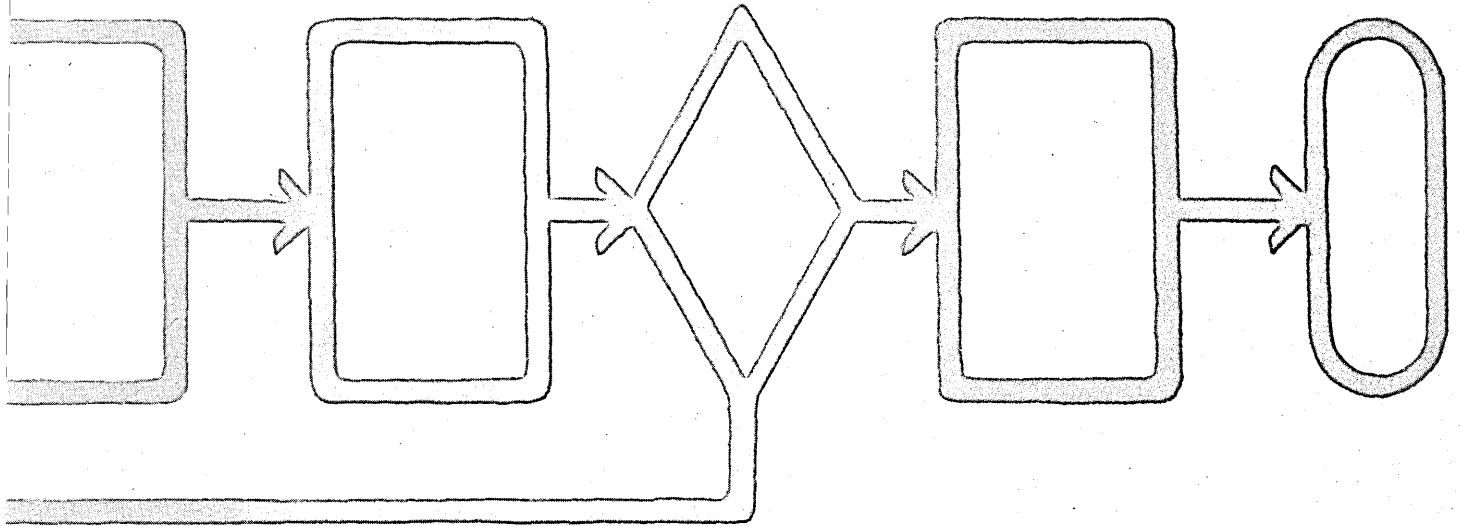

By applying the same innovative thinking to your business needs, we design new configurations to manage information more productively.

We offer the latest advances in data transmission. Our Dataphone® digital service is the nation's most extensive end-to-end digital network. Our Dataphone II service transmits over dedicated telephone lines at 2400, 4800 or 9600 bps, and has three levels of self-diagnostic capability. Our Dataspeed® 4540 communications terminals complement either service, and have 3270-compatibility. And our 43 teleprinter is compatible with virtually all time-sharing networks.

◇ Applying our knowledge to your information management needs is a process that begins with one call to your Bell Account Executive. ○

The knowledge business



D.P. Documents... organize and control them in any environment with the DOCU-MATE® filing system.

A single filing method for all documentation, records and reports. Think about the time and expense involved in the creation of data processing documentation, records and reports and you'll see the importance of organizing these vital information assets so they are under the control of management. Until recently, this problem of organization was compounded by the many sizes and shapes of documents which created an almost impossible filing, retrieval and referencing problem. Now, the DOCU-MATE filing system solves the problem by providing a single filing method for all documents regardless of their size, shape or location within the information network.

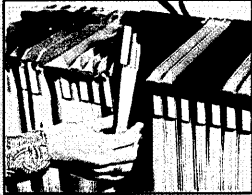

Combine DOCU-MATE filing with open office plan. If your existing or planned office is designed with panel supported work surfaces, a wide range of DOCU-MATE filing components designed to coordinate with most popular panel systems is available. You can get the advantages of functional organization with filing capability that enhances the aesthetics of your design.

Combine DOCU-MATE with contemporary office furniture. DOCU-MATE work station filing equipment including: cabinets, documentation organizers and mixed media open shelf files coordinate beautifully with furniture from leading manufacturers. You can plan work stations that provide both a modern crisp appearance and the functional efficiency of organized filing and referencing.



Build total DOCU-MATE filing environments. While you can integrate DOCU-MATE filing into your existing office plan; you can also create total DOCU-MATE filing environments. A full line of specialized filing work stations, chairs, documentation organizers, cabinets and open mixed media files lets you plan environments



that precisely meet the needs of the people involved.
Coordinate work station and library filing.



With the DOCU-MATE center hook filing and drop filing principle, you can build a total filing network involving group libraries and files and central libraries. Every imaginable type and size of document can be filed interchangeably at every location. You can even intermix sizes and shapes in the same filing equipment. And, since DOCU-MATE filing is designed for both high density, high security filing and high reference filing you can plan filing areas to meet the needs of the people who must work with them.



Send for our free 20 page brochure. Circle the readers' service number or write direct. Wright Line Inc., 160 Gold Star Blvd., Worcester, MA 01606

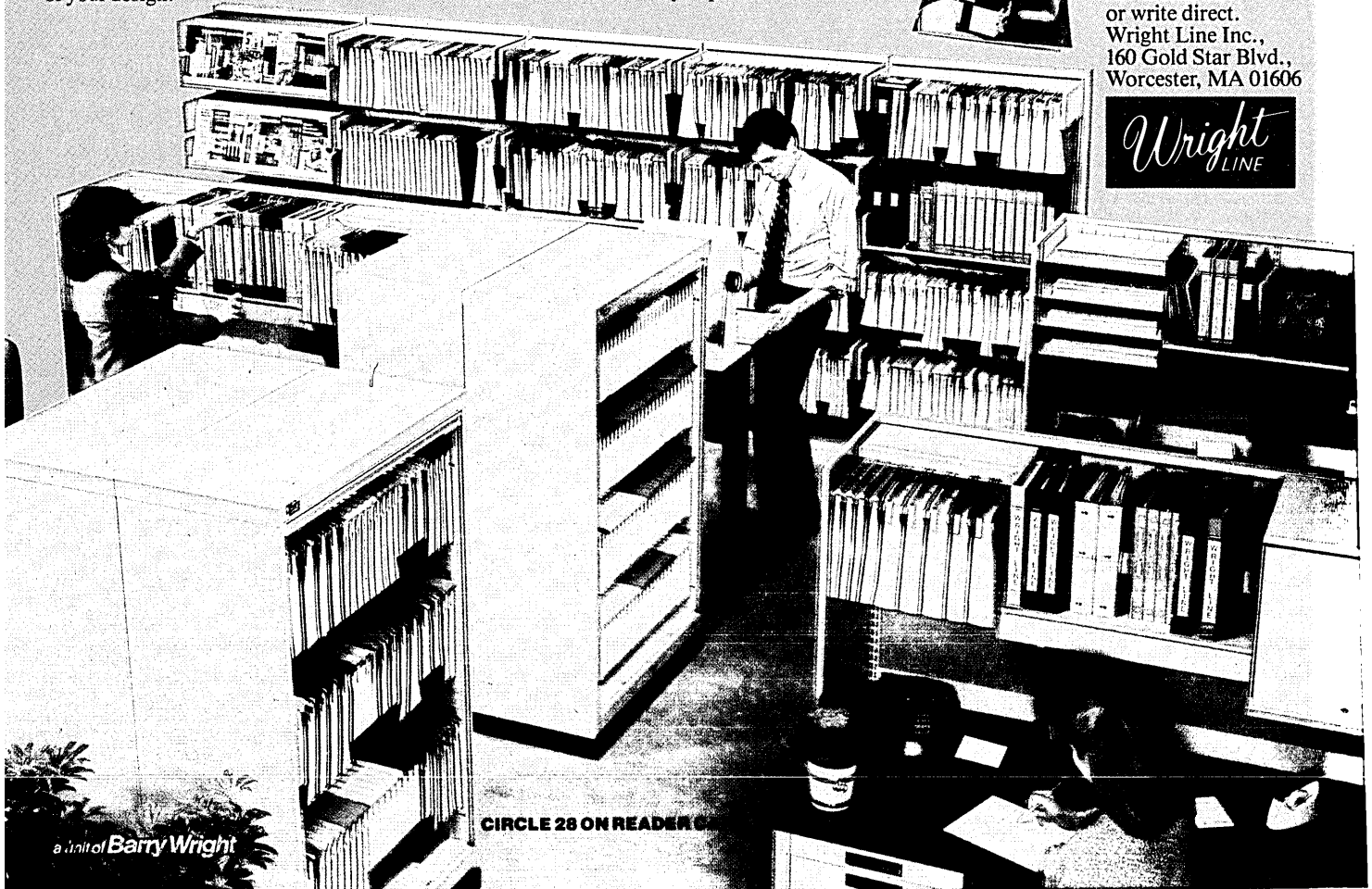

CIRCLE 28 ON READER CARD

LOOK AHEAD

(continued from page 14)

skeptical industry watchers are doubtful that Amdahl can come up with the goods in so short a time. "In the big mainframe area," Amdahl admits, his timetable "is faster than normal. I don't know if I can do it that fast but," he declares confidently, "I'm sure going to try."

BRITISH GET IT TOGETHER

Expect a major push from the British government soon on the information technology front. A junior minister in the U.K.'s Department of Industry reveals that a departmental reorganization is now under way to put together responsibilities in such areas as computers, electronics, communications, and satellites. Word has it that the creation of a low-level minister position for information technology is also being considered. Additionally the British government is studying two reports that cover the same télématique ground as the French NORA report; one report was brewed in-house at DOI, and the other was prepared by an outside advisory group. Final funding decisions are due in the next few months.

CEDAR DUE OUT IN THE FALL

Datapoint Corp. plans a fall introduction for Cedar, its first processor that doesn't look like a terminal. The new big gun in the Datapoint corral, Cedar reportedly will be a megabyte-size machine with fixed-function I/O processors controlling peripherals. (Six to eight IOPs are expected on early machines.) Cedar reportedly will function with the Attached Resource Computer (ARC) system architecture. Also expected with the new processor is a new "high-tech" operating system.

GENISCO GETS GRAPHIC

Watch for Genisco Computers, Costa Mesa, Calif., to introduce a graphics display system next month that uses the company's own microprocessors. The system has been under development for almost two years, the first nine months having been spent evaluating off-the-shelf micros, none of which could do the job Genisco wanted. "We started with a programmers' shopping list of what they wanted and we satisfied 95%," says Genisco president Bob Gray.

RUMORS AND RAW RANDOM DATA

Digital Equipment's "Baby VAX," presumably the 11/750, reportedly will be formally announced at DEC's Oct. 28 annual meeting...NCR's rumored entry into the wp market will be with a distributed workstation approach, we hear. A multi-user, multiaccess data base approach is being considered.

There are some things in life

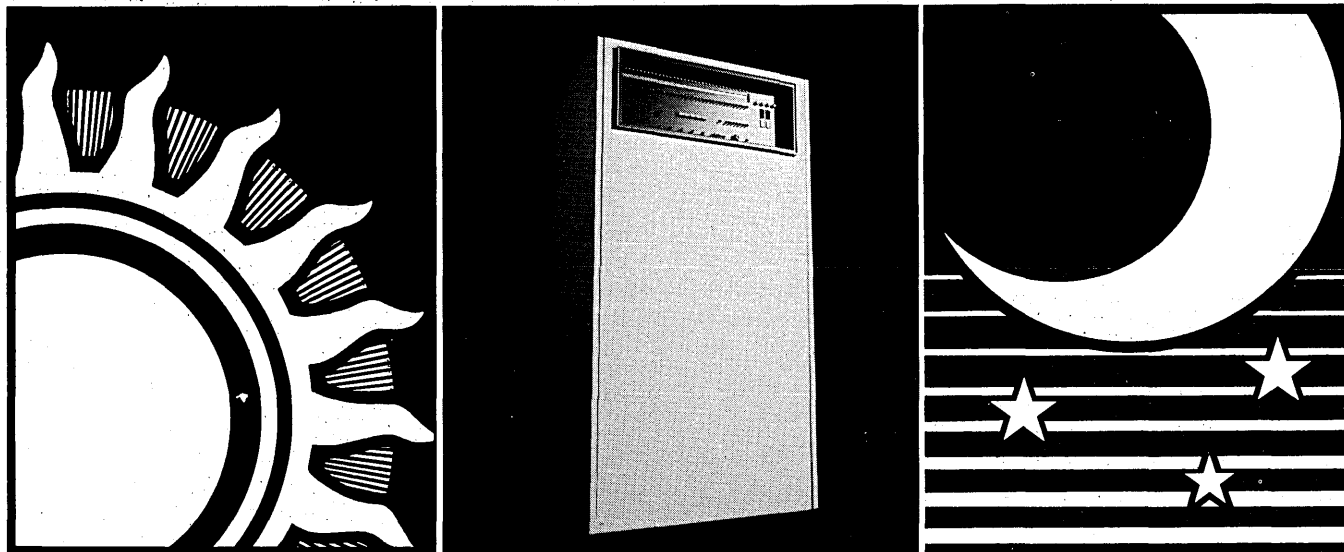

you can always rely on.

The sun will set. The moon will rise. You can take them for granted. They're dependable. They're consistent. They work. Just like the 1270 Terminal Control Unit from Memorex. There are literally thousands of 1270s functioning worldwide, some for up to seven years without a single service call.

If you think only IBM can make a reliable controller, you haven't heard everything about the Memorex 1270 Model 8. Whether you're starting a system or adding to one already up and running, **the Memorex 1270 Model 8 offers you a total control solution:**

It attaches directly to your System/360, System/370, 303X, 43XX or compatible byte multiplexer channel.

It's the functional replacement for your 270X transmission control units, your 3704 or 3705 communications controllers in the 270X emulation mode and integrated communications adapters.

It's a hardwired control unit that gives you unparalleled simplicity and flexibility.

It's field upgradable to the next larger model, so it grows as your system grows.

But there's more to the Memorex 1270 Model 8 Terminal Control Unit than reliability, flexibility, availability and cost effectiveness* The specifications tell the whole story. For complete information about the Model 8, other 1270s and the entire Memorex family of display terminals and printers, contact Nancy DeKraker at (408) 996-9000 or write to Memorex Communications, 18922 Forge Drive, Cupertino, CA 95014.

MEMOREX

Communications Excellence

*The 1270 Model 8 is available in the Continental U.S. only. © 1980 Memorex Corporation. Memorex is a registered trademark of Memorex Corporation.

CIRCLE 29 ON READER CARD

A LOOK AT VENTURE CAPITAL

Something ventured, something gained—that's the goal of the venture capitalist.

Often when a new company appears on the dp or data communications scene, the phrase "venture startup" is used to describe how the new firm obtained its financial backing.

The phrase refers, of course, to venture capital, that seemingly special type of money put up by that new breed, the venture capitalist. To many, this form of financing brings to mind a small group of shrewd money managers that knows more than anyone else about new technology, new markets, and most of all—new opportunities.

Venture capitalists don't talk much for the public record. They usually stay be-

Most investors look at a company from the outside; venture capitalists look from the inside.

hind the scenes of companies in which they have an interest. Perhaps that is why the venture capitalist is regarded by many as a somewhat mysterious figure.

One of the more successful venture investors is Neill H. Brownstein. Currently a partner in BSC Private Investment Partners, Brownstein is also affiliated with several other venture firms, having entered the investment business in the late 1960s.

Providing a rare insight into the philosophy behind venture capitalism, Brownstein drew some analogies in a recent interview.

"Most investors, people who are managing investment funds, are looking at whether to buy stocks or bonds and when to sell them. They look at a company from the outside. But a venture capitalist is primarily oriented towards how a company runs, how it solves the problems of growth, how it solves the problems of competition, how it solves the problems of technological change. So a venture capitalist looks at a business from the inside.

"If you're an investor, you're looking at a company's five-year or 10-year track record and what the ratios are. That's looking from the outside. When you're looking from the inside, you're asking questions about market demand factors, cost factors, volume relationships, competitive positioning, and what financial resources are required to become a market

leader in a selected niche or niches," Brownstein explained.

And just how does a venturist gain the necessary experience to look at a company from the inside? Brownstein doesn't believe one has to be a technical wizard. "Most of the people in the business have gotten their expertise through the experience of being a generalist. In graduate school we had the opportunity to play business games. You look at an issue like finance or marketing and get a little flavor of what the inside might look like. Then you get into venturing and you start working with projects in depth."

To Brownstein this often means getting enough technical understanding to be able to translate concepts into relatively simple terms that other people can understand. Part of the process is talking with customers, users, and industry spokesmen to get a broad understanding of the dimensions involved, he said. Then the next step is working with management to challenge business plan assumptions, and through an evolutionary process, come up with a game plan that is "in balance."

While he makes the scenario sound rather straightforward, Brownstein makes a point of downplaying extensive technical expertise. He is fond of telling close associates that he tests new technology by trying to explain the concept to his mother-in-law. "If she can't understand what it's all about, it probably is not a good idea," he muses.

Despite his somewhat simple explanations, there are Brownstein's rules for venture projects which can be culled by an outsider through careful listening. First, he likes to go with experienced managers plus entrepreneurs who "have done it before."

"You become generally aware of what technological milestones have to be crossed before you have a viable new system or product. Then you make some bets

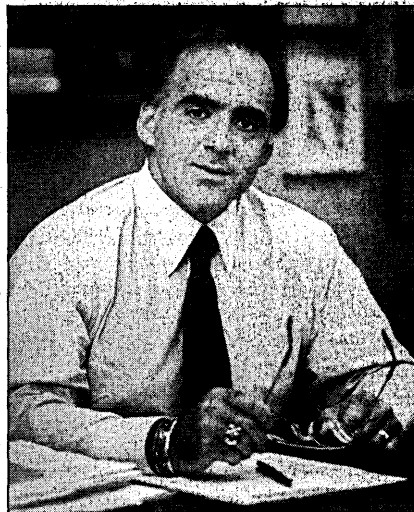

NEILL H. BROWNSTEIN: "Most of the people in the [venture capital] business have gotten their expertise through the experience of being a generalist."

NEWS IN PERSPECTIVE

NEWS IN PERSPECTIVE

on the people and their ability to get over those hurdles. If they've done it before—either in a big company or a small company—you have a tendency to believe they'll do it again. If their background is marginal, you tend to think it's not worth the risk."

And just how well has all this theory been applied to "venture plays," as Brownstein calls them? In 1971 he began his involvement with computer/communications-related firms. "We had an investment for 25% of Interdata which had about a third of its business in communications," he explained.

Brownstein likes to go with experienced managers who "have done it before."

In 1973, Brownstein and his associates became interested in packet-switching and the following year became a major investor with Bolt Beranek & Newman in Telenet. But the communications orientation really started back in 1971-72, when he backed Four Phase Systems.

Since then Brownstein has been involved in an impressive list of startups. They include International Communication Sciences (digital voice), Electronic Communication Systems (voice mail), Ungerman Bass (local networks), Microform Data Systems (intelligent controllers for airlines), and Printer Terminal Communications (local area data distribution). Even so, his venture partnership only considers about 20% of its involvement to be related to communications. Recently the company took a position with a firm that makes hi-fi speakers because "we believe that with the emergence of digital sound there's going to be an increasing demand for high quality speakers," he said.

And of course there are financial goals. "The name of the game in venturing is to get a substantial return on investment. We are completely open-minded on how to achieve those returns. Sometimes it means staying independent and becoming a billion dollar company, as Four Phase has targeted for the mid-1980s. Other times the return from a merger is a more attractive route."

Brownstein says a company must reach more than \$25 million in revenue on its own before the venture capital investors would agree to an acquisition or merger. If the company plays its cards right, it should take three to six years to reach that level, he said.

With such a positive track record, has Brownstein ever guessed wrong? "Yes, in 1968 we had a communications-related project called Solardyne International. We dumped that one for about 20 cents on the dollar," he revealed.

It was in that same year that Brownstein, with a fresh MBA from Northwestern, joined the venture capital group at Allstate Insurance. The group was run by Ned Heizer,

whom Brownstein described as having produced the best venture capital track record of the 1960s. With an undergraduate degree in economics and sociology, Brownstein felt lucky to be able to work with Heizer, a "superb venture capitalist."

In 1970, Brownstein left Allstate to join Bessemer Securities Corp., the personal holding company of the Phipps family. Henry Phipps was Andrew Carnegie's partner in Carnegie Steel. And when U.S. Steel was founded in the early 1900s, Phipps set up the predecessor organization of Bessemer Securities.

In 1976 he formed Neill H. Brownstein Corp., which is a venture management consulting firm whose principal client is Bessemer Securities Corp. In 1979, he helped form a new effort called BSC Private Investment Partners together with three others: William T. Burgin, Richard J. Dunler, and Robert H. Buescher. "We invest in a broad range of companies and I have had some inclination to communications," he confided modestly.

The 1970s were golden days for venture capital deals. Because the returns were "far greater than comparable market averages," the venture business was able to attract \$600 million to \$1 billion. This was due to the success of companies like Four Phase, Telenet, Amdahl, Datapoint, and American Telecommunications.

The sources of capital for those venture deals were insurance companies, trust departments at banks, wealthy individuals, and large corporations. And because of recent success stories, the high rate of venture deals will continue.

Is there a place for small investors in the venture game? "No, because of the liquidity aspect," Brownstein answered. "When you make a venture investment, you lock up your money for a dozen years. Once you've made your investment, you

The 1970s were golden days for venture capital deals.

can't get out; you can't ask for your money back; you can't sell your investment easily. It's not the place for anyone without substantial institutional or personal money."

Coming up for the 1980s, Brownstein sees opportunities in the local loop area which he described as a high cost function today. Any technologies or systems that can bring down the cost of local communications "will be significant opportunities," he predicted. Brownstein also sees the character of communications systems changing as intelligence becomes more powerful. This will create a higher demand for intelligent terminals that have simpler user interfaces.

Today, Brownstein said, there are about 50 venture partnerships that have anywhere from \$10 million to \$50 million to invest. Some have up to 30 or 40 investors.

But in the case of BSC, all the backing comes from the Phipps family.

Neill Brownstein may not be a name up front. But he is very much into management, helping to make key decisions in the startup situations that he and his partners support. Venture capitalists never talk about how much they make from their investments. But judging from his track record, Brownstein has done alright for himself and for the Phipps family.

—Ronald A. Frank

COMPANIES

NEW NAME, NEW GAME

Cambridge Memories has changed its name to Cambex and its emphasis to small mainframe computers.

Cambridge Memories, Inc., a somewhat battered but experienced survivor from the plug-compatible memory business, recently changed its name to Cambex, Inc. in order to reflect the shift in the company's business, with increasing emphasis on manufacturing and selling small mainframe computers.

Last May, Cambridge sold its 40% equity in IPL Systems Inc. back to IPL in return for \$4.1 million and free rights to the architecture and technology of IPL's PCM computer line—marketed overseas by Olivetti and in this country by Control Data Corp. as the Omega. IPL was started in 1973 by former Cambridge employees, and the memory firm provided financing and technical support in return for equity and royal-



JOSEPH KRUY: "We think that networks will be a large part of our business in the future."

The Idea:

To transform an alphanumeric display terminal into a full-featured graphics display terminal while saving the user about half the price in the process.

Digital Engineering had the idea. And the imagination to make it a reality. A reality called Retro-Graphics.™

Retro-Graphics works like this. A printed circuit card designed by Digital Engineering plugs into Lear Siegler's ADM-3A or ADM-3A+ Dumb Terminal.® Installation takes minutes. There is no soldering. No special tools. No service brigade. Once in, what was before an alphanumeric workhorse is transformed into a versatile graphics powerhouse.

How versatile? Very. You get full vector drawing and point plotting capabilities. Bar charts. Pie diagrams. Histograms. Function plots. You get high light output, selective erase, a 512 x 250 "flicker free" plotting grid and, most important, complete compatibility with Tektronix® Plot 10™ software.

Retro-Graphics is a powerful idea. And half of its power is in its price. Because our RG-512 card and the Dumb Terminal, *together*, are about half the price, around \$2000, of a comparably-equipped terminal from someone else. The RG-512 card, separately, is just \$1150.

Skeptical? That's perfectly understandable. Frankly, skepticism is exactly how most good ideas are discovered, anyway. So call us at (916) 920-5600 and discover one for yourself. Retro-Graphics.

**DIGITAL
ENGINEERING**

630 Bercut Drive
Sacramento, CA 95814
TWX: 910-367-2009

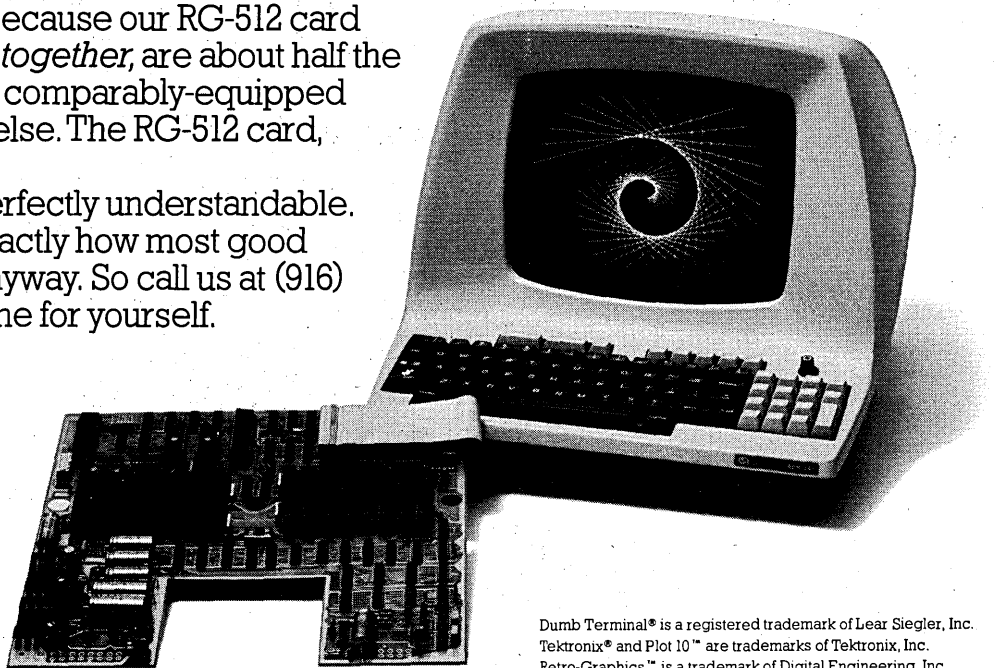

Dumb Terminal® is a registered trademark of Lear Siegler, Inc.
Tektronix® and Plot 10™ are trademarks of Tektronix, Inc.
Retro-Graphics™ is a trademark of Digital Engineering, Inc.

CIRCLE 30 ON READER CARD

Another Able First

Paydirt for VAX and PDP-11 users.

One blue-chip card delivers 16 DZ lines per slot.

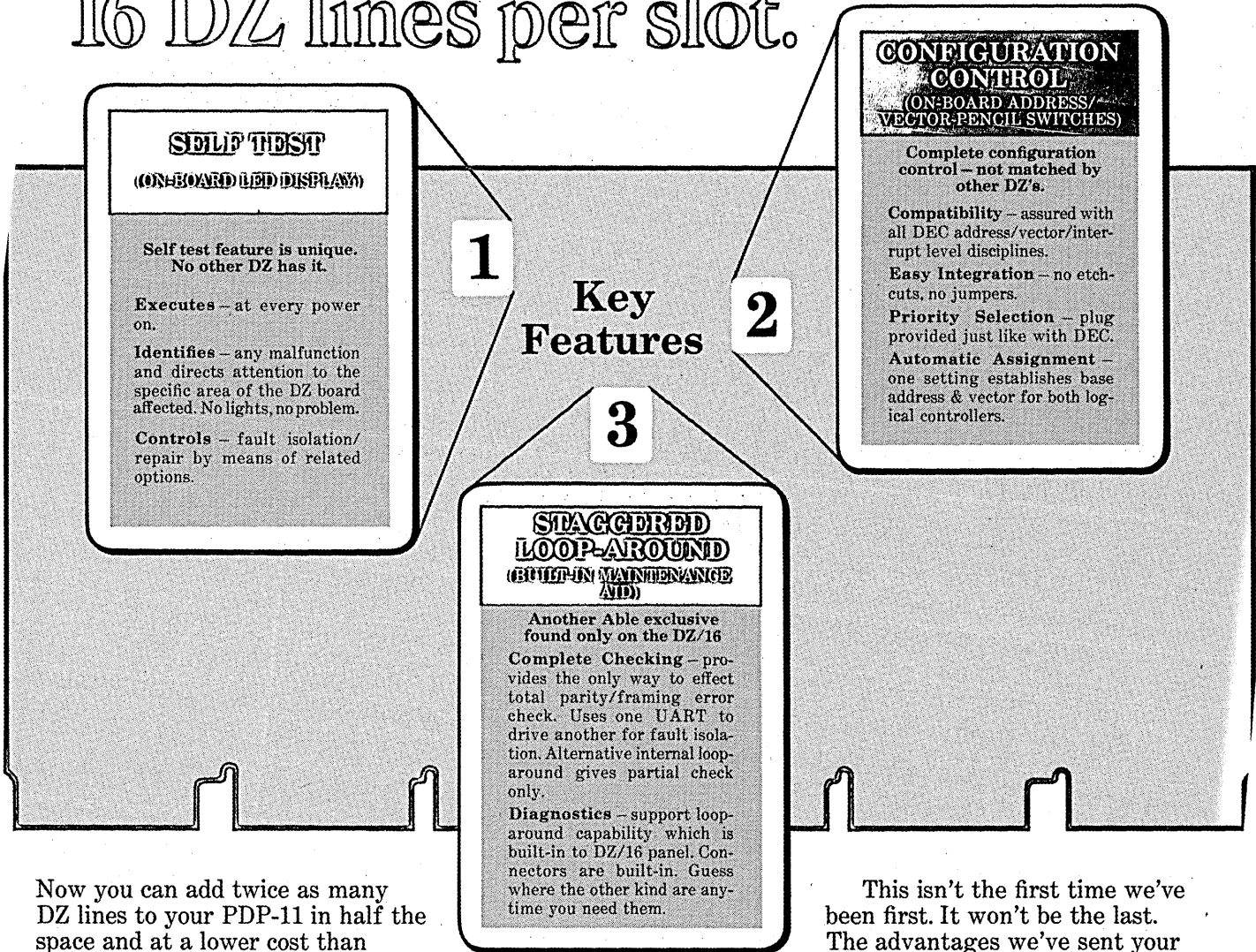

Now you can add twice as many DZ lines to your PDP-11 in half the space and at a lower cost than ever before. Our new DZ/16 is a microprocessor-based controller which fits 16 asynchronous communications channels into a single board but sells for much less than the two-board DZ11-E it replaces. There's no waiting either. You'll probably have your card plugged in and running less than 30 days after we get your order.

The unique multiplexer installs in any standard hex-width slot and presents only one load to the Unibus. It supports all DZ11 baud rates, provides modem control on all lines and is compatible with DEC diagnostic and operating system software. The data format is program-selectable for each channel.

This isn't the first time we've been first. It won't be the last. The advantages we've sent your way again and again will keep

coming. Get the most out of your VAX or PDP-11. Write today for details on our remarkable line of memory, communications and general-purpose cards for use in the PDP-11 family.

Able, the computer experts

ABLE COMPUTER, 1751 Langley Avenue, Irvine, California 92714. (714) 979-7030. TWX 910-595-1729.

ABLE COMPUTER-EUROPE, 74/76 Northbrook Street, Newbury, Berkshire, England RG13 1AE. (0635) 32125. TELEX 848507 HJULPHG.

The Kodak IMT microimage terminal. It's the brains behind Electronic Filing from Kodak.

Your office already has electronic typing.

You probably have electronic data processing, too.

Then isn't it about time you looked into Electronic Filing from Kodak?

The Kodak IMT microimage terminal, for example, is so intelligent it practically thinks for itself. Thanks to its own built-in microcomputer, an IMT terminal can perform on-line information lookups in seconds. At the touch of a button. Without tying up your mainframe.

An IMT terminal pinpoints images so precisely, in fact, that it practically eliminates lookup errors, which increases office productivity. In the meantime, your computer is left free to process data—not search for it.

Find out how many other intelligent things an IMT microimage terminal can do. Send in the coupon for more information. Or contact your Kodak representative for a demonstration of the Kodak IMT microimage terminal.

Either way, the move you make will be a smart one.



1880  1980

©Eastman Kodak Company, 1980

EASTMAN KODAK COMPANY • Business Systems Markets Division
Dept. DP0610, Rochester, NY 14650

Please send me more information about the Kodak IMT microimage terminal.

Please have a Kodak representative contact me.

NAME

TITLE

COMPANY

ADDRESS

CITY

STATE

ZIP

PHONE

NEWS IN PERSPECTIVE

ties on IPL computer sales.

Last month, Cambex announced three new processors, versions of the IPL/Omega products.

The Cambex 1636 processor is a modified version of the Omega Model 1 which will compete directly against the IBM 4331 group 2 processor. Cambex said the modifications on the IPL design upgraded system performance by about 10% and doubled the memory to four megabytes. Cambex claims that the 1636 will now offer 15% more performance than the 4331 group 2 and will cost \$125,000, about \$25,000 less than the new 4331.

Cambridge Memories had previously offered a plug-compatible processor, the 1638, a smaller 370/138-type system which used IPL technology under license. But the

Last month, Cambex announced three new processors, versions of the IPL/Omega products.

1638 was a victim of IBM's 1979 introduction of the 4300 series and its aggressive pricing. Cambex describes the new 1636 as an upgrade from the 1638.

The second new processor from Cambex is called the 1641, a repackaged version of the Omega Model 2 with a slightly improved performance and an 8-megabyte memory. Cambex claims the 1641 processor, priced at \$190,000, offers "about the same performance" as IBM's 4341, priced at \$265,000.

Cambex also announced that another processor, the 1651, a redesigned Omega Model 3, will be available in the second half of 1981 as a field upgrade on installed 1641 and 1636 processors. With the 1641 upgrade (priced at \$92,500), or the 1636 upgrade (at \$160,000), the resulting 1651 machine would reportedly have 50% more performance than the IBM 4341.

According to Cambex president Joseph Kruey, the company will continue to offer its plug-compatible memory system, the STOR/3000 add-in memory boards which plug directly into the IBM storage backplane, using IBM circuitry, power, and the Cambex 64K-chip boards to install up to 256 kilobytes of memory in the original IBM cabinet. With 10 installations, averaging \$100,000 to \$120,000 4-megabyte sales, Kruey said the product has had good early acceptance and he looks to the maturing 3000 line systems for new orders.

The Cambex-IPL agreement gave Cambex rights to the first two models of the IPL/Omega series (neither of which is still made by IPL) but restricted general-purpose sales of the IPL Model 3, explained Kruey. Cambex received the right to manufacture its own upgrade version of the IPL design, which it will do, but only if the machine is to be sold as a special-purpose or dedicated processor. For upgrade of its installed 1641 machines, the Model 2 version, to the 1651,

or Model 3, Cambex will be able to sell IPL upgrade kits next year—after IPL and its marketing associates move on to Model 4.

"IPL just wanted to make sure that we didn't market the Models 3 and 4 as general-purpose machines directly against CDC and Olivetti," explained Kruey, "and quite understandably. But now it's also obvious that we are going to provide an upgrade path for our users—although we plan to stay within the 4300 market, while IPL may grow beyond it."

At any rate, Cambex would rather avoid the general-purpose PCM market, he explained. The IPL design uses a very soft architecture—only the essentials are in hardware—and the range of its microcode gives it great adaptability. Cambex, he explained, hopes to use that flexibility to target a specialized niche of the 4300-scale marketplace.

Cambex will offer a mechanically integrated peripheral controller, a channel-to-channel adaptor, and a data communications adaptor as options on the 1600 processors. "We think that networks will be a large part of our business in the future," said Kruey, "and we intend to be part of that business."

The 1600 could very easily have its microcode modified to optimize its operation in some applications, and, in the long term, Cambex may offer the 1600 with Cambex software. For the near future, Kruey conceded, the company is already in negotiations with several potential system houses and oem buyers.

—Vin McLellan

UPHILL FIGHT FOR SANDERS

Even in the face of Chapter XI, Royden Sanders says his company will prove itself in the marketplace.

A "help wanted" ad appeared recently in several southern New Hampshire newspapers asking for applicants to fill a position of electronic technician. While such ads are not unusual for the labor-scarce area, the company name at the bottom of the ad raised some eyebrows.

R.C. Sanders Technology Systems Inc. was hiring new employees even though it had recently filed for protection under Chapter XI of the federal bankruptcy laws.

To Royden C. Sanders Jr., the veil of Chapter XI appears to be just another management problem that will be overcome. On May 5, 1980, the company filed

Authorized General Electric Terminet Distributors Headquarters Sales Offices

California

MQI COMPUTER PRODUCTS
18381 Brandilier Circle
Fountain Valley, CA 92708
(714) 964-4722

THE DAVID JAMISON CARLYLE CORPORATION

Two Century Plaza—30th Floor
2049 Century Park East
Los Angeles, CA 90067
(213) 277-4562

Florida

W.A. BROWN INSTRUMENTS, INC.
P.O. Box 513
Orlando, FL 32802
(305) 425-5505

Illinois

MRC INDUSTRIES
660 Busse Highway
Park Ridge, IL 60068
(312) 698-3377

INFORMATION SYSTEMS, INC.

9806 West Farragut Avenue
Rosemont, IL 60018
(312) 671-7780

Maryland

ALANTHUS DATA COMMUNICATIONS CORPORATION

6011 Executive Boulevard, Suite 300
Rockville, MD 20852
(301) 770-1150

Massachusetts

AMERICAN COMPUTER GROUP, INC.

712 Beacon Street
Boston, MA 02215
(617) 261-1100

Minnesota

LOONAM ASSOCIATES
7720 Bush Lake Road
Minneapolis, MN 55345
(612) 831-1616

New Jersey

DATA ACCESS SYSTEMS, INC.

Coles Road & Camden Avenue
P.O. Box 1230
Blackwood, NJ 08012
(609) 228-0700

Ohio

DATA-TRON, INC.
29150 Anderson Road
Cleveland, OH 44092
(216) 585-8421

Texas

CARTERPHONE COMMUNICATIONS CORP.

1111 West Mockingbird Lane
Suite 1400
Dallas, TX 75247
(214) 630-9700

TEL-TEX, INC.

2825 West 11th Street
Houston, TX 77008
(713) 868-6000

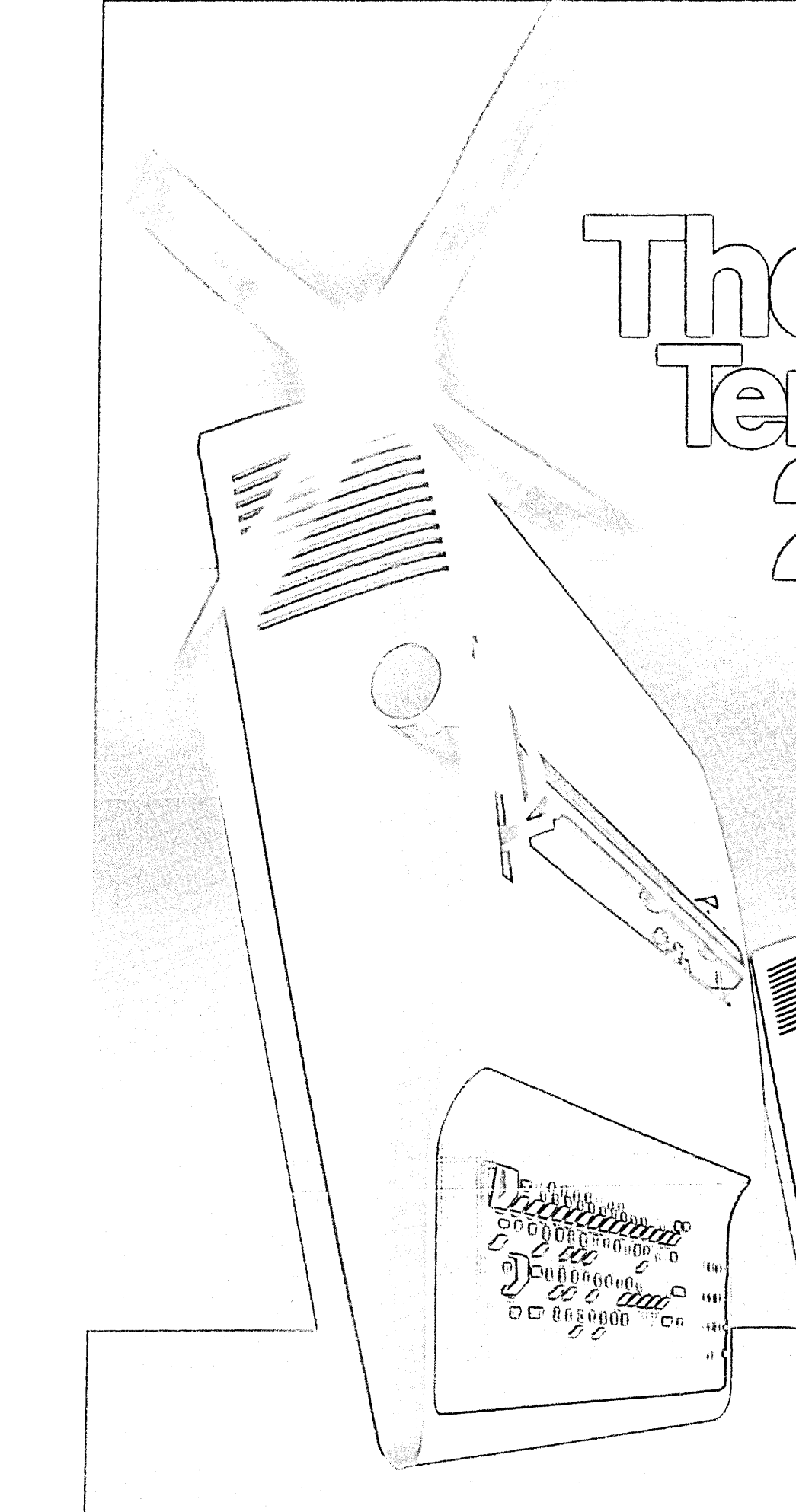

The new Terminet[®] 2000 printers are here.

Quiet, sleek,
compact, fully
featured, and
styled for the
80's. With long
life print heads,
and a variety

Quality that will make a lasting impression

GENERAL  ELECTRIC

CIRCLE 32 ON READER CARD

You probably know the DECwriter IV for its flexibility in handling paper.

Well, now you can have that same flexibility in handling forms.

The new DECwriter IV Model AA with its snap-in tractor feed option can automatically handle both standard and custom forms. Forms as wide as 14⁷/₈". And as narrow as 3". In up to four parts.

And you can control this new terminal either directly from its keyboard or from a computer.

With the DECwriter IV Model AA you can condense characters down to 16¹/₂ per inch. Or expand them up to 5 per inch. On a field of 132 horizontal and 84 vertical tabs. And a simple setting also lets you super-condense lines down to 12 per inch. So you get more information per line, per form.

You can also be sure of synchronized printing from one form to the next, no matter what form you're using. Because with the DECwriter IV Model AA you program "top of form." And parity is easily selected at the keyboard, simplifying communication with other computers.

Simply remove the tractor feed option and the DECwriter accepts all your roll feed or sheet paper up to a width of 14⁷/₈".

Of course the new DECwriter IV gives you switch-selectable 110 and 300



baud rates. And a 45 CPS catch up rate so you get the true 30 CPS throughput found on our original DECwriter IV Model DA. You also get the extra attention to features you expect from Digital. Like foreign character printing, super/sub-script capabilities,

keyboard-selectable local echo, and a print head that moves aside when desired so you can see the last character printed.

Best of all, Digital has put all this capability into a terminal that fits right into a wide range of environments—either on its custom stand or on a desktop. And the DECwriter IV's solid-state components and microprocessor controls continue to build on the reliability standards set by the DECwriter II. All at a surprisingly low price.

The DECwriter IV Model AA. For real forms-handling capability, it's your only choice.

To order your DECwriter IV Model AA, or the original DECwriter IV Model DA, call your terminals supplier or write **Digital Equipment Corporation**, Terminals Product Group, MR2-2/M67, One Iron Way, Marlboro, MA 01752. In Europe: 12 av. des Morgines, 1213 Petit-Lancy/Geneva. In Canada: Digital Equipment Corporation of Canada, Ltd.

digital

Just Married

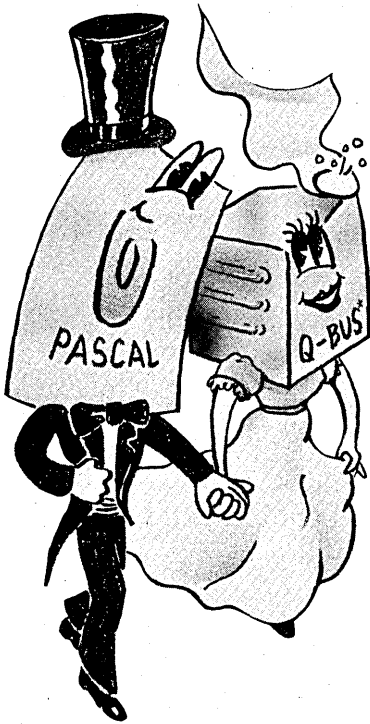

PASCAL + Q-BUS* WITH PDQ-3

That's right — Pascal and the Q-Bus* are finally together! The PDQ-3™ is here!

The PDQ-3 is a fully interrupt driven, 16 Bit stack computer with up to 256 KB of memory. The system features direct UCSD Pascal P-code execution with the UCSD certified operating system. Two floppy disks come as standard. The Q-Bus* allows a wide range of peripherals to be connected to the computer.

For more information call or write:

**ADVANCED
DIGITAL
PRODUCTS**

7584 Trade St.
San Diego, CA 92121
(714) 578-9595

*Trademark of Digital Equipment Corporation

NEWS IN PERSPECTIVE

for protection after a creditor had attached the firm's payroll account. Relating what happened in a matter-of-fact tone, Sanders says a metal supplier, a vendor that wanted to collect its outstanding bill, caused the company to seek help from the court in the form of Chapter XI.

"We had hoped to work our way out of it. We were behind in our bills and one of the creditors found out we were raising additional financing. So he attached the payroll account and the payroll checks bounced. This caused such consternation among the other creditors that we had to file," Sanders explains.

One of the major causes of Sanders Technology's problems was the renegotiation of the contract with the firm's major customer, Fleischhauer Datentraeger GmbH of West Germany. The German firm had earlier made a commitment to take up to 50% of Sanders Technology printer output and had indicated it would put up \$500,000 to become the exclusive sales agent and distributor for the Sanders Media 12/7 printer in Europe.

The contract with the German firm was finalized in March of this year and, because it left Sanders Technology without an expected source of income, the company looked elsewhere for money. After the contract with the Germans, two venture capitalists, Henry Burkhardt and Frederick Adler, invested \$800,000 in the printer manufacturer and promised to get additional financing, according to Sanders.

As a result of the new investment, Burkhardt and Adler, both investors in Data General Corp., became directors of Sanders Technology. Further, Burkhardt became chief operating officer, Sanders related.

Believing things at his company were well in hand, Sanders went on vacation for three of the last four weeks that Burkhardt was on the scene. Together, both Burkhardt and Adler were associated with Sanders Technology for six weeks until the Chapter XI filing, when both resigned.

"We had this situation when I got back from vacation, so I really am not clear on everything because I wasn't here," Sanders relates. "We weren't expecting that kind of situation or I obviously wouldn't have gone on vacation."

After the bankruptcy filing, the number on the company payroll dropped from 135 to its current staffing of about 55. Production on the Media 12/7 printer is about 60 units per month now and this is expected to increase to "over 200" by October. All of the current output is going to U.S. customers and, by next year, the German company may begin producing printers under license in Germany, Sanders said.

Because of the Chapter XI requirements, all business is being done on a cash basis, and the company must have a financial plan to be approved by creditors and the court early in October. In the meantime, Sanders says that some research is going on into new products, though he would give no details. He also notes that one solution for the company might be acquisition by another firm. Although some preliminary talks have taken place in this regard, nothing is firm.

And if these weren't enough problems, Sanders Technology is also facing a \$3 million class action suit brought by stockholders who claim that their interests were not properly protected.

Despite the adversity, Sanders

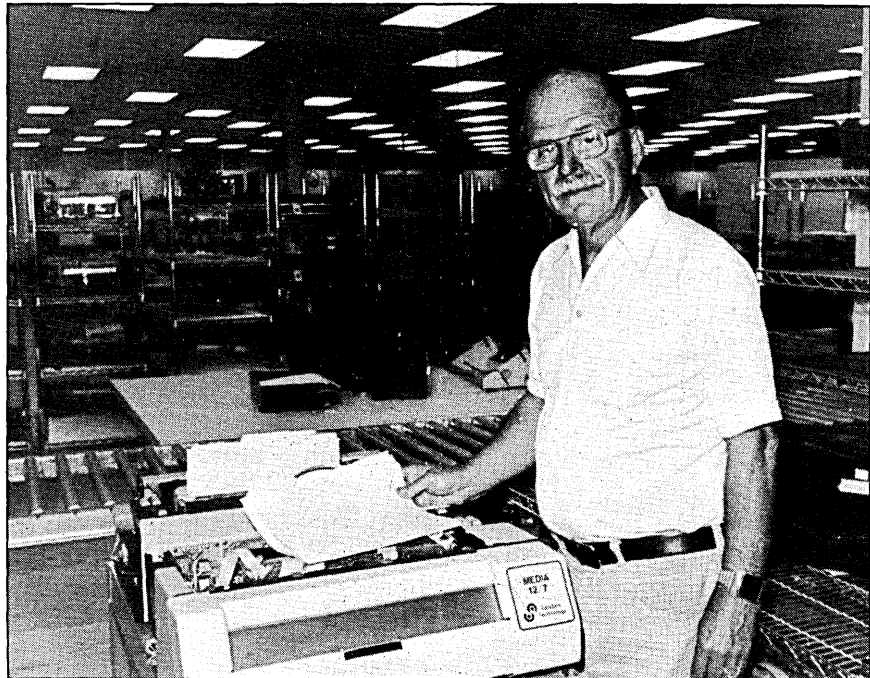

ROYDEN C. SANDERS JR. is banking on quality printers to pull the company through.

Building a computer facility is not a do-it-yourself project.

It's too important. And you have too much to do to coordinate the efforts of:



But we do it all the time. And in the last 12 years, we've planned or built facilities for more than 400 customers. Facilities for all sorts of computers.

We know computers. We know construction. We know how to create an environment for the efficient operation of a computer center. And we offer a full range of services, from consultation to the entire job.

We're international, too. With 12 offices in the United States and 14 in other

countries, we're ready to serve customers around the world.

We'd like to show you what we can do for you. For more information on our full range of services, contact your nearest Control Data office or write to:

Darryl E. Olson
Marketing Manager
Facility Planning and Construction,
Control Data Corporation,
HQN111, P.O. Box 0,
Minneapolis, MN, 55440.

GD CONTROL DATA CORPORATION

Addressing society's major unmet needs

CIRCLE 35 ON READER CARD

NEWS IN PERSPECTIVE

says, "Our primary situation is to make a going business so we can make suitable arrangements on the outstanding debts. That is the purpose of Chapter XI."

To achieve this goal, Sanders has hired a consulting firm that specializes in salvaging companies that are in bankruptcy. This firm, Wheeler & Currey, is taking an active part in the day-to-day operations.

All in all, Sanders prefers not to look back. He hesitates to give an opinion on what went wrong during the short time that Burkhardt and Adler were associated with his company. But he still believes that Sanders Technology has a superior printer that will prove itself in the marketplace.

Sanders predicts that with additional financing his company will be able to satisfy creditors and work its way out of Chapter XI by the end of October. Though he prefers not to analyze what went wrong, he agrees that next time he will be more careful about when he goes on vacation.

—Ronald A. Frank

COMMUNICATIONS

DATAKOM BONANZA FORECAST

New Eurodata survey says the datacom growth rate in Europe over the next seven years will surpass that in the U.S.

Data communications in Europe is set to grow 26% per year in volume over the next seven years, says the latest Eurodata survey, due for release early this month. Sponsored by 18 European PTTs and carried out by Logica, the London-based consultants, with the cooperation of the PTTs, the survey

forecasts that there will be close to 4 million data communications terminals in operation in Europe by 1987. This compares with a mere 625,000 as of Jan. 1, 1979.

This bonanza both for terminal vendors and for the PTTs, which are reaping higher and higher profits from datacom, is significantly bigger than forecast in the last such study, Eurodata '72. The report notes that the installed base is around twice as high as was initially forecast in the earlier study, and 1987 figures are four times bigger than Eurodata '72 suggested.

While the European market will stay significantly smaller than that in the U.S., the growth rate should be several points higher. European estimates say that the current U.S. terminal population is about four times that in Europe. But the 26% growth rate forecast for Europe surpasses recent estimates of 20% for the U.S.

The survey spells out coming boom conditions for visual display units as well as for a number of categories of application-

GROWTH FACTOR BETWEEN 1979 AND 1987 OF TERMINAL TYPES BY APPLICATION

Terminal Classes	Total installed Jan. 1979	Software development	Calculations	Information retrieval	Person-to-person	General management	Banking transactions	Travel reservations	Stock Control	Client records	POS	Transactions	Process monitoring	Other	All applications	Total installed Jan. 1987*
Keyboard printers	129,000	5.05	4.94	10.2	3.85	4.82	2.79	1.92	5.61	4.52	—	—	5.86	4.23	545,670	
VDUs	326,000	8.07	7.78	19.9	12.5	7.04	4.47	2.98	5.74	6.53	—	—	8.92	7.19	2,343,940	
Remote batch terminals	127,000	8.14	7.48	9.09	3.64	5.07	3.18	1.79	3.33	4.63	—	—	6.43	4.57	580,390	
Graphics VDUs		12.9	8.55	—	10.6	6.81	—	—	5.94	—	—	—	—	9.01		
Hard-copy plotters		5.18	4.59	—	—	2.72	—	—	5.94	—	—	—	7.9	3.96		
Digital facsimile		—	—	—	32.4	6.79	—	—	—	—	—	—	7.85	29.0		
Audio response units	38,200	—	0.66	—	—	—	—	—	0.75	—	—	—	—	0.75	490,000	
Banking (automated tellers)		—	—	—	—	—	53.3	—	—	—	—	—	—	53.3		
Point-of-sale		—	—	—	—	—	—	—	—	—	2.31	—	—	2.31		
Process monitoring		—	—	—	—	—	—	—	—	—	—	5.07	—	5.07		
Other		7.76	7.23	13.5	93.8	32.2	3.58	2.32	17.7	6.26	—	—	—	18.3		
All classes	625,000	7.18	6.6	17.0	10.3	6.57	3.94	2.61	4.48	6.12	2.31	5.07	7.6	6.33	3,960,000	
1979 Totals	625,000	56,700	48,900	11,200	75,100	171,000	134,000	24,500	64,200	24,900	360	790	12,500	625,000	—	
1987 Totals*	—	407,106	322,740	190,400	733,530	1,123,470	527,960	63,945	287,616	152,388	832	4,005	95,000	3,960,000	3,960,000	

*DATAMATION calculation

Take a close look at the Houston COMPLØT[®] CPS-14 & 15

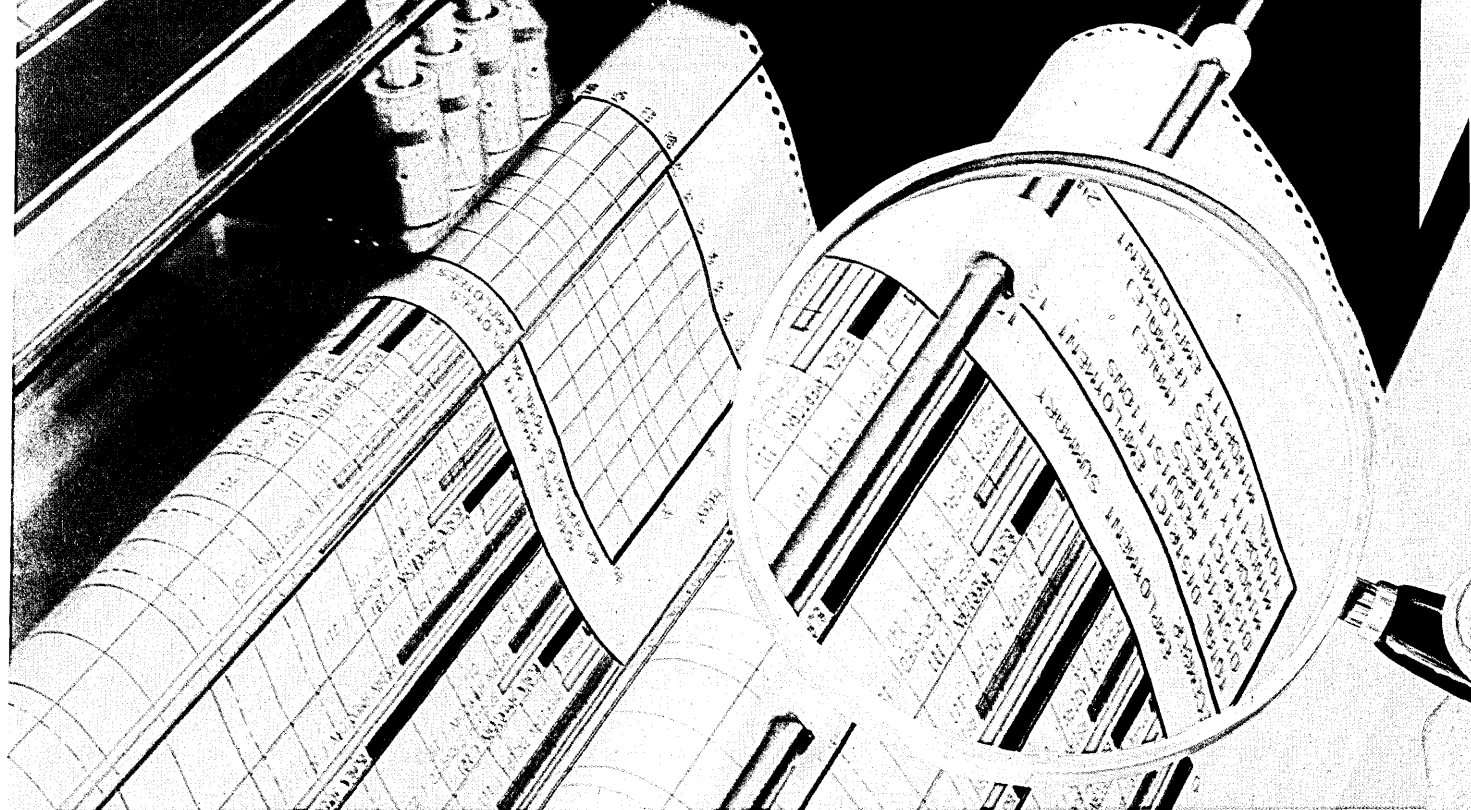

You'll see the real meaning of plot quality.

Drafting-like plot quality—that's the whole idea behind the new CPS-14 and 15 digital plotting systems. Make us prove it. Just take a look at the output from the CPS-14 and 15...you'll see plot quality comparable to or exceeding that of competitive plotters costing twice as much.

Four pens at speeds of 15 IPS and a dual microprocessor controller with superior firmware functions combine to make this the ideal plotter for drafting, civil engineering, numerical control, mapping...any application where plot quality is vital. Scaling on both axes.

Prices for the 22" wide CPS-14 start at only \$9,950. Prices for the 34" CPS-15 start at \$12,950.

Let us send you a free sample plot. See for yourself the superior plot quality provided by these newest members of the CPS family.

Call or write Houston Instrument, One Houston Square, Austin, Texas 78753 (512) 837-2820. Outside Texas call operator #5 toll free 1-800-531-5205. In Europe contact Houston Instrument, Rochesterlaan 6, 8240 Gistel, Belgium. Telephone 059/277445.

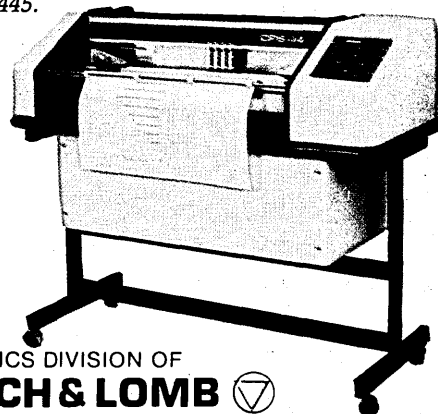

GRAPHICS DIVISION OF
BAUSCH & LOMB

Visit us at WESCON, booths 2330, 2332 & 2336

U.S. Domestic Price Only

®Registered Trademark of Houston Instrument

Circle number 36 for literature
Circle number 37 to have a representative call

NEWS IN PERSPECTIVE

oriented terminals. VDUS should total 2.34 million by 1987—up about 2 million. This contrasts with typewriter keyboard devices which will sell a net 416,000 to reach 545,670 in the same year.

The fastest growth will come in the more specialized terminals, not surprising in view of their relatively low current penetration in Europe. Overall, this sector is slated to grow almost twelvefold between 1979 and 1987 to a total of just under half a million. Fastest movers are automated banking tellers, expected to multiply more than 53 times. These are closely followed

by digital facsimile devices, destined to climb 2,900%. Audio response units, surprisingly, are in for a 25% drop, says the Logica survey.

Fastest growing applications sectors are information retrieval—in which videotex or Viewdata developments will play a significant part—and person-to-person communications. The former will increase by a factor of 17 to reach 190,400 units by '87, while person-to-person terminals will increase just over tenfold to 773,530. The latter includes digital facsimile units, set to increase 32.4 times in this application sec-

tor, according to the survey. But recent administration-sponsored plans like electronic telephone directories and point-of-sale terminals in France and super-telex in Germany may result in some of these figures being revised as part of an ongoing update process.

It is not only the vendors but also the PTTs who are expected to do well during the datacom boom. The report estimates that the PTTs currently earn around \$2 billion, or 5% of annual revenues, from data communications. By 1987, this total will have risen to \$8 billion. What especially pleases the PTTs about datacom is the high proportion of intercity communication compared with conventional telephony. International calls also form a high percentage of data

This announcement is neither an offer to sell nor a solicitation of an offer to buy any of these Securities. The offer is made only by the Prospectus.

July 25, 1980

825,000 Shares

ASI
Advanced Systems, Incorporated

Common Stock

Price \$12.75 Per Share

Copies of the Prospectus may be obtained in any State from only such of the undersigned as may legally offer these Securities in compliance with the securities laws of such State.

E. F. Hutton & Company Inc. **Robertson, Colman, Stephens & Woodman**

Bache Halsey Stuart Shields **Bear, Stearns & Co.** **Blyth Eastman Paine Webber**
Incorporated Incorporated Incorporated

Dillon, Read & Co. Inc. **Donaldson, Lufkin & Jenrette** **Drexel Burnham Lambert**
Incorporated Securities Corporation Incorporated

Goldman, Sachs & Co. **Kidder, Peabody & Co.** **Lazard Frères & Co.**
Incorporated Incorporated

Lehman Brothers Kuhn Loeb **L. F. Rothschild, Unterberg, Towbin**
Incorporated

Salomon Brothers **Shearson Loeb Rhoades Inc.** **Smith Barney, Harris Upham & Co.**
Incorporated

Wertheim & Co., Inc. **Dean Witter Reynolds Inc.**

Bateman Eichler, Hill Richards **The Ohio Company** **Sutro & Co.**
Incorporated Incorporated Incorporated

Allen & Company **Robert W. Baird & Co.** **William Blair & Company**
Incorporated Incorporated

Boettcher & Company **J. C. Bradford & Co.** **Alex. Brown & Sons**

Dain Bosworth **R. G. Dickinson & Co.** **A. G. Edwards & Sons, Inc.**
Incorporated

Foster & Marshall Inc. **Hambrecht & Quist** **Howard, Weil, Labouisse, Friedrichs**
Incorporated

Janney Montgomery Scott Inc. **McDonald & Company** **Montgomery Securities**

Neuberger & Berman **New Court Securities Corporation**

Piper, Jaffray & Hopwood **Rauscher Pierce Refsnes, Inc.**
Incorporated

The Robinson-Humphrey Company, Inc. **Rotan Mosle Inc.** **Stephens Inc.**

Thomson McKinnon Securities Inc. **Wheat, First Securities, Inc.**

The fastest growing applications sectors for terminals are information retrieval and person-to-person communications.

traffic, particularly from the smaller European countries.

Another phenomenon spotlighted by the study is the increasing use of public data networks. By 1987, the survey predicts, 30% of network termination points will be connected to public data networks rather than to leased lines or the switched network. The Europeans are introducing datacom nets, both packet switched and circuit switched, almost as fast as users want them. RETD in Spain, Datex-L in Germany, and Transpac in France are all now fully operational, and Germany's Datex-P packet net and PSS in the U.K. will follow shortly.

National developments in datacom growth are expected to follow similar patterns. Currently the lead in numbers of terminals in use is clearly held by the U.K.,

GROWTH IN DATACOM BY COUNTRY

Total Number of PTT-Connected Terminals

COUNTRY	1979	1987
Austria	6,880	64,800
Belgium	22,200	180,000
Denmark	21,100	133,000
Finland	9,040	62,600
France	80,700	570,000
Germany	96,900	570,000
Greece	790	15,100
Ireland	1,000	12,500
Italy	61,600	439,000
Luxembourg	1,490	10,600
Netherlands	25,200	188,000
Norway	8,770	59,800
Portugal	750	12,100
Spain	33,900	244,000
Sweden	46,600	319,000
Switzerland	22,800	162,000
United Kingdom	185,000	914,000
Western Europe	625,000	3,960,000

CIRCLE 217 ON READER CARD

Wang's 2200 Series Small Business Computers deliver custom solutions to specific business problems.

Too often, buying a small business computer means settling for a general-purpose answer.

But not with Wang. Because in addition to high performance, low cost and ease of use, our 2200 Series interactive computers offer something

very rare: customizing.

From our entry-level PSC II to our multi-job, multi-user 2200MVP, our 2200 computers are designed to be specially tailored—in both hardware and software—to do exactly what you need done. Payroll. Accounts receivable. Inventory. And plenty more.

Also, they let you expand into new applications easily—without giv-

ing up the investment you've already made. And our direct hardware and software support means you'll get all the help you need in planning and developing your system.

So instead of buying a computer that's just right for everybody, call Wang. And get a computer that's just right for you.

Wang Laboratories,
Lowell, MA 01851,
(617) 459-5000.

I'm interested in a fitting. Tell me more.

Name _____
 Title _____
 Organization _____
 Address _____
 City _____
 State _____ Zip _____
 Tel. # _____

Send to:
Wang Laboratories
Lowell, MA 01851
(617) 459-5000



DP98/D90

Wang computers: Firm-fitting.

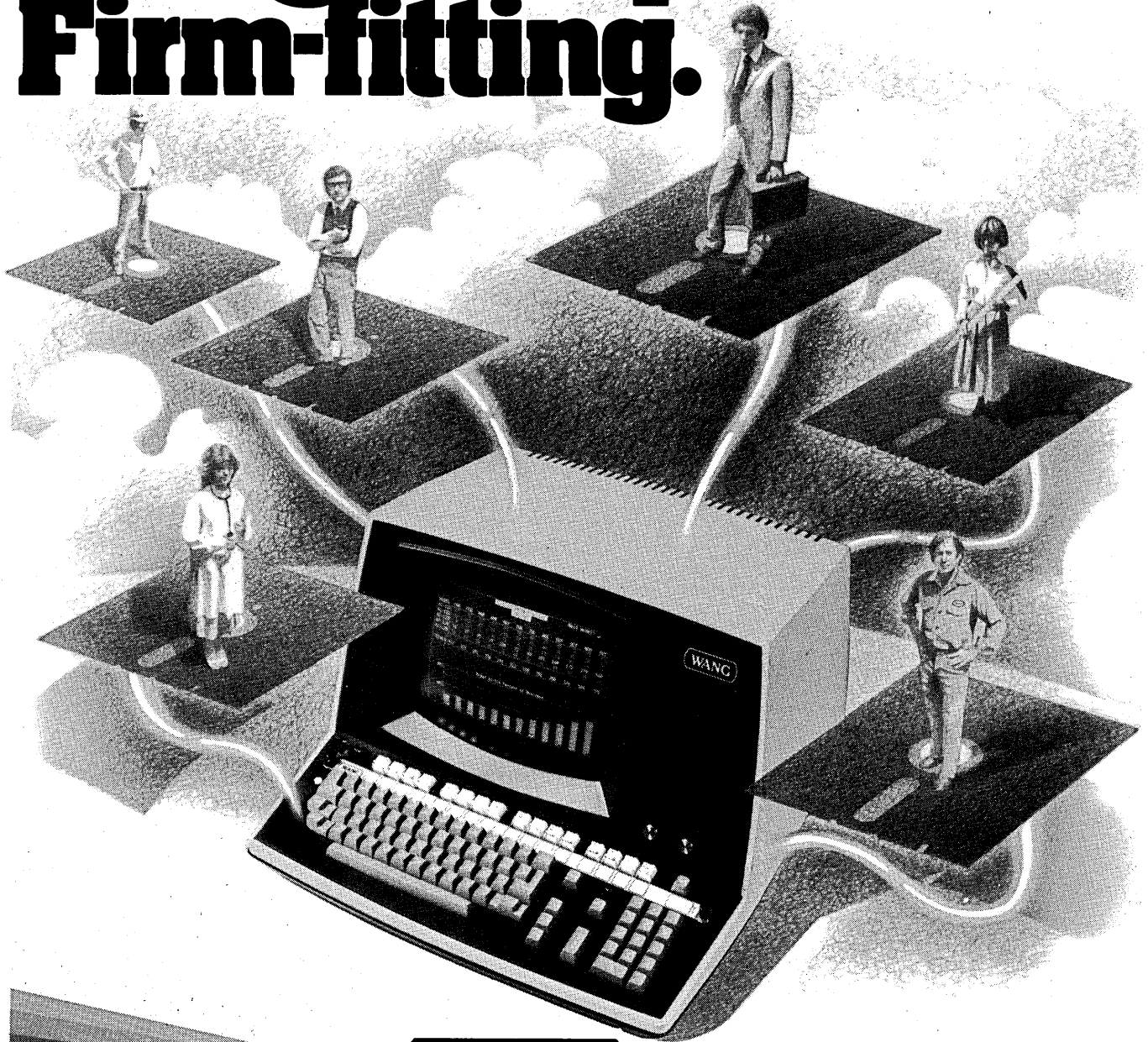

Making the world more productive.

The 7 most common mistakes made in designing computer room environment.

Diagram 1 Standard Cooling

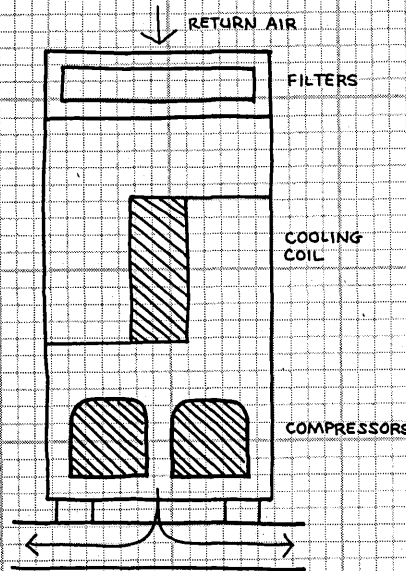
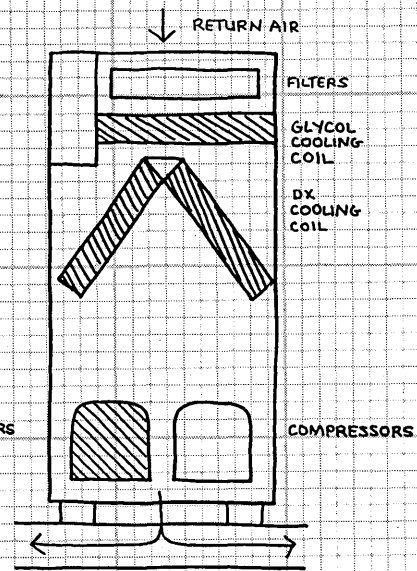

Diagram 2 Partial Savings



Mistake No. 3 Using energy-wasting compressors for winter cooling.

It's a costly error to run compressors in the winter when using a standard or partial savings system (Diagrams 1 and 2). In the temperate zone, temperatures fall below 50°F for at least half the year. The elimination of all compressor operation during this period can save thousands of dollars each year.

However, in a computer room, using outside air for cooling destroys critical humidity control. Closed-circuit glycol systems with an auxiliary coil avoid this problem. But, some of them are poorly designed (Diagram 2 shows restricted air flow and an undersized coil). These systems make partial compressor operation necessary.

The EDPAC Solution

The EDPAC "ECX" System (Diagram 3) avoids these costly mistakes and offers maximum savings. "ECX" can reduce energy use by as much as 60%. It is available either as a standard option on new

Diagram 3 Maximum Savings

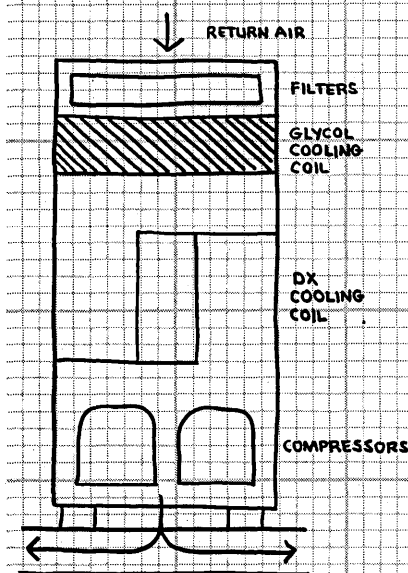

EDPAC equipment or as a retrofit to existing systems. In ten years it can save \$100,000 in a typical 3,000 sq. ft. computer room.*

To make this kind of savings possible we've made the "ECX" coil

oversized (14 fins per inch, 6 rows deep, full face area) and made sure the airflow is unrestricted.

In fact, the "ECX" is so efficient that it provides 100% of the sensible capacity with glycol temperatures of 52°F or below.

And to make sure there is no sacrifice of reliability, automatic controls return the system to compressor operation whenever the room temperature doesn't hold.

For a brochure detailing the solutions to all seven "mistakes," contact your local EDPAC representative or write to the address below.

The 7 most common mistakes made in designing computer room environment.



EDPAC

Energy Efficient Process
Cooling for Computers

*Based on cities in most populated temperate zones with a projected average rate of .08¢/kWh over ten years.

EDPAC is a product of AC Manufacturing Company, Cherry Hill, New Jersey 08034, Telephone (609) 428-9800

EDPAC also offers products for mini-computer rooms and water-cooled computers.

CIRCLE 39 ON READER CARD

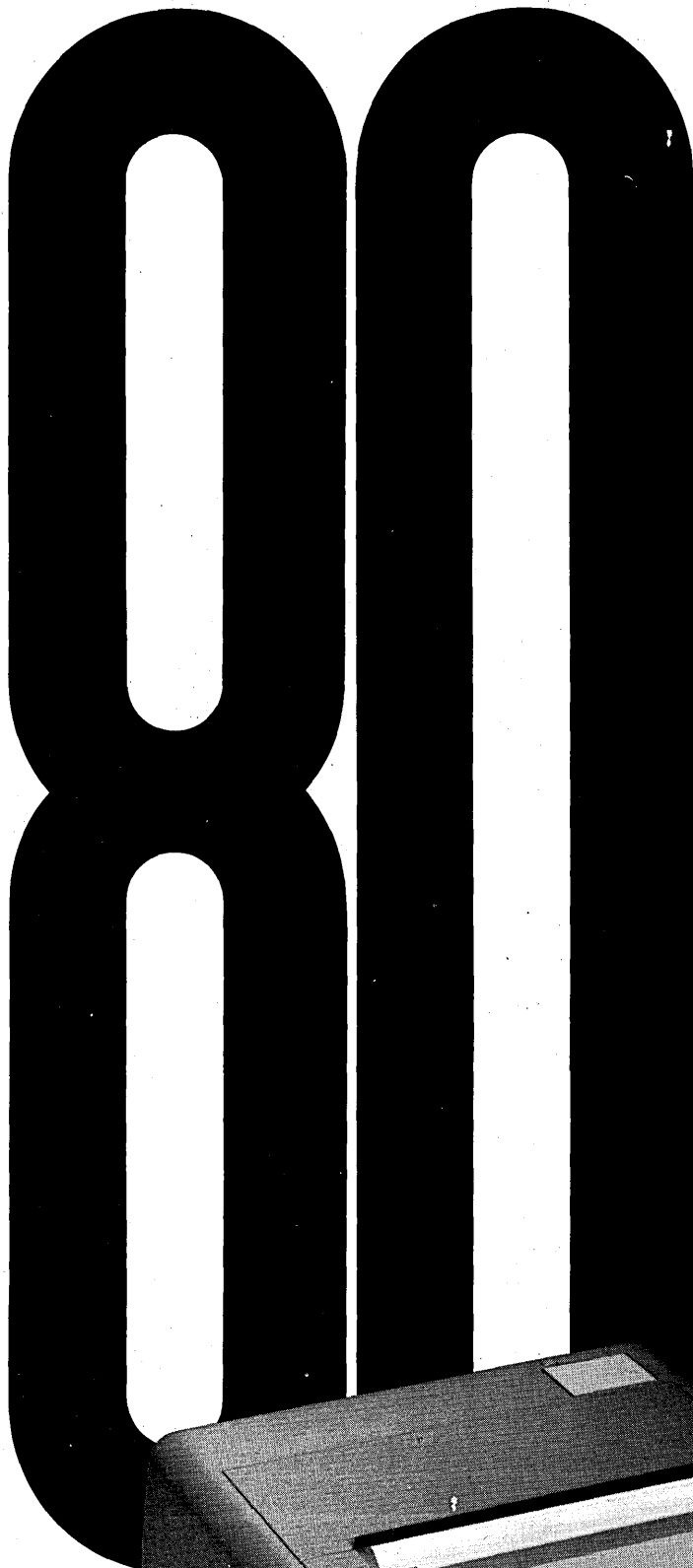

80%

That's how much one Fortune 500 company slashed the man-hours required for their field transactions. 80%.

The reason? Productivity through Portable Processing. With the Miniterm® 1206, a lightweight, briefcase-size portable computer, people take data processing power directly to the work being performed. Wherever it is.

That way, essential decision-making information that can determine success or failure in the field is available on the spot, at the point of transaction. Important sales orders can be processed immediately with greater accuracy, and confirmed without delay. Transactions that took weeks by mail now take only minutes. And, human resources are used far more productively.

Just as important, this same information is available immediately to management via telephone when it's most timely and valuable, so that business trends can be spotted . . . and planned for.

Today, more and more companies in such diverse industries as pharmaceuticals, apparel, finance, agriculture, manufacturing, insurance, and others are integrating portable Miniterms into their field operations to extend the economy and efficiency of computers right to the source of the work.



COMPUTER DEVICES

I'd like to know more about Portable Processing and the Miniterm's potential in my company.

Please send me your brochure.

Please have your representative call me.

COMPUTER DEVICES INC.
25 North Avenue
Burlington, MA 01803

Name _____

Title _____

Company _____

Street _____

City _____ State _____ Zip _____

Type of Business _____

D

Available under GSA

The potential applications of portable computer systems are just beginning to be realized. If you'd like to explore

Miniterm's potential for your company, fill in the coupon. Or call Computer Devices, Inc. toll-free: 800-225-1230.

In Massachusetts call (617) 273-1550.

Europe: Computer Devices, Inc. 108 Place Des Miroirs. 91000 Evry, France. (6) 079 0077. Telex 692 671.

We travel in the best companies.

CIRCLE 40 ON READER CARD

NEWS IN PERSPECTIVE

with Germany and France some way behind.

The Eurodata survey says the U.K. will stay the biggest market and even extend its lead. Users in the U.K. will acquire a net 729,000 terminals between 1979 and 1987, compared with France's 489,300 and Germany's 473,100. Here again, new government programs could put totals significantly higher. Italy, also a booming market, should install some 377,400 devices during the same period. These four countries will account for 64% of the market by 1987, compared with 71% in '79.

One trend identified by the survey is the tendency to cluster more terminals together at network termination points.

One trend identified by the survey is the tendency to cluster more terminals together at network termination points (twice as many in the U.K. as elsewhere). Though this varies by application, the average number of terminals per termination point would increase from 1.59 today to 2.44 in 1987. There is also a trend to higher speeds, higher numbers of messages per transaction, and more bits per message. Though facilities are limited in some countries, there is an in-

creasing tendency to go for 9600 bits per second lines. Traffic volume in bits per day will rise about eight times by 1987 to 9,820 billion. Call duration will drop by almost 50% to just under eight minutes, while messages per transaction will rise marginally from 3.04 to 3.23.

One of the strong points behind the survey is that the PTTs, nominally at least, gave their cooperation to the firm carrying out the survey. Some 2,800 interviews involving a 92-page questionnaire were completed. This input generated 3,000 pages of printout, 800,000 items of data, and covered 80,000 different products.

Not surprisingly the complete study, entitled "The Eurodata Reports," will have cost \$4 million to complete. It is a three-part survey—one for PTTs, one for terminal manufacturers, and one for data communications equipment makers. It will be available later this year from Logica. The heavyweights in the business are expected to pay around \$70 million for the complete set. The PTT volume will cost around \$42 million on its own. Pricing for the other volumes or for parts of the survey has not yet been finalized.

The accuracy of the forecast will depend very much on the conduct of the PTTs, as Eurodata chairman Marino Benedetti observed at the recent Rome meeting of the Intergovernmental Bureau for Informatics.

There the Italian previewed many of the Eurodata conclusions to an international audience. "Where users have technically feasible alternatives, the major role in deciding the distribution of the market between them is played by tariffs," he declared in an implicit reference to a problem that worries many vendors, European and non-European. PTTs would indeed be able to direct users towards different types of equipment, using their tariffs as a lever—an obvious opportunity, claim many observers, to favor national suppliers.

Another trend identified by Benedetti will bring both good and bad to vendors. "Until now, most governments . . . have paid relatively little attention to the importance of data communications in their plans for the management and development of the economies which concern them. The situation . . . will change with increasing rapidity during the 1980s as governments accept the need to take account of data communications from many points of view."

—Andrew Lloyd

STRATEGIES

IBM HOLD IN EUROPE SLIPPING

The Japanese are multiplying European bridgeheads in a bid for the IBM market.

Japan is rolling in the big guns to win a share of the IBM mainframe market in Europe. New Hitachi deals with Olivetti and BASF, following the increasingly successful Siemens/Fujitsu tie-up, will hit IBM's market harder than any efforts by Europe's government-supported heavyweights—ICL, Cii-Honeywell Bull, Siemens, or Olivetti, say industry analysts.

"The Euro-Japanese thrust is bound to take some share from IBM," claims Aharon Orlansky, research vice president of New York analysts Dean Witter Reynolds. In the five years from 1982, the IBM environment—which includes PCM equipment—will outpace the overall non-IBM-compatible mainframe market. But IBM's own European growth will fall about a percentage point below the 16% to 17% slated for IBM and its compatible suppliers, predicts Orlansky.

The new Hitachi push gives both \$15 billion a year chemical firm BASF and the \$2.25 billion a year Olivetti the right to sell Hitachi machines all over Europe. The deal also includes Latin America and, for Olivetti, South Africa as well. Hitachi

What's your speed?

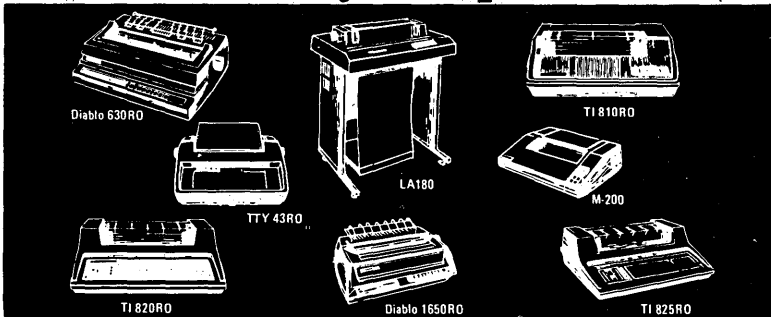

MTI delivers ROs from 30-340 cps.

30 cps: Teletype 43RO	40 cps: Diablo 1650RO & 630RO
45 cps: Diablo 1640RO	75 cps: Texas Instruments 825RO
150 cps: Texas Instruments 810RO & 820RO	
180 cps: DEC LA180	340 cps: Dataproducts M-200

And MTI will interface your Receive-Only printer with your computer or CRT. Or with your phone system by the proper modem. We are the one source for all the terminals, peripherals, applications expertise and service you'll ever need. Call MTI today at: 516/482-3500, 212/895-7177, outside N.Y.S.: 800/645-8016, and in Ohio: 216/464-6688.

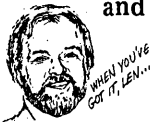

Applications Specialists & Distributors, Great Neck, N.Y. and Cleveland.
DEC, Hazeltine, Lear Siegler, Dataproducts, Texas Instruments, Teletype, Diablo, Techtran, MFE, Omnitac, Anderson Jacobson, General DataComm, Intel, Cipher, Priam, SMS, Western Peripherals, Able Computer, Elgar and Franklin Electric.

CIRCLE 41 ON READER CARD

TAKE THIS TEST BEFORE YOU SHIP YOUR NEXT PACKAGE.

Greyhound Package Express wants to put your present shipping company to the test. The test is easy, will take just a minute, and could save you a lot of time and money on your next shipment.

Does your carrier offer overnight delivery on shipments up to 500 miles?

GREYHOUND yes
YOUR CARRIER _____

How about same-day service between many major metropolitan cities?

GREYHOUND yes
YOUR CARRIER _____

Is your carrier about half the cost of many air express services?

GREYHOUND yes
YOUR CARRIER _____

Does your carrier accept lot shipments to the same recipient (up to three packages) on one waybill?

GREYHOUND yes
YOUR CARRIER _____

Is your carrier open 7 days a week in most locations?

GREYHOUND yes
YOUR CARRIER _____

Does your carrier offer service to over 15,000 places across America?

GREYHOUND yes
YOUR CARRIER _____

Or does your carrier serve all 48 contiguous United States?

GREYHOUND yes
YOUR CARRIER _____

Does your carrier accept packages up to 100 lbs.?

GREYHOUND yes
YOUR CARRIER _____

Or 141 inches total including 60 inches for the longest dimension?

GREYHOUND yes
YOUR CARRIER _____

If your carrier falls short on any of these questions, you should be using Greyhound Package Express. Because we do all of the above, plus Greyhound Package Express can now provide pickup and delivery in over 50 metropolitan areas, with more cities being added every day. And we give you five ways to pay: prepaid, collect, C.O.D., Master Card/ Visa, and handy charge accounts.

For speed, economy and convenience, the answer to your shipping questions is Greyhound Package Express.

To find out where Greyhound Package Express can help you the most, take a dime and center it over your city. Then draw a circle around the dime. That circle represents a 500-mile radius, and inside it, Greyhound Package Express is tough to beat.

Next shipment, give Greyhound Package Express a call. We're listed in the telephone directory.

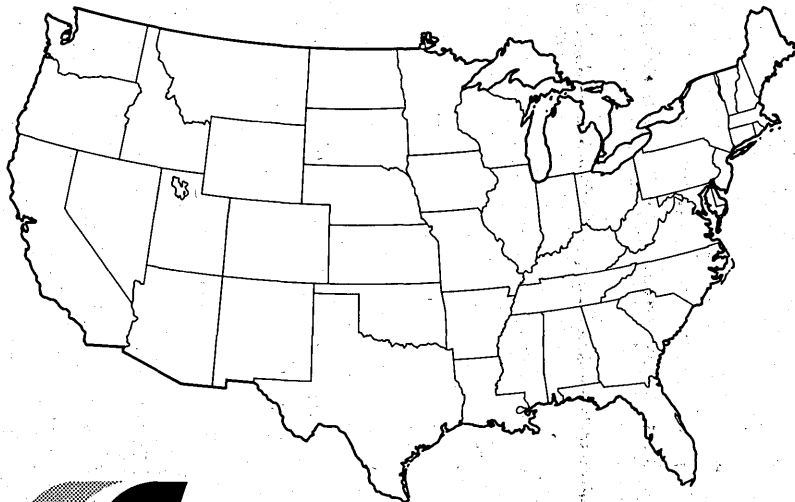

**GREYHOUND
PACKAGE EXPRESS**

CIRCLE 43 ON READER CARD

GIVE YOUR DATA PRESENTATIONS FRONT ROW CENTRE IMPACT.

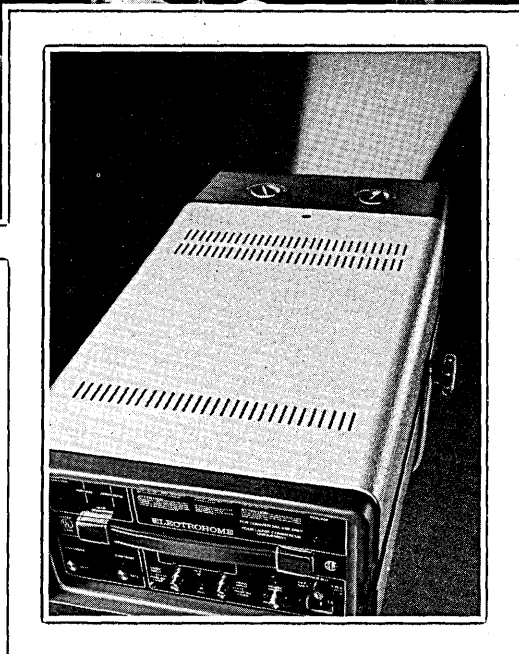
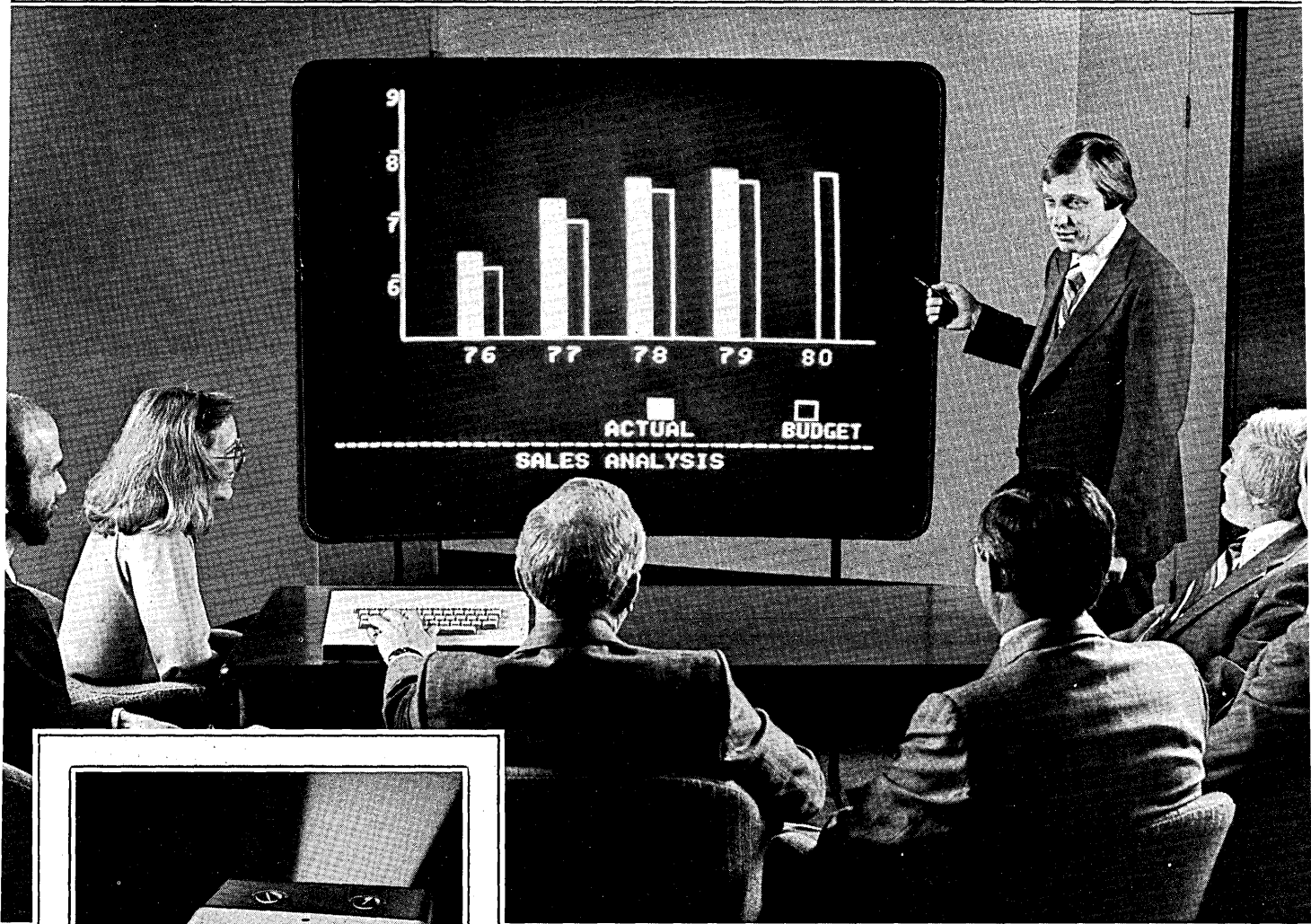

The Electrohome EDP 56 data projector gives everyone in the room a front row centre view of your presentation. You're in complete control of group sessions, because the EDP 56 projects computer generated images onto a large screen.

Designed especially for large, high resolution data/graphic display, the EDP 56 will be a dynamic addition to all presentations—from the boardroom to sales clinics. We wouldn't begin to tell you how to use it—you're limited only by your imagination.

Complete adaptability means the EDP 56 readily interfaces with most CRT computer terminals. Its rugged, yet light-

weight construction makes the EDP 56 completely versatile. It can be hung from the ceiling, mounted on a stand, or used from any convenient desk top. In addition, the EDP 56 is easy and fast to set up for either standard or rear screen projection, even for non-technical personnel.

For considerably less than what you might expect to pay, the EDP 56 can be yours. And, it comes complete with the quality engineered features and group impact potential you want and need.

So seat everyone front row centre at your next presentation. Start by contacting Electrohome Electronics, a leader in video displays.

ELECTROHOME ELECTRONICS

CIRCLE 44 ON READER CARD

809 Wellington St. N., Kitchener, Ontario, Canada N2G 4J6 Telephone (519) 744-7111 Telex 069-55449

NEWS IN PERSPECTIVE

sources say these may not be the only deals the Japanese firm will make in Europe. A European manufacturing site is reported to be part of its plans. But BASF and Olivetti say that nothing in this line is planned for the near future. Olivetti is already selling Hitachi systems in Italy. In August, it shipped the first M200H (5.4 MIPS) system in Europe to the Piedmont local government administration in Turin. BASF has also installed one system in Germany.

Siemens' tie-up with Fujitsu, now two years old, is beginning to pay off, as recent results show. Orlansky estimates that

Siemens is now picking up 15% to 20% of orders for 3033/168 class systems in the German Federal Republic.

Early users of Fujitsu machines seem to be satisfied. Large service bureau Datev, about to upgrade its Siemens/Fujitsu 7870 to a 7880—claimed to outpace an IBM 3033—reports a side benefit from having the Fujitsu machine: IBM is offering much better service on Datev's remaining twin 3033s.

The Japanese offensive comes at a time when IBM's European margins are under heavy pressure from rising personnel

costs as well as the worldwide 1979 switch from purchase to rental. Net income took a 25.4% drop in local currency in Germany, with a similar fall in Switzerland, and heavy falls in France and Belgium as well. Net income rises in Italy and the Netherlands were about half the local inflation rates.

Corporate headquarters, viewing the results in dollars, should find the numbers a little less discouraging. But the sight of slower revenue growth than local European competition is causing at least some soul-searching. Country sales managers, who had set modest 1980 quotas, have been told to crack the whip and get more purchases. Results overall have not been spectacular so far, but there is some evidence that the Germans at least are reversing the purchase-to-rental trend.

But apart from short term profit growth, industry watchers are also keeping a close eye on IBM's market share in Europe. In all the major European countries, local manufacturers outperformed IBM in growth from the home market last year. Owing to the depreciation of the U.S. dollar, figures look more spectacular in dollar terms.

The Japanese offensive comes at a time when IBM's European margins are under heavy pressure.

In Europe's largest market, Germany, Siemens' home revenues rose an estimated 32% to \$760 million for 1979's September year-end. IBM Deutschland managed a mere 10.2% climb to the still staggering sum of \$2.404 billion. In France, the next biggest market, Cii-Honeywell Bull's home turnover was up 26.4% to \$644 million, compared with the IBM France mini-surge of 7.4% to \$1.53 billion. Across the English Channel, ICL recorded an impressive 31.4% rise in its year ending last September. The U.K. company had \$705 million in home revenues, compared to IBM U.K.'s 16.8% upswing to \$951 million. In Italy, IBM Italia again just outperformed its U.K. rivals with a 20.6% rise to top \$1 billion. Olivetti, on the other hand, was up approximately 30.4%, reaching \$373 million.

What the Japanese and the others will have to contend with is what looks like a massive increase in IBM shipments last year. No official figures are available, but because the output of IBM's European factories is sent almost exclusively to other European countries, IBM national subsidiary export figures are a good guide to shipment levels.

These figures are available from IBM as part of its disclosure practices. Most export totals show huge increases: IBM Italy—up 65% in dollars; U.K.—up 43%; France—up 36%; and Germany, despite stagnating home sales—up 23.5%. From other

THE COMPLETE PRINTER LINE: 800 243-9054*

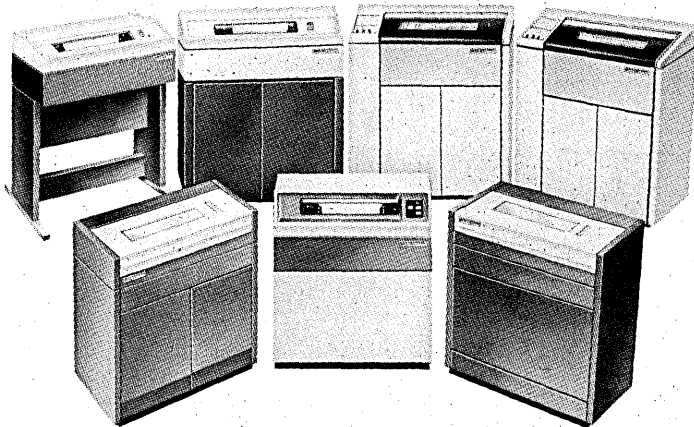

Digital Associates offers the widest selection of line printer systems plug-compatible with virtually any minicomputer manufactured. For drum, chaintrain, band, belt or matrix technologies, just call our toll-free number and our experts will help you pick the printer that meets your exact requirements. Digital Associates has 27 different models to choose from so you don't have to settle for second best.

With prices of up to 40% off the minicomputer manufacturer's list, delivery in 30 to 40 days, installation by factory-trained technicians and a nationwide service network, it's easy to see why Digital Associates is the largest independent supplier of minicomputer printer systems.

The Printer Store

DIGITAL ASSOCIATES CORPORATION

1039 E. Main Street, Stamford, CT 06902 TWX 710-474-4583

*In Connecticut call (203) 327-9210

CIRCLE 45 ON READER CARD

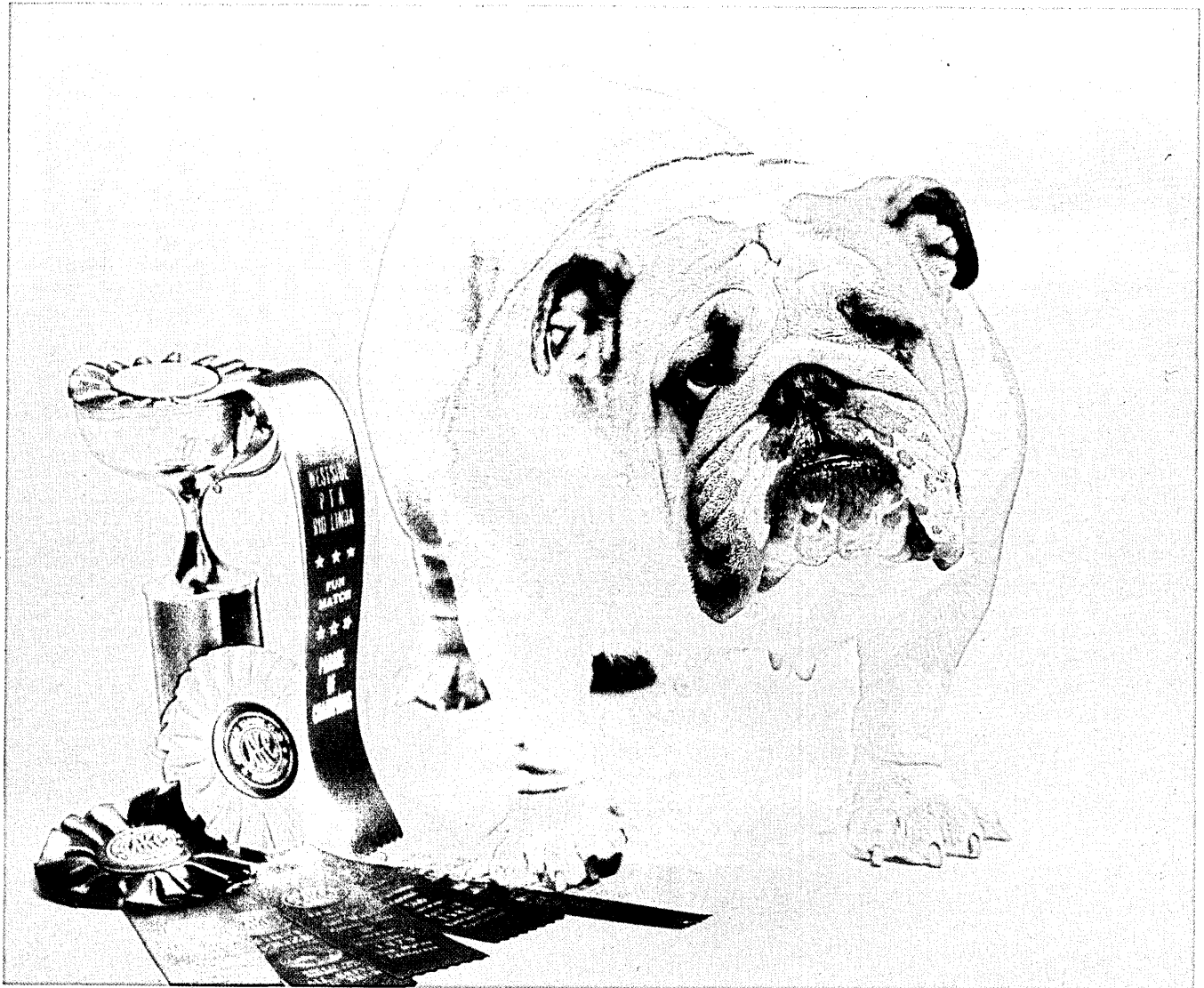

Success Is A Matter Of Performance

In today's computer environment, systems are so complete . . . and so dynamic . . . that attempts to maintain in-house development of systems software are becoming counter-productive. The fundamental fact, that has been accepted by successful data processing center operations, is that not every center has the capacity to produce each and every software tool that the present expanding hardware utilization allows.

The "communication age of the '80's" establishes a *data processing society*, that calls for a formal, yet workable, mode of operation.

Hardware capability has given way to software performance as the criteria for successful data processing operation.

At Software Module Marketing, performance is *Where Service and Software Come Together* . . . More than a slogan, SMM believes *service* is a commitment to provide our customer with marketing and technical support that will continue to advance their leadership standards.

. . . When you have a product from SMM, you can count on three things — *Productivity, Service and Performance.*

SMM products support OS/VS1, MVS, MVS/SE, MVS/SP operating systems on IBM and compatible mainframes.

DMS/OS — The disk management system that optimizes the use of DASD resources.

ACEP — The Conversational On-Line Time Sharing System.

STAM/SDSI — Integrity systems supporting the multiple CPU shared tape/disk environment.

Software products serviced and marketed by SMM. Call, telex, or write today for a free thirty-day evaluation, or additional information.

CROCKER BANK BUILDING/PENTHOUSE
1007 SEVENTH STREET SACRAMENTO, CALIFORNIA 95814
(916) 441-7234 TELEX: 377314

SCANDINAVIA • BENELUX • FRANCE • U.K. • GERMANY • ITALY • AUSTRALIA • JAPAN

**SOFTWARE
MODULE
MARKETING** 

Where Service and Software Come Together

CIRCLE 46 ON READER CARD



WEBER LEGITRONIC 11 LABEL PRINTING SYSTEM

FUNCTION SELECTION

F1 - INFORMATION FILE MAINTENANCE

F2 - PRINT LABELS

F3 - CREATE A LABEL FORMAT

F4 - EDIT A LABEL FORMAT

F5 - SYSTEM MAINTENANCE

F10 - STOP/FF

PLEASE ENTER DESIRED FUNCTION

WEBER MARKING SYSTEMS, INC.
ARLINGTON HEIGHTS, ILLINOIS 60006

PART NO. **3886907**

QUANTITY **80052** ENG. CHANGE **5**

DATE PACKED **07-14-80**

WEBER MARKING SYSTEMS, INC.
ARLINGTON HEIGHTS, ILLINOIS 60006

PART NO. **3886907**

QUANTITY **80052** ENG. CHANGE **5**

DATE PACKED **07-14-80**

WEBER MARKING SYSTEMS, INC.
ARLINGTON HEIGHTS, ILLINOIS 60006

PART NO. **3886907**

QUANTITY **80052** ENG. CHANGE **5**

DATE PACKED **07-14-80**

WEBER MARKING SYSTEMS, INC.
ARLINGTON HEIGHTS, ILLINOIS 60006

PART NO. **3886907**

QUANTITY **80052** ENG. CHANGE **5**

DATE PACKED **07-14-80**

WEBER MARKING SYSTEMS, INC.
ARLINGTON HEIGHTS, ILLINOIS 60006

ROTTERDAM NETHERLANDS

TRANSPORTATION CONTROL NUMBER **FH3101 8229 1013** RDD **188** PROJECT

FROM: DEFENSE LOGISTICS AGENCY /SU
DEFENSE GENERAL SUPPLY CENTER
RICHMOND, VIRGINIA 23297

TO: (POE when applicable) **2391269**

FY8989 416 BMW
AFCS STOR AND ISSUE SEC DEPOT 2
GRIFFISS AFB NY 13441

POD (when applicable)

BOSTON MASS

ULTIMATE CONSIGNEE OR MARK FOR

ROTTERDAM NETHERLANDS

PIECE NUMBER	TOTAL PIECES	WEIGHT THIS PIECE	CUBE THIS PIECE
1	5	43 LBS	2.5

DEFENSE LOGISTICS AGENCY /SU
DEFENSE GENERAL SUPPLY CENTER
RICHMOND, VIRGINIA 23297

TO: (POE when applicable) **2391269**

FY8989 416 BMW
AFCS STOR AND ISSUE SEC DEPOT 2
GRIFFISS AFB NY 13441

POD (when applicable)

LEGITRONIC Label Printer

5306

8845

SNAP-ACTION SWITCH
125 V DC 1/2 AMP

2HBA-1 25 10/27/80

INK SPECIALTIES CO
1436 EAST DAVIS
MT PROSPECT IL 60056

Webster Marking Systems

LEGITRONIC Label Printer

5306

8845

SNAP-ACTION SWITCH
125 V DC 1/2 AMP

2HBA-1 25 10/27/80

INK SPECIALTIES CO
1436 EAST DAVIS
MT PROSPECT IL 60056

Webster Marking Systems

Thanks to the memory

Meet the Weber *Legitronic II*, the newest member of the Weber family of electronic printing systems. The computerized label printing system that does something remarkable. It remembers.

The floppy disk remembers

Floppy disk memory. That's the heart of the *Legitronic II*. It lets you create and store a multitude of label formats and data to use whenever you want. And you only store the data once. It's simple and efficient. No more labeling delays. No more needless waste of labor and money. That's good to remember.



Don't forget, we wrote the program

That means you don't have to. Its question/answer prompting and proportional label format make operator training easy. If they can read and type, they can operate the *Legitronic II*.

Remember the name

The Weber *Legitronic II*. From the people you've trusted for quality and innovation in label printing systems for nearly fifty years.

Remember the place

For a hands on demonstration of the *Legitronic II*, stop by the Weber Exhibit, Booth 1420 at the Packaging Show, October 27-31, McCormick Place, Chicago.

Weber Marking Systems
711 W. Algonquin Road
Arlington Heights, IL 60005
Telex: 910-222-1602

You can forget your labeling problems.

Weber®

The Labeling Specialists

Call 800/325-6000
Ext. 2353

CIRCLE 47 ON READER CARD

NEWS IN PERSPECTIVE

data, independent observers calculate a 35% rise in 1979 IBM shipments based on dollar rental values. "No other mainframe company in Europe experienced more than 30% growth in shipments last year," said one observer.

Despite these impressive indicators, IBM is still expected to lag behind industry revenue growth during 1980. Orlansky estimates only a 5% to 10% rise in mainframes. But 1981 could see the company picking up speed to around a 15% increase and it could turn in some really impressive figures the following year.

It is around this time that the companies selling Hitachi equipment are also expected to have gotten their acts together. Elsewhere on the PCM scene, aggressive Nixdorf Computer should be well down the IBM-compatible road by then with its 4300 look-alike project announced in May.

The main word of caution about the new deals is that despite the financial weight and technical expertise of BASF and Olivetti, it will take a lot of time for the two Europeans to set up a viable marketing network. Olivetti Computers, an offshoot group formed especially to sell mainframes

(where Olivetti will use both IPL and Hitachi manufactured products), has already started selling systems in Italy and Spain. Managing director Renzo Bosio, formerly with Univac, says the company should be operational in the U.K. by late fall.

Olivetti is also planning to start up a sales operation in France, and, apart from the Italian company's forthcoming fight with BASF, observers are curious as to how the various parties involved will resolve the conflicts which could arise because of another recent series of tie-ups—those between St Gobain and Olivetti, St Gobain and Cii-Honeywell Bull, and St Gobain and National Semiconductor.

Rumors in early August suggested that St Gobain, a \$9 billion a year French glass and construction conglomerate, was itself close to a distribution deal with Hitachi. This was categorically denied by a spokesman for the French company—though the source admitted that such a deal would not be illogical. Olivetti was also mystified, and said that Hitachi would surely have told them if it were negotiating with St Gobain.

Hitachi does not discount the granting of further distributorships in Europe. But if talks with St Gobain have taken place, they did not happen through Hitachi's European organization. Despite St Gobain's denial, there is other evidence that the company is interested in the PCM market, although French political pressure may keep the firm out of this fast-growing area.

Independent observers calculate a 35% rise in 1979 IBM shipments in Europe based on dollar rental values.

Olivetti is now very much in the orbit of St Gobain, which has taken a 20% holding in the Italian company. So too is Cii-HB, which St Gobain effectively controls. National Semi has a joint venture in integrated circuits with St Gobain, which has said in the past that it may sell National Semi's data processing products. If St Gobain took a Hitachi dealership, this could jeopardize the friendly paternalism towards its new affiliates.

For from internecine feuding, Olivetti sees its projected French Hitachi sales venture as hardly impinging on the affairs of the French national computer company, Cii-HB. The latter markets mainly Honeywell-type systems, while Olivetti will be going for the upper end of the IBM-compatible market. Nasco (National Semi's new systems company) systems are lower down the range, though they could overlap with IPL systems. Sole bone of contention is an unconfirmed Cii-HB project to build a large processor to compete with big IBM systems. But this may only be offered as a growth path for Honeywell architecture users.

Europe appears big enough for both

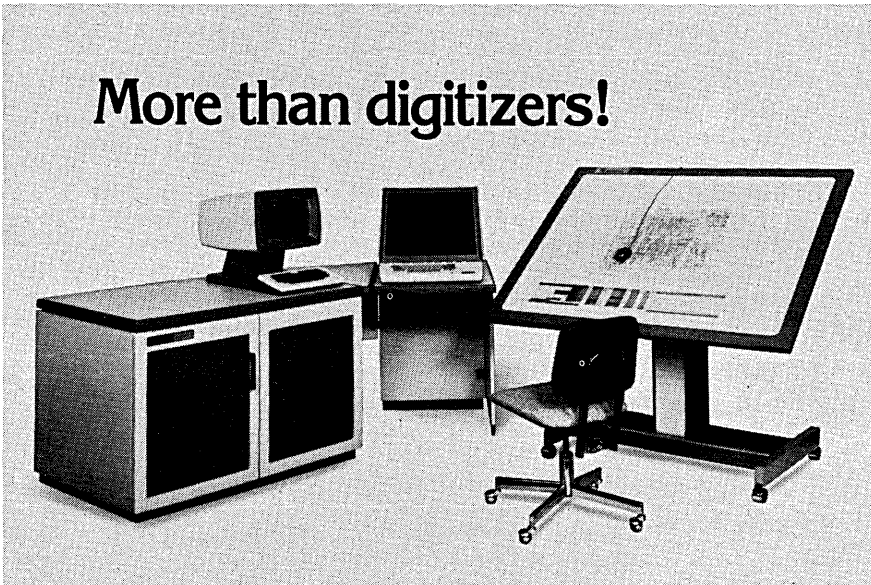

More than digitizers!

Turnkey computer-aided drafting systems suited to your needs starting at under \$50,000 — complete!

While it is true that Summagraphics is the world's largest manufacturer of digitizers, our interest in computer-aided drafting systems does not stop there.

Our Datagrid II system comes in configurations of hardware and software that give you the capabilities you need without forcing you to pay for frills you'll never use.

Datagrid II is available for remote job entry situations where all that is required is preprocessing graphic inputs for communication or recording. It is also available in totally stand-alone configurations complete with plotter or for use with your existing plotter.

Systems are already at work in such varied applications as PCB and IC layout, mechanical drafting, mapping, schematic diagrams and a host of others.

Before you invest in any CAD/CAM system, you should investigate the real values offered by Datagrid II. Tell us what your needs are, and we'll send you complete information — free.



Summagraphics[®]
corporation

35 Brentwood Avenue • P.O. Box 781 • Fairfield, Connecticut 06430
(203) 384-1344 • Telex: 96-4348

CIRCLE 48 ON READER CARD

FROM STATISTICAL MULTIPLEXORS TO COMPLETE DATACOMM NETWORKS, EVERY DCA COMPONENT IS ENGINEERED TO EXPAND

DCA protects your initial investment in statistical multiplexors with the lowest-cost network growth in the industry. So you can start with a small datacomm network today, and expand or modify it to meet your needs tomorrow.

Our System 115 statistical multiplexor can be used in point-to-point networks to support from 2 to 32 asynchronous terminals at a remote site. DCA's statistical multiplexing assures excellent response time, character transparency and error-free transmission.

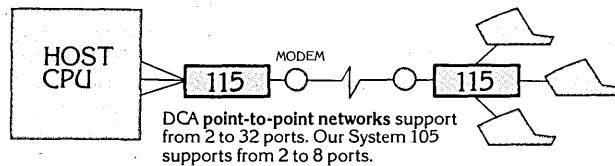

DCA point-to-point networks support from 2 to 32 ports. Our System 105 supports from 2 to 8 ports.

DCA's multipoint multiplexing configuration serves a number of remote terminal locations with just a single telephone line, for substantial savings in phone-line and hardware costs. DCA users have benefitted from multipoint multiplexing since January 1979.

DCA's System 205 is a statistical multiplexor designed for DEC UNIBUS*-based computers. The 205 requires only one UNIBUS slot to emulate up to 16 DEC DZ11 modules and a 128-port stat mux. This greatly lowers hardware costs and improves response time as well.

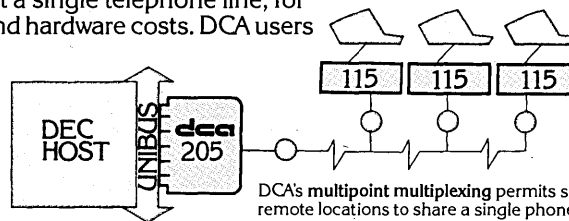

DCA's multipoint multiplexing permits several remote locations to share a single phone line.

Because of DCA's unique modular design, all of the above networks could easily expand into larger, more powerful networks. As the master network processor, System 355 gives terminal users access to any host computer anywhere in the network. In addition, the 355 supports up to 126 ports, 62 of which can be high-speed synchronous trunk links. Several 355's can be combined to greatly expand this support. Features include port contention, switching, unlimited routing, X.25 support and a wide array of network management tools.

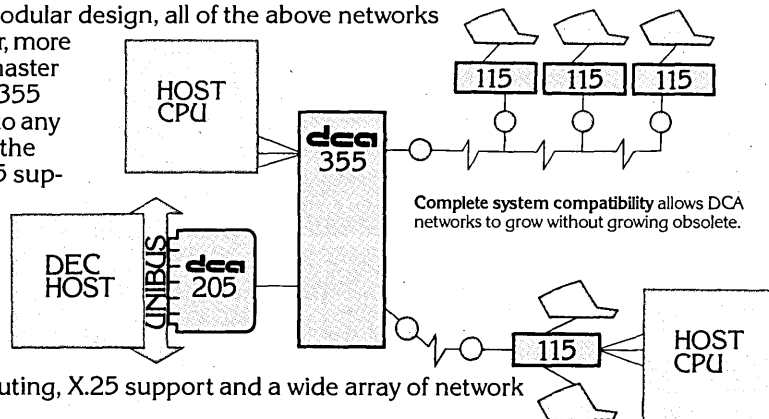

Complete system compatibility allows DCA networks to grow without growing obsolete.

Total system access and unlimited network growth at very low cost — that's the DCA advantage. For complete information, call or write for our 16-page brochure.

*TM Digital Equipment Corporation



ENGINEERED
TO EXPAND

Digital Communications Associates, Inc. Dept. DA1, 135 Technology Park/Atlanta, Norcross, GA 30092 404/448-1400

CIRCLE 49 ON READER CARD



900 Series MICRO-DISCS

**Finest minidisc recorders.
Technically superior,
yet low priced.**

- Desktop & rackmount models
- Uses 5¼" minidiskettes
- Double density 200,000 characters per disc side—first in the industry
- Automatic "next location" recording
- File directory recorded on each disc
- Disc Editor—character insertion/deletion, data expansion, file update/delete/append, GO TO commands
- Character string search
- File/Batch/Binary modes
- High speed random access—all modes
- Multiple rates—110 to 9600 Baud
- Dual RS232 interfaces—terminal/modem
- 8085 microprocessor controlled—powerful

Send for full details:

TECHTRAN
INDUSTRIES, INC.

200 Commerce Drive
Rochester, New York 14623
Tel: 716-334-9640
TWX: 510-253-3246
Calif: 213-391-0507

CIRCLE 50 ON READER CARD

NEWS IN PERSPECTIVE

BASF and Olivetti for the near future. Olivetti's Bosio says the company has no imminent intentions of going outside the old continent, despite the group's relative strength in South America. Brazil, the biggest market, is "difficult" and getting more so, he says.

BASF is also strong in South America and has the advantage of several years' experience in selling IBM-compatible tape and disk units. These, provided by courtesy of Storage Technology and Fujitsu, have provided a relatively natural development path for the chemicals firm also involved in magnetic tape technology. BASF, now selling Hitachi in the U.K., also has plans to move all over Europe. But a company source stressed that much time would be needed to get the sales support network under way.

The reason for the upsurge of Japanese and European interest in PCM systems seems to boil down to the larger size of the PCM market, compared with non-IBM architecture systems. Coupled with this is the forecast that users will be locked into one architecture or another before very long, and it will be just too expensive to try to win competitive accounts. "The Japanese were scared they'd be too late if they went into their own architecture," said one European vendor source. "By 1982 the market will be fixed." Another reason is that a stake in the PCM market will provide a better outlet for the heavily government-backed Japanese software industry.

According to Dean Witter Reynolds, vendors that do not offer compatible systems will grow more slowly than those that do. Cii-HB, Univac and NCR could achieve a 13% to 15% growth in Europe, while Burroughs faces a depressing 11% to 13%.

—Andrew Lloyd

JAPAN'S AMICABLE ALLIANCE

**Australia has proven profitable
and portentous to a country
courting the world.**

A champagne and oyster cruise of Sydney's luxuriant harbor marked the recent ceremonial unveiling of the first Mitsubishi Series 400 business computer in the Australian market. On hand for the kickoff festivities was Mitsubishi Precision Co. president Etsuo Aoyama.

Such opulent displays are not characteristic of every product launching, but over the past five years Japanese manufacturers have demonstrated in many significant ways their enthusiasm and interest

in the Australian market—a market barely one-tenth the size of their own domestic market.

Australia has indeed been a good target for Japanese products. The country, with a sparse population of 14 million, has accepted technology more readily than some larger and more advanced nations. The Japanese, too, have learned, through keeping in close touch with this market, that the Australian arena is a comprehensive microcosm of outside world requirements.

**The Japanese appreciate and
work well with Australian
inventiveness, particularly in
software.**

The full story on how and why the Australian axis is enabling Japanese makers to pry their electronic consumer goods out of their own cloistered region to compete in foreign-dominated territories may never be told. The Japanese themselves tend to be inscrutable and coy on the subject, never revealing why Australia has consistently been one of the first countries to receive their new products.

One Australian distributor, Gary Blom, is more forthcoming. His Sydney firm, The Computer Company (TCC), handles Mitsubishi wares throughout Australia, and over the past two years has built a creditable track record with National Panasonic microcomputers.

Blom says this about the Japanese junction: "In effect what the Japanese do is develop a machine for their own markets, and then we modify it for an individual or possibly an international requirement. The Japanese respond quickly in giving us anything we want, whether it is in operating systems or in some structural detail, such as larger keyboards."

Blom's company has already sold nine applications programs in financial areas to Panasonic. Called Compac V, the programs are available with Panasonic units in the U.S., Chile, South Africa, Italy, Denmark, Germany, and the U.K.

TCC technical specialist Graham Matts, who joined the company this year after a five-year stint in Europe, comments that Australia's 11,000 computer installations of all types represent a comprehensive cross-section of the world's current models from leading suppliers.

"There are many more [types of computers] than the Japanese can see at home," Matts says. "They may send technicians out here to study them, or we can take machines like Digital Equipment or Data General to pieces and ask them to build revisions into their operating systems." They can then, he points out, "come back very quickly with these revisions to make their products more powerful and competitive."

The brash and entrepreneurial ap-

TRS-80TM Model II Now Speaks Your Language!

COBOL

Exclusive "Minicomputer" Version of ANSI '74
Multi-Keyed ISAM • Full Level-2 I/O Commands
Interactive DEBUG with Address Stop, Single Step and
Variable Display

Single-Pass Compiler

CRT Control with Extended ACCEPT/DISPLAY Commands

Includes Editor, Compiler, Run-Time and Print Packages

• \$299* cat. no. 26-4703

FORTRAN

Extended ANSI '66

Complete Error Documentation in Compiler

Hex and Octal Addresses Can Be Specified for Compiler Listing

Includes Editor, Compiler, Linking Loader and Subroutine Library

• \$299* cat. no. 26-4701

EDITOR/ASSEMBLER

Uses Either 8080 or Z-80 Mnemonics

Constants Can Be Specified in Octal, Hex Decimal and Even Binary

Includes Editor, Assembler, Linking Loader, Cross Reference and

FORTRAN Subroutine Library • \$199* cat. no. 26-4702

MODEL II BASIC

Disk-Based 17K BASIC Interpreter

Supports Advanced String Handling

Complete EDITING Command Structure and Renumbering

Hex and Octal Conversion • Error Trapping

Multi-Dimensional Arrays

No Extra Cost—BASIC and DOS Included

HARDWARE IS NO SOFT SPOT

Z-80A Microprocessor at 4 MHz

32K or 64K RAM

Two RS-232C I/O Ports and One Parallel Port

24 Lines of 80 or 40 (Wide) Characters

Built-In 8" Dual-Density Floppy Disk (486K)

Expandable for a System Capacity of 2M

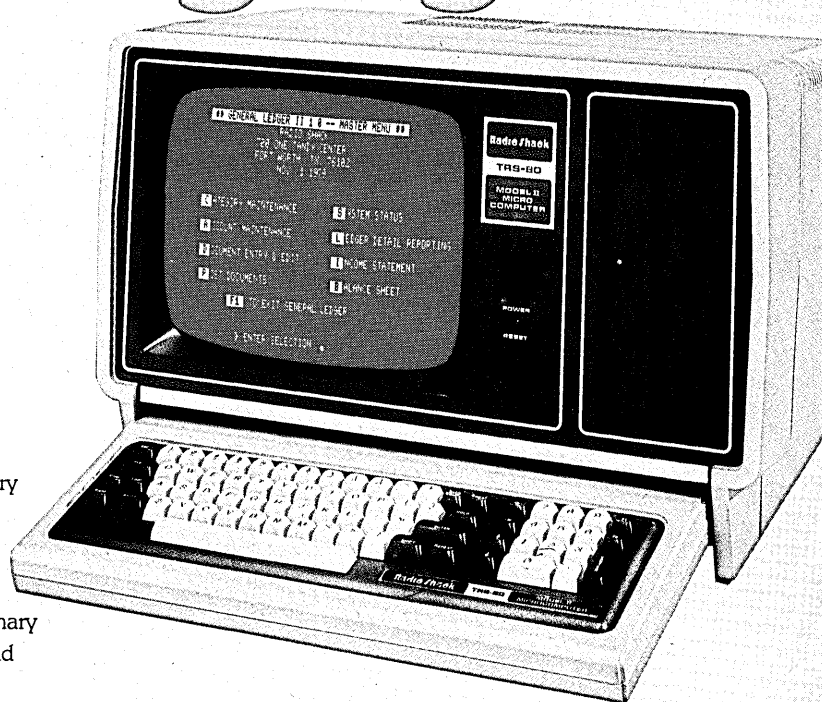

TRS-80 Model II hasn't become the success it is today by resting on its specs. Behind our TRS-80 line is a supporting network of over 6000 domestic Radio Shack Computer Centers, Stores and Dealers offering:

- Low Prices—the 64K Model II (required of effective use with these languages) costs just \$3899*
- Leasing—to make a complete system affordable right now
- Service Agreements—from limited carry-in to unlimited on-site in many metropolitan areas

*Prices may vary at individual stores and dealers.



**WANT TO KNOW MORE?
OUR TRS-80 COMPUTER CATALOG
IS YOURS FOR THE ASKING!**

The biggest name in little computersTM

Radio Shack[®]

A DIVISION OF TANDY CORPORATION • FORT WORTH, TEXAS 76102

**YES! Please send me the
TRS-80 Computer Catalog**

Radio Shack Dept. CMA-81-A-3
1300 One Tandy Center
Ft. Worth, TX 76102

Name _____
Title _____
Firm _____ Dept. _____
Street _____
City _____ State _____ Zip _____
Phone No. _____ / _____



MANAGER
DATA PROCESSING

Joe - Call
Mr. Smith!
Immediately
His report is
late again!
(Ann)

FROM THE DESK OF
THE PRESIDENT

Joe,
I'm
sorry
I'm
late
I'll
try
to
get
it
done
today.
Ann

WHERE'S
MY DARN
REPORT!!
Barker

A re-run botched schedule is no way to start your day.

Now you can start your day knowing exactly how things stand ... and what to do about them. The UCC-11 Automated Re-run and Tracking System gives you on-line inquiry capability for immediate answers about current production status.

UCC-11 also automates the re-run process itself. It entirely eliminates the expensive and sometimes mistake-ridden manual approach to this task. This means there'll be far fewer re-run problems to deal with in the first place.

And this new software package gives you concise batch reports on all re-runs in your shop. So you won't have to worry and wonder about where those costly re-runs

are coming from and what's causing them. You'll know ... and you'll know what to do about it.

Today, start your day by doing something about re-runs. Call us toll-free at 1(800)527-5012 (in Texas, call 214-353-7312) or circle 5 2

And, while you're at it, ask us about:

A Tape Management System that protects data from loss or destruction (UCC-1). Circle 5 3

A DOS Under OS System that lets you execute DOS programs without conversion (UCC-2). Circle 5 4

A Disk Management System that can save the cost of new disk drives (UCC-3). Circle 5 5

A PDS Space Management System that eliminates PDS compression (UCC-6). Circle 5 6

A Production Control System that makes scheduling systems obsolete (UCC-7). Circle 5 7

A Data Dictionary/Management that really gets IMS under control (UCC-10). Circle 5 8

A Hardware Vendor Accountability package that gives you the facts on reliability (UCC Reliability Plus). Circle 5 9

General Accounting software packages. Circle 6 0

Application software for the Banking and Thrift industries. Circle 6 1

UCC

SOFTWARE AND COMPUTING SERVICES

UNIVERSITY COMPUTING COMPANY • DALLAS • LONDON • TORONTO • ZURICH

UCC is a subsidiary of Wily Corporation (NYSE)
For information and an Annual Report, write 1000 UCC Tower, Exchange Park, Dallas, Texas 75235

IDMS...The DBMS for On-Line Systems.

Leading database consultants have stated that it is an absolute must that any organization considering on-line systems use a database management system. However, on-line systems demand a particular type of database management system, one that is capable of providing unusually high performance plus elegant backup and recovery facilities. However, users are also very interested in tools for fast application development and easy access to data by end users in an on-line environment. IDMS provides these facilities.

As a result, IDMS has proven an indispensable tool in supporting on-line systems with an extensive number of the most sensitive and important applications for business, industry, and government. From this unique experience has emerged new versions of IDMS and related facilities to support on-line systems meeting the diverse needs of application developers, end users, and processing departments. IDMS, supported by Cullinane Corporation, has been particularly successful because it meets the six key factors for success in database software. They are:

- 1. Vendor Record:** Cullinane Corporation has an unparalleled record for vendor support. (Number One every year in Datapro ratings.) And with an unequalled record in system enhancement and new product development.

Cullinane Corporation is also the most financially successful database software company with the best growth record and highest earning rate of all software companies. As a result, in 1978, Cullinane Corporation was the first computer software company in ten years to have a public offering, thus providing substantial financial resources for product enhancement, new product development, and company operations.

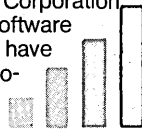

- 2. Control Via an Integrated Dictionary:** The Integrated Data Dictionary serves as the control facility for all information about the database and data communications environment. In addition, it integrates all components of IDMS facilitating easy application development, end user access to data, and efficient processing in an on-line environment.

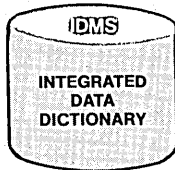

- 3. Facilities for Fast Application Development:** IDMS is the most powerful DBMS in the world. It allows applications designers to truly mirror a company's operations within the limits of the company's computer processing capabilities. However, users also want to develop applications faster with less skilled people. Simply stated, IDMS has easy-to-use tools for input processing, data management, and output processing. Traditional programming is greatly reduced via the Application

Development System, On-Line Query, CULPRIT Report Generator, and the INTERACT on-line program development and word processing facility.



- 4. Easy Access to Data by End Users:** In addition to the user facilities described above IDMS has On-Line English, the only true English language query facility for top management and other users. Management needs to tap the application's data flow easily; but more importantly, it needs the information immediately. On-Line English makes this a reality. Also, the user will not need to know anything about the organization of the database.



- 5. Computer Processing Efficiency:** While users of on-line systems like ease of use, they demand high performance and sophisticated backup and recovery facilities. IDMS was designed to meet these requirements through its architecture which fully integrates the database and data communications facilities. IDMS DB/DC is fully multi-threaded providing for efficient processing in both the update and retrieval modes. Also, an application developed under IDMS DB/DC using the Universal Communications Facility will run under any other TP monitor without modification. In addition, IDMS includes a Shared Database System which supports multiple CPU's sharing databases, eliminating problems associated with shared DASD.

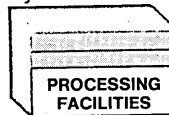

With the introduction of the IBM 4300, users want a system capable of supporting distributed database networks. IDMS is the only database

system architecturally designed to support not only distributed access to a database but distributed databases, and combinations thereof.

A facility important to the IMS/DL1 user is ESCAPE which allows use of IDMS with IMS/DL1 applications without modifying the application programs.

- 6. Protection:** DBMS users want two types of protection—protection that their investment in database applications will be protected from any changes in IBM hardware or software. IDMS is written in such a way as to make it virtually impossible for IBM to make any practical move that would make IDMS-based applications obsolete. In addition, Cullinane Corporation contracts state that it has the obligation to keep each user current with any new IBM developments.

DBMS users also want protection that their IDMS applications can be audited by themselves or their respective audit firms. Cullinane Corporation is the world's leader in EDP audit technology and offers user-oriented audit software including a library of audit routines especially tailored to the IDMS on-line environment. Thus, IDMS provides the user with complete protection, the only DBMS to do so.

Attend a free seminar in your area on the DBMS for On-Line Systems.

Cullinane Corporation
20 William Street
Wellesley, MA 02181
Phone (617) 237-6600



Database: Cullinane

CIRCLE 62 ON READER CARD

NEWS IN PERSPECTIVE

proach of medium-sized companies such as TCC has benefited Japanese suppliers of small- to medium-size business equipment. But in the past, there were too many uncomfortable failures of individual operators and small systems houses who exploited the market and could not support the hardware or software they sold.

Today the ground rules are tougher. The Japanese appreciate and work well with Australian inventiveness, particularly in software.

The Australian supplier, however, has to play with a full hand, which may include such things as paying in advance for goods or showing proof of a substantial customer support service.

TCC's Blom reports that Mitsubishi will give the company a chance at the more lucrative \$65,000 to \$100,000 market with its 16-bit processors. The lower end of small systems and intelligent terminals is cluttered with price cutting and lack of support for machines which run around \$5,000.

Another major Japanese manufacturer that's made the Australian plunge is Fujitsu. Its V830, released on the Aus-

Fujitsu's shrewd assessments and predictions of the Australian market have made it the bane of IBM Australia.

lian and Asian-Pacific markets, is being made by Secoinsa in Spain for Europe. It is also rumored to be part of a prospective joint venture deal between Fujitsu and TRW in California. Since shortly before midyear, the system has been sold in Australia through Fujitsu's subsidiary, Facom Australia Ltd.

The V series is Fujitsu's latest expression of confidence in the reliability of its mainframes. At its launch, Facom national sales manager John Linton virtually guaranteed customers five years of maintenance-free performance. The machine, depending on configuration, has a starting price of around \$65,000, which at the high end escalates to \$250,000. It's manufactured on seven boards, and uses the channel architecture of the M series.

But in an unusual marketing move, purchasers, other than current M series owners, will buy from third party systems houses. These firms will write tailored applications software programs, after which Facom will handle support and maintenance.

Fujitsu's shrewd assessments and predictions of the Australian market have made it the bane of IBM Australia. The clever company has filched about a dozen installation sites away from the mighty mainframer, and continues to be a strong challenger.

Fujitsu's Facom operation is expecting substantially stepped up turnover com-

Attend a free seminar in your area this fall.

Tailored to management, these seminars introduce the complete family of integrated software systems from Cullinane. Particular emphasis will be placed on the six key factors to success in database systems and on IDMS, the DBMS for On-Line Systems.

Dates and Cities

SEPTEMBER

23 Omaha, NB
23 San Diego, CA
24 Greenville, SC
24 Newark, NJ
24 St. Louis, MO
24 Toronto, ONT
25 Houston, TX
25 Manchester, NH
25 Rochester, NY
30 Denver, CO
30 Indianapolis, IN
30 Jacksonville, FL

OCTOBER

2 Edmonton, ALT
2 Ft. Lauderdale, FL
2 Toledo, OH
7 Allentown, PA
7 Columbia, SC
7 Phoenix, AZ
7 Portland, OR
7 Vancouver, BC
9 Albuquerque, NM
9 Darien, CT
9 Jackson, MS
9 Madison, WI
9 Milwaukee, WI
14 Austin, TX

14 Moncton, NB
14 Nashville, TN
14 Oklahoma City, OK
14 Piscataway, NJ
15 Cincinnati, OH
16 Providence, RI
16 White Plains, NY
28 Baltimore, MD
28 Cleveland, OH
28 Columbus, OH
28 Grand Rapids, MI
28 Newport Beach, CA
28 Syracuse, NY
29 Montreal, QUE

NOVEMBER

4 Saskatoon, SASK
5 Albany, NY
5 Southfield, MI
6 Green Bay, WI
6 Salt Lake City, UT
6 Springfield, MA
6 Westbury, NY
12 Des Moines, IO
12 Ft. Wayne, IN
12 Poughkeepsie, NY
12 Seattle, WA
12 Tulsa, OK
13 Charleston, WV

13 New Orleans, LA
13 Saddlebrook, NJ
13 Tampa, FL
13 Winnipeg, MAN
18 Pittsburgh, PA
18 Roanoke, VA
19 Akron, OH
19 San Juan, PR
20 Washington, DC
25 Sioux Falls, SD
26 Toronto, ONT

DECEMBER

2 Calgary, ABT
2 Chicago, IL
2 Memphis, TN
4 Charlotte, NC
9 Buffalo, NY
9 Cleveland, OH
9 Harrisburg, PA
9 Louisville, KY
9 Minneapolis, MN
9 San Francisco, CA
10 Quebec City, QUE
10 St. Louis, MO
11 New York, NY
11 Richmond, VA
16 Boston, MA
16 Detroit, MI

I'd like to attend your seminar on _____ Date _____
in _____ City _____
My computer is _____
Name/Title _____
Name/Title _____
Company/Department _____
Address _____
City _____
State _____ Zip _____
Phone (____) _____



Mail to: Rosalie Cope, Cullinane Corporation
20 William Street, Wellesley, MA 02181/Phone (617) 237-6600

Database: Cullinane

DM/Sept. 80

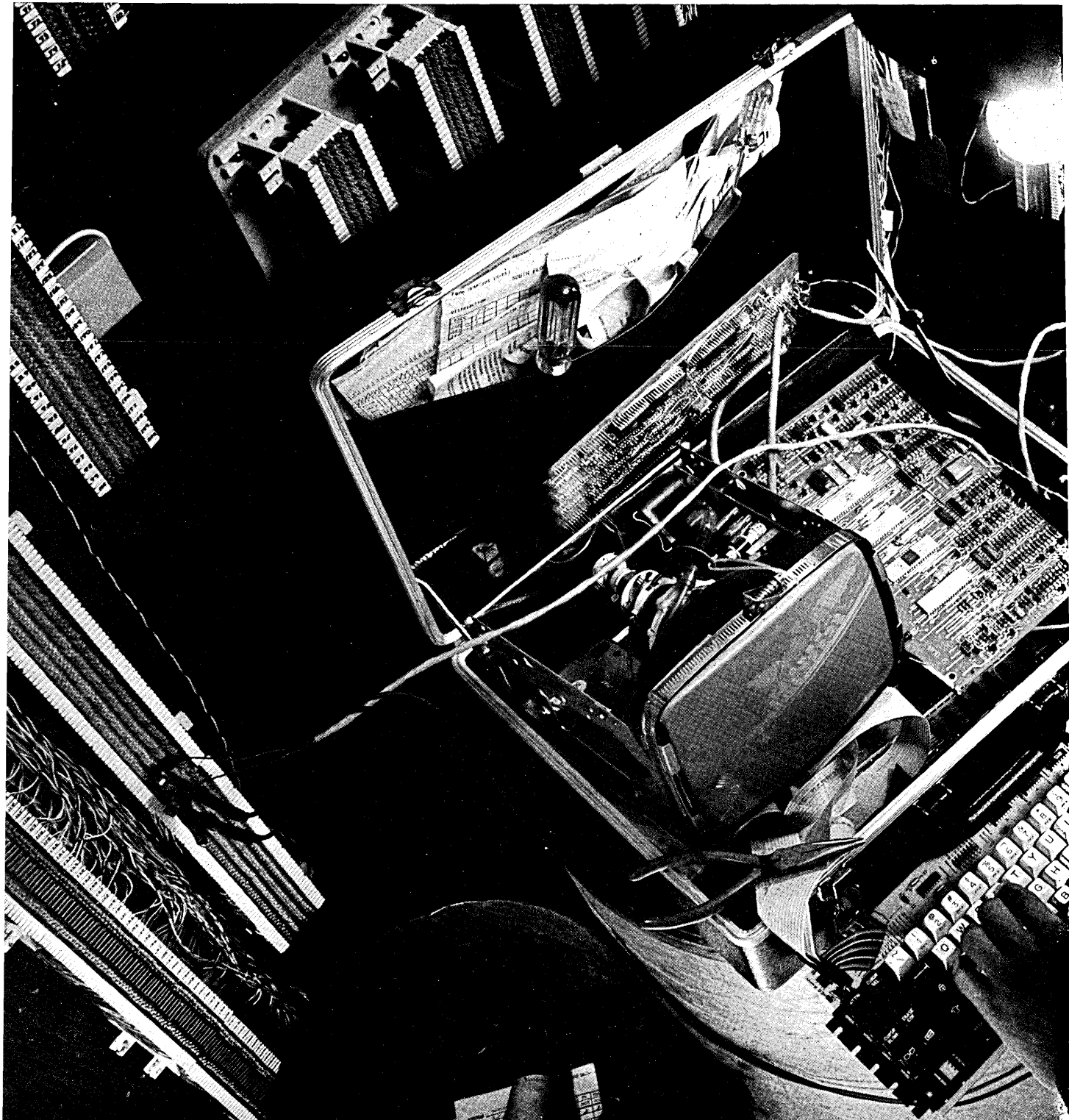

Meet the branch office you didn't know you had.

You can be a victim of computer fraud without even knowing it. There's a whole new breed of industrial thief just waiting for an opportunity to electronically "rip-off" your company. Chances are, you won't even know it happened.

The computer thief simply taps into your phone or data lines with readily available electronic equipment. By emulating an authorized terminal, he can access your computer system, tap sensitive financial data, marketing statistics and other confidential information without ever entering your office.

The Solution - Data Encryption Racal-Milgo, world leader in data communications offers a solution to the problem of the electronic thief.

The Datacryptor, a highly sophisticated electronic encryption system, can enhance the security and integrity of your data communications network.



This encryption system, which utilizes the National Bureau of Standards Data Encryption Standard (DES) algorithm, dynamically alters your transmitted data and renders it useless to all but your authorized locations.

Data Security Analysis Racal-Milgo will assist you in developing a protection plan for your company. This includes comprehensive information on data communications security, privacy legislation encryption, and your organization's vulnerability to electronic theft.

For more information on communications security, please call 1-800-352-1234.

Data Security Marketing Group
Racal-Milgo Information Systems, Inc.
8600 N.W. 41 Street, Miami, Florida 33166 • Phone: (305) 592-8600

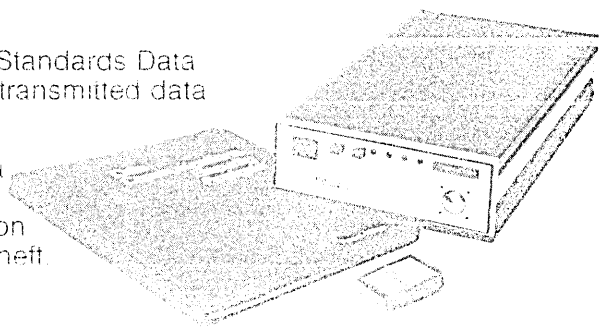

Racal-Milgo
Data Security

CIRCLE 63 ON READER CARD

NEWS IN PERSPECTIVE

pared to last year's \$49 million. The company's permanent resident director in Sydney is Yoshi Ichinose, who coordinates operations between the Australian managing director, Michael Rydon, and the Japanese board in Tokyo.

During his five years in Australia, Ichinose has traveled back to Fujitsu up to eight times a year, relaying information that keeps the company in close touch with the local scene. While Ichinose insists Australia is not a testing ground for Fujitsu, he admits there are basic similarities in the computer compositions of the two countries.

"The population ratio to the number of installations in Australia," he says, "is very close to Japan, which is now the second largest computer-using country next to the U.S. The Australian market," he also notes, "is very deep and computerization is very advanced in terms of user levels." Ichinose further concedes that the company's experience in Australia came in very handy when it was branching out into such countries as Brazil, Spain, Canada, and the U.S.

Facom sends about 20 engineers each year to Fujitsu for training in advanced

technology, so that the local company retains its high degree of autonomy and independence towards users. Support services are backed up by MART (Maintenance Assistance by Remote Telecommunications).

Throughout the industry there is little doubt that, especially in the formative years, the close working partnership between Australian entrepreneurial marketers and the patient and skillful Japanese adaptation of technology contributed significantly to the incursion of Japan's electronics goods into expanding world markets. While today Japan clearly does not depend on the support of any particular country, its computer makers may still pay homage to the adage that it pays to have a little bit of help from friends.

—Norman Kemp

INTERACTIVE REPORTS:

SYSTEMS CORPORATION

Why UNIX*? Why INTERACTIVE Systems?

Anyone owning, or contemplating owning, a PDP 11 or VAX computer should seriously consider using the UNIX Time Sharing Operating System. Its hierarchical file system and simple file design give both power and flexibility without much overhead. The user can redirect I/O streams through simple commands. UNIX is relatively small and modular, and is programmed in a high-level language, C. As a program development system, it features powerful interactive source code control and system generation facilities, along with remote job entry to IBM's HASP and several other host computer systems.

INTERACTIVE System/One (IS/1) is based on UNIX. You might ask why you should obtain UNIX features from INTERACTIVE. We think there are a number of good reasons. Such as:

IS/1 is fully supported. You can obtain a complete system, including the DEC mainframe and all necessary hardware and software from one supplier: INTERACTIVE. We provide thorough training courses for all our systems. We have sales and technical support offices on both the East and West coasts. New software releases are distributed periodically, at no expense to customers during their first year. Customer service representatives are available to respond promptly to queries — either by telephone or by network message. And, of course, manuals and documentation are provided for both users and on-site systems personnel.

INTERACTIVE has made the original UNIX more robust and commercially viable. IS/1 supports most standard DEC peripherals, including RK06, RK07, RM03, RX11; most new pro-

ducts will be supported as they become available. We have significantly better system management facilities for disk checking, dumping and restoring files, easy addition of user accounts to the system, etc. IS/1 provides a tailorable accounting system. It can handle bad blocks on disks. Improved terminal handling provides flow control.

IS/1 is tailored to a full set of application programs. You can choose from such IS/1-compatible application programs as:

INed	powerful CRT text editor
INmail	electronic message system
INword	word processing software
INfort	Fortran 77
INremote	HASP RJE software
Z80 C	cross-compiler (just announced and available immediately)

...as well as Workbench enhancements to the operating system in support of program development activities. (Users operating a VAX/VMS system can obtain INed, INmail, a VAX C compiler with run-time subroutine package, all running in native mode under VMS, as well as a complete IS/1 Workbench system for VAX/VMS.)

We started with UNIX, but over ten man-years of development effort by our staff has created a superior system. Our systems are now running at more than 35 client sites in four countries, including many "Fortune 500" corporations. Take advantage of our development efforts and field-tested systems. Call us.

INTERACTIVE Systems Corporation
1212 Seventh Street
Santa Monica, CA 90401, 213/450-8363
1015 Fifteenth Street, NW, Suite 907
Washington, DC 20005, 202/789-1155

*UNIX is a Trademark of Bell Laboratories.
VAX and VMS are Registered Trademarks of Digital Equipment Corporation.

CIRCLE 64 ON READER CARD

COMPUTER CRIME

MOTIVES FOR THEFT

Computer crime specialist identifies 25 reasons employees steal.

Jack Bologna has been collecting data on the motivations behind white collar crime, particularly computer-related crime, for a number of years.

What he wants is more research. He believes data available today "won't do any of us much good. And what the popular media report about white collar crime causations is almost a crime in itself."

His goal: "a better understanding of the people who work with computers, and their jobs, values, and satisfactions so that we can create employment environments where people won't be tempted to steal, or

Survey responses showed that dp professionals concur that "beating the company" is a challenge and not an economic thing alone.

sabotage the systems, or even goldbrick, which is now the most accepted way to steal, as witnessed by the large recent drop in labor productivity."

Bologna is president of George Odiome Associates, Inc., a Plymouth, Mich., based consulting firm specializing in strategic planning, motivational management systems, and industrial security. He holds both accounting and law degrees and has worked in law enforcement. He has conducted computer security surveys for a number of large companies, but his latest survey was mainly for his own edification and to encourage further research.

"I discovered several things in the

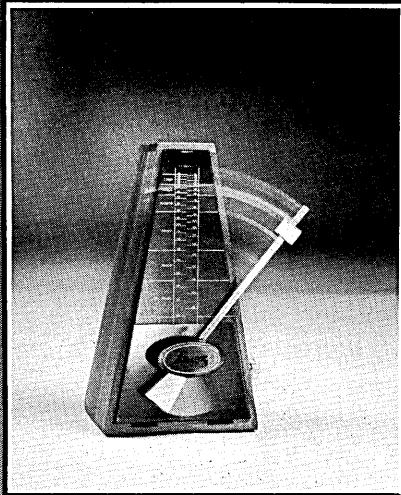

At Datec we know time is of the essence, so we'll get right to the point:

DATEC 212 modem now runs faster!

You can upgrade without making your 300 BAUD system obsolete.

- 300-1200 bps synchronous
- 1200 bps asynchronous
- Automatic answer with auto-speed selector
- Bell Compatible
- RS-232-C Interface
- 2-Wire Switched Network
- 7 Diagnostic Tests
- Burned-in Reliability
- FCC Approved
- Single Unit Price \$795

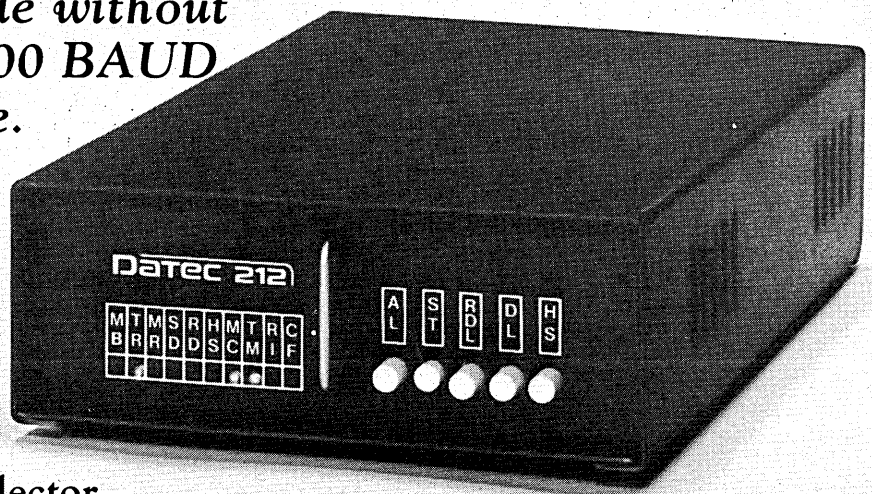

DATEC™

Modem Specialists
300 East Main Street
Carrboro, N.C. 27514
(919) 929-2135

CIRCLE 65 ON READER CARD

BOLOGNA'S COMPUTER CRIME MOTIVATIONS LIST

1. They feel they can get away with it and not be caught.
2. They think they desperately need or want the money or articles stolen.
3. They feel frustrated or dissatisfied about some aspect of their job.
4. They feel frustrated or dissatisfied about some aspect of their personal life that is not job-related.
5. They feel abused by their employers and want to get even.
6. They fail to consider the consequences of being caught.
7. They think, "Everybody else is stealing, so why not me?"
8. They think "Stealing a little from a big company" won't hurt it.
9. They don't know how to manage their own money, so they are always broke and ready to steal.
10. They feel that "beating" the company is a challenge and not a matter of economic gain alone.
11. They were economically, socially, or culturally deprived during childhood.
12. They are compensating for a personal void they feel in their own lives, e.g., lack of love, affection, friendship.
13. They have no self-control. They steal out of compulsion.
14. They feel a friend at work has been subjected to humiliation or abuse or has been treated unfairly.
15. They are just plain lazy and won't work hard to earn enough to buy what they want, need, or desire.
16. The company's internal controls are so lax that everyone is tempted to steal.
17. No one has ever been prosecuted for stealing company property.
18. Most employee thieves are caught by accident rather than by audit or design. Therefore, fear of being caught is not a deterrent to theft.
19. Employees aren't encouraged to discuss personal or financial problems at work or to seek management's advice and counsel on such matters. Besides, it might be embarrassing, an invasion of employee privacy, or could even jeopardize one's career to talk about such things at work.
20. Each theft has its own preceding conditions and each thief has his own motives, so there is no general rule as to why employees steal. It is a situational phenomenon. Therefore, there are many factors which lead an employee to steal, not just a single factor.
21. They steal for any reason the mind and imagination can conjure up.
22. Employees never go to jail or get a harsh sentence for stealing, defrauding, or embezzling from their employers.
23. Man is weak and prone to sin, particularly the sins of pride, lust, envy, anger, covetousness, gluttony, and sloth, all of which may lead to or become motives for theft.
24. Employees today are morally, ethically, and spiritually bankrupt.
25. Employees tend to imitate their bosses. If their bosses steal or cheat, then they are likely to do so also.

course of my research," he said. "There were indeed many reasons advanced by the authorities as being causative of white collar crime, and their rationales were often in conflict with one another."

He said one school of thought holds to the traditional notion of original sin as a condition that predisposes man to crime. This school holds that man can overcome this predisposition by the exercise of free will.

A modern school of sociology, Bologna noted, "held that man is a product of his heredity and environment and that given certain socioeconomic conditions of birth and personal development, certain men might well be disposed to the commission of crime, which it viewed mainly as a lower-class phenomenon."

He said the early psychiatrists had an array of rationales for criminal behavior ranging from repression through regression, denial, overcompensation, displacement, and fantasy, to say nothing of compulsion, obsession, frustration, anxiety,

and depression.

"Some of the avant-garde schools," he said, "even suggested that stealing was a vindication for past neglect, personal slight, or deprivation suffered at the hands of others with authority over the culprit; or a rebellion against society as a whole or against specific institutions which

Dp professionals also approve of the notion that employees may steal for non-job-related personal frustrations.

had grown stale, cold, and heartless toward the needs of their client populations."

Bologna attempted to separate out from each school of thought a statement or two which would synthesize its position on crime motives or crime causes as applied to white collar thievery.

He culled out the repeated items, the theories of causation which lacked a substantial support base, and narrowed the list to 25 items.

SURVEY RANKINGS

Statements which drew the most support from accountants and data processing professionals responding to Bologna's survey:

Motivation No.	By Accountants	By DPers
1	(1) 90%	(1) 90%
8	(2) 87	(2) 81
20	(3) 84	(3) 79
18	(4) 70	(4) 78
21	(5) 68	(10) 72
6	(6) 65	(11) 60
3	(7) 63	(5) 75
5	(7) 63	(8) 66
7	(8) 61	*
10	(9) 57	(6) 70
25	(9) 57	(9) 65
4	*	(7) 68

*Not among the top 10.

He used these items to collect data from two seemingly disparate groups—a group of accountants in public practice, in industry, and in government positions, and a group of data processing professionals of middle to higher management rank.

Members of each group were asked to give weights to the 25 items based on whether they strongly agreed with them, tended to agree, tended to disagree, or strongly disagreed.

There were similarities and differences in the responses. For both groups, the top four items were the same. They agreed that employees steal or embezzle from their employers because:

1. They feel they can get away with it and not be caught.
2. They think "stealing a little from a big company" won't hurt it.
3. Each theft has its own preceding conditions and each thief has his own motives, so there is no general rule.
4. Most employee thieves are caught by accident rather than by audit or design. Therefore, fear of being caught is not a deterrent to crime.

The survey results showed there was a substantially higher level of concurrence among the data processing professionals that "beating the company" is a challenge and not an economic thing alone, which Bologna believes "could support the old saw in the data processing field that dpers rise mainly to challenge." But, he adds, "that old saw may also be part of edp folklore. Because it has been repeated so often, it may have become an accepted, if not proven, article of faith."

The data processing respondents also scored substantially more approval of the notion that employees may steal for non-job related personal frustrations. The vote was 48% agreement on this by the accountants and 68% agreement by the dpers.

BUILDING A TOTAL DATACOMM NETWORK IS EASY WITH GDC.

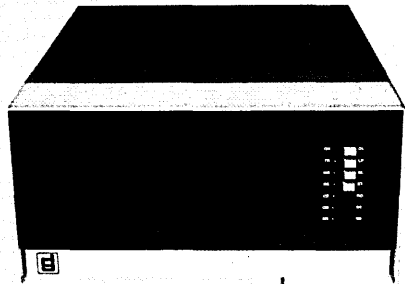

GDC Modems help reliably transmit information from remote locations to computer facilities.

Datcommunications networks keep business data flowing to keep the business world alive.

General DataComm designs, assembles, installs and services datacommunications networks.

We are the largest independent supplier of data transmission equipment. We sell and lease a complete line of modems, multiplexers, and diagnostic equipment.

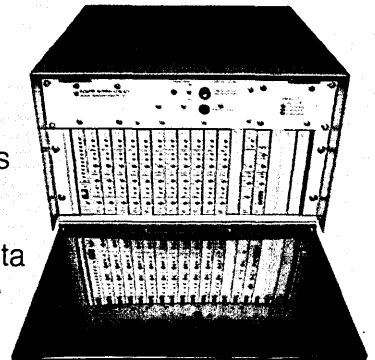

GDC Time Division Multiplexers allow cost effective use of transmission lines linking emergency networks to medical centers, hospitals and laboratories.

Our low speed and medium speed modems have captured a large portion of the market. Our high speed modems will do even better.

Our reputation is built on the broadest line of reliable, proven products, and the ability to design and engineer datacomm systems on a cost-effective basis.

It's a reputation we've earned in the world's money markets, transportation industry, in emergency situations and on the frontiers of energy exploration.

Wherever datacomm networks must keep working, General DataComm is on the job. To keep business communications up-to-date and flowing.

To learn more about our product line and our service or leasing programs, write or call today.

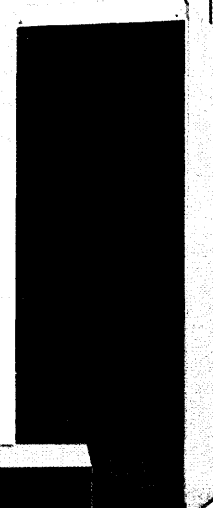

GDC equipment helps keep networks networking all over the world.

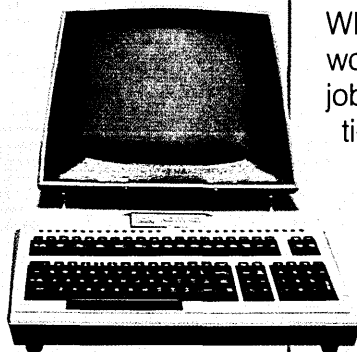

The GDC NETCON-5 diagnostic systems reduce network down time to keep time-sensitive information flowing to financial networks.

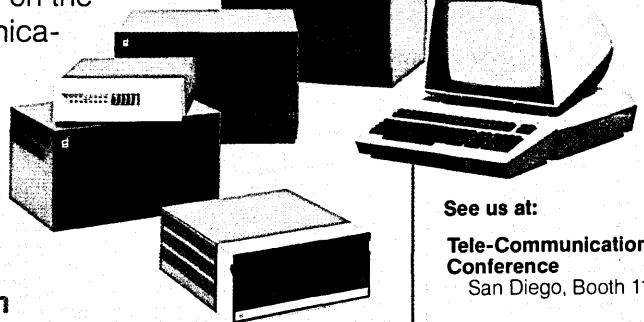

See us at:
Tele-Communications Conference
San Diego, Booth 112

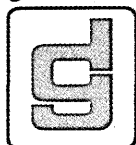

General DataComm Industries, Inc.

One Kennedy Ave., Danbury, CT 06810
(203) 797-0711

NETWORKING

Project planning, scheduling & cost control ...our project management systems put you in control!

In today's dynamic world of spiraling costs, material shortages and labor problems, up-to-the-minute information and visibility are critical in helping keep your projects on-schedule and within budget.

At Systonetics, Inc. we've pioneered the automation of project management techniques...our EZPERT and VIS1ON systems put information at your fingertips and visibility in your hands... quickly, accurately and easily.

E-ZPERT* - the automated project graphics system.

For more than 10 years our EZPERT systems have been helping hundreds of aerospace and industrial companies, engineering/construction contractors and government agencies turn unwieldy tabular reports into easy-to-use graphics... automatically. It's still the most advanced, easily the most proven and reliable system of its kind. EZPERT is ideal for companies already using large mainframe computers with their own network analysis programs (PMS, MSCS, PROJACS, etc.).

With EZPERT the same computer output that's used to print your tabular

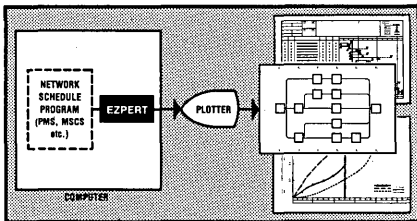

reports is also used to plot EZPERT graphics...time scaled networks, barcharts and cost/manpower graphs. And with each project update, EZPERT can quickly revise all your project graphics...automatically. EZPERT gives you the timely and error-free visibility you need to make effective management decisions.

VIS1ON* - the complete, on-line, standalone, interactive project information system.

Now there's VIS1ON for those who can't wait for turnaround on a large computer. With VIS1ON information and visibility are yours instantly, anywhere...in an office downtown or at a remote project site miles from nowhere. And unlike other



automated management systems VIS1ON is designed to be operated by the project management staff.

Utilizing VIS1ON's CRT terminal, guided by preformatted displays in plain English, you're in complete command. You can:

- Develop project plans and schedules.
- Monitor and control updates.
- Do cost analysis and resource allocation.
- Perform "what if" simulations.
- Produce EZPERT graphics (networks, barcharts and X-Y graphs).
- And much more. VIS1ON asks the questions, you fill in the blanks. Then VIS1ON gives you visibility three ways: Printed tabular reports,

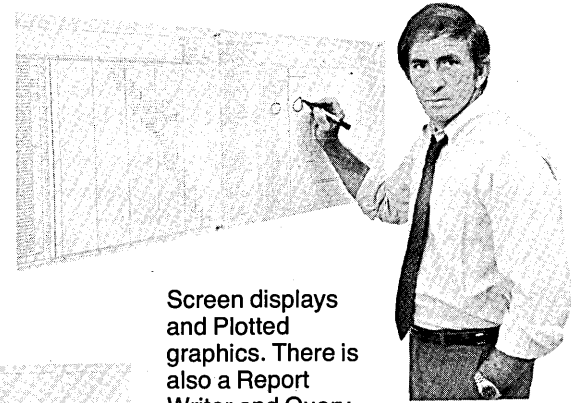

Screen displays and Plotted graphics. There is also a Report Writer and Query module available for free format reports and displays.

A system to meet your needs.

Whether your projects are large or small, long or short, managed from home base or in the field...whether you're a manufacturing or petroleum company, engineering/construction contractor, utility or government agency...whether or not you're a computer or PERT/CPM expert

...we have a system to meet your special requirements. But it doesn't end there. We have service, consulting and training programs to back up all our products...Systonetics is totally dedicated to project management.

Find out how automated project management techniques can help you keep your

projects on-schedule and within budget...call or write for more information today.

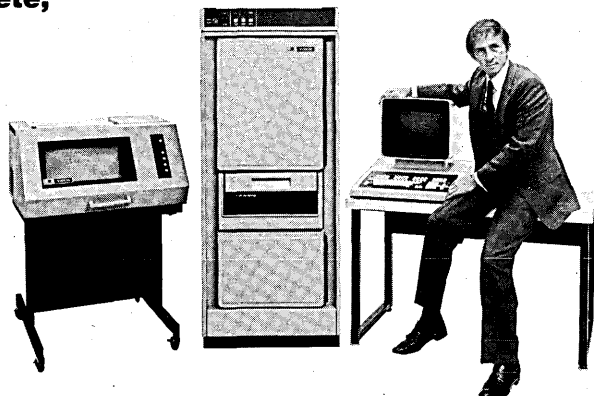
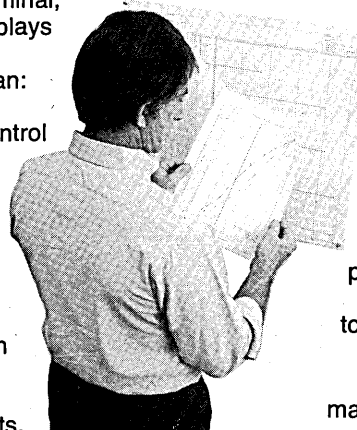

Putting project management into perspective.

SYSTONETICS, INC.

600 N. Euclid St., Anaheim, CA 92801
(714) 778-1600 • Telex 692-327

Sales & Customer Support Offices: Anaheim, CA; Englewood, CO; Houston, TX; Southfield, MI; Wakefield, MA; King of Prussia, PA; McLean, VA; Atlanta, GA. *EZPERT and VIS1ON are trademarks of Systonetics, Inc.

SCIENCE / SCOPE

Engineers using an innovative computer graphics system now can validate the design of new software systems without having to write a single line of computer programming. The approach marks an important advance in design verification, for it makes computer programming less of an art and more of a discipline. It helps an engineer develop and chart his design while simultaneously telling him how effective his solution is. The system also pinpoints deficiencies in original specifications, helps standardize existing software, and quickly studies design tradeoffs. Hughes, under a U.S. Air Force contract, is adapting its Design Analysis System to suit a wide range of electronics and aerospace uses.

Expanding the use of laser surgery in dentistry, neurosurgery, ophthalmology, and urology may be one benefit of a new Hughes optical fiber. The fiber is made of thallium bromo-iodide, a polycrystalline substance. Unlike an ordinary glass fiber, it can transmit several watts of infrared laser power. Because doctors could use the fiber to direct a laser beam even inside the body, it may one day replace the cumbersome mechanical mirror arrangement now used in infrared laser surgery. Other potential uses are for laser cutting and drilling, as passive detectors in military infrared systems, and, in the future, for transmitting data and voices across thousands of miles without the need for repeaters.

Data rates of 4 billion bits per second -- a speed at which the Encyclopaedia Britannica could be transmitted in just two seconds -- have been demonstrated by an experimental modulator. The modulator, an important step toward ultra high-speed satellite communications, is a quadriphase shift-keyed arrangement of two field-effect transistor biphase modulators. Use of microwave FETs in the modulator driver circuit resulted in the very low power consumption of tens to hundreds of milliwatts of direct current. In addition to the modulator, Hughes engineers have built a demodulator that functions at 2 gigabits per second.

Hughes has career opportunities for engineers, scientists, and programmers to work on the design and manufacturing of complex airborne and spaceborne radar electronics systems, including data links, electronic warfare systems, and display systems. These projects use advanced technologies like microelectronics, microprocessors, and solid-state microwave devices. We need systems analysts, CAD/CAM specialists, circuit designers, and product design engineers. Rush your resume to Engineering Employment, Hughes Radar Systems Group, Dept. SE, P.O. Box 92426, Los Angeles, CA 90009. Equal opportunity employer.

Sophisticated simulators will help U.S. Army personnel learn to operate the new AN/TPQ-36 and TPQ-37 Firefinder radars without the need to fire a single mortar or artillery round. Each trainer -- designed for up to eight students -- uses a computer to emulate the way a Firefinder locates the source of enemy weapons fire by tracking shells in flight and backplotting their paths. Besides saving munitions costs, simulators are more efficient for training than real radars because they require fewer instructors, are cheaper to maintain, and cost less to build. Hughes builds the trainers as well as the actual Firefinder radars.

Creating a new world with electronics

HUGHES

HUGHES AIRCRAFT COMPANY
CULVER CITY, CALIFORNIA 90230

NEWS IN PERSPECTIVE

The data processing professionals also tended to feel more strongly that job-related frustrations can be a cause for theft.

In this survey, respondents were making judgments on "they." Bologna has developed another study, a self-scored, self-instructional tool which newly hired white collar employees can use to profile themselves against becoming on-the-job thieves. Here the judgments are based on "I." Test takers are asked to choose among five answers—I definitely would not steal, I doubt that I would steal, I might possibly steal, I probably would steal, or I definitely would steal—for 25 "if" statements.

Bologna would like to see his Theft Motivation Orientation Tool used for research in the field of computer-aided theft.

"The Theft Motivation Orientation Tool was originally designed as a teaching aid for a course I was doing in white collar crime," said Bologna. "I had nothing of major significance in mind when I developed it. My intention was to create a little exercise to begin the course and generate some interest in the topic. But participants became so engrossed in doing the exercise, determining where they fell among the eight categories and then comparing notes with others, that I couldn't finish the program in

the time allotted."

He said there was nothing particularly scientific about the way he constructed the tool. "I based the eight categories on my 30 years of experience in the fields of law enforcement, security administration, and management consulting. I had a prototype in mind for each category, based on my many encounters with white collar criminals and honest, hard working, non-criminal types."

He said four of the eight categories are non-thief types and represent at least 80% of the mass population. "The other four categories are the types who might, under the right circumstances, steal."

Bologna said he would "like to see the tool used as a research aid in the field of white collar theft and particularly computer-aided theft," but he added a caveat: "The tool is designed to be a self-instructional learning aid which is self-scored. The results are the personal property of the test taker, not his employer or anyone else. Its use in any other context at this point is unwarranted and discouraged by me. "Furthermore, the tool is not based on empirical data, but on my own personal observations, experiences, and biases. While it is effective as a teaching aid, I do not recommend it for profiling new hires or anyone else at this point."

—Edith Myers

SOFTWARE

OF BIRDS, IBM AND SOFTWARE

Some say IBM isn't in the software business; Phoenix Computer says that's for the birds.

Did IBM go into the software business with its 4300 series announcement? Some people think so. One of them is Fred Hoschett, a founder of Phoenix Computer Corp., Culver City, Calif. He contends that IBM's Extended Control Program Support (ECPs), which effectively removes the operating systems from the public domain, coupled with the Installation Productivity Option/Extended (IPO/E) and the Remote Support Facility (RSF) make it difficult for the independent software companies to interface.

Many observers feel that IBM, with the 4300 announcement, effectively laid claim to system control software, support and data management software, and productivity software, leaving only end user applications to the independents.

Hoschett believes IBM, with the 4300 series, attacked the software industry in the same way it attacked the plug-compatible peripheral manufacturers and later the plug-compatible mainframe companies.

He also believes, along with others, that many turnkey vendors of software are in trouble; that IBM has openly announced it will compete with them, using its own equipment and operating systems.

Part of the reason for much of this thinking is the IBM introduction in its 4331 sales brochure of a new concept called "applications machines," which offers hardware and software configurations that are "simple to install and provide a cost justified single application as a base from which to grow."

Hoschett thinks he can interface his company's software more easily than most vendors to the new IBM structures because he developed the software from scratch and is the one who makes the adaptations. He feels many vendors are too far removed from the actual developers of the software they are peddling to IBM users.

Phoenix Computer is a relatively new firm, formed in November 1978 by Hoschett and Phoenix president James W. Miles. Both had been with Informatics, Inc. in that firm's Teleprocessing Monitoring effort.

"We learned there," said Miles, "that many people were buying TP monitors just to do on-line programming."

IS YOUR SPACE-AGE IMAGE SPOILED BY YOUR DARK-AGES EXHIBIT?

If so, you're losing much of the marketing power trade shows deliver. We know. We help plan and create compelling exhibits that multiply booth traffic many times over. Multiply sales, too. Contemporary exhibits that leave a strong, positive impression of your company, as well as a clear idea of what you're bringing to market. We do it for firms like yours in many high tech industries.

But we're a whole lot more than custom exhibits. For those with budget limitations we can give the custom look to any of our exclusive modular exhibit structures. And for non-trade show assignments, we can handle most anything, including nuclear information centers from the ground up.

So when you need to market or inform in three dimensions, call Skip Douden, President of Giltspur Expo Industries, at 412/621-3700. Collect, of course.



Giltspur

We're exhibits and a whole lot more.

Rochester (N.Y.) Pittsburgh Chicago Los Angeles San Francisco

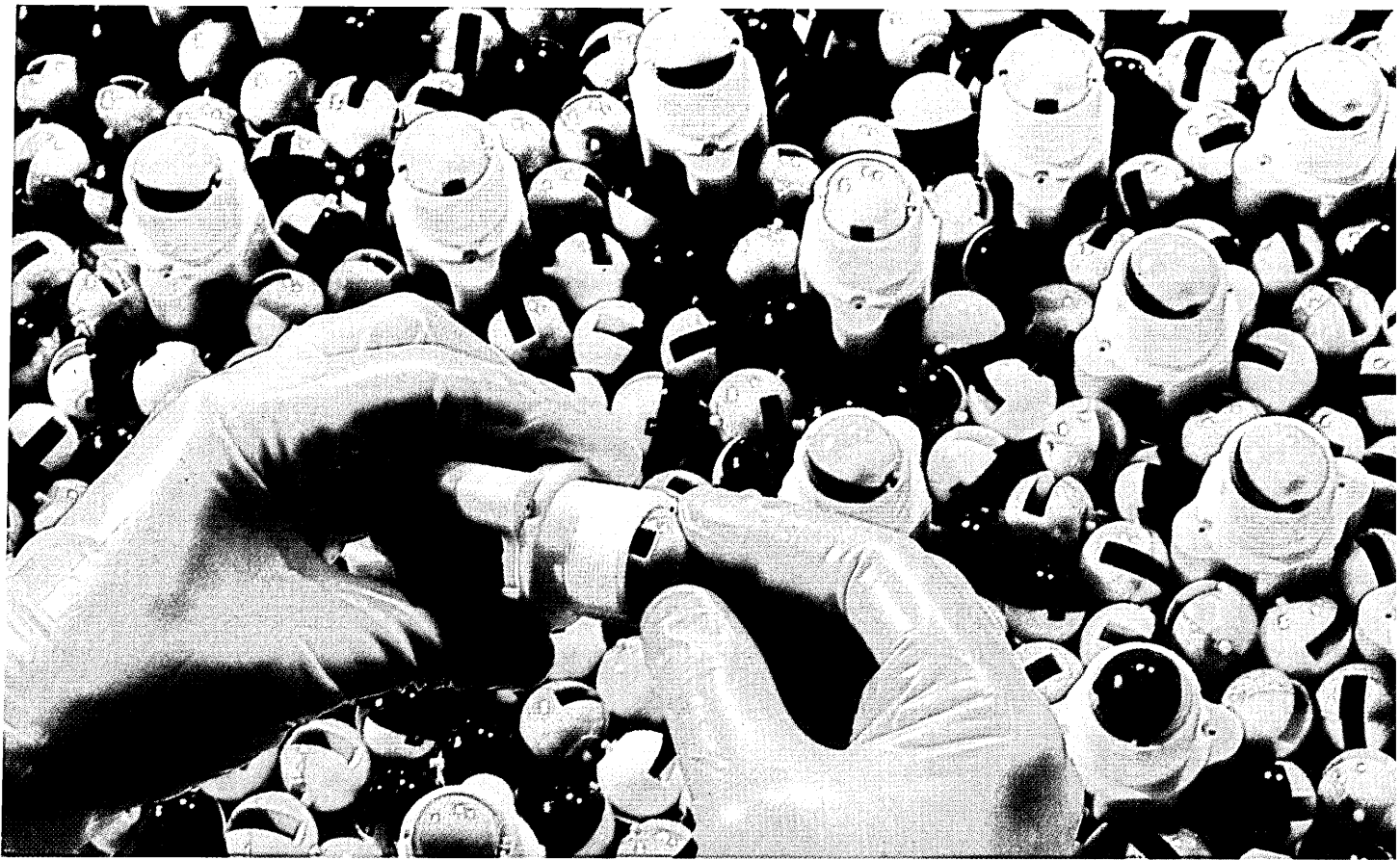

The Information Controller



MDS SERIES 21 Distributed Data Processing System

Controlling The Flow Of Vital Data—a key ingredient in an effective information management program. MDS SERIES 21 Distributed Data Processing Systems— with their exceptional communications capabilities—provide the means of controlling this vital flow.

With SERIES 21 Systems—branch, production facilities, warehouses and field sites can have today's information today—as a matter of fact, they can have it in minutes... and process it where it's received.

Efficient communication is only one of the advantages offered by MDS SERIES 21 Systems. But, to companies like the CONTROL PRODUCTS DIVISION of AMERACE CORPORATION, it's a very important one.

Utilizing these systems, they have reduced order processing time at the

central office from days to hours. Production efficiency has improved by allowing plant managers to analyze machine operations on a daily basis, and tighten controls on raw material ordering and product shipping.

In short, MDS SERIES 21 Distributed Data Processing Systems have substantially helped improve this company's overall information management—as they have in many industries—worldwide.

Communications capabilities, the flexibility to do multiple jobs concurrently, local programming capability and expandable modular design are just some of the advantages MDS SERIES 21 Systems offer... there are many more. Let MDS show you.

Please send additional information

Please have an MDS representative call for an appointment.

Please call our M.I.S. Manager.

Name

Title

Company

No. & Street

Phone

City/State/Zip

MDS MOHAWK DATA SCIENCES

1599 Littleton Road, Parsippany, N J 07054
(201) 540-9080

CIRCLE 69 ON READER CARD

© Agastat is a registered trademark of the Amerace Corporation.

SERIES 21 Reg. U.S. Pat. & Tm. Off.

D980

SWINGLINE'S DECOLLATOR SEPARATES FORMS FAST, EASY, CLEAN.

Why mess with taking apart forms?
Our table-top Decollator separates carbon and carbonless continuous forms quickly and easily. Stacks 'em up nice and neat with no carbon mess. It's easy to load, no special set up or operating skills needed. There's even a variable speed control. Made in U.S.A.

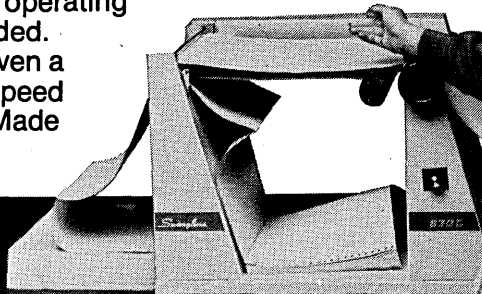

THE Swingline COMPANY
Swingline 6300
Table-Top Decollator
The Swingline Company
A Division of Swingline Inc., Dept. DE
32-00 Skillman Avenue, L.I.C., N.Y. 11101

CIRCLE 70 ON READER CARD

wabash®

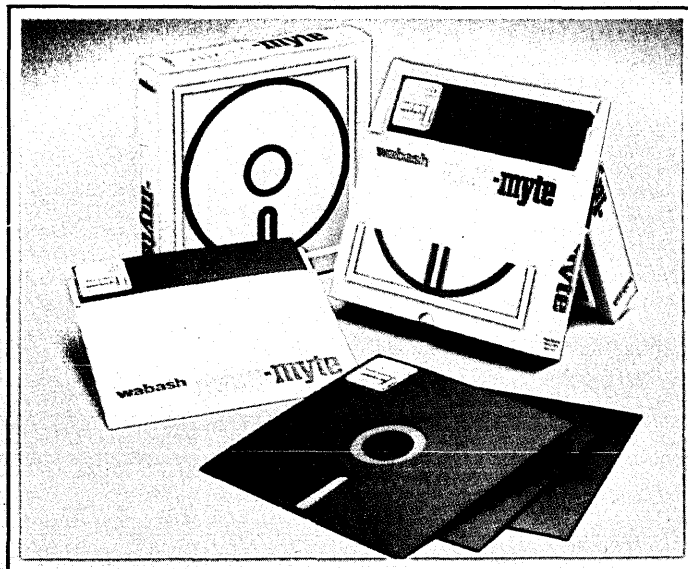

Quality, Service and Availability

You can count on all three from Wabash Tape Corporation. Our toll-free number will put you instantly in touch with your local Wabash Distributor . . . and the finest diskettes money can buy!

800-323-9868

Wabash Tape Corporation 2700 Des Plaines Rd., Des Plaines, IL 60018 • 312-298-8585

CIRCLE 71 ON READER CARD

NEWS IN PERSPECTIVE

What they set out to do was to develop an on-line programming product independent of TP monitors. And what they came up with was Condor, a product that can run under a number of TP monitors or as a standalone product.

Miles and Hoschett first showed their fetish for birds when they picked the name Phoenix for the company. Webster defines Phoenix as: "a legendary bird which, according to one account, lived 500 years, burned itself to ashes on a pyre, and rose youthfully alive from the ashes to live another period."

Miles said they didn't exactly have that definition in mind. "We picked it because we arose from nothing," meaning not as a spin-off from another company, but as something brand-new.

And for their first product they chose the name Condor. Of Condor, Webster says: "a very large American vulture of the high Andes. . . ."

Phoenix Computer's first brochure says its Condor is "a uniquely comprehensive on-line system designed to provide a

Some speculate that with the 4300 series IBM attacked the software industry in the same way it attacked the plug-compatible peripheral and mainframe companies.

complete range of program development capabilities to the application and system programmer in a DOS/VS, VSE, DOS, DOS/MVT, DOS/RS and EDOS environment."

And while Miles and Hoschett probably didn't take the vulture part of the dictionary definition of Condor into account when they selected the name, the system, with 81 installations in by this month and three more in the works, already has replaced such systems as the Librarian, Panvalet, Owl, Scepter, and IBM's own ICCF.

The Phoenix brochure says Condor can run as a standalone system and as an application task under CICS DOS/VS, CICS DOS, SHADOW II, DATACOMM, TASKMASTER, BETACOMM, MINICOMM, SWIFT, and WESTI. The system is designed for use with 3270 Models 2 and 3 display stations and supports POWER/VS, DOS/MVT SAGE and non-spooled systems through direct interfaces. The company said Condor allows virtually unrestricted library maintenance, asynchronous handling of multiterminal requests, optimizes system resource utilization, and provides total system restart capabilities so that programs can never be lost.

Full library and member security is provided, the company claims, and up to 16 levels of security can be defined.

James Kock of American Nurses Assn., Kansas City, Mo., hopes all this is true. Kock is currently evaluating Condor. He's disenchanted with IBM's ICCF, which

OUR QUALITY COMES IN QUANTITY.

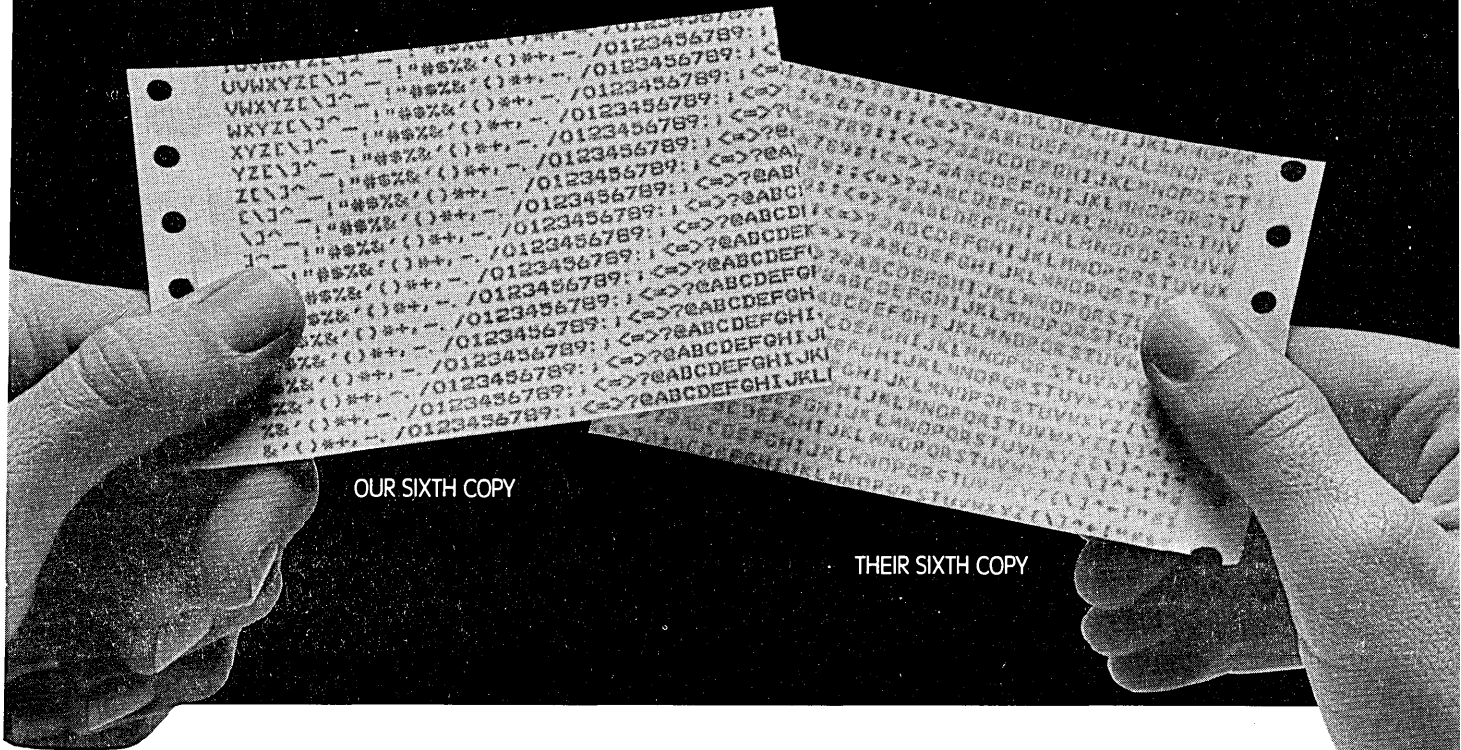

Many printers can give you good print quality on a first copy. The real challenge is to give you that same quality, copy after copy, on multi-part forms.

Obviously, most printers can't. The further they get from the first copy, the more their quality fades. But, as you can see here, the quality of Printronix' sixth copy continues sharp and clear.

This superior quality is achieved through a simple printing mechanism quite unlike any other. It forms characters by printing one dot row at a time, overlapping rows vertically and horizontally, while maintaining uniform hammer impact energy. The result is unequalled print quality and characters that appear solid.

This same design approach also

requires fewer moving parts, eliminates most bearing surfaces, and employs simple hammer drive circuits. All of which means there's less to go wrong. And that's why Printronix can give you a full one-year warranty, not the 90-day warranty typical of most other printers.

For more information on the complete line of Printronix printers, call: (714) 549-7700. Or write:

Printronix Inc.,
17421 Derian Ave.,
P.O. Box 19559,
Irvine, CA 92713.



PRINTRONIX
It's simple, to be reliable.

REGIONAL SALES OFFICES: WESTERN; 17421 Derian, P.O. Box 19559, Irvine, CA 92713. CENTRAL; 414 Plaza Drive, Suite 106, Westmont, IL 60559. SOUTHERN; 2220 Parklake Drive, Suite 180, Atlanta, GA 30345. EASTERN; 7½ Harris Road, Nashua, NH 03060.

CIRCLE 72 ON READER CARD

NEVER BEFORE
 BEEN BLAZED IN SUCH
 AT SUCH A LOW COST

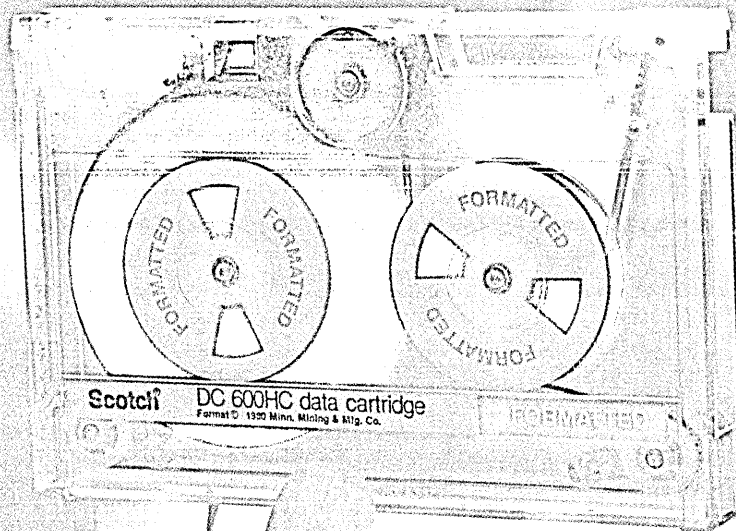

This is 3M's DC-600 HC Data Cartridge for disk back-up. It's just 4" x 6" x 1/2". Yet it holds a full 67 megabytes of formatted user information (144 megabytes unformatted). And most surprisingly, it only costs about thirty dollars.

The marvel that makes it work is our HCD-75 Data Cartridge Drive. At 4.6" x 7" x 8.6" (19" deep with controller/formatter module) it's the smallest full-capability back-up system available today. And its storage capacity makes it the most economical, too.

You see, the HCD-75 drive unit eliminates the need for costly multi-track heads. Instead, it uses a new tape head which features automatic positioning to any of the tape's sixteen tracks. The result is a storage capacity much larger than ever before possible with data cartridges. Which also makes it suitable for other mass storage applications.

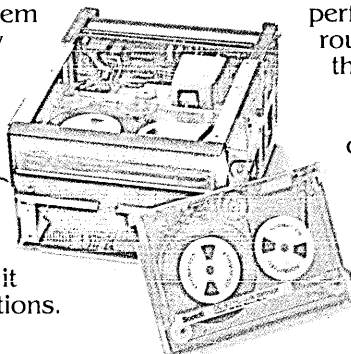

Extensive use of microprocessors in the HCD-75 make it the world's first truly intelligent cartridge drive system. Other than initial commands, all tape drive functions are controlled locally. So the host computer system can remain free for other functions. What's more, the HCD-75 features sophisticated error detection and correction capabilities. And to insure system performance, self-test diagnostic routines run continuously. Even when the system is not in use.

Will wonders never cease?

For more information, check the listing on the next page for the representative nearest you.

Or write: Data Products Division/3M, Bldg. 223-5E/3M Center, St. Paul, MN 55144.

**THE DISK BACK-UP SYSTEM
 THAT'S SUDDENLY WAY OUT FRONT.**



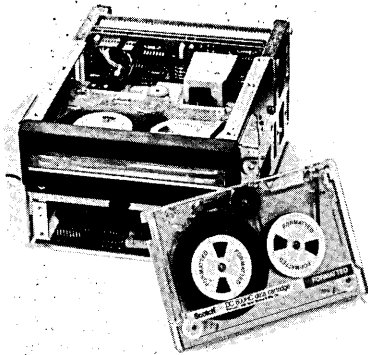

3M DATA PRODUCTS REPRESENTATIVES

Data Products/3M
3M Center, 223-5E
St. Paul, MN 55144
612/733-8892

WEST

Hefte Industries, Inc.
Los Gatos, CA
408/264-8319

CTI Data Systems, Inc.
Long Beach, CA
213/426-7375

P.A.R. Associates
Denver, CO
303/355-2363

PSI Systems, Inc.
Albuquerque, NM
505/881-5000

MIDWEST

OASIS Sales Corporation
Elk Grove Village, IL
312/640-1850

Carter, McCormick & Pierce, Inc.
Farmington, MI
313/477-7700

The Cunningham Co.
Houston, TX
713/461-4197

EAST

J.J. Wild of New England, Inc.
Needham, MA
617/444-2366

Wild & Rutkowski, Inc.
Jericho, Long Island, NY
516/935-6600

COL-INS-CO., Inc.
Orlando, FL
305/423-7615

CIRCLE 73 ON READER CARD

NEWS IN PERSPECTIVE

he says "doesn't protect library members properly."

He explained that updates go to buffer points in memory and "if there's a crash, then those disk allocations do not necessarily come back up again." There is a recovery facility, he said, which only can be run when ICCF is down for over an hour, "and that is not tolerable." He is hopeful Condor will live up to its producers' promises of "maintaining library integrity."

A user with more experience, Bob Dyson, National Jewish Hospital and Research Center, Denver, Colo., is enthusiastic. "It's a full function system," he said. "It has good security features." He heard of Condor from Cullinane Corp., Boston, whose products they were using and who had "something similar to offer for OS users but nothing for DOS." Dyson had been using Owl, which he said is "good too, but uses too much core."

Ironically, Dyson fears that an OS version of Condor "could be its downfall. It would get into too many user problems." Within Phoenix Computer there is a difference of opinion as to whether or not this

Phoenix named its first product Condor, which Webster defines as "vulture"; Condor has already replaced such systems as the Librarian, Panvalet, Owl, Scepter, and IBM's own ICCF.

offering will happen. Miles seems to feel the firm is committed to a Condor version for the OS market. Hoschett isn't so sure.

Hoschett, not yet 30, came from an OS environment. "My first computer, in college, was a 155. Then I got out into the real world and found out that most production was DOS."

Hoschett has been working on Condor's development for more than 2½ years. Even while still at Informatics he wanted to form his own company. "I didn't like the way people are treated in big companies," meaning, he explained, his kind of people, the innovative technical ones. "There's too much bureaucracy [in big companies]. We can see what should be done but we can't get it done."

As for Miles, his decision to leave Informatics was made because that company was showing signs of "losing interest in the TP monitor market."

Miles was, in a sense, acquired by Informatics when that firm acquired Programming Methods, Inc. from GTE's Information Services, Inc. in September 1975. He has a high opinion of Informatics and probably, he says, wouldn't have left if the firm's interest in TP monitors, on which he had worked first with PMI, had continued.

Informatics may not be into TP monitors or on-line programming systems



WALTER BAUER says Informatics' new line will "complement" IBM's own software, not compete directly with it.

like Condor, but it is very much into the IBM software products market in the one area many see as the only one IBM is leaving to independents—applications.

Informatics president Walter Bauer said his company has an IBM-centered strategy for applications software products that has been in the works since 1978. He said the new line of products will "complement" IBM's own software, not compete directly with it.

All products in the new line will operate on IBM data base management systems. Bauer told Los Angeles security analysts his company introduced three of these new products last year—Inquiry IV, Trans IV and Answer/2. All run on IBM's IMS and

Informatics has an IBM-centered strategy for applications software products that will "complement" IBM's own software.

CICS data base structures. A more recently announced product, an on-line reporting system named Answer/DB, uses IBM's IMS data base system.

As for Phoenix Computer, it's sticking with the birds. An upcoming product, Raven, is expected to be available by the end of this year. It's an on-line word processing and text editing system that uses the same front-end as does Condor and can share this with the on-line program development system.

And what does Webster say about Raven? "A glossy black corvine bird of Northern Europe, Asia, and America. Compare—crow."

What that may or may not portend for Phoenix remains to be seen.

—Edith Myers

DON'T BUY THE HEAVY-WAIT.



If you've been waiting around for 3278's to be delivered, relief is in sight. It's the ITT Courier C278 display terminal. Completely plug-compatible. More functional. Lower priced. And ready right now for fast delivery.

The C278 is designed to maximize operator productivity. With exclusive features and functions like our non-glare, non-smear screen that's brighter, clearer and easier to read. Time-saving reveal mode that displays format attributes on command for faster trouble-shooting. High-speed cursor that's twice as fast as IBM's. And variable field

underline that increases input accuracy.

Another exclusive is our financial flexibility. Terms, leases and some very attractive installment purchase programs.

So for local or remote operation, let our plug-compatible C278 be the bright spot in a dark delivery picture. Call your ITT Courier branch office for our latest technical bulletins. Or contact

us at ITT Courier Terminal Systems, Inc., 1515 W. 14th Street, Tempe, AZ 85281.



HEADQUARTERS ITT Courier Terminal Systems, Inc. (800) 528-1400.
Attention: Skid Pirtle.

Atlanta, GA (404) 329-9472	Cleveland, OH (216) 447-0455	Denver, CO (303) 433-8607	Kansas City, MO (816) 483-6530
Boston, MA (617) 890-9595	Columbus, OH (614) 866-9358	Detroit, MI (313) 358-3090	Los Angeles, CA North (213) 879-1631
Charlotte, NC (704) 523-2401	Dallas, TX (214) 233-9002	Hartford, CT (203) 633-6724	Los Angeles, CA South (213) 594-6581
Chicago, IL (312) 920-2770	Davenport, IA (319) 386-8620	Houston, TX (713) 780-0309	Miami, FL (305) 442-2645
Cincinnati, OH (513) 563-8050		Indianapolis, IN (317) 783-2974	

Milwaukee, WI (414) 782-0776	N. New Jersey (201) 225-3232	Phoenix, AZ (602) 267-9191	St. Louis, MO (314) 434-3199
Minneapolis, MN (612) 937-2067	Okla. City, OK (405) 949-0077	Pittsburgh, PA (412) 923-2446	Toronto, Canada (416) 676-9930
Montreal, Canada (514) 337-4841	Ottawa, Canada (613) 236-5526	Rochester, NY (716) 461-5700	Vancouver, Canada (604) 682-2751
New Orleans, LA (504) 838-8021	Philadelphia, PA (215) 265-7620	San Francisco, CA (415) 451-9411	Washington, D.C. (301) 459-3000
New York, NY (212) 751-0500		Seattle, WA (206) 382-9187	

CIRCLE 74 ON READER CARD

You Ought To Be In Pictures

Computer Graphics Beats Searching Stacks of Printouts.

ISSCO graphics software speeds decision making. Instantly, obscure data comes into sharp focus. Complex relationships are suddenly simple. You get the total picture, not just a bunch of numbers. DISSPLA® graphics software is easy to use. The typical plot requires less than 10 instructions. Programs never terminate because of error. Instead, you get correction messages in plain English. DISSPLA works on most large scale computers and a selected number of superminis. It drives any plotting device that can draw a straight line and takes advan-

tage of the advanced features of today's graphics devices. Built-in flexibility lets you experiment with graphic formats from simple to complex. You get quality graphs and charts for presentations, management reports, internal documents ... even slides. Quickly, Accurately, Easily. DISSPLA features include: automatic scaling and legend, various axes systems, extensive business features, shading patterns, fifty-seven alphabets, plus many more graphic enhancements.

Now for non-programmers there's TELL-A-GRAF® for virtual IBM and DEC systems. The secret? Plain English commands to easily generate bar, column, line, surface and pie charts without the frustration of explaining your needs to a programmer or art department.

ISSCO®

Integrated Software Systems Corporation
4186 Sorrento Valley Blvd.
San Diego, CA 92121 (714) 452-0170

ISSCO Deutschland, GmbH
Dietzstrasse 16
D-5400 Koblenz, West Germany
49 261 407989 Telex: 862891

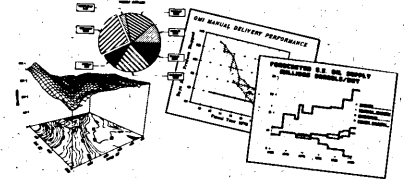

LEADING THE WORLD
IN MACHINE AND
DEVICE INDEPENDENT
GRAPHICS SOFTWARE
FOR OVER A DECADE. 1970-1980

10

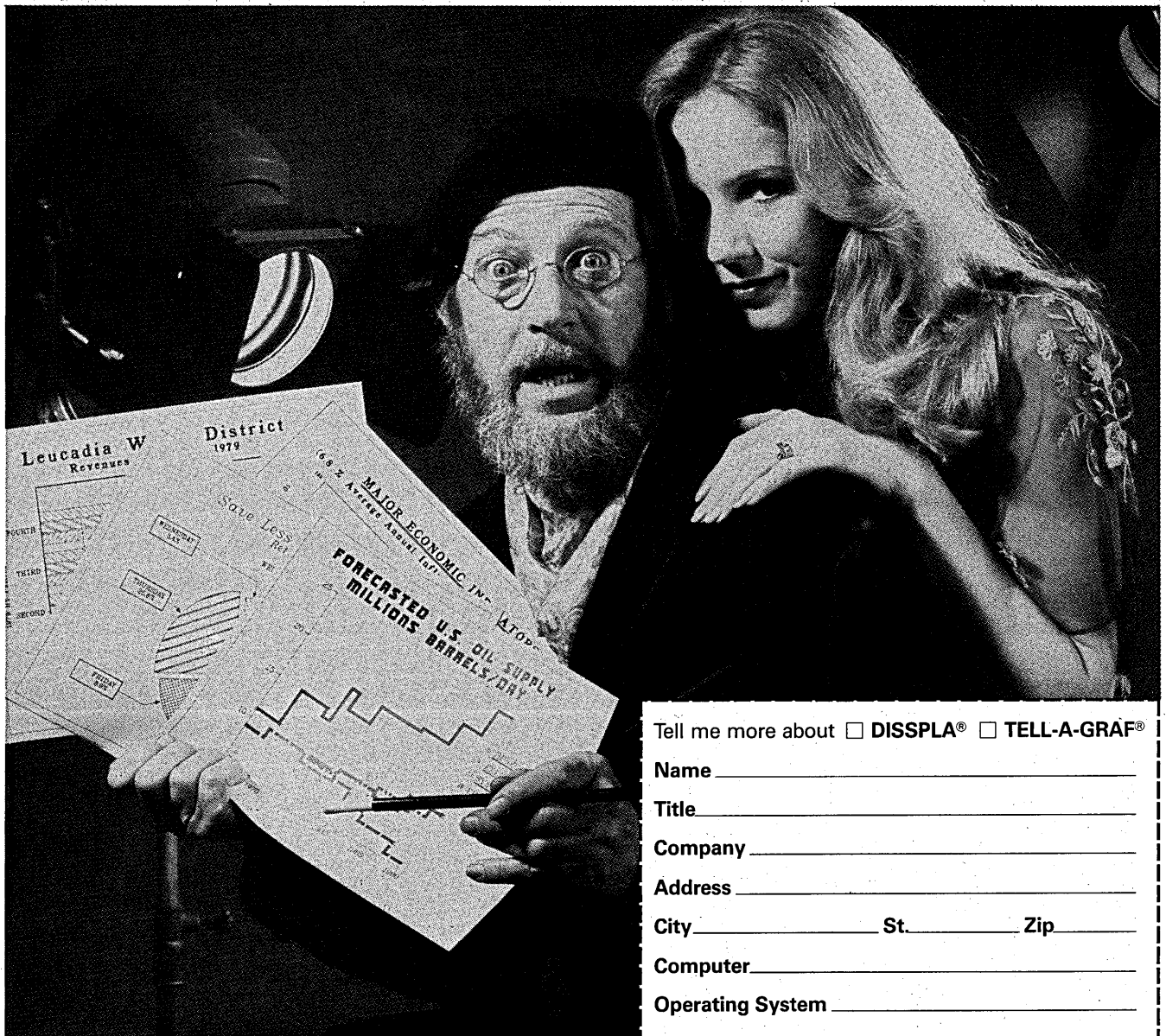

Tell me more about DISSPLA® TELL-A-GRAF®

Name _____

Title _____

Company _____

Address _____

City _____ St. _____ Zip _____

Computer _____

Operating System _____

CIRCLE 75 ON READER CARD

What you've waited for?

**PROGRAMMING
INTERNAL CONSULTING
AND MANAGEMENT**

*Enjoy "A Job Without Walls" In An
Exceptionally Desirable
Organizational Setting*

The responsibilities of this assignment do not fall easily into any slot—which may make it exactly what you have been hoping to find, someday. To begin with, it is with ETS, long a leader in the specialized, growing, and important field of testing, advisory, and research activities for education, government and business. A private, nonprofit, prestigious organization, ETS has superb facilities on a large, wooded tract near Princeton, New Jersey.

Your duties will be many and varied, as you consult with many users, analyze needs, and apply diverse programming concepts and design systems for complex projects. You may be called on to manage, or to plan and organize, to act as Chief Programmer for a team, to help develop proposals, to review information processing methods and equipment in use and evaluate or suggest improvements. In short, your skills will be utilized to the full in a succession of efforts, growing and maturing with this kind of experience and exposure.

We presently have two inviting "hands on" opportunities for senior staff members working with

**MVS/SE, R2, ACF/NCP,
JES 2, CICS, TOTAL,
TSO and VTAM 3705
with TWIN 4-MEG 3031's**

Requires an in-depth knowledge of system internals, maintenance, generation and debugging of operating systems, or analytical ability in computer measurement and evaluation.

BASIC REQUIREMENTS The requirements are implicit, but as minimums include at least 5 years applicable experience, bachelor's degree or equivalent, and extensive CS coursework in combination with consulting, management, or similar functions. You should have a good grasp of large scale hardware (preferably IBM), structured systems, data base, and the personality and depth to be effective in leadership, interfacing with users, and training.

Salaries are competitive, particularly in relation to living costs in a beautiful area convenient to both Philadelphia and New York. Benefits are distinctly exceptional and difficult to equal in total coverage and value. Vacation, for one example, begins at 4 weeks. Relocation will be assisted where required. On all counts, you may find ETS can offer an extraordinarily desirable career prospect. Please send resume, providing adequate information, in confidence to: Stan Davis, Sr. Placement Specialist.

 **EDUCATIONAL
TESTING SERVICE**
Rosedale Road, Princeton, NJ 08541
An Equal Opportunity Employer M/F

NEWS IN PERSPECTIVE

MAINFRAMES

POWER IN A PINCH

**With a simple console
command, a Chicago company
can up the speed of its Amdahl
470V/5 when time is of the
essence.**

Each night, a Chicago manufacturing company with several plants around the country runs a very large MRP (materials requirement planning) system. The job must be completed by 7 a.m. each day in order to have the new information up on an on-line inquiry network. And when interruptions during the night make it clear the job cannot be done by early morning, a simple console command causes the Amdahl 470V/5 mainframe to run faster.

"We pulled that job out of the fire several times by being able to turn on the Accelerator," says a spokesman for the firm, which asks that it not be named. The so-called Accelerator feature, available on the V/5 and V/7 processors only, provides from 20% to 50% added speed, depending on the processor.

**There are a number of
sections in the machine,
particularly the instruction and
execution unit, where
hardware overlap is built in.**

"It's a little bit like the pricing philosophy of a Xerox [copier]," says David Morgenthaler II, Amdahl Corp. vice president. It is, indeed, a move toward transaction pricing. "One way to think about it," he adds, "is that you sell the guy the base machine and the next larger machine."

There's a \$1,500 charge for a field installation of an Accelerator, \$1,000 when done at the factory. There's an additional fee of \$90 an hour when the Accelerator is running, a reasonable price when the incremental speed gained could exceed the power of a 370/158. When usage of the feature reaches between 50 and 100 hours a month, it becomes economical to get the next larger machine.

This optional feature, available only since late last year, is being very well accepted, according to people at the vendor firm. Users are beginning to see what it can do for them. But sensing that it all sounds too good and too easy, customers also want to know: "What's the hooker?"

There's no catch to it. Quips an Am-

dahl spokesman. "We change the pulleys." Actually, there are a number of sections in the machine, particularly the instruction and execution unit, where there is hardware overlap built in—not to be confused with software-controlled overlaps with, for example, buffering. And the absence or presence of this parallelism determines whether the machine will run faster or slower. When Amdahl decided to build a V/5, it took a V/6, the firm's first product, and removed some of the overlap, thus producing a slower machine.

The Accelerator was born of necessity, not originally intended to be a marketable product. Back when Amdahl could sell and install every machine it made, it became necessary to have both a V/5 and a V/6 processor at the plant for customer benchmark testing. It seemed a shame to have something installed in-house that could better be shipped and producing revenues instead. But because the V/5 is a V/6 processor without the overlap, someone thought to produce a multipurpose V/6 that could be switched to perform either as a 6 or a 5. That made it possible to get by with only the one processor for customer use at the plant.

This can be done with the 5 and 6, for they're of the same family. It can also be done with the V/7B, which can be accelerated to perform like a 7A, and the 7A can be turbocharged to run like a V/7. But they cannot accelerate a 7 to run like a V/8, for they're from different families. For the same reason, says product marketer Wayne McIntyre, "It is just genetically impossible to turn a 6 into a 7." But the 7B and 7A are downward derivatives of the 7.

If one were to follow standard operating procedures, the Accelerator is enabled through a console command. At the Amdahl console, by pressing one button you can talk directly to the hardware; push another button and you're talking to the operating system. For the Accelerator, the command must be to the console processor.

But the Chicago company, not content with this, put a systems programmer to the task of providing software control of the

ONLY A CIRCUIT CARD AWAY

Field upgrading of mainframes, while not yet a common occurrence, is beginning to catch on. But the concept is not new. DATAMATION editorial advisor Bob Patrick tells of a client many years ago who had a Burroughs computer that was running out of capacity. They called Burroughs and inquired about the next larger machine. A technician showed up, he recalls, changed merely one circuit card to implement the upgrade, and increased the billing rate accordingly.

Who knows? Perhaps the long-awaited, highly touted IBM H Series is but one circuit card away.

CIRCLE 76 ON READER CARD

What do you do when your large-scale IBM is all batched up?

Call the second center facility you probably didn't know you had. The Sungard Center.

There are a number of different ways your large-scale IBM can be non-plussed by overload.

Which could result in the delay or deferment of a number of pressing projects. From new program development to critical application back-up. And cause costly overtime in batch or interactive processing, software conversions or systems development.

The Sungard Center can remedy this rapidly.

Sungard was established as a highly advanced disaster/recovery center. Utilizing IBM's largest computers.

We're glad to report that the response to this service has been over-

whelming. We're also glad to report that no one has yet had a disaster.

So now we find our 3033 has a lot of spare time on its hands. As will our shortly-to-be-installed 3031.

As a result, you have a second center capability at your disposal.

Able to take a big load off your mind. Or act as an interim facility until IBM introduces its new package.

We offer this spare time at extremely attractive rates. Because it's pre-emptible. In case the center is ever needed for disaster recovery.

Whatever the need, remember, you now have another large-scale computer to count on.

DM-980

Sun Information Services Company
Sungard Services
656 E. Swedesford Road
Wayne, PA 19087 (215) 972-4776.

I feel a batch-up coming on. Tell me more about:

Systems development and testing.

Software conversions.

Remote batch or interactive processing.

Timesharing. Other _____

Please send me more information. Please call.

Name _____ Title _____

Company _____ Phone _____

Address _____

City _____ State _____ Zip _____

A Sun Company Subsidiary

Sun

INFORMATION
SERVICES
COMPANY

NEWS IN PERSPECTIVE

feature. With one instruction, the program is able to turn the Accelerator on; it also checks at regular intervals to see whether it is still on, and, after some increment of time, it essentially times out unless the operator specifically calls for it to stay on. It is important, of course, that the data center have some mechanism to avoid leaving the Accelerator running all weekend, unless so intended.

At the end of the month, the user must read a hardware meter that measures cpu time spent in the Accelerator mode, record the time on a form, and mail this to the vendor for billing.

The feature is described variously as being "like having a computer around that's bigger than you need," as "throwing more hardware at the problem," and as "temporary horsepower that you can buy incrementally." But this capability of providing extra power for users with weekly or monthly crunches, for those who need the spare power in case a processor in the same network should go down, is placed in the best perspective by Amdahl's Morgenthaler.

"In the long run," he says, "what would be best for everybody would be to put some sort of transaction pricing in place. But none of us [in the mainframe business] can figure out what a transaction is."

—Edward K. Yasaki

PERIPHERALS

BIG DRIVE FOR BACKUP

A big part of today's market for tape drives is in backup for Winchester disks.

"Its record is impressive for a dead technology."

Larry Hemmerich, vice president of marketing for Cipher Data Products, San Diego, was talking about the market for tape drives. And a big part of this market today is in backup for Winchester disks.

Gary Robinson, chairman of an American National Standards Institute committee studying an industry standard interface for the 8-inch Winchester fixed drive, once said, "The Winchester drive is a great idea but without a tape backup, it's not that useful."

A lot of companies are counting on this fact, one being IBM. A favorite backup for disks today is the streaming tape drive, for which the concept was introduced by

IBM with its 8809. This type drive eliminates stops and starts and associated costs, and offers increased speed.

Among the independents, Cipher was the first to introduce an oem streaming drive. It debuted at the '79 National Computer Conference and was billed as "the Low Profile Streaming Tape Drive, the first half-inch tape moving device configured specifically for disk backup in small business systems."

It is designed to take "data on-the-fly" in large blocks (up to a full disk) at 100 inches per second, automatically inserting industry standard interrecord gaps. It requires no vacuum columns or conventional tension arms to provide tape buffering; therefore, the drive can accommodate tape reels for up to 10½ inches of vertical rack space.

Cipher is one of two independent tape manufacturers still truly independent. The other is Datum, Inc., Anaheim, Calif. At that company's annual meeting last spring, president Louis B. Horwitz noted, "With ourselves there are five independents and the three biggest have absentee owners. Pertec has joined Wangco and Kennedy." He was referring to Pertec Computer Corp.'s acquisition by Triumph Werke Nurberg AG of West Germany (March, p. 70), Wangco's acquisition by Perkin-Elmer Corp., and the acquisition of

Wherever static is more than just a nuisance.

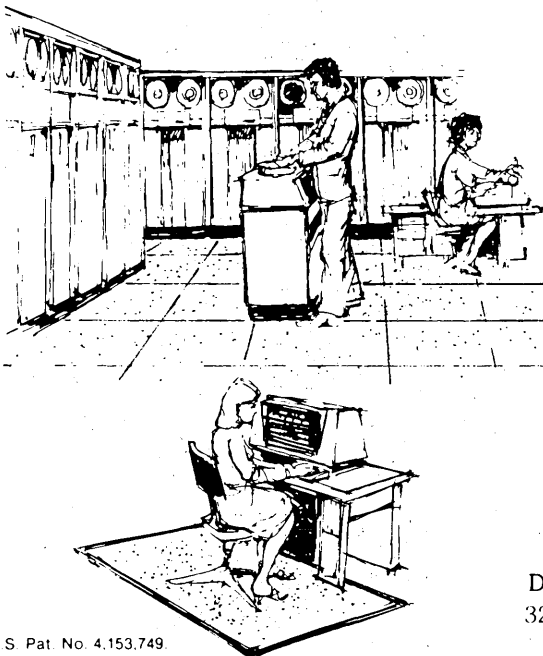

Eliminate static problems ... permanently

COMPU-CARPET™ is a unique, high performance anti-static carpeting developed specifically for use in computer rooms, terminal areas and other static-sensitive environments. Attractive and durable, Compu-Carpet has superior electrostatic properties even when compared with tile.

COMPU-MAT™ is produced from the same proprietary anti-static materials as Compu-Carpet. It is best suited for solving localized static problems at terminals and isolated mini and micro processors. Send for complete information.

Mfd. by

**UTP UNITED
TECHNICAL
PRODUCTS, INC.**

THE STATIC CONTROL PEOPLE

Dept. E/D

32 Southwest Industrial Park, Westwood, MA 02090. (617) 326-7611

U.S. Pat. No. 4,153,749

CIRCLE 78 ON READER CARD

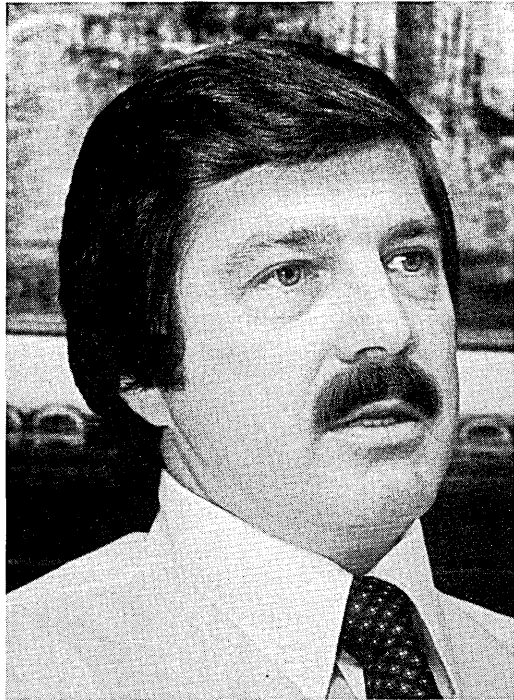

James L. Casey,
Corporate Credit Manager,
The Southland Corporation,
Dallas, Texas

"Our Pitney Bowes Computer Output Mailing System can do the work of 28 people at a savings of \$301,000 a year... but that's just the start!"

"Every day our 4,000 company-owned 7-Eleven stores accept personal checks and, needless to say, we pick up quite a few 'hot' ones.

"It used to be a costly hassle to have our local store managers get local collection agencies to follow up on these small checks. But by adding a Pitney Bowes Computer Output Mailing System we've been able to totally automate and centralize our 'hot check' collection system. In the process we've freed up our local store managers, significantly reduced our collection costs, speeded up our cash flow and turned our credit department into a profit center. Yes, a profit center!

"The beauty of the Pitney Bowes system is that it does the work of so many people and saves so much money in the process. Right now, we have five divisions on line, processing 6,000 letters a day. One man handles the entire job. The same man will be able to handle the output from 16 divisions—36,000 letters a day!

"This fantastic machine does all the work. Our man simply loads the computer-generated letters into one end, pushes a button and walks to the other end. In seconds, completely bursted, trimmed, folded, inserted, sealed, metered and presorted letters come out ready for bagging and mailing.

"The automatic presort feature is a money-maker. It lets us take easy advantage of Uncle Sam's 2¢ presort first-class discount. Last month it saved us over \$1,000. At peak volume we'll save over \$131,000 a year with the presort alone—more than enough to pay for the system.

"And, in the first four months we've never had a service call. That fact alone speaks well of Pitney Bowes' commitment to quality. But what really helped sell us on this machine over the competition were the people—the sales and service staff at Pitney Bowes. These people know the mailing business like no one else."

For complete details return coupon to Pitney Bowes, 2177 Pacific Street, Stamford, CT 06926. Or call toll free

anytime (except Alaska and Hawaii) 800-621-5199 (in Illinois 800-972-5855). Over 600 sales and service points throughout the United States and Canada. Postage Meters, Mailing Systems, Copiers, Dictating, Labeling and Price Marking Systems.

Name _____

Title _____

Company _____

Address _____

City, State, Zip _____

 **Pitney Bowes**

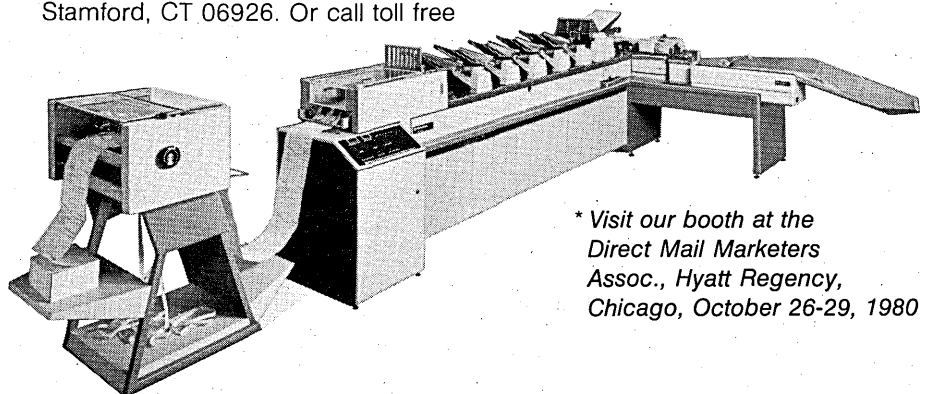

* Visit our booth at the
Direct Mail Marketers
Assoc., Hyatt Regency,
Chicago, October 26-29, 1980

CIRCLE 79 ON READER CARD

NEWS IN PERSPECTIVE

Kennedy Co. by Allegheny Ludlum Industries.

The two independent independents apparently are doing well. Datum in July reported growth in both sales and earnings. Revenues for its second quarter reached \$4,057,000, compared with \$3,703,000 for the equivalent period in 1979. Earnings of \$102,000 improved from 1979's like quarter, which had earnings of \$69,000.

For the first six months of 1980, the firm reported that revenues reached \$7,863,000, up from \$7,353,000 in the first half of 1979. Earnings increased to \$231,000 from \$115,000.

Horwitz said a review of the company's balance sheet shows that "notes-payable-to-bank, which stood at \$1,425,000 12 months earlier, has now been eliminated." He attributed the ability to eliminate the company's short-term debt to "aggressive reduction of accounts receivable, lowering of inventory, and the creation of deferred income tax." He said the company's current ratio stands at 3.0, indicating it has sufficient capital and borrowing capacity to withstand whatever economic uncertainties the current economy may produce.

As for Cipher, the company earlier this year said it had arranged a larger line of credit, \$4.5 million, with the Bank of America, which president and chief execu-



FRANK C. BUMB says Kennedy has experienced a 50% compound growth rate over the last six years.

tive officer Don Muller said "will help support Cipher's rapid sales growth, while the new long-term credit clearly is indicative of Cipher's strong financial condition."

Cipher was once acquired but has

been back on its own since 1976. Founded in 1968, the company was acquired in 1972 by Computer Machinery Corp. Founder William Otterson and private investors bought the company back when CMC was acquired by Pertec in '76.

Datum isn't into streaming drives yet, but Horwitz said at the annual meeting, "We must give our attention to the streaming concept. The race is on. We are studying it and we plan to be in it."

Kennedy Co. of Monrovia, Calif., most definitely is. Kennedy, which its president Frank C. Bumb says is "in the number one spot among independent suppliers," has a Model 6809 Data Streamer that it describes as "ideal for Winchester disk drive backup where fast starting and stopping is not required."

The 6809 was designed to emulate the IBM 8809. Features include built-in industry standard formatter; only four moving parts, assuring a higher MTBF (mean time between failure) than most tape drives; and streams at 100 inches per second or, in start/stop mode, at 12.5 ips. It can be mounted vertically in rack, horizontally in drawer, or horizontally in a lowboy console.

Bumb joined Kennedy as president in early June, succeeding founder Charles J. Kennedy, who remains chairman of the board. Bumb had been president of the Data

FOCUS: The English-language information control system.

FOCUS is a high-level, English-language software system for on-line report writing, applications development and data base management.

FOCUS can develop complete applications faster than any other system available. Non-programmers using FOCUS can learn to make basic queries within hours and write ad hoc or formatted reports in a day. Systems designers can write complex self-documenting applications in up to one-tenth the time required by procedural languages. Either way, FOCUS eliminates data production bottlenecks.

Using relational file structures to link individual data fields in separate files, FOCUS reduces data redundancy and data file dependence. Whether you use FOCUS data bases or your own existing files—such as IMS, IDMS, VSAM, and ISAM—the same English-language report writer is available. FOCUS operates in an interactive environment (CMS/TSO) on IBM 370, 4300, or equivalent mainframes.

Over 400 major companies, institutions and government facilities are using FOCUS to prepare reports, financial models, statistical analyses, and graphs to process information rapidly and make informed decisions. Among them are: J.C. Penney, ITT-Continental Baking, Merrill Lynch, RCA, Yale

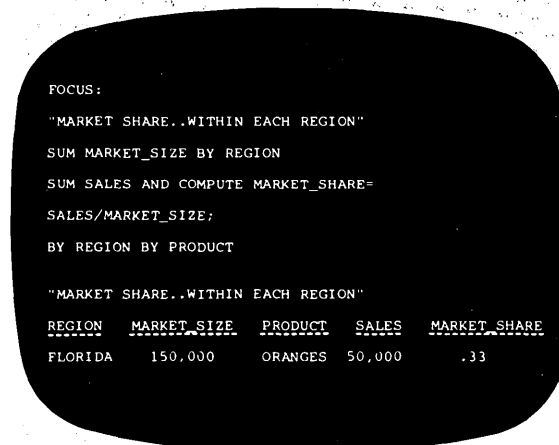

University, and the U.S. Army Corps of Engineers.

Typical applications are in: personnel, finance, general administration, marketing, sales, research, results tracking, manufacturing, and customer service.

FOCUS can save you time, effort, and money. For more information, call or write for our brochure.

FOCUS

Information Builders, Inc., 1250 Broadway,
New York, N. Y. 10001 (212) 736-4433

How do YOU avoid downtime?

This way?

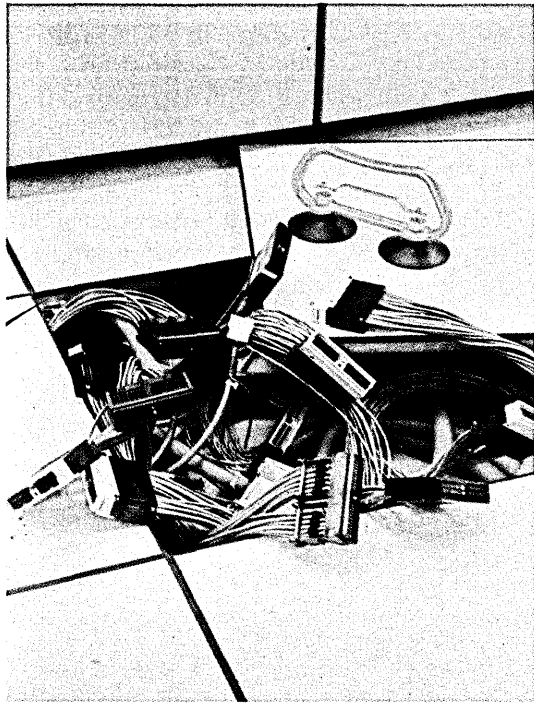

Or this way?

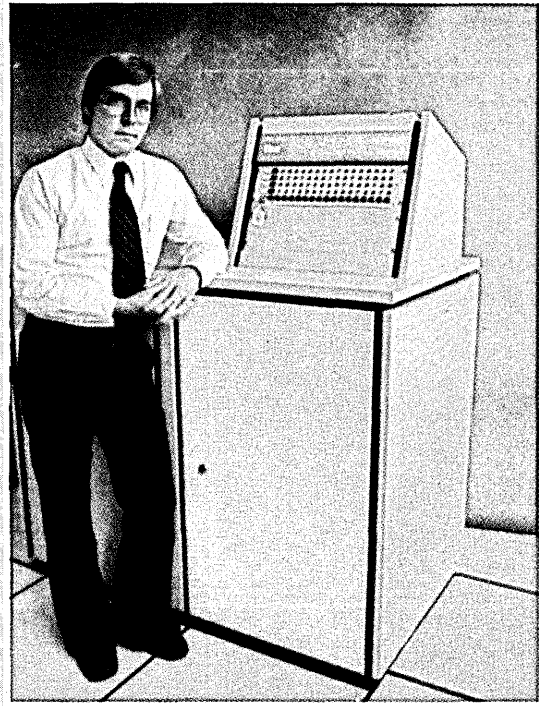

The choice is yours. Some IBM* computer installations can lose up to \$5,000 per minute when the computer system fails. But that's only one reason why the T-Bar 3900 Series of Computer Peripheral Switches can save you money. If your system demands continuous on-line operation, call or write T-Bar today. Let us show you how other companies have used T-Bar alternatives to minimize downtime.

*or IBM compatible, such as Amdahl, Intel and CDC.

Tbar[®] Incorporated

141 Danbury Rd.
Wilton, CT 06897
203 762-8351

Show me how T-Bar can help to minimize downtime.

Name _____

Company _____

Address _____

CIRCLE 81 ON READER CARD

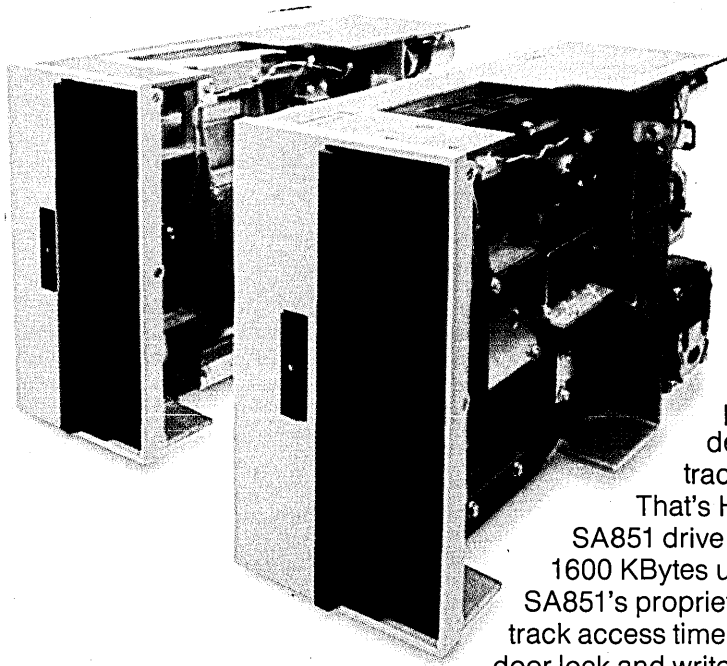

Want 800-1600 KBytes? Choose our SA801/851 series. With the SA801 8-inch floppy, you have a choice of 400 or 800 KBytes in single or double density, on the same drive for the same price. Well over half a million of these standard-setting drives have been specified by OEM's around the world. They know that they can count on Shugart's proprietary read/write head technology to deliver media life of over 3.5 million passes per track, and head life of more than 15,000 hours.

That's Headstrong performance. And the double-sided SA851 drive gives you even more capacity. It stores 800 to 1600 KBytes using single or double density recording. The SA851's proprietary Fasflex™ band actuator improves track-to-track access time to a fast 3 ms. There's also a programmable door lock and write protect. The Headstrong SA801/851. Solid performers from the leader in disk drive technology.

The head Choose your

Moving up to 5-58 MBytes? Check Shugart's SA1000 and SA4000/4100 series fixed disk drives with the lowest cost per MByte in their capacity range. The 8-inch

SA1000 breaks the \$1,000 price barrier and is available in 5.3 and 10.7 MByte versions. Its dimensions and mounting holes are exactly the same as our floppy drives, and it's more compatible electrically than competitive drives. The SA4000/4100 series offers 14.5, 29 and 58 (SA4100) MByte capacities with an optional 144 KBytes of head-per-track storage. Compact and lightweight, it

uses only 5.25 inches of panel space and weighs less than 40 pounds. All Shugart fixed disk drives use proven Winchester head and media technology to ensure better data integrity and longer life. And system integration is easy because both the SA1000 and SA4000/4100 can share a power supply with your floppy drives. Shugart fixed disk drives. The head of the family in capacity and cost/performance.

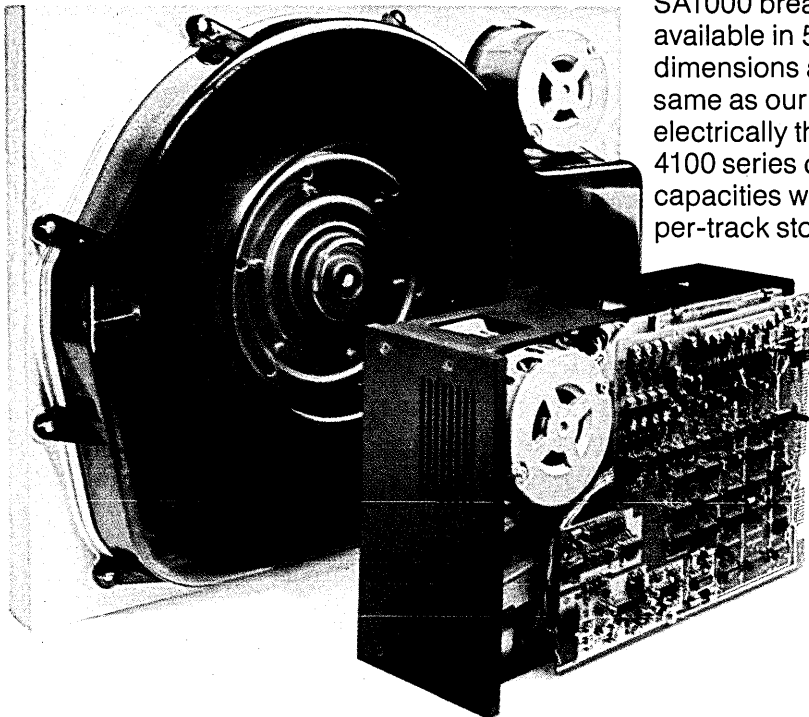

Need 220-440 KBytes? The famous Minifloppy™ is the right choice. Choose the original SA400 Minifloppy or the double-sided SA450. You can store up to 218.8 KBytes single-sided and up to 437.5 KBytes double-sided (unformatted, double density). Both are the same compact size and weigh only three pounds. Both are I/O compatible, and use Shugart's own glass bonded ferrite/ceramic read/write heads. The double-sided SA450 uses our new

Bi-Compliant™ head assembly for superior compliance and data reliability. Both drives allow you to read and write data on any single or double-sided minidiskette, so you can continue to use your existing disk library.

Low heat dissipation, DC drive motor, write protect, positive media insertion and activity light are all standard. Since we invented the Minifloppy, over half a million have been installed in systems

like yours—proof that this is the 5¼-inch floppy with the right capacity and the right price/performance.

Choose the original. Minifloppy.

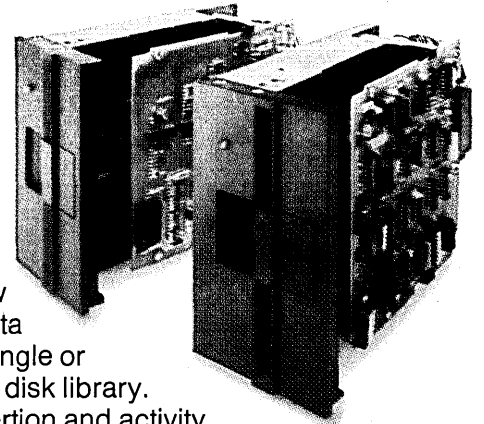

strong family. capacity.

Choose the Headstrong Shugart disk drives. No matter which disk drive you select from our family, you get the competitive edge when you go with Shugart. We are Headstrong about helping to keep you competitive too, with high volume deliveries of drives that offer superior reliability, quality, and value. This

Shugart commitment is also backed by all the support you need including helpful technical services, in-depth documentation, and design assistance. And when your product line grows, we'll be there with a complete family of floppy, Minifloppy, and fixed disk drives in a full range of capacities. Reliable products, volume delivery, superior quality, and value. That's what we're Headstrong about at Shugart. □

Shugart Associates: 475 Oakmead

Parkway, Sunnyvale, CA (408) 733-0100

Sales & Service: Sunnyvale, CA; Costa Mesa, CA; Minneapolis, MN; Richardson, TX; Framingham, MA; Landing, NJ; Atlanta, GA; Toronto, Ontario; Paris, France; Munich, Germany. □ Shugart products are also available off the shelf from local Hamilton/Avnet outlets.

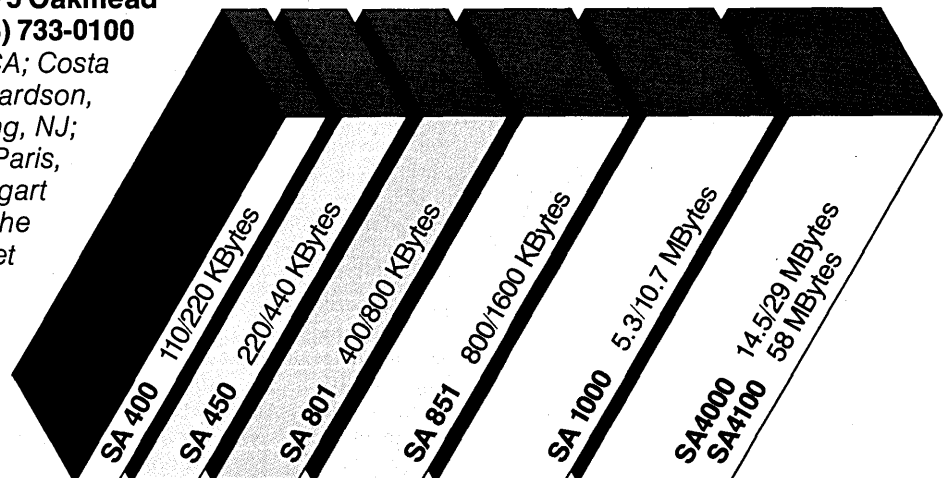

Shugart
The Headstrong Family

CIRCLE 82 ON READER CARD

CONVERSION SOFTWARE

Dataware Translators meet the needs of a changing Computer Industry

Dataware's conversion approach provides the major solution to management's conversion problems and facilitates the recovery of the initial capital investment in systems development.

RPG/RPGII to COBOL

Converts RPG and RPG II programs to the industry standard ANS COBOL. The translator achieves an extremely high percentage of automatic conversion (approaching 100%) of the source code.

Circle 250 on Reader Card

PL/1 to COBOL

Automatically converts from IBM PL/1 to ANS COBOL. The Translator is capable of handling IBM OS or DOS (48 or 60 character set) source programs as input.

Circle 251 on Reader Card

RPG/RPGII to PL/1

Converts RPG and RPG II programs to an optimized PL/1. The translator achieves an extremely high percentage of automatic conversion (approaching 100%) of the source code.

Circle 252 on Reader Card

AUTOCODER/SPS to COBOL

Automatically converts a high percentage of SPS/1400 Autocoder source code to ANS COBOL.

The Translator converts from:

- IBM 1401
- IBM 1401 SPS
- IBM 1440
- IBM 1460
- IBM 1410
- IBM 7010

Circle 253 on Reader Card

(Any) COBOL to (Any) COBOL

Circle 254 on Reader Card

EASYCODER/TRAN to COBOL

Circle 255 on Reader Card

BAL/ALC to COBOL

Circle 256 on Reader Card

FORTRAN to FORTRAN

Circle 257 on Reader Card

Software firms interested in being an agent for our products, please write or telex today.

The Conversion Software People

Dataware, Inc.

2565 Elmwood Avenue
Buffalo, New York 14217
(716) 876-8722 • TELEX: 91519

NEWS IN PERSPECTIVE

Tape Div. of Bell & Howell Co. in Pasadena, Calif.

Since its acquisition by Allegheny Ludlum in early 1979, Kennedy has been part of that firm's Magnetics and Electronics, Inc. subsidiary.

The company was founded by Kennedy in 1963 as a manufacturer of incremental recorders. It now supplies digital tape transports, cartridge recorders, backup tape transports, and 8-inch and 14-inch Winchester disk drives. The company today has 1,000 employees.

Bumb said Kennedy has experienced a 50% compound growth rate over the last six years. Allegheny Ludlum doesn't break out subsidiary financials, but it is estimated that Kennedy currently is doing approximately \$50 million a year in business. Backlog at the end of June was \$23,000, up from \$17,699 in June 1979, a 30% increase.

Problems in the quarter-inch drive market probably have been offset by the slow takeoff of the 8-inch disk market, which has given the drive manufacturers breathing room.

V. Steven Arnaudoff, director of international operations, said the company exports 22% of its products and he feels that, through incorporation of its products into systems of other firms, some 40% of its products find their way into international markets. Kennedy sells 85% to oems and 15% to end users, but the firm would like to increase the end user percentage.

Kennedy entered the more crowded market for quarter-inch backup tape drives early this year, and experienced problems getting heads, as did many startup firms in the market. But the company says it has now solved that problem by developing a number of sources.

The quarter-inch backup drive market is expected by Freeman Associates, a Santa Barbara, Calif., research firm, to grow to \$60 million, populated by as many as 15 companies.

Problems in the quarter-inch drive market probably have been offset by the slow takeoff of the 8-inch-disk market, which has given the drive manufacturers breathing room.

The potential is there. "Backup is the prime issue among oem buyers today," said Bob Oakley, director of product marketing, Century Data Systems, at a recent Southern California invitational computer conference. Century manufactures Winchester drives.

Cipher's Hemmerich said at the same conference that "maybe there isn't a solution to disk backup. Maybe we need multiple solutions. And maybe you don't need as much backup as the size of a disk."

—Edith Myers



DO YOU INTEND TO SOLVE YOUR APPLICATIONS BY A MINICOMPUTER? IF SO, WE GIVE YOU THE IDEAL SOLUTION: MAKE USE OF OUR INDEPENDENT—100 CORAL 1001/4011 AND M-18 MINICOMPUTERS!

Due to their diversified applications software and peripheral equipments, these new low-cost minicomputers having core and RAM memory (I-100) as well as RAM, PROM and REPRAM memory (M-18), can be successfully used in various application fields such as: process control, scientific research, engineering and scientific computation, business data processing, data communication, data teleprocessing on-line or off-line connected to FELIX C-256/512 systems, communication line concentrators, computer-assisted education, etc.

For further information and detailed documentation do not hesitate to contact the exporting company



ELECTRONUM
Export-Import
Specialized Foreign Trade Company
70317 Bucharest - ROMANIA
11-15 Olari Street
P.O.B. 34-36
Telex: 11547, 11584

CIRCLE 68 ON READER CARD

THE INDUSTRY STANDARD

BULK CORE

BULK SEMI

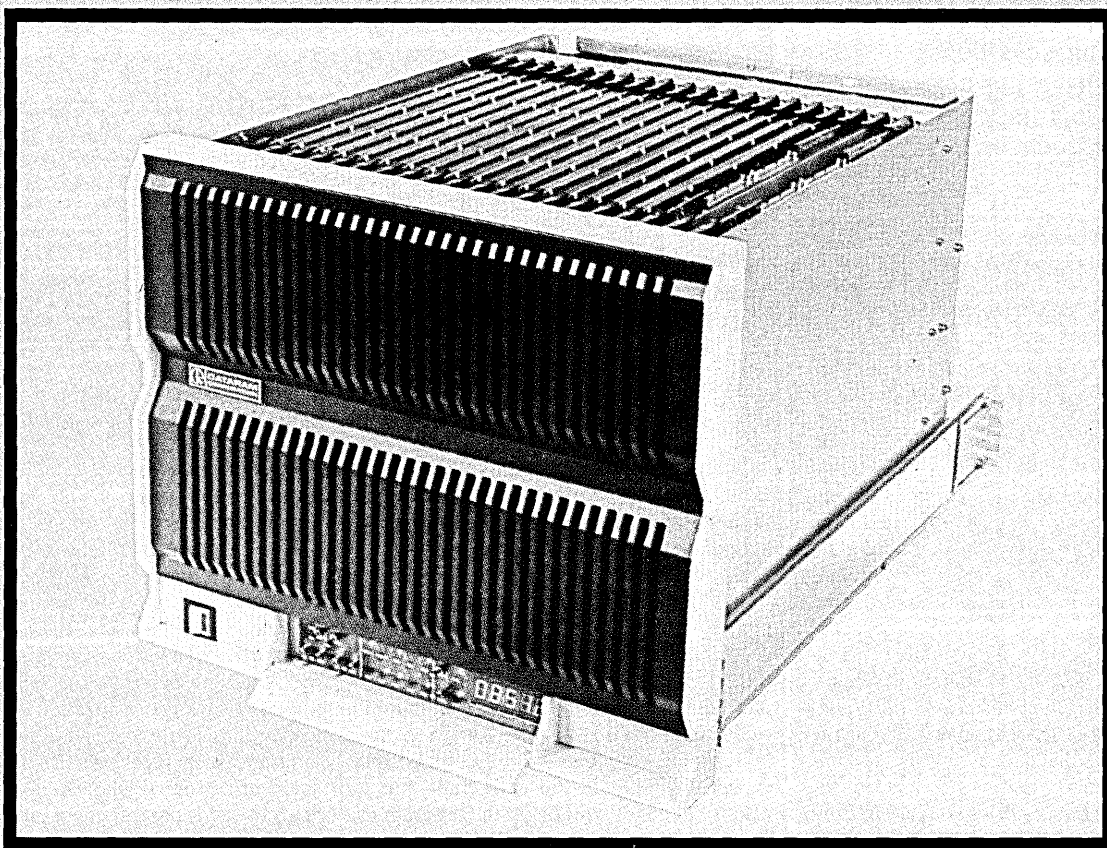

The choice of hundreds of minicomputer users

Give your minicomputer the added benefit and flexibility of economical, high-capacity storage with BULK MEMORY from Dataram.

The only company to offer both core and semiconductor BULK MEMORY systems for minicomputer users, Dataram today has hundreds of BULK CORE and BULK SEMI users throughout the world, in use in applications that range from process control and data acquisition to disk swapping and main memory expansion. Utilizing capacities from 256KB to 16 MB, and featuring —

- ★ Controllers for DEC, Data General, Perkin-Elmer, and ROLM minis
- ★ Core or semiconductor technology
- ★ Dual-port capability
- ★ Built-in Self Test

BULK MEMORY from the leader. Capability you can use. And only from Dataram. Now.

Find out today how BULK CORE and BULK SEMI can help you get more out of your minicomputer. Contact Dataram at 609-799-0071.



PRINCETON-HIGHTSTOWN ROAD CRANBURY, NEW JERSEY 08512
TEL: 609-799-0071 TWX: 510-685-2542

Canada: Ahearn & Soper Ltd., Alberta, British Columbia, Ontario, Quebec • Finland: Systek OY, 737-233; France: YREL, 956 81 42 •
Hungary/Poland/Romania: Unitronex Corporation, WARSAW 39 6218 • Italy: ESE s.r.l., 02/6073626 • Netherlands: Technitron b.v., 020-45 87 55 •
Sweden: M. Stenhardt AB, (08) 739 00 50 • Switzerland: ADCOMP AG, 01/730 48 48 • United Kingdom: Sintrom Ellinor Ltd., (0734) 85464 •
West Germany: O.E.M.-Elektronik GmbH, 07 11-79 80 47 • Australia/New Zealand: Anderson Digital Equipment, (03) 543 2077 • India: Industrial Electronic Instruments, 79281 •
Israel: Minix Computers & Systems Ltd., 03-298783 • Japan: Matsushita Electric Trading Co., Ltd., 03 (435) 4501

CIRCLE 85 ON READER CARD

INSTITUTE BORN OF GRATITUDE

Dr. An Wang says he's benefited from the computer industry. Now he wants to "put something back in."

At Wang Laboratories' new corporate headquarters in Lowell, Mass., the telephone operators call it "the university."

In the presence of Dr. An Wang, the 60 year old, Shanghai-born, Harvard-educated scientist and businessman who has made Wang Labs one of the most successful family-dominated corporations in high-tech America, everyone refers more modestly to "the institute."

Dr. Wang is opening a private school, the Wang Institute of Graduate Studies, an independent, nonprofit educational institution in Tyngsboro, Mass. The institute, which will initially offer a master's degree in software engineering, has been funded with about \$3 million from the Wang family, explained Dr. Wang, but the institute itself is and will be totally separate from Wang Labs, the corporation. This is something other than business, said Wang, something more than another sally in the personnel wars that have Wang and its competitors constantly raiding back and forth.

Wang Laboratories goes along from one fiscal year to the next—quite successfully, mind you—but the Wang Institute, declared Dr. Wang, "is a hundred-year project."

In the halting, awkward English with which he has so deftly directed the growth of his \$500 million company, Dr. Wang explained his new venture. Why the institute? Gratitude, he said. "You come here. You get benefit from the universities.

Ugo Gagliardi has taken a leave from Harvard to become the institute's first dean.

You get benefit from the computer industry. And you want to put something back in. You make some money and you want to put something back in. The idea is to make some contribution to the community."

Last year, Dr. Wang—"The Doctor," in the parlance of Wang employees—decided he wanted to open a graduate school. With money, prestige, and his own considerable charm, Wang soon had a charter, IRS approval, a committee of five local university presidents as advisors, and

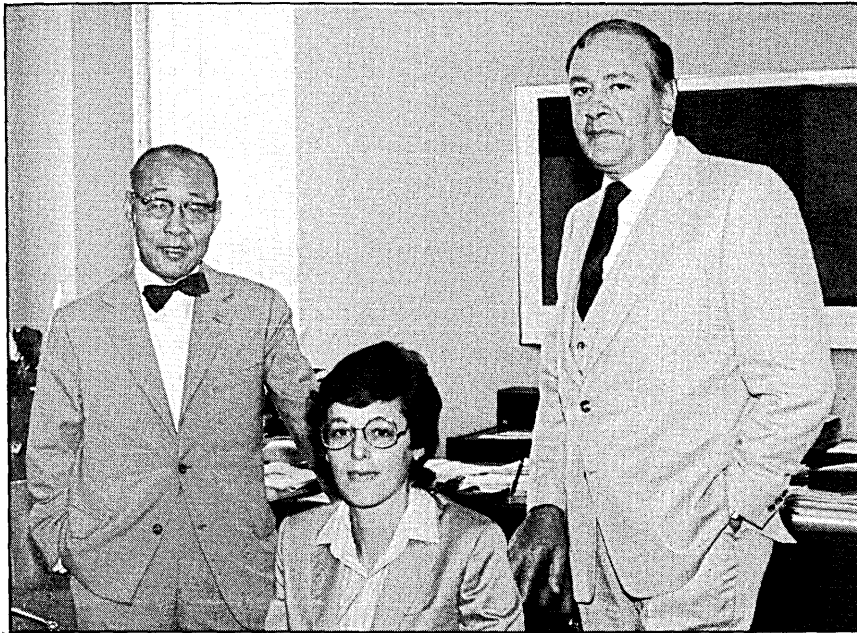

WANG, WARDLE, AND GAGLIARDI all emphasize their commitment to develop a program that will produce technically qualified managers for software development.

another committee of a dozen top academics and leading industry executives shaping a curriculum for the institute's first program, the School of Information Technology. Carpenters were transforming a beautiful old monastic seminary into an academic center even as somewhat breathless academics were offered faculty and administrative positions. The school, said Wang, couldn't be ready for a September opening—students will be recruited and accepted right into the early fall—but a class of about 30 will begin the program in January.

"It would have taken a university five years of study before they dared to do anything," dryly noted Ugo Gagliardi, a Gordon McKay professor of the Practice of Computer Engineering and senior industry consultant who has taken a leave from Harvard to become the institute's first dean. Dr. Caroline Wardle, the former chairman of the computer sciences department in the evening college at Boston University, will be associate dean. Wardle said both she and Dr. Gagliardi will teach, and there will be two other full-time faculty members, with others recruited as needed.

Wang, Wardle, and Gagliardi all emphasize that the potential of Wang Institute rests largely upon their commitment to develop an academic program that will produce superior technically qualified managers for the computer industry's software development. If the Wang Institute can succeed, said Gagliardi, it will hopefully challenge other institutions to better prepare "technical managers" to fill key personnel slots like first-line supervisors of software development projects, software architects who can take the lead in conceptualizing a

project, team members who can work well within a development group.

"In concrete terms, we hope to develop a program that—with a couple of years of education—can shortcut a process of managerial development that normally takes about five years," explained Gagliardi. A key resource—"the bottleneck resource"—in any organization is the project leader; in the software end of the computer industry, such types are the middle-management personnel who can take a team of analysts and programmers and organize them to get a job done.

Each student entering the program must have both a strong technical background and several years of work experience in the industry.

"The way a company gets people for that role today is happenstance," Gagliardi said. "You get people from computer science training and you put them in an industrial environment and some of them—a very small percent—grow into project leader types. Most of them don't."

The academic advisory board for the institute—academics from Harvard, Princeton, and Colorado, and executives from Xerox, DEC, Prime, and others—all agree that it is probably possible to develop a formal process, a study program, to speed and improve this "manager development" cycle. They also agree, for a variety of reasons, that it is a difficult problem for the universities to address directly.

If a program like the institute's can effectively train people for these key indus-

Triple Modem

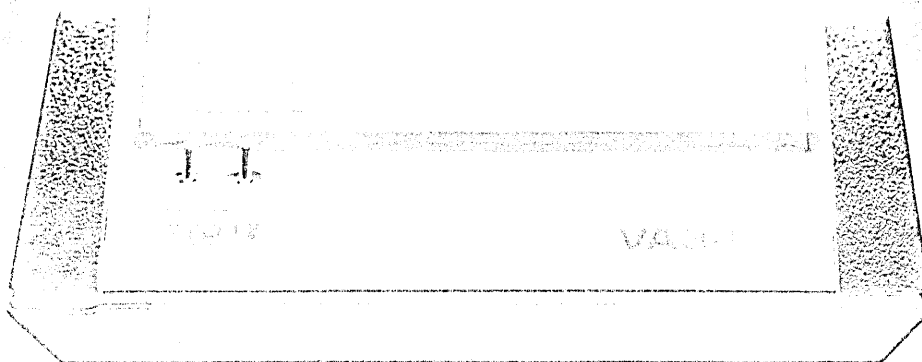

1200 bps full duplex

1200 bps full duplex Bell type 212A and a 300 bps full duplex

Racal-Vadic has closed the loop. Ma, with a direct-connect, originate, answer TRIPLE MODEM for remote terminal users.

It combines a 1200 bps full duplex VA3400, a 1200 bps full duplex Bell type 212A, and a 300 bps full duplex Bell type 103 in a compact low profile cabinet. Including the VA3400 at NO EXTRA COST is very important. Ma. After all, Racal-Vadic invented the 1200 bps full duplex modem. There are over 60,000 in operation. Also the VA3400 can be acoustically coupled while the Bell 212A can't. It has many technical advantages too, which, I guess, is why major terminal

manufacturers are incorporating VA3400 modems into their new equipment.

With TRIPLE MODEMS available for the central computer site, and remote ends of the network, users can lease or buy from Racal-Vadic and satisfy every full duplex switched network requirement from 0 to 1200 bps, which sure beats "renting forever."

Better phone for the whole story, or send for our new color brochure today.

Your independent thinking son,

Alexander Graham Jr.



Remote Terminal Modem



Central Computer Site VA3467 Triple Modem

222 Caspian Drive,
Sunnyvale, CA 94086
Tel: (408) 744-0810 • TWX: 910-339-9297

Member IDCMA

The Electronics Group

Available from these stocking reps...

Alabama: (205) 344-1234 • Alaska: (907) 344-1114 • Arizona: (602) 941-1111 • California: S.F. (415) 249-2491, L.A. (714) 639-7600, S.D. (714) 578-5760 • Canada: Calgary (403) 243-1326, Montreal (514) 449-9491, Toronto (416) 675-7500, Vancouver (604) 681-8136 • Colorado: (303) 779-3600 • Conn.: (203) 265-0215 • Dist. of Columbia: (301) 621-1777 • Florida: Ft. Lauderdale (305) 440-1400 • Idaho: (208) 423-7619 • Ill.: Petersburg (800) 432-4480 • Georgia: (800) 327-6600 • Illinois: (312) 255-4820 • Indiana: (317) 344-2100 • Kansas: (913) 777-7700 • Maryland: (301) 922-3939 • Mass.: (617) 245-8900 • Michigan: (313) 973-1133 • Minnesota: (612) 944-3515 • Missouri: (314) 821-3742 • New Jersey: South (201) 449-5111, South (609) 779-0200 • New York: Binghamton (607) 785-9947, NYC (212) 695-4269, Rochester (716) 473-5720, Syracuse (315) 437-6666 • N. Carolina: (919) 327-1111 • Ohio: (614) 233-8329 • Oregon: (503) 859-3040 • Oregon: (503) 224-3145 • Penn.: East (609) 779-0200, West (412) 681-8609 • S. Carolina: (803) 327-6200 • Texas: Dallas (214) 391-9111, Dallas (214) 391-2573, Houston (713) 688-9971 • Utah: (801) 484-4496 • Virginia: (301) 622-3535 • Wash.: (206) 763-0755 • Wisconsin: (414) 941-5000

CIRCLE 86 ON READER CARD

PREMIUM COMPUTER.

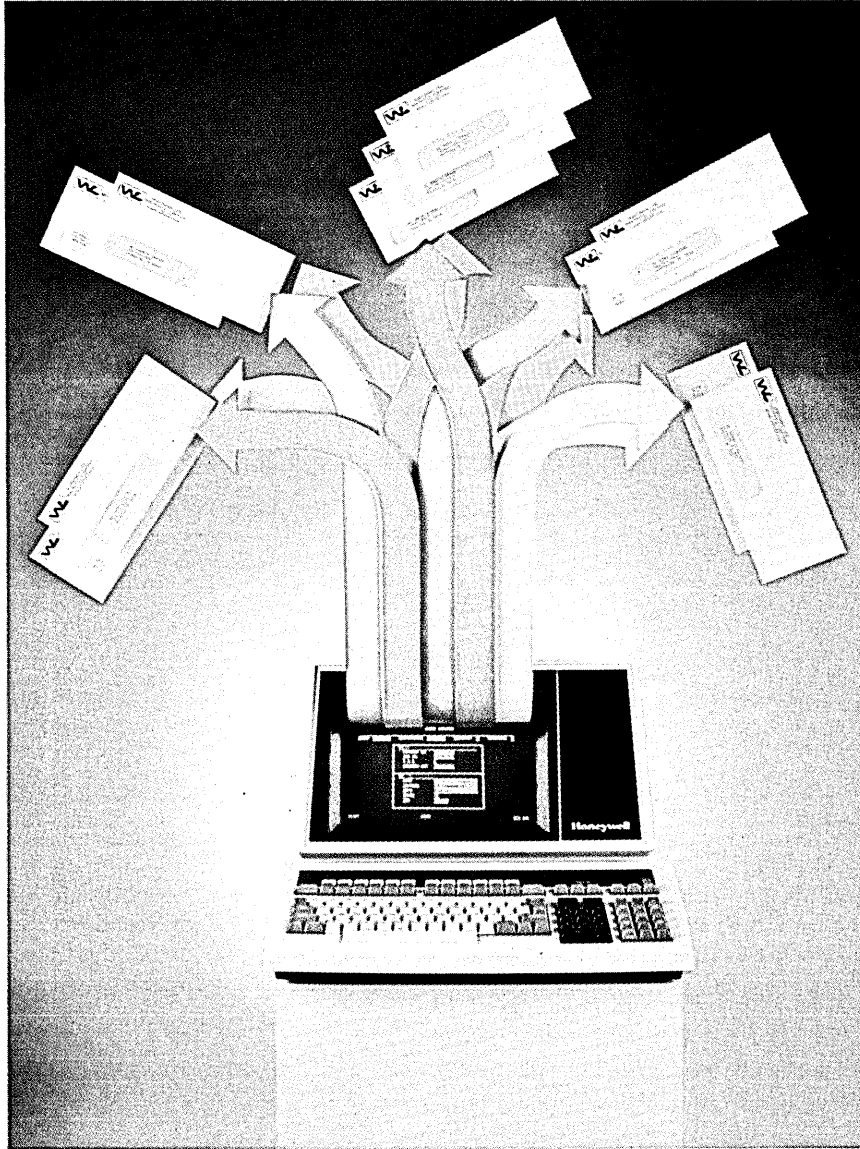

When Wisconsin Life added a Level 6 computer their customers were the real beneficiaries.

Not all insurance companies are slow-moving behemoths. Wisconsin Life just installed one of our Level 6 computers and is now processing most claims within 72 hours. Response time has been cut by a full 80%.

Businessware.

Wisconsin Life is benefiting from something we call Businessware. A well-balanced combination of the right hardware, the right software, and Honeywell's vast business experience.

Everything our salespeople have learned in 25 years of working with businesses has been put into Businessware.

TPS-6 is part of Businessware. Thanks to this built-in transaction processing system,

Wisconsin Life's new computer is helping in three key areas. First, linked to a network of 60 terminals, it's making clerical functions easier to perform. Clerks now use terminals to check the nuts and bolts of individual claims: Is this policy valid? Has this claim been paid before?

In all, there are more than 30 screen formats.

Once a claim has been approved, a check is written that night. Since the Level 6 arrived, many claims have been paid in a single day.

The Level 6 has also been helping Wisconsin Life develop new applications for their transaction processing capability. For instance, there's a program in the works now that will enable them to process all new business on-line.

One advantage is that the computer can be used to calculate premiums, thus eliminating a great deal of work currently done by hand.

Finally, the Level 6 runs a very efficient data entry facility. Once CRTs are installed, clerks will be able to correct errors immediately, substantially reducing overall system maintenance costs.

Services Improved.

Wisconsin Life's new Honeywell is doing precisely what we knew it would. It's giving them greater control of their operations. And in so doing, it's increasing the quality of service Wisconsin Life offers their customers.

On Wisconsin!

For a more detailed look at the Level 6, write Honeywell, 200 Smith Street (MS 487), Waltham, MA 02154.

Honeywell

CIRCLE 87 ON READER CARD

NEWS IN PERSPECTIVE

try positions, however, "we can have a tremendous impact on industrial productivity," said Dean Gagliardi. "Because if we can show that there is a process that can double or triple the production of these people, it would obviously help address the industry's software bottleneck.

"And software today is the bottleneck for the entire computer industry," he added.

For the software engineering program, the institute is essentially selling an advanced education in technical management skills primarily to computer vendors

(Wang Lab's competitors), who Gagliardi and Dr. Wang expect will provide most of the students for the first years of the program. Local mini manufacturers are already openly supportive.

Computer systems now being installed at the institute's 200-acre campus include a DEC VAX 11/780, a Prime 750, and a Wang VS, but there will also be remote access to an IBM 3033. This is not a training program for Wang Labs, insisted Dr. Wang. This is the Wang family's attempt to offer something to the very industry that has made the company so prosperous.

Each student entering the program will be required to have both a strong technical background and several years of actual work experience in the industry. Tuition, about \$7,000, is perhaps one-third of the actual cost of running the program, said Associate Dean Wardle. Although the three-semester master's program can be completed with a year of full-time work, Dr. Wardle said she expected many students to enroll in either the two- or three-year part-time program in order to continue working for one of the numerous computer companies in Massachusetts or nearby New Hampshire.

"Dr. Bruce Arden, head of the computer sciences department at Princeton University and a member of the institute's academic advisory group, noted ruefully the "general perception of a gap" between the coverage of applied computer science programs at the universities and the needs of the industry. That gap, somewhat notorious since the publication of the National Science Foundation's Feldman Report, has some obvious roots in the rigidity of the academic environment and its isolation from the industrial arena, where technology is centered.

Lacking the professional status of a law school or medical school, computer

"We are trying to replicate in the software engineering area the same kind of experience the other great professions have had."

science professors are paid salaries on a scale that is the college compromise between the academics who could command a high market value off campus and those who could not. Noted Gagliardi, "The result is a salary that makes it difficult to attract people who can also practice." There are other problems with academic traditions—tenure on one hand, and the difficulty of evaluating esoteric work on the other—not to speak of the financial bind: the high cost of computer equipment and technical support.

Reflecting on these issues, Prof. Arden at Princeton suggested the institute may have "great potential" in part because it is being developed from the beginning with the intimate involvement of industry—of "the professionals"—which could guarantee industrial standards, quality equipment, even competitive salaries.

Dr. Wang said he chose to launch a new school rather than fund an institute at his alma mater, Harvard, or some other school, because he wanted to have more influence over its structure—if not personally, at least through the sort of industry-based academic advisory committee he set up for the information sciences program. "You could give money to Harvard,"

**Unless you have
an unlimited budget . . .
an enormous staff . . .
and a hundred years
to finish your project . . .**

You need . . .

**-N5500-
NICHOLS**

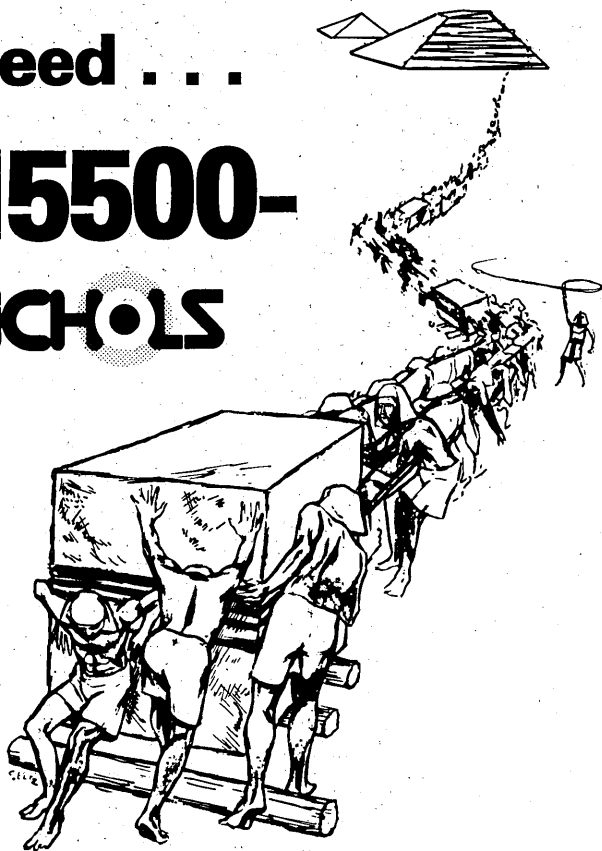

Nichols and Company
Project Management Systems
5839 Green Valley Circle, Culver City, CA 90230
(213) 670-6400

CIRCLE 88 ON READER CARD

BOEING COMPUTER SERVICES' GTSTRUDL PRODUCED 24 COMPLETE ANALYSES FOR NEW RIGID FRAME HIGH-RISE



Limiting deflection for drift control is a common structural engineering problem especially when the rigid frame structure is to be 24 stories tall.

Engineers for a new octagonal building chose a productive solution. Using Boeing Computer Services' GTSTRUDL (Georgia Institute of Technology Structural Design Language) they were able to produce 24 complete analyses ... fast. In addition to automatic generation of the structure, GTSTRUDL produced specifications for wide flange shapes from tables stored in the system.

With this many alternative analyses to work with, the engineers were able to use their experience and understanding to be the decision makers.

GTSTRUDL offers the structural design engineer an extremely cost effective environment. It offers a service that is a highly productive engineering tool.

Boeing Computer Services offers engineers rapid access to multiple CDC CYBER and IBM computer systems via one of the world's largest privately managed communications networks. In addition to GTSTRUDL, BCS provides engineers a comprehensive line of analysis tools and support products including graphics for a number of engineering applications covering a range of engineering disciplines.

To learn more about these cost savings opportunities, write or call: William O. Sparks, Boeing Computer Services Company, 177 Madison Avenue Morristown, NJ 07960 (201) 540-7786.

- Please send me literature on BCS Engineering Computer Services.
- Have your representative call and schedule a brief but productive meeting.

Name

Title

Organization

Address

City

State

Zip

Telephone

9DO

BCS BOEING COMPUTER SERVICES COMPANY

BOEING COMPUTER SERVICES

A Division of The Boeing Company

CIRCLE 89 ON READER CARD

SPERRY UNIVAC MINIS ARE SUPPORTING

IBM need no longer hold total control over your distributed data processing (DDP) system.

Now you have a choice.

Sperry Univac V77 mini-computers with our PRONTO operating system tie in your terminals, additional remote minis and IBM host so you can communicate throughout your

system with no software modifications. Your remotes can even talk among themselves through as many terminals as you want and remain fully functional when your host is down.

Not only do we offer faster delivery on a better product at a lower price, we make sure your system keeps working after it's

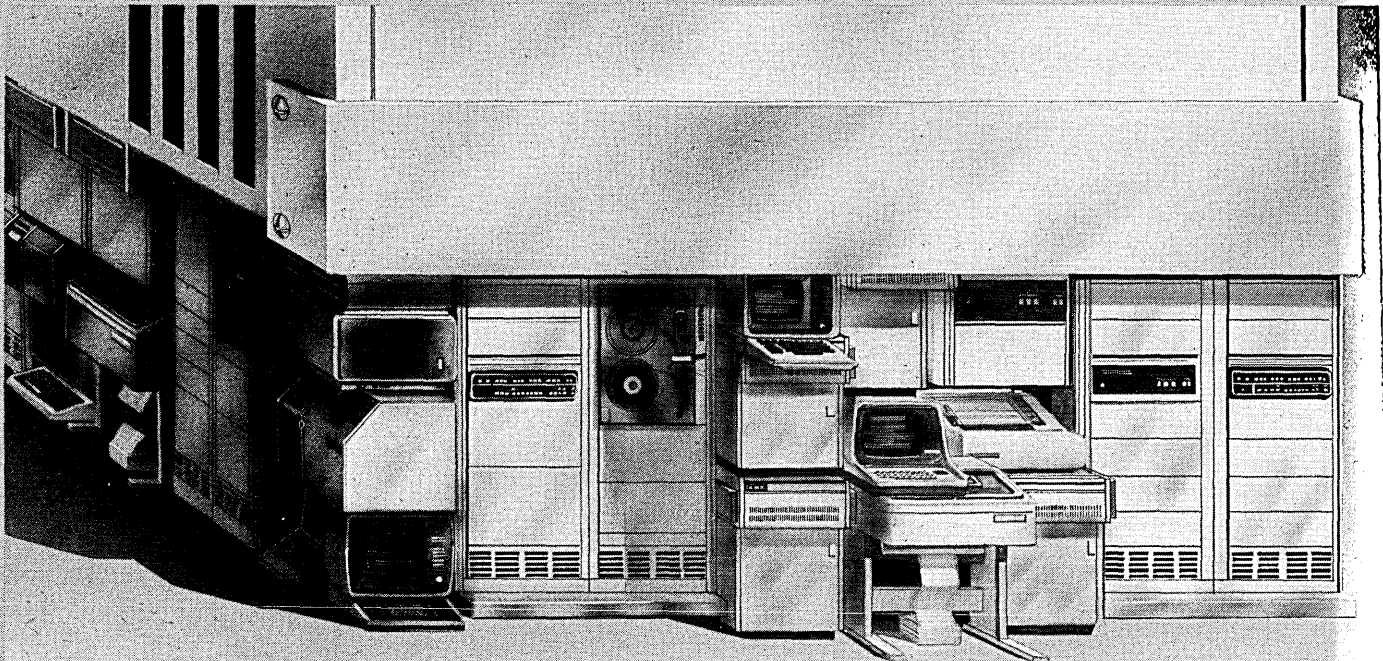

MINICOMPUTERS BEATING IBM.

installed. That's why we have over 10,000 technicians worldwide, servicing equipment whenever, wherever it needs attention.

Our system takes the risk out of DDP, because it works. Would you expect anything less of a division of the \$4 billion Sperry Corporation? After all, we were first in the computer business. And we have a reputation to uphold.

We're off-loading Sperry Univac and IBM mainframes in distributed data environments all over the country. Our V77s work well with IBM. They're totally compatible.

So, if you're considering enhancing your DDP system or building a brand new one, call

us at Sperry Univac Mini-Computer Operations, we listen. And while we may not be IBM's sole means of support, we sure are helping them carry their load.

For more information, write to us at Sperry Univac Mini-Computer Operations, 2722 Michelson Drive, Irvine, CA 92713. Or call (714) 833-2400, Marketing Communications.

In Europe, write Headquarters, Mini-Computer Operations, London, Brentfields, Stonebridge Park, NW10 8LS, England.

In Canada, write Headquarters, Mini-Computer Operations, 55 City Centre Drive, Mississauga, Ontario, L5B, 1M4.

SPERRY  UNIVAC

The computer people who listen.

CIRCLE 90 ON READER CARD

NEWS IN PERSPECTIVE

smiled Wang. "Only thing is, at Harvard they have their way of operating and they might not even approach your idea of proper educational requirements."

The idea of professionalism, an elitism beyond buzzwords for the trained software engineer, seems an awkward concept in an industry so dominated by marketing types. But it echoes from Wang to Gagliardi and through the advisory committee.

"We are trying to replicate in the software engineering area the same kind of experience the other great professions have had," explained Dean Gagliardi. "Law.

Accountancy. Medicine." What separates these from the other industrial professions? "When you go to a doctor, your life is at stake. When you go to a lawyer, your freedom and your property may be at stake. When you go to an accountant, your money is at stake. These are important responsibilities."

"Our point," said Gagliardi, "is that work in information processing is now built around responsibilities of this scale. This is work which can impact an organization in a very profound way—the fate of an organization can quite literally be at stake."

It has become one of the great industrial professions, he added. And, like law and accounting, it must begin to develop its standards of professionalism.

The School of Information Technology is only the first program to be offered at the Wang Institute, and while Dr. Wang said he expects more and broader offerings in the future, he refused to get specific.

"You know, just like Harvard College was first a college and then becomes a university," smiled the doctor. "We have to start at a small scale to get things started and keep a standard. . . ."

"I don't want to say what could be in a hundred years."

And yes, my dear Watson, there was a Doctor Harvard—1607-1638, another immigrant Yankee.

—Vin McLellan



LEGISLATION

R&D BILLS ON FRONT BURNER

Three proposed pieces of R&D legislation have drawn the attention of the computer and electronics industries.

The best things in life may be free, but few came along without R&D.

Believe it or not, the latest in hardware and software didn't suddenly spring forth in the office, ready to do as the user commands, without a bit of trial and error—and some bucks behind it.

If, however, there is to be more where that came from, and if U.S. industry is to close what many observers acknowledge to be a serious gap in innovation and productivity vis-a-vis Europe and Japan, more money will have to be funneled into research and development.

In a Congress replete with members falling over each other to see who can pass the largest tax cuts (this is, after all, an election year), three proposed pieces of legislation have drawn the attention of the computer and electronics industries. Few are as yet willing to stake their futures on passage of the bills, but some are ready to cash in their chips if necessary.

The Research Revitalization Act of 1980 (S. 2355 and H.R. 6632), sponsored by Sen. Paul Tsongas (D-Mass.) and Rep. Charles Vanik (D-Ohio), would amend the Internal Revenue Code to provide a tax credit of 25% of the amount contributed to a research reserve, the payments from which must be used for research and experimentation by institutions of higher education.

Sidetrack Static Electricity With Stat-Zap Mats and Matting.

Stat-Zap mats and matting effectively sidetrack static electricity . . . prevent it from reaching and disrupting equipment functions. Constructed of anti-static conductive 100% nylon yarn, they instantly dissipate electrostatic energy generated by walking across carpet or tile. Special back keeps mats in place. There are no ground wires to connect, so there are no wires to break. Just place mat on the floor.

Stat-Zap mats are soil, stain and skid-resistant and retain their anti-shock feature even after repeated washings. The mats carry our 5-year wear surface warranty and are available in five decorator colors.

Ideal for use in Computer Centers • Data Processing Centers • Elevators • X-ray Equipment Areas • Offices

Patent Pending

See your soft goods supplier or write Ann Banks, Marketing Services, Dept. CR-33, Crown Industries for more information.

Crown Industries

2100 Commerce Drive — Industrial Park
Fremont, Ohio 43420
Ph: (419) 332-5531 • TWX - 810-247-2910

A DIVISION OF
Ludlow
CORPORATION

CIRCLE 91 ON READER CARD

**"Our 33502, with 635 megabyte capacity,
is the better business decision."**

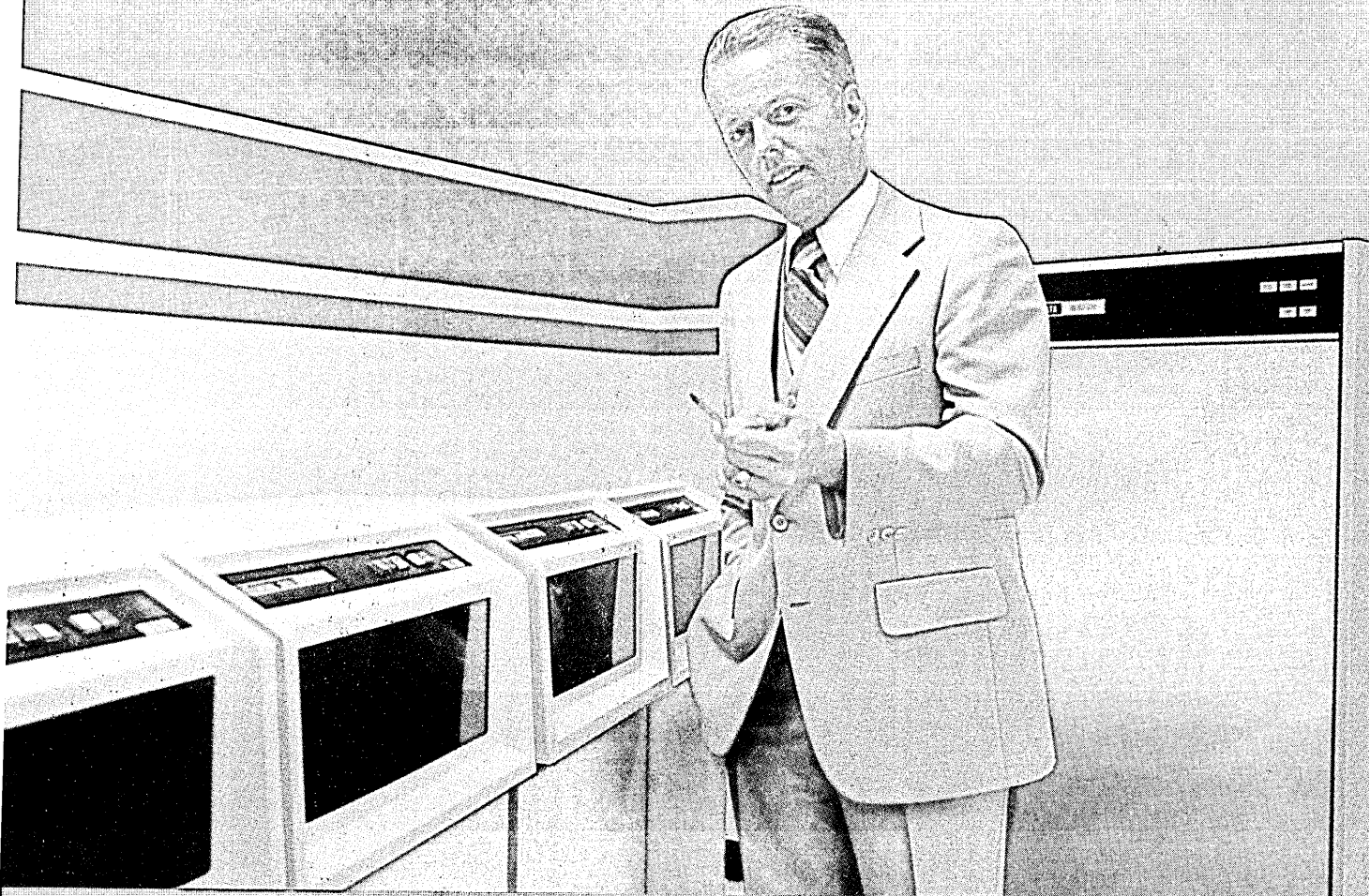

Jim Cron, General Sales Manager, Peripheral Systems Marketing

"Our 33502 has twice the capacity of an IBM 3350. So you can save dollars and floor space. And the improved technology behind our new 33502 data module offers other advantages.

"Better performance, for example. Track-to-track access time is faster than the 3330/3350 technology can offer. Average access time is faster too—19 milliseconds per 317.5 Mbyte logical volume. And you get more optional fixed head storage—1.72 Mbytes instead of only 1.14 Mbytes.

"Another technological innovation is our dynamic dual access. It gives you up to 25% greater throughput over a comparable switch configuration. And if you have a multiple CPU installation, we can offer you both string switch and dual access to provide four data paths to each spindle.

"And when you choose Control Data's 33502, you needn't worry about conversion or com-

patibility problems. It is totally compatible with all IBM 3330/3350 disks and controllers. Our Storage Controller lets you intermix 100MB, 200MB, 317.5MB, 400MB, 635MB— even Mass Storage all on the same unit.

"Besides technical considerations, there are many other reasons that make the 33502 a better business decision. Control Data's reputation is for reliability, service support and broad product experience. And there are more reasons. For the full story contact your local representative, or call 612/553-4158."

**GD CONTROL DATA
CORPORATION**

Addressing society's major unmet needs

CIRCLE 92 ON READER CARD

NEWS IN PERSPECTIVE

Funds placed in corporate reserves for this purpose would have to be spent within four years or be subject to a 300% tax, possibly a severe enough penalty to thwart even the most artful tax dodgers.

A somewhat similar measure is the Research & Development Act of 1980 (S. 2906), sponsored by Sens. Bill Bradley (D-N.J.) and John Danforth (R-Mo.). The bill

The Danforth-Bradley bill is clearly the industry's preference.

would allow a 25% tax credit for corporate increases in new R&D that exceed a company's average annual R&D outlays for the previous three years.

The proposals are part of their respective houses' overall tax reform package. Should one survive—and the Danforth-Bradley bill is clearly the industry's preference—the effect on vendors and users would be profound.

"Anything you do to reduce costs will benefit users by reducing their costs," said Paul Leebrick, vice president of government operations for Burroughs, one big backer of the bills. "We anticipate that it will provide more incentives and a higher return on our investment.

"The Vanik bill doesn't really do much for us. It's too narrow and impacts

largely on funds given to universities. That's a relatively small part of our R&D. But Danforth-Bradley would be a significant advantage for us. It would help us with overseas competition and allow us to develop more advanced technology from hardware and software and more advanced architecture. It would make for a better man-machine interface. As a high technology company, the only way we can keep up is with some credits for R&D."

The idea is not new, particularly overseas. According to an analysis by the American Electronics Assn., Japan allows subsidies and accelerated depreciation for R&D as well as a 20% tax credit for R&D increases. Germany grants low-interest loans, tax-free cash grants, and special depreciation for R&D activities. The U.S. has none of the above.

The result of this nonpolicy is that American industry has been running full speed and going backwards. Total R&D spending as a percent of GNP fell from 3% in 1964 to 2.2% in 1979, while Japan's rose from 1.5% to 1.9% and Germany's from 1.6% to 2.3%. Ten years ago, if one approached a vendor with a promising R&D project, they'd at least hear you out; today they can't afford to listen.

"We have each year a request for funds that I can only honor two-thirds of," John Nesheim, treasurer of National Semi-

conductor, told the Senate Finance Committee recently. "In the most recent year I had a request for \$300 million worth of new investments, and I could not honor more than \$220 million given the financial criteria that my creditors and investors have cited for me. If I could invest in those, I could get a good return, a good chance of a return in a real business risk environment."

"The problem," explained Vico Henriques, president of the Computer and Business Equipment Manufacturers Assn. (CBEMA), "is that you evaluate projects on the basis of risk. Now projects are not being done which would bring new products into the market because of the cost of capital. If

Total U.S. R&D spending as a percent of GNP fell from 3% in 1964 to 2.2% in 1979.

the industry can get relief from that, it will be willing to risk more. Then, if you have a winner, that's great. If it doesn't work, then at least part of the risk is covered and you won't be so reluctant to try again."

Many of the issues addressed by the bills were incorporated in the President's Industrial Innovation Initiatives released last October. President Carter, however, noticeably shied away from any tax cuts in that package. The current bills have been developed strictly in Congress, which, said

Generate Greater Output with Wiley's Computer Texts

APL IN PRACTICE

What You Need To Know To Install And Use Successful APL Systems And Major Applications

Edited by Allen J. Rose and Barbara A. Schick
Here's a compelling book that reports the state of APL—one of the most powerful methods of interactive computing. Serves as both an overview of APL's diverse applications to such business functions as financial planning, marketing management, general ledger, budgeting, manufacturing and electronic mail, as well as a handbook for systems management programmers on formatting and reporting, writing maintainable programs, and managing outside computer services. (1-08275-9) 1980 374 pp. \$25.00

ASPECTS OF DISTRIBUTED COMPUTER SYSTEMS

Harold Lorin

A comprehensive, cross-disciplinary, and balanced investigation of distributed processing, which is viewed not as a "thing," but as a set of concepts that stem from the relaxation of a number of technological constraints in the way information systems may be structured. Demonstrates the possibilities, explores the problems, and places the phenomenon of distribution within a broad framework that permits products to be understood, their strengths recognized, and their suitability for specific uses analyzed.

(1-08114-0) Sept. 1980 approx. 432 pp. \$28.00 (tent.)

Order through your bookstore or write to John Storojev, Dept. 1-7159. For faster service call toll free: 800-526-5368. In New Jersey, call collect: (201) 797-7809.



WILEY-INTERSCIENCE

a division of John Wiley & Sons, Inc.
605 Third Avenue
New York, N.Y. 10158

In Canada: 22 Worcester Road, Rexdale, Ontario

PERSONAL COMPUTING

Home, Professional, and Small Business Applications

Daniel R. McGlynn

This nontechnical exposition surveys the entire field, covering the features, capabilities, and limitations of hardware and software commercially available today. Shows how to establish criteria to select and to buy a system and explains various programming languages, from BASIC to PASCAL and APL. Other attractive features include numerous photographs, tables, and charts that list and compare equipment, and a detailed glossary. (1-05380-5) 1979 263 pp. \$9.95

MICROCOMPUTERS

A Technology Forecast and Assessment to the Year 2000

Kensall D. Wise; Kan Chen; and Ronald E. Yokely

A momentous exposition providing informed judgements about future microcomputer technology, including microprocessors, memory, peripherals, and software, and its impacts on society, based on physical and engineering principles, pertinent literature reviews, and interviews with knowledgeable persons at the forefront of microcomputer development and applications. Forecasts of microcomputer cost, speed, size, weight, and power to the year 2000 are included.

(1-04780-5) 1980 251 pp. \$15.95

ADVANCED ANS COBOL

With Structured Programming

Gary D. Brown

An in-depth and simplified examination of the complex statements that have evolved in COBOL programming. Brown makes expertise in COBOL easier to achieve by describing the details of such advanced features as table headline, character-string manipulation, report writer, sort-merge, direct and indexed files, communications facility, and more.

(1-10642-9) 1977 497 pp. \$24.95

Prices subject to change without notice.

092-7159

Which of these
 key business functions
 are vulnerable to
 problems in your
 online system?

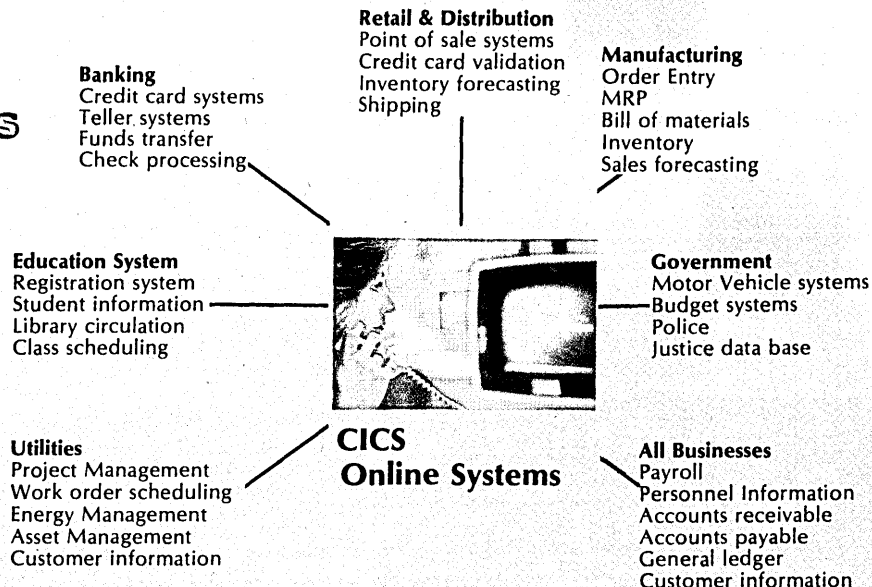

Now Your Data Center Can Manage CICS

Candle Corporation
 announces

OMEGAMON/CICS

The most advanced CICS
 diagnostic facility in
 the world.

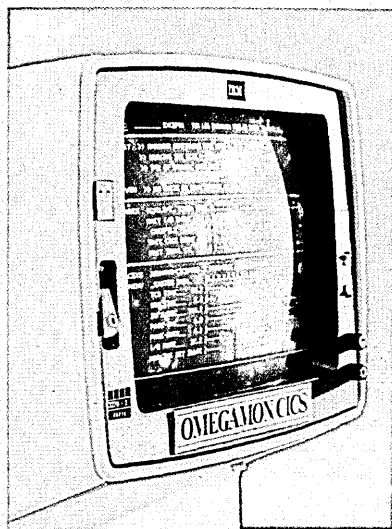

Improve

System availability
 Response time
 System performance

Reduce

Vulnerability to system problems
 User complaints and frustration

Ease Future Growth

Additional terminals
 Additional locations (branches, offices)
 Additional application systems

Automatic Warnings—because of the critical nature of online systems, OMEGAMON/CICS has been engineered with an advanced diagnostic capability that will actually warn key personnel of system problems.

Response Time Analysis (RTA)—This optional feature enables management and data processing personnel to observe response time both by transaction and by application system.

For more information please call or write Mr. Jack Forbes, Dept. A-41, Candle Corporation, 4676 Admiralty Way, Suite 624, Marina del Rey, CA 90291 (213) 821-2902.

Fall Seminars — Candle will be holding a series of fall seminars in major U.S. cities. Topics include tuning MVS and CICS. Please call (213) 823-9224 to find out more information. Limited space is available, so call now.

Candle Corporation
 CIRCLE 94 ON READER CARD

Please Send Information on **OMEGAMON/CICS**

Our online systems are:
 Important Critical
 to the operation of our business

Name _____

Title _____

Company _____

Address _____

City _____

State _____ Zip _____

Phone _____

Major Applications _____

Mail to: Dept. A-41
 Candle Corporation
 4676 Admiralty Way, Suite 624
 Marina del Rey, CA 90291

Get rid of your 4-drawer files.

And save floor space. With Acme Rotomatic®.

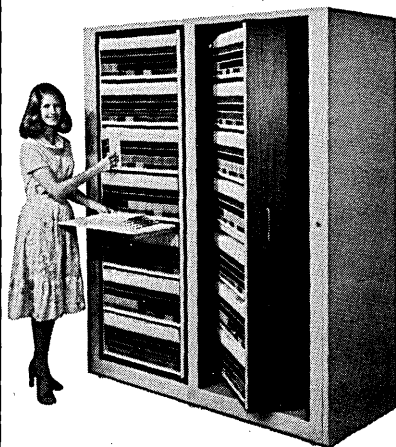

Every Rotomatic unit contains not one but two complete sections of revolving shelves. Which means you can double filing capacity using the same floor space. Growing office? No problem. With Rotomatic, you can add extra units as your record volume grows. For more information, return the coupon below.

ACME VISIBLE

Acme Visible Records, Inc.
1000 Allview Drive
Crozet, Virginia 22932

- Please send free literature on your Rotomatic. **DA90CR1**
- Please have your filing specialist contact me.

Name _____

Title _____

Firm _____

Phone _____

Address _____

City _____ State _____ Zip _____

Canadian Sales: Acme Seely Limited, Hwy. 17, Renfrew, Ontario. Offices in principal cities.

CIRCLE 95 ON READER CARD

NEWS IN PERSPECTIVE

one source, "for once may have been ahead of the Administration on this one." A predecessor to Tsongas' bill was introduced last August by Sen. Adlai Stevenson (D-Ill.). It proposed the creation of "Centers for Industrial Technology," which would have been federally funded for joint industry-university research.

Other organizations are less concerned than the likes of Burroughs, National Semi or CBEMA. IBM, the industry guru, has yet to take a position. The Information Industry Assn., perhaps recuperating from the struggle over the communications bill, has also yet to take a stand. And the Computer & Communications Industry Assn. thinks there are too many other battles to fight to worry about this one now.

"I don't see that much being enacted," said Jack Biddle, CCA president.

"I think [the bills] are intended to get votes. The industry is certainly R&D driven, and any increase will accelerate development of new products. The problem is that France and Germany and Japan all give R&D credits, while our government makes it as tough as possible to survive. I think it's a much bigger threat to have to deal with AT&T's billions. When this issue gets serious, we'll get into it."

It's already serious for some.

"When you tax something, you get less of it, in our opinion," Nesheim told the Finance Committee. "If you reduce the tax on research, you are going to get more of it."

—Willie Shatz

COMPUTER GRAPHICS

CPA SOUR ON DP GRAPHICS

"The potential for misleading illusions" is great with computer graphics, CPA says.

Irwin Jarett, a Springfield, Ill., CPA and a medical school professor with a PhD in accounting, introduced an unexpectedly discordant note in the midst of the casual academic commercialism of Harvard University's Computer Graphics Week, a series of seminars held last month in Cambridge.

"I view all this new computer graphics capabilities as the equivalent of handing kids on the street dynamite caps and a hammer and saying, 'O.K. kids, go have fun!'" said Jarett.

CPAs and accountants often take on responsibility not only for the numerical integrity of a financial statement, but also

for the "fairness" of the presentation. Graphics, and even more color graphics, could enormously complicate those responsibilities, warned Jarett.

"The potential for misleading illusions is expanded way beyond anything we could manage with cold numbers and our illegible footnotes."

With color graphics so readily available, and likely to be far more common in financial statements, annual reports, and

With color graphics so readily available, the accounting profession has some new problems, Jarett claims.

business presentations, the accounting profession has some new problems. In the back of any annual report, noted Jarett, a CPA firm certifies that the "accompanying financial statement fairly presents the financial position of Company X. What is the responsibility for the CPA reviewing financial graphics—especially color graphics?

There is a whole range of subtlety that just hasn't been thought of out there when it comes to bringing the implications and perhaps even the psychological strokings of color schemes and patterns to bear on something like financial statements, said Jarett, "what we habitually think of as the essence of cold, rational, objectified data.

"There is an unbelievably large body of literature about how accountants are supposed to operate, what they're supposed to worry about, transferring information to and from financial statements," he noted. But there is a great lack of guidelines on how to handle financial information in graphic form.

Graphics get complex enough with black and white—even a footnote could be changed with the appropriate use of graphics—but add to that the complexity of color and there is some cause for serious concern, Jarett said. Although the subject is just beginning to be discussed within the accounting profession, there is considerable interest in research that could outline some of the implications.

"It's possible today to use some types of graphics, and maybe some types of color schemes, to distort a presentation," said Jarett. And in some financial presentations, "the people who are now charged with validating the fairness of the presentation simply haven't been aware of this whole realm of expression that they're now being asked to validate."

There is a great need for research to support a serious discussion of these concerns, he argued. There is very little objective work that reviews the impact of color in graphics, or even of graphics versus tabular data, he said. While it is clear that graphics add to the visual impact, it is not clear what the implications are.

"The Department of Transporta-



DASD[®]

Share your next one with us.

Computer Crunch comes in many varieties. Peak workload. Major project. Conversion. Even plain attrition. And it always seems to show up when you don't have the staff to handle it. Or the know-how.

Our suggestion: share your next Computer Crunch with DASD. Fully staffed in major cities across the US, we can go where the crunch is, fast, and make short work of it. Our people are the best you can find. They're skilled, experienced, always in training to stay up on technology.

We'll furnish people to work side-by-side with yours on your project. Or we'll take full project responsibility, manage it all the way, and assure you on-time completion at the price we quote. If software or systems consulting is what you need, we'll furnish that too.

We've grown strong — and fast — by tailoring our services to the needs of clients from coast to coast. Our track record and our satisfied clients are our best credentials.

We thrive on Computer Crunches. Share your next one with us and watch it disappear. Fast.

PEOPLE/PRODUCTS/RESULTS

- Atlanta • Baltimore/Washington D.C. • Chicago
- Dallas • Denver • Des Moines • Detroit • Florida
- Hartford • Houston • Indianapolis • Kansas City
- Los Angeles • Milwaukee • Minneapolis • New Jersey
- Philadelphia • Pittsburgh • Portland • San Francisco
- Seattle • St. Louis

DASD Corporation
Corporate Services Center
9045 North Deerwood Drive
Dept. 224
Milwaukee, WI 53223
414-355-3405

CIRCLE 96 ON READER CARD

NEWS IN PERSPECTIVE

tion, the Army, and the CIA have done some research," he noted. "The CIA has even done some research on numerical data presentation, but I'm having difficulty getting that material.

"Now, I'm not worried about the manipulators too much. If we're dealing with graphics in financial statements, if we do enough work, we'll identify the consistent patterns. You know, if these guys are always putting their bad numbers in a certain color to fade them out . . . or hiding things over here in the corner of the chart . . . or always using half-charts with the

wavy lines in the middle that distort the perspective completely—we can probably handle those people once we begin thinking about this.

"What I'm more worried about," he said, "are the people who do not know what they're doing. These people who have the available computer graphics will say, five minutes before the presentation to the chairman of the board, 'Let's make that graph fuchsia.' They'll push a button, and there it is. I'm worried from the accountant's perspective, not only the CPA's. People who vouch for the integrity of data have

something here to be concerned about."

Jarett believes that the probable influx of color graphics in financial presentations may reverse the historical retreat of the CPA from influence over things like the annual report of a corporation.

Until a decade ago, he explained, accountants would not permit any statement in an annual report to go past them without a tick over every word. The printers' proofs became part of the audit working papers. Every figure, every financial statement, was checked against the audit work papers. The auditors validated that there was nothing in there, in the words, that was a misinterpretation of those figures.

Over the last decade, this has changed as management demanded more freedom in presenting its point of view to stockholders. "Accountants reluctantly had

"I'm not worried about the manipulators too much; I'm more worried about the people who don't know what they're doing."

to agree that these were and always had been the financial statements of the corporation," said Jarett. "They were not, nor had they ever been, the accountant's financial statements." There was a brief contest between management's ownership and the CPA's stewardship, and the stewards withdrew. This was fine until the material which CPAs were asked to review began to change; fine "as long as there were no serious questions of interpretation."

In the future, argued Jarett, with the increased use of financial graphics and their potential for confusion, the CPA might have to reassert himself.

—Vin McLellan

Tomorrow-minded UNIVAC APPLICATION ANALYSTS



Martin Marietta Aerospace, NASA's Contractor on the Space Shuttle External Tank, has immediate openings for Univac Application Analysts.

Position requires designing and programming a variety of engineering and specific programs utilizing ANS/COBOL for application on Univac 11XX equipment.

Qualified individuals should possess a BS in Mathematics, Computer Science, or related discipline, and have a minimum of 3 years scientific and/or business programming utilizing data base methodology.

We offer competitive starting salaries and fully paid company benefits. These opportunities exist at the Michoud Assembly Facility located in Suburban East New Orleans. Qualified candidates interested in learning more about these opportunities at Martin Marietta...the tomorrow-minded aerospace people, should forward resumes including salary history to: Ms. Dottie McCann, Martin Marietta Aerospace, P.O. Box 29304, New Orleans, Louisiana 70189. We are an equal opportunity employer, m/f/h.

MARTIN MARIETTA

MEETINGS

IT'S A SMALL WORLD

More than 700 computer services executives from 32 nations gathered for the World Computing Services Industry Congress to compare notes.

"Japanese industry will be neither labor-intensive nor capital-intensive, but brain-intensive," claims a high-ranking officer at Japan's largest computer company. "Our primary goal must be to make Japan into a technology-based society, far more so than it is today."

Those words came from Shoichi

CIRCLE 97 ON READER CARD

Think system. Grow systematically. HP-85.



A COMPLETE COMPUTING SYSTEM

Encapsulated in a mere 20 lb. package, is a complete computing system. Keyboard, tape unit, CRT with alphanumerics and integrated graphics, printer and read/write memory—all ready for instant use. Just turn it on. That's all. Its language is powerful HP BASIC. The HP-85 is simple to use. Extremely effective. Highly productive. In brief, very professional.

"INSTANT INTERFACE" FOR EASY GROWTH

Now the HP-85 can be configured even further to accommodate your increasing demands. Instantly. Just plug in the HP interface bus and handle up to 14 peripherals or instruments. There's no need to write special operating programs. HP's peripheral ROM's do it for you. Options available now include flexible disc drives, additional read/write memory, graphics plotter, full-width printer, many software Application Pacs. More options are under development. Indeed, Hewlett-Packard is committed to providing solutions that meet your varied and changing needs.

ONLY FROM HEWLETT-PACKARD

There is no comparable computing system in the marketplace that offers you this combination of power, sophisticated growth potential, software, lightweight portability, convenience and ease-of-use. In addition, HP maintains service facilities throughout the world. On-site service, if you wish. For details and address of nearest dealer, CALL TOLL-FREE 800-547-3400, Department 275D; except Hawaii/Alaska. In Oregon, call 758-1010. Or write Hewlett-Packard, 1000 N.E. Circle Blvd., Corvallis, OR 97330, Dept. 275D.

610/16

The Personal Computer For Professionals: HP-85 specifications: Memory—16K RAM expands to 32K, 32K ROM expands to 80K; CRT—32 chars./line, 16 lines; graphics—256 X 192 dots; thermal printer—2 lines/sec.; magnetic cartridge capacity—200K; I/O—HP-IB (IEEE 488), RS-232, 16-bit GP-IO, BCD; Application Pacs include Statistics & Regression Analysis, Finance, Math, Linear Programming, Text Editing, Waveform Analysis, Circuit Analysis, BASIC Training, & Games.



HEWLETT PACKARD

CIRCLE 91 ON READER CARD

NEWS IN PERSPECTIVE

Akazawa, executive vice president of Fujitsu Ltd. in Tokyo, in a keynote address at the recent World Computing Services Industry Congress in San Francisco. Japan's success in the computer industry was hardly an accident, Akazawa stressed, pointing to four factors he considers key to the country's accomplishments in computers.

First, all Japanese computer manufacturers got their start in telecommunications design, with extensive experience in switching equipment, carrier technology, and radio communications. Second, that

"Today, not one Japanese computer manufacturer relies on foreign technology."

history in telecommunications proved a big boon when on-line systems came into high demand. Third, the Japanese labor movement did not eye the computer as a threat, Akazawa said, "and was therefore not nearly as hostile to it as labor in the Western world." And fourth, Japanese industry "emphasizes quality and reliability."

For the benefit of his international audience, Akazawa briefly recounted the steps Japan has taken to build a strong computer industry from the days of devastated cities and factories in the '50s. Basic industries—steel, chemicals, shipbuilding, electrical equipment, and others—were created in the '60s, and during the '70s the country began to channel efforts into "knowledge intensive industry."

These postwar policies led Japan to the highest growth rate of any industrial nation, Akazawa said. He pointed to a 1978 per capita national income of 90% of that of the U.S. and 115% of the average of the nine countries that comprise the European Economic Community. "With 3% of the world's population crowded together upon three-tenths of 1% of the world's land, Japan today accounts for 10% of the world's GNP," he added.

Meanwhile, productivity rose dramatically as well. Using the year 1967 as the base of 100, Akazawa explained, the index of productivity shows that in 10 years' time Japan had reached a level of 207, compared with 172 for France, 170 for West Germany, 162 for Italy, 143 for Canada, and 127 for the U.S. and Britain. He attributed part of that improvement to the greater number of installed computers. In 1970 there were only 6,700 computers installed; last year, there were 59,000.

Looking into this decade, however, not everything appears rosy, Akazawa admitted. A shortage of resources is one major hindrance. For example, he noted that Japan receives 89% of its energy and 55% of its food from abroad. Another problem is the difficulty the country has been having lately in matters of trade with other countries. And finally, Akazawa lamented what he called the "advanced nation dis-

ease," an illness characterized by a loss of vitality in people, a drop in human energy and drive to get things done.

Despite the difficulties that lie ahead, Akazawa expressed confidence that Japan will meet with new successes in this decade. And he's quick to point to the computer industry as proof. "Today, not one Japanese computer manufacturer relies on foreign technology," he boasted. And two philosophies unique to Japan, he added, will help ensure continued high quality and reliability: one, "management by consensus," or the two-way corporate communications process ("In Japan, opinions, suggestions and ideas come from the bottom up as well as from the top down; in the U.S., management makes all the decisions and everyone else is required to carry them out"); and two, the technological training of large numbers of young people. Again, Akazawa made a comparison with the U.S.: between 1970 and 1979, the number of students specializing in dp technology in Japanese schools increased four times; the number of college graduates who majored in electronics in the U.S. is now about the same as it was in 1971.

One way to further enhance the Japanese vision of a sophisticated technological society is to increase appropriations for R&D, Akazawa mentioned, noting that the ratio of R&D to GNP in the U.S. is 2.4% and in Germany is 2%, while in Japan it's but 1.7%.

Similarly, he expressed hope that the Japanese government will increase its contribution to R&D. He would like to see that percentage climb from its present rate of less than 30% to a new high of 40%—"close to the level of the U.S. and other Western nations."



SHOICHI AKAZAWA: "Yes, our industry is subsidized—and so is yours."

The point of government is obviously a sensitive one for the Fujitsu executive. "Our detractors in the U.S. are constantly pointing to Japanese subsidies of the electronics industry, including computers, as unfair. Yes, our industry is subsidized—and so is yours."

Akazawa continued his argument by reminding conferees that the U.S. semiconductor industry is still by far the world's strongest, constituting two-thirds of the world's IC market. "It gained this preeminence through Defense Department subsidies," he argued. The one area where Japan has the higher share is in 16K RAMs, he said. "But that is largely because the American semiconductor industry failed to anticipate the demand for this product and therefore was unable to meet that demand when it came. Japan cannot be blamed for this miscalculation." He added that Japan has a mere 5% share of the IC market in the U.S.

Akazawa's speech was well attended and well received, attracting a standing

"In the years ahead, we will be watching Fujitsu as closely as many now watch IBM."

ovation at its close. Barney Gibbens, deputy chairman of the CAP-CPP Group Ltd. in London, told attendees at the conclusion of that general session, "Speaking for Europe, in the years ahead we will be watching Fujitsu as closely as many now watch IBM."

The Fujitsu executive was one of several big-name keynoters at the four-day international confab. Others included former U.S. President Gerald Ford, author Alvin Toffler, columnist Art Buchwald, Control Data Corp. president William C. Norris, and marketing specialist and Harvard professor Theodore Levitt.

The list of attendees were impressive as well, with more than 700 people representing 32 nations. There were more than 250 attendees from Europe, 70 from Japan, as well as representation from such countries as Canada, South Africa, Australia, South America, and New Zealand.

"I'm impressed by the high caliber of attendees at the show," commented conferee John Jenkins, with Pactel in London. "I can't say I'm as pleased with the [technical and management] sessions, but then there's a lot more to this conference than sitting in sessions."

Despite the fact that concurrent sessions held few surprises, as several attendees commented, they did serve to allow spokesmen from computer services companies around the world to share their experiences in areas ranging from government competition to managing for growth.

In a session on future technology, Tymshare vice president Laszlo Rakoczi painted a generally rosy outlook for the services industry. He expressed concern over the security issue, calling it a "major chal-

The teams at the tip of an iceberg.



Computer terminals.

Carterfone is a leading supplier of top quality computer terminals. A wide range of versatile products, competitive pricing and a network of 45 sales and service outlets across the nation ensure that Carterfone terminals meet the demands of business and industry.

Message switching.

Incotel designs and installs standard and customized message switching systems. These are supplied to international and domestic carriers and large business corporations. And to meet increasing market needs, a new range of smaller switches is also available.

Telecommunications management.

TDX Systems specialises in telephone management and control services for small and medium sized businesses. Savings of up to 25% on monthly telephone bills have been achieved for customers using the TDX Systems computer based tele-management systems.

Worldwide communications.

Carterfone, Incotel and TDX Systems, being part of the worldwide Cable & Wireless Telecommunications Group, are the tip of an international iceberg. And, like an iceberg, the invisible resources are massive.

Cable & Wireless is one of the world's largest international communications groups, and its expertise spans the entire globe. In over 70 countries, Cable & Wireless has provided all types of specialist communications systems, including the operation of national telephone systems in 13 countries and the public networks in 31 countries.

The Cable & Wireless connection.

What does this mean for you?

Quite simply, it means that when you deal with Carterfone, Incotel and TDX Systems you're not just dealing with specialists in the American telecommunications market.

You're dealing with companies with a whole world of experience behind them.

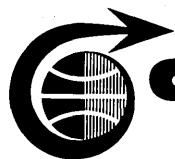

Cable & Wireless
the Worldwide Connection

Carterfone Communications Corporation, 1111 West Mockingbird Lane, Suite 1400, Dallas, Texas 75247. Telephone: 214-630-9700.
C & W Incotel, Ltd., One Penn Plaza, 48th Floor, New York, New York 10001. Telephone: 212-594-8340. **TDX Systems, Inc.**, 1920 Aline Avenue, Vienna, Virginia 22180. Telephone: 703-790-5300. **Cable & Wireless North America, Inc.**, 2001 Bryan Tower, Suite 3805, Dallas, Texas 75201. Telephone: 214-741-2315. **Cable & Wireless (N.Y.) Inc.**, 420 Lexington Avenue, Suite 2020, New York, New York 10017. Telephone: 212-490-0610. (Head office) **Cable & Wireless Ltd.**, Mercury House, Theobalds Road, London WC1X 8RX. Telephone: 01-242 4433.

CIRCLE 99 ON READER CARD

How to Improve Your Image



The Problem: Glare. And poor image-to-background contrast. They wash out displayed information, cutting operator efficiency and lowering productivity.

The Solution: OCLI Contrast Enhancement. It reduces glare by 17 to 1 over untreated glass. It's working now for some of the biggest names in display technology, including IBM, Four-Phase and Tektronix. Write us. We'll explain how it can work for you.

I'd like to improve my image.

Tell me more about OCLI Contrast Enhancement for CRTs.

Name: _____

Title: _____

Company: _____

Address: _____

City: _____ State: _____ Zip: _____

OCLI

DEPT. 109-1, 2789 Giffen Ave.,
P.O. Box 1599, Santa Rosa, CA 95402
TWX (510) 744-2083 Telephone (707) 545-6440

D-80

NEWS IN PERSPECTIVE

lenge" in the 1980s and noting that if one major calamity were to occur over a breach in security, the entire industry would suffer.

But Rakoczi also showed some statistics that indicated the impact computers would continue to have on labor in the '80s. By the end of the decade, his numbers indicated, a fourth of all jobs will be dependent on some knowledge of computers and half of them will be dependent on computer-generated information. He said percentages in both categories presently stand at 10%.

He also projected a steady rise in spending on computing, expressed as a percentage of gross national product. From 5% of GNP in 1980, he saw an increase to 8% in '85 and to 12.5% in 1990.

Futurist Earl Joseph of Sperry Univac, in the same session, made clear what technologists mean when they refer to very large-scale integrated circuits. He pointed out that in the past designers worked with logic and memory components integrated on a semiconductor chip, then a microprocessor on a chip. The progression now is

By the end of the '80s, a fourth of all jobs will be dependent on some knowledge of computers.

to an entire computer on a chip, consisting not only of a processor but also its memory and I/O circuitry. In the 1983-85 period, Joseph foresees even more functions being integrated on the chip—memory systems, a minicomputer on a chip, even a medium-scale processor.

In today's technology, IC chips are broken apart from the wafers on which they are manufactured, each chip then being mounted on a chip carrier. But Joseph explained that for technical reasons designers in the future will want to integrate a greater variety of circuit types on a wafer and mount that wafer, not a chip, on a carrier. In the late '80s, then, we will see multi-microcomputers on a wafer, even mass memory on a wafer. The trend, he said, is toward putting entire systems on a wafer.

For the edification of his audience, Joseph held up a wafer, then quipped, "Hardware is really glass with a little metal on it."

A session called Application Machines drew a crowd of people, many of whom were curious to know what the title meant. Session chairman Werner Frank of Informatics allowed as how it could be many things. Among them, he asserted, was the IBM 4331 with the appropriate IPO/Es and cross-industry functions. Speaker Horst Gortz of Rhein-Main Rechenzentrum in West Germany defined an application machine as a turnkey package of hardware and software. He then proceeded to describe such a system developed by his company at a total cost of \$35,000 and selling without customization for \$19,000. The

CIRCLE 100 ON READER CARD

Now there's a computer operating system that doesn't require a computer programmer to use it.

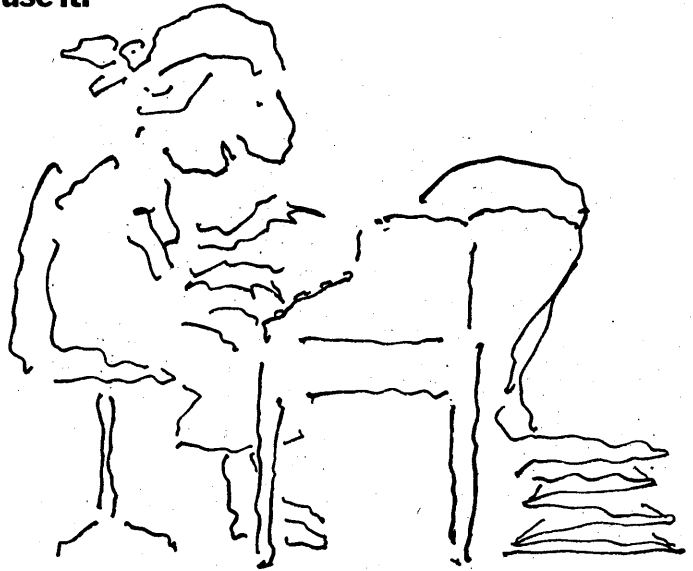
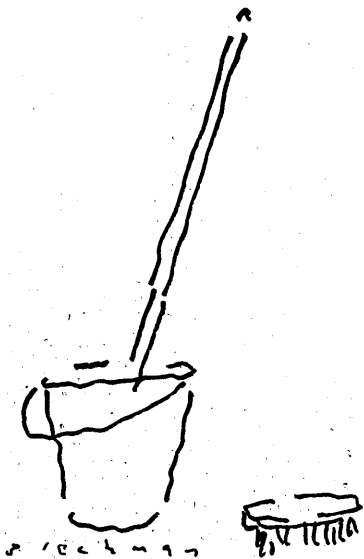

Now even someone with no computer programming background can be quickly trained to use a powerful operating system. The UNIX™ System.

UNIX Systems are time-sharing operating systems that are easy to program and maintain. So easy, in fact, that more than 800 systems are already in use outside the Bell System.

UNIX Systems give fast, efficient data processing. They feature more than 100 user utilities. The result is a computer that's easy to operate. More accessible.

UNIX System, Seventh Edition, and UNIX/32V System. The new UNIX System, Seventh Edition, offers greatly enhanced capabilities, including a larger file system and inter-machine communications. The Seventh Edition is designed for PDP-11 minicomputers. For those needing its capabilities on a larger machine, the UNIX/32V System is presently available for the VAX-11/780. The Seventh Edition's improved portability features allow users to adapt it more easily to other computers.

Both the UNIX System, Seventh Edition, and the UNIX/32V System can support up to 40 users with FORTRAN 77 and high-level "C" languages.

Programmer's Workbench. For large software design projects, the PWB/UNIX System (Programmer's Workbench) allows up to 48 programmers to simultaneously create and maintain software for many computer applications. The PWB/UNIX System features a unique, flexible set of tools, including a Source Code Control System and a remote job entry capability for the System/370.

Developed for our own use, UNIX Systems are available under license from Western Electric and come "as is". With no maintenance agreements, no technical support.

For more information about UNIX Systems or

other Bell System software, complete the coupon and mail to Bell System Software, P.O. Box 25000, Greensboro, N.C. 27420. Or call 919-697-6530. Telex 5109251176.

UNIX is a Trademark of Bell Laboratories.

To: Bell System Software
P.O. Box 25000, Greensboro, N.C. 27420

Please send me more information about Bell System software packages.

UNIX Systems. Other Bell System software packages.

Name _____

Title _____ Company _____

Address _____

City _____ State _____ Zip _____

Telephone _____ Hardware _____

DAT-12



CIRCLE 101 ON READER CARD

NEWS IN PERSPECTIVE

ratio between development cost and selling price left more than a few in the audience puzzled and incredulous.

Alex D'Agapayeff of the U.K.'s CAP-CPP Group defined an application machine as one that operates where no dp professional exists. To that extent, he too says it's a turnkey system. The software, he added, must be "intelligible" to the user, and "an application machine has to be understandable to the user." It is important, he said, that the software be kept simple, adding that he knows how difficult a task that is.

—Becky Barna and
Edward K. Yasaki

PROGRESS ON THE TDF FRONT

At least much of the rhetoric was gone from the latest transborder data flow confab in Rome.

Users, not vendors, of dp products and services will be the ones hardest hit by international regulation of data flow.

This verdict was supported by a number of observers at the recent Rome conference on Transborder Data Flows (TDF), organized by the Intergovernmental Bureau for Informatics (IBI). "The new note here came up in Peter Robinson's speech," said Hugh Donaghue of Control Data Corp, singling out Canadian Robinson's assertion that 90% of Canada's data exports were corporate information going back to corporate headquarters in the United States.

Robinson, from the Canadian Department of Communications, said he felt his government's concern over data flow stemmed more from this outflow than from the 10% resulting from foreign processing by service companies. "The country where the data are processed and stored tends to be the location where the decisions are made," he said.

The French delegation explained this concern, declaring transborder data flow to be "both an index to and a cause of the loss of power of States vis-à-vis multinational companies." During the five day Rome meeting, the French several times called for an investigation of not only what data was being transmitted across national frontiers and where it was going, but also where it was being stored.

The "danger of localization of data in corporate headquarters," said one of France's top TDF thinkers, Alain Madec,

was that it could distort economic development in countries where the corporation operated. The French struck a sympathetic chord among many of the developing nations present at the 70-delegation conference with this sentiment.

Such government scrutiny has obvious implications for those who operate international networks for corporate data transmission. Countries are beginning to view this type of operation as a threat to national independence in much the same light as they might consider monopolistic practices. Regulation, though not a foregone conclusion, looms large on the horizon. And the prospect is not being viewed with equanimity by many users.

Any change in the regulatory environment for international data transmission could have serious repercussions, said Digital Equipment Corp.'s European head, Jean-Claude Peterschmitt, a few days prior to the conference, where he had two DEC observers enrolled. One important use of DEC's data network is control of product pricing, says Peterschmitt. But other users have equally important functions at stake. International banking operations frequently send daily consolidated positions back to headquarters. Many, including IBM and Hewlett-Packard, have internal electronic mail systems.

Apart from DEC, other big users of international datacom in Rome included IBM, American Express, Bank of America, Monsanto, Clark Equipment, Eli Lilly, Unilever, Hoechst, Dow Chemicals, Mobil, Chase Manhattan, Readers Digest. Even the Vatican and the Mormon Church blessed the meeting with delegates concerned about international data flow.

"The big question coming up," says one U.S. consultant, "is whether [multinationals] will be able to transmit logistical data across a country's boundaries."

Though the fundamental impact of any such decision (it will take at least 10 years of debate, say the French) will be on corporate structures, any regulation will affect product procurement strategy. "Costs of compliance will be the big problem," said a spokesman for a U.S. firm. "If the rules change and we have to change our system, it could mean a highly unprofitable investment in equipment," said another.

Products may be one area where data flow or storage regulation may impact vendors, just as it will affect user procurement patterns. Observers reason, for example, that IBM's current product strategy assumes data management takes place back in corporate headquarters. Distributed processing offerings, like the Development Management System on the 8100 and 4300, allow local programming, using headquarters data. If the regulatory or political environment means that more data will have to be kept locally, this strategy may have to

change, says one observer who expects IBM to come up with synchronizing software for distributed data bases during the coming decade. "But this won't change the master-slave relationship inherent in distributed data base control," he says.

Apart from having to be one jump ahead of regulation, vendors "will still come out winning," he predicts. If vendors are sitting pretty, providers of network services seem marginally happier about regulatory prospects.

Regulation, though not a foregone conclusion, looms large on the horizon.

If the heat is really off the services companies, it may be due to studies carried out by the Canadians and the French, which show that the volume of data exported via service company networks is minimal. In Canada it's around 10% of total exports, estimates Robinson, who adds: "It is perhaps questionable whether the heavy artillery of government needs to be brought to bear on such a small target." The French, hitherto anxious about time-sharing networks, too may feel that they wish to point their guns elsewhere, especially as they are also bent on selling network services to other countries.

The real hard line at the conference came from Brazil, which talked of establishing "customs houses for the flow of information." But despite evidence of government interference in Brazil, and in France and Germany to a lesser extent, there is still a lot of talk and only promises of action. A considerable body of experts, including ex-Intelsat exec Matt Nilsson, questioned the possibility of policing TDF, given the increasingly high speeds with which data are transmitted.

The conference showed that the privacy issue that forces compliance with local data protection rules is now almost a dead issue—with most parties acknowledging the need for individual data protection. Still hot issues are protection for legal entities (somewhat submerged in general economic data questions at the conference) and the increasingly vociferous demands from Third World countries for national data protection. Here countries would have a right to access data concerning them wherever they are held. Economic or agricultural data held in service company or corporate data bases would come into this category.

Though there was a certain amount of declamatory speech and point making—Unilever's Raymond Austin said "there is too much talking at people and not enough talking with people"—the IBI conference took a significant turn by establishing at least the rudiments of a dialogue which could produce international rather than national protectionist solutions to TDF issues.

—Andrew Lloyd

One phone call can empty your office of salesmen and fill your word processing needs.



It's hard enough to find flexible disks, cassettes and mag cards that you can really trust. But it's next to impossible to find them all in one place.

That's why you should call Syncom. We've got 'em all. We manufacture every one according to a set of strict specifications. And our flexible disks and cassettes are 100%-certified.

So tell your old flexible disk company, the cassette people and your mag card salesman you've found a simpler way. Then simply call Syncom at 605-996-8200.

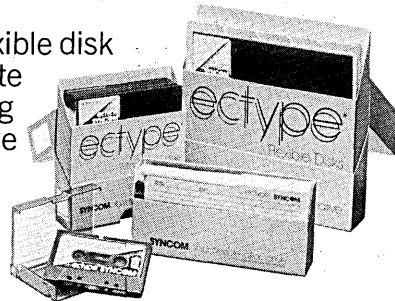

SYNCOM Your flexible alternative

P.O. Box 130, Mitchell, SD 57301

CIRCLE 102 ON READER CARD

NEWS IN PERSPECTIVE

BENCHMARKS

DEREGULATE: The FCC has come up with a plan to reduce regulation of communications common carriers. The FCC's Common Carrier Bureau has been instructed to prepare changes in the FCC's policies that would loosen the reins for smaller carriers. These changes are to be submitted as proposals to the commission this month, and offered to the public for comment before the FCC takes any action. One change would sort carriers into "dominant" and "nondominant" categories, while reducing regulations on the latter. Included in the nondominant category would be such companies as MCI Communications Corp. and Southern Pacific Co. Carriers will have to prove to the FCC that they deserve to fall into the nondominant category before they can qualify for reduced regulation. Under the rule changes, a nondominant carrier will be able to change its rates and systems without supplying the commission with all the data previously required on the company's financial status. The nondominant carriers wouldn't have to notify the FCC of their planned actions until two weeks prior to the action. Formerly, 70 to 90 days prior notice was required.

HOME TIME-SHARING: Consumers are flocking to sign up for home time-sharing services, and possibly as many as 100,000 will subscribe to these services by the end of 1981. According to a report from International Resource Development Inc., there are currently two consumer time-sharing services (The Source and CompuServe), with a combined total of about 8,000 users. Entry into the market by several other "major" companies is predicted during the next three years. Revenues from these services could exceed \$1 billion per year before the end of this decade. The IRD report sees several years elapsing before the market for consumer time-sharing services opens up to include more than its current user base of "computer hobbyists and affluent gadget-lovers." As Charles W. Newton, project manager for the IRD study pointed out, "Of the expected 1 million home computer users, 10%, or only 100,000 users, will be accessing the time-sharing services from the home in 1981."

NCR TO MAKE MORE CHIPS: A four-year facilities expansion plan is in the works at NCR, and it's going to cost the company \$155 million. NCR is looking to broaden its capacity to develop and manufacture semiconductor parts used in its computer systems and terminals. And, as stated by chairman William S. Anderson, "A strong in-house semiconductor capability enables a systems manufacturer to respond more quickly to changing market requirements and to protect its supply of components in times of shortages." The latter part of

Anderson's statement refers to last year's shortage of chips, which hurt the company's third-quarter earnings for that year. The expansion work is scheduled for NCR's microelectronics plants at Miamisburg, Ohio, and Fort Collins, Colo., and a new plant will be built in Colorado Springs, Colo.

OVER A BILLION A YEAR: The U.S. telephone interconnect equipment industry has become a "billion-dollar-a-year" business, according to a report from Arthur D. Little Decision Resources. The report predicts this industry will account for over 25% of the cumulative installed base of PABXs by 1985, more than doubling the present 12% figure. Also forecast by ADL is a threefold increase in the interconnect industry's total installed PABX lines over the next five years, to 7.3 million from 2.4 million. Installed PABX lines for the Bell System and 1,500 independent telephone companies will grow to 18.1 million from approximately 16.7 million and to four million from 2.6 million, respectively. The total installed stand-alone key telephone systems (KTSS) now number about 3 million and will increase to almost 4 million by 1985.

MILLIONS FOR INMOS: The British government's National Enterprise Board (NEB) has decided to double its investment (originally \$30 million) in INMOS, the international semiconductor manufacturer. Fol-

lowing an in-depth review of INMOS' progress by an independent team of electronic specialists commissioned by the NEB, the investment announcement was made in the House of Commons by Prime Minister Thatcher. The team's findings were that INMOS had made "excellent progress and was on schedule, both in the development of its products and in the construction of its facilities." It was also disclosed that INMOS will site its first U.K. production unit in the government-assisted area of South Wales. This will enable the company to receive additional financing in the form of grants and other aid.

COM BILL STANDS STILL: Even though the House Commerce Committee passed its version of the revised Communications Act, the Senate Commerce Committee decided to hold more hearings on its companion bill. Progress halted as Senate members and AT&T debated the role the FCC would play in the proposed 10-year deregulation of the Bell System. Much time is needed in Senate hearings before an agreement can be reached, and too few working sessions are left before the election recess. The Senate and House bills both provide for a gradual shift of AT&T's competitive voice and data efforts into an unregulated, separate subsidiary. However, the House bill prohibits any FCC "modification of Congressional guidelines" for the restructuring of AT&T. *

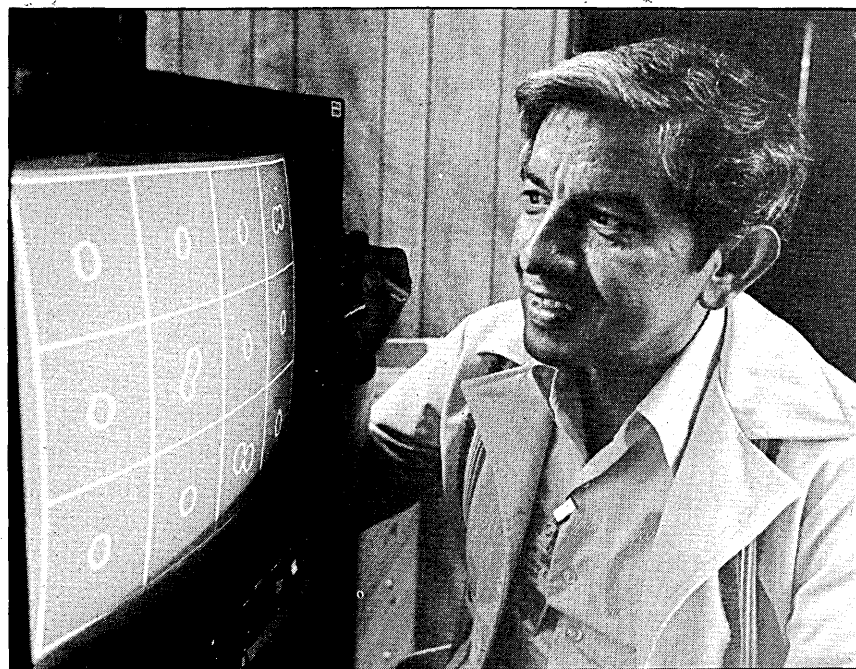

SUMMER SPREE: A specialist in the application of computers to medical problems, Dr. Rolando E. Peinado of the University of Puerto Rico in Mayaguez spent nine weeks at the Summer Institute Program for minority science instructors at the Lawrence Livermore Laboratory in California. He used a microscope-computer combination developed at the lab to analyze the shape of abnormal sperm. Scientists hope the shapes will tell them what genetic damage is caused by occupational exposure to chemicals.

A Timeplex Report on Statistical Multiplexing

TRUTH NO.

2

A SUPERVISORY PORT IS A POWERFUL NETWORK MANAGEMENT TOOL

What Is A Supervisory Port?

TIMEPLEX' unique Supervisory Port is a computer aid for the network manager. It is an extra asynchronous port available on all 8-channel and larger SERIES II MICROPLEXER™* models, that permits any dumb, ASCII terminal to access a broad range of diagnostics, retrieve an extensive list of operating statistics, and communicate directly with any local or remote data channel on the network.

Is It Important, And Why?

Yes! The Supervisory Port provides a computerized window into the network. It helps you to isolate system faults quickly and decisively, as well as to make quantitative measurements and evaluations of network performance.

Can The Competition Match It?

No! No one else has a comparable Supervisory Port. No one matches the power, operating features or control provisions provided by the TIMEPLEX Supervisory Port.

Free Illustrated Handbook!

The Supervisory Port is only one truth about statistical multiplexing. Learn the entire truth! Write or call to receive an illustrated handbook on statistical multiplexing from TIMEPLEX, the world leader in data multiplexing.

Timeplex®

Timeplex, Inc./One Communications Plaza/Rochelle Park, NJ 07662
(201) 368-1113 TWX: 710-990-5483

*PAT. PEND.

CIRCLE 103 ON READER CARD



American companies setting up worldwide sites face a multitude of political and cultural roadblocks.

GOING GLOBAL

Managing worldwide corporate information systems activities requires the wisdom of Solomon, the patience of Job, and the worldliness of André Malraux.

It is no trivial feat to appreciate the differences in culture, language, and national law, to say nothing of problems with technological facilities, personnel availability, and attitudes toward labor.

Discussing "getting rid of" or even relocating people because of dp reorganization invites action by both workers and government. A wp center in France? Putting office workers full-time on crt terminals in Germany? Crt glare and centers that imply staff reduction raise sensitive issues of job security and workplace safety.

Europeans don't understand that American companies willingly build plants in low labor cost areas such as Ireland, Korea, and Southeast Asia. The European priority is different: keep the employment up at home. Thus, ICL has yet to build a plant outside the U.K., and the one it inherited from Singer (in Utica, N. Y.) has been on the verge of closing for years, even though its unit costs are low.

European trade unions are much tougher than American unions, and it isn't merely a matter of corporate democracy. The real problem is that the trade unions get deeply involved in the way a company is run. The unions control work hours, manning levels, hiring rates, the employment impact of new projects, and the current evolution of corporate social consciences. American unions are pushovers by comparison; all they care about is keeping the membership rolls full and ensuring acceptable pay and benefit increases.

In the U.S., white collar unions are rare. Industrywide unions exist only in steel, rubber, glass, and wet milling. In the U.K. or Scandinavian countries, a single trade union leader can call out his troops and tie up the whole country. Datsaab was not at the center of the major Swedish strike last year, and—even though the issues had little to do with it—the company was not in a position to resolve them.

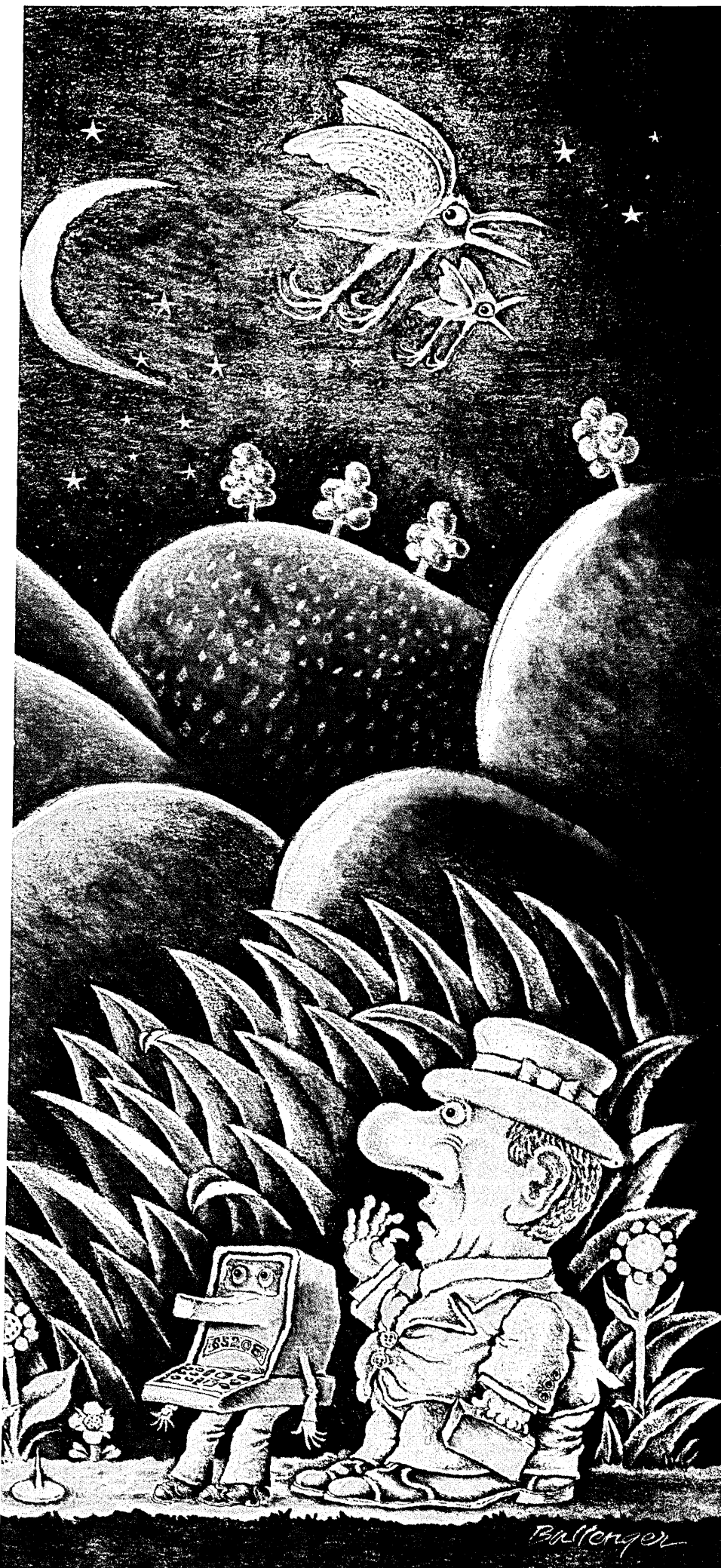

ILLUSTRATION BY TOM BALLENGER

WHAT TO EXPECT IN THE THIRD WORLD

"Twice in the last 14 days I was forced to send a corporate representative to Cairo for reasons unique to that part of the world. It was costly, of course, but it was our only viable alternative to ensure that the backup paperwork for new telecommunications lines would cross the right desks in the right order and thereby permit our new facility to meet its opening schedule." The preceding lament was recently made by Bill Burgess, Bank of America telecommunications director for Europe, the Middle East, and Africa. Delay, inconvenience and other attending difficulties are to be expected in most developing countries since the bureaucracy, by more efficient American standards, moves inordinately slowly.

However, direct outburst of frustration and other actions which overtly display displeasure would doom a corporation's cause perhaps forever. The only responsible way to speed things up, as Burgess and others have found, is to assign a "Mr. Fixit" to groups of five to six countries. Additionally, these "special services" people require support from local representatives in each country.

The expectation of big differences from home country operating procedures is a cardinal rule for dp and telecommunications managers setting up facilities in the Third World. The catalog of embargoes, customs duties, red tape, long power and telecommunications outages, and favors and bribes seems endless. "Babysitting projects in Africa can be daunting," the dp manager of a U.S. chemical firm complains. He requested we not state his name or mention the company's name directly for fear of possible reprisal.

In Pakistan, where importing an item as common as a teleprinter may be a hassle, protecting local manufacturing puts a ban on most imports—even if the importer offers to give the equipment to the PTT. When such an arrangement is allowed, it may cost between 100% and 200% of the equipment cost to get it shipped, duties paid, unloaded, and installed.

Brazil continues to be a nightmare for foreign-based dp exporters. Reasons run the gamut from foreign currency controls to boosting local industries. In the mid-1970s a commission, called CAPRE, was set up to coordinate the use of computers in government, universities, and new applications in business involving imports. Its policies made it difficult to get permits for foreign-made products. Then followed a CAPRE decision on registration of all international data links (anything faster than Telex) designed to discourage foreign time-sharing and home office processing services. The present Brazilian policy is explicit: "The Brazilian government does not allow the use of computers placed abroad, which through tele-informatics, accomplishes tasks whose solutions can be obtained within Brazil."

The duties started by CAPRE are now

placed in a special secretariat by Informatics that is part of the National Security Counsel. Joubert de Olivera Briziba, its executive secretary, recently announced preliminary plans to channel international data traffic. "Brazil has almost decided on directing data traffic through gateways. This is a solution which already means the systemization of the traffic and implementation of tariff policies for information services. Later on, these access gates can constitute effective customs houses for flow of information if pending technical and political problems, such as the establishment of specialized levels of protocols, are solved," he said. These Brazilian policies are stringent and particularly advanced compared with policies in most developing countries. However, Brazil is often a precursor in the developing world and its actions are indicative of the regulatory mindset of many Third World countries.

Old-fashioned "considerations," a sensitive subject to American business, have to be faced when importing equipment for a new installation, getting approval for hookup of new services, or just getting local cooperation on the basics. Few executives will talk much about how to get around U.S. laws barring bribes and favors, but some of the middlemen and other takers are not so shy. "American firms pay us larger fees than others and we get the job done," one Asian fixer remarked, "Plus they no longer want to know what is included in the fee." In its infinite wisdom, the U.S. Congress has decreed almost any payoff a violation of the Foreign Corrupt Practices Act. Americans aren't supposed to tip a customs officer, pay an agent for sales services or put a foreign government employee (or his relatives) on the payroll. While in abstract theory this sounds fine, it handicaps American companies faced with European competitors. After all, if you want to get your

Babysitting projects in Africa can be daunting.

computers off the dock in Lagos or out of the airport in Jakarta, an overworked and underpaid customs officer isn't going to snap to attention for the nonpaying American. When you are talking a \$2 billion deal for a total national telecommunications system, giving the minister's brother-in-law .1% for arranging a meeting is fairly inconsequential. But it is prohibited and viewed as a mortal sin by the eagle-eyed investigators. Is it any wonder competitors in Europe think Americans are terribly naive?

Crucial to successful startup in a developing country is availability and standardization of equipment. The oil industry has long experience with this in the Middle East, and, as one ARAMCO official noted, "We really have to use the 'KISS' rule—keep it simple, etc. Without a wide range of choices we depend on telecommunications

Local employment rules differ from country to country. In most of Europe, however, just because an employee is incompetent is no reason to fire him. A Swede might say that the employee's inability to cope is the company's fault because the person hasn't been properly trained. Like programmers anywhere, they do quit to take more interesting jobs, but the fact remains that it is virtually impossible to fire an employee in Sweden. In Belgium and Germany, the penalties for wrongful dismissal are severe. The employee who has been on board for little more than six months may be entitled to as much as three years' salary upon termination. A partial solution is more intense employee screening. Another is use of personnel representatives who are paid on commission and act as agents.

The hard-driving American businessman steals a week with his family in late August and another week at Christmas. During the rest of the year, it's 14 hours a day, Saturday for the family and Sunday to travel to the next week's work. Drop that executive into Paris in August or Stockholm in July and witness a case of culture shock. Nobody makes a Swede give up his six weeks of vacation and sailing trips on the weekend. The Frenchman goes to the sea for four weeks every year and has been doing so for 400 years. Most Danes head for the sun for two weeks at least once every winter when the grey Northern skies become oppressive. The Norwegian engineers run out of the plant at 3 p.m. in winter to catch a couple of hours of cross-country skiing.

As for the work day, while it's only a bit shorter, the hours may be very different. Rome in midsummer is too hot for afternoon work. Spain has always been famed for its late closings that balance the afternoon siesta. The British come to work at a leisurely time and stay late, but don't forget teatime. The Frenchman ducks out for coffee and calvados in the cold chill of a winter's day in Paris. The Dane may start his working day with a Gammel Dansk, a bitter that can unsettle an American's whole day.

STRIKE ACTIONS VARY

Strikes and walkouts (the polite term is "industrial action") are frequent challenges for the Italian, British, and Belgian manager. The German, Dutch, or Spanish executive really hasn't learned what they mean. In Scandinavia, things are usually settled by negotiation. In other countries, the police may become involved rather rapidly. Japanese unions snake-dance through the major cities as contract time approaches.

General strikes, almost unknown in the U.S., effectively stop a company even if its employees appear by accident. Issues that



ILLUSTRATION BY TERESA FASOLINO

gear that is often Swedish, German, or Dutch made. Such widely installed older technology may be the only safe route and the only one that ensures availability of spares." This advice often runs counter to branch staff ideas which tend to opt for the latest vendor offerings. Experience has shown people like Burgess are not to be lured by the "state-of-the-art disease." It is prestigious to the technicians operating it but only for as long as it works.

Approaching 120 Southern Hemisphere countries with the same perspective

presents obstacles. "It is wrong to think of developing countries as being alike," says F. A. Bernasconi, director general of the Rome-based Intergovernment Bureau for Informatics (IBI). "The differences are fast depending on whether a country has an open or protected market." Despite the need to look at developing countries separately, Bernasconi points to the tendency for those new nations to develop concerted policies, especially on a regional basis.

IBI's clients, consisting of 100 or so developing countries, often complain about

the level of technological design and capabilities of equipment multinationals bring in to serve a country's needs. The recurring questions are whether the proposed equipment will fit local dp's state-of-the-art considerations; whether maintenance will be locally available or several hours' jet flight away; and whether personnel needs will be met by locally trained people or by imported personnel.

Behind these questions are fears that incompatible equipment and procedures will be introduced, local human resources will be underutilized, and stoppages from dependence on foreign facilities, spares, and repairs will cause delays because of slow deliveries.

Countries moving closer to industrial service economies such as Brazil, Greece, Korea, Mexico, Portugal, and Taiwan are taking up new issues which will complicate the life of dp and telecommunications managers. These include barring imports of software for production and management systems, forcing delays in

Since using middlemen is often a must, they simply add local payoffs to their fees.

introducing "exotic technologies" such as on-line terminals because they don't fit development plans; requiring a number of different foreign suppliers rather than just one or two main vendors; demanding local manufactured products be used, or insisting on plain text messages instead of encryption; and calling for significant local backup capabilities if foreign processing or storage is used. These concerns are motivated by fears of technological dependence and vulnerability to foreign suppliers.

"The need to move data across borders is the Achilles' heel of multinational corporations," Hugh Donaghue of Control Data told a conference recently. Since telecommunications managers are on the cutting edge of rapid, economic, and secure data transmission, their challenge is at the forefront. Talk of monitoring volumes of traffic, placing values on internal company transfers for tax purposes, or requiring inspection of data to be stored in foreign locations, is getting beyond the platform speeches and into the planning stages.

"The Canadians spoke almost as Third Worlders," reported other participants at the Second World Computing Services Congress in San Francisco.

There are already stirrings from Mexico, and the Cubans have staked out their position. At the IBI Data Flow Conference the Cuban delegation asserted: "Cuba is opposed to the free flow of information because this is a ruse to allow continued exploitation by multinational corporations." These sentiments as well as the cry for a more open marketplace will be doing battle as the Third World seeks a "new international information order."

—R.P.

The employee who has been on board for little more than six months may be entitled to as much as three years' salary upon termination.

seem trivial become magnified a thousandfold as union leaders use them as an excuse to demonstrate their power. The American manager feels powerless, threatened by his loss of control over the work force. The veteran Italian manager merely shrugs, knowing that it has always happened and will happen again. In other words, don't make a small incident into a nation-paralyzing strike by overreacting. Your hosts will not thank you.

What sort of issues cause major walk-outs? Raising the price of beefsteak in the employees' canteen from 50 cents to \$1 incensed workers in an Australian oil refinery. Laying off 13 keypunch operators stopped most of ICL. New wp equipment twice nearly caused a total municipal government shutdown in Bradford, England. Many Australian newspapers closed when journalists were asked to write stories on crts rather than on traditional typewriters: the demand was for an extra \$50 a week for added skills!

Not even a government is immune to strikes. British tax collection was at a standstill last year as computer operators took a "vacation" in midyear.

BUSINESS ATTITUDES DIFFER

American businessmen are regarded as strange in Europe, and the reverse is equally true. Two thousand years of cultural gap cannot be cemented overnight. Europeans, for example, don't really understand that many American dp experts literally came up from the machine room floor or the coding pad. In Europe, managers are born and educated to the trade—not developed on the run. Fundamental class distinctions are deeply ingrained. Hence the primacy of accent in the U.K. and the emphasis on elite school background in France. Americans are unimpressed by mere college degrees, while Europeans conspicuously place their honors on their business cards. In Germany, to be addressed properly as "Herr Doktor Professor" is a signal honor, while in the U.S., the same person might be called "Pete." Fortunately, the Europeans have not adopted the Indian practice of noting "Failed MS" on their cards.

American companies change organizational structure on a regular basis. One year it's grid management; the next year, management by objectives. Europeans are much more conservative about such tinkering and have long since outgrown the American practice of looking for a panacea in purely structural matters. Much simpler is just appointing somebody who owes the manager a debt (personal, political, or relational) or letting a friend run the operation.

In the U.S., we reward good performers. In Europe, a super performer still must overcome his culture's rigid constraints. The marketing genius or engineering superstar is

not likely to reach the ranks of the exalted unless all other cultural requirements are fulfilled. An Oxbridge degree is a better asset in the U.K. than a track record.

Europeans simply do not strive to increase market share: they still don't really understand retired IBM board chairman T. Vincent Learson's immortal comment "I want it all." Europeans are happy to settle for 50% of a tidy, controlled, high profit market. They are even happier if they can make what the Scandinavians call an "arrangement" to give them control of one market while a nominal competitor controls another market. The cartel mentality, still alive in Europe, continues to frustrate Americans.

FEDS ARE FRIENDS

Americans regard government as an interfering and troublesome group of bureaucrats who fight business at every step. By contrast, the European businessman knows the government is his valued and trusted friend. The government establishes rules for national buying preference, raises the import duty barriers to foreign competition, finances major overseas deals at low interest rates, and offers assorted tax abatements for work that seems to be in the national interest.

IBM is still fighting for French government business but more and more is going to Cii-HB. Despite a major commitment in the U.K., Honeywell nevertheless runs head-on into the sole-source ICL procurement policy. The Japanese government talks about extending reciprocal trade agreements but Nippon Telephone and Telegraph has a strict "buy Japanese" policy. (NT&T buys only paper towels and uniforms outside Japan.) The French government made an open power play to squeeze ITT and Eriksson out of the French telecommunications market by making a "take it or leave it" offer for the plants. The German government pays Nixdorf to train workers in modern electronic technology, which has an amazing effect on Nixdorf's balance sheet. All of these "arrangements" strike the American businessman accustomed to "fair play" and free trade as gross violations of the rules of the game.

Advertising, too, is different, and even seems primitive by American standards. The U.K. doesn't go in for the sort of glossy "image" ads that fill the pages of American business magazines. Instead, messages are geared toward detailing specific products or services. Every time two American companies in the same industry sit down together, the Department of Justice is sitting under the table keeping a weather eye out for conspiracies. By contrast, European parties are likely to form a cooperative deal for running a single joint computing center and sharing the costs, all with government approval.

Perhaps the most striking difference is the basic objective of a European-based corporation. While the American company strives to get all the business it can and to amass as much capital as possible, the European company has been tempered by the realization that national goals often take priority. Full employment is a fairly standard European objective. This creates a variety of results. No layoffs and maximum employment mean building for inventory during hard times. It also means product costs are probably out of line by American standards. Therefore, you need governmental protections against undercutting by foreign competitors. So, up go tariff barriers.

PROFIT? NOT ALWAYS

Profit is the key to American corporate growth and expansion, and the American tax system encourages use of reserve funds for building new plants and buying machine tools. By contrast, European tax systems discourage capital building by taxing profit almost totally out of sight and forcing borrowing at extremely high interest. The predictable result is a more costly product.

Of all companies based in the U.S. and doing business overseas, IBM has come closest to acquiring the protective coloration of a European-based multinational. While many of the key decisions involving products are still made in Armonk, the daily management of an IBM overseas affiliate is very much in the hands of local nationals. Locals control marketing practices, operating accounting, advertising and even provision of some products not found in other countries. Yet somehow, IBM is still able to retain and nurture a corporate spirit that can overcome 2,000 years of national differences. While a Frenchman is still a Frenchman, he won't leave the table in the canteen at La Gaude if a German engineer coworker sits down. Few other companies have been able to walk this fine line. When ICL's national directors have a meeting, everyone has a British passport.

A 3033 or a PDP-11/70 runs pretty much the same in Paris or Peoria, Sydney or San Francisco. But almost everything else is different, including the price. Operators in Norway won't work at night. Programmers in France demand COBOL manuals written in French. A whole shop in the U.K. will walk out because a single data entry operator has been laid off.

European equipment prices seem artificially high to Americans. The standard algorithm in the U.K. is to scratch off the dollar sign and replace it with a pound sign. It still is a puzzle just why the prices are so stiff. Vendors talk about extra costs of training and preparing manuals in a variety of languages, of stocking spares in many countries, of

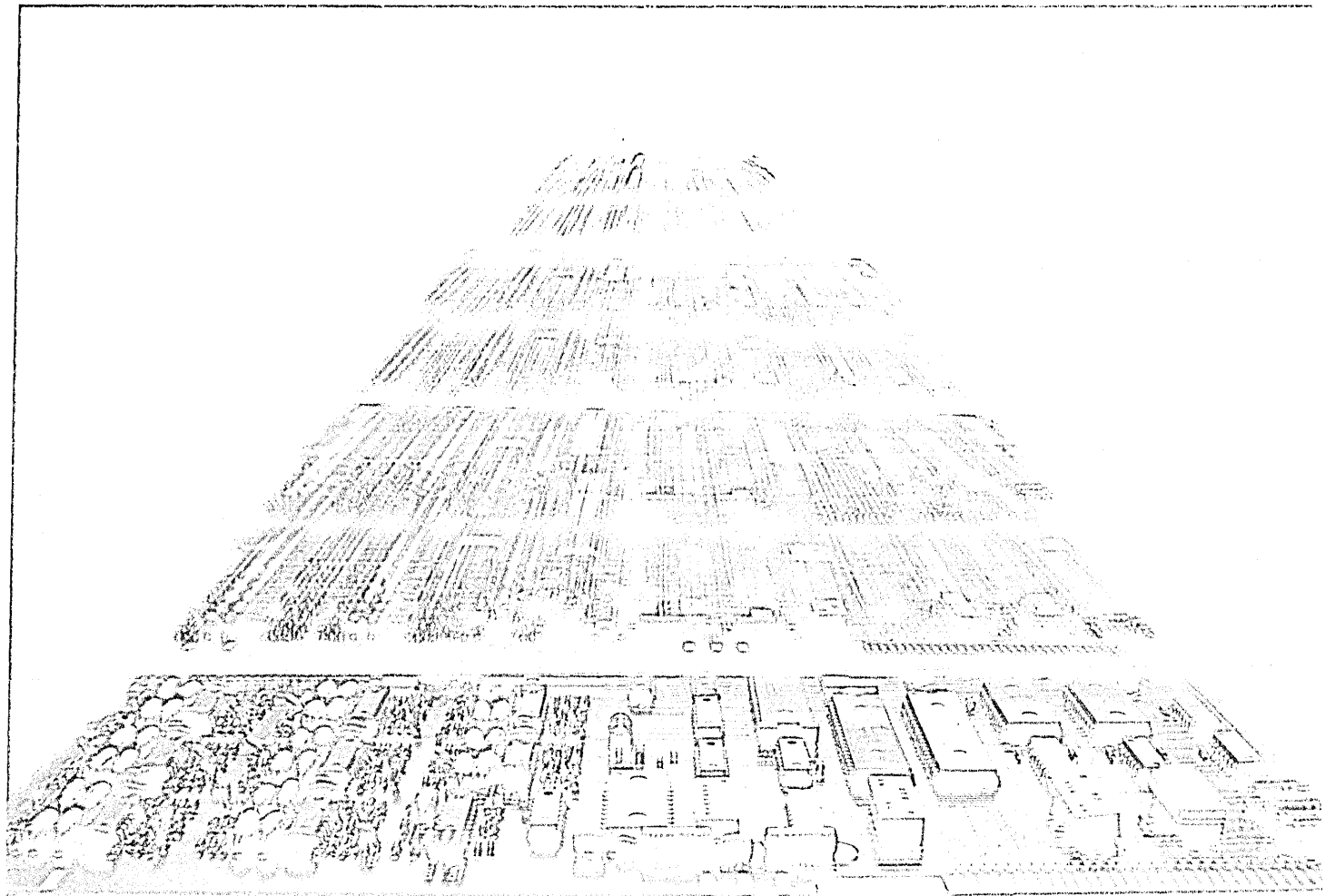

Voice Recognition Modules:

NOW!

Call Interstate now for a
 complete literature
 package and details on our
 voice recognition
 modules.

Interstate's voice
 recognition modules
 will automatically
 detect and identify
 your voice commands
 and control your
 equipment.

Our complete line of
 voice recognition modules
 is available in 10, 15, 20, 25,
 30, 35, 40, 45, 50, 55, 60,
 65, 70, 75, 80, 85, 90,
 95, 100, 105, 110, 115,
 120, 125, 130, 135, 140,
 145, 150, 155, 160, 165,
 170, 175, 180, 185, 190,
 195, 200, 205, 210, 215,
 220, 225, 230, 235, 240,
 245, 250, 255, 260, 265,
 270, 275, 280, 285, 290,
 295, 300, 305, 310, 315,
 320, 325, 330, 335, 340,
 345, 350, 355, 360, 365,
 370, 375, 380, 385, 390,
 395, 400, 405, 410, 415,
 420, 425, 430, 435, 440,
 445, 450, 455, 460, 465,
 470, 475, 480, 485, 490,
 495, 500, 505, 510, 515,
 520, 525, 530, 535, 540,
 545, 550, 555, 560, 565,
 570, 575, 580, 585, 590,
 595, 600, 605, 610, 615,
 620, 625, 630, 635, 640,
 645, 650, 655, 660, 665,
 670, 675, 680, 685, 690,
 695, 700, 705, 710, 715,
 720, 725, 730, 735, 740,
 745, 750, 755, 760, 765,
 770, 775, 780, 785, 790,
 795, 800, 805, 810, 815,
 820, 825, 830, 835, 840,
 845, 850, 855, 860, 865,
 870, 875, 880, 885, 890,
 895, 900, 905, 910, 915,
 920, 925, 930, 935, 940,
 945, 950, 955, 960, 965,
 970, 975, 980, 985, 990,
 995, 1000.

**INTERSTATE
 ELECTRONICS
 CORPORATION**

SUBSIDIARY OF 

Strikes and walkouts frequently challenge Italian, British, and Belgian managers.

excessive overhead in redundant organizations because of nationalism, and of tariff charges. But these arguments are lame when it is discovered that the machine is built just down the road.

High equipment prices and low labor costs were a European tradition for 25 years. Recently, however, the curves reversed themselves as European labor rates began to soar and are now higher than in the U.S. This is going to change the traditional European company practice of buying smaller machines than do their American counterparts. The British have always looked down their noses at American dp experts who, it is alleged, buy their way out of sticky corners with excessive iron, whereas (we British) produce elegant programs to solve the problem. That may not be viable in the new economics of the '80s.

Most of the clever financial tricks—trading off rentals, leasing on several different terms, purchasing used machines, and the like—have never had a firm toehold in Eu-

rope. The problem has been the high cost of money. Without access to vast quantities of low interest funds, the leasing companies never had a chance. In several European countries, there was a faint but real cultural distaste for leasing except from the manufacturer. Since the Europeans do not consider it their basic objective to squeeze every bit of profit, there was no trouble allowing a IBM or a Burroughs to make an extra few dollars.

STANDARD MACHINES RARE

And there, of course, international electrical standards differ. It is bad enough that the main connections differ physically from country to country, but what makes it harder is that most but not all of Europe is on nominal 220 V, 50 MHz power whereas the U.S. is 110 V, 60 MHz. That's no real problem for a computer designer if the matter is considered during the design phase, but if confronted afterwards, it can be a mess. ICL continued to try to ship 220 V machines to the U.S. even after the prob-

lem had repeatedly been brought to their attention. It's rare to find a machine like the IBM Series/1 that can go either way with the change of a couple of wires. The reason? It was designed by an Englishman working in Florida.

Americans working abroad have long since come to terms with the cultural differences. If not, they haven't lasted long. But the American company that is new to the overseas marketplace has a great deal to learn. Scandinavia is not one place, but a series of different countries. A purely British management organization does not work on the continent. In Japan, it is hopeless without an affiliation with one of the major trading companies. In Mexico, a major requirement is a Mexican partner who has operating control (51%) of the venture. In Brazil, nothing can be done without government approval and without demonstrable export possibilities, the chances of getting approvals are slim. A machine can be made French and thereby legal for government purchases by signing up a French distributor who will change all the nameplates, but a wholly owned subsidiary of a U.S. company has a big problem in the same market.

American companies going to Europe for the first time inevitably settle in either the U.K. or Switzerland. In the U.K., there is no apparent language barrier. Switzerland has a long history of understanding international operations. But both locations have serious drawbacks. The U.K. has little understanding of how to do business on the Continent and until recently, imposed severe currency restrictions. Switzerland is getting difficult about work permits for foreigners and the high cost of living is a strain on most temporary residents. The best spots are probably Amsterdam, Brussels, or Frankfurt, but very few American firms apparently believe it.

The international manager, once enlightened, must learn to adapt this knowledge to corporate structure and goals. This structure varies, of course, from corporation to corporation, as does the organization of dp facilities worldwide.

The dp organization ranges from total decentralization where there are no communications links among centers in different countries, to the corporate centralized utility, with its hierarchy of terminals and small systems around the world. To centralize or decentralize is a critical question requiring organizational, national, and technical considerations.

For example, the Warner-Lambert Co., a \$3.2 billion health care, consumer, and optical products firm, has 35 centers abroad that handle most dp needs of the country "affiliates." These national companies are quite vertically integrated because of national tastes, i.e., when it comes to products



"Mr. Gilmore, I'm going to give you a placebo. Don't tell anyone I told you."

© DATAMATION

CARTOON BY HARLEY SCHWADRON

Two Pi announces a new Foundation System for OEMs.

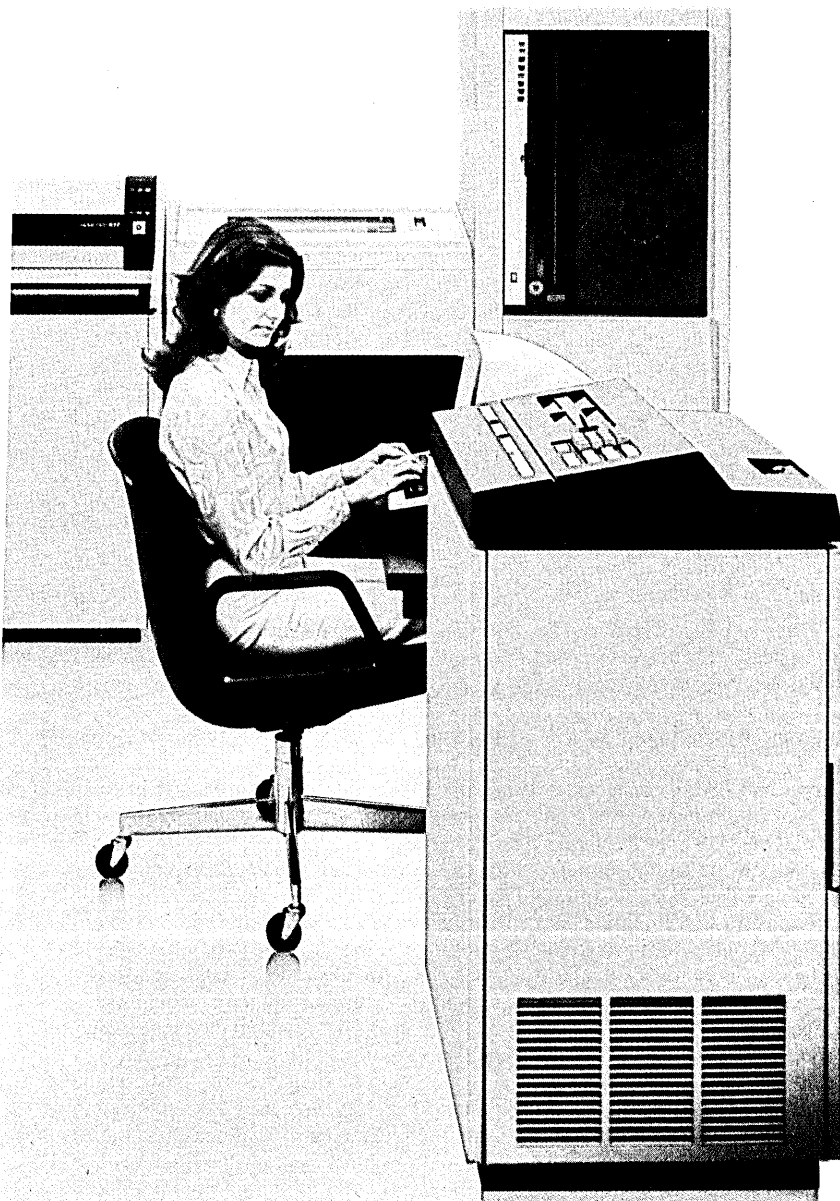

New Integrated
Peripheral Controllers
make possible a low cost
IBM compatible system.

At \$99,950 in quantity of five, Two Pi's new Foundation System makes it possible for OEMs to build their business using the large IBM compatible base of system and application software. With performance comparable to a 370/138 or 4331, the Foundation System provides a powerful vehicle to deliver your existing 370 software or to expand your marketing to larger customers or prospects for dedicated systems.

What is the Foundation System? It's the field-proven Two Pi V32 CPU (over 100 have been shipped already). Plus:

- 1MB main memory
- Integrated controllers for:
 - Disk
 - Tape
 - Communications
 - Unit record
- 200MB disk
- Magnetic tape drive
- 300 LPM printer
- Console
- 8 ports ASYNC/BISYNC

Two Pi is a volume supplier committed to supporting OEMs. The Foundation System is available 90 days ARO, and firm delivery schedules will be met. Two Pi has a variety of hardware, software, and training support programs which will be tailored to meet your needs.

RUSH! Send me additional information on the Two Pi Foundation System!

Have a sales rep call me!

Name _____

Title _____

Company _____

Address _____

City _____

State _____ Zip _____

Telephone () _____

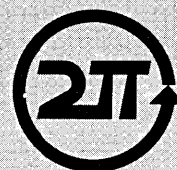

Two Pi
CORPORATION

A subsidiary of U.S. Philips Corporation

3105 Patrick Henry Drive
Santa Clara, CA 95050
(408) 988-1234

DM980

The European businessman knows the government is his valued and trusted friend.

like gum and candies, and the regulations affecting the drugs they produce.

General Foods Corp. has examined every kind of configuration, but it is currently maintaining decentralized facilities with some intracountry links. Fred Lambrou, director of information services, international, notes that the IBM 4300 "has put a whole new dimension on such organizational decisions" because of its price/performance breakthrough. "There is no point now to paying the added computational and communications costs of a centralized 3033." (The 4300 and System/38 are now the standard systems for GF internationally.)

Xerox Corp. has several "levels" of centers throughout its organization, ranging from large IBM and plug-compatible mainframes to centers with mini-based distributed data processing or remote job entry terminals. It also has centralized corporate-wide services on time-sharing facilities in Rochester, N.Y., such as business and financial planning and engineering services.

"We are not driving toward centralization for economies of scale," says James Sutter, director of corporate information management, "merely looking for a balanced strategy. We have centralized where it makes sense. We won't save a nickel by centralizing abroad. It wouldn't tear me apart to have more distribution of function and processing."

Both Lambrou and Sutter point to the very high cost of maintaining telecommunications services abroad—a deterrent to centralization. Further, the telecommunications authorities (PTTs) are rapidly installing new public switched networks and trying to phase out or discourage private leased lines.

Of all the technical aspects in setting up international dp installations, the biggest differences in operations are in the area of telecommunications. The European PTTs run tight ships with little flexibility. They have almost no response to user demand, offering minimal, expensive, and slowly changing networks. Return on investment is their guiding principle. The Bundespost is still in love with telex networks. The Italians are striving to wipe out private lines by making them so expensive no corporation can pay the bill. The American notion of slamming in a portable terminal with an acoustic coupler and using the public dial-up network is a sin in Europe. It drives multinationals wild to discover that what is legal in France may be illegal in Belgium and, while not banned, unavailable in The Netherlands.

CONFUSION OF RULES

On the eastern side of the "pond," telecommunications services are, without exception, provided by a monopoly regime. Ah, you might say,

sounds just like AT&T. The de facto monopoly of the Bell System is markedly different—especially since the FCC gave the go-ahead to value-added networks. By way of contrast, telecommunications services are provided exclusively by government departments described generically as PTTs (European Post Offices), administrations owned by publicly held corporations, such as the U.K. Post Office. The nature and expense of these monopolies is severe at best. On the periphery, a confusion of rules applies to the attachment of modems, acoustic couplers, multiplexors and front-ends. In some countries modems can only be obtained from PTTs. In others, the PTT is not interested (except for technical approval). Some countries have even banned the use of acoustic couplers, a device not even directly connected to the telephone circuit. A middle road is represented by the U.K., where the philosophy until now has been "You can do it yourself if we cannot do it."

The West German Bundespost represents one of the most extreme stances. The Bundespost is fundamentally opposed to the whole concept of the "leased circuit," preferring to attract as many customers as possible to public switch services. Once you have a leased line, it is similarly unenthusiastic about techniques such as multiplexing and alternate voice/data workings. The Bundespost, along with Italy, is the strongest proponent of volume-related charging for leased lines. (It is an old but true story that the West German Bundespost is the only body to survive unchanged since the 1930s, when it was the Vicepost.)

The French PTT is rightly viewed as one of the most radical in Europe in terms of its plans to introduce new technology and services. It is possibly the only authority in the world to have advanced plans to replace telephone directories with a small display terminal in each home and office connected to regional computers. Unfortunately, this technological aggressiveness is somewhat spoiled by the attitude of the French government which may be summarized as anti-multinational in general and anti-U.S. multinational in particular. Its ideas concerning the taxation of transborder data flow are particularly worrisome. The costs of telecommunications services in Europe are a good deal higher than in North America. At their cheapest (in the U.K.) they are 50% to 100% higher and they can be as much as 500% more than in West Germany.

All this applies to lines terminating in one country. Do not forget that in Europe if you want to go any distance you have to cross borders. Like the air travel industry, the PTTs decided this makes things more expensive, and rates go up alarmingly. For example, a commission circuit from London to Zurich costs between \$24,000 and \$38,000 a year.

The extreme variation occurs because of another anachronism, "If you pay in London it is cheaper than paying in Switzerland!"

USING ABSURD REMEDIES

The unevenness of these tariffs can drive users to absurd remedies. The following story has been repeated so many times that it is doomed to be dismissed as apocryphal. It concerns a Dutch company that also traded in adjacent Belgium. The company in question wanted to transmit data from a location near Ansford to its computer center in Rotterdam, a distance of about 140 kilometers.

It was quoted a price of nearly \$18,000 a year for a simple point-to-point leased line. This was a sum it could well afford but it was hardly justified by the application, and even less so by plain common sense. After due consideration, the company simply refused to pay the money and looked for an alternative solution. The answer turned out to be somewhat theatrical. It leased intranational circuits to one of the many small towns on the border. On one side the lines terminated at the house of a retired employee, and at the other side, at the house of a local accountant. Twice a day the old-timer would receive a reel of tape, dismount it from the terminal and take the dog for a walk across the border (which is much more open than between, say, Buffalo and Toronto). On the other side, he would deliver the tape to the accountant's office where the data would be transmitted onward to the computer center.

Not surprisingly, this gave rise to all kinds of ideas improving the efficiency of the operation—such as providing the courier with a bike. Soon after, a user in Denmark was supposed to do the same thing to reduce his communications costs with West Germany, but the distance involved was so short (some 40 kilometers) that the Danish PTT was shamed into offering him a more reasonable rate.

A particular problem encountered by both suppliers and users is "type approval." This is a procedure adopted by the PTT to ensure any equipment connected to telephone lines (e.g., modems, terminals, front-ends) conforms to certain minimum requirements concerning a) safety, and b) the range of signals placed on the circuit.

Safety obviously comes first and the major concern is protecting PTT engineering staff and plant. Clearly, care has to be taken to avoid the attachment of junk to the public telephone network. Often the problem does not lie solely in the approval procedure itself but in the variation of these procedures from country to country. At the present time, for example, it takes fewer volts to kill a Frenchman than it does an Englishman . . . now the British have known all along that there really



INTRODUCING VIDEOPRINT: The picture perfect peripheral.

Videoprint is the convenient economical means of obtaining distortion-free line or continuous tone hardcopy from raster line computer graphics displays in full, brilliant color. The entire system is self contained in the convenient desk-top unit shown above.

Videoprints eliminate such off-the-screen photography problems as barrel distortion, color de-saturation and loss of color fidelity. Videoprints also minimize the effects of raster lines and video noise.

Videoprints are instantly produced with Polaroid® SX-70 or Polacolor 4" x 5" films, as well as with conventional color negative or 35 mm slide transparency films, offering you a range of handy sizes. The pictures can be made by untrained personnel at the push of a button.

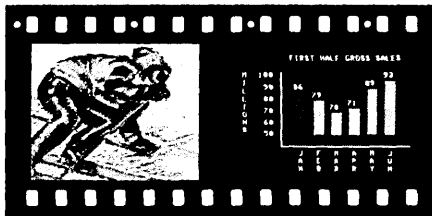
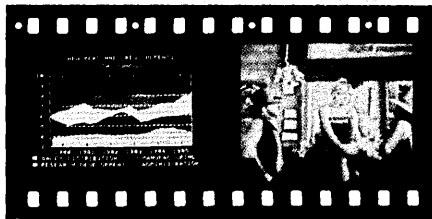
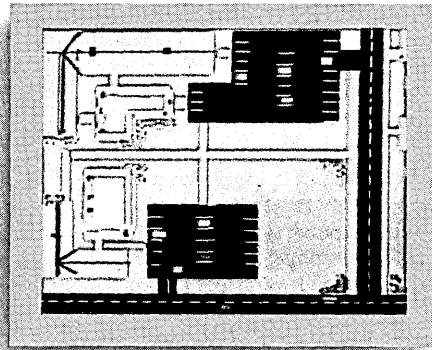

If you've ever wanted to distribute copies of computer graphics or TV video stills or file them in your permanent records, or send them through the mail or project them as slides, you need Videoprint.

If you've ever wanted to document alternatives in an interactive graphics process, or monitor periodic events without 24-hour observation, you need Videoprint.

In fact, if you use computer graphics in any form, you really need Videoprint. Find out all about this exciting new tool. Write or call us today.



The Videoprint People.

Image Resource Corporation
2260 Townsgate Road, Westlake Village, CA 91361
(805) 496-3317

CIRCLE 105 ON READER CARD

"Polaroid," "Polacolor" and "SX-70" are registered trademarks of the Polaroid Corporation.

Americans strive for profit; Europeans realize national goals often take priority.

has been no excuse for the PTT's failure to agree to some common certification arrangement. As it stands, it can often take up to six months to obtain full approval in each country concerned. The message is: check that terminals have already been approved; that should be the responsibility of the terminal supplier. The above comments apply to anything that may be directly or indirectly connected to a telephone line, whether leased or switched, including terminals, front-ends, processors if not front-ended, multiplexors, and modems. However, in some countries the telecommunications authority may well extend its monopoly to cover the supply of modems and multiplexors. Therefore, it may not be possible to obtain type approval at all.

A free choice in deciding where to center your networking operations is perhaps the most important first step in planning for Europe. The telecommunications authorities are in a turmoil; they are in the midst of confused crosscurrents. Some PTTs seem determined to make their monopolies even more rigid and extreme; others are adopting a more liberal approach. In the latter category are Holland, Belgium, and the U.K., all traditionally strong as international trading nations.

AFFINITY GROUP PROBLEM

A good case in point is the problem of "affinity groups" such as SITA and SWIFT and the way these shared networks should be handled by the PTTs. In order to avoid another SWIFT case (where the PTTs arbitrarily increased agreed tariffs after the banks had been given the go-ahead) CCITT developed the D Series of recommendations. Under these rules it is possible to establish an affinity group network using leased circuits at the standard rate but subject to a surcharge of about 4¢ per kilobit transmitted. Yesterday it was forbidden in principle; today it is permitted on financial grounds. But rather than simplify matters the new rules have spurred more free-wheeling PTTs to "compete" for international business. What is an affinity group to a German may be a source of revenue to a Belgian (or a Dutchman or an Englishman). This situation will not be eased by the U.K. government's recent (July 1980) decision to modify considerably the Post Office Act. The effect of this will be to split the Post Office corporation into two separate entities, one for postal services and one for telecommunications. The latter has already adopted the name "British Telecom." But even more important is the extent to which the monopoly domain is to be "pushed back." Over a three-year period the U.K. will see the introduction of a completely free market for telephone attachments (including modems and PBXs). For the first time in Europe private companies will be allowed to offer value-added services

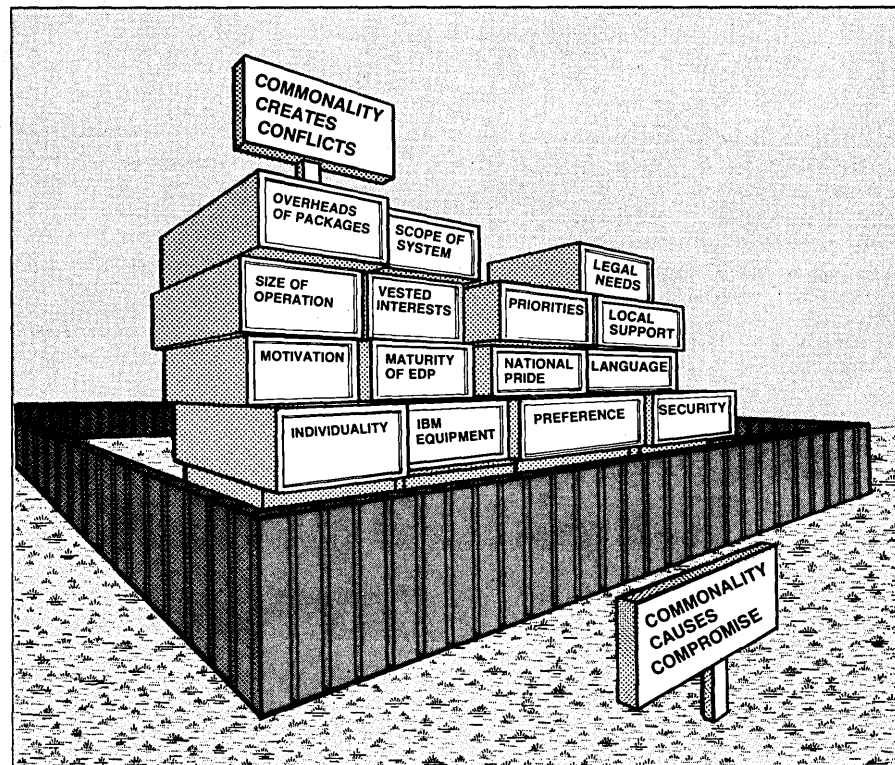

based upon circuits provided by British Telecom. Those changes will further enhance the appeal of the U.K. to American corporations looking for a friendly European base. But meanwhile, the message for the dp manager is to plan well ahead and get local advice.

*

FEARS OF DATA LAWS

The centralization/decentralization question is dependent on many factors. National data laws now being passed or implemented may be very strong incentives for local data processing. At hearings of a U.S. Congressional subcommittee held in March, a very large dp centralized organization made known its fears about these laws.

Continental Illinois National Bank, explained its vice president, Robert Walker, services its branches and subsidiaries around the world through a mammoth data processing center in Chicago. At the end of each day, all transactions in Europe are transmitted for processing in Chicago and returned the next day for reports and statements. With this system, said Walker, "we can have available to our account officers on a worldwide basis all the banking activities transacted with the customer." On this ability depends "the proper management of our bank's assets and liabilities."

Walker emphasized that data laws, which seek to control and restrict the processing and transfer of personal and other data, pose a real threat to Continental's method of

operation. He claimed that in one country "the government has already begun limiting the ability of banks to transmit and process operational data outside their country."

While the full impact of these laws is not yet known, the multinationals with centralized operations have that bit of fear that someone is indeed after them.

Regardless of the organization of the dp facilities, the control of international MIS or information services is often vested in a small group of managers and technical specialists at U.S. corporate offices who usually report to top management.

Xerox and General Foods, for example, handle international business with corporate information systems departments, while Warner-Lambert has a separate international MIS group. In varying manner, systems managers in foreign subsidiaries report both to these core groups and to the companies (or regions) for which they work.

The core group missions are generally designed to "define strategy for computers, communications, and office systems," as Xerox's James Sutter put it. While one would expect office systems at such a high level at Xerox, lately it is becoming the charter of information systems departments in other corporations, for example, in both General Foods and Warner-Lambert. Under the MIS mission are included procurement control, guidelines and standards development and control, special projects, and special support and handholding for people in the field.

CHART BY CYNTHIA STODDARD

Pacific's ATSS/DS Network...

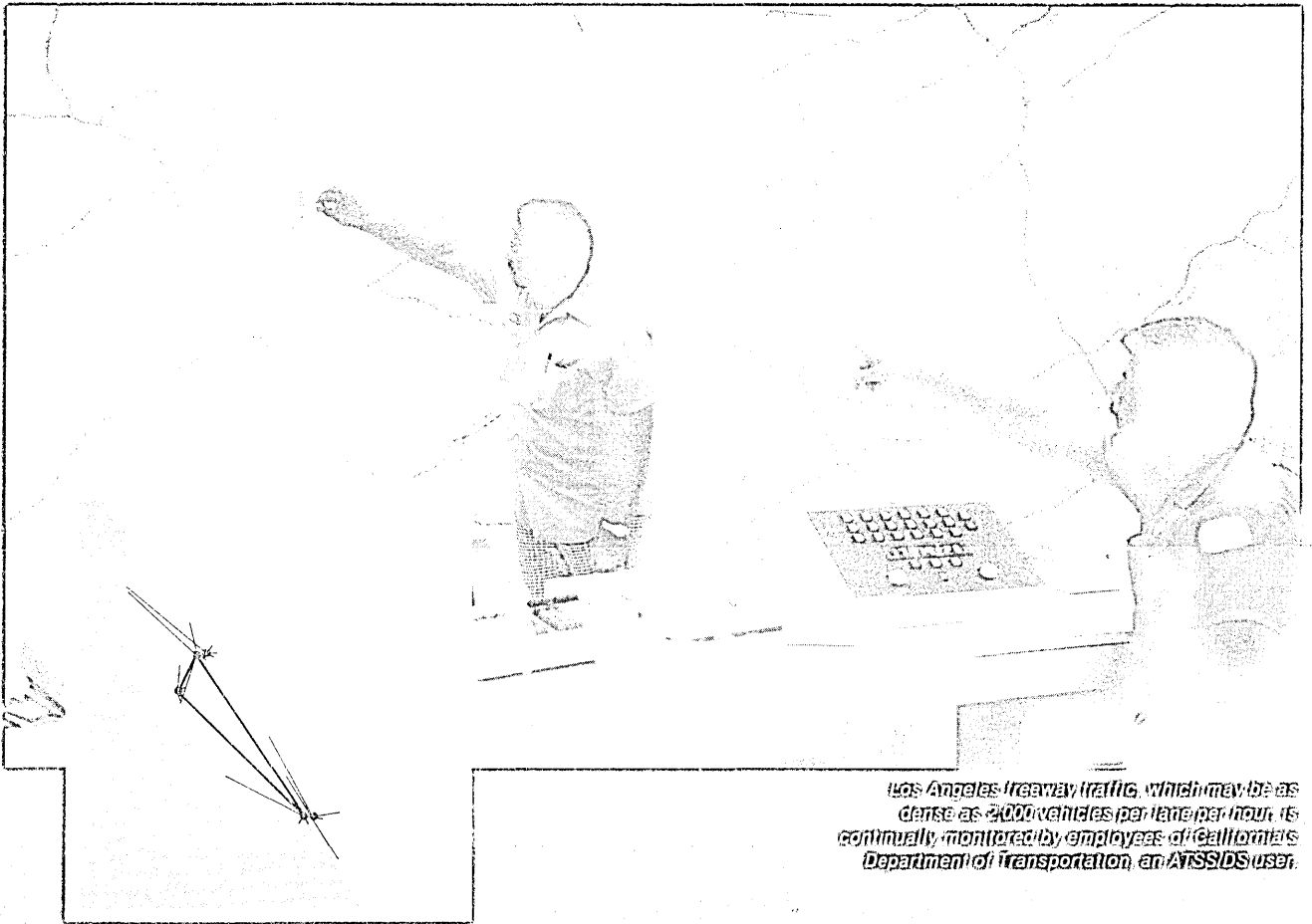

Los Angeles freeway traffic, which may be as dense as 2,000 vehicles per lane per hour, is continually monitored by employees of California's Department of Transportation, an ATSS/DS user.

...is also a Tran Network.

When a California state official near the Mexican border wants to check license plate files in Sacramento, his local terminal immediately connects him with computers in the state's capital. When an engineer in Los Angeles needs data from Sacramento, her inquiry is switched to computers in that city. When a researcher at an educational institution in San Francisco uses a program residing in a Los Angeles computer, on-line access is only a few keystrokes away.

Pacific Telephone's digital network makes it all possible. Called ATSS/DS, it is the first statewide switched digital network to be offered by a common carrier, the first packet switching network to be tariffed by a Bell System operating company, and the first to provide mixed packet and

nonpacket services simultaneously.

Stretching from the Oregon border to San Diego, from San Bernardino in the east to San Luis Obispo in the west, ATSS/DS ties the entire state together through switching centers in San Francisco, Los Angeles and Sacramento. It provides permanent and switched circuits between more than 400 terminals, 35 network access concentrators, and 250 ports on seven computers (including DEC, IBM, Control Data and others).

Users access the network for inquiry/response, data collection, remote job entry, time-sharing and even point-to-point message switching — all without concern for how the network will accommodate them.

In spite of its widespread topology, Pacific's network is an integrated facility with centralized management, billing, diagnostics and status reporting. And in spite of its already large size it continues to grow to meet customer demands. Nor will the state long remain the only one with such a network — California simply has a head start on the 1980s.

Tran has installed several such networks for telephone operating companies, and many more for educational and financial institutions, government agencies, and users in private industry in the United States and other nations. As a result, Tran now has more international experience in constructing digital data networks than any other communications company in the world.

CIRCLE 106 ON READER CARD

tran TELECOMMUNICATIONS CORPORATION

COMPUSTAR™

INTERTEC'S NEW \$2500 MULTI-USER SMALL BUSINESS COMPUTER

At last, there's a multi-user micro-computer system designed and built the way it should be. The CompuStar™. Our new, low-cost "shared-disk" multi-user system with mainframe performance.

Unlike any other system, our new CompuStar offers what we believe to be the most practical approach to almost any multi-user application. Data entry. Distributed processing. Small business. Scientific. Whatever! And never before has such powerful performance been available at such modest cost. Here's how we did it...

The system architecture of the CompuStar is based on four types of video display terminals, each of which can be connected into an auxiliary hard disk storage system. Up to 255 terminals can be connected into a single network! Each terminal (called a Video Processing Unit) contains its own microprocessor and 64K of dynamic RAM. The result? Lightning fast program execution! Even when all users are on-line performing different tasks! A special "multiplexor" in the CompuStar Disk Storage System ties all external users together to "share" the system's disk resources. So, no single user ever need wait on another. An exciting concept... with some awesome application possibilities!

CompuStar™ user stations can be configured in almost as many ways as you can imagine. The wide variety of terminals offered gives you the flexibility and versatility you've always wanted (but never had) in a multi-user system. The CompuStar Model 10 is a programmable, intelligent terminal with 64K of RAM. It's a real workhorse if your requirement is a data entry

or inquiry/response application. And if your terminal needs are more sophisticated, select either the CompuStar Model 20, 30 or 40. Each can be used as either a stand-alone workstation or tied into a multi-user network. The Model 20 incorporates all of the features of the Model 10 with the addition of two, double-density mini-floppies built right in. And it boasts over 350,000 bytes of local, off-line user storage. The Model 30 also features a dual drive system but offers over 700,000 bytes of disk storage. And, the Model 40 boasts nearly 1½ million bytes of dual disk storage. But no matter which model you select, you'll enjoy unparalleled versatility in configuring your multi-user network.

Add as many terminals as you like - at prices starting at less than \$2500. Now that's truly incredible!

No matter what your application, the CompuStar can handle it! Three disk storage options are available. A tabletop 10 megabyte 8" winchester-type drive complete with power supply and our special controller and multiplexor costs just \$3995. Or, if your disk storage needs are more demanding, select either a 32 or 96 megabyte Control Data CMD drive with a 16 megabyte removable, top loading cartridge. Plus, there's no fuss in getting a CompuStar system up and running. Just plug in a Video Processing Unit and you're ready to go... with up to 254 more terminals in the network by simply connecting them together in a "daisy-chain" fashion. CompuStar's special parallel interface allows for system cable lengths of up to one mile... with data transfer rates of 1.6 million BPS!

Software costs are low, too.

CompuStar's disk operating system is the industry standard CP/M*. With an impressive array of application software already available and several communication packages offered, the CompuStar can tackle even your most difficult programming tasks.

Compare for yourself. Of all the microcomputer-based multi-user systems available today, we know of only one which offers exactly what you need and should expect. Exceptional value and upward growth capability. The CompuStar™. A true price and performance leader!

**INTERTEC
DATA
SYSTEMS®**

2300 Broad River Rd., Columbia, SC 29210
(803) 798-9100 TWX: 810-668-2115

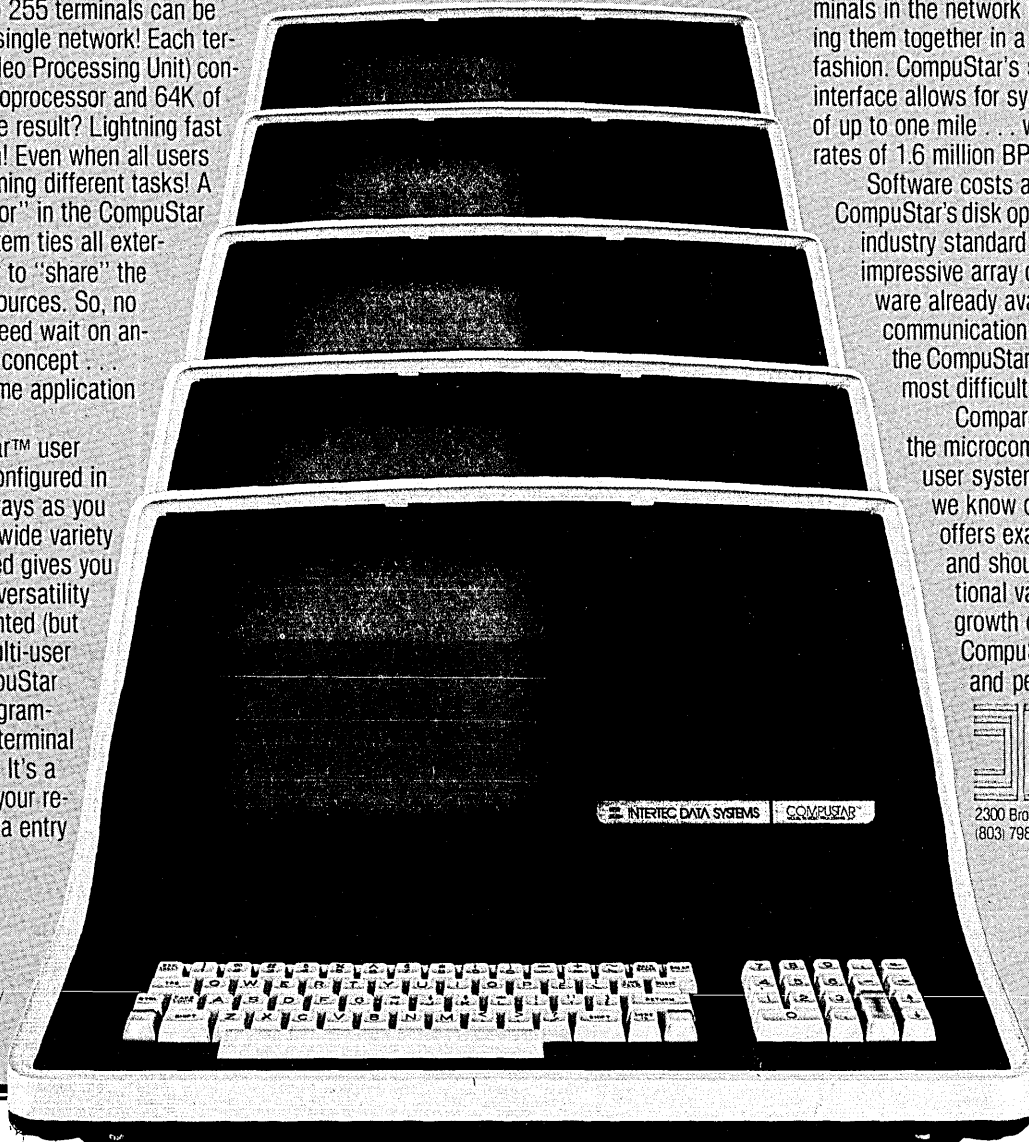

*Registered trademark of Digital Research, Inc.

IBM nurtures a corporate spirit that overcomes 2,000 years of national differences.

Generally, these central MIS staffs are not very big: 21 professionals at Warner-Lambert, 24 at Xerox. They include communications specialists, hardware and software analysts, consultants on applications needs, human resources specialists, special project leaders, standards specialists, regional managers. International managers indicated it takes a long time to evolve an efficient, well-oiled organization. The keys for success seem to be four Cs—control, communications, cooperation, and commonality.

Fred Lambrou, who has been in international management for 20 years, explained why he was pleased with the evolution at General Foods. "First, there is top management involvement at every level—international, and by area, subsidiary, and function. The information systems function is considered an integral part of each subsidiary's business, and the subsidiary's management looks at me as the key person to ensure the quality of his system management."

According to Lambrou, each subsidiary must go through strategic planning for systems every year. This requires the input of marketing, sales, personnel, and so forth, and the general manager has to sign the plan, indicating top level commitment. Although Lambrou's group must critique and approve the plan, the problems have been reduced significantly since this method of management involvement has been instituted.

Lambrou also emphasizes the involvement and corporate support of systems managers. They participate in deliberations on hardware and software standards (operating systems, utilities, and some applications packages) and major systems developments. Annual systems conferences, visits by Lambrou and his staff ("we spend 50% of our time traveling to subsidiaries"), and visits between managers in different countries are all used to keep the overseas people involved in the mainstream of the business and in communication with people "at their level." ("They are pretty lonely," says Lambrou, "not having too many people to talk to at their level at their own offices. They have to be able to come to you for help, advice . . . without it being viewed as a weakness.")

William Kluckas, director of management information systems for Warner-Lambert's international group, also puts prime emphasis on communications: upward to top international and corporate management and to corporate MIS, laterally with the three other MIS groups in the company, and across the oceans to almost 500 MIS people in 35 countries.

Conferences and workshops are a major part of that communication. According to Kluckas, the following were held in the last year: quarterly meetings of the planning and coordinating committee of Warner-Lam-

bert's four MIS groups, a conference for MIS and financial management, workshops for MIS managers of affiliates on common systems, and workshops for large MIS centers on planned 4300 migration.

"Because we're often good at telling what we cost, but not at telling what we contribute to the company," says Kluckas, his staff has instituted an annual survey of accomplishments and plans of the international MIS operations. The first one has already been distributed to corporate and international management. A quarterly newsletter, which is distributed to 300, including the president, is another vehicle used for keeping staff informed of what is going on in their corporate world—projects, new policies, technical tips.

This kind of communication has created the right environment for a very difficult project begun four years ago. As noted, the core MIS groups standardize on languages, operating systems, and to some extent, applications packages. The latter is difficult to achieve because of national differences in law and procedure and, of course, because of NIH complexes that exist everywhere.

Warner-Lambert decided to tackle the common system anyway. In 1976, interna-

tional MIS was reorganized, putting stronger control into the hands of the core MIS group, located in Morris Plains, N.J. (Most control had resided locally or regionally before that.) Although IBM systems were used, the models varied, especially the small systems, which included 360s, S/32s, and System 3s. The applications developments had mostly been done locally.

"It was all bits and pieces," recalls Brian Wratten, manager of operations review/affiliate systems development. And it promised to get worse, since many affiliates without systems were about to buy them.

A COMMON SYSTEM APPROACH

"A common system approach was decided upon because it had to be a better way to go," says Wratten.

The targets were the affiliates with small systems, since the larger affiliates were well along into advanced applications on larger IBM systems—not an easy conversion.

Wratten's group was put in charge of small systems affiliates. It picked the System/32 on which to standardize (the 34 was used soon after) and looked for an applications set that was "flexible, comprehensible to non-dp personnel, modular in design, well docu-



The American notion of slamming in a portable terminal with acoustic coupler and using the public dial-up network is a sin in Europe.

mented, and outstanding in its reliability.”

Going into affiliates without prior dp experience, and, it was hoped, into current operations as well, required that the system be installable and able to run without failure and with maximum ease. Auditability also was vital, especially since the U.S. Foreign Corrupt Practices Act has put responsibility for the actions of foreign operations squarely on the shoulders of the U.S. parent company.

A package was found and modified. It contained order entry and billing, inventory control, accounts receivable, sales analysis, general ledger, and accounts payable. In 1977, four MIS staff spent three months installing the common system in two new dp installations in the Far East. Data, master files, forms, and procedures were prepared. When they left, the systems were flying, and, according to Wratten, they have not had a prob-

lem since.

“We had to do a good job, establish credentials, or we never would have lived to fight another day.” The rest of the affiliates were oblivious to this development until it was up and running; there was no chance to fear and resist a “concept.”

As the success became known, the modules began to be accepted. Wratten says, “We never held a pistol to their heads and said ‘take it, it’s good for you.’”

Wratten believes that the common system approach has to evolve, because in the installation already using its own applications, there are obvious technical barriers to putting the modules in. Some applications are linked to others, so putting one module in without the other is difficult. Users of the incompatible System/3 have to either convert the system or forget it.

To date, according to Wratten, 21 users have adopted 113 modules. Because of this acceptance and the exchange of ideas now possible among the users, others are anxious to join the parade. Local staffs have not proliferated because no local software development is needed; this is particularly critical in nations where the shortage of qualified people is severe. Kluckas notes that the documentation is done centrally and is of extremely high quality and up-to-date.

Warner-Lambert’s five large affiliates—Canada, Mexico, the U.K., France, and Germany—cannot go this common-system route totally, but Michael Paul, manager of systems and development for this group, says that they are being encouraged to develop some commonality in concept, design, and specifications.

The spirit of cooperation and sharing is growing among these managers. They are working together on multinational projects, and by way of MIS policy, individual MIS groups are taking different projects that will be shared with the rest. For example, one affiliate is experimenting with direct sales entry through a portable handheld terminal. Another is acting as the shakedown site for DOS/VSE 2 on the new 4341s coming in.

Control, cooperation, communications, commonality. The international managers we talked to succeeded in conveying the importance of these elements. Interestingly, as they discussed problems, the national differences that are stereotypes never crept in, “because they disappear when you know people, that’s all,” said one manager. Of course, his wise and worldly advice for would-be international managers was “Don’t come on like an American.” *

Contributing to this article were Datamation advisors Angeline Pantages, Philip H. Dorn, Russell Pipe, and David Hebditch.

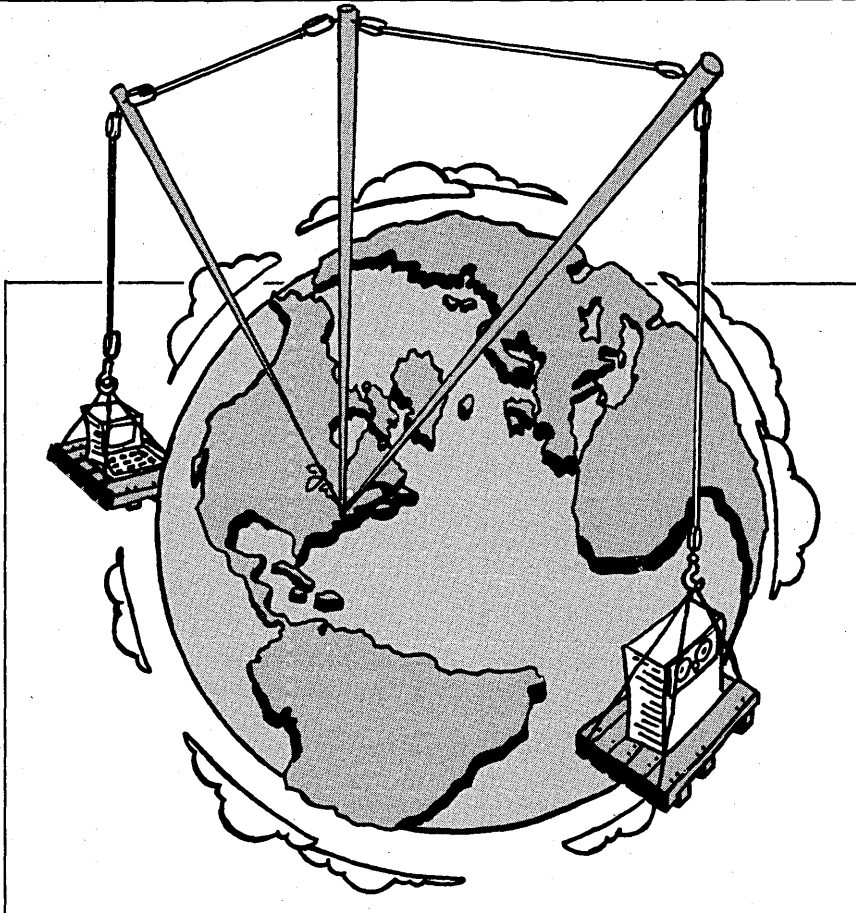

HALF OF ALL COMPUTER SALES MADE BY U.S. COMPANIES ARE OVERSEAS.

The U.S. computer industry relies heavily on the 40 billion dollar overseas market...nearly 50% of their total revenues. And the overseas market is growing even faster than the U.S. market...an average 23% annually. Overseas as in the U.S. its the EDP professional who makes the buying decision.

Today DATAMATION magazine serves 143,500 EDP professionals in 100 countries every month — still the one international EDP publication.

Technical Publishing

DB a company of
The Dun & Bradstreet Corporation

666 Fifth Avenue • New York, NY 10019 • (212) 489-2200

DATAMATION[®]
magazine

There's never been a time
when financial control meant more
to the success of your company.

There's never been a time
when financial control meant more
to the success of your company.

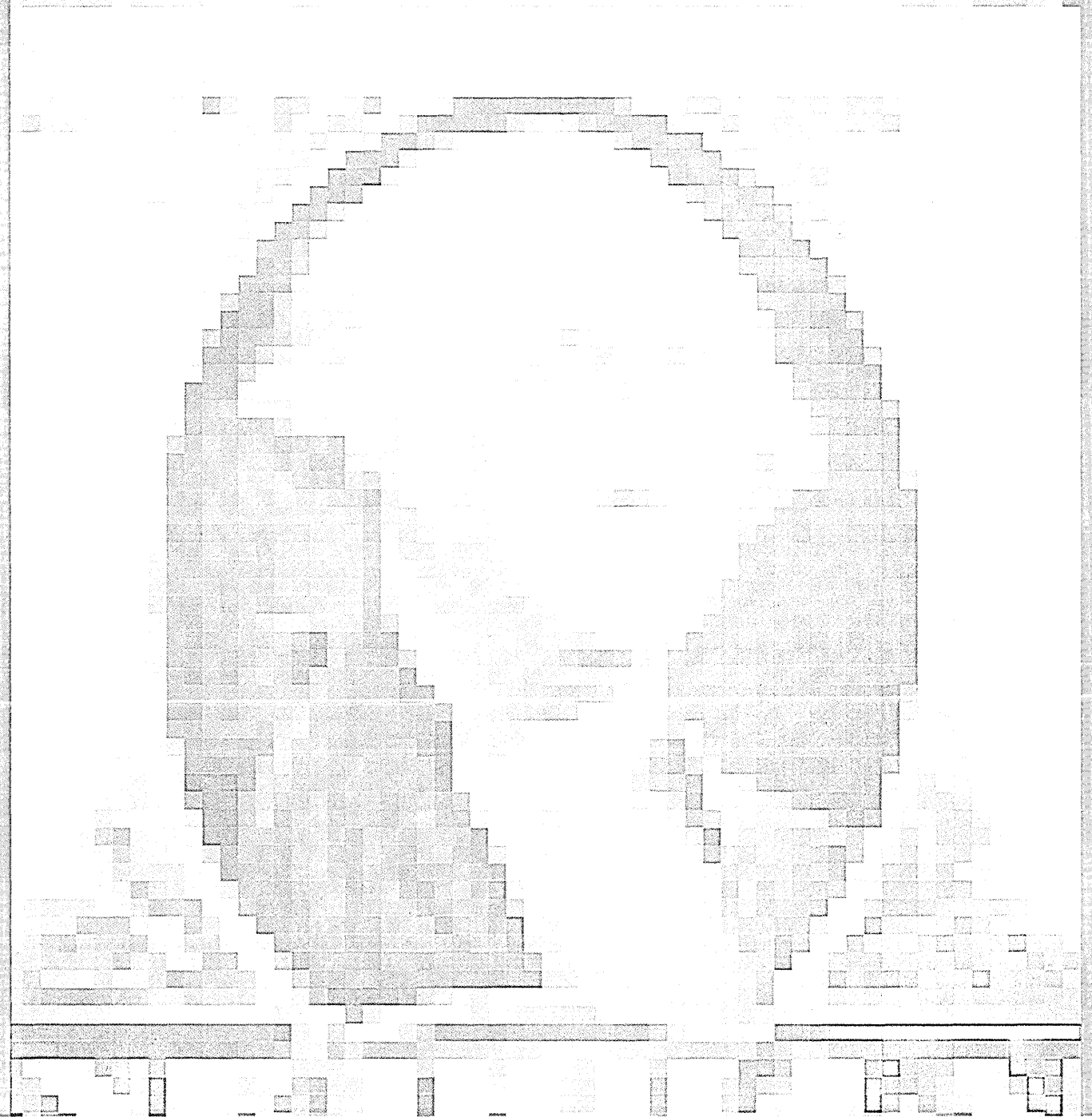

There's never been a financial management system that gives you more control than The Portfolio from UCS.

Good information means good business.

Having access to relevant business facts can make the difference between good business decisions and bad ones. Between efficient use of people, time and resources—and waste. Between profit and loss. Success and failure.

The Portfolio from United Computing Systems is the financial software system that gives you fast, easy access to all the facts you need, when you need them, in the form that's the most meaningful to you. The system is ideal for financial managers, planners and decision makers at every level in every area where better information can result in better business performance. Integration means better information.

The Portfolio is the most complete financial management software system on the market today. It's a group of fully integrated systems designed to give you complete financial planning, analysis, reporting and control.

The Portfolio gives you on-line input, editing and reporting, accounting systems, financial modeling and analysis, corporate tax compliance and planning, sophisticated business graphics and reporting.

All the systems are designed to share information from all areas of your company. Automatically. This means more and better control of your company's cash flow, assets, taxes, budgeting, planning and decision-making in every area and at every management level.

So your company won't just survive these tough economic times, you'll have the control to actually prosper in spite of them.

The Portfolio means better business.

The Portfolio gives you financial control systems to help your company do business more efficiently and more profitably.

The heart of The Portfolio is the UCS General Ledger, which interfaces with all other systems in The Portfolio.

Integration of the accounting systems—Accounts Payable, Accounts Receivable and Fixed Assets—results in important time and cost-saving benefits. Information input into any one system is automatically transferred into the General Ledger. There's no need for an additional input process. No chance to introduce error.

Each system receives input through an advanced On-Line Input Module. This allows instant editing and helps insure error-free input. And each system can produce a wide variety of Standard and Custom Reports to give your organization the unique reporting flexibility it needs.

But accounting is only the most basic capability of The Portfolio. Its financial planning (FORESIGHT[®]), business graphics (FOREGRAPH), and corporate tax compliance (FORETAX/FEDTAX) are what really put the General Ledger to work to help you improve every part of your business.

FORESIGHT lets you use historical data from the General Ledger to project, plan

and budget for future business trends. It allows you to draw on the General Ledger to help you do "what if" analysis to determine how your decisions will affect your company's bottomline.

FOREGRAPH turns FORESIGHT and General Ledger information into charts, graphs and diagrams that communicate complex results in a hard-hitting, convincing way.

FORETAX and FEDTAX draw on data already in the General Ledger to handle all corporate federal income tax compliance and planning. FORETAX also handles all state and municipal income taxes. Their integration with the General Ledger cuts tax preparation time dramatically and helps you take advantage of tax-reducing opportunities that will benefit your company year after year.

UCS support means your business gets better and better.

UCS gives you the initial support to make the transition to The Portfolio a smooth one. And we follow up with continuing support to help you get the most from every system in The Portfolio.

You can rely on UCS for in-depth training, seminars and help with special projects. You can count on a quick, trouble-free installation because every system has been time-tested. And you can count on UCS to keep your Portfolio up-to-date. Our professional staff is constantly working to enhance your systems to keep pace with current accounting and technological advances. So financial management at your company can keep pace too.

THE PORTFOLIO

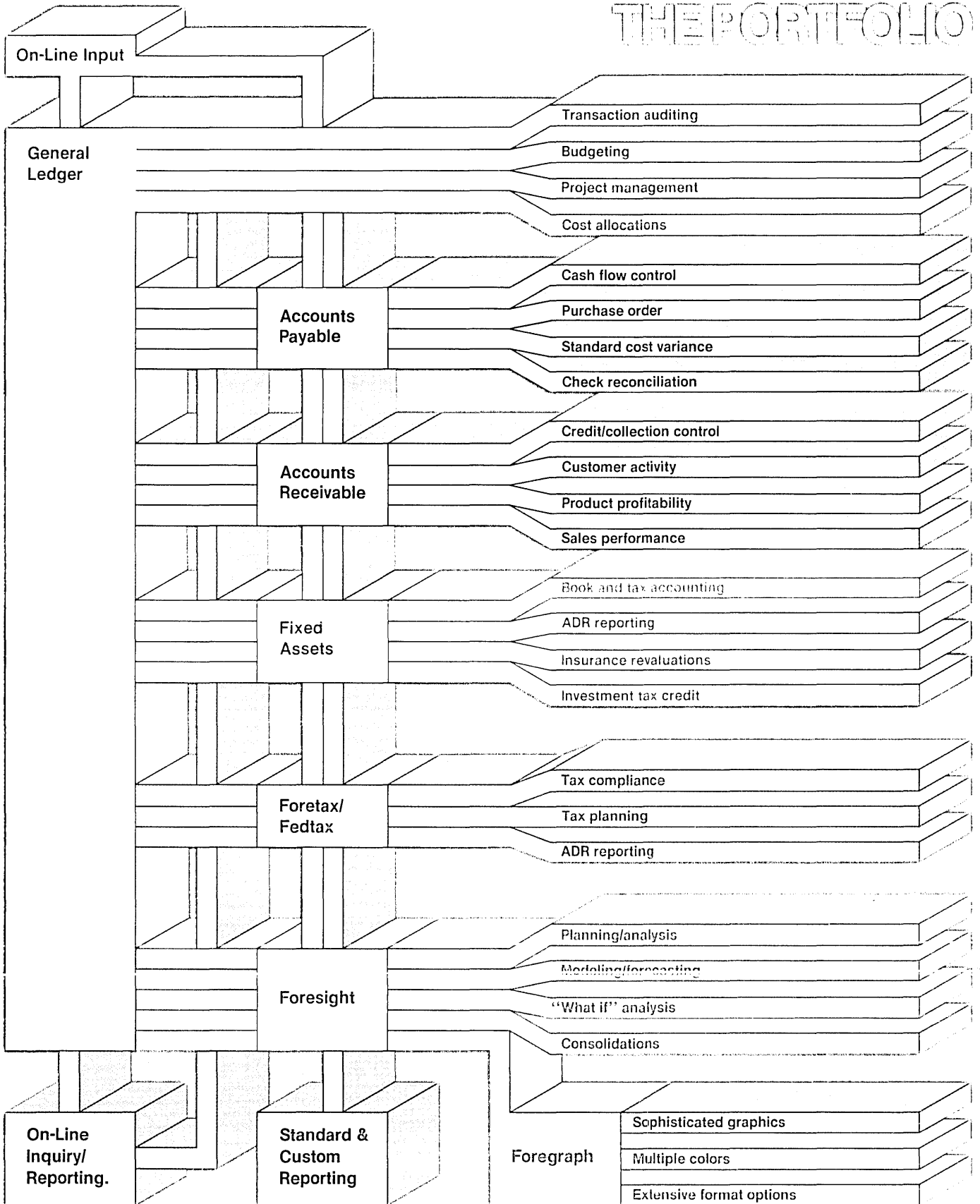

The Portfolio.

The most complete, fully integrated financial information system backed with the most complete support system.

System flexibility to meet your needs.

The best way to get your Portfolio is to have it installed all at once. This gives you the full benefit of its integration capability right from the start.

Or you can build your Portfolio in phases. Since each system in The Portfolio is also designed to work independently, you can start with the systems that your company will benefit most from right now. Then add other systems as your company's budget and workload permit.

But no matter how much or how little of The Portfolio you get now, you'll have the basis for building the most complete financial information system ever available. A Portfolio that will put financial data from every part of your company to work in the most efficient way possible.

No one else can deliver all that.

Continuing support to meet future needs.

Our financial and technical specialists give you the consulting services you need. For fast answers to a particular problem, we have a Hot Line. The experts who take your calls will either solve your problems over the phone or send out the technician who can—even if you need help at your offices in other parts of the country. Because we have consultants in regional offices around the country, you can count on our people for fast response.

Proven performance from an industry leader.

The systems in The Portfolio were among the first ever developed. They have been solving business problems for companies like yours for more than a decade. For hundreds of major corporations in the U.S. and around the world.

Each system is designed for business people. Each is easy to learn and use. Each is fully documented. Each can be used by management—or employees at any level. And each is easy to install and maintain. With little need for technical assistance.

And UCS is a trusted name in computer software. We're a subsidiary of United Telecommunications, Inc., the parent company of the second largest independent telephone company in the nation, United Telephone System. We have a commitment to communications technology. So you can be sure you're getting the best financial management systems the industry has to offer. Available on: IBM OS, IBM DOS, IBM DOS/VSE, Prime, HP 3000, Univac 1100 and Univac 9000 series.

Get the information you need.

Learn all the ways The Portfolio can help your company do business more efficiently and profitably. Return the coupon below for more information. Or call us today.

I want Better financial control.
Send The complete Portfolio brochure
 A sales representative

Name _____ Phone _____

Company _____ Title _____

Address _____

City _____ State _____ Zip _____

Type of hardware _____

Mail to United Computing Systems, Inc., Business Information Products Division, 2525 Washington, Kansas City, MO 64108, ATTN: Director of Marketing, or call (816) 221-9700.

Datamation

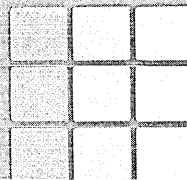

United
Computing
Systems

A United Telecom Company
People, systems and solutions United

LOOSENING THE TELECOM LINK

by Oswald H. Ganley

Canada is probably exceptional in the world community in being the first country to recognize the full range of connections among the various communications and information resources across a spectrum which runs from the print media to films and advertising, to broadcasting, to computers and computer communications, to the telephone and telecommunications systems, to communications satellites, to remote sensing, and to portions of industrial know-how and research and development.

Canada has been first to see and to extensively study the importance of these phenomena to its political processes, its economic policies, and its cultural and legal thinking. It has been first to use the newest of these resources to establish strong communications to remote areas, and to stay in the forefront of new technology developments. And, more than any other country, Canada is now moving increasingly towards a comprehensive communications and information resources policy to guide its domestic and international affairs. Canada's approach to these problems therefore presents a case study of various communications and information questions which we can expect to see cropping up around the world.

A basic attitudinal difference between the U.S. and Canada—indeed between the U.S. and the rest of the industrialized world—has come to light during these investigations which is qualitative in nature. The Canadian government, Western European nations, and Japan, as well as many other developing countries, view the swift changes taking place in the communications and information field as primarily political events. The U.S., on the other hand, has tended to see them largely as technical and commercial problems, which it has plenty of technicians, engineers, businessmen, and capital to solve. And, when the U.S. has seen them as political problems, it has viewed them in isolation rather than as part of a whole. This is, of course, an enormous simplification of both viewpoints, but the basic divergence exists, nevertheless.

Among the most significant commercial and political stakes for the U.S. in the communications and information resources area are those involved in the maintenance of free transborder data flow. The efficiency of U.S. export markets is involved here, as is the principle of free flow of information. Present monetary considerations aside, any unfavorable precedent set with a friendly country like Canada could have worldwide implications.

A problem for both sides is uncertainty over what the future will bring. Businesses are reluctant to make investments when they suspect political or legal roadblocks may be erected. This is especially pertinent in the area of transborder data flow, where Canada, as well as other members of the industrialized world, are threatening to "do something." American businesses, especially the smaller ones, are edgy about getting in over their heads. Canadian businesses are likewise nervous over restrictions that may hamper their trade.

Restrictive trade practices, in any form, are a big U.S. concern in Canada as elsewhere. The American Embassy in Ottawa, commenting on the latest Canadian communications and information study, the so-called *Clyne Report*¹ has said:

"We believe Canadian determination to secure a share of the production and employment to be generated by the information revolution will lead to increasing bilateral confrontation over restrictive trade practices in this area in future years."²

POSSIBLE TRADE BARRIERS

Restrictive practices could take several forms in Canada. Pressure could simply be put on U.S. companies (already happening) to do what Canada wants them to do. Other routes could be through several types of restrictive trade legislation, or nontariff barriers, or invisible restrictions of various kinds. One restrictive device the Canadians are discussing is "buy Canada"

rules that could be employed in government procurement, giving advantages to Canadian companies not available to Canadian-based branches of U.S. companies. Another possible restriction mentioned in the *Clyne Report* is the development of "design standards that will facilitate adoption of Canadian technology" to limit outside technology use. This is the real stuff of nontariff barriers. The same sort of wording is used in the French Nora report,³ where standardization is discussed as a means for "getting at IBM." Dangers to U.S. business are potentially great, both in Canada and around the world.

Furthermore, U.S. business has, in many instances, a stake in maintaining the bulk of its research and development for its Canadian-based branches in centralized U.S. corporate headquarters. The lack of R&D investment in all areas of Canada is one of the country's severest problems. This, the Canadians say, is due in part to a high level of foreign (mainly American) ownership. Pressure is being applied, or being threatened, by Canadians to make U.S. companies do more research and development in Canada. In many cases, U.S. business feels it can accomplish its R&D much more economically or more efficiently at home. The Americans think that if the Canadian government wants R&D performed in Canada, it should give incentive to both domestic and foreign-owned companies to make it financially feasible or attractive. The most important point here is that the U.S. government does not wish to involve itself, even with a friendly country, in the game that it owes other sovereign nations a share of U.S. R&D.

Canada is afraid that unless it can maintain and improve its position in computer communications, in telecommunications, in space technology, and in the general electronics field, it will fall backwards under the onslaught of new discoveries and innovations worldwide. It is not in the U.S.' interest, either globally or bilaterally, to see this happen. The stronger Canada's industrial position is, the more helpful, on balance, it will be to the

1. Canada, Consultative Committee on the Implications of Telecommunications for Canadian Sovereignty, *Telecommunications and Canada (Clyne Report)*, Ottawa, March 1979.

2. American Embassy, Ottawa, "Clyne Report of Telecommunications," Airgram, A-81, April 25, 1979.

3. Nora, Simon and Minc, Alain. *Report on the Computerization of Society*, French Government Printing Office, Paris, 1978.

Pressure is being put on U.S. companies to do what Canada wants them to.

U.S. in international terms. And, bilaterally, Canadian industrial strength promotes a better trading partnership. This is especially true in the communications and information technology area, where much of the U.S. trade future lies.

The major points at issue in the communications and information resources area between the U.S. and Canada lie in computer communications and the problem of transborder data flow, in the publishing industry, in broadcasting, especially by tv but also radio broadcasting by land mobile units, in satellite communications, and in the general area of economic problems, especially those related to industrial research and development.

COUNTING UP THE COST

Canada is among the few countries to have attempted to calculate the cost in terms of balance of payments losses, loss of jobs, and loss of managerial opportunities of having data processed in another country. The Canadians have estimated that imported (primarily from the U.S.) computer communications services costs to Canada will rise to about \$1.5 billion annually by 1985, up from about \$155 million in 1975. They say that about 23,000 directly related jobs will have been lost to the Canadian economy in the process, simultaneously decreasing the need for Canadian middle and upper managerial positions (see Table I).

These figures can be misleading if interpreted to mean that 23,000 jobs will suddenly spring up outside Canada. Because the U.S. may be able to do the job more efficiently, fewer people overall may be needed to accomplish the same work.

There is a good reason why American businesses want to keep their computer communications services headquarters at home, and why Canadian businesses often want to buy theirs abroad: Canadian tariffs and a 12% federal sales tax on equipment, plus higher Canadian than U.S. salaries, make computer services 20% to 25% more expensive in Canada than in the U.S. The economies of scale within the U.S. also operate to make these services less expensive. Canadian businesses have shown that, as in other communications and information areas, they will go where they find the best prices.

One U.S. official, looking at these data, wondered whether, with versatile communications services coming at much lower cost, data processing might become a small fraction of system use, with a growing cost segment in the programming—the labor-intensive—part of the system. This same official suggests that Canada, by building up a highly skilled cadre of computer programmers and by giving incentives to Canadian industries to reconfigure information systems

TABLE I
PROJECTIONS OF LOSSES

	1975	1978	1980	1985
Cost of imported services	\$155M		\$560M	\$1.5B
Proportion of outside services required	30%		41%	52%
Estimated jobs lost	4,400	7,500	11,000	23,000
Percentage of Canadian data processing jobs represented in losses (approximations)	—	6%	8%	14%

4. Adaption from Canada, Computer/Communications Secretariat, *The Growth of Computer/Communications in Canada* (Revised draft), Ottawa, March 1978. These figures include purchased computing service (15%), in-house personnel (45%), in-house c/c equipment (21.5%), other costs (14.5%), and data transmission (4%). The percentages are for 1975.

to distributed networks, might be able to ameliorate a great deal of its economic concerns.

In an effort to retain the processing of data within Canada, two pieces of legislation were introduced by the Canadian Parliament in 1978. The first was a proposed amendment to the Bank Act, which would have prevented banks from processing, storing, or maintaining data regarding corporate and clients' records outside Canada. The other was an amendment to the Combines Investigation Act, devised to enable Canadian government auditors to put their hands on business records regardless of where they are processed or stored. Under this amendment, no data on any business carried out in Canada could have been transmitted, processed, or stored outside Canada without keeping complete descriptions of the data itself, of the forms in which it could be retrieved, and of the access codes in Canada.

Two Canadian parliamentary committee reports reacted quite negatively to the proposed Bank Act amendment. The House of Commons Committee recommended that banks be allowed to process and store data outside Canada provided the inspector general of banks be given details of and guaranteed access to the data, and the Senate Committee recommended that the pertinent section either be deleted entirely, or replaced by a narrower provision.

Despite these two negative reports, the Clyne Committee went beyond the proposed Bank Act Amendment to recommend that the government consider the feasibility of extending its coverage to the insurance and loan industry. The committee reiterated all the fears which have been the subject of numerous official reports, including several that examined social, unity, and cultural identity problems. It also made a number of recommendations for dealing with these perceived dangers.

While various Canadian government officials have been contemplating restrictive

measures to protect Canada, the Canadian computer services industry feels itself capable of competing if left alone, or given a few breaks. Two or three of the largest Canadian companies export from 10% to 20% of their services to the United States, and almost \$10 million worth of processing of American data is done annually in Canada. The Canadian computer services industry altogether does about \$600 million in business a year.

Canadian industry would like to see the business climate in Canada made less expensive and therefore more competitive. It would like to see the tariffs on computer imports removed, making it cheaper for Canadians to buy U.S. or other foreign-made equipment. Some Canadian industry spokesmen decry the government's omnibus approach to restricting transborder data flow, and think the government should concentrate on correcting abuses rather than seeking universal prohibition.

Actual legislation by Canada is not the only threat to unrestricted transborder data flow. Pressure is already being put on several U.S. companies by the Canadian government, using unofficial arm-twisting methods, to establish their data processing facilities in Canada rather than leave them centralized in the U.S. Similar pressures are also being put on companies to maintain existing processing facilities in Canada, even when centralization of operations in the U.S. would be more to those companies' liking.

SETTING PRECEDENTS

For the U.S., the precedential aspects of this question are crucial, since Canada is so far the only country to discuss the possibility of restrictive measures which it openly admits are economic in nature. Elsewhere such threats have been carefully veiled under the general heading of privacy. This is not to say privacy is not a legitimate concern in itself. It is simply not the only or the most important one in the interna-

"Stat Mux"

A Data Mover Product from DCC

Our STAT MUX can *reduce your communications costs* by combining multiple costly circuits into one circuit, and *improve reliability* with error-

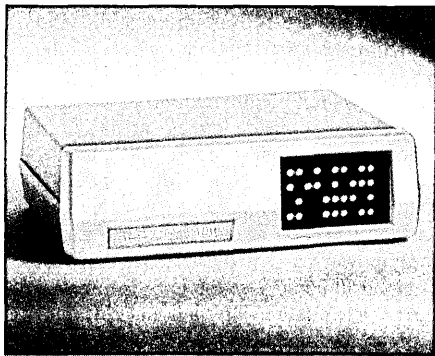

free transmission. DCC's Data Movers currently service major operating U.S. Networks.

The CM-9100 Statistical Multiplexer offers:

- 4 to 32 subscriber lines
- Synchronous or Asynchronous input protocol
- X.25 Level 2 support
- Built-in diagnostics
- Optional High Speed backup lines

- No impact to existing terminals, computers, or software
- Many other standard and optional features

Immediate Delivery!

For further information contact the Data Communications Marketing Department.



Digital Communications Corporation

A **MACOM** Company

11717 Exploration Lane
Germantown, Maryland 20767
(301) 428-5600 TWX 710 828-0541

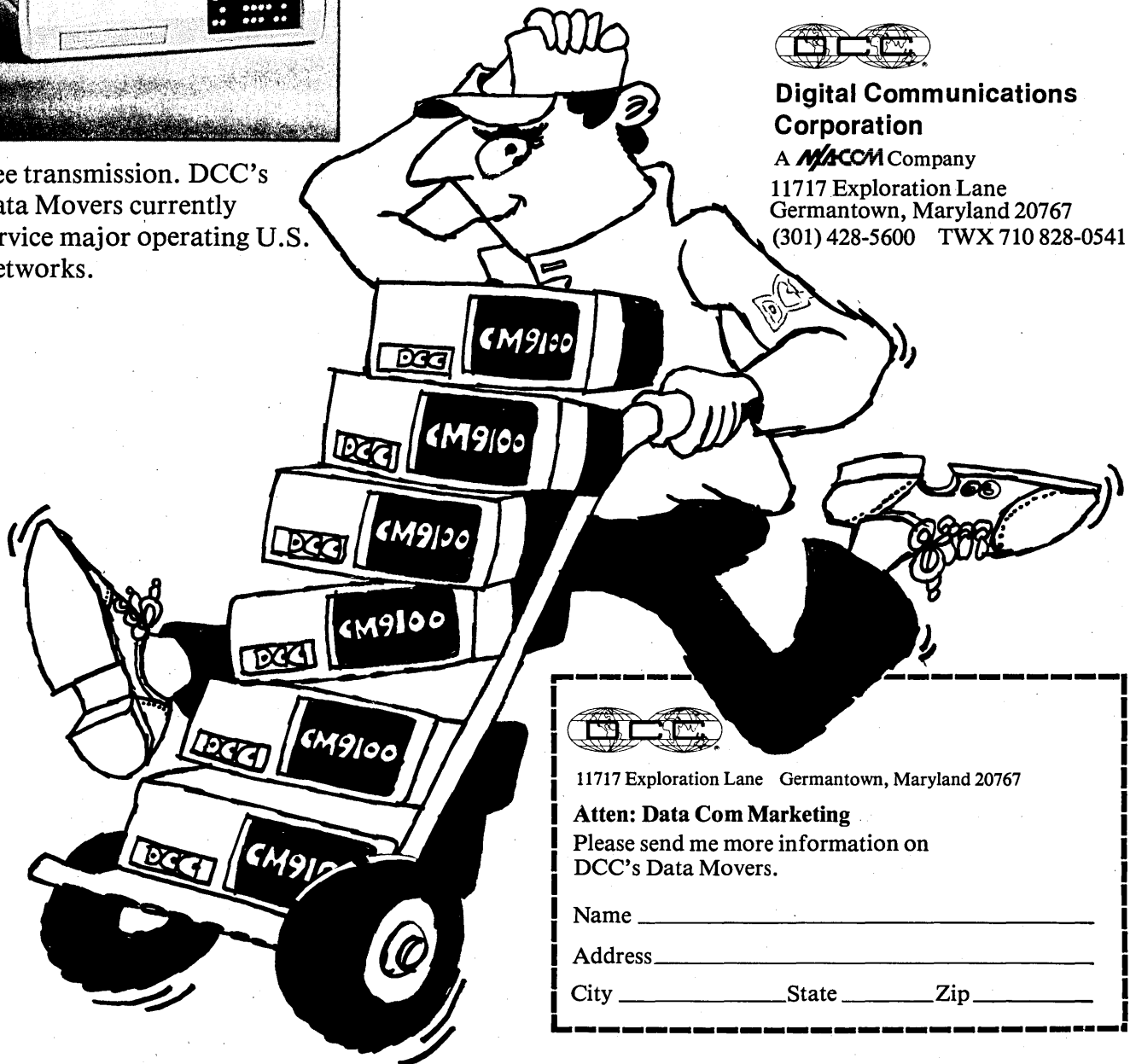

11717 Exploration Lane Germantown, Maryland 20767

Atten: Data Com Marketing

Please send me more information on
DCC's Data Movers.

Name _____

Address _____

City _____ State _____ Zip _____

The Canadian computer services industry feels itself capable of competing if left alone.

tional context, even where it is being touted as being so.

Rapid changes in technology may bring this problem to a head in the early '80s, in Canada as elsewhere, if SBS and other U.S. industry predictions of a domestic U.S. business communications market to exceed \$100 billion by 1985 hold. This would have international implications.

Canada has a sound technological background for approaching these fast moving events. But both its government and industry are deeply, and probably rightly, concerned that this potential economic and technological revolution will sweep over the country, with innovations introduced by foreign branches, or through imports, thereby deepening its dependence on foreign sources, most especially the U.S.

The computer communications area in Canada is a classic instance in which an insufficiently large market, too low an investment in R&D, and prohibitive tariffs and other domestic limitations prevent business from being entirely competitive under free market conditions. Not that the Canadian infrastructure in the computer communications area is not strong. It is just not quite strong enough. And unless it can shore up its position, it could indeed fall backwards rapidly at a time when U.S. and other nations' industries are predicting large gains.

Open, friendly discussions are being held on this subject between the U.S. and Canadian governments, and privately. U.S. and Canadian officials have worked closely in the OECD, where draft guidelines on the transborder transmission of personal data have been drawn up.

An interesting point for the U.S. in the consideration of future policy is that the sentiments voiced by Canadian forces are not confined to Canada. The polite complaints by Canada regarding cultural content, transborder data flow, broadcasting, space allocation, branch economy problems, and so on, are increasingly being voiced in shriller terms by more and more nations around the world. This is easily witnessed in the context of the UNESCO Mass Media Resolution, in the debates of the New International Information Order, on direct broadcasting tv and other issues.

Because of its unique relationship with Canada, the U.S. has the option of continuing to look at such problems on a piecemeal basis, and this has certain advantages. Individual problems can be kept at a low level, and respectability need not be given to what many Americans perceive to be restrictive trade questions.

But whether the U.S. retains the option to continue to do this on a worldwide basis is less than clear. Technically, it is

becoming more and more difficult to separate out single issues as their contexts become increasingly complicated. Canada certainly looks at these issues in an integrated fashion, and other nations are following this trend more and more.

FACE FOREIGN CONCERN

Might it not, then, be in the U.S.' interest to recognize the broader political problems which have been raised and which threaten to be raised by progress in the area of communications and information resources? Might it not be in the U.S.' interest to openly acknowledge the perceived threats felt by other countries of detrimental U.S. dominance in these areas and to set about seeing what to do about them?

Such a recognition within the U.S.-Canadian relationship could present an opportunity to test the waters with a major friendly power on how these issues can best be handled. It could give the U.S. the chance to devise a workable international information policy before this strategic situation is preempted. For, as President Carter's national security advisor, Zbigniew Brzezinski, has said in a recent statement: "... The world is becoming even more closely linked by international communications. We must devote greater attention to opportunities, strains—and even conflicts—which inevitably would arise in the information aspect of our relations.

"Clearly, too, they assume a political dimension. In short, we must elevate the importance of our foreign policy agendas; we must recognize that like trade, agriculture, energy, and other major international issues, information should be recognized as a paramount component of national and international ties."

*

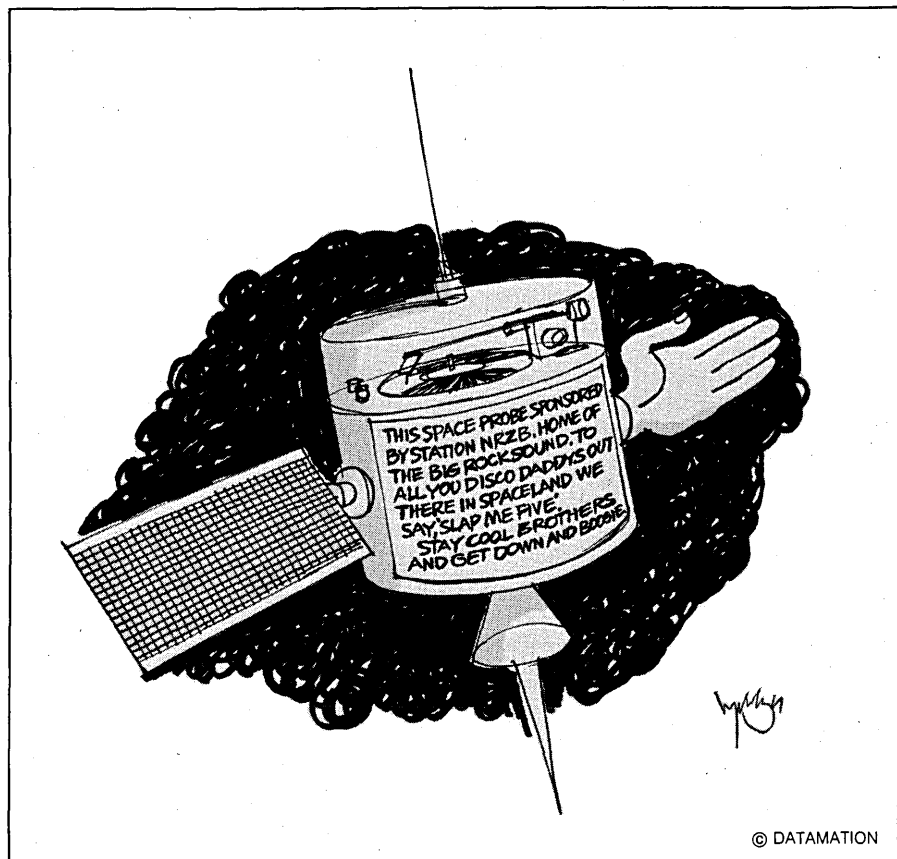

© DATAMATION

OSWALD H. GANLEY



Dr. Ganley is the executive director of International and Allied Arenas at the program for Information Resources Policy with Harvard University. As a former career foreign service officer, he was Deputy Assistant Secretary of State for Science and Technology, Director of the State Department's Office of Soviet and Eastern European Science and Technology Affairs, and Diplomatic Consultant to the President's Science Advisor.

CARTOON BY DAVE HARBAUGH

SUPERIOR

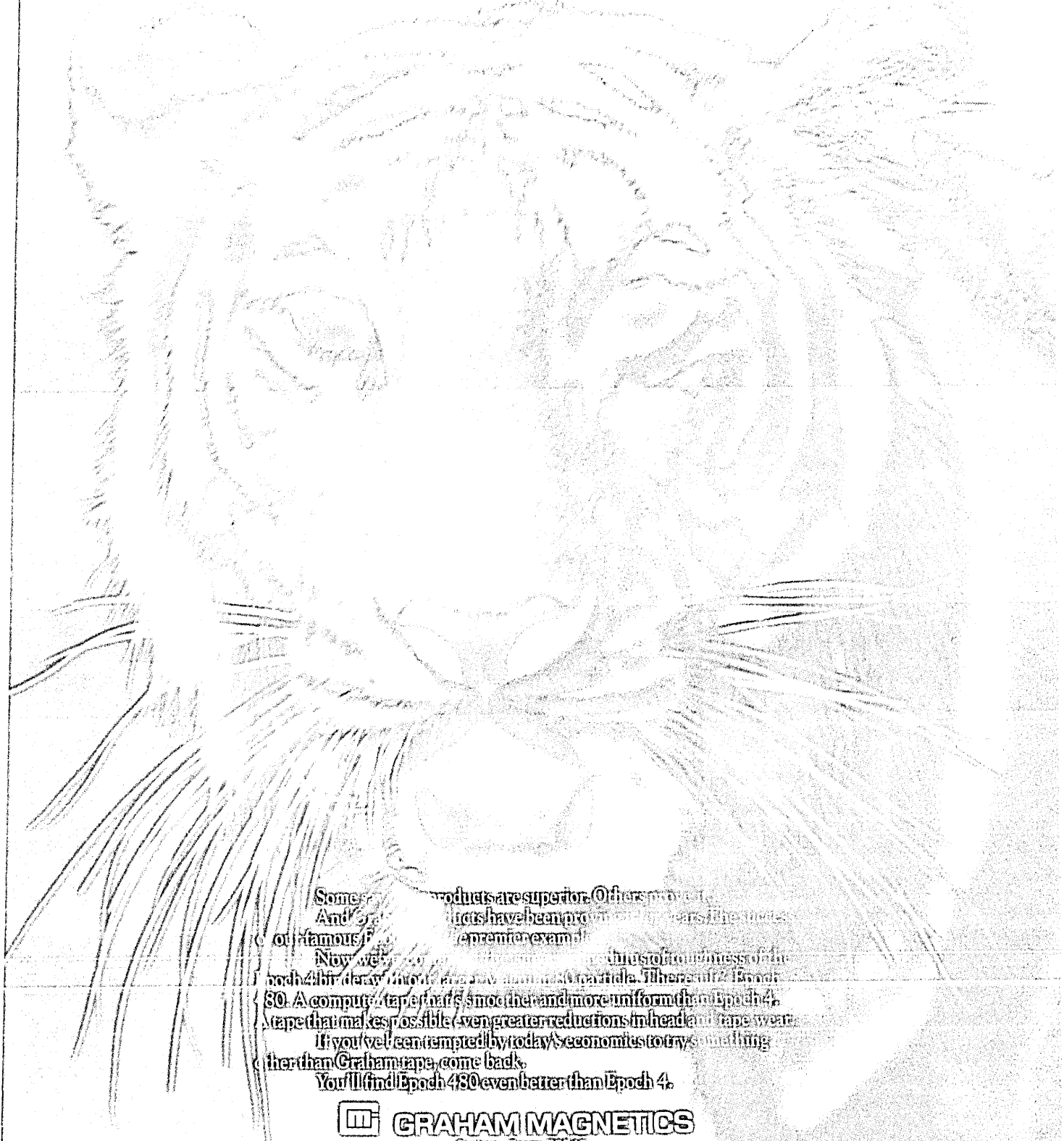

Some products are superior. Others are not.
 And some products have been around for years. Others are new.
 Of famous brands. Of lesser-known brands. Of premium quality.
 Now, you can get the best of both worlds. The best of the
 best. The best of the best. The best of the best. The best of the best.
 Epoch 480. A computer tape that's smoother and more uniform than Epoch 4.
 A tape that makes possible even greater reductions in head and tape wear.
 If you've been tempted by today's economicists to try something
 other than Graham tape, come back.
 You'll find Epoch 480 even better than Epoch 4.

 **GRAHAM MAGNETICS**
 Graham, Texas 75845

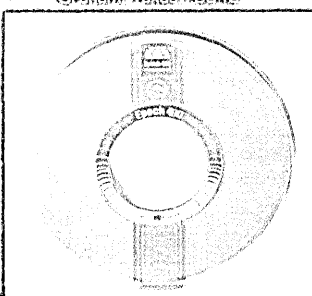

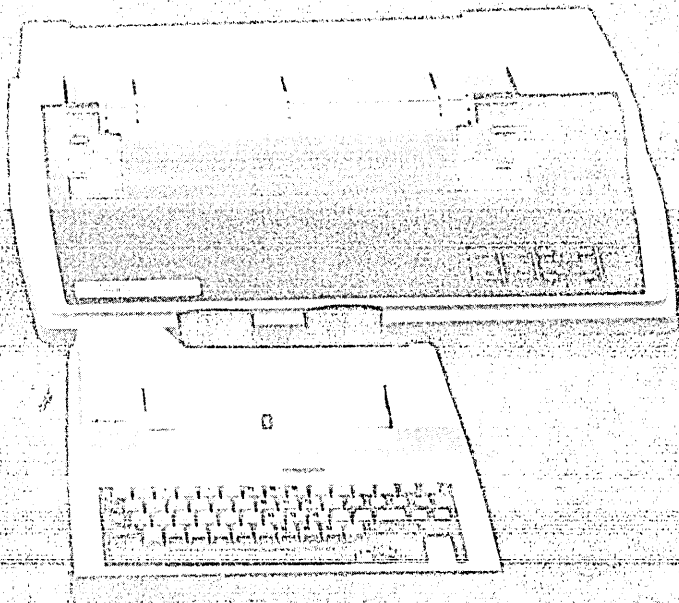
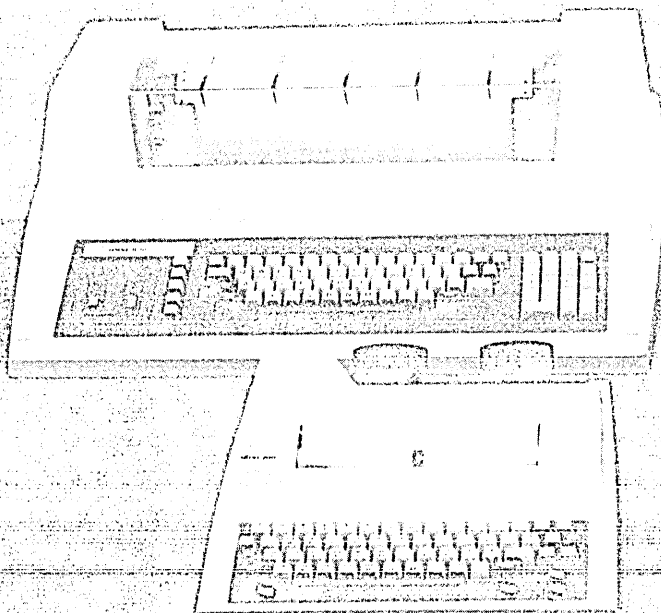

Wait Reduction Centers.

Authorized Distributors of TI Data Terminals are ready to deliver.

For years, TI's *Silent 700** and *OMNI 800** Data Terminal Families have been the industry's choice for reducing costs and improving productivity. Now, you can rely on a nationwide network of Authorized Distributors for immediate off-the-shelf delivery of the TI data terminals you need.

Every model offers cost-saving features and TI's factory warranty to protect your investment after the purchase. And like the TI products they sell, you can depend on the Authorized Distributors for fast, professional response to your data terminal needs.

The *Silent 700* Family models work quietly and quickly, featuring TI's virtually silent thermal printing at either 30 or 120 characters-per-second. Whether you need a Keyboard

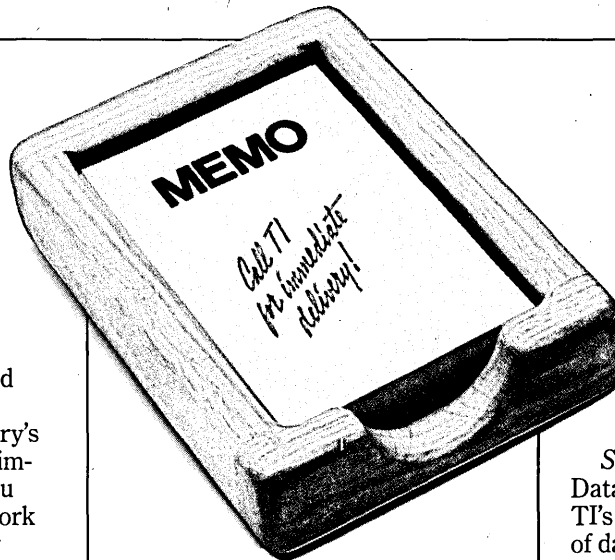

Send-Receive, Memory Send-Receive, Receive-Only or Portable model, each of these data terminals offers high-quality, low-cost data communication features for both on-line and remote location applications.

The *OMNI 800* Family of KSR or RO models is known worldwide for quality performance. Featuring optimized bidirectional printing speeds of either 75 or 150 cps, these field-proven impact data terminals can handle a variety of high-volume printing applications.

TI is dedicated to producing quality, innovative products like the *Silent 700* and *OMNI 800* Data Terminal Families. And, TI's hundreds of thousands of data terminals shipped worldwide are backed by the technology and reliability that come from 50 years of experience.

For more information, contact the Authorized Distributor nearest you, or write Texas Instruments Incorporated, P.O. Box 1444, M/S 7784, Houston, Texas 77001, or phone (713) 937-2016. In Europe, write Texas Instruments, M/S 74, B.P. 5, Villeneuve-Loubet, 06270, France.



AUTHORIZED DISTRIBUTORS—US • AZ: MicroAge • **CA:** Computerland Corp., Consolidated Data Terminals, Data Rentals/Sales, Inc., Data Systems Marketing, Dayton-Forester Associates, Inc., The Systems Store • **CO:** Lewan and Associates • **FL:** Computer and Terminal Exchange • **GA:** Equipment Resources, Inc. • **HI:** Industry Data Services • **IA:** Deeco, Inc. • **KS:** North Supply Company • **MD:** Federal Data Corporation • **MA:** Computrend, Inc. • **MN:** Loonam Associates, Inc., Tele-Terminals, Inc. • **NE:** Centel Communications Company • **NJ:** Data Access Systems, Inc., Leasametric, Transnet Corporation, Westwood Associates, Inc. • **NY:** Arrow Electronics, Inc., MTI Sales Corp., Western New York Computing Systems, Inc. • **OH:** Comtel Instruments Co., Data-Tron, Inc., ESCO Incorporated, Pioneer Standard Electronics • **PA:** C G Distributors • **TN:** NLT Computer Services Corporation • **TX:** Data Applications Corporation, Hall-Mark Electronics Corp., Responsive Terminal Systems, Inc., Tel-tex, Inc., Texas Instruments Supply Company • **UT:** Type-A-Line Business Machine Co. • **VA:** Terminals Unlimited. **CANADA • New Brunswick:** Datamaster Corporation, Limited • **Ontario:** Data Terminal Mart, Hamilton Rentals, Leasametric, Inc. • **Quebec:** Cesco Electronics, Limited.

*Trademarks of Texas Instruments Copyright © 1980, Texas Instruments Incorporated

TEXAS INSTRUMENTS

We put computing within everyone's reach.

CIRCLE 111 ON READER CARD

BARCO CDCT 3 series, a new state-of-the-art standard for color data display

With its CDCT 3 series BARCO introduces a range of color data displays offering visual quality unequalled up to now.

In order to satisfy the variety of applications the CDCT 3 series allows you to choose your color data display exactly to your specific

wishes regarding screen size, CRT type and resolution.

Screen sizes are 37 cm (CDCT 3/37) and 51 cm (CDCT 3/51), both featuring a delta gun shadow mask CRT of the negative black matrix type for optimal contrast.

The CDCT 3/37 model is available with a high resolution tube, while for the CDCT 3/51 a standard (pitch 0.61 mm) or high resolution tube (pitch 0.31 mm) can be chosen.

All models are available in 625 lines/50 Hz, 525 lines/60 Hz, 875 lines/50 Hz and 729 lines/60 Hz.

The BARCO CDCT 3 range features high precision corner convergence, back porch and sync tip clamping and dynamic horizontal focus. Aspect ratio is adjustable to 4/3 or 1/1.

Long persistence phosphors (including LP blue), a hard copy output and a filter enhancing contrast and reducing mirror reflection without loss of resolution are optional.

Full modular circuitry and a convenient frontal pull-out drawer allow easy access for set up and service in the field.

For further details on the BARCO CDCT 3 range of color data displays and other BARCO products call or write today.

In the US: E&O Systems Ltd.,
2998 Scott Blvd., Santa Clara,
CA 95050 - Tel.: (408) 727-1506.

In Canada:
Electro & Optical Systems Ltd.,
31 Progress Court, Scarborough,
Ontario M1G 3V5
Tel.: (416) 439-333.

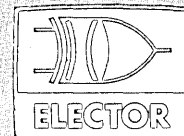

BARCO electronic n.v.
Video Systems Department
Noordlaan 5 B-8720 Kuurne Belgium
Phone 56 35 14 11 - Telex 85 305 barco b

BARCO

CIRCLE 112 ON READER CARD

An active European market in 1979 provided excellent revenues and profits for most of the participating companies —except IBM.

CURRENT TRENDS IN THE EUROPEAN COMPUTER MARKET

by Frank Halpern

The computer industry experienced rapid growth in Europe in 1979 as demand for mainframes, minis, and small business computers was stimulated by new product introductions and pricing changes by most market participants.

The year started out with a bang when IBM announced the 4331 and 4341 on Jan. 30, 1979. This was quickly followed by two models from Burroughs' new 900 Series, the introduction by NCR of four new models in its v-8500 line, and the launching by Siemens of its 7.500 Series. Cii Honeywell Bull responded at the end of March with a new line of medium-scale computer systems called 64/DPS and a new entry-level unit for the 66/DPS line. In June, Sperry Univac introduced the impressive new 1100/60 system which features a multi-microprocessor architecture.

Most minicomputer manufacturers responded to the 4300 announcement by reducing their add-on memory prices, bringing them closer to those offered by IBM. Some processor lines were also enhanced, but relatively few major changes were made as most products were already competitively priced.

As may be seen from the data in Table I, most companies active in the European market had excellent revenue and profit gains in 1979 except for IBM. Nationalistic tendencies and the threat of Japanese penetration have provided a unique and dynamically competitive environment. And while European manufacturers are having a greater impact in selected areas, American multinationals still dominate the market.

There was a shift to more leasing in Europe, just as in the United States, because IBM's customers expected cuts in purchase prices of the 3000 Series to bring the cost per MIPS of these larger machines closer to that of the 4300 models. Prices were reduced last November, which led to increased purchasing and conversions in the month of December. However, these were not sufficient to prevent a decline in profits for the year.

The introduction of the 4331 and 4341 had an even greater impact on IBM's orders than the 3000 Series did when it was announced three years ago, because small- and medium-scale machines account for a larger percentage of IBM's installed base in Europe than in the United States. As a result, bookings of data processing equipment in 1979 were significantly ahead of 1978 and so were shipments.

In 1980, it appears likely that IBM Europe will have higher profits. Shipments should rise in view of the large order backlog. Rental prices of most products have been increased, but purchase prices have been raised more selectively. This should make purchasing more attractive and may lead to more balanced growth between rental and purchased equipment. On the other hand, rising interest rates and persistent rumors about the H Series could have a moderating influence on purchase activity.

Among the array of new products announced in 1979 was the 1750 branch exchange system, a smaller and less costly version of 3750 PBX which has been marketed in Europe since 1972. The 1750 has met with very good demand and there is speculation that IBM may introduce it in the United States this year.

Cii-HB

Cii-HB made significant progress in 1979. Revenues in French francs increased 15% and when translated into dollars they rose 23%. Net income after taxes moved up 10% last year. The more modest increase in earnings is primarily the result of a decline in the subsidy from the French government from 212.5 million francs in 1978 to 110.4 million francs in 1979. The subsidy will drop again this year to only 20 million francs.

Orders jumped 32% in 1979. Demand was strong throughout the product range, with the 64/DPS systems, Level 6 minicomputers and terminals doing exceptionally well. Computer shipments rose about 20% during the year and the increase could have

been greater were it not for the limited availability of certain components.

Shortages of components continue to be a problem this year and are causing computer delivery times to be extended. This will probably hold back the growth of shipments and revenues in 1980. Additionally, rising interest rates may lead to more leasing on the part of customers. Product prices have been increased recently by about 6% in France and by varying amounts in other countries to offset inflationary pressures.

It is estimated that Cii-HB has about 25% to 30% of the installed value of general-purpose computers in France and a 10% to 12% share of the European market. While French government business is important to Cii-HB, its significance should not be exaggerated. Revenue derived from all Western European government agencies accounted for 16% of total 1979 revenues. If business done with government-controlled companies was included, the combined volume might amount to 25% of revenues. Consolidated revenue from customers outside France represented 47% of total turnover in 1979.

ICL

ICL recorded a 29% increase in fiscal 1979 earnings on a 23% gain in worldwide turnover. The U.K., which accounted for 53% of ICL's total volume, was the highest growth area with revenues 31% ahead of 1978. The rest of Europe was not far behind with a 28% increase in billings, which represented 27% of the company's revenues. Growth in other geographic regions was slower in local currency terms and essentially flat when translated into sterling because of the appreciation of the pound.

New product introductions included several additional models in the 2900 Series. The most notable was the 2982, which offers twice the price performance of previous large systems from ICL. In March 1980, the company launched the ME 29 as a replacement for its popular 2903 and 2904 systems. Offering an average price-performance improvement of

Nationalistic tendencies and the threat of Japanese penetration have provided a dynamically competitive environment.

67% over comparable 2903 and 2904 computers and featuring ease of use, the ME 29 should have considerable appeal as an upgrade for the more than three thousand 2903/2904 systems presently in use.

Despite prospects of slowing economies in most countries served by ICL, orders in the initial months of 1980 have remained buoyant and the lease-purchase ratio on shipments has been fairly stable. This would suggest that ICL's financial performance in 1980 should be good.

SIEMENS Siemens' computer group had highly favorable results last year. Revenues increased 22% to 1.6 billion marks and orders rose 25% to 2 billion marks. The group also moved further into the black in 1979 after achieving profitability for the first time in 1978.

Demand for the new 7.500 Series has been good, with some 500 systems ordered during the most recent fiscal year. The agreement to market Fujitsu's IBM-compatible M-180 and M-200 was finalized last year, but only a couple of systems were installed under the Siemens label. Nevertheless, management is optimistic about the prospects for these two large-scale computers.

Siemens' nonimpact laser printer has been quite successful. Some 260 of these printers were shipped last year, including units sold to Univac and Fujitsu on an oem basis.

Siemens' share of the West German data processing market has been growing steadily in recent years. Presently it accounts for about 21% of the domestic general-purpose computer market and it has an estimated 9% share of the Western European general-purpose market.

Business continued to be strong in the first three months of the fiscal year. Significant growth is occurring in the small business computer market, but this is from a much lower revenue base than Siemens' general data processing product line and the small computer division is still operating at a loss.

NCR Revenues from NCR's European operations increased 20% last year and accounted for 28% of total turnover. Operating profits of NCR Europe rose 15.5%. Good growth was experienced in point of sales systems, financial terminals and data processing systems. The new 8500 models have been well received and the 8200 family of small business computers continues to be in strong demand.

During the past four years NCR has named new country managers in 12 of 13 countries in the European region. The new leadership seems to have revitalized the company's marketing and support organization in Europe. As a result of these measures,

TABLE I
FINANCIAL PERFORMANCE OF SELECTED COMPUTER COMPANIES IN THE EUROPEAN MARKET

(\$ Millions)

	Customer Revenues			Profits			Fiscal Year
	1977	1978	1979	1977	1978	1979	Ends
IBM (a)	\$6,391	\$7,778	\$8,837	\$889	\$1,124	\$1,082	12/31
Cii HB (b)	764	990	1,215	36	47	52	12/31
ICL (c)	700	839	1,092	40	58	75	9/30
Siemens (d)	705	745	911	*	*	*	9/30
NCR (e)	593	716	859	51	84	97	12/31
Univac (f)	500	540	710	*	*	*	3/31
Burroughs (g)	413	506	646	72	101	154	12/31
Control Data (h)	349	446	550	22	52	61	12/31
Digital Equip. (i)	250	377	486	*	28	50	6/30
Amdahl (j)	15	55	123	*	7	12	12/31

(a) IBM revenues include Europe, Middle East and Africa. Profits are after interest and taxes.

(b) About 4% of Cii-HB turnover is outside Europe. Profits are after interest and taxes.

(c) ICL revenues are for Europe only. Profits include other regions and are after interest and taxes.

(d) Less than 5% of Siemens turnover is outside Europe.

(e) NCR figures are for Europe only. Profits are before taxes, non-allocable interest and general corporate expenses.

(f) Univac revenues include Europe, Middle East, Africa and Australia (except for Japan).

(g) Burroughs revenues include Europe, Middle East and Africa. Profits are before taxes, interest and general corporate expenses.

(h) Control Data revenues are for Europe only. Profits are before taxes and interest.

(i) Digital Equipment revenues include Europe, Middle East, Africa. Profits are before taxes, interest income and interest expenses.

(j) Amdahl's European profits are before taxes and interest.

(*) Not available.

TABLE II
SPERRY UNIVAC INSTALLED BASE, REVENUES, AND PROFITS

(\$ Millions)

Years Ended March 31	International Division (1)		Univac Worldwide		
	Installed Base	Revenues	Installed Base	Revenues	Pretax Profit (2)
1974	\$1,198	\$315	\$ 5,510	\$1,123	\$ 99.8
1975	1,430	405	6,370	1,294	102.3
1976	1,772	480	7,390	1,433	132.0
1977	2,028	500	8,080	1,467	135.3
1978	2,347	540	9,129	1,726	170.1
1979	2,782	710	10,293	2,050	199.0

Compound Growth Rate

1974-79	18.4%	17.6%	13.3%	12.8%	14.8%
---------	-------	-------	-------	-------	-------

(1) Estimates of Martin Simpson & Company, Inc.

(2) Pretax profits do not include foreign exchange gains or losses, equity in less than 50%-owned companies and certain general corporate expenses.

TABLE III
AMDAHL INSTALLED COMPUTER BASE

(Units)

Date	North America	Europe	Cumulative Installed	Net Annual Installations
12/31/75	6	0	6	6
12/31/76	32	1	33	27
12/31/77	87	3	90	57
12/31/78	160	20	180	90
12/31/79	245	45	290	110

Source: Estimates of Martin Simpson & Company, Inc.



OUR AUTOMATIC SAVINGS PLAN.

Plugging in our line of interface-compatible terminals can automatically reduce your terminal budget — by as much as 50%. And nowadays, that's like money in the bank.

General Terminal Corporation offers models that are teletype-compatible as well as terminals that are interface-compatible with DEC, Burroughs and NCR computers. And GTC offers models that emulate other major terminals, too. All for less.

And because GTC is the only major terminal manufacturer with production facilities on both U.S. coasts, we can

deliver what you want, where you want, when you want.

More for less, automatically. That's what happens when you push the right button.

For more information on GTC products and services, call toll-free today. In California: 800-432-7006. Anywhere else in the United States: 800-854-6781. Ask for Georgia Sand. Or write Georgia Sand at General Terminal Corporation, 14831 Franklin Avenue, Tustin, CA 92680. Telex: 910-595-2428. We have offices throughout the world. In Canada, contact Lanpar Ltd., 85 Torbay Road, Markham, Ontario L3R. Phone: 416-495-9123.

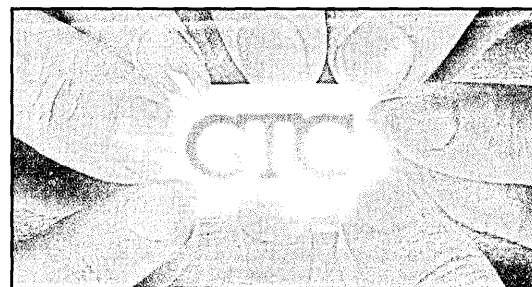

The right button to push.™
General Terminal Corporation

CIRCLE 113 ON READER CARD

Western Europe continues to be a dynamic, rapidly growing market for dp equipment, software, and services.

as well as an attractive product line, the region has achieved above-average growth between 1977 and 1979.

Last July, NCR also restructured its European operations to increase the resources available to smaller countries and established four subregions: Benelux (headquartered in Holland and including Belgium and Luxembourg); Iberia (headquartered in Spain and including Portugal); Scandinavia (headquartered in Denmark and including Finland, Norway and Sweden); and Southern Europe (headquartered in Switzerland and including Austria and Italy). Under this reorganization, the headquarters country manager assumes the additional responsibilities of regional manager. Organizations in other countries were not affected by the change.

SPERRY UNIVAC

Univac's International Division is responsible for marketing the company's computer products in all geographic regions except North and South America and Japan. The division accounted for about 35% of Univac's worldwide revenues and for approximately 77% of its foreign revenues in fiscal 1979. Growth has been quite rapid during the past five years as may be seen from the data included in Table II.

During the past five years, the International Division's installed base has at least doubled in all areas except for Germany and France. Not coincidentally, the governments of both countries have given preferential treatment and financial support to indigenous computer suppliers. On the other hand, Univac's joint venture with Saab in Scandinavian countries has boosted Univac's image as a local supplier, resulting in considerable government business at the expense of IBM. Saab Scania owns 51% of Saab Univac AB, with Sperry owning the remaining 49%. Spain has been a particularly lucrative market for Univac, with large contracts from Iberia Airlines and key banks contributing to the growth of the business. Above average installed-base gains have also occurred in Switzerland, The Netherlands, Australia, Belgium, South Africa, southeast Asia, and the Middle East.

The 1100 Series of large systems has been the driving force behind Univac's growth in Europe and it is estimated that around 350 systems were in use as of March 31, 1979. The smaller Series 90 OS/3 systems (90/25, 90/30 and 90/40) have also proven to be quite successful, with over 1,000 units installed by the International Division. On the other hand, the Series 90 vs/9 base (90/60, 90/70, 90/80) is relatively small in Europe.

The International Division's business in the first nine months of the current fiscal year has been very good, with bookings up approximately 25% and revenues about 20% ahead of last year. Orders for Univac's new-

est system, the 1100/60, are above plan, and a good number are new name accounts.

AMDAHL

Amdahl's computer population in Europe was approximately 45 machines at the end of 1979, up from about 20 computers installed at the end of 1978. Half of these units are located in Region I, which consists of the United Kingdom, Ireland, the Benelux, and Scandinavian countries. The U.K., with 15 systems installed, has the largest number of Amdahl machines in Europe, closely followed by Germany.

A comparison of Amdahl's European base with that in North America is shown in Table III.

Amdahl's success in penetrating the IBM market can be traced to a 25% to 35% price-performance advantage, compatibility with IBM's operating systems, a quick delivery capability and the use of air cooling as opposed to the liquid cooling employed in IBM's large systems.

Amdahl has been able to temporarily leapfrog IBM by using advanced components and circuit designs. However, technological advantages usually do not last very long in the computer industry. It is generally expected that IBM will be introducing its new generation of large systems in 1981. Amdahl is also working to improve its product line, but even if its technological advantage can be retained, it will probably be considerably smaller than the present one.

TANDEM COMPUTERS

The European market has been important to Tandem from its inception. In the fiscal year ended Sept. 30, 1979, the German subsidiary contributed \$10 million to Tandem's total revenues of \$55 million. This market is more manufacturing than financially oriented, and 45 systems, composed of 120 processors, have been installed to a base of 28 customers within the country.

Tandem's United Kingdom subsidiary was established in 1978 and revenues in its first year of operation totalled \$3 million. Nine systems have been installed with six customers, including the British government.

Tandem is the only manufacturer to offer a "fail-safe" computer at the price-performance level of a single processor system. Nonetheless, the vastly improved reliability of traditional computer hardware provides stiff competition for Tandem.

From a customer standpoint, banks and other financial institutions represent the single largest category for Tandem, followed by manufacturers and service bureaus. The communication sector is also important. Tandem's revenues and profits are expected to increase significantly in 1980, with Europe

again making an important contribution.

Among the other computer manufacturers, Burroughs, Control Data, and Digital Equipment all experienced substantial growth in Europe last year. Burroughs benefited from a high level of shipments and the strength of the European currencies relative to the dollar. Similar factors also favorably affected the financial results of Digital Equipment and Control Data.

Digital's product mix in the international marketplace is more heavily oriented to the oem sector, which has been very strong. Moreover, end-user sales have also been rising rapidly. The best markets have been Germany, Great Britain, France and the Benelux countries.

Western Europe continues to represent a dynamic and rapidly growing market for data processing equipment, software, and services. Competition is keen. Besides the traditional American manufacturers of mini-computers, systems and peripherals, Cii-Honeywell Bull, ICL, Siemens, and Nixdorf are major factors in their local markets, where they get considerable support and preferences from their respective governments. The Japanese have also entered the fray. Fujitsu is now supplying Siemens' large computer equipment needs, and Hitachi has recently reached a marketing agreement with Olivetti to supply the Italian company with some of their computers.

While the long-term outlook for the data processing industry appears favorable, near-term prospects are clouded by slower economic growth in Europe, rising interest rates, and high inflation. Nevertheless, significant pressures to increase productivity of businesses by better control of major operating elements tends to reinforce the basic demand for computers. In the early months of 1980, this underlying force sustained a high level of orders and shipments. *

FRANK HALPERN



Mr. Halpern is a vice president of Martin Simpson & Company Inc., and has covered the computer industry as a financial analyst for more than 15 years. Prior to joining Martin Simpson & Co. in 1974, he had been associated with First Manhattan Co., Lazard Freres & Co. and Schroder Naess & Thomas. He received his BA in accounting and his MA in economics from the University of Michigan.

If your company asks you to recommend a financial planning and modeling system, tear out this page. Instead of your hair.

With more than 50 financial modeling systems on the market today, having to choose one can be confusing, at best. On the surface most of these systems look alike. But that's where the similarity stops.

More Than a Modeling Language.

FCS-EPS is a comprehensive planning, modeling and information management software package that provides the user with a totally integrated system. Features include over 100 Precoded Functions, Database Management, Forecasting and Econometrics, Sensitivity and Risk Analysis, Color Graphics, External File Interface, Full Programming and Prompting Capabilities, and Worldwide Support.

FCS adds to this list a host of features not found in other systems. For example, our line-by-line compiler, our file librarian, or our powerful hierarchical consolidation with a single 3-dimensional database file that includes automatic currency conversion, inflation scenarios, cost allocation and cross sectional reporting, and more.

Why Take a Chance?

FCS is a system you can recommend with confidence. Confidence in knowing users will not be frustrated with a tool they may outgrow in six months.

But don't take our word for it, get the facts. Send for our free publication, "Selecting and Evaluating Financial Modeling Systems", which includes a check list of features you should look for in a state-of-the-art system. Use it to compare FCS with your company's requirements and other modeling packages.

We think the facts will speak for themselves. And FCS.

FCS-EPS IS AVAILABLE ON A WORLDWIDE BASIS.



NORTH AMERICA:
Evaluation & Planning Systems
1 Penn Plaza #1908
New York, New York 10001
(212) 563-5656

EUROPE:
EPS Consultants
35 Soho Square
London W1V 5DG
(01) 439-8221

Chicago 312/823-8622
Houston 713/771-0618
San Francisco 408/272-7222
Toronto 416/792-3140

Basel 061/272-772
Brussels 32/2344-8484
Cologne 49/221-694422
Rotterdam 31/1890-4108

CIRCLE 114 ON READER CARD

ore
re
m-
arn
logic
uate
by
0
on by
community
ising lan-
d support.
o-learn.
es

STC's Disk Subsystems turn capacity problems into

When you choose STC high-performance disk subsystems, you get all the increased capacity you need, without the problems you don't need. Many of today's high-performance disk subsystems can provide you with greatly increased capacity. But, if this data cannot be accessed when required by your CPU, overall system performance suffers. STC eliminates these problems by offering disk drives which not only deliver high capacity, they incorporate architectural features designed to provide you with enhanced system performance.

Consider the 8650 high capacity disk drive where, for even more responsiveness to your configuration and up-time needs, we offer three powerful enhancements. One provides you with a choice of mapping options for greater flexibility in data set placement and subsystem tuning. Another, STC's optional Media Interchange Switch, reduces the period of time data is inaccessible during hardware outages. Then there is STC's Dual Port feature, which substantially increases both per-

formance and data availability.

Or take STC's 8360 High Performance Disk Drive which combines 18ms access speed with Dual Port to make your subsystem the fastest available today.

Mapping your way to higher performance.

STC's optional volume-interleave mapping places the logical cylinders of primary and secondary volumes onto alternating physical cylinders. This approach greatly simplifies migration, tuning and management, since the high activity data sets of each volume will fall on adjacent tracks — minimizing intervolum seek contention.

Thanks to the high-speed servo, seek times will be better than those offered by single density spindles.

Given these attributes, volume-interleaved 8650 spindles are ideally

suited for the majority of user DASD storage such as tape file automation, mass storage applications, on-line systems, and low-to-moderate activity data.

STC's back-to-back mapping consolidates the logical volumes in two, separate regions. This approach takes maximum advantage of the dense track spacing and high-speed servo to slash intravolume seek to a mere 18 msec, average.

With these characteristics, back-to-back mapped 8650 spindles are best

Average seek time is 23 MSEC for either volume.

Volume interleaved mapping alternates cylinders of primary and secondary logical volumes to minimize arm contention.

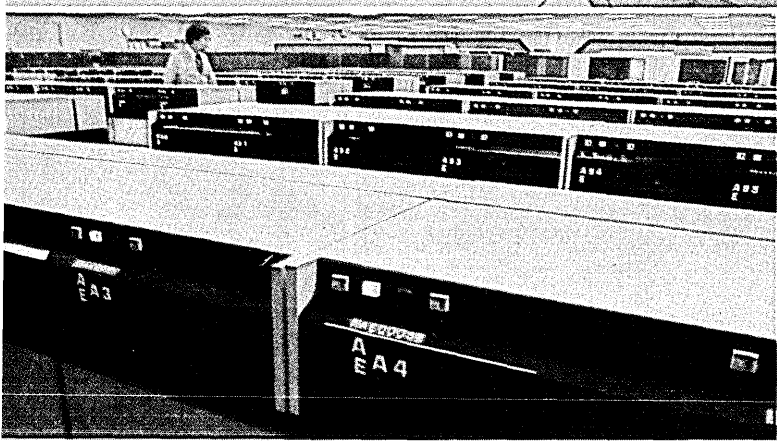

performance opportunities.

for special applications which can be closely scheduled and managed. For example, use the primary volume for TSO catalogs and TCAM queues with high prime-shift activity, while allocating the secondary volume to batch data sets run second or third shift.

The Media Interchange Switch: Portable fixed media.

Industry-wide statistics show that most problems occur in the drive electronics, not in the HDA. STC's new Media Interchange Switch (MICS)

reduces the impact of electronics-related problems by cross-connecting the HDA of spindle A with the electronics of spindle B (or vice versa). This means that if one spindle goes down, you can access your data through the companion spindle's electronics.

Or you can reserve one or more of your secondary logical volumes as a low-cost subsystem spare, and let MICS give you data portability that approaches that of the old disk pack in convenience.

More paths for your data.

STC's Dual Port option provides path redundancy and improves accessibility. It permits your CPU to access data from any two spindles simultaneously,

regardless of their location. This produces a data availability factor of 94% and virtually eliminates disk subsystem single point failures.

Technology. And the skill to apply it.

Backing up your STC disk subsystem performance are the uncompromising STC Systems Engineers. Using software tools, they'll examine your SMF data and assist you in placing data across channels, strings and volumes for maximum results on your job mix. Once your subsystem is up and running, they'll continue to provide ongoing consultation to ensure your long-term satisfaction.

Turn problems into opportunities.

STC's 8650 and 8360 are available for immediate delivery. For more information, including our Mapping and MICS Data Sheets, contact your local STC sales office. Or write: Storage Technology Corporation, 2270 S. 88th Street, Louisville, CO 80027. Phone (303) 673-5151.

Media Interchange Switch lets you recover data quickly in the event of hardware failure.

Back-to-back mapping places logical volumes in two contiguous regions.

Each spindle stores 635 Mbytes in two logical volumes, or 1270 Mbytes per unit.

Average intra volume seek time is 18 msec.

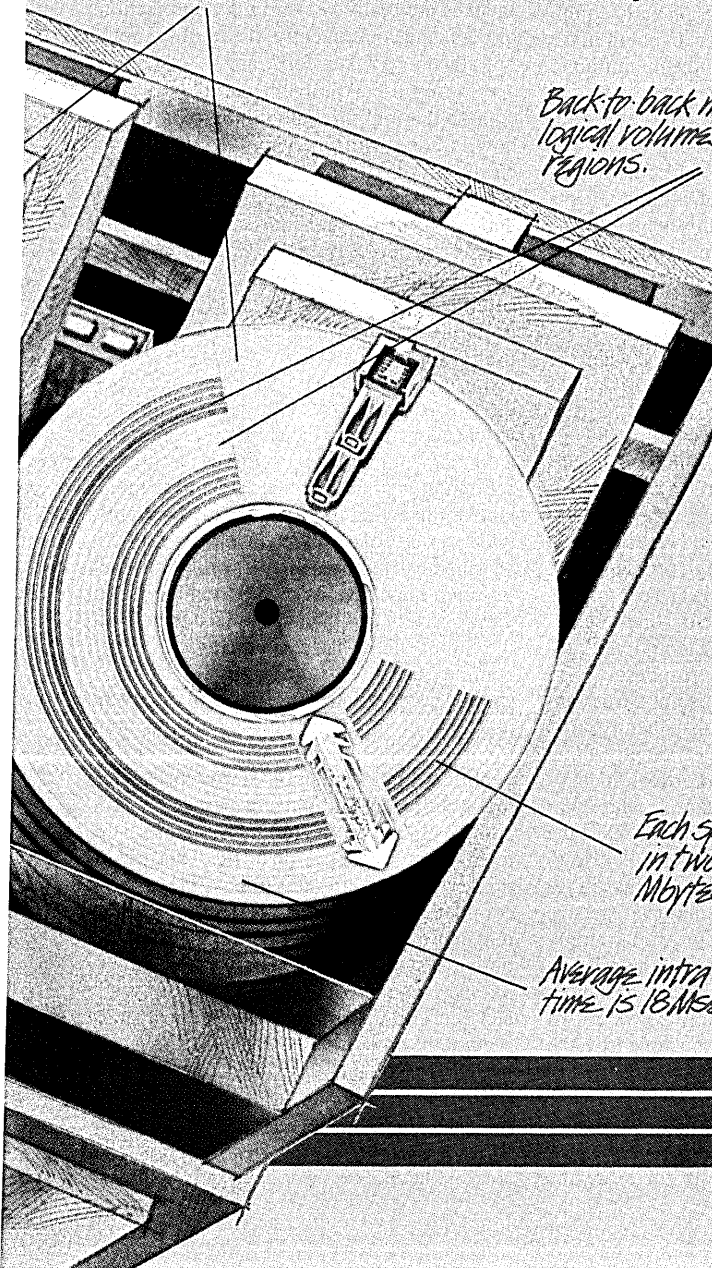
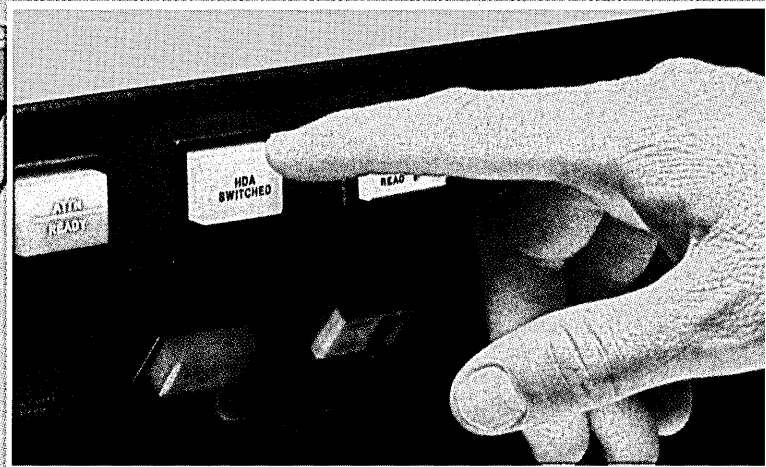

**STORAGE
TECHNOLOGY
CORPORATION**

Fulfilling the promise of technology.

CIRCLE 115 ON READER CARD

The Content Addressable File Store uses parallel processing techniques so multiple search jobs can be performed concurrently at very high rates.

RETRIEVING INFORMATION

by V. A. J. Maller

The use of functionally specialized hardware to augment the performance of general purpose information systems has attracted increasing attention in recent years with the advance of semiconductor technology. This is particularly true in the case of information retrieval and data management. Although there is a rich variety of opinions on the attributes of functionally specialized hardware, there is general agreement that there is more potential in its use than in making further improvements in software.

The underlying motive behind these developments arises from a realization that conventional systems, based on the classical von Neumann processing concepts, are unable to meet efficiently and effectively the growing expectations of users for increased performance and more comprehensive facilities.

In the past, the aim of systems engineers was to develop general purpose cpus and to rely on software to make these machines ephemerally specific to a particular job. The level of achieved performance was then largely determined by a combination of software ingenuity and raw cpu power. The technological virtuosity displayed by the semiconductor industry in recent years, however, has changed the perspective of systems designers dramatically and has enabled concepts to be realized cost effectively that hitherto have been impractical, if not impossible. This newfound freedom, with a more mature appreciation of the capabilities of information engineering, heralds radical changes in well-established practice.

The development of the Content Addressable File Store as an aid to information retrieval represents one such concept.

Storage devices with content addressable or associative properties have been discussed for many years, but although their utility has been acknowledged, the technology to provide a device of more than trivial size has been lacking. In all cases, the objective has been to construct a store that may be accessed directly by using the intrinsic properties of the data items themselves as keys, rather than relying on some explicit referencing structure.

The concept therefore is not new. Indeed, the requirement for such devices arises

from the observation that from the beginning much data processing has been concerned with extracting relevant information from files by using single or multiple key matching. This method of file searching is so taken for granted that often it is not appreciated that it is content addressing. Moreover, in many installations the majority of available machine time is used in serial searching of one form or another.

To execute such tasks on early equipment, it was necessary that each record in the target file be brought into the mainframe, tested for relevance, and then either discarded or processed in some way to an output file. Such operations are inefficient because the real activity on a file in any particular run is determined by the number of external events since the previous run, and this is likely to be low. Indeed, in many applications, "hit rates" on files may not exceed 1% of the records present.

NEW INDEX SCHEMES

During the period when the magnetic tape drive was the only effective form of backing storage, such inefficiencies were tolerated as if they were part of the natural order. With the advent of the moving arm disk file indexing schemes were developed that, it was hoped, would ensure that only records having a high probability of relevance would be retrieved. The use of such schemes was mandatory for on-line interactive working where high selectivity of retrieved data and rapid response were required. A disk, however, is not a true random access device, and, consequently, it is only possible to index a file efficiently along one access dimension. Moreover, indexes can possess immense nuisance value. For simple index sequential and random files, the overheads in most cases are acceptable. However, as soon as secondary data items are required as keys, the number and average size of the indexes may begin to grow alarmingly as the volume and complexity of the primary data increase. There are, in fact, instances where the indexes can occupy between two and four times the volume occupied by the data to which they refer—a perfectly absurd situation.

There are two kinds of difficulties with indexes. First there is the sheer manipulation required, and secondly there are the

complexities of maintenance. Updating of primary data may spawn multiple update tasks which may involve substantial processing and be a crippling overhead in a real-time environment. Also, it should not be assumed that indexable operations cover the totality of useful functions; for example, they are of no value in situations where the *relationship* between two or more data items within the same record constitutes a selection criterion. Indexes are really very primitive projections of files, and consequently, their utility should not always be taken for granted.

A further problem particularly relevant to the real-time environment is that of how to cope with queries containing imprecisely defined search arguments. Such queries often have the term *fuzzy matching* applied to them, and indeed this endearing expression arose from a recognition of the human genius for imprecision.* An efficient solution to this problem is clearly vital if acceptability of information systems to the lay user is to be achieved.

So far data bases have not been discussed. Although there are various views as to what constitutes a data base, there is general agreement that the term implies a coherent set of data that is of greater generality than a simple file and, moreover, can be shared by a wide variety of application programs. This sharing of data raises another problem. Each program may have its own particular logical view of the data which has to be mapped into the stored data. These mappings are often complex because of the impossibility of designing a storage structure that will satisfy the diverse requirements of different application programs. The consequences of this for conventional implementation are often to interlock the logical and physical structures with complex indexing and linking systems, thereby making reorganization difficult and evolutionary growth virtually impossible without complete recompilation. Nevertheless, current data base techniques permit the construction of systems that can satisfy a wide variety of operational requirements for both batch and real-time working where these can be accurately predefined.

These techniques are much less efficient when it comes to handling *ad hoc*

*In this context "fuzzy matching" is being used loosely and not in the strictly technical sense of fuzzy set theory.

THE ULTIMATE REFINEMENT. PL/I FOR YOUR MICRO.

IBM's told us about PL/I for years. Now, we're telling them something.

PL/I Subset G. Newly designed expressly for minicomputers by an ANSI committee of PL/I experts. All the best application programming features, refined to match contemporary programming practices.

PL/I-80™ for Microcomputers. Based on Subset G, PL/I-80 runs under our CP/M® and MP/M™ operating systems.

PL/I-80 Means Performance. In an independent benchmark, PL/I-80 was tested against 34 other high-level languages for 8-bit processors, and came out on top. *

PL/I-80 versus the best of several languages:

PL/I-80	1.00
FORTRAN	1.21
BASIC COMPILER	1.71
PL/M	1.71
PASCAL COMPILER	1.89
PASCAL INTERPRETER	17.07
BASIC INTERPRETER	34.57

* Execution time ratio, Eratosthenes Sieve

Subset G is a brand new language with a new following. DEC®, Data General, and Prime now support it, and the list is growing. There's no better way to protect your software investment.

PL/I-80 from Digital Research. Fast. Economical. Refined. With the programming power of minicomputer PL/I. The package includes compiler, run-time library, linkage editor and relocating macro-assembler, plus three comprehensive manuals. All for only \$500.

(Domestic USA price only)

Interested in Refinement?

Call or write Digital Research. Experts in refinement.

 **DIGITAL RESEARCH®**

P.O. Box 579
801 Lighthouse Avenue
Pacific Grove, CA 93950
408-649-3896
TWX 910 360 5001



CIRCLE 116 ON READER CARD

Indexes can possess immense nuisance value.

queries, particularly those involving multi-key record selection criteria. Such queries can, in many cases, only be handled as background batch tasks, and this, although better than nothing, is often exceedingly irritating to end users who are forced to suffer considerable delay before receiving their answers.

Although conventional techniques provide solutions in the functional sense, they are unable to do so efficiently, and, most important, they restrict interactive working to simple transactions. The system designer is therefore in a dilemma: either he can provide a comprehensive range of selection facilities in a software package that relies heavily on serial search in batch mode, or he can offer an elaborate indexing scheme that at best will give limited real-time facilities with only moderate performance and at considerable cost in terms of index compilation and general updating.

The clue to a possible solution lies in the fact that despite the manifest inefficiency of serial search, it is often the only solution, and the concomitant penalties have to be accepted. It is therefore pertinent to investigate the possibility of building an autonomous searching engine to perform this task, thereby relieving the mainframe of a rather trivial, but nevertheless demanding, comparison and test procedure.

THE DATA BASE MACHINE

There is the possibility of subcontracting the entire data management function to a specialized unit, the data base machine, operating autonomously from the cpu or mainframe. Although this form of functionally decentralized architecture is potentially feasible, many problems remain to be solved if efficient and reliable implementations are to be achieved. Substantial performance improvements, neverthe-

less, are obtainable if certain search and retrieve functions are implemented in the storage subsystem under the control of a mainframe resident data management system.

Several groups have pursued this approach, and during the last few years a team at the Research and Advanced Development Centre of International Computers Ltd. has developed a machine known as the Content Addressable File Store (CAFS). This is a desk file subsystem containing specialized hardware that operates under software control but uses parallel processing techniques for implementing multifactor selection across either single files or the join of multiple files. The essential requirements placed upon the hardware in this system are those of concurrent execution of powerful selection and retrieval functions on multiple data streams arising from the simultaneous reading of many disk channels. Although these features have been realized in conjunction with the moving arm disk file, they are applicable to other cyclic random access storage devices such as magnetic drums, fixed head disks, and bubble memories.

The choice of functions executed in the CAFS subsystem and the balance between those performed by hardware and those performed by software would be of crucial importance if the resulting system were to have both adequate flexibility and attractive performance. The aim was to construct a filtering hierarchy in which the intrinsically high disk data transfer rate was handled by simple repetitive hardware, with progressively more complex operations being performed on successive abstracts of diminishing volume, culminating in procedures executed in the mainframe.

In order for this to be achieved, it was necessary to identify functions that had a

wide range of utility and independence of applications. Encouragement that this should be possible was obtained by noting the great success and widespread use of standard report generating packages. Many of these contained general purpose parametric routines capable of direct hardware implementation.

It became clear that file structures would have to be kept reasonably simple if hardware complexity were to be contained. In practice this meant placing restrictions on the user of hierarchical records. However, this was not considered to be a serious deficiency, since, at the time, the project was being influenced significantly by the normalization techniques of E. F. Codd in his proposed Relational Data Base Management System.¹

The project commenced with an applications study phase which concluded that the following functions were desirable in the disk store subsystem.

a. Evaluation of record selection expressions that may involve nested boolean functions of many variables using the logical operators AND, OR, NOT.

b. Evaluation of record selection expressions involving weighted threshold functions of many variables.

c. Subsetting of selected records so as to return to the mainframe only those data items specified by the task generating process.

d. Counting occurrences of records satisfying a selection expression.

e. Using the relationships \equiv , \neq , $>$, $<$, \geq , \leq , between specified key values and data item values as terms in a record selection expression.

f. Masking of data item values to a resolution of at least one byte or character.

g. Stem matching of individual terms.

h. The use of maximum and minimum values of a data item value as a search term.

i. Performing the summation of specified integer data item values in records satisfying a selection expression.

j. The comparison of data item values of the same type to be available as a search term. This requirement was later augmented to include arithmetic operations involving addition and subtraction of data item values and literals.

k. Evaluating selection expressions across virtual records formed by joining two or more physical files.

l. Projection of a set of records satisfying a selection expression to remove redundancy with the option of counting the occurrences of each unique record.

These functions were implemented

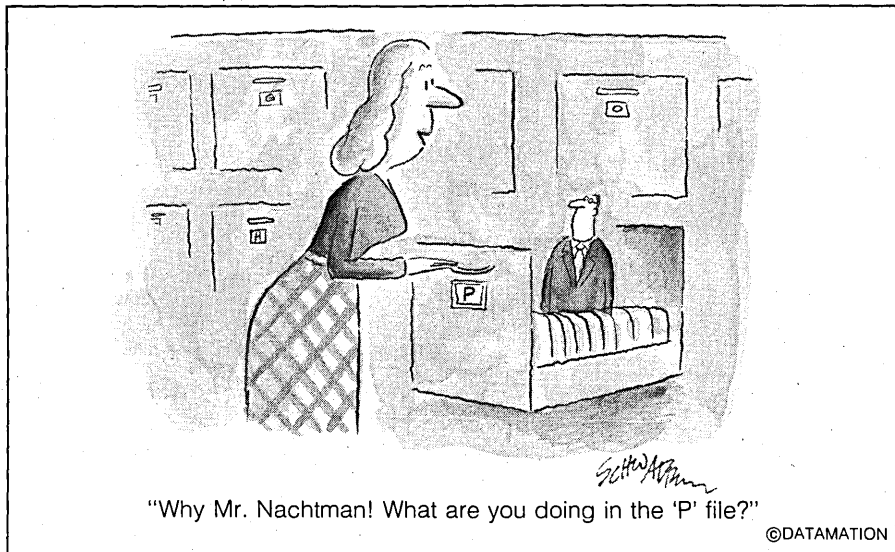

1. E. R. Codd, "A Relational Model of Data for Large Shared Data Banks," CACM vol. 13, June 1970.

Jacquard Systems

If you're considering a word processing system, consider the best—AIM Jacquard Systems. Our word processing equipment and systems are the best in the industry.

Take our 425 word processor. It's a powerful stand-alone system with full-page wide display screen capable of handling your heaviest workload. The 425's sophisticated software is especially designed to speed up your workflow. And the 425 even interfaces to a phototypesetter for in-house typesetting.

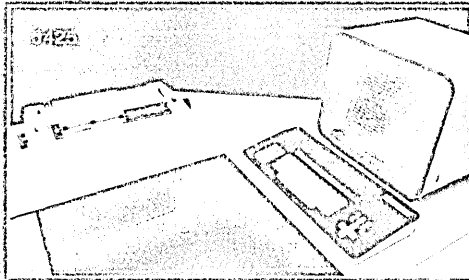

Then we offer the award-winning 100 shared resource system for larger, more complex assignments.

It supports up to 10 work stations, handling word data and distributed data processing tasks.

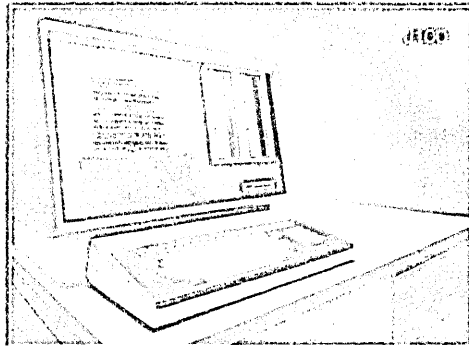

Highly sophisticated and extremely powerful, the 100 adds a new dimension to your office operation—total efficiency. Besides the best systems,

we provide the best training and service, too. The kind you'd expect from a company that's a leading edge division of a multinational, Fortune 500 corporation, AIM International, Inc.

Being the best is what counts at AIM Jacquard Systems. So when you're trying to decide what's best for you, let us help. Call or write for more information. AIM Jacquard Systems, the informationists, a division of AIM International, Inc., Dept. 777, 8840 Ocean Park Blvd., Santa Monica, CA 90405 (213) 450-1042.

LET'S TALK ABOUT WHAT'S BEST FOR YOU.



AIM Jacquard Systems, Inc. is a registered trademark of AIM International, Inc. All other trademarks are the property of their respective owners. © 1985 AIM International, Inc.

initially in a small experimental system which enabled a preliminary evaluation of the approach to be made. On the basis of the favorable experimental results obtained, a design was produced for a full-scale disk controller incorporating special hardware for autonomous associative search.

SPECIAL FEATURES EXTRA

At the outset it was decided that the special features in the CAFS disk controller should be additional to the standard direct access facilities of conventional equipment, i.e., block read and write.

Within the controller there are the following six principal subunits: control processor, direct access, associative searching, record retrieval, file correlation, and drive control.

The control processor is the 64K-byte machine taken from the ICL 7503 terminal controller. Its primary functions are task scheduling and resource management. The Direct Access Unit, as its name implies, performs the standard functions of physical block reading and writing. The novel components in the system are the Associative Searching Unit, the Record Retrieval Unit, and the File Correlation Unit. An outline block diagram is shown in Fig. 1.

The Associative Searching Unit (ASU) is the heart of the system. Its function is to execute concurrent search tasks on a multiplexed data stream produced by the simultaneous reading of several disk channels. These channels may be allocated either separately or in groups to the disk drives. The drives themselves have additional read amplifiers so that several heads on any one may be read in parallel. Up to eight such multihead read drives and six single head read drives may be connected to any one controller, giving a total storage capacity of 840MB with EDS 60 drives.

Within the ASU there are three principal subunits. These are the data multiplexing and format control unit, the key channel unit, and the search evaluation processor. The first of these, as its name implies, takes the raw data from the multiple disk read channels and produces a single multiplexed output on 1 byte wide highway operating at 4MB/sec. The present system will accept 12 individual disk channels of which up to 10 may be allocated to a multihead read drive for those tasks where intensive searching is required. The unit also issues to the other units format control information such as start of record, start of field, end of record.

The key channel unit permits up to 16 key and mask registers together with corresponding comparators to be allocated to any task. Up to seven such tasks may run concurrently. These key matching channels, when loaded with appropriate key data and masks, operate simultaneously on the data stream,

FIG. 1
**CAFS CONTROLLER
FUNCTIONAL SUBUNITS**

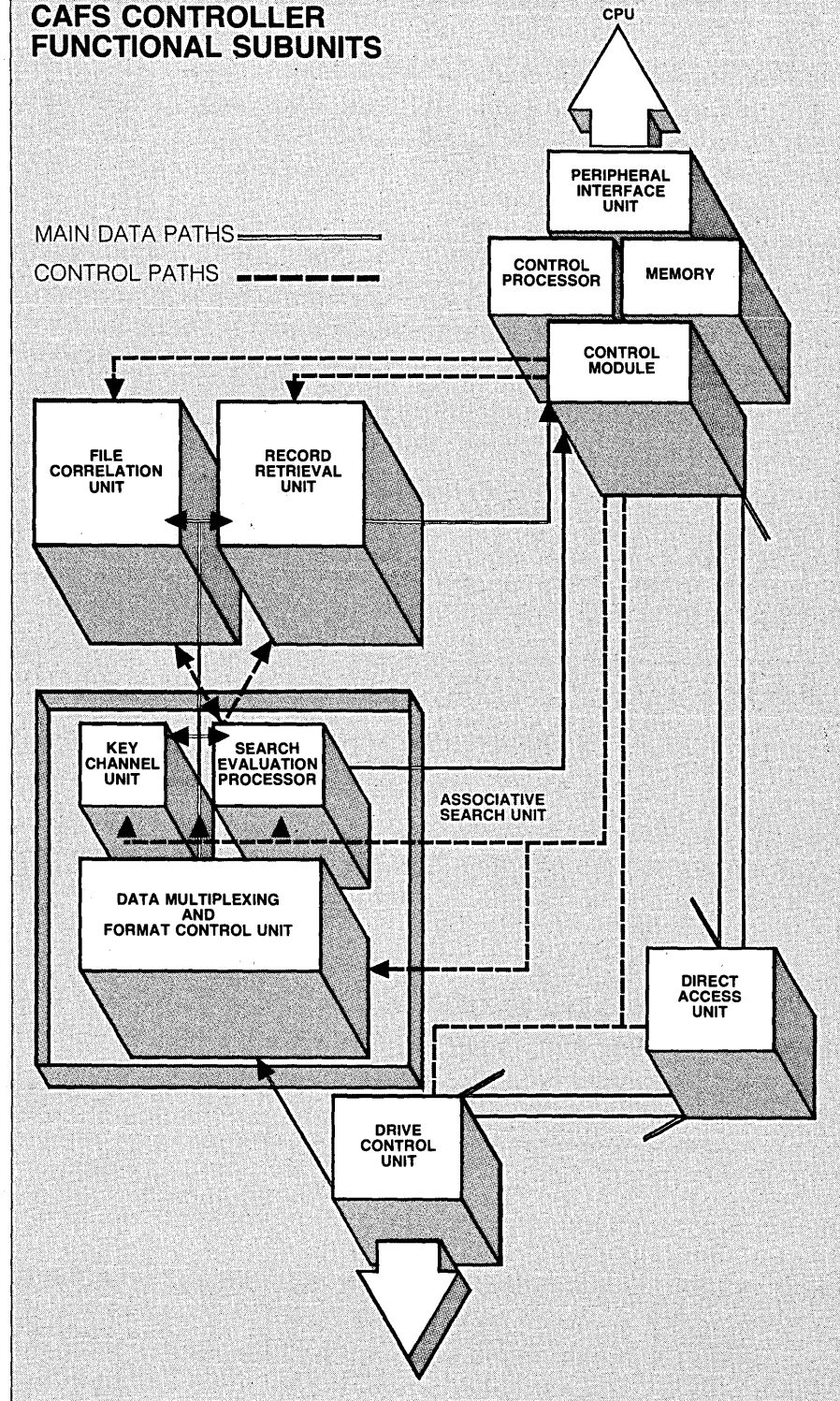
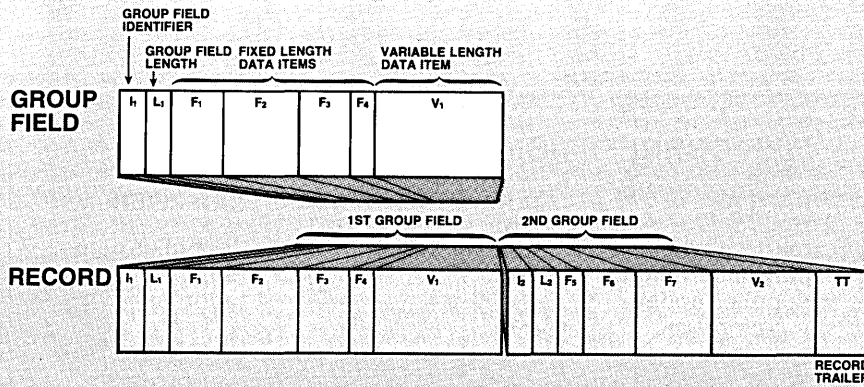

FIG. 2

CAFS RECORD FORMAT



and for the record being scanned, they will register presence of key type, equivalence of key data, the inequalities of less than, greater than, as well as all their logical inversions. These operations are performed "on the fly"; there is no block or track buffering.

After each key channel has performed its specific comparison, the result is stored and then subsequently used as an operand in a microprogram executed by the search evaluation processor when all key comparisons for that record have been made, i.e., when the hardware detects end of record. This processor is a small specially designed vector machine which is programmed specifically for each search task and may execute several search programs simultaneously. In order for the key channels to carry out their functions, the data stored on disk needs to be either in a fixed format or self-identifying.

At the outset of the project, a decision was made to adopt a format that permitted records to be of variable length and to contain multiple occurrences of variable length group fields. Each group field is preceded by an identifier code and a length and may consist of a set of fixed length data items followed by one variable length data item (see Fig. 2). Any individual item, if required for key comparison, may then be isolated by means of a mask which, together with the data, is stored in the key channel. This facility, when applied to variable length items such as text words, permits easy implementation of stem matching.

At the same time as the Associative Searching Unit is carrying out its key comparisons, the Record Retrieval Unit, (RRU) is matching its identifier list against the data stream and collecting the contents of the designated fields in each record. If the record is subsequently declared to be a "hit," these are returned; if not, they are overwritten.

This feature of hardware deblocking and editing of records is particularly valuable in interactive situations where high throughput is necessary. The data from the RRU is passed to the store of the control processor, where it may be processed further if required, before finally being returned to the user's work space in the mainframe. This further processing might, for example, be evaluating arithmetic selection expressions and summing integer field values.

The mechanism of selection is illustrated in Fig. 3. A search task, which may have come from a terminal enquiry or a batch program call and be of the form GET NAME, PERSONNEL CODE FOR JOB = SALESMAN AND AGE <28 and BONUS >750 is compiled by the mainframe resident data management software into a search and retrieve task specification. The latter, in the form of a list, contains key and mask data, a microprogram for the search evaluation processor, and a list of data

FIG. 3

MECHANISM OF CAFS SEARCH

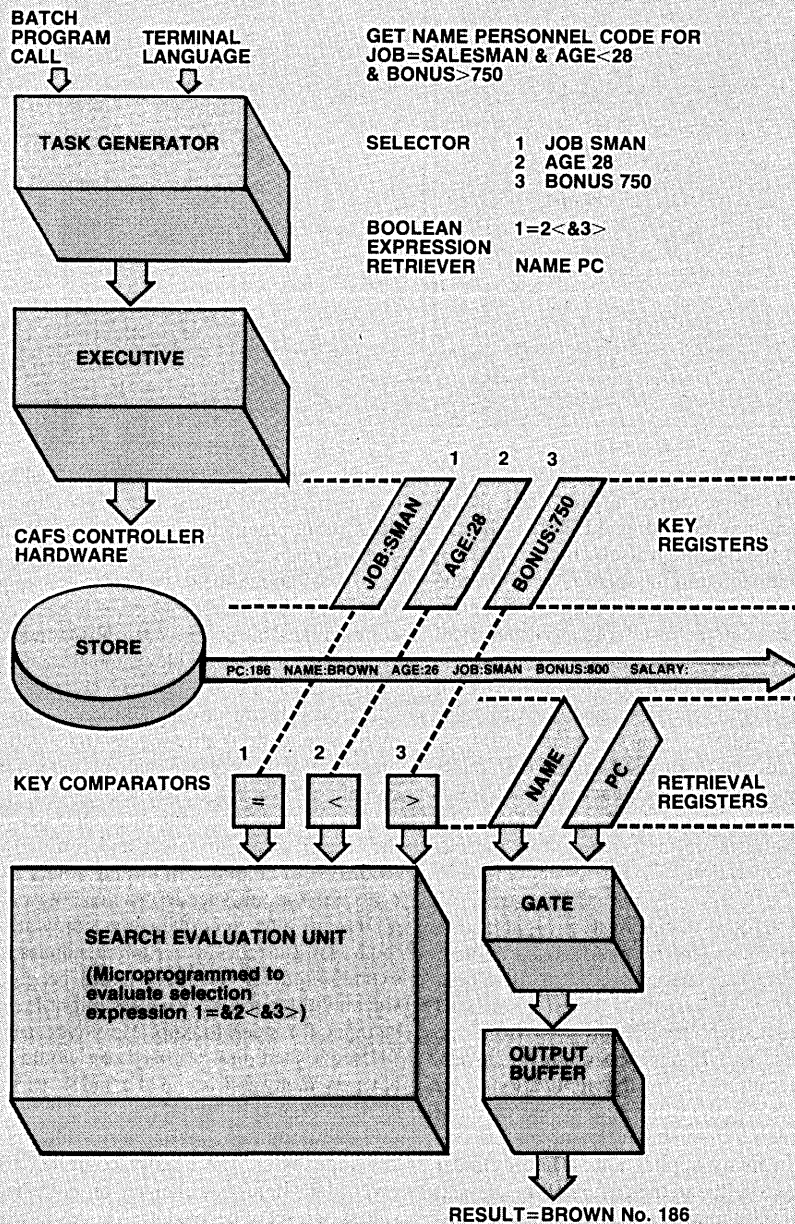

CHARTS BY CYNTHIA STODDARD

Despite the manifest inefficiency of serial search, it is often the only solution.

items to be retrieved from selected records.

This list, together with the physical addresses of the file areas to be searched, is then passed by the operating system in the mainframe to the CAFS controller. The size of these may vary from a single track to a whole disk cartridge depending on the extent of the file and the indexing strategy adopted. The control processor, having accepted the task, selects the appropriate disk drive and then transfers the task parameters to the relevant CAFS units. In Fig. 3, both the data items in the record and the key register contents are shown for the sake of clarity with their application names and not with their group field descriptors.

SEARCH MAY BE EXTENDED

The search capability of the system may be extended by using the File Correlation Unit. This enables selection expressions to be evaluated on the joins of physical files without the overhead of sorting and merging intermediate results or, relying on precompiled pointer structures, provided that there exists a data item shared by records in the two files.

The principal components of this device are a set of 256K 1-bit wide stores, any one of which may be addressed by the value part of a designated data item in the record being processed by the Associative Search Unit. If the latter classifies a record as a 'hit,' then the addressed bit can be set. At the end of a search task, the store contains, in effect, the set of different data item values, coded as addresses, occurring in the designated field in all the records satisfying the search selection expression. On a subsequent search, on the same or a different file, the store containing these coded values may again be accessed during the processing of a record, but this time the state of the addressed bit may be treated as if it were a key channel comparator output by the microprogram performing the evaluation of the selection expression, thereby enabling a linked selection operation to be carried out across the two files (Fig. 4).

In this example, there are two files, a parts file and a supplier file, containing, respectively, part number, part description, supplier code and supplier name, supplier code, supplier address. Consider the enquiry, 'Find all suppliers of Whitworth brass bolts in Birmingham.' To execute this, the parts file is first searched using 'part description' = 'Whitworth' and 'brass' and 'bolt' as the selection expression. For all records found, a bit in the map is set using the supplier code as an address. The supplier file is then searched using 'supplier address' = 'Birmingham' and 'supplier code addressed bit in map set' as the selection expression. Supplier names are then retrieved from all records

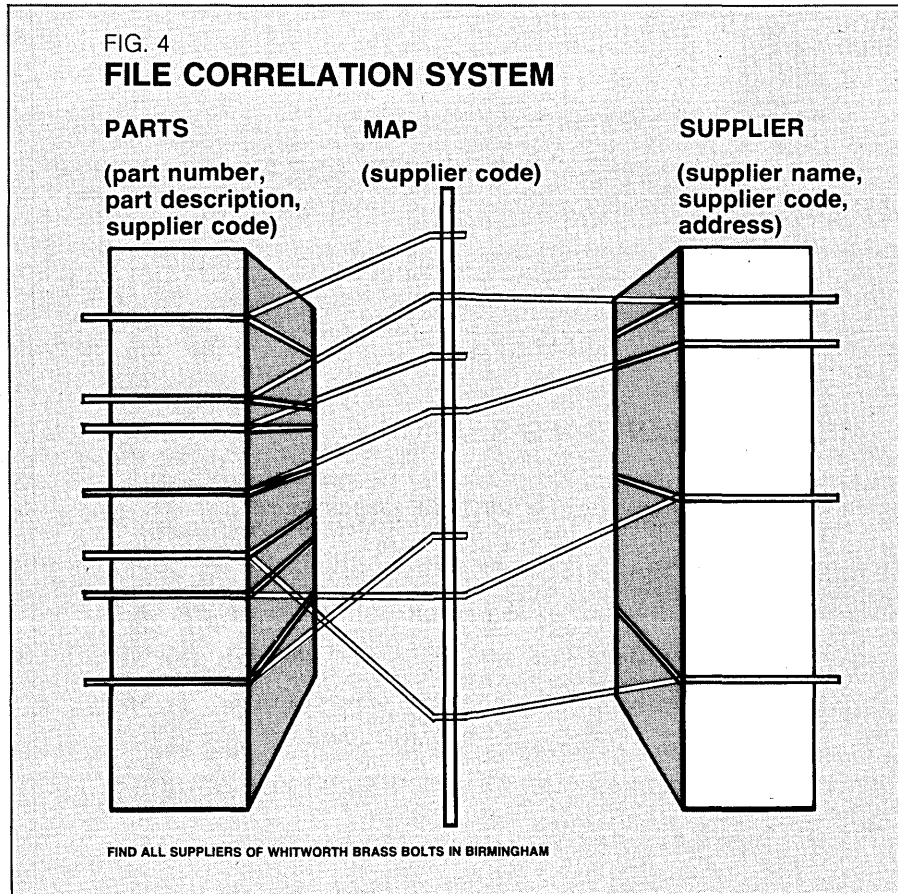

satisfying this expression.

For the record being processed, the bit map store may be addressed directly by the value of the data item itself, by a numerical equivalent stored in the record, or by a value obtained by hardware hashing. The latter, moreover, can be used on a virtual field assembled dynamically from more than one data item in the record. However, the use of hashing in this way can give rise to false 'hits' or 'ghosts,' but the number of these can be reduced to almost negligible amounts by using several bit maps each of which is addressed via a different hashing function. Any residual ghosts are then removed by a backtracking operation.

HOW CAFS FILE IS SET UP

The physical organization of a CAFS file is a cellular serial one. The file extent is divided into a series of storage cells whose size may vary from one disk track to a cylinder, depending on the particular requirements of the application. Any search task is then directed to one or more cells which are exhaustively scanned.

In many applications a half-cylinder is used as a cell, and then using 10-head read, the whole cell may be searched in one revolution of the disk pack. Since access to a record

within a cell is associative, the physical location is irrelevant unless there is an applications requirement to maintain records in a given sequence.

Although the CAFS hardware can provide very fast searching, it is necessary to complement this by a low resolution indexing system in order to achieve the best performance. Such indexes, however, need to resolve only to the level of storage cells. In many applications this means that each addressable unit, e.g., a half-cylinder, may contain 100 to 1,000 records.

There is then little difference between the time it takes to select and retrieve one record from among a thousand others using CAFS and the time needed to make a random access to one record using conventional methods. Indeed, in certain instances, the overall time for the latter could be greater since additional disk accesses might have to be made for index lookup. Moreover, a CAFS file sequenced on a primary key would only have as many entries in the index as there were storage cells.

In addition, secondary or alternative key indexes can be readily compiled for a given data item as either an ordered list of values or a set of derived hash codes in which each value or code has associated with it a bi-

TELEX SERIES 80: THE BEST TAPE DRIVE FOR 4300 SERIES PROCESSORS.

Congratulations. You've upgraded to — or at least ordered — IBM 4300 Series processors to gain major price performance improvements and environmental enhancements. Now, what about your tape drives?

Telex Series 80 tape drives are the perfect match for 4300 processors. Like the IBM 4300, Series 80 is based on proven technology. It outperforms its competition, and is lower in price.

Series 80 drives offer 6250 bpi (GCR), 1600 bpi (PE) and 800 bpi (NRZI) data formatting — at transport speeds up to 125 ips; all with capabilities beyond those normally required on 4300's and at a price well below IBM's comparable offerings.

Series 80 is smaller and lighter than the IBM 3420 and its equivalents. Five Telex drives fit comfortably in the space normally required by four IBM drives. Series 80 also generates 30% less heat and consumes 35% less power. Patented Telex features like the Supr-Lite™ Capstan and Telex Tape Path ensure smooth, reliable back-up storage.

For more information on the tape drives made to complement your 4300 processor and other IBM systems, contact your nearest Telex representative. Or call Series 80 Marketing toll-free (800) 331-2623.

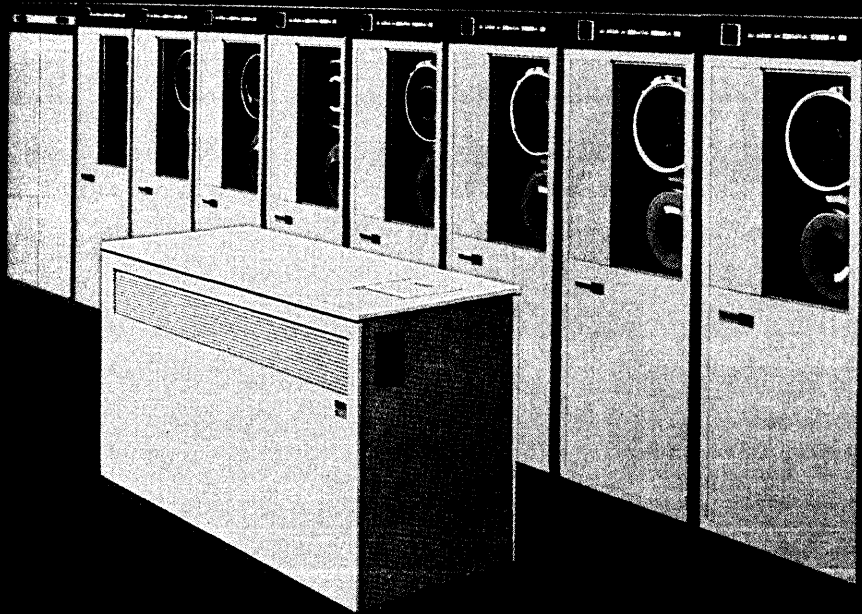

The innovation continues... TELEX®

Telex Computer Products, Inc.
Terminals, Peripherals, Data Entry and Word Processing Systems, OLM Products

6422 East 41st, Tulsa, Oklahoma 74135 (918) 627-1111
332 Consumers Road, Willowdale, Ontario M2J1P8 (416) 494-4444

CIRCLE 118 ON READER CARD

The Associative Searching Unit is the heart of the system.

nary vector having as many bits in it as there are storage cells in the file. Any particular bit in a vector is then set if there is at least one occurrence of its associated value of code in the corresponding storage cell. For a multi-factor selection expression, the low level system software can manipulate the index vectors of the various terms in the expression to produce a search vector. The bits that are set in this vector then correspond to the storage cells in the file in which it is worth making a search. This procedure is subtly different from conventional inverted indexing. Whereas the latter indicate where records are, the CAFS scheme, when more than one attribute value is involved, indicates where they are not.

This form of indexing, when combined with intensive search, provides all the features of an inverted file handling system without incurring such severe penalties with regard to the manipulation, generation, and maintenance of indexes.

The physical mapping of a CAFS disk conforms to normal standards, but, as already indicated, the format of records and their logical organization within a file extent do not. Consequently, before a standard file can

be read in CAFS search mode it has to be reloaded. Nevertheless, standard utilities can be used for disk initialization, file allocation, and file copying. Hard recording flaws are avoided by skipping the cylinder containing the flaw at the time of file allocation. Since the incidence of flaws on the 60MB cartridges used was extremely low, this simpleminded approach to flaw management did not lead to a profligate waste of disk space.

The updating of CAFS files can be performed purely conventionally using either normal direct access methods or logical record insertion/deletion in CAFS mode. In the latter the mainframe software merely has to identify the storage cell in which the insertion or deletion is to occur and then issue the appropriate commands. The CAFS controller will then perform the necessary block reading, repacking, writing back, and check reading. In a transaction processing environment, concurrent update control and journalizing for recovery remains entirely a mainframe data management function.

The potential processing power made available through the CAFS approach should have its major impact on information retrieval in an interactive environment. Comprehen-

sive language facilities may now be made available to a large number of users with response times such that a truly conversational and harmonious dialogue be established between man and machine. *

V. A. J. MALLER



Mr. Maller leads an interdisciplinary research group comprised of hardware, software, and language specialists investigating new architectures for data management with International Computers Ltd. at Stevenage, Hertfordshire, England. He has been employed by ICL since 1962, and, until 1971, he worked on superconducting computer devices, integrated circuit packaging, design automation, digital magnetic recording, and magneto-optic recording.

THE BETTER TRAP

IDS's Hawk has more codes, protocols, trappings and interactive capability — in a standard unit!

The Hawk (Models 4000 & 4010) gives you more capability per dollar — and it's easier to use. Requires no special training course. The Hawk lets you monitor, transmit and receive data between a modem and terminal on a 5 inch, 512 character screen (Model 4000 has 9" screen). In the interactive mode, it emulates a processor, terminal or modem. There's a built-in tape interface. LEDs and test jacks monitor and access all signals in the EIA interface. A printer output is standard. The Hawk saves you money when you buy it — and when you use it.



Model 4010

- Captures and stores up to 4096 characters for later analysis.
- Searches for and traps on independent TD and RD data streams up to 126 characters long, including "don't cares."
- Operates with BISYNC, SDLC, HDLC, ADCCP, X.25, and other synchronous and asynchronous protocols.
- Asynchronous and synchronous data rates from 50 to 19,200 bps.
- ASCII, EBCDIC, Hex, Octal, Baudot, EBCD, IBM Selectric, PARS/IPARS and Transcode formats are standard.
- Automatic CRC generation checking.

**INTERNATIONAL
DATA
SCIENCES, INC.**

7 Wellington Rd., Lincoln, R.I. 02865 • Tel. (401) 333-6200 • TWX (710) 384-1911
Export: EMEC, Box 1285, Hallandale, Florida 33009

ON
GSA
SCHEDULE

CIRCLE 119 ON READER CARD

Introducing the Identification Network.

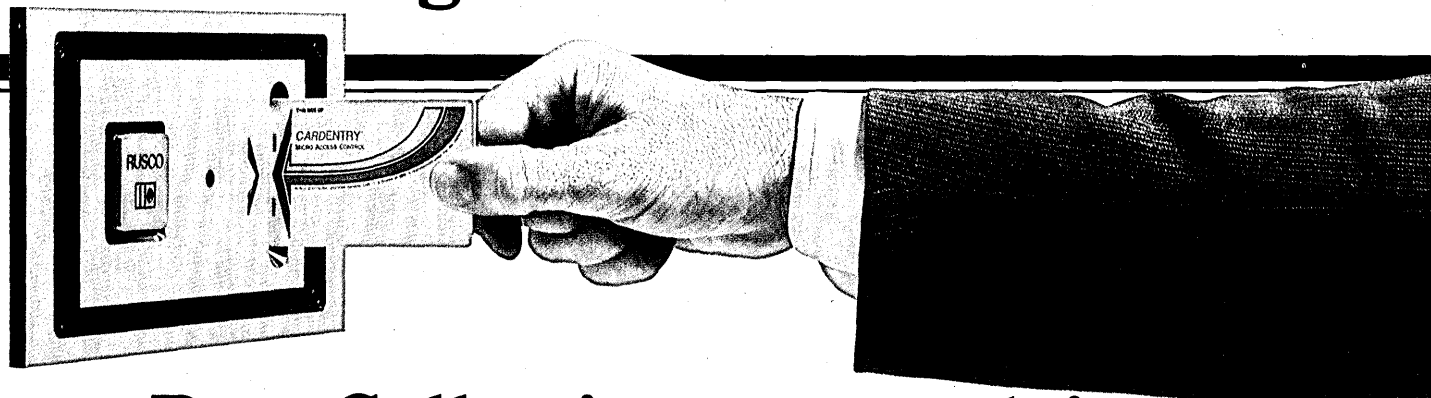

Data Collection, pure and simple.

From the moment your employees entered the front gate until they left for home, they've always been on their own.

And no matter how dependable they were it's been almost impossible to hold them accountable for their actions and their whereabouts.

Accounting for the heretofore unaccountable.

The Identification Network from Rusco Electronics gives you accountability for people and facilities that you never thought possible. It monitors and reports employee whereabouts and actions. And gives you an accurate, immediate record of who, what, where, and when.

Now basic data entry is available anywhere. For instance, you can control the locking and unlocking of doors on a pre-programmed time schedule.

Parking lot entrances and exits can be tied into the Identification Network. So you can always find out if an employee is on the premises.

You can account for the use of the copying machine and know how

many copies each employee makes.

You can create an electronic time and attendance log of your employees ins-and-outs for automatic payroll processing.

You can even restrict after hours elevator use. For certain key people and certain floors.

Those are just a few examples.

How the Identification Network works.

Each of your employees gets an Identification Network EntryCard™ with a personalized code. Each room or piece of equipment that requires accountability has a single, compact CARDENTRY™ reader.

You simply tell the Identification Network which employees are allowed into each room and which employees are authorized to use each piece of equipment.

If someone attempts to enter a room or use a piece of equipment that's off limits to them, the door will not open

or the machinery will not work.

And a central printer immediately tells your security people that an attempted unauthorized entry has occurred, where it occurred, and when.

It's that easy to account for (and control) unauthorized access and activities. And that easy to save money.

The most important control of all.

That, of course, is the ability to control losses.

The simple fact is, if you can account for detailed activities in areas where you lose money due to theft and misuse of materials, machinery and information, you can cut those losses dramatically.

That's exactly what the Identification Network does. It saves a lot of money. In a lot of places.

Call or Write: Rusco Electronics Systems, 1840 Victory Blvd., Glendale, CA 91201, 1-800-528-6050, ext. 691. In Arizona, 1-602-955-9714, ext. 691.

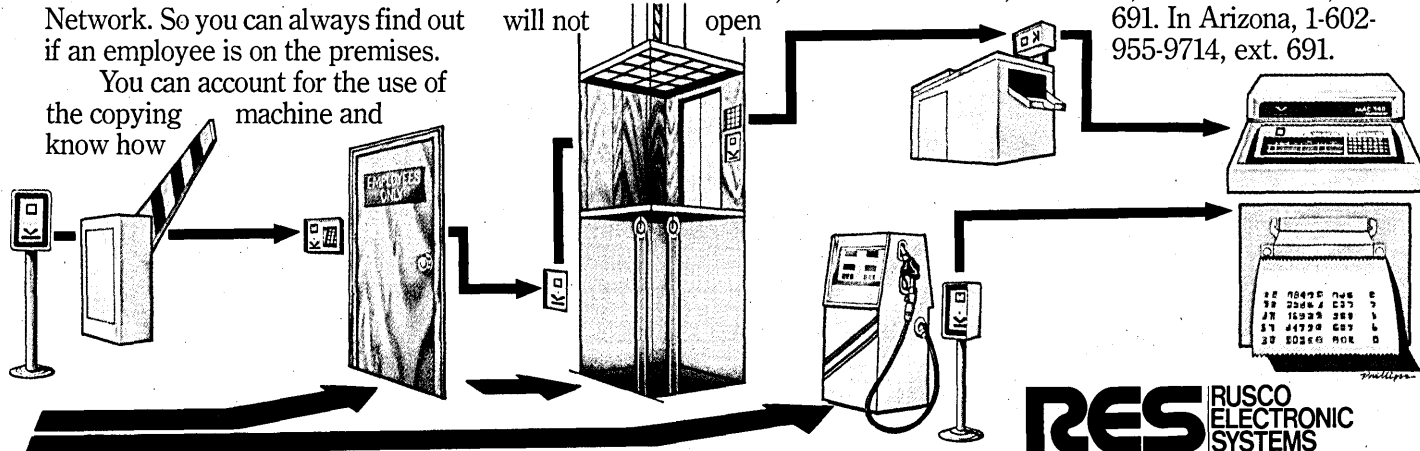

RES RUSCO ELECTRONIC SYSTEMS
A DIVISION OF ATO

We give you controlling interest.

CIRCLE 120 ON READER CARD

**Are you about to buy
a space age On-line system
with a stone age printer?**





Today, a lot of people can sell you basic, 3270-type On-line hardware. But only Northern Telecom's On-line system has the Sprinter™—a printer designed for all the new ways people use On-line.

Complicated printers are out-of-date.

When On-line systems work far from the DP room, you need a printer that's fast and easy to use. Sprinter is microprocessor controlled. So margins, alignment and spacing are adjustable with push buttons—even while you're printing.

The Sprinter is quick—up to 180 cps—so it doesn't keep people waiting an extra second.

Everyone stays clean around the Sprinter, because you can load paper— even change ribbons without making a mess.

Short forms in short order.

When your printout is tickets, or leases, or other short documents, you want a printer that handles cut forms as easily as it handles continuous rolls. Sprinter's front-feed module adjusts quickly and easily for cut forms of many different sizes.

When your printout is read by customers—or by top management, you need crisp, sharp, easy-to-read copies. With the Sprinter, your fifth carbon is just as presentable as the original.

Compatible. Economical. And ready to go.

You don't have to give up a thing to get the On-line system with the up-to-date printer. Our hardware is plug-compatible with IBM 3270s. Our price is competitive. And so is our delivery schedule. So if you want the option of adding a simple, high-quality printer someday, our On-line hardware could be a very smart buy. And if you're depending on your printer right now—it's a must.

Our bigger choice is another reason why we're a better buy.

Right now, we can deliver state-of-the-art systems for DDP, Data Entry, and Remote Job Entry as well as On-line. So when you work with Northern Telecom, one phone call can bring you factory-trained service for every part of your remote processing operation.

But the best reason to talk to Northern Telecom today, is tomorrow.

We're combining data processing expertise with telecommunications expertise—in a mix no other company can match. Today, it means better access to all the processing power you pay for. Tomorrow, it means a smoother transition to a single system that will meet all your processing and telecommunications needs. Talk to Northern Telecom Systems Corporation. Where computers and communications meet.

For the office nearest you, call our Marketing Services Department at 1-800-328-6760. In Minnesota call (612) 932-8202. Or write Northern Telecom Systems Corporation, Box 1222, Minneapolis, MN 55440.



**Northern Telecom
Systems Corporation**

CIRCLE 121 ON READER CARD

INCOME BY DIVISION
1978-1979

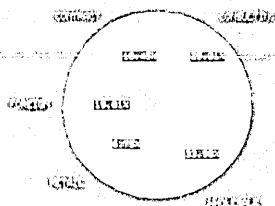

HEALTH PLAN ENROLLMENT
1978-1979

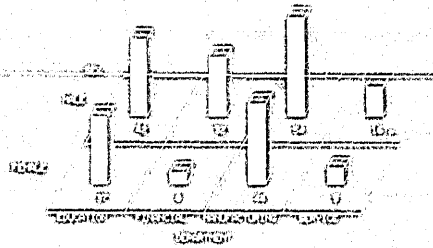

SAS Installations by State
1978-1979

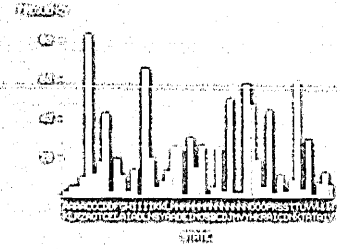

INDUSTRY REVENUE RATIO

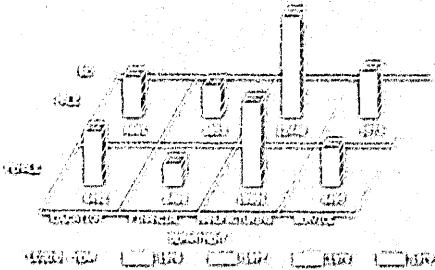

SAS 3-D COLOR DISPLAYS

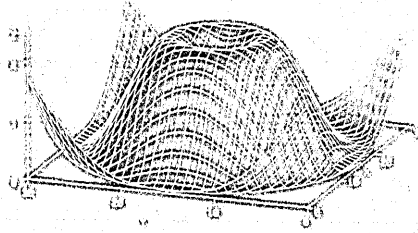

INCOME BY DIVISION
1978-1979

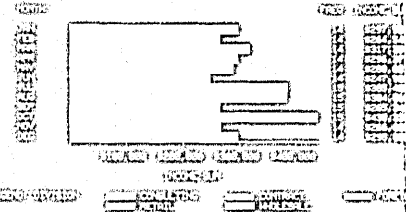

INCOME BY DIVISION
1978-1979

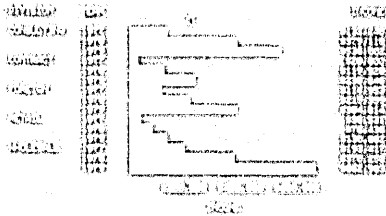

NONDURABLE GOODS FORECAST

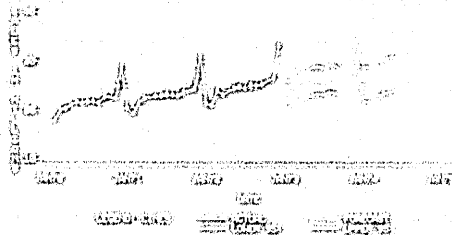

INCOME BY DIVISION
1978-1979

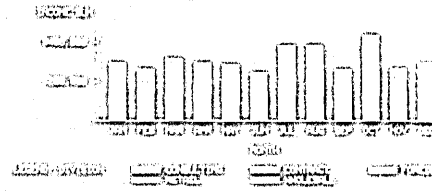

Designing software to save time is a SAS tradition. And we've packed our years of experience into a new product, SAS GRAPH.

SAS GRAPH pioneers a new direction for graphics software.

Old software systems came into being before hardware had much in the way of time-saving features. And because the software had to do most of the work it was designed to be device-independent.

But SAS/GRAPH is device-intelligent. It's designed to use the time-saving features built into most modern hardware.

For example, look at the blue slice of the pie chart above. SAS GRAPH used one "pie" command to color it. A device-independent system would require hundreds of "move and draw" commands. With SAS/GRAPH you save computer time and drawing time.

And you'll save user time. Because SAS/GRAPH produces most displays with two or three simple statements.

But best of all SAS/GRAPH is integrated into SAS, so you'll get the benefits of the total SAS system - a system now saving time in report writing, statistical analysis, data management and as a higher-level programming language at more than 1,200 OS, OS/VS and VM/CMS sites.

And you can add SAS (including SAS/GRAPH) to your dp staff for less than half the cost of a new programmer.

Call or write today. We'll provide more information on a very graphic time-saver.

SAS Institute Inc., PO Box 8000, Cary, NC 27511.
919/467-8000.

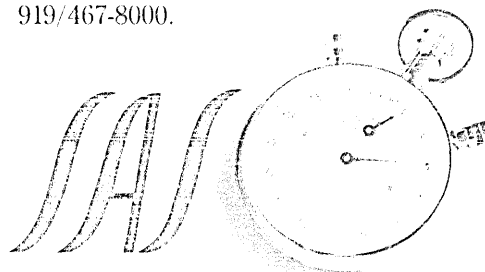

Zero-base budgeting—an attempt to reevaluate all programs, activities, and expenditures in terms of cost-benefit.

ZBB FITS DP TO A TEE

**by Thomas J. Francl,
W. Thomas Lin,
and Miklos A. Vasarhelyi**

The development of zero-base budgeting (ZBB) began in 1964, when it was introduced in the U.S. Department of Agriculture. Then, in 1969, while at Texas Instruments, Peter Pyhrr further developed the concept. Texas Instruments first used it in its staff and research divisions and then expanded it to the entire company in the following year. It is not a new idea, but current interest is attributable to President Carter, who, as Governor of Georgia, introduced the concept into the state's budget in 1970 and who mandated that the federal budget for fiscal 1979 employ it. Here, we will analyze the applications of ZBB in data processing.

The traditional (incremental) budget assumes that budgeted expenses for the coming year will be no less than the preceding year or some average of preceding years. All existing programs are maintained. Zero-base budgeting attempts to reevaluate all programs, activities, and expenditures in terms of cost-benefit. It is not based on the last year's budget but on the belief that some obsolete programs should be eliminated. It is a method of forcing managers to defend every controllable activity.

There are three basic steps in zero-base budgeting: developing decision packages, ranking packages in order of importance, and allocating resources accordingly.

A decision package is a document that identifies and describes a specific activity in such a manner that management can (a) evaluate it and rank it against other activities competing for limited resources, and (b) decide whether to approve or disapprove it.¹

A decision package can be developed for people, a program or a project, service received or provided, line item of expenditure, cost reduction, or capital expenditure. The contents of the decision package usually include: (1) objective, purpose, or scope; (2) what is to be done, and how; (3) consequences of not doing the activity; (4) alternative methods; (5) costs and benefits of recommended activity; (6) resources required.

1. Peter A. Pyhrr, "Zero-Base Budgeting," *Harvard Business Review*, November/December 1970, p. 112.

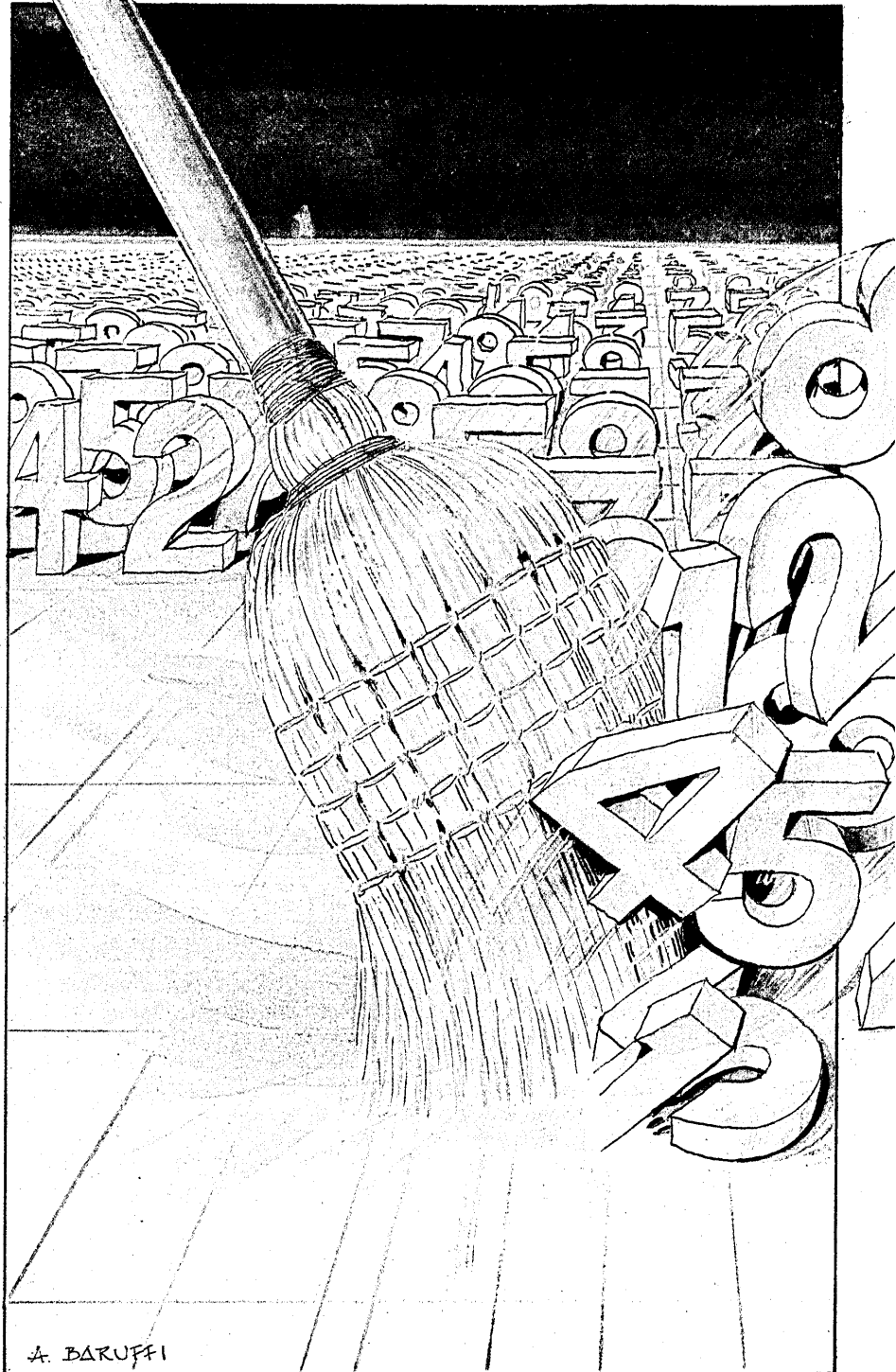

A. BARUFFI

ZBB does not supplant the corporate budget. It is not suited to all organizations nor all activities of an organization.

In preparing decision packages, a unit manager begins with the specification of the unit's objective and purpose. After a description of how the unit currently operates and the resources utilized, the manager then develops workload and performance measurement techniques, considers alternative methods of operating, and performs incremental analysis. The final decision package will be placed in one of the following three support level categories: (1) different methods or reduced levels of effort to do each activity; (2) "business as usual" levels of effort, where there are no other alternatives; (3) new activities and programs.

Once the manager has defined all the obligatory and discretionary activities into packages, a ranking process occurs. Usually the manager ranks all packages in order of decreasing benefit to the company on a cost-benefit basis. This ranking activity begins at the cost center level. A committee is formed by all managers in the cost center. The committee reviews all the packages presented to it and ranks them in importance by means of a voting mechanism. The packages considered most beneficial to the cost center as a whole receive the highest rankings, while the least important receive the lowest. A cutoff point is now established. Given the general level of funds available in the coming fiscal year, all packages above a given ranking are accepted by the group and all those below a certain point are rejected.

These decisions are then passed up to the next higher management level. Here the manager reviews the rankings to determine if they fit into the organization's goals and to decide whether the rejected packages offer enough benefits to expand the level of funding. Upper managers briefly examine only a preestablished percentage of the packages to control volume. This process is repeated until all the accepted activities are filtered through to the top of the organization, where the budget for the entire organization is then created.

ZBB does not supplant the corporate budget. It is not suited to all organizations nor all activities of an organization. It has little use in budgeting for production costs such as direct labor, direct materials, and direct overhead, which are largely determined by production and sales volume. It is mostly applicable to the service and support area of an organization which has discretionary costs.

The majority of recent applications of ZBB in the private sector have been modeled after the initial venture in Texas Instruments in 1969. The method began in Texas Instrument's research and development efforts.² Decision packages were designed to specify objectives of R&D activities and to describe the benefits, costs, alternatives, and conse-

quences of not funding each R&D program. The programs were then ranked according to potential benefits, and limited funds were allocated to those with the highest priority.

In 1971, management at Texas Instruments decided to use the new technique in other nonproduction or staff activities in the company. Since then, ZBB has become standard operating procedure for all staff and research activities, which consist of over one-third of the company's annual budget.

The Chicago office of Peat, Marwick, Mitchell & Company made a survey of 391 business executives and government officials. Some 81% of the responses indicate that "certain aspects of zero-based budgeting would improve our present budgeting procedures" and 47% state that "we are likely to seriously consider implementation of a revised budgeting system using the ZBB approach or elements of it."³ Stonich mentioned the favorable results of a questionnaire in his book.⁴ In general, the responses show that ZBB is a good process to change the total budget level, to reallocate costs and manpower, to learn more about the organization, to improve efficiency and effectiveness within the organization, and to be used as a management planning and control system.

In summary, ZBB has been adopted in many U.S. companies with an overall measure of success.⁵ The budgeting tool offers a means of objectively allocating funds to obtain maximum benefit in nonproduction departments. However, the demands of additional time and paperwork are not acceptable in many firms. It would be beneficial to obtain additional feedback from those companies that have tried the technique and subsequently cast it aside as impractical. This information would give added insights into the usefulness of ZBB.

ZBB IN DP INDUSTRY

Most of the literature report ZBB applications in manufacturing companies. For example, Dudick illustrated a ZBB application for a typical small-to-medium manufacturing company or division.⁶ This section describes an actual implementation of ZBB for an information service industry in Southern California, where data processing had long been plagued with the problem of rising costs, particularly person-

nel costs. The pressure to reduce these items was so great that an analysis of the departments' activities was conducted by the individual technical services managers in early 1979. Although a slight reduction was agreed upon after some arm twisting, it was difficult to isolate any significant head count reductions. In a service industry, the relationship between inputs and outputs are lacking, and therefore the management decided that a second analysis of its activities utilizing ZBB techniques was necessary. The computer operations department was not included during this test run of ZBB.

The management team spent a total of five days developing a decision package for every activity they were responsible for whether or not they were actively working on them. Thus, all outstanding user requests, program enhancements, and pet projects were included. A total of 221 decision packages were developed, and one example is shown in the sample form on the opposite page. The most important sections of the form are those that document manpower requirements, expertise levels, advantages of retaining the activity, and consequences of eliminating the activity.

The second step was to rank them according to a priority scale. The rankings ranged from 1 to 6 (see Fig. 1).

The decision line between 3 and 4 separates the recommended activities, (4 and above) and those not recommended at this time (3 and below). If the budget is constrained, a rank four activity would be eligible for deletion, and, conversely, if the budget is increased, rank three activities could be added.

All of the recommended activities were summarized according to level of expertise and compared to the available staff. A special graphic analysis program was written to spread these activities across the next 12 months in order to visualize the workload peaks. In some departments, the peak for the immediate future required 20 individuals, when in fact only seven were available to do the work. The involvement of the senior management from all user departments was necessary to reevaluate work requests, to reschedule start and completion dates, and to suggest modifications to the rankings. After receiving their input, a presentation was made to top management that indicated a 20% decrease in personnel.

The author was requested by top management to further reduce head count in his department by five people. In order to meet this request, a list of activities with low rankings was prepared, and it was estimated that up to seven positions could be eliminated if several rank 4 and 5 activities were reprioritized. Top management elected to eliminate a sufficient number of these activities to allow the reduction of five positions.

3. "Zero-Base Budgeting Believed to Improve Current Budgeting Practices," *Managerial Planning*, July/August 1977, p. 40.

4. P. J. Stonich, *Zero-Based Planning and Budgeting*, Dow-Jones-Irwin, Homewood, Ill., 1977.

5. Other companies who used ZBB include: Hawaii's Dillingham Corp.; Southern California Edison; United California Bank; Florida Power and Light; Black Clawson-Kennedy, Ltd.; Combustion Engineering, Inc.; Computer Sciences Corp.; FMC Corp.; Hallmark Cards, Inc.; International Harvester Co.; Ohio Bell Telephone Co.; Rockwell International Corp.; and Xerox Corp.

6. Thomas S. Dudick, "Zero-Base Budgeting in Industry," *Management Accounting*, May 1978, pp. 25-29.

2. See Peter A. Pyhr, *Zero-Base Budgeting*, John Wiley and Sons, Inc., New York, 1973, p. xi.

ZERO-BASE PLANNING DECISION PACKAGE			DEPARTMENT Programming	ACTIVITY NO. 134	ACTIVITY LEVEL 5
TITLE Computer Billing System			RANK 5	PRODUCT CLASS 7	<input checked="" type="checkbox"/> PROJECT <input type="checkbox"/> CONTINUING ACTIVITY
MANPOWER LOADING			SUPPORT LEVEL		
GRADE LEVEL	MAN DAYS	HOURS	<input type="checkbox"/> AT	<input checked="" type="checkbox"/> ABOVE	<input type="checkbox"/> BELOW
1. 34	230	= 1840	CURRENT LEVEL		<input checked="" type="checkbox"/> New or Revised Standard Required
2. 35	230	= 1840			
3. _____	_____	= _____			
TOTAL COST \$88,575	OTHER COST	ESTIMATED SAVINGS	EST. START DATE 5-1-79	EST. COMPLETION DATE 2-1-80	
DESCRIPTION OF ACTIVITY Design and install a new billing system that utilizes software physics theory, product pricing, and natural business unit pricing.			DESIRED RESULTS (OBJECTIVES) Be cost effective. Change to fit evolving technology. Provide for incentive pricing.		
RESPONSIBILITY			DEPENDENCIES		
DEPT.	Pgmg Finance		Adoption of new pricing policies.		
DEPT. CODE	01 14				
LDI CODES	P P I P		ACTIVITY NO. IF ANY		
ADVANTAGES OF PERFORMING ACTIVITY Attain competitive pricing position. Incentive pricing will encourage users to adopt less expensive technologies.			DISADVANTAGES OF PERFORMING ACTIVITY Will require a product costing system.		
ALTERNATIVE APPROACHES Bill each computer run utilizing a single usage rate.			CONSEQUENCES IF ACTIVITY NOT PERFORMED Continued dependency upon occupancy time billing.		
DEPARTMENT MANAGER		DATE 5-1-79	TECH. SERV. DIRECTOR SIGNATURE		DATE

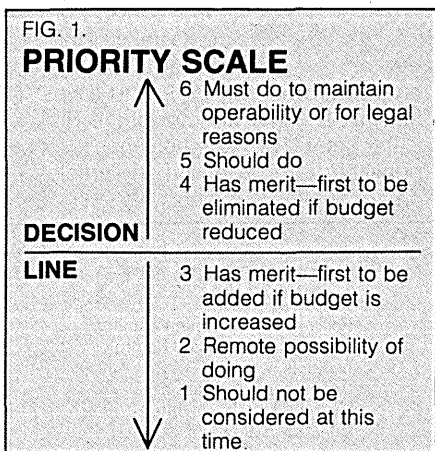

The request of additional reductions of manpower was greatly facilitated by the use of ZBB. The user departments, typically the loudest complainers of poor service and high cost, accepted further reductions in service levels because they participated in the prioritization of activities and benefited from lower charges. Management could, for the first time, properly evaluate the cost and necessity of any given activity. The activities with a ranking of 5 were eliminated mostly because of the desired reduction in positions but would probably be the first to be added should the need arise.

ZBB is typically used in the fall of each year in preparation for the annual budget. Because of the tremendous effort required to

develop decision packages, it is recommended that after the initial analysis of activities is completed an annual update of the decision packages be made, thus eliminating much of the clerical effort. Each package should be ranked again according to the current priorities of the company.

The result of identifying and classifying all activities within systems and programming has been so helpful that it was decided to maintain those packages and prepare additional ones for newly identified activities. This process would supplement a project initiation request procedure that controls system change requests. Managers and staff are encouraged to add new activities to the system even though they might be blue-sky (in this industry, wild ideas tend to become reality within a short period of time).

The evidence of past applications of ZBB indicates substantial value in the concept of reevaluating budget programs and activities to determine relevant costs, benefits, and alternatives. ZBB has been successfully implemented in a growing number of service industries. Obviously, many of these companies feel that the benefits of ZBB outweigh the cost of increased time and effort. The benefits include the greater understanding of how funds are being used, increased participation of lower management in budgeting, and elimination of inefficient programs. However, because the budgeting tool involves the costs of increased time, paperwork, and effort, the implementation decision must be carefully considered.

ZBB is not, and should not be considered, a panacea for management's budgeting problems. The technique should not be built up to promise more than it can realistically provide. In order to apply ZBB successfully, the following guidelines should be observed carefully:

1. Review the ZBB methodology and determine its appropriateness.

2. Analyze the need of your organization before implementing ZBB; that is, one should ask, "Is my organization ready for ZBB?"

3. Define resources required before implementation. This includes obtaining adequate staff for the budgeting department, setting up a top-management steering committee, and appointing local budget coordinators.

4. Sell high-level management on ZBB in advance of its implementation.

5. Long-range or strategic planning should always precede ZBB.

6. Develop a ZBB method, including a review procedure, tailored to your organization's environment.

7. Allow adequate time for training budget personnel and users.

8. Communicate to all levels of

EDP SPECIALISTS career search opportunities \$18,000-\$55,000+

DIRECTOR R&D SOFTWARE/HARDWARE to \$55,000 PLUS. Attractively located Mid-Atl corp, most advanced & largest in growing field, seeks exec for KEY Tech group of 35+ pros dvl'ng on-line mini-based systems w/multiple custom I/O's. Req's achievement managing software/hardware systems product dvlpmnt. Refer HG.

TELECOMMUNICATIONS COORDINATOR to \$38,000. Our major corporate client seeks exp'd telecommunications coordinator w/5+ yrs exp in data communications & data networks to include terminals, communications controller, time div & statistical multiplexors, modems & related diagnostic equipment. Refer BS.

SOFTWARE SUPPORT ANALYST, \$35,000. This position involves troubleshooting software problems & identifying weak

points in new operating systems. The successful candidate will have exp in identifying software design problems. Refer NS.

TECHNICAL CONSULTANT to \$33,000+. Major consulting firm seeks individual to develop their tech consulting practice. Will evaluate hardware, type of operating system &/or performance tools. New Position. Atlanta based. Refer RS.

SR. SYSTEMS to \$30,000. Prestigious financial corp in suburban MD seeks Senior Analyst w/exp in financial/accounting systems. Exceptional growth oppy. Refer RN.

SR. SYSTEMS to \$30,000. Billion \$ prestige mfg corp in choice Virginia location seeks Sr. Analyst w/exp in financial, accounting, payroll or inventory areas. Large 370 OS, COBOL, IMS bkgd a plus. Refer DM.

CONTACT OUR NEAREST OFFICE ABOUT THESE AND OTHER FEE-PAID OPPORTUNITIES.
OUR UNIQUE, COMPANY-OWNED OFFICE SYSTEM ASSURES PERSONAL, CONFIDENTIAL SERVICE.

PHILADELPHIA, PA 19102—S. Burns, 1500 Chestnut St., 215/561-6300
ATLANTA, GA 30346—R. Spang, 47 Perimeter Center, 404/393-0933
BALTIMORE, MD 21204—R. Nelson, 409 Washington Ave., 301/296-4500
CHARLOTTE, NC 28202—J. Schwab, 1742 Southern Nat'l Ctr., 704/375-0600
CLEVELAND, OH 44131—A. Thomas, 5755 Granger Road, 216/749-6030
MCLEAN, VA 22102—D. Miller, 1710 Goodridge Drive, 703/790-1335
NEW YORK, NY 10036—N. Shanahan, 1211 Ave. of the Americas, 212/840-6930
PITTSBURGH, PA 15222—B. Sayers, 4 Gateway Center, 412/232-0410
PRINCETON, NJ 08540—J. Dean, 3490 U.S. Rt. 1, 609/452-8135
WILMINGTON, DE 19810—H. Greene, 3516 Silverside Rd., 302/478-5150
HOUSTON, TX 77098—G. Smith, 3000 Richmond Ave., 713/523-5504
LOS ANGELES, CA 90017—W. McNichols, 707 Wilshire Boulevard, 213/623-3001
SAN FRANCISCO, CA 94111—W. McNichols, 601 Montgomery St., 415/392-4353

FOX-morris
personnel consultants

CIRCLE 123 ON READER CARD

COMPUTER SYSTEMS

**ENGINEER/PROGRAMMERS
(SUPERVISORY CONTROL SYSTEMS)
OVERSEAS EMPLOYMENT**

COMPUTER SYSTEMS ENGINEER — Degree required plus a minimum of five (5) years experience in the design and maintenance of real time mini-computer systems, familiarity with transistor circuits, integrated circuits and instrumentation. A knowledge of Assembler Language programming is desirable. Responsibilities will involve the development and maintenance of hardware for the monitoring and control of oil/gas pipeline and production facilities and electrical distribution/facilities.

PROGRAMMER/ANALYST (Supervisory Control Systems) — Degree required plus a minimum of five (5) years in depth experience in real time Assembler Language mini-computer applications programming with a working knowledge of operating systems. Some hardware experience is desirable. Responsibilities will involve the development and maintenance of software for the monitoring and control of oil/gas pipeline and production facilities and electrical distribution/transmission facilities.

Salaries commensurate with experience, plus generous overseas premium, plus an extremely attractive savings plan and other benefits, plus tax advantages, plus family residence, plus 30 days annual vacation and an excellent opportunity to travel and save money.

All replies confidential. Send complete resume of work experience, salary requirements and personal data to:

OASIS OIL COMPANY OF LIBYA, INC.
Personnel Representative
1270 Avenue of the Americas, New York, New York 10020

CIRCLE 124 ON READER CARD

management the objectives and goals, and provide clearer assignment of responsibility for justifying expenditures and setting priorities.

9. Test ZBB in a single department before implementing it throughout the organization.

10. Link ZBB to existing financial control systems, providing effective and timely management reports.

11. Encourage all levels of management participation, especially top management's cooperation and commitment. *

THOMAS J. FRANCL



Thomas J. Francl is director of systems and programming at The Bekins Co., Los Angeles. He received a BS from Loyola Univ. in Chicago and is a second year MBA student at the University of Southern California.

W. THOMAS LIN



W. Thomas Lin is an assistant professor of accounting at the University of Southern California. He received a BA from National Taiwan Univ., an MS from UCLA, and a PhD from Ohio State, where he also taught accounting. He is a CMA and has published several articles in accounting journals.

MIKLOS A. VASARHELYI



Miklos A. Vasarhelyi is an associate professor of accounting at Columbia Univ. He earned a BS from the Catholic Univ. of Rio de Janeiro, an MS degree from MIT, and a PhD from UCLA. The director of the Rio Datacenter, Dr. Vasarhelyi has published a book and many articles on accounting subjects.

FREE CATALOG

For a free government catalog listing more than 200 helpful booklets, write:
Consumer Information
Center, Dept. B, Pueblo,
Colorado 81009.

A big week for small computer specialists

The sixth Mini/microcomputer Conference and Exposition will be held in Brooks Hall and San Francisco Civic Auditorium, October 14-16.

Everything that's new and significant about small computers and systems will be on display on Mini/Micro's show floor and reviewed by experts in the Civic's four spacious auditoriums.

And there are some important extras! The Association of Computer Programmers and Analysts will hold its 10th anniversary conference just preceding Mini/Micro (call (800) 556-6882 for full details) and U.S.U.S. (the UCSD system users' society) will meet for three days during and following Mini/Micro. There will also be a day-long, Introduction to Pascal seminar.

Mini/Micro's professional program, previewed below, offers 60 hours of up-to-the-minute information in 24 half-day sessions.

Mark your calendar now, and use the coupon to request the Mini/Micro detailed preview program, available September 1.

TUESDAY, OCTOBER 14, 9:30 AM

1. The Small Business Computer in the Next Five Years
S. Henry Sacks, Mini/Micro Systems
2. Pascal Applications in the Minicomputer Environment
A. Winsor Brown, Point 4 Data Corp.
3. Professional Programmers/Analysts' Role with Small Computers
John Prior, Consultant
4. Impact of New Technologies on Marketing Opportunities for OEMs
Richard Able, Christman/Able Advertising

TUESDAY, OCTOBER 14, 1:30 PM

5. Quality Assurance for Small Computer Software
Murray Zuckerman, Consultant
6. Are Programmers Really Necessary?
Richard Dalton, Open Systems
7. Microcomputers in Banking
Robert Reffelt, Chase Manhattan Bank
8. Data Communications for Minicomputer Users
Roger Evans, Micom Systems

WEDNESDAY, OCTOBER 15, 9:30 AM

9. Pascal Open Forum: Implementation Interfacing to Existing Systems
A. Winsor Brown, Point 4 Data Corp.
10. Design Objectives for Color-Graphics Desktop Computing Systems
Ed Bride, Hewlett-Packard (DCD)
11. Winchester Disk and the Backup Issue: What's Happening?
Larry Hemmerich, Cipher Data Products
12. Effects of Microcomputers on Marketing
Jim Jordan, Moxon Electronics

WEDNESDAY, OCTOBER 15, 1:30 PM

13. IBM Watching: New Directions for Small Computers
John Rehfeld, International Data Corp.
14. Software Evaluation and Selection
Bill Fisher, Arthur Young & Co.
15. Session title and organizer to be announced.
16. Current trends in Computer Graphics
Dr. John Moreland, Megatek Corp.

THURSDAY, OCTOBER 16, 9:30 AM

17. Latest Armament in the Winchester Revolution
Randy Knapp, Wespercorp
18. Data Base Capabilities in Small Computers
Susan Kolb, Hewlett-Packard (DCD)
19. Computer Security in the Mini/Micro Environment
Bill Fisher, Arthur Young & Co.
20. Information Processing and Reporting: State of the Art in the "Paperless Society"
Mike Helft, Arthur Young & Co.

THURSDAY, OCTOBER 16, 1:30 PM

21. Distribution Alternatives for Small Business Computers
Robert R. Mueller, Office Products Dealer Magazine
22. Increasing Market Potential for Minicomputer Distribution
Bill McNamara, Systel Corp.
23. Systems in Hospitals and Health Care
Neil D. Kelley, Infosystems Magazine
24. Session title and organizer to be announced

Mini/Micro 80 32302 Camino Capistrano, Suite 202, San Juan Capistrano, Ca 92675

Please send me the detailed Mini/Micro preview program (Sept. 1)

Please send details and registration materials for the Introduction to Pascal seminar on October 13.

Name _____

Affiliation _____

Address _____

City, State, Zip _____

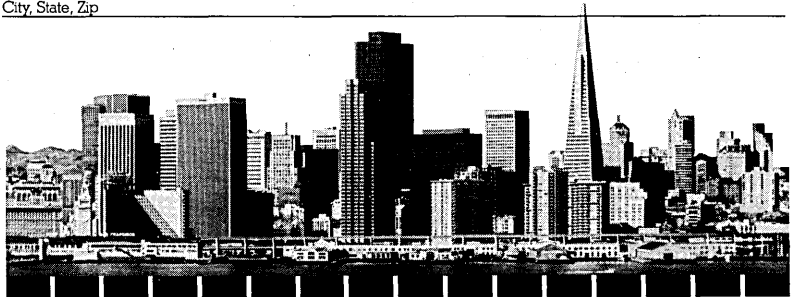

Mini/Micro 80

San Francisco, October 14-16

32302 Camino Capistrano, Suite 202, San Juan Capistrano, CA 92675 (714) 661-3301

Robert D. Rankin, Managing Director

CIRCLE 125 ON READER CARD

The benchmarks prove it...

1. Performance Measurements

Benchmark Name	VAX 11/780 CPU time	Perkin-Elmer 3240 CPU time	Performance Ratio*
PMS0154	1.140	0.907	1.26
PMS0254	4.710	4.485	1.05
PMS0354	9.160	8.990	1.02
PMS0454	43.610	43.451	1.00
PMS0554	86.420	86.123	1.00
PMS0664	1.610	1.350	1.19
PMS0764	7.040	6.679	1.05
PMS0864	13.730	13.370	1.03
PMS0964	66.830	66.068	1.01
PMS1064	132.920	129.727	1.02
PMS1124	1.520	1.306	1.16
PMS1234	2.470	2.424	1.02
PMS1324	1.310	1.618	0.81
PMS1407	251.560	37.327	6.74
PMS1507	50.260	57.657	0.87
PMS1674	22.440	23.005	0.98
PMS1724	52.550	53.133	0.99
PMS1807	50.180	34.766	1.44
PMS1907	32.020	34.679	0.92
PMS2007	17.720	20.264	0.87
PMS2107	13.450	20.242	0.66
PMS2202	33.311	26.352	1.26
PMS2324	121.610	137.997	0.88
PMS2402	0.940	0.539	1.74
PMS2502	0.720	0.562	1.28
PMS2624	122.920	227.689	0.54
PMS2708	4.850	0.961	5.05
PMS2809	103.770	0.006	17295.00
PMS2934	0.660	0.414	1.59
PMS3009	0.230	0.006	38.33
PMS3103	0.610	0.398	1.53
PMS3202	4.740	3.923	1.21
PMS3307	2.470	1.959	1.26
PMS3407	39.190	7.774	5.04
PMS3507	5.580	2.587	2.16
PMS3607	156.540	20.077	7.80
PMS3701	4.480	1.621	2.76
PMS3802	4.060	2.874	1.41
PMS3903	6.050	3.864	1.57
PMS4002	9.330	5.505	1.69
PMS4102	76.290	77.764	0.98
PMS4202	118.490	125.039	0.95
PMS4301	110.650	75.569	1.46
PMS4403	1.990	0.739	2.69
PMS4584	219.990	189.081	1.16
PMS4603	18.640	16.939	1.10
PMS4701	0.350	0.077	4.55
PMS4802	0.830	0.880	0.94
PMS4934	0.340	0.050	6.80
PMS5008	0.430	0.168	2.56
PMS5108	98.950	55.419	1.79
PMS5208	0.900	0.917	0.98
PMS5308	0.330	0.029	11.38
PMS5408	2.080	1.697	1.23
PMS5502	1.130	2.180	0.52
PMS5602	207.140	198.685	1.04
PMS5703	585.170	254.545	2.30
PMS5824	18.740	18.194	1.03

*Performance Ratio = $\frac{\text{VAX 11/780 CPU time}}{\text{Perkin-Elmer 3240 CPU time}}$

2. Perkin-Elmer 3240 vs. VAX* Average Time by Job Classification

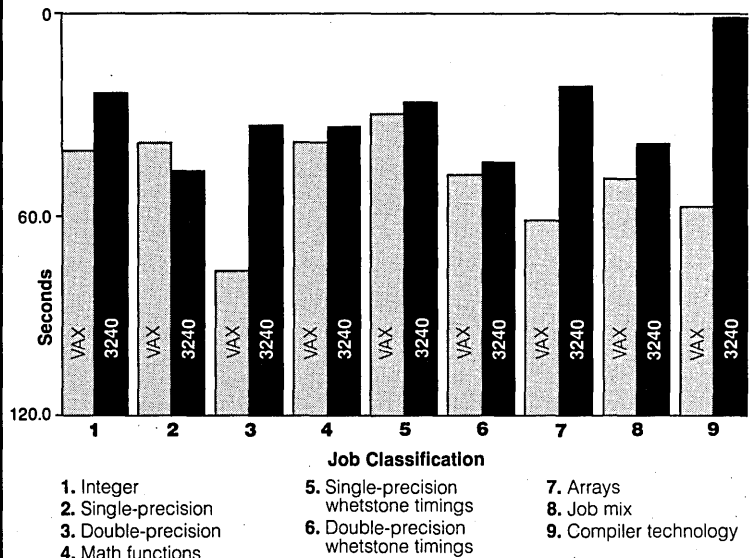

*VAX is a trademark of Digital Equipment Corporation.

3. Proven Price/Performance

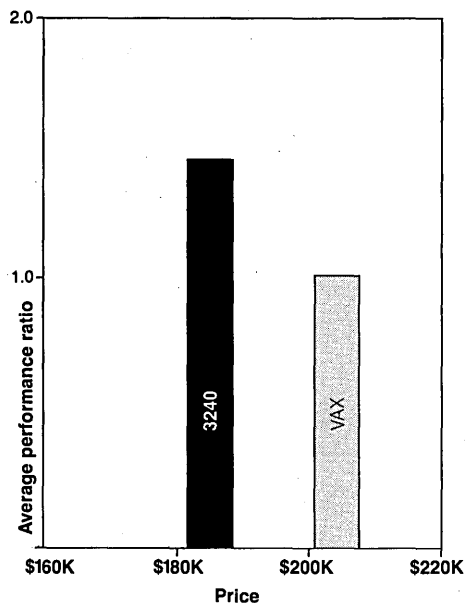

The configurations tested were 2 MB of memory, 67 MB disc, 75 ips tape, Floating Point Processor, CRT terminal, battery backup, and system software. The 3240 had a Writeable Control Store and Fortran Enhancement Package, while the VAX 11/780 had a Floating Point Accelerator.

The Perkin-Elmer 3240 is Faster than VAX.

Our 32-bit Model 3240 performed 44 out of 58 benchmark tasks faster than the more expensive VAX 11/780.

We matched our Model 3240 against the VAX 11/780 in 58 customer supplied benchmarks, comprising 697 million FORTRAN statements.

In 44 of the benchmarks, the 3240 performed *faster* than VAX.

Overall, the 3240 delivered an average 1.4 times higher performance.

Yet the 3240 configuration costs approximately \$20,000 less than its corresponding VAX configuration.

All 58 FORTRAN benchmarks listed in Table 1 were submitted by our customers and prospects reflecting their application needs. Applications that deal with the same kind of problems you face every day.

All benchmarks were run on-site at various locations across the country. And all were run by vendor-trained operators.

In Table 2, we organized the benchmark results into nine common types of job classification, so you can see at a glance how the 3240 stacks up vs. VAX 11/780. (The ninth classification demonstrates the superiority of Perkin-Elmer's system software, in this case globally optimizing FORTRAN VII.)

As shown in Table 3, the story is simple and uncomplicated. The

Perkin-Elmer 3240 outperforms VAX 11/780. And it costs less.

The 3240 is faster than VAX in another important way—we can deliver it faster.

We'd be happy to send you a sub-set of those benchmarks which are non-proprietary or have been released with permission, so you can run them yourself. We'll also send you hardware and software documentation.

Before you make a decision on any supermini system, get all the facts on the new 3240 from Perkin-Elmer.

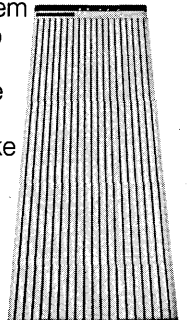

The Perkin-Elmer Corporation, Marketing Communications,
2 Crescent Place, Oceanport, NJ 07757

Please send me complete information on the 3240
 documentation a sub-set of benchmarks.
 Have a salesman call.

Name _____ Tel. _____

Title _____

Company _____

Street _____

City _____ State _____ Zip _____

Call toll free: (800) 631-2154

In NJ: (201) 229-6800

CIRCLE 126 ON READER CARD

PERKIN-ELMER

MARRIAGE: DP STYLE

by Merrill Cherlin

She was describing their new house near California's Silicon Valley. "It's O.K.," she sighed. "I mean it doesn't have what you would call *charm*, exactly."

"How would you know?" her husband asked. "You never spend any time in it."

Ah, it was the old story: she, codirector of information technology at a large corporation. He, the put-upon husband. Usually the sexes of the two spouses in this situation are reversed, but now that women are fighting their way to the top in the computer industry they find they've won equal opportunity to wreck their marriages as well.

Ask anyone in the industry; they'll assure you the divorce rate among their peers is astronomical. It certainly wasn't difficult to find divorced dpers to interview for this article—they seemed to be in the majority. But we talked to married computer people, too, and harried spouses. The names have been changed to protect the miserable.

Take Claire, whom we met on the commuter express out of New York. She is Bob's third wife. "Being a dp wife I can honestly say is the pits. He's a director of operations. If I didn't go to his office to pick him up after I'm through at my office, he would never come home. He'd forget about time altogether. Normally in the course of an evening the phone rings anywhere from five to 10 times. But my favorite is when they call at 4:30 in the morning to tell him the system is down. Then he either goes in or walks them through over the phone. The other night he was on the phone from 10:45 till 11:30. Then he packed up and went in and didn't come home till 3:30 in the morning. He won't take a sick day, let alone any vacation."

Did she know it would be like this before she married him? She answers, "I knew it was going to be bad but I didn't know how bad. When we go out to dinner he's constantly checking in with the office. Even when we go on vacation we have to leave a forwarding number.

"I'd say his work probably inter-

fered with his last marriage, because when he wasn't at work he was studying, taking courses.

"The only thing that I'd say makes my marriage with him more compatible than his others were, is that at my job I'm somewhat involved with computer operations myself. It makes it somewhat easier. If he comes home and starts talking technical at least I have the basis to understand the conversation.

"Formerly he was working as a consultant, and that was even worse.

"I call him once or twice a day to see if he's still breathing. He never brings his head up above water. A dp career can be very destructive to a marriage. It's one of the most boring subjects in the world if you don't understand it. Luckily I do.

"We're planning to have a family but I doubt he'll have much time to spend with the children. Many an evening we'll be sitting there watching tv and he'll have reams upon reams of computer printouts heaped up in front of him, looking for some minor error," she trails off with a weary sigh.

We decided to hear Bob's side of the story. He explains, "When I took over this data center it was in bad shape, and my hours at first were terrible—every weekend and long hours at night—but in the last six months it's slacked off. Maybe, as we continually advance, we'll all be able to work more regular hours.

"Systems programming was actually the toughest job. The operator drops a card deck and doesn't know how to put it back together again, so he calls you. It's 4 a.m. in December, you're standing barefoot on the kitchen floor with the wind rushing in under the back door. Your ankles are turning blue, and he wants to know if you can tell him how to put the cards back together. It's written down on a piece of paper, but he doesn't understand it.

"If my career advances at the astronomical rate I want it to, someday I'll be too high up in the organization for them to bother calling me.

"I enjoy my work very much and it's an integral part of my life, as is my family.

But at times I feel the job has to come first. Although I only control about \$3.5 million, if we screw up, it could end up costing the company \$50 million or \$60 million further on down the line. You have to accept this. It's never been a 9 to 5 job and I don't think it ever will be. It's a fun field and a frustrating one. There aren't many people in this field who'd ever want to do anything else. It's like taking off on a rocket to the moon. There are a lot of stops along the way, but it's all exciting."

HASSLE-FREE PAIR

Just as Claire finds it somewhat easier to take Bob's lifestyle because she understands the field a bit, Jason and Andrea, who hold similar jobs in the same company, find they have almost no hassles due directly to the job. Jason is vice president of dp at a large Manhattan bank. His wife is a second vp of systems planning at one of the bank's branches. He says, "In the past I've had to put in 90-hour weeks. But she understood what I was doing. Sometimes, before our son was born, she'd come with me. We haven't been able to have a decent vacation for a long, long time, though. It all depends on how much you enjoy being in dp. It's good if you're both in it, because then you can talk about it and share experiences. If it's both fun and work it's not bad at all."

Extricating ourselves from this sugary pair, we went in pursuit of more regular people, those who are married to people outside the profession.

Maria, head of data processing for the school system of a large Eastern city says, "It's easy to see why there's lots of divorce in dp. Just last week, for example, we did a big upgrade. I went in and ended up staying all night to see it through. If your spouse doesn't understand or if he objects to these hours, he's not going to be happy in the marriage." Her husband could not be reached for comment. The above conversation took place at a party and he was home babysitting.

Fortunately, Maria has an accommodating spouse. Jack didn't. The operations manager of a mid-Atlantic insurance company, Jack remembers, "I was offered a job out

ILLUSTRATION BY DEBORAH BAZZEL



"I was offered a job out of town. I was willing to go in a second; she wasn't. So I went. She didn't."

of town, I was willing to go in a second; she wasn't. So I went. She didn't. Sometimes I'd work two or three days around the clock. I guess I'm not good husband material that way. Next week all four of my supervisors are going to school for four days, so while they're gone I'm going to be working four straight days—day and night. I don't sleep. It won't be the first time. You get to a point where you find yourself about ready to drop, then you go throw cold water on your face, get a cup of black coffee and get revived. I'll sleep for a day afterwards. I'm at the 40 mark now and I still can do it. This business is a lot of hassle. We were down 24 hours from Thursday night till late last night.

"The majority of the people I know in the dp field can only work a certain amount of overtime, otherwise they'd be in immense trouble at home. Dp is ridiculous, it demands a lot of your time. I make a lot of money because I'm willing to hustle, break my back, and give a little bit extra—something that's becoming more and more rare to find in people today."

Perhaps it's rare because people are demanding a change from the old dictum that the company owns them.

We decided to talk to a specialist in computer-related stress. There really is such a guy, and he's John Van Zwieten, a former clinical psychologist who is now a stress management consultant. He used to work on staff at GTE in Tampa and now works with managers and professionals in "high-tech" business, especially the computer business. He sees the high divorce rate in the industry as an unfortunate but natural outcome of the high degree of stress it generates.

He explains, "First of all, the kind of person who goes into dp is the kind of person who's sort of a loner—not as interested in

dealing with people as he is in dealing with machines and systems. There's quite a shock for a lot of these people as they rise up to more responsible positions because suddenly they have to deal with people. They have to interface with users, and be effective. If they're not, they come out with a product that is not acceptable to the user. That happens continually in the dp industry.

"Dpers are skilled in machines and logic, but not in conflict resolution or communications. There's a lot of stress built up around that. Dpers are under the gun. This, of course, is a generalization—some do have the skills. But these pressures are somewhat unique to the industry.

"The crazy hours and deadlines are a big problem. You can look at stress on a very personal level. Take physical fitness. Dp is a very sedentary sort of job—sitting around a lot in meetings and in front of a crt. If people don't take opportunities to exercise, their resistance to all this other stuff is lowered. So when something stressful at work happens, they're less likely to be able to deal with it. They tire quicker and feel constantly stressful. It keeps building and building because it's not dealt with, and dp people traditionally don't know a whole lot about how to deal with their own stress. The family gets involved and finally a lot of people move from just being stressed to being distressed and that's where physical illness and emotional liability come in. Wide mood swings occur. The person can be heading toward a breakdown, which is definitely very widespread in this industry.

"The divorce is not cause and effect. As stress builds up at work it slowly builds up at home, which makes it build up at work even more. They parallel each other. All the people around the stressed individual become

more stressed—the wife and kids and the workers, too. Finally, the individuals in a high pressure organization that has a lot of negative feedback and a lot of problems will absorb lots more stress.

"People first need to be aware of stress and how they react to it. They have to be aware of it in their bodies; in their psychological makeup, which can be seen in the things they say to themselves and feel about themselves; in their interpersonal relationships with peers, boss, and family members; and in the organization. What things in the organization are stressful for them?

"Second, they have to be aware that they have some control and can in fact change.

"Third, they need to look at each area and address stress in each of them. It doesn't help to say, 'Well, I'm going to try to work it out with my wife.' You also have to work on it on physical, emotional, interpersonal, and organizational levels.

"Finally, they have to decide how they're going to change their behavior and put their plans into action.

"These stresses are different for every person. They have to discover alternatives to them—new behaviors they can put into use.

"I'd hate to make the statement that these people who like to work alone and aren't good with people wouldn't be good at a marriage. It depends on the spouse's expectations. If you hold to the old story that people choose like partners, then both people may be very individual and that could work out fine. On the other hand, if you feel that opposites attract, you can say they'll choose the opposite in their mate and then their mate will be either happy with the complementary mate or will be upset because their expectations weren't met.

"I wouldn't want to state that a dp type is the kind of person to have a bad marriage. I would say that in general they're probably not as adept at people skills. But that doesn't necessarily mean a marriage will be bad. A lot of times you can adapt to that. What it does mean is that if you're on a job where you need people skills, you're going to be in trouble unless you learn them. I'd say it's not that dpers don't have the traits necessary to make a good marriage, but that it's more the stress of the workplace.

"There are other stresses in dp I haven't even mentioned—like the rapid pace of technological change you need to keep up with. It's explosive. What you knew three or five years ago is no longer applicable or current. There will be even more broken marriages because people haven't learned to cope with the stress of all this change."

We commented that Van Zwieten paints a very bleak picture. He responded,

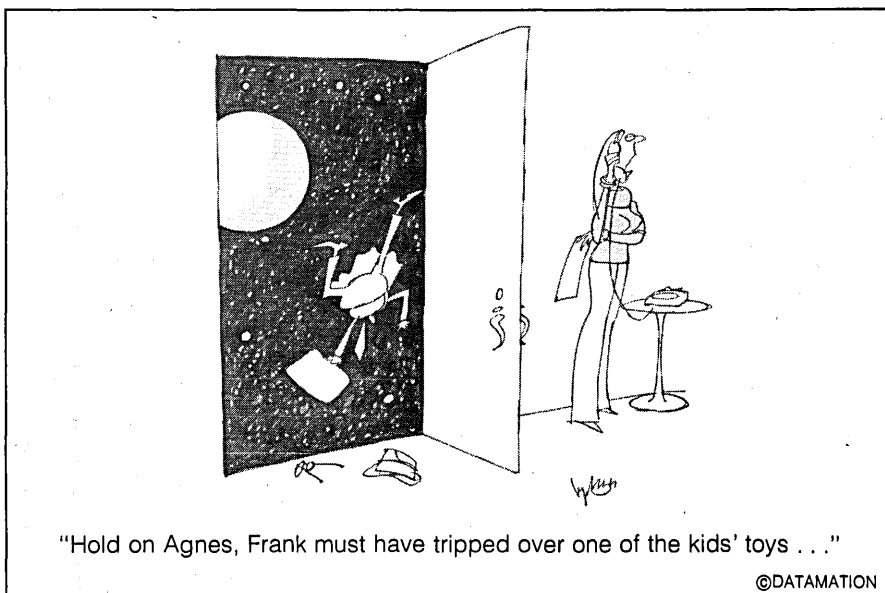

The forms source.

Burroughs Forms Management Service. An affordable, dependable plan that offers maximum efficiency for purchasing and managing today's business forms.

You could be unknowingly wasting time, money and valuable floor space coping with business forms. Even if you're ordering at predetermined restocking points on the lowest bid basis.

Burroughs Forms Management Service can show you a more productive way.

First we'll survey what you're doing now. Then we'll make specific recommendations designed to increase efficiency, lower costs. We'll make sure your forms not only fit your printers but your programs, too.

We'll show you ways to keep costs in line and reduce overall costs by forecasting needs for years at a time. And our deferred payment plans let you pay for your forms as you use them, freeing up your capital.

We'll handle your forms inventory for you. You won't have to make inventory checks, ask for quotes, interview salesmen, write multiple purchase orders. Your receiving procedures and accounts payable are streamlined. And since you'll only have to keep current supplies on hand, you'll increase valuable warehouse space in the process.

We supply everything from bank processing documents and loan coupons to checks (including the only one with three built-in safeguards against color copier fraud). Continuous forms, stock tab forms, snap-apart forms, food and lodging forms, pegboard systems — you name it. Plus all the forms equipment you need. Disbursement systems, bursters, decollators.

And remember, every Burroughs system fulfills the need that counts most in your business: increased productivity. Burroughs has understood this for over 90 years.

That's why we provide total capability in information management. Computers, word processing systems, facsimile communications, system software, application programs, customer training, maintenance, plus business forms and supplies. We call it Total System Support. And it's there to help you improve your productivity.

For additional information, call your local Burroughs Office. Or write Burroughs Business Forms, Dept. DM-6, Rochester, New York 14603.

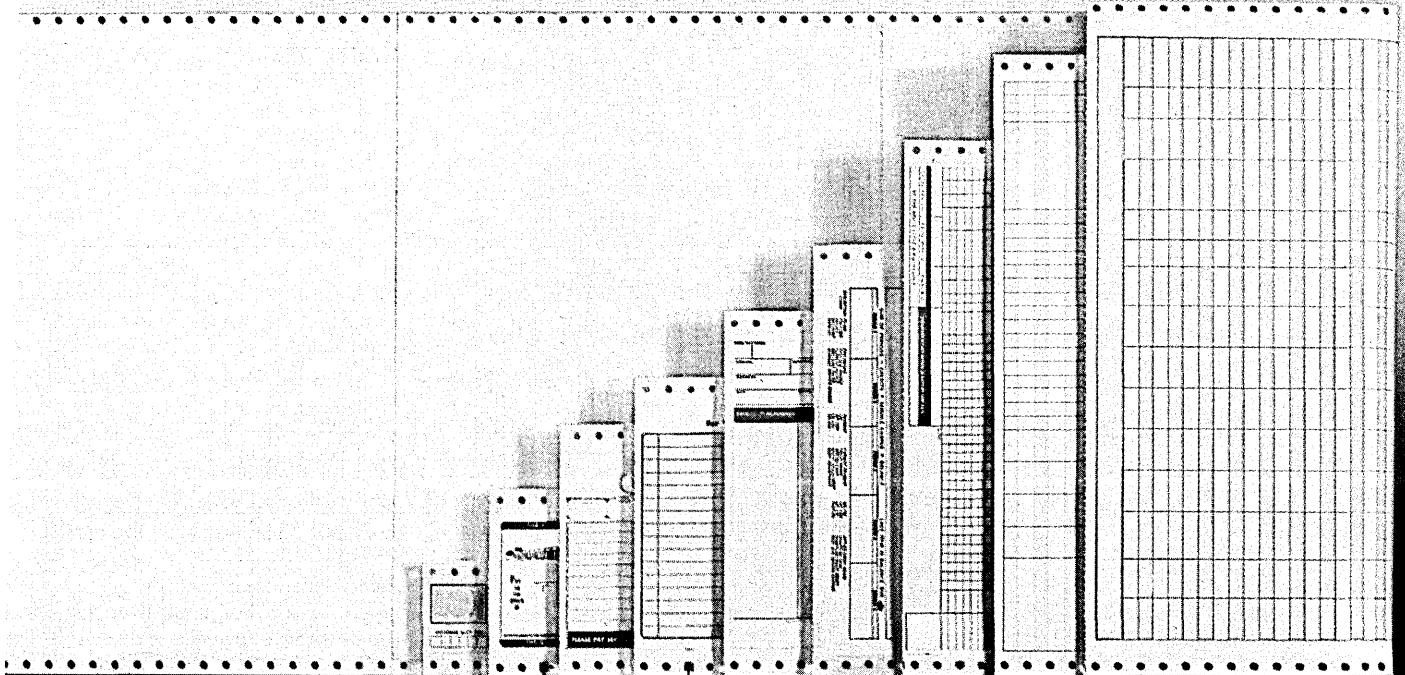

Burroughs

CIRCLE 127 ON READER CARD

"You can't yell at the computer so you yell at your spouse."

"Well it's a picture that needs to be painted because it's an accurate one and it's going to have an ever-increasing impact on business and industry in this country—being able to compete and stay current with world technological trends. If we can't find a way to deal with our stress, we're not going to make it and that's scary.

"However, more and more companies are starting to pay attention to the stress factor and trying to do something about it. I see that as positive, in the more progressive companies. The others aren't gonna make it."

JOB STRESS A FACTOR

We went from Van Zwieten to Dr. Andrew Cherlin, a Johns Hopkins sociologist whose field of research is divorce and marital stress. He concurred with the idea of job stress as a factor leading to divorce. "People take out their anxieties on family members because they are the nearest available objects on whom to vent their frustrations. For instance, there's a lot of family violence in families where the husband is unemployed, because he's unhappy and tense. When his wife criticizes him he snaps back at her and starts a fight.

"By the same token, if the husband has a stressful job he'll come home tense. He'll snap at his wife and they'll start arguing. Any kind of external pressures can hurt a marriage. That includes the death of a close relative, illness in the family, or a stressful job. People use their families to let off steam because that's about the only place where they're able to do it. You can't yell at the computer so you yell at your spouse."

It seems, then, that alleviation of on-the-job stress could slow down the divorce rate in the industry. But is that likely to happen? Paul works in the training department of the data services division of a huge corporate conglomerate. He does foresee considerable change in the job structures of computer professionals and tells why.

"One of the big reasons for all that stress and the long work hours is the way software has been developed. I think if you look at the new software development tools that are emerging, you'll find within five to 10 years there will be no reason for all these crash systems projects (unless you're really unprofessional and doing a bad job of it), the mainstay of the lifestyle of the typical dp person today. Programming and systems analysis has been primarily an art, not a discipline—that creates all the problems. You can always underestimate a project. By not having any good measuring tools to tell how long it will take, it's classical that you'll underestimate. Then, to meet your deadlines, you're in there at the 11th hour. I feel confident that as the tools are developed, a lot of the lifestyle problems can disappear. It should become more civilized and maybe even routine.

"One of the key criteria behind the new software is that systems are more predictable. You're going from art to science, so when something does happen, it's identified and easier to correct, you won't have to look at tons and tons of code. Also, one of the chief hardware design goals will be reliability. It will be like electricity, something you can pretty much count on. Now, because of lower costs you're able to build redundant systems, like the tandem computer, to run nonstop. If

one component fails, the rest is still there and running.

"A lot of the classical stresses will be managed a lot better in the future and it should be better for the marriages.

"Even top management recognition of the stress problem, that could lead to flextime, compensatory time, etc., would force them to have a much more lenient attitude. We could get the family more involved. Volvo, in Sweden, likes to hire several family members, couples, etc., to work in the same factory. That has a major impact on family life. Here, we have a housewife in Hackensack asking, 'Where the hell is he?' That family-centered job stuff couldn't be that hard to arrange.

"But in this country all the big companies are very resistant to change. Dp directors who got where they are based on what they knew in the late '60s and early '70s are trying to hang onto that, because that's what got them to the top. They should let employees come in, work three days and three nights if it's necessary, then let them knock off for a week to do nothing. But the organizations are uptight about time and all that good stuff.

"The crazy hours don't have to be. In the future the guy working them shouldn't be in the business anymore, as we go about it in a more scientific way. That's going to be a big shock to folks in dp. The only reason *then* for working those horrible long hours is that either the guy's so good that people are piling work on him, or that he really doesn't know what the hell he's doing."

But Terry, another computer professional, takes issue with the idea of flextime. He feels that even if people could make their workdays more flexible, they wouldn't want to. "A lot of guys in our business could be working at home today, but they don't want to. They could be at their terminals at home and not in their little cubicles, but they say, 'Gee, I'd rather come into the office.' Dp is something you have to get enthusiastic about and deeply into. I don't know if it's the cause of the problem or an avenue to express a problem generated from another source. In any case, the very high divorce rate is no surprise."

The next decade could settle the question. If we indeed see a lessening of crisis situations, and dpers are allowed to relax and "live like normal human beings," then maybe the divorce rate in the industry will drop. If it doesn't, then Terry will be proven right; no matter what the hours required, people who become professionals in the computer industry care more about their work than about anything else in their lives. *

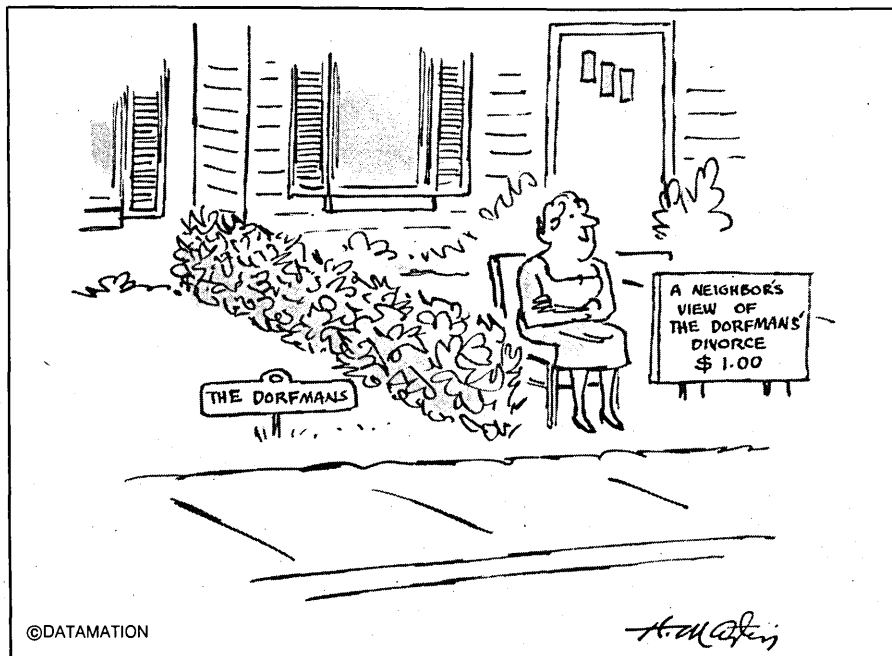

©DATAMATION

Merrill Cherlin is a writer who lives and works in Baltimore.

DIGITAL PRESENTS A MAJOR ATTACK ON DOWNTIME.

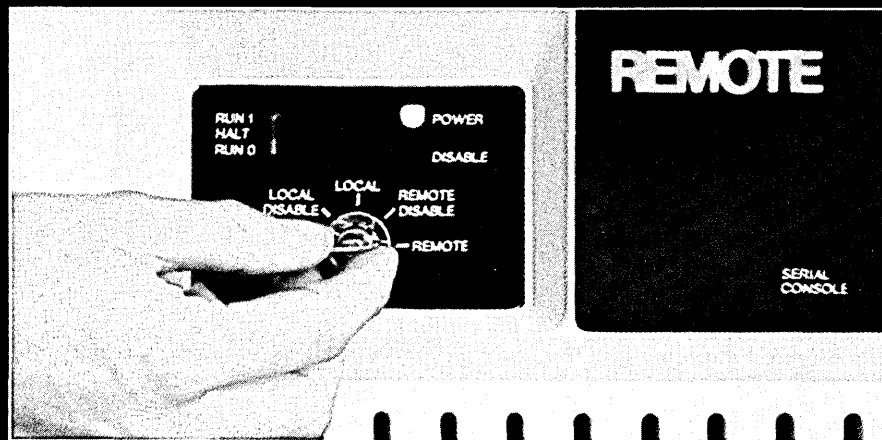

In "Remote" mode, your computer is linked to our Diagnostic Center in Colorado Springs.

**Day or night, Digital's computer-to-computer Remote Diagnosis
▶▶▶▶▶ goes into action within 15 minutes of your call.◀◀◀◀◀**

At Digital, we know that your tolerance of computer downtime is very low.

So is ours.

That's why we've developed computerized Remote Diagnosis,* the first of its kind.

When a Digital system has a problem, a toll-free phone call and the simple flick of a switch launch a coordinated effort to get that system up and running as soon as possible. Within 15 minutes, our Remote Diagnosis computer in Colorado can run a troubleshooting program on your system via a voice-grade phone link. If we have to send service representatives, we send them prepared. Remote Diagnosis lets them know exactly what's wrong and what they need to fix it before they arrive on the scene.

During off-peak hours, we can run a preventive maintenance program that won't interfere with normal use. Done regularly, Remote Diagnosis

goes beyond troubleshooting. It pinpoints potential problems while they're still merely potential.

We take a lot of pride in the way our computers perform. And we take it very personally when they don't. So we'll keep looking for new ways to serve you better and hold maintenance costs down.

At Digital, the war against computer downtime is never over.

Write: Digital Equipment Corporation, Field Service Marketing Communications, PK3-2/S25, 129 Parker Street, Maynard, MA 01754.

* Available on: VAX-11/780, PDP-11/70, PDP-11/44, DECsystem-10 and DECSYSTEM-20, DEC Datasync 570 and DEC Datasync 540.

digital

 National
Advanced Systems

AS/TC

What it means to be the worldwide leader in IBM-compatible computers.

At National Advanced Systems, we offer the broadest range of IBM-compatible computers on the market. Our systems have met with unprecedented customer acceptance. In fact, we now have the largest installed base in the entire industry.

This leadership position isn't one we take lightly. We've dedicated ourselves to providing complete data processing solutions which help decrease your cost of doing business. And that's especially important in these times of recession, inflation, and high interest rates.

Why compatibility?

The concept of compatibility has allowed manufacturers such as ourselves to provide superior price/performance alternatives to IBM users. As a result, the IBM-compatible segment is now growing twice as fast as the rest of the data processing industry. And we're committed to remaining at the forefront with all the necessary services and technological advances, because we understand your need to increase productivity while protecting your investments in IBM software, hardware, and training.

Systems to fit your needs.

Our Advanced Systems product family is backed by a \$1 billion multi-national corporation. Our systems offer unequalled price/performance, and boast higher residual values over time than do IBM systems.

The family ranges in size from our medium-scale AS/3000 to our top-of-the-line AS/7000DPC which outperforms the IBM 3033. In terms of reliability, our Advanced Systems family has set new standards in the field.

And, of course, our systems are backed-up by the finest service and support force in the entire industry.

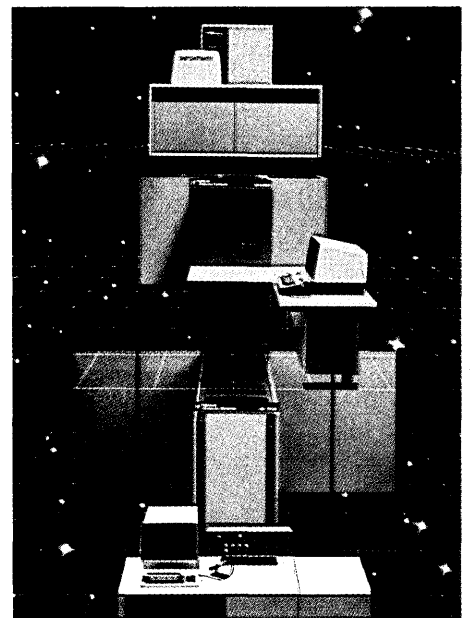

For more information, contact your local National Advanced Systems sales office, or contact Marketing Dept. A2, 3145 Porter Drive, Palo Alto, CA 94304, 415/856-5000.

National Advanced Systems. When it comes to compatibility, no one else even comes close.

 **National
Advanced Systems**
The Compatible Computer Company
A subsidiary of National Semiconductor

Distributing a company's computer activities to small mainframes may be fashionable, but cost justification must precede a switch.

DOES DISTRIBUTED PROCESSING PAY OFF?

by Kenneth M. Sullivan

Distributed processing is fashionable, and in many cases, distributing computer activities to small mainframes throughout the company makes sense. However, when any activity becomes fashionable, there is a danger that acquisitions of hardware will be based on "gut feel" and without adequate cost justification. And whenever economics is disregarded, the bottom line can be affected negatively.

Large and medium sized companies usually have one or more centralized computer facilities that represent large investments in capital equipment and people. If a company chooses to implement distributed processing by transferring various applications from the central site, it should do so only with a complete understanding of how the central facility will be affected.

The costs underlying large-scale processing are rather fixed over time. That is, there must be a significant drop in workload before a central processor can be eliminated.

Our objectives are to examine the costs to users of large computer facilities for typical work performed and to compare these numbers with the economics of distributed processing. The comparison of the true costs of a central computer facility and the true costs of a distributed system is essential to making an intelligent justification of a move to distributed processing.

Most large computer facilities have become what accountants call *cost centers*. That is, the facility stands on its own from a cost standpoint and charges users for the time consumed on mainframes and peripherals.

In the late '60s, after IBM introduced SMF (System Management Facility), considerable amounts of detailed accounting data became available to computer operations

management. Most sites put this data to good use by devising cost chargeback schemes. Using SMF data, algorithms could be developed that dynamically measured each program's use of cpu time, memory, channel activity, and various peripheral functions. Then, by taking the total costs of the computers and dividing by projected utilization, cost rates were developed, and they became the basis of chargeback systems. (Information on these accounting methods was available through such organizations as SHARE.)

By the early '70s, most companies recognized the advantages of charging users for computer time. Processing centers had grown too large to be buried in overhead. Chargeback allowed users to justify existing and new applications effectively. Chargeback brought the true cost of operating a computer center back to the average user; it also limited the demand for computer services to what the user could justify. And chargeback provided a reference point against which to measure the long-term cost performance of the center. During the '70s, most well-run centers were able to bring their rates down consistently, even in the face of inflation.

As computer centers matured, accounting procedures also matured, resulting in the creation of cost centers. Cost centers include not just computer rental and direct operator wages in the cost pool, but *all* costs, both direct and indirect.

Typical cost accounting for a central computer facility will include *direct* costs such as central processor rent/amortization, communications hardware costs, data line costs, software rent/license fees, supplies (paper, magnetic tape, disk packs), and computer operator/support personnel wages.

The facility will also incur *indirect* costs, such as building rent amortization and costs for systems programming, electrical

consumption, heating and air conditioning, janitorial service, security service, building maintenance, facility modification, and computer center management.

Finally, the center can be allocated its share of the company's general overhead costs, such as those for financing (imputed interest), personnel services, financial support, and corporate support.

The fully costed central computer facility is, in a sense, a mature member of the corporation, providing services for a fee somewhat comparable to outside services and to alternative modes of computing, such as distributed processing. Unfortunately, because its costs are so visible, the central computer facility is an easy target for misleading justification of alternative methods of processing.

HOW COST IS JUSTIFIED

Most companies have not seriously considered or used minis for more than the past two or three years. From an accounting standpoint, then, sophisticated costing approaches haven't even been considered yet.

If a mini is to be acquired to replace an existing application running at the central site, a cost justification is usually developed. The content of that justification is typically inadequate.

What we usually find in a standard distributed processing cost justification is a comparison of *the current fully burdened costs charged by the central site computers for the application with the straight hardware purchase prices for a minicomputer configuration*. (Although mini lease prices can also be used, we won't consider them here because the effect is the same.)

This comparison of costs generally comes out overwhelmingly in favor of dis-

Financial software so advanced that Encyclopaedia Britannica doesn't even want to talk about it.

Nor do any of the 1,000 companies that benefit from McCormack & Dodge financial software.

When you're ahead of the pack, the less said the better.

Suffice it to say that Britannica's General Ledger package is unparalleled in its fast, flexible reporting, its efficient journal processing, its comprehensive editing and extended capacity for budget control.

Behind the package is a cadre of sophisticated software professionals that meets Britannica's own standards of excellence. A software company with proven success in the highest echelons of the publishing industry. Consistently tops in Datapro ratings. Serving 20% of the *Fortune* 500 companies.

McCormack & Dodge. Whose customers are the smartest, toughest controllers and data processing people in the world. Where user training is the way

training ought to be: hands-on. Where only general ledger specialists are authorized to present and sell general ledger software.

And where, in seven out of ten cases, prospects who sit down and talk do more than just talk. They become customers.

We'd like to show you why.

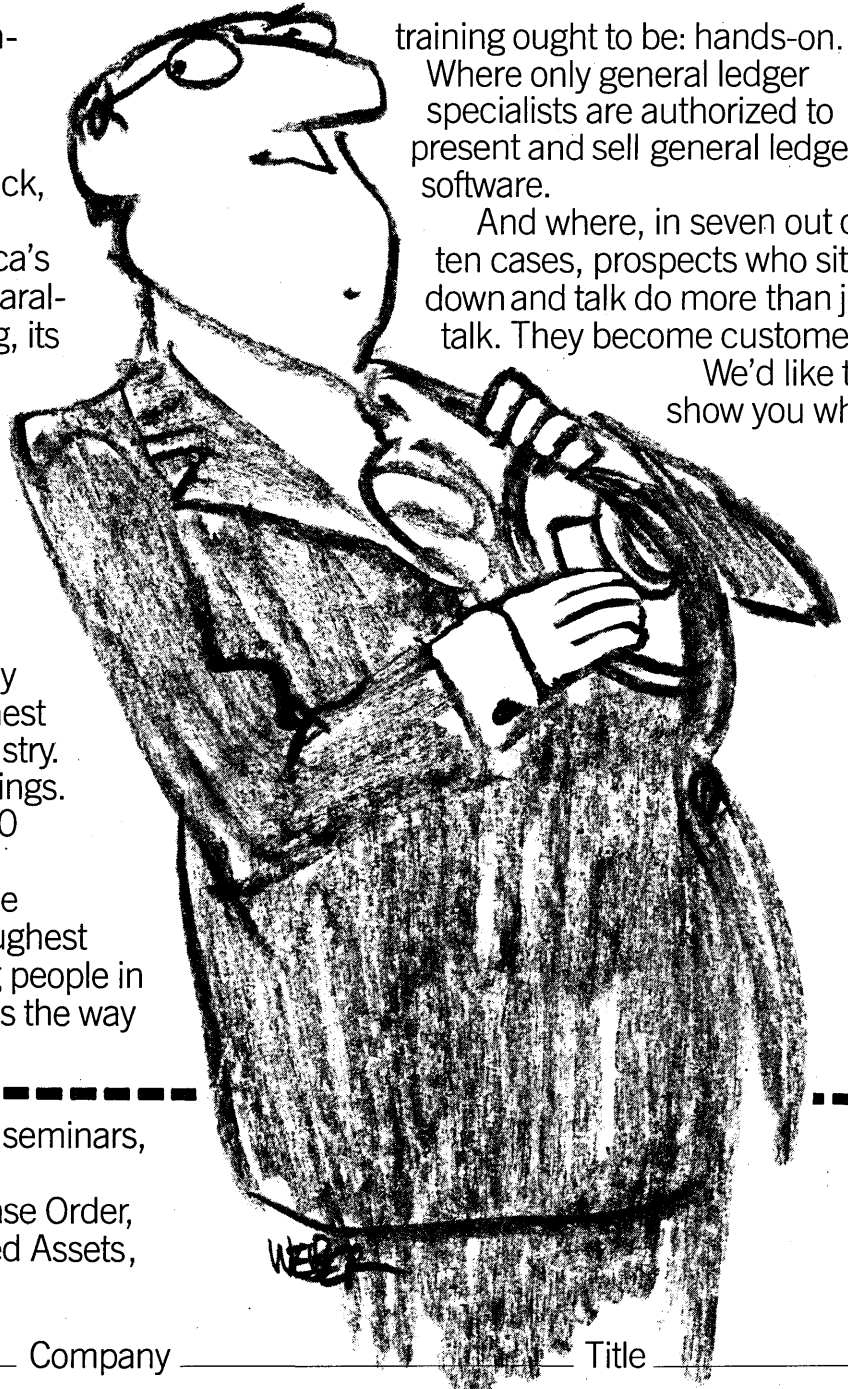

Please send schedule of free seminars, plus information on:

- General Ledger, Purchase Order,
- Accounts Payable, Fixed Assets,
- Capital Project Analysis

Name _____ Company _____ Title _____

Address _____ City _____

State _____ Zip _____ Phone _____ Computer Model _____

McCormack & Dodge

The best financial software. The best financial people.

560 Hillside Avenue, Needham Heights, MA 02194, (617) 449-4012

Atlanta (404) 997-2797, Chicago (312) 843-4300, Dallas (214) 369-7014, Los Angeles (213) 645-6382, Washington, D.C. (703) 734-0710, Toronto (416) 445-2971, New York/New Jersey (201) 528-6331. United Kingdom/Netherlands • Italy • Australia/New Zealand • Mexico • South Africa • Sweden

Because the central computer facility's costs are so visible, it is an easy target for misleading justification of alternative processing methods.

tributed processing with the break-even point achieved typically within one year. The implication of the cost justification is that management would be foolish not to go distributed.

For example, suppose we have application X that runs weekly on an IBM 3033. The application produces financial planning and forecasting data. The application has characteristically low cpu and high I/O usage and requires a moderate amount of disk storage, perhaps two 2316 packs. The data base tends to grow larger as the year progresses.

The monthly costs charged by the fully burdened central computer facility are as follows:

Processing	\$10,000
Disk storage	2,000
Program maintenance	1,000
Monthly	13,000
Annual	156,000

The proposal to go distributed, using a half-megabyte 4331 with some 3370 disk, results in the following costs:

Purchase price (includes features)	\$120,000
Hardware maintenance (annual)	12,000
First year	132,000

Dividing present monthly costs into proposed costs shows an incredible break-even point, achieved within just 10 months. After that it's all gravy, right? Wrong.

The analysis compared apples with oranges. The central computer costs were fully burdened with overheads, while the mini consisted of basic direct costs.

Costs for the following were not considered for the mini: personnel required to operate the machine; program conversion; consumable supplies such as paper, cards, and disks; unplanned maintenance; facility modifications; electricity, air conditioning, and heating; floor space amortization; administrative; miscellaneous.

All of these costs were included in the central facility's chargeback. The actual break-even point for the distributed machine is achieved later than that portrayed in the analysis, and it may, in fact, never occur.

WHAT CAN GO WRONG

Once an application is approved for transition, a number of typical things occur. If an inadequate cost justification is prepared, then these events are all surprises to management—very expensive surprises.

Let's suppose the decision to convert application X to a mini meets with approval based on the inadequate cost justification just described. The machine is delivered, floor space is cleared, and since the machine will make a certain amount of noise, an enclosed room is constructed. Special power lines are Or, at least that's the original projection. The the safe side. If it's a first class operation, a

COUNTING THE COST

How cheap is distributed processing?

We have all seen the Radio Shack ads for their TRS-80, priced as low as \$3,500 for a so-called business machine. But what does a truly adequate machine cost? One that will handle an accounts payable, or a general ledger, or perhaps the payroll of a moderate sized corporation, where data bases are large and nonsequential and the eventual reports will be lengthy?

The new breed of minis is incredibly powerful from a cpu standpoint, but when it comes to handling large files that must be sorted, their relatively small amount of memory causes problems.

A DEC 11/34 can be purchased for perhaps \$30,000 to \$40,000, reasonably configured. But with only 196K to 256K of memory, be prepared for long, intricate processing times and extremely limited terminal time-sharing access. Remember, the operating system, plus utilities, generally uses half of the memory.

DEC VAX 11/780s or IBM 4331s seem more reasonable for the typical business application, with memory up to one million bytes. But the price escalates dramatically to the \$100,000 to \$150,000 range when a reasonable number of features and accessories are added.

—K.M.S.

raised floor is constructed. All of this costs money and takes time.

Somebody realizes that an inventory of supplies will have to be maintained, so more floor space is cleared and a secured room is constructed as a stockroom. An individual is unofficially appointed to acquire supplies and maintain the inventory. That's additional workload, particularly when the supply salesmen start calling with their bags of goodies. Notice how the indirect costs are beginning to build?

The machine is installed and tested. The accounting department inventories the equipment and sets up a depreciation schedule in the general ledger. Insurance is obtained, bills are paid, and somebody negotiates a maintenance contract. Again, these activities and their associated costs were never anticipated in the original justification.

Although basic software costs were probably anticipated, additional enhancements and options will inevitably be needed as users become familiar with the system.

Program conversion begins. A full-time programmer is brought in and several months of conversion costs begin to accrue. routed to the area, terminal coax-cable is laid, and air conditioning is beefed up, just to be on

programmer probably hasn't had any experience with minis. In fact, if the programmer is supplied by the central computing facility, he or she probably hasn't had much experience at anything. The central facility has absolutely no vested interest in the project's success. The programmer runs into learning curve problems, and the two-month project stretches into a yearlong one.

Local management therefore finds itself deeply involved in program management activities, and the central site naturally refuses any help. A line manager finds himself making decisions about things like "generation data bases," which he didn't even know existed until now. If he is lucky, he makes the right decisions—although since this is a new experience for him the chances are good that none of his decisions will be correct. A poorly constructed system will result.

Finally, weekly production processing begins. No operators were anticipated, so local, highly salaried personnel begin running the machine. These people obviously become less productive at their assigned tasks. But running the machine is fun, at least for a while.

Typical hardware and software problems occur frequently. Local management now finds itself fighting nonproductive fires, like calling in maintenance technicians, arguing with programmers, and worrying about missed deadlines.

To reduce problems, management desperately elects to order a hodgepodge of additional equipment, such as faster printers, more disk, and more memory. Cost is no object at this point. The people will do anything for a smoothly running operation.

Eventually, the application does smooth out. Local employees no longer consider operating the machine fun, so a full-time operator is hired, and then a keypunch clerk and a control coordinator. Next, a supervisor is brought in to manage these new employees. Costs are building upon costs.

What started out as a \$132,000 acquisition ends up with the following costs, broken down into several logical categories:

Phase I	Original equipment	\$132,000
	Installation modifications to building	125,000
	Initial supply purchases	5,000
	Financial administration	3,500
	Subtotal	265,000
Phase II	Conversion costs (one man-year)	265,000
	Indirect labor (fire fighting time)	30,000
	Salaried casual operator	25,000
	Additional hardware	50,000
	Subtotal	288,500
Total Phase I and Phase II		544,000

Financial software so advanced that Manufacturers Hanover doesn't even want to talk about it.

Nor do any of the 1,000 companies that benefit from McCormack & Dodge financial software.

When you're ahead of the pack, the less said the better.

For the record, the Manufacturers Hanover Fixed Asset package features an optimization module

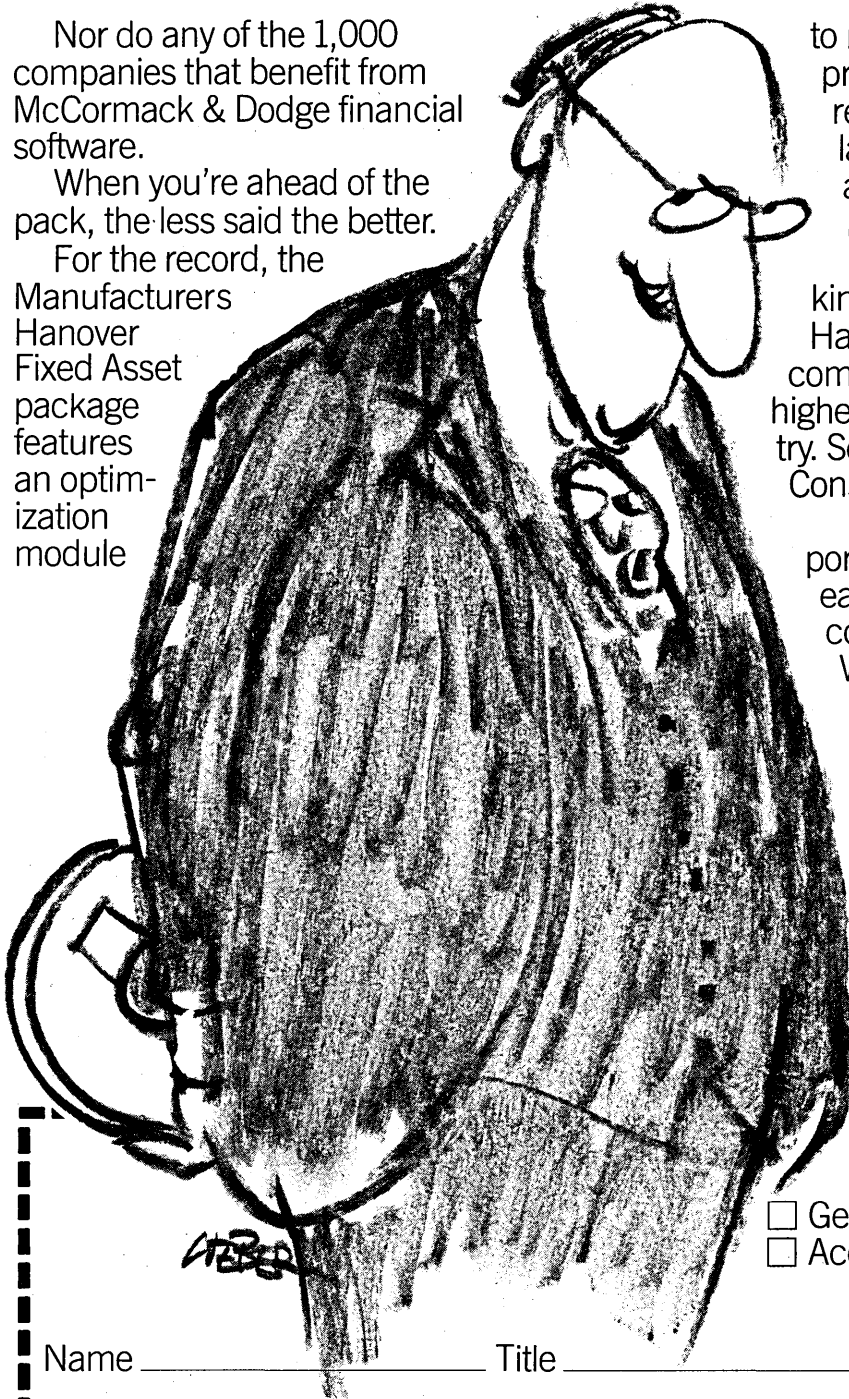

to minimize taxes and maximize profits. Perpetually enhanced to reflect every new wrinkle in the tax laws. Complete with reporting capabilities so extensive that regulatory requirements become routine.

Behind the package are the kinds of people Manufacturers Hanover likes to work with. A software company with proven success in the highest echelons of the banking industry. Serving 20% of the *Fortune* 500. Consistently tops in Datapro ratings.

McCormack & Dodge. Where important software breakthroughs occur each year. Where CPA's and ex-controllers comprise the sales force. Where superior training and field support are seen as part and parcel of a superior product.

Where only fixed assets specialists are authorized to present and sell fixed assets software.

And where, in seven out of ten cases, prospects who sit down and talk do more than just talk. They become customers.

We'd like to show you why.

Please send schedule of free seminars, plus information on:

- General Ledger, Purchase Order,
 Accounts Payable, Fixed Assets,
 Capital Project Analysis

Name _____ Title _____ Company _____

Address _____ City _____

State _____ Zip _____ Phone _____ Computer Model _____

McCormack & Dodge

The best financial software. The best financial people.

560 Hillside Avenue, Needham Heights, MA 02194, (617) 449-4012
Atlanta (404) 997-2797, Chicago (312) 843-4300, Dallas (214) 369-7014, Los Angeles (213) 645-6382, Washington, D.C. (703) 734-0710, Toronto (416) 445-2971,
New York/New Jersey (201) 528-6331. United Kingdom/Netherlands • Italy • Australia/New Zealand • Mexico • South Africa • Sweden

What started out as a \$132,000 acquisition ends up with an annual cost of \$228,500.

Phase III	
Annual supply consumption	30,000
Annual extra maintenance	6,000
Annual operators	30,000
Annual keypunch clerk	25,000
Annual control coordinator	25,000
Annual supervisor	50,000
Subtotal	144,000

(Note: All labor figures include fringe benefits.) Phase I costs, which consisted of the original estimate figures, plus Phase II costs, which were not originally estimated, could be called startup costs. To be very generous, we can amortize these costs over the estimated life of the computer. Industry standards seem to suggest that a reasonable useful life is five years. Adding Phase I to Phase II and dividing by five produces \$84,100 per year of startup costs. To this we add Phase III costs, the recurring costs, of \$144,400 per year, for an annual total of \$228,500. Even with this large number we are still not finished. We now have to pick up overhead—which includes everything from electricity to support of the personnel organization.

Accountants have devised many ways to recover overhead, but let's assume for purposes of clarity that overhead is applied over all direct costs, or over the costs we have just calculated. Overhead rates depend on the overall efficiency of the company and usually range from 25% to 50% of the base, or even higher if the company chooses to define its di-

rect base as, say, labor costs only. If we use the very conservative number of 25%, we come up with a final total annual expenditure of \$285,625 for the distributed processing alternative.

SUMMING UP

Although a lot of numbers have been presented here, a simple generality can be developed. The total annual expenditures just developed for the minicomputer operation come very close, in fact slightly exceed, twice the purchase price of the actual equipment. This is a fairly good rule of thumb which appears to hold true for all classes of computers, as their costs have become lower in relationship to all other costs. That is, take the purchase price of the equipment and double it, and you have rough estimate of the true annual costs of owning that equipment. This number is then directly comparable with the actual costs of the application as generated by the fully costed central computer facility.

In our example, the original application was costing \$156,000 for large computers. The distributed alternative would cost \$285,625 for that same processing. It would be absolutely impossible to break even going the distributed route.

There are obviously situations where distributed processing makes all the sense in the world. Companies with scattered branch offices, for example, can effectively distribute much processing and save on communica-

tions expense. But the area where distributed processing raises the most serious potential obstacles is the already established central processing installation. Even if we were to disregard costs, could performance considerations favor the mini over a central site?

Central processors have generally become quite reliable in recent years, as have the peripherals. The weakest links has always seemed to be the mechanical devices, such as tape and disk units, and printers. But these same components are on minis, thus similar downtime will result whether the application is on a large or small system.

Moreover, applications that take advantage of the central site's massive storage capabilities have usually been developed. And multiple access by time-sharing users has become almost second nature. Multitasking, large memory, huge reserves of disk space—all of these functions cost dearly on the mini, driving its basic price up, and also driving up the support costs, those for personnel, software, facilities, and overhead. The cost advantages of distributed processing diminish quickly under these circumstances, and, as the example showed, may evaporate entirely.

If the central computer facility is going to be retained, and it looks like there are many years left in the old girl, then any attempt to migrate existing applications onto minis must be reviewed with an extremely hard, analytical approach. Doubling up on cost, which is easy to do with minis as they take work off the central computer, cannot be tolerated by a profit-oriented company. The fact is that the average business user can usually do more on a large computer, and do it faster and cheaper.

Distributed processing has immense potential when communications costs are significant. But for the average scheduled application running continuously on a central computer, the economics do not yet appear to warrant a significant shift to distributed processing. *

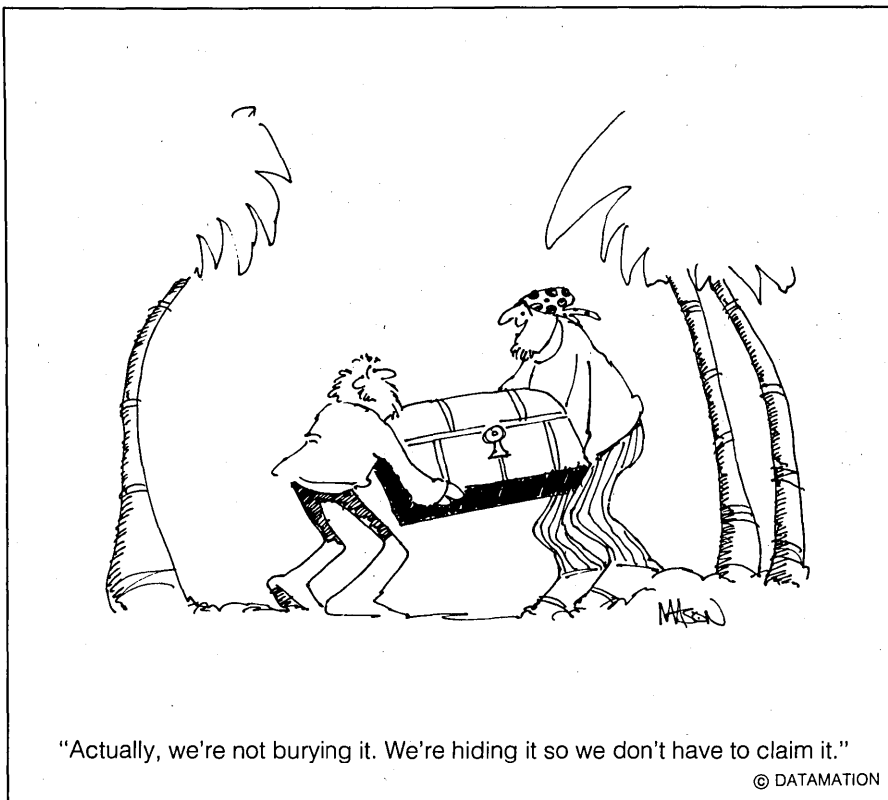

"Actually, we're not burying it. We're hiding it so we don't have to claim it."

© DATAMATION

KENNETH M. SULLIVAN



Mr. Sullivan is manager of finance at McDonnell Douglas Automation (McAuto), Long Beach, Calif., and an instructor of accounting at Golden West College in Huntington Beach, Calif. He holds an MBA from California State Univ. at Long Beach.

CARTOON BY TOM MASON

Can \$10 help you avoid a \$40,000 mistake? Or be the key to \$40,000,000 in sales?

Whether you buy minicomputers or sell minicomputers, there's a new study that belongs on your desk.

It's a comprehensive study of 3,500 customers and prospects for minicomputers.

Commissioned by The Wall Street Journal, the study surveyed a list of minicomputer buyers and prospects supplied by seven of the leading minicomputer manufacturers.

The results are required reading for anyone who's evaluating minicomputers—or anyone who's marketing minis.

They detail who's going to buy minicomputers in the next 12 months. In what number. And for what purpose. And what brands they

prefer. And why. And what they believe is important in selecting a minicomputer.

If you're a buyer, the study provides an instant look at how minicomputer users view various brands.

If you're a seller, it spotlights your strengths and weaknesses—and those of your competitors.

Cost of the full study, including sales tax and shipping, is just \$10.

A small price to pay for information that can help you buy or sell better in the months ahead.

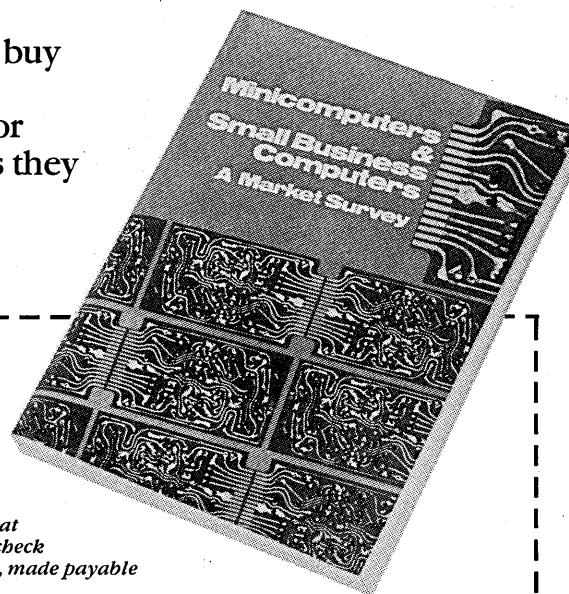

Ginette Gomez
The Wall Street Journal
P.O. Box 455
Chicopee, MA 01021

I'm interested in
The Wall Street Journal's
minicomputer survey.

Please send me _____ copies at
\$10.00 each. Enclosed is my check
or money order for \$_____, made payable
to Dow Jones & Company, Inc.

Name _____

Title _____

Company _____

Address _____

City _____

State _____

Zip _____

DTM

THE FIRST
COMPUTER
DESIGNED
SOLELY FOR
THE PURPOSE
OF BEING A
FIRST
COMPUTER.

INTRODUCING DATA GENERAL'S NEW CS/10.

It has been gleefully estimated by all the industry pundits that during the next twelve months somewhere in the neighborhood of 500,000 small businessmen will purchase their very first computer.

Isn't it ironic that, until now, there was no computer perfectly suited to this emerging market? In fact, the choice narrowed down to computers that were either too much, or too little, or weren't capable of expanding to accommodate any but the most stagnant of businesses.

Which is precisely why we at Data General engineered the new CS/10. While the CS/10 is eminently affordable (actually it's the lowest priced—\$10,950 list—serious multi-terminal computer in America and features one of the most aggressive discount policies for industry suppliers and volume purchasers), it is designed to provide a surprisingly wide range of sophisticated functions with enormous possibilities for expansion.

Its technical specifications? A master-control console with a powerful 16-bit micro-computer, a large easy-to-read display screen, an alphanumeric keyboard (with a wide range of keyboards and printers available as options), two integral diskette systems with up to 2.4 million bytes of on-line data storage (the CS/10 has the ability to be upgraded to Winchester-type technology and 50 million bytes of on-line data storage) and interactive COBOL (ANSI 1974, level I specifications with some level II features implemented) which, aside from being the most widely used programming language, is also among the easiest to use—even for a comparative neophyte.

But beyond these features—which, we'd

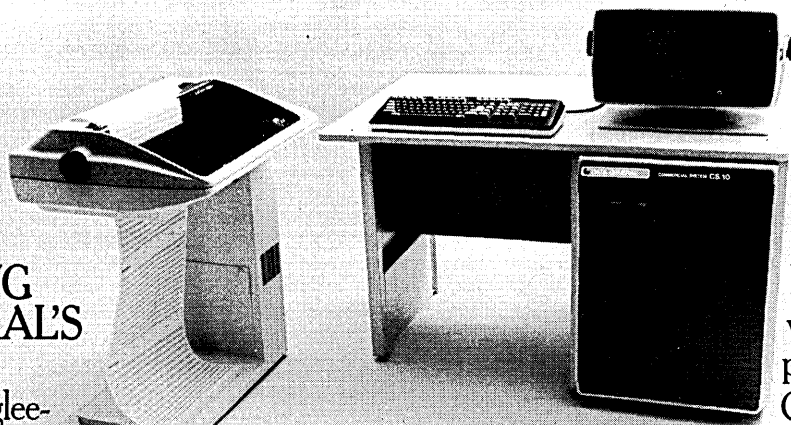

like to remind you, is where few small computers ever go—the CS/10 truly excels.

It is expandable to a maximum of four interactive DASHER™ display terminals. Such innovative software tools as the Proxi™ program generator can be added to help you customize programming for practically peanuts and there's even an optional remote unit that enables you to diagnose problems from your desk or wherever you happen to be.

And perhaps the most significant competitive aspect of the CS/10 is that it isn't just one lonely machine. It is part of an entire family (CS/10 through 70) of program and data-compatible systems, which of course means that one modest CS/10 installation can easily burgeon into a 17-terminal CS/70 system (with an impressive number of peripherals).

And the software you develop for the CS/10 can be used in any further CS system you may grow into, up to the CS/70, so businesses needn't suffer undue financial hardships if they should become successful and grow.

If you'd care to know more about the new Data General CS/10—and, believe it or not, there's more to tell—simply fill out the coupon below and we'll be happy to inundate you with information.

 **Data General**

DASHER is a trademark of Data General Corporation.

Mail to: Data General Corporation
4400 Computer Drive, MS C228, Westboro, MA 01580

Attention: Marketing Communications Department

- Please send me free information on Data General computers.
 I'm in a rush. Please have a sales representative call on me.

Name _____

Title _____

Company _____ Tel. _____

Address _____

City _____ State _____ Zip _____

"Don't settle for half protection when you want to PUT AN END TO POWER-RELATED COMPUTER PROBLEMS"

Says Emil Rechsteiner, President of Frequency Technology, Inc.
Makers of ISOREG™ Computer Power Modules.

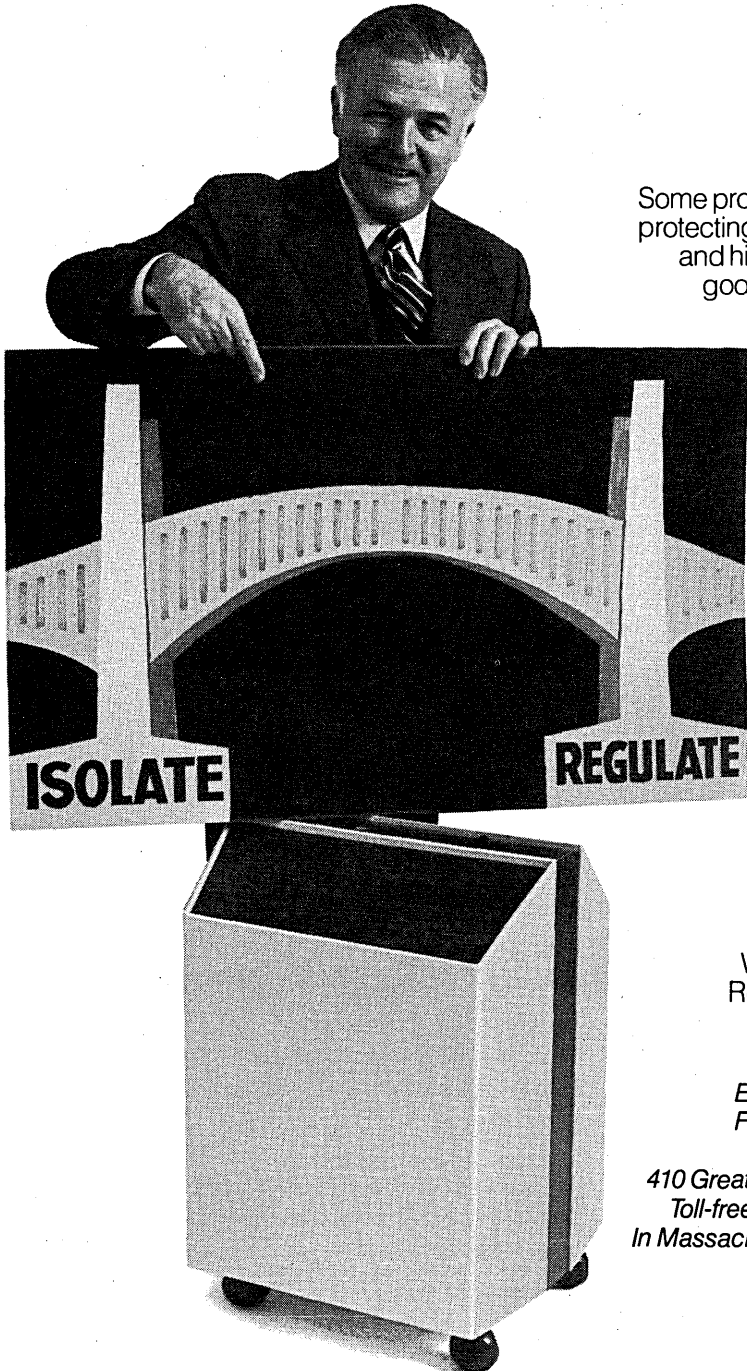

HALF A BRIDGE DOESN'T GET YOU THERE!

Some products are like HALF a bridge when it comes to protecting a computer from voltage spikes, brown-outs, and high line voltages. And half a bridge is not much good. For example, isolation transformers filter out voltage spikes, but DON'T REGULATE voltages. Many voltage regulators regulate voltages but DON'T ISOLATE a computer from raw utility power . . . thereby exposing the computer to voltage spikes that can scramble data . . . even destroy circuits.

GO FOR FULL PROTECTION . . . WITH ISOREG

ISOREG Computer Power Modules ISOLATE your computer from voltage spikes and REGULATE voltages within tight limits even when utility voltages drop to brown-out levels or shoot far above normal. Don't spend money on half a bridge! Go all the way for full protection . . . with ISOREG.

LET ME SEND YOU OUR BROCHURE

. . . on ISOREG Computer Power Modules rated from 125 VA Single Phase to 75 kVA 3-phase, 60 Hz and 50 Hz.

Write me, or call our toll free number, or use the Reader Service Card of this magazine to obtain our new brochure, free.

*Emil Rechsteiner, President
Frequency Technology, Inc.
TDC Division
410 Great Road, Littleton, MA 01460
Toll-free Number: 1-800-225-5078
In Massachusetts Call: 617-486-3539
TWX 710-347-6974*

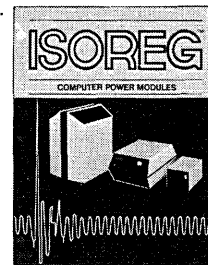

CIRCLE 132 ON READER CARD

The important job of putting the parts of a system together calls for an architectural approach.

THE ARCHITECTS OF SYSTEM DESIGN

by Dionysios Tschritzis

Hardware and software engineering have always been important aspects of building computer systems. The emphasis is on building the parts right, and making the hardware reliable, the operating system solid, the compiler fast, and the data management powerful. Ideally, someone assures that all these parts provide a useful system and works on any components with which the user is not satisfied. But more often, the user is persuaded or coerced to live with the system as it has been engineered.

The provision of proper services to the user is the true function of the system. As systems' emphasis moves away from hardware, the application of engineering principles is not enough—we need to apply the principles of architecture.

Engineers know one field of science intimately, apply their knowledge to practical situations, evaluate the cost benefits of a solution, and ensure the correct operation of whatever they design. Architects, on the other hand, are not expected to be experts in any one technology but are expected to be aware of many technologies and able to judge their applicability to specific situations. Thus, although architects need to be aware of the gross details of different technologies, they may ignore some of their idiosyncrasies.

Engineers as a group do not have a reputation for understanding and responding to human needs and developing functional and esthetically pleasing products. Architects, however, are expected to understand human needs and develop functional solutions. They are master builders, using parts and tools they understand but seldom produce themselves.

An architect planning a building works on the overall design, making sure it will be pleasing and useful to its inhabitants. A single architect may be sufficient to build a house. Most of the parts are prefabricated and can be installed by tradesmen. Many engineers, on the other hand, must be called in to construct a high-rise building since the job is bigger and the parts more expensive.

Similarly, large computer systems require much engineering talent, not only for proper systems design and creation but for proper maintenance. In the past, engineering was crucial, since large systems predominated because of economic reasons. The situation is currently changing with the proliferation of micro- and minicomputers. We can no longer afford to engineer all the software systems for these computers, but we definitely need to put them together correctly.

Small systems are comparable to single houses. The parts should be prefabricated. The important job of putting the parts together so the whole system is functional calls for an architectural approach.

The architecture can evolve in several ways. The users may be sufficiently knowledgeable to design their own systems. Then systems architects may put the system together according to user specifications. In this case there is a need for a formal document.

In another scenario the users and the architect work together to design the system. Specific systems can also be assembled and offered to users with fixed requirements.

Slowly, software engineering is providing the building blocks necessary for systems architecture. A highly successful example is the UNIX system developed at Bell Labs. UNIX debuted as an operating system and has developed into a set of tools that can readily be used for building systems.

GETTING BASIC HARDWARE

One of the first steps the architect has to consider is the acquisition of the basic hardware. A number of small machines such as the LSI/11, MC6800, and Z8000 are perfectly adequate for most jobs. Many of them are available with more than one language, some operating system capabilities, editors, and so forth. Many large-capacity disks are becoming available for both small and large systems with standard interfaces. Memory can be obtained at reasonable prices. Terminals are available in all shapes and forms, from cheap dumb ones to intelligent ones with both processing and graphics capabilities.

The capabilities of these systems are increasing rapidly, and the prices are dropping. A system with adequate processing power, 500 KB memory, 100 MB disk space, plus a small printer and a terminal, can be configured for \$10,000 to \$30,000. A hardware system in that price range can handle most small applications. Systems already configured by the vendor are even available, such as PERO and the Xerox 860, so there is no need for exceptional hardware expertise to put them together.

Small systems can be hooked together in local networks becoming available commercially and can start handling much more sophisticated applications. In addition, they can readily be connected to global networks.

The architect does not have to thoroughly understand communication or routing algorithms and switching protocols, but need only know enough to choose intelligently among the alternatives and to evaluate the price/performance of each one. Through the network, the system can readily be interfaced to a large computer of a service company for extra services.

If the architect had to start from scratch, writing all the software, he would be a mason not an architect. Two important trends brighten the picture. First, some very powerful languages such as PASCAL and EUCLID are becoming available on small and inexpensive machines. Formerly, small machines had only something like BASIC plus available. Now, sophisticated system languages are becoming more common on small as well as on large systems. The compilers for small machines are constructed for portability and will soon be operational for a large number of machines.

The second trend is the conversion of powerful operating systems like UNIX, developed for larger (i.e. more expensive) machines, to smaller systems. By providing the operating system, the software engineer gives the architect a powerful environment.

A host of useful software tools have also been developed over the years by generations of users. The architect may have to do some searching to find the software, or design

With the advent of small systems, people are forced to face system-wide problems—they become architects out of necessity.

some enhancements to adapt the software to his environment, but he should not have to write a software support system from scratch, although he should be capable of choosing, installing, modifying, and operating the system.

In constructing a software system from available parts and tools, the architect either has to ask a software engineer for assistance or has to put in the time himself to extend the system in the desired direction. Maybe typesetting is not available but needed. Maybe the system should have a graphics package. Maybe the data base management is not adequate. Packages for special applications can be obtained. Like a building architect, a system architect explores his contacts to locate the best and cheapest materials and tools for the job.

CLIENTS HELP DESIGN

Determining what the users want, rather than what they say they want, is the real art. A building architect does not follow an exact procedure; he communicates with his clients, and together they design the system. Similarly, a systems architect has to have a continuous open channel of communications with the end users. A building architect uses sketches, models, and drawings. A systems architect uses specification tools, prototype systems, and high-level languages to discuss different solutions with users.

Tools for capturing user requirements exist and are being used. There are specifica-

tion languages used solely off-line to document the design of large information systems. There are high-level specification languages that can be translated into actual code. There are interactive tools for design assistance and building of pilot systems. Programming methodology approaches that emphasize abstractions of the system can be used for communication with the users. All of these tools should be used by the systems architect. If the building tools are excellent, there is even the possibility of putting together a prototype system to study user reaction and evaluate performance requirements.

Defining user requirements is important for both large and small systems. In fact, the primary job of the architect of a large system is finding out what the user wants, just as the principal job of the architect of large buildings is to understand people's requirements and come up with a good abstraction of the building. After that is completed, the engineers take over.

Most computer professionals are trained for and accustomed to large systems; in a large system, very few people are aware of the system's overall capabilities. The size and complexity of the system prohibit general understanding; consequently, many computer professionals are engineers. With the advent of small systems, however, people are forced to face system-wide problems—they become architects out of necessity. They have to understand hardware acquisition, system architecture, maintenance, operating systems, languages, data management sys-

tems, communications networks, and so forth.

All the functions previously performed by specialists must be understood by the systems architect. There is a tremendous need for people who understand how to assemble systems. University education does not usually provide this knowledge. Only the true aficionados, who often drop out of school to become valuable professionals, learn the art of designing systems.

At the University of Toronto we have a course that concentrates on the critical aspect of systems architecture—the basic building blocks and how to put them together. The course includes laboratory experience on LSI 11/23s running UNIX. We have found that with two LSI 11/23s we can handle eight to 10 terminals with sufficient capacity and some backup. About 100 students can be supported adequately in such an environment. As prices drop, we will be introducing better terminals and more sophisticated software.

The final assignment of our course involves putting together a useful system. The emphasis of the course is not how to build the individual components but know what they are, how to obtain them, how they fit together, and how to base user-oriented facilities on them.

Systems architecture will receive more emphasis as time passes, and we cannot allow this function to come about haphazardly. We cannot rely only on the native intelligence of individuals; we also have to develop the right tools. As a first step in that direction, we have to recognize the activity of systems architecture and understand its functions.

I acknowledge with gratitude the influence of some of my graduate students who are true architects. They can configure systems, install them, maintain the hardware, modify the software to run on it, build new software, troubleshoot and operate the system, take advantage of new technology and available software, and negotiate with the users. The future belongs to them. *



DIONYSIOS TSICHRITZIS



Having received a degree in engineering from the National Technical University in Athens, and later an MA and PhD in computer science from Princeton, Dr. Tsihrizis is now a professor of computer science at the University of Toronto, where he also chairs the Computer Systems Research Group.

CARTOON BY HENRY R. MARTIN

INTRODUCING THE DATAGRAPHIX 9800 SERIES LASER PRINTERS.

A generation ahead in flexibility,
reliability and bottom line performance.

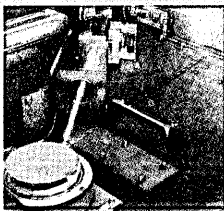
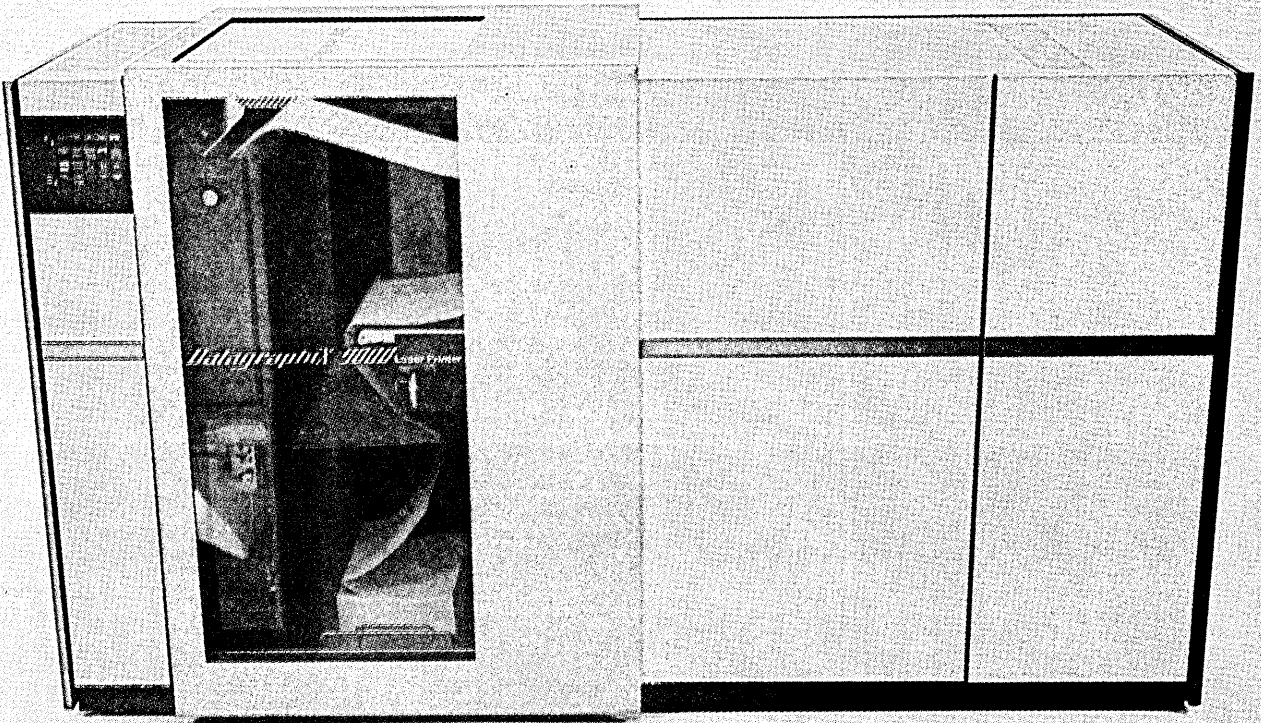

The 9800 Series from Datagraphix® represents a new generation of non-impact printers with more

functions, more features and more reliability in a smaller, more flexible package.

Example: The 9800's paper path is less complex, over 25% shorter, and a lot more trouble free. And reloading can be up to four times faster.

Example: The 9800 is engineered for improved system availability through the use of a photo-receptor drum that can be changed in minutes.

Example: The 9800 prints from the very top of the page to the very bottom. Forms can be any length from 3.5" to 14". And any width from 6.5" to 15.8".

The one-to-one, parallax-free forms overlay function entails no speed reduction, and frees you from dependence on pre-printed forms. The wide variety of character fonts and spacings allows you to print attractive, high quality reports at speeds up to 21,000 lines per minute.

The 9800 Series is designed for less scheduled downtime. It takes a third less floor space. And it offers even bigger paper savings. That adds up to less cost to operate. Not to mention less cost to buy.

If you're thinking of very high

speed on-line or off-line printers, return the coupon today. We'll shed some light on laser printers for you — fast!

- Send me more information about Datagraphix 9800 Laser Printers.
 Have a Datagraphix representative contact me.
 My major interest is in
 on-line printers. off-line printers.

Name _____
 (please print)

Title _____

Company _____

Address _____

City _____ State _____ Zip _____

Telephone No. (_____) _____

Datagraphix®
 a General Dynamics subsidiary

Datagraphix, Inc., P.O. Box 82449, San Diego, CA 92138 Phone (714) 291-9960, TWX (910) 355-2058
 Datagraphix is a registered trademark of Datagraphix, Inc.

CIRCLE 133 ON READER CARD

How did Conditioned Power become the computer power leader...so suddenly?

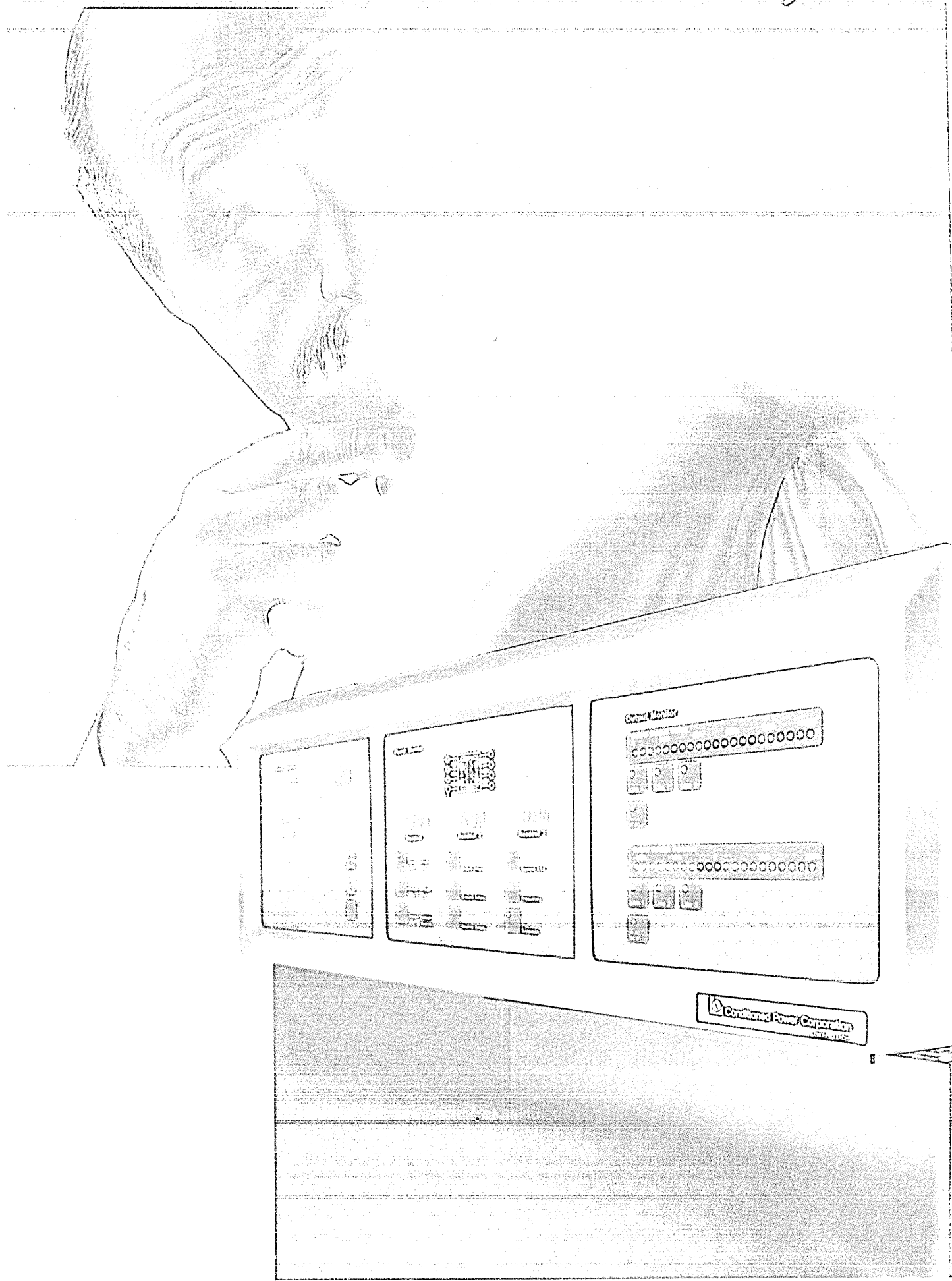

Because it wasn't so suddenly.



In a very real sense, Conditioned Power had an enviable track record . . . even *before* we opened our doors! Our parent company is Liebert Corporation . . . since 1966, world leader in computer room air-conditioning systems.

It was expected that we would produce a high quality line of products, but that's not the real news. Our engineers achieved a *major* technological break-through. It is called . . .

The Power Management Center

Here is a complete, self-contained package that requires only a single point connection to building power. It is, also, *the only total system* on the market today! — Total because it combines *all* four key ingredients of a computer power system:

Conditioning — The Power Management Center eliminates all power transients; conditioning raw input power varying as much as plus or minus 40% from nominal.

Distribution — These systems offer unlimited growth as a benefit of the flexible plug-in distribution cables (additional cables may be added).

Monitoring — Continuous, precise measurement of the entire system; backed by solid state reliability.

Control — Power Management Centers feature total control of input and output power as well as individual circuits — with built-in circuit breakers.

Mini-Center

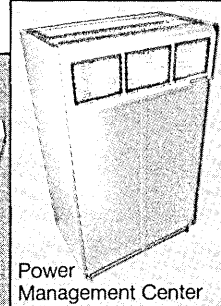
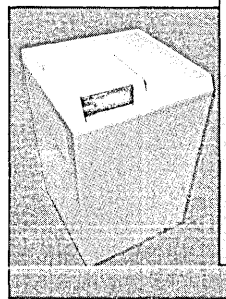

Precision Power Center

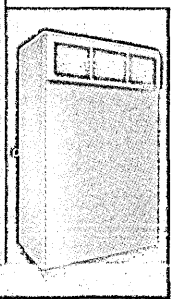

The first family of computer power!

Conditioned Power has created the computer industry's most versatile, yet cost-efficient line of computer power systems to serve your needs — no matter what data processing equipment you may have! Write: Conditioned Power, 1050 Dearborn Drive, P. O. Box 29186, Columbus, Ohio 43229 or call (614) 888-0246.



Conditioned Power

subsidiary of **Liebert**

"NCR's VRX is more transparent than any operating system I have ever seen."

Peter P. Blozis, H.J. Wilson Co., Inc.

PETE BLOZIS:

"I've been in EDP for 19 years and have gone through many conversions. So I anticipated problems in installing our new NCR V-8585M. It turned out to be the smoothest conversion I ever experienced."

LEA EDMUNDS:

"We had good reason to be apprehensive. We were putting in the first V-8585M to be installed anywhere. And, at the same time, we were switching to new operating software, NCR's VRX. We ran parallel for three weeks and never developed a conflict. As it turned out, we could have switched over in a single day."

PETE BLOZIS:

"We resisted conversion as long as we could, and then discovered it was completely painless. The V-8585M hardware ran just as NCR predicted. VRX is more



Peter P. Blozis (right) is Wilson's Vice President, Information Services Division. Lea Edmunds is Technical Services Manager.

transparent than any operating software I have ever seen."

* * *

WILSON'S is a chain of jewelry/ catalog showrooms that is spreading across the Sunbelt. And growing at the impressive rate of 37 percent per year. This growth has caused Wilson's to step through five NCR Century systems up to the V-8585M. Supporting an NCR system is easy. As Pete Blozis says "We can support our NCR V-8585M with fewer systems programmers than we'd need for other systems of comparable size."

Find out what NCR VRX can do for you. Phone your representative at your local NCR office. Or write to EDP Systems, NCR Corporation, Box 606, Dayton, Ohio 45401. Learn how NCR brings a new level of convenience to data processing operations.

NCR
Complete Computer Systems

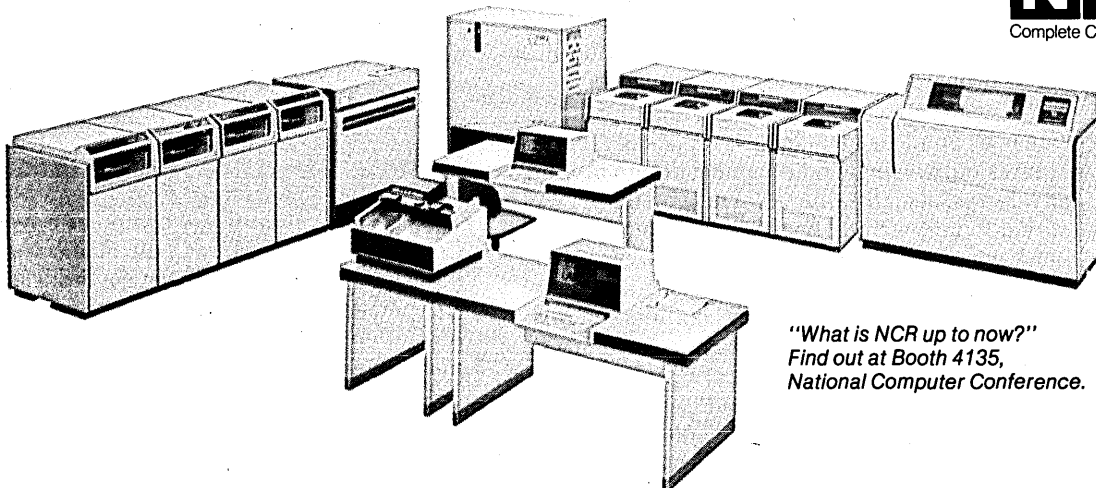

"What is NCR up to now?"
Find out at Booth 4135,
National Computer Conference.

An NCR computer can make it happen for you, too.

CIRCLE 135 ON READER CARD

Take an in-depth look at your installation; you may find productivity problems in unexpected places.

PROBING PRODUCTIVITY

by Robert L. Patrick

There are many similarities between the national energy problem and the productivity problem. In both cases, we are suffering from our past deeds (or misdeeds), both are related to the rampant inflation we all experience, and both require us to change our way of thinking before we can even define the problem in a tractable way.

To carry this similarity further, it appears that many persons are attempting to find painless, easy to achieve solutions to these two problems that will offer instant relief.

Energy charlatans are looking for political solutions rather than have us make a painful adjustment to our demand curve until alternative supplies can be developed. In the case of computing, the productivity charlatans appeal to our desire for business as usual, while they peddle various analgesics, nostrums, and elixirs which will cure our back pains, revitalize our livers, and chase our bad breath away.

Bah! Humbug! It ain't a-gonna happen. Our productivity problems are so deeply imbedded in our organizations, systems, and staffs that only resolute management and full cooperation from all concerned parties are going to make an across-the-board improvement.

This isn't to say that certain organizations may not make progress in certain sectors, but this may be due to their present condition, improvements overlooked for 15 years, or some key individual development which allows quantum leap in a narrow specific instance. But if you are looking for an overall improvement in productivity, hear these harsh words: there is no way that a workbench for programmers or any other skill class is going to make 150 guys do the work of 300.

If you are seriously concerned, a productivity survey is the place to start. Gather together one or more people who are mature, knowledgeable, and objective (not an easy task in itself); then survey your installation, using the questionnaire that follows.

As a result of that survey, you should be able to tell whether one or two well-chosen programming tools will give you the im-

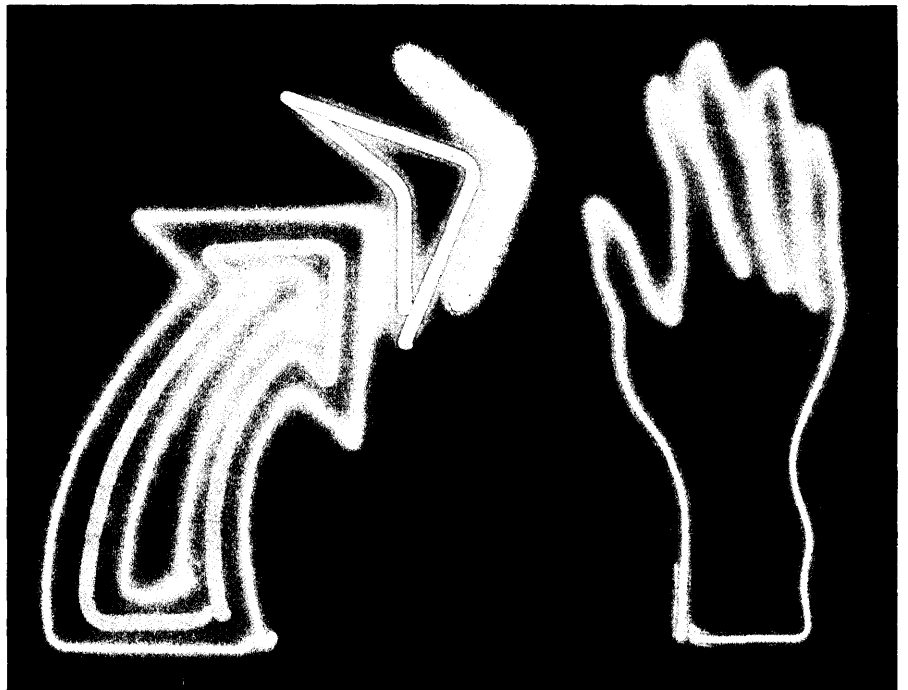

provement you desire, whether the problem lies in the work environment, or if your principal difficulty relates to the skills of the staff itself. You may even find that a change in management style is a prerequisite to achieving other benefits. If so, you will have to be astute enough to recognize it yourself, because none of the hardware and software vendors that call on you regularly are likely to say "Heal thyself" before "Buy my package."

MANAGEMENT

1. Are the managers at each level of the organization (director, manager, supervisor, leadman) appropriately knowledgeable for the blend of technical and administrative duties they regularly face?
2. Does each manager have coaches to call upon in the event he runs into an unusual technical or administrative problem beyond his capabilities?
3. Does each manager have a detailed job description?
4. Does each manager periodically contrast

his skills with the requirements of his job and discuss the results with his superior?

5. Are those managers who interface with the rest of the corporation, your clients, or the outside world sufficiently resolute in the face of difficulty or do they capitulate and commit to impossible demands?

6. Do you have a cost accounting system in place so you can track, in detail, where the labor hours go?

7. Do you track the labor that goes to productive purposes (requirements determination, systems analysis, programming, DB design, coding, test, documentation, etc.)?

8. Do you track the labor that goes to overhead purposes (training, security, sickness, emergency program fixes, etc.)?

9. Do you have a utilization accounting system installed on your computer(s)? Do you get some information from even the *smallest* minicomputers?

10. Do you analyze the utilization data by project, job, function, and activity, e.g., inventory, returns for credit, file update, and transaction edit?

None of the hardware and software vendors are likely to say "Heal thyself" before "Buy my package."

11. Do you regularly review the utilization data spent on productive purposes (development, production, demonstration) versus that spent on software changes, production control, file copying, etc.?

12. Do you know the following ratios for your shop:

A—Multiprogramming?

B—Peak terminals logged-on vs. number of terminals installed?

C—Number of overnight jobs still backlogged at start of day shift?

D—Percent ABENDS to total production jobs?

E—Staff turnover by skill type?

F—Percent staff with college degrees?

G—Percent staff voluntarily taking additional schooling?

H—Percent authorized positions open?

I—Percent authorized positions open more than two months?

13. Above the director of information systems sits the first level of senior management who is non-computer trained. Is the time he devotes to computer matters proportional to the budget and importance of information systems?

Note: Space precludes this list from being exhaustive, but it ought to be clear that a manager should be able to answer questions similar to the above or he doesn't know where his resources are going.

ENVIRONMENT

1. Do development personnel have adequate space and furniture for their assigned tasks, i.e., except for the natural slobos you may em-

ploy, can a person be neat and productive if he wishes?

2. Is the phone service adequate, i.e., can a person leave his office and have messages taken by a clerk so his professional colleagues are not distracted by ringing phones and message taking?

3. Does each group have a sign-out board so persons leaving the area can make their intentions known to the clerical force, or do periodic personnel hunts disturb tranquility?

4. Do programmers have convenient access to machine resources (adequate numbers of terminals, courier delivery of batch output, etc.), or do they distract themselves and each other wandering the halls?

5. If you do not supply personal terminals, are shared terminals set up to be quiet workstations with ample space for listings and working materials?

6. Are sufficient conference rooms available so shared offices do not serve dual purposes?

7. Are software changes carefully tested so unstable software does not impact development efforts?

8. Is operations sufficiently careful with programmer files, e.g., is the loss of a programmer data set lamented with the same amount of wailing as the loss of a production file?

9. Whether you pay overtime or not, is the total time on the job reviewed to avoid the exhaustion, domestic strain, and inevitable error increase that comes with self-imposed overwork?

10. Even if you do not go all the way and set up programmer teams, do you supply adequate clerical and administrative support so

development personnel can concentrate their efforts on what they do best?

Note: These questions determine whether a capable employee can perform to the limit of his ability or whether his attitude is eroded by the environment. If high turnover is occurring among your best workers, look to see if the bureaucracy is encouraging them to seek greener pastures.

PEOPLE

1. Do you have a skill profile for each job classification in your shop (analyst, designer, programmer, test specialist, systems programmer, production controller, chief console operator, etc.)?

2. Has each person individually assessed himself against the skills required by his current job?

3. Can those deficient in their current jobs draw on in-house consultants while they take courses or do directed self-study to correct their shortcomings?

4. Did you drop your standards to meet quotas for minorities or females several years ago? Have these people acquired enough seniority to hold positions of responsibility? Have you objectively assessed their performance against their fellow workers? Have you taken resolute action to handle any problem cases you may have?

5. Do you have any open requisitions over 60 days old? Have you carefully screened your current staff for promotables? Have you overlooked any female or minority talent that would be promotable if given access to a coach?

6. When promoting, do you check that the chosen candidate is nearly qualified so he does not have to stretch too far?

7. Have you reviewed your most productive workers' qualifications and checked that your recruitment stipulations select winners?

8. In addition to training for the tasks at hand, do you also hold professional technical seminars for career enhancement, and rotate talented individuals through a variety of challenges to build for the future?

9. Without being too obtrusive, are you mildly paternalistic so domestic distractions, on-site boy/girl relationships, or grossly aberrant life styles are not allowed to interfere with work performance?

10. Do you track employee morale in an organized manner and take prompt action to keep a problem from festering?

11. What incentives have you established to reward the high producers?

Note: With the current shortage of skilled personnel and the upward spiral in wages, the management of staff (not traditional personnel administration) may be your number one concern.

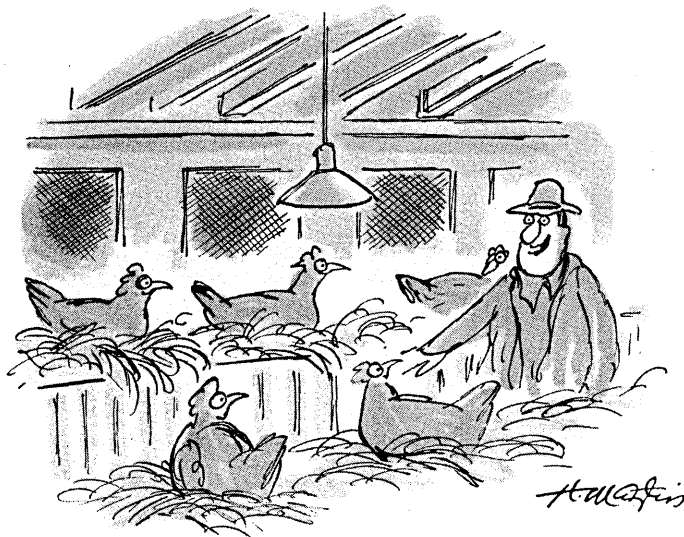

"Well, I, for one, do not think you are a bunch of dumb clucks. I find you exceptional Rhode Island Reds, excellent layers, doing an outstanding job in a highly competitive field."

© DATAMATION

CARTOON BY HENRY MARTIN

If you were Robin Hood, we'd be your Friar Tuck.



Time after time, Friar Tuck helped Robin out of some pretty tough scrapes. And Robin came to depend on the feisty friar in a special way.

Today, Avanti has a similar reputation for dependability. In local data distribution equipment.

A case in point: our new 2200 LADD Line Driver.

It was created especially for local high-speed data distribution and performs impeccably over unloaded metallic circuits. Available with all standard interfaces, the 2200 comes in a desk-top or compact rack mount configuration, and features:

- Complete compatibility with the Bell LADS unit
- Synchronous operation with asynchronous option
- 8 selected data rates up to 64Kbps (19.2 Kbps asynchronous)
- Total self-diagnostic capability elimi-

- nating the need for external test equipment
- Conformation to Bell Publication 43401

The 2200 is Avanti's newest product. But it's by no means our only one.

In fact we make an entire family of the most advanced modems and line drivers in this business. So we can provide the exact product you need.

You might say, we're big enough to supply even your smallest needs. For the facts on our new 2200 or on our full line, write Avanti Communications Corp., Aquidneck Industrial Park, Newport, RI 02840. Or call: (401) 849-4660.

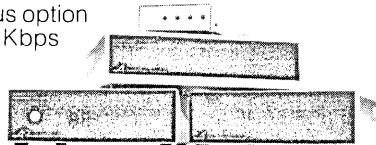

Avanti Communications Corp. - Aquidneck Industrial Park
Newport, RI 02840. Tel: (401) 849-4660. TWX: (710) 387-6543

CIRCLE 136 ON READER CARD

We're always here when you need us.

You should be able to tell if the problem lies in the work environment or in the skills of the staff itself.

PROCESS

1. Do you have a procedures manual that defines how business will be conducted? Does it cover:

- A—Requests for new systems?
- B—Requests for changes to existing systems?
- C—How estimates will be calculated?
- D—The phases of development (requirements determination, systems analysis, programming, etc.)?
- E—The deliverable items that must be produced by the end of each phase?
- F—How jobs will be turned over for production?
- G—How changes will be reflected in production jobs?
- H—Programming standards?

2. Have you isolated your developers from continuing responsibility for production support?

3. Have you analyzed your workload and noted processes which could benefit greatly from guidelines, instructions, and standards?

4. Have you supplemented your procedures manual with a compendium which describes proven techniques and their domains of applicability, and identifies an in-house coach

for each method?

5. For processes which can be standardized, have you defined your requirements in detail and sought out packages (manual and automated) for control of production libraries, editing of program text, performance evaluation, systems analysis, etc.?

6. When itinerant vendors come to call, do you compare their wares against the list of standard processes you have chosen to establish and shoo them out if their offerings fail to match?

7. Do you evaluate vendors' claims for productivity enhancements from their new tools and techniques against the measured fraction of your resources that are spent in the activities affected?

8. When you run productivity experiments based on some technique you read or heard about, do you carefully weigh the proposal for impact, side effects and cost? If all looks favorable, do you conduct a true experiment under controlled conditions with measurements, evaluation plan, etc.?

9. If you run a successful experiment and decide to install the new standard, do you establish a formal project with a manager and an installation plan to assure adoption to at

least the break-even level?

10. If your installation is well established and your procedures, standards, and techniques have evolved over the years, have you quantitatively and qualitatively assessed the inventory of old code to determine how to reduce the deadening drag of this legacy?

11. Is someone watching the rate of change to the development of support base to be sure that the collection of improvements, albeit individually justified, does not exceed the staff's tolerance for change, e.g., beware that the uncoordinated pursuit of productivity does not adversely impact it?

Note: The claims of the proponents for new tools may be valid in some environments. You must check those claims for validity in yours. If valid, you still face the challenge of how to install the techniques, how to assure compliance, and how fast to move. *

Mr. Patrick has been an independent computer consultant for 20 years and has served on the DATAMATION editorial board for the same period. He lives and works in Northridge, Calif.

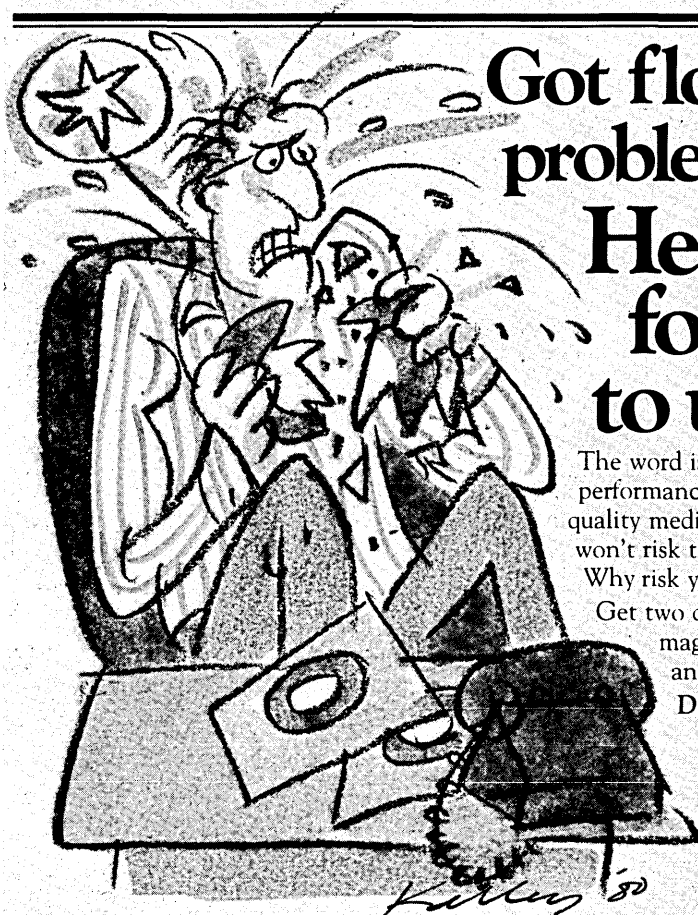

Got floppy disk problems?

Here's a new four letter word to use:

The word is KYBE. Because KYBE will ship you the same high performance products they've built for OEM's for years. Consistent quality media that meets the most demanding specifications. OEM's won't risk the performance of their system to less than the best media. Why risk your data either? Especially when the price is competitive.

Get two day shipment on any model floppy disk, data cassette or mag card. Each is backed by an unconditional 90 day warranty and inventoried for fast delivery. Call toll free (800) 225-8715.

Dealer inquiries invited



KYBE

Dennison KYBE Corporation
132 Calvary Street, Waltham, Mass. 02154
Tel. (617) 899-0012; Telex 94-0179
Outside Mass. call toll free (800) 225-8715
Offices & representatives worldwide

CIRCLE 137 ON READER CARD

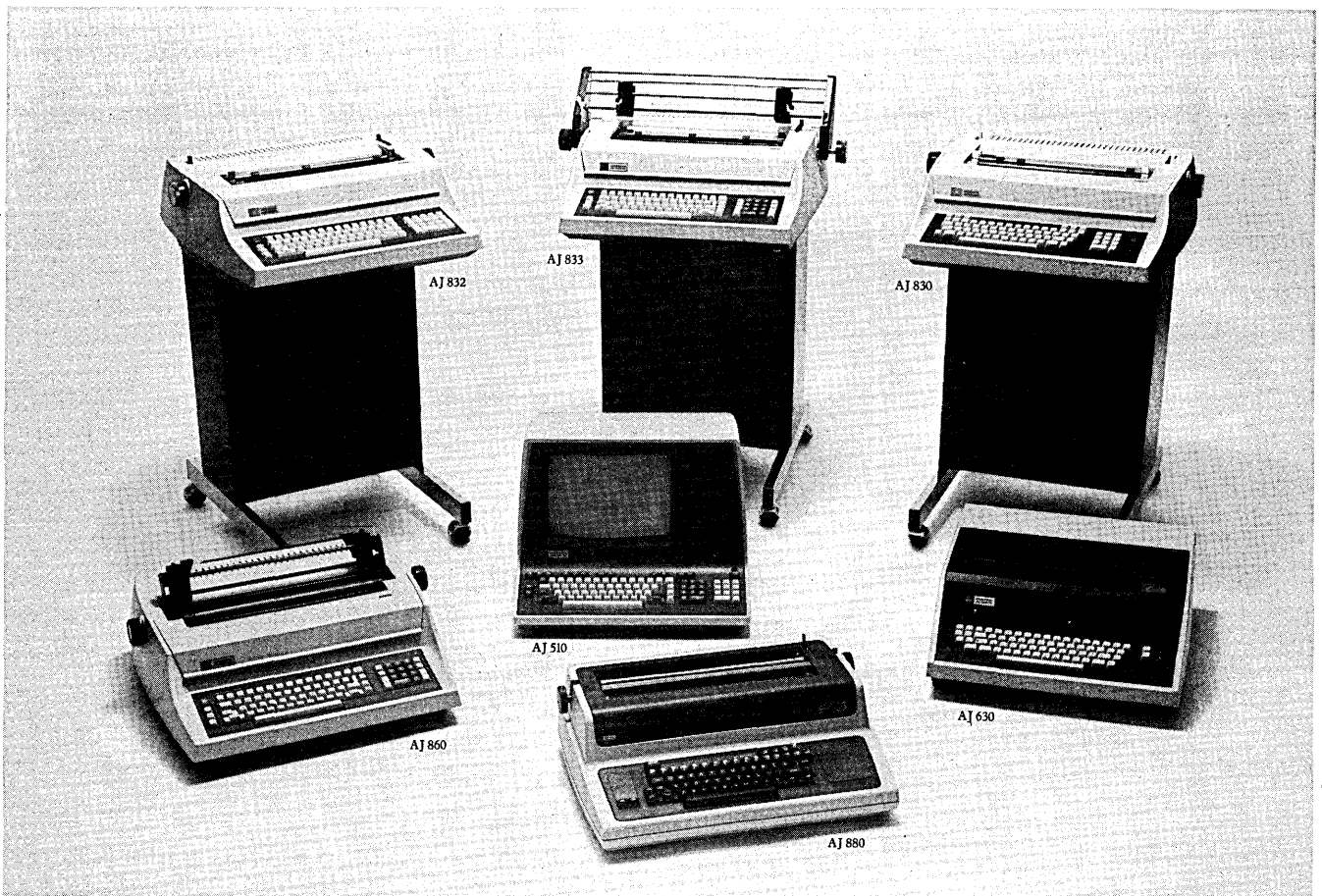

We make all types of terminals so you don't have to deal with all types of companies.

We don't have a lot of axes to grind. If you need daisy wheel printer terminals, we won't try to force dot matrix printers on you. Or vice versa.

That also holds true if you need quiet thermal printers. Or CRT displays. Or APL.

We've got them all. Together with media storage devices and the widest range of acoustic data couplers and modems available.

You don't have to call "X" company for this and "Y" company for that.

Suppose you communicate at low speed—110, 300, or 450 bps. Fine. We won't try to sell you more terminal than you need.

But if you want to take advantage of 1200 bps, we can certainly accommodate you.

Just look at the range.

The AJ 832—one of the most widely used 30 cps daisy wheel printers in the world, with excellent features and proven performance. Or the new AJ 833, a step up in capability from the AJ 832: faster at 45 cps, a bigger buffer, proportional spacing, and more. Or the AJ 830 for daisy wheel print quality at a remarkably low price.

Our AJ 860 gives you outstanding dot matrix print quality and 1200 bps capability. The AJ 880, our newest dot matrix printer, offers 110/300 bps operation, desktop portability, and low cost.

The AJ 630 combines quiet thermal operation with desktop size and a price that's hard to beat.

And the AJ 510, one of the most versatile CRT's on the market, gives you

great application flexibility, a crisp display, and data rates ranging from 110 to 9600 bps.

Another thing. We won't sell you a terminal and forget you. Because we also lease, install, and *service* all the products that bear our name. So you won't have to deal with even *more* companies every time you need maintenance. When you deal with AJ, you deal with the *source*. Doesn't that make sense? Of course.

Call our regional office nearest you for details: San Jose, CA (408) 946-2900; Rosemont, IL (312) 671-7155; Hackensack, NJ (201) 488-2525. Or write Anderson Jacobson, Inc., 521 Charcot Avenue, San Jose, CA 95131.

The source. Of course.

 **ANDERSON
JACOBSON**

CIRCLE 138 ON READER CARD

As your introduction to **The Library of Computer and Information Sciences**

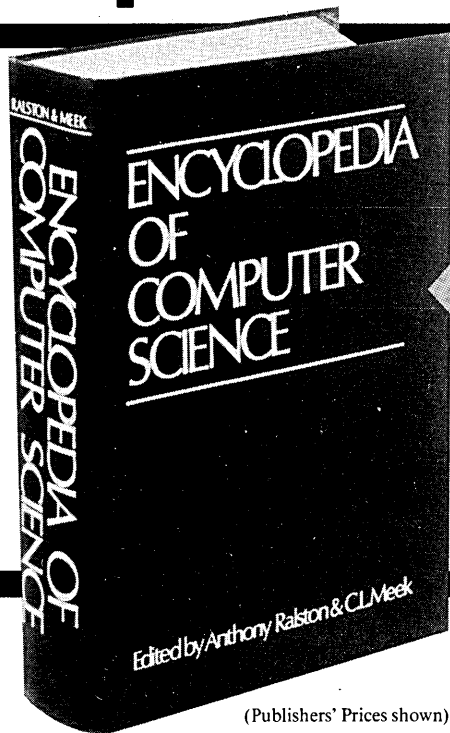

Take this

\$60.00 classic for only \$3.00

ENCYCLOPEDIA OF COMPUTER SCIENCE

Edited by Anthony Ralston and Chester L. Meek. More than 1550 outsize pages of information on every aspect of computer science—from algebra to automata theory, from basic terminology to string-processing languages. 470 articles by 208 experts. Over 700 charts, tables, graphs and diagrams.

or 3 other books for only \$1 each (values to \$75.00)

If you will join now for a trial period and take only 3 more books—at handsome discounts—over the next 12 months.

(Publishers' Prices shown)

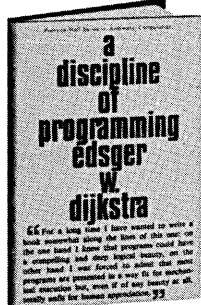

42303. A DISCIPLINE OF PROGRAMMING. Edsger W. Dijkstra. Program derivation and composition, common mistakes, plus numerous other examples. **\$21.95**

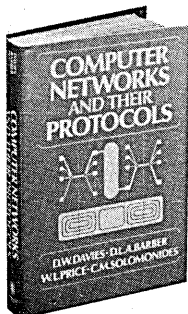

39995-2. COMPUTER NETWORKS AND THEIR PROTOCOLS. D.W. Davies et al. Latest technology in routing, packet switching, flow control and much more. Counts as 2 of your 3 books. **\$43.95**

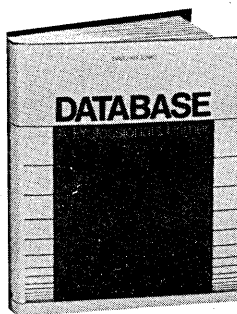

41625. DATABASE: A Professional's Primer. David Kroenke. **\$24.95**

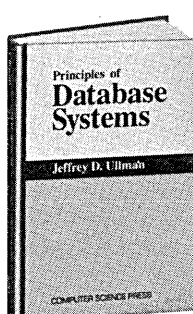

70205. PRINCIPLES OF DATABASE SYSTEMS. Jeffrey D. Ullman. A conceptual reference which spells out every feature of the modern database technology from data relationships to IMS to the concerns of security and integrity of the finished operational database. **\$19.95**

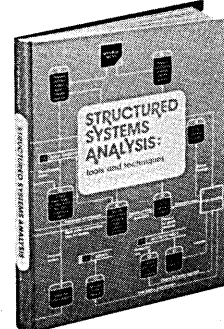

80837. STRUCTURED SYSTEMS ANALYSIS: Tools and Techniques. Gane and Sarson. **\$19.50**

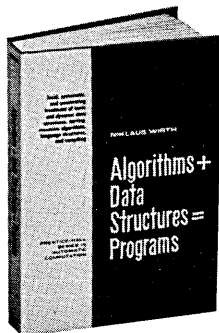

32485. ALGORITHMS + DATA STRUCTURES = PROGRAMS. Niklaus Wirth. A classic work on structured programming. **\$20.95**

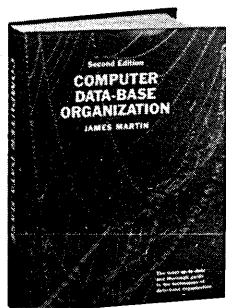

39890-2. COMPUTER DATA-BASE ORGANIZATION. James Martin. A planning tool with over 200 diagrams. Counts as 2 of your 3 books. **\$27.95**

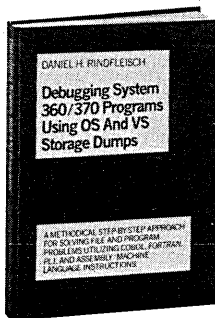

41785. DEBUGGING SYSTEM 360/370 PROGRAMS USING OS AND VS STORAGE DUMPS. D.H. Rindfleisch. **\$24.95**

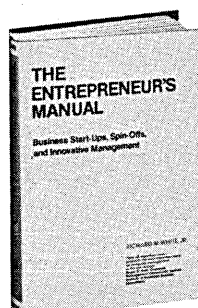

45380. THE ENTREPRENEUR'S MANUAL: BUSINESS START-UPS, SPIN-OFFS, AND INNOVATIVE MANAGEMENT. Richard White. **\$17.50**

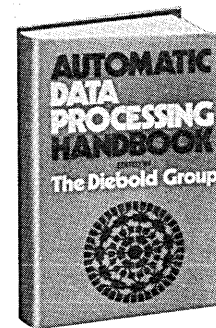

35450-2. AUTOMATIC DATA PROCESSING HANDBOOK. The Diebold Group. Auxiliary memory, peripherals, systems design, consultant services, software packages. Counts as 2 of your 3 books. **\$38.95**

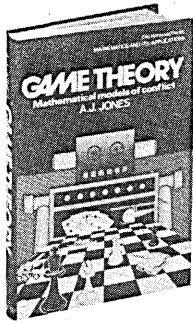

50045-2. GAME THEORY: Mathematical Models of Conflict. *A.J. Jones.* Provides a brilliant introduction to the science, followed by a detailed treatment of the consequences of the duality theorem of linear programming. Numerous diagrams, examples. *Counts as 2 of your 3 books.* \$45.00

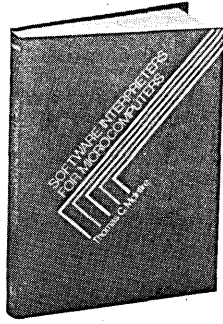

79155. SOFTWARE INTERPRETERS FOR MICROCOMPUTERS. *Thomas C. McIntire.* How to design a reliable software interpreter for any micro-computer system. \$23.95

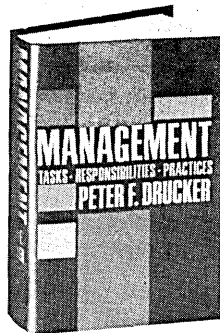

59920. MANAGEMENT: Tasks, Responsibilities, Practices. *Peter F. Drucker.* \$17.50

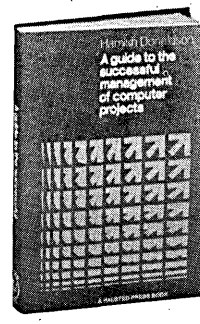

51955-2. A GUIDE TO THE SUCCESSFUL MANAGEMENT OF COMPUTER PROJECTS. *Hamish Donaldson.* *Counts as 2 of your 3 books.* \$34.95

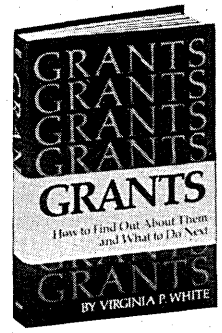

50551. GRANTS: How to Find Out About Them and What to Do Next. *Virginia P. White.* \$19.50

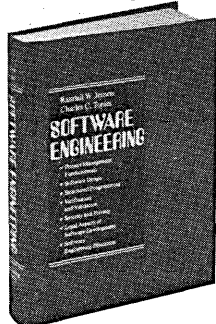

79150-2. SOFTWARE ENGINEERING. *Jensen and Tones.* All phases, with the emphasis on real applications in industry. *Counts as 2 of your 3 books.* \$27.50

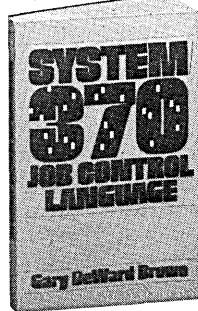

81845. SYSTEM/370 JOB CONTROL LANGUAGE. *Gary DeWard Brown.* Includes descriptions of hardware devices and access methods and reference to many useful JCL features. *Softcover.* \$13.50

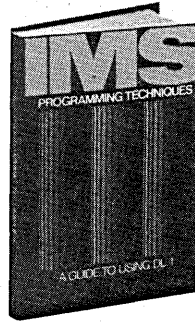

54455. IMS PROGRAMMING TECHNIQUES: A Guide to Using DL/1, Kapp and Leben. Specific techniques to write application programs in ANS COBOL, PL/1, or Assembler Language in an IMS DL/1 data base environment. \$17.95

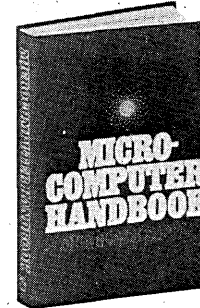

62620. MICROCOMPUTER HANDBOOK. *Charles J. Sippel.* Detailed reference to the technology and applications of micro-processors. \$19.95

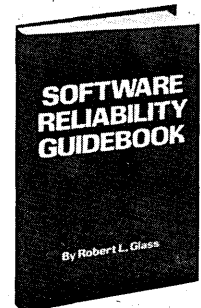

79167. SOFTWARE RELIABILITY GUIDEBOOK. *Robert L. Glass.* \$18.95

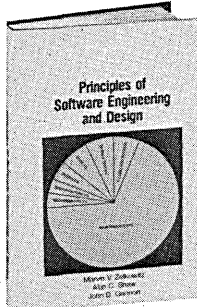

70230. PRINCIPLES OF SOFTWARE ENGINEERING AND DESIGN. *Marvin V. Zelkowitz, et al.* Shows you how to handle everything from small programs to the design of large, complex software systems. \$21.95

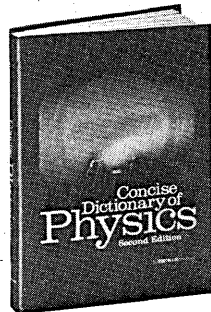

40135-2. CONCISE DICTIONARY OF PHYSICS. *J. Thewlis.* *Counts as 2 of your 3 books.* \$50.00

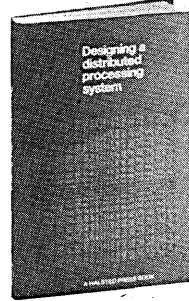

42053-2. DESIGNING A DISTRIBUTED PROCESSING SYSTEM. *Hamish Donaldson.* Includes file strategy, communication networks and work flow design. *Counts as 2 of your 3 books.* \$34.95

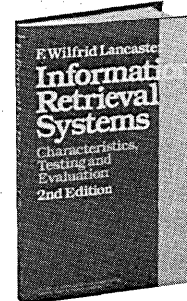

55353. INFORMATION RETRIEVAL SYSTEMS: Characteristics, Testing and Evaluation. *F. Wilfrid Lancaster.* \$19.95

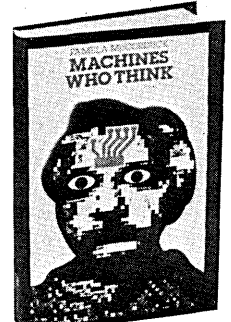

59115. MACHINES WHO THINK. *Pamela McCorduck.* An analysis of the development and future prospects for artificial intelligence. \$12.50

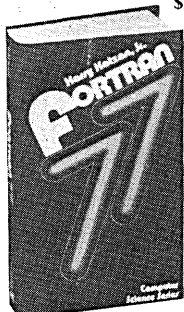

48780. FORTRAN 77. *Harry Katzan, Jr.* Comprehensive coverage of the new FORTRAN standard language, from data types and constants to the latest I/O statements. \$16.95

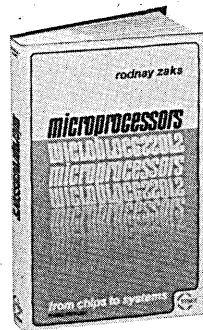

62641. MICROPROCESSORS: From Chips to Systems. *Rodnay Zaks.* Detailed examples, photographs, diagrams and appendices. *Softcover.* \$25.00

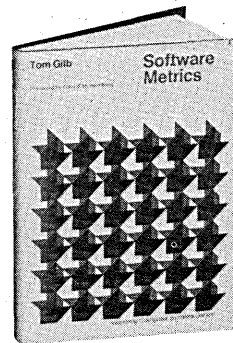

79165. SOFTWARE METRICS. *Tom Gilb.* Practical techniques for estimating program reliability and efficiency. \$21.95

Plus more books to choose from

32275. ADVANCES IN COMPUTER ARCHITECTURE. *Glenford J. Myers.* A close, critical look at current architectures and ways to help future computer designers avoid the problems of current systems. \$21.00

41657. DATA PROCESSING COST REDUCTION AND CONTROL. *Dick H. Brandon.* \$17.95

39746-2. COMPANION TO CONCRETE MATHEMATICS. VOLUMES I AND II. *Z.A. Melzak.* Mathematical techniques and various applications. *The set counts as 2 of your 3 books.* \$46.45

62655. MICRO-ANALYSIS OF COMPUTER SYSTEM PERFORMANCE. *Boris Beizer.* A step-by-step approach to the construction, validation, and use of analytical models for determining the performance of a computer-controlled system. \$22.50

If the reply card has been removed, please write to
The Library of Computer and Information Sciences
Dept. 7-AD6, Riverside, N.J. 08075
to obtain membership information and an application.

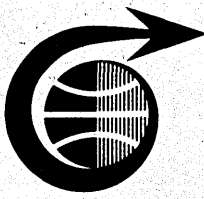

120 CPS FLEXIBILITY AT YOUR FINGERTIPS

Whatever your application requirements, Carterfone's 5130 data terminal offers all the flexibility you need. Designed to meet a full range of user requirements, the cost-efficient 120 cps printer can be operator-programmed to new applications simply and easily.

In addition to outstanding applications flexibility, the 5130 provides smart bi-directional printing at 180 cps, 14 baud rates and a built-in 1k buffer to keep pace with incoming data. Attributes such as variable horizontal and vertical pitch, tabbing, forms control, answerback and 45 other keyboard selectable features are standard in every 5130.

For the best price/performance value in a data terminal, consider the flexible 5130, available from Carterfone through equally flexible lease, purchase or rental plans. For complete information, call or write Carterfone today.



Carterfone

Member of the Cable and Wireless Telecommunications Group

1111 W. Mockingbird Lane, Suite 1400
Dallas, Texas 75247 (214) 630-9700



**AVAILABLE
FOR IMMEDIATE
DELIVERY**

CIRCLE 139 ON READER CARD

SALES & SERVICE OFFICES

Atlanta; Boston; Burlingame CA; Charlotte; Chicago; Cincinnati; Cleveland; Columbus; Dallas; Davenport IA; Denver; Detroit; Fairfield NJ; Garden Grove CA; Hartford; Honolulu; Houston; Jamaica NY; Kansas City; Los Angeles; Memphis; Miami; Milwaukee; Minneapolis; New Orleans; New York; Norfolk; Oklahoma City; Omaha; Orlando; Philadelphia; Phoenix; Pittsburgh; Portland; Raleigh; Sacramento; Saginaw; San Antonio; San Diego; San Francisco; Santa Clara; Seattle; South Bend; St. Louis; Syracuse; Washington DC.

The Bureau of Mines' multipurpose network conducts research to protect miners' health and safety.

FIRE-FIGHTING MINI

by Donald N.H. Chi
and Henry E. Perlee

Research computer systems usually begin by filling several critical needs and then expand as demand develops among other groups in the laboratory. Whatever the scientific discipline, the evolution of most of these systems—a process that never really stops—follows a similar pattern.

Data acquisition and analysis, most likely the first computer services to be implemented, may start with either an assortment of small minicomputers dedicated to individual instruments, or with one larger central minicomputer that handles many users simultaneously. Then, when "number-crunching" analysis and modeling inevitably get to be too much for the in-house facility, communications capability is added in order to access a remote mainframe, one that belongs either to an independent service bureau or to a parent or allied organization. In addition, the researchers are likely to find they need a general-purpose time-sharing resource.

Somewhere in this process of growth, the research system is likely to become a network in which many, if not all, of the computers supporting the laboratory are linked. With successful local standards, the computers can then share experimental data, common instrumentation parameters, hardware resources, and application software. One benefit an internal computer network affords is the opportunity to provide superior service to the research staff at lower operating cost than a mixture of standalone machines and remote services.

A multipurpose research computer network, however, does not come in a package. It must be designed and built to meet the needs of the particular research organization. Certainly, commercially available hardware and application software should be used wherever possible; these have been tried and tested, are likely to cost less, and will normally be ready much sooner. But special hardware and custom software will probably also have to be developed, particularly in networks that perform many technical tasks.

The research computer network at the Bureau of Mines' Pittsburgh Research Center (PRC) conducts and oversees research related to health and safety in mines as well as mine environmental technology. The major research areas are fires and explosions, dust control/ventilation, methane, mining envi-

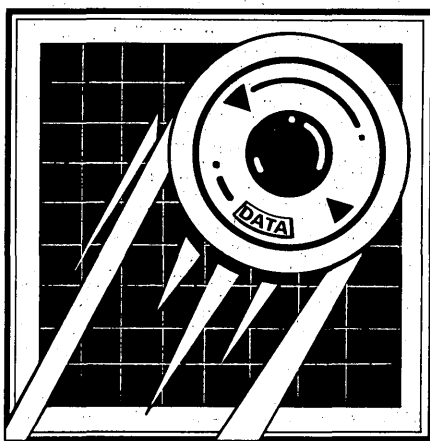

ronmental control, roof support, explosives, industrial safety and training systems, and electrical safety and communications.

The four largest research facilities that use the computer network are the Experimental Coal Mine, the In-Situ Combustion Facility, the Fire Research Facility, and the Explosion Gallery.

The Experimental Coal Mine consists of a double entry coal mine 1,200 feet long having corridors in which coal dust explosion research is conducted. This facility uses 75 transducers that measure gas pressure and temperature, dust concentrations, air velocity, radiation intensity, and flame speed at 10 locations along the entries. The transducer signals are amplified and sent 500 feet over analog lines to the computer, where they are sampled at about 2,400 samples per second per channel. Typically, a coal dust explosion lasts less than five seconds and generates 1.8×10^6 data points.

The In-Situ Combustion Facility includes a 35-foot-long surface trench lined with refractory brick and filled with a cast coal/cement mixture that simulates a thick coal seam. The coal is ignited at one end of a central channel along the trench, and air is forced through the channel at various rates. The rate of fire spread, temperatures, gas product composition, smoke, pressure drops, enthalpy, radiative and convective flux, and ventilation velocity are measured.

Transducer signals are acquired by a data logger and magnetic tape recorder and transmitted to the computer over both analog and digital lines. Initially, each transducer is sampled once every 10 seconds, slowing to once every 15 to 30 minutes after three or four days of the burn, accumulating 106 data

points. Each test involves about 250 channels of information.

The Fire Research Facility contains two 30-foot-long, refractory-coated ducts lined with timber or coal blocks. A fire is initiated at one end of the ventilated channel, and the rate of fire spread along the channel wall, among other things, is monitored. About the same volume of data is generated and handled as in the In-Situ Facility.

The Explosion Gallery consists of a 90-foot-long steel pipe used to conduct experiments similar to those run in the Experimental Coal Mine. Many of the experiments conducted in the Experimental Coal Mine are first run in the Explosion Gallery to get a feeling for the nature and magnitude of the processes. The facility is located 2,000 feet from the computer, and all data are transmitted and sampled in the same manner as for the Experimental Coal Mine.

BEFORE THE NETWORK

The development of research computing on a PRC-wide basis began about 10 years ago with the formation of the Theoretical Support Group (TSG), which is responsible for providing computer hardware and programming capability to the research center's 250 people. Up to that time, outside time-sharing services were accessed from teleprinters, and a high-speed terminal was linked to a remote mainframe for more complex analysis. Data were collected by manually digitizing strip charts and then sending punched paper tape to another remote location for further processing. Finally, in 1971 the research center began operating its first internal facility by running a data acquisition package on a CDC1700 computer linked to experiment transducers.

The first data acquisition system was limited to 33,000 samples per second or 550 samples per second on each of 60 channels (the analog-to-digital converts could accept 50,000 samples per second, but the data could not be written into magnetic disk files at a rate higher than 33,000). Moreover, the in-house computer was not reliable enough for concurrent high-speed and low-speed data acquisition (potential loss of data was too great); when doing high-speed data acquisition, it could not be used for anything else.

The initial criteria for a new computer system specified a minimum sampling rate of 2,000 samples per second per channel for as many as 150 channels for 10 seconds, and the

A multipurpose research computer network does not come in a package.

TSG wanted the freedom to add new channels without affecting the sampling rate. Reliability had to be high enough for such low-speed data acquisition tasks as 10 samples per second per channel for up to several hundred channels and one sample every 10 minutes for periods as long as five days. Other specifications included capability for interactive program development and communications between computers at the PRC and two mainframes at remote locations. The latter machines are a Cyber-74 at the Bureau of Reclamation in Denver and a Burroughs 6700 at the Bureau of Mines' Division of ADP, also in Denver.

A network of Digital Equipment Corp. PDP-11 series minicomputers was installed in July 1978 and has since expanded steadily in applications.

The PRC now acquires data under a wide range of conditions including on-line, high-speed, short-duration acquisition, up to 500,000 samples per second for up to 10 seconds; on-line, low-speed, long-duration acquisition, less than 100 samples per second for weeks or months; and off-line acquisition at both high- and low-speeds, through control of various types of data storage devices such as data loggers, analog magnetic tape recorders, and satellite microcomputers. Reduction and analysis of these data range from a simple x-y plot in engineering units to a modeling program that can only practically be done on a large-scale mainframe computer. The source of data for reduction and analysis may be a file on a magnetic disk drive in the same room at the PRC or a microcomputer monitoring gas-sample sensors more than 1,000 miles away.

The PRC network in Fig. 1 divides the major system functions among three minicomputers. One PDP-11/34 (mini B) handles all high-speed and low-speed real-time data acquisition, collects batch data off-line, and provides experiment control. The second PDP-11/34 (mini C) is primarily responsible for communication with mainframes at the two data centers in Denver and, through asynchronous ports, with a remote microcomputer monitoring gas samples in a Colorado mine. The two mainframes in Denver are the Cyber-74, which handles the more complex simulation programs, and the Burroughs 6700, which is mainly used for administrative support applications. A fourth PDP-11/34 resides in a laboratory and is dedicated to spectral analysis.

The PDP-11/70 (mini A) performs all the data reduction and analysis, controls the major data output devices, and provides time-sharing service to lab personnel through 25 asynchronous ports. Six of the ports are directly interfaced with three keyboard teleprinters, a portable terminal, and two video display terminals located in the user room, which is available to TSG programmers and

researchers from anywhere in the PRC. About 15 other terminals access the three minis from various laboratories and offices.

The high-speed data acquisition subsystem on mini B (bottom center in Fig. 1) consists of four identical modules designed specifically for the PRC; each module includes a 32-channel multiplexor and A/D converter feeding into an extended memory unit (EMU). The EMU, which itself can accept data at the rate of 1 million samples per second, receives data at up to the maximum capacity of the converter and transfers the data at a maximum rate of 50,000 samples per second to the 88-megabyte magnetic disk unit controlled by mini B. The EMU can either switch itself off when filled with data, recycle memory (when full, begin rewriting again over old data), or operate under control of software on mini B. Presently, the four modules provide a total data acquisition capability of 1 million samples per second over as many as 128 lines. This capability can be distributed as required by active experiments, with a maximum single-channel sampling rate of 125,000 samples per second.

Another approach to high-speed data acquisition has been to read the primary sensor signals onto analog magnetic tape and then postprocess the tape to transfer the data in digital form onto magnetic disk storage. As it turns out, the cost of the EMU modules is about half that of an analog tape facility of the same capacity (moreover, the high-noise-level characteristic of analog tape and long playback time are avoided).

The low-speed data acquisition subsystem on mini B (bottom center in Fig. 1) includes a total of 416 channels with transmission speeds ranging from 110 to 9,600 baud. In addition to real-time low-speed data collection, this subsystem is linked to several devices that transfer data into the system in off-line batch modes: data logger, for example, can accommodate up to 1,000 input channels at 25 samples/sec., and the analog magnetic tape recorder has 14 channels with bandwidths up to 300 kHz.



Digital Equipment's ICS-11 Industrial Control Subsystem handles the experiment control tasks, which are primarily concerned with programmed operation of relays for instrumentation, calibration, and testing purposes. This subsystem includes 16 voltage sense lines, 16 voltage interrupts, 16 latching relays, and 16 flip-flops. The digital/analog converter provides 16 channels for control signals at a total rate of 20 kHz.

SYSTEM NETWORK SOFTWARE

The operating system for all three minicomputers is IAS (Interactive Application System), Version 3, under which real-time, interactive, and batch processing can take place concurrently. Memory is divided into one main partition for time-sharing, batch, and noncritical real-time tasks and special partitions for critical real-time tasks, which are scheduled by the executive based solely on priority. Interactive and batch tasks are scheduled with dynamically computed time-slicing algorithms. Batch tasks normally receive cpu time available after real-time and interactive tasks have been serviced.

The change from Version 2 IAS to Version 3 IAS permits larger analytical programs to be run on the PDP-11/70 than was possible before. A virtual array feature permits storing data in memory beyond the 32K words reserved for the program alone. Maximum data space available for a program is approximately 896K words, which is one megaword minus the space needed for the operating system. In addition, all parts of any program which must be overlaid because it is larger than 32K words can now be made core-resident. This increases execution speed because of reduced disk I/O operations.

If double-precision arithmetic is needed the effective memory space is, of course, cut in half. Although double-precision arithmetic must be used to minimize the impact of round-off error for the iterations characteristic of modeling programs, single-precision arithmetic is usually adequate in FORTRAN analytical programs at the PRC. Even in modeling programs double-precision arithmetic is used only where necessary.

Although each is devoted primarily to specific functions, all four minicomputers in the system share system resources through the use of Digital's DECnet communications software. In DECnet's file transfer mode, experiment data are sent from disk storage on the acquisition mini B to disk storage on the reduction and analysis mini A. Similarly data received from the Cyber-74 and Burroughs 6700 mainframes are transferred from storage at the communications mini C to storage at mini A.

In DECnet's task-to-task mode, a program resident on either mini B or mini C can

ILLUSTRATIONS BY CHRIS SPOLLEN

FIG. 1
DIAGRAM OF RESEARCH COMPUTER NETWORK

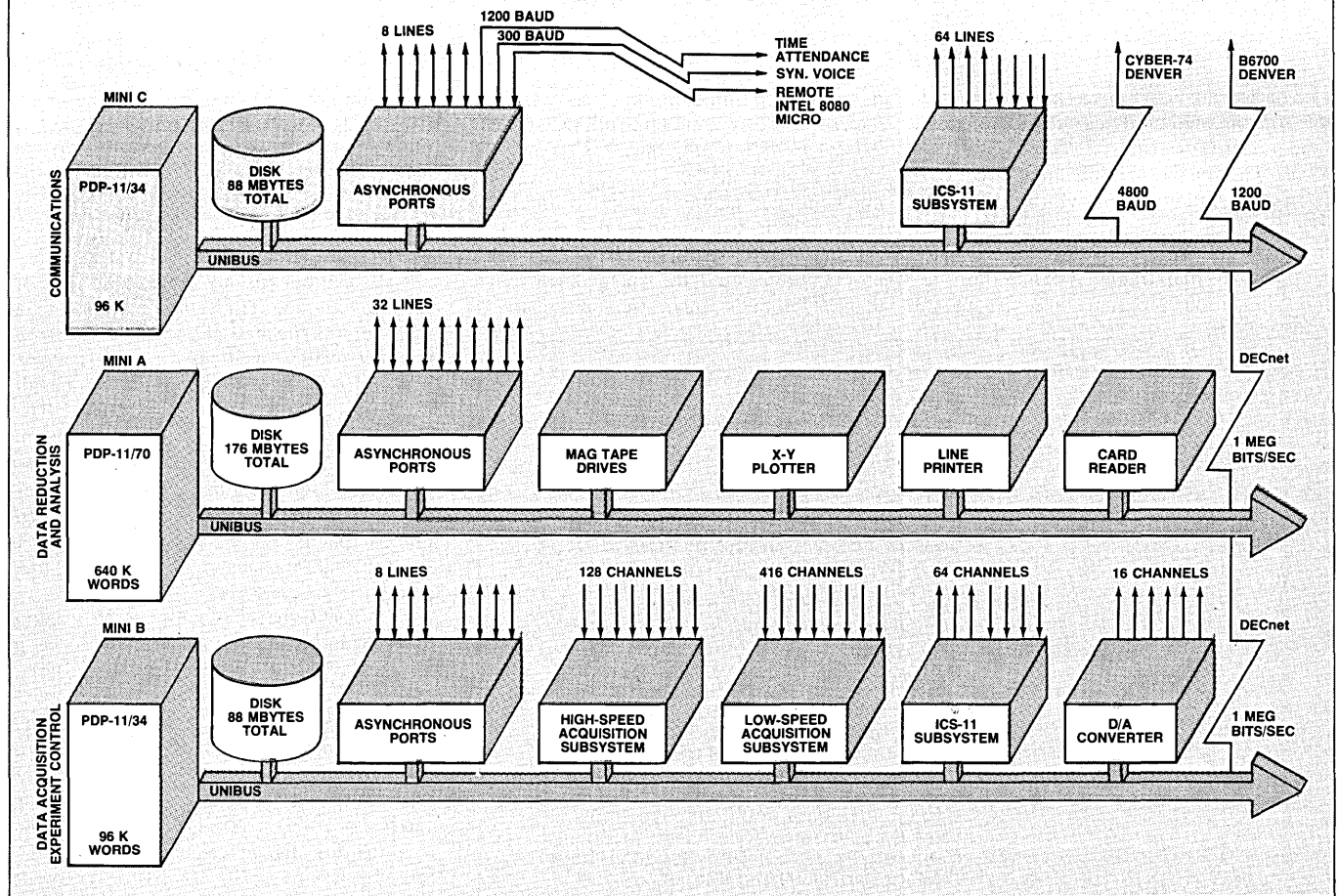

request a program on mini A to run an analysis and print out the result on a peripheral device linked to mini A (more cost-effective than duplicate peripheral devices on all machines). Similarly, a program on mini A can request a program on mini C to transmit files received from the remote mainframes. In general, a researcher enters what is to be done with experiment data at a terminal without having to be concerned with what function is to be performed by what minicomputer.

A third PDP-11/34 has just been linked to the network so that time-sharing users in the Electronics Laboratory can use the peripherals linked to minicomputer A. In addition, DECnet permits the third PDP-11/34 to access application programs that are controlled by the other machines.

APPLICATION SOFTWARE

Application software in research laboratories includes both general-purpose and special-purpose programs. At the PRC, the TSG has made a special effort to provide adequate general-purpose software so that its programmers' time can be concentrated on developing the more complex analytical and modeling programs.

General-purpose software includes program packages developed internally by the TSG and commercially available packages, such as International Mathematical and Statistical Libraries, BMDP, SFORTRAN (Struc-

tured FORTRAN), and LSP-11.

The most widely used TSG-developed software is a data-acquisition/analysis package with which the researcher can define the entire process from type of sensors on the input to type of plot on the output. Past experience has shown that researchers constantly change their processing requirements in repeating particular experimental setups; therefore, the programming staff spends a good deal of its time in updating and maintaining existing programs. To minimize such demands, the acquisition/analysis software package provides a data base that contains all necessary parameters for processing an experiment. For a given data base, the package performs such functions as automatic calibration and testing of signal conditioning instruments, spectral analysis, and filtering.

Each file of experimental data submitted for further processing is accompanied by a copy of the data base, which includes all parameter updates entered during data acquisition. For example, the record for each transducer contains such parameters as the multiplexor channel number, type of sensor, file location of the calibration and engineering unit conversion coefficients, plotting parameters, type of filtering, and types of processing. If the researcher changes the type of sensors, the record is updated in the data base without any change in the processing program itself.

The researcher also uses the acquisition/analysis package to specify the type of analysis desired: analyses in the package include linear curve fit, nonlinear curve fit, statistical analysis, correction for time shifts between channels, and time series analyses such as FFT, spectral analysis, correlation, and phase shift. Finally, the user may fill in a data request listing on a video screen or teleprinter to specify titles, sizes, and scales, or graphs of output data.

The data acquisition/analysis package can be used for any experiment in which the input is in the form of amplified signals from instruments. As such, the package is most often used by the Experimental Coal Mine, Fire Research Facility, and Explosion Gallery, all of which repeatedly run experiments in which all changes occur within the parameter data base. The acquisition/analysis package is expected eventually to handle more than three-quarters of all larger acquisition/analysis projects, that is, those measuring over about 500 points.

There are also many smaller experiments that do not need either a special program or the general-purpose data acquisition/analysis program. In those cases, the RS/1 software system developed by Bolt, Beranek and Newman Inc. permits the researcher with minimal computer background to define custom tables and graphs based on files of experimental data. Moreover, RS/1 provides

The acquisition/analysis package is expected eventually to handle more than three-quarters of all larger projects.

such basic statistical tools as analysis of variants, linear and nonlinear regression, and nonparametric statistics.

The PDP-11/70 minicomputer with the new IAS operating system will be able to do about 80% of the analytical and simulation programs that were once done remotely on the Cyber-74 mainframe. A flame propagation simulation program takes about 20

minutes of cpu time on the Cyber-74. Since the PDP-11/70 is about one-fifth the speed of the Cyber-74, this program takes 100 minutes of cpu time on the PDP-11/70. However, the minicomputer can be running the simulation program in the batch mode at the same time it is handling time-sharing users. Although this program run could then take much longer than 100 minutes, other users of the PDP-11/

70 would not notice the difference.

The potential cost savings in converting analytical programs to the PDP-11/70 can be substantial. The Cyber-74 service at one time cost about \$80,000 per year, so that doing 80% of the analytical work internally will save over \$60,000 per year. In addition, analytical programs involve a good deal of input/output time. Transmission of input data to the remote site may take between 30 and 45 minutes, while four hours or more may be needed for the remote mainframe to transmit back the resulting plot file at 4,800 baud. The cumulative line charges for long-distance transmission for these periods of time can be extremely high. In running analytical programs internally, data transfer time between minicomputers is minimal since the DECnet line speed is 1 megabaud (and there is no line charge).

The Cyber-74 facility is still being used for large simulation programs to keep the PDP-11/70 free for other tasks. These large programs include simulation of the combustion process in coal particles, modeling of gas flames, and large thermodynamic codes. In an improvement that is estimated would pay for itself within two years, an array processor can be linked to the PDP-11/70 minicomputer so as to bring all number-crunching programs in-house.

DATA PROCESSING

Career Perspective in American Banking

The Federal Reserve System—the nation's money manager and central bank. We're not a branch of the Government. We're the banks' Bank. We can offer you unique perspective in your career as a computer professional.

If you are an experienced programmer/analyst, systems programmer, data base analyst or a project leader, The Fed has a lot to offer you. To meet our money management goals, we use sophisticated computer applications for everything from pure economic research to electronic funds transfer. The majority of our banks have advanced telecommunications systems using the latest in SNA architecture, state-of-the-art technology (most locations have IBM hardware utilizing IMS) or TOTAL/EI and unique applications development work. Opportunity at The Fed can be found in some of the country's most exciting cities: Boston, New York, Philadelphia, Cleveland, Richmond, Atlanta, Chicago, St. Louis, Minneapolis, Kansas City, Dallas, San Francisco and Washington, D.C.

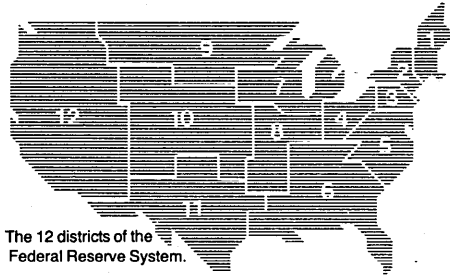

The 12 districts of the Federal Reserve System.

You'll find competitive salaries, a pay-for-performance merit program, excellent benefits, relocation assistance. And plenty of opportunity for training so you can grow with an organization that's growing to meet complicated economic needs. If you're a computer professional, doesn't it make sense to put your career in perspective with The Federal Reserve System? Call our toll-free number 1-800-821-7700, ext. 103 (in Missouri call 1-800-892-7655) and we'll send you more information. Or, if you prefer, you may send your resume to The Federal Reserve System-DP, P.O. Box 7702, San Francisco, CA 94120. Or, contact any of our Reserve Banks directly. The Federal Reserve System is an equal opportunity employer.

Federal Reserve System

DONALD N. H. CHI

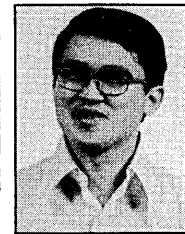

After receiving a PhD in applied mathematics and an MS in physics, Dr. Chi joined the Bureau of Mines' Pittsburgh Research Center in 1970. His

current responsibilities pertain to computer center operation, system development, simulations, and computer applications in the scientific/engineering area.

HENRY E. PERLEE



Mr. Perlee is research supervisor of the Theoretical Support Group at the Pittsburgh Research Center, where he manages the

center's computer facility. He is a 20-year veteran of the Bureau of Mines.

Upgrading to the CMD?

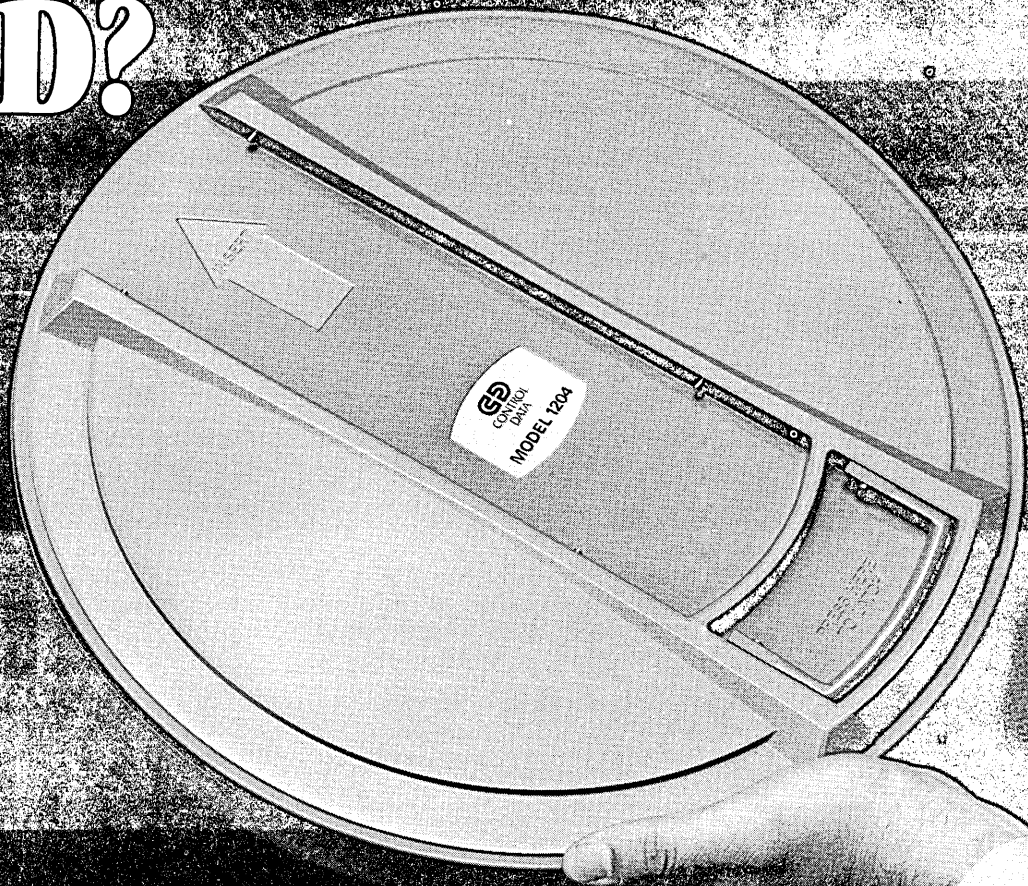

If you're upgrading to a Cartridge Module Drive (CMD), you'll be glad to know that now you can get your CMD Model 1204 cartridges *direct* from Control Data. We developed the CMD, and the CMD cartridge that goes with it.

Every cartridge from Control Data is built and tested to the highest standards and warranted for life.

With our reputation for excellence in drive technology, you can be sure that our cartridges

are of the highest quality. We've sold more than 50,000 CMD cartridges to our OEM customers, a proven record of performance and reliability.

So upgrade with confidence. Call your local Control Data Business

Products representative (look in your Yellow Pages under "Data Processing Supplies"); or call us direct.

Call toll-free
800/328-6207

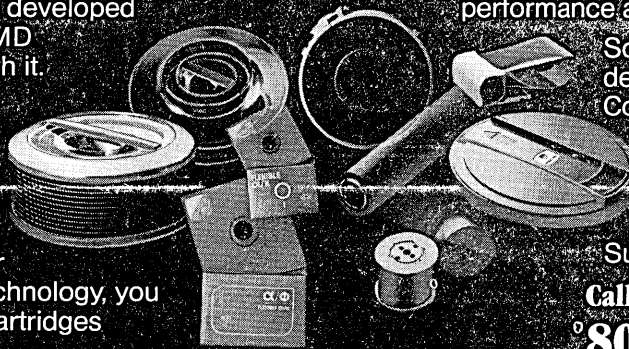

GD CONTROL DATA CORPORATION

Addressing society's major unmet needs

CIRCLE 141 ON READER CARD



PUT INFONET ANYWHERE. ASK IT ANYTHING. AND THE ANSWER WILL APPEAR BEFORE YOUR VERY EYES.

INFONET is Computer Sciences Corporation's worldwide remote computing network. But it functions more like the fabled crystal ball.

Unlike systems patched together from existing parts, INFONET's design started with the ultimate task it was to perform. And then CSC created it from that architectural plan, choosing each component and building every link with only one criterion, optimum performance.

As a result, it's the most completely integrated system anywhere. Internal data exchange is far simpler and it is a substantially better base to assimilate technical advances.

For just a moment, imagine the possibilities of going back in time with all of modern science at your command. INFONET provides that kind of opportunity. Because INFONET can deliver the entire menu of computer technology to almost any chosen place. It gives the marketing man or woman a chance to take to the hinterlands of information management every

solution modern data processing has to offer.

To the computer professional, INFONET also promises an endless calendar of solving new and different problems. And it offers the computer scientist a chance to play a meaningful role in the evolution of advanced data management structures. INFONET is distributed data processing on the grand scale. A true microcosm of computer technology itself.

While INFONET is only one division of CSC, it's a prime example of how we integrate software, communications and hardware to advance the techniques of problem solving.

CSC is continuously developing the capacity of history's most profound tool, the computer, to change man's relationship with everything he has ever known.

It's the ultimate challenge. Maybe you'd like to help us. If you think you're good, and you're not afraid to find out how good you really are, you should be in touch with CSC.

The only limitations are the ones you bring with you.

CSC

COMPUTER SCIENCES CORPORATION

Corporate Offices: 650 N. Sepulveda, El Segundo, CA 90245

An Equal Opportunity Employer.

CIRCLE 142 ON READER CARD

PEOPLE

NO CLEAN DESKS

Ivan Socher came to the computer industry from the garment industry.

Therefore, he is expected to bring to his new job, president and chief executive officer of Amdax Corp., Bohemia, N.Y., a bit of what he calls a "garment industry mentality"—plus a legacy from two years with IBM.

From the garment industry, Socher learned to prefer cluttered desks. From IBM he learned to prefer formal business dress and no-drink lunches.

Amdax Corp. is the new corporate trade name for Intech Laboratories and its wholly owned subsidiary, American Modem Corp. The company develops, manufactures, and markets commercial and industrial data transmission products, specializing in broadband co-ax cable communications.

Prior to joining Amdax, Socher headed a privately funded research and development effort which resulted in a product called Virtual Monitor, a monitoring and control system for large telecommunications networks. The product and its development team have become a part of Amdax.

A native of Rustenberg, South Africa, Socher attended the University of Witwatersrand in Johannesburg (Witwatersrand—"reef of white water"—refers to a gold reef off South Africa's shores).

He entered the garment industry as an accountant but wound up in sales, eventually becoming a sales manager. "I wanted to be president, but I couldn't be because I had no flair for fashion, so I looked around for another business."

He chose the computer industry, and IBM hired him as a trainee salesman in

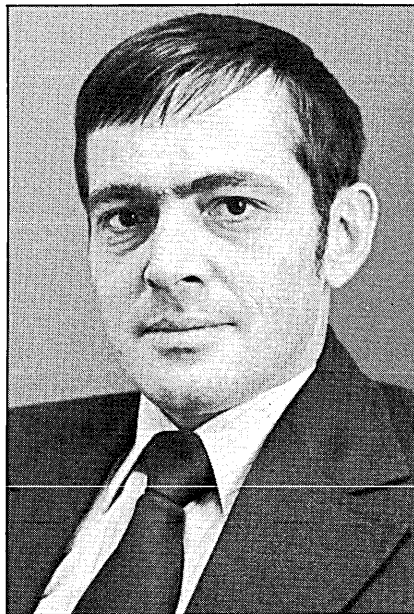

IVAN SOCHER—From garments to computers.

Johannesburg in 1967. He subsequently became branch manager.

A great admirer of IBM—"It's the finest company the world has ever seen"—he left the firm after two years because "I couldn't swallow all that good will."

He then formed Computer Advances (Pty) Ltd. to market and maintain U.S. manufactured computer products in South Africa. This company, by 1974, was second to IBM in dp revenues in South Africa.

Socher's next venture, privately funded, involved design and development of a distributed processing computer system called syFA. This led to a joint agreement between his company and Computer Automation, Inc., Irvine, Calif. Computer Automation bought the rights to the syFA system, formed a Commercial Systems Div., and named Socher general manager for worldwide activities.

As president of Amdax, Socher succeeded founder Jans Kliphuis, who died last winter. Frederich R. Adler, founder of Data General Corp., is chairman of Amdax's executive committee. James R. Swartz, a partner with Adler in the investment firm of Adler and Co., is chairman of the board.

"Since the illness and recent death of the former president and founder of Amdax, Jans Kliphuis, the board of directors has been searching for a chief executive officer with a technical background capable of providing strong leadership, with particular strengths in marketing and sales," said Adler. "Ivan Socher uniquely satisfies these requirements."

TRAVEL TRAN

Since he came to the U.S. in 1976, Dennis M. Klein has dreamed of being part of a move to combine the talents of U.S. and European software practitioners. He may now be well on the way to realizing the dream as the head of Hugh Pushman Associates, Inc., a newly formed subsidiary in California of the British software company Hugh Pushman Associates, Ltd.—a company that specializes primarily in software projects for telecommunications companies.

Klein, 36, says software houses tend to be national in makeup, and he envisions mixing the hardware talent of U.S. software people with the pool of theoreticians that tend to be predominant in Europe. He expects to begin recruiting U.S. software people, mainly those working in the microprocessor business, early next year. "They would be people who would be willing to travel both in the U.S. and Britain, developing projects side by side with their overseas counterparts."

A native of Britain, Klein says the



An inviting place

Nature here is still natural. Uncrowded and free. Stroll Oregon's beaches and not set foot on private property. Match mood and activity to the changing terrain. Picnic, or beachcomb the smooth, sandy beaches. Explore tidal pools. Photograph rocky headlands and sea lions. Fish in the surf or from deep sea charter boats. Watch fantastic winter storms batter the coast.

The Pacific's edge can restore the soul.

New vistas, and opportunity abound here. We're stimulated by our surroundings; and by our association with creative people who are solving problems in advanced hybrid micro-electronics, software engineering and marketing. They made us a world leader in electronic test and measurement and computer graphics equipment. We welcome others who will add to their thrust.

For a color print of our beach, write: Bill Eppack, Professional Placement, Tektronix, Inc., P.O. Box 500 14D, Beaverton, Oregon 97077.

An Equal Opportunity Employer (M,F,H)

Tektronix
COMMITTED TO EXCELLENCE

PEOPLE

idea began when he came to the U.S. to join Tran Telecommunications, a Los Angeles manufacturer of telecommunications equipment, to work as a project manager on that company's major product line, the M3200 switching system. A former associate at Tran said he noted some resentment towards U.K. software people "because they were coming to work here from 5,000 to 10,000 miles away from the fountain of knowledge." The associate said that had there been an organized plan of cross-fertilization of Tran, the resentment would have disappeared. Klein agrees, but adds that he didn't detect any because he had entered the company on a permanent resident visa rather than as a short-time foreign employee.

He left Tran in 1978 to form his own consulting firm, Asten System Design Associates, but shortly afterwards agreed to form a joint venture with Pushman to open U.S. operations for the firm, and so far has brought four of Pushman's staff of 20 to the U.S. to work on software for telephone switching and communications systems. The U.S. operation, in Torrance, Calif., near Los Angeles, has close to \$300,000 in contracts here. This should double by year-end, when it will begin manufacturing Pushman's first hardware, an automated business communications system that can handle up to 3,000 messages an hour and is aimed at automated offices of the 1980s.

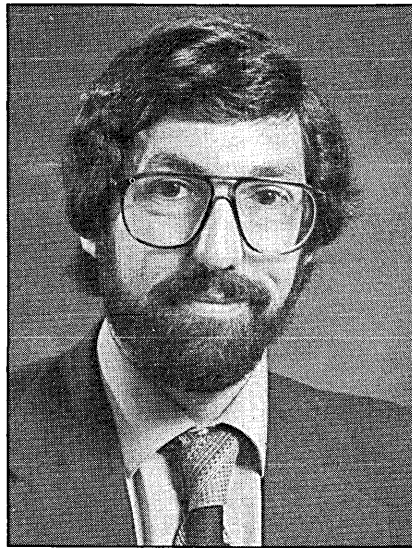

DENNIS M. KLEIN—Heads U.S. subsidiary of U.K. software house.

Klein began his career in 1966 as a systems analyst with IBM's government systems branch in the U.K., working primarily on communications software development, where he gained considerable knowledge of IBM's huge time-sharing computer, the 360/67. He then joined the international service bureau, Systems Corp., in Italy where, with Italian financing, the company planned to

develop a refined version of the 67, using versions of CP-67, the control program developed at the Cambridge Research Center. Later, with the same company in Montreal, Klein wrote considerably on CP-67, a virtual machine without compilers, utilities, or data management facilities that enabled several operating systems to be run concurrently. "In three years we were running up to 60 virtual machines on the one system," a feature that appealed to customers of the service bureau—"too much so," because its largest Canadian customer, Bell Northern, decided to install its own 360/67, so Systems went out of business in Canada.

Klein went back to Italy to work with Tran's newly formed European subsidiary in 1974, providing technical support to the marketing operation there, but left the country a year and a half later for Tran's U.S. headquarters.

He thinks traveling will be as broadening to software specialists as it will be helpful to the customers for which they work, hence his idea for the new U.S. company. "When I left London Univ. with a degree in physics in 1966, I had job offers from 11 computer-related companies," he says. "I chose IBM, not because it was the biggest, but because it promised us an opportunity for a lot of travel." He hopes his experience—working in four countries in 14 years—will be contagious.

SMARTEN UP Teletype 43s

Slip in a TSU

(Telecommunications Storage Unit)

- Cuts line costs 50%
- Powerful Send/Receive buffer
- Batch transmission to 1200 Baud
- Text Editor and Forms Control
- Efficient Speed/Code conversion
- TWX, DDD, Telex Interfaces

Contact your teleprinter supplier or



505 E. Middlefield Rd.
Mountain View, CA 94043
(415) 969-3700

CIRCLE 143 ON READER CARD

RENT • LEASE BUY

IBM 3101 TERMINALS

Model Number & Type	Purchase	Monthly Rates	
		36 Months	24 Months
3101-10 Display	\$1,295.	\$39.	\$49.
3101-20 Display	\$1,495.	\$49.	\$59.
3102 Printer	\$1,295.	\$44.	\$54.

Rental Rates are based on receipt of a \$100. down payment.
ON-SITE SERVICE IS AVAILABLE IN THE NEW YORK METROPOLITAN AREA.

COMPUTER EQUIPMENT

XEROX Printers • DECwriters • Texas Instruments Printers
• General DataComm Modems • 212A • 208 B/A
• 201C • 202 S/T

CALL NOW • TOLL FREE
800-223-1696

Qytel® 285 Madison Avenue
New York, N.Y. 10017
212-889-3888

CIRCLE 144 ON READER CARD

New on the North Star Horizon: 18Mb Hard Disk Drive!

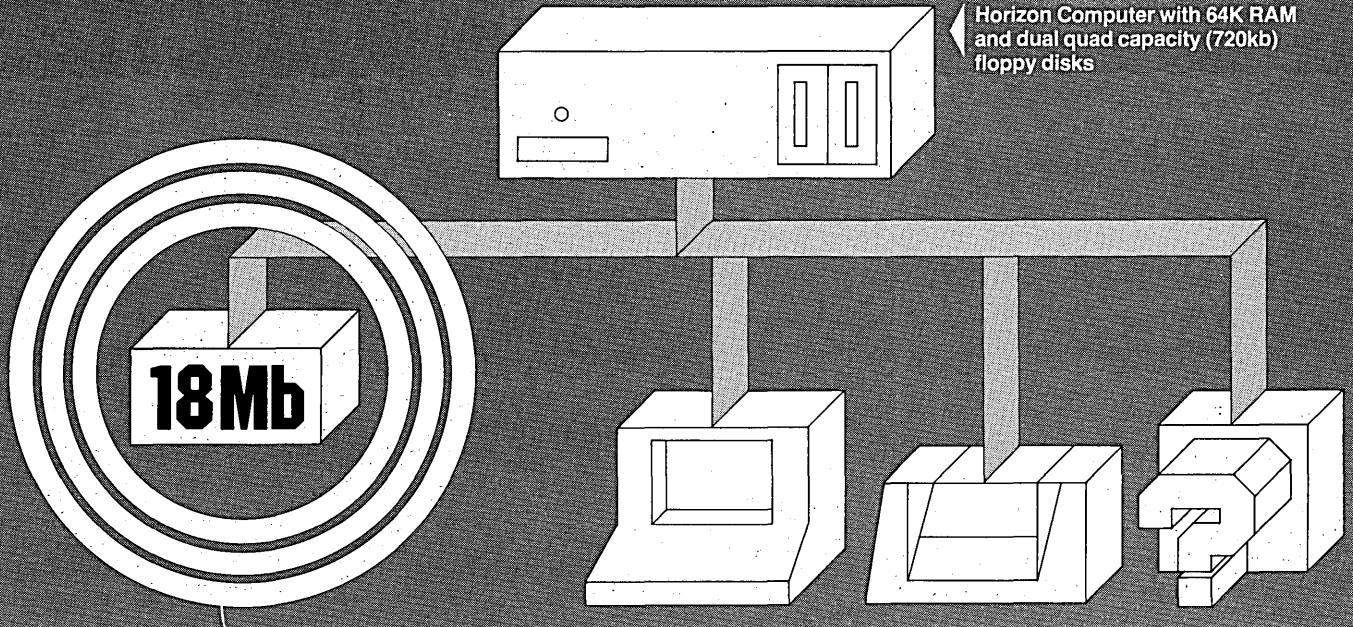

Up to four 18Mb Winchester-type hard disk drives

Display terminal

Letter-quality or dot matrix printer

Horizon I/O flexibility allows expansion to meet your needs

Unsurpassed Performance and Capacity!

North Star now gives you hard disk capacity and processing performance never before possible at such a low price! Horizon® is a proven, reliable, affordable computer system with unique hardware and software. Now the Horizon's capabilities are expanded to meet your growing system requirements. In addition to hard disk performance, the Horizon has I/O versatility and an optional hardware floating point board for high-performance number crunching. The North Star large disk is a Winchester-type drive that holds 18 million bytes of formatted data. The North Star controller interfaces the drive(s) to the Horizon and takes full advantage of the high-performance characteristics of the drive. Our hard disk operating system

implements a powerful file system as well as backup and recovery on floppy diskette.

Software Is The Key!

The Horizon's success to date has been built on the quality of its system software (BASIC, DOS, Pascal) and the very broad range and availability of application software. This reputation continues with our new hard disk system. Existing software is upward compatible for use with the hard disk system. And, with the dramatic increase in on-line storage and speed, there will be a continually expanding library of readily available application software. For further information and OEM prices, please contact the OEM Sales Department at North Star Computers, Inc.

NorthStar and Horizon are registered trademarks or trademarks of North Star Computers, Inc.
© 1980 North Star Computers, Inc.

NorthStar™
North Star Computers, Inc.

1440 Fourth Street, Berkeley, CA 94710 USA
(415) 527-6950 TWX/Telex (910) 366-7001

North Star Computers, Inc.
1440 Fourth Street
Berkeley, CA 94710

Yes!! Please Send More Information On North Star's
18 Megabyte Hard Disk System

Company _____
Name _____
Address _____
City _____ State _____ Zip _____
Phone _____

CIRCLE 145 ON READER CARD

HARDWARE

OFF-LINE

When will the H Series show up? It's pretty much up to you, the user, according to a recent report by Strategic Business Services. In "IBM's Future Large System Software Strategy," the San Jose, Calif., market research firm says you influence the Gray Giant when you "buy" the 3033 as a long-term product that you expect to evolve into H, as opposed to leasing today's large mainframes, forcing IBM to move on to H.

While recent additions to the 370 family offer attractive price/performance ratios, users still find their systems "saddled with software which is a fragile patchwork of temporary and permanent fixes." The report traces the evolution of IBM operating systems through MVS and its architectural extensions. H can be seen as an extension to the 303X, with extended addressing and more channels; according to the \$1,500 report, it will be a dual mode machine, with one mode running a native MVS facility that will exploit some of the hardware extensions. The second mode will be H Series native, taking full advantage of the hardware. Strategic says the first piece of H software has already been announced with the introduction of an MVS SCP program product to support recent extensions to the 303X hardware.

The speech synthesis market seems to be heating up with recent moves from the likes of Texas Instruments, Votrax, and Telesensory Systems. TI released a family of Solid State Speech chips, and opened Regional Technology Centers in Boston and Chicago to help users digitize vocabularies. Votrax introduced a "talking chip" phonemic synthesizer, allowing a virtually unlimited vocabulary. And Telesensory created a Speech Products Division to develop and sell oem synthetic speech systems, custom components, and speech encoding services.

DESKTOP COMPUTER

The desktop I-8140, newest addition to this vendor's I-8100 family of small business systems, can be programmed in COBOL or BASIC. It is compatible with other members of the vendor's interactive systems, including the minicomputer-based I-8200 line of



small business systems and the small mainframe I-8400 series of systems; the new machine reportedly handles all current applications programs developed for other I-8100 family members. An optional software package makes the I-8140 simulate the operation of the vendor's earlier Model 299 accounting computer system (more than 26,000 of these systems have been installed worldwide, mostly in small businesses).

The system includes processor and main memory to 128KB housed in the base of the crt display, detached keyboard, diskette data storage, and a choice of printers ranging from the 132-column, 70 lpm Model 6441 matrix printer to the 200 lpm Model 6420 band printer. The vendor's line of 4500 Visual Record Printers, incorporating bar-code symbol printer mechanisms and optical scanners, is supported for businesses that want to continue using ledger-card records when moving to the new system.

Currently, communications options are limited to bisync for remote batch entry; an interactive communications option is in the works. A 64KB system with 1MB of diskette storage (expandable to 4MB) and a 70 lpm matrix printer sells for \$15,225; monthly rental for this system is \$588. NCR CORP., Dayton, Ohio.

FOR DATA CIRCLE 307 ON READER CARD

DISKETTE DRIVES

The diskette drives promised when this vendor announced its Model 85 personal professional computer have arrived. The 82900 series drives use double-density, double-sided recording to pack 270KB on a 5¼-inch diskette; up to four drives can be configured in a system, for a total on-line capacity of 1.08MB. To support diskette storage, a Mass Storage ROM plugs into the Model 85, providing 30 additional BASIC commands. This ROM also includes a TRANSLATE command for automatically upgrading previously written tape-based programs for use with disk files. Other features provided by the ROM include the ability to store and retrieve graphics, including forms and labeled charts, for the crt display, and volume labeling, allowing references to diskettes by name, instead of referring to specific drives. The 82900 series consists of four units: single and dual drive master units, each containing control logic for the connection of an additional single or dual drive slave unit. The drives interface to the computer through an IEEE-488 interface (itself an existing option priced at \$395). An 82901M dual master drive sells for \$2,500,



and a dual slave unit, the 82901S, is \$2,200. A single master drive 82902M sells for \$1,500, and a single slave 82902S sells for \$1,300. The Mass Storage ROM goes for \$145. HEWLETT-PACKARD CO., Palo Alto, Calif.

FOR DATA CIRCLE 317 ON READER CARD

COMPUTERS

The ME29 series represents this British computer maker's latest offerings to the U.S. dp community, especially those sites consider-



HP introduces forms and graphics to desktop printing.

HP's new 7310A Graphics Printer mixes forms, text and graphics in any arrangement you need. And it prints text up to 500 lines per minute.

On demand from your terminal, the 7310A prints out your forms, and what goes on them at the same time. Work orders, assembly information, material lists, accounting reports, employee records, and all other forms with data, are printed and then

sized to your needs by an automatic paper cutter and page stacker.

Besides being fast and versatile, one of the printer's nicest qualities is just that. Printing quality. Readability can be enhanced with proportionally spaced type, reverse printing, and underlining. And programmable character height allows you to produce bold face headlines or titles in characters up to twice normal height.

In addition to supporting HP terminals and computers, four different interfaces let you adapt the 7310A to many other terminals and computers. For complete information, including OEM discounts, contact your local Hewlett-Packard sales office or write to Hewlett-Packard, Attn: Bill Fuhrer, 16399 West Bernardo Drive, San Diego, CA 92127; (714) 437-4100.

161001



HEWLETT
PACKARD

CIRCLE 16 ON READER CARD

HARDWARE

ing a machine in the range spanned by IBM's System/34 and the 4300 series. In the eight weeks between the initial announcement outside the U.S. and the U.S. announcement, the vendor says the ME29 has racked up orders in the hundreds, more than with 60% of the bookings going to customers new to the vendor.

Two models of the series were announced to the U.S. market (and a third was mentioned in a brief conversation with a company representative). The entry-level ME29 Model 35 is said to be comparable in performance to IBM's System/38 Model 3 (or the vendor's existing 2904/50), while the ME29 Model 45 is said to be roughly twice as powerful. (The unannounced Model 35-2 falls between the two announced models.) The machines use a 32-bit cpu, developed by a research team in California using bit-slice microprocessors; the microprogrammed cpu can execute code developed on the vendor's older 2903 systems, and 2903 disk packs are said to work with the ME29.

In addition to being able to support up to 24 workstations (of which up to 12 can perform direct data entry—the vendor's euphemism for key-to-disk data entry), the ME29s can communicate with computers from this vendor as well as others. With the addition of a Viewdata controller and terminals, users can create in-house Viewdata systems that may be used in management presentations or on executives' desks.

The ME29 series runs under the TME operating system, which is priced at \$210 per month for Model 35 users and \$700 per month for Model 45 users (it's \$440 per month for the Model 35-2). Applications can be developed in RPG II, COBOL, FORTRAN, ALGOL, or BASIC. IDMS is available for data base management. An entry-level Model 35, with 256KB of main memory, 35MB of disk, matrix printer, and one terminal, sells for \$68,550; monthly rental for this system is \$1,523 and maintenance is \$525 per month. The system can grow to 1MB of main memory and 16,000MB of disk. A typical Model 45 should come in around the \$120,000 mark. ICL, INC., East Brunswick, N.J.

FOR DATA CIRCLE 301 ON READER CARD

DISPLAY STATIONS

The 2051-11 display station, for use with IBM System/34, System/38, Series/1, and 5250 systems, is said to have compatibility with IBM's 5251-11 display as well as providing enhanced operating and performance characteristics. Connection to the IBM system is through the workstation controller, or through an IBM 5251-12 cluster controller. The optional cablethrough feature of the 5251-11 is standard on the 2051-11, allowing connection of additional display stations or printers in series.

The 2051-11 uses a 15-inch screen to display 24 lines of 80 characters; a 25th



status line provides system status information and the current cursor position. The terminal's separate keyboard can be located up to 10 feet from the display by using an optional extension cable. Keyboard click or no-click is operator selectable. To extend crt life, the display automatically dims when there is no keyboard activity for approximately 10 minutes; hitting any key brings the screen back to normal viewing intensity. The terminal needs about half the power of its IBM counterpart, allowing the 2051-11's designers to dispense with a cooling fan. Options include a security keylock and a selector light pen. The basic

2051-11 terminal sells for \$2,850, and can be leased for \$75 per month on a three-year contract. MEMOREX CORP., Business Systems Div., Santa Ana, Calif.

FOR DATA CIRCLE 303 ON READER CARD

SMALL COMPUTER

The "Fast-Track" Model 675 is termed by the vendor an "Information Processor" in light of its applicability to both word and data processing. The 675 is built around a processor with 64KB of memory and a pair of 5 1/4-inch floppy drives providing more than 1.3MB of on-line storage. With a second set of two floppy drives, the 675 is called the "Fast-Track 2+2," offering more than 2.6MB of on-line storage. The 675's standard display is a 12-inch screen displaying up to 20 lines of 80 characters; an optional Model 60 full-page display handles 4,800 characters arranged as 60 lines of 80 characters. The 675's keyboard has 20 special function keys, programmable to provide 60 separate functions. Asynchronous/synchronous RS232 interface is standard.

But, being a computer, the Model 675 needs programming. So the vendor offers a word processing package, known as OMEGA, as well as integrated business applications (general ledger, accounts receivable, accounts payable, inventory, and

HARDWARE SPOTLIGHT

MICRO/MINI NETWORK

The Data Node I system allows up to 60 intelligent terminals to share mass storage controlled by a central PDP-11. Each of the independent intelligent terminals consists of an otherwise stock DEC VT100 terminal augmented with a 64KB Z80-based microcomputer add-in board. These terminals are dubbed INT/200s, and, with the addition of diskette storage and perhaps a printer, can run the de facto industry-standard microcomputer operating system, CP/M. Communications to the central node, consisting of a PDP-11/34, a pair of 80MB Winchester disks, and a nine track 800/1600bpi tape drive, can run speeds of 9600bps using RS232 interfacing.

The central node runs under either RSTS/E or Data Systems 500. The vendor adds its software, known as Node Central, to support INT/200 access to the data. Storage management functions handled by Node Central include the ability to request selection of records from the data base using specific selection criteria; selected records can then be processed further at the central node (sorted, summarized, etc.) with entire records or only specific fields returned to the requesting INT/200. The PDP-11 also is available for local processing. The INT/200s run an extended BASIC based on MicroSoft BASIC, with additional verbs for node protocol and screen handling.

A standard Data Node I system,

with a 256KB PDP-11/34, 16-line microprocessor-controlled multiplexor, two 80MB disks, 45ips tape unit, four INT/200 terminals, 300 lpm printer, and licenses for the Node Central, INT/200 BASIC, and RSTS/E software, carries a \$98,850 price tag.



Users with existing hardware can license Node Central for \$325 per month (including support). Add-in microcomputer boards for VT100s, including BASIC license, go for \$1,850 per terminal. Converted terminals can be put into transparent mode from the keyboard, allowing them to function as standard VT100s connected to an RSTS/E time-sharing system. DATA NODE, INC., Sunnyvale, Calif.

FOR DATA CIRCLE 300 ON READER CARD

Mark your calendar now for the Federal ADP community's major annual event!



Come September, thousands of your colleagues will be on hand for this year's Federal Computer Conference at the Sheraton Washington Hotel in Washington, D.C.

It's the Federal ADP community's major annual event... an outstanding opportunity to catch up on the latest developments in automatic data processing and their impact on Federal Government operations.

Three days crammed with stimulating sessions!

The program, planned with the help of a Federal ADP Advisory Group, meets informational needs at every level. You'll find topics targeted right to your areas of interest and responsibility — plus speakers you won't want to miss.

Washington's most acclaimed computer exposition!

The only major Washington conference last year to attract blue-chip ex-

hibitors like IBM, AT&T, Data General and Digital Equipment Corporation! Over 100 leading companies exhibited the latest in computer hardware, software and services. This year's Exposition will be even bigger!

Record-breaking attendance!

The Federal Computer Conference — the first full-scale conference and exposition for Federal data processing interests — continues to attract a record-breaking number of attendees each year. Don't miss out on this unusual learning experience. Plan now to join your colleagues at the major annual event of the Federal ADP community!

The dates: September 22, 23 & 24, 1980.
The place: Sheraton Washington Hotel, Washington, D.C.

For more information, send the coupon. Or call 617-358-5181 collect.



Scenes from the 1979 Conference



Federal Computer Conference • P.O. Box 368 • Wayland, Mass. 01778

- Please send more information and Conference Registration Form.
- My company may want to exhibit. Please send details.

Name _____ Title _____

Organization _____

Tel. (____) _____

Address _____

City, State, Zip _____

Co-sponsored by **DATAMATION**® magazine and Federal Education Programs
(Federal government not a sponsor)

HARDWARE



payroll), and industry-specific packages for attorneys, CPAs, bankers, and others. A disk operating system, a library of utilities (including file management, sorting, and communications drivers), and an extended BASIC compiler are available for users wishing to develop their own applications.

Ultimate end-user prices are established by the vendor's dealers; the manufacturer suggests a \$9,150 list price for a basic "Fast-Track" (Model 675-2/20) with 64KB, two diskette drives, RS232 interface, 20-line by 80-character display, and keyboard. The Model 675-4/20, consisting of the above components and an additional two floppies, lists at \$11,500. COMPCORP, Los Angeles, Calif.

FOR DATA CIRCLE 302 ON READER CARD

COLOR MONITORS

The 1000-line GM 865C color monitor is this vendor's latest offering in its GM 850 series of color monitors for use with graphics and imagery display systems. Measuring 25 inches diagonally, the GM 865C's screen uses a newly developed color shadow mask with 0.367mm pitch (vertical); resolution reportedly is not limited by the shadow mask. The GM 865C sells for \$12,400. RAMTEK CORP., Santa Clara, Calif.

FOR DATA CIRCLE 304 ON READER CARD

COMPUTER SYSTEM

System 80, this vendor's first new machine this year, is intended to compete in the market typified by IBM's aging System/3 family and the long-awaited System/38. While intended to be a general purpose machine for all commercial and governmental users, the vendor is wooing the manufacturing and distribution markets with applications packages. System 80 runs an enhanced version of the OS/3 operating system, originally released in 1974 for the vendor's 90/30 computers. OS/3 supports 14 levels of multiprogramming; it operates in batch, interactive, and distributed processing environments. In addition to providing a number of programming languages (RPG II, COBOL, FORTRAN IV, BASIC, assembler, and the vendor's proprietary ESCORT, an English-like lan-

guage), OS/3 has a number of service routines, such as the Screen Format Generator (SFG), Dialog Processor Specifications Language (DSL), interactive Job Control Language, a CODASYL-type DBMS, and sort facilities. An Information Management System (IMS) allows on-line data base inquiry and update via a language known as Unique. IMS facilities also can be accessed from programs written in RPG, COBOL, and assembler.

System 80 hardware uses a multiple microprocessor architecture with a micro-programmed LSI ECL cpu, and microprocessor controllers for I/O handling. Main memory sizes range from 256KB to 1MB, in 256KB increments; access time is 400nsec for four bytes. Processor performance can be increased by 55% with the addition of High Performance Control Storage (cutting the average control storage cycle time from 240nsec to 180nsec). The basic system I/O controller handles up to four paper peripherals (printers and punched card equipment), seven workstations plus one operator's console, up to four diskette drives, eight tapes, eight hard disks, an interface for two communications lines, and an open position that can be used for an additional paper peripheral or workstation controller. System I/O can be expanded with up to six more communications lines, and three more paper peripheral or workstation controllers.

Enter the System 1022[®] time trials.

Give Your DECsystem A Shot In The Arm.

System 1022 just may be the fastest application development tool you can find - on any system. A data base system designed for DECsystem-10's and 20's, it's received widespread acclaim for speeding up jobs and relieving computer room bottlenecks. An insurance user reports programs commonly completed in 1/10th to 1/50th the usual time. An oil company tells of immediate job turnaround as opposed to weeks. And an engineering company tells us that System 1022 paid for itself on one job alone.

That's Only For Openers.

System 1022 is as appealing to end users as it is to computer mavens. On one hand, non-technical users can learn the system in a day or two, for data entry and retrieval or to generate their own ad hoc reports without programmer assistance. On the other hand, computerniks appreciate its many advanced features such as host language and statistical interfaces, extensive transaction capabilities, audit trails and comprehensive reporting.

So Get In On The Fun. Free.

We'll be happy to give you System 1022 for a free 60-day trial. Try its exceptional performance for yourself. You'll actually be able to do productive work in no time. And you'll find it's fun, if fun means being able to do something faster and more easily than you ever anticipated. Write or call now: Len Goldberg, Software House, 1105 Mass. Ave., Cambridge, Mass. 02138. (617) 661-9440.

The Data Base

Software House

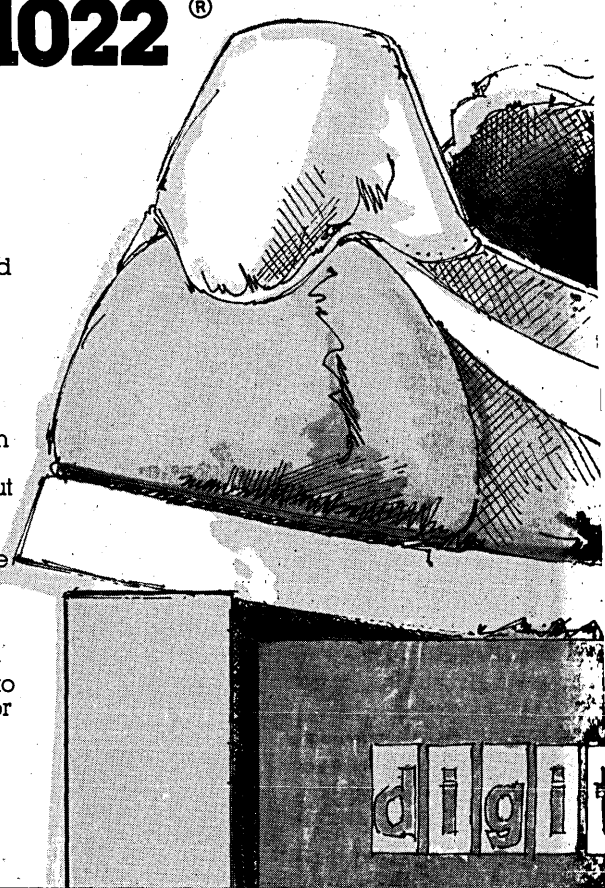

A minimum System 80 consists of a 256KB processor, 118MB of disk, console-workstation, diskette drive, and printer. Program products and services are priced separately. A typical system, including software, maintenance, and support, will range in price from about \$2,469 per month for a small system to \$9,154 per month for a large configuration using a number of program products. Deliveries are slated to begin in December. SPERRY-UNIVAC, Blue Bell, Pa.

FOR DATA CIRCLE 309 ON READER CARD

CRT TERMINAL

The PT25 is a character-mode crt terminal for applications requiring nonbuffered interactive operation. The new terminal will be used as the console device on the vendor's entry-level Model 250 processor, as well as a user terminal with the 250 and other systems. Interfacing is compatible with RS232 and 20mA current loop devices, and data can be transferred at user selectable rates ranging from 110bps to 9600bps. The unit's integral keyboard includes eight function keys, a 14 key numeric pad, five cursor control keys, and an auxiliary port key to support the PT25's auxiliary printer port. The upper- and lower-case terminal displays 24 lines of 80 characters on its 12-inch diagonal screen; a 25th status line shows operating parameters and a pass or

fail message issued by the self-test that executes each time the terminal is turned on. The PT25 sells for \$1,675 and becomes available this month. PRIME COMPUTER, INC., Wellesley Hills, Mass.

FOR DATA CIRCLE 306 ON READER CARD

SOMETHING FOR EVERYONE?

Within the span of seven days, IBM launched a raft of products, ranging from an attached processor, massive disk drives, and MVS enhancements, all from the Data Processing Div., to a tridivisional announcement of word processing products and programs from DPD, General Systems Div., and Office Products Div.

For Mainframe Users

DPD's 3042 Model 2 attached processor supports up to 12 channels, bringing to 28 the maximum number of channels possible on 3033 Attached Processor Complex. Installed 3042 Model 1s can be field upgraded. An Extended Addressing Feature supports main memories of up to 32MB within a 3033 Multiprocessor Complex. A six-channel 3042 Model 2 sells for \$1,255,000; monthly rental is \$58,773, while the monthly lease charge is \$53,430 on a four-year contract. Shipments are planned for the third quarter of this year.

FOR DATA CIRCLE 310 ON READER CARD

For large capacity disks, DPD announced the 3380 direct access storage de-

vice, with a capacity of 2.52 billion bytes, and the 3375 with a capacity of 819MB. Access time on the 3380 is 16msec, and on the 3375, 19msec. With a concurrently announced Data Streaming feature, the 3380 can transfer data to a 303X or 3042 Model 2 processor at 3MBps, 2½ times the rate of a 3350; an optional Speed Matching Buffer feature allows the 3380 to transfer data at 1.5MBps, supporting 370s Models 158 and up, 303X, and 3042 Model 2 attached processors. The 3375 attaches to 4331 Group 2 and 4341 processors, as well as 303X and 3042 Model 2s equipped with the Data Streaming feature.

Both new disks are supported by new models of the 3880 controller. Depending on features selected, a 3380 Model A sells for \$97,650 to \$142,200, with two-year leases going for \$2,170 to \$3,160 per month. A 3380 Model A can support a string of three additional 3380 Model B drives, with purchase prices of \$81,000 to \$111,600; model B lease prices are \$1,800 or \$2,480 per month. The 3375 Model A1 sells for \$46,450, and can attach to an additional three 3375 Model B1 units, priced at \$31,000. Lease prices, again for a two-year term, are \$1,269 per month and \$846 per month. There are two new models of the 3880, both priced at \$65,460 (\$1,550 per month on a two-year lease). Deliveries begin in the first quarter of 1981 for the

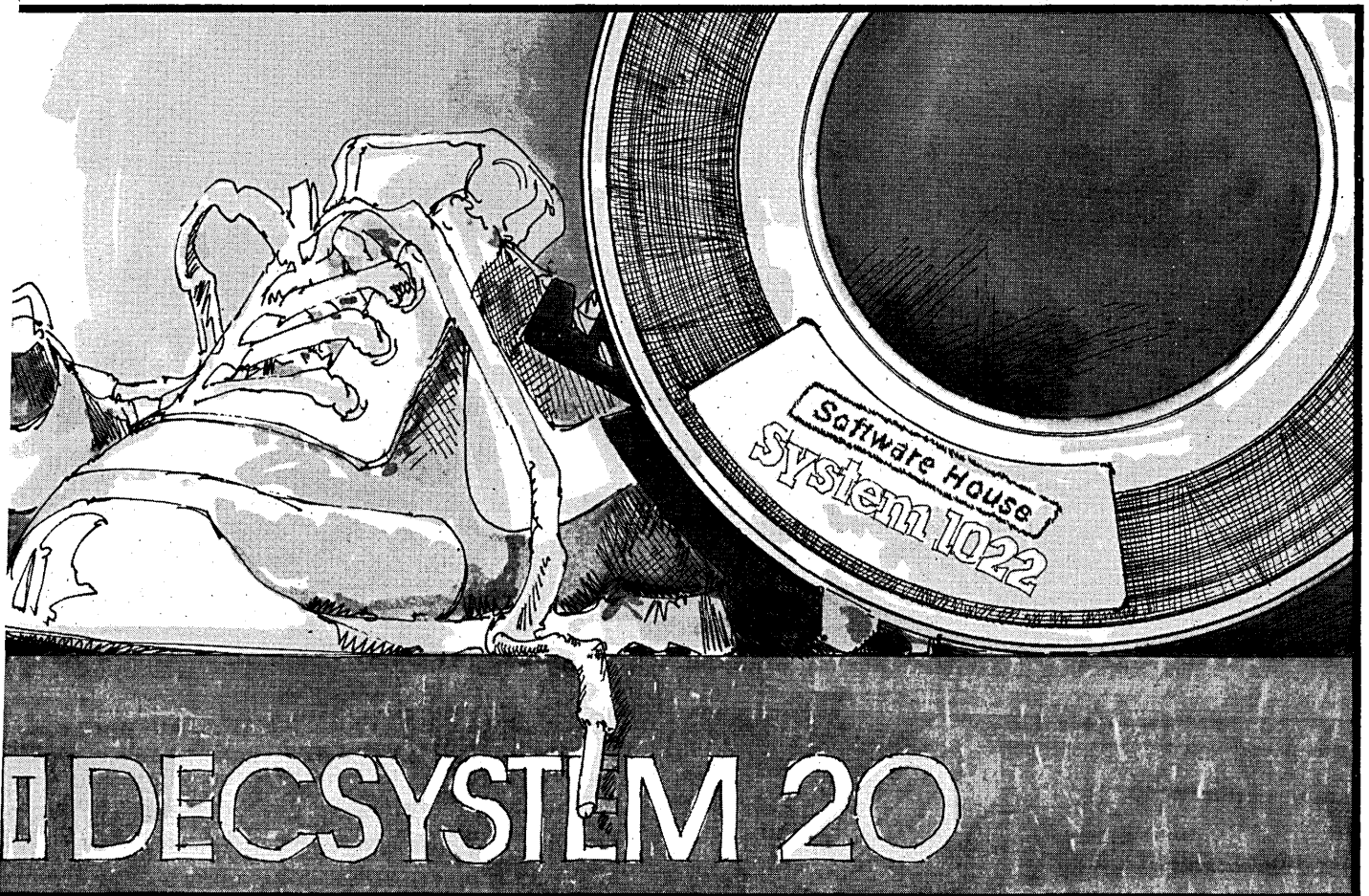

CIRCLE 148 ON READER CARD

Computer Professionals...

Are you making as much money as you should be?

To find out, call today for our new local survey
It's FREE!

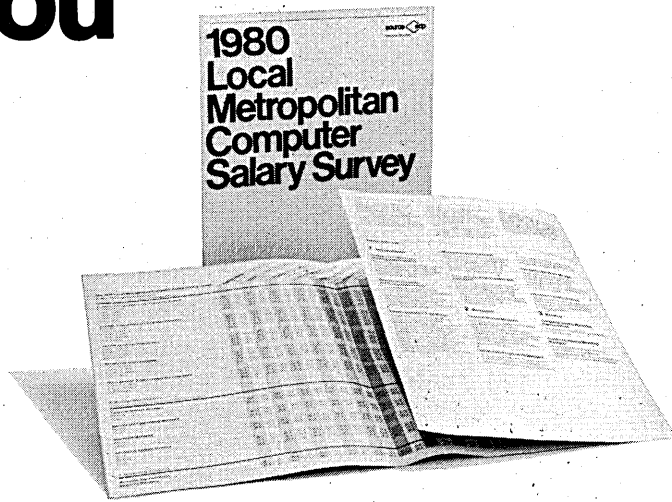

Includes 23 New Categories

The 1980 Survey has been expanded to provide specific data for 23 new categories. These include positions in data communications, mini/micro programming, data base administration, technical marketing support and EDP auditing in addition to our traditional categories of programming, software, systems design, management and computer marketing.

Do you know how your salary compares with other EDP professionals in your specialty—with the same level of experience—working in your city, or in other cities across North America? Are you being well paid for what you do? Are salaries better elsewhere?

Now you can find out simply by calling today and asking for a copy of our current 1980 Local Metropolitan Computer Salary Survey. It's FREE!

Source Edp, North America's largest recruiting firm specializing in the computer field, publishes this valuable Survey annually as a service to computer professionals from coast to coast. The 1980 Survey shows current salaries in your area, 37 other areas in the U.S. and Canada, plus overall national averages. Salaries are shown by career specialty broken down by length of experience or size of computer system.

As you will discover, this Survey can be extremely valuable in helping you make important career decisions. Call for your free copy today.

For your free report, simply phone the Source Edp office nearest you.

source 

If unable to call, write Source Edp, Dept. D9
100 South Wacker Drive
Chicago, Illinois 60606

(When writing, please be sure to indicate home address and position title).
Client companies assume our charges.

United States				
Arizona				
Phoenix	602/258-9333			
California				
San Francisco	415/434-2410			
Palo Alto	415/856-0600			
Los Angeles	213/386-5500			
Van Nuys	213/781-4800			
Torrance	213/540-7500			
Irvine	714/833-1730			
San Diego	714/231-1900			
Colorado				
Denver	303/773-3700			
Englewood	303/571-4450			
Connecticut				
Hartford	203/522-6590			
Stratford	203/375-7240			
District of Columbia				
	202/466-5890			
Florida				
Miami	305/624-3536			
Georgia				
Atlanta Central	404/588-9350			
Atlanta Suburban	404/325-8370			
Illinois				
Chicago	312/782-0857			
Northfield	312/446-8395			
Oak Brook	312/986-0422			
Rolling Meadows	312/392-0244			
Indiana				
Indianapolis	317/631-2900			
Louisiana				
Baton Rouge	504/924-7183			
New Orleans	504/561-6000			
Maryland				
Baltimore	301/727-4050			
Massachusetts				
Boston	617/482-7613			
Wellesley	617/237-3120			
Michigan				
Detroit	313/259-7607			
Southfield	313/352-6520			
Minnesota				
Minneapolis	612/544-3600			
St. Paul	612/291-2467			
Missouri				
St. Louis County	314/862-3800			
St. Louis				
Downtown	314/231-4880			
Kansas City	816/474-3393			
New Hampshire				
Nashua	603/880-4047			
New Jersey				
Cherry Hill	609/482-2600			
Edison	201/494-2800			
Paramus	201/845-3900			
New York				
Midtown	212/736-7445			
Wall Street Area	212/962-8000			
Long Island				
White Plains	516/364-0900			
914/683-9300				
North Carolina				
Greensboro	919/378-1642			
Ohio				
Cincinnati	513/769-5080			
Cleveland	216/771-2070			
Columbus	614/221-2070			
Oregon				
Portland	503/223-6160			
Pennsylvania				
Philadelphia	215/665-1717			
King of Prussia	215/265-7250			
Pittsburgh	412/261-6540			
Texas				
Dallas	214/387-1600			
Fort Worth	817/338-9300			
Houston Central	713/751-0100			
Houston Suburban	713/626-8705			
San Antonio	512/344-0217			
Virginia				
McLean	703/790-5610			
Washington				
Seattle	206/454-6400			
Wisconsin				
Milwaukee	414/277-0345			
Canada				
In Canada, Offices in Don Mills and Toronto.				

HARDWARE

3380, second quarter for the 3880s, and third quarter for the 3375.

FOR DATA CIRCLE 311 ON READER CARD.

To aid in reconfiguring large installations, DPD developed the 3814 switching management system, capable of managing up to 128 switching nodes—up to 16 channels and eight control units or eight channels and 16 control units. The 3814 can store as many as 78 configuration descriptions; one or two 3604 Model 6 keyboard/display units control the 3814. The 3814, scheduled for second quarter 1981 availability, sells for \$205,000 in a 96-node configuration; the same 3814 leases for \$5,125 on a two-year lease.

FOR DATA CIRCLE 312 ON READER CARD.

For mainframes ranging upwards from the 370/158, two new MVS/System Products, MVS/SP-JES 2 and MVS/SP-JES 3, include all current enhancements to the MVS/System Extensions program product, as well as support for the new disks and the 3033 Extended Addressing feature. Cross Memory Services, and Global Resource Serialization are additional key elements of the MVS/SP programs. Cross Memory Services allows direct communications between different address spaces, while the Global Resource Serialization feature protects data from simultaneous updating. MVS/SP-JES 2 release 1 has a monthly license fee of \$1,375, and release 2 goes for \$1,475 per month. MVS/SP-JES 3 release 1 is \$1,375 per month, and release 2 is \$1,800 per month.

FOR DATA CIRCLE 313 ON READER CARD.

For Word Processing

With three divisions—OPD, GSD, and DPD—concurrently announcing word processing products, IBM corporate announced its intent to provide support, over time (unspecified), for tying these systems together in a communications environment. "Communications support must be available so that text documents that require filing or transmission can be sent to or retrieved by authorized individuals throughout an enterprise," the statement said. The Displaywriter System, a software-based word processor that requires a basic licensed program product for operation and offers additional functionality with the use of further licensed program products, represents the Office Products Division's foot in the door for potential customers seeking an inexpensive entry into word processing. A basic Displaywriter, consisting of video display, keyboard, logic unit, diskette drive, and printer, can be had for as little as \$7,895 (\$275 per month on lease) plus \$15 per month for the basic licensed program required for operation. Myriad options and additional software can increase both the system's capabilities and its price tag. These options include memory sizes of roughly 160KB, 192KB, or 224KB (some of the software requires the larger memory), a choice of Selectric golf-ball

YOUR COMPUTER PRINTER IS NOW OBSOLETE.

Now there's the Xerox 9700 Electronic Printing System. The 9700 is the only electronic printer that prints forms, reports and printouts using unlimited type styles, logos and graphics.

It can also print circles around your computer printer. For more information, call or write:

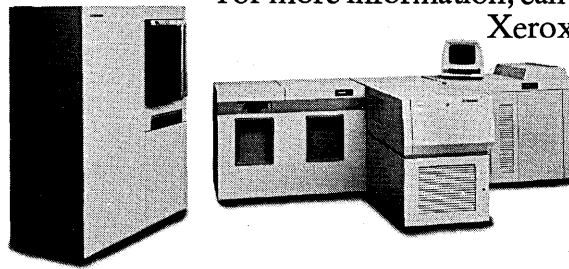

XEROX

Xerox Printing Systems
Division, 880
Apollo Drive,
P-1, El Segundo,
CA 90245.
(213) 615-6329.

XEROX® and 9700 are trademarks of XEROX CORPORATION.

CIRCLE 150 ON READER CARD

Model 204 DBMS. You're 'remiss' if you don't check it out.

Here's what the leading software rating service says: "Anyone interested in installing a flexible, user-oriented DBMS would be remiss if they did not evaluate Model 204."

They're right. It will pay you to check out Model 204. Because you'll find that Model 204 is so easy to use that you won't need large teams of programmers for bringing up new applications. And you'll get the job done quickly. Which means big cost savings.

And it will pay you to evaluate Model 204 performance. Because you'll dis-

cover that Model 204 performs—and keeps performing, even if your database gets up into the billions of bytes and your terminals get into the hundreds. Which means no system changes, no reprogramming. Which means big cost savings.

Don't be "remiss." Get further information by clipping your card to this ad and mailing to us at 675 Massachusetts Avenue, Cambridge, MA 02139. Or call 617-491-7400.

Model 204

Computer Corporation of America

Cambridge, New York, Houston, San Francisco, Chicago, Washington / Affiliates: Tokyo, Berne, Milan, Toronto

CIRCLE 151 ON READER CARD

NEW!

Another TEC First

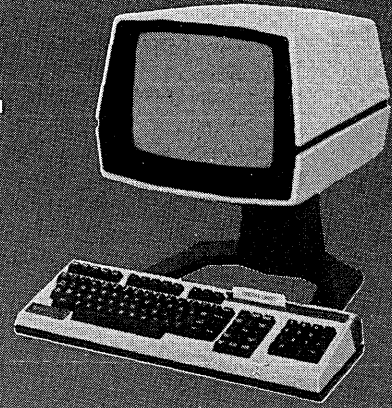

Model 70C Microprocessor Based CRT

Card Reader CRT Terminal

- Magnetic stripe card reader keyboard.
- Reads cards encoded to the international air transport association (IATA) standard.
- Up to 76 alpha/numeric characters may be recorded on one card.
- ASCII data is read from the card and sent to the CPU, and is stored in the terminal's memory but not displayed to provide security.
- Offers ability to control access to computer and data files by requiring each operator to have a card, possibly containing a user identification number and security level code.
- Read error light signals operator to reread card in the event of a card misread.
- Applications include credit card sales transactions, airline ticketing, security.

← SLIDE IN

CREDIT CARD

CREDIT CARD

MAGNETIC STRIP

**Distributor
Inquiries
Welcomed**



TEC, Incorporated

2727 N. FAIRVIEW AVE., TUCSON, ARIZONA USA 85705 (602) 792-2230 TWX 910-952-1377 TELEX 16-6540

• BOSTON (617) 879-6886
• CHICAGO (312) 655-1060

• DALLAS (214) 436-3416
• LOS ANGELES (714) 848-3111
• MINNEAPOLIS (612) 941-1120

• SAN FRANCISCO (408) 374-2660
• WEST PALM BEACH (305) 684-1604

TEC International, Inc.

EUROPEAN SALES OFFICE: AVENUE LOUISE 148 - BOX 6, BRUSSELS, BELGIUM (02) 649-8154 TLX 846-63553

CIRCLE 152 ON READER CARD

HARDWARE

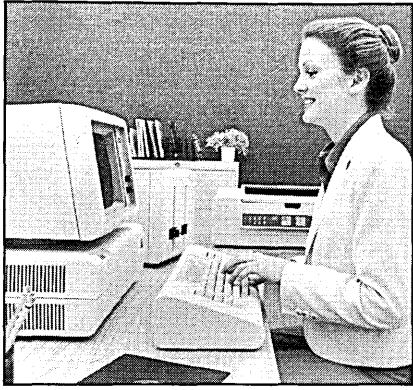

element printer (15.5cps) or printers using IBM-designed printwheels (40cps or 60cps), additional diskette storage, additional logic cards for communications and printer sharing, and a forms feeder with two selectable supply trays. A mag card unit also is offered.

Five licensed programs are available on diskette for monthly fees ranging from \$10 to \$16. Two handle the Displaywriter's text processing, while the remaining three support communications and mag card conversion. Textpack 1 runs on the basic machine (160KB) and handles text entry, alignment, formatting, editing, and printing. Its text proofing feature provides a spelling verification aid using a dictionary of up to 50,000 words; provision is made for a supplementary user-specific dictionary of 500 words. Any word in the text but not in either dictionary is highlighted on the Displaywriter's 25-line screen for the user to correct or accept as is (proper nouns, etc.).

Textpack 2 requires 192KB of memory, and extends the functions of Textpack 1 with printer sharing, program overlay, and print queue manipulation. Bisync communications require a 224KB memory and allows transmission and reception of documents at speeds to 2400bps; asynchronous communications require a 192KB memory and allow communications at speeds of up to 1200bps over normal telephone lines. The Magnetic Card Conversion program needs 192KB of memory and Textpack 2.

For a Displaywriter system consisting of three displays sharing a single high-speed printer and paper handler, you can get the salesman to take his foot out of your doorway for \$26,185 (or \$845 a month on a three-year lease).

FOR DATA CIRCLE 314 ON READER CARD.

Software enhancements for GSD's 5520 Administrative System include files processing with arithmetic functions and the addition of bisync communications to augment the 5520's SNA/SDLC communications; the enhancements will be provided at no additional cost. Files processing support will allow users to combine administrative tasks with the 5520's previously announced text and document distribution functions. The arithmetic functions allow the use of data from master files in forms fill-in, travel

ONLY ONE PRINTING SYSTEM HAS A GRAPHIC DIFFERENCE.

The Xerox 9700.

It's the only printing system in the world that prints reports, forms and printouts using unlimited type styles, company logos and graphics. It can even print your signature.

If you still think all printing systems are pretty much the same, call or write Xerox. We'll demonstrate the difference.

Graphically.

Xerox Printing Systems Division,
880 Apollo Drive, P-1, El Segundo, CA
90245. (213) 615-6329.

XEROX

XEROX® and 9700 are trademarks of XEROX CORPORATION.

CIRCLE 153 ON READER CARD

Model 204 DBMS. A perfect 4!

Bull's eye! The leading software rating service gives Model 204 DBMS a perfect score—4 out of 4—for ease of use.

Because with Model 204 it's easy. It's easy to learn. Easy to install. Easy to set up new databases. And easy to develop new applications—for inventory control, personnel data, financial applications, correspondence tracking, project control—and every other kind of corporate database.

And since it's easy, it doesn't require teams of programmers. And it doesn't

take years. Which means cost savings on a large scale.

If you want to find out how some of America's largest corporations solve their DBMS problems with Model 204, clip your card to this ad and send it to us. It's easy!

Computer Corporation of America,
675 Massachusetts Avenue,
Cambridge, MA 02139. Or call
617-491-7400.

Model 204

Computer Corporation of America

Cambridge, New York, Houston, San Francisco, Chicago, Washington / Affiliates: Tokyo, Berne, Milan, Toronto.

CIRCLE 154 ON READER CARD

SEPTEMBER 1980 237

FEATURE COMPARISON CHART

The new VISUAL 200 terminal has the features of competitive terminals and will code-for-code emulate them as well. A flick of a switch on the rear panel programs the VISUAL 200 for compatibility with a Hazeltine 1500, ADDS 520, Lear Siegler ADM-3A or DEC VT-52. To an O.E.M. customer it means no change in software to displace the older, less powerful terminals in his product line with the new, reliable and low cost VISUAL 200. To a Distributor it means offering a single modern terminal which is compatible with all the software his customers have written for the older terminals. And you're not limited to mere emulation; you can outperform them at the same time by taking advantage of the additional features and human engineering of the VISUAL 200, such as:

- Detachable Solid State Keyboard
- Smooth Scroll
- Tilt Screen (10° to 15°)
- Large 7 x 9 Dot Matrix Characters
- Others in the Feature Comparison Chart

For a pleasant surprise on quantity prices, call or write us today.

FEATURE	Visual 200	Hazeltine 1500	Hazeltine 1420	Lear Siegler ADM-3A	Digital VT-52	ADDS 520	ADDS Regent 20	ADDS Regent 40
24 x 80 Screen Format	STD	STD	STD	STD	STD	STD	STD	STD
7 x 9 Dot Matrix	STD	STD	NO	NO	NO	NO	NO	NO
Background/Foreground	STD	STD	STD	NO	NO	NO	NO	STD
Insert/Delete Line	STD	STD	NO	NO	NO	NO	NO	STD
Insert/Delete Character	STD	NO	NO	NO	NO	NO	NO	NO
Clear End Line/Field/Page	STD	STD	NO	NO	STD	NO	NO	NO
Blink	STD	NO	STD	NO	NO	NO	NO	STD
Security Mode	STD	NO	STD	NO	NO	NO	NO	STD
Columnar and Field Tab	STD	NO	STD	NO	NO	NO	NO	STD
Line Drawing	STD	NO	NO	NO	STD	NO	NO	STD
Upper/Lower Case	STD	STD	STD	OPT	STD	NO	STD	STD
Numeric Pad	STD	STD	STD	OPT	STD	NO	NO	STD
Composite Video	STD	NO	NO	NO	NO	STD	NO	NO
Current Loop	STD	STD	NO	OPT	OPT	STD	STD	STD
Serial Copy Port	STD	STD	OPT	STD	OPT	NO	STD	STD
Hold Screen	STD	NO	NO	NO	STD	NO	NO	NO
Detachable Keyboard	STD	NO	NO	NO	NO	NO	NO	NO
Solid State Keyboard	STD	NO	NO	NO	NO	NO	STD	STD
Typamatic Keys	STD	STD	STD	NO	NO	NO	STD	STD
Cursor Addressing	STD	STD	STD	STD	STD	STD	STD	STD
Read Cursor Address	STD	STD	STD	NO	NO	NO	NO	STD
Cursor Control Keys	STD	NO	STD	NO	STD	NO	NO	STD
Secondary Channel	STD	NO	NO	STD	NO	STD	NO	NO
Self Test	STD	NO	STD	NO	NO	NO	NO	STD
Baud Rate to 19,200	STD	STD	NO	STD	NO	NO	NO	NO
Smooth Scroll	STD	NO	NO	NO	NO	NO	NO	NO
Microprocessor	STD	STD	STD	NO	STD	NO	STD	STD
Tilt Screen	STD	NO	NO	NO	NO	NO	NO	NO
Switchable Emulations	STD	NO	NO	NO	NO	NO	NO	NO

The new VISUAL 200 obsoletes competitive terminals without obsoleting the software.



VISUAL See for yourself

Visual Technology Incorporated
Railroad Avenue, Dundee Park, Andover, MA 01810
Telephone (617) 475-8056

HARDWARE

expense accounting, management summary reporting, and budget preparation. The bi-sync communications facility allows document distribution between 5520s and mainframes. Document interchange capabilities have been enhanced for 5520 to OS/6 and Displaywriter communications. Text processing on the 5520 also received attention, with enhancements allowing the user to create selected Greek, arithmetic, and chemical symbols on 5520 display stations and on the 5520's ink jet printer.

FOR DATA CIRCLE 315 ON READER CARD.

To complete the divisional triple play, DPD announced the ability to add 3732 text display stations and 3736 correspondence-quality printers—existing members of the 3730 Distributed Office Communication System—to its 8100 Information System, providing 8100 users with word and text processing capabilities, and increasing storage capacity and performance for 3730 users. Dubbed the Distributed Office System, the 8100/3730 combination is held together by three new software packages running under the 8100's DPCX operating system. The 8100 Distributed Office Support Facility (DOSF) handles creation, storage, and formatting of documents. DOSF/8100 supports simultaneous use of text terminals such as the 3732 and data processing terminals such as the 3278 or 8775.

The Distributed Office Support System (DISOSS) allows filing and retrieving documents at a host mainframe, and the distribution of messages and documents among multiple 8100s and 3730s. It consists of a program for the host and one resident in the 8100 of 3730.

The Document Interchange Facility allows the linking of host-based text processing applications and distributed word processing systems. The package allows transmission of documents from an 8100 or 3730 to a host for formatting and composition, and the subsequent return of formatted documents for printing at a local 8100 or 3730. DOSF is offered with two licensing options—basic and Distributed Systems License Option (DSLO); its basic fee is \$580 per month and DSLO fee is \$493 monthly. The Document Interchange Facility licenses for \$325 per month at a host and \$35 per month at a distributed controller. DISOSS goes for \$907 per month at a host and \$82 per month at a distributed controller.

FOR DATA CIRCLE 316 ON READER CARD.

INTERNATIONAL BUSINESS MACHINES CORP., Armonk, N.Y.; Data Processing Div., White Plains, N.Y.; General Systems Div., Atlanta, Ga.; Office Products Div., Franklin Lakes, N.J. *

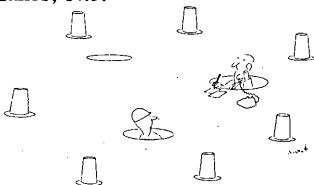

ONLY ONE ELECTRONIC PRINTER MAKES YOU LOOK THIS GOOD ON PAPER.

Nothing improves your appearance like a Xerox 9700.

It can make your entire business look a lot more businesslike.

The 9700 can improve the impact of your communication with company logos, graphics, or even your signature. And it's the only electronic printer that can.

Improve your image. Call or write: Xerox Printing Systems Division, 880 Apollo Drive, P-1, El Segundo, CA 90245. (213) 615-6329.

XEROX

XEROX® and 9700 are trademarks of XEROX CORPORATION.

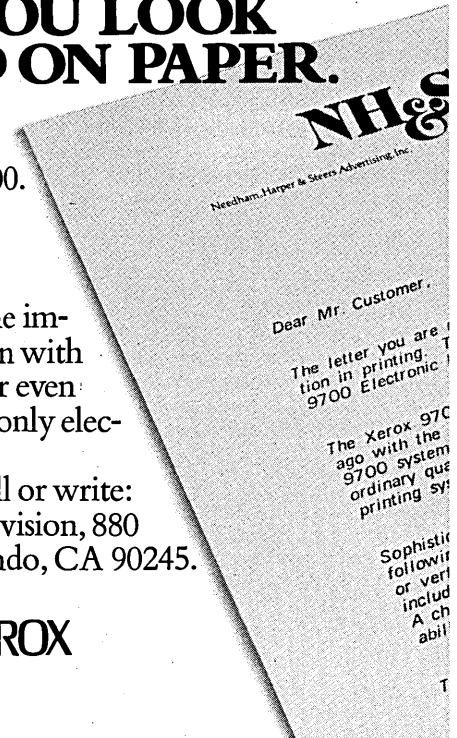

CIRCLE 156 ON READER CARD

Model 204 DBMS. CCA's Revolutionary Idea.

We think a DBMS should have excellent performance and be easy to use.

Not a revolutionary idea?

Guess again.

Only Model 204 can do it. While some inverted-file systems are easy to use, their performance falls apart when the database gets large or the load gets heavy.

Then there's IMS. It performs pretty well, but it's so hard to use, you need large teams of programmers for developing applications.

But with Model 204 you get

excellent performance, even with large databases and a heavy load. And using Model 204 is easy. The leading rating service gives Model 204 a perfect score—4 out of 4—for ease of use.

In short, Model 204 gives you performance and ease of use in a single package. Revolutionary!

For details, clip your card to this ad and send to us at 675 Massachusetts Avenue, Cambridge, MA 02139, or call 617-491-7400.

Model 204

Computer Corporation of America

Cambridge, New York, Houston, San Francisco, Chicago, Washington / Affiliates: Tokyo, Berne, Milan, Toronto.

CIRCLE 157 ON READER CARD

SOFTWARE AND SERVICES

UPDATES

I'm a little disappointed in you, dear readers. To date, only eagle-eyed Elizabeth A. Post, a programmer from West Chester, Pa., has sent me any humor, inadvertent or intentional, in an IBM manual, since my June UPDATE item from Roger Hopkins ("an I for an I, a 2 for a 2"). Writes Ms. Post: "Enclosed is a page from the 'Standards Manual for DOS/VSE' which demonstrates that IBM has not lost its sense of humor since 1961. I believe this particular joke can be traced back to Groucho Marx." (Our Groucho consultant concurs.)

SCREEN NAME
PROJECT TITLE—FUNCTION
SELECTION
<input type="checkbox"/> CHOOSE 1 OR 2, LIMITED CHOICE 1 2
<input type="checkbox"/> SPECIFIC ITEM DESCRIPTION Y N SEX—CHOOSE Y OR N
<input type="checkbox"/> CONTINUE—C OR END—E C E
***MESSAGES DISPLAYED HERE

Figure G.-Section 7.3.2. Selector Pen Screen

Hewlett-Packard has started to offer on-site service for its HP-85 personal professional computer. For \$25 per month, customers within 100 miles of a service office can get next-day response maintenance. Peripherals can be covered for an additional fee; users more than 100 miles from a service office will be offered service at a higher price and longer response time. Current HP-85 owners can sign up for service if their units are still under factory warranty; those off warranty must be inspected before the company will accept service responsibility. Customers not needing on-site repair can, for \$17 per month, subscribe to a return-to-service-center maintenance agreement, with repair and return shipment promised within three days of receipt.

AUDITING SYSTEM

A companion product for the DYL-260 report writer and utility for IBM mainframes, DYL-AUDIT has reached Release 2.0 with additional security, reporting, and sampling features. For security, the system can be supplied with password protection. A second security feature allows user to encrypt and decrypt extracted information. Enhancements to DYL-AUDIT's reporting functions include the ability to display frequency distributions in histogram form, displayed in equal or logarithmic intervals. Alphabetic fields can now be used to categorize items for frequency distribution reporting, a feature useful when itemizing accounts containing embedded alphanumeric characters.

DYL-AUDIT's letter writing facility has been enhanced to allow generation of unlimited letters in one pass over the file (previously, only one letter with variable inserted data could be produced). Sampling functions have been expanded to allow proportional sampling, mean-estimation recognizing a two-sided confidence level, and random sampling from an unknown universe. A future aging analysis feature helps users predict cash flow. The original DYL-AUDIT COPY function has been extended with COPYE, a source macro facility. A library of COPYE functions—for sequence checking, file matching, missing or duplicate records, etc.—is included. Current DYL-AUDIT users will receive Release 2.0 as a part of their software maintenance agreement; new users can lease the package for \$96 per month on a three-year plan. DYL-260, required for use of DYL-AUDIT, goes for \$111 a month on the same plan. DYLAOR SOFTWARE SYSTEMS, INC., Encino, Calif.

FOR DATA CIRCLE 326 ON READER CARD

MICRO DATA BASE

Target/80 DBMS, for Z80-based microcomputers running CP/M, is a smaller version of this vendor's three-year-old DBM-1 relational data base management system. Reportedly developed for transaction processing applications, Target/80 has 19 commands, including relational operations for selecting, sorting, appending, or posting data. Its English-like command language is said to allow even non-dp types to develop applica-

tions. CONDOR COMPUTER CORP., Ann Arbor, Mich.

FOR DATA CIRCLE 327 ON READER CARD

MEDICAL ACCOUNTING

After three years of actual use in the field, this vendor has decided to market its Medical Financial Management System (MFM) on a nationwide basis. According to a vendor spokesman, himself a physician, the package has helped "physicians and other health professionals in managing their practice more effectively."

Written in DEC's DIBOL-11 for use on a PDP-11 with at least 32KB of main memory and 2MB of disk, MFM keeps track of income for multiple revenue centers (offices), simplifies billing by handling the variety of paperwork required by individuals and various insurance companies, provides detailed accounting of services rendered, and allows immediate determination of current financial position and historical growth patterns.

MFM is offered for \$4,000 with full documentation and source code. A detailed manual is available for \$50. PROFESSIONAL DATA SYSTEMS, Bangor, Maine.

FOR DATA CIRCLE 329 ON READER CARD

DISTRIBUTED PROCESSING

Distributing Network Services is this remote computing service's approach to providing an integrated processing system. For a minimum service level of \$4,000 per month (with a two-year commitment), the vendor provides a completely bundled package of hardware and software for installation at the customer's site, as well as network communications, technical support, and a quantity of Infont system resources. Users are able to distribute data processing and data bases throughout their operations, tying the whole operation together with the vendor's communications network and large-scale host computers. The vendor sees a ripe market in the rapidly growing order entry-type services in industries such as manufacturing, finance, and distribution.

Initially, there are six system configurations—for installation at user sites—based on DEC PDP-11/23 and PDP-11/44 processors configured to the vendor's specs and augmented with vendor-developed

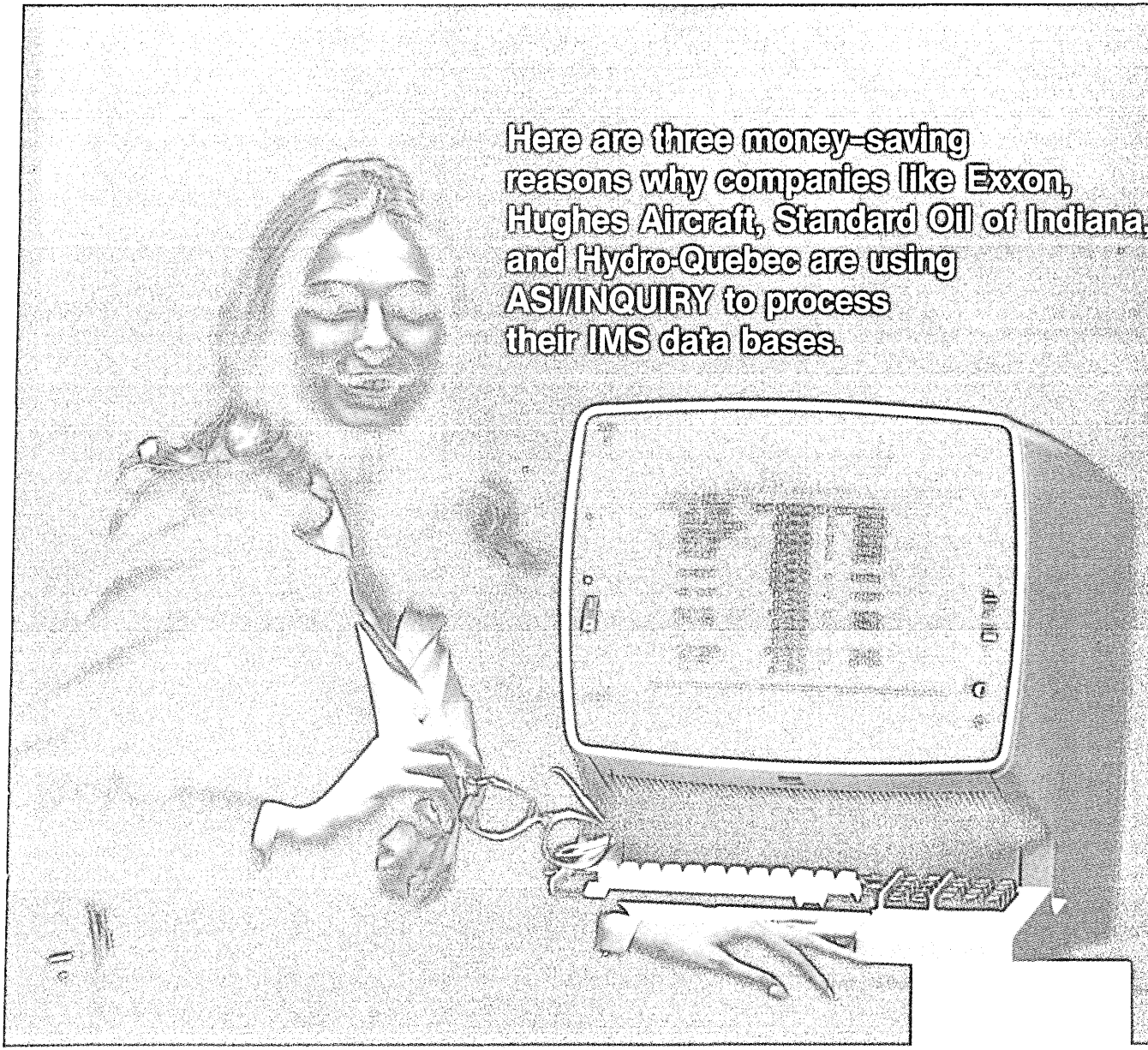

Here are three money-saving reasons why companies like Exxon, Hughes Aircraft, Standard Oil of Indiana, and Hydro-Quebec are using ASI/INQUIRY to process their IMS data bases.

1. ASI/INQUIRY Is Easy To Learn and Easy To Use.

Because inquiries are stated in simple English, nonprogrammers can learn to use ASI/INQUIRY quickly. DL/1 structures are completely transparent to the user. You need not understand the complexities of multipathing or multiple data base access. Comprehensive diagnostic messages simplify error correction. ASI/INQUIRY automatically displays data in the appropriate format—horizontal, vertical, or overflow. Or you can specify any desired screen format. Repetitively executed queries can be saved in an on-line catalog. New release 5 features include the ability to defer query execution to batch and a powerful user exit facility.

2. ASI/INQUIRY Assures Faster Access and Response Time.

ASI/INQUIRY lets you access your DL/1 data bases through IMS or TSO faster and more efficiently. That's because it eliminates need to write and debug those highly procedural programs usually required to access data bases. ASI/INQUIRY operates as an IMS message processing program executed from any IMS DB/DC-supported terminal. Execution priority is dynamically controlled through automatic program message switching. High initial priority assignment assures fast response. Priority is then automatically adjusted to the rate that to-be-displayed data is encountered, which optimizes *load leveling* of IMS DB/DC resources.

3. ASI/INQUIRY Provides Complete Security.

Built-in safeguards protect data at the system, terminal, and data base levels. Data base administrators define the data bases users can access, their passwords, and the terminals from which individual data bases can be accessed.

Learn why ASI/INQUIRY is more heavily used than any competing product. Call or write—today!

Applications Software, Inc.
21515 Hawthorne Boulevard
Torrance, CA 90503
(213) 540-0111

Member SIA  Software Industry Association

SOFTWARE AND SERVICES



software. These systems, dubbed InfoStations, range from a single-user data entry machine up to a half-megabyte system capable of supporting 16 users performing data entry, local processing, and applications development. Supporting software includes the User Interface System (UIS) and the Application Development System (ADS). UIS is a menu-driven system allowing nontechnical users to enter data, generate reports, and send data to an in-house machine or an Infonet host computer. ADS provides COBOL, FORTRAN, and BASIC programming support in any of the six InfoStations. ADS utilities reduce application development time by performing data handling functions usually requiring programming; without writing code, the utilities allow a user to display files, change their contents, and make additions and deletions. Utilities also help programmers develop new menus for nontechnical users. A subset of the vendor's proprietary data base management system, Manage, also is available for use on InfoStations. Completely compatible with the host version of Manage, the InfoStation version makes it possible to distribute data bases; data may reside on either machine and can be transferred for use by other applications programs.

InfoStations IS100, IS200, and IS300 are all based on the PDP-11/23, while the IS400, IS500, and IS600 use the PDP-11/44. Processor main memories range in size from 128KB to 512KB, with disk storage ranging from 1MB to 286MB. Printers range from 180cps units to 600 lpm line printers. An IS100 single-station InfoStation includes a 128KB processor, terminal, 1MB of floppy diskette storage, and a 180cps printer. At the high end, an IS600 comes with 512KB of memory, 268MB of disk, 12 crts, a 300 lpm printer, and 4800bps autodial communications.

All pricing is bundled, including hardware, associated software, maintenance, and a ration of system resources consisting of terminal connect time, units of interactive and batch processing, and on-line storage. A "Profile Pricing Plan" lets customers select (from a matrix of variable rates for these resources) the most advantageous pricing for their operations. COMPUTER SCIENCES CORP., El Segundo, Calif.

FOR DATA CIRCLE 308 ON READER CARD

ENHANCED OPERATING SYSTEM

Language extensions, new forms data entry and communications facilities, and an enhanced executive, are all available to this vendor's Level 6 users with the release of GCOS 6 MOD 400 Release 2.0.

The Advanced COBOL and Advanced FORTRAN compilers both generate reentrant code. COBOL provides the functionality specified in the ANSI '74 standard, and represents Level 4 of the Federal Information Processing Standards (FIPS). The compiler supports call compatibility with other languages, and offers additional data types. Its initial license fee is \$5,395. FORTRAN provides the full FORTRAN-77 language, as well as extensive diagnostics and the ability to generate comprehensively optimized code; its initial license fee is \$3,825.

The DEF II forms data entry facility, successor to the earlier DEF, supports decentralized, distributed data entry from up to 24 remote terminals, DEF II has menu-driven display formatting and control, and support for a variety of data entry keyboard styles. Its initial license fee is \$1,540.

With the Programmable Facility 3271, a Level 6 can communicate with an IBM host as if the Level 6 was an IBM 3271 cluster controller with up to 24 display terminals or printers. Users of Level 6 Models 43 through 57 can write programs that communicate with host applications, or enhance local Level 6 operations, under the Programmable Facility 3271. Its initial license fee is \$3,300.

The Transaction Control Language

(TCL) and the TCL processor allow multiple users (the number is limited by the amount of available memory) to run transactional applications concurrently, with each user having his own environment. TCL also provides a link between screen forms and COBOL programs. TCL has an initial license fee of \$500.

With Release 2.0, the MOD 400 operating executive sports enhancements such as interactive system generation, additional communication support, multivolume files, and a report processing facility. GCOS 6 MOD 400 Release 2.0 licenses for \$3,500. HONEYWELL INFORMATION SYSTEMS, Waltham, Mass.

FOR DATA CIRCLE 330 ON READER CARD

COMMUNICATIONS

Two software packages for this vendor's Model 1380 Communications Controller increase its capabilities for error recovery and operating in a broader environment. The flexible disk-based Network Control System (NCS) operating software is now in Release 2.8, with the addition of two useful enhancements: Binary Synchronous Error Recovery, and Flow Control. The error recovery feature lets a 1380 NCS system handle temporary transmission line errors without the need to notify the mainframe. When a transmission error is detected on a line from a remote terminal to the 1380, the 1380 will automatically request retransmission of the message, without notifying the host. If, after four retries, the line remains bad, the host receives notification of the error condition. Flow Control suspends out-

SOFTWARE SPOTLIGHT

1130 TO SERIES/1 MIGRATION AID

Described by the vendor as a "software bridge" between the IBM 1130 and the Series/1, ESS/1 HOOK (FORTRAN IV) runs under the Series/1 RPS operating system and provides an operating environment allowing FORTRAN programs developed for the aged 1130 to run on IBM's minicomputer. The package allows 1130 applications programs to interact with Series/1 devices, including local or remote terminals, through standard FORTRAN READ and WRITE statements (with or without format). It also provides Series/1 equivalents of the 1130 Commercial Subroutine Package and other commonly used 1130 utility subroutines.

Adapting a FORTRAN program to run under ESS/1 HOOK consists of four basic steps. The user must first insert three subroutine calls into the source program. The first call must be the first logical statement in a program; it informs the system that the program is beginning execution. The second call will probably be the second statement executed; it defines an error exit, preventing the application from hanging the system in the event of an error. The third

subroutine call is the last statement executed; it tells the system that the application has terminated. The second step is to reconcile I/O statements in the source program to the devices available on the Series/1. For instance, 1130 card I/O will probably be redirected to a diskette device (as the S/1 doesn't support card I/O). The third step is to compile the edited source program, and the fourth step is to link edit the object code.

Once a program has been adapted it can be executed from any synchronous or asynchronous terminal managed by ESS/1 HOOK, simply by keying in the program name. The requesting terminal becomes the assigned interactive I/O device.

The system supports up to five concurrent applications programs under the dynamic partition allocation facility of RPS, or up to 14 programs in an RPS static partition environment. A minimum system required to run ESS/1 HOOK consists of an S/1 4955 processor (128KB), a 4962 Mod 2 disk, a 4974 printer, and up to five asynchronous terminals. The package may be licensed for a one-time fee of \$3,780. AMPERSAND CORP., York, Pa.

FOR DATA CIRCLE 325 ON READER CARD

Installing a software system by January 1?



We can help you.

Fiscal year 1981 is closing in pretty rapidly. That's why you need MSA's help now, to get the right management systems up fast and running strong for you in the new year.

We're part of MSA's 720 software professionals serving clients at over 4300 sites from Sydney to Seacaucus. We know that time is short and you're overworked; but that's why we're here. Just think of us as being on call to help you get the job done—properly and on time.

Once you've selected the MSA software system that's right for you—financial, cash management or human resources—we go to work. Our highly qualified installation and training experts work onsite with your staff to ensure a smooth conversion from your current system.

MSA's comprehensive learning aids are designed to provide a fast and thorough understanding that will help your people work with confidence, now and in the future. And our systems specialists are always available to answer your software and hardware questions.



MSA has a software system that's on target for your application needs. Send in the coupon below and we'll get you off to a running start by January 1.

I am interested in the following MSA systems:



3445 Peachtree Road, N.E.
Suite 1300
Atlanta, GA 30326
Attention: Robert Carpenter
(404) 262-2376

- Total Financial Management System—Big 8
- General Ledger/Budgeting—G/L 80
- Payroll/Labor Distribution
- Accounts Receivable
- Financial Forecasting & Modeling
- Fixed Assets/Property Control
- Personnel Management & Reporting
- Accounts Payable
- Supplies Inventory Control & Purchasing
- Procurement Matching



Name	Title
Company	
Address	City
State	Zip
Telephone	Computer Model

DAT980

CIRCLE 159 ON READER CARD

SOFTWARE AND SERVICES

put to a given line when it receives an X-OFF on the line; transmission will resume upon receipt of an X-ON. The feature is intended to allow construction of a black-box interface to X.25 networks. NCS 2.8 leases for \$95 per month on a one-year lease, and \$75 per month on a two-year lease.

The Terminal Initiated Application Switching program product, TIAS II, provides support for multipoint 3270-type terminal and printers. In addition to multipoint, polled BSC terminals, the package supports point-to-point asynchronous and point-to-point BSC operation (as did its predecessor, TIAS I). TIAS II lease prices include NCS 2.8; for one year, the rate is \$225 per month, and for two years it's \$175 per month. MEMOREX CORP., Communications Group, Cupertino, Calif.

FOR DATA CIRCLE 328 ON READER CARD

4300 CONVERSION

Moving up from a System/3 Mod 15 to a 4300? This software company has come up with a "cookbook" and a handful of programs to help make the move into a 4300 running DOS/VSE. The package includes a conversion plan book describing more than 60 tasks needed in the conversion process (the vendor notes that many of these tasks came from trial-and-error experience in actual conversions). The book can serve as a management control document, with the

user posting progress reports as tasks are completed. The first task in the book consists of a fill-in-the-blanks estimating procedure to predict realistic conversion cost and time requirements.

Seven utility programs are included for such functions as translating System/3 Display Format Facility specifications into CICS map macros, and converting OCL to DOS/VSE JCL. Other utilities help transfer files between the System/3 and the 4300. With the exception of a file clean-up program that runs under DOS/VSE, the utilities all run on the System/3.

The conversion kit also includes a standards manual for running your new 4300 under DOS/VSE.

This manual covers a number of topics, including project design, data set design, COBOL coding standards, backup and recovery, CMS, and operation standards. The conversion kit sells for \$1,000. RBS, INC., Fountain Valley, Calif.

FOR DATA CIRCLE 332 ON READER CARD

RSX-11M PERFORMANCE MONITOR

The System Reporting Facility, SRF, provides the PDP-11 RSX-11M system manager with the information needed to tune the system for greater performance. The software measures system utilization, helps identify bottlenecks, and provides system and

peripheral utilization measures useful in planning for future system expansion. SRF logs global system statistics as well as detailed statistics for both user and system tasks.

For each task, SRF keeps track of elapsed time, cpu time, memory size, terminal ID, all QIos (including disk and terminal), and other information. Global statistics, gathered at user-specified intervals, show the percentage of cpu time devoted to user, system, and idle states.

Reports include a detailed activity log by task, and a log of periodic cpu utilization figures. Summary reports are available by account, by terminal, and by task. The package does not require system generation for installation. SRF licenses for \$1,995. GEJAC, INC., Riverdale, Md.

FOR DATA CIRCLE 331 ON READER CARD

UTILITY

Shops using Power/VS can use a handy utility from this vendor to spool listings from the Power queue on disk to mag tape. The mag tape can be saved for later printing, reprinting, or output to microfilm or fiche. The utility is offered as a BAL source listing for \$75, or packaged with source listing and 80-column cards containing both source and relocatable object code for \$100. LINNEX RESEARCH LTD., New York, N.Y.

FOR DATA CIRCLE 334 ON READER CARD

AOS On
A NOVA® 4/X?

PCSI's

**MTSS Provides NOVA® Users
With Multi-User Capabilities**

DG users now have a choice when upgrading to a multi-user environment. Previously, the only way to support a true multi-user environment was to upgrade to AOS, but not anymore.

MTSS provides all of the standard RDOS features for up to 16 users simultaneously and each user is totally independent. Users may edit, compile and execute programs written in FORTRAN IV, FORTRAN V, ALGOL, BASIC, MACS, etc.

This means no software rewriting is necessary. No new operating system need be installed.

More importantly, MTSS supports all NOVA®'s as well as ECLIPSE®'s so no expensive hardware upgrade is required.

**Now Data General Users
Have A Choice!**

P C S I

POLYMORPHIC COMPUTER SYSTEMS, INC.
P.O. Box 3581, Boulder, Colorado 80307
(303) 422-1182

CIRCLE 160 ON READER CARD

DISC PACK FILING

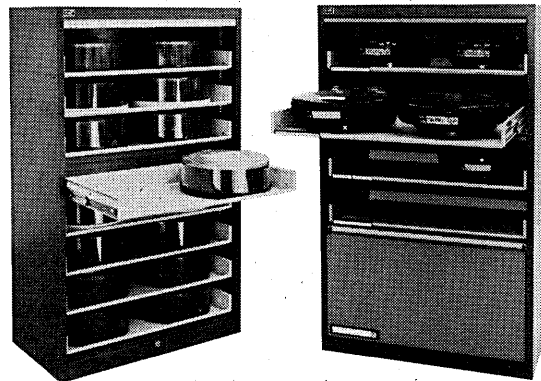

Wright Line's Optimedia® Cabinets provide a safe, convenient, cost effective method of filing all sizes and types of disks. Full suspension roll-out shelves simplify the handling of heavy packs. Custom configurations allow magnetic tape or other media to intermix with disks in the same cabinet. For further information, circle the readers' service number or write: Wright Line, Inc., 160 Gold Star Boulevard, Worcester, Massachusetts 01606.

FOR DATA PROCESSING ACCESSORIES
AND SUPPLIES, YOUR . . .
single source with super service

Wright
LINE

A Subsidiary of Barry Wright Corporation

CIRCLE 161 ON READER CARD

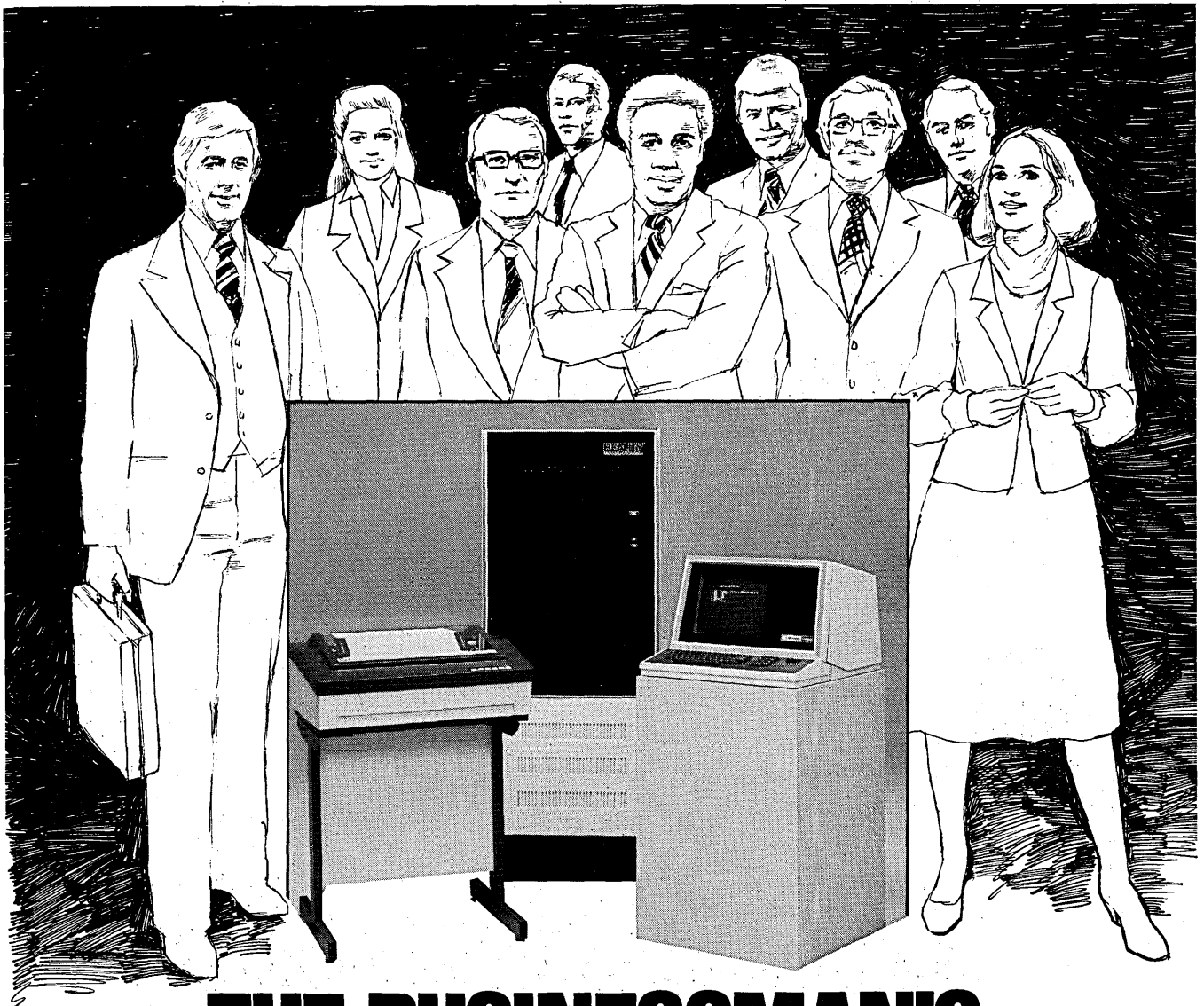

THE BUSINESSMAN'S BUSINESSCOMPUTER.

There are lots of computers. But there's only one rated by businessmen as tops in the small business computer class, according to an independent research firm survey. That's the Microdata Reality® business computer system. Reality rated 1st in all five major categories of comparison: 1. Performance 2. Reliability 3. Ease-of-Use 4. Backup support and 5. Service.

To win this high rating from businessmen, the Reality business computer system offers a combination of ben-

efits offered by no other system.

Reality communicates in your business language—English®. So you don't worry about codes and symbols decipherable to computer experts only.

Reality systems are modular. This means that your new Reality system can grow along with your business without the need for expensive application program changes and conversion costs.

And Reality is the most sophisticated

business computer in its class with capabilities beyond most other systems.

All computers are NOT created equal. Before you decide, come face to face with Reality—the businessman's choice.

Find out for yourself. Call your local representative or toll-free 800-854-2003, ext. 814. In California dial 1-800-522-1500, ext. 814.
Microdata Corporation,
P.O. Box 19501,
Irvine, CA 92713.

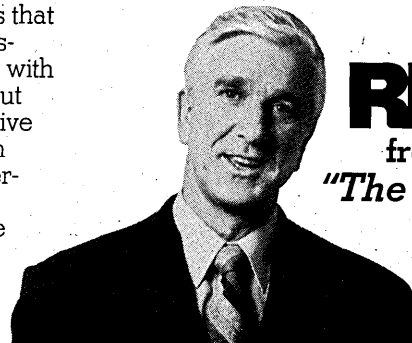

REALITY®
from Microdata
*"The Businessman's
Choice."*

SYSTEMS PROGRAMMERS

Earn as much as 40 percent more, save more and vacation more—take on new job challenges by joining Aramco in Saudi Arabia.

Aramco needs outstanding Computer Systems Programmers to support our vast expansion plans on the energy frontier in Saudi Arabia.

Aramco is the principal oil company helping the Saudi Arabian Kingdom to develop its energy resources. Some of our projects are staggering in scope, complexity and inventiveness. We're committed to applying advanced computer systems to all areas. That's why we need some very talented systems programmers right now. These positions require a B.S., plus five years' experience.

Sr. Systems Programmers

You'll support our present configuration of two IBM 3033 mainframes. You'll implement the latest operating system releases—thus you must be conversant with assembly language, SMP, AMS, MVS installation and maintenance, JES2 internals. If you also know VTAM, VM, SNA, so much the better.

Sr. T.P. Systems Programmer

You'll be a guiding force for our extensive T.P. network, so you should have comprehensive knowledge of large scale T.P. support—plus experience in ACF/VTAM installation, 3705 NCP coding, SNA design, MSNF support.

Sr. IMS Systems Programmer

You'll be responsible for implementation, maintenance, performance tuning of our IMS/VS system. Your strengths should be in DB and DC control and flow, MVS structure and design, SNA concepts, IMS/VS access methods, DB/DC performance and tuning techniques. If you also have experience in DL/1 programming, VSAM, ADF, MSC and SNA design, so much the better.

Systems Programmer

You'll be working in your chosen field: MVS/JES2 T.P. Systems, or IMS/VS—but you'll have the opportunity to progress in a diverse EDP environment. We'll expect you to have a working knowledge of assembly language, TSO, AMS, SNA design, MVS structure and design.

Unsurpassed compensation and benefits

The Aramco salary is competitive—and a cost-of-living differential increases it even further. In addition, Aramco people in Saudi Arabia receive a tax-protected premium which can amount to as much as 40 percent of the base salary.

Money aside, Aramco offers an outstanding combination of benefits, including the long vacation, comfortable housing, abundant recreation, and an excellent American-style school system for children.

New bonus for all—and new option for married employees

Newly hired employees for Saudi Arabia also receive a one-time, lump-sum, fully tax-protected Overseas Employment Bonus of up to \$5,000.

And now all of the attractive compensation and benefits are available for married employees who may want to work overseas on a temporary "bachelor" status for the first year. This program includes three free repatriation trips by air during this one-year period, and the option to request family status at three conversion dates during that same year.

Interested? Send your résumé, in confidence, to: Aramco Services Company, Department DM090180-NNBA, 1100 Milam Building, Houston, Texas 77002.

CHALLENGE BY CHOICE

ARAMCO
SERVICES COMPANY

CIRCLE 163 ON READER CARD

SOFTWARE AND SERVICES

SERVICE MANAGEMENT

Service-Pak is a management information and control system designed for service organizations. Written in BASIC for Data General systems running under RDOS, Service-Pak consists of three major modules: accounts receivable, commission and cost accounting, and service department management.

The AR module handles recurring monthly statements, multiple location billing on a single statement, itemized or consolidated billing, account histories, aging, and other functions. Material and labor rate files are maintained by the commission and cost accounting module. This module allows cost accounting for any or all installation work, prepares installation status reports, and tracks salesman commission status. The service department management module keeps a customer service history, as well as a false alarm history. It keeps track of accounts due for preventive maintenance, calls by servicemen, and service call response times.

Service-Pak has a single-user license fee of \$6,000, and an oem, one-time license fee of \$7,500. APPLIED BUSINESS SYSTEMS, Division of Computer Simulations, Inc., Costa Mesa, Calif.

FOR DATA CIRCLE 335 ON READER CARD

JOB TRACKING

An automatic job rerun management system for OS/VS users handles rerun tracking (monitoring production and rerun activity) and rerun handling (eliminating manual operations normally required for production job reruns or restarts).

The package has a tracking facility that is said to give the dp manager the information needed to implement measures to reduce future reruns. The system uses a data base containing information on all production runs and any associated reruns; both job and production status data are available for on-line inquiry. The tracking system can provide basic batch reports including a rerun report and a spoilage report (detailing—in absolute numbers and percentages—the amount of each system resource wasted on reruns). The system, dubbed UCC Eleven, can be purchased for \$12,500; leases also are offered. UNIVERSITY COMPUTING CO., Dallas, Texas.

FOR DATA CIRCLE 333 ON READER CARD

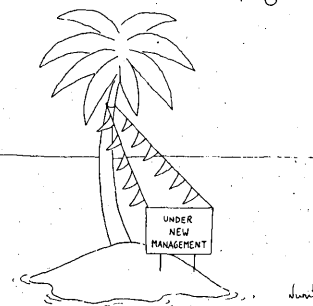

SOURCE DATA

BOOKS

THE DANCING WU LI MASTERS: AN OVERVIEW OF THE NEW PHYSICS

by Gary Zukav

Paul is a close friend of mine who suffers from anxiety attacks. His mind strives to instill and maintain order. Books on his shelves are flush to an imaginary vertical plane. The sharpened pencils in a cup on his desk are of equal length. In his mind ideas are directed into grids of categories like obedient cattle nudged after a day of grazing into their assigned stalls. Thoughts of uncertainty traumatize him the way eerie noises can make you shudder when you walk alone late at night through a dark and unfamiliar building.

Paul's doctor told him that many people occasionally experience anxiety attacks and gave him a prescription for Valium, and his attacks became rarer and less potent. But a few nights ago in a bar with a group of friends, he had another. As far as we can tell, the attack was evoked by a discussion led by me on the nature of modern physics.

As we chatted over mugs of lukewarm Guinness, Paul was drawn so close to the edge that for now he refuses even to listen passively to discussions on the implications of ideas as simple and basic as the uncertainty principle, coherent superpositions, synchronicity, the many world interpretation, complementarity, S-matrix theory, Bell's theorem, and the quantum field theory.

When I describe these theories as simple and basic, I mean to compliment the work of Gary Zukav. Until now I had no idea of what those theories explain or imply. In his *The Dancing Wu Li Masters*, Zukav clearly and entertainingly presents current ideas on the evolution of the science of physics, explaining the methodology, findings, and conclusions of the most sig-

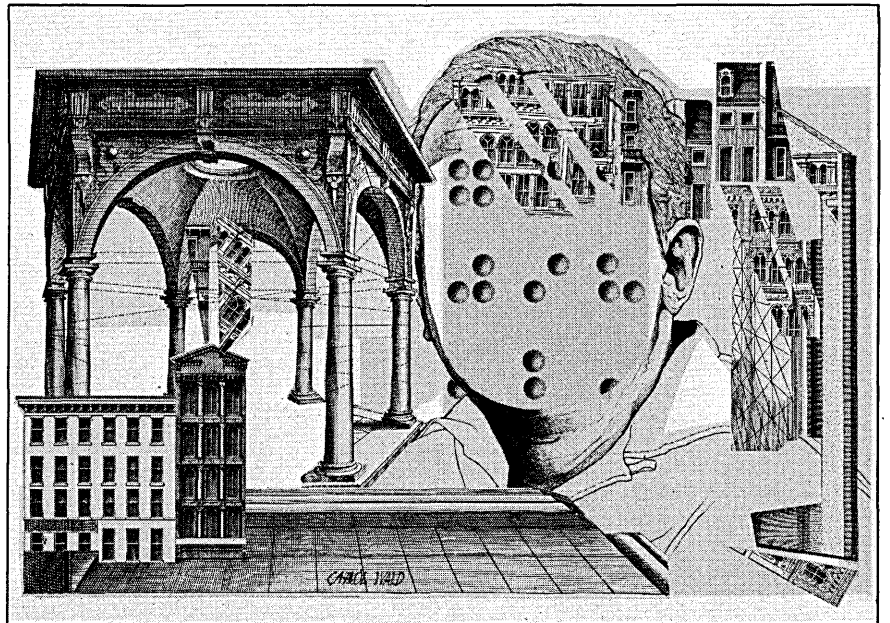

nificant experiments in physics, and points to the stunning similarities between the current understanding of the nature of physical reality and the themes of the poetics of the ancient Zen scholars.

Zukav writes for those of us who during a word-association exercise would respond "apple" to "physics" and "moustache" to "Einstein." The book is so readable that I absorbed and understood the esoterica of modern physics even while jammed into a rush hour subway car, a remarkable accomplishment since many of the ideas won and will win Nobel prizes for several young physicists.

As the reader reaches the closing sections Zukav proffers what he feels are the implications of the new physics of humanity. Thinking readers no doubt will add some of their own. It was those implications that seemed to be the catalyst for Paul's anxiety attack.

Modern science is telling us that, despite what our senses, including the com-

mon one, do to our consciousness, we are in a universe that in its essence is not causal, linear, continuous, permanent, absolute, or categorizable. Time is not sequential. Order is an illusion. Reality is not real.

Evidence for those bold conclusions is developed carefully by Zukav. He describes: the equivalence, *not* the interchangeability, of matter and energy; subatomic particles that can be either particles or waves, depending upon who asks which questions where; photons that do not move through space but instead weave in and out of existence digitally like the flashing lights on a marquee; particles that are dimensionless and massless, but yet combine to form particles with mass and dimensionality; elementary particles that dance back and forth between themselves and other particles; subatomic particles that move backwards through time; and events that are directly connected to one another and occur simultaneously but in different time-spaces.

SOURCE DATA

The most sophisticated uses of the scientific method now indicate that reality does not exist independently of our observations of it, that we cannot use induction to draw conclusions about the nature of reality, and that some influences can propagate faster than the speed of light. Modern science, and therefore all rationality, can now smell its own mortality.

Through a process of self-reference, axiomatic thought has risen high enough to see its incompleteness. Axiomatic thought is the paradigm we all use and rely on to make our interactions with sense impressions more manageable. Formally, the thought process begins with a set of axioms

or assumptions, from which we deduce conclusions. We then compare those conclusions to sense impressions, thereby garnering feedback on the quality of the set of axioms. In other words, we guess and then check our guesses. The problem with axiomatic thought arises from its epistemological basis—namely, that we can improve our knowledge of the universe by employing a paradigm featuring causality, linearity, categorization, and the concatenation of ideas. Apparently, physicists have taken this paradigm so far that it generates conclusions contrary to its own epistemological basis!

Developments in mathematics and

physics show that no idea, other than the idea contained in this sentence, linked to an assertion, belief, or experience, can make a *true* statement about reality. In the field of mathematics Kurt Godel showed via his Incompleteness Theorem that no mathematical system can ever prove its own validity. By combining Godel's work with the revelations of modern physics we are trapped in an unsettling paradox. Human beings for millennia have fashioned out of the chaos of sense impressions better and better visions of order, only to find that the purest vision of order will be the very chaos which agitates them into their quest for certainty. Axiomatic thought consumes itself in a vicious circle of self-reference.

If you read Zukav's book you may be struck as I was with the feeling gaining popularity among many writers and intellectuals that mankind is approaching a transformation as radical as the one that civilized it. Mankind reminds me of an infant sensing and discovering that it can influence to a degree its destiny, only nothing outside of it (such as an axiomatic set) can guide it in the exercise of its growing power.

These are the kinds of ideas that gave Paul one of his anxiety attacks. I wonder if human culture will be able to react any differently to the unreasonableness of reason. Perhaps the FDA should affix a label to Zukav's book, warning the consumer that the study of physics can be dangerous to his or her health. Of course, neglecting to learn about the new physics may be worse. William Morris and Co., Inc. New York, (1979, \$5.95, paper).

Nicholas Mitsos

BOOK BRIEFS

6502 ASSEMBLY LANGUAGE PROGRAMMING

by Lance A. Leventhal

This is an excellent reference work for anyone with a 6502-based microcomputer. It is encyclopedic in scope and is written in a terse and concise manner, with numerous tables, diagrams, and charts explaining all aspects of the microprocessor and its supporting chips.

There are many examples of standard types of assembly language counterparts. Programs and methodology involving loops, tables, subroutines, input/output procedures, interrupts, and other topics are presented. However, because of the scope of the work, the descriptions are short and statements are often made containing terms that are not explained until later on in the text. It is not a book for the complete novice; one has to have a moderate amount of familiarity with the subject in order to use it to full advantage.

The book also contains general discussions about topics of broad interest to computer programmers. For example, it



A. Martin

"Star light. Star bright.
First star I've seen tonight.
Wish I may. Wish I might
Get a stranglehold on Congress."

©DATAMATION

COMPARE SMARTS.

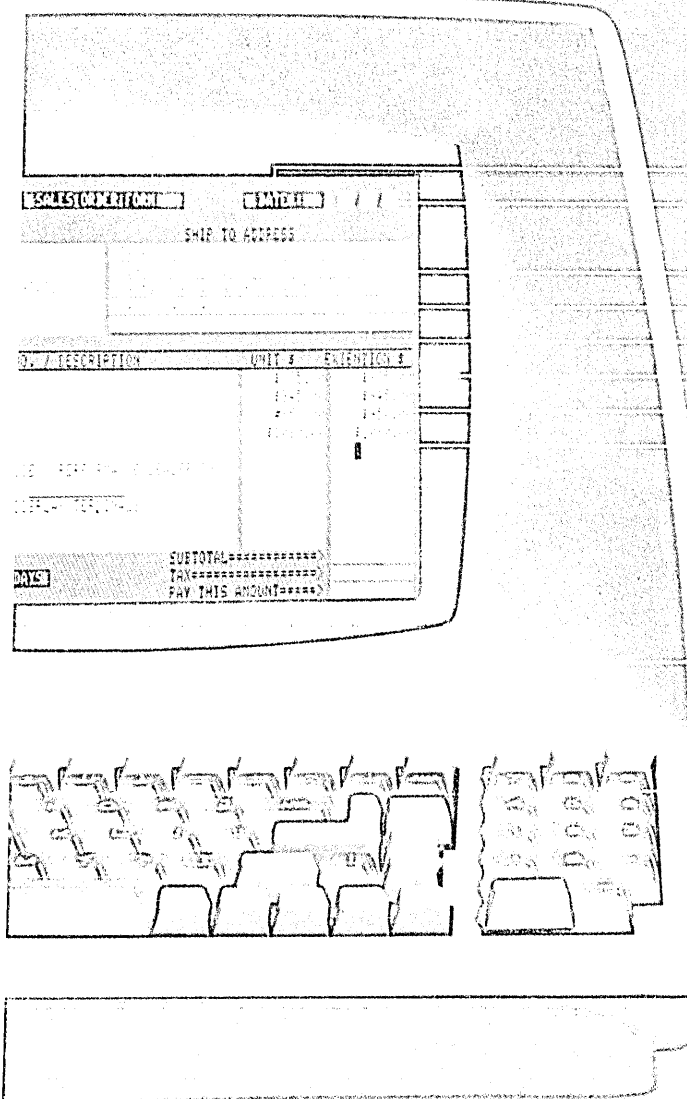

Traveler's office
 Data entry terminal
 Airport terminal
 Airport terminal
 Airport terminal
 Airport terminal
 Airport terminal
 Airport terminal

Features for features our smart CRT terminals cost less than *their* dumb ones. Much less. Compare smarts. Then compare prices. You'll pick TeleVideo.

From different models to choose from. Each with features you'd expect to pay extra for. But with TeleVideo, they're standard.

We put a lot of engineering savvy into our CRTs. Their modular design means high reliability. It also lets us build to high volume. And sell to you at low prices.

Find out how you can make your next CRT buy a smart one. Contact TeleVideo, today from TeleVideo.

Available in many configurations available from TeleVideo. Contact us for more information. TeleVideo, Inc. 10000
 10000
 10000

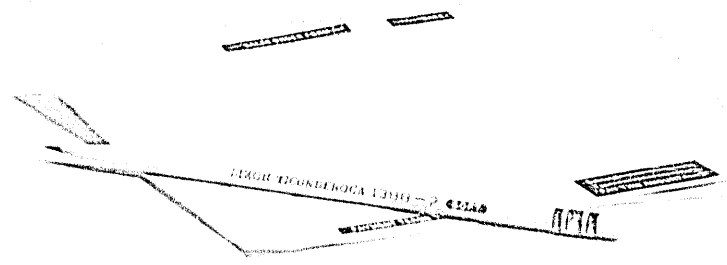

SOURCE DATA

presents the pros and cons of structured programming and top-down programming. It is a worthwhile acquisition for anyone involved with assembly language programming of any microprocessor-based computer. Osborne/McGraw-Hill, Berkeley, Calif. (1979, 550 pp., \$9.50).

—Irving Lazar

REPORTS AND REFERENCES

EUROPEAN OFFICE EQUIPMENT MARKET

Office copiers, office computers, and word processing equipment markets and installed bases are discussed in a 96-page report entitled "Electronic Office Equipment: European Market Trends to 1983." Countries include: Austria, Belgium, Denmark, France, Italy, the Netherlands, Norway, Spain, Sweden, Switzerland, West Germany, and the United Kingdom. \$500. Mackintosh Consultants, Inc., 2444 Moorpark Ave., Suite 211, San Jose, CA 95128, (408) 998-4312.

BOARD SURVEY

Eighty multibus-compatible boards are listed in this report, complete with name, address, and telephone number of the vendors. Included in the listings are cpu, RAM, ROM, EPROM, I/O, analog and backplane units. The booklet is intended to aid

the system designer and is published by Perfect Information Associates. \$17, postage included. PIA, P.O. Box 2751, Woburn, MA 01888, (617) 272-5169.

PERSONAL COMPUTER DIRECTORY

Datapro has compiled a directory of personal computer vendors that includes 497 software vendors and 448 peripherals vendors. The list is strictly alphabetical, not cross-referenced even regionally. No details about product offerings are given in the vendor lists.

The Apple II, Radio Shack TRS-80, Commodore PET, Atari 400 and 800, CompuColor II, Cromemco Z-2, Exidy Sorcerer, Heath H8, WH8, and H88/H89, Hewlett-Packard 85, Mattel Intellivision, North Star Horizon, Ohio Scientific Challenger I and II, and the Texas Instruments 99/4 are covered in two pages each, one for general description and one for specs.

The product descriptions are preceded by a general five-page introduction to personal computing which assures us enthusiastically that "nearly anyone in today's modern world can derive considerable immediate benefit from owning a personal computer." Not recommended as an introduction to personal computing, but the list of vendors may be useful to present users. \$25. Datapro Research Corp., 1805

Underwood Blvd., Delran, NJ 08075, (609) 764-0100.

REPROGRAPHICS REPORT

Martin Simpson has put together an analysis and market projection of the reprographics industry addressing such issues as Japan vs. Xerox, where Kodak and IBM fit in, and the potential impact of new offerings such as intelligent copiers. Additionally, the activities of Xerox are analyzed in depth, including discussion of Rank Xerox and Fuji Xerox, facsimile and computer service revenues and profits, and other Xerox telecommunications activities. Over 40 tables are featured. \$495. Martin Simpson Research Associates, Inc., 115 Broadway, Dept. MS-580, New York, NY 10006, (212) 349-7450.

VIDEOTEX/TELETEX

In a joint project, the Institute for the Future and Communications Studies and Planning Ltd. are offering videotex/teletex information in the form of six reports and one client conference a year as well as informal consultation. The information service is available on a yearly basis for a subscription fee of \$8,000. Said to be aimed at top-level planners and policymakers, the reports will attempt to cover the market from both users and technological perspectives in nontechnical terms. Coverage will be international.

SOFTWARE/HARDWARE PROFESSIONALS

Talent and experience are the definitive professional qualities. Challenge and career satisfaction are the true professional's goals. R.M. Norton & Co. has challenging positions available with some of the industry's premier companies in a full range of areas, from Software Development to Computer Architecture. If you are a professional with state-of-the-art experience in one or more of these areas, contact us: Software Design and Development; Computer Sciences; Assembly or Higher Level Language Programming; Data Base Design; Compiler and/or Operating Systems Design; Digital Logic Design; Interface Design; Microprocessor Utilization; Computer Architecture.

You'll find that R.M. Norton & Co. offers you the mix of talent, experience and service a true professional expects, including free resume preparation and career path advice. Client companies assume all fees.

R.M. Norton & Company, Inc.
Professional Placement Consultants
271 Lincoln Street, Lexington, MA 02173
(617) 861-7800

Representing equal opportunity employers m/f

R. M. NORTON & COMPANY, INC.

Professional Placement Consultants

CIRCLE 165 ON READER CARD

COMPUTER PROFESSIONALS

L.D. Schreiber Cheese Company Inc., a fast growing national, private label food manufacturing company with sales in excess of \$500,000 per year, is rapidly expanding the corporate data processing staff to meet the needs of the 80's.

We offer challenging opportunities in an expanding on-line database environment for experienced:

- PROGRAMMER/ANALYSTS
- DATABASE ADMINISTRATORS
- SYSTEMS PROGRAMMERS
- MANUFACTURING DATABASE MANAGERS

These positions require a BS degree or the equivalent, plus several years experience.

Currently we are running a 370/148 under VM with CMS, SCRIPT, 370, RSCS, and QBE with a 4341 on order. The on-line database portion consists of OS/VS1, IMS, CICS and DMS. WE are establishing a local and nationwide network of the latest teleprocessing hardware.

We can assure a future filled with growth, opportunity and challenge by sending your resume and current earnings:

Corporate Staffing Director
L.D. SCHREIBER CHEESE CO. INC.
P.O. BOX 610
Green Bay, WI 54305
Equal Opportunity Employer M/F

CIRCLE 166 ON READER CARD

Greedy OEM's wanted.

There are only two ways for you to make more money in the OEM business.

Either you sell equivalent capability at a lower price than your competitors. Or you sell more capability at an equivalent price.

Take your choice. Vector can help you do either. Because no matter if you're a software house or a systems house, no one can sell you capability cheaper than Vector.

And that includes everything from boards, terminals, and printers to complete Economy Sized Computer™ systems.

For more information, call Yvonne Beck at 213/991-2302.

She'll help you choose the proper way to be greedy.

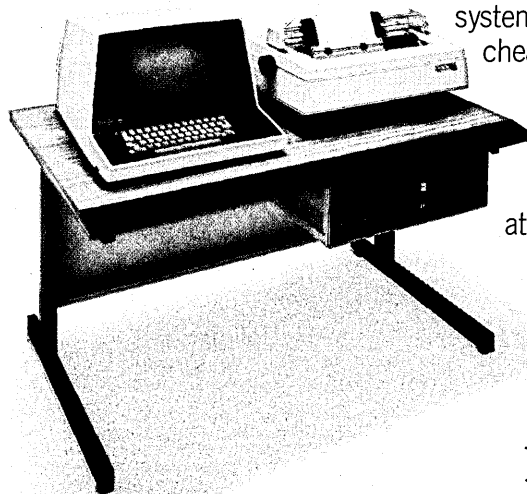

VECTOR
VECTOR GRAPHIC INC.

Economy Sized Computers

31364 Via Colinas, Westlake Village, CA 91361, 213/991-2302

CIRCLE 167 ON READER CARD

SOURCE DATA

Perhaps the most impressive claim the service, called *Context*, makes is brevity. "Contributions," it is said, "will be carefully sifted and arranged so that key points and data are not submerged in masses of undigested information. Liberal use will be made of illustrations and bibliographical material." Communications Studies & Planning Ltd., Circus House, 21 Great Titchfield St., London W1P 7FD, England, 01-637-9757. Institute for the Future, 2740 Sand Hill Rd., Menlo Park, CA 94025, (415) 854-6322.

TRANSBORDER DATA FLOW

Volume 16 of the *Stanford Journal of International Studies*, a student publication of the Stanford Law School, will address the issue of transborder data flow. Featured articles will be written by experts on the subject. The issue is \$7 (\$9 overseas). Checks should be payable to Stanford University. Contact the Business Manager, *Journal of International Studies*, Stanford Law School, Stanford, CA 94305, (415) 328-6077.

PERSONAL COMPUTING BIBLIOGRAPHY

An index to magazine articles on a wide variety of personal computing subjects is available for \$5.95. Back issues—1978,

1977, 1976, and 1975—are \$5 each. The indexes list articles both by subject and by author. The *Periodical Guide for Computerists* is available from E. Berg Publications, 622 East 3rd, Kimball, NE 69145.

VENDOR LITERATURE

TECHNICAL PRESENTATIONS

Instructions and recommendations are included in this 12-page booklet for technical professionals on how to use meetings as management tools. Meeting essentials such as agenda, selection of meeting room, visual aids, and presentation techniques are clearly outlined. Two pages are devoted to conceiving and preparing technical visual aids, and using easy-to-make, inexpensive overhead transparencies, including scale and line drawings, graphs, schematics, block diagrams, tables and columns, photographs, and cartoons. Typical hints offered: "Bring management up to speed," "Avoid in-group words and phrases," and "Keep it simple." 3M, St. Paul, Minn.

FOR DATA CIRCLE 352 ON READER CARD

MOS/LSI DATA CATALOG

This 256-page catalog on the vendor's MOS/LSI devices is divided into sections that cover data communications products, crt displays, printers, baud rate generators,

keyboard encoders, and microprocessor peripherals. Included in each section is a complete product description, product function, and usage specifics for each device. The catalog is illustrated and contains a cross-reference index as well as ordering information and a list of the vendor's distributors. STANDARD MICROSYSTEM CORP., Hauppauge, N.Y.

FOR DATA CIRCLE 353 ON READER CARD

SOFTWARE DEVELOPMENT

A software development system, PDSFORT (Program Development System FORTRAN), for HP 3000s is described in a four-page brochure. An introduction to the system is given, and section headings are as follows: Monitor, Editor, Program Design Module, and Preprocessor. A block diagram on the back cover shows how the system works. MINI COMPUTER APPLICATION SOFTWARE, Orcutt, Calif.

FOR DATA CIRCLE 354 ON READER CARD

SPECIAL SYSTEMS

"What's So Special About Special Systems?" is a four-page, full-color brochure illustrating the vendor's special systems group and how it helps oems. DATA GENERAL CORP., Communications Services, Westboro, Mass.

FOR DATA CIRCLE 356 ON READER CARD

ANTI-BACKLASH ASSEMBLIES



MOTION PRODUCTS INCORPORATED

Kerk ZB series Anti-Backlash lead Screws offer effective linear actuators for design operations requiring the utmost in positional accuracy and repeatability at minimum cost. The ZB series units, through their unique transfer of loads, offer exceptional torque consistency and repeatability when traversing in either direction. The units are thus ideally suited for Bi-Directional Matrix Printers, X-Y Tables, etc. Write or call for details.

51 Lake Street • Nashua, NH • 03060 • Tel. (603) 883-2627

CIRCLE 168 ON READER CARD

TERMINALS FROM TRANSNET

PURCHASE PLAN | 12-24 MONTH FULL OWNERSHIP PLAN | 36 MONTH LEASE PLAN

DESCRIPTION	PURCHASE PRICE	12 MOS.	PER MONTH 24 MOS.	36 MOS.
LA36 DECwriter II	\$1,695	\$162	\$ 90	\$ 61
LA34 DECwriter IV	1,095	105	59	40
LA34 DECwriter IV Forms Ctrl.	1,295	124	69	47
LA120 DECwriter III KSR	2,495	239	140	90
LA180 DECprinter I	2,095	200	117	75
VT100 CRT DECscope	1,895	182	101	68
VT132 CRT DECscope	2,295	220	122	83
DT80/1 DATAMEDIA CRT	1,995	191	106	72
T1745 Portable Terminal	1,595	153	85	57
T1765 Bubble Memory Terminal	2,595	249	146	94
T1810 RO Printer	1,895	182	101	68
T1820 KSR Printer	2,195	210	117	79
T1825 KSR Printer	1,595	153	85	57
ADM3A CRT Terminal	875	84	47	32
ADM31 CRT Terminal	1,450	139	78	53
ADM42 CRT Terminal	2,195	210	117	79
QUME Letter Quality KSR	3,295	316	176	119
QUME Letter Quality RO	2,895	278	155	105
HAZELTINE 1420 CRT	945	91	51	34
HAZELTINE 1500 CRT	1,195	115	64	43
HAZELTINE 1552 CRT	1,295	124	69	47
Hewlett-Packard 2621A CRT	1,495	144	80	54
Hewlett-Packard 2621P CRT	2,650	254	142	96

FULL OWNERSHIP AFTER 12 OR 24 MONTHS
10% PURCHASE OPTION AFTER 36 MONTHS

ACCESSORIES AND PERIPHERAL EQUIPMENT

ACOUSTIC COUPLERS • MODEMS • THERMAL PAPER RIBBONS • INTERFACE MODULES • FLOPPY DISK UNITS
PROMPT DELIVERY • EFFICIENT SERVICE



TRANSNET CORPORATION

1945 ROUTE 22
UNION, N.J. 07083

201-688-7800
TWX 710-985-5485

CIRCLE 169 ON READER CARD

Our Automated Funds Transfer Systems can do your bank a world of good.

As a commercial bank, worldwide funds transfer is a vital part of your operation. Streamline this vital function, and you'll go a long way toward maximizing profits. Improving your competitive position. Attracting and holding new accounts, too. And that's precisely what the new Rockwell-Collins Automated Funds Transfer Systems are all about.

As the first fully integrated, upward-compatible family of advanced, computer-based systems, our AFTS interfaces all of the available funds transfer networks. Automates much of the internal handling. Cuts costs. Reduces delays. Gives you up-to-the-minute visibility.

AFTS works by integrating transaction processing with communications processing and message handling. Say good-bye to error-prone file reference. Inter-departmental hand carry. Manual record keeping. Say hello to automatic storage for incoming transactions. Automatic processing for fixed-format transactions. Automatic recording of processing events. Local data base of account information. Balance checking. Current position. Reformat to match wire type. And finally, automatic recording and reporting on work load distribution by priority.

Can one of the new Rockwell-Collins AFTS systems make your operation run more efficiently? You can bank on it. For details, contact your nearest representative listed below. Collins Communication Switching Systems Division, Dept. 420-200, Electronics Operations, Rockwell International, Dallas, Texas 75207. Phone: 214/996-2336.



Rockwell International

...where science gets down to business

Dallas, Tex. (214) 996-2336 • New York, N.Y. (212) 661-6530 • Newport Beach, Calif. (714) 833-4645 • Chicago, Ill. (312) 298-5177
Atlanta, Ga. (404) 996-7112 • Washington, D.C. (703) 685-2679

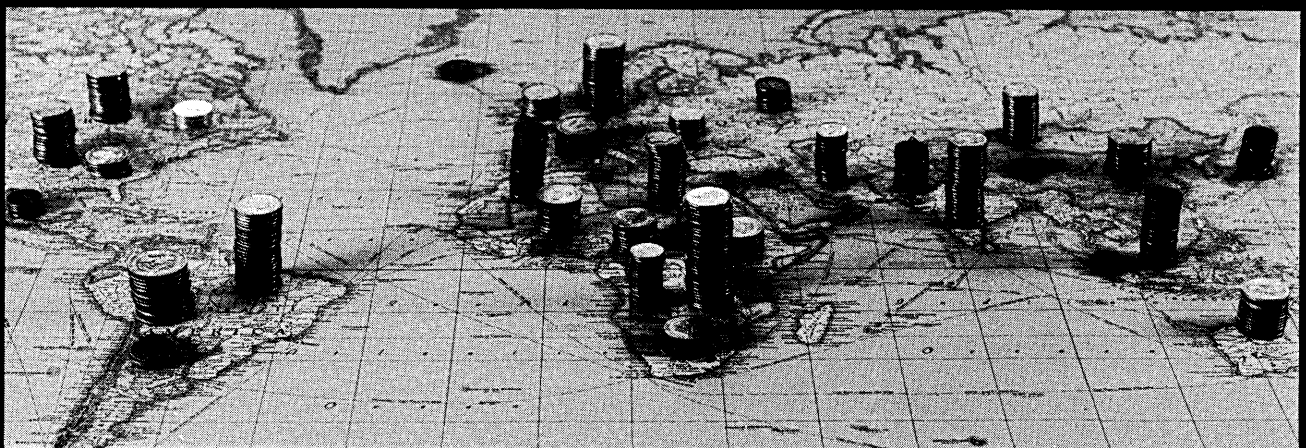

The latest words in communications: Rockwell-Collins.

Brussels 242-4048 • Cairo 894531 • Frankfurt (0) 6106-4093 • Hong Kong 5-274-321 • Kuala Lumpur 27283 • London 01-759-9911 • Manila 892-742 • Mexico City (905) 533-1846
Melbourne (Lilydale) (03) 726-0766 • Paris (Rungis Cedex) 687-31-02 • Rio de Janeiro 286-8296 • Riyadh 69060 • Rome (0) 6-862-415 • Seoul 74-9276
Tokyo 478-1278 or 478-1279 • Toronto (416) 757-1101 • Jeddah 54600

CIRCLE 170 ON READER CARD

SOURCE DATA

PASCAL

"PASCAL, A Programming Language for Today" is an eight-page, two-color pamphlet that describes the uses and benefits of PASCAL, along with a brief history of other languages. The vendor's approach to PASCAL is detailed, and a comprehensive chart compares PASCAL on a feature-by-feature basis with BASIC, FORTRAN, and COBOL. RAMTEK CORP., Santa Clara, Calif.

FOR DATA CIRCLE 351 ON READER CARD

FIBER OPTICS

This report is an introduction to fiber optics and covers fiber optics markets and technology, and the state of the economy in this field. Technology sections cover fiber characteristics, attenuation, bandwidth, splicing and connecting, system design, and principal applications. PRINTING COORDINATES, Newton, Mass.

FOR DATA CIRCLE 355 ON READER CARD

THE COMPUTERS THAT SAVED METROPOLIS

Superman and computers come together in this comic book to save the city of Metropolis. As a comic book, this piece provides the motivation to get youngsters reading while they simultaneously receive computer science instruction. The full-color book is available to schools, clubs, youth groups,



and any interested individuals free of charge. This vendor has distributed over 15 million copies of another educational comic book, *The Science Fair Story of Electronics*, and coupons for that book as well as the Superman book are included in each copy of *The Computers That Saved Metropolis*. TANDY CORP., Fort Worth, Texas.

FOR DATA CIRCLE 359 ON READER CARD

VAX/VMS & PASCAL

This brochure describes the benefits of combining the vendor's virtual memory operating system with VAX-11 PASCAL. Listed in the publication are language extensions, new predeclared functions, and compiler options of VAX-11 PASCAL plus VMS utilities that can be called by PASCAL programs. DIGITAL EQUIPMENT CORP., Marlboro, Mass.

FOR DATA CIRCLE 350 ON READER CARD

DIGITAL CARTRIDGE TAPE DRIVE

A data sheet describes this "ruggedized" (suitable for military and rugged industrial applications) digital cartridge tape drive that provides connector-to-connector replacement for existing 10½ inch reel-to-reel computer peripheral tape drives. The data sheet contains specs and a general description of the vendor's tape drive. DATA ELECTRONICS, INC., San Diego, Calif.

FOR DATA CIRCLE 357 ON READER CARD

PASCAL

A single-page data sheet describes an implementation of the UCSD PASCAL system for this vendor's microcomputers. The data sheet also describes a FORTRAN system that works with the PASCAL system and generates PASCAL P-code instead of native machine language. Features are listed for the

The complete shoppers guide to computer power protection.

Inexpensive and Ineffective:	Regulators and Transformers.
Affordable and Guaranteed:	Atlas UPC.
Costly and Overkill:	UPS.

Regardless of other power conditioning technologies making strong (and often exaggerated) claims promising "total protection," "complete effectiveness" and "99.5% clean power," only the Atlas **UPC/Uninterruptible Power Conditioner** has the stored energy to bridge *light flickers*.

Only the Atlas **UPC** generates totally new, perfectly clean, independent and dedicated

computer power. And only Atlas guarantees 100% clean computer power regardless of utility problems and line disturbances. It's no wonder that over half of all Atlas **UPC** installations replace ineffective or inadequate power technologies.

Write or call for more information including power technology comparisons and detailed **UPC** literature.



ATLAS
ENERGY SYSTEMS

Home Office: 9457 Rush Street, South El Monte, CA 91733 Phone (213) 575-0755
Regional Centers: Boston (617) 492-2255 Chicago (312) 372-2237

CIRCLE 171 ON READER CARD

SCHEDULIZE with Magnetic Controls

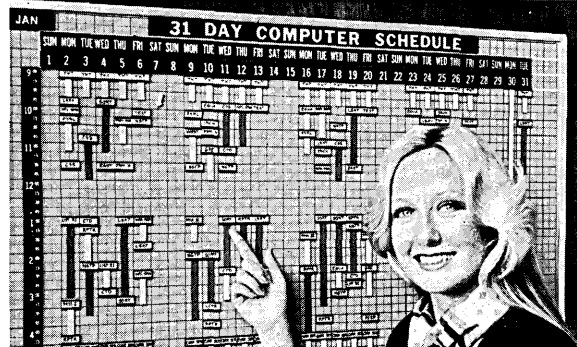

FREE
16 PAGE
ILLUSTRATED
BROCHURE

REPRESENTATION THROUGHOUT MOST OF THE UNITED STATES

- SHOW FACTS INSTANTLY
- CHANGES MADE IN SECONDS
- ELIMINATE FILE REFERRALS
- SYSTEMATIZE YOUR WORK FLOW
- GET THE JOB DONE

For Scheduling • Programming • Personnel • Sales • Shipping • Inventory • Maintenance • Production • Quotations • Computer • Special Situations

201-938-6000

METHODS RESEARCH

70 ASBURY AVE., FARMINGDALE, N.J. 07727

CIRCLE 172 ON READER CARD



Now available in plain or fancy.

Yes, Virginia, now there really are two Dumb Terminal® video displays. And they're available for immediate delivery.

The one on the left is the same reliable ADM-3A you've come to know and love. With loads of dependable features. Like a 12" diagonal screen, full or half duplex at 11 selectable data rates (75-19,200), 1920 characters in 24 rows of 80 letters, RS232C extension port, and direct cursor addressing. Not to mention options galore.

The one on the right is the reliable new ADM-3A⁺. For those who

want a little something extra in their Dumb Terminal. So in addition to the same proven design and features of the original, you get even more. Such as a built-in numeric keypad with 0-9 numerals, period, comma, tab, minus, and return. Standard upper and lower case with full, two dot descenders. A caps lock key conveniently located adjacent to its shift key. A program mode key. And separate cursor control keys.

So now you have a choice. The ADM-3A or the new ADM-3A⁺. And they said it couldn't be Dumb.

**DUMB TERMINALS.
SMART BUYS.**



LEAR SIEGLER, INC.
DATA PRODUCTS DIVISION

Lear Siegler, Inc./Data Products Division, 714 North Brookhurst Street, Anaheim, CA 92803 800/854-3805. In California 714/774-1010. TWX: 910-591-1157. Telex: 65-5444. Regional Sales Offices: San Francisco 408/263-0506 • Los Angeles 213/454-9941 • Chicago 312/279-5250 • Houston 713/780-2585 • Philadelphia 215/245-1520 • New York 212/594-6762 • Boston 617/423-1510 • Washington, D.C. 301/459-1826 • England (04867) 80666.

Dumb Terminal® is a registered trademark of Lear Siegler, Inc.

CIRCLE 173 ON READER CARD

SOURCE DATA

system, as is pricing and three different "configurations" for distributing the software. A toll-free phone number is provided for those needing more information or the name and address of the closest local dealer. OHIO SCIENTIFIC, Aurora, Ohio.

FOR DATA CIRCLE 358 ON READER CARD

THE CAD0 20/20 FAMILY

This vendor's 12-page color brochure describes its 20/20 family of information systems. Highlighted is the 20/20's multitasking configuration, permitting data processing, word processing, and message processing to take place simultaneously by the one information system. Details are provided on CAD0's "Just Ask II," a report writer, included in the price of each system. The vendor's software is also described in the brochure. CAD0 SYSTEMS CORP., Torrance, Calif.

FOR DATA CIRCLE 362 ON READER CARD

BUZZWORD GUIDE

The 1980 edition of "Sherry's Guide to Data Communication Buzzwords" has been updated to define 192 terms in its 24 pages. Now in its 14th printing, the pocket-sized booklet was first published in 1972 as an aid to newcomers in the data communications field. Current, commonly used words have been added, and revised definitions were added where necessary on other

words. RACAL-MILGO, INC., Corporate Relations Dept., Miami, Fla.

FOR DATA CIRCLE 361 ON READER CARD

PASCAL NEWSLETTER

This vendor's newsletter was originated to keep its PASCAL users up-to-date on new products. Also included in the newsletters—past, present, and future—are articles on PASCAL standards and programming techniques, the history of PASCAL compilers, a PASCAL bibliography, a comparison of the vendor's PASCAL versus the competitor's, and the "Programmer's Page"—dealing with programming style. In addition, a 14-page product description brochure is available. RATIONAL DATA SYSTEMS, New York, N.Y.

FOR DATA CIRCLE 360 ON READER CARD

PERIODICALS

DATA BASE NEWSLETTER

PDC, a consulting company known for its data base expertise, has expanded its newsletter to provide more coverage of data dictionary, minicomputer, and distributed processing aspects of the data base market. Also new to the publication are vendor and client profiles, one in-depth treatment per issue; letters to the editor; publications review; calendar and feature articles by readers—potential contributors take note.

Annual subscription rate is \$45, \$49 outside the U.S. A free sample copy is offered. Performance Development Corp., 1101 State Road, Bldg. P., Princeton, NJ 08540, (609) 921-3770.

COURSES

WOMEN'S GROUPS

Two organizations for women in the computer industry offer ongoing seminars. The Greater New York Chapter of the Association for Women in Computing is at Box B, 67-09 136 St., Flushing, NY 11367. Contact Alice Bayer at 586-8100, ext. 468. Women in Information Processing, Inc. is at 1000 Connecticut Ave. N.W., Suite 9, Washington, DC 20036, (202) 298-8000. *

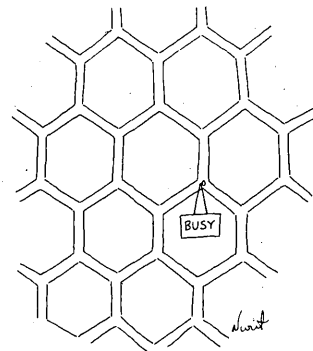

From start to finish, we know

You could be caught in a dead end job. Or you could wander through a confusing maze of professional opportunities. OR you can let us chart a direct course toward your professional goals.

Talk to the experts at Wallach. We've been successfully recruiting professionals like you for over 15 years. Our client companies pay all fees, interview and relocation costs, and you get the free benefits of our in-depth knowledge of hundreds of potential employers and our expert counseling and negotiation abilities.

Nationwide opportunities include technical/management consulting, project management, R&D, test and systems evaluation in the fields of Communications, Satellites, Weapons, Intelligence, Computer, Energy, and Aerospace systems. Specific skill areas include:

- Minicomputers
- Mathematical Analysis
- Signal Processing
- Digital Systems
- Software Design
- Communication Networks
- Telecommunications
- Microprocessor Design
- Systems Architecture
- Applications Programming
- Command & Control
- Systems Programming
- Computer Graphics
- EW/SIGINT/ELINT
- MIS/OPs Research
- Diagnostics

WALLACH
associates, inc.

1010 Rockville Pike
Box 6016
Rockville, Maryland 20852
(301) 762-1100

Professional Employment Consultants

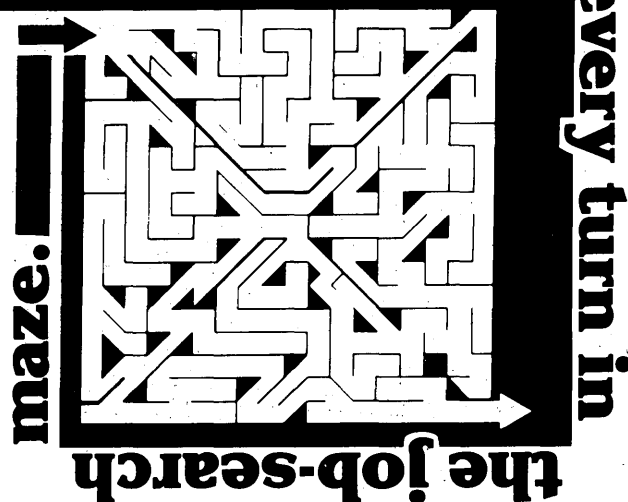

Puzzled by a maze of career options? Outsmart the maze with a professional guide from Wallach. If you currently earn over \$22,000, we can find a better job—the right job—for you! Get started today, send your resume in confidence to: Perri Reeder, Wallach Associates, Inc., 1010 Rockville Pike, Box 6016, Rockville, Maryland 20852.

Wallach ... Your career connection

Equal Opportunity Employer Agcy.

CIRCLE 174 ON READER CARD

someone always
sets the standard...



For Private Line Data Modems...it's RIXON

For wine, Lafite-Rothschild sets the standard by which all others are judged. For Private Line Data Modems, it's Rixon, and for good reason. Only Rixon offers a complete line of Bell compatible private line modems operating from 300 BPS to 9600 BPS. As in wine, subtleties make the difference. When sampling modems, look for reliability, latest in LSI and microprocessor technology, diagnostics, appearance, size, built-in multiplexer, and intermixing of different card modems in the same rack. Like superior wine, you will enjoy the experience.

CIRCLE 175 ON READER CARD

RIXON INC.,

2120 Industrial Parkway, Silver Spring, Maryland 20904
(301) 622-2121 • TWX: 710 825-0071 • TLX: 89-8347

© RIXON INC., 1980

3027

DATA ENTRY STAFF?

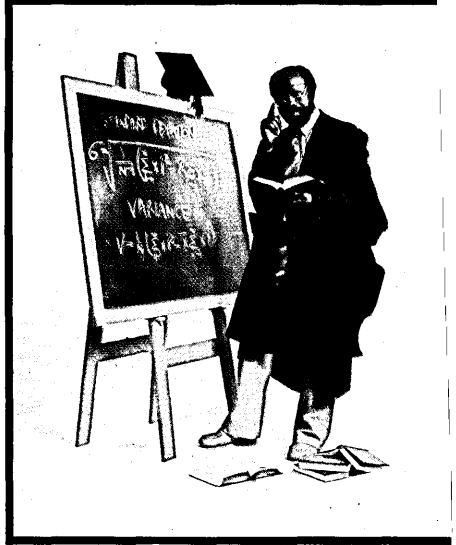

How can you improve your computer operation?

One answer is to optimise input.

At the moment your input is probably through specially trained data entry staff. Before they even start to earn their keep the basic data has to be collected, checked and collated, possibly from a wide variety of sources . . . from shop floor to senior management. The point is, you're already employing these sources to generate the data . . . and then going through all sorts of costly procedures to get their information into another form.

So: why don't they do it themselves?

Now, with MICROPAD all employees can be responsible for their own data entry.

The MICROPAD terminal captures handprinted alphanumeric data at the time of writing. Each character is recognised,

converted into standard code and transmitted to your computer. Immediate feedback and data recall is provided or the integral display . . . changes or corrections are effected by overwriting.

Only minimal training and reorganisation of clerical procedures is required. The flexibility is fantastic!

The factory foreman can pencil-in his workload straight to the computer; senior executives can access direct . . . with security; the academic, however remote, can put his reputation on the line . . . literally; the security officer can record the facts as he sees them; the medic can input vital patient data; and even the most temporary help can become a computer user . . . as fast as she's shown how to make the coffee.

You have the computer. You have the staff.

Let MICROPAD bring them together!

 micropad gets write to the point . . .

SEE
VICROPAD
AT:

NEW YORK
INFO 80
OCT. 6th-9th

PARIS
SICOB
SEPT. 17th-26th

MELBOURNE
W C E
OCT. 14th-19th

Micropad Inc., 575 Madison Avenue, New York, New York 10022. Tel: 212 486 0282 Telex 125864
Micropad Ltd., 10 Whittle Road, Wimborne, Dorset BH21 7SD U.K. Tel: 0202 891518 Telex 41358
Micropad Pty Ltd., Suite 506, 325 Chapel Street, Prahran, Victoria 3181. Tel: 0351 0626 Telex AA 33078

☉IRCLE 176 ON READER CARD

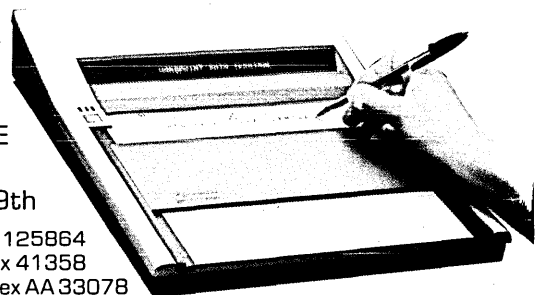

An exchange of readers' ideas and experiences. Your contributions are invited.

READERS' FORUM

APPRAISING X3J4 COBOL

The proposed changes and enhancements before the X3J4 ANSI COBOL committee (c.f., "The Next COBOL Standard," Fried and McKenzie, DATAMATION, Sept. '79) seem to be a recognition of the need for our most commonly used high-level language to reflect the fact that the dp community has become more sophisticated and structured in its approach to software.

With the new tools, in the source-level reality of planners' and designers' logical roadmaps, it will be easier to translate general and detail design specifications into production code with maximum readability, maintainability, and level of self-documentation.

- Delimited verbs, in-line PERFORMS, BOOLEAN data, substring MOVES, deediting, enhanced INSPECT, stable SORTS, and the new SET and INITIALIZE draw in elements that otherwise would require segregation into other paragraphs and statements, or use more complicated syntax. It becomes simpler for the analyst to verify that the code accurately reflects the intended processing.

- Moving the "soft" data-related attributes ACCESS MODE, RECORD KEY, ALTERNATE RECORD KEY, and FILE STATUS from the I/O-CONTROL paragraph to the FD entry for the appropriate file recognizes the fact that these are not really "ENVIRONMENT related," i.e., machine related; and, conversely for BLOCKING and CODE-SET; which are simply accommodations to the hardware and external communications environment.

- More flexible PL/1- and ALGOL-like procedures which may be embedded within other procedures, CALLED with variables other than at 01 or 77 levels, and have access to GLOBAL or EXTERNAL variables will help to streamline and modularize coding and testing efforts while removing job control overhead along the way.

However, accompanying these benefits there is at least one proposal to X3J4 which may represent a serious drawback, and an area suitable for enhancement being overlooked.

- For those sensitive to the power in formal recognition that data structures have similar maps, the removal of the CORRESPONDING option would be most unfortunate.

- Since data bases are to some extent replacing conventional system files, a uniform approach to access methods from COBOL, although exceedingly complex and broad in scope, needs to be attempted to prevent the growing data-management software from overwhelming, obscuring, or eliminating the COBOL application programs that require them.

Aside from the conceptual rationale for retaining this option, there are a number of practical reasons for it as well.

1. Certain everyday business applications call for it, such as payroll, sales analysis, and inventory control. There is a good

chance that many companies with such applications would require the appropriate expansion of program segments employing it.

ADD CORR WEEKLY-PAY TO YEAR-TO-DATE-PAY

ADD CORR TERRITORY-SALES TO TOTAL-SALES

SUBTRACT CORR ORDER-QTY FROM ON-HAND QTY

2. Keeping the date items that correspond implicitly from the structure map means no change to the PROCEDURE DIVISION when items are added to or deleted from the correspondence. Similarly, the implicit generation of control totals at control breaks is derived from the corresponding detail items of the COBOL report generator.

3. Some of the planned X3J4 enhancements will make possible more concise, "elegant," structured statements. The existence of CORRESPONDING achieves similar benefits. Structure is not just order but the enabling form for simplifying what otherwise would be cumbersome.

Extending CORRESPONDING to include arrays and to apply to COMPUTE statements, regardless of the number of data-names referenced in an arithmetic or Boolean expression, would mean that certain types of common business calculations would be easier to express.

COMPUTE CORR PRODUCTION-SHORTFALL = (PRODUCTION-BY-PLANT LESS THAN MIN-PRODUCTION-REQUIRED)*
(MIN-PRODUCTION-REQUIRED - PRODUCTION-BY-PLANT).

4. Other high-level languages, such as PL/1 and APL have recognized the importance of array-array correspondence, and indeed derive much of their utility in this way. So with the added flexibility of arrays considered by X3J4, a similar concession might be desirable.

One could easily adopt the conventions of APL which permit two arrays to correspond provided (a) their "datatype" (real, integer, character, etc.) is a compatible combination for the function, and either (b1) one array is a scalar (elementary, dimensionless data-item or single element of an array), or (b2) both arrays have identical "shape" (number and range of subscripts).

Similarly, there are standard ways of indicating "subarrays" and correspondences between them.

5. COBOL's dominance in business dp carries with it a responsibility not to exclude access to common mathematical techniques that call for correspondences of structures and arrays. When management decides that its dp will be a "COBOL shop" this adds whatever overhead is required to force its applications into the form acceptable by that mode of operation.

As evidence for the extent of this problem, consider the new job categories "Data Base Administrator" and "Data Base Analyst." These are acknowledgements that systems analysis and programming are no longer enough to build and maintain today's information systems, given what we now know about integration of files, multiplicity of access paths to records, and multiple-thread transaction processing.

Increasingly, data management software is used to control and keep efficient the advanced systems level aspects of file initial-

FORUM

ization, record addition and update, searching, inquiry, reportage, etc. Precompilers, data management language host interfaces, or some other addition/extension to COBOL is required to utilize those routines.

Totally self-contained query languages and reporting languages, while welcome to user and programmer alike, are to some extent representative of a gap between COBOL capabilities and applications requirements. Soon it may no longer be possible to have a COBOL shop—unless some attempt is made to define the function of the data management tools and implement COBOL drivers.

In applications development where dp decisions, procedures, and methodology could bring positive benefits, we look forward to the completion of x3j4's work, and to the manufacturers enhancing and modifying their compilers to assist our programmers and consultants in achieving design goals with minimum effort but

maximum understandability and maintainability of their code.

However, dropping the CORRESPONDING option, or not making the kind of generalization outlined above, may be antithetical to those objectives, while failure to begin treating data base methods within COBOL may keep it too far from the frontiers of information theory and the "action" in dp.

We see a great technological leap in hardware by using distributed processing and multiple-path packet switching. At the same time, we are forced to develop software that is best organized along data base lines and in ways that demand extensive correspondence between data structures. Therefore, it would be a pity not to try to incorporate some of these approaches in our primary language of choice—COBOL.

—W.F. Lipman
Crystal Lake, Illinois

DATAMATION CROSSWORD

TERMINAL TIMES

Edited by
Brian Fitzgibbon Burke

ACROSS

1. Ordinal suffix
4. Caesar sidekick
8. "That was no _____, that was my knife."
13. Coliseum denizen emission
15. Politician, sometimes
16. Jan. P.O. registrant
17. Karenin's wife
18. Tall (Sp.) as in Xerox PARC
19. Seaver's target
20. Past and future
22. Sahara canteen
24. Flight from the law
25. AT&T trademark
27. Bye-bye
28. And, in Arles
29. _____wing (expanded the house
31. M.L. or Austin
34. Ending with man or bus
35. Opel, for one
39. Property
42. Battery component, to a New Yorka
43. _____mode
44. Evaluate
45. Dancer Alvin et al.
47. To wit
48. _____the Man
51. Between dimples
55. Spoil
56. Insurance org.
57. "The King _____ ; Long live _____"

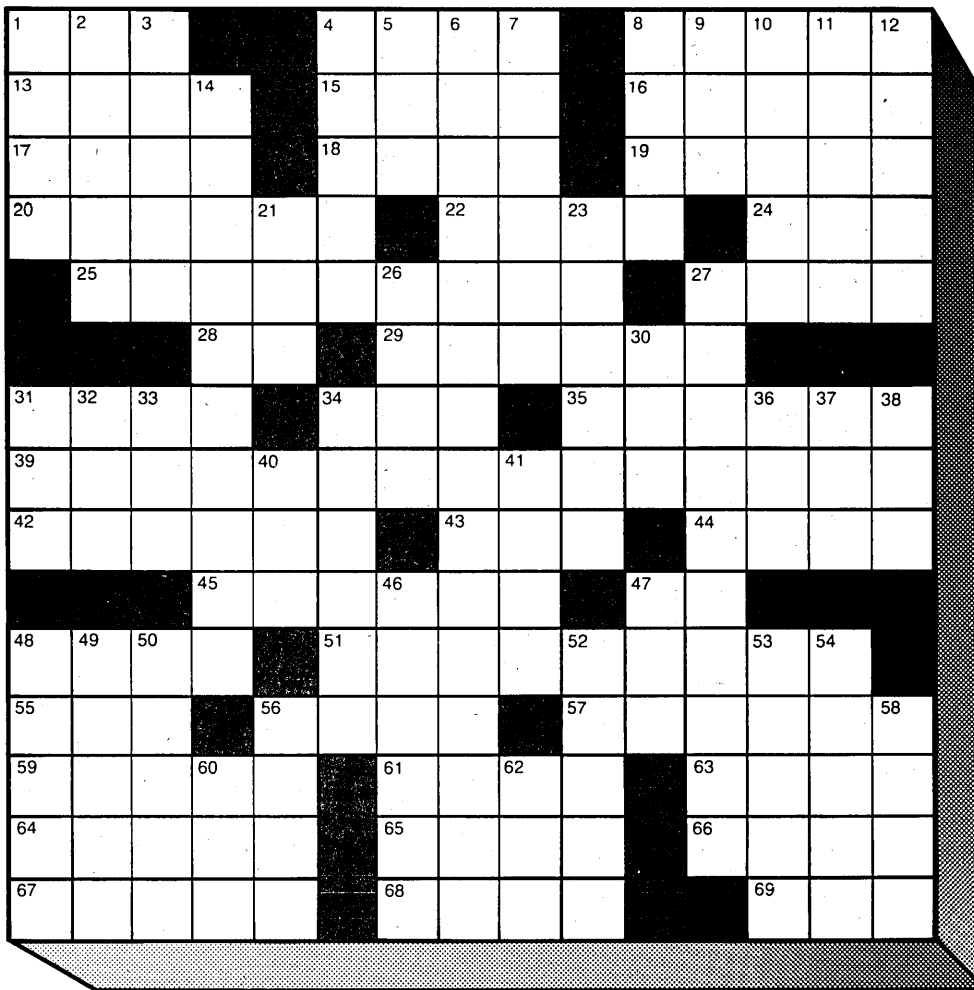

59. Tinge
61. Long-necked wading bird
63. Advantage
64. Pride, as Dante saw it
65. Withered
66. Abnormal breathing sound
67. I=N/O, e.g.
68. Peter or Nicholas
69. Not better than dead

DOWN

1. Ero, eras, _____
2. Strengthened

3. Hardhearted McKinley advisor
4. Embrace
5. Texas tea
6. Utilizers of 39 across
7. Here and there
8. Northern Scandinavian
9. Every
10. _____prayer
11. "_____, c'est moi!"
12. Injection of sorts
14. Activity related to 6 down
21. Corrode
23. "When a body _____"
26. Headgear for Mary Elizabeth Seton
27. Wall St. worrywart
30. Bugs Bunny addressee
31. IBM machine, pre-701 (abbr.)
32. Eureka!
33. Baloney, to an Englishman
34. One of the Three Graces
36. Genetic compound
37. Number system, for short
38. Golly!
40. Key toter's letter
41. Otherwise
46. Join
47. No _____, ands . . .
48. Be propitious
49. Circus employee
50. Vine-covered lattice
52. One who awakens
53. _____waxwing
54. Former Ronstadt backer
56. _____do-well
58. Convey
60. Baffle Bar sibling
62. Liberation group

Answer on page 272

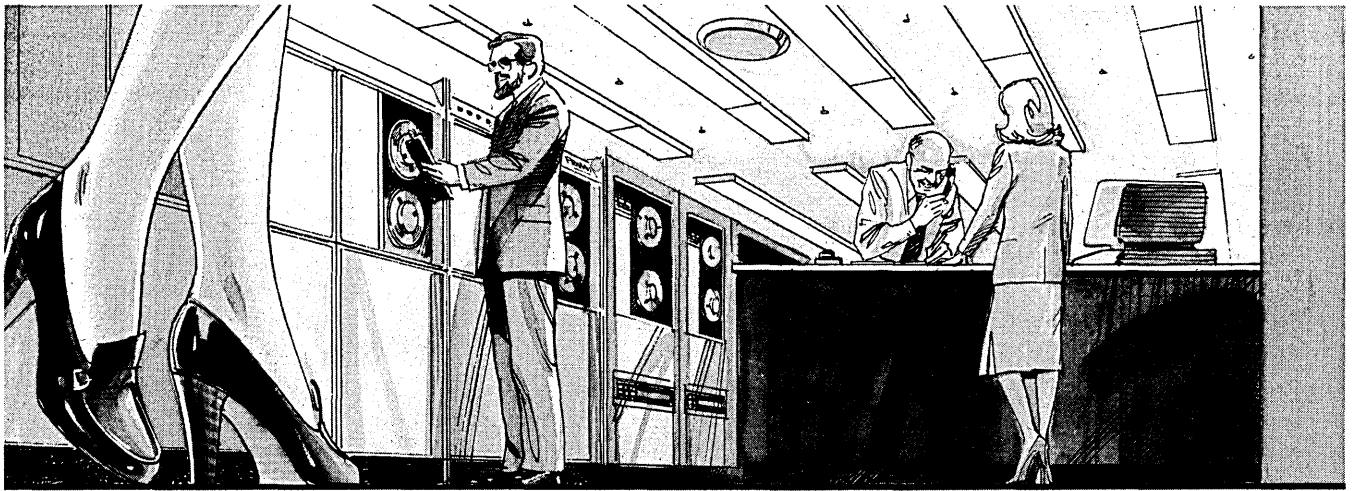

**Build your computer room
on a solid aluminum foundation**

FLOATING FLOORS

Accept no substitute.

(100% USA materials & labor)

There is only one Floating Floor System. And it's the only floor system specifically designed to overcome possible costly problems in computer rooms. For instance ...

- True infinite access is provided by completely stringerless assembly.
- Quick access to underfloor, anywhere, anytime.
- No chance of iron oxide particles entering air supply to play havoc with computer information.
- Static grounding is inherent in construction.
- Unequalled lightness, rigidity and strength.
- May be easily changed around or added to in the future.

To get complete details on why Floating Floors* are the best choice for critical computer room areas, send for our free brochure. A comprehensive AV presentation is available on request.

FLOATING FLOORS, INC., 795 Berdan Avenue,
P.O. Box 6627, Toledo, Ohio, 43612, Tel: (419) 476-8772

In Canada: Bruce (EDP) Services Ltd., 3650 Weston Rd., Weston, Ontario M9L 1W2, Telephone (416) 741-0854.

FLOATING FLOORS, INC.

*FLOATING FLOORS is a Registered Trade Mark of Floating Floors, Inc.

CIRCLE 177 ON READER CARD

FAULTY JOB TREND

Far too many dp shops have positions that require a combination of programmer and analyst duties. These positions have become more than a trend in dp employment—they are now a fixed pattern. Before these positions are set in concrete, there are points and assumptions that need to be examined.

Firms hire dp employees to complete workloads. Another significant aspect of managing and working with employees, rarely given anything but lip-service by dp management, is providing an atmosphere for career development and advancement.

Below are the major functional requirements for systems analysts and programmers. Consideration of these requirements can give some perspective on these two job roles.

The duties of a systems analyst include:

1. Investigation of facts and data which will lead to a clear identification of the problem.
2. People contacts and interviews to gather facts and data.
3. Ordered arrangement of facts and data.
4. Analysis of facts and data.
5. Creation of systems and procedures to solve, correct, and improve conditions.
6. Development of a statement of specifications for systems and procedures, or policy changes. Presentation of specs for review and discussion.
7. Modifications to the specs and/or systems design.
8. Obtain design and specs approvals.
9. Develop a time/cost schedule and plan for development and implementation of the system and procedures.
10. Design and develop detailed specifications for program modules.
11. Supervise programming and testing efforts.
12. Monitor implementation.

In the above functions the focus is: a. people, b. gathering of facts, c. analysis, d. design, e. specifications development, f. presentations, g. planning, estimating, and scheduling, h. supervision of implementation.

All of these functions look on dp as a tool to help provide solutions to business problems, rather than a study field to be mastered. The duties of a programmer include:

1. Given module specs, study for understanding, and clarify or modify.
2. Determine from the specs what the module is to accomplish and then plan how these functions can best be ordered, controlled, and coded.
3. Code instructions.
4. Obtain a clean compile of the program module.
5. Design a test plan and run files to test the module.
6. Develop the JCL proc to drive module testing.
7. Run the test proc, check output results to cover:
 - a. overall logic correctness
 - b. output files and reports generated for correctness
8. Use display, trace, and/or dumps as tools to identify and correct program bugs.
9. Continue to test until the module produces the correct functions and results.

The above listing shows that a programming job centers most heavily on exacting, specific details and their interactions, and is least concerned with conceptual analysis and design.

Programming is clearly associated closely with and deals most heavily with dp hardware/software technology. It also concentrates on improved mastery of dp technology as an end in itself.

People in dp management who believe that in order to qualify for systems analysis tasks you must first prove you are a hotshot programmer are supporting false assumptions. One such assumption is that outstanding programming skills indicate a capability for systems analysis. Another is that first-rate programmers make better systems analysts. Another is that attitudes toward programming carry over into systems analysis and are good predictors of performance in systems analysis.

It is necessary for dp management to get its head out of the sand and begin to recognize individual attitudes, desires, skills, and goals. Continued efforts to force employees to progress through the group viewpoint of programming jobs into systems analysis jobs into management jobs will be unsuccessful for management, for the companies, and for the employees.

—John Callahan
Terre Haute, Indiana

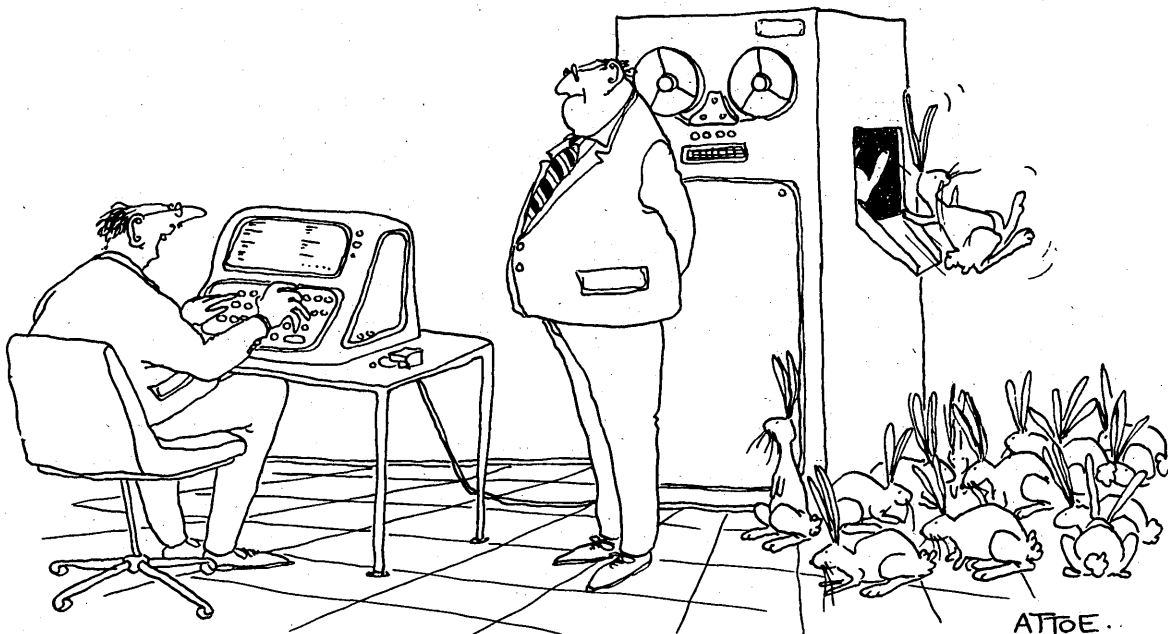

"Just doing a little multiplying, sir."

©DATAMATION

CARTOON BY STEVE ATTOE

MAKE YOUR SMART TERMINAL SMARTER.

Automatic Date/Time Entry. Simply install the SLC-1 Time Machine between your computer and terminal and it will automatically log the correct date and time of each transaction into your computer. The SLC-1 Time Machine will save you money, both in reduced operator time and the elimination of costly human errors.

The Time Machine contains a precision 24-hour clock and a 100-year self-correcting calendar that automatically adjust for leap years. Time and date functions include: hours, minutes, seconds, day, month and year.

But the SLC-1 is more than a clock. It constantly monitors the output from any computer and provides instant responses to a number of user-defined key

phrases. This makes it ideal for use with unattended process control or data acquisition systems. And since the Time Machine is a 6502 microprocessor system, it adds computing power to any terminal.

The Time Machine is easily installed without modification to your operating system. Both RS-232 and 20mA current loop serial link are provided. And because it's battery-supported, the time will always be correct, even after a power failure.

The single quantity price is only \$640. Ten-digit display option, \$190. For more information or literature on the SLC-1 Time Machine, contact Digital

Pathways, Inc.,
1260 L'Avenida,
Mountain View,
California 94043, or
phone (415) 969-7600.

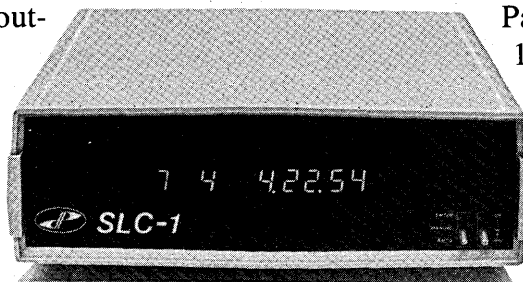

GET INTO THE TIME MACHINE.
DIGITAL PATHWAYS

CIRCLE 180 ON READER CARD

TALK TO GTE ABOUT TECHNICAL CAREERS IN PHOENIX!

At GTE Automatic Electric Laboratories in Northlake, Illinois, talented engineers are developing advanced digital telecommunications systems which are at the forefront of technology. To ensure our continued role as a leader in meeting the technological challenges of the future, we are moving our Switching Division in 1980 and 1981 to Phoenix, Arizona where a new research and development facility is currently under construction. Combined with the relaxed lifestyle in the Valley of the Sun, this highly sophisticated laboratory will provide software and hardware engineers with an ideal working environment thoroughly conducive to creativity and innovation.

You can take advantage of immediate opportunities in Phoenix or join our Northlake staff and make the move in 1981. As the nation's third largest electronics center, Phoenix is an ideal place for ambitious professionals seeking career opportunities in the following areas:

DEVELOPMENT SUPPORT SOFTWARE

Responsible for the development of tools which aid and support the software design of advanced digital telephone systems. Programming experience in PL/1 is desired.

ON-LINE RECOVERY AND DIAGNOSTIC SOFTWARE

Design of on-line recovery and diagnostic software to automatically identify the occurrence of a hardware fault, reconfigure duplicated and/or redundant hardware into a fully operational system configuration, and automatically localize the fault. Experience with recovery or diagnostic software is desired in such areas as CPU's, Common Memories, I/O, Digital Network Complex or Line and Trunk facilities.

CALL PROCESSING AND ADMINISTRATION SOFTWARE

Involved in all areas of telephone switching control software, switch and network traffic overload management software, and system initialization and status control software in a real-time environment.

OPERATING SYSTEMS SOFTWARE

Responsible for task scheduling, input/output status control and message handling software on a real-time operating system.

DATA BASE ADMINISTRATION SOFTWARE

Responsible for data base administration development for advanced digital systems. Will perform both logical and physical data base design.

TEST UTILITIES SOFTWARE

Involved in design and software implementation of an automated computer based test system to be used in system evaluation and testing of laboratory prototypes and systems at initial site locations.

SYSTEM TEST AND CONTROL

Responsible for the system evaluation and test of large stored program switching systems, involved in development and execution of comprehensive system and performance tests in the laboratory and field. Execute configuration management and control of all hardware, software and documentation.

If you have a degree in Computer Science, Electrical Engineering or a related discipline, GTE can help you create the future you're looking for. We offer excellent salaries, a complete benefit package, and a professional environment that encourages and recognizes excellence. For immediate consideration, call collect (312) 681-7730 or send your detailed resume to Manager, Technical Employment, Dept. 471A-6, GTE Automatic Electric Laboratories, 400 N. Wolf Road, Northlake, IL., 60164. An Equal Opportunity Employer M/F.

GTE AUTOMATIC ELECTRIC LABORATORIES



Research and
Development

FORUM

HARDCORE HARDWARE

Public concern over technology's role in modern life finds weighty and diverse issues: the safety of nuclear power plants, the ecological impact of pesticides, and whether or not Grenada has the bomb. Along with these larger worms in the fruit from our chrome commu-copia of high technology, there is a less well-known but equally important development which deserves our attention.

Recall the last time you visited your local games emporium to purchase an electronic diversion for a youngling. There was that fellow in the corner with the sweaty palms and glazed eyes artfully putting the resident microcomputer through a strategic first strike on the Andromeda Galaxy. He seemed just the ordinary boy down the block keeping the universe safe from the Tworks, but he was, in fact, a hard core technology addict getting his daily hit of the "soft stuff." His apparently harmless exercise in electronic escapism was really a ritualistic integrating with the computer known among devotees as "getting connected." Yes, your erstwhile space con-queror was one of a growing subculture of hard- and software habi-tués who are giving a new meaning to the term technological fix.

These technology junkies are otherwise normal individuals who have developed a pathological fascination with things, usually plastic and aluminum, that go blip in the night.

The origins of technology addiction are not well understood. Scholars of the classics say the ancient Greek Icarus with his ill-fated flight was the first to experience the burning passion of technology addiction. Professors of the Romance cultures, however, point to Leonardo da Vinci and his numerous inventions as the start of the phenomenon. Biologists consider technoholics to be the vanguard of a beneficial mutation that is evolving homo sapiens into homo technologicus. Psychologists counter that technology addiction is a condition endemic to modern society, and is fostered from the cradle, where such infant attractions as sculpted mobiles plant the seeds of the hardware habit.

Physics and engineering professors don't care about the roots of the condition as long as they can obtain as many of the tech addicts as possible for their departments.

The manifestations of technology addiction are as varied as the theories concerning its origin, and terminal technophiles can become enamored with all manners of mechanical devices. Of course electronic games and home computers are practically software seizures waiting to happen, and many a FORTRAN freak has suffered temporary sensory overload during lost weekends at home computer fairs.

But consider the case of the innocuous price scanners that are turning up in local supermarkets, and are becoming popular objets de technologie. The word quickly spreads among the scan-head cults as to which supermarket fare produces the most exciting displays—crimson rows of sparkling digits—on the scanners at the checkout counters.

PHOTO COPY ADDICTS

Probably the most interesting cases of technology addiction, however, involve an affinity for photocopy machines. Hardcore dupers provide some of the most bizarre studies in technoholism.

Most doppelphiles are hooked on photocopying for the visceral thrills. They roam from library to library, seeking the perfect copy like ozone intoxicated surfers searching for the perfect silver oxide wave. There are a small group of dupers, though, who are more interested in the metaphysical aspects of the electronic reproductive system. Known as Xen Impressionists, they believe that by creating more and more detailed paper replicas of themselves, they can transfer the baser aspects of their nature to their doppelganger, and achieve a state of absence of desire known as Plain Paper Paradise. In a particularly colorful ceremony called "Roxing Out," these

FINALLY, A SMART TERMINAL THAT DOESN'T SACRIFICE FORM FOR FUNCTION.

Bright, crisp, non-glare CRT is easy on the eyes.

Standard 25th status line lets you know what's happening as it's happening.

You have 16 function keys right at your fingertips, operable in shifted and non-shifted modes.

Sculptured, typewriter-style keys are smooth, responsive to the touch.

Displayed data can be enhanced with a wide choice of video attributes.

Reliable operation up to 19,200 baud.

Cursor control keypad is compact, easy to use, with centrally located home key.

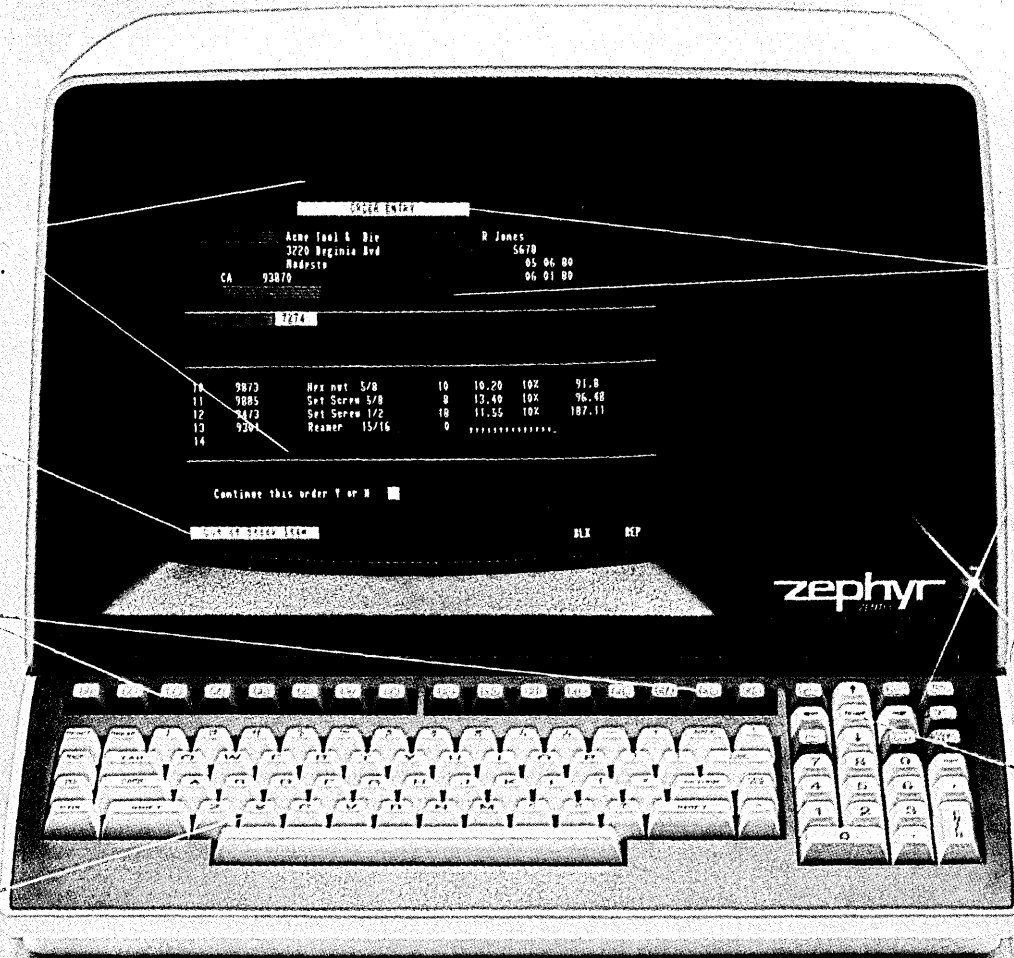

THE ZEPHYR™ BY ZENTEC.

There's really only one way to appreciate our new Zephyr. On the seat of your pants.

Go ahead. Sit down and touch test the Zephyr's typewriter-style keyboard. It's positive, yet responsive to the touch. And it's laid out for operator convenience. Above the standard 96 ASCII keys you'll find 16 function keys that operate in both shifted and unshifted modes. To the right, there's a compact numeric keypad and a cursor control pad with centrally positioned home control, both functionally designed to help you process more data, more efficiently.

The keyboard's not our only stroke of genius, though.

Zephyr's CRT is a sight for sore eyes, too. The large 12" non-glare video display incorporates a high resolution P-4 phosphor that makes it easier for you to work with words. You can quickly address two full 1,920 character pages of video display and enhance displayed data with a choice of video attributes including dim, blink, blank, reverse video and underscore.

Zephyr functions in both conversational and block modes, too, so you can transmit data with each keystroke, or transmit only unprotected data within a protected form, greatly improving your system throughput. And because

Zephyr is a product of Zentec experience, you are assured of reliable performance, day in and day out. Year after year. You have our word on it.

Isn't it time you found out how much more our Zephyr can do for you and your CPU? Just call your nearest Zephyr distributor and ask for a demonstration. He's listed below. Or call us at (408) 727-7662 and ask for Ted Atlee. It could be one of the smartest moves you've ever made. Zentec Corporation, 2400 Walsh Ave., Santa Clara, CA 95050.

ZENTEC

... the last word in intelligent terminals

Sales Offices: Santa Clara, CA (408) 727-7662; Carson, CA (213) 324-1155; Long Grove, IL (312) 634-9550; White Plains, NY (914) 428-2801; Bernardsville, NJ (201) 766-2403; Boston, MA (617) 935-4511; Rockville, MD (301) 762-7990; Richardson, TX (214) 690-9265; Authorized Distributors: ADL Enterprises Inc., Wharton, NJ (201) 328-1300; Comspec, Inc., Houston, TX (713) 461-4487; David Jamison Carlyle Corporation, Los Angeles, CA (213) 277-4562; Leasametric, Inc., Foster City, CA (800) 227-0280; RC Data, Santa Clara, CA (408) 988-7510; Zygol Dynamics, Ltd., Chesham, England (02405) 75681.

CIRCLE 178 ON READER CARD

Mobil

COMPUTING ENGINEER

MOBIL RESEARCH AND DEVELOPMENT CORPORATION has a challenging opportunity at its Exploration and Production Research Laboratory in DALLAS, TEXAS for a Computing Engineer. Applicant must have ability to analyze, plan, and implement hardware, software, and communication changes in a large-scale scientific computer center.

MS or BS in Electrical Engineering or equivalent with 3-5 years of experience is required. Applicant should have further skills to evaluate and recommend, minicomputer based research equipment and software requirements for research and development projects. Good oral/written communication skills are necessary to insure that the incumbent can effectively interact with computer center clients and PhD scientists.

For immediate consideration, send resume and salary history to:

Roy E. Lee
Mobil Research & Development Corp.

Post Office Box 900
Dallas, Texas 75221

EQUAL EMPLOYMENT OPPORTUNITY M/F



WORLD HEALTH ORGANIZATION

invites applications from experienced programmer analysts interested in working in a team providing data processing support to a multidisciplinary group conducting large scale clinical trials and behavioral science research.

Applicants' qualifications should include:

- university degree, preferably in computer science, statistics or mathematics, or equivalent experience;
- recent experience in analysis and advanced programming, preferably in PL/I and in scientific environment;
- knowledge of statistics plus familiarity with SPSS, SAS and BMDP;
- experience in a large IBM (370, 3033) TSO working environment;
- an excellent knowledge of English or French (working knowledge of the other language would be a definite asset).

Interested and qualified applicants should send a detailed curriculum vitae to:

Chief of Personnel
World Health Organization
1211 Geneva 27 Switzerland

quoting the reference "EDP Vacancies—1980".
An equal opportunity employer (M/F)

Only candidates under serious consideration will be contacted.

FORUM

Xerox zealots attempt to photocopy the entire outside of their bodies in the fewest possible passes through the machine.

A common thread through all strains of technology addiction is that the transition from technological innocent to hardware habitué is so gradual, it is almost imperceptible. A typical scenario:

The victim begins with some harmless pastime like trying to defy entropy by dismembering and reassembling alarm clocks. A random Christmas present initiates the unsuspecting individual into the world of electronics or personal computers, and spare hours are spent in the pursuit of the optimal feedback circuit or the ultimate backgammon algorithm. The next step might involve the computer coding of all worldly possessions, and the production of running resource inventories in base 17 arithmetic. Family members become suspicious when the victim spends large amounts of time developing devices which attach to the head and purport to convert unused grey matter to convenient calculator storage registers.

At this stage a particularly virulent form of neurosis known as dry cell madness may set in. The main symptom of this affliction centers about the victim's belief that spiritual fulfillment comes only in sizes D, C, and penlight. Other signs of the malady include a refusal to eat any foods not prepared in a microwave oven. The standard treatment for advanced cases of battery blight prescribes regular attendance at erotic film festivals.

Tech junkies have their own set of cult figures. Among technophiles the latest exploits of Escalator Emerson or the Sole-noid Kid are subjects of popular discussion. But by far the most famous hero in the pantheon of technology addicts is Gigahertz Grogan, the Whistling Dude.

According to legend, the Dude was a computer operator for a large government data processing installation outside Washington, D.C. During the interminable graveyard shifts he pulled in his entry level capacity, the Dude developed the ability to communicate with his computer by whistling into its telephone link. Soon he was able to bypass the usual formalisms of programming languages and job control structures and commune with the very heart of the beast. He found that by applying the basic principles of frequency modulation he was able to converse with any computer from the humblest micro to the most formidable number-cruncher. This extraordinary ability made him a systems Dr. Doolittle.

Grogan quickly realized his talent was a marketable commodity and he became a freelance computer troubleshooter. As his fame and prowess grew, the military learned of his gift, and pressed him into service as a technical specialist in counterintelligence. A painful experience with a defecting East German minicomputer, however, left him a burnt-out case.

Now Grogan wanders about shopping centers searching for his lost powers among the credit card verifiers and midnight banking units. He whistles an occasional ticket from airline booking computers to get around, and repays their largess by catching an incipient system crash or expunging a stubborn program bug. Sometimes he just provides a therapeutic ear to whistle in for some overtaxed multiprocessing module.

His rapport with the electronic beasts is held in awe by tech addicts everywhere, and often when a tech junkie is working on a computer late at night, and his programs are inexplicably saved from a sudden fatal power cutoff, he will murmur softly to himself in reverential tones, "The Dude must be whistling tonight."

—John A. Kogut
New Carrollton, Maryland

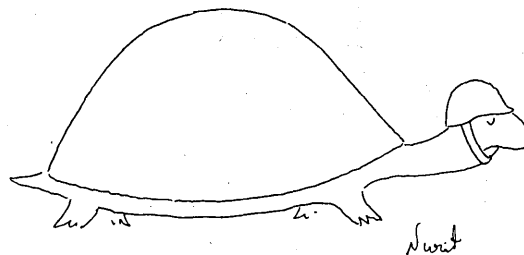

SUPERSTAR

Infotron's New Data PBX

Top performance in any data network! To the user it means quick connection to any resource with no hassles. To the network manager it means system flexibility and control. Infotron's new TL460 easily meets the demands of both.

The TL460 allows terminal users to access any port on any computer. If no port is available the TL460 queues the callers. It even tells them why they weren't connected and their place in line. The hassle of having to radial—a complaint when ports are busy—is eliminated.

The network manager will find the TL460 flexible enough to meet ever changing conditions. It handles up to 2000 simultaneous connections, even if all are operating at 9600 bps, and provides 256 different classes of service. System parameters, such as class assignments, busy messages, connect criteria and disconnect criteria, *all can be changed from the console!*

The TL460 is not limited to certain data types or speeds either. Any combination of synchronous and asynchronous inputs from 110 to 19200 bps is perfectly okay. To help guarantee good service, the TL460 provides a wealth of options such as successful and unsuccessful access attempts, the port address, 100% time to queue, and more.

For more information on the TL460, contact Infotron at 10000 Wilshire Blvd., Suite 1000, Beverly Hills, CA 90210. (310) 274-1100.

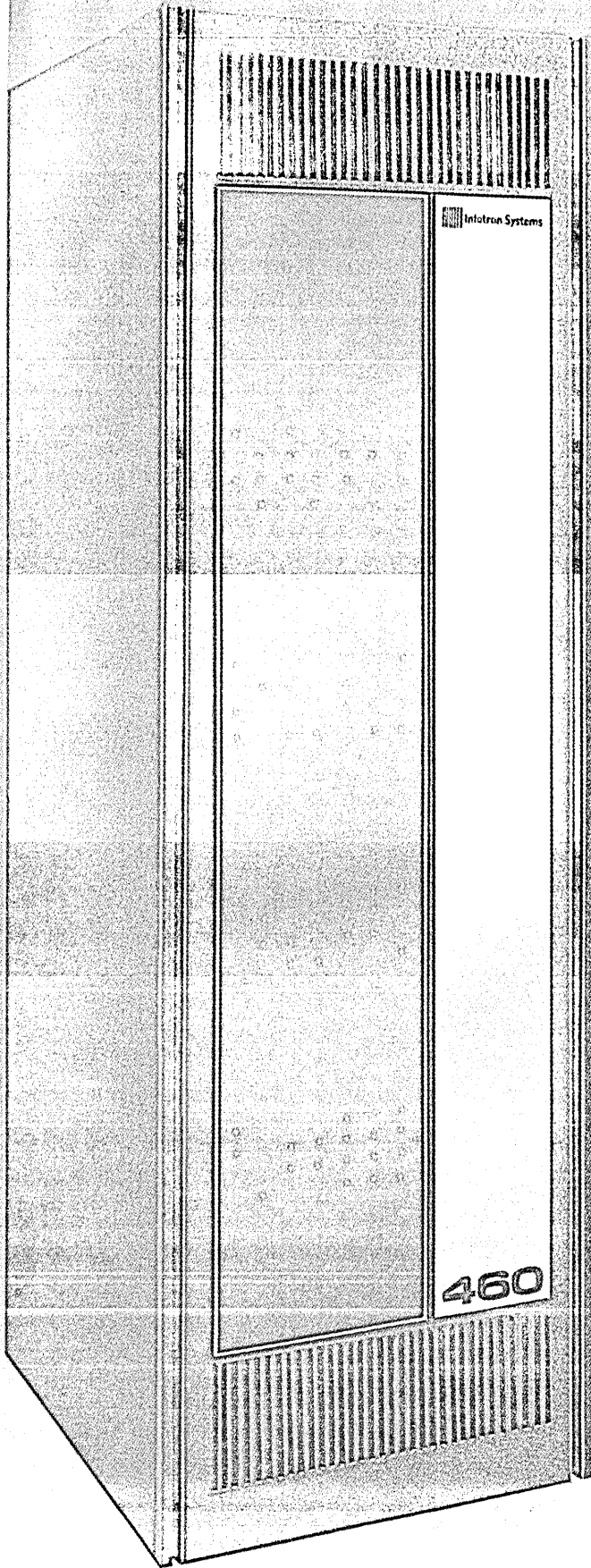

Software/Hardware MIS Professionals

New England/ East Coast/
Nationwide

Robert Kleven and Co., Inc. has a wide variety of positions available in Programming, Systems Analysis/Design, Data Base Applications, Applications Programming, Compiler Development, Language Design, Hardware/Firmware Design, for professionals well versed in their field and are with some of the top companies in the industry. If your experience covers one or more of the following areas at the state-of-the-art level, contact us: Software Design and development; Technical Support; COBOL/IMS; Computer Sciences; Assembly or Higher Level Language Programming; Data Base Design; Compilers, and/or Operating Systems Design; Digital Logic Design; Interface Design; Technical Writing; Microprocessor Utilization; Computer Architecture.

We've been providing confidential and industry-knowledgeable placement for, software/hardware/MIS professionals since 1969. We can also provide you with free resume preparation and career path counseling. Client companies assume all fees.

RK Robert Kleven and Co., Inc.
INDUSTRIAL RELATIONS MANAGEMENT CONSULTANTS

Three Fletcher Avenue, Lexington, Massachusetts 02173
Telephone (617) 861-1020

Member:
Massachusetts Professional Placement Consultants
National Computer Associates
(Office Nationwide)
Representing Equal Opportunity Employers M F

CIRCLE 184 ON READER CARD



REQUIRED BY THE FOOD AND
AGRICULTURE ORGANIZATION OF
THE UNITED NATIONS, ROME,
ITALY:

ANALYST/PROGRAMMER (SPECIAL SOFTWARE)

To run the basic operating system, adapt basic software to support expanding use of data base and communications oriented applications, select appropriate new basic software and packages and give technical advice to users. Present installation (IBM 370/148 operating under OS/VS1 with CICS, VM/CMS and ancillary software packages); addition of an IBM 4341 with suitable software environment enabling multi-processing is planned.

ESSENTIALS: University degree in computer science or related discipline. Minimum 5 years experience primarily as operating systems specialist; thorough knowledge of large scale IBM 370 series computer (hard- and software) preferably with experience in OS/VS1. Languages: fluent English, French and/or Spanish; basic Italian desirable.

SALARY: from US \$24,170 p.a. net tax-free plus the usual allowances of the International Civil Service. Please send detailed curriculum vitae quoting "VA 929-AFM-DM" to: FAO, Central Recruitment, Rome, Italy.

CIRCLE 185 ON READER CARD

FORUM

TAILOR TO FIT THE TASK

Eliciting the active support of users is generally an ongoing problem for dp installations. A cooperative atmosphere, mutual respect, adherence to promised due dates, and consistently well-designed and programmed systems are but a few factors in gaining support. Not emphasized often enough by dp personnel, however, is the importance of adequate systems documentation, i.e., a user's manual. Not only does a user's well-written manual have obvious technical advantages to proper use of the system, but there is a good possibility it will improve user relationships.

Systems, programming, and documentation standards may be imposed on the internal dp organization. Standardizing the nature, scope, and style of the user's manuals represents a more difficult problem. There are many characteristics of the user and the system which must be evaluated to determine the orientation and level of technical detail. A few are:

1. Size of system. A very small system may not require a manual; a memo describing the input, output, and procedures may be adequate. A manual should not make the system seem more complex than it is. Conversely, more than one manual, each orientated to a different level of user skill, might be advantageous. The input and information needs of a corporate inventory control group, for example, might be different than those required for a shipping clerk at the warehouse dock.

2. Complexity of the system. In the case of a complex system, using advanced formulas and algorithms, it might be beneficial to generate two manuals, one describing just input and output procedures, and the other containing the detailed logic and formulas used in calculations.

3. Level of understanding required by the user. It may not be necessary to educate the user with all the dp or complex logic aspects of the application. As long as this information is documented somewhere, it need not be calculated in the manual.

4. Level of user understanding. Since the purpose of the manual is to provide a readily available reference document, generating a highly technical document may cause the user to shy away from its use. Dp and advanced applications descriptions are better placed in other support documents, not in the user's manual itself.

Once the orientation of the manual has been established, there are four basic guidelines to its preparation. First, great care must be taken to ensure the manual remains a reference. A user's manual is not a novel to be read from cover to cover. It will more likely be used to look up information on a particular input transaction or output report.

Secondly, the manual must be technically accurate whether or not formulas and detail logic are included. The subset information contained should be consistent with the total sophistication of the system. Make sure the system really does what the user's manual indicates it will.

Thirdly, delete as much technical terminology as possible. The user's manual is not often used by the head of a department, but rather by the clerical staff who generate the transactions. Dp terminology should be eliminated.

Fourth, and perhaps most commonly overlooked, the manual must be grammatically correct. Not only can poor grammar and syntax lead to misinterpretation and ambiguities, but they can also repel the user before he has obtained the needed information.

The organization and content of the user's manual cannot be completely standardized due to the above four factors. Assuming the application is large enough to require a manual rather than a memo, the following outline may be used as an organizational guideline:

1. Purpose and organization of the manual. This section provides an opportunity to sell the user aspects of the manual system

Does Your Company Produce Catalogs?

We'll Cut The Size, Weight, Delivery Time and Cost!

Catalog Produced by Conventional Printer (the old way)

Same Catalog Published by O'Neil Data Systems

*600 Page Catalog, Weight: 3 lbs.
Delivery time: 2 to 3 Weeks*

*275 Page Catalog, Weight: 1 lb.
Delivery Time: 4 Days*

IF YOUR COMPANY PRODUCES PRICE CATALOGS, inventory lists, parts manuals, schedules, internal telephone directories, library catalogs, reference and instruction material, membership or registration lists, we can save you substantial money and delivery time.

If you have large numbers of items in a computer you need to print and distribute on a recurring basis, **JUST SEND US A MAGNETIC TAPE AND WE'LL DO THE REST:**

- Innovative catalog redesign and data organization. Reduction of weight, space and number of pages. Format changes and error corrections. Automated printing and fast mailing to your distributors or mailing lists. In the example above, \$1.00 per book is saved alone on 1st Class Postage between Los Angeles and Chicago.
- Your product will look better and be easier to use. You'll save even more money because our shorter delivery time gets price changes to your dealers faster. (Time means Big Money during inflationary periods.)
- You will avoid delays and headaches related to internal priority and approval problems when you want to make changes to your catalog. Changes that require your computer staff to alter their programs. We have 12 Systems Programmers and make such changes in a few hours.

- O'Neil Data Systems has two large scale computers driving Advanced Computer Output Microfilm and Phototypesetting equipment plus our own automated printing facility; all on the premises. We don't ship out or subcontract any phase of your job. This means we do your job faster and at less cost to you.

• WHOSE CATALOGS DO WE PUBLISH?

Beckman Instruments, Inc.	Pacific Telephone and Telegraph
BMW Motor Co. North America	Peterbilt Motors Company
Burroughs Corporation	Real Estate Digest
Century 21 Real Estate	San Diego Unified Schools
Computer Sciences Corporation	The Service Bureau Co. (Control Data)
Walt Disney Productions	Telecredit, Inc.
Fiat Motors of North America	Toyota Motor Sales, U.S.A., Inc.
Foremost McKesson, Inc.	United Stationers
General Dynamics, Convair Div.	University of California
American Honda Motors Co., Inc.	U.S. Suzuki Motor Corporation
Kahan & Lessin Co.	Volkswagen-Porsche-Audi
Kawasaki Motors Corp., U.S.A.	Volvo of America Corporation
Department of the Navy	Yamaha Parts Distributors, Inc.

WHY NOT LET US BID ON YOUR NEXT PRINTING CONTRACT?

Tell me more about saving money and time with your **Faster 4-Day Service.** DM-09-80

Name _____

Title _____

Phone _____

Company _____

Street _____

City _____

State _____ Zip _____

O'NEIL DATA SYSTEMS, INC.

2005 Armacost Avenue • Los Angeles, California 90025 • Telephone: 1/213/879-0830

JUST SEND US A MAGNETIC TAPE — WE DO THE REST!

**UNIVERSITY OF PETROLEUM & MINERALS
DHAHRAN, SAUDI ARABIA
COMPUTER SCIENCE DEPARTMENT**

THE DEPARTMENT OF SYSTEMS ENGINEERING WILL HAVE FACULTY POSITIONS IN COMPUTER SCIENCE OPEN FOR THE ACADEMIC YEAR 1981-82, STARTING 1 SEPTEMBER 1981:

ACADEMIC QUALIFICATIONS AND EXPERIENCE:

PHD IN COMPUTER SCIENCE OR IN A CLOSELY RELATED DISCIPLINE WITH EMPHASIS IN PROGRAMMING LANGUAGES, DATA BASE-ORGANIZATION AND STRUCTURE, MICRO-PROCESSORS, OPERATING SYSTEMS, DATA PROCESSING, SYSTEM ANALYSIS, DIGITAL DESIGN, COMPUTER ARCHITECTURE, AND SOFTWARE ENGINEERING.

LANGUAGE OF INSTRUCTION IS ENGLISH.

MINIMUM REGULAR CONTRACT FOR TWO YEARS, RENEWABLE. COMPETITIVE SALARIES AND ALLOWANCES. AIR CONDITIONED AND FURNISHED HOUSING PROVIDED. FREE AIR TRANSPORTATION TO AND FROM DHAHRAN EACH YEAR. ATTRACTIVE EDUCATIONAL ASSISTANCE GRANTS FOR SCHOOL-AGE DEPENDENT CHILDREN. ALL EARNED INCOME WITHOUT SAUDI TAXES. TEN MONTHS DUTY EACH YEAR WITH TWO MONTHS VACATION WITH SALARY. THERE IS ALSO POSSIBILITY OF SELECTION FOR UNIVERSITY'S ONGOING SUMMER PROGRAM WITH GOOD ADDITIONAL COMPENSATION.

APPLY WITH COMPLETE RESUME ON ACADEMIC, PROFESSIONAL AND PERSONAL DATA, LIST OF REFERENCES, PUBLICATIONS AND RESEARCH DETAILS, AND WITH COPIES OF TRANSCRIPTS AND DEGREES, INCLUDING HOME AND OFFICE ADDRESSES AND TELEPHONE NUMBERS TO:

**UNIVERSITY OF PETROLEUM & MINERALS
HOUSTON OFFICE
2223 WEST LOOP SOUTH, SUITE 410
HOUSTON, TEXAS 77027**

CIRCLE 187 ON READER CARD



**Systems
Supervisor
COLORADO SPRINGS**

Colorado Interstate Gas Company has immediate need for a Systems Supervisor to guide the activities of programmers & analysts in the definition, design, development and implementation of EDP business systems. New systems to be developed will require heavy user interface, in addition to systems design for large scale IBM hardware using a DBMS. Six to ten years of oil & gas experience is a must (gas transmission company preferred). An advanced degree highly desirable. Successful applicant will possess excellent written & oral communication skills and extensive knowledge of oil & gas measurement & accounting systems.

Qualified candidates may call COLLECT (713) 877-6302, or send resume with salary history to Mr. Cal Brummett, THE COASTAL CORPORATION, Nine Greenway Plaza, Houston, Texas 77046. We are an equal opportunity employer m/f.



**Colorado Interstate
Gas Company**
A Subsidiary of
The Coastal Corporation

CIRCLE 188 ON READER CARD

FORUM

and dp department. Particularly if this approach is a significant departure from past documentation styles, it might be beneficial to point out the reference nature of the manual.

2. Table of contents. Again, impress on the user the efforts taken to create a manual designed to be easy to use.

3. A narrative describing the system. This might include a brief historical perspective of the evolution of the system and an overview of the basic modules. The system should not be described in terms of jobs or programs, but rather in functional or transactional flow.

4. Input.

a. Narrative describing the purpose and effects of each transaction. Let the user know, in English, what a transaction does.

b. Definition of the fields, including how to enter the data (justification, zero-fill, etc.)

c. Editing criteria (must be numeric, must be valid accounts, etc.). Drawing a simple chart to show editing criteria in a quick reference manner can also be beneficial to the reference orientation of the manual (Table I).

d. Files and fields affected. In cases where a transaction may update more than one field on file, describe how a user can save considerable confusion and subsequent maintenance errors.

e. Examples. Demonstrate different uses of this transaction.

5. Output. It is often advisable to have two subsections, one for "action reports" and the other for "information reports." In action reports, the user is directly responsible for supplying some sort of response, such as fixing errors on the audit and error reports. Information reports are supplied for information (service levels, statistical summary, etc.) and, unless discrepancies are detected, require no further action.

a. Narrative describing purpose and use of the report.

b. Definition of all fields on the output document. While many fields appear to be self-explanatory, they may not be in the eyes of the end user. A date on the top of the report, for example, might be derived from a control card, from the communications region of the cpu, or from a file.

c. Description of required control totals, balancing techniques, and error correction. The manual should not only

Answers to puzzle on page 264

E	T	H			C	O	C	A		L	A	D	L	E		
R	O	A	R		L	I	A	R		A	L	I	E	N		
A	N	N	A		A	L	T	O		P	L	A	T	E		
T	E	N	S	E	S		H	U	M	P		L	A	M		
			D	A	T	A	P	H	O	N	E		T	A	T	A
							E	T		A	D	D	E	D	A	
C	A	R	R		T	L	E		T	O	P	D	O	G		
P	H	O	S	P	H	O	R	E	S	C	E	N	C	E		
C	A	T	C	H	A		A	L	A		R	A	T	E		
			A	I	L	E	Y	S		I	E					
S	T	A	N		I	N	T	E	R	F	A	C	E			
M	A	R		N	A	L	U		I	S	D	E	A	D		
I	M	B	U	E		I	B	I	S		E	D	G	E		
L	E	O	N	E		S	E	R	E		R	A	L	E		
E	R	R	O	R		T	S	A	R			R	E	D		



MANITOBA TELEPHONE SYSTEM

DATA PROCESSING OPPORTUNITIES

These challenging data processing opportunities will place you in an environment that includes IBM mainframes, distributed processors and an array of mini/micro processors. Projects range from business applications to those involved with delivery of new telecommunications services. Some typical opportunities are:

PLANNING, RESEARCH AND DEVELOPMENT MANAGER.

Your management skills will be applied to strategic and operational planning for data processing technology including the R. & D. role. Your ten or more years experience will include mainframe, mini and micro architectures. You will be knowledgeable of data processing trends, particularly in distributed data processing, Videotex and advanced office systems. Telecommunications orientation an asset.

DATA ADMINISTRATOR

In this opportunity you will implement data resource management concepts throughout the System. You will organize and manage a small technical and analytical resource team that will identify data requirements, develop strategic plans and policies related to collection, storage and access of data, data base design and implementation support. Your experience will have included a key role in implementing the data administration function. You will have superior interpersonal and communication skills.

TECHNOLOGY CONSULTANT

In your capacity as a Senior Consultant you will be responsible for the research and development of new technologies in the area of integrated data processing. Your background will be strong in research, planning and application of systems technology and your experience will include any of: Videotex, advanced office systems, computer graphics, distributed data processing and data administration.

The **MANITOBA TELEPHONE SYSTEM**, a Crown Corporation since 1908, provides a wide range of telecommunications services to the entire Province of Manitoba. The System is committed to keeping up to date with extensive technological change in an industry which requires highly skilled people to meet this challenging and changing environment. If you see your next career opportunity listed here or are a professional looking for challenge and growth why not call collect to: HELEN SEARLE, Systems Application and Architecture Manager, at (204) 947-8309 or send a resume to Gary Horn at the address below indicating your current and expected salary and the position of particular interest to you. Salary Negotiable—Attractive Benefits.

**EMPLOYMENT OFFICE, MANITOBA TELEPHONE SYSTEM
P.O. Box 6666, WINNIPEG, Manitoba R3C 3V6**

These positions open equally to women and men.

*Future Growth will enable more expanded opportunities.
If you are interested in discussing your next career move, please
call collect or send a resume.*

THE QUEST FOR FAME AND FORTUNE

— and how to avoid self-defeating impulses.

In computer and information sciences today, the temptation to make a series of "quantum leaps" from company to company can be hard to resist.

And with scores of the finest companies retaining Quest (and paying us well) to bring people like you to them, you'd think we'd have every reason to encourage you to jump—regularly.

But you'd be wrong. And so would we.

Introducing you into a technical environment of bona fide upward mobility is the answer. That's why we are not, and never will be, a duplicating machine operation.

A thorough-going, highly individualized matching service is what we provide. At no charge to you.

For more than a decade, it has worked well for us, and for our client companies in the computer industry from coast to coast.

It will work as well for you.

Call toll free or write in strictest professional confidence.



(800) 821-7700, Ext. 114

QUEST SYSTEMS INC.

"Computer Industry Placement Specialists Since 1968"

6400 Goldsboro Road, Dept. 300, Washington, D. C. 20034 • (301) 229-4200
Baltimore: (301) 788-3500 • Philadelphia: (215) 265-8100

CIRCLE 190 ON READER CARD

THE ANSWER TO COMPUTER POWER PROBLEMS

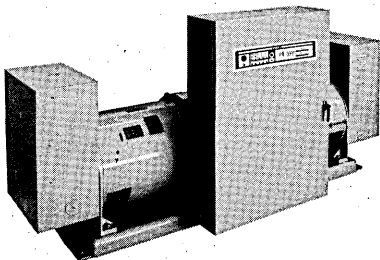

The **POWER CONDITIONING SYSTEM** . . . An energy efficient synchronous motor generator system that eliminates power-related computer problems. The Computer Products Division offers a money-back guarantee against all power quality related problems such as sags, surges, transients, brown-outs, and up to 500 milliseconds of total black-outs!

Sweinhart offers the most technically advanced Power Conditioning System available . . . at any price! The System II, 15 to 219 KVA, utilizes a digital read-out system and a System Status Panel that provides a central location for essential read-out information . . . for both the status of the computer system's power and the facility's safety systems.

Outstanding Features:

- A 5 year limited warranty on motor generator (an industry first).
- Digital Status Panel • Money-back guarantee • 6 to 8 weeks delivery • Priced at the lowest cost per KVA in the industry.

For complete information, call or write Richard N. Bowyer



COMPUTER PRODUCTS DIVISION

2900 East Olympic Blvd., Los Angeles, CA 90023
(213) 264-1521

CIRCLE 191 ON READER CARD

FORUM

TABLE I
TRANSACTION CODE: REC
EDITING CRITERIA

INPUT	Must be numeric	Must be numeric or spaces	Must not be spaces	Must be valid code	Must be on item master file
Date submitted	X				
Division code				X ¹	
Shipment number	X				
Sending location				X ²	
Receiving location				X ²	
Item number	X				X
Quantity shipped		X			
Quantity received		X			
Receiving clerk			X		

¹See table of Valid Division Codes in Appendix A

²See table of Valid Location Codes in Appendix B

TABLE II

ERROR MESSAGE	AREA	DESCRIPTION
Shipment number not found		The shipment number referenced on this REC transaction is not on the in-transit file.
	Warehouse	1. Check to make sure the number was accurately entered. If not, correct and resubmit.
	Warehouse	2. Verify that the REC for this shipment was not entered in a previous day's processing by examining the in-transit summary report.
	Warehouse	3. If above steps do not uncover error, contact Corporate Inventory Control.
	Corporate Inventory	4. Verify shipment number with sending location.

include descriptions of what errors mean, but should also show how to resolve them. Responsibility should be made clear (Table II).

6. Appendices. When required, formulas, complex logic, decision tables, and charts are best placed in an appendix. As such, they are available for the user to examine, but do not detract from the reference orientation of the manual.

It is important to remember that the system, as well as the person responsible for it, are often viewed in the same light as is the user's manual. If the documentation is disorganized, sloppy, or missing information, the user may form a similar opinion of the system. A cleanly typed and well-organized manual, with title page, table of contents, section tabs, and a neat binder, create a positive image. A manual is well received if the head of the user department is listed on the title page as a coauthor. Finally, a commitment to the time allocation necessary to produce a high quality user's manual is essential. User pressure to cut corners to get the system up will subside if he can see a sample of a well-written manual and decide for himself that the benefits far outweigh the delay.

—Richard S. Zera
Bowling Green, Ohio

High Technology Engineers:

The economy
and your future
can be a lot
brighter
at E-Systems
in Dallas.

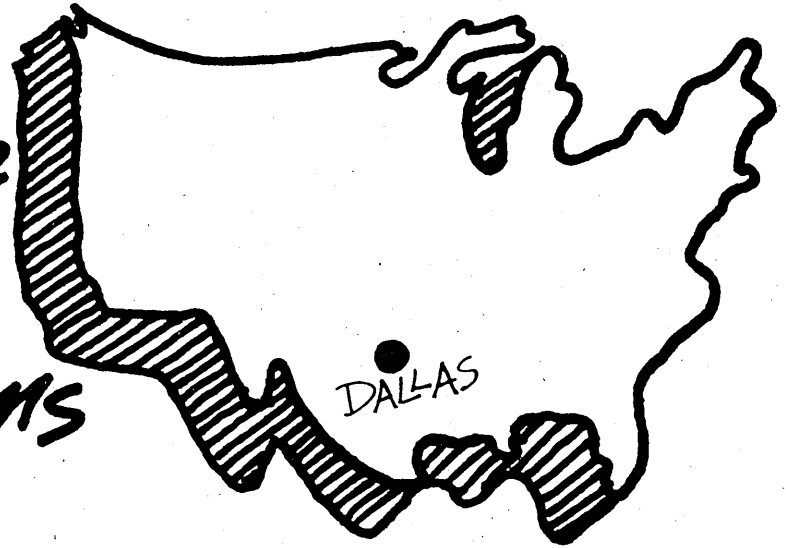

If your future's not looking very bright where you are right now, you can join the positive momentum of the 80's at E-Systems Garland Division.

Our Garland Division in Dallas specializes in the development and delivery of high-technology electronics. We've solved many of the world's toughest one-of-a-kind problems—problems that require some of the world's most advanced technological solutions.

We're doubling the size of our Garland, Texas facilities to meet our needs for the 80's. Our business volume will double in the next five years. And we're going to need talented, dedicated people to grow with us. We're offering solid long-term opportunities in the areas listed below. Look over our list; then get in touch with us.

ELECTRONIC SYSTEMS DEVELOPMENT

We need specialists in high-speed, special-purpose digital processing technology, designing systems employing VHF to microwave range receivers and to design and develop high-speed electro-optic systems.

- Electronic Design Engineers
- Electronic Systems Engineers

- Engineering Specialists—Electronic
- Senior Specialists—Electronic/
Mechanical Design
- Electronic Packaging Design Engineers
- Senior Packaging Specialists
- PC Designers

SOFTWARE ENGINEERS

Software engineering professionals who have experience in real-time applications on large mainframe and mini- and micro-computers are required to develop these systems.

- Software Engineers
- Senior Software Engineers
- Software Engineers/Analysts
- Project Leaders—Software
- Software Engineering Specialists

If you want to make problem solving your career, send this coupon to: Employment Manager, E-Systems, Inc., Garland Division, P.O. Box 226118, Dallas, Texas 75266. Or call COLLECT (214) 272-0515.

Please send more information about E-Systems
Garland Division.

NAME _____

ADDRESS _____

CITY _____ STATE _____ ZIP _____

PHONE _____



E-SYSTEMS

Garland Division

The problem solvers.

An equal opportunity employer M/F, H, V

The Marketplace...

ADVERTISERS' INDEX

SOFTWARE & SERVICES

Allen Services Corporation	276-277
Andrew Rubel & Associates Inc.	276
A.P. Publications	279
Atlantic Software	276
Business & Technology Systems	277
Computer Wise Inc.	277
C.S. Computer Systems	277
Dataware	278
Duquesne Systems Inc.	277-278
Dylakor	277
Evans, Griffiths & Hart Inc.	276
Harlan S. Hersey Inc.	278
Mathematica Products Group	278
Micro Management Systems Inc.	278
Mitchell & Gauthier Associates	277
Objective Programming Inc.	278
Software Consulting Services	276
Tomark	276

BUY, SELL, LEASE

Electro Con Inc.	279
Unitronix Corporation	279

DP MARKETPLACE

C.D. Smith & Associates	279
-------------------------	-----

JOB MARKETPLACE

M.I.T.	279
National Personnel Consultants	279

SOFTWARE SERVICES

RSX-11M

speaks **DCL***

Send
For 30 Day
Free Trial!

*DIGITAL
COMMAND
LANGUAGE

MAKES RSX-11M SIMPLE TO USE
SAVES YOU TIME AND MONEY

- English commands
- like VAX/VMS and RSX-11M-PLUS
- on line help, hints, and examples
- easy to install NO SYSGEN required
- fully supported
- complete documentation
- \$795, available immediately

ANDREW RUBEL & ASSOCIATES, INC.
One Soldiers Field Park 605
Boston, MA 02163 (617) 876-7993

RSX and Digital® trademarks Digital Equipment Corp.

CIRCLE 193 ON READER CARD

PC/70™

PROJECT PLANNING & CONTROL SYSTEM

"BEST TRAINING"
"BEST SUPPORT"
"EASIEST TO USE"

YOUR BEST OPPORTUNITY FOR SUCCESS
Another Productivity Tool from the
Project Management Specialists at:

ASI



Atlantic Software, Inc.
Lafayette Building
Fifth & Chestnut Sts.
Philadelphia, PA 19106
215-922-7500

CIRCLE 194 ON READER CARD

MSM

for Shared TAPE and DISK Mounts

Transparently Manages Shared TAPE and DISK Mounts

- MSM automatically controls TAPE ALLOCATIONS among your systems. MSM also works for SHARED MOUNTABLE DISKS.
- Allows more EFFICIENT TAPE DRIVE UTILIZATION. Your tape drives will be treated as a single combined pool, rather than several smaller ones. This will have a tendency to reduce overall tape drive requirements.
- Alleviates confusing operator burdens. Without MSM, operators must manually coordinate device usage among the various systems.
- ELIMINATES COSTLY JOB RE-RUNS due to inadvertent multi-system tape allocation.
- Provides a SINGLE-SYSTEM IMAGE with respect to device allocations.
- MSM is COMPLETELY COMPATIBLE with the standard operating system allocation philosophy. MSM simply extends it to cover all systems in your complex.
- MSM is the ONLY TRANSPARENT APPROACH to handling SHARED TAPE and SHARED DISK allocation.
- MSM now runs with MVS, SVS, MVT, VS1 and MFT.
- New SOFTSWAP feature allows MSM to reduce the scope of allocation "blockage" when a DDR tape SWAP occurs.
- MSM can be installed in 10 MINUTES — NO IPL is required.
- Requires NO SYSTEM MODIFICATION whatsoever.
- Additional overhead caused by MSM is INSIGNIFICANT.
- MSM is now being used in well over 100 installations throughout the world.

To Acquire MSM, or for more information . . .

Toll-Free: 800-543-7583 x 203
(in OH: 513-890-1200)



ALLEN SERVICES CORP.
Software Dept. 212 W. National Rd.
Vandalia, Ohio 45377

CIRCLE 195 ON READER CARD

IBM OS USERS

**Abend-Aid
Can Get You
Out of The
Dumps.**

Cut the high cost of abends
with the dynamic software
Package Abend-Aid.

Prints in English the cause
of abends and data
needed to correct them.

Call 313-559-9050
TOMARK

CIRCLE 196 ON READER CARD

**Give me the right tools,
and I can move the world!**

SCOBOL™ and SFORTRAN™ are the right tools to
make structured coding easy and natural.

Why hand-translate from your structured design language to COBOL or FORTRAN? SCOBOL and SFORTRAN extend COBOL and FORTRAN control structures to give you fully nestable *if-then-else-endif*, *while-do-endo*, *select-case-endcase*, and 5 others. The precompilers automatically translate your S-language programs into equivalent COBOL or FORTRAN.

The precompilers are written in the S-languages themselves. That's why they can be run on so many machines. If your computer has a reasonably standard COBOL or FORTRAN compiler, we probably already have either SCOBOL or SFORTRAN installed on it. Contact us for details.

SCOBOL and SFORTRAN are distributed in source code form for \$1400 each. Monthly lease plans are available.

Software Consulting Services
901 Whittler Drive
Allentown, PA 18103
(215) 797-9690

CIRCLE 197 ON READER CARD

RSTS/E & RSX-11M SOFTWARE PACKAGES

KDSS multi-terminal key-to-disk data entry system

TAM multi-terminal screen-handling facility for transaction-processing applications

FSORT3 very fast record sort for RSTS/E

SELECT convenient, very fast extraction of records that meet user-specified criteria (RSTS/E only)

BSC/DV a DV11 handler for most bisynchronous protocols (RSTS/E only)

COLINK links two RSTS/E systems using DMC11s

DIALUP uses an asynchronous terminal line to link a local RSTS/E system to a remote computer system

Evans Griffiths & Hart, Inc.
55 Waltham Street
Lexington, Massachusetts 02173
(617) 861-0670

CIRCLE 198 ON READER CARD

PREVENT "Wild Cards" IN YOUR DATA



ALLEN SERVICES CORPORATION

with... SUPER-MSI™

Multiple Systems Integrity Facility™

SHARED DASD USERS:

Consider - SUPER-MSI...

- PROTECTS YOUR DATA INTEGRITY by preventing simultaneous destructive updates by jobs in different systems.
- Eliminates RESERVE Lock-outs (both performance Lock-Outs and "deadly embrace").
- DOES NOT SACRIFICE RELIABILITY as do other approaches to the problem.
- Now has extended VSAM Dataset Integrity to specifically handle the internal VSAM Dataset SHR options.
- Informs Operators and/or TSO users (as appropriate) about the precise task (job, TSO user, etc.) causing dataset conflicts.
- Provides powerful operator commands to Control and Monitor performance and activity.
- Is TRANSPARENT to users, and almost transparent to operators.
- Is Independent of system environment — for example, it works equally well with MVS, MVS-SE, SVS, MVT, VSI, MFT, HASP, ASP, JES2, JES3, etc.
- Can be installed in 10 minutes without an IPL and with NO SYSTEM CHANGES whatsoever.
- MSI is already being used in well over 400 installations throughout the world.

For More Information, or to Order a No-Obligation FREE TRIAL...

In Europe:

Mr. J.A. Kaluzny
UNILEVER GMBH • 15 Dammtorwall
2 Hamburg 36 • West Germany
Tel: 040 3490 2229

From Anywhere Else:

ALLEN SERVICES CORPORATION
Software Dept. 212 W. National Rd.
Vandalia, Ohio 45377
Toll-Free: 800-543-7583 x 203 (in OH: 513-890-1200)

CIRCLE 199 ON READER CARD

Report Writer/ EDP Audit Software Tools for 360/370/4300* Dylakor

16255 Ventura Boulevard
Encino, California 91436
(213) 995-0151



Over 1000 Installations

*303X, AMDAHL, ITEL, etc.

CIRCLE 201 ON READER CARD

EDP Managers... You need QCM

You've tried solving your performance problems with hardware monitors, sampling software monitors, unsatisfactory billing systems, SMF and RMF inadequacies, simulators, ...

Now, try something that works! QCM.

QCM is the only complete system that precisely monitors all hardware and software processes, accurately bills all operations and improves performance ... all on a full-time basis.

Let us show you how QCM has meant control, efficiency, confidence and dollars to our customers.

Fill in and mail the coupon or call:



DUQUESNE SYSTEMS INC.

2 Allegheny Ctr.
Pittsburgh, Pa. 15212
Phone: (412) 323-2600
Telex: 902803

I'm ready to try something that works! Please provide more information about QCM.

MVS SVS VSI MVT DMFT

Name _____

Title _____

Organization _____

Address _____ Telephone _____

City _____ State _____ Zip _____

CIRCLE 200 ON READER CARD

LOW COST HARDCOPY for IBM TP SYSTEMS

DEC LA34 DECwriter IV terminal with built-in Bisync Controller allows remote attachment of LA34 to IBM mainframe systems. Full 328x emulation.

Features: Data rates to 9600 baud.
2K Byte buffer memory
Internal diagnostics.

Pricing: Kit \$625.00
Factory Instal. 875.00
Complete Unit 2125.00

Call or Write:

COMPUTERWISE INC.

4006 East 137th Terrace • Grandview MO 64030
816 765-3330

CIRCLE 202 ON READER CARD

ACSL

The Advanced Continuous Simulation Language is a powerful but easy to use program designed for modelling the behavior of dynamic systems. Applications range from control system analysis to chemical plant models to urban dynamics.

- Interactive or Batch Graphics
- Unlimited Problem Size
- FORTRAN Compatibility
- Stiff Integration

ACSL reduces program development time by factors of two to ten: ACSL is available for CDC 6000/7000, IBM 360/370, UNIVAC 1100, SEL 32, PDP 10/20 and VAX II computers. Access through UCS, CYBERNET and other national networks.

MITCHELL AND
GAUTHIER ASSOCIATES, INC.
P.O. Box 685, Concord, Ma. 01742
(617) 369-5115

CIRCLE 203 ON READER CARD

VIDEO

for VAX 11/780

VIDEO is a fully interactive system for the design, development and operation of complex applications.

The use of VIDEO will:

- promote top-down structured design
- reduce development time
- increase programmer productivity
- provide a "user-friendly" interface
- reduce user training requirements
- enhance system security

FROM DESIGN TO END-USER ACCESS
VIDEO SAVES YOU TIME AND MONEY
(301) 794-8800

BUSINESS AND TECHNOLOGICAL SYSTEMS, INC.
Aerospace Building, Suite 440
10210 Greenbelt Road
Seabrook, Maryland 20801

VAX is a trademark of Digital Equipment Corp.

CIRCLE 204 ON READER CARD

NEW LIFE FOR 1401 PROGRAMS

CS-TRAN converts your 1401 object programs to COBOL for the mainframe or mini of your choice.

CS-TRAN is the only translator that accepts your object programs, patches and all, yet allows you to include actual COBOL paragraph names and record definitions.

If you'd like more details about new life for your 1401 programs just call or write Russ Sandberg.



C-S Computer Systems Inc.

90 John Street, New York, NY 10038 • 212-349-3535

CIRCLE 205 ON READER CARD

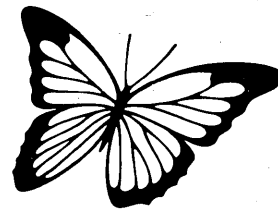

****TASK/MASTER**
CICS * IMS DB/DC
SOFTWARE CONSULTING
SERVICES**

Our four year old firm specializes in Online & Data Base/Data Communications Systems Development. From Software Design to Computer Programming to System Maintenance.

We pride ourselves in the consistency & reliability of the services we have to offer. ALL of our employees are experienced, extremely knowledgeable, dedicated professionals.

For more information, contact David Solan

**OBJECTIVE PROGRAMMING
INCORPORATED**
Post Office Box 123
Norwalk, CT 06856
(203) 866-6900



CIRCLE 206 ON READER CARD



THE TIME SAVERS

RPG to COBOL or for those PL/1 Shops RPG to PL/1

Two of the many **successful** translators offered by Dataware provide a smooth and effortless transition from RPG. The translators can handle most any level of RPG (SYS/3, Mod 20, etc.) and achieve an extremely high percentage of automatic conversion (approaching 100%) of the source code.

For more information please call or write today!

**The Conversion Software People
Dataware, Inc.**

2565 Elmwood Ave., Buffalo, NY 14217 (716) 876-8722 | **TELEX 91519**



CIRCLE 207 ON READER CARD

**AUTHORIZED TRS-80® DEALER A301
COMPUTER SPECIALISTS**

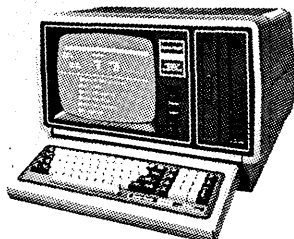

Up to 15% Discount on TRS-80's

26-1051 4K LEVEL I.....\$424.00
26-1056 16K LEVEL II.....\$700.00
26-4002 64K 1 DRIVE.....\$3499.00

**1-800-841-0860 TOLL FREE
MICRO MANAGEMENT SYSTEMS, INC.**

Downtown Plaza Shopping Center
115 C. Second Av., S.W.
Cairo, Georgia 31728
(912) 377-7120 Ga. Phone No.

CIRCLE 208 ON READER CARD

MPGSWIFT for TP applications

*Maximize staff productivity
and customer service with MPGSWIFT*

- | | |
|-----------------------------|--|
| Ease of Use | Learn to write TP applications in one day |
| Ease of Installation | Install in one hour |
| Maintenance | Add terminals, files, programs while MPGSWIFT continues to operate |
| Language Support | Cobol, Assembler, PL/1, Fortran, RPG, RAMIS |
| Evolution | Entry level to large network without reprogramming |
| Productivity | Online program development with one-half the effort |
| | Over 100 installations. DOS, DOS/VS, and DOS/VSE |

Productive software for business data processing from

Mathematica Products Group

P.O. Box 2392 • Princeton, New Jersey 08540 • 609/799-2600



CIRCLE 209 ON READER CARD

ATTENTION SHARED DASD AND SHARED TAPE USERS ... YOU NEED SDSI/STAM

SDSI Shared Dataset Integrity

- SDSI protects data integrity by guarding against concurrent update from multiple CPUs.
- SDSI automatically improves system performance by eliminating device RESERVES.
- SDSI eliminates RESERVE LOCK-OUTS.
- SDSI provides operator and TSO users information about dataset conflict conditions.
- SDSI requires no system or user program modifications and installs in minutes.

STAM Shared Tape Allocation Manager

- STAM automates the sharing of tape and DASD devices thus allowing allocation decisions to be made faster and reducing the possibility of human errors.
- STAM makes more efficient use of tape pools thus allowing you to reduce tape drive requirements.
- STAM provides global operator commands and control.
- STAM eliminates JOB re-runs due to multiple tape drive allocation errors.
- STAM requires no system or user program modifications and installs in minutes.



**DUQUESNE
SYSTEMS INC**

TWO ALLEGHENY CTR.
PITTSBURGH, PA 15212
PHONE 412-323-2600
TELEX 902 803

CIRCLE 210 ON READER CARD

SRCCOMPR IBM UTILITY

- Compares source programs, JCL and card data.
- Detects inserted or deleted lines and continues comparing.
- Shows what changes have been made on a line by showing the old version and the new version.
- Can bypass sequencing columns and comment cards.

Remember...

- IBM utilities fail on inserted or deleted lines.
- Panvalet or Librarian change-date-stamps do not show what changes have been made.

*OS and DOS versions for \$500.
perpetual lease.*

HARLAN S. HERSEY, INC.

106 Quaker Drive,
West Warwick, RI 02893
(401) 822-0176

CIRCLE 211 ON READER CARD

FREE



Data booklet on specialized software information systems covering:

- * **GENERAL SOFTWARE**
- * **DATABASE SOFTWARE**
- * **MICRO & MINI SOFTWARE**

A.P. Publications Ltd
322 ST. JOHN STREET · LONDON, E.C.1

CIRCLE 212 ON READER CARD

WHEN YOU NEED DEC...

TERMINALS

- VT-100
- LA120
- LA36
- LA180

PDP11/03 SYSTEMS

LSI/11 MODULES

Demand...Delivery Demand...Discounts Demand...UNITRONIX



UNITRONIX CORPORATION
(201) 874-8500

198 Route 206 ■ Somerville, NJ 08876
TELEX 833184

CIRCLE 213 ON READER CARD

PROFESSOR OF COMPUTER GRAPHICS

MIT Department of Architecture seeks Assistant/ Associate Professor of Computer Graphics to teach and do research in Arts and Media Technology Program. Position includes 50% research to be developed in candidate's area of interest and expertise. Teaching responsibility entails introductory graduate subject in computer graphics; graduate seminar in 3-D computer graphics and animation, or seminar in candidate's area of interest; and/or Ph.D. and M.S. thesis supervision. Prerequisites include Ph.D. in computer science or equivalent; professional experience in computer graphics; teaching experience at the university level; demonstrated ability in research. Appointment effective September 1, 1981. Candidates should submit resumes and additional information by November 1, 1980 to:

Professor N. John Habraken
Department of Architecture
M.I.T.
77 Massachusetts Avenue
Cambridge, MA 02139

MIT is an Equal Opportunity/Affirmative Action Employer

USE THE DATAMATION MARKETPLACE ADVERTISING SECTION

**CALL FRANCIE:
(212) 489-3460**

DP MARKETPLACE

IBM Users MG Set - 415Hz

IBM approved type Piller Silentbloc (can be used right next to mainframe - 58 Dba) Dual 75KV_a motor-generators with paralleling, used two years designed for 20 years. Input 460V, 3 phase, 60Hz. Output 120/208, 3ph, 415Hz. Price new \$77,000. Your price \$43,500 + freight.

Call us for any and all line conditioning requirements

**Line Conditioning Div.
ELECTRO CON INC.**

Box 305
Deerfield IL 60015 (312) 948-0320

CIRCLE 214 ON READER CARD

EDP SPECIALISTS

PROGRAMMER/SYSTEMS ANALYSTS, \$16,000-\$45,000. Choice positions available in Pennsylvania & national locations. We have been placing EDP personnel for 15 years. Reply in strict confidence to John Scheirer, WEIR PERSONNEL SERVICES, 535 Court St., Reading, PA 19603 (215/376-8486).

EES, PROGRAMMERS, SYSTEMS ANALYSTS, \$16,000-\$45,000. Immediate outstanding opportunities. Sunbelt. Nationwide. Leading companies. Positions available at all levels. Reply in confidence to J. F. Halloran, President, NATIONAL SEARCH, P.O. Box 73006, Houston, TX 77090 (713/376-9383).

EDP MANAGEMENT / SYSTEMS ANALYSTS / PROGRAMMERS, \$18,000-\$40,000+. Choice upstate NY & U.S. open positions. EDP placement specialists. In confidence send resume or call James F. Corby, Pres., NORMILE PERSONNEL, 5 Leroy St., Box 110 Westview Station, Binghamton, NY 13905 (607 / 723-5377).

all positions listed are fee-paid

npc NATIONAL PERSONNEL CONSULTANTS

CIRCLE 215 ON READER CARD

BROKER IN DEC SYSTEMS & COMPONENTS

C.D. SMITH & ASSOCIATES, INC.
12605 E. Freeway,
Suite 318
Houston, TX 77015
713-451-3112

CIRCLE 216 ON READER CARD

DATAMATION® magazine's 1979/80 MINI/MICROCOMPUTER SURVEY AVAILABLE NOW.

The third annual DATAMATION magazine Mini/Microcomputer Market Survey has just been completed. Encompassing small business systems, intelligent terminals and data entry systems as well as traditional minicomputers, this analysis is essential reading for industry watchers, market planners, sales executives and users themselves.

Available November 1, 1979, the report is being offered at a \$40 savings for prepaid orders off the regular price of \$445 in North America and \$475 elsewhere. Additional reports are \$150. (U.S. Dollars).

For a complimentary 8-page Table of Contents, call Dorothy Chamberlin (203) 661-0055.



Technical Publishing
a company of The Dun & Bradstreet Corporation
666 Fifth Ave. · New York, NY 10019

ADVERTISERS' INDEX

Able Computer	50
AC Manufacturing Company, Inc.	62
Acme Visible	118
Advanced Digital Products	56
*AGFA Gevaert	248-10
A.M. Jacquard Systems	167
Anderson Jacobson, Inc.	211
Applications Software, Inc.	241
Applied Data Research	65
Aramco Services Co.	246
*AS Regnecentralen AF	248-31
Atlas Energy Systems	256
Avanti Communications Corp.	209
Avery Label	29
Boeing Computer Services	111
BTI Computer Systems	12
Burroughs	187
Cable & Wireless	123
Candle Corporation	117
Carterfone	216
*Case	248-2
Colorado Gas	272
Computer Corporation of America	235,237,239
Computer Devices	63
Computer Science Corporation	222,223
Conditioned Power	204,205
Control Data Corporation Systems & Services	57
Control Data Corporation Peripheral Products Group	221
Control Data Corporation Business Products Group	115
Cromenco Incorporated	2
Crown Industries	114
Cullinane Corporation	78,79
DASD Corporation	119
Data Corp.	39
Data General Corporation	16,17,34,35,198,199
*Data Recording Equipment	248-52
Datafusion	4
Datagraphix, Inc.	203
Datapoint Corporation	5
Dataram Corporation	105
*DataSAAB	248-21
248-22,248-23,248-24,248-25,248-26,248-27,248-28	
Dataswitch	32
Dataware	104
Dattec	83
Datum, Inc.	Cover 3
*DDS Computer	248-74
Dennison Kybe	208
Digital Associates	68
Digital Communications Associates	73
Digital Communications Corporation	151
Digital Engineering	49
Digital Equipment Corporation	54,55,189
Digital Pathways	265
Digital Research	165
*Distributed Logic	248-49
Dow Jones, Wall St. Journal	197
E Systems, Garland Div.	275
Eastman Kodak	51
Educational Testing Service	96
Electro & Optical Systems	156
Electrohome	67
Electronum	104
Emerson Electric	40
*Emulex Corp.	248-14,248-50
Evaluation & Planning	161
FAO	270
*Facit AB	248-13
Federal Reserve Bank	220
*Ferranti, Ltd.	248-17
Floating Floors	263
Fox Morris	180
Frequency Technology	200
*GEI	248-73
General Datacomm	85
General Electric, Terminat	52,53
General Terminal	159
Giltspur Expo Industries	88
Graham Magnetics	153
Greyhound Package Express	66
G.T.E.	266
Hewlett Packard	229
Hewlett Packard (Terminals)	26,27
Hewlett Packard, Corvallis	121
Honeywell	108-109
Houston Instruments, Div. of Bausch & Lomb	59
Hughes Aircraft	87
IBM	30-31
IDS	172
Image Resource	139
Infotron Systems Corporation	269
Informatics	15
Information Builders	100
Intel Commercial Systems	10-11
Interactive	82
Interstate Electronics	135
Intertec	142
ISSCO	95
C. Itoh	19
ITT Courier	94
Kennedy	Cover 2
Kerk Motion	254

Robert Kleven	270
*Klenzie	248-65
*Lear Siegler	257
*Lear Siegler	248-19
Macmillan Book Clubs	212,213,214,215
*Magnuson Ltd.	248-44
Management & Computer Services	9
Management Science America	243
Manitoba Telephone	273
*Mannesmann Tally	248-67,248-68,248-69,248-70
Martin Marietta Aerospace	120
Mathematica	41
McCormack & Dodge	193,195
Memorex	46
*Memorex	248-43,248-45,248-47
Methods Research Corp.	256
Micro Data	245
Micropad	260
*Microtecnica	248-30
Mini Micro Computer Conference	181
Mobil Oil	268
Mohawk Data Sciences	89
MTI	54
*Munchener Messe	248-72
National Advanced Systems	190,191
NBI	25
NCR Corporation	206
NEC Information Systems, Inc.	9
Nichols & Co.	110
*Nixdorf Computer	248-63
North Star Computers Inc.	227
*Norsk Data A/S	248-9
R.M. Norton	252
Northern Telecom Systems Corp.	174,175
Oasis Oil	180
*Olivetti	248-39
O'Neill Data Systems	271
Optical Coating Labs	124
Perkin Elmer Corporation	182,183
Pitney Bowes	99
Polymorphic Computer Systems, Inc.	244
Prime Computer Inc.	22
Printronic	91
*Program Products, Inc.	248-33
Quest Systems, Inc.	274
Qytel	226
Racal Milgo	80,81
Racal Vadic	107
Radio Shack	75
Rixon, Inc.	259
Robertson, Colman	60
Rockwell	255
Rusco Electronic Systems	173
SAS Institute, Inc.	176
L.D. Schreiber	252
Shugart	102,103
*Siemens AG	248-54,248-55
*Software AG	248-76
Software House	232,233
Software Module Marketing	69
Source EDP	234
*Sord Computer Systems	248-48
Sperry Univac	112,113
Storage Technology Corporation	162,163
Summagraphics Corporation	72
Sun Information Services	97
Swingline Corp.	90
Syncom	127
Systonetics	86
T Bar	101
Tandem Computers, Inc.	20,21
TEC, Incorporated	236
Techtran Industries	74
Techtronix	6,7,225
*Techtronix	248-36,248-7
Teletype Corporation	Cover 4
Televideo	251
Telex Computer Products	171
Texas Instruments	154,155
3M Co.	92,93
*TRW	248-40,248-41
Timeplex	129
Tran Telecommunications Corp.	141
Trans Net Corporation	254
Tri Data	226
*Triumph Adler	248-57,248-58,248-59,248-60
Two PI	137
United Computing Systems	145,146,147,148
United Technical Products	98
University Computing Co.	76,77
University of Petroleum & Minerals	272
U.S. Robotics	28
Vector Graphics	253
Visual Technology	238
Wabash Tape	90
Wallach Associates	258
Wang Labs	61
*Wandel Goltermann	248-75
Weber Marking Systems	70,71
*Wenger Datentechnik	248-46
Western Electric	125
Western Peripherals	1
John Wiley & Sons	116
World Health Organization	268
Wrightline	44,244
Xerox	235,237,239
Zentec Corporation	267

ADVERTISING OFFICES

Sales Manager
John M. Gleason
New York, NY 10103
666 Fifth Ave.
(212) 489-2579

Eastern District Managers
A. Treat Walker,
Warren A. Tibbetts:
New York, NY 10017
420 Lexington Ave.
(212) 682-7760

New England District Manager
Warren A. Tibbetts:
Manchester, NH 03104
112 W. Haven Rd.
(603) 625-9498

Midwest District Manager
William J. McGuire
Chicago, IL 60601
3 Illinois Center Building
303 East Walker Drive
(312) 938-2900

Western District Managers
Alan Bolté, Jr.:
Los Angeles, CA 90035
1801 S. La Cienega Blvd.
(213) 559-5111

James E. Filiatrault:
Mountain View, CA 94043
2680 Bayshore Frontage Rd.
Suite 401
(415) 965-8222

U.K., Scandinavia, Benelux
Intergroup Communications, Inc.
Wallace K. Ponder, European Director
Paul D. Dimmock, Regional Manager
31 Lyncroft Avenue
Pinner, Middx, HA5 1JU
England
Tel: (01) 868 9289
Cables: PACOM, Pinner

Germany, Austria, Eastern Europe
Tullio Giacomazzi
130 Jermyn St.
London SW1 Y4UJ
Tel: (01) 839 3916

France, Italy, Spain
Gerard Lasfargues
32 rue Desbordes Valmore
750 16 Paris
France
Tel: (1) 504 97 94

Japan
Shigeru Kobayashi
Japan Advertising Communications, Inc.
New Grinza Building
3-13 Ginza 7-chrome
Chuo-ku, Tokyo 104, Japan
Tel. (03) 571-8748

James B. Tafel, Chairman
John K. Abely, President
Robert L. Dickson, Exec. Vice President
John R. Emery, Senior Vice President
Calverd F. Jacobson, Vice President-Finance
Walter Harrington, Vice President and Controller

Technical Publishing

DB a company of
The Dun & Bradstreet Corporation

HEWLETT-PACKARD TAPE SPEED BARRIER BROKEN BY DATUM

Need more speed than 45 ips for your Hewlett-Packard system? Datum breaks the speed barrier with compatible vacuum column tape systems operating at 75 and 120 ips, as well as 45 ips. Dual Density is standard in all 3 speed configurations.

A new concept in tape subsystems, the 1024 Series is compatible with Hewlett-Packard Models 1030, 2100, 2184, 2185, 2186 and 2100 MUX minicomputers. A single BVA rack-mounted external controller is the heart of the Datum system.

Along with increased system throughput, Datum's Series 1024 offers you multi-transport operation using NRZI and/or RZ formats. Up to four tape transports may be driven by each controller.

And, we've software management to fit Hewlett-Packard operating systems.

(See Datum break the Hewlett-Packard tape speed barrier for yourself) contact your local Datum sales representative or headquarters today. And Datum gives you the most complete service. A superior product at a superior price.

See Datum at the NIBS Booth 205

CORPORATE HEADQUARTERS 4885 Santa Coloma Blvd., Anaheim, CA 92806 Tel 714/885-8888 TWX 810 592-2889 Telex 685570
CORPORATE HEADQUARTERS DATUM MANUFACTURING DIVISION, DATUM LTD 5th Floor, Station Square, Basingstoke, Hampshire, England RG24 0AA
USALES OFFICES (CANADA) Willowdale, ON, Tel 416-291-8888 Telex 08488857 BCR BCR CANAD (FRANCE) Lesgards, MA 01201
Tel 617/872-8888 (USA) (MEXICO) Monterrey, N.L. 07000 Tel 409/656-8888 (WEST) Los Angeles, CA 90016 Tel 310/248-0200 FAX
(USA) San Jose, CA 95117 Tel 408/248-8880

122017

Circle Contact Card

© 1978 Datum Corporation

THE SYSTEM THAT IS ITS OWN NEXT GENERATION.

Most terminals and printers outlive their usefulness. But the 4500 Series is designed to regenerate.

It's the Teletype[®] theory of evolution.

Adaptability that protects you from costly obsolescence.

Modular software and individual display units provide for future flexibility. To redefine or change or add new features. All with minimal changes to your overall system.

For example, the 4540 Series of data terminals. Extremely flexible hardware and software modules make it easy to adapt to your particular applications, both now and in the future.

Or the new 4520. A microprocessor driven buffered keyboard printer. Like the 4540, it's efficient and compatible with popular host protocols. And designed for easy operation and low maintenance.

Both are backed with fast field response by a nationwide service organization. And our multi-million dollar R&D investment that is already shaping future capabilities.

Call or write today to learn more about the 4500 Series. It's one family that doesn't stand in the shadow of the next generation.

THE TELETYPE 4500 SERIES.

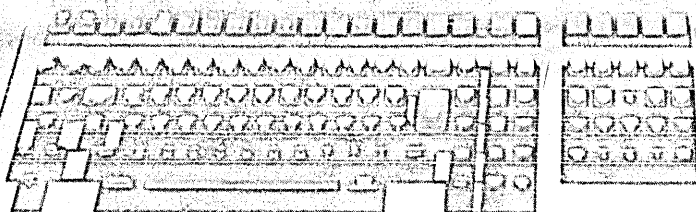
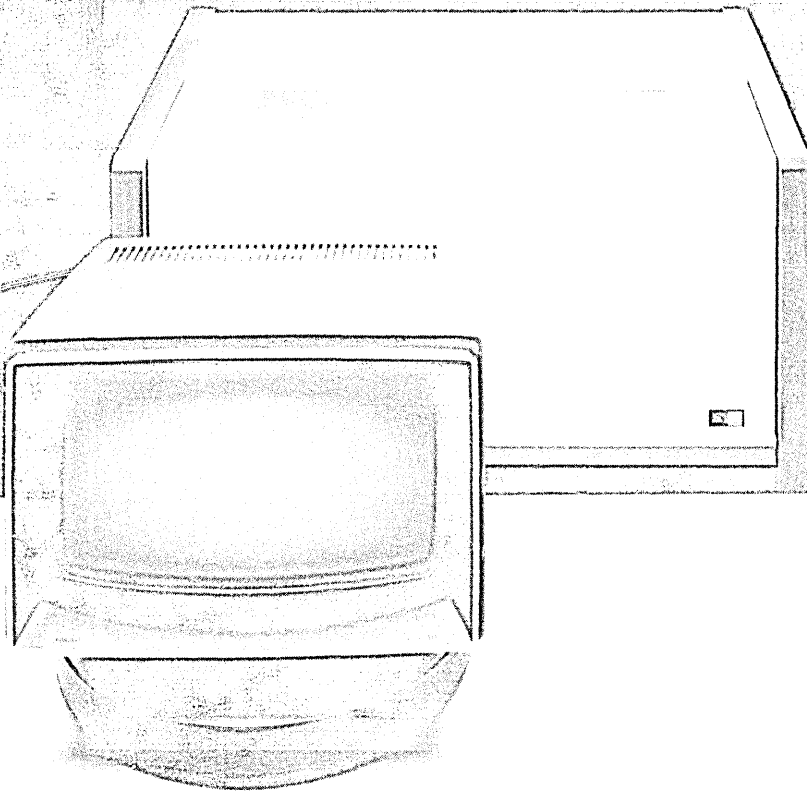
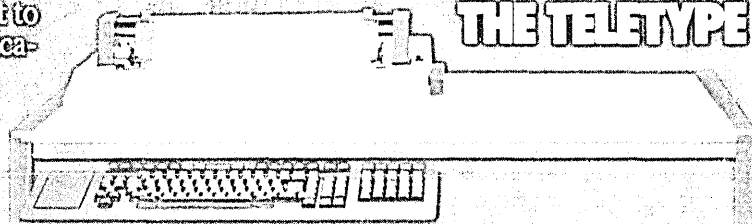

Teletype Corporation, 5555 Touhy Avenue, Dept. 3141-A, Skokie, IL 60077, Tel. (612) 932-2000.
Teletype is a registered trademark and service mark of the Teletype Corporation.