

Sorry I didn't return your call but things have been sort of piling up around here and I've been too busy to get anything done. Frankly it's not as if it's any of your business, anyway ...why have I had this headache since February? Look, how about I get back to you...um...next week? Nothing is funny anymore... Nothing is...

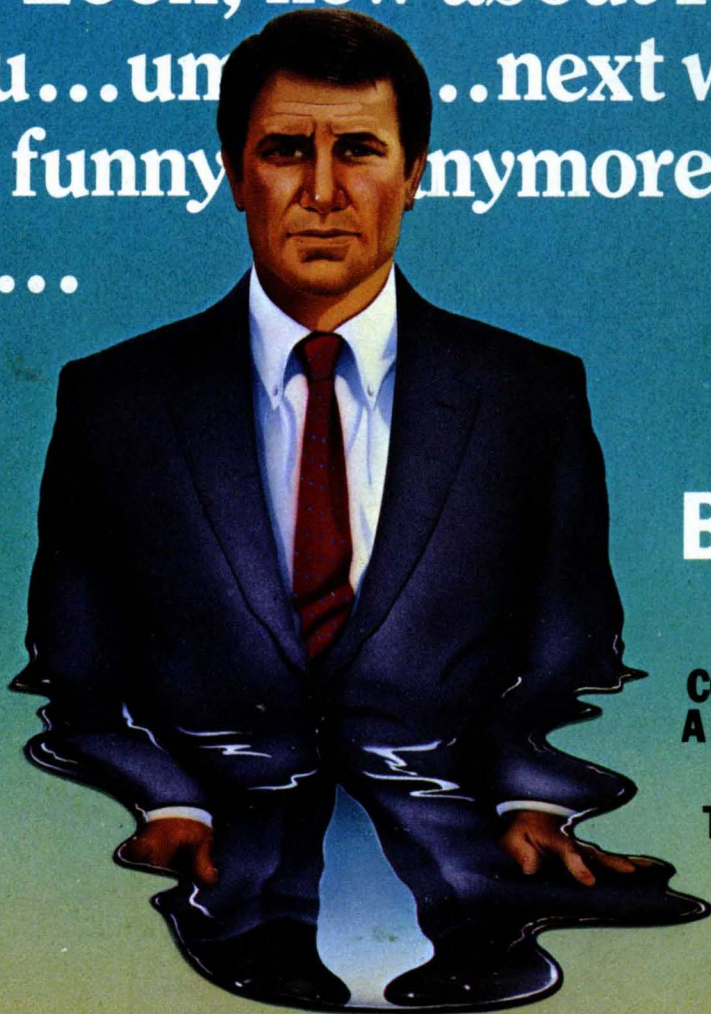

## BURNOUT

ALSO:  
**COMPUTERS IN  
COMMUNICATIONS:  
A RATINGS SURVEY**

**ACCEPTANCE  
TESTING WITH AN  
ON-LINE SYSTEM**

# When you ask some people about backup — they back off.

And for good reason. Ask any other supplier of peripheral products for system backup, and you'll find that some can supply a disk, some can supply a cartridge recorder, others a streaming tape drive. But none can supply the drives which Kennedy can offer.

Kennedy is the only company that can offer an 8MB, 5 1/4" computer disk drive (Model 7300) and an 82 MByte Winchester disk drive (Model 8200). You can't find any other company that can offer a 1/2" cartridge (Model 8300), a 2" Data Streamer tape recorder.

Kennedy was the first to utilize the 1/2" 8MB cartridge for disk backup. Kennedy was the pioneer in Winchester disk technology, and was a leader in developing a low cost streaming tape drive.

All of these products were conceived and designed to meet the need for reliable, low cost backup — for our systems or for any other system.

Kennedy has always backed its products. That's why we're No. 1. Call or write us about your problem.

We won't back off.

KENNEDY INSTRUMENTS, INC.  
 1650 Shamrock Ave.  
 Monrovia, CA 91016  
 (714) 857-8887  
 Telex: 742777  
 Fax: (714) 857-8887  
 KENNEDY is a subsidiary of  
 KENNEDY ELECTRONICS, INC.  
 1650 Shamrock Ave.  
 Monrovia, CA 91016  
 (714) 857-8887  
 Telex: 742777

## KENNEDY

Subsidiary Magnetics & Electronics Inc.

1650 Shamrock Ave., Monrovia, CA 91016  
 (714) 857-8887 WWW: 910-685-8249

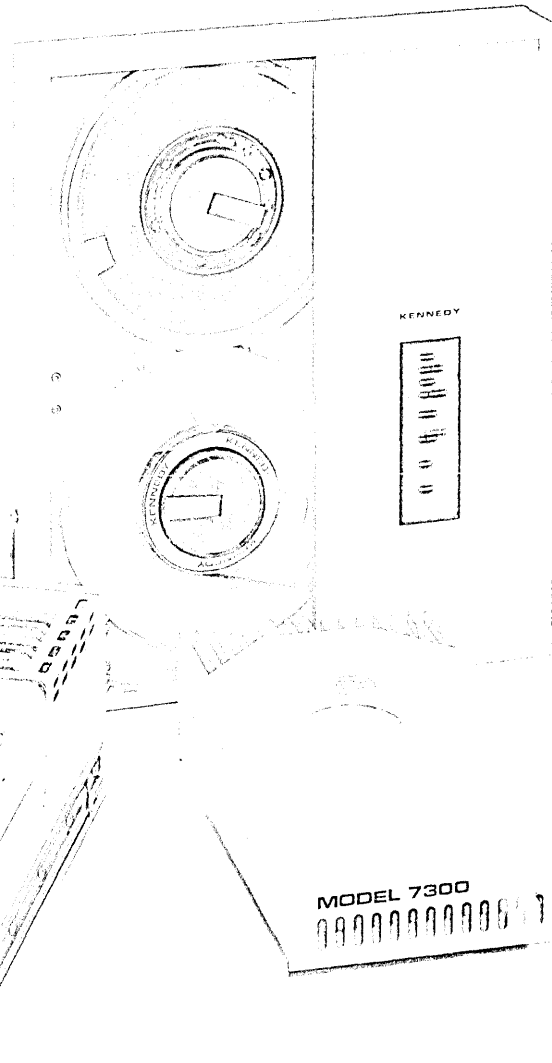
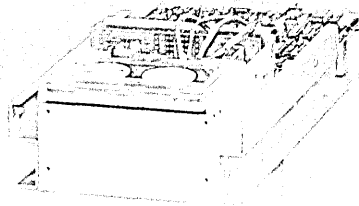

# **AM** Jacquard Systems

The AM Jacquard 121 entry level computer system does two things for your office. Word and data processing.

And it does a whole lot more. It interfaces to AM Varsity phototypesetters, can easily communicate with mainframes, and can handle electronic mail and a multitude of tasks that other systems can't. And all for about \$13,500 per screen.

This efficient office automation system can grow with your business, too. Buy it now with only two workstations and add more, for under \$5,000 per screen, as you need them. The J121 offers ease of operation, expandable on-line storage, high speed throughput, and comes with

a choice of two letter-quality printers.

The AM Jacquard J121 is designed to boost your office's productivity and profitability. No one, but no one, offers so much versatility and flexibility for the money. And we know what we're talking about. Our parent company, AM International, Inc., has been designing products to modernize offices for more than 90 years.

If you want to know more—and you should—about our Datapro award-winning J121, contact AM Jacquard Systems, the Informationists, a division of AM International, Inc., Dept. 777, 3340 Ocean Park Blvd., Santa Monica, CA 90405. (213) 450-1242, Ext. 777.

## **IT'S A WORD PROCESSOR.**

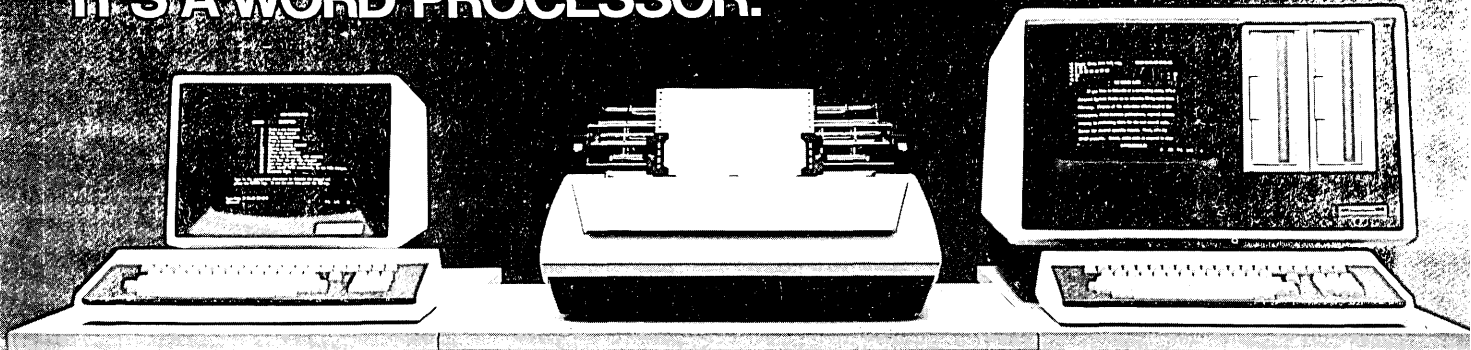

## **IT'S A DATA PROCESSOR.**

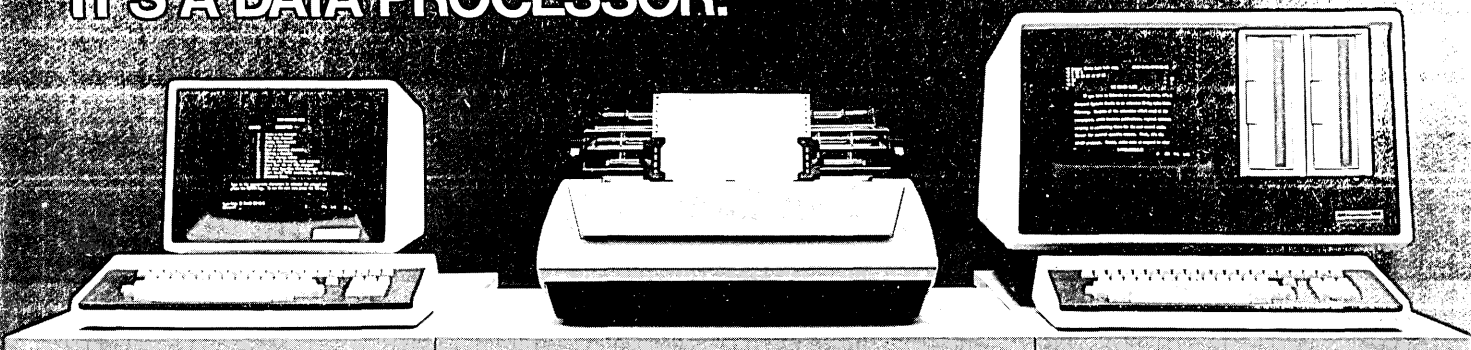

## **IT'S A STEAL AT THE PRICE.**

© 1980 AM International, Inc.  
AM Jacquard and Jacquard Systems are registered trademarks of AM International, Inc.  
The Informationists is a trademark of AM International, Inc.

CIRCLE 4 ON READER CARD

Wild Hare Software Systems  
Multiply the Capabilities of  
Data General's

RDOS  
INFOS®  
ICOS  
DOS

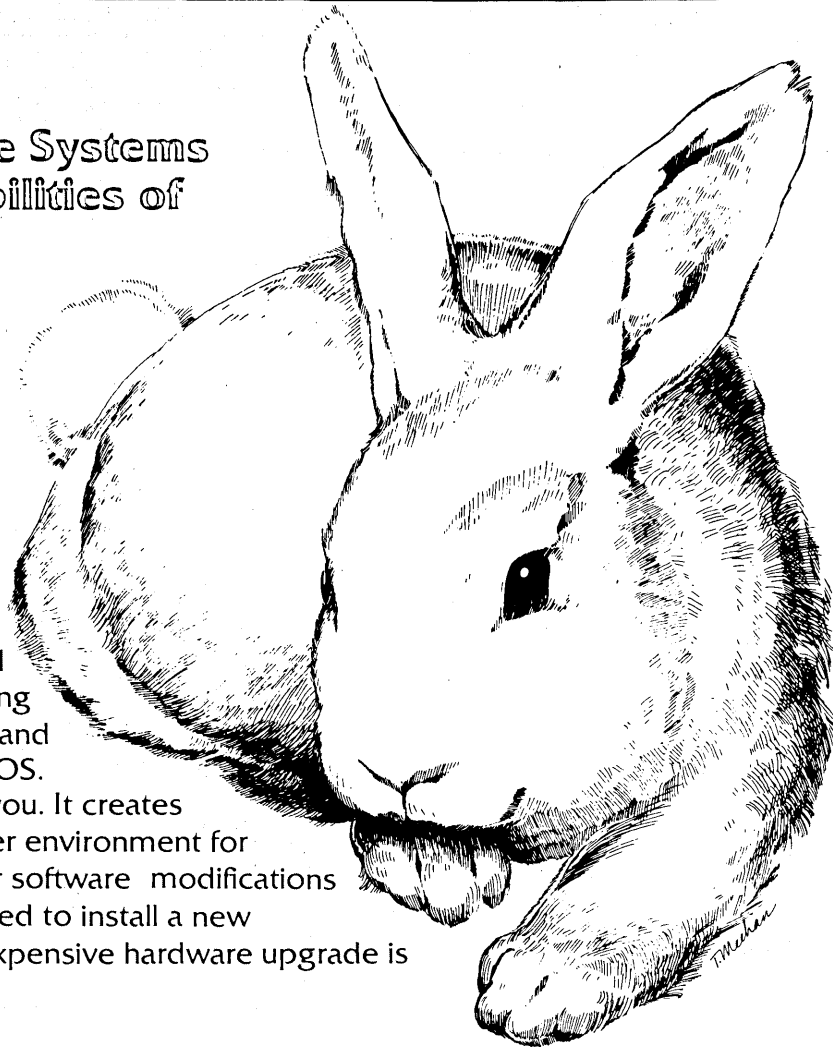

Wild Hare gives Data General users a choice when upgrading to a multi-user environment and eliminates the need to use AOS. Wild Hare makes it easy for you. It creates a true multi-lingual, multi-user environment for your current system. No user software modifications are necessary. There is no need to install a new operating system. And, no expensive hardware upgrade is required.

**Features**

- Each user is totally independent of all other users.
- Each user may run all standard Data General software.
- Each user may independently edit, compile, execute and debug programs written in any language supported by RDOS, INFOS®, ICOS and DOS.
- Standard languages supported include: Fortran IV, Fortran V, COBOL, ALGOL, RPG, DG/L™, BASIC, PASCAL, MAC, etc.
- All NOVA's® and ECLIPSE's® are supported.
- Wild Hare guarantees its software systems on a money back basis.

Wild Hare's Software  
Gives Data General Users  
A Choice!

**WILD HARE** COMPUTER  
SYSTEMS INC.

P.O. Box 3581, Boulder, Colorado 80307  
(303) 494-0221

NOVA, ECLIPSE, and INFOS are registered trademarks of Data General Corporation.

JULY 1981/\$4.00 U.S.A.  
VOLUME 27 NUMBER 7  
This issue, 158,635 copies

## FEATURES

### 26 IN FOCUS

Mainframe shipments this year are expected to be flat or up only slightly over last year, says the annual mainframe survey for DATAMATION by G.S. Grumman/Cowen & Co.

### 92 BURNOUT: VICTIMS AND AVOIDANCES

Merrill Cherlin

It's the new name for an age-old complaint—being fed up with one's job. We've included a test for you to determine if you, too, are burning out.

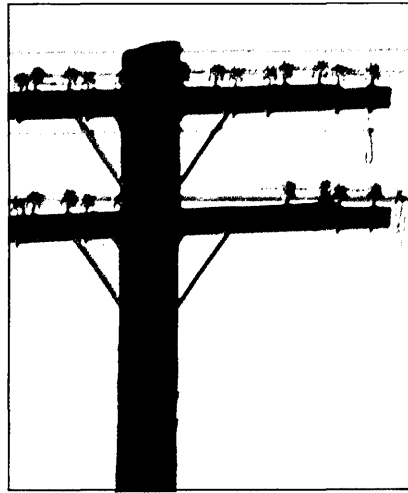

### 100 COMPUTERS IN COMMUNICATIONS: A RATINGS SURVEY

The features, functions, and performance of 23 computer system groups are rated by 1,611 users at 1,525 sites. Charts begin on p. 114.

### 140 ACCEPTANCE TESTING AN ON-LINE SYSTEM

Daniel Fidlow

The problem was to perform second site testing while highly sensitive electronic funds data were being exchanged among 200 banks.

### 155 MODELING FOR MIS

Brent Bowman,  
Gordon Davis,  
and James Wetherbe

Developing a three-stage model helps provide perspective in management information systems planning.

### 211 READERS' FORUM

"The Love Song from the Baseband" by S. Williams-Haik and W. R. Crisp is followed by comments on "Ada" by Eric A. Weiss. This month's DATAMATION Crossword, by Brian Burke, is "Gentle Tinkers." Also, J.P. "Buz" Murphy explains why the beast should be shot in "Dead-Ended."

## NEWS IN PERSPECTIVE

34 **MINICOMPUTERS**  
DG's high stakes gambling.

36 **OFFICE AUTOMATION**  
Xerox's office assault.

49 **PERIPHERALS**  
Tiny Ibis takes on Big Blue.

52 **TERMINALS**  
CDI's terminal strategy.

56 **ROBOTICS**  
Japanese push robotics.

61 **SERVICES**  
AT&T slammed on EIS II.

68 **COMMUNICATIONS**  
You're on (and in) the air.

73 **COMPANIES**  
A new ICL in the making.

80 **APPLICATIONS**  
Dp moves in on cable tv.

86 **BENCHMARKS**  
SBS snafus; Fujitsu mainframes; XTEN axed; New word processor; Air Force contract; Cpu rights.

## DEPARTMENTS

- 8 **LOOKING BACK**
- 13 **LOOK AHEAD**
- 18 **CALENDAR**
- 21 **LETTERS**
- 25 **EDITOR'S READOUT**



- 167 **PEOPLE**
- 171 **HARDWARE**
- 191 **SOFTWARE & SERVICES**
- 199 **SOURCE DATA**
- 201 **ADVERTISERS' INDEX**
- 206 **MARKETPLACE**

COVER ILLUSTRATION BY DICK PALULIAN

# THE AJ 833. ONE TERMINAL TO HANDLE ALL YOUR APPLICATIONS.

If you're using a lot of different printing terminals for a lot of different jobs, you're losing efficiency. Operators can't easily switch. Training becomes complicated. Various supplies must be stocked. And maintenance can be a real problem.

Now consider the AJ 833 daisy wheel printer. No other terminal of its kind can match it for applications versatility. It's ideal for timesharing, communications, text processing, letter writing, even high-resolution plotting.

And APL jobs of every kind.

The AJ 833 is so versatile because we've built-in a lot of capability. Such as a unique, *totally programmable keyboard*, including seven multi-function keys. A non-volatile memory for storing terminal status. Bidirectional 45 cps printing. Selectable line rates up to 450 bps. X-Y plotting.

And a long list of options including 600/1200 bps full duplex operation, a 16K or 32K memory, and 2741 compatibility.

Plus a text enhancements package with bold face printing, automatic

centering, underscoring, and margin justification. There's even a proportional spacing option.

So your AJ 833 can handle virtually all your printing terminal applications, especially those that require letter-quality typing.

If you have AJ 832's installed, we can upgrade them to full AJ 833 capability.

Call your nearest AJ regional office for details: San Jose, CA (408) 946-2900; Rosemont, IL (312) 671-7155; Hackensack, NJ (201) 488-2525. Or write Anderson Jacobson, Inc., 227 Devcon Drive, San Jose, CA 95112.

 **ANDERSON  
JACOBSON**

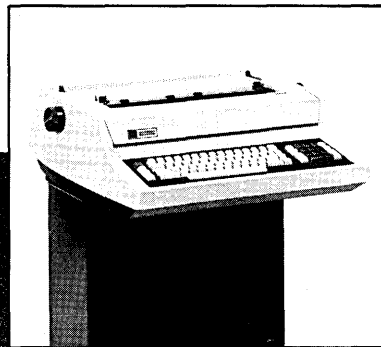

**ANOTHER  
AJ INNOVATION  
TO MAKE YOUR  
COMPANY RUN BETTER.**

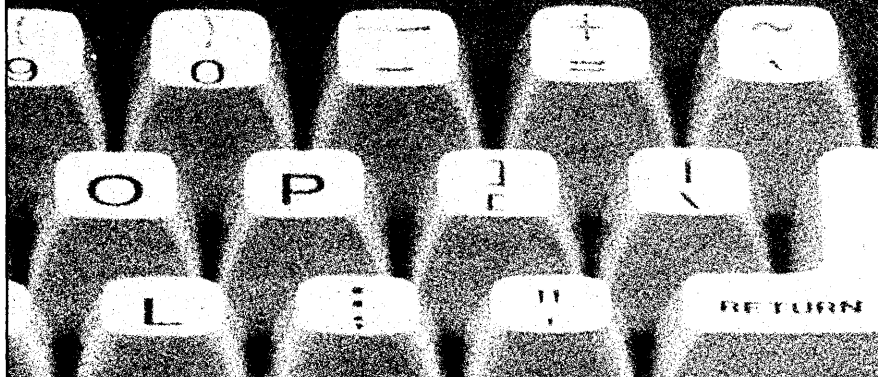

CIRCLE 6 ON READER CARD

## DATAMATION

**Editor** John L. Kirkley  
**Articles Editor** Wendy Reid Crisp  
**News Editor** Becky Barna  
**International Editor** Linda Runyan  
**Managing Editor, Europe** Andrew Lloyd  
**Products Editor** Bill Musgrave  
**Copy Editor** Florence Lazar  
**Associate Editor** Kenneth Klee  
**Assistant Editor** Deborah Sojka  
**Bureau Managers**  
**San Francisco** Edward K. Yasaki  
**Los Angeles** Edith D. Myers  
**Boston** Ralph Emmett  
**New York** John W. Verity

**Technology Editor, Europe** Fred Lamond  
**Correspondents**

**Washington** Willie Schatz  
**London** Malcolm Peltu  
**Sydney, Australia** Norman Kemp  
**Telecommunications Editor** Ronald Frank  
**Editorial Advisor** Robert L. Patrick  
**Technical Advisor** Lowell Arndahl  
**Contributing Editors** Ralph G. Berglund, Howard Bromberg, Philip H. Dorn, David Hebditch, John Imlay, Angeline Pantages, Russell Pipe, Carl Reynolds, F. G. Withington.

### EDITORIAL OFFICES

**Headquarters:** 666 Fifth Ave., New York, NY 10103. Phone (212) 489-2588. **New England:** 1 Chaucer St., RFD 2, Sandwich, MA 02563, (617) 888-6312. **Western:** 1801 S. La Cienega Blvd., Los Angeles, CA 90035, (213) 559-5111; 2680 Bayshore Frontage Rd., Suite 401, Mountain View, CA 94043, (415) 965-8222. **International:** 6605 Burlington Pl., Springfield, VA 22152, (703) 569-3383. **Foreign:** 221 Blvd. Raspail, 75014 Paris, France, (331) 322-7956. **New York, N.Y. TELEX 640-229.**

**Art Director** Kenneth Surabian  
**Assistant Art Director** Susan M. Rasco  
**Production Manager** Robert Gaydos  
**Asst. Production Mgr.** Kathleen Monaghan  
**CIRCULATION**  
666 Fifth Avenue, New York, NY 10103  
**Circulation Manager** Joseph J. Zaccaria  
**Director of Marketing** Deborah Dwelley  
**Business Manager** Charles J. Johnsmeyer  
**Publisher** James M. Morris

## Technical Publishing

**CB** a company of  
The Dun & Bradstreet Corporation

**VBPA** Circulation audited  
by Business Publications Audit

**★ABP** Member American Business Press, Inc.

**DATAMATION** (ISSN 0011-6963) Magazine is issued monthly on or about the first day of every month, with the exception of August, which is semimonthly. Published by Technical Publishing, a company of the Dun and Bradstreet Corp., 1301 South Grove Ave., Barrington, IL 60010; James B. Tafel, Chairman; John K. Abely, President. Executive, advertising, editorial offices, and subscription department, 666 Fifth Ave., New York, NY 10103. Published at East Greenville, Pa. Subscription rates: \$36 (U.S. and Possessions), \$45 (Canadian). Reduced rate for qualified U.S. students: \$18. Foreign subscriptions: £43. Additional charge for airmail: £40. Japan, Australia and New Zealand: £47 (air-shipped). Sole agent for all subscriptions outside the U.S.A. and Canada is J. B. Tratsart, Ltd. 154 A Greenford Road, Harrow, Middlesex HA13QT, England, (01)422-8295 or 422-2456. No subscription agency is authorized by us to solicit or take orders for subscriptions. Controlled circulation postage paid at New York, NY 10001 and at additional mailing office. Copyright 1981 by Technical Publishing Company, a Division of Dun-Donnelley Publishing Corporation. All rights reserved. "Datamation" registered trademark of Technical Publishing Company. Microfilm copies of DATAMATION may be obtained from University Microfilms, A Xerox Company, 300 N. Zeeb Road, Ann Arbor, Michigan 48106. Printed by Brown Printing Co., Inc. POSTMASTER: Form 3579 to be sent to Technical Publishing Company Circulation Office: 666 Fifth Avenue, New York, NY 10103. Single copy: \$4.00 in U.S.A.



## Cause for Celebration... your new 4300 with Intel's DBMS

**Your DP staff is out celebrating a long-sought solution: hardware and software which work for them.**

It feels good to be right. You've chosen Intel's SYSTEM 2000®/VSE data base management system to go with your 4300. It's a match that certainly calls for celebration.

### **SYSTEM 2000®/VSE DBMS: Made for the 4300.**

Intel's DBMS is specially tailored to the IBM 4300 line and you, the user. Intel knows you have a diversity of application requirements and an urgent need to develop and maintain application software. You face a two-pronged challenge: to clear out backlogs and respond to increasing growth de-

mands, while keeping budget and DP staffing on an even keel. Towards this end, you expect your software to relieve you of two fundamental concerns: *people productivity* and *low maintenance*.

Intel answers these people-intensive needs by providing:

- powerful productivity tools for programmers;
- simplified interfaces for end users;
- extensive prototyping facilities for application development; and
- flexibility to respond to modifications and change.

### **It's software that brings life to the party.**

SYSTEM 2000/VSE DBMS, teamed with the 4300, allows you to maximize your valuable human resources by providing them with tools that make their jobs easier.

*Programmers* applaud Intel's versatile programming language extensions, which greatly facilitate their design efforts and free them to develop new applications as well as to update old. *End users* appreciate the free-form, English-like language that allows them to create, update and retrieve data bases without programmer assistance. Both enjoy Report Writer's comprehensive facilities which make reporting a routine and worry-free task. No programming is required.

And because SYSTEM 2000/VSE is dictionary-driven, you need never be apprehensive about changing your data base. The Integrated Data Dictionary (IDD) ensures that adjustments will not throw off the rest of the system in a "ripple effect."

Haven't had a good celebration for a long while? Call Intel's Market Information Office at 512/258-5171, or clip the coupon below. For you, the celebration has just begun. 4300 plug-compatible guests are also invited.

Please tell me more about  
SYSTEM 2000/VSE DBMS in 4300  
(compatible) environments.

Name \_\_\_\_\_

Company \_\_\_\_\_

Mailing address \_\_\_\_\_

City \_\_\_\_\_ State \_\_\_\_\_ Zip \_\_\_\_\_

Telephone \_\_\_\_\_

Return to: Intel Market Information Office  
P.O. Box 9968  
Austin, Texas 78766

Europe: Intel Corporation S.A.  
Commercial Systems Division  
Rue du Moulin a Papier 51, Boite 1  
B-1160 Brussels, Belgium  
32-2-660-3010 TLX: 846-24814

Canada: Intel Semiconductor of Canada, Ltd.  
Willowdale, Ontario

**CIRCLE 7 ON READER CARD**

**intel delivers solutions**

# The Tektronix 4114 Computer Display Terminal

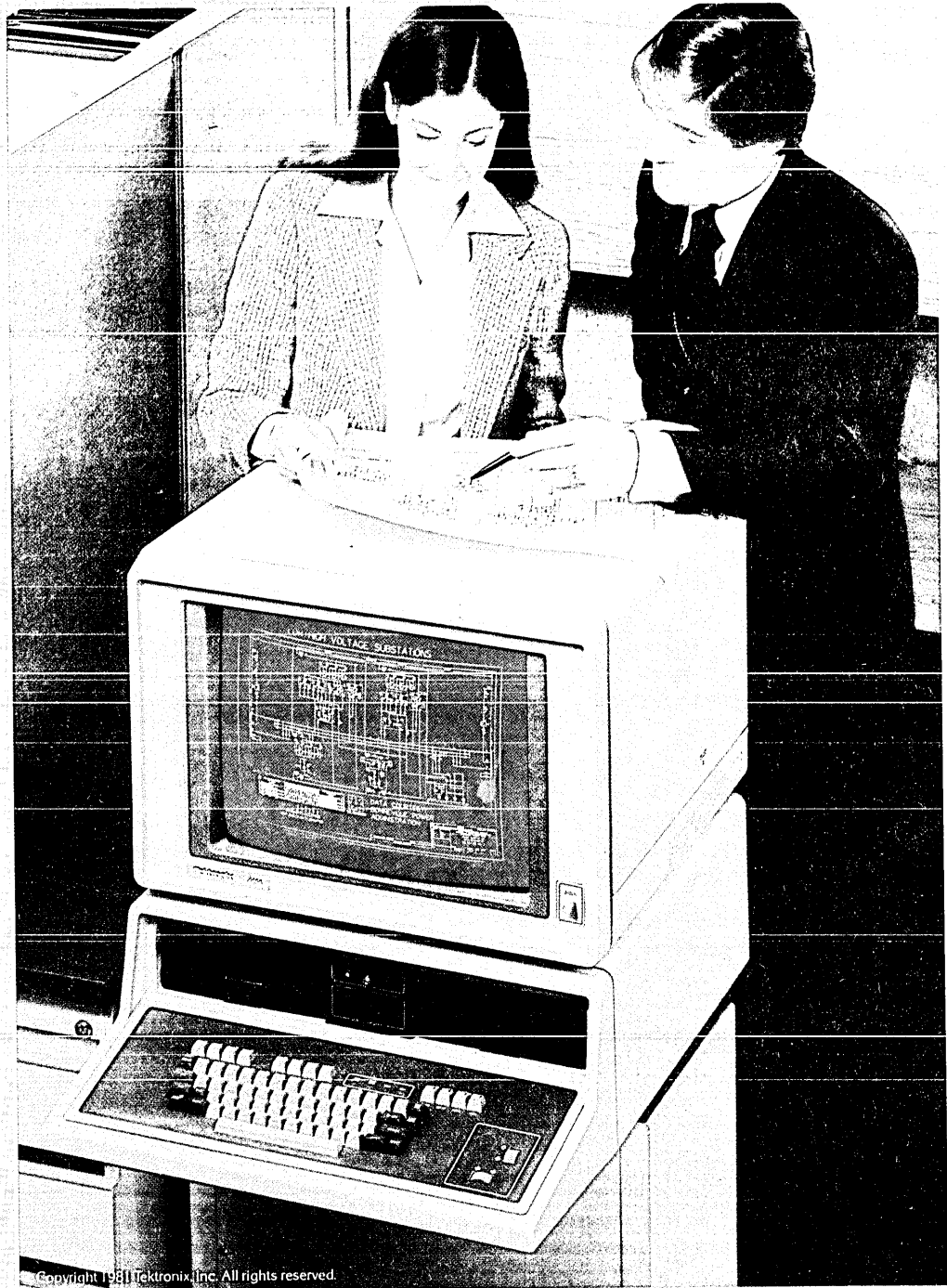

High resolution 4114 displays can be scaled up, as below, using local 2-D transforms. You can recall locally retained picture elements and position them within the display under thumbwheel cursor control. RAM/ROM is expandable to 1 megabyte.

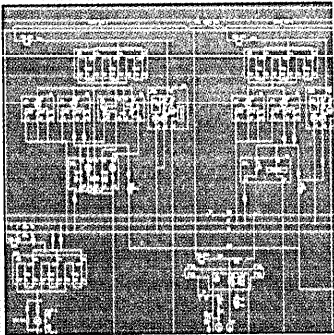

Copyright 1981 Tektronix, Inc. All rights reserved.



# Local segments. Fast redraw. Refresh dynamics. 19.2K baud communications.

## When you can't work any harder, we'll help you work faster.

**The power you've always wanted is right before your eyes.**

The new Tektronix 4114 combines host computer power with unprecedented local intelligence and transmission speed. It combines the unequalled resolution of the 19-inch Tektronix storage tube with the capacity to construct, store, redisplay and manipulate graphic elements locally, without transmission from the host. It includes 3000 short vectors of local refresh and new fast redraw capability.

It adds up to a reduction in the delays, interruptions and high line costs that inhibit creative thinking and productive results—and a boost to the graphics interactivity that inspires them.

**You can stay linked to the host without being locked into it.**

Command local graphic primitives. Create character sets. Store and retrieve picture segments

locally. Perform local translation, rotation and scaling. Try alternatives in refresh mode. Then communicate with the host at speeds up to 19.2K baud.

You can even define the size and location of a scrollable, refresh dialog area—the functional equivalent of a second alphanumeric display.

**Optional enhanced version keeps refreshed information in high-contrast color.** A particularly convenient, easy-viewing feature in high-density graphics environments.

**You can expand user RAM memory to 800K bytes, and add optional integrated single or dual flexible disk mass storage.**

You can consolidate and reorganize files, display directly from disk, or send data from disk to plotter while you turn the terminal to other tasks.

Why waste time waiting for what you can see right now? A Tektronix sales engineer can show you the 4114 in action.

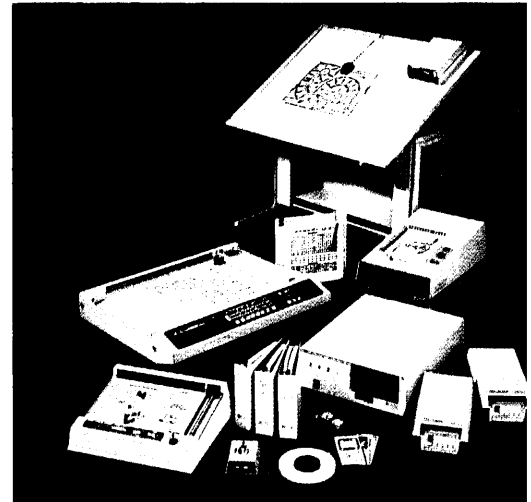

Or call toll-free, 1-800-547-6711 (in Oregon, 1-800-452-6773 for complete product details or OEM quotations.

**Tektronix, Inc.**  
Information Display  
Division  
P.O. Box 4828  
Portland, OR 97208  
**Tektronix  
International, Inc.**  
European Marketing  
Centre  
Postbox 827  
1180 AV Amstelveen  
The Netherlands

### THE GRAPHICS STANDARD

**Tektronix®**  
COMMITTED TO EXCELLENCE

CIRCLE 8 ON READER CARD

# FINANCIAL RESEARCH ANALYST

Federal Express Corporation, the nation's leading air express service linking over 13,000 domestic and international communities, has exciting and challenging financial positions at its Memphis headquarters. Our dramatic growth history of 40% per year has created opportunities in Finance for dynamic individuals with strong quantitative skills.

These positions are responsible for:

- Financial and manpower modeling
- Performance reporting and analysis
- Marketing and pricing support
- Operations analysis
- Development of information and control systems

We are looking for candidates who enjoy working in a highly creative environment with significant exposure.

Requirements include at least 1-2 years of related experience, excellent communication skills and proven ability in computer assisted analysis (FORTRAN, PL-1, SAS or a financial modeling language). A technical undergraduate degree along with an MBA is preferred.

At Federal Express our employees enjoy excellent compensation and one of the industry's most outstanding benefit programs. Join the excitement of Federal Express and experience the opportunity to excel in a fast-paced, rapid-growth organization.

Candidates should send a resume including salary history in confidence to:

**Ann Mullis**  
Personnel Department

**FEDERAL  
EXPRESS  
CORPORATION**  
P.O. Box 727  
Memphis, TN 38194



**An Equal Opportunity  
Employer M/F**

Twenty Years Ago/Ten Years Ago

# LOOKING BACK

## GOING FOR BROKE

*July 1961:* After some months of trepidation on the part of DATAMATION's editors, Jackson W. Granholm's seminal essay, "How To Lose Money In Computing," finally saw the light of day. Granholm recommended that hopefuls start out by hiring a lot of salesmen adept at pronouncing words that end in "-tronic." Once the entrepreneur had a large sales force and a few engineers on board he was advised to go after a government contract, which was to be obtained on an Infinitesimal Bid-Massive Overrun basis. Contract in hand, the new tycoon could proceed with the business of commercially marketing a thinly disguised version of the machine he'd made for Uncle Sam. A proper marketing effort meant organizing salesmen into a department of Outlandish Claims, which would work closely with a department of Ridiculous Estimates. Delivery of the machine was to occur no less than 8.2 months prior to release of the first reference manual.

In News Briefs that month, DATAMATION noted that RCA had dedicated its new \$4 million production plant for the 301 in Palm Beach Gardens, Florida. Westinghouse announced that in 18 months it would install the first of its Mol-E-Com molecularized digital computers, which would use a solid semiconductor crystal in place of transistors, resistors or tubes. And A.C. Nielsen Co. in Chicago disclosed plans to install a Honeywell 800, a machine destined to discern the U.S. public's awesome fondness for "The Beverly Hillbillies."

## STORM WARNINGS

*July 1971:* "Dissatisfied persons are learning what to destroy."

That was one of the alarms sounded in "A Contingency Plan For Disaster," DATAMATION's lead article, in which D. Van Tassel warned of the extreme vulnerability of computer installations to destruction, both accidental and deliberate. Van Tassel described the damage done when

Dow Chemical's computer center at Midland, Michigan, was "invaded by war protesters" in November 1969; the \$2 million in destruction accomplished by students who set fire to the computer center at George Williams University in Montreal in January 1969; the havoc wrought in several computer centers when Hurricane Celia blew through Corpus Christi, Texas, at 162 mph in 1972; and the computer casualties resulting from the 1970 bombing of the Army Math Research Center in Madison, Wisconsin. He didn't mention the life lost in the latter incident. Prudent managerial measures, according to Van Tassel, included insurance for information and supporting software, the creation of backup files, strict fire protection measures, and careful selection of site location.

## COMPUTER PEACENIKS

*July 1971:* "The Computer People for Peace, many of whom affect a hippie style, looked even more out of place than usual."

That was at the 1971 Spring Joint Computer Conference, which took place in Atlantic City. DATAMATION's conference wrap-up went on to note that AFIPS had "acceded to nearly all the CPP's demands for space and sessions, and that may have been the radical group's undoing." The organization found itself speaking largely to its own supporters, and even they seemed bored with the CPP speakers' denunciations of racism and sexism. The peaceniks were further disappointed by the absence of Honeywell, whom they were wont to denounce as the number one "war contractor," and by the fact that an FBI agent they had targeted for a "citizen's arrest" also failed to appear.

An unusual exhibitor at the exhibit was the Iron Mountain Security Storage Corp., which for a fee would store magnetic tapes beneath a mountain, where they would be safe from atomic attacks and insurrections.

—Ken Klee

CIRCLE 9 ON READER CARD

# Introducing the NEC 7700.

## Cost of ownership counts.

The new NEC 7700 Series of Spinwriter™ letter-quality character printers deliver unparalleled "cost-of-ownership" benefits right now. You save on service, sparing, inspection, testing, software, interfaces and transportation.

Seven basic models—Qume- and Diablo-compatible mechanisms, plus five RO and KSR terminals—fit every letter-quality printing application at speeds up to 55 cps.

Single-board electronics provide a 4-1 reduction in board sparing. A standard universal power supply provides simple voltage conversion.

Our 2,500-hour MTBF sets a new high that keeps your cost of service low. Series 7700 Spinwriter™ printers are so reliable you may never have to open the box. Dock merge with your system or direct ship to your customer with complete confidence.

Interchangeable forms handlers. NEC designs and builds more handlers than any one else. On any Model 7700, an oper-

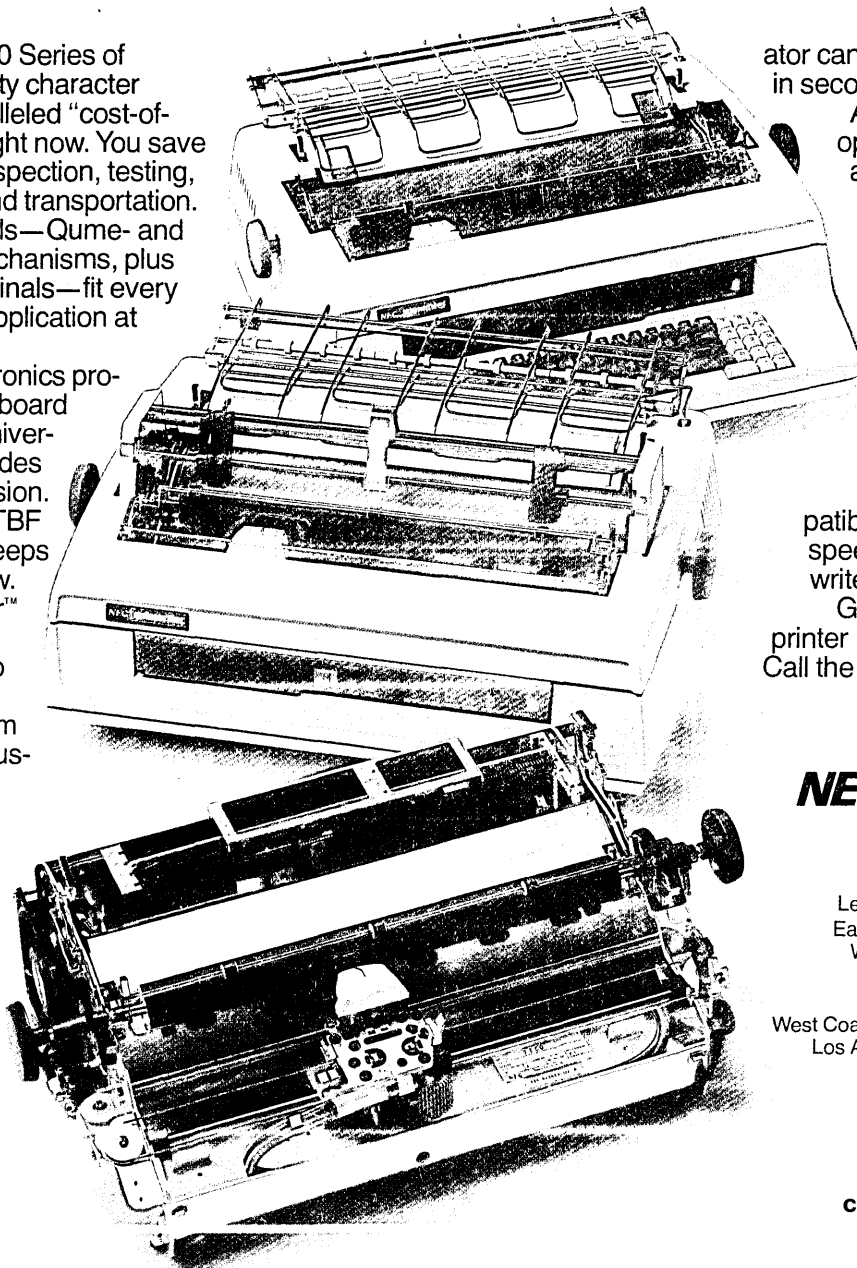

ator can install any forms handler in seconds.

A powerful WP-assist option provides more than a dozen word processing print functions automatically.

That's not all. The 7700 Series offers new operator controls, a 30-minute MTTR, and NEC's huge selection of up to 128 character print thimbles. And the 7700

Series is functionally compatible with NEC's medium-speed 3500 Series of Spinwriter™ printers.

Get the best letter-quality printer money can buy. Right now. Call the NEC office nearest you.

NEC

## NEC Information Systems, Inc.

Home Office: 5 Militia Drive,  
Lexington, MA 02173, (617) 862-3120  
Eastern Office: 36 Washington Street,  
Wellesley, MA 02181, (617) 431-1140  
Central Office: 551C Tollgate Road,  
Elgin, IL 60120, (312) 931-1850  
West Coast Office: 8939 S. Sepulveda Blvd.,  
Los Angeles, CA 90045, (213) 670-7346

CIRCLE 10 ON READER CARD

## NEC. Going after the perfect printer.



*Mr. Fred R. Meier,  
President,  
Business Machines Group,  
Burroughs Corporation.*

***“Our Respond System  
is an important step in Burroughs  
commitment to be second to  
none in customer service.”***

“Our new Respond System is more than a service-dispatching system. It’s a comprehensive support system, with management involvement every step of the way.

*When you call on our new Respond System, you’re calling on our management commitment to comprehensive customer support.*

“Your call to our Customer Service Center ties you into a computerized system that alerts successively higher levels of management. That way, your service needs are automatically escalated to the level that can get you back in operation. Fast.



“The System will be operating throughout the U.S. and in 18 other countries by year’s end. Results to date have been excellent. In one area, we have cut our ‘time to respond’ by better than 50% and service calls have decreased by a third.

“Our Respond System is part of a Burroughs commitment to earn the same high marks for innovative customer support as we have for innovative information systems and software.”

We’d like to tell you more. Call your local Burroughs office, or write Burroughs Corporation, Dept. D-12, Burroughs Place, Detroit, MI 48232.

# Burroughs

CIRCLE 11 ON READER CARD

# What's the score on the BTI 8000?

|   | BTI<br>8000 | DEC<br>11/780 | PRIME<br>750 | DG<br>MV/8000 |
|---|-------------|---------------|--------------|---------------|
| <b>32-BIT SUPER MNIS</b>                |             |               |              |               |
| MAX. NO. TERMINALS                      | 200         | 96            | 63           | 128           |
| MAX. NO. GPUs                           | 8           | 1             | 1            | 1             |
| MAX. MEMORY - MBYTES                    | 16          | 8             | 8            | 4             |
| MAX. MASS STORAGE - GBYTES              | 8           | 9.6           | 4.3          | 67            |
| AGGREGATE<br>BUS TRANSFER RATE - MB/SEC | 60          | 18.3          | 8.0          | 35.4          |

In this game, it's clearly no contest. The BTI 8000 32-bit multiprocessor system gives you the lead in the first inning, and keeps you there all the way. And, you can sign it up for 30 percent less than competitive systems.

Furthermore, the BTI 8000's hardware and software architecture will continue to make it a top performer, long after other systems have been traded away.

For example, starting with a basic system, BTI's exclusive Variable Resource Architecture lets you increase processing power by ten times, just by plugging in resource modules. You don't have to rewrite systems or applications software either.

Despite its "superstar" status, the BTI 8000 is friendly to users and a real team player. A virtual machine environment, hierarchial ac-

count structure and fail-soft architecture eliminate any worries about security, control or downtime.

As for reliability, BTI bats near 1000, thanks to service via remote diagnostics. BTI has been using this method for over 10 years, and currently supports over 3000 systems.

These are just a few reasons why you should put the BTI 8000 in your starting line-up. For a complete scouting report, contact your nearest BTI office.

**BTI**  
COMPUTER  
SYSTEMS

Corporate Offices: 870 West Maude Avenue, Sunnyvale, CA (408) 733-1122 Regional Offices: Piscataway, NJ (201) 457-0600; Palatine, IL (312) 397-9190; Atlanta, GA (404) 396-1630; Sunnyvale, CA (408) 733-1122. Sales Offices in major U.S. cities. In the United Kingdom: Birmingham (021)-477-3846

BTI is a registered trademark of BTI Computer Systems

# LOOK AHEAD

## STARGAZING AT HONEYWELL

After getting burned in 1977 with its never-delivered 66/85 large-scale processor, Honeywell has been fairly quiet about developing a new machine using the current-mode logic (CML) technology originally targeted for that aborted system. But we hear the firm is working on a machine code-named Orion, or Advanced Design Processor (ADP). No details on system specs or pricing have leaked out of the Phoenix plant, due primarily to the tight security management has placed on the project for fear of a repeat of the 66/85 fiasco. Meanwhile, the firm is understood to be marketing six- and seven-processor versions of its DPS 8 family to those that need large capacity machines.

## MARCHING TO THE SAME DRUMMER

Looks like Data General's new Tiny Business System is leading a parade, having stolen a march on arch rival DEC. But the Maynard, Mass., mini giant is now expected to respond with its own \$7,000 small business computer within two months to compete with DG's Enterprise.

And following not too far behind is IBM. Sources say Big Blue is gearing up for product families at its Raleigh, N.C., manufacturing facility to cover the entire span from \$250 to \$10,000 small business computers. One specific machine mentioned in the rumor mill is a very small business computer code-named Fairway -- expected to be cheaper than the IBM 5120. Announcement from IBM isn't expected until some time in the third quarter.

## GRAPHICS FOR MICROS

What's believed to be the first graphics software package for a microcomputer-based system is being readied by Intelligent Systems Corp., Atlanta. Developed by grad students at Georgia Tech, IGS (for Intelligent Graphics System) will run initially on ISC's models 8300 and 8900, each a family of from 10 to 12 small computer/word processing systems. The package will create pie charts, pulling out a wedge as needed; pan in on charts, rotating them and shading parts as needed, and will enable users to define what they want in an English-oriented language. It's expected out in early fall.

## FROM TOKYO WITH LOVE

The talk of the town in Tokyo is what's coming next from IBM. Sources there tell us that IBM will announce in the next few months a file-processor with 31-bit addressing, expected out of the San Jose, Calif., lab. By the end of the summer, they expect IBM to debut its "Acorn Personal com-

# LOOK AHEAD

## ZENITH READIES ANNOUNCEMENT

puter as the IBM 31XX, featuring Pascal, Basic, and later, APL. Following that will be a 4341-3 announcement -- an attached processor.

And the Japanese have one bone to pick with IBM: although volume discounts have begun on 4300s (10% on orders for 40 units; 15% on 50-plus units), this will not apply to Japanese customers.

In its attempt to get solidly entrenched in the small business market, Zenith Data Systems is coming out later this year with a hard disk system. Using Memorex's model 101 8-inch drive, the new Zenith unit will store about 10 megabytes and will sell in the \$6,000 range. It will include a double-density, dual-sided floppy disk drive for back-up. Deliveries are set for October.

## SERVICES FROM IBM

We hear that IBM is making quiet attempts to get back into the services business in a big way from Boca Raton, Fla. The new effort is rumored to be headed by Jim Hewitt, who comes out of DPD. The fact that the operation is located near a major GSD plant has given room for speculation that the offerings may include small computers for customer sites.

## XCS PUSHES HARDWARE

A push into hardware sales is underway at Xerox Computer Services, El Segundo, Calif. It plans to sell DEC PDP-11s on a turnkey basis using software acquired when it bought Praxa, a New Jersey systems house specializing in manufacturing software. XCS has an oem agreement with DEC that it claims will make it one of the largest DEC oems around.

## COMING SOON FROM P-E GROUP

The Perkin-Elmer Data Systems Group recently formed a Business Systems Division to push its traditionally scientific and simulation-oriented 32-bit computers into commercial markets. The new division plans to introduce its first major product by mid-month. We hear it will be a system incorporating relational data base technology developed in England. It will join the firm's transaction processing system and a highly successful COBOL compiler.

## RUMORS AND RAW RANDOM DATA

Having just closed two of its computer stores, is it possible that DEC isn't as committed to this retail route as it once was?....Insiders tell us that Data General might settle out of court the antitrust suit brought by Fairchild/Digidyne (see p. 34) -- and do so before the damages trial on Oct. 5....Computer Automation seems to be using reverse nomenclature on us. The newest and most powerful addition to its SyFa line, due out this fall, is dubbed Acorn.





## Think what your programmers could do if your users did their own reports.

Answer/DB, the latest Implementation System from Informatics, is the new on-line software tool for report generation. It lets non-DP people develop their own report requests at a terminal—in an English like language—with as few as four simple statements.

That means much faster report turnaround, wider smiles from non-DP people in your organization, and greatly increased programmer productivity.

Answer/DB has made old-fashioned batch reporting systems obsolete because it's designed to handle the problems you'll be facing in the data base and data communications world. Answer/DB operates with your standard OS/DOS files and IMS data bases. And it offers completely interactive, on-line query entry with syntax checking and editing capabilities for creating error-free report requests.

For more information on Answer/DB and other information retrieval systems, just complete the coupon. Or, call us at (213) 887-9121.

Informatics Inc., 21050 Vanowen Street, Canoga Park, CA 91304  
 Tim Corey, Product Manager  
 (213) 887-9121 Telex: 69-8473

- Send me complete details on Answer/DB.  
 Send me complete details on:  
 Other Informatics report writers  
 Inquiry systems  
 Have a salesman call me.

**informatics inc.** 

Name \_\_\_\_\_ Title \_\_\_\_\_

Company \_\_\_\_\_

Address \_\_\_\_\_

City \_\_\_\_\_ State \_\_\_\_\_ Zip \_\_\_\_\_

Telephone (\_\_\_\_) \_\_\_\_\_

Computer \_\_\_\_\_ Operating System:  DOS/VS  OS/VS  
 TP Monitor:  IMS/DC  CICS/VS  TSO D7-81

# Introducing Answer/DB™ by Informatics®

CIRCLE 13 ON READER CARD

The Information Management Company.

# Timeplex systems compatibility adds up.

Flexibility and performance  
of the Microplexer

Plus the Advanced  
Intelligent Modem

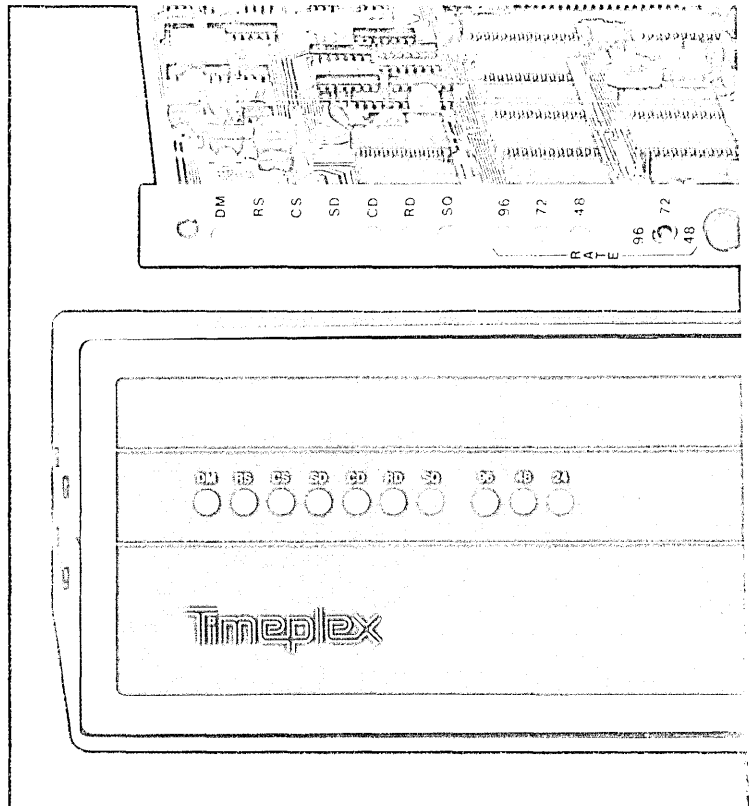
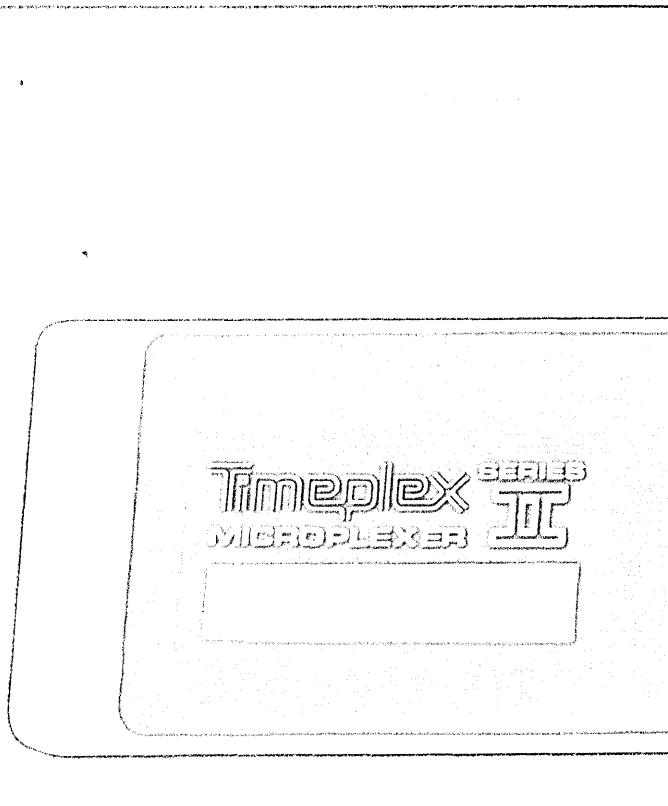

**ADVANCED INTELLIGENT MODEM.** The MICROPLEXER is the most flexible member of a family of 4- to 16-channel modems for time-sharing systems. Take a look at some of its features:

• **Timeplexer's** unique gateway Port permits a single terminal to be used in a system, perform high-speed data transfer, and monitor operating statistics and control the system.

• **Timeplexer's** unique gateway Port simultaneously serve up to 16 terminals. Planning model, for example, for two 9,600 BPS channels, or one 19,200 BPS channel.

• **Timeplexer's** unique gateway Port can be individually controlled to serve any terminal, no matter how many are connected.

**ADVANCED INTELLIGENT MODEMS.** A new Advanced Intelligent Modem series enhances Timeplex systems compatibility. Features include:

- ▣ Data speeds of 9,600; 4,800; and 2,400 BPS.
- ▣ Up to 16 modems in one 10.5 inch high rack mount shelf, in any combination of speeds.
- ▣ Interchangeable modules for both stand-alone and rack-mounted configurations.
- ▣ Split stream capability.
- ▣ Async to sync conversion.
- ▣ End-to-end diagnostics from one central control site.

**Plus superior network  
control and control**

**Equals integrated  
data networks**

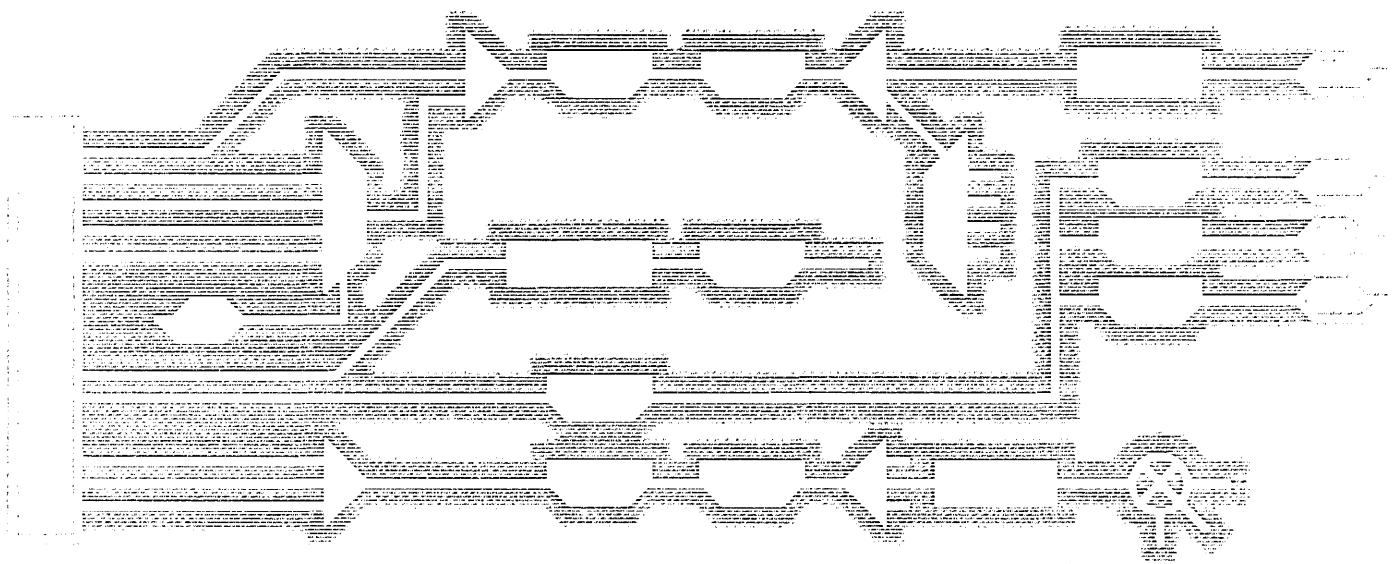

**PLUS INTEGRATED DATA NETWORKS.** Our products have been designed to meet the highest industry standards for performance, reliability and control. We offer a complete line of performance, fully compatible products for your data network with superior control and control. The basic integrated line includes:

- Data communications controllers
- Data communications controllers
- Data communications controllers
- Data communications controllers

**FREE NETWORK PLANNING KIT.** Our products are designed to meet the highest industry standards for performance, reliability and control. Our approach can enhance your network. We offer a *Network Planning Kit* that includes a data communications template and valuable information to assist you in finding the optimum system.

Timeplex, Inc., One Commerce Center, Suite 1000, Newark, N.J. 07102. Phone: 201-335-1111. Telex: 270-000. Attention: Corporate Communications.

**Timeplex**

The technology leader  
in data communications

CIRCLE 14 ON READER CARD

# CALENDAR

## JULY

### **Eighth Cranfield International Conference on Mechanised Information Transfer, July 21-24, England.**

The conference is organized by the Information Div. of the Institution of Electrical Engineers. Contact The Marketing Dept., INSPEC, Station House, Nightingale Rd., Hitchin, Herts., SG5 1RJ, England.

### **Symposium on Reliability in Distributed Software and Database Systems, July 21-22, Pittsburgh.**

The IEEE Computer Society presents this symposium. Contact Marie S. Hreha, LRDC Bldg., University of Pittsburgh, Pittsburgh, PA 15260, (412) 624-4908.

### **OCR Users Association's Summer Conference, July 26-29, Minneapolis.**

The conference theme is "Managing Data Entry Productivity in Turbulent Times," held in conjunction with EXPO '81. Contact OCR Users Assn., 10 Banta Pl., Hackensack, NJ 07601, (201) 343-4935.

## AUGUST

### **1981 ACM SIGGRAPH Conference and Exposition, August 3-7, Dallas.**

ACM's Special Interest Group on Computer Graphics sponsors this annual event. This year's theme is "The Eighth Annual Conference on Computer Graphics and Interactive Techniques." Contact Henry T. Cronan, Robert T. Kenworthy, Inc., 866 United Nations Plaza, New York, NY 10017, (212) 752-0911.

### **Seventh International Joint Conference on Artificial Intelligence, August 24-28, Vancouver, B.C., Canada.**

Computer applications for medical diagnosis, computer-aided design, robotics, programmable automation, speech understanding, and vision are some of the topics to be discussed in this five-day conference. Contact Richard Rosenberg, Computer Science Dept., U.B.C., Vancouver, B.C., Canada V6T 1W5, (604) 228-3061.

### **National Small Computer Show, August 26-29, New York City.**

Free lectures are presented daily, and this year there will be a five-hour seminar on the understanding, acquisition, and use of small computers in business. Contact National Small Computer Show, 110 Charlotte Place, Englewood Cliffs, NJ 07632, (201) 569-8542.

## SEPTEMBER

### **Soft '81, September 2-4, London, England.**

This is the third in the international Soft '81 series; each conference concentrates on the software market of the country in which it is held. Previous conferences were held in Paris and Munich, and the

fourth (and last) in the series is scheduled for Stockholm in November. Contact Soft '81, Acorn Studios, Barnes, London SW13 9HP, United Kingdom, (01)748-0287.

### **Fifth International Conference on Computer Hardware Description Languages & Applications, September 8-9, Kaiserslautern, Germany.**

Cosponsored by the ACM, IEEE, and others, this conference features discussions on Hardware Description Language issues, design methodologies and applications, CHDL in Education, and CHDL-based tools. Contact Will Sherwood, Digital Equipment Corp., 75 Reed Rd., MS HL1-1/Q05, Hudson, MA 01749, (617) 568-4316.

### **Comcon Fall, September 14-17, Washington, D.C.**

The IEEE's Computer Society has selected "Productivity—An Urgent Priority" as this year's theme. Contact Comcon Fall '81, P.O. Box 639, Silver Spring, MD 20901, (301) 589-3386.

### **1981 International Micrographic Congress, September 21-24, Mexico City.**

"Technologies Today and Tomorrow" is the theme of the congress. Contact IMC Public Relations Committee, P.O. Box 33600, St. Paul, MN 55144, (612)733-9534.

### **Federal Computer Conference, September 21-23, Washington, D.C.**

The fourth annual conference providing a forum for information by Federal ADP users. Contact Federal Education Programs, P.O. Box 368, Wayland, MA 01778, (617)358-5181.

### **COMSEC '81, September 29—October 1, Chicago.**

This is the International Communications and Security Conference and Exposition featuring exhibits, meetings, and courses examining communications security implementation and cost in industrial and government areas, etc. Contact Michael A. O'Bryant, Information Gatekeepers, Inc., 167 Corey Rd., Brookline, MA 02146, (617) 739-2022.

## OCTOBER

### **INFO '81, October 12-15, New York City.**

"Increasing the Responsiveness of Information Systems" will be the theme of the Information Management Exposition and Conference. Conference topics, hardware, and a special section devoted to prepackaged and customized software are attuned to this theme. Contact Clapp and Poliak, Inc., 245 Park Ave., New York, NY 10167, (212) 661-8410.

### **WPOE '81, October 13-15, San Jose.**

This is the fourth annual Word Processing and Office/Business Equipment Trade Show and Conference featuring equipment, products, and sessions geared to the automated office. Contact Cartledge and Associates, Inc., 491 Macara Ave., Suite 1014, Sunnyvale, CA 94086, (408) 245-6870.

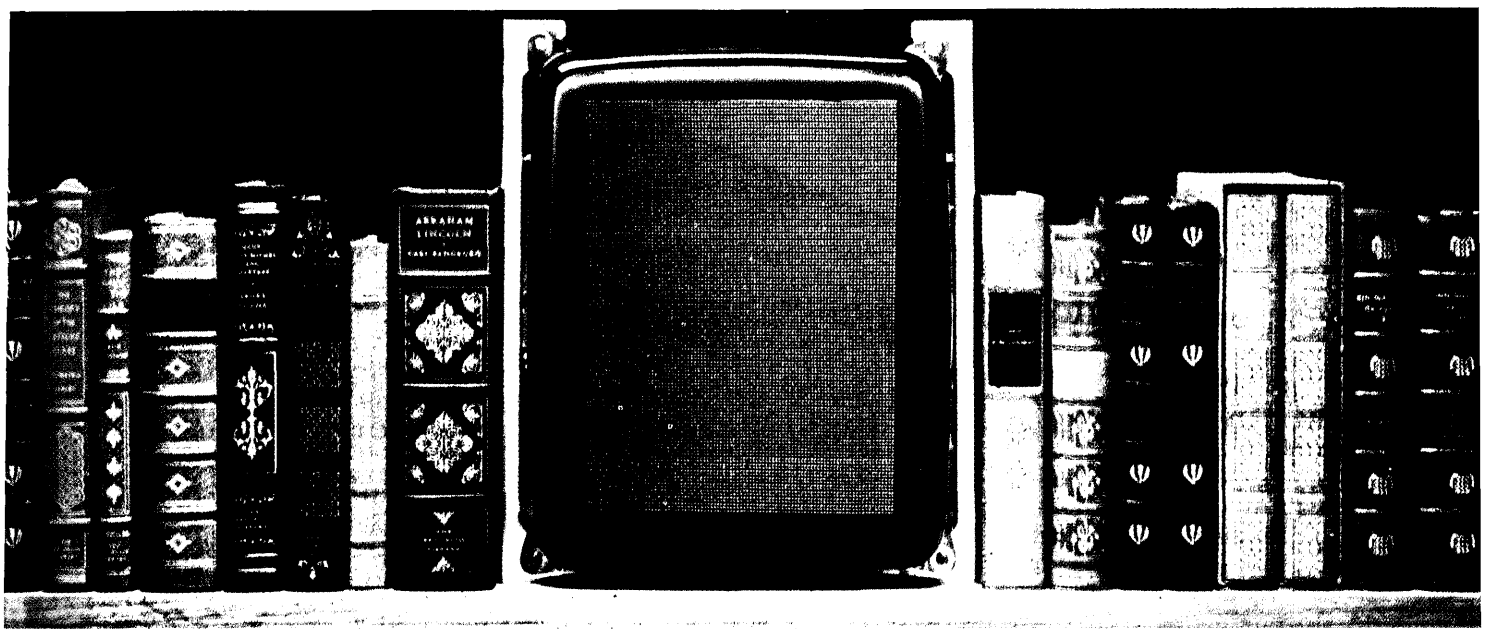

# INCREASE YOUR WORD POWER.

Boost your word processing power with C. Itoh's new CIQ-15V 15-inch full-page monitor. Fully compatible with industry standards, it displays more than 6,000 characters in a 9 x 16 character block. Or up to 66 rows of 96 characters each. It's the monitor with superior interface operation to virtually eliminate flicker. A non-glare screen to reduce eye fatigue. And an impressive list of advanced features. Including two wideband video amplifiers, a high-resolution CRT and dual-axis dynamic focus for maximum character clarity.

C. Itoh also gives you positive and negative video signal inputs (using BNC connectors) without the added circuitry usually required. Performance specs are equally impressive: 50 MHz-3dB

video bandwidth, 1600 line resolution and a 30 KHz standard scanning frequency.

A special low-noise power supply reduces interference. And choice of power input (55VDC, 115/230VAC or optional 100VAC) adds versatility. You even get a choice of CRT phosphors: P4, P31 or P39.

C. Itoh's new full-page monitor is

designed to meet all DHEW, UL and CSA standards. And it's easily integrated into a wide variety of terminal equipment. Naturally, if you need help with special applications or product support, C. Itoh's personalized service is available nationwide.

So improve your word power with C. Itoh's new 15-inch monitor. (We also offer a full range of monitors in a variety of other sizes.) Contact C. Itoh Electronics, Inc., 5301 Beethoven St., Los Angeles, CA 90066; Tel. (213) 306-6700. N.Y. office: 666 Third Ave., New York, NY 10017; Tel. (212) 682-0420.

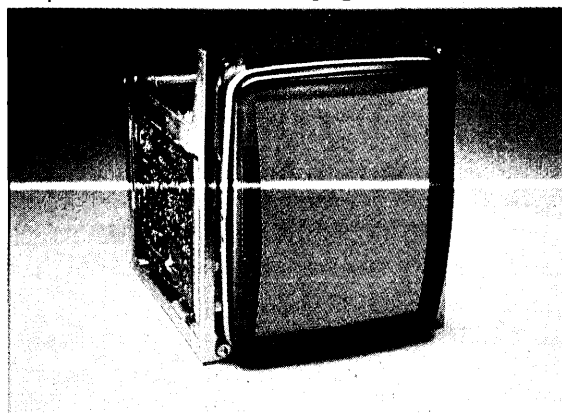

 **C. ITOH  
ELECTRONICS, INC.**  
One World of Quality

CIRCLE 15 ON READER CARD

## Introducing the most powerful minicomputer ever.

The new Prime 850 multi-stream processor is the most powerful mini system ever made for multi-user environments. It sets a new standard of technological leadership for our family of high performance 32-bit systems.

The Prime 850 has ultra high density MOS memory that stores 64K on a single chip. This new system supports up to 128 interactive user terminals for outstanding cost effectiveness. And it's right at home working simultaneously on such diverse applications as energy development, product analysis and design, office automation, and general business computing.



Like all 50 Series systems, the Prime 850 combines power with ease of use. It has 32-bit architecture and virtual memory for speed, efficiency, and economy. Industry standard software for convenient program development and data management. Networking that can extend your system across the office or around the world. And the PRIMOS® operating system that makes the entire 50 Series totally compatible.

In addition to introducing the Prime 850, we've also enhanced the price/performance capabilities of other 50 Series members, including the Prime 250-II and 550-II. To meet the leader, contact the nearest Prime office or write Prime Park, MS 15-60, Natick, Massachusetts 01760. In Europe, write Prime Europe, 6 Lampton Road, Hounslow, Middlesex, TW31JL, England. Tel: 01-570-8555.

# PRIME Computer



# LETTERS

## CORRECTIONS & COMMENTS

Re: "DBMS for Micros" (April, p. 165), there is an error in Fig. 1. The arrow pointing from "Aircraft" to "Flight" should be labeled with the word "Used." As it stands, the present placement of "Used" in Fig. 1 has no meaning.

C. W. HOLSAPPLE  
Assoc. Professor of Business  
Administration  
University of Illinois  
at Urbana-Champaign  
Champaign, Illinois

Re: "Professor Ramac's Tenure," (April, p. 195), readers might be interested in knowing that Georgia State University was the only college or university I know of that had a 305 RAMAC as its main computer.

JOHN W. HAMBLEN  
Chairman, College of Arts and Sciences  
University of Missouri—Rolla  
Rolla, Missouri

Re: "Letting George Do It" (March, p. 168), George says, "The moment you relate information to computer programming and what computers can do, you're 360 degrees away from what the business can do . . ."

I don't think I would let George do it for me. If he puts me 360 degrees away from where I was, I may be dizzy, but I will be facing in exactly the same direction as before.

LAURENT SIKLOSSY  
Professor, College of Engineering  
University of Illinois at Chicago Circle  
Chicago, Illinois

Re: "Cataclysmic Computing," (April, p. 168), according to the table of contents in April "April Foolery" started on page 175. However, judging by the description of "huge rocks and ice" catapulted off Mt. St. Helens "at velocities from 19,000 to 24,000 feet per second (equals 13,000 to 16,000 miles per hour) on p. 171, I'd say the foolery started four pages early. Or did some of that ash make its way to New York to infiltrate your pocket calculators?

CHUCK HANSEN  
Mountain View, California

. . . at that speed, some of the matter would have been put into orbit reaching an altitude of 70,000 feet.

ANTHONY WHITMAN  
Computer Systems Specialist  
Systems Development Corp. of Japan, Ltd.  
Tokyo, Japan

*The author, Jim Rose, responds: The gentlemen are, of course, correct. The velocity should be in feet per minute. As an ex-rocket engineer, I should have known better.*

Re: Crossword (April, p. 274), I have often had difficulty swallowing the answers given for some of your definitions, but my gullet was strained to the limit in getting down the answer to 32 Across.

In my part of the English-speaking world, a pronoun is used as a substitute for a noun or a noun equivalent . . . in addition, the word "of" has always been a preposition.

I would truly be interested to learn where the word "of" is a pronoun and for which noun it substitutes.

DON E. LAUDERDALE  
Mercantile Bank  
Dallas, Texas

*In Manhattan, in a high-rise office building, in a tiny corner of one particular office, the*

*word "of" is a pronoun, a substitute for the noun "ersatzeditor."*

Re: "Industry Report on Applications Development," (March, p. 165), Linda Runyan reported, "The consensus among industry experts is that the day of true and successful applications generation is a long way off," and that application development tools of this type are still in their infancy.

My research has shown just the opposite.

While it is true that PSL/PSA (developed at the University of Michigan) is still very much a research tool, Generation Five, first developed by American Management Systems in 1975, is actively generating applications.

As a speaker at a recent conference on financial information systems, I was interested to note that not only myself, but three other speakers talked about the availability of application generators and their coming use within their own organizations. At least these experts believe that the day of application generators is here.

JERROLD M. GROCHOW  
Vice President  
American Management Systems  
Arlington, Virginia

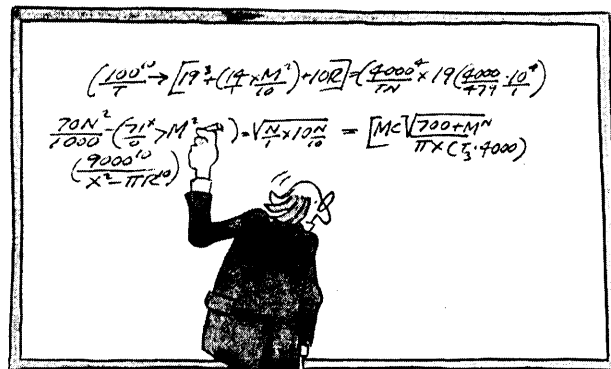

DAWES

CARTOON BY JOSEPH A. DAWES

© DATAMATION

# RELATIONAL DBMS IS A FOUR- LETTER WORD.

**INFO.** It's the high productivity language with a powerful relational DBMS capability.

INFO has other capabilities too. Built-in screen painter, data entry/data update, query language, report generator and application development language.

INFO's simple English commands make computers easier to use for everyone—Managers and Secretaries alike.

INFO is so efficient it improves programmer productivity by 10 times over

COBOL in application program development.

More than 400 operating installations—on DEC VAX, Prime, Honeywell DPS/6, IBM 4300, 303X and 370 systems—prove INFO capabilities.

INFO. It's more productive. For details write or call.

Henco, Inc., 35 Walnut St., Wellesley, MA 02181.  
(617) 237-4156.  
(TWX 710 383 7529).



INFO. FOR GREATER PRODUCTIVITY.

CIRCLE 17 ON READER CARD

## UP & RUNNING

### DASI IS NOW PERFECTLY COMPATIBLE WITH BURROUGHS.

DASI presents the Visual SRI/Century. A low-cost, quality terminal that perfectly emulates the Burroughs TD 830 and MT 983 series. The basic terminal does it all: TDI and RS232 synchronous and asynchronous; an alternate serial I/O port; concurrent data entry and background printing; user-defined function keys; multiple display keys; keyboard-select software options. Plus DASI's local off-shelf delivery and 24-hour field service, with free on-site 90 day warranty. Call toll free now for information on DASI lease, rental and purchase plans. We'll have you up and running in no time.

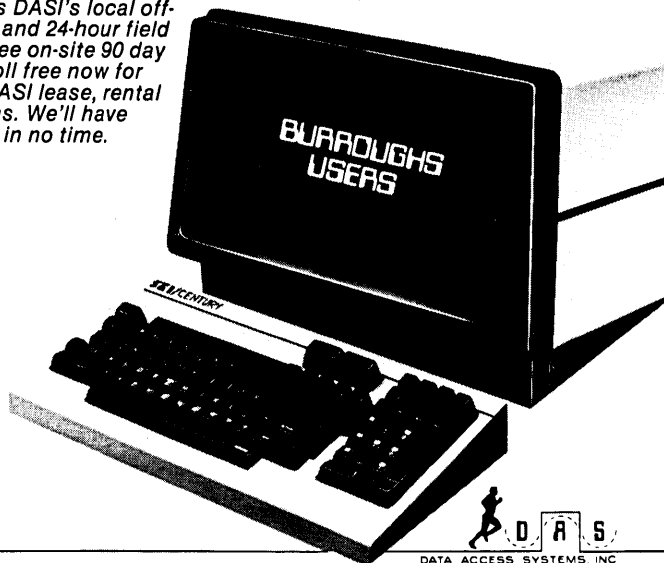

DATA ACCESS SYSTEMS INC

Data Access Systems, Inc., Cole Rd. & Camden Ave., P.O. Box 1230, Blackwood, NJ (609) 228-0700. DASI has nearly 30 Sales and Service Offices coast to coast. For the one nearest you call Dotti D'Attoma toll free: (800) 257-7748. In New Jersey: (800) 232-6510. Your distributor for TI, Diablo, LSI, DEC, Visual, Hazeltine, Visual, HP, Teletype, Rixon, GE and Memorex.

CIRCLE 18 ON READER CARD

## LETTERS

### FOOTNOTE TO HISTORY

Re: "Professor Ramac's Tenure" (April, p. 195), to the best of my recollection, the RAMAC was developed in San Jose amidst great secrecy . . . even from Thomas Watson, whose marketing people had figured about 12 or 13 costly, large computers would fairly saturate the market. No, IBM would stick to unit record equipment. But, it was through the efforts of his son, Tom Jr., that this project survived in a somewhat clandestine fashion, really opening the doors to modern data processing.

RICHARD S. BEERS  
Massachusetts Bankers Assn.  
Boston, Massachusetts

### DOCUMENT, DOCUMENT

Re: "Death, Taxes, and DP Documentation" (Feb., p. 73), bravo to Lindsay Wilson for her highly interesting article. It is clear, very well structured, and written in a good, simple, comprehensive English. This reflects a high ability to communicate. In my opinion, nothing can be a better ad for a technical writer and for the need of a clear documentation in dp.

However, I would like to point out the lack of good, clear, and efficient documentation of the scientific application packages used by the scientific community. If having serious problems with the checks of a pay system is "one step from disaster," as the author titled her second case study, what would you call a program error in designing the cooling systems of a nuclear reactor? In this particular case, is the user's documentation inadequate? What is it responsible for? No one is probably willing or able to answer such a fussy question.

In the scientific fields, it is now possible to perform very complex analysis using many commercial and university programs. A potential user needs to be able to quickly verify that all judgments implicit in the program are suitable for his specific application. In addition, it is not uncommon to perform several and sometimes many computer runs of the same program before getting a satisfactory result. Without a complete knowledge of the basic assumptions and theory in the program this "black box" use of computer programs causes problems in interpreting results. Without an adequate programmer's manual, the operation and enhancement of such programs are increasingly difficult and costly.

GEORGE AKHRAS  
Transport—Quebec  
Quebec City, Canada

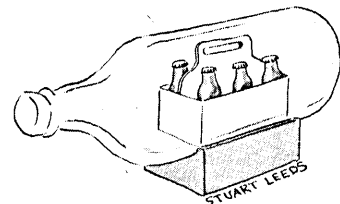



Distributed Computing Carried To Its Ultimate

# PERQ\*—The Processor Per Person Machine

Why settle for a piece of a computer when Three Rivers can add a PERQ\* to your benefits package. Imagine having a display that shows you data the way you

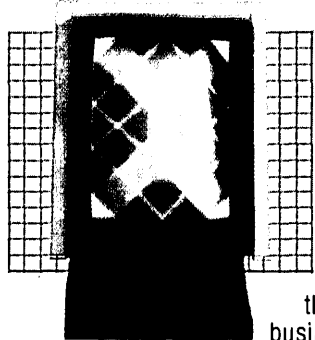

really want it—crisp, proportionally spaced, black on white text in a variety of fonts, and high resolution graphics. We think our picture is the best in the business, and wait till you see how fast we can update it.

For interacting with the screen, a cursor positioning tablet is standard equipment. You point—

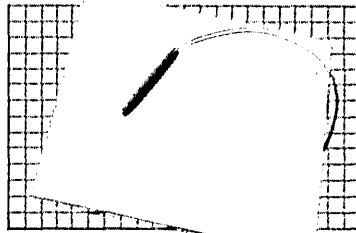

PERQ performs. Check out the keyboard. It's compact, detachable, reliable. It's your key to a powerful software package that includes a user friendly, easy to use operating system, a super pascal compiler, a what-you-see-is-what-you-get text editor, and other software attractions too numerous to mention.

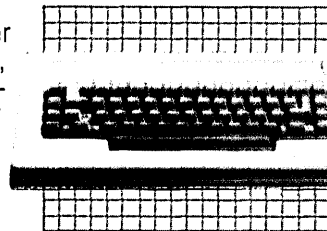

microprogrammable with our optional writable control store.

PERQ comes complete with 256K—1M memory, 12-24M of hard disk storage, RS-232 & IEEE-488 interfaces. Plus—PERQ is on the bus, with our compatible 10 M BIT/SEC Ethernet\*\* local network option.

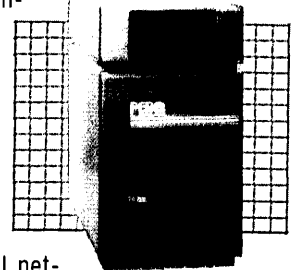

So—why share? You deserve another PERQ.

\*PERQ is a trademark of Three Rivers Computer Corporation.

\*\*Ethernet is a trademark of Xerox Corporation.

And—your very own processor. It's fast, has a 32 bit virtual address system to handle your big programs, and it's



**Three Rivers Computer**

Three Rivers Computer Corporation  
720 Gross Street  
Pittsburgh, Pennsylvania 15224  
412/621-6250

CIRCLE 19 ON READER CARD



# GRAPHICS MADE SIMPLE

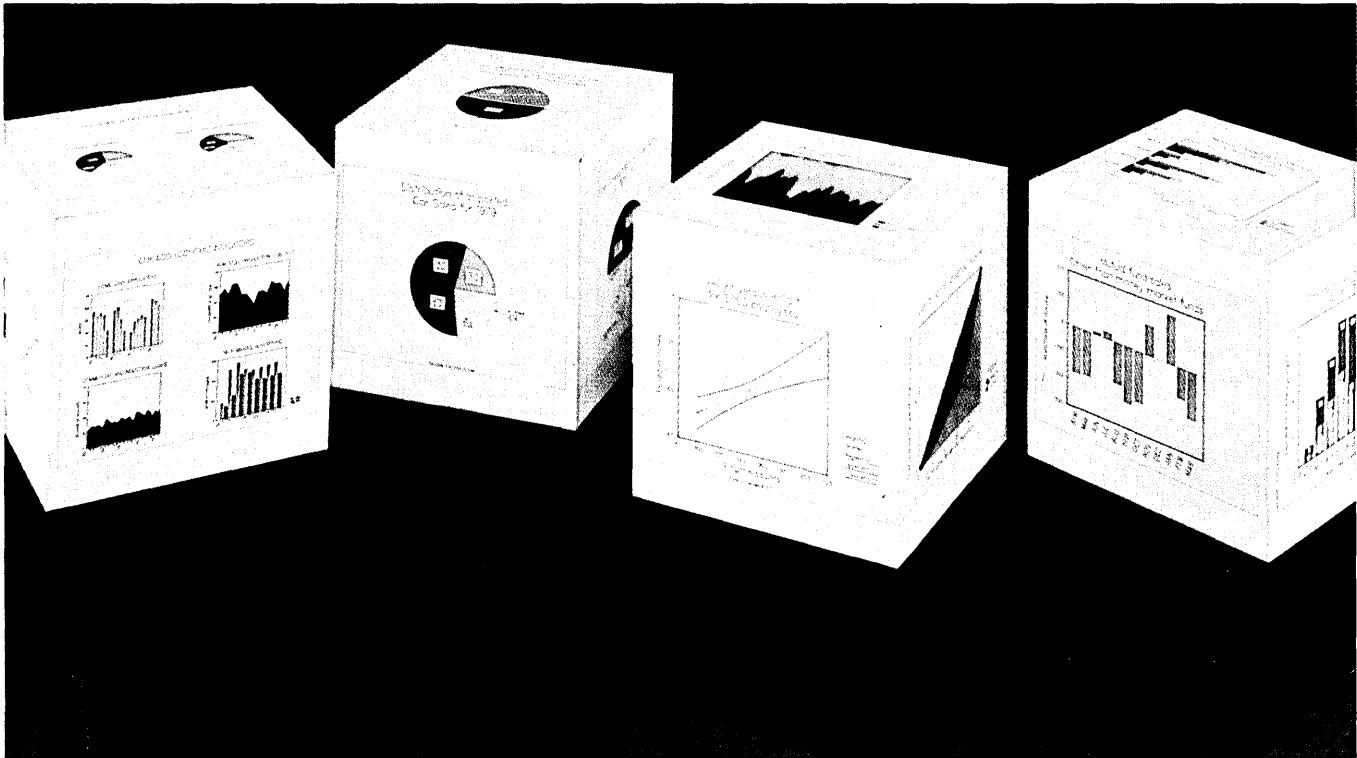

Now the world's leading producer of computer software for data analysis—SPSS® Inc.—and the world's leading producer of graphics software—ISSCO®—have developed the most useful graphics package you can find—at any price. It's SPSS Graphics: the state of the art in versatility, range of options, simplicity, and "artistry".

#### **Management graphics in one easy step.**

Backed by the power and simplicity of the SPSS Data Analysis System, SPSS Graphics allows you to operate directly from large amounts of data to produce elegant graphs and charts. There's no need to involve data processing people. *You do it yourself: data in/graphics out!*

#### **Take control over form and content.**

You choose the colors and/or shaded patterns as you wish. Use or modify a wide range of automatic "artistic" decisions too: label placement, margins, legends and scaling, for example.

#### **Exclusive interactive preview capability.**

Produce hundreds of graphs—preview them on a graphics terminal—decide which to use—and have graphs drawn on a hard copy device—*all in one step!* You may combine independent graphs (pie charts,

bar charts and/or line graphs) on a single page, in any order.

*Other SPSS Graphics features:* simple or fancy displays; pie charts with "exploded" segments; bar charts with bars that extend above and below a given point; line graphs with color and/or pattern shading between the lines; automatically generated summary statistics; directly generated graphs of statistical functions; and complete use of SPSS data management facilities.

And, as you'd expect, SPSS Graphics was developed

with the user in mind. It's a research and management tool that's easy to use, easy to learn, highly sophisticated, flexible, portable, and economical. With SPSS Graphics, you can have complete data summary and display facilities for less than you'd pay for a report writer alone!

To appreciate the simplicity and elegance of SPSS Graphics, call or write: Marketing Department SPSS, Inc.

Suite 3300, Dept. D7-81  
444 N. Michigan Avenue  
Chicago, IL 60611  
312/329-2400

See for yourself why SPSS Graphics is another reason to choose SPSS—the largest selling data analysis system in the world!



Currently operational or soon to be operational on: IBM 360, 370, 4300, OS, CMS/DEC Systems 10, 20, VAX/Prime 400-750/Univac 1100/Other SPSS conversions will be available. Contact SPSS, Inc. for more information.

© 1981 SPSS, Inc.

**CIRCLE 20 ON READER CARD**

# EDITOR'S READOUT

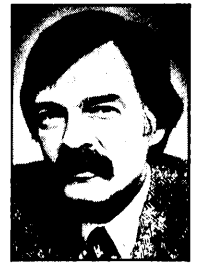

## SEVENTH HEAVEN

**The road to international communications standards is a rocky one. Is IBM the villain of the piece?**

There's been some fussing in this magazine and other computer trade publications about IBM's reluctant and minimal support of the X.25 communications protocol.

Now IBM should be fussed at from time to time. As the dominant company in our industry and the major influence on the creation of de facto standards, it deserves to be badgered and pressured by users and vendors alike. It comes with the territory. But in the case of X.25, perhaps it is bearing a bit too much of the brunt.

IBM has offered X.25 compatibility in France, Canada, and a few other overseas countries and has made provisions for compatibility with the Series/1 for U.S. customers. Hardly what one would call wholehearted support; IBM is responding to pressure from its customers. Obviously it would prefer an SNA world, but the success of the CCITT-promulgated standard means that even the Grey Giant can no longer ignore X.25. The standard apparently is here to stay.

But X.25 is only one level of a seven-layered model that the International Standards Organization is proposing. The first two are already in place and if they were to be changed, X.25 would have to be changed as well. It appears, then, that layers one through three are stable, and IBM's lack of support for X.25 reflects a dog-in-the-manger attitude. Further, say some in-



dustry watchers, IBM should be in the forefront of the push to define and gain acceptance for levels four and five.

(Even the most optimistic hold little hope that layers six and seven will be defined and implemented in the near future. Louis Pouzin, the gadfly of international standards activity, refers to layer seven, the applications layer, as "seventh heaven," an idyllic paradise that may never be reached.)

But one must be aware that the world of international standards, and especially that of communications protocols, is a complex and slippery place. It is a world where a handful of technical consultants still ply their arcane trade, a world inaccessible to all but a few of the most sophisticated users. Just when you think you have a rock-hard standard like X.25, you find you are building on shifting sands.

X.25, adopted in 1976, will evidently be undergoing some changes in frame structure this year. As a result, about 15% of currently operating X.25-compatible equipment will have to be retrofitted in order to function. Also,

we are told, X.25 is implemented differently from country to country. It appears that X.25 is far from being the rock of ages; rather, it is a moving target.

Compounding the problem is the fact that there is so much at stake. A great deal of money rides on which protocols are adopted and within what specific time frame. National governments are involved; the PTTs in Europe and Japan are in the middle of the fray; AT&T is, of course, highly active. A good deal of power and pressure is being brought to bear.

It may be easy, when casting around for someone to castigate for skulduggery and foot dragging, to finger point at IBM and chastise it for its recalcitrant attitude toward X.25. But the fact is that no one company, no matter how powerful, no one standards organization, no matter how influential, nor even any one country, no matter how strong, has the influence and power to pull these standards together and impose them on the rest.

Instead, it appears that we have ahead of us at least three or four years of argument, jockeying for position, and indecision.

In the meantime, the beleaguered user must structure his international networks and somehow present his management with a cohesive and comprehensible five-year plan. Rather like trying to walk a tightrope blindfolded in the middle of a hailstorm.

We would urge our big users, those who carry significant clout in the domestic and international standards-setting arenas, to put as much pressure as possible on the various players in this game. In the long run, flexible, workable standards are far more beneficial than the anarchy we have today.

Who knows, we might even make it to that seventh heaven. \*

## THE CPU MARKET: A SURVEY

**Before the 3081, there was a veil of uncertainty over the mainframe market; now, demand for top-of-the-line systems is revitalized.**

Despite an increasingly aggressive IBM dominating the market, mainframe suppliers should have a fairly good year or two ahead, according to a detailed survey of mainframe user plans completed recently by DATAMATION and G.S. Grumman/Cowen & Co., the Boston investment research firm. Users have a large backlog of applications and an unabated hunger for more processing power, increased mass storage, and additional terminals.

With most of IBM's competitors, both traditional and plug-compatible, having answered the industry leader's highly successful 4300 series machines, the mid-range market has entered a new growth period. At the high end, however, Burroughs, Honeywell, Univac and NCR have as yet done little to counter IBM's 3081.

The survey, based on responses from 6,076 users, concludes, however, that from a financial point of view not all is so rosy. Several of the traditional mainframers are not expected to show shining results for the year ahead, mostly due to fierce competition, more narrow profit margins, and delays in product deliveries. The lease-to-sales ratio for the industry as a whole has improved from the money-tight days of 1979-80, but high interest rates and some user reluctance to purchase machines may denigrate sales and profits, the survey reports.

For IBM's traditional competitors—NCR, Burroughs, Univac, and Honeywell—it looks as if the current year will be one of "transition," the report says. Shipments of cpus for the most part are expected to be flat or up only slightly over last year, with product cycle and economic factors sharing the blame equally. IBM-compatible suppliers, however, are expected to gain from the at-long-last introduction by IBM of its new 3081 H Series mainframe and 3375/3380 disk drives. The PCM market had been adversely affected by users holding back on purchase decisions until they could determine exactly what IBM had up its sleeve.

The distributed processing business, long expected to be a high growth market, appears to be just that. The survey shows that distributed processing-oriented sites project an annual rate of growth in hardware

spending of 12.3% (versus 11.7% for all sites) and in software spending of 15.7% (versus 14.7% for all sites). IBM in particular is gaining a strong distributed processing foothold outside its own user base, being mentioned as a prospective supplier at 11% of those sites planning to implement distributed systems by 1982.

As expected, the growth of the software business exceeds that of pure hardware, with packaged software gaining credibility and popularity at all levels of mainframe usage.

Nevertheless, applications development by mainframe users has jammed up for various reasons. Nearly half of IBM high-end installations surveyed said they had more than a two-year backlog of new applications waiting to be implemented. According to the report, the shortage of in-house software staff resources is a "serious constraint" and the single largest inhibitor to new applications development.

Finally, the report sees the major industry growth path for the next decade to be the melding of traditional data processing and office automation functions, a route that is widening in scope and investment.

The biggest news in the mainframe arena during the past year was obviously the IBM 3081, the first of the so-called H Series, which had had everyone riveted to their various grapevines in anticipation. The machine, finally introduced in November 1980, is the first of a new family of IBM mainframes.

The survey showed that the 3081 was well received by IBM users, sparking a resurgence in planned installations over the next couple of years. Survey figures show that among the 3,909 IBM users interviewed, 104 IBM 3081s were ordered. The majority of those machines will not replace another mainframe, but will provide additional cpu power at heavily loaded sites.

The 3081, however, will not be a major contributor to IBM's total shipments this year; not until 1982 will it be moving in great quantity. Evidence of delayed and

**The 3081 will not be a major contributor to IBM's shipments until 1982.**

anceled orders of systems currently deliverable suggests that there could be a "sizeable fallout from initial 3081 backlogs before 1982 year-end," the report says.

Stretched out delivery times on the 3081 appear to have provided an opportunity for large-scale plug-compatible mainframe suppliers such as Amdahl and National Advanced Systems (NASCO). The survey showed the PCM penetration at the high end of the IBM-compatible spectrum up markedly over last year. Amdahl's share of the installed base in this class of systems stood at 12% this year (compared to 8% last year). NASCO maintained its same 2% stake for the third consecutive year. IBM's trump card in

FIG. 1

**YEAR-AHEAD DEMAND OUTLOOK**  
**PERCENT OF MENTIONS\***  
**IBM SURVEY**

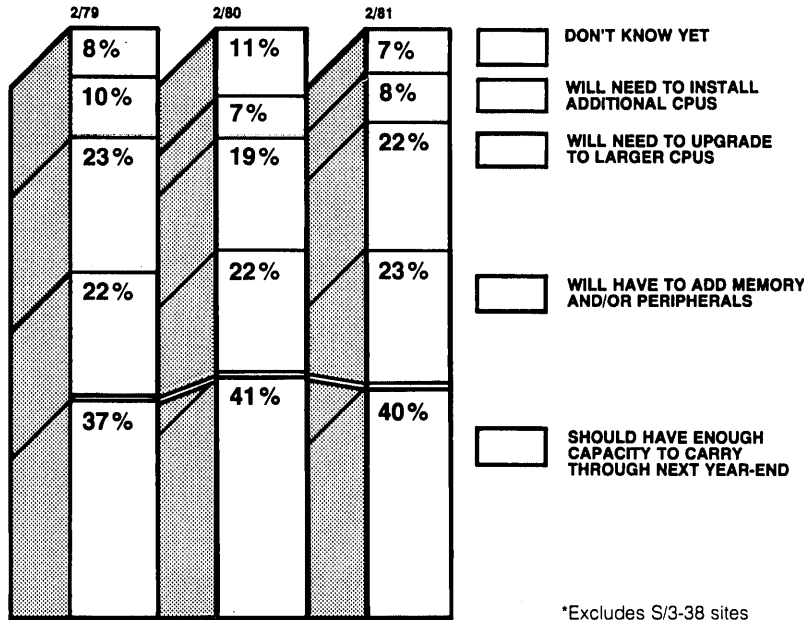
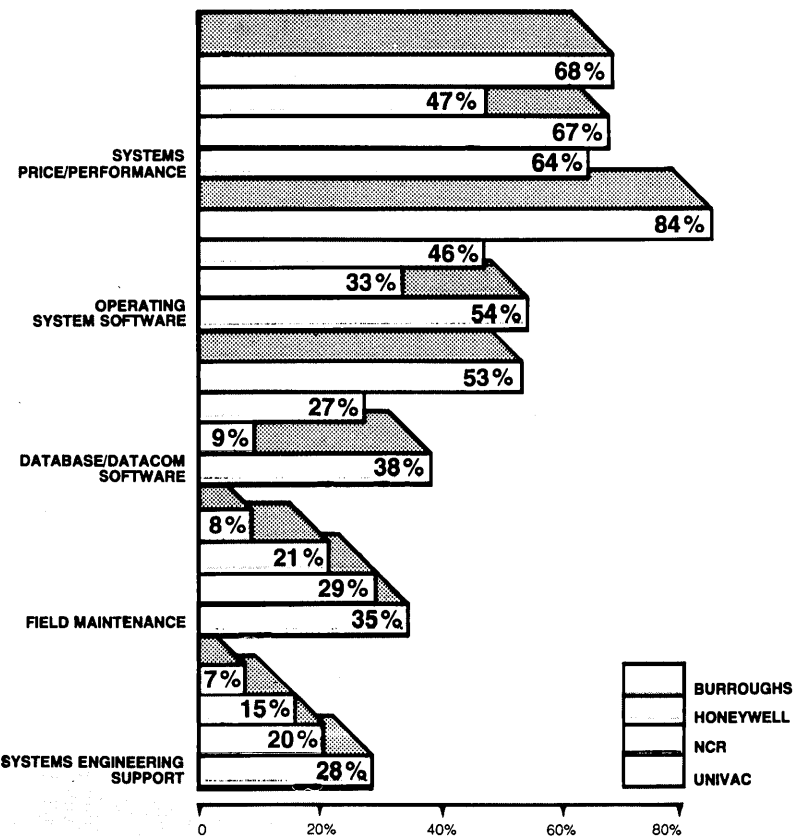

FIG. 2

**PERCENTAGE RATING VENDOR'S PRODUCT/SERVICES SUPERIOR TO IBM**



CHARTS BY CYNTHIA STODDARD

this end of the market is clearly the 3081, and whatever early shipments it can make will perhaps stem the tide toward Amdahl's recently introduced 580 systems.

Compared to last year's survey (DATAMATION, June 1980), IBM users showed a marked increase in the number of installed 4300 and 303X machines, with a corresponding drop in installed 370 systems. As a percentage of the installed base mix of high-end systems, 4300s garnered 10%, 303X systems stood at 49%, and 370s at 39%. Last year the respective figures were 1%, 32%, and 60%.

The value of IBM mainframe systems to be installed between now and early '83, as anticipated by survey respondents, breaks down as follows: 30% for 3081s, 40% for 4300s, and only 28% for 303X machines. Two years ago, the projected value of IBM mainframes to be installed in the 303X class stood at 69%, prompting speculation of a "wind-down phase" in the 303X product cycle.

The lease/purchase ratio that had earlier plagued IBM's bottom line showed definite signs of improving, according to survey figures which show users leaning once again towards purchase. This welcome trend towards purchase is credited to a number of factors including: two rounds of broadly implemented rental and service price increases; 4331 and 4332 Group 2 introductions; the 3081 announcement; and 303X purchase price cuts.

**Delays in deliveries and snags in maintenance and systems engineering have given Burroughs a poor image with users.**

In the peripherals area, survey data show IBM's share of the disk add-on market improving to 76% from 70% last year. IBM is expected to garner the dominant share of the prospective market for shipments of 3380 and 3370/75 type disks through next year. Storage Technology's share of the 3350 market is up to about 25%, dropping IBM back to about 59%. The plug-compatible firm's share of the tape market has expanded to about 31%, largely at the expense of IBM. The industry leader does seem, however, to be maintaining roughly a two-thirds share of the crt terminal segment.

IBM would seem to be in a good position to gain from defections of other mainframe vendors. Some 17% of Burroughs survey sites, 24% of Honeywell sites, 14% of Univac sites, and 17% of NCR sites said they are "seriously considering switching vendors." In aggregate, nearly half of those sites said they were looking to "the IBM world" as a future supplier while the rest leaned largely towards traditional minicomputer suppliers.

As for SNA, IBM's networking scheme, about 12% of the IBM user respon-

## IN FOCUS

dents said they had it in use and another 10% indicated they would be using it by 1982. The banking community showed the highest usage of SNA and front-end communications processors.

Although the surveyed user base is still primarily batch-oriented, data base/data communications usage was up to 20% (from 19% last year), and interactive/time-sharing usage was up to 16% (from 11% last year).

Looking at the Burroughs user base, delivery problems were cited as a major setback for the firm. The company's troubled B3950 mid-range system, coupled with some economy-related woes, seem to bode ill for Burroughs, which could show "essentially level" cpu installations this year. However, a dramatic upshift in purchase intentions, particularly among large systems users, is expected to bolster the ailing firm's revenue and bottom line results for 1981.

Asked if in the past year they had canceled or delayed any mainframe system orders placed with Burroughs, the 655 Burroughs users surveyed indicated that approximately one-sixth of the machines to be installed come under that category. The services and banking users were the hardest hit by the delays and cancellations, the survey showed. However, many of the users who had canceled or delayed orders said they would reconsider Burroughs, leading to the assumption that Burroughs' cancellation problems have peaked.

Delivery problems and snags in maintenance and systems engineering were said to have given Burroughs a rather poor image with users, and an image that the

### Below-average order rates in NCR's traditionally strong areas of wholesale/retail and banking could create problems down the road.

report said "looms as a genuine potential Achilles' heel." This is so particularly among B4700/4800 and B6000/7000 users who showed a high propensity to consider switching vendors, the survey concluded.

NCR's near-term outlook as seen by the survey was mixed. With a shift from leased to purchased cpus and a low level of canceled or deferred orders, the firm's financial stance for 1981 seems fairly positive, but below average order rates in NCR's traditionally strong areas of wholesale/retail and banking could create problems down the road. The firm also has substantially completed the transition of its Century users to the newer 8000 series mainframes, leaving little potential for more replacements. This would seem to presage a new processor introduction later this year or in 1982.

In the meantime, the firm's add-on peripherals business appears to be gaining momentum, particularly in the categories of

FIG.3

### GROWTH OF UNBUNDLED SOFTWARE REVENUES

Percentage of annual dp budget currently spent on unbundled software from IBM and other outside software packages (Excludes System/3,32 and 34)

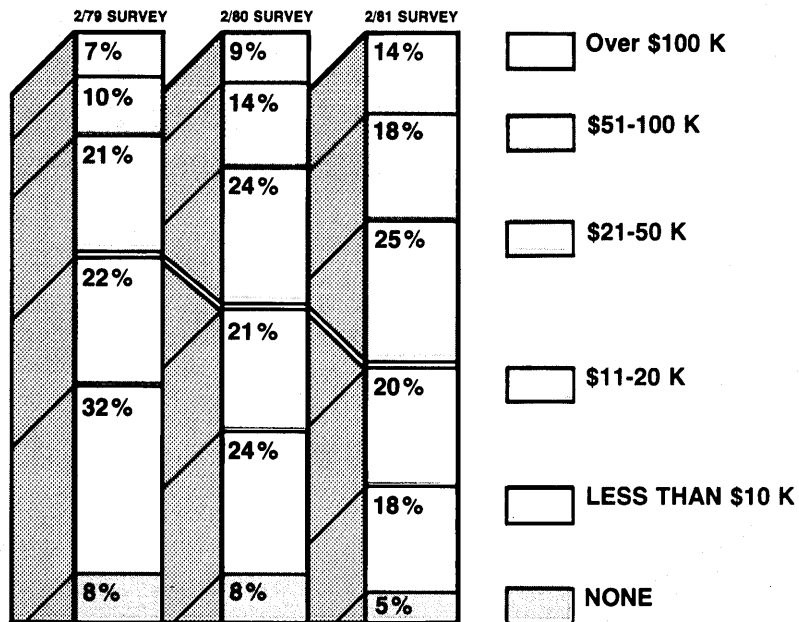
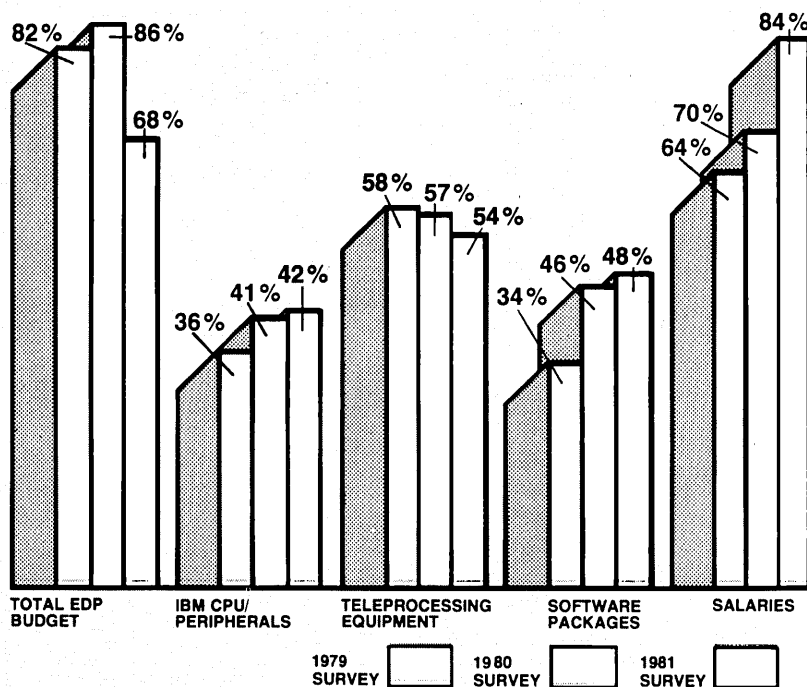

FIG. 4

### PLANS FOR 1981 EDP-RELATED OUTLAYS PERCENT OF SITES PLANNING HIGHER SPENDING IBM SURVEY



AVERAGE PER SITE INCREASES  
(FOR ALL SITES)

|                       |       |       |       |
|-----------------------|-------|-------|-------|
| TOTAL EDP BUDGET      | 10.5% | 13.0% | 12.5% |
| IBM CPU/PERIPHERALS   | 3.5%  | 5.5%  | 7.1%  |
| TELEPROCESSING EQUIP. | 16.1% | 15.7% | 12.7% |
| SOFTWARE PACKAGES     | 6.3%  | 11.6% | 12.0% |
| SALARIES              | 8.8%  | 11.4% | 11.8% |

# EASIER.



One of the latest innovations from the Memorex® Communications Group, the 2078 Display Station, serves as a good example of how

one company works to respond to and anticipate the demands of its many marketplaces. Demands for products that perform faster, last longer, are built smaller and smarter. But most important today perhaps, for products that make life and work easier on the people using them.

To that last point, the 2078 is particularly noteworthy. And human engineering is the key, with features designed-in to make the operator's job less fatiguing and the operator more comfortable and productive. The non-glare screen reduces eye strain, while the tilt-screen design allows positioning for easy readability. We've included a line and column indicator, a status line, a switch-selectable unprotected field indicator, a choice of keyboard layouts and other features that make the 2078 a much easier

display station to use.

But it is much more efficient and flexible as well. The detachable monitor can be located on a shelf or bookstand

to conserve space and allow use by more than one operator. The 2078 incorporates an automatic dimming feature to preserve the quality of the display. The unit also generates less heat and uses less power. And teamed with the small, smart-looking 2076 Remote Cluster Controller, which can be conveniently located separately, the 2078 delivers more configuration flexibility.

The 2078 Display Station is, of course, just one expression of excellence from our Communications Group. But it certainly helps explain why we're so proud of our twenty years of making better products for the tough, rapidly changing marketplaces of high technology. And we look forward to the next twenty years, during which time we'll be working harder than ever to make things easier.

# MEMOREX

*For twenty years, the*



*expression of excellence.*

San Tomas at Central Expressway, Santa Clara, CA 95052 (408) 987-1000

CIRCLE 21 ON READER CARD

FIG. 5

**POTENTIAL FOR VENDOR SWITCHES**

PERCENT OF RESPONDENTS  
"SERIOUSLY CONSIDERING A CHANGE"  
FROM PRESENT VENDOR

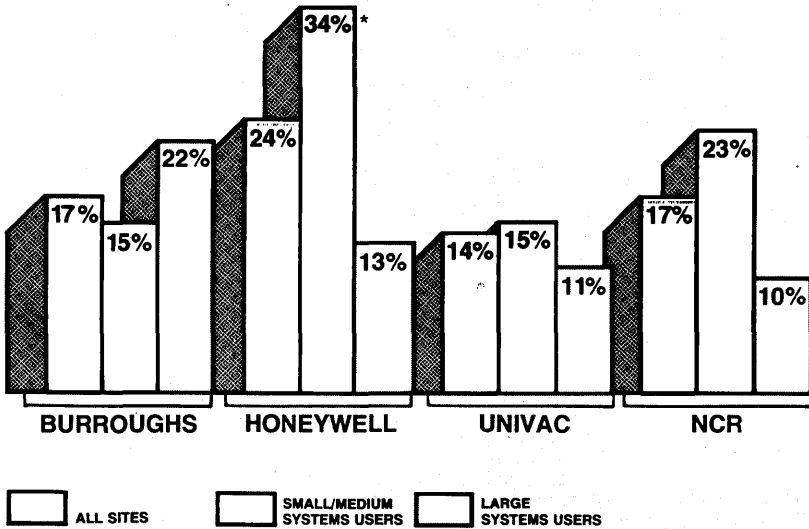

\*LARGELY AT H200/2000 AND LEVEL 62 SITES

FIG. 6

**LIKELY SUPPLIER IF SWITCHING VENDORS**

DISTRIBUTION OF RESPONSES

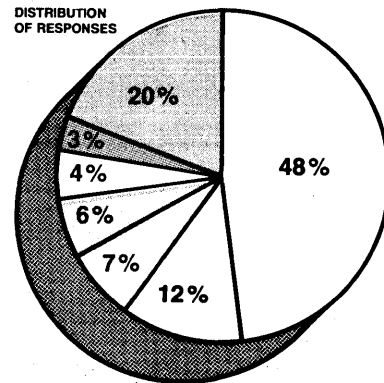

POTENTIALLY SWITCHING TO:

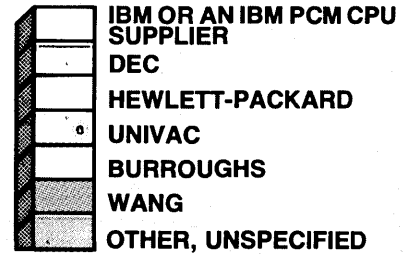

# The CICS User's Security Blanket

Call us today  
for a  
**GUARDIAN**  
brochure.

GUARDIAN, the on-line security system for CICS users.  
Comprehensive. Flexible. Easy to use. . .

**ON LINE SOFTWARE INTERNATIONAL**

65 Route 4 East, River Edge, NJ 07661  
(201) 488-7770

**800-526-0272**

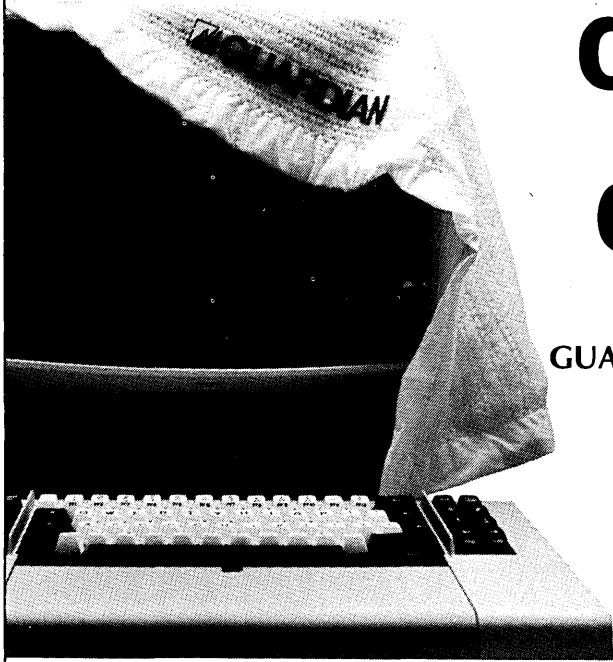

CIRCLE 22 ON READER CARD



# Supplying software that works is IBM's business.

## Making it work harder is ours.

The business community and the data processing industry have come a long way since the days of mysterious machine-filled rooms isolated behind showcase windows. The cost of data processing hardware has decreased to the point that corporate data centers now house complex networks of mainframes, yet the cost of complementary software, its development and maintenance, has skyrocketed.

Just keeping the operation up and running takes an inordinate amount of human resources and machine capacity, to the extent that productivity can be seriously degraded, — the very problem computers were purchased to solve in the first place. But what can you do about operational inefficiency, the *intangible* that profoundly affects your ability to provide service and conduct day-to-day business?

### Our software tools give you a window into the overall operation

Boole & Babbage, a pioneer in the development of software designed to make your systems work harder, was founded in 1967. We provide products for capacity and security management, resource and job accounting, and both program and programmer productivity enhancement. Instead of "curing" your computer problems by selling you more hardware, we make your existing systems perform to operational standards that may even exceed their original design. Over the past 13 years we've set new standards for the data processing industry, emerging as the SINGLE SOURCE of software for large IBM mainframe users.

### Enhance programmer productivity

TSA (Total System Analyzer) and VAM/SPF (VTAM Application Monitor for SPF) significantly increase both systems and applications programmer productivity by helping you find problems, resolve them and reorganize the way the computer works to make it work harder. And, our

innovative architectural redesign concept, as it applies to foreground and background timesharing tasks, increases SPF programmer productivity. The results are better overall systems performance, response times and crucial user service levels.

### Increase capacity through optimized performance

Our Capacity Management tools, Comprehensive Management Facility (CMF), RESOLVE, and CONTROL/IMS REAL-TIME, operate at the system level for systems fine tuning. They provide the data center manager with both on-line and periodic historical system performance analysis. In addition to diagnosis, device and configuration analysis, and bottleneck interrogations, our products generate action services to optimize workloads for increased capacity and better performance.

### Information management for total CONTROL

Collection of workload and service level performance data has historically been an arduous task with high overhead and minimal payoff. Boole & Babbage's powerful CONTROL tools provide extensive IMS, CICS and operating system information for cost accounting on user and job levels (down to the individual transaction) as well as historical performance analysis. Through workload optimization and more detailed charge-back accounting, the data center manager is now able to better control the center's resources and improve its service levels. Our SECURE products provide that last step of crucial protection against inadvertent data loss and unauthorized access to sensitive programs, data and files.

### You don't have to be a wizard to improve your system

The shortage of qualified systems programmers is magnified by the labyrinthian complexity of today's data centers. At best, it is an intimidating task for most people to make their systems work more efficiently.

Boole & Babbage makes sense of that confusing world with harder working software to improve not only your data center's operations, but your bottom-line as well.

To find out more about Boole & Babbage products, call TOLL FREE 800-538-1893 (in California call 408-735-9550) or send the coupon to 510 Oakmead Parkway, Sunnyvale, CA 94086.

# Boole & Babbage

## Harder Working Software

Name \_\_\_\_\_ Title \_\_\_\_\_

Company \_\_\_\_\_

Address \_\_\_\_\_ City \_\_\_\_\_

State \_\_\_\_\_ Zip \_\_\_\_\_ Phone \_\_\_\_\_

Tell me more about:

\_\_\_\_ Programmer Productivity Products  
(\_\_\_\_ TSA, \_\_\_\_ VAM/SPF)

\_\_\_\_ Capacity Management Products  
(\_\_\_\_ CONTROL/IMS RT, \_\_\_\_ CMF,  
\_\_\_\_ RESOLVE/CICS, \_\_\_\_ RESOLVE)

\_\_\_\_ Information Management Products  
(\_\_\_\_ CONTROL/IMS, \_\_\_\_ CONTROL/SMF,  
\_\_\_\_ CONTROL/CICS, \_\_\_\_ SECURE,  
\_\_\_\_ SECURE/CICS)

CIRCLE 23 ON READER CARD

FIG. 7  
**IMPLEMENTING DISTRIBUTED PROCESSING**  
**PERCENTAGE OF LARGER SYSTEMS USERS**

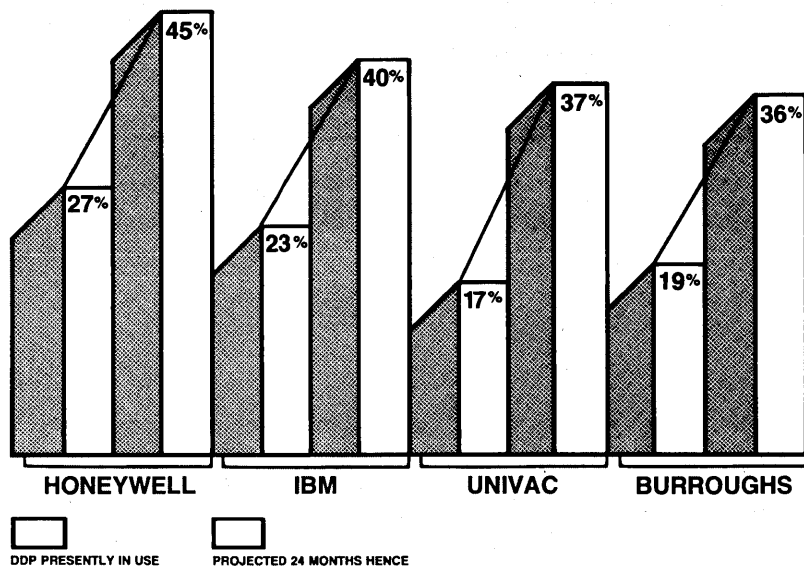
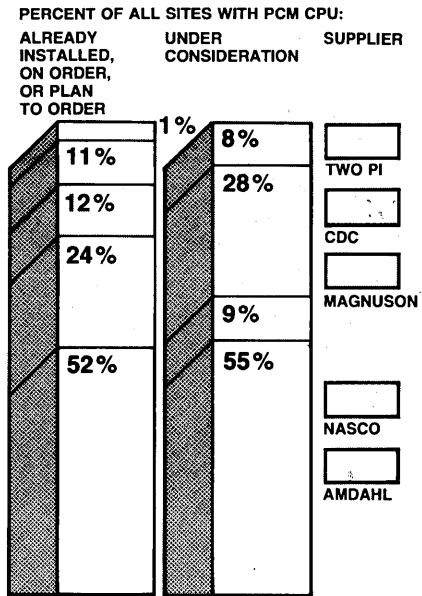

FIG. 8  
**SHARE OF AGGREGATE PCM CPU INSTALLATIONS**



memory and terminals. The large installed base of 8500-class machines was said to account for the upsurge in the peripherals sector.

User spending for packaged software was also up, perhaps because of NCR's aggressive moves to unbundle operating system software over the past few years. Packaged software, it was noted, comprises about 8% of the NCR user respondents' data

**A substantial number of large-scale Honeywell users have resisted making the move to the DPS 8.**

processing expenditures. The company has captured 73% of the packaged software revenues, the same as in the 1981 survey.

Looking into 1982, 5% of the NCR users surveyed said they would need to install additional cpus, 16% said they would need to upgrade to larger cpus, and fully 25% said they would need to install additional memory and peripherals. NCR was shown to have a major share of its users' distributed processing equipment, but survey results showed IBM is coming on strong.

Turning to Honeywell, the survey showed users to be most satisfied at the high end of the product line, where the DPS 8, brought out last year, reigns. Nonetheless, a substantial number of large-scale Honeywell users have resisted making the move to the DPS 8. According to the survey, 44% of the 661 users responding said they had no plans to install DPS 8 hardware, and 10% of those said they had long-term plans to switch vendors. The three major reasons

offered for not going the DPS 8 route were that present systems are adequate, dissatisfaction with Honeywell as a supplier, and no requirements for the machine's advanced features.

Honeywell's nurturing of its acquired Xerox computer base has changed little from last year. The 1981 survey showed 14% of the Sigma users planning to eventually switch to DPS 8/Level 66 hardware, about 31% planning to install non-Honeywell equipment, and 9% planning to distribute their workloads via minicomputers. Fully 39% of the Xerox users said they didn't know yet what their long-term expansion plans would be.

Add-on peripherals business for Honeywell appears healthy for 1981, with the firm showing particular strength in disk, tape, and add-on memory. The firm's terminals business is gaining slowly but surely, but independent suppliers such as ITT/Courier still control substantial portions of the business, the survey said.

Honeywell's small computer operation, which sells the Level 6 line, has been extremely successful. The Level 6 has already replaced 22% of the aging H200/2000 base, and has a strong standing in larger users' distributed processing plans.

The picture of Univac users presented in the survey was one of strong plans to order equipment throughout the coming year, particularly in the 1100/60 arena. Survey results also indicated the firm's V77 small computer will take off as a distributed processing device. Orders for the 1100/60 were termed "quite impressive" for the year ahead, compensating for the winding

down in demand for the 1100/80 and high-end 90 series product lines. Gross and net installations appear destined for only modest increases in calendar 1981.

Univac's base of loyal 90 series users has not gone overboard in converting to the firm's mainstay 1100 series. Presumably the VS-9 attached processor, introduced late last year to help move customers away from dead-ended 90/80 systems and into the 1100 mainstream, has helped sway some minds. Only 34% of the 90/80 users responding said they would evaluate the 1100 series, though that's 10% higher than the number considering converting in last year's sample.

Among those 90/80 users who said they would not consider moving up, the major reason cited was incompatibility with present systems.

In the add-on peripherals area, Univac users have big plans to add disk, memory, and terminals to their systems, with

**Survey results indicate that Univac's V77 small computer will take off as a distributed processing device.**

Univac bound to gain most of that business. Compared to its competitors, Univac's add-on business ranks second only to IBM's.

As for adding cpus, 9% of the users said they will need to install additional systems by year-end, and 11% said they would upgrade to larger cpus. If that business stays with Univac, the company can expect 1982 to be a good year for shipments.

—John W. Verity

**Get your Green Book now—free.**

28 valuable discount coupons worth \$11,000 toward the purchase, lease or rental of terminals, printers, modems and more.

Without it your next data products acquisition could cost you more than it should. Lots more.

USIR can provide you with any data product you need. Or

any combination of products as a package. Even competing lines. With service nobody can beat ... not even the original manufacturer. And now the Green Book saves you thousands of dollars!

You get it all from USIR: top name brands, nationwide service, guaranteed delivery, and flexible financing. Including our new Extended Term Rental program that com-

bines the convenience of renting with the lower rates of leasing.

Send the coupon today and get the best possible deal on data products. From USIR.

**United States  
Instrument Rentals, Inc.**

**US**

A U.S. Leasing Company

# Save up to \$11,000 this year on data products.

**Don't buy, rent or lease any data products  
without the USIR Green Book.**

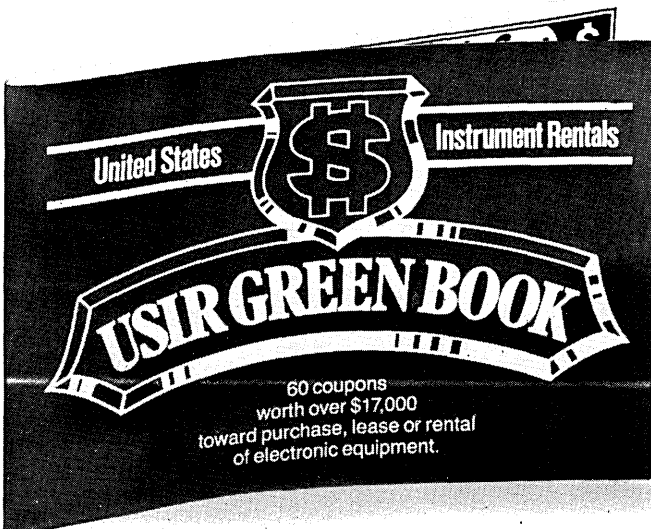

O.K. USIR, send me your free Green Book.

Name \_\_\_\_\_

Title \_\_\_\_\_

Company \_\_\_\_\_

M.S. \_\_\_\_\_

Phone \_\_\_\_\_

Street \_\_\_\_\_

City/State/Zip \_\_\_\_\_

USIR, 2988 Campus Drive, San Mateo, CA 94403,  
(415) 572-6600.

DAT 7/81

# NEWS IN PERSPECTIVE

## MINICOMPUTERS

### DG'S HIGH STAKES GAMBLING

**"We've sacrificed short-term profit for long-term position," Data General's Brad Stroup says of the firm's shift towards vertical integration.**

Over the past five years Data General has gambled nearly \$200 million on the speedy transformation of its single line minicomputer family into a fully integrated systems line.

Yet despite this, insiders are predicting no immediate relief to the down trend that has afflicted the company's operation since 1978. They expect a further decline in growth to 15%, with return on sales at around 11%, when the company's seemingly "unlucky 13th" year ends in September.

But what is also being said by these sources is that this depressing pattern was largely expected by the company in its ambitious business plan. This plan, intended to shift DG's emphasis from short-term to long-term goals, is predicated on no notable turnaround until 1983, say sources.

The company's strategy began in earnest five years ago, when the Massachusetts based mini maker was growing at 50% per year by what the trade calls "pumping iron" into the market—in DG's case, by selling its machines in high volume to oems.

But the company had resolved that to prosper in the years ahead it would have to design and manufacture everything else as well—peripherals, semiconductors, and software. A very risky process known in the business as vertical integration.

Data General's president, Edson D. de Castro, reasoned that the minicomputer business would go the way of the auto industry of the late 1920s and early 1930s. He said that a few fully integrated concerns would emerge from a lot of companies making bits and pieces.

According to Data General's public affairs director, J. Bradley Stroup, the company saw a new pattern emerging and moved to meet it. "The oem mix started to change," he explained. "Our customers began pushing for more complete systems from us with more software packaged in."

With demands for more complex configurations came the first perceptible market for service and support, he added.

But many experts spurned the notion of vertical integration. One of these, Kenneth G. Fisher, took over the ailing Prime

Computer which had been trying to sell oem against Data General and the mini market leader, Digital Equipment Corp.

Fisher quickly turned Prime to profit by steering it on a completely different course from Data General. He argued that it made more sense to buy a high proportion of the system product outside. This insured low inventories, lower development expenses, and higher revenue per employee, he explained.

He also moved away from oem selling. Instead, he repackaged Prime's processor and sought out commercial end users. That way he eliminated discounts and sold fewer units at higher margins. This approach avoided uncontrolled oem demands and the big investments in manufacturing capacity required by them.

It also gave Prime a chance to control its growth by regulating the number of salesmen it hired.

The result is that Prime has enjoyed an 85% compound growth rate since 1976. In stark contrast, Data General's approach has meant that it has had to spend, spend, spend. Though its compound growth of 38% over the same period is still high, the company has endured a steady decline in growth and profitability since 1978.

Data General's capital spending over the past three years alone has exceeded \$150 million, according to Stroup. To put this in perspective, Honeywell proudly claimed that it increased its capital spending on computers by 36% to \$62 million last year. Data General, at 40% of Honeywell's size, also spent \$62 million in 1980.

"We've sacrificed short-term profits for long-term position," says Stroup. "But this is the price that today's high flyers

---

**Frank P. Silkman, a former head of IBM's Office Products Division, has been brought in to run DG's new three-division business structure.**

---

[Prime, Tandem, etc.] will also have to pay for a real future in this business."

An example of this, says one industry watcher, has been DG's massive expansion of field services—from a staff of 540 in 1976 to an estimated 2,000 by the end of this year. The money for this has been committed by DG's management over the years in the firm belief that service/support revenues will become a dominant factor in the computer market in the 1980s.

Already there are clear signs that this investment will soon pay off and that its success is closely allied to the company's stand on vertical integration.

Insiders point out that Data General expects to turn over some \$150 million in services revenues this year. This figure nearly matches the company's total sales in 1976. Projections within the company clearly show that it could be pulling in \$300

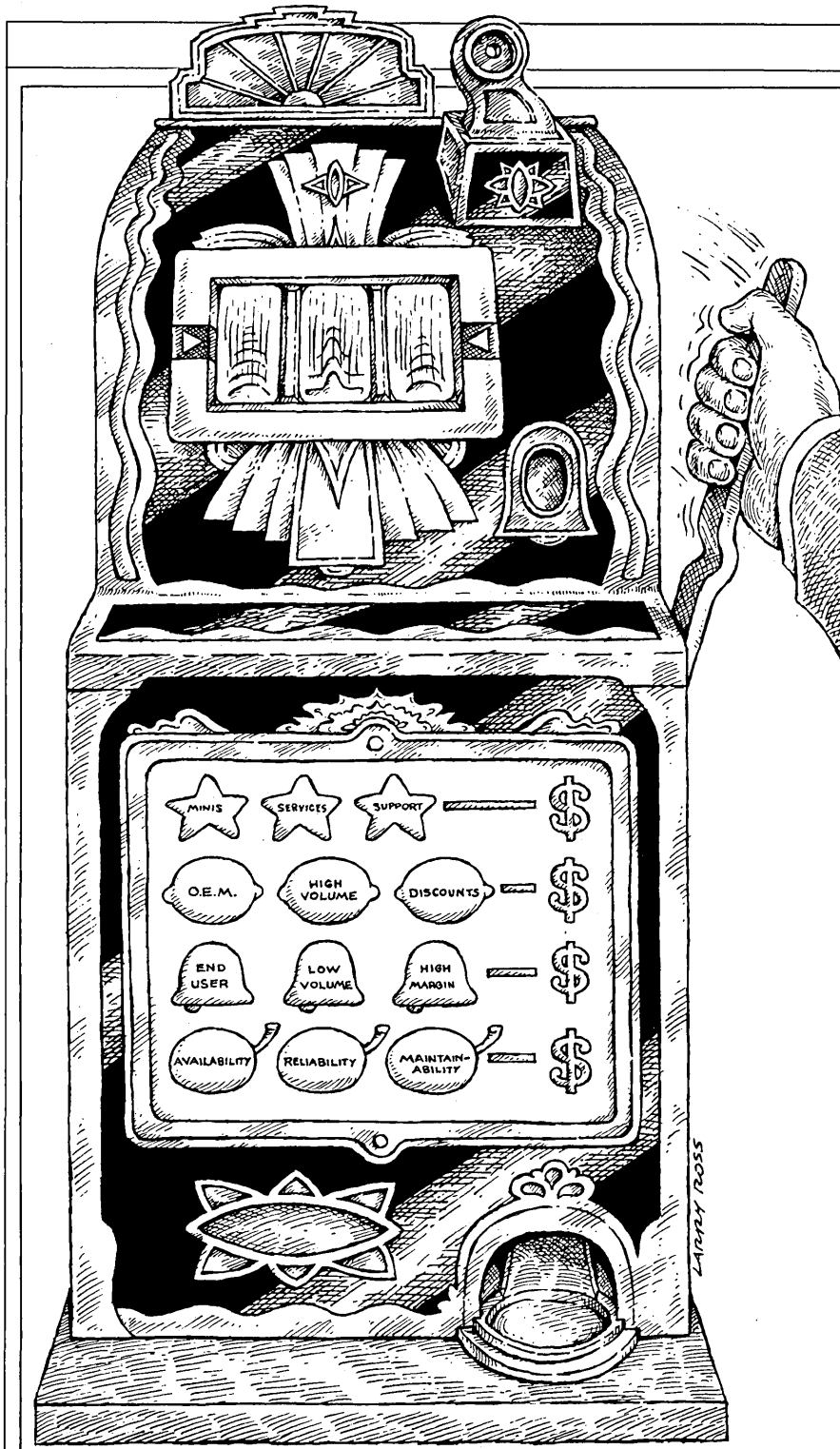

ILLUSTRATION BY LARRY ROSS

million a year in services by September 1983, or in excess of 25% of the company's anticipated total sales that year.

But according to de Castro, those companies that have not integrated their product offerings will not fare so well in services. He said that such producers will be trying to sell and support systems that they don't fully understand.

"Because we now design and manufacture more than 80% of what we sell, we can optimize performance for our customers at the systems level," said Stroup. This is known within DG as offering the customer

an ARM (Availability, Reliability, Maintainability), since the company can design in these characteristics.

In contrast, those companies less integrated, like Prime, will have to stand in line to buy parts from suppliers that are optimized at the subsystem or component level.

Another key advantage to Data General is that vertical integration will eventually reduce the company's manufacturing cost as its economies of scale become effective.

These facts don't seem to have been missed by Fisher and Prime. During 1979

Prime's balance sheet showed that its first real boost in services personnel had resulted in a nibbling away at the company's soaring profits. And just last November, Fisher said that to go for bigger orders the company would have to invest heavily in volume manufacturing of its own terminals.

Though Fisher may have to concede that there is an evolutionary pattern which, at a certain level of growth, seems to draw mini makers into vertical integration, his foresight in moving away from the oem area was considerable, say observers.

Before its shift, Prime was one of a number of "second tier" companies (DEC, Hewlett-Packard, and Data General are

### DG's capital spending over the past three years alone has exceeded \$150 million.

considered the first tier) which stayed in the oem business. By the end of 1978, many of this group—which includes Computer Automation, General Automation, SEL, ModComp, and Microdata—had run into problems. Suddenly, according to estimates at the time, there seemed to be maybe \$300 million worth of oem business going begging to the first tier companies with the best delivery positions. Through its own horizontal integration (bigger minis, networking products, etc.), DG had already started to make inroads into the profitable end-user sectors. But as 1979 progressed, the company took the calculated risk of shifting production from its high margin Eclipse computers to mount a massive oem challenge around its new micro-based Nova 4.

This all-or-nothing gamble depended on DG reducing lead time on the Nova 4 to the point that oems would flock to them. DEC and Hewlett-Packard, by comparison, didn't seem to be doing anything out of the ordinary.

The planned coup might have been a master stroke but for an unforeseen crunch in the semiconductor memory business (the one main area where DG still buys outside), which cut supply and kept lead time on the Nova 4 out at six months for most of the year.

Though Data General says that it secured a good deal of the oem business, the outcome of its gamble was that earnings were squeezed because of related disruptions in the company's end-user business.

Some experts have since claimed that DG was only too pleased to go for the oem business because its management still hadn't developed any real marketing sensitivity to the end-user sector as an alternative focus.

According to several DG employees, there is some truth to this view. Said one, "The company has been aware that there is a stage in its evolution when it would be drawn into the end-user sector for its future growth. But it has been reluctant to leave the

## NEWS IN PERSPECTIVE

### BUT ONE MORE WORRY

Compounding Data General's financial worries is last month's decision by a San Francisco jury which found DG's use of "tying arrangements" a violation of federal antitrust laws.

In this case, the core issue was not whether joint or "bundled" sales of operating systems and cpus are allowed, but whether a vendor can refuse to offer each product for sale independently (May 1980, p. 85). Data General's sales technique was to license its operating systems only to customers who signed a program license agreement promising to use the software solely upon a specific DG cpu. Data General also required its software licensees to purchase a minimum amount of DG memory and peripheral products (a "minimum equipment configuration" or MEC), calculated differently for each OS product, or pay a sizable license charge.

Citing Data General's strong position in the operating systems market, the jury decided that the company has sufficient power to influence sales of its computers, thus making the "tying arrangements" illegal. Data General said it will challenge that finding in an appeal.

Chances of a successful appeal, however, look dim, according to Calvert Cray, a litigation analyst for Bear, Stearns & Company. He believes that the Data General case is not "an obvious case for reversal."

"A lot of cases I look at say that the

jury or judge did something wrong. In this case, there was nothing the jury did wrong; the issues were handled conservatively. It's more a case of appealing the legal questions—whether computers and software are separate products or whether there is such a thing as a business justification for tie arrangements. That means new law would have to be established, and it's difficult to get new law established. In my opinion, DG has an uphill battle in appeals court," said Cray.

While industry analysts say they are not too concerned about the long-term effects of the verdict on the company, DG president Edson D. de Castro admitted legal expenses contributed to a drop in operating margins in the quarter ended in March.

Meanwhile, trading of DG stock on the New York Stock Exchange was halted June 9, the day of the decision, but not before the price dropped 1 3/4 points to 59 1/2.

Although at press time the jury had yet to determine damages, the two plaintiffs, Fairchild Camera and Instrument Corp., now a division of Schlumberger Ltd., and Digidyne Corp., a small, privately held San Diego computer maker, have asked for a combined total of approximately \$100 million. That sum would be trebled under antitrust law.

At one time the suit, filed in 1978, included seven plaintiffs. The other five either settled out of court or dropped out of the suit.

into such a cohesive whole. He said that he was first head-hunted by DG last June: "I never intended to leave IBM," he said.

Apart from the stock and salary incentives offered him, Silkman said he was attracted by the challenge of channeling Data General's "incredible energy into a sense of company identity." But he said he won't need to go as far as IBM's paternalism, "which is something you tend to take home with you," he said.

Silkman emphasized that there are no problems at DG that he "hadn't seen 10 years before when helping to plow IBM's Rochester Division through the \$1 billion to \$2 billion barrier."

Though insiders warn of the continuing decline in real growth this year for DG, there's no disguising their feeling of an impending turnaround in the company's fortune.

—Ralph Emmett

## OFFICE AUTOMATION

# XEROX'S OFFICE ASSAULT

**Xerox has hitched its wagon to a Star—a Star that's being watched by Wall Street, users, and some big competitors.**

A riddle: it's driven by a mouse, it's never existed before, it's supposed to help office workers do their jobs better, and it's modestly dubbed Star.

The question is not what is it, but rather will it sell at \$17,000 a shot?

It is, of course, Xerox's new "personal information system," designed to help out that vastly undercapitalized soul—the professional. It is also the "keystone," a bold move by Xerox to become a leader in the promising office electronics field, a move that's being watched closely by Wall Street users, and some large competitors.

With a series of four product introductions so far this year, Xerox is staging a major assault on the office. As the firm's own Ethernet ads show, the writing is on the wall: office paper is being replaced by digital bits, the copier business won't grow forever, and Xerox must get into office automation in a big way.

Judging by the thick crowds swarming around the firm's NCC booth in May, Star may have already lived up to its name. But industry observers are not sure how the machine and its accompanying entourage of word processors, file servers, fax machines, and electronic typewriters will fare against

shelter of its large oem customers."

The simple truth seems to be that though DG currently has a split in its business of 60% oem and 40% end user, the company has only just begun to put a structure in place that can handle end users.

One of the biggest barriers to an end-user push has been the company's traditional oem sales force. "These have been sharp, aggressive hustlers," one employee explained. "They had to be to compete against the likes of IBM and DEC."

"They were like wolves out there following de Castro's maxim of survival

### Insiders say Data General expects to turn over some \$150 million in services revenues this year.

first and success second," said another employee. ●

Stroup explained that the company has had to move from a more "entrepreneurial sales force to a more professional group. From individualists to company men." As a result, nearly 40% of the old sales force has left the company within the past 18 months. "But those left are working primarily for DG, not for themselves," said Stroup.

But the criticisms of the company

have continued. Though many critics have conceded the validity of the company's quest for technological integration, they point out that DG has been less than systematic in setting up the necessary management structure.

One consultant who follows the company offered a pointer: "A system or structure by definition has to be considered from the point of view of the whole rather than of any single part. Yet until now, the company's total performance has revolved around the decisions of one man."

President de Castro says that this reference to him was perhaps valid four years ago. But since that time, he says, he's tried to push decision-making out of his office.

Last autumn de Castro got together with all his senior managers to hammer out a management structure that would devolve some of his power and offer more employee incentive. But to make it all work, he's had to step outside the company—in fact, to IBM—to find the right man.

Frank P. Silkman, a former head of IBM's Office Products Division, has been brought in to run DG's new three-division business structure.

Silkman wasn't shy about admitting that de Castro was looking for some of the management magic that seems to bind IBM

# Why do we keep changing the system that manages more fixed assets than any other package in the world?

## Introducing FA Plus, Version 5.

Eleven years ago, we made a promise that we would never allow our fixed asset package, FA Plus, to become out of date. We put it in writing. Right on our user contract.

That was the beginning of one of the most remarkable product success stories in the annals of the software industry. Today, our FA Plus package manages a greater volume of fixed assets than any other package in the world. The FA Plus user list reads like a "Who's Who in American Banking and Industry." The total number of users has climbed to over 600. Scores of these companies are in the *Fortune 500*. Our commitment to them is why we've worked long and hard to produce FA Plus, Version 5.

It's a complete rewrite of FA Plus. The fifth since the package was introduced. It keeps the promise we made eleven years ago. By keeping our clients up to date with the very latest changes in tax law and accounting practices. We've incorporated lease accounting in accordance with FASB-13, a replacement cost feature in accordance with FASB-33 – and new tax procedures in accordance with the IRS.

Like all McCormack & Dodge packages, FA Plus, Version 5 is built for smooth, easy startup. Installations are supervised by instructors who have the most successful user training record in the industry. They see to it that your people learn in a hands-on environment. Errors are worked out in our classrooms, not your office.

McCormack & Dodge. All over North America, prospects who sit down and talk to us do more than just talk. They become customers.

We'd like to show you why.

Please send schedule of free seminars, plus information on:

General Ledger  Purchase Order  Accounts Payable  Fixed Assets  Capital Project Analysis

Name \_\_\_\_\_

Company \_\_\_\_\_ Title \_\_\_\_\_

Address \_\_\_\_\_ City \_\_\_\_\_

State \_\_\_\_\_ Zip \_\_\_\_\_ Phone \_\_\_\_\_

Computer Model \_\_\_\_\_

### McCormack & Dodge

The best financial software. The best financial people.

560 Hillside Avenue, Needham Heights, MA 02914, (617) 449-4012, Atlanta (404) 997-2797, Chicago (312) 843-3400, Dallas (214) 369-7014, Los Angeles (213) 645-6382, San Francisco (415) 398-2960, Washington, D.C. (703) 734-0710, New York/New Jersey (201) 528-6331 • Canada • United Kingdom/Netherlands • Italy • Australia/New Zealand • Mexico • South Africa • Sweden • Hong Kong

DATA

## NEWS IN PERSPECTIVE

the fierce competition expected from the likes of Wang, IBM, Burroughs, and the Japanese. Can Xerox pull it all together, they ask, in the face of such strong competition? Can the company, which has never been spectacularly successful in the word processing arena, sell the office manager on such unorthodox concepts as Star and Ethernet? Does the firm have the marketing savvy

### **Xerox has begun peppering the public's consciousness with ads touting local networking, new products such as Star, and the company's commitment to information processing.**

to cater to the needs of small offices as well as large corporate entities?

Xerox appears to be taking some new approaches to product design and marketing as its assault begins. Starting with last year's Ethernet publicity blitz, it has begun peppering the public's consciousness with ads touting the local networking scheme, new products such as Star, and the company's commitment to the information processing marketplace. The campaign seems to have worked, if measured only by the uncharacteristic but typically vague "directional statement" by IBM last year con-

cerning its office networking plans. Other vendors, trying to cash in on the apparent local networking bonanza, have been forced to stack their schemes up against Ethernet, spec for spec. All this despite Ethernet's never having been fully defined or ready for delivery as a product.

As for product design, the Star system is by far the "newest" office terminal product to come out in a long time, according to most analysts. Designed to help professionals—lawyers, engineers, and analysts, for instance—perform their jobs more efficiently, Star combines several new facilities to provide easy-to-use computing, text editing, graphics, and communications. The firm emphasizes, "It's not just a new machine; it's a totally new concept."

Indeed. The machine's most striking feature is its "user interface." Using a high-resolution, two-page bit-map display, Star shows text and graphics precisely as they will appear in hardcopy. A choice of several character fonts, detailed graphics that can be sized interactively, grey tones and justified columns are shown in black on white. The system moves information onto the screen quickly and can be flexibly windowed into separate areas, each corresponding to particular documents or files.

The user interacts with the system through a standard keyboard, a free-roaming cursor called the mouse and a set of

"icons." Icons are small graphic symbols which signify functions, storage areas within the system, and remote destinations for electronic documents. Thus, instead of having to learn a peculiar command language to run Star, users move the mouse from icon to icon, telling the system what to do in the process.

The firm claims that because the machine was designed from the beginning for use by professionals who were not necessarily familiar with computers, the average user can begin using it with as little as 20 minutes of instruction and be fully proficient with no more than four hours of machine-guided lessons.

As might be expected, the system attaches to Ethernet, sending and receiving

### **Star's target is not the office clerk who works with numbers, but the professional who works with ideas.**

text documents, tabular files of numerical data, graphics, and any combination thereof. It can store information locally on a hard disk or keep it on the shared Ethernet file server Xerox introduced late last year.

As for price, the Star goes for \$16,595 with basic software, or rents for \$695 a month on a one-year lease. Several software packages offering such features as



### **The perfectly natural interface.**

Touch. Man uses it to learn. Before sight, before taste and long before anything as complex as keyboarding.

Mother Nature invented the sense of touch. But Carroll Manufacturing developed the technology to apply it as an interface on displays.

Carroll is the leader in touch technology. To solve the man/machine interface dilemma. To make your system friendly and more responsive.

To find out more about touch technology and Carroll's approach to touch, write or call: Carroll Manufacturing Company, 1212 Hagan Street, Champaign, IL 61820. 217/351-1700.



Keeping computers in touch with people.

CIRCLE 27 ON READER CARD



# The most advanced general ledger software ever to run on the IBM 370.

## Now available for the IBM System 34, HP 3000 and the whole Prime line.

You're a data processing manager in a hectic, fast-growing minicomputer shop, and you love your job.

But there are times when you envy data processing managers in larger, more traditional shops. Those *Fortune 500* corporate departments with their massive mainframes, endless resources and heavy duty software. You envy them every time you can't get a report out. Every time you put in another 16-hour day, trying to make your system do more than it was designed to do.

McCormack & Dodge would like to shorten your work day. With GL Plus, the general ledger package used by *Fortune 500* data processing managers to meet impossible closings. To generate every conceivable forecast, trend analysis and product/profit report that competitive financial operations require on a daily, even hourly, basis.

Until recently, you could not run GL Plus unless you had access to a major mainframe computer. An IBM 360, 370, 303X or 43XX. But now, all it takes is an IBM System 34, HP 3000 or any Prime, and much less startup time than you imagine. Because the hands-on training you get from McCormack & Dodge is as far ahead of the field as our software.

McCormack & Dodge. All over North America, prospects who sit down and talk to us do more than just talk. They become customers.

We'd like to show you why.

Please send schedule of free seminars, plus information on:

General Ledger  Purchase Order  Accounts Payable  Fixed Assets  Capital Project Analysis

Name \_\_\_\_\_

Company \_\_\_\_\_ Title \_\_\_\_\_

Address \_\_\_\_\_ City \_\_\_\_\_

State \_\_\_\_\_ Zip \_\_\_\_\_ Phone \_\_\_\_\_

Computer Model \_\_\_\_\_

## McCormack & Dodge

The best financial software. The best financial people.

560 Hillside Avenue, Needham Heights, MA 02914, (617) 449-4012, Atlanta (404) 997-2797, Chicago (312) 843-3400, Dallas (214) 369-7014, Los Angeles (213) 645-6382, San Francisco (415) 398-2960, Washington, D.C. (703) 734-0710, New York/New Jersey (201) 528-6331 • Canada • United Kingdom/Netherlands • Italy • Australia/New Zealand • Mexico • South Africa • Sweden • Hong Kong

DA7A

# HP presents graphic improven



# nts in engineering productivity.

Whether it's computer-aided engineering, image processing, simulation or management presentations, Hewlett-Packard graphics can give you a fast, easy way to focus on the facts. From initial system set-up to final hard copy output.

## Peripheral vision.

All our plug-in graphics peripherals are designed to work together, so you can build a complete workstation with the products that make the most sense for your applications.

Start with our easy-to-use input devices. Digitizers, data tablets and light pens let you convert line drawings, schematics, flow charts and other graphic information into coordinate data for processing and storage.

Then you can display and manipulate your data on any of our high-performance graphics terminals or integrated graphics systems. All use HP's powerful graphics language extensions, giving you extraordinary flexibility to shape the way your information is presented. And for hard copy output, our graphics printers and eight-color plotters put the equivalent of an entire art department right at your fingertips.

## The picture of productive systems.

HP offers a full range of technical computer systems to support our graphics products. Which means that the compatibility is designed right in.

If you'd like to see an eye-opening demonstration of our graphics workstations, call your local HP sales office listed in the White Pages. You can also write for more information to: Hewlett-Packard, Attn: Pete Hamilton, Dept. 04104, 3404 E. Harmony Road, Ft. Collins, CO 80525.



**HEWLETT  
PACKARD**

CIRCLE 29 ON READER CARD

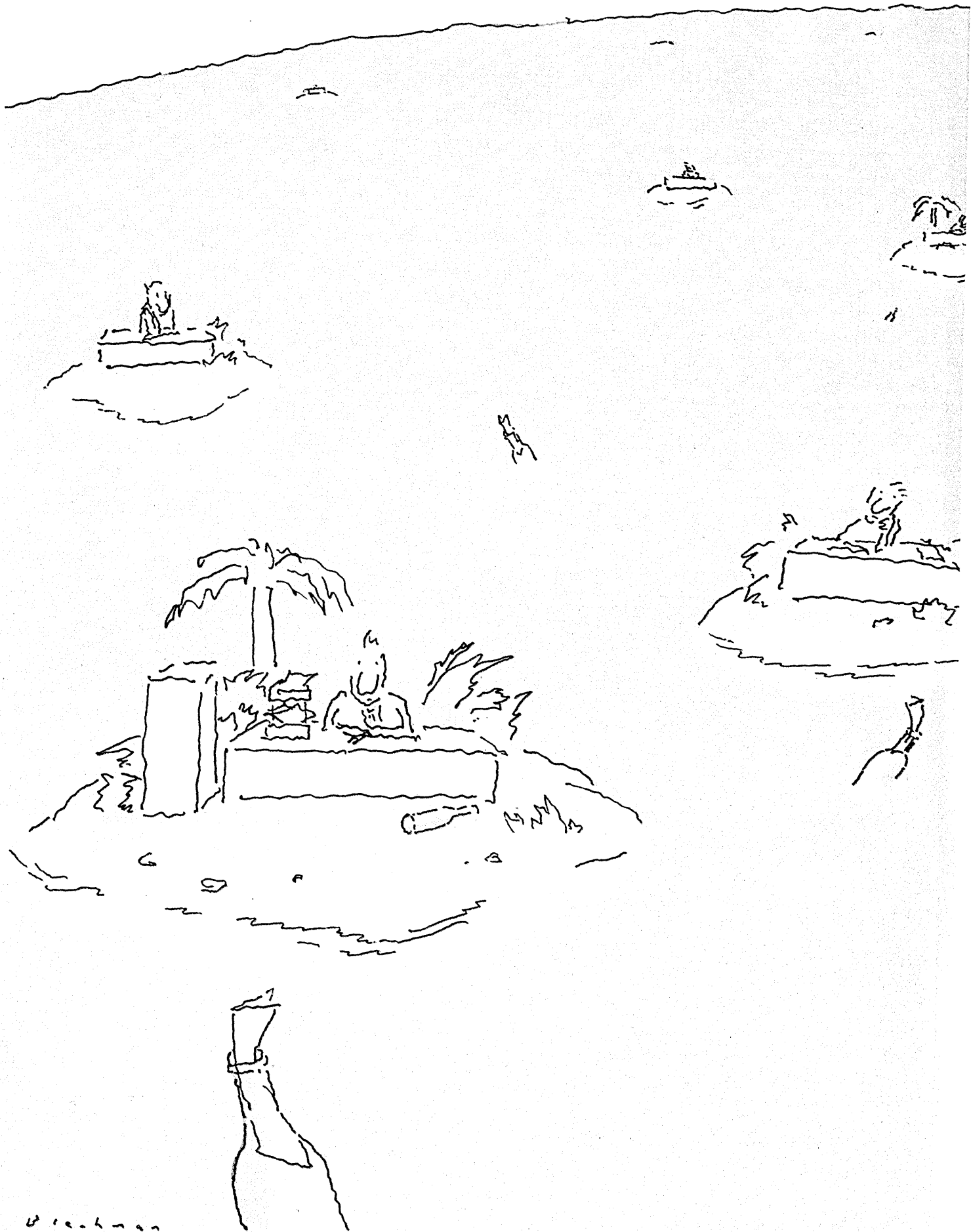

© 1988

## Are you and your branch offices having difficulty communicating?

No branch need be an island.

Yet many branches are. Lacking access to headquarters' computers, they are marooned by inadequate information.

Headquarters is in the same boat. Because to make intelligent decisions, you need intelligence from every one of your locations, no matter how remote.

With this in mind, we at IBM created the IBM 5280 Distributed Data System. It spreads your computer's intelligence where your end users can make the best use of it. So you can build bridges to every part of your organization, whether across the hall, across town, or across the country.

Case in point. Owens-Illinois Corp. is using 5280's to get quick, accurate orders from its remote plants. So orders that previously had to be mailed in are now available instantly. Freeing headquarters from long waits for local data.

The IBM 5280 also frees remote locations to do their own processing locally. They can do payroll, inventory, and other local management applications.

And you can put a network of 5280's to work for you very quickly. Because they're simple to install. They're also simple to use, so your local managers won't be in over their heads.

The 5280 speaks COBOL, DE/RPG, and communicates in both BYSYNC and SNA. It can communicate with most IBM host computers: Systems 3, 370, 360, 34, 38, the 4300, the 303X processor and others.

It can even grow with your remotes: 1-4 workstations, 32-288K memory, .25-9.6 meg diskette storage, 40 CPS—up to 560 LPM printer.

And it's nice to know that IBM service is available even for your remotest offices. In case they should ever get into hot water.

So call your IBM General Systems Division representative or write P.O. Box 2068, Atlanta, GA 30055. Headquarters will benefit. And your remote locations will thank you.

Because they'll no longer be left high and dry.

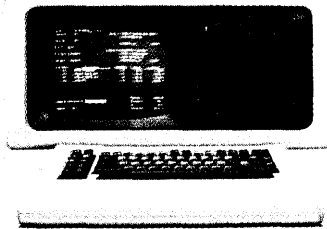

## A little IBM can mean a lot of freedom.

**IBM**

General Systems Division

CIRCLE 30 ON READER CARD

# Things that are easier to use do more work.

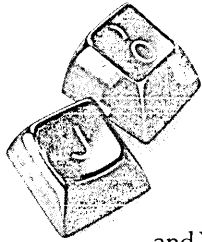

Video terminals are very personal devices. And many people who use them are not familiar with computers.

So we designed the VT100 and VT132 (for smart, block mode applications) to be as easy to use as possible.

Even friendly.

The keys on the detached keyboard are patterned and sculptured to feel like those on your favorite electric typewriter. Smooth scrolling of text onto the screen allows new data to be reviewed easily. You can

display 80 or 132 columns so you can review the data printed on 14-inch wide reports without wraparound.

Crisp, well-defined characters are easy on the eyes. And to make it easier to isolate information, lines can be made larger and characters can be reversed, brightened, underlined, or even made to blink. A line drawing character set makes video forms look like the printed forms you're used to.

You can even split the screen so new material scrolls smoothly, while other important data, such as column headings or status lines, remain stationary.

And best of all, you can easily customize Digital's video terminals to your own personal preferences straight from the keyboard, and save your preferences in a non-volatile memory. Thus you can configure them to suit a wide variety of work situations for any system supporting asynchronous ASCII terminals.

You would think that, designed as they are for easy use, our terminals would lead a life of ease.

They don't. You'll find they work even harder.

To buy a VT100 or VT132, contact your Digital terminals dealer. For the names of dealers nearest you, call 800-225-9378 (outside the Continental U.S. and in Massachusetts call 617-467-7068) between 8:30am and 5:00pm Eastern time, or contact your local Digital sales representative.

Digital Equipment Corporation, Terminals Product Group, MR2-2/M67, One Iron Way, Marlboro, MA 01752. Tel. (617) 467-7068. In Europe: 12 Av. des Morgines CH-1213 Petit-Lancy/Geneva.

In Canada: Digital Equipment of Canada, Ltd.

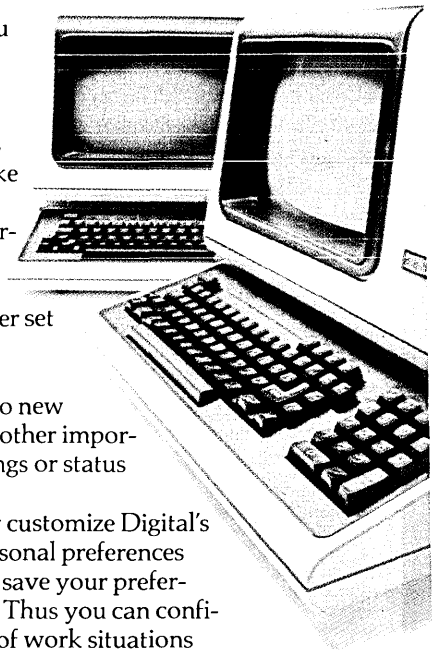

**digital**

**We change the way  
the world thinks.**

CIRCLE 31 ON READER CARD

## NEWS IN PERSPECTIVE

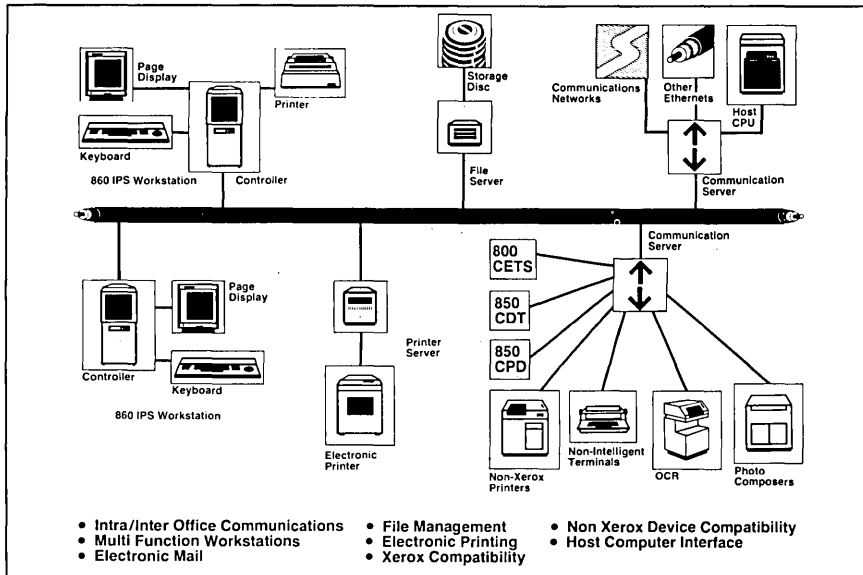

**A COMPLETE SYSTEM:** The Xerox 8000 network system includes electronic office file, laser printer, and communications units. It links different types of office equipment—including competitive gear—into a single integrated network.

records processing, advanced graphics, and a spelling checker are separately priced. Xerox said deliveries will begin this summer and the system will be available in 32 major cities across the country by October.

As the keystone of the Xerox office automation push, Star embodies some innovative ideas in automating office functions. Xerox said at the product's introduction that Star represents its largest R&D investment so far within the electronics field. The machine's target is not the usual office clerk or secretary who Xerox says works with numbers or words, respectively. Rather, it is the professional who works with ideas.

As told by David Liddle, vice president of Xerox OPD and product manager for Star, the system will "sell itself" in sophisticated user organizations. The machine is highly attractive to the creative minds of professionals, and even if there is no overall plan for implementing a network of Stars,

**Product manager Liddle says Star will "compete with the pleasures of the flesh."**

the system will find itself well used, he says. It is so easy to use and genuinely powerful, Liddle says, that it will "compete with the pleasures of the flesh." It "gets the creative juices flowing," he adds.

Such rhetoric might be dismissed as pure promotional hype except for Star's ancestry in the Alto office automation project undertaken within Xerox and tested in the White House at one time. Alto was a test bed for much of the Star concepts and software, although its actual configuration differs greatly, according to Xerox officials. Those who have used Alto claim it truly does improve productivity and it does have an attraction for the creative mind.

However, with a \$17,000 price tag, the almost essential requirements of at least a low-speed character printer and an Ethernet connection, installing a Star would seem to be a fairly major investment for the user. Taking into account Star's newness to the marketplace, its requirement of other Stars

to make it most effective, and the relative inexperience of the Xerox sales force at selling systems, the question remains: can Xerox sell Star?

Donald J. Massaro, president of OPD and a corporate vice president who has been credited with giving OPD much of the aggressiveness it has been showing lately, says the firm's sales strategy will be one of capturing market share now "while it's cheap." Small, lower cost machines will be sold to large accounts in volume and, through retail channels, to smaller office users in ones and twos, he says.

Helping the firm along in that direction will obviously be the recently introduced 820 desktop computer word processor, nicknamed Worm. Priced in its most basic configuration at \$2,995 for computing only or at \$5,895 for word processing, the machine, it is hoped, will compete aggressively with such systems as IBM's price-setting Displaywriter and the Apple small computer. Xerox has designed the machine to run the popular CP/M operating system so that users will be able to run the many currently available software packages developed on other CP/M machines.

As a word processor, the 820 will come in under the firm's 850 and 860 models which have not done particularly well in the fiercely competitive word processing arena. The 820 offers a low-cost entry into

## Model 204 DBMS. You're 'remiss' if you don't check it out.

Here's what the leading software rating service says: "Anyone interested in installing a flexible, user-oriented DBMS would be remiss if they did not evaluate Model 204."

They're right. It will pay you to check out Model 204. Because you'll find that Model 204 is so easy to use that you won't need large teams of programmers for bringing up new applications. And you'll get the job done quickly. Which means big cost savings.

And it will pay you to evaluate Model 204 performance. Because you'll dis-

cover that Model 204 performs—and keeps performing, even if your database gets up into the billions of bytes and your terminals get into the hundreds. Which means no system changes, no reprogramming. Which means big cost savings.

Don't be "remiss." Get further information by clipping your card to this ad and mailing to us at 675 Massachusetts Avenue, Cambridge, MA 02139. Or call 617-491-7400.

**Model 204 DBMS**

# Computer Corporation of America

Cambridge, New York, Houston, San Francisco, Chicago, Washington, Los Angeles / International Affiliates: Tokyo, Berne, Milan, Toronto

CIRCLE 32 ON READER CARD

*This announcement is neither an offer to sell nor a solicitation of an offer to buy any of these Securities.  
The offer is made only by the Prospectus.*

Not a New Issue

**2,600,000 Shares**

**Apple Computer, Inc.**

**Common Stock**

---

**Price \$31¼ a Share**

---

*Copies of the Prospectus may be obtained in any State from only such of the  
undersigned as may legally offer these Securities in compliance  
with the securities laws of such State.*

**MORGAN STANLEY & CO.**  
*Incorporated*

**HAMBRECHT & QUIST**

**BACHE HALSEY STUART SHIELDS**      **THE FIRST BOSTON CORPORATION**      **BEAR, STEARNS & CO.**  
*Incorporated*

**DILLON, READ & CO. INC.**      **DONALDSON, LUFKIN & JENRETTE**      **DREXEL BURNHAM LAMBERT**  
*Incorporated*      *Securities Corporation*      *Incorporated*

**E. F. HUTTON & COMPANY INC.**      **KIDDER, PEABODY & CO.**      **LAZARD FRERES & CO.**  
*Incorporated*      *Incorporated*

**LEHMAN BROTHERS KUHN LOEB**      **MERRILL LYNCH WHITE WELD CAPITAL MARKETS GROUP**  
*Incorporated*      *Merrill Lynch, Pierce, Fenner & Smith Incorporated*

**L. F. ROTHSCHILD, UNTERBERG, TOWBIN**      **SHEARSON LOEB RHOADES INC.**

**SMITH BARNEY, HARRIS UPHAM & CO.**      **WARBURG PARIBAS BECKER**  
*Incorporated*      *Incorporated*

**WERTHEIM & CO., INC.**      **DEAN WITTER REYNOLDS INC.**

May 28, 1981



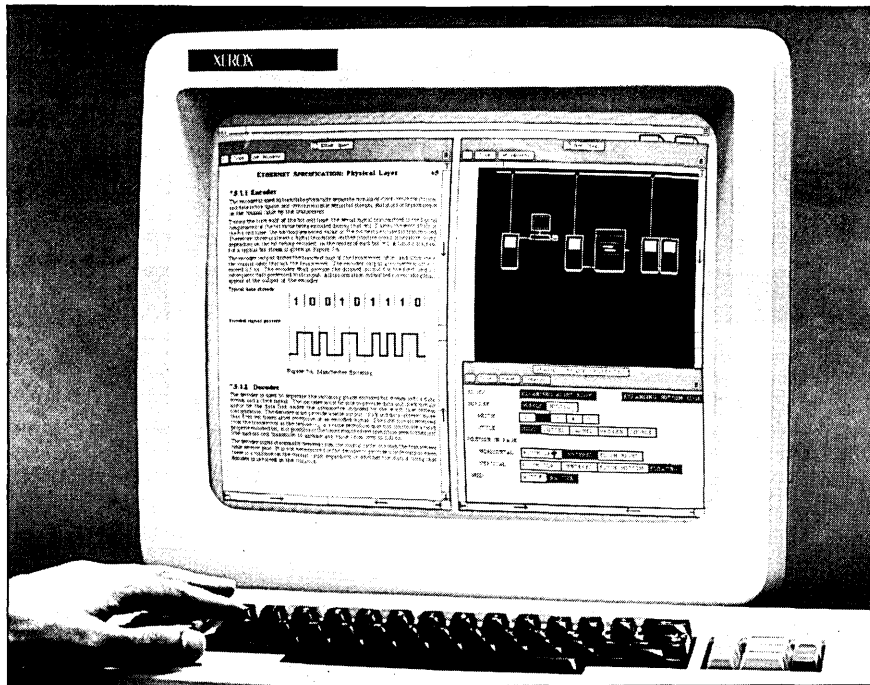

NOW SHOWING: A wide range of text and graphic information can be created on the two-page display screen of the Xerox 8010 Star system.

word processing; it also works well as a personal computer, a 3270-emulating terminal communicating with a large host, or as a workstation attached to an Ethernet.

Thus, according to Massaro, users will be induced to install an 820, 850, or 860 system (or at an even lower cost, the firm's planned Sabre line of communicating electronic typewriters which are due for introduction in September) as the first step towards wiring their offices with Ethernet links. Then, as the spirit and marketing efforts of Xerox move them, users will add Ethernet at an estimated cost of about \$2 per foot of cable, according to Massaro. Once enough terminal devices have been installed, the file server and print server introduced late last year can be added, enabling the user to move documents electronically throughout the office and giving enhanced printing facilities. Meanwhile, he notes, because of Ethernet's claimed compatibility with non-Xerox systems, users will be able to attach other vendors' minicomputers, word processors, and even large mainframes.

Once such a network is in place, the addition of Star workstations "is a natural," says Massaro. Instead of just helping out the clerical workers as word processors and computers mostly do, he notes, Star will appeal to the professional, the worker who is one step above the clerks but one step below the manager. There are 20 million such professionals in the U.S. alone.

Liddle claims that installing one or a few Stars in an office can be incentive enough for an office to see the benefits of Star.

Looking at the competition, Xerox

officials say they see no one company able to provide the range of office electronics it can, especially by the end of the year when the "major pieces" of the Xerox line are in

place. IBM, in particular, has so far not offered a local networking capability, but industry sources expect the firm to broaden its office products range shortly with computing facilities for the Displaywriter (Look Ahead, June, p. 13), some sort of communicating electronic typewriter, and a method to tie various office systems together into a communicating network.

Wang, Burroughs, and the Japanese also loom large as significant competitors to Xerox as it mounts its office assault. Wang has gained a strong foothold in the shared logic word processing arena and has recently countered IBM's Displaywriter with the Wangwriter. Burroughs is due to ship a new line of office machines as reported in these columns earlier (May, p. 46). The Japanese seem most likely to gain market share in the small computer arena and perhaps in word processing, although no one vendor has emerged as a leader from those shores.

So, Xerox is not without its challengers. It is not clear, either, how it will divide its energies between large accounts where it can sell so-called systems, or multiple unit orders, and smaller accounts where machines are bought one at a time, and not necessarily with networking in mind.

Some observers suggest that Xerox's latest wave of products, particularly the Star, are of such advanced nature that the market may not be ready for them yet.

## Model 204 DBMS. A perfect 4!

Bull's eye! The leading software rating service gives Model 204 DBMS a perfect score—4 out of 4—for ease of use.

Because with Model 204 it's easy. It's easy to learn. Easy to install. Easy to set up new databases. And easy to develop new applications—for inventory control, personnel data, financial applications, correspondence tracking, project control—and every other kind of corporate database.

And since it's easy, it doesn't require teams of programmers. And it doesn't

take years. Which means cost savings on a large scale.

If you want to find out how some of America's largest corporations solve their DBMS problems with Model 204, clip your card to this ad and send it to us. It's easy!

Computer Corporation of America,  
675 Massachusetts Avenue,  
Cambridge, MA 02139. Or call  
617-491-7400.

### Model 204 DBMS

# Computer Corporation of America

Cambridge, New York, Houston, San Francisco, Chicago, Washington, Los Angeles / International Affiliates: Tokyo, Berne, Milan, Toronto

CIRCLE 34 ON READER CARD

---

# We're Your Washington Connection To World Markets

Interested in selling your products abroad? Do it the easy way. The International Trade Administration of the U.S. Department of Commerce has a unique vehicle to put you in touch with interested and ready buyers for your products overseas—International Trade Exhibitions, custom-tailored to your specific products.

Our project managers will take care of all the details—from helping you plan your marketing strategy to the nuts-and-bolts of arranging transportation, customs clearance, and booth design, including electricity, water pressure—whatever you need. We'll do all the leg work—all you do is arrive and throw the switch.

You specify the audience you want to target, and the U.S. embassy will go to work promoting your products to interested buyers and inviting them to visit your booth at the exhibition. You don't have to go to the buyers—they'll come to you.

Twenty-two International Trade Exhibitions are planned in the coming months, for computers, peripherals, software, data communications, word processing, and other business equipment—in cities like Sao Paulo, Paris, Tokyo, Milan, Munich, Geneva, Mexico City, Birmingham, Taipei, and Ismir.

**Like more details? Call us today:**

**Robert Wallace**  
Project Manager  
(202) 377-3002

**Simon Bensimon**  
Project Manager  
(202) 377-2298

Or write:

U.S. Department of Commerce, International Trade Administration,  
Office of Export Promotion/IPD, Room 6015A, Washington, D.C. 20230

---

## NEWS IN PERSPECTIVE

Only a very few companies have the resources to spare and the foresight to plan for future networks now and invest in such a "new" product as Star, they say. Xerox's answer to such doubts is that Star and its companions will "speak for themselves."

Another problem seen by office automation analysts is that despite the massive push Xerox has given to Ethernet with its substantial advertising and public relations budget, and despite the concept's backing by several large vendors, there is still no standard for the exchange of information between different types of office systems. There is no guarantee that a file created on a Hewlett-Packard computer would be fully compatible with a Xerox Star's file handling routines. Control characters defining formats and the like differ widely from vendor to vendor so that files wouldn't necessarily be transferable as easily as implied by much of the talk surrounding Ethernet, observers note.

Whatever the odds, Xerox has taken a fighting stance, determined not to let its future slip through its fingers. Despite having failed spectacularly in the mainframe computer business several years ago, the firm has been quietly preparing for its big push into office automation with a gathering of highly successful peripherals firms (Diablo, Shugart, Century Data, and Versatec, among others) and a revamping of top management. Executive vice president John Titsworth, formerly of Control Data, and Massaro, a star in his own right from Shugart, are credited with the current push.

They appear to have the backing of the corporation. Even quiet Xerox Computer Services is eyeing OPD's projected success with plans to tie its machines into Ethernets, providing users with large-scale storage and computing facilities.

—John W. Verity

## PERIPHERALS

# TINY IBIS TAKES ON BIG BLUE

**What Ibis Systems is promising is "the largest disk drive in the world."**

While such firms as Memorex and Storage Technology Corp. scurry to enhance their versions of IBM's 3350 disk drive to take advantage of the giant's slipped delivery date on its big 3380 drive (DATAMATION, May, p. 48), a small Duarte, Calif., company is quietly playing a game of one-upmanship.

When and if the 3380 becomes

available, it will be IBM's biggest disk yet. What tiny Ibis Systems, Inc., is promising is the "largest disk drive in the world."

Jack Jones, president of the company which was incorporated last December and got its funding in March, said its Ibis

**The Ibis 5000 will be based on a ferrite head and a thin film disk, not on the thin film read/write head technology that seems to be causing IBM some problems.**

5000 will have a five gigabyte capacity, double that of the 3380.

He believes IBM's once-slipped delivery date for the 3380 will slip again. "They're now talking about March 1982, but we believe that will slip to mid-1982 or maybe even the latter part of next year." He said Ibis expects to have a prototype of its drive by the end of this year and to begin deliveries in the early part of 1983.

Jones notes that the firm has \$4.2 million in funding to get the prototype ready and "commitment past that for enough cash for the exact technology to meet market needs."

Funding for Ibis comes from two venture capital firms, New Court Securities, New York City, and Hillman Co.,

Pittsburgh, Pa. Founders of the company, along with Jones who came from Memorex, are Karl Hawkins, also from Memorex; Jack Taranto from Burroughs, and Dick Weir from Xerox's Electro Optical Systems. Jones was vice president of sales and marketing for Memorex's Computer Media Group, and Hawkins was vice president of finance for the firm's Flexible Disk Media Div.

At Ibis, Hawkins is vice president of finance; Taranto, vice president of operations; and Weir, vice president of engineering. The company has some 50 employees whose previous employers include Memorex, Storage Technology, Century Data Systems, and Exxon (from the Star Systems Operation sold to Storage Technology).

While the IBIS 5000 will be totally compatible with the IBM 3380, it is not based

**Ibis expects to have a prototype by the end of this year and to begin deliveries in the early part of 1983.**

on the thin film read/write head technology which seems to be causing IBM some problems. "Our drives," says Jones, "will be based on a ferrite head and a thin film disk. The idea of a thin film disk is not new. It exists in Burroughs Corp."

## Model 204 DBMS. CCA's Revolutionary Idea.

We think a DBMS should have excellent performance and be easy to use.

Not a revolutionary idea?

Guess again.

Only Model 204 can do it. While some inverted-file systems are easy to use, their performance falls apart when the database gets large or the load gets heavy.

Then there's IMS. It performs pretty well, but it's so hard to use, you need large teams of programmers for developing applications.

But with Model 204 you get

excellent performance, even with large databases and a heavy load. And using Model 204 is easy. The leading rating service gives Model 204 a perfect score—4 out of 4—for ease of use.

In short, Model 204 gives you performance and ease of use in a single package. Revolutionary!

For details, clip your card to this ad and send to us at 675 Massachusetts Avenue, Cambridge, MA 02139, or call 617-491-7400.

**Model 204 DBMS**

# Computer Corporation of America

Cambridge, New York, Houston, San Francisco, Chicago, Washington, Los Angeles / International Affiliates: Tokyo, Berne, Milan, Toronto

**CIRCLE 36 ON READER CARD**

**Begin  
at  
square  
one.**

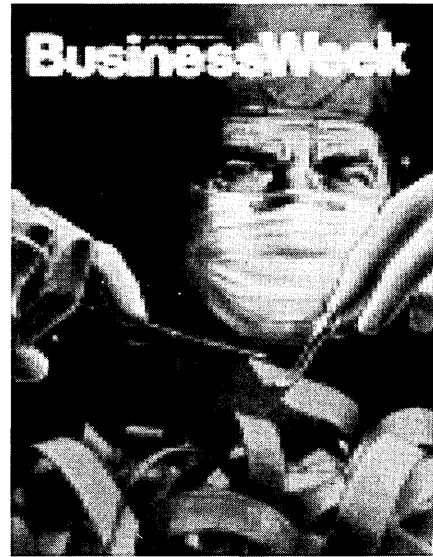

**No one covers the computer world like Business Week.** Business Week is the only business publication with an entire editorial section, Information Processing, covering the computer industry. Week after week, Business Week keeps more than 5½ million

business leaders up to date on important changes and developments in the world of computers, computer software and services. When it comes to computers, Business Week has much more coverage than Fortune, Forbes or the Wall Street Journal.

**Business Week readers have purchasing power.** 9 out of 10 Business Week subscribers hold management positions. And over 30% are involved in the purchasing or leasing decisions for computer equipment, services and software. **Business Week has the lowest cost per thousand.** Business Week has the lowest CPM of any

newsweekly or business publication in reaching managers who make purchasing decisions in the electronic data processing category, both for equipment and services. You get the best audience there is, for the smallest byte out of your advertising budget. So get the complete picture

from Frank Long at Business Week, McGraw-Hill Building, 607 Boylston Street, Boston, Massachusetts 02116, 617-262-1160, or Donald Thompson, Business Week, 425 Battery Street, San Francisco, California 94111, 415-362-4600, or your nearest Business Week representative.

Sources: BW Profile '81. MRI (Spring 1981)

**BusinessWeek** 

CIRCLE 37 ON READER CARD

## NEWS IN PERSPECTIVE

Ibis, in fact, sprang from a business relationship between Jones and Taranto when Jones was representing Memorex and Taranto, Burroughs.

"We were having conversations about the disk drive market and what was developing. We decided to get together," Jones explains.

Ibis hasn't priced its drive yet, but

### Ibis plans to attack the end user market first, delaying oem marketing and sales to PCMs probably until 1984.

Jones feels it will be half the cost per megabyte (\$32) of the 2.5 gigabyte 3380. And, he claims, his drives will be more reliable. "The key lies in the medium itself, the thin film disk. It's smooth. There's no roughness, and it doesn't create contaminants."

Jones isn't against the thin film head technology. "We have a development program now with thin film heads. Weir and Taranto were in on the earliest development work with thin film heads at Burroughs five years ago. Thin film heads are not so difficult to develop. The real problem is in manufacturing."

Thomas H. Kemp, vice president of engineering for Infomag, the Goleta, Calif., manufacturer of recording heads which has a prototype of a thin film head that it will

market to the PCMs, said thin film heads are expensive to manufacture. "They require expensive equipment. They lend themselves to more automated manufacture." But Kemp sees disk drives based on thin film heads "emerging in the next year or so to the point they will equal Winchester's in popularity."

Jones is confident that IBM will overcome whatever problems it is now having with the 3380. "I'm ex-IBM, and so are Taranto and Weir. We know they [IBM] will fix their problem. We expect to be the only other significant manufacturer, capturing 2% to 4% of the market in the short term. In the long term we look for more."

Jones believes IBM will welcome Ibis. "We haven't gotten their attention yet, but they will not ignore us." He isn't concerned about the other PCMs. Memorex, Storage Technology and Control Data have all announced 3380-type products. "They have to copy IBM, do reverse engineering. It'll be 1984 or 1985 before they have 3380-type drives on the market."

Jones says the prototype his firm will have ready by year-end will measure 32 in. by 40 in. by 6 ft. in height and will contain four spindles and four HDAs (head-disk assemblies). "It will replace ten 3350s from a space standpoint."

He adds that the company is looking for a larger facility somewhere in Los Ange-

les, Orange or Ventura counties. "We're starting now to bring in manufacturing management and are looking for someone heavy in field engineering. We're ahead of our benchmarks and are starting to consider beta sites." Jones points out that the company will manufacture its own thin film disks.

Ibis plans to attack the end user market first, delaying oem marketing and sales to PCMs probably until 1984.

And what is an Ibis? "It's an ugly Egyptian bird," explains Jones. "When we were looking for a name for our company, my wife and I saw a picture of one in a Santa

### While Ibis hasn't priced its drive yet, it expects it to be half the cost per megabyte of IBM's 3380.

Clara museum. It stands for excellence and greatness in science. It's supposed to have been the scribe for the Greek god Thoth, god of knowledge in math and logic."

The bird may be ugly, but it must be popular. When Jones had the name checked out, he found some 7,000 firms were using it. But none were in the computer industry and none were called Ibis Systems.

"It's a short bird with long legs and a long droopy beak, but it has character," Jones remarks.

—Edith Myers

## MOVE THE GOODS.



## USE THE DATAMATION MARKETPLACE ADVERTISING SECTION

Call Kathy or Shirley  
800-223-0743 or 800-223-0746

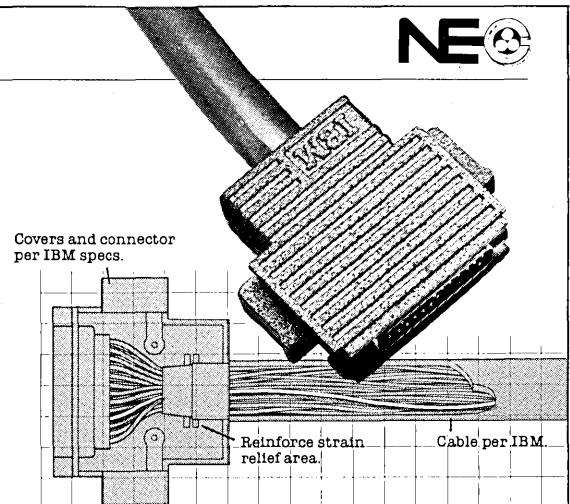

## Make connections with us.

For cable assemblies built to your system's specifications, National Electric Cable can provide technical assistance and the correct assembly to get you on line in a hurry.

For new and expanding systems by IBM, Wang, Four Phase, Incoterm, Texas Instruments and Inforex, to get standard and custom assemblies, bulk cable, patch panels, and application engineering, make connections with us.

Send for catalogs.

### National Electric Cable

1730 Elmhurst Rd., Elk Grove Village, IL 60007 (312) 593-8100  
16566 S.W. 72nd Ave., Portland, OR 97223 (503) 620-9400 (800) 323-6604

CIRCLE 39 ON READER CARD

## NEWS IN PERSPECTIVE

### TERMINALS

# CDI'S TERMINAL STRATEGY

**Computer Devices is targeting its portable processing power to a wider body of nontechnical users.**

The portable terminal is becoming a more sophisticated device, and one that is taking on aspects of larger processors. And while technology is making it feasible to add more storage and intelligence to these terminals, the cost will not necessarily escalate.

One company that has been involved strictly with portable terminals for years is Computer Devices Inc., Burlington, Mass. Although the company has a smaller share of the portable terminal market than, say, Texas Instruments, CDI's emphasis has always been on providing customers with more features and greater value, claims Kermit Stofer, executive vice president.

The technological capabilities are expanding all the time and it is inevitable

**CDI sees portable terminals, now used primarily for business applications, creeping into the home for "after hours" usage.**

that portable terminals will become more intelligent, explained Gerald Galicki, CDI's vice president of engineering. While he stresses that his comments are conceptual in nature and not necessarily reflected by firm marketing plans at his company, Galicki talks about adding micro-floppy storage and "half-screen" CRTs to today's portable terminals without significantly increasing either their size or weight.

Obviously these are important parameters well understood by anyone who has traveled on and off airplanes with a portable terminal. Improved technology will greatly increase performance with only "nominal increases" in manufacturing costs, Galicki predicted.

While today's applications are primarily based on access to a distant mainframe for data, Galicki believes that more storage will make it possible for these terminals to incorporate their own specialized databases.

It is probable that soon a salesman making a call on a customer could have the previous sales history already loaded into the terminal, thus reducing the need for on-

line access. But portability and communications will continue to be unique aspects of these terminals, Galicki explained.

Stofer, who heads up the CDI marketing operation, thinks users want more of a systems capability with their terminals. He is currently finalizing an electronic mail service that will soon be available to users of CDI equipment. The electronic mail feature will be the first of more hardware/software offerings that will be available for specific applications. A key element of these tailored offerings will be more user-friendly features, such as function keys that allow network log-on to be performed with one keystroke or prompting routines stored in the terminal to help with specific operations.

Because portable terminal users are, of course, very mobile, Stofer attaches high priority to reliability. In the 20,000 units CDI has in the field, the average failure occurs at 17 months. That record is improving

**It is inevitable that portable terminals will become more intelligent.**

due to better technology, he contended.

Based on research of applications, CDI has identified four areas that are most suited to portable terminal usage. These are field auditing in such areas as tax preparation or energy usage; order entry in many industries where on-site entry of customer requirements provides immediate inventory and similar data; in manufacturing for process control and inventory control where the terminal is used right at the operation, such as in an assembly line; and as a selling aid to provide product information and other supporting data during a sales call.

Although the mobile terminals are primarily used in business applications, Galicki sees them creeping into the home for "after hours" usage. In many ways such personal use would duplicate the role now being played in the home by personal computers. But both Galicki and Stofer see a

**CDI is finalizing an electronic mail service that will soon be available to users of its equipment.**

continuing need for what eventually will evolve into the "portable computer."

While this device will have some features in common with the personal computer, it will continue to be aimed primarily at business users who need mobility and communications for their applications. In this regard, CDI is targeting its portable processing power to a wider body of nontechnical users. By combining user-friendly terminals with dedicated application-oriented software, Stofer hopes to keep CDI in the forefront of the portable terminal area.

—Ronald A. Frank

## How Magnuson got to be #1:

The latest annual user ratings survey from Datapro Research Corporation shows computer users across the country rate Magnuson's M/80 mainframe computer Number One for "overall satisfaction."

What's more, Magnuson captured first place easily—beating out computer heavyweights like IBM, Sperry Univac and Amdahl.

Users polled said Magnuson met their expectations in responsiveness, delivery time, software support, reliability, ease of expansion, compatibility and more. Most even reported that their Magnuson systems actually cost less than originally quoted.

And an overwhelming majority (94%) of all Magnuson users polled said they would recommend the Magnuson system to other users—a sure sign of a happy customer!

To find out about the Number One mainframe in America, fill out the DATAMATION reader service card.



2902 Orchard Park Way, San Jose, CA 95134, 408/946-8100.

# MAGNUSON M/80: DATAPRO's #1 COMPUTER IN USER SATISFACTION

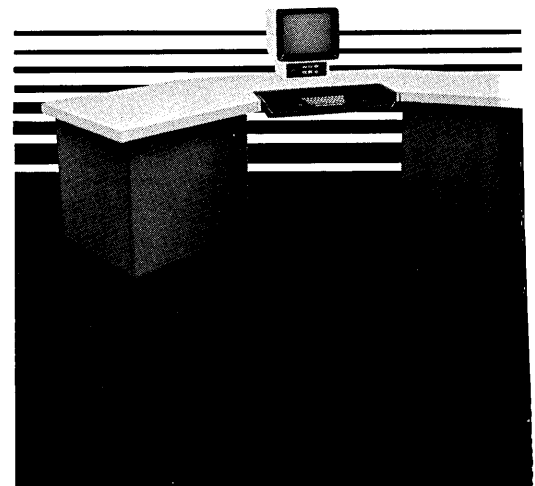

**Stop apologizing for inadequate computing capacity and get a system that will grow with your needs.**

Before you trade your overloaded 370 for a 4331, consider how soon it will be before you're forced to move up to a 4331-2. And then migrate to a 4341. And on and on. Every time you change systems, you lose time and money. Not to mention productivity.

Magnuson puts an end to this costly process with a 4300-compatible mainframe that is field-upgradable.

**Magnuson's M80/31 gives you more throughput for less cost.**

The Magnuson M80/31 provides up to 20% more throughput than the 4331-2, for as much as 20% less cost. And the M80/32 offers up to 50% more

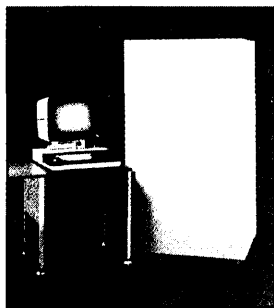

*In its compact configuration, the M80/31 occupies 70% less floor space than the 4331-2.*

performance than the 4331-2 for about the same cost.

As your system requirements expand, Magnuson simply adds or swaps

**MAGNUSON M80 SYSTEM UPGRADE PATHS**

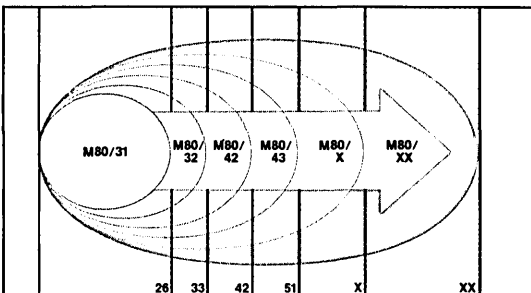

*More memory, channels and processing capacity are added as needed by simply adding or exchanging circuit boards.*

*M80/31 users may upgrade to our current top-of-the-line model, with four times the computing power!*

the 4331-2. That means that all of your existing 370 applications software will run on an M80, so you don't lose the time

and money you've already invested.

and money you've already invested.

**Magnuson does more to support your system.**

At Magnuson, we know we're not the biggest, but we give you more of the day-to-day support you need.

We're more responsive when you call us, more helpful in solving problems, more flexible in our financing.

**Magnuson's microcoding capability provides continuous compatibility.**

In short, you can count on Magnuson to help keep your DP operation more productive and more cost-effective for your company.

To find out more—please call us toll-free at 800-538-7909, ext. 312.

Magnuson uses microcode to emulate all the IBM target instructions and features offered by IBM or third-party vendors. We even provide special productivity enhancements for popular packages such as Cullinane's IDMS.

and money you've already invested.

**Magnuson does more to support your system.**

At Magnuson, we know we're not the biggest, but we give you more of the day-to-day support you need. We're more responsive when you call us, more helpful in solving problems, more flexible in our financing.

In short, you can count on Magnuson to help keep your DP operation more productive and more cost-effective for your company.

To find out more—please call us toll-free at 800-538-7909, ext. 312.



2902 Orchard Park Way, San Jose, CA 95134

# Magnuson means never having to say you're sorry.



# The Multi-User Computer

## MmmOST

### Throughput

Because each user has his own computer and memory (housed in the TeleVideo Smart CRT terminal), programs are executed in the user station. Throughput is maintained without degradation, even when there are 16 user stations!

## MmmOST Software (CP/M®)

The entire TeleVideo computer product line uses the CP/M® operating system. More application software is available for CP/M® than any other operating system.

## Nationwide Service

Nationwide service is available from General Electric Company's Instrumentation and Communication Equipment Service Centers.

## Worldwide Availability

Albany, CA 404/255-9338  
Bloomington, IL 312/351-9350  
Boston, MA 617/668-6891  
Dallas, TX 214/980-9978  
Santa Ana, CA 714/557-6095  
Sunnyvale, CA 408/745-7760  
United Kingdom:  
West End Surrey 44-9905-6464

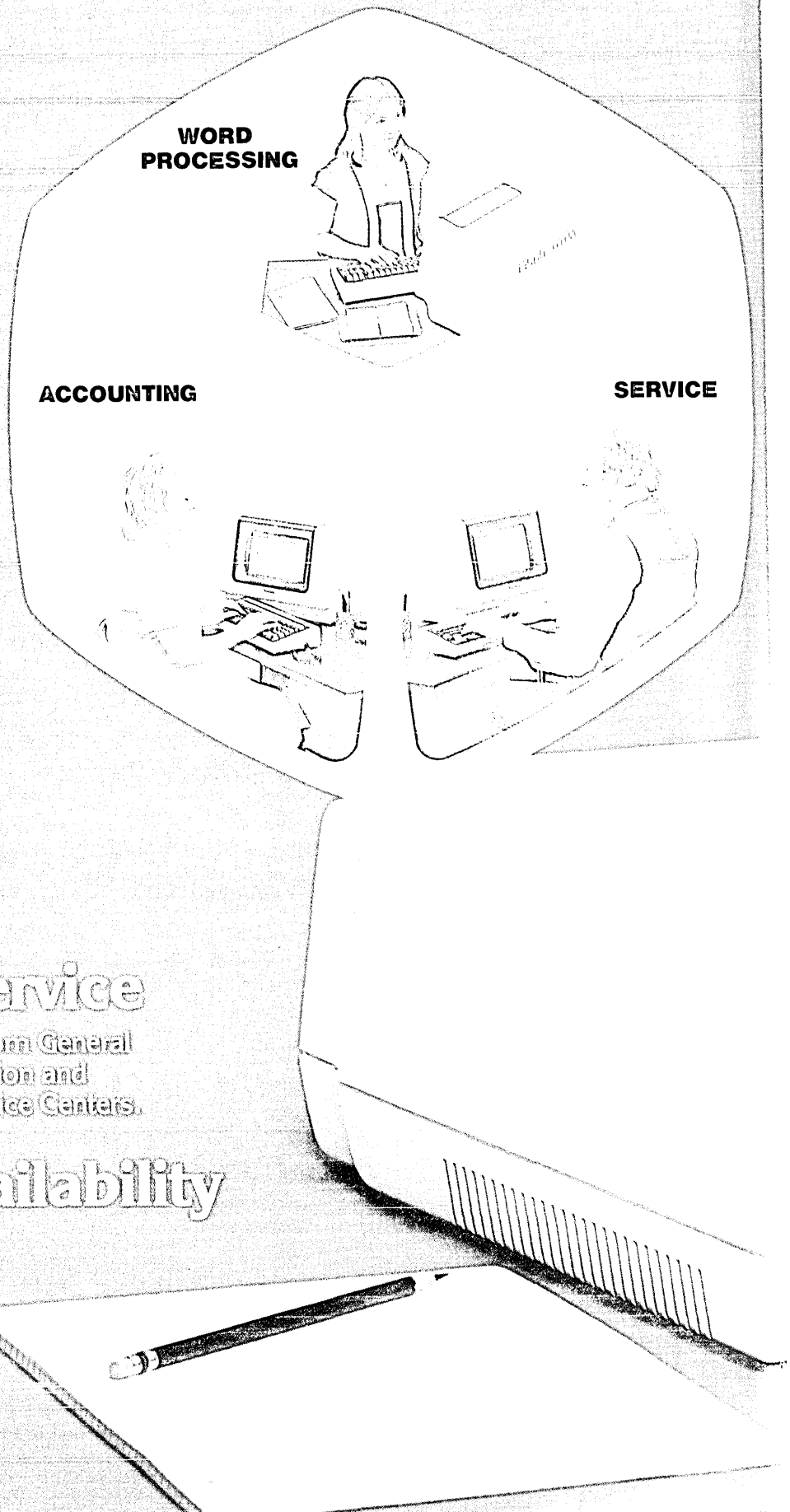



# With The MinnOST<sup>®</sup>

Multitasking • Multitasking • Multiprocessor • Operating System Technique

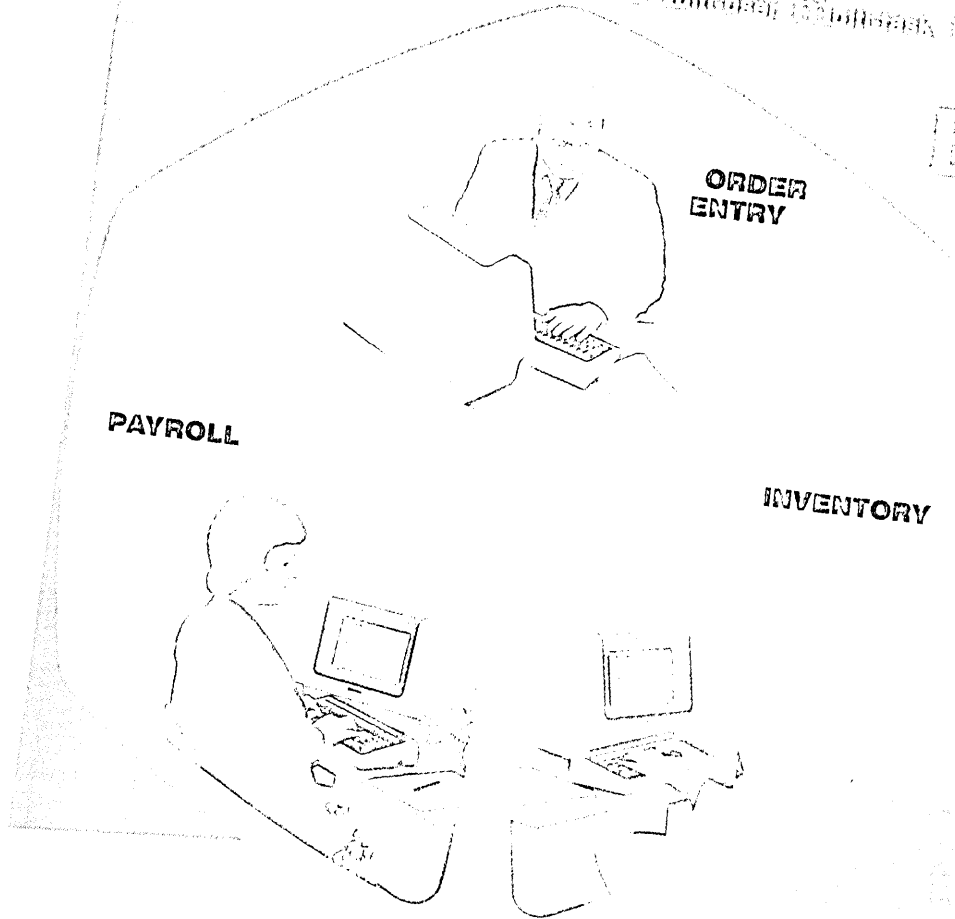

Every user  
has his own  
computer  
and 64K of  
memory.

The Trask's family  
of computers pro-  
vides the MinnOST  
users up to a  
total of 16...

FOR MORE  
INFORMATION

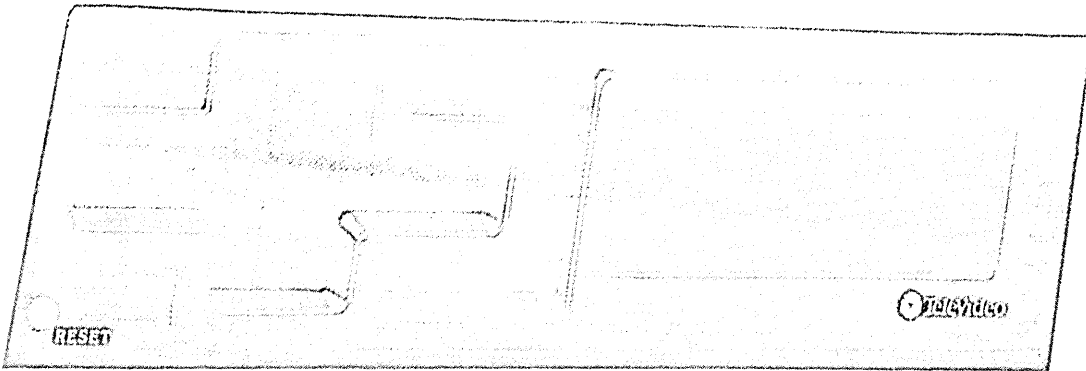

System II Shown

ROBOTICS

# JAPANESE PUSH ROBOTICS

**The Japanese government has set up a leasing company to assist domestic producers of industrial robots.**

The Japanese government is now doing with industrial robots what it did two decades ago with mainframes.

To assist domestic mainframe manufacturers, the government established Japan Electronic Computer Co., Ltd. in 1961. The sole purpose of JECC was to finance the leasing of systems, thus removing this financial burden from the hardware vendors. The success of this venture is shown by its performance in the fiscal year ended March 1980, the latest figures available. In that year, it rented 690 systems with an if-purchased value of more than \$700 million, the highest annual value in the history of that organization. At the end of that period more than 2,000 systems had been installed.

Now the Japanese are trying a similar tack with industrial robots. Japan Robot Leasing Co., Ltd. was inaugurated in April 1980, and at the end of its first year the organization had installed robots at user sites with an if-purchased value of \$5.5 million. That was 160% of the year's business goal, says JAROL's executive managing director, Kenichi Kido. The new target for the current fiscal year is \$12.5 million, based on a conversion rate of 200 yen to the dollar.

Statistics on robot activities in Japan are questionable at best, particularly since they include devices that are not considered robots by some segments of American industry.

But according to Kanji Yonemoto, executive director of the Japan Industrial Robot Assn. in Tokyo, Japanese production of robots in 1980 came to \$375 million, is expected to rise to \$1 billion in 1985, and could reach \$2.6 billion in '90. He says exports by the Japanese are a mere 3% of sales now but could reach 12% in '85.

There are said to be 75,000 robots installed in Japan, but Yonemoto says this figure drops to 14,000 if one excludes a category the Japanese call manual manipulators, which require direct human operation, and those that follow only a fixed sequence of operations, called pick-and-place robots.

The largest users, not surprisingly, are automakers, who account for almost 40% of installations, followed by the electrical machinery industry and makers of

## INDUSTRIAL DISTRIBUTION OF JAPANESE ROBOTS

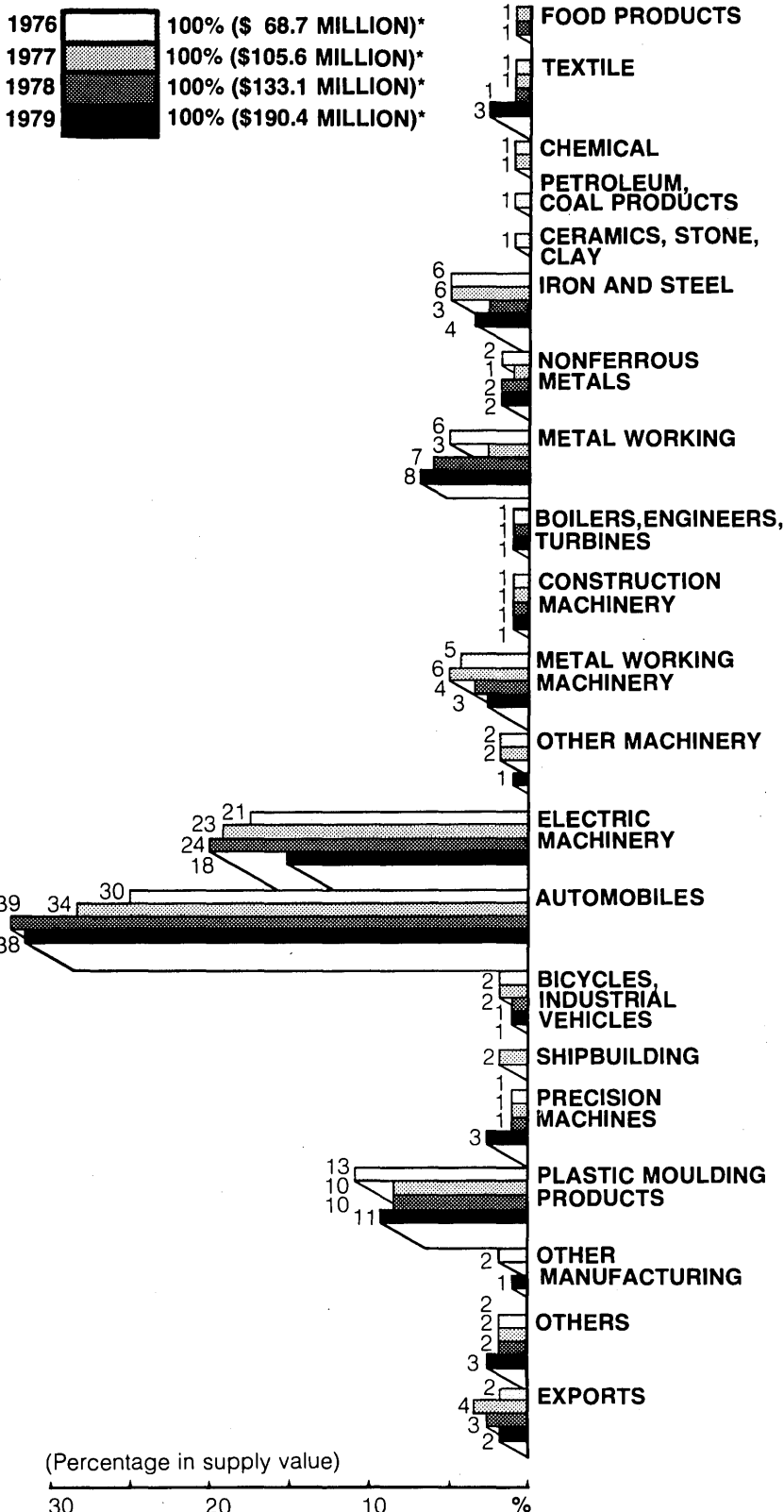

Source: Japan Industrial Robot Assn.  
 (The year 1979, above, means through March 31, 1980.)  
 \* Approximate figure, based on 200 yen to the dollar.

# Programmer Productivity.

You can improve it by getting better organization of completed documentation and work-in-process.



## DOCU-MATE® filing systems for all D.P. Documents

This specialized line of filing devices and equipment makes it possible to build sensible systems for the physical management of data processing documentation at work stations, group libraries and central libraries. It can help you to avoid the costly and unnecessary task of recreating lost documentation, unacceptable delays in getting program changes or corrections on-line and tedious unproductive clerical work by systems analysts and programmers.

Get complete details along with a copy of our helpful booklet "Guidelines 1 — Organizing and Controlling D.P. Documentation." Circle the readers' service number or clip and mail the coupon today.

Wright Line Inc., 160 Gold Star Boulevard, Worcester, Massachusetts 01606



Wright Line Inc.  
160 Gold Star Boulevard  
Worcester, Massachusetts 01606

Please send me a copy of "Guidelines 1 — Organizing and Controlling D.P. Documentation" plus complete details on DOCU-MATE filing systems.

Name \_\_\_\_\_ Title \_\_\_\_\_

Organization \_\_\_\_\_

Address \_\_\_\_\_

City \_\_\_\_\_ State \_\_\_\_\_ Zip \_\_\_\_\_

Telephone ( ) \_\_\_\_\_

Guidelines 1

Producing a precise, instant color print from your color display, in the size you need, needn't be a big production.

The reason being, Polaroid combines quality and immediacy with the flexibility of three different formats for hard copy records.

Consider our 8x10 print. It's a clear, convenient management tool for summarizing reams of otherwise overwhelming data. The graphic presentation helps you digest information quickly. So you spend less time deciphering words and numbers in meetings, presentations and reports.

Our 4x5 and 3 1/8 x 3 1/8-inch formats are similarly advantageous for keeping records and supplementing correspondence and proposals.

The fact that our hard copy is instant lets you acquire and disseminate data immediately. Giving you the benefit of making decisions based on the latest information.

All in all, it helps you spot trends and problems, track performance and focus special marketing, promotional, technical and scientific efforts.

Our hard copy is the highest-quality instant record obtainable.

Faithfully reproducing all the detail, shading and color of the images generated by your computer.

The cameras that produce our hard copy are compatible with color display systems and terminals.

So, whether your application is CAD/CAM, business graphics, cartography, demographics, or animation, the next time you need color hard copy in small, medium or large, call us toll-free from anywhere in the continental U.S.: 800-225-1618. (In Massachusetts call collect: 617-547-5177.) And **Polaroid** try us on for size.

# Polaroid hard copy gives you the Great Lakes in small, medium or large.

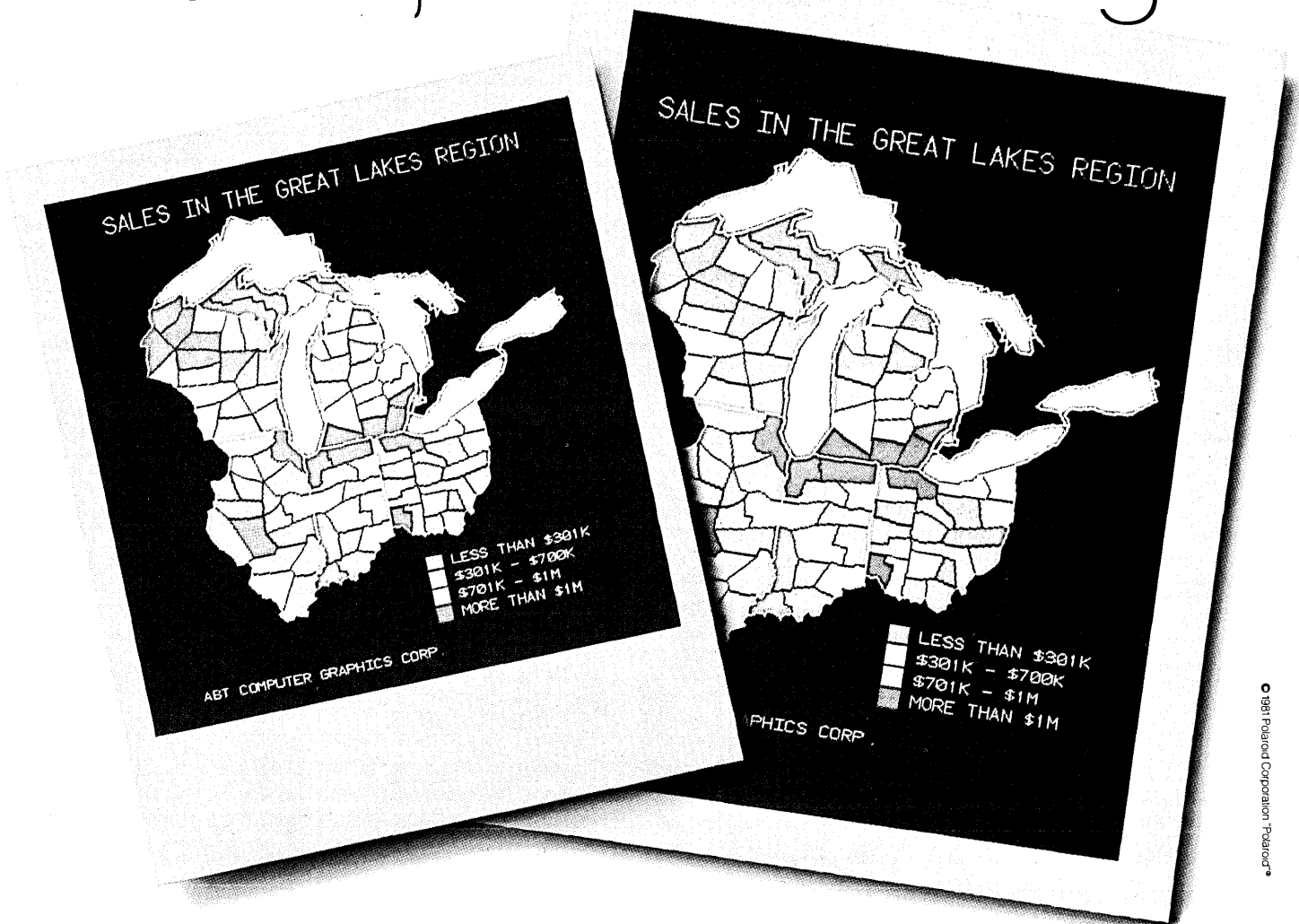

# SALES IN THE GREAT LAKES REGION

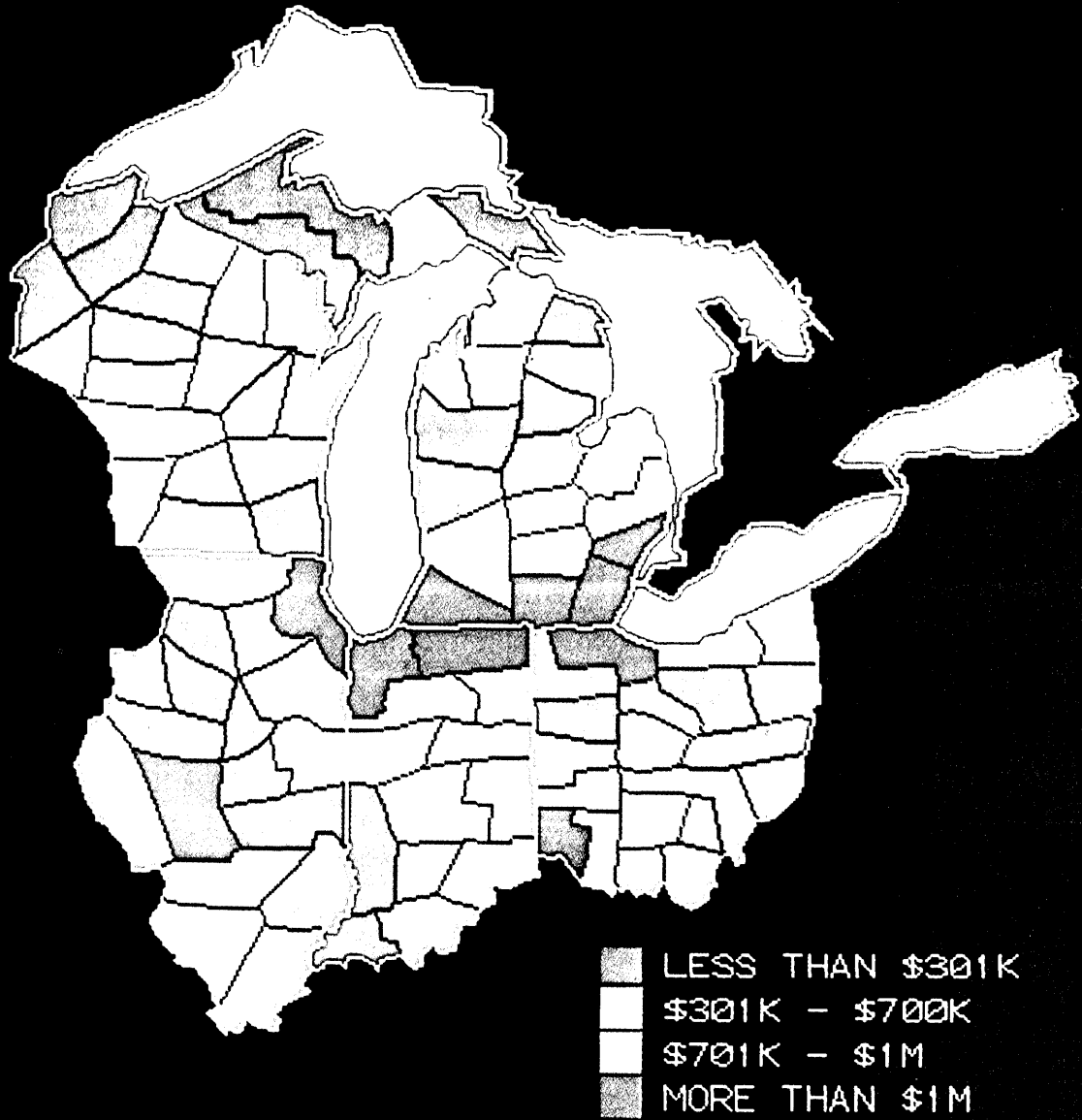

ABT COMPUTER GRAPHICS CORP.



# Take a dare to the summit of carbonless excellence. NCR Paper\*

The summit of carbonless excellence!

As daring climbers have conquered mountains, so has NCR Paper brand of carbonless paper surmounted carbon waste and mess.

NCR Paper is your best choice for multiple copy data processing printouts. It has a proven record for clean, smear-free copies without the mess and bulk of carbon interleaves. There's no shifting of sheets or misalignment of data. And NCR Paper brand of carbonless paper will not jam and smear printouts when decollated.

For the utmost in copyability, specify NCR Paper, Black Print — the *blackest* black imaging carbonless available. Its high-contrast copy image is excellent for photocopy and microfilm reproduction.

If your dream is to conquer the mountain of waste in time and materials, reach that peak with NCR Paper. Find out how NCR Paper works and why you should specify it. Try samples. Just write for our "why" folder.

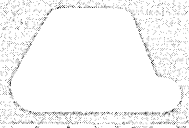
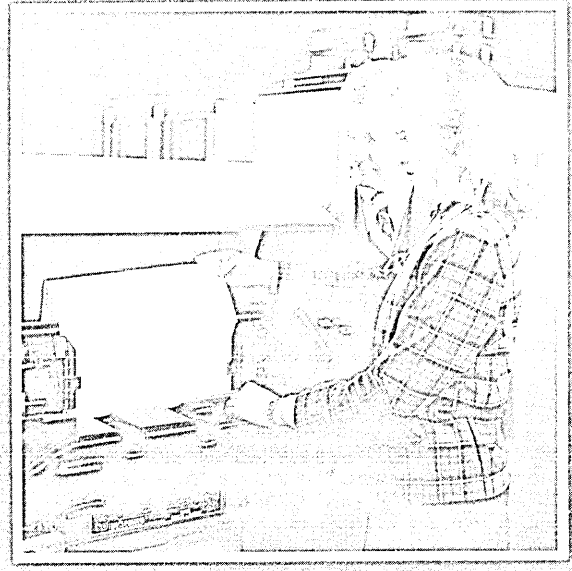

**APPLETON PAPERS INC.**  
GENERAL OFFICES: PO. BOX 469, APPLETON, WI 53012

\*NCR Paper is a registered NCR Corporation trademark of Appleton Papers Inc.

## NEWS IN PERSPECTIVE

molded plastic products. Those three make up two-thirds of the total.

While the application of industrial robots is credited with the increase in productivity in Japan, the nation also has an interest in automating routine and uninteresting tasks, as well as dangerous ones. Yonemoto says the robot association has a committee studying a robotic system capable of climbing trees and sawing off limbs, a replacement for man with his trusty chain saw.

Still, the infancy of this industry is shown by its size: about half that of JECC, which accounts for only a fraction of total computer systems sales. And so the leasing company, JAROL, has its job cut out. Its typical contract is a six-year, noncancelable, full-payout lease, but the organization is also considering the handling of short-term rentals—say, a two- or three-year contract, perhaps a 70% payout, says JAROL's Kido. He explains that some 24 robot makers are members of JAROL. There are said to be 130 manufacturers, but according to Kido about half of them could be termed captive makers, turning out robots only for internal use. He says membership in JAROL is open to all domestic makers. The largest vendor, Kawasaki Heavy Industries, makes the Unimate robot under license from Unimation Inc. of Danbury, Conn., and accounts for 10% of robot sales.

According to Kido, the average price of a pick-and-place robot is from \$10,000 to \$15,000, for a variable sequence control robot about \$25,000, and for an intelligent robot about \$65,000. He adds that the intelligent variety comprise some 20% of the nation's installed base, while pick-and-place robots account for an additional 15%. The remainder are of the variable sequence variety. Included in the latter category are welding robots, painting robots, and the like.

—Edward K. Yasaki

## SERVICES

# AT&T SLAMMED ON EIS II

**Southwestern Bell's Electronic Information System II (EIS II) experiment in Texas has been put on hold—at least for now.**

The myriad competitors of AT&T may have Datapoint to thank in the latest test on how far Ma Bell can go in her push to provide information services.

Without Datapoint's intervention in

the Electronic Information System II (EIS II) squabble in Austin, Southwestern Bell might well have been permitted to proceed with its scheduled June 1 opening of parent

## The Massachusetts Newspaper Publishers Assn. quashed New England Telephone's proposal for a service called Dial-It.

AT&T's latest home information offering. Now Southwestern has been ordered to cease and desist in the EIS experiment by the Texas Public Utility Commission (PUC),

pending a July 6 hearing on the merits of the various parties' causes.

The Texas Daily Newspaper Association (TDNA) has been—and still is—carrying the brunt of the assault on EIS, which Southwestern Bell described in its request for approval to the PUC as a database system "composed of white and yellow page listings, government caption sets, yellow pages ads, sales/special ads, catalog ads, Call Guide information, personal numbers, and subsidiary information."

The planned 680 residential and 60 business customers would have been able to

*This advertisement is neither an offer to sell nor a solicitation of an offer to buy any of these securities. The offering is made only by the Prospectus.*

June 10, 1981

1,806,500 Shares

 **SOFTWARE AG**  
INTERNATIONAL, INC

Common Stock

Price \$18 Per Share

*Copies of the Prospectus may be obtained from such of the Underwriters as may legally offer these securities in compliance with the securities laws of the respective states.*

Alex. Brown & Sons

Bache Halsey Stuart Shields  
Incorporated

Bear, Stearns & Co.

The First Boston Corporation

Blyth Eastman Paine Webber  
Incorporated

Dillon, Read & Co. Inc.

Donaldson, Lufkin & Jenrette  
Securities Corporation

Drexel Burnham Lambert  
Incorporated

Goldman, Sachs & Co.

E. F. Hutton & Company Inc.

Kidder, Peabody & Co.  
Incorporated

Lazard Frères & Co.

Lehman Brothers Kuhn Loeb  
Incorporated

Merrill Lynch White Weld Capital Markets Group  
Merrill Lynch, Pierce, Fenner & Smith Incorporated

L. F. Rothschild, Unterberg, Towbin

Salomon Brothers

Shearson Loeb Rhoades Inc.

Smith Barney, Harris Upham & Co.  
Incorporated

Warburg Paribas Becker  
A. G. Becker

Wertheim & Co., Inc. Dean Witter Reynolds Inc. Hambrecht & Quist

## NEWS IN PERSPECTIVE

create a personal number database, where specific listings and other data could be stored. The test, the fourth in Bell's nationwide experiment to "assess consumer interest in the concept of electronic information services and develop marketing strategies that will result in a consumer-driven, quality product/service," also would have provided users with an auto-dial capability, with which they could telephone any number appearing in a listing or ad. Southwestern would furnish the terminals, at no charge to participants. The test was scheduled to end in August 1982.

Approval of Southwestern's request was granted by the PUC last August, although the combatants dispute whether that action was sufficient to allow Southwestern to proceed. The TDNA, eventually getting wind of Southwestern's scheme, wrote to the PUC last October protesting the purported approval, and then filed a complaint last December.

In that document to the PUC, TDNA described Southwestern's request as clothing its "activities in the information generation processing market with the legal protections afforded a regulated monopoly." The paper boys further complained that the market for information and information services could not be a competitive one if the sole supplier of the distribution network also supplied the information and informa-

tion services. Such an entity would have a stranglehold over the market, they claimed. The very existence of such power, they argued, would be unfair to all other suppliers, anticompetitive in a way that could not be remedied by regulatory action, and contrary to the public interest in diversity of information sources.

In case the PUC missed the legal and regulatory implications, TDNA also claimed EIS II violated the FCC's Computer Inquiry II ban on Bell's offering enhanced services

### The key question is whether the sole supplier of the distribution network can also supply the information and information services.

other than through a separate subsidiary.

Them's fightin' words, but the TDNA appeared headed for a knockout when the PUC examiner wrote that "the complaint is completely premature in its allegations of the anticompetitive nature of the experiment" and recommended to the commissioners that it be dismissed. Then, three days before the commissioners were to make their final order, along came Datapoint.

Although not providing a service in the EIS mold, Datapoint noted in its complaint, its own line of dispersed dp and telecommunications equipment could be classi-

fied as customer-premises equipment which might be used in providing enhanced services. The San Antonio manufacturer also stressed that the recent introduction of its Integrated Electronic Office System, which it described as "a single system providing word processing and electronic message functions fully integrated with dispersed data processing functions," served as a basis for the PUC to gong Southwestern.

Datapoint then let'er rip, arguing that "Bell asked this commission to bless an illegal endeavor with tariff protection. Bell's tariff and proposed EIS II offering are in violation of the Final Decision (in Computer Inquiry II). Furthermore, they both constitute practices which, in serious and substantial ways, tend to restrict or impair competition with Bell by others which sell or lease equipment or perform services in competition with Bell."

The commissioners then threw the examiner a lethal combination. They remanded the case for a public evidentiary hearing on the allegations made by the TDNA and Datapoint, and directed Southwestern to "cease its conduct of the EIS II experiment" pending the hearing.

"There's no specific evidence to indicate the commission wouldn't have reached its decision without Datapoint's intervention, but I'm sure it helped," says a lawyer involved in the case. "They're a

# DEC® COMPUTER SYSTEMS COME IN SMALL PACKAGES!!

The SMS Disk System 11X is a powerful table top DEC computer system. Using the latest Winchester disk storage, DEC's RT-11 and RSX-11M operating systems run without the expense, inconvenience, and space requirements of DEC's RL01/RL02 disk cartridge peripherals. Weighing only 80 pounds and requiring only 10 1/2" of table top or rack space, it also offers the following benefits:

#### MAXIMUM PERFORMANCE AND CAPACITY

- 8.9M bytes of formatted Winchester disk storage plus 1.2M bytes of usable floppy disk storage.
- Fast data transfer of **427K bytes/sec** for Winchester and 63K bytes/sec for floppy.

#### INDUSTRY COMPATIBILITY

- Automatic recognition of DEC RX01, RX02 and IBM diskette formats.
- Increases performance of DEC's RT-11 and RSX-11M operating systems.
- Emulates DEC RX02 floppy disk system.

#### CONVENIENT "MINUTE-PER-MEGABYTE" BACKUP

- Only **40 seconds** required for Winchester backup onto 1.2M byte floppy diskette.
- Standard RT-11, RSX-11M, and SMS utility software supports partial or selective file backup and load operations.

#### UNSURPASSED RELIABILITY

- Modular construction and minimal parts count ensure **long MTBF** and **short MTTR**.
- Offline system and drive test.
- On board **self test** verifies correct Flynchester controller and disk operation.
- CRT based **interactive diagnostics** ease system test and fault isolation.
- **Automatic bootstrap** tests CPU, memory and Q-bus operation before software loading.

#### EXCEPTIONAL DATA INTEGRITY

- Winchester disk **flaw management** deletes permanently flawed disk areas.
- Automatic **error retry** recovers soft or temporary errors.
- **ECC (Error Correction Code)** recovers corrupted data without system shut down.
- Patented PLL circuitry requires no field adjustments and provides maximum margins for worst case bit shifted data recovery.

#### AVAILABLE SOON!!!

Look for 20M byte and 30M byte DEC computer systems in the near future.



## Scientific Micro Systems

777 East Middlefield Road  
Mountain View, CA 94043  
(415) 964-5700 TWX: 910-379-6577

CIRCLE 46 ON READER CARD

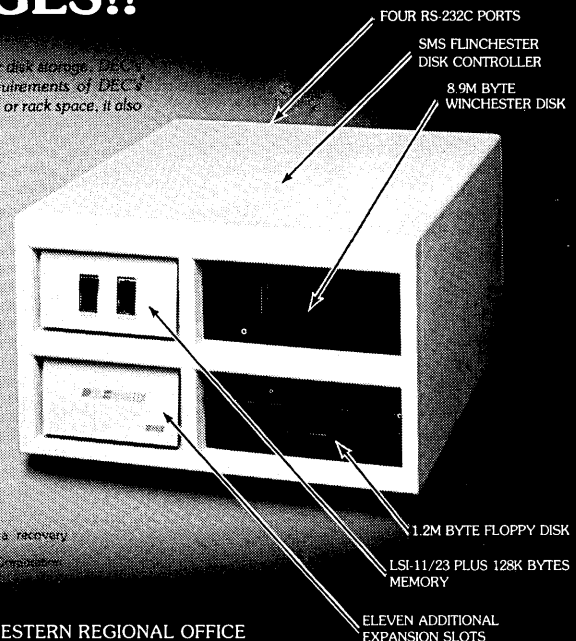

WESTERN REGIONAL OFFICE  
(602) 978-6621

MIDWEST DISTRICT OFFICE  
(312) 966-2711

EASTERN REGIONAL OFFICE  
(617) 246-2540



# Xerox Computer Services announces more Xerox computer services.

Business is changing. And so are we. This year, we have more ways than ever to help solve your business problems.

## **Our software. Your hardware.**

For the past ten years, Xerox Computer Services has provided on-line integrated computer



services to hundreds of companies and public agencies. Our software has been one reason for our success.

Now for the first time, we're licensing this proven software with over 25 applications to run on in-house equipment. And we're also offering mini-computer turnkey systems and other software products.

## **Run your own network.**

If your business operates in

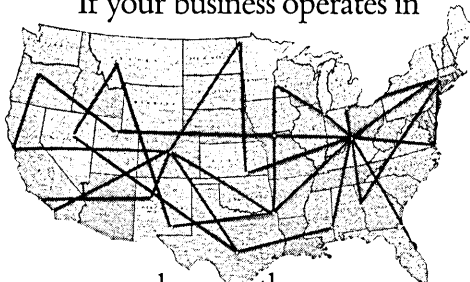

more places than one, even in Europe, we can help you be everywhere at the same time. Our network services give you the information you need from any of your locations in a moment's notice.

## **A common production problem.**

We'll help make sure the right jobs are done in the right order. Instead of putting the cart before the horse. For years we've been helping manufacturers improve their material requirements planning, priority scheduling, production control, and inventory control.

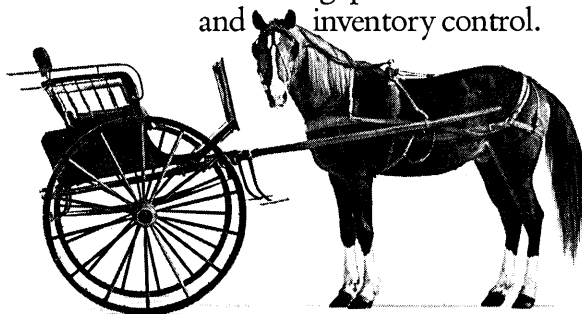

## **No bikinis in Alaska.**

When it comes to distribution, it's all in your delivery. Our systems can help you manage inventory and oversee multiple warehouses making various shipments from each. Without leaving anyone out in the cold.

For more information call or write

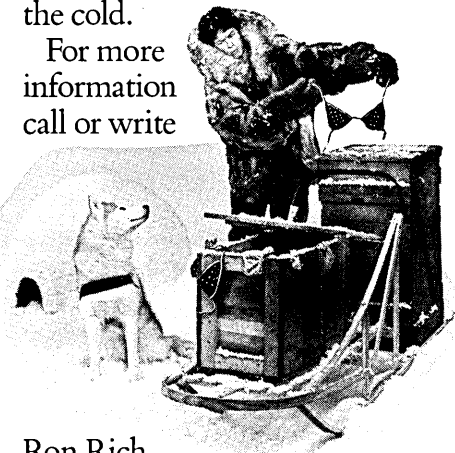

Ron Rich  
c/o Xerox Computer Services,  
5310 Beethoven St., Los Angeles  
90066, (213) 306-4000. And you'll  
see how we can help you keep  
from manufacturing problems  
and distributing mistakes.  
**Xerox Computer Services**

**XEROX**

## NEWS IN PERSPECTIVE

large Texas manufacturer and I'm sure that carried significant weight."

"We're really glad to have them in there," TDNA counsel Earnest Casstevens says, "because they bring a technical dimension that we don't have to pay for and is better than anything we could buy. They've been a tremendous help."

"It would have been easy to dismiss the newspapers as solely concerned about advertising," says Jack Menachie, Datapoint's vice president and general counsel. "But we required the commission to examine the effect of competition on Texas, and that's a much harder question."

"This isn't as imminent a threat to us as it is to the papers," Menachie adds. "Our issue is off into the future. But in the long term, every home will have a computer. Right now our ISX [voice and data switch] is in direct competition with Bell. And it's definitely in our financial interest to see EIS stopped. We may want to compete for that market. If so, we want to have a chance to win it. Electronic yellow pages is just the beginning. If the phone company has it and gets its usual monopoly on it, it'll be a crime."

"This wasn't an easy decision for us," the Datapoint counsel continued. "A lot of companies are intimidated and afraid to speak out because they're suppliers to Bell. We are, too, and we weren't too

thrilled about doing this. We really had to search our souls."

So, apparently, did Tandy Corp., parent of Radio Shack. Tandy entered the fray just prior to a hearing in the Travis County Circuit Court in March.

"We weren't concerned about the advertising, but we were very worried about the offering of enhanced services," says Tandy attorney Don Kothman. "We took some time to take a hard look at it before we

### AT&T's offering of EIS II "could have a chilling effect on competition and the marketplace," says a Tandy spokesman.

intervened. And we are in a different position from TDNA and Datapoint, because we have both home computers and accompanying software. We just started an agricultural information service on commodities, an EIS similar to Southwestern's offering.

"AT&T has already been advertising the EIS, with its supposedly better prices and equipment, and that could have a chilling effect on competition and the marketplace. If the telephone monopoly extends into information, that's a serious problem, and I think it should be prevented."

So far, so good, and if the three musketeers have their way it will continue

apace. There are numerous permutations surrounding Bell's appeal and the PUC's hearing. The complainants' dream scenario has the appeals court upholding the district judge's opinion that jurisdiction rests solely in the PUC, and therefore affirming the PUC's order that Bell cease and desist. Bell's fantasy has the appeals court reversing the district court, deciding that the PUC has no jurisdiction to issue a cease and desist order, proceeding with plans for EIS II, on which it already has spent a reported \$7 million, and thus prevailing at the July 6 hearing. Southwestern's *raison d'etre* has been that EIS II is a "management prerogative of conducting experimental trials of potential new offerings" which is not prohibited by Computer Inquiry II.

"At this point, Southwestern Bell is only attempting to gather information," the company says in its motion to dismiss the TDNA's complaint. "No intent by the FCC to put a moratorium on Bell System trials in a burgeoning and technologically changing environment pending the creation of an unregulated subsidiary can be found in the order [Computer Inquiry II]. Nor would such a holding be in the public interest. To say the Bell System's hands are tied while technology and time move on pending final resolution [of Computer Inquiry II] and the passage of future federal legislation, is without merit."

# If FOCUS was an athlete, it would be All-Pro.

FOCUS, the total English-language software system, scores again and again with its unsurpassed completeness and versatility. Using high-level English-language commands, FOCUS answers queries, writes reports, develops complex applications, handles data entry, and also gives you a comprehensive DBMS. With FOCUS' power, 5 key functions are combined . . .

**1. Report generator & query language . . .** English sentences solve your ad hoc problems and prepare standard reports with full formatting and calculating.

**2. Relational file structures . . .** link individual data fields in separate files to access full information quickly and easily, while limiting data file dependence and data redundancy.

**3. Database management . . .** attends to all your data entry, data validation, and add-delete-change maintenance.

**4. Access to existing files . . .** provides instant interface with all your current data ranging from simple sequential files to complex structures such as IMS, IDMS, TOTAL, VSAM, etc.

**5. Graphs, financial models, formal statistics . . .** FOCUS contains complete



sub-systems to produce decision-supporting analyses.

And more . . . Operating interactively (VM/CMS, TSO/MVS, CICS) on IBM 3000s, 370s, 4300s, or equivalent mainframes, FOCUS can develop complete applications in as little as 1/10th the time of procedural languages. Users can learn to query their files within hours, write formatted reports within a day, and write complex, self-documenting applications after two days of training.

FOCUS is used in over 400 major firms, institutions and government facilities. Applications are in personnel, finance, administration, sales, marketing, research, manufacturing, and customer service.

Let FOCUS score for you. For more information call or write for our brochure.

## FOCUS

Information Builders, Inc.  
1250 Broadway  
New York, N.Y. 10001  
(212) 736-4433

(FOCUS is also available on a service bureau basis through Tymshare Inc.)

CIRCLE 48 ON READER CARD

# IT WAS INEVITABLE

Sooner or later, someone had to take all this proven microcomputer hardware and software technology and wrap it up in a portable package at a price that shocks the industry. Adam Osborne decided to do it sooner.

The OSBORNE 1<sup>®</sup>, from Osborne Computer Corporation. You get full CP/M<sup>®</sup> disk computer capabilities—Z80A<sup>®</sup> CPU, 64K bytes of RAM memory, a full business keyboard, a built-in monitor, and two floppy drives with 100K bytes each of storage. You get two interfaces, the IEEE 488 and the RS-232C. Just connect a printer, via either interface.

Software? You get CP/M<sup>®</sup>, CBASIC-2<sup>®</sup>, Microsoft BASIC<sup>®</sup>, the WORDSTAR<sup>®</sup> word processing system with the MAILMERGE<sup>®</sup> mailing list feature, and the SUPERCALC<sup>®</sup> electronic spreadsheet package. All standard. All for \$1795.



And it's *portable*. When the keyboard is clipped over the display panel, only the weatherproof plastic case is exposed. (There are even optional modem electronics, couplers, battery packs, and external monitor connections, providing practically unlimited system portability.)

It's all business. The OSBORNE 1 delivers *significant* productivity at an irresistible price. At \$1795, it's immediate and lasting success as a personal business computer is, quite simply, inevitable.

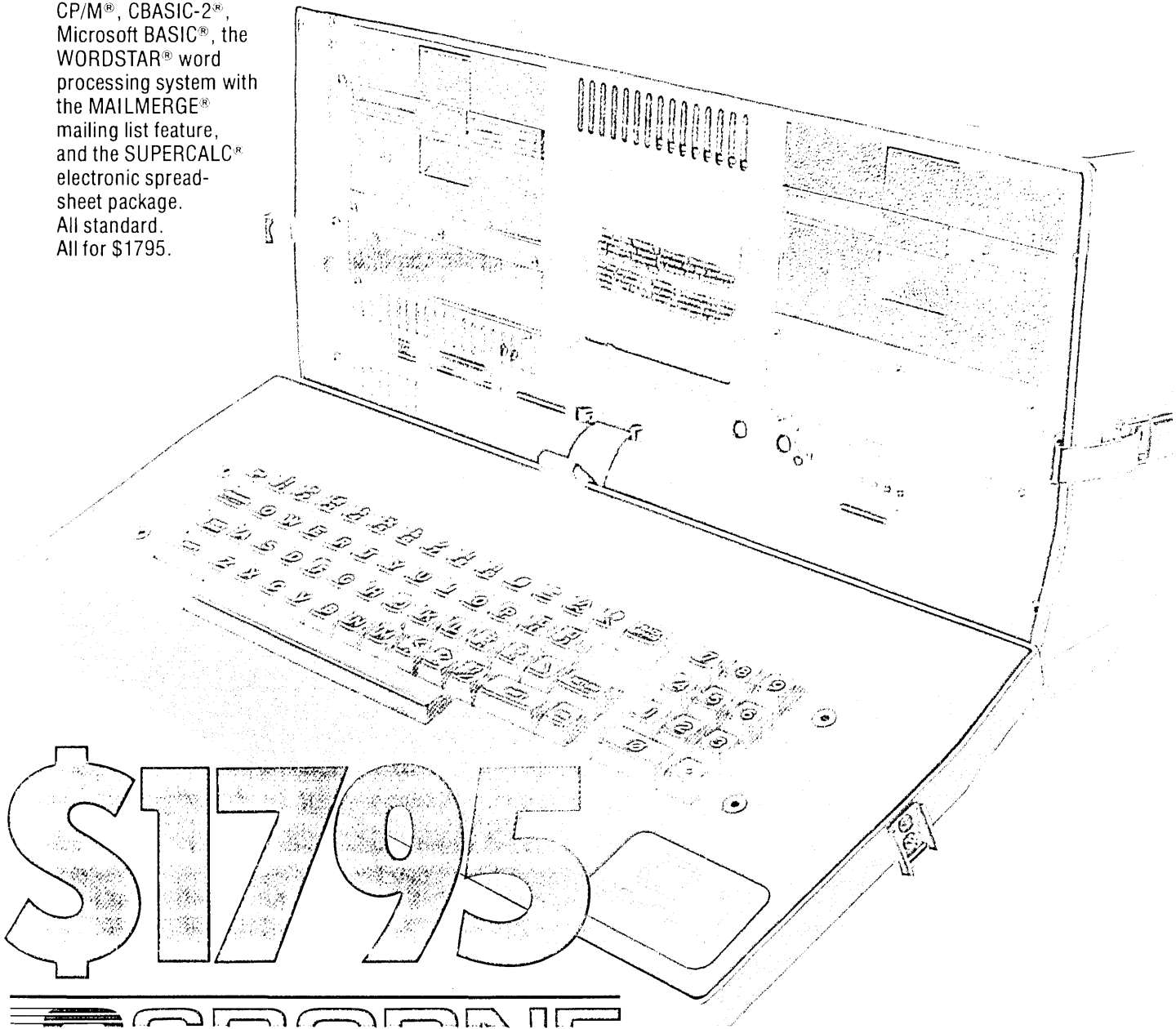

# \$1795

## OSBORNE

COMPUTER CORPORATION

26500 Corporate Avenue Hayward, California 94545 Phone (415) 887-8080 TWX (910) 383-2021

CIRCLE 49 ON READER CARD



## Introducing a two terminal system. Under twenty.

It's a system who's too big to start small, but too small to start big. Only from Texas Instruments' Termi Model 3. At less than \$20,000 (optional one, U.S. domestic price) it includes two terminals, 256K byte dual diskette, 1MB bytes of memory and a 150 CPS printer.

The Model 3 features COBOL software, upward compatibility with the DS990 line, and expandability

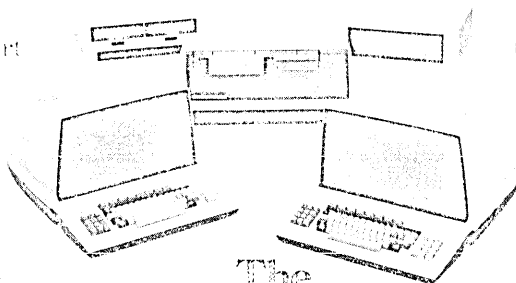

The  
New DS990 Model 3.  
For the medium-size  
Businessman.

to 11 terminals. For more information, contact your local distributor or call (214) 353-0100. This communication is intended for use only by computer systems professionals and you're not a reseller. The DS990 Model 3. It's the right choice at the right price. For more information, contact Texas Instruments Incorporated, Box 209140, Dallas, TX 75220, Phone (800) 251-5291 (Texas collect 214-353-0100). Refer to code A09130.

TEXAS INSTRUMENTS  
INCORPORATED

CIRCLE 50 ON READER CARD

## NEWS IN PERSPECTIVE

Stay tuned, through Congress, the courts, the FCC (with which ADAPSO has filed an informal complaint against EIS II), or all of the above for final testing of that theory. But EIS is a mere preliminary to the show of shows, which will be even bigger than Texas.

"What we're talking about is who will supply information to the public," insists TDNA executive vp John Murphy. "Bell says we're trying to cloak ourselves in the First Amendment, but we couldn't do that even if we wanted to. This is an economic issue. All we're trying to achieve is to keep this open so that everybody has a chance to provide the service. Congress is ultimately going to write the bottom line, but what we can prove will have an effect on what Congress will pass. We can show AT&T's action here will have a chilling and devastating effect on competition."

Such a precedent may well have been established by Murphy's colleagues in Massachusetts, where New England Telephone in October filed with the state Department of Public Utilities (DPU) a proposal called "Dial-It." For the same quarter it costs to use a pay phone in some areas of the country, subscribers would have had available, 24 hours a day, information on seven different subjects from Dial-A-Joke to sports and stock quotations. New England Tel conceded that the service, scheduled to

begin in the last quarter of this year, offered information and entertainment content "normally, but not necessarily, available from other sources such as broadcast and print media."

The Massachusetts Newspaper Publishers Association filed a petition to intervene, which the DPU granted. "Like other newspaper associations," the MNPA wrote, "we oppose any plan that would enable the phone company to be an information provider as well as a common carrier and thus enter into competition with newspapers." A hearing was held by the DPU in January. But before any decision was reached, New England, citing "uncertainties" raised by the Computer Inquiry II decision that enhanced services had to be offered on an unregulated basis through a separate subsidiary, withdrew Dial-It. There is, of course, no guarantee that it will not rise again.

"I don't think these people are concerned enough," frets Walter Hinchman, former chief of the FCC's Common Carrier Bureau and now a Washington consultant assisting the TDNA and the American Newspaper Publishers Association (ANPA) in the technical aspects of the case.

"This is the last ditch fight. Once AT&T gets in there, that's it. Don't give them any electronic information systems at all."

"There's nothing to prevent AT&T from getting into Associated Press and Unit-

ed Press International and getting that information," TDNA's Murphy contends. "They'll wind up as the one gatekeeper. It's obvious that they could control the entire flow of information. And given their past history, it's a certainty they'll do it."

No way, insists the world's largest corporation. Bell's refrain, reverberating throughout the land, is that it is merely trying new methods of improving services to its customers.

But there are too many who have been around too long to still believe.

"Bell has the same vision everybody else has," Menachie says. "The way the price of computers keeps coming down, the price of phones ought to be a nickel by now. But you know you'll never see that because of their monopoly. And if they get another monopoly on EIS, they'll be bigger than the GNP."

"Knowing AT&T," Hinchman says, "no matter what they say now, if they're not completely barred from something, they'll do it. If you don't stop Bell here, you can talk all you want about George Orwell and the government controlling information in 1984, but this could be something much worse."

Not if Datapoint and friends can help it. But stay tuned. You never know who'll bring you the next episode.

—Willie Schatz

# GLITCH HUNTERS

**The diligent duo.** Minichek is Astrocom's original, unique pocket-size BERT data test set. Maxichek is a more sophisticated, handheld microprocessor-based data analyzer. Each is, within its range of problem-solving capability, the simplest, least expensive glitch hunter on the market. Minichek provides the field engineer with a handy tool for quick diagnosis and isolation of data communication problems. Maxichek is a more comprehensive error tracer for installing and servicing terminals, multiplexers and modems; it has all the capability of test kits far more expensive and bulky. Both testers are battery powered, eliminating power-supply problems. And like all Astrocom products, both are human-engineered for easy use with minimal training. The basic Minichek is \$335 (rechargeable battery kit, \$49.50 extra). The most fully equipped Maxichek is \$995.

For more information, write or call:  
Astrocom Corporation, 120 West Plato Blvd.,  
St. Paul, MN 55107. (612) 227-8651.  
Or call toll-free 1-800-528-6050, ext. 1103.

**astrocom corporation**  
Delivering solutions in data communications.



## NEWS IN PERSPECTIVE

### COMMUNICATIONS

# YOU'RE ON (AND IN) THE AIR

**With definite plans for phones on planes, can high flying portable terminals be far behind?**

Airborne telephone calls from commercial airliners to ground locations are coming soon—and passengers with portable terminals exchanging information with their favorite cpus may not be far behind.

The effort to provide commercial telephone service in airliners is being spearheaded by Airfone Inc., a subsidiary of Goeken Communications Inc., Washington, D.C. The latter company is named after John D. Goeken, the spirited founder of MCI Communications who began the specialized common carrier industry.

These days Goeken is just as enthusiastic about the communications potential from planes. His company has developed a sideband transmission scheme that will

more than double the number of communications channels available to airborne callers, compared to earlier FM methods. Called Amplitude Compandored Sideband Transmission, the method has already been tested from planes to ground stations with good results.

Airfone is planning to install telephones in 150 wide-bodied airliners within the next year. A passenger would place a call by using a major credit card to unlock the phone from its holder. The card would be retained in the telephone holder until the phone was replaced, at which time the machine would give up the card.

Rates are expected to be \$5 for the first three minutes, with \$1 for each additional minute to any point in the U.S. The phone includes a self-contained transmitter so that once it is unlocked from its holder by a credit card, the passenger can return to his

**Airfone is planning to install telephones in 150 wide-bodied airliners within the next year.**

seat to place the call. Goeken expects to install about 10 phones in a typical wide-body, although this will depend on agreements with individual airlines.

While the telephone service will be revolutionary, Goeken also sees a potential for data transmission using the same facili-

ty. With an ever-increasing number of businessmen using electronic mail systems or accessing company databases on a regular basis, such applications would get frequent

**Airfone has developed a sideband transmission scheme that will more than double the number of communications channels available to airborne callers.**

use during long flights, he explained.

It is feasible to install portable terminals on planes with the same credit card billing mechanism as is used for telephones. In addition, Airfone might provide facilities for passengers traveling with their own terminals to interconnect the equipment.

Although any airborne data transmission service would primarily be aimed at business users, other passengers could also use the terminals. It may not be too long before teenagers will access their favorite space game from 30,000 feet in the air instead of at home on their own personal computer keyboards.

Telephone service from airliners is expected to begin in mid-1982, and Goeken sees data service following close behind if negotiations with network and database providers work out.

—Ronald A. Frank

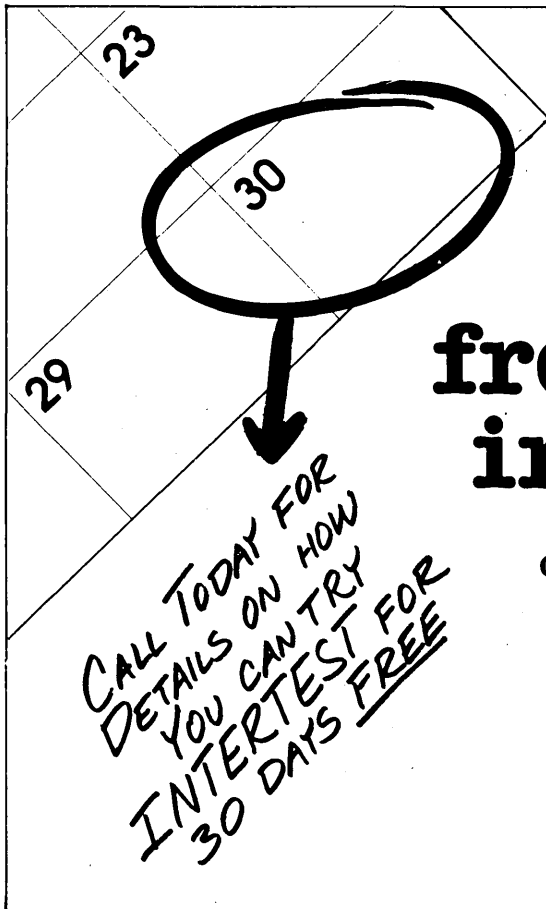

# INTERTEST prevents CICS crashes from occurring in your system

Cuts CICS application development time by 75%.  
Makes testing and debugging a breeze.

65 ROUTE 4 EAST  
RIVER EDGE, NJ 07661  
201-488-7770  
800-526-0272

**ON  
LINE SOFTWARE  
INTERNATIONAL**

CIRCLE 52 ON READER CARD



Get a competitive edge.

It's easy to add the competitive power of Voice Recognition to your product line. The cost is low and the return on the investment is very attractive. Whether you are an OEM or an end user, Interstate has a Voice Recognition product to suit your needs; terminals and boards for system integration and chips to create your own sub-systems.

**Terminals.** Interstate standalone Voice Recognition terminals perform voice controlled data and word processing with a vocabulary up to 100 words and 99%+ accuracy. You unpack them, power them, and immediately begin talking to your system. You can develop and execute resident application software using voice data input without going through expensive, time consuming integration.

**Boards.** Interstate Voice Recognition Q-Bus,<sup>™</sup> Multibus,<sup>™</sup> and Lear Siegler Dumb Terminal<sup>®</sup> compatible boards are capable of recognizing up to 100 words or short phrases in any language. They perform all training, updating, word recognition and communication for your selected vocabulary. Accuracy is 99%+.

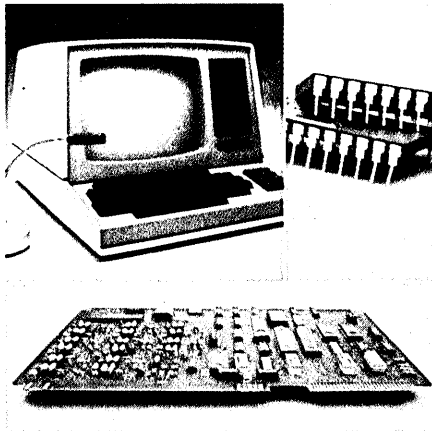

And if you need voice response we also offer a Multibus board with a 1500 word vocabulary.

**Chips.** Three separate chip products from Interstate provide Voice Recognition capabilities with 100, 25, and 8 word vocabularies and accuracies up to 99%+ for your commercial, industrial and consumer applications.

**Discover the world of voice.** Data entry via direct human to computer communication makes voice recognition ideal for a broad range of application areas including office and factory automation, word processing, small business data processing, computer-aided design, building security and many more. Whatever your application, the benefits of voice are virtually unlimited.

**Talk to the experts.** We listen just as well as our computers. Tell us your voice recognition needs. We've got the terminals, the boards, and the chips to meet them. And we've got them now.

Write to: Manager, Marketing, Voice Recognition Products, Interstate Electronics Corporation, 1001 East Ball Road, P.O. Box 3117, Anaheim, California 92803. (714) 635-7210 or call toll free (800) 854-6979.

**INTERSTATE  
ELECTRONICS  
CORPORATION**

**CIRCLE 53 ON READER CARD**

Call to attend our nationwide voice seminars.

Q-Bus is a trademark of Digital Equipment Corporation. Multibus is a trademark of Intel Corporation. Dumb Terminal<sup>®</sup> is a trademark of Lear Siegler, Inc.

VOICE  
RECOGNITION



# NCR has the answer to your interactive direct processing needs: The I-9000 Series.

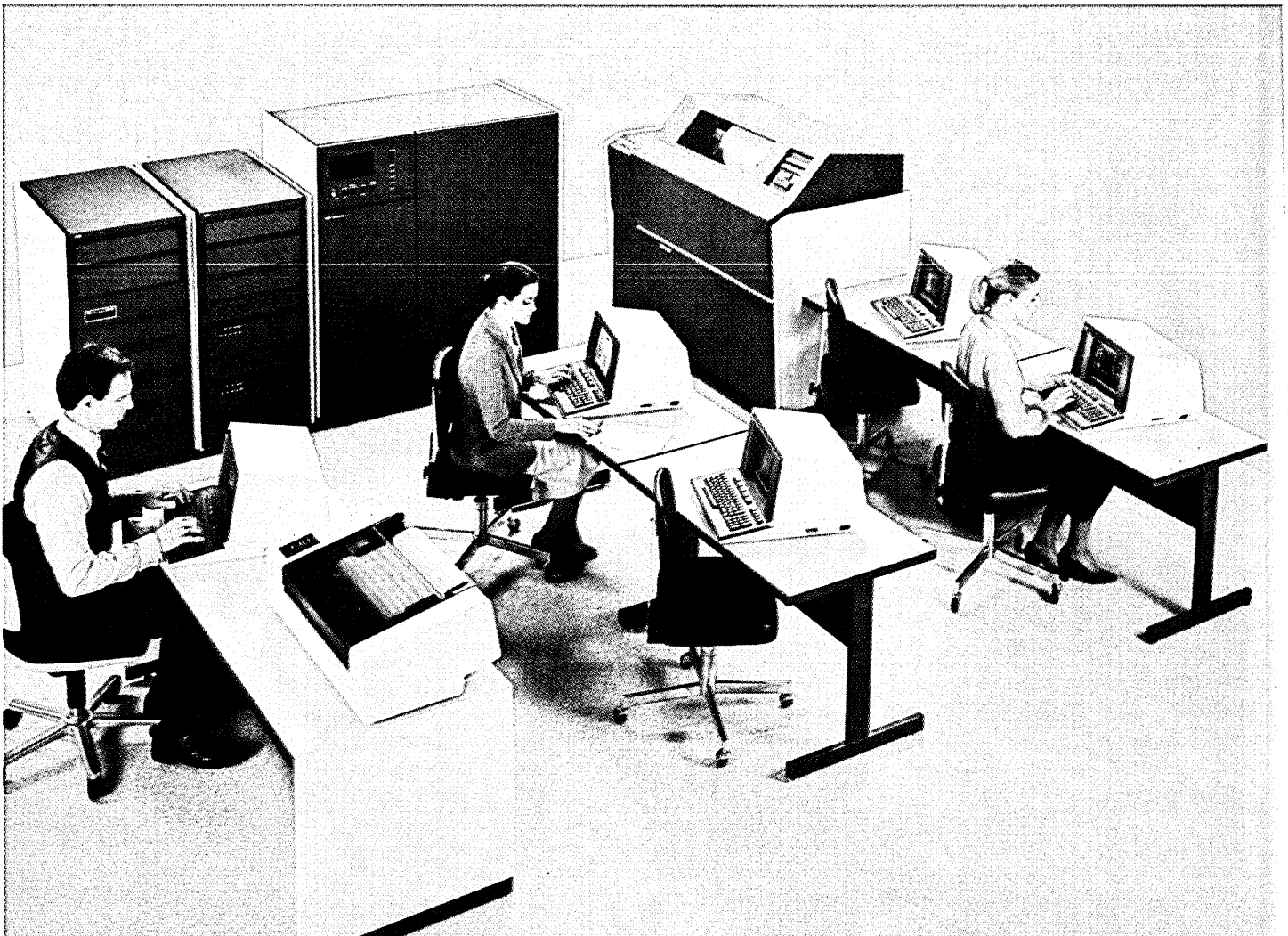



---

## *Ranging from an 8-bit desk-top system to a 32-bit mainframe.*

---

The I-9000 Series provides one of the largest selections of interactive configurations in the industry. It steps through four levels from an enhanced desk-top micro-system to a 32-bit mainframe, a new top-of-the-line system which more than doubles the interactive power available from NCR.

Migration is smooth and easy from bottom to top even across the system boundaries. The I-9000 Series is a step beyond and fully compatible with the I-8000 systems.

The subtle new styling is more than skin deep, it's ergonomic. With features like detachable keyboards and non-glare glass, every workstation can accommodate any operator in comfort. With less fatigue and eye-strain. New lines and colors blend into any office or computer-room setting. Eventually, the new styling and ergonomics will pervade the entire NCR product line.

New software capabilities provide support for COBOL, BASIC, communications, data base management and transaction processing. And a correspondence-quality printer is now available as well.

For more information on the I-9000 Series, call your local NCR office, or write to EDP Systems, NCR Corporation, Box 606, Dayton, Ohio 45401.

**NCR**  
Complete Computer Systems



I-9010



I-9040

**The new I-9050** 32-bit mainframe uses NCR's powerful Interactive Resource Executive operating software and provides up to three megabytes of memory. It increases NCR's interactive power spectrum 2.6 times.

**The I-9040** is a powerful and versatile 16-bit miniframe with up to 2 megabytes of memory. It features a smaller footprint and virtual memory technology based on the successful I-8400 architecture.

**The I-9020** is a 16-bit general-purpose single-board minicomputer with main memory of half a megabyte. It features higher reliability, lower noise level and lower power consumption than its predecessor, the I-8200.

**The I-9010** table-top 8-bit micro-oriented system offers advanced ergonomic design, multi-language support and communications capability. It is easy to operate and understand.



I-9020

Raster brilliance, contrast and erasability. Z-8001 intelligence plus programmability. All in a desk top, high resolution (1024 x 792), monochrome, graphics terminal ticketed at a low \$10,000.\*

Genisco's G-1000 is the low cost graphics terminal you've been holding your purchase order for. It is the first direct raster replacement for the Tektronix 4014-1\*\* terminal — plug to plug and software compatible. But, at the same time, the on-board Z-8001 microprocessor plus 16K words each of RAM and PROM let you develop your own programs at

your pace while your system is up and running on existing software (like PLOT-10).

Because the G-1000 is a bit map raster scan device it can do things a storage tube can't approach — like provide easy viewing in normal room light, and allow erasure of any portion of the screen without altering or redrawing the rest of the display. Genisco has equipped the G-1000 with all the quality features — 60Hz noninterlaced refresh for flicker free viewing, a large 19 inch display, a detachable keyboard with cursor joystick. And, an optional alphanumeric overlay eliminates the

need to use a second terminal. The unit supports a selection of I/O equipment including graph tablet and hard copy devices. With all that and the Z-8001 intelligence, the list of future capabilities is virtually open-ended.

Take a look at Genisco's new G-1000 — the 4014-1 replacement and a whole lot more.

Call or write for more information to Genisco Computers Corporation, 3545 Cadillac Avenue, Costa Mesa, California 92626. (714) 556-4916.

\*Price varies according to quantity.

\*\*Trademark of Tektronix  
Graphics software from ISSCO Graphics.

**Genisco**

CIRCLE 55 ON READER CARD

THE  
COMPETITION  
IS GREEN  
WITH ENVY



## NEWS IN PERSPECTIVE

### COMPANIES

# A NEW ICL IN THE MAKING

**Though the new management team can expect tough times ahead, it plans to take the debt-plagued British firm in new and profitable directions.**

The two new head honchos at ICL Ltd. face a tough uphill fight.

Apart from the not-so-insignificant task of trying to turn around the debt-plagued British mainframer, the management duo has a myriad of other concerns to tackle. They can expect to encounter resistance to their expressed plans for significant cutbacks in products, development projects, and manpower. They must gain confidence from their critics who are quick to point out that neither has experience in the computer industry. They must overcome resentment at the fact that the British government effectively placed them in power.

### FOR THE NUMBER CRUNCHERS

With ICL trading at a loss, the company has instituted plans to cut the work force by 17%. In the half year ended in March, income was down 8% to about \$640 million, with a loss of about \$70 million. That compares to a profit of about \$40 million for the equivalent period last year. Company chairman Chris Laidlaw said that it would be optimistic to expect ICL to break even in the full financial year.

Company staff will be cut by 5,200, of which about 1,000 will be outside the U.K. Half the cut will be in marketing operations staff and 550 in product development. Managing director Robb Wilmot ordered the cuts before completing his strategic review. He said cuts will be made on the basis that all functions must "share in the sacrifice."

Wilmot said he did not see the need

Both the new chairman, Chris Laidlaw, and the new managing director, Robb Wilmot, admit to being new to the computer business. Laidlaw comes from oil company BP, where he was deputy chairman. Thirty-six-year-old Wilmot has spent all his working life with Texas Instruments, but mostly in the calculator side of the business. So, to get up to speed on computers in general and ICL in particular, the two-man team is taking the first few months to assess ICL's present

for further cuts. He added that 10,000 staff would have been lost by 1985 if the company had been taken over by a rival manufacturer. The extra losses would have arisen when customers migrated to rival gear.

Sales at ICL have been hardest hit in the U.K. and Europe. Wilmot and Laidlaw put the blame on the general economic recession in these countries. Outside Europe, ICL is trading profitably, with sales particularly healthy in Australia and South Africa.

ICL hopes that sales of smaller systems will pick up later this year. A replacement for the System Ten small business machine has been developed at Utica, N.Y., and was launched at the end of last month. ICL acquired the Utica facility and the System Ten when it bought Singer Business Systems about five years ago.

—M.P.

position. Then in September they plan to reveal a detailed long-term strategy, one that is expected to shift the focus of ICL's product line towards distributed networks, multifunction workstations, and small systems. Once their plan of attack is set, they want to move quickly.

"Short-term opportunities must be addressed in real time," Wilmot insists. "I believe in action. I will not be prepared to allow projects to amble along if they are

# FREE

**EXPANDED '81 CATALOG**

**200 NEW PRODUCTS**



Virtually all your information processing supply needs are available from the thousands of top quality items in the fully-illustrated SOURCE catalog.

- CDC and BASF disk packs.
- Digital equipment (DEC) manufactured supplies, printers and terminals—*All in stock for immediate delivery.*

**TOLL-FREE**  
800-621-8313  
Illinois (312) 642-8322

**source**  
SOURCE SYSTEM INC.  
716 N. Wells St., Chicago, IL 60610

CIRCLE 56 ON READER CARD

# IJCAI-81



**SEVENTH INTERNATIONAL JOINT CONFERENCE  
ON ARTIFICIAL INTELLIGENCE**

**24-28 AUGUST 1981**

**UNIVERSITY OF BRITISH COLUMBIA  
VANCOUVER, B.C., CANADA**

The major international artificial intelligence conference  
All-day Tutorial Program, August 24  
Week-long A.I. Research and Development Exhibit Program

**Conference Information:** Richard Rosenberg,  
Department of Computer  
Science,  
University of British Columbia,  
Vancouver, B.C.,  
Canada V6T 1W5  
(604) 228-3061

**Tutorial and R&D Exhibit  
Programs Information:** Louis G. Robinson,  
American Association for  
Artificial Intelligence,  
Stanford University,  
Box 3036,  
Stanford, CA 94305 U.S.A.  
(415) 495-8825

CIRCLE 57 ON READER CARD

## NEWS IN PERSPECTIVE

consuming money without any tangible returns." This tough, quick-response control is one of a number of key management techniques Wilmot plans to import from his experience at TI.

"We must also have a clear long-term strategy to overlay short-term actions," he explains. "This provides line managers with a framework within which they can judge whether particular actions are right or wrong."

Each line manager will be given strategic targets along the way. If those targets are not met, senior managers will be

alerted. "We cannot have evolution on a random basis. We must be nimble in responding to change and track performance closely. But we must also know where we are going over, say, the next five years," Wilmot stressed.

In addition he wants to implement improved "design to cost disciplines," particularly in the small systems area where he has most experience. "You have to be prepared to take risks when developing, say, a workstation or a small computer. This means there must be new design methods and constraints compared to the traditional

mainframe business.

Wilmot has been impressed by the depth of technical expertise within the company. He has also endorsed some of the major system developments implemented by the previous managing director, Dr. Chris Wilson.

Wilmot's emphasis on management disciplines and the circumstances under which he was brought to the company clearly indicate why the government and ICL shareholders decided to ditch both Wilson and previous chairman Philip Chappell.

Wilmot's formula for success is relatively simple: plan long, monitor progress, act quickly and decisively to meet immediate requirements, and implement disciplined design and management procedures. This is precisely the opposite of tactics taken by Wilson and Chappell, according to their critics.

The government was among those critics, although its own dealings with ICL were poorly planned and managed. A period of uncertainty about ICL's future at the beginning of this year led to Sperry Univac's preparing a bid to take a minority stake in the company.

ICL unilaterally broke off talks with Univac after an internal fight with the government resulted in the decision to give ICL

---

**ICL's product line is expected to shift towards distributed networks, multifunction workstations, and small systems.**

---

one more chance at remaining independent by bringing in new management. This action followed reports in British papers which suggested that Univac intended to close down U.K. development centers and drastically cut back on U.K.-based staff if it took a share in ICL.

Although J. Paul Lyet, chairman and chief executive of Sperry Corp., vigorously denied these reports, they stirred up a patriotic spirit within those senior ministers in the government who argued that ICL, as a private company, should be left to free market forces.

ICL users in the U.K. summarized the arguments to keep ICL British in a telegram sent to Prime Minister Margaret Thatcher by their user association. "Britain's strength in the use, design, and production of information technology owes a great deal to the presence in the U.K. of ICL research, development, and manufacturing centers," the users stated.

And they added: "We believe that ICL now has a good product line. We have invested much money in helping in this development. It would be a tragedy for users and the nation as a whole if we lose the rewards of this investment now that it is about to bear fruit."

According to Lyet, ICL had suggest-

## More than digitizers!



## Turnkey computer-aided drafting systems suited to your needs starting at under \$50,000 — complete!

While it is true that Summagraphics is the world's largest manufacturer of digitizers, our interest in computer-aided drafting systems does not stop there.

Our Datagrid II system comes in configurations of hardware and software that give you the capabilities you need without forcing you to pay for frills you'll never use.

Datagrid II is available for remote job entry situations where all that is required is preprocessing graphic inputs for communication or recording. It is also available in totally stand-alone configurations complete with plotter or for use with your existing plotter.

Systems are already at work in such varied applications as PCB and IC layout, mechanical drafting, mapping, schematic diagrams and a host of others.

Before you invest in any CAD/CAM system, you should investigate the real values offered by Datagrid II. Tell us what your needs are, and we'll send you complete information — free.



**Summagraphics**  
corporation

35 Brentwood Avenue • P.O. Box 781 • Fairfield, Connecticut 06430  
(203) 384-1344 • Telex: 96-4348

CIRCLE 58 ON READER CARD

# COMPUSTAR™

## INTERTEC'S INCREDIBLE 255 USER SMALL BUSINESS COMPUTER

At last, there's a multi-user micro-computer system designed and built the way it should be. The CompuStar™. Our new, low-cost "shared-disk" multi-user system with mainframe performance.

Unlike any other system, our new CompuStar offers what we believe to be the most practical approach to almost any multi-user application. Data entry. Distributed processing. Small business. Scientific. Whatever! And never before has such powerful performance been available at such modest cost. Here's how we did it . . .

The system architecture of the CompuStar is based on four types of video display terminals, each of which can be connected into an auxiliary hard disk storage system. Up to 255 terminals can be connected into a single network! Each terminal (called a Video Processing Unit) contains its own microprocessor and 64K of dynamic RAM. The result? Lightning fast program execution! Even when all users are on-line performing different tasks! A special "multiplexor" in the CompuStar Disk Storage System ties all external users together to "share" the system's disk resources. So, no single user ever need wait on another. An exciting concept . . . with some awesome application possibilities!

CompuStar™ user stations can be configured in almost as many ways as you can imagine. The wide variety of terminals offered gives you the flexibility and versatility you've always wanted (but never had) in a multi-user system. The CompuStar Model 10 is a programmable, intelligent terminal with 64K of RAM. It's a real workhorse if your requirement is a data entry

or inquiry/response application. And if your terminal needs are more sophisticated, select either the CompuStar Model 20, 30 or 40. Each can be used as either a stand-alone workstation or tied into a multi-user network. The Model 20 incorporates all of the features of the Model 10 with the addition of two, double-density mini-floppies built right in. And it boasts over 350,000 bytes of local, off-line user storage. The Model 30 also features a dual drive system but offers over 700,000 bytes of disk storage. And, the Model 40 boasts nearly 1½ million bytes of dual disk storage. But no matter which model you select, you'll enjoy unparalleled versatility in configuring your multi-user network.

Add as many terminals as you like - at prices starting at less than \$2500. Now that's truly incredible!

No matter what your application, the CompuStar can handle it! Three disk storage options are available. A tabletop 10 megabyte 8" winchester-type drive complete with power supply and our special controller and multiplexor costs just \$4995. Or, if your disk storage needs are more demanding, select either a 32 or 96 megabyte Control Data CMD drive with a 16 megabyte removable, top loading cartridge. Plus, there's no fuss in getting a CompuStar system up and running. Just plug in a Video Processing Unit and you're ready to go . . . with up to 254 more terminals in the network by simply connecting them together in a "daisy-chain" fashion. CompuStar's special parallel interface allows for system cable lengths of up to one mile . . . with data transfer rates of 1.6 million BPS!

Software costs are low, too. CompuStar's disk operating system is the industry standard CP/M\*. With an impressive array of application software already available and several communication packages offered, the CompuStar can tackle even your most difficult programming tasks.

Compare for yourself. Of all the microcomputer-based multi-user systems available today, we know of only one which offers exactly what you need and should expect. Exceptional value and upward growth capability. The CompuStar™. A true price and performance leader!

**INTERTEC  
DATA  
SYSTEMS®**

2300 Broad River Rd. Columbia, SC 29210  
(803) 798-9100 TWX: 810-666-2115

**CIRCLE 59 ON READER CARD**

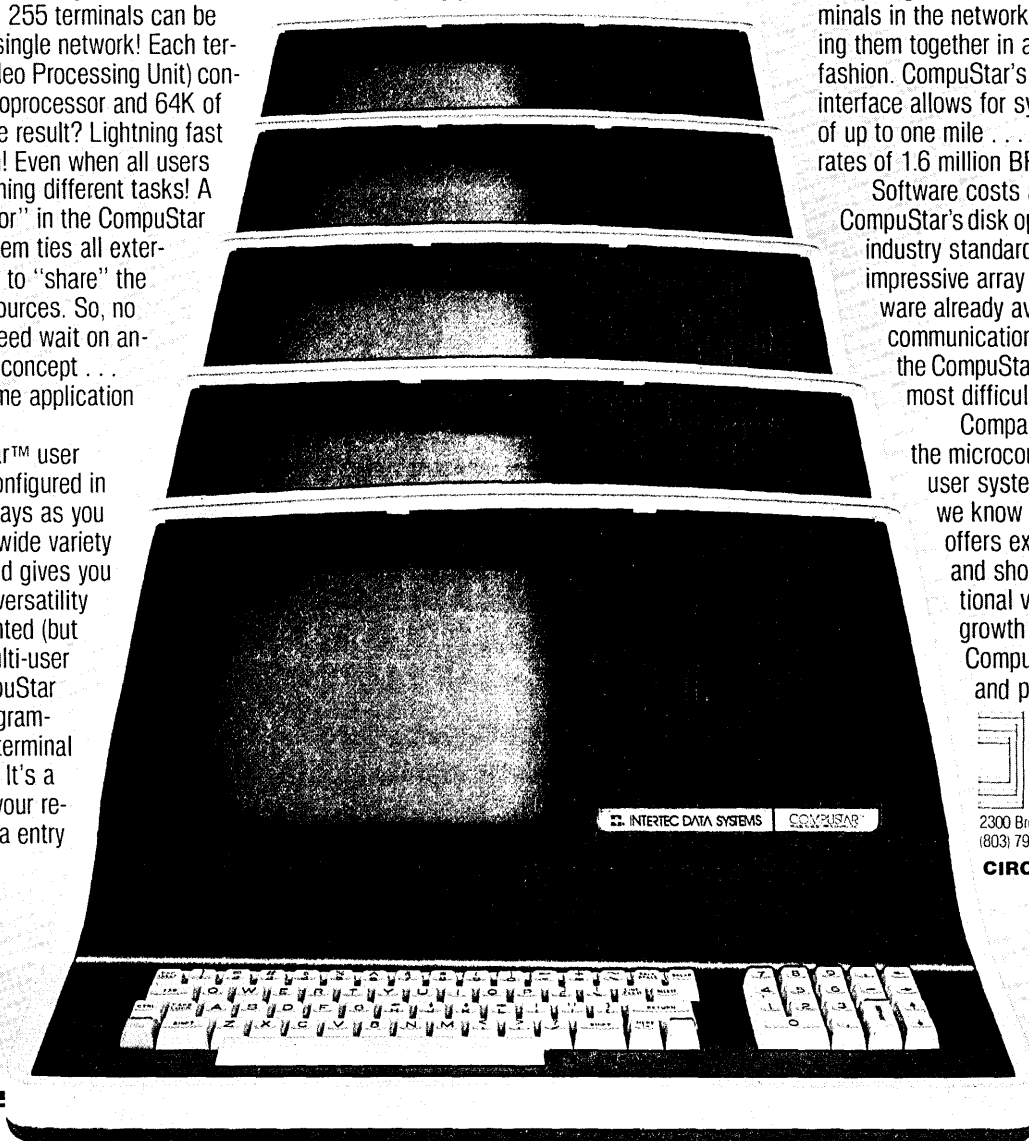

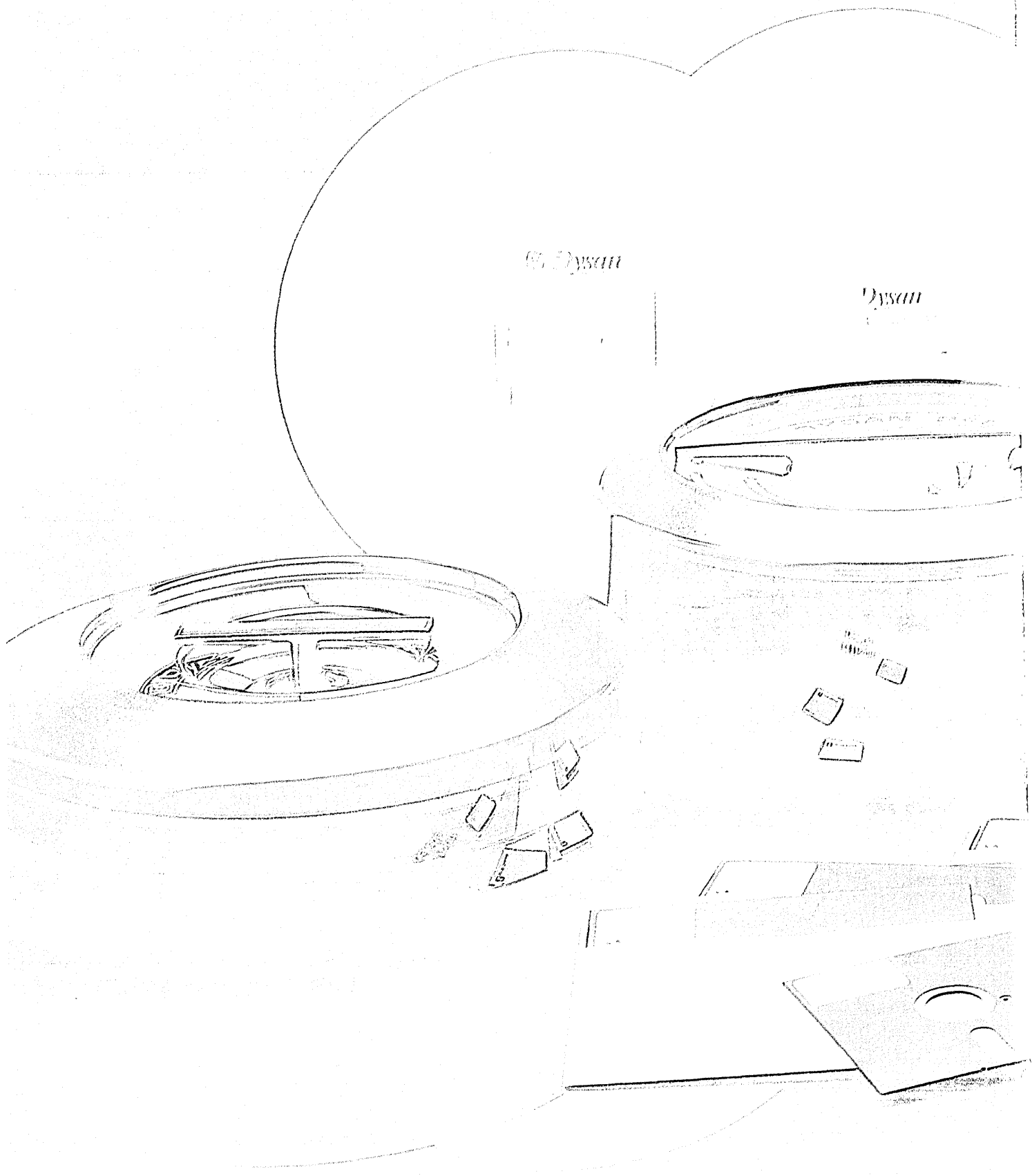

Dyson

Dyson

OUR MEDIA IS

Over the past seven years we've earned a name for ourselves by making the best magnetic media in the business. Precision magnetic media — Diskettes, Mini Diskettes, Diagnostic Diskettes, Rigid Discs, Disc Packs, and Disc Cartridges — all certified to be 100% error free both on-track and between the tracks.

Now we're making it easier for you to buy the best. Just dial Dysan direct TOLL FREE at 800/4538-3150 (or 408/988-3472 (in California) or contact your local Dysan office listed below. Precision magnetic media from Dysan. Our media says it all.

**dysan** **Dysan**  
CORPORATION

50450 Pittman Highway Drive  
San Jose, CA 95150  
408/988-3472

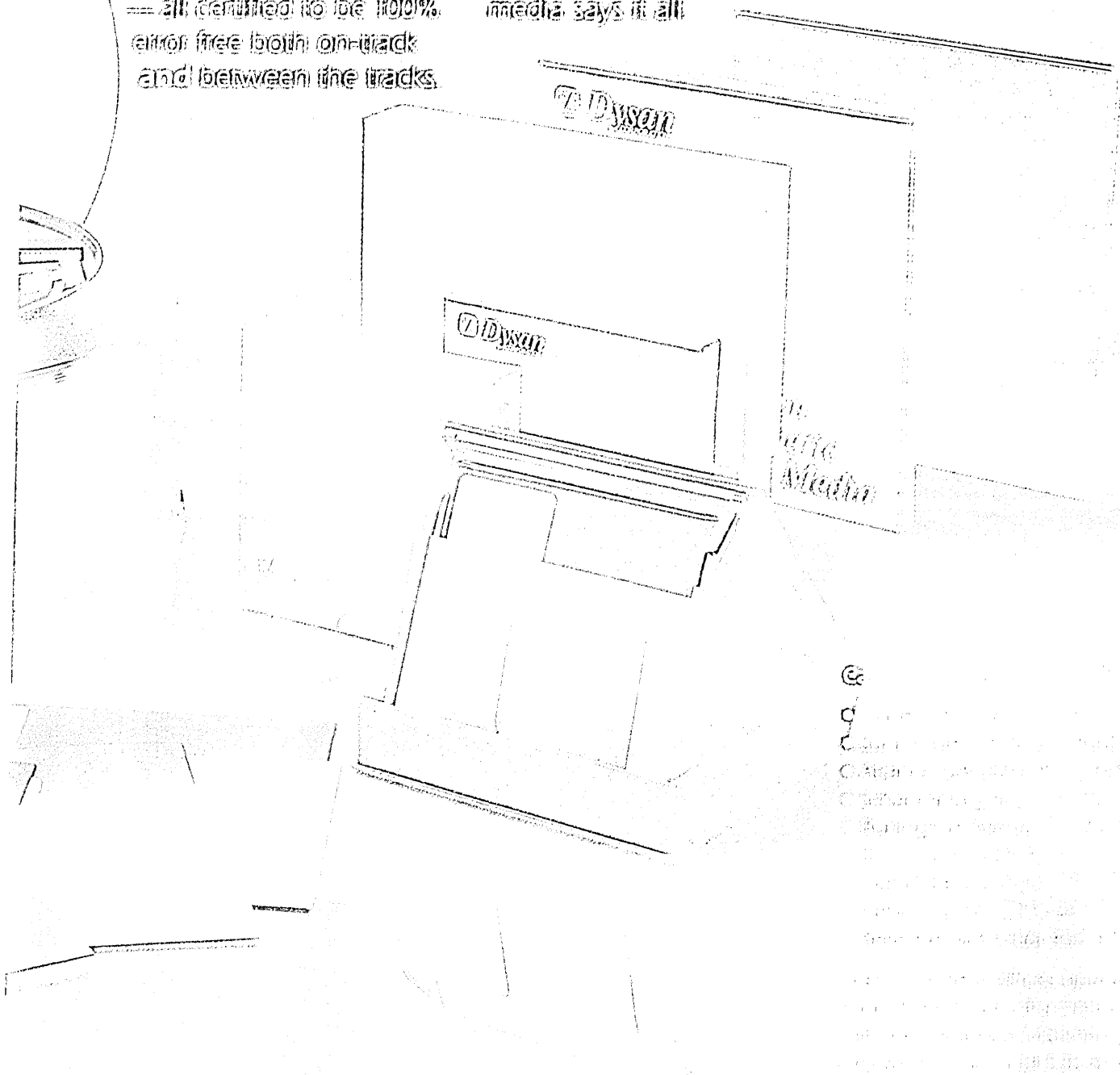

- ©
- 1
- 2
- 3
- 4
- 5
- 6
- 7
- 8
- 9
- 10
- 11
- 12
- 13
- 14
- 15
- 16
- 17
- 18
- 19
- 20
- 21
- 22
- 23
- 24
- 25
- 26
- 27
- 28
- 29
- 30
- 31
- 32
- 33
- 34
- 35
- 36
- 37
- 38
- 39
- 40
- 41
- 42
- 43
- 44
- 45
- 46
- 47
- 48
- 49
- 50

CIRCLE 60 ON READER CARD

# The Consummate Compact Computer.

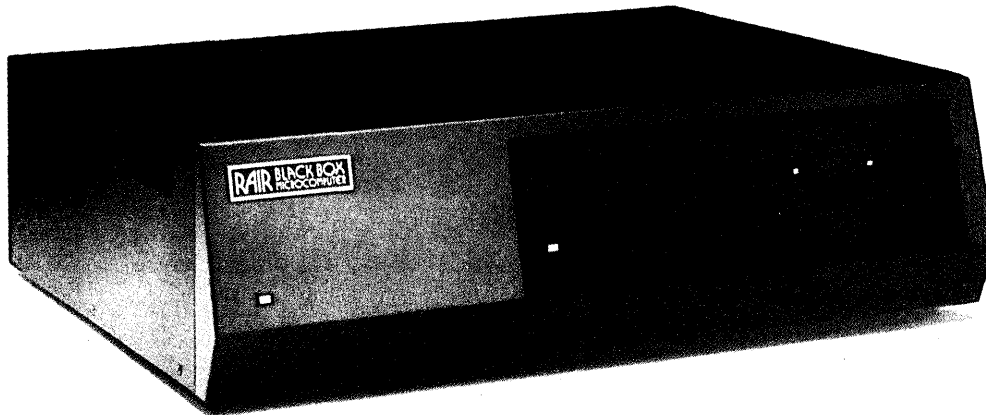

You'll love the Black Box 3/30. It's everything you've ever wanted in a desktop computer. Including a very attractive price tag.

Take a look inside its modest enclosure. And you'll find an advanced 5-Mbyte micro-Winchester for fast-access, high-capacity storage. Plus a dual-sided, double-density floppy for backup.

The Black Box 3/30 gives you the ultimate in memory management and I/O flexibility. You can expand from 64k right up to 1/2-Mbyte of addressable RAM. And there're 16 programmable I/O ports along with an IEEE 488 bus that support VDUs, printers, other peripherals—and datacomm.

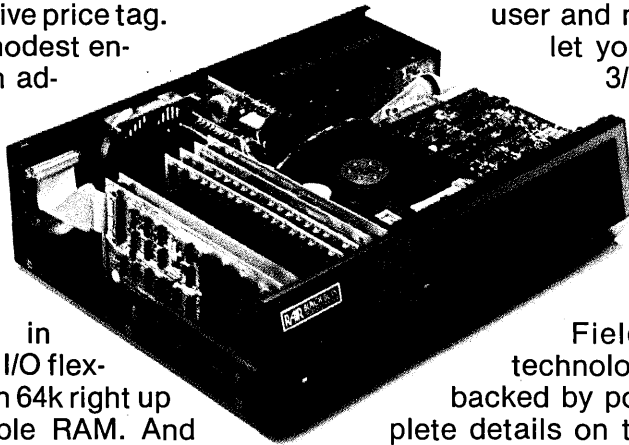

When it comes to software support, there's simply none better. Our single-user, multi-user and network operating systems let you configure the Black Box 3/30 to meet the widest range of tasks. For applications and development, you have a choice of BASIC, PL/1, PASCAL, FORTRAN, and COBOL languages.

The Black Box 3/30. Field-proven microcomputer technology perfectly packaged. And backed by powerful software. For complete details on the Black Box 3/30, call or write the RAIR office nearest you. Be sure to ask about our discount pricing for OEMs and distributors.

**United States:** RAIR Microcomputer Corporation  
4101 Burton Drive, Santa Clara, CA 95050, Telephone: (408) 988-1790 Telex: 677038

**West Germany:** RAIR Computer GmbH  
Clemensstrasse 5-7, 5000 Köln 1, Telephone: (0221) 219811 Telex: 8881915

**United Kingdom:** RAIR Ltd., Wellington House,  
6-9 Upper St Martins Lane, London WC2H 9EQ Telephone: (01) 836 6921 Telex: 298452

**CIRCLE 61 ON READER CARD**

# RAIR



## NEWS IN PERSPECTIVE

ed that it was already considering cutting back on about 1,500 staff. Univac's proposals, he said, would have satisfied all user requirements for continued support of existing products and continuing growth. It is probable that without government intervention, the Univac bid would have succeeded.

The government's right to interfere in ICL's affairs comes from two agreements. Earlier this year, the government provided a \$200 million loan guarantee over two years (no additional financial aid has been offered to Wilmot). In addition to normal commercial conditions on this guarantee, the government was given a say in management changes and a veto over ownership transfer to non-British sources. A similar veto was also tied to a \$40 million development loan provided to help develop the 2900 series.

The government therefore has a direct say in ICL's future, although it no longer has a shareholding in the company and its economic philosophy argues against such intervention.

In December 1979, the government sold its 25% share in ICL to eager private investors. Less than a year later, ICL reported that it was trading at a loss. Most of ICL's difficulties were direct results of government policy, high interest rates, and a resultant high exchange rate for sterling. In addition, manufacturing industry in Britain has gone through a dramatic recession and the government has cut back its spending, including its spending on new computers.

The government and private investors from the City of London blamed Chappell and Wilson for failing to warn them of the sudden drop in trade. When the government offered the \$200 million loan guarantee in March, the reason given was purely that the government used many ICL computers and could not afford to see support for these systems cut off.

This led to two months of speculation about buy-ins, with ICL being linked with virtually every other American, European, and Japanese mainframe manufacturer except IBM. No bid was made asking for a majority shareholding in ICL. The government also says no bid was made which would have provided sufficient protection for its U.K.-based operations and support to customers.

Before Univac had actually made a firm offer, the government broke off negotiation talks. And yet nothing had happened in those two months to suggest that ICL was in any better position to remain substantially independent.

The net result of the government's action is the worst of both worlds. While proclaiming a policy of nonintervention, it went to the other extreme of effectively choosing the new management team.

Wilmot and Laidlaw therefore have a difficult job on their hands. For one thing, the two top men did not get off to a good start when they were introduced to the

press. They had finally signed their contracts late on a Sunday night, which suggests there was considerable pressure on them to come to a quick decision before the

### ICL unilaterally broke off merger talks with Univac after the government opted for bringing in new management.

Univac bid could be put to the shareholders. When they met the press the next day, Laidlaw and Wilmot admitted they knew little about the detailed company prospects.

Laidlaw indicated that he was even unaware that the government had a preferential procurement policy towards ICL. He also suggested that he had taken the ICL job only after he had failed to get the chairmanship at BP.

Laidlaw's presence at ICL, however, is significant primarily for financial reasons. He is expected to help maintain confidence among investors. It is in Wilmot's hands to develop a detailed strategy.

Wilmot earned an impressive record at TI. An Englishman right out of college, he joined the company in the U.K. in 1966.

## TERMINALS FROM TRANSNET

PURCHASE PLAN • 12-24 MONTH FULL OWNERSHIP PLAN • 36 MONTH LEASE PLAN

| DESCRIPTION                     | PURCHASE PRICE | PER MONTH |         |         |
|---------------------------------|----------------|-----------|---------|---------|
|                                 |                | 12 MOS.   | 24 MOS. | 36 MOS. |
| <b>DEC</b>                      |                |           |         |         |
| LA36 DECwriter II .....         | \$1,095        | \$105     | \$ 58   | \$ 40   |
| LA34 DECwriter IV .....         | 995            | 95        | 53      | 36      |
| LA34 DECwriter IV Forms Ctrl. . | 1,095          | 105       | 58      | 40      |
| LA120 DECwriter III KSR .....   | 2,295          | 220       | 122     | 83      |
| LA120 DECwriter III RO .....    | 2,095          | 200       | 112     | 75      |
| VT100 CRT DECscope .....        | 1,595          | 153       | 85      | 58      |
| VT132 CRT DECscope .....        | 1,995          | 190       | 106     | 72      |
| <b>TEXAS INSTRUMENTS</b>        |                |           |         |         |
| TI745 Portable Terminal .....   | 1,595          | 153       | 85      | 58      |
| TI765 Bubble Memory Terminal    | 2,595          | 249       | 138     | 93      |
| TI Insight 10 Terminal .....    | 945            | 90        | 53      | 34      |
| TI785 Portable KSR, 120 CPS .   | 2,395          | 230       | 128     | 86      |
| TI787 Portable KSR, 120 CPS .   | 2,845          | 273       | 152     | 102     |
| TI810 RO Printer .....          | 1,895          | 182       | 102     | 69      |
| TI820 KSR Printer .....         | 2,195          | 211       | 117     | 80      |
| <b>DATAMEDIA</b>                |                |           |         |         |
| DT80/1 CRT Terminal .....       | 1,695          | 162       | 90      | 61      |
| DT80/3 CRT Terminal .....       | 1,295          | 125       | 70      | 48      |
| DT80/5L APL 15" CRT .....       | 2,295          | 220       | 122     | 83      |
| <b>LEAR SIEGLER</b>             |                |           |         |         |
| ADM3A CRT Terminal .....        | 875            | 84        | 47      | 32      |
| ADM31 CRT Terminal .....        | 1,450          | 139       | 78      | 53      |
| ADM42 CRT Terminal .....        | 2,195          | 211       | 117     | 79      |
| <b>HAZELTINE</b>                |                |           |         |         |
| 1420 CRT Terminal .....         | 945            | 91        | 51      | 34      |
| 1500 CRT Terminal .....         | 1,095          | 105       | 58      | 40      |
| 1552 CRT Terminal .....         | 1,295          | 125       | 70      | 48      |
| <b>TELEVIDEO</b>                |                |           |         |         |
| 920 CRT Terminal .....          | 895            | 86        | 48      | 32      |
| 950 CRT Terminal .....          | 1,075          | 103       | 57      | 39      |
| <b>NEC SPINWRITER</b>           |                |           |         |         |
| Letter Quality, 55/15 RO .....  | 2,895          | 278       | 154     | 104     |
| Letter Quality, 55/25 KSR ..... | 3,295          | 316       | 175     | 119     |
| <b>QUME</b>                     |                |           |         |         |
| Letter Quality KSR, 55 CPS ...  | 3,395          | 326       | 181     | 123     |
| Letter Quality RO, 55 CPS ...   | 2,895          | 278       | 154     | 104     |
| <b>CENTRONICS</b>               |                |           |         |         |
| 730 Desk Top Printer .....      | 715            | 69        | 39      | 26      |
| 737 W/P Desk Top Printer ....   | 895            | 86        | 48      | 32      |

FULL OWNERSHIP AFTER 12 OR 24 MONTHS • 10% PURCHASE OPTION AFTER 36 MONTHS

### MICROCOMPUTERS

APPLE • COMMODORE • HP85 • DEC LSI 11

### ACCESSORIES AND PERIPHERAL EQUIPMENT

ACOUSTIC COUPLERS • MODEMS • THERMAL PAPER • RIBBONS • INTERFACE MODULES • FLOPPY DISK UNITS



**TRANSNET CORPORATION**

1945 ROUTE 22 • UNION, N.J. 07083 • (201) 688-7800

TWX 710-985-5485

CIRCLE 62 ON READER CARD

## NEWS IN PERSPECTIVE

One of his early jobs was to design chips for integrated circuits for ICL machines. His main managerial jobs before becoming head of TI's U.K. company in 1978 were in the calculator business.

Wilmot was based in Lubbock, Texas, for a while and then at TI's European headquarters in Nice. He helped TI fight off Hewlett-Packard's challenge in the professional calculator market, and in the last three years turned TI's U.K. operation into one of the corporation's most profitable national units. The main lesson he has learned from his multinational experience, he says, is that "people in the U.K. can perform as well as anyone in the world, provided they are properly managed."

His experiences using TI's management information network dominate his initial view of ICL's future role. He likes ICL's Information Processing Architecture (IPA) with its commitment to open systems networking because it fits with his concept of distributed systems composed of many different processors and workstations. He also wants ICL to "supply more than just computers." He wants the company to help users by "analyzing their requirements and providing complete specifications" of their distributed computing requirements.

Although Wilmot says he is "not a computer expert," he has a good understanding of the hardware. His main technical weakness lies in software.

ICL products that Wilmot would describe as "ambling along" include the Distributed Array Processor (DAP) and the Contents Addressable File Store (CAFS). They have great technical ingenuity and commercial potential which has not yet been fully realized, he explains. These and similar projects will be reevaluated by Wilmot.

### **ICL is negotiating with Three Rivers Computer in Pittsburgh for marketing rights to its Perq workstation.**

Some will be chopped; others will be given high priority and backed to the hilt.

In some activities, such as office automation, telecommunications, specialized workstations, and even high-speed computers, Wilmot will be seeking joint ventures with other companies. Ideally, he would like partnerships with companies in complementary business activities rather than in direct competition to the traditional dp business.

The previous management had already initiated complementary types of joint ventures. One of the most interesting, in view of Wilmot's emphasis on workstations, is a deal that is being discussed with Three Rivers Computer Corp. of Pittsburgh. ICL has been interested in the manufacturing and marketing rights of the Three Rivers Perq system, a powerful, high resolution graphics workstation. ICL will also

adopt a local area network developed by another company, probably the Xerox Ethernet, although it has also shown interest in two British systems, the Cambridge Ring and Xionics Xibus.

Commenting on possible associations with companies like Univac or CDC, Wilmot said, "If you take two companies in roughly the same business, you will find that one plus one equals one and a half when you try to put them together."

—Malcolm Peltu

## APPLICATIONS

# DP MOVES IN ON CABLE TV

**Cable tv operators have been using dp via service bureaus for years; now they want something of their own.**

Digital Equipment Corp. is staking a claim to the leadership position as a data processing supplier to the cable television industry.

Digital was the only computer manufacturer exhibiting at the big 30th annual convention and exposition of the National Cable Television Assn. in Los Angeles in late May.

Its booth, which it shared with two of its oems, Applied Data Research (ADR) and Business Controls Corp. (BCC), both of New Jersey, was a dignified contrast to what might be termed a PG-rated expo, dominated by show business-oriented booths and sprinkled with samples of the late-night offerings of some cable operations that have given cable a bad name in some parts of the country.

"It's all show business here," said Richard J. Rose, cable marketing manager for Digital's Graphic Arts Product Group, "but cable is going to move far beyond that."

Digital is planning to move with it. "We're uniquely positioned to provide solutions that will help today's booming cable industry keep up with growth. And yet, as cable systems mature, we can also provide solutions that respond to the cable operator's need for better market penetration and cash flow management," he said.

Digital has been watching the progress of cable since the days when it was known as CATV or Community Antenna Television. "In those days their [cable operators'] operations were simple," said Rose. "They offered good tv reception in remote areas—a single service for a flat fee. Now they offer multiple services. Their op-

# A plan for all seasons.

## The Payroll Savings Plan

is a safe, automatic way to save for any and all seasons to come.

A little is taken out of each paycheck toward the purchase of U.S. Savings Bonds. The amount is up to you. Depending on what goal you're saving for.

Could be a new car in a couple of years. A down payment on that new house someday. For way down the road when you retire. Or even for that rainy day you can't predict.

One thing is certain. Buying Bonds through the Payroll Savings Plan is one of the easiest, safest ways to get started on the savings habit.

So whether it's a new venture for some coming spring, or a warm vacation during a cold winter, the Payroll Savings Plan is for you. It's a plan for all seasons. For all Americans.

Take  
stock  
in America.



*When you put part of your savings into U.S. Savings Bonds you're helping to build a brighter future for your country and for yourself.*

# What's the biggest difference between HP's 7580A drafting plotter and other \$30,000 plotters? About \$15,000.

**A technological breakthrough cuts the cost of high performance plotting in half.**

An ultra-lightweight drive system replaces the massive drums or crossarms used in other plotters. And that means high performance and reliability at much lower cost.

**Fast throughput and high quality output.**

The 7580A offers 4 g's acceleration and 60 cm/s (24ips) speed. Numbers that add up to fast throughput.

Addressable resolution is 0.025mm(0.001"), with a mechanical resolution of 0.0032mm (0.00012") — or about 1/50 the width of a human hair. Curves are smooth and lines are straight for superior plot quality.

**Our 7580A is probably the easiest-to-use large plotter ever built.**

Paper loading takes only seconds. Pen force and

pen velocity are set automatically. And thanks to automatic pen capping, even liquid-ink drafting pens stay ready to write for up to several days.

Eight pens of different colors, line widths and types can be accessed automatically. It even sets plot boundaries, automatically.

Use of individual sheets permits plotting on standard company and government forms ranging in size from 20.3cm x 26.7cm (8" x 10.5") to 62.2cm x 119cm (24.5" x 46.85").

For CAD/CAM, drafting, mapping and a lot of other uses, we think the 7580A is a real plotter breakthrough with exceptional price, performance and ease-of-use advantages. Domestic USA price only \$15,450.

Write to Nancy Carter for more information. Hewlett-Packard, 16399 West Bernardo Drive, San Diego, Ca. 92127, USA, or call Bill Fuhrer at (714) 487-4100.



**HEWLETT  
PACKARD**  
CIRCLE 63 ON READER CARD

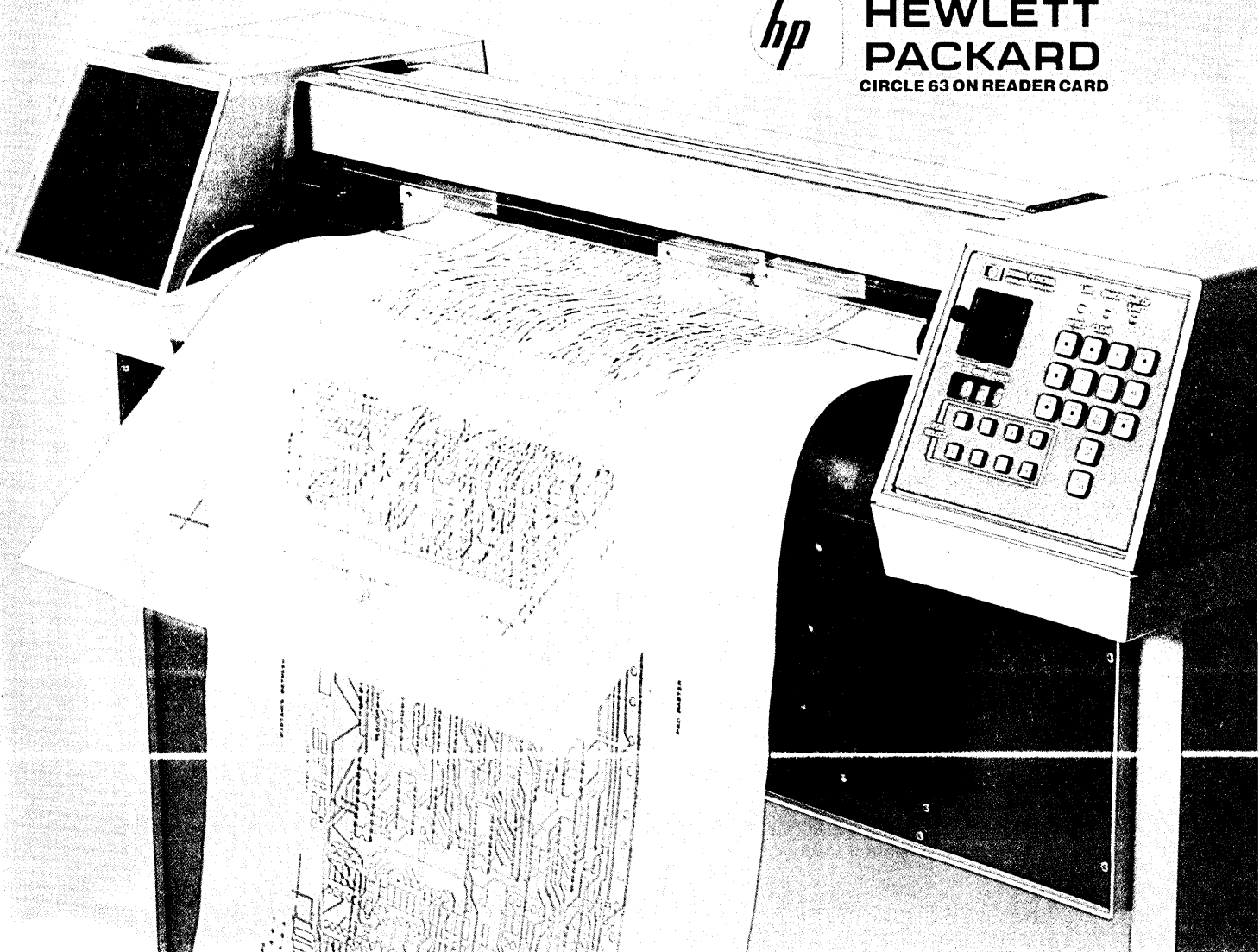

6Fluctuating, unpredictable power was a constant computer room threat...until now9



**Now - 100% effective power conditioning in a single package!**

Data processing managers agree, the total solution is here and it's called —

**The Power Management Center.**

Imagine! From a single-point connection to normal building power - *all fluctuations are eliminated* and input power (varying as much as  $\pm 40\%$ ) is conditioned to a source quality well within all manufacturers specs.

The Power Management Center stands out as the economical way to protect *uptime* because it combines 100% conditioning with flexible distribution, precise monitoring and total control for your data processing management.

Call or write - Conditioned Power, 1050 Dearborn Drive  
P.O. Box 29186, Columbus, Ohio 43229 (614) 888-0246.

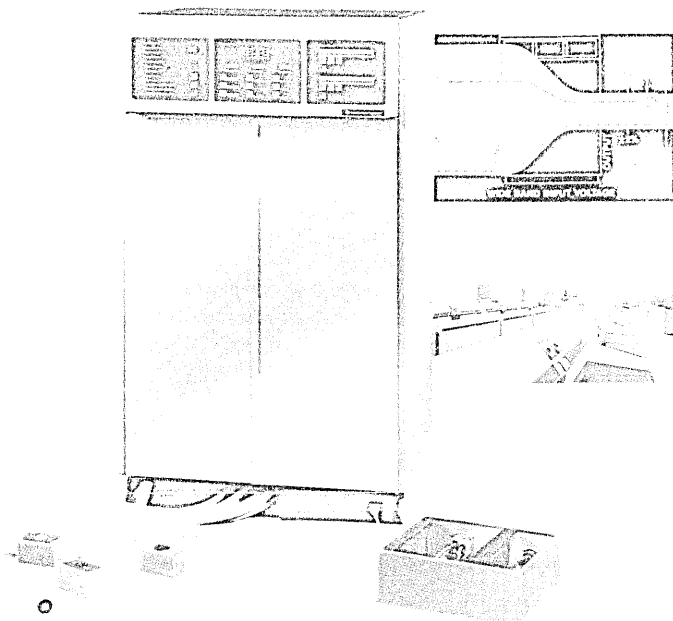

CIRCLE 64 ON READER CARD

 **Conditioned Power**  
subsidiary of **Liebert**

**“Our lab test results are critical to effective health care. We wouldn't trust them to anything less than Scotch® Brand Disk Packs.”**

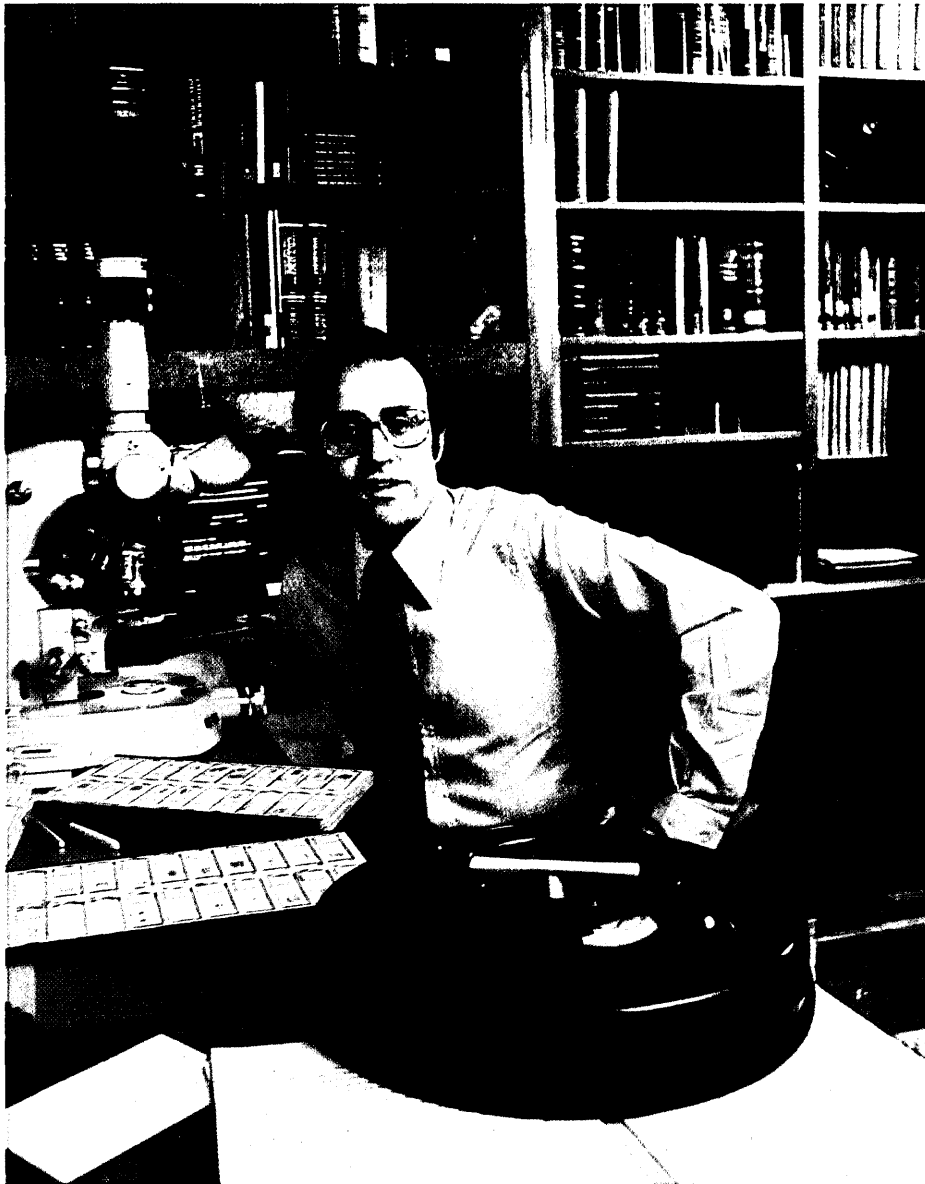

**Dr. David B. Kaminsky,  
Director of Laboratory,  
Eisenhower Medical Center,  
Rancho Mirage, CA**

Eisenhower's health care programs depend on the accuracy of almost 30,000 clinical tests every month. So its laboratory depends on Scotch 949/80 Disk Packs.

Every Scotch Disk Pack is designed to resist the damage caused by head crashes and to protect critical data—two advantages of the exclusive 3M CRASHGUARD® protective disk coating.

Each pack is tested to assure it exceeds industry performance standards before it leaves our plant. We make certain you can depend on every pack, because we know nothing less than the best is acceptable for your vital data.

Scotch Disk Packs are available in a wide range of configurations to meet your needs.

For information about how you can purchase Scotch Disk Packs, call toll free: 800-328-1300. (In Minnesota, call collect: 612-736-9625.) Ask for the Data Recording Products Division. In Canada, write 3M Canada, Inc., London, Ontario N6A 4T1.

**If it's worth remembering,  
it's worth Scotch  
Data Recording Products.**

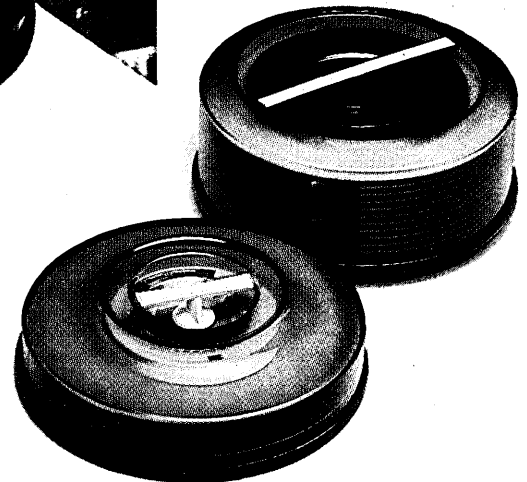

**3M**

CIRCLE 65 ON READER CARD

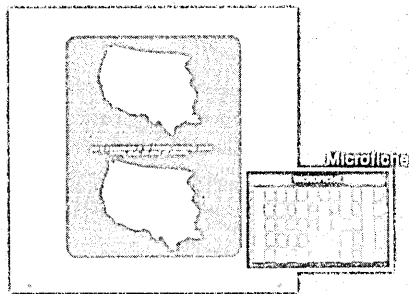
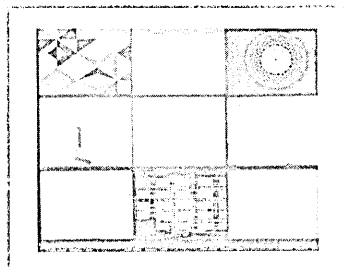
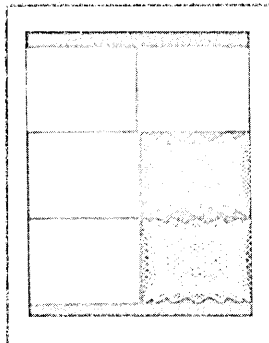
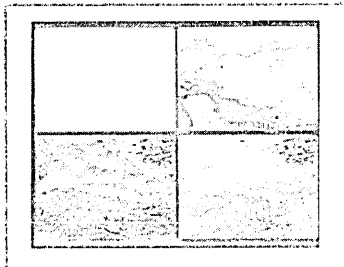
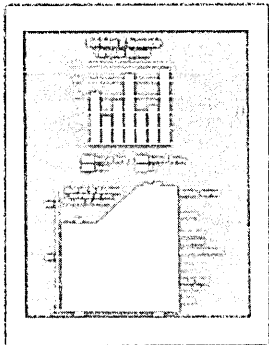
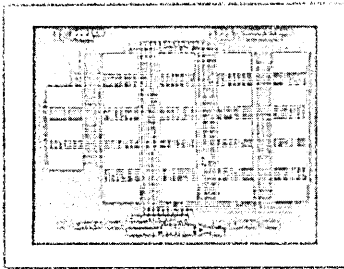

# Color Graphics Hard Copy... Made Easy

The Matrix Color Graphic Camera System converts the output of any raster scan computer color terminal into brilliant, high resolution photographic hard copy. Both line and continuous tone images can be made with accurate, bright, saturated colors.

Our system does what no other instrument can do — it produces instant, on-the-spot results with Polaroid® 8 x 10 film, 8 x 10 color transparencies for backlit displays and overhead projection, 35mm color slides, 60 image color microfilm, and 16mm/35mm color animation films. All with one camera system. It also allows recording of multiple image formats. Related and sequential images can be recorded in orderly arrays, on a single sheet of 8 x 10 instant print film. The resultant ease of comparison and analysis is unmatched. The system is also fully modular and field upgradeable... you purchase only the capability that you need now.

Microprocessor based electronics provide many automation, self-calibration, self diagnosis and remote control functions. Color graphics hard copy made easy by Matrix Instruments, the leading manufacturer of precision electro-optical imaging cameras for diagnostic medical applications.

For more information, film samples, or a demonstration, contact Matrix Instruments, 230 Pegasus Avenue, Northvale, New Jersey 07647. Telephone (201) 767-1750 Or call toll free: (800) 528-0274.

**MATRIX  
INSTRUMENTS**

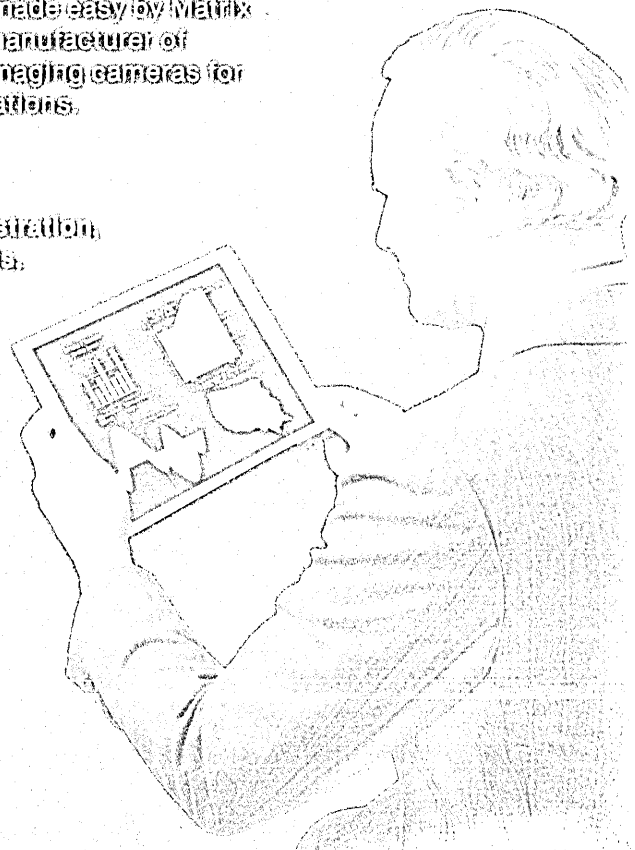

Overhead Projection Transparencies



Slides

Hard copy shown reduced from original 8" x 10" slide, and microfilm film. Multiple images recorded on a single sheet of film. "Polaroid" is a registered trademark of the Polaroid Corporation.

## NEWS IN PERSPECTIVE

erations are complex and they need dp."

He said cable tv operators have been using dp via service bureaus for a number of years but now, he feels, they need something of their own. "We are the leaders."

"Digital is committed to meeting the present and future needs of the cable industry with interactive computing, communications networking, and applications

### DEC hopes to be the leading dp supplier to the cable tv industry.

software. We have established working relationships with these software houses in order to provide the broadest and deepest range of computer products and services in the cable industry today," Rose said.

He said Digital's Graphic Arts Product Group instigated the developments of both oems. The group handles applications for all media, both print and broadcast. "Our name is misleading," said Joseph W. Ford, Graphic Arts product line manager, "and we're going to change it." He wouldn't say to what. "That's touchy internally."

ADR's system, called CADRE, for Computerized Automatic Data Retrieval and Entry, is billed as an on-line management system for cable television. Its features include: on-line database including

subscriber payment, installation history, street files, and work in progress; automated multiple systems and services invoicing, payment processing and work-order generation; automatic rate calculation—basic, pay tv, residential and commercial; on-line new subscriber account assignment; total subscriber accounting package; printed work orders on connects, disconnects, changes and repairs; immediate response to information inquiries; management reports for accounting, sales, installations and operations; and total self-containment and ease of operation.

An enthusiastic ADR spokesman, demonstrating the system at the NCTA show, was as excited about the market as he was about his product. "There are some 5,000 cable operations going now; another 3,000 or so are licensed and getting going, and thousands more licenses are pending."

Cable tv operations are franchised by municipalities. This is an area of some concern to DEC's Rose. "The franchises (exclusive to a territory) are granted based on promises, and some cable operators are getting franchises based on promises which they haven't the foggiest notion of how to keep—like, in time, offering two-way.

He concedes that the technology for two-way is there. The best-known example is the Qube system in Columbus, Ohio, a joint venture of Warner Communications

and American Express Co. Users can participate in instant opinion polls and order merchandise which is charged to their Qube account. Qube was the subject of a recent showing of the tv magazine *PM*, titled "Talk Back to Your Tv."

DEC itself is involved in a New Jersey experiment with Scientific Atlanta, which Rose calls a "first step" toward two-way tv. With most cable offerings, a subscriber is presented a menu of services—movies, sports features, news, etc.—from which he selects the programs he wants, and then gets them on a regular basis. In the N.J. experiment, special offerings are made each week and customers can opt to take them or not. Initially a customer telephones in his

### The success of two-way tv experiments depends on customer acceptance.

decision but, ultimately, keying in via touch tone phones will be possible. The variations in service, though, provide new billing problems which Rose said the ADR software can handle.

Rose feels the real problems with promising two-way capability lie in the fact that success of such offerings is tied to customer acceptance and "we don't know what that is yet."

—Edith Myers

# THE ANN ARBOR AMBASSADOR™

## SETTING THE NEW STANDARD IN PRICE AND PERFORMANCE

\$995\*

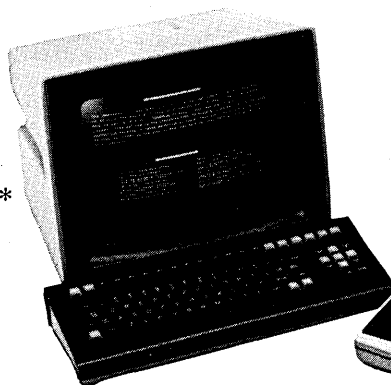

\*OEM 100 pc. price,  
U.S. domestic sales

\$1100\*

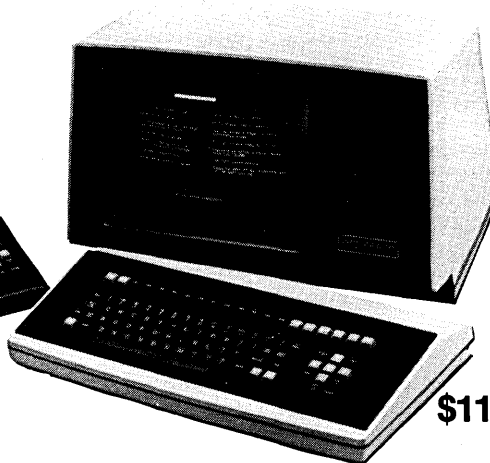

The Ann Arbor Ambassador offers an impressive array of features for any CRT terminal application: Large 15-inch screen • 60 line display • Zoom and Scroll • Selectable host areas and scrolling region • 5 graphic renditions • 5 area qualifications • 22 cursor controls • 12 tab controls • 13 erase controls • 12 edit controls • 12 send controls • 10 print controls • 11 receiving modes • 11 operator convenience modes • 6 setup lines • Self-diagnostics • Down-loadable function keys • Support of ANSI X3.64, ECMA-48 and ISO DP 6429 coding • Ann Arbor quality • And much, much more.

Call or write us for more information!



6175 JACKSON ROAD • ANN ARBOR, MICHIGAN 48103 • TEL: 313-663-8000 • TWX: 810-223-6033

◀ CIRCLE 66 ON READER CARD

CIRCLE 42 ON READER CARD

## NEWS IN PERSPECTIVE

### BENCHMARKS

**SBS SNAFUS:** Operating a communications satellite these days is not always the smoothest thing. Satellite Business Systems launched its SBS-1 late last year and the "bird" has experienced a series of "minor anomalies" that have made it necessary to use some of its built-in redundancy, an SBS spokesman admitted. Many of the problems weren't technical, but they included a malfunctioning transponder that had to be taken out of service, although there are six spares. Also affected were a rocket motor used to position the satellite, a thermal cover which contracted during solar eclipses and decreased geographical coverage, and two redundant receivers which malfunctioned due to a faulty switch. All in all, "station keeping" corrections required use of some precious fuel, and some redundant capacity is now unavailable. Despite these headaches, SBS said it is pleased with the performance of its first satellite, and it made a "substantial" incentive payment to Hughes, which manufactured the unit. Even though none of the problems are serious enough to affect service to users, further problems could change all that. As a precaution, SBS has notified its insurance underwriter that it reserves the right to file a claim if conditions warrant. Meanwhile, both the new carrier and users will feel more secure when SBS-2 is launched later this year. Until then, SBS said it would continue to hook up its first users as planned, and SBS-1 should perform satisfactorily.

**FUJITSU MAINFRAMES:** In what was seen as an attempt to counter Hitachi's February introduction of a high-end cpu, Fujitsu has come out with a new generation of large-scale mainframes ranging in power up to 30 MIPS. The M-380 uniprocessor and

M-382 dual processor also compete with IBM's new 3081. Fujitsu said the M-380 can run as much as 64 megabytes of main memory and a maximum of 64 I/O channels. Both cpus are architecturally similar to the 580 series introduced last November by Amdahl, which uses Fujitsu components in its line of IBM-compatible machines. Initial deliveries of the Fujitsu systems will be in mid-1982, with the M-380 renting for \$165,000 per month for a 16-meg memory. The company said it expects to sell about 100 M-380s and about 50 M-382s in Japan in four years, while less than 100 have been targeted for foreign markets.

**XTEN AXED:** The Xerox XTEN network may be gone, but it left a legacy that will ultimately become a service for users, say industry observers. By gaining FCC authorization for Digital Termination Services (DTS) in the 10 GHz area, XTEN proved that there are alternatives to the traditional dependence on telephone company local loops. The Xerox decision to scrap its big network plans was based on competitive pressures in the copier area, which had priority for corporate funds. But tests had been conducted with operational models of the microwave DTS system, and these experimental data will be available to an organization that wants to go forward with a DTS system. Although Xerox says officially that it has no plans to spend further money on XTEN, corporate officials reportedly told the FCC that some type of partnership with another carrier for a DTS offering might be considered.

During its more than two-year life, the XTEN marketing group talked to some 200 potential users about signing up for the service. Many members of this marketing group had been handpicked and lured away from good careers with other carriers by

XTEN recruiters. While there was little outright bitterness in that group, many expressed disappointment that corporate funds were cut off before service began.

**NEW WORD PROCESSOR:** In response to the price-setting IBM Displaywriter and Wang Labs Wangwriter, Philips Information Systems, Inc. came out with the Micom 2002 word processor. Expandable to a four-station system able to store up to 12,000 pages of text, and programmable to handle data processing tasks, the new machine represents Micom's hopes to keep its line competitive with the new wave of low-priced systems now appearing on the market. A minimal dual-crt system with a single printer and 128K byte processor sells in single quantities for \$16,500, which on a per-station basis makes the system price-competitive with IBM's Displaywriter. Philips Information, based in Dallas, is now headed by John Clark, formerly a top man at Intel. The company markets products built in Montreal by Philips Data Systems, a subsidiary of N.V. Philips, the Dutch electronics giant. The Micom 2002 line, a spokesman said, would be marketed worldwide.

**AIR FORCE CONTRACT:** As the sole bidder, Honeywell was awarded a potential \$163 million contract by the Air Force Data Services Center in the Pentagon for up to 20 large-scale DPS-8 machines, front-end communications controllers, and support services. The deal apparently locks Honeywell into the data center for 16 years, the first eight of which involve the installation of hardware while the remainder cover training and system support. The new machines will replace aging General Electric 635 and IBM 360/75 computers, according to Pentagon officials. Although the Air Force had solicited bids from close to 100 firms, Honeywell was the only respondent. There was no explanation as to why that firm was sole bidder, although it was later pointed out that Honeywell planned to replace the massive tape library covered by the contract by subcontracting that job out to Masstor Systems Corp., Sunnyvale, Calif.

**CPU RIGHTS:** As part of an attempt to reinforce its commitment to the scientific market, Sperry Univac acquired nonexclusive manufacturing rights to a high-speed array processor it has marketed for the last year. The machine was designed and has been built for Univac by Datawest Corp., Scottsdale, Ariz., and marketed as the Univac 3063. The machine, which will be built by Univac at its Roseville, Minn., plant, works with the Univac 1100/80 series mainframes. Univac sells it for \$997,000, or leases it for five years for \$30,017 per month. First shipments of the Univac-made models will be this summer, according to a Univac spokesman at Blue Bell (Pa.) headquarters. \*

**TELEX CHIEF DEAD:** Roger M. Wheeler, chairman and chief executive officer of Telex Corp., Tulsa, Okla., was shot and killed last month after finishing a round of golf at his country club in Tulsa. The killing was unexplained as of press time, although speculation centered on his business interests in jai-alai gambling. Mr. Wheeler was credited with moving the firm strongly into the IBM-compatible market, offering tape drives, disk drives and 3270-type terminals. It was also under Mr. Wheeler's command that the company brought IBM to court for antitrust law violations. Telex won its first suit but was rebuffed by IBM at the appeals level. Although the two firms subsequently settled out of court (and on the eve of a decision from the Supreme Court), the trial testimony gave the industry an unprecedented



view of IBM's inner workings and future plans. Stephen J. Jatras, Telex president, has assumed Mr. Wheeler's duties.



# Dear Ma:

## With this all-star line up of 1200 bps Full Duplex Modems, it's no wonder that Racal-Vadic delivers more than anyone!

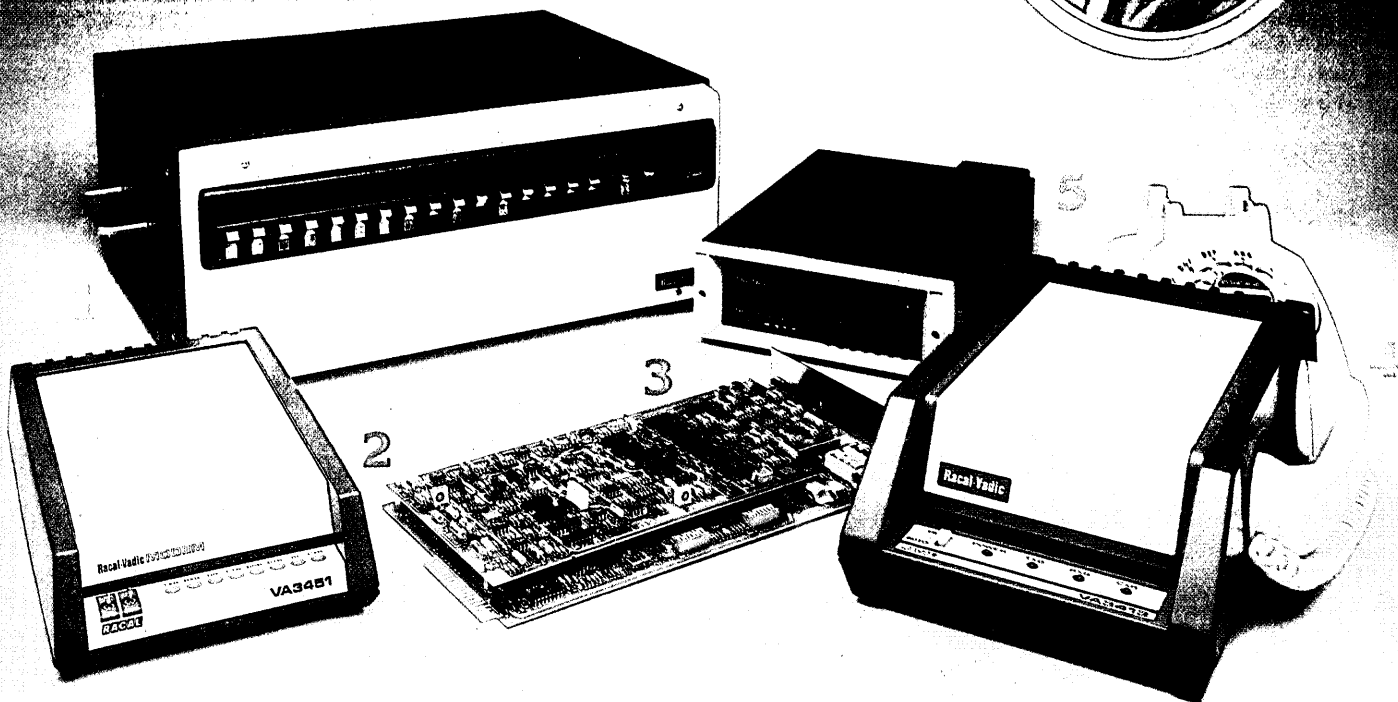

Without a doubt, Ma, Racal-Vadic offers the industry's broadest, most versatile line of 1200 bps full duplex modems.

No wonder. Racal-Vadic invented 1200 bps full duplex in 1973, years ahead of the rest. And they've been widening their lead ever since. Over 150,000 VA3400 type modems have been delivered to date.

Take a close look at this star studded line up, Ma, and see why.

- 1 **VA3480 Triple Modems:** A direct connect triple modem for computer sites that automatically changes into a VA3400, a 212A or a 103 type modem. Compatible with our Singleline or Multiline Automatic Calling System.
- 2 **VA3450 Triple Modems:** A direct connect triple modem for remote terminal users. Housed in a sleek desk top package, this modem provides originate/answer VA3400, 212A and 103 operation.
- 3 **OEM Triple Modem Cards:** Racal-Vadic is designing integrated full duplex 1200 bps modems on compact PC cards for major terminal manufacturers per their packaging and performance specifications.

- 4 **VA3413 Dual Acoustic Coupler:** The first acoustic coupler to provide full duplex 1200 bps and 0-300 bps operation. It's the only coupler fully compatible with the Racal-Vadic VA3400 series and Bell 103/113 type modems.
- 5 **V11222 V.22 Compatible Modem:** A CCITT compatible 1200 bps full duplex modem that is fully compliant to alternatives A, B and C.

For more info contact the nearest Racal-Vadic stocking rep or phone 800-543-3000, OPERATOR 502 today.

Your independent thinking son,

*Alexander Graham Jr.*

**Racal-Vadic** Member IDCMA

222 Caspian Drive  
Sunnyvale, CA 94086  
Tel: (408) 744-0810 • TWX: 910-339-9297

**RACAL**  
The Electronics Group

Racal-Vadic Regional Offices: West: (408) 744-0810 • East: (301) 459-7430  
Central: (312) 932-9268 • Northeast: (617) 245-8790 • Southwest: (817) 277-2246

### Available from these stocking reps...

Alabama: (800) 327-6600 • Alaska: (907) 344-1141 • Arizona: (602) 947-7841 • California: S.F. (408) 727-6491, L.A. (714) 635-7600, S.D. (714) 565-1557 • Colorado: (303) 779-3600  
Connecticut: (203) 265-0215 • District of Columbia: (301) 649-6000 • Florida: Fort Lauderdale (800) 432-4480, Orlando (305) 423-7615, St. Petersburg (800) 432-4480 • Georgia: (800) 327-6600 • Illinois: (312) 255-4820 • Indiana: (317) 846-2591 • Kansas: (913) 362-2366 • Maryland: (301) 649-6000 • Massachusetts: (617) 245-8900 • Michigan: (313) 973-1133 • Minnesota: (612) 944-3515 • Mississippi: (800) 327-6600 • Missouri: (314) 821-3742 • Nevada: (800) 422-4591 • New Jersey: North (201) 445-5210, South (609) 779-0200 • New Mexico: (505) 299-7658 • New York: Binghamton (607) 785-9947, N.Y.C. (212) 695-4269, Rochester (716) 473-5720, Syracuse (315) 437-6666 • North Carolina: (800) 327-6600 • Ohio: Cleveland (216) 333-8375, Dayton (513) 859-3040 • Oregon: (503) 224-3145 • Pennsylvania: East (609) 779-0200, West (412) 681-8609 • South Carolina: (800) 327-6600 • Tennessee: (800) 327-6600 • Texas: Austin (512) 451-0217, Dallas (214) 231-2573, Houston (713) 688-9971 • Utah: (801) 262-3000 • Virginia: (301) 649-6000  
Washington: (206) 364-8830 • Wisconsin: (414) 784-9379 • Canada: Calgary (403) 243-2202, Montreal (514) 849-9491, Toronto (416) 675-7500, Vancouver (604) 681-8136

CIRCLE 67 ON READER CARD

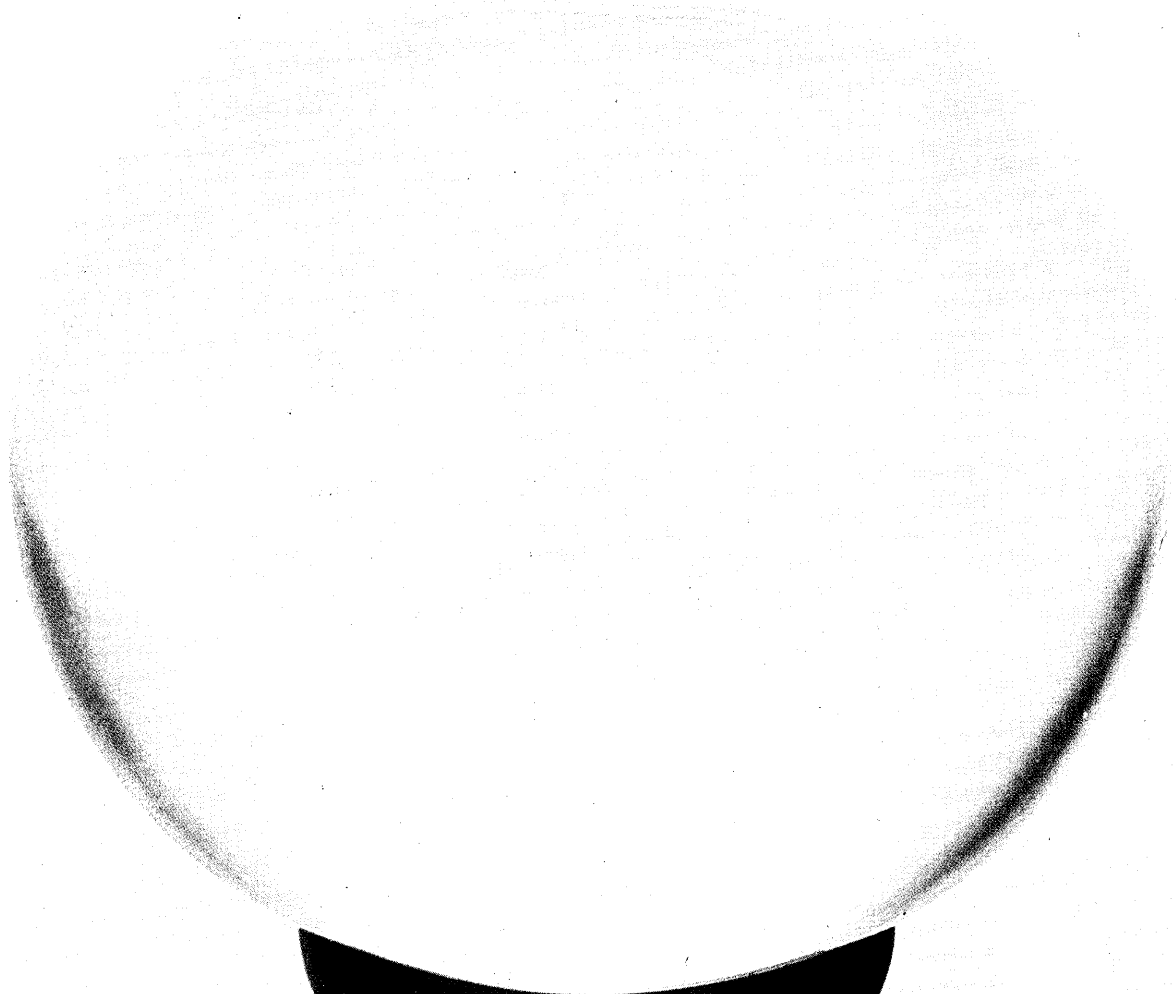

INFONET

# **PUT INFONET ANYWHERE. ASK IT ANYTHING. AND THE ANSWER WILL APPEAR BEFORE YOUR VERY EYES.**

INFONET is Computer Sciences Corporation's worldwide remote computing network. But it functions more like the fabled crystal ball.

Unlike systems patched together from existing parts, INFONET's design started with the ultimate task it was to perform. And then CSC created it from that architectural plan, choosing each component and building every link with only one criterion, optimum performance.

As a result, it's the most completely integrated system anywhere. Internal data exchange is far simpler and it is a substantially better base to assimilate technical advances.

For just a moment, imagine the possibilities of going back in time with all of modern science at your command. INFONET provides that kind of opportunity. Because INFONET can deliver the entire menu of computer technology to almost any chosen place. It gives the marketing man or woman a chance to take to the hinterlands of information management every

solution modern data processing has to offer.

To the computer professional, INFONET also promises an endless calendar of solving new and different problems. And it offers the computer scientist a chance to play a meaningful role in the evolution of advanced data management structures. INFONET is distributed data processing on the grand scale. A true microcosm of computer technology itself.

While INFONET is only one division of CSC, it's a prime example of how we integrate software, communications and hardware to advance the techniques of problem solving.

CSC is continuously developing the capacity of history's most profound tool, the computer, to change man's relationship with everything he has ever known.

It's the ultimate challenge. Maybe you'd like to help us. If you think you're good, and you're not afraid to find out how good you really are, you should be in touch with CSC.

**The only limitations are the ones you bring with you.**

# **CSC**

**COMPUTER SCIENCES CORPORATION**

Corporate Offices: 650 N. Sepulveda, El Segundo, CA 90245  
An Equal Opportunity Employer.

**CIRCLE 68 ON READER CARD**

WE DIDN'T  
INVENT  
DISTRIBUTED  
DATA  
PROCESSING.  
WE MERELY  
PERFECTED  
IT.

# THE ONLY DDP SYSTEM THAT COMES COMPLETE: DATA GENERAL'S ECLIPSE SYSTEM.

Since its inception about five years ago, conservative estimates place the amount of money business has invested in DDP to be an astonishing three billion dollars.

Astonishing, particularly when one considers that almost all of it has gone for systems that, to put it mildly, are incomplete.

In point of fact, it's lamentably rare to find any DDP system that doesn't suffer from one form of this malady or another.

Some manufacturers have seemingly mastered the hardware but are all too wanting in software.

While others are reasonably sound at software but at best only fair when it comes to communications.

However, there is one company with world-wide software and service support whose systems are operating

in over 75% of the Fortune 100 companies, as well as countless other companies throughout



the world, that offers through a unique combination of power, function and flexibility, the most comprehensive approach to Distributed Data Processing in the industry. Data General.

What specifically is it about Data General that allows us to claim superior DDP capabilities? Simply this: ECLIPSE® Systems supply more of the key ingredients for successful Distributed Data Processing at the same place and the same time than any other system you can buy.

For example, ECLIPSE Systems utilize the widest and most comprehensive range of software available. Instead of the traditional heavy, complex software that takes too much time to manage, Data General has dedicated a large part of its Research & Development resources over the past 12 years to provide you with

easy-to-use, quality software, with sophisticated and simplified programmer productivity tools.

Software such as our Advanced Operating System (AOS), a modern, proven operating system designed for the interactive environment; ANSI-standard Interactive COBOL with easy-to-use display extensions; PL/I; INFOS® file system; a

CODASYL compliant DBMS; and AZ-TEXT™

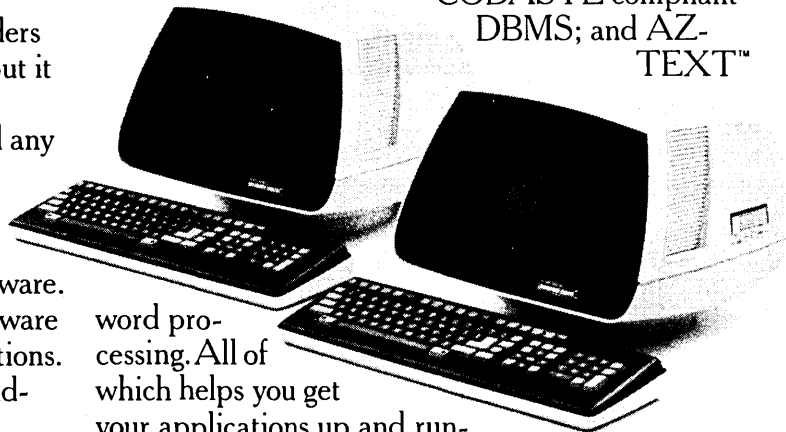

word processing. All of which helps you get your applications up and running faster, while measurably helping to reduce the time spent on enhancements and maintenance.

ECLIPSE Systems have the most comprehensive proven-in-use communications capability available and working today. Not only RJE and 3270, but also networking software based on X.25 protocols that have been successfully implemented in our customers' accounts for years.

And with Data General you get compatibility across our product line. This gives you the benefit of using your Data General software expertise on each successive distributed data processing application without costly program rewriting or programmer retraining.

There is a wide variety of sizes to choose from, ranging from a 1 to 4 terminal system to a 128-terminal mainframe-size system. And the selection of terminals and storage devices is, without question, unsurpassed in the industry.

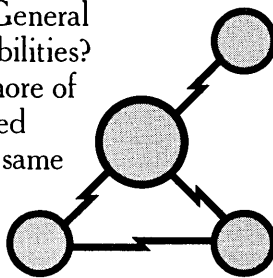

If you have new applications or you want to distribute out of the mainframe environment, and you want the power, function and flexibility that allow you to implement, enhance and maintain applications not just on time, but in budget, contact our local office or write to Data General, 4400 Computer Dr., Westboro, Mass. 01580.

You'll discover our solution to DDP is the most comprehensive in the industry because our thinking is the most comprehensive in the industry.

 Data General

Bored? Cynical? Impatient and irritable? Exhausted, but unable to sleep? Paranoid? Depressed? Feeling unappreciated?

You may be in the throes of a midlife crisis—or you may be a victim of the trendy trauma “burnout.”

Burnout is actually just a fancy name for an age-old problem: being fed up with one’s job. Burnout seems to be running rampant among data processing professionals lately, so we tried to find the reason why. In droves, they came forth to complain.

A West Coast consultant says, “My

# BURNOUT: VICTIMS AND AVOIDANCES

experience has been that the people who tend to suffer from burnout are people who work for large, sophisticated dp shops where there are a lot of programmers. What happens is—either because of the way the organization is set up or their individual expertise—they get themselves trapped with an assignment that goes on year after year, such as maintaining a bank’s DDA [direct deposit accounting] system that was written 12 years ago in a peculiar language that is now dead. Nobody else knows the language, and it’s such a heavily used system that lots of modifications are

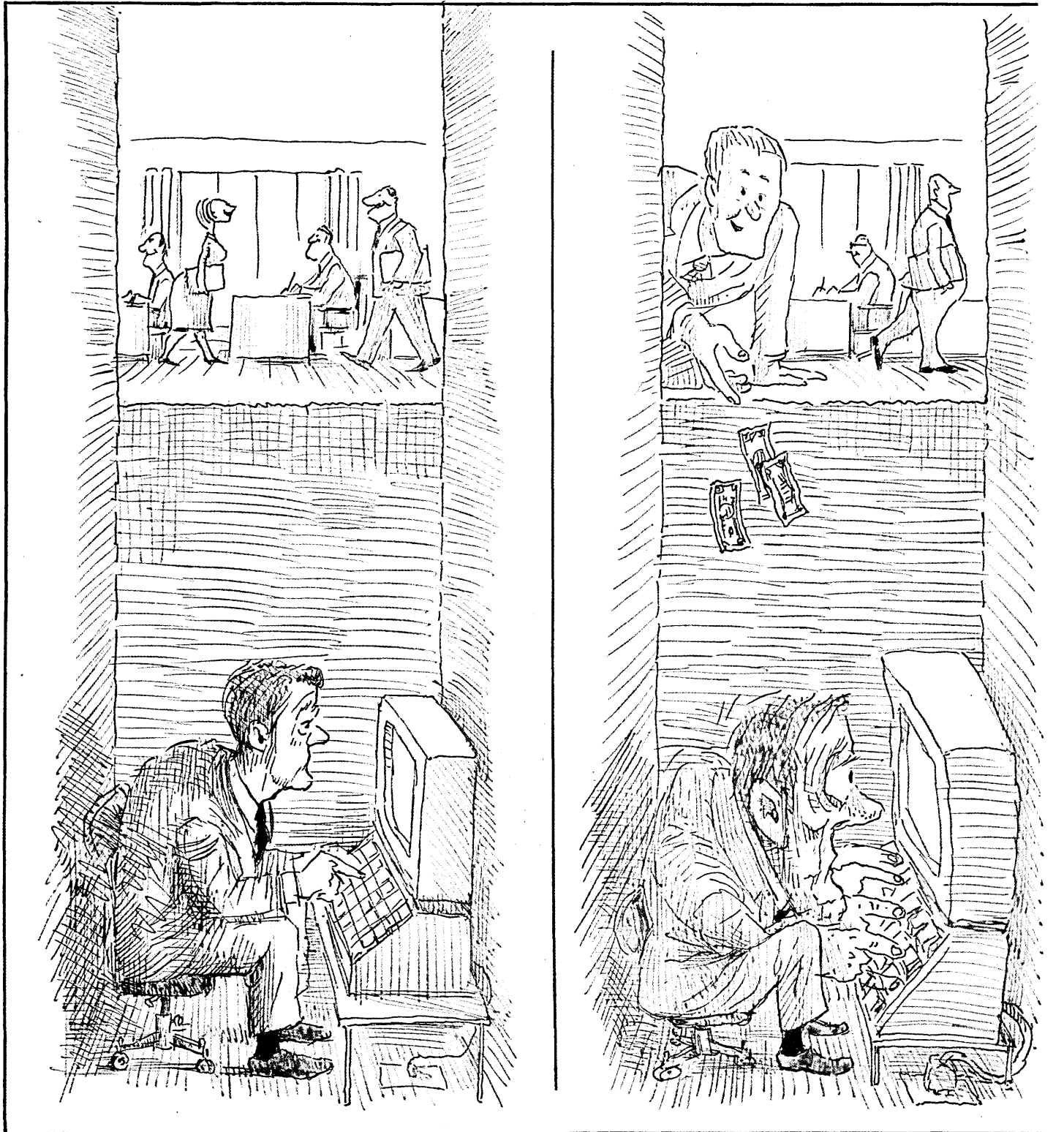

required, and plenty of fixes have to be done. This person is the only one who knows the system and the bank says, 'Gee, we're going to rewrite that system one of these days, so just keep patching it.'

"It's such a huge job and they never budget for it. So, people get trapped and make a career of maintaining one system. They get burned out.

"Or, they work for a manufacturer and are associated with a particular application. Every time a manufacturer sells a system, say to a hospital, the same person does

## The long hot summer has a trendy new trauma that may turn programmers into parsnip farmers.

by Merrill Cherlin

the setup for the hospital, no matter where it is. They get burned out because the challenge is gone. They know the system and they know the problems and it's so repetitive that they're bored."

A senior systems analyst for a major industrial firm concurs, saying, "A good person will be given more and more systems. He has to maintain them all, and at the end of a few years he's doing nothing but maintenance. Then, rather than learning new applications and technologies, he's stuck with old technologies because no one else is capable of

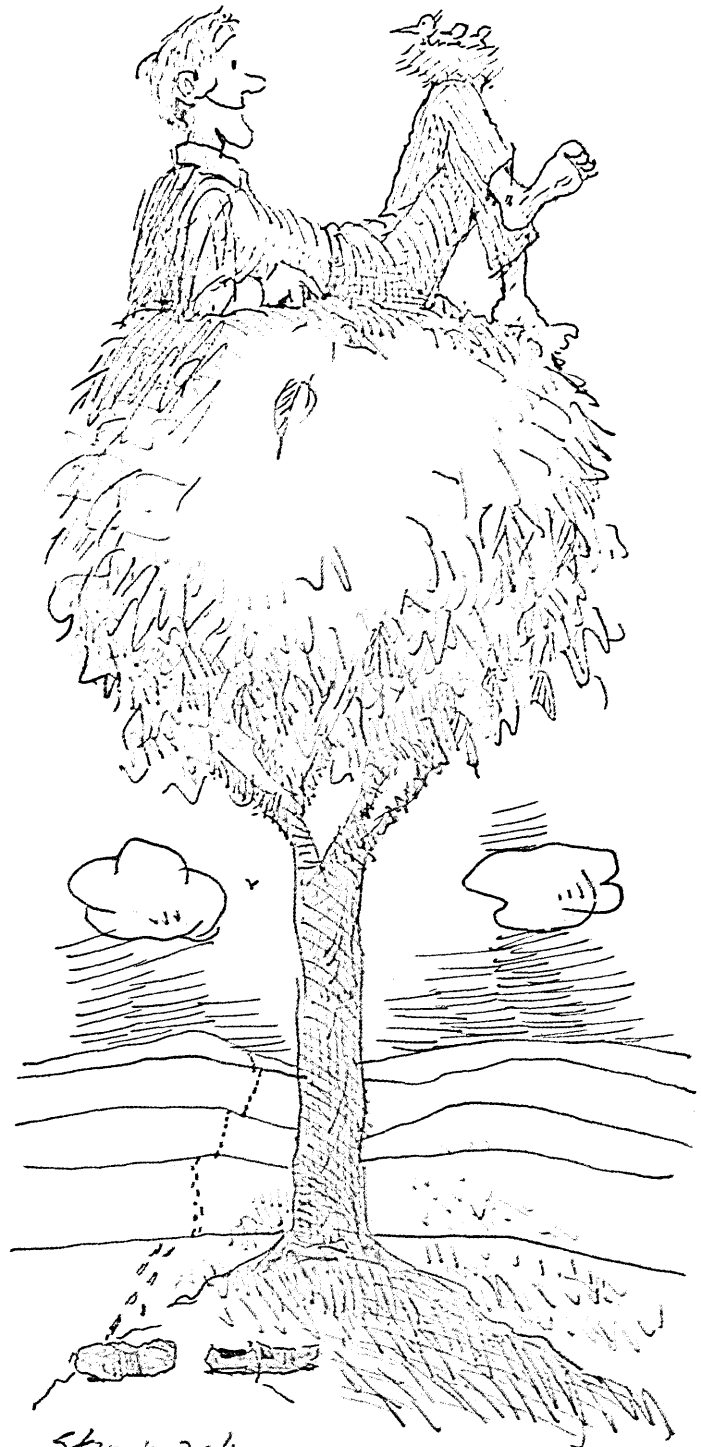
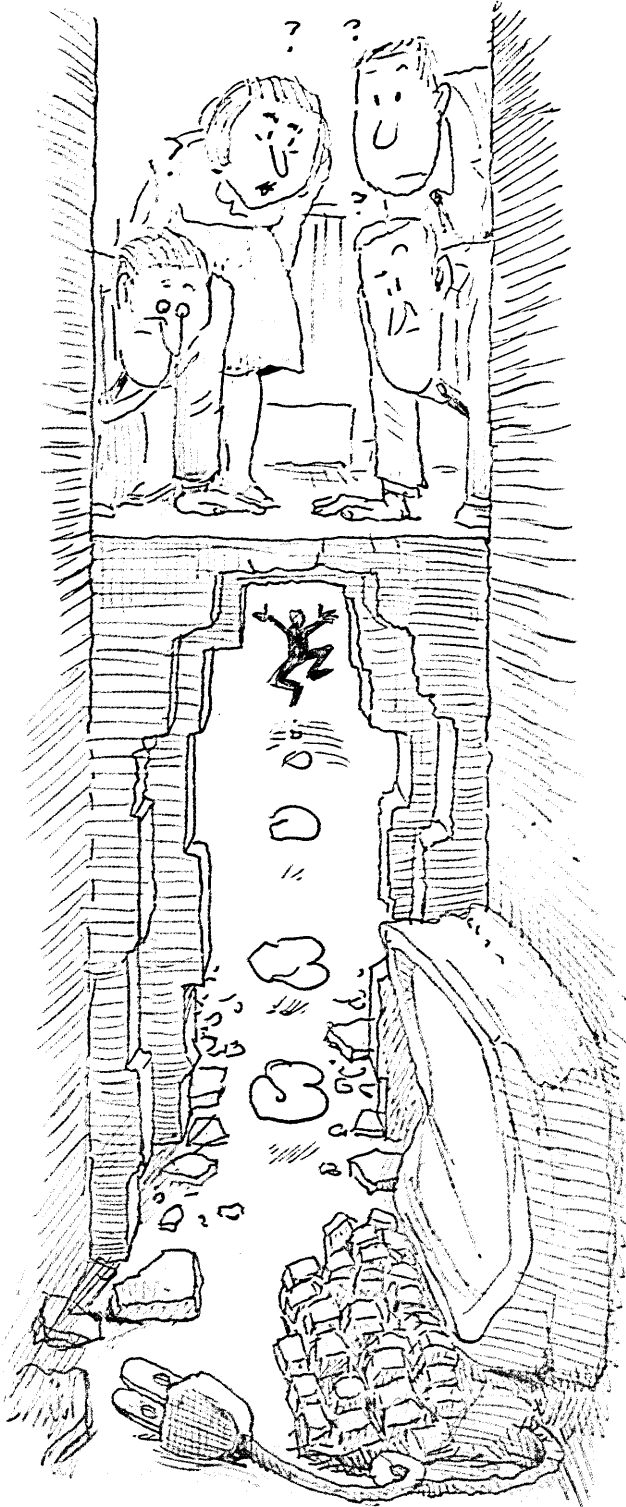

ILLUSTRATION BY STAN MACK

handling it. And then management says, 'Hey, you don't know the new technology. We'll go out and hire somebody.'

'I'm trying to keep track of 20 different systems. I'm still trying to learn the new technology and it's rough.'

'The jobs most prone to frustrations are those done on a daily basis, with a variety of input—an order processing system, for instance, or daily banking. The chances of a system being at fault are virtually nil, but nevertheless, you get pressure from other departments.'

'Of course, problems with the machine going down or head crashes occur often enough to give them the leverage they need to have you do the research for them. But most of the problems we've had stem from user error. Boredom comes in when you have the same error occurring over and over and the user doesn't bother to see if he's made an error.'

'After five or six years of running a system, you've gotten damn near all the bugs out. Anything coming up now is the user's problem.'

A dp middle manager at a large New York company says with exasperation, 'As much as the industry has changed over the years, the fundamentals of doing the job correctly are basically the same. People who have been around a long time see the same mistakes over and over again.'

'The dp community experiences one crisis after another. You're the whipping boy in the corporate community. They look at a report and something's wrong so they immediately make noise about it.'

'Think of payroll, for instance. Every month or every week you're running the stupid payroll and there's always some input that comes in late. This creates pressure that never ends, and it's *absolutely* never gonna end.'

'People who've been in the industry a long time usually graduate to a staff position. That's what happened to me. I don't want to have to fight a payroll every Monday morning or be worried about some stupid report at the end of every single month. You see these young whippersnappers making the same mistakes you made and you get to the point where you just don't care anymore.'

### IT'S NEVER PERFECT

'About 15 years ago I said, 'Damn it, someday I'm going to get this system to be just about perfect.' And I did—and I ended up getting canned because they said, 'This guy's got nothing to do—what the hell's he doing? He's just going around bs-ing.' I was such a good manager, I could delegate things perfectly. I knew what everybody could do. I did nothing. I didn't bother to play the political game

### "ISN'T ANYONE INTERESTED IN DP ANYMORE?"

When Sidney Dunayer left his position as assistant vice president of dp with a major New York financial institution, he was discouraged. His track record was above average—10 solid years rising through the ranks of system programming—but as he said, 'I got too good for the business.' Now he's a consultant.

'I don't like the term 'burnout'; what we're really talking about is extreme discouragement. It starts because management tailors the way it does business so that the least-skilled person can handle it. The claim is 'We don't want to waste your talent,' but your management doesn't come up with anything interesting for you to do. There are only five or six thousand good people in this industry, and they are a threat to management because they can do management's job, maybe even better than management can. The competent people get discouraged, and they can't move around like the lower level people can. All they're good for is to have their brains picked. The innovation is gone: there are no new languages, compilers, or monitors being written anymore. You get to the point where you have to give up.'

'There must be an industrywide attitude change before this situation can



SIDNEY DUNAYER: "The innovation is gone. You get to the point where you have to give up."

change. Management must cooperate, get rid of the incompetent dp people, and slow down. Vendors should stop pushing a package because 'anyone can operate it,' and should permit programmers to touch software, because the quickest solution does not always answer the need.'

—Deborah Sojka



"Maybe it's not something in the program, Bob. Maybe it's something in you."

PHOTOGRAPH BY MARK WEINSTEIN

CARTOON BY LEONARD TODD



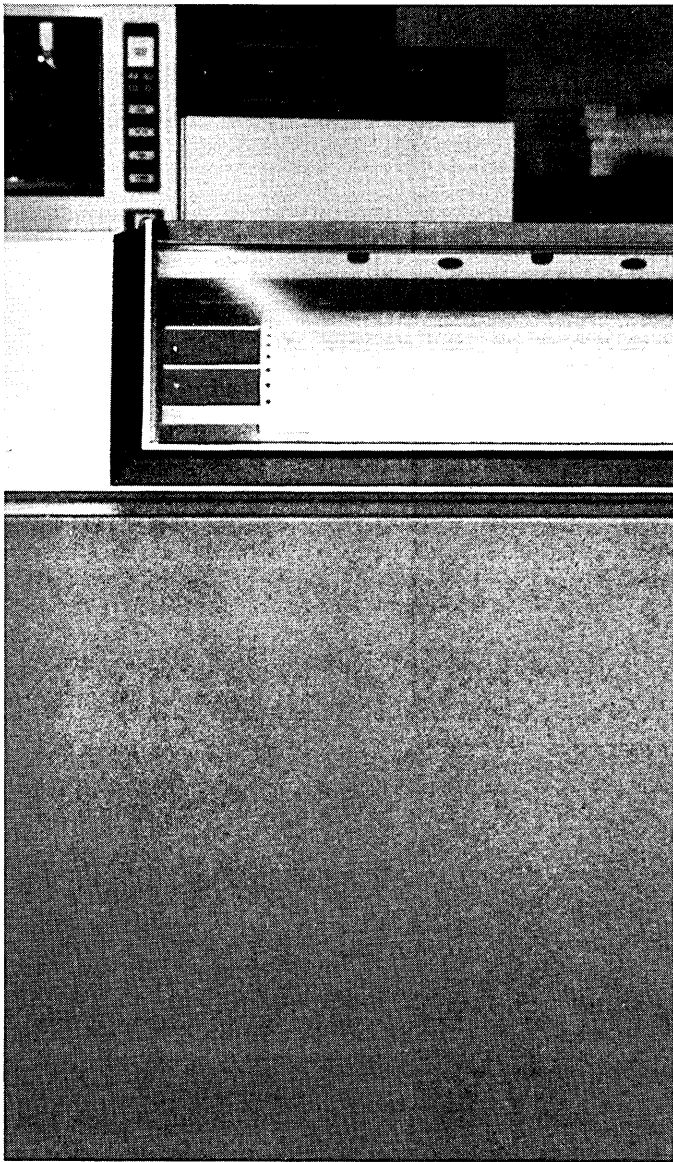

# For efficient computer-generated mail, a good computer is only half the answer.

In computer-generated mail, a fast finish is just as important as a fast start. The payoff factor isn't how fast a computer can zip out invoices or letters but how fast a processing system can zip them through to the post office.

All too often, computer forms have to run a stop-and-go obstacle course. Someone hauls them from the computer room to another room for slitting and bursting, then on to a folder for folding and stacking and finally to the mailing room for insertion, sealing, metering and zip-code sorting.

In this day and age, this kind of processing makes no economic sense. Because Pitney Bowes has an automated system that takes over where your computer leaves off. Our high-speed Computer Output Mailing System performs the entire sequence of forms-processing, inserting and mailing steps in one straight-through operation. A single operator simply threads the computer-output web into one end of the system, presses a button and gets set to unload ready-to-mail envelopes at the other end.

Modular design concept permits custom configurations for virtually any application. Systems can be equipped for multiple insertions, electronic scanning, document verification and selective collating. Modular output arrangements can include single or dual mailing machines, code-triggered exception sorting and stacking, high-volume power stacking and zip-code edge marking or deflection. In short, everything required to speed mailings out faster so that cash and orders can flow in faster. For complete details, return coupon to Pitney Bowes, 2199

Pacific Street, Stamford, CT 06926. Or call toll free anytime (except Alaska and Hawaii) 800-621-5199 (in Illinois 800-972-5855).

I'd like complete facts on the Pitney Bowes Computer Output Mailing System.

Name \_\_\_\_\_  
 Title \_\_\_\_\_  
 Company \_\_\_\_\_  
 Address \_\_\_\_\_  
 City, State, Zip \_\_\_\_\_

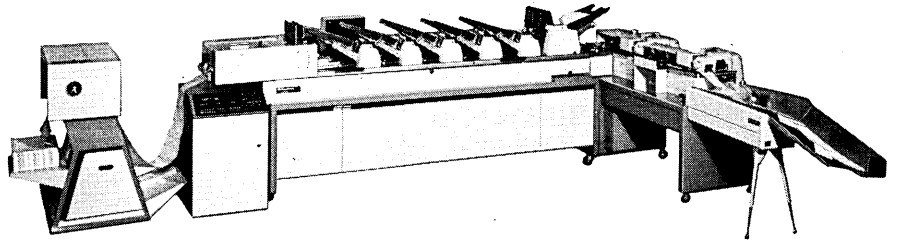

 **Pitney Bowes**

Over 600 sales and service points throughout the U.S.A. and Canada. Postage Meters, Copiers, Mailing, Dictating, Labeling, Price Marking and Word Processing Systems, Business Forms and Office Supplies.

CIRCLE 76 ON READER CARD

# "We never gained the respect of the rest of the corporation. We are like the people who work in the cafeteria."

so I ended up getting canned. I wasn't smart enough to realize that I wasn't an exception. The corporate world goes on in spite of people like me.

"But there was a time, a long, long time ago, when I ran down every error with the idea, 'Man, I can stomp 'em out. I can make it perfect.' But you can't. It's impossible—just like getting the perfect tune-up on your car. It doesn't last very long.

"You lose your idealism. You stop beating your head against the wall. Instead of

saying, 'I want to get this fixed tonight,' you say, 'Oh, the hell with it. I'll solve this problem tomorrow. If I don't have this one, I'll just have another one.' You get to the point where you don't care anymore. But, it does matter. People do a better job if they care."

An operations manager insists, "My job is the worst. Three or four mornings a week you come into work and find out the night shift screwed up. There's nothing in the world you can do about it. Even if you're there, they still screw up.

"If you've really got a disaster, no one's going to break your chops because they're afraid. They just say, 'Well, gee, see what you can do about it.' But when you have a good operation and an acceptable level of errors, people start breaking your chops because that's the name of the game."

Besides the tedium of the daily and yearly grind, dp'ers find the corporate attitude toward the dp function a contributing factor to discontent.

One man says, "At one time dp was

## PERSONNEL TRENDS: A LOOK AT THE INSURANCE INDUSTRY

Burnout and turnover in the dp industry are often attributed to the quirky, peripatetic nature of technical people, and to the fact that the industry has not yet found its niche. Because of such "understandable" industry characteristics, many firms have come to regard a certain amount of employee disgruntlement and turnover as normal.

Some executives, however, see these difficulties as symptoms of management failures, exacerbated by the often isolated nature of the dp operation, the industry's rapid growth, and the shortage of personnel. They argue that "people problems" are solvable. DATAMATION recently talked to Thomas Bigelow of Allstate Insurance, who for two consecutive years has conducted a personnel survey of the insurance industry for the GUIDE/LOMA groups. Here-with some of his findings:

- There has been a change in the nature of dp recruiting. While over one-third of all respondents make special efforts to attract computer science majors; there is a significant reduction in their performance evaluations after one year on the job when compared with recruits from other sources. Computer science majors display only slightly better language familiarity and often have low understanding of business data processing and systems design.

Dissatisfaction is particularly evident among larger companies, which are increasingly looking to agencies and internal transfers—and away from colleges—for new employees. Agency recruited candidates often have desired business and dp experience; internal transfers bring both relevant business knowledge and company loyalty. Turnover among the latter group, once retrained, is very low.

- Ranking of the major sources for job candidates in 1980:

1. Agencies
2. Transfer
3. College Recruiting
4. Referrals
5. Newspapers
6. Walk-ins

The 1979 ranking was the same ex-

cept for college recruiting, which has dropped from first to third. Three firms reported using walk-ins as their major candidate source.

- Seventy-four percent of the survey respondents have in-house training staff and regularly scheduled dp classes, which may lessen their need to attract college-trained candidates. Companies are apparently shifting their efforts toward finding a sharp person and training him/her to suit their needs. "This development," says Bigelow, "is both a question of supply and of the relative effectiveness of the successful new staff member." Over half of all surveyed firms are teaching on-site COBOL, systems design, assembler, and CICS classes, and nearly a third teach IMS and PL/I. There is likewise a marked trend toward longer and more comprehensive programming classes.

- Turnover at insurance companies has averaged about 20% a year for systems staff—somewhat below the all-industry average. Nevertheless, several firms reported more than 40% turnover in applications programmers. While salary is the most frequently cited cause for leaving a firm, 27% of survey respondents listed job challenge ahead of salary. One-third of all returns ranked salary and challenge as the two most critical factors. The most important reasons for turnover were, in order:

1. Salary
2. Challenge
3. Location
4. Technical Training
5. Pressure
6. Benefits

This order has not changed in the last year, and staff size apparently has no bearing on turnover rate. The survey also showed that programs enacted to reduce turnover have become more comprehensive, less gimmicky, and now tend to address job challenge directly. Included among efforts to combat turnover are rotational programs, career planning, promotional acceleration, seminars, and professional meetings.

- Turnover has contributed to the increased

use of outside resources to supplement staff at many firms. Consulting services, software houses, vendors, and accounting firms all contribute significantly to new or on-going company programs. "Growth in consulting firms and software companies can be seen as one response to the lack of opportunity many professionals experience in their company jobs," asserts Bigelow, "Yet as a company moves into a new technology, it also becomes a visible target for 'raiders' among these companies."

- Job challenge seems a particular failure in dp and a major cause of both burnout and turnover. "People want enriched jobs," says Bigelow, "yet both top management and dp executives have tended to confine their people to strictly technical roles. There are several types of people who enter the dp field, and the completely technically oriented types are actually only a small portion of the industry's professionals. Perhaps 20% responded to predictions years ago that this was a good area for future career opportunities. The true technical whizzes—those who thrive on designing compilers and the like—are an even smaller portion, perhaps 10%. The vast majority of dp professionals—and those whom the industry must seek out and nurture—are those who see dp as a tool to solve business problems. Such people have often been neglected." The challenge now is to integrate them with the rest of the company and to offer them increased job and career opportunities.

- "There appears to be no increase in systems people moving into top management. If a firm has a good person, they too frequently want to keep him where he is," Bigelow comments. "Yet information systems should logically be a window to see how an entire operation really works. Dp projects integrate many aspects of a company." The prevailing compartmentalization in many companies contributes to job dissatisfaction, low morale, turnover, and, ultimately, unhappiness with central dp operations. Broader use of dp personnel should reward both employee and employer.

—Janet Crane

# HOW ELECTRONIC PRINTING CAN KEEP YOUR COMPANY OUT OF RED INK.

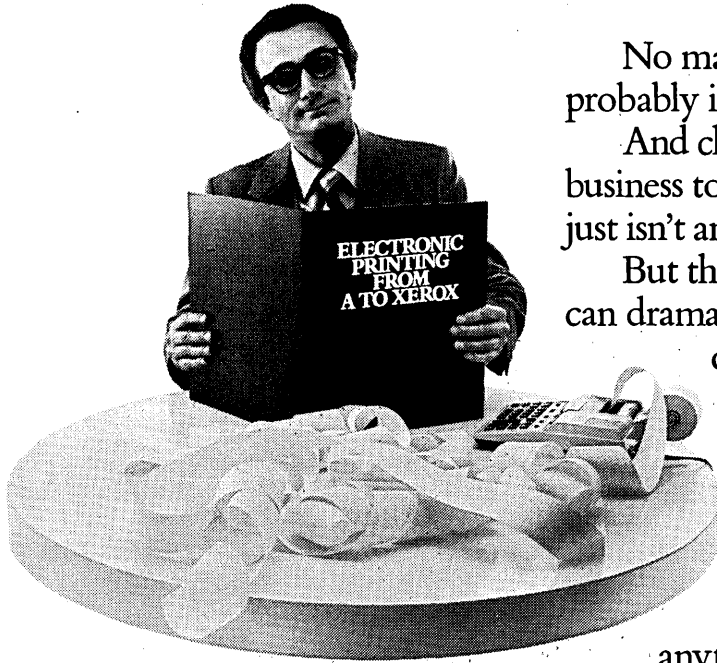

No matter what business you're in, you're probably in the printing business, too.

And chances are you're not finding it a profitable business to be in. Because conventional printing just isn't an efficient way to get the word out.

But the Xerox 9700 Electronic Printing System can dramatically lower your company's printing costs. And streamline the entire printing operation.

With our new software package, the printing process has never been easier. We call it the Xerox Integrated Composition System. Or XICS. And it will work with anything from a mini to a mainframe.

Now for the first time, you can speak to the 9700 in English. Not computer talk. The entire printing operation, which used to occupy a number of people with galleys, paste-up and so on, can now be quickly and easily done by one person. Turnaround time is greatly reduced. And revisions are easy.

The 9700 can print on demand an entire document from cover to cover, including the covers. It can create bar charts, graphs, company logos or even your own signature. And print them in a split second. It can change the way your company communicates. And it can do it right now.

If you'd like to know more about electronic printing, talk to the people who wrote the book on the subject. In fact, if you contact us, we'll send a Xerox representative to deliver the book:

*The Xerox Guide to In-House Printing and Publishing.*

Write to: Keith Davidson, Xerox Printing Systems Division, 880 Apollo Street, P1-60, El Segundo, California 90245.

You'll be very happy. And so will your accountant.

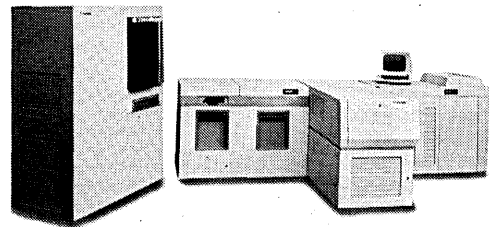

# "I didn't bother to play the corporate game, so I ended up getting canned. The corporate world goes on in spite of people like me."

the panacea, an important function within the corporation. It is, but it's still pretty much 'the grubby guys in the computer room.' We never gained the respect of the rest of the corporation. We're like the people who work in the cafeteria.

"In your typical 1,500-person corporate office in New York no one has an assembly line operation other than data processing. Here are these little projects you have to complete, and everyone else is planning programs or managing salespeople. You say to yourself, 'We tried to be accepted by the corporation but we weren't and who cares, anyway?' You throw up your hands and say, 'Well, I'm just working from paycheck to paycheck.'"

## THE BLUE AND THE WHITE

A systems analyst agrees. "We are blue collar workers in a white collar organization. We provide a service. We're the people who develop the programs to provide this service, and white collars look at it just that way. Now, in fact, the names of many systems are data services or information services.

"Most people, if they make good bucks, probably don't care much about this, unless they're trying for the top of the heap. Dp is not the way to the top—there's an obstacle. You can't get up there from here. You never have a direct link to the top, at least not in the companies I know."

A long-suffering manager adds, "There's a pyramid and that's it. Most people don't desire a corporate position because they like computers. So you reach a point where you're not going to advance—maybe there's only one job ahead of you and that job is political because you have to go to a lot of dumb meetings and answer a lot of stupid questions. People still basically put dper against the wall and throw darts at them.

"As hard as you try, you're never going to be perfect. After you've had to face all these unreasonable bastards for 15 years, you get tired of it."

A consultant who sees burnout as "A major problem—major, major, major!" lists some of the symptoms he sees in his travels. "They take longer lunches. They make up excuses for why they don't have to come to work. They think more evil thoughts about their employers. When they get up in the morning and brush their teeth, they're not enthusiastic about going to the office.

"It's probably a function of an individual's personality whether or not he lets his private life become affected. A lot of people let their jobs get to them."

When people do burn out, their usual recourse is to change jobs. The consultant continues, "Everyone loses when someone leaves a job and goes to work for someone

## ARE YOU BURNING OUT?

Review the past six months. Have you been noticing changes in yourself or in the world around you? Think of the office . . . the family . . . social situations. Allow about 30 seconds for each answer. Then assign it a number from 1 (little or no change) to 5 (for a great deal of change) to designate the degree of change you perceive.

1. Do you tire more easily? Feel fatigued rather than energetic?
2. Are people annoying you by telling you, "You don't look so good lately"?
3. Are you working harder and harder and accomplishing less and less?
4. Are you increasingly cynical and disenchanted?
5. Are you often invaded by a sadness you can't explain?
6. Are you forgetting (appointments, deadlines, personal possessions)?
7. Are you increasingly irritable? More short-tempered? More disappointed in the people around you?
8. Are you seeing close friends and family members less frequently?
9. Are you too busy to do even routine things like make phone calls or read reports or send out your Christmas cards?
10. Are you suffering from physical complaints (aches, pains, headaches, a lingering cold)?

11. Do you feel disoriented when the activity of the day comes to a halt?

12. Is joy elusive?

13. Are you unable to laugh at a joke about yourself?

14. Does sex seem like more trouble than it's worth?

15. Do you have very little to say to people?

Very roughly, now, place yourself on the Burnout Scale. Keep in mind that this is merely an approximation of where you are, useful as a guide on your way to a more satisfying life. Don't let a high total alarm you, but pay attention to it. Burnout is reversible, no matter how far along it is. The higher number signifies that the sooner you start being kinder to yourself, the better.

## The Burnout Scale

0-25: You're doing fine.

26-35: There are things you should be watching.

36-50: You're a candidate.

51-60: You are burning out.

Over 65: You're threatening your physical and mental well-being.

From the book *Burnout* by Herbert J. Freudenberger, PhD. Copyright 1980 by J. J. Freudenberger. Published by Doubleday & Co., Inc., New York.



CARTOON BY JACK E. SCHNEIDER

©DATAMATION

else. The customers are saddled with less experienced personnel and the employer loses a perfectly good worker only because he didn't take into consideration any career planning. That happens all over. It's also a function of the economy. When it's an up market, and there are many jobs available, people will leave. When it's a down market, and it's tough to find a job, people stay and become bored blobs who don't give a damn. Their productivity falls."

A manager says, "Not many people leave the industry to do something completely different, though. If they go into sales, they'll usually go into dp sales."

"But I do know one dp burnout who went to Florida and opened up a sing-along family bar where they don't sell liquor. They say he's happy as a clam down there."

## HOW TO PREVENT BURNOUT

What can be done to prevent burnout? There were a few obvious suggestions. One programmer says hopefully, "The super-programmers now have terminals in their homes, so if there's a big systems problem, they don't even have to come in to work, they can just look at it on their terminals."

Also suggested was the use of rotating assignments to keep people challenged.

Our consultant friend suggests, "To prevent burnout, all the programming managers should recognize that they have the use of people for a certain period of time. They have to consider themselves as college football coaches. They have these people for three or four years and then they're going to move on. They should then schedule their operation in such a way that they move their people in and out of different assignments. People will not stay on one assignment forever. They should say, 'We'd like you to have this assignment for two years, and after a year and a half you're going to train your successor, then you are going to move into another area.' They should keep the technical staff in constant motion. You could also have flexible work hours, opportunities to go for more education, in-house training and external classes."

"A lot of people leave their jobs to become contract programmers. While they will tell you they became contract programmers because the money's better, the real reason is that they are independent. They can work for six months and take off for six months. They decide when they want to come back to work. That kind of freedom draws many people out of these major programming shops once they start getting bored."

"The best way to prevent burnout may be to work for a progressive company that recognizes that people are the most important asset, and nurtures and challenges and rewards this asset."

Finding a company that "progressive" may be nearly impossible, although CBS *Morning News* recently ran a story on a former computer programmer who became a Trappist monk in a South Carolina abbey. \*

Merrill Cherlin is a freelance writer who lives in Baltimore, Md.

# He's suffering from a Heart Attack, but he may die from ignorance



Because the people around him have no idea what to do. And, because they don't, he may die. Needlessly.

If you don't know how to help a heart attack victim, it's time you learned.

If you discover someone who has collapsed, chances are you can save him if you know CPR (cardiopulmonary resuscitation). CPR will teach you how to tell whether his heart has stopped, or whether he has just fainted. If his heart has stopped, you'll know how to keep him alive until medical help arrives, with mouth-to-mouth ventilation and closed chest cardiac compression. CPR has to be learned. Contact your local American Heart Association for information on CPR training in your area.

If you don't know CPR, the only thing you can do is call the emergency medical service as fast as you can. Because if his heart isn't beating, he'll be past any kind of help in six minutes.

So remember what we've told you. Take the time to learn CPR.

Ignorance is a terrible reason to die.

The American Heart Association   
**WE'RE FIGHTING FOR YOUR LIFE**

# COMPUTERS IN COMMUNICATIONS: A RATINGS SURVEY

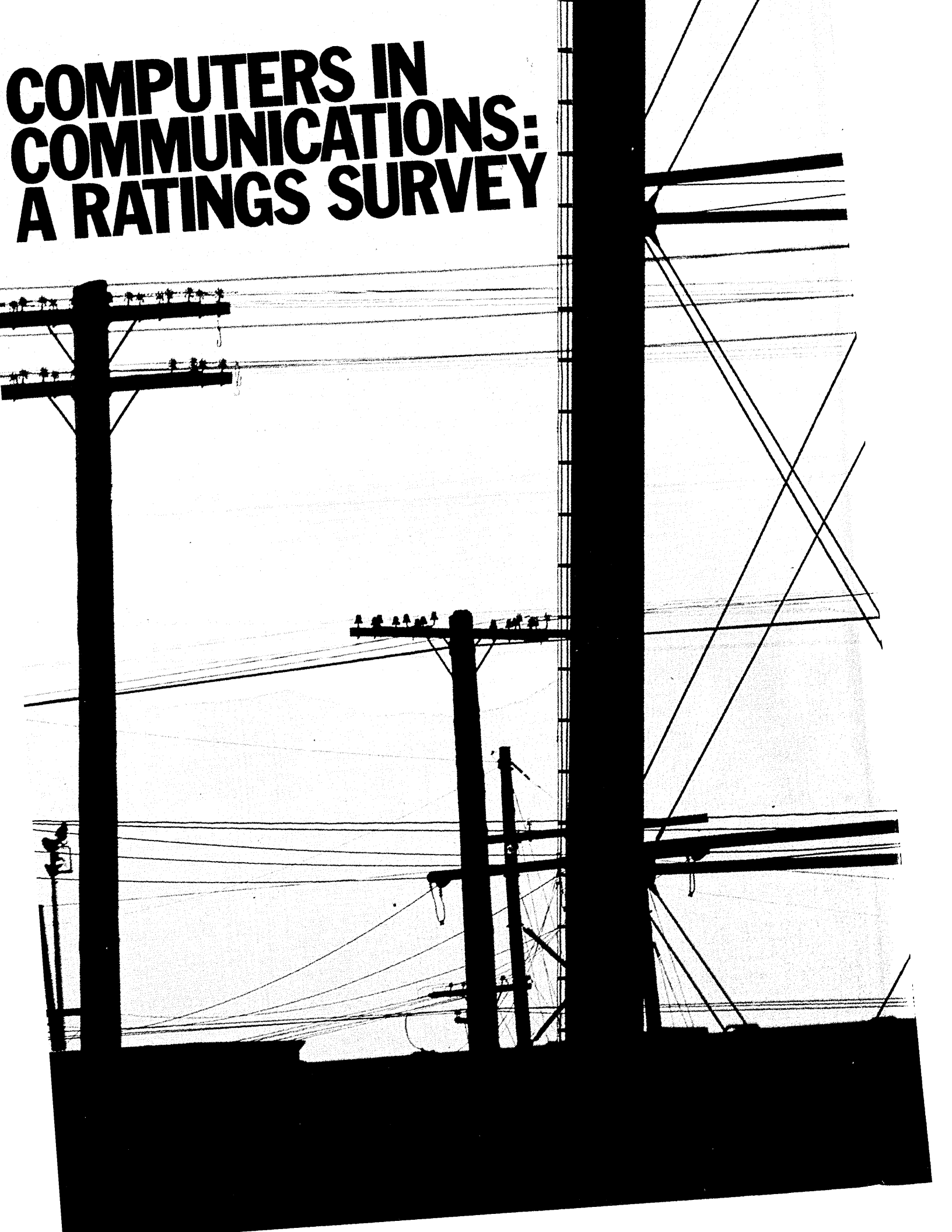

## Users give their opinions on features, functions, and performance of 23 computer system groups.

This report presents the results of a nationwide survey of users known to have specific computer systems installed in a data communications environment. This survey, designed by Data Decisions, employed a probability sampling of all systems known to be installed in a communications environment. A sister company of Data Decisions provided the total installed base from which the statistical samplings were made. Considerable efforts were made to complete interviews with members of the survey sample, in order to obtain greater assurance of representativeness than could be obtained from a broad-brush, nonstatistical approach.

The known installed base was divided into 24 model/family groups. The divisions were made to group similar systems and to provide an adequate base for sampling for each group. A total of 3,722 known users at 3,537 sites comprised the statistical sample. These users were asked to rate the specified computer system with respect to features, functions, and performance criteria. Special care was taken in developing the ratings scales used. To aid precision and ensure that the users had a complete understanding of the different ratings, verbal as well as numeric values were used. The use of a 10-point scale from "Superior" to "Inadequate" provided a broad spectrum of possible options that allowed the users to fine tune their responses. Additional questions explored usage patterns.

A total of 1,611 questionnaires were completed, including 320 telephone interviews, from 1,525 sites for a net response of 44%. Of the returned questionnaires, 1,256 addressed 23 of the identified computer model/family groups and gave ratings and usage patterns. (One model was dropped from the survey because the response level was insufficient.)

### TYPICAL SYSTEMS

The 23 computer system groups were divided into small, medium, and large systems, based on estimated performance. Presented below are the values that tend to characterize the groups. (See the vendor mix for the contribution of each vendor to the averages. See the ratings bar charts for the values for each member of each class.)

|   | Class Averages |        |       |
|---|----------------|--------|-------|
|   | Small          | Medium | Large |
| Age, months                                       | 28.3           | 25.3   | 25.1  |
| No. of local terminals                            | 13.4           | 22.7   | 38.5  |
| No. of remote terminals                           | 11.4           | 32.2   | 51.0  |
| Typical no. of terminals operating simultaneously | 14.1           | 33.7   | 49.6  |
| % Site dp   | 79.0%          | 72.9%  | 70.3% |
| % Cost  | 28.4%          | 26.7%  | 27.0% |

# CINCOM REDEFINES THE DATA DICTIONARY CONCEPT

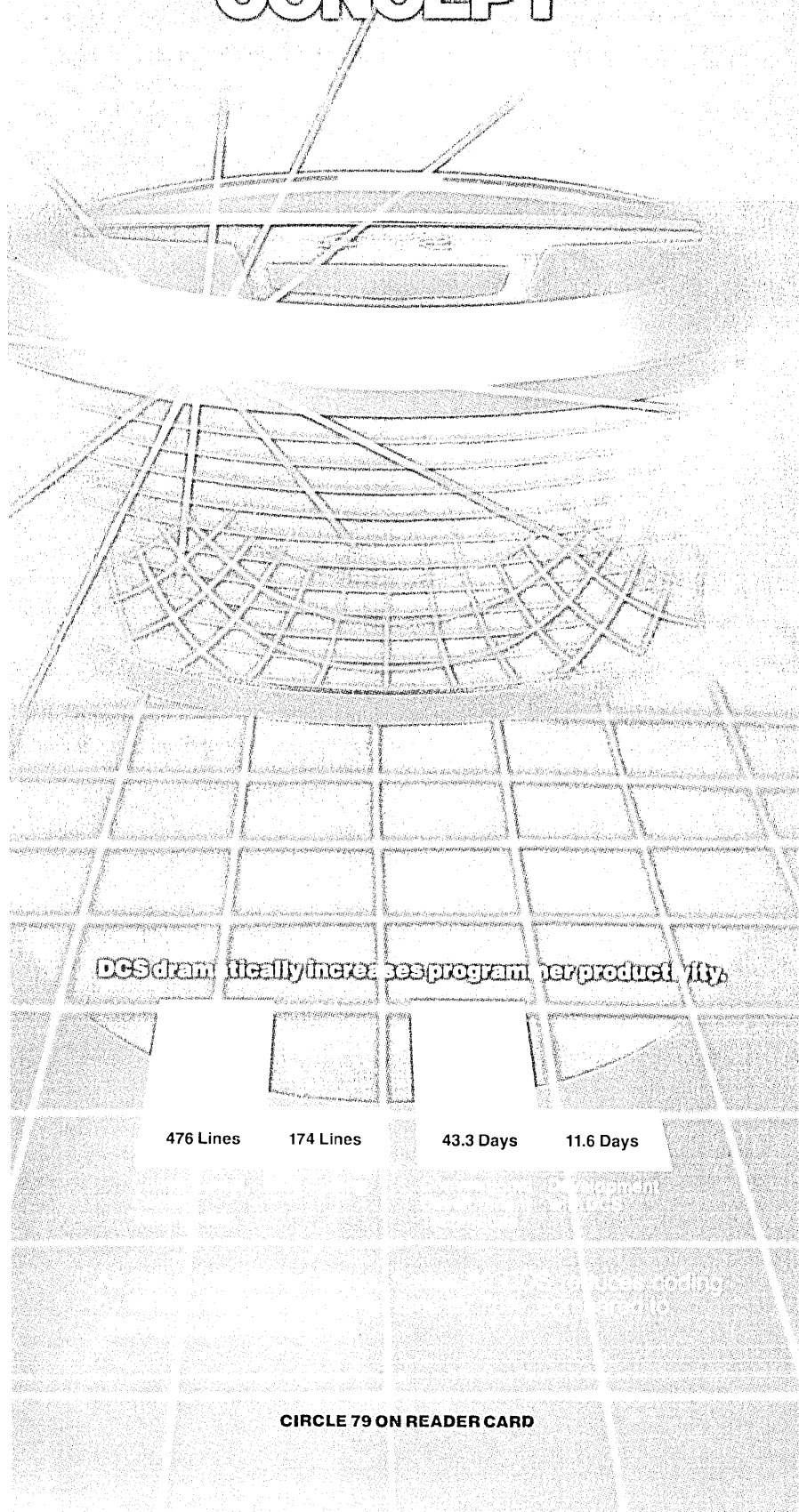

DCS dramatically increases programmer productivity.

476 Lines

174 Lines

43.3 Days

11.6 Days

Development  
with DCS

Development  
without DCS

CIRCLE 79 ON READER CARD

## Introducing Series 80 Data Control System The dawn of a new technology.

Cincom Systems moves computer technology out of the maintenance mode and into the planning mode—with Series 80 DATA CONTROL SYSTEM. DCS is the first interactive online data dictionary that reduces initialization effort, reduces system development, and maximizes database security. And that's the future of data control technology.

This new technology offers a unique combination of facilities, all in one powerful system:

- o **The Interactive Data Dictionary**—provides online data entry, query and reporting, to reduce initialization effort by 40% and eliminate massive tabular reports.
- o **The Systems Development Facility**—eliminates 60% of the programming normally required for database applications through a new automatic code generation facility. And using sophisticated structured analysis and top-down design methodologies, DCS users can reduce development and documentation of complex systems by one-third.
- o **The Data Security System**—maximizes database security at the file and element level through advanced password control.

Unprecedented control. Advanced application design. Integrity. Maximum security. A new technology for today. A standard for tomorrow. That's Series 80 DATA CONTROL SYSTEM.

For an in-depth demonstration of Series 80 DCS, contact our Marketing Services Dept. You'll make DCS your standard of the future.

User Information Hotline:  
800-549-3010  
In Ohio: 513-661-6000

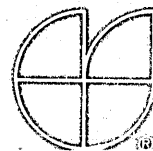

Cincom Systems, Inc.  
2600 Montara Avenue  
Cincinnati, Ohio 45211



# SURVEY OF COMPUTERS IN COMMUNICATIONS

The % site dp entry refers to the portion of the total site performed by the system reported on. The % cost entry refers to the portion of the total computer cost represented by data communications.

The average installation time (age) is comparable for all three classes and indicates mature installations. The portion of the site data processing activities conducted by the subject computer systems was fairly constant among the three classes. The high value reported indicates that the responses reflect mainstream usage. The largest distinction among the three classes was in the number of terminals supported. As can be seen under current and future activities, there is not so much a distinction about what a computer system does or how it does it based on the size of the computer as there is for the amount of it that it does. The portion of systems cost devoted to communications activities does not vary all that much based on size of computer system, further supporting that view.

## Vendor mix

The influence on each class average by each vendor represented is presented below.

| Computer System   | Class Averages |        |       |
|-------------------|----------------|--------|-------|
|                   | Small          | Medium | Large |
| Groups in Class   | 7              | 6      | 10    |
| Amdahl            | 0%             | 0%     | 10%   |
| Burroughs         | 14             | 17     | 10    |
| Control Data      | 0              | 0      | 10    |
| Digital Equipment | 0              | 17     | 0     |
| Hewlett-Packard   | 14             | 0      | 0     |
| Honeywell         | 14             | 0      | 20    |
| IBM               | 43             | 33     | 30    |
| NAS (Itel)        | 0              | 0      | 10    |
| NCR               | 0              | 17     | 0     |
| Sperry Univac     | 14             | 17     | 10    |

## Systems represented

The 23 computer system models/families represented in this survey are presented below grouped by size class. Within each class, the systems are presented in descending order according to the average of the means for three ratings assigned by users for operations, applications, development, and training. (The operations rating is itself the average of the means of the ratings for four questions, as detailed in methodology.)

### Small Systems:

Class Average • 6.8.

8.1 • Hewlett-Packard HP 3000.

7.2 • IBM System 32/34/38.

6.9 • Burroughs B 1800/B 2800.

6.6 • Sperry Univac 90/30-40.

6.5 • Honeywell Series 60 Level 62/64.

6.0 • IBM System 3/Model 15D and IBM System/370 115/125.

### Medium Systems:

Class Average • 6.2.

7.0 • Digital Equipment DECSYSTEM 10/20.

6.5 • Burroughs B 3800/B 4800.

6.0 • IBM System/370 138/148 and IBM 4331.

5.9 • NCR 8000.

5.6 • Sperry Univac 90/60-70-80.

### Large Systems:

Class Average • 6.3

6.9 • Burroughs B 6800/B 7800.

6.7 • NAS (Itel).

6.5 • Amdahl 470V.

6.4 • Honeywell Series 60 DPS and Sperry Univac 1100.

6.3 • IBM 303X and IBM 4341.

6.1 • IBM System/370 158/168.

6.0 • Honeywell Series 60 Level 66/68.

5.4 • Control Data Cyber.

## Ratings

Users were asked to rate their system on a scale of 10 to 1 in several aspects. (To assist the users in determining a fair rating, verbal levels were assigned to the ratings. A rating of 10 to 9 was called Superior; a rating of 8 to 6 was called Very Good; a rating of 5 to 3 was called Acceptable; and a rating of 2 to 1 was called Inadequate.) The means of the ratings users assigned to each system are presented in the accompanying bar charts, along with numerical values for class averages. Below are presented the values for class averages.

|                     | Class Averages |        |       |
|---------------------|----------------|--------|-------|
|                     | Small          | Medium | Large |
| Operations          | 7.56           | 7.14   | 7.16  |
| Ease of app. devel. | 7.06           | 6.37   | 6.33  |
| Training            | 5.64           | 4.96   | 5.37  |
| Average             | 6.75           | 6.16   | 6.29  |

### means of ratings

There is a noticeable difference in the level of satisfaction expressed by users of small systems compared to users of medium and large scale systems as represented by the ratings assigned by users. The types of processing activities do not vary that much among the three classes (see current and future activities). However, the mix of activities and the volume of processing are higher for the medium and large scale systems, leading to more demanding use and probably more critical evaluation. There is a significant difference between medium scale and large scale systems for training. The explanation may be that the medium scale system users have not developed sophisticated staffs to handle system design considerations and they may therefore be more dependent on computer vendors.

## Difficulties

Users were asked to identify difficulties experienced for several aspects of data communications operations on their system. They were given verbal choices of Rarely/ Never, Occasionally, Often, and Very Often.

They were also given a choice of "Does Not Apply." The results are presented below as the sum of the Often and Very Often responses expressed as a percent of the users responding to each question.

|                          | Class Averages |        |       |
|--------------------------|----------------|--------|-------|
|                          | Small          | Medium | Large |
| Computer vendor software | 6%             | 8%     | 19%   |
| Independent software     | 9              | 11     | 18    |
| Hardware reliability     | 3              | 5      | 6     |
| Service                  | 7              | 8      | 13    |
| Communications lines     | 16             | 20     | 25    |

### % Often and Very Often

These figures tend to indicate relatively trouble-free performance among all three classes of computer systems. The slight decline in satisfaction within all categories going from small to large systems may be explained by more demanding usage. The entry for communications lines is not properly a characteristic of individual computer systems and is not reported in the bar chart section for individual systems. A correlation check indicated that there was little connection between the assessment for communications lines difficulties and the ratings for the computer systems. A relatively small percentage of users (typically 30% to 40%) reported on independent software; most indicated that the parameter did not apply. For this reason, this value was not reported for individual systems within the bar chart section.

## Current activities

Users were asked to identify specific activities that they currently support on the computer system reported on. Presented below are the results.

|                        | Class Averages |        |       |
|------------------------|----------------|--------|-------|
|                        | Small          | Medium | Large |
| Batch                  | 94%            | 93%    | 97%   |
| Interactive            | 87             | 86     | 92    |
| Database               | 53             | 66     | 78    |
| Timesharing            | 45             | 52     | 70    |
| Distributed processing | 31             | 38     | 41    |
| Transaction processing | 75             | 68     | 71    |

Specific definitions were given to each type of processing activity to standardize responses; these are given in the methodology section. The picture drawn by the figures above is clear. Batch and interactive processing are universal. Transaction processing is almost as pervasive. A surprisingly high percentage of users are using timesharing activities, probably mostly for program development, especially for the larger systems. Database activities are also strongly supported. Distributed processing is not so actively supported now, but see below for future plans.

## **SPERRY UNIVAC DEFINES COMPLETE MINICOMPUTER CAPABILITIES.**

We're Sperry Univac Mini-Computer Operations (MCO), the full-service mini-computer arm of Sperry Univac. And when it comes to minis, we offer complete support and complete capabilities.

Our powerful V77 minicomputer family is field-upgradable, cost-effective, and fully compatible with our complete line of systems software. And for distributed data processing, we provide interconnection schemes compatible with virtually all network architectures, including the SPERRY UNIVAC Distributed Communication Architecture (DCA), as well as public data networks (X.25 protocol).

Our OEM program is complete, too. Thanks to the Sperry Univac Software Application Network, our OEMs have access to field-proven vertical software packages that get them into the market quickly and inexpensively.

And once you get started, we're always there to back you up, with over 10,000 field engineers worldwide, servicing equipment whenever and wherever it needs attention.

If we sound like your kind of company, we'd like to tell you more about ourselves. So give us a call.

After all, there's no good excuse not to.

Contact Sperry Univac Mini-Computer Operations, Marketing Communications, 17900 Von Karman Avenue, Irvine, CA 92714.

Or call toll-free 800/854-7517 (8:00 a.m. to 4:30 p.m. PST). In California, call 714/557-9398 collect.

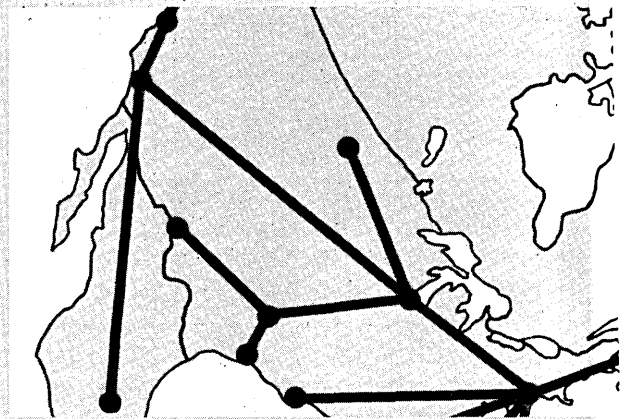
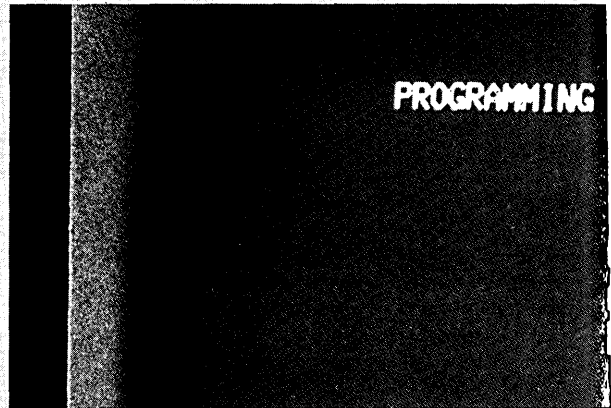
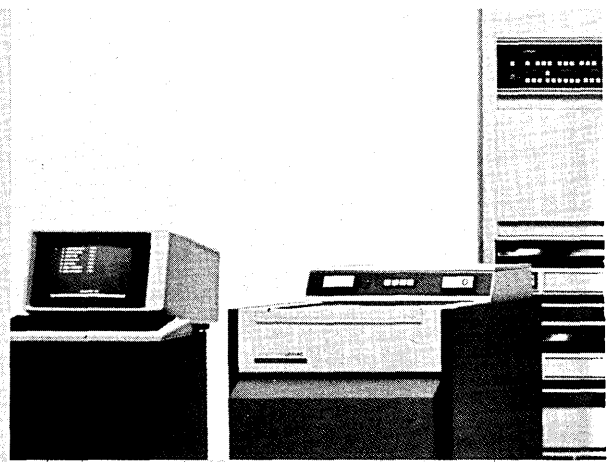

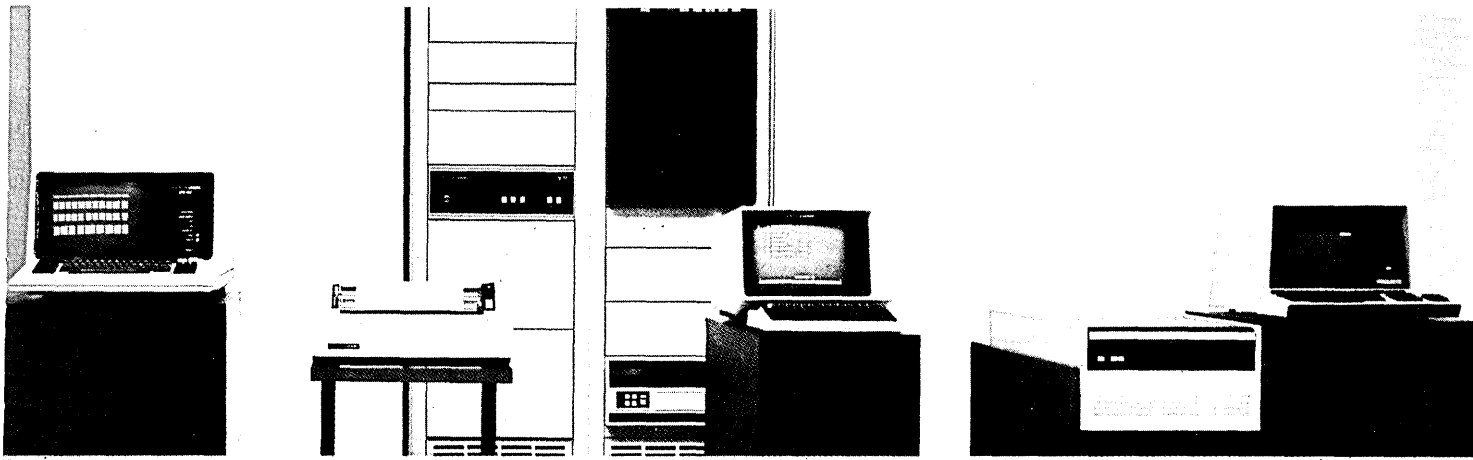

**LANGUAGES:**

FORTRAN  
ALGOL  
COBOL  
PASCAL  
C  
C++  
PL/I  
SPL  
SQL  
SIMULA  
SIMULINK  
LISP  
PROLOG  
RPL  
RPL/2  
RPL/3  
RPL/4  
RPL/5  
RPL/6  
RPL/7  
RPL/8  
RPL/9  
RPL/10  
RPL/11  
RPL/12  
RPL/13  
RPL/14  
RPL/15  
RPL/16  
RPL/17  
RPL/18  
RPL/19  
RPL/20  
RPL/21  
RPL/22  
RPL/23  
RPL/24  
RPL/25  
RPL/26  
RPL/27  
RPL/28  
RPL/29  
RPL/30  
RPL/31  
RPL/32  
RPL/33  
RPL/34  
RPL/35  
RPL/36  
RPL/37  
RPL/38  
RPL/39  
RPL/40  
RPL/41  
RPL/42  
RPL/43  
RPL/44  
RPL/45  
RPL/46  
RPL/47  
RPL/48  
RPL/49  
RPL/50  
RPL/51  
RPL/52  
RPL/53  
RPL/54  
RPL/55  
RPL/56  
RPL/57  
RPL/58  
RPL/59  
RPL/60  
RPL/61  
RPL/62  
RPL/63  
RPL/64  
RPL/65  
RPL/66  
RPL/67  
RPL/68  
RPL/69  
RPL/70  
RPL/71  
RPL/72  
RPL/73  
RPL/74  
RPL/75  
RPL/76  
RPL/77  
RPL/78  
RPL/79  
RPL/80  
RPL/81  
RPL/82  
RPL/83  
RPL/84  
RPL/85  
RPL/86  
RPL/87  
RPL/88  
RPL/89  
RPL/90  
RPL/91  
RPL/92  
RPL/93  
RPL/94  
RPL/95  
RPL/96  
RPL/97  
RPL/98  
RPL/99  
RPL/100

**APPLICATION SOFTWARE:**

HOTEL MANAGEMENT  
MANUFACTURING MANAGEMENT  
RETAIL INVENTORY CONTROL  
DISTRIBUTION AND WAREHOUSING

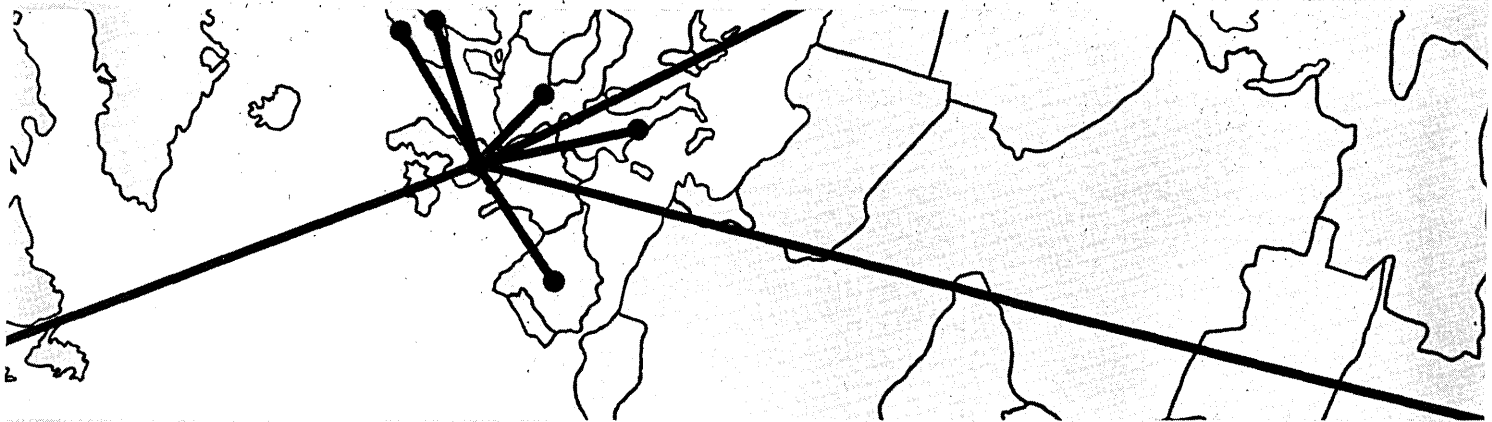

**SPEERRY  UNIVAC**  
*The Computer People Who Listen.*

**CIRCLE 80 ON READER CARD**

# SURVEY OF COMPUTERS IN COMMUNICATIONS

## Future activities (24 months)

Users were also asked to identify which of the specific activities they planned to support within the next 24 months. The results are presented below as the sum of those users currently supporting plus those planning to support particular activities within the next 24 months, indicating in effect the total level of support 24 months from now.

|                        | Class Averages |        |       |
|------------------------|----------------|--------|-------|
|                        | Small          | Medium | Large |
| Batch                  | 96%            | 95%    | 97%   |
| Interactive            | 95             | 93     | 96    |
| Database               | 71             | 83     | 90    |
| Timesharing            | 49             | 59     | 75    |
| Distributed processing | 48             | 60     | 67    |
| Transaction processing | 86             | 77     | 85    |

As could be expected, given the almost universal current support for batch and interactive processing (see current plans), there was little increase of support for these activities. Database and distributed processing activities show substantial growth, however. There was virtually no growth indicated for timesharing and a modest growth indicated for transaction processing.

## Terminal Activities

Along with the data processing activities and plans, we requested the users to identify activities for local and remote terminals attached to the subject computer (attached terminals) and for terminals "belonging" to another computer system (other terminals). The results for each system are presented in the accompanying bar charts along with numerical values for the class averages. Below is a breakout of those activities by class.

|  | Class Averages |        |       |
|--|----------------|--------|-------|
|  | Small          | Medium | Large |
| <i>Current activities Attached terminals</i> |                |        |       |
| Remote databases                             | 32%            | 32%    | 38%   |
| Remote applications                          | 25             | 29     | 31    |
| Transfer programs                            | 17             | 24     | 23    |
| <i>Other terminals</i>                       |                |        |       |
| Local databases                              | 26             | 35     | 35    |
| Local applications                           | 29             | 33     | 41    |
| Program download                             | 12             | 17     | 18    |

*Activities planned within 24 months Attached terminals*

|                        | Small | Medium | Large |
|------------------------|-------|--------|-------|
| Remote databases       | 52%   | 52%    | 62%   |
| Remote applications    | 41    | 42     | 50    |
| Transfer programs      | 34    | 38     | 44    |
| <i>Other terminals</i> |       |        |       |
| Local databases        | 44    | 53     | 62    |
| Local applications     | 43    | 49     | 62    |
| Program download       | 29    | 31     | 37    |

**% of users supporting now and within 24 months**

These figures serve to indicate the relative emphasis given by users to the principal activities within a distributed processing environment and indicate a high level of "distributed" functions in use, with even more utilization planned for the future.

## OPERATING CHARACTERISTICS

Users were asked to identify various operating characteristics of the computer system reported on. The results are presented below.

|                    | Class Averages |        |       |
|--------------------|----------------|--------|-------|
|                    | Small          | Medium | Large |
| <i>Speeds</i>      |                |        |       |
| 10-300 bps         | 17%            | 31%    | 50%   |
| 600-2400           | 54             | 60     | 68    |
| 4800               | 47             | 58     | 70    |
| 9600               | 40             | 53     | 69    |
| 56K                | 2              | 2      | 8     |
| Other              | 3              | 6      | 6     |
| <i>Codes</i>       |                |        |       |
| ASCII              | 51%            | 62%    | 71%   |
| EBCDIC             | 59             | 58     | 61    |
| APL                | 1              | 4      | 10    |
| Other              | 1              | 3      | 5     |
| <i>Protocols</i>   |                |        |       |
| Async              | 41%            | 60%    | 69%   |
| Bisync             | 54             | 55     | 66    |
| Other sync         | 21             | 24     | 32    |
| SDLC               | 10             | 8      | 17    |
| Other bit-oriented | 1              | 1      | 1     |
| Other              | 2              | 4      | 3     |
| <i>Lines</i>       |                |        |       |
| Leased voice       | 51%            | 56%    | 70%   |
| Leased high speed  | 37             | 43     | 54    |
| DDD                | 36             | 52     | 62    |
| DDS (digital)      | 7              | 10     | 16    |
| Other digital      | 1              | 1      | 1     |
| Packet switched    | 1              | 5      | 8     |
| Privately built    | 6              | 16     | 16    |
| Other              | 4              | 7      | 9     |

The results indicate that up to 9600 bps is commonplace; higher speeds are not yet in common usage. One interpretation of the figures among the three classes of com-



CARTOON BY HENRY R. MARTIN

THESE ARE THE QUESTIONS YOU SHOULD ASK YOURSELF

WHAT DATA SET  
IS BEING USED  
WHAT ARE YOU  
GOING TO DO  
ABOUT IT?

FIRST SECURITY BANK CORP.  
1000 WEST 1000 SOUTH  
SALT LAKE CITY, UT 84119  
801-464-1000

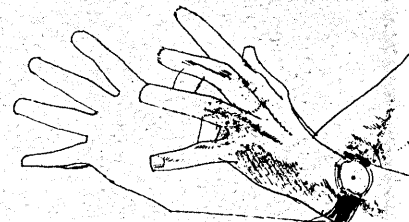

Datasets *are* exploding! The space requirements in most data centers have doubled in the last three years.

What's causing this dataset explosion? The online boom, for one. More users with more access automatically equals more datasets created. The application expansion, for another. Plus business' continually increasing dependence on Data Processing.

Two things are sure: the explosion is here . . . and there's no slackening in sight. We don't need to tell you what this means. You know that your data storage needs are going through the roof. And that Dataset Management has become one of your most pressing problems.

There is one company — UCC — that can help you do something about the dataset explosion. We offer a complete line of Dataset Management software that works together to manage your datasets — their creation, usage, storage and retention (or disposal) — whether they're on disk, tape or MSS.

For further information about UCC's unique Dataset Management software call us toll-free at 1 (800) 527-5012 (in Texas: 214-353-7312) or circle 81

- The UCC-1 Tape Management System
- The UCC-3 Disk Management System
- The UCC-6 PDS Space Management System

“ Online is what we're all about. We serve the equivalent of 150 branches in two states, a teller terminal system that was totally propagated in the last 18 months, plus 22 ATM's installed with an anticipated growth to 70.

As a result, we've experienced dynamic disk growth. We use up the cycles of a 158 every nine months with increased online volume. Tape isn't a dead issue, however, and never will be. We don't see MSS in our future, though, since our growth area is online.

The UCC-1 Tape Management System and UCC-3 Disk Management System are critical to our dataset management set-up. They work well by themselves but, more important, they work exceptionally well together. We have control of each and every dataset — from the time it is built, until it is archived or scratched.

UCC-3 controls our production datasets on disk; UCC-1 controls dataset retention. As a bonus, UCC-3 paid for itself its very first day on the job, when it freed up \$25,000 in disk space. We use it 24 hours a day, 7 days a week to maintain and monitor all of our dataset activity. We review the reports daily, because we can't afford to run out of space in our online environment. The system's scratching/migration capability and parameters allow us to effectively police space usage.

We haven't lost a dataset yet. And, with UCC-1 and UCC-3, we won't.”

**Mark Day**

Ass't Vice President/Operations  
First Security Bank Corp.  
Salt Lake City, Utah



“Our operating philosophy is to maximize efficiency by automating the data center. Effective dataset management has played a key role in achieving our objective.

To do this, we've expanded our disk space by a factor of 5 or 6 over the past three years . . . while reducing our tape library from 15,000 to 5,000 volumes. We're now operating sixty-four 3350 disk spindles and 20 tape drives.

We're running over 30,000 batch jobs per month, plus providing all of our online needs. And we're doing it with a total of 48 computer services people.

The UCC-1 Tape Management System and UCC-3 Disk Management System have proved indispensable in our drive for efficiency. Where we had three tape librarians and three operators supporting the tape function on each shift, we now have no librarians and only part of one person's time is spent dealing with tape support. There's no set-up on any job — the operators work directly out of the tape library.

We've got 100% protection of datasets, which is fundamental. Once you accept the idea that datasets should be on the least costly storage media consistent with their need to be accessed, most disk data sets can migrate to tape soon after creation — allowing frequent reuse of the same disk space.

By automating dataset management, we've been able to make giant strides in automating the data center.

To be frank, we couldn't run the place without UCC-1 and UCC-3 . . . or substantially increasing the staff.”

**Alfred G. Carter, Jr.**  
Vice President/Data Processing  
Girard Bank  
Philadelphia, Pennsylvania

“Our software philosophy is very simple: solve the problem for less than the problem is costing you. We were faced with an astronomical growth of datasets as we converted to an online environment, continually expanded applications, and enjoyed a strong business trend. Our disk storage needs literally exploded.

Our solution was three-fold: First, we increased our storage capacity by installing MSS. Second, we assigned storage responsibility to the most logical medium — online datasets to disk, non-online datasets to MSS, with tape used only where it was most practical or necessary. And, third, we installed the most efficient and effective dataset management software we could lay our hands on — the UCC-3 Disk Management System, UCC-6 PDS Space Management System and the UCC-1 Tape Management System.

This software puts you in control of the dataset management problem, and keeps you there. With MSS, we couldn't have gotten off first base without UCC-3 and UCC-6. And, as for UCC-1, I wouldn't work in a shop that doesn't have it.”

**Raymond O. Gibson**  
Director of Data Processing Operations  
Western Regional Center  
American Express Co., Card Division  
Phoenix, Arizona

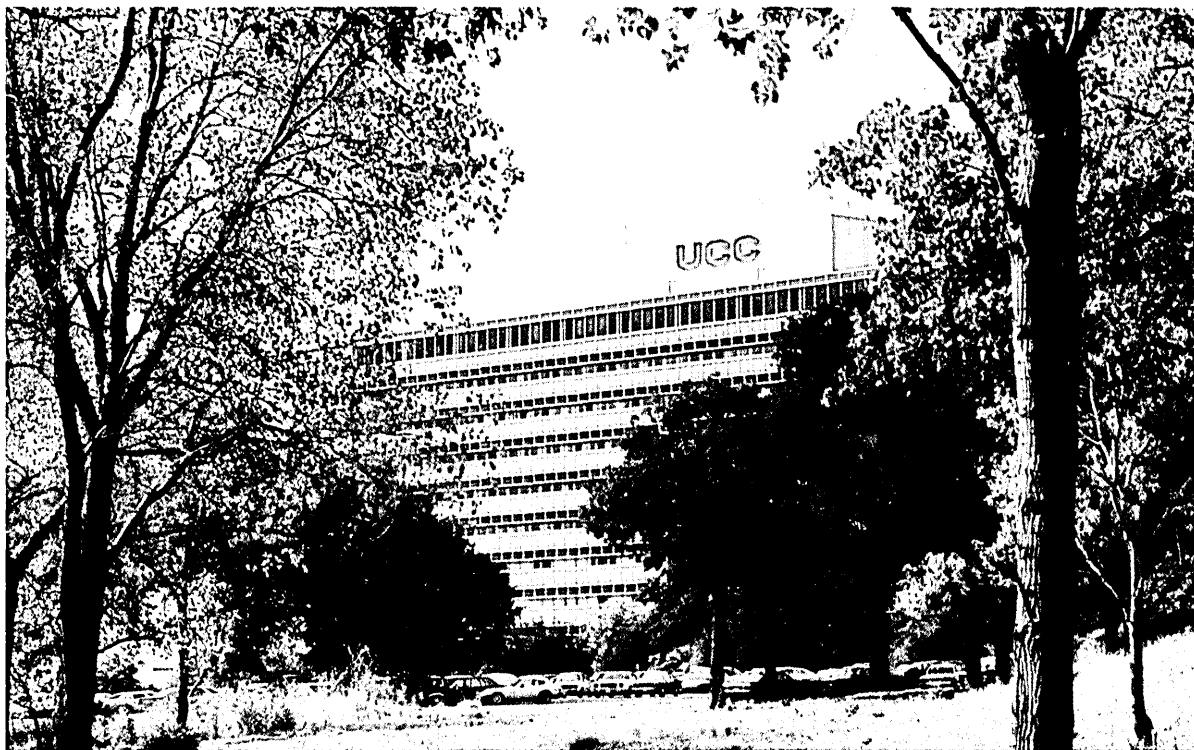

UCC's job is to look ahead . . . to anticipate the problems of the data processing industry. And be ready with the solutions . . . when they are needed.

That's how our Software Division got to be one of the largest independent software vendors in the U.S.

That's how our Computing Services Division got to be a leading processor of scientific and engineering data.

That's how our newest Division, Digital Systems, got to be the #1 supplier of

turnkey systems to the CPA market and a leading distributor of computing equipment and supplies through Computer & Terminal Exchange.

And overseas, that's how UCC became the most comprehensive computing services network in Europe.

We've been solving DP problems with software and services since 1963. Our solutions for the '80's are ready . . . and we're working to solve the problems of the future.

## UNIVERSITY COMPUTING COMPANY

SOFTWARE COMPUTING SERVICES TURNKEY SYSTEMS

DALLAS PENSACOLA TORONTO LONDON ZURICH



puter systems is that the medium and large scale systems tend to employ more variety of speeds within each system.

ASCII and EBCDIC dominate among data communications codes. Synchronous transmission leads asynchronous transmission in usage among all classes of computer systems. This tends to agree with the speed results above.

The large usage of high speed leased lines reported is surprising. We suspect that the substantial level of 4800 and 9600 bps usage reported (which is frequently referred to as high speed among terminal and modem vendors) may have led users to misinterpret the classical division of communications lines; without further information, we would not construe these results to indicate substantial usage of wideband facilities. However, for large scale systems, with their support of a large number of terminals (and lines, we presume) high speed facilities may be being used to support multiple medium speed channels over a single high speed facility.

## COMPUTER SYSTEM RATINGS AND USAGE

The accompanying bar graphs present the results for each of the 23 computer model/family groups, arranged alphabetically within small, medium, and large classifications. Numerical values for the class averages for each of the three classes are presented along with the stub entries in the left column for easier comparisons. The values for computer system model/families groups are presented graphically in the adjoining columns. The meaning of each question is clarified in the legend at the bottom of each page and detailed in the methodology section.

## METHODOLOGY

### Universe and sample

Because the primary focus of this study is on user perception of specific computer system groups in a data communications environment, the sample was selected from a universe of installations, with communications capability, identified as using each computer system.

The 24 groups were assembled from the available list of makes and models to combine similar systems and to provide an adequate universe for each group to be sampled.

For those groups used by more than 250 installations, a sample of 250 sites was selected on an every nth basis. For those computer system groups represented by 250 or fewer installations, an effort was made to collect data from all known users of the computer systems.

### Mailing and responses

In total, 3,722 questionnaires were sent to identified users of 24 different computer system groups at 3,537 different sites.

Questionnaires were addressed to a specific individual at the location, most often the data processing manager. Three weeks after the initial mailing, a follow-up mailing to nonresponders was made in an effort to maximize response to the survey. In order to increase the overall response rate and to ensure an adequate response base for each individual computer system, a randomly selected subsample of the 2,352 nonrespondents to the mail survey was contacted for telephone interviews. The subsampling fraction was varied across the computer system model/family groups, taking into account the rate of response to the mail study.

A total of 1,291 questionnaires from 1,214 sites was returned through the mail. A total of 320 telephone interviews were completed out of 353 attempts. The total number of survey responses was 1,611 responses from 1,525 sites. (A total of 79 questionnaires, addressed to 77 sites, was undeliverable by the post office.) The net response was 44%.

The questionnaire used in the telephone interview portion of the survey was essentially identical to that used in the mail survey, but with minor wording variations to accommodate oral communication. Comparison of completed telephone and mail interviews revealed that question response was not affected by change in interview method.

### Questionnaire

The questionnaire on which this report is based first qualified the respondent as a user of the specific computer system and determined that the system was used in a data communications environment. Then it explored various dimensions. Specific questions were asked about ratings, difficulties, current and planned system and terminal activities, and environment.

The ratings questions asked for the users' evaluations of the computer system on six characteristics relating to various system features, reliability, and vendor performance. The first four questions dealt with various aspects of operations including specifically: normal data communications operation (i.e., when all equipment and lines are working to specifications); reliability of network (i.e., up time); ease of recovery from line and equipment failures; and ease of using network protocol (i.e., procedures for log on, accessing applications program, accessing database, transferring data files, etc.). The ratings given for these four questions were averaged to produce a single operations rating for presentation purposes. The other questions were ease of development of communications-oriented applications programs and training/instruction support from computer vendor for communications activities. A 10-point scale was used in all ratings questions. To aid precision, verbal guides as well as numerical val-

ues were given: 10 and 9 were identified as "superior"; 8, 7, and 6 as "very good"; 5, 4, and 3 as "acceptable"; and 2 and 1 as "inadequate."

The difficulties series included five questions: communications software from your computer system vendor; communications software from an independent vendor; communications hardware reliability; computer vendor service/maintenance for communications equipment; and reliability of communications lines. The users were asked to identify the frequency with which users experienced problems via a four-level verbal scale giving users choices of "rarely/never, occasionally, often, and very often."

The current and planned system and terminal activities series asked the users to identify current support and support planned within 24 months for data processing (six activities), terminals attached to your computer system (four activities), and terminals attached to another computer system (three activities). Specific definitions were given for each activity. Under data processing, the activities were batch processing (i.e., large volume file/report oriented); interactive processing (i.e., direct user interaction with applications programs via display/keyboard or other workstation); database processing (i.e., inquiry and/or data-relating oriented); time-sharing (i.e., multiple user, application independent); distributed processing (i.e., independent processing and data storage at remote sites connected to your site); and transaction processing (i.e., chained input, processing, and file update). The attached terminals activities included: access to multiple applications programs on your computer system; access to database(s) and/or files stored on remote computer system(s); access to applications programs running on remote computer system(s); and transfer of programs from your system to a remote system for execution. Other terminal activities included: access applications programs running on your computer system; access database(s) and data files stored on your computer system; access program library on your system for download and execution of applications programs on remote system.

The environment question series asked about length of installation, number of local terminals connected, number of remote terminals connected, and typical number of terminals operating simultaneously. An additional series of questions asked about operating characteristics including speed, code, protocol, and type of communications facilities used.

### Findings

The findings presented in this report reflect user perceptions of computer system performance in a data communications environment in response to the particular dimen-

# SURVEY OF COMPUTERS IN COMMUNICATIONS

sions probed in the survey questionnaire. These are not intended to be all-inclusive, nor do they necessarily produce evaluations comparable to those which would be obtained under conditions of a controlled engineering test or experiment.

As in all sample surveys, the numbers reported are estimates within a range of what would have been obtained had all user sites in the survey universe been similarly enumerated. The margins of sampling variation or "tolerances" applicable to ratings of individual aspects of computer system performance are given in the accompanying table.

## Average Tolerances for Specific Attribute Ratings (68% Confidence Level)

| Sample size | Rating Level |          |      |             |
|-------------|--------------|----------|------|-------------|
|             | Under 5.0    | 5.0, 6.0 | 7.0  | 8.0 or Over |
| 60 or more  | —            | 0.25     | 0.20 | 0.20        |
| 50-59       | 0.30         | 0.35     | 0.30 | 0.25        |
| 40-49       | —            | 0.30     | 0.30 | 0.25        |
| 25-39       | 0.35         | 0.40     | 0.30 | 0.25        |
| 11-24       | 0.35         | 0.55     | 0.55 | 0.35        |

Table reads: The chances are approximately two in three that a reported rating differs by no more than the indicated tolerance from the rating that would have been obtained had all eligible sites been enumerated.

For example, suppose a sample of 40 sites gives a computer system a rating of 7.0

on a specific attribute. The table indicates a tolerance of 0.30 on this estimate. Thus, the chances are two in three that the interval 6.7-7.3 includes the rating that would have been obtained had all eligible sites been enumerated.

## Survey Response

### Small systems

Class average • 1,135 mailed; 507 total, 386 net responses.

Burroughs B 1800/B 2800 • 127 mailed; 59 total, 53 net responses.

Hewlett-Packard HP 3000 • 154 mailed; 71 total, 56 net responses.

Honeywell Series 60 Level 62/64 • 40 mailed; 24 total, 22 net responses.

IBM System/3 Model 15D • 249 mailed; 106 total, 97 net responses.

IBM System/32/34/38 • 246 mailed; 99 total, 49 net responses.

IBM System/370 115/125 • 189 mailed; 77 total, 42 net responses.

Sperry Univac 90/30, 90/40 • 130 mailed; 71 total, 67 net responses.

### Medium Systems

Class average • 1,018 mailed; 447 total, 355 net responses.

Burroughs B 3800/B 4800 • 124 mailed; 60 total, 54 net responses.

Digital Equipment DECSYSTEM 10/20 • 132 mailed; 56 total, 52 net responses.

IBM System/370 138/148 • 250 mailed; 101 total, 71 net responses.

IBM 4331 • 250 mailed; 104 total, 71 net

responses.

NCR 8000 • 178 mailed; 83 total, 68 net responses.

Sperry Univac 90/60, 90/70, and 90/80 • 84 mailed; 43 total, 39 net responses.

### Large Systems

Class average • 1,492 mailed; 635 total, 515 net responses.

Amdahl 470V • 133 mailed; 71 total, 56 net responses.

Burroughs B 6800/B 7800 • 97 mailed; 38 total, 37 net responses.

Control Data Cyber • 63 mailed; 26 total, 25 net responses.

Honeywell Series 60 DPS • 52 mailed; 25 total, 23 net responses.

Honeywell Series 60 Level 66/68 • 142 mailed; 59 total, 55 net responses.

IBM System/370 158/168 • 250 mailed; 103 total, 87 net responses.

IBM 303X • 250 mailed; 103 total, 92 net responses.

IBM 4341 • 250 mailed; 102 total, 47 net responses.

NAS (IteI) • 122 mailed; 51 total, 45 net responses.

Sperry Univac 1100 • 133 mailed; 57 total, 48 net responses. \*

This report is based upon a survey and research by Data Decisions, Inc. The full study appears in the firm's *Computer Systems* reference service, \$25 from the publisher at 20 Brace Road, Cherry Hill, NJ 08034.

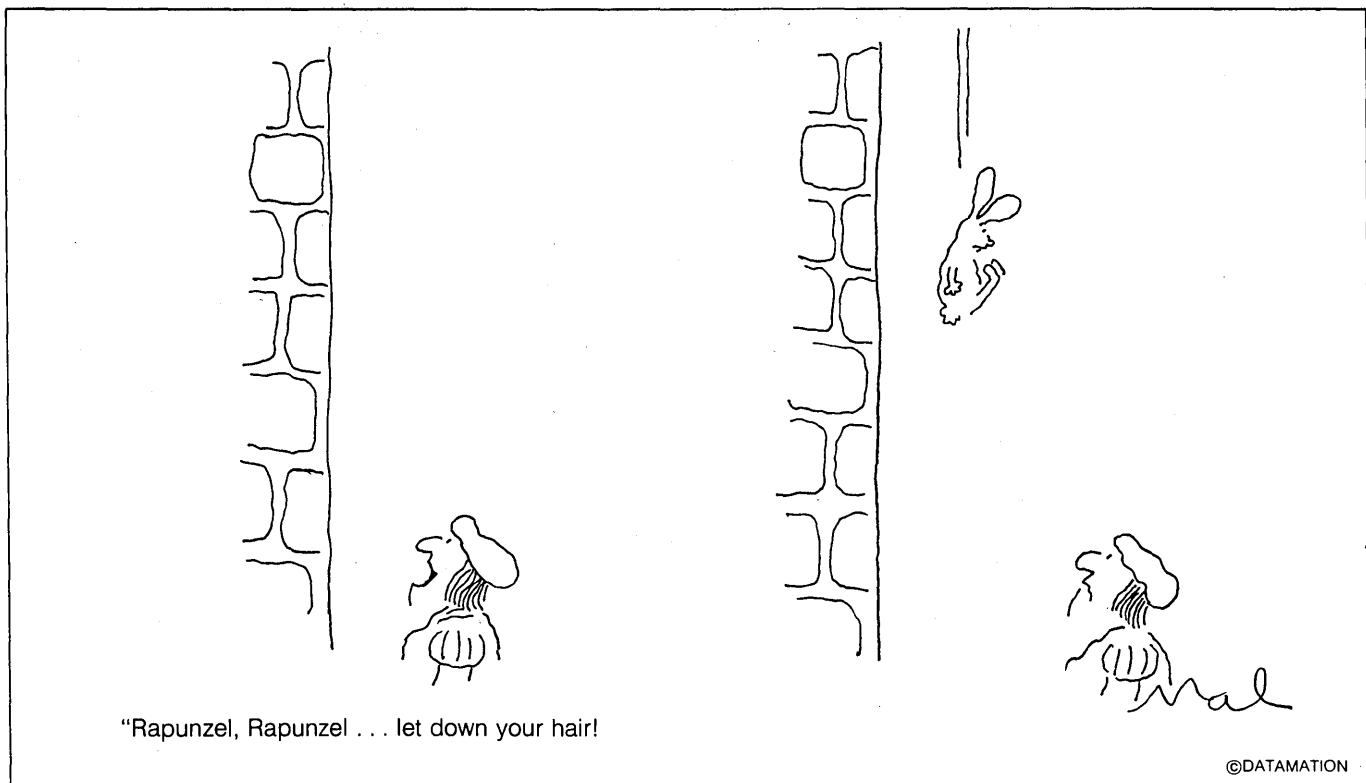

# DATAGRAPHIX 132-COLUMN DISPLAYS GIVE YOU NOT ONLY BETTER QUALITY, BUT LETTER QUALITY.

It's the CHARACTRON  
that makes the difference!

Reproduced from an unretouched photograph of a CHARACTRON CRT.

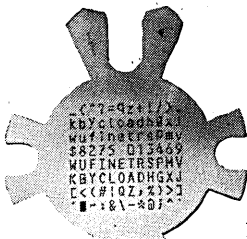

Why suffer with display terminals that show only part of your output? Or if you do get a 132-column display, why suffer eyestrain trying to read it?



The innovation that makes all other 80- and 132-column display terminals and their dot matrix characters seem primitive is the Datagraphix CHARACTRON® CRT. A Datagraphix exclusive that literally stencils letter-perfect characters on the screen with an electron beam. Sharp, clear, fully-formed characters that are even easier to read than most hard-copy computer printout pages.

No more wasted time and money on programming to reformat the computer output to 80 columns. No more lost computer time and wasted paper running hard-copy printouts to see the complete 132-column picture.

The Datagraphix 132-X series has a model with just those features you want. From the simple character mode 132-1, to the DEC-compatible 132-1D, to the advanced editing, block mode 132-2.

You don't have to spend a fortune either. The Datagraphix 132-X series of display terminals feature a surprisingly low factory price, or liberal terms if you prefer to lease. Also there are more than 100 convenient locations for factory-direct service. It is a combination unmatched by any other manufacturer.

There's no waiting either.

Delivery is from stock for most orders. But don't just take our word for Datagraphix display superiority. Send us the coupon today and we'll arrange a live demonstration right in your facility. You have to see it to believe it.



**Yes, I want to see your letter quality display terminals.**

- Please call me to make arrangements for a demonstration of the low-cost 132-1  132-1D  132-2 .
- I am interested in receiving information on the 132-1  132-1D  132-2 .
- I am interested in receiving information about your advanced editing terminals 132A, B  132-70 IBM-compatible system .

Name \_\_\_\_\_ (please print)

Title \_\_\_\_\_

Address \_\_\_\_\_

City \_\_\_\_\_ State \_\_\_\_\_ Zip \_\_\_\_\_

Phone (\_\_\_\_\_) \_\_\_\_\_

Mail to:  
Datagraphix  
Display Products Department  
P.O. Box 82449, San Diego, CA 92138  
(714) 291-9960

D7-81

**Datagraphix®**

Datagraphix, Inc., is a General Dynamics subsidiary  
Datagraphix® and Charactron® are registered trademarks of Datagraphix, Inc.

CIRCLE 82 ON READER CARD

# COMPUTER COMMUNICATIONS RATINGS

## SMALL SYSTEMS

### CLASS AVERAGES

#### RATINGS

Operations • 7.56 avg  
 Appl Devel • 7.06 avg  
 Training • 5.64 avg  
 Average • 6.75 avg

#### DIFFICULTIES

Software • 53/41% avg  
 Hrdwr Reliab • 51/45% avg  
 Service • 54/40% avg  
 Average • 53/42% avg

#### ACTIVITIES/PLANS

##### Data Processing:

Batch • 94/2% avg  
 Interactive • 87/7% avg  
 Database • 53/18% avg  
 Timesharing • 45/4% avg  
 Distrib • 31/17% avg  
 Transaction • 75/11% avg

##### Attached Terminals:

Multiple Appl • 88/6% avg  
 Remote DB • 32/20% avg  
 Remote Appl • 25/16% avg  
 Transfer Prog • 17/17% avg

##### Other Terminals:

Local Appl • 29/14% avg  
 Local DB • 26/18% avg  
 Dwnld Prog • 12/16% avg

#### ENVIRONMENT

% Site DP • 79% avg  
 % Cost • 28% avg  
 Age • 28.3 mo avg  
 Local Term • 13.4 avg  
 Remote Term • 11.4 avg  
 Simul Term • 14.1 avg

### BURROUGHS B 1800/B 2800

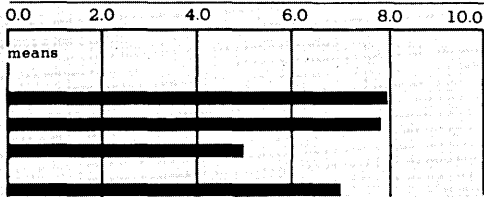

0 20 40 60 80 100

% occurrence of difficulties  
 ■ % Rarely-Never / □ % Occasionally

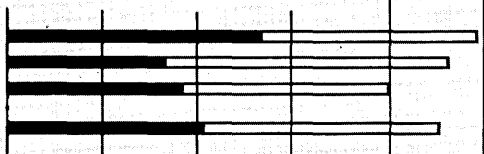

■ % Supported Now / □ % Planned within 24 mo

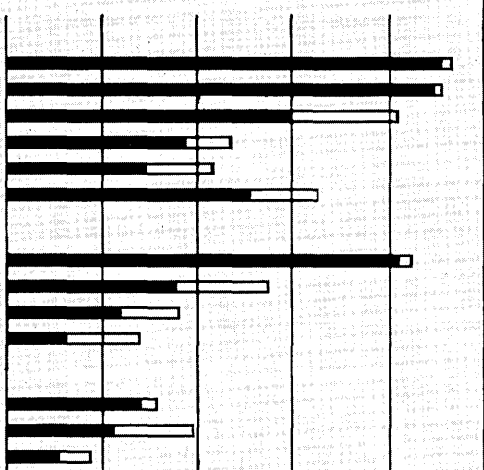

% of Site DP capacity and cost

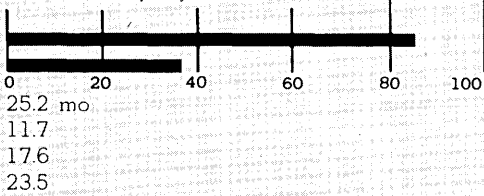

### HEWLETT-PACKARD HP 3000

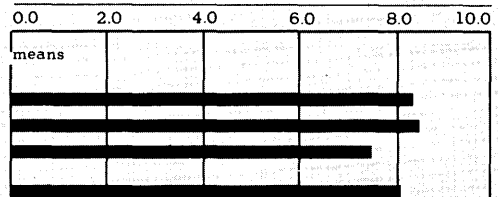

0 20 40 60 80 100

% occurrence of difficulties  
 ■ % Rarely-Never / □ % Occasionally

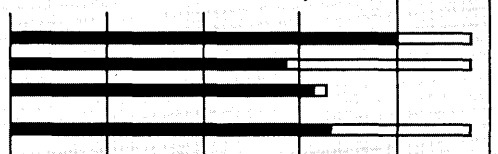

■ % Supported Now / □ % Planned within 24 mo

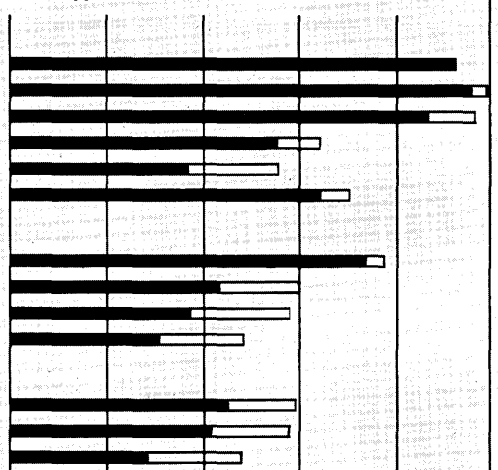

% of Site DP capacity and cost

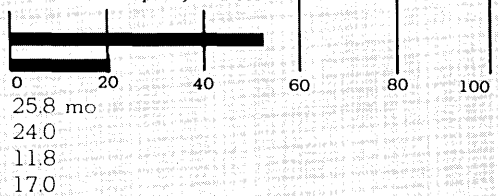

#### LEGEND

**Class Averages** • averages of the values for all members of one group (i.e., Small, Medium, or Large Systems).

**Ratings** • values presented are means of users' ratings on a scale of 10 to 1, with a rating of 10-9 indicating Superior, 8-6 indicating Very Good, 5-3 indicating Acceptable, and 2-1 indicating Inadequate • Operations is the average of 4 questions • Appl Devel is applications program development • Training is training and instruction support • Average is the averages of the 3 ratings • see Methodology for details.

**Freedom From Difficulties** • % of users responding to questions asking them to identify the degree of difficulty they experienced with several areas; users also had choices of Often and Very Often in addition to Rarely/Never and Occasionally • Software is computer vendor communications software • Hrdwr Reliab is communications hardware reliability • Service is computer vendor

service/maintenance • Average is computed from averages of counts.

**Activities & Plans** • % currently supported and % not now supported, but planned within 24 months; see Methodology for specific definitions used in questionnaire • Data Processing identifies computer system activities at the site • Attached Term identifies activities initiated from a local or remote terminal attached to the subject computer system; Transfer Prog indicates transfer of program for execution on remote system • Other Terminals indicates activities initiated by terminals "belonging" to a computer other than the subject computer system; Dwnld Prog indicates access to local program library for download and execution of programs on remote system.

**Environment** • % Site DP indicates how much of the site's total data processing is handled by the subject system • % Cost indicates how much of the total computer cost is devoted to data communications • Age is average length of installation • Local and Remote Term are the average number attached to the system • Simul Term is the average number of terminals operating simultaneously.

# Now you can watch your four favorite programs...

The new HP 2626 display station will give you a view of your computer system you've never seen before.

It lets you divide the screen into as many as four separate "frames," each attached to a different workspace in the terminal's memory. You can check a program listing in one frame and access a file in another. Fill out a form in one workspace while the computer loads the next form into another. Or do text preparation and editing in adjacent frames.

What's more, you can set line lengths of up to 160 characters in any workspace. Then scroll horizontally to get the entire picture. (The built-in thermal printer includes a compressed mode that prints up to 132 characters per line.) Scroll vertically, too, or change the size of the frame at the touch of a key.

## Split decisions.

The HP 2626 has two data communications ports instead of one, so you can hook up the terminal to two computers at the same time (or to the same one twice). Then, it's like getting a multi-tasking capability right in the terminal — your systems designer can compile, execute, monitor and edit programs as if two stations were available.

## ...same time, same station.

And while your user is filling out a form, the terminal can be sending data from the previous form to a computer. And downloading the next form into an adjacent workspace. By smoothing out the "type and wait" of data entry, you can take advantage of less expensive, low-speed transmission lines without sacrificing the efficiency of your operator. The result? You'll get more out of the entire system.

If you'd like to watch a program on the new HP 2626 display station, or any of our terminals, just call your local HP sales office listed in the White Pages. You can also write for more information to Hewlett-Packard, Attn: Tom Anderson, Dept. 489, 974 East Arques Ave., Sunnyvale, CA 94086.

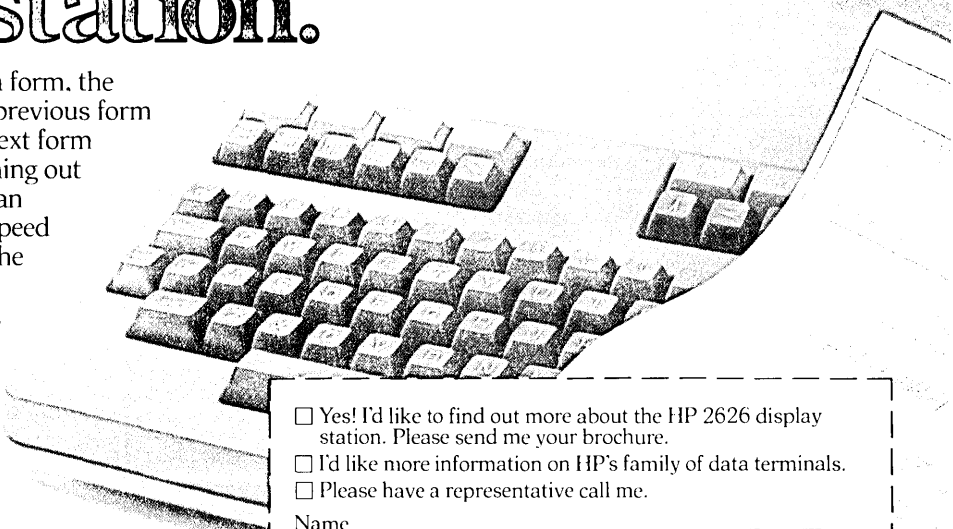
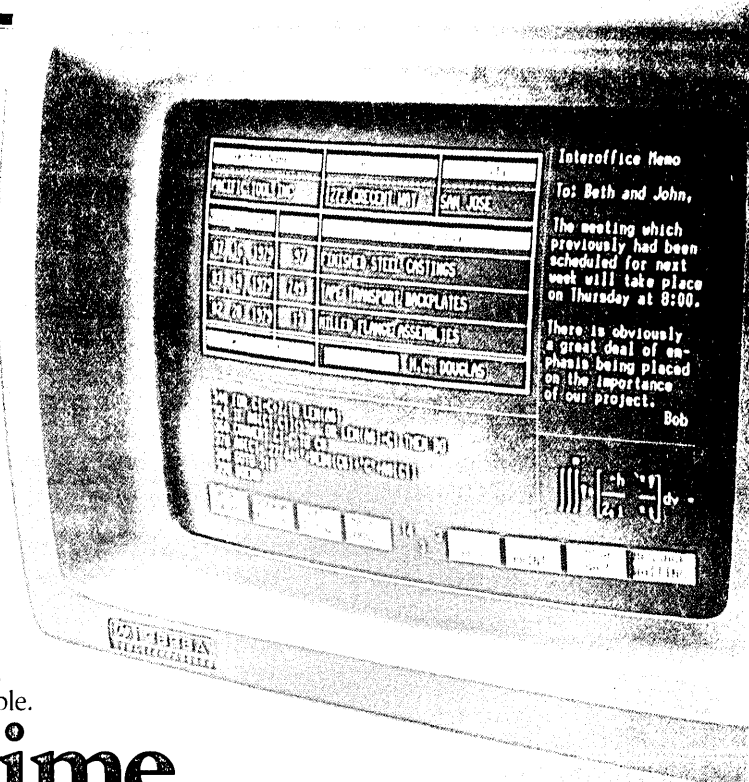

- Yes! I'd like to find out more about the HP 2626 display station. Please send me your brochure.
- I'd like more information on HP's family of data terminals.
- Please have a representative call me.

Name \_\_\_\_\_

Title \_\_\_\_\_

Company \_\_\_\_\_

Address \_\_\_\_\_

City/State/Zip \_\_\_\_\_ Phone \_\_\_\_\_

Mail to: Hewlett-Packard, Attn: Tom Anderson, Dept 0489,  
974 East Arques Ave., Sunnyvale, CA 94086.

DM7-1



# COMPUTER COMMUNICATIONS RATINGS

## SMALL SYSTEMS

### ■ CLASS AVERAGES

#### RATINGS

Operations • 7.56 avg  
 Appl Devel • 7.06 avg  
 Training • 5.64 avg  
 Average • 6.75 avg

#### DIFFICULTIES

Software • 53/41% avg  
 Hrdwr Reliab • 51/45% avg  
 Service • 54/40% avg  
 Average • 53/42% avg

#### ACTIVITIES/PLANS

##### Data Processing:

Batch • 94/2% avg  
 Interactive • 87/7% avg  
 Database • 53/18% avg  
 Timesharing • 45/4% avg  
 Distrib • 31/17% avg  
 Transaction • 75/11% avg

##### Attached Terminals:

Multiple Appl • 88/6% avg  
 Remote DB • 32/20% avg  
 Remote Appl • 25/16% avg  
 Transfer Prog • 17/17% avg

##### Other Terminals:

Local Appl • 29/14% avg  
 Local DB • 26/18% avg  
 Dwnld Prog • 12/16% avg

#### ENVIRONMENT

% Site DP • 79% avg  
 % Cost • 28% avg

Age • 28.3 mo avg  
 Local Term • 13.4 avg  
 Remote Term • 11.4 avg  
 Simul Term • 14.1 avg

### ■ HONEYWELL SERIES 60 LEVEL 62/64

0.0 2.0 4.0 6.0 8.0 10.0

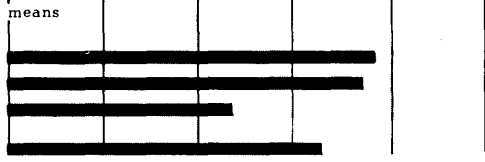

0 20 40 60 80 100

% occurrence of difficulties  
 ■ % Rarely-Never/□ % Occasionally

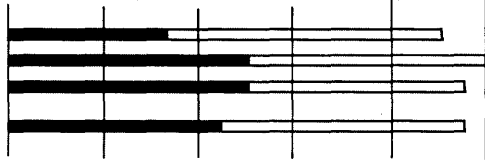

■ % Supported Now/□ % Planned within 24 mo

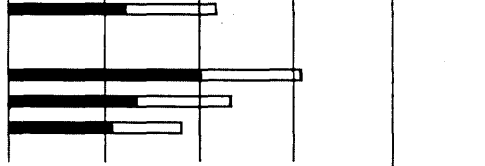
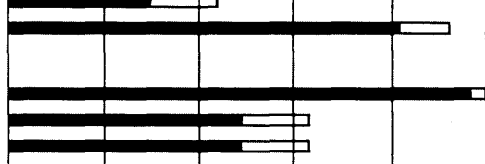
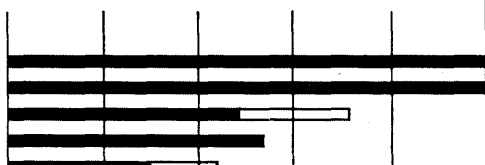

% of Site DP capacity and cost

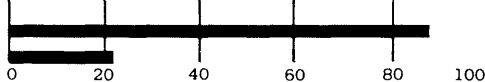

31.3 mo

13.1

7.1

12.8

### ■ IBM SYSTEM/3 15D

0.0 2.0 4.0 6.0 8.0 10.0

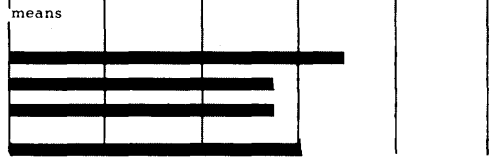

0 20 40 60 80 100

% occurrence of difficulties  
 ■ % Rarely-Never/□ % Occasionally

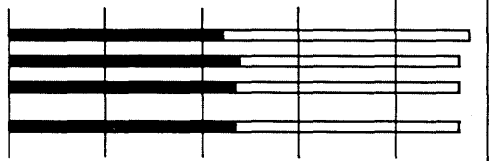

■ % Supported Now/□ % Planned within 24 mo

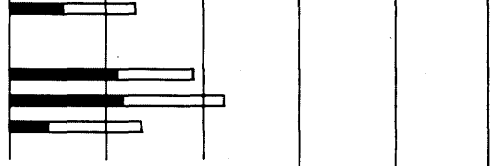
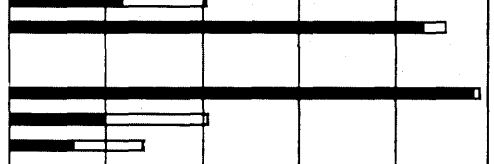
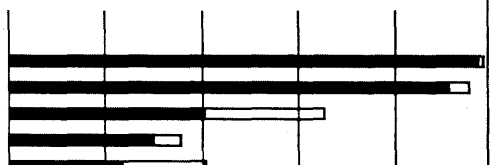

% of Site DP capacity and cost

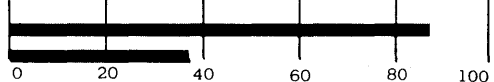

33.0 mo

13.5

10.6

10.3

#### LEGEND

**Class Averages** • averages of the values for all members of one group (i.e., Small, Medium, or Large Systems).

**Ratings** • values presented are means of users' ratings on a scale of 10 to 1, with a rating of 10-9 indicating Superior, 8-6 indicating Very Good, 5-3 indicating Acceptable, and 2-1 indicating Inadequate • Operations is the average of 4 questions • Appl Devel is applications program development • Training is training and instruction support • Average is the averages of the 3 ratings • see Methodology for details.

**Freedom From Difficulties** • % of users responding to questions asking them to identify the degree of difficulty they experienced with several areas; users also had choices of Often and Very Often in addition to Rarely/Never and Occasionally • Software is computer vendor communications software • Hrdwr Reliab is communications hardware reliability • Service is computer vendor

service/maintenance • Average is computed from averages of counts.

**Activities & Plans** • % currently supported and % not now supported, but planned within 24 months; see Methodology for specific definitions used in questionnaire • Data Processing identifies computer system activities at the site • Attached Term identifies activities initiated from a local or remote terminal attached to the subject computer system; Transfer Prog indicates transfer of program for execution on remote system • Other Terminals indicates activities initiated by terminals "belonging" to a computer other than the subject computer system; Dwnld Prog indicates access to local program library for download and execution of programs on remote system.

**Environment** • % Site DP indicates how much of the site's total data processing is handled by the subject system • % Cost indicates how much of the total computer cost is devoted to data communications • Age is average length of installation • Local and Remote Term are the average number attached to the system • Simul Term is the average number of terminals operating simultaneously.

# SMALL SYSTEMS

## CLASS AVERAGES

### RATINGS

Operations • 7.56 avg  
 Appl Devel • 7.06 avg  
 Training • 5.64 avg  
 Average • 6.75 avg

### DIFFICULTIES

Software • 53/41% avg  
 Hrdwr Reliab • 51/45% avg  
 Service • 54/40% avg  
 Average • 53/42% avg

### ACTIVITIES/PLANS

#### Data Processing:

Batch • 94/2% avg  
 Interactive • 87/7% avg  
 Database • 53/18% avg  
 Timesharing • 45/4% avg  
 Distrib • 31/17% avg  
 Transaction • 75/11% avg

#### Attached Terminals:

Multiple Appl • 88/6% avg  
 Remote DB • 32/20% avg  
 Remote Appl • 25/16% avg  
 Transfer Prog • 17/17% avg

#### Other Terminals:

Local Appl • 29/14% avg  
 Local DB • 26/18% avg  
 Dwnld Prog • 12/16% avg

### ENVIRONMENT

% Site DP • 79% avg  
 % Cost • 28% avg  
 Age • 28.3 mo avg  
 Local Term • 13.4 avg  
 Remote Term • 11.4 avg  
 Simul Term • 14.1 avg

## IBM SYSTEM 32/34/38

0.0 2.0 4.0 6.0 8.0 10.0

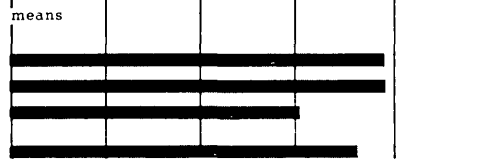

0 20 40 60 80 100

% occurrence of difficulties  
 ■ % Rarely-Never □ % Occasionally

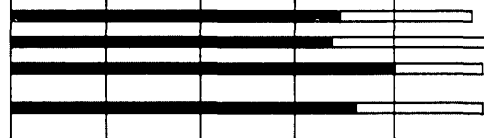

■ % Supported Now □ % Planned within 24 mo

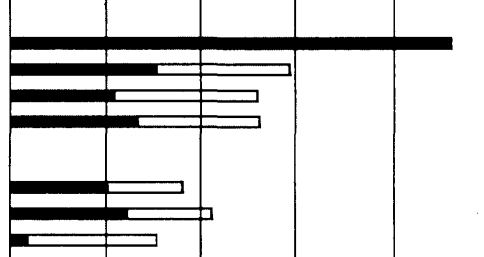
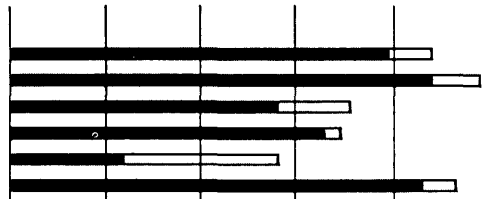

% of Site DP capacity and cost

19.6 mo  
 8.9  
 4.6  
 7.3

## IBM SYSTEM 370 115/125

0.0 2.0 4.0 6.0 8.0 10.0

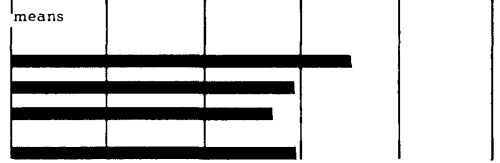

0 20 40 60 80 100

% occurrence of difficulties  
 ■ % Rarely-Never □ % Occasionally

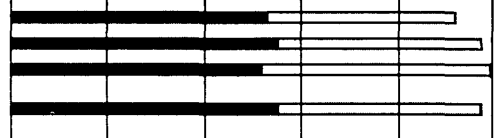

■ % Supported Now □ % Planned within 24 mo

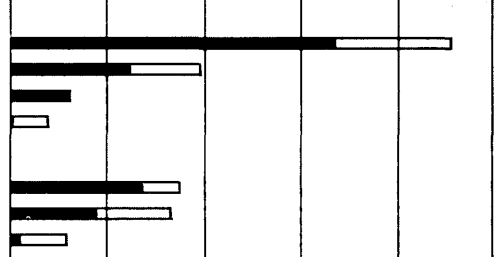
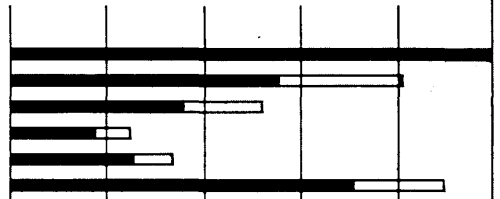

% of Site DP capacity and cost

32.2 mo  
 5.8  
 11.5  
 10.6

### LEGEND

**Class Averages** • averages of the values for all members of one group (i.e., Small, Medium, or Large Systems).

**Ratings** • values presented are means of users' ratings on a scale of 10 to 1, with a rating of 10-9 indicating Superior, 8-6 indicating Very Good, 5-3 indicating Acceptable, and 2-1 indicating Inadequate • Operations is the average of 4 questions • Appl Devel is applications program development • Training is training and instruction support • Average is the averages of the 3 ratings • see Methodology for details.

**Freedom From Difficulties** • % of users responding to questions asking them to identify the degree of difficulty they experienced with several areas; users also had choices of Often and Very Often in addition to Rarely/Never and Occasionally • Software is computer vendor communications software • Hrdwr Reliab is communications hardware reliability • Service is computer vendor

service/maintenance • Average is computed from averages of counts.

**Activities & Plans** • % currently supported and % not now supported, but planned within 24 months; see Methodology for specific definitions used in questionnaire • Data Processing identifies computer system activities at the site • Attached Term identifies activities initiated from a local or remote terminal attached to the subject computer system; Transfer Prog indicates transfer of program for execution on remote system • Other Terminals indicates activities initiated by terminals "belonging" to a computer other than the subject computer system; Dwnld Prog indicates access to local program library for download and execution of programs on remote system.

**Environment** • % Site DP indicates how much of the site's total data processing is handled by the subject system • % Cost indicates how much of the total computer cost is devoted to data communications • Age is average length of installation • Local and Remote Term are the average number attached to the system • Simul Term is the average number of terminals operating simultaneously.





# A solution to a human problem in information management.

The Bell System knows that information management works best when it's people oriented. After all, that's been the basis of our business for years.

So our Dataspeed® 4540 data communications terminal is human engineered.

It has a display unit with a tilting screen to eliminate glare and eye fatigue. Plus simplified controls on the console. And you get a choice of keyboards with numeric cluster arrangement.

Of course, the terminal is every inch an information management problem-solver. It transmits at speeds from 2400 to 9600 bps efficiently, has built-in diagnostics, greater hardware flexibility and 3270 compatibility.

Its microprocessor-based controller interconnects with up to 32 devices. Eight of them can be printers which can be located up to 2000 feet away from the controller. Keyboard displays can be up to a mile away.

The Dataspeed 4540 data communications terminal. You can expect it to add efficiency and economy to business applications involving inquiry response, data entry and retrieval.

With our knowledge, our advanced communications technology, our thousands of experienced information management specialists, we can help your business. A call to your Bell Account Executive will put our knowledge to work for you.

**The knowledge business**



# COMPUTER COMMUNICATIONS RATINGS

## SMALL SYSTEMS

### CLASS AVERAGES

#### RATINGS

Operations • 7.56 avg  
 Appl Devel • 7.06 avg  
 Training • 5.64 avg  
 Average • 6.75 avg

#### DIFFICULTIES

Software • 53/41% avg  
 Hrdwr Reliab • 51/45% avg  
 Service • 54/40% avg  
 Average • 53/42% avg

#### ACTIVITIES/PLANS

##### Data Processing:

Batch • 94/2% avg  
 Interactive • 87/7% avg  
 Database • 53/18% avg  
 Timesharing • 45/4% avg  
 Distrib • 31/17% avg  
 Transaction • 75/11% avg

##### Attached Terminals:

Multiple Appl • 88/6% avg  
 Remote DB • 32/20% avg  
 Remote Appl • 25/16% avg  
 Transfer Prog • 17/17% avg

##### Other Terminals:

Local Appl • 29/14% avg  
 Local DB • 26/18% avg  
 Dwnld Prog • 12/16% avg

#### ENVIRONMENT

% Site DP • 79% avg  
 % Cost • 28% avg

Age • 28.3 mo avg  
 Local Term • 13.4 avg  
 Remote Term • 11.4 avg  
 Simul Term • 14.1 avg

### SPERRY UNIVAC 90/30, 90/40

0.0 2.0 4.0 6.0 8.0 10.0

means

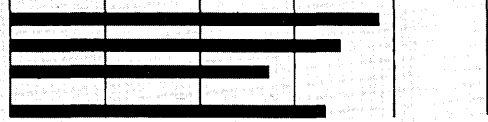

0 20 40 60 80 100

% occurrence of difficulties  
 ■ % Rarely-Never □ % Occasionally

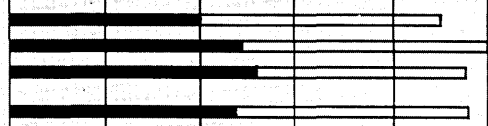

■ % Supported Now □ % Planned within 24 mo

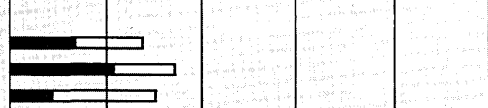
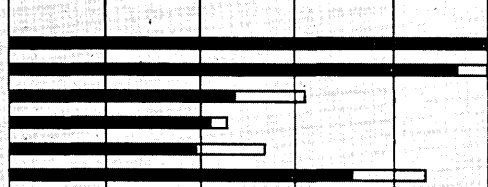

% of Site DP capacity and cost



31.3 mo  
 16.9  
 16.6  
 17.0

#### LEGEND

**Class Averages** • averages of the values for all members of one group (i.e., Small, Medium, or Large Systems).

**Ratings** • values presented are means of users' ratings on a scale of 10 to 1, with a rating of 10-9 indicating Superior, 8-6 indicating Very Good, 5-3 indicating Acceptable, and 2-1 indicating Inadequate • Operations is the average of 4 questions • Appl Devel is applications program development • Training is training and instruction support • Average is the averages of the 3 ratings • see Methodology for details.

**Freedom From Difficulties** • % of users responding to questions asking them to identify the degree of difficulty they experienced with several areas; users also had choices of Often and Very Often in addition to Rarely/Never and Occasionally • Software is computer vendor communications software • Hrdwr Reliab is communications hardware reliability • Service is computer vendor

service/maintenance • Average is computed from averages of counts.

**Activities & Plans** • % currently supported and % not supported, but planned within 24 months; see Methodology for specific definitions used in questionnaire • Data Processing identifies computer system activities at the site • Attached Term identifies activities initiated from a local or remote terminal attached to the subject computer system; Transfer Prog indicates transfer of program for execution on remote system • Other Terminals indicates activities initiated by terminals "belonging" to a computer other than the subject computer system; Dwnld Prog indicates access to local program library for download and execution of programs on remote system.

**Environment** • % Site DP indicates how much of the site's total data processing is handled by the subject system • % Cost indicates how much of the total computer cost is devoted to data communications • Age is average length of installation • Local and Remote Term are the average number attached to the system • Simul Term is the average number of terminals operating simultaneously.

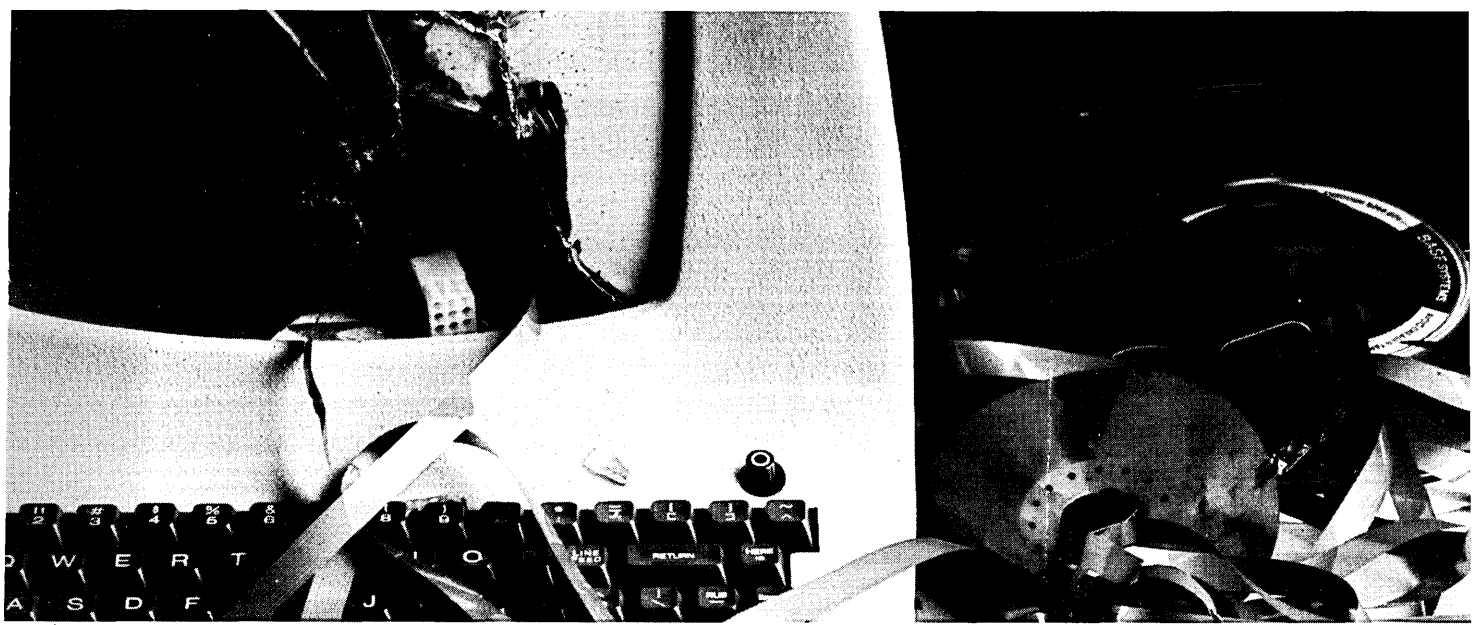

# "Oh no! Somebody got into the computer room last night"

**"I don't know who was madder — our data processing manager, our controller or our auditors. But they all came into my office and complained that anyone could get into the computer room — at any time. So we installed an RES CARDENTRY® system, and now we control who uses the computer room. And our smart machines are protected by some other pretty smart machines!"**

As well they should be.

Without an RES CARDENTRY system to protect your data processing facility, it can be subject to information security breaches, as well as damage to your expensive computers.

An RES CARDENTRY system solves the problem of securing your data processing equipment. It also does away with employee keys (and the possibility of duplicating them), and lack of personnel accountability.

When we install a CARDENTRY system, we give each employee a RUSCARD™ with a personalized code. The cards are virtually impossible to dupli-

cate. Your computer or DP room has a single, compact CARDENTRY reader. You tell your system who's allowed in and when. Then, if an unauthorized person tries to enter the room the door won't open.

What's more, a central printer immediately tells your security guard where and when an unauthorized entry has been attempted — in easy-to-read English text.\*

It's that easy to account for (and control) unauthorized access and activities. And it's that easy to save money.

Your RES CARDENTRY system can even turn utilities on and off at pre-determined times, streamline your data collection activities and provide real-time monitoring, pre-defined, and user-defined historical reports. Small wonder we're the world leader in access control systems.

So if your computer isn't already protected by our system, it should be. After all, do you know who's using it right now?

For more information, call or write Rusco Electronic Systems, 1840 Victory Blvd., Glendale, CA 91201, 1-800-528-6050, Ext. 691. In Arizona, 1-602-955-9714, Ext. 691.

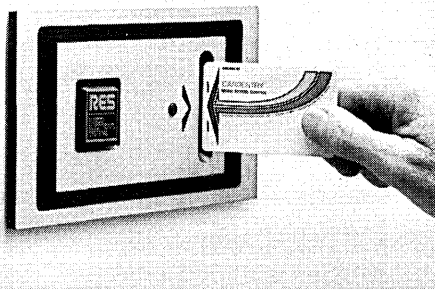

**RES** RUSCO  
ELECTRONIC  
SYSTEMS  
A DIVISION OF **ATO**

**CIRCLE 85 ON READER CARD**

CARDENTRY is a registered trademark and RUSCARD is a trademark of Rusco Electronic Systems.

\*Also available in French, German or Italian.

# THE LEADING EDGE

---

#1 in a series of reports on new technology from Xerox

---

*About a year ago, Xerox introduced the Ethernet network—a pioneering new development that makes it possible to link different office machines into a single network that's reliable, flexible and easily expandable.*

*The following are some notes explaining the technological underpinnings of this development. They are contributed by Xerox research scientist David Boggs.*

The Ethernet system was designed to meet several rather ambitious objectives.

First, it had to allow many users within a given organization to access the same data. Next, it had to allow the organization the economies that come from resource sharing; that is, if several people could share the same information processing equipment, it would cut down on the amount and expense of hardware needed. In addition, the resulting network had to be flexible; users had to be able to change components easily so the network could grow smoothly as new capability was needed. Finally, it had to have maximum reliability—a system based on the notion of shared information would look pretty silly if users couldn't get at the information because the network was broken.

## **Collision Detection**

The Ethernet network uses a coaxial cable to connect various pieces of information equipment. Information travels over the cable in packets which are sent from one machine to another.

A key problem in any system of this type is how to control access to the cable: what are the rules determining when a piece of equipment can talk? Ethernet's method resembles the unwritten rules used by people at a party to decide who gets to tell the next story.

While someone is speaking, everyone else waits. When the current speaker stops, those who want to say something pause, and then launch into their speeches. If they *collide* with each other (hear someone else talking, too), they all stop and wait to start up again. Eventually one pauses the shortest time and starts talking so soon that everyone else hears him and waits.

When a piece of equipment wants to use the Ethernet cable, it listens first to hear if any other station is talking. When it hears silence on the cable, the station starts talking, but it also listens. If it hears other stations sending too, it stops, as do the other stations. Then it waits a

random amount of time, on the order of microseconds, and tries again. The more times a station collides, the longer, on the average, it waits before trying again.

In the technical literature, this technique is called carrier-sense multiple-access with collision detection. It is a modification of a method developed by researchers at the University of Hawaii and further refined by my colleague Dr. Robert Metcalfe. As long as the interval during which stations elbow each other for control of the cable is short relative to the interval during which the winner uses the cable, it is very efficient. Just as important, it requires no central

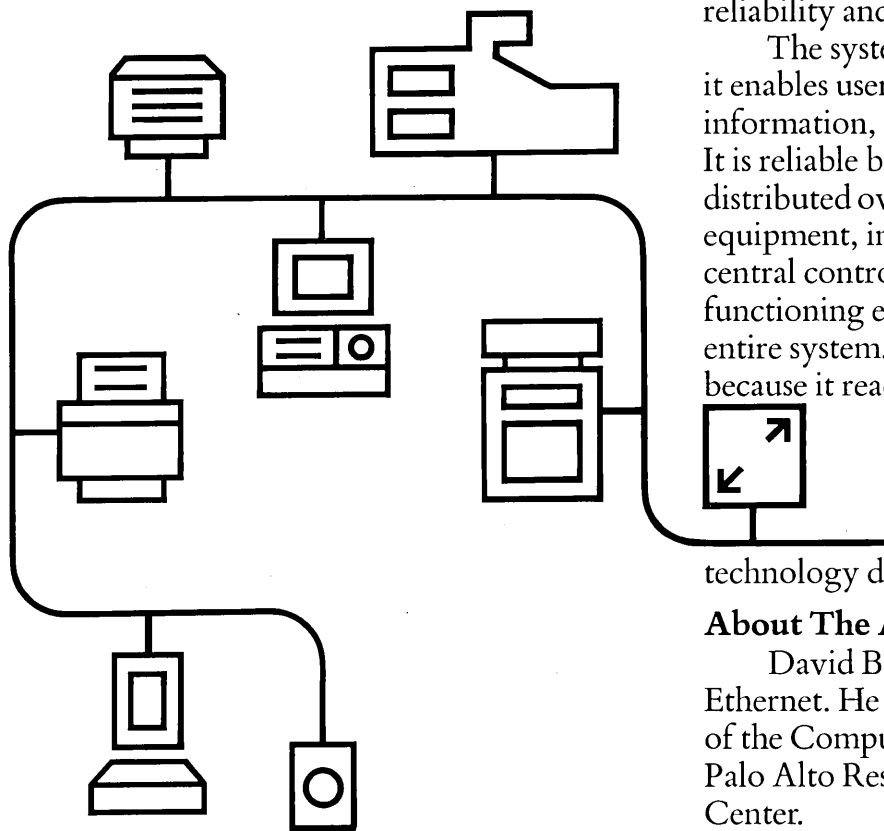

control—there is no distinguished station to break or become overloaded.

### The System

With the foregoing problems solved, Ethernet was ready for introduction. It consists of a few relatively simple components:

Ether. This is the cable referred to earlier. Since it consists of just copper and plastic, its reliability is high and its cost is low.

Transceivers. These are small boxes that insert and extract bits of information as they pass by on the cable.

Controllers. These are large scale integrated circuit chips which enable all sorts of equipment, from communicating typewriters to mainframe computers, regardless of the manufacturer, to connect to the Ethernet.

The resulting system is not only fast (transmitting millions of bits of information per second), it's essentially modular in design. It's largely because of this modularity that Ethernet succeeds in meeting its objectives of economy, reliability and expandability.

The system is economical simply because it enables users to share both equipment and information, cutting down on hardware costs. It is reliable because control of the system is distributed over many pieces of communicating equipment, instead of being vested in a single central controller where a single piece of malfunctioning equipment can immobilize an entire system. And Ethernet is expandable because it readily accepts new pieces of information processing equipment. This enables an organization to plug in new machines gradually, as its needs dictate, or as technology develops new and better ones.

### About The Author

David Boggs is one of the inventors of Ethernet. He is a member of the research staff of the Computer Science Laboratory at Xerox's Palo Alto Research Center.

He holds a Bachelor's degree in Electrical Engineering from Princeton University and a Master's degree from Stanford University, where he is currently pursuing a Ph.D.

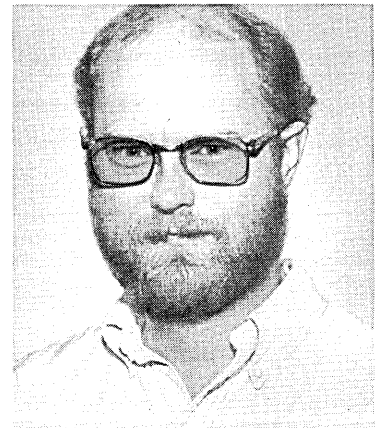

# XEROX

CIRCLE 86 ON READER CARD

XEROX® and Ethernet are trademarks of XEROX CORPORATION.

# THE LATEST ADVANCE IN VIDEO GRAPHIC HARD COPY RECORDING FROM HONEYWELL

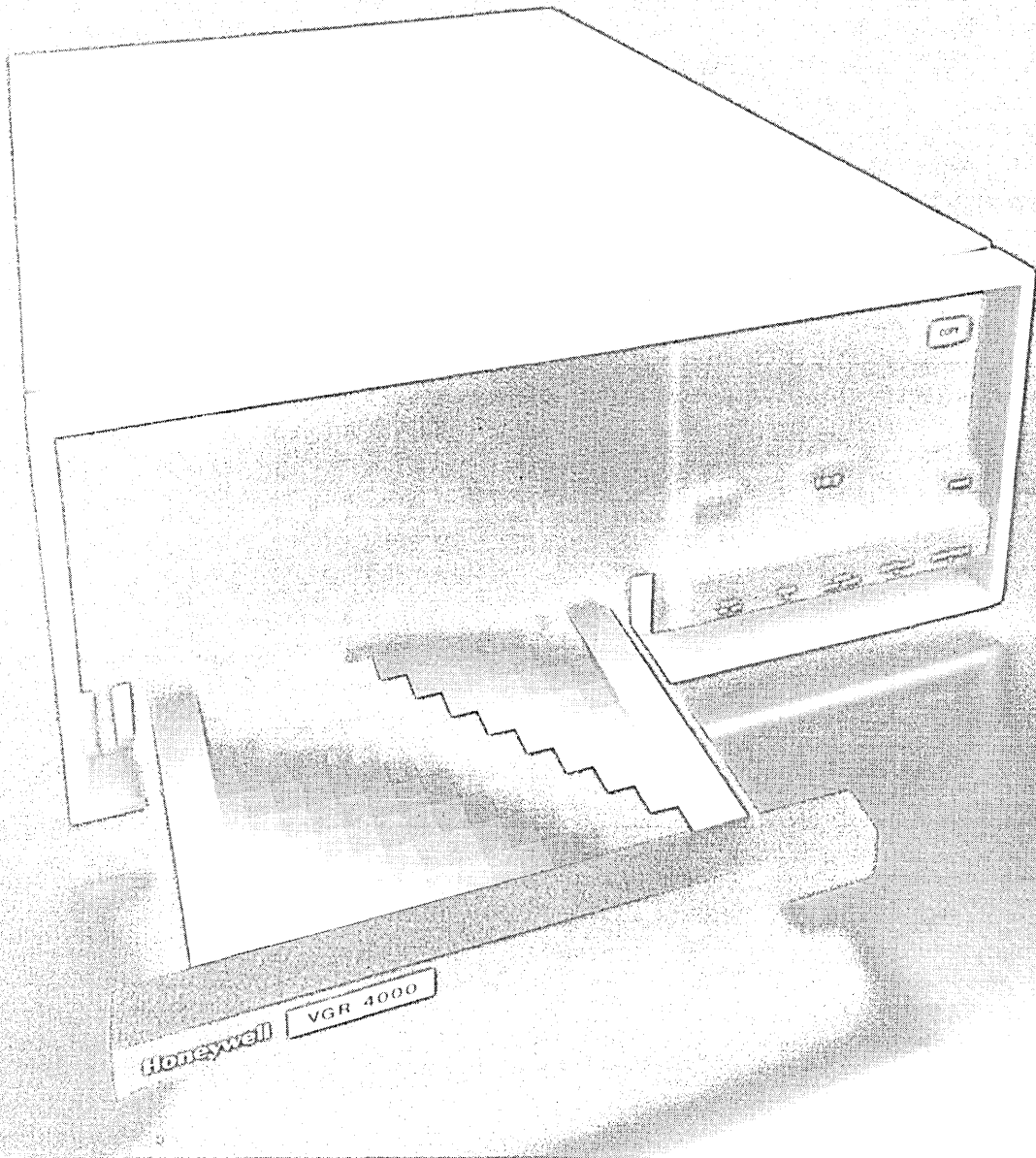

VGR 4000, Honeywell's new and advanced video graphic recorder, provides fast, crisp, 8½ x 11" hard copies on dry silver paper from most CRT's and other video sources.

White-on-black or black-on-white images are as simple as flipping a switch. With options, images can be produced having up to 16 shades of grey or even more.

An innovative processing technique eliminates the need for large heated platens. This allows the recorder to run cool, consuming very little energy.

The VGR 4000 is the only recorder on the market available with a self-contained test-pattern generator providing a choice of formats for proper copy verification.

Rugged, yet cleanly designed for easy

operation, the compact VGR 4000 can be used on a desk top or rack-mounted, taking up only 7" of front panel space.

Honeywell's VGR 4000 is the latest advance in video-input hard-copy reproduction systems, built by the people with the most fiber-optic CRT recorder experience in the field.

To get the whole story on the VGR 4000 and how it can meet your needs, call Durke Johnson at 303/773-4700. Or write Honeywell Test Instruments Division, Box 5227, Denver, Colorado 80217.

**WE'LL SHOW YOU A BETTER WAY.**

**Honeywell**

**CIRCLE 87 ON READER CARD**

HON 6-631

## MEDIUM SYSTEMS

### CLASS AVERAGES

#### RATINGS

Operations • 7.14 avg  
 Appl Devel • 6.37 avg  
 Training • 4.96 avg  
 Average • 6.16 avg

#### DIFFICULTIES

Software • 40/52% avg  
 Hrdwr Reliab • 39/56% avg  
 Service • 38/54% avg  
 Average • 39/52% avg

#### ACTIVITIES/PLANS

##### Data Processing:

Batch • 93/2% avg  
 Interactive • 86/7% avg  
 Database • 66/17% avg  
 Timesharing • 52/7% avg  
 Distrib • 38/22% avg  
 Transaction • 68/9% avg

##### Attached Terminals:

Multiple Appl • 87/3% avg  
 Remote DB • 32/20% avg  
 Remote Appl • 29/12% avg  
 Transfer Prog • 24/14% avg

##### Other Terminals:

Local Appl • 33/17% avg  
 Local DB • 35/18% avg  
 Dwnld Prog • 17/14% avg

#### ENVIRONMENT

% Site DP • 73% avg  
 % Cost • 27% avg

Age • 25.3 mo avg  
 Local Term • 22.7 avg  
 Remote Term • 32.2 avg  
 Simul Term • 33.7 avg

### BURROUGHS B 3800/B 4800

0.0 2.0 4.0 6.0 8.0 10.0

means



0 20 40 60 80 100

% occurrence of difficulties

■ % Rarely-Never / □ % Occasionally



■ % Supported Now / □ % Planned within 24 mo

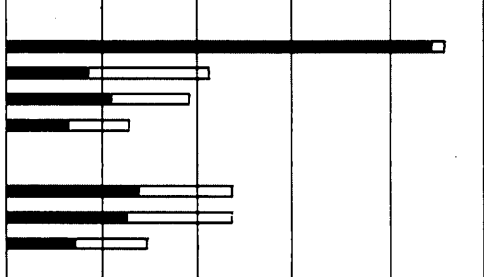
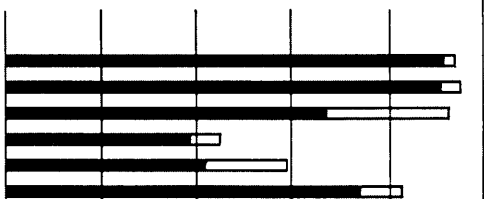

% of Site DP capacity and cost

0 20 40 60 80 100  
 26.0 mo  
 21.4  
 44.8  
 45.6

### DIGITAL EQUIPMENT DECsystem 10/20

0.0 2.0 4.0 6.0 8.0 10.0

means



0 20 40 60 80 100

% occurrence of difficulties

■ % Rarely-Never / □ % Occasionally



■ % Supported Now / □ % Planned within 24 mo

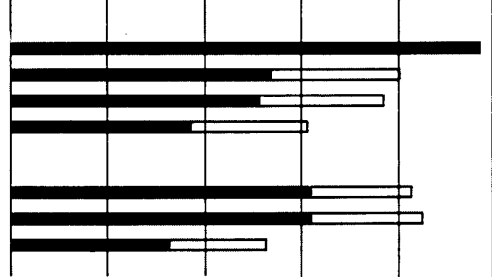
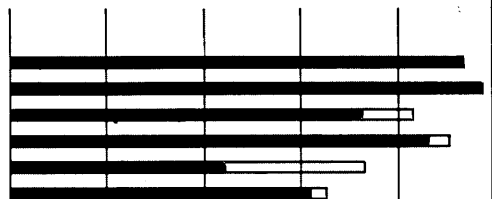

% of Site DP capacity and cost

0 20 40 60 80 100  
 33.7 mo  
 34.2  
 34.3  
 46.5

#### LEGEND

**Class Averages** • averages of the values for all members of one group (i.e., Small, Medium, or Large Systems).

**Ratings** • values presented are means of users' ratings on a scale of 10 to 1, with a rating of 10-9 indicating Superior, 8-6 indicating Very Good, 5-3 indicating Acceptable, and 2-1 indicating Inadequate • Operations is the average of 4 questions • Appl Devel is applications program development • Training is training and instruction support • Average is the averages of the 3 ratings • see Methodology for details.

**Freedom From Difficulties** • % of users responding to questions asking them to identify the degree of difficulty they experienced with several areas; users also had choices of Often and Very Often in addition to Rarely/Never and Occasionally • Software is computer vendor communications software • Hrdwr Reliab is communications hardware reliability • Service is computer vendor

service/maintenance • Average is computed from averages of counts.

**Activities & Plans** • % currently supported and % not now supported, but planned within 24 months; see Methodology for specific definitions used in questionnaire • Data Processing identifies computer system activities at the site • Attached Term identifies activities initiated from a local or remote terminal attached to the subject computer system; Transfer Prog indicates transfer of program for execution on remote system • Other Terminals identifies activities initiated by terminals "belonging" to a computer other than the subject computer system; Dwnld Prog indicates access to local program library for download and execution of programs on remote system.

**Environment** • % Site DP indicates how much of the site's total data processing is handled by the subject system • % Cost indicates how much of the total computer cost is devoted to data communications • Age is average length of installation • Local and Remote Term are the average number attached to the system • Simul Term is the average number of terminals operating simultaneously.

# COMPUTER COMMUNICATIONS RATINGS

## MEDIUM SYSTEMS

### CLASS AVERAGES

#### RATINGS

Operations • 7.14 avg  
 Appl Devel • 6.37 avg  
 Training • 4.96 avg  
 Average • 6.16 avg

#### DIFFICULTIES

Software • 40/52% avg  
 Hrdwr Reliab • 39/56% avg  
 Service • 38/54% avg  
 Average • 39/52% avg

#### ACTIVITIES/PLANS

##### Data Processing:

Batch • 93/2% avg  
 Interactive • 86/7% avg  
 Database • 66/17% avg  
 Timesharing • 52/7% avg  
 Distrib • 38/22% avg  
 Transaction • 68/9% avg

##### Attached Terminals:

Multiple Appl • 87/3% avg  
 Remote DB • 32/20% avg  
 Remote Appl • 29/12% avg  
 Transfer Prog • 24/14% avg

##### Other Terminals:

Local Appl • 33/17% avg  
 Local DB • 35/18% avg  
 Dwnld Prog • 17/14% avg

#### ENVIRONMENT

% Site DP • 73% avg  
 % Cost • 27% avg

Age • 25.3 mo avg  
 Local Term • 22.7 avg  
 Remote Term • 32.2 avg  
 Simul Term • 33.7 avg

### IBM SYSTEM 370 138/148

0.0 2.0 4.0 6.0 8.0 10.0

means

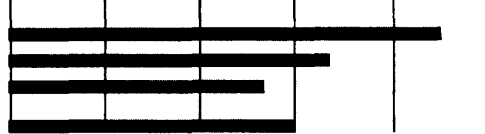

0 20 40 60 80 100

% occurrence of difficulties

■ % Rarely-Never/□ % Occasionally

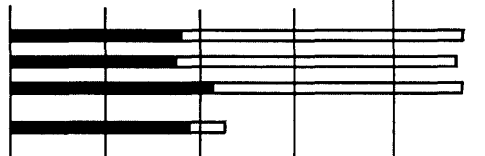

■ % Supported Now/□ % Planned within 24 mo

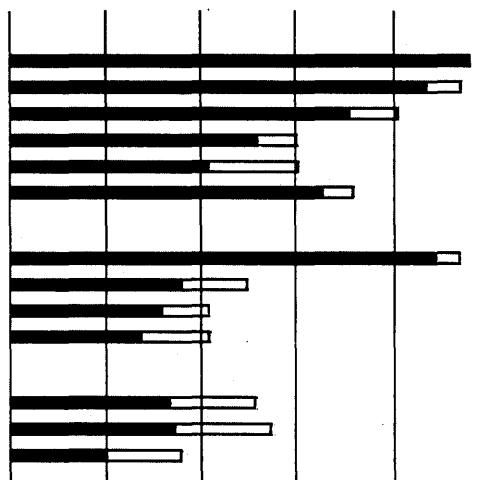

% of Site DP capacity and cost

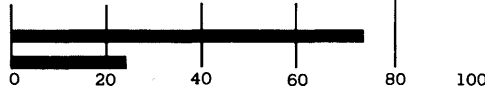

32.6 mo  
 27.7  
 26.9  
 28.0

### IBM 4331

0.0 2.0 4.0 6.0 8.0 10.0

means

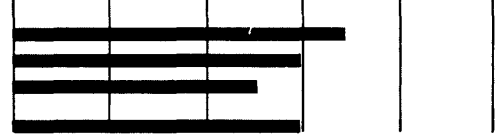

0 20 40 60 80 100

% occurrence of difficulties

■ % Rarely-Never/□ % Occasionally

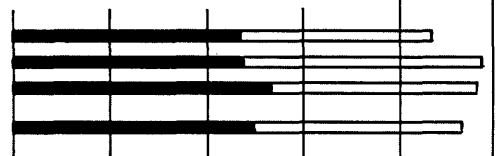

■ % Supported Now/□ % Planned within 24 mo

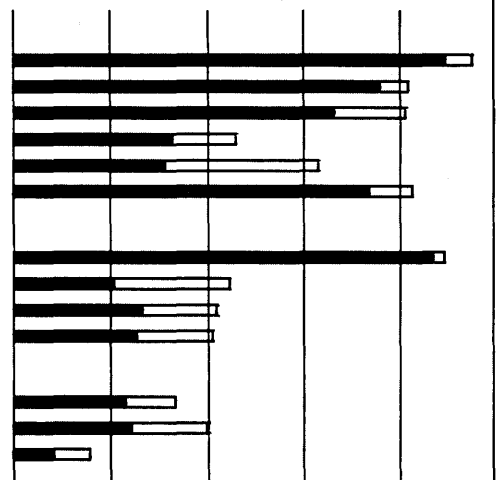

% of Site DP capacity and cost



10.6 mo  
 14.5  
 16.3  
 15.3

#### LEGEND

**Class Averages** • averages of the values for all members of one group (i.e., Small, Medium, or Large Systems).

**Ratings** • values presented are means of users' ratings on a scale of 10 to 1, with a rating of 10-9 indicating Superior, 8-6 indicating Very Good, 5-3 indicating Acceptable, and 2-1 indicating Inadequate • Operations is the average of 4 questions • Appl Devel is applications program development • Training is training and instruction support • Average is the averages of the 3 ratings • see Methodology for details.

**Freedom From Difficulties** • % of users responding to questions asking them to identify the degree of difficulty they experienced with several areas; users also had choices of Often and Very Often in addition to Rarely/Never and Occasionally • Software is computer vendor communications software • Hrdwr Reliab is communications hardware reliability • Service is computer vendor

service/maintenance • Average is computed from averages of counts.

**Activities & Plans** • % currently supported and % not now supported, but planned within 24 months; see Methodology for specific definitions used in questionnaire • Data Processing identifies computer system activities at the site • Attached Term identifies activities initiated from a local or remote terminal attached to the subject computer system; Transfer Prog indicates transfer of program for execution on remote system • Other Terminals indicates activities initiated by terminals "belonging" to a computer other than the subject computer system; Dwnld Prog indicates access to local program library for download and execution of programs on remote system.

**Environment** • % Site DP indicates how much of the site's total data processing is handled by the subject system • % Cost indicates how much of the total computer cost is devoted to data communications • Age is average length of installation • Local and Remote Term are the average number attached to the system • Simul Term is the average number of terminals operating simultaneously.



# MEDIUM SYSTEMS

## CLASS AVERAGES

### RATINGS

Operations • 7.14 avg  
 Appl Devel • 6.37 avg  
 Training • 4.96 avg  
 Average • 6.16 avg

### DIFFICULTIES

Software • 40/52% avg  
 Hrdwr Reliab • 39/56% avg  
 Service • 38/54% avg  
 Average • 39/52% avg

### ACTIVITIES/PLANS

#### Data Processing:

Batch • 93/2% avg  
 Interactive • 86/7% avg  
 Database • 66/17% avg  
 Timesharing • 52/7% avg  
 Distrib • 38/22% avg  
 Transaction • 68/9% avg

#### Attached Terminals:

Multiple Appl • 87/3% avg  
 Remote DB • 32/20% avg  
 Remote Appl • 29/12% avg  
 Transfer Prog • 24/14% avg

#### Other Terminals:

Local Appl • 33/17% avg  
 Local DB • 35/18% avg  
 Dwnld Prog • 17/14% avg

### ENVIRONMENT

% Site DP • 73% avg  
 % Cost • 27% avg  
 Age • 25.3 mo avg  
 Local Term • 22.7 avg  
 Remote Term • 32.2 avg  
 Simul Term • 33.7 avg

## NCR 8000

0.0 2.0 4.0 6.0 8.0 10.0

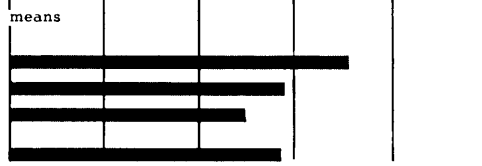

0 20 40 60 80 100

% occurrence of difficulties  
 ■ % Rarely-Never □ % Occasionally



■ % Supported Now □ % Planned within 24 mo

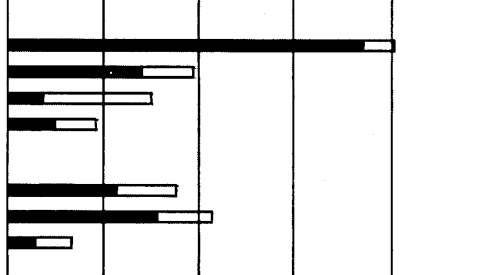
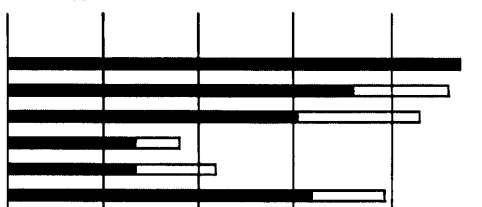

% of Site DP capacity and cost  
 0 20 40 60 80 100  
 24.6 mo  
 13.3  
 33.1  
 25.9

## SPERRY UNIVAC 90/60, 90/70, 90/80

0.0 2.0 4.0 6.0 8.0 10.0

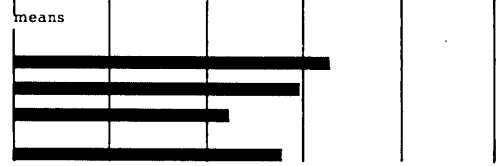

0 20 40 60 80 100

% occurrence of difficulties  
 ■ % Rarely-Never □ % Occasionally



■ % Supported Now □ % Planned within 24 mo

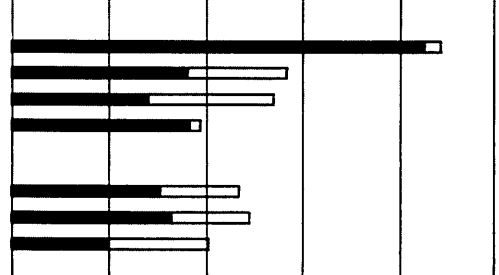
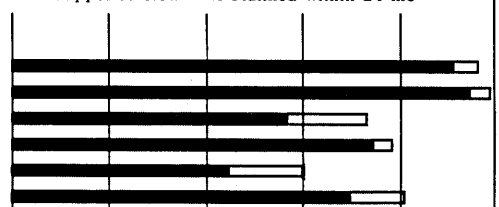

% of Site DP capacity and cost  
 0 20 40 60 80 100  
 24.3 mo  
 24.8  
 37.6  
 40.6

### LEGEND

**Class Averages** • averages of the values for all members of one group (i.e., Small, Medium, or Large Systems).

**Ratings** • values presented are means of users' ratings on a scale of 10 to 1, with a rating of 10-9 indicating Superior, 8-6 indicating Very Good, 5-3 indicating Acceptable, and 2-1 indicating Inadequate • Operations is the average of 4 questions • Appl Devel is applications program development • Training is training and instruction support • Average is the averages of the 3 ratings • see Methodology for details.

**Freedom From Difficulties** • % of users responding to questions asking them to identify the degree of difficulty they experienced with several areas; users also had choices of Often and Very Often in addition to Rarely/Never and Occasionally • Software is computer vendor communications software • Hrdwr Reliab is communications hardware reliability • Service is computer vendor

service/maintenance • Average is computed from averages of counts.

**Activities & Plans** • % currently supported and % not now supported, but planned within 24 months; see Methodology for specific definitions used in questionnaire • Data Processing identifies computer system activities at the site • Attached Term identifies activities initiated from a local or remote terminal attached to the subject computer system; Transfer Prog indicates transfer of program for execution on remote system • Other Terminals indicates activities initiated by terminals "belonging" to a computer other than the subject computer system; Dwnld Prog indicates access to local program library for download and execution of programs on remote system.

**Environment** • % Site DP indicates how much of the site's total data processing is handled by the subject system • % Cost indicates how much of the total computer cost is devoted to data communications • Age is average length of installation • Local and Remote Term are the average number attached to the system • Simul Term is the average number of terminals operating simultaneously.

# COMPUTER COMMUNICATIONS RATINGS

## LARGE SYSTEMS

### ■ CLASS AVERAGES

#### RATINGS

Operations • 7.16 avg  
 Appl Devel • 6.33 avg  
 Training • 5.37 avg  
 Average • 6.29 avg

#### DIFFICULTIES

Software • 27/54% avg  
 Hrdwr Reliab • 34/60% avg  
 Service • 33/54% avg  
 Average • 31/56% avg

#### ACTIVITIES/PLANS

##### Data Processing:

Batch • 97/0% avg  
 Interactive • 92/4% avg  
 Database • 78/12% avg  
 Timesharing • 70/4% avg  
 Distrib • 41/27% avg  
 Transaction • 71/14% avg

##### Attached Terminals:

Multiple Appl • 91/6% avg  
 Remote DB • 38/24% avg  
 Remote Appl • 31/19% avg  
 Transfer Prog • 22/21% avg

##### Other Terminals:

Local Appl • 41/21% avg  
 Local DB • 35/26% avg  
 Dwnld Prog • 18/20% avg

#### ENVIRONMENT

% Site DP • 70% avg  
 % Cost • 27% avg

Age • 25.1 mo avg  
 Local Term • 38.5 avg  
 Remote Term • 51.0 avg  
 Simul Term • 49.6 avg

### ■ AMDAHL 470V

0.0 2.0 4.0 6.0 8.0 10.0

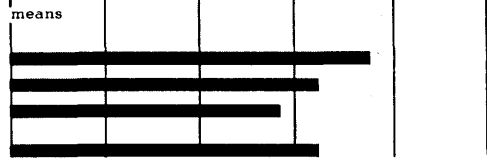

0 20 40 60 80 100

% occurrence of difficulties  
 ■ % Rarely-Never/□ % Occasionally

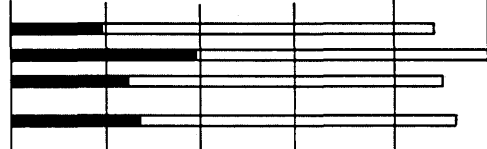

■ % Supported Now/□ % Planned within 24 mo

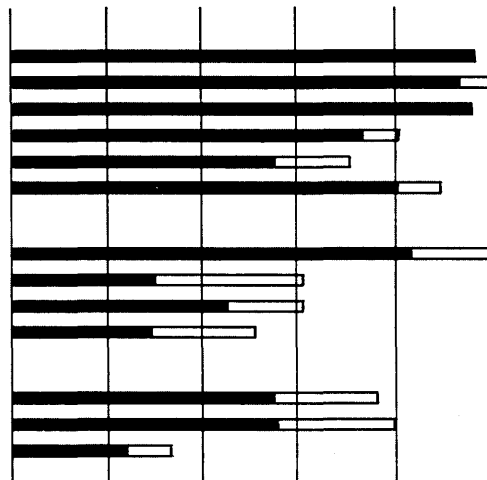

% of Site DP capacity and cost

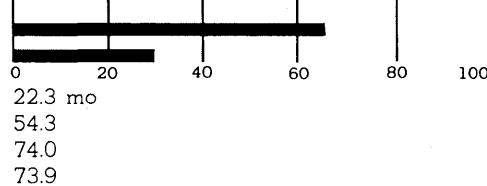

### ■ BURROUGHS B 6800/B 7800

0.0 2.0 4.0 6.0 8.0 10.0

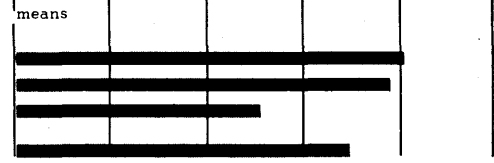

0 20 40 60 80 100

% occurrence of difficulties  
 ■ % Rarely-Never/□ % Occasionally

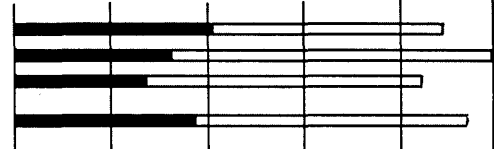

■ % Supported Now/□ % Planned within 24 mo



% of Site DP capacity and cost

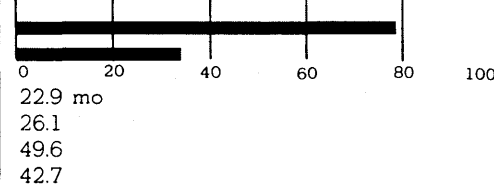

#### LEGEND

**Class Averages** • averages of the values for all members of one group (i.e., Small, Medium, or Large Systems).

**Ratings** • values presented are means of users' ratings on a scale of 10 to 1, with a rating of 10-9 indicating Superior, 8-6 indicating Very Good, 5-3 indicating Acceptable, and 2-1 indicating Inadequate • Operations is the average of 4 questions • Appl Devel is applications program development • Training is training and instruction support • Average is the averages of the 3 ratings • see Methodology for details.

**Freedom From Difficulties** • % of users responding to questions asking them to identify the degree of difficulty they experienced with several areas; users also had choices of Often and Very Often in addition to Rarely/Never and Occasionally • Software is computer vendor communications software • Hrdwr Reliab is communications hardware reliability • Service is computer vendor

service/maintenance • Average is computed from averages of counts.

**Activities & Plans** • % currently supported and % not now supported, but planned within 24 months; see Methodology for specific definitions used in questionnaire • Data Processing identifies computer system activities at the site • Attached Term identifies activities initiated from a local or remote terminal attached to the subject computer system; Transfer Prog indicates transfer of program for execution on remote system • Other Terminals indicates activities initiated by terminals "belonging" to a computer other than the subject computer system; Dwnld Prog indicates access to local program library for download and execution of programs on remote system.

**Environment** • % Site DP indicates how much of the site's total data processing is handled by the subject system • % Cost indicates how much of the total computer cost is devoted to data communications • Age is average length of installation • Local and Remote Term are the average number attached to the system • Simul Term is the average number of terminals operating simultaneously.

# LARGE SYSTEMS

## CLASS AVERAGES

### RATINGS

Operations • 7.16 avg  
 Appl Devel • 6.33 avg  
 Training • 5.37 avg  
 Average • 6.29 avg

### DIFFICULTIES

Software • 27/54% avg  
 Hrdwr Reliab • 34/60% avg  
 Service • 33/54% avg  
 Average • 31/56% avg

### ACTIVITIES/PLANS

#### Data Processing:

Batch • 97/0% avg  
 Interactive • 92/4% avg  
 Database • 78/12% avg  
 Timesharing • 70/4% avg  
 Distrib • 41/27% avg  
 Transaction • 71/14% avg

#### Attached Terminals:

Multiple Appl • 91/6% avg  
 Remote DB • 38/24% avg  
 Remote Appl • 31/19% avg  
 Transfer Prog • 22/21% avg

#### Other Terminals:

Local Appl • 41/21% avg  
 Local DB • 35/26% avg  
 Dwnld Prog • 18/20% avg

### ENVIRONMENT

% Site DP • 70% avg  
 % Cost • 27% avg

Age • 25.1 mo avg  
 Local Term • 38.5 avg  
 Remote Term • 51.0 avg  
 Simul Term • 49.6 avg

## CONTROL DATA CYBER

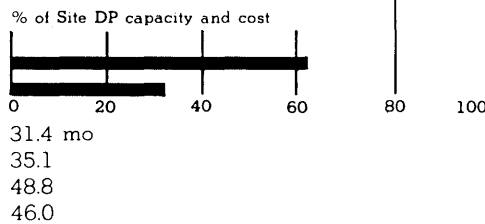
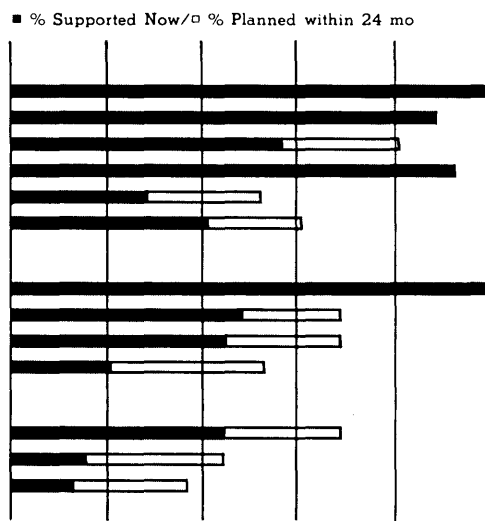
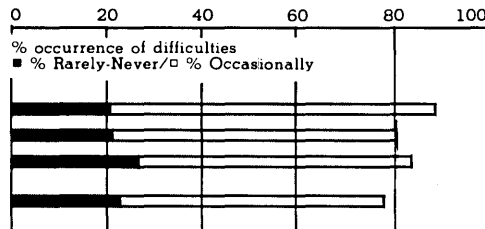
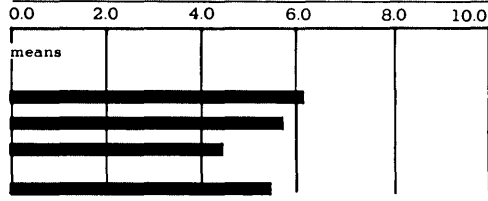

## HONEYWELL SERIES 60 DPS

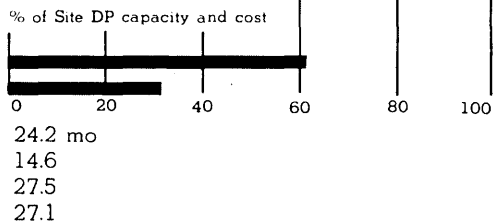
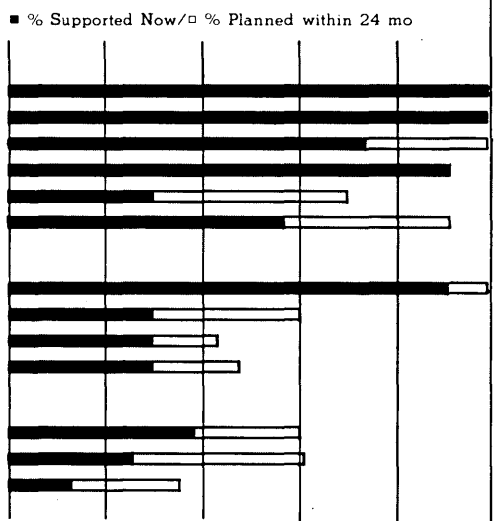
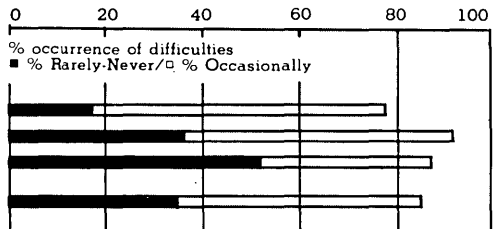
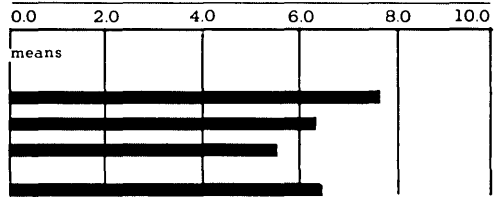

### LEGEND

**Class Averages** • averages of the values for all members of one group (i.e., Small, Medium, or Large Systems).

**Ratings** • values presented are means of users' ratings on a scale of 10 to 1, with a rating of 10-9 indicating Superior, 8-6 indicating Very Good, 5-3 indicating Acceptable, and 2-1 indicating Inadequate • Operations is the average of 4 questions • Appl Devel is applications program development • Training is training and instruction support • Average is the averages of the 3 ratings • see Methodology for details.

**Freedom From Difficulties** • % of users responding to questions asking them to identify the degree of difficulty they experienced with several areas; users also had choices of Often and Very Often in addition to Rarely/Never and Occasionally • Software is computer vendor communications software • Hrdwr Reliab is communications hardware reliability • Service is computer vendor

service/maintenance • Average is computed from averages of counts.

**Activities & Plans** • % currently supported and % not now supported, but planned within 24 months; see Methodology for specific definitions used in questionnaire • Data Processing identifies computer system activities at the site • Attached Term identifies activities initiated from a local or remote terminal attached to the subject computer system; Transfer Prog indicates transfer of program for execution on remote system • Other Terminals indicates activities initiated by terminals "belonging" to a computer other than the subject computer system; Dwnld Prog indicates access to local program library for download and execution of programs on remote system.

**Environment** • % Site DP indicates how much of the site's total data processing is handled by the subject system • % Cost indicates how much of the total computer cost is devoted to data communications • Age is average length of installation • Local and Remote Term are the average number attached to the system • Simul Term is the average number of terminals operating simultaneously.

“One-Call  
Service. We believe that’s  
all it should take to  
get a computer  
up and running again.”

Sy Kraut  
Vice President & General Manager  
Honeywell Field Engineering

Some day computers may be monitored remotely by other computers and repaired by robots. But until that day arrives, people will continue to be the most important element of service. Information, tools, and spare parts make up the rest of the equation, but it requires experts to apply them, also.

---

*“We’re talking about  
person-to-person service.”*

---

The bedrock of our service is personal contact. We make a single individual responsible to you for providing quality service on your entire system. We call him our Customer Service Account Representative.

This “Service Rep” will quickly become familiar with your operation and its special requirements. He will be there to supervise maintenance and upgrades — to handle any questions or emergencies that may arise.

In short, this individual is personally responsible for every job, large or small, relative to your system.

---

*“Call anytime — day or night.”*

---

Our National Response Center is manned 24 hours a day. One call alerts your “Service Rep” who ensures that our systems and experts are set in motion to analyze





your situation. He has the full resources of our Technical Assistance Centers at his disposal. In many instances, these experts can diagnose and correct the difficulty via the telephone.

If an on-site correction is required, the best available expert is dispatched along with the proper information, tools, and parts to do the job. All from one call.

That's our aim at Honeywell Field Engineering where *service is our business and customer satisfaction our goal.*

# Honeywell

The ingenuity of people, the power of computers.

CIRCLE 88 ON READER CARD

# COMPUTER COMMUNICATIONS RATINGS

## LARGE SYSTEMS

### CLASS AVERAGES

#### RATINGS

Operations • 7.16 avg  
 Appl Devel • 6.33 avg  
 Training • 5.37 avg  
 Average • 6.29 avg

#### DIFFICULTIES

Software • 27/54% avg  
 Hrdwr Reliab • 34/60% avg  
 Service • 33/54% avg  
 Average • 31/56% avg

#### ACTIVITIES/PLANS

##### Data Processing:

Batch • 97/0% avg  
 Interactive • 92/4% avg  
 Database • 78/12% avg  
 Timesharing • 70/4% avg  
 Distrib • 41/27% avg  
 Transaction • 71/14% avg

##### Attached Terminals:

Multiple Appl • 91/6% avg  
 Remote DB • 38/24% avg  
 Remote Appl • 31/19% avg  
 Transfer Prog • 22/21% avg

##### Other Terminals:

Local Appl • 41/21% avg  
 Local DB • 35/26% avg  
 Dwnld Prog • 18/20% avg

#### ENVIRONMENT

% Site DP • 70% avg  
 % Cost • 27% avg

Age • 25.1 mo avg  
 Local Term • 38.5 avg  
 Remote Term • 51.0 avg  
 Simul Term • 49.6 avg

### HONEYWELL SERIES 60 LEVEL 66/68

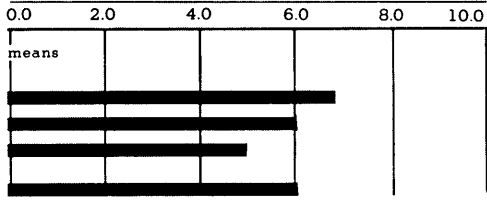

0 20 40 60 80 100

% occurrence of difficulties  
 ■ % Rarely-Never / □ % Occasionally



0 20 40 60 80 100

■ % Supported Now / □ % Planned within 24 mo

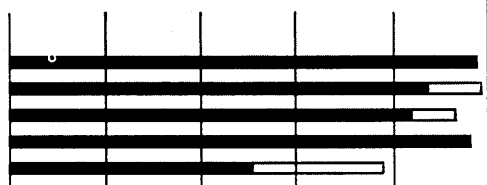

0 20 40 60 80 100

■ % Supported Now / □ % Planned within 24 mo

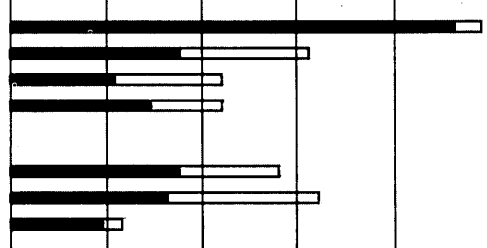

% of Site DP capacity and cost

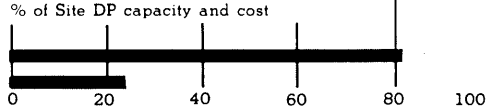

34.4 mo  
 29.1  
 39.8  
 44.5

### IBM SYSTEM 370 158/168

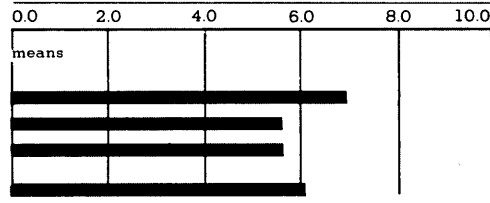

0 20 40 60 80 100

% occurrence of difficulties  
 ■ % Rarely-Never / □ % Occasionally



0 20 40 60 80 100

■ % Supported Now / □ % Planned within 24 mo

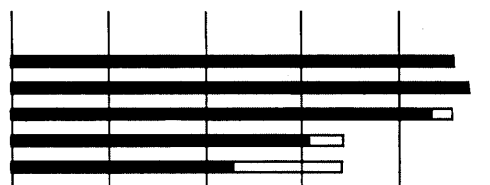

0 20 40 60 80 100

■ % Supported Now / □ % Planned within 24 mo



% of Site DP capacity and cost

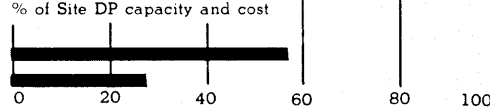

35.0 mo  
 54.8  
 70.1  
 63.4

#### LEGEND

**Class Averages** • averages of the values for all members of one group (i.e., Small, Medium, or Large Systems).

**Ratings** • values presented are means of users' ratings on a scale of 10 to 1, with a rating of 10-9 indicating Superior, 8-6 indicating Very Good, 5-3 indicating Acceptable, and 2-1 indicating Inadequate • Operations is the average of 4 questions • Appl Devel is applications program development • Training is training and instruction support • Average is the averages of the 3 ratings • see Methodology for details.

**Freedom From Difficulties** • % of users responding to questions asking them to identify the degree of difficulty they experienced with several areas; users also had choices of Often and Very Often in addition to Rarely/Never and Occasionally • Software is computer vendor communications software • Hrdwr Reliab is communications hardware reliability • Service is computer vendor

service/maintenance • Average is computed from averages of counts.

**Activities & Plans** • % currently supported and % not now supported, but planned within 24 months; see Methodology for specific definitions used in questionnaire • Data Processing identifies computer system activities at the site • Attached Term identifies activities initiated from a local or remote terminal attached to the subject computer system; Transfer Prog indicates transfer of program for execution on remote system • Other Terminals identifies activities initiated by terminals "belonging" to a computer other than the subject computer system; Dwnld Prog indicates access to local program library for download and execution of programs on remote system.

**Environment** • % Site DP indicates how much of the site's total data processing is handled by the subject system • % Cost indicates how much of the total computer cost is devoted to data communications • Age is average length of installation • Local and Remote Term are the average number attached to the system • Simul Term is the average number of terminals operating simultaneously.

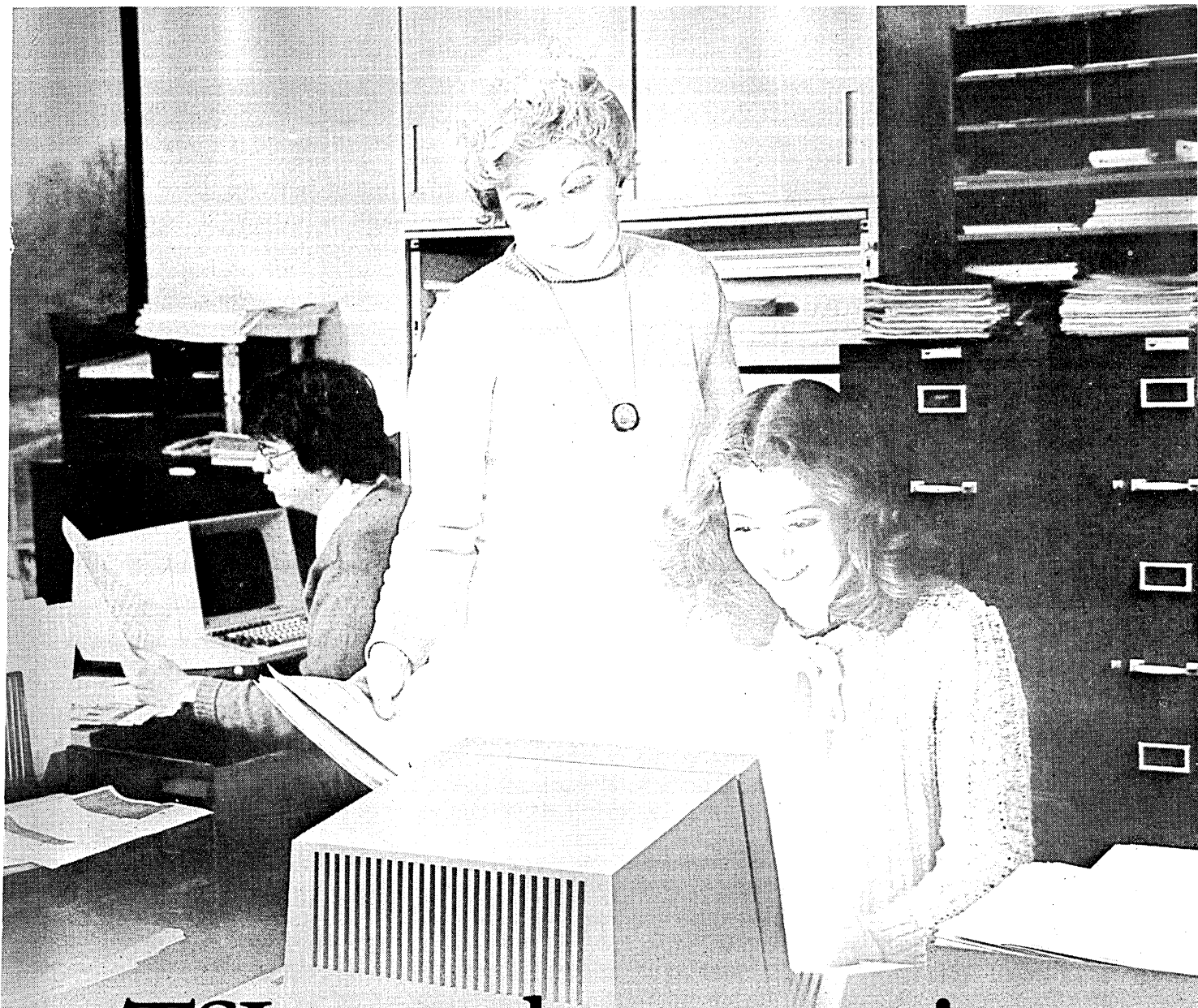

# TSI puts data entry in a whole new light.

If you're in the dark about how to make your data entry system more efficient, TSI International has some eye-opening news for you.

About an on-line system called Key/Master<sup>®</sup>

Key/Master allows you to enter *very* clean data. *Very* fast. Because it reduces data entry to its simplest equation: entry at the source, directly into your system.

And because Key/Master is easy to use, non-technical people can design their own input formats interactively—in minutes. And enter data immediately, correcting errors on the spot.

Key/Master also offers powerful editing functions, like

range testing, table look ups, running totals, field balancing and more.

And Key/Master runs under CICS, using your existing on-line terminals.

You can start using it the day you install it. And save money right from the start.

For more enlightening information about Key/Master, call (203) 853-2884 for the location of our office nearest you. Or clip your business card to this ad and send it to TSI International at the address below.

**Hardworking software that's easy to use.**

**National CSS**

**DB** a company of  
The Dun & Bradstreet Corporation

CIRCLE 89 ON READER CARD

**TSI International**

System Products Division  
50 Washington St., Norwalk, CT 06854

# COMPUTER COMMUNICATIONS RATINGS

## LARGE SYSTEMS

### ■ CLASS AVERAGES

#### RATINGS

Operations • 7.16 avg  
 Appl Devel • 6.33 avg  
 Training • 5.37 avg  
 Average • 6.29 avg

#### DIFFICULTIES

Software • 27/54% avg  
 Hrdwr Reliab • 34/60% avg  
 Service • 33/54% avg  
 Average • 31/56% avg

#### ACTIVITIES/PLANS

##### Data Processing:

Batch • 97/0% avg  
 Interactive • 92/4% avg  
 Database • 78/12% avg  
 Timesharing • 70/4% avg  
 Distrib • 41/27% avg  
 Transaction • 71/14% avg

##### Attached Terminals:

Multiple Appl • 91/6% avg  
 Remote DB • 38/24% avg  
 Remote Appl • 31/19% avg  
 Transfer Prog • 22/21% avg

##### Other Terminals:

Local Appl • 41/21% avg  
 Local DB • 35/26% avg  
 Dwnld Prog • 18/20% avg

#### ENVIRONMENT

% Site DP • 70% avg  
 % Cost • 27% avg

Age • 25.1 mo avg  
 Local Term • 38.5 avg  
 Remote Term • 51.0 avg  
 Simul Term • 49.6 avg

### ■ IBM 303X

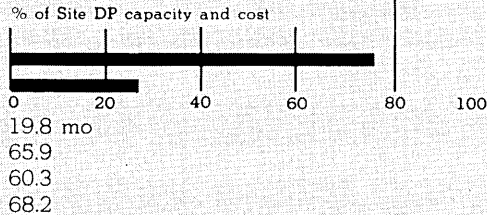
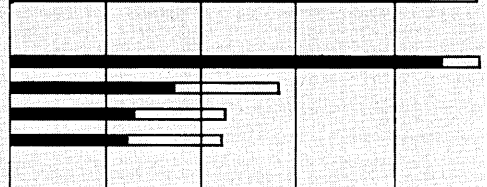
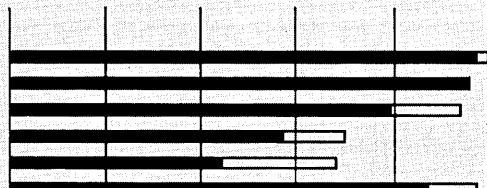
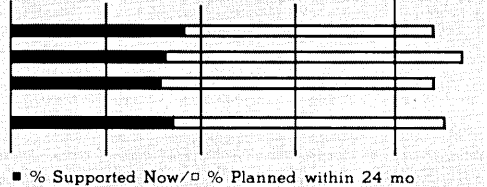
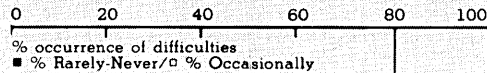
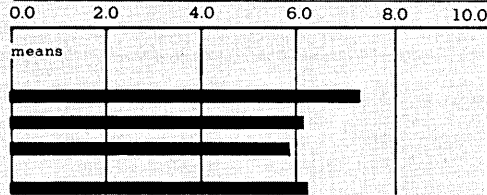

### ■ IBM 4341

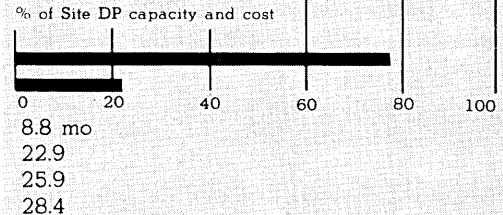
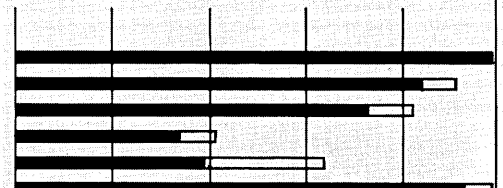
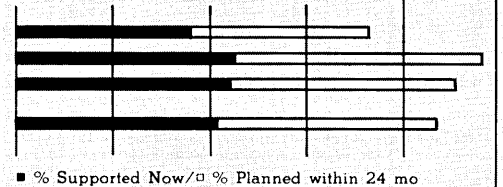
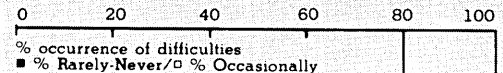
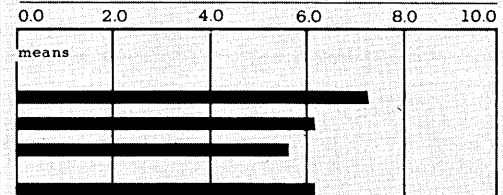

#### LEGEND

**Class Averages** • averages of the values for all members of one group (i.e., Small, Medium, or Large Systems).

**Ratings** • values presented are means of users' ratings on a scale of 10 to 1, with a rating of 10-9 indicating Superior, 8-6 indicating Very Good, 5-3 indicating Acceptable, and 2-1 indicating Inadequate • Operations is the average of 4 questions • Appl Devel is applications program development • Training is training and instruction support • Average is the averages of the 3 ratings • see Methodology for details.

**Freedom From Difficulties** • % of users responding to questions asking them to identify the degree of difficulty they experienced with several areas; users also had choices of Often and Very Often in addition to Rarely/Never and Occasionally • Software is computer vendor communications software • Hrdwr Reliab is communications hardware reliability • Service is computer vendor

service/maintenance • Average is computed from averages of counts.

**Activities & Plans** • % currently supported and % not now supported, but planned within 24 months; see Methodology for specific definitions used in questionnaire • Data Processing identifies computer system activities at the site • Attached Term identifies activities initiated from a local or remote terminal attached to the subject computer system; Transfer Prog indicates transfer of program for execution on remote system • Other Terminals indicates activities initiated by terminals "belonging" to a computer other than the subject computer system; Dwnld Prog indicates access to local program library for download and execution of programs on remote system.

**Environment** • % Site DP indicates how much of the site's total data processing is handled by the subject system • % Cost indicates how much of the total computer cost is devoted to data communications • Age is average length of installation • Local and Remote Term are the average number attached to the system • Simul Term is the average number of terminals operating simultaneously.



# It'll cause a mini revolution in America

*System* is a unique teleprocessing system that will revolutionise the American mini-computer market.

Manufactured by Systime, the UK's largest supplier of turnkey computer systems, *System* provide interactive transaction processing on up to 256 terminals per processor (VAX\*).

At present *System* is available for DEC\*PDP 11 44-70 or VAX\* 11/750-780 systems and will give transaction processing concurrent with other applications and a distributive processing network.

**CIRCLE 90 ON READER CARD**

VAX\* PDP\* DEC\* are all trademarks of the Digital Equipment Corporation.  
*System* is a registered trade mark in the U.K.

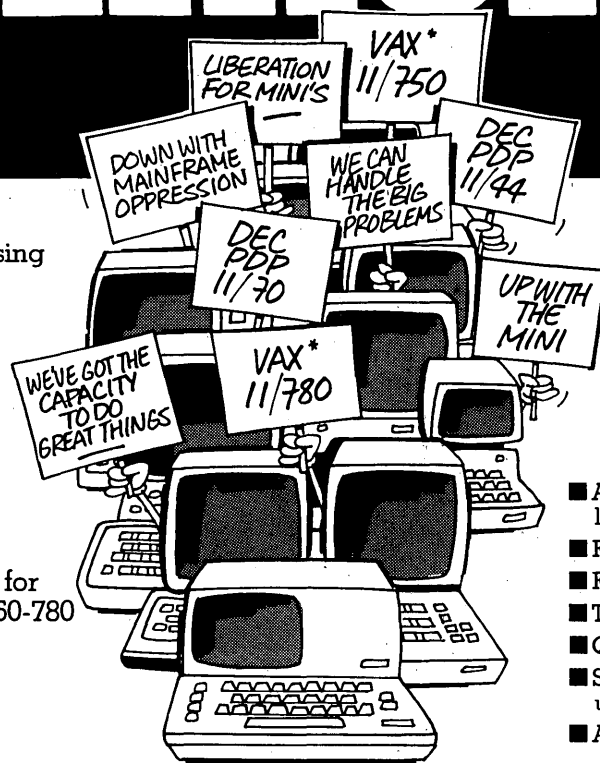

*System's* advanced features provide:

- Efficient memory management and usage. All transactions employ multi threading.
- *System's* advanced transaction control language increases your processing capability while decreasing application development and implementation.
- Access security on individual terminal locations, files and records.
- File journaling and recovery.
- Forms generation. ■ Message handling.
- Training mode.
- On-line program development.
- System supplied transaction and external utility programs
- Advanced T.P. monitor features.

If you have a DEC\*PDP 11/44-70 or VAX\* 11/750-780 and want to revolutionise its capability then contact:

**JOHN N. WARD SYSTEM INC.**  
8980K ROUTE 108, COLUMBIA,  
MARYLAND 21045  
Tele: 301-730 4424 Twx: 230-908273

## SYSTEM

Now available in America

## SYSTEM

# COMPUTER COMMUNICATIONS RATINGS

## LARGE SYSTEMS

### CLASS AVERAGES

#### RATINGS

Operations • 7.16 avg  
 Appl Devel • 6.33 avg  
 Training • 5.37 avg  
 Average • 6.29 avg

#### DIFFICULTIES

Software • 27/54% avg  
 Hrdwr Reliab • 34/60% avg  
 Service • 33/54% avg  
 Average • 31/56% avg

#### ACTIVITIES/PLANS

##### Data Processing:

Batch • 97/0% avg  
 Interactive • 92/4% avg  
 Database • 78/12% avg  
 Timesharing • 70/4% avg  
 Distrib • 41/27% avg  
 Transaction • 71/14% avg

##### Attached Terminals:

Multiple Appl • 91/6% avg  
 Remote DB • 38/24% avg  
 Remote Appl • 31/19% avg  
 Transfer Prog • 22/21% avg

##### Other Terminals:

Local Appl • 41/21% avg  
 Local DB • 35/26% avg  
 Dwnld Prog • 18/20% avg

#### ENVIRONMENT

% Site DP • 70% avg  
 % Cost • 27% avg  
 Age • 25.1 mo avg  
 Local Term • 38.5  
 Remote Term • 51.0 avg  
 Simul Term • 49.6 avg

### NAS (ITEL)

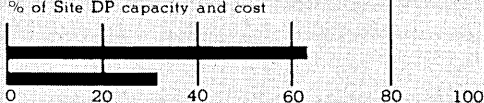
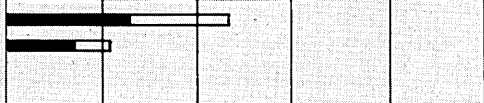
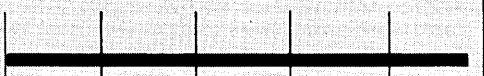
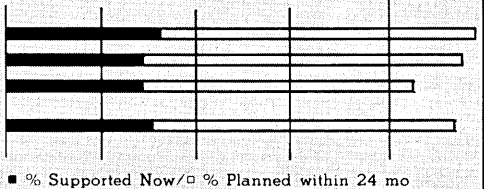
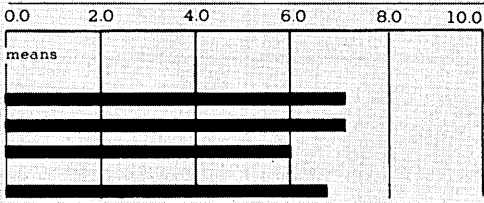

### SPERRY UNIVAC 1100

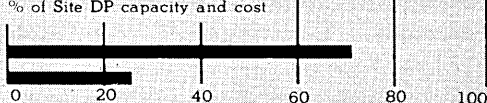
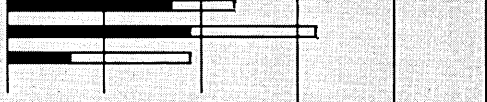
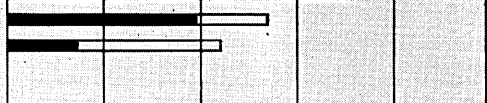
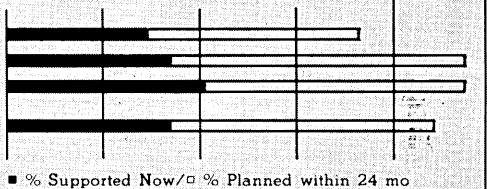
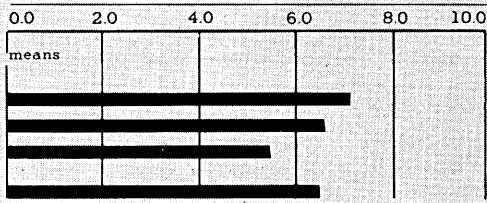

#### LEGEND

**Class Averages** • averages of the values for all members of one group (i.e. Small, Medium, or Large Systems).

**Ratings** • values presented are means of users' ratings on a scale of 10 to 1, with a rating of 10-9 indicating Superior, 8-6 indicating Very Good, 5-3 indicating Acceptable, and 2-1 indicating Inadequate • Operations is the average of 4 questions • Appl Devel is applications program development • Training is training and instruction support • Average is the averages of the 3 ratings • see Methodology for details.

**Freedom From Difficulties** • % of users responding to questions asking them to identify the degree of difficulty they experienced with several areas; users also had choices of Often and Very Often in addition to Rarely/Never and Occasionally • Software is computer vendor communications software • Hrdwr Reliab is communications hardware reliability • Service is computer vendor

service/maintenance • Average is computed from averages of counts.

**Activities & Plans** • % currently supported and % not now supported, but planned within 24 months; see Methodology for specific definitions used in questionnaire • Data Processing identifies computer system activities at the site • Attached Term identifies activities initiated from a local or remote terminal attached to the subject computer system; Transfer Prog indicates transfer of program for execution on remote system • Other Terminals indicates activities initiated by terminals "belonging" to a computer other than the subject computer system; Dwnld Prog indicates access to local program library for download and execution of programs on remote system.

**Environment** • % Site DP indicates how much of the site's total data processing is handled by the subject system • % Cost indicates how much of the total computer cost is devoted to data communications • Age is average length of installation • Local and Remote Term are the average number attached to the system • Simul Term is the average number of terminals operating simultaneously.

# Valedictorian of the Smart Editing Class of Terminals.

FEATURE COMPARISON CHART

| FEATURE   | Visual 400 | Lear Seigler ADM-42 | Perkin Elmer 1251 | ADDS Regent 60 | Hazeltine Executive 80, Model 30 | Beehive DM30 |
|---|------------|---------------------|-------------------|----------------|----------------------------------|--------------|
| ANSI X3.64 Specified                                | STD        | NO                  | NO                | NO             | STD                              | NO           |
| Set-up Modes Eliminate External Switches            | STD        | NO                  | STD               | NO             | NO                               | NO           |
| Typomatic Solid State Keyboard                      | STD        | NO                  | NO                | NO             | STD                              | NO           |
| Detached Keyboard                                   | STD        | STD                 | OPT               | NO             | STD                              | STD          |
| CRT Saver   | STD        | NO                  | NO                | NO             | NO                               | NO           |
| Block or Underline Cursor                           | STD        | NO                  | STD               | STD            | STD                              | NO           |
| 80 and 132 Columns                                  | STD        | NO                  | NO                | NO             | OPT                              | NO           |
| Double Size Characters                              | STD        | NO                  | NO                | NO             | OPT                              | NO           |
| Smooth Scrolling                                    | STD        | NO                  | NO                | NO             | OPT                              | NO           |
| Horizontal Split Screen                             | STD        | NO                  | NO                | NO             | STD                              | NO           |
| Video Attributes Require No Display Space           | STD        | NO                  | NO                | NO             | STD                              | STD          |
| 8 Area Qualifications                               | STD        | NO                  | NO                | NO             | NO                               | NO           |
| 8 Resident Nat'l Char. Sets Including Line Drawing  | STD        | NO                  | NO                | NO             | NO                               | NO           |
| Programmable Non-volatile Function Keys             | STD        | OPT                 | STD               | NO             | NO                               | NO           |
| Display of ALL Control Codes                        | STD        | STD                 | STD               | STD            | NO                               | STD          |
| Insert Delete Line with Push Up or Down             | STD        | NO                  | NO                | NO             | NO                               | NO           |
| Insert Delete Character with Push Right or Left     | STD        | NO                  | NO                | NO             | NO                               | NO           |
| Select Editing Extent to Field, Area, Line, Page    | STD        | NO                  | NO                | NO             | NO                               | NO           |
| 20 mA Current Loop                                  | STD        | STD                 | OPT               | OPT            | OPT                              | STD          |
| Programmable Message Framing (non-volatile)         | STD        | NO                  | STD               | NO             | NO                               | NO           |
| Programmable Answerback                             | STD        | NO                  | STD               | NO             | NO                               | NO           |
| Baud Rates to 19200 BPS                             | STD        | NO                  | NO                | NO             | STD                              | STD          |
| Independent Xmit/Receive Rates                      | STD        | NO                  | NO                | NO             | NO                               | NO           |
| Printer Port Independent of Communication Interface | OPT        | OPT                 | STD               | STD            | OPT                              | STD          |
| Paging  | OPT        | STD                 | NO                | NO             | STD                              | STD          |

Compare the new VISUAL 400 with the other smart terminals. Then compare it to your own specification. And if that doesn't do it, we have "Room for RAM" for custom modifications in large quantities.

For a pleasant surprise on pricing, call or write us today.

## VISUAL 400



## VISUAL

See for yourself

Visual Technology Incorporated  
540 Main Street, Tewksbury, MA 01876  
Telephone (617) 851-5000, Telex 951-539

CIRCLE 91 ON READER CARD

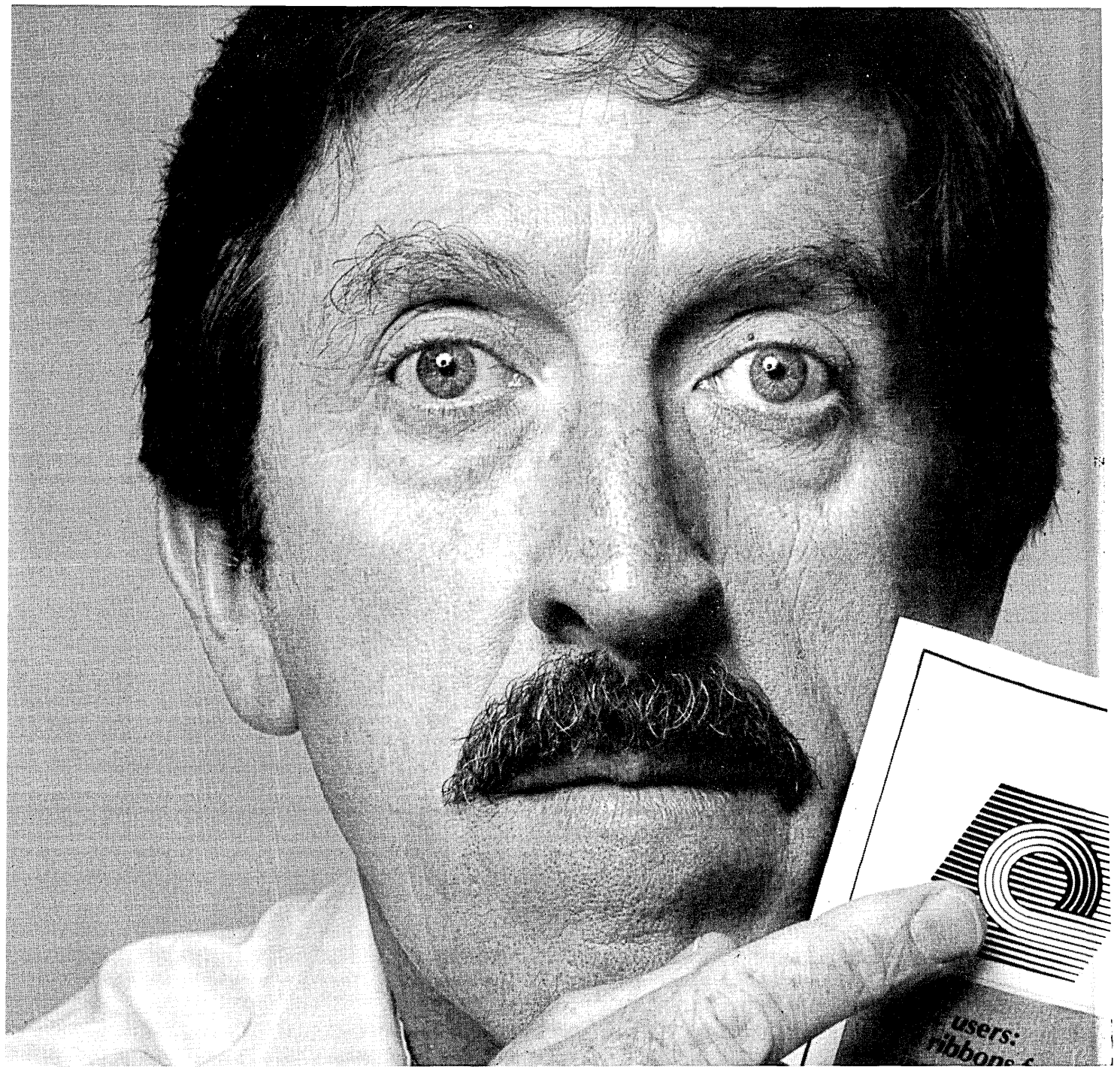

"I'm Bob Sharkey. I'm in Manufacturing Operations at Inmac, and I am not crazy. We've built a big business on a very simple premise: Giving you what you need, when you need it.

"Need disks, tapes or floppies? We have them compatible with almost every mini and micro computer made. You need ribbons? We have ribbons compatible with 753 different printers. You need cables and connectors? We have 538

different kinds—in stock, ready to ship.

"We'll custom build cables to your specs. We'll give you any length you want. We can help you connect your CPU to virtually any peripheral you choose.

"And those are just a fraction of the more than 1000 computer-related products we stock and sell. I might get an ulcer trying to keep track of all that stuff, but I don't think I'll have to

**"If we don't have the  
computer supplies  
you need, I will  
eat this catalog."**

Bob Sharkey  
General Manager, Manufacturing Operations



eat a catalog sandwich.

"Call my bluff. Next time you have a problem getting what you need, call Inmac. We give you a sure-fire guarantee on anything you buy from us. You have 45 days to decide that you're fully satisfied. If you're not, we'll give you a replacement, refund or credit. And no hassle.

"We'll give you fast delivery. We have regional distribution centers, so we can deliver

to over 90% of the computer sites in the U.S. within two days — by regular surface transportation. Or if you need it tomorrow, we'll get it to you tomorrow.

"Call us. Ask for our free catalog. Better yet, give us an order. All we need is your company P.O. number. Our hotline numbers are listed below."

 **Inmac**

**Computer supplies, accessories and cables. More. Better. Faster.**

**CIRCLE 92 ON READER CARD**

Detroit (313) 961-6865 • Los Angeles (213) 852-0973 • Wash. D.C. (202) 362-8214 • Boston (617) 536-9141 • Manchester, U.K. 92-35-67551

**BankWire's problem: how to perform second site testing while highly sensitive electronic funds data were being exchanged among 200 banks.**

# ACCEPTANCE TESTING WITH AN ON-LINE SYSTEM

by Daniel Fidlow

BankWire, with the cooperation of its central vendor, Rockwell International, had to solve the critical problem of how to do acceptance testing on the second site of a two-site computer network (Jersey City, N.J., and Dallas, Texas) whose first site was 1. performing on-line message switching functions 14 hours per day; and 2. intimately interactive with the second site.

Traffic through the system is highly sensitive electronic funds transfer messages being exchanged among almost 200 banks across the U.S. A carefully structured plan of testing was therefore required in order to assure safety to the on-line operation, certainty that second site hardware and software was absolutely ready to go, and preparedness for the problems peculiar to two-site operation.

Because of the interactive nature of the design, a flaw in second site software could bring both sites down during testing, yet such testing had to be done. In the system concept, only one site, the primary, controls traffic acceptance and delivery functions at any time, with the other site, the backup, acting in a message-mirror capacity. There is no load sharing. Fig. 1 diagrams the two-site interaction whose purpose is to keep message files at both sites equal so that in case of primary site failure, switchover to the backup can occur.

The proper solution to acceptance testing was conceptualized according to Fig. 2. Two phases were defined: an off-line phase preceding an on-line phase, each with its own characteristics and objectives.

The objective of off-line testing was to rigorously exercise interaction between the two sites so that when on-line testing and operation began, it would be largely a subset of what had gone before. Thus off-line testing would pressure the system under various stress and load conditions, while on-line testing, with users passing live traffic all the while, would be limited more closely to the types of stress scenarios that might be seen in actual operation. As both sites were involved in all testing, it could only be scheduled during nighttime or weekend hours. As it turned

out, most testing was done on successive Saturdays.

The off-line tests were divided into two categories: stress and load, with four individual stress tests and three individual load tests alternated on successive Saturdays; i.e., stress, then load, then stress, then load, etc. This alternation gave two weeks' time between tests of the same type for problem analysis and correction. When successfully completed, a user-access Saturday was scheduled preparatory to beginning the on-line tests.

## USING STRESS TESTS

The purpose of the stress tests was to show that the system could perform without error (although in degraded response time mode, as necessary) under various forms of stress. For example, the following conditions were imposed simultaneously:

- Single disk operation (each mainframe cpu has dual disks); then the second disk was placed on-line and contents were copied from the original disk to update the second disk while normal message processing continued, greatly increasing the number of accesses.
- Depletion, in which core buffers were artificially marked as busy. This placed the system into successively deeper levels of regulation, until all polling and selecting of the network stopped. Then buffers were released.
- Decreasing the traffic zone, a disk allocation, so that the look-ahead function which protects undelivered traffic must run more frequently.

But the most significant stresses, laid on top of all the others and the major activity throughout the tests themselves, were the extended and complex failure/recovery scenarios. Components were failed individually and in combination in order to verify that the system recovered correctly. The components to be failed included concentrators, deconcentrators, and mainframe cpus. Various failure methods were used: depressing the reload switch, introducing zeros into critical core locations, forcing time-outs by jumping to own location, disconnecting trunks, or failing modems. Depending upon the particular failure, automatic recoveries took the form of

invoking an alternate path, reloading from disk, or restarting on a duplexed processor.

The most important recovery tests involved failure of the primary site. Then switchover to the backup site occurred (as from Jersey City to Dallas), making it primary. This was possible because the per-message interactive nature of the system keeps the message files equal between sites. Therefore, following a switchover, the new primary is ready to continue processing from the same point at which the other site failed. The failed site becomes the backup when repaired, but is presumed to have lost all of its message information. Therefore, the primary begins sending individual message text and status from start-of-day to the backup while continuing its normal on-line functions. When this information has been completely sent so that message files at both sites are again equal, it is possible for another switchover to occur. In several of the stress tests, five such switchovers took place in one day, and reconciliations showed that the system still closed with message files equal at both sites.

When processor failure occurs, the affected user sees a small service interruption: typically under a minute for intrasite recovery; site switchover—since certain manual functions are involved—might take several minutes. Then a recovery message appears at each terminal, giving its last input sequence number, output sequence number, log state, and information that a site switchover occurred (if it did). Processor failure occurring during terminal input requires the user to reenter the message (input sequence number returned in the recovery message resolves any question of whether or not the system accepted a particular message before failure). If failure occurs during output, the system will redeliver the message tagged "Possible Duplicate." Depending on the component failed, not all users will be affected. For example, a concentrator failure will not result in recovery messages to users on the other concentrators. Also, a failure of the backup site will not create any recovery messages to the user network.

The system was open for user participation during the stress tests, for example, for

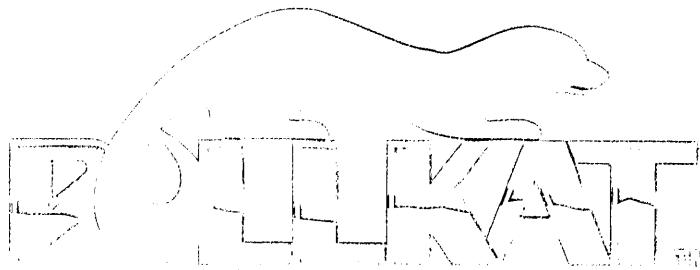

ROTHKAT is a leading manufacturer of high quality, heavy-duty, low cost, full-line office equipment. We are currently seeking qualified individuals for the following positions:

- Sales Representative - Must have 3-5 years experience in sales of office equipment. Will be responsible for sales and customer service in a specific geographic area.
- Sales Representative - Must have 3-5 years experience in sales of office equipment. Will be responsible for sales and customer service in a specific geographic area.
- Sales Representative - Must have 3-5 years experience in sales of office equipment. Will be responsible for sales and customer service in a specific geographic area.

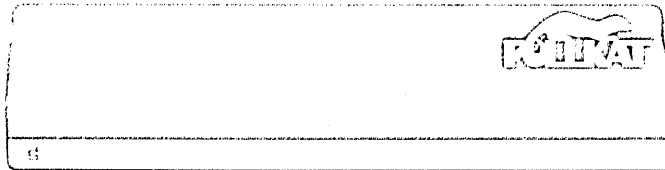
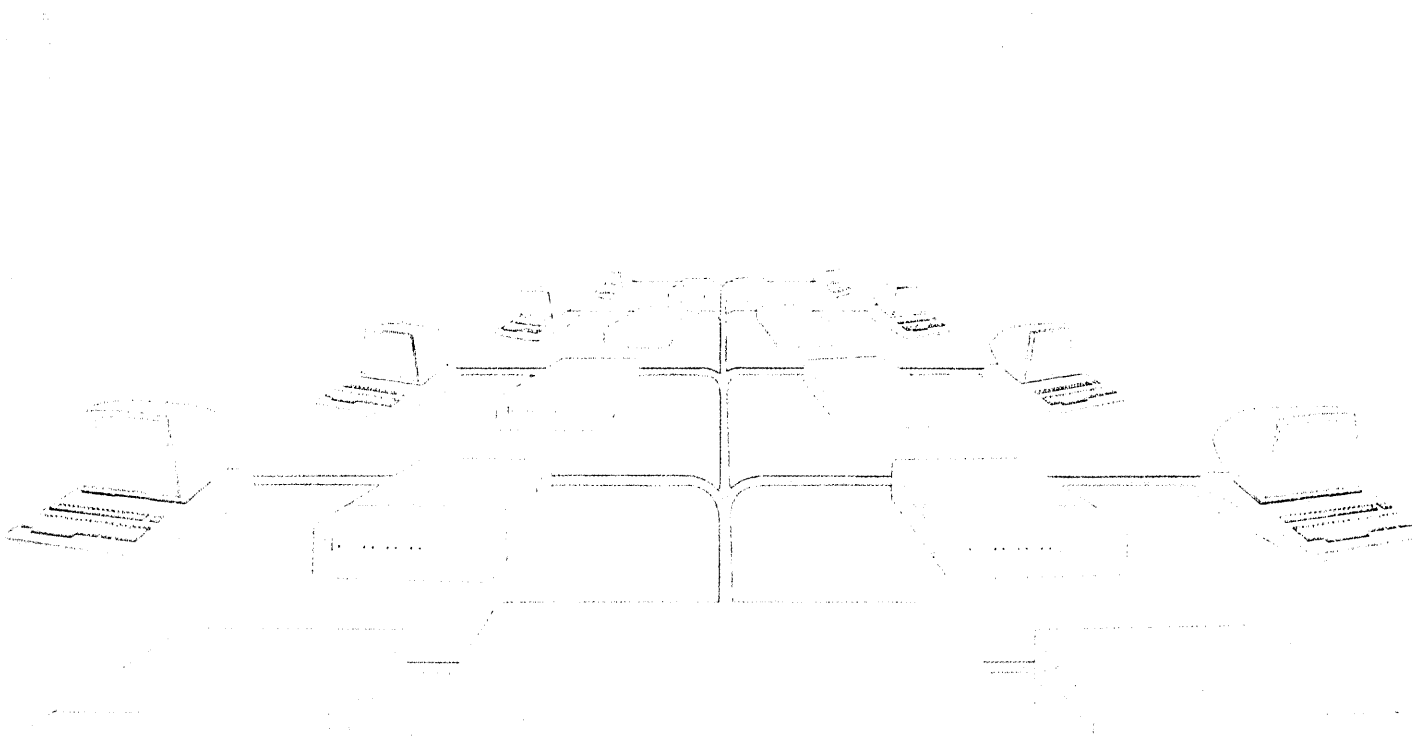

How can we help you find a job? Here are ways:

For the United States, contact our Sales Representative in your area. For the United Kingdom, contact our Sales Representative in your area.

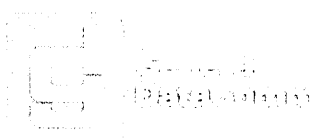

**General DataComm Industries, Inc.**  
One Kennedy Avenue  
Danbury, CT 06810  
(203)757-0750

**General DataComm Industries (Canada) Ltd.**  
Suite 211 West  
4210 Sheppard Avenue East  
Willowdale, Ontario M2N 2W5  
(416)491-6765

**General DataComm (UK) Ltd.**  
Kewley House  
Milton Keynes, Bucks MK14 6JL  
UK  
(07592)405 400

**U.S. SALES OFFICES**  
Atlanta, GA (404)955-4662  
Boston, MA (617)452-6581  
Chicago, IL (312)238-4585  
Cincinnati, OH (513)988-8960  
Dallas, TX (214)988-8366  
Houston, TX (713)781-8880

New York, NY (212)225-6000  
Orlando, FL (305)293-6887  
Pittsburgh, PA (412)225-6000  
San Francisco, CA (415)998-2880  
Seattle, WA (206)388-8850  
Santa Ana, CA (714)957-8840  
Tampa, FL (813)881-8887

Commonwealth  
Dallas, TX (214)225-6560  
Everett, WA (206)355-8800  
Green Valley, IL (309)352-8400  
Indianapolis, IN (317)351-7000  
Memphis, TN (901)957-8550  
Portland, OR (503)620-8520

Scotts Area, CA (714)957-8880  
Tampa, FL (813)795-7270  
Fairford  
Mansfield, VA (703)573-8700  
Wheaton, IL (312)652-8250

FIG. 1.  
**TWO-SITE INTERACTION**

banks that were developing a computer interface and wanted their own test time to work with the system. But the primary traffic background which exercised the system was created by four terminals at the BankWire offices entering multiaddress and group code messages whereby one input can be automatically exploded into 100 outputs. This generated about one-fifth of current daily traffic output.

The system is designed to handle 65,000 messages per day, with a peaking rate of 9,000 messages per hour, about three times current traffic volume. Three tests were designed to verify that the system could handle this load under various conditions, as follows:

Load 1. No site failures.

Load 2. Backup site failure (no switchover occurs); recovery after one hour. During this hour, the primary site continues passing traffic as normal and, when the backup is restored, sends it the messages processed during that hour.

Load 3. Primary site failure and switchover to the backup site as the new primary. Following restoration of the failed site, the primary sends it all of the traffic processed by the system from start-of-day.

During load tests, the system was disconnected from the live network except for eight terminals in different locations used for monitoring response times. Traffic was artificially created by placing a message-generating function in each of four concentrators. This function created a total of 65,000 messages over the day, following an expected traffic profile of slow and peak hours. It sent "real" messages to the mainframe cpu, which then properly delivered them to the addressed terminals. Individual message segments were timed for delivery according to line speed requirements, just as in the real system. Only when the message was finally received by a concentrator was it discarded. Thus the load tests were not simulations as far as the mainframe cpu was concerned, but true traffic processing.

**USER ACCESS SATURDAY**

Following successful stress and load testing, a Saturday was scheduled for users to exercise the system in a simulated operating day. Banks were requested to open their wire transfer rooms and to flood the system with dummy traffic. Selected recoveries, a subset of the stress tests, were repeated during this time.

How do we know that this, or any, test has passed? Executing all steps is a necessary but not sufficient condition. Of course it must perform correctly in other respects, including that

- All system functions work right: messages switched; user service requests (e.g., retrieval or cancellation) responded to; cutoffs in

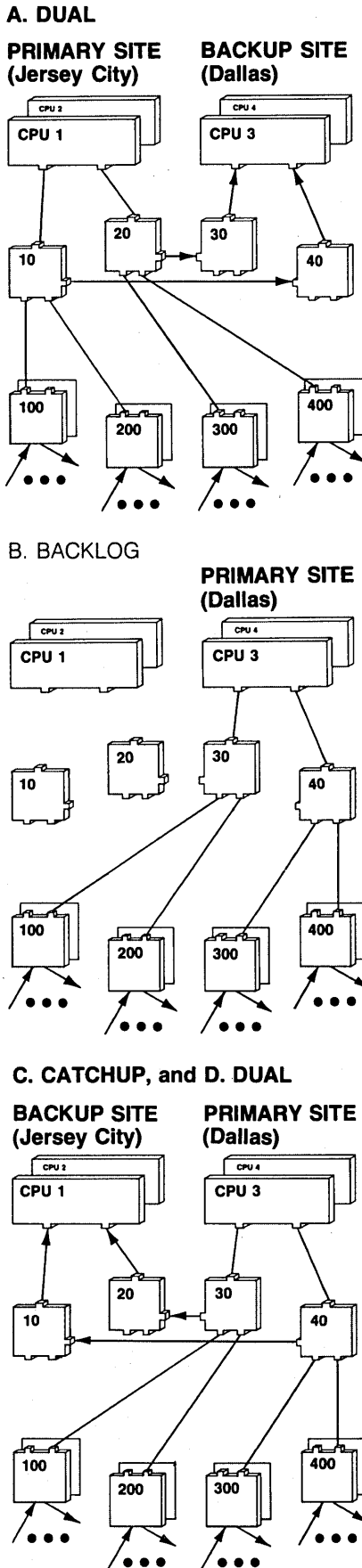

A. Duplexed network concentrators 100 through 400 are on-line with primary site deconcentrators 10 and 20, where message entry and delivery control resides in cpu 1. Before a message is accepted, it will be stored in the backup site via 10 passing it to 40 or 20 to 30. The system is termed in DUAL because message files are equal at both sites and are being maintained equal.

B. Primary site fails. Switchover occurs to the backup site as the new primary. Rerouting of the four concentrators to deconcentrators 30 and 40 is automatic (trunks are in place). The system is now in BACKLOG: accepting and delivering messages while also retaining them in a separate queue for delivery to the failed site, upon restore.

C. Failed site restores. Primary "catches it up" by sending messages (via 40 to 10 and 30 to 20) from the head of its intersite queue, starting with previously processed traffic from start-of-day, while adding messages-in-process to the tail. The system is now in CATCHUP; message files will not be equal until head and tail of the intersite queue point to the same message. Thus, should the primary site fail, switchover to the backup could not yet occur because it does not have current traffic.

D. CATCHUP has completed, system is in DUAL: Before accepting a message, a copy is sent to the backup site. Message files are equal; switchover could occur again. DUAL is the normal system state.



# At last.



**A new  
system**

**that does everything the  
Tandem NonStop<sup>TM</sup> system  
does,  
and then some..**



# NonStop II.™ An enormous

## **The original NonStop™ System:**

The original system set a whole series of breakthrough standards for high availability in a transaction processing system. With a level of up-time never before experienced in computer systems because no single module failure will stop the system, plus modular expandability which allows a system to increase processing power when needed, without changing any of the original hardware and without any software modification.

## **All this and more:**

NonStop II is a brand-new system which builds on the original design and includes an enormous expansion of the system's potentials.

**The keys are flexibility, for now and for the future; ease of support and service; and compatibility that puts other system evolutions to shame.**

The new system utilizes 32 bit addresses, to give the user access to virtually unlimited data space. Up to one BILLION bytes of data per processor under the direct control of the Operating System.

With this extended addressability, Tandem NonStop II systems easily provide both hardware and software support for very large applications. NonStop II can handle many hundreds of terminals and communications lines interactively. With remarkable efficiency. With no down time because of a module failure.

## **Full serviceability:**

Fault isolation and error detection have been enhanced in NonStop II as well. A new Operations and Service Processor, the OSP, is a separate, self-contained processor which can reduce hardware mean-time-to-repair by detecting and reporting problems on-line, plus providing service personnel with local and remote on-line system diagnostic capability.

## **A memory for the future:**

Recognizing the potential user needs for larger memories, NonStop II has been designed so that each of the 2 to 16 processors per system is ultimately capable of addressing 16 megabytes of physical memory, eight times the current limit.



## expansion of the system's potentials.

It was a powerful memory to begin with. The architecture can now handle even the largest, most demanding business and communications requirements.

The flexibility to offer additional capabilities in the future is provided by the new loadable control store, which allows the addition of functions to micro-code as part of continuing standard software updates.

### Full compatibility with existing installations:

This is not the tongue in cheek compatibility systems users are accustomed to. NonStop II is application software compatible with existing Tandem NonStop system installations and can be integrated into a Tandem

EXPAND communications network without any software modification. And customers will be able to upgrade to a NonStop II system without any application software changes.

### For high volume on-line transaction processing, there isn't a system out there to touch the Tandem NonStop II system.

In terms of continuous system availability, data base integrity, protection against loss or duplication of transactions in process, expandability without penalty in hardware and without reprogramming or recompiling software, and a level of on-line performance that rivals the cost effectiveness of any other machine on the market—in all of these considerations, no one else even comes close.

You'll want the complete story.

**For full information and a demonstration of our unique capabilities, call or write Tandem Computers Incorporated, World Headquarters, 19333 Vallco Parkway, Cupertino, California 95014 U.S.A. Offices throughout the U.S.A., Canada, Europe, United Kingdom, Hong Kong, Mexico and Japan. Distributors in Australia, Finland, Greece, Korea, Taiwan and Venezuela.**  
**TOLL FREE: 800-538-3107 or (408) 725-6000 in California.**

**TANDEM**  
**A whole generation ahead.**

CIRCLE 95 ON READER CARD

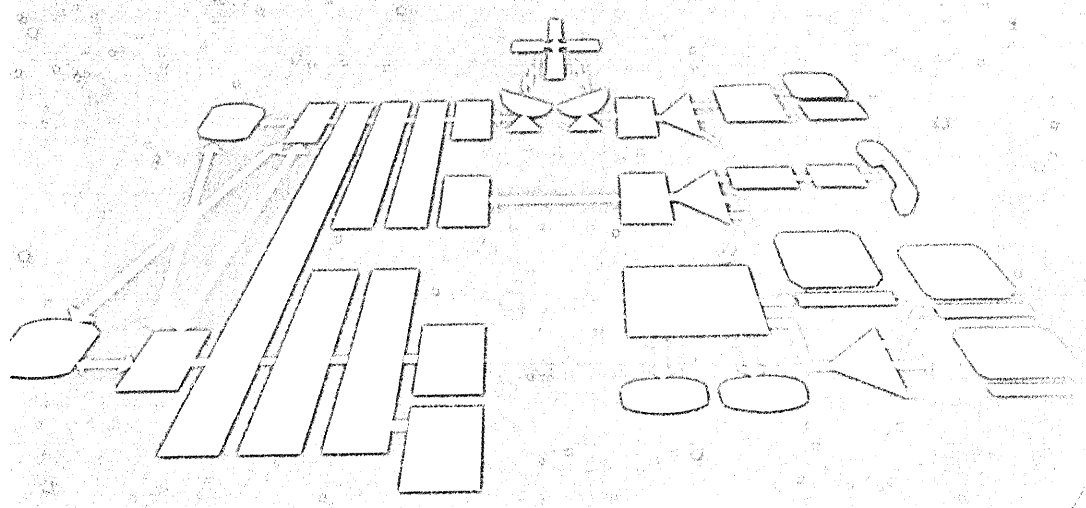

Imagine  
 what data communications  
 will be like  
 in the next few years.

Envision a comprehensive data communications network that provides the kind of flexibility, responsiveness, and cost-efficiency that you've always wanted... digitized voice and data sharing the same bandwidth... distributed work stations integrating both word and data processing... teleconferencing with digitized video images... intelligent switching systems that can store, convert, and route information.

At Racal-Milgo, we're developing a full product line today that will enable you to employ these capabilities tomorrow. And that's important. Because the success of your business will depend more and more on how you manage the precious resource of information. Integrated business communications is the key, and we're planning now to make it a reality.

If you would like to discuss your specific needs for the future, call or write Racal-Milgo, Inc., 8600 N.W. 41st Street, Miami, Florida 33166. (305) 592-8600.

Integrating business communications...  
 your future and ours.

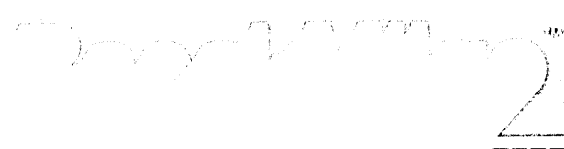
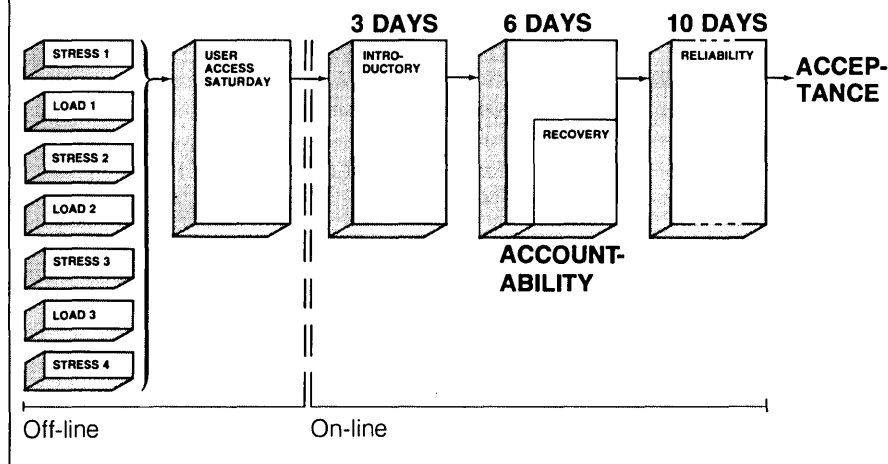

FIG. 2

## OVERVIEW OF ACCEPTANCE TESTING



effect; automatic reports generated; etc.

- Recoveries from processor failure occur in a timely manner with correct information returned to each terminal and with automatic restart on all system resources (e.g., site-to-site trunks begin catch-up).
- There is no instance of a lost message under any circumstance of failure (i.e., message accepted but not delivered).
- Various response time requirements are maintained for picking up a poll, delivering a message, switching sites, servicing a retrieval request, etc.
- System-generated reports to individual terminals and for site operations are accurate, regardless of primary site.
- At end-of-day, the files in both centers must be identical, with exactly the same messages recorded as entered and then disposed of as follows: 1) delivered, or 2) in queue awaiting delivery—receiver's terminal may be off, or 3) canceled by originator while in queue, or 4) rejected on input.

Event tape analysis was a key tool in verifying that test results met these requirements. Every time a message (an "event") enters or leaves the system, a record of that occurrence is placed in a core buffer. When the buffer is filled (or every 300 msec), it is written to disk. At system close, a disk-to-tape utility captures the whole day's events for off-line processing and analysis. Each data message will normally have three events associated with it: its input event, logical acceptance event returned to the originator, and delivery event. Each event records key identification data: origin/destination terminal, input/output sequence number and time, system reference number, flag settings to indicate specific conditions (as alternate route or possible duplicate delivery), etc. Actual message text, however, is not part of the event. The tape is used for billing runs and various statistical analyses such as those used to assist users with a high reject rate or to determine line loading. For acceptance testing, an event tape is taken at both centers at the close of each test. Following are some of the verifications, mostly automated, made on these tapes:

- No zeroed fields in the time stamps, character counts, etc., also legal field ranges are checked.
- Input and output sequence numbers, by terminal, are monotonically increasing without gaps or duplication—unless explainable as a system characteristic.
- Response time analysis. For example, if a particular teleprinter always has a loop tape of messages ready to send, input times for that station taken from the event tape can show if it is being polled within spec'd frequency (stop-watch observation would give fewer samplings).
- Event tapes taken at both sites are identical with respect to user traffic. This checks that message files are equal at end-of-day, even (especially!) after a switchover, and is made by finding events with the same (unique) system reference number on each tape. Then a character-by-character compare is done, and mismatched events are printed out. Also, events at one center that do not have a twin at the other (which may be a more serious error than mismatched events) are flagged.

### HOW TO VERIFY TESTS

The checks just described involve analysis of individual event tape fields or comparison of event tapes across sites. The system generates many other reports besides, at both sites and at user terminals, which contain information on current message status. It was found that the same information frequently appears in reports sent to each terminal in the network at end-of-day, as is summarized in different forms in various operational reports appearing only in the Jersey and Dallas sites. Therefore, a cross-report reconciliation was possible to validate system consistency. This activity was structured into two categories by

1. selecting a sample of 20 banks, based on fair geographic distribution, and correlating their per-terminal reports with appropriate site reports; and
2. correlating various site reports (that users do not see) against each other.

An example of the first category involved the traffic report that each terminal

receives. It lists the number of messages entered by the terminal that day and how many of these were accepted vs. rejected. Also, both sites' originator error reports give rejected message identification. Therefore, a correlation of individual traffic reports for terminals of the 20 selected banks against the two originator error reports can be done. If all data exists and is consistent, the correlation is good. An example of the second category involved the Messages in Queue (MIQ) report (which is a count and identification of all traffic the system must carry forward for next-day delivery) and the drain tape (mag tape to which actual copies of the undelivered messages are "drained" after close in case some overnight failure destroys disk), both taken at each site. Then messages identified in the MIQ report at one site are searched out on the drain tape from the other site, and vice versa. If all are found, the correlation is good.

In both examples reports from opposite sites were correlated in order to verify that the message files creating them were equal. In all cases, formal checkoff sheets were used in the reconciliation activity.

Besides (1) event tape analysis and (2) operation reports reconciliation, the following methods of test verification were used.

3. Control terminals. The system automatically produces, near end-of-day, a set of funds reports per bank which summarize dollars sent and received, net debits and credits, date of money good, etc. For testing, four terminals were selected, each one representing a different time-zone bank. Then a set of funds transfer messages was devised for sending between these terminals (A sends to B, C, D; B sends to A, C, D; etc.), which exercised all of the end-of-day report categories. Expected results were first calculated by hand, then verified on a stabilized system. During actual acceptance, these "control" messages would be entered several times at critical test points so that they were in the process of being sent or received during main-frame cpu failure or site switchover. After each test, end-of-day report totals were compared to their expected values for discrepancies. Of course, no other funds transfers would be sent or received from terminals A, B, C, and D during these tests.

4. Funds reports reconciliation. The preceding verification described controlled input, with expected results known. However, the normal case is random input. Here the concern was to show that both sites would give identical dollar summaries in the end-of-day reports. To do this, copies of funds reports of the 20 selected banks were generated individually at each site on a local printer. Then amount comparisons were made, which should be equal regardless of generating site. While this method would not detect if reports were identically wrong out of both sites, that

check was done under method 3.

5. End-of-day compare. Direct examination of the disk queues of undelivered traffic at both sites was made at end-of-day to verify that delivery notices were sent by the primary site and recognized by the backup upon individual message delivery out of the primary. When the backup site received this notice, it logged the appropriate message as delivered, just as the primary did. Thus the message was removed from the undelivered queues of both sites. Therefore they should have compared identically.

6. User observation. Users were urged to carefully observe and report any anomalies to site operations or to the Bank-Wire staff. Items to watch for were terminal sequence number gaps or duplications during recovery, slow system response times or poll/select stops, retrieval or other service requests not being filled, and any valid funds transfer not listed in the end-of-day reports.

## HOW TO PROCEED

There are some questions that arise at all stages of testing:

- What constitutes failure, so that a whole session must be rerun?

• If problems arise that do not constitute failure, how shall the fixes be demonstrated?

• How should one proceed if a fix introduces problems into a portion of the test already passed, or unmask a new problem?

In order to deal with questions of this sort and allow testing to continue in a reasonably flexible manner, the following approach was agreed upon:

1. Certain problems of sufficient severity would require a total rerun, for example, inability to complete a test session or completing it with significant mismatch of message files at the two sites. Otherwise, problems occurring during the execution of a test would not generally result in abandoning the test.

2. Demonstration of fixes to problems arising out of a test could be done in separate subtests before the next formal test or in the next formal test itself, possibly with steps added. If the fix could affect other (successfully completed) portions of the original test, these would also be repeated. In general, all manifestations of a single problem had to be retested.

3. If problems of limited severity were not fixed before the next scheduled test, this test could still be run with these problems carried over for later resolution. Anomalies arising from these known problems would not constitute failure of the test.

4. If in later testing a problem is found to be related to a previous test step that had been performed correctly (or been corrected), then, of course, the problem condition would override and it would enter the

TABLE I  
ON-LINE TEST SCHEDULE

| DAY   | TEST              | DESCRIPTION—STARTING WITH JERSEY PRIMARY                                       | RECOVERY TEST TOO? |
|-------|-------------------|--|--------------------|
| 1     | Introductory #1   | Dallas goes backup at 7 p.m.   | no                 |
| 2     | Introductory #2   | Dallas goes backup at 7 p.m.   | Recovery subset    |
| 3     | Introductory #3   | Dallas backup all day. Fail backup at 10 a.m.; restore at 1 p.m.               | no                 |
| 4     | Accountability #1 | Jersey→Dallas site switchover at 11 a.m.                                       | no                 |
| 5     | Accountability #2 | Dallas primary, Jersey backup, all day. Fail backup at noon; restore at 1 p.m. | Recovery #1        |
| 6     | Accountability #3 | D→J at 11 a.m.   | no                 |
| 7     | Accountability #4 | Initialize with Dallas primary. Then D→J at 10 a.m. and J→D at 1 p.m.          | no                 |
| 8     | Accountability #5 | D→J at 10 a.m. J→D at 1 p.m.   | Recovery #2        |
| 9     | Accountability #6 | Initialize with Jersey primary. Then J→D at 10 a.m. and D→J at 1 p.m.          | Recovery #3        |
| 10-19 | Reliability       | J→D once first week. D→J once second week.                                     | no                 |

correction cycle. Related portions of the earlier test might require rerunning also.

5. Problems found by independent customer or user testing, even though not formally defined as part of the official test plan, would enter the correction cycle.

6. Some noncritical problems might remain at the end of testing, which should not postpone acceptance of the system as long as the vendor has provided a timely fix-and-verify schedule for after acceptance.

Reviews were held for any problems or deviations from expected results (three weeks allowed for this activity from each test session), and follow-ups were determined based on impact of the problem to further testing and to users, effort required to fix it, and schedule. Of course, many problems were immediately evident, and had to be fixed before testing could proceed.

On-line acceptance testing began with a fresh software build, the "test build," incorporating in source code all the patches acquired by the previous build during off-line testing. Should a catastrophic failure occur, the same procedures would apply as at any time a new build that did not work was put on-line (this has not happened): fallback to the prior build. On-line acceptance was performed during the hours of operation, 8 a.m. to 10 p.m. on business days, and was composed of the following tests: introductory (three days, two of them partial), accountability (six days), recovery (three days simultaneous with accountability), and reliability (10

consecutive days) (see Table I).

The introductory tests were meant to gradually ease the on-line system into a two-center operation; final software adjustments would be made (patches to the new build). On day 1 these tests started at 7 p.m., a low traffic time, when the Dallas site was connected as backup to Jersey, which continued passing traffic as it had done all day, and Jersey began "catching it up," i.e., sending Dallas a copy of the day's traffic since Open so that by Close (or before), message files at both sites would be equal. Full end-of-day operations were then performed at both sites as they would be from now on, e.g., taking various reports and mag tape functions (event tape, etc.). Again, on day 2, starting at 7 p.m., the Dallas site was connected as the backup to Jersey and caught up with the day's traffic. During this interval, a subset of the recovery tests that would later be performed was exercised. The third day of introductory tests opened at 8 a.m. with Jersey primary, Dallas backup, and continued in this mode all day. At 10 a.m., the backup site was failed and restored three hours later in order to demonstrate that traffic processed by the primary site during that time was properly sent to the backup upon its restoral.

The purpose of accountability was to apply the tools of successful test verification to the on-line system: event tape analysis, operations and funds reports reconciliation, end-of-day compare, and user observation. The activities were as follows:

# Now the fastest-growing industry in the world has its own newspaper.



The software industry, already a massive market, will be one of the premier growth industries of the 1980's and it deserves more than just an occasional article or a department or a column. It deserves a publication of its own. Introducing Software News, the monthly computer software newspaper.

Software News is published by Technical Publishing, a company known for its responsiveness to the DP market and its information needs. Technical publishes Datamation, the monthly information source for the EDP professional.

The editorial staff of Software News will save readers time and money by collecting, researching, analyzing, cataloging, and reporting on the products now being offered by more than 3,000 software producers. And they'll bring incisive

coverage of application packages, systems software, program development aids, language processors, data bases, productivity enhancements, user ratings and surveys, data and software security, software legal issues, job opportunities and much more.

Software News has a controlled circulation with a guaranteed minimum of 50,000 software buyers and specifiers: qualified subscribers are accepted only on a direct request basis.

For information and a complete media kit, call Jean Gallant (617) 562-9308. Be part of the excitement of the software industry's first newspaper.

## Technical Publishing

**DB** a company of  
The Dun & Bradstreet Corporation

5 Kane Industrial Drive • Hudson, MA 01749 • (617) 562-9308

**It's been under wraps just long enough.**

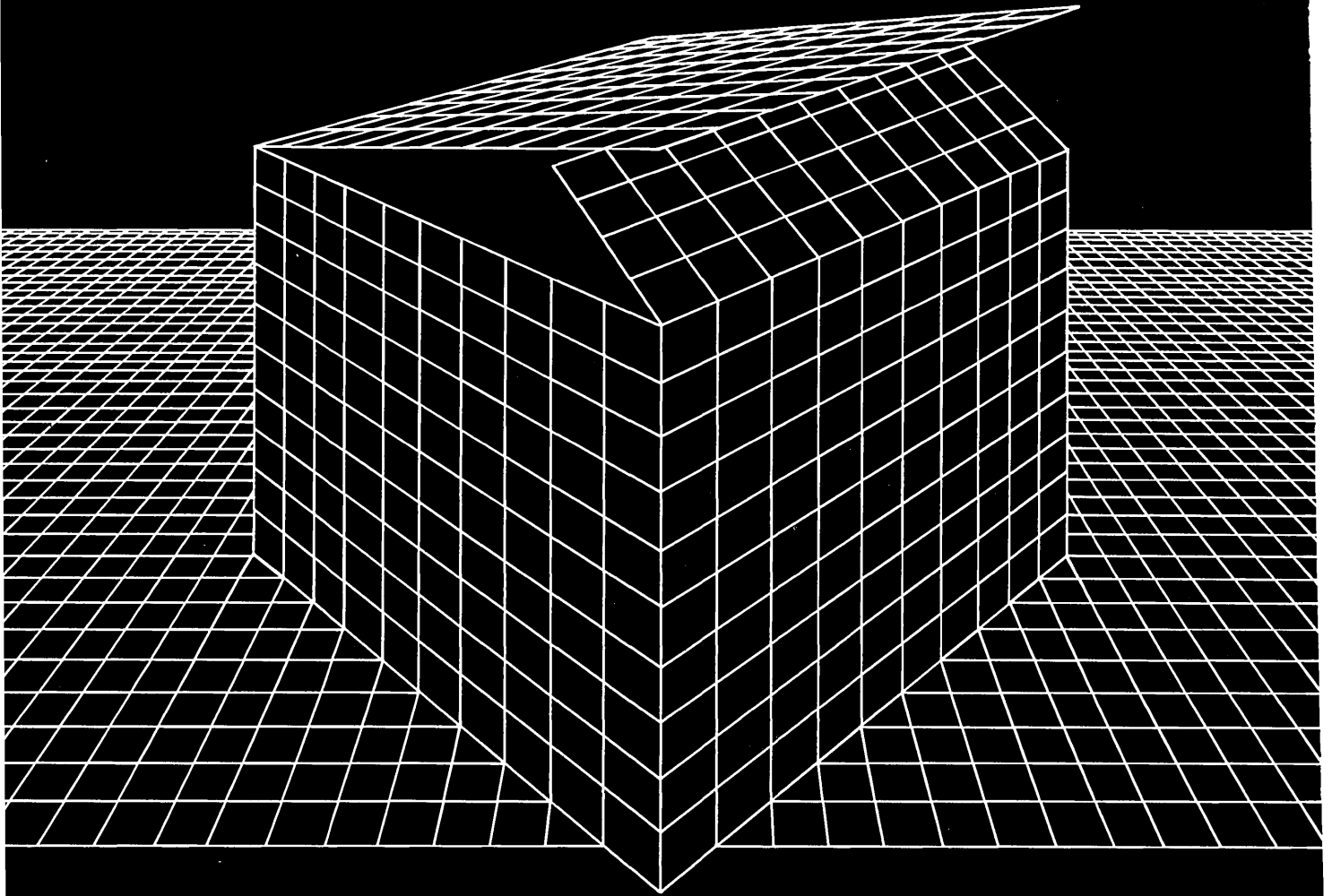

**BOEING INTRODUCES  
THE COMPLETE  
DATA PROCESSING  
PRODUCTIVITY  
PACKAGE.**



Productivity starts at the top. With your best trained and most talented people. It's vital to give them the tools they need to produce their best work.

The Boeing Company learned that a long time ago. And through Boeing Computer Services created an information services organization designed to assist you in getting the most out of your best.

Productivity gets stalled due to internal resource contention. Your most talented programmers are frustrated by inside "traffic jams." It happens often in the data processing departments of government agencies and the country's largest companies. It's a real problem to increasing productivity.

Boeing Computer Services (BCS) has answers to that problem and others. These answers, developed through years of data processing problem solving experience, come packaged under the theme "Shared Productivity . . . New Dimensions in Information Services." Now, we're ready to share these new dimensions with you.

## **ALL YOU HAVE TO DO IS DIAL-UP BOEING.**

First, there's a carefully chosen menu of software productivity tools available on our MAINSTREAM®-TSO timesharing service, designed to make your most valuable people even more valuable.

This menu is accessible through IBM 3270-type display terminals whose efficiencies are enhanced by the IBM Systems Network Architecture (SNA). Thanks to one of the industry's largest privately operated telecommunications networks, you can dial up the Boeing Computer Services productivity menu anytime, from anywhere in the U.S., and keep working away at your 3270. You get continuous accessibility to the major productivity tools you need. There's no waste of time. Frustration disappears, productivity increases.

Here's a concise look at what the new productivity service looks like. Each of the elements is not new. However, the menu represents a unique collection of time-tested, state-of-the-art programmer productivity aids.

### **CICS (Customer Information Control Systems)**

A general-purpose teleprocessing monitor used to control and manage on-line resources. CICS promises every user access to vital information in seconds. It's an application programmer's dream, automating application design, development and maintenance tasks. With CICS, productivity expands dramatically right where it counts most — with the user.

### **CICS/SDF (Screen Definition Facility)**

Increases the capabilities of the CICS monitor dramatically, eliminates the need for manual coding. What used to take days, takes hours with SDF.

### **CICS/DMS (Development Management System)**

DMS is a flexible application tool operating under CICS which makes application design and development simpler for programmers. Frees top level personnel for more critical tasks while reducing total development time and costs.

### **PANVALET**

The first direct access library system in the world. Provides positive, flexible, foolproof data security, while eliminating card storage of programs. The ideal way to maintain and manage your source library programs.

### **SPF (System Productivity Facility)**

A real time saver. SPF allows programmers to process or manipulate information of all kinds with a minimum of terminal typing. Makes the 3270 more efficient and flexible.

## **DATABASE MANAGEMENT: CHOOSE WHAT'S RIGHT FOR YOU.**

This new service provides you a choice between two of the most popular and time-saving database management systems.

### **DL/I (Data Language/I)**

A database management system which allows users to manage large amounts of information rapidly. Reduces data redundancy, provides data security, and reduces application costs.

### **IDMS (Integrated Database Management System)**

A powerful, flexible database management system which simplifies application development and data access for all users, while at the same time eliminating data redundancy and inconsistency. A potent tool for productivity.

The above elements complete the menu of service offerings available on MAINSTREAM-TSO . . . but there's more.

## **TO COMPLETE THE PACKAGE — HERE ARE THREE MORE WAYS BCS CAN IMPROVE YOUR COMPANY'S PRODUCTIVITY.**

### **A Solution to Static: The TSU, exclusively from Boeing.**

Error-corrected networks are not new. Error correction from your terminal over local lines to the network point of entry is new. Exclusive from BCS, is the Terminal Service Unit (TSU), a microprocessor telecommunication device used with low-speed terminals. It solves a variety of communication problems that beset any computer terminal using local voice-grade telephone lines. The TSU eliminates these problems by providing automatic error correction and control, data quality monitoring and terminal usage statistics.

### **SL/1: A new plateau in software development productivity.**

System Language/One (SL/1) is a high-level language available to COBOL programmers. By providing automatic design, programming and documentation, it can cut systems development time by up to 66%. Now that's what we call productivity.

### **CRAY: Lightning fast for engineers who can't wait.**

The CRAY-1 is a new computer capable of unusually rapid information processing. Its unique vector processing characteristics make it a scientific/engineering tool of exceptional value. As a matter of fact, it is capable of solving complex problems as much as 16 times faster than conventional computers.

At Boeing, we've linked a 1,000,000-word CRAY to our existing MAINSTREAM-EKS (engineering) system. The result! A power-packed tool for engineers in a hurry.

## **SHARED PRODUCTIVITY . . . NEW DIMENSIONS IN INFORMATION SERVICES. THE BCS THEME FOR THE EIGHTIES.**

This complete productivity package didn't just happen. It was assembled with great care based on years of serving the computer service needs of major companies and government agencies.

By integrating these products and services into those already available through Boeing Computer Services, we provide the means for all users, on a shared basis, to obtain exceptional productivity breakthroughs.

Now that we've unwrapped the package, you should examine its contents in detail. To do that, all you have to do is call your local BCS representative or write: **Director of Marketing, Boeing Computer Services Company, 7980 Gallows Court, Vienna, Virginia 22180.**

But do it today. And start building productivity tomorrow.

# **BOEING COMPUTER SERVICES**

Shared Productivity — New Dimensions in Information Services.

CIRCLE 99 ON READER CARD

# The purpose of the stress tests was to show that the system could perform without error under various forms of stress.

*Day 1.* Open with Jersey primary, Dallas backup. In the morning, the first on-line site switchover was done, Jersey failed, Dallas becoming the primary site. Then Jersey was restored as the backup by being sent the day's traffic from Dallas.

*Day 2.* Open with Dallas primary, Jersey backup. At noon, fail the backup site. Upon restoral after an hour, catch it up with traffic processed by the primary during that time. The first recovery test was also executed this day.

*Day 3.* Open with Dallas primary, Jersey backup. In the morning, perform a site switchover bringing Jersey up primary.

*Day 4.* This was the first double switchover day. Open with Dallas primary, Jersey backup (that is, at Open, initialize the system in the opposite state from Close of day 3). In the morning, fail Dallas and switchover to Jersey as primary. Then restore Dallas as backup. When message files are equal at both sites, perform the second switchover: fail Jersey and bring up Dallas as primary.

*Day 5.* The second double switchover day: Dallas to Jersey, then Jersey to Dallas as in day 4. The second recovery test was fitted around these switchovers.

*Day 6.* The third double switchover day, but in opposite direction from above: Jersey to Dallas to Jersey (system initialized opposite to yesterday's Close). The third recovery test was superimposed on these switchovers.

The three days of recovery ran concurrently with days 2, 5, and 6 of accountability testing just described; thus, no new time was added to the overall schedule. Tables of failure/recovery scenarios were defined and performed around the site switchovers already included in accountability. The purpose of recovery testing was to show that the system can continue to function with one or a combination of its parts out of service. In no case will accepted messages be lost, and re-

covery messages back to individual terminals will carry information allowing users to pick up correctly from the point of failure (last input and output sequence numbers of that terminal, plus its log state). If, because of a certain combination of failures, processing cannot continue, then orderly network shutdown occurs.

The system never loses track of where it is and, as failed components are restored, normal processing paths resume. The tools of successful test verification apply so that any problem that turned up in recovery would constitute a problem in accountability also, and vice versa.

## WHAT REALLY HAPPENED

This article has presented the theoretical construct under which acceptance testing was done. This construct was largely followed.

However, a dose of mutual judgment and agreement, invoking the principles described under proceeding with known problems, was needed at many points where particular anomalies arose to avoid a rigid following of plan. On one occasion, for example, different manifestations of the same software problem occurred during different test sessions, masking the common cause of them all. Finally, when the common cause was found, a substest was created out of all those places where the problem had showed up. Running this substest demonstrated the fix.

On another occasion, the same problem kept coming up across different test sessions despite its being fixed each time. It was found that each time the problem was due to a different cause. Finally, all the causes were nailed down and a substest, constructed from all of the places where they had occurred, demonstrated the fix.

Another time, a serious indication of message file mismatch occurred during test execution. Comparison of the files at both

sites showed that they were exact: it was the indicator of mismatch that was faulty. Such false alarms (and there might be hundreds) had to be fixed when they occurred during regular operation; each had to be investigated for validity. Testing was able to proceed through several sessions with this as a recognized open problem.

Following accountability, both centers had been operating on-line for nine days. Thus, in effect, cutover of second site had been achieved.

The purpose of the final portion of acceptance, reliability testing, was to demonstrate an up time of 99.5% per day (allows 4 minutes, 12 seconds outage in a 14-hour operating day) for 10 consecutive operating days for each major system component-concentrator, deconcentrator, Jersey and Dallas main-frame cpus. In addition, not more than one failure per day in each of these components was allowed. Note that neither the down time nor failure counts were averaged, but were applied per processing unit per day. Of course scheduled failures, e.g., a center switchover (one was done each week, and will be on a continuing basis) did not count against reliability if routine recovery occurred. We are pleased to record that the system passed the 10 consecutive days of reliability testing soon after completing accountability.

The 80-20 rule applies as much to acceptance testing as to creating the original system design itself: 20 parts of the effort belong to the mainline paths (which occur 80 parts of the time), and 80 parts of the effort belong to the exception paths (which occur 20 parts of the time). The major effort in testing was to force out the exception path defects that can devastate a system afterwards and then be so hard to find and to fix. This was done by applying various combinations of stress to the system such as full-load operation, failure/recovery scenarios, and degraded mode operation (sustained component outage).

In summary, the acceptance test procedure, although at times arduous, allowed BankWire's central vendor, Rockwell International, to deliver a system of high reliability that meets or exceeds the state-of-the-art technology required for a sensitive electronic funds transfer service. \*

Daniel Fidlow is vice president of Payment and Telecommunication Services Corp, where he was responsible for ensuring proper development of the BankWire system. He has also worked extensively on the Federal Reserve Communications System and Western Union's InfoMaster network. Mr. Fidlow has an MBA and a masters degree in mathematics and was a faculty member in computer science, Newark College of Engineering.

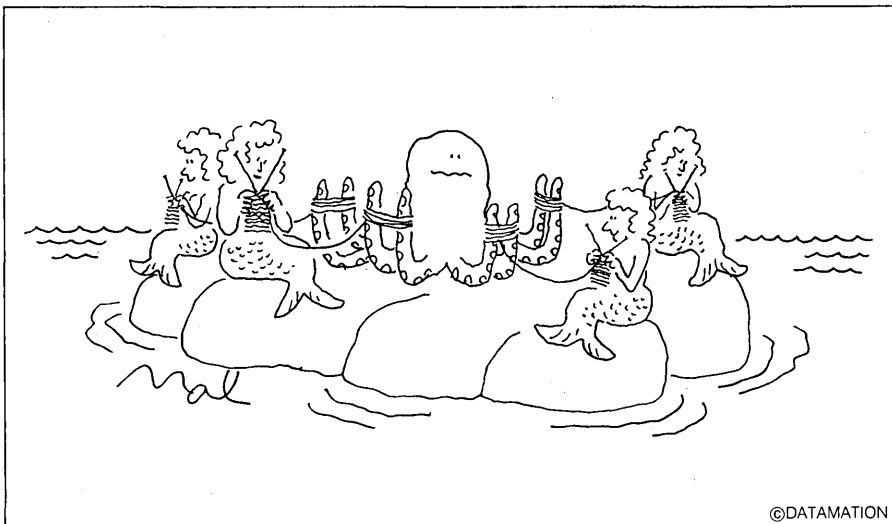

OUR COMPETITORS SEE RED  
WHEN THEY HEAR ABOUT  
OUR ON-TIME DELIVERY.

**COMPUTREND**

THE COMPUTER SOFTWARE SPECIALIST

**CIRCLE 100 ON READER CARD**

**"This year's Conference program is right on target for a Federal ADP community searching for ways to manage change . . ."**

Morris Edwards, Program Chairman

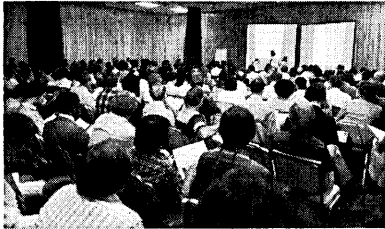

Managing change. It's the major challenge for today's Federal ADP professional faced with new policy initiatives, new technological developments, new constraints on personnel and computer resources.

That's why this year's Federal Computer Conference is especially important to you.

Our 1981 program features special sessions devoted exclusively to managing change

in Federal ADP operations. You'll also find a wide variety of other sessions, seminars and workshops dealing specifically with your own areas of interest or responsibility. It's a Conference for Federal ADP users at all levels, in both military and civilian departments and agencies. And the Exposition held with the Conference is the only show in Washington where you get to see the computer industry's leading companies.

The 1981 Federal Computer Conference. In a time of change, a unique opportunity to stay on top of what's new . . . and prepare for what's ahead.

Go for it!

**For information on attending or exhibiting, write:**  
**Federal Computer Conference**  
**P.O. Box 368**  
**Wayland, Massachusetts 01778**  
**Or call 617-358-5181 collect.**



Sponsored by Federal Education Programs  
(Federal government not a sponsor)

**September 21, 22 & 23, 1981**  
**Sheraton Washington Hotel**  
**Washington, D.C.**

© 1981 Time, Inc. All rights reserved.



# MODELING FOR MIS

by Brent Bowman,  
Gordon Davis,  
and James Wetherbe

There are four major problems in MIS (management information systems) planning, according to dp executives:

- alignment of MIS efforts with the overall strategies and objectives of the organization
- development of a long-range structure for services while still responding to short-range application development efforts
- allocation of development and operations resources among competing applications
- selection and use of competing methodologies for establishing requirements and allocating development resources

The first problem is making sure the MIS planning identifies and selects applications that fit the overall organization priorities. If the selection and scheduling are based only on projects submitted by users, the projects will instead reflect computer-use biases of managers, aggressiveness of managers in submitting proposals, and interesting aspects of organizational power. It is often difficult for users to define completely their application requirements; managers are constrained by their bounded rationality which prevents many useful computer-based solutions from being considered.

Perceived needs are also biased by human processing limitations that cause users to fix on recent problems as the most important and to draw unwarranted conclusions from a small number of occurrences. Therefore, requests for information needs often result in requirements that are not complete nor arranged in a realistic order of priority.

Rational allocation of resources is difficult, particularly if the portfolio of potential applications does not fit an overall organizational plan and user requirements do not fit into an orderly framework. Organizational dynamics such as relative power and aggressive advocacy (i.e., politics) may replace objective decision-making.

The fourth problem is the existence of competing planning methodologies. Each methodology is presented as the solution by enthusiastic developers and users. However,

even though the techniques are competing, they are not necessarily equivalent: presumably each methodology has a set of circumstances under which it is superior. There is very little guidance to make such a selection based on the contingencies confronting an organization.

There is a need for a comprehensive model of MIS planning so the process can be researched, explained, and applied.

## 3-STAGE PLANNING MODEL

A basic MIS planning model (Fig. 1) consists of three generic activities (Table I).

The three-stage basic MIS planning model can be illustrated by a case study in which an organization unknowingly stepped through the model. A large corporation, acting on advice from its external auditors, upgraded its computing capabilities from predominantly batch, second-generation systems. Major problems in processing speed and the ability to integrate data were encountered in accounting. Processing had been so slow in accounts payable that the company's credit rating was affected. Therefore, the company made a strategic decision to upgrade its computing capabilities to an on-line database environment with emphasis on improving accounting processing.

Although it did not use a formal approach, the organization had, at this point, gone through the strategic stage: top management was determining MIS objectives.

During the next six months the organization hired a new MIS management team and had it analyze the new system and review overall requirements. This exercise was the requirements analysis planning stage. The MIS group used the BSP methodology (Business System Planning) to conduct the analysis.

During the following 18 months several systems were implemented in accounting and operations. User management then complained: they wanted more systems and they wanted faster response to requests for new systems. But MIS costs had proliferated during the past two years, and top management (and consequently, MIS management) was concerned about allocating limited resources to increasing demand. This put the organiza-

tion in the resource allocation stage. It decided to install a charge-out system to allocate resources.

The case illustrates how, based on organizational requirements, MIS planning moves from one stage to another. It also illustrates how specific formal models may be selected for use in each of the three stages. In this situation, the formal models were BSP in the analysis stage and charge-out in the resource allocation stage. A formal model was not used in the strategic planning stage, but MIS decisions were based on overall company strategy.

## PLANNING STAGES EXPANDED

To define more vividly the characteristics of the three-stage planning model, Fig. 1 can be expanded to include the major activities and outputs of the three stages (Fig. 2). In doing this, the model moves from a high level of abstraction to a more concrete form of MIS activities.

During the strategic planning stage, it is critical to align MIS planning with overall company planning. The organization must assess organizational objectives and strategies; set an MIS mission; assess the environment; and set MIS policies, objectives, and strategies.

The result should be a clear idea of the company's hopes and plans, a new or revised MIS charter, and a statement of policies, objectives, and strategies for the MIS effort.

The first phase of Organizational Information Requirements Analysis (OIRA) consists of assessing current and projected information needs to support the decision-making and operations management of the organization. This effort should not be confused with the information requirements analysis for application system specifications (e.g., report and terminal display layouts). This is a higher level of requirements analysis to develop an overall information architecture for the organization.

The second phase of the OIRA stage is assembling a master development plan. This plan is derived from the information architecture, and it defines specific system projects, ranking of projects, and a development schedule.

# Everyone Working on Network Software Should Stop.

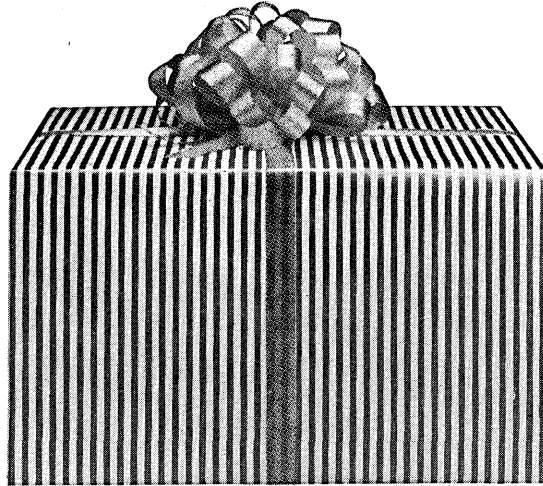

## We've Started Giving It Away.

Introducing a one-of-kind communications system called C/30. Based on a microprogrammable mini and priced under \$25,000, what makes the C/30 special is that it comes with all the communications software you need to build a network of any size. Efficient, cost-effective, packet-switch software.

Only BBN Computer packet-switching gives you true adaptive routing, both node and

network transparency regardless of hardware, plus speed and message control. All field proven for over a decade on the world's largest packet network.

If you've discovered network hardware is easy to come by and network software impossible to find, stop. Our new C/30 gives you the best of both.

And at this price, it's like getting the software absolutely free.

### **BBN Computer**

BBN Computer Corporation, C/30 Marketing, 33 Moulton Street, Cambridge, MA. 02238. (617) 497-2800.

- Send me complete C/30 product information.
- Have your representative call.
- Tell me more about packet-switching.

Name \_\_\_\_\_

Title/Dept. \_\_\_\_\_

Company \_\_\_\_\_

Address \_\_\_\_\_

City \_\_\_\_\_ State \_\_\_\_\_ Zip \_\_\_\_\_

Phone No. \_\_\_\_\_

DM/81

CIRCLE 102 ON READER CARD

# There is a need for a comprehensive model of MIS planning so the process can be researched, explained, and applied.

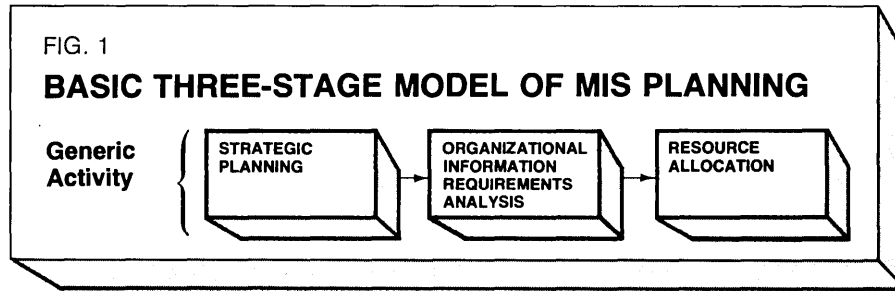

TABLE I  
**GENERIC ACTIVITIES**

| MAJOR MIS PLANNING ACTIVITY                      | DESCRIPTION   |
|--|---|
| Strategic MIS planning                           | Establishing the relationship between the overall organizational plan and the MIS plan.   |
| Organizational information requirements analysis | Identifying broad, organizational information requirements to establish a strategic information architecture that can be used to direct specific application system development projects. |
| Resource allocation                              | Allocation of both MIS application development resources and organizational resources.  |

Resource allocation is hardware, software, data communications, facilities, personnel, and financial plans needed to execute the master development plan defined in the OIRA stage. This stage provides the framework for technology procurement, personnel planning, and budgeting.

The activities within the stages (Fig. 2) and the stages themselves have a sequential flow starting with "assess organization objectives and strategies" and ending with "develop resource requirements plan." A complete execution of the model is not necessary at each planning effort. The annual planning cycle may only consist of assessing organizational requirements, assembling a master plan, and developing a resource allocation plan. The time interval between planning and executing the entire model is a function of how rapidly the organization's overall objectives and strategies are changing in ways that impact MIS requirements. The interval between comprehensive planning cycles may be from one to five years.

How do the many planning methodologies relate to the three-stage planning model (Fig. 3)? Several of the most publicized methodologies are listed below:

- Strategy Set Transformation
- Business System Planning (BSP)
- Critical Success Factors (CSF)
- Business Information Analysis and Integration Technique (BIAT)

- Return on Investment (ROI)
- Charge-out
- Zero-Based Budgeting (ZBB)

## MIS STRATEGY SET

W. R. King<sup>1</sup> has proposed an approach termed "strategy set transformation." The overall organizational strategy is viewed as an "information set" consisting of the mission, objectives, strategies, and other strategic variables (e.g., managerial sophistication, proclivity to accept change, important environmental constraints, etc.) Strategic MIS planning is the process of transforming the organizational strategy set into an "MIS strategy set" of MIS system objectives, constraints, and design strategies.

Step one of this methodology is the identification and explication of the organizational strategy set. The obvious starting point in this activity is review of the organization's long-range plan. If such a document does not exist, or if it is deficient in providing guidelines, a strategy set may be constructed. King describes the strategy set construction process as:

1. Declining the claimant structure of the organization (i.e., owner, managers, employees, suppliers, customers, creditors, governmental agencies, local communities, competitors, etc.)

2. Identifying goals for each claimant group

3. Identifying organizational purposes and strategy relative to each claimant group

Once the tentative statement of the organizational strategy set has been developed, it should be presented to top managers for review and comments.

The next major step involves transforming the organizational strategy set into an MIS strategy set. This process identifies MIS strategic elements for each element within the organizational strategy set. Analysts then construct alternative structures for the overall architecture subject to the MIS objectives, strategies, and constraints enumerated as the MIS strategy set. The general alternatives are then presented to management.

This methodology focuses exclusively on strategic MIS planning. To be successful, it requires concise articulation of organizational objectives and strategies. This technique can result in a strategic long-range MIS plan.

Information analysts are the key players here. It is their task to enumerate the strategy set elements and to develop alternative designs for the overall architecture.

Business Systems Planning (BSP)<sup>2</sup> was initially developed for IBM's internal use, but as customers expressed an interest, BSP was released as a general methodology.

BSP is basically a two-phase approach. Phase one develops a broad understanding of the organization and identifies how MIS currently supports the business, specification of the gross network of information systems required to support the business, and identification of the highest priority subsystems to be implemented within the network. Data are primarily gathered through interviews with managers. The analysis concentrates on business processes without regard for organizational structure.

The objective of the second phase is to develop a long-range plan for the design, development, and implementation of a network of information systems to support the business process. Current systems are assessed and deficiencies noted. Processes and users that share data are identified, and the potential for common information systems across organizational boundaries is determined. The output of the second phase is the information systems plan.

The fundamental purpose of BSP is to identify the information necessary to run the organization. It is suggested that the master development plan include resource requirements, but the principles and guidelines of the methodology are directed at information requirements.

1. W. R. King, "Strategic Planning for Management Information Systems," *MIS Quarterly*, vol. 2, March 1978, pp. 27-37.

2. IBM Corp., *Business Systems Planning—Information Systems Planning Guide*, Publication No. GE20-0527.

# Mainframe power.

---

---



## Announcing the HP 3000 Series 44.

*Our new, state-of-the-art, most powerful computer supports everything  
in the photograph, including the new HP 2680 Laser Printing System.  
And you can take delivery on the computer in just 12-16 weeks.*



# Small system price.

The new HP 3000 Series 44 extends our computer family's performance range dramatically. For a system price starting at just \$115,000\*

It has the power to handle 4 megabytes of memory, 1.9 billion characters of on-line disc storage, up to 96 terminals, 4 line printers, 7 synchronous data-comm lines and 8 mag tapes.

In five minutes, on-line users can access an IMAGE data base 1,560 times to enter or update orders. At the same time, the computer will respond to 51 inquiries into the data base, and generate formatted reports for all of them, with subtotals and totals. In the background, it can compile a 1200-line COBOL program 1.5 times. And read, sort and report a 9,000-record file twice. It will do all this while giving each on-line user a response in an average of 1.5 seconds!\*\*\*

## Six years of compatible software.

The Series 44 continues the HP 3000 tradition of compatibility. So it will run the software developed for earlier models. Or for smaller members of the current family.

And if you have a Series 30, 33 or III, you can get Series 44 performance and power by exchanging system processor units.

It also has all those other HP 3000 features—including IMAGE data base management and forms management—that make our computer family so easy to use and program. And we've given it an enhanced operating system, MPE IV, to manage the increased memory and discs even more efficiently than previous versions.

What's more, we made the Series 44 so reliable and supportable that you can get it with an extraordinary service guarantee.

## Introducing Guaranteed Uptime Service.

This is a new maintenance agreement covering the processor and two discs. It guarantees 99% uptime over any three-month period or our service on these critical components is free for the next month\*\*\*

For more information about the powerful Series 44 and its remarkable service guarantee, call your local HP sales office. Or write Hewlett-Packard, Attn: Bob Bond, Dept. 491, 11000 Wolfe Road, Cupertino, CA 95014.

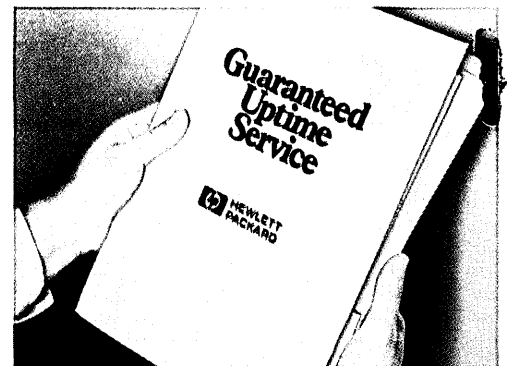

\*U. S. domestic price includes 1Mb System Processor Unit, 50Mb disc, 1600 bpi tape and CRT console.  
\*\*Series 44 and 4Mb memory, 3-120Mb disc drives, 1- 1600bpi tape drive, 1- 400LPM printer, 24 terminals (terminal activity simulated by HP TEPE program).  
\*\*\*Initially available in the U.S. only.

47102HPG67

CIRCLE 103 ON READER CARD

FIG. 2

## MAJOR ACTIVITIES AND OUTPUTS IN THREE STAGES OF MIS PLANNING

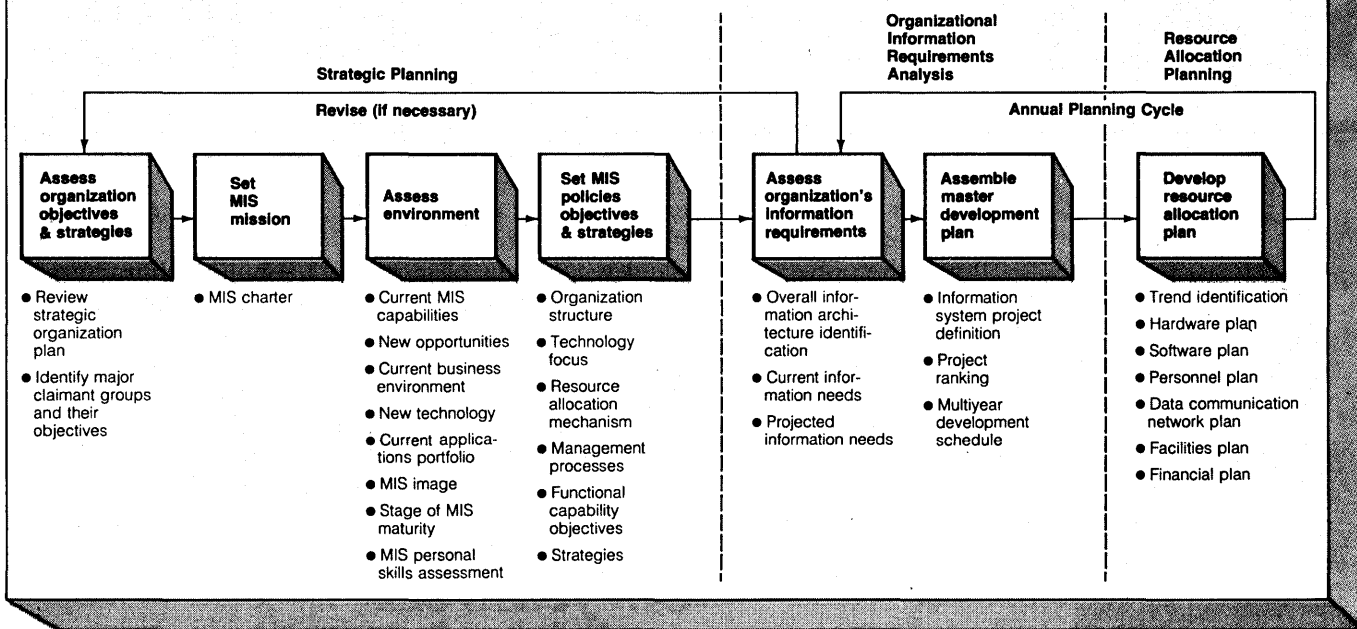

BSP utilizes a top-down approach. Information about company processes and needs is obtained by the study team through observation and interviews. Without explicit consideration of overall strategic plans and objectives, the resulting plan could lack the proper long-range perspective. Another drawback of the interview approach is the significant time required to collect and analyze information. Many managers must be interviewed to understand the organization's processes. Although IBM proposes useful matrices and other graphic techniques to assist the team in collecting data, analysis and synthesis of the large volume of data into a viable plan can be difficult.

### CRITICAL SUCCESS FACTORS

Another interesting approach<sup>3</sup> to identifying the information needs of top managers was developed at the Center for Information Systems Research at MIT. This approach is based on critical success factors, i.e., the key sections for any organization in which performance must be satisfactory if the business is to survive and flourish. The MIT research team identified the four primary sources of CSFs as:

1. Industry-based factors
2. Competitive strategy, industry position, and geographic location
3. Environmental factors
4. Temporal factors

The CSF approach involves a series of interviews (though not nearly so many as with BSP) conducted in two or three sessions. In the first session the manager is asked his goals and the CSFs that underlie those goals. The second session focuses primarily on identifying specific measures and possible reports. Additional sessions are held to obtain agree-

ment of the CSF reporting sequences; the systems required to provide the reports are then designed by the MIS group.

As described, the CSF is not intended to be a comprehensive approach to identifying organization-wide information requirements. The transaction processing and operations management information systems are not addressed. Embedded in a broader MIS planning process, this methodology may prove a useful tool in overcoming the inadequacy of many information systems to supply information to support top and middle management decision-making.

The personnel time requirements are reportedly low (from three to six hours) to explain the method and conduct the interviews. Concentration on current information needs will, in all likelihood, result in a planning process with a short- to medium-term time horizon. The information needs of top executives are certainly very dynamic, but in view of the long lead times required to design and implement significant information systems, a longer-range perspective may prove beneficial.

The technique called Business Information Analysis and Integration Technique (BIAIT)<sup>4</sup> is a distinct demarcation from other approaches. Most of them tend to use open-ended questions that elicit information from managers about their requirements and priorities.

Burnstine, through extensive experimentation with over 400 items, has factored out seven close-ended questions that can be used to determine a normative set of information requirements. These questions require only a yes or no response. From the responses to these questions, requirements can be defined theoretically.

### SEVEN QUERIES OF BIAIT

The focus of the seven questions is on orders and suppliers. Suppliers are persons, departments, or organizations that respond to orders. Orders are anything that require a response from a supplier. The entity ordered is either a thing, a place, or a skill. The key point is that if a supplier, be it an organization, department, or individual, receives no orders, it has no reason for existing.

The seven questions of BIAIT are as follows:

1. Do you bill customers or accept cash?
2. Do you deliver products or services in the future or immediately?
3. Do you create and maintain profiles of customers' buying behavior or not?
4. Do you negotiate price or operate on a fixed price basis?
5. Do you rent or sell your products or services?
6. Do you perform product recall and update to the product or service you have offered?
7. Do you make to order or provide from stock the product or service that you supply?

These seven questions allow an analyst to classify an organization in terms of its systems and to establish a generic model of the information handling activities necessary for it to operate. BIAIT is in an experimental state, but initial applications show promise.

ROI is a cost-benefit analysis technique; typically, projects are ranked in descending order, and the highest ranked projects providing an acceptable rate of return are selected. Considerations other than ROI, such as resource constraints, organizational priorities, or politics, may alter the selection process.

To the extent that costs and benefits are quantifiable, ROI is a useful planning tool.

3. J.F. Rockart, "Chief Executives Define Their Own Data Needs," *Harvard Business Review*, vol. 49, March-April 1979, pp. 115-126.

4. D.C. Burnstine, *BIAIT, An Emerging Management Discipline*, BIAIT: International, Inc., New York, 1980.

The SLC-II is a microprocessor — it can speak. That's right. Its vocabulary runs well over 3000 words. And when it wants to, it will spell for you in English.

The SLC-II interprets messages from your computer, and takes specific actions. Just hook up the SLC-II between your CPU and your terminal with its standard RS-232 or 20mA serial loop interface, and you're set. With no software changes needed.

It automatically dials a pre-set telephone number and delivers any given message in an electronically synthesized voice. So it can take orders up, the SLC-II can make the necessary phone calls to have it fixed. That's why it's so

much better than just a simple monitor, which can only helplessly record events. The SLC-II can act on them.

It can call and tell you when there's an overflow, when security needs tightening, when telephone rates up — even when it gets up in the morning.

Find out today how little it costs to add a voice to your computer. Call or write for more information about the SLC-II from Digital Pathways today, at (260) 474-4444, Mountain View, CA 94043. Telephone: (415) 939-7600. FAX: (415) 939-6054.

**DIGITAL  
PATHWAYS**

# MEET THE SLC-II. IT TALKS TO SIMPLY EVERYBODY.

*Sorry, credit  
for amount \$327.88?  
It's overdrawn.*

*Help! Alarm  
fire in building 3!  
Send assistance.*

*Wake up, Sleepless,  
it's now 7 am!*

*Your computer  
is down.*

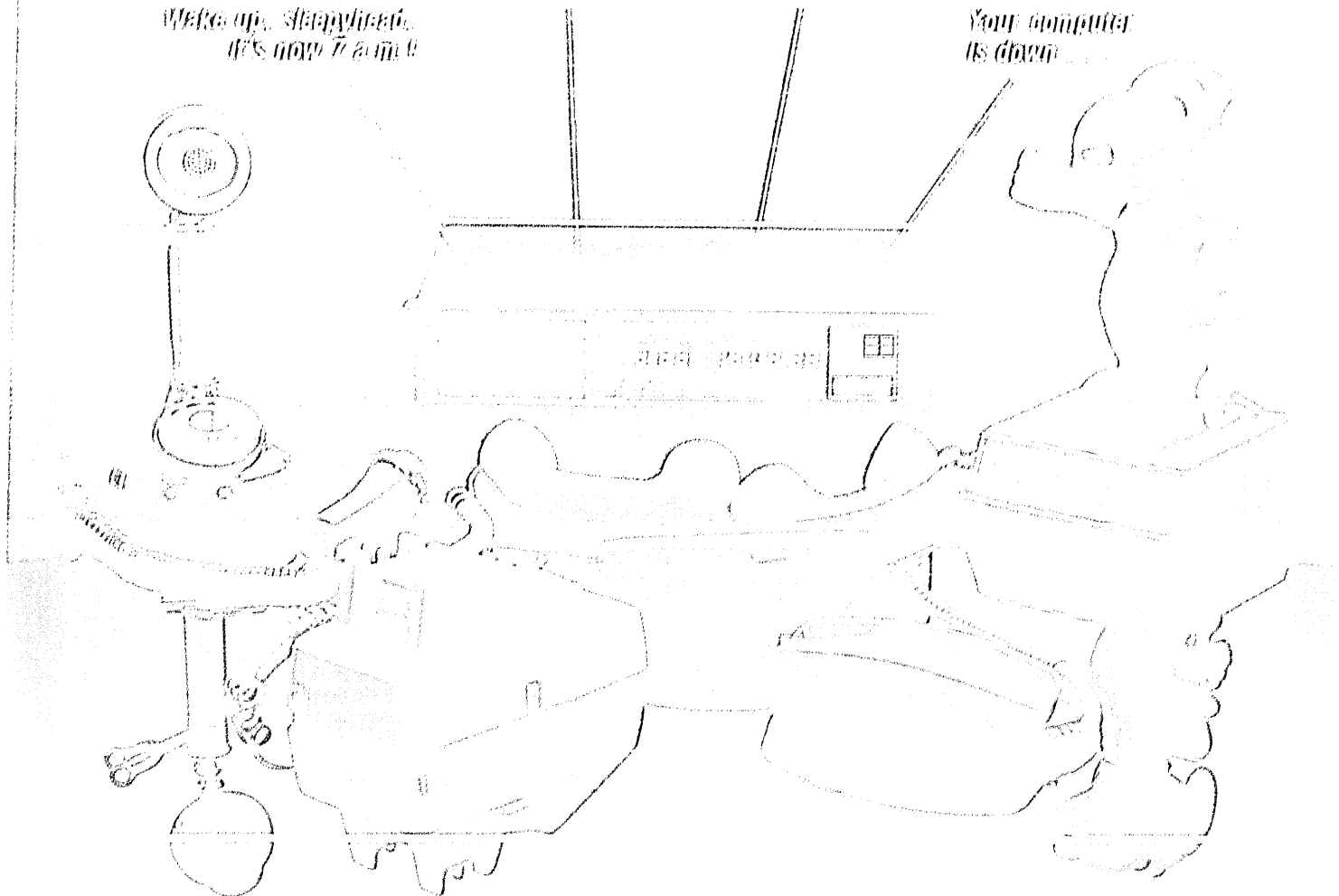

# During the strategic planning stage, it is critical to align MIS planning with overall company planning.

Unfortunately, MIS projects often do not lend themselves to easy quantification and estimation of costs and benefits. The costs and benefits of MIS projects are variable, complex, interrelated, and difficult to estimate. These difficulties often negate a meaningful ROI analysis.

In large organizations, MIS is often organized as a service bureau to provide services to all organizational subunits. Fee schedules are developed for each unit of service (e.g., CPU seconds, DASD I/Os, lines printed, programming time, etc.) with the objective of recovering (or partially recovering) MIS expenditures. Users are charged for those MIS services consumed. In theory, holding users responsible for the cost of their information systems foster greater planning and control of those systems.

Charge-out-based planning systems are typical of the traditional approach to MIS planning. The nature of charge-out-based planning systems varies; without specific procedures to the contrary, however, there are no systematic mechanisms linking information system planning based on charge-out to broaden organizational strategy and objectives. This may result in strictly bottom-up development of information systems with short-range time horizons.

ZBB is a highly structured planning technique developed as an alternative to incremental budgeting.

We suggest that ZBB be used as an MIS planning and control tool and as an alternative to charge-out-based systems. The first step in

FIG. 3

## ALTERNATIVE MIS PLANNING METHODOLOGIES

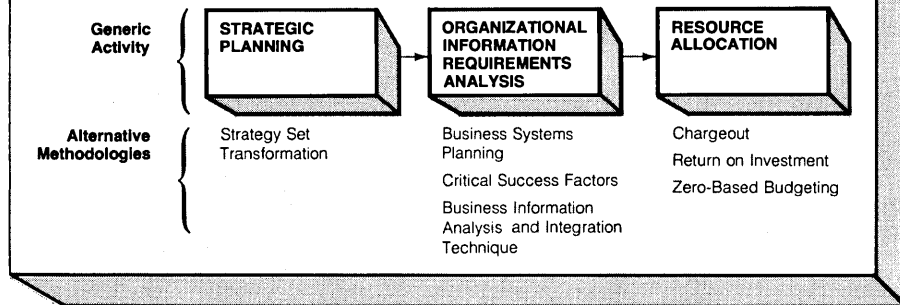

this process involves conceptually reducing all MIS activities to zero base, i.e., no development or maintenance of information systems. Next, all potential information systems applications are identified and structured into sequentially dependent incremental service levels. Expected benefits and MIS resource support requirements are listed for each service level. The projects are combined into an applications portfolio and submitted to a steering committee (or some other resource allocation mechanism) for priorities to be established. The projects are listed in ranked order of priority and cumulative resource requirements are calculated. Selection of projects to be implemented becomes a function of the MIS funding level.

This technique is particularly useful in

identifying applications that have outlived their usefulness. It has a strong bottom-up orientation, and the service level concept could conceivably result in a logical evolutionary design of the MIS. This methodology has a strong focus on resource allocation, but again, there is no explicit strategic planning cycle or direct link to the host organization's overall planning process. Compared with ROI, ZBB allows a more subjective analysis that does not require quantification of all cost and benefits. Compared with charge-out, using an MIS steering committee to establish priorities adds a centralized, high-level perspective to planning decision-making, but the lack of explicit consideration of strategic MIS planning may result in a planning process with a short-range time horizon.

The amount of personnel time required to utilize the ZBB approach can be significant. Information analysts must devote a considerable amount of time interacting with users in identifying information system projects and structuring proposed systems into incremental service levels. Also, preoccupation with service level definition may narrow the search for alternatives.

### FIT OF METHODS TO MODEL

The methodologies that have been reviewed fit into the framework of the basic MIS planning model. Each may be classified as applying primarily to one of the three generic activities:

1. Strategic planning
2. Organizational information requirements analysis
3. Resource allocation

Strategy set transformation is the only methodology described in this article that falls into the strategic planning category. In fact, it is the only methodology we are aware of that is designed to provide a direct link to overall organizational strategic planning.

BSP, CSF, and BIAIT fall into the information organizational requirements analysis (OIRA) category. The three approaches differ

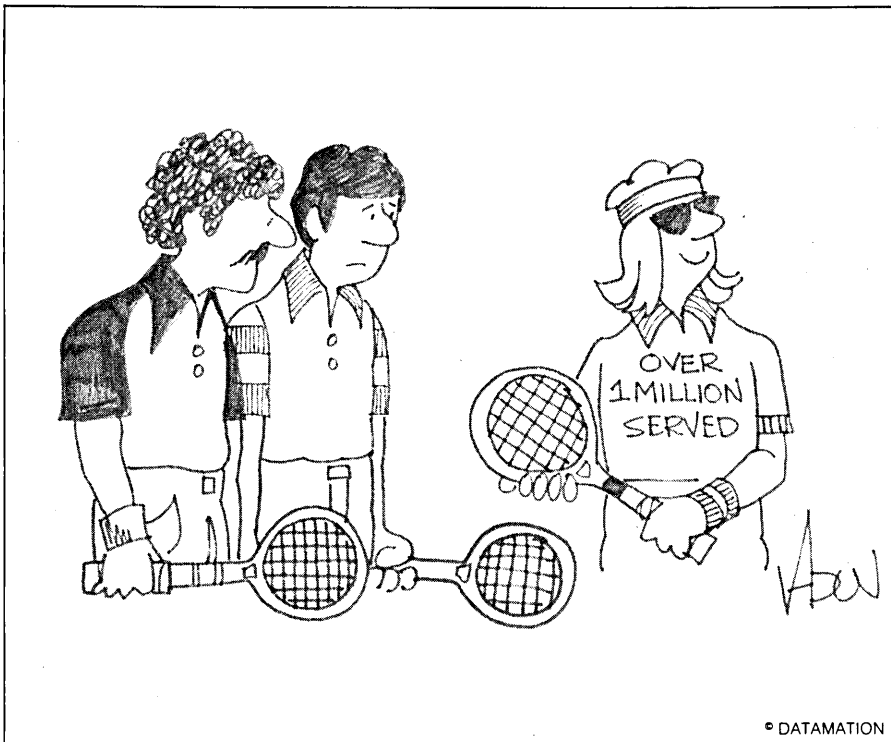

© DATAMATION

CARTOON BY CHUCK VADUN

# Now that the WICAT 68000 based system has quietly proven itself...



President of WICAT Systems Robert W. Mendenhall

## We're ready to announce it.

While others were announcing their MC68000-based systems, we were proving ours. While other companies were scrambling to build and debug prototypes, WICAT's system was working successfully in Fortune 100 companies.

While others are promising 68000's, WICAT is delivering. Ask any of our Fortune 100 customers. Or ask us.

Call or write today for additional information.

### **WICAT Systems.**

1875 South State P.O. Box 539 Orem, Utah 84057 801 224-6400

**CIRCLE 105 ON READER CARD**

# MIS projects often do not lend themselves to easy quantification and estimation of costs and benefits.

in their method and comprehensiveness. BSP is the more comprehensive and labor-intensive approach and generates a more extensive definition of total information requirements. CSF is less labor intensive and directs information requirements analysis at higher-level management requirements. BIAIT is a highly structured engineering approach that appears to be efficient in arriving at a set of normative requirements. A concern is whether it is applicable to high-level decision-making information requirements.

Charge-out, ROI, and ZBB fall into the resource allocation category. All three approaches are concerned with allocating resources; however, their orientations are quite different. Charge-out advocates a decentralized "marketplace" decision making with cost recovery. ZBB advocates a centralized planning committee decision making with MIS expenses carried as overhead. ROI can be used in either a centralized or a decentralized decision-making.

The ability to classify the various planning methodologies within the three-stage model adds validity to the model. Since each planning methodology has been implemented in a number of organizations, under certain circumstances, each one performs a useful and needed function.

To establish MIS planning needs, an organization should conduct a stage assessment (Table II) to determine the extent to which each stage of MIS planning has been accomplished. After the MIS planning needs at each stage have been established, appropriate methodologies can be selected. \*

James Wetherbe is an associate professor of management information systems at the University of Minnesota, and director of the Management Research Center (a partnership agreement between the University of Minnesota and 20 large companies).

Gordon Davis is a professor of management information systems at the University of Minnesota, and author of 13 books in that field. His current research interests include MIS planning, information analysis, and audit and control.

Brent Bowman is a candidate for a doctoral degree in management information systems at the University of Houston. He received his BBA and MBA degrees from Idaho State University. He was most recently employed by Occidental Petroleum Corp., where he was responsible for MIS security and various data center administrative functions.

TABLE II

## STAGE ASSESSMENT

*The stage assessment is performed for each of the three stages of the MIS planning model. To conduct a strategic stage assessment, an organization should ask the following questions:*

1. Is there a clear definition of organizational objectives and strategies?
  - a. Has the strategic organizational plan been reviewed?
  - b. Are the major claimant groups and their objectives identified?
2. Is there an MIS mission expressed in an MIS charter?
3. Is there an assessment of the MIS environment?
  - a. Are MIS capabilities adequately assessed?
  - b. Are new opportunities identified?
  - c. Is the current business environment understood?
  - d. Is the current applications portfolio defined and documented?
  - e. Is the MIS image healthy?
  - f. Is the stage of edp growth understood?
  - g. Are MIS personnel skills accurately inventoried?
3. Are MIS policies, objectives, and strategies established?
  - a. Is the MIS organization appropriate to the overall organization?
  - b. Is the MIS technology focus appropriate to the technology focus of the organization?
  - c. Is the mechanism for allocating MIS resources appropriate?
  - d. Are the functional capability objectives appropriate?

*If answers to these questions indicate a strategic stage weakness, a strategic planning exercise is in order. Strategy set transformation offers a formal methodology for conducting such an exercise. However, a formal methodology may not be necessary.*

*To conduct an OIRA stage assessment an organization should ask the following questions:*

4. Is there an adequate assessment of organization requirements?
  - a. Is the overall organizational information architecture identified?
  - b. Is there a good understanding of current information needs of the organization?
  - c. Is there a good understanding of projected information needs of the organization?
5. Is there a master MIS development plan?
  - a. Are MIS projects defined?
  - b. Are projects ranked by priority?
  - c. Is there a multiyear development schedule?

*If an organization does not have acceptable answers to the OIRA stage questions, an OIRA planning exercise is in order. Examples of formal planning methodologies available to conduct such exercise are BSP, CSF, and BIAIT.*

*To conduct a resource allocation stage assessment, an organization should ask the following questions:*

6. Does the organization have a resource requirements plan?
  - a. Are trends identified?
  - b. Is there a hardware plan?
  - c. Is there a software plan?
  - d. Is there a personnel plan?
  - e. Is there a data communications plan?
  - f. Is there a facilities plan?
  - g. Is there a financial plan?
7. Does the organization have an adequate procedure for resource allocation?

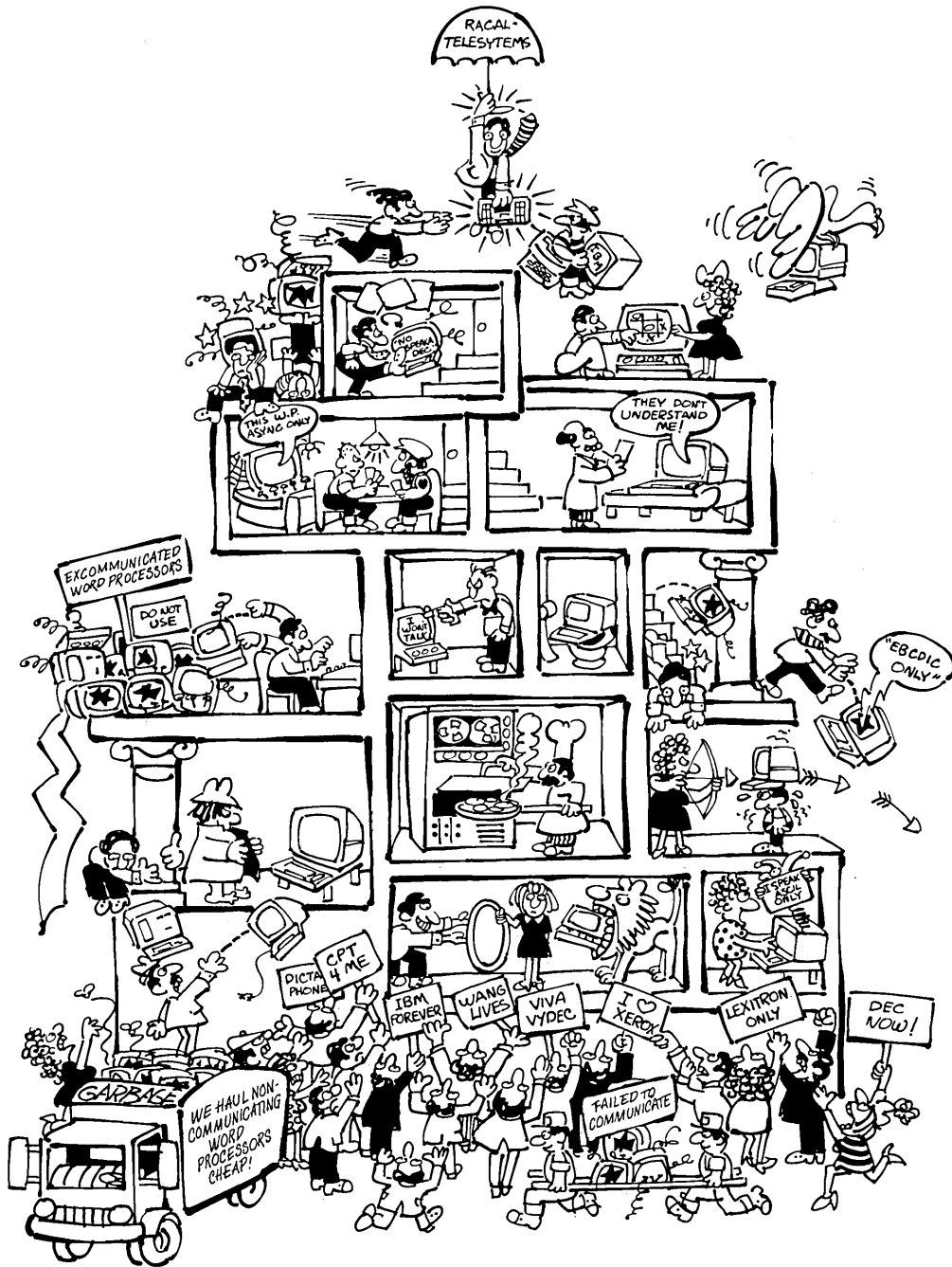

## Is your office information system a Tower of Babble?

"Where is it written," we ask, "that IBM word processors can only talk to other IBM word processors, Wang to Wang, etc?" "You mean," you ask with hope in your heart, "that it is possible for them to talk to each other?" "Not only with each other," we proclaim with ill-disguised pride, "but with your computer as well!" "Surely you jest!" you cry. "What is this marvel called?" "The 303 Protocol Translator from Racal-Telesystems. It brings peace and compatibility between IBM, Wang, DEC, Lexitron, Vydec, Dictaphone, AM Jacquard, CPT, IBM 6670, Computer ASCII and EBCDIC. It turns babble into dialogue." "More," you plead, "tell me more." Smiling broadly, we politely point to the coupon at the right, or call (312) 329-0700.

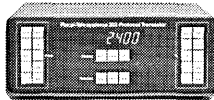

## Racal-Telesystems

The Compatibility Company  
Racal-Telesystems, Inc.

410 N. Michigan Avenue Chicago, Illinois 60611 (312) 329-0700 © 1981

"More. More. Tell me more about the Racal-Telesystems 303 Protocol Translator."

Name \_\_\_\_\_

Company \_\_\_\_\_ Title \_\_\_\_\_

Address \_\_\_\_\_

City \_\_\_\_\_

State \_\_\_\_\_ Zip \_\_\_\_\_

Phone ( ) \_\_\_\_\_

DAT 7/81

**RACAL**  
The Electronics Group

CIRCLE 106 ON READER CARD

# THE WORLD MEETS AT THE SICOB-PARIS.

**SICOB:**

**2,433 MAKES FROM 31 COUNTRIES**

**356,316 VISITORS FROM 97 COUNTRIES**

**SICOB:**

**EVERYTHING IN TELEMATICS**

**EVERYTHING IN OFFICE AUTOMATION**

**EVERYTHING IN DATA PROCESSING**

**EVERYTHING IN OFFICE ORGANIZATION**

**THE PARIS SICOB.  
THE GREAT INTERNATIONAL TRADE FAIR.  
SEPTEMBER 23RD TO OCTOBER 2ND 1981.  
AND CONVENTION INFORMATIQUE**

**THE INTERNATIONAL SOFTWARE CONGRESS  
SEPTEMBER 21ST TO 25TH 1981**

FOR INFORMATION, APPLY:  
INTERNATIONAL TRADE SHOWS IN FRANCE  
FRENCH CHAMBER OF COMMERCE IN THE UNITED STATES INC.  
1350 AVENUE OF THE AMERICAS  
NEW YORK NY 10009  
TEL.: (212) 502-4960  
TELEX: FISHOWS 427 563

PUBLICIS U 8024



## LET'S MAKE A DEAL

From the way he bills himself—one of the “principal deal makers in the computer services industry”—you’d think Bernie Goldstein is a big-time investment banker working out of an oak-panelled office overlooking New York harbor’s Brooklyn Bridge. Or perhaps out of an executive suite on Montgomery Street, within sight of San Francisco’s Bay Bridge. After all, he’s had his hand in some big deals, some of the biggest ever.

You’d be wrong. Goldstein, the man to whom colleagues only half jokingly refer as “Mr. Computer Services,” works with a couple of other guys on the first floor of a not-so-glamorous concrete office block straddling the exit ramp of the George Washington Bridge—in Fort Lee, N.J.

It’s only a 15-minute ride by car across the George Washington from Goldstein’s old Upper West Side neighborhood to Fort Lee, but he’s taken almost 25 years to get there. On the way, he’s probably learned more about the business of computer services than anyone else around.

After a stint in the Navy and an MBA from Columbia, Goldstein was bitten by the entrepreneurial bug and, with about \$5,000 cash from his and friends’ pockets, he formed Computech, Inc. Modeled after IBM’s Service Bureau Co., the firm sold computerized accounting services in the New York City area. At the time, 1958, the computer was hardly a well-known business tool, and Goldstein and company had to do their share of educating the public.

“When we first went out on sales calls,” he remembers, “they didn’t know what I was talking about. So I bought an old calliope, the kind with metal records, and



**BERNIE GOLDSTEIN:** He’s one of the “principal deal makers in the computer services industry.”

used it to show people the concept of a machine that could take instructions from a punched card. I was using a hundred-year-old antique to sell the latest technology.”

That kind of salesmanship seemed to work because in 1964 Goldstein and partners sold Computech to Control Data for \$1.5 million, a relatively large sum in those days. (Automatic Data Processing, Inc., Goldstein recalls, was at that time showing revenues of about \$1 million and its stock was selling “under the counter.”) Goldstein met CDC chief William Norris, he recalls, who impressed the New Yorker with a comment that CDC would someday make a large portion of its revenues from comput-

ing services. Norris was in turn impressed with Goldstein and named him district manager for New York.

He stayed with the Minneapolis firm for little more than a year, when the urge to run his own show hit again. He and Al Eisenstat, now vice president and general counsel of Apple computer, managed to raise about \$750,000 to start United Data Centers. His old partner remembers that raising the cash was no problem since Goldstein had by that time established a “good track record.” The firm grew to include 14 data centers, mostly on the West Coast. Leveraging off a couple of proprietary software packages, United Data grew steadily, went public in “the heady days” of 1968-69 and, with annual revenues of about \$15 million, found itself fast approaching a wall. The handwriting on that wall was clear: to survive meant going on-line. By 1974, the batch-only service bureau’s days were numbered.

To make that move meant money for new technology, and the two former frat brothers (at the Wharton School for undergraduate work) decided to sell the company. Cupertino-based Tymshare bought United Data and put Goldstein in charge of scoping out future acquisitions. Eisenstat joined him.

Nobody’s quite sure how many deals Goldstein helped secure for Tymshare (Eisenstat remembers evaluating “about 150 firms” at one time or another), but the company grew substantially, caught the attention of Wall Street, and expanded its services functionally and geographically. Goldstein honed his merger skills and acquired a reputation for having a keen business sense.

He was responsible for Tymshare’s acquisition of Western States Bankcard Association, a processor of credit card receipts and one of the more important deals done by Tymshare, in Goldstein’s estimation. An often told story of Goldstein’s persuasive tactics during the Western States negotiations has him setting up a plate of fortune cookies at a Chinese restaurant where execs from both sides of the bargaining table were

## PEOPLE

dining one night. The Western States diners' cookies read: "Your company is about to be acquired by Tymshare." The ploy obviously worked.

But Goldstein's merger skills run far deeper than that, business colleagues claim. Eisenstat describes him as having an "enormous intellect" and the ability to evaluate options unemotionally: "Even when a deal went sour, Bernie would walk away and still be friends. He'd even give advice to the other side, for free."

Other colleagues call him a "tough negotiator," one who enjoys the competition, perhaps for its own sake. "Money is the scorecard for him, not the end in itself," one former partner says. "It's just a measure of how well he's done. He doesn't need it now." Another points to "unsurpassed problem-solving skills" and calls him "extremely hardworking." Eisenstat gives him

high marks for "good political sense," for being able to find where power resides, and for taking advantage of it.

Dun & Bradstreet's 1979 purchase of National CSS showed Goldstein's skills at their best, according to observers. Having joined NCSS as chairman of the board upon leaving Tymshare in 1978, Goldstein was on the lookout for potential buyers of the up and coming timesharing firm. D&B, searching for an established computer network with which to distribute its information services, had been firmly turned away by Tymshare. So it began talking with NCSS. The timesharing firm was showing annual revenues of about \$60 million and a net worth of about \$50 million.

D&B's initial offer for NCSS has never been disclosed, but insiders recall a hectic weekend during which Goldstein, "playing devil's advocate," held rein on his board of

relatively "green" directors and persuaded them to negotiate further. D&B was forced to raise its offer to a record-setting \$164 million, the largest deal ever signed in the computer services arena. It was perhaps the pinnacle of Goldstein's career as a deal maker.

His acute sense of timing, political savvy, and straight shooting style are backed by what colleagues describe as an unsurpassed understanding of the services industry, much of which was gained through his activities with ADAPSO (the Association of Data Processing Services Organizations). He joined the trade organization in 1964, during its formative years, and is credited with instilling much of the group's current momentum.

Sal Parisi, former ADAPSO president and now vice president of corporate development with Sun Information Services Co., recalls a younger Goldstein volunteering to be the group's membership director and traveling the country, visiting service bureau after service bureau with pen in hand. "From that experience," Parisi says, "Goldstein probably knows more people and more companies than anyone I know."

Jerry Dreyer, who joined ADAPSO as executive director just as Goldstein was finishing his membership drive, remembers that he was instrumental in getting ADAPSO to take political stands, particularly in the area of banks offering what were seen as unfairly competitive computing services. "He's our Mr. Industry guy," comments Dreyer.

His mission completed at National CSS, Goldstein joined Broadview Associates, Inc., in Fort Lee, where he and partner Gilbert Mintz help buyers and sellers get together in the fast moving computer services sector. Broadview, which usually has a half dozen deals under way at any given time, claims to outdo its Wall Street competitors, most of which are a hundred times larger both in staff and capitalization. "We enjoy tweaking the nose of the big investment banks," Goldstein says.

Broadview, founded by Mintz in 1973, seems to be on to a good thing. Last year the firm counted 87 industrywide services mergers worth a total of \$688.4 million. Broadview handled about 20 of those deals. And, with the pace of mergers and acquisitions expected to grow steadily over the next few years, Broadview plans to be at the forefront. It may, Goldstein says, also branch out to new areas of investment banking activity.

Meanwhile, Goldstein makes his home with a wife in Rye, N.Y., raising three children, playing tennis, and among other things, serving on the board of a Defense Department think tank, the Riverside Research Institute.

As for the future, Goldstein sees no major changes: "I'm having too much fun."

—John W. Verity



"If your batting average doesn't improve, you can kiss your Krinklies commercial goodbye."

©DATAMATION

CARTOON BY CHUCK VADUN

# CARTS & CRAFTS

## The Definitive Source for Computer Graphics Professionals

If you're involved in CAD/CAM, business or scientific computer graphics, SIGGRAPH/81, the Eighth Annual Conference on Computer Graphics and Interactive Techniques, is the place to be! For years, the conference has been recognized as the leader in providing a sharply-focused perspective on the most advanced hardware, software, theory, applications and capabilities of this challenging aspect of computer technology.

### You'll see it first at SIGGRAPH/81!

SIGGRAPH/81 features an intensive program of education and exposure targeted to your professional needs:

- The largest exhibition of new state-of-the-art graphics hardware, software and services, featuring over 100 vendors.
- An extensive, 18-course training program — from introductory tutorials to advanced seminars.
- Presentation of 34 technical papers in eight timely topic areas and three technical panel sessions.
- A singular opportunity to make contact with other users, knowledgeable vendor representatives and leading graphics experts.
- A vendor forum for presenting the latest products and applications for business, industry and education.
- Plus, the chance to discuss, compare and evaluate a wide range of computer graphics systems.

If you only attend **one** conference this year, make it SIGGRAPH/81. It's the definitive source for information, ideas, inspiration and input on effective computer graphics. Plan to join us in Dallas, August 3-7, 1981.

**For conference registration information call or write:**

**SIGGRAPH/81**  
**Conference Office**  
**One Illinois Center**  
**111 East Wacker Drive**  
**Chicago, Illinois 60601 U.S.A.**  
**312/644-6610**

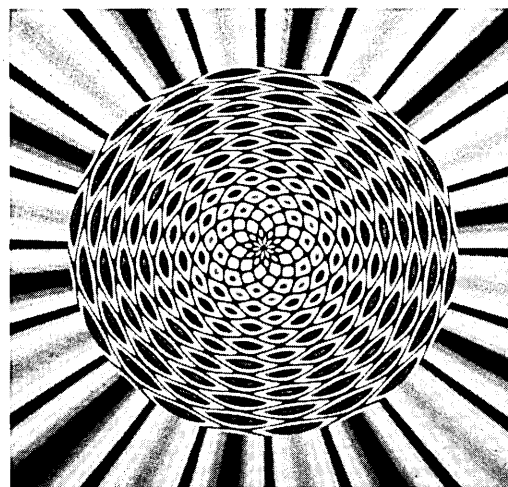
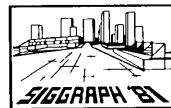

Computer graphic by M. Thompson, M. Schecter

# SIGGRAPH/81

# This Publication is Available in **MICROFORM**

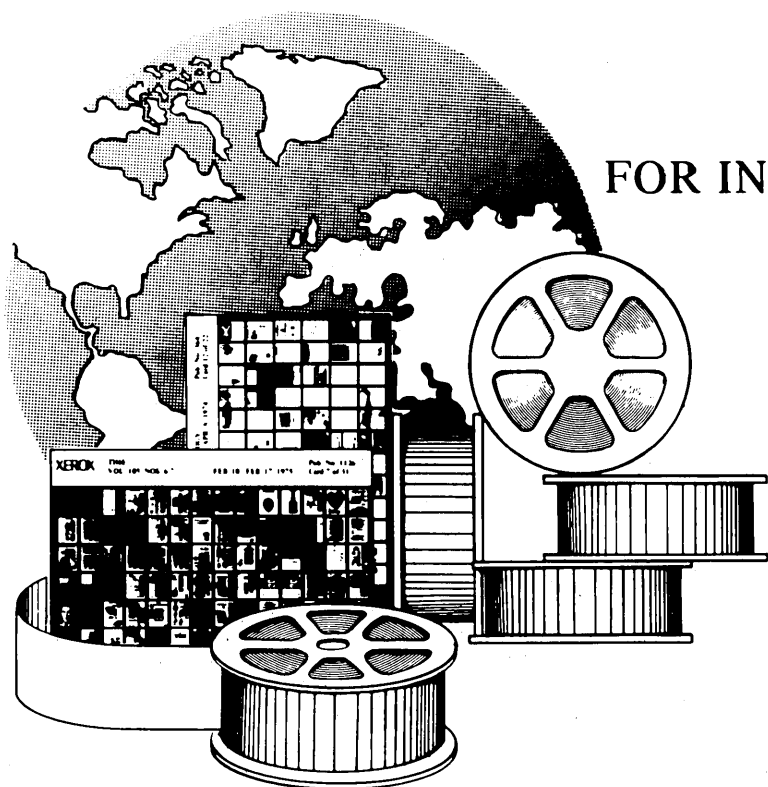

FOR INFORMATION  
WRITE:

## **University Microfilms International**

Dept. F.A.  
300 North Zeeb Road  
Ann Arbor, MI 48106  
U.S.A.

Dept. F.A.  
18 Bedford Row  
London, WC1R 4EJ  
England

# HARDWARE

## OFF-LINE

An IBM engineer described the company's third generation electron beam lithography device to fellow engineers attending the 16th Symposium on Electron, Ion, and Photon Beam Technology held in Dallas at the end of May. Richard D. Moore, manager of electron beam systems development at IBM's General Technology Div. at East Fishkill, N.Y., explained the EL-3, which can operate with 1 micron geometries. EL-3 can write from 10 to 20 round silicon wafers per hour; it also can create masks for mass producing chips once their design has been frozen. Controlled by a pair of Series/1 minis and using a pattern buffer made from modified 370/168 memory, the EL-3 uses a technique called subfield vector writing. A modification of raster scan techniques, subfield vector writing lets the EL-3 skip areas of the wafer that require no writing, thus speeding the writing process.

Panasonic has built a new speech synthesis chip, the MN6401, that can speak up to 63 words (or sounds) in either a male or female voice. Combining functions that previously took three separate chips, the MN6401 has its own internal 32Kb ROM. External ROM can be added if needed for the application. The chip uses PARCOR (Partial Auto Correlation) technology developed by Nippon Telephone and Telegraph.

Digital Equipment shipped its first PDP-11/24 to Evans and Sutherland, the Salt Lake City graphics company, just three days after the new mini was announced.

## SIGNATURE VERIFICATION

Micropad, Inc., the subsidiary set up by Quest Automation to market its handprint character recognition input device, demonstrated its latest advance—signature verification—at the Chicago NCC. The new unit, called QSIGN, uses the existing Micropad handprint data entry device, and performs both data entry and signature verification. QSIGN's internal 16-bit microprocessor and firmware analyzes both the shape and "rhythm" of the signature. Based on work performed at the National Physical Laboratory in England, QSIGN verifies signatures in two phases.

Initially, the user enters a reference signature five times on a master terminal, which distills the information into at most 40 characters. The encoded reference signature can then be stored on a mag stripe card, or held in a computer database. During signature verification at a user QSIGN terminal, the user is requested to sign in (at whatever point the application dictates), the reference signature is retrieved from disk or read from a mag stripe card, and the terminal compares the two, producing a closeness-of-match value. The application program then accepts or rejects the signature, based on an application program specified threshold. Since the Micropad input is on a paper form and the user writes with a common pencil or pen, a hard copy record, including signature, is available for retention. The system

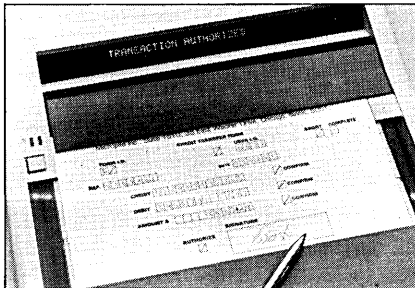

communicates via standard RS232 interfacing using ASCII characters. The QSIGN master terminal sells for \$5,000; user terminals are \$3,750. Deliveries are to begin in the third quarter. MICROPAD, INC., Chicago, Ill.

**FOR DATA CIRCLE 301 ON READER CARD**

## HIGH-END MINI

Prime Computer revamped its line of virtual memory timesharing systems with the introduction of a new top of the line, the 850, which incorporates dual instruction execution units, from 2MB to 8MB of memory, and support for up to 128 terminals. Three existing systems have been enhanced for greater performance and additional terminal support. Dubbed the Mod-II systems, the tuned-up systems are the models 150-II, 250-II, and 550-II. The Mod-II systems have better price/performance than the vendor's 450 and 650 systems which have been removed from the current product line. The 750 remains essentially unchanged, although it now supports up to 96 users, as opposed to the previous maximum of 64. Prime's product offering now consists of five compatible systems: 150-II, 250-II, 550-II, 750, and 850.

The 850 comprises three major components—two Instruction Stream Units (ISUs) and a Stream Synchronization Unit (SSU). The ISUs can each process an independent stream of instructions, allowing the 850 to execute simultaneously two instruction streams. Each ISU has 16KB of cache, an instruction preprocessor, and an instruction execution unit. The instruction preprocessors take instructions from cache, decode the instructions, and resolve effective addresses. The instruction units perform the actual instructions, including hardware multiply and divide, decimal arithmetic, and character string manipulations. Context switching is handled by the ISU under firmware control. The SSU coordinates ISUs,

## HARDWARE

making certain that data in cache are both valid and current. It manages internal system messages passing between ISU, handles memory access synchronization, and runs internal diagnostics ensuring the integrity of the data flow. The 850 also offers burst mode I/O at up to 8MBps. The entire system runs under a single copy of the PRIMOS operating system, and can make use of Prime's existing system software, including compilers, file management systems, and database systems.

A typical system, priced at \$525,000, consists of an 850 cpu, 4MB of memory, one 300MB disk, one tape drive, one 600 lpm printer, networking hardware and software, 20 terminals, FORTRAN '77 and COBOL compilers, DBMS (Prime's CODASYL-compliant database software), and PRIMOS. Deliveries are to begin this month. PRIME COMPUTER, INC., Natick, Mass.

**FOR DATA CIRCLE 302 ON READER CARD**

### DISK DRIVE

Iomega's Alpha 10, a 10MB disk drive, is difficult to classify: it weds several disk technologies. We've heard several people



call it a floppy drive, but it's not exactly what we consider a floppy. True, the media is flexible, and the Alpha 10, with integrated controller, fits into the same mounting slot engineered for 8-inch floppies. On the other hand, unlike floppies, the head does not contact the recording surface. And the media itself is packaged in a rigid plastic envelope, much like Sony's tiny 3½-inch floppy. With the number of technologies combined in the Alpha 10, it isn't surprising that Iomega has 13 patent applications pending. Its performance sounds impressive, with an average access time quoted at 35msec and a data transfer rate of 1.1MBps. In oem quantities of 500 per year, the Alpha

10 with controller (for up to four drives) sells for \$2,300; additional drives are \$1,250. Preformatted 10MB cartridges will sell for about \$30 in quantity. IOMEGA CORP., Ogden, Utah.

**FOR DATA CIRCLE 300 ON READER CARD**

### MICROCOMPUTER NETWORK

Corvus Systems, the company that began business configuring 8-inch Winchester disks with interfaces for personal computers, has now developed its own local network for various microcomputers. Dubbed Omninet, the system bears a functional resemblance to Xerox's Ethernet. Like Ethernet, Omninet can connect systems to allow them to communicate among themselves. The product offerings include a disk server, allowing shared access to Corvus Winchester. Future offerings are to include a print server, gateways to other nets (including Ethernet), and a modem server allowing access to phone lines.

Unlike Ethernet, Omninet operates at a slower data rate of 1Mbps, using an RS422 twisted pair of up to 4,000 feet as its medium. All devices connect to the twisted pair via a proprietary "transporter" built around a 6801 microprocessor and a custom gate array. Initially transporters are offered for three micros: Apple II, Onyx C8000, and DEC LSI-11. Transporters also are available to connect to any Corvus peripheral. Future transporters will be offered for Apple III, TRS-80, S-100 bus machines, and others.

The transporters use DMA, and their on-board 6801s relieve the host micro of communications overhead. Messages may be sent to a specific node or broadcast throughout the net. Retransmission of garbled messages is automatic, and the user can specify the maximum number of retries. Within each host, up to four addressable "sockets" (buffers) can be defined. The transporters are controlled by a set of send-message and receive-message commands from the host micro. Transporters sell for \$495 (Apple II interface), \$750 (LSI-11 interface), and \$650 (Onyx C8000 interface). The disk server sells for \$990 sans disk. CORVUS SYSTEMS, San Jose, Calif.

**FOR DATA CIRCLE 303 ON READER CARD**

### MULTIPROCESSOR

Tandem Computers, makers of the NonStop multiprocessor fault-tolerant system, has introduced its second system, the NonStop II. Intended for applications in large transaction processing environments requiring hundreds of on-line terminals and communications lines, NonStop II retains compatibility with applications written for the original NonStop computer (programs containing privileged instructions may require modification). Key features of the NonStop II include 32-bit addressing, an Operations and Service Processor, and writable control store.

## HARDWARE SPOTLIGHT

### DATA CONCENTRATOR

Three-and-a-half years and 20,000-plus units later, Micom's bread-and-butter product, the Micro800 Data Concentrator, has spawned a successor. The Micro800/2 Data Concentrator (a statistical multiplexor) offers roughly eight times the performance of its predecessor at about the same price, with about \$650 worth of what used to be options thrown in as standard equipment. And, of course, it has capabilities that go beyond

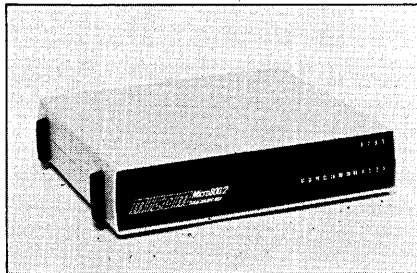

those of the original Micro800, such as a command port and terminal initiated channel configuration, speed conversion, data compression, and support for synchronous and bit-oriented protocols.

The Micro800/2 can be had with from two to 16 input channels, each capable of operating at data rates of up to 9600bps. Designed for simple one-two-three (set port configuration dip switches, plug in RS232 cables, plug in the power) setup by the user, Micro800/2s will typically be configured back-to-back, with one unit at the computer site and another at the remote user site. A synchronous link running at up to 19.2Kbps (or asynchronous link running to 9600bps) connects the two concentrators in this con-

figuration. For users wishing (and able) to develop the systems programming, the host-side concentrator can be replaced with demultiplexing software to save communications ports. Using a Micro200 Port Concentrator at the host can save about 60% of the programming effort in having the host demultiplex traffic.

The Micro800/2 can be configured with two, four, eight, 12, or 16 input ports operating at independent speeds. Each port is full-duplex, and can operate at split rates (an option) supporting special applications such as Viewdata, where the host transmits at 1200bps and the user responds at 75bps. Synchronous and clocked-asynchronous terminal support is optionally available for one channel on a two-channel Micro800/2; any of the top four channels in an 8-, 12-, or 16-channel unit can also support this option. Autobaud detection (to 1200bps) is standard, as are local and remote diagnostics, message broadcast, alarm messages, and periodic reports on data traffic, average and peak buffer utilization (by channel), block retransmissions, and telephone line quality. Remote printing is supported as a background task so as not to impact terminal users. An option is available to accommodate satellite links and their inherent transmission delays.

While existing Micro800s cannot be upgraded to 800/2s, the new units can be expanded in the field. A four-channel Micro800/2 lists for \$1,850, while a 16-channel unit is \$4,700. Adding synchronous input support adds \$400 to the price. MICOM SYSTEMS, INC., Chatsworth, Calif.

**FOR DATA CIRCLE 336 ON READER CARD**

# “Datapoint business computers are designed for the only thing management can predict with certainty.”

## “Change.”

**I**t won't be enough for your next computer to solve today's problems well. It must also be ready to solve tomorrow's.

**Word Processing, Electronic Mail, Voice Communications. You're going to need them all.**

This is the first computer that handles *all* the basic business functions—data processing, word processing, electronic message service, and management of voice and data communications.

All functions are truly integrated and available at every workstation. You can enter data ... compute and file ... retrieve and incorporate in text ... and transmit to other workstations across the hall or across the nation. This is Datapoint's Integrated Electronic Office, a unified approach to office automation with virtually unlimited growth potential.

**The cornerstone is a local network that's at work now.**

Datapoint introduced local networking over three years ago. Now more business is processed on ARC™ coaxial networks than all other cable systems combined.

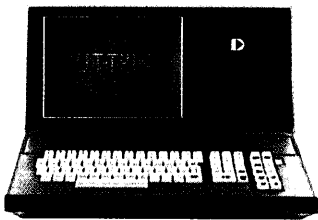

*Datapoint workstations integrate data processing, word processing, and electronic mail utilizing a common data base.*

ARC networks enable workstations, processors, printers, and files to be linked together so that all resources are available to all users. And users may access physically distributed files as a common information base containing both words and data.

**You decide what to start with, what to add next.**

Start with a single workstation or a small cluster. Order data processing and word processing to begin.



*Vic Poor is Executive Vice President of Research and Development at Datapoint. He pioneered dispersed data processing, designed the first computer-on-a-chip, and developed ARC™ — the most widely used coaxial network for linking business machines.*

Graduate to communications management and electronic mail as you go along. Or vice versa.

A choice of compatible processors and a broad range of peripherals allow you to match capacity precisely to the job.

**Stop replacing hardware. Stop rewriting programs.**

Many computers bog down trying to provide more and more functions to more and more users. This one won't.

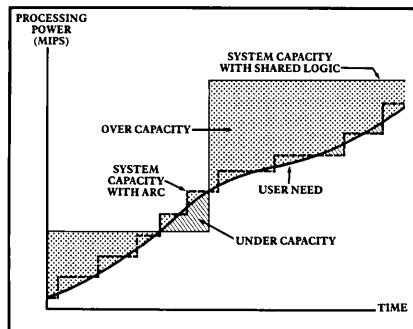

*With conventional computers you can only add processing power in large, expensive steps. With ARC, you can add power in small increments, closely matching capacity to user needs.*

With ARC you can add processing power, workstations, storage, and peripherals as your needs require *without constant reprogramming*. And no matter how large the system grows, you'll still get responsive performance at each workstation.

**Word processing with new search power.**

Add word processing to existing workstations whenever you're ready. Because WP and DP are truly integrated, you can retrieve information from DP files and incorporate it into WP documents.

And Datapoint word processing offers you a productivity tool no one else can. It's AIM™, Datapoint's Associative Index Method™. With AIM you can search files and documents by their content. You don't need to know the document number or title.

Search by subject or a remembered phrase. AIM will find every document or data file in which the key words occur.

Electronic message capability allows completed documents to be transmitted to other Datapoint workstations, cutting paper work and speeding communications.

**Cut long distance telephone costs up to 40 percent.**

Your telephone expense may be rivaling your data processing costs. We can help there, too.

The Datapoint Long Distance Control System operates with your existing PBX or CENTREX and automatically routes each long distance call over the least-cost line. It can hold specified calls until a low-cost line becomes available. And it prints out information on phone costs and traffic to let you optimize and control your telephone usage.

**Begin now. We're ready with service and support.**

Datapoint systems have been proven in more than 30,000 user locations and are backed nationwide by over 800 customer service engineers.

For more information, send for "The Executive Guide to the Integrated Electronic Office." Write: Datapoint Corporation, Corporate Communications T-41DM, 9725 Datapoint Drive, San Antonio, TX 78284. Or call (512)-699-7059.

  
**DATAPPOINT**

**CIRCLE 110 ON READER CARD**

## HARDWARE

Like the original NonStop, NonStop II contains from two to 16 processors. With its new 32-bit data access architecture, each processor has an extended virtual address space of 1 billion bytes, available under control of the operating system. Currently, NonStop II processors can be configured with from 512KB to 2MB of real memory; anticipating further advances in the density of memory, each processor has the inherent capability of addressing up to 16MB of real memory. Although the processors retain the 16-bit word size used in the original NonStop, 32-bit addressing results in a 16-fold increase in both I/O buffer space and transfer size available to each processor. The Operations and Service Processor (OSP) is a separate processor providing system status and diagnostic facilities to service personnel; an integral modem lets a remote terminal control the system, allowing remote diagnosis and operation of the system. The OSP also detects and reports system faults on-line.

NonStop II includes all the features of the original NonStop. It can make use of existing software and it can coexist with earlier NonStops in a network environment. A basic NonStop II, consisting of dual processors, each with 512KB of memory, mag tape drive and controller, and OSP, carries a price tag of \$144,475. TANDEM COMPUTERS INC., Cupertino, Calif.

**FOR DATA CIRCLE 304 ON READER CARD**

## SMALL CAD SYSTEM & LOW-COST DIGITIZER

GTCO chose NCC to introduce its Interactive Graphics Digitizer (IGD), an entry-level, standalone CAD system, and the \$735 (quantity one) Demi-Pad 5, an 11-inch square digitizer.

The IGD can operate standalone or as a graphics preprocessor cooperating with a host-based graphics system. Priced at less than \$12,000, the IGD includes turnkey CAD software for entry, editing, storage, analysis, zooming, windowing, overlaying, and other related functions. The software is menu-driven to simplify operation. Hardware consists of a Micro Digi-Pad 11-inch

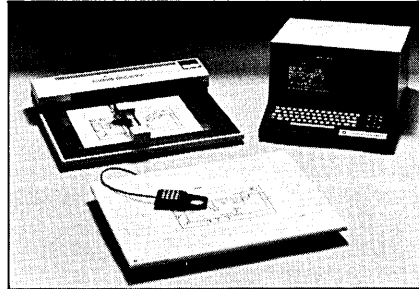

by 17-inch digitizer with .001-inch resolution and a 16-button cursor, dual Z80 microprocessors, 96KB of RAM, dual minifloppies (total capacity: 320KB), a 9-inch crt with 512 by 256 resolution, four RS232 ports.

four parallel ports, and an RS170 output for either a remote monitor or video printer. The standard system also includes a full ASCII keyboard with cursor control keys and a 12-key pad for numeric data entry and function control. Larger digitizers, additional RAM, two more floppies, Winchester disks, plotters, and modems are available as options. Optional software includes UCSD Pascal, CP/M or MP/M and the many compilers and packages supported by the two operating systems. Base price on the IGD is \$11,065, with oem discounts available.

GTCO is the least expensive 11-inch digitizer on the market today. It features .001-inch resolution, two parallel and two serial interfaces (50bps to 19.2Kbps), and microprocessor control allowing it to emulate virtually any digitizer on the market today. Direct bus compatible interfaces are planned for most popular personal computers. Oems can pick up the Demi-Pad 5 for \$551 in quantities of 100. GTCO CORP., Rockville, Md.

**FOR DATA CIRCLE 305 ON READER CARD**

## MICROCOMPUTER

The Stratos is a single board Z80 microcomputer housed in a teakwood cabinet which also contains the system's floppy disk drives. The bundled system comes with a number of bells and whistles, including a battery-backed real-time clock, character

# FOR BIG DOLLAR SAVINGS AND FASTER DELIVERY, BUY YOUR T.I. SILENT 700\* THERMAL PAPER DIRECT FROM NASHUA!

\*Trademark of  
Texas Instruments.

We make thermal paper for Texas Instruments Silent 700 printers. It meets ALL manufacturer's specs and keeps your equipment warranty valid. Nashua® thermal paper is prime quality, has a bond-like appearance that gives you black print on a white background for superior legibility and excellent contrast for better photocopies. Nashua thermal paper meets TI residue and

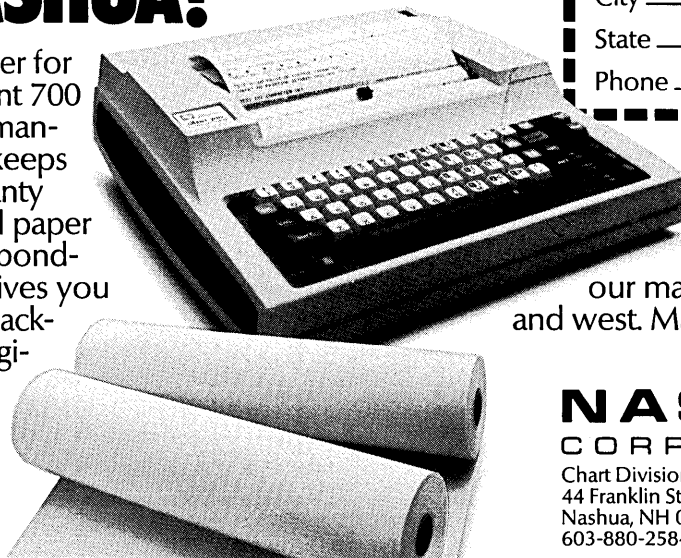

Nashua Corporation  
44 Franklin Street  
Nashua, NH 03061

YES. I'm interested in saving money on thermal paper for my TI Series 700 printers. Please send me price and ordering information.

Name \_\_\_\_\_

Title \_\_\_\_\_

Co. Name \_\_\_\_\_

City \_\_\_\_\_

State \_\_\_\_\_ Zip \_\_\_\_\_

Phone \_\_\_\_\_

abrasion specs for longer print head life. We ship within 24 hours of order acceptance from one of our major stocking locations east and west. Mail the coupon or call now for price list.

## NASHUA CORPORATION

Chart Division  
44 Franklin Street  
Nashua, NH 03061  
603-880-2584

**CIRCLE 111 ON READER CARD**



IMMEDIATE  
DELIVERY

# Network Affiliates.

**TI's Bubble  
Memory  
Data Terminals  
extend distributed  
data entry for  
business.**

**TI's Silent 700\***  
Models 763 and 765  
Bubble Memory Data  
Terminals bring an  
added dimension to con-  
ventional distributed processing net-  
works with off-line data entry  
capabilities. These memory experts  
can collect information right at the  
source to optimize your communica-  
tions costs.

The lightweight  
Model 765 Portable Bubble  
Memory Data Terminal has  
increased cost efficiency  
for utilities by allowing  
them to conduct off-line  
energy audits for their resi-  
dential customers. In  
remote sales order entry  
applications, salesmen  
are speeding up sales turnaround time  
and improving productivity with the  
Model 765's built-in acoustic coupler  
for instant data access during sales  
demonstrations.

The Models 763 and 765 data  
terminals are ideal for paperless  
health care claims processing which

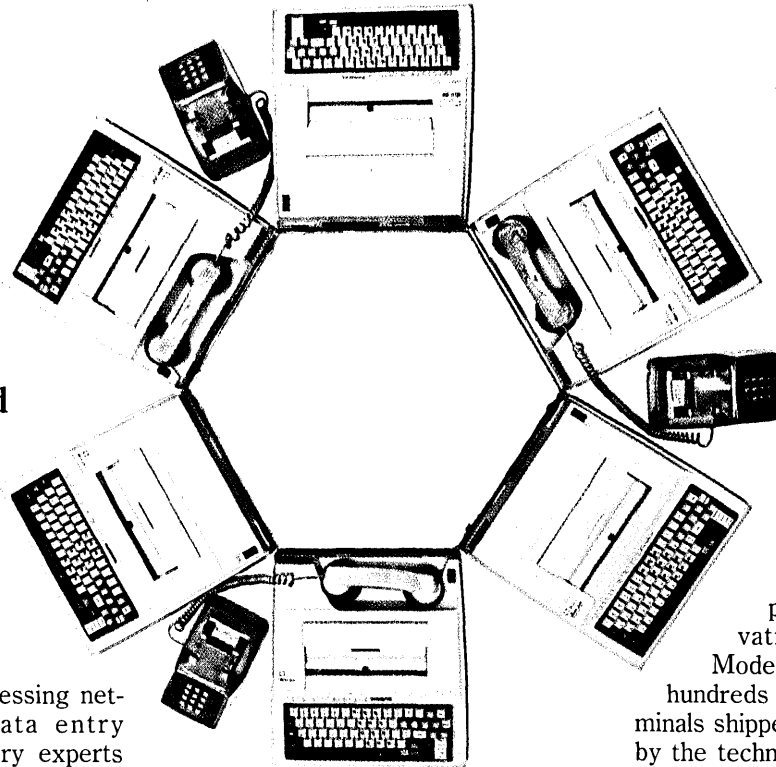

optimizes office productivity for phy-  
sicians, dentists and insurance compa-  
nies, and reduces mailing time delays  
to increase customer support. Auto-  
motive parts manufacturers and dis-  
tributors are using the Models 763 and  
765 for fast, accurate parts ordering,  
and for managing parts inventories.

Both models offer up to 80,000  
characters of reliable bubble memory  
data storage and a file management  
system, and can execute user-devel-  
oped programs to meet individual  
application requirements.

In a variety of businesses, TI's  
Models 763 and 765 Bubble Memory  
Data Terminals are providing power-  
ful, economical extensions to data pro-  
cessing networks.

TI is dedicated to  
producing quality, innova-  
tive products like the  
Models 763 and 765. And, TI's  
hundreds of thousands of data termi-  
nals shipped worldwide are backed  
by the technology and reliability that  
come from 50 years of experience.

Supporting TI's data terminals is  
the technical expertise of our world-  
wide organization of factory-trained  
sales and service representatives, and  
TI-CARE†, our nationwide automated  
service dispatching and field service  
management information system.

For more information on the  
Model 763 and 765 Bubble Memory  
Data Terminals, contact the TI sales  
office nearest you, or write Texas  
Instruments Incorporated,  
P.O. Box 202145, Dallas,  
Texas 75220, or phone (713)  
373-1050.



*We put computing  
within everyone's reach.*

**TEXAS INSTRUMENTS  
INCORPORATED**

In Canada, write Texas Instruments Incorporated, 41 Shelley Rd., Richmond Hill, Ontario L4C 5G4, (416) 884-9181. In Europe, write Texas Instruments, M/S 74, B.P. 5, Villeneuve-Loubet, 06270, France, (93) 20 01 01. In Asia Pacific, write Texas Instruments Asia Ltd., 990 Bendeemer Rd., Singapore 1233. Telex RS 21399, or phone 2581122.

\*Trademark of Texas Instruments †Service Mark of Texas Instruments Copyright © 1981, Texas Instruments Incorporated

CIRCLE 112 ON READER CARD

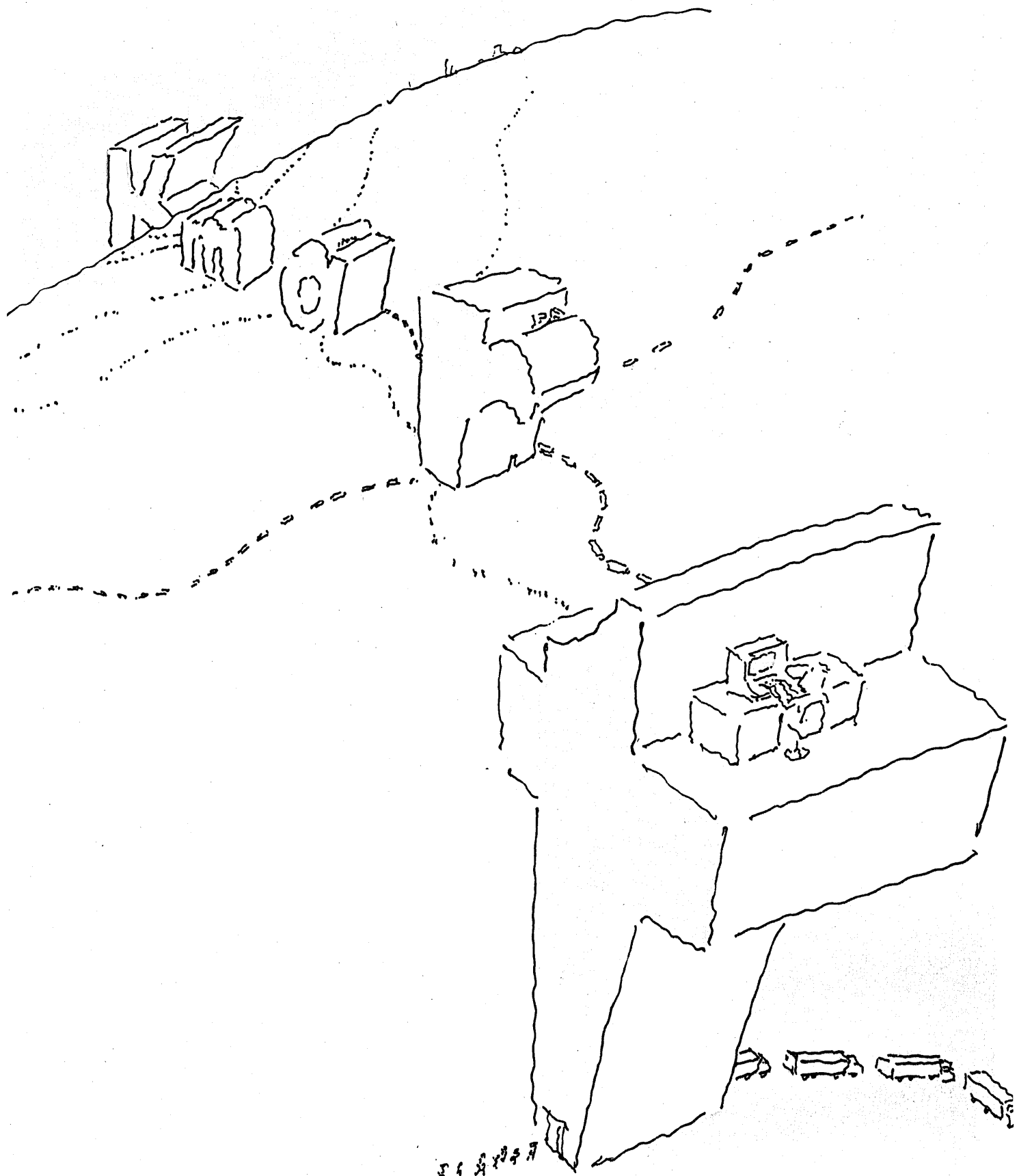

Handwritten text at the bottom of the page, possibly a signature or a note. The text is written in a cursive or shorthand style and is difficult to decipher. It appears to be a name, possibly "D. J. ...".

# Even a big business can use a little IBM.



Gerry Fletcher, V.P. Of Corporate Information Systems, K mart.

K mart is one of the world's largest retailers. But that doesn't mean they use only the largest computers.

In fact, K mart has bought hundreds of IBM's smaller computers, the Series/1. And they've ordered more.

And that shouldn't surprise anyone.

Gerry Fletcher, K mart's V.P. Of Corporate Information Systems, explains. "We needed to have processing capabilities available at local stores similar to those we have at headquarters. Series/1 has more than met our needs."

One need was freeing central management from long waits for local data.

"Now local stores can forward orders electronically to headquarters and on from there directly to the vendors."

And K mart's store managers needed freedom to do their own processing locally.

"Series/1 has greatly reduced clerical effort by handling many local management applications such as payroll, accounts payable and inventory control."

As K mart has discovered, Series/1 is one of IBM's most versatile computers.

Because it's modular, a wide variety of Series/1 components can be used as building blocks, to custom tailor a solution to many different requirements, ranging from distributed data processing to energy management to industrial automation.

For more information about Series/1, call your IBM General Systems Division representative or write us at P.O. Box 2068, Atlanta, GA 30055.

"Series/1 is helping free K mart to be more productive," says Gerry Fletcher. "In a company like ours, small systems can produce big results."

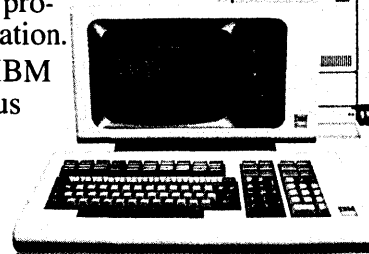
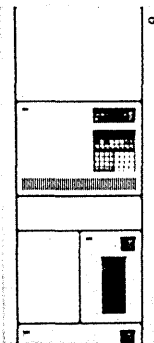

## A little IBM can mean a lot of freedom.

The IBM logo, consisting of the letters "IBM" in a stylized, bold font with horizontal lines through them.

General Systems Division

CIRCLE 113 ON READER CARD

# Heat. It makes life And life in your high impossible.

There's enough heat, up to 400° F, inside your Xerox 9700 to actually scorch ordinary bond paper.

That's why, when the first generation of two-copies-per-second copiers came

on the market, Champion realized they would need a new breed of paper. We also realized the computer printout room was about to become as common as the typing pool.

To meet these requirements and this demand we developed Champion Xerocopy Bond.



# on earth possible. speed copier nearly

A new kind of paper to serve a new kind of machine in a new kind of office.

Champion Xerocopy Bond meets the exacting performance requirements demanded by the equipment. And it's backed by a national network of merchants and Champion representatives.

People who know your needs as well as your high-speed machines and

how to serve them both.

At Champion we're not only growing trees to make paper.

We're also growing ideas to meet the future.

*Champion Paper Company*

**Planting seeds for the future**

CIRCLE 114 ON READER CARD

## HARDWARE

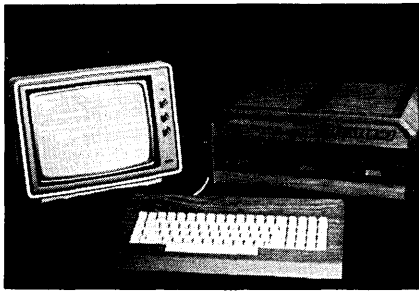

fonts loadable from diskette, a Key-Tronics word processing keyboard (also housed in teakwood) with 19 special function keys and 80KB of bank switched memory. A 12-inch green phosphor video monitor with audio capabilities is provided as the standard display; it's memory mapped and formatted as 28 lines of 80 characters. A pair of RS232 serial ports are standard.

A built-in ROM monitor and C/P/M are included with the Stratos. The customer has the choice of either a CBASIC or Pascal compiler. Word processing, financial applications, and Reminder, a tickler file that operates in conjunction with the real-time clock, also come with the system. One of the most interesting packages included in the bundled software is Font, which allows the user to define custom character fonts using a light pen; the fonts can be saved on diskette for later use. Several other programs also are shipped with the Stratos.

Configured with a pair of 5¼-inch floppies, the Stratos sells for \$6,400; with 8-inch floppies the price is \$6,800. SYMBIOTIC SYSTEMS, INC., Santa Cruz, Calif.

**FOR DATA CIRCLE 306 ON READER CARD**

### PROFESSIONAL WORKSTATION

Xerox's 8010 Star information system complements the foundation of Ethernet-compatible devices announced six months back, extending the usefulness of Ethernet systems from the clerical realm into that of staff professionals. Star is not billed as a "management workstation" (i.e., "another gizmo for the ceo"), but rather as a tool for those who spend much of their time collecting, analyzing, summarizing, and reporting information. It allows users to create documents using a variety of type sizes and styles, and incorporating graphics; these documents can be printed—as they appear on the screen—on a xerographic print server attached to an Ethernet. The workstation also supports filing and retrieval of documents, as well as sending and receiving electronic mail. Star can also communicate with computers, and perform local processing such as data extraction and sorting.

Star comprises a two-page desktop display screen, keyboard, mouse (a position sensor for pointing at things on the screen), and a small local processor with disk. Most of Star's functions can be invoked by using

the mouse to point at an "icon" displayed on the screen. These icons represent common office items, such as in and out baskets for electronic mail, files and folders for storage and retrieval, and printers for hardcopy.

A user can create graphics using the mouse to move predefined images, such as arrowheads or rectangles. Various line types—solid, dotted, or dashed—in various widths can also be moved by the mouse. Graphics can be moved about and scaled up or down as desired. Additionally, the Star can convert numeric tables into graphs. When graphics are inserted into a document, the Star will automatically adjust the text around the graphic, allowing the professional to perform page layout without

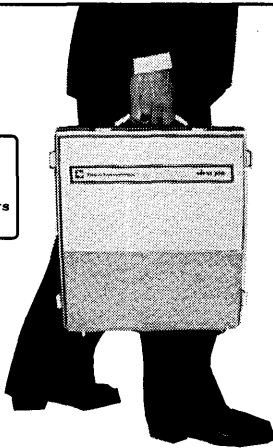
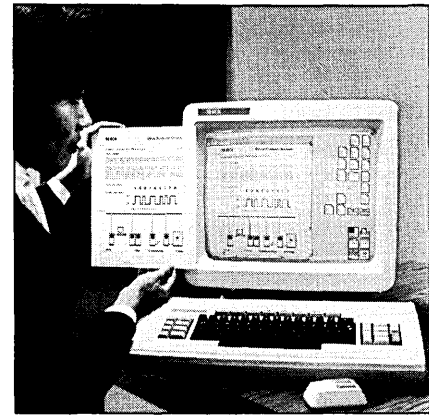

1.

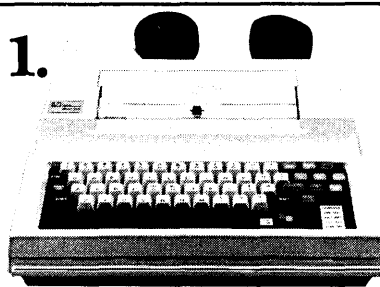

**TI785-120 cps**

features bi-directional thermal printing, operator programmable answerback memory and built-in originate-mode acoustic coupler with Vadic 3400 and Bell 113A compatibility.

2.

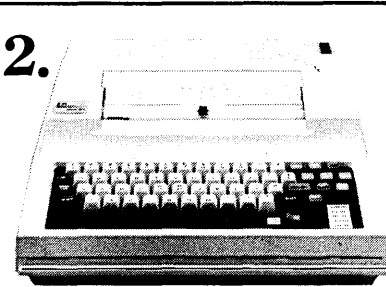

**TI787-120 cps**

features bi-directional thermal printing, operator programmable answerback memory, built-in direct-connect modem with Vadic 3400, Bell 103A and Bell 212A compatibility, memory dial-up and originate/automatic answer operation.

## MTI gives you 2 easy ways to take your computer along at 120 cps.

MTI's Texas Instruments *Silent 700\** Portable Data Terminals bring your computer as close as the nearest telephone and electrical outlet.

They're ideal for inventory reporting and control, insurance program planning or any application that requires fast, reliable printing and versatile communications capabilities.

MTI is the one source for all of the terminals, peripherals, applications expertise and service you'll ever need. And you'll find that our pur-

chase and lease prices are hard to beat. Call us.

New York: 516/482-3500, 212/895-7177, 518/449-5959

Outside N.Y.S.: 800/645-8016

New Jersey: 201/227-5552

Ohio: 216/464-6688



Applications Specialists & Distributors, New York, New Jersey and Ohio. DEC, Texas Instruments, Intel, Dataproducts, Lear Siegler, Hazeltine, Diablo, Teletype, Racal-Vadic, Anderson Jacobson, General DataComm, Digital Engineering, Techtran, Cipher, Priam, SMS, Western Peripherals, Able Computer, Elgar and Franklin Electric.

\*Trademark of Texas Instruments

**CIRCLE 115 ON READER CARD**

# MAKING THE TOUGH DECISIONS

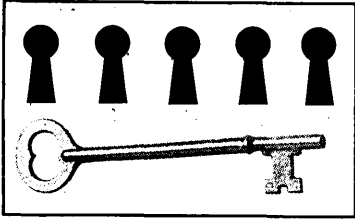

## A budget-management report from United Way

At United Way, volunteers carefully review the budgets, operating patterns and track record of agencies asking to become part of the United Way organization.

They scrutinize the various functions performed by the agency, look at the kinds of people it helps, and evaluate its success in delivering its services.

But what happens when a new service agency wants to become a United Way organization—especially when there may be two or more equally qualified organizations equally in need of United Way support? Who chooses? And on what basis?

The answer to this question is often complex. And sometimes it can be an agonizing decision to admit one agency instead of another.

### The people decide

But the bottom line is that volunteers do make the decisions after carefully weighing all the pros and cons. It's sometimes a hard process, but it's as fair as we know how to make it.

Volunteers work free of charge doing everything from collecting money to deciding how it will be used, so administrative costs are kept low.

And that's how United Way works so well. And why.



**United Way**  
Thanks to you, it works.  
for all of us.

Ad Council A Public Service of This Magazine & The Advertising Council

# There's no business like dough business.

**T**he business of making money. It's all very exciting.

But without the ability to lay out a large amount of cash, you can't take advantage of the financial opportunities that come your way.

And venturing all your money without savings in reserve can be dangerous. Because savings are the base of any financial plan.

One of the surest, easiest ways to save some dough is joining the Payroll Savings Plan and buying United States Bonds. You'll never miss the little taken out of each paycheck.

Meanwhile, the Bonds grow up to play a part in your future.

Of course, with Bonds you're sure of the ending. But then, there's nothing wrong with a happy ending.

Take  
stock  
in America.



Ad Council A public service of this publication and The Advertising Council.

## MANAGER/DATA BASE SYSTEMS (Administration)

You will be responsible for the control, design and administration of all project data base systems, along with the standards and conventions relative to data base systems associated with the Northwest Alaskan Pipeline Project. Must possess the knowledge to ensure all data base systems will integrate on the project computer. The ideal candidate must be an accomplished manager with supporting skills in the technical areas of data base management systems. Position requires emphasis on IMS, DB/DC and INQUIRE along with 10 plus years of experience. A minimum of a Bachelors Degree in Data Processing or related discipline along with additional data base experience is desired. This position is located in our Irvine, California office.

A move to Northwest Alaskan Pipeline Company might be the most important move of your career. If you are interested in challenging your abilities, make your move to our expanding energy company. We offer an excellent salary and benefit package. For immediate consideration, please send your resume including salary history to: Herman G. Best, Northwest Alaskan Pipeline Company, C/O Fluor Engineers & Contractors, 3333 Michaelson Drive, Irvine, CA 92730. We are an equal opportunity employer m/f.



CIRCLE 116 ON READER CARD

JULY 1981 181

## HARDWARE

involving a drafting or graphics department.

The system includes self-training software, allowing a user to learn the use of functions necessary to perform his or her job. An introductory session, teaching system basics, reportedly takes about four hours to complete. A help function can be invoked to explain the currently selected function.

Plans call for additional software support, including a programming language for automatic updating of records and reports. The 8010 Star, with basic software, sells for \$16,595. The same Star rents for \$695 per month on a one-year lease. Some software products carry additional charges. Deliveries are slated to begin in September. XEROX CORP., Office Products Div., Dallas, Texas.

**FOR DATA CIRCLE 307 ON READER CARD**

### COLOR TERMINAL

The Colorscan 10 is a DEC VT100-compatible terminal capable of displaying alphanumeric and simple business graphics in up to eight colors. When initially turned on, the Colorscan functions as a monochrome VT100 look-alike; colors are displayed in response to command sequences sent from a host resident applications program. Data are displayed in two basic formats—24 lines of 80 characters or 24 lines of 132 characters. Ninety-six ASCII characters and 13 special

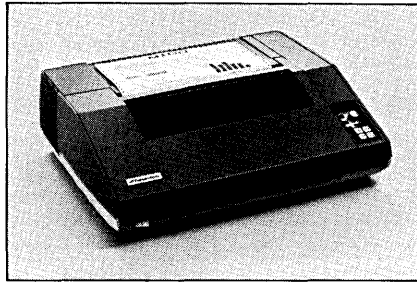

graphics symbols are standard. In color operation, both character and background colors can be specified. The eight colors are red, green, blue, cyan, magenta, yellow, black, and white. Bidirectional smooth or jump scrolling can be selected by either the operator or application program. Split screen operation is also provided. Standard interfacing is RS232, with data rates ranging up to 19.2Kbps; a 20mA current loop interface is optional. Shipments are slated to begin in September; quantity one pricing is \$3,795. DATAMEDIA CORP., Pennsauken, N.J.

**FOR DATA CIRCLE 310 ON READER CARD**

### MATRIX PRINTER

The M-100 is a 140cps 132-column bidirectional logic-seeking dot matrix printer using a newly developed 14-wire printhead. Built by Dataproducts, the M-100 forms upper and lower case characters in a 9 by 9 matrix.

With the 14-wire head, the printer produces true descenders on lower case letters, and it can print super- and subscripts for scientific notation. True underlining is possible at any position in the output. Its standard character set contains 128 characters: 96 ASCII and 32 commonly used international characters. Options include block letters ranging from .08 inches to 0.8 inches in height, UPC bar code generation, an additional 128-character programmable character generator (down-line loadable), and raster graphics. Standard interfacing is Dataproducts parallel with a single line buffer. Optional interfaces include Centronics-compatible parallel and RS232 or current loop serial (with 2KB of buffering). The M-100 sells for \$2,200 in oem quantities of 200; the graphics option is an additional \$250 in the same quantities. Deliveries are quoted at 90 days ARO. DATAPRODUCTS CORP., Woodland Hills, Calif.

**FOR DATA CIRCLE 311 ON READER CARD**

### NETWORK CONTROL

The RM300 real-time network management and control system provides communications managers with up-to-date information for real-time network control, day-to-day configuration, and capacity management planning for future expansion. The system provides real-time control displays, continuous communications measurement,

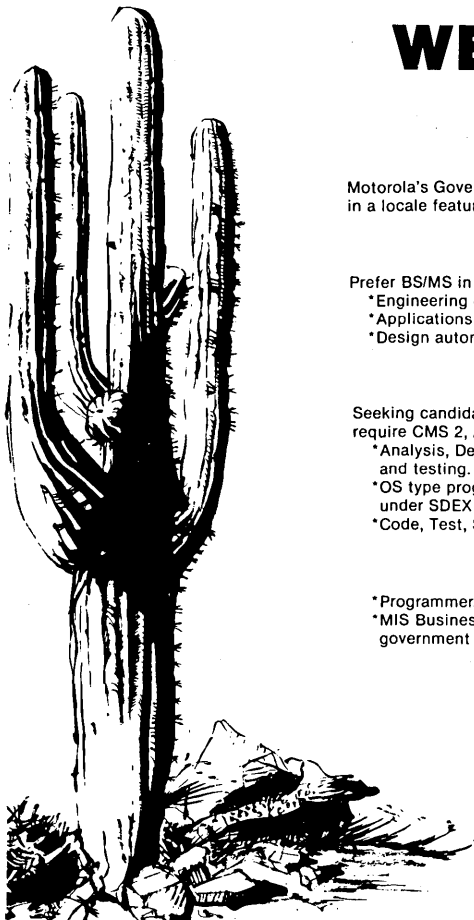

# WELCOME TO ARIZONA

It's Not Only What You Do . . .  
It's Where You Do It.

Motorola's Government Electronics Division offers a great combination — an R&D environment of advanced technology in a locale featuring beautiful weather and numerous recreational opportunities.

### SOFTWARE ENGINEERS (Hayden Plant)

Prefer BS/MS in Computer Science, Electrical Engineering or Math with experience in any of the following:

- \*Engineering or scientific software design/testing
- \*FORTRAN, Pascal, Assembly or Ada
- \*Applications on minicomputers or microprocessors
- \*UNIVAC OS/1100, Assembler
- \*Design automation, CAD/CAM software

### SOFTWARE ENGINEERS (Price Plant)

Seeking candidates experienced in developing military software systems. Positions require CMS 2, AYK-14 or UYK-20. Responsibilities are:

- \*Analysis, Design, Test for top down software design of real time systems, integration and testing.
- \*OS type programs with I/O handlers, file managers and dynamic storage allocation under SDEX executive.
- \*Code, Test, Support ground station software utilizing MIL-STD-483/490

### MIS BUSINESS APPLICATIONS (Hayden Plant)

- \*Programmer/Analyst with 2-5 years of OS, COBOL, IMS DB/DC, PANVALET and TSO.
- \*MIS Business Analyst with 5 years of problem analysis, data base technology, government cost accounting standards C/SCSC and strong communication skills.

Forward resume to:



## MOTOROLA INC.

Government Electronics Division

Dept. 1076  
Hayden Plant  
8201 E. McDowell Rd.  
Scottsdale, AZ 85252

Dept. 1076  
Price Plant  
7402 S. Price Rd.  
Tempe, AZ 85282

An Equal Opportunity/Affirmative Action Employer

**CIRCLE 118 ON READER CARD**



## ADVERTISING OFFICES

Sales Manager: **John M. Gleason**  
New York, NY 10103  
666 Fifth Ave.  
(212) 489-2579

Eastern District Manager: **A. Treat Walker**  
New York, NY 10170  
420 Lexington Ave.  
(212) 682-7760

New England District Mgr.: **William J. McGuire**  
Newton, MA 02159  
181 Wells Ave.  
(617) 964-3730

Mid-Atlantic District Mgr.: **John A. Bartlett**  
Plymouth Meeting, PA 19462  
Plymouth Plaza, Suite 201  
(215) 825-4410

Southern District Mgr.: **Warren A. Tibbetts**  
West Palm Beach, FL 33406  
7621 West Lake Dr., Lake Clark Shores  
(305) 964-6298

Midwest District Mgr.: **Joseph P. Gleason**  
Chicago, IL 60601  
3 Illinois Center Building, 303 East Wacker Dr.  
(312) 938-2926

Western District Managers:

**Alan Bolte, Jr.**  
Los Angeles, CA 90035  
1801 S. La Cienega Blvd.  
(213) 559-5111

**James E. Filiatrault:**  
Mountain View, CA 94043  
2680 Bayshore Frontage Rd., Suite 401  
(415) 965-8222

U.K., Scandinavia, Benelux  
**Tulio Giacomazzi, Martin Sutcliffe**  
Technical Publishing Co.  
130 Jermyn Street, London, SW1 4UJ, England  
Tel: 01-839-3916  
Telex: 914911

Germany, Austria  
**INTER MEDIA Partners GmbH**  
Ludwig-Uhland-Strasse 7  
828 Ennepetal, West Germany  
Tel: 0233-76008/9, Telex: 8592207

France, Spain: **Gerard Lasfargues**  
32 rue Desbordes Valmore  
750 16 Paris, France  
Tel: (1) 504 97 94

Italy: **Luigi Rancati**  
Milano San Felice Torre 7  
20090 Segrate, Milano, Italy  
Tel: 2-7531445, Telex: 311010

Switzerland: **Andre Lehmann**  
ALAS AG, CH-6344  
Meiershappel/LU  
Tel: (042) 64 2350

Japan: **Shigeru Kobayashi**  
Japan Advertising Communications, Inc.  
New Ginza Building, 3-13 Ginza 7-chrome  
Chuo-ku, Tokyo 104, Japan  
Tel: (03) 571-8748

Israel: **Igal Elan**  
Daphna Str. 24, Tel-Aviv  
Tel: 268020

**James B. Tafel**, Chairman  
**John K. Abely**, President  
**Robert L. Dickson**, Exec Vice President  
**John R. Emery**, Senior Vice President  
**Calverd F. Jacobson**, Vice President-Finance  
**Walter M. Harrington**, Vice President and Controller

**Technical Publishing**

**DB** a company of  
The Dun & Bradstreet Corporation

## EXXON OPPORTUNITIES

### for Scientific Programmers, Systems Analysts and Systems Programmers

Exxon Production Research Company, Houston, Texas, one of the largest exploration & production research organizations in the world is currently developing a computer network to handle exploration data processing needs.

If you are a recent BS or MS, or PhD graduate in the fields of:

- Math •Computer Science
- Electrical Engineering
- with experience in:
- IBM OS/MVS
- CRAY-1 Vector Computer
- Distributed Processing
- Interactive Graphics & Image Processing
- Seismic Applications Programming

Send your resume to:

**J.J. Hedgemon**  
Exxon Production Research Company  
Department 309  
P.O. Box 2189 • Houston, Texas 77001

EXXON PRODUCTION RESEARCH

# EXXON

an equal opportunity employer, m/f

CIRCLE 119 ON READER CARD

## EDP SPECIALISTS career search opportunities \$18,000-\$50,000

**COMPUTER SALES to \$42,000.** Leading DP corp is expanding its metro DC operations. Time sharing bkgd, deg, 3 yrs gov't sales exp. Refer DM.  
**NETWORK DESIGN SPECIALIST, \$40,000.** Resp for configuration of Data Communications network, insuring high performance at minimal risk using state-of-the-art equip & services. Req's min 3 yrs planning & implementing data communications systems, including knowledge of communications equip & protocols & familiarity w/common carrier facilities & tariffs. BSEE definite plus. Refer JD.  
**IMS SYSTEMS PROG., \$40,000.** 4 wks vacation 1st yr. Several clients seek exp'd IMS internals pros. Req's min 2 yrs industrial exp & knowledge of BTAM, VTAM or other access methods. Refer MF.  
**DIV. MGR. to \$40,000.** Southeast financial organization seeks progressive mfr to become key member of mgmt team. Re-

fer LS.  
**MGR. SYSTEMS/PROG. to \$38,000.** Req's indiv w/strong system dvlpmt exp & demonstrated mgmt ability in IBM environ. Will supv staff of 15. Expanding med-sized co in desirable recreation area. Refer GW.  
**SYSTEMS PROG. to \$35,000.** Work in magnificent suburban setting surrounded by co's outstanding country club facilities. "Fortune 500" corp, exceptionally pro environ which will be growing significantly. Req's exp in IMS/MVS tuning. SYSGENS. IBM systems. Refer JC.  
**PROG./ANALYST to \$26,000.** Mfr's corp hdqtrs in Baltimore seeks COBOL programmer w/mfg applications on IBM 370. Refer CN.  
**SR. PROGRAMMERS to \$30,000.** Req's either CICS, TOTAL, DBOMP, IMS & exp in design & implementation of MRP, inventory control & related mfg systems. Refer IS.

CONTACT OUR NEAREST OFFICE ABOUT THESE AND OTHER FEE-PAID OPPORTUNITIES.  
OUR UNIQUE, COMPANY-OWNED OFFICE SYSTEM ASSURES PERSONAL, CONFIDENTIAL SERVICE.

PHILADELPHIA, PA 19102—G. Romagna, 1500 Chestnut St., 215/561-6300  
ATLANTA, GA 30346—R. Jennings, 47 Perimeter Center, 404/393-0933  
BALTIMORE, MD 21204—C. Newman, 409 Washington Ave., 301/296-4500  
CHARLOTTE, NC 28202—L. Stone, 1742 Southern Nat'l Ctr., 704/375-0600  
CLEVELAND, OH 44131—A. Thomas, 4401 Rockside Road, 216/524-6565  
COLUMBUS, OH 43229—R. Spang, 6600 Busch Boulevard, 614/436-8400  
FLORHAM PARK, NJ 07932—M. Feiger, 248 Columbia Turnpike, 201/966-1571  
HOUSTON, TX 77098—G. Smith, 3000 Richmond Ave., 713/523-5588  
LOS ANGELES, CA 90017—A. Jackson, 707 Wilshire Boulevard, 213/623-3001  
MCLEAN, VA 22102—D. Miller, 1710 Goodridge Drive, 703/790-1335  
NEW YORK, NY 10036—J. Dean, 1211 Ave. of the Americas, 212/840-6930  
PITTSBURGH, PA 15222—B. Sayers, 4 Gateway Center, 412/232-0410  
PRINCETON, NJ 08540—J. Dean, Route #1, CN 6100, 609/452-8135  
RALEIGH, NC 27625—S. Hubbeling, 3101 Poplarwood Court, 919/872-2940  
SAN FRANCISCO, CA 94111—W. McNichols, 601 Montgomery Street, 415/392-4353  
WILMINGTON, DE 19810—G. Whitwell, J. Clark, 3516 Silverside Rd., 302/478-5150

# FOX-morris

personnel consultants

CIRCLE 120 ON READER CARD

## HARDWARE

data logging, reporting facilities, and support for up to 256 communications lines. A variety of protocols are supported, including IBM 3270 bisync, SNA/SDLC, 2780/3780 with multileaving, and 2260 synchronous and asynchronous. Support for asynchronous ASCII, Honeywell VIP, Univac Uniscop, Burroughs Standard Poll Select, and IBM IPARS are scheduled for release this year.

In addition to identifying network failures, the RM300's real-time network control function alerts the network manager of degrading response times and increasing retransmissions. For configuration management, the RM300 provides historical analysis of peak loading, line utilization, response times, and other information useful in deciding on where to place new terminals and devices, as well as specifying additional lines and new line speeds. Historical data can also help plan for future growth. A basic four-line RM300 sells for less than \$75,000, while a 32-line system is under \$100,000. TESTDATA SYSTEMS CORP., McLean, Va.

**FOR DATA CIRCLE 308 ON READER CARD**

### REMOTE PRINTING

The Remote Printing System (RPS) from Digital Associates allows remote line printers to run at their full rated speed. RPS connects to a minicomputer via a parallel printer interface instead of a communications

port. Operator intervention is required only to set up the communications link. The RPS performs data compression, parallel to serial conversion, error control, serial to parallel conversion, and decompression of the received data. Synchronous communications are used: 2400bps for 300 lpm printers, 4800bps for 600 lpm printers, and 9600bps for 1000 lpm printers. RPS is sold only to customers buying printers (at discounted prices, of course) from Digital Associates. The user must supply the modems. RPS is priced in the \$3,500 to \$4,000 range. DIGITAL ASSOCIATES CORP., Stamford, Conn.

**FOR DATA CIRCLE 314 ON READER CARD**

### DESKTOP COMPUTER

Digilog's System 1500 packs a 5MB 5¼-inch Winchester disk, minifloppy drive,

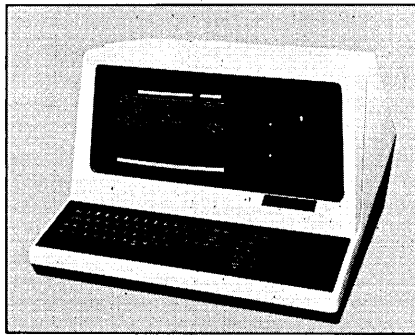

and a Z80 microcomputer with up to 64KB of memory into a single desktop package that also houses the computer's 12-inch display screen and keyboard. CP/M comes with the unit as its standard operating system. In its basic configuration, the System 1500 comes with 32KB of memory, both rigid and floppy (700KB per diskette), 80 character by 24 line display, RS232 communications interface, parallel printer interface, and an S-100 bus adaptor. With CP/M, this system sells for \$9,995. Additional memory, in 16KB increments, sells for \$215. An auxiliary RS232 interface goes for \$350, while dual RS232 ports are priced at \$450. Asynchronous communications to 9600bps are standard, with synchronous communications to 4800bps available as an option. Centronics and NEC printers are supported by the parallel interface. In addition to the standard upper and lower case typewriter keyboard, the System 1500 has a 13-key cluster that serves dual duties as both an adding machine cluster and function keys for word processing. DIGILOG BUSINESS SYSTEMS INC., Horsham, Pa.

**FOR DATA CIRCLE 313 ON READER CARD**

### DESKTOP LASER PRINTER

General Optronics' Electronic Page Printer is a laser-driven plain paper raster scan printer which uses conventional toners (such as those used in office copiers). De-

## MANAGER, RECORDING SYSTEMS

This is an unusual opportunity to utilize your technical understanding of state-of-the-art optical and/or magnetic recording systems in the management of a Development Engineering Group. Our client is a recognized leader in commercial and government electronics.

You will be responsible for directing the efforts of engineers and other personnel on advanced recording development programs such as:  
-optical disc recorders  
-high performance image recorders  
-laser film recorders

You should have a BS/MS in Electrical Engineering, and experience in Design Engineering which includes supervisory responsibility.

You will be working just outside a major East Coast city, close enough to enable you to take full advantage of the cultural activities offered but without city wage taxes and daily traffic jams.

If you would like to have more information about the above openings please call COLLECT or send your resume to:

**(215) 968-0707**

### WALSH

Engineering Placement Service  
The Commons West  
268 Newtown Yardley Road  
Newtown, PA 18940

Equal Opportunity Employer

**CIRCLE 121 ON READER CARD**

## PROGRAMMERS PROGRAMMER/ANALYSTS

### HARDWARE • SOFTWARE

If you have one or more years experience on any of the following:

- IBM 370 3033 4331 4341 8100 VM CMS CICS OS VSI MVS DOS VSE VSAM COBOL ASSEMBLER IMS
- HONEYWELL 6000 SYSTEMS LEVEL 6 66 40 DUAL IDS DM4 COBOL GCOS GMAP
- UNIVAC 1100 (EXEC 8) OR 90 SERIES (OS 3) OS 1100 OR OS 3 INTERNAL 3 DMS 1100 TIP CMS QLP ASC 11 COBOL
- DEC PDP 11 23 34 44 45 70 VAX 11 780 RSX 11M K RSTS E VAX VMS MACRO 11 BASIC 2 FORTRAN ASSEMBLY LANGUAGE
- NCR 8550 8585 8200 VRX IMOS STORE IV TRAN PRO NEAT 3 COBOL ON LINE SPECIAL NEED FOR CIF
- BURROUGHS 3890 4700 6700 6800 ALL SOFTWARE NEEDED

and would like the most individualized job search in data processing today on a company fee paid basis, nationally, send your resume in confidence to:

### SOUTHERN COMPUTER SERVICES

P.O. DRAWER 2679 N  
SARASOTA, FLORIDA 33578  
813-365-5826

Please DO NOT circle reader service number.  
Merely send resume in confidence

# **SCIENCE/SCOPE**

A charge-coupled memory device that can be made with only one additional mask is now under study at Hughes. The chip is a CCD mask-programmable nonvolatile serial read-only memory. It's programmed by a two-step implantation into the region underneath the storage gate electrodes. The first implantation puts buckets of charge under the selected gates using an n-type dopant for n-channel devices and a p-type dopant for p-channel devices. The second implantation uses the same mask and an opposite polarity dopant. Its purpose is to offset surface potential changes that occurred as a result of the first dopant. Implanted regions retain information after start-up by the use of refresher circuits between input and output. The chip also can function as a standard CCD.

A new all-optical logic device could make many electronics systems immune to effects of natural or man-made "noise," including lightning strikes and radio interference. Hughes scientists have fabricated a high-speed optical device that uses no electronic signals. It is made of discrete components, including four reflecting surfaces and a slab of nonlinear material (gallium arsenide). The device has shown optical bistability (flip-flop behavior) with switching times of 3 nanoseconds and switch energies under 100 microjoules. Although propagation delays have kept the device's speed under the theoretical limit up to 10 gigahertz, the speed will be increased by further miniaturizing of the device on an integrated optic chip. The device could be used in fault-tolerance computers, flight control systems, and ultra high-speed signal processors.

A communications system delivered to the U.S. Navy saves weight and space over previous systems. The Hughes tactical information exchange system (TIES) uses a single set of hardware to accommodate many different digital and voice communications processing. This was made possible by a new frequency translator unit and a programmable signal processor. Previous systems used separate pieces of equipment for amplitude modulation or frequency modulation of voice and data.

Hughes Radar Systems Group has career opportunities for engineers, scientists, and programmers. We design and build many of today's most complex airborne and spaceborne radar electronics systems, including data links, electronic warfare systems, and display systems. We need systems analysts, microwave specialists (antenna, receivers, transmitters, data processors), circuit designers (analog, digital, RF/IF), scientific programmers, mechanical designers, systems and test engineers. Send resume to Engineering Employment, Dept. SE, Hughes Radar Systems Group, P.O. Box 92426, Los Angeles, CA 90009. Equal opportunity employer.

A copier that uses a laser scanner to read a page in two seconds can send very high quality copies to widely dispersed locations via satellite. The copier transmits at speeds up to 70 pages per minute, more than 100 times faster than conventional facsimile. Also, using electronic collating, documents of more than one page can be printed at many locations sequentially, eliminating the need for mechanical sorters. AM International developed the copier for Satellite Business Systems. Hughes built the satellites and earth terminals.

*Creating a new world with electronics*

**HUGHES**

HUGHES AIRCRAFT COMPANY  
CULVER CITY, CALIFORNIA 90230

(213) 670-1515 EXTENSION 5964

## HARDWARE

signed for oems in a variety of markets—word processing, graphics, digital facsimile, photocomposition, and dp printing—the unit features 6-inch per second printing with 300-dot per inch resolution. The basic unit accepts “video input” full bit mapped raster scan) at 4.7Mbps. While General Optronics can provide character generators and data processing or word processing interfaces, it plans to let oems provide these features as appropriate to their target markets.

The desktop printer uses a solid state laser and a proprietary holographic scanning system called Holoscan. Continuous printing is possible with the printer's dual input paper cassettes. A microprocessor controls the page printer's operation. In annual quantities of 1,000, the printer sells for \$4,000 including cabinetry. Character generators and standard serial or parallel interfaces are available, but the vendor feels these items are best left to oem customers as their value added contribution. GENERAL OPTRONICS CORP., Plainfield, N.J.

**FOR DATA CIRCLE 309 ON READER CARD**

### SPEECH OUTPUT

Votrax, one of the earliest purveyors of phonemic speech synthesizers, has come up with an inexpensive (\$345) standalone synthesizer, complete with its own microprocessor, to perform translation between

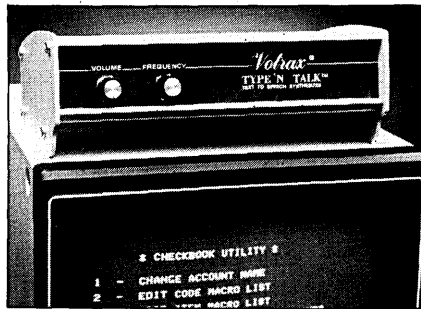

ASCII strings of English text into phonemic representations for synthesis. Named Type-'N-Talk, the unit also includes an audio amplifier, 750 characters of buffer memory, and RS232 interfacing (data rates from 75bps to 9600bps). Type-'N-Talk can be connected between the computer and terminal device; an escape sequence activates or deactivates the synthesizer. For exceptional cases or specific user requirements, the unit can accept and synthesize a stream of phonemic codes, bypassing the text-to-phoneme translation phase. VOTRAX, Troy, Mich.

**FOR DATA CIRCLE 312 ON READER CARD**

### PRINTERS

Mannesmann Tally introduced two series of serial printers, comprising five models, at NCC. The 80-column MT 100 series comes in three versions, while the multifeatured MT

440 (nominally 132 columns) has two models. All offer the users choice of serial interfaces—RS232, RS422, or current loop. Each of the dot-matrix printers can optionally print graphics, bar codes, and OCR characters. All use the ASCII character set.

The MT 100 series has print speeds ranging from 100cps to 160cps using logic seeking bidirectional printing. A special plotting mode, as yet unpriced, will allow bit image control of dot placement and a selectable set of graphics characters. Either the operator or application program can select from any of seven different foreign character sets, as well as setting 10-, 12.5-, or 16.5-pitch printing. The MT 110 prints at 100cps and sells for \$745; the MT 120 prints at 160 cps and sells for \$895. The MT 120L is a dual-mode printer capable of correspondence quality printing at 40 cps (using a 40 × 18 character cell) or 160 cps (7 × 9 dot matrix); it sells for \$1,095.

The MT 440 series offers the same three selectable character pitches and seven foreign character sets. It also offers optional four-color printing (green, blue, red, and black). The MT 445 operates at 400 cps and sells for \$2,790. The MT 445L is a dual-mode word processing and draft printer capable of 100cps and 400cps printing, respectively. It sells for \$3,250. MANNESMANN TALLY, Kent, Wash.

**FOR DATA CIRCLE 315 ON READER CARD**

## SOFTWARE/ SYSTEMS DEVELOPMENT/ MIS PROFESSIONALS

Robert Kleven and Co. has **New England/  
East Coast/  
Nationwide** been providing confidential and industry-knowledgeable placement for software development/ systems development/MIS professionals since 1969.

Our clients, some of the top companies in the industry, are seeking solid professionals with in-depth knowledge of these disciplines: Programming, Systems Analysis/Design, Data Base Applications, Applications Programming, Compiler Development and Language Design.

We have a variety of positions available for professionals who possess experience in applying the latest techniques in one or more of these areas: Software Design and Development; Technical Support; Computer Sciences; Assembly or Block Structured Languages such as PASCAL, ALGOL, “C” LISP, PL/I; Higher Level Language Programming; Data Base Design; Compiler and/or Operating Systems Design; Technical Writing; Microprocessor Programming; Software QA; Software Tools and Methodology Development, Computer Architecture, Computer Performance Measurement, Firmware, Microprogramming.

Let Robert Kleven and Co. enhance your career. We will provide you with career path counseling and no-cost resume preparation. Client companies assume all fees.

**RK Robert Kleven and Co., Inc.**  
Industrial Relations Management Consultants

Three Fletcher Avenue, Lexington, Massachusetts 02173  
Telephone (617) 861-1020

Member: Massachusetts Professional Placement Consultants  
National Computer Associates,  
4 Offices Nationwide  
Representing Equal Opportunity Employers M/F

**CIRCLE 125 ON READER CARD**



REQUIRED BY THE  
FOOD AND AGRICULTURE ORGANIZATION  
OF THE UNITED NATIONS, ROME, ITALY:

### CHIEF, MANAGEMENT INFORMATION SYSTEMS UNIT

to plan, develop and implement FAO's management information system(s) (an IBM 370/148 with remote and interactive access is presently installed; more advanced hard/software of relevance to MIS applications is planned) by ascertaining users requirements for MIS services, advising on feasibility and cost/effectiveness of proposed systems and on hard/software developments relevant to systems operating or in development, and conducting workshops on MIS systems.

**ESSENTIALS:** University degree in business administration, computer sciences or related discipline. Minimum 10 years experience relevant to the job; thorough knowledge of current information processing techniques (such as data base management, communications processing, MIS software).

**SALARY:** from US\$34,800 p.a. net tax-free plus the usual allowances of the International Civil Service. Please send detailed curriculum vitae quoting “VA 151-AFM-DM” to: FAO, Central Recruitment, Via delle Terme di Caracalla, 00100 Rome, Italy.

**CIRCLE 126 ON READER CARD**

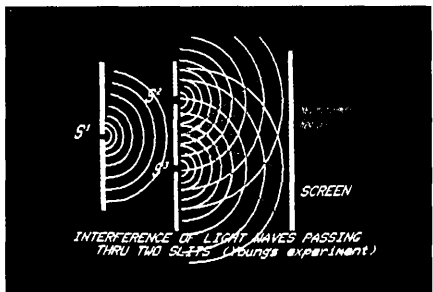

Physics Simulation

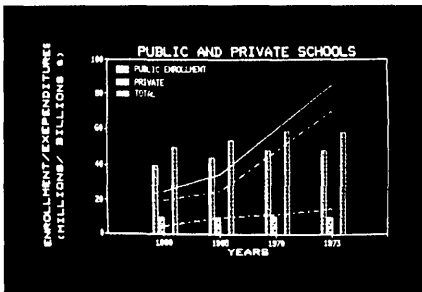

Financial Plotting

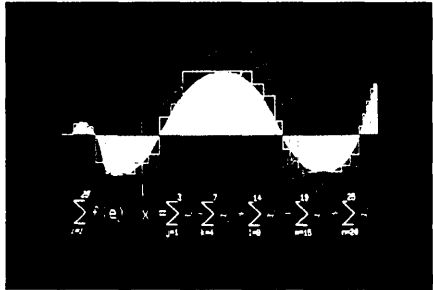
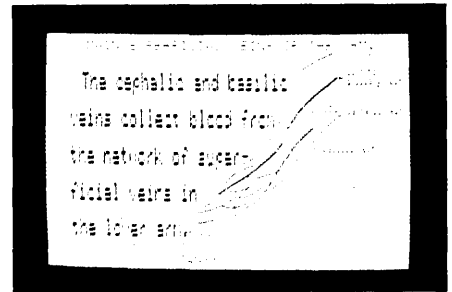

Scientific Formula

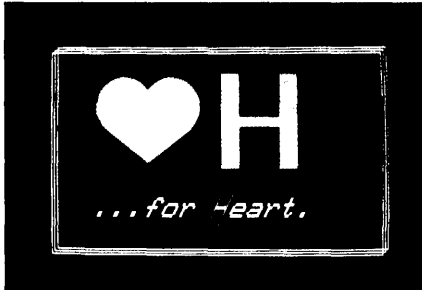

Special Needs Education

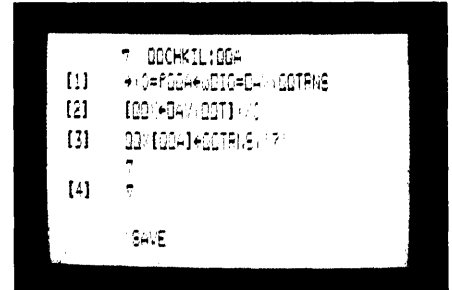

APL Programming

Sample Characteristics

| TEST CASES | Low Bound | No. Cases | % Cases |
|------------|-----------|-----------|---------|
| 1          | -1.78     | 91        | 7       |
| 2          | -1.24     | 154       | 12      |
| 3          | -0.80     | 180       | 15.4    |
| 4          | -0.48     | 203       | 21.8    |
| 5          | 0.00      | 229       | 17.9    |
| 6          | 0.48      | 144       | 11.2    |
| 7          | 1.12      | 140       | 7.8     |
| 8          | 1.68      | 69        | 6.9     |

Statistical Table

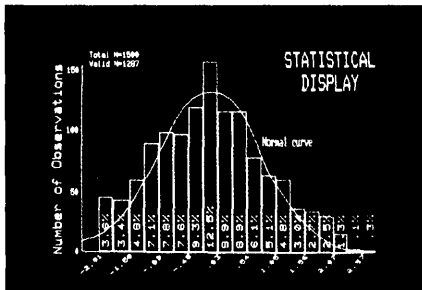

Statistical Graph

Wait'll you see the rest of the demo.

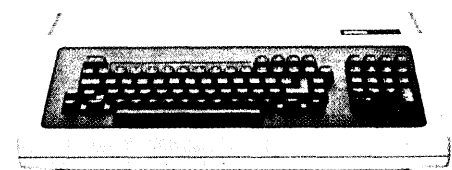

There has never been a terminal like Digital's new GIGI™ terminal. It's an intelligent terminal with exciting text processing functions. A graphics terminal with impressive resolution. And it's also a conventional interactive terminal. With applications software that makes all these capabilities easy to use, all at the same time.

So you no longer have to adapt your application to the limitations of your terminal. And you can run on our VAX, PDP-11 RSTS/E, and DECSYSTEM-20 computers.

Digital's new GIGI terminal. Originally designed for education, it's now available to anybody.

Anybody who needs the world's most versatile terminal.

For a demo, call your local Digital sales office, or send your business card to: Digital Equipment Corporation, Media Response Manager, Dept. A-7, 129 Parker St., PK3-2/M94, Maynard, MA 01754.

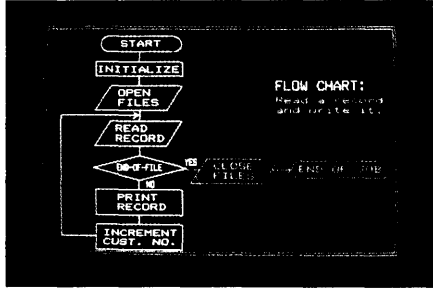

Program Documentation

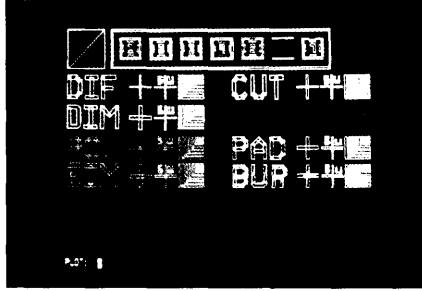

CAD/CAM

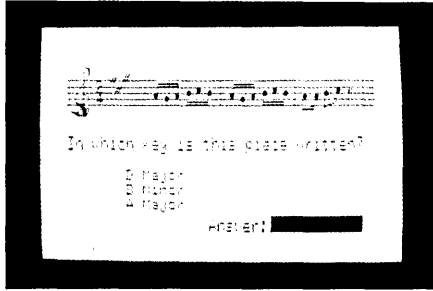

CAI

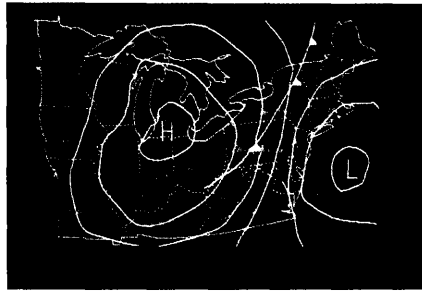

Mapping

Data Entry

Data Entry

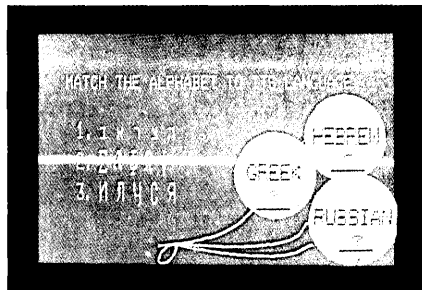

Multiple Languages

**digital**  
We change the way the world thinks.  
CIRCLE 127 ON READER CARD

# Get SNA on.

At Northern Telecom, we believe that you shouldn't have to wait for tomorrow to get the technology you need today. So we're not only offering you on-line systems with SNA/SDLC (PU-2 level) compatibility, we're offering them to you today. You can have them working for you within 45 days. No long wait for delivery.

## **The bottom line's good, too.**

Another important fact about our SNA on-line is what it does for your bottom line. Our Model 296c remote system and 294c "large cluster" are both economical, in fact, they're priced substantially below IBM. A low price to pay for such sophisticated technology.

And if you're moving from bisync to SNA/SDLC, you'll appreciate this feature:

at the flick of a switch you can switch protocols. Both models feature a special dual adapter, so you can use either protocol without extra hardware.

## **The human factor.**

To top it all off, these systems are designed for the people who use them. Both are human-engineered with features like a special non-glare display, with an adjustable stand and a keyboard where you can feel the difference.

To find out more about these efficient and economical SNA on-line systems, call your local Northern Telecom representative or Gary Johnson at 800-328-6760 (in Minnesota, 612-932-8459), or send in the coupon.

We won't keep you waiting.



**northern  
telecom**

# line, on time.



To: Northern Telecom Inc., P.O. Box 11222  
Minneapolis, MN 55440

I would like to know more about your SNA on-line.

Send me more information.

Have a sales representative call me.

Name \_\_\_\_\_

Address \_\_\_\_\_

City \_\_\_\_\_

State \_\_\_\_\_

Zip \_\_\_\_\_

CIRCLE 128 ON READER CARD

D-7-1

# SAS/GRAPH saves time... on the Zeta 1453.

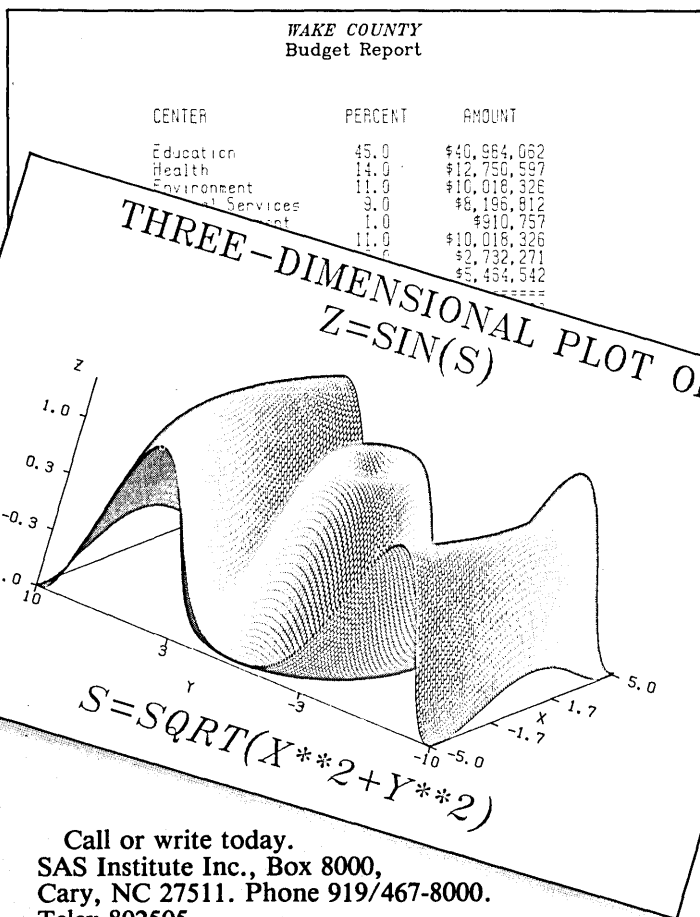
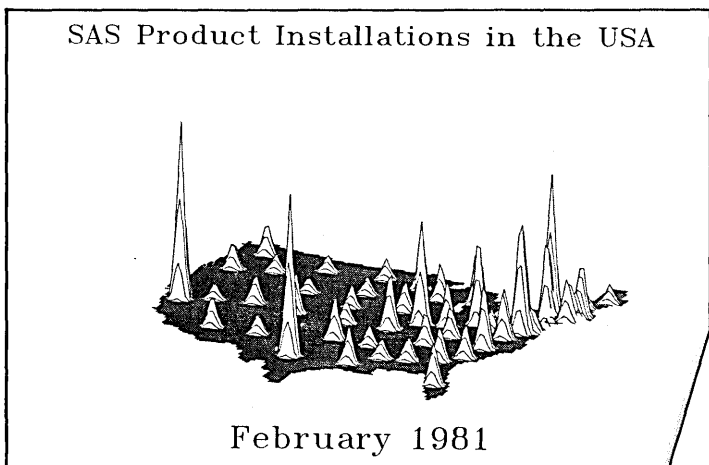
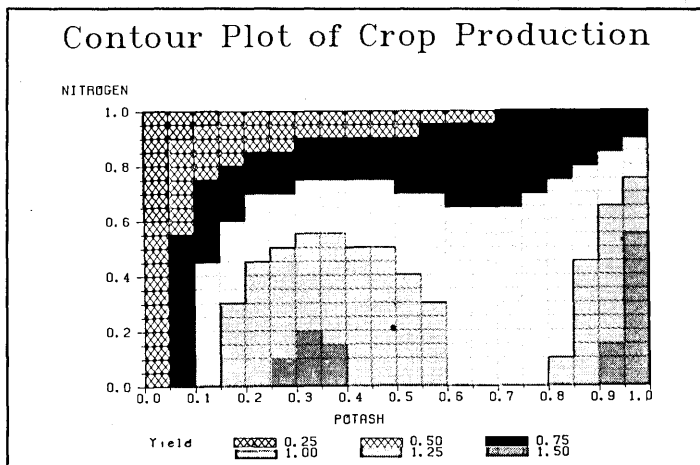
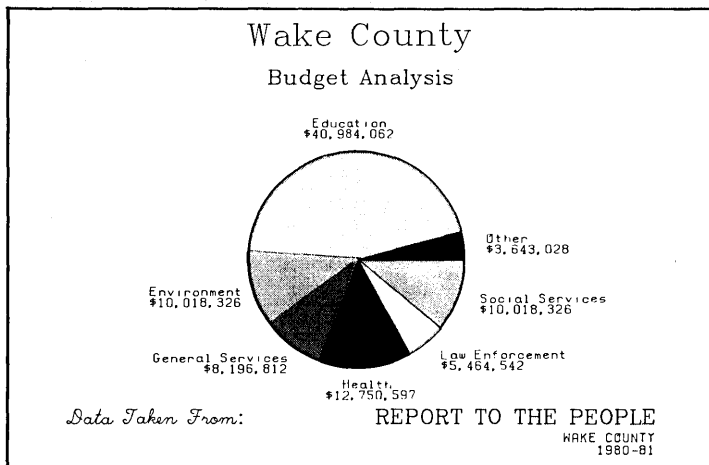

Since its beginnings, SAS has provided a software system to save time. Now SAS/GRAPH adds a new dimension to the powerful, time-saving SAS system.

With SAS/GRAPH, you don't need a different software system for each of your different graphics devices. The same SAS/GRAPH system supports ADI, Calcomp, Chromatics, Hewlett-Packard, IBM, Ramtek, Servogor, Tektronix and Zeta equipment with device-intelligent software. SAS/GRAPH also provides a universal driver that can be easily linked with vendor-supplied software for most other devices.

Whatever device you use, in batch or interactive mode, you only need two or three simple statements to produce most displays. And that adds up to a big time-savings.

But best of all SAS/GRAPH is integrated into SAS, so you get the benefits of the total SAS system—a system now saving time in report writing, statistical analysis, data management and as a higher-level programming language at more than 2500 OS, OS/VS and VM/CMS sites.

And you can add SAS (including SAS/GRAPH) to your dp staff for less than half the cost of a new programmer.

Call or write today.  
SAS Institute Inc., Box 8000,  
Cary, NC 27511. Phone 919/467-8000.  
Telex 802505.

In Europe: SAS Institute, The Centre, 68 High  
Street, Weybridge, Surrey KT13 8BL,  
UK. Phone 0932-55855.  
Telex 8954665.

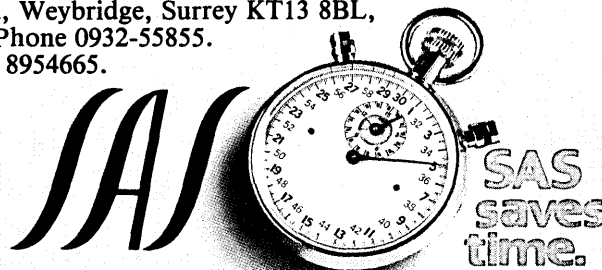

For information on the Zeta 1453, write or call Nicolet Zeta Corporation, 2300 Stanwell Drive, Concord, CA 94520 (415/671-0600).

CIRCLE 129 ON READER CARD



# SOFTWARE AND SERVICES

## UPDATES

Hewlett-Packard has begun a software marketing program that will both benefit software developers and marketers, as well as help HP increase the quantity and quality of third party programs available for its equipment. Called HP PLUS, the marketing lets software suppliers market to HP prospects and current users through HP's sales force. Installation and support remain the software vendor's responsibility. HP PLUS has two major aspects. "Referenced" software are applications for any of HP's machines. HP will list these in its Software Directory, and its sales force will assist users in locating desired packages. HP's sales force will distribute the software vendor's sales literature, while the supplier will be responsible for actually making the sale. The second aspect of HP PLUS pertains to utility software for the 3000 series. HP will sell, distribute, and invoice the packages. While the programs will be listed on HP's corporate price list, they remain the property of the developer, which can continue to market them independently. Support remains the developer's responsibility.

For a package to become available under HP PLUS, it must have an existing base of happy customers. The software company must also show that it is viable financially and that it can support its products. At least six HP customer references must rate the packages for reliability, function, performance support, documentation and training. Vendors interested in participating in HP PLUS should contact their local HP sale office.

## 32-BIT SYSTEMS SOFTWARE

Data General has increased its software offerings for its 32-bit Eclipse MV/8000 computer with the introduction of native-mode language processors for APL, COBOL, and RPG II. A COBOL program generator, additional utilities, and support for SNA networks (also available for 16-bit AOS environments) round out the product line.

AOS/VS APL lets users have workspaces of up to 512MB; up to 25 interactive terminals can make use of a single shared copy of the interpreter. Production runs can also take place in batch mode. A "sharing monitor" allows AOS/VS APL to use databases and programs created by other AOS/VS 32-bit languages. DG says its APL "has a high degree of compatibility" with other APLs, including IBM's APL.SV and VSAPL, and the offerings of I.P. Sharp Associates and Scientific Timesharing. The company's Special Systems Div. offers the model 6110 APL display terminal and two APL line printers. The initial license fee for AOS/VS APL is \$12,000.

### FOR DATA CIRCLE 330 ON READER CARD

Native mode, 32-bit COBOL programs are reported to run at up to twice the speed of 16-bit COBOL (on compute-bound applications). COBOL licenses for \$10,000. The PROXI COBOL program generator runs under AOS or AOS/VS on 16-bit and 32-bit Eclipse systems; the COBOL source code for both 16-bit and 32-bit systems is compatible. PROXI simplifies writing data entry, inquiry, file maintenance, and report generation programs. It licenses for \$6,300. RPG II, which licenses for \$4,000, can be used for report generation file maintenance, data processing, and data preparation.

### FOR DATA CIRCLE 331 ON READER CARD

DG's DBMS, based on the 1978 CODASYL recommendations, supports multiple COBOL and FORTRAN programs concurrently. It also offers a query facility to satisfy ad

hoc information requests. The INFOS data management system has also moved under the AOS/VS umbrella. DG/DBMS licenses for \$18,000 and INFOS II licenses for \$2,625. A 32-bit sort/merge utility has also been developed; it licenses for \$2,000.

### FOR DATA CIRCLE 332 ON READER CARD

DATAPREP is a large volume data entry package that can run as a single process controlling up to 12 Dasher terminals. Operating on either 16-bit or 32-bit AOS systems, DATAPREP allows on-line screen formatting. It maintains its own files, which are not available to other processes until they are unloaded, by DATAPREP, to AOS files. The package licenses for \$8,900.

### FOR DATA CIRCLE 333 ON READER CARD

Data General also announced an AOS/VS 32-bit version of its XODIAC network management software, as well as AOS/VS versions of its other communications software offerings. Carrying the same price tags as its 16-bit counterparts, XODIAC licenses for \$7,500, with X.25 support licensing for \$1,800. SNA support, in the form of three modules, has been added to both versions of XODIAC. DG/SNA licenses for \$8,000, while DG/SDLC and SNA/3270 each licenses for \$2,000. DATA GENERAL CORP., Information Systems Div., Westboro, Mass.

### FOR DATA CIRCLE 334 ON READER CARD

## DATA DICTIONARY

Stating that no current data dictionary (including its own Total Data Dictionary) fully lives up to the potential of the concept, Cincom Systems introduced its new Series 80 Data Control System at the NCC. Series 80 DCS comprises four major subsystems: an on-line data dictionary, a systems design facility, a programmer workstation, and a centralized security system. Cincom president and founder Thomas M. Nies said, "Although traditional data dictionaries showed great promise, users found them

## SOFTWARE AND SERVICES

difficult to use and cumbersome to maintain. Series 80 Data Control System overcomes these problems and goes beyond by combining sophisticated systems development facilities."

The Series 80 DCS Interactive Dictionary operates on-line through a 3270-type terminal. It stores information about entities and attributes. Data and documentation for both new and existing entities are entered, validated, and stored immediately, or the data entry transactions can be batched or staged to ensure consistency with all changes occurring at one time. There is also an interactive query facility which provides a relational view query language; queries may be cataloged for repeated use. Twenty-five canned query procedures are predefined and may be modified by the user to meet local requirements. Series 80 DCS can also generate formatted, volume reports for reference or documentation needs.

Structured analysis and top-down design methods are used by the Systems Design Facility to produce a blueprint of an application system. It's a three-step process. First, Logical Systems Design creates a structured analysis schematic of the application. Next, a Logical Data Model is produced using data flows identified in the previous phase. The data model is reduced to the Third Normal Form of relations. Finally, DBMS implementation maps the logical model onto the physical DBMS.

The DCS Programmer Work Station isn't hardware (as the name might imply) but rather software that provides users at 3270-type terminals with full-screen text editing capabilities for preparing programs, JCL, test data, documentation, etc. It allows access to any system source library, or a DCS, Panvalet, or The Librarian library. Programs and JCL streams may be sent to the host operating system's internal readers for compilation, testing, and execution. Output may be returned to the workstation, and if desired, left in the output queue for printing.

Security in Series 80 DCS controls access via a password system maintained at both the file and data element level. A trans-

action level recovery system protects files, data terminals, and transactions.

Series 80 DCS runs on IBM and compatible mainframes under DOS/VS, DOS/VSE, VSI, SVS, MVS, and MVS/SP. DCS is available for use with Cincom's Series 80 Environ/1 on-line control monitor, or in a standalone version. The Interactive Data Dictionary has an installation fee of \$3,000, purchase

price of \$29,500, and an annual usage fee of \$2,950. The Program Generation Facility and the Systems Design Facility are each priced at \$10,000, with installation, annual usage, and rentals \$1,500, \$1,000, and \$215, respectively. Cincom offers a 100% trade-in credit to its existing data dictionary users. CINCOM SYSTEMS, INC., Cincinnati.

**FOR DATA CIRCLE 335 ON READER CARD**

## SOFTWARE AND SERVICES

### APPLE BUSINESS PACKAGES

Personal Software has created four new packages for the Apple II and Apple II Plus microcomputer, as well as enhancing the ever-popular VisiCalc package. All five of the Visi-series packages require a 48KB machine with at least one diskette drive; all are compatible with Apple's 16-sector diskette format. In most instances, data entered or calculated by one package can be read and used by the other packages.

A high-resolution graphics and plotting package, VisiPlot can produce graphs and charts in six different formats and six different colors. Data may be entered directly or calculated by the new 16-sector compatible release of VisiCalc. VisiPlot can produce bar graphs (both cumulative and side-by-side), time series line plots, area charts, pie charts, hi-lo charts, and scatter charts using either symbols or points. The program can accommodate up to 16 data series (maximum of 645 data points) in memory, and plot up to 150 data points on a single graph. The menu-driven package allows titling and annotations. Printed output can be produced on Apple Silentype or Trendcom 200 thermal printers, NEC Spinwriters, and IDS' Paper Tiger 440 or 445. The \$179.95 package requires two diskette drives and Applesoft BASIC.

**FOR DATA CIRCLE 325 ON READER CARD**

VisiTrend/VisiPlot combines statistical and trend forecasting capabilities with the graphics of VisiPlot. It too can accept data files prepared by VisiCalc. It allows the user to perform multiple linear regression and trendline forecasting, generate fitted and residual series, and perform descriptive statistics for one or more data series. The package includes VisiPlot and has the same hardware requirements. Its price is \$259.95.

**FOR DATA CIRCLE 326 ON READER CARD**

While VisiTrend/VisiPlot and VisiPlot seem most appropriate to those who must deal with numbers, the two remaining new packages, VisiDex and VisiTerm, should have a more general appeal to most managers and professionals.

VisiDex allows storage and retrieval of screens full of information in a free-form, unstructured manner. It can also maintain a calendar of appointments and reminders. Users can input up to 20 lines per screen, which will then be stored on diskette. As many as 36 six-character keywords can be

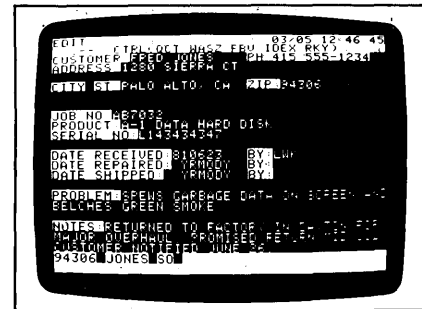

specified for each screen, and the screen can be recalled by any keyword (shorter keywords can increase the number associated with each screen; conversely, longer keywords may be used, decreasing the number per screen). Additional facilities include the ability to set up templates for applications such as mailing lists, on-screen editing, sorting keywords in alphabetic or numeric order for subsequent ordered printouts of the screens, and selective printing of partial screens. VisiDex sells for \$199.95.

**FOR DATA CIRCLE 327 ON READER CARD**

VisiTerm allows the Apple computer to communicate over phone lines at speeds of up to 1200bps (depending on your modem). It supports a number of modems, including the DC Hayes Micromodem (with autodial). The package provides full upper and lower case ASCII communications, with proportional spacing and smooth scrolling. VisiTerm allows transmission of VisiCalc spreadsheets, text, VisiPlot graphics, and programs. It lets the user specify operating parameters, including line speed, parity, and the number of stop bits. Users can also define their own character sets, and the program comes with predefined regular, bold-face, and APL characters. One-stroke macros—series of commands, such as log-on sequences—also may be defined. VisiTerm retails for \$149.95.

**FOR DATA CIRCLE 328 ON READER CARD**

VisiCalc has been updated to work with Apple's 16-sector diskette format. It also features full implementation of the Data Interchange Format—a program independent data storage scheme—and 17 new commands that simplify definition of VisiCalc models. Support for Boolean functions and arithmetic comparisons have also been added. The new version of VisiCalc sells for \$199.95. PERSONAL SOFTWARE INC., Sunnyvale, Calif.

**FOR DATA CIRCLE 329 ON READER CARD**

## ANTWORTH

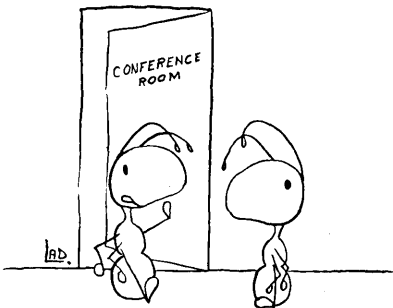

"I'd say it was a typical design committee meeting. We began with three alternatives and narrowed it down to eight."

©DATAMATION

**Announcing . . .**

**3rd Annual**

# **Directory of Systems Houses & Minicomputer OEM's**

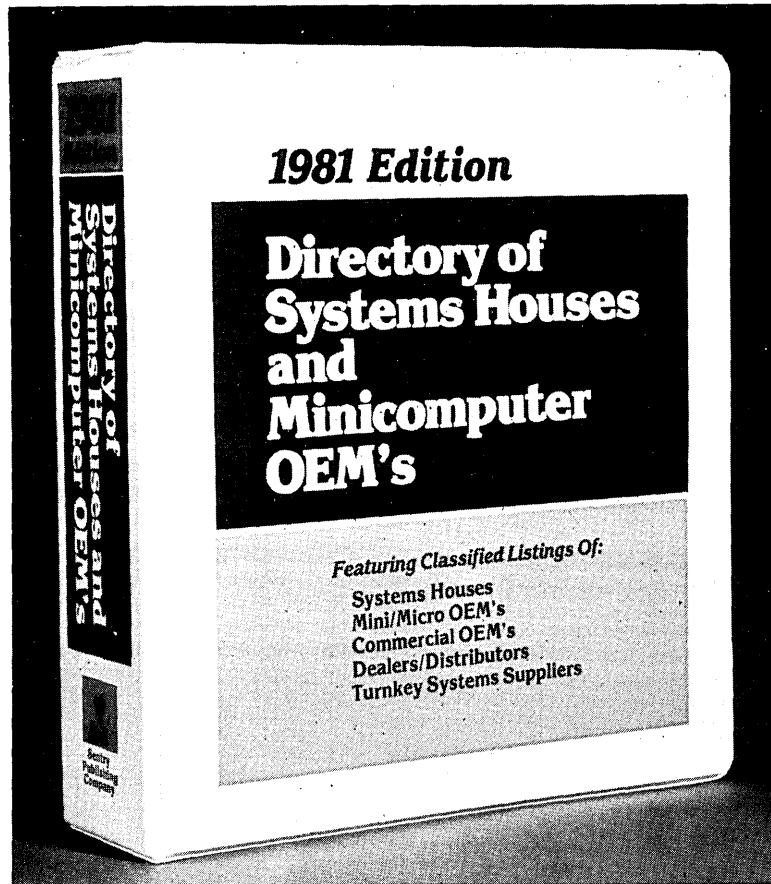

Order your copy of the most widely used compendium of systems houses, computer OEM's, and systems integrators.

Includes over 500 pages of systems house listings with full address, phone number, application specialties, product descriptions, chief executives, annual sales, and brand of computers being used.

The listings are indexed four different ways allowing the reader to locate systems houses by **name, city, application expertise, and brand of computer.**

**Totally revised & updated**

## **LIMITED EDITION**

Order **NOW** to make absolutely sure a copy of the 1981 Directory is reserved in your name. Full refund guaranteed if not completely satisfied.

Now available for immediate shipment.



**Sentry Database Publishing**

5 Kane Industrial Drive  
Hudson, MA 01749

## **ORDER FORM**

- My check for \$347 is enclosed for 1 copy of the 1981 **Directory of Systems Houses & Minicomputer OEM's**
- Authorized company purchase order for \$347 is enclosed for 1 copy of the **1981 Directory of Systems Houses & Minicomputer OEM's.**

Mass. residents add 5% sales tax.

For airmail delivery outside North America, add \$25.00.

|   |              |          |
|---|--------------|----------|
| Name  | Please Print | Title    |
| Company   |              |          |
| Address (Please, no P.O. Boxes. All shipments via UPS.) |              |          |
| City  | State        | Zip Code |
| Telephone ( )   | Date         |          |

**NOTE:** Check must accompany order unless submitting an official company purchase order.

Sentry Database Publishing • 5 Kane Industrial Drive • Hudson, MA 01749 USA





**“I just installed the most flexible graphics software available...”**

**“It sure paid off.”**

A revolution was taking place. We learned computer graphics dramatically improved the decision-making process. Graphics software with “FLEXIBILITY” was the only way to make it happen. We already had some basic graphic software. It was hard to maintain and not adequate for our needs. Our users were demanding more productive and higher quality tools.

After installing DISSPLA<sup>®</sup> and TELL-A-GRAF<sup>®</sup>, ISSCO trained our users so that we were discovering profitable new applications immediately. Before ISSCO left our center, all of our output devices were interfaced. Field-proven code, maintenance, support, and ISSCO’s 11 years of experience—for me it really paid off.

TELL-A-GRAF’s<sup>®</sup> English-like commands made graphical representations of the information in our data bases simple and easy to access. We now can produce a graph with only one command and as needs dictate we can easily adjust any aspect of our graphics to enhance understanding. Both our highly demanding computer specialists and our secretaries easily learn to chart or graph the masses of data already in our computers. ISSCO GRAPHICS imbedded in existing applications programs has become very popular.

For us, installation of DISSPLA<sup>®</sup> and TELL-A-GRAF<sup>®</sup> was the right decision.

ISSCO GRAPHICS run on **IBM, DEC, CDC, CYBER, CRAY, BURROUGHS, PRIME, UNIVAC, and HONEYWELL.**

Call or write now for more free information.  
714/452-0170  
4186 Sorrento Valley Blvd., San Diego, CA 92121



**DISSPLA<sup>®</sup> · ODYSSEY · TELL-A-GRAF<sup>®</sup>**  
CIRCLE 132 ON READER CARD

|                                   |             |           |
|-----------------------------------|-------------|-----------|
| Tell me more about ISSCO GRAPHICS |             | 7E        |
| Name _____                        |             |           |
| Title _____                       | Phone _____ |           |
| Company _____                     |             |           |
| Address _____                     |             |           |
| City _____                        | St. _____   | Zip _____ |

# Nobody sizes up your network needs like Digital.

Digital's know-how is changing the way networks are planned to perform right from the start.

Not everyone takes sizing as seriously as Digital.

You'll see networks offered on the "one technology fits all" theory. Networks that fill a number of needs but may not get top potential from your investment or allow for future growth.

At your earliest planning stages—where it really pays off—you can put Digital's years of network experience to work for you.

Experience works out the ideal balance of speed, throughput, cost, data integrity, flexibility, control.

Experience asks the right questions to start with. Basics such as: What business problem do you want your network to solve? What systems must communicate?

To specifics: What size should each individual node be for the job it has to do locally? How much communication

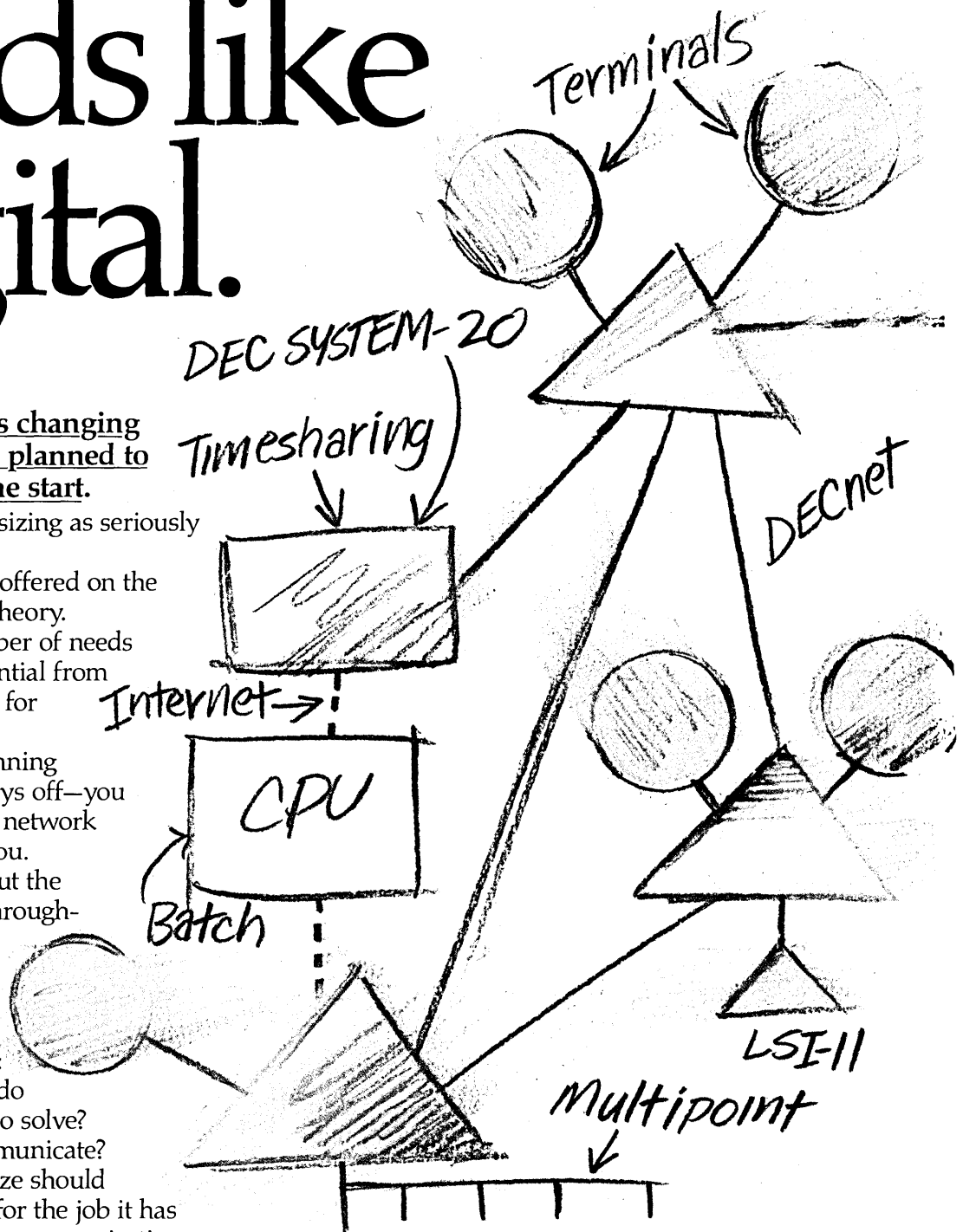

redundancy should be planned to avoid downtime? What options are possible later for future growth?

And how do you meet your requirements most economically?

### Digital's range of options.

No other vendor can match Digital's broad range of flexible, cost-effective communications and processor options which allow networks to be sized to your organization's particular needs.

A few examples. Some manufacturers support only BISYNC or X.25. Digital supports Batch BISYNC, Interactive BISYNC, and other standard

mainframe communications protocols.

An advanced SNA protocol emulator allows Digital systems to participate in IBM/SNA networks.

And Digital offers X.25 Packetnet™ System Interfaces so Digital systems can communicate to public packet-switched networks.

DECnet™ Digital's highly functional networking software, provides features not available with mainframe protocols. With DECnet, you have point-to-point, multipoint, and parallel communications.

You can automatically reroute information around problem areas so network operations can continue even when communication links or nodes fail.

Even add new nodes without shutting down operations. With DECnet, you can have complete control.

### Your Digital Network Profile.

A Digital team of networking experts will work closely with you, from concept through installation through support.

First, a written Profile details your network requirements. The number and location of each

proposed node, each terminal. Types of network applications. Volume of data to be transferred between individual nodes. Data urgency and importance. Line and system reliability, availability, and maintainability.

Costs. Network operations and security. Future growth.

### Digital's Customer Support Plan.

Based on your Network Profile, our experts, working with you, document how Digital will help satisfy your needs. Installation, start-up, training, network maintenance, troubleshooting. This plan clearly spells out what Digital will do, when it will be done, and how it will be accomplished.

Following this thorough preplanning, Digital field service and software support experts will install and verify the hardware and software needed at each node, and demonstrate working network connections.

### Digital planning leads to Digital performance.

A working network, ready to go. Ready to perform to the maximum now. Capable of expanding later as your business grows.

To date, Digital has implemented over 5,000 network nodes around the world. And we don't just install them. We support them, too, with an international team of over 14,000 service people. At Digital, we're changing the way technology works for your needs.

**Digital Equipment Corporation,**  
129 Parker St., Maynard, MA 01754.

In Europe: 12 av. des Morgines, 1213  
Petit-Lancy/Geneva. In Canada:  
Digital Equipment of Canada, Ltd.

©1981, Digital Equipment Corporation

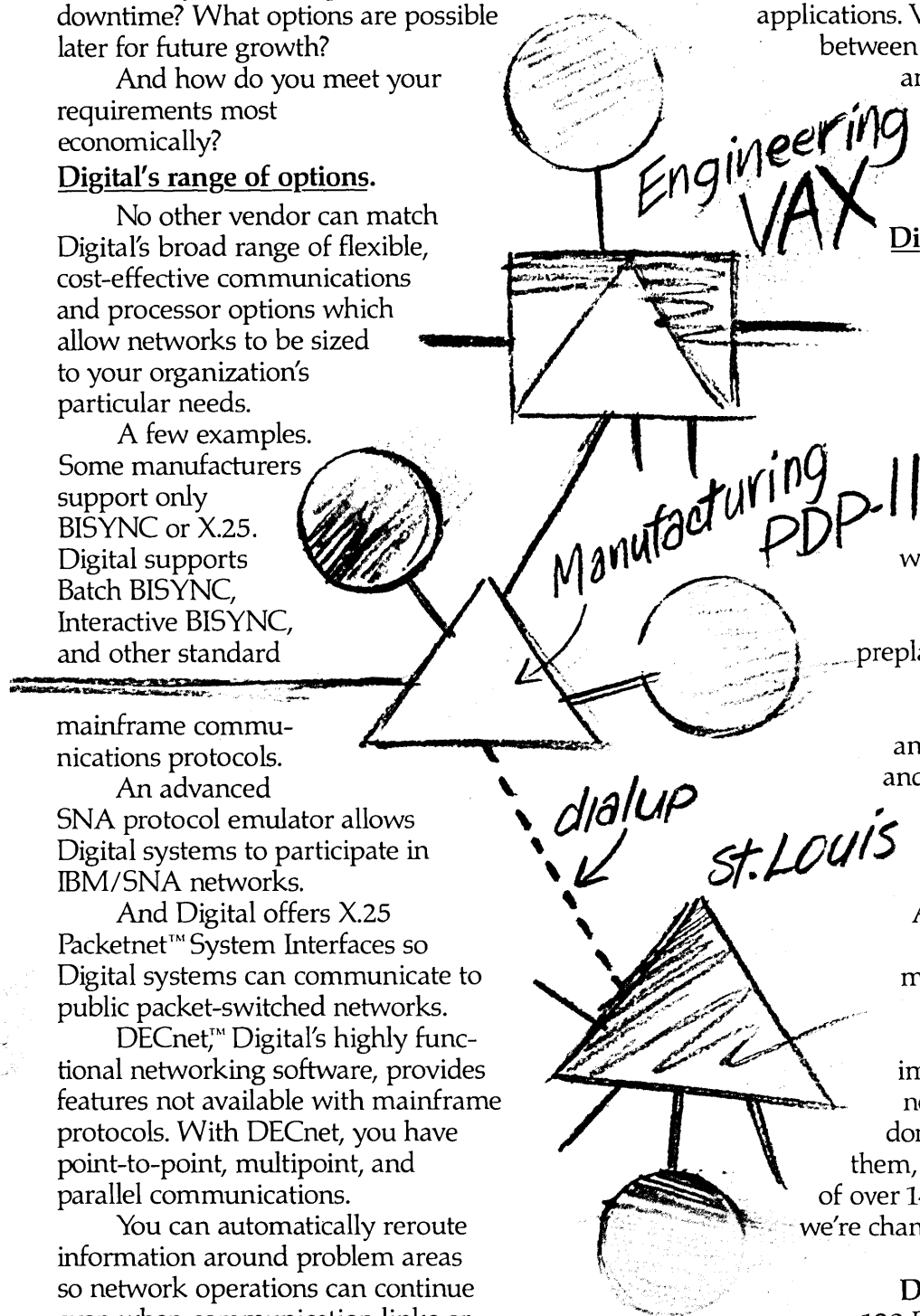

**digital**

**We change the way  
the world thinks.**

# Your Smart Choice!

BEEHIVE'S NEW INDUSTRY STANDARD

DM5

**\$880** LIST\*

- Editing Capability
- Block and Character Transmission
- Mem-Lock (Split Screen)
- Anti-Glare P42 Green CRT
- Line Drawing Capability
- Programmable Status Line

DM5A

## EXTENDED FEATURES

- Function Keys ■
- 12-Key Pad ■
- Auxiliary Printer ■
- Port with Flow Control ■
- Current Loop ■
- X-on X-off ■
- Printer Control ■

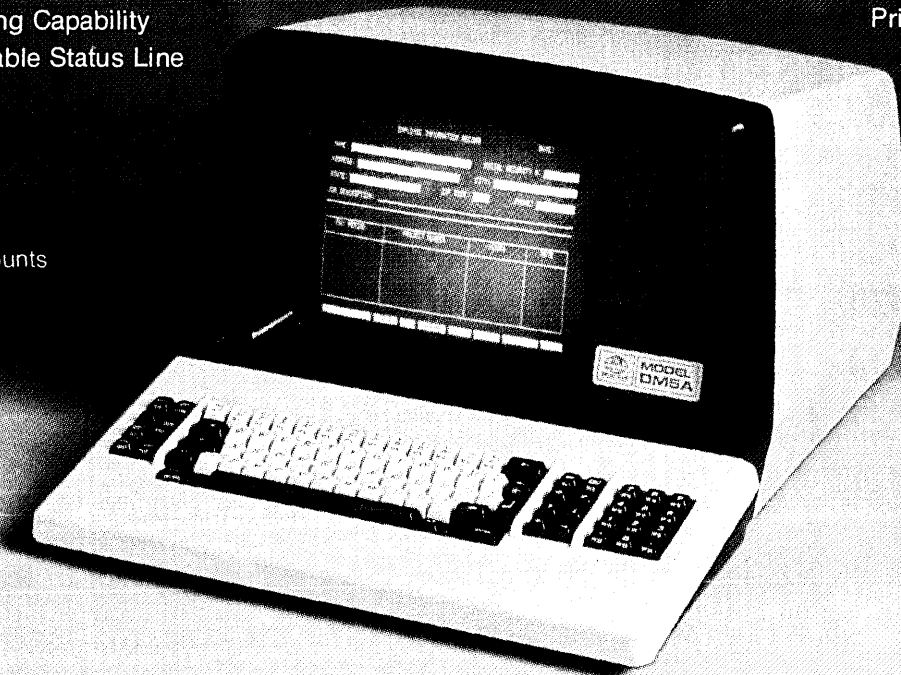

\*Quantity Discounts Available

*plus even more!*

- Cursor Control Keys ■ Upper / Lower Case Characters ■ Programmable Baud Rates
- Scrolling ■ Line Lock ■ Tabbing Capability ■ Cursor Addressing & Sensing
- Field Attributes: Half Intensity; Blinking; Reverse Video;
- Underline; Security; etc. ■ Self Test ■ Line Monitor Mode ■ Keyboard Enable / Disable
- Transmission Cancellation ■ Intelligent, Detached Keyboard

CALL TOLL FREE

**(800) 453-9454**



## BEEHIVE INTERNATIONAL

*"A proven competitive manufacturer of smart terminals"*

**CALIFORNIA** Costa Mesa (714) 540-8404 • Sunnyvale (408) 738-1560 **FLORIDA** Altamonte Springs (305) 830-4666  
**ILLINOIS** Arlington Heights (312) 593-1565 **MASSACHUSETTS** Woburn (617) 933-0202 **NEW YORK** New York  
(212) 682-2760 **TEXAS** Dallas (214) 239-3330 **UTAH** Salt Lake City (801) 355-6000 **WASHINGTON, D.C.** (VA) Falls  
Church (703) 356-5133 **EUROPE** The Netherlands Phone 020-451522

CIRCLE 134 ON READER CARD



# SOURCE DATA

## BOOKS

### THE BIGGEST COMPANY ON EARTH: A PROFILE OF AT&T by Sonny Kleinfield

A couple of years ago, a staff assistant at AT&T headquarters in New York allowed me to tag along with him as he went about his business. In the two days I spent with him I was barely able to figure out whom he worked for; I never did discover what his job was. There was an organizational chart pinned to his door, but that, apparently, was a secret. He kept it covered with his coat.

Such are the obstacles one faces in reporting on the phone company. It's a big operation, and just figuring out whom to talk to (out of over 1 million employees) is a sizable task. Unfortunately, Sonny Kleinfield (who under the byline N.R. Kleinfield first published this material in the business section of *The New York Times*) has let the size get the better of him. Despite (or maybe because of) his access to hundreds of people and facilities at AT&T, he asks us only to marvel, not to evaluate.

Not that there aren't plenty of interesting things to learn while wandering around the company; at its best, the book is a series of enjoyable (if carefully supervised) factory tours. Electronic switching? We watch a unit in operation and hear a crisp explanation of what it does. How many phones are there? A gee-whiz visit to the big Western Electric factory in Indianapolis has enough information and quotes on phone durability and color to satisfy anyone. Throughout, there are peeks into the odd nooks and crannies that exist in any big place. You mean they have someone just to do *that*? One team of psychologists studied how to write instructions for depressing the phone switchhook.

Need cocktail-party chatter? It's here in abundance. One out of every seven numbers is unlisted. Mother's Day is the heaviest calling day of the year. Telephone poles last 35 years. On 30% of all calls, either the line's busy or there's no answer. There once was a woman whose laugh was

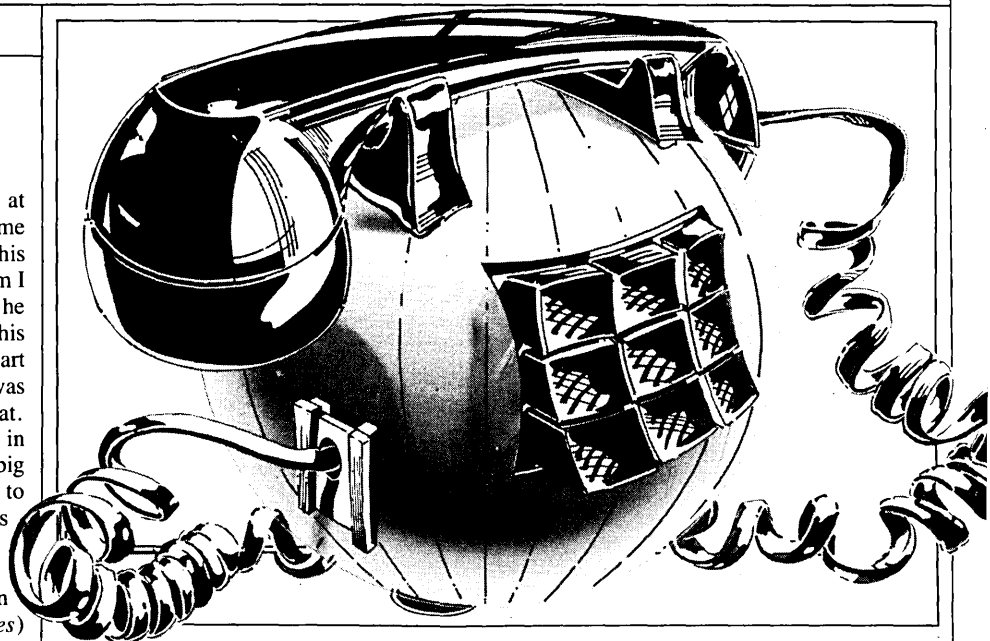

at such an odd frequency, it tripped a switch and cut her off. Kleinfield even found the woman who records all those time, weather, and out-of-service messages.

*The Biggest Company* also has some merit as a business book for the uninitiated. Much of the corporate ritual and governance Kleinfield describes can be found at any large company. The nonsense at annual meetings, the board of directors' often ineffectual gatherings, the tension of bidding at a big debt offering—all these are nicely sketched. Going off AT&T's beaten path, the author devotes a chapter to the phone company's one big corporate scandal—a bizarre case of regulatory rate fixing down South, complete with surveillance, midnight meetings, and suicide. The subculture of technological thieves, kibitzers, and crazies also gets entertaining treatment.

But there is, or should have been, more to the project than a parade of interviews, and these weaknesses are the book's ultimate undoing. First, there is Kleinfield's style. His writing is terse and occasionally sarcastic, but in describing all these people and places, there's not much sense of a consistent personality or opinion. Then,

too, the book itself is a Spartan production—no pictures, graphs, or maps—and this in a book where complex interrelationships and high technology cry out for some sort of illustration. Most crucially, there is little attempt to put the phone company in perspective. An assessment of corporate personality and strategy is needed, as are comparisons with other companies and industries, and some comment on AT&T's future.

Here is the book's real problem. Kleinfield's contribution, the mortar between the countless descriptions and quotes, boils down to some how-big-is-too-big musings. The author tells us early on that he'll make no attempt to give us anything more than a "serendipitous odyssey" through the company; it's just too big, he says, to make any generalizations about. As the book wears on, this seems more and more like a case of just plain chickening out. The phone company, after all, is just a company—a big one, sure, but also a vulnerable and changing one.

We get hints of some crucial questions that are really at the heart of the matter: the massive but necessary change from an

## SOURCE DATA

engineering company to a marketing company, from a firm with a solid, inertial monopoly on communications to one planning dozens of diversifications and defensive strategies. The book opens, after all, with a description of how Bell squeezed mighty Western Union out of the picture back in the late 1800s. That probably won't happen to Bell this time around, but it seems a bit silly to write on the company at such length and neglect what the cable, newspaper, and data processing industries are cooking up in the way of competition. The shots are hard to call, but some effort would be appreciated.

Instead, the book closes with a quote of surpassing foolishness from an "industry observer": "It [AT&T] is so big that no one can ever truly understand its immensity." There's a kind of freak-show logic at work here; Kleinfeld hopes that the company's size alone is reason enough for a book, and for our attention. It isn't. Holt, Rinehart, and Winston, New York (1981, 319 pp., \$14.95).

—Tom Baker

### THE COMPUTERIZATION OF SOCIETY

by Simon Nora and Alain Minc, introduction by Daniel Bell

When first published in late 1978 under its original French title, *L'Informatisation de la Société*, this book was widely reviewed. Until now, it has not been widely available in an acceptable English translation.

Former French president Valéry Giscard d'Estaing had an intense interest in the role to be played by France in the emerging information-based society. He assigned the exploratory task to Inspector Général des Finances Simon Nora, who, together with a younger collaborator, Alain Minc, produced the report. What they did was patiently dissect the components of the information society, objectively assess French strengths and weaknesses, and provide a road map, which, if followed, would allow France to break loose from American domination of information technology industries.

How good the plan was and how well it was followed can now be assessed. French progress in what the report calls "telematiques" has been very good. Consider the steady improvement in CiiHB, the current experiment with microprocessor-based credit cards, the development of the electronic telephone directory, the arrangement between Alcatel and the Source for a \$100 data terminal, the ownership shares in Olivetti, the joint ventures with National Semiconductor, and a whole host of other steps taken in only the past two years. The plan is working. The book belongs, however, to a previous administration, and the effects of François Mitterrand's announced plans for nationalizing key telematique corporations remain to be seen.

The Nora/Minc report is the work of professional civil servants at their best. They have provided the politicians with a base from which to work. U.S. companies that do business in France or compete with French companies would be well advised to read the English version. Rarely has a plan been described so clearly and effectively. MIT Press, Cambridge, Mass. (1980, 186 pp., \$12.50).

—Philip H. Dorn

## REPORTS & REFERENCES

### PUBLICATIONS CATALOG

The IEEE's Computer Society has released its 32-page 1981 *Publications Catalog*. Over 300 publications are listed in the catalog, covering all aspects of applications, methodologies, and techniques in computer software and hardware. It also contains over 40 technical-level tutorial texts for the computer scientist and engineer. More than 50 new publications (not in the 1980 catalog) are described, and a listing of books by subject/title is provided. Copies of the 1981 catalog are available free of charge by writing to the Computer Society Press, P.O. Box 639, Silver Spring, MD 20901.

### PRIVACY LAWS

The *Privacy Journal's* latest *Compilation of State and Federal Privacy Laws* includes

new sections on computer crime, insurance, mailing lists, and telephone solicitation that reflect the trends of state legislatures throughout the U.S. Currently, 10 states have passed laws punishing computer-related crimes. More than 80 new privacy laws, 15 of them passed in 1980, have been added to the compilation. To order a copy, send \$16 to the *Privacy Journal*, P.O. Box 8844, Washington, DC 20003.

### THE TEN ICCS

The ICCS (Invitational Computer Conferences) are a series of one-day seminar/displays geared toward the needs of quantity buyers of computer and peripheral equipment. Displays from 40 manufacturers are exhibited, and technical product seminars run all day, every day. The shows begin in September and will continue in various cities through April '82. For detailed information, contact B.J. Johnson & Associates, Inc., 2503 Eastbluff Dr., Suite 203, Newport Beach, CA 92660 (714) 644-6037.

## VENDOR LITERATURE

### SYSTEMS ILLUSTRATED

This vendor's line of word and data processing systems is described in their latest brochure, "Office Systems from Digital Equipment Corporation. . . . With Tomorrow in Mind." DIGITAL EQUIPMENT CORP., Maynard, Mass.

FOR DATA CIRCLE 350 ON READER CARD

### GRAPHICS GLOSSARY

A listing of computer graphics terminology, this 40-page booklet is intended for reference use by both the novice and sophisticated graphics users. MEGATEK CORP., San Diego, Calif.

FOR DATA CIRCLE 351 ON READER CARD

### SUPPLY CATALOG

Prices and other information on magnetic media, terminal furniture, media storage systems, etc., is given in this vendor's 29-page catalog of dp and wp equipment supplies. ASSOCIATED COMPUTER SUPPLIES, INC., Monroe, Conn.

FOR DATA CIRCLE 352 ON READER CARD

### INTELLIGENT RECORDING

A six-page brochure describes the company's intelligent recording system by listing features, specs, dimensions, recorder and command mode information, and a functional block diagram. MEMODYNE CORP., Needham Heights, Mass.

FOR DATA CIRCLE 353 ON READER CARD

### DESKTOP STATION

This vendor's desktop integrated workstation is illustrated in a four-color, foldout brochure. Applications, features, and specs are included. CALLAN DATA SYSTEMS, Westlake Village, Calif.

FOR DATA CIRCLE 354 ON READER CARD



"I quit smoking and lost my job at the Lab."

© DATAMATION

CARTOON BY JACK E. SCHNEIDER

# ADVERTISERS' INDEX

|   |  |  |
|---|--|--|
| Alex Brown & Sons.....61                | Carroll Manufacturing.....38                   | Dysan.....76,77                          |
| A.M. Jacquard.....1                     | Champion Papers.....178,179                    | Exxon Product Research Co.....183        |
| Anderson Jacobson.....4                 | Cincom.....102                                 | FAO Rome.....186                         |
| Ann Arbor Terminals.....85              | Computer Corporation of America.....45,47,49   | Fox Morris.....183                       |
| Appleton Papers.....60                  | Computer Sciences.....88,89                    | General Data Comm.....141                |
| Aramco.....204,205                      | Computrend.....153                             | Genisco Computers.....72                 |
| Associated Computer Consultants.....202 | DASD.....216                                   | Henco.....22                             |
| Astrocom.....67                         | Data Access Systems, Inc.....22                | Hewlett Packard.....40,41,81,117,158,159 |
| AT&T.....118,119                        | Data General.....90,91                         | Honeywell Info Systems.....130,131       |
| BBN Computer.....156                    | Datagraphix.....113                            | Honeywell—T.I.....124                    |
| Beehive International.....198           | Datapoint Corp.....173                         | Hughes Aircraft.....185                  |
| Boeing Computer Service....150,151      | Digital Communications Corp.....203            | IBM/GSD.....42,43,176,177                |
| Boole & Babbage.....31                  | Digital Equipment Corp.....187                 | IJCAI-81.....73                          |
| BTI.....12                              | Digital Equipment Corporation Terminals.....44 |  |
| Burroughs.....10,11                     | Digital Equipment Corp.....196,197             |  |
| Business Week.....50                    | Digital Pathways.....161                       |  |

## DATAMATION® magazine's

# 1981 MAINFRAME USER SURVEY AVAILABLE NOW.

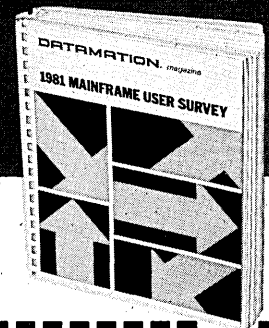

The 6th annual comprehensive analysis of EDP users' present equipment status, buying plans and attitudes toward the market has just been completed. This up-to-date report provides essential data for industry analysts, planning and marketing executives as well as computer users themselves.

### INSTALLATION PLANS OVER THE NEXT TWO YEARS . . .

Over 6,000 user sites in the U.S. with more than 7.5 billion dollars worth of systems installed submit detailed answers about their plans to take delivery of 3,431 large mainframe systems, plus add-on disks, tapes, terminals and memory.

### FIVE SURVEYS IN ONE . . .

With a penetrating look at the plans of IBM, Burroughs, Honeywell, Univac and NCR user bases . . . 1981/82 order profile for the 4300's and 303X's . . . all other systems . . . principal peripherals . . . purchase vs. lease intentions . . . plans to sell used computers . . . buying intentions for plug-compatible CPU's, peripherals and minicomputers . . . network implementation plans . . . operating systems and packaged software usage . . . 1981 budget plans and a "look ahead" to 1982.

### NAMES, ADDRESSES AND SITE PROFILES OF SALES PROSPECTS . . .

. . . for large mainframe users are detailed in the "Mainframe User File." This data base of sites surveyed includes the installed mainframe base and sites planning to purchase more than 3,431 large mainframes during 1981-82. For more information call Shirley Stirling or Kathy Murray, 800-223-0743.

**Return to:**  
GSGC/DTM Reports  
DATAMATION magazine  
666 Fifth Avenue  
New York, NY 10103

### ORDER YOUR 1981 MAINFRAME USER SURVEY NOW . . .

- Bill me: \$750. (plus postage and handling)
- Payment enclosed: \$700. (postage paid)  
Pay now and save \$50. plus postage and handling costs.  
\$350 for each additional copy.
- Please send information on the Mainframe User File.

Signature \_\_\_\_\_  
Name (please print) \_\_\_\_\_  
Title \_\_\_\_\_ Phone \_\_\_\_\_  
Company \_\_\_\_\_  
Address \_\_\_\_\_  
City/State/Zip \_\_\_\_\_

DA

|                              |         |
|------------------------------|---------|
| Informatics .....            | 15      |
| Information Builders .....   | 64      |
| Inmac .....                  | 138,139 |
| Intel .....                  | 5       |
| Interstate Electronics ..... | 69      |
| Intertec .....               | 75      |
| ISSCO .....                  | 195     |
| C. Itoh .....                | 19      |
| Kennedy Co. ....             | Cover 2 |
| Robert Kleven .....          | 186     |
| Leeds & Northrop .....       | 214     |

|                              |         |
|------------------------------|---------|
| Liebert .....                | 82      |
| Magnuson .....               | 52,53   |
| Matrix Instruments .....     | 84      |
| McCormack & Dodge .....      | 37,39   |
| McDonnell Douglas .....      | 194     |
| Memorex Communications ..... | 29      |
| Micom .....                  | Cover 3 |
| Morgan Stanley .....         | 46      |
| Motorola .....               | 182     |
| MTI .....                    | 180     |
| Nashua Corp. ....            | 174     |

|                                 |         |
|---------------------------------|---------|
| National Electronic Cable ..... | 51      |
| NCR .....                       | 70,71   |
| NEC .....                       | 9       |
| Northern Telecom .....          | 188,189 |
| Northwest Energy Co. ....       | 181     |

|                                |       |
|--------------------------------|-------|
| On Line Software International | 30,68 |
| Osborne Computer Corp. ....    | 65    |

|                      |       |
|----------------------|-------|
| Pitney Bowes .....   | 95    |
| Polaroid .....       | 58,59 |
| Prime Computer ..... | 20    |

|                               |         |
|-------------------------------|---------|
| Racal Milgo .....             | 146,165 |
| Racal Vadic .....             | 87      |
| Rair Microcomputer Corp. .... | 78      |
| Raytheon Computer .....       | 210     |
| Rusco Electronics .....       | 121     |

|                                  |         |
|----------------------------------|---------|
| SAS Institute .....              | 190     |
| Scientific Micro Systems .....   | 62      |
| Sentry Database Publishing ..... | 193     |
| Sicob .....                      | 166     |
| Siggraph/81 .....                | 169     |
| Source EDP .....                 | 215     |
| Source Systems .....             | 73      |
| Southern Computer Services ..... | 184     |
| Sperry Univac .....              | 104,105 |
| SPSS .....                       | 24      |
| Summagraphics .....              | 74      |
| System Computers .....           | 135     |

|                               |             |
|-------------------------------|-------------|
| Tandem Computers .....        | 143,144,145 |
| Tektronix .....               | 6,7         |
| Teletype .....                | Cover 4     |
| Televideo .....               | 54,55       |
| Texas Instruments .....       | 66,175      |
| Three M Company .....         | 83          |
| Three Rivers Computer .....   | 23          |
| Timeplex .....                | 16,17       |
| Tran Telecommunications ..... | 213         |
| Trans Net .....               | 79          |
| TSI .....                     | 133         |

|                               |                 |
|-------------------------------|-----------------|
| University Computing Co. .... | 107,108,109,110 |
| US Instrument Rentals .....   | 33              |

|                              |     |
|------------------------------|-----|
| Visual Technology .....      | 137 |
| Walsh Co. ....               | 184 |
| Wicat .....                  | 163 |
| Wild Hare Computer Sys. .... | 2   |
| Wrightline .....             | 57  |

|                               |         |
|-------------------------------|---------|
| Xerox .....                   | 122,123 |
| Xerox-Computer Services ..... | 63      |
| Xerox-XPSD .....              | 97      |

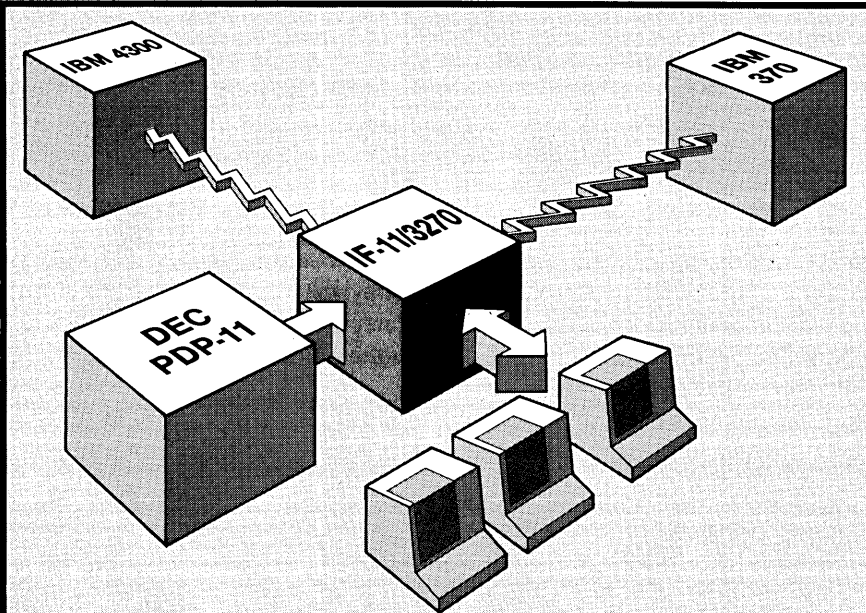

# 3270

## COMMUNICATION LINK

IBM mainframe users have an alternative 3270 information display system, the IF-11/3270. Up to 31 display terminals can be clustered with a PDP-11 or VAX system. Individual terminal users may access either of two IBM 370 type hosts, or the local DEC processor at will, or can initiate data transfers between the DEC processor and the hosts.

Displays can be DEC VT-100s or other ANSI-compatible terminals. Under user control, the IF-11/3270 can switch displays

from emulation of standard intelligent IBM terminals to normal PDP-11 operation.

A typical installation entails a centralized IBM mainframe database with DEC minicomputers at remote field sites. Since the IF-11/3270 does all BSC protocol processing, the unencumbered DEC system is available for everyday tasks.

If you want more details on how the IF-11/3270 system can serve you better, contact us today.

### ASSOCIATED COMPUTER CONSULTANTS

228 EAST COTA STREET, SANTA BARBARA, CA 93101  
(805) 963-8801 TXW 910 334-4907

DEC, PDP AND VAX are trademarks of Digital Equipment Corp.

CIRCLE 136 ON READER CARD

# “Stat Mux”

## A Data Mover Product from DCC

Our STAT MUX can *reduce your communications costs* by combining multiple costly circuits into one circuit, and *improve reliability* with error-free transmission. DCC's Data Movers currently service major operating U.S. Networks.

The CM-9100 Statistical Multiplexer offers:

- 4 to 32 subscriber lines
- Synchronous or Asynchronous input protocol
- X.25 Level 2 support
- Built-in diagnostics
- Optional High Speed backup line
- No impact to existing terminals, computers, or software
- Many other standard and optional features
- Immediate delivery

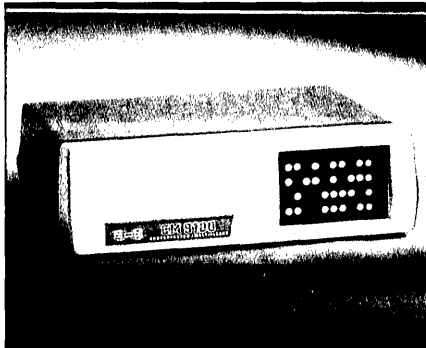

### Thirty-day free trial

For further information, or details about our new 30 day free trial offer, contact the Data Communications Marketing Department.



### Digital Communications Corporation

A *MACOM* Company

11717 Exploration Lane  
Germantown, Maryland 20767  
(301) 428-5600 TWX 710-828-0541

Atten: Data Com Marketing  
Please send me more information on  
DCC's Data Movers.

Name \_\_\_\_\_

Address \_\_\_\_\_

City \_\_\_\_\_

State \_\_\_\_\_

Zip \_\_\_\_\_

Digital Communications Corp.  
11717 Exploration Lane  
Germantown, Maryland 20767

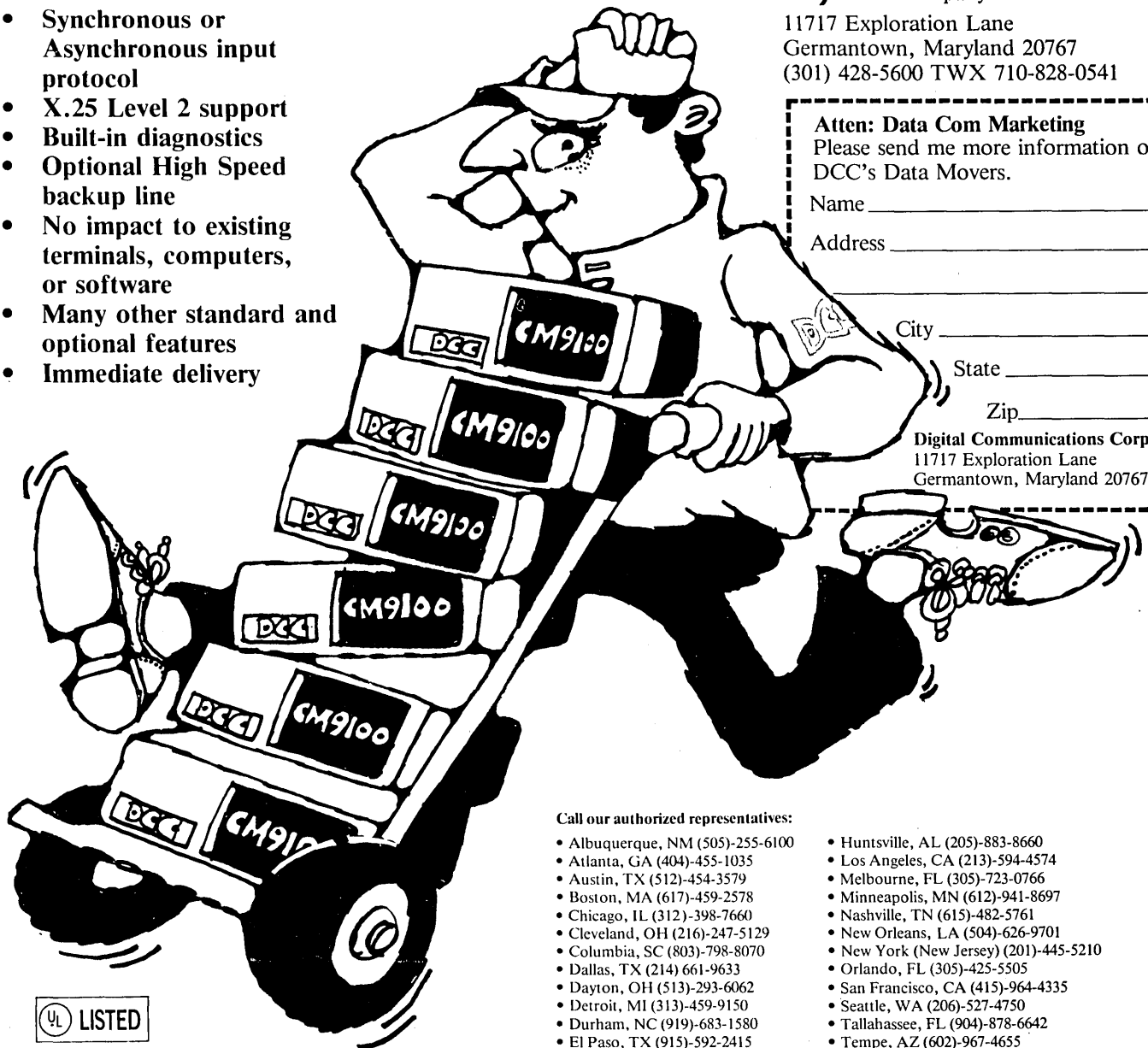

#### Call our authorized representatives:

- Albuquerque, NM (505)-255-6100
- Atlanta, GA (404)-455-1035
- Austin, TX (512)-454-3579
- Boston, MA (617)-459-2578
- Chicago, IL (312)-398-7660
- Cleveland, OH (216)-247-5129
- Columbia, SC (803)-798-8070
- Dallas, TX (214) 661-9633
- Dayton, OH (513)-293-6062
- Detroit, MI (313)-459-9150
- Durham, NC (919)-683-1580
- El Paso, TX (915)-592-2415
- Ft. Lauderdale, FL (305)-776-4800
- Houston, TX (713)-681-0200
- Huntsville, AL (205)-883-8660
- Los Angeles, CA (213)-594-4574
- Melbourne, FL (305)-723-0766
- Minneapolis, MN (612)-941-8697
- Nashville, TN (615)-482-5761
- New Orleans, LA (504)-626-9701
- New York (New Jersey) (201)-445-5210
- Orlando, FL (305)-425-5505
- San Francisco, CA (415)-964-4335
- Seattle, WA (206)-527-4750
- Tallahassee, FL (904)-878-6642
- Tempe, AZ (602)-967-4655
- Tulsa, OK (918)-252-9646
- Wash. DC (301)-428-5600

CIRCLE 137 ON READER CARD

# “Since I came to work for Aramco in Saudi Arabia, I’ve saved an average of \$15,000 a year.”

---

Listen to a 30-year-old engineer tell how he’s outdistanced his classmates both professionally and financially.

---

“It’s hard *not* to save a lot of money here,” says Charles Gallavan, a pipeline engineer with Aramco in Saudi Arabia.

Aramco pays Charles a base salary that’s competitive with what he could expect in the States. But in addition to the salary, Aramco pays employees in Saudi Arabia an after-tax expatriate premium of 40 percent on the first \$30,000 of base pay, and 20 percent premium on the next \$20,000.

## How the Gallavans save

Gallavan goes on to say, “Our net disposable income every month is substantially more than what it was in the States. We don’t have all the expenses we had before we came here. We pay a modest rent for a beautiful house, with our utility bills and maintenance included.

“Our biggest expense is for food,” says Charles, “because so much of it must be imported. However, Aramco gives us a cost-of-living differential so that the higher costs of things like that come out of the company’s pocket and not ours.”

## More chances to save coming up

Charles and Lori Gallavan’s savings can mount up even more in another couple of years when Charles completes 60 months of service and becomes fully vested in Aramco’s Savings Plan. The company adds 50 percent to the first 6 percent of salary that the employee saves. The contribution increases to 100 percent

after 10 years of service.

Today, newly hired employees for Saudi Arabia have it even better. They receive a lump-sum Overseas Employment Bonus of as much as \$5,000 after tax.

## Young talent gets recognition

“The money isn’t the only thing that’s

I believe I’ve gotten the equivalent of five years’ field experience in only three.

“If I stayed in the States,” says Gallavan, “I would have spent a couple of years being a kind of museum curator, watching dials in a plant just idling along. Here, Aramco put me to work doing hy-



*Charles Gallavan describes Aramco in Saudi Arabia as “an engineer’s dream come true.” The compensation and benefits are excellent. More important, young engineers get to work on projects that it might take years to get in the States.*

great,” says Gallavan. “You get opportunities here to work on things that it might take years to get in the States.

“If you have the initiative and the ability, Aramco will let you carry as heavy a load as you can handle.

drostatic testing on some of the largest and most important pipelines in the world.”

Aramco is simply too busy to waste young talent and give all the important projects to older hands. If you have skill and commitment.

Aramco has assignments to challenge you.

Aramco has projects that are awesome in size, complexity and cost. Projects that range from development of the world's largest onshore and offshore oilfields to construction of a vast electrical power system — even to the building of entire communities.

### **Came for three years, may stay 20**

Charles recalls that when he decided to take a chance on Aramco in Saudi Arabia, he set his own time limit of three years to make a go of it. "That did not seem like too much time at my age. Even if I did not make a career out of it, it seemed like it would be a worthwhile experience. Now I'm thinking seriously about staying for good."

Today a married employee can come to Aramco in Saudi Arabia on a special voluntary "bachelor" status. If you don't want to move your family over right away, you can try it out as a "bachelor" for a year. We'll fly you home three times so you can tell the folks what it's like. Then at the end of the year or sooner, all of you can decide whether or not this is the life for you.

### **Vacation travel most people only read about**

Don't get the idea that the Gallavans save \$15,000 a year because they never go anywhere. They use Charles' 40 days of paid vacation every year, plus the 12 paid holidays, to take trips you wouldn't believe.

How's this for a vacation? The Gallavans took an auto trip from Holland to Dhahran. They rode along the Danube to Vienna; crossed the Alps to Yugoslavia; car-ferried from Dubrovnik to Corfu; and also stopped over at Izmir, Antioch and Aleppo. "Fabulous," says Lori Gallavan.

They have also taken a Nile barge trip from Luxor to Aswan; snorkeled in the Philippines; and toured some of Sri Lanka's famous tea plantations.

Like all North American Aramco employees, the Gallavans can get home to the States regularly. Aramco pays air fare for annual "repatriation" trips.

### **"This is home now"**

The Gallavans live in Dhahran, in an Aramco community that's become

their hometown. Comfortable homes. Green lawns, tall trees and flower gardens, tennis courts and swimming pools. Even a 27-hole golf course. In any city in the world, Dhahran would be considered a nice neighborhood.

### **First-rate schools and medical/dental facilities**

When young engineers settle down

on Accreditation of Hospitals.

Dental care is excellent but, unlike medical care, it is not free for Aramco employees.

### **Find out more about the Aramco head start**

If you think you might be interested in following Charles Gallavan's example, give us a call. It's completely confidential. We have open-

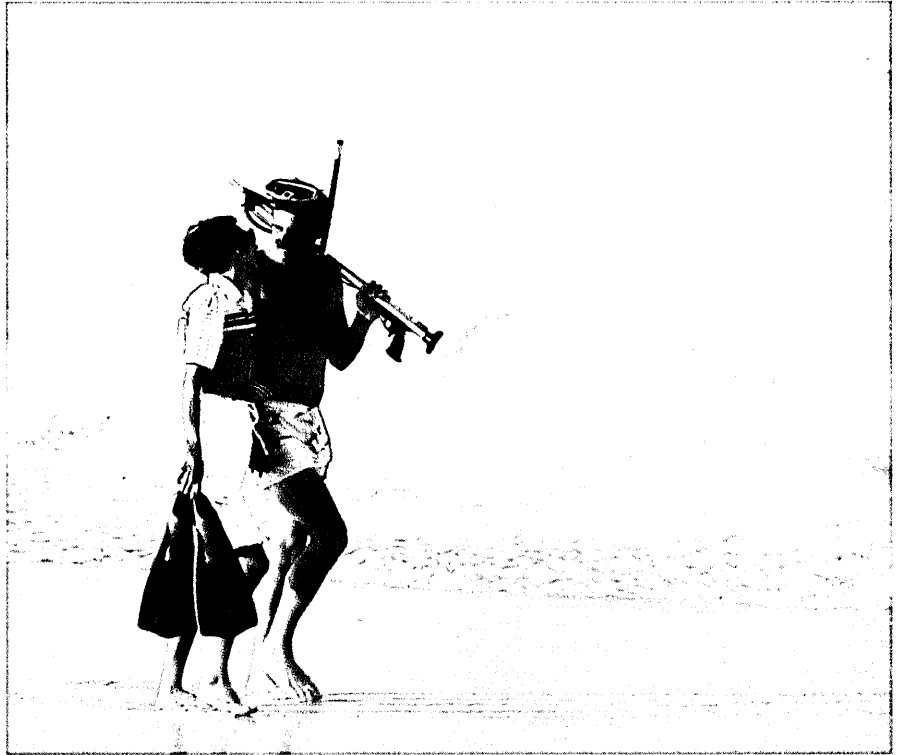

*Recreation facilities abound in the Aramco communities in Saudi Arabia and contribute to the casual, comfortable lifestyle of the 4,800 North Americans who work there for the company.*

in Saudi Arabia, those with children send them to Aramco's top-notch schools. Many of the teachers hold master's degrees. And when the Aramco system's SAT scores were compared with a group of U.S. schools, Aramco ranked with the top 10 percent.

The Aramco schools go through ninth grade. For older children in high school, the company pays 80 percent of the expenses for boarding schools in Europe or the U.S., up to \$5,350 per student per year.

If somebody gets sick while in Saudi Arabia, the individual is covered by Aramco for *all* medical expenses, even prescriptions, which are incurred while in Aramco medical facilities. And those facilities are excellent. Our modern hospital has the latest diagnostic and intensive care equipment and is fully accredited by the Joint Commission

ings in just about every discipline. Call (713) 750-6965 anytime. Or call toll-free, (800) 231-7511, Ext. 6965, Monday through Friday between 7 A.M. and 5 P.M. Central Time.

If you prefer, send your résumé or write for more information to: Aramco Services Company, Dept. DM0701ML04A, 1100 Milam Building, Houston, TX 77002.

Watch this publication for stories about other engineers who have taken a career shortcut with Aramco in Saudi Arabia.

**ARAMCO**  
SERVICES COMPANY

# The Marketplace...

## ADVERTISERS' INDEX

### SOFTWARE & SERVICES

|                                       |     |
|---------------------------------------|-----|
| Allen Services Corporation .....      | 206 |
| Allen Services Corporation .....      | 207 |
| Allen Services Corporation .....      | 208 |
| Amcort Computer Corp. ....            | 207 |
| American Used Software Co. ....       | 206 |
|                                       |     |
| Dataware, Inc. ....                   | 208 |
| D/B Services .....                    | 207 |
| Duquesne Systems, Inc. ....           | 206 |
| Duquesne Systems, Inc. ....           | 207 |
|                                       |     |
| EEC Systems .....                     | 208 |
| Electronic Interface Assoc. Inc. .... | 208 |
| Evans Griffiths & Hart, Inc. ....     | 208 |
|                                       |     |
| Friedman Associates .....             | 208 |
| Mathematica Products Group .....      | 207 |
| Micro Tech Exports .....              | 206 |
|                                       |     |
| Plycom Services, Inc. ....            | 208 |
|                                       |     |
| S-Cubed Business Systems .....        | 207 |

### PERSONAL COMPUTING

Micro Management Systems, Inc. ... 209

### DP MARKETPLACE

Rental Electronics, Inc. .... 208

### BUY, SELL, LEASE

C. D. Smith & Associates, Inc. .... 209

Thomas Business Systems, Inc. .... 209

### JOB MARKETPLACE

Aetna Life & Casualty .....

Southern Bell .....

## SOFTWARE SERVICES

# A AMERICAN for DEC\* SOFTWARE

## PROVEN Software Products for DEC 11 & VAX\*



### DBMS/Application Development System

- In use for 10 years . . . over 150 sites
- The acknowledged technology leader in DBMS



### Decision Management System

- Interactive business modeling system for VAX
- Complete facilities, including linear programming



### Project Management System

- Family of project management software
- Over 800 systems installed, from the world leader

Call for a FREE Briefing Book: 617-437-7600

American Computer Group, Inc. • P.O. Box 68, Kenmore Sta., Boston, MA 02215

\*DEC and VAX are registered trademarks of Digital Equipment Corporation

CIRCLE 500 ON READER CARD



## for Shared TAPE and DISK Mounts

Transparently Manages Shared TAPE and DISK Mounts

- **MSM** automatically controls TAPE ALLOCATIONS among your systems. MSM also works for SHARED MOUNTABLE DISKS.
- **Allows more EFFICIENT TAPE DRIVE UTILIZATION.** Your tape drives will be treated as a single combined pool, rather than several smaller ones. This will have a tendency to reduce overall tape drive requirements.
- **Alleviates confusing operator burdens.** Without MSM, operators must manually coordinate device usage among the various systems.
- **ELIMINATES COSTLY JOB RE-RUNS** due to inadvertent multi-system tape allocation.
- Provides a **SINGLE-SYSTEM IMAGE** with respect to device allocations.
- **MSM is COMPLETELY COMPATIBLE** with the standard operating system allocation philosophy. MSM simply extends it to cover all systems in your complex.
- **MSM is the ONLY TRANSPARENT APPROACH** to handling SHARED TAPE and SHARED DISK allocation.
- **MSM now runs with MVS, SVS, MVT, VS1 and MFT.**
- **New SOFTSWAP feature** allows MSM to reduce the scope of allocation "blockage" when a DDR tape SWAP occurs.
- **MSM can be installed in 10 MINUTES** — NO IPL is required.
- Requires **NO SYSTEM MODIFICATION** whatsoever.
- Additional overhead caused by MSM is **INSIGNIFICANT.**
- **MSM is now being used in well over 100 installations** throughout the world.

To Acquire MSM, or for more information . . .

Toll-Free 800-543-7583

(in OH: 513-890-1200)

Ask For x301

ALLEN SERVICES CORP.

Software Dept 212 W National Rd  
Vandalia, Ohio 45377



CIRCLE 501 ON READER CARD

## ATTENTION SHARED DASD AND SHARED TAPE USERS . . . YOU NEED SDSI/STAM

### SDSI Shared Dataset Integrity

- **SDSI protects data integrity** by guarding against concurrent update from multiple CPUs.
- **SDSI eliminates RESERVE LOCK-OUTS.**
- **SDSI provides operator and TSO users information** about dataset conflict conditions.
- **SDSI requires no system or user program modifications** and installs in minutes.
- **SDSI automatically improves system performance** by eliminating device RESERVES.

### STAM Shared Tape Allocation Manager

- **STAM automates the sharing** of tape and DASD devices thus allowing allocation decisions to be made faster and reducing the possibility of human errors.
- **STAM makes more efficient use of tape pools** thus allowing you to reduce tape drive requirements.
- **STAM provides global operator commands and control.**
- **STAM eliminates JOB re-runs** due to multiple tape drive allocation errors.
- **STAM requires no system or user program modifications** and installs in minutes.



**DUQUESNE SYSTEMS INC**

TWO ALLEGHENY CTR.  
PITTSBURGH, PA 15212  
PHONE 412-323-2600  
TELEX 902 803

CIRCLE 502 ON READER CARD

CP/M® ↔ IBM

CP/M ↔ DEC

Compatibility with

## REFORMATTER™

Exchange data files with most IBM and DEC equipment through **REFORMATTER** disk utilities. With **REFORMATTER**, you can read and write IBM 3740 and DEC RT-11 formatted diskettes on your CP/M system. Programs feature bi-directional data transfer and full directory manipulation. ASCII/EBCDIC conversion provided with CP/M ↔ IBM.

Each program \$195.00 from stock. Specify CP/M ↔ IBM or CP/M ↔ DEC when ordering.

Program Data Sheets and Application Guide available from Microtech Exports, Inc., 467 Hamilton Ave., Suite 2, Palo Alto, CA 94301 □ Tel: 415/324-9114 □ TWX: 910-370-7457 MUH-ALTOS □ Dealer & OEM discounts available.

CP/M® is a registered trademark of Digital Research.

CIRCLE 503 ON READER CARD



The Effective Solution for  
**DETAILED JOB COSTING**

**J.A.M.I.S.**

(Job Cost & Management Information System)  
Integrates:

- Job Cost
- Payroll
- Accounts Receivable
- Accounts Payable/  
Purchase Orders
- General Ledger
- Inventory/Order Entry
- Fixed Assets



**S-Cubed Business Systems**  
Box 1620, La Jolla, CA 92038  
PH: (714) 755-7237; 453-0060

CIRCLE 504 ON READER CARD

**PERFORMANCE MANAGERS  
AND ANALYSTS . . .**

You've tried solving your performance problems with hardware monitors, sampling software monitors, unsatisfactory billing systems, SMF and RMF inadequacies, simulators . . . Now, try the premier product in the industry! QCM. QCM is the only complete system that precisely monitors ALL hardware and software processes, accurately bills ALL operations and IMPROVES performance . . . ALL on a full-time basis. Let us show you how QCM has meant control, efficiency, confidence and dollars to our customers.



**DUQUESNE  
SYSTEMS INC**

TWO ALLEGHENY CTR.  
PITTSBURGH, PA 15212  
PHONE 412-323-2600  
TELEX 902 803

CIRCLE 506 ON READER CARD

**MPGSWIFT for TP applications**

Maximize staff productivity  
and customer service with MPGSWIFT

- |                             |  |
|-----------------------------|--|
| <b>Ease of Use</b>          | Learn to write TP applications in one day                          |
| <b>Ease of Installation</b> | Install in one hour  |
| <b>Maintenance</b>          | Add terminals, files, programs while MPGSWIFT continues to operate |
| <b>Language Support</b>     | Cobol, Assembler, PL/1, Fortran, RPG, RAMIS                        |
| <b>Evolution</b>            | Entry level to large network without reprogramming                 |
| <b>Productivity</b>         | Online program development with one-half the effort                |
- Over 100 installations. DOS, DOS/VS, and DOS/VSE

Productive software for business data processing from

**Mathematica Products Group**  
P.O. Box 2392 • Princeton, New Jersey 08540 • 609/799-2600



CIRCLE 507 ON READER CARD

**SYSTEM 34 SOFTWARE  
DMS \$450.00**

**DISKETTE MANAGEMENT SYSTEM**  
Automatically keeps track of diskette usage/contents. Eliminates cataloging to locate files/libraries on diskette.

**DBSLIB - PROGRAM LIBRARIAN - \$375.00  
DATA DICTIONARY**

Automatically provides complete cross reference from field to job. Online inquiry at any level (Field-File-Program-Job-System).

**DBSAFE - \$950.00  
AUTHORIZED JOB/  
PROGRAM FACILITY**

Prevents unauthorized execution at job/program level via userid. Complete security without special menus or sign-on.

**D/B SERVICES**  
218 WASHINGTON STREET  
INGLESIDE, ILLINOIS 60041  
(312) 587-2008

CIRCLE 508 ON READER CARD

**DEC RSTS  
APPLICATION  
SOFTWARE**

ICP MILLION DOLLAR AWARDED  
DEC GOLD STAR RATED

**ACCOUNTING SYSTEMS:**

- ACCOUNTS RECEIVABLE
- ACCOUNTS PAYABLE
- PAYROLL
- GENERAL LEDGER/FINANCIAL MANAGEMENT

**BUSINESS CONTROL SYSTEMS:**

- ORDER PROCESSING/BILLING
- INVENTORY CONTROL
- SALES ANALYSIS

**amcor computer corp.**



1900 Pintaide Dr., Louisville, KY 40299 - 502/491-9820  
Regional Offices - Atlanta, GA/San Jose, CA

CIRCLE 509 ON READER CARD

**PREVENT "Wild Cards"  
IN YOUR DATA**

with... **SUPER-MSI**  
Multiple Systems Integrity Facility™



© "Wild Cards" - Allen Services Corporation, 1979

Consider - SUPER-MSI...

**SHARED DASD USERS:**

- **PROTECTS YOUR DATA INTEGRITY** by preventing simultaneous destructive updates by jobs in different systems.
- **Eliminates RESERVE Lock-outs** (both performance Lock-Outs and "deadly embrace").
- **DOES NOT SACRIFICE RELIABILITY** as do other approaches to the problem.
- **Now has extended VSAM Dataset Integrity** to specifically handle the internal VSAM Dataset SHR options.
- **Inform Operators and/or TSO users** (as appropriate) about the precise task (job, TSO user, etc.) causing dataset conflicts.
- **Provides powerful operator commands** to Control and Monitor performance and activity.
- **Is TRANSPARENT** to users, and almost transparent to operators.
- **Is Independent of system environment** - for example, it works equally well with MVS, MVS-SE, SVS, MVT, VS1, MFT, HASP, ASP, JES2, JES3, etc.
- **Can be installed in 10 minutes** without an IPL and with **NO SYSTEM CHANGES** whatsoever.
- **MSI is already being used** in well over 400 installations throughout the world.

For More Information, or to Order a No-Obligation FREE TRIAL...

**In Europe:**

Mr. J.A. Kaluzny  
UNILEVER GMBH • 15 Dammtorwall  
2 Hamburg 36 • West Germany

**From Anywhere Else:**

ALLEN SERVICES CORPORATION  
Software Dept. • 212 W. National Rd.  
Vandalia, Ohio 45377

Tel: 040 3490 2229 Toll-Free: 800-543-7583 X 300 (In OH: 513-890-1200) X 300

CIRCLE 510 ON READER CARD

# GCD

Global Console Director™

GCD now runs with MVS, SVS, MVT, VS1, and MFT.

The **Global Console Director** is an extremely flexible tool. It allows (selected message streams from different systems to be logically "blended" to create a **unified system image** to whatever degree desired). In a slightly different vein, GCD allows any console on any system to be logically attached concurrently (and perhaps in different ways) to any set of systems in your complex!

GCD allows commands entered from any console to be directed and processed any-

where in the complex; in this respect, all consoles are effectively linked to all systems. In almost every aspect, GCD is philosophically and operationally compatible with the standard system console support.

GCD can improve overall throughput by simplifying operations. By allowing several physical consoles to be logically merged, excess devices can be eliminated for immediate savings, or deployed elsewhere to strategic advantage.

GCD is absolutely transparent to your users, and aside from major simplifications, nearly transparent to operations.

ALLEN SERVICES CORP.  
Software Dept.  
212 W. National Road  
Vandalia, Ohio 45377  
Toll Free: 800-543-7583  
(in OH: 513-890-1200)

Ask For x302



CIRCLE 511 ON READER CARD

Another Time Saver  
from the EXPERTS

# FILECOMP

A HIGH SPEED  
FILE COMPARE UTILITY

DOS and OS versions available

The first efficient File Compare routine to truly go beyond IEB COMPR. Extended features include optionally omitted fields, hex or character printing, variable error limits and file alignment after extra or missing records.  
For more information call or write today.

The Conversion Software People  
**Dataware, Inc.**



2565 Elmwood Avenue  
Buffalo, New York 14217  
(716) 876-8722 • TELEX: 91519

CIRCLE 512 ON READER CARD

Specializing in  
IBM System/38 & 4300  
**FRIEDMAN & ASSOCIATES, INC.**

106 Wilnot Road  
Deerfield, Illinois 60015  
(312) 948-7180

Totally on-line order entry,  
complete manufacturing systems,  
MFG - with on-line price change

- Fixed price software
- Including customizing
- Management consulting
- Ten years experience

We make it work!

CIRCLE 513 ON READER CARD

## LEX-11 WORD PROCESSING FOR THE VAX, PDP-11, AND LSI-11

Immediate availability for all DEC operating systems; RT-11, RSX-11M, RSTS, VMS also TSX-PLUS. LEX-11 is easy to use and has complete word and list processing, full screen editing, single keystroke functions, user definable menus, forms, calculator and data base management facilities plus much more. LEX-11 is a proven system with installations world wide.

Local distributors wanted, excellent OEM discounts.

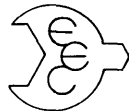

### EEC Systems

315 Goodman's Hill Road  
Sudbury, MA 01776  
(617) 443-6376 (617) 443-6805

CIRCLE 514 ON READER CARD

## RSTS/E & RSX-11M SOFTWARE PACKAGES

**KDSS** multi-terminal key-to-disk data entry system

**TAM** multi-terminal screen-handling facility for transaction-processing applications

**FSORT3** very fast record sort for RSTS/E

**SELECT** convenient, very fast extraction of records that meet user-specified criteria (RSTS/E only)

**BSC/DV** a DV11 handler for most bisynchronous protocols (RSTS/E only)

**COLINK** links two RSTS/E systems using DMC11s

**DIALUP** uses an asynchronous terminal line to link a local RSTS/E system to a remote computer system

**Evans Griffiths & Hart, Inc.**

55 Waltham Street  
Lexington, Massachusetts 02173  
(617) 861-0670

CIRCLE 515 ON READER CARD

## PACKAGES FOR SERVICE BUREAUS USING PDP-11'S AND RSTS/E

Specifically designed for timesharing PLYCOM has general accounting applications available for immediate delivery. Already installed at over 20 Service Bureaus, this software is extremely solid and reliable. Menu orientation and excellent documentation make these systems easy to learn and to use. Have your staff work on customer specific projects. Let PLYCOM solve your problems in:

- Accounts Payable
- General Ledger
- Financial Reporting
- Accounts Receivable
- Payroll
- Fixed Assets

**Plycom** services, Inc.  
P.O. Box 180  
Plymouth, IN 48563  
(219) 835-3121

CIRCLE 516 ON READER CARD

## RT-11, RSX-11M, VMS MASS-11 WORD PROCESSING

FULL DOCUMENTATION  
AND SUPPORT

COMPLETE SOFTWARE  
PACKAGES FROM \$3500  
call or write:



38 East 29th St.  
N.Y.C., N.Y. 10016  
Phone: 212-683-9100

CIRCLE 517 ON READER CARD

## DP MARKETPLACE



This free new catalog offers 4,931 "like new" electronic instruments for sale.

All the electronic equipment offered has been recently removed from the inventory of Rental Electronics, Inc. and comes with a money back guarantee. To take a look at a very large variety of well-priced electronic test equipment and instrumentation . . .

Phone toll-free (800) 225-1008

In Massachusetts, call (617) 273-2777. Or, you may get your free new catalog by writing:

**REI Sales Company**  
19527 Business Center Dr.  
Northridge, CA 91324

CIRCLE 518 ON READER CARD

# MOVE THE GOODS.

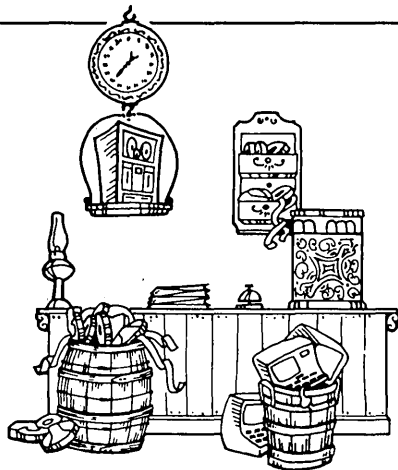

## USE THE DATAMATION MARKETPLACE ADVERTISING SECTION

**CALL KATHY  
800-223-0743  
OR SHIRLEY  
800-223-0746**

BUY, SELL, LEASE

# DEC

## SYSTEMS & COMPONENTS

C.D. SMITH &  
ASSOCIATES, INC.  
12605 E. Freeway,  
Suite 318  
Houston, TX 77015  
713-451-3112

CIRCLE 519 ON READER CARD

PERSONAL COMPUTING

DISCOUNT TRS-80<sup>®</sup> DEALER A301

COMPUTER SPECIALISTS

FREE  
COMPUTER  
CATALOG  
UPON  
REQUEST

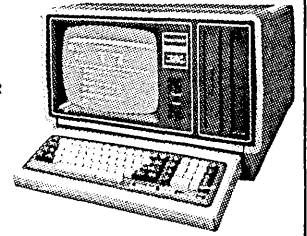

**\$ DISCOUNT \$ on TRS-80's**

26-3001 4K Color..... \$353.00  
26-1062 16K Ill..... 865.00  
26-4002 64K DRIVE..... 3440.00

**1-800-841-0860 TOLL FREE  
MICRO MANAGEMENT SYSTEMS, INC.**

Downtown Plaza Shopping Center  
115 C. Second Ave., S.W.  
Cairo, Georgia 31728  
(912) 377-7120 Ga. Phone No.

CIRCLE 520 ON READER CARD

SYSTEMS \* PERIPHERALS \* PARTS

# DG

*Phil Thomas*  
305/272-2339

# DEC

*Bryan Eustace*  
305/272-2338

*Jennifer Eustace*

TELEX 807-219

**BUY · SELL · TRADE · LEASE**

## THOMAS BUSINESS SYSTEMS, INC.

CIRCLE 521 ON READER CARD

JOB MARKETPLACE

### Experienced Systems Programmers/ Programmer Analysts

Send resumes to: Mary Scott,  
(203) 273-3790, Recruiting  
Office, Aetna Life & Casualty,  
900 Asylum Avenue, Hartford,  
CT 06156. An equal opportunity/  
affirmative action employer.



CIRCLE 522 ON READER CARD

ATLANTA  SUN BELT

Technical Sales Support  
Start 21 to 28K

Plus Merit Compensation

YOU WILL BE:  
Technical Sales Support Specialist  
Programmer/Systems Analyst  
Data Communications Specialist

YOUR EXPERIENCE WILL INCLUDE:  
3.5 Years Systems Analyst  
Computer Science/Technical Degree + 2 Years Experience  
Good GPA  
Leadership

**Begin Tomorrow Today**

Management Dept. DPDC P.O. Box 4455  
Atlanta, Georgia 30302

An Equal Opportunity Employer

CIRCLE 523 ON READER CARD

# SUBMARINE SIGNAL

There's only one place to go for the finest careers in undersea technology: Raytheon's Submarine Signal Division. We've assembled on the shores of the Atlantic the most gifted teams of professionals, dedicated to superiority in ASW Technology, Sonar, underwater systems, oceanography and marine systems and equipment. With the support of a multi-billion dollar company and major R&D commitment backing up our vision.

You'll find the chance to work on an unparalleled variety of

tasks, from small water resource studies to major systems design. And we'll sharpen your skills with top-notch colleagues, in-house educational programs, and flexibility of assignments to short and long term programs.

If you want to work in undersea technology, come to Raytheon Submarine Signal Division. You'll be right in your element.

Raytheon Submarine Signal offers you an incomparable working and living environment in Portsmouth, RI, one of the Northeast's best kept secrets. Whatever lifestyle you seek, urban or rural, modern or traditional, countrified or oceanside, our convenience to Providence, Boston and New York provides the answer. Plus, you'll enjoy Raytheon's excellent salary and benefits package.

# The Capitol of the Undersea Community.



★ Portsmouth, RI

## SOFTWARE

### Sr. Engineers

Translate systems requirements into software architecture, and direct a team of software engineers through the implementation of this system to delivery. This involves Fire Control Systems applications including reliability, error reporting, display graphics, target geometry. High order and assembly languages required.

### Methods Engineers

Extend our integrated software development environment (PDP-11 and VAX-11-780 with interactive time sharing system) in the areas of program requirements and design languages, software tools and target interfaces. We seek individuals with all levels of experience, plus formal training in languages/compiler development, Ada, simulation and modeling.

## SYSTEMS

### Fire Control

Analyze, design and specify advanced functional level systems. You should have Fire Control Systems knowledge (MK 113/10, MK 117, MK 118) and experience with the implementation on AN/UYS-7 based combat systems.

### Sonar

Comprehensive sonar systems involvement, with substantial customer contact. Total sonar systems design experience is required, with in-depth knowledge of signal processing hardware and/or software systems design procedures.

### Systems Analysis/Simulation

Apply scientific computers to modeling simulations and analyses. Experience solving practical physical problems through applying analysis/simulation techniques.

## Surface ASW

Translate our customer requirements into a comprehensive system architecture, and define critical items for development.

## Systems Analysis

Experience in applying estimation theory to Kalman Filtering and other estimation problems in applied environment.

## Command/Control

For both submarine and surface applications, develop command and control systems for tactical employment, display communications, navigations, sensor and weapons systems.

*If you possess a minimum BS and 5 years' experience, send your resume and salary history to: Manager of Professional Employment, (Dept. D-7), Raytheon Company, P.O. Box 360, Portsmouth, RI 02871.*



RAYTHEON

RAYTHEON COMPANY

SUBMARINE SIGNAL DIVISION

An Equal Opportunity Employer

CIRCLE 141 ON READER CARD

# READERS' FORUM

## THE LOVE SONG FROM THE BASEBAND

Local nets, when you an I  
No longer batch against an evening sky  
And Ethernet is spread on coax cable.

In the room, the pulses come and go  
It's compatible, but it's slow . . . .

I grow old . . . I grow old . . .  
Waiting for stations to be polled.

Do I dare to packet switch?  
I have heard the mermaids singing, tell me which  
Is pinned and wriggling on the wall.  
Do I dare to make a call?

My life is measured out in MIPS and KOPS  
'Til voice output awakes us and it stops.

Front-end, month-end, payroll tax  
And April is the cruellest month . . .  
(Mixed T.S. and TSO)  
In the room, the pulses come and go.

As commuters from suburbs rich & germinal  
Data is loosed in every terminal  
Printout blurred and characters shot  
Daisy-wheel loves me not . . .

Alone, standalone  
Intelligent, dumb  
All these and more  
Linked to my core.

Do I dare a fast-track risk  
When there's no backup for the disk?

Once stars, now satellites  
Absorb my days and mock my nights  
How do I wander . . .

I gave her channel number five  
She gave me her transponder.

Edit and audit the library of my mind  
As tapes unwind  
And still I find

Her conversation was a vector  
I cry out and find no selector.



I scan my terminal existence  
Life offers me no ace  
I know, at last, I have become  
The vendor of my database,  
A pair of ragged clause  
Scuttling through an RFP.  
That laugh, that drink was long ago in the room.  
The pulses come and go.

Be still, and know that I am Baud.

Consultant's fee  
Shantih  
Shantih

—S. Williams-Haik  
W. R. Crisp  
Pound Ridge, New York

## READERS' FORUM

# ADA

The report that Ada, the Department of Defense's new programming language, is being trademarked by DOD brought me a sense of déjà vu as I recalled Calvin N. Mooers' effort *circa* 1970 to give similar protection to his computer controlling language system TRAC. Because TRAC was trademarked, any mention of it had to be accompanied by a footnote stating that TRAC is "the trademark and service mark of Rockford Research Institute Incorporated in connection with its standard computer controlling languages." The only other trademarked language of that time was JOSS which had to be footnoted as "the trademark and service mark of the RAND Corporation for its computer program and services using that pro-

gram." Today, language trademarking has proliferated. A glance through the personalized computing advertising columns shows a plague of bugs: the R-in-a-circle and the tiny TM attached to all manner of software. (One firm even seems to claim FORTRAN as a trademark.)

I am sorry to see the DOD put Ada in this company. It has always seemed to me that the ridiculous legalisms associated with language name trademarks and heavy-handed attempts at control impede the free discussion of a language in publications and effectively block the publication of textbooks. If a language is not written about and does not stimulate good textbooks, it will decline and die.

I am sure that Lt. Col. Druffel's objectives, "to ensure that Ada is established as a consistent, unambiguous standard," are admirable, but the evidence of the trademarking of TRAC and JOSS may tell us something important. Certainly impediments to publica-

# DATAMATION CROSSWORD

**GENTLE TINKERS**  
by Brian Burke

### ACROSS

1. Plant of the arum family
6. Lifted
11. Measurement gp.
14. Scratch
15. Worn
16. Business: suffix
17. Belle, Bart, or Brenda
18. Know-it-alls from Oak Brook
20. Joes
22. Matter
23. Desire
24. 18 across, for one
27. Upstate N.Y. school
29. To a \_\_\_\_\_
30. More than this
31. Dogpatch word
33. Alias initials
35. Catarrh
40. Accountant's friend in Needham
44. Wing: prefix
45. Start of a Dickens quote
46. Choose
47. Dress
50. Korean currency
52. Charisse
53. DBMS man on the o-t-c
59. U.S. chemist Harold C.
60. Uncle, in Madrid
61. Resort
62. Watches the Street from the Orioles' nest
65. Ceiling
69. First word of Dante's Inferno
70. Light, to Livy
71. Duck
72. Draft org.
73. Inveigle
74. Edsel, e.g.

### DOWN

1. Paleolith
2. Skill
3. Grassland
4. "Key \_\_\_\_\_"
5. No power, no mooring
6. Granatelli's balm
7. Pope's triple crown
8. Ill-natured
9. Occupant, sometimes

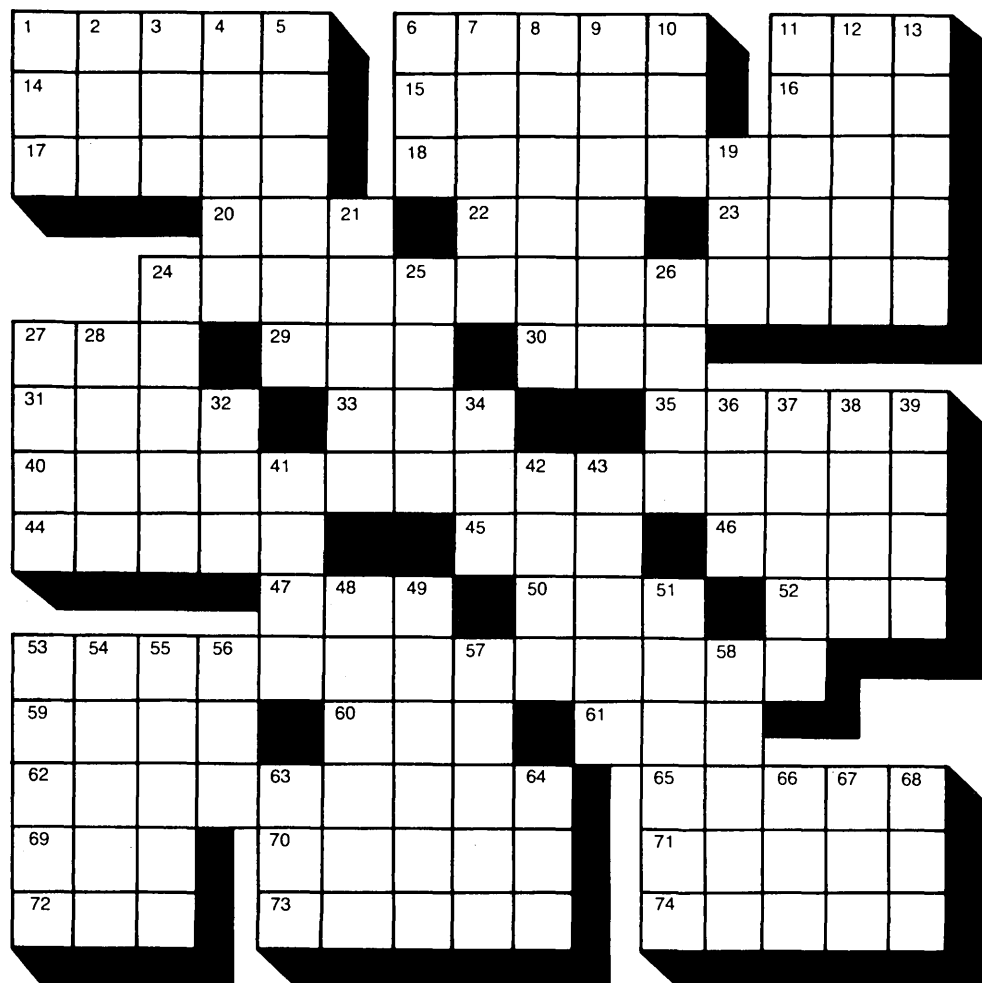

10. Former name for Tokyo
11. Jawaharlal or Pandit
12. Hoosegows
13. Chinese silver ingot
19. Am able, in Apulia
21. Clam's fate
24. Ago
25. New Zealand flightless bird
26. Dense
27. Graded roadway
28. Denizen of ancient Britain
32. Jutting rock

34. Apostolic doing
36. Ad \_\_\_\_\_
37. Elicit
38. George of "Midnight Blue" tv
39. Pinochle declaration
41. Campus org.
42. New Zealander, to an Aussie
43. See 62 across
48. Imitate Houston McTear
49. Tumor of neuroglia cells
51. Tyrrhenian port
53. Peron et al.

54. Shield borders
55. Leans
56. Greek goddess of night
57. Scowl
58. Ingenuous
63. Fed. data agency
64. Comp. dir.
66. Like Rasputin
67. Mountain near Troy
68. Derek, e.g.

**Solution on p. 216**

# Georgia's USCN Network ...

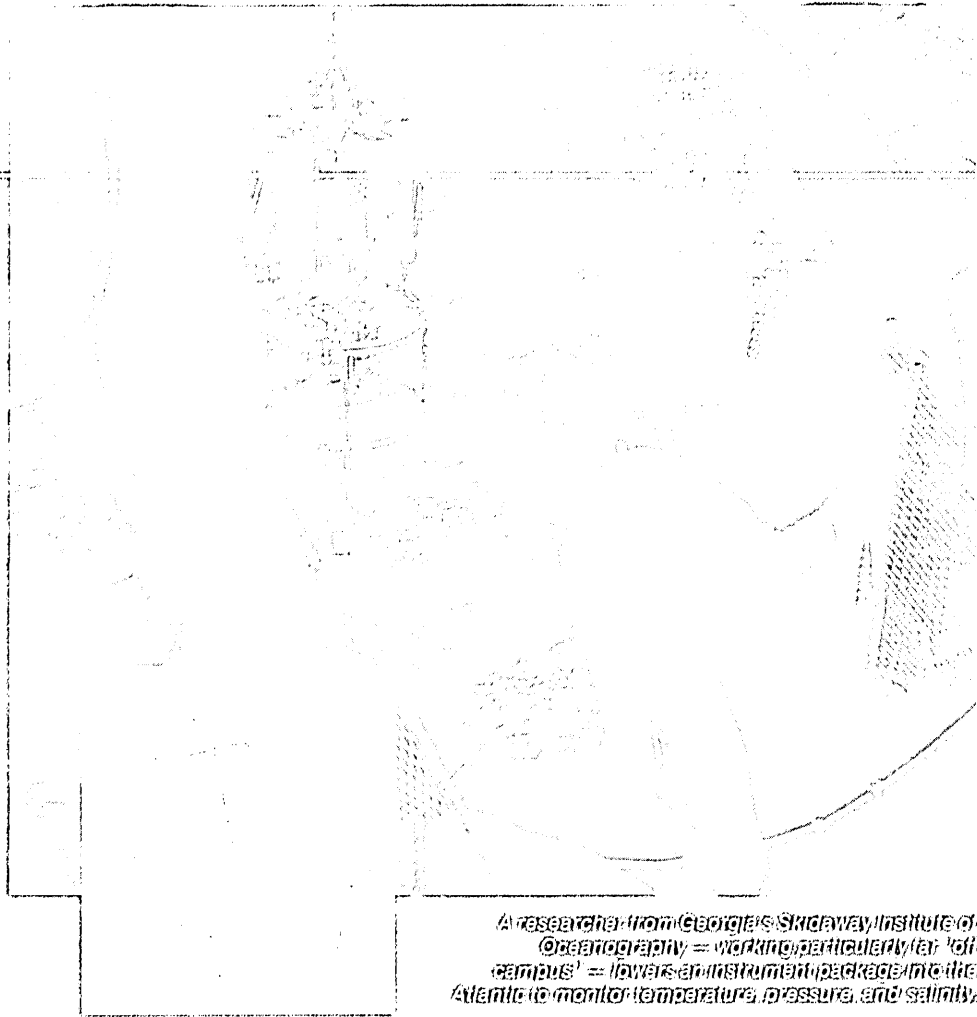

A researcher from Georgia's Skidaway Institute of Oceanography = working particularly for 'off-campus' = towards an instrument package in the Atlantic to monitor temperature, pressure, and salinity.

## ... It also a Tran Network.

Georgia's University System Computer Network was officially established in May, 1970 to provide access to major computer resources for all units of the university system. The problem then, as now, was in providing a cost-effective communications path from any terminal to any computer.

Today USCN encompasses hundreds of pieces of communications equipment and over 2,500 miles of private and foreign exchange telephone lines. It links the central offices, 38 campuses, experiment stations, the Skidaway Institute of Oceanography, and several other user sites throughout the state. And cleanup facilities further extend its reach.

The additional campus, campus

ently supports switched synchronous and asynchronous traffic at up to 9600 bits per second statewide, plus simultaneous packet and time division-switched traffic at 50,000 bits per second between its main nodes in Atlanta and Athens.

Over thirty computers are tied to the network; at present, the largest of which are Control Data Cyber 70/74's, IBM 370/158s, and Univac 9080s which serve as network hosts. Remote job entry stations plus many hundreds of remote and local terminals keep the processors busy.

No census of the rapidly growing and changing mix of computers, front end communications processors and terminals stays current long. And

putting this USCN designer produced a network which is easily re-configured and which can quickly grow to accommodate new users and applications. In these respects too, USCN continues to be a happy success, confirming the original design philosophy.

Tran has installed several such networks for university systems, and many more for telephone companies, financial institutions, government agencies and private industry in the United States and other nations. Simultaneously performing X.25-compatible packet, circuit, and Packet switching, its networks are unmatched by any other in the world.



AN AMTRAK COMPANY

TRAN TELECOMMUNICATIONS CORPORATION

Corporate Headquarters: 250 Ward Avenue, Marietta, GA 30067. Call (404) 622-8200. Tran Communications, Inc., Ontario, Canada: 1-800-387-1111. Atlanta: 1-800-387-1111. Sydney, Australia: (02) 233-6666. Digital Network Engineering: 1415 Georgia Avenue, N.W., Atlanta, GA 30309. (404) 252-1550. Fax System: (404) 252-1550. Raleigh, North Carolina: (919) 876-6666. Johannesburg, Rep. of South Africa: (011) 261-6666.

## SYSTEMS PROGRAMMERS

*Leeds & Northrup's Systems Unit has the right career opportunity for you!*

If you're looking for a position offering professional career development and challenging and diversified work assignments in a stimulating technological environment, Leeds and Northrup's Systems Unit has the opportunity for you. During more than 35 years of constant growth we have been designing and manufacturing process control systems that expand production, upgrade product quality, optimize yields, conserve energy, protect the environment, prevent pollution and preserve our resources. Career opportunities are available now!

### DEVELOPMENT

**VAX SYSTEMS PROGRAMMER.** We seek a qualified systems programmer capable of generating, maintaining and enhancing the VAX/VMS system and of developing new software tools for program development. You should have several years experience in a VAX environment and be competent to deal daily with VAX and VMS systems functions.

### INDUSTRIAL APPLICATIONS

Positions available within the expanding Industrial Systems Section for entry and experienced programmers/software engineers who are seeking challenging opportunities in the state-of-the-art, real time process control applications. Specific opportunities exist in each of the following areas:

- **CUSTOMER PROJECT:** Project leaders with 3 to 5 years experience in customer interface, cost and schedule control, and real time systems.
- **APPLICATION DEVELOPMENT:** Engineers or programmers to participate in the design and implementation of a Host based distributed control systems. Experience in FORTRAN, PASCAL, Assembly on mini, Z80/8086 microprocessors, desired.

### ELECTRIC POWER APPLICATIONS

Openings available for real time systems programmers to work on complex projects. Systems and man-machine interface software and advanced application programs in FORTRAN and Assembly languages. Latest programming tools and professional environment with unlimited opportunities in growing company. BS in CS, Math or Engineering with minimum of 2 years experience.

### POWER PLANT APPLICATIONS

Position available within the expanding Steam and Nuclear Power Systems Section for an experienced programmer to lead the production of software for our customer orders. Responsibility includes all technical aspects, cost control, scheduling and direct customer interface. We apply 16 Bit minicomputers coupled with 16 & 8 Bit microprocessors to monitor and control generation of electricity. We are seeking a senior level programmer/analyst with a BS in Computer Science, Engineering or Math and 5 to 10 years programming experience in a real-time systems environment. Experience in project leadership involving user interface, cost and schedule control responsibility is definitely preferred. Programming experience should include Assembly and FORTRAN languages.

Our modern manufacturing facility is located in North Wales, Pa. Philadelphia, with its abundance of theaters, art and science museums, restaurants and outstanding teams for every major sport, is only 30 minutes away. New Jersey seashore resorts with their ocean swimming, sandy beaches and casinos as well as the winter and summer attractions of the Pocono Mountains are easily and quickly accessible by car or public transportation. In addition to the advantages of continued professional growth, we offer a competitive salary and an ALL company paid benefits package which includes 14 holidays, service days, tuition refund, dental plan, savings and investment plan, just to mention a few. For immediate consideration forward your resume INCLUDING SALARY HISTORY AND REQUIREMENTS to Joel Tokarz, Professional/Technical Employment, Department D, Leeds & Northrup, Sumneytown Pike, North Wales, Pa. 19454, or call for additional information, (215) 643-2000, Ext. 2010.

An Equal Opportunity Employer, M/F/H



**LEEDS & NORTHRUP**  
A UNIT OF GENERAL SIGNAL

*Technology For The Future...Now!*

CIRCLE 143 ON READER CARD

## READERS' FORUM

tion harm the spread and use of a language. Perhaps if control is exercised which restrains the computing community from fooling with and attempting to improve a language, the end result is nonuse and early death.

Perhaps there is no need to worry. If Ada is good, it probably will be used and adjusted outside the DOD embrace, perhaps under a pseudonym like *Ida* or *Dada*.

—Eric A. Weiss  
Sun Company  
Radnor, Pennsylvania

## DEAD-ENDED

### Why the beast should be shot.

1. *System Cants.* There are numerous "system cants" as in "the system can't handle that," or "the system can't give us that," etc.
2. *Manual Labor.* There are people doing manual, routine, clerical functions that should be automated.
3. *Lost Business.* Business has to be turned down or changes to products have to be cancelled or delayed because the system can't be changed.
4. *Interfaces.* The system can't be made to interface with other systems.
5. *Data Entry.* There is difficulty in entering error-free data, slow turnaround of errors, and entire rekeying of corrections.
6. *Legal Requirements.* It is difficult to satisfy legal or corporate requirements and therefore manual systems must be put in place.
7. *Volumes.* Large volumes (accumulated or projected) adversely affect the system—in run time, turnaround time, response time, etc.
8. *New Technology.* The system can't adapt to "new" technology such as the laser printer, on-line inquiry, on-line data entry, random access files, master record philosophy, etc.
9. *Unique Needs.* There are unique hardware or software requirements that can't be changed, e.g., MFICM, OCR, MICR, Data Cell, user written sorts, internal tables, 90 column cards, paper tape, RCA equipment, etc.
10. *No Support.* A purchased package is no longer supported by the vendor or it has not been kept up to the latest release by the user.
11. *Problems.* The number of system/program problems and the time it takes to fix them are increasing.
12. *Antique Technology.* Old-fashioned technology abounds—cards, tape master files, 80-character records, multiple programming languages (e.g., RPG, BASIC, APL, assembler), hard-coded record descriptions instead of copy modules, redundant data found in multiple records or files, operator intervention required, complex/meaningless codes (November = J, NJ = 29), undecipherable error codes or messages, second generation emulation, etc.
13. *Complexity.* It takes an expert to understand or make changes to the system—new/junior people require a long training period to become productive because of the system's complexity.
14. *Spaghetti Code.* The source program code is unreadable, convoluted, meandering, obtuse, mumbo-jumbo that no one dares change.
15. *Obsolete Language.* The programs were written in a language that is no longer supported (e.g., COBOL 72, PL/I-F, FORTRAN II)



**Call for your free copy today!**

# New! 1981 Local Metropolitan Computer Salary Survey.

Do you know how your salary compares with other EDP professionals in your field of specialty—with the same level of experience—working in your city, or in other cities across North America? Are you being well paid for what you do? Are salaries better elsewhere?

Now you can find out simply by calling today and asking for a copy of our new 1981 Local Metropolitan Computer Salary Survey. It's FREE!

Depending on your particular field of specialty and where you live, you'll find compensation levels have increased dramatically over last year—in some cases by more than 20%.

In all, 48 specific position categories are surveyed ranging from Programmer through MIS Director. This new report will let you know whether

your earnings are really keeping pace with others living and working in your geographic area.

Source Edp, North America's largest recruiting firm specializing in the computer field, publishes this valuable Survey annually as a service to computer professionals from coast to coast. The 1981 Survey shows current salaries in your area, 37 other areas in the U.S. and Canada, plus overall national averages.

As you will discover, this Survey can be extremely valuable in helping you make important career decisions. Call for your free copy today.



North America's largest recruiting firm devoted exclusively to the computer profession. Client organizations assume our charges.

## FREE Report!

Call your nearest Source Edp office today.

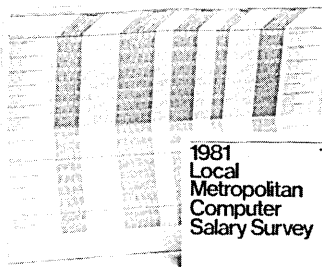

If unable to call, write:  
Source Edp, Department D7  
2 Northfield Plaza, Suite 227,  
Northfield, Illinois 60093

(When writing, please be sure to indicate home address and current position title.)

### United States

**Arizona**  
Phoenix 602/258-9333

**California**  
San Francisco 415/434-2410  
Mountain View 415/969-4910  
Los Angeles 213/386-5500  
Van Nuys 213/781-4800  
Torrance 213/540-7500  
Irvine 714/833-1730  
San Diego 714/231-1900

**Colorado**  
Denver 303/571-4450  
Englewood 303/773-3700

**Connecticut**  
Hartford 203/522-6590  
Stratford 203/375-7240

**District of Columbia**  
Washington 202/466-5890

**Florida**  
Miami 305/624-3536  
Fort Lauderdale 305/491-0145

**Georgia**  
Atlanta Central 404/588-9350  
Atlanta Suburban 404/325-8370  
Atlanta North 404/953-0200

**Illinois**  
Chicago 312/782-0857  
Northfield 312/441-5200  
Oak Brook 312/986-0422  
Rolling Meadows 312/392-0244

**Indiana**  
Indianapolis 317/631-2900

**Kansas**  
Overland Park 913/888-8885

**Louisiana**  
New Orleans 504/561-6000

**Maryland**  
Baltimore 301/727-4050  
Towson 301/321-7044

**Massachusetts**  
Boston 617/482-7613  
Burlington 617/273-5160  
Wellesley 617/237-3120

**Michigan**  
Detroit 313/259-7607  
Southfield 313/352-6520

**Minnesota**  
Minneapolis 612/544-3600  
St. Paul 612/291-2467

**Missouri**  
Kansas City 816/474-3393  
St. Louis County 314/862-3800  
St. Louis Downtown 314/231-4880

**New Hampshire**  
Nashua 603/880-4047

**New Jersey**  
Cherry Hill 609/482-2600  
Edison 201/494-2800  
Morristown 201/267-3222  
Paramus 201/845-3900

**New York**  
Midtown 212/736-7445  
Wall Street Area 212/962-8000

Long Island 516/364-0900  
White Plains 914/683-9300  
Rochester 716/263-2670

**Ohio**  
Cincinnati 513/769-5080  
Dayton 513/461-4660  
Cleveland 216/771-2070

**Oregon**  
Portland 503/223-6160

**Pennsylvania**  
Philadelphia 215/665-1717  
King of Prussia 215/265-7250  
Pittsburgh 412/261-6540  
Wilkins Township 412/247-4400

**Texas**  
Dallas North 214/387-1600  
Dallas Downtown 214/749-1900

Fort Worth 817/338-9300  
Houston Central 713/751-0100  
Houston Suburban 713/626-8705

Houston North 713/957-8555  
San Antonio 512/344-0217

**Virginia**  
McLean 703/790-5610

**Washington**  
Seattle 206/454-6400

**Wisconsin**  
Milwaukee 414/277-0345

**Canada**  
Toronto 416/865-1125  
Don Mills 416/425-5730

# Chained to your System/3 by CCP?

## Convert to CICS... Automatically.

Break the chains with DASD's new automatic translator. Automatically converts your System/3 CCP RPG programs to standardized, modularized CICS/VS Command Level COBOL.

There's more. It also converts all screen references to CICS RECEIVE-MAP/SEND/READ-NEXT/WRITE/REWRITE instructions. Generates complete routines for MAPFAIL, IOERR, END FILE, DUPKEY and others. And converts screen definition from DFF to BMS... automatically adjusting for attribute byte differences between CCP and CICS, and producing either CICS/VS Version 1.4 or 1.5, plus printed diagnostics.

This is one of many DASD translators now available — all proven and thoroughly documented. From the list shown here, select those you're interested in. Then send or call for more information.

DASD can provide any level of conversion service, from simple per-line/per-program conversions through complete turnkey projects. We're the conversion specialists.

## Conversion Programs Available

RPG/RPG II to COBOL  
CIRCLE 144 ON READER CARD

NEAT/3 to COBOL  
CIRCLE 145 ON READER CARD

DIBOL to COBOL  
CIRCLE 146 ON READER CARD

COBOL to COBOL  
CIRCLE 147 ON READER CARD

FORTRAN to FORTRAN  
CIRCLE 148 ON READER CARD

DOS ALC to OS ALC  
CIRCLE 149 ON READER CARD

MAP to COBOL  
CIRCLE 150 ON READER CARD

COBOL ISAM to COBOL VSAM  
CIRCLE 151 ON READER CARD

Job Control Language Translators  
CIRCLE 152 ON READER CARD

MAPGEN on-line CICS Productivity Aids  
CIRCLE 153 ON READER CARD

Business Graphics Reporting System  
CIRCLE 154 ON READER CARD



Member of the Cap Gemini Sogeti Group  DASD Corporation  
Corporate Services Center  
9045 North Deerwood Drive  
Dept. 236  
Milwaukee, WI 53223  
(414) 355-3405

## READERS' FORUM

or written in one language and mechanically converted to another.

16. *Patches*. The programs which suffer from chronic problems are constantly being patched rather than being rewritten, probably because no one truly knows what they do or how they do it.
17. *Object Level*. Changes have been made to programs at the object level.
18. *Source Library*. A complete library of up-to-date source code is not maintained.
19. *Large Programs*. There are very large programs (say, over 5,000 statements).
20. *Simple Programs*. The programs are neither modular nor have a common structure.
21. *Field Changes*. Changes to data elements are extremely difficult, (e.g., the input record, or the files, or the output reports cannot be modified to handle a new element, an expanded element or a new code. In other words, if the 9-digit zip code doesn't kill us, the year 2000 will).
22. *JCL*. The JCL is "sacred" and must never be changed.
23. *Daily Cycle*. The system must be babied through every cycle, must be restarted often, and sometimes just doesn't run.
24. *Documentation*. The documentation of data elements, programs, load modules, procedures, user routines, runbooks, etc. are not complete and/or coordinated, or up-to-date, or intelligible, or all of the above.
25. *Report Writer*. It is difficult to retrieve data—there is no report generator to satisfy ad hoc requests for information.
26. *Testing*. It is very difficult to test changes to the system outside of production.
27. *Morale*. It is difficult to keep people because they hate the system, are bored or depressed by it, can't understand it, or can't improve it.

—J. P. "Buz" Murphy  
Haddonfield, New Jersey

## Answers to puzzle on p. 212

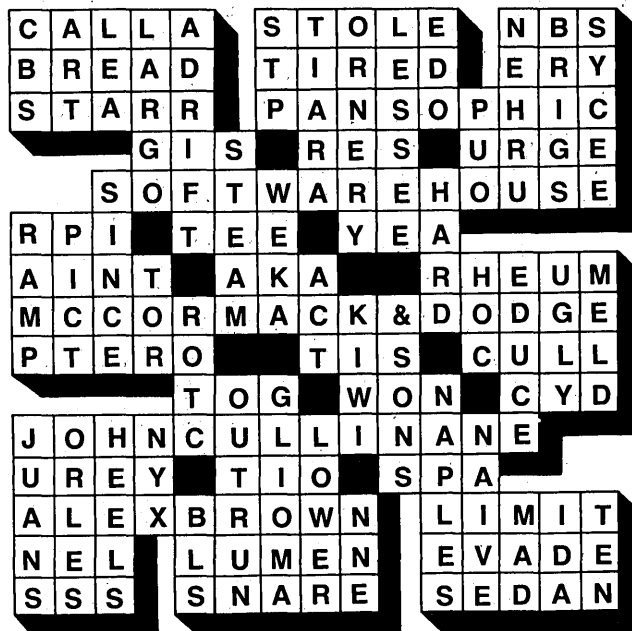

# Multidrop communications for minicomputer users. Save lines, save modems, save money.

If you're using multiple asynchronous dumb terminals (or many of your minicomputer system) you're probably resigned to the high cost of these point-to-point leased lines. There's a better way to connect your terminals to the mainframe.

With a single MICOM's unique Micro900 Multidrop Concentrator you can multidrop those dumb terminals at several different remote locations single and duplex and share a single multidrop line. You can slash your telephone bill immediately *without special software*. What's more, the Micro900 provides automatic retransmission error correction to ensure error-free data transmission on the multidrop line. This is really suited for use with BSC, Data General, Wangware, or any other

available minicomputer system.

With Micro900's unique Micro900 Multidrop Concentrator, you can multidrop those dumb terminals at several different remote locations single and duplex and share a single multidrop line. You can slash your telephone bill immediately *without special software*. What's more, the Micro900 provides automatic retransmission error correction to ensure error-free data transmission on the multidrop line. This is really suited for use with BSC, Data General, Wangware, or any other

available minicomputer system. With Micro900's unique Micro900 Multidrop Concentrator, you can multidrop those dumb terminals at several different remote locations single and duplex and share a single multidrop line. You can slash your telephone bill immediately *without special software*. What's more, the Micro900 provides automatic retransmission error correction to ensure error-free data transmission on the multidrop line. This is really suited for use with BSC, Data General, Wangware, or any other

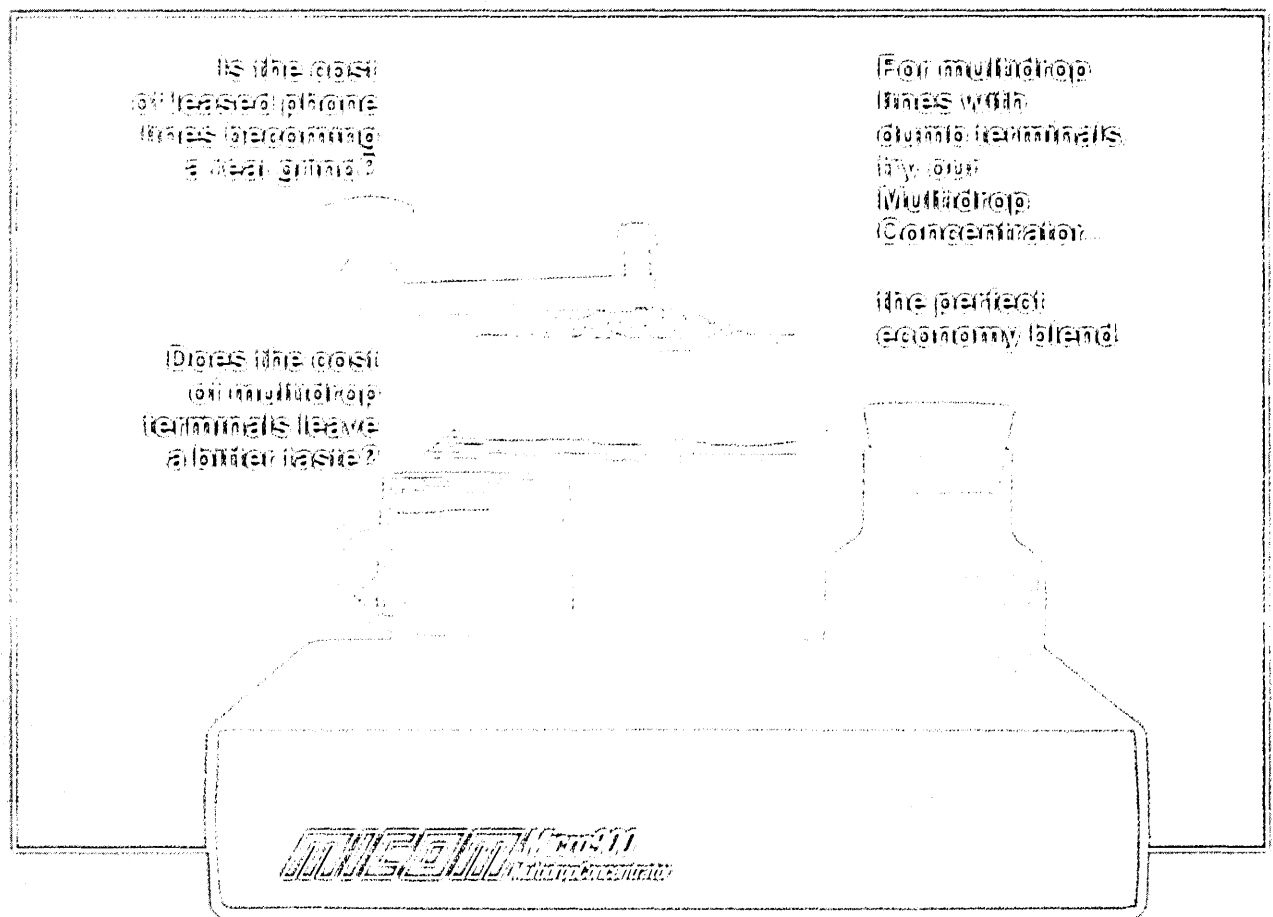

## MICROMULTIDROP *Concentrator for Dumb Terminals*

MICOM SYSTEMS, INC. • 2015 North St. (Glastonbury, CT 06033) Telephone (203) 882-8890 • FAX (203) 882-2910  
 Eastern Regional Sales and Service • Plaza Wng, Suite 514 • 800 Route 9 • Woodbridge, NJ 07095 • (201) 750-1120  
 Regional Sales Offices • Atlanta, GA (404) 385-2222 • Dallas, TX (214) 251-1774 • St. Louis, MO (314) 576-7621  
 MICOM/BORER LTD. • Bal Gouac • 16 Graddock Road • Reading, Berkshire RG2 0AT, England • (0734) 888301 • Telex 647165

Available only from these distributors.

- Atlanta (404) 385-2222 • Austin (512) 271-3167 • Boston (617) 271-3167 • Chicago (312) 271-3167 • Dallas (214) 251-1774 • Denver (303) 425-1120 • Detroit (313) 425-1120 • Fort Worth (817) 271-3167 • Houston (713) 271-3167 • Los Angeles (213) 271-3167 • Miami (305) 271-3167 • Minneapolis (612) 271-3167 • New York (212) 271-3167 • Phoenix (602) 271-3167 • Portland (503) 271-3167 • San Francisco (415) 271-3167 • Seattle (206) 271-3167 • St. Louis (314) 576-7621 • Tampa (813) 271-3167 • Washington (202) 271-3167 • Wichita (316) 271-3167

## THE TERMINAL THAT TELLS YOU WHERE IT HURTS.

Because the Teletype® 4540 terminal is so reliable, there's one feature people rarely see—its unique ability to diagnose its own problems.

Built into every component of the 4540 is a diagnostic system activated by a simple yet thorough test. In an instant, a visual display tells you where the problem lies. Whether it's in the communications facility or in the terminal itself.

If it's in the terminal, the 4540's compact modular design makes it easy to swap components and get back on line in a hurry.

The 4540 also offers a wide variety of applications-oriented printers. Plus a long list of standard features that let it adapt to human beings, instead of the other way around.

The full-featured, reliable Teletype 4540. You may never need its self-diagnostics, but it sure won't hurt to know they're there.

### THE TELETYPE 4540.

Not just another 3270-compatible tube.



Teletype Corporation, 5555 Touhy Ave., Dept. 3212-A, Skokie, IL 60077, Tel. (312) 982-2000  
"Teletype" is a registered trademark and service mark of the Teletype Corporation.

CIRCLE 3 ON READER CARD