

DATA**83**MATION

MAY 4 1983 USA



ALSO

NEWS ADDRESS SPACE ODYSSEY
A PBX COOKBOOK
THE STORMING OF THE PTTs

Model 6455 Cartridge Tape System

Loaded with Features — Loaded with Benefits.

Kennedy products have always provided innovative new features. And these features have always provided real benefits and convenience for the user. For instance, our Model 6455 offers these features and benefits:

Feature: Start/Stop Operation

Benefit: Drive can emulate a 1/2" tape drive. And you have the ability to perform selective file backups, file restructuring, journaling and recovery updates.

The drive is effectively a 1/2" drive in a much smaller package.

Feature: Hard Read Error Space (HRES) Mode

Benefit: Best data reliability. In any mode, the drive gives the user confidence in the backup medium.

Feature: Onboard Diagnostics

Benefit: Drive checks itself for errors. Equipped with a self-test menu.

Feature: Cartridge Jam Protection

Benefit: Protects the cartridge from damage if cartridge jams. This is accomplished by sensing a current surge and then disabling the motor. Thus insuring that the cartridge will not be damaged.

Feature: High Density Recording

Benefit: Storage capacity of 28 MB on a single cartridge.

As you can see, we're driving at. Model 6455 has a lot of unique features and benefits for you. For the complete story, write or call us today.

KENNEDY

an Allghany International Company
601 Sandrock Ave. Menlo Park, CA 94025
(415) 351-8300 TELEEX 472016 KENNEDY
FAX 310-555-8249

ALLGHANY INTERNATIONAL INC.

601 Sandrock Ave. Menlo Park, CA 94025
Tel: (415) 351-8300
Telex: 472016 KENNEDY
Fax: 310-555-8249

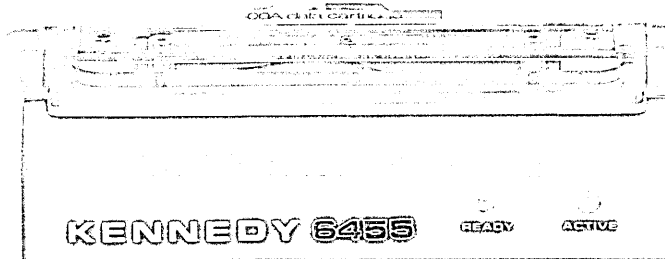
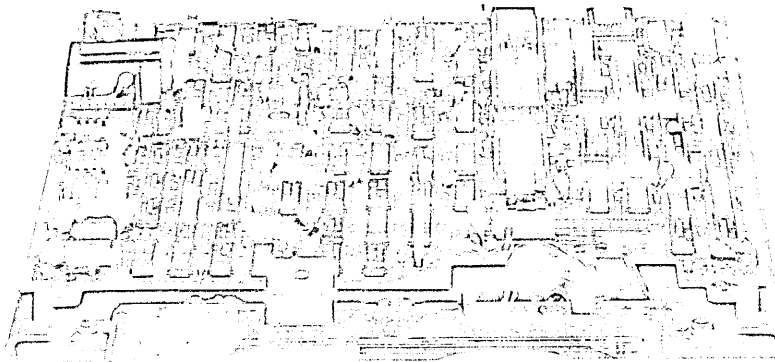

KEN

ON IT

Why should you care that we became the big name in the little end of the concentrator business?

One reason you might care is that we got there by building a family of data concentrators which saved you money and solved your data communications problems.

Micro800/2 Data Concentrators

The world's most popular line of data concentrators. Specifically designed for the user of minicomputers and "dumb" asynchronous terminals, they can pay for themselves in a few months by supporting many remote terminals on one telephone line, while also providing Automatic Retransmission on Error, Satellite Capability, Synchronous Channel Support, a Command Port, and much more.

Micro800/2 Multidrop Concentrators

Bringing the benefits of MICOM's data concentration to users whose terminals are widely scattered, so that "dumb" terminals in up to 16 different locations can share a single telephone line.

Micro800/2 HP Data Concentrators

Specially designed to handle the unique requirements of HP 3000 systems employing HP's ENQ/ACK protocol.

Another reason you might care is that now we can solve your next data communications problems too, with new family members such as:

Micro860 Concentrator Switches

Brand new kinds of products which bring add-on switching, contention queuing, and centralized management to networks of up to eight data concentrators.

Micro800/X-25 Concentrator PADs

Products which combine the benefits of Micro800/2 Data Concentrators with CCITT X-25-compatible packet assembly to allow asynchronous terminals and computer ports to access public or private Packet Data Networks easily and inexpensively.

And still another reason is that concentrators are only one family of MICOM products. Now we can be the only source you need for minicomputer data communications products from modems to data PADs to local networks. Thanks to you, we're big in those fields too!

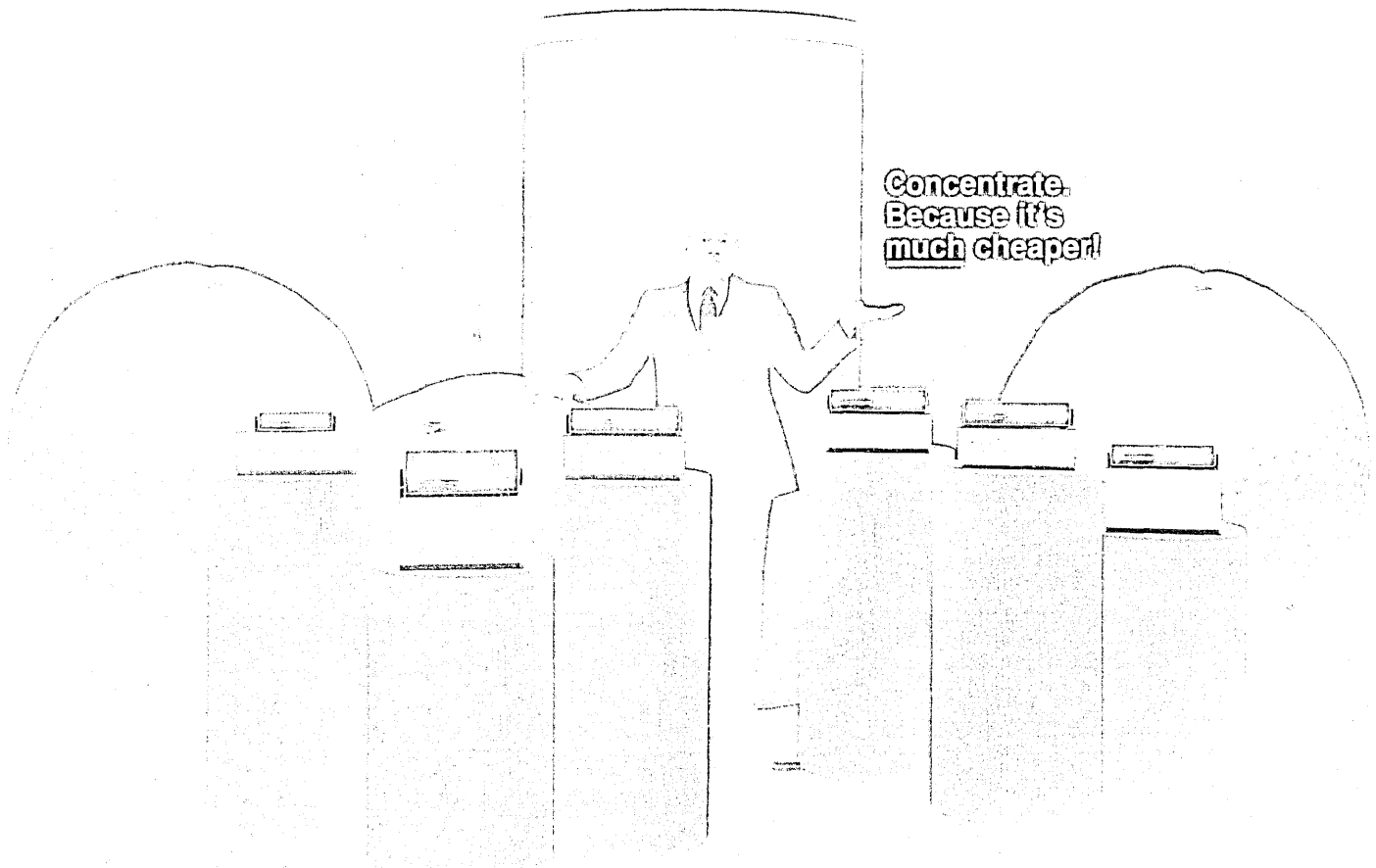

MICOM[®] *Microcomputers for Data Communications™*

MICOM SYSTEMS, INC. • 20151 Northolt Street • Chatsworth, CA 91311 • Telephone (818) 892-8844 • TWX 810/454-4910
Regional Sales/Service • Atlanta, GA • (404) 485-2399 • Boston, MA • (617) 527-4010 • Chicago, IL • (312) 642-8808 • Dallas, TX
(214) 258-0774 • Philadelphia, PA • (610) 776-0183 • St. Louis, MO • (314) 576-7626 • Woodbridge, NJ • (201) 750-1120
MICOM (REGOR) LTD. • Bell Court • 15 Graddock Road • Reading, Berkshire RG2 0JF, England • (0734) 866801 • Telex 827185

CIRCLE 4 ON READER CARD

Candle Corporation®

Candle Corporation – a software company supplying performance monitoring programs to MVS, CICS, and IMS installations.

MVS

For MVS installations, Candle's OMEGAMON® realtime monitor has gained worldwide recognition for being able to reduce IPLs. DEXAN™ for MVS helps analyze the performance of batch and TSO in realtime. EPILOG/MVS™ is a background performance management system.

CICS

OMEGAMON/CICS® is a realtime monitor that warns of CICS problems as they are happening. The RTA/CICS™ option will display response time information graphically. ESRA/CICS™ is a new intelligent background performance analyzer that searches for response time problems and then looks for the causes.

IMS

Candle is currently introducing a series of IMS products. OMEGAMON/IMS™, RTA/IMS™, and DEXAN/IMS™ will provide realtime windows into IMS problems, response time and degradation. EPILOG/IMS™ will perform in a background mode looking for and diagnosing response time problems.



MCAUTO® – Monitoring multiple MVS systems using OMEGAMON.

Candle.

Dept. MI • 10880 Wilshire Blvd., Suite 2404
Los Angeles, CA 90024 • (213) 821-2902

Please send me more information on products that monitor performance of: MVS CICS IMS

Please enter my free subscription to the Candle Computer Report

CPU _____ Operating System _____

Name _____ Title _____

Company _____

Address _____

City _____ State _____ Zip _____

Phone _____

A-186

EDUCATION

Candle provides top level technical support to customers. We offer courses, seminars, video-tapes, tuning guides, and special reports to help keep users up to date on how to monitor the ever changing IBM systems.

TECHNICAL NEWSLETTER

The Candle Computer Report is a newsletter that explores current topics and news in MVS, CICS, IMS and IBM hardware. It is provided free to IBM and IBM compatible installations.

DATA MATION®

MAY 1983/\$4.00 U.S.A.
VOLUME 29 NUMBER 5
This issue, 172,655 copies

FEATURES

40 IN FOCUS

The industry's strongest growth is no longer coming from mainframes but from a number of smaller markets, according to this year's Cowen & Co./DATAMATION cpu survey, reports John W. Verity.

114 OUR NEWEST HIGH-TECH EXPORT: JOBS

Laton McCartney

Lower labor costs are not the only reasons many American dp firms have set up offshore operations.

122 IBM'S ADDRESS SPACE ODYSSEY

DATAMATION notes the arrival of IBM's Extended Architecture with a two-part report. In "The View from the Trenches" (p. 125) Robert T. Fertig presents the results of a survey he did last year on users' migration plans. In "The View from White Plains" (p. 139) IBM's Ronald L. Bond provides an unprecedented view into the workings of XA.

155 THE STORMING OF THE PTTS

Dan Schiller

U.S. deregulation of the telecommunications industry is being copied by countries around the world.

162 NCC: TOO BIG FOR COMFORT?

Willie Schatz

"Oh to be in Anaheim now that NCC's there" may not be your verse, but few sites are big enough to contain the monster conference. Also: highlights of the dozens of technical sessions and professional development seminars scheduled.

169 NCC PRODUCT PREVIEW

Michael Tyler

A preconference look at some 50 products that will be unveiled at Anaheim on May 16.

207 WHICH MICROFLOPPY IS RIGHT?

Peter Krass

Three technologies are contenders in the office automation marketplace: magneto-optical, perpendicular recording, and isotropic recording.

211 SAYING SAYONARA TO THE 19TH CENTURY

Linda Runyan

Faced with economic realities, the Japanese are recognizing the need to automate their offices.

216 A PBX COOKBOOK

Robert L. Patrick

How do you decide if a PBX is right for your company? Part three of a four-part series on the private branch exchange.

227 DECENTRALIZED SYSTEM TESTING

Robert M. Sturm

A corporation's thorough planning plus user participation resulted in a successful material management system test.

238 THE COMPUTER MUSEUM

W. David Gardner

Nostalgia for old-timers and history for the younger generation: the Marlboro, Mass., home of early computers.

247 CATALOGING THE PROGRAM LIBRARY

Melinda Thedens

New efficiency for programmers with library reference guides.

252 THE HISTORY OF MYTH NO. 1

Werner L. Frank

The creator of a famous curve depicting ever-rising software costs vs. ever-falling hardware costs rejects his offspring.

260 THE OTHER HALF OF THE COMPUTER REVOLUTION

Jeremy Rifkin

Genetic engineering, computers, and our economic future are examined in *Algeny*, a new book by the author of *Entropy: A New World View* and *The Emerging Order*.

NEWS IN PERSPECTIVE

56 STRATEGIES

Plugging the mole holes.
A talk with Trilogy.

75 MINICOMPUTERS

Low-end action at IBM.
Out from under a shadow.

83 STARTUPS

Queue and count.
Keys's form of Magix.

92 TERMINALS

3270 makers react.

96 PROGRAMMING

OS/VS COBOL on a micro.

101 GOVERNMENT

Feds open R&D purse.

109 PRINTERS

Diablo sees new markets.

110 BENCHMARKS

DEPARTMENTS

8 LOOKING BACK

13 LOOK AHEAD

18 CALENDAR

23 LETTERS

37 EDITORIAL

Are micros a macro scam?

289 HARDWARE

303 SOFTWARE & SERVICES

314 ADVERTISERS' INDEX

320 MARKETPLACE

325 SOURCE DATA

332 ON THE JOB

335 READERS' FORUM

OEM SUPPLEMENT P. 282-1

- 5 HIGH HOPES AT THE HIGH END

-15 COMPUTER SERVICE FOR THE OEM

-27 OASIS, PICK, AND UNIX: OS FOR OEMS

COVER BY JOAN STEINER
PHOTOGRAPH BY E. AND J. STALLER

Our one option is free.

The AJ 520. All that a professional display terminal was meant to be. Loaded with features. A 15-inch screen. Big, easy-to-read characters in 80 and 132 columns. Simple set-up menu. Large memory. User programmable. ANSI standard, VT-100, VT-52 compatible. Optional green or amber screen. Exacting AJ quality throughout. APL and ASCII models, too.

Manufactured, sold, leased, and serviced by AJ. Write for our free catalog, Anderson Jacobson, Inc., 521 Charcot Avenue, San Jose, California 95131.



When you need more than
just a display terminal.



Sales and service throughout North America and Europe. Regions: Eastern (201) 794-9300; Central (312) 671-7155; Western (408) 946-2900. Subsidiaries: Canada (416) 475-5510; France 657-12-10; Germany 02204-53051; U.K. Slough 25172.

CIRCLE 6 ON READER CARD

DATAMATION

Editor John L. Kirkley
Managing Editor Becky Barna
Senior Editor Larry Marion
News Editor John W. Verity
Features Editor Kenneth Klee
Copy Editor Florence Lazar
New Products Editor Michael Tyler
Assistant Features Editor Deborah Sojka
Assistant Copy Editor Jill Grossman
Assistant Editor Lauren D'Attilo
Editorial Assistant Donna Lyons

Bureau Managers

San Francisco Edward K. Yasaki
Los Angeles Edith D. Myers
Minneapolis Jan Johnson
Boston Ralph Emmett

Editorial Advisor Robert L. Patrick

Technical Advisor Lowell Amdahl

Contributing Editors Howard Bromberg,

Philip H. Dorn, Joseph Ferreira,
 Bruce W. Hasenyager, David Hebditch,
 John Imlay, Terry G. Mahn, Laton McCartney,
 Angeline Pantages, Russell Pipe,
 Carl Reynolds, F. G. Withington, Amy Wohl.

International Editor Linda Runyan

Managing Editor, Europe Paul Tate

Technology Editor, Europe Fred Lamond

Correspondents

Washington Willie Schatz

London Malcolm Peltu

Sydney, Australia Norman Kemp

Art Director Kenneth Surabian

Assistant Art Director Susan M. Rasco

Production Manager Kathleen Monaghan

EDITORIAL OFFICES

Headquarters: 875 Third Ave., New York, NY 10022. Phone (212) 605-9400; telex 429073. **New England:** 1 Chaucer St., RFD 2, Sandwich, MA 02563, (617) 888-6312. **Mid-western:** 3607 Garfield Ave. S., Minneapolis, MN 55409, (612) 827-4664. **Western:** 1801 S. La Cienega Blvd., Los Angeles, CA 90035, (213) 559-5111; 2680 Bayshore Frontage Rd., Suite 401, Mountain View, CA 94043, (415) 965-8222. **International:** 6605 Burlington Pl., Springfield, VA 22152, (703) 569-3383; telex 440-413.

CIRCULATION

875 Third Avenue, New York, NY 10022

Circulation Manager Joseph J. Zaccaria

Business Manager Charles J. Johannmeyer

Research Director Laurie Schnepf

Publisher James M. Morris

Technical Publishing

DB a company of
 The Dun & Bradstreet Corporation

BPA Circulation audited
 by Business Publications Audit

ABP Member American Business Press, Inc.

DATAMATION (ISSN 0011-6963) Magazine is issued monthly on or about the first day of every month. Published by Technical Publishing, a company of The Dun and Bradstreet Corp., 1301 South Grove Ave., Barrington, IL 60010; John K. Abely, President. Executive, advertising, editorial offices, and subscription departments, 875 Third Ave., New York, NY 10022. Published at East Greenville, Pa. Annual subscription rates: U.S. and possessions: \$42; Canada: \$60; Japan, Australia, New Zealand: £57; Europe: £52 air freight, £95 air mail. All other countries: £52 surface, £95 air mail. Reduced rate for qualified U.S. students, public and school libraries: \$30. Single copy: \$4 in U.S. Sole agent for all subscriptions outside the U.S.A. and Canada is J. B. Tratsart, Ltd. 154 A Greenford Road, Harrow, Middlesex HA13QT, England, (01)422-8295 or 422-2456. No subscription agency is authorized by us to solicit or take orders for subscriptions. Second-class postage paid at New York, NY 10001 and at additional mailing office. ©Copyright 1982 by Technical Publishing Co., a Division of Dun-Donnelley Publishing Corp., a company of The Dun and Bradstreet Corp. All rights reserved. "Datamation" registered trademark of Technical Publishing Company. Microfilm copies of DATAMATION may be obtained from University Microfilms, A Xerox Company, 300 No. Zeeb Road, Ann Arbor, Michigan 48106. Printed by Foote & Davis/Mid-America. POSTMASTER: Send address changes to Datamation, 875 Third Avenue, New York, NY 10022.

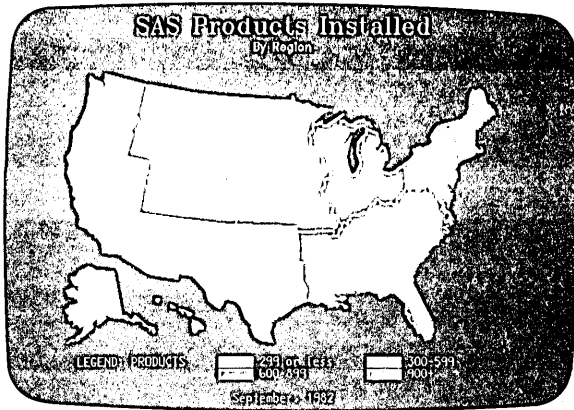

Choropleth Map of Products

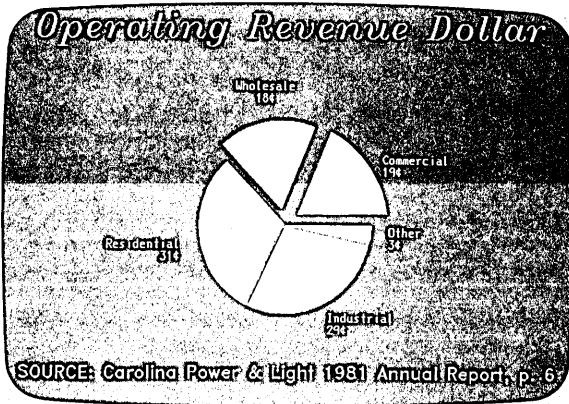

Pie Chart of Revenue

TELEPHONE EXPENDITURES FOR TELEMARKETING
(Estimated Figures)

	(In Millions)	
	1980	1976
Residential originated local calls	\$ 569	\$ 232
Residential originated toll calls	689	269
Business originated local calls	4,144	3,045
Business originated toll		
WATS, 800 calls	443	2,502
TOTAL	\$9,845	\$6,048

SOURCE: ADMA, End-Book on Direct Marketing

Telephone Expenditures

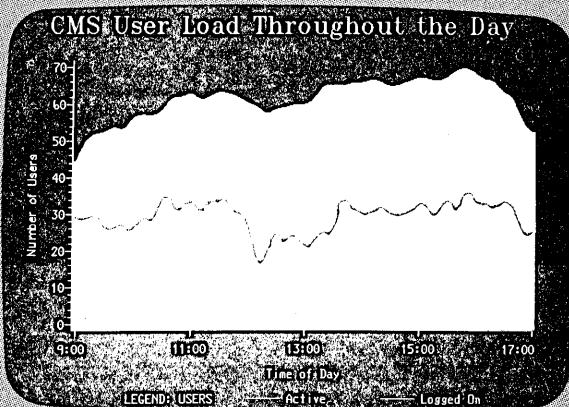

Plot of Load/Time

SAS/GRAPH brings you Instant Replay

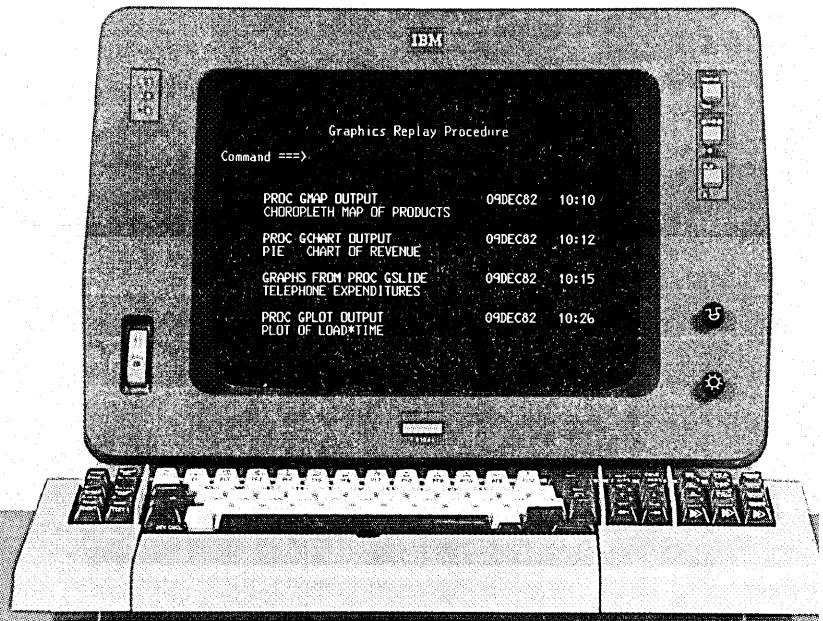

Since its introduction in 1980, SAS/GRAPH has provided "state of the art" software for business graphics. Now SAS/GRAPH brings you a new decision support tool—Instant replay.

With the menu-oriented replay facility in SAS82 (our newest release) your DSS group can

- 1 generate numerous graphical analyses and store the results. Then you can
- 2 choose the best graph—charts, plots or maps—from the annotated selection SAS/GRAPH provides and
- 3 instantly display the graph with the touch of one PF key on your IBM 3279.

It's as simple as 1 + 2 + 3. And that adds up to a big time-savings.

Think of the flexibility instant replay adds to your operation. Your DSS staff can run overnight batch jobs to graph CPU utilization reports, sales totals and production figures.

The reports are ready for display at your desk the next morning.

Best of all SAS/GRAPH™ is integrated into the SAS system, so you can get the benefits of: SAS for data management, statistical analysis and report writing; SAS/ETS™ for econometric forecasting and modeling; SAS/FSP™ for data entry, editing and letter-writing; and SAS/IMS-DL™ for interfacing to IMS data bases. The SAS system operates on the IBM 370 Family and compatible machines at more than 5000 OS/MVS, VM/CMS, DOS/VSE and SSX sites around the world.

Call or write today, SAS Institute Inc., Box 8000, Cary, NC USA 27511-8000. Phone (919) 467-8000. Telex 802505.

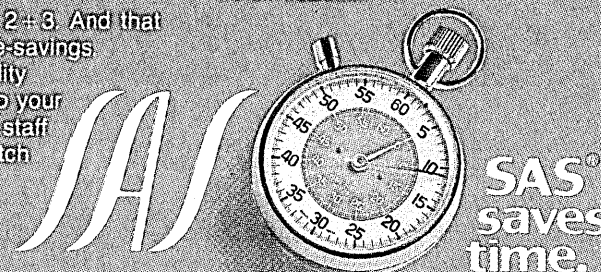

MEGAFRAMETM

Now you can let DEC, DG, and H-P play catch-up with you.

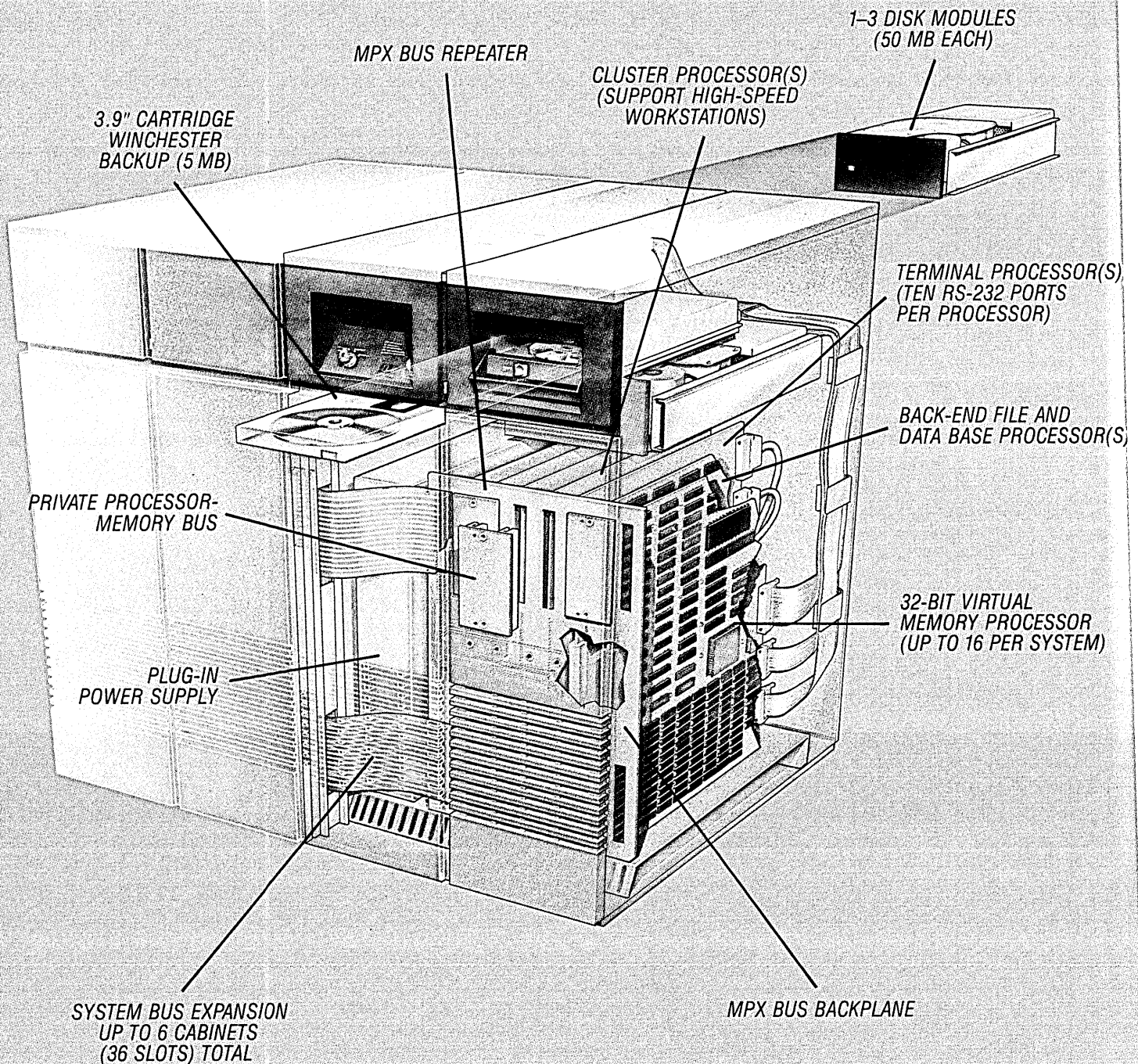

□ **Supports multiple operating systems (including UNIX) simultaneously sharing files and resources.**

□ **Multiple specialized processors distribute the workload to achieve outstanding performance.**

□ **Designed to support workstations and terminals to achieve a least-cost fit for any application.**

□ **Low-cost processor modules provide incremental expansion from 8 to 128 users.**

Computer manufacturers and system builders face tough demands these days — demands that are just about impossible to meet with conventional hardware. So Convergent designed Megaframe: a highly unconventional new system. Its innovative architectural features solve with one stroke the major problems of multiuser system design.

The Distributed Mainframe: Multiple processors, multiple operating systems.

Programs in a Megaframe system run on up to sixteen virtual-memory Application Processors — each with a 32-bit CPU, private RAM, and UNIX operating system kernel. But when a program needs to access a disk, communications line, or other system resource, the request is sent to one of the specialized high-performance service processors. So the application's I/O overhead is reduced to virtually zero.

But that's only the beginning. You can add separate processors to the Megaframe to simultaneously run completely different operating systems — like CTOS,[™] which provides real-time multitasking and supports attached clusters of Convergent workstations.

The independent File Processors function as powerful back-end Data Base machines, providing relational DBMS, ISAM, and other disk-related services, with fully transparent file sharing by all operating systems.

Megaframe's dedicated front-end Terminal Processors and Cluster Processors offload user communications from the Application Processors, ensuring fast, flexible response. They also manage access to facilities like SNA and X.25 networks, print queues, local-area networks, etc.

Configurable to exactly match application load profile

The various Megaframe processors can be installed in multiples, depending on the requirements of the specific application.

CPU-intensive jobs can utilize multiple Application Processors and expansion RAM. Systems with heavy disk usage can distribute this load among several File Processors. And the number of user ports can be expanded at any time by installing more Terminal Processors and/or Cluster Processors.

Modularity even extends to disk storage. Compact, 50-megabyte Winchester modules simply plug in — up to four per cabinet. High-capacity

cluster can be supported unchanged.

Inclusion of one or more Application Processors allows running UNIX System V. All standard UNIX tools including C are included, along with COBOL, FORTRAN 77, a BASIC interpreter and compatible compiler, plus Pascal.

Communications options include 3270 and 2780/3780 emulation (both Bisync and SNA), X.25, and Convergent's media-independent network software.

Data management facilities include multi-key, multi-user ISAM, relational DBMS, and a powerful ad hoc query language and report generator.

Megaframe: The solution with staying power

No system has ever combined the power, flexibility, and expandability of the Mega-

frame. Highly cost-effective at any performance level from "supermicro" up, with a per-user cost that will embarrass DEC, DG, and H-P, Megaframe is the ideal solution when needs are unpredictable or subject to rapid change.

Megaframe represents a true turning point in computer system evolution. The direction for the future is clear. Join us...don't be left behind.

For more information about the new Convergent Megaframe call (800) 538-7560 (in California (408) 980-0850), or write:
Convergent Technologies
Dept. D583
3055 Patrick Henry Drive
Santa Clara, CA 95050

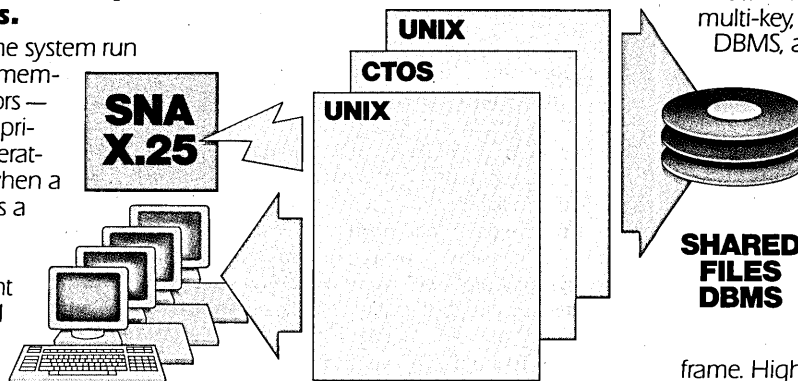

SMD devices can be attached via a separate intelligent interface processor. File backup utilizes compact Winchester cartridges, 1/2" magnetic tape, or both.

Multiple cabinets daisy-chained for up to 8 MIPS and 128 users

A minimum Megaframe system supports 16 users efficiently for about \$20,000 — quantity one. As needs grow, Megaframe grows — to a 128-user system, with up to 8 MIPS execution, 24 MB of error-correcting RAM, and 21 billion bytes of disk.

Megaframe software: ready-made solutions

Megaframe offers system builders an extremely wide range of choices in application development tools.

If the chosen configuration includes Cluster Processors, then any software running on an existing Convergent



Convergent Technologies

Where great ideas come together.

CIRCLE 8 ON READER CARD

VM

Software Inc.

**INFORMATION
CENTER?**

**DEVELOPMENT
CENTER?**

WE'VE GOT IT!

VM Software, Inc. has exactly the software products you need to be effective with VM from the start... As much or as little as you need. From the undisputed leader in VM products.

VMBACKUP Allows full or incremental dumps of both CMS and non CMS data, saving system programmer, support personnel, CPU, and tape resources.

VMTAPE Provides flexible control for managing tape volumes and drives, saving tapes and operator and librarian time.

VMARCHIVE Provides space management tool to end users, saving disk space and tapes.

VMSECURE Provides comprehensive security for the VM environment, ensuring data protection.

VMDEFER Permits users to schedule any event on any basis, facilitating load balancing of CPU.

VMLIB Allows users to share source code without duplication, saving disk space.

Call Us
703/821-6886
or Write

Name _____
Title _____
Company _____
Address _____
City _____
State _____ Zip _____
Phone (____) _____
CPU _____

VM Software, Inc.
7777 Leesburg Pike,
Suite 2205
Falls Church, Virginia 22043

CIRCLE 9 ON READER CARD

Twenty Years Ago/Ten Years Ago

LOOKING BACK

GOING ON LINE

May 1963: On-line dp systems had recently become a topic of great interest to digital computer applications specialists. In the first part of a series on the subject, W.L. Frank, W.H. Gardner, and G.L. Stock, all of Informatics Inc., looked at some of the programming problems involved.

Two types of systems were discussed. The first was automatic systems, in which response times were measured in milliseconds. Most of these systems were closed loop, since timing requirements precluded man's intervention. Process control applications, radar tracking, and recording systems were examples of these systems.

The second type of system was the interactive machines connecting to a number of interrogation and display devices to permit a man-machine relationship. In these systems, not only were the hardware characteristics important, but also the communication devices and communication language. Examples of applications were military command, control systems, and commercial reservation systems.

After describing the problem characteristics of these application areas, the article discussed programming implications. Since timing and control were cited as the most critical aspects of the problems, the authors gave detailed consideration to the hardware features bearing on the efficacy of the programming system.

Until recently, the article noted, major interest in real-time systems had been limited to three principal areas: military command and control applications, commercial process control applications, and guidance and control applications (aboard missiles and satellites).

Within the past year interest in on-line systems had accelerated rapidly and applications now included such government and business functions as space flight and tracking, simulation, management analysis and control, airline reservations, banking systems, automatic checkout, merchandising, teaching, hospital automation, and information retrieval.

LET'S MAKE A DEAL

May 1973: Control Data signed an agreement with Rumania that would involve the manufacturing of standard, "nonstrategic"

gear. The equipment the Rumanians were interested in manufacturing included a 1,200-card/minute card punch, 250cpm reader, and a 200-line/minute printer. Although several licensing agreements already existed, this was the first time a U.S. computer company formed a partnership in a manufacturing venture with equity investment.

Rumania was a likely candidate for this first trade agreement because the country was anxious for "most favored nation" trading status with the U.S. It had been the first Soviet Bloc country that then-President Nixon had visited. While the U.S. government had not yet approved the contract officially, it was expected to do so swiftly. The contract signing in Bucharest by deputy minister Cornel Mihulecea and CDC president William Norris was given a great deal of fanfare, including satellite transmission of the event.

The contract called for the Rumanian Industrial Group for Electronics and Vacuum Technology (CIETV) to own 55% of the company and to provide \$2.2 million in plant facilities, tooling, and cash. Control Data would get 45% of the company and would be responsible for providing \$1.8 million in know-how and technical assistance—no cash. Profits would be split on the same percentage and Control Data would have the option of taking its profits in U.S. dollars or in products to use with its own systems, or it could reinvest its share of profits in the company or in other ventures in Rumania.

In another news story, DATAMATION reported that China was on the verge of approving a 10-day U.S. computer show, to be held in Peking in September '73. CDC, Burroughs, Honeywell, Univac, NCR, Mohawk Data Sciences, and Monroe had all agreed, tentatively, to participate.

The same news story also noted that in April the Soviet government signed a contract to buy \$700,000 worth of dp equipment from IBM, Datapoint, Sykes, and Mohawk Data Systems. The deal included a 32K 2400 series MDS computer system, two IBM 3330 disk subsystems, two Datapoint 1,800-character alphanumeric displays, thermal printers, and acoustic couplers.

—Lauren D'Attilo

NATURAL™ For Online Applications Development



When you absolutely, positively can't be late.

NATURAL from Software AG can help you deliver on time, every time. NATURAL is an online programming productivity package that can eliminate 90% of the time it now takes to develop new applications or modify existing ones. In a single comprehensive system it provides all the tools necessary to quickly implement sophisticated yet practical online applications.

NATURAL handles data management programming, map definition, program testing, ad-hoc queries, and report generation. The total transportability of NATURAL between different operating environments eliminates the need for programmers' expertise in such areas as job control language, TP systems commands and online

test procedures. And since it is totally interactive, NATURAL makes it easy to respond to changing user needs without risking late delivery of the completed system.

NATURAL is designed to be used with ADABAS, the most comprehensive and flexible data base management system available for IBM and plug-compatible mainframes. Don't delay, find out more about NATURAL by returning the coupon today.

Software AG Worldwide
Software AG
of North America, Inc.
11800 Sunrise Valley Drive
Reston, Virginia 22091
(703) 860-5050

In Europe:
Software AG
Hilpertstrasse 20
D-6100 Darmstadt
West Germany
06151-84072

Please send me information on NATURAL.
 Please send me information on your FREE DBMS seminars.

Name _____

Title _____

Company _____

Address _____

City _____ State _____

Zip Code _____ Telephone () _____

CPU _____ Operating System _____

SOFTWARE AG
OF NORTH AMERICA, INC.
CIRCLE 10 ON READER CARD

DM 0583

HOW TO GET USERS OFF YOUR BACK AND ON THE SIDE.

GOOD MORNING,

THIS IS YOUR INFORMATION CENTER,

HOW CAN I HELP YOU? =

The answer is in front of you.
SYSTEM 2000®
 Intel's Database Management System.
 And iDIS™
 Intel's Database Information System.
 Together, they allow your corporate decision makers to gather all the information they need.

From your information center data base.

Not from their personal computer.

And users get their data from a terminal. Right in their office. Right on their desk. In seconds.

Versus the days it might take you, just to get to their request. Days that can seem like weeks.

Especially when management is breathing down your neck.

iDIS is a fully integrated, XENIX* based, multi-user microcomputer system. Featuring the Intel 86/735 microcomputer-based system. The most versatile, most powerful 16-bit system on the market.

Industry-standard VLSI and peripheral technology are also designed-in, to protect your long-term investment.

And to protect your information from unauthorized use, iDIS maintains complete data security at every terminal.

iDIS gives users the ability to perform local database definition and creation, as well as updating and reporting.

But iDIS doesn't stop there. Users also get a wide range of software, to aid

them in planning, analysis and office management.

iDIS even has tools for data processing. By using the XENIX command interpreter, menu/forms and conventional programming languages, programmers can create custom applications for users.

	1	2	3	4	5	6	7
1							
2							
3							
4							
5	East	Budget	Budget	Upsize			
6	James	3700	2500	15000			
7	Smith	3100	9750	1000			
8	Ellis	2150	2000	10000			
9							
10	Reg. Total	10400	18275	65000			
11							
12	West	3000	5000	7000			
13	Johnson	2500	4000	6500			
14	Budgets	1500	3500	5000			
15							
16	Reg. Total	7000	12500	21000			
17							
18	NATIONAL TOTALS	17400	30775	66500			

Credit our spreadsheet, with quick numbers directly from the corporate data base.

USER OPERATIONS	
mail	Electronic mail
cal	Maintain appointment calendar
wp	Word processing
sv	Spread sheets
db	Data base operations
file	File management
help	Get help information

For ease-of-use, our menu format is made-to-order.

Faster than management can send you a data request.

And while iDIS is helping you, SYSTEM 2000 will be helping users to help themselves.

By creating greater user self-sufficiency and increased productivity. Producing better control of information, for higher quality decisions.

Call us toll-free, for more information. (800) 538-1876. In California, (800) 672-1833.

Or write us. Lit. Dept. H 14, 3065 Bowers Avenue, Santa Clara, CA 95051.

Or contact the Intel Sales Office nearest you.

We'll back you, with all the support you'll need.

To get users on your side.

*XENIX is a trademark of Microsoft, Inc.

intel delivers solutions

See us at NCC, Booth #3910

CIRCLE 11 ON READER CARD

ONE GENERAL LEDGER IS THE INDUSTRY STANDARD

GENERAL  ELECTRIC

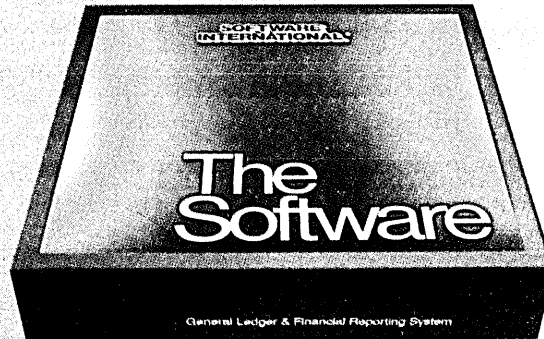

4,000 USERS AGREE

SOFTWARE INTERNATIONAL's® General Ledger and Financial Reporting System is hard at work at more than 4,000 sites worldwide—in some of the world's largest, most diverse, and best-managed corporations. That's more than any other competitive product. Firms like E.I. DuPont, R.J. Reynolds, Miller Brewing Company and hundreds of other Fortune 500 companies have selected our General Ledger over the competition. That's why it's the *industry standard*, a state-of-the-art product continually improved to stay at the leading edge of software technology and give you more "account-ability" than any other financial software package.

No other General Ledger provides as much easy-to-use reporting power and on-line access to information. On-line review of account activity and balances gives you better control of budgets, minimizes the need for paper reports, and frees your accountants for more financial analysis. Labor saving on-line standard journal entries are convenient to use, reduce posting errors, and facilitate fast, easy checking. A powerful interactive editing capability helps you identify and correct errors before information is updated. Our General Ledger gives users immediate access to current, accurate information by simultaneously updating both posting and summary level accounts throughout the system.

The system is installed quickly. Many users report that they are closing their books faster, producing reports in hours instead of days, and generating more relevant information for better business decisions.

Because no business operates solely from a General Ledger, our system interfaces with our top-quality Accounts Payable, Accounts Receivable, Fixed Asset and Payroll/Personnel packages to form a comprehensive and powerful financial information system.

Software International has been installing and supporting high-quality, problem-solving financial application packages for almost two decades. That's why THE SOFTWARE gives you something extra: *confidence*. Confidence in complete, thorough training and documentation. Confidence in our commitment to product enhancement and stringent quality control. And confidence in our customer support. As a subsidiary of General Electric Information Services Company, we are part of a worldwide family of more than 5,000 computer and business professionals.

Find out why our General Ledger is the one you should measure the others against. Ask a user. Or call us for more information. You'll easily see why THE SOFTWARE is the industry standard you can account on.

CONFIDENCE IN EVERY PACKAGE

**SOFTWARE
INTERNATIONAL®**

A Wholly-Owned Subsidiary Of General Electric Information Services Company
One Tech Drive, Andover, MA 01810 (617) 685-1400

CALL TOLL FREE 1-800-343-4133

(IN MASSACHUSETTS 1-800-322-0491)

Atlanta (404) 955-3705 Boston (617) 685-1400 Chicago (312) 773-8008 Columbus, OH (614) 773-2167 Dallas (214) 960-0220 Denver (303) 388-9593 Houston (713) 444-3348
Kansas City, MO (816) 471-4664 Los Angeles (213) 573-0402 New York (914) 253-8050 San Mateo (415) 574-5800 St. Louis (314) 342-7860 Wilmington, DE (302) 478-8980
Montreal (514) 845-6124 Toronto (416) 924-1461 Vancouver (604) 669-6122

Australia, Colombia, France, Guam, Hong Kong, Israel, Italy, Malaysia, Mexico, New Zealand, Saudi Arabia, Scandinavia, Singapore, South Africa, Spain, Switzerland, The Netherlands, United Kingdom, West Germany

CIRCLE 12 ON READER CARD

LOOK AHEAD

DELAYS AT CRAY

Delays in getting some advanced componentry have pushed back the first delivery date of the Cray-2 supercomputer. Cray Research had originally set the first quarter of 1984 as the delivery date, but it has apparently had trouble in getting parts from its supplier, Fairchild. The computer company isn't wasting time, however; it's decided to go ahead with a 256K RAM version of the machine immediately, instead of phasing in such advanced technology gradually. Look for first shipments in the middle of next year.

NO SOURCE, SAYS SOURCES

Though users may think IBM's upcoming restrictions on source code are tough, they're nothing compared to what the firm's management committee is understood to have originally suggested. A plan completed early last year called for a complete withholding of source code for the new MVS-XA, but senior managers warned that users would not "swallow it." As a result, an industry relations committee was mobilized to test the waters by talking to leading customers, selected software companies, and certain IBM factions. The result is the policy of "conditional" withholding implemented today.

CONNECTICUT STARTUP

Watch for a small Wesport, Conn., startup, Non-Procedural Systems, Inc., to unveil later this year a fourth generation language system for microcomputers. The company is headed by Harold Feinleib, a cofounder of remote computing services supplier National CSS. Feinleib was a key developer of that firm's relational database manager Nomad.

MICRO TO MAINFRAME

Look for a June introduction from Sunnyvale, Calif.-based Dialogic Systems of a microcomputer designed to link into mainframes. Using what the firm calls "layered interactive processing," the system will provide users with the best of the micro and mainframe in a transparent fashion. The company has a venture capital war chest of \$12 million. It was founded in 1980 by Cornell Spiro and Alan Amber, both formerly of Amdahl Corp., where they developed the idea but could not get management's support for it.

SWIFT KICKS

Members of the Swift network, which is used to transfer funds internationally, were surprised to find the generally dignified organization hawking in its April newsletter a game called "Bank Invaders from Outer Space." Running on the network, the game had as its object to infiltrate

LOOK AHEAD

MORE WINDOWS FOR MICROS

another bank's customer pool and capture accounts. The game was to alleviate boredom among Swift operators on low-traffic days. Alas, it was all an April Fools' joke.

A Santa Monica startup, Quarterdeck, says it has developed a "multiwindow user environment" that integrates various applications programs on microcomputers. The software is designed to compete with Apple's Lisa system and the forthcoming VisiOn multiwindow package promised by VisiCorp. Quarterdeck's software, designated DesQ, has been implemented for IBM's P.C. at first, but is claimed to run under MS-DOS, CP/M, Unix, and other operating systems.

ALL THE NEWS THAT FITS

An experimental editing and copy layout system supplied by Xerox to the "New York Times" has apparently run into some problems. "We haven't worked out all the bugs," says a "Times" source. "We're still trying to get it all working." The ambitious system, installed late last year by Xerox's Electro-Optical Systems division, is designed to assemble copy automatically according to generalized layout rules. The system is an outgrowth of Xerox's Star and other office automation technologies. The "Times" and Xerox, sensitive to union resistance, expect to decide in a few months whether to put the system in production, the source says.

NOT MY BAG, MAN

One of the most maddening foul-ups in this "information age" of ours is an airline losing checked luggage. In an attempt to streamline baggage handling, Eastern Airlines is starting to use laser-scanned bar code stickers to guide bags through the maze of conveyors between check-in counter and airline hold. So far the system has worked reasonably well, says one Eastern manager, but we've experienced otherwise.

RUMORS AND RAW, RANDOM DATA

We hear Barclays Bank, British Rail, and Cables & Wireless, Ltd., among others are setting up a company to run a long-haul fiber-optic network in Britain....CPT Corp. is to introduce an integrated office automation system, known internally as Phoenix, at NCC this month....Wang Labs has apparently dropped plans to move voice on its broadband Wangnet product. At least that's what a company spokesman implied at a recent office automation conference session....American Bell is set to introduce a wealth of new products this year, including a desktop workstation integrating voice and data....Best bet for NCC in Anaheim this year is that attendance will top 100,000.

First in a series of reports on the role of personal computers in the office.

What's the secret behind the most profitable company in America?

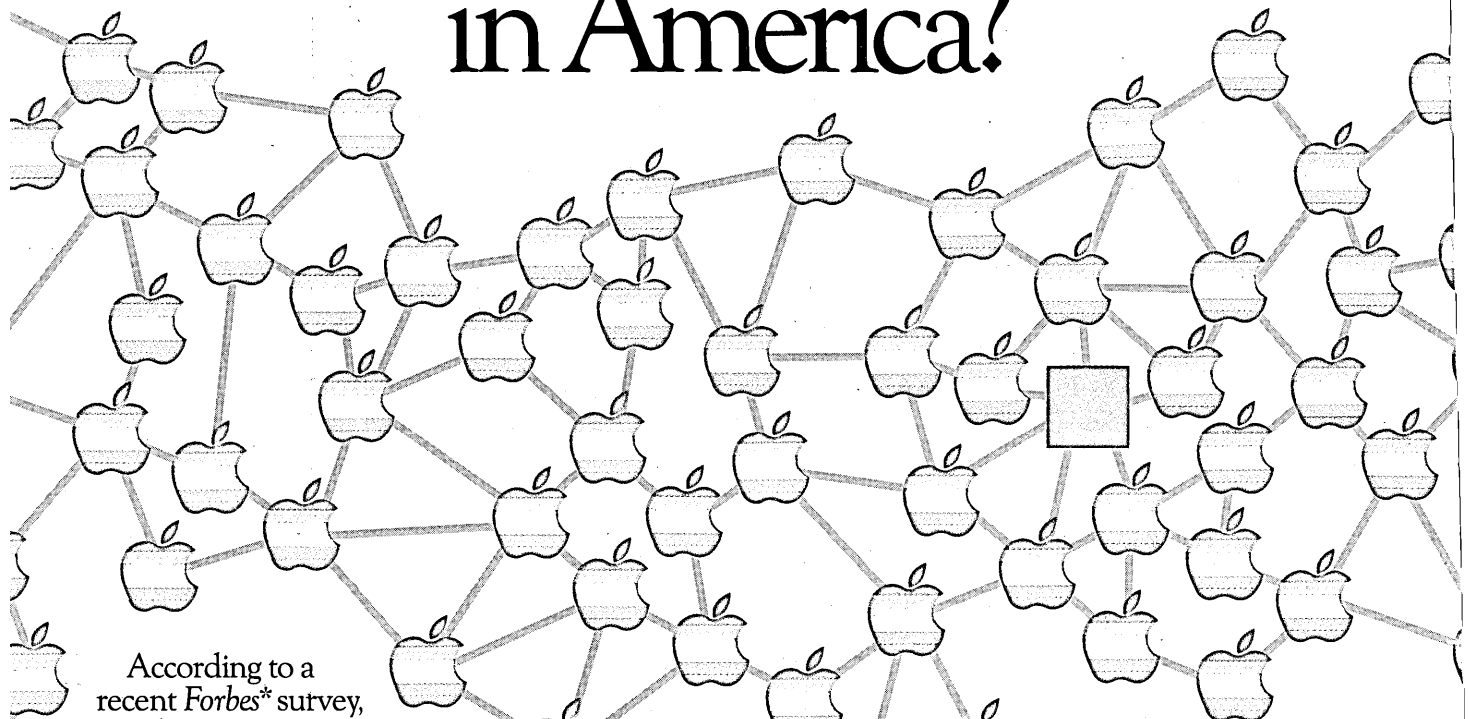

According to a recent *Forbes** survey, Apple Computer Inc. achieved the highest average return on equity and capital of any American company over the last five years.

Just because we sell a lot of personal computers?

That doesn't hurt.

But we also use a lot of personal computers.

Over 3500 Apples.* All part of a cost-efficient and productive information system.

Here, we'll explore how this system works. And how companies like yours can make the transition to personal computers smoothly and successfully.

No theories or fantasies. Just facts, from our own fruitful experience.

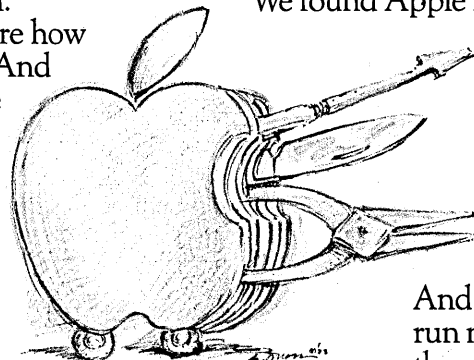

Apple comes to you with nationwide on-site service and support.

To each his own Apple.

At Apple, we put Apples on every desk. The nature of the work determines the nature of the Apple. We found Apple II's (and now

Apple II's) to be the most affordable solution for most of our dedicated, ready-to-run applications.

And because they run more software than any other personal computer,

users can pick the program that best suits their needs.

In some cases, II's can also serve as terminal emulators.

"With an average annual return on equity of nearly 119%, Apple is indisputably number one..."— *Forbes*

Apple III's, with even more memory and processing capability, offer us important standalone virtues. Including an impressive choice of powerful management tools—from word processing to presentation graphics.

The III can also serve as a sophisticated terminal emulator. (Apple's new Protocol Converter can handle most 3270 series terminals, so any Apple can communicate with mainframes—in our case, an IBM 4341-2.)

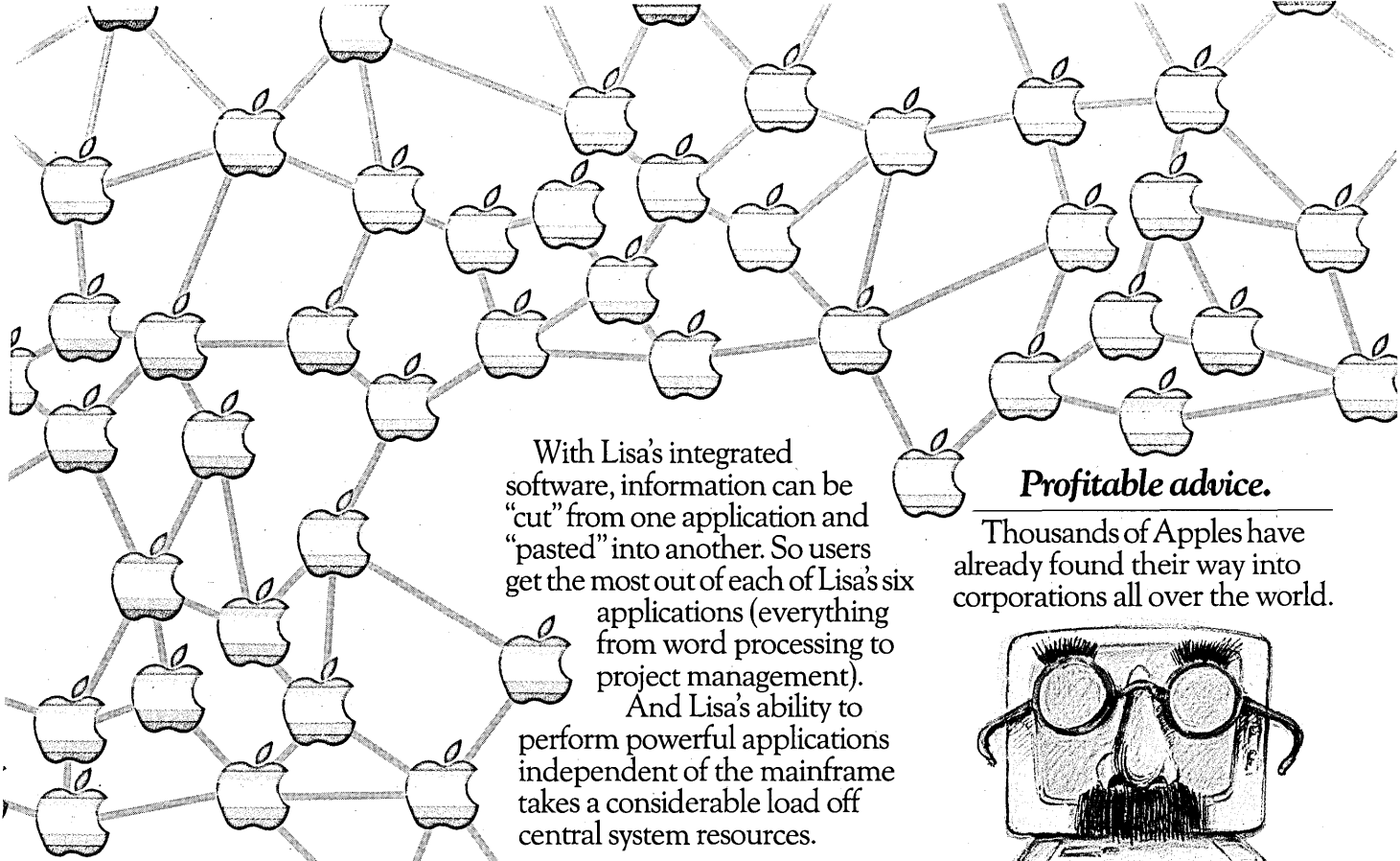

With Lisa's integrated software, information can be "cut" from one application and "pasted" into another. So users get the most out of each of Lisa's six applications (everything from word processing to project management).

And Lisa's ability to perform powerful applications independent of the mainframe takes a considerable load off central system resources.

Profitable advice.

Thousands of Apples have already found their way into corporations all over the world.

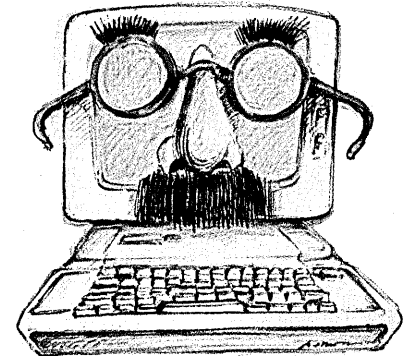

People will go to any lengths to disguise their purchases of personal computers.

Lisa: Revolution without chaos.

Lisa™ is nothing short of revolutionary.

Its hardware alone makes it the most powerful personal computer available (see below).

But the real story is how quickly Lisa puts that power in your hands.

Because Lisa replaces complex computer commands with familiar symbols and a "mouse" pointer, learning time is reduced from over 20 hours to under 30 minutes.

Getting the family together.

Apples linked in local and company-wide networks are allowing us to exchange information between PC's, and access corporate mainframes.

Soon, II's, III's and Lisas will be on AppleNet. Designed especially for Apples, this cost-efficient local area network will also interface to other LAN's.

For long-haul communications, any Apple can communicate with any other personal computer or mainframe over standard phone lines.

For example: Our distribution centers can enter customer orders and sales data into our DEC or IBM computers, transfer it over public networks, consolidate it on our headquarters' mainframe, and make it available to any of Apple's Apples (with proper security clearance) first thing every morning.

The Apple National Account Program was designed to help you make the best use of these Apples, tailor future purchases to your needs, and coordinate shipments and service.

We offer a variety of support services, including nationwide on-site service (in conjunction with RCA Service Company). And a toll-free support line.

Plus on-site training and a host of self-teaching tutorials.

So, no matter how large your company, Apple has all the elements necessary to improve your information systems management.

And to help you profit from our experience.



apple
The most personal computer.

APPLE IIe

Expandable 64KB standard memory. Versatile standalone management tool for operations or planning. Thousands of ready-to-run applications.



APPLE III

256 KB standard memory. Advanced standalone capability, with terminal emulation and sophisticated programming. Runs more business applications than any other PC.



LISA

1MB memory, 32/16 bit MC68000 Microprocessor. Revolutionary user interface with integrated application software enhances installation, operation and networking.



*Forbes 35th Annual Report on American Industry, Jan. 3, 1983. Note: The same survey also found Apple to be number one in sales and profit growth. For information regarding corporate purchases through our National Account Program call (800) 538-9696. Or write Apple Computer Inc., MIS/EDP Marketing Dept., 20525 Mariani Ave., Cupertino, CA 95014. © 1983 Apple Computer Inc.

CALENDAR

MAY

COMPUTA '83

May 11-15, Singapore, contact: Kallman Associates, 5 Maple Court, Ridgewood NJ 07450, (201) 652-7070.

IFIP/Sec '83.

May 16-19, Stockholm, Sweden, contact: John Rice, Math Sci. 428, Purdue University, W. Lafayette, IN 47907, (317) 494-6007.

National Computer Conference.

May 16-19, Anaheim, Calif., contact: American Federation of Information Processing Societies, Inc., 1815 N. Lynn St., Arlington, VA 22209, (703) 558-3624.

Europe Software 1983.

May 17-19, Utrecht, The Netherlands, contact: Royal Netherlands Industries Fair, P.O. Box 8500, 3503 RM Utrecht, The Netherlands, (30) 955 911, telex: 47132.

SICOB and Convention Informatique, Spring.

May 30-June 3, Paris, France, contact: The Secretariat, Spring Convention, 4/6, Place de Valois, F-75001 Paris, France, telex: 212597F.

JUNE

5th Annual National Educational Computing Conference.

June 6-8, Baltimore, Md., contact: Dept. of Math and Computer Science, Towson State University, Baltimore, MD 21204.

MAPTEK Europe 1983.

June 7-9, Venice, Italy, contact Robert B. King, Quantum Science Corp., 1114 Ave. of the Americas, New York, NY 10036, (212) 997-0070.

IFCOM/TELECOM.

June 8-10, Köln, W. Germany, contact: Deutsche Telecom e.V., c/o Deutsch-Atlantische Telegraphen-Aktiengesellschaft, Kaiser-Wilhelm-Ring 30/32, D-5000 Köln 1, West Germany, telex: 888 27 58.

Syntopican XI.

June 13-16, San Francisco, Calif., contact: International Information/Word Processing Association, 1015 North York Rd., Willow Grove, PA 19090, (215) 657-6300.

International Robot Conference & Exhibition (INTEROBOT '83).

June 14-16, Long Beach, Calif., contact: Tower Conference Management Co., 143 N. Hale St., Wheaton, IL 60187, (312) 668-8100.

11th Annual EDP Auditors Association International Conference.

June 19-22, Los Angeles, Calif., contact: EDP Auditors Assn., 373 South Schmale Rd., Carol Stream, IL 60187, (312) 682-1200.

Computech '83.

June 21-26, Taipei, Taiwan, contact: Philip Snare, American Insti-

tute in Taiwan, 11310 Palisade Ct., Kensington, MD 20895 (301) 652-6406.

1983 American Control Conference.

June 22-24, San Francisco, Calif., contact: Dr. Harish S. Rao, Systems Control, Inc., 1801 Page Mill Rd., Palo Alto, CA 94303, (415) 494-1165.

National Computer Graphics Association '83

June 26-30, Chicago, Ill., contact: Nancy Lefebvre, NCGA, 8401 Arlington Blvd., Fairfax, VA 22031, (703) 698-9600.

Videotex '83.

June 27-29, New York, N.Y., contact: Online Conferences, Ltd., Argyle House, Northwood Hills, Middlesex HA6 1TS, England, 44 9274 28211, telex: 923498.

20th Design Automation Conference.

June 27-29, Miami Beach, Fla., contact: Paul Losleben, DARPA/IPTO, 1400 Wilson Blvd., Arlington, VA 22209, (202) 694-5037.

JULY

10th Annual Conference on Computer Graphics and Interactive Techniques (SIGGRAPH '83).

July 25-29, Detroit, Mich., contact: ACM/Siggraph, 111 East Wacker Dr., Chicago, IL 60601, (312) 644-6610

AUGUST

1983 International Computer Engineering Conference and Exhibit.

Aug. 7-11, Chicago, Ill., contact: The American Society of Mechanical Engineers, 345 E. 47 St., New York, NY 10017, (212) 705-7740.

National Conference on Artificial Intelligence (AAAI-83).

Aug. 22-26, Washington, D.C., contact: Claudia Mazzetti, AAAI, 445 Burgess Dr., Menlo Park, CA 94025, (415) 328-3123.

IBM PC Faire.

Aug 26-28, San Francisco, Calif., contact: Jim Warren, Computer Faire, 345 Swett Rd., Woodside, CA 94062-9990, (415) 851-7077.

SEPTEMBER

Federal Computer Conference.

Sept. 13-15, Washington, D.C., contact: Federal Computer Conference, P.O. Box 368, Wayland, MA 01778, (617) 358-5301.

IFIP Ninth World Computer Congress.

Sept. 18-23, Paris, France, contact: AFIPS, 1815 N. Lynn St., Arlington, VA 22209, (703) 558-3600.

Sixth International Conference on Digital Satellite Communications.

Sept. 19-23, Phoenix, Ariz., contact: Conference Administrator, c/o COMSAT, 950 L'Enfant Plaza S.W., Washington, DC 20024, (202) 863-6248.

The printer for the people who need hardcopy now.

Dataproducts B-Series line printers help you put the paper in the hands of the people who need it. When they need it.

The family of three, the B-300, B-600 and the B-1000, was designed to whisk out the printout, from 300 lines per minute to as much as 1100 LPM. And to operate at those speeds day after day.

How could we build 160,000 line printers and not make an impression?

We've produced more line printers than all other independent computer printer makers combined.

So why isn't Dataproducts a household word? Because most Dataproducts line printers are delivered to end users with somebody else's name on them.

Virtually every major OEM in the business has selected our B-Series printers for the systems they sell. Each has made that selection after months, sometimes a year, of intensive evaluation.

More than anything else, they look for a machine that can perform reliably over a long period of time. Their reputations are at stake.

Which is why the safest choice for your company may be a printer you've never heard of.

The best printers are the easiest to use.

Dataproducts probably knows more about the people who use computer printers than anybody. We know how they slam cabinets. How

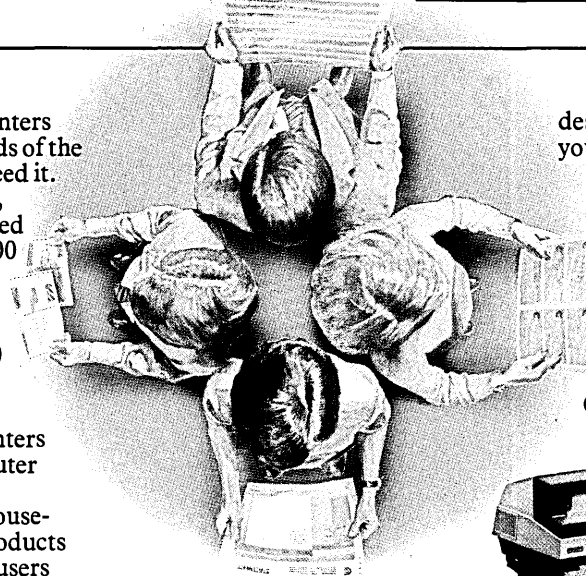

designed to help service people get you back on-line quickly.

And because we make so many of these printers, we don't have to charge a lot of money for yours. You get low initial cost. And low cost of ownership.

If you'd like to know more about our B-Series printers, or the name of our distributor in your area, call (213) 887-3924. Or send the coupon below.

they jam paper. How they smear ink on their pants.

We conceived the B-Series for the operator. Extensive diagnostics help the operator locate and correct troubles fast. Long-life ribbon cartridges are

quick and clean to load. The machines open wide so all controls are easy

to see and easy to reach.

In less than a minute, the operator can even change the print band—to a different typeface, a different language.

The best printers are the least expensive to own.

90% parts commonality within the family minimizes spares inventories and training. Power consumption is low.

Operators fix most problems. When they can't, the B-Series is

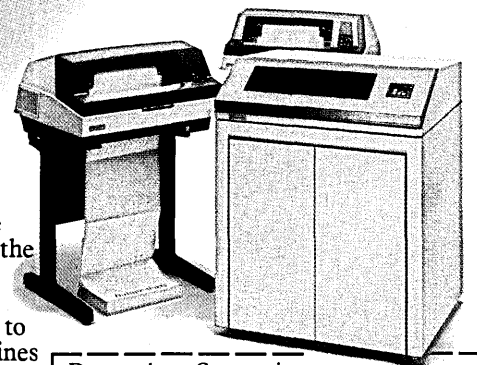

PIR Systems

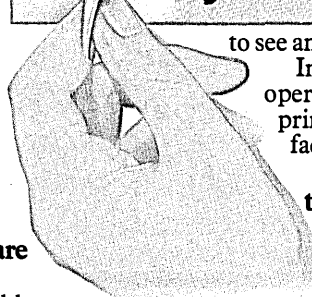

Dataproducts Corporation,
6200 Canoga Ave., Woodland Hills, CA 91365

Send details! Send a sales rep!

Name _____

Title _____

Company _____

Type of business _____

Address _____

City _____ State _____ Zip _____

Telephone _____ Ext _____

Also send information on:
 120-200 LPM dot matrix printers Graphics and label printers
 35-55 CPS letter quality printers 1500-2000 LPM high performance printers Printer supplies

Dataproducts is a registered trademark. B-300, B-600 and B-1000 are trademarks of Dataproducts Corporation.

DATAPRODUCTS

The Printer Company

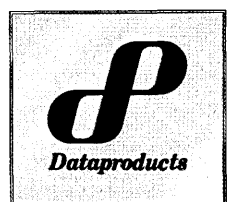

AIS/AMERICAN BELL DELIVERS THE NEWEST ADDITION TO THE FAMILY.

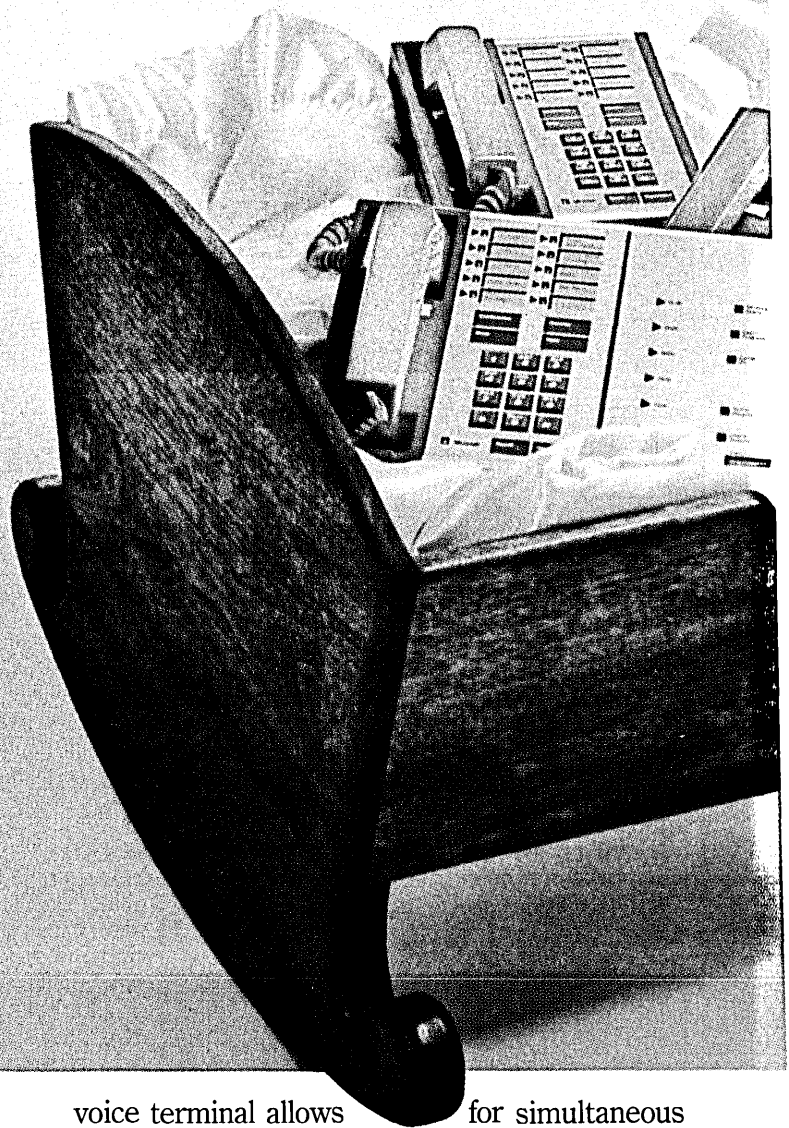

We're proud as can be.

AIS/American Bell, the company that was itself born on January 1, now delivers a completely integrated voice, data, office, building, and network information system. One that will help you lower costs, improve response times, increase revenue streams and enhance profits.

We're calling the latest member of our product family DIMENSION® AIS™/System 85. It's the only business system that offers all these functions to help streamline your communications and information flow:

Voice management—A new 40-character display

voice terminal allows for simultaneous transmission of voice and data. You can scan messages, leave your own, screen incoming calls, and automatically return calls.

Data management—An advanced Digital Communications Protocol (DCP) will enable data transmission speeds of up to 64 kbps. Initially, it supports up to 19.2 kbps. Our applications processor offers terminal emulation, so you can communicate and share information with other computer systems.

Office management—Electronic Document Communication cuts down on routine paperwork by preparing, editing and sending information, and

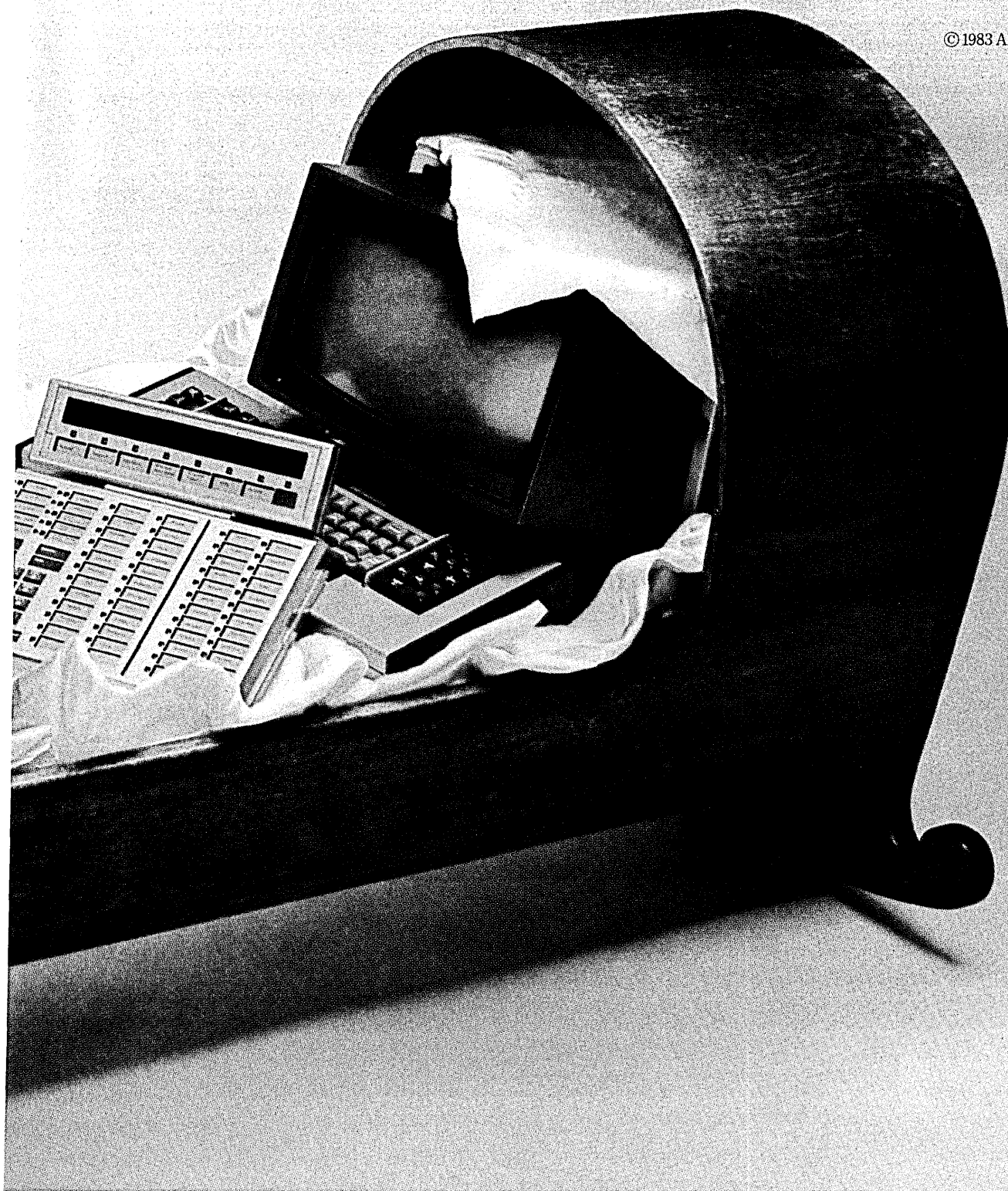

its electronic mail allows you to get the right information to the right people faster so they can make important decisions. A Message Center answers calls, takes and stores messages electronically.

Building management—Sensors monitor your doors and windows for increased security, and can also regulate light, temperature and pressure to save energy.

Network management—Centralize control over and integrate voice, data, office and building management functions into a single network. Reduce costs too by routing long-distance calls over the most economical path.

As you can see, the Dimension System is quite a family. And precisely because it is a family, new functions can be added on to your current Dimension System as they're developed, without replacing a lot of equipment or retraining personnel. Think how much smoother your business will run with a system you can control and maintain yourself.

The Dimension family's new System 85. It's the family that will be around for generations to come.

DCA's SYSTEM 355 readily adapts to any size data communications requirement. DCA's flexibility makes the SYSTEM 355 right for simple networks and essential for the most complex networks.

Start with a SYSTEM 355 and your system can grow as your organization's network expands. Start with anything else and you're going to spend the next few years piecing your network together.

SYSTEM 355 is in a category by itself. Its superiority results from DCA's Integrated Network Architecture, which turns upgrading

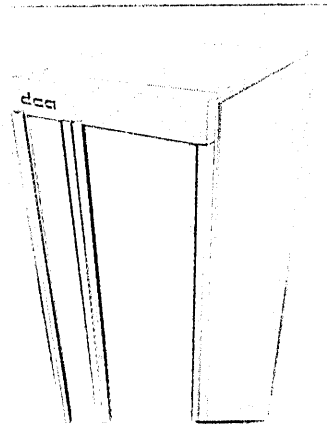

or repairs into simple matters of replacing or adding modules.

DCA sells networks...others sell pieces. If you want today's most adaptable network...one that is ready for tomorrow...you want the DCA SYSTEM 355. Call toll-free (800) 241-5793. Digital Communications Associates, Inc., 303 Research Drive, Norcross, Georgia 30092

dca[®]

Digital Communications Associates, Inc.
DCA Products are Available Worldwide
CIRCLE 20 ON READER CARD

ONLY ONE COMPANY CAN PUT ANY SIZE NETWORK IN ONE BOX.

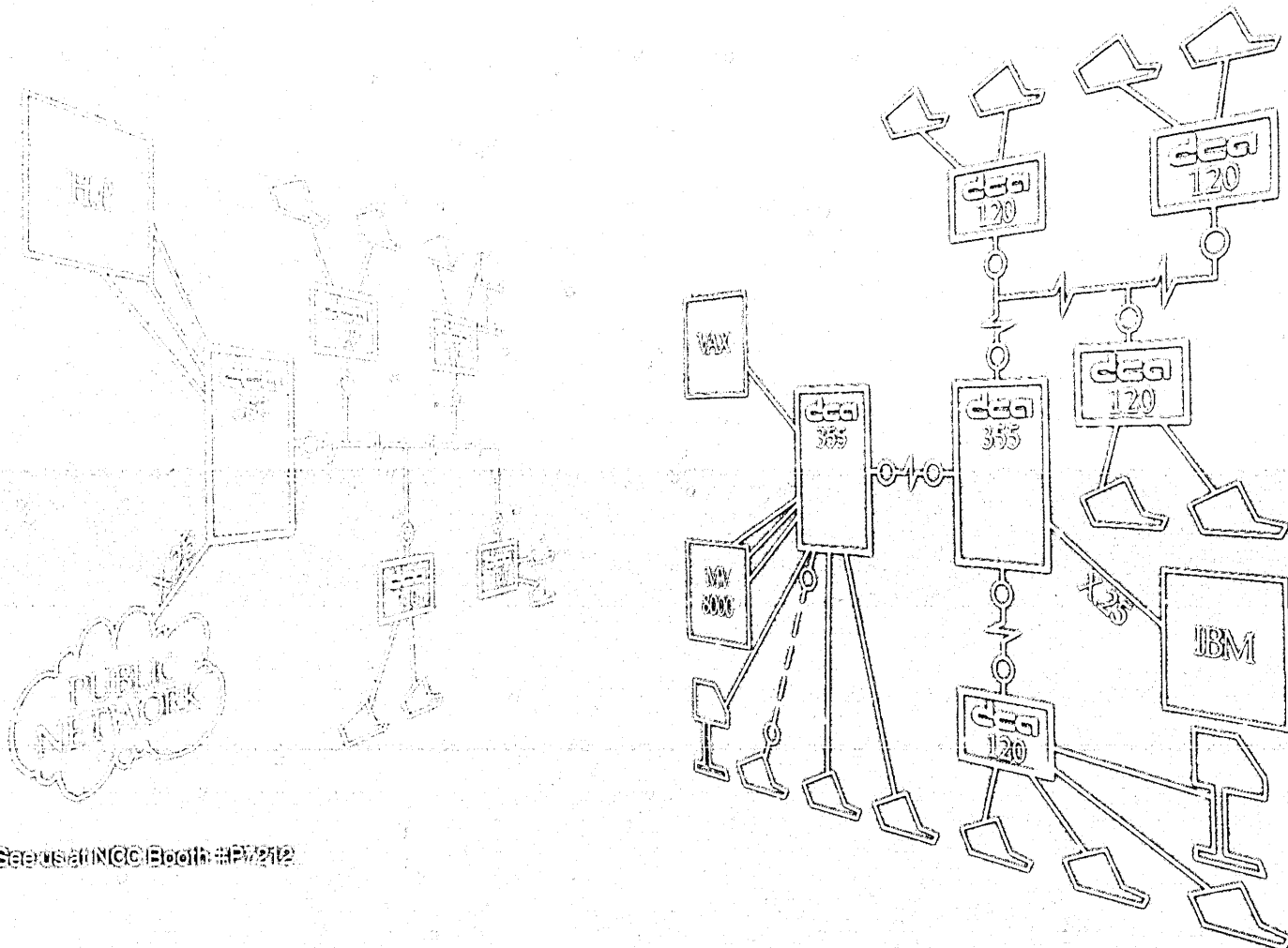

LETTERS

IF YOU CAN'T LICK 'EM . . .

I believe your News in Perspective story titled "Crossing the Bridge" (December) should have made the point that the senior member of the dp/information services function must be a member of the corporate management team. With the prime objective of increasing company productivity, it is essential that he/she fully understand top management's needs, recommending the best overall business solution. The controlled introduction of personal computers can make a valuable contribution to increasing efficiency. Strange, therefore, that any "catalyst of change" (i.e., a dp manager) should resist these machines when adopting an active advisory role can only benefit their major functional objective.

ALAN HOWARTH
Group MIS Manager
Harpers Management Information Services
Kuala Lumpur, Malaysia

IN NUCULAR FASHION

Is anyone besides me annoyed by the term "videotex"? Whenever I see it, I can't help but think of "artic" and "nuclear." What's the matter with "videotext"?

ALAN WEISS
Silverback Software Company
Carpinteria, California

Videotex was the French-coined word for either the dial-up or broadcast technology, and the word has been adopted by the CCITT as generic for all services that display alphanumeric information captured from computer databases on domestic tv. The Germans, however, call their viewdata version videotext. Our international editor, Linda Runyan, approves of videotex, and that's why we use it in DATAMATION. —Ed.

MUCH ADO ABOUT SEXISM

Tricky, tricky, or who's kidding whom? Data processing publications are rife with letters to the editor complaining about sexist advertising (January). One thinks that computer professionals, and editors, would have been tipped off to this

latest of advertising agency ploys for attention, but apparently not.

The tactic seems to go like this:

1. Produce an overtly sexist ad.
2. Wait for publication of letters of complaint.
3. Rest in the knowledge that said letters will excite enough curiosity to gain additional advertising mileage.

Tricky, those advertising people. But what does this say about us?

PETER KUSHKOWSKI
Manager
Process Computer Engineering
Northeast Utilities Service Co.
Hartford, Connecticut

WE CARE TOO!

Congratulations! Your article titled "Stoned at the Office" (February) was so representative of the problem as it exists that it feels as though you were peeking in my window.

For 18 years, from 1955 to 1973, I was an executive secretary. My former employers were Standard Oil of Indiana (four years), a top Chicago litigation attorney (four years), a large Chicago advertising agency (two and a half years), Hughes Aircraft Co. Patent Department (two years), Electron Dynamics Division Research Lab. (two years), International Industries in Beverly Hills (two years), Pennsylvania Life Insurance (one year), and Los Angeles's oldest law firm (one year).

My positions were as secretary to the president, chairman of the board (in two instances), general manager, vp and general manager, and senior partner. At no time during those 18 years were my employers aware that without exception, every day I was stoned at the office.

Although I drank at night and sometimes at lunch, alcohol was detectable and, for me, unpredictable, so I substituted chemicals, to achieve that "good," "OK," "energetic" yet comfortable feeling about which you wrote.

I was married three times, declared bankruptcy twice, and became a single par-

ent. (Since my recovery, my now 22-year-old son has begun recovery from drug addiction and has three years of abstinence.)

I was always late, hurried, and terribly officious—my only defense against inquiry. I often had bouts with the "flu," which I have since discovered occurred when I changed medication or attempted to quit. (These symptoms were, in reality, those of acute drug withdrawal.)

There were many physicians who prescribed my drugs; they all acquiesced to my pleas for specific chemicals (speed and tranquilizers) and never once in those 18 years was I given a complete checkup.

I shared my pills with coworkers, sold pot and street drugs to judges, state's attorneys, and lawyers (not the ones I worked for) and used mail rooms of my companies to traffic large quantities of pot cross-country.

In 1973, near death from acute alcoholism and toxic poisoning from chemicals, I found help in Alcoholics Anonymous. A year later I started a Narcotics Anonymous meeting in Connecticut, where I had moved for a new beginning. I have since started and nurtured 14 N.A. meetings, first in New England and later in Virginia. I have sponsored over 100 young women in Narcotics Anonymous who were seeking recovery from alcoholism/drug addiction and its related problems.

I have spoken to conventions, Navy and General Hospitals, treatment facilities, police departments, jails, and various other institutions about the disease, its detection, and treatment. For over two years I was employed by the city of Virginia Beach as an emergency mental health counselor and was carefully trained in crisis intervention, suicide prevention, mental health assessment, evaluation, and referral. I was responsible for assisting many persons experiencing mental/emotional crisis into appropriate treatment—that of treatment for chemical dependency.

As I write this letter, I am sitting in the office of one of the computer industry's largest software manufacturers—once

When you attend NCC...



look for the blimp
to lead you to the

**TECHNICAL
CAREER JOB FAIR®**

held simultaneously nearby
**NCC NATIONAL
COMPUTER CONFERENCE**
SHERATON ANAHEIM HOTEL
Two Days Only!
Mon., May 16 • Tues., May 17
11 AM - 9 PM Both days

Over 50 leading hiring corporations looking for ad-
vanced professional-level computer personnel, and
engineers, will sponsor booths at this special Techni-
Career Job Fair held simultaneously near NCC.

"We are not an employment agency"

TECHNICAL RECRUITERS!

LEASE YOUR TECHNICAL
RECRUITING
PROBLEMS!

Rent booths
at the...

**TECHNICAL
CAREER
JOB FAIR®**
...the original

IT WORKS!

concentrated advertising and publicity campaign
bring out an abundance of qualified technical candi-
dates. Your company interviews prospects "right on
the spot." No hiring fees! Your only cost is a modest
booth rental.

Upcoming 1983 Schedule of Job Fairs

Washington, DC - May 23-24	San Jose, CA - Sep. 12-13
Tampa, FL - June 6-7	Dallas, TX - Sep. 19-20
Philadelphia, PA - June 13-14	Denver, CO - Sep. 26-27
Orlando, FL - June 27-28	Washington, DC - Oct. 3-4
Boston, MA - July 11-12	Minneapolis, MN - Oct. 17-18
Chicago, IL - Aug. 8-9	San Jose, CA - Nov. 14-15
Dallas, TX - Aug. 15-16	Boston, MA - Nov. 21-22
Phoenix, AZ - Aug. 22-23	Los Angeles, CA - Dec. 5-6

*Special Edition Fairs Schedule subject to change

Limited Booth Space Available!

Toll Free: 1-800-328-4032

In Minnesota: 612/370-0550



Sponsored nationally by **BPI**
100 North 7th Street,
Minneapolis, MN 55403

CIRCLE 21 ON READER CARD

LETTERS

again as secretary to an executive—but this time as a Kelly Girl. I find it very difficult to be closely associated with other employees on a long-term basis in an office setting without trying to "fix" everyone—so I do not put myself in this position on a regular basis.

In your article, you mentioned that many companies are organizing employee assistance programs, and I am certain that because of your article many more will consider the idea.

I made a decision several weeks ago to go back into the field of counseling, but have found no inroads thus far here in Atlanta, so your article is timely to my own purpose. It is my desire to be of service to my brothers and sisters in the professional world who suffer from the disease of addiction. Perhaps a few will not have to continue on that terrifying merry-go-round for as many years as I did.

I have been clean and sober for over nine years, regularly attend AA and Narcotics Anonymous meetings, have been trained in the Johnson Institute method of crisis intervention with the chemically dependent, present a professional appearance, have good references, and I care.

Thank you for your thorough and insightful coverage—it is obvious that you care too.

NAME WITHHELD BY REQUEST

4 GLs? BALONEY!

In reply to the Readers' Forum by Read and Harmon (February), no one with any experience at all in the data processing industry can intelligently argue against the use of

fourth generation languages (4GLs). Let us first state clearly that there is nothing new about 4GLs. Timesharing companies were offering them by the late 1960s, since their targeted customers were the functional users, who did not understand data processing languages and did not want to. All they wanted was the results needed to do their jobs properly, and the internal data processing group was the perceived competition for the timesharing vendors. The timesharing companies did not call their proprietary languages 4GLs, of course, since no one knew what a 4GL was. Indeed, such late 1960s software products as MARK IV, INQUIRE, etc., are now recognized as 4GLs.

The points made by the Read and Harmon are all valid—as far as they go. The problem is that they do not go far enough. There is a strong implication that the mere use of 4GLs presents an opportunity to solve all problems. Logically, therefore, they would be perceived by most people, including dp management, as another panacea. All of us should be aware by now that there is no such universal problem-solver available, nor will there be until Mr. Spock reveals his hardware and software vendors. If we may counter with another of Murphy's Laws: "If everything appears to be going well, you have obviously overlooked something." What has been overlooked in the Forum article is that the foundation stone of any successful information system, information center, et al, is that "data analysis is the key component of information engineering," as James Martin so eloquently and correctly says.

Very simply reduced to common



CARTOON BY HENRY MARTIN

NOW FROM MICRO-TERM

ERGO® 301

GUARANTEED
VT100*
COMPATIBLE
FOR ONLY

\$895

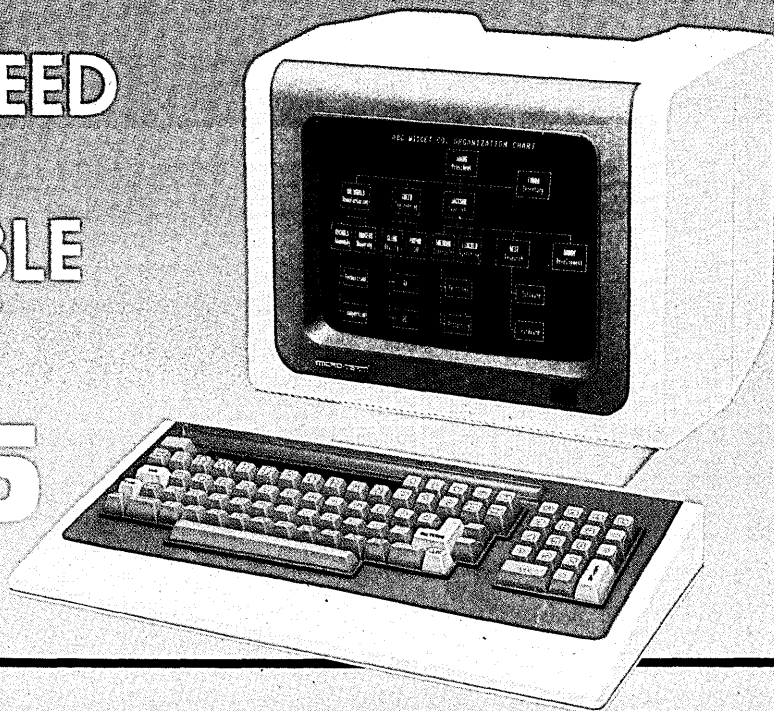

Micro-Term has been manufacturing VT100* emulators almost as long as DEC has been manufacturing VT100's. We guarantee that our ERGO 301 will correctly operate your DEC software—ALL of it. If we're wrong, return the unit for a full refund.

In addition to complete DEC compatibility, check these extra features. At \$895 list, it's worth a try.

- Advanced video standard
- Bidirectional printer port
- 2 pages of memory
- Plain English set-ups
- User programmable function keys
- Green Screen with Screen Saver
- Superior 132 column clarity
- Optional Plot 10 and ReGIS Graphics
- Full one year warranty

On site service available at over 450 locations through Western Union.

MICRO-TERM, INC.

Terminals are our only product, and we put more into them.

CALL OR WRITE: 1314 HANLEY INDUSTRIAL COURT, ST. LOUIS, MISSOURI 63144
(314) 968-8151, TWX: 9107601662, MICROTERM, STL.

*VT100 is a registered trademark of Digital Equipment Corporation.

"ADD UP TO 512K RAM, ASYNC AND SYNC COMMUNICATIONS, A CLOCK AND POWER SUPPLY SUPPORT-UP TO FOUR I/O PORTS IN JUST ONE SLOT?"

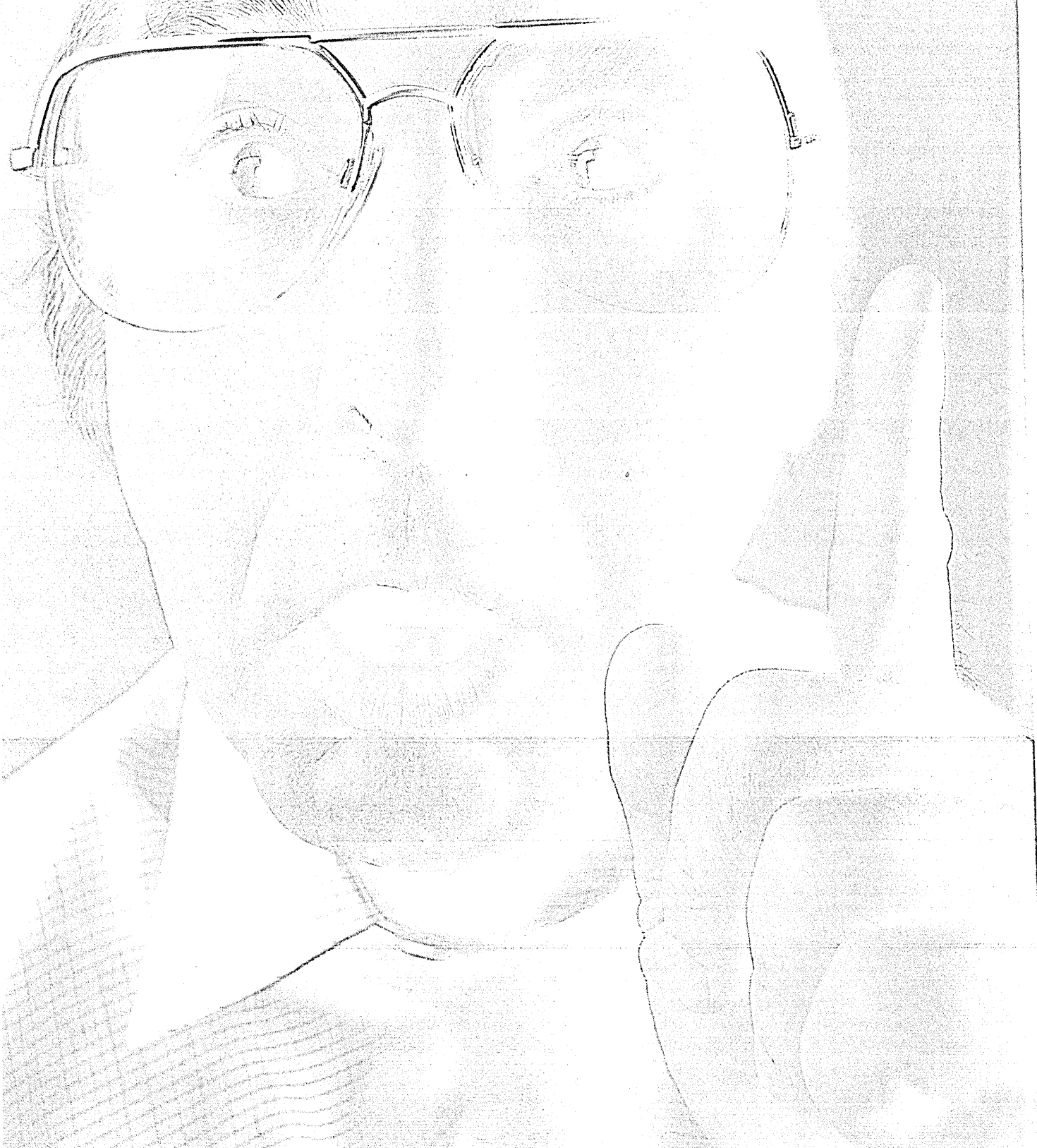

"YOU CAN WITH PERSYST."

The Persyst Time Spectrum. It's the most powerful and expandable multi-function PC board you can buy.

A Persyst Time Spectrum™ multi-function board can make any personal computer work better.

Whether you own an IBM PC or XT. Or the IBM compatible Compaq or Columbia.

There's even a Time Spectrum board for the Texas Instruments PC.

With Time Spectrum, you can combine up to six powerful functions—plus two advanced software programs—on just one board. And get performance and features like nothing else.

For the IBM PC, Compaq and Columbia, maximum capability in minimum space.

For example, Time Spectrum is the only multi-function board that lets you expand your IBM PC from 64K up to 512K RAM. Add a calendar clock. Add as many as two RS-232 asynchronous communications ports, or two synchronous and one asynchronous communications port. Plus print spooling and as much as 320K of RAM disk memory.

Up to four I/O ports—in just one slot.

How did we do it?

With the Cliffhanger™ A unique, RFI-shielded connector system that solves the problem of tying two or more I/O ports to peripheral equipment like a printer or modem, without consuming two or more slots. And only Persyst has it.

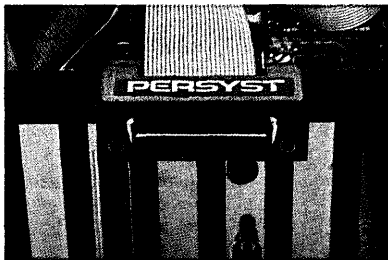

The Time Spectrum Cliffhanger™. So ingenious, it's patented.

What's more, expansion functions can be plugged right onto the Time Spectrum board. Or added with Versapak™ piggyback modules. So you can add exactly the capability you need, when you need it.

Extra flexible expansion for the IBM XT.

For the IBM XT, Time Spectrum not only delivers exceptional one-board expansion capability, but extra flexibility, too.

First, we designed Time Spectrum so you can add the RAM you want without having to fill the memory rows on the XT mother board.

And with Time Spectrum plug-in expandability, you can continue to add functions as you add requirements.

Start with basic memory and a calendar clock. Then add another asynchronous communications port. Parallel printer port. Additional memory. Or any combination of functions.

With Persyst, the choice is yours.

And now, one-slot capability for your Texas Instruments PC.

Now there's even a Time Spectrum multi-function board for your TI PC. With it, you can add up to 512K RAM, two serial ports, calendar clock and light pen port—capability to handle even the most complex and difficult computing functions.

And still only consume *one* slot.

The Persyst Time Spectrum board.

Maximum expandability now. And quality and versatility so you can keep on expanding later.

See your IBM or TI PC dealer and insist on Persyst.

PERSYST™

Persyst Products, Personal Systems Technology, Inc.,
15801 Rockfield Blvd., Suite A,
Irvine, CA 92714. Telephone:
(714) 859-8871. TWX: 467864.

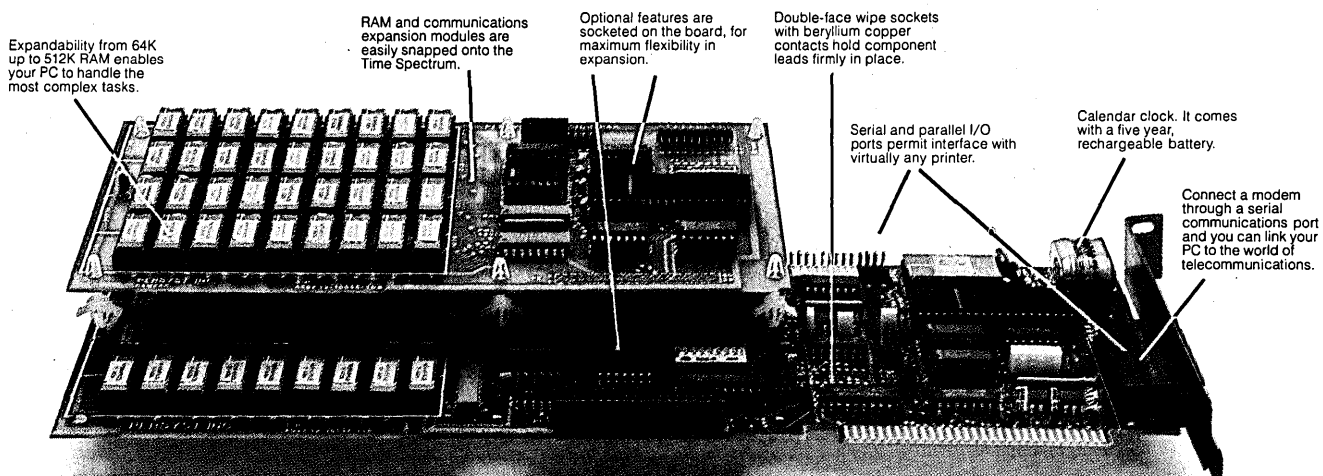

THE TIME SPECTRUM™ BY PERSYST.

CIRCLE 31 ON READER CARD

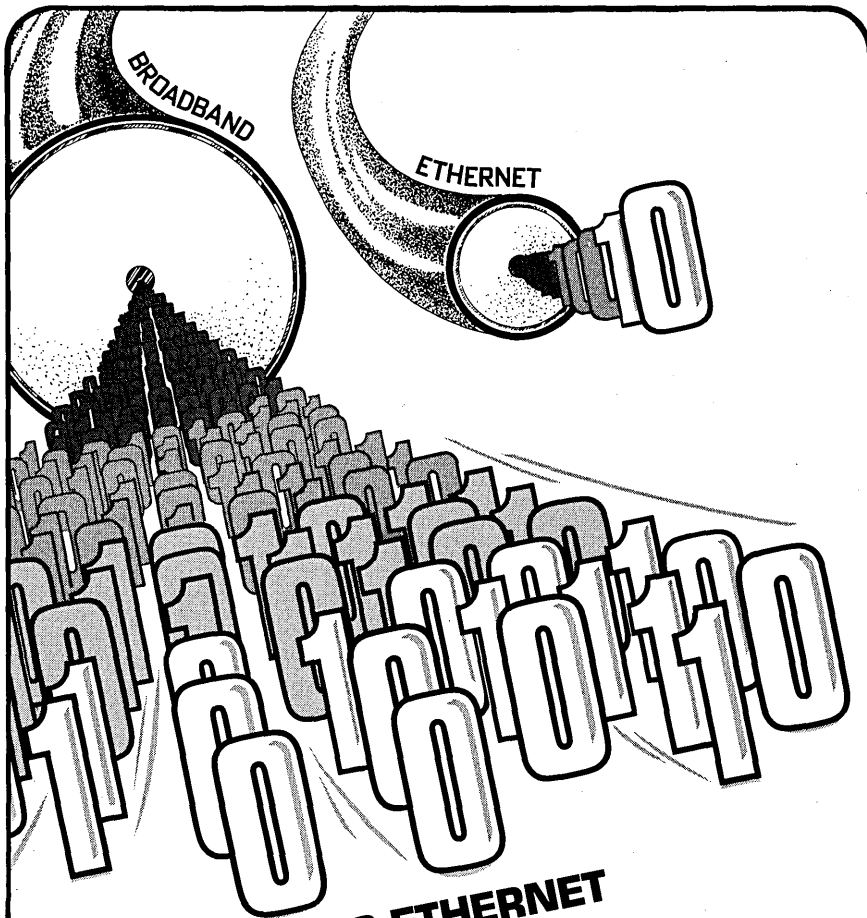

BROADBAND VS ETHERNET

Broadband gives you 50 times the capacity.

So, if you're installing coax, why not go with the technology that gives you room to grow? With broadband you'll have an actual aggregate data capacity of over 350 MBS compared to Ethernet's much less than 10 MBS. You'll have a multidrop capacity of up to 24,000 compared to Ethernet's 1,024. And, broadband gives you voice and video capability you just can't have with baseband.

Unlike other technologies, broadband equipment is readily available now. Over the past four years Comtech has delivered hundreds of broadband modems into networks around the world. Comtech is committed to broadband technology. We are continually enhancing our broadband product line.

Comtech's engineering excellence is helping networkers find solutions to their data communications problems. For help with yours, call Comtech. Applications notes, specifications, prices and delivery sent on request. Call or write Comtech Data Corporation, 350 North Hayden Road, Scottsdale, AZ 85257, (602) 949-1155 or TWX 910-950-0085.



COMTECH
Data Corporation
Creative Solutions in Data Communications

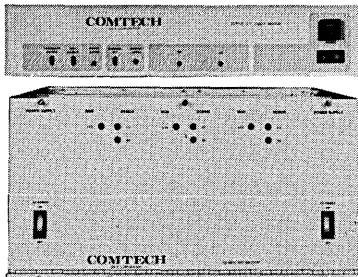

LETTERS

language, this means that if you do not analyze the data properly, and if you do not do logical data modeling, you will eventually produce a high probability for chaos, regardless of whether you use a 4GL, 3GL, 2GL, or whatever. The use of a 4GL, irrespective of which one, will certainly let the user, be he a data processing person or a functional user, get answers much faster, and there is no argument about that. Without data analysis, however, that fast answer may well operate on nonvalid or obsolete data, or data that other users cannot verify, or data that are multiply-defined, and therefore suspect.

Perhaps we should briefly examine the concepts of shared versus private data. Certainly, there are some data that will be private, but equally certain is that the overwhelming amount of data belong to the entire organization and must be shared by all who need access. What people are drifting into, whether we want it or not, is the erroneous use of the concept of the information center, and all that it implies. As soon as we begin to talk about shared data, we understand why the need for data analysis is imperative. If many people are to have access to common data, then those data must be properly analyzed, structured, and modeled, before meaningful results in terms of integrated databases can be obtained. Even if some data are to remain private for the user, who is going to help that user to understand that he will end up building a database without even knowing what a database is (try explaining database concepts to someone who doesn't care) and therefore must have controls to avoid redundant data, and a plan to address the anomalies of databases?

The alternative to organizational sharing of data is for every potential user of a terminal or PC to create and maintain his own private database, produce reports that are meaningful to him, and then justify the content and quality to his peers or superiors. If one wishes to define chaos, this seems like a reasonable starting point.

What must be done instead is to properly model the information requirements of the entire enterprise. Once this overall "information architecture" is defined, the proper subject area databases can be modeled and constructed. Then, and only then, can data be properly distributed and duplicated/replicated so that individual users can extract the data they need, be it via an information center, or 4GL, or placed on their own PC.

Some of the other issues raised in the Forum appear to either be emotional opinions (misstated as factual) or based on a lack of exposure to what is available. A statement such as "... this system development methodology produced a litany of systems that overran budgets, missed delivery schedules, compromised user functionality, and often didn't work" incorrectly

digital



Whitesmiths, Ltd. Introduces the Newest Idea in Software: The Craftsman's Seal.

Like the craftsman's seal on a fine work of art, Whitesmiths' Authorization Seal is more than just a means of identification. It represents the pride in workmanship, sense of tradition, and commitment to value on which we have always prided ourselves.

At Whitesmiths, we've established a tradition of producing some of the industry's most innovative and dependable software. Our C and Pascal compilers and cross compilers run in over 30 environments on DEC, Intel, Motorola and Zilog computers. Idris, our highly portable

operating system, is compatible with UNIX and runs on all those vendors' machines too. And our full line of Software A La Carte items – from assemblers to special purpose tools – permits our customers to pick and choose what they need to tailor our products for unusual requirements.

The Authorization Seal is one more way we can take pride in our products. Once affixed to the machinery on which the software is to run, the Authorization Seal verifies, at a glance, ownership, product

code, and the software copyright – all of which reduce order turnaround time and upfront expenses for both OEMs and end-users. No contracts to sign, no documents to read. Just good software, plain and simple.

The Whitesmiths, Ltd. Authorization Seal. It's one more way that we're committed to becoming a software tradition in your time.



Contact Whitesmiths, Ltd.,
97 Lowell Road, Concord,
MA 01742, (617) 369-8499
TLX 951708 SOFTWARE CNCM.

Whitesmiths, Ltd.

Software Craftsmen

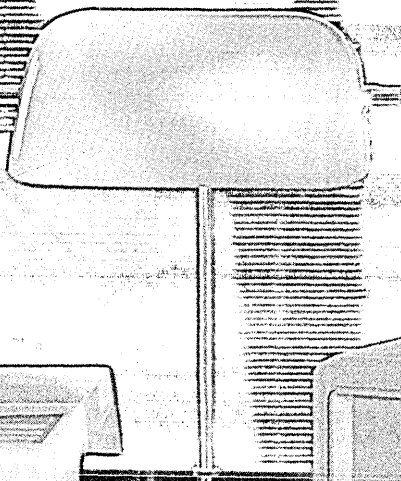
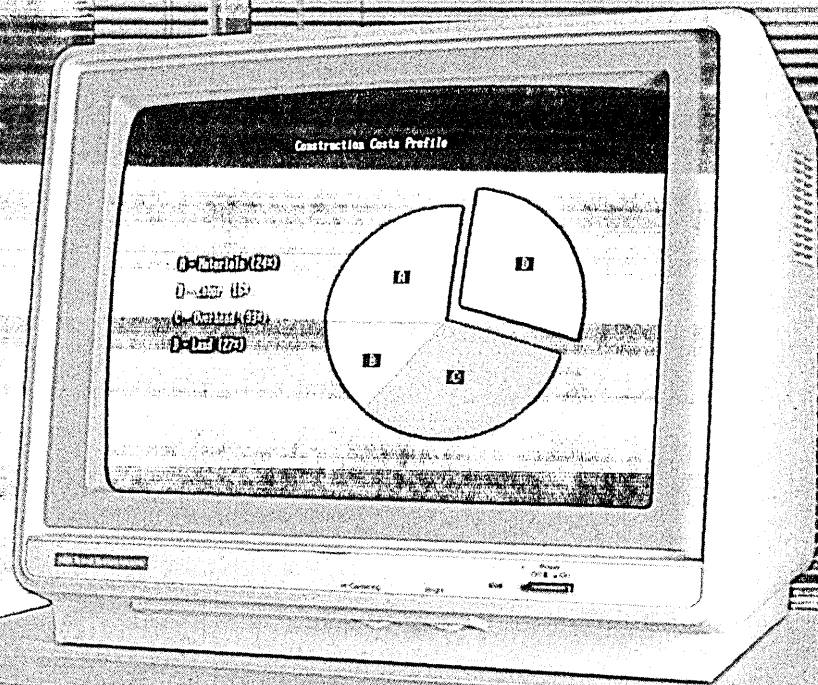

The new TI Professional Computer. It's the answer for information systems managers.

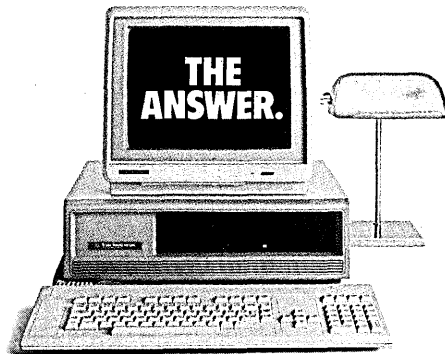

When it's your responsibility to choose a professional computer, you look for the one that's not only powerful and easy to use, but is also expandable enough to meet your company's present and future needs. A computer that helps increase productivity. One with the advanced design to permit it to effectively co-exist with information systems, today and tomorrow. The new Texas Instruments Professional Computer is the answer.

It works with you and your system. The new TI Professional Computer has the memory, the software and the user-friendly design that will quickly help the unsophisticated user become more productive. Its versatile communications capabilities enable it to work well with mainframes and office automation systems.

High resolution displays with dedicated memory. You get brilliant full-color or monochromatic graphics and text displayed with extremely high resolution. And

since our graphics board has its own memory, using graphics doesn't tie up the main memory. As a result, graphic displays appear on the screen much faster than other desktop computers.

An Easier-To-Use Low-Profile Keyboard. The slim profile of our keyboard features the popular typewriter layout and infinite height adjustment from 5 to 15 degrees slope. It also provides separate numeric keypad and cursor control clusters, plus improved key tactile response for quick positive entries.

It's the answer to your microcomputer needs. Now and in the future. All the leading operating systems and programming languages are available. You can use many popular application programs from the best software suppliers to help your managers generate spreadsheets, do word processing, construct graphics, commu-

nicate with other data bases and create their own.

Future enhancements will include speech recognition, speech synthesis, telephone management, natural language query capability with a true relational data base package. All this means greater productivity in your company today and tomorrow.

There's more information in store for you. It's simple to get more answers about how the TI Professional Computer can meet your needs. Just complete the coupon below and mail to: Texas Instruments, Dept. 1B, P.O. Box 402430, Dallas, Texas 75240. Or call toll free: 1-800-527-3500.

Creating useful products and services for you.



TEXAS INSTRUMENTS

SPECIFICATIONS

System Unit

16-bit, 8088 microprocessor
64K byte RAM, expandable to 256K bytes
4K byte graphics display memory
5-slot expansion bus

Keyboard

Specially designed low profile
Popular typewriter layout
97 keys, including 12 function keys
Separate numeric keypad and cursor control clusters

Tactile response, for quick positive entry
Upper- and lowercase letters

Display Units

12-inch monochrome (green phosphor) or
13-inch full-color, 25 lines x 80 columns
High resolution, 720 x 300 pixels

Mass Storage

Built-in 320K byte diskette standard
Additional internal storage of 320K byte diskette, or 5 or 10 Mbyte Winchester disks optional

Communications Options

300 BPS or 300/1200 BPS internal modem
TTY, 3780
3270 SNA stand-alone (Summer 1983)
3270 BSC and SNA cluster (Fall 1983)

Operating Systems

MS™-DOS, Digital Research™ CP/M-86®, and
Concurrent CP/M-86™, UCSD p-System™

Languages

BASIC, COBOL, FORTRAN, Pascal

Applications Software

Over 100 programs available from the most popular software vendors such as Microsoft, Ashton-Tate, Micro-Pro, IUS, Sorcim, Peachtree, BPI, Lifeboat and others.

Printers (Available Spring 1983)

150-cps TI 850 Series for most applications

FOOTNOTES: MS-DOS is a trademark of Microsoft Corporation. CP/M-86 and Concurrent CP/M-86 are trademarks of Digital Research, Inc. UCSD p-System is a trademark of the Regents of the University of California.

Get the Answer. Please send more information about the new Texas Instruments Professional Computer.

Name: _____

Title: _____

Company: _____

Address: _____

City: _____

State: _____ Zip: _____

Phone: (____) _____ Have Salesman Call.

Return Coupon To: Texas Instruments, Dept 1B,
P.O. Box 402430, Dallas, Texas 75240

DCA1B3DT318C

LETTERS

implies that any methodology will produce such unsatisfactory results. There are methodologies available that avoid many of those problems, get the functional users involved with the data processing department in defining the business problems, and result in a jointly developed solution that produces extremely high-quality systems that work in the day-to-day environment and are delivered, to use a cliché, on time and within budget. One methodology that we work with addresses all the elements of the development process, including data analysis, logical data modeling, database systems, using 4GLs, prototyping, etc.

We resist the implication that the use of 4GLs will solve all the problems that are raised by Read and Harmon. They are merely one more very valuable means to help address, define, and solve the myriad problems that face managers, both within and outside of data processing. To develop and deliver systems that are usable by both functional areas and data processing requires that a great deal of thought, planning, and direction be given to many other areas besides the use of 4GLs. If we insist on promoting 4GLs as the answer, then we in data processing will again be guilty of making promises to users that cannot be fulfilled. We think that we have already been through that unpleasantness enough times in the past. It is time for us to think clearly

about the user's business problems before we start propounding easy solutions.

JOHN CARDULLO
HERB JACOBSON
Technology Information Products Corp.
Burlington, Massachusetts

AUTHOR'S RESPONSE

Our article made no claim that fourth generation languages (4GLs) were a panacea for all dp ills. Instead we stated that "4GLs are as major a technological advance to computer programming as integrated circuits were to computer hardware." All technologies are continuously evolving; 4GLs are the latest advance in software technology, but there is no such thing as an ultimate panacea. We are watching the development of fifth generation languages (artificial intelligence tools) with great interest.

The central issue of our article was that most end users are profoundly dissatisfied with their dp departments, and that a major tool for reducing this dissatisfaction—fourth generation languages—is being actively resisted by those same dp departments. The article was not intended to describe technical details of how 4GLs should be used. This was done in our February 1981 DATAMATION article entitled "Assuring MIS Success," in which the term "fourth generation language" originated. In this article we described the critical im-

portance of database design, with strong emphasis on relational structures. And, for this reason, all 4GLs include a sophisticated, powerful relational DBMS for data handling—in addition to the many other technical features. We did not overlook this in our article; it was simply not germane to the central issue. In fact, James Martin, who was quoted favorably on this subject, paid a special visit to us in San Diego and he taped a discussion with us on this very topic.

For historical perspective, 4GLs were invented in the late 1960s by a genius software whiz, Gerald D. Cohen, who wrote the early version of RAMIS for CSS Corp. In the early 1970s he formed his own company, and building on his experience, wrote a much more sophisticated product, FOCUS. 4GLs are "total system" application development tools. The late 1960s versions of MARK IV and INQUIRE, however, were primarily report generators that employed nonprocedural commands, i.e., a subset of 4GL capabilities. They are both excellent products that, in common with many others such as Sperry's MAPPER, are currently evolving into 4GL status. Our 1981 article identified INQUIRE as a 4GL.

Douglas Harmon and I welcome further discussion on any of these subjects.

—NIGEL S. READ
Fourth Generation Technology Inc.
San Diego, California

AND IT DOES IT IN 1/10 THE TIME:

Now you can make perfect drawings like these in just a fraction of the time . . . without the expensive drudgery of templates and hand lettering. The Datascribe IV's computer memory and preprogrammed cassettes let you select from more than 3,000 symbols and characters. And the built-in microprocessor gives you a choice of over 18,000 height and width variations of each character and symbol . . . plus character rotation in any direction.

An LCD display lets you preview characters and instructions before lettering. Built-in memory for up to 8000 characters and 50,000 character cassette storage cuts repetitive drafting time to an absolute minimum.

With Datascribe IV, your staff will be far more productive. And it's so affordable, that the system can pay for itself in less than 6 months. To see one in action, call or write.



OZALID

Ozalid Corp., 1000 MacArthur Blvd.
Mahwah, NJ 07430 (201) 529-3100

- Please call me to schedule a Datascribe IV demonstration.
 Please send me literature on the Datascribe IV.

Name _____ Title _____

Company _____

Address _____

City _____ State _____ Zip _____

Phone No. _____ DA5

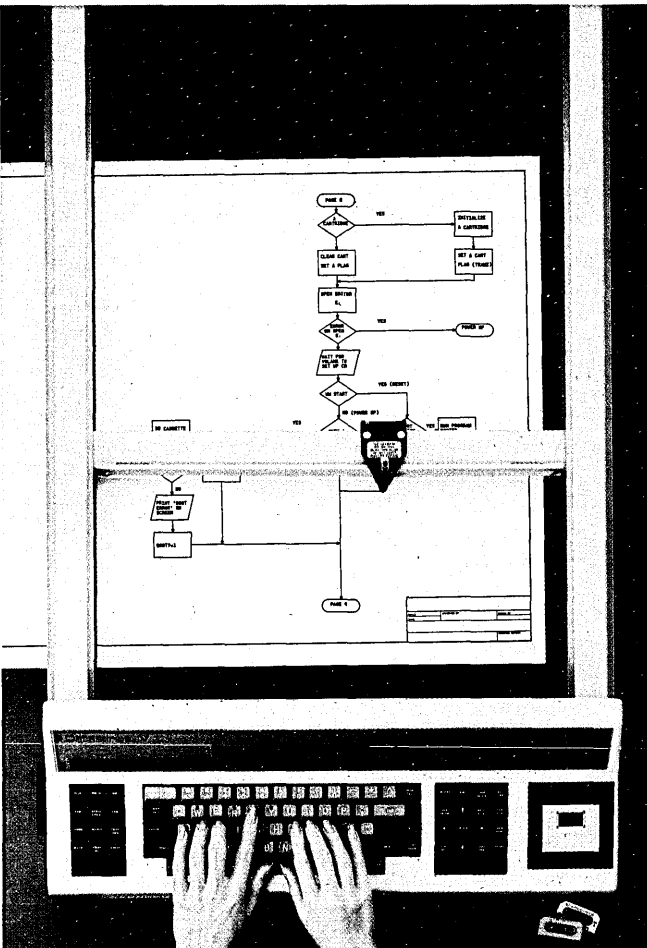

EXXON
Office Systems
presents
the future...

without
the shock.

The Exxon 8400

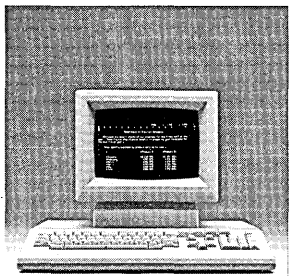
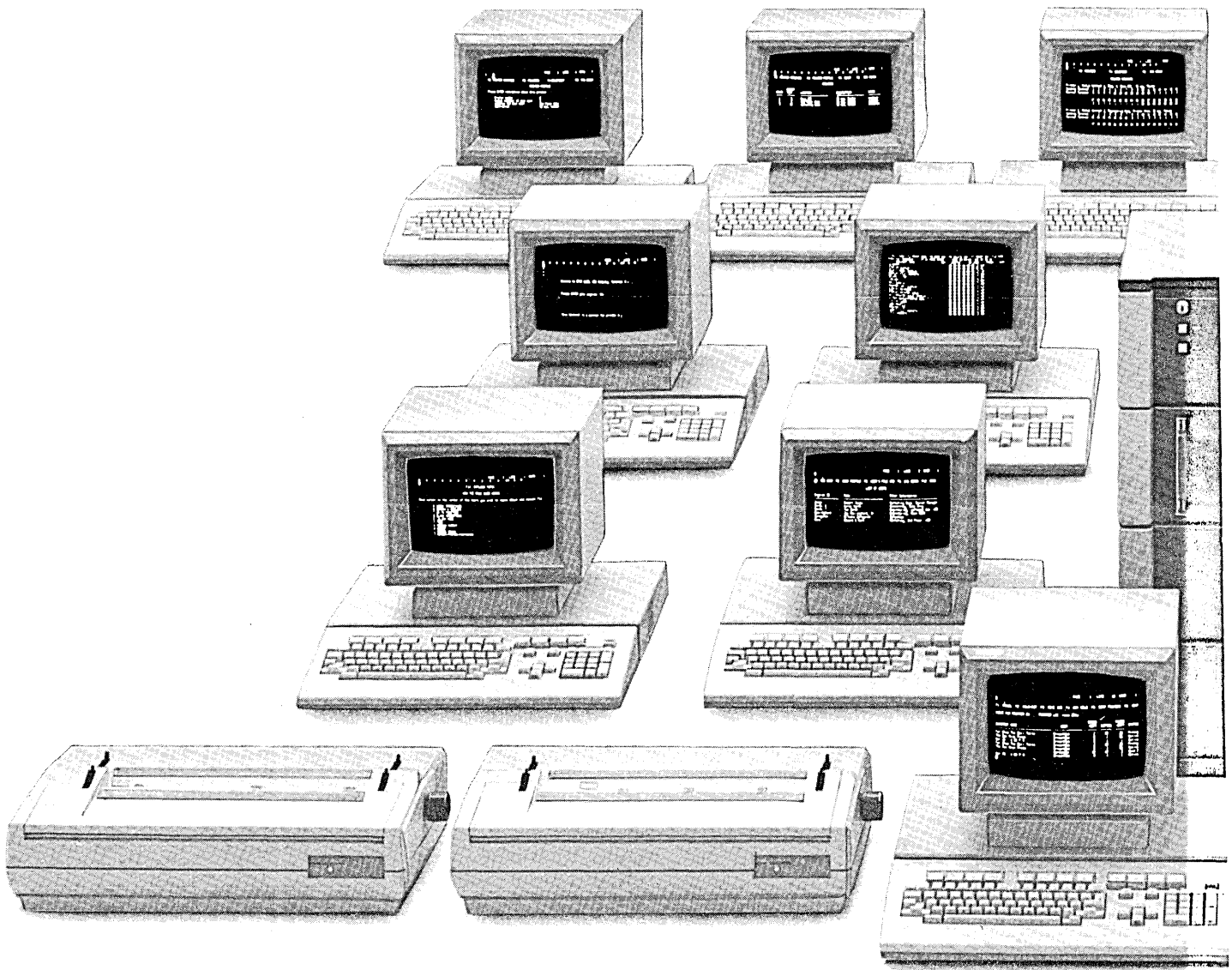

The best part is, you don't have to start with all of it.

Guiding an office into the future can be a very shocking experience, especially in the ever-evolving world of office automation.

But at Exxon Office Systems, we've worked hard to take the high anxiety out of high technology. We've brought the high-tech office down to earth by designing it to grow the way you grow. For instance, you can start an office automa-

tion system simply with just one of our remarkable EXXON 500 Series Information Processors.

Then as your needs grow you can expand, workstation by workstation, cluster by cluster, up to a fully functioned, shared resource office automation system ... The EXXON 8400 Series System. And that means you'll never face the shock of owning expensive word processing equipment that's obsolete because it can't expand.

Series System.

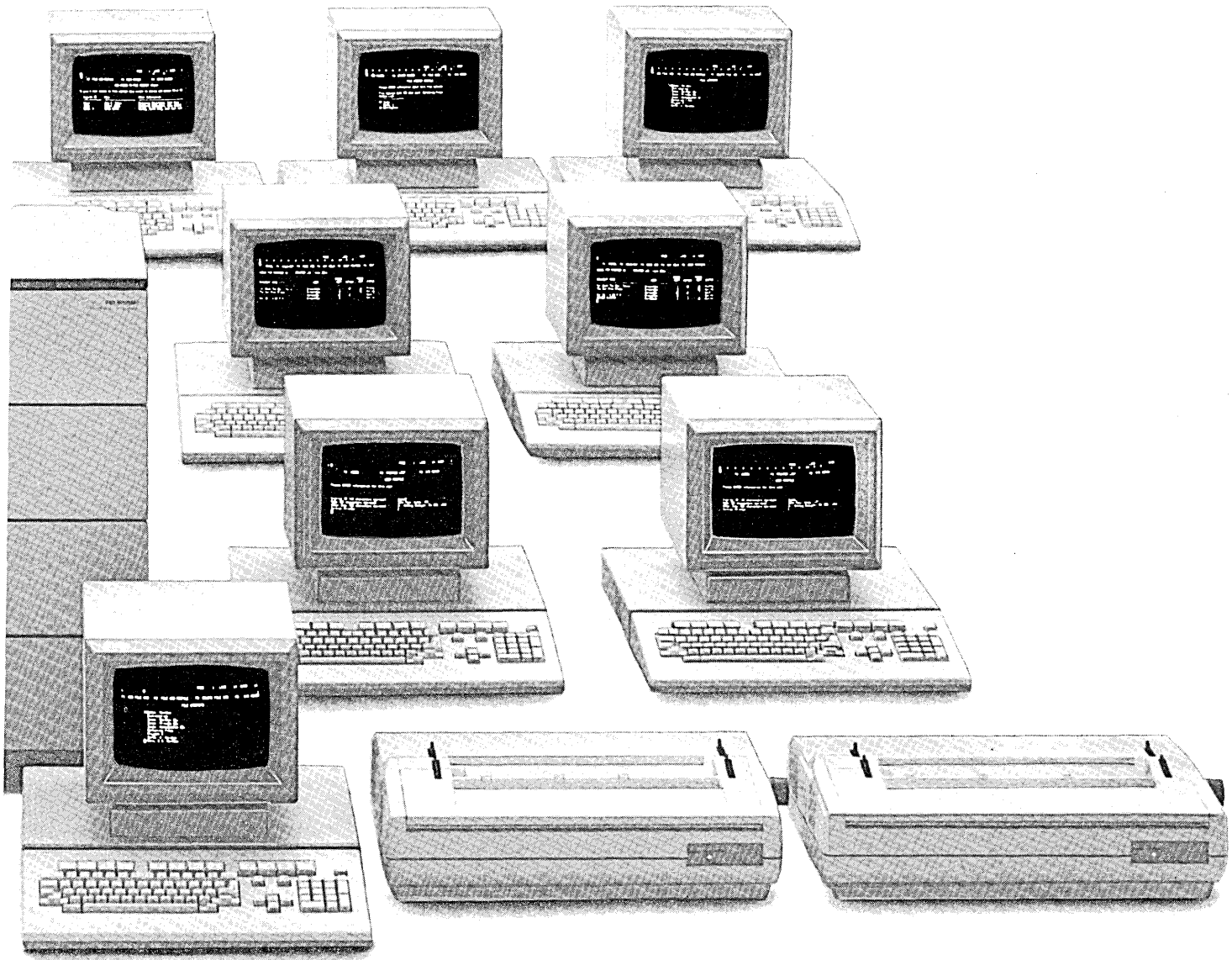

The EXXON 8400 Series System's fully functioned capability is awesome. Operators can create, edit, reformat, file, share and retrieve documents, all with the touch of a key.

There's a dictionary to check spelling automatically. An electronic mailbox for sending messages. A program for keeping calendars and scheduling meetings. A tickler file with an electronic signal to alert you to appointments, and more.

The EXXON 8400 System features an advanced central controller/microprocessor. Its upgradeable storage can hold up to 235,000 pages of typed material and supports up to 16 systems, archiving or stand-alone workstations.

Step into the future without the shock of unnecessary costs from expanding or upgrading inefficiently. Start automating your office now with one of our EXXON 500 Series Information Processors.

Beat the shocking, high cost of office automation with Exxon's new clustered systems.

We don't think the office of the future has to have a price that's out of this world.

To prove it we've created three specially priced and expandable clustered configurations. They let you start automating your office at a level and price that's right for you. And they're ideal for companies that want to move into the office of tomorrow and still stay within their budgets today.



The Cluster Model I
\$27,500

One EXXON 8411 dual 16 bit controller/microprocessor with 512k memory and a 14.8MB formatted hard disk including all operating software.

Three EXXON 500 Series Information Processor terminals, one single diskette drive, not shown, and one EXXON 935 letter quality daisy wheel printer.

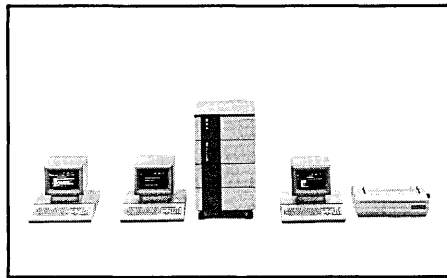

The Cluster Model II
\$31,500

One EXXON 8421 dual 16 bit controller/microprocessor with 512k memory and a 29.4MB formatted hard disk including all operating software.

Three EXXON 500 Series Information Processor terminals, one single diskette drive, not shown, and one EXXON 935 letter quality daisy wheel printer.

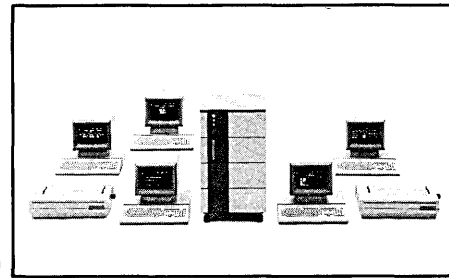

The Cluster Model III
\$54,500

One EXXON 8431 dual 16 bit controller/microprocessor with 512k memory and a 67.5MB formatted hard disk including all operating software.

Five EXXON 500 Series Information Processor terminals, one single diskette drive, not shown, and two EXXON 935 letter quality daisy wheel printers.

For more information on the EXXON 500 or our new upgradeable and expandable office automation system, just send in the coupon below. Or call **800-327-6666**.

Exxon Office Systems

P.O. Box 10184, Stamford, CT 06904

INS

I'd like to know more about

- the EXXON 8400 Series System
- the EXXON 500 Series Information Processor

Please have your representative call.

Name _____ Title _____

Company _____

Address _____

City _____ State _____ Zip _____

Telephone _____

800-327-6666

IN CONNECTICUT 800-942-2525

EXXON OFFICE
SYSTEMS

The future...without the shock.

EDITORIAL



ARE MICROS A MACRO SCAM?

There are those who regard the introduction of the personal computer into the business environment with the same fondness that Southern cotton growers greeted the boll weevil. If Dow Chemical marketed a spray guaranteed lethal to microcomputers, you can bet there would be a lot of data processing managers stalking the darkened hallways of their corporations late at night administering the last rites to every PC they could find.

Why is it that many dp managers are less than enchanted with these new miracle machines? Supposedly the corporation's savior, micros will unlock the applications logjam by giving computer power to the users; promote widespread computer literacy, once restricted to the high priests of dp; and bring processing power to the unwashed masses. Business will boom as happy users, cradled in the security of fourth generation languages and empowered by access to massive databases, bring new levels of productivity and creativity to the corporate scene. One would think that the dp/MIS managers would welcome the personal computer with open arms.

We brought this anomaly to a few members of our editorial advisory board for an off-the-cuff opinion.

"Micros in the corporation? Beneficial? Ha!" said one vehemently. "They're a waste of time, energy, and money. This kind of ad hoc computerization by untutored individuals simply allows unskilled users the luxury of burying in microelectronics the same confusions they brought to the job all along.



"And," he added, "by the time you package a PC system with the necessary peripherals and software to make it work properly, your cost per unit of processing is about the same as that of the more powerful combination of terminal and mainframe.

"The person who needs the work done is not necessarily the one who should do it," he observed, pointing out that most good businessmen are mediocre systems implementers.

And then there is the dangerous and very real fascination that these machines exert. Give the user a micro and he's liable to tinker forever, lost in a corner, punching numbers and neglecting the real world and his company's

business. We live in an analog world after all, he reflected, a world of concepts, planning, salesmanship, body language, imprecision, subtleties, nuances—all the things that make us human and all the things a machine can't handle. "At present you're better off with a good programming staff and plenty of terminals," he concluded.

Another advisor, who has micros at home and at the office, found that there is little difference between the amount of effort and concentrated attention required to program a micro and to program a big machine. The real difference, he said, is what you can accomplish per hour.

"Compare any micro being used as a word processor with a stand-alone dedicated wp machine or a terminal hooked to the mainframe and you'll see just how limited the personal computer really is. For individual spreadsheets, they're terrific. But just imagine what would happen if VisiCalc suddenly ceased to exist—we'd be using our micros for paperweights."

An advisor who spends a good deal of time with MIS directors reports that some regard the PC in business as a fad, a new and interesting entertainment that will fade away as quickly as it arrived, much like the hula hoop and the Nehru jacket.

"Of course, he mused, "when the light bulb, the telephone, and the automobile were first introduced, people said they were fads too. It might just be that as personal computers evolve into truly functioning workstations the little rascals will be with us for a long time to come." *

ELXSI System 6400. or large as a 40

ELXSI System 6400 represents the most dramatic change in system architecture in 20 years. It's an architecture so modular that expansion is perfectly natural and economical.

A computer system that can grow from a supermini to a large, multiprocessor configuration without having to modify software, user environment, operating system or existing hardware.

A system whose computational power increases *in direct proportion* to the number of incremental CPU's you add.

A system that can handle multiple interactive *and* batch jobs concurrently and with equal efficiency.

A 64-bit, byte addressable multi-purpose computer system organized around a 320 megabyte/second system bus.

Extraordinary price/performance

A complete ELXSI system with one CPU and peripherals and capable of executing four million Whetstone instructions per second sells for around \$600,000—the best price-performance in the industry.

Instruction Times per CPU

Instruction	Time
64-bit Integer Add	100 ns
8 Byte ASCII Add	200 ns
32-bit Floating Point Add	150 ns
32-bit Floating Point Multiply	200 ns
64-bit Floating Point Multiply	300 ns

High performance I/O is provided by dedicated I/O processors, each with a bandwidth of 16 megabytes/second.

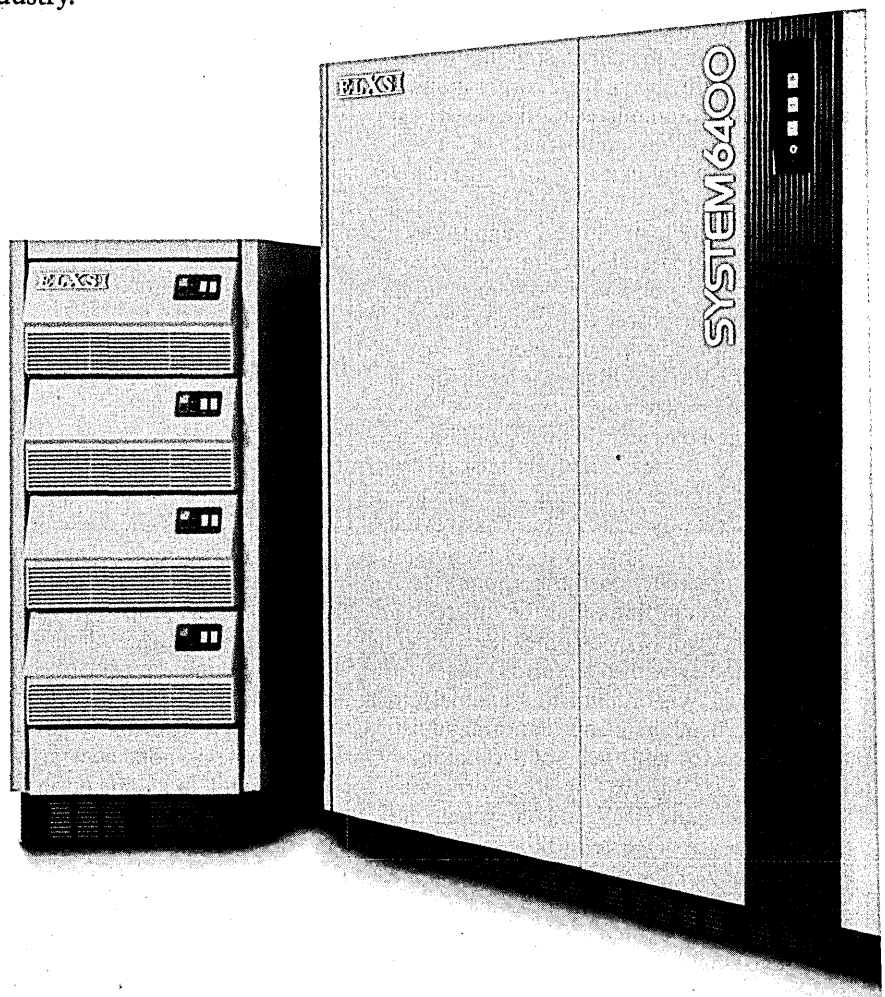

Small as a supermini MIPS mainframe.

Advanced ELXSI packaging means that a configuration providing in excess of 20 MIPS of computational power, 64 million bytes of main memory and dual-ported I/O controllers is contained in a single air-cooled 32" x 59" cabinet and requires only 12 KVA of power.

Massive Memory

High performance systems call for increasingly vast amounts of main memory to support high throughput. ELXSI provides the largest real memory of any system—up to 192 megabytes—and four billion bytes of virtual address space per user process.

A More Productive User Environment

EMBOS™, the ELXSI Message Based Operating System, provides a high performance, interactive system environment. It includes a powerful command language, a full operational set of software tools, plus enhancements for real-time, time sharing and transaction processing applications.

Pascal, FORTRAN-77, COBOL-74, C, and BASIC are offered with support for the ELXSI Relational Data Base Management System.

The ELXSI System 6400 shows what can be accomplished when a company is totally committed to designing from the ground up, using the leading edge of technology.

ELXSI, 2334 Lundy Place, San Jose, CA 95131. (408) 942-1111. Telex: 172320.

TATA-ELXSI, 37 Joo Koon Circle, Jalan Ahmad Ibrahim, Singapore 2262. Telephone: 2616727/8, 2640011. Telex: RS 34413 TESING.

In Australia: Techway, P.O. Box 373, 61 Lavender Street, Milsons Point, N.S.W., Australia 2061. Telephone (02) 920858. Telex: AA 27987.

ELXSI

See the ELXSI System 6400 at NCC in Anaheim, May 16-19, Disneyland Hotel Convention Center, Booth D1500; or at COMPUTA '83, Booth 207, May 11-15, at the World Trade Centre in Singapore.

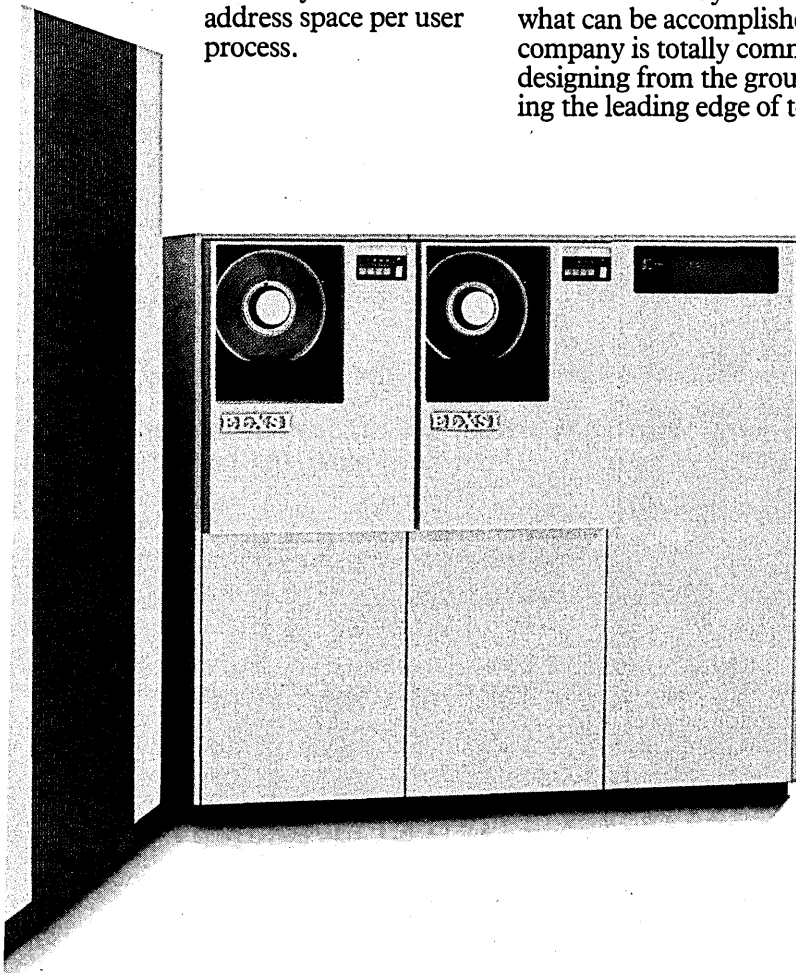

INFOCUS

THE CPU MARKET: A SURVEY

While IBM enjoys strong orders for its 3380 disk and 308X mainframes, the other mainframers are struggling to find business in office systems and minicomputers.

Once again IBM is showing its muscle in the annual Cowen & Co./DATAMATION survey of mainframe buying plans. The industry leader has enjoyed strong order rates during the past year and is apparently poised to gain even more ground this year on its plug-compatible rivals and the traditional mainframe competitors.

This year's survey compiles answers received from a total of 5,416 users who were asked about their installed equipment and expected order activity for the previous and following 24 months as of mid-February this year. Questionnaires were sent to users of IBM, Burroughs, Honeywell, NCR, and Univac computers.

While the survey does not pretend to speak for the entire U.S. user population, it gives a well-rounded picture of a substantial number of users and sketches out important trends that will affect product marketing and product development plans for the industry this year.

If any single overriding trend can be seen stretching across company boundaries, it is that the industry's strongest growth is no longer coming from mainframes but rather from a number of smaller, rapidly expanding markets. Among these are distributed processing, minicomputers, personal computers, office systems, software, and communications. Each of these markets was investigated in depth this year, providing an unprecedented view of how users are spending their money.

In addition, specific analysis was made this year of the implications of IBM's growing dominance in the marketplace, especially for the traditional mainframers, and the battle between the industry leader and its plug-compatible competitors.

In the fast-growing distributed data processing market, IBM's success has been especially strong. In those non-IBM user sites planning to first distribute their computing in 1983 or 1984, 14% specified IBM as the principal vendor. Of those who have already implemented ddp, fully 8% said they would use IBM primarily, compared to last year's comparable figure of 3%.

Among large systems users, distributed processing was found most pervasive

among IBM sites, but it was growing fastest among Burroughs and Honeywell users. Among IBM sites in the large systems category, it was found that just over half would be using distributed processing over the next 24 months, compared to 33% already using it. By comparison, only 22% of Burroughs sites were into ddp at the time of the survey but 45% said they would have it under way in the next two years. Honeywell users indicated similar figures.

Moreover, IBM has been making strong inroads into its own and other mainframers' sites in the area of office systems. Of IBM users, almost half said they would use IBM office systems. By comparison, only 31% of Honeywell sites, 21% of NCR sites, 14% of Univac sites, and 14% of Burroughs sites said they would use their mainframer's office systems.

As a supplier of office systems and word processors, IBM earned 46% of mentions from the IBM user population, compared to Wang's follow-up figure of 21%. Some 33% of the other mentions were split into 2%, 3%, and 4% shares for CPT, Lanier/AES, Xerox, and others. In similar figures last year, IBM had a 41% share, compared to Wang's 28%. Wang's share of the office systems mentions was greater among users with annual revenues of \$250 million or more, as compared to smaller users. CPT scored well (6%) with smaller organizations.

A total of 3,636 IBM sites provided information for this year's survey. Those users were found to be installing 308X machines at a rapid clip, losing interest in 303X and 4300 gear and, among other trends, rearranging their lease/purchase mixes.

In terms of total dollar value of 370-type machines installed at IBM sites, the

The industry's strongest growth is no longer coming from mainframes but rather from new, emerging markets.

308X line accounted for 33%, just one point under the value of installed 303X machines. The 4300 line made up 23% of the total value while 370s now account for only 10% and 360 gear only 0.4%. Last year's comparable numbers were 8% for the 308X, 21% for the 4300 line, 46% for the 303X, and 22% for 370 machinery.

Together, the survey data suggest that between 1,100 and 1,200 IBM 308X systems are already installed in the U.S. and Canada as of the survey's cutoff date. Also, the data show how important the high end of the computer spectrum is to IBM's total sales and that the 4300 line did not turn in a spectacular year in 1982.

Meanwhile, plug-compatible manufacturers Amdahl Corp. and National Advanced Systems, selling Hitachi mainframes, appeared not to have gained any

FIG. 1

RESPONDENTS' INSTALLATION PLANS

VALUE OF PLANNED INSTALLATIONS AS PERCENTAGE OF INSTALLED BASE

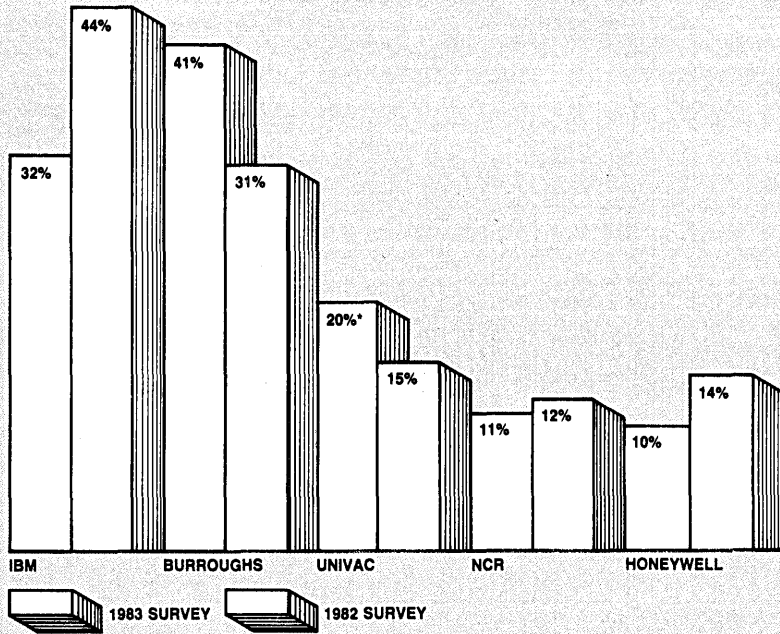

*Does not include USAF order for 153 1100/60s to be delivered in 1983 through 1985

market share in the large-scale systems segment over last year's survey. Their combined share of total value remained just over 15%, divided as last year at 14% for Amdahl and just below 2% for NAS. It should be remembered that shipments of Amdahl's 580, delayed by engineering problems, were just beginning late in 1982 while IBM was enjoying its first full year of 3081 shipments.

Looking ahead for the next 24 months, IBM respondents said they would be installing equipment valued at 32% of their current installed machines. Only 7% of that planned spending was to be for non-308X equipment, implying that IBM will be heavily dependent on 3083 and 3084 equipment during the two-year time frame. Moreover, the data suggest that the company is due soon to introduce a new line of midrange systems as a replacement for the 4300 line.

At the low end of IBM's product line, the System/38 was seen as doing particularly well, bolstering, in fact, the company's business there. In terms of dollar value, the System/38 is expected to account

IBM users are moving away from leasing and towards purchasing their systems.

for more than half of the installations from formerly General Systems division machines (System/3, 32, 34, and 38). Some respondents mentioned plans to install IBM's as-yet-unannounced System/36.

For Amdahl, 470 systems continued to be the major source of installation activity, according to its respondents. Looking ahead into 1983, they said 36% of their planned Amdahl orders would be for 470 V/8 systems, 20% for other 470s, and only 44% for the oncoming 580 line. In terms of dollar value, however, the 580s will gain a majority share of orders.

The lease/purchase mix for IBM sites will see some shifts in the coming 24 months. In particular, among 308X shipments, third-party leasing will see a dramatic rise to 37% of total dollars spent from last year's outlook of 22%. Direct purchase from IBM will apparently remain level, at about 42% to 43%. Long-term leasing from IBM is on the downswing, showing only a 15% share of planned activity, compared to last year's figure of 32%. These changes were seen as reflecting IBM's pricing actions last year that were geared to make purchase more attractive.

In to-be-installed 4300s, a marked shift away from IBM leases and rental agreements was seen. Whereas last year's survey respondents said they would spend 54% of their dollars on IBM two-year leases, only 23% said they would this year. In contrast to that downshift was an upswing in third-party leasing activity, rising to 27% of the total dollar volume in this year's survey

FIG. 2

PRESENT AND PROJECTED USE OF DDP

PERCENTAGE OF LARGER SYSTEMS USERS

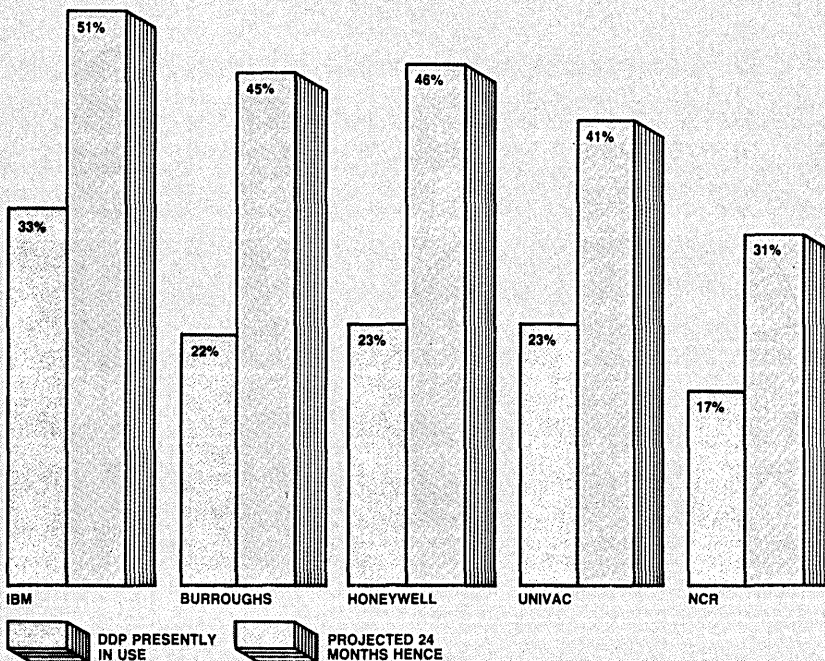

CHARTS BY CYNTHIA STODDARD

IN FOCUS

from 11% last year. Purchase of 4300s will see a slight increase to 32% from last year's 25%. IBM Credit Corp. is expected by respondents to take in about 7% of the total dollars spent.

For Amdahl, the survey showed a tangible rise for 1983 of sales-to-lease ratio as the company's 580 machine begins volume shipments. A substantial number of 470s are being installed on lease, which could hurt the company if it is forced to make price concessions.

Asked if they had shifted their attitude towards purchasing systems, the majority of the 7% of IBM sites leaning towards lease said product cycles are changing too fast and that they were uncertain about the useful lives of machines. But IBM's lowering of purchase prices inclined 22% of the sites to say they favored purchase.

The 4300 remains the largest component of IBM's installed lease base, despite evidence that there has been substantial conversion to purchase during the last year. In terms of dollar value of leased/rented systems, the 4300 accounts for 44%, followed by the 3081 at 36%.

About one fifth of the leased 4300s are to be converted to purchase in 1983, respondents indicated. The same figure of 19% held for System/3 and 38 sites, while only 14% of 308X sites are expected to be switched this year.

Survey respondents indicated strong erosion in used computer prices for all classes of computers except the 3081, with the Amdahl V/6 model selling for as little as 7% of its original list price.

In the add-on IBM peripherals arena, a decided shift to sales, away from lease,

Used computer prices are eroding as product cycles shorten and IBM's aggressive pricing policies take hold.

was seen for all devices except tape drives. For instance, 71% of the sites procuring disk drives said they would rent or lease from IBM, compared to last year's figure of 78% and the year earlier's 82%. This is partially a reflection of moves IBM has made recently to encourage purchase of the 3380 drive.

Overall, peripherals add-on activity was seen for the next 24 months as being about as strong as foreseen a year ago. About two fifths of the respondents expect to add disk, about 10% plan tape acquisitions, 10% plan add-on memory acquisitions, and two fifths will buy terminals.

Indeed, plug-compatible manufacturers had disk installed at only 23% of the responding sites, down from 25% last year; terminals to 32% of the sites, the same as last year; and, dramatically, add-on memory to only 22%, down from 42% two years ago. Pcm penetration into the System/38 base was found to be very low as indicated

FIG. 3

PERCENTAGE OF RESPONDENTS BUYING OFFICE AUTOMATION EQUIPMENT FROM THEIR MAINFRAME SUPPLIER

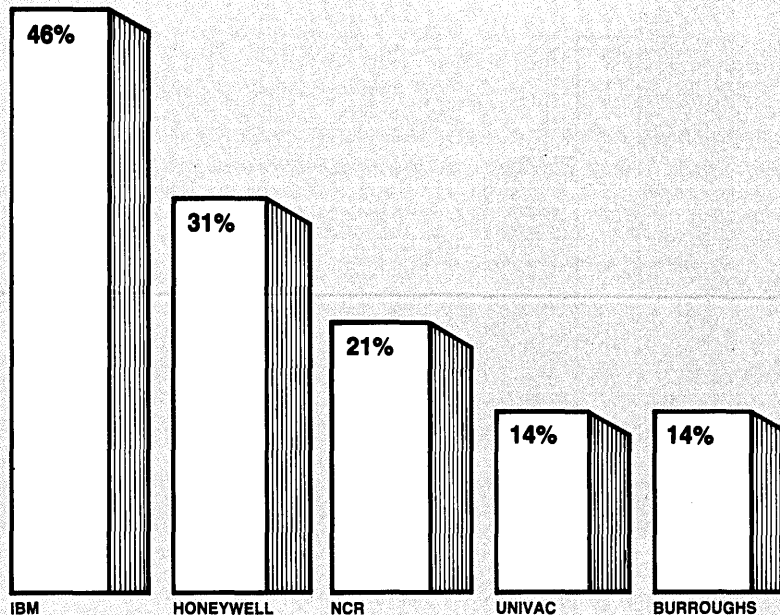
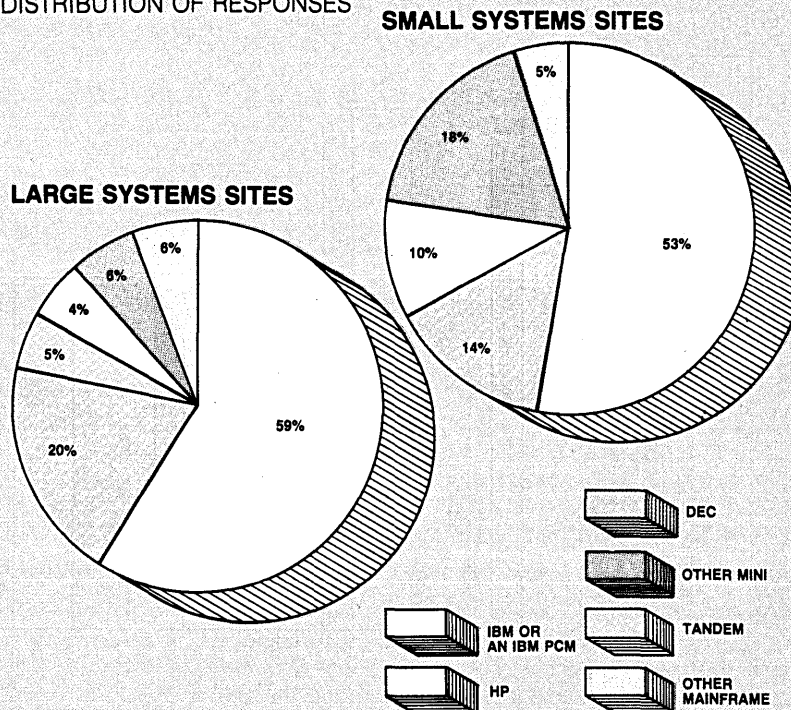

FIG. 4

POTENTIAL NEW VENDORS AT SITES CONSIDERING SWITCHING

DISTRIBUTION OF RESPONSES



History will record as a profound irony
that the most powerful word processing package
ever created for the IBM® Personal Computer
wasn't created by IBM.

LEADING EDGE.®

*IBM is a registered trademark of International Business Machines Corporation.

LEADING EDGE PRODUCTS, INC.
FORTUNE 1300 DIVISION
21 HIGHLAND CIRCLE
NEEDHAM HEIGHTS, MA 02194
(617) 449-6762 1-800-343-3436

HEADQUARTERS & RETAIL DIVISION
225 TURNPIKE STREET
CANTON, MA 02021
(617) 828-8150 1-800-343-6833

CIRCLE 84 ON READER CARD

IN FOCUS

in previous surveys.

Of course 1982 was the year IBM's 3380 disk came into the market in volume, capturing a large share of total disk sales to IBM respondents. Survey respondents indicated that, looking ahead 24 months, 53% of their disk units ordered would be 3380s, 21% would be 3370/5s, and the rest of 3350 or other vintage. By the end of 1984, it was shown, fully 47% of the total megabytes installed by respondents to machines they currently run would be in the form of 3380 disk drives.

In the midrange cpu-oriented 3370/5 disk market, IBM reversed a trend seen in last year's survey of pcms gaining ground. The industry leader had installed this year 93% of the total market, compared to last year's figure of only 83%.

In the add-on memory market, once populated by as many as a dozen vendors, only Amdahl (4%) and Control Data (2%) are left with any significant market share (2%). IBM controls 83% of the installed base.

In the terminal market, pcms have gained on IBM, but the company's late win-

Plug-compatible peripherals makers have not had an especially good year, particularly in the disk arena.

ter product introductions are expected to change that situation. This year's survey showed IBM with a 53% share of respondents' terminals, compared to last year's figure of 64% and a 1980 figure of 67%. Telex came in as runner-up, showing 5% share.

For Burroughs, the survey this year brings some good news and some bad news. Its users indicated a strong shift of attitude towards their supplier, the second year such a shift has been seen following 1980, when a decidedly negative attitude was seen. More importantly for Burroughs, fewer users this year than last view the company and its products as inferior to IBM. This comes as the Detroit firm boosted its product line at the low end and attempted to correct many of the perceived faults of previous years.

Moreover, planned installation activity is up in this year's survey. Burroughs respondents said they would install equipment valued at about 41% of their currently installed gear, compared to last year's figure of 31%.

The company's 900 series products are apparently catching on quite well with users, so well that the company may have to find a follow-on product fast to maintain the order activity it is apparently enjoying. In other words, the B 4900 and B7900 product cycle could peak rather swiftly.

Add-on peripheral activity was seen as on par with last year's readings: about a fifth of users plan to install disk drives, about 30% plan to add terminals, and al-

FIG. 5

EXPANDING AMDAHL SHARE OF PCM SYSTEMS USER POPULATION

PERCENT OF ALL SITES WITH PCM CPU ALREADY INSTALLED, ON ORDER, OR PLAN TO ORDER

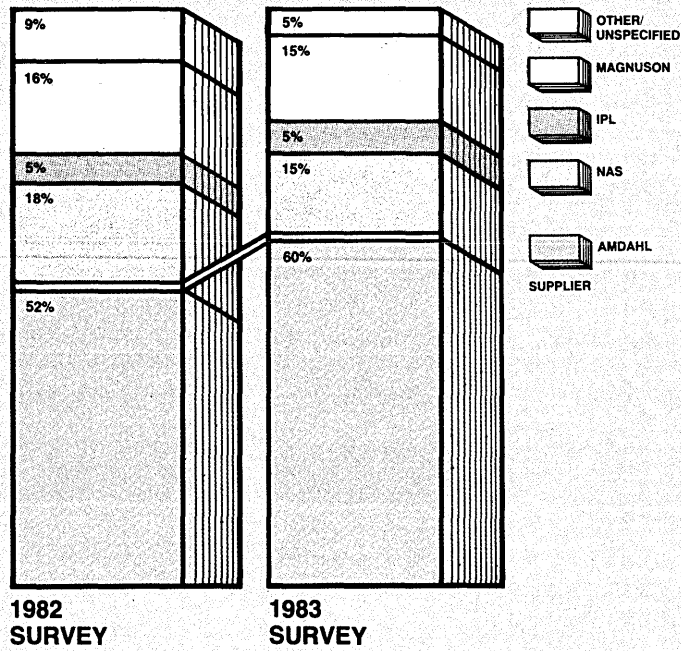
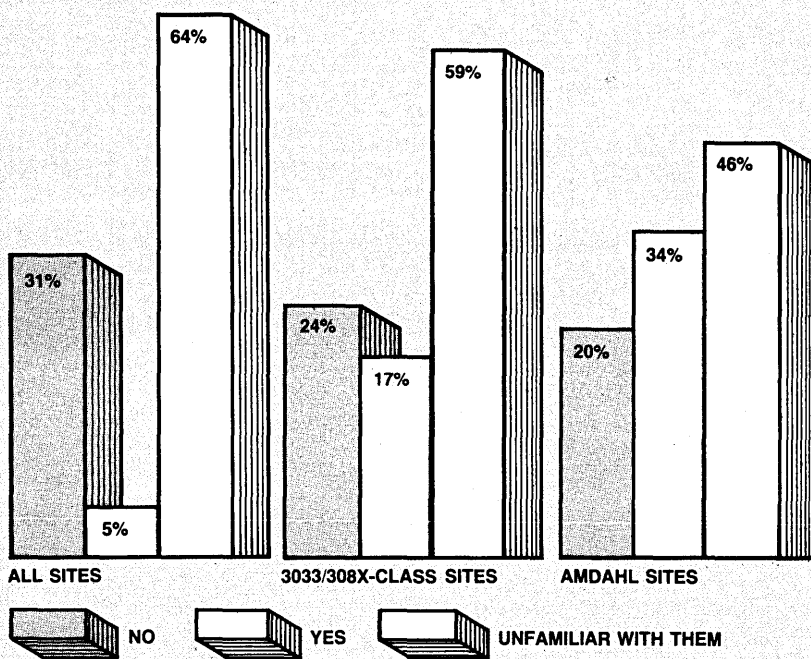



FIG. 6

EARLY INTEREST IN TRILOGY SYSTEMS AMONG AMDAHL USER SITES



How to Get 3270 SNA/SDLC Networking Flexibility.

1.  The PCI 78, keystroke for keystroke 3270 keyboard compatible terminal. PCI's ASCII CRT solution eliminates operator retraining.

2. **Personal connections.**  Large main-frame applications bend to the power of the micros.

3. **Other ASCII's.**  DEC, Lear Siegler, TeleVideo, Hazeltine, ADDS, etc, etc, etc ASCII CRTs become 3270 terminals. ASCII printers, Qume, Epson, Okidata, etc, etc, etc become 3287 printers.

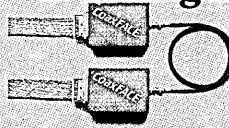
4. **Getting it together.**  One, by phone (modems), two by coax (PCI CoaxFACE™), or three by twisted pair. The connection is made.

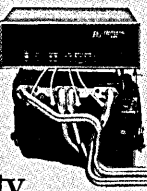
5. **The engine makes it work.**  PCI's 1076, the engine for 3270 SNA/SDLC compatibility.

6. **Need we say more? Yes.** Get technology, quality, reliability and SNA/SDLC networking the flexibility with PCI 1076.

(Incidentally, you also get enormous economic benefits.) Call or write today. Protocol Computers, Inc./6150 Canoga Avenue, Suite 100, Woodland Hills, CA 91367-3773 (800) 423-5904, In California: (213) 716-5500 

7. Here's how to get networking flexibility.

Send me more information on:

- The PCI 1076 for SNA/SDLC 3270 emulation
- The PCI 78 CRT
- The PCI Personal Computer Support book
- All PCI Products

Name _____
 Company Name _____
 Address _____
 City/State/Zip _____
 Phone _____

 **PROTOCOL COMPUTERS, INC.**

6150 Canoga Avenue Suite 100/Woodland Hills, CA 91367-3773

Also available:

1067: SNA/SDLC to ASCII 3270 emulation. The NTO alternative.
 1051: ASCII to Sys 34/38 5250 emulation.
 71B/SNA: BSC 3271 to SNA/SDLC 3274 emulation.
 75B/SNA: BSC 3275 to SNA/SDLC 3276 emulation.
 1071: ASCII to BSC 3270 emulation.
 73SX: SNA/SDLC through X.25 connection interface.
 1076X: ASCII to 3270 SNA/SDLC through X.25 networks. (With PAD included.)
 PCI 51: Keystroke-for-keystroke 5251 keyboard compatible ASCII CRT.
 PCI 7887 Plus: IBM-PC software package for 3270 emulation.
 PCI 5156 Plus: IBM-PC software package for Sys 34/38 emulation.

(800) 423-5904
 (213) 716-5500
 In California



***“Do you realize, Rutherford,
if Ripley gets his hands on those reports
he could run off to Rio!”***

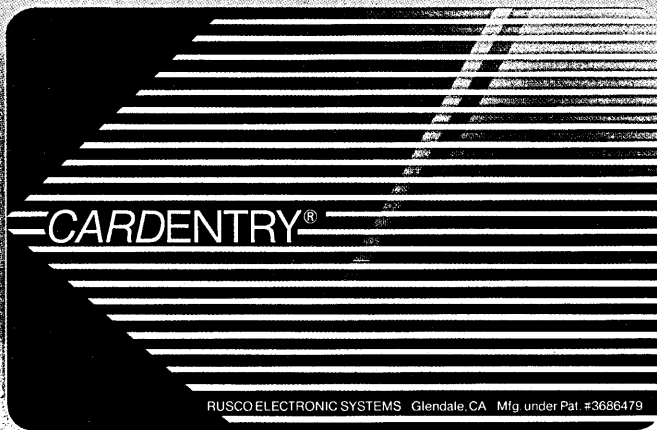

**How to keep an eye on the company files,
guard the computer room, patrol the halls
and watch the back door, all at the same time.**

To be in 14 places at once, you need a system. The Cardentry® system from RES, the leader in access control.

It all starts with a card. A durable, wallet-size plastic card. With its coded information inside, invisible, and protected.

Insert the card into a Cardentry reader, and the code is instantly transmitted to the controller. If the person's authorized, the door opens. If not, the door stays shut. In either case, his name, location and time of day are recorded.

Aha, you say, what if I lose power or communications from the card reader to the controller? You're still in control. Because, like the controller, the card reader has a mind (and memory) of its own. It still lets the right people in, and keeps the wrong people out. That kind of security only comes with the Cardentry system.



Well, you say, what if I expand my operations, outgrow the system and have to junk it? Can't happen. Each Cardentry system integrates, on site, with the next system up. So you can upgrade, anytime, easily. (That's something else no other company offers.)

What's more, with a Cardentry host processor, the system becomes a powerful and flexible data processor. One that gives you detailed management reports, all in plain English, the moment you need them. All while your controllers and card readers are controlling who goes in what door, when.

If you can't be everywhere at one time, get the system that can. The Cardentry system, from RES.

Because if Ripley never reads those reports and runs off to Rio, Reynolds might.

RES, Headquarters, 1840 Victory Blvd., Glendale, Ca. 91201.
 Offices in principal cities worldwide. Call toll free: 1 (800) 528-6050 x691; Arizona: 1 (800) 352-0458 x691; Phoenix: (602) 954-4600 x691; Alaska and Hawaii: 1 (800) 528-0470 x691.

RES RUSCO
 ELECTRONIC
 SYSTEMS
 A FIGGIE INTERNATIONAL COMPANY

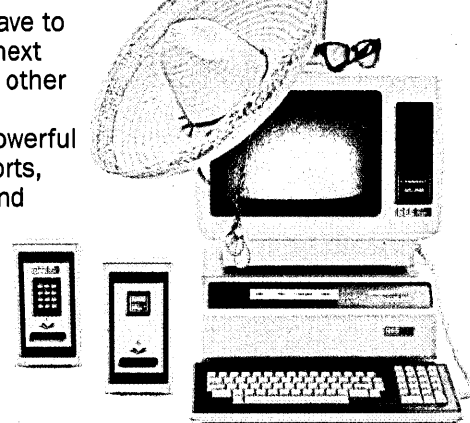

CIRCLE 44 ON READER CARD

IN FOCUS

most 15% plan to add memory.

In the small system area, Burroughs is finding apparent success with the workstations it buys from Convergent Technologies but is having dismal results from its Ofis 1 word processing/office automation systems. Presumably, however, Convergent's equipment is helping Burroughs extend beyond its own user base and develop new markets.

The year ahead for Honeywell will apparently be one of struggle to stem what appears to be a continuing trend of defection to other vendors, especially in the large-scale mainframe arena. The survey found little demand for the firm's top-of-the-line DPS 88, a winding down of the DPS 8 cycle, and projected order activity that is markedly subdued. In all likelihood, the company will suffer from lower net shipments in 1983.

The company's main strength is coming from the DPS 6/Level 6 small computer line, which is clearly a successful business. The minicomputers appear to be selling well not only to Honeywell's main-

Honeywell's main strength is coming from the DPS 6/Level 6 minicomputer line, which sells well as an adjunct to the firm's mainframes.

frame users for distributed processing purposes but also to other shops. The firm's office automation efforts are showing some signs of success within the mainframe base, but perhaps not enough yet to ensure a major avenue of future growth.

One positive trend was a move by large-scale users to the new GCOS 8 operating system, which may portend upgrades of hardware next year.

NCR continues to have a lackluster outlook this year, showing potential strengths for the years beyond 1983 in some of its newest businesses, but not much in the way of growth in the mainframe arena. The company, it should be remembered, gains much of its revenue from overseas and from terminal systems activities.

NCR users, however, indicate an appetite for future capacity needs, suggesting a potentially strong reception for the recently introduced 9300 series and an expected 9500 line. Like Burroughs, NCR is finding success from the gear it purchases from Convergent Technologies and sells as the Worksaver line. Moreover, NCR has entered several new businesses lately—merchant semiconductors, personal computers, oem-oriented microcomputers, for instance—that are expected to grow rapidly in coming months.

Those new strategies will be vital to NCR in light of a continuing trend of defection by users from the firm's traditional mainframe base. In terms of comparing NCR to IBM, only half the share of users this year

FIG. 7

CHOICE OF STANDARD PC VENDOR

PERCENT OF MENTIONS

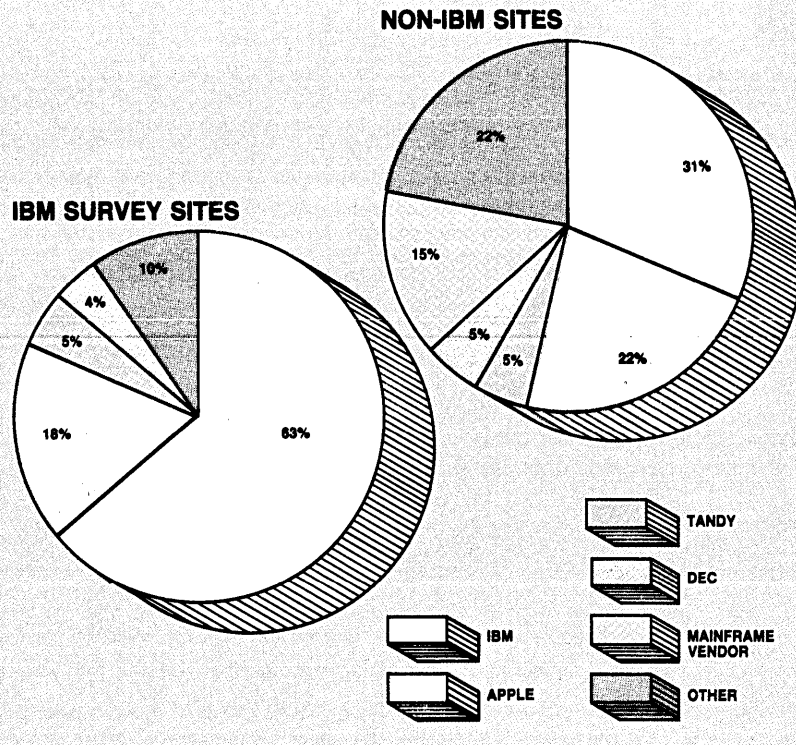
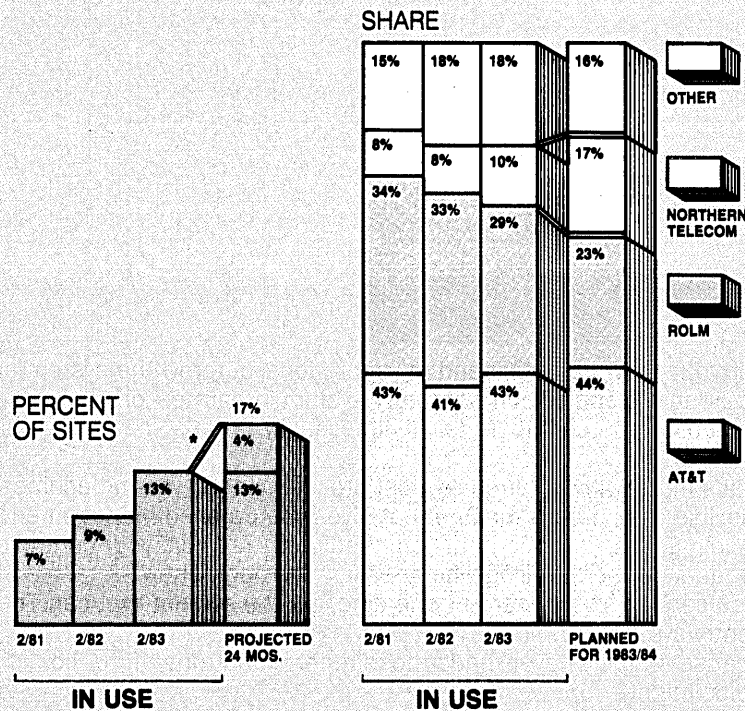
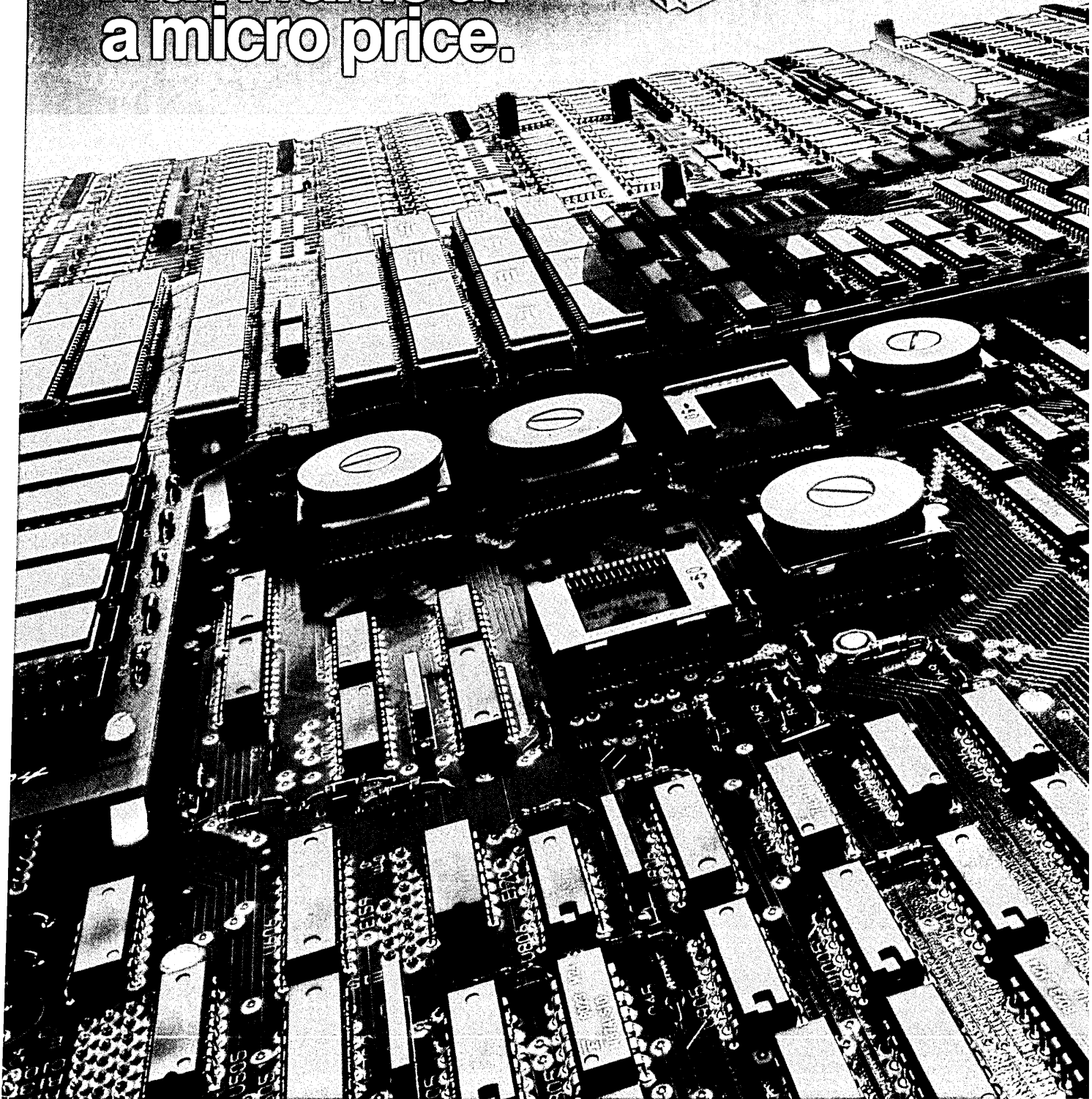
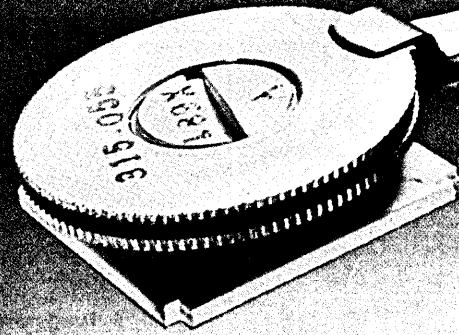

FIG. 8

PBX VENDOR MARKET SHARE



**NCR announces
the VLSI
breakthrough.
A business
mainframe at
a micro price.**



NCR 9300

The first full 32-bit VLSI Mainframe for business.

Ten ways better than what you're using now.

From hardware to software, the exciting new NCR 9300 is a technological marvel. It propels the "state-of-the-art" a quantum leap forward. The NCR 9300 is the first full 32-bit — internal and external — mainframe available for business applications. It gives you the power of an IBM System 38 at the price of a System 34.

NCR's proprietary VLSI (Very Large Scale Integration) technology makes it all possible. VLSI is the catalyst for increased reliability, reduced size and weight, powerful software, quick and easy servicing and dramatically improved price/performance.

1. New state-of-the-art customized 32-bit VLSI chip set

Four VLSI chips — a Central Processor Chip (CPC), an Address Translation Chip (ATC) and two System Interface Chips (SIC) — are the heart of the 9300. Together, these chips share the 9300's workload so that you realize the power and performance of three types of microprocessors instead of just one.

2. Ten boards of electronics reduced to one reliable VLSI chip

Using Very Large Scale Integration, NCR now puts the electronics of ten 11"x14" printed circuit boards on the Central Processor Chip no larger than a dime. Not only does VLSI save space, it eliminates almost all of the vulnerable electrical connections where system failures usually occur.

3. Guarantee your data integrity with memory scrubbing

NCR's newly patented memory scrubbing method cleans the 9300's four megabytes of main processor memory every 16

seconds! It does this by correcting any transient single-bit errors — effectively eliminating catastrophic double-bit memory errors. All of this is done automatically by the Address Translation Chip with no central processor overhead.

4. Mainframe power in a two cubic foot, fifty-pound box

With the 9300, you can put full 32-bit VLSI power almost anywhere. The 9300 weighs only fifty pounds and measures a scant 7.5"x17.6"x25.8". The processor requires no special air conditioning or humidity control. In office or computer room, put the 9300 processor wherever it's convenient for you — even on the wall.

5. Uses a standard 120-volt outlet while cutting power consumption 90%

The 9300 uses only 0.4 KVA compared with the 4 KVA requirements of comparable mainframes. Plus, there is no need for heavy-duty wiring. The 9300 runs on readily accessible voltage and conventional wiring.

6. New ITX operating system links high and low order processing

The new Interactive Transaction Executive multiprogramming operating system extends the 9300's communications capabilities.

beyond NCR's multi-industry expertise in interactive transaction processing. With ITX, the 9300 provides the unprecedented link in interfacing multiple CRTs, industrial terminals, retail terminals and financial terminals, local and remote. The 9300 extends communications to other NCR processors through use of remote

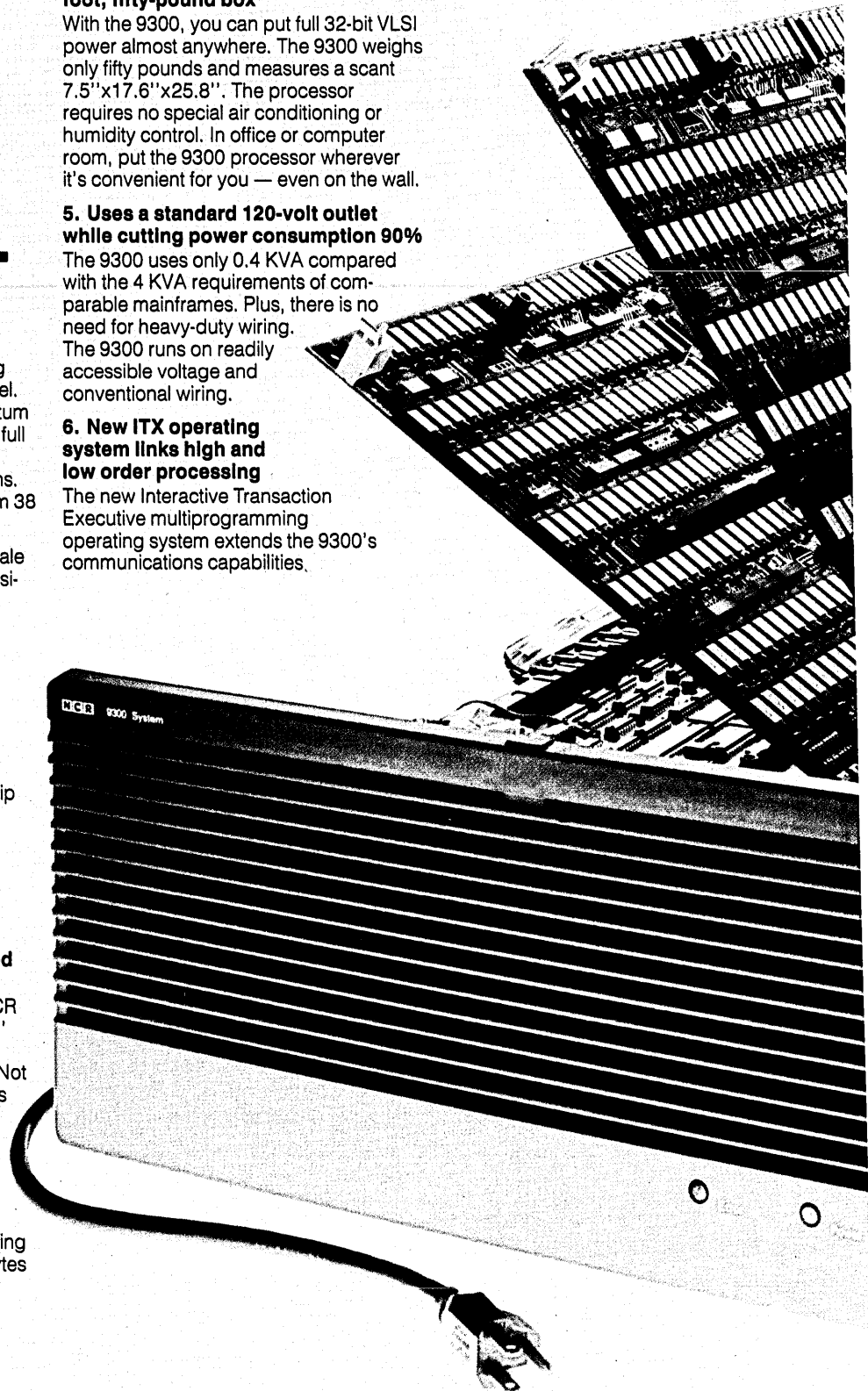

batch or DDP, and to non-NCR processors in SNA environments.

The Terminal Application Processing System (TAPS*) takes the complexity out of transaction processing. It works with ITX to provide efficient and consistent handling of transactions. It provides standardized coding to simplify development of sign-on, sign-off and security procedures, the design and sequencing of screens and the editing of data formats. It takes transaction processing out of the application programs.

In addition, ITX offers automatic load leveling, batch queuing and remote support. And you have COBOL and BASIC for application programming, with more languages to come.

Of course, ITX adheres to NCR's philosophy of easy and fully supported system migration. For I-series users that means continuing compatibility with current interactive operating systems.

7. Choose your computer environment — Host, DDP, SNA

The 9300 has the unsurpassed ability to work for you in a host environment, in a peer-to-peer Distributed Data Processing environment and in an SNA network. Whatever your choice, you get the communications support you need — SDLC, X.25, BSC, DLC, TTY and ISO-Async. And the 9300 integrated communications allow you to connect up to 42 lines. In a DDP environment, the 9300 supports message passing between peers, including NCR's IRX, IMOS, and VRX. In an SNA network, the 9300 provides you with the vital link between high and low order processing.

8. SOLON — a revolutionary way of creating programs without programming.

Now, almost anyone can create computer programs by answering simple questions. NCR's new application development system, SOLON, helps the business professional or EDP expert to create application programs in a fraction of the time necessary for traditional methods. Think of it! Cut your EDP backlog from years to weeks — just as fast as you'd like.

*TAPS is a product of Informatics General Corporation

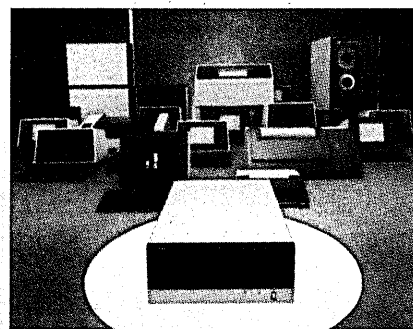

9. Powerful software tools increase productivity

Supportive software for the 9300 increases programmer productivity. You get transaction support capabilities, a query language, a report generator and a word processing system. In addition, there are a number of other software development/productivity tools available for your specific requirements.

10. The strengths of three data base methods in one

NCR's data base management system gives you the strengths of the hierarchical, network and relational models all in one system. It is a relational environment which complies with CODASYL specifications. So you are assured of data integrity, elimination of data redundancy, data restructuring with minimal program impact, and data access through multiple paths. And all enhanced by our query language and other optimization tools.

NCR 9300, the most advanced technology you can buy

First in the new world of business mainframes, the exciting new 9300 is at least ten ways better than what you are using now. To find out exactly what the 9300 can do for you, call (800) 543-8130 [in Ohio, (800) 762-6517] now for a free copy of the brochure, "NCR 9300... A New Generation." Or write NCR Corporation, Dept. L, Box 606, Dayton, Ohio 45401.

NCR

99 Years Experience
in Business Systems

CIRCLE 45 ON READER CARD

See the amazing 32-bit 9300, Tower 1632, the 8600 family, and the new personal computer from NCR, DECISION MATE V, at the NCC booth number S-5028.

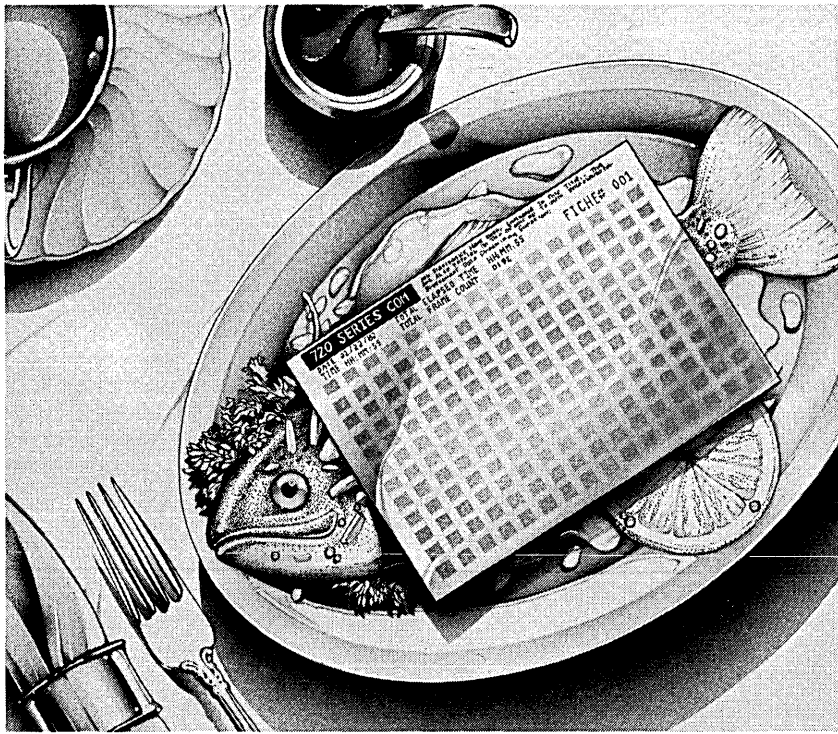

Now you can have fiche with everything on it.

Now virtually any computer-output application you use can be put onto microfiche.

With 3M's Series 720 COM Systems.

Systems that will hook right up to your computer-output. Providing an easy-access data bank. One that's so versatile, it allows you to create any number of output formats. Including electronic forms creation, multi-character fonts and sizes, and numerous titling capabilities. As well as everything from production work to SYSOUT. Without the need for host computer data handling and reformatting.

Fact is, 3M's Series 720 has the highest degree of input and output flexibility and versatility of any cut-fiche COM system available today.

What's more, the Series 720 COM speeds turnaround time with dry silver cut and processed fiche. It even offers the option of roll/scroll type processing for high volume production applications.

So whether you need an on-line COM, an off-line COM, or one that's switchable, the 3M Series 720 COM Systems are the ones that will give you your fiche. With everything on it.

3M's Series 720 COM Systems are supported by a sales and service organization throughout the world. For more information, call toll-free: in the U.S., 1-800-328-1684 (in Minnesota 1-800-792-1072) and in Canada,

1-800-268-9055 (operator 13). Or complete this coupon and mail it to us.

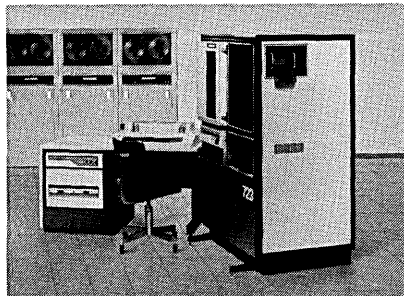

3M Series 720 works along with your computer.

I want to put everything on my fiche. Please send me more information on the 3M Series 720 COM Systems. DMT 5/005

Name _____

Title _____

Company _____

Phone () _____

Address _____

City _____

State/Zip _____

Send to: 3M COM Systems, P.O. Box 33050, St. Paul, MN 55133 Attn: G. Collins

3M hears you...

3M

IN FOCUS

compared to two years ago rated NCR inferior to the industry leader.

Sperry Univac's outlook for 1983 is relatively positive compared to the previous two years. The company's winning of large (over \$400 million) government contracts for commercial and military machines will tide the firm over while its user base apparently waits for the 1100/90 systems to begin deliveries. Nevertheless, users indicated a disappointingly low requirement for additional processing capacity—in fact, the number of orders for the 1100/90 was surprisingly low (a total of only six among all respondents), considering the time since it was introduced.

On the bright side, Sperry has apparently found some success with its Sperrylink office automation system, particularly among users of its 1100/60 mainframes.

As has been the case for several years, there is a substantial dissatisfaction among users with the company and its fragmented product line (1100s and 90s). Few 90 users have taken to the firm's costly migration path to the 1100 series, suggesting the firm may suffer from defections to IBM and others. Among 90/30 users, there was found to be an increasing number of sites tending towards replacing their Univac systems altogether.

—John W. Verity

The full results of this survey are available in a 275-page report for \$750. Please call Sheila Connolly, (212) 605-9590.

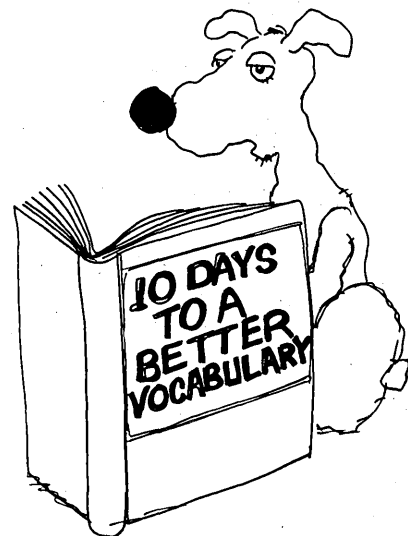

core et

"Quack!"

CARTOON BY JACK CORBETT

HOW TO PROTECT YOURSELF IF YOU BUY THE WRONG DBMS.

(Cut out dog, stick on office door. It may hold your management at bay.)

OR BUY OUR BRAND NEW MODEL 204 DBMS FOR DOS.

If you operate in a DOS environment, you want an online DBMS that gives you productivity, ease of installation and resource conservation. That leaves you two possibilities. Buy our new DOS version of MODEL 204 DBMS. Or have a doggone good story ready.

The reason? MODEL 204 is the only commercial DBMS ever designed from scratch for online systems. It's also the only DBMS with a direct teleprocessing interface. Which means you won't need a separate TP monitor. Or an extra programmer. In short it won't bite into your resources.

You can also get new applications up faster. 5 to 50 times faster in fact. And your applications and databases are much easier to maintain. As a matter of fact you'll find that MODEL 204 can serve as the only data management tool in your installation.

In spite of all this sophistication, MODEL 204 is simple to install and we give you the best documentation and education of anybody in the business. Now you know why MODEL 204 DBMS received the highest ratings in a recent *Datapro* survey: 3.5.¹ And why it's the fastest growing system for IBM mainframes from an independent vendor.²



OR BUY OUR BRAND NEW MODEL 204 DBMS FOR CMS.

If you operate in a CMS environment, or have been thinking about switching, you want the most performance, capacity and productivity you can get. That leaves you two possibilities. Buy our new CMS version of MODEL 204 DBMS. Or have a doggone good story ready.

The reason? Our multi-user CMS implementation of MODEL 204 supports up to 513 billion records and 999 concurrent updates.

We achieved this phenomenal performance with a unique approach to disk management. We made MODEL 204 utilize OS-format disks in native CMS implementation. And they're supported without modification to CMS or the VM System Control Program. Our multi-user design can also be utilized by a single CMS user on their virtual machine. And that facilitates

system administration and high-speed database loading. In addition, you can have a native CMS copy of MODEL 204 and a copy of MODEL 204 running under a guest operating system on the same machine. And both can utilize the same database. A CMS user can also communicate with the copy of MODEL 204 on the guest system using VMCF. Now you know why MODEL 204 DBMS received the highest ratings in a recent *Datapro* survey: 3.5.¹ And why it's the fastest growing system for IBM mainframes from an independent vendor.²

MORE ON MODEL 204 DBMS FOR DOS.

DM5B

- Make a presentation. Let's put MODEL 204 in and benchmark.
 Send me a brochure. Send me info on free DBMS seminars.

NAME _____ TITLE _____
COMPANY _____
ADDRESS _____
CITY _____
STATE _____ ZIP _____
TELEPHONE _____

**Computer
Corporation
of America**

Four Cambridge Center, Cambridge, MA 02142 (617) 492-8860

MORE ON MODEL 204 DBMS FOR CMS.

DM5B

- Make a presentation. Let's put MODEL 204 in and benchmark.
 Send me a brochure. Send me info on free DBMS seminars.

NAME _____ TITLE _____
COMPANY _____
ADDRESS _____
CITY _____
STATE _____ ZIP _____
TELEPHONE _____

**Computer
Corporation
of America**

Four Cambridge Center, Cambridge, MA 02142 (617) 492-8860

1. *Datapro*: "User Ratings of Proprietary Software-COMLETE" November 1982. 2. *Computerworld*: December 20, 1982.

IBM, WANG, DEC

Our business computer systems have all the power of an IBM, all the flexibility of a Wang, all the memory capacity of a DEC.

And all the fame of Harvey Schmidt! Perhaps our name would remain unknown if not for one tiny, little thing:

The price.

We're Alpha Micro and our systems go for so much less than the competition, you're going to wonder how we do it.

So we'll tell you.

One reason is all our systems are designed around the 68000, one of the most advanced, most powerful microprocessors there is.

Another reason is AMOS.

AMOS is our very own multi-user, multi-tasking operating system. It gives you the ability to grow from one to over sixty users without redeveloping software.

You can use an Alpha Micro system

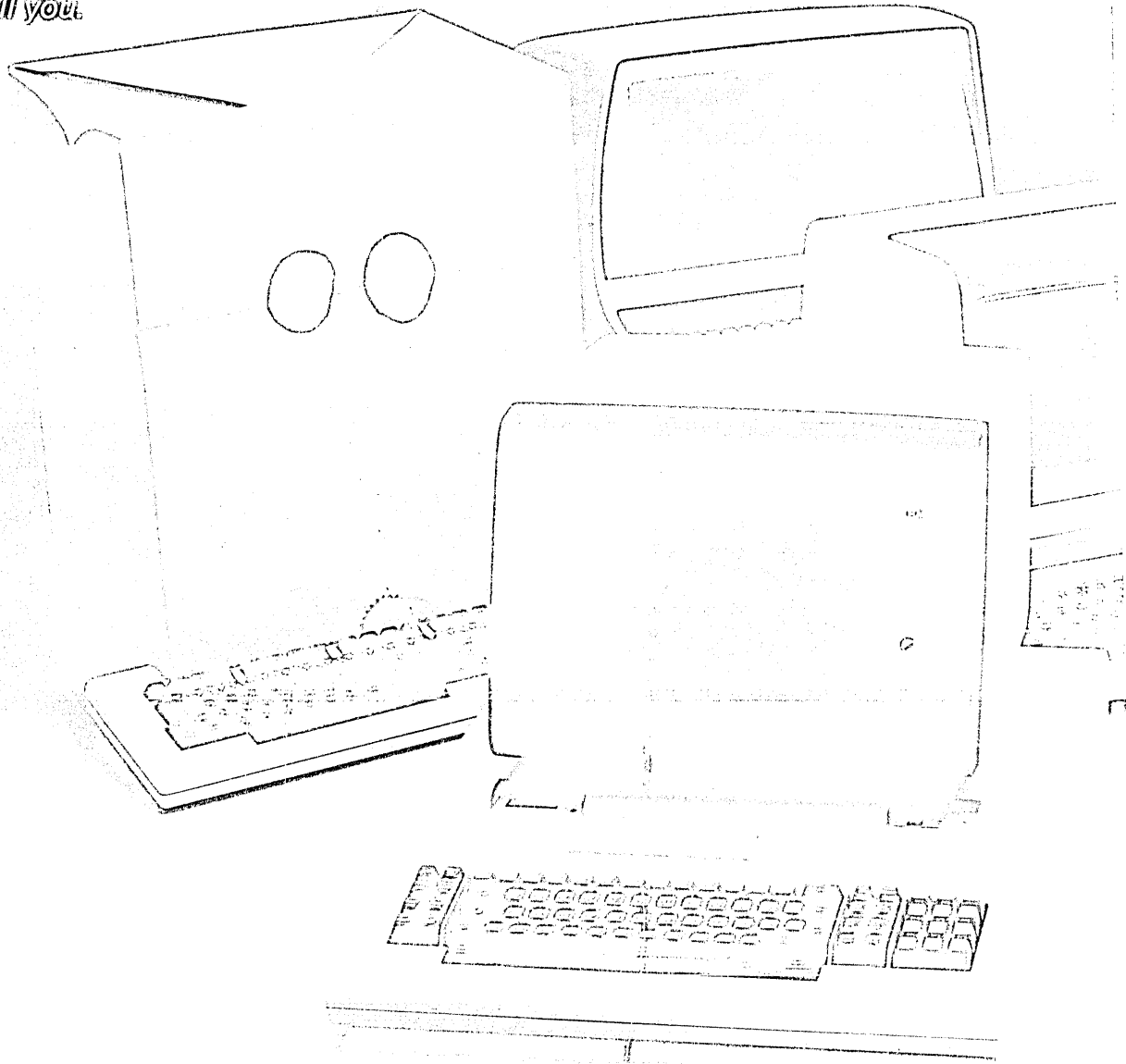

Come see us at the NCC Show, Booth W6000.

IBM is a registered trademark of International Business Machines, Corp. DEC is a registered trademark of Digital Equipment Corp. WANG is a registered trademark of Wang Laboratories, Inc. AMOS is a registered trademark of Alpha Micro. © Alpha Micro 1983 17332 Von Karman, P.O. Box 18347, Irvine, CA 92714. Who's Harvey Schmidt?

AND WHO?

with almost any terminal or printer. Yours. Ours. Anybody's.

And so your system doesn't get lonely, we've developed a way for it to communicate with other Alpha Micro systems and IBM-compatible mainframes.

What about reliability? Relax.

We've been at this longer than just about any other microcomputer company. We've got thousands of systems up and running. And we've got an international network of

dealers and factory-trained specialists to give you all the service and support you'll ever need.

Call 800-854-8406 and find out more about an Alpha Micro system. (In California, call collect 714-644-0386.)

It's everything a computer is supposed to be. Except expensive.

ALPHA MICRO

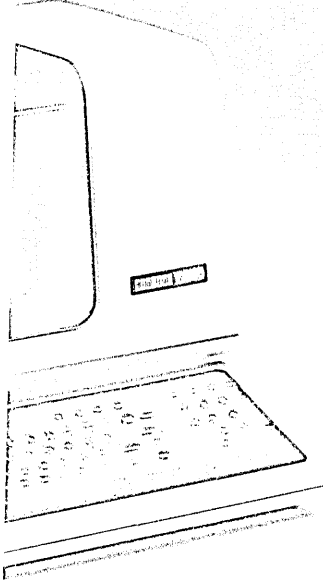

NEWS IN PERSPECTIVE

STRATEGIES

PLUGGING THE MOLE HOLES

IBM's plans to withhold systems source code may portend stricter measures.

IBM's plan to "conditionally" withhold source materials for its MVS operating system come September closes a 20-year chapter in the company's history. At the same time, the decision prepares the way for a massive rebundling of the computer business by the industry leader, according to some major customers.

Source code has been freely available to users and competitors alike on all descendants of IBM's System/360 operating software since it was offered "unprotected" to the public domain in 1964. As a result, the restrictions on the availability of "source," as well as other tough conditions aimed at stamping out the redistribution or piracy of sensitive licensed program materials, have sent shock waves rippling through the industry since their disclosure by IBM in February.

IBM has publicly justified the measures as a means of protecting the integrity of its operating system and preventing theft of its trade secrets. Some experts believe that the tough new policy is intended primarily to hobble IBM's plug-compatible competitors, particularly the Japanese. IBM's real target, however, is its own customers, claimed a consensus of major IBM users contacted privately by DATAMATION.

"IBM's overriding intent," suggests one leading customer from the insurance sector, "is to prevent its users from modifying and tailoring their operating systems to suit their own needs.

"This practice over the years," the user continued, "has tended to run counter to IBM's migration and support strategies and so the company is understandably concerned that [the practice] will have a detrimental effect on conversion to the new extended MVS architecture, MVS/XA.

"IBM's plan, or rather, hope," the user confided, "is to protect XA by cleaning up its internal code so that the user doesn't have to go into the system, but can work just from the applications interface."

Another customer, this time in the experimental science area, said that this would eventually allow IBM to offer XA as a "fully bundled" system with all the instructions hidden away in hardware and microcode.

Users agreed that IBM's next steps to

this end would probably be to hide MVS system code behind a screen of new data encryption and protection software, and to make less documentation available to customers.

These issues have been taken up over the past 18 months within the GUIDE and more vocal SHARE user groups since word of IBM's intentions first began to filter down from top management. Their response to IBM's management committees is that pulling source at a time when MVS internal code is not "clean" is counterproductive—and even dangerous.

"Our main concern," says one SHARE member, "is IBM's decision to prevent the reverse compilation and assembly of its licensed programs using source." This user, like many others, noted that without permission to recompile, he can't input such things as new security codes into his system. "But in a more general sense, we can't properly support our current modified environment with the source restrictions."

Most modifications, or "mods," fall into three main areas: JES, CICS, and VM. Mods happen for a number of reasons: to obtain better security, to achieve more

Some users think IBM's intention is to protect the new MVS/XA from being copied by competitors.

productive use of computing facilities (including non-IBM products), or simply to optimize applications programs. But, as users are taking pains to point out to IBM as they deal for a better position, most mods are needed to do nothing more than fix faults and bugs in each new release of the operating system as it is mounted in their installations.

Users also pointed out that they are not the only ones making mods. This has also been the domain of a select band of so-called systems houses that have developed a symbiotic relationship with IBM's major customers. What is now emerging from sources is that these software companies—only about 25 in number—are already early casualties of IBM's new closed-hand approach.

Like users, these systems houses have used source to burrow deep into MVS to find hooks for their off-the-shelf products in such areas as performance evaluation and optimization, capacity planning, and security. No more than 10 of these companies—including Applied Data Research, Boole & Babbage, BGS Systems, Candle Corp., CGA, Johnson Systems, and Marino Associates—have user bases of any size. Though essential to IBM early on, these companies are cumulatively a thorn in the company's side. It's doubtful if they've ever had IBM's goodwill, but at least they have had source materials—that is, until early last year,



when IBM's management decided to use the software companies for what could be seen as a test run for its new policies.

Sources reveal that during 1982 IBM began to withhold MVS source materials from these companies, most notably for its ISPF, front-end screen language program for modifying MVS. Many of these companies have been adversely affected in some way by this move, according to insiders. For some it has meant that part of their new product family was threatened. Others have apparently had their very existence placed in jeopardy.

Last spring, when word filtered out that IBM would withhold source details from these companies, several began to get in touch with IBM president John Opel by let-

ter. Others pleaded their case through IBM's Industry Relations group in White Plains, sources explain. Some of these systems houses are currently involved in "delicate"

The issues have been discussed at SHARE and GUIDE meetings over the past 18 months.

negotiations with IBM. At the same time, the U.S. software trade association ADAPSO told DATAMATION that it is arguing their case in a series of meetings with senior IBM managers and trying to seek an "understanding." As a result, none of the participants are making any public comments.

The systems houses and ADAPSO

seem to be urging IBM to remember that users and software companies coexist in a symbiotic relationship: what hurts one might very well harm the other. IBM, for its part, appears to be complaining that there have been too many mods to its internal code that unnecessarily complicate its support environment and endanger migration to new architectures.

"There's been some compromise by IBM," said the chief executive for one of the software companies, who recently came to an agreement with the computer leader. "From now on we've contracted to pay for the source materials we need, and we've signed documents that outline the restrictions that will be placed on their use," he revealed.

ILLUSTRATION BY DAVID FEBLUM

NEWS IN PERSPECTIVE

The executive wouldn't go into greater detail, but he claimed that several other leading systems houses have come to similar agreements with IBM. "The upshot of all this," he confided, "is that it is no longer wise, or feasible, for any of us [the 10] to look for hooks deep within the IBM system.

"If we want to continue doing that," he sighed, "we will have to let IBM in on our future development plans. So, from now on, we will concentrate our development activities on the MVS subsystems area"—that is, at the level of the database and data communications interfaces in IMS, RACF, TSO, VSAM, VTAM, and JES, for instance. "So far IBM's restrictions haven't reached that level yet, but they will, as IBM drives users and competitors alike right out to the applications interface," he ventured.

Yankee Group, Boston, research director Dale Kutnick took up the theme: "Software companies like Cullinet and

Several systems software companies are talking privately with IBM, often at high levels.

Software AG sell to the subsystem interface for DBMS, and they are considered by IBM as competition that must be gotten rid of." He predicted that IBM would attempt this in the years ahead by disguising and pushing the subsystem interfaces into a combination of microcode and hardware, i.e., rebundling.

"As XA progresses, IBM's database software instructions will be buried in its 3380 disk drives and 3880 controllers and among its dynamic channel processors," Kutnick claimed.

(It's notable that Cullinet Software, for one, has been switching its development focus to the applications area, as reflected by its recent name change from Cullinane Database Systems.)

Not only IBM has been pushing the operating system code out into microcode and hardware. This is now the response of large-scale pcm Amdahl, Sunnyvale, Calif, so far IBM's largest pcm challenger. Formerly Amdahl had to use IBM's source code to reverse-engineer IBM's microcode changes and rewrite them as software for the Amdahl—the kind of reverse-engineering process that IBM is trying to root out. But nowadays pcms like Amdahl and the medium-scale 4300 challenger, IPL Systems, Waltham, Mass., "only need to look at source and IBM's MVS Principles of Operation [the POO, or POOP as some call it] to go about the perfectly legal business of writing their own microcode equivalent from scratch," IPL president Steve Ippolito explains.

Ippolito suggests that IBM has no valid reason to deny source to IPL (or, presumably, to Amdahl) "because we'll abide by all their restrictions on its use." That is, no duplication, reverse compilation/assem-

BLACK MARKET CODE

IBM's attitude towards user modifications to its operating systems has largely been one of patience and indulgence. The company often benefited from changes users made and little was done to prevent the practice.

The company, however, changed its tune in the early '70s when it was determined that user mods would present a slippery migration problem for the proposed Future System (FS) line of computers. Many of the user mods were incompatible with each other and would prevent FS from taking hold. IBM eventually dropped FS, reworking some of its technologies into other product lines, but it also began developing future extensions to the MVS operating system in a special, protected systems programming language known as PLS.

What happened next testifies to the ingenuity of the IBM user community. It also provides a hint of what may happen if the company pursues an expected rebundling of its systems' source code. At IBM sites necessity has definitely proved to be the mother of invention.

That was certainly the case with a gifted and enterprising systems programmer at the Rand Corporation, Santa Monica, Calif. Using only a few PLS manuals IBM had made available to describe the language, Rod Frederickson managed to build a PLS compiler from scratch in 1976. It "worked just like a jewel," he recalls. Frederickson had in his hands the perfect tool for IBM's users to change the structure of their operating systems to suit their needs—and yet maintain compatibility.

"Within weeks of its completion," says Frederickson, "other members of SHARE wanted access to the compiler, and Rand agreed to issue it." The response from IBM was swift and accusatory. "A senior vp came to the Rand site and charged that the PLS compiler couldn't have been designed without access to internal IBM doc-

uments. He couldn't believe that I had worked from just the PLS manuals, even though I explained that I'd had extensive training in designing compilers at Stanford University," he says.

ument. He couldn't believe that I had worked from just the PLS manuals, even though I explained that I'd had extensive training in designing compilers at Stanford University," he says.

ument. He couldn't believe that I had worked from just the PLS manuals, even though I explained that I'd had extensive training in designing compilers at Stanford University," he says.

ument. He couldn't believe that I had worked from just the PLS manuals, even though I explained that I'd had extensive training in designing compilers at Stanford University," he says.

ument. He couldn't believe that I had worked from just the PLS manuals, even though I explained that I'd had extensive training in designing compilers at Stanford University," he says.

ument. He couldn't believe that I had worked from just the PLS manuals, even though I explained that I'd had extensive training in designing compilers at Stanford University," he says.

ument. He couldn't believe that I had worked from just the PLS manuals, even though I explained that I'd had extensive training in designing compilers at Stanford University," he says.

ument. He couldn't believe that I had worked from just the PLS manuals, even though I explained that I'd had extensive training in designing compilers at Stanford University," he says.

ument. He couldn't believe that I had worked from just the PLS manuals, even though I explained that I'd had extensive training in designing compilers at Stanford University," he says.

ument. He couldn't believe that I had worked from just the PLS manuals, even though I explained that I'd had extensive training in designing compilers at Stanford University," he says.

ument. He couldn't believe that I had worked from just the PLS manuals, even though I explained that I'd had extensive training in designing compilers at Stanford University," he says.

ument. He couldn't believe that I had worked from just the PLS manuals, even though I explained that I'd had extensive training in designing compilers at Stanford University," he says.

ument. He couldn't believe that I had worked from just the PLS manuals, even though I explained that I'd had extensive training in designing compilers at Stanford University," he says.

ument. He couldn't believe that I had worked from just the PLS manuals, even though I explained that I'd had extensive training in designing compilers at Stanford University," he says.

ument. He couldn't believe that I had worked from just the PLS manuals, even though I explained that I'd had extensive training in designing compilers at Stanford University," he says.

Built In Beats Bolted-On

Braegen's Way Puts True 16-Bit Personal Computing Inside A Low-Cost, 3274-Compatible Cluster Controller.

Several companies now offer personal computing capability as part of their 3270 terminal package. Their approach, however, has built-in problems—primarily because the personal computing *isn't* built-in, but just bolted on.

Braegen's way works better. Because our new 8410 Cluster Controller features integral personal computing, the user gets maximum processing versatility and performance while the DP Manager gets maximum control and cost savings.

More Versatility And Power. You can attach up to eight ergonomic display stations to the 8410—and with one keystroke turn them all into true 16-bit PCs. You can access a wide range of applications software operating under MP/M-86. And you can upgrade from 128 to 640 Kb of RAM—or integrate a 10-Mb Winchester drive for optimum multi-user response and security.

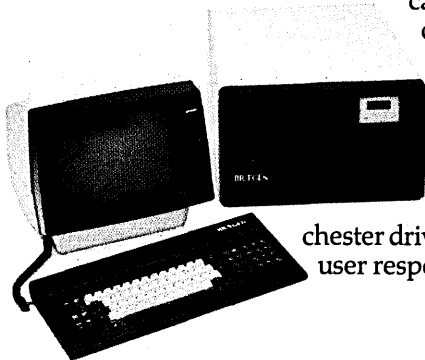

More Control And Economy. Undoubtedly, it is the control you gain and the dollars you save that really distinguish the 8410. Because the PC capability is integrated into the controller, each user is tied into the overall corporate communications network—giving the DP Manager control over critical computer resources.

Just as important is the considerable cost control achieved. First, the 8410 *starts* as a more cost-effective alternative, even operating only as a 3274 remote cluster controller. But by adding multi-user PC capability, the 8410 can save you thousands of dollars—and a lot of space—in equipment alone. There's no investment in additional software for each workstation, or in additional communications lines. Expensive resources—such as letter-quality printers and Winchester drives—can be shared. And a unique remote-maintenance feature that lets our Field Engineers dial up and diagnose the 8410 from any location reduces down-time costs.

For ten years now, Braegen's way has worked for an impressive base of customers. The 8410 with integral personal computing; its low-cost counterpart, the 8400 Remote Cluster Controller with up to 16 attachments; as well as our nationwide sales and service network are just three persuasive reasons why.

Put Braegen's way to work for you. Call or write The Braegen Corporation, 20740 Valley Green Drive, Cupertino, CA 95014 (408) 725-1252; TWX: 910-338 7332.

BRAEGEN

All over the world, one name

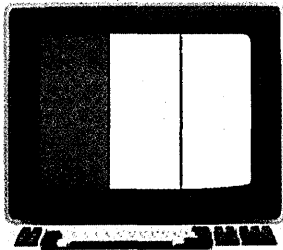

Paris

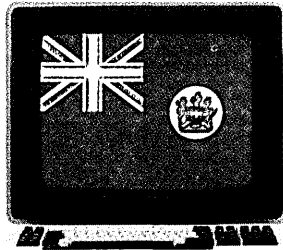

Hong Kong

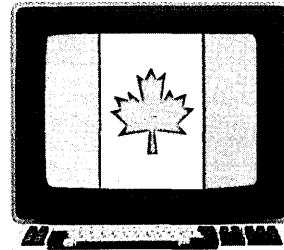

Montreal

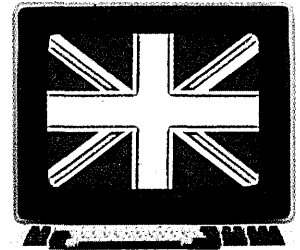

London

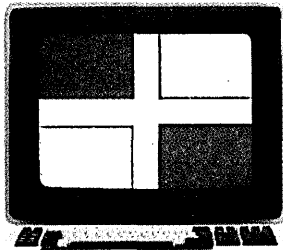

Santo Domingo

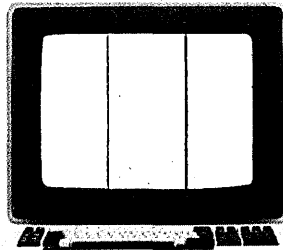

Lima

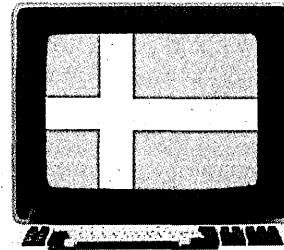

Stockholm

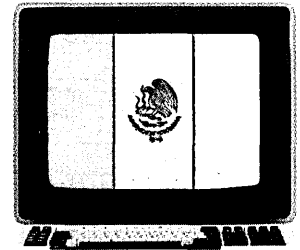

Mexico City

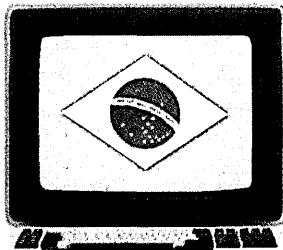

Rio de Janeiro

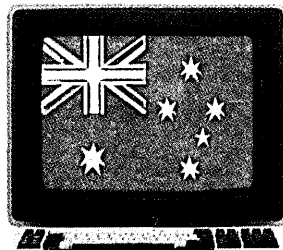

Sydney

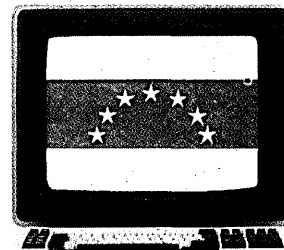

Caracas

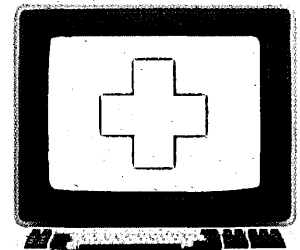

Zurich

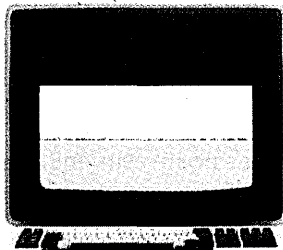

Bonn

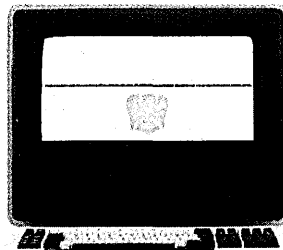

Cairo

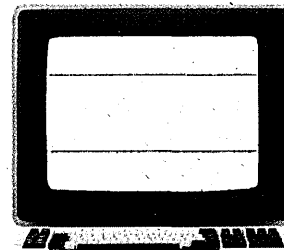

Madrid

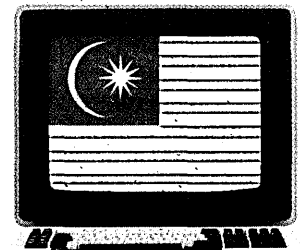

Kuala Lumpur

A little over a decade ago, McCormack & Dodge was a one-package software company in Needham, Mass. That one package, however, was years ahead of its time. And our company began to grow. Today we're a world software leader.

With more international offices than some of the biggest international corporations. As for our software (now many packages instead of one), it's still years ahead of its time. While most software companies are still talking about such features as borderless query and

means tomorrow's software today.

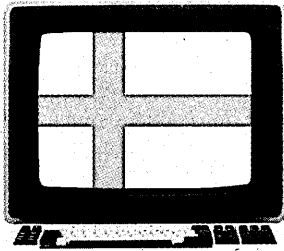

Helsinki

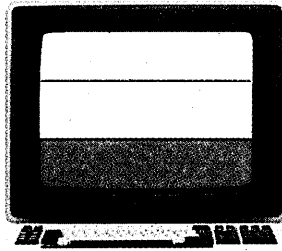

Amsterdam

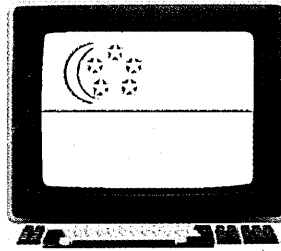

Singapore

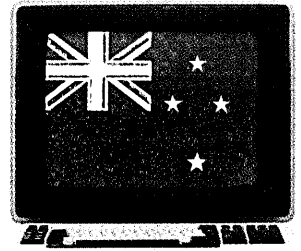

Wellington

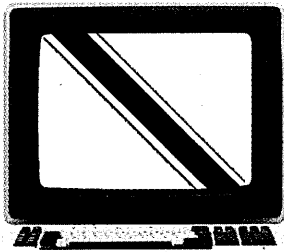

Port-of-Spain

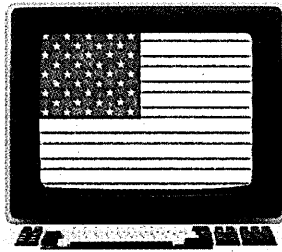

New York

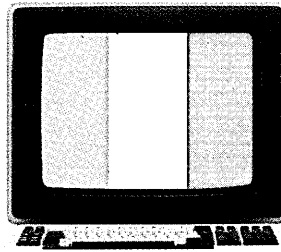

Abidjan

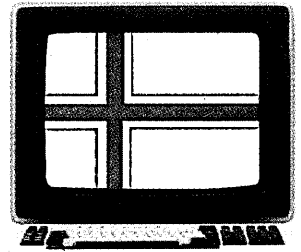

Oslo

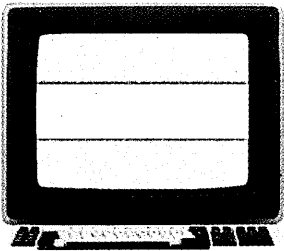

Buenos Aires

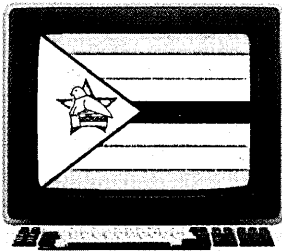

Harare

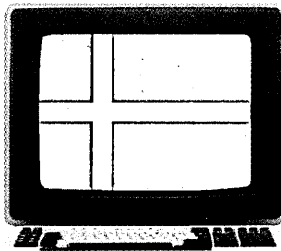

Copenhagen

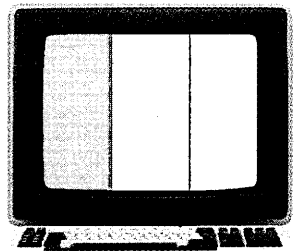

Rome

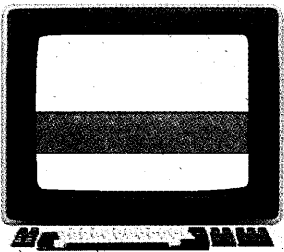

Bogotá

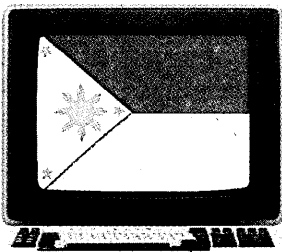

Manila

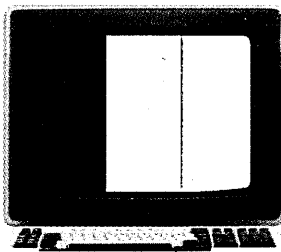

Brussels

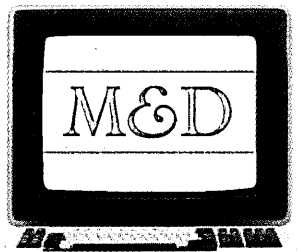

Needham, Mass.

interactive PC link, we routinely offer them as finished products.

There's a world of difference between today's software tomorrow and tomorrow's software today. Because we offer the latter, there's a world of demand for McCormack & Dodge.

support offices throughout North and South America, Europe, Asia, Australia and Africa.

McCormack & Dodge

- General Ledger
 - Payroll/Personnel
 - Accounts Payable
 - Fixed Asset Accounting
 - Capital Project Analysis
 - Purchase Order Management
- Mainframe and minicomputer systems.

(800) 343-0325*

*Telex: 710-325-0329

Tomorrow's software today.

NEWS IN PERSPECTIVE

XA ONLY OK

IBM's Extended Architecture (XA) has finally been made available to the general public but apparently its performance isn't all it was hoped to be.

The company released the MVS/XA software as promised, on the last day of the year's first quarter, along with some performance numbers that didn't exactly overwhelm. Indeed, the firm found it necessary to up the main memory capacity of its largest mainframes, the 3081G and K, in order to give XA enough of a boost to make it attractive to users.

While eight early support program (ESP) users found the XA enhancement provided some extra oomph, a planned press conference at which they were to discuss their XA experiences was canceled by IBM at the last minute, suggesting that perhaps all is not well with the MVS extension.

Several customers contacted by DATAMATION had expected only about 1 megabyte of what IBM calls virtual storage constraint relief—that is, extra real memory space for problem programs to reside in. IBM, however, said the VSCR will be 2.16 megabytes with the first release of XA.

According to IBM, that added storage space can be translated several different ways: 510 more IMS instructions per minute and 500 more attached terminals; or 309 more TSO terminals; or 726 more CICS transactions per minute with as many additional terminals.

All of these are expected to be luscious enough carrots to lure possibly stubborn users to make the transition from the current 24-bit addressing world to XA's expansive 31-bit world. As detailed elsewhere (see p. 139), migrating to XA is no small task, and IBM is trying to make the move as attractive as possible.

Other carrots dangled by IBM include a 30% increase in channel task usage (working with the 3380 disk drive), DBMS resource sharing between CICS and IMS, as well as true multitasking with CICS and true VSAM.

Many industry analysts had expected a 20% to 25% improvement in overall system performance from XA, compared with MVS 1.3. This didn't materialize, however. The actual increase in price/performance seems to top out at 16%, calculated with a 48-megabyte 3081K machine. That represents the new main memory capacity IBM introduced for delivery beginning in the fourth quarter of this year.

With the previous top-end 32-meg model K in a fully unconstrained environment, the performance improvement is little better than zero. (The improvement seems to vary between minus 0.7% to positive 6%.) This works out, at \$25,000 per megabyte, to a total user investment of \$400,000 in hardware alone to get any appreciable performance improvement over the 32-meg configuration.

On top of that is a 9% increase, on average, in monthly software license charges.

As Robert Fertig of Enterprise Information Systems, Greenwich, Conn., points out, most 3081 users running 32 megs are constrained in real memory and will be able to gain "much better than marginal improvements in performance by moving to XA, although there was no way for IBM to measure this."

Upwards of 40% of IBM's MVS customers are thought to have reached the release 1.3 stepping-off point, from which the next step is XA. IBM therefore faces the large task of speeding up migration of the rest of its MVS users through various lower levels of the operating system.

Whether the first XA release provides enough incentives to speed that process is hard to tell so early on, but IBM has clearly got its work cut out for it.

Two hindrances to that process are the lack of an XA version of COBOL and a VM/XA operating system. Given that some 70% of MVS sites are heavy COBOL users, the lack of such a compiler would seem a major stumbling block for IBM to address.

Enterprise's Fertig predicts that a 31-bit COBOL compiler will be made available by IBM in "a few months" and notes that until then users will be able to run their current 24-bit products.

As revealed in these columns previously (Feb., p. 42), IBM is understood to have its hands full training support personnel in an unannounced VM/XA product. Such a product, when introduced, would make it possible for users to test their 31-bit programs in real time. The software is believed to be more than a year behind schedule, however.

Among the products unveiled by IBM were MVS/SP version 2 release 1.1, scheduled for June availability, which enhances the XA environment and supports 3880 disk controllers models 11 and 13; a new version of MVS/XA data facility product (release 1.1.1), which provides 31-bit virtual storage accessing; CICS/VS 1.6.1, available in August; a new version of the resource measurement facility (RMF) with availability slated for October; and the 48-megabyte models of the 3081G and K mainframes.

In a brief statement, IBM said its early support customers had found the migration to MVS/XA "easier than expected and similar to a normal MVS release transition." Those customers also reported "the quality and overall results" of the migration "far exceeded their expectations," IBM said.

Meanwhile, it was learned that a massive training program is under way at IBM to enable its field technical staff to help users with migration problems. Upwards of 1,000 field engineers have been trained in the new product, sources said.

—R.E. and J.W.V.

of Spartacus Computers, Bedford, Mass. "But we all tend to forget that moles have a constructive use, because their holes allow air, water, and nutrients to flow through the soil.

"On an other level, this is the flow of U.S. high-tech innovation that can only reach the IBM customer if his options aren't all plugged. If they are," McQuilken reflected, "the users' installation can quite literally dry up and become rigid and inflexible."

McQuilken, whose company will shortly challenge the Armonk firm with an IBM-compatible workstation/local network combination, argued that a massive IBM re-bundling shift would hurt more than IBM's users. "It could have an enfeebling effect on the whole of U.S. information technology."

Not everybody agrees with this view. "The argument is mostly fallacious," counters Yankee Group's Kutnick. "Even if you concede that IBM is hell-bent on forcing everybody out to the applications interface, there is no earthly reason why programmers shouldn't be as innovative there as anyplace else. It's when IBM sews up *that* interface that we should all start worrying!" he said.

It should perhaps be said that IBM hasn't always been "anti moles." "Without them in the past," mused Bob Patrick, a California-based consultant and computer architect, "IBM couldn't have ironed out half the inefficiencies in its internal code." Another way of looking at this, he suggested, "is that IBM's users are the largest unpaid software company in the world . . . as well as its largest unpaid maintenance crew!"

—Ralph Emmett

A TALK WITH TRILOGY

Gene Amdahl's company is designing new levels of reliability and performance into large-scale mainframes.

"You buy the machine and 30 months later it breaks, and just before it breaks again you throw it away."

A disposable computer? Well, not exactly. That's just Gene Amdahl talking about the large-scale mainframe his company, Trilogy Systems Corp., plans to build and deliver in 1985.

Trilogy is emphasizing long mean times between failure (MTBF) for its IBM-compatible machines, which are slated to

BURROUGHS HONEYWELL

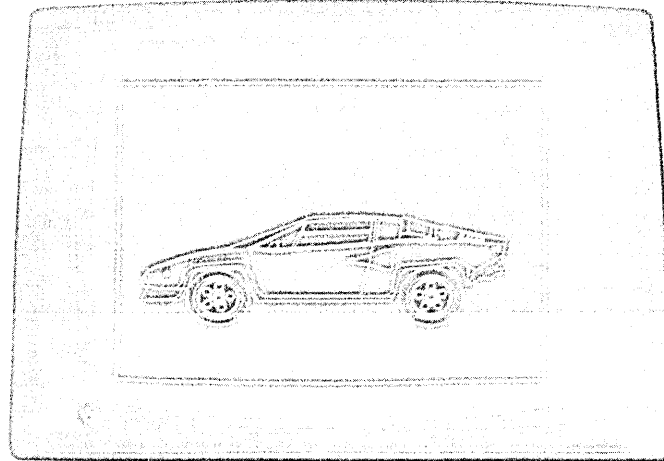

Cybernex 102
Graphics (Tektronix)
with Spivakoff Stand
Illustrated

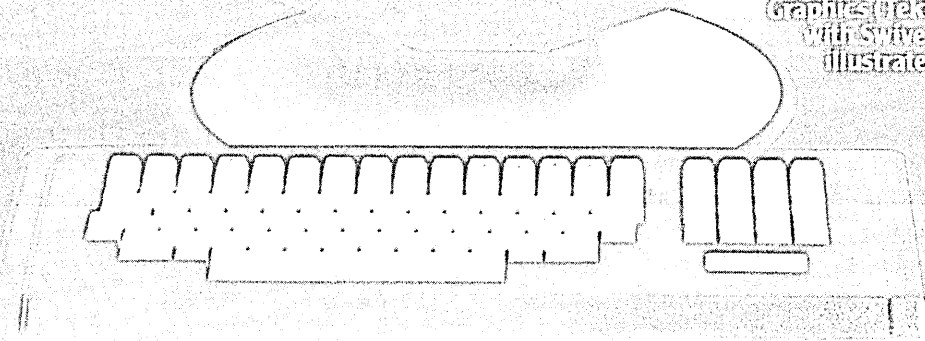

CYBERNEX, GREAT IMPERSONATIONS

**GREAT BECAUSE OUR
TERMINALS AREN'T JUST
EMULATIONS, THEY'RE
BETTER THAN THE
ORIGINALS.**

Proof of this is in the advanced features we offer: large our 12" CRT displays, anti-glare mesh printer pads, megapixel resolutions, touch screens, multi-line addresses, sync protocols, programmable keys and high-end components.

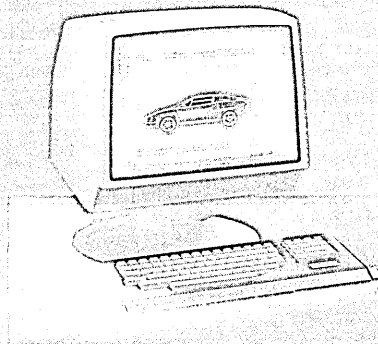

Great impersonations from Cybernex include:

- Burroughs 180-880
- Honeywell 7800 Series
- Tektronix 4010 & 4012 Graphics
- Data General Dasher
- MAN/Basic Four
- Hazeltine 1510
- NCR 796/101
- Rexon



HEAD OFFICE: CYBERNEX LIMITED 1257 ALBERTA ROAD, OTTAWA, ONTARIO, CANADA K1B 3W7 TELEPHONE: (613) 741-1500 TELEX: 052-0000
 CYBERNEX, INC. 6200 CASCADIA BLVD. MINNEAPOLIS, MN 55426 TELEPHONE: (612) 725-2577
 CYBERNEX LTD. 1000 BROADWAY, SUITE 1000, NEW YORK, NY 10018 TELEPHONE: (212) 486-2500

CIRCLE 40 ON READER CARD

NEWS IN PERSPECTIVE

perform in the 30- to 60-MIPS range. Reliability and other concerns of the well-funded startup were discussed by company executives in an exclusive interview with DATAMATION.

"We expect to build a machine that is four times as fast as IBM's biggest machine today," says Frederick T. (Ted) White, president and chief operating officer. "It'll be as big as what we think will be there [in the marketplace] in 1985."

And even more reliable, the company hopes, having spent much of its efforts designing new methods of achieving uptime for its machine, which is slated to outperform IBM's current largest, the 3084, by 40%. Moreover, Trilogy's machine is planned to consume less power, be one tenth the physical size, require 40% less cooling, use only 5% the number of components, and cost only half of IBM's to build. And, as Amdahl points out, it will break down only once in its useful lifetime.

It's not that disposable computers are the focus at Trilogy. Indeed, reliability is what's being emphasized, if one can believe an MTBF of 31,900 hours, or 3.6 years. But behind the startling statistics—the achievement of faster, smaller, and more reliable machines at lower cost—are a myriad of innovations Trilogy is faced with making on its own. These new developments are primarily in semiconductor de-

sign and process technology.

Making these advances won't come cheap, as the company is finding out. When company founders met with the press in October 1981, they boasted of having raised, up front, \$160 million, which included grants from the Irish government to build a factory there, the value of the facilities now occupied in Cupertino, Calif., which the company is leasing, and interest on the money raised from an R&D limited partnership. Those funds were thought to be

"Significant additional financing will be required," Trilogy partners were told.

adequate to carry the company through its first customer shipment in late 1984.

Alas, it was not to be. In a March '83 report to its limited partners, who had put up \$55 million, the company said first shipments will not be until the first half of '85, the result of delays in development projects, and that expenditures are exceeding original estimates.

"Significant additional partnership financing will be required to complete all phases of the project through to projected project completion in the first half of 1985," reports White. This despite the raising of an additional \$20 million last December via preferred stock.

While the management has underestimated its costs, its objectives are clear and its models of what is possible apparently are confirming early design goals. Says Ted White, "We will probably have three models, one that's twice as fast as IBM's fastest today, one that's three times, and one that's four times faster." Explaining that that kind of performance can't be accomplished with off-the-shelf componentry, White shows a tiny power supply to a visitor, a mundane device that a small-volume manufacturer would normally buy outside. But Trilogy has designed this one to produce more than 1,750 watts even though it is a mere one tenth the size of what one would expect a power supply with that much output to be. That small size, however, means "incredible reliability," improved by a factor of 25, says White. And it means lower cost.

White, formerly chairman of Amdahl Canada Ltd. and before that with IBM, repeatedly emphasizes reliability in discussing Trilogy's products. Others tend not to put that much emphasis on it, he adds. "But when you start to look at reliability from the ground up, you find that you cannot not pay attention to things like the power supply."

So Trilogy will make its own. Each computer will use nine of them, although seven are required. That means two of them can fail without affecting the operation of

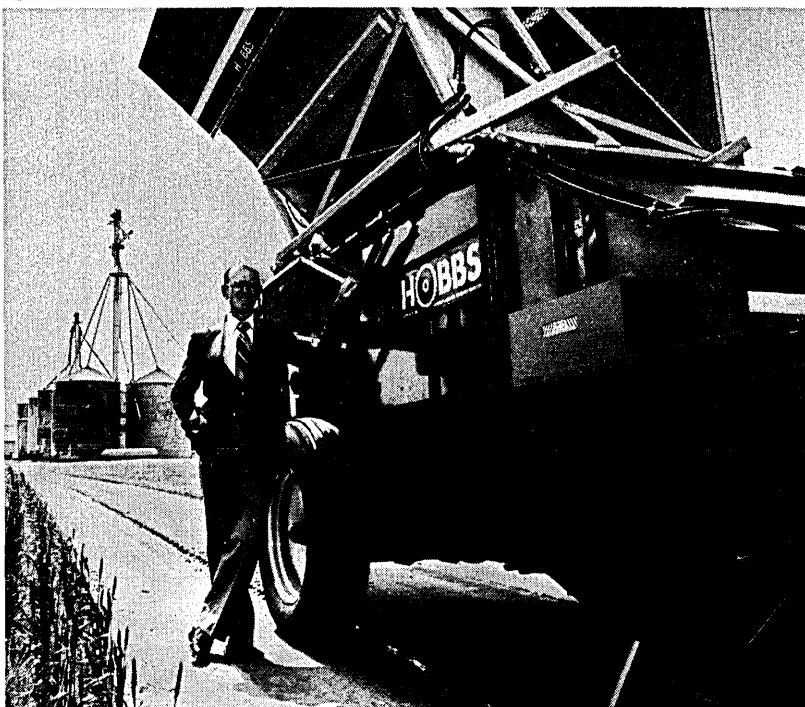

Oliver K. Hobbs, President, Hobbs-Adams Engineering Co., Suffolk, Virginia (85 employees)

One reason Oliver Hobbs exports more and more of his food processing equipment is the big money overseas.

Another is the big help here at home.

Can we provide some for you?



A Public Service of
This Magazine &
The Advertising Council

Write:
Secretary of Commerce, U.S. Dept. of Commerce
Industry and Trade Administration, BED 20
Washington, D.C. 20230

Start with a great idea...



...and

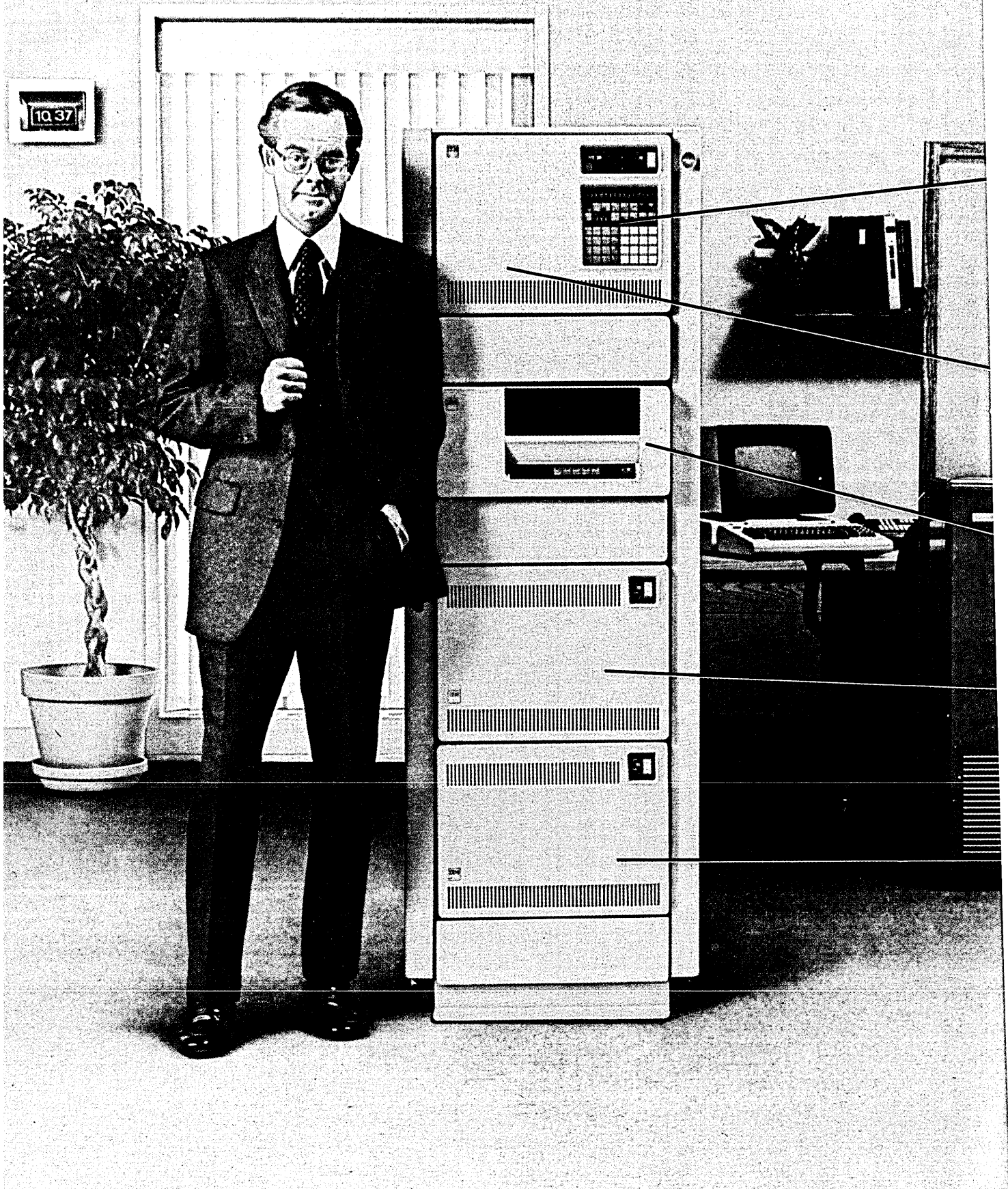

great things happen.

A new high-end processor—The IBM 4956 doubles the Series/1's maximum main memory to one megabyte and offers major improvements in price/performance. It supports more terminals and applications. Its automatic internal monitoring, for even greater reliability, is generally associated with larger, more expensive computers.

Enhanced operating systems—They support these new announcements. They support more applications, more addressable memory and more attachments. You can link multiple processors, viewing them as one, to help insure data integrity and permit adding units without disruption.

A new magnetic tape unit—The 4968 is an inexpensive way to backup data and programs. It provides automatic loading, which means faster, more convenient use.

A new high-performance disk unit—Each 4967 contains 200 megabytes of storage. It incorporates cache technology, which catalogs data for faster access time.

New communications support—You can communicate with and operate within public communications networks. You get more support for host-based and peer-to-peer networks. And Series/1's new remote manager easily accesses management programs in a host for network control from your central site.

On November 16, 1976, we announced the IBM Series/1 computer. Since then, we've introduced many improvements to the system. If you had acquired a Series/1 over the past six years, with its open architecture you could have simply plugged in most of those improvements. Without sacrificing your original investment.

Now, IBM announces even more enhancements that make a big difference for Series/1 users, both present and future. The 1983 version may look like the 1976 system, but what's under the covers means increased power, more function and better communications.

We've just introduced the most powerful processor ever offered for the Series/1. Its greatly improved price/performance, plus better operating and communicating ability, make the Series/1 more attractive to businesses that already use them, and to a wider range of first-time users.

And if you're responsible for data processing in a large company, the Series/1 can now bring you all the benefits of centralized control and standardization, from an entry-level system up to one of the most powerful minis on the market.

For more information, send us the coupon or contact your local IBM office.

The IBM Series/1, with its open design, has been offering modularity and growth for over six years. It goes to show you where a great idea can take you.



IBM
DRM, Dept. IE3/82
400 Parson's Pond Drive
Franklin Lakes, N.J. 07417

5-83

Please send me more information on the "new" Series/1.

Name _____ Title _____

Company _____

Address _____

City _____ State _____ Zip _____

Phone _____

NEWS IN PERSPECTIVE

the machine. When one does fail, it disconnects itself, turns on an LED, and waits to be fixed. The mainframe then would automatically phone Trilogy staff in Cupertino who would schedule a service call. An unskilled person would be able to replace the failed unit without stopping the computer.

"What we've tried to do is to build a nonstop mainframe," says White, who laments that Tandem Computer has acquired the rights to that term. Gene Amdahl says he thinks Trilogy's system "will be more nonstop" than Tandem's. "In any event," adds White, "we'd like to have the word but we don't."

Trilogy figures its machine will weigh about a third of the Amdahl 5860, largest of that company's stable, and be

Trilogy is going to wafer-scale integration for its logic chips.

smaller than IBM's fastest current model. The target manufacturing cost for 1986 is \$500,000 per MIPS, thought to be a fourth of Amdahl's manufacturing cost and less than half of IBM's. This despite the belief that IBM has the lowest manufacturing costs around, based on its large volumes. According to White, the planned production level for Trilogy in 1986 is about 190 units. Current plans are to announce the product in the first quarter of 1984 and ship the first machine a year later.

But a funny thing has been happening to Trilogy on its way to the marketplace. Like a race car builder choosing rocket propulsion over the internal-combustion engine, Trilogy has decided to leapfrog the integrated circuit and go to wafer-scale integration. It is developing a logic chip that measures 6 centimeters on a side, approximately 2½ inches square, using high-speed ECL technology. It could be compared with IBM's thermal conduction module (TCM), which holds 120 IC chips. In terms of its functional characteristics, Trilogy's wafer/chip contains about two thirds the logic of a TCM, but it has about twice the power of a TCM because it runs so much faster.

"When Gene and I started this project," says Carlton G. Amdahl, Gene's son and vice chairman of Trilogy, "we spent a considerable amount of time analyzing the characteristics of high-speed computers, trying to determine what we should do to make the appropriate kind of advance in performance. It turned out, when one did that analysis, that at least half of all the time spent in computation was actually just in the wires, just moving signals from one place to the other in a high-speed computer.

"As a result, even if we could develop an infinitely fast switching device, if it occupied the same volume as current devices, we could only develop a machine that was twice as fast." Thus it became mandatory that the focus be on reducing the

distances signals must travel.

"When you look at what IBM has done with its thermal conduction module," Carl continues, "that is in fact exactly the approach they've taken. They've used a reasonably mundane circuit technology [TTL] but packaged it in a novel way, and that allows it to reduce interconnect distances."

In the TCM, of course, IBM packages many ICs in a small space. But it still means a signal must get on to one chip, do its thing, and leave before proceeding on to another chip. There's still that travel time to take into consideration. Additionally, each of the 120 chips in a TCM has from 100 to 120 solder nodules where it meets the outside world, and these interconnections represent potential failure points.

An IC chip the size of a wafer makes it possible to perform many logical operations before a signal must leave the chip. But a large chip is anathema to the semiconductor industry, where small is beautiful. The larger the die, after all, the greater the likelihood of its having a defect. And when the die is the size of a wafer, the odds are there will be many defects on it, forcing the designer to add redundancy, as is being done to increase yields on 64K RAMs.

"What we've developed is a process whereby through redundancy, having multiple copies of the circuits on a big chip, we can tolerate defects," says Carl. "So we would expect on this chip between 300 and 400 defects. And with the redundancy strategy, we have overcome the limitations of traditional technology."

On 64K RAM chips there are redundant columns, and in the test process one determines the good and bad columns. With random logic, however, it is very difficult to test and determine exactly where a fault may lie.

"So what we've done," the younger Amdahl explains, "is incorporate the test logic along with the functional logic on the chip, to a point that we call active redundancy. If something fails on the chip, we don't even have to test it. The chip knows that it has failed, and it knows how to select the appropriate logic element to get the good result. That's all incorporated on there." It is, then, a self-repairing chip.

"If it fails in the customer's site," he adds, "it fixes itself, for all practical cases. We believe this is the first application of a truly self-repairing technology in the computer field, at least for any commercial product."

On the way to becoming a computer company, then, Trilogy has developed a technology that can be harnessed by itself and many other companies to make a variety of products, not just IBM-compatible mainframes. Accordingly, the company is looking for licensees of the technology, a potential source of significant amounts of revenue. This attempt to market the tech-

nology can be compared with the development of a 32-bit microcomputer chip set by NCR and that company's attempts to become a merchant supplier of chips (and a follow-on board-level product).

In the case of Trilogy's first licensee, however, the French Cii-Honeywell Bull organization has the right to manufacture the chip in France for its own use and is expected to use this technology in its next machine. But Trilogy, in addition to selling licenses on a royalty basis, could also someday become a "systems foundry"—producing chip designs and even custom chips for others. Ted White points out that its attributes are speed, low cost, self-repair, and high reliability. "And that's motherhood," he says.

To make this a reality, the company has been spending heavily on the development of design automation tools, having found nothing on the market that would do the job. Carl Amdahl says if it were possible to enlarge the image of the 6-cm chip sufficiently to show its smallest feature, perhaps to where it is a tenth of an inch in size, the total image would measure 300 feet on each edge. This means hand-checking or hand design would be impossible.

"So we've had to develop a significant number of new tools to manipulate successfully that much data," says Carl. "The advances we've made in CAD tools are perhaps as significant as those we've made on the technology side." The firm has 60 professionals devoted to CAD development, twice the number of people using

"If the chip fails, it fixes itself."

those tools. "Hopefully," says Ted White, "that will not always be the case."

He adds that the company is not pushing the state of fabrication technology—it is not basing its designs on the achievement of smaller line widths, for example. "We didn't need another set of uncertainties," he says.

Carl points out, too, that Trilogy's self-repairing designs can also be implemented in CMOS or gallium arsenide, meaning it has wide applicability. Trilogy's chip, which he describes as "like a macrocell-type of array," is like a gate array. It consists of a number of transistors that can be put together in different groupings. It will have from 20,000 to 40,000 gates, considerably more than the largest bipolar gate array now available, one with 2,500 gates. That one measures a quarter-inch on a side and is only now going into production. The gate array that IBM uses in its 3081 has 700 gates. Amdahl Corp.'s has some 400. So the Trilogy chip could be the equivalent of 100 Amdahl Corp. chips.

This is not to imply, of course, that Trilogy is facing a severely limited market for large-scale mainframes. To the contrary,

The biggest problem
facing management
today
IS
information float.

One system
eliminates it.

Information float. It's when your sales manager in Phoenix needs accurate inventory information from the warehouse in Atlanta—and at the exact same time a salesman at the Seattle office is asking for the product. Or when your plant foreman in Boise needs clarification on product specs from the engineering manager at the lab in Boston. When *any* of your people, in short, has an immediate need for timely, up-to-the-second information from people at other locations—and can't get it. That's information float.

Tandem's NonStop network solves the problem.

A NETWORK OF NETWORKS

With a Tandem information system, it doesn't matter where you're sitting—you've got complete and instantaneous access to the information you need—regardless of whether it's across town, or clear on the other side of the world.

The reason is simple. Each Tandem NonStop computer system

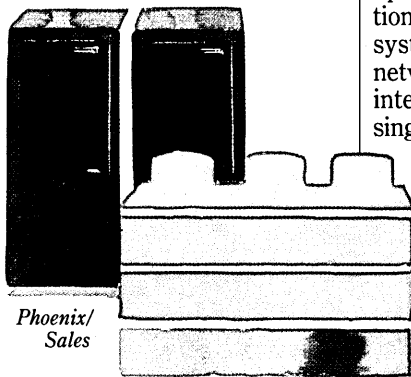

Phoenix/
Sales

By putting the most often used data on the local system, you get faster response time and lower communications costs.

A single, distributed database lets users at any location...

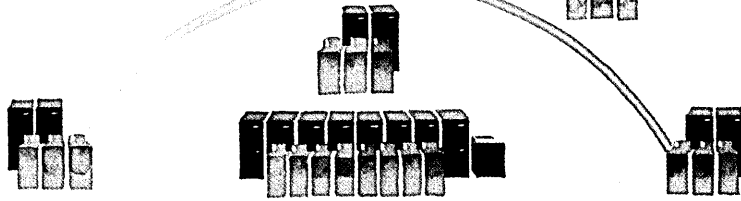

access information or update the entire network...

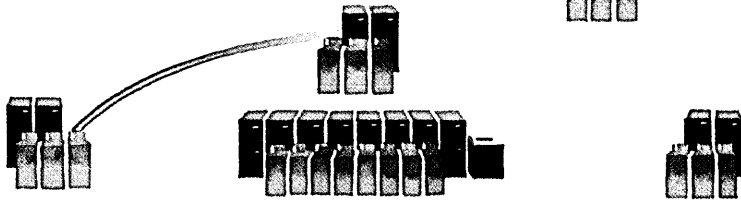

automatically, right from their local terminals.

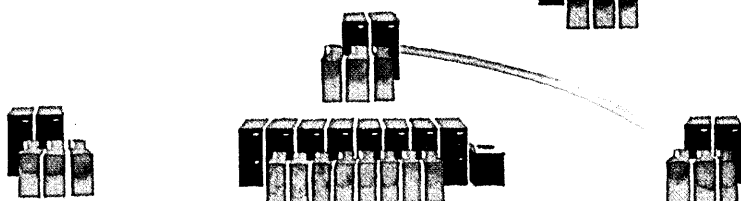

has been designed from the ground up as a total information/communications system. Which means that each system is actually a self-contained network. A network that encompasses interprocessor communications in a single system at one physical location, and extends all the way to a 255-system configuration spread across the globe.

Working the way you work.

This approach to system design conforms to the way information is actually used and communicated throughout an organization—at different times by many people in various locations and at different

levels of responsibility. That means that you can place the information you deal with most on your local system, giving you better response times for your users, lower communication costs, and independence from any problems that might occur at other points in the network.

In addition, because each location needs different *kinds* of information, the Tandem system lets you determine up front which departments can access what kinds of data. This control can be established at corporate headquarters, with appropriate local controls implemented at each site as well. The result is that network-wide data is always available for corporate-level reporting and management, while the appropriate local data is available for managerial decision-making at each department, office or facility.

The Tandem NonStop™ Network



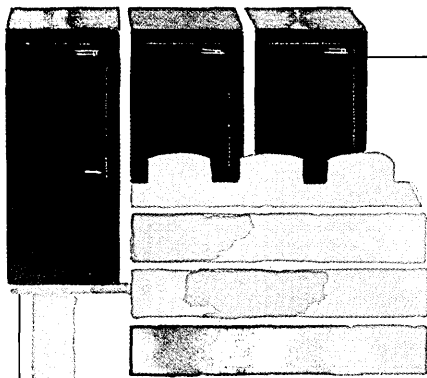

Boston/Engineering

your data files as needed, transferring the most often used files to the local node. So you can be continually fine-tuning your system, moving your data to where it makes the most sense, with no penalties in performance. In the process, you are reducing the float on information by dramatically lowering user response time, as well as saving network resources and increasing overall system performance.

WHEN YOU NEED IT WITHOUT FAIL

The most important prerequisite for an on-line, distributed database is the ability of the system to ensure consistent and available data. And Tandem is the industry standard by which all other systems are judged.

From the CPU itself (which was rated more reliable than that of any other major computer vendor in the most recent report on maintenance by the International Data Corporation), to our new satellite links, the entire system is maximized for completely fault-tolerant operation.

This is achieved through the use of multiple processors, high-speed dual bus communications, mirrored discs and multiple power supplies. If any component fails, the corresponding device or alternate data path automatically takes over and

performs the function. And the defective unit can be repaired or replaced without shutting down the system.

The data protection solution.

What happens when many users want to access the database at the same time? Or when a power failure interrupts system operation?

Tandem's multiple hardware modules aren't the only protection the system provides for your data. On the software side, our ENCOMPASS database manager includes a special subset called the Transaction Monitoring Facility (TMF), which is devoted solely to ensuring network-wide data integrity and recoverability.

With TMF, the system maintains an audit trail of all transactions, protects files from access when the database is in an intermediate state, and provides complete backout

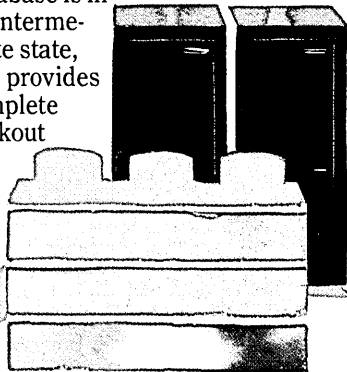

Atlanta/Warehouse

and roll-forward recovery procedures if a transaction cannot be completed for any reason. So you get complete protection against database contamination by component failure or power outage.

In addition, Tandem's GUARDIAN™ operating system

complements the ENCOMPASS database manager to oversee all aspects of NonStop architecture, further ensuring that all database linkages are consistent at each node of the network.

THE TANDEM SUPPORT NETWORK

Whether it's a two-processor system or a 255-system global network, the Tandem NonStop network is uniquely suited to the complete information requirements of multi-divisional, multinational corporations.

Tandem provides local sales and service support in the major computer markets around the world. Including fourteen software education centers in the U.S., Canada and Europe offering professional technical training courses for your programmers and analysts.

Whatever the shape of your system, or the needs of your users, you can be assured that the Tandem NonStop network can satisfy both. And always with the same result: getting the right information to the right people at the right time. No matter where they're located. And without fail.

After all, eliminating the problems caused by information float is exactly what effective communications are all about.

For more information on the Tandem NonStop computer network, contact the sales office nearest you.

When you need it without fail, there is only one.

TANDEM

CIRCLE 250 ON READER CARD

Getting the message across.

Making sure your information gets to the right people at the right time is the job of a variety of innovative Tandem communications products. Together, they form the pathways for moving that information across a truly comprehensive, fault-tolerant network.

These products include software that allows a network of Tandem systems to be linked to other mainframes or networks (including SNA); a state-of-the-art fiber optics system for connecting hundreds of processors within your headquarters or plant; a satellite link (in conjunction with American Satellite Company) for connecting widely dispersed offices; and an advanced communications package, called TRANSFER™, to manage it all.

Plenty of room to grow. And change.

Tandem's modular approach to hardware design gives you a simple, on-going, "building block" procedure for system expansion or rearrangement. You don't have to

communications facilities in low-cost increments. And without having to rewrite a single line of software. The result is that your original investment in equipment and programs is always protected.

THE KEY IS A SINGLE, DISTRIBUTED DATABASE

This flexibility in the movement of information at different levels and locations within an organization

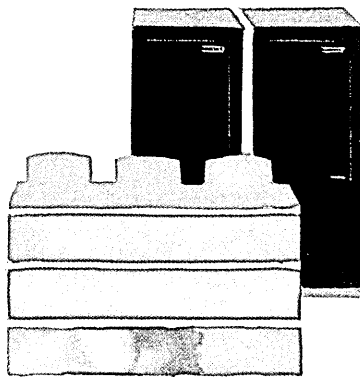

Boise/Production

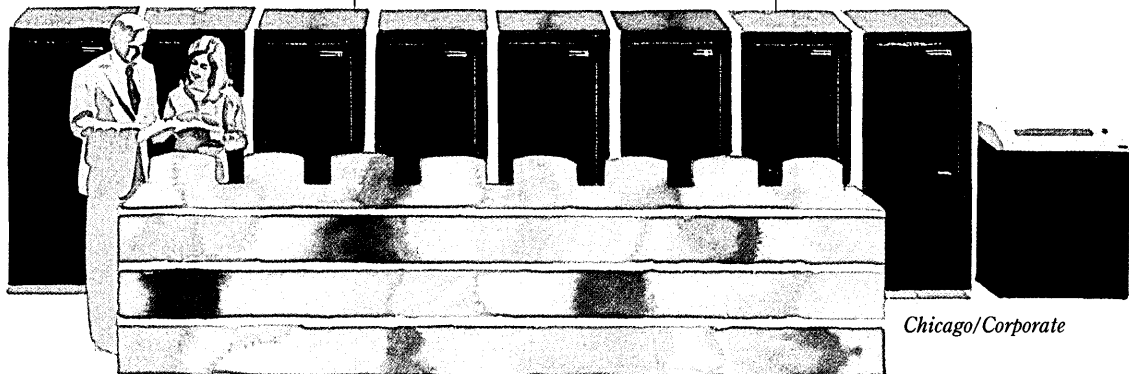

Chicago/Corporate

know up front exactly what your configuration will be. Or how — and when — it might change again.

That way, you start only with what you need, and add or shift processors, peripherals, and com-

At corporate headquarters, management has network-wide access to continuously updated information for operations and reporting.

is in part the result of the next logical step in distributed information management: the truly on-line, distributed database.

Because Tandem's unique ENCOMPASS™ DBMS actually distributes a single, unified database across the entire network, your users get two important advantages: first, no matter where they are on the network, they can access data from anywhere else, without having to know where that data is located.

And second, by simply entering information at their local terminal, your users are instantaneously updating every single node in the system — automatically.

The only restrictions are the ones that *you* define up front; namely, which users can access which data, and what they are allowed to do with it. That way, you have total control over the entire system.

Relating data to information.

The key to manipulating data in such a simple, straightforward manner is Tandem's high-performance relational database. Because setting up files merely involves creating or filling in tables with data records, no device-dependent "pointers" are used

to maintain relationships, making the database extremely easy to use.

New files can be set up at any time, in any location — just by adding new tables or more rows to existing ones. This allows you to reconfigure

DOMESTIC U.S. SALES OFFICES

Arizona
Phoenix (602) 264-2206

California
Long Beach (213) 595-9471
Los Angeles (213) 749-7356
Sacramento (916) 971-0861
San Diego (619) 571-7610
San Francisco (415) 777-1230
Santa Clara (408) 980-0440
Universal City (213) 506-1715

Colorado
Denver (303) 779-6766

Connecticut
Hartford (203) 249-7253
Stamford (203) 324-5200

Florida
Jacksonville (904) 396-4431
Miami (305) 264-9999
Orlando (305) 671-6408
Tampa (813) 877-7466

Georgia
Atlanta (404) 953-2377

Hawaii
Honolulu (808) 523-7771

Illinois
Chicago (312) 856-1133
Schaumburg (312) 397-5200

Indiana
Fort Wayne (219) 436-2386
Indianapolis (317) 875-8144

Iowa
Des Moines (515) 223-1424

Kansas
Kansas City (913) 649-9002

Louisiana
Metairie (504) 831-3582

Maryland
Baltimore (301) 859-4230

Massachusetts
Boston (617) 964-6500

Michigan
Detroit (313) 425-4110
Grand Rapids (616) 784-6181

Minnesota
Minneapolis (612) 854-5441

Missouri
St. Louis (314) 878-7180

Nebraska
Omaha (402) 493-6616

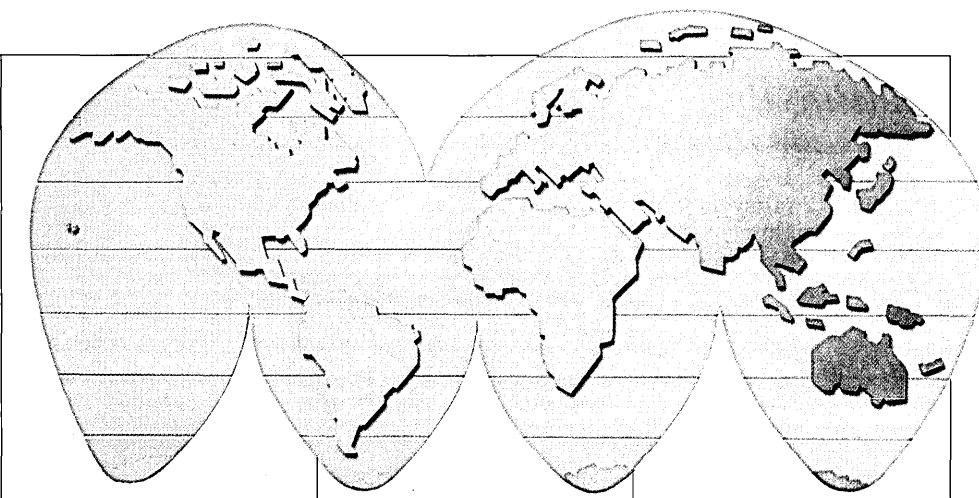

New Jersey
Atlantic City (609) 646-6928
Newark (201) 288-6050

New York
Long Island (516) 681-8224
NYC Uptown (212) 947-3850
NYC Downtown (212) 558-6655
Rochester (716) 248-5300

North Carolina
Charlotte (704) 523-3170
Greensboro (919) 294-6131

Ohio
Cincinnati (513) 984-2044
Cleveland (216) 447-0880
Columbus (614) 764-2400

Oklahoma
Tulsa (918) 663-0940

Oregon
Portland (503) 295-0300

Pennsylvania
Philadelphia (215) 674-0600
Pittsburg (412) 562-0262

Tennessee
Memphis (901) 332-3777

Texas
Austin (512) 835-8182
Dallas (214) 980-0051
Fort Worth (817) 640-9736
Houston (713) 861-6515

Utah
Salt Lake City (801) 268-6312

Virginia
Richmond (804) 264-0012
Washington DC (703) 379-7900

Washington
Seattle (206) 881-8636

Wisconsin
Milwaukee (414) 784-4211

INTERNATIONAL SALES OFFICES

Australia
Melbourne 267-4133
Sydney 438-4566

Belgium
Brussels 322-648-7330

Canada
Calgary (403) 263-9064
Montreal (514) 342-6711
Ottawa (613) 234-0074
Toronto (416) 475-8222
Vancouver (604) 298-6461

Denmark
Taastrup 525-288

England
Birmingham 454-9772
High Wycombe 494-21277
London 628-0661
Northolt 841-7381

France
Paris 687-3466

Hong Kong
Kowloon 3-7218136

Italy
Milan 308-7386

Japan
Tokyo 81-3-984-6000

Mexico
Mexico City (905) 521-8688

The Netherlands
The Hague 3170-824-131

Norway
Oslo 472-123330

Singapore
Singapore 65-2241628

Sweden
Solna 734-0340

Switzerland
Zurich 411-461-3025

West Germany
Dortmund 144401
Düsseldorf 1035720
Frankfurt 50071
Hamburg 351721
Mannheim 510088
Munich 492011
Stuttgart 7156781

INTERNATIONAL DISTRIBUTORS

Argentina
Buenos Aires 393-6030

Finland
Helsinki 3580-42021

Israel
Haifa 9724-524222
Tel Aviv 9723-454975

Korea
Seoul 34-6531

Kuwait
Safat 965-450265

Philippines
Manila 63-2-504076

Saudi Arabia
Al-Khobar 966-3-8640272

Taiwan
Taipei 773-1302

Venezuela
Caracas 323150

TANDEM

NEWS IN PERSPECTIVE

some market forecasts indicate a growing market worldwide, reaching shipments of more than 2,000 in 1985, up from 1,200 or so in 1981.

But Gene Amdahl admits that the IBM pcm business is becoming more difficult than it was when he started Amdahl Corp. in 1970. Product complexity has increased, he notes, and IBM is withholding the details of its products and interfaces as long as possible.

"I think the hardware business in general is getting more difficult," adds Carl. "The capital investment required to have any kind of competitive edge is rapidly becoming enormous." He cites Hewlett-Packard's expenditures of \$100 million to develop its 32-bit computer chip, employed initially in the desktop HP 9000 processor. He also cites money Trilogy is spending to develop its technology. "I think the cost of technology is rapidly becoming a nonrecurrent cost, where the unit copies are almost free but to design it and to get tooled up to build it is an enormous cost. I think it's going to make it very difficult for a new startup to enter the field and really have the kind of splashy success that was possible five or 10 years ago."

But it looks as if Trilogy Systems will make a stab at it anyway.

—Edward K. Yasaki

MINICOMPUTERS

LOW-END ACTION AT IBM

A sweeping range of new products is helping IBM meet competition from DEC, HP, and AT&T.

It appears that IBM is making its Personal Computer a universal intelligent terminal for its full line of business computers. The company has introduced options for the personal machine and many of its other computers that enable the P.C. to attach and communicate in SNA networks.

Perhaps the most obvious of these attachments is the P.C. option for 3278 crt terminals that attach to 370/303X and 308X mainframes. But in early April the company introduced an adapter and software to connect P.C.s to System/34 and 38 business computers. The new products enable the P.C. to emulate the 5250 terminal. Additional software for the System/38 facilitates moving files between the two machines, IBM said, noting that the adapter is priced at \$600 while the emulation software carries a

one-time fee of \$164.

Meanwhile, the company also unveiled a P.C.-Series/1 connection. The new software makes the P.C. emulate an IBM 3101 ASCII terminal but enables the P.C. to enter data through the Series/1 into Systems Network Architecture (SNA) networks. The program has a one-time fee of \$150 and is to be generally available in June.

IBM said that each of the two new P.C. attachment arrangements enables users to switch between local P.C. operation and terminal emulation. Data collected in emulation mode can be processed by the P.C., freeing the host to perform other work.

Thus it seems apparent that IBM is making it possible for its personal machine to attach to just about any other IBM computer. All that is missing, it would seem, is a local network to enable various IBM small computers—the Displaywriter, Datamaster, P.C., and Series/1, for instance—to communicate more easily. IBM, of course, is understood to be close to introducing such a network, which is expected to use a token-passing scheme.

Meanwhile, the firm has upgraded its System/38, Series/1, and 5280 small computers. The System/38 line saw a new model, number 8, introduced with a doubled main memory and disk storage capacities—8 megabytes and up to eight 3370 disk drives, respectively. This upgrade is said to increase the machine's total direct access storage to 4.95 gigabytes.

A new workstation controller option for all System/38 models increases the number of stations to 128 from 80 for the new model 8 and to 116 from 80 for the models 3, 4, 5, and 7. The feature carries a purchase price of \$6,200.

IBM noted that smaller System/38 models can be field upgraded to model 8 level, maintaining software compatibility. The new machine's purchase price starts at \$160,000 and ranges up to \$252,990. Volume purchase discounts are available, as are leases from IBM Credit Corp. Shipments are to begin in July.

In the area of programming, IBM added the BASIC language to the System/38, claiming that it extended the machine's "powerful database function into the area of problem-solving applications." The BASIC package carries a one-time charge of \$3,600, includes an interpreter and compiler, and is said to take advantage of the System/38's file structure.

IBM issued a vague statement of direction, saying that it "intends to maintain compatibility in the area of BASIC statements used to control display screen handling among current IBM products which conform to the emerging American BASIC national standard." It was not clear which products the company referred to.

Other System/38 enhancements included a no-charge 3270 terminal emulation package designed to attach the machine

to Series/1 networks and an \$873 adapter to connect the system to AT&T's 56Kbps DDS network.

In the Series/1 area, IBM topped off the six-year-old line with a model 4956 processor that is said to offer internal speeds 20% faster than its predecessor, the 4955 F. The new model also ups the maximum Series/1 main memory capacity to a full megabyte.

Meanwhile, IBM introduced a new software package designed to manage remote Series/1 processors from a central site. This is expected to appeal to large commercial customers such as insurance companies and to industrial customers who are using the small computer in control applications.

Also for the Series/1, IBM introduced a new disk subsystem with cache memory, an autoloading mag tape drive, a

IBM added new top-end models to its Systems/38 and Series/1 lines, doubling the main memory size of each machine.

new version of the RPS operating system that supports X.25/HDLC packet-switching communications, and adapters to connect the 5200 series of printers.

IBM also improved its Series/1 discount schedules for volume purchases, decreased prices for some licensed programs, and changed the volume license program discounts for value-added remarketers.

New storage and printer features were introduced for the model 5280 intelligent terminal, a machine IBM sells for word processing and communications in offices. The new disk is a 5¼-inch unit storing 10 megabytes, up to seven of which may be mounted in a 5280 station. Shipments begin in July, IBM said. The company also introduced gear to attach the 5217 and 5242 printers to the 5280 systems. Lastly, a 10% increase in lease and rental charges was levied for all 5280 models and features, along with a 15% increase in monthly 5280 software charges.

The sweeping small computer enhancements and price changes were seen as signs of increased IBM aggressiveness in the low-end arena, where the company has found strong competition from Digital Equipment, Hewlett-Packard, and a number of other vendors. Moreover, IBM is thought to be helping customers connect as many of their terminals together under the SNA umbrella to counter a perceived threat from American Bell, which is expected to unveil a line of business computers, including personal models, this year.

In another recent announcement aimed directly at AT&T, IBM has made its Information Network timesharing services available over Telenet's packet network, giving users local access in some 250 cities

Smooth Sailing...

...is a fault tolerant computer complex with total control from end to end.

Data Switch Configuration Management Systems give you "end-to-end" control of your data processing and data communications resources from the central site computers to remote terminals. CMS switching and control systems let you instantly reconfigure equipment interconnections through simple English commands at a common minicomputer-based command console.

Learn about our CMS switching and control systems at the National Computer Conference, May 16 to May 19 at the Anaheim Convention Center, Booth #P-7412.

Data Switch/CMS makes your systems

**Win a Hobie
Turbo 14.**

**See us at NCC
Booth #P-7412.**

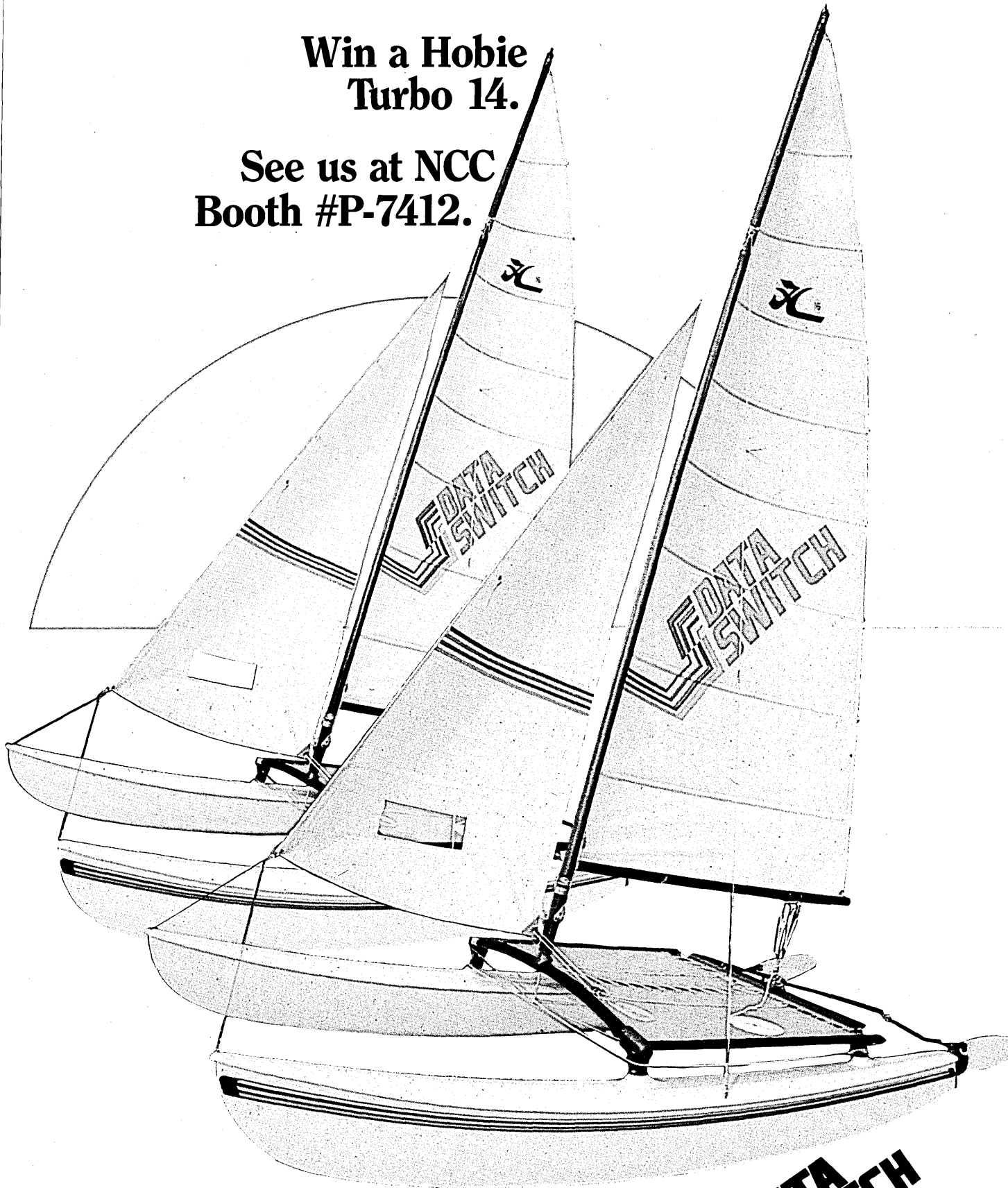

FAULT TOLERANT. FROM END TO END.

**DATA
SWITCH**
444 Westport Avenue
Norwalk, Connecticut 06851

CIRCLE 55 ON READER CARD

We've cut the mustard...

at R.T. French



We're Cyborg Systems, and we solved the Payroll/Personnel problems at R.T. French. We'd like to do the same for you.

Cyborg has developed the most flexible, comprehensive On-Line Payroll/Personnel software package on the market. We're flexible enough to serve any industry, on most any brand of mainframe. In fact, we run on (and of) the top mainframe manufacturer's equipment.

Give us a call. We'll show you how we can cut through your problems, as we've done for R.T. French and hundreds of other companies.

Cyborg Systems, Inc.
The Payroll/Personnel People

Jana Kuska • 2111 Riverside Plaza • Suite 2110
Chicago, Illinois 60606 • (312) 454-1865
Telex: 910227K606

Chicago • Los Angeles • New York • Philadelphia • Dallas • Ontario

CIRCLE 6 ON READER CARD

NEWS IN PERSPECTIVE

nationwide. Previously IBM had only offered such access in about a dozen major locations, but it is clear the company does not intend to let American Bell's Net/1000 data network effort enter the marketplace uncontested.

—John W. Verity

OUT FROM UNDER A SHADOW

Computer Automation is attacking the office automation market with a local network and a micro.

The Commercial Systems Division of Computer Automation Inc. is trying to crawl out from under a Big Blue shadow.

"We've lost the fox," says new vice president of marketing and sales Carl W. Jack, who joined Computer Automation last month from Datapoint. He is talking of the marketing of Computer Automation's SyFA system against IBM's 8100. "We're not going to fit into IBM's market. That way we get one hit out of seven. I want a better hit rate than that."

Computer Automation has been selling SyFA heavily against the 8100 and late last year went so far as to start a trade-in program allowing certain users of 8100s to swap them for SyFA systems.

"We have an established product," says Jack, "and we are going to attack the entire office automation market. We'll be selling SyFA, not our ability to connect with IBM. We'll sell SyFA's strengths, then say, 'Incidentally, we do SNA and X.25 and do it better than IBM.'"

And for the office automation market, Computer Automation has made a foray into local area networking (March 1982, p. 115) and has gotten into the microcomputer arena.

Its micro product, the Micro SyFA, introduced at Comdex late last month, was actually a by-product of the local area network (LAN) product, SyFAnet, introduced early this month.

SyFAnet is in the broadband camp of the local area networking battle, and Dick Comstock, CA product marketing manager, says it has overcome some of the drawbacks of broadband, particularly cost and control of wavelengths and protocols.

He points out that CA has gone beyond CSMA/CD (carrier sense multiple access/collision detection) to CSMA/CA, with the CA standing for collision avoidance. And with SyFAnet, the broadband coaxial cable is completely passive. "The ca-

For those who think Mohawk Data Sciences is another name for data entry...

Our name's been synonymous with key-to-storage data entry for 20 years. Ever since our first industry breakthrough.

But we haven't rested on laurels. We innovated the concept of distributed data processing with our *Series 21* product line. We made it reliable, flexible, expandable. In an industry where these features are often claimed but rarely found.

So take another look at MDS. Multi-divisional. Multi-national. A profitable company with multiple products for data processing. Word processing. Data communications. Electronic mail. Network management. And data entry.

For more information call one of our 300 sales and service offices worldwide, or our headquarters at 7 Century Drive, Parsippany, NJ 07054, (201) 540-9080.

Mohawk Data Sciences, the company that makes you think again.

MDS MOHAWK DATA SCIENCES

Building on the Theory of Productivity.

CIRCLE 57 ON READER CARD

think again.



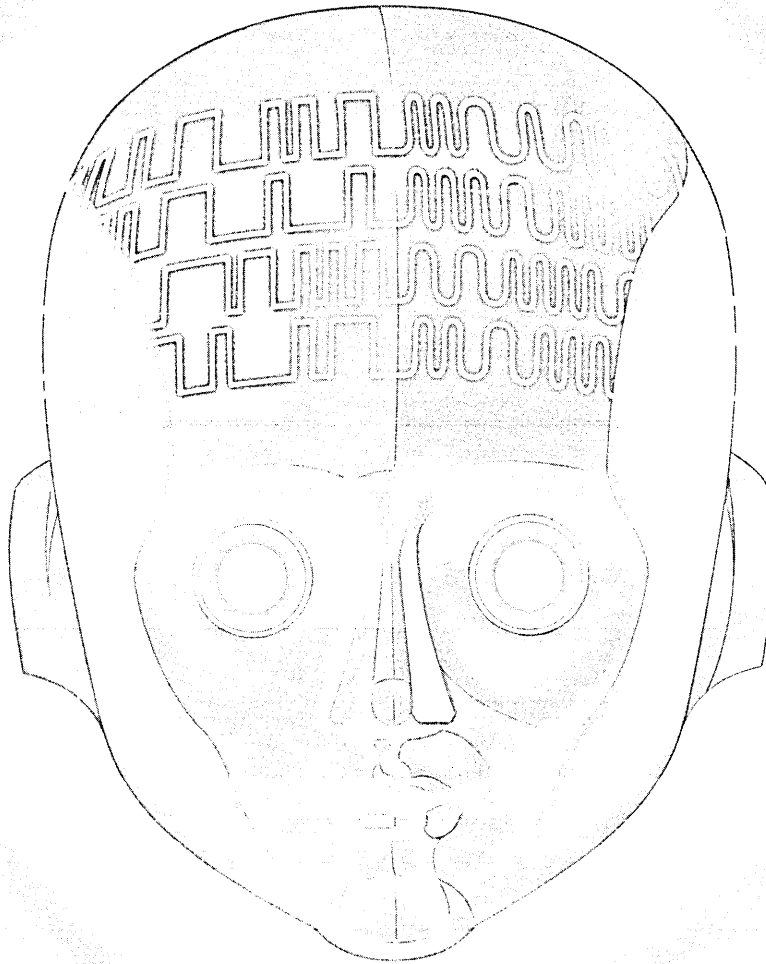

A MODERN HAS TWO FACES.

Shouldn't you buy

from the company that understands both?

Lynch Communication Systems!

Modems are really computer port telephones, and as such they should perform with the same high reliability as do voice facilities. Most modem manufacturers are experts on the digital interface side, but have limited knowledge of the telecommunications network.

For 37 years Lynch has produced telecommunications equipment for virtually every major telephone company in North America, and many overseas telephone authorities.

The Lynch analog carrier systems were among the first to be installed when subscriber pairs ran

short in the 1950's. In the 1960's Lynch digital telephone line repeaters and channel banks were the first to incorporate custom digital integrated circuits. Experts have said that the Lynch digital concentrator was years ahead of its time.

Lynch's dedication to advancing both digital and voice communication technology has produced a superior line of voice/data integration packages as well as low-speed modems, high-speed modems, base band products and multiplexers.

Whatever your data networking needs, come to the people who can show you the whole picture.

Lynch offers modems for 300bps, 1200bps, 2400, 4800, and 9600 bps as well as multiplexers and group band products up to 44kbps.

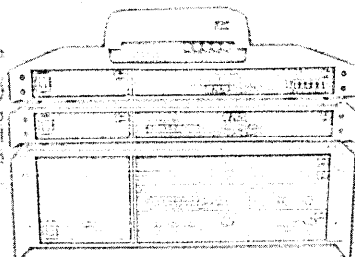

Lynch
COMMUNICATION SYSTEMS INC.

2031 Edison Way Reno, Nevada 89520
Telex 35-4429 (702) 785-8700 Cable Address LYNCOMCOM

IN CANADA CONTACT
LYNCH TRANSCOM INC.
2891 Stanger Street St. Jerome, Quebec H7V 1K7 (613) 436-8225

CIRCLE 58 ON READER CARD

3270 Users...

Get 3278 Features for less than 3178 Prices. ...from PHAZE

A superior value

IBM announced its 3178 on March 8, 1983. The PHAZE P3278 has been available since November 8, 1982. Our lower cost, more functional 3278/3178 alternative is available **now**. And, at \$1545, our coax plug-compatible P3278 will be the star of your add-on and replacement program. That's because PHAZE makes the addition easy. More importantly, you'll get a host of special features not found on theirs. That makes PHAZE a good buy, and a superior value.

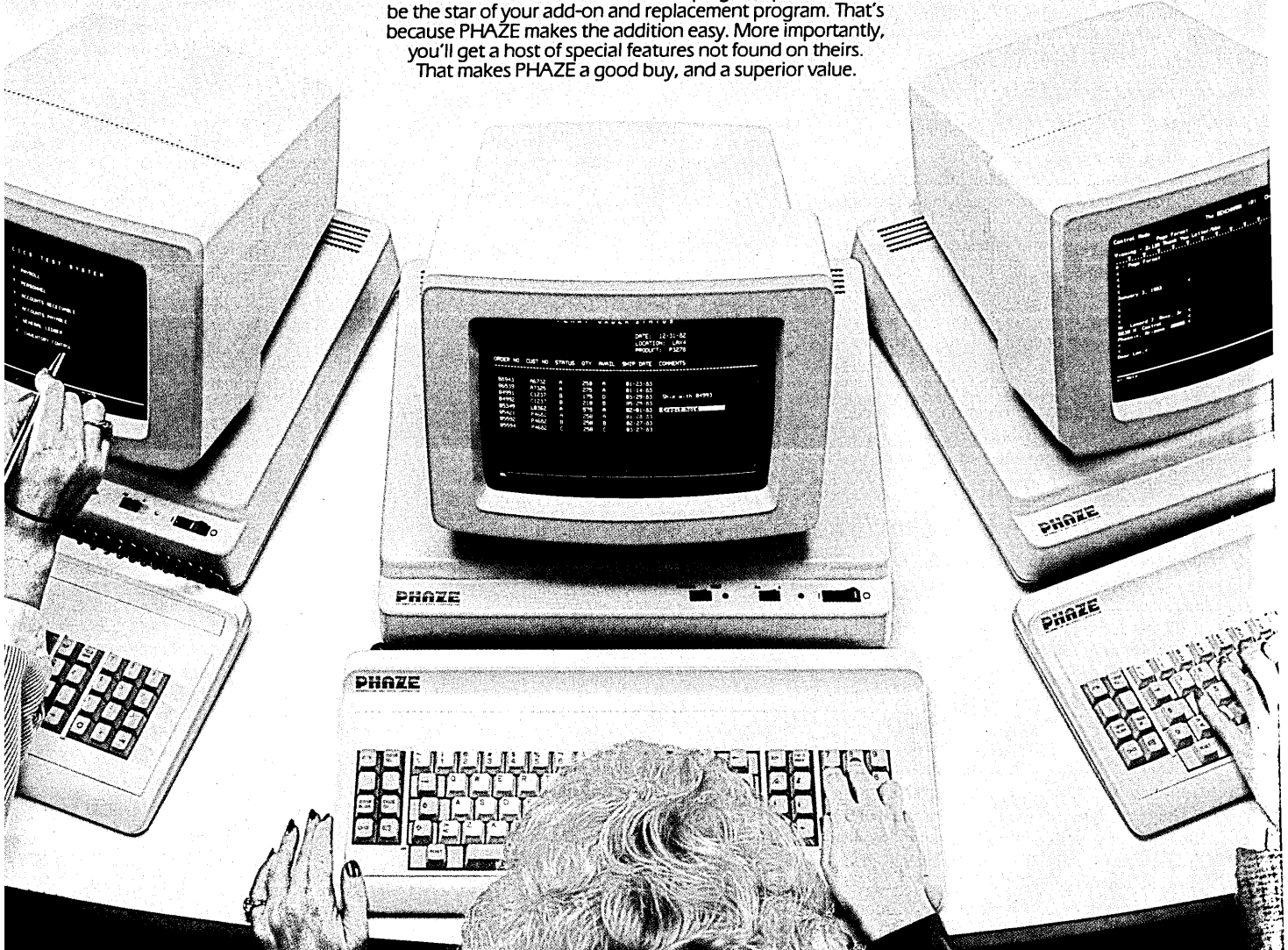

Easy to use

The compact, modular P3278 can be installed in less than 60 seconds. Without heavy lifting. Without tools. Easy installation reflects the human engineering features of the unit. Features like an easy-on-the-eyes, non-glare screen that tilts and swivels with fingertip command. A thin movable keyboard, with a continuously adjustable angle through the optimum range. And PHAZE meets the tough European human factors requirements.

Extras that don't cost extra

Standard features include an 87-key typewriter keyboard with 24 program function keys, a 12-key numeric keypad, automatic video shutdown,

combination security locks, a numeric lock and an audible alarm. The only option to buy is a light pen.

Satisfaction guaranteed

PHAZE makes your purchasing decision risk-free. In addition to our standard 90-day warranty, we offer a 30-day money back guarantee if you're not completely satisfied with our product.

Terrific price. An unusual range of features. Money-back guarantee. And liberal quantity discounts. PHAZE will make you a purchasing legend in your own time. Call us today to place your order or to obtain more information. Ask for H. P. Watson at **(602) 991-6855**.

PHAZE is a registered trademark of PHAZE Information Machines Corporation.

PHAZE
INFORMATION MACHINES CORPORATION

We make the addition easy

PHAZE Information Machines Corporation
7650 East Redfield Road
Scottsdale, Arizona 85260
CIRCLE 60 ON READER CARD

NEWS IN PERSPECTIVE

application languages not heretofore available with syFA systems. CA also will offer the CP/M 86 operating system with task processor workstations making still more applications programs available to users.

Comstock said a user can grow from one standalone workstation up to 254 nodes locally and from there up to a theoretical maximum of 16,000 nodes within an extended network.

It was in developing its syFAnet 8088-based workstations that Computer Automation came up with its Micro syFA. It simply added disk memory and had a standalone workstation from which users can grow into a full broadband network.

To bolster its new product offerings and reinforce its out-from-under-the-shadow marketing stance, the Commercial Systems Division is beefing up its direct sales staff and going for the first time to distributors. Jack says he expects to double both the sales and support staffs in the next three to four quarters. And he's aiming to sign up to 300 to 400 distributors, "oems and resellers who add value. We're structuring our price list to make it easy for them. I know it'll take a year or more to get as many as I want but I hope to have 75 to 100 by the end of this year."

—Edith Myers

STARTUPS

QUEUE AND COUNT

That's how a new firm's computer is said to provide a new level of price/performance in nonstop computing.

Yet another startup has entered the fault-tolerant processing market. Auragen Systems Corp., Englewood Cliffs, N.J., is striving to create a niche for itself in the potentially huge market pioneered by Tandem Computers but now eyed by half a dozen or so firms, all of which are but a few years old.

Auragen's claim to fame is a micro-processor-based machine that runs a Unix-compatible operating system and takes advantage of several industry standards while providing fault-tolerant processing for about \$70,000 per MIPS (millions of instructions per second), according to Tom Garvey, marketing vice president.

Auragen started in late 1980 as Parallel Computer Systems (it had to change its name to avoid conflict with a West Coast startup of similar title) and has raised from its founders and venture capitalists some

For those who think good service only comes in big blue packages...

MDS may not be as large as you-know-who, but we're equally committed to you-know-what. Service. Fact is, we feel so strongly about this aspect of our business that we formed an entire division to support it!

According to *Datapro*, *IDC* and our own service studies, we're the best... even better than the biggest. And we cost less too.

Of course, given the reliability we engineer into our *Series 21* products, our service isn't called on very often. But when it is, we respond. With over 1,600 people in 300 offices and hundreds of distributor facilities in 60 countries around the world. With a Service Call Management system using our own *Series 21* systems to remotely diagnose a need and keep track of response time, PM schedules, parts inventories and more.

For more information call one of our 300 sales and service offices worldwide, or our headquarters at 7 Century Drive, Parsippany, NJ 07054, (201) 540-9080.

MDS Service. For those who don't want to worry about it.

MDS MOHAWK
DATA
SCIENCES

Building on the Theory of Productivity.
CIRCLE 61 ON READER CARD

think again.

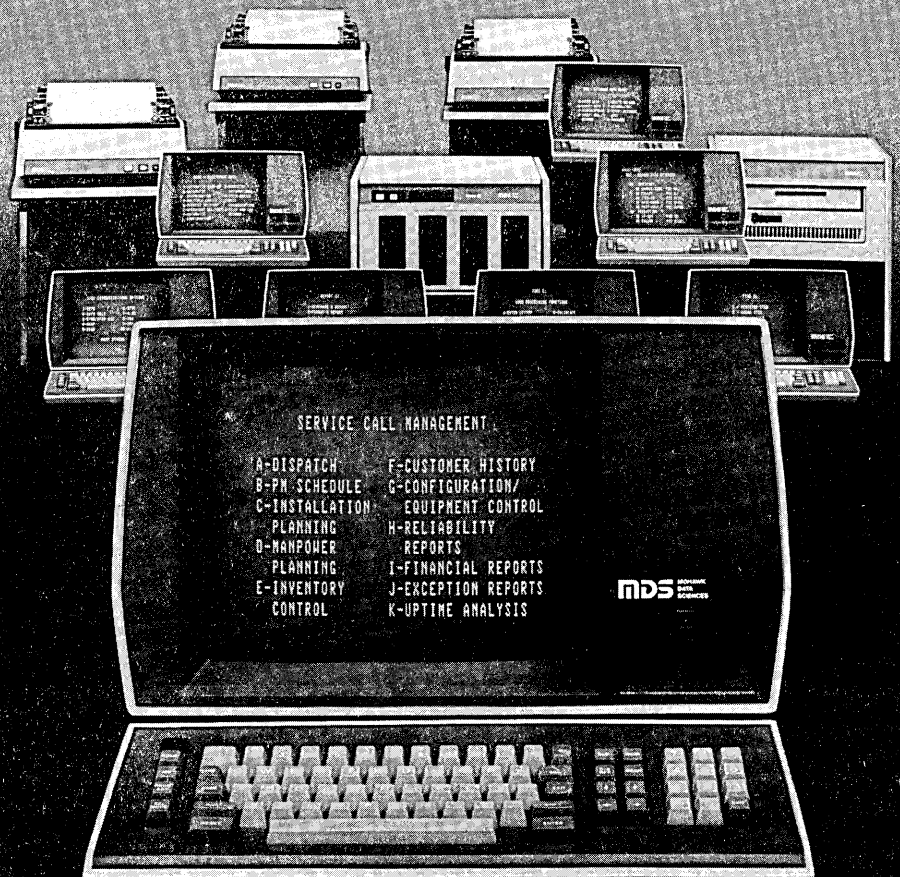

MDS and *Series 21*
Reg. U.S. Pat & TM Office.

NEWS IN PERSPECTIVE

\$13.3 million, Garvey says. It is showing its first prototype at this month's National Computer Conference, where market leader Tandem Computer may unveil its long-expected follow-on product. (Many industry analysts say Tandem's new product is long overdue, especially as startups such as Auragen, Stratus, and Synapse move onto its lucrative turf.)

"We're not going to go out and try to beat out Tandem and Stratus," says Garvey, formerly of IBM, where he spent 22 years in marketing support and management. "We intend to create separate niches for ourselves, taking advantage of standards so that we have a low-risk profile."

The primary standard is the Unix operating system, viewed by Garvey as offering a large stock of software currently running on Digital Equipment VAX and PDP-11 computers and other systems. Auragen has written a compatible operating system it calls Auros, which adds to the Unix kernel routines needed to handle high-volume transaction processing, fault tolerance, and virtual memory. Auros also includes separate file and screen "servers," procedures that enable more flexible programming; and a menu-driven command shell that makes the Unix environment more friendly to non-technical users.

At the heart of the Auragen system is the Motorola 68000 microprocessor, an

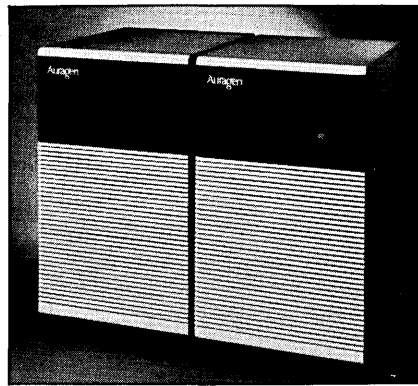

SYSTEM 4000: Auragen's new computer is based on the Motorola 68000 and is designed to be fault tolerant in transaction-processing applications. It runs a version of the Unix OS and is intended primarily for handling large COBOL programs.

8MHz chip that many companies, including competitors Stratus and Synapse, have chosen for recent computer architectures. In addition to providing a healthy price/performance, the Motorola part also supports a relatively large address space, which is useful in database and transaction processing applications.

Auragen's approach to fault tolerance is claimed by Garvey to be unique in

that backup processing is not performed until a fault is encountered. Unlike other designs that either run mirrored processors (each performing the same work as the other in synchronization) or use periodic software-based checkpointing (which requires a substantial amount of processor overhead), Auragen's system is essentially a matter of "exception processing," states Garvey. Tightly coupled processor clusters, each based on the Motorola 68000, communicate via a common bus. During normal processing, Garvey explains, a backup processor is kept "nearly up to date" with the primary processor. All input transactions to the primary are also made available to the backup, so that when a failure occurs the backup has merely to catch up by processing the same input that was processed by the primary, he states.

From time to time, the primary process and its backup are automatically synchronized by what Auragen has dubbed a "queue and count" process. The company claims it has made a trade-off between a relatively slower (compared to Tandem and Stratus, for instance) recovery time of between two and five seconds and the ability to run different processes and take full advantage of the system's hardware during normal processing. In other words, says Garvey, the primary and backup can be working on different tasks—which pro-

Boxey Says: "We can't interface a toaster to a refrigerator... Yet."

One of our customers heard we could (they said) but we can't...yet.

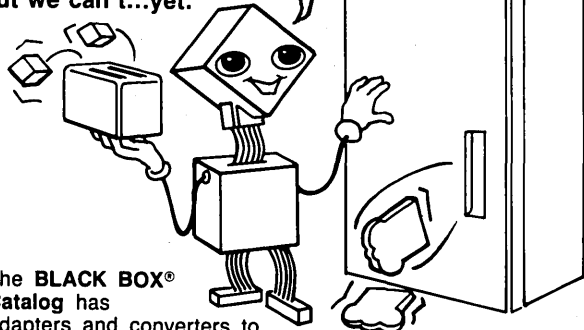

The **BLACK BOX®** Catalog has adapters and converters to interface almost any dissimilar types of computer equipment, but we haven't solved the toaster-refrigerator problem...yet.

However, whatever you need for system installation or expansion, from data cables to protocol converters, chances are it's one of the 282* products in the **BLACK BOX®** Catalog of Data Communication Devices. It's free.

Send for your copy today!

*56 models of Data Switches, 23 types of Data Cables, Cable Parts, 14 Test Sets, 7 Modem Eliminators, 6 Line Drivers, 5 Protocol Converters, 9 Communication Adapters, 8 Printer Interfaces, 8 Terminal/Line/Modem sharing devices, Tools, etc., etc.

Phone or write:



BLACK BOX Catalog

A MICOM COMPANY
Dept. SY • P.O. Box 12800 • Pittsburgh, PA 15241
(412) 746-2910 • TWX 510-697-3125

CIRCLE 62 ON READER CARD

Workaholic!

That's what you ask of a UPS. That's what you get! ContinuAC and DependAC UPS systems have been on the job 24 hours-a-day, 365 days-a-year for 18 plus years.

Here's why:

- Documented 105,000 MTBF
- Simple regulation design assures reliability
- Takes switching power supplies, non-linear loads, motors, leading and lagging power factors
- Proven, continuous 50°C operation
- In-depth service from initial project planning, through cutover and beyond

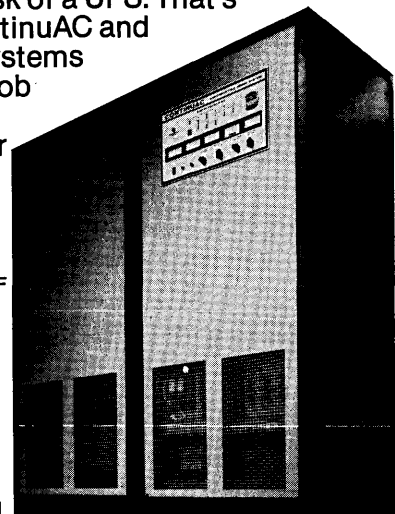

"Chips off the Old Block" Now there's a whole family of "workaholic" LorTec Uninterruptible Power Systems from 2kVA to 125 kW. All are designed, engineered and built to meet the world's toughest power specs. Challenge us!

LORTEC
Power Systems

LorTec Power Systems, Inc.
5214 Mills Industrial Parkway
North Ridgeville, Ohio 44039
Phone: 216/327-5050
TLX: 98-0314

CIRCLE 63 ON READER CARD

METHOD/1: A Blueprint for Building Systems Success

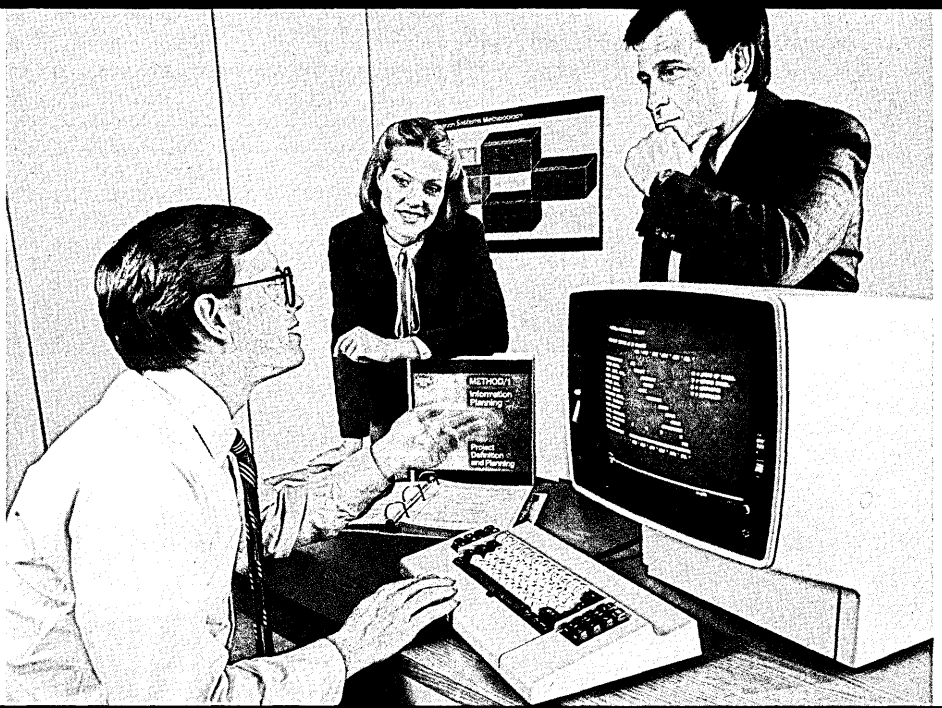

Successful systems demand a blueprint and foundation on which to build. METHOD/1 is a proven systems methodology that provides you with this structure for systems success.

METHOD/1 provides a complete framework for the planning, design, implementation and maintenance of your information systems, including guidelines, specific steps and documentation. So, your projects can come in on time within budget, and meet the needs of your users.

It's a planning and design guide that simplifies your systems activities. METHOD/1 provides a basis for maintaining project consistency and control. It also assists you in building the vital bridge linking technical design to user understanding and acceptance.

**ARTHUR
ANDERSEN
& CO.**

METHOD/1 includes a training program for all levels of personnel from programmers to systems managers, from users to senior management.

METHOD/1 has been adopted by over a hundred organizations in both the public and private sectors. METHOD/1 is the foundation upon which Arthur Andersen & Co. has developed the world's largest management information consulting practice.

Discover how METHOD/1 can aid you in developing successful information systems, call William Odell at (312) 580-2506. Or, write him at 69 West Washington Street, Chicago, Illinois 60602.

Visit us at NCC, Booth #P-7246

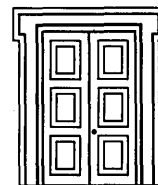

CIRCLE 64 ON READER CARD

NEWS IN PERSPECTIVE

vides price/performance benefits to the user—until a failure occurs.

The periodic synchronization between primary and backup processors is

Auragen's machine is based on the Motorola 68000 chip, a popular choice among new architectures.

handled by the operating system and need not be the concern of programmers, Garvey states. Moreover, complete reprocessing of a transaction is avoided by the backup pro-

cessor because it can pick up from the last synchronization.

Garvey says that the Auragen system's throughput with two processors is between 1.8 and 1.9 times that of a single processor during normal operation.

Transaction processing, estimated to be a possible \$22 billion market by 1986, is the main target of Auragen, which plans to concentrate its marketing efforts in finance, securities trading, banking, and communications. Telephone companies, which are already large users of Unix and obvious beneficiaries of fault tolerance, are

a key market, Garvey notes.

In order to get to market quickly, Auragen has signed a manufacturing and marketing deal with Nixdorf Computer Corp., Waltham, Mass. The U.S. subsidiary of the West German computer company expects to begin manufacturing the Auragen system by midsummer, according to Nixdorf president Mike Anderson.

"Nixdorf also has set up a new fault-tolerant systems division in Paderborn, West Germany, where it will work on its own version of the Auragen machine," Mr. Anderson said. He emphasized that Nixdorf's interest in Auragen is in the start-up's technology, not in taking an equity position or controlling the firm. "We want to see Auragen prosper on its own and provide a good technological base to work from."

Manufacture of the Auragen product will take place in North Reading, Mass., Anderson said, noting that West German production of a Nixdorf machine would not begin until late 1984. That product would be designed to sell in the European market. He added that the prepaid royalty agreement between the two firms allows Nixdorf U.S.A. to market machines here, but no plans have been made to do so.

For its part, Auragen plans to concentrate its sales efforts in the New York and Washington, D.C., areas at first, primarily so it can hand-hold initial customers,

The computer runs an enhanced version of AT&T's popular Unix operating system that has been dubbed Auros.

says Garvey. He says a West Coast office, probably in Los Angeles, will be opened by year-end, however. Currently Auragen's staff is about 90 people, but that number will grow to about 140 by early next year. Some 25 of those persons will be field sales or technical people, he adds.

The company's president and chief executive is Rick J. Martin, formerly product manager for IBM's 370/138 and 148 systems and subsequently the 4331 system. Sales vice president is Robert P. Gardner, formerly vice president of Eastern operations for Prime Computer Inc. The company's software development is headed by Sam Glazer, who comes from Advanced Technology Systems, Exxon's Verbex subsidiary, and Honeywell. The director of hardware development is Narasimha Visweswara, formerly of Exxon's Xonex subsidiary, Xerox Office Systems, and MAI's Wordstream operation. Vice president of finance is Raymond V. Sozzi, most recently chief financial officer of Decision Data Computer Corp. and previously MAI's Genesis One subsidiary.

Auragen plans to ship two field test machines in September 1983, according to Garvey, who expects that a total of 12 sys-

NOW A PERSONAL COMPUTER THAT MEANS BUSINESS

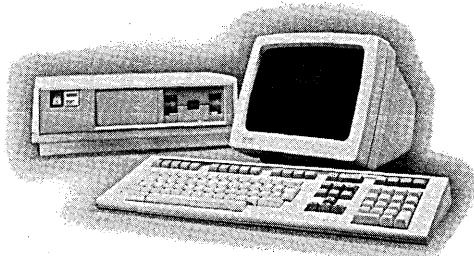

The DEC Rainbow 100*

Good news is worth waiting for, and Continental Resources has it — the Rainbow 100* from DEC. If you've been waiting for a personal computer that has the power and advanced features of a professional system, then the Rainbow 100 is for you.

The DEC Rainbow runs both 8 and 16 bit CP/M† software. That means you've got access to thousands of CP/M-80 and CP/M-86 programs — for all your business needs.

The Rainbow 100 comes complete with video display monitor, 64K RAM, an ergonomically designed 103 key keyboard, and up to 1.6 million bytes of data storage. There's also a list of options that are the envy of the industry.

More good news. When you buy, rent or lease your Rainbow from Continental Resources you get the best support organization around. Continental has been selling, leasing and renting DEC terminal systems for over 7 years. And we have a complete line of DEC and DEC-compatible products and supplies. Printers like the versatile LA100RA or the economical LA50RA. A full selection of ribbons, printwheels, diskettes even complete workstations.

The best news. You can rent a new Rainbow for as little as \$225 a month. Or, if you prefer, lease one for only \$130 a month! No matter how you look at it the Rainbow 100 is a great deal.

So call Continental Resources at the numbers listed below, or drop us a line for more information about the exciting DEC Rainbow 100. You'll be surprised at how inexpensive good news can be.



CONTINENTAL RESOURCES, INC.

175 Middlesex Turnpike, Bedford, MA 01730

Massachusetts: (617) 275-0850

New York City: (212) 695-3206

New Jersey: (201) 654-6900

Philadelphia area: (609) 234-5100

Washington D.C. area: (301) 948-4310

Atlanta area: 800-327-3444

Orlando: (305) 855-9544

Illinois: (312) 860-5991

Midwest: 800-323-2401

South Central: 800-527-0296

Dallas area: (214) 458-7616

Houston area: (713) 880-0054

Austin area: (512) 451-8331

N. California: (408) 727-9870

Los Angeles: (213) 638-0454

Orange County: (714) 540-6566

San Diego: (619) 292-0750

Santa Barbara: (805) 653-1696

Southwest: 800-421-1211

*Rainbow 100 and ergodynamic are trademarks of Digital Equipment Corporation †CP/M is a trademark of Digital Research, Inc.

DISCOVER THE DYSAN DIFFERENCE

Pack All Your Troubled Packs and Cartridges in an Old Kit Bag

And Save. Save. Save!



SPECIAL LIMITED OFFER. DOUBLE TRADE-IN VALUE:

If you act now, you can receive twice the trade-in credit you normally earn toward the purchase of Dysan's superior quality disc packs and cartridges. So, pack up your old disused disc packs and contact Dysan by July 31, 1983.

Need more information? Call your nearby Dysan Representative or use our toll free 800-551-9000 number. Or simply fill in the coupon. Discover the difference Dysan's precision magnetic media can make. For your system *and* your budget.

dysan **Dysan**
CORPORATION

Corporate Headquarters
5201 Patrick Henry Drive
Santa Clara, CA 95050
(800) 551-9000

CIRCLE 67 ON READER CARD



SPECIAL LIMITED OFFER!

- Yes, I'm interested in Dysan's Double Trade-In Value Offer.
- Yes, I'd like a free copy of your rigid media service brochure.

Name: _____

Company: _____

Address: _____

City: _____ State: _____ Zip: _____

Phone: (_____) _____

NEWS IN PERSPECTIVE

tems will be shipped this year. Next year the plan is for 100 systems to be shipped, followed by 300 in 1984, at which time the company will break even, he says. Revenues in 1986 will be on the order of \$144 million, he notes.

Eyeing the transaction-processing market has created the need for COBOL capability, the executive points out. To that end, the company has licensed the Micro-Focus COBOL compiler, which meets ANSI-74 standards and comes with a debugging package. Demand paged virtual memory, handled by the Auros operating system, permits users to address up to 32 megabytes on a single processor cluster. Auros also handles files, protecting them in case of a system crash and enhancing I/O speeds beyond the normal Unix level.

Configuration of a system includes choosing among executive, work, and data communications processors; up to four disk/tape processors; and up to 8 megabytes of RAM, all of which are clustered around a 20 megabyte-per-second cluster bus. Up to 32 clusters may be attached to dual 16-megabyte-per-second buses, providing a maximum capacity of over 30 MIPS, the company claims.

Pricing details of the system are sketchy, but Garvey says a 1.7 MIPS system, comprising two clusters with a megabyte of memory each, would list for \$138,000.

—J.W.V.

KEYS'S FORM OF MAGIX

It's a software system that is seven things at once

What is a database manager, screen writer, forms definer, data dictionary, transaction processor, operating system executive, and procedural code compiler all rolled into one?

It's Magix. At least that's the way the folks who developed the Magix software system describe it. And they're some of the same folks who gave us CP-V and CP-6, the popular multi-user operating systems offered first by Xerox Data Systems and then by Honeywell.

Meet Sam Keys, Jack Jackson, and Dave Robinson of Sabaki Enterprises Inc., Los Angeles. Keys, Sabaki president, and Jackson were members of the development team for both CP-V and CP-6. Robinson worked with Xerox Canada and got in on the development of CP-6. The name Sabaki comes from the Japanese game go, and means a kind of elegance. "I just hope

we'll be as successful as the other company that took its name from go," quipped Keys. He was referring, of course, to Atari.

Impetus for the development of Magix came appropriately from the first customer for both CP-V and CP-6, Science Dynamics Corp. (December '78, p. 62), Torrance, Calif., on-line service bureau for the medical profession.

"We got into micros extensively in the late '70s, said Sandy Panzarella, Sci-

He once considered micros something no self-respecting systems "heavy" would have anything to do with.

ence Dynamics president. "Our customers are wanting more and more local applications. We support 2,000 terminals and get 3,000 requests per year for software changes and 90% of these are for format changes." He said he considered selling turnkey systems on minis but the price range was such that only a small percentage of his market would buy. "In trying to solve our problems with micros, we found that the hardware technology was there but the software was not. We studied all the software on the market and even built our own COBOL compiler. It wasn't enough."

Panzarella took his problem to Keys and Project 919 (so named because it was launched on 9/19/81) was under way. "I'd spent a lot of time in an ivory tower working with big mainframes," said Keys, "and I learned that a big key to getting software done is tools, good tools to develop applications."

Like other mainframe hackers, Keys once considered micros "something no self-respecting systems 'heavy' would have anything to do with." He's changed his mind. "I don't know why they [micros] haven't ruled the world yet. They're not toys. They can be put together in ways that didn't exist 10 years ago. The future is in networking micros."

He sees Magix as the first good set of tools for developing micro applications. And, while it was developed for micros, it can work with mainframes. He likened Magix, in some ways, to the Pascal p-system, "only it is more machine independent."

In the very beginning of Project 919, Keys said, "we limited the problem to database application systems because we found that in the real world this covers a vast percentage of processing."

Although the system is machine independent because it produces an applications interpreter, Keys and company have been working toward a system for Science Dynamics based on IBM P.C.s and their compatibles. Specifically they have been working with Eagles from Eagle Computers Inc., Los Gatos, Calif.

The Magix-based system developed for Science Dynamics is called Spectrum

700 and a prototype will go into beta test July 1 at Eugene Hospital and Clinic in Eugene, Ore. Keys and Panzarella said the clinic has been in on development of the systems since the beginning.

The Spectrum 700 is a configuration of one to 96 computer workstations connected to a file server supporting up to 2.4 gigabytes of storage. Each workstation is a complete processing unit (8086 based) that, under Magix software, is responsible for all procedural processing in a given application. This enables the file server (8086 Multibus based) to concentrate on the file management responsibility and output processing requirements. Adding workstations does not degrade performance.

The Magix executive, Keys explained, combines the power of a mainframe operating system with an efficient sophisticated file management database structure with easy application generation capabilities.

The systems can execute non-Magix applications at the workstation concurrently with Magix-controlled application programs.

In building a unique application, a Magix definition language program is created that incorporates whatever data elements and their relationships are required. This program is compiled using Magix's database compiler feature, and the systems forms definer capability is used to create a user's desired screen and report formats. The outputs of the database compiler and the forms definer are then loaded and the system is ready to run.

Magix allows a programmer to easily create new applications or reconfigure existing ones through the database compiler by defining the data dictionary and establishing key/file access definitions. The user still can control his own data entry and report formats, authorization to directives, and free form inquiries.

In Spectrum 700, the workstation itself is a dual microprocessor (8086 and

The system can execute non-Magix applications at the workstation concurrently with Magix-controlled application programs.

Z80) based unit. It has more than enough power to double as a personal computer. The workstation can load a copy of a CP/M 86 operating system and instantly be able to run more than 3,000 application programs now available for CP/M 86. As an option, for the user requiring local floppy or Winchester disks, CP/M 86 and MS-DOS have been modified to request the file server when needing disk I/O. In such cases, performance will be as if each unit does have its own storage because the local area network speed is as fast or faster than that of normal disk I/O. Thus, any workstation, with prop-

Here's Why Precision Visuals Is Now The Leader In Graphics Software Tools!

One Program Drives Many Devices

This single advantage can save you hundreds of hours of programming time. It enables you to use your hardware (both host computer and graphics devices) to its fullest. It protects your software investment against obsolescence and frees you from exclusive ties to hardware vendors.

Precision Visuals currently offers tailored interfaces for over 30 graphics devices from these companies: AED Applicon Calcomp Calcomp lookalikes Chromatics DEC Digital Engineering HP Houston Instruments IBM Imlac III KMW Megatek Printronix Ramtek Raster Technologies Sanders Selanar Servogor Tektronix Tektronix lookalikes TI Trilog Versatec Visual Technology Zeta.

They Run On Most Popular Computers

Including IBM, VAX, PR1ME, Hewlett-Packard, CDC, Honeywell, Data General, DEC 10/20, Harris, Univac, Cray, and DEC PDP-11.

Precision Visuals software tools require a surprisingly small amount of computer resources. Even on smaller machines they provide access to the full capabilities of the CORE graphics standard.

"At Martin Marietta, DI-3000 serves as a common interface between our numerous graphics devices and software applications. We use DI-3000 for applications including structural analysis, business charts, graphs, animation, 3D modeling, and general-purpose graphics."

Karin Bruce
Senior Graphics Software Engineer
Martin Marietta Denver Aerospace

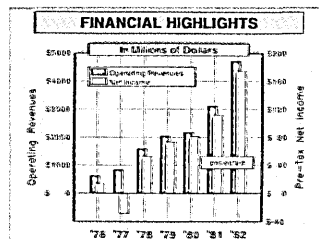

Make better decisions, faster, using GRAFMAKER's specially-placed annotation and color.

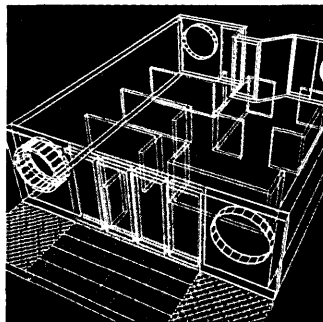

Build highly interactive computer-aided design applications with the DI-3000 core system.

Rich Capabilities Mean Limitless Applications

Precision Visuals software tools are proven in applications such as computer-aided design, business graphics, process control, mapping, geological data analysis, document layout, plus many specialized applications. System integrators (OEMs) use them as the graphics nucleus in turnkey systems and as the graphics component of database management and financial modeling systems.

\$12,000 For Our Most Popular System

DI-3000™, the core system, starts at \$8,000 and goes to \$12,000 for our most powerful and best-selling level. Add \$6,000 for GRAFMAKER™, the business presentation specialty system, and you'll have one of the most versatile graphics systems available at any price. Other popular options include the METAFILE SYSTEM for a device-independent

picture library, and our new CONTOURING SYSTEM for advanced surface graphics.

These are single-CPU, end-user, U.S. list prices. Multiple CPU and OEM discounts are also available.

Find out how Precision Visuals graphics software tools can open a new world of flexibility, economy, and standardization for your graphics applications. Call us at 303/530-9000.

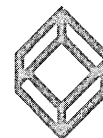

Precision Visuals

6260 Lookout Road
Boulder, Colorado 80301 USA
303/530-9000
TELEX 45-0364/TWX 910-940-2500

Amsterdam: Ponder Associates
Phone 030445352 / TELEX 70634
Sydney: Techway
Phone 02920858 / TELEX 27987
Tokyo: Nichimen Company Ltd.
Phone 032775017 / TELEX 22329
Zurich: Computer Graphix AG
Phone 019323482 / TELEX 875447

CIRCLE 68 ON READER CARD

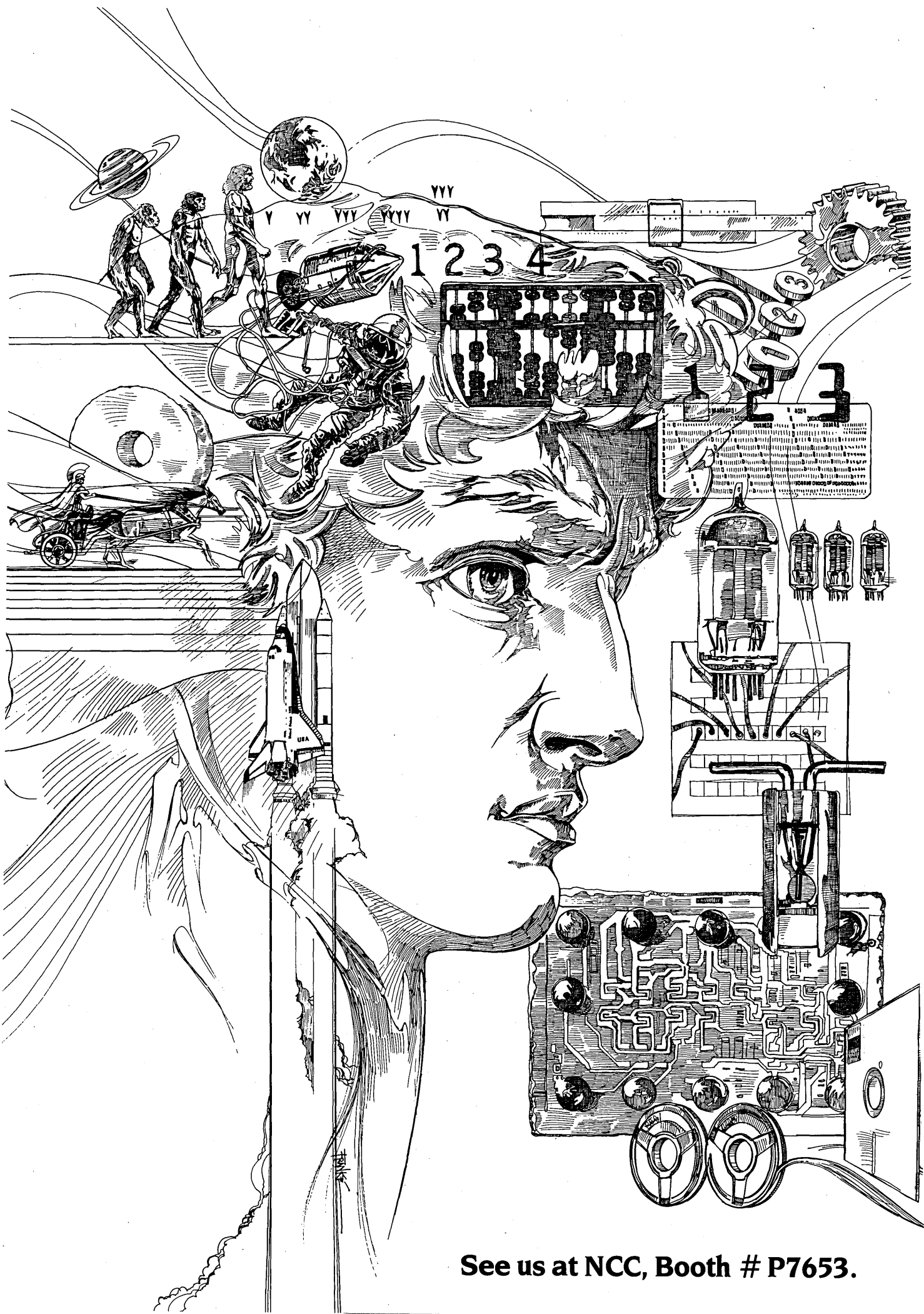

See us at NCC, Booth # P7653.

Introducing the Auragen of the computer species.

Now a higher form of computer technology has evolved. It combines fault tolerance, high performance and ease of use. The natural selection for your business transaction needs.

Now you can have fault tolerant applications at price/performance levels never available before. For under \$138,000, our entry level 2-Cluster system provides up to twice the performance of today's fault tolerant systems.

AURAGEN™ begins with an advanced 32-bit distributed architecture. Both your professional and end-user staff will find it easy to learn and use. AUROS™ our operating system based on UNIX™ is enhanced with performance, security, privacy and recovery capabilities specifically tailored for the transaction market. We provide ANSI 74 High Level COBOL, FORTRAN 77, Pascal, C and even business BASIC that run fully fault tolerant. No special instructions are necessary. No reprogramming. No retraining. No added expense.

We also provide a full range of interactive productivity tools for programmers, including AURAGEN's full-function relational DBMS and Transaction Processing Management System. Then we've added menus, help facilities, and an English-like query language to make your staff more productive. The extensive communications packages that we provide include SNA, BSC, X.25 and more.

The concept that sets us above and apart from all other fault tolerant systems is simple. Our fault tolerance is totally transparent and is so efficient you'll never want to turn it off. Our backup hardware is available to do productive work during normal operations. No downtime. No manual backup procedures. No added expense.

With AURAGEN's distributed design, you can grow in precisely controlled increments. The basic fault tolerant system contains two Clusters. Each Cluster contains several tightly coupled MC68000 processors. Separate processors handle fault tolerance, user programs, communications, and database functions. The system can be expanded to 32 Clusters.

AURAGEN is so advanced, you'd select our system even if we didn't provide fault tolerance.

But we do. In today's competitive business environment, you need every survival factor working for you. We provide them all. And we want to tell you more about them. That's why we invite you to ask for more information.

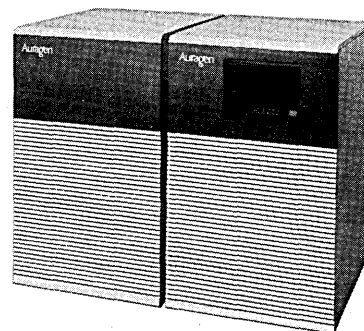

Auragen Systems Corp.

THE NATURAL SELECTION

DM5

AURAGEN Systems Corp.

Two Executive Drive, Fort Lee, N.J. 07024
Call toll-free 800-847-4276. In New York, (212) 605-0152.

I'm interested in the AURAGEN System. Tell me more.

Name

Title

Company

Address

City State Zip

Telephone

™AURAGEN and AUROS are registered trademarks of AURAGEN Systems Corp.
™UNIX is a registered trademark of Bell Laboratories.
© 1983 AURAGEN Systems Corp.

CIRCLE 69 ON READER CARD

NEWS IN PERSPECTIVE

er authorization, can break away from the Magix application system and become a personal computer with complete privacy and isolation from other users and with better performance without additional hardware. A user can install multi-user word processing without any system configuration changes. Any workstation can create a document, and store it on the file server for any other station to use or edit. Output can be to a central daisywheel or laser printer on the file server, or, if a workstation is dedicated to wp, a printer can be driven directly off the station.

In addition to the application program availability under CP/M 86 or MS-DOS,

Any workstation can break away from the Magix application system and become a personal computer.

various host language compilers allow a user well versed in BASIC, for instance, to create and execute any program directly from his workstation.

The center of the Spectrum 700 system is the database server, which is somewhat less general purpose than the file server but more powerful. The database server, Keys explained, can be one Eagle, "or if [the users] want to get fancy it can be a Multibus 8086 with a 100-megabyte disk. We have one customer [Science Dynamics] with two 3-megabyte disks. If you want to play MIPS [millions of instructions per second], we'll win that hands down." Magix, its creators say, can be run on any machine from the smallest 8-bit unit to the largest mainframe.

Keys said all it takes to write applications programs using Magix is computer literacy. But he emphasizes that he doesn't want to obsolete programmers. "I am one. Programmers like it because it makes programs easier to write and they can write them faster."

Panzarella said a major program Science Dynamics uses, called MARMS, was rewritten beginning in 1970 to create a new generation and it took 25 man-years. "Now [with Magix] the same thing could be done in five man-years."

All Magix programs are compatible with each other, he said. "In the past we had to worry about conversion as from CP-V to CP-6. With Magix, the fastest, lowest-cost way to make a change is to redo."

Keys said Magix turned out "to be better than I thought it would be." He talks about "return on imagination." "I used to dream of something, then fight like hell for 10%. With Magix we got 100% return on imagination." He went on his own and away from major companies because he feels in big companies "to work to make something as good as it can be is not the same as success."

Panzarella likes Magix because it

gets him away from the BUNCH (Burroughs, Univac, NCR, Control Data, Honeywell). "I didn't want to be caught again [as he was when XDS got out of the general purpose computer business]," although he says he got better support from Honeywell with CP-6 than he did from Xerox with CP-V and he's still very happy with what CP-6 is doing for him.

Science Dynamics has become the marketing arm for Magix. "It's a game almost anybody can play," said Panzarella. "We're talking everything from just selling applications to selling large end users, big manufacturers, people building systems."

He describes it as a system that can take a program of 100,000 lines in BASIC and put it in a briefcase. It's an on-line system but "if you want batch you just assign a workstation to that."

As for Keys, he's not selling his creation. But for any computer literate who brings up an application with it, he has a T-shirt proclaiming that person a "Magixian."

—Edith Myers

TERMINALS

3270 MAKERS REACT

Plug-compatible manufacturers say they aren't frightened by IBM's recent moves in the 3270-P.C. arena.

Personal computing and networking—just the mention of these two can send information system managers reaching for the aspirin. Calm down. Sit back. IBM, in its usual fashion, has set the direction for the 3270 environment with new products.

IBM has an interest in keeping systems managers happy, satisfied, and, most important, loyal, for they provide about 70% of its total revenues, it has been estimated. In one fell swoop IBM has matched swords with the micro makers, local area network providers, and those bolting on 3270 emulators for access to IBM mainframes (April, p. 86).

Using the recently announced IBM 3270 P.C. attachment, a user gets personal desktop computing power plus access to the host computer at the application level without having to string a new network. In addition, IBM has seen fit to offer some price cuts and volume discounts that bring this little ensemble into a more appealing price range. So what does this do to the plug-compatible competitors?

Most vulnerable to this recent strategy direction, speculate several industry observers, are the upstarts emerging out of the async world—the Beehive, Lear Siegler, Apple, and Tandy crowd that have added 3270 emulators to their micros. Their strongest appeal has been price and personal computing power; their weakest point has

Many pcms are prepared, they say, with P.C.-terminal products that will be introduced this year.

been the method with which they addressed the 3270-to-host connection. History has proven in the pcm market that if one's strongest asset against IBM is price, one's most likely outlook is certain death. IBM nails competitors on service, support, manufacturing efficiencies, and/or sales savvy. As for the personal computing appeal, it is well known that software sells the micro and software written specifically for the IBM micro is busting out all over.

But there is another group of pcms, the 3270-like pcms. They could be the real sleepers in this madcap hoopla to win a place in the hearts and budgets of MIS strategy planners. For instance, take a look at how Lee Data Corp., Minneapolis, has fared in the wake of IBM's 3270 announcements.

Not only does Lee Data's Product strategy reflect most of the features of IBM's integrated P.C.-3270 product, it moves into the realm of local area networking.

"We had been thinking since we started the company [April 1979] about how to add function to the 3270 system," recalls John Lee, president. "Distributed data processing had been a buzzword of the early '70s but it didn't really make sense till the P.C."

Asked if he thinks the day of the dumb terminal is coming to a close, he adds, "It's not that black and white. Although not every application may need personal computing capabilities, the corporation may want to put it out there. It may make sense to offload the application processing out to the terminal with a P.C. on it. The response time may get better and it may even put off for some time the addition of more computer capacity. I think that might be a long-term evolution path of the P.C. into these companies."

Like IBM, Lee Data's approach to personal computing was to attach intelligence to the workstation. In LDC's case, that workstation is its All-In-One display, which incorporates the features of IBM's 3278, models 2, 3, 4, and 5. The All-In-One also features a tilt-and-swivel crt and a detachable keyboard.

In assessing how important the P.C. market is to the plug-compatible companies, John Lee estimates that the total market for his company's products, which in-



Seeing your data resource under control begins with sending the coupon.

Chances are, your organization's data and information systems are getting out of control. It's no wonder. The proliferation of information delivery systems and new, structured methodologies has made it easier to respond to increasing end-user demands with short-term solutions. Solutions that have only compounded the problem.

MANAGER SOFTWARE PRODUCTS' DATAMANAGER™ offers a permanent solution. One that's fully compatible with your IBM mainframe environment now, yet one that will let you cope with a continuously changing systems environment and growing end-user demands in the future.

DATAMANAGER is the world's leading data resource management system. The first such system designed specifically to help you develop, manage and control your entire data resource. The first system to converse with not only IS professionals, but with end-users – in language they understand. And the first system to interface with all the leading data base management systems, TP monitors and programming languages.

DATAMANAGER is driven by the world's most versatile data dictionary; one that can be easily tailored to your specific needs. It's a stand-alone system, yet it can be fully integrated with other dictionary-driven products in MSP's MANAGER family – such as DESIGNMANAGER™, the logical data base design and modeling system, and SOURCEMANAGER™, the COBOL application development system.

Find out how DATAMANAGER can let you see your data resource under control. Send the coupon today. Or call (617) 863-5800 (Telex 710 326 6431).

mSP

MANAGER SOFTWARE PRODUCTS INC

Offices worldwide: Australasia, Benelux, Canada, Italy, Japan, Scandinavia, Spain, Switzerland/Austria, U.K./Eire, U.S.A., West Germany.

Send me more information about MANAGER SOFTWARE PRODUCTS' family of integrated, dictionary-driven products:

DATAMANAGER DESIGNMANAGER
 SOURCEMANAGER

Name _____ Title _____

Company _____

Address _____

City/State/ZIP Code _____

Telephone Number (____) _____

Send coupon to MANAGER SOFTWARE PRODUCTS INC,
131 Hartwell Ave., Lexington, MA 02173.
Or call (617) 863-5800. Telex 710 326 6431

NEWS IN PERSPECTIVE

cludes a portion of the asynchronous market, will be about \$7 billion by 1986. "The P.C. will represent somewhere between \$4.5 billion and \$5 billion of that market, so that product is very important to us," he said.

Asynchronous? That's right. Lee Data has its hand in another pie in addition to the 3270 market. The company is the only 3270-system supplier at present that offers links into the asynchronous world. Its trick is the Series 400 controller, which the company started shipping last June.

The 400 allows 32 displays to connect to one IBM host, either local or remote, and 16 other hosts through async ports. At present, on the async side, the company only offers DEC emulation. Soon to come will be HP emulation and another IBM host channel. The enhanced Series 400 system will then be able to replace DEC VT-100 terminals, 3270 terminals, and HP terminals with an All-In-One display.

"This is the sort of hybrid product we are evolving into that will really reduce our vulnerability to IBM," stated Lee. "When we started out we were paying very high bucks for the microprocessors. [The controller has a multimicroprocessor archi-

ture that includes the 8085, 8086, and 8088.] But we were betting on the outcome. Now we are adding more functions, lowering our prices, and increasing our margins. We've shipped a lot of this product."

At the opposite end of the scale, Lee Data has yet to counter IBM's low-end 3270 offering, the 3178. The Minneapolis-based company indicated that a 3178 equivalent

Added value and function are the keys to playing the 3270 game, especially since IBM dropped prices.

will be forthcoming this year. Expect to see a larger screen than IBM's 3178 and, more important, compatibility with Lee Data's P.C. attachment. IBM, as yet, does not offer its P.C. attachment for the 3178.

IBM has said it will not entertain any special feature requests for the 3178 display nor will it lease the 3178. Lee Data, like other 3270 pcms, intends to continue offering a variety of special features and lease arrangements.

In responding to IBM's aggressive discount structure, Lee says he doesn't ex-

pect to see many customers in the 3000-units-per-order, 40%-discount range. "The average purchase discount is in the 20% to 25% range and we think we can continue to achieve better than average margins at that range." At present, the company is achieving a 21% after-tax margin, according to Lee. On the P.C. attachment, Lee felt that IBM's pricing was high. "We are well under that price with our product."

Had IBM come out with its low-end 3178 two years ago, however, "it would have hurt us," acknowledged Lee. "But today it helps. We are now at a volume where we can manufacture such a product at a cost that still allows us to achieve good margins. Also, it is a timing that is consistent with our growth and the maturing of our customer service organization."

In March, the company moved into a new 250,000-square-foot facility that houses the management team as well as all manufacturing, which covers about 120,000 square feet. "We have the capacity to produce 10 times what we are producing now. This facility can take us to a \$300 million company," beams Lee as he walks through the plant.

Last November the company went public to raise \$31 million to cover its faster than expected growth. At the end of fiscal 1982 (ending March) the company reported \$13 million in revenues, 110 customers, and about 275 employees. At the end of fiscal '83, the company reported \$53 million in revenues, about 250 customers, and 725 employees.

Taking a different tack from Lee Data and IBM is Braegen Corp. which put intelligence in its terminal controller, the 8410. "We feel a built-in solution is better than a bolted-on one," says George Everhart, Braegen vice president of marketing. "With our shared resource approach it reduces a company capital outlay."

The obvious savings is that a company doesn't pay for personal computing at every terminal site: buy one 8410 controller and attach up to eight terminals. "Then anyone on the cluster can share files and data," said Everhart. That brings down the cost of licensing P.C. applications. Instead of licensing eight copies of one program, one copy is shared among eight terminals. "After 2.5 P.C.s or more, we start to be competitive and increase exponentially," the Braegen executive says.

Like Lee Data, Braegen has distinguished itself as a company that offers functions not available from IBM. In addition to attaching hosts and displays to the Braegen controller, system printers and card readers can be attached. Another unique feature is that the Braegen controller can accommodate up to six different IBM hosts, either local or remote. Plans are to take that number up to eight, says Everhart.

Braegen's answer to IBM's new 3299 multiplexor is a multidrop coaxial ca-

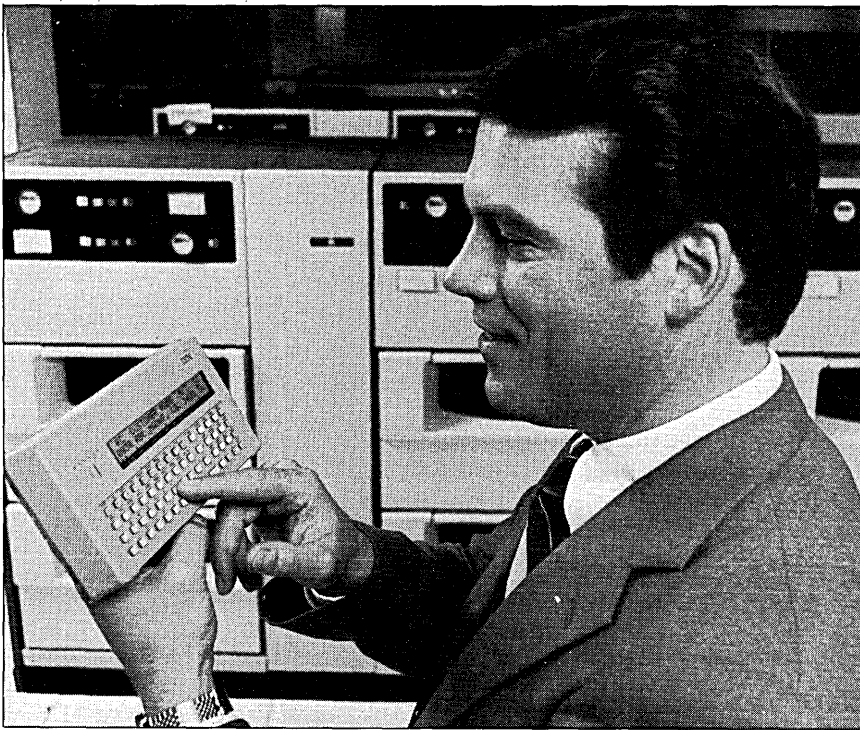

TESTING 1-2-3: IBM's service reps will soon be carrying this portable terminal that communicates via 800MHz radio transmission with mainframe computers. The terminal will enable the reps to be notified of customer calls, enter service data, and order parts, according to IBM's field engineering division. IBM recently received permission from the FCC to use the 800MHz band in 250 cities; telephone connections will be used where radio is impractical. The system, developed by IBM and Motorola, will begin testing next January in Chicago. Motorola will install the equipment it has designed and maintain it for IBM. The programmable unit features a two-line 54-character display, ROM and RAM, and an alphanumeric keyboard. It weighs 28 ounces, IBM said, noting that the new system would replace a one-way pager system currently in use.

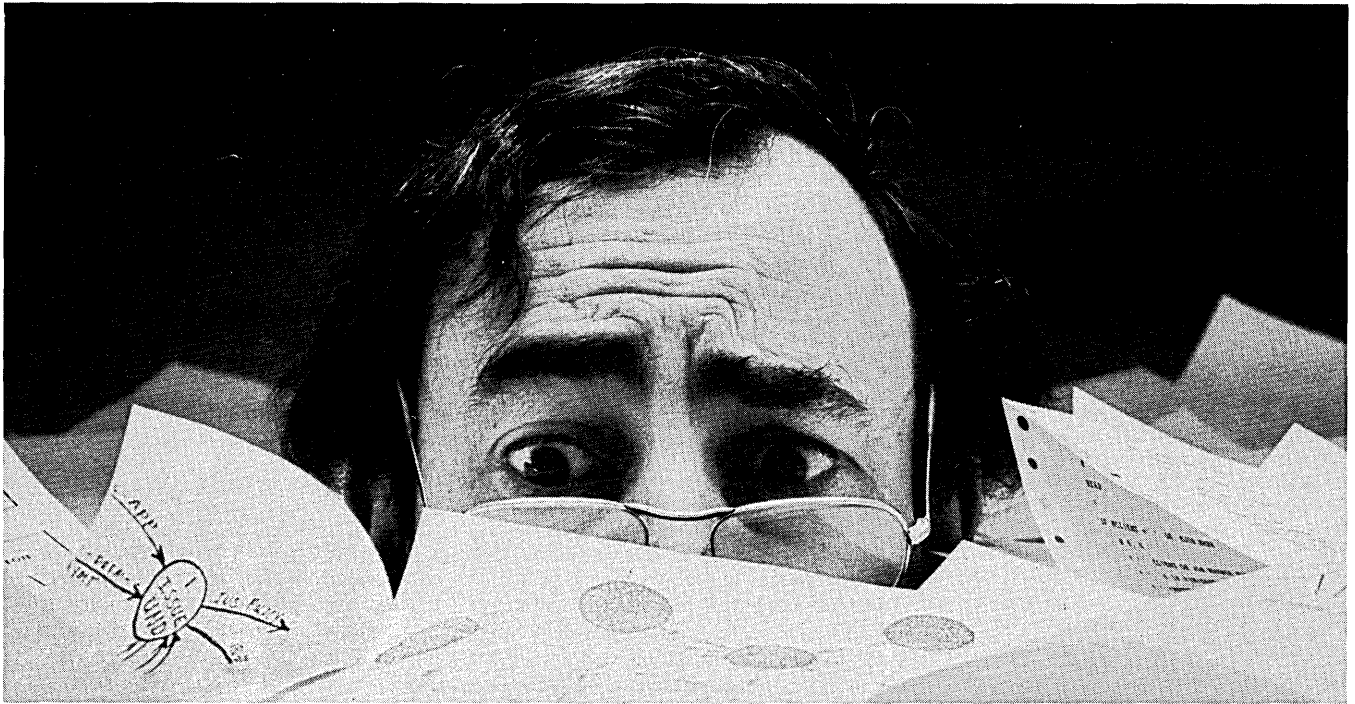

A little couponwork takes the endless paperwork out of data base design.

People involved in data base design have had good reason to be frustrated: They've had to endure a maze of endless paperwork and manual procedures so that others may escape it.

MANAGER SOFTWARE PRODUCTS' DESIGNMANAGER™ provides them with a method of carrying out data analysis and data base design quickly and cost-effectively – without endless paperwork.

DESIGNMANAGER's central driving force is a modeling dictionary that holds information about your organization's data resource. The content of the modeling dictionary is interactively built up by end-users and analysts directly through two complementary methodologies: top-down (Enterprise model) and bottom-up (userview model).

The reconciliation of these two components provides the basis upon which you can construct and verify models of your organization's data, and generate stable, third-normal form logical data base designs.

DESIGNMANAGER can increase user productivity whether used as a stand-alone system or fully integrated with other dictionary-driven products in MSP's MANAGER family. These include DATAMANAGER™, the data and information resource management system, and SOURCEMANAGER™, the COBOL application development system.

Find out how DESIGNMANAGER can take the endless paperwork out of your data base design work and increase productivity. Send the coupon today. Or call (617) 863-5800 (Telex 710 326 6431).

mSP

MANAGER SOFTWARE PRODUCTS INC

Offices worldwide: Australasia, Benelux, Canada, Italy, Japan, Scandinavia, Spain, Switzerland/Austria, U.K./Eire, U.S.A., West Germany.

Send me more information about MANAGER SOFTWARE PRODUCTS' family of integrated, dictionary-driven products:

DESIGNMANAGER DATAMANAGER
 SOURCEMANAGER

Name _____ Title _____

Company _____

Address _____

City/State/ZIP Code _____

Telephone Number (____) _____

Send coupon to MANAGER SOFTWARE PRODUCTS INC,
131 Hartwell Ave., Lexington, MA 02173.
Or call (617) 863-5800. Telex 710 326 6431

The clever gift for computer lovers

HIGH-TECH, MINI-SIZED COMPUTER TERMINAL



**It's a bank!
It's a planter!
It's a personal caddy!**

Made of high quality molded plastic, measuring 4 1/2" x 6" x 4 1/4", and available in assorted colors, each CompuGift has a clear acrylic screen which holds your favorite photo. The **Computer Caddy** stores pens, pencils, rulers and note pads. The **Computer Planter** looks great anywhere, and the **Computer Bank** provides an interesting place for loose change.

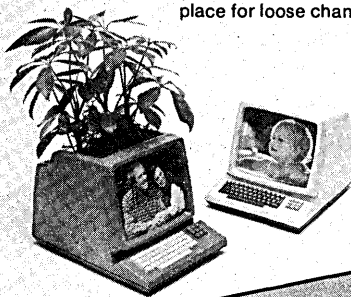

Attractive gift item



Only \$9.99 each plus \$2 each for shipping (\$6 maximum). (For Canada, Hawaii and Alaska, double shipping charges).

Colors available in
a. Beige b. Dark Grey c. Yellow d. Magenta

Item	Color & Quantity			
Computer Caddy	a	b	c	d
Computer Bank	a	b	c	d
Computer Planter	a	b	c	d

Subtotal	
Tax (CA res.)	
Shipping	
Total	

Name _____
Address _____
City _____
State _____ Zip _____

Custom Imprinting/Inquire Quantity Discount

CompuGift, Inc.

27802 Peralas St. Dept. 0401
Mission Viejo, CA 92692
(714) 768-8223

Satisfaction Guaranteed

CIRCLE 72 ON READER CARD

NEWS IN PERSPECTIVE

ble scheme that it has offered for some 10 years, says Everhart. Instead of having to string one piece of co-ax for each 3270 crt, Braegen's approach requires only one cable from the controller to a cluster of tubes. Lee Data answered the co-ax problem several years ago with its "co-ax eliminator," which can multiplex up to eight terminals from a single cable.

At the other end of the 3270 market are Raytheon, ITT Courier, and Telex. Both Raytheon and Telex believe that the intelligent controller direction is the more promising one. Yet while Telex claims that as its long-term strategy—to put the intelligence in the controller—its current P.C. capability comes in the form of a box that attaches to Telex's 278 display. The P.C. unit is called Proffit.

Meanwhile, Raytheon has yet to unveil its P.C. entry, but company strategy, said Bert Hochfeld, director of marketing, "is to use the workstation in an intelligent cluster controller arrangement." An announcement should be forthcoming by year-end, he added.

Less widely known than its 3270 family of products is Raytheon's RDS 200, a desktop computer that is primarily used in the word processing market, said Hochfeld. "It is available with CPM, SuperCalc, and dBase," he adds. Within six months or so, the product should be attachable to Raytheon's current 3270 controllers, says Hochfeld. "Thereby the user would have a triple threat: full-function word processor, a 3270 display, and a P.C."

Observes Hochfeld when asked about IBM's push toward purchase and away from leasing, "IBM apparently does not feel it has a place for leasing its equipment. We feel we do. The product can be used on the intelligent controller. IBM must not be intending to have its workstation be attachable to an intelligent controller without some kind of modification," he speculates.

Expect to see a 3178 answer from Raytheon in the third quarter of this year.

Raytheon, Braegen, and ITT Courier all say they can continue to compete effectively with IBM.

Addressing IBM's 3299 multiplexor entry, Hochfeld says Raytheon has had its product design "under development for some time."

As for ITT Courier, it caught up with most everyone in April, announcing a low-end product with a 12-inch screen, small foot print, and features "that pretty much meet IBM head on," states Paul Smith, vice president of product management. On the P.C. side, Courier took a two-pronged approach, explains Smith. One prong allows IBM's P.C. to attach to Courier's controller, giving the customer P.C. capabilities but only limited 3270 capabilities.

The other approach is to plug the IBM P.C. into a Courier 3270-type display. This arrangement requires the user to purchase a special board for the Courier display. The customer "gets the highest quality 3270-type equipment but a less capable P.C., one that is not quite as user friendly," adds Smith.

Don't look for any tottering pcms to drop off the ledge from this latest round of 3270 announcements from IBM. If a shake-out is in the cards it will probably become more evident as the intelligent controller emerges. For now, though, vendors say they are positioned to cope with the IBM product announcements as well as with the new pricing structures. None of the pcms seem surprised by the product directions. "This was one of the most widely known announcements prior to the announcement that I've ever seen out of IBM," commented Ron King, senior vice president of marketing for Telex.

—Jan Johnson

PROGRAMMING

OS/VS COBOL ON A MICRO

A California startup says it can offload COBOL program development from mainframes to desktops.

SoloSystems thinks it has a better mouse-trap for COBOL programmers. It's a stand-alone workstation that can help code cutters write, edit, compile, test, and document their programs independently of a mainframe.

The Sunnyvale, Calif., startup has introduced a microcomputer that offers a complete IBM OS/VS COBOL compiler, programming aids, and networking capability. Starting at \$35,000 per workstation, the Solo machine is claimed to offer the raw processing power of a 370/158 mainframe while having the features of a personal computer.

"Developing programs on a mainframe can be like driving nails with a jackhammer," says Mitchell Goozé, president of the venture capital-backed firm. "Our machine can improve programmer productivity while freeing up mainframe cycles for production work."

The product, based on two Motorola 68000 microprocessors, is expected to provide its biggest savings in improving programmer productivity, Goozé says. Its multitasking environment enables a pro-

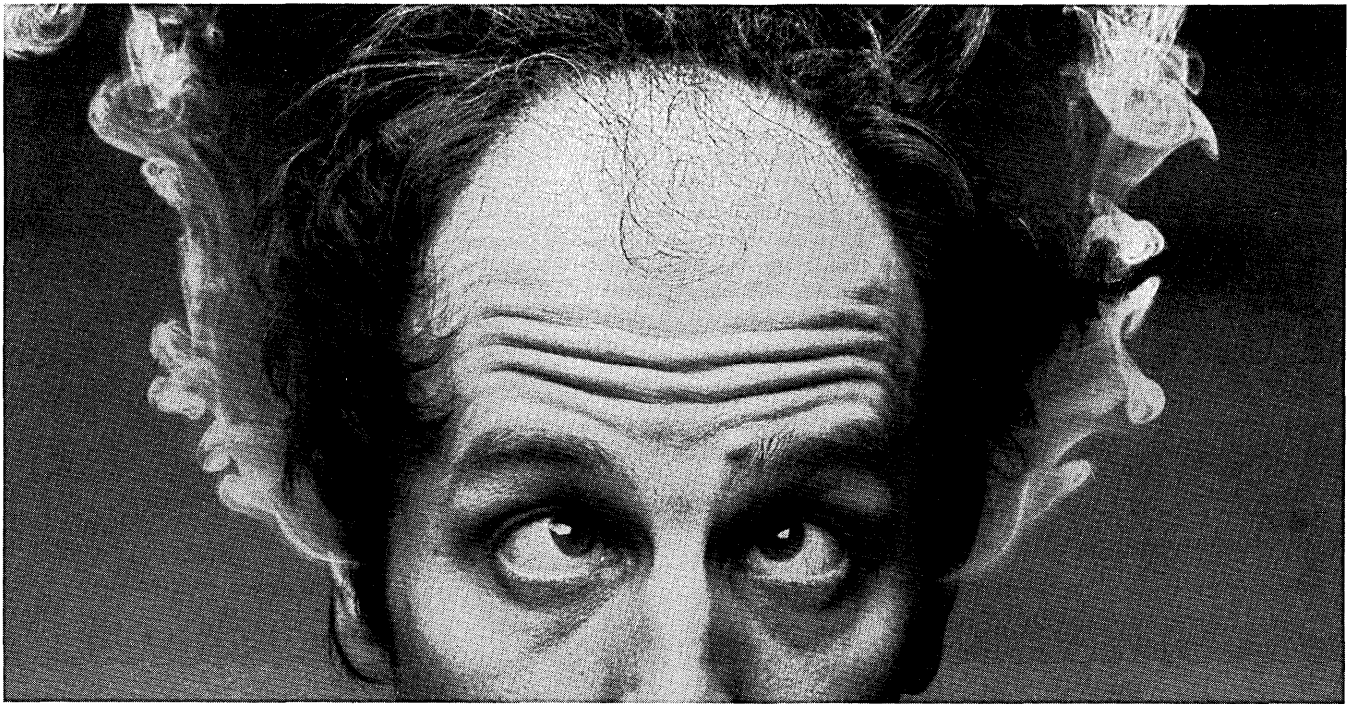

Send the coupon. Save a programmer.

Right now, every one of your programmers may be a serious candidate for "programmer burnout." That's because without realizing it, they spend much of their time rewriting existing source code – a tedious task for them, and a major productivity drain for you.

MANAGER SOFTWARE PRODUCTS' SOURCEMANAGER™ frees your programmers from this task and lets them get on with the challenge and pleasure of writing procedural code. Which of course greatly reduces the time required to develop COBOL applications in an IBM environment.

SOURCEMANAGER is an on-line, dictionary-driven, COBOL application development system. It automatically generates standardized data definitions and program documentary sections. It helps programmers develop a library of re-usable code – and helps them develop procedural code. It even detects standards and style violations, and provides efficiency controls.

SOURCEMANAGER performs brilliantly as a stand-alone system. Yet it can be fully integrated with other dictionary-driven products in MSP's MANAGER family – such as DATAMANAGER™, the data and information resource management system, and DESIGNMANAGER™, the logical data base design and modeling system.

Find out how SOURCEMANAGER can help you prevent programmer burnout and increase productivity. Send the coupon today. Or call (617) 863-5800 (Telex 710 326 6431).

mSP

MANAGER SOFTWARE PRODUCTS INC

Offices worldwide: Australasia, Benelux, Canada, Italy, Japan, Scandinavia, Spain, Switzerland/Austria, U.K./Eire, U.S.A., West Germany.

Send me more information about MANAGER SOFTWARE PRODUCTS' family of integrated, dictionary-driven products:

SOURCEMANAGER DATAMANAGER
 DESIGNMANAGER

Name _____ Title _____

Company _____

Address _____

City/State/ZIP Code _____

Telephone Number (____) _____

Send coupon to MANAGER SOFTWARE PRODUCTS INC,
131 Hartwell Ave., Lexington, MA 02173.
Or call (617) 863-5800. Telex 710 326 6431

CIRCLE 73 ON READER CARD

NEWS IN PERSPECTIVE

grammer to test one program while compiling another, for instance, and receive the compilation sooner than would be possible in typical large dp shops, he claims.

The company's founders come from American Microsystems Inc., a Silicon Valley chip house.

"Measuring by wall clock time, our compiler can compile between 1,000 and 2,000 lines of code a minute," he states, pointing out that the results of such a proce-

dure would be immediately available to the user. "The user wouldn't have to wait for someone to rip the output off a printer and deliver it to a numbered bin."

Goozé says the potential for saving money with his machine stems from the replacement of timesharing with the versatility of a personal computer. His product uses a 132-column screen that, controlled by one of the 68000 chips, can be divided into different windows, much like Apple's Lisa and Xerox's Star office workstations. Two internal hard disks offer 10 megabytes of removable mass storage while a separate

enclosure can handle an additional 50 to 80 megabytes, Solo says.

First shipments were slated to begin in April, following testing at two unidentified test sites, according to Goozé. Additional compilers, most probably for DOS COBOL and PL/1, will be offered in the future, he adds.

Like many Silicon Valley companies, Solo has its roots in the semiconductor industry. Goozé and partners Henry Davis, vice president for technology, and Ronald Denchfield, vice president of corporate development, all came from American Microsystems Inc. Goozé was director of that firm's array products group until November 1981, when he and the others formed Solo. The company was financed at first under an R&D tax shelter that brought in \$1 million. A sale of stock helped to bring in another half-million dollars and then a venture capital investment, headed by Bay Partners of Mountain View, Calif., raised the total financing to \$3.7 million.

"Our research showed a great need and a vast potential market for new programming technologies," says Goozé. "We decided to challenge the programming crisis in an innovative way."

So far the company has just over 40 employees, a number that is expected to grow as manufacturing comes on-line, says Goozé. The company is aiming its marketing effort at large IBM shops that typically use TSO for timesharing a large-scale mainframe. Goozé estimates that some sites spend as much as \$25,000 a year in cpu time alone for each of its programmers.

Software on the 1116 workstation includes a full-screen editor; a viewer for quickly scanning files; a compiler that checks syntax and semantics; a verifier; a comparator, for line-by-line comparison of files; a logic diagrammer; a profiler that tracks the usage of phrases or routines; a variable cross-referencer; and a "help" function.

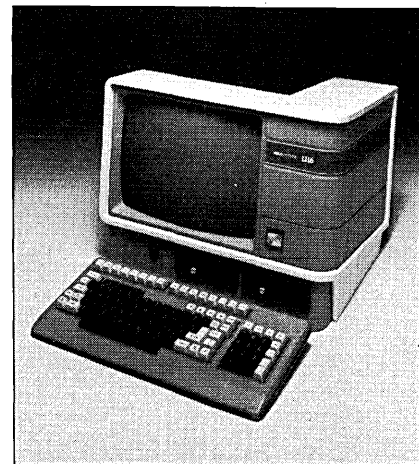

COBOL WORKSTATION: SoloSystems' desktop unit is designed to help COBOL programmers write for the OS/VS environment.

WHEN YOUR COMPUTER'S DOWN AND OUT, WE'LL GET IT UP AND RUNNING. FAST.

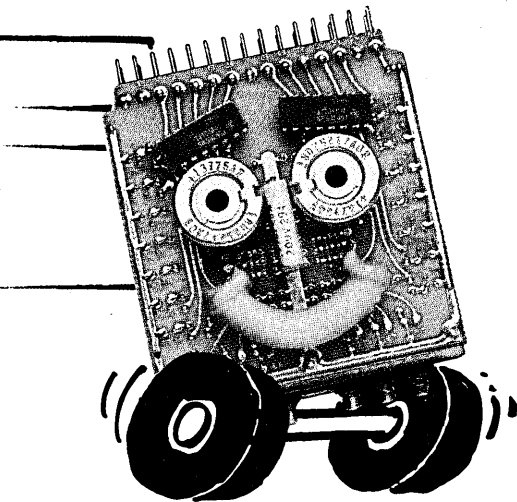

**CALL CONTROL DATA.
800/328-3980**

IN MINNESOTA 612/931-3131

Nothing cuts downtime better than a responsive, results-oriented customer service organization—one committed to keeping your equipment in excellent condition. It's just what you'd expect from the largest independent supplier of computer peripherals in the world. Call us.

GD CONTROL DATA

*Addressing society's major unmet needs
as profitable business opportunities*

CIRCLE 164 ON READER CARD

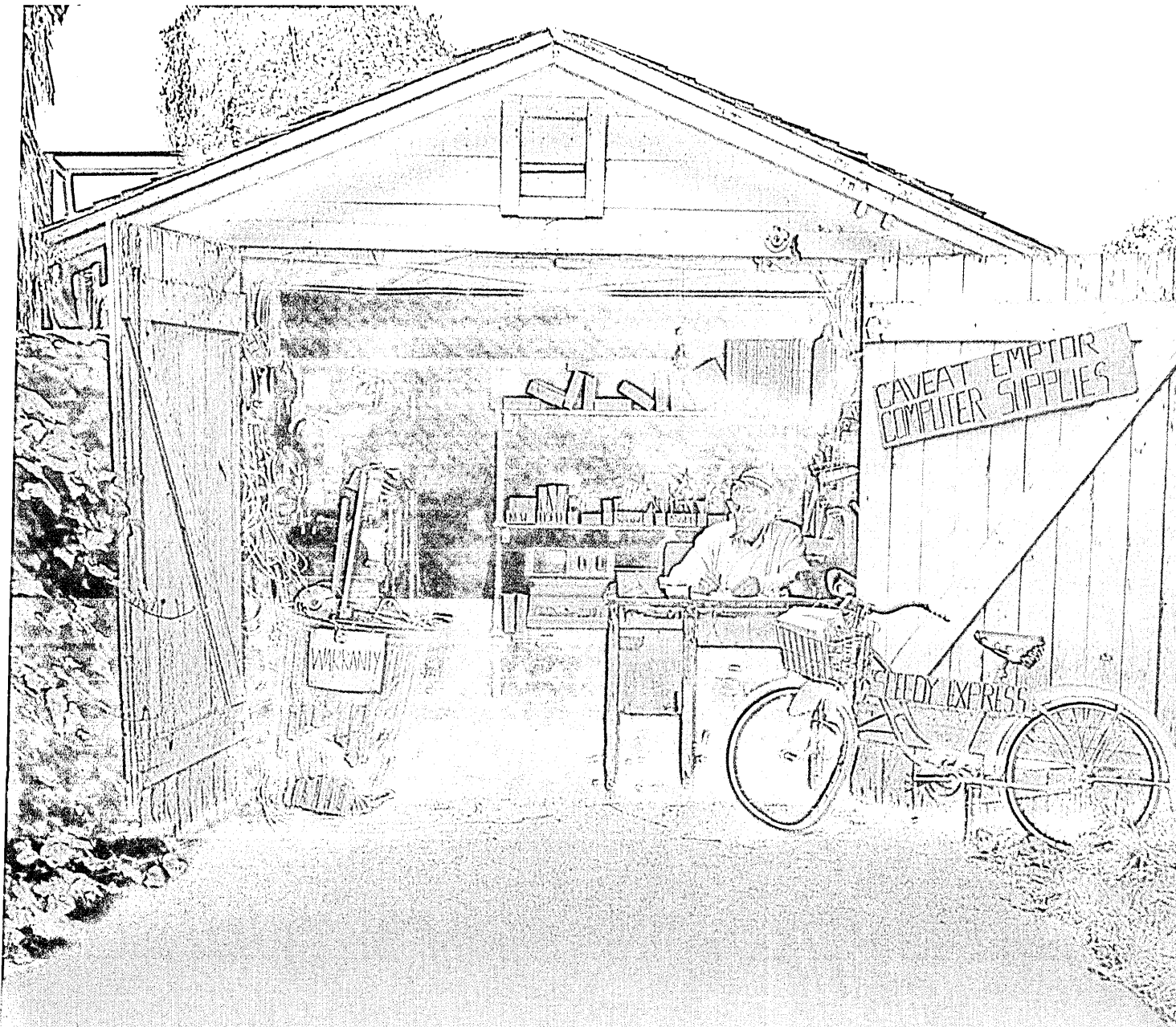

If your source for peripheral parts and supplies seems like this, maybe it's time for a change.

CPX is a full-range and full-service supplier of peripheral parts and accessories.

If you are not a CPX customer, you probably haven't experienced the capabilities we have to offer. In other words, we are not the typical garage shop.

Our goal is 24 hour turnaround on every order. If we don't make that deadline, there's a good reason for it.

We can provide that kind of service because we stock more

disk drive and other parts for more than twenty manufacturers. If we don't stock it, we know how to get it fast.

Even exotic, hard-to-find orders are no problem. The CPX Locator Task Force, a full department of trained professionals, can fill the most difficult requests.

No one in the computer parts business can make any promises, but our fast, complete service is making us the largest in the industry.

Whatever your needs — peripheral components, subassemblies, filters, floppy disks, head or printer cleaning kits — call CPX for the kind of service you may not be getting right now.

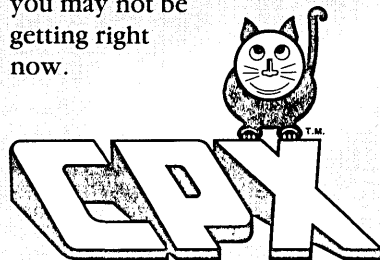

CORPORATE OFFICE: 19821 Nordhoff Street • Northridge • CA 91324 • Phone (213) 341-3783 • Telex 18-1537
NORTHEASTERN REGION: 3001 Hadley Road • Building 5B • South Plainfield • NJ 07080 • Phone (201) 756-8040
SOUTHWESTERN REGION: 5250 Gulfton • Building 4 • Suite G • Houston • TX 77081 • Phone (713) 661-3424



Reliable.

You can count on 3M diskettes. Day after day.

Just like the sun, you can rely on 3M diskettes every day. At 3M, reliability is built into every diskette. We've been in the computer media business for over 30 years. And we've never settled in. We're constantly improving and perfecting our product line, from computer tape and data cartridges to floppy disks.

3M diskettes are made at 3M. That way, we have complete control over the entire manufacturing process. And you can have complete confidence in the reliability of every 3M diskette you buy.

Look in the Yellow Pages under Computer Supplies and Parts for the 3M distributor nearest you. In Canada, write 3M Canada, Inc., London, Ontario. If it's worth remembering, it's worth 3M diskettes.



3M hears you...

CIRCLE 77 ON READER CARD

3M

NEWS IN PERSPECTIVE

Additional software helps move programs to and from a mainframe and manage the workstation's filing, security, and backup functions.

A planned networking feature would make it possible for a programming team to share files, Goozé notes. No date has been set for its introduction.

—J.W.V.

GOVERNMENT

FEDS OPEN R&D PURSE

A new program at the National Science Foundation is designed to help small companies get government funding for research.

The official government line on the dispersion of federal research and development funds (R&D, to its friends) is that small business must receive its "fair share." It's right there in writing. As Casey Stengel so often

told the world, you could look it up.

You could even memorize the exact wording, for all the good it would do you. The language doesn't mean a damn thing as far as small businesses are concerned. The big boys could care less what the law says. They've got things just the way they like them right now. So if you've got a wonderful new computer idea that's just going to stand the industry on its cpu and you want government R&D support, don't plan the dream vacation too soon. It will be a very long wait before someone or something gives you his time, never mind his money.

"Small firms have a bitch of a time trying to get federal money," admits Roland Tibbetts, program manager of the Small Business Innovation Research (SBIR) program for the National Science Foundation (NSF). "Agencies stay with the firms that have done the job for them. In almost all cases that's a major firm like IBM, DEC, Honeywell, and others. The agencies don't want to risk taking a chance on a small business they don't know."

Well, now they may have to start gambling a little. The enactment of P.L. 97-219, the Small Business Innovation Development Act (SBIDA), is designed to open, at least a crack, the vast vaults of federal R&D funds. The intended targets of this largesse are small high-technology firms. "Small" means under 500 employees, which seems

quite large in the eye of a single entrepreneur struggling with his latest brainstorm. In FY 1983, which ends Sept. 30, around \$45 million will go to small high-tech firms through SBIR programs. Overall, the government will spend more than \$1 billion for R&D conducted at such firms.

Under P.L. 97-219, every federal agency with an R&D budget over \$20 million—and that means almost all of them—

You don't just mosey on down to the NSF and pick up your check.

must establish goals for prime contracts, grants, and cooperative agreements with small firms. In addition, each agency with an R&D budget in excess of \$100 million must establish an SBIR program. When fully phased in, each agency will set aside 1.25% of its extramural R&D obligations for its SBIR program.

Theoretically, this will make life less difficult for folks like Bob Noyes, a senior technical staff member of Century Computing in Silver Spring, Md. The 14 people at Century have been seeking financial assistance to further develop their proposed IBM-VAX interconnection. So far they've been shut out. The firm has also twice been turned down by DEC on its proposal to enhance the DEC KMS-11 interface.

"It's incredibly difficult to break

User Perfect.

If you want to know who consistently makes the very best word processors, ask the people who use Philips. You'll find the proof in the two major independent surveys of word processing users.

Of all the word processors rated in the Advanced Office Concepts® survey, Philips placed first overall in 1981 and 1982.

Advanced Office Concepts is a registered trademark of Advanced Office Concepts Corporation. Datapro is a registered trademark of Datapro Research Corporation.

ASK ANYONE WHO HAS ONE.



For five consecutive years, Philips has been selected to the esteemed Datapro® User Survey Honor Roll.

If you want to join the satisfied users, call Philips today at 1-800-828-6211 (1-800-462-6432 in New York State) and we'll send you free copies of the reports.

**PHILIPS
INFORMATION
SYSTEMS**

PHILIPS

CIRCLE 78 ON READER CARD

MAY 1983 101

**How
to be certain
that nothing
is added
to what
you send.**

Today, with the sheer volume of information being transmitted, the necessity of having to *retransmit* data that was garbled is not only inefficient and nonproductive, it can double the time it takes to receive accurate data. The engineers, scientists, and marketing executives of the Bell Network have developed communication concepts that allow you to be *certain* that what you send is what they get—the first time, 99.5% of the time.

Consider this scenario: You have an inquiry response system that provides information on demand. This data is virtually error-free. You select among a variety of transmission speeds. Retransmissions, practically nil. Downtime, minimal.

The concept is Data Management through Bell's Data Information Systems. And with DATAPHONE® Digital Service, you are able to transmit 56,000 bits of information each second, accurately and reliably. In fact, 99.5% accurate, 99.9% reliable. At any speed.

How? Digital transmission through the most powerful communication network in the world, the Bell Network. Digital eliminates the problems created by noise and distortion over distance. The flexibility and back-up system of the Bell Network monitors accuracy, notes trouble spots and takes corrective action. The Network can even tell you the location of the problem even if it's your own equipment. Your people have more time to do productive work because troubles and retransmissions have been reduced to a minimum.

As part of a distributed processing system where six or eight computers around the country share the load, they can efficiently communicate in their own language as if they were all in the same room. Without the chance of conversion error. While minimizing downtime, and virtually eliminating continued retransmission and customer network supervision.

To handle high volumes of data, Bell has both digital and analog High-Capacity Channels that can "bundle" your data, voice and image transmissions for better efficiency, performance and economy.

For analog transmission, Bell's Expanded 800 service allows you to predesignate the routes your data will take. Your unique network within the Network allows you to distribute dial-up traffic for maximum efficiency.

To find out how Bell can help you tailor a high-performance data system, large or small, that puts the Network to work for you, call **1800 821-2121**.

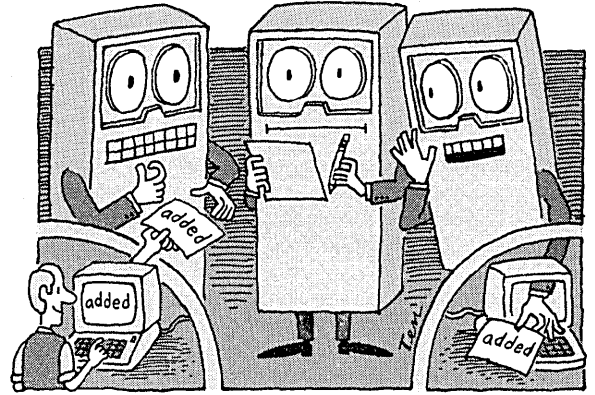

Communication Concepts from the Bell System

Expanding your ability to communicate.



NEWS IN PERSPECTIVE

in," Noyes says. "The large companies don't make it easy. They prefer to do all their R&D in-house. It's very difficult to get a big company to support your idea. And it's very expensive to develop a proposal."

Clearly, then, the key to survival for Noyes and his peers is to make it less exorbitant to come up with the idea to end all

"For too many years, small business has had decreasing access to technology," says Control Data chief William Norris.

ideas. So when the NSF recently held "Interagency Conference for Small Firms on Federal R&D," it was standing room only. There were 650 people in Phoenix and 750 folks in Washington who came to see what the SBIR is all about.

"I came to get a better idea of how to write a winning proposal," Noyes said. "Do I have to be innovative par excellence or do I just need a good idea and then see if it works?"

What Noyes and others like him need more than anything is a willingness to tolerate paperwork and ambiguity. The SBIR may indeed be a gift from the small business gods, but you don't just mosey on down to the NSF and pick up your check. They make you work for what you get. And

there's no guarantee you'll even get it no matter how much work you do.

All SBIR programs come in three parts. In phase one, small firms compete for limited funds (no less than \$20,000 or more than \$50,000) to conduct feasibility studies on topics chosen by various agencies. Project proposals are judged on their scientific and technical merit. Only one third to one half of those who start the process make the first cut.

The survivors proceed to phase two. These proposals may request support for up to a two professional person-year level of effort annually for a period up to 24 months. These awards average \$200,000, and in the NSF's infinite wisdom are granted to those companies who have shown the most promise after finishing phase one.

If you live through phase two, which half of those trying to do so actually accomplish, you're on your own. The government kisses you goodbye and dumps you into the big bad world of paying your own way. Phase three is conducted by the small business firm and must be privately funded through a third-party source. The goal of this final phase is to pursue commercial objectives from the NSF-supported research carried out in the first two phases. In short, if your idea isn't going to make money, the government doesn't want to know you.

"We're trying to open the system," Tibbets says. "Small business is not getting a fair shake. It would be the healthiest damn thing for the country if it could. Hopefully, this law will be the start."

At the rate R&D funds have been drying up, it's approaching the end. The portion of federal R&D procurement funds going to firms with 1,000 or fewer employees has decreased from 4.9% in 1960 to 2.7% in 1982.

"For too many years, small business has had decreasing access to technology," Control Data Corp. chairman and chief executive William Norris told the Washington conference. "The result has been that the innovating capabilities of small business have been seriously retarded at a time when our country is in desperate

If you live through phase two, the government kisses you goodbye and dumps you into the big bad world of paying your own way.

need of expanded innovation to create more new jobs.

"Small companies are much less frequently able to perform as brilliantly in developing and applying technology as they did during the '50s and '60s. Research and development, both federal and industrial,

C-CALC™

C-CALC -- the high-performance 3-dimensional spreadsheet you won't outgrow. Currently available for DEC computers: RSTS, VMS, RSX, VAX/UNIX, IAS, P/OS (DEC's PRO 350)

C-CALC's features include:

- Comprehensive worksheet consolidation
- Built-in training and on-line HELP
- Menu-oriented for ease of use
- Variable width columns
- Fully transportable data
- Supports most types of terminals
- Dynamic sorting capability
- User-defined procedures and functions
- Generates boardroom quality reports
- Written in "C" (No compiler needed)
- On-going customer support and service
- Multi-level training classes available

DSD CORPORATION
12620 120th Avenue N.E., Suite 201
Kirkland, WA 98033 (206) 821-7507

(Formerly DIGITEC Software Design, Inc.)

CIRCLE 80 ON READER CARD

Four Reasons Why N5500 Makes The Project Manager's Job Easier:

- 1 Flexibility...**N5500 is an automated system that schedules labor and machine time, tracks progress and status of all projects, provides cost and earned value information, does performance analysis, develops estimating guidelines and generates graphic and tabular reports that precisely meet the information needs of project leaders, department managers and executive level personnel.
- 2 Simplicity...**N5500 uses only a handful of simple user-friendly input formats or screens. Your staff can quickly learn how to use N5500 to develop information in a host of meaningful formats.
- 3 Versatility...**N5500 can be used to manage large or small projects in engineering, data processing, manufacturing, facilities maintenance, construction, research and marketing. It handles multiple planning approaches including strategic, tactical and dispatch planning. And it supports precedence or I/J notation.
- 4 Availability...**N5500 can be run on IBM (compatibles), HP 3000, VAX 11/780, Burroughs, Honeywell, Univac 1100, Prime, Wang VS/, Perkin-Elmer, Data General and CDC. And it's even available to selected micro users through designated service bureaus.

To learn more about N5500 or the regional "hands on" seminar nearest you, call or write Nichols and Company today.

5839 Green Valley Circle
Suite 104
Culver City, CA 90230
(213) 670-6400

NICHOLS

5 Marineview Plaza
Suite 304
Hoboken, NJ 07030
(201) 795-0813

PROJECT CONTROL SOFTWARE FOR A WORLD OF APPLICATIONS

CIRCLE 81 ON READER CARD

Anadex SILENT SCRIBE™ Printers:

Shhh! Quiet Zone.

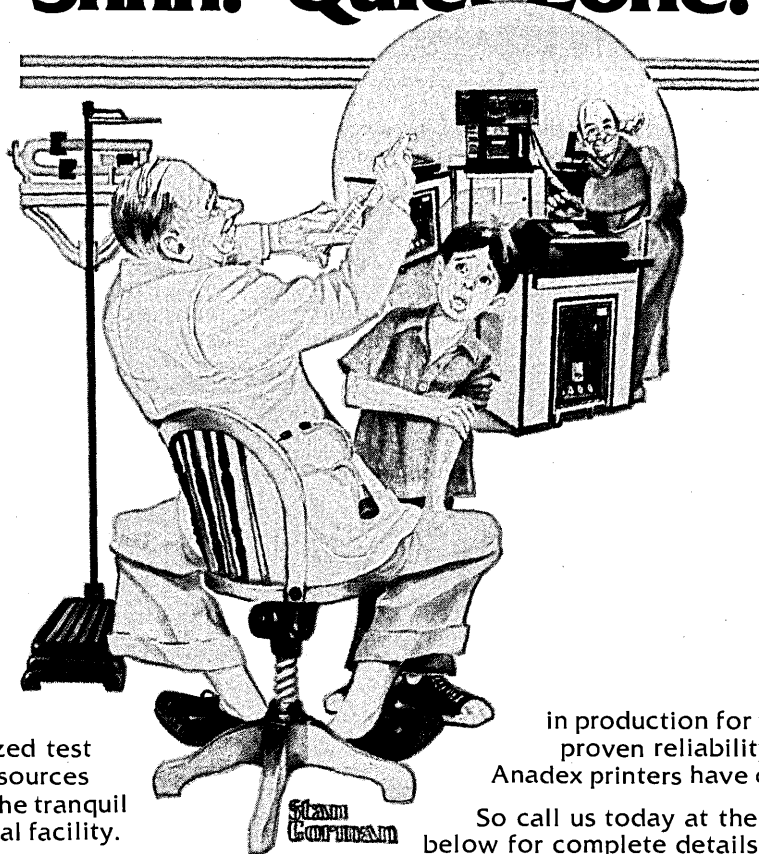

From needle-shy children to computerized test labs, potential noise sources can play havoc with the tranquil atmosphere of a medical facility.

And although there may be no easy way to quiet panicky children, Coulter Electronics – a leading manufacturer of blood analyzing systems – significantly reduced their system noise levels by installing our Silent/Scribe matrix impact printers. Operating at less than 55dBA, they run almost unnoticed while recording test data.

But besides being among the quietest printers available, there are a number of excellent reasons for buying Anadex printers.

Here are reasons people give us.

- The ultimate in printing flexibility... high speed for drafts and letter quality for finished copy.
- High resolution graphics capability standard with all printers...and simple software.
- Ribbons are quick-in, quick-out long lasting cartridges; no messy, difficult spool-threading.
- Both RS232C serial, and parallel interfaces are standard, so interfacing to your computer is usually a matter of plug-it-in and start printing.
- Anadex printers are among the most reliable you can buy. The basic print mechanism has been

in production for well over two years with proven reliability. Field data verifies that Anadex printers have over 99% reliability.

So call us today at the toll-free numbers listed below for complete details and to set up a demonstration.

You may not need the quiet atmosphere of a hospital in your home or office, but isn't it nice to know that it's available?

CALL (800) 792-7779
In California Call (800) 792-9992

Anadex
 ©Copyright 1983, Anadex, Inc.

MADE IN
USA
 FOR THE WORLD

Model
 DP-9000A

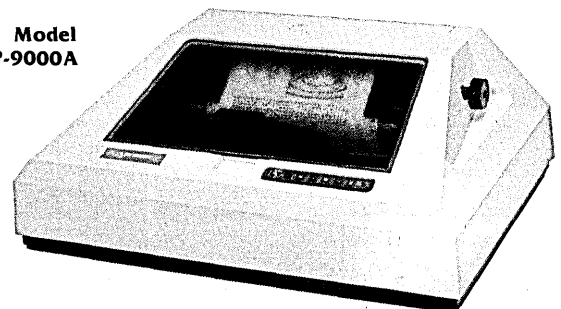

Silent/Scribe Printers. Quietly going about your business.

ANADEX, INC. • 9825 De Soto Avenue • Chatsworth, California 91311, U.S.A. • Telephone: (213) 998-8010 • TWX 910-494-2761
U.S. Sales Offices: San Jose, CA (408) 247-3933 • Irvine, CA (714) 557-0457 • Schiller Park, IL (312) 671-1717 • Wakefield, MA (617) 245-9160
 Hauppauge, New York, Phone: (516) 435-0222 • Atlanta, Georgia, Phone: (404) 255-8006 • Austin, Texas, Phone: (512) 327-5250
ANADEX, LTD. • Weaver House, Station Road • Hook, Basingstoke, Hants RG27 9JY, England • Tel: Hook (025672) 3401 • Telex: 858762 ANADEX G
ANADEX GmbH • Behringstrasse 5 • 8752 Mainaschaff • Frankfurt, W. Germany • Tel: 011-49-06021-7225 • Telex: 4188347

CIRCLE 82 ON READER CARD

NCC Booth #N4716

NEWS IN PERSPECTIVE

has become highly concentrated in large government laboratories, large universities, and large corporations. Therefore, it behooves all of us to focus on expediting the implementation of SBID so benefits for all to see can be derived as quickly as possible."

One of the reasons behind Norris's "all for one and one for all" message may

"I think this program provides an opportunity for small firms to live and survive in a technological world that gobbles everything up."

be that small companies produce 24 times more innovations per dollar than larger ones. Perhaps another is that the little guys produce two and a half times more innovations per employee than the big guys.

Those statistics may also have been the *raison d'être* behind the presence in Washington of IBM, GTE, Honeywell, Motorola, and several other major corporations. They were on hand to offer insight on how the outsiders can get inside.

"You must be aggressive with us," Jim Bogart of United Technologies advised. "You have to tell us who you are, because we don't know you. Why are you different from everybody else? What can you do that we can't do ourselves?"

"What am I doing here? I'm not

sure," confessed Donald Long, chief scientist at Honeywell's corporate physical sciences center. "It's the first time we've done something like this.

"We do perform an awful lot of in-house R&D. But we can't cover everything that we need to be technologically on top of. We're on top of the things that count the most. But technology is mushrooming so fast that we can't stay abreast of it all. Maybe the smallest firms can help us do that. We don't have a whole lot of room for outside ideas, but this idea [the SBIR] has potential."

The potential will not be realized immediately, though. There is significant, entrenched opposition within government agencies to changing the way it's always been done, despite what the law mandates. When the SBIDA was first conceived, every government agency save the SBA testified against the idea. The fact that it's alive, if not necessarily well, is more a tribute to the persistence of those who wanted to see it through than the foresight of those it is designed to help. P.L. 95-507, which requires government prime contractors with contracts exceeding \$500,000 to subcontract part of their work to small firms, has been equally ill received.

"If the agencies did reach a large number of small high-tech firms, they would get better ideas for less money,"

says a government official familiar with the R&D game. "But when agencies deal with R&D there's no consideration of cost. The big firms all know that. They all look out for each other and shuffle contracts back and forth constantly. There are more and more opportunities for large firms and fewer and fewer for small. And the ratio of awards to proposals under SBIR is getting worse while proposals are getting better.

"You know why the big powers love government staying out of business and cutting back generally? The less government involvement, the easier it is to perpetuate the circle of shuffling between government and big business. It isn't who you are. It's what firm you represent."

If it's you you're talking up, usually no one listens. If the government has never

"If the [government] agencies did reach a larger number of small high-tech firms, they would get better ideas for less money."

heard of you, it generally doesn't want to. The goal of SBIR is to make those agencies stop and listen. Then maybe they'll even look.

"The agencies automatically assume they'll get trash from a small firm," asserts Kris Dines of XData Corp. in Indian-

This Publication is Available in MICROFORM

FOR INFORMATION
WRITE:
Dept. F.A.

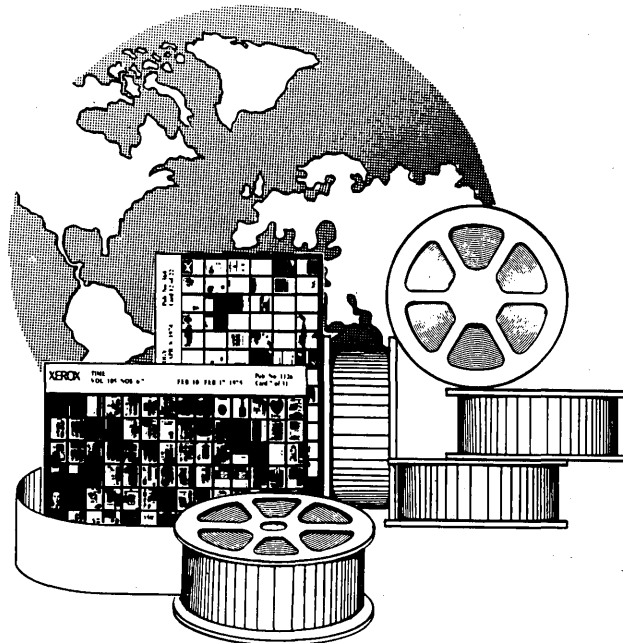

University Microfilms International

300 North Zeeb Road
Ann Arbor, Mich. 48106
U.S.A.

18 Bedford Row
London, WC1R 4EJ
England

Sweet software— A DBMS package that's relational and loaded with goodies.

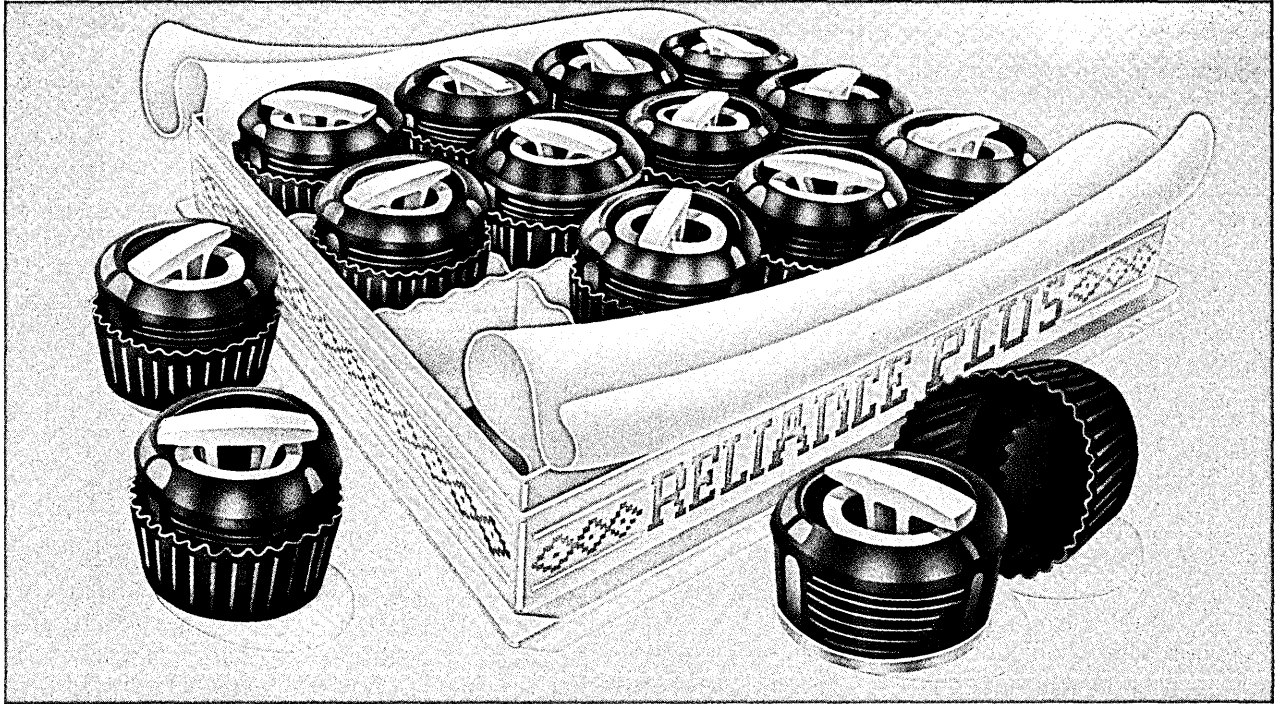

©1982 The Perkin-Elmer Corporation

Our new Reliance PLUS treats you to all the tantalizing features you're reading about in the news today.

A transaction controller. A relational DBMS. A data dictionary. Query/report processing. All in one package for on-line data management.

In Reliance PLUS, they're fully integrated. With more automatic features than any other system. It's the most complete DBMS.

Everything for the lowest cost.

Some vendors offer some of these components. Some offer others. Only Reliance PLUS gives you them all. And at a lower price than the closest competitor.

And you get 32-bit software performance with a relational DBMS on our full line of 32-bit superminis—everything you

need for application development—from one vendor.

Fast application development.

This assortment of facilities in Reliance PLUS also gives you the performance to get your application up quickly.

For one thing, it manages all the support functions automatically. Concurrency control. Rollback and recovery. On-line reorganization. Database integrity. All features to cut development time, leaving programmers free to concentrate on applications. And score big gains in productivity.

User-friendly.

Another unique feature of Reliance PLUS is its layered approach to data access. Your customer can choose higher performance, directly accessing the database.

Or easier development and maintenance, using relational views.

The system is so user-friendly, even the operator with no programming knowledge can design screen forms. Inexperienced users can query the database for reports unassisted. Training for both operation and development shrinks. Costs plunge and productivity soars.

Don't delay. Take a bite.

Write or call now for all the facts about this new advance in on-line data management. Reliance PLUS is available immediately on our full line of 32-bit superminis and includes a year of free software maintenance. The Perkin-Elmer Corporation, Oceanport, NJ 07757. **Tel: 800-631-2154.** In NJ 201-870-4712.

PERKIN-ELMER

CIRCLE 83 ON READER CARD

Introducing applications software that will make you a hero in your company.

Computer Associates scores a long-awaited breakthrough:

Business applications software that fills all your end users' needs — and delivers all the technical expertise and support you require too.

We started with our ten years of solid experience in designing highly efficient, highly productive systems software products. Then we collaborated with professionals who know day-to-day business problems to develop the *Advanced Business Software Series*.

Because these software packages are from Computer Associates, they are not only designed to fulfill specific end user needs, they are also engineered to enhance the overall productivity of your data processing operation.

Our *Advanced Business Software Series* consists of separate components which independently provide powerful, specific solutions and together combine to form comprehensive business systems for every operation in your company.

This broad range of business solutions includes general ledger, accounts payable, accounts receivable, financial planning, order processing, inventory control and many more.

All are user-friendly. Easily understandable, simple to use — without the need for time-consuming help from your programming staff.

Computer Associates worldwide service capability is always ready to provide any and every assistance our more than 11,000 clients might need.

When you recommend our *Advanced Business Software* to your company, you will be a hero, because our products offer the solid company-wide benefits that really impress top management. Contact us now to arrange a full briefing: Computer Associates, 125 Jericho Tpke. Jericho, New York 11753; 800-645-3003; in New York 516-333-6700.



COMPUTER ASSOCIATES

ADVANCED BUSINESS SOFTWARE

NEWS IN PERSPECTIVE

apolis. Dines and his wife operate the firm, which is trying to develop new ideas for image processing. "I've gotten nowhere trying to find help. Most of the time you have no idea what projects the agency is even interested in, and they're not about to tell you.

"There's an incredible bias toward university research. Over the phone the government doesn't tell you you don't have as much chance as you would if you came from a university. They know it's against the law. But the fact is that you do have less of chance except for a special program like SBIR."

"I think this program provides an opportunity for small firms to live and survive in a technological world that gobbles everything up," says Huron Breaux, a 13-year Silicon Valley veteran. Breaux spent those years working for a number of firms in the area before starting his own consulting firm, which now has four members and thus qualifies as a small business under any microscope. He came across the country looking for contracting options and contacts.

"I'd say awareness of SBIR is low to moderate among the small business high-tech community," Breaux says. "But it's picking up. SBIR certainly broadens the spectrum of ideas throughout the computer industry. It specifically allows small firms to survive and have the cash flow to pursue their personal dreams. Now an avenue exists that didn't before."

Whether it will be easy to walk upon remains to be seen. There's plenty of talk but, as Norris admitted, that doesn't always mean there will be an equal amount of action. Or any action at all.

"Although I am encouraged by legislative action, despite the process taking longer than it should," he told his audience, "experience shows that passage is not a guarantee that legislative objectives will

"SBIR broadens the spectrum of ideas throughout the computer industry. It specifically allows small firms to survive and have the cash flow to pursue their personal dreams."

be realized." Norris cited several of his pet projects, including the Microelectronics and Computer Technology Corporation (MCC) and Business and Technology Centers (BTC), as ways the job is getting done right now. But while the effort may be large, the effect to date has been minuscule.

"What this law is trying to do is break up the consolidation of federal R&D," contends Philip Speser, president of Foresight, the consulting firm that developed the conferences. "We've tried to hand-hold small firms through the R&D bureaucracy and cut 900 layers of red tape. Only 10% to

20% of high-tech firms even know who to contact about getting money. This thing isn't going to turn around overnight."

"I can't begin to tell the number of times we've written and called companies and agencies and heard nothing," Noyes says. "In our company it's a significant event when somebody says they're going to call you back and they actually do."

If SBIR does its job, his phone ought to start ringing off the hook.

—Willie Schatz

PRINTERS

DIABLO SEES NEW MARKETS

The daisywheel printer maker is expanding its product line with a nonimpact page printer and enhancements to its matrix line.

Significant changes are under way at Diablo Systems Inc., the firm that first introduced the innovative daisywheel printer. The Hayward, Calif., company, finding itself fighting for leadership with Qume Corp., last fall introduced a line of matrix printers. Now it has unveiled a nonimpact printer that operates at six pages per minute, as well as a newly designed daisywheel with double the number of characters.

"We used to be an oem daisywheel printer company," explains Paul J. Shapiro, the firm's marketing manager. He describes the daisywheel as "our heartland business," but says Diablo's strategy now is to expand beyond that technology and become known as a broadbrush oem printer company. This is in recognition of its customers' needs for all types of printers. Accordingly, the company has also begun offering enhancements to its matrix printers, adding the capability for those models to make multiple passes and to produce near-letter-quality characters.

It's not a bad market to be in. Total printer shipments are expected to grow to \$13.5 billion in 1986 from \$5.7 billion in 1981, or at almost 19% compounded annually, says Creative Strategies International, the San Jose, Calif., research firm. And the fastest revenue growth is expected to be in daisywheel printers running at more than 30cps. Other sources estimate that close to 320,000 daisywheel printers were shipped in 1982 and that Diablo has between 30% and 40% of that market.

Shapiro doesn't dispute the numbers. He says, however, that diversification

of Diablo's product lines is only one of the moves made by the company in the last few years. "The first strategy is to be extraordinarily capital-intensive," he explains, "to build close to the locus of our markets." This decision can be contrasted with that of Atari, the video game and personal computer maker that is moving its production from California to Southeast Asia. To be successful, Diablo's strategy requires, of course, that the labor content in the firm's products be minimized. The advantages, Shapiro explains, are that the company will avoid the import duty, insurance, and freight charges on products assembled abroad, and the long pipelines of inventory it would otherwise have to handle to serve its customers from those remote factories, where the cost of labor is lower.

"In 1980 and 1981, we spent \$45 million and built by far the most automated factory in the world for the fabrication of daisywheel printers," Shapiro says. The new facility, in Fremont, Calif., down the road from Hayward, is heavily automated. But the company also assembles printed-circuit boards in southern California and is said to be doing so at lower costs than could be done in Formosa. And it has built a printer plant in Lille, France, to serve the European market, Diablo's second largest. Since 1978, Shapiro adds, the company has cut the labor content in its products by 75%.

To better serve its customers, who are oems and industrial distributors, Diablo has also invested heavily in what Shapiro calls the logistics business. The company

Diablo recently opened a highly automated factory to enable production to remain in the U.S.

has put up eight service centers, five of them in the U.S., and a refurbishment center here. These are the kinds of facilities that would be difficult for its offshore competitors to develop here, and yet Diablo perceives them as necessary if it is to deliver its products at a competitive price.

Moves such as these are the result of an evaluation of the competition made three years ago, the conclusion of which was that the primary companies Diablo faced in the market were from abroad. The California company, a part of the Xerox organization, has thus invested to make possible lower product costs and higher levels of service to its customers. It is equipped, for example, to drop-ship one printer anywhere in the U.S., Canada, and Western Europe within 48 hours' notice—with the customer's paint and logo on the box, customer's packing slip, and container. Diablo will even invoice the buyer on the customer's behalf, all moves to capitalize on what the company sees as weaknesses of its offshore competitors.

—Edward K. Yasaki

NEWS IN PERSPECTIVE

BENCHMARKS

SOCIAL INSECURITY: Paradyne Corp., Largo, Fla., was accused by the Securities and Exchange Commission of using "fraud and deceit" to win a \$100 million order from the Social Security Administration for data communications gear. The SEC's charges said Paradyne, a fast-growing company that makes modems, multiplexors, and distributed processing systems, had built phony equipment and put its name on another manufacturer's gear to win the contract. Paradyne, the SEC said, stripped DEC's name off a minicomputer and put its own name on the box and also displayed an "empty box with blinking lights" as an encryptor. Meanwhile, the *New York Times* reported that a former Social Security staffer who had been involved with the contract, the largest SSA had ever let, was now working for Paradyne. Following that disclosure, the *Wall Street Journal* reported that sources told it the SEC's investigation of the matter was focusing on alleged insider trading by SSA employees in Paradyne stock and that of other firms that bid on the contract in 1981. Following the SEC's initial charges, Paradyne's stock plunged about \$10 in voluminous trading. Paradyne and SSA maintained that no wrongdoing had occurred and that shipments of the Paradyne equipment would continue to SSA branch offices.

STARTUP: CGX Corp. of Acton, Mass., has entered the IBM 3250-compatible graphics display market with a microprocessor-controlled system that mixes color raster and monochrome vector terminals on a single controller. Backed by \$7 million in venture capital, much of it from General Electric, the company is planning to ship its first machines this month, according to president and chief executive officer Kenneth R. Leavitt. He claims the company is poised for rapid growth due to its latching on to the IBM CAD/CAM market share that is now second only to ComputerVision's. In addition to offering what is claimed to be flicker-free vector displays, the CGX system can transfer data at twice the speed of IBM's 3250, which it gets built to IBM specs by Sanders Associates. IBM itself is expected to make some major moves in CAD/CAM this year, introducing a low-priced terminal and, say some sources, a standalone computer aided engineering system for circuit design and other applications.

IBM MANAGEMENT MOVES: The industry leader has been adjusting its top management lately, forming a new corporate management board and reassigning the president of its National Marketing division. The new board, which operates as an internal board of directors, replaces the corporate office and corporate management committees. IBM said the new board would

enable the company to react more efficiently to marketing opportunities that arise in the coming decade, in which the firm wants to compete industry-wide. The board, made up of most of the company's senior executives, will have two committees: policy and business operations. The policy committee is to establish corporate goals, make decisions on technology, investment, and financial matters, and generally formulate company policy. Business operations will handle day-to-day concerns such as major product introductions. Observers pointed out that IBM's new structure brings in the heads of all its major divisions, increasing the number of executives involved in policymaking to 16 from seven. Frank Cary, former chief executive and now chairman of the board's executive committee, will have a seat on the management board, IBM said. Meanwhile, J. Richard Young, who became president of National Marketing division in January 1982, was named to "head a special marketing support project" at the Information Systems Group headquarters in Rye Brook, N.Y. He remains a corporate vice president, but the company did not specify his duties except to say in an internal memo that he would be helping "coordinate . . . balanced growth in ISG's marketing channels."

BACKS OUT: TRW is backing out of its joint U.S. venture with Fujitsu to sell business computers in the U.S. TRW agreed to sell its 49% stake in TRW-Fujitsu Co. to the Japanese partner, providing the latter with a U.S. marketing arm staffed by U.S. nationals. As yet unprofitable, the three-year-old venture has some 375 employees selling point-of-sale systems, small business machines, and desktop computers. Although no plans have been disclosed, it is thought likely that Fujitsu will use the U.S. operation to bring in Japanese-made IBM-compatible computers, which would be a first for it here. The company has a large stake in Amdahl Corp., which makes large-scale systems, and is a large supplier of plug-compatible machines in several foreign countries. Apparently the company's current line of U.S. products has not been selling particularly well, having met with stiff competition from U.S. manufacturers. Also, the joint venture was plagued with some late product deliveries and certain products were seen as ill-matched for the U.S. marketplace. Fujitsu is now expected to tighten ties between its Japanese engineering operations and U.S. marketing.

SHAKE-UP: For the second time in a year, Software AG has lost its chief operating and financial officers. Bruce Smith, named executive vice president and chief operating officer in February, and Lloyd Brubaker, senior vice president and chief financial officer, left the company in March after a disagreement with chief executive

and chairman John Maguire. The losses come at a time when the database software supplier is struggling to reverse a series of six down quarters. Maguire, a founder of the company, is considered to be an especially good marketeer, but apparently hasn't been as good a chief executive; reportedly, he is looking for a replacement for himself in that role. Software AG was one of several software companies that went public in 1981, when the stock market took a strong liking to such firms. It has not, however, been a stellar performer, its stock having been selling below its opening price.

LAYOFF: Three percent of Storage Technology's work force, about 500 persons, was let go in mid-March as the company strived to cut costs in the face of sagging order rates. The firm also said it would pay no management bonuses this year, pay no salary increases until June at the earliest, and reduce leased nonmanufacturing space. Apparently STC miscalculated demand for its products and expanded too much over the last year or so, according to analysts. Several new products, including an optical disk, and first production shipments of the firm's 3380-type disk were hoped by management to help the plug-compatible manufacturer come through the year healthier than it now appears to be. Revenues for 1982 were \$1.07 billion, from which the company earned \$63.3 million. A year earlier the firm earned \$82.4 million on revenues of \$921 million. Meanwhile, the company said it had shipped its first 8380 disk drive, designed to compete with IBM's 3380, to an unidentified customer in Denver. The company had long promised a first quarter 1983 first customer shipment, but was only able to deliver an engineering version of the disk drive. Claiming it will eventually ship more than a thousand 8380s this year, the firm said it expects volume production to begin in the third quarter. Memorex also said it had shipped its first 8380 look-alike, although it declined to identify the customer.

CATCHING UP: A former salesman for OPM Leasing, which collapsed under the weight of a \$200 million fraud two years ago, has been sued by OPM's trustee for aiding in the fraud and defrauding the company as well. The salesman is George Prussin, who worked at OPM from June 1976 to 1979. He has been sued by James P. Hasset, OPM's trustee, who is working to sort out the bankrupt leasing firm's papers. Hasset's suit charges, among other things, that Prussin and his company, Sha-Li Leasing Associates Inc., New York, were paid more than \$7.8 million, most of it in cash, by OPM and that Prussin helped prepare bogus lease agreements as collateral for loans to OPM. Prussin denies the charges, claiming his company was a victim of the OPM fraud, not a participant. *

TEACH YOUR COMPUTER TO GET OUT THE COMPANY'S MAIL AND BRING IN THE SAVINGS.

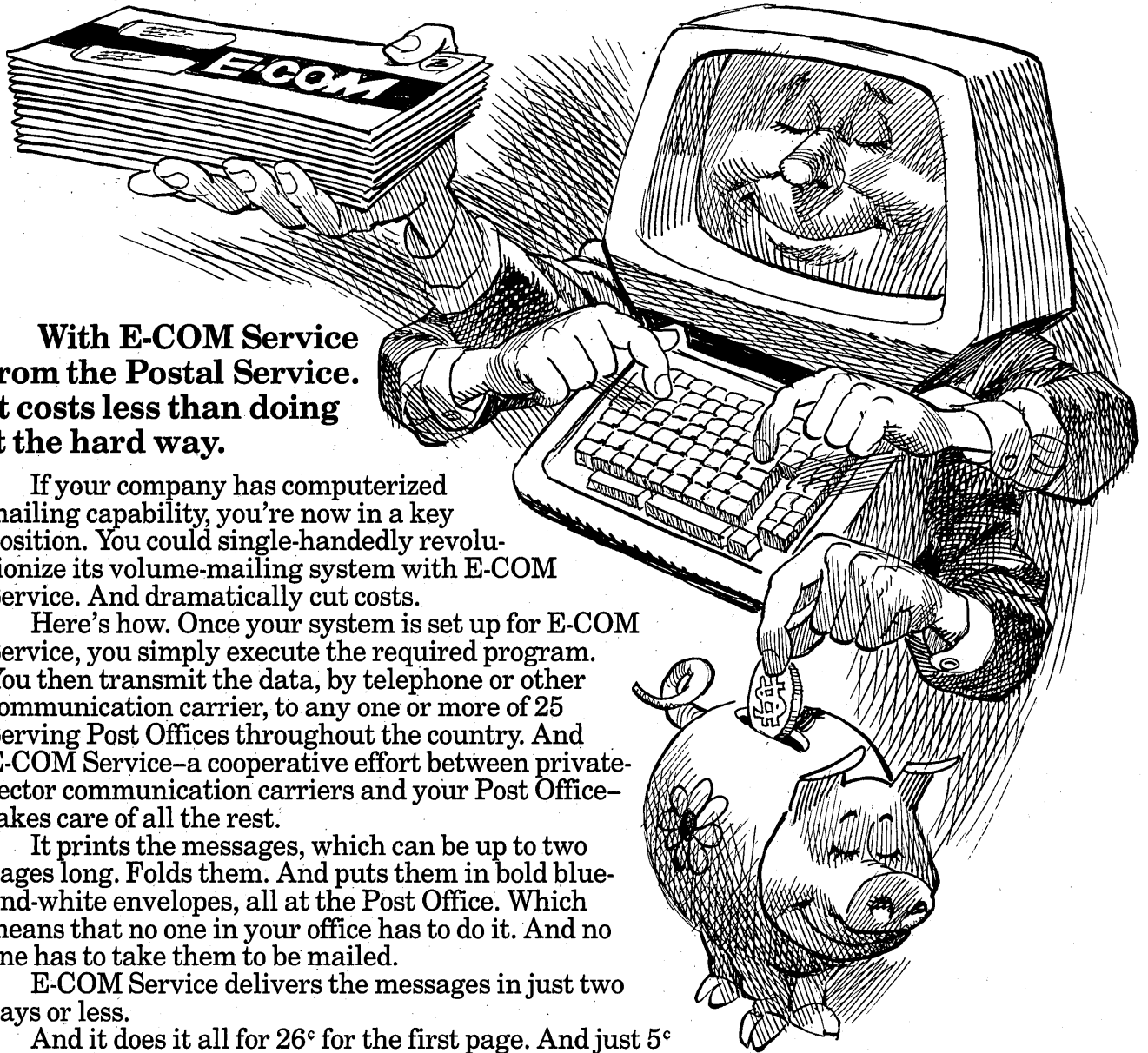

**With E-COM Service
from the Postal Service.
It costs less than doing
it the hard way.**

If your company has computerized mailing capability, you're now in a key position. You could single-handedly revolutionize its volume-mailing system with E-COM Service. And dramatically cut costs.

Here's how. Once your system is set up for E-COM Service, you simply execute the required program. You then transmit the data, by telephone or other communication carrier, to any one or more of 25 Serving Post Offices throughout the country. And E-COM Service—a cooperative effort between private-sector communication carriers and your Post Office—takes care of all the rest.

It prints the messages, which can be up to two pages long. Folds them. And puts them in bold blue-and-white envelopes, all at the Post Office. Which means that no one in your office has to do it. And no one has to take them to be mailed.

E-COM Service delivers the messages in just two days or less.

And it does it all for 26¢ for the first page. And just 5¢ more for the second. Your only additional costs are for telephone or communication-carrier services provided by others. So your company can spend less than they're spending now on supplies, labor, and postage—doing the job the hard way.

We can help you figure out the best way to access E-COM Service. And we can even give you any technical advice you might need.

So why not find out more about E-COM Service? Think of all it can do for your company.

And imagine what that can do for you.

For more information, simply call or write your communication carrier or your local Postmaster.

E-COM[®]



IT DELIVERS SAVINGS ALONG WITH THE MAIL.

© USPS 1983

CIRCLE 85 ON READER CARD

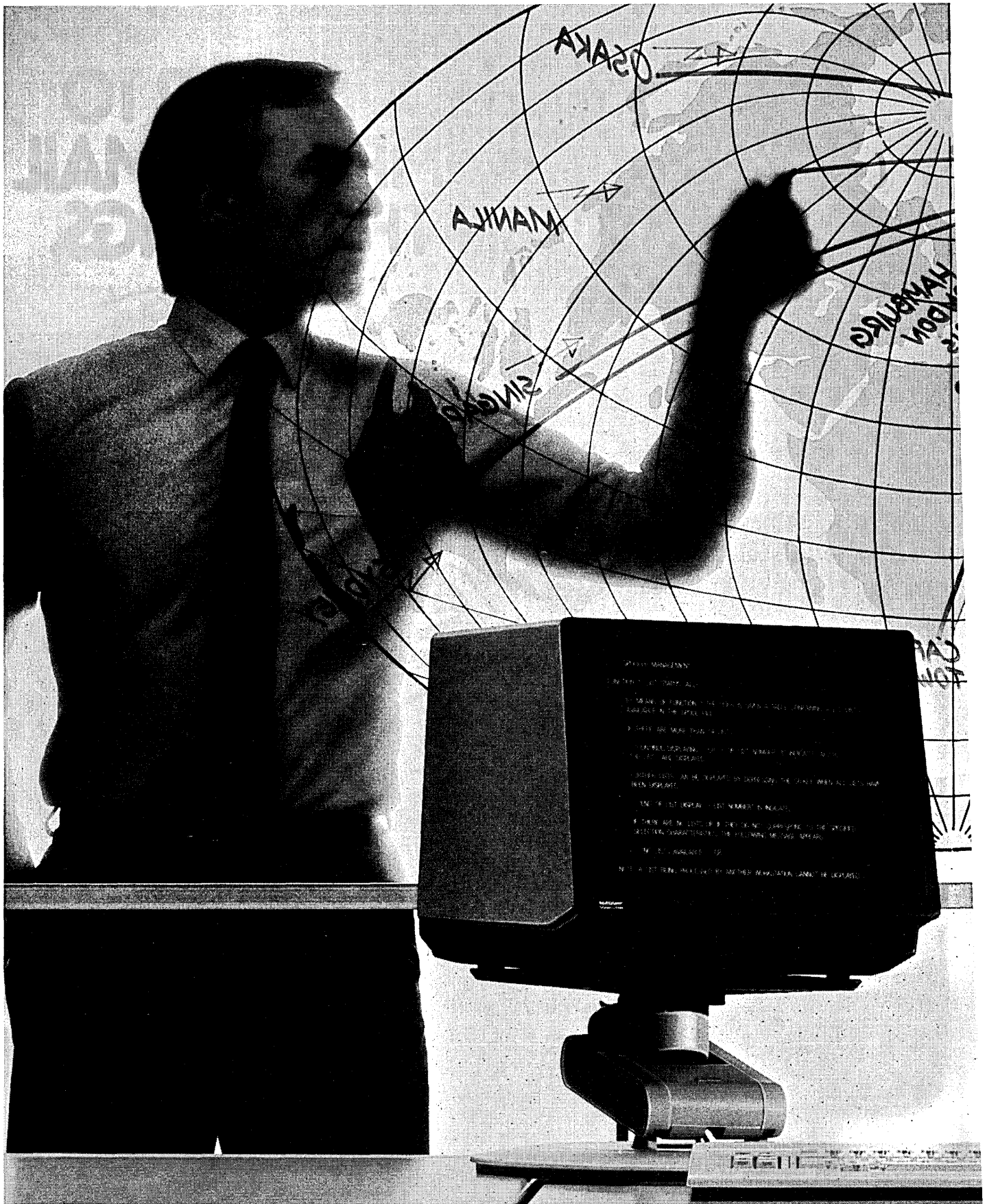

Whether you need to keep information flowing across the hall or around the world, here's an important consideration. Thousands of the world's most successful companies have already selected Nixdorf as the best computer company for the job.

Nixdorf makes it simple to tie all your offices together into one efficient network. And, we have the experience, products and support capability to keep information flowing in banking, insurance, government, retailing, transportation and other specific industries.

International businesses demand software systems that are at home anywhere. And only Nixdorf can offer COMET International, a total business information system with over 10,000 installations in 30 countries. COMET International is a valuable contributor because it has capabilities in seven

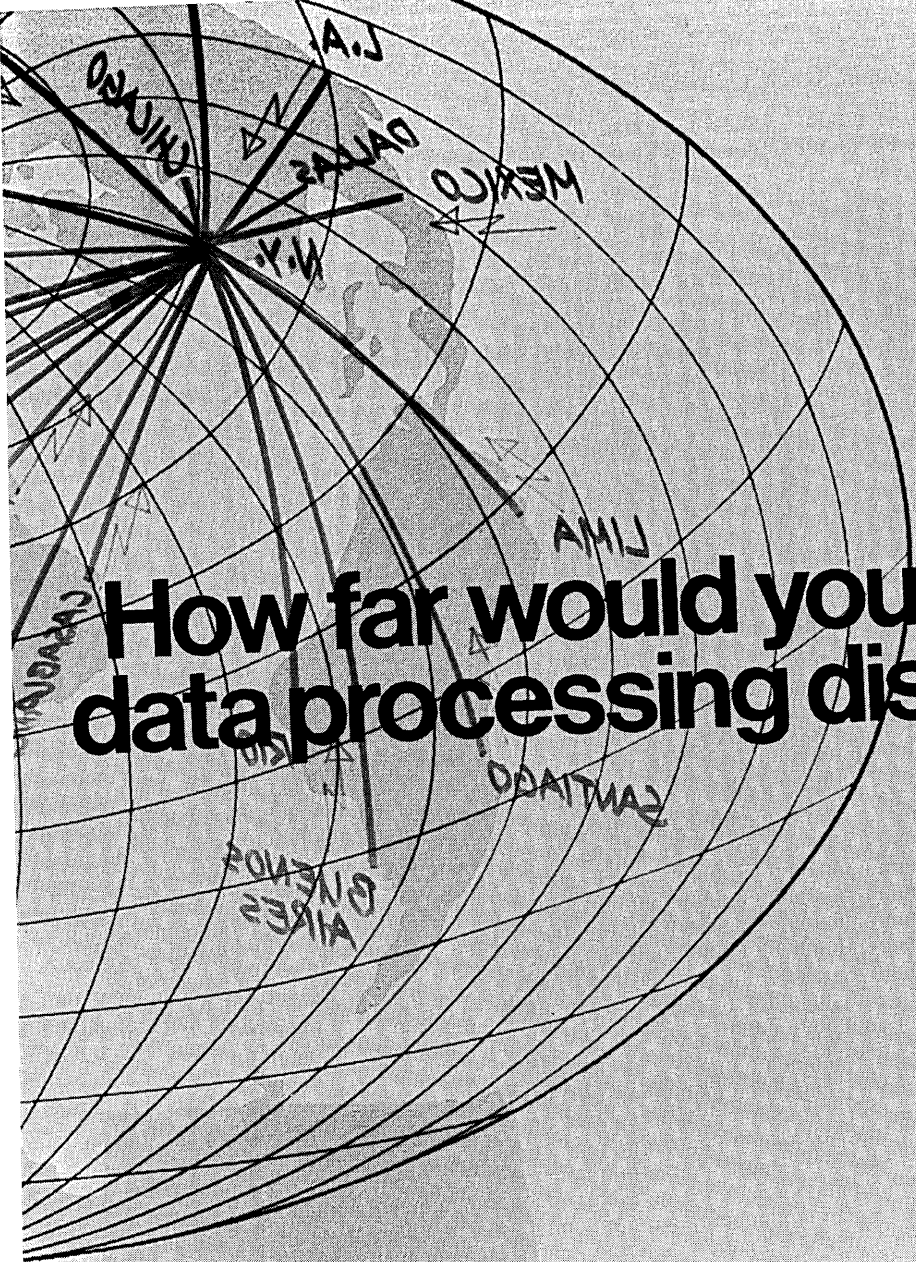

How far would you like your data processing distributed?

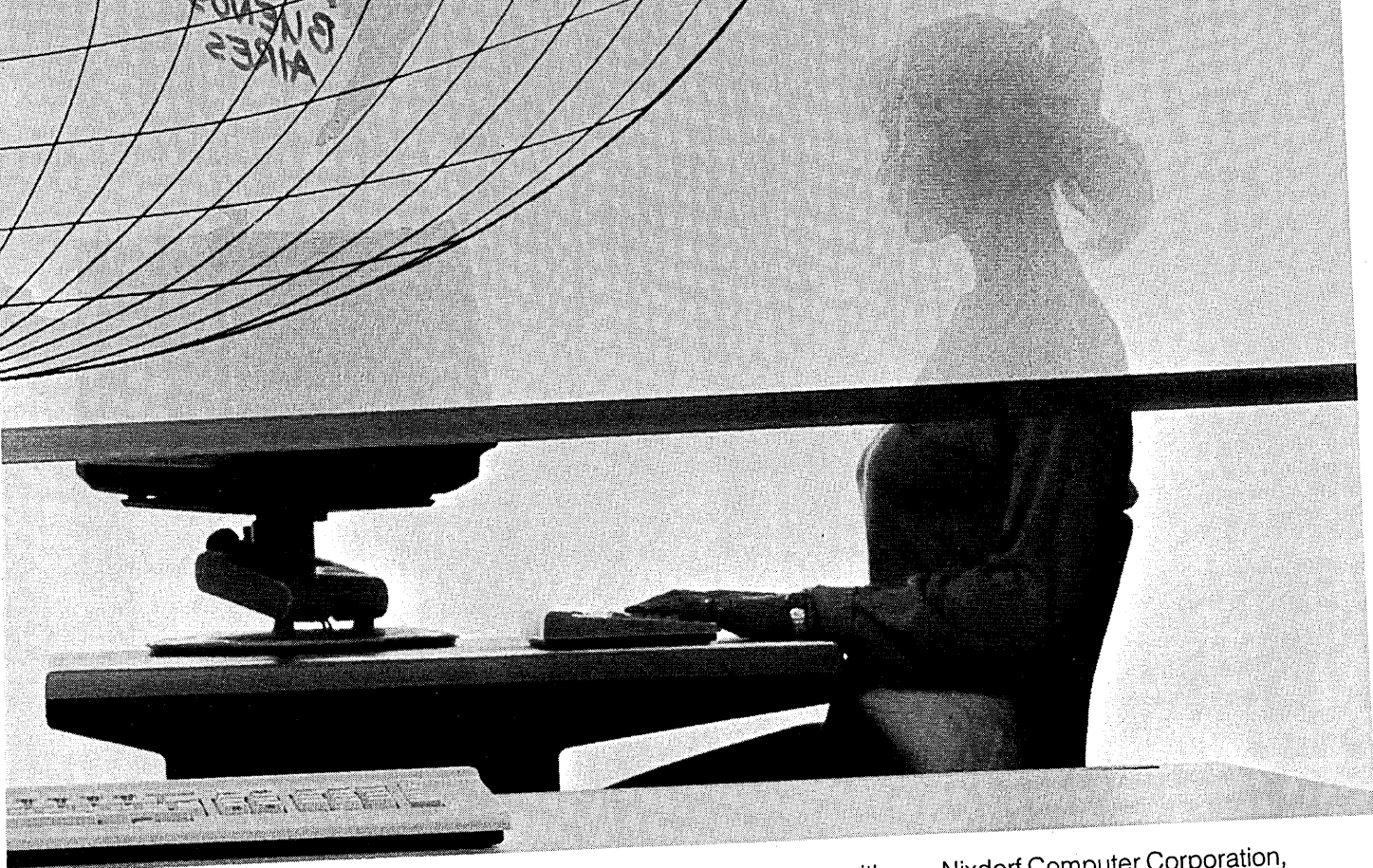

foreign languages and 19 currencies, and also meets the demands of local accounting principles and exchange rates.

For 31 years, Nixdorf has been providing solutions for the information processing needs of all kinds of businesses. And today, we're a suc-

cessful international company with 16,000 people and over 110,000 computer systems installed around the world.

So no matter how far you want to go, remember Nixdorf. We're making it a small world for some of the world's largest companies.

Nixdorf Computer Corporation,
300 Third Avenue, Waltham, MA 02154

CIRCLE 86 ON READER CARD

NIXDORF
COMPUTER

Buy American, say the corporate spokesmen. But when it comes to labor, more and more of them are shopping offshore.

OUR NEWEST HIGH-TECH EXPORT JOBS

by Laton McCartney

Item in the Wall Street Journal, Feb. 23, 1983: "Atari to Idle 1700 at California Site, Move Jobs to Asia"

One can almost imagine the scene. Atari's run of extraordinary success hits a major snag. The market has softened. Cartridge sales have slipped. Coleco has turned out to be a far more formidable threat than Atari envisioned. To stay competitive, Atari has been discounting its products since late last summer, and, as a result, profit margins have gone to hell in the proverbial handbasket. Something has to be done to get the company back on the track.

Enter the corporate guys from Warner Communications, Atari's parent company located in New York. They view the universe in terms of the bottom line, and the bottom out at Atari's headquarters in Sunnyvale, Calif., is way out of whack.

The first thing the corporate guys see when they get to Atari is cars, an enormous employee parking lot filled with hundreds and hundreds of cars. These guys who look out the window of the Warner's Fifth Avenue offices only to see if it's raining are not used to seeing miles and miles of employees' cars. The employees who come into Manhattan by car tend to be executives who can afford the \$15 a day parking tab.

Looking at all those cars, one of the corporate guys does some quick arithmetic. Each of those cars is owned by an Atari employee who earns at least \$8 an hour, maybe more, plus all your benefits, your insurance, your retirement plan. Suppose, the corporate guy thinks to himself, Atari were to eliminate a couple of thousand jobs in Sunnyvale and move the work to the Far East where the company already has a number of products manufactured and the workers are happy to get \$8 a day and ride a bike to work. That would represent enormous savings, maybe enough to get the company back on the track.

In shifting production to the Far East, Atari is pursuing a policy that seems to be increasingly the rule rather than the exception

today. At a time when many U.S. high-technology firms have taken to waving the flag and sounding the cry "buy American" to counter the threat of growing competition from the Japanese and other foreign rivals, a number of these same firms are "buying foreign" when it comes to the labor market. These corporations are increasingly taking manufacturing and processing jobs that normally would have gone to Americans and offering them to non-U.S. workers in countries where wages are often a fraction of those paid here and corporate taxes minimal or nonexistent.

Indeed, this offshore development has become so extensive that some major American corporations now have as large a share of their operations outside the U.S. as in it. "Half our business is outside the U.S.," explains Richard Love, director of international marketing for Hewlett-Packard, which has major facilities in Mexico, Singapore, and a number of other countries.

Today, more than 70 countries including Korea, Singapore, Taiwan, Sri Lanka, India, Scotland, Jamaica, Mexico, the Philippines, and Malaysia are vying to attract U.S. facilities. In the past few years, Ireland alone has drawn almost \$1 billion in fixed-asset investments from about 350 U.S. firms, including IBM, Apple, Cado, Digital Equipment, Storage Technology, Prime, Modular Computer, Wang Labs, General Electric, Cincom, and Four-Phase.

What's the incentive to go offshore? Lower labor costs are only part of the package. Listen for a moment to E. Anton Norris, a soft-spoken Barbadian with the dignity of a diplomat. Norris is a director of the Barbados International Development Corp., which has its U.S. headquarters in New York. For a visiting reporter he ticks off the facts and figures underscoring Barbados's appeal: one of the world's highest literacy rates, excellent airline connections, an extremely stable government. Then to bring home his message, Norris flicks on a slickly produced film extolling Barbados's business climate. The bottom line is that an American company relo-

cating to Barbados gets more than an enormous reduction in labor costs (the average electronics assembly worker draws between \$155 and \$215 a month, while an industrial department head may only make slightly more than twice that). The new arrival is also granted full exemption from all corporate taxes for 10 years, receives large cash grants for worker training, and is fully exempt from import duties on parts and materials. Then, there's the added perk for management of being able to fly down to Barbados in mid-winter and get in some golf and beach time after checking out the plant.

LURING YANKEE COMPANIES

Barbados spends big bucks in promoting itself, advertising in a variety of business and information processing publications, and has experienced considerable success in luring Yankee companies to its shore. Among them are electronics and computer firms such as Microdata and Intel, which has an LSI plant on the island that is expected to employ 2,000 workers by 1984. Several offshore data entry firms, operations that either use air freight or satellite to transfer keypunch work back and forth from the States, have also situated here. In addition, American Airlines recently closed down its data entry operations in Tulsa, Okla., and is in the process of hiring 200 Barbadians to perform this work. American will employ a satellite to link its data entry operation in Barbados with its data processing center in Tulsa.

Other developing or Third World countries have registered similar successes. In Singapore, for example, Apple builds personal computers, printers, and disk drives; Digital Equipment produces minis and floppy disk drive assemblies; Hewlett-Packard turns out data cartridges, programmable calculators, and peripheral printers; and Seagate Technology, Tandon, National Micronics, and Micro Peripherals have also set up shop here.

With one of the lowest wage scales outside India, Indonesia, and South America,

ILLUSTRATION BY RAFAL OLBINSKI

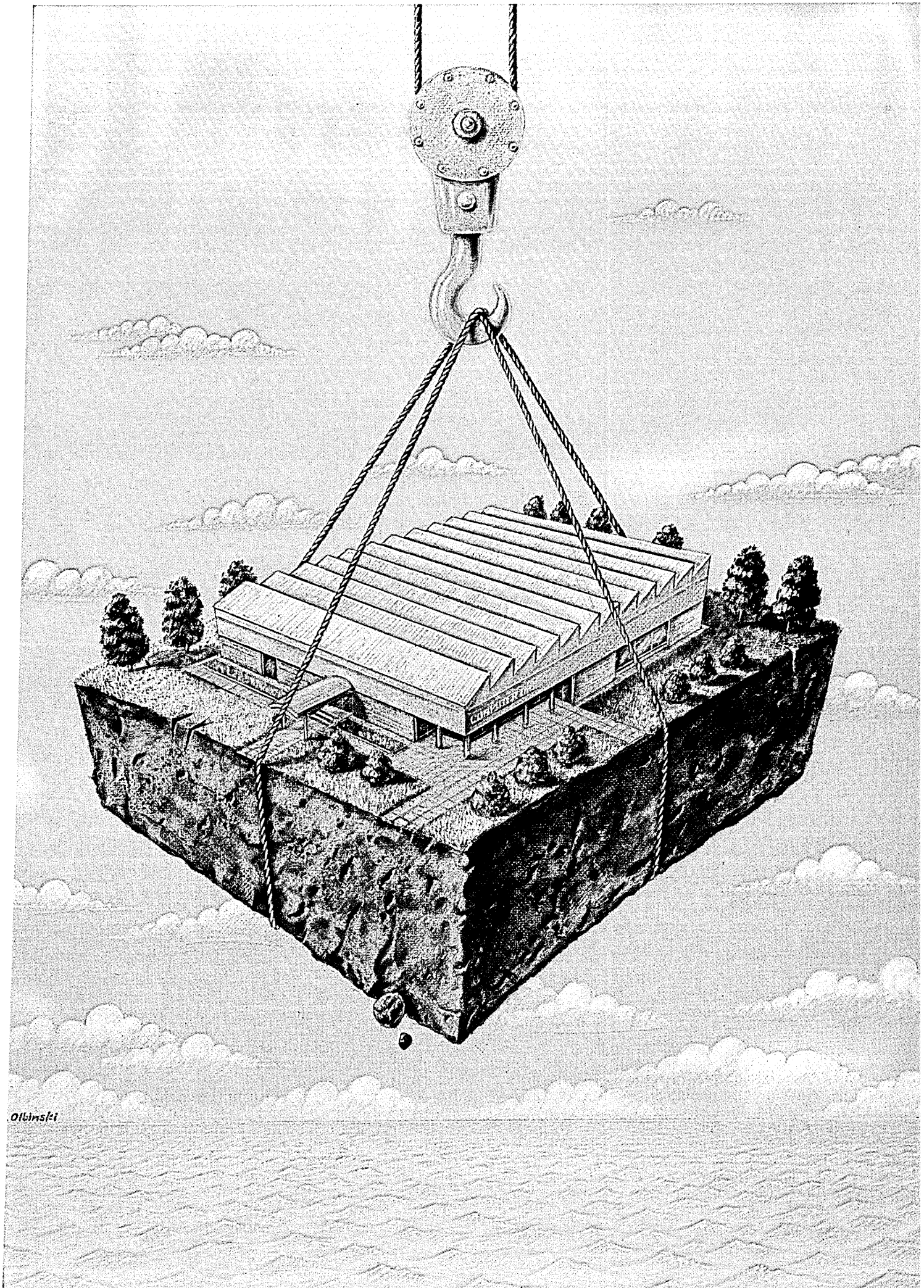

Oltinski



LocalNetTM keeps university students from learning too much.

Like the latest grade point averages. Or details of the dean's expense account.

Take Brown University, for example.

LocalNet's broadband technology connects Brown computer users to administrative and educational data centers. While programmable channel selection and end-to-end encryption can keep inquiring minds from inquiring in the wrong places. Yet still give them access to the tools they need to enrich their education.

No small feat when you consider that Brown's network handles over 800 terminals and ports, plus diverse timeshared computers. Along with energy management and campus security data. Twenty four hours a day, seven days a week.

It takes experience to design local area networks with this kind of performance. Our experience includes over 200 networks worldwide. More than any other open network supplier. Nearly a dozen at colleges and universities alone.

And what we learn on campus we share with LocalNet users in industry, finance, and government.

So if you're designing a local area network, or think you should be, contact us at Sytek, Inc., 1225 Charleston Road, Mountain View, California 94043. Telephone (415) 966-7333.

Ask us your toughest design questions.

The answers are academic.



"SEE US AT NCC"

CIRCLE 87 ON READER CARD

An American company relocating to Barbados gets more than an enormous reduction in labor costs.

the Philippines has also managed to attract significant offshore development. Most of the activity is based in the Philippines' own version of the Silicon Valley near the Manila International Airport. American companies operating here include Data General, Intel, American Microsystems, Zilog, and Advanced Micro Devices.

Of course, going offshore is not all sunshine and piña colodas. Two Control Data executives were kidnapped not long ago by angry workers at a CDC computer component plant in Seoul as part of a labor dispute. They remained locked in the plant conference room until the Korean police finally came to the rescue. National Semiconductor Corp. had to comply with so many training and hiring requirements in Malaysia that it was forced to set up 11 separate training programs, each with its own library, training manager, and classroom, just to serve two plants at Penang and Malacca. In El Salvador armed rebels took over a core memory assembly plant run by the Dataram Corp. and tried to unionize the operation at gunpoint.

To hedge against such risks, some companies have tried to keep their offshore activities as close to home as possible. "Mexico, particularly over the last year [with the devaluation of the peso], has become one of the major contenders as far as offshore operations are concerned," says John A. Sartori, director of industrial development, Imperial Valley-Mexicali, El Centro, Calif. "It has become extremely cost-competitive and offers the additional attraction of being close for the purpose of control management. Its cost right now is about 84 cents an hour for labor including all fringe benefits."

Today, Sartori estimates there are about 650 American plants employing roughly 140,000 workers that operate inside the Mexican border. In his area, Mexicali, which is about 100 miles inland from Tijuana, there are approximately 70 U.S. plants with 8,000 or so employees. Among them are GE, Printronix, and Hughes's Electronics Division. Other companies such as Xerox let work out to Mexicali assembly firms on a subcontracting basis.

Typically, Mexican operations (at least those near the U.S. border) are set up on a dual-plant basis, with one plant in Mexico where the labor-intensive work is carried out and another on Uncle Sam's side of the line to perform fine-tuning and final product preparation.

American firms are also pulled offshore by their desire to sell duty-free in the European Common Market. Ireland, consequently, serves as a Common Market base for Amdahl mainframes, DEC minis, Storage Tech drives, and Dataproducts printers. It's the same story in Scotland, which has pushed hard in the past few years to try to catch up

with Ireland as an offshore haven and boasts IBM, Burroughs, NCR, DEC, Hewlett-Packard, and National Semiconductor among its American companies. The industrial belt between Glasgow and Edinburgh is currently so concentrated with American technology firms that the Scots have taken to calling the area Silicon Glen.

Moves to non-European countries where the labor savings are most pronounced are often the result of sudden, unexpected shifts in the marketplace. "Usually what happens is a American company gets 'hit' by an offshore manufacturer," explains Robert H. Conrads, a Los Angeles-based principal at McKinsey & Company, the management consulting firm. "For example, three or four years ago Televideo came into the market with an exact copy of the Lear Siegler 80M31 terminal and was using offshore sourcing from Korea and doing the final assembly and testing here. This was the first product that TVI came out with, and it beat Lear Siegler's price by about 25% to 30%."

"All of a sudden Lear Siegler was faced with a situation where it had to reduce costs if it was going to succeed in the market. The company started to investigate offshore sourcing opportunities."

TAKING A PROACTIVE STANCE

Today, Conrads says, companies are acting rather than reacting when it comes to making the move offshore. "They are taking a proactive stance and saying to themselves, 'Gee, we can gain market share by cutting costs, and we can cut costs by going offshore.'"

Whatever the reason for the move, there are basically two ways to make it, Conrads says. A company can simply pick up stakes and shift an existing operation overseas a la Atari. But the more common ap-

proach involves "growing" volume production abroad. "This is to a large degree what Hewlett-Packard and Mattel have done with their electronics products," Conrads explains. "They start out in the States with a manufacturing capacity, and as their volume grows, they maintain the plant here to do the initial startup production. However, when they go volume they either contract for or build facilities for the volume overseas."

"They'll always keep a facility running here on a startup mode for the new products because you have to have your manufacturing operation closely coupled with your engineering during startup since there are always bugs. But once you get that startup production stabilized, you can move overseas."

Conrads says this volume production abroad approach is becoming more and more common. This means, he explains, that in a few years Route 128, the Silicon Valley, and the other hubs of American Technology will be far less labor intensive, employing a limited number of higher level workers, including engineers and administrators. The assembly production that is kept at these complexes will be highly automated.

This represents a grim picture if you've been unfortunate enough to tie your career to a high-tech assembly line, but the impact of offshore development doesn't end here. Some American companies that initially looked abroad for the lowest level assembly line jobs have recently begun scouting around for engineering and data processing assistance overseas as well. National Semiconductor, for example, went to Israel, which has an abundance of engineers, scientists, and technicians, and had Israeli engineers develop its 32-bit micro. Control Data, Intel, and Motorola have also established research and development centers there.

The offshore approach is also being



"This manhattan tastes like New Jersey."

The Scots have taken to calling the industrial belt between Glasgow and Edinburgh Silicon Glen.

employed for software development and programming projects. Burroughs, for instance, and Tati, the biggest industrial firm in India, have an agreement by which Tati will supply Burroughs with software development through Tati's own software subsidiary.

George Simpson, chairman of Satellite Data Corp. in New York, likens this evolution from low-level assembly jobs to high-level engineering and technical projects to what happened in the garment industry. "Thirty years ago you made a good living having T-shirts manufactured in India," he says. "Now you have a whole line of clothes with different styles and colors made. Same with electronics. The electronics firms started out having crude assembly done. Now Intel, for instance, has a pretty sophisticated LSI facility in Barbados, and in places like Taiwan the whole product is being manufactured, and they do a better job than we do."

Two factors are making this evolution possible, Simpson says. First, in places like Taiwan and Barbados, the infrastructure (communications, education, and a lot of other systems) is developing to the point where it at least approximates the infrastructure of, say, Route 128.

At the same time, the geographic barriers that traditionally kept the more difficult and less readily supervised engineering and manufacturing projects from being sent offshore are breaking down. "The only thing that separates Jamaica from Hartford, Conn., in terms of jobs is the price of a phone call," asserts Simpson, who runs a data entry business in Barbados from his office in Manhattan via satellite.

With satellite, Jamaica, Barbados, and Taiwan are, for most intents and purposes, no farther away than the data entry room down the hall, the typing pool upstairs or the data processing shop in the next building. This has staggering implications for a country like Jamaica, Simpson says. It also has some staggering implications for Hartford or Route 128 or Silicon Valley. Suppose the president of XYZ insurance in Hartford decides he can double his company's profits by moving all the company's clerical work to Singapore. Or, perhaps, the ceo at American Airlines figures, "What the hell, why not move the entire data processing operation to Barbados?"

"As a practical matter you get ceos at large companies preaching to buy American,

but that's only preaching," says Simpson. "If there's a profit to be made by moving offshore, they'll take it. This is capitalism, man!"

Conrads of McKinsey & Co. echoes these thoughts. "If companies in Europe like Philips, Siemens, Nixdorf, and Olivetti tried to move offshore, they'd have a hell of a problem. The governments in their countries would exert all kinds of pressure for them to replace the business and retrain the workers and put them into a new business area."

But in the U.S., the government isn't about to step in, even with unemployment over 10%, and the workers who have thus far been displaced are not unionized and don't have any real say in the matter.

One final note: the U.N. has a program, the Industrial Development Organization, that trains developing countries in attracting business from the U.S. and other industrial powers. Guess who provides a major portion of the financing for the program? *

Laton McCartney, a former managing editor of DATAMATION, is currently a free-lance writer in New York and a regular contributor to the magazine.

Successor Planning Executive Selection Europe

Your management's decision on who will supervise your investment in Europe is essential to successfully marketing products and services here.

The input you receive from your people at country and European level will determine the quality and success of many of your strategies; the input your European employees receive from their local managers will determine their level of involvement in the future of your company.

It is almost impossible to over-emphasize the importance of finding the right person for a given position. Identifying management talent in Europe's high technology industries is our business.

Since 1969 we have assisted both American and European companies to staff almost 1000 key management functions with experienced, result oriented executives. Below are examples of:

Positions filled	High-tech. branches served
Regional Vice President ● General Manager ● Controller ● Marketing/Sales/Product Managers ● F. & A. Manager ● Software Manager ● Systems Software Support ● Customer Engineering ● Branch Office Manager ● Advertising ● Personnel ● General Council ● Auditors ● Public Relations	VLSI - Mainframers ● Plug Compatible ● MINIS ● MICROS ● Small Business Systems ● Printer/Word Processor Manufacturers ● Data Comm. ● Packaged Software ● Systems Houses ● EDP & Management Consultants ● CPA Firms ● Time Sharing ● Computer Services ● Data Center ● EDP Users

If successor planning or staffing your European organisation requires professional attention please contact us for the lion's share of your staffing questions. Video interviews of candidates screened to your specifications as well as guarantees for the success of both the search and the selection process are a few of the many advantages you have with Dolan Consulting.

Representatives of our company will attend the NCC in Anaheim in May. Please arrange for an appointment now or call us when you are in Europe next.

DOLAN CONSULTING

Human Resource Management

Untermainkai 34 · 6000 Frankfurt/M. 1 · Telefon (611) 23 08 76
for the lion's share of staffing questions
Germany · Austria · Switzerland



**The Information Center and
The Development Center...
The Micro/Mainframe Connection...
Relational Database Management Systems...
Everyone says it doesn't make any sense to wait.**

Bull?

**Three essential seminars that save you time,
money, and let you cut through the Bull.**

As a DP/MIS Manager you're being squeezed. Micros are pouring through the door like water...end-users are trying to tackle your application development backlog, and they're coming to you for advice on the technology they need to do it. At the same time, salespeople are telling you that all the pieces are available now, and that they have the ideal solution for your needs.

The pressure is on. But, who's right? How do you afford the time to examine all the available products, cut through the marketing dazzle, and determine which products, if any, can help you get the job done, bring everything back together, and stay ahead of the game?

**Software and Micro Decision Symposiums
independent in-depth analyses**

Each two-day symposium provides you with the opportunity to find out the real story, and about the various products and implementations themselves. Here are some comments from past attendees:

"...extremely informative. I would estimate that we saved some three months of research. The presentation was truly unbiased and a refreshing change."

Jeanette Pearman
Information Center Manager
Albuquerque National Bank

"We thought we had done our homework beforehand...but we found so many new insights into the competing products that most of our preliminary legwork was invalidated. I can't imagine any attendee not getting more than his money's worth of decision support from the Software Decision Symposium."

William D. Masters
Michael Reese Hospital
and Medical Center

"Most helpful... anyone reaching a point where a decision is to be made should not do it before attending this symposium."

Henri Robitaille
Le Soleil Limitee

In short, the Merlyn Software and Micro Decision Symposiums present a remarkable opportunity for today's DP/MIS Management to quickly find out which claims can be believed, and which are Bull.

**1. The Information Center and The
Development Center.**

Can you really accelerate the applications development process?

Application Generators, productivity tools, fourth generation languages, end-user query systems, database management systems. They all claim to be just what you need... instant answers to the backlog crisis... but which ones really are, and how do you implement them?

Schedule:

New York City	May 3-4	Chicago	May 25-26
Pittsburgh	May 11-12	Toronto	June 8-9
Baltimore	May 18-19	San Jose	June 14-15

**2. The Micro/Mainframe Connection.
The end-users way out...or yours?**

What, how, and where you buy are important, but they're only part of the challenge. The real issue is control...control of everything from acquisition to support. What are the selection, configuration, and acquisition criteria? How do you compare micro hardware and software? What about communications and compatibility? How do you integrate micros into the overall systems strategy, and maintain security, data integrity, and auditability?

Schedule

Seattle	April 20-21	Boston	May 17-18
San Francisco	April 27-28	New York City	May 24-25
Dallas	May 3-4	Baltimore	June 15-16
Chicago	May 10-11	Toronto	June 28-29

**3. Relational Database
Management Systems.**

Does end-user computing demand Relational Database?

User-friendly access to data is becoming a critical issue, and Relational Database products claim to provide the answer. Which products really are relational? What about the 'relational-like' products? How do you compare and implement relational technology?

Schedule

Pittsburgh	May 11-12	Toronto	June 8-9
Baltimore	May 18-19	San Jose	June 14-15
Chicago	May 25-26		

To Register.

To register, or get more information, call (800) 241-9970 or (404) 252-0516. Price per person is \$595. If more than one attendee registers from the same company, in either symposium or any city, the second and subsequent registrants receive a 25% discount. The fee, which must be paid in advance, includes symposium coursebooks, all meeting materials, lunches, coffee breaks and a cocktail reception at the end of the first day.

If your schedule won't permit you to attend, expanded coursebook sets, covering each symposium, are available for \$495.



Merlyn Corporation 6075 Roswell Rd./Atlanta, GA 30328

**1-800-241-9970
or 1-404-252-0516**

We built in 14 gooc to offer you an upt

During operational breaks, key systems are automatically exercised, electronically, to check system integrity.

Contains a powerful minicomputer with built-in intelligence to control system operation.

To provide precise form-to-data registration and allow immediate updates, electronic forms are designed and stored in the system itself.

Automatic check and recheck of all incoming data assures accurate printout.

System software contains built-in diagnostic program for early warning of potential problems.

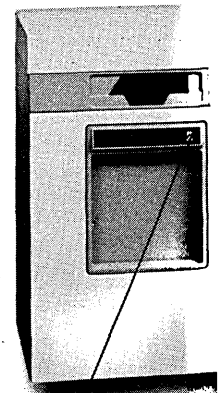
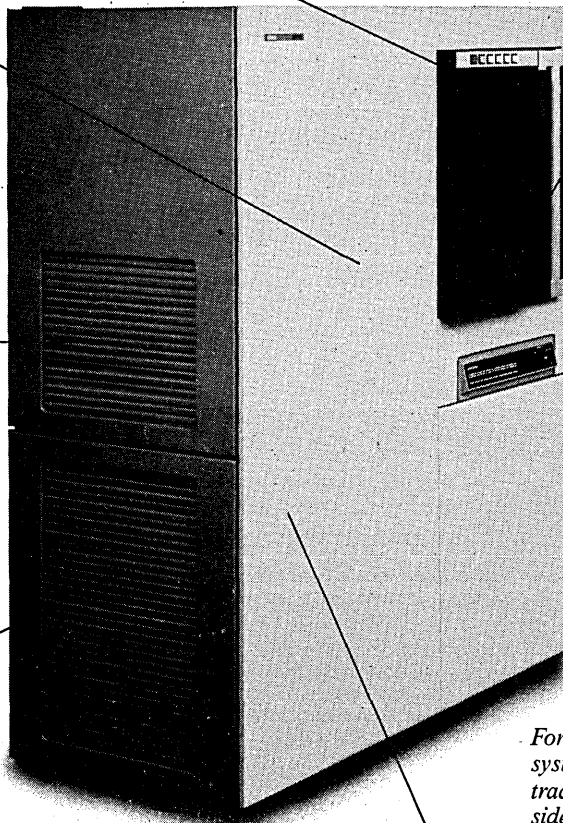

For optimum printing accuracy, system monitor automatically tracks every character on both sides of paper.

Software's error-management design allows continued operation in event of recoverable failures.

If we wanted to, we could point out a lot more. But you get the idea.

Our Xerox 9700 electronic printing system is designed to operate in your data center. Every day. 365 days a year.

Just like our 8700 electronic printing system.

Which is why we can guarantee its uptime to you for an average of 684 out of the 720 hours in each month, on a quarterly basis.

Less the time needed for regularly-scheduled servicing, of course.

If we're wrong, we'll credit you for your down-time.* And we'll give you that guarantee in writing.

All we ask is that you help us take care of your system according to the provisions of the Xerox Uptime Guarantee Program.

To further assure that you get flexible, high-quality document production, we'll also train your people.

And we'll assign one of our special teams of Customer Engineers directly to your machine.

(They come with months of lab training, and a

XEROX

reasons we guarantee.

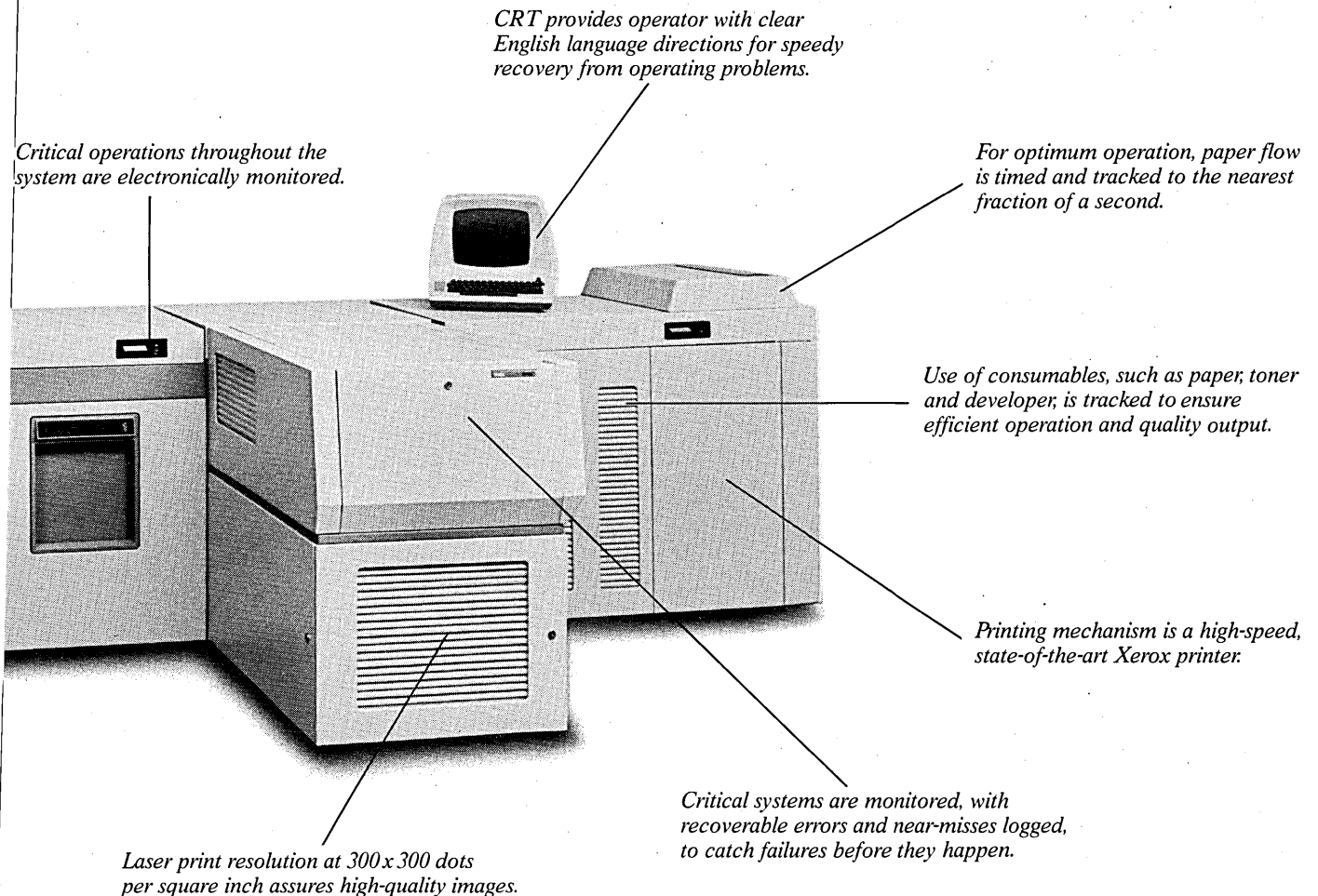

national communication and computerized parts-backup system that lets them make any needed corrections quickly and accurately.)

We'll even regularly update your software. So you'll always have the latest in system capabilities and reliability.

Unlike some Johnny-come-lately electronic printers, the Xerox 9700 doesn't come with just promises.

It comes with a written guarantee.

If you want more information, call toll-free,

1 (800) 556-1234, Ext. 95. In California, 1 (800) 441-2345, Ext. 95. Or write: Xerox Printing Systems Group, 880 Apollo Street, P1-60, El Segundo, California 90245.

That'll get you the rest of our story.

The Xerox 9700 Electronic Printing System.

CIRCLE 90 ON READER CARD

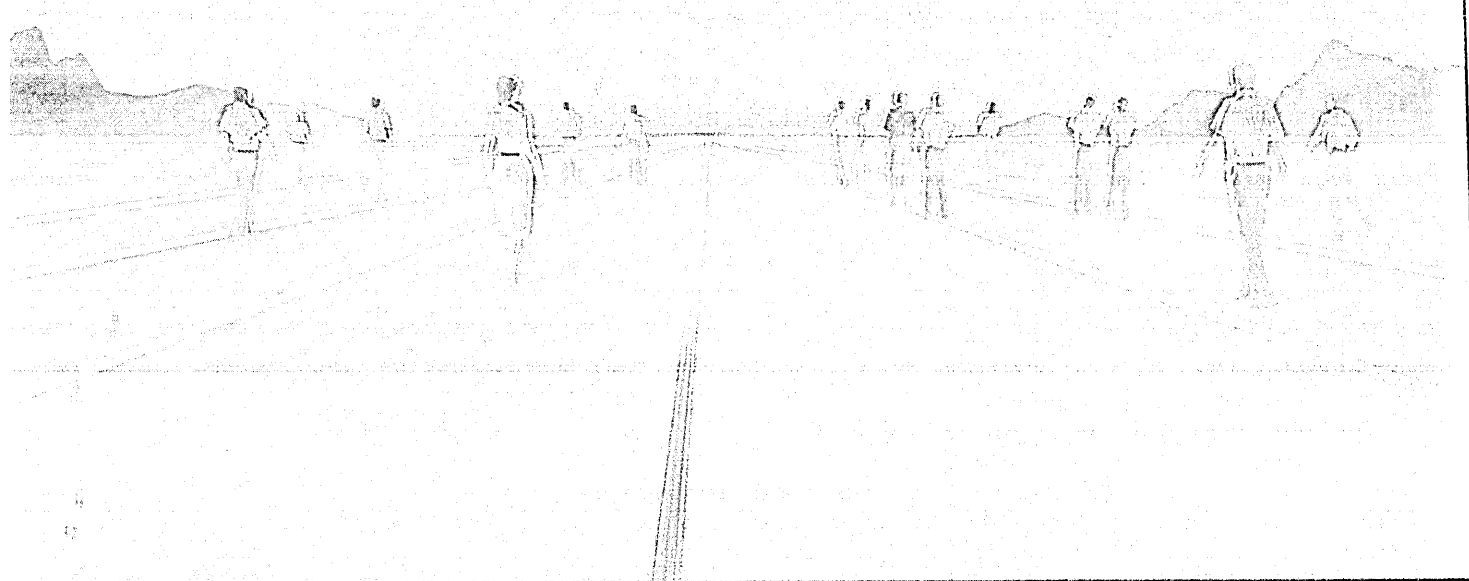
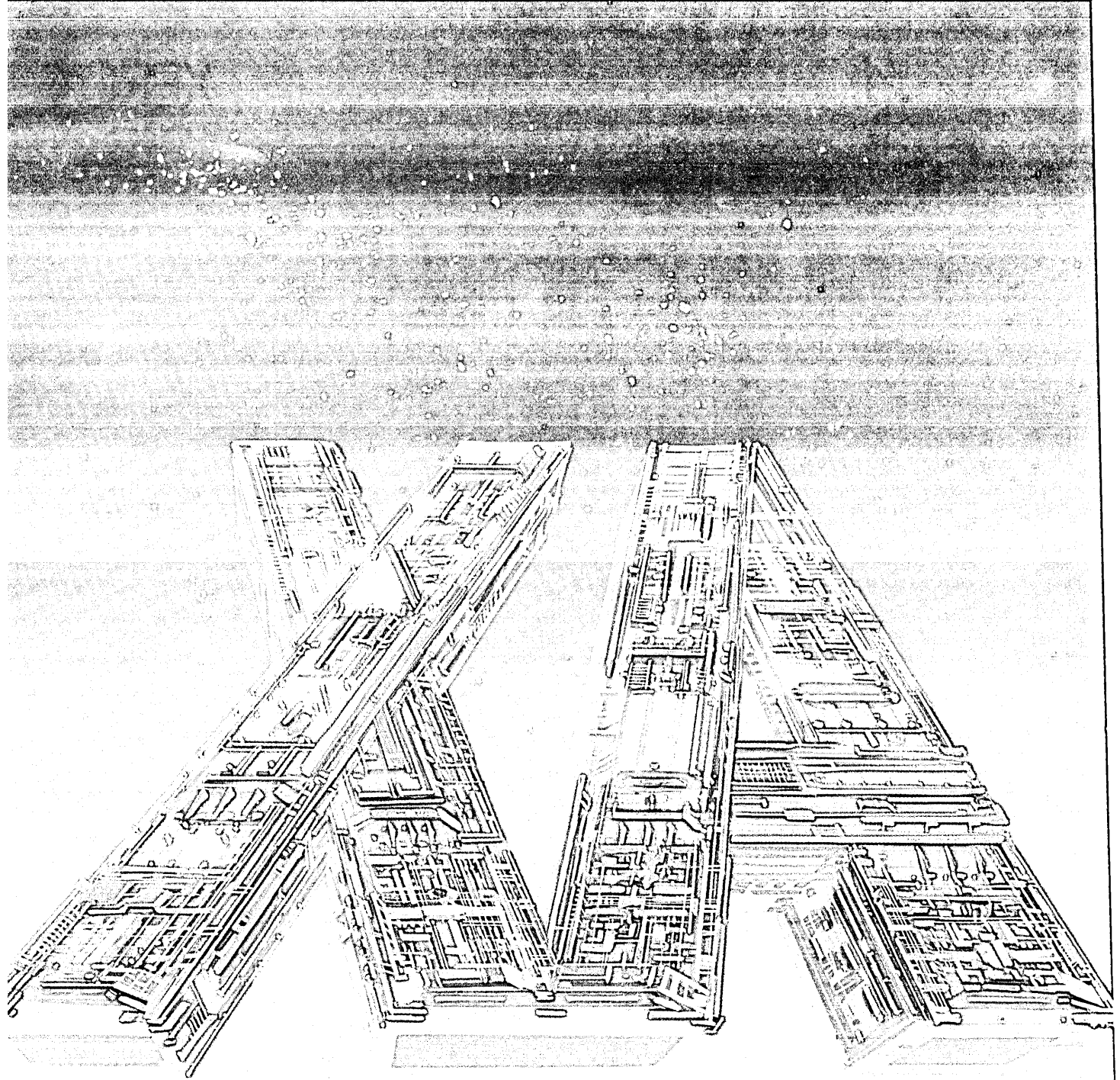

IBM'S ADDRESS SPACE ODYSSEY

In the beginning there was OS. A venerable operating system, it has served its users and creator, IBM, for almost 20 years. Now, as of March '80, a major new version of OS is available (Extended Architecture (ESA)).

Using a 31-bit addressing scheme, 7-bit bytes (as its predecessor, OS/360 promises to support programs vastly larger than any previously possible on IBM hardware. It also promises to bring new levels of reliability to MVS, helping users meet the large-scale computing needs of coming years.

Such a large leap in functionality, however, raises some questions. How much will it cost to migrate to ESA? What does one do about conversion of existing programs? Where does one find the know-how to make the change? What will systems pro-

grammers need to learn to take advantage of the new capabilities? Will operators need retraining? How much will clock time and up time will be required to migrate?

These and other questions came to mind in the months following IBM's Oct. 20, 1979 introduction of ESA. In an attempt to address them, *DATAWATION* asked industry analyst Robert U. Berthé and IBM itself for some answers.

In an exclusive report, Berthé presents the findings of a survey he made late last year of users' plans for ESA migration. Surprisingly, he found that users have generally underestimated the time and money required to get from standard MVS to the new ESA version.

IBM's detailed description of MVS/ESA and its many new features

comes from the pen of Ronald H. Bond, who has worked intimately on the architecture for several years. He provides an unprecedented view into the workings of ESA and the benefits users can expect. The prime short-term benefit will be immediate relief of virtual storage constraints, Bond writes. Next will be the improved ESA features, making life easier for users, programmers, and operators.

Needless to say, ESA's immaturity so far. It was only made generally available a month ago. *DATAWATION* intends, however, to continue tracking the architecture's evolution, that of MVS/ESA, and users' experiences. Indeed, the magazine welcomes information from anyone—user, manufacturer, or software supplier—who has something to say about the new IBM product. —AVAF

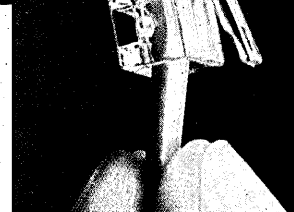

“Today we installed 27 terminals but not a foot of data cable. We’re using Teltone’s DCS-2 instead.”

There’s only one thing you can count on these days. If anything can change, it will. And sooner than you think.

That may be why more than 300 companies have installed our DCS-2 Data Carrier System: to help them cut the cost of adding or moving terminals by using existing PABX wire to carry both voice and data traffic—simultaneously.

With DCS-2, a PABX (or Centrex) becomes a common communications network. From then on, making a computer hookup is as easy as plugging in a phone. Up to 9600 bps of dedicated-channel, full-duplex data can be transmitted or received by any RS-232C terminal in your system. But the data won’t interrupt phone service.

At a time when drilling one hole for cable can cost \$100 or more, the Data Carrier System is a smart choice economically. Logistically, it can make your next move faster and far less troublesome. Like the one you’ll probably be making next week?

For fast information call 1-800-227-3800 Ext. 1122 (in California 1-800-792-0990 Ext. 1122) or write Teltone Corp., PO Box 657, Kirkland, WA 98033. In Canada call (416) 475-0837 or write 91 Telson Road, Markham, Ontario L3R 1E4.

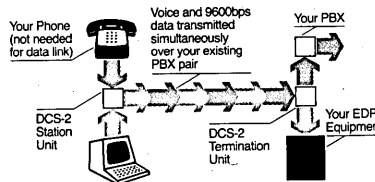

FCF Part 68 registered. For users of DEC, Prime, Data General, Tandem, IBM Series/1, H-P and other asynchronous computers.

CIRCLE 91 ON READER CARD

Will converting to the IBM XA world be worth the time, effort, and money? A survey of users provides some answers.



THE VIEW FROM THE TRENCHES

by Robert T. Fertig

Users of IBM's 370 and 303X systems have been or will soon be experiencing serious performance and capacity constraints caused by several intrinsic limitations of the machines' 20-year-old architecture. Those limitations include the following:

1. Limited address space of 16 megabytes stemming from the 24-bit address mode (25 bits with special 3033 SE feature)
2. Restricted number of channels, I/O bandwidth, and access flexibility
3. Maximum of two processors in a multiprocessor configuration
4. Lack of fault tolerance to meet the high reliability, availability, and serviceability (RAS) needs of the mid-'80s
5. Insufficient resource management facilities for large multiprocessor complexes.

IBM has sought to remove these constraints and provide its largest users with room to grow by introducing Extended Architecture (XA). XA is implemented in fully unbundled software (the new MVS/SP2 [XA] system control program), microcode, and hardware that all reside in the 308X mainframe. Migrating to XA will be a major job for users, for it will involve converting applications and systems programming, retuning systems for maximum performance, and training staff to manage the significantly changed systems environment.

As such, XA poses some important questions to users: How does one convert to the IBM XA world? What will it cost to migrate? What real, tangible benefits can be expected? How long will it take to get there? Will XA affect the compatibility of non-IBM software (i.e., user-written and independently supplied code)? How will XA affect future residual values of the IBM 303X series?

These and other issues were explored last winter in a survey conducted of user expectations and migration plans for XA. Several hundred questionnaires were mailed, yielding valid responses from 53 sites representing nearly 80 large-scale IBM systems. Many sites were at Fortune 500 companies.

Data were received from the following industry sectors: insurance companies (23%), manufacturers (15%), utilities (16%),

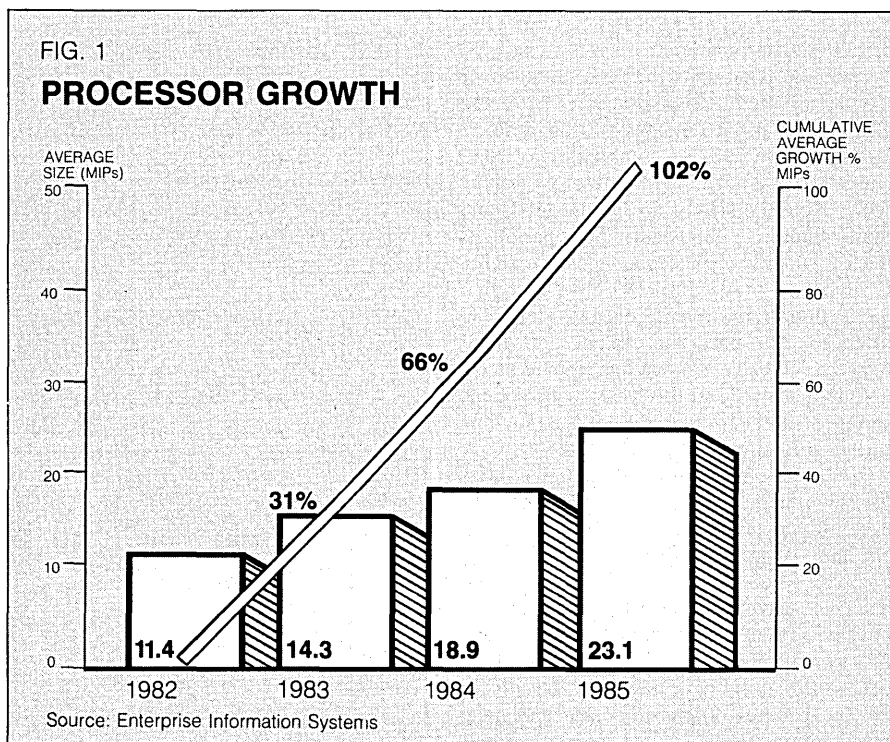

financial institutions (9%), service bureaus (7%), petro/chemical firms (7%), other industries (23%). Follow-up phone interviews were made to confirm facts, and extreme highs and lows were eliminated from the statistics in order to not distort the results. Trend data for the period 1982 through 1985 were also received. This article considers only the "averages" because of space limitations.

Before discussing positioning for and migration to XA, it is useful to review site plans in terms of processor growth, storage expansion, communication trends, and workload characteristics, among other trend indicators. Naturally, these statistics vary widely depending on the industry sector and application mix of a particular site.

In 1982 the average large-scale system site, according to our sample, had 11.4 MIPs of processing power, with an expected cumulative growth of 102% through 1985 (see Fig. 1). The reasons for this doubling of cpu power over a three-year period include:

- 1) greater on-line database/data communications applications; 2) higher prime shift time-sharing, transaction, and batch peak workloads; 3) need for additional processor backup for critical DB/DC applications; and 4) increased functions and cpu load from MVS and its major subsystems—IMS, CICS, VTAM, TCAM, JES, etc. The ratios of cpu (MIPs) growth to memory, DASD, and terminals are also presented.

MAIN STORAGE TRENDS

Cumulative main storage growth over this same period was projected to be 101%. A typical user had 14 megabytes (MB) in 1982, which is expected to grow to 29MB by 1984 (see Fig. 2). Our sample indicates consistency between cpu power (MIPs) and main storage growth rates.

Note: IBM XA and other information used in this article is based on data available from the manufacturer as of Mar. 1, 1983. Therefore, subsequently released information from IBM and its Early Support Program (ESP) sites may materially affect the author's views.

If IBM storage prices decline to about \$10K per MB in 1983 and to \$5K per MB by 1985, as we forecast, then memory expansion should accelerate over this three-year period. Thus, 2MB per MIP may represent an average ratio for large-scale systems by 1985.

Main storage capacity is the key limiting factor for performance growth. In the 1970s, programs were paged in and out of memory because of the lower density and higher cost of RAM chips. By the mid-'80s, many time-sensitive programs and data will remain resident in main storage, as the price approaches \$5,000 per MB and capacities approach 100MB or more.

Fig. 3 presents the DASD trends over time as reported by our survey. The average site had about 55.6 gigabytes (GB) of auxiliary storage in 1982 (a combination of 3350 and 3380 disks). This will grow to 91.4GB by 1985. Note the steady decline in 3350s and rapid increase in 3380s during this period, as the XA dynamic channel-reconnect capability is supported only with 3380 disks and their 3880 controllers. In addition, the 3380/3880 offers greater speed and capacity per dollar than the 3350. We expect IBM to introduce a double-density 3380 this year, with volume shipments to begin in 1984, thus stimulating further migration and growth to 3880s.

It is interesting to compute the ratios for MIPS, memory, and DASD over time. The trends (averages) indicate that by 1985 a typical large-scale site will include a processor complex of 23 MIPS, memory size of 29MB, and DASD capacity of 91.4GB. Most sites will have more than one cpu at that time. The ratio of DASD to cpu power is 4GB/MIP and the ratio of DASD/main storage is about 3GB/MB. As DASD capacities double to 5GB per spindle, faster access to data will become a critical issue and data staging (buffering) will increase in importance. IBM's 3880 controller will be expanded to handle these buffering requirements.

Terminal unit increases contrasted with communications line growth is illustrated in Fig. 4. Our sample shows an average user with 65 lines and 537 active terminals in 1982, growing to 91 lines and 880 active terminals by 1985—a final ratio of nearly 10 terminals per line. Naturally, the line speed and type of terminal used are important factors, but most terminals were of the IBM 3270 display type. A comparison of processor performance (MIPS) versus terminal ratio shows only 47 terminals per MIP in 1982, declining to about 38 terminals per MIP by 1985. The slow growth in terminal usage (compared to cpu, memory, and DASD growth) seems to contradict the other industry indicators. However, the fact that these sites are currently severely inhibited from increasing the number of active terminals because of MVS/SP 1.3 virtual private space limitations can ex-

FIG. 2

MAIN STORAGE GROWTH

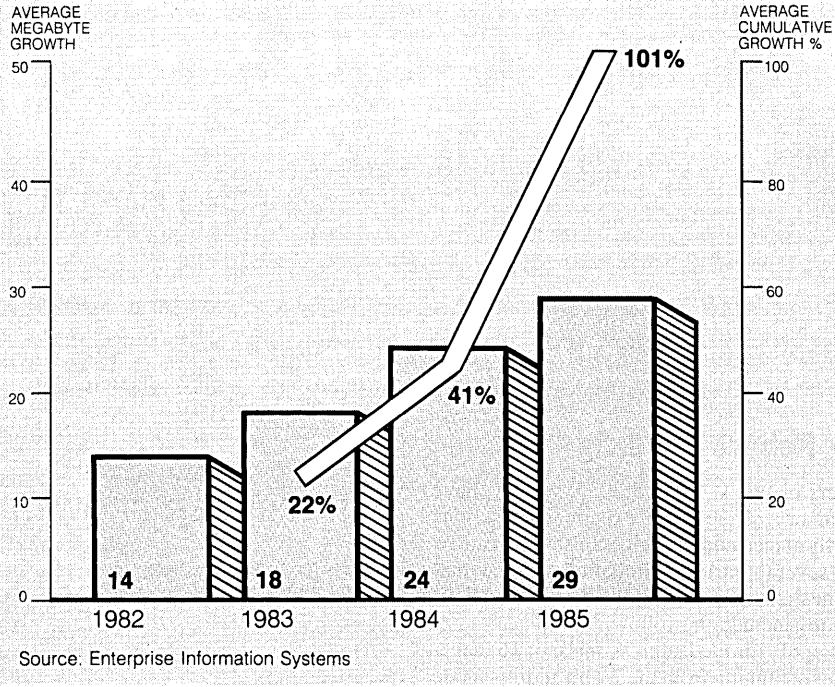
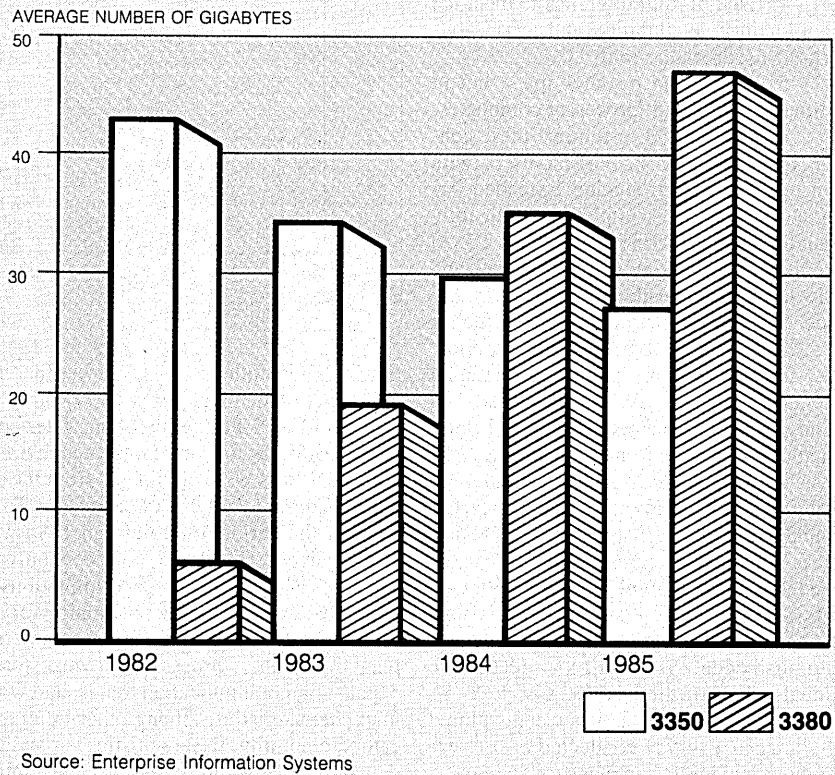

FIG. 3

DASD GROWTH



plain the shallow growth in this area. This relative decline is also reasonable if one considers the added functions (and cpu cycles) required to process a transaction by the mid-'80s. Extrapolation of these ratios suggests that a 2,000 terminal network will require at

least a 50 MIPS processor complex in 1985.

A forecast of large-scale site plans concerning cpu workload and workload characteristics (summarized by Figs. 5 and 6) shows that in 1982 average cpu utilization was 62% and peak was 85%. Note the great-

INTRODUCING

DAVID

IBM 3274 COMPATIBLE COAXIAL MULTIPLEXER

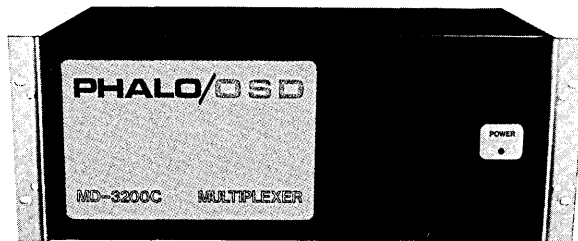

What is it?

DAVID is a multiplexer designed to allow the connection of up to 32 display devices (327X and 328X) into one 3274 at your central site, over a single coax or fiber cable, up to 5,000 feet distance. This is performed at local channel speed of over 2 Mbits/sec, not at 9600 bps like the current method.

Diagnostics?

Of course. PHALO integrates real diagnostics into every piece of communication equipment we manufacture. DAVID will self-test each of the 32 channels, end-to-end, with a true pattern recognition test, just like the expensive Bit Error Rate testers. Except that we include it for free.

You need fewer than 32 channels?

No problem. DAVID can start off with only eight channels and grow in increments of

eight channels as your system expands. You may add the cards yourself in the field, without paying for a service call.

Multidrop?

Sure! DAVID is available with a fiber optic link which "drops" up to four units of eight or multiple eight terminals in small clusters.

Expensive?

Hardly. A full 32-channel system will cost less than \$300 per channel. That's less than the price of the coax cable you'd buy to connect 32 terminals the old way. Far less.

If you would like DAVID to tackle your Goliath interconnect problems, contact:

PHALO/OSD
OPTICAL SYSTEMS DIVISION

9240 DEERING AVENUE
CHATSWORTH, CA. 91311
(213) 998-3177

A TRANSITRON COMPANY

CIRCLE 92 ON READER CARD

er-than-50% average cpu growth or demand for more MIPS each year and the 21% to 23% spread between average and peak cpu utilization between 1982 and 1985. Naturally, sites must base their upgrade plans on peak load expectations.

The workload mix trends through 1985 indicate a relatively low batch growth rate of 1.6 times; a moderate 1.9 times growth rate for transaction processing; and a huge increase in timesharing of 3.4 times. These values should be considered conservative because a typical banking transaction in 1985 should execute twice as many instructions as now, or about 500,000 with a one-second response time, according to Dr. Glen Bacon of IBM's General Products Division (GPD) in a recent public statement. A 25 MIPS machine, dedicated to transaction processing, may then, for example, support 50 transactions per second by 1985. IBM claims that half a million instructions per "average" transaction is required to handle the greater functionality needed at that time. This situation would further reduce the current (MVS/SP 1.3) virtual storage private area (VSPA), which in turn means that XA migration is the only solution.

Why the huge growth in the timesharing over this period? Transaction and batch processing represents a planned steady, probably predictable growth rate, while the professional terminal user (personal computer, graphics terminals, etc.) represents a new and less predictable surge in workload.

VSPA FORCES MIGRATION

The key driving force for users to migrate to XA is the VSPA problem (IBM likes to refer to it as "virtual storage constraint relief"). Among our sample firms (Fig. 5), 38% thought they were about to reach their VSPA upper limits in 1982, another 28% projected this stage for 1983, and still another 28% expected to exhaust their VSPA by 1984. All of the large-scale sites said they would run out of private space for their applications programs by 1985. A move to MVS/SP2 (XA) would immediately make available as much as 2MB of virtual storage, without converting 24-bit programs to 31-bit addressing or exploiting XA features. (It should be emphasized that not all users will gain the full 2 megabytes; the gain depends on many factors.)

Why didn't IBM anticipate this serious constraint and impact on its own revenue growth well in advance of the problem? Maybe it did forecast the VSPA problem, but could not respond in time with a viable 308X hardware and MVS/SP2 software solution. Moreover, if it were possible to provide a field upgrade kit (fix) for the older 303X series, that would impact future IBM sales of 308Xs. Alternative methods are, however, known to

FIG. 4

COMMUNICATIONS GROWTH

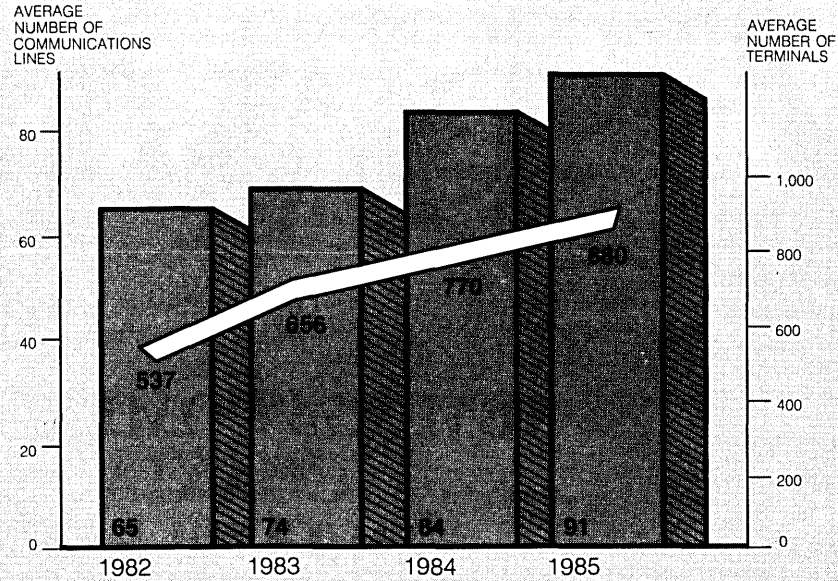

Source: Enterprise Information Systems

FIG. 5

CPU WORKLOAD TRENDS

	CURRENT STATUS 1982	GROWTH % EACH YEAR		
		1983	1984	1985
Average cpu Utilization	62%	53%	55%	58%
Peak cpu Utilization	85%	76%	76%	79%
Virtual Private Area Limits Reached	38%	28%	28%	6% = 100%

Source: Enterprise Information Systems

FIG. 6

WORKLOAD CHARACTERISTICS

	CURRENT STATUS 1982	GROWTH % EACH YEAR		
		1983	1984	1985
Transactions Per Day	116K	151K 32%	193K 26%	223K 16%
Batch Processing Load	1661	1985 19.5%	2191 20.6%	2651 21%
Timesharing Load	96	146 53%	230 58%	329 43%

Source: Enterprise Information Systems

The IBM Modem: high availability with rock-steady reliability.

A modem is only as good as its signal quality and its availability. The IBM Modem, thanks to an advanced IBM microprocessor, offers excellent signal quality, high availability and rock-steady reliability.

It shows its ability on networks large and small, especially the complex kind that present the toughest operating problems.

The IBM Modem helps you manage your network. For example, it continuously analyzes telephone line quality. If a line degrades, the modem adapts its signal so that data transmission is maintained. And, working with IBM software available for many host systems, it alerts the operator and pinpoints the source of the problem.

The IBM modem family includes the 3863, 3864 and 3865, with a line speed range of 2400 to 9600 bps. They work on standard, unconditioned lines, including switched lines. In point-to-point and multi-point configurations. With fast turnaround at all speeds.

Combine all this with IBM service and quantity discounts and you'll agree, IBM has the modem to meet your data transmission and network management needs.

For a free brochure or to arrange to have an IBM representative call you, telephone us toll free at 1 800 631-5582 Ext. 82. In Hawaii or Alaska, 1 800 526-2484 Ext. 82.

Try a set of IBM Modems for up to four weeks through the special IBM Modem trial program.

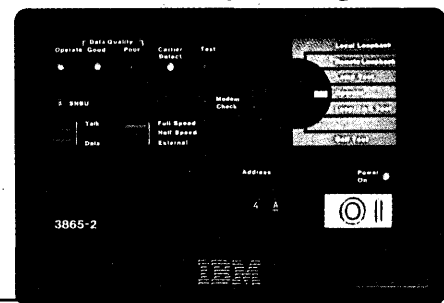

IBM Corporation
Direct Response Marketing
Department 7AG/522
400 Parson's Pond Drive
Franklin Lakes, New Jersey 07417

D-5-83

- Please have a representative call me.
- Please start me on the four-week trial.
- Please send me more information on IBM Modems.

Name _____

Title _____ Phone _____

Company _____

Address _____

City _____ State _____ Zip _____

MEMEMO

3270 Compatible Display Stations

Memorex is compatible.

When we say compatible, we mean plug-to-plug compatible. In monochrome or color. As you mix and match with Memorex, you'll protect in-place investments in applications programs, existing hardware and user training.

Memorex is reliable. We produce some of the most reliable products in the industry. Backed by a worldwide network of Memorex personnel dedicated to excellence. From production at headquarters to support in the field, you can count on us.

Memorex is user-friendly. Comfortable operators are more productive. So we led the industry by introducing a monitor that tilts so you don't have to. Our non-glare, smudge proof screen reduces eye fatigue. An operator information line keeps users aware of error conditions and helps reduce mistakes.

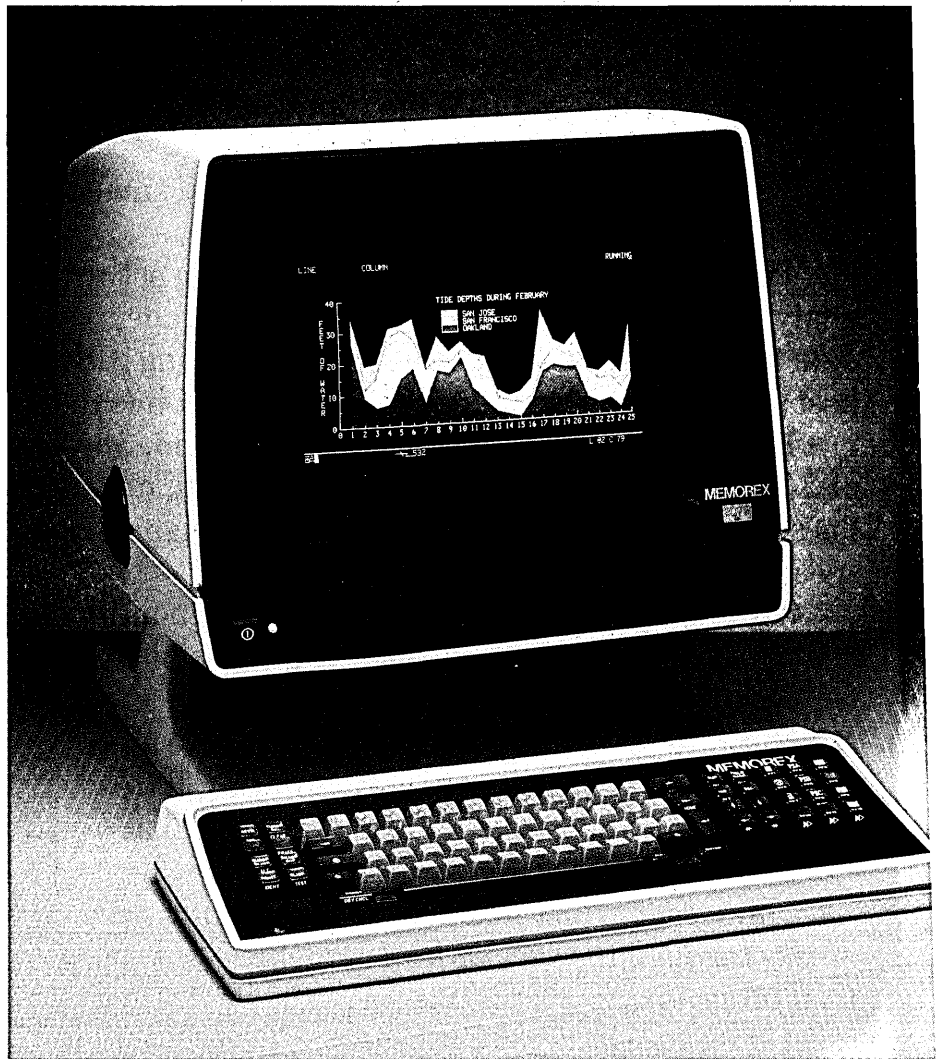

Memorex 2079 Color Display Station

Memorex is a leader. We're the only plug-compatible vendor with seven colors and graphics. And, our colors are crisper, cleaner and *always* in focus. By design, there is no need to perform time consuming convergence routines or to worry about magnetic fields that may interfere with the clarity of the display.

Memorex is productive. Graphics displayed on our screens allow you to absorb informa-

MEMOREX



Memorex 2078 Display Station

tion, spot trends and make decisions faster.

Memorex is economical. Along with being competitively priced, we save you money over the long haul. Our display stations use substantially less power than our competitors... up to 58% less. And if you leave the display unattended for more than 20 minutes, its screen will automatically dim to prevent screen burn, extend the life of internal components,

and conserve energy.

Memorex is flexible. We offer a full choice of models and a wide range of options including a selection of 16 keyboards. Plus our display stations function in bisynchronous and SNA/SDLC environments.

Memorex is available. Instantly, in many cases. Ask about our quick delivery program. You'll find that, when you need us, we'll be there.

Memorex is experienced. We offer computer peripherals and magnetic media of consistent quality to satisfied customers and have for over 22 years. Our worldwide sales and service organization spans the globe

providing you the best solutions and support.

So call us, now. Toll free, dial (800) 538-9303. In California, we're at (408) 996-9000. Ask for extension 616. Or write to us at 18922 Forge Drive, Cupertino, CA 95014-0784.

MEMOREX
A Burroughs Company

The estimated man-months to get to MVS 1.3 (positioning) ranged from 7.8 to 14.2.

be available to extend the life of the 303X, within limits, by expanding its capability in the field.

A clear picture of the expected movement from MVS releases 3.8 and SP1.1 to release 1.3 and then to SP2 (XA) is presented in Fig. 7. In 1982, about 5% were running MVS 3.8 and 3.0 each, and 45% were using MVS/SP1.1 and 1.3, respectively. A whopping 90% planned to move to 1.3 by year-end 1983. Only 10% expected to use MVS/SP2 (XA) in 1983, but this shifts dramatically to over 50% in 1984 and 90% by 1985. In spite of the survey results, EIS, Inc. does not expect more than 25% to 30% of IBM's large-scale base to migrate to XA by 1984, or approximately 60% to 70% to move by 1985. Why? Because IBM's systems engineers are not yet fully trained to handle XA and probably won't be until 1984, the VM/XA migration aid is not available until the fourth quarter of 1983, and, as always, it takes longer than expected to convert. (If 90% of the IBM sites were somehow able to move to XA by year-end 1985, the plug-compatible mainframe manufacturers would be seriously affected.)

Surprising and interesting is the fact that most users surveyed didn't know (or were unable to establish) what specific benefits they would gain from XA. Despite this, they are undertaking the costly conversion/migration to XA. Is this an example of the "herd instinct," or just good IBM salesmanship, or both? We researched these key issues and got the following answers from IBM: 1) eight early support sites realized 1.3 to 2.4 MB VSCR; 2) XA-improved I/O capability should translate to a 30% improvement in on-line response time; 3) a 10% to 30% reduction in software IPLs should be realized when XA replaces MVS/SP 1.3.

The "positioning" phase—a move from earlier versions of MVS to MVS/SP 1.3—ranges from 7.8 to 14.2 man-months, while the "migration" phase—MVS/SP1.3 to MVS/SP2—is expected to take between 17.5 and 32.4 man-months. The statistics on positioning for XA (moving to MVS/SP 1.3) should be considered more accurate than migration statistics because most of the sample sites had already completed the positioning stage. Three of the four systems still using MVS 3.8 thought it would require only 3.6 to 7.0 man-months to release SP1.3. These sites, we believe, are grossly underestimating the task. A more realistic estimate is probably double these values, judging by those who have already done the task. In contrast, the final migration to XA (from MVS/SP 1.3), we think, is probably grossly overestimated because getting to 1.3 is believed to be more difficult than moving to SP2.

Exploitation of XA is something else—that will take a long time, years. Exploitation involves redesigning old applica-

FIG. 7

OPERATING SYSTEMS MIGRATION PATTERN

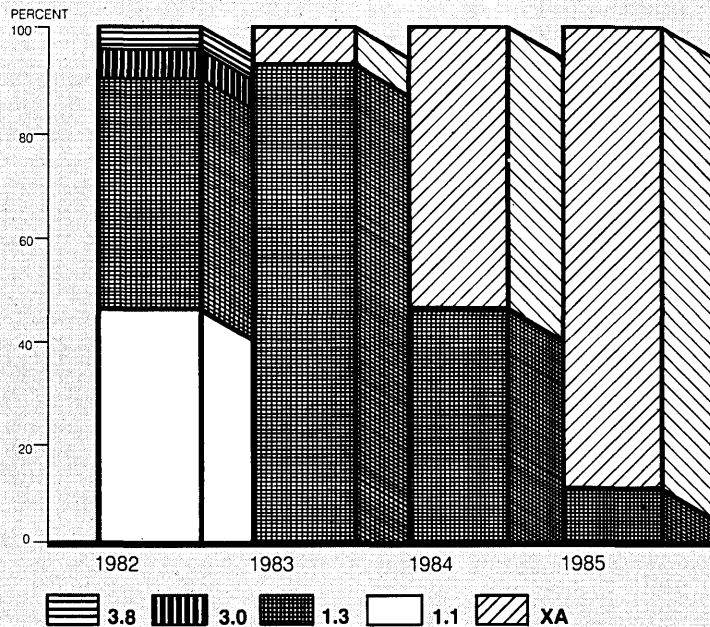

Source: Enterprise Information Systems

Note: Numbers refer to MVS releases.

tions to take advantage of larger storage sizes, new I/O capabilities, multiprocessing, and new functions. Many applications may not have to be changed, but some recompiling and lots of testing will be required. (Note that some of IBM's competitor systems are still limited in design to a maximum of 16MB and still others lack virtual storage features.)

MIGRATION TIME AND COSTS

Actual time and cost needed to migrate to XA depend on the state of the current system and subsystems software and applications code. However, the estimated man-months to get to MVS 1.3 (positioning) ranged from 7.8 to 14.2 man-months; the forecast for MVS 1.3 to MVS/SP2 (migration) was 17.5 to 32.4 man-months. Combining these values yields a minimum of 25.3, a maximum of 46.6, and an average of 36 man-months for our survey sample. If we use a \$6,000 monthly staff cost factor, the annual budget ranges from \$152,000 to \$280,000, for an average of \$216,000.

Later on, in the same questionnaire, we asked the user to give us his own bottom line estimate. The 53 sites responding claimed it would take a total of 32 man-months, at a cost of \$248,000. These values seem to fall within reasonable limits, if one compares them to our separate estimates, although the cost is slightly higher. The user estimates may be based on higher staff costs

and/or an inflation factor, which would explain the small difference. The higher estimates could also result from the fact that some customers have many assembler programs that depend on, or modify, control blocks. Still others have not stayed current with IBM's various releases for MVS, JES, IMS, CICS, NCP, VTAM, and other program products, or with independently supplied software packages.

Customers' views on IBM SCP license fees showed an average increase of monthly fees estimated at \$4,582 during conversion to XA and \$8,917 after conversion. We believe the monthly cost during conversion will be much greater than the cost after conversion/migration, since the site will be dealing with two sets of license fees on one or more systems during migration—both old and new software. (Again, user sites seem to have misjudged.) For example, the minimum annual charges should be at least \$120,000 when one considers the initial charges all required license fees and maintenance during conversion, but excludes fees for applications and other program products (Fig. 8).

IBM's customers on average were also planning for a 28% increase (compared to before conversion) in software fees during conversion, and a 34% increase after conversion to XA. If past IBM software (and services) pricing trends are indications of the future, then a 40% to 50% total increase between

BASF QUALIMETRIC™ A TOTALLY NEW DIMENSION OF QUALITY.



From BASF comes a totally new level of excellence in magnetic media—the Qualimetric standard, a standard so advanced that BASF FlexyDisks® are confidently backed by an extraordinary new lifetime warranty. The Qualimetric standard is maintained without compromise through every step of BASF design, production, inspection, and testing...reflecting an unwavering BASF commitment to media fidelity and durability.*

*Our FlexyDisk jacket incorporates a unique two-piece liner that not only traps damaging debris away from the media surface, but also ensures precise media-to-head alignment. The result—certified 100% error-free performance, backed by BASF's exclusive lifetime warranty.**

For information security, tomorrow and beyond, look for the distinctive BASF package with the Qualimetric seal. Call 800-343-4600 for the name of your nearest supplier.

ENTER TOMORROW ON BASF TODAY



BASF

*Contact BASF for warranty details. © 1982, BASF Systems Corporation, Bedford, MA

CIRCLE 95 ON READER CARD

FIG. 8

SAMPLE INITIAL FEES AND LICENSE CHARGES

	INITIAL COST	MONTHLY	MAINTENANCE
MVS/SP2	\$12,000	\$4,000	\$500
DFP	1,350	450	60
RMF V/3	2,100	700	80
TSO/E	1,560	520	80
ACF/VTAM	2,745	915	175
IMS		3,500	500
	\$19,755	\$10,085	\$1,395
		x 12	
		\$121,020	

FIG. 9

SUPPORT STAFF & GROWTH

FUNCTION	PERSONS			
Staff Support	82	83	84	85
System Software	13	14 8%	15 15%	16 23%
Application Software	106	114 8%	121 14%	127 20%
Other Staff	31	33 6%	35 13%	37 16%
Total Staff	150	161 7%	171 14%	180 20%

Source: Enterprise Information Systems

1982 and 1985 should be expected (budgeted) for all software—not just for systems-related program products. A compensating factor that would tend to reduce this “bubble effect” (double software fee) is the IBM five-month test allowance policy. Production programs, however, must pay the full fees.

STAFF SUPPORT FOR SITE

Staff requirements to support a typical IBM large-scale site are projected in Fig. 9. As indicated, in 1982 the average site required 150 people—13 systems specialists, 106 applications developers, and 31 other personnel (management and operations). If we assume an average annual cost of \$48,000 per person, including fringe benefits and overhead, but excluding inflation, the yearly staff budget would be approximately \$7.2 million. Obviously, the range would vary substantially, based on the size of the installation, the workload, application development emphasis, and industry.

The cumulative growth in staffing is expected to be 20% between 1982 and 1985, producing a total average staff of 180 during that time. Note that the systems staff grows faster (23%) than the applications group (20%) over the three-year period. Thus, XA conversion/migration should also cause a kind of bubble effect, i.e., less resources to be available for the important application development activities during this positioning and migration, followed by more systems people being freed afterwards to support applications activities.

A comparison of systems staff requirements with non-IBM computer sites may prove interesting. EIS, Inc. believes that the large-scale sites of some IBM competitors like Burroughs, Univac, and Honeywell may require fewer systems specialists because IBM MVS sites are generally more complex.

COBOL continues to live on. About 74% of all the applications surveyed were developed using this compiler. Note that an XA version of COBOL has not yet been announced and this could delay migration. FORTRAN and Assembler show only a 4% and 6% usage factor, respectively; however, all high-level languages call upon modules of assembler code. Why then did IBM announce XA versions of Assembler and FORTRAN ahead of COBOL, PL/1, and IMS? The possible answers are poor planning, lack of internal resources, or the complexity factor (i.e., IBM converted the easiest software first).

Statistics collected on the number of programs that modify control blocks or are dependent on existing control block structures or locations (those which have nonstandard interfaces) revealed that few sites have a major problem. The range was from 0 to 400 programs, with an average of 48 programs

per site. About 35% of the sites did not allow many nonstandard interfaces or dependencies on control blocks, although many of the independently supplied software packages were affected.

Since there are large and small systems programs and applications, both critical and otherwise, which may be affected by the XA conversion, there was admittedly room for more specificity in this question. Note also that 42% of approximately 600 MVS control blocks have either been changed, moved, or eliminated with XA.

SITES STATE XA CONCERNS

In our survey we asked the sites to list their independent software usage and state their specific concerns related to XA. A long list of packages was given, but the most frequently listed were Librarian, Syncsort, Panvalet, SAS, UCC-n, Ramis, FDR, Total, Focus, MSI, Resolve, and ADABAS.

Typical (sample) concerns about packaged software and XA are as follows: “Most [packages] use assembler and reference MVS control blocks; will that delay my conversion?” “If IBM cuts back on microfiche [or source code] will the software vendors have a hard time?” “Compatibility and ease of conversion.” “Will the code run above the 16MB line?” “Timeliness.” “Sup-

port for 31-bit addressing.” “Nonstandard MVS interfaces.” “Performance.” “Software vendor cost-justification in adapting to XA.” “Will they work?”

The availability or lack of source code and MVS/SP2 interface information is probably the key issue. It may not be in IBM's best interest to release detailed XA specifications, since the plug-compatibles would benefit from such revelations. Yet to not release any details would clearly impact (if not destroy) the marketability of some major independently supplied software.

Furthermore, some of IBM's best and biggest customers are dependent on this software; therefore, the company cannot afford to ignore their concerns. IBM claims that a number of independent software suppliers worked closely with the eight early support program (ESP) test sites and these sites had few problems interfacing to MVS/SP2 (XA). Note: On Feb. 8, 1982, IBM announced a new policy on the distribution of its license programs and materials. Essentially, IBM will provide entry and exits for “selected” program products (not detailed specifications) for most XA systems products. Source code will be available, but will only be released if IBM believes it is necessary, and then only on a restricted basis.

If a “typical” large-scale IBM customer site was spending \$7.2 million (aver-

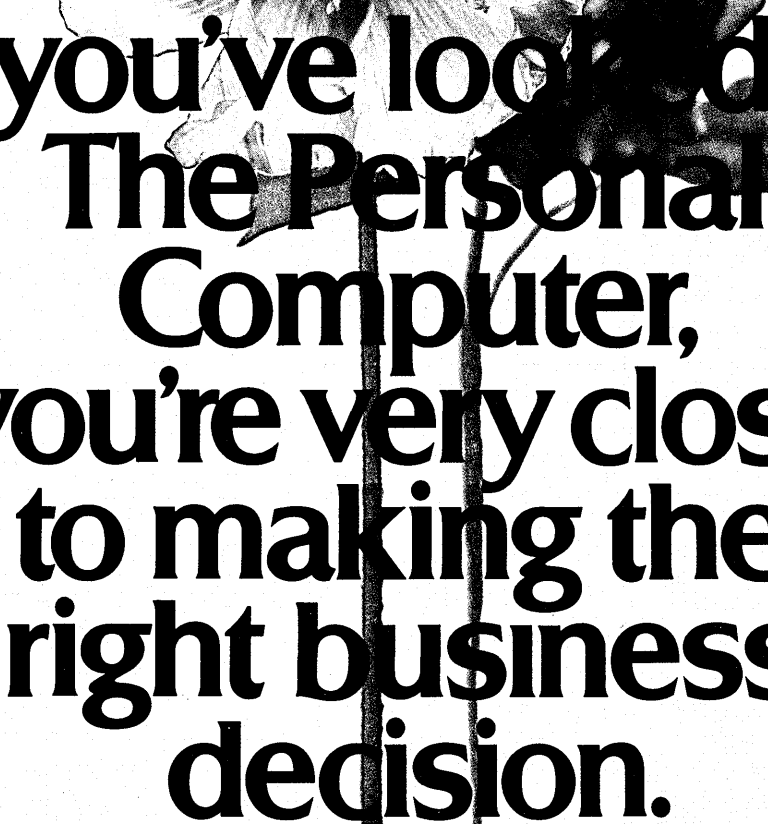

If you've looked at The Personal Computer, you're very close to making the right business decision.

The next step is to look at Poppy,[™] the expandable Personal Business System. "Personal," because it is easy-to-use even for the first-time computer user. "Business System," because it has the power, programs and expandability needed in a business environment.

You won't outgrow Poppy because you can add to your system. And that means you won't have to make another computer buying decision in the future. If you need more power—add storage to Poppy. If you need more workstations—add them, up to 12 whenever you are ready.

Poppy is the technically advanced system for business with a 16 bit processor, a detachable typewriter-

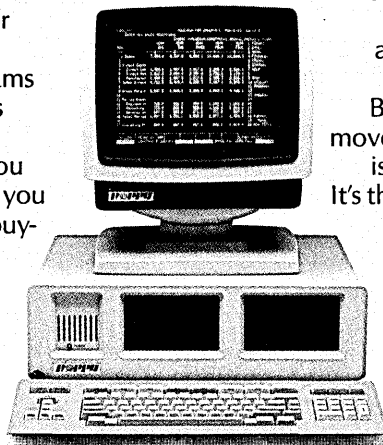

style keyboard, a 14" tilt/swivel monitor, and industry-standard operating systems. Plus it runs proven business programs such as financial planning, word processing, general ledger, and dozens of others. Buying a personal computer is the right move for any business. But, buying a Poppy is the right move now, and in the future. It's the Personal Business System that grows with you. Call (800) 327-6779 for the name of your local Poppy dealer.

POPPY[™]
The Personal Business
System. By Durango

Poppy is a trademark of Durango Systems Inc. © 1983 Durango Systems Inc.

CIRCLE 96 ON READER CARD

TAILORED TOOLS.

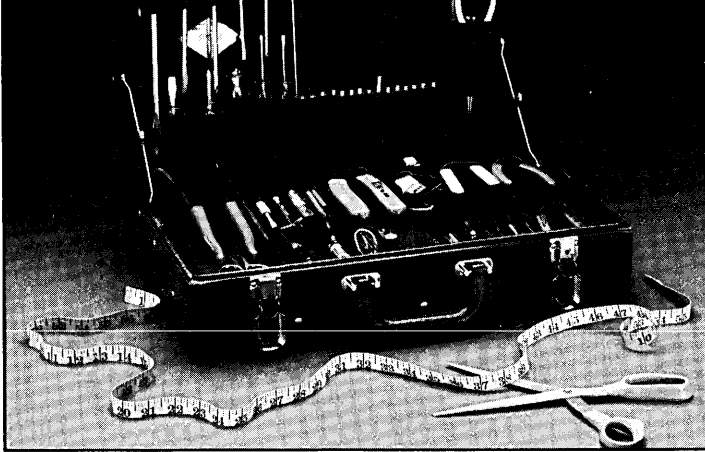

Computers, business machines, electronic systems... whatever your field, we have the tool kits your service personnel need for installation and repair of virtually any electronic equipment, including the newest state-of-the-art hardware. Our kits are designed from a wide variety of manufacturers and our own 15,000 item inventory, so that you get only the tools that are specifically tailored to your unique application. We can even custom-design a kit for you at a cost that's lower than if you did it yourself, and an enormous savings in time. Contact us for a copy of our new catalog and discover our high quality products, competitive prices, and timely service. At Specialized Products, the "special" is you.

SPECIALIZED PRODUCTS COMPANY

2324 Shorecrest Drive Dallas, TX 75235

Toll Free: 800/527-5018

CIRCLE 97 ON READER CARD

Get the programmers you need from a leader in computer training.

Control Data Institute (CDI) is one of the world's leading EDP entry-level personnel training organizations, and an educational service of Control Data Corporation.

CDI graduates are trained in popular languages and qualified to work with virtually all modern hardware and systems. For information about nationwide cost-free recruiting, write Ron A. Williams, HQA02J, Control Data Institute, P.O. Box 1903, Twin Cities Airport, MN 55111 or call collect now. (612) 853-5249

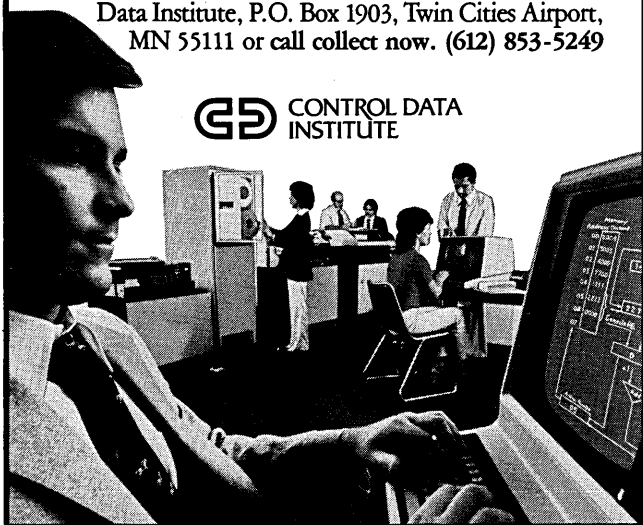

CIRCLE 98 ON READER CARD

age) for a staff of 150 in 1982, then you might argue that a quarter-million dollar cost for conversion and migration to XA is a relatively small price to pay (less than 3.5%). If we exclude the costs for applications and other staff and compare this total estimated XA expense (for both positioning and migration) to the cost of people (systems staff) responsible for migration ($14 \times \$48K = \$672K$) in 1983, then the \$250,000 cost to get to XA represents about 37% of the systems staff budget.

Extra hardware costs during migration are also not insignificant. While one may position to MVS 1.3 using current 3033 hardware and generate the MVS/XA operating system, the essential testing must be done on either a dedicated 3083 or one half of a diadic 3081 (the other half can be running production work). If we assume a total elapsed time, of say, three to six months for test and stress analysis that's a few hundred thousand dollars added on. But why spend anything to migrate if you cannot quantify the benefits to be realized?

IBM has an interesting dilemma: if MVS/SP2 performance (as demonstrated by early benchmarks) is about equal to MVS/SP1.3, then many customers may delay the move to XA. On the other hand, if MVS/SP2 performance represents a quantum performance boost (25% or better), then many customers will rapidly migrate to XA, but may also delay their next processor upgrade (or actually downgrade to a smaller 308X processor), thus impacting IBM revenues.

The latter case would also destroy 303X residual values, which are already eroding rapidly, and impact software-compatible manufacturer profit margins for such suppliers as Amdahl, NAS, Fujitsu, and Hitachi. Clearly, severely constrained systems that are running out of virtual private area or are inhibited by other hardware/software architectural restrictions should show substantial performance improvements.

As reported earlier, 38% of the users surveyed said they would be constrained by year-end 1982. Most sites also stated that they expected to bump up against such performance inhibitors before 1985. These customer sites have no choice but to move to XA if they are to support their workload growth rates as previously indicated. Their virtual storage private area (VSPA) limit will reach a crisis level and without much warning the system will go down.

So the snowball is beginning to roll downhill. Momentum is building for a massive migration to XA by the mid-1980s. This time around, IBM has learned some lessons from the past—it will not subject customers to the difficult and expensive conversion problems of the early '70s (e.g., the MVT to MVS fiasco)—but the move to XA will not be a free or painless one either. *

Robert T. Fertig is president and founder of Enterprise Information Systems Inc., Greenwich, Conn, which offers for sale copies of the full XA survey results.

The new COMPAQ Portable Computer. IBM compatibility to go.

Simple, isn't it? The COMPAQ™ Portable Computer can do what the IBM® Personal Computer does. To go.

It runs all the popular programs written for the IBM. It works with the same printers and other peripherals. It even accepts the same optional expansion electronics that give it additional capabilities and functionality.

There's really only one big difference. The COMPAQ Computer is designed to travel.

Carry the COMPAQ Computer from office to office. Carry it home on the weekend. Or take it on business trips.

If you're a consultant, take it to your client's office.

If you use a portable typewriter, you can use the COMPAQ Computer as a portable word processor instead.

If your company already uses the IBM Personal Computer, add the COMPAQ

you'd probably need to buy an additional display screen because the built-in screen is too small for certain tasks, like word processing. The COMPAQ Computer's display screen is nine inches diagonally, big enough for any job, and it shows a full 80 characters across. And the built-in display offers high-resolution graphics and text characters on the same screen.

The bottom line is this. The COMPAQ Computer is the first uncompromising portable computer. It delivers all the advantages of portability

In the standard configuration, the COMPAQ Computer has three open slots for functional expansion electronics as your needs and applications grow. It accepts standard network and communications interfaces including ETHERNET™ and OMNINET™.

If you're considering a personal computer, there's a new question you need to ask yourself. Why buy a com-

puter that isn't portable?

For more information on the COMPAQ Portable Computer and the location of the Authorized Dealer nearest you, write us. COMPAQ Computer Corporation, 20333 FM149, Houston, Texas 77070. Or call 1-800-231-9966.

without trading off any computing power capability. And what do those advantages

cost?

Nothing.

The COMPAQ Portable sells for hundreds less than a comparably equipped IBM or APPLE® III. Standard features include 128K bytes of internal memory and a 320K-byte disk drive, both of which are extra-cost options on the IBM. Memory and additional disk drive upgrades are available options to double those capacities.

Portable as a mobile unit that can use the same programs, the same data disks, and even the same user manuals.

There are more programs available for the COMPAQ Computer than for any other portable. More, in fact, than for most non-portables. You can buy them in hundreds of computer stores nationwide, and they run as is, right off the shelf.

With most other portables

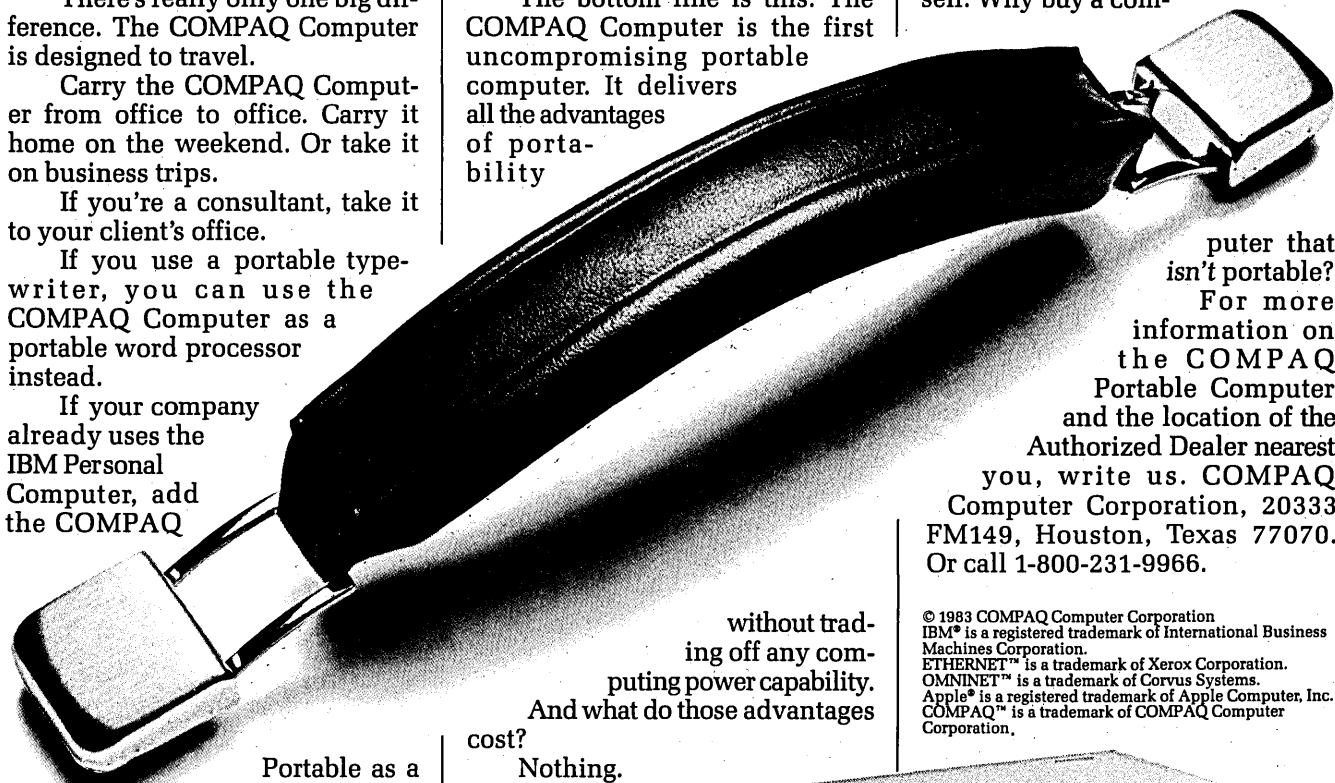

© 1983 COMPAQ Computer Corporation
IBM® is a registered trademark of International Business Machines Corporation.
ETHERNET™ is a trademark of Xerox Corporation.
OMNINET™ is a trademark of Corvus Systems.
Apple® is a registered trademark of Apple Computer, Inc.
COMPAQ™ is a trademark of COMPAQ Computer Corporation.

COMPAQ™
PORTABLE COMPUTER
The most computer you can carry

CIRCLE 100 ON READER CARD

IBM's XA product administrator describes the system and tells users what they'll have to do to get there.



THE VIEW FROM WHITE PLAINS

by Ronald L. Bond

The evolution of the OS operating system began in the mid-'60s with IBM's introduction of the System/360 computer line. It continues today with the release of the Extended Architecture (XA) for the 308X line of large-scale computers. Combining new elements of software and hardware, XA brings large-scale users new levels of functionality, reliability, and usability while maintaining a large degree of compatibility with previous programming environments.

A brief review of the history of the OS operating system will set the stage for an in-depth review of the features XA brings to users, the methods used to exploit the architecture's full potential, and the best means of migration.

The original OS/360 was a real storage operating system. It was designed to run on System/360 computer models. That combination was superseded in 1972 by OS/SVS, which brought IBM users the benefits of virtual storage for the first time. Again, compatibility was maintained with the most recent version of OS/360—the MVT system. Soon after, in 1974, IBM came out with OS/MVS, which, running on System/370 hardware, provided multiple virtual storage address spaces of 16 megabytes to each of several concurrent system users.

MVS continued to be IBM's primary large-scale operating system, with periodic enhancements to accommodate new hardware and provide additional functionality to 370, 303X, and 308X users. As larger capacity processors became available, however, it was found that balancing system resources such as virtual and real storage and input/output became increasingly difficult. Applications used more on-line database management systems and sophisticated networking. MVS subsystems themselves demanded additional resources to provide their increased functionality.

The MVS operating system's resources management algorithms were sensitive to the

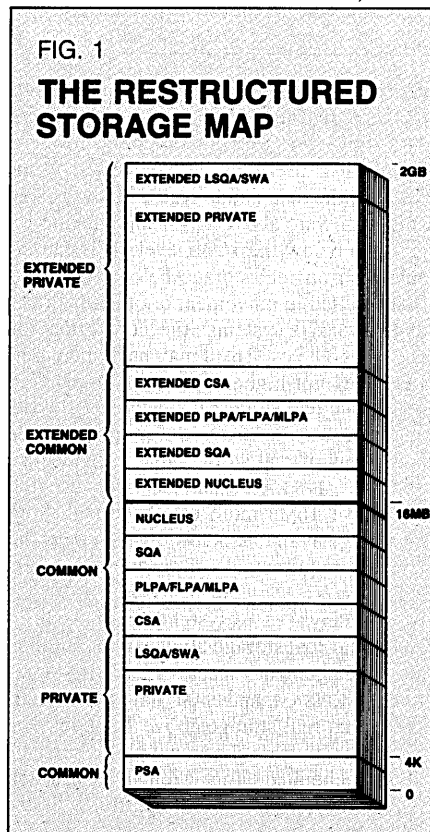

amount of particular system resource they could manage: they could easily manage small amounts, but increased operating system overhead could be incurred when large amounts of resource were called upon by increases in user workload.

Recognizing that trend, IBM in 1976 began to develop a new system architecture. Introduced in 1981 as System/370 Extended Architecture (s/370-XA), the new combination of hardware and software was designed to take full advantage of IBM's large processors and additional system resources and provide increased capacity.

The new s/370-XA is supported by an enhanced MVS operating system known as

MVS/XA that uses subsystems designed to run with MVS/370 so that only the BCP and data management functions need be changed. The new hardware and software team up efficiently to manage the system resources of processor, virtual storage, real storage, and I/O. Achieving a balance between those resources in today's increasingly complex system environments is the goal of Extended Architecture. What follows is a review of the benefits XA brings in the areas of increased capacity for growth, better RAS (reliability, availability, and serviceability), and productivity.

There has been rapid growth in installed hardware capacity in recent years. MVS/XA focuses primarily on providing a system software base for expansion in the amount of workload an installation can handle, while balancing the use of system resources. It extends the capacity of a system by supporting s/370-XA. MVS/XA takes advantage of extended virtual storage, extended real storage, and the I/O capabilities of the dynamic channel subsystem.

EXTENDED VIRTUAL STORAGE

In many large installations the combination of operating system, subsystem, user application programs, and data requires more than the 16MB of virtual storage available. The most used area of virtual storage has been the MVS Common Service Area (CSA), which is concurrently available to all users.

CSA may require over half of the total available virtual storage as additional system functions are provided and installations implement large database/data communications networks with complex workloads. As the workload increases, the requirements for CSA grow larger. MVS/XA introduces 31-bit virtual storage addressing that supports up to 2 gigabytes (2048MB) in each address space, 128 times larger than that of MVS/370 (see Fig. 1).

The virtual storage map has been restructured to use the 2 gigabyte (GB) address space. The extended virtual storage area (above 16MB) and the nonextended virtual

MVS/XA introduces 31-bit addressing that supports up to 2 gigabytes in each address space, 128 times larger than that of MVS/370.

storage area (below 16MB) are treated externally by MVS/XA as a single logical area. The map may be viewed as being in two parts. The nonextended virtual storage area consists of a common and a private area, much as it did in MVS/370, and can be accessed by either a 24-bit or a 31-bit virtual storage address. The extended virtual storage area can be accessed only by using 31-bit virtual storage addresses.

A number of the BCP subcomponents have been rewritten to run in 31-bit addressing mode and have relocated modules and control blocks to the extended virtual storage area. Thus, the new virtual storage structure becomes the basis for making virtual storage available in the nonextended virtual storage area where today's 24-bit applications run.

With few exceptions, existing programs and data can continue to operate in 24-bit addressing mode without change while portions of the MVS/XA operating system operate in 31-bit addressing mode. S/370-XA and MVS/XA provide a bimodal addressing capability to protect the investment in 24-bit programming. Most 24-bit problem programs that adhere to external interfaces will execute without modification as MVS/XA system services take care of switching the mode.

A program can execute instructions in either 24-bit addressing mode, just as in the S/370 architecture, in 31-bit addressing mode, or in a combination of both. Special instructions are provided to facilitate an orderly conversion of 24-bit programs to use 31-bit addressing. This bimodal capability allows a program to change modes during execution or to provide different interfaces for use from either addressing mode. Bimodal addressing is very efficient since both 24-bit and 31-bit instructions execute at native speeds—there is no performance implication associated with either.

MORE VIRTUAL STORAGE

Laboratory measurements indicate that MVS/XA (at the MVS/SP 2.1.1 level) makes available from 1.8MB to 2.1MB of additional virtual storage below 16MB as compared to MVS/SP 1.3.0. This may allow expansion of existing programs, increased number of terminals, and greater workload. The extended virtual storage area can be used for development of new applications (e.g., large teleprocessing and database networks), particularly those with large data requirements, and subsystem extensions.

Increased capacity below 16MB means that many installations will incur less manpower costs to manage and tune virtual storage, and those installations that have not needed to consider virtual storage tuning to date may never need to.

The S/370 architecture was extended

FIG. 2

THE NEW UPPER LIMITS

	S/370-XA	MVS/XA SOFTWARE	3083 WITH MVS/XA	3081 WITH MVS/XA	3084 WITH MVS/XA
Devices	65,536	4,096	4,080	4,080	4,080
Channel Paths	256	256	8-24	16-24	48
Paths Per Device	8	8	4	4	4
Real Storage	2048MB	2048MB	8-32MB	16-XXMB	32-64MB
Virtual Storage	2048MB	2048MB	2048MB	2048MB	2048MB

over time to provide for the attachment of up to 32MB of real storage; the real storage above 16MB, however, was not supported for user I/O. When a user program requested I/O in MVS/370, the data had to reside below 16MB. If the data were above 16MB, they had to be moved to below the 16MB level. This caused contention on real storage below 16MB and often resulted in movement of other data. On 32MB MVS/370 systems, the contention for real storage below 16MB may have increased as I/O rates got higher.

The real storage manager was rewritten for MVS/XA to provide a more homogeneous view of real storage than provided by MVS/370. MVS/XA system services use the area above 16MB more effectively, making real storage available below 16MB to meet the increased requirements of programs and services.

Many MVS/XA system areas have been placed into real storage above 16MB, and the data management access methods (SAM, DAM, PAM, VSAM, and ISAM) have been modified so that real storage above 16MB may be used for I/O buffers. For example, when IMS/VS is generated for exclusive use on MVS/XA, certain database I/O buffers will use real storage above 16MB.

Several system resource management facilities have been improved to lessen the large system effects of increased capacity. For example, the storage allocation lock has been broken into a number of smaller locks to reduce lock contention in multiprocessing 3081 and 3084 environments. Also, MVS/XA page frame search algorithms have been shortened to minimize the effects of lengthening page frame queues.

Most application programs have no dependencies on real storage; therefore, changes in MVS/XA to better utilize real storage over 16MB will be transparent. For some current application programs that execute virtual-real (V-R) or that use EXCPVR, real stor-

age below 16MB is required, and the real storage manager will supply it at program initialization or when a page fix is requested.

In S/370-XA, the dynamic channel subsystem performs the S/370 channel functions. The dynamic channel subsystem is an independent microcoded processor that is connected to the processor and memory of the 308X processor family.

The I/O supervisor (IOS) in MVS/XA has been completely rewritten to support the new dynamic channel subsystem, to provide large I/O configurations and to support 31-bit addressing. Some of the IOS functions have been transferred to the microcode of the new dynamic channel subsystem, thereby simplifying I/O initiation.

Selection of a path to a device is handled by the microcode of the channel subsystem. Each device supported by MVS/XA can be connected to four channel paths. The channel subsystem handles device- and path-busy conditions.

Although IOS now runs in 31-bit addressing mode, compatibility interfaces have been maintained for existing 24-bit programs that use the standard data management access methods or the EXCP processors.

As Fig. 2 indicates, S/370-XA will support a theoretical maximum of 65,536 devices, 256 channel paths, and eight paths per device. The initial MVS/XA software implementation with S/370-XA supports a maximum of 4,096 devices. The 308X processor family implements up to 4,080 unique device addresses and four paths per device. The remaining 16 device addresses are used for internal communications. The number of channels and real storage supported is dependent on machine model.

In comparison, MVS/370 had a theoretical limit of 1,917 devices. Owing to the way MVS/370 managed the internal control structures that represented the devices, however, the practical limit was quite a bit less;

What's Behind the Supermux 380 Multiplexer?

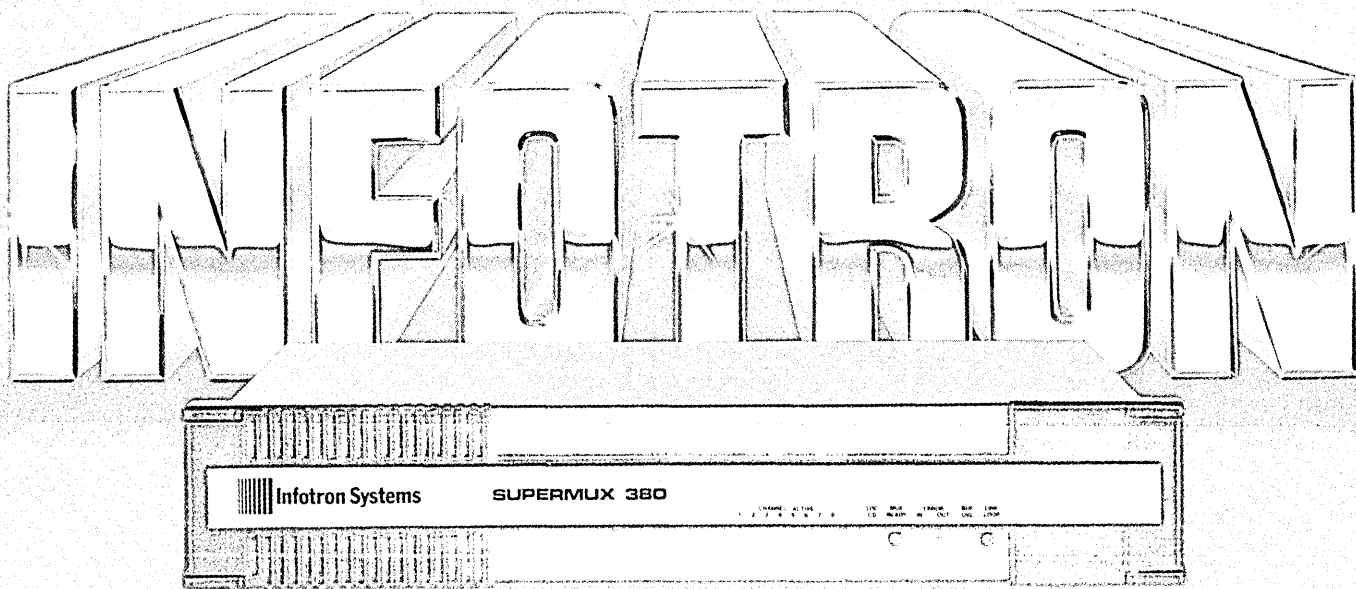

The Foremost Company in Data Communications

Moving data over telephone lines is costly and hazardous. Supermux 380 statistical multiplexers reduce the costs. Infotron Systems Corporation eliminates the hazards.

Supermux 380 multiplexers reduce the costs by concentrating data from up to eight asynchronous terminals over a single telephone line. You save the cost of extra telephone lines and modems and you also enjoy protection from line "hits"

that can cause errors. Data is checked and retransmitted, if necessary, all transparent to your existing hardware and software.

Infotron Systems Corporation eliminates the hazards. For 14 years we have been building data communications systems for thousands of customers worldwide. Our products cover the full range, from simple LDMs to sophisticated network concentrators. You get the benefits of

our diverse experience—the Supermux 380 includes many large system features, capabilities and safeguards. Don't settle for less.

Infotron has also made it easy for you to get started by providing local support, before and after the sale. We've set up a network of qualified distributors with experience on IBM, DEC, Data General and other systems. Call the foremost company in data communications. Call Infotron.



Infotron Systems

First in Performance and Reliability

Infotron Systems Corporation, Cherry Hill Industrial Center, Cherry Hill, New Jersey 08003
Telephone: 800-257-8352 609-243-9400 TWX: 710-940-1247

AL: HallMark (205) 837-8700. CA: Advanced Technology (415) 785-8345/Dayton-Forester Assoc. Inc. (714) 978-7455. (218) 701-0127/HallMark (618) 289-1201. (609) 778-9990/Cherry Hill, N.J. Company (218) 925-7745. (415) 982-2452. (714) 834-2200. (618) 624-8050. (415) 982-8957. CO: HallMark (800) 684-1662. CT: General Technology, Inc. (603) 777-1189/HallMark (603) 974-9230. (603) 855-4020. (618) 575-9999. GA: Atlanta Associates, Inc. (404) 457-0116/General Technology, Inc. (404) 455-0350/HallMark (404) 447-3000. HI: HallMark (813) 830-3300/Interbusiness Corp. (612) 459-8888. IL: KS: HallMark (618) 888-7277. MD: Emp. Systems, Inc. (301) 842-2520/HallMark (301) 798-3300. MI: Peripheral Integration, Inc. (616) 924-2020. (601) 925-2140. MA: Butler Associates, Inc. (617) 864-5270/Marketechs, Inc. (617) 237-4848. MN: Harris/Rep. Co. Minnesota (612) 844-2097/HallMark (612) 484-0088. MO: HallMark (314) 291-8850. NC: HallMark (609) 424-7300. (201) 575-4415/Hansen & Hughes (201) 652-7055. (800) 526-5411. NY: Reactive Systems, Inc. (914) 365-0325. NJ: General Technology, Inc. (618) 854-8520/HallMark (618) 832-4185. OH: Ohio Distributor Co. (518) 485-4240/HallMark (216) 478-2207. (611) 891-5555. OK: HallMark (918) 365-3200. PA: Erie Distributor Co. (412) 366-5036/Incocon, Inc. (215) 687-9930. TX: Computer Associates, Inc. (214) 632-1120. (714) 974-8002/HallMark (512) 258-8848. (214) 681-1177. (714) 781-6100. VA: Virginia Data Communications Service (804) 857-4269. WA: Sili Corporation (206) 768-8981. (206) 693-2085. WI: HallMark (414) 781-0500.

CIRCLE 101 ON READER CARD

It's time you
business presents

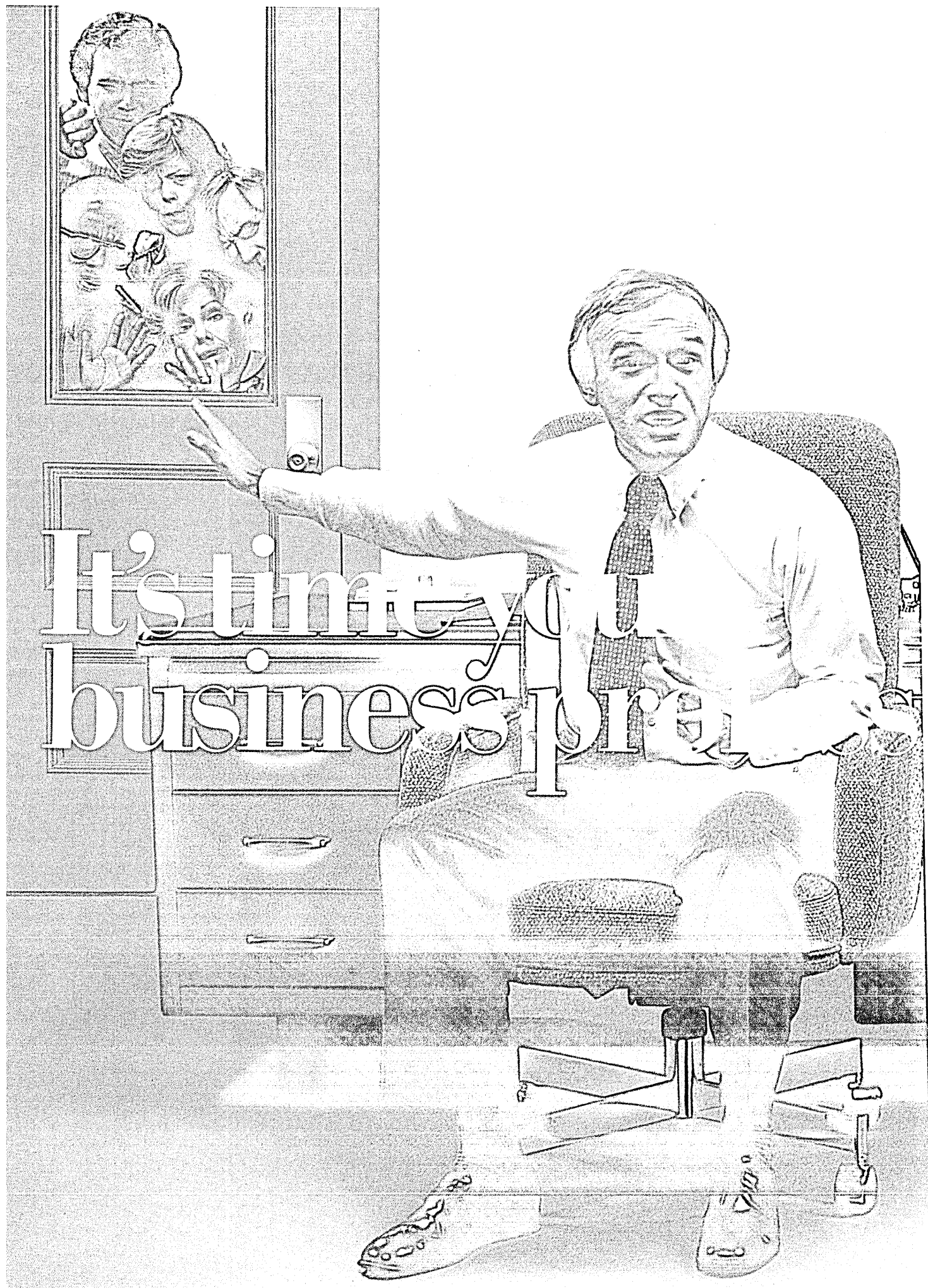

If managers, decision-makers and technical users aren't knocking down your door, they are finding other ways to meet their needs. Business professionals want answers now.

To give them what they want, install the IBM Business Professional System.

At one stroke BPS gives your users all the facilities they need most, from query and report writing to color graphics, electronic mail and document preparation. In its pre-generated form BPS is an "off-the-shelf" product you can install in less than one day on an IBM 4331.

Together, the BPS components give your users the capabilities they most urgently want: To extract information and create

reports that assist in decision-making. To manipulate planning forecasts and ask "what-if" questions. BPS provides computerized business communications. And the personal support of calendar maintenance, task management and directory services.

Supported by the VM operating system, BPS includes all the software you need to provide a full-fledged corporate or distributed Information Center. And as your business professionals get their own answers, your DP professionals will have more time for the work that only they can do.

Learn what the Business Professional System can do for you and for your company. Call your local IBM representative today or return the coupon.

CIRCLE 102 ON READER CARD

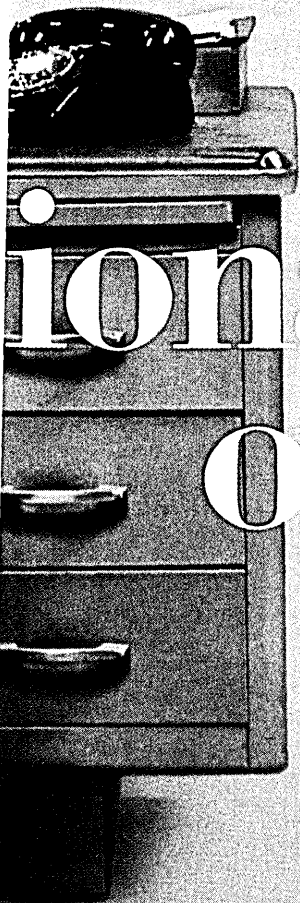

Business professionals got their own answers.

D-5-83



R.H. Torgler
IBM Business Professional Center
10215 Fernwood Road
Bethesda, MD 20817

- Please send me more information on the IBM Business Professional System.
- Have a representative contact me.

Name

Company

Title

Address

City

State

Zip

Phone

The new I/O reconnection facility offers new options to configuration and capacity planners.

typically, installations were unable to define more than about 1,400 devices.

When many local devices were defined, or when a common MVS/370 system was defined for use across multiple systems, MVS/370 often would not allow definition of enough different devices. This led to specialized system definitions and more complex system management. When a system outage occurred, and work required movement from one system to another, the target system had to be reinitialized with a different set of definitions. That could significantly hamper recovery.

PLAN ON SMOOTHER RECOVERY

Because MVS/XA has expanded the device definition capability, installations can plan on larger configurations and smoother recovery in these environments. The dynamic channel subsystem connects all devices and channels in a single logical group whether there is one processor as in a 3083, two as in a 3081, or four as in a 3084. There are no channel sets as were found in S/370 and no associated algorithms to direct I/O to start from a specific processor because of channel affinity. Also, any processor in a 3084 or 3081 can process I/O interrupts no matter which processor initiated the request. These enhancements should improve responsiveness of the system.

A laboratory experiment was run to demonstrate the combination of the 308X dynamic channel subsystem, MVS/XA, and the 3880/3380 I/O subsystem. The 3880 direct access storage device (model AA4) has a capability called dynamic path reconnection (DPR) that allows the controller in the 3380 to switch to an alternate 3880 storage control (or second 3880 storage director) should the first 3880 storage director be busy.

In the experiment, a group of synthetic programs accessed 6KB records from the 3380s using direct access storage device (DASD) files but without seeking (i.e., moving the DASD heads). Other programs created I/O work on 3350 DASD on the same channels to provide differing levels of channel utilization. The 3380 I/O rate was held constant. Fig. 3 shows the results. When DPR was not in use, the rotational delays increased as the average channel load increased. When DPR was used, the I/O response time did not deteriorate nearly as rapidly as average channel utilization increased, showing that reconnection through the alternate I/O path was generally successful. As a result, with MVS/XA and 3380 DASD, DPR installations may see up to an additional 70% in channel capacity at equal response time, or up to a 30% improvement in response time at equal capacity.

This new I/O reconnection facility offers new options to configuration and capacity planners. Clearly, the I/O subsystem, when

FIG. 3

RESULTS OF THE DPR EXPERIMENT

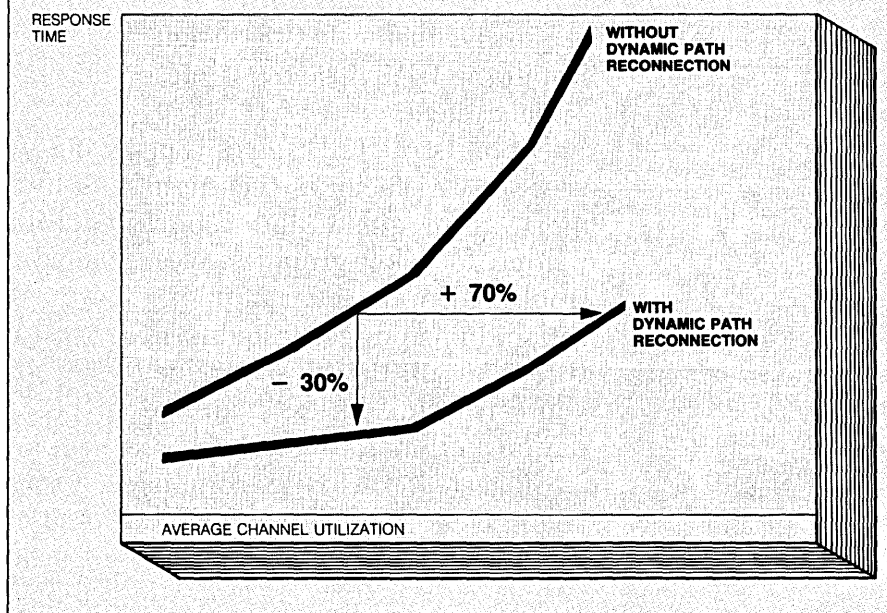

primarily configured with 3380s, is far less sensitive to channel utilization. That should reduce the fluctuations in user response time due to I/O load and automatically provide better load balancing within the available configuration. An installation could well take the approach of managing channel utilization to reduce I/O response time.

The above improvements in system resources allow MVS/XA to maintain higher levels of balancing and offer significant increases in system capacity. MVS/XA can support significantly larger systems than prior MVS/370 systems.

The additional virtual storage available with MVS/XA below 16MB can be directly translated into additional users, terminals, programs, or databases where a limit may have formerly existed.

MVS/XA support of larger real storage and the improved efficiency of larger processor storage should minimize large system and multiprocessing effects with IBM large processors. The ability to define and manage today's larger I/O configurations is likely to offer many installations improved flexibility and possibly better backup at lower system programming costs.

HEAVY EMPHASIS ON RAS

While addressing the needs of capacity for growth, MVS/XA designers recognized that only a small part of the increased capacity would come from batch processing or remote job entry (RJE). Most of the growth would come

from increased on-line transaction-driven systems and interactive end-user computing. Both types of work require the highest possible availability; therefore, MVS/XA places heavy emphasis on reliability, availability, and serviceability.

Since so much attention has been paid to RAS in the past, additional enhancements are becoming more difficult and are often quite detailed in nature. S/370-XA and the very basics of the 308X processor family design add important capabilities that enhance RAS. MVS/XA takes advantage of all previously provided MVS/370 enhancements and addresses particular systems elements that had formerly been identified as needing improvement.

For example, although the BCP has had error recovery (software retry) routines since the original development of MVS/370, many have been enhanced. In addition, new ones have been provided to improve overall MVS/XA recovery.

Quite a large number of critical system control blocks and tables have been isolated from the more active data areas in the system to reduce the probability of an accidental overlay, another frequent cause of unscheduled outages. Programs in key system areas are protected from overlays via a newly architected page protection mechanism.

The MVS/370 nucleus required a contiguous block of real storage. MVS/XA no longer requires contiguous real storage for the nucleus. This means that the nucleus can be relocated around uncorrectable real storage

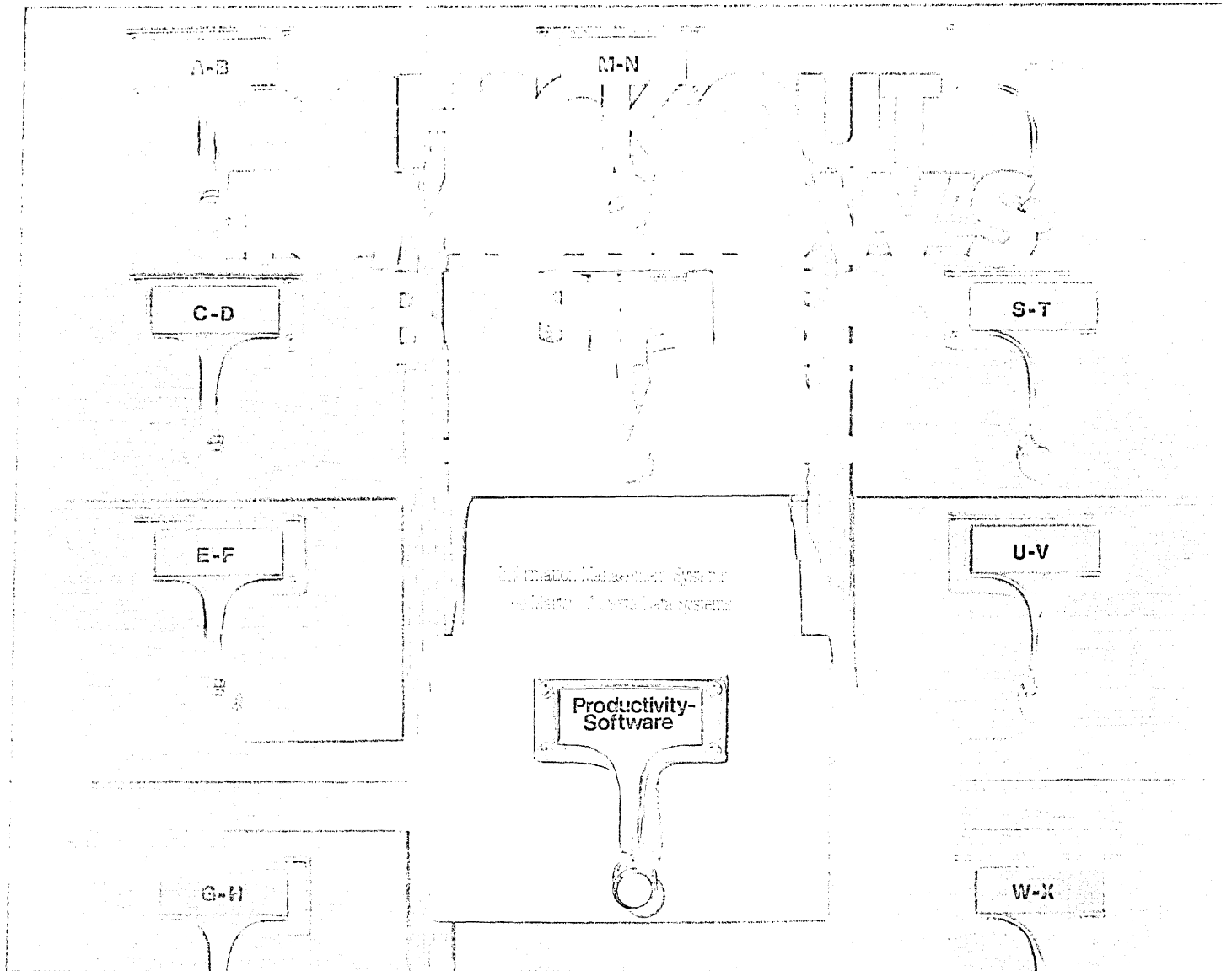

It's available today from Martin Marietta Data Systems: over 100 information management software packages ready to serve your business needs through our versatile computing services network.

PICK A SUBJECT

Almost any subject. Our shelves are stacked with problem-solving software to meet the demanding requirements of today's increasingly complex business environment. Financial Analysis and Modeling tools. Engineering tools. Energy Analysis Systems. Manufacturing Control Systems. In integrated modular units. Everything you need to analyze, plan, forecast and direct the course of your business in more profitable directions.

PROBLEM DEPENDENT SOLUTIONS.

Choose from a variety of database management systems, information systems and decision support systems, financial management and users, as well as programmers. From classics like MARK IV to best sellers such as RAMS II. Most of them compatible with both mainframe and remote batch environments.

WIDELY ILLUSTRATED.

Vibrant display programs are available to help you provide your company's decision-makers with a clear, concise picture of business problems and solutions. In black and white or in color. Powerful tools like SAS, GRAPR and TELL-A-GRAP.

POWERFUL BY MULTI-LANGUAGE.

Choose from a variety of computer languages: FORTRAN, BASIC, ALGOL, APL and FORTRAN 77 (EXTENDED). They're all on our shelves. Along with conversion tools to translate

from one system to another. Plus a full range of prompters, optimizers, debugging aids and training tools.

TOMORROW'S LIBRARIANS.

Meet a new breed of information specialist... trained by Martin Marietta to serve as your guide through our library of business software. Knowledgeable professionals who will help you select the most effective combination of software tools to increase productivity, accuracy and control. Packages that deliver timely, up-to-date solutions to your most demanding end users.

To check out our ever-expanding library of problem-solving software, call us toll-free at (800) 638-7080. In Maryland: (800) 492-7170. We'll send you our 40-page *Software Directory* free.

MARTIN MARIETTA DATA SYSTEMS ◊
Marketing Services, D-E
6307 Ivy Lane
Greenbelt, Maryland 20770

CIRCLE 103 ON READER CARD

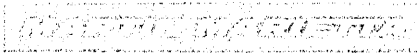

Several enhancements improve on the installation's ability to maintain a single system image.

errors so that work can continue until it is convenient to repair the hardware.

Two studies have been done to classify errors that cause unscheduled outages. Enhancements in MVS/XA have been made to address many of these classes of errors. The first study was an analysis of IBM's Retain problem management database. In this study, reported software outages on 3081s for two different weeks late in 1982 were analyzed. The results of this study indicated that up to 13% of the outages may be avoided with MVS/XA.

The second study referred to data collected some years ago in a reliability analysis program. The results of this study indicate that MVS/XA enhancements may avoid up to 30% of the unscheduled outages seen as resulting from software failure. That represents some 13% of the total unscheduled outages within the second study. These enhancements were over and above MVS/370 improvements.

IMPROVED ERROR DETECTION

In addition to the significant RAS value achieved by addressing the virtual storage constraint problem and by the dynamic channel subsystem's ability to use alternate paths and alternate cpus in error situations, the following MVS/XA RAS enhancements have been provided:

Error detection, prevention, and recovery are enhanced by the use of additional

checking to detect errors, by protection of key system programs and data, and by new and improved recovery routines and operator capabilities.

Error data capture is improved by earlier error detection, improved tracing, improvements in recovery routines, improved data gathering by the dumping services, and by support of new dumping options that allow dump requests to indicate in a more flexible way the data to be dumped.

Another enhancement ensures that hardware registers and related data are included when a dump is requested via an installation-applied trap.

The system trace has been greatly enhanced. Hardware gathers new trace data, new trace entries, and new data in old entries. A new Macro enables users to include their own entries in the system trace table. The TRACE command has been improved to allow the operator to dynamically control the system trace. In addition, the system trace and the generalized trace facility may be run concurrently.

Numerous enhancements have been made to aid problem determination. MVS/XA provides error symptoms for every dump taken. The symptoms are used to determine if the dump was requested for a known problem. For problems that cannot be solved by symptoms and summaries alone there are numerous enhancements to print dump and IPCS. The extensive use of control block and

module identifiers will be of great use in debugging. Dump symptoms will be provided by the DISPLAY DUMP command, by EREP, and by print dump. A new function called dump analysis and elimination will use the symptoms to identify recurrences.

Interactive problem control system (IPCS) enhancements include significant command list functions and performance enhancements. Interactive system productivity facility (ISPF) will provide full-screen dialogs, concurrent access to multiple dumps, access to any dataset that can be read sequentially, and the retention of defaults across IPCS sessions.

Operational enhancements allow the operator and system programmer greater control over MVS/XA, which should reduce system outages and reduce workload. MVS/XA contains two new and 11 enhanced operator commands. For example, one new command, CONFIG, allows the operator to configure the processors, storage, and channels. This facility can be used to check that the desired configuration is on-line, or to modify the configuration.

Support of the system parameter library has been enhanced to allow the use of blocking and multiple extents. Additional system controls have been added to this library.

Several enhancements improve on the installation's ability to maintain a single system image. Support for 4,096 devices allows the I/O configurations for several systems to be defined in a single system. The movement of LOGREC off the system residence data volume allows the use of this volume for multiple systems.

A second usability enhancement eliminates the need to tune the library list by preloading a new private address space with the program directories for each library in the list.

A third area of usability enhancements is the copy utility, which now supports the reblocking of load modules. This helps to optimize fetch performance.

EXPENSE RATE IMPROVED

As a system's price/performance improves, it is increasingly important that system, application programming, and operational costs be controlled. It is unreasonable to allow these expenses to increase with increases in system capacity. Instead, they must improve at approximately the same rate as the system's price/performance curve. MVS/XA should allow information system professionals to be more productive. There are two basic categories of productivity enhancements.

In the first one, system programmer work related to tuning and balancing system resources, management of performance, and

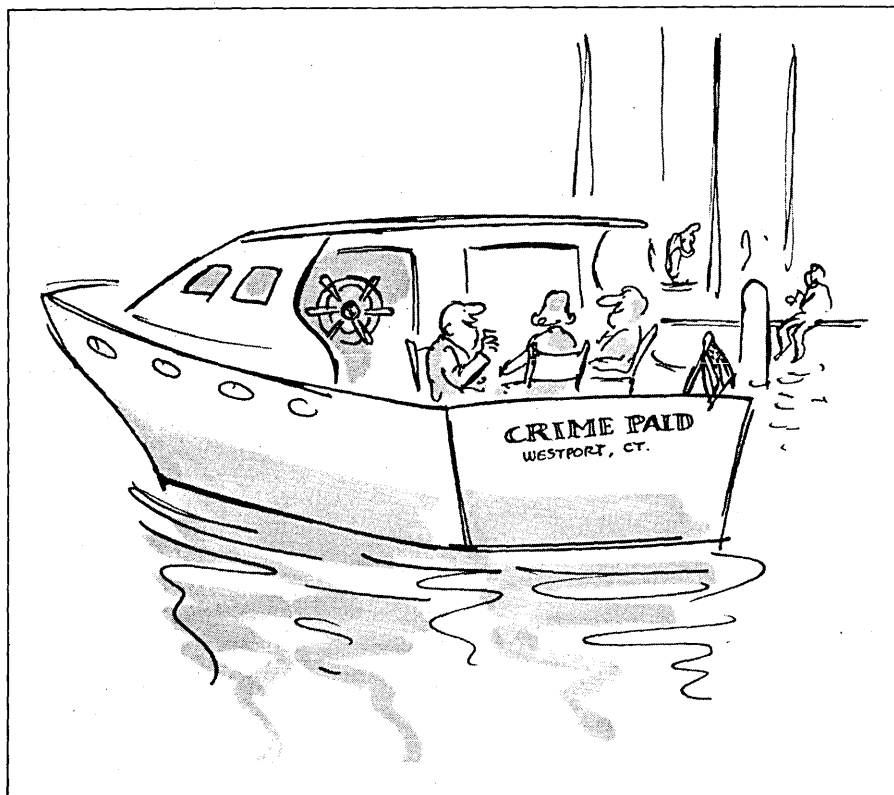

CARTOON BY HENRY MARTIN

EASY READER

It's 3270-compatible and a lot more productive than monochrome.

It isn't hard to see why our easy-reading color display helps operators achieve more throughput and fewer errors than monochrome.

Instead of a whole screenful of one-color text, your operators see different fields displayed in different colors.

And, with our exclusive feature

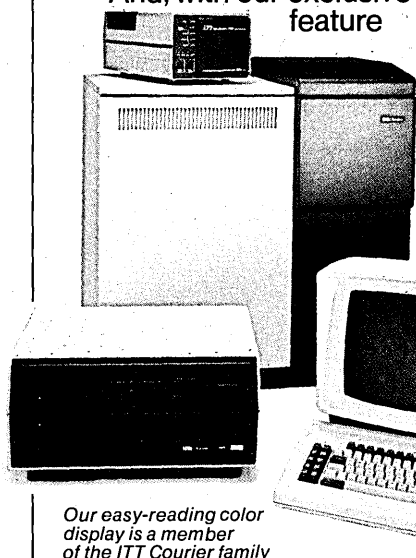

Our easy-reading color display is a member of the ITT Courier family of IBM-compatible products.

called Dynamic Color Assignment, you can "assign" the exact color you want each field to have. Either at the work station or at the cluster level.

Of course, with input information much easier



For even easier reading, our Dynamic Color Assignment feature lets you change color fields at the work station or cluster level.

to enter, customers using our color display find that their operators are much more productive.

On top of that, operators say that they get less eye-strain and neckstrain, and have fewer headaches than with monochrome.

Their managers report that our color display relieves budget pains, too. That the extra initial cost of our color display over

our monochrome display is paid for in just six months by extra productivity.

Plus, when our color

display replaces IBM monochrome, it looks even more cost-effective. You see, ITT Courier color is priced about the same as IBM monochrome.

So, looking at the big picture, an ITT Courier color display is not only easy to read, it's easy to buy. Or to lease.

For all the details, contact your nearest ITT Courier sales office. Or call toll-free:

1-800-528-1400 Ext. 7711.

Sales Support Dept.
ITT Courier Headquarters
Marketing
1515 W. 14th Street
Tempe, Arizona 85281

ITT Courier®

Wait a minute.

That's how fast you can make photo-quality hard copies with Polaroid's Video Printers.

We really didn't expect you to arrive and come to us. But we did venture forth on the incredible speed at which you can now make photo-quality hard copies from your graphics terminal.

Of course, there are plenty of other reasons to buy the new Polaroid Model 2000 and 3000 Video Printers. Instant Color film is available in the low cost of the hard copy (less than the only other choice

available) and much less than the other, lower quality alternative. The new Model 2000 and 3000 offer photo-quality hard copy available with the same menu-driven system available on the other Polaroid models. And, with the same excellent resolution and contrast as the other models, the new Model 2000 and 3000 offer the same excellent resolution and contrast as the other models. And, with the same excellent resolution and contrast as the other models, the new Model 2000 and 3000 offer the same excellent resolution and contrast as the other models.

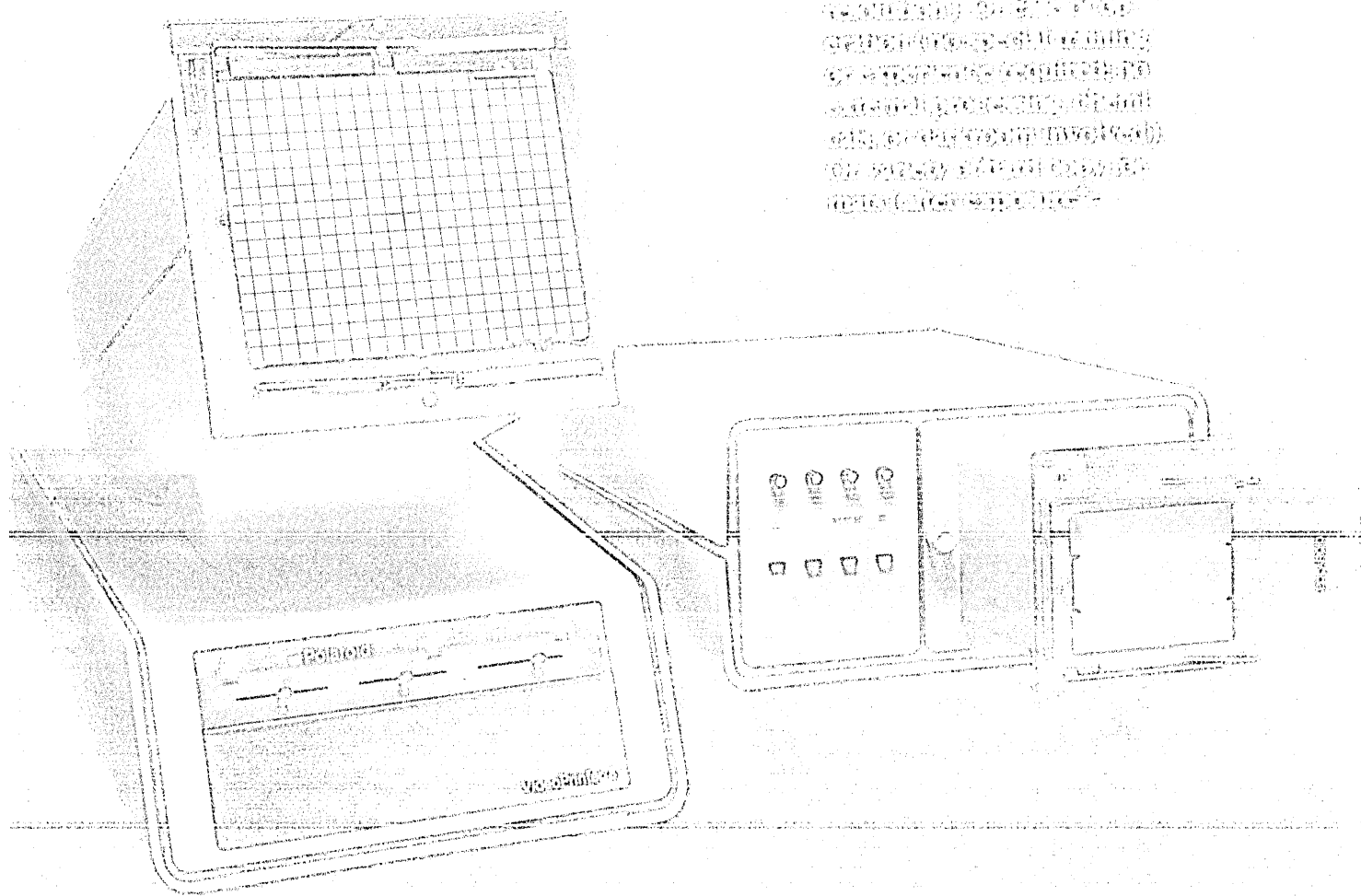

© 1985 Polaroid Corporation. Polaroid, Polaroid logo and Video are trademarks of Polaroid Corporation. All other trademarks are the property of their respective owners.

Polaroid® 8 × 10 film (also comes in Colorgraph® 8 × 10 transparency)

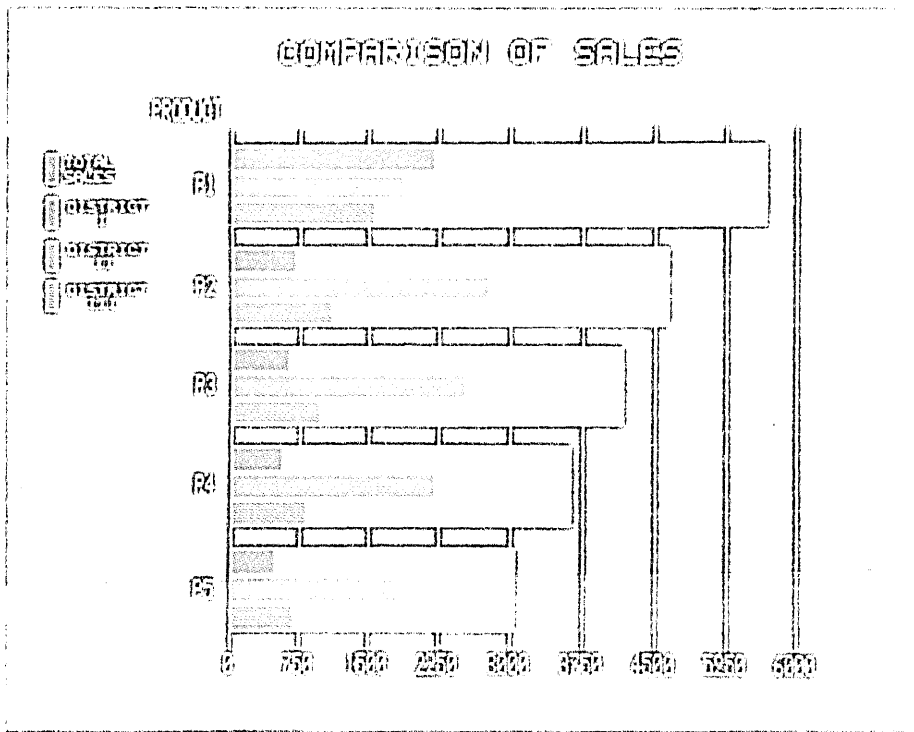

Model 4 makes 4 × 5" or 3 1/8 × 3 1/8" working copy size prints ready in 60 seconds and conventional or new Polaroid Auto-process 35mm slides ready in less than 5 minutes for slide presentations. Model 6 makes ready-to-use 8 × 10" presentation size color prints in 60 seconds and 8 × 10" color overhead transparencies in only 4 minutes.

And Polaroid Microfilm records the value of your hardware investment and provides a valuable new service for management decision-making.

If you've found this minute valuable, spend a few more moments with your Polaroid representative.

Operator 4 × 5 film

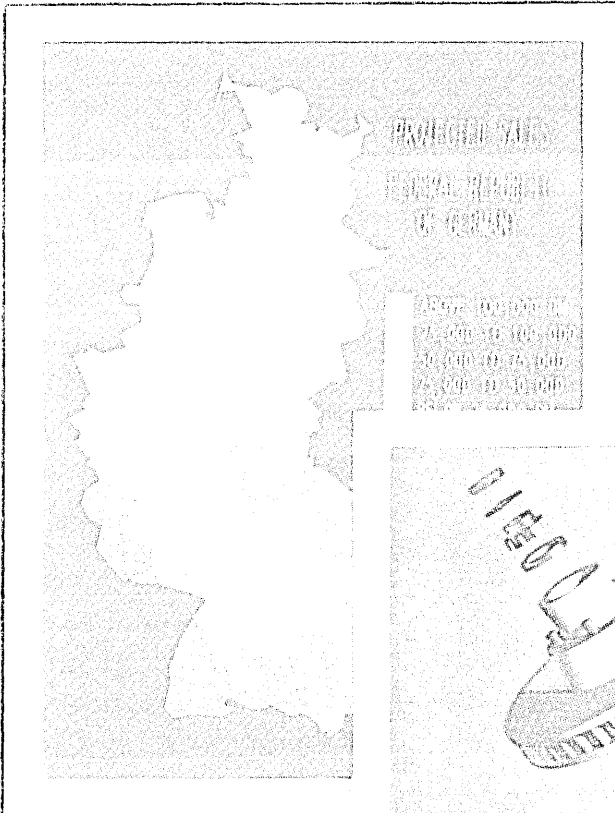

Courtesy - Battelle Ohio

Reprint of 35mm slide

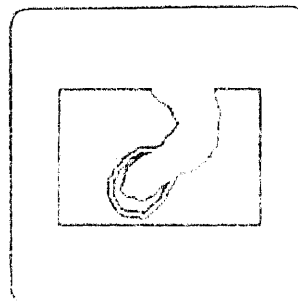

Courtesy - Baird Corp.

3 1/2 × 3 1/2 film

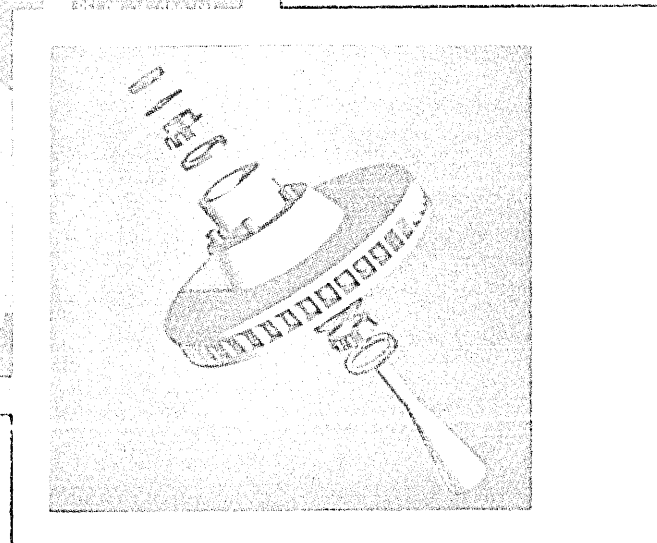

Courtesy - Rescan Technology

For more information, contact your nearest Polaroid representative or write to: Polaroid Corp., 100 Broadway, Cambridge, MA 02142.

Polaroid Corp., Dept. 1000, 100 Broadway, 5th Floor, Cambridge, MA 02142.

— Please send me information on...
— Please send me information on...
(Indicate model number)

Name _____

Title _____

Company _____

Address _____

City _____

State _____

Zip _____

POLAROID

BARRETT BONDENBERGER

A main objective in the design of MVS/XA was to provide a high degree of compatibility so that user programs did not have to be changed.

providing virtual storage capacity for growth is reduced. Some installations, where virtual storage has limited growth for some time, devote several system programmers full time to work on system tuning. Even some smaller installations have system and application programmers spending time on this problem. Where this is done, the amount of programming and management time spent increases as system capacity goes up.

Almost every installation has had to manage real storage and I/O configurations. System programmers concerned about performance and capacity planning have spent a considerable amount of time on these. Since MVS/XA can take better advantage of large processor storage sizes, it should mean reduced concern about management of real storage. Also, the dynamic channel subsystem provides better data in the area of I/O tuning.

The second area of potential productivity gains has to do with application design and development. As was the case with the original implementation of virtual storage, the extended virtual storage area of MVS/XA reduces the need to manage to design limits in application programs. With S/370's virtual storage, the increases over prior real storage systems were in the range of two to eight times. In MVS/XA, the increase is 128 times.

This means that applications can be expanded to use large amounts of virtual storage above 16MB for programs or data. Programs can put tables of reference information into virtual storage instead of in data files. Virtual storage is easier to program for, which can reduce programming effort. Functions that previously had to be in individual programs can be combined in a single program. Where applications require collections of temporary data (data created during application execution, then discarded), virtual storage arrays can be significantly easier to use and certainly a better option than the temporary data files of the past. All these enhancements may not apply to every installation, but in most instances several will apply. It is likely that every installation either currently using MVS or contemplating a migration to MVS will see compelling reasons to consider MVS/XA installation in the coming months.

PHASES OF MIGRATING TO MVS/XA

Let's now look at what an installation needs to consider in its implementation of MVS/XA.

A migration to MVS/XA can be divided into four phases. Phase one is project management. A migration project is established and a team is selected, with development by a migration plan as its first order of business. The plan would define activities and time schedules.

Phase two is the preparation or positioning phase. It involves potential product upgrades of currently installed IBM-licensed programs to release levels compatible with MVS/XA. In many cases, installations will already be at the proper release levels for most IBM-licensed programs.

Phase three consists of the education and planning necessary to install and migrate to MVS/XA. This means developing detailed plans for installing, maintaining, and implementing MVS/XA, activities that are performed in the final phase.

Phase four is the execution of those tasks necessary to prepare and implement MVS/XA as the production system. It contains such tasks as initial installation of the MVS/XA system, installing software that will be used in the new system, updating programs that are not compatible with MVS/XA, training operators, testing applications, and making necessary accounting changes.

A main objective in the design of MVS/XA was to provide a high degree of compatibility so that user programs did not have to be changed. This objective was met, as only internal system interfaces were changed. Most existing programs and jobstreams will be able to execute in MVS/XA without change.

There are no required changes to user catalogs and procedure libraries. High-level language programs are compatible and require no changes. With only minor exceptions, assembler application programs will execute without change. Those that might have to be reworked are user-written, system-type programs or utilities that either interrogate control blocks or use authorized services. Finally, programs need not be recompiled or relinked to operate with MVS/XA, unless, of course, program updates are made.

The MVS/XA Conversion Notebook publication is particularly useful for planning as it points out product differences between MVS/SP1.3 and MVS/XA. It should be used to help define specific tasks involved with each installation's migration.

Applications migrating to MVS/XA where 31-bit program support is desired should consider a staged migration. The first stage could be called the compatibility stage, where all programs would execute in the non-extended area of virtual storage in 24-bit addressing mode as they do with MVS/370. In the second stage of the migration, which comes at any time thereafter, applications that will benefit by having more virtual storage than provided in the nonextended area can be redesigned (high-level language programs may need to be recompiled or relinked) to execute in the extended area.

It is important to understand that there is never a requirement to migrate programs to the extended area unless additional virtual

storage address space is desired. Programs running in the nonextended area execute with the same processing speed as those executing in the extended area. As new applications are designed, they can be designed exclusively for the extended virtual storage area and thus take advantage of this much larger virtual storage area for application use.

One of the most important activities installations can do to prepare for MVS/XA is to migrate IBM-licensed programs to the product's release level that is supported by MVS/XA. These product migrations are referred to as positioning migrations:

1) Migrate to MVS/SP 1.3 (MVS/SP-JES2 1.3.0 or MVS/SP-JES3 1.3.1). These levels of JES2 and JES3 are compatible with MVS/XA.

2) Take an inventory of system-type assembler language programs. Inspect them for MVS/XA incompatibilities as documented in the Conversion Notebook. Change those that can be changed and still execute with MVS/SP1.3. IBM has made changes to MVS/370 that include MVS/XA interfaces. User programs may be changed and tested with MVS/370, and will be compatible with MVS/XA. For those that cannot be changed, document them prior to installing MVS/XA and include them in the future conversion plan.

The rationale for the preceding activities should be clear: they will make the installation's MVS/370 system as "MVS/XA-like" as possible. This will minimize concurrent change during the MVS/XA installation. In addition, training requirements are minimized as the positioning products have already been learned during the positioning phase. Finally, the installation will have maximized system coexistence and backup capabilities. Both are possible because MVS/SP1.3 and MVS/XA can operate and share data in the same system complex.

Compatibility between MVS/XA and MVS/SP1.3 systems is achieved when the same level of JES is used on each processor in a loosely coupled system complex. This allows coexistence and backup when there is a mix of S/370 and s/370-XA processor and operating systems. This coexistence allows an installation to plan a staged migration. S/370 processors may be migrated to s/370-XA processors or the MVS/370 operating system to MVS/XA. As a processor is converted to MVS/XA, the next processor can be converted, and so on, until all the processors are operating with MVS/XA.

Since MVS/XA and MVS/SP1.3 can both operate with the same functional level of JES2 or JES3, workload backup is possible as the systems can share the same spool complex for SYSIN and SYSOUT data. If global resource serialization functions of MVS/SP1.3 are used, they too are fully supported in MVS/XA, and coexistence at this level of processor communication is possible.



Your most productive asset has been dodging work.

Look at it this way.

If you had to dodge irksome screen glare while entering data. Hour after hour. Just how efficient would you be?

The fact is, CRT glare takes its toll. On your terminal users. And on department productivity.

But now there's a sensible solution.

Introducing Glare/Guard® anti-glare panels.

Glare/Guard instantly eliminates up to 94 percent of all CRT glare. Resolution is always sharp. And image brightness and clarity are dramatically enhanced—even under bright, fluorescent lighting.



Without anti-glare panel



Etched panel



Glare/Guard

The result? No screen washout.

Glare/Guard's secret is HEA®—a special High-Efficiency Antireflection coating we applied to the windows of NASA's Space Shuttle. And only Glare/Guard has it.

Glare/Guard's durable, laminated-glass design lasts indefinitely. It quickly retrofits to virtually every leading display terminal—no tools required. Its smooth surface is easily cleaned. And Glare/Guard sells for \$99, regardless of display size.

Of course, there are less expensive anti-glare products available. But the nylon strands of mesh screens cause fuzzy images. While etched panels merely spread glare around and blur resolution.

Only Glare/Guard does exactly what an anti-glare panel is supposed to do.

And that's getting your terminal users attention out of the glare, and back onto the screen.

Try one.

And see for yourself.

Place a trial order from your dealer and install Glare/Guard on your busiest terminals.

Then sit back and watch.

You'll see the difference. On the CRT screen. And in your terminal user's performance.

For your free brochure, talk to your authorized Glare/Guard dealer. Or call 707/525-7448. Glare/Guard, OCLI, Dept. 109 D/D, 2789 Northpoint Pkwy., Santa Rosa, CA 95401. NCC Booth Numbers: P-7043 & P-7045.

Glare/Guard® and HEA® are registered trademarks of OCLI—Optical Coating Laboratory, Inc. © 1983 OCLI—Optical Coating Laboratory, Inc. All rights reserved.

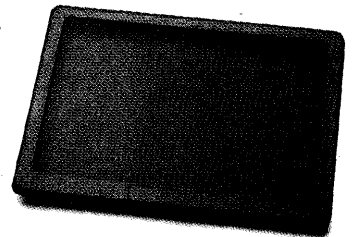

Glare/Guard®

A difference you can see.

CIRCLE 106 ON READER CARD

The migration to MVS/XA should not be much different than previous MVS release-to-release migrations.

MVS/XA INSTALL PROCESS

To prepare an MVS/XA system, a system generation (SYSGEN) must be performed. Because of the full SYSGEN, all system libraries are rebuilt. Thus, programs that do not have SYSGEN support (e.g., IBM-licensed programs, user exits, user Macros, user programs) and that reside in system libraries will have to be reinstalled.

The SYSGEN and all maintenance activity can be performed on any MVS/SP1.3 system in the installation; it need not be a 308X processor. Testing, however, requires a 308X processor initialized in s/370-XA mode.

A VM/XA Migration Aid is scheduled to be available in the fourth quarter of 1983, and will enable daily production work on the 308X processor with MVS/SP1.3 at the same time MVS/XA is being tested.

Many of the post-test analysis activities can be performed once again with the MVS/SP1.3 system. For example, the print dump and/or IPCS facilities from the MVS/XA system can run on the MVS/SP1.3 system to do problem diagnosis. EREP Version 2 can be used to print MVS/XA LOGREC reports with MVS/SP1.3. MVS/SP Version 2.1.1 will provide facilities to reduce SYSGEN activities with the IBM SMP/E licensed program.

Most accounting and billing procedures depend on machine resource data captured and recorded by the System Management Facility (SMF) of MVS. All previous data collected by SMF are still being collected in MVS/XA along with additional data. These new data can be ignored if they are not planned for use at the outset. Thus, it is possible that existing accounting and billing programs will run without change in MVS/XA.

The new data collected in MVS/XA SMF measure the amount of time each dataset incurs I/O activity, and the virtual storage used in the extended private virtual storage area.

Processor usage will be recorded in the same way as in MVS/370. As is true in any change of operating system levels (e.g., an MVS/SP1.1 to MVS/1.3 change), variations may be experienced, and if billings are critical in this area, potential variations need to be analyzed.

An I/O resource is generally used to bill for dataset I/O activity. These counts will be the same for application datasets, but could be somewhat higher for I/O activity against program-load libraries. The reason for this is that in MVS/XA program fetch (the routine that reads programs) has been modified. Thus, if installations use EXCP counts captured on program-load libraries, they will need to determine if these potentially higher counts may affect current accounting routines.

Operational changes have been kept to a minimum with MVS/XA. Typically, a class will be held for operators where the new functions of MVS/XA are taught, followed by training sessions. Most of this training can be done during application testing. Some changes to operator documentation may be required. Procedures such as initialization, reconfiguration, backup, and recovery should be reviewed and updated as appropriate.

There are only two new operator commands introduced by MVS/XA. An additional 10 commands have had new command parameters added to them. Also, there will be some new system messages to which the operator must respond, and some of the older

messages will get new component identifications, but the message number and content will remain the same as the MVS/SP1.3 message. Operators should have little difficulty in making the transition. For installations using color consoles, MVS/XA offers enhanced support, including the use of seven colors, blinking, and reverse video.

EFFECT ON PERSONNEL

The migration to MVS/XA should not be much different than previous MVS release-to-release migrations. This is especially true if positioning has been accomplished prior to the implementation of MVS/XA. The tasks associated with implementing MVS/XA are very similar to those associated with previous MVS product release upgrades. The major tasks in the migration will be those assigned to the system programming staff. Performance and accounting personnel will be responsible for some changes in system performance and data collection techniques.

Application programmers should only have a minor involvement in the migration to MVS/XA. Most programs should not require changes. Application programmers will mainly be responsible for the testing of their applications. They should, however, be educated on system differences and in 31-bit address programming when appropriate.

Operators will have to be trained in the new and changed commands and messages. They will learn to run the system during application and system test. They will also be responsible for updating procedure books when changes affect system operation. End users should be unaffected by the change in systems if positioning has been done beforehand.

Laboratory measurements and the results of testing in selected customer environments clearly demonstrate the value of MVS/XA operating with s/370-XA. The enhanced functions provide capacity and the ability to effectively balance system resources for business growth, higher levels of RAS, and increased productivity.

Once migrated, user applications can take full advantage of MVS/XA 31-bit addressing, at a user-defined pace. IBM's assembler language and FORTRAN compilers have been announced as supporting 31-bit addressing capabilities. IBM will also provide 31-bit addressing facilities for COBOL, PL/1, and APL/TSO environments. *

Ronald L. Bond is a senior product administrator for IBM's National Accounts division, based in White Plains, N.Y. He has been with the company for 14 years. He has an MSE from Arizona State University and a BSCE from the University of Kansas.



For High Performance

CGA SYSTEMS TO
 Ware Collection

The Top Selling
 Package for
 Resources

Reduces 60-80%
 Time
 on Including

no
 gain

Single
 = time
 of System
 for Single

• MSM - Material
 Allocation

• MSM - Material
 Allocation

• GCD - Consolidated
 Consols For Control

Single System Speed -
 Multi-System Power

- No modifications
- Completely transparent
- Usable in any combination
- More than 1000 products installed

Prized high-performance winners in
 hundreds of installations around the
 world. Put CGA software to work for
 you. Call 800-237-2057 for a free product
 trial.



800-237-2057

Speak software. Talk to CGA.

CGA Software Products Group
 80-80-2000
 Holmdel, NJ 07733

Two ways to take 3270 where it's never been before.

**True
blue.**

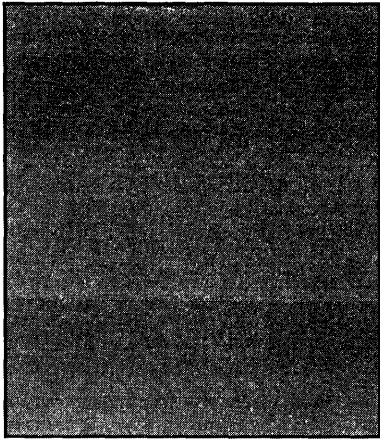

If you're thinking of extending your 3270 network, true blue is a great way to go. Just install IBM's 3270 series controllers, terminals or printers. As many as you need. Or can afford.

Then connect them. If the new IBM peripherals are going across the room or down the hall, you'll need a little high-cost cable. And if they're going across town or further, add some very expensive leased lines.

True blue. If you can afford it.

**Or an
economical,
reliable,
secure
3270 network
of a
different
color.**

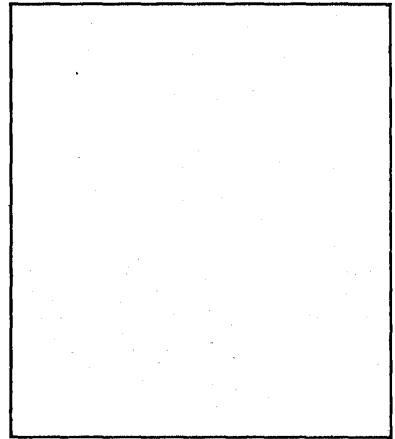

Fortunately, there's a better way. Datastream.

Our Remote Cluster Controllers let you take your 3270 network anywhere you need it. You can build clusters using low-cost ASCII terminals, printers and personal computers. The Remote Cluster Controller provides main-frame compatibility and 3270 functionality to the entire cluster.

And we've got a list of features that won't quit. Models for either 3270 SNA or 3270 BSC networks. Direct-connect or dial-in access from every terminal in the cluster. Sophisticated password security. Remote diagnostics and system upgrade. Multi-host support. And more.

If you want to take your network down the hall or across the country. Without the heavy expense of cables, leased lines or IBM peripherals. Call us.

Datastream. You can't afford to overlook us.

Call toll free: 800-952-2500
(Outside California)

DATASTREAM

1115 Space Park Drive
Santa Clara, CA 95050
408/727-2980

CIRCLE 108 ON READER CARD

As the U.S. deregulates its telecommunications structure, other nations are finding they have to follow suit just to remain competitive.

THE STORMING OF THE PTTs

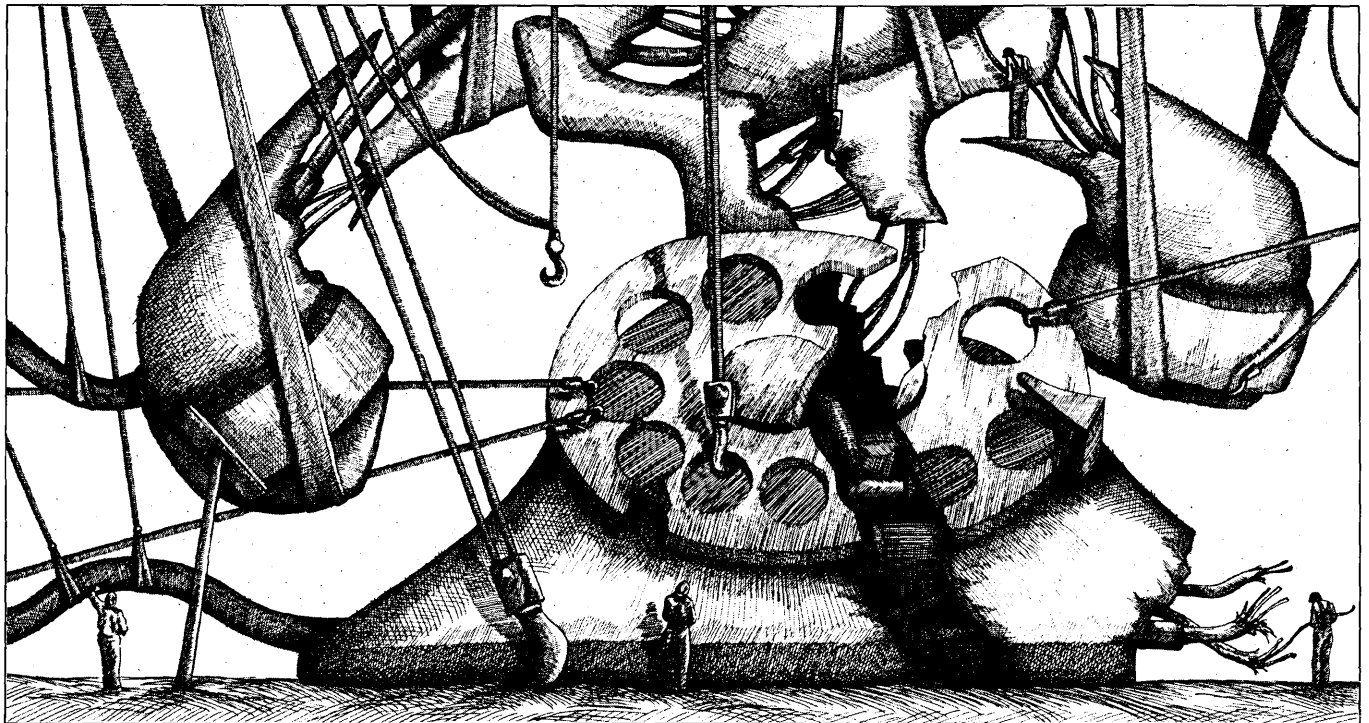

by Dan Schiller

Across the developed world—with the outstanding exception of the United States—telecommunications has long been the preserve of the government. Public ministries of posts, telephones, and telegraphs (PTTs), not private companies, own and operate most national telecommunications networks. Together with tightly knit groups of domestic equipment suppliers—Thomson and CGE in France; Siemens and AEG-Telefunken in West Germany; Fujitsu, Hitachi, NEC, and Oki Electric in Japan—these PTTs direct and execute telecommunications policy. The nature and pace of technical change and the availability, prices, and uses of equipment and services all customarily come under the dominion of PTT.

An assault has recently been mounted, however, against the citadels of PTT control. While other U.S. exports languish in a

stagnant world economy, our domestic policy of deregulating the telecommunications industry is being successfully marketed around the globe. Consider the following recent developments:

- In Australia, the report of the Davidson Committee in October 1982 paved the way for massive deregulation of Telecom Australia's PTT monopoly. Essentially, the report argued that Telecom should exchange its traditional role for a "greater business orientation." Its many specific recommendations include authorization for private networks operating in competition with Telecom; a wide-open market for terminal equipment, unrestricted resale, and sharing of leased lines; cost-based pricing; and extensive PTT reliance on outside contractors for construction of capital works.

- In the Netherlands and in Japan, major government-commissioned studies in 1982 advocated sharp new restrictions on the mo-

nopoly powers of their respective PTTs, if not actual transfer of telecommunications to the private sector.

- In West Germany, and even in France, debate has sprung up over the role of the PTT as a state monopoly, and whether encouragement of private competition in telecommunications might prove beneficial.

- Most impressively, in the United Kingdom, 1981 saw passage of the British Telecommunications Act, subjecting British Telecom (the PTT) to unprecedented competition in selected equipment and service markets. British Telecom had previously been separated from the British Post Office to prevent cross-subsidies between the two services. Then in 1982, Mercury Communications—a business-oriented carrier formed by Cable & Wireless, British Petroleum, and Barclays Bank—undertook to furnish a fiber optic-cellular radio network to compete with British Telecom. A continuing series of oth-

As telematics networks gained an increasingly critical role, companies pushed for more control over the evolving resource.

er, parallel changes, including the planned sale by the Conservative Thatcher government of 51% of British Telecom to private investors, is rapidly consolidating the privatization of telecommunications in the U.K.

Like previous technical advances in telecommunications, these institutional shifts will have a critical impact on both users and suppliers of telecommunications equipment and services—especially those operating in a transnational environment. How can we account for these manifold moves to deregulate, liberalize, and privatize telecommunications?

Privatization is the fruit of a quarter of a century of technical change, skyrocketing business demand, and deep-seated regulatory shifts in the United States—the largest national market and the historic initiator of the computerization process. By the 1950s, U.S. multi-unit businesses were rapidly integrating computers into their various operations. They then began to call for new telecommunications services to transmit data on an ever-expanding scale, and for radical changes in the structure of the U.S. telecommunications industry. They did so for two reasons. First, as business dispersed across the country to gain cheaper access to materials, markets, and labor, communications costs exploded. Today they often comprise 2% to 4% of revenues—the second or third largest operating expense. (In 1980 Citicorp spent \$130 million on telecommunications; Holiday Inn and General Motors each spent around \$100 million.) Therefore, business users demanded more operational and more strategic power to shape and direct telecommunications than proved possible in the AT&T-dominated monopoly environment.

As merged computer-communications (telematics) networks began to play an increasingly critical role across a wide range of business activities, companies pushed for more control, both minute-to-minute and longer term, over the evolving telecom resource. As far back as 1957, the American Automobile Manufacturers Association declared to the Federal Communications Commission: "We should have the same latitude in the use and implementation of our communications facilities that we enjoy in the use and implementation of the many thousands of other tools, facilities, and services necessary to the conduct of our business."

U.S. LEADS THE WAY

U.S. policymakers have consistently agreed. The 1959 FCC decision to permit growth of private microwave networks facilitated an emerging shift in the balance between public and private telecommunications. Although for nearly two decades AT&T successfully diminished the decision's impact with its Telpak series of

tariffs, today there are over 1,000 private microwave networks, making use of 226,000 route miles of facilities and 15,000 relays. The common carriers themselves operate fewer than 9,000 microwave links. Private satellite-based networks today are conforming to the trend; the number of companies applying for earth station licenses grew from 29 in 1975 to 1,500 in 1981.

The FCC's 1968 Carterfone decision, authorizing independent supply of terminal equipment, was equally significant. In its wake, a mushrooming interconnect industry has sprung up to offer a vast array of specialized terminal equipment. More recently, with a series of resale and sharing decisions permitting rapid growth of specialized, flexible, user-configured telecommunications services, decisive growth of private telecommunications has been assured. AT&T itself is now free, through its American Bell subsidiary, to furnish telematics and even data processing services and equipment outside government regulation.

With these dramatic changes, the action has shifted to the international arena. For business telecommunications users making this shift, the logic is simple. When companies can harness new and efficient or competitive tools and processes through telecommunications, their incorporation of these specialized services races toward a new global business standard. Because nations exist in a world market, competitive advance in one area practically compels analogous growth elsewhere. The freedoms won in the U.S. market have whetted users' desires for global deregulation: only on such a foundation can system-wide, transnational integration of needed services take place.

For equipment and service suppliers, the motivation is equally apparent. Arthur D. Little, the business research and consulting group, estimates world telecommunications equipment expenditures for 1981-1990 will approach an astounding \$640 billion (in constant 1979 dollars). More is likely to be spent on telephone equipment during this one decade than was spent from the time the instrument was invented in 1876 up to 1980. Together, Europe and Asia will account for just over half of this market. AT&T, GTE, ITT, Motorola, and a host of other U.S. equipment firms seek to profit from this burgeoning international demand for advanced telecommunications.

U.S.-based users and suppliers, however, must first confront the basic fact that government PTTs and their preferred domestic suppliers have many lucrative markets virtually sewn up. In this era of fast-rising protectionist barriers, especially in high-technology fields that may be key to future economic growth, PTT controls over telecommunications appear especially ominous.

A major campaign to open up overseas telecommunications markets through privatization has thus been overtaken. Realizing that in a private telecommunications environment government authorities will have less power to monitor or direct policy, transnational business users have begun to force PTTs backward, out of the enhanced or specialized services on which these users have come to rely. And, in response to users' demands for new services, U.S. suppliers have been foraging into the international arena through a series of mergers and joint ventures with traditional PTT suppliers.

In Australia, Belgium, Britain, West Germany, Japan, Switzerland, and elsewhere, business telecommunications users, following the U.S. lead, have formed associations to press for private supply of customer equipment, resale and sharing, cost-based pricing, authorization for private networks, and other changes.

And, in the wake of the British Telecommunications Act and of projected rapid development of a variety of new technologies across Europe, a horde of U.S. suppliers has moved across the Atlantic. Scientific Atlanta has joined with the British firm Plessey to supply satellite and cable television hardware to European markets. Plessey, whose strength is in conventional telecommunications, is one of three main suppliers to British Telecom, the PTT. Racal, another prominent British equipment company, has linked up with Oak Industries of California, whose strengths are in cable TV, and, in another venture, with the U.S. company Millicom to provide equipment for the newly unlocked British cellular radio market. Another consortium, including the British firm Cable & Wireless, has hooked up with AT&T's rival cellular system (designated AMPS) and has appointed AT&T International as its advisor. Motorola, choosing a different path into the British cellular market (which could be worth £300 million between now and 1990), has announced plans to build a plant in Hampshire to produce cellular base station transmitters and mobile units.

Though Great Britain appears to be spearheading the drive for European telecommunications markets with its U.S. partners, other European countries have deals brewing. In West Germany, Siemens has formed a joint venture with Corning Glass of the U.S., to supply 100,000 kilometers of optical fiber for the Deutsche Bundespost (the PTT). The group hopes to win additional orders from commercial customers in Germany and abroad. The common element in these ventures is the erosion of a protected national market for PTT suppliers. Why should such favored companies—Plessey or Siemens—trade in their sheltered status for the uncertainties of competition?

Unibase™ has 10X the power of conventional databases...plus UNIX* software.

Uniq Computer Corporation introduces Unibase, a powerful new concept in database management. More than a conventional software-based system; more than a single, limited use computer; Unibase combines the best of several worlds to give you a system that is truly unique.

You get multiple benefits in addition to exceptional power and UNIX Software.

- **LOW COST.** This extra database capability comes to you at about half the cost of conventional approaches.
- **UNTAPPED POWER LYING DORMANT.** Raw crunching power resides untouched in the host computer that comes with Unibase.
- **EXPANDABLE FOR GROWTH.** With Unibase you can share data with other computers... or add computers as the need arises.

What exactly is Unibase?

Unibase is a complete relational database system, a combination of software and hardware. It consists of two processors, a host and a back-end. The host is DEC's powerful 32-bit VAX running UNIX System III while the back-end processor provides the real horsepower for handling data management functions. The complete integrated system can be combined with up to 63 additional hosts to form a shared-access database network.

More unique features.

Unibase systems can communicate with the IBM HASP and JES subsystems for mainframe data sharing. The system includes an interactive query language—IDL, the Easy-Writer report writer, and programming language libraries. Database features include the advanced relational data model, transaction logging, multiple security levels, and hardware self-diagnostics.

The real strength is single vendor support.

Uniq is another way of saying "unparalleled support." For hardware and software. Customer Technical Assistance (CTAC). Training. Enhancements. Custom software development and UNIX systems. Our staff is highly experienced and ready when you need us. To support the whole product—not just a part of it.

Also, rigorous financial screening, done annually as a Digital requirement for Authorized Distributors, is your assurance of dealing with a financially sound organization. That's an important consideration in protecting your investment.

For the rest of the story on the Uniq Unibase System, call or write for literature.

For greater speed and efficiency in your transaction processing or database management activities you need Unibase. Call us now for more details concerning this innovative approach to database management.



Uniq Computer Corporation
28 S. Water Street
Batavia, IL 65010 (312) 879-1566
Washington, DC (703) 448-8508
Santa Ana, CA (714) 541-5520

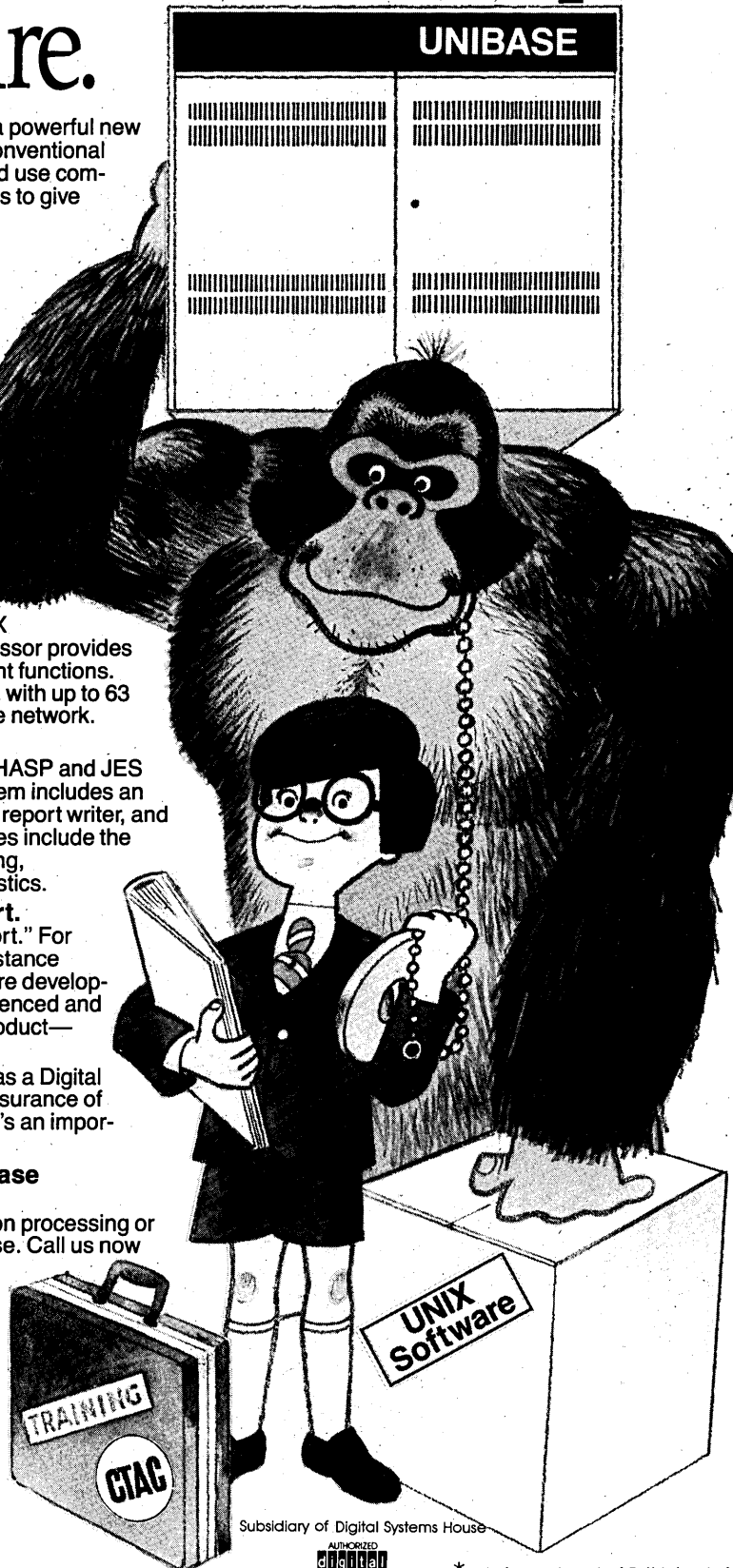

Subsidiary of Digital Systems House

AUTHORIZED
digital
COMPUTER DISTRIBUTOR

*UNIX is a trademark of Bell Laboratories

CIRCLE 109 ON READER CARD

"SEE US AT NCC, BOOTH #8041/8043!"

The FCC has proved vital in pushing PTTs to reconsider long-standing policies.

QUEST FOR WORLD MARKETS

Once more the answer is simple: the economics of the telecommunications equipment industry today dictate a quest for world markets. The cost of developing competitive new products—digital switches, say, at between \$20 million and \$40 million—will simply not repay investment within a single domestic market, no matter how well protected. Thus, any nation that refuses to enter the global privatization race runs a real risk of being preempted from the vast new markets that may spell success or failure for its preferred supplier companies. Combined with intensifying business user pressure to deploy the most up-to-date services, the coming scramble for global equipment markets is creating a new wave of mergers and joint ventures in international telecommunications.

The most formidable of these is doubtless the spectacular new link forged between AT&T and the Dutch electrical giant, Philips. An insider to the procurement practices of European PTTs, and a power in international electronics (owing to an established network of 60-odd offices across the globe), Philips will furnish the necessary leverage to gain world markets for AT&T's unfolding line of digital switching systems. With its newfound Philips connection, Bell's clear recognition that some products will be profitable only as world-class items will be aggressively translated into action.

International satellite services give promise of further loosening the grip of government PTT ministries. Satellite Business Systems, the consortium created by IBM, Comsat, and Aetna Life & Casualty, has reached operating agreements with British and Italian authorities to provide high-speed digital private line data and videoconferencing services, thereby entirely bypassing traditional public switched networks. American

Satellite has concluded a similar arrangement with Telesat Canada.

Benefiting from these substantial changes are not only suppliers but also business users, who continue to forge ahead in pursuit of pan-European privatization. The International Telecommunications Users Group (INTUG), for example, has moved to obtain an unprecedented hearing for corporate telecommunications consumers within the key telecommunications policymaking organizations: the European Economic Community, the Organization for Economic Cooperation and Development, and the International Telecommunications Union itself. Transnational businesses located in noncompliant countries may also choose to transfer their costly communications centers to other, more liberal nations, where they can find the flexibility and cost economics they desire.

The progress of privatization is made still more compelling through the efforts of the United States Government. The Federal Communications Commission, in particular, has proved vital in pushing PTTs to reconsider long-standing policies. The FCC has demolished traditional divisions between domestic and international services and between record and voice services. With these shifts at the U.S. end, the commission has encouraged provision of cheaper, more integrated service offerings for business users—even at the expense of the smaller carriers and their PTT correspondents.

Putting yet more pressure on prices for international service, the FCC instituted an investigation of the carriers' rate setting practices, and found their profits to be around 35%; required that carriers unbundle equipment and service tariffs; and proposed to eliminate the "Authorized User" ruling, in order that Comsat might be permitted to furnish end-to-end satellite service directly to customers, rather than only through the other

international carriers. Despite the hostile responses they invite, FCC measures to subject international circuits to resale and sharing provisions—thereby depriving PTTs of revenues—have been resurgent since the domestic resale and sharing decisions were taken in the mid-1970s. Finally, in planning for new international telecommunications facilities, the U.S. has interfered consistently in private dealings between the carriers and their PTT correspondents to exact concessions beneficial to transnational users. In short, the U.S. government has used all the considerable bargaining power at its disposal to force the pace of global deregulation.

What will the infusion of competition into telecommunications systems long owned and operated by PTT monopolies bring with it for the general public, and for the telecommunications industry itself?

Today we see the beginnings of many new partnerships and joint ventures in telecommunications; the AT&T-Phillips venture is perhaps the most impressive recent example. Will the world class products that result from these new groupings speed creation of an international oligopoly in telecommunications? What will the emerging global partnerships bode for suppliers seeking to remain independent, and for the national communications policies to which such suppliers are ordinarily closely tied?

Will the progressive opening of protected national markets to outside competition promote job loss? Where will the work of supplying global telecommunications markets be concentrated?

Finally, as specialized private networks proliferate, will the trend toward basic universal service be reversed—as it has already in the United States? Without some sort of subsidy—precisely the kind that the demand for cost-based pricing seeks to eliminate—universal service will certainly not be achieved. As increasingly sophisticated or enhanced capabilities are added to telecommunications systems, will an expanding information underclass also be created?

These issues, of crucial economic and political significance, should be resolved before the great scramble for global telecommunications markets proceeds any further. It would be an error of colossal magnitude for them to be decided not by deliberate social policy but simply by the process of deregulation itself. *

Dan Schiller is assistant professor of communications at Temple University in Philadelphia, and author of *Teleatics and Government* (1982, Ablex, Norwood, N.J.). He has a PhD in communications from the University of Pennsylvania and specializes in international telecommunications issues.

CARTOON BY T.O. SYLVESTER

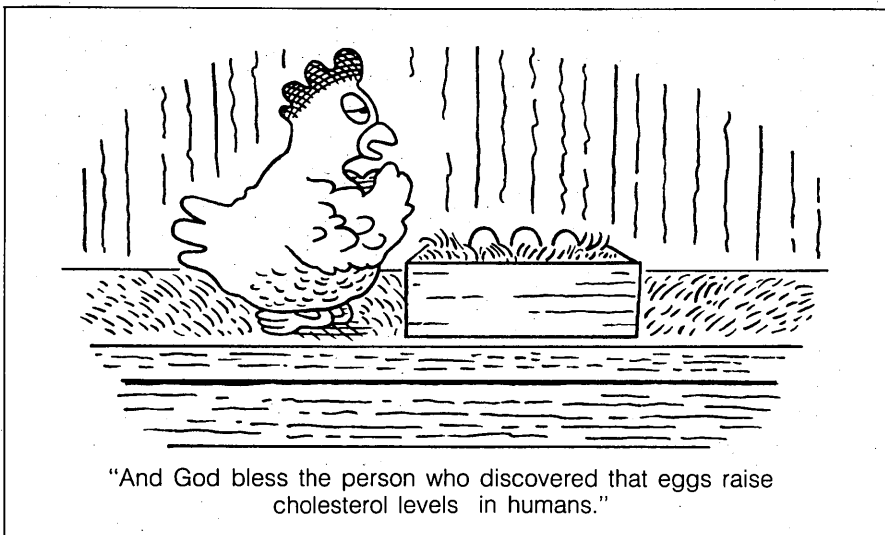

"And God bless the person who discovered that eggs raise cholesterol levels in humans."

Introducing the Radio Shack TRS-80® Arcnet™ Integrated Office System

- Link from 3 to 255 Individual TRS-80 Microcomputers Into a Local Network
- Keeps Productivity High, Costs Low
- Share the Same Programs and Peripherals
- Users Perform Independent Tasks without Interruption
- Based on Datapoint's Field-Proven "ARC" Technology
- Available for Immediate Delivery

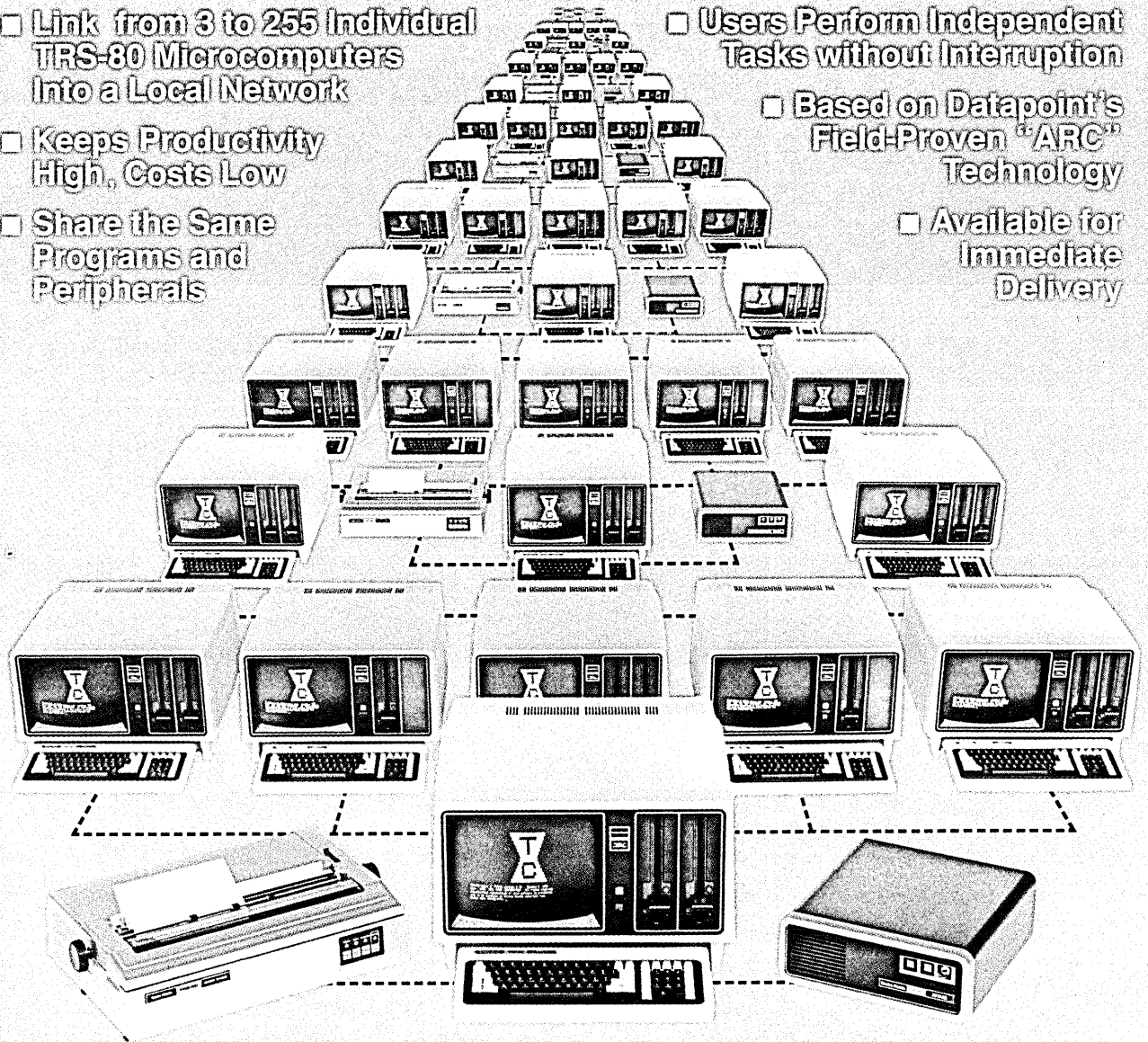

Now, an Affordable Computer Network. Radio Shack's new TRS-80 Arcnet is a full-function local area network that interconnects all of the TRS-80 Model 12 and Model II computers used in your office. Office personnel can share the same collection of programs and up-to-the-minute information—without realizing that anyone else is even on the network! They even share the same printers, hard disk systems and other peripherals, which results in significant cost savings. And with Arcnet, you can add more power by adding more computers—at about \$400 per computer.

Get the Big Picture. Stop by one of our selected Radio Shack Computer Centers for a demonstration—today!

Radio Shack
The biggest name in little computers®
A DIVISION OF TANDY CORPORATION

Send me a free copy of your new TRS-Arcnet brochure, plus the new TRS-80 Computer Catalog.

Mail To: Radio Shack, Dept. 83-A-196
300 One Tandy Center, Fort Worth, Texas 76102

NAME _____
COMPANY _____ PHONE _____
ADDRESS _____
CITY _____ STATE _____ ZIP _____

Arcnet is a trademark of Datapoint Corporation.



Brand new terminal.

Same old story.

If you're looking for the best terminal value, look to a familiar name: TeleVideo. The story of our new 924 is the same story you've heard for the last four years. We've combined the best innovations in technology, design, and quality manufacturing to give you everything you want in an advanced terminal. And we've done it at a price that can't be beaten.

The 924 is comfortable, with a tilt and swivel non-glare screen. Its lightweight, low profile keyboard fits your fingers naturally. Our 32 programmable, non-volatile function keys turn often used instructions into simple one-button commands. The 924 provides extra display features, including full screen editing, character and block graphics, definable scrolling regions for multiple window operation, plus 32 character-by-character visual attributes.

The 924 has the intelligence you need too, with logical attributes to define protected and unprotected regions. And, with standard one page or optional four page memory, there's plenty of room to work.

If you don't need all the power of the 924, try our 915. It has all the design advantages of the 924, and is the superior terminal in its class. It just costs less.

The 924 and 915 mark a great new chapter in the TeleVideo story. And, like all TeleVideo terminals, they're reliable performers, backed nationwide by General Electric Instrumentation and Computer Service Centers. Contact us today about the 924 and 915 story and you'll enjoy the happy ending. Call 800-538-8725 (in California call (408) 745-7760), or send us this coupon.

TeleVideo Systems, Inc.
Dept. 209J
1170 Morse Avenue, Sunnyvale, CA 94086

Yes, I'd like to know more about
TeleVideo's new 924 and 915 terminals.

Name _____
Address _____
City _____
State _____ Zip _____
Telephone (_____) _____

Santa Ana/California, 714-557-6095
Sunnyvale/California, 408-745-7760
Atlanta/Georgia, 404-399-6464
Dallas/Texas, 214-980-9978
Chicago/Illinois, 312-351-9350
Boston/Massachusetts, 617-668-6891
New Jersey/New York, 201-267-8805
Woking, Surrey/United Kingdom, 44-9905-6464



TeleVideo Systems, Inc.

See us at NCC Booth #A3008

CIRCLE 111 ON READER CARD

AFIPS finds there're only a few places in the country that can accommodate the burgeoning computer show.

NCC: TOO BIG FOR COMFORT?

by Willie Schatz

So you've thought it over, and on the whole you'd rather not be in Anaheim for NCC '83. Join the crowd. The folks who are bringing you NCC '83 don't really want to be there either.

Don't get the AFIPS folks wrong. It's not the climate. This is southern California, after all. It's not that the Magic Kingdom has lost its magic. It's just that there isn't enough space to put all the bodies.



"There are three principal ingredients we look for in every NCC site," explains Jim Kroell, AFIPS' director of conferences. "The most important is meeting space for our technical sessions. We need 10 meeting rooms capable of holding 500 people each. Second is adequate hotel rooms reasonably convenient to the site. That means a minimum of 20,000 rooms within 20 miles. Third is adequate exhibit space. That means 1 million square feet."

Anaheim's batting .333, which may win a title in the National and American Leagues but doesn't cut it in the NCC site game. Meeting room space is close, but no cigar. Hotels are no problem. Exhibit space, however, is a major difficulty. The Anaheim Convention Center, even after adding an extra hall, totals 500,000 square feet. Throw in two floors and the ballroom of the Disneyland Hotel and 110,000 square feet of space in temporary buildings erected in the Conven-

tion Center, parking lot, and you still come up 290,000 feet short.

It's enough to make a body want to go to Houston.

"Anaheim was booked many years ago," Kroell says. And, as any law school professor will be quick to tell you, a contract is a contract is a contract (unless it involves a sports figure). So even if Anaheim is the wrong place, it's the only place.

"Our biggest problem is that we've grown faster than we ever an-



MODEL BY JOAN STEINER
PHOTOGRAPH BY E. AND J. STALLER

NCC '83 PROGRAM HIGHLIGHTS

In addition to hundreds of vendors showing thousands of products, and several tons of those strange hors d'oeuvres hotels serve at receptions, NCC '83 has, like its predecessors, a theme: "The Emerging Information Age: Computers, Communications, and People."

The keynote will be struck on Monday, May 16, by John Imlay, chairman and CEO of Management Science America and a contributing editor of this magazine. Imlay's speech is entitled "The Information Transformation—A Study in Survival."

As in past years, Wednesday is Pioneer Day. This year's topic is the Harvard Computation Laboratory, where in the mid-'40s Howard Aiken and his team did their famous work with the Mark I Automatic Sequence Controlled Calculator, a giant electromechanical machine. The first session, "The Machines," will discuss Marks I through IV, and a second will examine "The Laboratory." There will also be a panel discussion on the accomplishments of Aiken, the man of whom Thomas Watson Jr. is reported to have said, "If Aiken and my father had had revolvers they would both have been dead."

Half-day and all-day professional development seminars will cover topics ranging from "Improving Productivity of COBOL Programmers" to "Synergistic Management" and "Letting Go of Stress." That last seminar will include a "guided meditation producing deep relaxation," which could prove useful at an NCC.

And then there are the technical sessions, more than 80 of them arranged in 11 tracks. Program chairman Allen Smith, manager of corporate systems with Atlantic

Richfield, says that "the program places heavier emphasis on communication, social and human factors than ever before. All of the program tracks will interweave communications, social factors, and computing issues in the various sessions."

Following is an arbitrary sampling of the sessions attendees will be able to choose from. Check your NCC program guide for the locations of the sessions listed here and descriptions of the many that aren't.

SPEAK ENGLISH, DAMMIT

On Monday at 1:30 Martha Evens of the Illinois Institute of Technology will lead a session on currently available systems for asking databases questions in English. The focus will be on methods of enabling users to choose the subset of English appropriate to their own applications. Panelists are Larry Harris of Artificial Intelligence Corp. and Barbara Grosz of SRI.

DATABASE MACHINES

Michael Plesset of Aerospace Corp. will lead this session, which is also on Monday at 1:30. Four presentations will describe applications of a database machine, use of massively parallel processors, use of the Britton-Lee machine, and future directions for db machine architectures.

PC FUTURES

A group of well-known consultants, led by Portia Isaacson of Future Computing, will predict the future of personal computers at 3:30 on Monday. Topics will include retailing, professional workstations, startup opportunities, and "maybe consumer robots."

TALKING ABOUT MY (FIFTH) GENERATION

At 8:30 Tuesday morning Franklin Kuo of SRI will lead a session on U.S. efforts that parallel the Japanese advanced computing projects. Government and industry leaders will describe their plans for building up the technology base for the U.S. computers of the 1990s.

DECISIONS, DECISIONS

How do you put together a decision support system that's really useful to a manager? By going beyond computers and communications, says Dr. Daniel T. Lee of the University of Hartford. He and some colleagues will discuss varied approaches to designing DSSs in two Tuesday morning sessions, one at 8:30 and the other at 10:30.

MICROS FOR BIG SHOTS

More and more managers are using micros to prepare budgets and financial projections. This session, led by David Chereb of Getty Oil, discusses the role of the micro-computer in the large organization's management information system and should provide attendees with some idea of what's to come in micro-based planning models. It's on Tuesday at 10:30.

FAULT TOLERANCE

The session leader is Omri Serlin of Itom International, and the panelists are the chief executives of three relatively new firms in this rapidly growing market, plus a key executive from Tandem. Tuesday at 1:30.

PORTABLE PC SOFTWARE

On Wednesday at 8:30, Paul O'Grady of Micro Focus will join with Tom McCalmont of Cromemco and Tom Rollander of

ticipated," Kroell admits. "NCC is as big as two years ago. In 1980 we had 180,000 net square feet of floor space. This year we'll have 325,000. We had 70,000 people in 1980. Last year we had 96,000. This year I'm betting we'll have 125,000.

"We're in real trouble for our future sites. With our space, meeting, and hotel requirements, only two cities in the country qualify: Chicago and Las Vegas."

It should come as no surprise, then, that NCC '84 will be held in Las Vegas and NCC '85 will be held in Chicago. After that, neither the NCC Board of Directors (NCCB), which establishes policy for the NCC and AFIPS' other major conference, the Office Automation Conference (OAC), nor the NCC Committee (NCCC), which manages the nitty-gritty of each NCC, knows for sure what's going to happen or where it's going to happen.

Site selection and policy direction are only two of the issues occupying the NCCB's and NCCC's time. While attendees are thinking about which technical session to attend or which exhibit to visit or which parties to frequent, the people who put the show together are worrying about space allocation and budgets for the next year. If you don't think

ahead in the conference game, you get left behind. Way behind. That's why AFIPS has a 12-person conference department for both NCC and OAC. The department comes in four parts: conference marketing, conference operations, exhibit operations, and exhibitor sales. NCC is tentatively tied up through 1987. OAC is penciled in through 1990.

"The perpetual issue in NCCC activities is the conference site," says Bob Spieker, director of marketing information systems for AT&T and chair of the NCCC. "This year the discussion [for NCC '84] was endless. First we were going back to Houston, then we were talking about Las Vegas. It's always a major issue. OAC, because it's so much smaller, is not as constrained in the number of possible sites.

"The problem is that the growth vastly exceeds expectations. When that happens, the plans and budgets you made in good faith five years ago suddenly become invalid and you have to start all over again. It's incredibly time-consuming."

So is everything else about the NCC. Attendees have it made. All they have to do is show up. Even exhibitors don't have it too tough. All they have to do is set up their booths. It's the folks who make it look so

easy who have it hard. It may look like magic, but it's nothing but work.

Resting atop the NCC pyramid is the NCCB. What it says, goes. There are eight members, four from AFIPS and four from the NCC sponsoring societies—the Association for Computing Machinery (ACM), the IEEE Computer Society, the Data Processing Manufacturers Association (DPMA), and the Society for Computer Simulation. All representatives are appointed by their respective presidents. The AFIPS vice president doubles as the NCCB chair. The AFIPS treasurer plays the same role on the NCCB. The NCCB chairmanship alternates yearly between AFIPS and the sponsoring societies.

All key decisions—budget, site, date—emanate from the board. It appoints the NCCC chairman, who serves ex officio as a member of the board. He's responsible for seeing that The Word is obeyed. The NCCB's thrust is policy. The NCCC's mission is operations.

WHO DOES THE DIRTY WORK?

Most of the NCC's dirty work is accomplished by the NCCC's nine-member Finance and Program Direction subcommittees. The Finance sub-

Digital Research to discuss some of the approaches being taken toward portable software for microcomputers.

APPLYING ADA

"With Ada and its programming support environments," says Grady Booch, "we have a tool to help us control the cost and improve the quality of software through the application of modern software practices." Booch, a consultant based in Lakewood, Colo., will lead a session on Ada applications on Wednesday at 1:30.

SOFTWARE IN THE YEAR 2000

Will software engineers do their jobs by conversing with HAL-like computers in the year 2000? Or will they be programming in Ada or in noncompatible extensions to the latest ANSI standard FORTRAN? Panelists Barry Boehm of TRW, Lee Belady of IBM, Larry Druffel of the DOD, and Tim Gilb, a consultant from Norway, will try to answer these questions in a session led by Dr. Jock A. Rader of Hughes Aircraft. It'll take place on Thursday morning at 8:30.

COMPUTER LITERACY

Are the computer skills acquired by college students serving them well when they enter the business world? Dr. Jason Frand of UCLA has assembled a panel—consisting of three professors and three businessmen—that will mull this question on Thursday morning at 10:30.

CAD/CAM COMMENTS

This session led by David Herstad of Arthur Andersen will feature a user, a technician, and a theorist. Attendees should get a good overview of the CAD/CAM world.

committee submits recommended budgets and estimated revenues on the five-year plan. These are reviewed by the NCCC, which then passes its views to the NCCB, which has the last word. The Program Direction subcommittee assists in the selection of the program chairman, who is appointed by the conference chairman. The NCCC reviews the program plans to ensure they meet the board's guidelines for content and the posture it wants to present to the industry. Other than that overview, the program chairman, who this year is Allen Smith, manager of corporate systems for Atlantic Richfield, is on his own.

Local details are handled by a Conference Steering Committee. The more experienced this group, the better. This year's group had its way paved by those who worked on NCC '80, also held in Anaheim. The idea is to call upon the logistical expertise of the locals to ease the job of the NCCC. Of course, when there's no booming dp community around, it's not easy to get good help. That's why next year outside assistance will arrive from Houston. Vegas isn't known as a hotbed of the computer industry.

What happened to business in this corner of committees? Not to worry. Presenting

"No matter where NCC is, somebody always comes up to you and says, 'What are we doing here?'"

the Industry Advisory Panel, a group started about a decade ago because the AFIPS people felt they weren't close enough to the business piece of the industry to get a balanced view of what was going on there. The avowed goal was to get a cross-section of personnel from large, small, hardware, and software companies, put them on a panel, and have them give advice and consent to the operations and policy types. So far, so good.

"We're an autonomous body," says IAP chair Sandy Lanzarotta, who volunteers his time when he can get away from his work as Xerox's manager of corporate affairs, Western Operations. The other six members of the IAP, as well as the members of the NCCC and its subcommittees, don't get paid for their work. The only folks making a living off the NCC are the professional staffers at AFIPS.

"We don't tell the AFIPS people what to do," Lanzarotta says. "We try to give them our perspective on what they're doing. If they come to us and ask us to find out something, we'll obviously do it. We'll also bring something to their attention if we don't think it's right."

Take Houston, for example. That was pretty much wrong in 1982. If you were there, you know. When AFIPS and the city started making noises about getting it on again in 1984, the group sought the IAP's input. The panel reviewed an AFIPS survey of exhibitors and found that Houston was not high on the list of most desirable places to spend an NCC. The panel also sought opinions about visiting Las Vegas. With the answers equally divided, the IAP voted, 4-3, to return to Vegas. That's not the only reason the NCCB chose it, but it's one motivating factor.

HOW THEY LIMIT THE MOBS

The IAP also is responsible for what conference organizers hope will be a significant force in keeping attendance at mob level. Prior to this year, exhibitors were given unlimited free tickets. Their totals may have looked impressive on the final attendance sheet, but it didn't make walking the aisles too much fun. The IAP suggested that exhibitors be given a limited number of free tickets and an unlimited number of discount tickets, good for \$10 off at the function of the ticket holder's choice. The immediate hope is that a higher quality of exhibitors and attendees will result. The ultimate goal is holding attendance to 100,000.

"We don't want to grow indefinitely," says professor Steve Yau, chair of the department of electrical engineering and computer science at Northwestern University and this year's NCCB chair. "The board has been doing a continuous study on how to limit attendance. We think 100,000 is a natural limit. We don't want to shut anybody out, but there are ways we think we can do it.

"One would be to substantially improve our technical sessions and overall conference program. We've got to increase the percentage attendance at the sessions. If we improve the quality of those, a higher quality of people will come. We can also cut down on our publicity. Obviously the show is well known, but we don't have to go out of our way to encourage people to come. I guess, though, we may be caught in a monster."

The monster is all-consuming. Yau and Spieker estimate they spend 20% of their time on their NCC functions. Most board and committee meetings take place on weekends because the members can't get away from their jobs. Site review is continuous. Even allocating exhibitor space takes months. The Exhibitors Advisory Committee has set up a procedure that makes *Robert's Rules of Order* look like *My Weekly Reader*. The points for choice space allocation date back to the first Fall and Spring Joint Computer Conferences in 1953. The waiting list is longer than many for football season tickets. AFIPS has four people doing nothing but allocating space. The number of companies wanting in has risen 60% in two years. This year 700 will get in. Three hundred will have to stay out. For them, there isn't always next year. Floor space is guarded with the exhibitors' lives.

"People go to the conference, look at the people sitting up on the dais, and think, 'Who the hell is that stuffed shirt?'" Lanzarotta says. "I know. I used to think the same thing. But let me tell you something. The NCCB and the NCCC work their tails off. These people are unbelievably conscientious. They're working Saturday and Sunday until 7 p.m. They're not up there looking down their noses.

"I know why attendees think that about the NCC people, but they couldn't be more wrong. After the past few conferences, I don't see how attendees can cling to that opinion."

One item will remain forever on the agenda, however. You can't keep all of the people happy all of the time. Given the possibilities, it's astonishing how little flack AFIPS actually receives over NCC locations. The organization hasn't even thought about starting a complaint department.

"We really get very little negative feedback. I'd call it negligible," says Kroell. Since he came to AFIPS three years ago, he's earned nine weeks' vacation. He's taken one.

"With 700 companies, somebody's always unhappy," Kroell cheerfully concedes. "No matter where you go, somebody always comes up to you and says, 'What are we doing here?'"

Think long and hard before popping that question in Anaheim. You could be in Houston.

15 pointed questions to ask MSA or any software supplier



Save this box. It can help you make an intelligent software decision.

1. Can you offer us a complete range of software systems designed to work together?

Or will we have to piece together a patchwork of systems?

2. Are your systems just record keepers, or can they really help us make decisions?

Can we pull together information from any of our integrated systems? In exactly the form we want it?

3. Can you provide business software for both mainframe and microcomputers?

Do you develop this software yourself or do you simply market it for another company?

4. Are your systems truly online—so all of our information is current?

How many of your systems are online? How secure are they?

5. Will my company have to be the one that discovers the bugs in your brand new system?

Just how long have your systems actually been used, and how have they been tested?

6. Will you update your systems as technology advances and regulations change?

What are some of your most recent updates? Will you keep us current on regulatory changes?

7. Do your systems really do everything you say they will?

Or will we have to change them or add to them to get the features we want?

8. How long have you been in business?

What are your revenues? What is your growth record? Where will your company be five years from now?

9. How many systems has your company installed?

How many of these were installed in the past six months? How many of your earlier customers are still using—and liking—your systems?

10. Do your financial systems handle unlimited foreign currencies?

Do your financial systems use a common set of currency exchange rates?

11. Can you link our executives' computers directly to the mainframe—so they can get their own information?

Is that software available right now?

12. How will you make sure my people thoroughly understand your system?

Do you have educational centers near us, or will we have to travel all the way across the country to find one? Will you be there to help during installation and after?

13. How many of your people specialize in software for my industry?

How many accountants work for you? Human resource specialists? Manufacturing experts?

14. Do your systems have built-in features that make them easier to use?

What happens if someone needs help figuring out a feature? Do you have online documentation that's easy to understand?

15. As my business changes will your system be flexible enough to change with it?

Or will I have to pay a lot to revamp it? Or even regenerate it?

These questions will help you when you sit down with individual software companies.

They're tough questions. Relevant ones. And any supplier who is worth his salt should be able to answer them without backpeddling.

Ask MSA

We'll answer all these questions to your satisfaction—plus any others you may have.

In fact, we're probably the best equipped to answer them. Because MSA is the software company. We offer the most complete line of totally integrated systems in the software industry, including financial, human resource and manufacturing.

So you avoid the headache of trying to tie together individual systems. (And the even bigger headache of adding to them.)

We've planned our growth, and the

growth of our products. Instead of acquiring systems piecemeal, then trying to integrate them, MSA carefully develops each system to work with the others.

With MSA's integrated systems, there's no unnecessary duplication of data or effort. Reporting is faster. All your company's information is more timely and accurate—and in the right form.

In short, we do everything we can to help your executives make informed business decisions, without creating unnecessary headaches for your department.

Our technical edge comes from experience

Staying ahead is easier for a company that's steeped in software technology. MSA has spent years developing, refining, testing and enhancing our systems.

This year alone, we'll invest \$25

million to make sure all our systems are technologically razor sharp. That gives us a decided advantage over flash-in-the-pan technology that may not have the bug-free logic of a more experienced system.

It also gives you a decided advantage over "custom" systems you have to update yourself.

MSA relieves you of that time-consuming burden. We update and enhance your software for a full year. Then we continue this service for a surprisingly low annual fee.

Maintenance includes keeping your system up to date technologically. Enhancing it with new features that make it work even harder for you. And making sure it reflects changes in accounting procedures and government regulations, including 401(k), TEFRA, and FAS52. (That eliminates a lot of tedious work you normally have to do.)

If we can do all this, you can be sure

MSA's software is flexible enough to accommodate changes in your business. Your company won't have to unexpectedly invest in customizing or completely regenerating your systems when you expand or reorganize.

35,000 days of training

New software can't improve your business until your company's employees feel comfortable using it—and know it well enough to exploit all its capabilities.

We make sure your people have a firm grasp of our systems. Last year alone, MSA conducted more than 35,000 student days of customer training for over 1,800 companies. At education centers all over the world, as well as at our headquarters.

From training sessions to cassettes to complete, easy-to-understand documentation, MSA provides the most extensive Customer Education Programs in the industry. We even do a follow-up audit after installation to make sure you're getting the most from our system.

MSA not only enhances software, we enhance the people who use it. Regular user meetings give our customers a forum to express their likes, dislikes and suggestions. These often lead to new product developments.

Our systems are always ready to HELP

MSA systems are just as friendly as our people. Our online HELP feature actually guides users through our systems. And EASY-SCREEN™ lets them design their own screens without creating data processing nightmares.

If there's ever a question or problem with our systems, MSA customers are always close to service. Our Account

Managers are knowledgeable, responsive, and backed by a complete team of industry specialists.

This team is responsible for solving the specific software needs of your industry. So you'll never get a blank look or an answer that doesn't relate to your business.

The heart of our integrated systems

It's MSA's General Ledger System. Combined with Accounts Payable/Purchase Order Control and our other systems, it gives your company complete control over your financial information.

Over 800 data processing specialists, accountants, and financial experts work together to make MSA's financial systems the most advanced and most highly integrated in the industry.

MSA has the answers

Whatever your size—whatever your business—MSA has a total software solution.

We'll provide the highest quality integrated online software.

We'll tie your business and manufacturing software systems together, using our exclusive Extended Closed Loop™ manufacturing system.

We'll provide business software for your microcomputers, through our Peachtree Software Company.

We'll even link your microcomputers to your company's mainframe—with MSA's Executive Peachpak™ application software. A revolutionary concept that lets executives get the mainframe information they need through their personal computers.

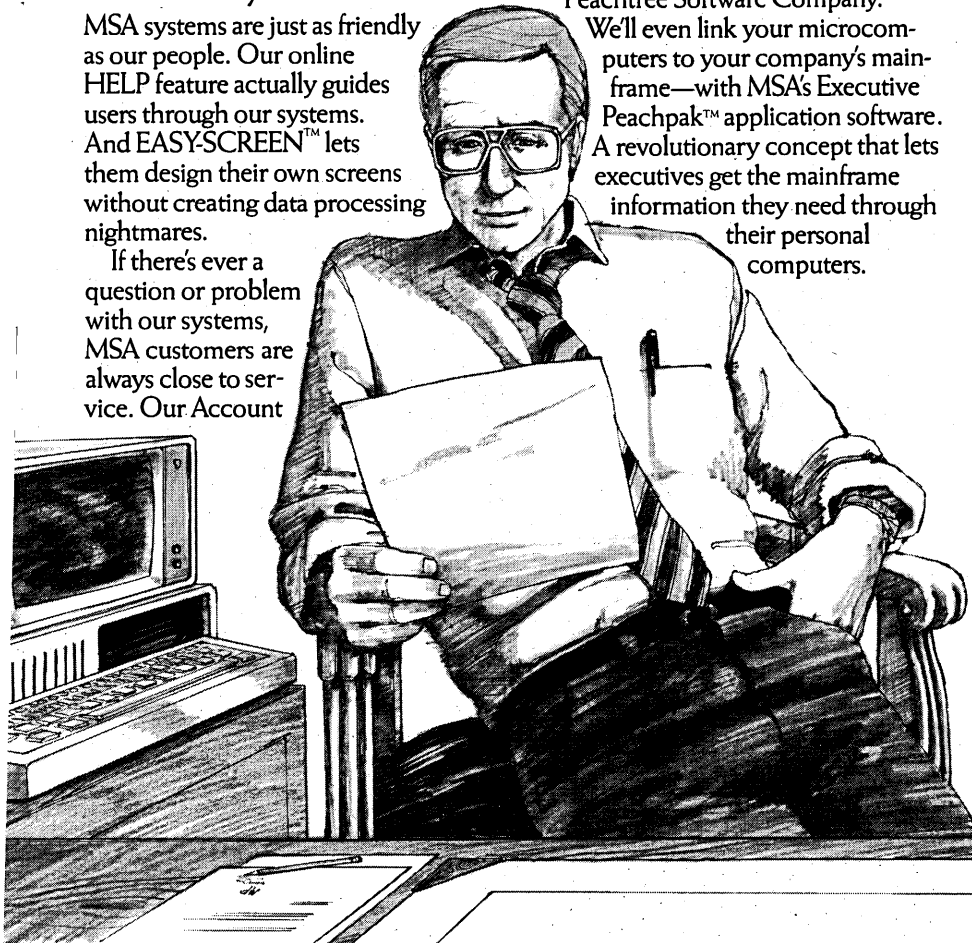

MSA ready-to-install applications software	
1.	General Ledger
2.	Accounts Payable/Purchase Order Control
3.	Budgetary Control/Encumbrance
4.	Fixed Assets Accounting
5.	Capital Expenditure Tracking
6.	Forecasting & Modeling
7.	Accounts Receivable
8.	Foreign Exchange
9.	Inventory & Purchasing
10.	Payroll
11.	Personnel Management & Reporting
12.	ALLTAX™ Taxing System
13.	ALLTAX Reporter™
14.	Manufacturing Control System (MRP II)
15.	Executive Peachpak™
16.	Peachtree Software™ business systems for microcomputers
17.	Peachtree Software™ office productivity systems for microcomputers

Talk to us

If we've whetted your appetite with our 15 questions, clip the coupon below.

We'll send you a concise booklet that will help you even more in your deliberations. We'd also like to send you more information on how MSA can help you plan for software. And on individual systems.

Just fill in the information below, or contact Robert Carpenter at (404) 239-2000.

DA17b(5/83)

Management Science America, Inc.
3445 Peachtree Road, N.E.
Atlanta, Georgia 30326

Please send me a free detailed brochure.

Please send more information on the following systems. (Write numbers from product list)

Mainframe Type/Model _____

Name _____

Title _____

Company _____

Address _____

City _____

State _____ Zip _____

Business Phone (____) _____

MSA
The Software Company

CIRCLE 112 ON READER CARD

SCIENCE/SCOPE

A semiautomatic production line makes solar cells that are higher performing and much lower in cost than conventional cells. The facility at Spectrolab, a Hughes Aircraft Company subsidiary, creates highly uniform cells and increases productivity. It uses the latest techniques, including photolithographic masking for contact patterns, with subsequent contact plate-up. The first "mechanized" cells have been delivered to Hughes for the Intelsat VI communications satellites.

Printed circuit boards made of a new material may permit better direct soldering of large leadless ceramic chip-carriers. A Hughes study proposes using quartz-fabric-reinforced polyimide resin in place of glass-epoxy or glass-polyimide boards. The new material has nearly the same thermal expansion coefficient as ceramic chip carriers. When a leadless carrier is soldered directly to a quartz-fabric polyimide board, there are no shear stresses caused by heating or cooling. Such stresses often cause solder joints to fail on conventional reinforced printed circuit boards.

A new device "super cools" spaceborne infrared sensors to increase their sensitivity to thermal radiation. The Vuilleumier cycle cryogenic refrigerator is especially suited for use in space. The low internal forces required in this type of cooling cycle cause little wear on bearings and seals. The result is a long, maintenance-free operating life. Hughes engineers, under U.S. Air Force contract, expect to extend the operating life of the cooler beyond three years by 1985. Three space-qualified models have already been built, and over 60,000 hours of tests have been run on three engineering development models.

In the 80 seconds a cruise missile reaches a ship after breaking the horizon, an advanced radar system directs counterfire with extreme accuracy. The Hughes Mk-23 Target Acquisition System (TAS) combines with NATO's Seasparrow missile system to defend ships from sea-skimming and high-diving missiles that often escape conventional radar detection. TAS detects anything that flies above the water -- even a small cruise missile skimming the waves at the speed of sound -- because it filters out radar clutter caused by interference from the sea, land, weather, chaff, or electronic countermeasures. TAS will be carried by all U.S. Navy aircraft carriers and over 40 other high-value ships.

Hughes is seeking engineers to develop advanced systems and components for many different weather and communications satellites, plus the Galileo Jupiter Probe. Immediate openings exist in applications software development, data processing, digital subsystems test, microwave/RF circuit design, power supply design, digital communications, signal processing, spacecraft antenna design, system integration test and evaluation, and TELCO interconnection. Send your resume to Ray Bevacqua, Hughes Space & Communications Group, Dept. SE, Bldg. S/41, M.S. A300, P.O. Box 92919, Los Angeles, CA 90009. Equal opportunity employer.

Creating a new world with electronics

HUGHES

HUGHES AIRCRAFT COMPANY

For more information please write:
P.O. Box 11803, Los Angeles, CA 90291

Get ready for the industry's biggest annual bash with a rundown on more than 50 products that will debut in Anaheim.

NCC PRODUCT PREVIEW

by Michael Tyler

Get out your walking shoes and sunglasses, because it's time for the biggest bash the industry's ever seen, the 1983 National Computer Conference. More than 100,000 people will converge in sunny southern California to see upwards of 600 vendors strut their stuff in 310,000 square feet of exhibit space. Sponsored by the American Federation of Information Processing Societies (AFIPS), this show of shows will be held May 16 to 20 at the Anaheim Convention Center and adjacent Disneyland Hotel Convention Center.

This year's conference chairman is Don P. Medley, professor and chairman of the Information Systems Department in the School of Business Administration at California State Polytechnic University.

There will be products by the thousands at this year's NCC, traditionally a premier showcase for vendors' wares. Many exhibitors will be displaying their full lines and many others, including those listed here, will take this opportunity to unveil new offerings.

If you intend to peruse the plethora of products, be prepared. The NCC is a little like nearby Disneyland: lots and lots of people come to see some very exciting exhibits, but there are big crowds and very long lines and never enough time to do everything you want to do. If you were to spend only five minutes in every booth, you would need 50 hours to cover the whole show, in addition to the 100 hours you would spend on lines and in transit between booths; yet the exhibit area will only be open for about 40 hours. (Exact scheduling was not available at press time.)

So wear cool clothes and comfortable shoes, and carefully choose the exhibits you want to see. To give you a little help, we've compiled a sneak preview of products that will be shown for the first time at NCC. These should at least whet your appetite.

ADDISON-WESLEY PUBLISHING CO.
Reading, Mass.
P.C. SOFTWARE
Booth N3716

This vendor will be showing two new packages for the IBM Personal Computer. MicroDynamo is a system dynamics modeling lan-

guage which compiles and simulates complex models of cause-and-effect relationships over time. The package lets users create their own models and specify which variables are to be printed or plotted without using format statements. Dynamo interprets the model internally to produce the tabular and plotted results for color display or monochrome printing. The package can handle models with up to 100 variables and is designed for applications in marketing, personnel, energy, fishery management, and engineering systems, among others. It costs \$245.

Micro-DSS/Finance is a decision support system that combines built-in standard financial functions—depreciation, internal rate of return, amortization, etc.—with the power to manipulate, cross reference, and rearrange information. Unlike spreadsheet packages, DSS/Finance allows users to solve simultaneous equations, generate color graphics, produce consolidations, and automate series of commands. It costs \$1,500. Both packages require 128KB RAM, two floppy disk drives, a monitor, and a printer.

FOR DATA CIRCLE 400 ON READER CARD

ALTOS COMPUTER SYSTEMS
San Jose, Calif.
MICROCOMPUTER
Booth W6218

This vendor will be premiering the model 568 microcomputer system, which is similar in

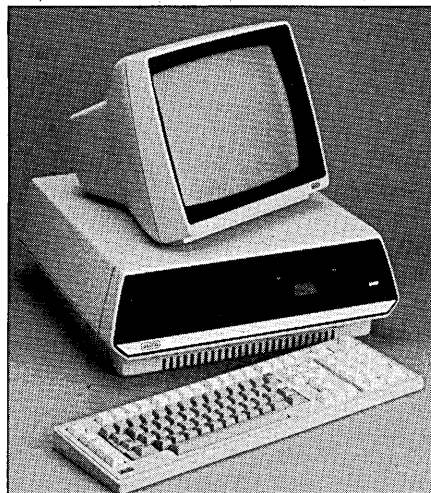

many respects to the 586 introduced last November. The 568 is based on a 68000 microprocessor running at 12MHz, with 512KB to 1MB main memory. The system can support one to five users under the RM/COS or Unix III operating systems. Two 5¼-inch disk drives provide a megabyte of floppy disk storage and 20MB of Winchester storage on-line; the Winchester capacity can be expanded to 160MB using 8-inch drives. The multitasking system comes with six serial RS232 ports, which can be expanded to 10 as a factory option. A communications system option includes a 300 baud modem, an Ethernet two-chip set, and four serial ports; this option will cost \$1,400 and be available next month. Other additions include a virtual memory option which will be available later this year when the 68010 microprocessor becomes available in bulk quantities. The 568, which costs \$10,990, supports five programming languages: BASIC, COBOL, FORTRAN, Pascal, and C. In addition, communications protocols including Altos-Net, Ethernet, 2780/3780, 3270, ASCII, SNA/SDLC, and X.25 are supported. The 568 has a power fail detection feature to prevent the loss of data written to disk in the event of a power failure. Disk backup is provided by an MTU magnetic tape drive, which costs an extra \$2,310. The system also includes a real-time clock and a multi-bus-compatible expansion port.

FOR DATA CIRCLE 401 ON READER CARD

ANN ARBOR TERMINALS, INC.
Ann Arbor, Mich.
TERMINALS
Booths W6613-W6614

This vendor will demonstrate several new terminal products. One is the Guru terminal, which offers all of the power and features of the vendor's Ambassador terminals with more memory and display capability. The terminal comes standard with 28KB memory, which is equivalent to 15 pages of an 80 × 24 display. The display format is 170 characters horizontally by 66 lines vertically—nearly six times more characters than a conventional 80 × 24 display. The editing terminal, which transmits in block mode only, costs \$2,200.

The vendor is also offering its Ambassador terminal with a portrait display op-

NCC PRODUCT PREVIEW

tion. The monitor is positioned vertically, giving the user a 60-line display. It includes all the features of the standard Ambassador and costs \$1,800.

Finally, the Graphics Master retrofits the Ambassador or Guru terminal into an interactive graphics terminal. Its resolution is 760 × 576 pixels, and it emulates Tektronix 4010 series terminals, including the interactive cross-hair graphics cursor. It is compatible with many standard software packages, including Plot-10, Disspla, Tell-A-Graph, SAS/Graph, DI3000/Grafmaker, and SLAC Unified Graphics. It costs \$1,500.

FOR DATA CIRCLE 402 ON READER CARD

APPLIED DATA COMMUNICATIONS

Tustin, Calif.

PORTABLE FLOPPY DRIVE TESTER Booths P7006-P7008

The PT-350 portable floppy disk drive tester/exerciser measures 12 × 5 × 12 inches and weighs 10 pounds. Based on a Z80 and a one-chip floppy disk controller, the unit performs 70 functions, including exercises, test programs, maintenance routines, density and format routines, parameter routines, and data pattern routines. The programs are contained in ROMs, and can be used with a single 8-, 5¼-, or 3½-inch drive. An optional feature is a built-in printer for hardcopy of test results. To facilitate test selection, the unit has a 20-key membrane keyboard and 20-character alphanumeric display. The tests and exercises available are a selected subset of those incorporated in the larger T-400 system. The unit features a calibrated test margin circuit and measurement of early and late margins of the data window. Margin limits can be established for all read tests. Normal data integrity testing is performed using standard soft-sectored FM/MFM formats. The unit costs under \$3,000.

FOR DATA CIRCLE 403 ON READER CARD

AURAGEN SYSTEMS CORP.

Englewood Cliffs, N.J.

FAULT-TOLERANT SYSTEMS Booths P7653-P7661

Formerly Parallel Computer Systems, this vendor will be showing its new fault-tolerant computer system, based on several 68000 microprocessors in a semiredundant architecture. The system is organized around two 16Mbps system buses, which connect up to 32 clusters of processors (each processor connects to both buses). Every cluster is built around a 68000 executive processor, which interfaces with the system bus and runs the Auros fault-tolerant version of the full Unix operating system. In addition, every cluster has two 68010 virtual memory microprocessors which act as application processors, under the control of the executive processor. These communicate on a cluster bus with the

cluster's main memory, a cluster communication processor, and a disk/tape controller. Up to four communications processors (also 68000s) can be attached to the cluster bus; each connects to up to eight interface boards, and each interface board, using a single protocol, connects to eight terminals or printers. Thus, each cluster can handle up to 256 ports.

Every interface board (and every disk drive or tape drive) is connected to two cluster communications buses, so that if one cluster goes down the terminals and storage are still available on-line. Each disk/tape controller (there can be four on a cluster bus) can handle four disk drives and four tape drives. The clusters act as backups for each other, but not with the continuous checkpointing found in other fault-tolerant systems. Rather, each time a processor sends a message to another processor, it also sends the same message to two additional processors in a multidrop manner. If the message is not acknowledged from any of the processors, that processor is taken off-line automatically and one of the others resumes processing with no data loss. This will result in a recovery time of about five seconds and a possible slowdown in processing speed due to the increased burden on the other processors, but this form of fault tolerance involves an overhead of about 20% of processor capacity compared to a 50% capacity of other systems. A two-cluster system with 4MB of main memory, a 260MB Fujitsu disk drive, printer, 10 terminals, and software (Auros, the Aurelate DBMS based on Oracle, and screen managers) costs about \$210,000.

FOR DATA CIRCLE 404 ON READER CARD

CALIFORNIA COMPUTER GROUP

Costa Mesa, Calif.

MINICOMPUTER SYSTEMS Booths P7940-P7942

UltraVAX is a family of minicomputers based on DEC's VAX-11 cpus. Systems to be introduced at NCC are the Ultra 730 and Ultra 750, based on the low-end models of the VAX line. In addition, an UltraKit will be introduced; it will provide VAX-compatible disk, tape, and communication subsystems for the entire VAX line. The Ultra line substitutes firmware-driven controllers on each Unibus, CMI-bus, or SBI-bus for the more traditional, logic-driven controllers used in standard DEC configuration. The controllers comprise bipolar bit slice microprocessor designs incorporated onto single board or single board extended packages that fit into VAX backplane slots without modifications. All basic control, status, and data transfer operations are implemented by microcode. The controllers are software transparent to VMS, Unix, and DEC diagnostics. The controllers provide users with flexibility by enhancing storage capacity, eliminating speed bottlenecks, avoiding

hardware duplication, and improving the efficiency of multiplexed communications. Typical prices for the UltraVAX 730 range from \$43,950 to \$75,000, and for the UltraVAX 750 from \$75,500 to \$130,250.

FOR DATA CIRCLE 405 ON READER CARD

CALIFORNIA COMPUTER PRODUCTS

Anaheim, Calif.

PLOTTER

Booth N3838

The model 84 eight-pen desktop plotter represents this vendor's first foray into the business graphics market. The plotter handles 8½

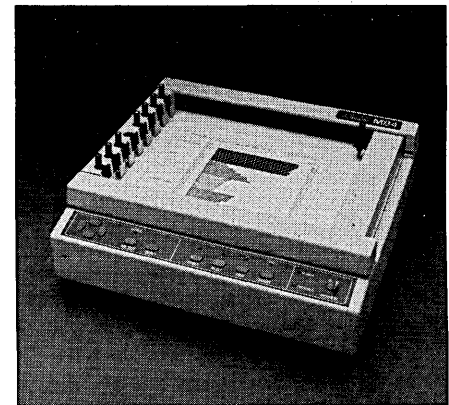

× 11-inch or A4-size paper and transparencies. Multicolor plots are drawn by liquid ink, nylon tip, or ceramic tip pens. A Business Graphics ROM is available as an option, allowing users to plot bar, pie, and line graphs from basic commands. The model 84 offers speeds of up to 16.5 inches per second, with a resolution of 0.004 inch. The plotter, based on the Z80 microprocessor, has built-in firmware commands that include five-line styles, selectable angular rotations in degrees, special symbols, six character sets, windowing, scaling, and circle drawing. The model 84 incorporates a print mode that enables the user to verify the plotter's configuration when in self-testing and to print plot commands. The unit can connect to most microcomputers, minis, and mainframes using one of three interchangeable interfaces: RS232C, IEEE 488, or Centronics parallel. With the RS232C interface, baud rates are switch-selectable from 110 to 9,600bps. The printer supports Disspla, Tell-A-Graph, SAS/Graph, and GSX. It uses the vendor's host computer basic software package with BASIC and FORTRAN. The model 84 costs \$2,000 in single units.

FOR DATA CIRCLE 406 ON READER CARD

CANON USA

Lake Success, N.Y.

PRINTER

Booth P7626

This vendor will exhibit its new PW-1080, an 80-column dot matrix impact printer. The

OmniCalc

the First and Fastest
Electronic Spreadsheet for CICS

Now, at long last, you don't have to buy microcomputers to run electronic spreadsheet programs. For years, VisiCalc*, the electronic spreadsheet for microcomputers, has been the largest selling software product. Now, OmniCalc, the electronic spreadsheet program for CICS, is available for large multi-user systems. IBM 303X, 308X, 4300, and System/370 users can now run this valuable planning tool as a CICS application. With OmniCalc, CICS users can analyze data for financial schedules, cash forecasts, budgeting, sales forecasts, expenses, and many other individual plans as they're being made.

A simple matrix, virtually unlimited in size, lettered across the top of the screen and numbered vertically down the left side allows each user to design his own unique matrix size and write programs for any "what if" application. Once the worksheet has been designed, as many changes as desired can be made to the information by simply entering new values into the matrix. The computer instantly does all calculations and displays the results at every location affected. Some of the more significant features of OmniCalc are as follows:

- Variable Matrix Size
- Multi-dimensional Matrix Support
- On-line Help File
- Database and User File Interface
- Complete Password Protection
- Data Encryption For All Matrices
- User Defined Sub-catalogs
- Fully Programmable Matrix
- Split Screen Viewing
- Easy to Implement

OmniCalc reduces the long hours associated with planning by eliminating the need for traditional paper worksheets, pencils, erasers, and calculators. You will see as you develop your plans, the answers to all of those "what if" questions that typically accompany any planning session. Best of all, for only \$1999.00, OmniCalc can be used by everyone on your CICS network.

OmniCalc, another powerful management tool from Tower Systems.

* VisiCalc is a registered trademark of VisiCorp

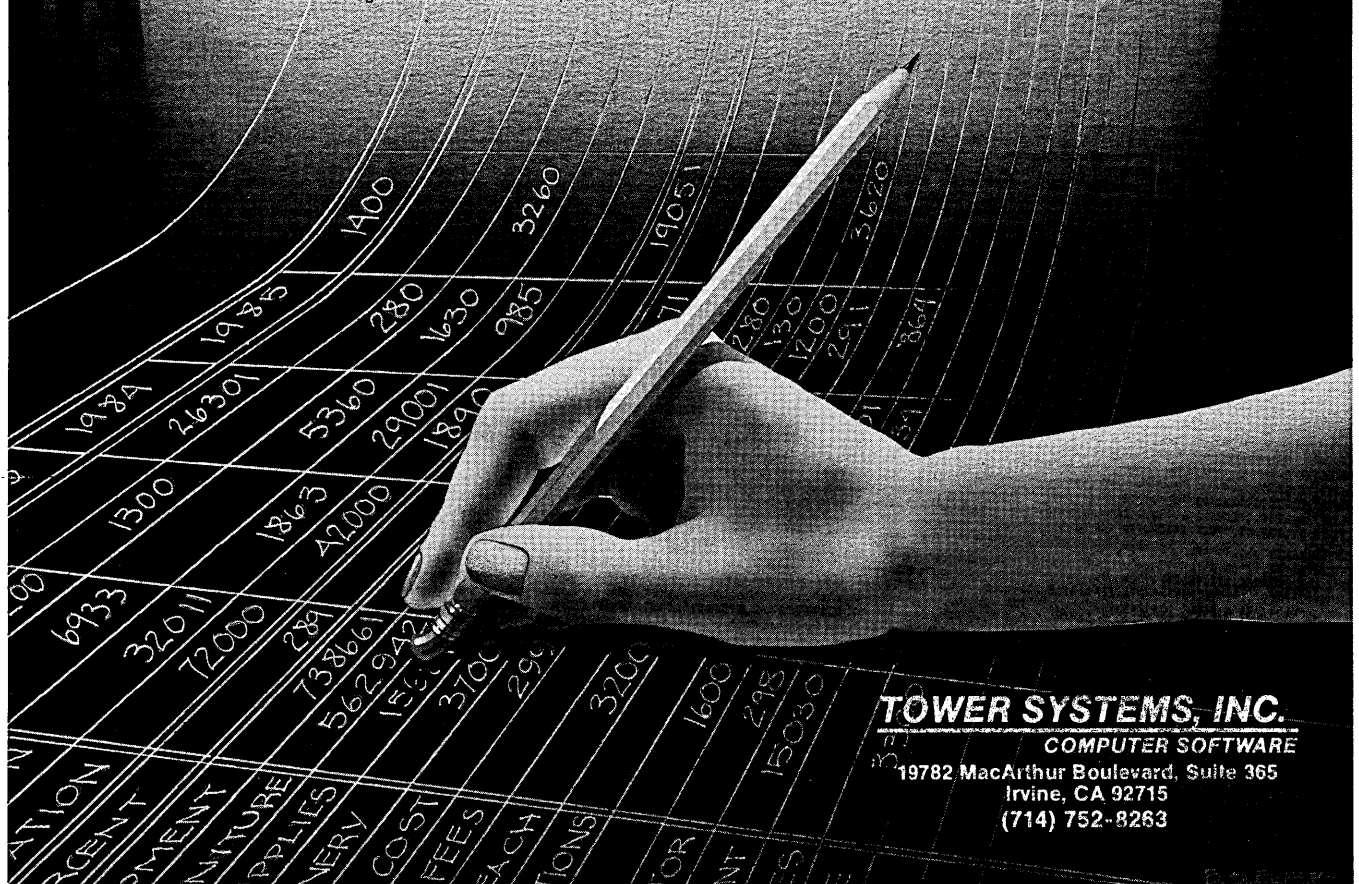

TOWER SYSTEMS, INC.
COMPUTER SOFTWARE
19782 MacArthur Boulevard, Suite 365
Irvine, CA 92715
(714) 752-8263

The one and only R.

Cullinet's relational database management system for IBM computers. It's called IDMS/R.

IDMS/R is a single solution to the two-sided problem of providing useful database applications for both end user and production tasks.

This is how it works:

As a true relational system, it allows you to select data from separate and unrelated files; join it, then project it in ways that make it possible for you to handle small-scale applications and unstructured end user requests for information quickly, directly and intelligently.

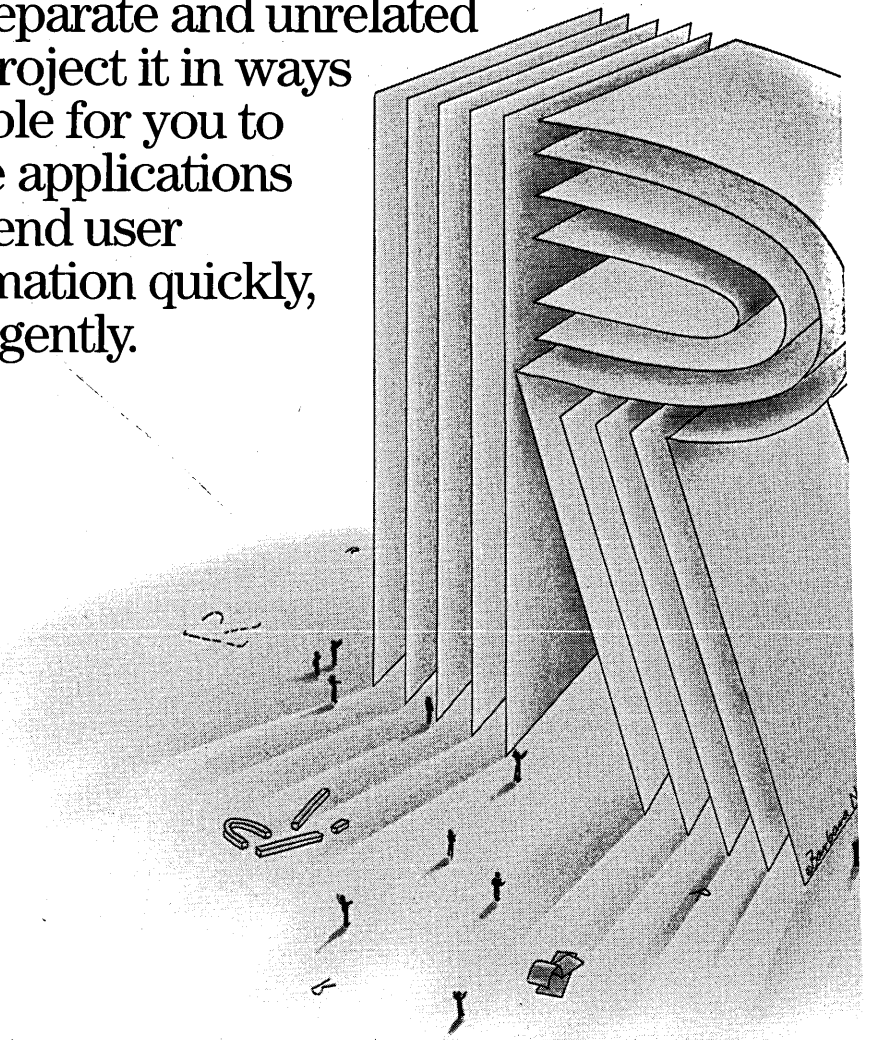

What's unique is that IDMS/R also allows you to handle high-volume, production applications with the proven network technology best suited for the job.

It's this marriage of architectures that makes Cullinet's relational DBMS stand apart. In fact, where others have tried to propose relational or pseudo-relational components that exist separately from the production database, Cullinet's is the only one that lets both work together. Thus serving the whole corporation by serving all of the needs within it.

IDMS/R.

To get everything out of the database that you've put into it, the answer is software.

And software is Cullinet.

Cullinet

©1983 Cullinet Software, 400 Blue Hill Drive, Westwood, MA 02090.

CIRCLE 116 ON READER CARD

NCC PRODUCT PREVIEW

unit operates at up to 120 characters per second using bidirectional printing. It is capable of printing standard, enlarged, and condensed characters on plain paper, roll paper, fanfold, or cut sheets. Each character is formed on a 16 × 16 dot matrix for high density approaching letter quality. The printer is also capable of image printing with a resolution of 480 or 960 dots per line using vertical eight-dot input. In the image printing mode, the unit operates from left to right only and prints 5,760 dots per second. The printer has a one-line character buffer (40, 80, or 136 characters) or a 1,920 byte image buffer. It requires a Centronics 8-bit parallel interface. The desktop unit weighs 17.6 pounds and measures 16 × 12½ × 4½ inches. It costs about \$600, depending on quantities, and is being sold only through OEMs.

FOR DATA CIRCLE 407 ON READER CARD

CENTRONICS Hudson, N.H. PRINTERS Booth N3600

This vendor will be showing four new printers—a 400 line per minute band printer and three additions to its Printstation 350 line of dot matrix printers. The Linewriter 400 band printer uses a linear hammer technology that creates even characters without slicing tops or bottoms the way some angular hammer printers often do. The printer offers a throughput rate of 300 to 500 lines per minute, and operates at 64 dba; a container coming later this year will reduce the noise level to 55 dba. The unit has a four-digit alphanumeric display to guide users through operation and through internal diagnostics. All service can be done through the front panel. While no specific price was available at press time, the vendor says that the Linewriter 400 should cost about 30% less than its current band printers.

The three additions to the Printstation 350 series have double the speed of corresponding existing members of the series. The bus-oriented 355, dp-oriented 357, and near letter quality 358 all operate at 400 characters per second. They use a stored energy printhead similar to that used on band printers, rather than a ballistic printhead; the stored energy mechanism, in which the print wires are held away from the paper by a magnet and spring toward the paper when the current is released, is said to be more energy efficient than the ballistic mechanism. The 355 comes with a parallel interface only; the 357 is the same printer with a reformatter for RS232 and RS449 interfaces. The 358 is a 357 with a double pass capability for 100cps near letter quality printing. A cut-sheet feeder has three bins for letterhead, envelopes, multipart forms, or fanfold. The feeder costs \$1,000.

FOR DATA CIRCLE 408 ON READER CARD

CHARLES RIVER DATA SYSTEMS Natick, Mass. SMALL BUSINESS SYSTEMS Booth P7618

This vendor will be using the soapbox of NCC to introduce Ryan-MacFarland COBOL for its Universe 68 line of 32-bit small business

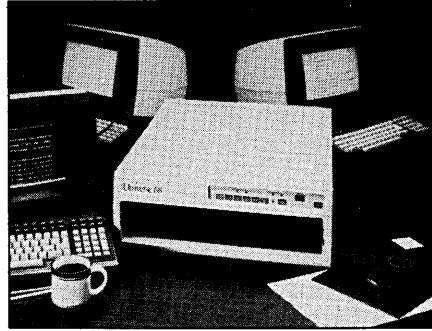

computer systems. The widely used implementation of COBOL will be running on the vendor's 6805, its first 32-bit system priced under \$10,000. RM/COBOL runs under the vendor's proprietary UNOS operating system, a Unix-compatible system with real-time, transaction-oriented capabilities. In multiterminal systems, UNOS allows RM/COBOL to run simultaneously with other supported languages, including BASIC, Pascal, and FORTRAN.

FOR DATA CIRCLE 409 ON READER CARD

CYBEREX, INC. Mentor, Ohio UPS SYSTEMS Booth N4501

ADVISE is a loose acronym for Advanced Information System for Edp Managers, which fails to mention that the system is designed specifically for management of uninterruptible power sources. The system provides information on UPS status and can display voltage, current, and frequency readings. This information can be printed on hardcopy as an option. In the case of a system abnormality,

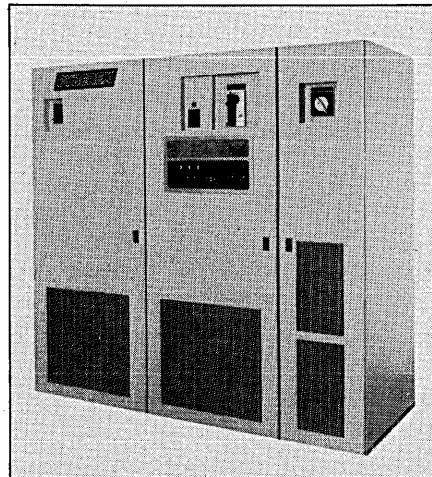

ADVISE alerts the edp manager by means of visible and audible alarms. Through its video display, the system provides instructions for quick, correct recovery procedures and provides a fail-safe audit trail in case of UPS or main power supply failure, the vendor says. The product also produces complete digitalized analog waveforms of input, output, and control voltages, which can be transmitted to an off-site location for detailed technical analysis. The ADVISE system will be shown with the vendor's recently announced transistorized UPS, available in 60 or 415Hz models. Systems cost \$20,000 to \$75,000.

FOR DATA CIRCLE 410 ON READER CARD

CYNTHIA PERIPHERAL CORP. Palo Alto, Calif. PAGE PRINTER Booth A3104

The MP-60 is a magnetic nonimpact page printer. The printer can produce 88 pages per minute, or 6,000 lines per minute. Full intelligence features are provided, including a line printer emulation. The printer is said to offer a mean time between failures of 1 million pages. It costs approximately \$20,000 in quantities of 500, but will not be available until sometime next year.

FOR DATA CIRCLE 411 ON READER CARD

DATA DEVICES INTERNATIONAL Chatsworth, Calif. TAPE CERTIFIER Booth 4500

The Minicertifier is a magnetic computer tape machine that enables users to identify any tape defect, and in most cases to correct it. In operation, the certifier stops the tape when it detects a defect, and places the portion of the tape in a microscope repair station. The defect can then be repaired by trained personnel. The product costs \$30,000, but is said to replace systems costing \$100,000. The micro controls and software programming make the price reduction possible, the vendor says. The certifier will be available in July.

FOR DATA CIRCLE 412 ON READER CARD

DATA MAGNETICS CO. Santa Clara, Calif. STREAMER HEADS Booth 7744

This vendor will be introducing a series of advanced nine-track RAW double-density PE heads for streaming applications. Gap-to-gap distance is .300mm. The face of the head is covered with a plasma-coated ceramic, which is intended to extend the product's life. The vendor expects that the head will function for over 20,000 hours at 100 inches per second, although it can be used at up to 125ips. The custom-made streamer head costs \$40 to \$300, depending on customer specifications.

FOR DATA CIRCLE 413 ON READER CARD

WE BUILD THE MOST EFFICIENT COMMUNICATIONS DEVICES YOU'LL NEVER SEE.

Once they're in place, Amdahl digital communications network systems perform so smoothly and unobtrusively that some users actually forget they're there.

Fine. That means we're doing our job properly. It also means that you are achieving optimum facility use with lower line costs and reliable operations. You also have the ability to respond to change in a planned, economical manner.

Best of all, you have a choice of system solutions to meet your specific networking requirements.

Cost-effective packet switching networks.

If you require a high performance, full feature X.25 data network with from one to over 100 nodes—our 4400 Series Network Concentrators and Administrators combined with our 4410 Network Processor provide the means. They give you protocol conversion and the resource-sharing capabilities you need, plus outstanding network management functions. You protect your present data processing investment, and the 4400 can be your gateway for affordable access to other public and private X.25 networks.

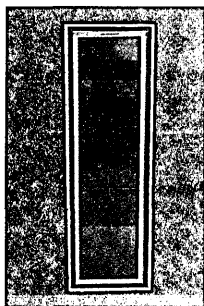
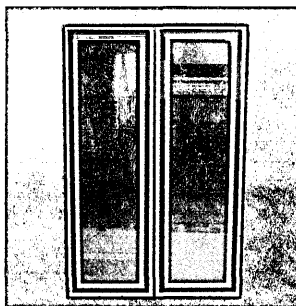
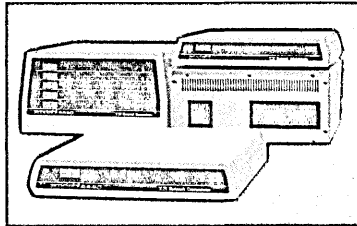

Versatility in data switching networks.

To integrate diverse computing resources into one network, our 3400 Data Switching System readily supports many different architectures and protocols—to give all your users full-service access to all necessary resources.

Value added in non-switched networks.

For efficiency in point-to-point and multi-point digital networks, our soft-configured 2200 Series Time Division Multiplexers with network management capabilities are designed to meet a broad variety of applications.

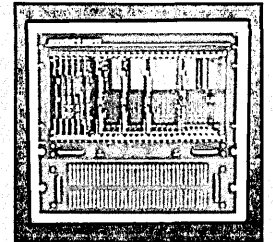

High performance in front-end processing.

To effectively meet your expanding tele-processing needs, our 4705 Communications Processor offers compatibility with advanced, high throughput operating characteristics.

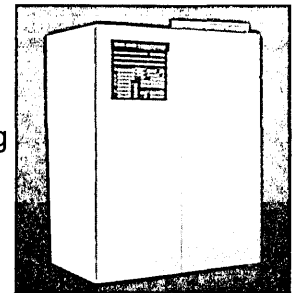

Price/performance in limited distance modems.

Feature for feature, our 982 Data Sets are the industry's biggest value. And an array of communications test equipment rounds out the complete Amdahl line.

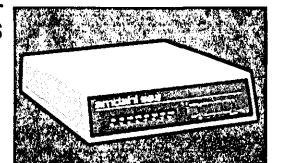

While you might not "see" our products, our product support is highly visible. It includes turn-key installation, comprehensive training, system documentation, and customer service performed by Amdahl Field Engineers located worldwide. For full information on any Amdahl communications system solution, call or write us today.

The invisible links from

amdahl COMMUNICATIONS SYSTEMS DIVISION

2500 Walnut Avenue, Marina del Rey, CA 90291
(213) 822-3202

CIRCLE 117 ON READER CARD

To a world of chaos and confusion rational approach to

Today, most organizations realize how critical it is to manage information effectively. After all, information is a key resource. So the choices you make today for data processing,

part, are incompatible.

It is a market characterized by chaos and confusion.

OPEN World—finally, an approach that makes sense.

Northern Telecom has introduced a rational approach to the planning and building of information management systems: the OPEN World.* It is based on the simple concept that all information can be handled in one integrated system. One system that will allow many makes and types of equipment and transmission highways to work together harmoniously. One system that will give you freedom to choose from many different suppliers. One system that will evolve to protect against obsolescence.

The OPEN World is a planning framework embodying these concepts, and a program for the introduction of products and features to enable you to plan and build optimum information systems, designed around the key common element—communications.

We're backing the OPEN World with a research and development commitment of one billion dollars to be spent on R & D in the next five years on OPEN World systems, products and features.

The Five C's—five criteria to judge our approach. Or theirs.

There are five key criteria against which any information management system or component should be evaluated.

1. Continuity.

The system or equipment should be able

An example of continuity: we have evolved the telephone network to allow yesterday's equipment to work as effectively as today's.

The OPEN World

A corporate commitment

Northern Telecom's commitment reflects the importance of information to the future of all organizations... to business, large or small, government, and others.

Information management is fraught with complexity... in technology... in the diversity of products... and in a bewildering array of suppliers.

It is to this environment that Northern Telecom brings "Open Protocol Enhanced Networks"—OPEN World—universal information management systems through communications.

Communications is the common denominator for effective information management.

OPEN World is intelligent systems that can evolve and grow to meet any communications requirement.

OPEN World is versatile, planned information management... communications products and a universal planning framework.

This is Northern Telecom's commitment to information management... OPEN World.

Walter F. Light
Walter F. Light
Chairman of the Board
and Chief Executive Officer
Northern Telecom Limited

Edmund B. Fitzgerald
Edmund B. Fitzgerald
President
Northern Telecom Limited

OPEN World: our commitment to information management systems that meet the Five C's—continuity, compatibility, congeniality, control and cost-effectiveness.

voice and data communications, word processing and image communications will determine, to a large extent, your future success.

But deciding on an information management system can be very complex.

Obsolescence is a constant concern. Because of the rapid pace of technology, today's innovation too often becomes yesterday's generation. To compound the problem, the needs of your organization are also constantly changing. How do you know what your requirements are going to be next year?

Also contributing to the complexity is the ever-growing number of suppliers offering a vast array of products and services. Products, which for the most

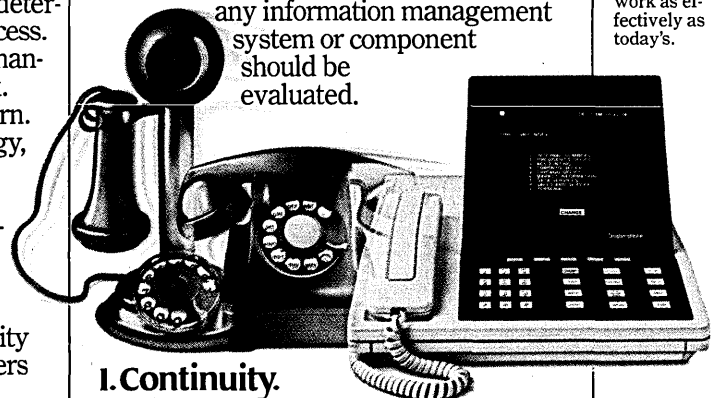

Northern Telecom brings the first information management.

to evolve to meet future needs, to accommodate future technological developments, and to provide new features. Only in this way can it be "obsolescence-proof."



In the OPEN World, many different makes and types of equipment can work together.

2. Compatibility.

Many makes and types of equipment must be able to work together as a harmonious whole. Components and systems from different manufacturers and transmission channels from different suppliers all must be compatible.

3. Congeniality.

If people find equipment or systems intimidating, unattractive, or difficult to use, they simply won't use them. Even advanced technology should be attractive and simple to use.

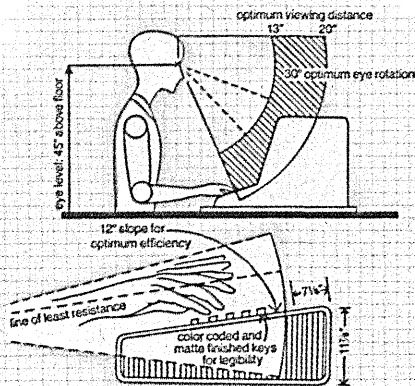

OPEN World systems are congenial—designed for ease of use and comfort.

4. Control.

You, not a supplier, should be in control of your information

In the OPEN World, you can control the design, building and operation of your system.

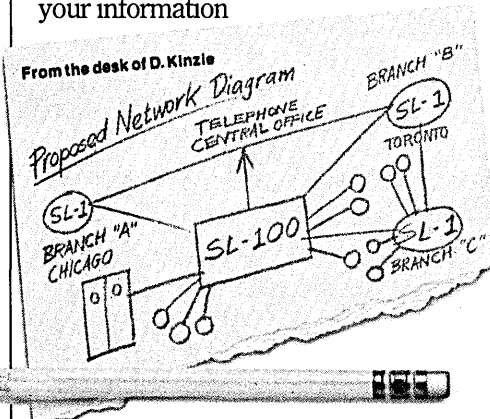

management system. The system should

not lock you in to a single source or limit options in the future. And the system should also provide the tools to control the cost and flow of information in your organization.

5. Cost-effectiveness.

The bottom line. Long-term financial considerations, as well as initial cost, must be

considered.

All of the other four criteria—continuity, compatibility, congeniality and control—have a bearing on cost-effectiveness.

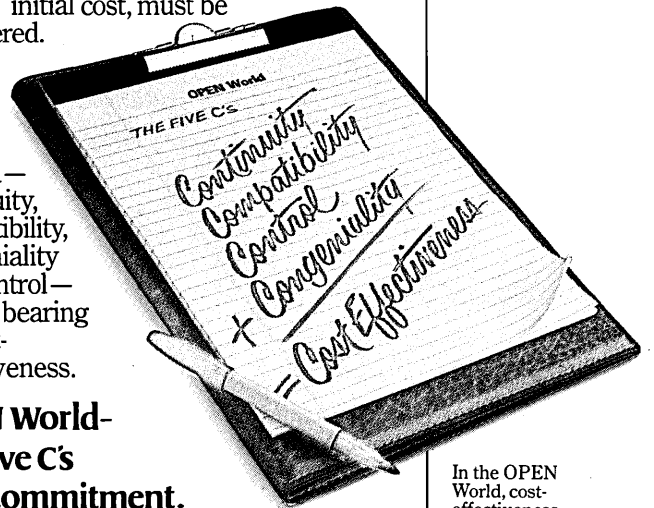

OPEN World—the Five C's plus commitment.

As the international leader in digital telecommunications, the technology that ties computers and communications together, Northern Telecom is in the unique position of being able to make the OPEN World a reality.

Our technological heritage allows us to meet the five criteria conclusively, as we have always done, for example, in providing equipment for the telephone network. When you place a long distance call, it may pass through many generations of equipment, all working smoothly together. Use of the telephone is simple, although much complex technology is involved. And the relative cost of using the telephone has steadily decreased, although its capabilities are constantly expanding.

In supplying telephone equipment for over 100 years, we've met all the criteria we propose for business communications.

If you'd like a brochure describing our commitments to each of these criteria, or more information about the OPEN World, write OPEN World, Northern Telecom Inc., 259 Cumberland Bend, Nashville, TN 37228.

In the OPEN World, cost-effectiveness is the bottom line.

OPEN World. For information management, it's the best of all possible worlds.



NCC PRODUCT PREVIEW

DATAPRINTER CORP. Malden, Mass. BAND PRINTER Booth N3748

The model 2000 band printer is designed for high-speed, high-volume oem printing applications. Its compact design is a departure from the vendor's older, more bulky printer designs in this speed range. The 2,000-lines-per-minute printer includes advanced diagnostics, refined print quality, and reliable paper handling. Operator-changeable fonts in 48, 64, and 96 character sets will be available in a variety of print styles and sequences. The printer will cost about \$15,000.

FOR DATA CIRCLE 414 ON READER CARD

DATARAM CORP. Cranbury, N.J. MINICOMPUTER Booth S5284

The A22 LSI-11/23-based minicomputer system is software compatible with the RT11, RSX-11, RSX-11M, RSX-11 Plus, Unix, and

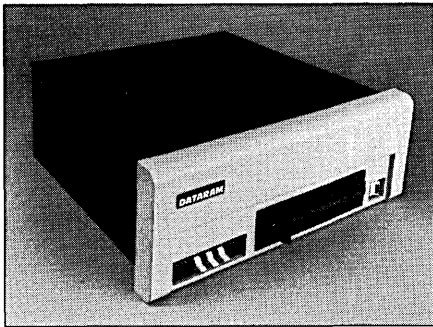

TSX-Plus operating systems. The 7-inch-high unit comes with a single 8-inch floppy disk drive and a 5¼-inch Winchester drive. It can be provided in a rack-mount configuration or as a desktop unit. The chassis contains an eight-quad slot Q-bus card cage for standard DEC dual or quad boards. A minimum configuration, with an LSI-11/23 processor, 256KB memory, floppy drive, and Winchester drive costs \$9,800. The A22 can be expanded to 4MB of main memory. The unit provides 22-bit addressing and the card cage area uses two fans for push/pull cooling.

FOR DATA CIRCLE 415 ON READER CARD

DATA TYPE, INC. Mountain View, Calif. GRAPHICS TERMINAL Booths P7758-P7760

This vendor will be premiering its AutoGraph XK2 graphics display terminal, which is similar to the previously announced XK1. The new terminal features a green P39 phosphor 19-inch screen with 1,024 × 1,024 resolution. The \$5,000 terminal provides Tektronix 4010 and 4014 emulation, and is capable of zoom, pan, scroll, and block fill functions, as well as line, circle, arc, and ellipse drawing.

The unit can also be used as a smart data terminal, with TeleVideo compatibility. It can produce 96 ASCII characters on an 80 × 24 screen, with screen editing and video attributes. The terminal can communicate in block or conversational modes using 15 baud rates in half or full duplex through two RS232C serial ports.

FOR DATA CIRCLE 416 ON READER CARD

DRANETZ ENGINEERING LABS. INC. Edison, N.J. LINE MONITORS Booths N4407-N4409

This vendor will be showing its new remote monitoring units. The 626-RMU series comprises standalone units designed to permit power line disturbance analyses at multiple locations for a low cost. The 626-RMUs are

SUPPORT SYSTEM

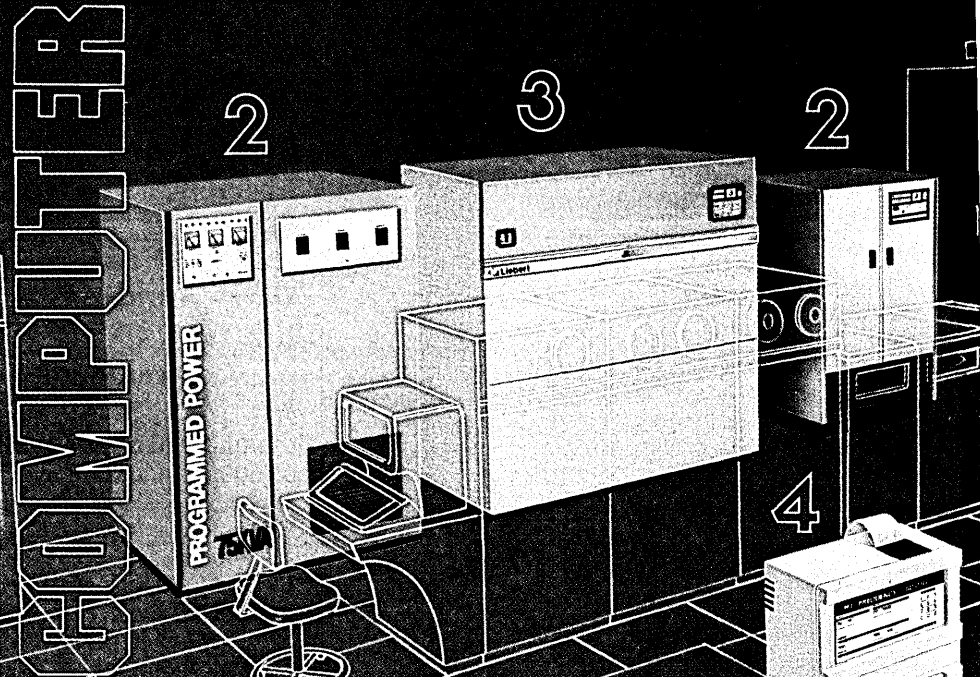

When designing your data don't forget Steps 2, 3



World leader in computer support systems
CIRCLE 119 ON READER CARD

intended for organizations that need to monitor power conditions at many sites simultaneously. The units have no front panel controls; all setups and data reports are done by connecting the units to the vendor's Series 626 universal disturbance analyzer. There are two models: the 626-RMU-1, under \$1,500, is designed for single phase AC monitoring; the 626-RMU-3 is for three-phase AC and DC mon-

itoring, and costs under \$2,000.

FOR DATA CIRCLE 417 ON READER CARD

DYMARC INDUSTRIES, INC.
Baltimore, Md.
POWER CONDITIONER
Booths P7158-P7160

This vendor is showing its Super Clipstrip, a multifunction 1500VA, six-outlet power

strip. The Clipstrip provides transient protection for both common and normal mode transients. In addition, the unit provides line conditioning and RF spike protection in the 100KHZ to 10Mz damaging range. The unit is the vendor's first conditioner that can provide current regulation of 1500VA capability in the \$500 price category. The Clipstrip plugs directly into any 120-volt outlet and provides up to six power outlets for computer room use.

FOR DATA CIRCLE 418 ON READER CARD

ELECTROHOME LTD.
Kitchener, Ont., Canada
VIDEO PROJECTION
Booth P7018

The single lens data/graphics and video color projection unit ECP-1000 is designed with la-

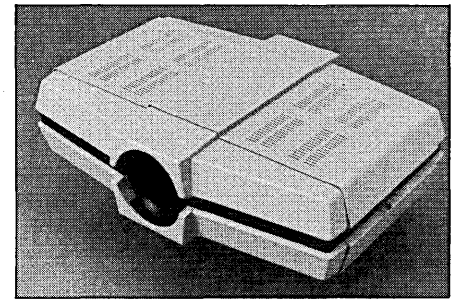

ser aligned dichroics for optimum convergence. The unit is intended for high-resolution graphics and large-screen video displays. It interfaces with most color and monochrome terminals and can switch from data to video with one toggle switch. An automatic optical rangefinder assists in the setup of the unit, which takes less than a minute to warm up. The unit is portable and can be used with curved, flat, or rear projection screens. It costs about \$15,000 and will be available within six weeks.

FOR DATA CIRCLE 419 ON READER CARD

FIRST SYSTEMS CORP.
Manhattan Beach, Calif.
CROSS-DEVELOPMENT TOOLS
Booth P8138

Several enhancements to this vendor's MicroSet-86 cross-development tool set for the Intel 8086 family of microprocessors will be shown. The MicroSet-86 tool set is now available on Data General's line of 32-bit Eclipse computers as well as on VAX and IBM S/370-compatible hardware. It is designed to produce object code for target 8086-based systems, and supports a fully extended Pascal compiler and an Intel-compatible linker, loader, assembler, host-target communications programs, multimode symbolic cross-debugger, and utilities. The high-level language symbolic cross-debugger now also supports debugging of 8086 assembly language modules. Support for other languages

MS BY LIEBERT

3

2

1 You've invested countless hours selecting the right computer - now, look to the leader for energy efficient computer support systems that will make your investment pay off!

2 **Electrical Power Protection.** Liebert now offers the two best alternatives: The Programmed Power Center™ for uninterruptible power ... and ... The Power Management Center™ with patented Datawave™ technology for unmatched cost efficiency!

3 **Environmental Control Systems.** Liebert sets the standard for precise control of computer room temperature, humidity and air cleanliness!

4 **Support System Surveillance with Liebert Sitemaster™.** A versatile, micro-processor-based monitoring system that provides constant surveillance of all key support functions.

center and 4!

Liebert Corporation, 1050 Dearborn Drive,
 P. O. Box 29186, Columbus, Ohio 43229,
 614-888-0246 Telex 246655 LIEBERT WOGN

Please send your free booklet on "Data Center Design".

Name: _____

Title: _____

Company: _____

Address: _____

City: _____ State: _____ Zip: _____

Have salesman call. Phone: _____ DTM53

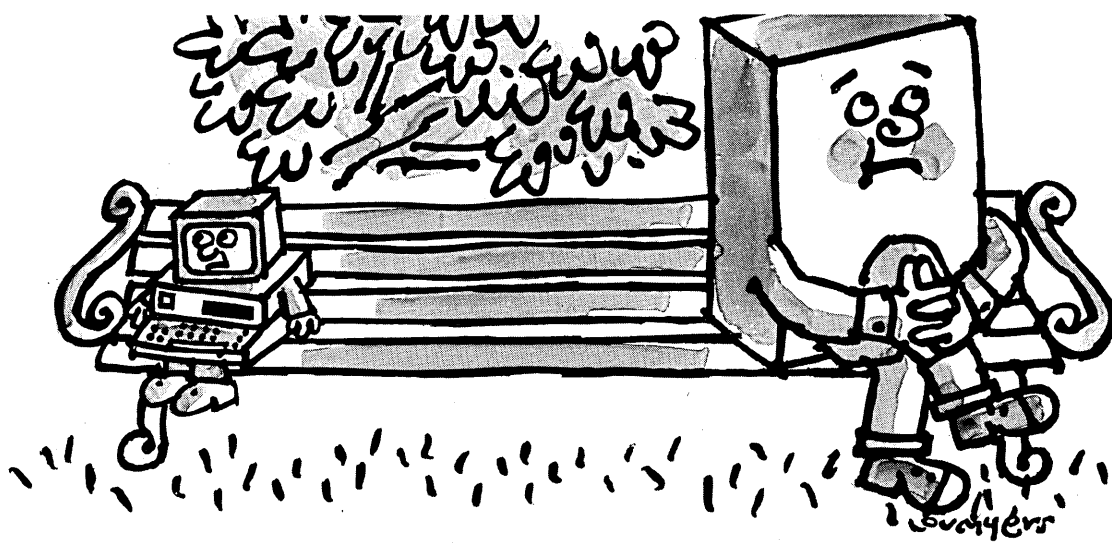

Introducing Omni-Link™, the software that lets your IBM®/PC and mainframe understand each other.

The IBM Personal Computer has made a lot of friends in business. Unfortunately the IBM mainframe isn't one of them. Even though the two of them can be wired together, each has an operating system which the other can't quite understand.

That's why we created Omni-Link, a software package that lets your IBM Personal Computer and mainframe speak the same language. Omni-Link connects them together so each can use information from the other. Your IBM Personal Computer can finally be the valuable business tool it was meant to be.

Put the resources of your mainframe at your executives' fingertips.

Omni-Link lets your executives access and process information from the mainframe on their IBM Personal Computers. So now they can make decisions based upon more complete, up-to-date information. This information can then be distributed to other people throughout your computer network.

English is no longer a foreign language.

Now you can get information without knowing a lot of codes or computer languages. By using Omni-Link and your PC, you can ask questions in plain English. Omni-Link will search the mainframe for your information and present it in the format you need. By eliminating the language barrier, Omni-Link gives your PC access to all the resources of your mainframe.

Electronic mail on a very personal level.

With Omni-Link your IBM Personal Computers can be used to send and receive messages, reports and data to any person, terminal, printer or word processor on the system. You can even store communications for future reference in your own "electronic file drawer."

You don't have to be a programmer to write programs.

Usually when you have a one time job to do, you have to wait for a special application program to be written. But with Omni-Link you can easily write the program yourself using a simple non-technical language.

Turn your PCs into WPs.

Omni-Link has word processing capabilities built right into the system. And it's integrated word processing. You can pull information from the mainframe, draft your letters or documents, and electronically distribute them throughout the system. And if your company already has word processors they can be tied into Omni-Link and also be used for electronic mail.

Get your personal computers into pictures.

Omni-Link brings out the artist in your computer. Its graphic facility lets you turn piles of numbers or stacks of data into easy-to-understand graphs and charts. Omni-Link even lets you add the graphics to documents or send them to other PCs.

Spreadsheets also come standard.

Now you can use the information in your mainframe to work spreadsheets on your personal computer. You can revise business plans, sales trends, etc. in seconds instead of days. It's available to all executives with PCs. So they're in a better position to adjust to change.

Omni-Gard security software, a very special option.

Now that so many people will be benefiting from the resources of your mainframe, security is more important than ever. Omni-Gard security software protects all aspects of your computer system. So only certain people have access to certain types of information. It's the only security software comprehensive enough to be called Omni-Gard.

Make your IBM Personal Computers and mainframe one big happy family.

Contact On-Line Software International today about Omni-Link and dramatically increase the capabilities of your personal computers. It's about time your IBM Personal Computers and mainframe had a more productive relationship.

Omni-Link from  **ON-LINE SOFTWARE**

INTERNATIONAL

Fort Lee Executive Park
Two Executive Drive, Fort Lee, NJ 07024
(201) 592-0009, Toll Free (800) 526-0272

TECHNOLOGICAL BREAKTHROUGH IN BUSINESS COMPUTERS!

**CADO introduces world's first tri-level, 16-bit supermicro...
all the power you need to support up to 64 users at incredible speeds!**

New CADO TIGER family has up to 14 processors in a three-level architecture that share the work load and give you the power and response to do *all* your processing jobs at the same time.

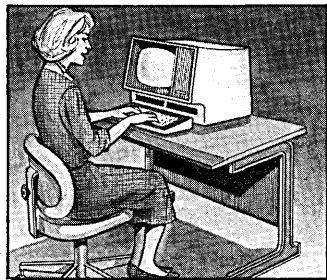

First, there's the Transaction Processor. The workhorse of the system, it interfaces with user terminals, printers, modems and other peripheral devices. Alone, each Transaction Processor has more computing capacity than many complete computer systems.

Secondly, the Intranet Processor takes on the long processing jobs to free up the Transaction Processor.

Finally, the Control BiProcessor interfaces to the disk-and-tape-storage devices to speed up disk access and memory-to-memory transfers.

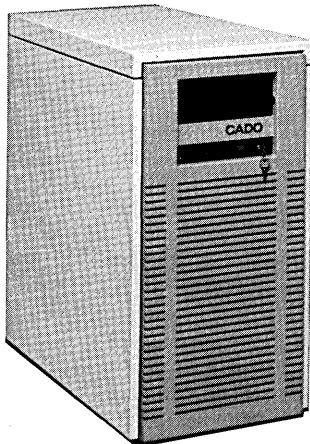

CADO TIGER ATS 32

Three levels of processors working *together* give you more power and faster response than any other micro—or mini—computer can match.

CADO makes it easy to grow with your TIGER, too. You start with a few peripherals and 15 million bytes of storage. And you can end up with 64 devices and 1.1 billion bytes of data storage!

Whether it's your first or next system, chances are this CADO TIGER will be all the computer your business will ever need.

And you'll be amazed at how little all this power costs. No more than lesser micros. And much, much less than minicomputers.



Now part of the \$3.9 billion Contel organization, CADO has been a leader in business systems technology for seven years and is sold and serviced by over 180 distributors worldwide.

Your nearby CADO Distributor is a data processing professional. He sells *business* computers. He has software packages proven in many businesses like yours or will design custom software just for you.

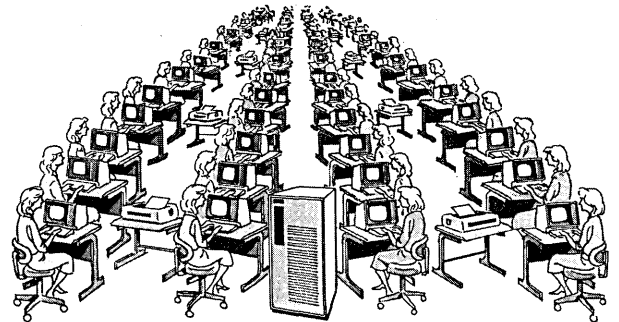

So before you choose your next business computer, call your nearby CADO Distributor or send in the coupon below. For the name of your CADO Distributor or more information, call us at **800-556-1234, ext. 128**; in California, **800-441-2345, ext. 128**. Ask about the CADO TIGER—the technological breakthrough that just made all other business computers obsolete.

CADO A Contel Company

2055 West 190th Street • P.O. Box 3759 • Torrance, CA 90510
(213) 323-8170 • Telex: 66-4711 CADO TRNC

Please rush me more information.

NAME _____
TITLE _____
COMPANY _____
ADDRESS _____
CITY _____ STATE _____ ZIP _____
TELEPHONE _____

NCC PRODUCT PREVIEW

and 8-bit targets will be available as well. The complete tool set costs \$25,000; the Data General version will be available in June, while the others will be available at the show.

FOR DATA CIRCLE 420 ON READER CARD

GIMIX, INC. **Chicago, Ill.** **MICROCOMPUTERS** **Booths P7946-P7948**

This vendor will be introducing the GMX III microcomputer system. Based on the 6809 microprocessor, it features the vendor's new

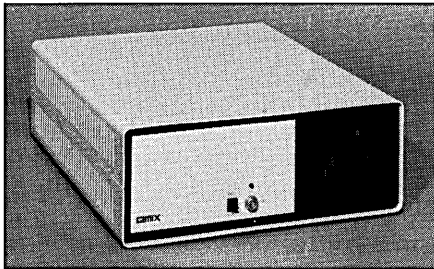

GMX III cpu board, the OS-9 GMX III multi-user, multitasking operating system, and an intelligent I/O processor board. The cpu board features high-speed memory-to-memory DMA transfers and automatic task switching on interrupts and operating system calls for higher system throughput, as well as a time clock with battery backup. To prevent system crashes caused by errors in individual user's programs, the system has fully protected user modes with illegal instruction and out-of-range memory reference trapping and write protection. The system hardware also includes 256KB of static RAM, a 40MB unformatted 5¼-inch Winchester hard disk drive, a 1MB unformatted 5½-inch floppy disk drive, and three RS232C serial ports. Power is provided by a constant voltage, ferro-resonant supply with sufficient reserve capacity to support a fully expanded system. Hardware options include memory expansion to a megabyte, nonvolatile battery backup RAM, additional mass storage capacity, and I/O ports for additional terminals and peripherals. The Unix-like OS-9 operating system includes debugger, editor, and assembler. The system supports BASIC, Pascal, COBOL, and C. The base price of a three-user system is \$10,000.

FOR DATA CIRCLE 421 ON READER CARD

HOLLAND AUTOMATION **Santa Ana, Calif.** **CP/M APPLICATIONS** **Booths D2104-D2106**

The HAI*Line sales order processing module will be introduced at NCC to complement the vendor's offerings in inventory control, general ledger, and accounts receivable. The modules all run under the CP/M operating system, and will be running under MS/DOS for

16-bit microcomputers in July. They also run under the vendor's proprietary 16-bit operating system, HAI*DOS. The sales order processing module is intended to facilitate the management of a company's back orders. After keying the orders in as they are received, the user can access information in the backlog by customer name, product name, or both. The product can then calculate invoicing using a flexible pricing schedule with programmable discounts. Whenever data are updated in any of the package's modules, they are automatically updated in all modules through the integrated software. Users can buy as many modules as desired and add others later. The sales order processing module costs \$500.

FOR DATA CIRCLE 422 ON READER CARD

INPUT-EZ CORP. **Englewood, Colo.** **TERMINAL STAND** **Booths P7406-P7408**

The T-26 Retractable Keyboard Unit is a terminal stand designed to be placed atop existing furniture where space is limited. The unit sits on 26- or 27-inch-high furniture, such as typing stands and deeper work surfaces. The keyboard, when in use, lies in a direct line with the work surface and the crt screen. The video unit sits on top of the unit, toward the back of the desk. In front of it, on a diagonal plane, is a work surface large enough to hold two side-by-side 8½ × 11-inch sheets of pa-

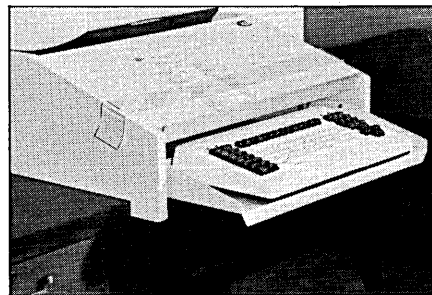

per. A Lucite strap secures paper to be copied and acts as a line marker. Under this work area is the keyboard, which slides out when in use and otherwise retracts into the stand. The keyboard platform accommodates keyboards up to two feet wide and glides out smoothly on ball bearing slides, latching into place in the open position. The stand costs \$357.

FOR DATA CIRCLE 423 ON READER CARD

IOMEGA CORP. **Ogden, Utah** **CARTRIDGE DISK DRIVES** **Booth D330**

These disk drives utilize the Bernoulli technique to attain durability, high capacity, and high performance on a removable floppy disk. The Beta-5 has a 5¼-inch removable

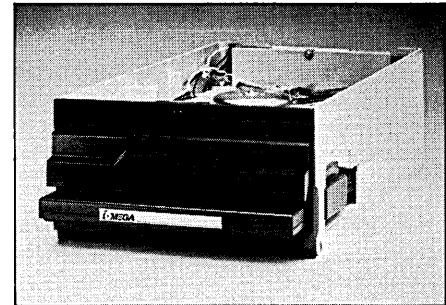

cartridge with 5MB of formatted data. The interface and performance are ST506 compatible to work with currently available controllers. Flying media recording, rotary voice coil actuator, and track following closed loop servo are utilized to enhance performance, reliability, and areal density. A flexible media stabilization capability is built into the drive to make it more resistant to shock and vibration, and media compliance in the cartridges protects against contamination. The drive uses no air filtration to boost the start/stop performance. The drive is available for \$495 in quantities of 1,000, beginning next month. Cartridges cost \$25 apiece in these quantities.

The vendor will also be showing its Alpha drives, which provide 10MB or 10.5MB of storage in an 8-inch format. The 10MB Alpha-10 and the 10.5MB Alpha-10.5 cartridge disk drive subsystems each cost \$1,080 in quantities of 1,000. Cartridges for the drives cost \$32 in the same quantities.

FOR DATA CIRCLE 424 ON READER CARD

JENSEN TOOLS, INC. **Phoenix, Ariz.** **PORTABLE COMPUTER** **Booth N4908**

The Escort 942B220 portable computer includes a Z80A cpu with 64KB of dual ported RAM, two fully implemented RS232 ports, a 9-inch monochrome display, a detachable 91-key keyboard, dual 5¼-inch Winchester cartridge drives with 5MB capacity, and a storage/carrying case that complies with FAA regulations for carry-on luggage. The unit's software includes CP/M, Microsoft BASIC and Multiplan, and Lexisoft Spellbinder, Mailmerge, and Spellcheck. The unit is expandable, with five extra slots on the STD bus. The crt offers a 24 × 80 display with an extra status line and affords the same functions as an editing terminal, such as inserts and deletes, reverse video, underlining, blinking, and dual intensity. The detachable keyboard mimics the IBM Selectric layout and includes a numeric keypad. The RS232 ports communicate at any of 16 selectable baud rates; a Centronics parallel interface is also provided for the \$6,000 unit.

FOR DATA CIRCLE 425 ON READER CARD

Memory Upgrades from EMC²

PRIME[®] users save **\$4,200**

The PRIME Compatible E8 Memory Card with 1MByte Capacity, ECC, and Wide Word.

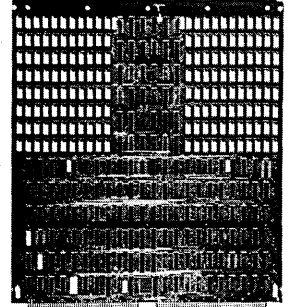

WANG[®] users save **\$3,100**

The WANG VS-90 and VS-100 Memory Card with 1MByte Capacity and ECC.

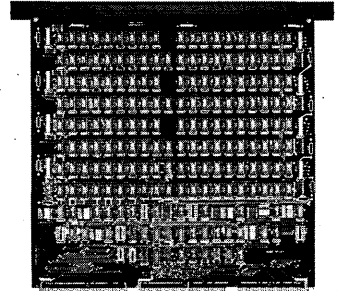

digital users save **\$6,500**
VAX[®]

The VAX 730 and 750 VX Memory Card with 1MByte Capacity and ECC.

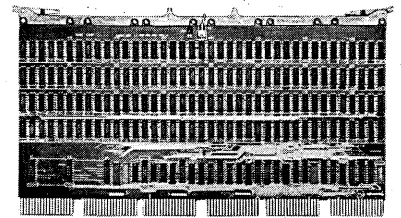

6 more reasons to choose EMC:

- Buy a pair, rent a spare for less than your monthly service cost
- Free loaner — Call to see if you qualify
- Trade in your old 256 KByte cards
- Delivery — From stock to 2 weeks
- 5 Year Warranty
- All memory cards have EMC's Comfort Switch to Enable/Disable each card

EMC²

EMC Corporation
385 Elliot St.
Newton, Ma. 02164
Tel: (617) 244-4740
TLX: 922531

- ® Registered Trademark of Prime Computer
- ® Registered Trademark of Wang Laboratories
- ® Registered Trademark of Digital Equipment Corporation

CIRCLE 121 ON READER CARD

NCC PRODUCT PREVIEW

KEN ORR & ASSOCIATES
Topeka, Kans.
SYSTEMS DEVELOPMENT SOFTWARE
Booths P7252-P7254

The DSSD Management Library, a new "how to manage" systems development reference guide, will be introduced by this vendor at the show. The library includes the data-structured systems development methodology developed and marketed by this firm. The library, a companion to the DSSD Design Library released last year, provides an integrated approach to project management, estimating guidelines, and quality control checklists. The DSSD Management Library procedures correspond to the tasks described in the DSSD Design Library; the latter is a step-by-step reference guide to the data-structured approach to systems development. Management Library section topics include planning, management, user participation, project acceptance criteria, estimating, scheduling, systems assurance, change control, and project status review. The package costs about \$15,000.

FOR DATA CIRCLE 426 ON READER CARD

KENNEDY CO.
Monrovia, Calif.
CARTRIDGE TAPE TRANSPORT
Booth N3616

This vendor's model 6470 seven-track cartridge transport employs fixed heads to re-

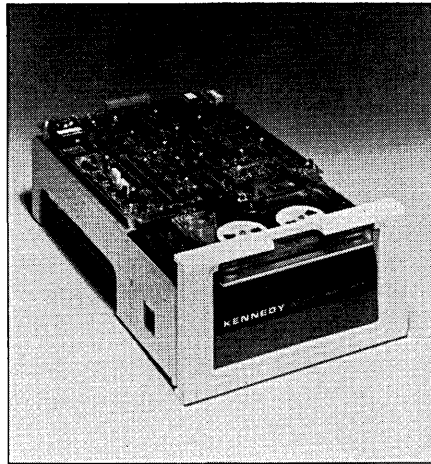

duce mechanical complexity. It has a formatted capacity of 40MB with 450-foot tape cartridges or 50MB with 600-foot cartridges. An internal diagnostic technique allows tape ramp and speed adjustment in the field without using an oscilloscope. The 6470 was designed to back up 8- and 5¼-inch Winchester disk drives. In start/stop mode, it permits data and file management procedures while storing and restoring disk data. For mirror backup, the 6470 establishes gaps on the fly while streaming. Time to transfer 40MB on the \$2,000 transport is 18 minutes. A selective erase function permits editing prerecorded tapes without affecting adjacent blocks or

tracks. Normally found only on half-inch reel-to-reel transports, the function is useful in word processing, program development, and other applications where it is necessary to alter individual blocks without re-recording the complete tape. The fixed head mechanism enables the vendor to add this feature; the transport requires no stepping mechanism, which means that the heads are accurately aligned and well maintained. Individual head spacing is arranged so that media can be interchanged among the vendor's four- and seven-track transports.

FOR DATA CIRCLE 427 ON READER CARD

LAMARCHE MANUFACTURING CO.
Des Plaines, Ill.
UPS SYSTEMS
Booth S5560

LaMarche will introduce a new line of uninterruptible power source systems, designed for EIA rack, desktop, or wall mounting. The units require 80% less space than previous

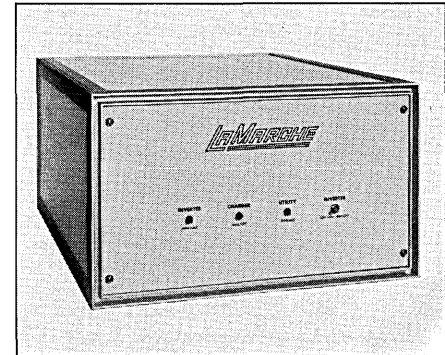

models the vendor has sold, and are intended for laboratories, offices, and production areas where space is tight. The A52CP supplies continuous, disturbance-free, computer-grade power regardless of the condition of the AC line. The unit utilizes CMOS logic and highly reliable sine weighted pulse width modulation. The unit is equipped with electronic output voltage regulation, quartz time base, 120% current limit, and power walk-in. Prices for the UPS system start at \$2,500.

FOR DATA CIRCLE 428 ON READER CARD

LIEBERT CORP.
Columbus, Ohio
ENVIRONMENTAL CONTROLS
Booth N3668

This vendor will show its new top-of-the-line Environmental Control System for dp installations. The microprocessor-driven control functions permit a programmable environment for any data center. The system provides monitoring capabilities for complete information on the total data center—both environmental and control system parameters. The system manages air temperature, humidity, and cleanliness within close tolerances. Features of the system include redundant

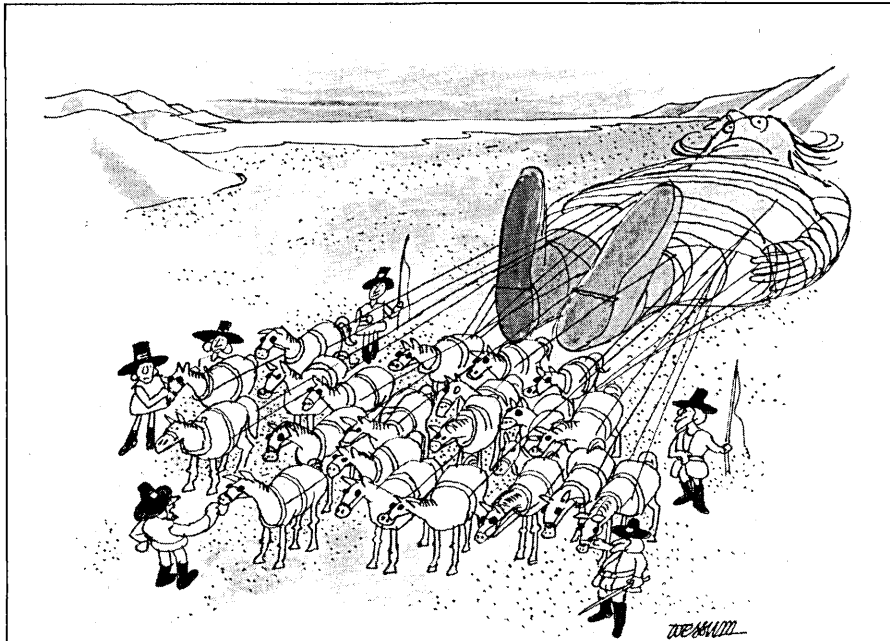

"When we complain about the bad conditions of the roads, the toll money, the high price of oat, the horse tax, and other burdens put upon us, the Minister of Transportation does not hear us. How about not hearing *him* now?"

CARTOON BY JAN VAN WESSUM



"OUR C & D COMPUTER BACK-UP POWER SYSTEM SAVED US FROM SEEING RED WHEN THE LIGHTS WENT OUT."

A break or other variance in AC voltage lasting just one nanosecond can destroy the accuracy of computer programs in progress. A few seconds longer and memory banks, storing data worth tens of thousands of dollars, could be wiped clean. Outages may even cause expensive hardware damage. Now, with a UPS (Uninterruptible Power Source) using C & D batteries, you can provide the on-line power necessary to save valuable computer data and equipment during a momentary surge or blackout.

Because when the lights go out, reliable battery power from a UPS may be all that stands between a profitable computer installation and financial disaster. Specify dependable C & D batteries and you'll discover the reasons why so many Fortune 500 companies have made C & D North America's leading supplier of industrial batteries...

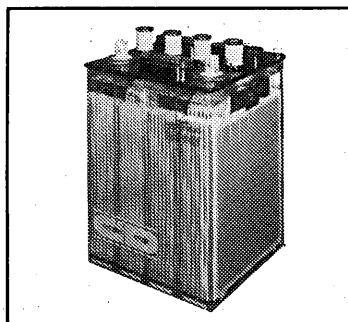

Reliable, On-line Power—C & D cells provide 20 years or more of dependable on-line power.

Compact Systems—C & D's exclusive 4LCW battery requires 40% less space than other systems.

Longer Water Intervals—C & D batteries operate with watering intervals of up to 2 years.

Superior Electrical Conductivity—C & D's unique copper post inserts improve connection integrity and high discharge rate performance.

Expert Installation and Maintenance—75 offices nationwide put specially trained service personnel as close as your telephone.

For more information on UPS batteries from C & D, or any other industrial battery need, check the Yellow Pages for the C & D office nearest you.

C & D Batteries
An **ALLIED** Company

3043 Walton Road, Plymouth Meeting, PA 19462
LEADER IN BATTERY ENERGY SYSTEMS
CIRCLE 122 ON READER CARD

HOW WE WON THE PRINTER WARS.

With a simple but effective strategy.

We set a standard that no one could match.

A standard that changed the way users think about dot matrix line printers.

And the way they buy them. So far, we've delivered more than 50,000 line printers. Thousands more than *any* other manufacturer.

We sell more because Printronix printers do more and fail less. Performance under fire, you might say.

For example, take our P300. At 300

lines per minute, it was the first dot matrix line printer ever to offer OCR, bar code and alphanumerics in a single package.

Or consider the P600. The same dependability plus twice the throughput. It's the best of the past and the leading edge of the future.

Or our MVP. A tabletop line printer that puts maximum versa-

tility into microcomputer systems.

Printronix printers aren't just tougher; they're smarter. With an Intelligent Graphics Processor that's programmed to make your work easier. Whether you need forms, bar codes, large labels, compressed print or any other graphics.

Printronix. We're the field-proven standard for reliability and versatility—a real battle veteran. And still the *one* to beat.

THE FIRST LINE IN PRINTERS.

PRINTRONIX

17500 Cartwright Rd., P.O. Box 19559,
Irvine, CA 92713 Phone: (714) 549-7700
TWX: 910-595-2535

CIRCLE 123 ON READER CARD

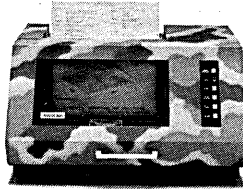

dual-module cooling system, A-frame coils with interwoven piping circuitry; semihhermetic compressors for efficient operation and field service; and a highly precise infrared humidification process. The Environmental Control System costs from \$5,000 to \$25,000 installed.

FOR DATA CIRCLE 429 ON READER CARD

LOBO SYSTEMS INC.
Goleta, Calif.
MICROCOMPUTER
Booth P7030

Lobo Systems will be introducing its second version of MAX-80, a Z80-based microcomputer. The new version offers color and graphics, as well as a local area network capability. The unit comes with standard 64KB of main memory, which cannot be expanded. It runs CPM or LDOS, a TRS/DOS-compatible operating system sold by Logical Systems, Inc. The unit comes with no disk drives, but has interfaces built in for 5¼- or 8-inch, single- or double-sided, single- or double-density floppy or Winchester disk drives. The unit generates a 24 × 80 screen, but can be modified to TRS-80 16 × 64 or 16 × 32 modes through software. The full 128-character ASCII set and 64 graphic symbols are RAM based and can be redefined. For communications, MAX-80 has two built-in RS232C ports with independent baud rates, as well as a parallel port. A monochrome monitor is provided as an option. Although pricing is not yet definite, the revised MAX-80 should cost under \$1,000; the original version costs \$800. The new computer will be available in the third quarter.

FOR DATA CIRCLE 430 ON READER CARD

MEGADATA CORP.
Bohemia, N.Y.
TERMINALS
Booths S5079-S5083

The Series 8000 terminals and controllers are designed to be reconfigured with a minimum of modification, to meet the needs of fast growing companies. Terminals can be clustered with up to 32 terminals feeding a single controller, or they can operate independently. Terminal and controller are both built around the 68000 microprocessor to provide local intelligence in the distributed processing system. The terminals have adjustable height, rotation, tilt, and keyboard angle; the keyboard contains up to 155 keys and is detachable. The model 8188 is a standalone terminal, which is capable of supporting a printer, disk drives, and other peripheral devices. The model 8178 terminal is designed for attachment to the 8174 controller. The controller is based on Multibus-compatible modules to meet a variety of application requirements. It runs the Unix-like UniPlus operating system with real-time enhancements and a

choice of programming languages, including RM/COBOL, Pascal, BASIC, and FORTRAN. Terminals can be located up to 2,000 feet from the controller, and are connected by co-ax cable with a 1Mbps data rate. All models use a multidiscipline controller chip that supports a variety of protocols and two host communication channels running at 56Kbps. The controller can support Winchester and floppy disk drives as well. In large quantities, each terminal costs about \$2,600 and the controller costs about \$4,000.

FOR DATA CIRCLE 431 ON READER CARD

MEGATEK CORP.
San Diego, Calif.
ENGINEERING TERMINAL
Booth N3826

This vendor will introduce the second member of its Whizzard 1600 line of engineering terminals. The 1645 is a black-and-white version of the 1650 color terminal, which was introduced last November. Its resolution is higher than the color version, with 1,280 × 980 pixels, and is therefore better suited for intricate design applications such as integrated and printed circuit board design and finite element analysis.

Both terminals provide concurrent graphics and alphanumeric capabilities, as well as DEC VT100/52 compatibility. In addition, Tektronix 4014 emulation is being promised for both terminals. The terminals are compatible with the vendor's WAND software and offer much of the functionality of the vendor's larger 6200 and 7200 computer graphics systems. The 1600 family's local intelligence off-loads many processing tasks from the host system. The 1645 costs \$14,000 to \$15,000, depending on configuration, and will be available midsummer.

FOR DATA CIRCLE 432 ON READER CARD

MICRO DATA BASE SYSTEMS, INC.
Lafayette, Ind.
PC SOFTWARE
Booth D408

Knowledge Man is an integrated set of software facilities for a range of personal computers. It includes data management, ad hoc query, spreadsheet analysis, statistical analysis, programming language, screen management, and report forms management capabilities. Unlike other integrated software products, such as MBA and 1-2-3, which are built around their spreadsheet and graphics capabilities, this product is built around the data management function. The system can be as simplified or as sophisticated as the user desires, the vendor says. Security is provided through automatic encryption and read/write access controls at the field level. The Knowledge Man system costs \$500, although NCC showgoers will be able to buy it for \$250.

FOR DATA CIRCLE 433 ON READER CARD

NIXDORF COMPUTER
Waltham, Mass.
WORKSTATION
Booth W6100

The 8810 is a self-contained personal computer that attaches directly as a workstation to this vendor's 600, 8870, 8860, and 8890 host systems. The 8810 will allow the professional end user to access data on the host and run CPM-compatible programs with that or other data. The 8810 is based on two Z80A microprocessors and contains 96KB of user memory. Up to two floppy diskette drives can be added to the workstation, each with one megabyte capacity. The 8810 uses the same crt as the vendor's DAP 4 workstation and has a range of detachable keyboards. The unit will be available in September at a cost of about \$5,000.

FOR DATA CIRCLE 434 ON READER CARD

NORTRONICS CO., INC.
Minneapolis, Minn.
STREAMER HEAD
Booth 4111

This nine-track, two-channel Serpentine Streamer Head provides 45MB Winchester backup on quarter-inch cartridges. Options include piggyback erase, mounting hardware, cable or connector termination. Features include head contour designed to operate at tape speeds of 30 to 90 inches per second, allowing for reliable recording at 10,000 FCI. The unit's internal design provides for suppression of write-to-read feed through voltage of 4% maximum with 2% minimum. An optional lifetime ceramic coating is available for extended wear life and elimination of tape gutters. The units cost \$250 each in prototype quantity, and will be available next month.

FOR DATA CIRCLE 435 ON READER CARD

OLIVER ADVANCED ENGINEERING, INC.
Glendale, Calif.
EPROM PROGRAMMER
Booths S5005-S5007

This vendor will be exhibiting its new device programmer for EPROMs, microprocessors, and bipolar devices. The as-yet-unnamed product utilizes the vendor's 64-pin Universal PROM Programmer Chip to program all popular HMOS, CMOS, and NMOS EPROMs through 27256 without the use of personality modules. Both standard and fast-programming algorithms are supported. A 40-pin socket allows the system to program all popular single chip microprocessors. A second version can program a range of bipolar devices as well. Both versions have dual RS232C ports for screen editing, printing, uploading, or downloading data. Crt screen menus eliminate hexadecimal keyboards and reference cards, the vendor says. All devices are listed by device number on the screen, so

The Interactive Systems/3M Videodata® Broadband Network

Not just a futuristic concept, but a system that's at work right now in hundreds of major installations.

Local-area networks have received considerable attention in the last couple of years, and a lot of EDP, datacomm, and systems managers have received the impression that such networks — whether baseband or broadband — are a new and relatively unproven concept.

Not so.

Since 1972, more than 300 broadband local-area networks from Interactive Systems/3M have been put to work in office buildings, factories, defense installations, college campuses, and hospitals. They

are handling applications as diverse as high-speed data communications, energy management, process control, voice and phone links, and closed-circuit TV over distances as great as 40 miles.

In this series of ads, we're focusing on some of the many customers who are being served by our reliable, proven Videodata® technology. For more information, including a free 16-page brochure titled "How to Choose a Local-Area Network," phone 800-328-1684 toll-free. (In Minnesota, 800-792-1072.) Or fill in and mail the accompanying coupon.



Case History #127

Appalachian State University

Appalachian State University is a school of 10,000 students in Boone, North Carolina. Until recently, its mountainous setting made good television almost impossible. This meant that instructors and students were denied access to concerts, plays, and other educationally useful programming on public television.

University administrators decided in 1979 that the time had come to do something about the problem. After a careful study, they invested in an

Interactive Systems/3M Videodata® broadband network. Today, the university is benefiting from a system that combines the proven concept of cable television with high-density, two-way communications for such purposes as digital information, voice, and energy management as well as commercial and public TV, campus-originated programming, and training materials on film or videotape.

The IS/3M Videodata network in-

corporates more than 17 miles of ½-inch coaxial cable. A dual-trunk configuration was chosen to provide enough bandwidth for an unusually large number of future television channels. (Normally, one main cable would suffice for all types of communications, since frequency- and time-division multiplexing allow simultaneous two-way communications by thousands of devices. Appalachian State wanted the extra capacity because 35 TV channels

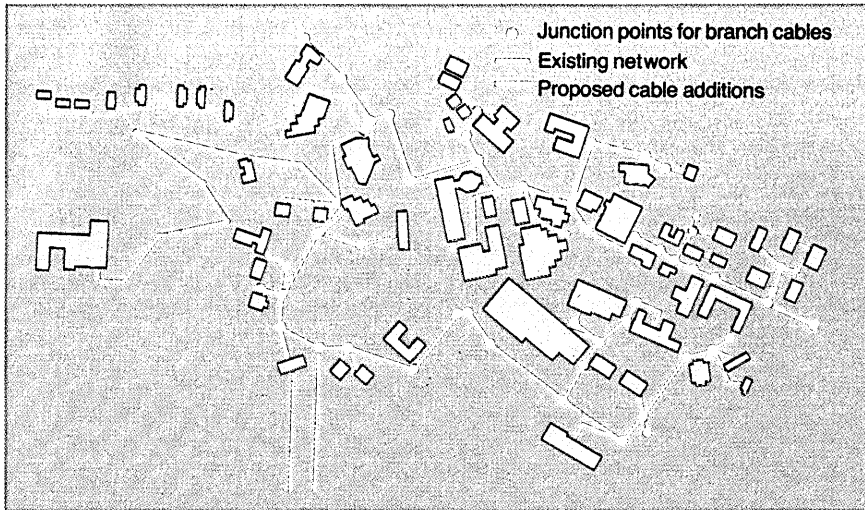

This diagram shows the existing campus-wide Videodata network at Appalachian State University. (For simplicity, the two parallel coaxial cable trunks are represented by a single line.)

Proposed network extensions are also indicated, as are current and future junction points for branch cables that serve buildings or campus areas.

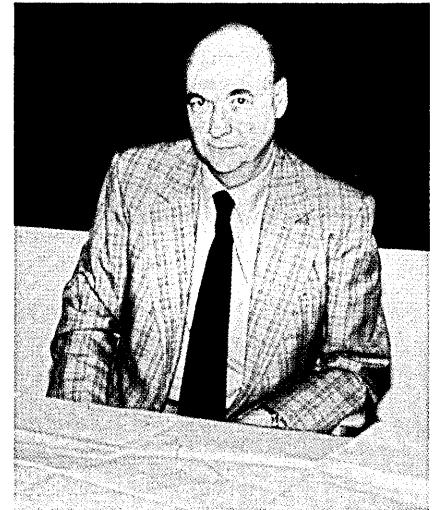

Richard Arnold, associate vice chancellor for business affairs, worked with university departments and IS/3M in planning Appalachian State's Videodata network.



Remote CRT terminals can be plugged into the Videodata network wherever a connection point exists. No rewiring is needed.

are already being used, and full-motion video requires far more bandwidth than other types of signals.)

The two cable trunks, which total 90,000 feet in length, run side by side and share ducts with the university's telephone and power networks. Access to cable taps and amplifiers is through manholes. Parallel branch cables run from the main network into buildings, where they terminate in cable jacks at convenient points for plug-in installation of modems and/or multiplexers for use with television sets, CRT terminals, and other devices.

Although the need for distributing video signals was a major reason for the network's installation, data communications are equally important. The school uses a large Univac 90/80 computer for administration and management DP as well as instructional use by the physics, mathematics, business education, history, political science and computer science departments. On-line terminals serve functions such as registration, accounting, student records, parking, and traffic control.

"We have nearly 150 remote CRT terminals in buildings outside our computer center," says Ernest L. Jones, director of computer and management service. "Most of them have been operating over leased telephone lines. With the coax system, we'll be able to serve these users more efficiently, with faster communications speeds and far faster installation time than we can get with our telephone connections." Jones adds that departmental mini- and microcomputers may also be



The Videodata network currently offers 35 television channels for distribution of campus-produced programming as well as commercial and public TV.

linked to the mainframe via the IS/3M network in the near future.

Associate vice-chancellor Richard Arnold reports that the university is pleased with the network's performance to date. "Our broadband network is very straightforward and mechanically simple," he notes. "Its simplicity is especially remarkable when one considers its huge capacity. We're only beginning to learn how the Videodata network can increase efficiency and improve communications for both administrative and academic users. We're confident that broadband communications will serve our needs economically for many years to come."

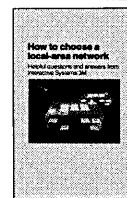

ASK FOR FREE BROCHURE

Call 800-328-1684
TOLL-FREE* OR WRITE:
Interactive
Systems/3M,
P.O. Box 33050
3M Center, St. Paul,
MN 55133

Please send:

- "How to Choose" Brochure
 Information on VIDEODATA Networks

Please have a Sales Engineer call D 5

Name _____

Title _____

Organization _____

Address _____

City _____

State _____ Zip _____

Phone _____

*In Minnesota, 800-792-1072

3M hears you . . .



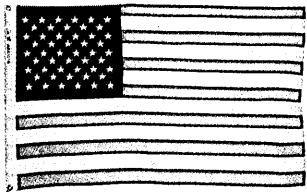

United States

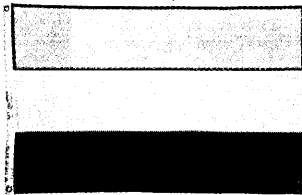

Netherlands



Brazil

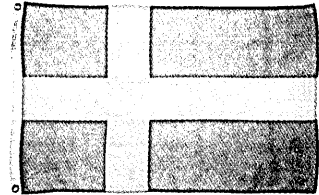

Sweden

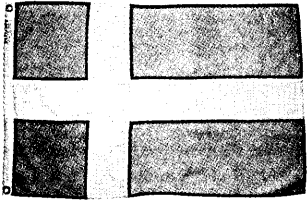

Denmark

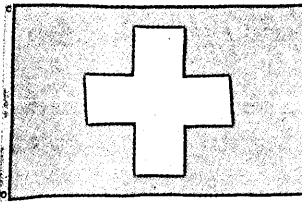

Switzerland

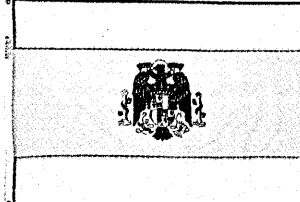

Spain

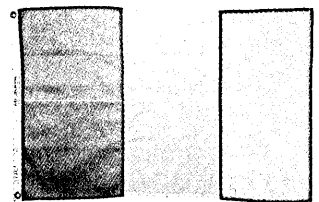

Italy



Saudi Arabia

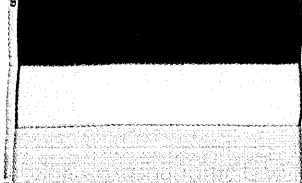

West Germany

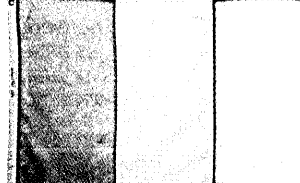

Ireland

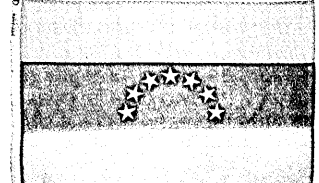

Venezuela

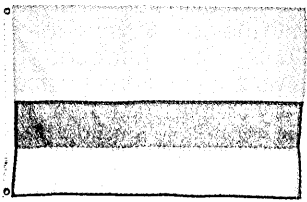

Colombia

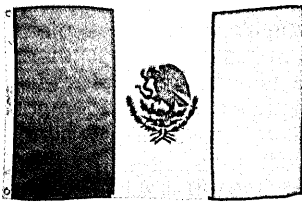

Mexico

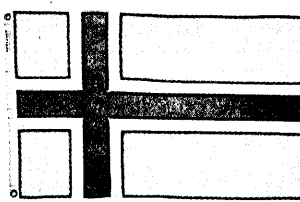

Norway

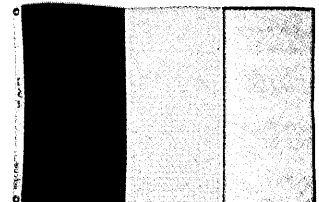

Belgium

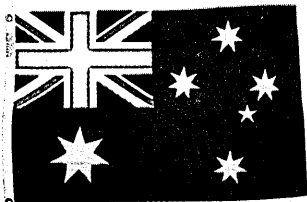

Australia

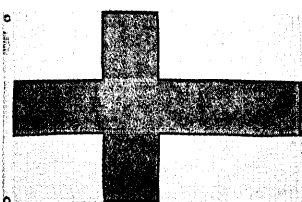

Finland

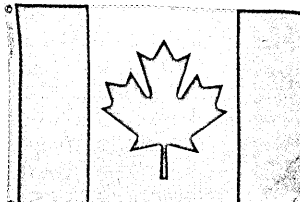

Canada

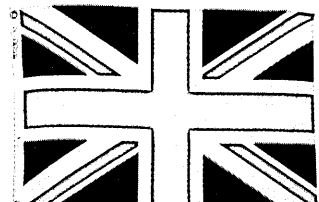

United Kingdom

Where in the world are people getting the most advanced information systems today?

It takes an experienced company to meet the worldwide demand for advanced information systems.

And nobody can meet that demand better than Ericsson.

Today Ericsson offers one of the broadest, most advanced lines of information products and services in the world, all over the world. From Saudi Arabia and Australia to Mexico and the United States.

More than 100 countries in all.

And wherever you find Ericsson you find a total commitment to customer needs. We have made that commitment in the United States by establishing a sales and service network, backed by our own manufacturing plants, research laboratories, training centers, maintenance and diagnostic centers.

If you're wondering who in the world can meet your information

systems needs, the answer is simple. For your information, it's Ericsson.

Anaconda-Ericsson
Information Systems, 7465
Lampson Avenue, P.O. Box 938,
Garden Grove, CA 92642,
(714) 895-3962.

In Canada, Anaconda-Ericsson
Communications Inc., 1799
Argentia Road, Mississauga,
Ontario L5N 3B1, (416) 821-9400.

For your information. It's **ERICSSON** 

that users need only select the part to be programmed and place the part in the appropriate socket. Devices that are damaged by static or are incorrectly inserted will be detected by the unit. All programming algorithms are stored on an EPROM table, so a simple EPROM change will update the programmer's capability as new memory devices are developed. The two versions cost \$1,850 and \$3,250.

FOR DATA CIRCLE 436 ON READER CARD

PRINTACOLOR CORP.
Norcross, Ga.
PRINTER
Booth D2133

This booth introduces the TC-1040 color ink jet printer, which can produce over 4,900 different hues on standard bond paper of var-

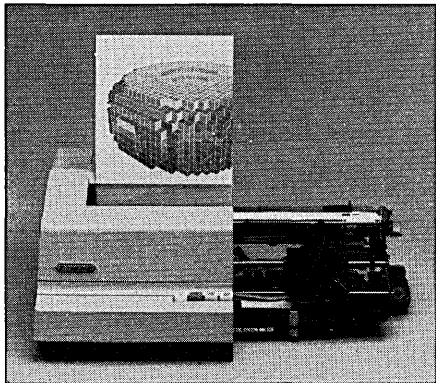

ious widths. User-loadable lookup tables provide a method of specifying colors in a format compatible with most color graphics computer systems. The TC-1040 prints horizontally in 85 or 120 dots per inch resolutions and vertically in 85 dot per inch resolution. A maximum 12.1 inches of printing surface is provided, allowing up to 1,440 individually addressable pixels per horizontal line. Paper width is variable from 5½ inches to 15½ inches by way of an adjustable pin-feed mechanism. Print speed averages 108 raster inches per second. Average time for a 512 × 512 pixel image at 85 dots per inch is under 30 seconds unidirectionally and under 15 seconds bidirectionally. (Print time is dependent on the amount of activity in the image, since the unit has a full image-seek capability.) The TC-1040 interfaces via either an RS232 or a parallel port. It costs about \$7,000, and will be available early next month.

FOR DATA CIRCLE 437 ON READER CARD

PRINTRONIX
Irvine, Calif.
PRINTER/PLOTTER
Booth W6188

This vendor will introduce the high-resolution model 4160 dot matrix line printer/plotter with a print speed of 130 lines per minute. The combination of small dot size and large dot overlap are intended to make the product

attractive for applications requiring high resolution, such as graphics, precision industrial bar code labels, quality business forms, and facsimile printing. As a plotter, density is 160 dots per inch with a plot width of 13.6 inches and a maximum plot speed of 13.6 inches per second. A complex 8½ × 11-inch A-size drawing can be plotted in 40 to 50 seconds, the vendor says. Dot diameter is

0.010 inch. The unit plots on plain paper, with from one to five copies. As a bar code label printer, the 4160 approximately doubles the resolution of the vendor's previous printers. The 4160 prints code 3 of 9 characters at a density of nominal 7.5cpi and interleaved 2 of 5 code characters at nominal 10cpi. The 4160 also prints large labels for outer shipping containers and business documents,

RETRO-GRAPHS™ AND

TeleVideo



Digital Engineering is offering new GEN.II™ Retro-Graphs terminal enhancements for TeleVideo's® 910, 912, 920, 925 and 950, Lear Siegler's ADM 3A and 5, and the ADDS Viewpoint.

GEN.II Retro-Graphs, our second generation enhancement, turns these popular text terminals into powerful, bit-map graphics terminals. With no loss of existing features. Tektronix® 4027 and 4010 simulation and protocol familiar to most programmers. "Resident" graphics intelligence and English-like commands for speed and ease of operation. Compatibility with industry-standard graphics software. Extensive documentation and timely customer backup. And at a price half that of comparably equipped graphics terminals.

GEN.II Retro-Graphs for TeleVideo. Lear Siegler and ADDS. Available only from Digital Engineering. Call Vicki at (916) 447-7600 or telex 910-367-2009 for ordering details.

DIGITAL ENGINEERING

630 Bercut Drive, Sacramento, CA 95814
 (916) 447-7600 Telex: 910-367-2009

GEN.II and Retro-Graphs are trademarks of Digital Engineering, Inc. TeleVideo is a registered trademark of TeleVideo Systems, Inc. Tektronix is a registered trademark of Tektronix, Inc. See us at NCC Booth D230 & at DEXPO, Booth 424 © 1982 Digital Engineering, Inc.

CIRCLE 126 ON READER CARD

NCC PRODUCT PREVIEW

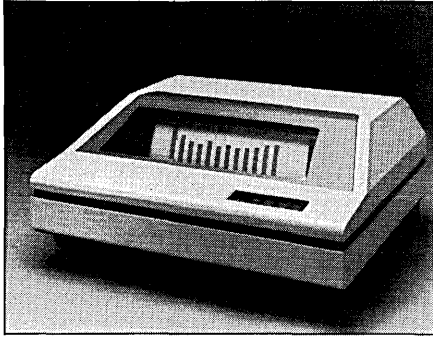

forms, and reports. The end-user price for the printer/plotter will be \$5,380.

FOR DATA CIRCLE 438 ON READER CARD

QUALITY MICRO SYSTEMS

Mobile, Ala.

PRINTER CONTROLLERS

Booths P7601-P7609

The QuicRIP printer controller system will be introduced at this vendor's booth. The intelligent graphics processing system will be driving a 60-page per minute Delphax ion deposition printer. The QuicRIP system gives printers the ability to do letter-quality word processing, industrial graphics, bar coding, bit-mapped graphics for business and scientific use, CAD/CAM graphics, intermixed fonts, multiple forms overlay, edp line printing, and multipage collated document printing. As with the vendor's other controllers, the QuicRIP system allows the operator to send print instructions in the normal data stream, eliminating the need for extra software packages. The QuicRIP system will use the same Quic programming now used by the vendor's Lasergraphix 1200 printer. Interfaces available on the system are Centronics; Dataproducts positive and negative true; RS232 and active and passive current loop with various protocols; IBM 3270, 3271, 3272, 3274A, 3274B, 3276, System/34 and System/38, 2780/3780, and 8100; Burroughs TC500 and TC3500; synchronous or asynchronous TDI; NCR 8200 and 9020; RS449 serial; Wang VS; and Ethernet. QuicRIP is being sold only with the printer bundled in. Prices start at \$25,000 for the QuicRIP controllers with a Xerox 2700.

FOR DATA CIRCLE 439 ON READER CARD

RANDOMEX DATA MAINTENANCE

Signal Hill, Calif.

CARTRIDGE CLEANER

Booths N4000-N4002

This vendor will exhibit its model 850 fully automatic disk cartridge cleaner, along with its previously announced line of automatic inspection and cleaning equipment for removable hard disk packs and cartridges. The 850 has the ability to clean disk cartridges dating from the original IBM 1130 system (2315 cartridge) up to the most recent CMD

cartridges. The portable cleaner can be used to clean all front, side, and top-loading cartridges, and DEC RK-06 and RK-07 two-disk cartridges. All versions of Control Data's CMD Phoenix cartridges are also handled by the system, which costs about \$4,000. The vendor says that the cleaner will be much smaller and have many more capabilities than its previous cleaners, and will be available in the third quarter.

FOR DATA CIRCLE 440 ON READER CARD

RING KING VISIBLES

Muscatine, Iowa

DISKETTE TRAY

Booths P7144-P7148

This vendor will introduce its MDT070, a locking storage system for 5¼-inch magnetic media. The new product features a hinged lid, two built-in carrying handles, and interi-



or dividers. The rugged tray is injection molded with high-impact plastic. The locking tray holds a maximum of 70 diskettes and costs \$2,500.

FOR DATA CIRCLE 441 ON READER CARD

SAS INSTITUTE, INC.

Cary, N.C.

MAINFRAME APPLICATIONS

Booth W6530

Two packages for IBM mainframe users will be introduced by SAS Institute. FSCalc, a new procedure in the SAS/FSP (Full Screen Product) library, is an electronic spreadsheet for financial modeling and analysis. It offers capabilities to perform "what if" analyses and sophisticated financial analyses of new products, mortgage schedules, etc. The FSCalc procedure includes an on-line help facility, enabling users to take advantage of several features. These include an unlimited spreadsheet size; a modeling language that supports most features of the SAS "Data" step, including arrays and macros; optional protection of cells; use of color to highlight protected and unprotected fields; ability to define names for rows and columns and add descriptions of

rows; varying column lengths; ability to create temporary variables; ability to add titles, subtitles, and footnotes to screens; ability to consolidate the current screen with a previously saved screen; ability to split screen to view spreadsheet and programming statements concurrently; and ability to create, save, read, and update SAS datasets from an FSCalc screen. Several users can share data since SAS/FSP operates in the 3270 network. Current SAS/FSP users will receive the procedure at no charge; the entire FSP library, including procedures for interactive data entry, editing, retrieval, and letter-writing applications, can be leased to corporate customers for \$3,600 the first year and \$1,800 each year thereafter.

The second product to be announced is SAS/OR, an operations research tool for business planning and scheduling. In addition to procedures for linear programming and critical path method (for scheduling), SAS/OR includes procedures to handle general assignment problems; to determine minimum cost flow through a network (including transshipment problems), maximum flow, and the shortest path; and to determine the quantity of goods to be shipped from supply points to demand points. SAS/OR will be available to corporate SAS customers in the U.S. for \$3,000 the first year, and \$1,500 each year thereafter.

FOR DATA CIRCLE 442 ON READER CARD

SEITZ/DATA MOTION

Torrington, Conn.

SHEET FEEDERS

Booths W6538-W6542

This vendor is actually two sister companies, Seitz Tek and Data Motion. The former will be introducing a line of sheet feed attachments to office printers. The Apache single bin, stack sheet feeder has a capacity of 125 sheets. The Bristol III Any Paper Feeder is designed to allow the operator to correlate envelopes, single and multipart forms, letterhead, checks, cards, and other types of forms, in 6- to 12-bin variations. The operator need only set up the bins and start the printer. Both units attach to the printer, swing aside, and detach. Mechanisms are platen driven and available with mechanical or electronic interfaces. The bracketry can be custom fit for most word processors, typewriters, and printers. Apache and Bristol each cost about \$300 in quantity.

Data Motion will be showing a dual feed tractor, a new entry in its line of 4, 5, 6, and 8 uni- and bidirectional tractor heads. The feed tractor takes both letterhead and perforated paper. A compensating pulley in the unit is used to correct a discrepant shaft. The tractor assembly's price varies according to its installation, but is approximately \$50.

FOR DATA CIRCLE 443 ON READER CARD

The New Rixon Intelligent R212A Modem...

The Intelligent R212A has literally leap-frogged the competition and revolutionized the 212A modem market. All beta site customers report that the Intelligent R212A is the most amazing 1200 BPS full duplex modem with an integral automatic dialer they have ever seen. Installation is the simplest of any modem ever because all options are soft (programmed from the keyboard)—no screw drivers or tools required, just plug it in.

The Intelligent R212A features:

- Automatic log on to databases with a single key stroke
- User friendly HELP list menu
- Store up to 10 numbers and alpha descriptions
- Automatically sets parity
- Automatically selects tone or pulse dial
- Dial stored numbers with a single key stroke or other numbers from the keyboard



- Initiate modem tests from the keyboard and review results on the CRT screen
- Battery backup protects all memory
- Link to another number if first number busy
- Redial selected numbers 1 to 99 times
- An unprecedented low price of \$495.00

The Intelligent R212A continuously monitors the progress of each call and reports its status by displaying — “Dialing Number”, “Waiting”, “Ringing”, “Busy”, “No Answer”, “Linking” and “On Line”.

The Intelligent R212A is so small it stands to reason the circuit card is very popular with OEM's. The OEM card is .5" x 5.4" x 8.8" (47 sq. inches).

Call Bill Vance today, at RIXON Inc., at (301) 622-2121, ext. 431. Bill can explain to you how the RIXON Intelligent R212A has revolutionized the 212A modem market.

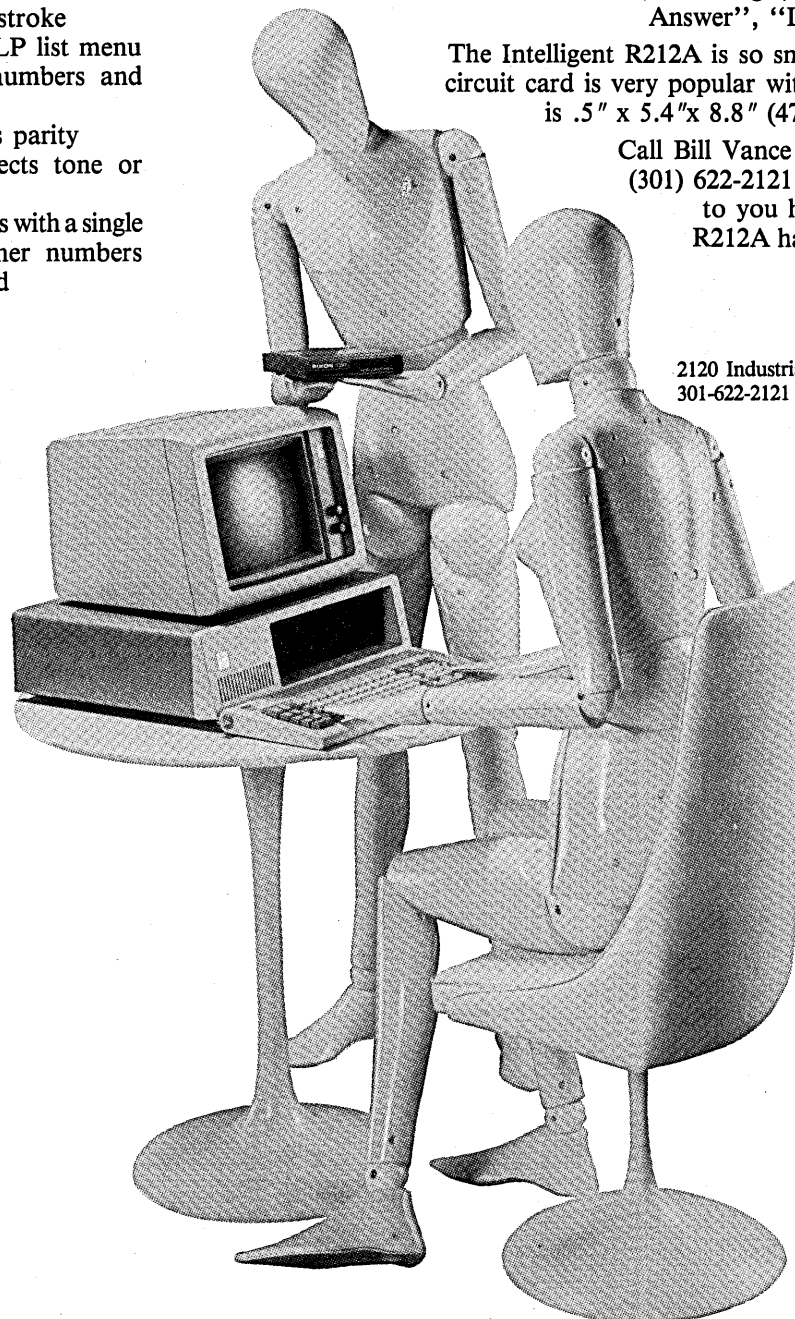

RIXON INC.

2120 Industrial Pky., Silver Spring, Md. 20904
301-622-2121 TWX 710-825-0071 TLX 89-8347

RIXON INC. 1983 3044

A Message From The Experienced Intelligent Network People

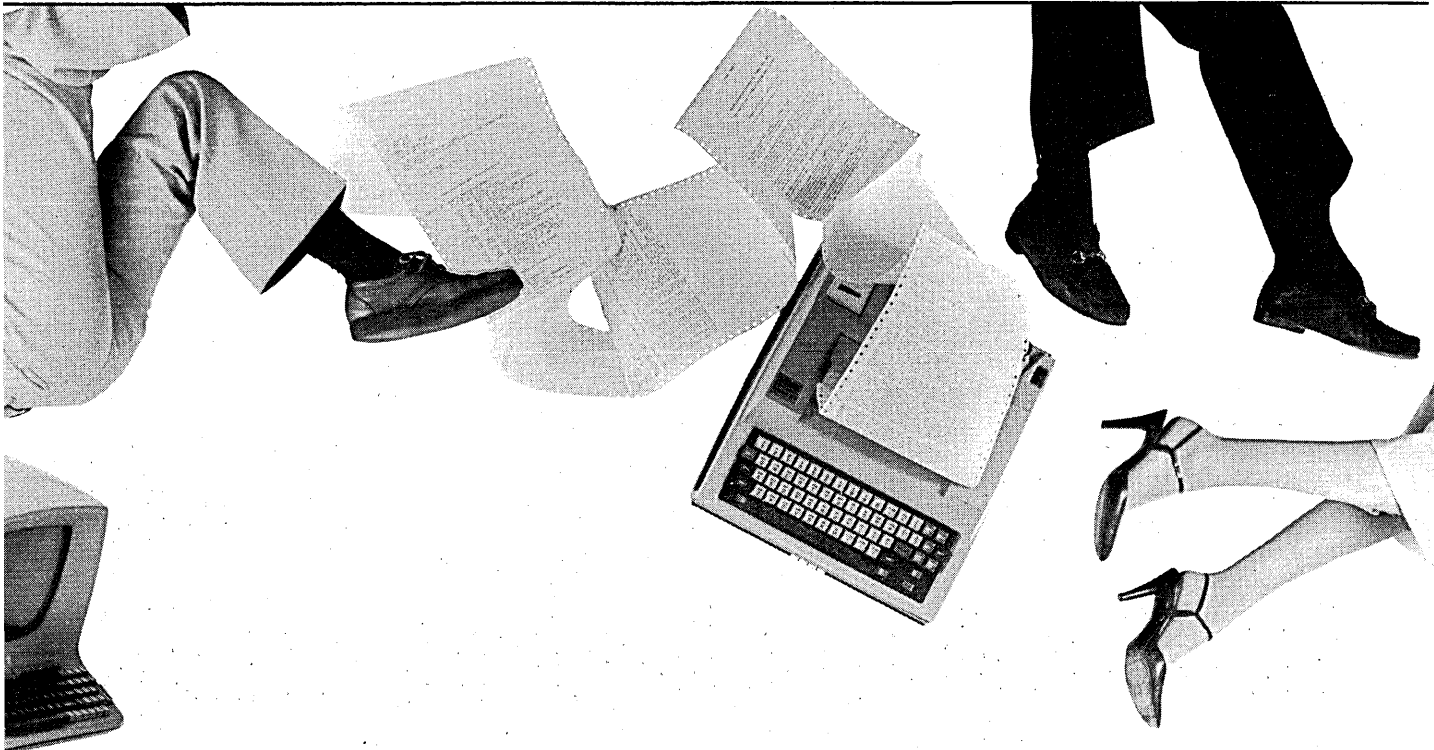

Up In The Air About Data Networks?

We have solutions.

Accessibility?

We're one of the world's largest public packet networks. And growing... local-call access now in more than 400 U.S. cities. International access as well.

Compatibility?

We give you device and vendor independence through built-in network "value-added's"... code conversions, speed matching, protocol translations—X.25, Async, 3270 Bisync, SDLC, and RJE/HASP. We'll help you talk to anything.

Network management?

We do it all. You get the control without the hassles and finger-pointing exercises.

Growth?

Whether your monthly communications costs are \$5000 or \$500,000; whether you need 10 locations or several hundred, TYMNET is where you ought to be. With support you can grow on. Now and tomorrow.

Dedicated network systems?

Have a TYMNET network of your own. Anything from a dedicated connection to a stand-alone private network complete with management facilities.

Cost-effectiveness?

No capital investment is required to start saving money on the public network and there are no long-term commitments.

Call or write us for details: (408) 946-4900; TYMNET, Inc., 2710 Orchard Parkway, San Jose, CA 95134

TYMNETTM

Serving more than 6 million data calls per month
CIRCLE 128 ON READER CARD

A Tymshare Company



SHARP ELECTRONICS CORP.
Paramus, N.J.
POCKET COMPUTER KIT
Booth P7204

This vendor will be displaying its line of pocket computers, including the latest model, the PC-1250. The unit is smaller, lighter, and slightly more powerful than the PC-1211, the vendor's first pocket computer. (The PC-1500 is larger and more powerful than both.) The PC-1250 uses extended BASIC programming running off an 8-bit CMOS microprocessor. The operating system and BASIC interpreter are contained in 24KB of ROM or 512 bytes of RAM. In addition, there is 1.7KB of RAM for user data or programs, and a cassette interface for larger programs or data. The unit includes 18 reversible keys for defining frequently used commands, statements, and mathematical functions. The keyboard includes a QWERTY alphabetical layout and a separate numeric keypad. Program access is password protected. The unit's display is a 24-digit dot matrix line. When the unit is left on, an auto power-off feature turns off the machine without losing information from RAM. The unit comes with a wallet case, and costs \$110. A separate cassette interface/printer can attach to the unit. It includes a microcassette recorder and a 24-character dot matrix printer and it wraps around the unit to form a single piece about the size of a hard-cover book.

FOR DATA CIRCLE 444 ON READER CARD

SOLA ELECTRIC
Elk Grove Village, Ill.
UPS SYSTEM
Booths N3559-N3565

Designed to maintain precise, conditioned AC power and reserve battery backup during total line failure, this vendor's new 5 KVA UPS operates continuously during normal power line conditions, providing voltage regulation and isolation from noise and transients. An internal solid-state bypass transfer automatically switches the load directly to the utility power line when load demands exceed system overload capacity of 200% for 167 milliseconds. The system maintains phase match between UPS output and bypass line to assure no-break transfer. Normal operation is restored automatically with correction of the overload condition. The unit has a full-bridge multipulse-width inverter design. The UPS accepts input voltage fluctuation of +10% to -15%, and regulates output voltage to within 1.5%. Output distortion is held under 5% of total RMS and 3% single harmonic. A standard control panel includes a digital meter for monitoring the AC output and current, the DC bus voltage and current, and a primary AC breaker and battery breaker. Audible alarms alert personnel to any fault condition. The UPS is available in a 60Hz model with I/O at 120 VAC

with single phase two-wire, at 120/240 VAC with split single-phase three-wire, or at 208 VAC with single-phase two-wire. The system costs \$14,000.

FOR DATA CIRCLE 445 ON READER CARD

SRW COMPUTER COMPONENTS CO.
Fountain Valley, Calif.
DISKETTE STORAGE

Booth N3557

Versapak is a storage container for 5¼-inch floppy diskettes being sold through OEMs. The package can hold up to five diskettes in three-ring binder sleeves. The storage units will cost about 75 cents each in very large quantities.

The vendor will also be displaying its recently announced Color Coder diskette

Wang word processors can now communicate with their IBM mainframe, without losing a word.

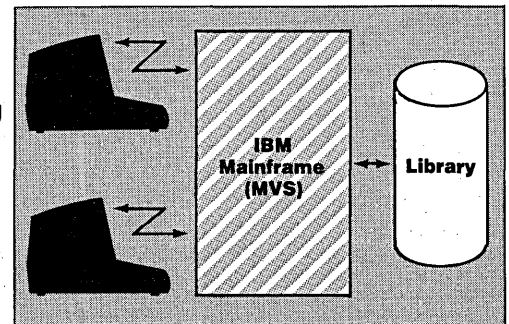

It used to be that storing documents on the mainframe was no easy task for Wang word processors. Literal transmission of characters was accomplished, but document format and administrative information was lost.

Soft-Switch™ has changed all that.

Soft-Switch is a distributed software product developed by Integrated Technologies, Inc. to expand the capabilities of document routing and archiving. With Soft-Switch, Wang OIS, VS and WPS word processors can now archive documents on the mainframe—totally intact, down to the number of key strokes—and index them as you like (e.g. keyword, author, date). These documents can then be transmitted to other Wang stations, or even IBM or NBI stations, using ITI's extensive

edit level translation capabilities. This is done using Soft-Switch's store-and-forward mode—utilizing an IBM (or compatible) mainframe with the MVS operating system. This means that no communication is necessary between the WP operators—the recipient receives the document directly from the mainframe. And only one routing instruction is necessary, regardless of the number of destinations—within one office, across the country, or around the world.

For more information about Soft-Switch, call or write.



Integrated Technologies, Inc.

200 North Warner Road
 King of Prussia, PA 19406
 (215) 768-9330 TELEX: 469600

Like DEC's.

\$9,800 system price*

256KB minimum...
up to 4MB!

Media and software
compatibility with
DEC's RX02 8" floppy
(vs. MICRO/PDP-11's
non-compatible 5 1/4" floppy)

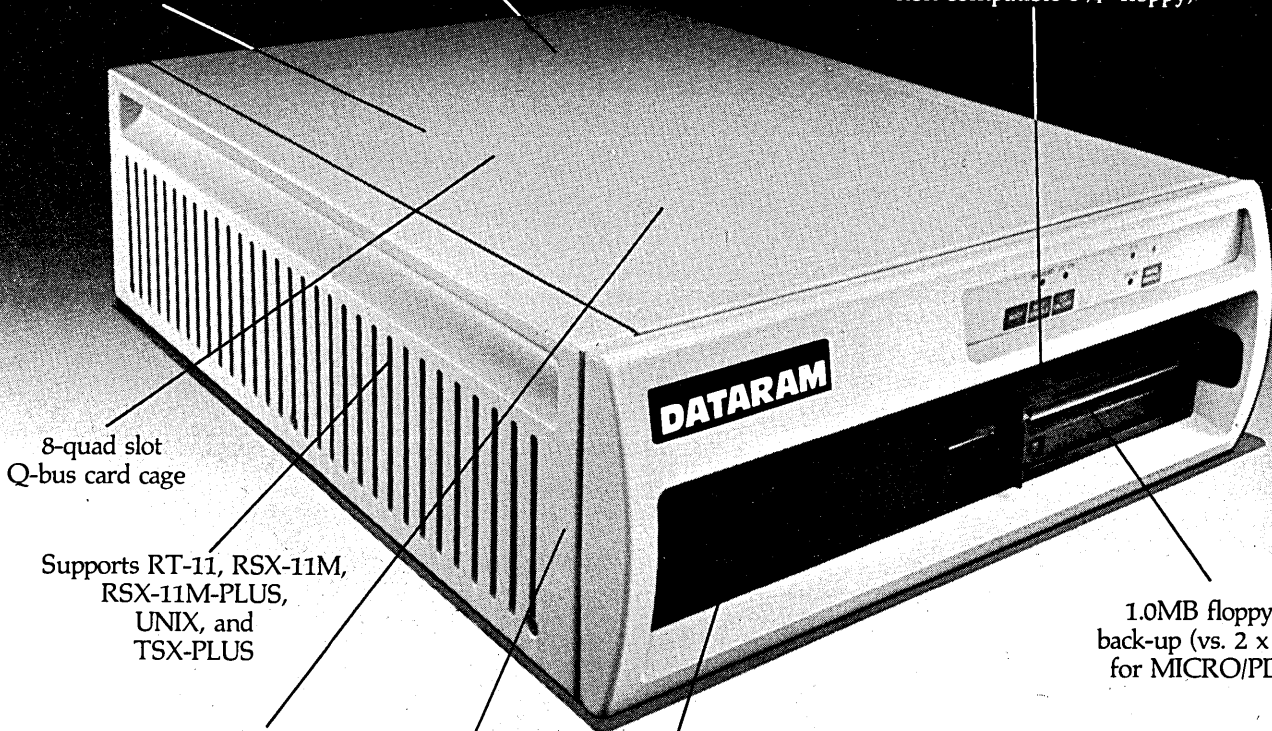

8-quad slot
Q-bus card cage

Supports RT-11, RSX-11M,
RSX-11M-PLUS,
UNIX, and
TSX-PLUS

Two fans in card cage
area (vs. one in
MICRO/PDP-11)

Space for
future 40MB
cartridge tape
drive.

RL02-compatible
10MB 5 1/4"
Winchester disk
standard;
20MB optional

1.0MB floppy disk
back-up (vs. 2 x 400KB
for MICRO/PDP-11)

Only better.

By paying a little more than you would for a MICRO/PDP-11, you can get a lot more! Like an 8" RX02-compatible floppy. 10MB or 20MB 5 1/4" Winchester and space for a 5 1/4" cartridge tape. Two fans provide push-pull air flow in the card cage area. The A22 with LSI-11/23, 256KB, 10MB Winchester, and 8" floppy is only \$9,800. 30-day delivery. For more information, forward this coupon to us, or, for faster response, call (609) 799-0071.

Send information. Contact me immediately.

Name _____

Company _____

Address _____

City _____ State _____ Zip _____ Phone _____

Return to:
Dataram Corporation, Princeton Road, Cranbury, NJ 08512

See Dataram
at NCC '83

Booth S5284

*\$9,800 is single-quantity domestic price for A22 with LSI-11/23, 256KB, 10MB Winchester and RX02-compatible 8" floppy.

DEC, LSI-11, PDP, RSX, and RT-11 are trademarks of Digital Equipment Corporation. TSX-PLUS is a trademark of s&h computer systems, inc. UNIX is a trademark of Bell Laboratories.

DATARAM

Dataram Corporation □ Princeton Road □ Cranbury, New Jersey 08512 □ Tel: 609-799-0071 □ TWX: 510-685-2542

CIRCLE 130 ON READER CARD

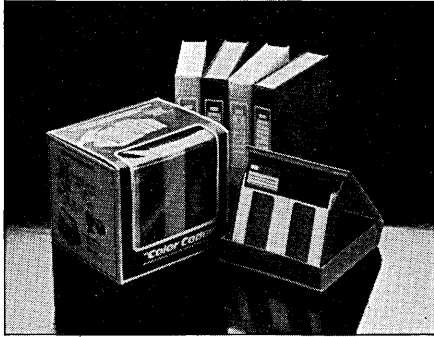

storage systems. Each system comes with five boxes that can each hold ten 5¼- or 8-inch diskettes. Each box comes with 10 diskette labels and a spine label and is a different color: the label corresponds to the color of the box. The system does not include diskettes. Each box can open up to form an easel for more efficient browsing through the diskettes. Two color patterns are available—"classic" and "colorburst." Classic colors are navy, gray, red, cream, and black; colorburst colors are white, red, green, yellow, and blue. A complete storage system, with five boxes and 55 labels, costs \$20.

FOR DATA CIRCLE 446 ON READER CARD

SYMBOLICS, INC.
Chatsworth, Calif.
AI MINICOMPUTER
Booths 2505-2508

The 3600 has a 36-bit tagged architecture with 32-bit data paths. It executes programs at 1MIP. Virtual memory consists of over 1 million pages of 256 words of 36 bits each. The basic hardware system features 2.3MB of MOS memory with ECC; one parallel and three serial I/O ports; a 10Mbps Ethernet interface; a graphics console with 1,100 × 800 bit map raster display, 88-key keyboard, three-button mouse and programmable audio output; and a 169MB SMD-compatible Winchester disk

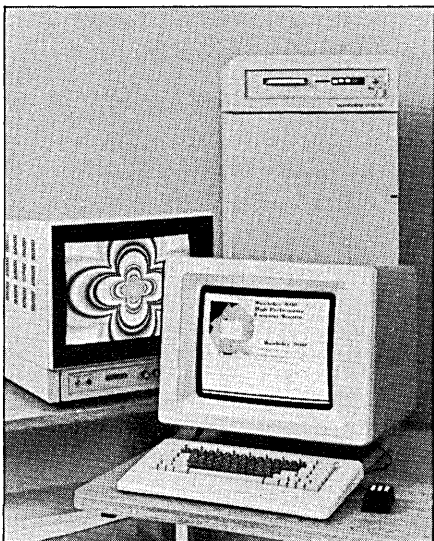

drive. Each memory board has single and double bit error detection. Up to 15 memory boards can be installed in the standard chassis, providing a total of 34MB of main memory. A 68000 acts as a front-end processor. The 3600's software includes a display system with multiple overlapping windows for monochrome and color displays; a real-time editor; incremental compilers for Lisp, FORTRAN, Pascal, and C; dynamic linking; full Ethernet support; electronic mail; and debugging tools. The primary language is Zetalisp, an enhanced version of Lisp. The computer also supports Flavors, an object-oriented programming language that transcends the essentials of Smalltalk and is fully integrated with Zetalisp. The 3600 is a single user system designed specifically to handle the massive programs typically associated with artificial intelligence. The unit costs about \$85,000.

FOR DATA CIRCLE 447 ON READER CARD

T-BAR INC.
Wilton, Conn.
NETWORK SOFTWARE
Booth W6370

This vendor will announce its Overlord control and MIS software package, which offers a program that controls the configuration,



monitoring, testing, record keeping, performance analysis, and trouble signaling for the data network and the multiple cpu environment. The program is currently available for Hewlett-Packard computers, but is adaptable to other mini and mainframe protocols. Menu driven with color graphics and light pen support, Overlord gives users remote control capability and management information ranging from remote terminal identification to network management. Reports can be generated to document detailed equipment status,

failure trends, and maintenance downtime. The software also offers trouble ticket reporting and monitoring capability developed to meet the needs of most computer and communications environments. The product starts at about \$35,000.

FOR DATA CIRCLE 448 ON READER CARD

TELERAY
Minneapolis, Minn.
TERMINALS
Booth N3720

The model 18 is a very smart multipage terminal compatible with ANSI X3.64 standards. It has dual display modes—either four pages of 80 columns or two pages of 132 columns—which can optionally be nonvolatile. All control codes and sequences are user changeable, and all keyboard keys can be recorded. (The vendor refers to this capability as "hot buttons.") It has 6KB RAM, DEC-compatible keypad mode, optional RS422 interface, and optional downloadable character generator. The model 18 has a 2KB nonvolatile programmable function memory (32 functions); in addition, any of its unused 6KB display memory can be used as function memory. The terminal features four different sized displayable characters, logical line length (to 255 columns) and page length, horizontal and vertical smooth scrolling, five display attributes, and seven area qualifications. It has a built-in calculator and clock, with musical operator alerts. The terminal is offered with 9-, 12-, or 15-inch screens, and costs \$1,595.

The vendor will also be displaying its model 16-HON terminal, introduced last month. This terminal is a four- or eight-page ANSI X3.64-compatible terminal with an alternate Honeywell 7801-compatible mode; in this mode, it has unlimited attributes per line, unlimited qualified fields, and unlimited line drawing. The terminal has a four-page display memory, which can either be volatile or nonvolatile; in addition, it also features logical line length to 255 characters and logical page length; 32 user-recodable macro keys (or 64 with shift); and horizontal and vertical smooth scrolling. Four displayable character sets with 256 characters each, a calculator, and a clock are also built in. The model 16-HON is also available in 9-, 12-, or 15-inch versions, and costs \$1,695.

FOR DATA CIRCLE 449 ON READER CARD

TELTONE CORP.
Kirkland, Wash.
MULTIPLEXORS
Booth P7706

This vendor will be introducing an addition to its DCS-2S data carrier system. The DCS-2S adds full synchronous capabilities to the system's asynchronous capabilities. Internal and external clocking are supported for both

NCC PRODUCT PREVIEW

standalone and tail circuit applications. Full duplex data rates of up to 9,600 baud are supported concurrently with normal voice traffic on a single in-place, in-service twisted pair PBX wire. As with the async-only DCS-2, the DCS-2S eliminates the need to install dedicated data cable within a range of 5,000 feet. EIA controls for synchronous polling applications are provided. The DCS-2S will cost about \$700 per channel and will be available for volume delivery in the third quarter.

The vendor will also be showing its line of recently introduced statistical multiplexors. The M-860 line provides composite link speeds of up to 76.8Kbps and can be configured with 8 to 32 async input channels at individually programmable speeds of 50 to 9,600 baud. An eight-channel version of the mux starts at \$2,400.

FOR DATA CIRCLE 450 ON READER CARD

TII ELECTRONICS East Setauket, N.Y. POWER SUPPLIES Booth 1703

The EHVG switching power supply provides full and semiregulated outputs, as well as an

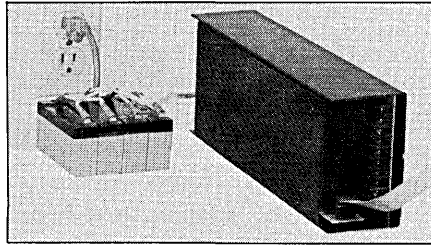

optional battery backup. The battery backup can be retrofitted to previously shipped units. The EHVG is available in 155 watt and 220 watt versions. The units can be configured to have one, three, or four outputs with various current ratings and regulation. Fully regulated outputs have 0.2% line and load regulation; semiregulated outputs have 5%. Input voltages are field selectable. The battery backup board contains the battery charger, soft transition logic, and communications logic. TTL-compatible signals indicate AC low, battery low, and battery charged conditions. Automatic power-down logic allows system shutdown after an AC low time-out or after a battery low time-out. A third shutdown mode allows the system to control

power down via the shutdown inhibit input. It costs \$190 in quantities of 1,000.

FOR DATA CIRCLE 451 ON READER CARD

UNITED SOFTWARE SYSTEMS AND SERVICES Los Angeles, Calif. DBMS Booths 7900-7904

This company will exhibit Clio, a database management system that was introduced in France about three years ago. Since then, over 200 Clios have been installed in France; the product is making its U.S. debut at NCC. The DBMS is designed to run on IBM mainframes under OS/MVS, VM/CMS, DOS/VSE, and related operating systems; it also runs on Siemens, Honeywell, and DEC PDP and VAX cpus. Clio files can be accessed by a set of English-like user languages or through a host programming language. A third access language is the Clio Smart User language, which can be customized to a user's requirements. Clio permits specification of a wide variety of data structures and relationships (hierarchical data independence, so that neither dp nor non-dp users' need to know the file structures,

B. Dalton The Source for Computer Books

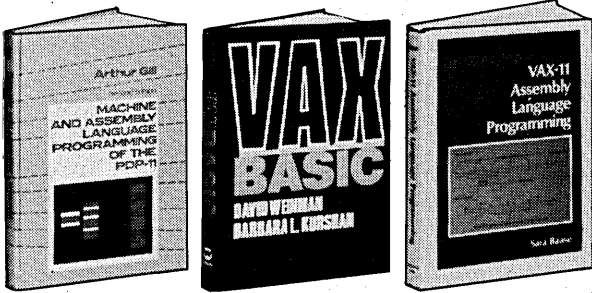

MACHINE AND ASSEMBLY LANGUAGE PROGRAMMING OF THE PDP-11

Arthur Gill \$26.95 hardcover

New and updated. Major revisions on addressing modes, condition code instructions, coding hints, program traps. Appendix with full ASC 11 set. New material on MUL, DIV, ASH, ASHC, XOR, and SOB operations.

VAX BASIC

David Weinman & Barbara L. Kurshan
\$24.95 hardcover

An introduction to computer programming using VAX-11 BASIC with emphasis on writing usable programs. No familiarity with computers is assumed, and only high school algebra is needed.

VAX-11 ASSEMBLY LANGUAGE PROGRAMMING

Sara Baase \$29.95 hardcover

Introductory instruction in assembly language for the widely-used VAX-11. Examples of how specific instructions work in programs, 300 exercises, tables of instructions, illustrative figures and diagrams.

These titles available in selected stores.

CALL TOLL FREE

1-800-328-3890 ext. 6020

IN MINNESOTA 1-800-682-3816 x 6020

IN MPLS/ST. PAUL 922-6699

IN ALASKA 1-907-276-3242 (store hours)

IN PUERTO RICO 1-809-752-1275 (store hours)

CREDIT CARD ORDERS ONLY.

B. Dalton
BOOKSELLER

CIRCLE 131 ON READER CARD

TELEPROCESSING ENGINEERS FOR IPA, SAUDI ARABIA

Institute of Public Administration (IPA) has immediate openings for very experienced and qualified Computer Networks/Teleprocessing Specialists.

Experience in NCP/VTAM; SNA/X.25 Protocols.

AN IBM 3033/A ENVIRONMENT

BENEFITS:

IPA OFFERS:

- * Attractive salaries (in the range of US \$36,000 - 70,000 per year depends on qualification and experience).
- * Furnished Apartment.
- * Airline Tickets for the Specialist and his family.
- * 45-days paid vacation.
- * Free Medical Treatment at Public Hospitals.

Tax-free income in Saudi Arabia.

Knowledge of Arabic Language preferable.

Those who are interested should write to:-

**INSTITUTE OF PUBLIC ADMINISTRATION,
P.O BOX 205,
RIYADH 11141,
SAUDI ARABIA.**

TELEPHONE: 4777959

TELEX: 201160 IPADMIN

CIRCLE 132 ON READER CARD

Everything a VAX user could ask for in a storage subsystem.

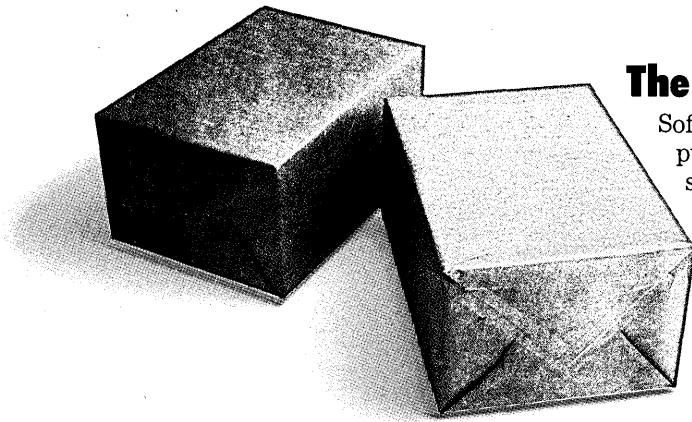

The Emulex package deal.

Software transparency, low prices, rental/purchase option plans, a trade-in program and a service security blanket. Included are pretested drives and controllers; direct factory installations; fulltime hardware/software applications assistance; and nationwide service through Control Data, General Electric and Tymshare.

Emulex innovation—introducing our Eagle disk/Keystone tape combination.

Where else can you get a unit that optimizes the Fujitsu Eagle's 1.8 MB/sec transfer rate and provides backup, archiving, journaling, and the media interchangeability of 1/2-inch tape? All in one 42-inch cabinet. Best yet, the PXD-51 is available in six DEC-emulating models for PDP and VAX users on the CMI, SBI or Unibus.

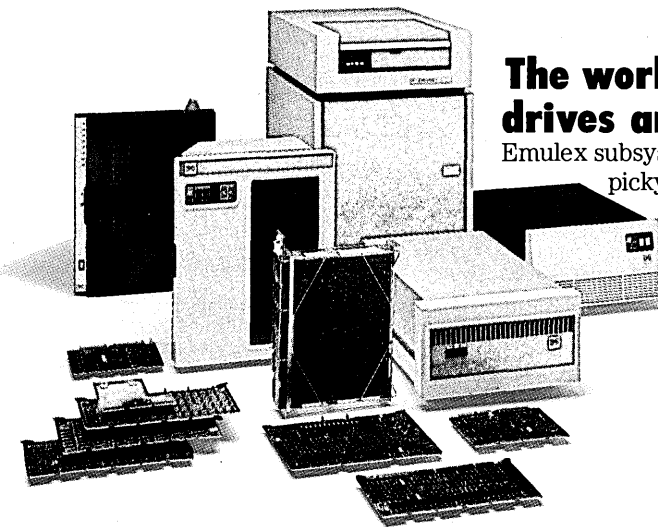
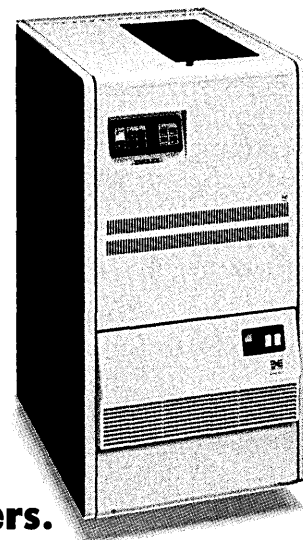

The world's best drives and controllers.

Emulex subsystems let you be very picky. You select proven tape drives and disk drives from 80 to 675 MBytes. Plus you can mix and match fixed and removable disk drives of varying sizes and configurations. At the heart of the subsystem is an Emulex controller designed specifically for your particular DEC CPU.

Emulex has been and continues to be the pioneer in DEC-compatible subsystems. And in each product our objective is clear: to make your DEC system faster, more efficient and capable of processing larger, more complex programs more reliably than any other alternative.

Find out more about the total Emulex package. Phone toll free: (800) 854-7112. In California: (714) 662-5600. Or write: Emulex Corporation, 3545 Harbor Blvd., P.O. Box 6725, Costa Mesa, CA 92626.

DEC and Unibus are registered trademarks of Digital Equipment Corp.
Eagle is a trademark of Fujitsu Corp.
Keystone is a trademark of CDC Corp.



The genuine alternative.

R&D had certain requirements that had to be met; manufacturing, accounting and marketing had others. Then microcomputers started showing up on desktops, with modems and printers here and there. Now you face the task of making it all work together. Sharing resources. Sharing information. And making more effective use of the information processing equipment you've already invested in.

NET/ONE LEAVES YOU IN CONTROL OF EQUIPMENT DECISIONS.

Net/One® is a general purpose communications system that turns equipment from different vendors into a fully functional, fast, powerful, information processing network. Because it can connect equipment from virtually any vendor, you remain free to choose equipment based on capability, rather than compatibility.

Off the shelf, Net/One supports industry-standard equipment interfaces—Async, Bisync, SDLC, through RS-232, V.35, RS-449 and IEEE-488 — as well as many high speed parallel interfaces. The list is expanding every month. But if you have special equipment that isn't in that list, Net/One is the only local area network that's fully programmable at every level so special interface protocols can be added now, or when you need them, later.

BROADBAND, BASEBAND, OR ANY COMBINATION THEREOF. YOU CALL THE SHOTS ON MEDIA, TOO.

Net/One is the only local communications system that gives you the option of broadband or baseband or a combination of both, with architecture that will allow you to add other media such as fiber optics in the near future.

YOU DON'T HAVE TO KNOW EXACTLY WHERE YOU'RE GOING TO BUY A NETWORK THAT WILL GET YOU THERE.

Everything about Net/One has been designed to respond to your needs, as they evolve, and to remain fully adaptable to evolving communications technology. System architecture is completely modular, so it can grow at the

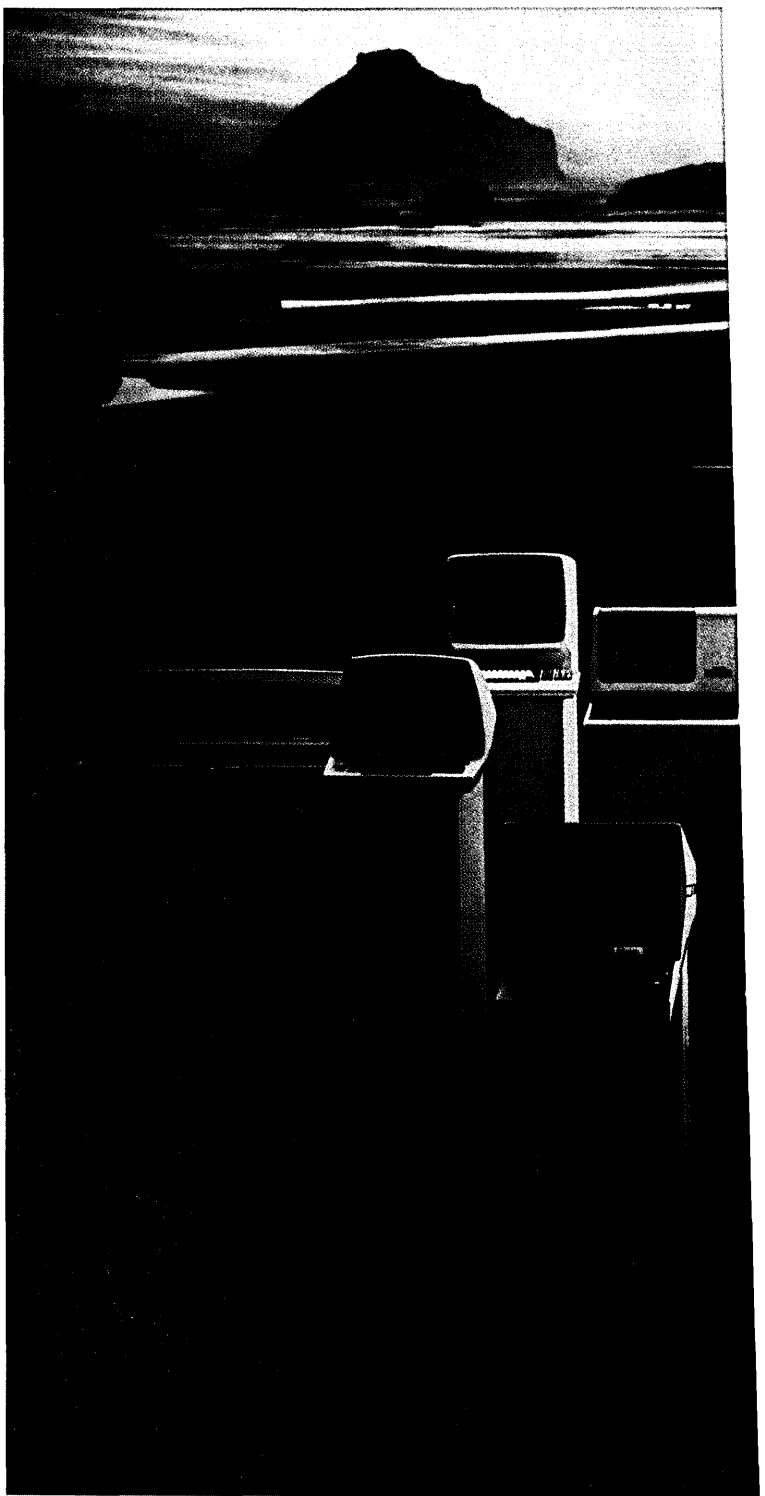

Net/One turns the e now into the netwo



same time and in the same direction you do. Regardless of the direction that turns out to be.

When separate divisions within a company or a campus need to share resources, one Net/One system can be bridged to others, and to remote networks. These bridges can interconnect baseband, broadband, or Net/One systems that include both. And like vendor independence and media independence, this bridging capability is available now from Ungermann-Bass.

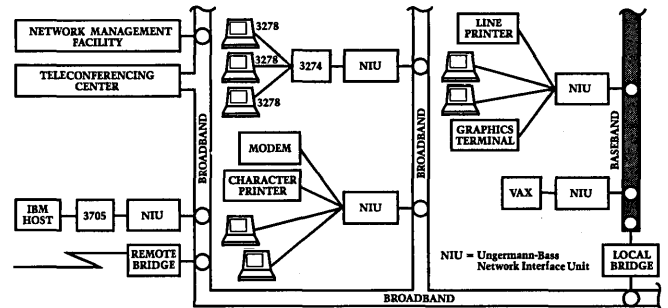

NOW, THE IMPORTANT DIFFERENCE BETWEEN TALKING A GREAT NETWORK AND DELIVERING ONE.

We've been installing Net/One since July of 1980. Hundreds of our systems are already out there moving information for people like Control Data, Caltech, Fairchild, ITT, RCA, Boston University, U.S. Forest Service, and Ford Aerospace.

So we can do more than talk about what you need in a local area network. We can actually deliver one, now. And we can refer you to a long list of customers who are actually using one (or two or three) now.

Let's talk about how to turn the equipment you have, now—whatever it is—into the network you want, now. And the network that can take you wherever you want to go from here. Net/One.

Ungermann-Bass, Inc., 2560 Mission College Boulevard, Santa Clara, California 95050. Telephone (408) 496-0111.

Net/One from Ungermann-Bass 

equipment you have
network you want. Now.

NCC PRODUCT PREVIEW

cal data independence, so that neither dp nor non-dp users need to know the file structures, format, or physical location of the store data. Clio can be used to construct or access information, develop reports in the required format, and add, delete, or modify fields without reorganizing the entire database. Administration functions include a data dictionary, security protection even at the field level, and restart/recovery utilities. Clio costs \$60,000 to \$80,000, or can be leased for upwards of \$2,500 per month.

FOR DATA CIRCLE 452 ON READER CARD

USI INTERNATIONAL

Brisbane, Calif.

MOUSE

Booths D2227, D2326

This vendor will be showing its OptoMouse, an optical mouse controlled by a designed-in microprocessor and based on a custom optical imaging system. It can emulate existing graphics protocols, including Tektronix Plot 10 and the Summagraphics bit pad. For a host interface, the unit requires an RS232C serial or TTL port; data can be sent at 110, 150, 300, 600, 1,200, 2,400, 4,800, or 9,600bps. The baud rate is selected either by a hardware

jumper or automatically from the host. The mouse meets all FCC/EMI MIL-STD 1472C requirements, and costs under \$300.

FOR DATA CIRCLE 453 ON READER CARD

UVP INC.

San Gabriel, Calif.

EPROM ERASERS

Booth N4509

The Memorase C-25 and C-50 EPROM erasing systems are designed to provide safe tools for the exposure of EPROM to shortwave ultraviolet radiation. The systems, which can erase one to 50 EPROMs simultaneously, each include a timer that sets the exposure required, a safety interlock to prevent accidental UV exposure, high-intensity UV grid lamps for minimum erase times, a cooling fan to minimize heat buildup under heavy use, view ports to observe the lamp's operation, and a conductive foam pad to dissipate charge buildup. Erase times vary from eight to 37 minutes, depending on the number of EPROMs and the intensity desired. Since the lamp's peak output declines with age, the erase time will increase with use over a life span of 5,000 hours. The C-25 will handle one to 25 EPROMs, and the C-50 will handle 46 to 50

EPROMs. The units cost \$400 to \$1,500.

FOR DATA CIRCLE 454 ON READER CARD

ZENITH DATA SYSTEMS

Glenview, Ill.

PERIPHERALS

Booth S5000

This vendor is introducing several peripherals and a terminal for its line of microcomputer systems. The model Z-207 8-inch flop-



py disk drives are available in single or dual drive versions. The drives are double sided and double density, and offer a megabyte of storage per diskette. Single drive versions can be upgraded to add a second drive when desired. The drives are half-height standard format drives, and are IBM 3740 compatible. The Z-207-41 single drive costs \$1,600; the Z-207-42 dual drive costs \$2,300.

The vendor is also releasing a 256KB dynamic RAM card, which is IEEE 696 compatible for use in S-100 bus computers. It automatically recognizes 8-bit or 16-bit addressing and offers byte parity. The card costs \$1,000.

The Z-100 line of desktop micros now includes a model featuring a built-in 5¼-inch Winchester disk drive with 11MB formatted capacity. The system also comes with a 5¼-inch floppy drive; transferring software from the floppy to the Winchester takes less than five minutes, the vendor says. The Winchester drive uses one of the computer's five S-100 expansion slots, and features error correction circuitry, direct memory access, and the ability to control two drives. The computer costs \$5,500 to \$5,600 with the Winchester drive.

Finally, the vendor is introducing a line of terminals that can be set up for operation from an on-screen menu. The Z-29 terminal is compatible with ANSI protocols and the DEC VT52. Its detachable keypad has 77 keys and a separate 14-key numeric keypad. LED lights indicate power status, whether the keyboard is locked to prevent use when receiving information from the host, and upper or lower case characters. Users may select an audible key click that makes the terminal sound more like a typewriter. The terminal costs \$850.

FOR DATA CIRCLE 455 ON READER CARD

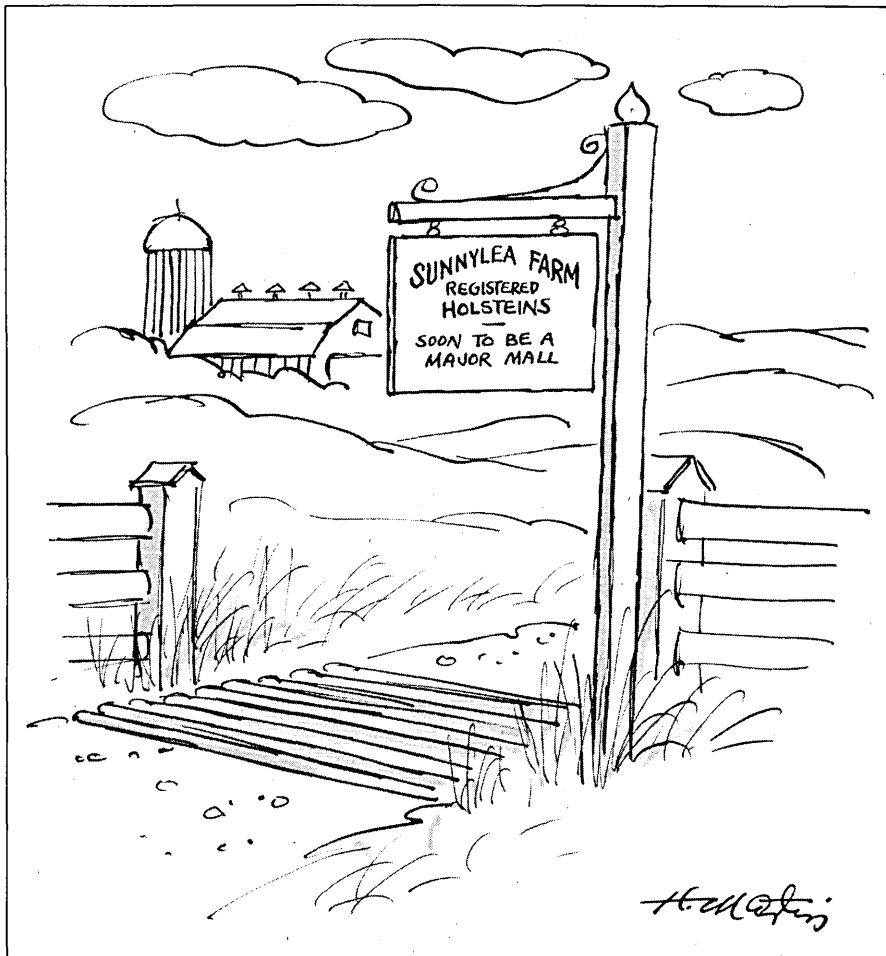

CARTOON BY HENRY MARTIN

Now that Motorola stands behind Four-Phase,

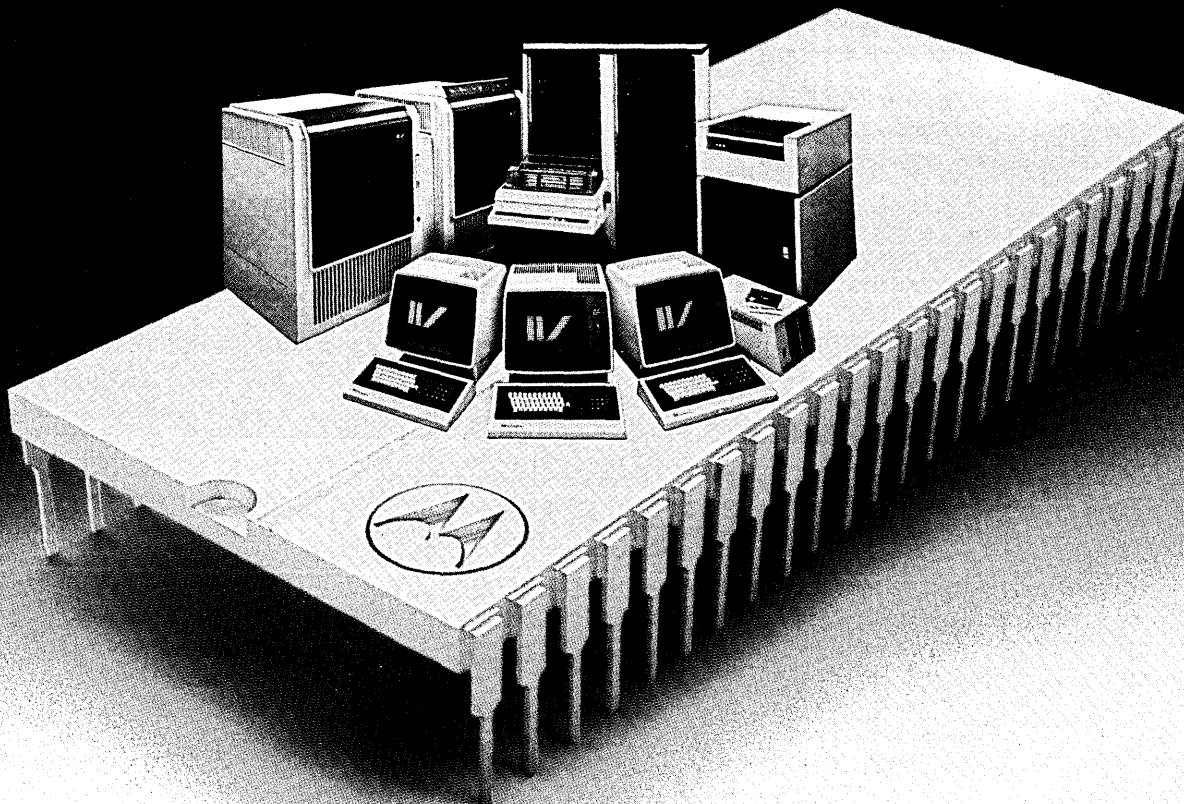

What do you stand to gain?

A way out of chaos.

We are in the midst of a revolution in the way we use information. The computer terminal has joined the telephone and the calculator as part of day-to-day business life.

It is a time of confusion. Everyone has some kind of "office automation" to sell, based on everything from word processing expertise to networking capability. It's all very confusing if your task is to plan your company's future, your responsibility to manage its resources wisely.

But, there is a way out: the solution made possible by the Four-Phase/Motorola alliance. The combination of resources and experience brought together by that union now makes it possible for you to work with a

coherent, integrated, complete office automation system... Not just isolated functions.

Four-Phase has over a decade of experience in the creation of computer-based systems. We have pioneered in the distribution of computer functions and the design of computer networks that bring together your corporate computing facilities with the personal computing needs of your managers,

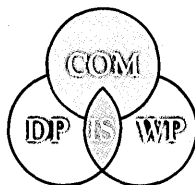

Four-Phase unites data and word processing with powerful communications capabilities to bring you complete information systems.

designers and engineers.

Motorola adds strong financial and management strength. It offers a host of complementary technologies and related subsidiaries whose efforts and expertise will now be joined with that of Four-Phase. And, not the least contribution is Motorola's powerful M68000 microprocessor that now becomes the nucleus to drive and bind together a growing family of Four-Phase office automation systems.

Put chaos behind you. If you would like to hear more about the rational, orderly — complete — Four-Phase/Motorola approach to office automation, write us on your letterhead, indicating your specific areas of interest. Four-Phase Systems, 10700 N. De Anza Blvd., Cupertino, CA 95014.



MOTOROLA INC.
Information Systems Group

Four-Phase and the Four-Phase logotype are registered trademarks of Four-Phase Systems, Inc. Motorola and (M) are registered trademarks of Motorola, Inc.



Four-Phase Systems
The Office Automation Company

See us at Booth #5392,
at NCC in Anaheim, May 16-19.

CIRCLE 135 ON READER CARD

11

12

13

14

15

16

17

18

19

20

21

22

23

24

25

26

27

28

29

30

31

32

33

34

35

36

37

38

39

40

41

42

43

44

Vertical text on the right margin, possibly a page number or index.

Horizontal line across the page.

Horizontal line at the bottom of the page.

THIS IS WHAT WE'VE BEEN WAITING FOR.

The dawning of the Information Age. It's creating an increasingly dynamic marketplace. One in which we at Teletype Corporation—a subsidiary of Western Electric—will be a strong factor. Never in our 75 year history has there been a time quite like now. And even though we've developed our share of innovations over the years, we have the technology to do far greater things today.

You see, we've taken our technology beyond the realm of traditional terminals for communications and network control systems. We're branching out into new areas including office automation, professional work stations and intelligent terminals. At the same time, we're focusing on improving the products and services that have built our reputation.

Much of what we're doing has been made possible by expanding our research and development. This year alone, we're increasing R & D expenditures by over 25 percent.

We're set to be more competitive in terms of product technology, features and functions. So that in the long run our reputation for value will become even stronger.

The four new products we introduced on April 11 clearly demonstrate this value. They include a dot-mapped CRT with full graphics capabilities; advanced editing and conversational asynchronous CRTs; and a highly reliable, cost-effective 3270-compatible CRT. The value these products represent is further enhanced by our established nationwide service organization.

We're rising to the challenge of the new day. And it holds the promise of a brighter future for Teletype Corporation and you.

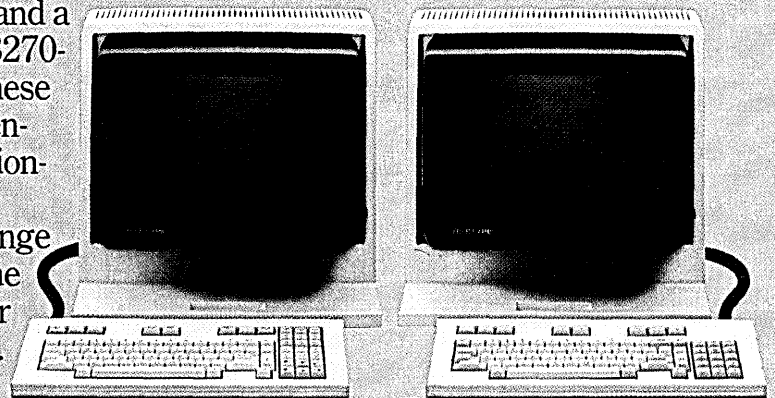
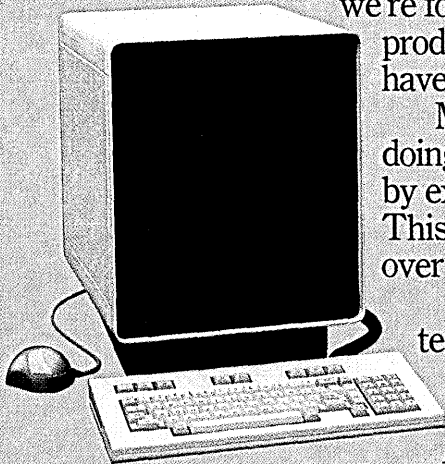
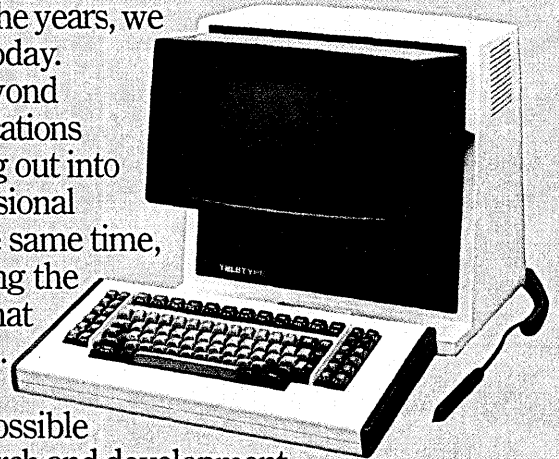

TELETYPE® VALUE SETS US APART.





Our 8" Slimline disk drives are the smallest and our 5 1/4" half heights are rolling out by the truck load.

That's R&D you can bank on: Response and Delivery.

You say you need drives that are half the height but all-the-way reliable? From a source that's equally reliable? And you want a choice of configurations too?

Our response is a line of 5 1/4" Slimline™ drives built with three different heads and color styles, your choice of direct or built drive motors, and choice of two densities, 48 TPI or 96 TPI. But only one quality standard: the highest.

They come single or double sided, with capacities from 250 Kbytes to 1 Mbyte. And for those who can do with a little less speed, MPD responds with a consistent model at a lower price tag.

And when you wanted smaller, compact 8" drives, we replied with the smallest ones there are. Our 8" Slimline™ series. Only 2" thick and 11.5" deep. The selection doesn't end there. You can also get a 4 1/2" bezel as well as a half size version at 2.5".

To the cry for ever-smaller disks, MPD answered with the smallest disk drive ever. A 3" mini floppy that interfaces with 5 1/4" systems, handles 500 Kbytes of data and uses double protection by a hard shell so you can carry it in your shirt pocket safely.

That's how MPD operates. By responding with what you need. Then delivering. By the truck load from the West Coast. By the shipload from Singapore. Our own second source in the Orient then duplicates the precision production of our California plant. Where, of course, we are manufacturing our own heads.

That all adds up to MPD's brand of R&D: Response and Delivery. And that makes us the company to bank on.



MICRO PERIPHERALS, INC.

West Peripherals Inc. 3720 Stearns Ave. Chasworth, CA 91707 Phone: (714) 786-4200 FAX: (714) 786-4201
 MPD Inc. Europe West Peripherals (Europe) B&B Maschinenbau Phone: (49) 4300 1460 Fax: (49) 4300 1461

CIRCLE 187 ON READER CARD

The microfloppy race is on, and the results will make a difference in the office automation market.

WHICH MICROFLOPPY IS RIGHT?

by Peter Krass

The flexible disk has become an almost universal part of information processing. The 8-inch diskette serves as an interchange medium among many word processors and small business systems, largely because it has IBM's blessing. The 5¼-inch diskette is also popular in office systems, but has outdistanced the 8-inch type because it is used on personal computers as well as many office machines, where it is the basis of software publishing as well as a data medium. Now even smaller diskettes are coming to the fore, but the move toward standardization, a fact of life in larger diskettes, appears to be nowhere in sight. Clearly, companies planning new products that might use the smallest standard diskette want to move ahead. But which way they're likely to move depends on whom you ask.

"I've had the opportunity to talk to a pretty good sample of systems manufacturers during the last couple of months," says Jim Porter. "I can tell you what they intend to do, most of them: if they feel a need to go to a microfloppy in the next year or so, they are going to go with the 3½ inch. By this I mean the Sony design as changed by the Americans [whom Sony now agrees with]."

Jim Porter is the man behind *Disk/Trend Report*, the bible of the disk business. While he characterizes talking to people who use disks as his opportunity, a good number of people think a chance to talk to Porter is really their opportunity, because Porter has displayed an uncanny knack for sorting out the magnitude and direction of trends in the disk business. Porter's predictions about the Sony drive becoming a standard might be self-fulfilling.

Nevertheless, IBM has indicated it does not want to adopt the revised Sony standard, at least not yet. Instead, IBM is proposing a 3.9-inch device, and is trying to sell it to other manufacturers. Because IBM invented the floppy in the first place and because a lot of what IBM does becomes a standard, the IBM unit has to be taken seriously.

Also to be taken seriously are offerings from other vendors and coalitions of

vendors, including the 3¼-inch unit pushed, notably, by Seagate and the 3-inch microfloppy favored by Hitachi and Matsushita.

Many oems will never worry about microflopplies. The small diskettes are not for every application. They clearly are important to makers of portable systems, where it's vital to save space. But portable computers are increasingly being used to capture data that will be used on fixed systems, and those fixed systems may well come from an oem or systems house, rather than from a company specializing in fitting a general purpose micro-computer into a briefcase.

In addition to portable systems, microflopplies have great potential in fixed equipment that uses a small footprint as a selling point. Hewlett-Packard, for instance, was the first American company to go with a microfloppy, selecting a Sony drive for small but not truly portable scientific computers. For many oems, it's as hard to ignore HP as to ignore IBM. They recognize that devices put in a computer today may well appear in electronic instruments tomorrow.

Lastly, in a market that is not yet important to many oems, but which may affect the fortunes of certain systems houses, the microfloppy may become a standard peripheral. This sector is office automation, where there is a real need for small storage devices in word processing equipment. For the big producers in this market, there are possibilities not only for business applications of a microfloppy, but also for huge sales to casual users, like students, who now buy portable typewriters, and other specialized users.

EMULATING 5¼-INCH MEDIA

The most important factor in any microfloppy, according to Jim Porter, is compatibility with 5¼-inch media. "That's the logical diskette volume to be emulated, not the 8-inch. Then system integrators can take advantage of the standard single-chip controller circuits, which are inexpensive. I believe Western Digital and NEC are selling their floppy controllers for as little as \$8 to \$10." But all of the microflopplies announced to date, with the exception of IBM's, adhere to standards estab-

lished in the 5¼-inch market. They have 6,250 bytes per track and either 40 or 80 tracks per side.

IBM's microfloppy records a different amount of data on each track, and that requires a special type of controller that's not yet a standard. This doesn't mean that IBM can't create a standard, but a lot of vendors now designing products around microflopplies are counting on one or another unit that looks, to a controller, like a 5¼-inch drive. None, to date, have announced adoption of the IBM concept—and neither has IBM.

"The IBM unit is 2.6 inches high," Porter points out. "It can't be combined on a modular assembly basis with any other floppy or any of the hard disks. It's also running a 40 millisecond track-to-track access, and it must compete with drives as fast as 3 to 6 milliseconds track-to-track." It is clear, however, that IBM may well enhance its initial offering in order to sell it.

Omri Serlin, a Los Altos consultant, thinks it's too early for oems to write off IBM. He believes that "IBM has significant engineering talent and could rework its initial design into a very powerful product." But the industry could end up living with two micro-diskette standards, just as it has gone with ASCII character codes while IBM has, except in some of its smallest products, stuck with EBCDIC.

Even Sony, the first company to get into the business, had to go from the 70-track unit it initially developed into an 80-track unit before it could sign up business in America.

For an oem that has to make a decision today, the Sony type of unit appears to be the safest bet. "Support for the 3½-inch type has been firming up," says Porter. "There are a whole lot of manufacturers who tell me they are planning to go that way."

As the 5¼-inch diskette established a form factor that led to standard sizes for companion Winchester disks, the 3½-inch diskette drive is leading several makers of small hard disks toward physically compatible micro-Winnies with capacities in the 5- to 10-megabyte range. This, too, will be considered by oems who plan to ride components

Three technologies to watch are magneto-optical, perpendicular recording, and isotropic recording.

down the price curves forged by competition and experience. Jim Porter suggests that "many manufacturers will want to stay in the mainstream" as microdiskettes and small Winchester disks gain acceptance.

If, as Porter suggests, oems adopt the Sony type of microfloppy, software publishing will quickly catch up to any new products that incorporate the small drive. Because the format is just like that of the 5½-inch floppy, diskette duplication equipment now in use can work with the new diskettes as soon as a new drive is attached.

The 5½-inch floppy is still on its way up, even as the 3¼-inch unit and its rivals are coming into the market. The only change in the diskette market that has really affected oems so far is the move to half-height 5½-inch floppy disk drives. Along with the 1.65-inch-high minifloppy has come a flattened Winchester disk, enabling oems to design increased storage capacity into existing cabinets. The market already offers multiple sources of these products, something that must be present before oems rush to embrace a microfloppy standard the way they have the minifloppy.

Nor will any perceived advantages of a microfloppy for new oem designs be adopted by companies that must install new equipment compatible with an existing base that is using a larger diskette format, at least not in systems that must interchange diskettes among old and new machines. The diskette type that is feeling the market shift is the 8-inch floppy, and it's only staying around, says Jim Porter, because of media interchange requirements. (In the floppy disk world, "staying around" means a growing market, as opposed to a booming one.)

The shift to microflops may result in greater systems reliability. The smaller dimensions of the microdiskette yield a reduction in certain mechanical problems inherent in diskette subsystems as the recording medium stretches and shrinks with changes in temperature and moisture.

FLOPPIES ARE MADE THE SAME

As for cost advantages, Porter thinks they're a way off. Volume production may keep the drive prices in the same range, but the media used with microflops is apt to be a bit more expensive than that used in 5¼-inch units. All floppy disks are made of pretty much the same components. The recording medium is a coating of ferrous material on a mylar substrate. After production, which involves preparation of the mylar so the magnetic material will properly bond to it, the diskette is burnished for smoothness and lubricated to reduce friction with the recording heads in a diskette drive. The diskette medium is placed in a jacket made of thermoplastic. Between

FIG. 1

TOTAL WORLD SALES OF FLEXIBLE DISK DRIVES (IN THOUSANDS OF UNITS)

YEAR	5¼-INCH	MICROFLOPPY
1981	2,205.2	5.0
1982	3,805.3	63.0
1983	5,209.8	211.1
1984	6,635.5	474.5
1985	7,724.7	952.2

Source: *DiskTrend Report*, Mountain View, Calif.

FIG. 2

TOTAL VALUE OF WORLD MARKET IN FLEXIBLE DISK DRIVES (IN MILLIONS OF DOLLARS)

YEAR	5¼-INCH	MICROFLOPPY
1981	498.8	2.4
1982	862.2	15.8
1983	1,239.1	14.5
1984	1,772.3	89.3
1985	2,288.1	156.4

Source: *DiskTrend Report*, Mountain View, Calif.

the jacket and the diskette there is a liner of nonwoven material that picks up dirt from the surface of the diskette. Microdiskettes use a hard plastic jacket, while larger diskettes use a soft one. Also, the microdiskette package comes with a door that opens when a diskette is placed in a drive; larger diskettes are permanently exposed to the environment via windows cut in the jacket that are there to permit access to the medium by recording heads (and to allow holes in the diskette to signal rotational position to the drive).

"There's little difference in materials cost resulting from the smaller size of the microfloppy," says Porter. "But the hard jacket of a microfloppy will be slightly more costly than the minifloppy jacket for some time. I'd say that for a while microfloppy diskettes will cost about 20% more than minifloppy diskettes. Profits to the media makers will be about the same for both types."

One issue oems are considering is whether to ignore microflops for the moment and wait for further advances in technology. If an oem's customers will not benefit from smaller storage devices than the half-height 5¼-inch diskettes (and related Winchester) provide, perhaps it will pay to be patient. But for oems with diverse interests and with a need to offer a range of current technologies, the huge volume of microflops likely to be sold in the next few years makes the device a serious candidate for inclusion in systems.

When Jim Porter looked into his crystal ball, he saw several promising technologies looming in the not-too-distant future. But these means of data storage may well coexist with floppy disks of various sizes, as there is no telling when their costs and storage capacities will be more attractive for many oem products than current offerings.

Three technologies to watch, he says, are magneto-optical, perpendicular recording, and isotropic recording. Magneto-optical recording uses the combination of a laser that can heat magnetic materials to their Curie point and magnetic fields to put data in very small areas. Because the technology allows data to be altered, it seems to be more promising than pure optical technology for computing applications. Perpendicular recording increases densities by orienting the residual magnetic fields up and down relative to the diskette (or hard disk) surface instead of in directions parallel to the plane of the surface. Isotropic recording is similar to present techniques, but with a high-resolution medium data can be stored at densities eight times the present practical maximum—about 50,000 bits per inch. All three techniques are working in laboratory models today, says Porter, but "none is going to make an impact on disk shipments until after 1985." *

Peter Krass is an editor of *Technology News of America*, an international news service based in New York.

RAMIS II

The Leading 4th-Generation Language

In the past five years, more copies of RAMIS II have been sold than all other 4th-generation languages combined.

Why? Because the comprehensive capabilities of RAMIS II make it the best business software package available today for application programmers and end users alike.

RAMIS II quality is no matter of chance. It happens by design. MIPG builds quality and performance into its software by investing more than fifteen percent of its annual revenues in product development.

It's that kind of investment that allows RAMIS II to offer a comprehensive database management system, an efficient application manager, and an easy-to-use nonprocedural language for reports, queries, interactive editing, and more.

And it's that kind of investment that enables MIPG to continue to add new capabilities like complete screen formatting and relational data access.

Users at more than 800 VM, MVS, and DOS/VSE installations are taking the lead with MIPG software.

Attend a free RAMIS II seminar and learn how you can gain the same advantages.

For more information, call or write

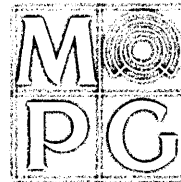

Mathematica

Products Group, Inc.

P.O. Box 2392

Princeton, NJ 08540

(800) 257-5171 • (609) 799-2600

Telex 643479

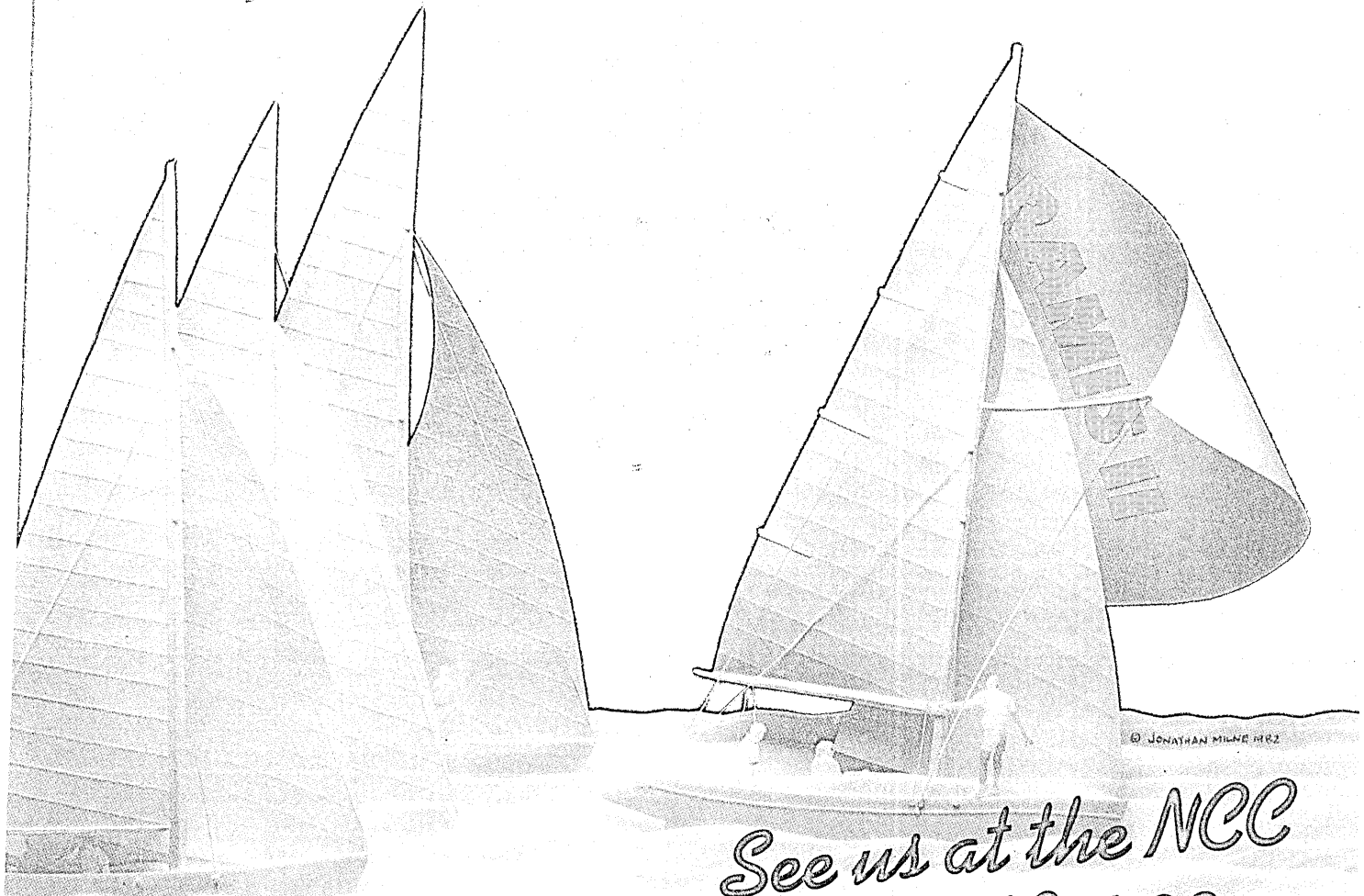

© JONATHAN MILNER 1982

*See us at the NCC
Booth #P7432*

RAMIS II...The Leader by Design

CIRCLE 138 ON READER CARD

ON-LINE SPREADSHEETS FOR CICS USERS

MAXICALC™ combines mainframe power and VISICALC® simplicity.

At last there's a quick, easy and inexpensive way to satisfy the growing demand for electronic spreadsheets in your company. If you have CICS, MAXICALC from Oxford can give all your terminals on-line electronic spreadsheet capabilities. It's like giving your people the advantages of a personal computer . . . but with the vastly superior power and flexibility already available in your mainframe and CICS terminals and printers.

MAXICALC provides the easy-to-learn, simple-to-use environment of today's popular microcomputers. And non-DP personnel can learn to use it quickly and easily with minimal programmer support.

Best of all, MAXICALC is inexpensive . . . and you can install it in less than one hour.

Just consider these MAXICALC features, and you'll know that it's the product you've been hoping for . . .

- 512 row x 64 column capacity
- Fully automatic scrolling
- Split screen viewing
- Direct row and column positioning
- Full range of arithmetic functions
- Prints on any CICS printer
- Provides built-in security
- Offers built-in back-up support

MAXICALC . . . from OXFORD, the #1 independent supplier of CICS applications development software. Call or write for details.

 **OXFORD SOFTWARE CORPORATION**
174 BOULEVARD/HASBROUCK HEIGHTS, NJ 07604/201 288-1515

- Reserve my copy of MAXICALC and have an Oxford Representative call.
- I'd like a MAXICALC trial. Please call and set a date.
- Please send me more information on MAXICALC.

D5/83

NAME _____

TITLE _____

COMPANY _____

ADDRESS _____

CITY _____

STATE _____

ZIP _____

PHONE () _____

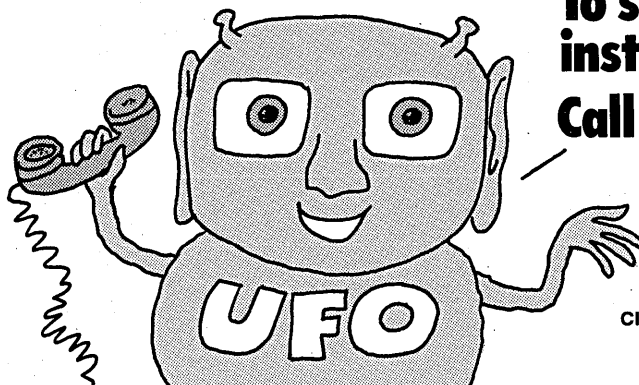

**To schedule an
installation or trial...
Call (800) 631-1615**

VisiCalc is a registered
trademark of VisiCorp.

CIRCLE 139 ON READER CARD

There's a world of difference in the office automation scene in Japan.

SAYING SAYONARA TO THE 19TH CENTURY

by Linda Runyan

When it comes to office automation, Japan is truly an island unto itself. While many European and American companies have been busy modernizing their office chores, the more tradition-minded Japanese firms have been more or less content with their 19th century methods. That contentment, however, could not last forever. Confronted with harsh economic realities, the Japanese have finally recognized the need to boost office productivity using some of the ways, but not the wares, of the Western world.

Transplanted to Japanese soil, office automation means something different than it does in Europe or the States. In Japan today, office automation is still in its infancy, despite a recent hard-sell media blitz by vendors. Indeed, the fanciest device to be found in a typical Japanese office is a plain paper copier. Typewriters, even nonelectric ones, are a rarity, since most Japanese documents are handwritten. This automation deficiency is in fact reflected in statistics that show Japan's office productivity lagging far behind America's and Europe's.

All this from a nation that prides itself on its technological strides. All this from a nation that brought automation to the factory floor. So what about bringing it to the office desk? Virtually every electronics vendor in Japan is now trying to do just that—so far with mixed success.

Outsiders, impressed with Japan's prowess in the hardware realm and its savvy in selling these products on the export market, are often baffled by the country's backwardness in the office automation field. Trapped in what seems to be a time warp, Japanese office users are in reality many years behind their counterparts in Europe and America. Culture and language are the main reasons for this.

It's obvious that language has been a major impediment to the introduction of office automation in Japan. Written Japanese is made up of thousands of kanji ideographs. This creates severe machine input problems—problems that manufacturers have tried to overcome with their Japanese language word processors. While progress has

been made, this equipment, with its complicated keyboard, is still hard to use.

These language difficulties caused the Japanese to turn their attention to facsimile and copier devices. Within a matter of years the ambitious nation became a world leader in these office wares. Now the country is out to conquer a new office automation frontier that hopefully will also help it get around its built-in language problems. That frontier is voice input/output technology. Recent output research in Japan has focused on high resolution displays and printers.

Nippon Electric Co. (NEC) and Fujitsu are currently strong in the speech recognition arena, both at home and abroad. This technology turf, however, may prove to be the only place where Japan can stake its claim to fame in the overall office automation realm. Indeed, experts don't believe the enterprising nation will be able to make a significant dent in the export market.

Other industry observers also don't see Japan becoming a major player on the global office automation scene. The hardware-heavy nation, they contend, won't be able to solve the office problems of users outside their own backyard. Certainly, the software tailored for their home market will not be exportable.

LIMITED EXPORT CHANCES

The Japanese too seem to realize that their export chances on the office automation front are limited. Taking this message to heart, many Japanese companies appear to be concentrating on the local market—a market where the few foreign rivals won't cause much worry. While Digital Equipment, IBM, Control Data, and Burroughs have actually beefed up their office automation sales efforts in Japan, the payoffs so far are hardly promising.

Such sluggishness could be blamed on the general lethargy in Japan toward office automation. But that's only part of the story, and a small part at that. Japanese companies have in fact become more enthusiastic of late about using office technology tools to step up office efficiency and productivity. This new receptivity is reflected in the upsurge in office automation business—business that has

mostly benefited the homegrown suppliers.

In 1981 sales of office computers (small business systems), personal computers, Japanese word processors, and facsimile equipment totaled over \$2 billion, according to the Japan Office Machinery Industry Association. The association predicts that by 1985 sales could reach approximately \$6 billion.

The growth in sales of office automation equipment in Japan is expected to average about 30% per year. More optimistic observers believe this growth rate could spurt as high as 45% per annum. That means an awful lot of machinery will be going into the novice hands of Japanese office workers in the near future.

Pushing those products the hardest will be the local suppliers, who seem to be doing a lot better with their office automation gear than they did in the past. During fiscal 1981 the 23 leading Japanese producers shipped over 50,000 office computers alone, reports the Japan Electronic Industry Development Association. This represented a 53% increase over fiscal 1980.

Still the most ubiquitous piece of office hardware in Japan is the facsimile terminal. The language handicap explains its success. In a recent survey conducted by the Japan Institute of Office Automation (JIOA), the fax terminal ranked as the most popular piece of newly installed office equipment. Further down the list were personal computers, followed by Japanese word processors, on-line terminals, and small business or office computers.

In 1979, JIOA reports, Japan had 171,244 facsimile terminals in operation—close to the U.S. total of 180,000. This parity situation was turned upside down, however, in the other major office equipment categories. While America had 100,000 small business systems worth over \$4 billion in 1979, Japan had only 33,859 systems valued at just over \$1 billion. But it's in word processors that the gap was the widest. Compared to the States' 470,000 total, Japan could only claim a paltry 1,000 word processors a short four years ago.

Other statistics pointed out by JIOA help illustrate the sharp contrast that existed in 1979 between the two technological titans

Japanese users see fewer roadblocks to office automation than they did in the past.

in the office automation realm. In 1979 there were 701 Japanese office workers for every office or small business computer, compared to the 493:1 ratio in the States. And once again, the built-in language constraints were reflected in still another set of figures that showed Japan falling far behind the U.S. in the installation of word processors. In 1979, according to JIOA, the worker-word processor ratio was about 105:1 in America, while it was an incredible 23,740:1 in Japan.

Four years later those statistics aren't quite so bleak. But it's also clear that the Japanese have a long way to go to catch up in the worldwide race to automate the office. The JIOA in fact notes that "no significant investments" have yet been made in Japan in office automation. "With the exception of facsimile terminals, offices in Japan," JIOA says, "have little office automation equipment."

Despite this snail's-pace progress, the JIOA survey found that office automation in Japan is "booming." What indeed seems to be booming, or more correctly, building, is the national awareness of the need to modernize and streamline office procedures. Most of the companies responding to the JIOA survey said they were motivated to implement office automation by internal factors, which really translates into improving the bottom line. They wanted to increase the productivity of office work to strengthen their competitive muscle.

Most of the organizations in the JIOA study also viewed office automation as an "extension of computerization of the past." They said they saw the technology linking conventional computers and office gear such as fax devices, word processors, and small business computers, reorganizing and integrating these various equipment items into efficient systems.

The JIOA probe also confirmed the fact that the major responsibility for promoting office automation rested mainly with the

data processing department. In fewer cases, the administration department took over this chore.

Those in charge of the office automation drive within a company of necessity must make the equipment acquisition decisions. In the short term, JIOA found that the users it questioned would be opting for Japanese word processors, followed by personal computers, on-line terminals and workstations, small business computers, and facsimile terminals. The big push, however, was on Japanese word processors and personal computers, which have gained much popularity in Japan in the last year or so.

JIOA's user sample was decidedly more hesitant about pinning down their equipment preferences over the next 10 years. Instead, what they cited were needs for advances in the general technology areas of voice input, electronic files, and fiber optic communications circuits.

JAPAN'S INPUT PROBLEM

The survey reflects Japanese users' concern about the indigenous input problem, while various approaches to the problem, including handwritten-character OCR, have been tried, voice input appears the most promising to the surveyed users. "Voice input in particular," JIOA explains, "is expected to become a powerful means of solving the complicated input troubles." The survey also turned up a big demand for large capacity storage-retrieval systems.

The JIOA investigation revealed that Japanese users see fewer roadblocks to office automation than they did in the past. Nevertheless, hurdles remain. "Lack of standardization and unification of office work" was listed by nearly half of the respondents as a major problem. Other problem areas by priority were:

- Currently available office automation equipment doesn't have high enough capaci-

ties and performance levels to enable office work to be more efficient.

- Too little actual experience in using office automation equipment, coupled with the unknown usage effects, have made it difficult to convince top management to promote office automation.

- Currently, there are not enough specialists capable of tying the various pieces of office automation equipment together into an integrated system.

Added to these problems are headaches on both the management and system side. JIOA's report on "The Automated Office in Japan" compares the American management style with the Japanese. While U.S. management places emphasis on individuals, the Japanese philosophy stresses joint responsibility.

These differences are important to the successful implementation of office automation. The Japanese have found that the way the office environment is structured can also have an important impact on office automation efforts. Japanese middle managers and staff, according to JIOA, "are often impressed by the work American secretaries do." That's because in Japanese companies, secretaries are only partly used, and then mainly to do writing chores. In the U.S., however, secretaries, operating various electronic gear, compile documents and maintain files. Coding is therefore "advanced, and transfer to databases is easier compared with the Japanese style," JIOA explains.

Summing up, JIOA declared that office automation in Japan requires "incorporating the good points of the American management system" and effectively using electronics technology. "The necessity of converting to the American management system has begun to be recognized in Japan, and office automation will progress by taking advantage of only the good points in both the American and the Japanese systems," the JIOA predicts.

It's interesting to note that the Japanese don't seem to stress the ergonomic angle in office automation—this despite the fact that the JIOA says "business in Japan gives weight to the so-called human factor."

Ergonomic concerns, which have been of paramount importance in Europe, are also becoming more significant in the States. In Japan, which frequently uses the U.S. as a model, the vendors are at least paying lip service to these sensitive subjects. Hitachi's advertising dubs office automation "humanification." Meanwhile, Matsushita claims office technology "pays respect to human nature." JIOA also strikes a note for human harmony, concluding that "what will be important in the future will be to achieve efficient communications among all people working in offices."

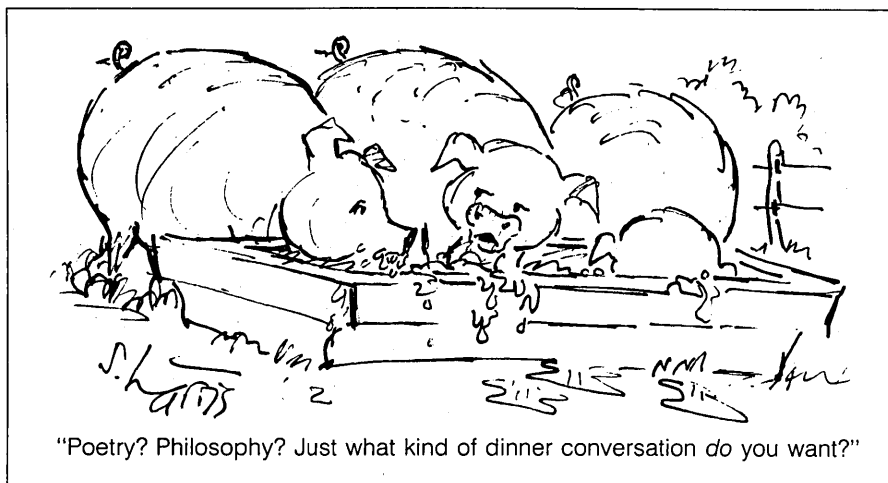

CARTOON BY SIDNEY HARRIS

SCAN/370—The system that automatically simulates the execution of every
cleanly compiled COBOL program, giving you critical analysis information
which reveals how the program will execute at run time—information
not obtainable via cross referencers, flowcharts, or other analysis tools.

SCAN/370

SCAN/370 is a comprehensive COBOL enhancement system
designed to speed the development and maintenance of COBOL
programs and improve their operational reliability.
MAINTENANCE AND DEVELOPMENT PRODUCTIVITY: Isolates problem
areas in COBOL programs—before testing. Simplifies resolution of
compiler diagnostics. Removes the drudgery from new program
development. Reduces the time required to analyze COBOL programs.
PROGRAM RELIABILITY: Detects and flags latent bugs in production
programs—before they happen. Highlights maintenance booby-traps.
DYNAMIC PROGRAM DOCUMENTATION: Generates concise and
accurate program level documentation. Recreates
documentation automatically with every clean compilation.
QUALITY ASSURANCE: Graphically distinguishes well structured
code versus poorly structured code. Detects and
flags COBOL keywords that do not conform to user
defined restrictions. EDP AUDITING: Documents the differences
between two versions of the same COBOL program.
SYSTEM RESOURCE SAVINGS: Saves millions of lines of computer output
every single month. Reduces the load on your teleprocessing network.
OPERATING ENVIRONMENT: IBM 360/370 and compatible systems.
GROUP OPERATIONS, INCORPORATED
1110 Vermont Ave., N.W. Washington, D.C. 20005 (202) 887-5420

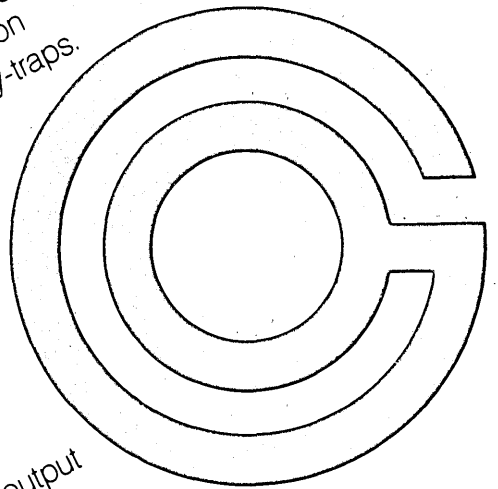

How to declare your independence with TSI International...

the software company that gives you the freedom to succeed.

CASE HISTORY #1



The International Diversified Corporation budget meeting has turned into total chaos. Every department head is clamoring for increased operating funds for next year. CEO Winston Hawkbill is looking nastier by the minute.

You, the MIS director, take the floor. "Well, sir, I plan to adjust the Data Processing budget by 15% next year!" you say proudly. Hawkbill lands in front of you. "Not on your life! Enough is enough!"

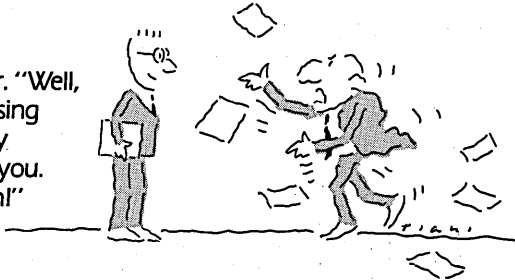

"Pardon, me sir, before you get ruffled," you say, "I'm revising the budget downward by 15% to reflect the savings we've shown since we started using KEY/MASTER, the on-line data entry system from TSI." "Savings?" squawks Hawkbill.

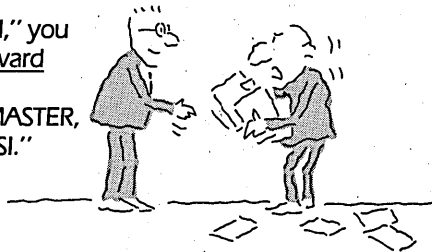

"And so's your future with Diversified. Brilliant thinking never goes unrewarded." "Hawkbill," you think, "you're not such a tough old buzzard after all."

"Yes, sir, thousands. You see KEY/MASTER replaced our outdated, expensive data entry equipment overnight, cut the cost of handling data and eliminated errors. All while saving us money and speeding up turnaround time. Why, KEY/MASTER can be used by anyone in every department. The possibilities are endless."

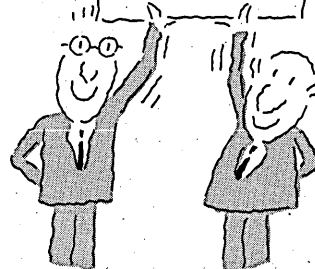
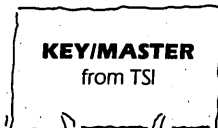

KEY/MASTER from TSI, the independent software that's upgrading computer systems around the world.

Call (203) 853-2884
for more information.

TSI International
division of National CSS

DB a company of
The Dun & Bradstreet Corporation

50 Washington Street
Norwalk, Connecticut 06854

KEY/MASTER is the leading on-line data entry system for CICS. Applications are built on-line without programming. And data is validated at the source, eliminating costly "downstream" errors and delays. KEY/MASTER increases the level of service to end users and cuts costs for your business every day.

Declare your independence from outdated systems and let your company grow with software from TSI... a company of The Dun and Bradstreet Corporation. The source for KEY/MASTER™, DOCU/MASTER™, DATA CATALOGUE 2™, The Data Analyzer™, and FACETS™.

MEET THE INFORMATION ANALYSIS SYSTEM THAT WON'T JUST SIT ON THE SHELF.



Some software systems are like bookends; they spend most of their time gathering dust. But not SPSSX.™ Because it offers everything you need to organize, summarize and display volumes of information in scores of useful ways. A totally new software product which we've designed with the most advanced capabilities yet. To bring you the hardest working Information Analysis System you can get.

Need help managing complex files? SPSSX lets you read and define almost any file, regardless of complexity or structure. It even tells you when records are out-of-sequence or missing.

Searching for sophisticated statistics? With its basic and advanced statistical capabilities, SPSSX allows you to extract meaning from masses of information with greater ease than ever. You can choose among a wide variety of procedures. From simple plots and tables to complex multivariate analyses.

Want to write presentation-ready reports? With the system's built-in Report Writer, you can manipulate complex records containing long strings of characters, perform basic statistics, and print out a

custom-formatted report—all in one easy, automatic step! Then use our device-independent Color Graphics Option to produce professional graphs, charts and displays.

Yet for all its sophistication, SPSSX is remarkably simple to use. With minimal training, even inexperienced users can quickly obtain the vital information they're after. Which means they'll spend less time inputting problems, and more time focusing on solutions.

If you're ready for a software system that'll do much more than sit on your shelf, call or write for our descriptive brochure today.

© Copyright 1983, SPSS Inc.

**PRODUCTIVITY
RAISED TO
THE HIGHEST POWER™**



SPSS Inc. 444 N. Michigan Ave. Chicago, Illinois 60611 (312) 329-2400

SPSSX currently runs on IBM OS, CMS and Digital VAX™ systems. Conversions will soon be available for IBM DOS, DEC 10 and 20, PRIME, Univac 1100, Data General MV 8000 series and other minis and mainframes.

How to tell if a private branch exchange is the missing ingredient in your company's recipe for advanced communications.

A PBX COOKBOOK

by Robert L. Patrick

The computerized private branch exchange (PBX) presents an opportunity that may not recur for 20 years. Today, a voice-only PBX is a cost-effective approach to telephone service. If you select the correct third generation system, the add-on features may be just the right combination of technology and service to provide the proper foundation for many years of office automation.

Readers of the first two installments in this four-part series are aware of what these systems offer, including switched synchronous circuits up to 56Kbps, contention resolution, and modemless communication internal to the plant. This article explains how to decide if a PBX is right for you—and if it is, how to go about procuring and installing one.

Perhaps because of the glitter of computers and our rampant budgets, office telecommunications has not received much attention in the last 20 years. Most industrial telephone systems are the responsibility of some administrator within a facilities and services organization. The costs of office telecommunications, until recently, have been fairly stable, the service offerings pedestrian, and the manager's latitude limited by the offerings available from Ma Bell and her prosaic counterparts.

In the '70s it became possible to buy equipment from any qualified vendor and connect it to the telephone network. Not many of us did because the troubles were large and the benefits were slight. In the '80s the balance changed and the benefits became more or less commensurate with the problem. Today important benefits are clearly in sight, but a company needs talent, organization, and vision to reap those benefits. That's where the data processing manager comes in.

Senior data processing personnel are acquainted with digital technology, are fa-

miliar with in-depth systems analysis, and are (more or less) comfortable running multimillion dollar projects in the limelight. None of these three statements holds true for the current crop of telephone administrators. Thus, if the job is going to get done, the projects will probably have to be led by dp personnel.

The time will come in every organization when computing and telecommunications are merged. The question is only when and how. This article tells how to get going and contains enough decision points to allow you to start now and proceed as long as the decisions are favorable. Pauses can then be arranged as required until the situation changes and progress is once again practical.

Before describing the opportunities and how to proceed with a telecommunications systems analysis, some words of caution are in order. Many of us in dp are more comfortable in the back office among our acronyms and our kin than we are dealing with the line managers who run the corporation. Although we have done our jobs, kept abreast of our own rapidly changing technology, and fought annually for budgets and head count, we seldom get appointed to corporate committees that don't involve computing and don't often socialize with our non-computing peers. Quite frankly, many of us are not known as multifaceted individuals with general management backgrounds. Thus the only way for us to sally forth, gain larger responsibility, and manage a broader class of services is *carefully*.

Many people think of themselves as telephone experts when in fact they have little knowledge of what goes on behind the handset. Be that as it may, a telephone system fails publicly. Everyone knows instantaneously about service interruptions, and all changes must be announced in advance. In contrast, computing is easy.

Over the years the U.S. telcos (Bell,

GTE, or whoever) have borne this responsibility and produced the world's greatest telephone system. We can communicate reliably (expensively, unresponsively, and clumsily, but for the most part reliably). To exploit the opportunities that are available to you and your corporation you'll have to install Brand X equipment because the telcos are not yet leaders in the integrated voice and data business. When you elect to be independent, you'll incur the wrath of your local phone company.

Never underestimate your local telco; it makes up in mischief and political acumen what it lacks in product. If you're not ready to be a multivendor shop and incur the heat that goes along with that decision, you've just reached your first decision point. However, if you're looking for new fields to conquer and if you feel politically secure, then press on and see whether a PBX makes technological and economic sense for your company.

EIGHT UPGRADE PHASES

There are eight phases in the PBX upgrade process (see Fig. 1). The goals of Phase 1—assessing the state of the art—are twofold. First, you must educate yourself in that jargon of the telephone community. Second, you must sift the 200 or so features the frequently appear in trade literature and vendor descriptions to find those 20 or so meaningful to your company. This is fairly easy if you have an old switchboard installed and 100% of the incoming calls are handled by operators; any action will be an improvement.

You should start by determining what speed is prevalent throughout your terminal network today. You may find that an improvement from 2.4kpbs up to 56kpbs synchronous is sufficient, in which case you needn't consider any of the more exotic techniques—you don't really down-line load

ILLUSTRATION BY RICHARD ANDERSON

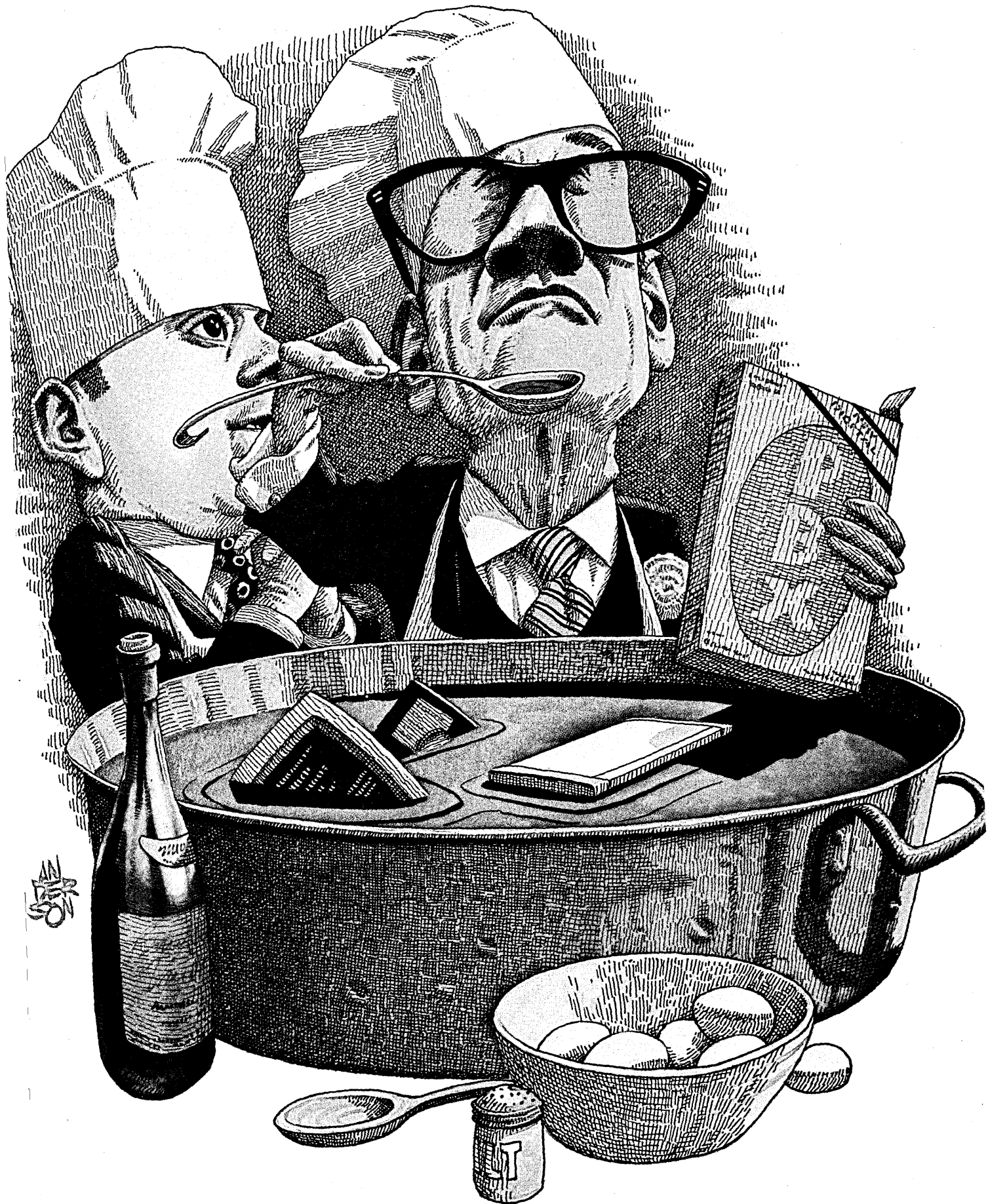

The time will come in every organization when computing and telecommunications are merged.

much bulk data to graphic terminals anyway. When you survey your existing systems, your hardest digging and your most informative days will be trying to find out what a given service costs today. Typically these costs are so diffuse throughout the accounting system that it will be a real eye-opener when you put them all on one sheet of paper and discover what you're paying for your voice network, for the communications associated with energy control in a big plant, for the lines assigned to plant protection, and the like. One large industrial firm was amazed to find 17 overlapping telecommunications systems in place.

After you record what you have and get yourself educated, you can solicit statements of interest from vendors. These will probably narrow the vendor population from 30 to five and give you some planning and budget numbers. Once you have analyzed the vendor responses, you're at the second decision point. If it still looks interesting, you can proceed; but if your current systems have a large book value, or if things are going along fairly smoothly, or if you have no critical outstanding requirements, then pause for a while. PBX systems are getting cheaper and more reliable all the time.

If you do elect to proceed, then get briefings from the few vendors that appear to be qualified. Send them all the same agenda, ask them all the same questions, and get ready to build a vendor comparison matrix. You'll probably have to go back to some of the vendors who presented early in the cycle and get them to answer some new questions or sharpen their answers based on knowledge you picked up in later sessions.

If things still look good, you're ready to proceed with Phase 3. While you can draw up a complete set of requirements and ask each vendor to respond to a 100-page questionnaire, that approach is not recommended unless you are legally bound to follow it. Each PBX is custom configured to the installation. The configuration job and the pricing of that configuration are so complex that many vendors have an automated pricing program. Rather than state what is important to you in a request for proposal, ask the vendor what he needs to price a configuration to fit your needs. Some vendors will bring the input sheets for their pricing programs right into the meeting and ask you for the data they need to run their pricing program. The parameters are surprisingly common.

They'll ask how big a system you need to have operating on the day you accept it (the equipped configuration), and how much additional capacity you are willing to pay for (the wired configuration). Thus if your plant has 8,000 telephones today, you would probably equip the system for 8,000 telephones and wire the back panels of the

switch for 10,000 lines. If you did this, and if the building were wired compatibly, then you could merely plug in line cards and install handsets when you grew from 8,000 to 10,000 lines.

Try as you may you won't get comparative proposals from the several vendors. When you sit down and digest the proposals you receive, you can start to fill in a column of your comparison matrix for each vendor while keeping a notepad handy to record the questions that will naturally arise.

Unfortunately telephony has not been a competitive market very long. You will be amazed (and later appalled) at the difference in quality you see between PBX marketing representatives and the marketing representatives who frequent the computer side of the house. While there are some exceptions, the marketing efforts in this new field can be quite frustrating. Some proposals will not be responsive even though you meticulously spell out in the briefings exactly what you want, and the representatives agree to respond accordingly. There have even been serious proposals with unnumbered pages, many typos, and no indexes.

These are reputable companies and the products they have are good; it's just their marketing that is not yet mature. If you can wait a couple of years, all this will settle down and you can expect clear and concise responsive proposals. Doing business today, however, will require some additional effort on your part.

ASSEMBLE AND TRAIN A TEAM

It is not recommended that you hire a consultant and turn your fortunes over to him because once the system is procured, you've got to operate it. Therefore you must assemble a team of people and train them so they can get along with the chosen vendor and install the system successfully. A consultant may help, but if you're going to install a PBX in the next few years, you'll have to carry some of the responsibilities for systems analysis and telecommunications management that have heretofore been borne by the telcos.

Some of the most attractive PBXs are offered by small companies with varying amounts of experience and financial strength. Over the years we in computing have had to deal with similar companies. We learned to write our contracts carefully, to be wary if the salesman says something the company later wants to strike out of the contract, and to build performance checkpoints and penalty clauses into the legal instrument when conditions warrant.

In a PBX procurement, conditions will warrant special care since many vendors need progress payments to keep afloat financially. Thus you could pay half the cost of the sys-

HOW TO SPEAK PBX

The computer person interested in plunging into telephony will be hampered by the field's strange, inconsistent vocabulary, which is even curiously than ours. The words defined below cover most of the important principles you will encounter.

1. Switch. The heart of the modern PBX is a software controlled intelligent switch that interprets dialing pulses/tones/keyboard characters and makes the

a) proper logical connection between two local telephones;

b) connection between a local telephone and external carrier services including the local central office, remote (foreign exchange—FX) central office, the nationwide dialing network (DDD), special tariffed services such as WATS, off-site tie lines, or other common carrier;

c) connection between two compatible terminals; or

d) connections between terminals and local/remote processors such as word processors, electronic mail, timesharing, dp, or other digital computer service.

The switch itself consists of a digital computer, software, storage device, and some racks of specialty hardware to perform the actual connections.

2. Second generation. A PBX and associated equipment that consists of a software controlled digital computer that controls switching circuits through which analog signals flow.

3. Third generation. A PBX and associated equipment that consists of a software controlled digital computer that controls switching circuits through which digital signals flow. Some third generation architectures are distributed, some are centralized.

4. End-to-end digital. An architectural attribute of some third generation switches that digitize voice in the telephone handset using a codec chip and transmit digital signals throughout the system until another codec chip immediately adjacent to the called party's handset reconstitutes the analog voice. Since digital is its language, an end-to-end digital switch allows data and voice to be mixed in an integrated fashion.

5. PCs—personal computers. Those little devices that come in boxes for small prices and soon want to communicate with one another or a big brother.

6. Word processors. PCs with different software.

7. Time slots. Internally a digital switch samples an incoming line, reads the digital code present, and transmits this coded signal to the device that appears in the connection table entry that was created when the call/session was set up. If a switch

samples internally, the capacity of a centralized switch in terms of the numbers of calls/sessions that can be in process simultaneously is easy to determine. Merely divide the number of attached devices by the number of available time slots to determine the percentage of devices that can be simultaneously active. If this number is less than 100, a communications engineer must perform periodic traffic studies for the system's entire installed lifetime to be sure the system is continually tuned to the traffic it experiences. Some distributed switches have time slots of their own. In this case a limiting device analysis must be performed because capacity bottlenecks can occur in the interconnecting circuits or buffers.

The communications community has traditionally lived with switches that saturate when 10% to 15% of their devices are simultaneously active. If you intend to pass both voice and data through your switch, these traditional percentages may be too low, depending on your terminal usage pattern. A switch can run out of capacity because the processor runs out of cpu cycles, there is insufficient memory to hold the queues and control tables, the hardware connection matrix limits the number of simultaneous logical circuits, or you run out of time slots. The first resource to saturate determines the capacity of your switch.

8. Nonblocking. An architectural property of some third generation switches that allows 100% of the installed devices to be simultaneously active and minimizes the extent of traffic engineering required.

9. Dilemma. State of a dp manager who has shrinking budgets but knows digital devices need to communicate.

10. Digital contention switch. A computer accessory that moves just data, in parallel with your voice network; today, the cheapest way to let X terminals get to Y computer ports. Must be supported by your own wiring, your own system engineers, a maintenance contract, and a lot of planning and coordination if you frequently move engineers or clerks who need both voice and data services to be productive.

11. Modem. A device to convert a digital signal that you have to an analog signal that you don't want, just so you can transmit it across a noisy circuit to another modem that reverses the process.

12. T-carrier. The name for the Bell long lines digital carrier system that will transmit at 1.544 megabits per second. This is usually divided into 24 voice channels of 64 kilobits per second, each of which is used to carry voice in an eight-level code sampled at 8,000 samples per second.

Most interesting is Bell's announcement that direct access to T-carrier trunks will soon be available to those whose PBXs have this feature. Once such connections become commonplace, the signal from a digital terminal will no longer have to be translated into analog (by a modem) for transmission to the local central office so it can be converted back to digital and flow across a T-circuit to some remote central office where it is converted to analog to go through the central office, transmitted to the corresponding computer, and pushed through a second modem that translates the analog back to the same digital signals you had in the first place.

13. Direct inward dialing. A pair of compatible features in your local central office and in your PBX that allows an outsider in your area to dial a seven-digit number and ring the telephone on your desk without the assistance, cost, and delay introduced by an in-plant telephone operator.

14. Call detail recording. A feature of third generation PBXs that creates a log of every telephone call and terminal session so a data reduction program can determine usage patterns and a billing program can charge on the basis of services rendered. Looks suspiciously like the System Measurement Facility known to data center managers familiar with IBM equipment.

15. Cable plant. The wires in your building, as distinct from the database (usually not current) that describes them. It has been said that beauty lies in the eyes of the beholder. For proof, wait until you try to buy your existing wiring from your local telco so you can install a Brand X switch.

16. Directory. A dynamic database maintained in a third generation PBX that allows the information operator to determine your current extension; allows the PBX to determine, during call setup, your account code, the dialing privileges you enjoy, and the priority to be associated with any calls that must be queued in your behalf; and further allows maintenance and diagnostic programs to know the exact configuration of devices on your desk and the cable path from the switch to those devices.

17. Résumé. What every dp manager should prepare if he lets a facility get (re)wired without insisting on an analysis that considers integrated voice and data under a single universal wiring plan.

18. Wired for. The configuration of back panel wiring you order and pay for to allow growth without major rework of the switch electronics. See Equipped for.

19. Equipped for. The number of line cards, telephone handsets/terminals you install to handle your current user pop-

ulation. See Wired for.

The equipped configuration can be easily increased through the addition of line cards and devices in quantities of one until the wired-for limit is reached. Expansion beyond the wired-for limit is possible, but requires systems analysis, changes to the electronics, and some software changes—provided you are still within the ultimate capacity limit of your chosen switch.

20. Frustrated. The user manager who has a phone that works but data devices that don't. See Dilemma.

21. Popular user features. There are as many packages of feature options as there are PBX vendors (about 50). Just because a switch will perform a function and the vendor has implemented the software to control it, however, does not mean it is useful in your environment. Before getting entranced with long lists of exotic features, determine whether those features are likely to be used in your office environment. Here are some of the more practical features.

Least cost routing allows a PBX to know the costs associated with various off-site telephone services, and to select the cheapest service that is not busy, or to queue calls for busy circuits provided the caller can stand the delay.

Callback queueing allows the switch to maintain a list of callers who have requested a busy line, and to call them back automatically when the line is available.

Speed dialing provides a little table for each telephone extension so the person at that extension can dial a two-digit code and have the switch reference the associated list to find the full digit string desired and any associated accounting information.

Call forwarding is a way to temporarily route the calls from your extension to some other extension within the plant. Thus you can transfer all your calls to a secretary, or if you are going to be working in a conference room, automatically switch all your calls there until you return to your office and reset the transfer condition.

Redial is a switch feature that causes the switch to remember the last number you dialed so it can be automatically redialed by the simple actuation of a feature button, thereby saving you the trouble of creating that character string again.

With an end-to-end digital system, many of the voice features are also available from your terminal. You can initiate a session from the keyboard, speed dial from a keyboard, enjoy the benefits of least cost routing if you are going off site, and be queued for automatic callback if all ports on the computer you requested are busy.

—R. L. P.

tem before any racks and cabinets were delivered. This is cause for concern, but the risks can be reduced by carefully checking the vendor's reputation among his installed population (the old-boy computer network is just great for doing this), by visiting the factory, and by setting up a series of demonstrations if you need some features that were not available or were not popular in his early installations.

After you sign the contract, get ready for a hard run, because the vendor will tend to take over the project. He knows he has to install and cut over his system on the proposed schedule or he won't make any money. Therefore he'll keep your staff under pressure to carry out your side of the bargain and get the facilities ready so he can install and start to test when the equipment is ready. While there is some variation among the vendors, most installations are enough alike that checklists and PERT charts exist for this phase of the upgrade.

Except for hardware maintenance, the vendor won't give you much help after you have accepted the system and paid for it. It is up to you to organize your operator force, to train your entire establishment in the use of the new system and its deluxe features, to maintain change control over the configuration, and to set up trouble reporting and diagnostic procedures. Except that 100% of the corporate family is involved, these are the things computer people have done with big applications for years. The systems analysis, project management, training, and documentation techniques that operate order status or accounts receivable or claims processing systems will serve you well when you take over your new PBX.

WHAT THE VENDOR WILL DO

When you're planning the installation of your new PBX, the vendor will probably take the lead in telco relations concerning trunks, dialing protocols, schedules, and cutover assistance—specifically, the things he needs to get installed, cut over, accepted, and paid. It will be up to you to monitor, plan, watch, and bring about the series of steps required to remove existing telco equipment from your premises without disturbing nontelco systems, and to reconcile the services your telco provided with that all-important final bill.

Obviously if you're moving into a new facility, there is no equipment to discontinue, remove, and argue about. Thus Phase 8 is optional.

If, however, you're upgrading in place, give careful attention to removing, discontinuing, or stubbing off existing cabling as you may have cables supporting other telecommunication services in the same cable trays, raceways, and conduits.

FIG. 1

UPGRADING TO A PBX

Follow these steps in sequence to upgrade your current telephone system and install a third generation PBX capable of integrating voice and data. Note the five decisions allow you to pause in the process, until it all comes together, and then proceed again. The indented items indicate time sequencing within each phase.

PHASE 1—ASSESS THE STATE OF THE ART

- Survey your existing telecom systems
- Decision to proceed #1
- Self-education
- Requirements determination
- Bidders' list
- Solicitation of interest
- Vendors respond
- Analysis of responses

PHASE 2—INVESTIGATE THE OFFERINGS

- Decision to proceed #2
- Agenda for vendor briefings
- Briefings from selected vendors
- Analyze presentations

PHASE 3—OBTAIN QUOTES COVERING FUNCTION, COST, SCHEDULE

- Decision to proceed #3
- Request proposals
- Prepare proposals
- Analyze proposals

PHASE 4—CONTRACT NEGOTIATION

- Decision to proceed #4
- Specific requirements
- Negotiate contract
- Negotiate financing

PHASE 5—CONTRACT EXECUTION

- Decision to proceed #5
- Review contract
- Adjust as required
- Sign contract

PHASE 6—INSTALLATION

- Plan wiring
- Negotiate with local telco
- Build database
- Construct equipment room
- Initial training
- Wire/rewire facilities
- Preshipment test
- Install equipment
- Test solo
- Bulk training
- Test telco
- Load test
- Incremental cutover
- Formal acceptance test
- Final payment

PHASE 7—INITIAL OPERATION

- Mandatory record keeping
- Shake down new system

PHASE 8—DISCONTINUING EXISTING SYSTEM (OPTIONAL)

- Remove instruments
- Remove central equipment
- Remove in-plant cabling
- Settle accounts

The terminals that face up to everyone's problems.

Now Qume offers a line of three CRT terminals that help you face every one of your company's needs: The Qume QVT™ series.

The low-cost Qume QVT 102™ has all the best features of the four most popular terminals and can emulate all four with a keystroke! QVT 103™ is code-compatible with the DEC VT100/VT 131 and offers 80 or 132 character/line, split screen and up to 4 pages of memory. And QVT 108™ faces up to the most demanding jobs with 22 function keys, 13 editing functions and 2 pages of memory.

Qume QVT terminals all share striking ergonomic design. Tilt/swivel screens in green or amber. Detached, low-profile keyboards. Big 9 x 12 character cells. And a long list of other features to make people more comfortable and productive.

Best of all, Qume QVT terminals are very competitively priced. You can have performance, features and reliability without facing a budget problem.

Talk to your Qume sales office about filling all your terminal needs with a single purchase of QVT terminals. Or write Qume, 2350 Qume Drive, San Jose, California 95131.



One size fits all.

Qume
A Subsidiary of ITT

QUME CORPORATION

HEADQUARTERS
2350 Qume Drive
San Jose, CA 95131

CALIFORNIA
San Jose (408) 995-6144
Culver City (213) 410-1458
Santa Ana (714) 957-4040

COLORADO
Aurora (303) 752-3000

ILLINOIS
Palatine (312) 991-7250

OHIO
Dayton (513) 439-0469

TEXAS
Irving (214) 659-0745

NEW JERSEY
Edison (201) 225-5005

MASSACHUSETTS
Bedford (617) 275-3200

GEORGIA
Decatur (404) 284-8500

GERMANY
Düsseldorf PH: 211743016

ENGLAND
Reading, Berkshire
PH: 734-584-646

FRANCE
Boulogne PH: (1) 6082334

CANADA
Quebec PH: (514) 695-3837

CIRCLE 150 ON READER CARD

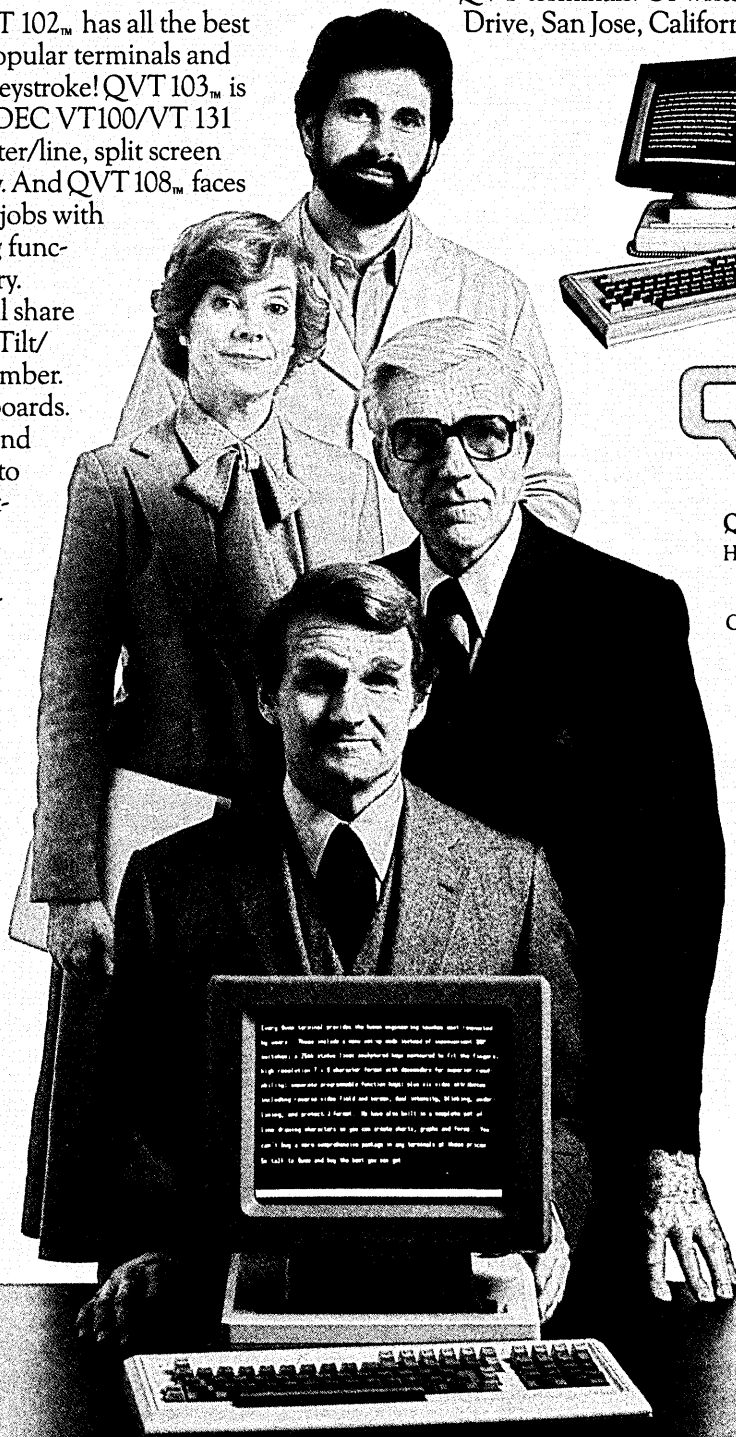

1969 DYL-250
1972 DYL-260
1979 DYL-AUDIT
 FIXED-FORM
1981 DYL-AUDIT
 FREE-FORM
1981 DYL-280*
1983 **NEW** DYL-280*
 with a TRUE Structured
 Programming Facility

**STATE-OF-THE-ART
 SOFTWARE FOR
 THE 80'S**

Report writing, utility, data management and audit software products that stand the test of time. Always state-of-the-art. Designed with your data processing needs in mind. Proven products developed and supported in-house by Dylakor since 1968.

- For IBM 360, 370, 30xx, 43xx and compatibles.
- Use everyday, English language to write reports with speed and ease. Ideal for your end-users in an information center environment.
- Perform highly sophisticated utility and development functions. Save valuable system programming time.

■ Experience DYL-280's NEW Release 3.0 with a Structured Programming Facility, COBOL Data Definition Support, Cross Reference, Exponentiation and much more - for as little as 20¢ per hour.

*Over 1000 installations in its first year.

Dylakor

17418 Chatsworth Street
 P.O. Box 3010
 Granada Hills, CA 91344
 (213) 366-1781

CIRCLE 151 ON READER CARD

**Data Kinetics
 can transform your
 ordinary ASCII video
 display terminal into
 a full-screen
 IBM 3270.
 Without any
 hardware
 modifications or
 additions.**

**Data
 Kinetics**

97 Norman St.
 Ottawa, Canada K1S 3K5
 (613) 238-6709

Chicago Dallas Seattle New Jersey Minneapolis Toronto Calgary

Data Kinetics now offers a low cost, software protocol converter to meet your full-screen needs. Called SIM3278*, it transforms an ordinary ASCII terminal running under VM/370 into a simulated 3270 terminal. SIM3278 brings new productivity to your existing terminals, be they micros, dumb terminals, personal computers or executive workstations. It takes only 15 minutes to install, works with most ASCII terminals and supports up to 255 CRTs per application. SIM3278 now provides full-screen capabilities at 100 user sites.

Call us today for a free 30 day trial.

Dallas (214) 991-0038
 Seattle (206) 277-0394
 Toronto (416) 751-6020

*SIM3278 is a product of SIMWARE, INC

CIRCLE 152 ON READER CARD

Some numbers may help guide your strategic planning. If you haven't been following telecommunications, it will take you six months to get educated while you continue to do your present job. In a medium-size company, just the documentation of your current telecommunications systems will require another six months of part-time effort. If the company is big and you have a dozen or more overlapping telecommunications systems in place, it could take an analysis team a year to find out the exact configuration for each system, describe it, draw a schematic, determine what the operating and capital costs are, and do a traffic study so you know the volumes of each type of communication that passes through the system.

If you get into a political squabble about who has jurisdiction (even if you *do* have the necessary talent, skill, and staff), then skip all these time estimates and resolve the politics first.

The procurement itself—requirements, vendor presentations, proposal evaluation, and initial contract negotiations—will probably take six to nine months. It might be done more quickly with a full-time staff, but unless that staff was thoroughly trained and seasoned before the start of the project, too much haste in these activities can lead to the wrong system, or a system that omits one or more features dear to your corporate heart.

The vendor will tell you how long it will take him to build it, install it, and cut over. This usually runs another six to nine months depending on the previous commitments by his manufacturing facility and whether he has field personnel available in your locality. Keep in mind the fact that you don't want this period too short as you have people to train and there will be some disruption from the pulling of cables. If your base telephone number changes, you've got stationery to print and your whole business community to inform.

Thus in about 30 months (more or less), you can replace an archaic existing telephone system with a new modern one that will provide you a foundation to grow upon for the next 20 years. It is a big job, but you may not only save some money today, you will insulate yourself against future price rises for telephone services. Further, you will set yourself up so you can transmit data from workstations to processors using the telephone cabling. What may be best of all, you'll get control of the administrative mechanism so you can move, add, and change both voice and data services on schedules chosen by your management. *

Bob Patrick, the senior DATAMATION advisor, has been an independent computer consultant since 1959 and a regular contributor to DATAMATION. For the past few years he has also been performing systems analyses in the telecommunications arena. Today he has three clients investigating their telecom needs. If all three were to order PBXs, they would install seven PBXs to service their 28,000 lines.

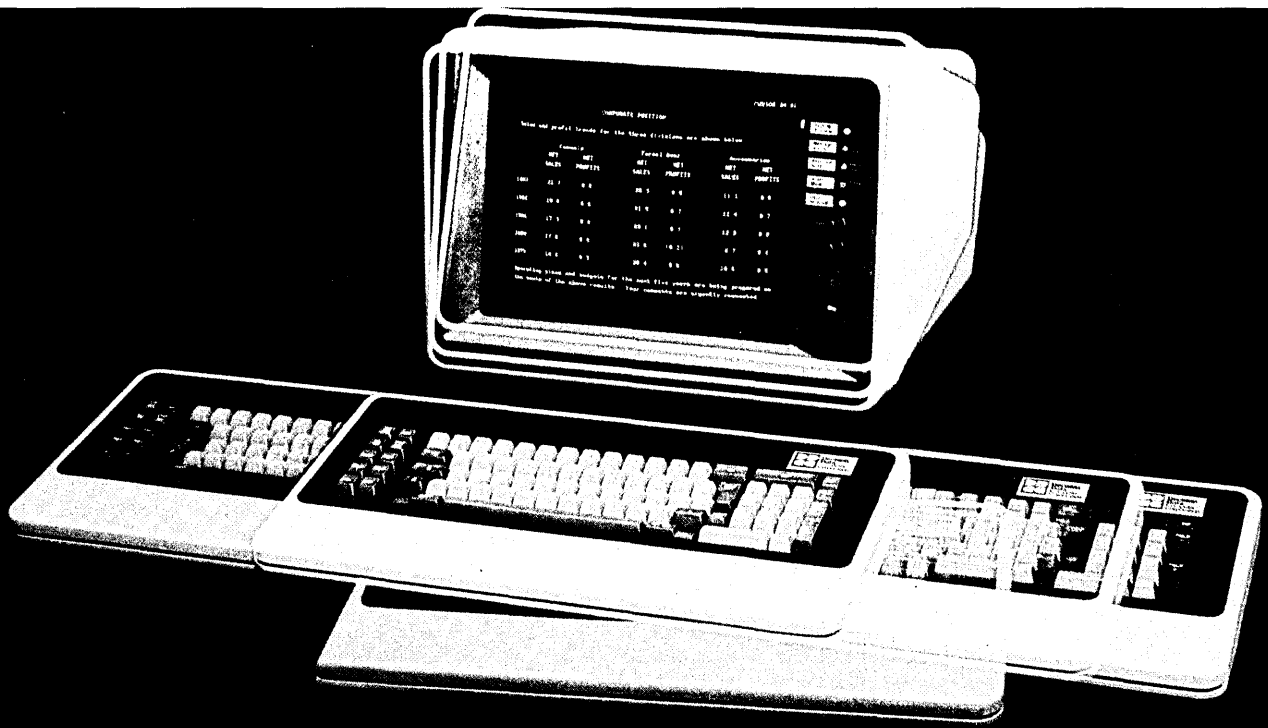

IBM MAKES WORK STATIONS FOR THE SYSTEMS 34 AND 38. WE MAKE THEM BETTER.

Nobody makes better computers than IBM. But work stations aren't computers. And the simple truth is that the best work station for your IBM System 34 or 38 doesn't come from IBM. It comes from Decision Data.

The Decision Data Work Station for the System 34 and System 38 offers improved productivity, efficiency and operator comfort. The large etched, non-glare, tiltable screen provides a larger work area, with cursor position and error display. Plus a movable keyboard with a comfortable palm rest.

Decision Data also produces a cluster controller to enhance the productivity of your system. It includes 4 ports, a single cluster feature, an EIA interface and an expansion feature which doubles the number of ports. All standard from Decision Data, all extra from IBM.

Decision Data is your

primary source for work stations, matrix and band line printers, serial printers, communications controllers and other computer peripherals which raise the productivity of IBM computers. Decision Data equipment does more work, more quickly, more easily, for less money. And it's reliable — backed by our nationwide and international service.

When people think of computers, they think of IBM. But when they think of the best peripherals, they come to Decision Data. And that's a very smart Decision.



**Decision
Data
Computer
Corporation**

Box 3505
100 Witmer Road, Horsham, PA. 19044

Please tell me more about the work stations that work harder. Better yet, I'll phone (800) 523-6529. In PA call: (215) 674-3300.

Your Name _____

Company _____

Telephone _____

Address _____

City _____

State _____

Zip _____

WE MAKE THE RIGHT DECISIONS

*The data flood.
How are you riding it out?*

The flow of data keeps growing, seemingly unchecked. Space requirements have more than doubled in the last three years.

And, as applications continue to expand, there's no end in sight. Your datasets will continue to multiply and storage needs

are simply going to explode.

There is one company — UCC — that can help you do something about this flood. Our complete line of Dataset Management software works together to manage your datasets . . . automatically. That includes their crea-

tion, usage, storage and retention or disposal — whether they're on disk, tape or MSS.

After all, Data Processing is automated . . . isn't it about time Dataset Management was, too?

Call 800-527-5012
(in Texas 214-353-7312.)

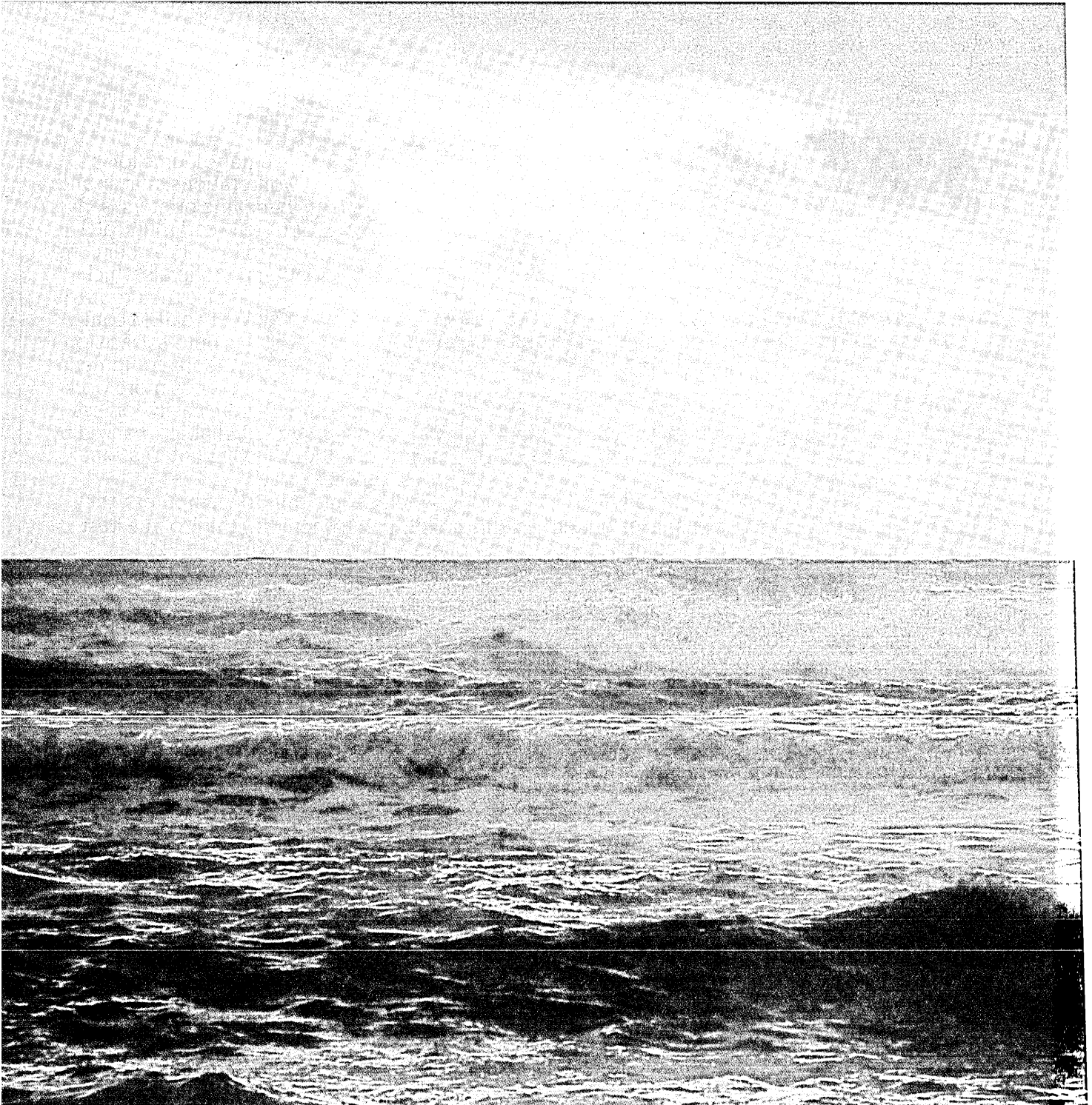

**THE MOST COMPLETE
SOFTWARE COMPANY
IN THE WORLD.**

CIRCLE 154 ON READER CARD

University Computing Company • Dallas • Toronto • London • Paris • Dusseldorf

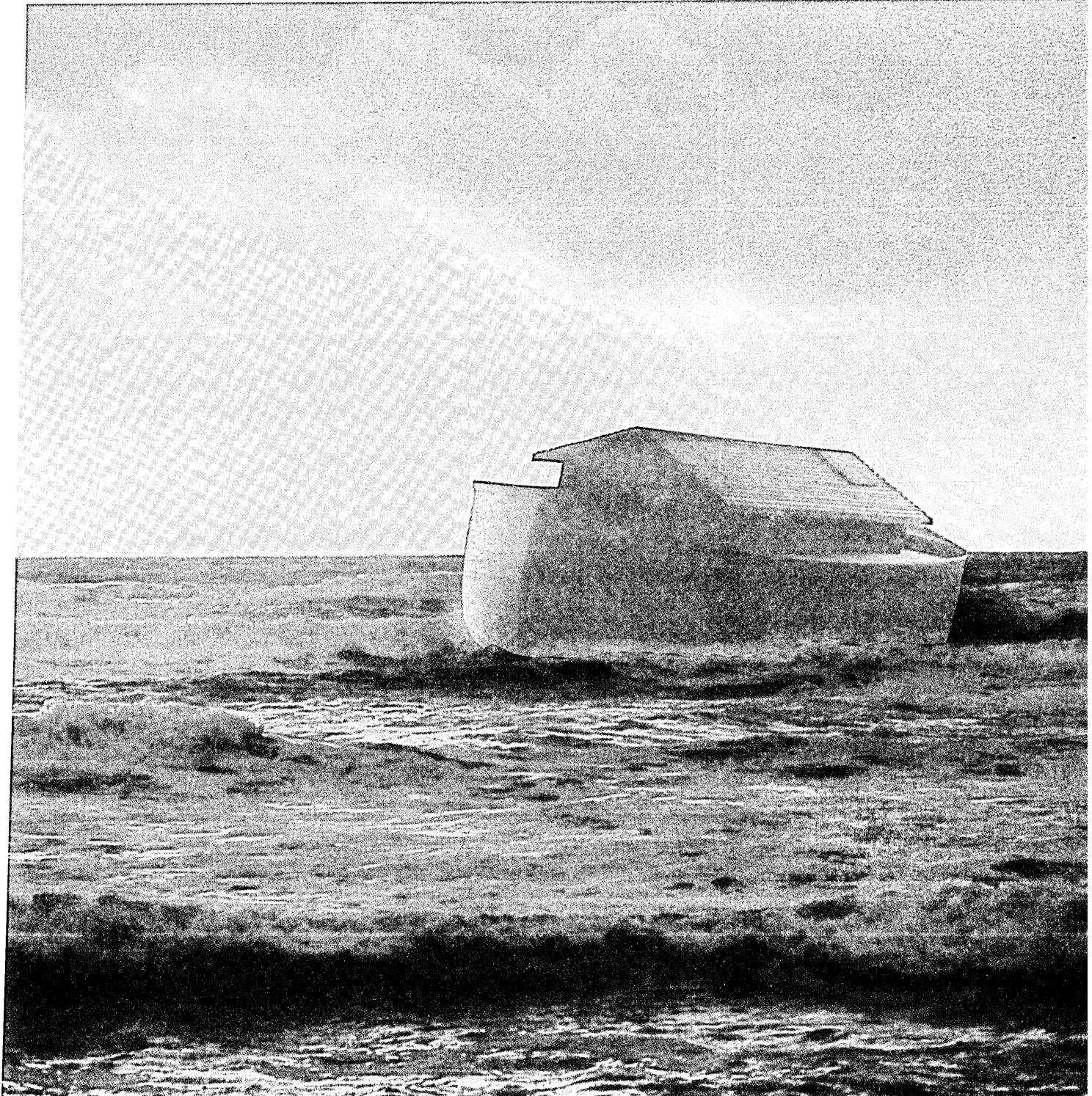

What's In A Name?

At Timeplex it's always been
Statistical Multiplexing

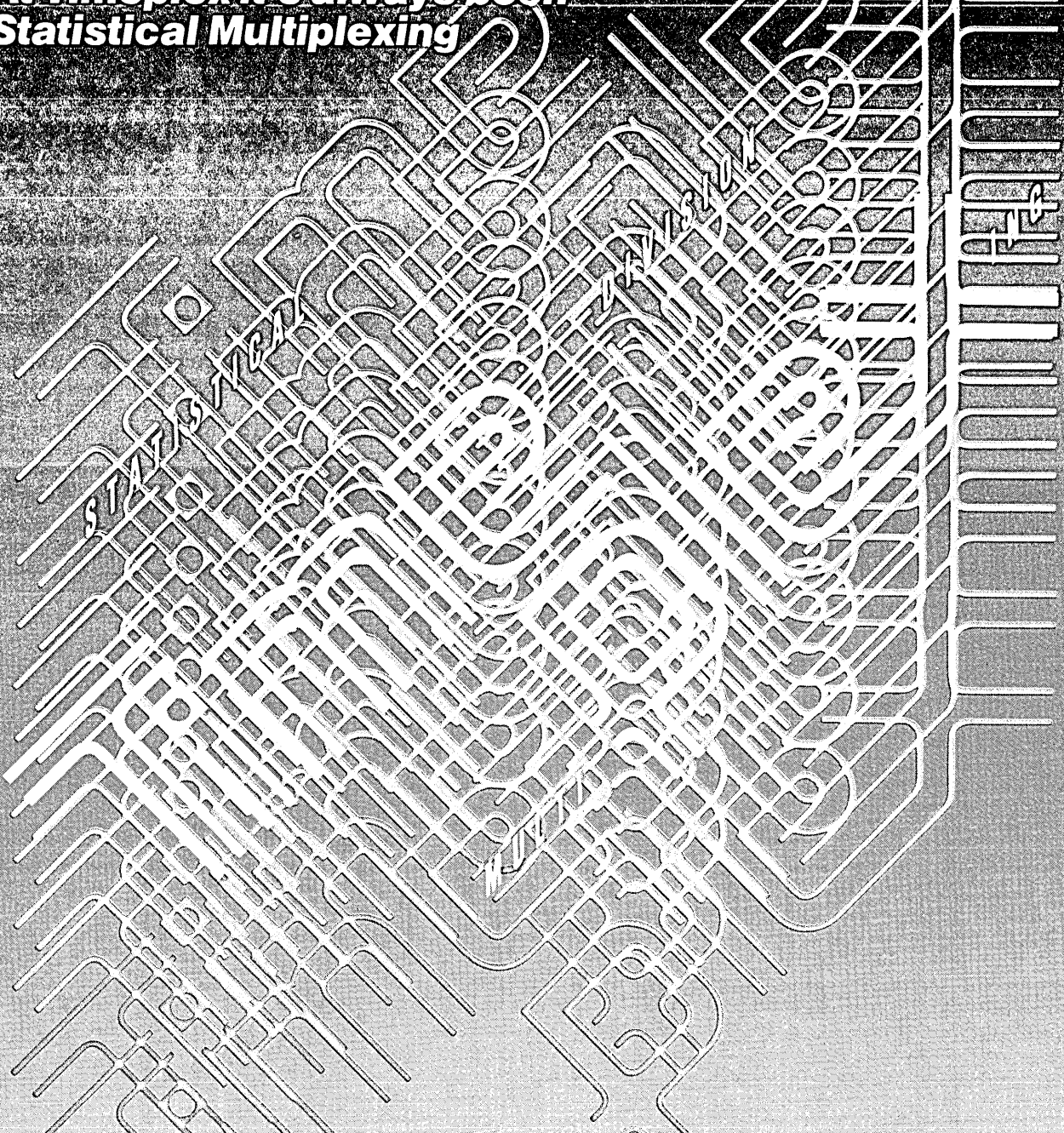

That's because the Timeplex MICROPLEXER is synonymous with statistical time division multiplexing.

When the best in stat muxing is needed, data communications managers simply specify MICROPLEXER.

Their confidence in the MICROPLEXER to meet any network challenge is based on experience. And, in data communications, as in most things, it's experi-

ence that counts. When it comes to stat muxing, nobody's got more than us.

We're living up to our name.

For more information on how multiplexing with the MICROPLEXER can benefit you, write or call us today: Timeplex, Inc., 400 Chestnut Ridge Road, Woodcliff Lake, NJ 07675. Phone: 201-930-4600. Attention: Marketing Communications.



The technology leader
in data communications

CIRCLE 155 ON READER CARD

How Evans Products tested a crucial material management system that serves several regional offices.

DECENTRALIZED SYSTEM TESTING

by Robert M. Sturm

Evans Products is a large, diversified corporation in the building and transportation industries. It consists of five decentralized divisions, with corporate headquarters in Portland, Ore. The Homes Group division is the largest manufacturer of precut, custom homes in the United States. In 1980 it had sales of \$150 million.

Homes Group headquarters are in Philadelphia. This division is also decentralized. At the time of system development it had six nationwide shipping regions and a mortgage facility in Washington, D.C. Each region has different material handling policies.

The data processing environment consists of an IBM 3032 under MVS/JES2 located in Portland, Ore. All locations (there were over 30 in 1981) are connected to the IBM 3032 via remote batch and 3270-type terminals. The teleprocessing monitor in use is Software AG's Com-Plete. The database package is ADABAS.

All major system development is done at Homes Group headquarters. In 1981 there was a core staff of 14 people, supplemented during programming peaks by up to seven outside consultants. Both the corporate and Homes Group staffs had their own database administrators (DBAs).

Each Homes Group location has a small dp organization consisting of a dp manager, operator, programmer, and data entry clerks. Each site has keybatch equipment for data entry. Input is via DATA 100 terminals to the IBM 3032. Reports print back at each site according to printer route commands. Input can also originate from the 3270-type terminals. Output can be reviewed from these terminals and canceled if necessary.

In 1979 the Homes Group data processing department went to regional management to propose the development of a new manufacturing system. The new system would replace a second generation material system. The old system was developed for an IBM System 3, converted to an IBM 360/65 (MVT/HASP) converted back to an IBM System 3, converted again to the IBM 360/65, and then converted to an IBM 3032 (MVS/JES2). The old system is very difficult to restart and

run. It is tape oriented and has few controls. But it is the most important system at Homes Group because it controls the shipping of all material to customers.

Regional management accepted the proposal to replace the existing system. Two of the five Homes Group regions volunteered to be pilot test sites. One was in Colorado, the other in Indiana.

The new system uses batch edits, updates, reports, and on-line screens under ADABAS. It is easy to restart and has excellent data and run-to-run controls. It consists of five major update programs, various report programs, on-line screen programs, and miscellaneous programs (92 programs in all). The system makes extensive use of subroutines with dynamic calls (subroutines are not part of the resident load module but are loaded into core as needed at execution time). As was the case with the old system, the new system would be run independently by each regional data processing manager.

From 1979 to 1981 the new system went through the phases of design, development, and programming. There was extensive user feedback from all five Homes Group regions. A process called heuristic development was used. In 1981 the Material Management System (MMS) was ready for testing.

The system test had to be very thorough because it was critical that there not be any problems with MMS after it went into production. Shipping the material in a house and tracking it is the essence of the Homes Group business. The regions had a material system that worked; MMS was something very new. If there were any problems with MMS, the regions would return to the old system and probably never use MMS again voluntarily.

The system test had to prove that MMS worked well and was better than the existing material system. The test also had to serve as a training tool for regional users. A great deal of planning of specific tasks, time estimates, and their respective dates preceded the test. All five regions were kept informed of the test's progress via a biweekly status letter written by the project administrator.

The test team was organized into a matrix structure that allowed for dual lines of control—technical and project administration

(see Fig. 1). The project administrator was a non-dp person, a manager from the Homes Group regions who understood and thought in terms of user requirements. He was a go-getter who could kick people in the pants if and when necessary.

The systems and programming manager acted as the technical and system test coordinator for the project. It was his responsibility to verify that all development followed existing data processing standards and to arbitrate disputes among the technical staff. The systems and programming staff and outside consultants were grouped into three programming teams, each headed by a project leader. Each team was responsible for specific sets of programs, grouped together by functionality. A Homes Group non-dp analyst was the liaison between the Homes Group project team and the regional teams.

REGIONAL USERS LED TEAMS

Each of the two pilot regional teams was led by a regional user from the material side of the company who devoted nearly all of his time to the project. Each regional team leader reported to top regional management. Other regional members participated as needed. During the system test all questions and problems from the regional team leaders funneled through the Homes Group user liaison to the project teams. Problem resolutions went from the project teams back through the user liaison to the regional team leaders.

The system test lasted several months. It was organized into seven major cycles (fast track, normal, verification, enhancements, reverification, conversion preparation, and parallel). Each cycle consisted of several passes (three to nine) of running different data through the material management system (see Fig. 2). Depending upon the requirements of a cycle, a varying number of passes could be run in each cycle. If the jobs in a pass and the reports that were printed were always correct, only one run of the job stream per pass was necessary.

An attempt was a run of the job stream. The attempt had to be correct before a new pass could begin. How quickly errors found in a pass were corrected determined the number of attempts for that pass; the average

number during the system test was 3.2, which was close to the estimate of three attempts per pass made prior to the start of the test. After a pass was verified as correct, the next pass could begin.

The series of set procedures associated with every run of a pass/attempt included the following tasks:

- A meeting was held with the project manager, test coordinator, database administrator, user liaison, and project team leaders to verify that everyone was ready for the next running of the job stream.
- The regional teams prepared the test data according to the requirements of each cycle and the conditions they wanted to test. At least one day before the start of a new cycle, they transmitted the test data to files at the central computer site. The regions notified the Homes Group user liaison when the test data were ready and loaded onto the test files. The Homes Group project teams reviewed the test data files via 3270 terminals.
- One Homes Group team member was assigned the responsibility of running the test. He initiated the processing of the test data by the manufacturing system programs. The complete test data job stream consisted of 62 separate jobs (31 per pilot test site). The job stream was set up so that when a job completed successfully, it automatically released the next job. This process was repeated until all 62 jobs were executed. Thus, the Homes Group team member only had to start the first job of the entire job stream.
- The person running the test set up three control sheets: an execution preparation checklist, an execution control checklist, and a verification checklist. The execution preparation checklist identified the cycle, pass, and attempt that were being run. This unique number was made part of the accounting information for all jobs in a run of the job stream. Thus, it was easy to associate a job with a particular cycle, pass, and attempt.

This list also identified whether the database should be backed up or restored by the DBA. If the previous run of the job stream was successful, jobs associated with backing up the database files would be run. If the previous run of the job stream was unsuccessful, jobs associated with restoring the files would be run. The files would be restored to the condition in which they existed prior to the start of the incorrect run of the job stream.

The execution control checklist identified all the jobs in the job stream by name and number. When a job began executing, its number was written on the checklist. The checklist was monitored by the operations department during the two to three hours that the job stream ran. It provided controls as to which jobs ran success-

LISTING BY NAME, NUMBER

fully and when various output reports were ready to be printed.

Normal daily production rah at Homes Group headquarters during the system test. It used the same printer as the system test and usually lasted two to three hours. Owing to contention for the line printer, the test output was prioritized and sent to one of four different print queues.

The one-page control reports from the six update programs were printed first. Then, data-intensive reports needed by the user liaison that dealt with dollars (accounts payable, job cost, etc.) printed from the second queue. All other reports printed from the third queue. Specially tailored pre-update and postupdate database file dumps were in the

fourth queue. They were printed only as needed. The programming staff used Natural (the ADABAS query language) to do quick checks of the data on the database. The update control reports and file dumps printed only at Homes Group, not at the pilot regions.

When the jobs in a pass ran to completion, the output was distributed to the user liaison and the project teams. The regional team members and the Homes Group user liaison reviewed duplicate sets of reports and discussed the results. The user liaison wrote down any potential problems on a log and gave them to the appropriate project team to fix. Each regional team was expected to review its reports within six hours.

CHARTS BY CYNTHIA STODDARD

FIG. 1

MMS MATRIX ORGANIZATION

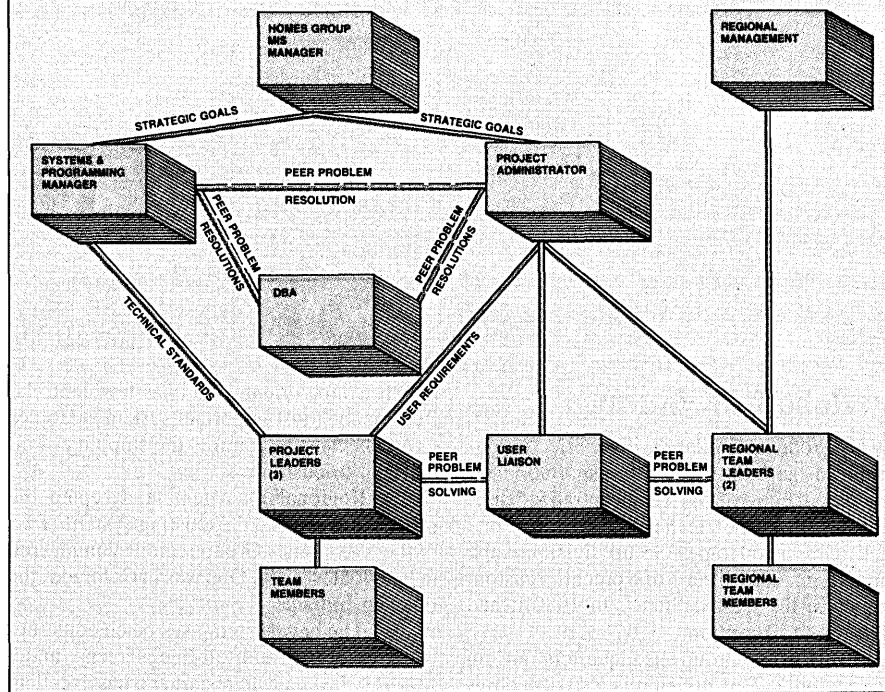
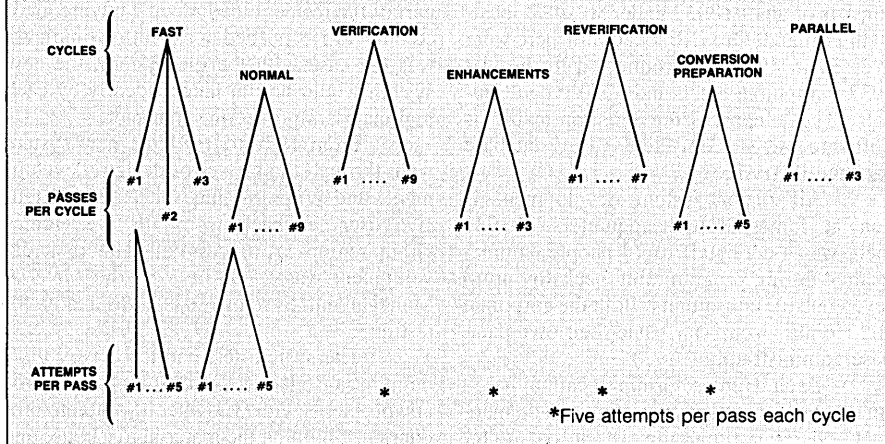

FIG. 2

SYSTEM TEST STRUCTURE



The Inspector IV MPC, The Detector II and Protector.*

Super Stars



These Media Management devices from Graham Magnetics keep your computer tapes performing better, longer.

Graham Magnetics' leadership position in computer tape technology has led to the development of three remarkable devices, each designed to do a specific job to reduce drop-outs, tape damage, stoppages and resulting system downtime:

The Inspector IV* MPC—This microprocessor-controlled tape evaluator/cleaner locates and isolates error-prone and damaged tape in your library. It can clean and evaluate a 2400' tape in just 3.6 minutes.

The Detector II*—Also microprocessor-controlled, this tape cleaner uses proprietary vacuum-grid cleaning tech-

nology to remove most error-causing contaminants. It can clean, retension and rewind a 2400' reel in 3.3 minutes.

The Protector*—This patented cleaner employs vacuum technology to remove error-causing debris, including micron-sized particles, from the inside of self-loading cartridges. It automatically adjusts to clean most cartridges in two minutes or less.

Graham Magnetics' position is simple: Put Epoch 480* computer tape in your library, then utilize our Media Management Program® to keep it in top shape. With Graham "Super Stars" in place, your media will last longer and run virtually error-free.

Act Now!—to improve your data center's productivity:

Marketing Services, Graham Magnetics Incorporated, 6625 Industrial Park Blvd., North Richland Hills, Texas 76118

Please send me information on the following Graham Magnetics products:

- Complete Media Management Program
 Inspector IV Detector II Protector
 Epoch 480 "Permanent" Computer Tape

Name: _____ Title: _____

Company/Organization: _____

Address: _____ Phone: _____

City: _____ State: _____ Zip: _____

*Registered trademarks of Graham Magnetics Incorporated.

CIRCLE 156 ON READER CARD



GRAHAM MAGNETICS CARLISLE

Toll Free: 1-800-433 7632, 433 7633 In Texas: (817) 281 9450



See you at NCC,
booth numbers S 5607-5608.

AT 11 A.M. ON MARCH 2ND, THE WORLD CHANGED.



(10:59 A.M.)



(11:00 A.M.)

If you decided to buy a computer system before 11 A.M., March 2nd, it was possible to make a purchase decision without fully considering Data General.

But on that date, the world changed.

At 11 A.M., we introduced the most powerful 32-bit virtual supermini ever produced by a computer company. Our ECLIPSE™ MV/10000.

Yet our ECLIPSE MV/10000 is simply the latest of a series of steps we have taken over the last year to make choosing Data General the best business decision you can make.

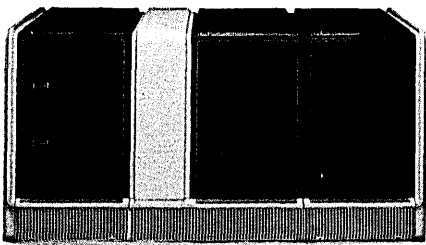

So now, if you do a comprehensive evaluation of your options – you may be surprised at the results.

RANGE. With ECLIPSE MV/10000, we now have the broadest range of computer capability in the business. Which means there's a Data General computer that meets your exact needs. Whatever level of performance you need.

PRICE. When you compare any Data General computer with its competition, you will find one of two things. It will either have a similar price and a lot more performance, or it will have similar performance and a lot lower price. Because that's the way we've always made Data General computers.

COMPATIBILITY. Unlike our competition, we've gone out of our way to keep our entire line of computers compatible. Which has kept a very important option open for you. In the event your needs ever happen to change, you can take your entire investment in software and peripherals onto larger (or smaller) Data General computers.

APPLICATION SOFTWARE. Over this last year, we have signed agreements with major suppliers of software for mechanical, electrical and architectural engineering; medical, process control; financial and decision support applications. Additionally, the MV/10000 forms the base of a powerful integrated office automation system.

SUPPORT. Since our customers are looking to us not simply for computers, but for a close working relationship, we're providing the kind of support that requires. Uptime guarantees of up to 99%. A national phone center. Remote diagnostics.

GRAPHICS. And since wherever computers are being used, the people working with them are working better with graphics, we've developed (and just introduced) the most advanced graphics workstation ever produced by a minicomputer company.

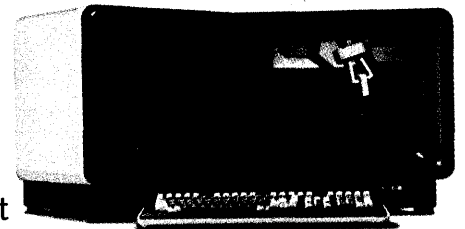

When you look carefully at where Data General is today – and where the competition is today – the world has changed.

In the past, you may not have fully considered Data General. But as of March 2nd, it will be in your own best interest to look at us very carefully.

For additional information, contact Business Group M.S.F.134; Data General Corporation, 4400 Computer Drive, Westboro, MA 01580. Telephone (617) 366-8911, extension 5880.

 **Data General**

See us at NCC Booth #S5174

CIRCLE 157 ON READER CARD

FIG. 3

ERRORS BY TYPE FOR EACH PASS OF NORMAL CYCLE

BAR CHART OF SUMS

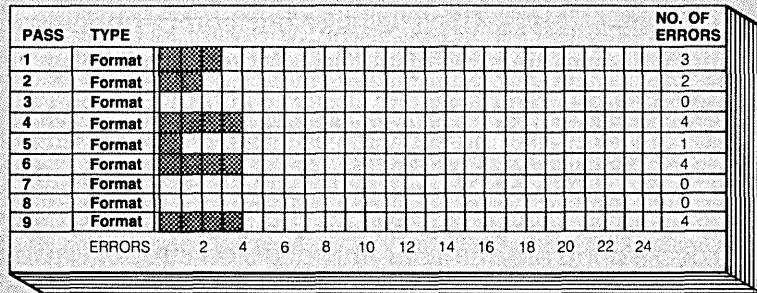
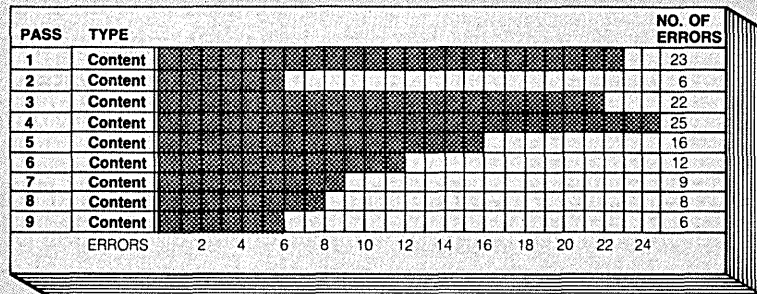
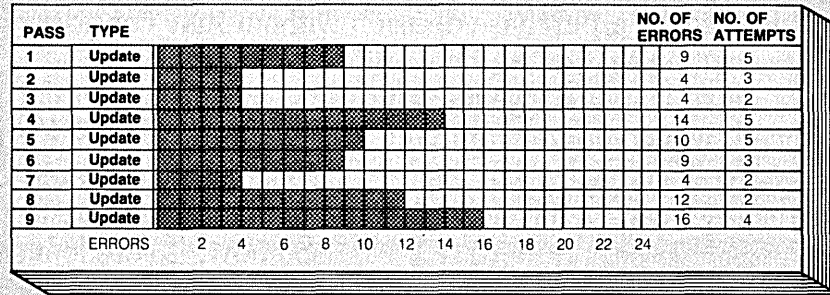

Each potential problem was identified in the log by pilot region, test cycle, pass number within a cycle, attempt within a pass, customer number, and test condition. The project team responsible for correcting the problem was also noted, as was the date when the problem was assigned. The completion date for each problem was logged. If the project team leader determined that the problem was not severe, the test job stream could be rerun without the problem being corrected. This error condition would be fixed in a subsequent run of the test.

Within each project team one member was assigned the responsibility of checking the results of a specific update (there were six altogether). This person verified that the files, data reports, and update control reports were correct. He also met with the user liaison to discuss his efforts at resolving errors. The team member indicated if the identified errors were corrected and if he required a rerun of the pass/attempt.

He did this by initialing a line on the third control sheet. The verification checklist indicated if he was ready for the next pass or next attempt (a rerun of the same pass). The checklist was placed on the wall outside the test coordinator's (also the system and programming manager's) office. It was easy to see who had not initialed the sheet and who might require help. The seven lines on the verification checklist had to be signed once for each region and once for each update before a new cycle, pass, or attempt could begin. This process of using the three checklists to control the system test was retained for most of the test cycle.

If there was an error, the same pass would be rerun. If there weren't any errors, the next pass would be run.

There were seven cycles in the system test. The first, called *fast track*, was designed to familiarize Homes Group and regional personnel with system test procedures. The primary technical function tested in this cycle was the ability to create meaningful data for use by all programs. It was accomplished by inputting only valid transactions that moved a customer quickly through the system.

THREE RUNS IN CYCLE

The cycle consisted of three runs of the job stream. Ten customers who did not have any exceptions to the normal rules of shipping material were processed. These customers could be set up on the files and their material shipped in three passes (runs) of the update/report job stream.

The number of runs for this cycle averaged 2.7 attempts per pass and took two weeks for a total of eight attempts. Output report review procedures took longer than anticipated. There were fewer problems than

expected with the update programs, a sign of good unit testing.

The second cycle was called *normal*. Its purpose was to test all conditions defined by the users, including daily and month-end business functions and interfaces to and from existing systems (accounts payable, accounts receivable, marketing, inventory, order status, and sales leads). Both valid and invalid transactions were input. Invalid transactions required recycling to correct their predefined errors. Most of the customers in this cycle had exceptions to the rules for shipping material. Technical functions tested were identical to the fast track, but expanded to include additional program logic. Each pass of the normal cycle tested different portions of the programs.

The normal cycle consisted of nine passes of the job stream and lasted eight weeks. During this time six customers per region were set up on the files and processed until all of their material requirements were satisfied. The number of runs averaged 3.4 attempts per pass for a total of 31 attempts. Users at the regions were responsible for recycling invalid transactions. Thus, this cycle

was a training tool. The last five passes were also used to test interfaces to existing production systems. Update errors in the last two passes were minor; since all major update problems were resolved, users began checking the finer points of the system.

During the running of the normal cycle, error corrections were classified into one of three types—update, content, and format. Fig. 3 summarizes the occurrences of these error types during the nine passes of the normal cycle. Updates were the most serious kind of error, and passes could not be rerun until they were corrected. They resulted from an update program putting incorrect data on the database.

The next class of error, content, occurred when the information on the database was correct but the report programs displayed these data incorrectly. It was the responsibility of the project team leaders to decide if a content error was serious enough to delay a rerun of a pass or a run of a new pass. It often took a while to determine if bad data on a report were content errors or update errors. In these situations the project team used formatted dumps of the database.

M/A-COM DCC Means Multiplexing

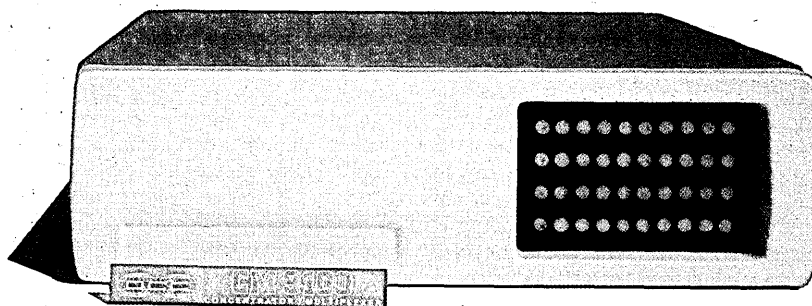

M/A-COM DCC has applied its expertise in X.25 packet-switching equipment to develop a line of cost-effective multiplexing products. Our products easily integrate with your existing equipment to reduce your data communications costs and increase your network's efficiency and capability.

First, we introduced our **Statistical Multiplexer** that successfully decreases user phone line expense by 75 percent or more.

We continued to lead the way with the first low-cost **Switching Multiplexer** that gives you full network connection and configuration flexibility.

We proceeded by adding a **Lightwave Multiplexer** that provides secure high bit rate communications in virtually any environment by means of fiber optic technology.

And now we have developed the **Advanced Statistical and Switching Multiplexers** that

combine low-cost multiplexing with effective network management—and automated performance monitoring.

M/A-COM DCC works continuously to provide you with the BEST multiplexing equipment available.

Contact us directly or our extensive domestic and international sales staff to learn how our multiplexers can improve your data communications. M/A-COM DCC, Inc., 11717 Exploration Lane, Germantown, Maryland 20874-2799, Tel: (301) 428-5600, TWX: 710-828-0541

M/A-COM DCC Sales Offices

Maryland Headquarters (301) 428-2721, **California** (213) 306-2294, (408) 257-4060, **Massachusetts** (617) 235-4419, **New Jersey** (609) 424-1850, **Texas** (817) 267-2732, **Argentina** (01) 332-021, **Austria** (0222) 45 21 75, **Canada** (613) 737-5941, **Denmark** (02) 96 98 22, **Finland** (00) 735 774, **France** (06) 446 34 56, **Germany** (0611) 666 1003, **Hong Kong** (05) 8933386, **India** 274043, **Italy** (02) 4388 3221, **Japan** (03) 436-9511, **Korea** (02) 723-8236, **Lebanon** 349490, **Mexico** (905) 689 2121, **Netherlands** (070) 25 12 12, **New Zealand** (04) 856-769, **Norway** (042) 26175, **Peru** (014) 271-132, **Portugal** (019) 979-469, **Singapore** 747-4561, **Spain** (01) 458-8011, **Sweden** (08) 520 520, **Switzerland** (055) 484191, **Taiwan** (02) 5964225, **Thailand** (02) 391-7315, **United Kingdom** (0734) 596-226, **Venezuela** (02) 39 1442.



M/A-COM DCC, INC.

**Leading the Way in Data
Communications Technology**

CIRCLE 158 ON READER CARD

See us at the NCC show in Anaheim, May 16-19, Booth #N4708

The combination of thorough planning and active user participation resulted in a successful system test.

The last and least serious type of error, format, happened when a regional user was dissatisfied with the format of a report or on-line screen. These errors and the two other types were funneled through the Homes Group user liaison. Format changes were kept to an absolute minimum. Format errors did not impede the running or rerunning of passes.

The normal cycle took over two months and uncovered various errors. Project leaders were concerned that modifications made to a program in one pass (i.e., pass 6) could affect the way that the program processed data from an earlier pass (i.e., pass 4). The effect of the program change upon the earlier pass (i.e., pass 4) would not be tested. In order to test that all program changes made during the normal cycle would work with the data from an earlier pass of the normal cycle, a *verification* cycle was added.

This cycle consisted of rerunning the data from one region for passes one through nine of the normal cycle. The cycle took two weeks to complete, and the average number of runs was 1.6 attempts per pass. The Homes Group staff ran the cycle and was responsible for correcting and recycling error transactions. In the normal cycle the regional users corrected the errors. Only a major update problem caused a pass to be rerun. Regional users received a full set of reports, and any problems they identified were fixed after the verification cycle was complete.

ENHANCEMENT CYCLE

The fourth cycle, *enhancement*, began 17 weeks into the system test. The regional users and Homes Group project team developed a list of 80 enhancements that were important to a successful running of the MMS system. The enhancements were categorized by update type and prioritized. They included changes to the structure of the database as well as to programs. During the normal and verification cycles the project teams coded many enhancements to test-mode versions of the programs but they only "desk" debugged them. Since only one database existed for system testing, the enhanced versions of the programs could not be easily unit tested.

The version of the system (database, programs, subroutines, copy statements, etc.) that existed at the conclusion of the verification cycle was copied. A total of eight weeks was allocated for unit testing (three weeks) and then system testing (five weeks) the enhancements. If the enhanced versions of the programs had major problems during system testing, the version of the system saved from the verification cycle was used.

Sixty-five enhancements were successfully unit tested, and the program documentation was modified to reflect the en-

hancements. An enhancement system test cycle consisting of three passes of the job stream was established to test the modifications. As before, the regional users prepared test data to verify that the enhancements were correct. This cycle averaged three attempts per pass and ran for two weeks.

Because project leaders expressed a concern that enhancements might have adversely affected the update programs, a *re-verification* cycle was established. It would use input transactions from the verification and the enhancement cycles. The number of passes was reduced from nine to seven. After each pass Homes Group project team members compared the output reports from this cycle with the output reports from the verification cycle. As long as any differences were explainable, the next pass could begin. The regional users were bystanders during this cycle, which took three weeks and averaged 1.6 attempts per pass.

The purpose of *conversion preparation*, the next cycle, was threefold: to establish and document the steps required to transfer data from production files to the MMS database files, to test the steps necessary to make the system operational, and to create files for use in the parallel cycle. The operations documentation (two volumes) was given to regional users at this time. The cycle was a dry run of the actual conversion process, estimated at four, eight-hour days.

At the end of one month, all necessary production files were saved, transferred, and used to create database files. MMS monthly reports were run against the database files and compared to monthly reports from the production systems. Certain differences, due to small changes in accounting procedures, were expected. Small problems with the conversion programs surfaced during this dry run (i.e., data being moved to the wrong field, a wrong data element being processed).

Eleven database files were created from 17 existing files (disk and tape) in seven production systems. About 10 million data elements were converted. New elements not in production systems were loaded with blanks or zeroes. The conversion preparation cycle lasted two weeks, during which there were three runs of the conversion program job stream.

Up to this point the Homes Group staff ran the MMS job stream and user participation was limited to members of the regional test teams. In the *parallel cycle* the two pilot regions ran the MMS system at their sites. Live data were processed by them through existing production systems as well as the MMS system. They compared output results of both systems. Now other people besides the regional test teams were being trained in input procedures and the output reports.

Other benefits of this cycle were fi-

nalizing the job stream production run schedules, providing a volume test of the conversion programs, and evaluating the accuracy and completeness of all user procedures and documentation. Two Homes Group project members were present at each regional site during the two weeks of the parallel cycle. They were there to assist the regions in running the system and to answer any questions.

Originally, a restart recovery cycle had been planned to verify that the programs, procedures, and training necessary to recover the system existed in the proper places. Restart and recovery were handled successfully many times during the system test, however, and this step was eliminated.

KEYS TO SUCCESS OF TEST

With the system test portion of the project complete, final training for users and operators, conversion of the files, and heavy user support during the first month of operation were the remaining tasks for implementation of the MMS system. The system test proved fruitful. Errors found in the programs were corrected. Regional users had a high degree of confidence in the system and were thoroughly trained in its use.

Several factors were key to the success of this test. They included a high degree of communication among project team members, commitment and support from senior management, adherence to a detailed project plan (down to the task level), and the use of checklists to control the test. Also important were the user liaison who acted as a conduit between regional users and the Homes Group project team, and the existence of "understudies" for key project personnel in case of resignations or firings. Perhaps most important of all was the extensive participation in the test by regional users.

The MMS development was not without its share of problems. At one point, the three project leaders refused to talk with each other. The system was delivered late and went through two project administrators. But the combination of thorough planning and active user participation resulted in a successful system test. By the end of the test regional users had a great deal of confidence in MMS and felt it was their system, rather than something that data processing was forcing upon them. They became boosters of MMS with their management and their peers. *

Robert Sturm is manager of systems and programming for Evans Products Co. and a lecturer at Ursinus College, Collegeville, Pa. He has been involved with all phases of information systems for the past 15 years. He has a BS from Rensselaer Polytechnic Institute and an MBA from Temple University.

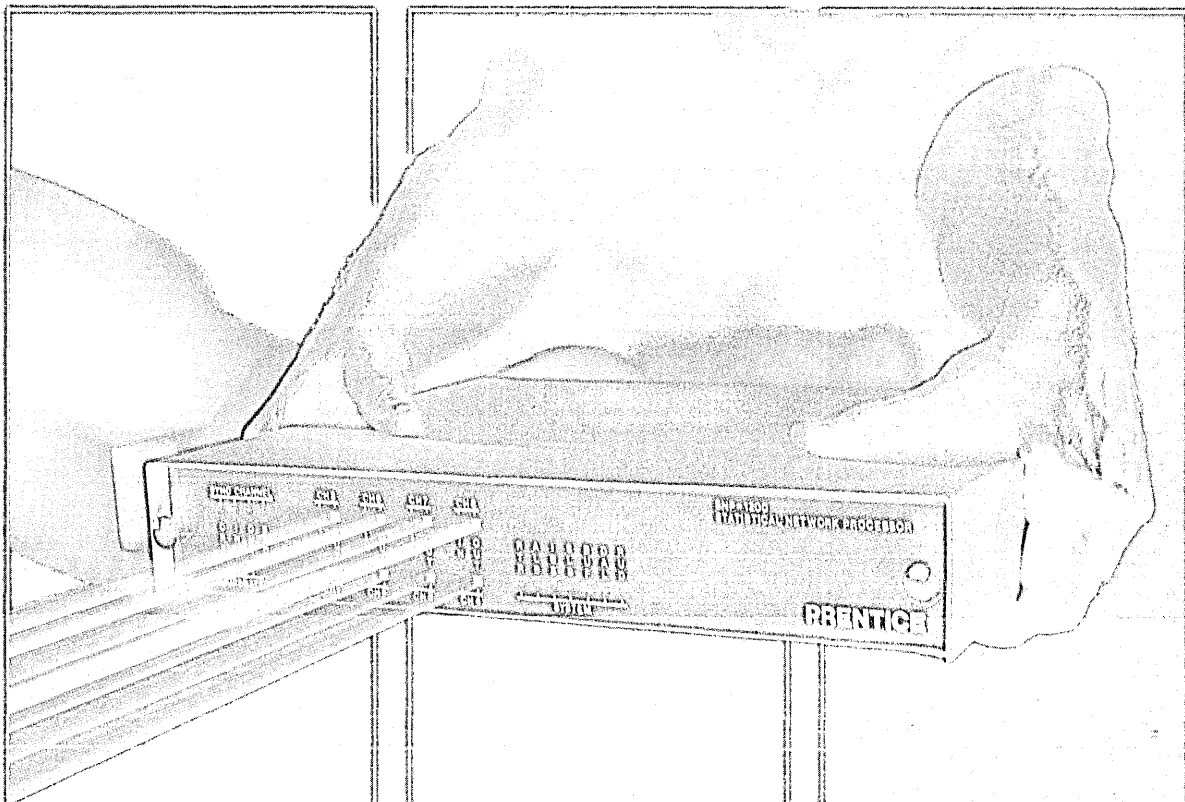

This Multiplexer Delivers

PRENTICE multiplexers pay for themselves in a few short months because they deliver:

- Lower Line Costs
- Less Down Time
- Lower Equipment Costs

The typical result? A 20% or more cost savings for you with a straightforward solution.

If you have a minicomputer that communicates with remote terminals, you may be paying too much. Contact a PRENTICE representative for

a detailed cost analysis. We'll demonstrate how our statistical multiplexer delivers.

PRENTICE, 266 Caspian Drive,
Sunnyvale, CA 94086.
(408) 734-9810
TELEX: 1741885

PRENTICE®

Data Communications

Our
Experience
Benefits
You

CIRCLE 159 ON READER CARD

"No matter who you're selling to," remarks Merrill Likes, "the fact that you can go from an inexpensive VAX-11/730 all the way to a million dollar installation without changing software or operating systems is an incredible advantage.

"Digital has done a great job at keeping things compatible and growing," he says. "At providing easy migration paths, and linking things together more and more. With the VAX™ family I can satisfy almost any customer and keep him happy for years."

Merrill points to the VMS™ operating system as another key to VAX's commercial success. "Digital really thought it through," he remarks. "It supports all popular languages. It's terrific for interactive applications. Or timesharing. It has exceptional data communications and mass storage. It's the most user-friendly operating system I know about."

Merrill says that the friendliness of VMS software combined with the reliability of VAX hardware is quickly earning the computer a reputation in commercial markets equal to what it enjoys in technical and engineering circles.

Uptime installed the first commercially-applied VAX-11/730 and had the system up and running on-site in just 90 minutes. "Some of our new customers don't believe what it can do," Merrill laughs. "So we prove it to them. VAX will carry us through the 80s. For commercial OEMs, it's becoming a classic."

To find out what VAX can do for your business, call toll-free: 1-800-DIGITAL, extension 200. Or write: Digital Equipment Corporation, 200 Baker Avenue, CF01/M94, West Concord, MA 01742.

© Digital Equipment Corporation 1983

At Uptime Systems, they customize VAX with applications software for commercial markets like horse and cattle breeding, oil and resource exploration. VAX has made them more productive and more profitable. No other computer, they say, lets them produce, maintain and support software so efficiently.

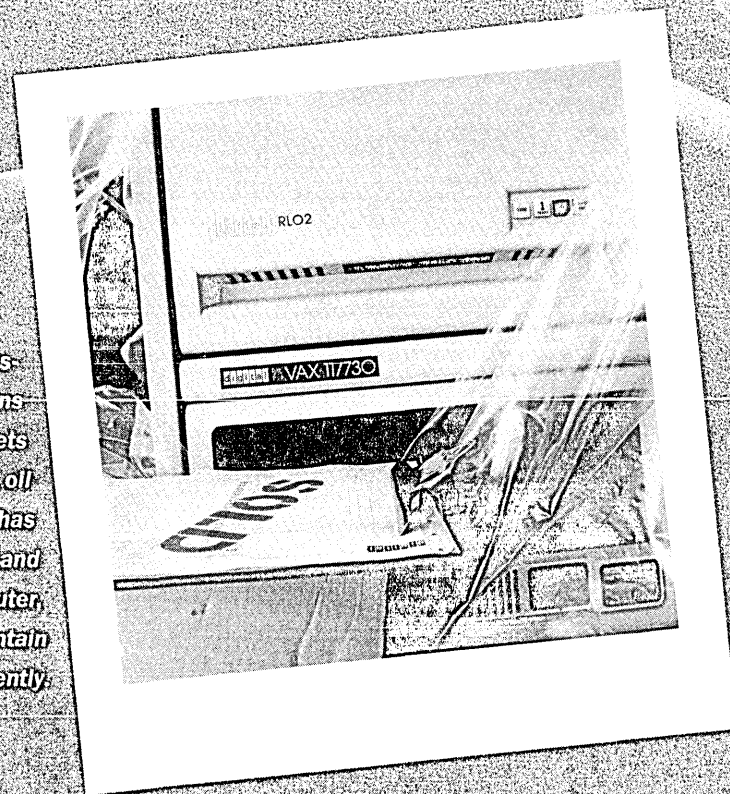

WAX

**"WAX IS PRACTICALLY SELLING ITSELF
IN COMMERCIAL MARKETS.
EVEN THE UNUSUAL ONES!"**

**—Merrill Likes, President
Uptime Systems, Inc.**

digital

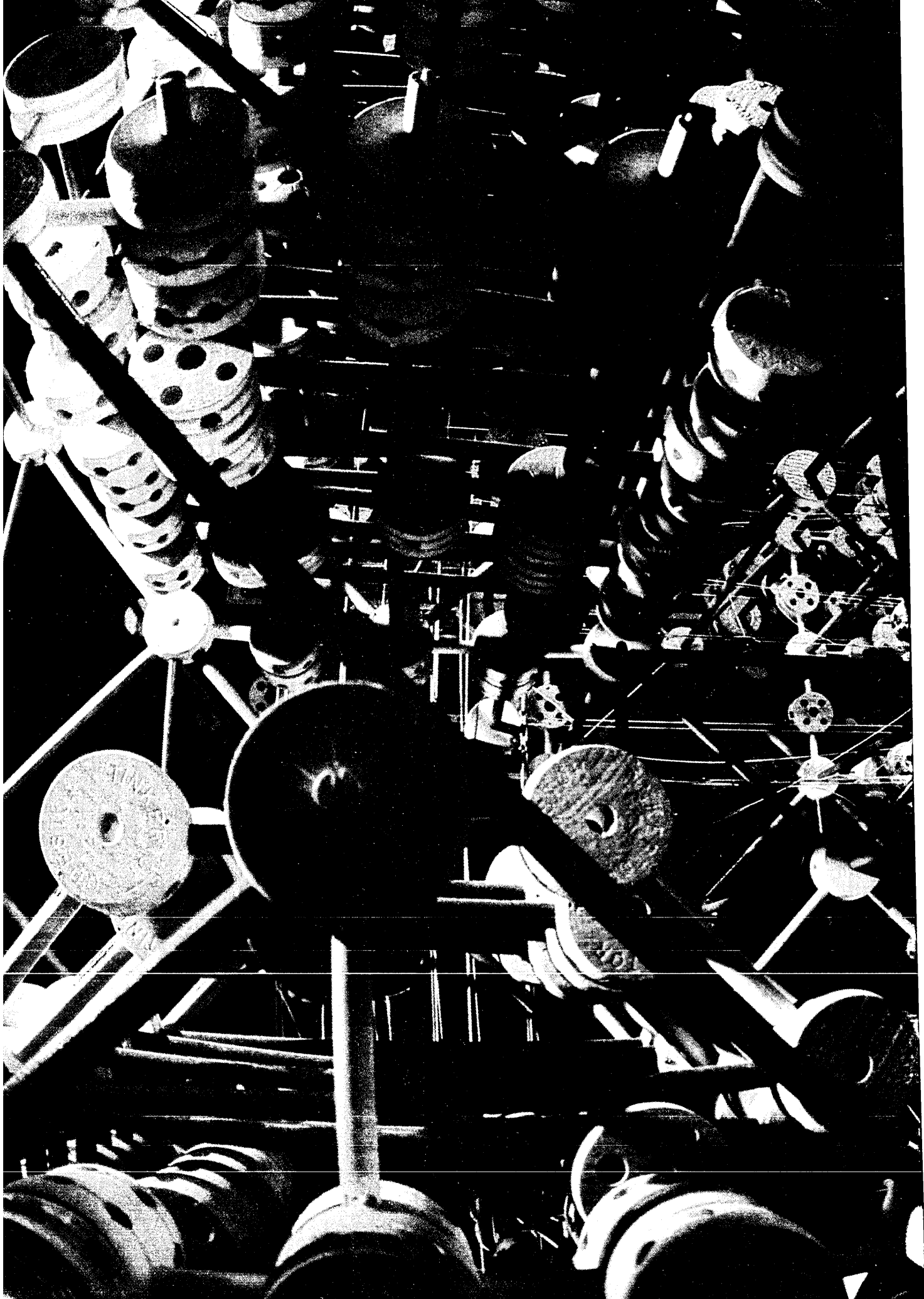

The computer industry may be young, but it has a rich past. Many of those riches are on display in a building in Marlboro, Mass.

THE COMPUTER MUSEUM

by W. David Gardner

Just off Interstate 495, where the rolling Massachusetts hills are still struggling to make up their minds whether to go high technology or remain picturesque New England countryside, sits a bronze-tinted glass building. More than 10 years ago, it was built by RCA as headquarters for its computer operation, then on its way to becoming the second largest computer company in the world.

Today the building, in Marlboro, Mass., is in fact owned by the second largest computer company in the world, but that, of course, means that the owner is Digital Equipment Corp. and not RCA, which has departed the computer business. As such, the building is a monument, the computer industry's very own Tomb of the Unknown Soldier, representing all those lost while trying to fight IBM head-on.

Moreover, there is something wrong with the building. It has been decapitated—its planned 12 stories were chopped to six, with the result that the executives who briefly occupied its top floors were never able to see the Boston skyline 48 miles away. But as befits any would-be headquarters, the building has a huge and impressive lobby and long, sweeping public areas.

That spaciousness has turned out to be appropriate because the building is now the home of the Computer Museum, an independent, nonprofit foundation dedicated to preserving computing's past but in a living, vital way. "It's a big boy's museum really" says Gwen Bell, director of the museum. "It brings out the kid that's in all computing people if you scratch the surface."

Visitors entering the museum are struck first by artist Harold Cohen's bright murals (see *DATAMATION* cover, October 1981). Cohen generated the murals on a PDP-11/45 using a drawing program.

The exhibits range in history from a set of John Napier's calculating bones dating back to the 16th century to recent micropro-

The Tinker Toy computer. Inset: The 4004 (left) and the 8008, one of which was the first microprocessor.

PHOTOGRAPHS BY CARL HOWARD

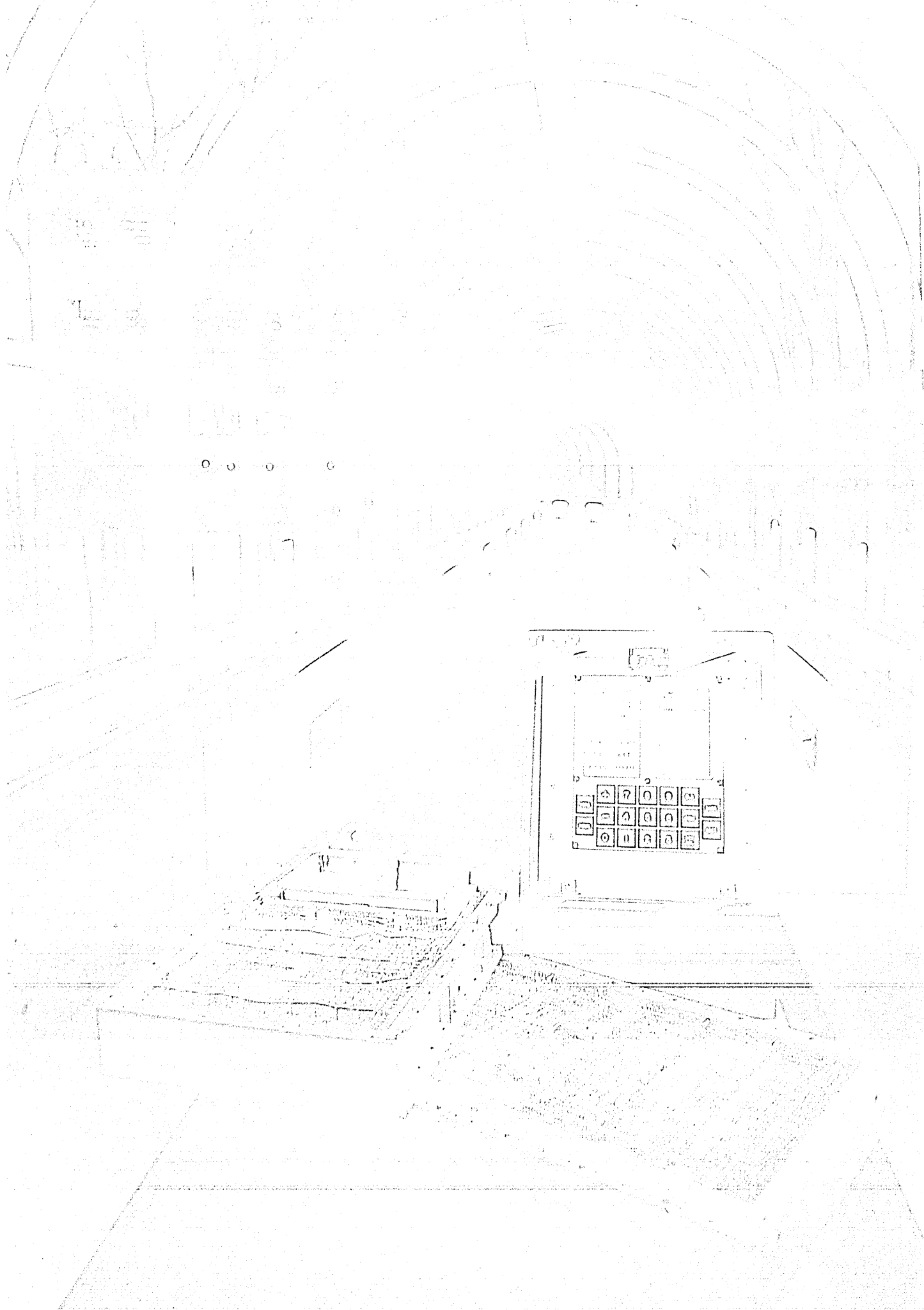

Table with grid of characters and symbols.

1	2	3	4	5	6	7	8	9	10
11	12	13	14	15	16	17	18	19	20
21	22	23	24	25	26	27	28	29	30
31	32	33	34	35	36	37	38	39	40

The museum's exhibits humanize the phenomenon for computer people and their families.

cessor components. Looking to the future, Ms. Bell notes the museum had already requested a model of Apple Computer's widely heralded Lisa computer before it was available for commercial delivery. In size, the exhibits range from an entire Control Data 6600 supercomputer to tiny silicon chips.

"We're fundamentally in the collecting stage still," says Ms. Bell. She and Jamie Parker, the museum's exhibit coordinator, have become international sleuths possessing the relentless determination of anthropologists hot on the trail of Cro-Magnon Man as they track down their computing and calculating artifacts. A trip to England yields a complete Williams tube, a console of an IBM 360/195, and a logic door from the Ferranti Mark I from the University of Manchester. A trip to North Bay Ontario by Jamie Parker helps the museum acquire that huge mastadon of computing—the AN/FSQ-7. This computer, sometimes called Whirlwind II, operated around the clock for more than 20 years as a key component of the SAGE air defense system. It's difficult to imagine what anyone could do with the machine, but the Computer Museum will find a place for it.

The museum contains components from many of the famous early computers like the ENIAC. There is a selection from the mercury delay line storage element in the EDSAC, the world's first stored program computer. Other early computers represented include Lincoln Laboratories' TX-O and IBM's first computer, the 701. As computers have shrunk in size, the museum has been able to include entire machines, like the PDP-1,

DEC's first computer, and the MITS Altair.

The transistor is celebrated with an exhibit and a deadpan quote from its inventor, William Shockley, who said in 1939, "It has occurred to me that an amplifier using a semiconductor rather than a vacuum is, in principle, possible."

10,000 VISITORS EXPECTED

Who visits the Computer Museum? This year well over 10,000 visitors are expected to tour the exhibits and to sit in on the various lectures and seminars the museum presents. "The number of industry VIPs is very high," says Ms. Bell. "One recent visitor was a director from Matsushita—a very busy man who just had to see the museum. On the other hand, we get a lot of computer people who come by with their mothers-in-law to show them why they're not home at night."

Indeed, a casual stroll through the museum will usually find a computer person explaining computers to his family. Often they've had difficulty articulating precisely what computers are, and the museum's exhibits humanize the phenomenon for them and their families. Many visitors are from Digital Equipment Corp., which has been the museum's primary source of support to date.

The museum sponsors six major annual lectures by pioneers as well as a series of seminars that range from demonstrations of computer music to discussions on the use of an old machine, such as a talk by ENIAC user Richard Clippinger, the first to propose a stored program for the famous machine.

The lectures are videotaped for the use of scholars in the future. Sometimes new information or new perspectives develop from the lectures; for example, after Dr. Herbert Grosch gave a talk on the 1945-1950 years at the Watson Scientific Laboratory at Columbia University and the development of the selective sequenced electronic calculator there, the museum's officials decided that the machine was more important than had previously been thought. One result is that the SSEC will get a place in the museum's Pioneer Computer Timeline, which displays the evolution of computers.

Grosch, who was working at the Watson Laboratory at the time, indicated that the ENIAC helped push IBM to design the SSEC. "For the first time IBM felt threatened by a development that it had not really foreseen or understood," Grosch recalled in his lectures. "Thomas Watson Sr. . . . was incensed that someone would produce something that he didn't know about and hadn't sponsored.

"A group of people were brought together to write the specifications for a gigantic new machine, the SSEC. The design of the SSEC went ahead day and night, seven days a week at the IBM engineering laboratory at Endicott. The machine was put together at Endicott, run, taken apart, and moved to New York City. At the [dedication] luncheon," Grosch said, "the old man got up and told us how he loved us, how wonderfully we had behaved, and how we were all part of the IBM family. It was a fantastic exhibition of the kind of excitement that Watson, then in his mid-70s, could generate."

HUMAN SIDE OF COMPUTING

Other speakers at the museum have also caught the human side of computing, a side so often lost in all the babbledegook of bits, and bytes, and bauds. Maurice V. Wilkes, designer of the EDSAC, recalled the point when he discovered that computer programming would not be an easy chore. "As soon as we started programming," Wilkes recalled, "we found to our surprise that it wasn't as easy to get programs right as we had thought. Debugging had to be discovered. I can remember the exact instant when I realized that a large part of my life from then on was going to be spent in finding mistakes in my own programs."

Jay Forrester, director of Project Whirlwind, ticked off some of the great accomplishments of the project: "Magnetic core storage, marginal checking, high reliability, cathode-ray displays, a light gun, and a kind of timesharing were all part of Whirlwind."

Dr. Gene Amdahl, the world's premier designer of computers, told a crowd at the museum in March about his early computer designs—about his WISC (Wisconsin In-

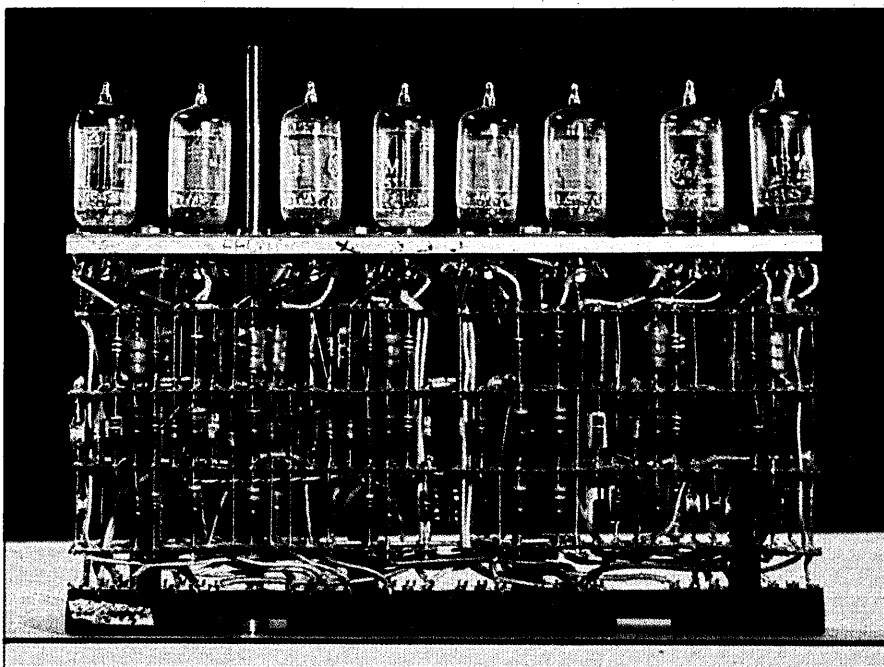

Left: a prototype of the on-board guidance computer from the Apollo space program. Above: A Vacuum tube module from the 701, IBM's first computer.

Most fun of all is the PDP-1 display, complete with a working version of Space War, the granddaddy of all computer games.

tegrally Synchronized Computer) floating point machine, developed in his graduate school days at the University of Wisconsin in the late 1940s, and his design of IBM's 704, still considered by computer architecture buffs to be the most elegant machine design ever accomplished at IBM. And, in addition to providing some details about his design of IBM's 360 family, Amdahl even spoke of his new "superchip," which makes it possible to place an entire large-scale IBM computer in a 2½-inch cube. He is designing the superchip at his new company, Trilogy Systems. It would be difficult, if not impossible, for a museum in another field to present a lecturer who can speak with intimate knowledge about early inventions—in Amdahl's case, the Ice Age of Computing—and at the same time look into the outer space of technology and predict the future with some precision.

"We try to have lecturers who make things happen," says Ms. Bell. "We have what we call 'our first row group' at the lectures. They show up early to get seats in the front. The lectures and seminars are a very high priority for them."

The museum has gone to great pains to maintain its neutrality and tries to be dispassionate about giving credit for computing achievements. An example: one museum lecturer was Dr. John V. Atanasoff, the inventor of what many believe was the first automatic electronic digital computer. Understandably, perhaps, Atanasoff is not popular with the "old boy" network of computing associated with the ENIAC, which believes it invented the first automatic electronic digital computer. But Atanasoff was invited anyway and a copy

of the ABC machine he developed at Iowa State University in the late 1930s is prominently displayed in the museum's Pioneer Computer Timeline. Museum officials don't think that giving Atanasoff credit for his work takes anything away from the brilliant achievement of the ENIAC.

How is one to decide who invented the microprocessor? The museum simply displays Intel's 4004 and 8008 side by side. Designed in 1969, the microprocessors—the first central processing units contained entirely on chips—were both made by Intel, but the 4004 was designed by Intel's Ted Hoff and the 8008 by Datapoint's Victor Poor. Intel claims Hoff invented the microprocessor while Datapoint says that Poor was the inventor. The debate no doubt will continue for years. Museum visitors can look at both chips and blowups of each design and make up their own minds on the issue.

There is another interesting example of an effort to be objective that could not have been accomplished without some pain: a copy of Data General's Nova, the first 16-bit MSI computer, is given a prominent display in the museum in spite of the fact that a bitter vendetta existed between Data General and Digital Equipment for many years. Photos of the Data General founders—once regarded as traitors when they left DEC to form their company—are displayed, but there are no photos commemorating Kenneth Olsen, DEC's president, or any other DEC principals.

The two companies are fused in another way: there is an exhibit of DEC's famed PDP-8, the 12-bit minicomputer that sparked the minicomputer revolution and propelled

Digital Equipment into the front ranks of the computer industry. While the machine was designed at DEC under the aegis of Olsen and Gordon Bell, another key designer was Edson de Castro, who, of course, went on to become president of Data General.

FORCE BEHIND MUSEUM

Olsen was the main force behind the establishment of the museum. Joining with Bob Everett, the president of Mitre, he bought the Whirlwind computer just before it was to be consigned to a junkyard. The two men, both of whom had worked on the Whirlwind after the World War II, stashed the machine away in a DEC warehouse. Another computer equipment junkie, Gordon Bell, vice president of engineering at DEC, had long been collecting old computing and calculating artifacts with his wife, Gwen, now the museum's director. Ms. Bell recalls the Bell house piling up with pieces from old computers and calculators. Finally, on a trip to Fujitsu's headquarters in Japan, where Gordon Bell observed Japanese engineers proudly showing off an early relay computer, he decided there must be a way to display some of the early equipment that he and Olsen had collected. With that, the museum was established in 1979 and it has been growing ever since. DEC has been godfather to the museum, but has been moving away from active involvement in the endeavor as the museum moves toward its ultimate goal of being entirely independent and, one day perhaps, moving into the immediate Boston area where it would be accessible to more people.

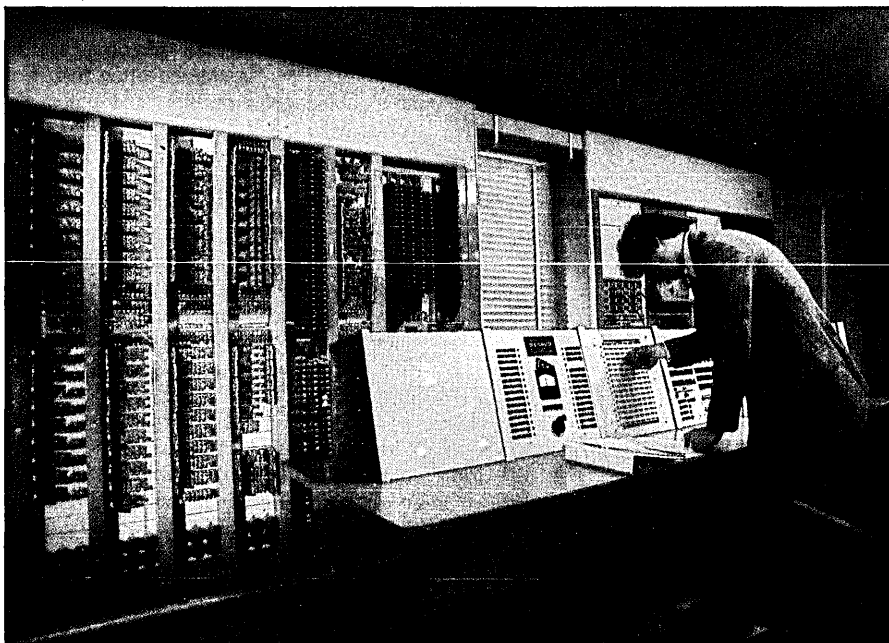

This TX-O computer from Lincoln Laboratories, an MIT affiliate, was successfully used to test early transistors.

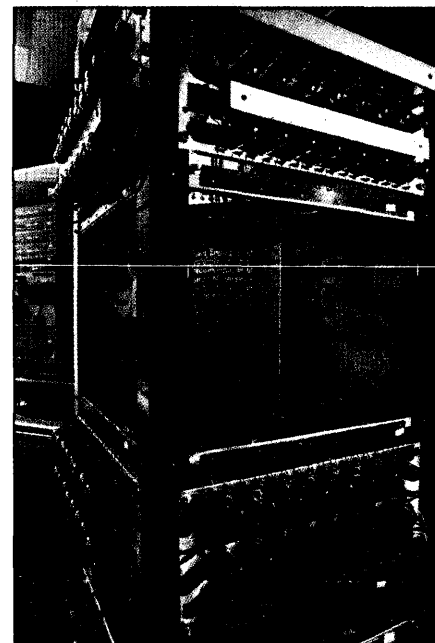

The vacuum tubes on the Whirlwind computer still work.

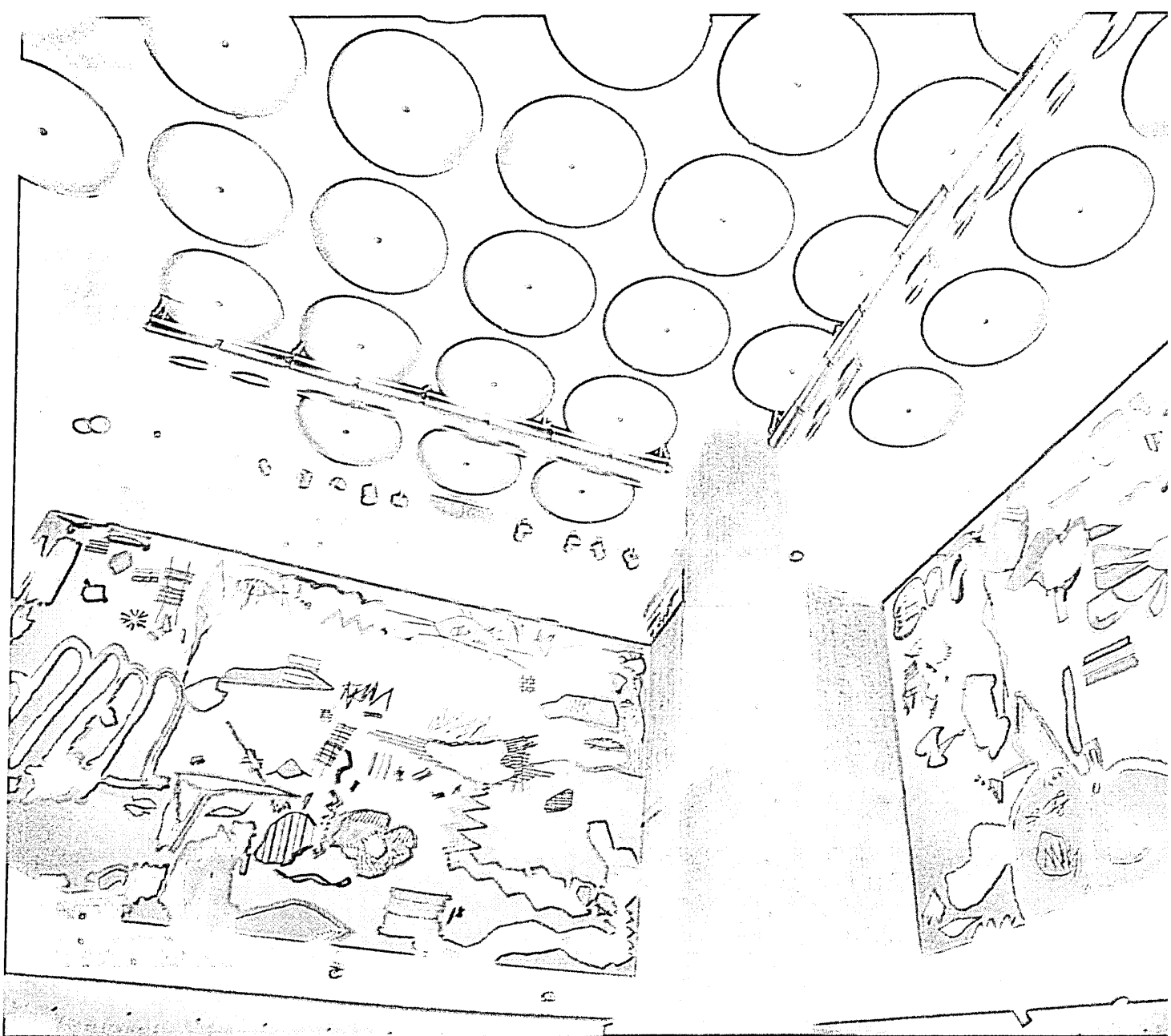

The museum's entrance is dominated by Harold Cohen's bright murals.

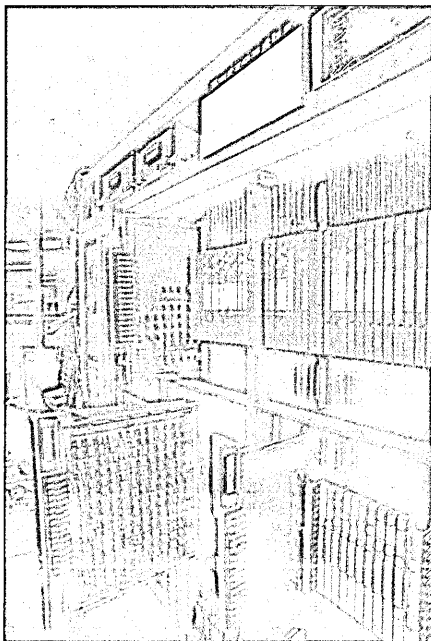

The ILLIAC IV. This 2 MIPS machine was the most powerful of its time.

There's even a whiff of fun around the museum. Maurice Wilkes may be famed as a great inventor, but at the museum he's established himself as a Renaissance man as well. Wilke's play on Charles Babbage entitled *Pray, Mr. Babbage* was produced recently in the museum by a professional repertory company. It was well received, and friends and associates of the septuagenarian scientist have good-naturedly been urging him to embark on a playwrighting career.

One of the most unusual exhibits is the Tinker-Toy computer, a real working computer that is unbeatable at tic-tac-toe. It was designed using a Lisp program on a PDP-10 at MIT's Artificial Intelligence Lab. The Tinker-Toy parts are supplemented with brass pins, tiny lead weights, and string. The machine is currently "down"—its wooden parts temporarily stuck.

Most fun of all, though, is the PDP-1 display, complete with a working version of Space War, the granddaddy of all computer games. The game was created by a group of hackers at MIT. Some of the former MIT stu-

dents come back from time to time and the museum people say that the game and the memories it brings back often bring tears to the eyes of the players.

Space War was the precursor of all computer games and even to some extent to the video game-space movie craze that has swept the world in recent years. Space War had rockets, joysticks, torpedoes, explosions. Tapes of Space War spread around the world and the game began showing up on PDP-1s all over and, finally, on research computers just about everywhere. Today, attorneys representing the video games companies come to watch Space War as they fight over precisely who owns what rights to the various computer games. Like other visitors, the attorneys are finding that the best place to learn all about the historical side of computers is the Computer Museum. *

A former editor of DATAMATION, Dave Gardner frequently contributes articles on computer industry subjects to this magazine.

9600QP

The newest LSI high-speed member of our DataComm Modem family gives you high reliability with error-free throughput and quick polling with training on data at a surprisingly low price.

The 9600QP is completely compatible with GDC's DataCommonality and NETCON[®]-5 Network Management System.

- Private line point-to-point or multipoint
- 40 or 80ms Quik-Poll
- 7200 or 4800 bps fallback
- CCITT V.29 compatible
- Powerful automatic equalizer
- Remote loopbacks
- Train on data

Introducing: The 9600QP Quik-Poll™ Modem

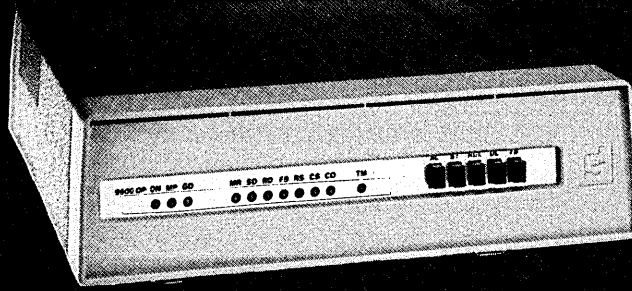

GDC's entire modem product line features advancements such as comprehensive built-in local and remote diagnostics, advanced large scale integration, state-of-the-art microprocessor technology and inter-product commonality. Only GDC offers such a complete line of modems, multiplexers, network management systems as well as custom designed OEM products. And, GDC supports their complete product line with an extensive nationwide service program. No one takes the work out of networking like General DataComm.

MEGAMUX[®]

Super powerful data/voice multiplexer transmits voice and data to 2 Megabits with non-interfering automatic system reconfiguration.

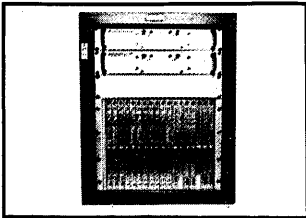

NETCON[®]-5 NMS

The most versatile network management system, NETCON-5 is easily integrated with all user networks. Wraps around any datacomm hardware, offering centralized supervision, diagnostics and restore. True Network Management for • analog • digital • DDS • local area • multiplexers • financial loops

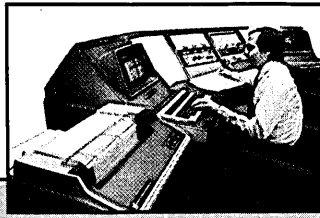

MULTIPLEXERS

Widest range of Frequency Division, Time Division, Statistical and Polling Multiplexers for the simplest to most complex networks.

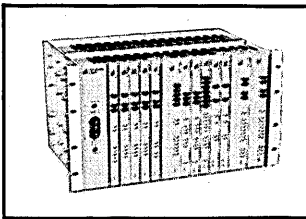
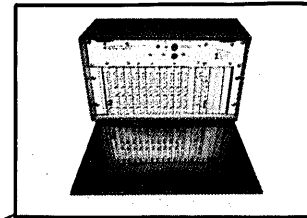

DATACOMM MODEMS

All speeds, all models for analog, digital and local area networks.

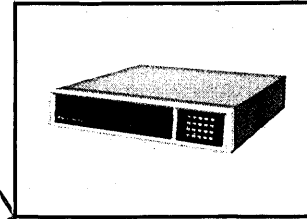
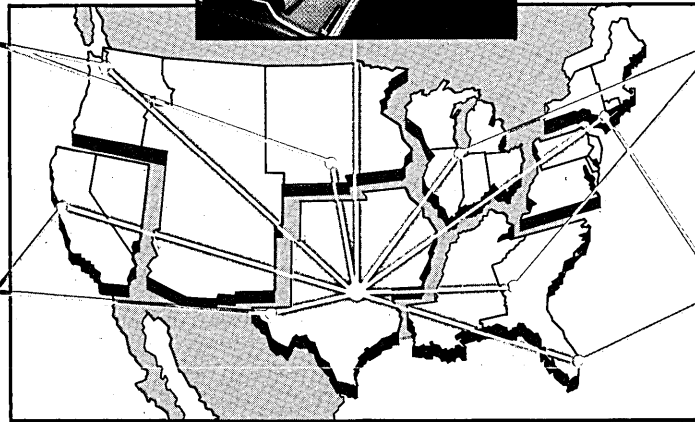

GEN-NET™

Statistical Network Concentrator, expandable, up to 96 channels, 4 composites to 168 Kbps.

THE GREAT AMERICAN TELECOMM PUZZLE...

When it comes to Systems and Solutions no one can match GDC's combination of advanced technology, product diversification, network management and service. Our competitors may talk about dealing with pieces of the puzzle, but ...

GDC CAN TIE ALL THE PIECES BACK TOGETHER FOR YOU

U.S. Business User Sales: Atlanta, GA (404)955-0682; Boston, MA (617)229-2740; Chicago, IL (312)298-4181; Dallas, TX (214)980-0803; Detroit, MI (313)540-4110; New York, NY (212)423-5080; San Francisco, CA (415)569-3115; Santa Ana, CA (714)957-0244; Washington, D.C. (301)596-0888.

U.S. Telecomm Sales: Atlanta, GA (404)993-2596; Chicago, IL (312)653-9262; San Francisco, CA (415)924-7799; Santa Ana, CA (714)957-0244; St. Louis, MO (314)441-9055; Mt. Laurel, NJ (609)235-5367; New York, NY (914)969-5162; Middletown, NY (914)343-2882; Washington, D.C. (301)428-3311; Dallas, TX (214)241-5383; Seattle, WA (206)355-4800; Puerto Rico (809)792-6855.

A Member of The GDC Family of DataComm Modems

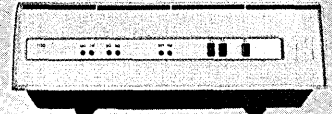
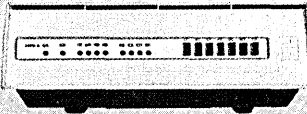

HIGH SPEEDS

DataComm 208B/A
Bell 208 compatible 4800 bps switched network or private line with 25ms Quik-Poll™

DataComm 4827
V.27 bis compatible async/sync 4800 bps private line with 2400 bps fall-back and 25ms Quik-Poll

DataComm 4800
Async/sync 4800 bps (208A) private line with 25ms Quik-Poll

DataComm 9600
9600 bps point-to-point full-duplex private line with 4800 bps fallback

DataComm 9600QP
Symmetrical multipoint 9600 bps private line with 40-80ms Quik-Poll

GDC 9604*
9600 bps sync full-duplex with integral 4 channel mux

MEDIUM SPEEDS

DataComm 201C
2400/2000 bps direct connect Bell 201B/C and CCITT compatible, private line

DataComm 201CK
2400/1800 bps auto-dial async/sync, switched network, half-duplex. Bell 201C compatible.

DataComm 201-7
Private line 2400/1200 bps sync with low error rate

DataComm 201-8
Sync/async 2400/1800/1200 bps private line with signal quality monitor for NETCON application.

DataComm 2400 ASM
Sync/async 2400/1800/1200 bps full-duplex point-to-point or multipoint

DataComm FLM 2447
IBM 3600/4700 financial loop replacement, 1200/2400/4800 bps, automatic adaptive line equalizer

LOW SPEEDS

DataComm 103J-M
Low cost 300 bps dial network originate/answer

DataComm 202S/T
1200/1800 bps async switched network/private line. 5 band reverse channel.

DataComm 202T
Async half- or full-duplex 1200/1800 bps private line. Bell 202T compatible.

DataComm 212A
Full-duplex, async/sync 1200/300 bps switched network private line. Port security.

DataComm 212M
1200/300 bps async/sync switched network. Bell 212A compatible

BASEBAND

GSU-1M*

Sync local wire line data to 9600 bps. Fully automatic line equalization.

LCM 2020*

Sync point-to-point/multidrop 2.4 to 19.2 Kbps, switch selectable

DataComm NMS 2020
Sync wire line data to 19.2 Kbps with integral NETCON-5 diagnostics

Downline NMS programmable automatic line equalization

LCM 1010/1020*

Async to 19.2 Kbps with switch-selectable equalizer

DATA SERVICE UNIT

GSU-500B*

2400, 4800, 9600 bps Bell DSU-500B replacement switch selectable speed, diagnostics or NETCON-5 diagnostics.

MULTIPLEXER

1209R

Lowest cost, smallest size, least power 4-channel async TDM on market

*Does not fit into DataComm shelf.

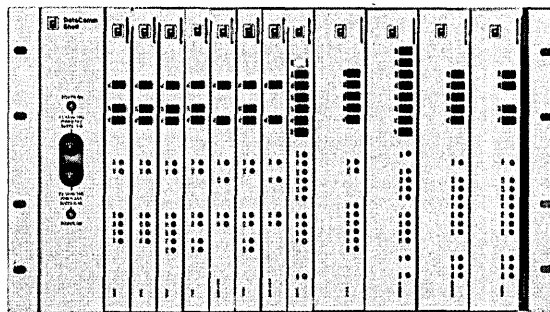

DATACOMMONALITY

Only GDC modems feature DataCommonality, an advanced packaging technique enabling the same GDC card to be mounted in either a standalone enclosure or high-density rackmount unit — accommodating up to 16 cards.



**General
DataComm**

General DataComm Industries, Inc., One Kennedy Avenue, Danbury, CT 06810 (203)797-0711
General DataComm Industries Ltd., Suite 410 West, 2255 Sheppard Avenue East, Willowdale, Ontario M2J4Y3 (416)498-5100
General DataComm (UK) Ltd., Toulley Road, Wokingham, Berkshire, RG11 5QN, England (0734)791 444

SEE US AT ICA: Anaheim, Booth 1340
 CIRCLE 273 ON READER CARD

How do you create a microcomputer to match the power of the UNIX™ operating system?

Imagine. You are perfecting a revolutionary operating system. In about two years, it will be the system of choice for 16-bit microcomputers.

It will be called the UNIX operating system.

But the breakthrough features of this operating system are going to make stringent demands on the computer.

The microcomputer developed specifically for the UNIX operating system more than two years before its commercial distribution is called ONYX.™

ONYX will live up to every demand and expectation.

To achieve the ultimate flexibility, simplicity, efficiency and productivity, the UNIX operating system will incorporate a file system of highly uniform sets and sub-sets of directories, arranged in a tree-like hierarchical structure.

And flexible directory and file protection modes, allowing all combinations of "read," "write," and "execute" access, independently for each file or directory, or for a group of users.

But these advantages will require intensive disk access, and superior memory management. In simple language, disk access must be as fast as possible, and the disk must have an unusual capacity to maintain complex file systems on-line at all times.

Floppy disks with their low capacities and high access times won't do.

Winchester disk drives that utilize slow-moving stepper motor head positioning devices won't do.

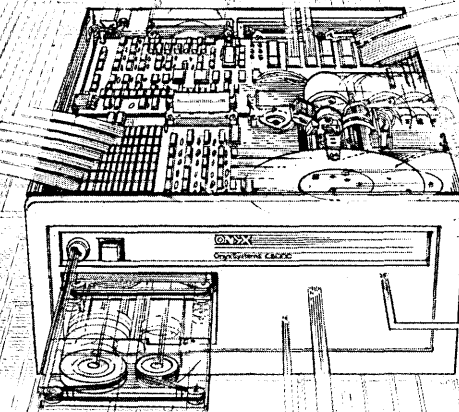

ONYX's IMI Winchester disk storage system, with its servo-driven voice coil head positioning, is more than twice as fast!

So, obviously the ONYX C8002 will do.

And, as developed, the ONYX C8002 features expandable memory up to 1 Mbyte, and disk storage up to 160 Mbytes on-line. Its cartridge tape backup offers cyclical redundancy checking on every backup. Both the Winchester disk storage system and the cartridge tape backup are *internal*.

In the UNIX operating system environment, the disk becomes an extension of main memory. "Swapping" programs between the disk and main memory

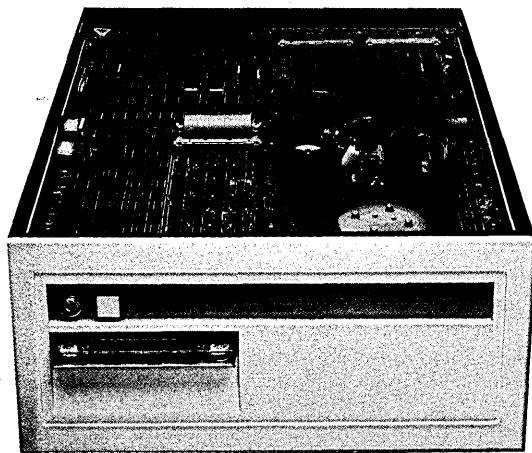

increases the number of operations that can run concurrently. ONYX's memory management system utilizes "scatter" instead of "contiguous" allocation, and the more efficient swapping minimizes demand on the disk channel. That's why ONYX assures a highly efficient environment for the UNIX operating system.

Now it's 1982. The UNIX system's preeminence among 16-bit operating systems is established. And ONYX is the only company that has significant production experience with UNIX systems.

ONYX has installed over 1500 UNIX systems.

Today there are a lot of systems being developed to operate UNIX (and "look-alike") operating systems. But there are many reasons why you should consider ONYX and the UNIX operating system as inseparable.

System III available now for immediate delivery.

Phone this special number: (408) 946-6330 Ext. 251. Ask about these System III enhancements, including:

- Multi-key index sequential files under RM COBOL;
- "Term Cap" capability that supports a wide variety of terminal interfaces;
- Enhanced printer handling capability;
- SCCS to maintain edit histories in text management applications.

*UNIX is a trademark of Bell Laboratories.

Make the Connection

ONYX UNIX

OPERATING SYSTEM

Onyx Systems Inc., 25 East Trimble Road, San Jose, CA 95131

CIRCLE 162 ON READER CARD

Library reference guides help programmers find the routines they need quickly and efficiently.

CATALOGING THE PROGRAM LIBRARY

by Melinda Thedens

Donna Williams is a macro programmer. Sitting at a terminal, she scrolls through a long file, looking for a routine to use. She isn't sure there is one. Ten minutes later, she gets up to search for another programmer who may know where to find such a routine.

John Cooper has been hired to write a section of code for a project that's already in progress. No one has the time to train him, so he is expected to find what he needs by experimenting or asking someone. John sits at his desk, combing through a pile of listings to get a feel for the resources available to him.

Programmer time is expensive. Deadlines are always staring you in the face. How can you help your programmers make more efficient use of their time? You probably have a library of routines and tools so that programmers don't waste time rewriting them for each application. To use the library effectively, programmers need to know what routines are available and how to call them. If it's faster to write a routine than to find one in the library, your library isn't serving its purpose.

You can put the time spent searching for routines and tools to better use if you provide a library reference guide. It could be an on-line query program, a traditional manual that each programmer can keep on his or her desk, or a combination of both. As long as it's well designed and up-to-date, a library guide will help programmers save time.

The guide has two functions: it helps programmers find the routine they need, and it tells them how to use it.

The library's organization and index should function like a card catalog, reflecting the programmer's way of thinking about library routines. Sometimes programmers remember a routine they'd like to use, but not how to use it. They may or may not remember its name. Other times they have a function in mind and aren't sure that the routine exists. The ideal organization, then, is by

function, with each routine indexed by tasks performed as well as by name. The index may be on paper, directing programmers to a page in a manual or it may be keywords that call up a file or choice of files on-line.

Without a library reference guide, a programmer must study the code to see what a routine does. With one, he can glance at a functional description to find that information. To use a routine, programmers need to know what the routine does and doesn't do; the setup required, if any; input: what and where; output: what and where; what gets destroyed or altered in the process; and where to find it.

Since the purpose of a library guide is to save time, make sure that everything the programmer needs to know about a routine is included in its description. Although it might seem reasonable to put the information that is common to several routines in one chapter, remember that when a programmer wants to use a routine, he is interested only in that routine. Programmers won't be reading the library as if it were a novel. Each description should be complete in and of itself, even if the same information is repeated for many routines.

Because programmers are looking for a routine by its function, it makes sense to organize the library guide along those lines. You might group stack routines together, conversion routines together, and so on. If you organize routines by what they do, you can later split the library guide into smaller, easier-to-handle booklets when it becomes too large. If possible, provide labeled tabs or dividers for each section. The fewer steps needed to look something up, the better.

INDEX BY NAME AND TASKS

Index each routine by name and by task(s) the routine performs. Describe each routine in a two- or three-word sentence containing a subject, a verb, and possibly a modifier. A programmer may look for a routine by its subject

(a file block, a flag, a stack) or by the action she plans to take (initialize, open, read). For example, a routine called INIT may INITIALIZE a FILE. This routine should be indexed under INIT; INITIALIZE, FILE; and FILE, INITIALIZE. Think of the index as a series of pointers to where the information resides.

If your library guide is going to be on-line, it won't need chapters, but it will need separate text files for each topic. The smaller the files, the less scrolling and searching someone must do to get information. As with a printed manual, however, each file should contain all the information a programmer will need to use a routine, and should be indexed thoroughly. A programmer needs to locate information about library routines by more than one topic, especially when routines are complex and perform several functions. This suggests a hierarchy of keywords, much like the indexing used in hardcopy manuals.

The implementation of a keyword scheme depends on the system you start with and the resources available to you. It can be menu or command driven, or it can be a menu program that accepts typed-in data. Programs that are completely menu driven may frustrate programmers, who are accustomed to the flexibility and speed of direct access to data.

You need a way to associate keywords with files. You can search through the text of each file to find a match, but that's slow on most systems—especially if the library is a large one—and limits you to an exact match.

A quicker way is to store all keywords in one file as if it were an index. When a programmer enters keywords (or selects them from a menu), the query program locates the matching keyword string in the keyword file. That string could be associated with a specific file or with several secondary keywords.

Although there are a few ways to select files in a keyword system, each file must be uniquely identified by at least one combination of keywords. You could have, for in-

The implementation of a keyword scheme depends on the system you start with and the resources available.

stance, several files with the keyword INITIALIZE; to distinguish between them, you might also assign the name of a routine to each file. A file describing the INITST routine might be assigned the keywords INITST, INITIALIZE, and STACK. This file could be uniquely identified by the keyword string INITIALIZE STACK INITST (in any order) or by the keyword INITST. A programmer entering INITIALIZE STACK may get a list of two files (or two secondary keywords) to choose from, while a programmer entering INITIALIZE may get a large list of possibilities. An on-line guide using keyword selection might look like this:

Enter one, two, or three keywords:

1 _____ 2 _____ 3 _____

There are two files related to INITIALIZE STACK:

INITIALIZE STACK NEW	INITST
INITIALIZE STACK EXTEND	INITEX

Enter additional keyword or press EXECUTE to end program:

3 _____

MENU THAT RESEMBLES AN INDEX

Another method is to create a menu that looks like a traditional index, comprised of the available keyword combinations. The programmers position a cursor on one of the entries to select a file. Where two or more files could be tied to a keyword string, the entry produces a directory of those files and the means to select one. An index-like menu requires some way to get to the middle or end of the alphabet quickly. On some systems you can enter the first letter to get to the right section. On others, the main menu might list the menu pages with all the proper keyword strings, or only primary keywords, as in this scheme:

Position cursor and select one by pressing EXECUTE:

INITIALIZE
INITEX
INITST

There is one file and there are three keywords for INITIALIZE. Select one:

FILES	keyword
IMPURE	keyword
PROGRAM	file
STACKS	keyword

The larger the documentation database, the more likely it is to require several layers of keywords. If the program accepts more than one keyword at a time, you speed up the process of getting to the right file.

How "intelligent" the query program is depends on your resources. It could check keyword spelling, offer alternative keywords, and permit selection based on AND or OR. It might simply list files related to a keyword and leave it to the programmer to call up the file(s) that interest him.

CHECKLIST FOR MAINTAINING THE SYSTEM

New Routine

1. Gather all information
2. Call up the template
3. Fill it in and edit
4. Add name of routine and all possible keywords to index
5. Add to table of contents
6. Test description for accuracy
7. Print out the page or add it to the on-line query system
8. Announce the routine to all programmers

Existing Routine

1. Gather all information
2. Call up the file
3. Fill in the DATE UPDATED section
4. Make the modifications and mark with update bars
5. Change index entries, if appropriate
6. Print out the page, if it's on paper
7. Announce the change to all programmers

Once the program is in place, as with printed manuals, anyone can add or modify descriptions. One advantage of a well-designed on-line library guide is that memos can be made available through the program by adding keywords to the text file.

When writing the library guide, make sure it is task oriented. The routine's development history is irrelevant here; an audit trail of fixes and updates belongs elsewhere.

If a complex routine has several options, begin with a general description and then detail each option separately. The result is a clear, uncluttered "how to" without exceptions to the rule, changes in syntax, or complex choices.

Examples can clear up the most difficult concepts. Illustrate the stack the programmer must set up, show a sample of the code required to call the routine, or draw a diagram of the interface block. Use lists and tables instead of paragraphs whenever possible. Keep to the point and use short, imperative sentences in the active voice.

Next, you must design a form, or template, that can be used for each routine. Choose informative headings and put the information most often needed at the top of the display or page. If the page format is consistent, programmers will be able to pick out the information they need without reading through the entire page.

Your template headings might look like this:

Description
Format
On Entry
On Return
On Error
Requirements

Options
Special Case
Examples
Updated
Found in
See Also

You won't use all the headings for each routine, so delete those that don't apply.

KEEP IT SIMPLE AND EASY

Now you are ready to consider maintenance. The most important thing to keep in mind is simplicity. Make it easy to add new or change old routines' descriptions.

Page numbering can be a real headache or can make updating easy. Avoid paragraph numbering. Such numbers change constantly, and are unnecessary in a well-organized guide with a standardized layout. If the routines are in small task-related sections, number pages by section and by page within each section. Add new routines at the end of a section to avoid any changes in page numbers. If an update to an existing routine changes the page numbers, it affects only that section. Keep the sections relatively small.

If possible, let the computer keep track of the numbers for you. Some text editors even have automatic cross-referencing; find out if yours does. Use a global search and replace function (most editors have one) to locate changes that affect more than one routine.

Updating an on-line query system can be fantastically easy. Query the system for the topics that have changed, then modify the files. If you "write protect" the information, provide a way to specify an EDIT mode so that updating is as easy as retrieving information.

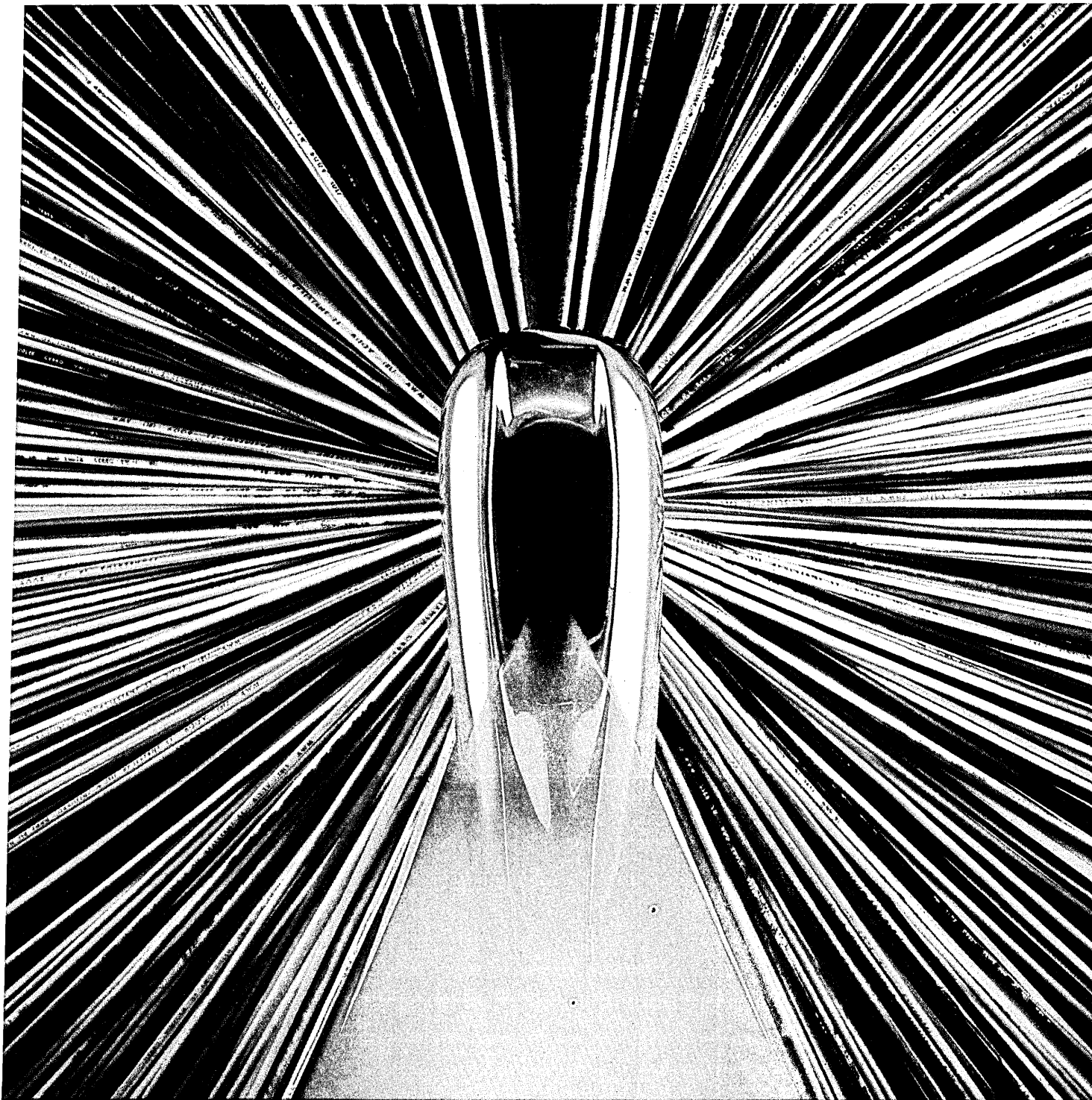

When we thread the needle, communication costs less.

The 3M Videodata® System carries thousands of messages on a single cable. It's an information utility that's cutting communication costs for 250 companies worldwide.

One cable is threaded through a factory or any spreadout institution. Up to 10,000 information sources can be connected. Computers, word processors, TV monitors and more can handle data simultaneously and never interfere with each other.

Our system can cut installation and expan-

sion costs in half compared with the cost of routing and re-routing conventional two-wire hookups.

Hearing the needs of the information age has helped 3M pioneer over 600 products for the voice, video and data communication field. We make everything from computer diskettes to high-speed translators that put computer data on microfilm.

And it all began by listening.

3M hears you...

For your free 3M Voice, Video and Data Communications Brochure, write: Department 053205/3M, P.O. Box 4039, St. Paul, MN 55104.

Name _____

Address _____

City _____ State _____ Zip _____

Or call toll-free: 1-800-323-1718, Operator 365. (Illinois residents call 1-800-942-8881.)

Program libraries are dynamic, not static; the guide describing them must also be dynamic.

If you have selected your keywords well and provided enough cross-referencing, the job of updating should be almost no job at all. You might also include a file called UPDATES, so that programmers can get a quick look at recent changes.

The last part of designing the guide is organizing the routines by task. Create a table of contents according to the organization you have designed and begin filling in the template for each routine, indexing as you go.

Once the template is in place, writing a description is relatively simple. Copy the template into a text file (you may have a separate text file for each routine, or use one file for a whole section). The template headings should remind you of all the information programmers require to use the routine. Put only a general description of function in the "description" section, since most of it belongs under specific headings such as "error handling" or "input arguments."

Be lazy. If you need to explain the concept of a procedure for more than one routine or option, use your text editor to copy those lines where needed, then modify them to fit each routine. Take the examples from someone's code instead of inventing them, if

possible. Realism is important, and besides, it's less work.

UPDATING THE SECTIONS

Writing about a routine is only the beginning. Program libraries are dynamic, not static; the guide describing them must also be dynamic. Establish clear communication channels between programmers and the person in charge of the library reference guide. In a large programming group, code may change almost daily; the document describing it must change just as frequently.

Accuracy is important. When a programmer finds an inaccurate statement, the whole manual appears unreliable. Inaccuracy comes from omitted information, information presented in the wrong order, typographical errors, or ambiguous descriptions. To avoid these problems you must test the documentation as you would test code.

Instead of issuing memos to describe a change, update the corresponding page in the manual. An updated manual makes a better reference than a collection of memos. Update bars help programmers identify the most recent changes without having to read the

whole description again. The date that the routine and the documentation was last changed tells a programmer how recent the description is, and may alert her to check it out if it's old. Programmers should read a library guide only when they need a routine, not each time someone makes a change to the library. The information will be there when they need it.

A program library reference guide will increase your programmers' efficiency by giving them quick access to the information they need. Donna Williams, the experienced programmer, won't waste time scrolling through a long file to find a routine. John Cooper, the new hire, will get up to speed quickly since he won't have to read listings to learn what routines and tools are available to him. Best of all, their time will be put to productive use, moving the project along to completion. *

Melinda Thedens is currently a software communicator for ATEX Inc., Bedford, Mass. Before joining ATEX, Ms. Thedens was a senior technical writer with Bolt, Beranek, and Newman, in Cambridge, Mass.

PopComTM

PERSONAL COMMUNICATIONS

© BRICKER ASSOCIATES 1982

CIRCLE 74 ON READER CARD

250 DATAMATION

TERMINALS FROM TRANSNET

PURCHASE PLAN • 12-24 MONTH FULL OWNERSHIP PLAN • 36 MONTH LEASE PLAN

DESCRIPTION	PURCHASE PRICE	12 MOS	24 MOS	36 MOS
LA34 DECwriter IV Forms Ctrl.	\$1,095	\$105	\$ 58	\$ 40
LA100 Letter Printer RO	1,995	190	106	72
LA120 DECwriter III KSR	2,295	220	122	83
LA120 DECwriter III RO	2,095	200	112	75
LA12A Portable DECwriter	2,950	280	155	106
VT100 CRT DECscope	1,695	162	90	61
VT101 CRT DECscope	1,195	115	67	43
VT125 CRT Graphics	3,295	315	185	119
VT131 CRT DECscope	1,745	167	93	63
VT132 CRT DECscope	1,995	190	106	72
VT18XAC Personal Computer Option	2,395	230	128	86
T1745 Portable Terminal	1,595	153	85	58
T1765 Bubble Memory Terminal	2,595	249	138	93
T1940 CRT	1,795	173	96	65
T1785 Portable KSR, 120 CPS	1,795	173	96	65
T1787 Portable KSR, 120 CPS	2,195	211	117	80
T1810 RO Printer	1,695	162	90	61
T1820 KSR Printer	2,195	211	117	80
ADM3A CRT Terminal	595	57	34	22
ADM5 CRT Terminal	645	62	36	24
ADM32 CRT Terminal	1,165	112	65	42
CIT-101 CRT	1,525	147	82	55
CIT-161 Color CRT	2,675	257	143	97
CIT-427 Color Graphic CRT	3,095	297	165	112
TELEVIDEO				
910 CRT Terminal	650	62	36	24
925 CRT Terminal	850	82	46	31
950 CRT Terminal	1,075	103	57	39
NEC SPINWRITER				
Letter Quality, 7715 RO	2,695	259	144	98
Letter Quality, 7725 KSR	3,195	307	171	115
GENERAL ELECTRIC				
2030 KSR Printer 30 CPS	1,195	115	67	43
2120 KSR Printer 120 CPS	2,195	211	117	80
EPSON				
MX-80 F/T Printer	745	71	42	27
MX-100 Printer	895	86	48	32
TIMEPLEX				
E0400 4 Channel Stat Mux	1,525	147	82	55
E0800 8 Channel Stat Mux	2,050	197	110	74

*DEC is the trademark of Digital Equipment Corporation

FULL OWNERSHIP AFTER 12 OR 24 MONTHS • 10% PURCHASE OPTION AFTER 36 MONTHS

MICROCOMPUTERS
APPLE • COMMODORE • HP87 • DEC

ACCESSORIES AND PERIPHERAL EQUIPMENT
ACOUSTIC COUPLERS • MODEMS • THERMAL PAPER • RIBBONS • INTERFACE MODULES • FLOPPY DISK UNITS

TRANSNET CORPORATION
1945 ROUTE 22 • UNION, N. J. 07083 • (201) 688-7800
TWX 710-985-5485 800-526-4965 OUTSIDE N. J.

CIRCLE 75 ON READER CARD

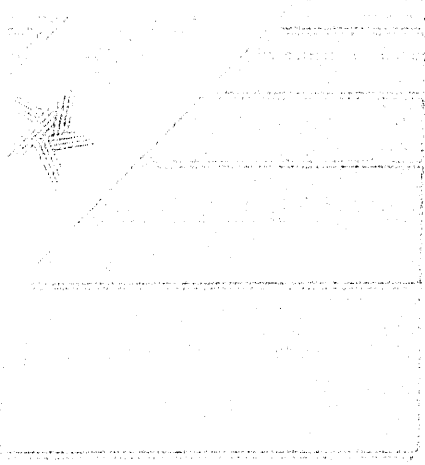

D B M S

DESIGN

IBM DBM/VS2 PROVIDES THE MOST ADVANCED DBMS EVER BUILT

PERFORMANCE

IBM DBM/VS2 PROVIDES THE MOST ADVANCED DBMS EVER BUILT

RELIABILITY

IBM DBM/VS2 PROVIDES THE MOST ADVANCED DBMS EVER BUILT

END USER

IBM DBM/VS2 PROVIDES THE MOST ADVANCED DBMS EVER BUILT

SECURITY

IBM DBM/VS2 PROVIDES THE MOST ADVANCED DBMS EVER BUILT

IBM SUPPORTS IBM MAINFRAMES AND OS, OS, VM/CMS THE MOST ADVANCED DBMS EVER BUILT

U.S.

INTERNATIONAL BUSINESS MACHINES CORPORATION
NEW YORK, NEW YORK
IBM DBM/VS2
IBM DBM/VS2
IBM DBM/VS2

IBM DBM/VS2
IBM DBM/VS2
IBM DBM/VS2



Its time to put the myth of increasing software dominance to rest, says the man who feels responsible for starting it.

THE HISTORY OF MYTH NO.1

by **Werner L. Frank**

In 1978, I published an article entitled, "The Ten Great Myths of Software." Myth No. 1 stated the common opinion of the day as follows: "Software represents a growing proportion of total data processing expenditures."

The argument (*Computerworld*, March 6) then went on to challenge this assertion that software costs were rapidly increasing as a percentage of total costs, while hardware steadily decreased. Indeed, the prophets of doom forecast the overwhelming dominance of software costs in the edp budget, some believing that, by the late '80s, hardware might account for only 10% of these costs.

While similar statistics were offered in a variety of trade press articles and scholarly books, other data were provided that questioned the validity of such observations. Every budget estimate and forecast over a considerable period of time showed a remarkable constancy in percentages of edp expenditure allocated among hardware, purchased services, people costs, communications, utilities, and supplies.

Despite my attempt in the aforementioned article to call attention to this apparent contradiction, predictions of ever-rising software costs and ever-falling hardware costs still continue. Because I feel partially responsible for the start and perpetuation of this erroneous belief, I am conscious of an enormous sense of guilt. By once more making public the circumstances that gave birth to the myth, I hope, finally, to eradicate my guilt along with the myth.

A second inducement to set the record straight was provided by my discovery of another voice in the wilderness that described the cost percentage curve as a fable. The voice belongs to Harvey G. Cragon of Texas Instruments who, in the December 1982 issue of the *IEEE Computer* magazine, attacks "The Myths of the Hardware/Software Cost Ratio." As Cragon traced only a portion of the myth's history, I feel the time has come to put the whole story together.

The mythology began in June 1968,

when DATAMATION published a contribution of mine that discussed the requirements of "Software for Terminal Oriented Systems." Those were the early days, when crts were still a novelty. The article predicted, however, that these display units would ultimately become ubiquitous and would create a great demand for applications. The argument was that the expected proliferation of such terminals, requiring a handful of applications per user, would exponentially increase software requirements and lead to the predicament illustrated in Fig. 1. This was, to the best of my knowledge, the first publicly stated assertion of Myth No. 1. My colleague Frank V. Wagner insists that an even earlier version was included in one of my 1963 internal planning documents for Informatics General Corp., then known as Informatics Corp. (See F.V. Wagner, "Implications of Future Developments in Computing Technology," AGARD Conference Proceedings, 1977.)

In those days, being unaware of Pareto's law, I was not sophisticated enough to apply the now famous 80-20 rule in drawing the curve. Careful inspection of the figure reveals that it was hand-drawn and not very precise. Curiously, subsequent figures produced by other authors, in different contexts, somehow retained the crudeness of this first rendition.

MYTH SPREADS RAPIDLY

when Barry W. Boehm's article, "Software and Its Impact: A Quantitative Assessment," appeared in DATAMATION (May 1973) with Fig. 2. This portrayal resulted from a number of Department of Defense-related studies concerning hardware and software expenditures. Because Boehm's article was widely read and much quoted, the dissemination of the myth proceeded rapidly, as indicated by the following set of charts:

R.C. Kendall and E.C. Lamb represented the figure as "a classic chart" in their paper, "Management Perspectives on Programs, Programming and Productivity," offered at the Guide 45 meeting in 1977. This

paper was later published as a chapter of the book, *Programming Productivity: Issues For the Eighties*, edited by Capers Jones and issued in 1982 as an IEEE tutorial.

Another chapter in the same tutorial, "The Systems Development Dilemma—A Programming Perspective," cited and duplicated the now famous chart (Fig. 3). This is the paper originally published by Jack Evers and Iris Vessey in the Society for Management Information Systems journal, *MIS Quarterly* (June 1981).

Two more repetitions of the software versus hardware fantasy appear in "Software Quality: Standards and Controls," by L.G. Stucki of Boeing Computer Services, and "Managing Knowledge as a Resource in Large Organizations," by C.M. Cook of the University of Maryland (Figs. 4 and 5).

Other authors exhibited some creativity in drawing the curve. For example, Fig. 6 was published in a special report on data processing in *Dun's Review* (July 1977). When I saw this, I decided to issue a correction of this persistent error and I wrote the 1978 *Computerworld* article, "The Ten Great Myths of Software."

It was to no avail. Not only do the unrealistic charts continue to appear, but new variations on the theme are being produced. For example, more sophisticated renditions of the chart, apportioning the software component between development and maintenance, are shown in Figs. 7 and 8. These are from two works by Boehm, the October 1976 TRW Software Series publication, "Software Engineering," and the excellent textbook, *Software Engineering Economics*, published by Prentice-Hall in 1981. This refinement of the original chart appealed to other authors, as is proved by Fig. 9, taken from L.K. Jensen's paper, "On the Education of Software Development Managers," published in the fall 1977 proceedings of the IEEE COMPCON international conference in Washington, D.C.

Another innovation is shown in Figs. 10 and 11, where the curve is displayed in a rotated position. These data come from *Electronic Design* (January 1981) and the 1980 Science Research Associates publication, *In-*

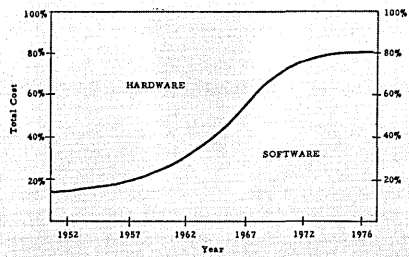

Fig. 1 DATAMATION, June 1968

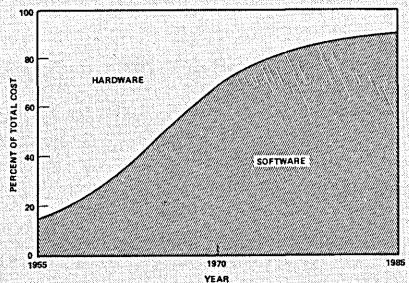

Fig. 2 DATAMATION, May 1973

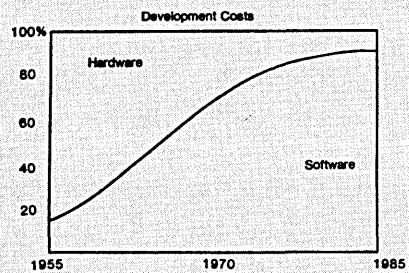

Fig. 3 MIS Quarterly, June 1981

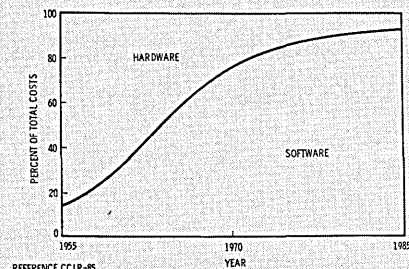

Fig. 4 "Software Quality: Standards and Controls," L. G. Stucki

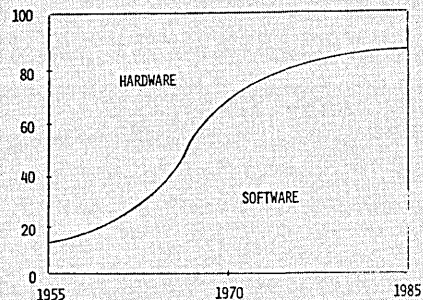

Fig. 5 "Managing Knowledge as a Resource in Large Organizations," C. M. Cook

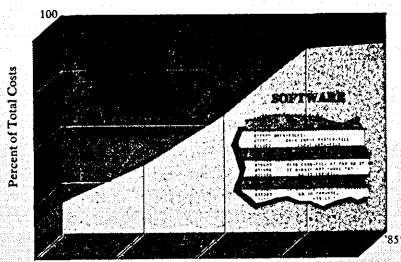

Fig. 6 Dun's Review, July 1977

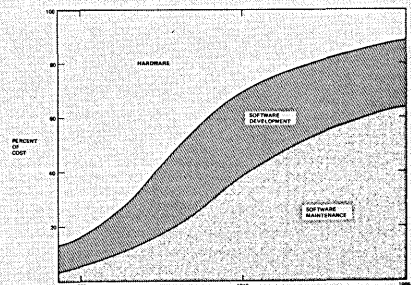

Fig. 7 Software Engineering, TRW, October 1976

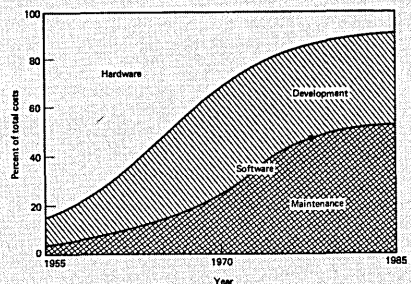

Fig. 8 Software Engineering Economics, Prentice-Hall, 1981

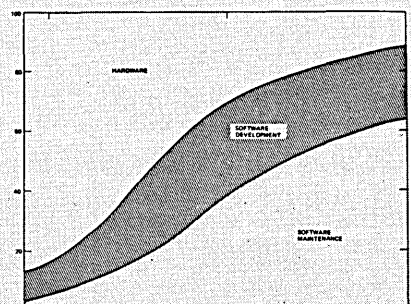

Fig. 9 Fall 1977 proceedings, IEEE COMPCON

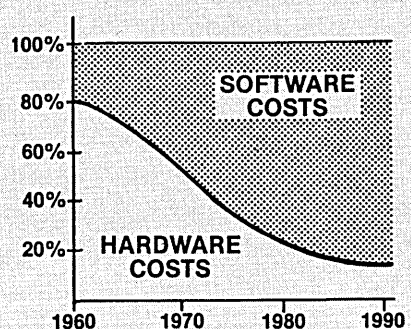

Fig. 10 Electronic Design, January 1981

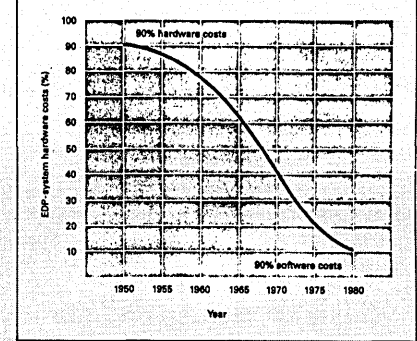

FIGURE 11-1 Estimated distribution of EDP-system costs

Fig. 11 Information Process, SRA, 1980

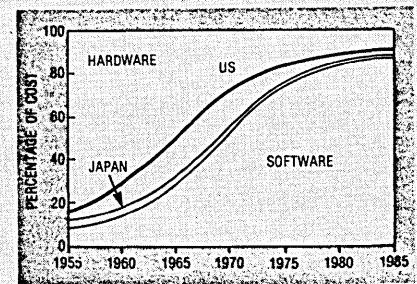

Fig. 12 Science, February 1982

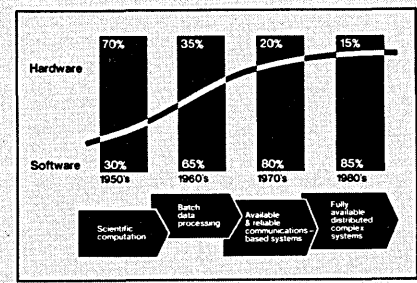

Fig. 13 Maaseh Choshev, June 1975

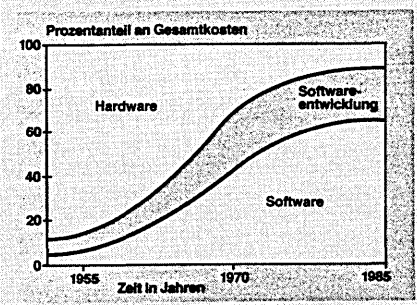

Fig. 14 Online, July/August 1981

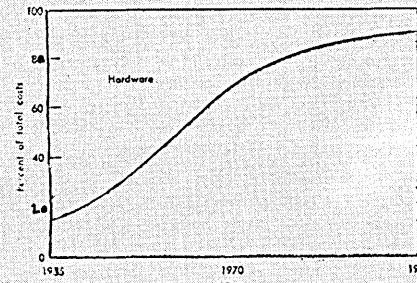
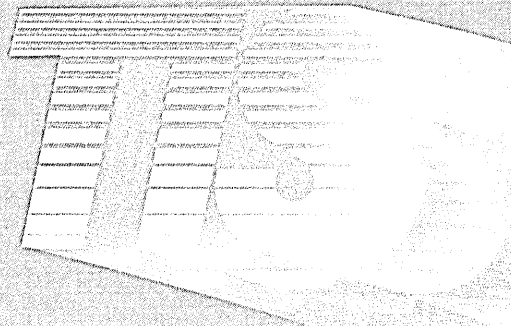

Fig. 15 Computer, March 1983

NOW, IMS AND IDMS USERS HAVE A MIGRATION PATH FORWARD.



First generation, mainframe-based DBMS products like IMS and IDMS face major shortcomings in meeting modern needs: limited integration, limited flexibility, and limited data insulation from both the DBMS and the data structures. Most important, they cannot meet

the diverse application requirements of your organization in the future. Clearly, new technology is needed to meet your modern requirements. Our technology built from Cincom Systems' real-life, working software has a proven ability to migrate your IMS and IDMS data to a modern, powerful database.

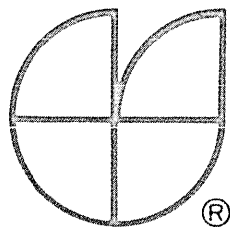
 **Cincom**

TIS is much more than a DBMS. It's a complete integrated information system with an entirely new architecture designed for your wide diversity of needs and readily usable by your end-users.

TIS: Modern technology for modern needs.

Designed for diverse, high volume, complex data base environments, TIS provides:

- Full in-line integration, so that one system can be used to meet the needs of all users with unprecedented security and control.
 - A relational view of data which gives programmers and end-users complete data structure independence.

- A powerful 4th generation procedural language to serve requirements of both programmers and end-users.
- A new Data Manipulation Language so powerful only four commands are needed to handle even the most complex logical data base processing: GET, INSERT, UPDATE, DELETE.
- An intelligent query language to provide instant information to end-users for virtually all ad hoc needs.
- A new DBMS component that provides unique data structuring capabilities with high performance.

TIS: Your migration path forward from older technologies.

As users outgrow older DBMS technology, TIS offers a smooth and powerful migration path forward. For more on how you can partner with Cincom to capture the power and excitement of TIS, contact our Marketing Services Department, 2300 Montana Avenue, Cincinnati, OH 45211.

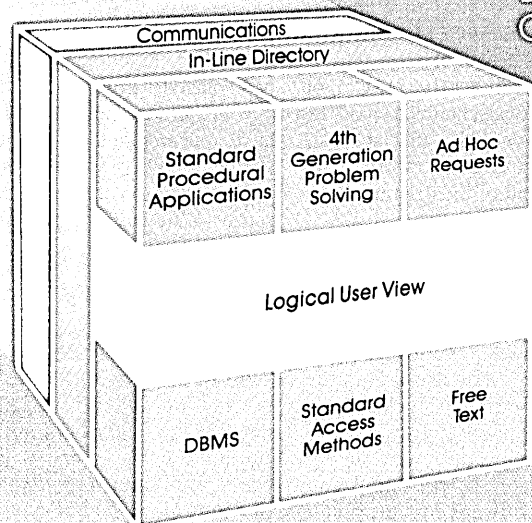

800-543-3010

(In Ohio: 513-661-6000)
(In Canada: 416-279-4220)

TIS, the next generation of integrated data base technology.

Systems

Your strategic software partner.

CIRCLE 166 ON READER CARD

Changing Computers?

Retain your SOFTWARE INVESTMENT

Let Dataware provide proven software and dependable services for your conversion

- COBOL to COBOL
Circle 170 on Reader Card
- AUTOCODER/SPS to COBOL
Circle 171 on Reader Card
- EASycODER/TRAN to COBOL
Circle 172 on Reader Card
- BAL/ALC to COBOL
Circle 173 on Reader Card
- DOS/ALC to OS/ALC
Circle 174 on Reader Card
- PL/1 to COBOL
Circle 175 on Reader Card
- RPG/RPG II to COBOL
Circle 176 on Reader Card
- RPG/RPG II to PL/1
Circle 177 on Reader Card

Call or write today.

the
Conversion
Software
Experts!

Dataware, Inc.
2565 Elmwood Avenue
Buffalo, New York 14217
Phone (716) 876-8722
TELEX: 91519

The 1968 article predicted that crts would become ubiquitous and create a great demand for applications.

formation Processing.

A final example of artistic expression is the presentation of L.M. Branscomb's Fig. 12, originally published in "Electronics and Computers: An Overview," from *Science* (February 1982) and reproduced again in the July 1982 issue of IEEE's *Computer*.

The curve has even crossed the ocean, as is shown by Figs. 13, 14, and 15. The first of these, faithfully reproducing the original curve, appeared in the June 1975 Hebrew journal *Maaseh Choshév*, published by the Information Processing Association of Israel. The second comes from the July/August 1981 issue of the German magazine *Online*, where software is described as the key to the technology of tomorrow. The third example was published in the March issue of IEEE *Computer*, accompanying an article on "Software Quality Improvement" in Japan. The author, Yukio Mizuno of Nippon Electric Co., accepts this "famous chart" and adds the situation for Japan, showing its hardware/software cost trend lagging the U.S. by about five years.

CHALLENGE TO THE MYTH

Having attempted in vain to correct this long-lived error, I was delighted to see, at last, the challenge to the computer community issued by Cragon. In the "Open Channel" column of IEEE's *Computer* (December 1982), Cragon identifies the old software/hardware cost ratio as a myth and concludes that software today may have, at most, a cost ratio to hardware of 0.66:1, instead of the 4:1 ratio cherished for so long.

In rejoinder to Cragon, Barry Boehm jumps back into the fray and defends his earlier-cited 1973 diagram in the March 1983 issue of IEEE's *Computer* magazine. Once more, the curve is advanced, but this time with analytical prowess. Boehm argues that software expenditure should include programmers or computer specialists plus the claimed six additional people who support every 10 of the direct practioners. Also, Boehm adds to the software cost the manu-

facturer's expenditure for software that is typically bundled or embedded in the hardware itself. This amount is claimed to be between \$1 and \$3 spent on software for every \$1 spent on hardware. Through this argument Boehm arrives at a 1980 hardware/software cost ratio of 1:5.3; or 84% of total cost is ascribed to software.

At best, this ratio simply considers all the labor costs associated with dp workers as software expenditures. Only direct expenses due to the manufacturing process of hardware for a single year of shipments are counted as hardware costs. The ratio does not, therefore, reflect the cost distribution of a user's dp budget.

Boehm understands this well, indicating in his refutation of Cragon that there are really many hardware/software cost ratio curves, each depending upon what economic issue or situation is being studied. Indeed, the particular curve under discussion in this article may be valid and useful in analyzing a large R&D program, such as those conducted by the Department of Defense. Other curves would, however, be needed to describe a more commercial situation.

Unfortunately, Boehm's insight has not accompanied the reproduction and exploitation of this popular curve. Rather, the graphic has been blindly accepted and used outside of the context in which Boehm has now placed it.

Perhaps now that formal corrections have appeared in the IEEE journal, *Computerworld*, and DATAMATION, most of computerdom will be on the alert to reject this nonsense. Will any writer with pretensions to computer expertise dare include a version of this S-shaped curve in his or her analysis again? *

Werner Frank is president of the Werner Frank Computer Group, a consulting firm based in Calabasas, Calif. His book, *Critical Issues in Software*, published this year by John Wiley & Sons, contains a detailed discussion of Myth No. 1.

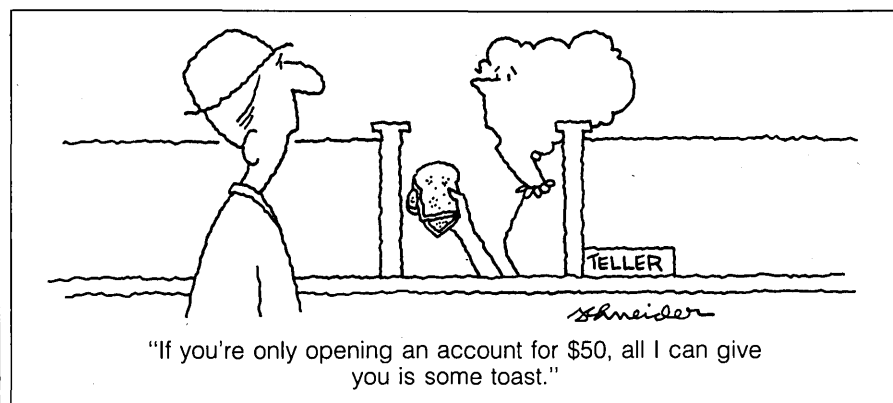

Wang. Finally a computer company that takes service personally.



It's no secret that, historically, most computer companies have taken sales more seriously than service.

But Wang is changing all that with WangCare.

WangCare, our total service philosophy, is your assurance that the office automation system you buy today will be maintained at maximum running efficiency. Automatically.

WangCare includes uptime guarantees, extended service coverage, software support, our Technical Assistance Center, and Call Control Centers that are ready to respond to your request for service where and when you need it.

What's more, Wang provides a

range of personal comprehensive customer support programs including hands-on training, documentation, multi-site installation guidance, and advanced applications assistance.

Wang Customer Engineering, our worldwide network of service specialists, has made service a full-time business.

And that's our commitment. The service we deliver has to be just as good as our system. After all, would you expect anything less from the world leader in office automation?

For more information, call 1-800-225-9264, or write to Wang Laboratories, Inc., Business Executive Center, One Industrial Avenue, Lowell, MA 01851.

WANG

The Office Automation Computer Company

A828

© 1983 Wang Laboratories, Inc.

WE DO W

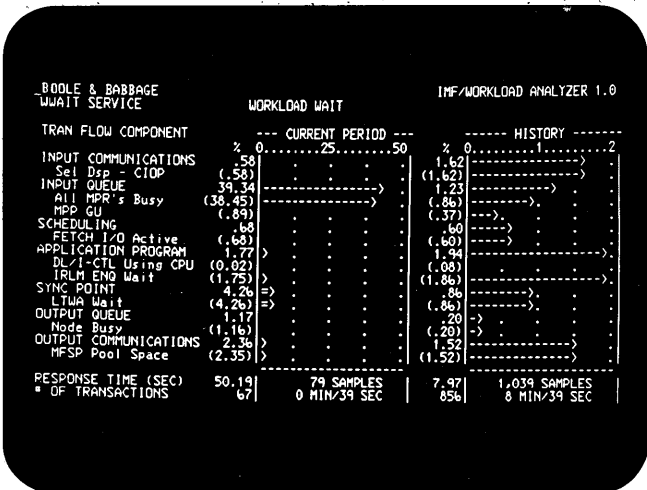

Slowsdowns in response time are usually caused by transactions waiting for some IMS resource. WORKLOAD WAIT eliminates guesswork by quickly showing you exactly *where* the bottleneck is — so you can concentrate on solving the problem.

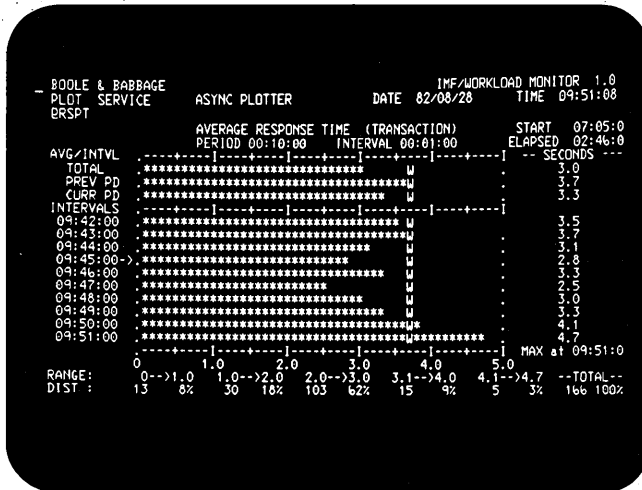

The on-line IMF MONITOR PLOTS present the activity patterns for the hundreds of monitored IMS items. They show whether exceptions are transient, or trending toward a problem condition. Activate the Automatic Screen Refresh, and a response time plot is a continuous realtime picture of user service delivery.

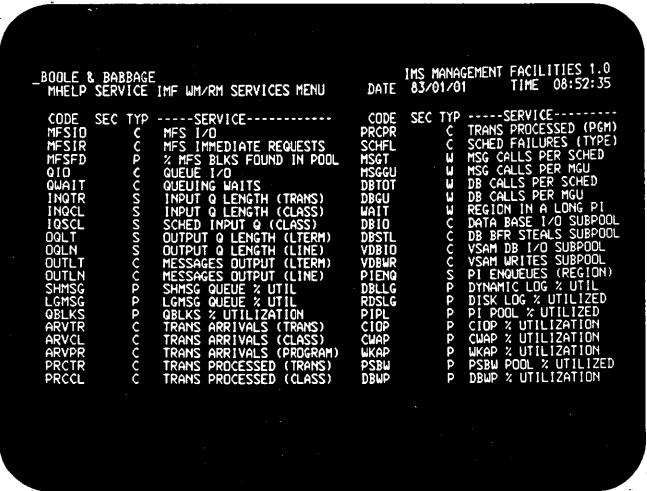

Each IMF product has a HELP SERVICES MENU of the hundreds of items you can analyze, monitor or plot. You choose which group of user transactions, or which IMS resources, you want IMF to monitor or you want to investigate.

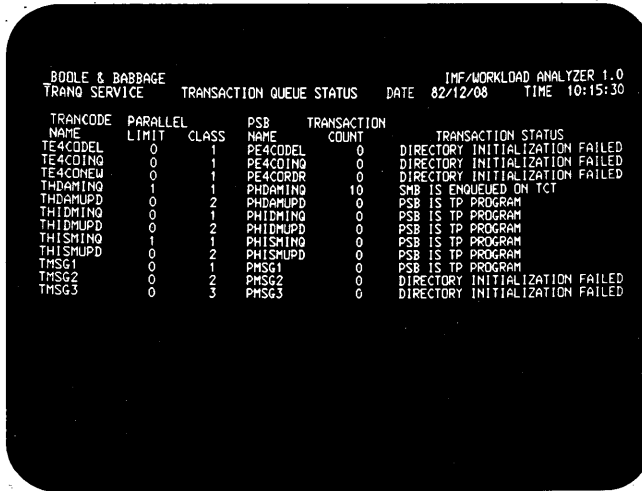

TRANSACTION QUEUE STATUS actually displays the transactions sitting on the input queue. Another unique IMF feature, it's far more than a simple display of queue status — it shows you exactly what user work is waiting in the queue.

NO ONE ELSE OFFERS SO MUCH IMS INSIGHT.

These are just a few of the 628 realtime services and monitors provided by Boole & Babbage's IMS Management Facilities (IMF)™. While others have offered piecemeal monitoring aids, only IMF provides an integrated, comprehensive management architecture. Each of the nine IMF components is a powerful management tool in its own right. But joined together, they form a complete,

synergistic management system.

Look into our windows today. Write Boole & Babbage, 510 Oakmead Parkway, Sunnyvale, CA 94086. Or call 800-538-1893 (in Calif. 408-735-9550). In Europe contact the European Software Company, GmbH: Adersstrasse 30, 4000 Düsseldorf 1, West Germany. PH: 0211-370794.

INDOWS.

```

BOOLE & BABBAGE                                IMF/RESOURCE ANALYZER 1.0
STAT SERVICE SYSTEM STATUS                     DATE 82/12/08    TIME 14:52:30
RGN 1 2 3 4 5 6 7 8 9 10 11 12 13 14 15
TYPE BUI BUI MPP MPP MPP BMP
STAT DL/1 WF-W ACTV SCHD IDLE ACTV INAC INAC INAC
WARN W-P1 NOBK
--INS.DATA SETS--
SHORT          5,500          1,925 35      3,575 65      (HI= 3602)
LONG          7,200          1,080 15      6,120 85      (---THRESHOLD)
OBLKS         1,600           800 50      800 50      (HI= 1263)
DYN LOG        7,200           0 0      7,200 100    (---WRAPPED)
DISK LOG       4,800          2,600 54      2,200 46
--P1 POOL--
CURRENT        92,160         90,768 99      1,392 1
MAXIMUM       204,800        203,408 100     1,392 0
--STOPPED RESOURCES-- LINES: 2 TRANS: 0 DB'S: 1 RTCDE'S: 5
RESTART TIME 07:38:26
--SCHEDULING-- FAILURES: 18,540 30% SCHEDULING STOPPED (---DYNAMIC LOG
CLASS 001 002 003 004 005 006 REST FP TOTAL
O'D 0 075* 002 0 1 0 28* 0 116*
PROC 10968 29154 3322 6008 14076 105 1406 0 65039
    
```

A time-saving first step in analyzing IMS operation, the **SYSTEM STATUS** display tells you at a glance whether or not things are okay. Should further analysis be required, you can select specific areas to investigate with the IMF analyzers.

```

BOOLE & BABBAGE                                IMF/WORKLOAD ANALYZER 1.0
DTRAC SERVICE DISPLAY WORKLOAD TRACE          DATE 82/12/08    TIME 11:14:30
TRACENOF= 4
Trancode: DB91T01 Ltrm:MASTER Node:G99992C Class: 1 Arrive-07:28:53.3
Start-07:28:53.3 Stop-07:28:55.5 Elapsed- 1.7 sec Response Time- 1.7sec
DC Calls:1,105 DB Calls: 0 #I/O: 0 Appl CPU 345 msec IMS CPU 226 msec
Trancode: DB91T01 Ltrm:MASTER Node:G99992C Class: 1 Arrive-07:29:31.1
Start-07:29:31.1 Stop-07:29:35.5 Elapsed- 4.0 sec Response Time- 4.0sec
DC Calls:1,190 DB Calls: 0 #I/O: 0 Appl CPU 294 msec IMS CPU,943 msec
Trancode: EDTX900 Ltrm:A03581AR Node:A03581AR Class: 3 Arrive-07:30:36.6
Start-07:30:37.7 Stop-07:30:43.3 Elapsed- 6.5 sec Response Time- 6.0sec
DC Calls: 2 DB Calls: 9 #I/O: 3 Appl CPU 6 msec IMS CPU 392 msec
Trancode: EDTX900 Ltrm:A03581AR Node:A03581AR Class: 3 Arrive-07:30:49.9
Start-07:30:49.9 Stop-07:30:49.9 Elapsed- 0.3 sec Response Time- 0.3sec
DC Calls: 4 DB Calls: 0 #I/O: 0 Appl CPU 0 msec IMS CPU 2 msec
-----
TOTAL OF ALL TRACES
#Trans: 15 AVG DC CALLS:142.2 AVG DB CALLS: 6.1
AVG APPL CPU 119 msec AVG IMS CPU: 152 msec AVG # I/O: 4.66
AVG I/O TIME 0.1sec AVG E/T TIME 2.3sec AVG RESP TIME: 2.4sec
    
```

WORKLOAD TRACE is entirely unique, and provides a detailed, on-line trace of any transaction—or group of them—inside IMS. Unlike IBM's DC Monitor, it shows you only what you want to see—immediately, and without the high overhead.

```

BOOLE & BABBAGE                                IMF/RESOURCE ANALYZER 1.0
DSPST SERVICE DISPATCHER STATISTICS          DATE 82/12/08    TIME 14:53:32
***** OS DISPATCHER *****
REGION TYPE ASID DSP/SEQ SRV.UNITS TCB CPU DOMAIN PFGR PFPD
0 CONTROL 9 241/ 6 2,428,068 4,328 13 13 1
1 BMP-WF1 11 239/ 9 129,452 60 1 1 1
2 BMP-WF1 15 118/ 12 488 66 1 1 1
3 MPP 12 240/ 7 448,724 1,400 13 13 1
4 MPP 10 238/ 10 1,014,360 1,750 13 13 1
5 MPP 14 239/ 8 814,360 2,248 13 13 1
6 BMP 13 117/ 13 44,122 25 1 1 1
***** IMS DISPATCHER *****
0 TOTAL SAPS 0/ 0 HIGH SAP WAITERS (PRV/NON)
30 DYNAMIC SAPS 0/ 0 WAITING FOR SAP (PRV/NON)
0/ 0 TOTAL WAITED FOR SAP (PRV/NON)
6 DEPENDENT REGIONS 393,684 TOTAL ITASKS CREATED
3 ACTIVE BMP REGIONS 3,342,817 TOTAL ITASKS DISPATCHED
1 ACTIVE MPP REGIONS
9 ACTIVE ITASKS 0 TOTAL SELECTIVE DSP EVENTS
0 ISWITCHED ITASKS 154,051 TOTAL IPOST CALLS
    
```

DISPATCHER STATISTICS gives a quick summary of activity across all active IMS processing regions, showing whether MVS is providing the service you expect the SRM to deliver. This lets you see if IMS is getting the resources needed to process the work.

```

BOOLE & BABBAGE                                IMF/RESOURCE ANALYZER 1.0
SCHED SERVICE SCHEDULING STATISTICS          DATE 82/12/08    TIME 14:33:16
SCHEDULING ACTIVITY
61,417 TOTAL SMBS EXAMINED 19 TOTAL PROGRAM CONFLICTS
42,877 TOTAL SCHEDULED 70% 0 TOTAL PRIORITY CUTOFFS
18,540 TOTAL FAILURES 30% 45 TOTAL INTENT FAILURES
18,476 TOTAL OTHER REASONS
SCHEDULER SEQUENCE QUEUE
REASON FOR WAIT RGN TYPE CLASSES CPRTY PSBNAME TRANCODE
WAITING FOR MESSAGE (IDLE) 3 MPP 1
WAITING FOR INTENT (DB) 4 MPP 3 4 10
WAITING FOR GU (WF1) 1 BMP
GISPSB GIS
    
```

SCHEDULING STATISTICS shows unsuccessful as well as successful schedule attempts. It also indicates the reasons why attempts have failed, so you can take appropriate corrective action quickly, without the traditional trial-and-error guesswork.

Boole & Babbage
NEW VISIONS IN SYSTEMS MANAGEMENT

©1983 Boole & Babbage, Inc.

CIRCLE 182 ON READER CARD

Excerpts from the new book "Algeny," which explains how computers and genetic engineering are teaming up to reshape our entire economic structure.

THE OTHER HALF OF THE COMPUTER REVOLUTION

by Jeremy Rifkin

The term "algeny," coined by Dr. Joshua Lederburg of Rockefeller University, means to change the essence of a living thing by transforming it from one state to another; more specifically, it is the upgrading of existing organisms and the design of wholly new ones with the intent of "perfecting" their performance. Algeny is humanity's attempt to give metaphysical meaning to its emerging technological relationship with nature.

The age of pyrotechnology began in earnest around 3,000 B.C. in the Mediterranean and Near East when people shifted from the exclusive use of muscle power to shape inanimate nature to the use of fire. Pounding, squeezing, breaking, mashing, and grinding began to play second fiddle to fusing, melting, soldering, forging, and burning. By referring the cold remains of what was once a fireball itself, human beings began the process of recycling the crust of the planet into a new home for themselves.

Now that humanity has fashioned this second home, it finds itself in short supply of the raw energy and resources necessary to maintain that home. At the same time, the problem is compounded by the fact that this new home is increasingly inhospitable to the rest of life's creations, which are largely unable to adjust to this alien "man-made" environment. To put the magnitude of the problem in perspective, it is estimated that during the dinosaur age, animal species became extinct at a rate of about one per thousand years. But the early stages of the industrial age, animal species were dying out on the average of one per decade. Today, as we enter the final period of the long age of pyrotechnology, plant and animal species are dying off at the rate of one every 60 minutes. According to Thomas Lovejoy of the World Wildlife Fund, nearly 17% of all the plant and animal species remaining on earth will become extinct between now and the year 2000.

Humankind, then, faces two crises si-

multaneously. The earth is running low on its stock of burnable energy and on the stock of living resources at the same time. We are at a turning point in the history of civilization, and it is at this critical juncture that a revolutionary new approach to organizing the planet is being advanced; an approach so overwhelming in scope that it will fundamentally alter humanity's entire relationship to the globe. After thousands of years of engineering the cold remains of the earth into utilities, human beings are now setting out to engineer the internal biology of living organisms in the hope of staving off the crisis at hand and laying the base for a new world epoch. We are moving from the age of pyrotechnology to the age of biotechnology. The transition is indeed staggering.

For thousands of years humanity used fire to convert the earth's crust into new shapes and forms that never existed in nature. Now, for the first time in history, humanity has found a way to convert living material into new shapes and forms that never existed in nature. In 1973, American scientists performed a feat in the world of living matter to rival the importance of fire itself. Biologists Stanley Cohen of Stanford University and Herbert Boyer of the University of California reported that they have taken two unrelated organisms that would not mate in nature, isolated a piece of DNA from each, and then hooked the two pieces of genetic material together. The result was literally a new form of life, one that had never before existed on the face of the earth.

A product of nearly 30 years of investigation, climaxed by a series of rapid discoveries in the late 1960s and 1970s, recombinant DNA is a kind of biological sewing machine that can be used to stitch together the genetic fabric of unrelated organisms. Dr. Cohen divides recombinant DNA surgery into four stages. To begin with, a chemical scalpel, called a restriction enzyme, is used to split apart the DNA molecules from one source—a human, for example. Once the DNA has been cut into pieces, a small segment of genetic material—one or a few genes in length—is separated out. Next, the restric-

tion enzyme is used to slice out from the body of a plasmid a short length of DNA found in bacteria. Both the piece of human DNA and the body of the plasmid develop "sticky ends" as a result of the slicing process. The ends of both segments of DNA are then hooked together, forming a genetic whole composed of material from the two original sources. Finally, the modified plasmid is used as a vector, or vehicle, to move the DNA into a host cell, usually a bacterium. Absorbing the plasmid, the bacterium proceeds to duplicate it endlessly, producing identical copies of the new chimera. These are called clones.

THE MOST DRAMATIC TOOL

The recombinant DNA process is the most dramatic technological tool to date in the growing biotechnological arsenal. The biologist is learning how to manipulate, recombine, and reorganize living tissue into new forms and shapes, just as his craftsmen ancestors did by firing inanimate matter. The speed of the discoveries is truly phenomenal. It is estimated that biological knowledge is currently doubling every five years, and in the field of genetics, the quantity of information is doubling every 24 months. We are literally hurling ourselves into the age of biotechnology.

Already, a great schism is developing between the last generation of the age of pyrotechnology and the first generation of the age of biotechnology. Our children are beginning to conceptualize the world in a fashion so fundamentally different from anything we can readily identify with that the empathetic association that traditionally passes down through the generations, uniting past with future, seems at times to be irretrievably severed—as if to suggest the termination of one great lifeline in history and the abrupt beginning of another. Our children are the first sojourners of the second great economic epoch. While they still carry with them most of the conceptual trappings of the age of fire, they are beginning to experience the world from a profoundly altered frame of reference.

To begin with, their language is the

Excerpted from Jeremy Rifkin's book, *Algeny*, © 1983 by the Foundation of Economic Trends, and reprinted by arrangement with Viking Press. *Algeny* is being published this month.

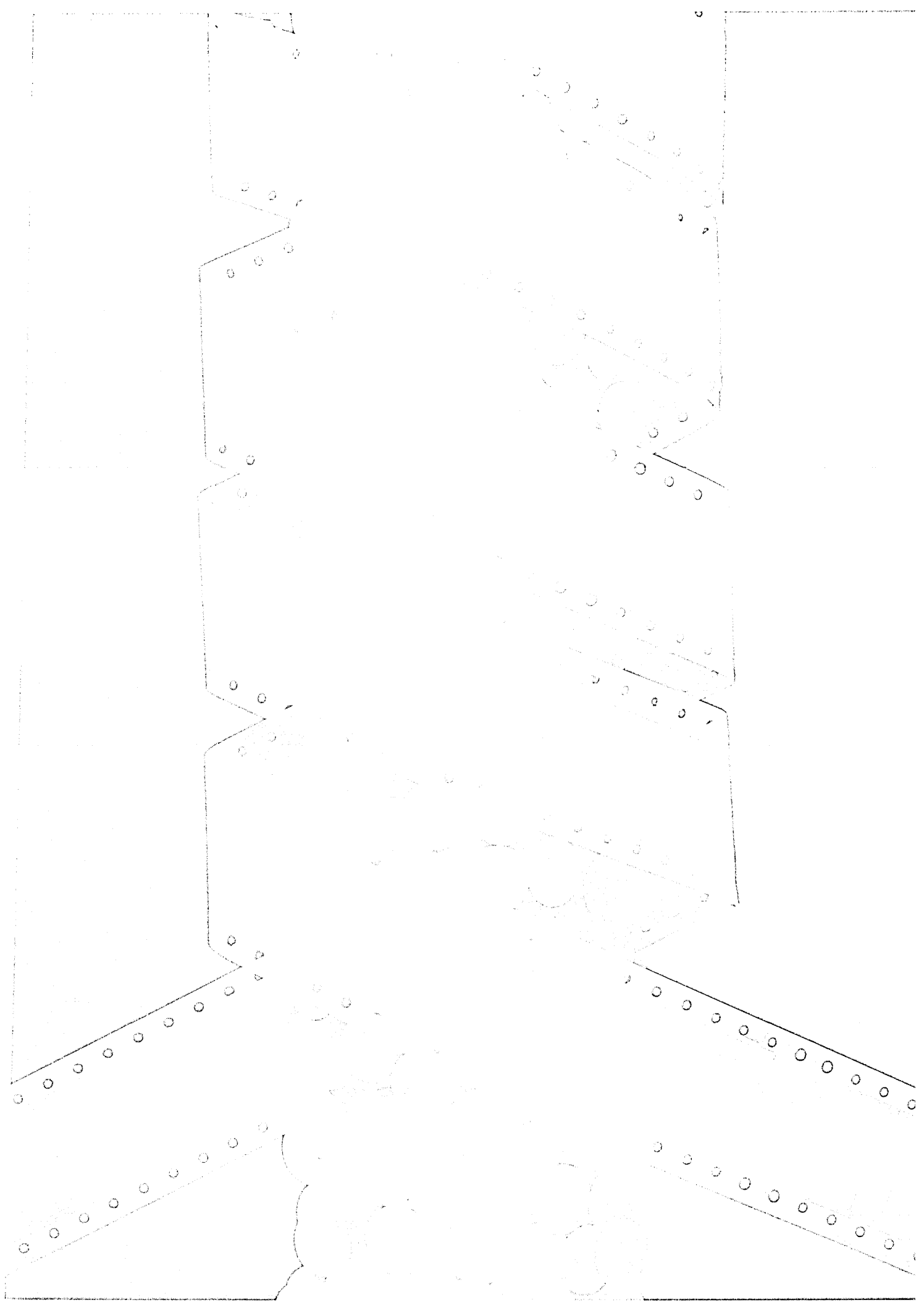

"The effect of the computer on learning and thinking is comparable to that of the invention of writing."

language of the computer. Their world of communications is made up of computer programs, electronic games, word processors, video disks. The average American child now spends approximately 28 hours per week with electronic learning tools, compared to 25 hours per week with print learning materials. The electronic image and the computer printout are increasingly taking the place of the spoken and written word. A *New York Times* article reports mathematician Seymour Papert of MIT saying that "the effect of the computer on learning and thinking is comparable to that of the invention of writing."

Alan Newall of Carnegie-Mellon University, one of the experts in the new field of artificial intelligence and the computer sciences, argues that the true import of the computer is that it opens students' minds to a "whole new language for describing behavior." This new language is drastically altering our children's perception of the world. Many educators now believe that our young people are beginning to conceptualize the world in the same terms that animate the operations of a computer system.

Joseph Weisenbaum, professor of computer science at MIT, best expressed the conceptual revolution that separates the generations when he observed: "To him who has only a computer, the world looks like a computer domain." The world seen from a computer perspective is very different from the one we have experienced in the past. In this new world, all physical phenomena are reduced, reorganized, and redefined to meet the operating requirements of the computer. The computer recasts the world in its own image, transforming all of nature into bits of information to be processed and programmed. In point of fact, the computer creates a new context for organizing the world, one that supersedes the industrial frame. It is this new "context" for which the first generation of computer babies is being prepared.

Most futurists have yet to perceive the full significance of the computer revolution. While they have been correct in their appraisal of the impact of the computer and the information sciences, they have misunderstood their ultimate role. Most futurists see the computer revolution as a new method for organizing the industrial age. While it is true that the computer has been successfully adapted to industrial processes, it should be noted that its appearance coincides with the final stages of the industrial era. The industrial age peaked in the early 1970s. Ever since that time, the world community has been finding it more and more difficult to locate and process a dwindling supply of nonrenewable energy. Because nonrenewable energy is the organizing material of the industrial age, its depletion marks the end of the economic era built from it and maintained by it.

COMPUTER BEGINS NEW ERA

The entire industrial era ran its course without the aid of the computer. This new organizing mechanism didn't come "on-line" until the mid-1960s. It didn't begin to exert a commanding presence until the early 1980s. The computer only caught the tail end of the industrial era. While it will no doubt be used in a myriad of ways to stretch out the remaining years of the industrial epoch, its real import has yet to be gleaned by the future forecasters.

The computer is the organizing mechanism for the age of biotechnology, just as the industrial machine was the organizing mechanism for the industrial revolution. Whereas the machine transformed non-renewable resources into economic utilities, the computer will transform biological material into economic products and processes.

The computer is also the language of the biotechnical age. Every great economic period brings with it a unique form of communication. Hunter/gatherer societies relied on sign and oral language, while every advanced agricultural society had some form of written language. The printing press was used during the early stages of the industrial revolution. No self-respecting anthropologist, however, would refer to the Paleolithic period as an oral economy, or the Neolithic period as a written economy, or the Industrial Age as a print economy. Yet today's futurists believe that what lies ahead is the computerized information economy. They fail to understand that the computer and information sciences do not in and of themselves comprise the new economy. Rather, they comprise the organizing language for the new economy. They are the means of communication that humankind will use to reorder living material in the biotechnical age.

In 1981, the first computerized gene machine made its debut. One need only type out the genetic code for a particular gene on the computer's keyboard and within a matter of a few hours "the machine delivers a quantity of synthetic gene fragments that can be spliced together and put into the DNA of living organisms." With the gene machine it is possible to begin transforming living material into new designs and products in large enough volumes and with sufficient speed to provide a cost-effective starting point for the biotechnical economy. This, however, is only the beginning stage of the coming economic revolution. Eventually scientists hope to mesh living material and the computer into a single mode of production. Already, corporate funds are being channeled into research designed to replace the microchip with the biochip and the microcomputer with the biocomputer. According to James McAlear, president of EMV, one of the firms pioneering in this research: "Our aim is to build a com-

puter that can design and assemble itself by using the same mechanism common to all living things. This mechanism is the coding of genetic information in the self-replicating DNA double helix and the translation of this chemical code into the structure of protein."

Within the coming decade, the computer industry and the life sciences are expected to join together in a new field—molecular electronics. Companies like Japan's Mitsui Corp. are already planning for the day by acquiring "a large stake in both biotechnology and microelectronics." The grand objective is to turn living material into biocomputers and to use these biocomputers to further engineer living materials. In the future, biocomputers will be engineered directly into living systems, just as microcomputers are engineered into mechanical systems today. They will monitor activity, adjust performance, speed up and slow down metabolic activity, transform living material into products, and perform a host of other supervisory functions. Scientists even envision the day when computers made of living material will automatically reproduce themselves, finally blurring the last remaining distinction between living and mechanical processes.

According to Dr. Zsolt Harsanyi, vice president of DNA Science, the day of the biocomputer is within grasp. He predicts that by the time today's babies reach adulthood, the biocomputer will be commonplace. The biocomputer represents the ultimate expression of the biotechnical age. By successfully engineering living material into an organic computer that can think, reproduce itself, and transform other living material into economic utilities, humanity becomes the architect of life itself in the coming age.

KIDS WILL PROGRAM NATURE

Although the biocomputer is not yet a reality, our children are already being prepared for the day when living systems will be programmed by computer design. As mentioned, the next generation is being immersed in the world of the computer. The computer is becoming so integral to every facet of our children's lives that they are coming to regard their whole environment as a computable domain. Once our children are comfortable with the idea of thinking of nature as "systems of information," they are all but ready for the task of programming nature by computer design.

For our children, then, nature will no longer be something they are born into but rather something they program. Already scientists are feverishly at work in the new field of computer graphics, attempting to bring this new biotechnical process on-line. In their book *Life for Sale*, science writers Sharon and Kathleen McAuliffe speculate that eventually "computer graphics may be coupled



THE CASE FOR SOFTWARE SYNERGY: YOUR PROGRAM IS MORE IN TUNE WHEN ALL COMPONENTS HARMONIZE.

When two or more software products *work as a team* they produce greater benefits than the same software products working independently: that's synergy.

Computer Associates offers you the broadest line of DOS and OS systems software products in the world, designed with that synergy in mind.

Our products don't just "talk" to each other, they all work together as a team, supporting each other and doing more for you in a given time. Separately, each of our products provides a powerful solution of significant benefit to you. You will achieve even greater benefits with two or more of our products working together.

This means your entire Data Processing Center performs with greater overall efficiency — and economy.

The result is greater productivity from your entire organization.

This is our Case for Software Synergy. Let us send you our comprehensive brochure and prove it. Call (800) 645-3003, in NY: (516) 333-6700.



COMPUTER ASSOCIATES

COMPUTER ASSOCIATES INTERNATIONAL, INC.
125 Jericho Tpke, Jericho, NY 11753

CIRCLE 183 ON READER CARD

Help stamp out OBSOLETE data.

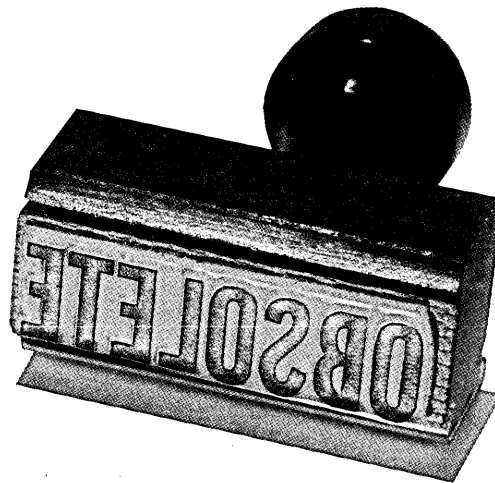

Get Data Sources—the only quarterly DP buyer's directory. It tells you who's selling the hardware, software, systems, and services you need, today.

The first thing people do when they get Data Sources is use it.

A lot.

2.0 times a week, on the average.

With an average of 4.8 other people sharing in the use.

Because Data Sources gives them the first-cut information they need to list all their options. And the details they need to cull the misfits.

The next thing people do with Data Sources is throw it out.

Four times a year.

Because they know the price to be paid for trusting obsolete listings. Consider these typical increases from one quarterly issue of Data Sources to the next:

327 new computer system listings.

473 new software package listings.

120 new memory device listings.

That's an average of 25 new systems and 36 new software packages a week. Imagine the developments in peripherals. In communications networks. In word processing.

That's why we publish so often.

And why our intelligent subscribers throw us away so often. They know that no annual publication alone will suffice. And that even a quarterly quickly becomes obsolete.

What we are, what we're not.

What we are, is the first source to turn to when you're considering the purchase of any data processing hardware, software, systems, or services.

You come to us first because we have the most complete and up-to-date listings of what you need: 7,000 companies supplying more than 26,000 products, including mainframes, minis, micros, supplies and software (14,000 software listings alone). Fully indexed and cross-indexed by product type,

supplier, and system compatibility. With names and phone numbers to make your job easier.

You get to see all your options, not just some. And you get the information you need to identify the most practical choices. Quickly.

Which brings us to what we're not: an evaluative service. We don't, in our 2,700+ pages, rate or recommend things. Other people do that and do it very well. But they do it in such depth that they can only review a limited number of the products and services you'll find in Data Sources, and only annually at best. So even if you use an evaluative service—as well you should—you still need Data Sources for a complete and current picture of the industry.

Our free offer. And bonus.

The best way to see how much Data Sources has to offer is to use a copy yourself. Let us send you our latest issue, FREE. We'll also send you an "OBSOLETE" stamp to use as you wish.

Then, after 30 days, we'll send you an invoice for a year's subscription to Data Sources at only \$60—half off the cover price of the four issues.

If you find Data Sources to be everything we've said it is, simply pay the invoice and receive a full year subscription at half price. If you're not convinced, write "cancel" on the invoice and return it.

Either way, keep the first issue and the stamp as our gift. But remember, if you miss the other three issues, get ready to use the stamp.

To accept our free offer, use the coupon below. Or call, toll-free, 800-227-1617 Ext. 251. (In California, 800-772-3545 Ext. 251)



See us at NCC—Anaheim, CA, May 16–19, 1983 • Booth P-7342

DATA SOURCES

P.O. Box 5845,
Cherry Hill, NJ 08034

Send my first issue of the Data Sources buyer's directory. And my free "OBSOLETE" stamp. I understand that, in thirty days, you will invoice me \$60.00 (half price) for a four-issue subscription and that I may decline your offer at that time by writing "cancel" on the invoice and returning it to you.

Name _____ Title _____

Company _____

Address _____

City _____ State _____ Zip _____

Telephone _____

Type of End User (11) VAR/OEM (21) Distributor (31)

business: Manufacturer (41) Other (51) _____ T020

An information product of Ziff-Davis Publishing Co. Satisfaction guaranteed.

CIRCLE 181 ON READER CARD

*"Instruct a wise man
and he will be wiser still."*

Proverbs 9:9

Even wise choices in Computer-Based Manufacturing Systems cost a lot of money and require commitment from everyone. Although these systems *can* improve productivity and achieve many other cost efficiencies, they need to be well implemented. But, where can you go to get the information you need to make such important decisions?

The InfoResearch Institute has prepared a pair of reports to guide you through the needs analysis, evaluation, selection and implementation processes with computer-based systems in the manufacturing environment — alternatives and strategic solutions that address your problems. And all information is based upon extensive studies of user and supplier experiences.

The *Executive Report* is written for and covers issues to be addressed by the *non-EDP executive*. The *Industry Report* is written for the *EDP executive* and highlights criteria for system preparation and installation.

With such important decisions, it's nice to be a little wiser!

**To order your reports,
call 612/835-0448**



**To get free, descriptive
brochures, mail this coupon**

The InfoResearch Institute
c/o Info-Dyne, Inc.
7417 Bush Lake Road
Minneapolis, Minn. 55435

Please send me
a free Manufacturing Systems brochure:

- The Non-EDP Executive Report
 The EDP Industry Report

Name _____ Title _____

Company _____

Street _____ State _____ Zip _____

Telephone (_____) _____

(please print)

The InfoResearch Institute

co-sponsored by DATAMATION and INFO-DYNE <>

“Within the coming decade, the computer industry and the life sciences are expected to join together in a new field—molecular electronics.”

with recombinant DNA technology, facilitating the production of genetic blueprints that correspond to make-believe molecules. In this way, pictures on a video display screen could readily be transformed into their real-life counterparts.”

With computer programming of living systems, the very idea of nature being made up of discrete species of living things, each with its own inviolate identity, becomes a thing of the past, a relic of the prebiotechnical era. Simply by punching in instructions on a keyboard, it will be possible to cross species walls and program an entire array of novel organisms. Our heirs will live in a world engineered and populated by their own creations. Imagine, then, how completely alien their perception of nature will be from our own and that of all those who preceded us. The order of difference is of a magnitude far greater than any that has ever separated one generation from another in world history.

The fact is, the next generation is going to entertain a radically new image of nature and humanity's relationship to it, one compatible with the bioengineering of living systems by computer design. If we are to understand the dimensions of the coming age, we need to begin with an understanding of the new concept of nature that is going to emerge among the first generation versed in the language of the computer and the biotechnical arts.

Every age has its own unique view of nature, its own interpretation of what the world is all about. Knowing a civilization's concept of nature is tantamount to knowing how a civilization thinks and acts. For our century, Darwin's theory of evolution has served as the centerpiece of the cosmological order. Five generations of human beings have accepted Darwin's interpretation of how nature works. We think of the world in a Darwinian way. We act in the world in a Darwinian manner. If we want to answer the ultimate futurist question of how generations not yet born will think and act differently from us, we need to know about the new concept of nature our children will adopt and how it will differ from our own.

This, then, is the story of the new view of nature that's going to replace Darwin's theory of evolution and provide a framework for the first generation of the biotechnical age. It's also the story behind the story; an account of the process by which the new concept of nature has been arrived at. To understand that process, we have to begin with an examination of the role concepts of nature play in the life of a civilization.

Ecology, the new physics, and process philosophy all contributed to the liberation of time and helped lay the groundwork for a temporal theory of evolution. Now these sweeping conceptual changes are joining

hands with a revolutionary change in the way people go about organizing their day-to-day activities. A great technological transformation is occurring in the world. Humanity is radically changing the way it interacts with the environment. That change is deeply affecting the way people conceptualize the world they live in. In order, then, to appreciate fully the character of the new temporal theory of evolution it is first necessary to understand the technological revolution that is nurturing it.

The Roman statesman Cicero said that by means of our hands we endeavor to create, as it were, a second world within the world of nature. With the steady development of consciousness, humanity increasingly separated itself from its surroundings. From a distance, we began to refashion the various elements of nature into a new construction that bore our own imprint. Our intent was to become invulnerable, and all of Western culture attests to the human desire to overcome the physical limitations imposed by nature and achieve a totally self-contained status. Technology has been the chief means to advance this end.

TOOLS TO TRANSFORM NATURE

Technology, quite simply, is tools we design to extend and amplify the human body in order to transform more of nature into ourselves. The clothes we wear and the homes we live in are extensions of our skin. The containers we use are extensions of our cupped hands. The weapons we use are extensions of our throwing arms.

Technology, then, is a transformer. It allows us to speed up the conversion of natural resources into economic utilities. We develop new and more ingenious ways to transform available matter and energy from the environment to ourselves. Technologies allow us to overcome our biological limits so that we can exercise greater control over the forces of nature. Through technology we conquer time and space. We surround ourselves with technology, and it, in turn, surrounds us with a remade second nature. It's no wonder humanity has always been so admiring of its tools. We gaze upon them with a mixture of awe and respect, as we would our own body organs. They are our enlarged body, and through them we are able to inflate our sense of ourselves well beyond the proportions with which nature endowed us.

We watch over our tools, constantly seeking to hone them to new levels of performance: They become our obsession as we become the increasing object of our own attention. As we outfit ourselves with more sophisticated technological garb, nature seems to shrink in size and our own gait seems to stretch out over larger terrain.

Technology translates our innermost desires for plenitude, security, and self-perpetuation into concrete forms that we can take hold of and believe in. The more successful we are at trapping, converting, and assimilating the world around us, the more assured we are of continued abundance, a safe future, and a self-perpetuating existence. Technology is our way of proving to ourselves that we will prevail. As such, it has always enjoyed a most exalted status.

Technology helps define the world around us. That's because our understanding of the environment is deeply influenced by the way we go about organizing it. Abraham Maslow once remarked, "To him who has only a hammer, the whole world looks like a nail." It is not surprising, then, that as we have changed our organizing tools, our cosmologies have changed as well, reflecting the new approach we are using to capture and transform parts of nature into ourselves. Through our cosmology, we project ourselves into nature. Through our cosmology, we turn our technological relationship with nature into timeless truth. Our ideas about how the universe operates are conditioned by the way we are operating in a tiny fraction of the universe at any given moment. We convince ourselves that the way we come to fashion nature conforms to the way nature itself is fashioned.

The new temporal theory of evolution, like other concepts of nature that have preceded it, expresses the new organizing relationship we are establishing with our environment. We are undergoing revolutionary transformation in our mode of technology, and that organizational change is laying the base for the age of biotechnology and the new temporal cosmology that will accompany it.

Two historic developments took place in the early years of the 1950s that together marked the beginnings of the age of biotechnology. In England, two young scientists, James Watson and Francis Crick, discovered the double helix, fully exposing the gene to human scrutiny for the first time in history. Across the Atlantic, the first working computer was installed in Blue Bell, Penn. for use by the U.S. Census Bureau. For the next three decades, developments in biology and the computer sciences traveled along separate lanes of the same developmental pathway. Today, biology and the computer sciences are about to merge into a single dynamic. The fusion of the computer and living tissue signals the end of the age of pyrotechnology and the beginning of the age of biotechnology.

The electronic computer marks a new chapter in human history. For the first time we have developed a technological means of projecting the human mind directly into nature. This new approach to organizing the

videotex

the future is here

Videotex '83 – the latest in a series of international conferences and exhibitions dedicated to the North American market. Its predecessors, Videotex '81 and '82, drew exhibitors and delegates from all over the world. At those shows videotex ventures were mostly trials and theory, now the wraps are coming off solid commercial services.

Videotex '83 will provide a definitive forum addressing the many important marketing, programming, financial, communications and technical factors which will make the difference between success and failure. The conference program will consist of over 30 separate sessions, and feature presentations from more than 100 authoritative speakers.

Videotex '83 has been designed to meet the needs of knowledgeable decision makers – those who want to deal with the practices and practicalities of videotex and teletext. Newcomers haven't been forgotten though, and there are some foundation sessions to get them on the learning curve.

Videotex '83 promises an exhibition which will be bigger and better than ever. As well as a full

range of hardware products, there will be a wide range of systems illustrating the operating capability of both videotex and teletext services. The impressive exhibitors' list includes RCA, Sony, Time Video, Videotex America, IBM, Radio Shack, American Bell, Panasonic, Viewdata Corp of America, Philips and Modular Computer Systems.

Videotex '83 – for full details clip the corner of ad with your business card marked 'Exhibitor' or 'Delegate' and return to the organisers of the Videotex series:-

online

London Online Inc., 1133 Avenue of the Americas, Suite 3314, New York, NY 10036.
Phone: (212) 398 1177, Fax: (212) 398 1392.



Videotex '83 is organized in cooperation with the United States Videotex Industry Association.

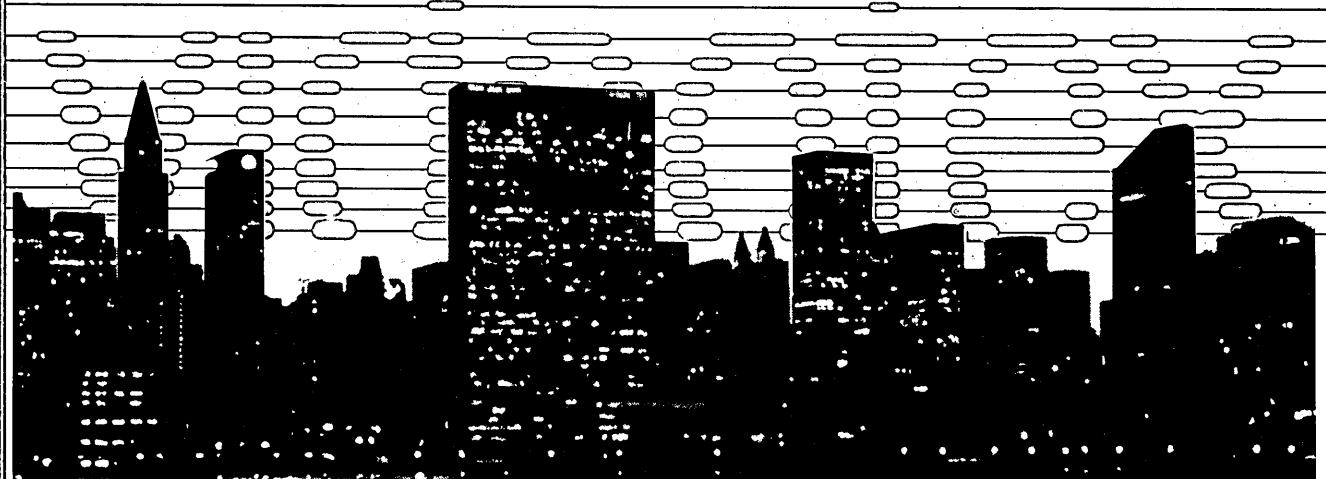

International Conference and Exhibition

The New York Hilton June 27-29 1983

"In psychological terms, we are moving from the "industrious" age to the "informed" age.

environment is radically changing our conception of nature. Remember, the industrial era was characterized by the technological projection of the human body into nature. When the machine replaced muscle power, our cosmology changed, reflecting the new method of organization. Darwin constructed nature in the image of the industrial machine. The new temporal theory of evolution is reconstructing nature in the image of the electronic computer. Nature as "matter in motion" is being replaced by nature as "mind in action."

RADICAL CHANGE IN WORK

The change in technological modes is already effecting a radical change in workplace psychology. Programming a computer requires a far different psychological orientation than attending a machine. In the industrial era, workers were rewarded for their diligence and reliability. "Industrial" comes from the Latin word *industrialis*. Today, "industriousness" is no longer held in as high esteem as it was in our parents' and grandparents' generation. In fact, when we refer to someone today as industrious, we often think of him as a hard-working, plodding type to be respected but not venerated. Industrious behavior is behavior generally associated with physical labor. In an age when the human body was projected onto the environment in the form of "the machine," it's not hard to understand how a premium would be placed on being industrious.

The psychological motivation that goes with the computerized society is of a very different sort. The new worker strives to

be creative, resourceful, integrative, and informed. The new psychological orientation values mental acumen over physical strength and fits nicely into an age in which the human mind is projected onto the environment in the form of "the computer." In psychological terms, we are moving from the "industrious" age to the "informed" age.

The psychological reorientation of the worker is just a small part of the sweeping changes that are taking place as the human family adjusts to the shift from a society organized by the industrial machine to a society organized by the computer.

While the electronic computer is fast replacing the industrial machine as the critical operating technology of civilization and is forcing a basic change in the psychological orientation of work-related activity, it is also becoming the chief metaphor for the reconceptualization of the origin and development of species. It is no mere coincidence that many of the operating principles that animate the computer happen to be the same operating principles that biologists now claim are the bases of all living systems. The cosmologists are once again borrowing the organizing technology of the society and projecting it onto nature. To the question How does nature operate? the new answer is that it operates in a manner similar to the electronic computer.

In order to digest fully the extent of the projection, it is necessary to delve into the operating principles that underlie the computer revolution. Those principles first took concrete form during World War II, when teams of engineers and scientists were assembled by the government with a mandate to devise new ways of organizing an increasing

array of disparate information into an intelligent, efficient mode of operation. The undertaking was called operations research, and from it a new approach to organization emerged; it was called cybernetics, and it provided the operating principles for the computer revolution.

"Cybernetics" comes from the Greek word *kybernetes*, which means steersman. It is a general theory that attempts to explain how phenomena maintain themselves over time. According to philosopher Carl Mitcham of St. Catherine's College, cybernetics is not concerned with "what a thing is but how it behaves." Cybernetics reduces behavior to two essential ingredients—information and feedback—and claims that all processes can be understood as amplifications and complexifications of both.

MIT mathematician Norbert Wiener, the man who popularized cybernetic theory, defines information as the "name for the content of what is exchanged with the outer world as we adjust to it, and make our adjustment felt upon it. The process of receiving and of using information is the process of our adjusting to the contingencies of the outer environment, and of our living effectively within that environment."

Information, then, consists of the countless messages that go back and forth between things and their environment. Cybernetics, in turn, is the theory of the way those messages or pieces of information interact with one another to produce predictable forms of behavior.

Cybernetics is primarily concerned with negative feedback. Wiener points out that "for any machine subject to a varied external environment to act effectively, it is necessary that information concerning the results of its own action to be furnished to it as part of the information on which it must continue to act." Feedback provides information to the machine on its actual performance, which is then measured against the expected performance. The information allows the machine to adjust its activity accordingly, in order to close the gap between what is expected of it and how it in fact behaves. Cybernetics is the theory of how machines regulate themselves in changing environments. More than that, cybernetics is the theory that explains purposeful behavior in machines.

MACHINES HAVE A PURPOSE

It was in a landmark article published in the *Philosophy of Science* in 1943 that Wiener first introduced the notion that machines can exhibit purposefulness. Wiener defined purposeful behavior as "a final condition in which the behaving object reaches a definite correlation in time or space with respect to another object or event." For Wiener, all purposeful behavior

CARTOON BY LEO CULLUM



How to get a lot more color for your money.



Actual unretouched photo taken directly from screen.

Introducing the HP 2627A Color Graphics Terminal.

Now you can have a bright, sharp image that's easy to read. For only \$5,975. Which means our compact new color graphics terminal is setting completely new price/performance standards.

You get 8 basic colors, plus hundreds of additional user-defined ones. Including colors that match our plotter pens. On a black screen with 512 x 390 line resolution. You get raster display technology for fast, selective screen updates. You get vector graphics and polygonal area fills, a combination that makes it easy to create complex shapes, symbols, and even typestyles. In a lot less time. With a lot more precision.

Of course, it's also software-compatible. In addition to HP's DSG/3000

and Graphics/1000-II software, the 2627A runs PLOT 10 from Tektronix, SAS's SAS/GRAPH, Precision Visual's DI-3000 and GRAFMAKER, ISSCO'S DISSPLA and TELL-A-GRAF.

But that's not all; the 2627A has user-definable softkeys and graphics edit keys that make this one of the easiest-to-use terminals on the market. It even gives you complete alphanumeric

capability. In a separate memory. So whether you're interested in business or technical applications, just return this coupon and we'll send you more information. Or call your local HP sales office. We're listed in the white pages.

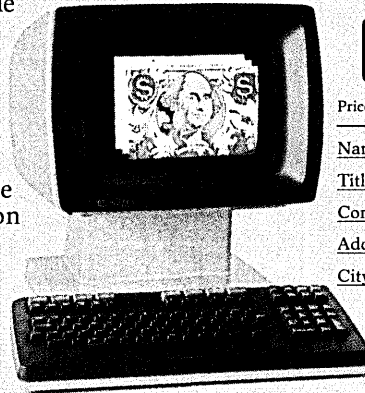

Price U.S. list.

42204

Name: _____

Title: _____

Company: _____

Address: _____

City: _____

State: _____ Zip _____

Send to: Hewlett-Packard, D.T.D., Dept. 04159,
974 E. Arques Ave., Sunnyvale, CA 94086
Attn: Tom Anderson, Marketing Manager
(408) 735-1550 ext. 2468 DM5/1

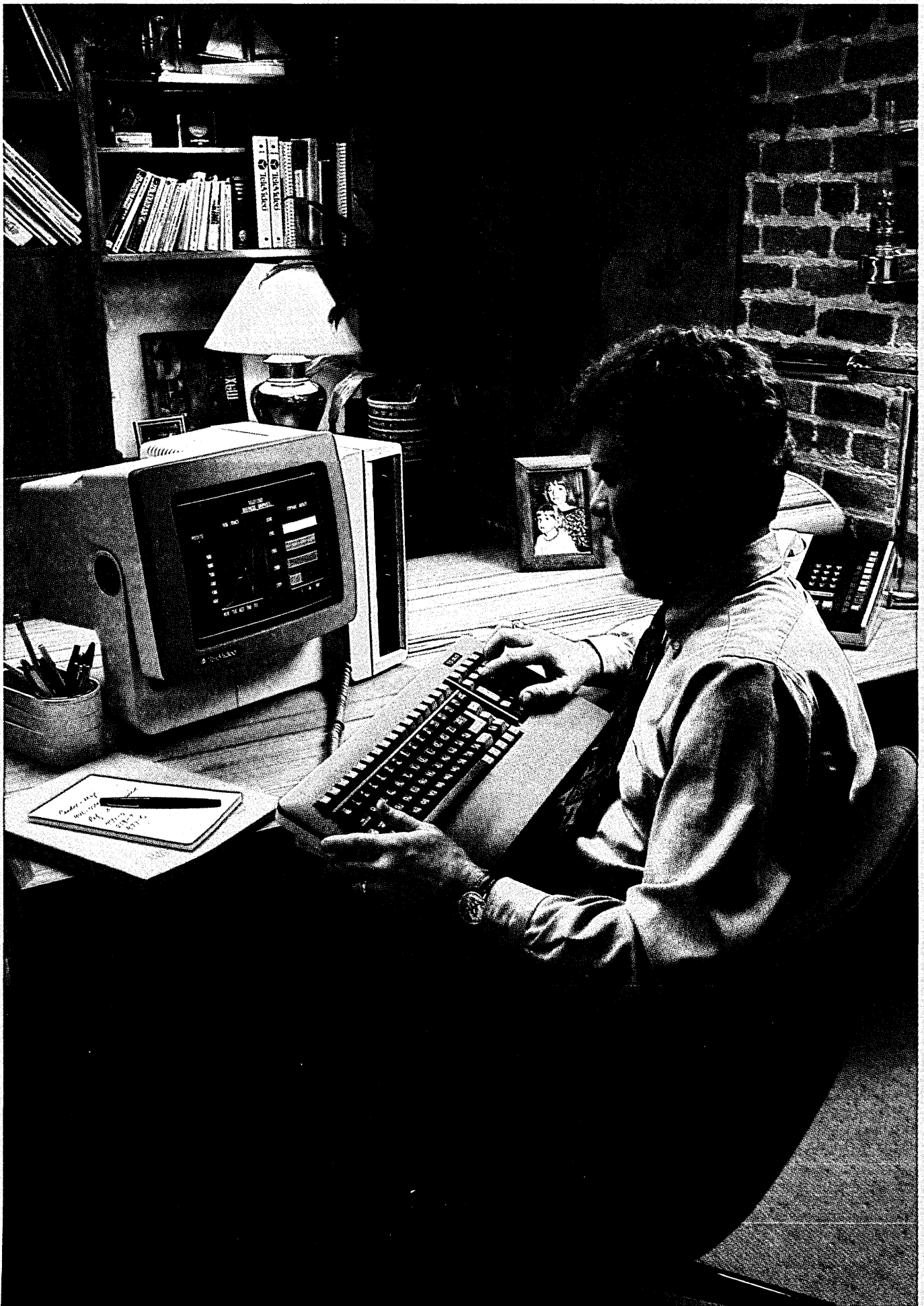

The TeleVideo Personal Computer. Not the first. Just the best.

When we set out to build the new TeleVideo Personal Computer, we decided to do it better than anyone else. It wasn't easy. All we had to do was design a special casing that keeps heat away from sensitive electronics, with no fan for no noise and greater reliability, put in a big clear 14" screen that tilts for your comfort, include a detachable keyboard so advanced it eliminates typing fatigue, throw in extra storage (for an unformatted total of 1 MB), and put it all in a very smooth and easy-to-use integrated package. We call it the TS 803.

We also made it CP/M® compatible, so you can choose from the largest selection of applications software in the world. And we made it possible to link up to sixteen TS 803s in one system, so more people can work smarter together. Then we did one final thing. We included

a powerful graphics package and priced the TS 803 at \$2,495. That's about \$1,000 less than a comparably equipped Apple.* So try our TS 803. Improving on something that's very good isn't easy, but we're sure you'll be happy with the results.

For more information, write TeleVideo Systems, Inc., 1170 Morse Ave. Sunnyvale, CA 94086, call toll-free 800-538-1780 (in California call (408) 745-7760), call one of our authorized distributors or dealers, or contact one of our regional sales offices, listed below.

Northeast Region, 617-369-9370.
Eastern Region, 212-308-0705.
Southeast Region, 404-447-1231.
Midwest Region, 312-969-0112.
South Central Region, 214-258-6776.
Northwest Region, 408-745-7760.
Southwest Region, 714-752-9488.
European Sales (Holland), (31) 075-28-7461
UK/Scandinavia Sales, (44) 0908-668-778
TeleVideo Systems are fully serviced nationwide by TRW.

 **TeleVideo Systems, Inc.**

Please See us at NCC Booth #A3008

CP/M is a registered trademark of Digital Research, Inc. Apple is a registered trademark of Apple Computer, Inc. *Based on manufacturer's suggested retail price.

CIRCLE 188 ON READER CARD

Funny how computers grow on you.

of information media management products, including filing devices, cabinets and work surfaces, to help you keep things from getting out of hand.

In fact, nobody else can begin to approach our system for its flexibility or its ability to integrate so perfectly into any workstation environment.

Whether it's a conventional office or open plan furniture.

And because we know everybody works differently, our system is designed to be designed. To let you structure it precisely to your own work style or personal preference.

No matter what stage your projects are in — in-process, reference or archival — you get a system that fits you. Which means we can actually help you spend more time working with your media. And less time fighting it.

So, if your workstation seems like a bad dream, let us know. Before things start getting under your skin. For more information contact Wright Line, 160 Gold Star Boulevard, Worcester, MA 01606.

Wright Line
A UNIT OF BARRY WRIGHT

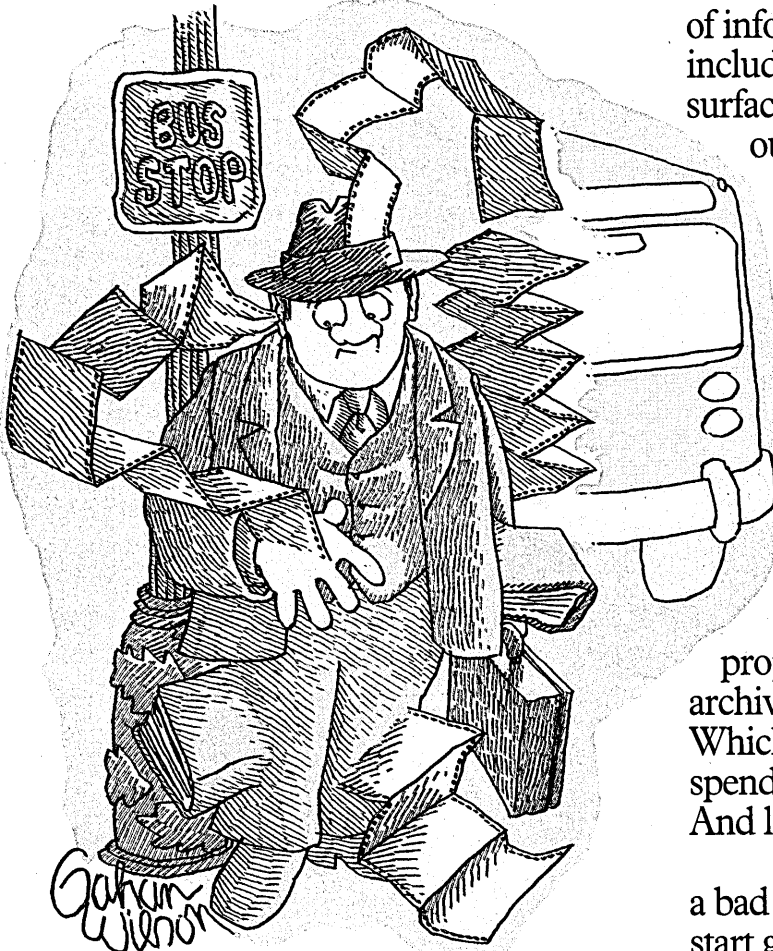

Oh, it all starts out innocently enough. A printout here. A reference manual there.

But before you know it, all those papers and books and program listings are sprouting up all over the place.

And if you haven't got a way to keep it all under control, well, you could have a real nightmare on your hands.

The fact is, without an efficient, well thought out approach to managing project materials at your workstation, you can easily waste up to 25% of your time just trying to keep all that information under control.

At Wright Line, that kind of mayhem is one thing we just don't want to see you cultivate. So we offer a unique system



Biologists now view living organisms as information systems.

reduces itself to information processing: "It becomes plausible that information . . . belongs among the great concepts of science such as matter, energy, and electric charge. Our adjustment to the world around us depends upon the informational windows that our senses provide."

After careful deliberation, Wiener concluded that "society can only be understood through a study of the messages and the communications facilities which belong to it." It's no wonder he came to view cybernetics as both a unifying theory and a methodological tool for reorganizing the entire world. Apparently, the succeeding generation of engineers and scientists fully concurred. With the aid of the computer, cybernetics has become the primary methodological approach for organizing economic and social activity. Virtually every activity of importance in today's society is being brought under the control of cybernetic principles. Information processing via the computer is fast becoming the hallmark of our technological society. Nowhere is this more in evidence than in the economic system. Once considered an adjunct to the management of large-scale economic organizations, information processing has risen to the top of the corporate pyramid and now defines the organization itself. Corporations are increasingly viewed as information systems. In her book *Systems Analysis in Public Policy*, sociologist Ida Hoos of the University of California observes that "the management of information has become equated with and is tantamount to the management of the enterprise." According to Hoos, "Management of information has receded from view and management by information has become the mode."

Cybernetics has not only changed the way we go about organizing the world, but has also affected the way we go about conceptualizing it. To begin with, the operating assumptions of cybernetics are antithetical to the orthodox view of the relationship between parts and whole. During the industrial era, it was assumed that the whole was merely an aggregate of the assembled parts that comprised it. Cybernetics, in contrast, views the whole as an integrated system. The constant feedback of new information from the environment and the continual readjustment of the system to the environment set up a circular process in contradistinction to the linear mode of organization that characterized the Industrial Age. The self-correcting circularity of this new mode of organization "blurs the distinction between cause and effect." According to the cyberneticians, in an increasingly complex environment it is no longer possible to entertain the simple fiction that one event in isolation leads to another event in isolation. We are now coming to realize that every event in some way affects

everything else. Because everything is interrelated, it is necessary to organize activity into integrated systems.

Cybernetic thinking has made its way into the very construction of machines. In the industrial era, machines were made up of many individual parts assembled into a working whole. Today, cybernetics has combined with computer design and electricity to "integrate more and more functions into fewer and fewer parts, substituting 'wholes' for many discrete components." The watch is a prime example of the transition in thinking and design that has occurred. Alvin Toffler points out that "whereas watches once had hundreds of moving parts, we are now able to make solid-state watches that are more accurate and reliable—with no moving parts at all."

In an article entitled "The Development of Cybernetics," Charles R. Dechert, professor of political philosophy at Catholic University of America, sums up the importance of the new set of organizing principles that have replaced the assembly-line mentality of the Industrial Age: "Cybernetics extends the circle of processes which can be controlled—this is its special property and merit." Lest there be any doubts as to the efficacy of this new organizational form, futurist Robert Theobald cautions us that there is no way to turn back the clock. "Let us be very clear: the only way to run the complex society of the second half of the 20th century is to use the computer." Increased reliance on the electronic computer ensures the institutionalization of cybernetic principles as the central organizing mode of the future.

NATURE IS REDEFINED

It is a measure of the immense influence engineering has had on biology that most biologists have come to accept cybernetics as an operating language for their discipline. Cybernetics is providing a brand new form of communication for biologists, and it is the shared acceptance of this new language that is laying the groundwork for the reconceptualization of nature and the acceptance of a temporal theory of evolution.

Biologists now view living organisms as information systems. W.H. Thorpe defines living organisms as things that ". . . absorb and store information, change their behavior as a result of that information, and . . . have special organs for detecting, sorting and organizing this information . . ." Biologists have been completely won over to the idea that all phenomena are reducible to information processing. Thorpe says the older Newtonian model, which viewed nature as "the movement of a particle under the action of a force," has been replaced with a new model that defines nature as "the storage . . . and

the transmission of information within a system." When one stops to consider that information is a nonmaterial thing, the full impact of the revolution in thinking begins to come into focus. Because it is nonmaterial, information does not exist in a static spatial context in the sense that Newton had in mind when he defined the world in terms of matter in motion. When a biologist talks about a living organism as an information system, he is saying it is an instruction or program that "describes a process and further, instructs that this process should be done," writes Thorpe. When a biologist talks about process, he is referring to something that takes place over a period of time. Therefore, living systems in the new way of thinking are information programs that unfold in a predictable manner over time.

"The most important biological discovery of recent years," says Thorpe, "is the discovery that the processes of life are directed by programs . . . [and] that life is not merely programmed activity but self-programmed activity." If the word "life" was removed from the above quote, one might well suspect that what Thorpe and the other biologists are talking about are computers with their information processing, their programs, their self-regulating activity. Indeed, the computer is what they are talking about in a very roundabout way. It has become the new metaphor for defining life, and it will be every bit as convincing to a generation raised on video games and pocket calculators as the industrial machine was for defining life to those conditioned by the industrial era. In Darwin's day, life was viewed as an aggregate of separate, interchangeable parts assembled into a working whole. Today, life is viewed as a code containing millions of bits of information capable of being programmed in a number of specific ways. We are experiencing the transformation from industrial machine to computer, from assembling to processing, from space to time, and from the cosmology of the industrial age to the cosmology of the age of biotechnology.

The battle over competing biological paradigms is as much a struggle over competing languages and metaphors as anything else. The neo-Darwinists continue to use the language and metaphors of the industrial age, while a new generation of scientists are using the language and metaphors of the age of biotechnology. It's a battle between those who continue to think in terms of the best-built machines versus those who think in terms of the best-designed programs.

Philosopher Kenneth M. Sayre of Notre Dame University is from the new school. He says, without qualification: "The fundamental category of life is information. . . ." Other scientists of his ilk are anxious to prove the point and are setting out to

NO PURCHASE

NECESSARY.

There's one thing Codex won't ever sell you. And yet it's worth as much as anything Codex sells.

It's the services of a Codex Applications Engineer.

The people involved in the Codex Applications Engineering program are experts in the field of data communications. They work with the broadest range of networking products. Many of them have advanced degrees, and all of them have years of practical experience in the science of planning and building a data communications network.

They're located in just about every Codex sales office around the world. To help you and work with you in coming up with practical, workable plans for your own data communications network.

No matter what other equipment you'd like to integrate. Or how simple or how complex the networking problem.

There's no bigger, more able support service in the industry. And no group more in tune with your needs, or with the idea that every data communications problem requires a unique solution.

True, you could plan a data communications network without the help of a Codex Applications Engineer.

But with all that they can bring to a job, why on earth would you want to?

For more information about what a Codex Applications Engineer can do for you, call **1-800-821-7700** Ext. 885. Or write: Codex Corporation, Department 707-85, 20 Cabot Boulevard, Mansfield, MA 02048.

codex



MOTOROLA INC.
Information Systems Group

SEE US AT NCC, MAY 16-19, BOOTH #S-5050.

© 1983 Codex Corporation

CIRCLE 190 ON READER CARD

Any self-respecting computer programmer would be tickled with the picture that is emerging.

redraw the map of life. Any self-respecting computer programmer would be tickled with the picture that is emerging.

The French biologist Pierre Grassé, in his book *Evolution of Living Organisms: Evidence For a New Theory of Transformation* (1977), has laid out a detailed presentation of the new approach to the conceptualization of nature, using the language of cybernetics. Grassé begins by framing all of life in cybernetic terms: "Information forms and animates the living organism. Evolution is, in the end, the process by which the creature modifies its information and acquires other information."

Grassé then goes on to develop a cybernetic model of a living organism. He starts with the strands of DNA that make up the genetic code. According to Grassé, the code represents the intelligence of the species. Grassé is willing to concede that DNA is "... the depository and distributor of the information," but he takes exception to James Watson, Francis Crick, and many of the surviving neo-Darwinists who contend that it is also the "sole creator." Grassé compares the genetic code of an organism to a library and argues that neither one fabricates information; they are merely repositories of information received from the outside. Both DNA and the library classify and store. It is at this point that Grassé applies the principle of feedback to living systems: "DNA has to receive messages either from other parts of the cell or from organs (e.g., hormones) or from the outside world (sense stimuli, pheromones, etc.). Of itself, by what miracle could it generate information adequate to performance of a given function?"

To drive home his point, Grassé feels compelled to use the computer as an appropriate reference point: "The computer is limited in its operations by the program controlling it and the units of information fed into it. To enlarge its possibilities, its contents have to be enriched. What is new comes from outside."

Grassé concludes that the living organism, like the computer, has "to be programmed and fed with external information in order for novelties to emerge." The picture he sketches is a cybernetic model of life; a circular process in which the genes, the organism, and the environment continually feed information back and forth, allowing the organism to regulate itself in response to changing external cues. After cataloging all the ways that external factors influence the genes and vice versa, Grassé acknowledges the role that cybernetics has played in helping to redefine the very operational design of life itself. He concludes that "the cybernetic model, of which philosophy has not yet fully taken advantage, is applicable to all kinds of biological systems. . . ."

The new cybernetic model of living organisms is the operational counterpart of Whitehead's notion of "subjective aim." Cybernetics secularizes Whitehead's process philosophy by turning a metaphysical insight into a technological modality. Remember, Whitehead's contention was that all living things are constantly "taking account" of the many changes going on and continually adjusting their own performance to anticipate future states. According to Whitehead, this process is at the center of all activity in nature and is really a shorthand description of "mind" at work. Cybernetics reduces Whitehead's description of mind in nature to quantifiable proportions, replacing any vitalistic or spiritual embodiment with a purely technological definition of behavior.

ORGANISMS IN FORMATION

By reducing all activity to information feedback and processing, cyberneticians are saying that the most important defining characteristic of mind is the ability to anticipate and respond to changing conditions over time. For the cybernetician, information feedback and information processing serve as a kind of all-embracing technological description of how the mind operates at every level of existence. Information feedback and processing, in turn, are ways of describing how an organism changes over time. In fact, if we dissect the word "information," we find that it means "in formation." The cybernetician views living organisms as in formation. A living organism is no longer seen as a permanent form but rather as a network of activity. With this new definition of life, the philosophy of becoming supersedes the philosophy of being, and life and mind become intricately bound to the notion of change over time.

While cybernetics is largely concerned with how systems maintain themselves over time, it also makes room for the idea of evolutionary change in systems by way of positive feedback. Ilya Prigogine, a Belgian physical chemist, has devised a theory of dissipative structures to explain how cybernetic principles can incorporate the notion of evolution as well as that of homeostasis. According to Prigogine, all living things and many nonliving things are dissipative structures. That is, they maintain their structure by the continual flow of energy through their system. That flow of energy keeps the system in a constant state of flux. For the most part, the fluctuations are small and can easily be adjusted to by way of negative feedback. However, occasionally the fluctuations may become so great that the system is unable to adjust and positive feedback takes over. The fluctuations feed off themselves, and the amplification can easily overwhelm the entire system. When that happens, the

system either collapses or reorganizes itself. If it were able to reorganize itself, the new dissipative structure would always exhibit a higher order of complexity, integration, and a greater energy flow than its predecessor. Each successive reordering, because it is more complex than the one preceding it, is even more vulnerable to fluctuations and reordering. Thus, increased complexity creates the condition for evolutionary development.

Like Prigogine, many scientists are coming to view evolution as the tendency of all living systems to advance toward "increased complexity of organization." Organizational complexity, in turn, "is equivalent to the accumulation of information. . . ." In other words, evolution is seen as improvement in information processing. The more successful a species is at processing more complex, more diverse kinds of information, the better able it is to adjust to a greater array of environmental changes. By this new way of thinking, the key to evolution itself is to be found in how information is processed. Negative feedback leads to stasis. Positive feedback leads to transformation. The upshot of this reformulation, says John Ford, former executive director of the American Society for Cybernetics, is that "together with philosophy, cybernetics [becomes] . . . the basis of the evolving theory of development."

In a society of increasing complexity, in which the process of collecting, exchanging, and discarding of information is proliferating at unparalleled speed, and in which success is measured in terms of one's ability to process larger chunks of information, it is easy to see why biologists might come to see the same forces at work in nature.

The story of creation is being retold. This time around, nature is cast in the image of the computer and the language of cybernetics, the operating tools of the biotechnical age. With both the computer and living organisms, time becomes the primary consideration. Each succeeding generation of computers is more adept at processing increasing amounts of information in shorter periods of time. Coincidentally, biologists are coming to see a similar pattern of development in nature.

According to the new temporal theory, each succeeding species in the evolutionary chain is more adept at processing increasing amounts of information in shorter periods of time. It's not hard to understand, then, why the first generation raised in a fully computerized society will come to accept so readily the new concept of nature that is emerging. They will grow up using the computer to organize their entire environment. Is it any wonder, then, that they will come to believe that nature itself is organized by the same set of assumptions and procedures they themselves are using when they manipulate it?

CRYSTAL UNIFORMITY
 ADVANCED BINDER
 REFINED LUBRICANT
 IMPROVED JACKET
 INTENSIFIED CALENDERING

THE GOLD STANDARD

You can wait for industry standards to mandate improved performance. Or you can have it now on Maxell. The Gold Standard.

What distinguishes a Maxell floppy disk? Improvements great and small, achieved in a decade of innovation. We developed unique, uniform crystals to assure dense oxide packing. Intensified the calendering process to minimize the need for abrasive burnishing. Created an improved binder and lubricant. And a new jacket design that leaves industry standards in our wake.

It would require photomicrographs to make some of these improvements observable. On the job, the advantages become obvious. Resolution enhanced by 20% creates a cleaner

signal output. And guarantees the read/write accuracy in double-density applications. New jacket construction, heat-resistant to 140°F, extends disk use without risk of mistracking. In effect, durability is redefined. And in accelerated tests against the most respected names in the industry, Maxell sustained the highest and most consistent output over time.

We applaud industry standards that aspire to dropout-free, reliable disk performance. The Gold Standard expresses a higher aim: perfection.



See us at NCC
 Booth P7012

maxell
 IT'S WORTH IT.

Computer Products Division, Maxell Corporation of America, 60 Oxford Drive, Moonachie, N.J. 07074 201-440-8020

CIRCLE 191 ON READER CARD

Many scientists are coming to view evolution as the tendency of all living systems to advance toward "increased complexity of organization."

COMPUTER AS METAPHOR

To sum up, cybernetics is the organizing framework for the coming age, the computer is the organizing mechanism, and living tissue is the organizing material. Cybernetics fuses the computer and living organisms into a single technological context by providing a common language.

It is instructive to recall that even the initial discovery of the double-helix structure of DNA by Sir Francis Crick and James Watson was explained in the language of the computer sciences. MIT's Joseph Weizenbaum, an authority on the role of the computer in modern society, in his book *Computer Power and Human Reason: From Judgment to Calculation*, says that from the very beginning of the revolution in molecular biology, the computer provided the appropriate metaphor and computer language provided the appropriate explanation for understanding how biological processes function. "The results announced by Crick and Watson fell on a soil already prepared by the public's vague understanding of computers, computer circuitry, and information theory . . . Hence, it was easy for the public to see the cracking of the genetic code as an unraveling of a computer program, and the discovery of the double-helix structure of the DNA molecule as an explication of a computer's basic wiring diagram."

Now that cybernetics has been firmly accepted as the linguistic framework for both living tissue and mechanical processes, the technological groundwork has been laid for using the computer to engineer living tissue.

In the second great economic epoch, the computer sciences and the bioengineering

sciences fuse together into a single technological configuration. Already scientists are busy at work preparing for the union. In a cover article appearing in the May 1982 issue of *Discover* magazine, the popular science journal owned by Time, Inc., scientists sketched out the new vision of the organic computer:

"On the outside it looks like another ho-hum electronic device, perhaps a hand-held calculator. But inside this garden variety box lurks an alien computer. In place of the usual green plastic boards holding silicone microchips are ultrafine films of glass crusted over with invisible layers of proteins, linked together in complex crystal patterns not unlike those of the arctic retreat in the movie *Superman*. Within the delicate protein latticework are organic molecules, called biochips, that dance at the touch of an electric current, winding or unwinding, passing hydrogen atoms from one end to the other. . . .

"As they shift positions or shapes, the molecules pass along information in the manner of ordinary integrated circuits. But because they are so tiny and so close together, they can perform a calculation in about a millionth the time of today's best chips. One more thing: these molecular diodes, transistors, and wires, as well as the protein architecture that holds everything together, were manufactured by simple *E. coli* bacteria fashioned to do the job by genetic engineering. It can almost be said that the computer is alive."

The meshing of computer and living tissue will result in a new type of world economy, one made almost exclusively of biologically engineered utilities. At this stage

it's simply impossible for the human mind to imagine the contours and boundaries, the apertures and processes of such an alien environment, for we still relate to a world forged in the fires of the age of pyrotechnology.

The age of biotechnology is likely to unfold in three distinct stages, with knowledge gained in each providing the basis for the next. The first stage is already well along. Scientists are learning more each day about how to modify genes, insert genes, and change genes. With genetic engineering, biologists are becoming increasingly adept at changing specific characteristics. However, genetic engineering is merely the first manifestation of the age of biotechnology. As the scientists increase their knowledge of how genes function, they will also become increasingly aware of their limited role within the organism. At the same time, their attention will turn increasingly toward forces beyond the gene that exercise a controlling influence over it. An understanding of the cybernetic relationship between gene, cell, organism, and environment will lay the basis for the second stage of the age of biotechnology. At this stage, scientists will be able to expand beyond the engineering of genetic characteristics and begin applying engineering design to the construction of entire organisms. Moving from the engineering of simple temporal characteristics to the engineering of entire temporal programs will have to be followed closely by the development of stage three. In fact, stages two and three are likely to overlap, since both greatly depend on each other for their expression. Stage three is the engineering of entire ecosystems and involves the sophisticated programming of systems of biological information contained within other systems of biological information.

The three stages of bioengineering, then, deal with the engineering of the individual characteristics of the organism, the engineering of the organism itself, and the engineering of the entire ecosystem. Engineering on the first level requires knowledge of the genetic code. Engineering on the second and third levels requires knowledge of biological clocks and fields. The unifying language that fuses characteristics, organisms, and ecosystems with genetic codes, clocks, and fields is cybernetics—the language of the biotechnical age. *

Jeremy Rifkin has authored five books in the past five years on economic, political, cultural, philosophical, and theological themes. In addition to *Alegny*, his most recent books include *Who Should Play God?*, *The North Will Rise Again*, *The Emerging Order*, and *Entropy: A New World View*.



"I like drama absurdist, my art surreal, and my tv violent."

CARTOON BY HARLEY SCHWADRON

Symbolics 3600
Symbolics 3600
High Performance
Computer System

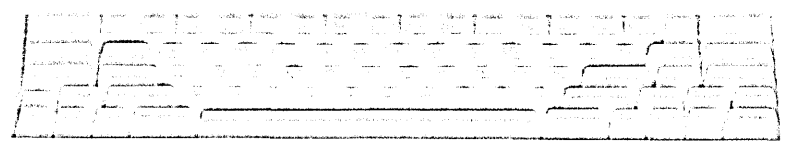
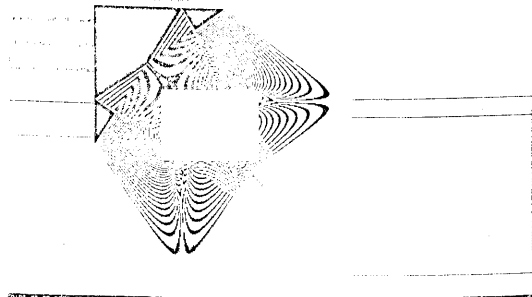

Introducing the sophisticated professional workstation.

The Symbolics 3600 Lisp-based system puts unlimited computing at your fingertips

Unlimited computing power

The Symbolics 3600 puts the level of computer power associated with supermini class computers in your hands at a fraction of the usual cost. It has a 36-bit tagged architecture and executes programs at an average of one million high-level instructions per second. Our standard 3600 system software, a powerful and proven Lisp-based operating and program development environment, also supports FORTRAN, PASCAL, C, Interlisp compatibility and Flavors object-oriented programming.

Symbolics' innovations in symbolic computing extend the limits of solutions in traditional applications. For example, large-scale software system development and VLSI circuit design are massive undertakings. The Symbolics 3600 software environment takes care of many of the

routine tasks a programmer or designer is now required to perform, dramatically reducing programming and design time while significantly in-

creasing productivity. These benefits apply to emerging application areas such as development of expert systems, symbolic mathematics, robotics, CAD/CAM, genetic engineering, training simulators, and a broad range of research activities. Each user in a typical workstation environment has access to all other computing facilities on the network.

Join the new age of computing
The Symbolics 3600 brings to you today a new age of computing—symbolic processing systems that are being used by a growing number of 3600 customers as the sophisticated means for problem-solving. Join them in this new age of computing.

Call or write today. Symbolics, Inc., 9600 The Soto Avenue, Chatsworth, CA 91311 (213) 998-3600.

Symbolics 3600 Capsule Specifications

System CPU 36-bit tagged, stack oriented architecture 2.3 megabyte RAM with ECC, expandable to 34 megabytes 1.125 gigabytes virtual memory 20 million byte/second memory bus Floating point accelerator (optional)	50 KHz sample rate audio output Color: 1280 x 1024 with 8 to 32 bits/pixel, 10 bits color RGB (optional)	Autodial Autoanswer 1200 baud modem (optional)
Console and Keyboard Bit-mapped raster display B&W 17-inch, landscape format, 1100 x 800 pixel 88 keys with n-key rollover 3-button mouse	Mass Storage Built-in 169 megabyte Winchester Optional disk memory up to 1.8 gigabytes Optional cartridge or 9-track tape drives	Operating System Enhanced Zetalisp with on-line edit, compile, inspect, debug, network file system, electronic mail Totally interactive with sophisticated display system
	Communications 10 megabit/second Ethernet local area network One parallel and three standard serial ports	Languages Lisp, Fortran-77, C, Pascal Interlisp Flavors object-oriented programming
		Printer Laser Graphics Printer LGP-1 (optional)

symbolics inc.

Symbolics is a trademark of Symbolics, Inc., Cambridge, Massachusetts.

© 1983 Symbolics, Inc. Domestic sales offices: Chatsworth, CA (213) 998-3600 • Palo Alto, CA (415) 494-8081 • Cambridge, MA (617) 576-2600 • Houston, TX (713) 820-3001 International distributors: United Kingdom and Western Europe: Scientific Computers Ltd., England, Tel. (0444E) 5101 • South Central Europe: Delco, Electronic Design Systems SpA, Italy, Tel. (0584) 31881 • Japan: Nichimen Corporation, Tel. (03) 277-5017

When your people need information from the company computer, they should be able to get it with their own two hands.

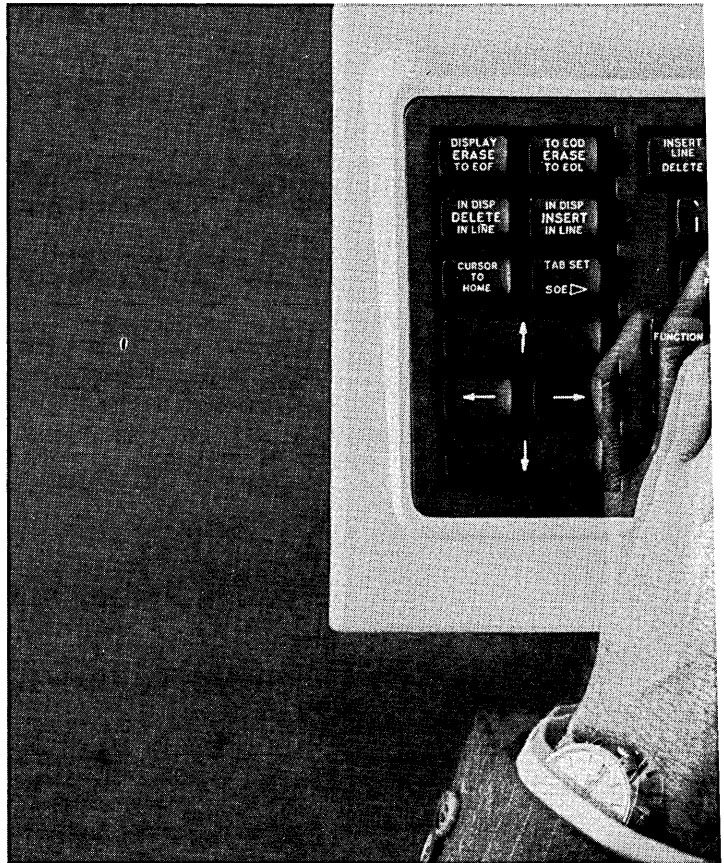

Information.

It can be useful or useless. Timeliness makes the difference.

And therein lies the problem. In the conventional scheme of things, you can't get immediate answers from a computer. Because your questions can't be answered until after they've been translated into FORTRAN or COBOL or RPG II or some other programming language.

Consider, now, the achievement of the System 80 computer.

One of the good things System 80 brings you is ESCORT, a unique programming language you and anyone else in your company can

handle with fluency. Because it reads like English. And you work with simple sentences.

ESCORT gives you the power to create your own precisely defined reports instantly, whenever the need arises. Right at your desk.

In fact, anyone in your organization with a need to know can generate customized reports in a matter of minutes. ESCORT actually enables even a novice to create programs while learning. A tutorial mode takes the user through the process, step by step, explaining what's required.

Because the information content is defined by the user request, the

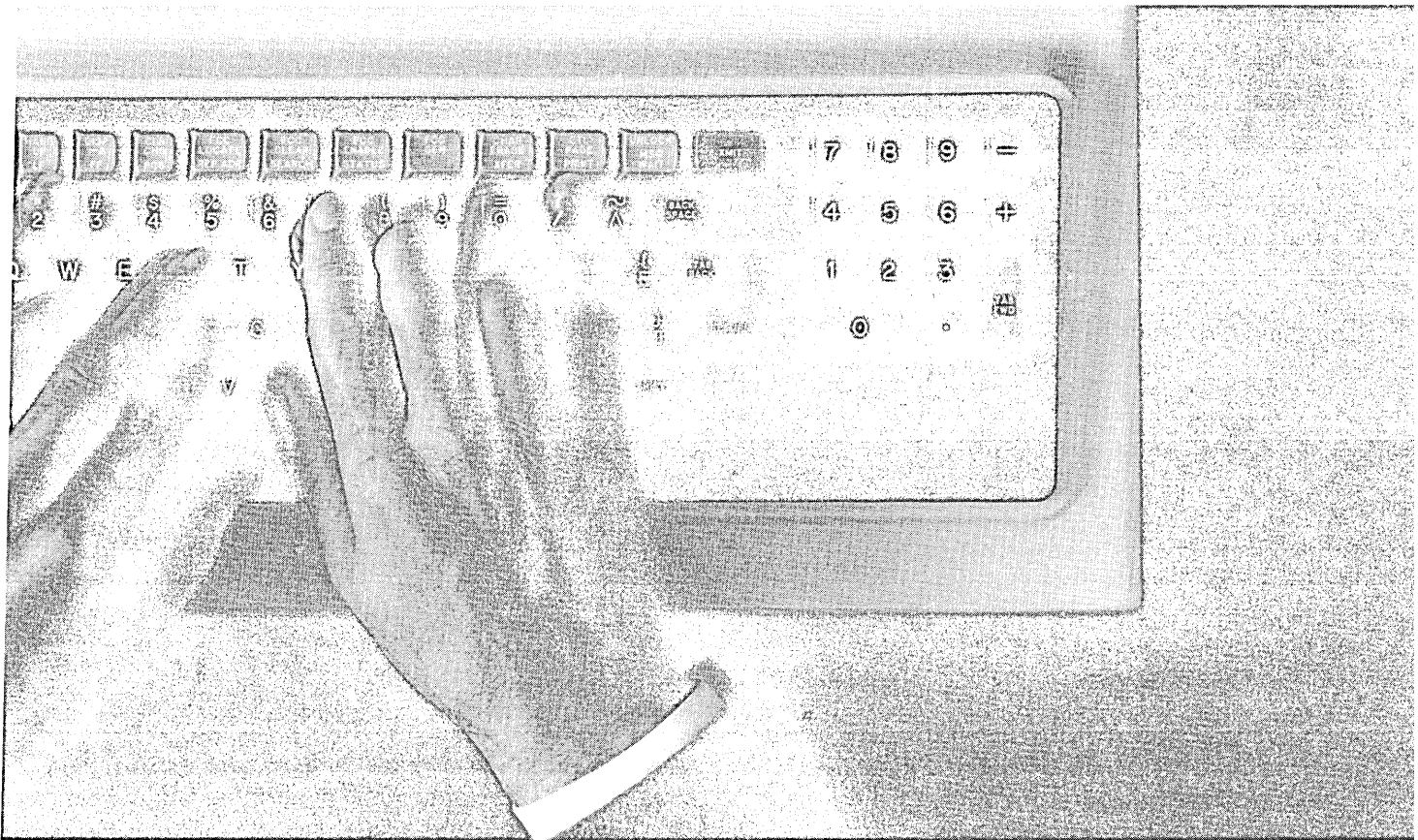

SYSTEM 80 ESCORT

user gets only the information required. The computer gives you everything you asked for, not everything it has.

So you not only save time getting data, you save time evaluating it.

The potential for application spans all departments, at all levels, from top management on down. ESCORT dispenses the information riches of the data base to each according to his need.

With or without ESCORT, System 80 is a superb medium-

scale business computer. The fact is, it outperforms the competition, model for model, in most parameters of consequence. And as your needs expand, you can upgrade capabilities without replacing the entire system. That is not universally true in the industry.

The System 80. Another demonstration of how we at Sperry define our products by the real-world needs of the people who use them. Another demonstration of the value of listening.

We invite you to review the System 80's uncommon capabilities. Our "System 80 vs. IBM" and our ESCORT brochures are a good place to begin. Copies are yours for the asking from your local Sperry marketing office.

Or call or write Sperry Corporation, Computer Systems, Department 100, P.O. Box 500, Blue Bell, PA 19424. Toll-free phone: 800-523-2496 (9 a.m. to 5 p.m. E.D.T.). In PA call collect 215-646-3378.



We understand how important it is to listen.

CIRCLE 194 ON READER CARD

We Don't Just Drop A Tape On You!

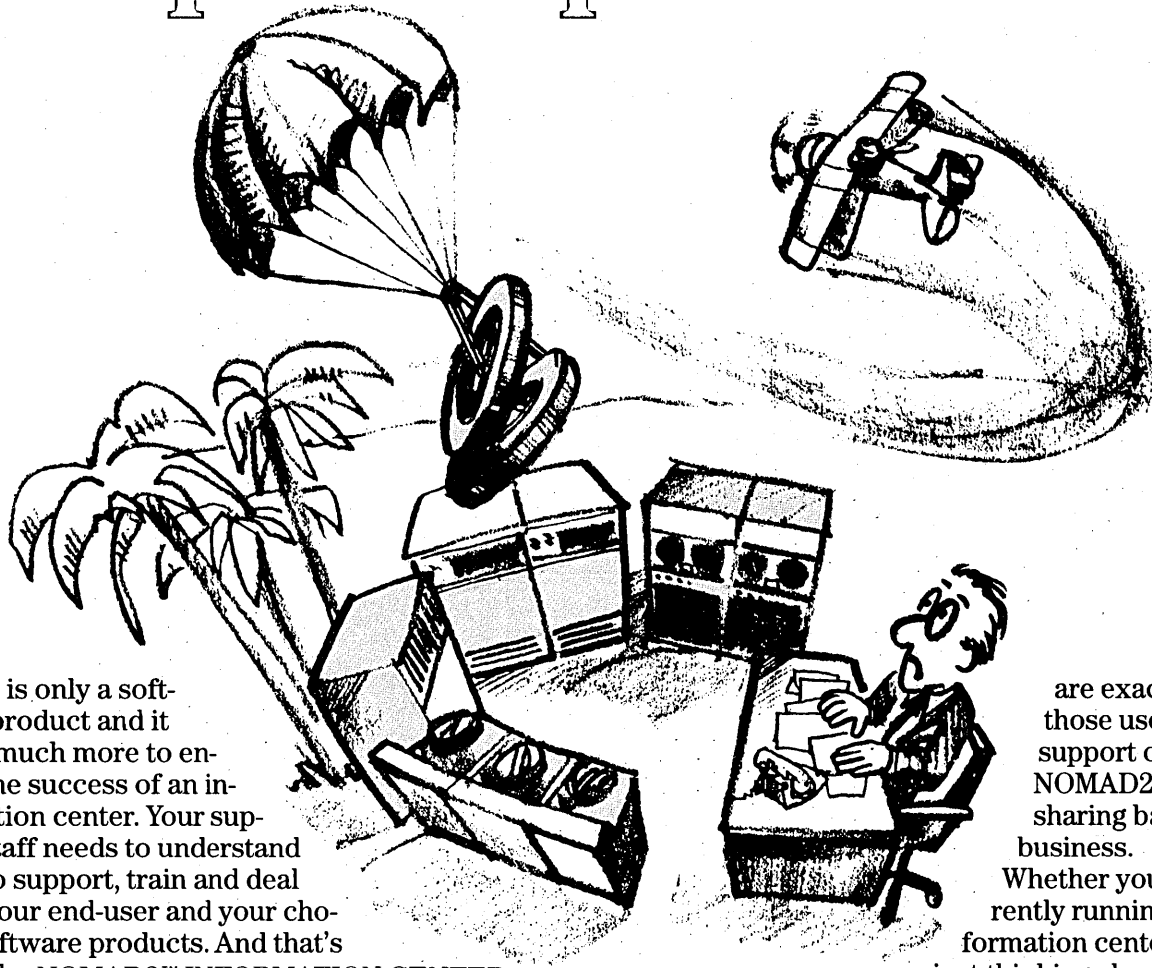

A tape is only a software product and it takes much more to ensure the success of an information center. Your support staff needs to understand how to support, train and deal with your end-user and your chosen software products. And that's what the NOMAD2™ INFORMATION CENTER is all about. The NOMAD2 INFORMATION CENTER consists of: NOMAD2, the most powerful 4th generation language/DBMS currently available; support staff training, product education, documentation and product support; and of greatest value, our 16 years of experience in delivering end-user computing.

NOMAD2 is widely recognized in the industry as the premier end-user oriented software product. Its report writer is unsurpassed and its graphic capabilities, relational properties and broad spectrum of built-in functions allow it to fully respond to end-user needs, no matter what those needs are. The in-depth training and support materials

are exactly those used to support our NOMAD2 time-sharing based business.

Whether you're currently running an information center, or just thinking about setting

one up, examine the options available to you and then talk to us. And if someone tries to drop a tape on you, ask them what they know about delivering and supporting end-user computing. For further information call Charles Graham at (203) 762-2511, or write to:

N2IC, National CSS,
187 Danbury Road,
Wilton, CT 06897

NOMAD2 *Information Center*

is
Experience the difference
^

National CSS

DB a company of
The Dun & Bradstreet Corporation

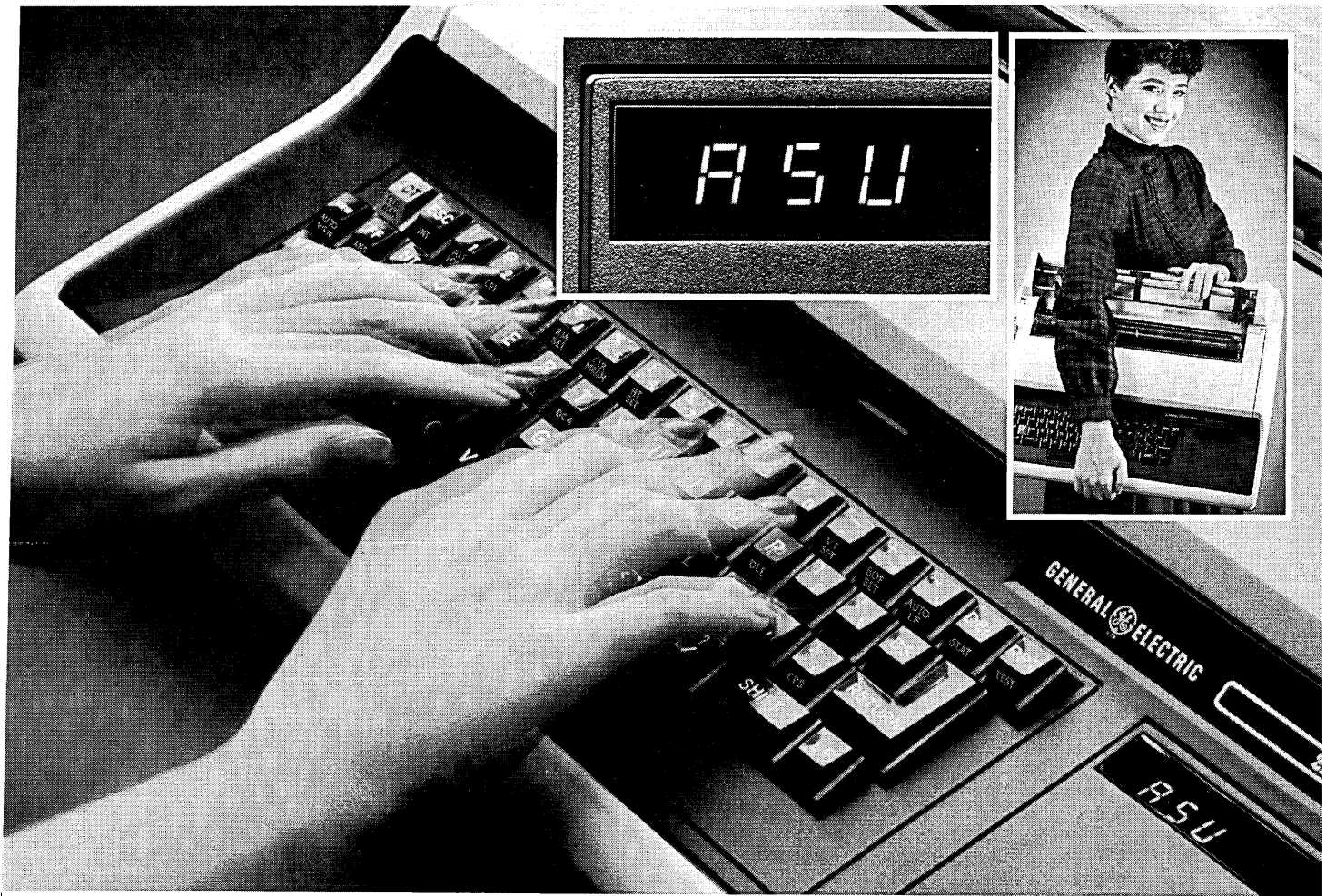

Using the GE 2120 teleprinter is understandably simple.

Easy to understand. Simple to use. This is the advantage General Electric has built into the reliable GE 2120 teleprinter.

Over a decade of electronic printing experience has led us to a special appreciation of human engineering...the science of designing machines with the user in mind.

That's why today's GE 2120 teleprinter is compact, lightweight, attractively styled, and most important, easy to use.

The keyboard is designed like a common typewriter keyboard. It's color coded and annotated for quick, easy set-up and format changes. All operations can be programmed and selected from the keyboard.

A conveniently located, easy to read digital LED display gives you printer parameters, print position, self-test diagnostic readouts and error messages...all in plain English.

There's also 150 cps print speed, high reliability under heavy workloads, options like a 32K text editor, and of course more. But take a close look at the GE 2120 teleprinter yourself. We're sure you'll find it's one man-made machine that's truly made for man.

General Electric. We introduced the first fully electronic printer with LSI circuitry in 1969. And our complete line today makes us the industry leader you should look to first.

First In Electronic Printing.

For the solution to your printing needs, call
TOLL FREE 1-800-368-3182

General Electric Company, Data Communication Products Department A311, Waynesboro, VA 22980. In Virginia, call 1-703-949-1170.

See us at the NCC.
Booth S5018

GENERAL  **ELECTRIC**

CIRCLE 196 ON READER CARD

Introducing:

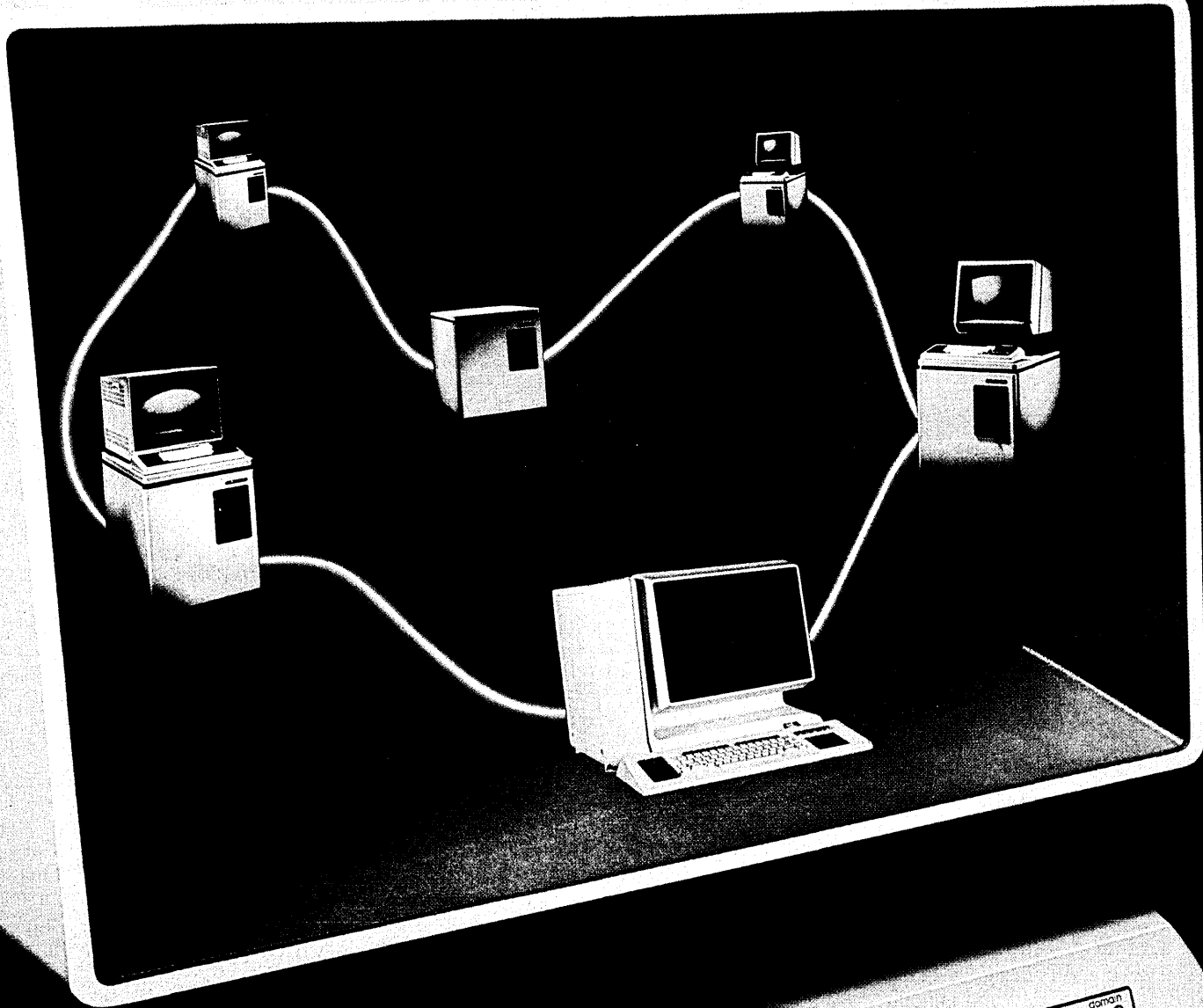

apollo
computer inc. **coman**
D300

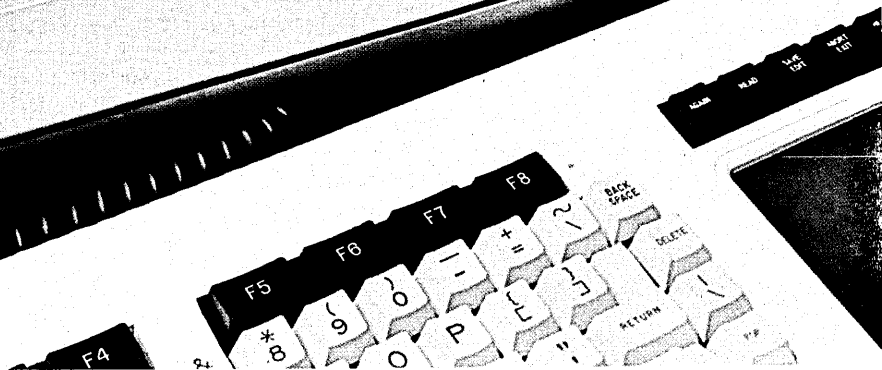

the \$10,000 desktop mainframe.

THE NEW APOLLO DN300 WILL COMPLETELY CHANGE THE WAY TECHNICAL PROFESSIONALS USE COMPUTERS.

The DN300 is quite possibly the single most important computer system ever introduced for the technical professional. For the first time ever, these technical professionals have fingertip access to a desktop mainframe, and all the power that goes with it. The power to utilize time in the most efficient possible way. The power to increase technical productivity and innovation. The power to try out and refine new ideas and concepts. The power to reduce design-time cycles. The power to create better, more cost-effective products.

In a unit that takes no more space than a daily newspaper, the DN300 gives you a high performance, 32-bit virtual memory processor, high resolution bit map graphics, and an integrated local area network that provides network-wide virtual memory access.

The DN300, latest in the family of DOMAIN processing nodes, supports up to 1.5 million bytes of main memory and 15 concurrent processes of 16 million bytes each, so you can execute large programs. Its 17-inch 1024 x 800 pixel landscape display provides the high-resolution graphics you need for technical

applications. The 12 million bit-per-second high speed token-passing network lets you access data anywhere in the network without sacrificing performance.

The DN300 is fully compatible with Apollo's DN400, 420, and 600 and supports multiprogramming environment, large virtual address space, network communications, multi-window display management, and extensive command library.

SOFTWARE YOU NEVER THOUGHT YOU'D SEE ON YOUR DESKTOP.

Standard with every DN300 is AEGIS, the only network-wide virtual memory operating system available.

Optional software includes ANSI-FORTRAN 77, Pascal, C, SIGGRAPH Core Graphics, X.25, HASP, 3270, D3M distributed database system and AUX, a software environment based on UNIX™ System III.

NEW DOMAIN SERVER PROCESSOR—A LOW COST WAY TO HANDLE NETWORK PERIPHERALS AND GATEWAYS.

The new DSP80 intelligent peripheral server lets DOMAIN users freely share the same, centrally located peripherals.



That relieves individual nodes of peripheral support. So nodes have more time and more power to handle applica-

tion-related computing.

And you save money by sharing disks, tape drives, printers and plotters. The DSP80 also provides every user with access to communication gateways, large-scale file storage, and print/plot spooling.

FIND OUT MORE

The DOMAIN network gives you low entry cost, high performance, easy and natural incremental growth, reliability, and long-term investment protection. And it gives your technical staff the excitement and satisfaction of working with an innovative, highly productive new tool. For more information call Apollo's marketing department at (617) 256-6600, extension 608, or write Apollo Computer Inc., 15 Elizabeth Drive, Chelmsford, MA 01824.

UNIX is a trademark of Bell Laboratories.

USA price \$9,933, system builder, quantity 35 DN300 with .5Mb memory, 17-inch graphics display, network interface, and AEGIS operating system.

A DOMAIN professional productivity network puts an application specific mainframe on every user's desktop.

The truly exciting aspect of a DOMAIN network is its ideal combination of individual initiative and teamwork. Users get not only the benefits of a high performance, 32-bit computer dedicated to their application, but also retain the benefit of shared resources.

For example, use the color DN600 or monochromatic DN420 nodes for solids modeling, VLSI CAD, finite element analysis, pre- and post-processing, and image analysis. . . . Use the DN300 for computer-aided software engineering, design documentation, high-quality presentation graphics, drafting, and electrical design capture and simulation.

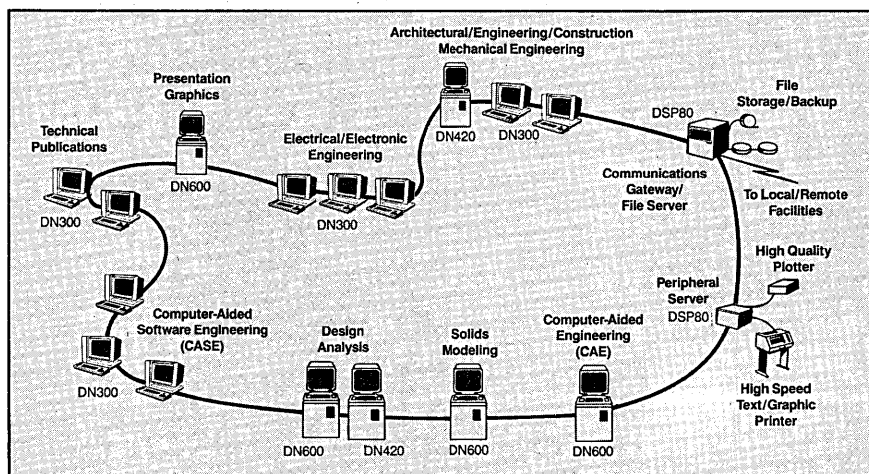

apollo
computer inc.

Domain. The Next Generation

CIRCLE 161 ON READER CARD

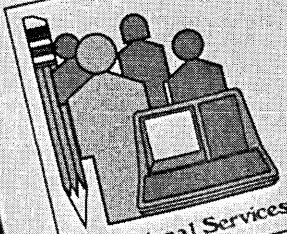

Student Opinion Form

Educational Services/Quality Assurance Program

Course Name: _____
 Course Number: _____
 Course Ending Date: _____
 Training Center: _____

This Student Opinion Form is designed to help Digital assure the quality and usefulness of its training courses. Please respond carefully and objectively as indicated below.

- Complete the course information above. Do *not* write your name anywhere on this sheet.
- The other side of this sheet consists of two sections: *Background Information* and *Evaluation of Course*. In the *Evaluation of Course* section you will find a list of numbered statements that may or may not describe your opinions about this course. Please indicate whether you agree or disagree with each by selecting the appropriate lettered box from the following choices:
 SA = Strongly Agree
 A = Agree
 U = Uncertain
 D = Disagree
 SD = Strongly Disagree
 NA = Not Applicable

PLEASE READ DIRECTIONS ON THE OTHER SIDE. SELECT THE *ONE* BEST ANSWER.

BACKGROUND INFORMATION

- What is your relationship with Digital? (a) customer (b) employee (c) other
- What is your primary job area?
 (a) hardware (b) software (c) management (d) education (e) other
- How many years of experience have you had with computers?
 (a) less than 1 (b) 1-3 (c) 4-6 (d) 7-9 (e) 10 or more
- Did you meet all the stated prerequisites? (a) Yes (b) No
- Why did you take this course? (a) general interest (b) required for current job
 (c) required for new job (d) to help get new position
- What is your native language? (a) English (b) Spanish (c) French (d) German
 (e) Italian (f) Japanese (g) Chinese (h) Dutch (i) Swedish (j) Other

EVALUATION OF COURSE

SA=Strongly Agree A=Agree U=Uncertain D=Disagree SD=Strongly Disagree NA=Not Applicable

COURSE DESIGN AND RESOURCES

- 1. I learned a lot of valuable skills and information.
- 2. The course content met my expectations.
- 3. The course was well organized.
- 4. The course materials were easy to understand.
- 5. I needed all the information contained in the course materials.
- 6. The course emphasized the real job.
- 7. My test scores accurately reflected what I learned.

INSTRUCTOR

- 8. The lab exercises were useful for learning.
- 9. The instructor was very knowledgeable in the subject.
- 10. The instructor answered difficult questions easily.
- 11. The instructor's presentations were easy to understand.
- 12. The instructor made the course interesting.
- 13. The instructor managed class discussions well.
- 14. The instructor took the time to answer questions.
- 15. The instructor was patient and helpful.
- 16. The instructor emphasized the objectives of the course.
- 17. The instructor made effective use of the available time.

TRAINING FACILITY

- 18. The training center provided all the services I needed.
- 19. My workspace in the classroom was comfortable.
- 20. The classroom was well laid out.
- 21. The lab was functionally laid out.
- 22. The lab time was adequate for this course.
- 23. My housing was satisfactory.

24. Please indicate your *overall* impression of this training experience.
 E=Excellent VG=Very Good G=Good F=Fair P=Poor

FEED

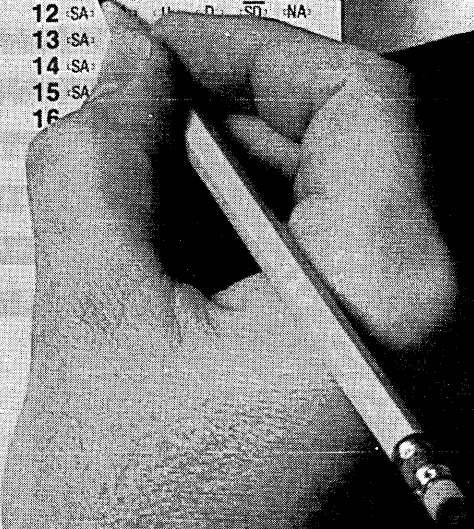

The toughest test in a computer course at Digital is the one we use to test ourselves.

At Digital's Educational Services, quality is something we never take for granted. That's why we use a tough test to help us track how we're doing week after week.

And judging from recent results, we're doing very well.

You see, everyone who comes to our 27 worldwide training centers, whether they're studying basic programming or VAX/VMS system management, is asked to fill out a Student Opinion Form.

Course material, instructor performance, the overall educational experience, everything is covered.

And so far this year, 93% of the 55,000 people who've come to our training centers have given our instructors the highest ratings on the form. Results for course content and computer resources are equally as impressive.

Most important, our ongoing effort to create and preserve quality doesn't end in our classrooms. At Digital, it extends to every educational product we make. Our A/V and self-paced courses. Customer seminars. Computer-based instruction. And our Professional Educational Series, designed for anyone who wants to learn more about computers, even if they're not using Digital's computers.

So, whether you come to Digital for education, or our materials and courses come to you, you'll be getting a product that's proven successful. A product prepared by experts who not only know computer technology, but also the best ways to teach it.

For more information on the more than 550 computer courses we offer and our wide variety of educational formats, write to:
Digital Equipment Corporation, Educational Services, Box M-BUO/E55,
12 Crosby Drive, Bedford, MA 01730.

digital

OUR 21,000 LPM PRINTER TAKES MANY FORMS.

If you need high volume and flexibility, you should know that the DatagraphiX 9800 isn't just a 21,000 LPM laser printer. It also accepts the widest variety of paper form sizes of any non-impact printer, with form widths of 6.5" to 16" and a length range of 3.5" to 14". And all 9800 printers feature perf-to-perf printing on paper weights of 16 to 110 pounds, depending on paper type.

The 9800 series is an entirely new generation of non-impact, high speed laser printers — with more functions, features, and reliability. It offers up to 34 standard character sets, with a font editor that helps you create a nearly unlimited variety of fonts, logos or signatures of your

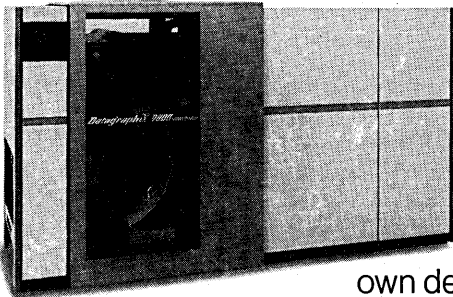

own design.

The 9800 series comes in a variety of on-line, off-line, or on-line/off-line configurations compatible with a broad selection of CPUs. Off-line models offer user-oriented menu-driven software, hard copy log, 6250 BPI tape drives with ping-ponging capability and more. On-line models offer full IBM 3800 compatibility, in addition to the advantages of DatagraphiX's advanced engineering.

Combine these advanced features with excellent print quality and unmatched reliability, and you begin to see why DatagraphiX is recognized as a supplier of superior computer output management products. The full-featured 9800 printers are available now, setting industry standards for up-time in customer sites throughout the U.S. and Canada.

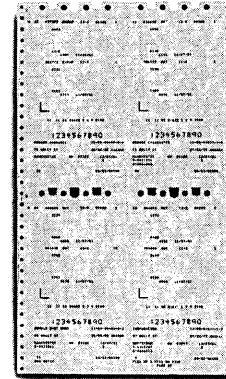
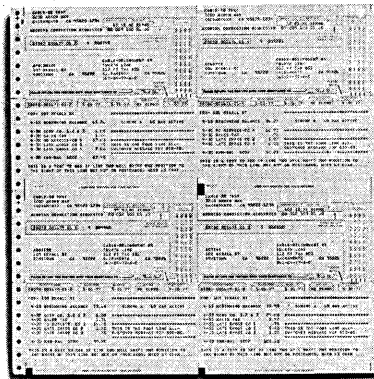
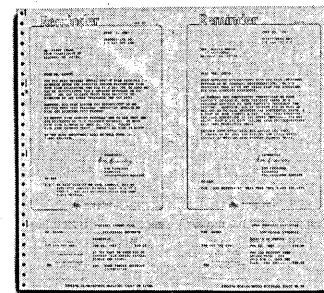
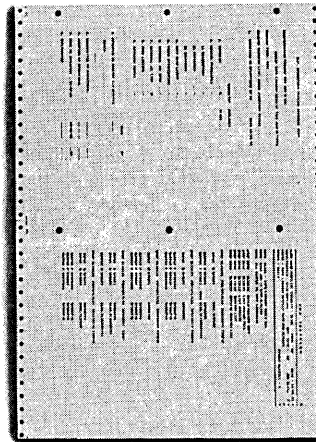
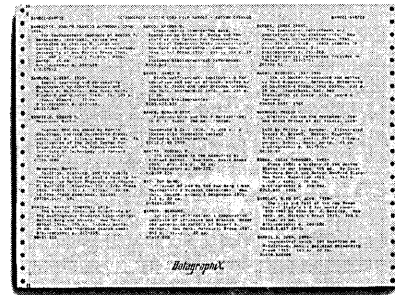
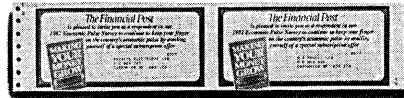
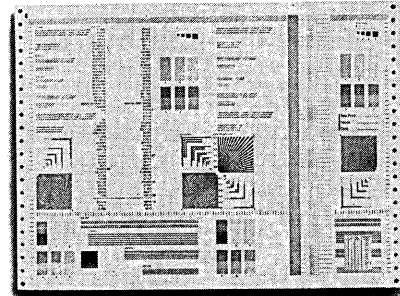
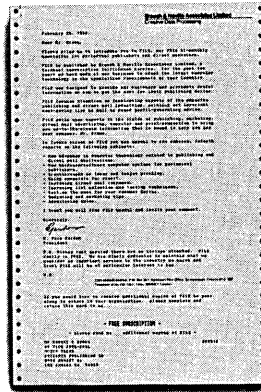

DatagraphiX®

The Computer Output Management Company
a General Dynamics subsidiary

Dept. 3515, P.O. Box 82449, San Diego, CA 92138
(800) 854-2045, Ext. 5581
In California, please call (619) 291-9960, Ext. 5581
TWX: 910-335-2058

HARDWARE

OFF-LINE

You might think that things are not looking up in the 5¼-inch floppy disk drive world; after all, Winchester and cartridge drives have moved in, and now the various microflops are becoming popular. Nonetheless, it looks as if the floppy drive industry will continue to grow at a compound annual rate of 29% over the next five years, according to the Venture Development Corp., Wellesley, Mass. Not bad at all.

Take a Perq 1 graphics workstation, manufactured by Three Rivers Computer in Pittsburgh. Ditch the proprietary operating system in favor of Unix, add millions of dollars of support from London-based ICL Ltd., double the main memory, add a 70MB Winchester, and add some applications packages. Presto! Now you have the Perq 2 graphics workstation, with landscape or portrait display and high resolution for a little over \$20,000.

Seymour Cray has been talking about using gallium arsenide in his supercomputers for a long time, but finally he has found a source, it seems. Cray Research and Harris Microwave Semiconductor have signed an agreement on a joint program to explore the use of gallium arsenide integrated circuits in supercomputers. The two companies will develop concurrently several types of gallium arsenide circuits using compatible designs and processes.

The Net/One local area communications system from Ungermann-Bass can now support devices that use IBM's BSC protocol, and soon will be able to support SDLC devices. The network system is available in Ethernet compatible baseband and CATV compatible broadband versions. Until now, only EBCDIC and ASCII versions were supported; they are still supported.

32-BIT VLSI MAINFRAME

The 9300 mainframe computer system, designed as a general purpose business system, is based on this vendor's proprietary 32-bit VLSI microprocessor chip. The externally microprogrammable processor is augmented by an interactive operating system, data communications capabilities, and fourth generation software programming tools.

The system is configured around three boards in a box occupying two cubic feet. One board contains the cpu chip and support, a second contains 2 megabytes of RAM, and the third contains data communications hardware including SNA/SDLC, BSC, DLC, and X.25 support. A second 2MB RAM board can be inserted in the box, which can support seven terminals. The system can be expanded by adding additional boxes; each box includes a control board and support for 21 terminals. Up to 120 terminals can be supported on the system.

The Interactive Transaction Executive (ITX) operating system incorporates facilities to support transaction, word, interactive, and batch processing, as well as telecommunications networks and decentralized systems that connect over public and private networks. The operating system supports COBOL, BASIC, and Pascal, as well as an ITX/DBX database management system. The SOLON application generator is also provided, so that end users will be able to develop their own programs after an estimated two days of initial training. Systems range in price from \$23,000 to over \$125,000, depending on the number of users and peripherals. A typical system, including support for about 10 users, 2MB of RAM, and 81MB disk drive, a printer, ITX, and COBOL, costs \$54,000. NCR CORP., Dayton, Ohio.

FOR DATA CIRCLE 301 ON READER CARD

INK JET PRINTER

The 965 ink jet printer uses proprietary ink and snap-in cartridges that contain enough fluid for 4 million characters. Microprocessors fire 32 independently functioning print nozzles in combinations that produce alpha-

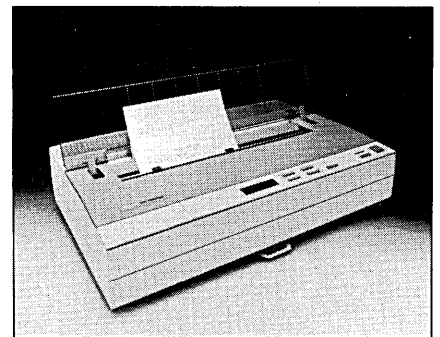

numeric text in a variety of fonts as well as special or oversized characters and symbols in scientific and technical applications.

The printer, intended for use with the vendor's series 500 information processors, operates at 60 to 90 characters per second, depending on pitch. The unit is quiet, with a noise level of less than 55 dba. A friction feed platen is standard, and a sheet feeder is optional.

Thirteen type fonts and nine international variations are available. Eight 96-character fonts or four 192-character fonts can be stored and retrieved using keyboard commands. Two scientific fonts are available. The unit costs between \$4,500 and \$6,500, depending on the fonts chosen. EXXON OFFICE SYSTEMS CO., Stamford, Conn.

FOR DATA CIRCLE 302 ON READER CARD

COMMUNICATIONS PROCESSOR

The DCP-88 is a multiline, multiprotocol distributed communications processor module for the IBM Personal Computer that includes an on-board 8088 microprocessor, up to 64KB of dual-ported RAM, and optional line printer support for line printers with throughput rates of up to 600 lines per minute. The ability to send and receive data allows the module to communicate with a host computer or with other P.C.s.

The DCP-88 offers dual-channel synchronous/asynchronous communications at baud rates of up to 256Kbps. ASCII, BSC, HDLC, and SDLC protocols are supported. An optional IBM bisync software driver is available, as is a four-channel version.

HARDWARE

The \$595 module works with all operating systems supported by the P.C. PERSYST, Irvine, Calif.

FOR DATA CIRCLE 303 ON READER CARD

POWER SUPPLIES

The Companion series of compact power supplies is intended for medium-range electronic systems. It provides a standardized switch model AC/DC power supply with several single or multiple outputs. The units are convection cooled and incorporate filtering to meet FCC conducted and emitted radiation specifications.

The units are designed for high efficiency operation with full-load operating temperatures of 40 to 50 degrees Celsius. A 150-watt model measures 11¼ × 5 × 3 inches, while a 300-watt model measures 11¼ × 5 × 5 inches. Mean time between failures for the Companion line is over 100,000 hours, the vendor says.

The Companion units have four LEDs, which provide input and output diagnostics, TTL-compatible signals for power fail, remote inhibit/OVP reset, and a sync port for use in paralleling supplies. Protection includes fold-back current limiting, latching overvoltage, and soft start at turn on. Line and load regulation is 0.2%. In

addition, fully protected remote sense capability is provided. A battery backup unit is available for \$476 in quantities of 100 for the 150-watt model. The Companion 150-watt power supply itself costs \$294 in quantities of 100. LORAIN PRODUCTS, Lorain, Ohio.

FOR DATA CIRCLE 304 ON READER CARD

DG ETHERNET CONTROLLER

The NI4010A Data General Ethernet/IEEE-802 CSMA/CD Communications Controller board is an intelligent controller that contains the data communications controller logic required for interfacing DG's Nova, Eclipse, and 32-bit Eclipse/MV minis to an Ethernet local area network. The controller implements onboard all of the industry-standard Ethernet specifications and is available with AOS and RDOS device drivers.

The unit has been designed to minimize the service load placed on the host DG

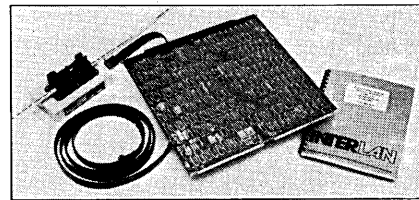

system. The controller board can store up to 13.5KB of received frames (200 minimum length frames or eight maximum length frames), protecting the DG system from receiver overruns due to the unpredictable arrival times characteristic of CSMA/CD network traffic.

By minimizing the possibility of dropping incoming frames, the NI4010A can engage in high-bandwidth virtual circuit communications with other stations on the network. For transmit buffering, the NI4010A has a 1.5KB transmit buffer from which all frame retransmissions are made when transmit collisions occur.

All data block transfers between the NI4010A and system memory are under the control of an onboard data channel controller. The board also included diagnostics such as power-up self tests, loopback and transceiver verification tests, and a pass/fail LED indicator. The unit cost \$2,490 in single units, with oem discounts. INTERLAN INC., Westford, Mass.

FOR DATA CIRCLE 305 ON READER CARD

LARGE-SCREEN TERMINALS

The Omega Data X7's 17-inch crt can display 10,560 characters for applications requiring large display areas. The terminal's 160 × 66 display is intended to enable users to see large spreadsheets or computer printouts in their entirety. In a split-screen mode, users can view two full 8½ × 11 pages simultaneously; the last two pages of information always remain on the screen so that when new data are added, information scrolls from the left window to the right. Data normally off the screen in most displays remain on the right window for reference, and continue to be accessible for editing purposes.

The terminal is DEC VT100 and ANSI compatible; it includes 96 ASCII upper and lower case characters with descenders, as well as 32 graphics symbols. A P4 Phosphor crt allows users to display characters with any combination of several attributes, including blink, half-intensity, reverse video, double high, double wide, and double high/double wide.

A graphics option includes Plot 10 commands with a standard resolution of 480 × 264 pixels. Users can specify over 2,000 programmable RAM graphics characters for more complex graphics.



HARDWARE SPOTLIGHT

TERMINALS

Four terminals from this vendor cover a broad segment of the terminal market. The 5410 asynchronous conversational terminal operates in a character-at-a-time mode under the ANSI 3.64 standard. It features an 80- or 132-column screen and eight programmable function keys. Each function key has an associated screen label to describe its current function; the ASCII string associated with each key can be downloaded from the host for each application, thereby allowing each key to have several different functions.

Other on-line capabilities include horizontal split screen (with up to six lines on the top or bottom "static"—not scrolling), editing, cursor movement commands,

and 96 graphics symbols. It costs \$995.

The 5420 has a 72-line memory, which can be read in any of four ways. Scroll mode permits the user to scan all 72 lines in a conventional scrolling pattern; horizontal split screen partitions the screen into fixed and scrolling portions; windowing divides the display into up to four work spaces, each of which can view a different part of the memory; page mode splits memory into three distinct 24-line pages that act as three virtual terminals. All of the features found on the 5410 are also on the 5420.

The 5620 (\$6,115) has a portrait-style bit-mapped display with a mouse interface and uses downloaded Unix software to mimic up to seven simultaneous virtual terminals. Each window on the screen looks like a separate terminal to the host, and all can be active simultaneously. The unit has 256KB of memory, of which about 100KB remain after downloading Unix. The 15-inch crt has a resolution of 100 dots per square inch for graphics and line drawings.

The 5540 is a continuation of the vendor's 3270-compatible line. It includes a 5¼-inch floppy drive for controller programming, device identification, and options. Different diskettes support either SNA/SDLC or BSC protocols. A tabletop controller supports 12 terminals or printers, and a floor model supports 32 devices. The terminals will be available in the third quarter. They start at \$4,500. TELETYPE CORP., Skokie, Ill.

FOR DATA CIRCLE 300 ON READER CARD



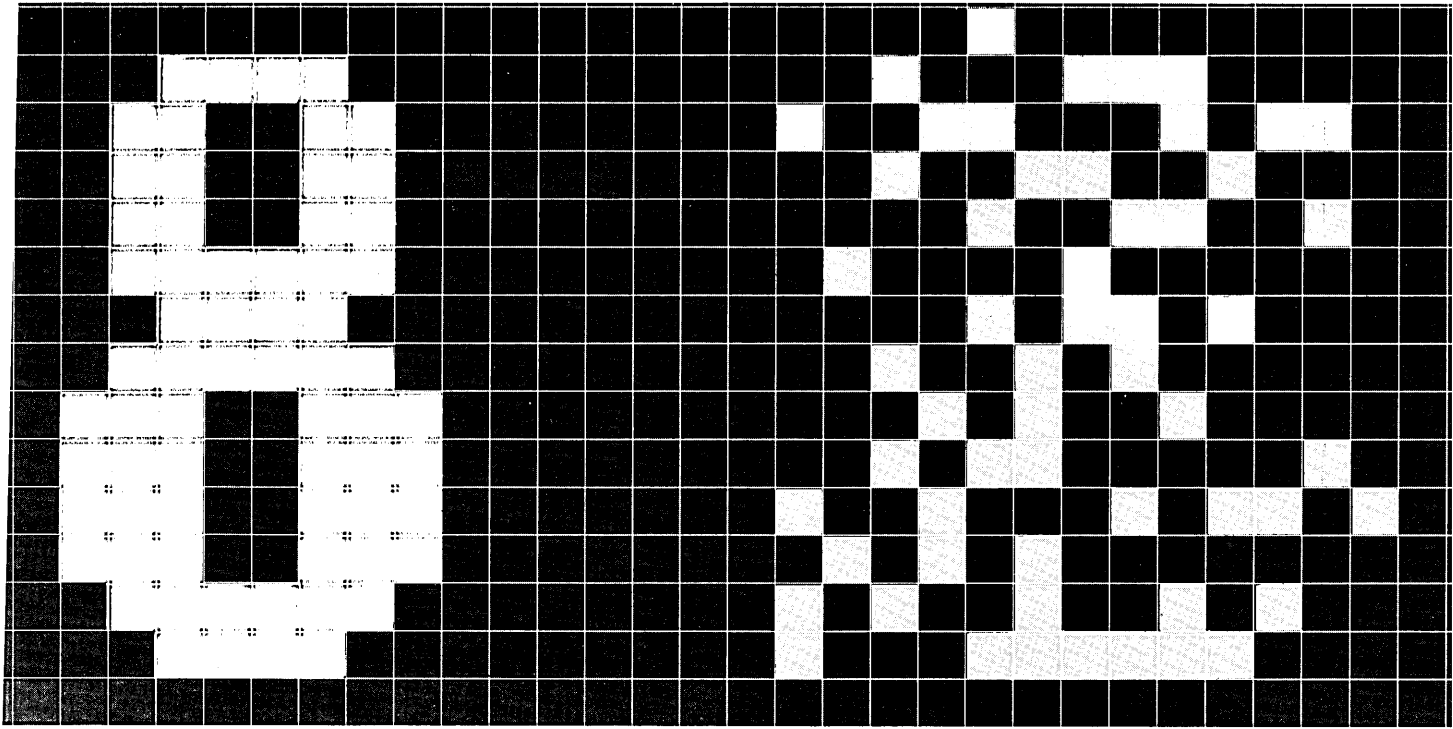

T-BAR AHEAD!

New In Look . . . New with advanced operational features . . . new cost effective expansion flexibility . . . new with what hundreds of users have asked for.

Now for IBM 2914, 3814 and other present and future computer switch users, T-Bar's ready with a CRT controlled superstar computer switch — the new 3690 which scores ahead of its nearest competitor at least eight significant ways:

- 1. Incremental Upgrades:** By single channel or single port.
- 2. Versatile Control:** Programmable CRT Micro-control with manual back-up.
- 3. Most sizes:** 379 matrix sizes from 2x2 to 16x24.
- 4. Investment Protection:** Wrap-around upgrade of existing T-Bar computer switches.
- 5. Advanced Design:** Technology already compatible with state-of-the-art bidirectional applications.
- 6. Expanded Diagnostic:** Activity Indication All Channels. Latchable LED diagnostic indication with access for recording and analysis.

- 7. Operator Protected Switching:** Eliminates inadvertent data interruption.
- 8. Low Price:** As much as 20% less than comparable units.

T-Bar's 3690 continues a tradition began in 1975 when T-Bar first engineered dependability, reliability and compatibility into a computer switch. Those first early models — still on-line and compatible with every IBM upgrade since — set a standard of excellence that is the distinguishing characteristic of every T-Bar product.

Today, as central host sites multiply, system capabilities expand, interfaces and peripherals increase, T-Bar's 3690 is ready to facilitate a variety of tasks: simplified service restoral, rotate peripherals, increase up-time, reduce capital costs, control and monitor countless connections and many other functions. If your data processing system is ready for a matrix switch, you're ready for a 3690. Call or write T-Bar Incorporated, 141 Danbury Road, P.O. Box T, Wilton, CT 06897 (203) 834-8368.

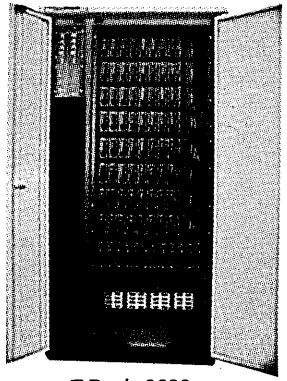

T-Bar's 3690
Computer Matrix Switch



**SWITCHING TECHNOLOGY
FOR CRITICAL APPLICATIONS**

CIRCLE 200 ON READER CARD

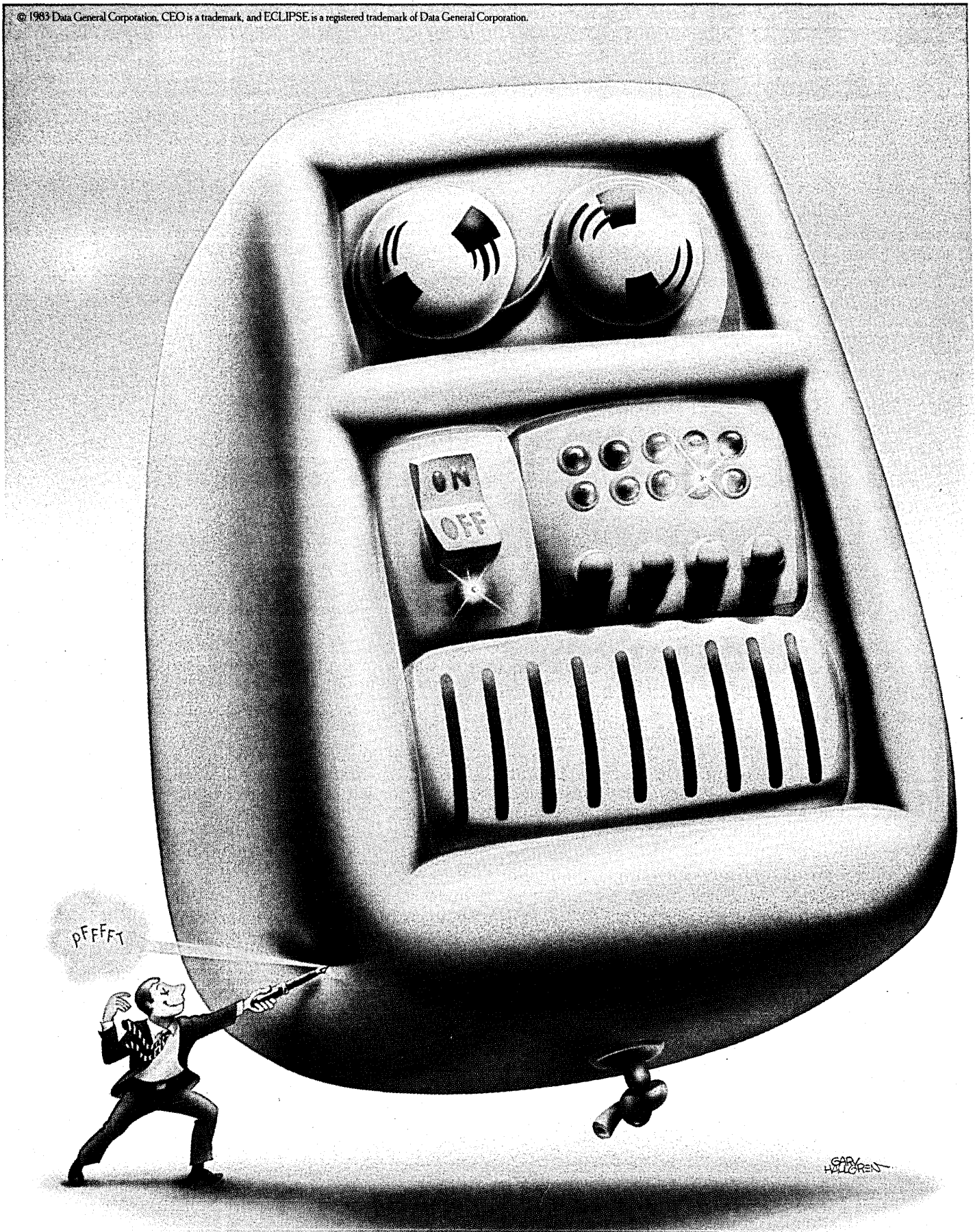

DATA GENERAL INTRODUCES THE OFFICE AUTOMATION SYSTEM INGENUOUSLY POSITIONED BETWEEN THE OVERPRICED AND THE OVERPROMISED.

Until now you've had two choices for automating a large office. A system from the company that seems to feel price is no object. Or a system from the company that promises complete systems which turn out not to be complete.

Now Data General offers the office automation system that doesn't force you to choose between compromises.

The CEO™ Comprehensive Electronic Office system based on the industry's newest and most powerful 32-bit processor—the Data General ECLIPSE® MV/10000. It provides the power and performance of a mainframe at less than one third the price. And can bring down the cost of automating large organizations to under \$7500 a workstation.

Our systems also protect your investment. Because they're compatible with both the mainframe world and the word processing world. (We provide SNA and X.25 communications, and an interface with most Wang word processing.) Which means you won't undermine your previous investment in either world for the sake of true, integrated office automation.

And CEO systems enjoy another advantage worth considering in an industry that's been more timely with

new product announcements than with the new products themselves. Our systems exist, they're backed by a worldwide service and support network already in place, and they're available now.

All of which gives you two things you've been denied up until now:

A reasonable price.

And reason to believe you'll get what you've been promised.

For more information on the complete line of Data General office automation systems, write to Data General, CEO 36, 4400 Computer Dr., Westboro, MA 01580.

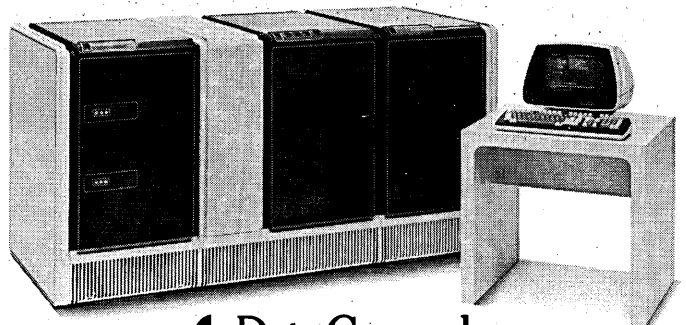

 Data General

HARDWARE

A single board contains an 8085 microprocessor with DMA and 32KB of RAM. An RS232C communications interface is standard, and a Centronics parallel interface is optional. An eight-connector STD bus is provided for memory and I/O expansion. Ten transmission rates from 75bps to 19.2Kbps are keyboard programmable. The terminal costs \$2,600 in single units or \$2,850 with the graphics package. QUADRAM CORP., Norcross, Ga.

FOR DATA CIRCLE 306 ON READER CARD

GRAPHICS COMMUNICATIONS

The Graphcom executive graphics communication system is a turnkey system that uses proprietary Execuvision software to combine data analysis, color graphics, and

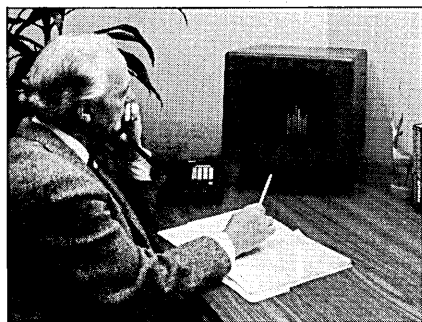

data communications abilities. It allows executives to keep track of daily operations and to engage in local teleconferencing by using the telephone keypad as terminal input and using a 13-inch high resolution color monitor for output.

Each executive using the system would have a monitor on his desk; the monitor is housed in a wood grain cabinet with tilt and swivel capabilities. The software allows one user to call up and graph data, while other users' monitors show the same screen.

The telephone handset is used for both voice and data transmission, so that users can discuss and manipulate the data from their own offices. Large screen projection is also supported.

Each Executive Information Station is a CPM-based system consisting of the color monitor, floppy disk, and multiple hard disk options, and a 300/1,200 baud autodial modem. The information station includes the Execuvision spreadsheet, color graphics, and communications software; communications modules provide file transfers from internal or external databases, between EIS stations, and from personal computers.

The station accommodates a second monitor, allowing the system to be shared by two users, and supports an optional 19-inch high resolution monitor and black and white or ink jet color printer. Each EIS costs from \$13,500 to \$30,000. A network server costs \$30,000. DIGIGRAPHIC SYSTEMS CORP., Minnetonka, Minn.

FOR DATA CIRCLE 307 ON READER CARD

SMALL BUSINESS SYSTEM

With three times the main memory capacity and twice the processor clock rate of other models in the B 90 line, the B 96 represents this vendor's fastest and most powerful small business computer system. The B 96, an entry level, terminal-based system, is intended to attract first-time users as well as larger companies looking for data communications capabilities in distributed processing networks.

First in the B 90 series to use 64K chip technology, the B 96 employs a 4MHz processor and has main memory capacities ranging from 512KB to 1.5MB. Four communications ports allow async or bisync transmission over leased or switch lines. The unit's data communications power package allows a 60Kbps bandwidth.

The B 96 processing unit includes an 80MB fixed disk and an optional 1MB minifloppy disk drive in a single cabinet occupying under five square feet of floor space. The system runs the vendor's Computer Management System software, making it fully compatible with other terminal-based systems in the vendor's family. The unit also includes the Superstart menu management system, which includes application development aids. A typical configuration costs \$38,000. BURROUGHS CORP., Detroit, Mich.

FOR DATA CIRCLE 308 ON READER CARD

VOICE/DATA TERMINAL

The SL-1 Displayphone combines aspects of this vendor's previously available SL-1 telephone and Displayphone products into a package 11½ × 14½ × 8½ inches. The unit is designed to permit managers and professionals to use computerized information resources and electronic mail systems by means of a video screen and keyboard attached to a telephone.

The SL-1 Displayphone provides simultaneous voice and data communications and includes features such as a message waiting indicator, conferencing, and ring

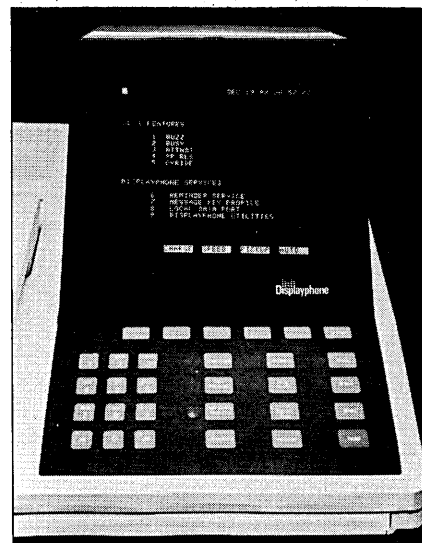

again, which notifies users when a busy extension is free. The terminal is controlled by a built-in microprocessor and the SL-1 private branch exchange computer.

Features common to both the stand-alone and SL-1 Displayphone units include a calling directory with a 90-number capacity, automatic dialing, an appointment reminder service, call timing, and hands-free operation. The SL-1 Displayphone is capable of asynchronous data communications at up to 1,200bps and can communicate with terminals connected to other asynchronous SL-1 data interface devices. The SL-1 Displayphone costs \$1,800 with volume discounts available. NORTHERN TELECOM INC., Richardson, Texas.

FOR DATA CIRCLE 309 ON READER CARD

SMART CACHE

The Smart Cache second generation heuristic cache memory learns, remembers, analyzes, and projects in order to reduce I/O seek and latency time lags. The unit, intended for the Sperry Univac market, is a high-speed semiconductor memory residing in the vendor's dual controller. It uses the standard Univac 5046/5056 disk handler and currently supported operating systems.

Smart Cache minimizes subsystem access time and transfer rate by buffering large blocks of frequently used data in high-speed memory, and maintaining less frequently used data on disk. These repetitive accesses occur in microseconds, the vendor says.

The unit holds up to 7.11 megawords of memory and is housed in a standard 19-inch rack mount chassis. A starter system consisting of the dual controller, four 600MB drives, and 2MB of cache costs \$209,000. CENTENNIAL COMPUTER PRODUCTS INC., Rockville, Md.

FOR DATA CIRCLE 310 ON READER CARD

CP/M CARD

The Premium SoftCard IIe combines CP/M, 64KB of memory, an 80-character display, and BASIC onto a single card for the Apple IIe. The card fits into the video slot of the 8-bit personal computer and essentially doubles many of the standard features of the computer.

The card is based on the Z-80 microprocessor and uses the CP/M-80 version of Digital Research's popular operating system. It allows users to employ application development tools that were not specifically developed to work with the Apple/DOS operating system. Once installed, the user specifies which operating system is to be used—Apple/DOS or CP/M-80—by booting the appropriate Z-80 or 6502A diskette.

The card also includes 64KB of RAM, doubling the amount standard on the Apple IIe. Two versions of the vendor's BASIC interpreter are included on the card; these include special statements designed to sup-

Check to see how SEED® sets the standard for DBMS comparison.

Compare any DBMS with SEED for...

Transportability SEED lets you standardize development within your organization by running on a wider range of hardware than any other DBMS—DEC, IBM, Prime, Perkin-Elmer and CDC. You can transport applications across machines, and develop applications on a mini to operate them on a mainframe—or the reverse.

SEED DBMS Other DBMS Other DBMS



Flexibility SEED's flexibility answers your demands for reduced programming, faster development and more efficient operation. SEED supports a variety of data base architectures.



"Smart" Decision Support Tools SEED's non-procedural decision support tools—HARVEST® query language, BLOOM® report writer, and RAINBOW graphics get information out of a complex data base without the need for programming.



Application Development Tools SEED KERNEL® employs a dictionary to permit centralized definition of your data base contents. KERNEL lets you build custom applications with COBOL, FORTRAN, or VISTA, the SEED screen formater. KERNEL utilities help you in tuning your application, speeding its development, ensuring its data reliability, loading the data base from files, and testing your data access algorithms.



Journaling and Security Facilities SEED's journaling capability keeps your data base uncorrupted. SEED also adds its own security features to those of your host computer to protect your information from unauthorized access.



Service We put experienced professionals at your disposal. Through a telephone hotline, you have access to an extensive consulting team, personalized on-going support and maintenance.



Get Complete Details on SEED now. Find out more about how SEED DBMS increases productivity for managers, programmers, and end-users, and how SEED makes DBMS maintenance and operation more economical. Send for the SEED DBMS Information Kit now. It's free. Or call us at (215) 568-2424. Also ask for information on our free DBMS Seminars.

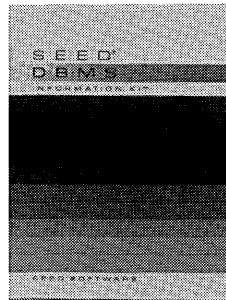

- Send me the Information Kit. #D583
 Call to discuss my specific requirements.
 Send me details on DBMS Seminars.

Name _____ Title _____

Company _____

Address _____

City _____ State _____ Zip _____

Telephone _____

OEM System Integrator End User

Computer _____

Operating System _____

 UNITED TELECOM
COMPUTER GROUP

SEED SOFTWARE
2300 Walnut Street
Suite 734
Philadelphia, Pa.
19103
(215) 568-2424

HARDWARE

port Apple graphics. The MBASIC version supports the low resolution graphics and the GBASIC version supports both high and low resolution graphics. The vendor's BASIC compiler is also available as a \$395 option. The softcard is also compatible with the vendor's FORTRAN and COBOL compilers. It costs \$500. MICROSOFT CORP., Bellevue, Wash.

FOR DATA CIRCLE 311 ON READER CARD

3270 ENHANCEMENTS

A Personal Computing Attachment now available from this vendor allows users to employ their 3278 model 2 terminals as Personal Computers. With the attachment—which is essentially a P.C. with no keyboard or monitor—users can access data from the mainframe host and store them directly to disk. They can then convert the terminal from 3278 mode to P.C. mode and process the data locally. The attachment emulates the P.C., but not the recently announced P.C. XT.

The vendor also announced new members of the 3270 family, although these members will not run with the P.C. attachment. The 3178 is a more compact terminal that incorporates a subset of the 3270's features, including tilt and swivel and some editing features. The \$1,660 to \$1,720 terminal is available 10 days. ARO.

A second new model is the 3290 gas panel display, which can be divided into up to four windows and display almost 10,000 characters. The screen is made up of a sealed sandwich of two flat glass plates 1/70 of an inch apart, with neon and argon gases in between. The gases glow as electrical charges are selectively applied to 737,280 intersections of a wire grid. The terminal is intended for use in application development, where the user can access multiple subsystems in different windows simultaneously; in report retrieval, where output reports can be displayed in full pages; and in database/data communications applications, where the multiple interactive screen and multiple copy screen modes allow operators to work on several "logical terminals" simultaneously. The 3290 costs \$7,100. IBM CORP., Rye Brook, N.Y.

FOR DATA CIRCLE 312 ON READER CARD

HIGH RESOLUTION WORKSTATION

The 80G graphics/engineering workstation offers a bit-mapped screen resolution of 1,728 by 2,180 pixels for applications in CAD/CAM and typesetting. The workstation is serviced by the vendor's new model 80 supermicro running a 10MHz 68010 under the Unix operating system. The workstation packages includes a megabyte of main memory, up to 2MB of graphics refresh memory, 40MB of hard disk storage, and a choice of backup disks. It costs \$19,900.

The engineering core of the 80G

consists of three major subsystems: the Graphics Execution Module executes the complete set of Raster-Op functions in hardware, processing 9.75 million pixels per second; the Multipurpose Adaptive Graphic Image Component provides 8 million pixels of image storage, twice the image dimension displayed; the Cauldron video processing and mix-down module generates a steady stream of 156 million pixels per second as required by the 70MHz interlace display.

Several software application packages are available, including a multiwindow user interface, a Siggraph CORE-based two-dimensional and three-dimensional graphics tool kit, typesetting, and proofreading programs. INSTRUMENTATION LABORATORIES, PIXEL DIV., Andover, Mass.

FOR DATA CIRCLE 313 ON READER CARD

WINCHESTER DRIVES

A 14-inch Winchester disk drive is available for the IBM Personal Computer. The drive is part of a subsystem jointly developed by this vendor and X-Comp, which makes the controller. The subsystem will allow IBM P.C. owners to have an 80MB Winchester drive for about \$5,000.

This vendor is also offering two new DEC-compatible disk drives. The 80MB model 3306 emulates Control Data's model 9762 for the RMO-2 and has a five-year reliability. The 160MB model 4160 is compatible with two RA-80s and has all of the DTA features required by DEC hardware, including a rotary positioner, clean air package, and rack mountable size. Rails, SMD interface, and an integrated power supply are included. DISC TECH ONE INC., Santa Barbara, Calif.

FOR DATA CIRCLE 315 ON READER CARD

MULTIPLEXOR

The Squeezplexer coaxial multiplexor permits connection of up to 32 IBM 3270 terminals or printers via a single coaxial cable to an IBM 3274 cluster controller. The unit combines signals for transmission of up to 4,000 feet. A 32-port mux can be attached with the single cable to a 32-port demultiplexor or can be multidropped to various combinations of 8-, 16-, or 24-port units. Using such a strategy, a single multiplexor can service several small clusters of terminals located, say, on different floors of a building.

The mux allows several terminals to

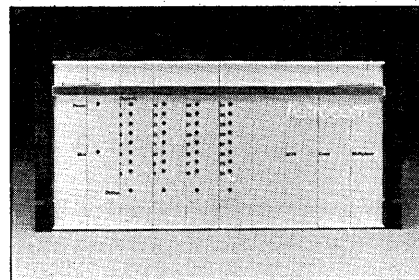

share a cable rather than use individual cables, reducing cable installation costs. Rack mounted units in single quantities cost \$4,100 for the 32-port Squeezplexer, \$3,491 for the 24-port unit, \$2,883 for the 16-port unit, and \$2,275 for 8-port device. A standalone 8-port Squeezplexer is available for \$1,450. ASTROCOM CORP., St. Paul, Minn.

FOR DATA CIRCLE 316 ON READER CARD

SUPERMINI

The Concept 32/67 supermini computer system is intended to be a midrange product in the vendor's line, filling the gap between the low-end 32/27 and the high-end 32/87. The system includes a 32KB two-way set associative cache memory with separate 16KB byte banks for data and instructions. By separating data from instructions, the machine is able to achieve a processing speed of about 2 MIPS.

The 32/67 is actually three products: the 32/6705 includes the cpu, an I/O processor, a megabyte of MOS memory, and a single cabinet with 24½ inches of vertical rack space near the top for optional peripherals; the 32/6750 is similar to the 32/6705 except that the empty space in the cabinet is filled with a SelBus expansion chassis, giving users more slots for memory and I/O expansion; the 32/6780 includes the same hardware as the 32/6750, as well as an internal processing unit and 2MB of main memory.

The internal processing unit is identical in hardware to the cpu. Each contains three plug-in modules; a key-lock switch on the front panel determines which processor will act as the cpu and which as the ipu. When the system is powered up, different sets of firmware are loaded into the two processors' control stores. During operations, the two execute different tasks in parallel, nearly doubling the processing power of the system. The ipu handles compute-bound tasks and the cpu handles all interrupts and I/O processing.

Like the other Concept 32 systems, the 32/67 line is supported by the vendor's proprietary real-time MPX-32 mapped programming executive and the Unix operating system. Base prices for the 32/6705, 32/6750, and 32/6780 are \$120,000, \$130,000, and \$170,000, respectively. First deliveries are planned for next month. GOULD S.E.L., Fort Lauderdale, Fla.

FOR DATA CIRCLE 314 ON READER CARD

COLOR GRAPHICS CONTROLLERS

The System 1500 Multi-Station provides a variety of interactive graphics features in monochrome or color (16, 256, or 4,096 simultaneous colors from palettes of 16 million colors). The key to the workstations, the vendor says, is the controller, which supports up to four workstations. When configured with a communications controller, it can support up to 64 workstations.

Why two when one will do?

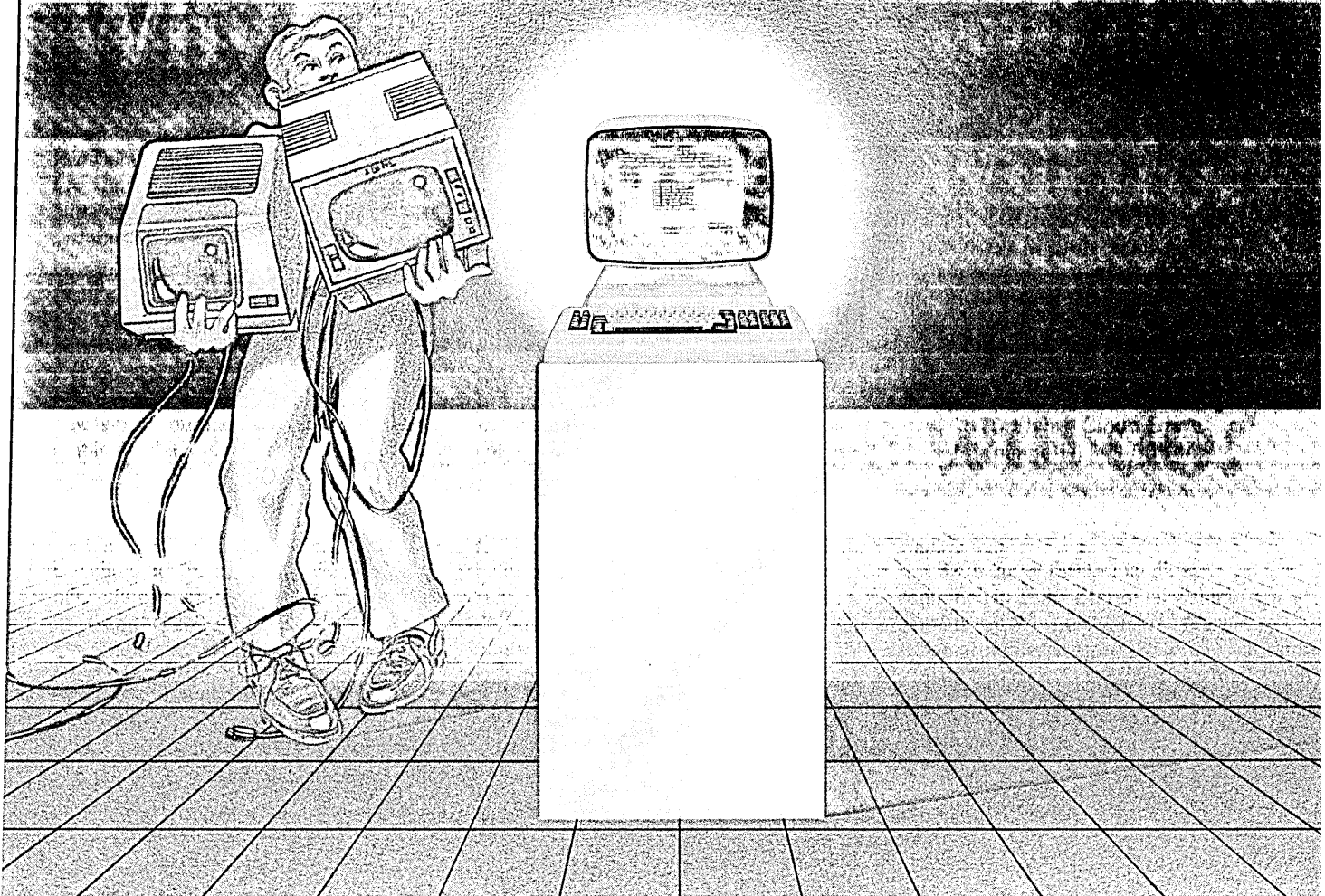

Lee Data's universal terminal system design provides access to both 3270 and VT100 applications.

Now with Lee Data's new 3270/Async Communication System (Series 400) you can eliminate the cost and inconvenience of needing separate displays for access to 3270 and VT100 applications.

The Lee Data universal terminal system approach is another innovative Lee Data design that allows a single Lee Data display to access applications and data from an IBM CPU, a non-IBM system such as DEC, H-P or Prime, and timesharing services. And a simple command entered from the display keyboard is all that is required to switch from 3270 to VT100 operating mode and back again. What could be easier?

The Series 400 System incorporates a new hybrid approach to system operation that is simpler and more efficient than

protocol conversion. This approach allows a Lee Data controller to provide dedicated 3270 and VT100 processors for concurrent, but independent application access.

In addition, a single Lee Data controller provides you 3270 compatibility via either a remote BSC or SNA/SDLC or a local SNA or non-SNA interface, as well as 1 to 16 RS232C ports for your asynchronous application needs. Line speeds available are from 300 to 19,200 BPS.

The Series 400 System also provides you support for up to 32 devices, including Lee Data's unique All-In-One display that offers dynamic selection of 4 screen sizes—three 80-column and one 132-column. Lee Data's 3279-compatible color displays and a full line of printers are

also available as part of the 32-device complement.

3270 and VT100 capabilities combined in a single terminal system—a reality with the new 3270-plus-Async system from Lee Data.

Discover what our system can do for your company's terminal network. Call our system specialists toll free:

800/328-3998.

**Designers of innovative systems
for the information worker**

**LEE DATA
CORPORATION**

**7075 Flying Cloud Drive
Minneapolis, MN 55344**

HARDWARE

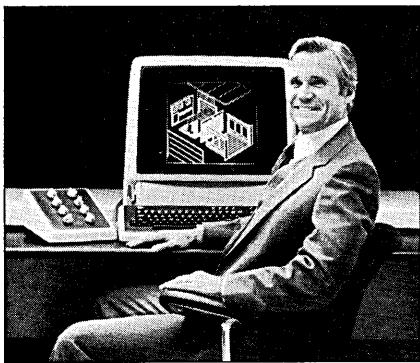

Parallel 32-bit interfaces are offered for IBM, Perkin-Elmer, or DEC host processors.

The workstations use a 1,024 × 1,024 resolution raster scan monitor for 2-D and 3-D applications including CAD/CAM, signal processing, seismic interpretation, command and control, simulation, and mapping. The hardware allows users to rotate, scale, and translate images. Multiple viewports can be defined and transformed images clipped to their boundaries at real-time rates.

The System 1500 controller performs all graphics-related functions. Groups of workstations can be placed up to 200 feet from the controller. The Prism software package, developed specifically for the 1500, supports GKS with extensions. The System 1500 controllers start at \$19,900. SPECTRAGRAPHICS CORP., San Diego, Calif.

FOR DATA CIRCLE 317 ON READER CARD

TRILEVEL MICRO

The ATS 32 and ATS 64 microprocessor-based business computer systems use a tri-level hardware architecture to support large numbers of terminals simultaneously without response degradation. The system is built around three dedicated processing modules, each of which is based on at least one Intel 16-bit microprocessor. Each of these modules has its own dedicated RAM, but all three share a global memory ranging from 256KB to a megabyte. This memory provides full buffering of entire tracks, minimizing the number and frequency of disk accesses.

Each Transaction Processor incorporates an 8086 and processes short-duration transactions for up to eight terminal devices, each operating at up to 19.2Kbps. The transaction processors support concurrent async or bisync communications.

The Intranet Processor, also based on the 8086, serves as a system resource manager and scheduler. Its 32KB of RAM and 16KB of ROM are intended to aid in performing long tasks assigned to it by any transaction processor, freeing them for immediate response to terminal requests.

The Control Bi-Processor uses the 8089 dual channel processor to interface to the storage devices. It optimizes disk accesses and performs all DMA and data trans-

fer functions. With its 8KB I/O buffer, it can transfer a full track at a time from a disk to the global memory in a single disk revolution. Up to 1.1GB of Winchester storage and 60MB of streaming tape storage are available on the ATS 64, while 60MB of micro-Winchester storage and 20MB of streaming tape storage are available on the ATS 32.

The system includes its own operating system, which supports the CADOL and COBOL programming languages and a range of applications packages. The system is upward compatible with all previous systems the vendor has sold. The ATS 32 supports 32 terminals while the ATS 64 supports 64. Prices range from \$30,000 to \$250,000, depending on configuration. CADO SYSTEMS CORP., Torrance, Calif.

FOR DATA CIRCLE 319 ON READER CARD

CLUSTER CONTROLLER

This vendor's modular 3270 cluster controller is designed for use with its Executive/Professional Deskset telephone/terminals. The 8-port device, because it is modular, can function in three distinct ways: first, it works as a single 3274-51C replacement 8-port controller; second, it acts as a coaxial cable eliminator, permitting up to seven 3270-type devices to share a single cable with no degradation in performance; third, it works in combination with other controllers manufactured by the vendor as a 3274-21C or 3274-31C replacement controller, for support of up to 32 terminals or printers.

The modular design is said to reduce terminal downtime; the architecture offers a high degree of redundancy so that failure of any one component does not have a large effect. The coaxial cable elimination can result in a reduction of up to 84% of cable normally required, the vendor says. Individual terminals and printers can be located as far as 10,000 feet from the controller. The controller costs \$3,880, including software. DATAVOX, Merrimack, N.H.

FOR DATA CIRCLE 318 ON READER CARD

DISKETTES

The Pulse I (VHR III) 5¼-inch floppy diskette fits all 35, 40, and 48 tracks-per-inch drives, and the Pulse II (VHR II) 5¼-inch diskette fits all 70,77, and 96 tpi drives. Both are sold in double-sided, double-density versions only, with capacities of 512KB and 1MB respectively. The diskettes come in packages of 2, 6, or 10, with detached labels. (Writing on a preattached label, especially with a ball-point pen, can damage the diskette.) Each package includes an instruction manual, a product description, a list of the features of the diskette, and warranty information. (The product has a lifetime guarantee.)

The Pulse I costs \$10 for 2, \$28 for 6, or \$45 for 10. The Pulse II costs \$13 for 2, \$37 for 6, or \$60 for 10. They are sold through mass merchandisers such as Sears

and J.C. Penney, department stores, computer specialty stores, college bookstores, office supply outlets, and by direct mail. BROWN DISC MANUFACTURING INC., Colorado Springs, Colo.

FOR DATA CIRCLE 321 ON READER CARD

KEYBOARD

This low-profile pad capacitive keyboard incorporates all of the features required by the DIN specification. It is 18mm tall from the top of the printed circuit board to the top of the home row keycaps. Each key module consists of five parts—keycap, housing, plunger, spring, and metalized mylar pad. The design utilizes the pad as one capacitive plate, which is positioned over a second plate on the pcb. Capacitance changes with key travel; since the pad is angled there is increased key hysteresis, which aids in the elimination of "teasing."

A proprietary sense amplifier is used to detect changes in capacitance. The sense amp incorporates an any-key-down output when a drive pulse is applied from other keyboard electronics. Linear or pad tactile feed is available, both with a positive stop. Full 0.150-inch nominal travel is standard. Operating force is 2 oz., with a 2½ oz. version available as a no-cost option. Life expectancy is 100 million operations. Single unit pricing for an 83-key microprocessor fully encoded keyboard is \$150. CHERRY ELECTRICAL PRODUCTS CORP., Waukegan, Ill.

FOR DATA CIRCLE 322 ON READER CARD

VIDEO PRINTER

The Video Printer allows IBM Personal Computer users to produce presentation quality 35mm slides or photographic prints

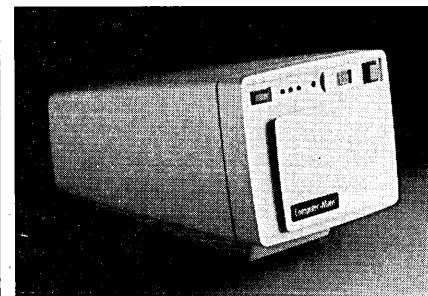

of their computers' video displays. No special knowledge of photography is needed to use the printer, since most of the functions are fully automatic, such as film advance and rewind. A port is provided for previewing the image to be captured. Chroma, brightness, contrast, and raster can be adjusted without loss of resolution. The unit uses standard 35mm film, which can be processed at any local photo store or lab. The unit is color coordinated with the P.C.; it measures 7½ × 9½ × 17½ inches and takes as input the RGB input to the monitor. The Video Printer costs \$2,500. COMPUTERMATE INC., Richardson, Texas.

FOR DATA CIRCLE 320 ON READER CARD

LEASING COULD BE YOUR BEST BUY.



Leasing can bring the highly-rated Ramtek 6211 Colorgraphic Terminal or 4100 Color Printer into your office or plant without the delay and constraints of capital expenditure budgeting. Not only do you avoid the heavy out-of-pocket expenditures of purchase, the leasing charges are deductible and you get an automatic hedge

against equipment obsolescence—while freeing up your working capital for other needs. You couldn't ask for a better buy than that!

To see exactly how leasing the 6211 Colorgraphic Terminal or the 4100 Printer can be a "best buy" for your company, call the Ramtek office nearest you. Or contact us at 2211 Lawson

Lane, Santa Clara, California
95050. (408) 988-1044.

Ramtek

OUR EXPERIENCE SHOWS

World Headquarters—Santa Clara, CA.
European Headquarters—Ramtek Europe BV,
Meidoornweg 2, 1171 JW Badhoevedorp, The Netherlands.
Regional offices—Dallas, TX; Santa Ana, CA; Seattle, WA;
Schaumburg, IL; Houston, TX; McLean, VA; Denver, CO;
Cleveland, OH; Rochester, NY; Maitland, FL; East Brunswick,
NJ; Boston, MA.

Plan now to attend the

2nd Annual IBM/Amdahl Users Computer Security Workshop

July 18-20, 1983, New York Statler Hotel

This intensive workshop program, presented by Computer Security Institute, focuses on those computer security topics and areas of special interest to users of IBM, Amdahl, and other IBM-compatible systems. It differs in both form and purpose from CSI's Annual Computer Security Conference, which addresses the entire range of computer security.

GENERAL SESSIONS

Two general sessions, featuring nationally known authorities, are scheduled in the program: Monday's opening keynote address and Tuesday's guest speaker presentation.

WORKSHOPS

You will have the opportunity to attend 4 of the 16 half-day workshops offered—2 on Monday, July 18th, and 2 on Tuesday, July 19th. These workshops are led by experienced, knowledgeable practitioners, and participants should expect to take an active part in group discussion.

SPECIAL INTEREST SESSIONS

On Monday evening, July 18th, you will be able to attend one optional, unstructured Special Interest Session from 7:00-8:30. These session topics are set up according to those areas of interest expressed by Workshop registrants.

OPTIONAL SEMINARS (Open to the general public)

You may attend one of four optional one-day seminars scheduled for Wednesday, July 20th, at the conclusion of the Workshop Program. Workshop participants can register for these seminars at a reduced rate.

WORKBOOK

Each participant will receive a personalized workbook produced especially for this program. It is available only to Workshop registrants and is not for sale. Included in the workbook are outlines, summaries, notes, background materials, and bibliographies, covering both general sessions and individual workshops. You'll find this a valuable reference source after the program as well as a useful addition to your professional library.

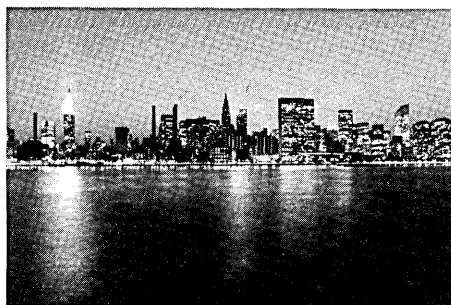

ABOUT

COMPUTER SECURITY INSTITUTE

Computer Security Institute, sponsor of this Workshop program, is the only full-service membership organization devoted to helping computer security practitioners safeguard their organization's data processing assets. Established in 1974, CSI is the world's leader in training computer security professionals and helping them keep current in the field. Members of Computer Security Institute receive the 500-page *Computer Security Manual* and the bimonthly *Computer Security* newsletter; access to CSI's Hot Line referral service; special reduced rates for CSI-sponsored conferences, seminars, and workshops; and discounts on other CSI publications, including *Computer Security Handbook: The Practitioner's "Bible,"* and *Computer Security Journal*, the first journal in the field and the only one designed for the practical needs of the working professional. Annual membership in Computer Security Institute is only \$85 (\$115 overseas). For more information, send in the coupon or call (617) 845-5050.

FOR MORE INFORMATION...

Send to: Computer Security Institute
Dept. DI-3
43 Boston Post Road
Northborough, MA 01532
(617) 845-5050

Please send me full details of the 2nd Annual IBM/Amdahl Users Computer Security Workshop.

Please send me information about joining Computer Security Institute.

Please send me information about subscribing to *Computer Security Journal*.

Please send me information about the *Computer Security Handbook*.

Please help us get our program moving by sending your **COMPLIMENTARY** Guidelines for Establishing a Computer Security Program.

NAME _____

TITLE _____

ORGANIZATION _____

ADDRESS _____

CITY _____ STATE _____ ZIP _____

TELEPHONE () _____

A TESTIMONIAL FOR THE BURROUGHS B20 FROM SOMEONE WHO SPENT 17 YEARS AT IBM.

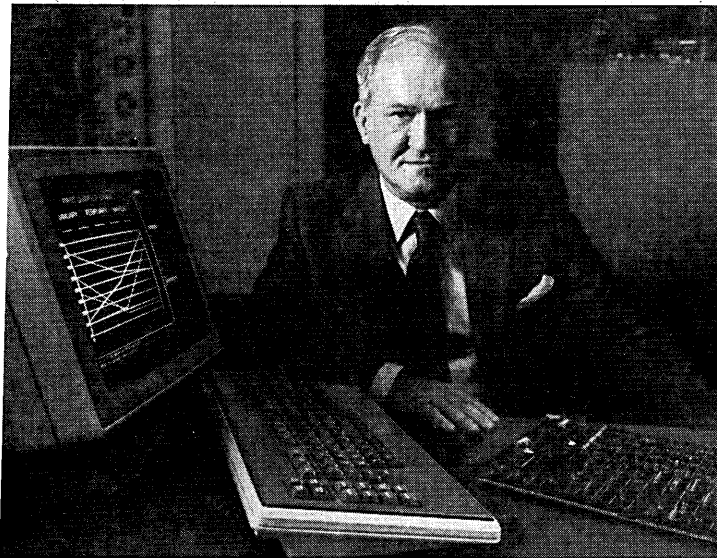

Dr. W. LEE SHEVEL
Senior Vice President, Corporate Operations, Burroughs Corporation

In operating systems, the B20 will soon give you a choice of CPM[®] or MS-DOS[™]. Or you can choose BTOS, our own operating system, which has more features.

To operate the B20, all you do is open the carton, plug it in,* choose one of our many business software programs (payroll, accounts receivable, inventory control, etc.), and you're in business. (Our step-by-step training manuals are so easy to use, you can be doing sales projections, accounting tasks, or scheduling in a matter of hours.)

If there are any questions, just call the Burroughs hot line. Trained Burroughs computer specialists will help with any problem that arises. (90% of all questions are answered in the first call.) We also have service depots in 19 cities throughout the U.S., or you can choose on-site servicing.

So, when it comes to choosing between IBM and Burroughs, take it from someone who knows both.

The question isn't who's bigger. It's who's better.

Burroughs

THE QUESTION ISN'T WHO'S BIGGER.
IT'S WHO'S BETTER.

CIRCLE 207 ON READER CARD

Some people think that because IBM is bigger than Burroughs, they're better than Burroughs. After working for many years at IBM, I can tell you that bigger doesn't necessarily mean better.

Take small business computers: the Burroughs B20 and IBM's Datamaster.

The B20 Series can offer up to five times more memory capacity, can store twice as much data, can have more workstations, offer more kinds of printers, and has a 25% bigger screen (to display more data at once).

With its powerful 16-bit processor and up to 640K bytes of RAM in each workstation, the Burroughs B20 gives each user his own computer, but with the power, memory and data base that was once associated only with mainframes.

More importantly, the B20 can be networked with other B20's (while sharing the same data base, printer, or mainframe communications), so everyone is always working with the latest, up-to-date information.

And because the B20 supports all four industry-standard languages (COBOL, FORTRAN, Pascal and BASIC), users can select the language best suited to their individual needs. With IBM's Datamaster you have one choice—BASIC.

*B22 mass storage unit requires installation by a qualified Burroughs service representative.
CP/M is a registered trademark of Digital Research, Inc.
MS-DOS is a trademark of Microsoft Corporation.
For more information call 1-800-621-2020 or mail coupon below.

I'm interested in the Burroughs B20 small business computer. D-5
Please send me more information.

Name _____
Title _____
Company _____
Address _____
City _____ State _____ Zip _____
Telephone _____

Send to: Burroughs Corporation
Dept. B20, Box 10934, Chicago, IL 60610

© 1983 Burroughs Corporation



“

Users and DP form powerful team, thanks to INQUIRE

Anthony Gambatese
Vice President, Data Processing

Robert W. Amick
Vice President, Marketing

”

The day-to-day insurance business of \$1 billion-a-year Blue Cross of Northeast Ohio (BCNO) has been automated for a long time. Enrollments are made quickly. Claims are paid promptly.

But competition for group insurance business had become strong in the eleven-county market surrounding Cleveland. Blue Cross marketing executives knew there was a considerable amount of information already on the computer which would help the company stimulate aggressive growth in its market. "The challenge," said Vice President of Marketing Bob Amick, "was how to turn existing customer information into meaningful marketing information."

Using INQUIRE, a small team of DP people were able to prototype each part of

the required application as marketing people looked on. The final system met the users' objectives because they had been directly involved in its development. INQUIRE was used to retrieve ad hoc reports from diverse and widespread databases. INQUIRE made it possible to do user-specified multi-key searches for information. The INQUIRE User Language allowed DP people to develop complex systems for end-users to run themselves.

Said Vice President of Data Processing Anthony Gambatese, "The Marketing Information System has shown us what is possible for application development through INQUIRE. Now we're turning to INQUIRE for Executive Decision Support, budgeting, HMO utilization, and much more. We call INQUIRE our user-enabling tool."

If you run MVS, VSI or VM, productive software from Infodata can help in your Information Center or Development Center. Call us today to find out exactly how.

Infodata

Infodata Systems Inc.
5205 Leesburg Pike
Falls Church, VA 22041
800-336-4939
In Virginia, call 703/578-3430
Telex 899-125

Offices in:
Dallas, Los Angeles, New York, Rochester, NY,
Houston, Cleveland, Tampa, Washington DC,
San Francisco, Chicago

©1983 Infodata Systems Inc.

®INQUIRE is a registered trademark of Infodata Systems Inc.

SOFTWARE AND SERVICES

UPDATES

It's migration time again. Many of the news releases we receive report on how various software packages have been ported from one cpu or one operating system to another. Herewith, a recent sample: Computer Corp. of America's Model 204 database management system has been available only on IBM mainframes running OS-based operating systems; now it can run in VM/CMS and DOS environments as well. MARC Software International's MUSE word processing software now runs on Prime and Apollo cpus. The Evans Griffiths & Hart KDSS key to disk data entry package now runs on VAX cpus under VMS, in addition to PDP-11 machines running RSTS/E or RSX-11 operating systems. And finally, the popular Tell-A-Graf and Disspla graphics software sold by Integrated Software Systems Corp. (ISSCO) now run on VAX-11/730, Prime 2250, and Apollo computer systems.

Data General is trying to overcome its image as a hardware company for scientific or technical use. One giant step in that direction came when E.F. Hutton decided to install 300 to 400 Branch Information Processing Systems based on the Westboro, Mass., vendor's Comprehensive Electronic Office integrated software package. The contract is worth some \$40 million, which is quite an amount for software-based products.

Buying software isn't easy, and it can often be the most frustrating thing in the world. So a company called ISD, in Fort Collins, Colo., is offering a service called One Stop Soft Shop. It lets the user go to one place for a search for software, evaluation of chosen software, purchase, configuration to work on the user's system, and backup.

REPORT GENERATOR

Fusion 4/38 is designed to allow nontechnical IBM System/38 users to extract and produce professional quality reports from any data resident in their computer systems. The menu-driven system can also perform mathematical calculations and custom document formatting and can be interfaced to output devices including laser printers and 198-column line printers.

At the heart of the 4/38 system is the vendor's data dictionary, which controls and provides access to any piece of information defined to the system in conjunction with the System/38's own data management functions. The dictionary also stores a standard heading for each data element, as well as its decimal alignment and its standard display format.

The product supports the full complement of System/38 security functions. Sensitive elements can be secured with password protection and filtered from the view of users not authorized for those data.

The 4/38 system is fully interactive and table driven, so that it does not generate the overhead of source and object libraries or require compiles to be performed. Each report is formatted and presented one page at a time to the specified display device. A preview feature allows the user to verify the output format before executing a request, so that the report would not have to be rerun.

The 4/38 system costs \$5,000 in single order quantities, with multiple copy licenses available. FUSION PRODUCTS INTERNATIONAL, Mill Valley, Calif.

FOR DATA CIRCLE 326 ON READER CARD

SUPERMINI NETWORK

The PENnet network protocol is designed to allow the vendor's series 3200 family of 32-bit superminis to communicate with other systems in geographically dispersed or locally clustered network configurations using private lines or packet switched networks. The PENnet product supports X.25 and will soon support SNA and Ethernet, the vendor says.

The PENnet software allows terminals attached to one terminal system to log

into or sign on to Reliance transaction processing or MTM timesharing environments in a second system and have the same capabilities they would have had if they were directly connected. This utility also reduces the number of long distance links needed, because the local cpu multiplexes several terminals and sends a single message to the remote cpu.

PENnet also includes a file transfer utility that allows files of any length to be copied from one system to another system on the network. A Network Printing Facility allows programs running under the OS/32 operating system, multiterminal monitor, or transaction processing environment to send reports, memos, or other data to printers physically connected to other systems in the network.

Facilities for the control and monitoring of network activities are provided by the software. In addition to commands that allow operators to inquire about the status of individual communications lines, the Network Control facility maintains a log of significant events that occur during network operation and allows communications lines to be removed from the network for maintenance and error analysis. The PENnet capabilities are available only on computers made by the vendor. A license for the PENnet software costs \$7,000; additional copies cost \$1,750. PERKIN-ELMER CORP., Oceanport, N.J.

FOR DATA CIRCLE 327 ON READER CARD

MICRO SNA

The CT-SNA package allows this vendor's distributed intelligence desktop workstations to communicate with IBM mainframes using the SNA protocols. The product exploits the cluster architecture of the vendor's workstations to offer users of IBM mainframes multifunctionality. Up to 16 workstations can communicate with the mainframe using a single communications line. The CT-SNA package consists of three distinct products: the SNA Network Gateway, the SNA/3270 Emulator, and SNA/RJE. The SNA Network Gateway provides low-level communication services between the

What's Important to You?

Productivity? Reliability? Portability? Ease of Use?
They're a reality for business software development with

COGEN™ **Cobol Program Generator**

COGEN is a program generator for creative business applications with ANSI-74 COBOL. Simple interactions with menus and data entry screens produce modular, bug-free and self-documenting programs for business applications such as file maintenance, screen input and

display, and report generation. COGEN is a powerful and proven productivity tool, used at hundreds of installations to reduce lead time on new applications, impose consistent coding standards for easy maintenance, improve training of new programmers, and ensure software portability. For Manufacturers, OEMs and Distributors, Bytel provides COGEN SELF-DEMO, a demonstration package for use by non-technical sales personnel.

MENUPRO™ **Cobol Menu Processor**

MENUPRO is an ANSI-74 COBOL menu processor for packaging production software and in-house developments. MENUPRO virtually eliminates the tedious and time draining task of implementing a user input/output interface for applications, an important aspect of any successful software product. A friendly menu-driven system is created in minutes, directly from conception to execution. MENUPRO constructs multi-level (tree-structured) menus with built-in security, and no compilation is required—the menus are interpreted directly. Start using MENUPRO today to give your programs the polish and friendliness you've wanted but lacked the resources to implement.

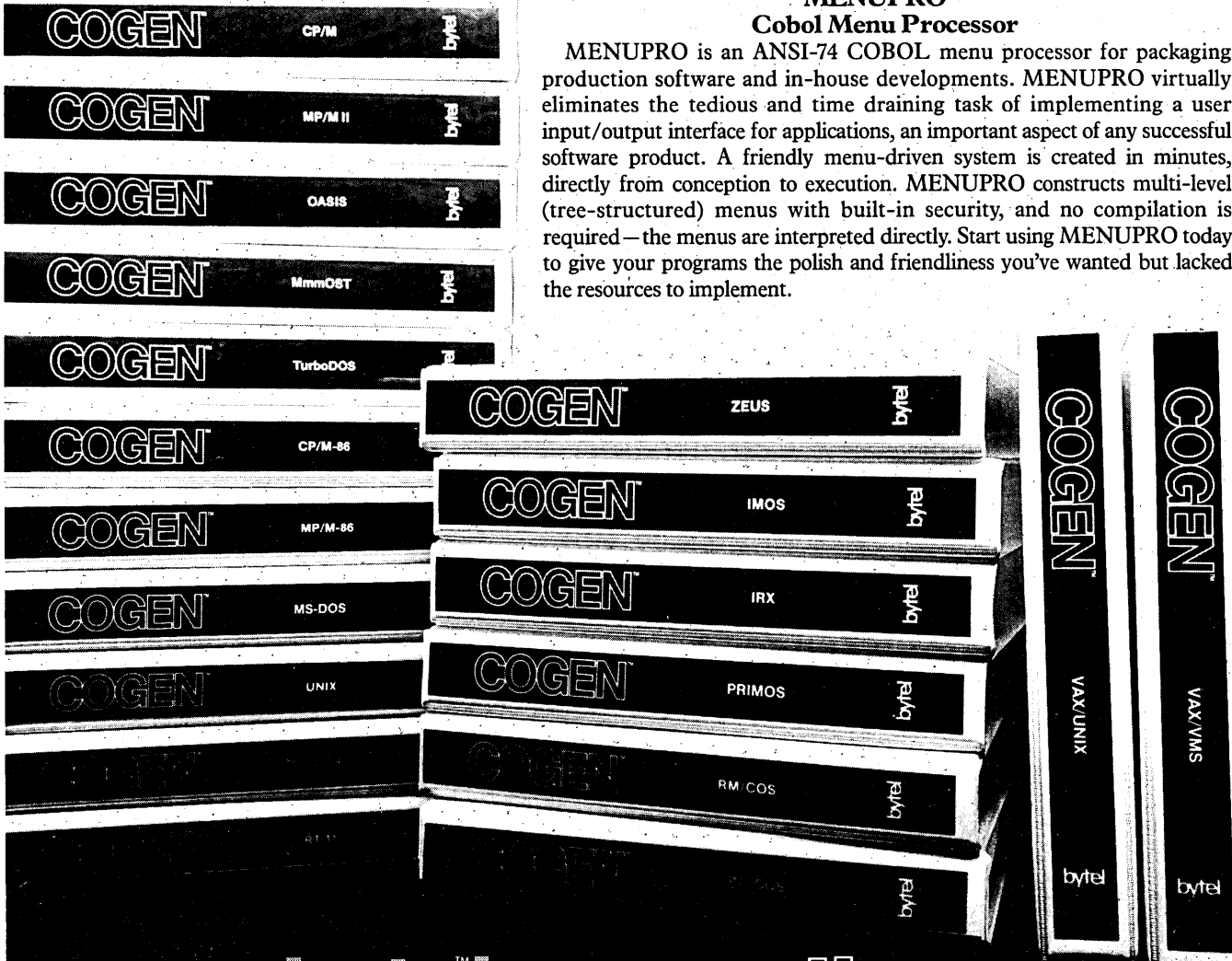

bytel corporation

1730 Solano Avenue • Berkeley, California 94707 • (415) 527-1157 • TLX 176609

SOFTWARE AND SERVICES

workstation cluster and the IBM mainframe. The SNA/3270 Emulator supports high-level presentation services from the workstation in the cluster to the mainframe via the network gateway; the emulator provides PU.T2 (3276) functionality with LU.T2 (3278) and LU.T3 (3278) support. The SNA/RJE package allows files to be transmitted between a cluster and a mainframe.

Designed for distributed dp applications, CT-SNA allows data to be extracted from the mainframe and accessed on desktop computers to support various departmental functions. Once data have been used at the workstation level, they can be returned to the mainframe, and records compiled on workstations though data entry may be transmitted to the mainframe periodically for storage.

The SNA/RJE product is not yet available. The SNA Network Gateway and the SNA/3270 Emulator are bundled together and cost \$40,000 for an oem license or \$2,000 for a single copy. CONVERGENT TECHNOLOGIES, Santa Clara, Calif.

FOR DATA CIRCLE 328 ON READER CARD

LAB TEST MANAGEMENT

The VAX-11 LIMS/SM interactive software package manages the progress of samples through entire laboratory testing and reporting sequences. The package supports multiple video terminals and simultaneous test procedures, and can be linked through hardware and software interfaces to laboratory instrumentation.

The menu-driven system is designed to be used by lab personnel with little or no computer experience. It includes modules for data entry, such as logging in and assigning identifiers for each sample; worklist generation; inquiry for status re-

ports on sample testing; report generation on test results; and management summaries on current and pending workloads, equipment status, sample testing times, and cost factors.

The LIMS/SM package allows a user to tailor a sample management system to fulfill specific lab environments. Menus can be created and fields added to screen formats to incorporate sample-specific data, nonstandard procedures, testing sequences, or reporting schedules. Tolerances can be established to flag test results that fall outside expected ranges. Screen highlighting enables such data to be easily recognized. The system licenses for \$20,000 and runs on the VMS operating system on VAX computers. DIGITAL EQUIPMENT CORP., Maynard, Mass.

FOR DATA CIRCLE 329 ON READER CARD

POCKET COMPUTER SPREADSHEET

The PocketCalc IV spreadsheet program is designed for the Sharp PC-1500 and Radio Shack PC-2 pocket computers, which have one-line, 26-character displays that have made programming difficult. The product allows users to post numbers and perform cross-footing with commands for multiple row sums and percents, multiple column sums, and an adding machine feature. Users can continually add or subtract numbers in a specific cell, without writing formulas or recalling the cell.

The program's 99-row x 39-column size and the select-row-by-name feature let users develop inventory control applications. There are also commands for average, cumulative sums, percents, and a "growth" function. A single keystroke switches between calculations and the

printing of bar or line charts and tables. The display is moved across the spreadsheet in any direction by using four control keys. Menus and function keys are intended to keep operation as simple as possible.

Templates are available on tape cassette for posting money amounts to a general ledger and for maintaining an expense account. Each provides period and item sums. The program costs \$23, and each template costs \$8. POCKETINFO CORP., Beaverton, Ore.

FOR DATA CIRCLE 331 ON READER CARD

MICRO OS SHELL

SimpliFile is a front-end shell to CP/M, PC/DOS, and CP/M-86 that is aimed at first-time and experienced microcomputer users. The product logically displays file information, including the user's own 42-character file description. It is intended to replace file utilities used by the popular 8-bit and 16-bit operating systems by having a user point at a file with the cursor and type natural one-character commands (V for view, B for backup, etc.). SimpliFile loads and runs other programs from a menu of program names, with control automatically returning to SimpliFile at the end of the program run. The system requires 32KB of disk space and costs \$100. DURANT SOFTWARE, Berkeley, Calif.

FOR DATA CIRCLE 330 ON READER CARD

SAS ON DEC

The Portable SAS system is, as its name implies, a full version of the popular statistical analysis system that has been ported from IBM hardware to DEC hardware. A beta test version of Portable SAS is currently running on the VAX series of cpus under the VMS operating system.

The beta version includes the SAS package for data management, statistical analysis, and report writing; the SAS/Graph package for color graphics presentations; and the SAS/FSP package for interactive data entry, edit, retrieval, and letter writing applications. Portable SAS will be available from Digital Equipment Corp. under a cooperative marketing agreement between DEC and the vendor.

While in beta test, Portable SAS is free for 90 days. When production versions are available, the standard 30-day free trial will apply. First-year licenses for Portable SAS will range from \$5,000 to \$7,000; yearly renewals are \$2,800. SAS INSTITUTE, Cary, N.C.

FOR DATA CIRCLE 332 ON READER CARD

P.C. DATABASE

The MicroRIM database management system, currently available for the IBM Personal Computer, was originally developed for use on mainframes in conjunction with the NASA space shuttle project. The Relational Information Database is transportable from the P.C. to many types of computers in a

SOFTWARE SPOTLIGHT

MULTI-CURRENCY GL

This vendor's Multi-Currency General Ledger system is intended for IBM Personal Computer users who work in international banks or in branches of corporations that do business in more than one currency. The product provides financial information by individual currency, and consolidates balance sheet and income statement data in different currencies into a single report. It will perform an automatic revaluation of foreign currencies to current rates and calculate the profit or loss due to these rate movements. It can also store transaction data and may be used to produce customer and due-to/due-from account statements.

The product is fully menu driven, with fill-in-the-blanks data entry forms. Displays are immediately available at the system terminal or may be directed to a printer. The package includes a seven-lesson tutorial program. The tutorial program leads the user through a step-by-step instruction course that introduces and ex-

plains most of the system's functions.

All foreign currency transactions are captured in their original currency and stored in individual accounts by currency. Consolidation of different currencies is performed by converting amounts into a user-selected base currency. Revaluation to current rates can be performed as desired, with the movements from successive revaluations individually posted and displayed.

A currency position report, including both balance sheet and forward positions, is available at the terminal. A variety of options exists within the chart of accounts that direct the system in the specific calculations of currency positions and revaluation. The Multi-Currency General Ledger includes all software and documentation, and requires a Personal Computer with 64KB of memory and two 320KB disk drives. Hardware and software combined cost about \$10,000. NISSIM ASSOCIATES, San Francisco, Calif.

FOR DATA CIRCLE 325 ON READER CARD

SOFTWARE AND SERVICES

network environment.

The microcomputer version retains all of the capabilities of the original mainframe version and can be used to share data with companies and government agencies already using the mainframe RIM. The product is also available for 8-bit and 16-bit hardware systems running the CP/M, CTOS, and MS/DOS operating systems.

The Microrim DBMS provides column records, data formats, and combinations of different tables of information. The software includes standalone query, database definition, and report writer capabilities. A full-screen entry/edit function loads data and updates the database. The system costs \$600 for the IBM P.C. An optional Program Interface, which allows system developers to reduce development time by enabling groups of applications to share a common database, costs \$400. MICRORIM INC., Bellevue, Wash.

FOR DATA CIRCLE 333 ON READER CARD

TICKER PROTOCOL SUPPORT

The Financial Ticker Protocol Support (FTPS) package is designed to run on this vendor's Stratus/32 Continuous Processing System. The package allows applications to read the high-speed ticker tape lines supplying stock, bond, and option trading information.

The package reads the data provided by any of the financial trading services that use the binary synchronous broadcast ticker protocol. FTPS provides data transmission checking, blocking, transparency to control characters, code conversion, and error detection. Applications programs written in COBOL, BASIC, Pascal, FORTRAN, and PL/1 use a standard FTPS interface to initialize data links and to read ticker broadcast messages. The product costs \$5,000. STRATUS COMPUTER INC., Natick, Mass.

FOR DATA CIRCLE 334 ON READER CARD

EUROPEAN DATABASES

Two major European databases, COMEXT and CRONOS, are available in the U.S. through this vendor. The databases, which are produced and maintained by the Statistical Office of the European Communities (EUROSTAT), are accessible on-line through the CISInetwork.

COMEXT is a comprehensive European trade database that covers imports and exports of over 8,000 products between the European Economic Community nations and all of their trading partners. COMEXT includes a three-year history of monthly trading and is updated monthly. It uses the European NIMEXE nomenclature, which provides maximum product detail. Cross-indexing with the United Nations SITC classification system is also available.

The CRONOS database specializes in European macroeconomic data. It has a special section covering developing coun-

tries, and provides comparative statistics for the United States and Japan. It contains over 600,000 time series, and is also updated monthly. The databases will be supported locally through this vendor, with informational assistance from EUROSTAT available. CISINETWORK CORP., Van Nuys, Calif.

FOR DATA CIRCLE 335 ON READER CARD

CAI PACKAGE

The Data Center Manager Series is a computer aided instruction self-study training package for developing and improving leadership skills among computer center management and supervisory personnel. The system is usable on the IBM Personal Computer or on an IBM mainframe with the Interactive Instructional System available from the vendor.

The package contains five courses designed to give students insight on—and provide practical solutions for—the problems managers and supervisors face in running a medium- or large-scale computer center. Course titles are "Data Center Organization Structures and Functional Responsibilities," "Personnel Resource Management," "Data Center Planning and Objectives," "Management of Change and Quality Performance," and "Budgeting, Rate Development, and Chargeback Systems."

The package can also be used as an introductory management training tool for technical personnel and as a refresher program for experienced supervisors and managers. Prices range from \$1,500 to \$2,500 for individual course modules. The complete series costs \$6,000. COMPUTER SYSTEMS RESEARCH INC., Avon, Conn.

FOR DATA CIRCLE 336 ON READER CARD

STRUCTURAL ANALYSIS

Cadfram is designed to automate the structural analysis of plane frame works. Developed for use on Apple II or III micros, the product can perform an analysis using the stiffness method of any plane framework of arbitrary geometry on a structure consisting of up to 100 members, with each member either rigidly fixed or pinned to the rest of the structure. Input data are divided into three main areas—geometrical, loading, and support. Each area has its own subsets, which are entered independently so they can be stored and edited independently.

The analysis of structure types includes single or multibay portals, multibay and multistory rigid frames, braced frames, continuous beams, subframes, lattice girders, and trusses. Cadfram can execute simultaneous solutions for these structures for up to nine load cases, with each case comprising commonly encountered loading types. An unlimited number of load combinations can be performed with user-selectable partial safety factors for each case and combination.

A post processor will automatically

extract, for up to 20 load combinations at a time, the bending moment and shear force envelopes for any or all of the members and print out these worst-case values graphically and in tables. The menu-driven system costs \$1,500. PM INTERNATIONAL, Buckfield, Maine.

FOR DATA CIRCLE 337 ON READER CARD.

WP FOR HP-75C

The Take-a-Memo text formatting software for Hewlett-Packard's handheld HP-75C computer allows the unit to print on a variety of parallel interface printers using the HP-GPIO interface. The program provides access to all type styles available on each printer system supported and gives the user a variety of formatting capabilities including variable margins and indents, tabs and decimal tabs, centering, bold and expanded type, page numbering, and inserting date and time from the HP-75 internal clock and calendar in documents. The program also provides special graphics symbols and a ruling font using printer graphics capabilities. The \$90 program includes user documentation, a quick reference card, and sample documents. Currently, users can develop their documents on the move and print them on Epson, C. Itoh, and HP printers when they return. MANN/ASSOCIATES, Pasadena, Calif.

FOR DATA CIRCLE 338 ON READER CARD

ZIP CODE ACCESS

This package interfaces with IBM System/34 MAPICS Order Entry and Invoicing modules to indirectly assess customer orders by zip code without the user having knowledge of the MAPICS customer number. The menu-driven system requires the user to enter the zip code of the inquiring customer. A display of all customer names and addresses within that zip code then appears on the screen along with each MAPICS customer number. Entry of the selected customer number will interface into the MAPICS open and back orders for that customer. The package is intended to speed up customer service by eliminating the need to search for customers by their MAPICS customer numbers. A package including software, documentation, and on-line instructions accessible through the menu costs \$300. After June 30, it will cost \$500. COMPUTER CARE ASSOCIATES, Trumbull, Conn.

FOR DATA CIRCLE 339 ON READER CARD

INVESTMENT DATABASE

Micro/Scan is a completely self-contained computer software and investment database service that covers 1,400 stocks in 88 industries. Some 52 variables are tracked for each stock. The service is available for users of Apple II Plus, IIe, and III computers, as well as on the IBM Personal Computer.

The Micro/Scan system is intended to be used for database screening, selecting stocks to buy or sell, acquisitions search

TEMPLATE

Graphics software. Better by design.

There are lots of graphics software packages to choose from today. Some claim to do this, others that. At Megatek, it's performance that counts.

Take our Template™ software, for example. The first true 3D graphics package for 32-bit or larger computers. Device intelligent and independent. Supports Tektronix, CalComp, Ramtek, Genisco and any other graphics device from a dumb terminal to a sophisticated system. And, what's more, it simply outperforms the others. Megatek-ology™ is software technology, too.

What makes Template so good? Well, it was developed by a leading computer graphics hardware manufacturer—Megatek—and we know what it takes to use a system's full programming power. Then, there's its high speed and performance giving you a quantum increase in productivity. And, after all, isn't increased productivity what it's all about?

There's more, however. Total graphics functionality, for instance. Scientific analysis, seismic work, process

control or engineering design. Literally dozens of applications. In short, Template easily handles your toughest programming tasks.

But don't take our word for it. Ask the major main-frame system integrators why they recommend Template as their basic graphics software package. They'll tell you powerful performance. True 3D. Total functionality. Increased productivity. Megatek-ology.

So you decide: claims or performance? If you want performance, you want Template. At Megatek, we know about performance. After all, we built a reputation on it.

Making History out of
State-of-the-Art.



UNITED TELECOM COMPUTER GROUP

World Headquarters • 3985 Sorrento Valley Blvd., San Diego, CA 92121 • 619/455-5590 Telex: 910-337-1270
European Headquarters • 34, avenue du Tribunal-Fédéral • CH-1005 Lausanne • Switzerland • Tél. 21/207055 • TX 25037 mega ch
See our Megatek-ology exhibit at NCC. Booth #N3826.

CIRCLE 210 ON READER CARD

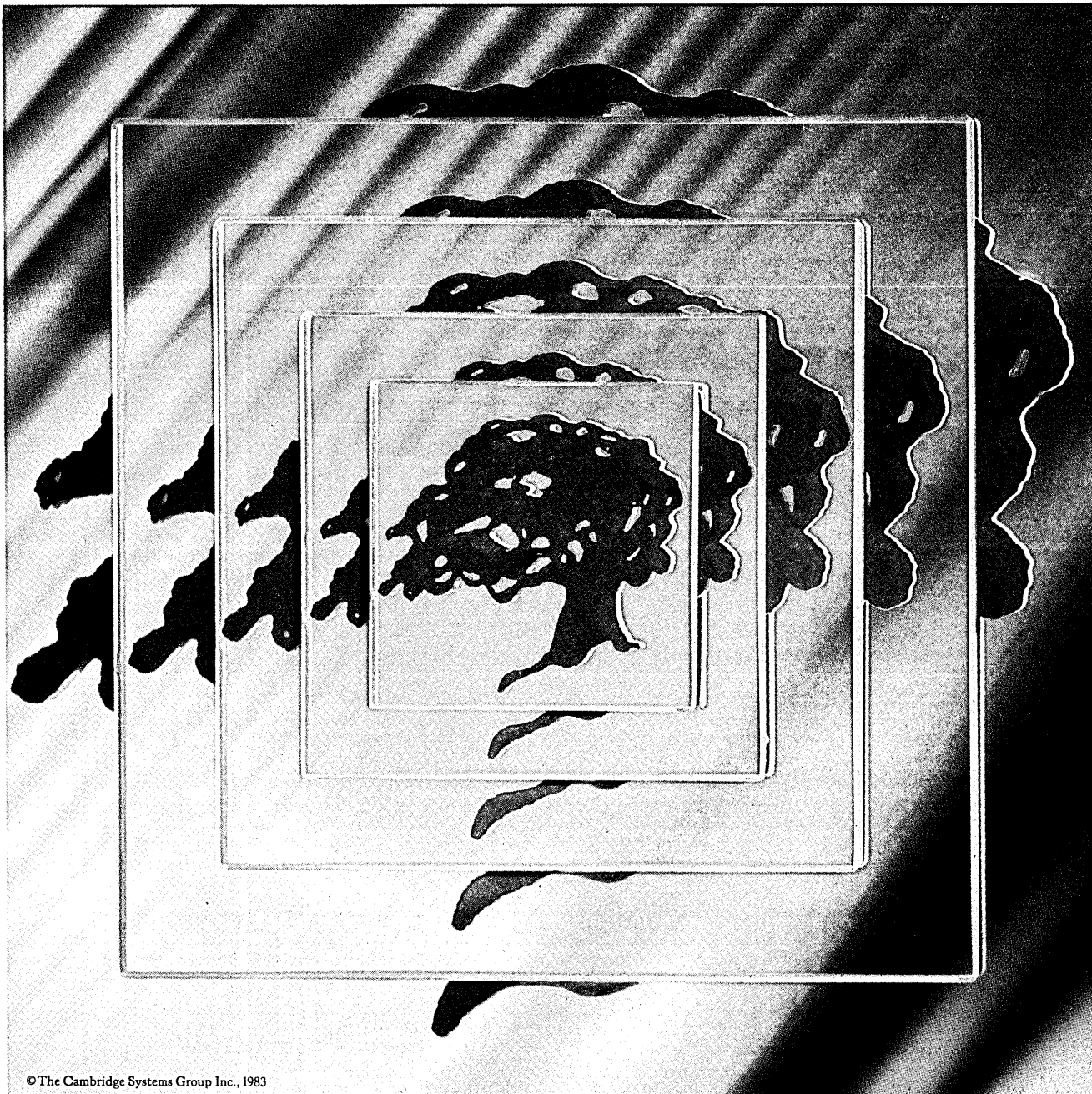

©The Cambridge Systems Group Inc., 1983

REFLECTIONS ON THE BEST IN SYSTEMS SOFTWARE

When 1300 IBM users worldwide needed high performance systems software for their OS/VS operating systems, they looked to the Cambridge Systems Group.

The reason is simple. Our ultra-sophisticated A**2 line of systems software, for DASD space management (ASM2), computer security (ACF2, marketed by Cambridge only in the United States and Canada) and job scheduling (ADC2), provides practical solutions to complex problems.

In just eight short years, we have proven that our systems software products work effectively in the most demanding IBM environments.

Finding solutions that manage and control OS/VS operating systems may not be easy, but a close look will tell you why others trust Cambridge. Now and in the future Cambridge software products reflect the highest standards in systems software.

**The Cambridge
Systems Group**

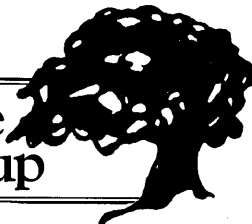

CORPORATE HEADQUARTERS
THE CAMBRIDGE SYSTEMS GROUP, INC., 24275 ELISE, LOS ALTOS HILLS, CALIFORNIA 94022, TEL: (415) 941-4558 - TELEX: 357437
EUROPEAN OFFICES

FRANCE - TELEX: 697773 WEST GERMANY - TELEX: 523221 UNITED KINGDOM - TELEX: 299512

ACF2 is developed by SKK, Inc., Rosemont, Illinois 

CIRCLE 211 ON READER CARD

SOFTWARE AND SERVICES

and analysis, industry analysis, portfolio analysis, and report generation—all areas where timesharing or downloading systems previously were used. Micro/Scan provides users with unlimited access to all data at all times with no timesharing charges, data access charges, or per-use charges. Subscribers receive new data diskettes each month, with the 52 variables updated for all 1,400 companies.

The package costs \$6,250 a year, which includes all software, 12 months of new data diskettes, and a demonstration diskette. A complete user's manual is available for \$35. The system requires an IBM P.C. with 128KB RAM or an Apple II Plus or IIe with 64KB RAM and an 80-column board with inverse video, or an Apple III with 128KB RAM. Two disk drives are required for all systems. ISYS CORP., Cambridge, Mass.

FOR DATA CIRCLE 340 ON READER CARD

PORTABLE SOFTWARE

One complaint often heard about this vendor's portable Compass Computer was that it was not compatible with other microcomputers and terminals on the market, and thus was isolated from most packaged software available. Several products have closed that gap. Gridterm, for example, is a terminal emulator that gives Compass users the ability to communicate with a variety of mainframes and minis on the market as if it were a nonintelligent asynchronous terminal. Two customized versions allow the unit to emulate DEC's VT100 series of terminals or IBM's 3101 and 3270 (with protocol conversion) terminals.

The vendor has also ported the popular MS/DOS operating system to the Compass, enabling users to run the wide variety of software packages that run under that system. In particular, programs written for the IBM Personal Computer will run on the Compass because the unit supports both the operating system and the 5¼-inch floppy disk drive format employed by the P.C. MS/DOS costs \$150.

The addition of MS/DOS will allow users to interchange data across multiple personal computers, supplementing the vendor's set of five integrated management tools and four communications tools. All nine share a common command set, so that users need learn only one set of commands. One product, the Gridreformat package, automatically puts data received from other computers into a format suitable for use by any of the Compass management tools. It converts data from one format into a usable record. GRID SYSTEMS CORP., Mountain View, Calif.

FOR DATA CIRCLE 341 ON READER CARD

APPLICATION DEVELOPMENT

The System Specialist is an integrated combination of several of this vendor's systems software packages. It is intended to facili-

tate application development and response to end-user requirements. The package is based around Info, the vendor's relational database management system and fourth generation programming language; it also includes Info-Flow, a system that generates automatic documentation of Info applications. Finally, it includes Info-Call, an applications interface that allows users of third generation languages to link programs with Info and take advantage of its application development capabilities.

The System Specialist is available for implementation in all Prime 50 series systems. The complete package for a Prime 150 through 850 superminicomputer costs \$19,700 in a one-time license; for the Prime 2250, the package costs \$14,500. Training and initial maintenance are included. HENCO SOFTWARE INC., Waltham, Mass.

FOR DATA CIRCLE 342 ON READER CARD

QUERY SYSTEM

Uversion is a natural language, fourth generation query and reporting database management system. It requires no use of syntax when creating a query, the vendor says, nor does it require any knowledge of dp in order to access data files.

The product includes a split-screen capability that allows users to generate complex reports to a terminal or a printer in several minutes, the vendor says. The user can also extract subfiles of information and in effect create a relational database for specific needs. Users can also create labels, generate letters and forms, and produce summary or unformatted reports.

The Uversion system creates a data dictionary based on the company's sequential, indexed, or relative data files. To the end user, this data dictionary is a collection of named fields that can be queried. Programmers can use the system's file maintenance utility for batch updating and deleting.

The system runs on the IBM System/34 and on S/370 compatible mainframes, as well as on Tandem's NonStop computers. It is transportable to any COBOL-based mainframe or mini. The product will be available in the third quarter; a one-time perpetual license costs \$17,500 for a minicomputer and \$22,500 for a mainframe. Maintenance for the first year is included. NORTH AMERICAN COMMUNICATIONS LTD., Lake Bluff, Ill.

FOR DATA CIRCLE 343 ON READER CARD

OVERSEAS PROGRAMMING

The high cost of programmers has long been a source of frustration in dp circles. While many vendors have attempted to combat this problem indirectly, with application generators and the like that reduce the amount of time that programmers spend programming, this vendor has taken a different route: reduce programmer costs.

This vendor has more than 100 pro-

grammers and systems analysts in India, all of whom have at least five years' experience and a BS or MS degree. Essentially, the vendor lets corporations farm their programming overseas, where the average cost of a programmer is much lower. The vendor says that a job that needs one man-year of programming would cost only \$18,000 in India, compared to the \$20,000 to \$25,000 it would cost here. COMPUTER OFFICE SERVICES INC., Bedford Heights, Ohio.

FOR DATA CIRCLE 344 ON READER CARD

FILE TRANSFER

Net488 is a file transfer package for DEC computer networks that uses the IEEE-488 bus standard as the communications link. The computers linked together in the network may be based on any combination of Unibus or Q-bus backplanes. The Net488 network software is compatible with the RSX-II, RT-II, VMS, and Unix operating systems. The main advantage provided by Net488 is the ability to transfer files between different operating systems running in different DEC computers, the vendor says. The operator interface to the file transfer software consists of query responses. File transfers may be initiated from a user-written application program.

A typical configuration would include the Net488 package for a network of four Q-bus computers separated by about 150 feet, all running RT-11; such a system would cost \$15,000. Future products are expected to interface the IEEE-488 bus to S-100 and Multibus computers as well. NATIONAL INSTRUMENTS, Austin, Texas.

FOR DATA CIRCLE 345 ON READER CARD

PURCHASING AND WAREHOUSING

This vendor's purchasing software package, which runs on the HP-3000, handles most major purchasing functions. These include creation of purchase orders, preparation of modified purchase orders when necessary, updating of inventory records, monitoring of open purchase orders, preparation of receiving reports, monitoring of vendor performance, and preparation of cash commitment reports of open purchase orders.

The product utilizes the capabilities of Hewlett-Packard's Image database management system running under the MPE IV operating system. The \$9,800 purchase price includes documentation and support.

The vendor also is selling its warehouse distribution application for the HP3000. The package has been enhanced to include order entry capabilities for both labor and materials. If a company wants installation or repair of its products, both parts and labor can be entered; several types of labor orders are accepted, including warranty or nonwarranty orders. In all cases, both labor hours by type of labor and material can be entered to keep full accounting and inventory control records as a byprod-

SOFTWARE AND SERVICES

uct of normal order entry.

The package can handle an unlimited number of different labor services. Like the purchasing package, the warehouse distribution application uses the Image DBMS and was developed using Quasar Systems' application generators. Each module costs \$6,000. BAKCO DATA INC., Arlington Heights, Ill.

FOR DATA CIRCLE 346 ON READER CARD

CROSSTABS ON APPLE

This product enables Apple II or III users to analyze customer data with the traditional kind of cross-tabulations used in market research, and with 16-column banners. The data analysis program permits study and restudy in any arrangement desired, and can be adapted for use with most forms of customer data.

The program provides for data entry, marginals, table labels, banner headings, three-way tables, and printing cross-tabs. It processes up to 100,000 units of information per survey, which is the equivalent of 1,250 single punched 80-column cards. Up to 36 answers per question are allowed, and up to 255 questions can be handled by a single survey.

Hardware requirements for the program are an Apple II Plus or Apple III microcomputer, with at least 64KB RAM, two 5¼-inch disk drives, the CP/M operating system, and a 132-column printer. The program costs \$300, including a user manual. The manual is available separately for \$20. SURVEYTAB, Pacific Palisades, Calif.

FOR DATA CIRCLE 347 ON READER CARD

PRODUCT COSTING

The Standard Product Costing (SPC) package is an interactive, comprehensive tool that maintains standard or estimated costs for both manufacturing and account management. SPC maintains up-to-date costs for all products, parts, and services provided by a company. Deviations of current cost from planned objectives can be spotted through the product's software, and the problem areas can be identified for management attention.

Since the SPC package is integrated with the vendor's inventory management and standard product routing packages, labor and material figures are automatically kept consistent. The SPC package maintains both beginning of the year (standard) and up-to-date (current) cost projections. Current purchase prices deviating from the standard material costs are highlighted on the purchase price variant report generated by the package.

Other functions include "what if" cost analysis and ratios such as gross margin percentages and cost variances. SPC requires the vendor's inventory management and bill of material processor packages. A source code license for SPC running under RT-11 in DEC environments costs \$3,000.

MINICOMPUTER BUSINESS APPLICATIONS INC. (MCBA), Montrose, Calif.

FOR DATA CIRCLE 348 ON READER CARD

DBMS ENHANCEMENTS

Version 2.0 of this vendor's INGRES relational database management system for VAX computers includes three new subsystems and performance and functional enhancements. The revised package is said to offer 40% greater performance than the previous version, due to improvements primarily in the IO subsystem and internal sort routines.

Concurrent access to data by multiple users has been improved by enhancements to the locking system. Row size has been increased and multiple databases on different disk volumes are now supported. Data and money data types have been added to the DBMS, allowing flexibility to enter variations on these formats; for example, dates can be entered as 29-Nov-83 or as 11/29/83 or as "today."

The three subsystems are Report by Forms, Graph by Forms, and Application by Forms. The report and graph subsystems are intended to enable nonprogrammers to build reports and graphs that can be cataloged and recalled for later use. Users can visually define reports and graphs on a video display using the cursor and keypad to achieve the desired result. The graph subsystem provides formatting controls for graph type, size, layout, and labeling. Bar charts (single or clustered with shading), pie charts, line and multiline plots, scatter plots (with optional linear regression), and logarithmic and semilogarithmic plots are available. The graphics package is an option on the DBMS, and costs \$2,500.

The Report by Forms subsystem includes several preformatted report styles that can be used as is or modified. Users select report options from menus to determine page size, sort order and sequence, data selection criteria, and the calculation of summary statistics.

The third subsystem is an application generator, which allows users to create, test, modify, store, and execute fully developed applications without coding in a computer language. The application and report generators are being distributed free to current INGRES users. RELATIONAL TECHNOLOGY INC., Berkeley, Calif.

FOR DATA CIRCLE 349 ON READER CARD

PAYROLL ENHANCEMENT

The 401(K) enhancement to this vendor's payroll software system is intended to allow employers to decrease substantially the administrative burden of implementing and controlling a 401(K) plan. With the program, earnings types applicable to the deferral can be indicated, allowing organizations and employees to exclude certain types of earnings easily.

The maximum deferral percentage

or dollar amount can be indicated by the individual employee or by a specific classification of workers, such as sales representatives or secretaries. Users can exclude the deferred amounts from federal or state income taxes with the program. All plans may not qualify for this tax deferral, however, and the program can accommodate these requirements.

Deferred amounts are automatically excluded from W-2 reporting, eliminating the year-end clerical effort to deduct amounts deferred from taxable income. The system can capture deferred amount accumulations by current pay period, monthly, quarterly, annually, and on an inception-to-date basis. This provides the information necessary for an annual review of deferrals by highly compensated and lower-compensated employees to ensure plan qualifications. The enhancement, like the payroll system, runs only on IBM and compatible mainframes. It is being distributed free to InSci users. INFORMATION SCIENCE INC., Montvale, N.J.

FOR DATA CIRCLE 360 ON READER CARD

IBM P.C. CAD

The Vector Sketch computer aided design software package for the IBM Personal Computer is designed to be used in conjunction with this vendor's Digi-Pad 5 digitizer. The general purpose package is suitable for applications like business graphics, space planning, construction, architecture, and mechanical and electrical design. The program allows the operator to input drawings by entering data via the digitizer. Vectors are displayed on the graphics monitor and can be stored onto disk; they can then be printed in sizes up to 24 x 36 inches on plotters or dot matrix printers.

A minimum configuration, including the digitizer and software, consists of the P.C. with dual disk drives, graphics monitor and card, 256KB RAM, and an async adapter. The package, including digitizer, costs \$3,000. GTCO CORP., Rockville, Md.

FOR DATA CIRCLE 361 ON READER CARD

RESERVOIR ENGINEERING

The Reservoir Engineering and Formation Evaluation program for microcomputers assembles the common algorithms and correlations and other routines often used in this field of engineering into 12 modules. For example, the program RADFLO groups together calculations for transient radius for drainage, permeability, stabilization time, stabilized rate, reservoir Z-factor, viscosity, gas compressibility, and gas volume factor. All factors are interactive, prompting required inputs and units.

The reservoir engineering package costs \$200 for all 12 modules. The 144-page manual, including equations, flow charts, and program listings, costs \$30. GULF PUBLISHING CO., Houston, Texas.

FOR DATA CIRCLE 363 ON READER CARD

SMALL NEWS: SORBUS® SERVICE FOR IBM OWNERS NOW COMES IN ALL SIZES.

You already know that Sorbus is the #1 alternative to IBM service on big equipment.

Now, get to know the smaller side of Sorbus: personal computer service, and parts and supplies.

A LOT OF SERVICE FOR YOUR LITTLE IBM.

In addition to fixing the System/3, 360, 370, 34, 4300, and 303X in your computer room, Sorbus now fixes the IBM personal computers that are on desktops everywhere.

So when an executive comes to you in a cold sweat, just call Sorbus.

We'll get the machine up and running *the same day*, with on-site repair by one of our field engineers, or with fast pick-up or carry-in service.

EVERYDAY SUPPLIES AS CLOSE AS YOUR TELEPHONE.

The 64-page Sorbus catalog features everything you need for the day-to-day care and feeding of your IBM equipment.

Printwheels. Ribbons. Diskettes. Even paper. All high quality. All competitively priced.

To place an order, or to get your free copy of the Sorbus® Supply catalog, just call the toll-free Sorbus supply number: 800-523-0552.

(In Pennsylvania, dial 215-296-6200.) Or mail the coupon below.

Act now, and start saving time and money on the parts and supplies you need most.

SORBUS IS AN IBM SYSTEM'S BEST FRIEND.

Big or small. Healthy or ailing. Out of commission, or just out of paper.

Whatever the need, your answer is the same: Think Sorbus, to keep your IBM equipment running longer and stronger—for less.

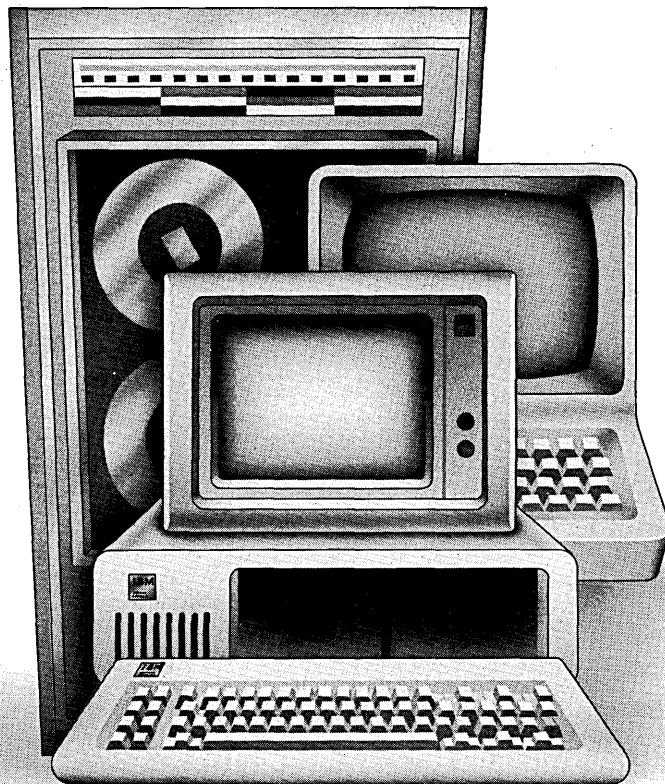

**UPTIME IN NO TIME.
SORBUS FIXES COMPUTERS. FAST.**

MAI Sorbus
Service®

Sorbus Service Division of
Management Assistance, Inc.
50 E. Swedesford Road, Frazer, PA 19355
(215) 296-6000

Please send me more information on:

- Sorbus Supplies
- Same-day service for IBM Personal Computers
- Service for other IBM systems: _____
- Other _____

NAME _____ TITLE _____

COMPANY _____

ADDRESS _____

CITY _____ STATE _____ ZIP _____

PHONE _____

The DataCode™ System



Put Together to Work Together With Any Computer System

The key to your data-processing-ID-security system is the ID badge or card your employee carries. Here's why your computer system needs DataCode:

1. Exclusive Single Layer/High Energy Magnetic Strip - your code can't be erased or altered by a magnetic field.
2. Variable Information Inserts - can incorporate name, department, social security number, numerical numbering and other information.
3. Special Coding - will accept any coding, including bar coding/ OCR, optically-read holes, infra-red coding, proximity-reading, and inductive.
4. Flush-With-Surface Photo Mounting - recessed aperture accepts any photo by our camera or yours.
5. Impregnated Tamper-Resistant Seal - visible or invisible seal can be impregnated inside outer layer.
6. Durable Durafilm Polyester won't break or crack - unconditional 2-year warranty.
7. Key punching - your badge can also be Hollerith coded.
8. Security Screen/Panagraph Background - can be designed and printed to your specifications.
9. Inside & Out Polyester Durability - double polyester laminate.
10. DataCode System Design Service - we'll design an ID badge to solve your specific data collection and security problems.

The DataCode™ System

A Division of Graphic Laminating, Inc.
5122 St. Clair Avenue, Cleveland, Ohio, U.S.A. 44103
(Ohio) 800-272-9455 (Other States) 800-272-7447

CIRCLE 213 ON READER CARD

312 DATAMATION

ADVERTISING OFFICES

Advertising Sales Mgr.: **William J. McGuire**
New York, NY 10022
875 Third Ave.
(212) 605-9715

Eastern District Managers:
Francie Bolger, John M. Gleason
New York, NY 10022
875 Third Ave.
(212) 605-9400

New England District Mgr.: **Jack Orth**
Newton, MA 02159
181 Wells Ave.
(617) 964-3730

Mid-Atlantic District Mgr.: **John A. Bartlett**
Plymouth Meeting, PA 19462
Plymouth Plaza, Suite 201
(215) 825-4410

Southern District Mgr.: **Warren A. Tibbetts**
West Palm Beach, FL 33406
7621 West Lake Dr., Lake Clark Shores
(305) 964-6298

Midwest District Mgr.: **Joseph P. Gleason**
Chicago, IL 60601
3 Illinois Center Building, 303 East Wacker Dr.
(312) 938-2926

Western District Managers:
Alan Bolte, Jr., William M. Wilshire
Los Angeles, CA 90035
1801 S. La Cienega Blvd.
(213) 559-5111

James E. Filiatrault
Mountain View, CA 94043
2680 Bayshore Frontage Rd., Suite 401
(415) 965-8222

U.K., Scandinavia, Benelux, France, Spain
Robert Saidel, Martin Sutcliffe
Technical Publishing Co.
130 Jermyn Street, London, SW1 4UJ, England
Tel: 01-839-3916, Telex: 914911

Germany, Austria, E. Europe: **Robert S. Gibson**
Regional Manager, Technical Publishing
6000 Frankfurt 60
Scheidswaldstr 41, West Germany
Tel: (611) 439625, Telex: 4170039TP

Italy: **Luigi Rancati**
Milano San Felice Torre 7
20090 Segrate, Milano, Italy
Tel: 2-7531445,
Telex: 311250 PPMII Per Rancati 7531445

Switzerland: **Andre Lehmann**
ALAS AG, CH-6344
Meierskappel/LU
Tel: (042) 64 2350, Telex: 864958

Japan: **Shigeru Kobayashi**
Japan Advertising Communications, Inc.
New Ginza Building, 3-13 Ginza 7-chome
Chuo-ku, Tokyo 104, Japan
Tel: (03) 571-8748, Telex: J22745

Israel: **Igal Elan**
Daphna Str. 24, Tel-Aviv
Tel: 268020, Telex: 341667

John K. Abely, President
Robert L. Dickson, Exec Vice President
John R. Emery, Senior Vice President
Walter M. Harrington, Vice President and Controller

Technical Publishing

 a company of
The Dun & Bradstreet Corporation

NOW. THE ADVANTAGES OF TAPE, AT FULL CHANNEL SPEEDS.

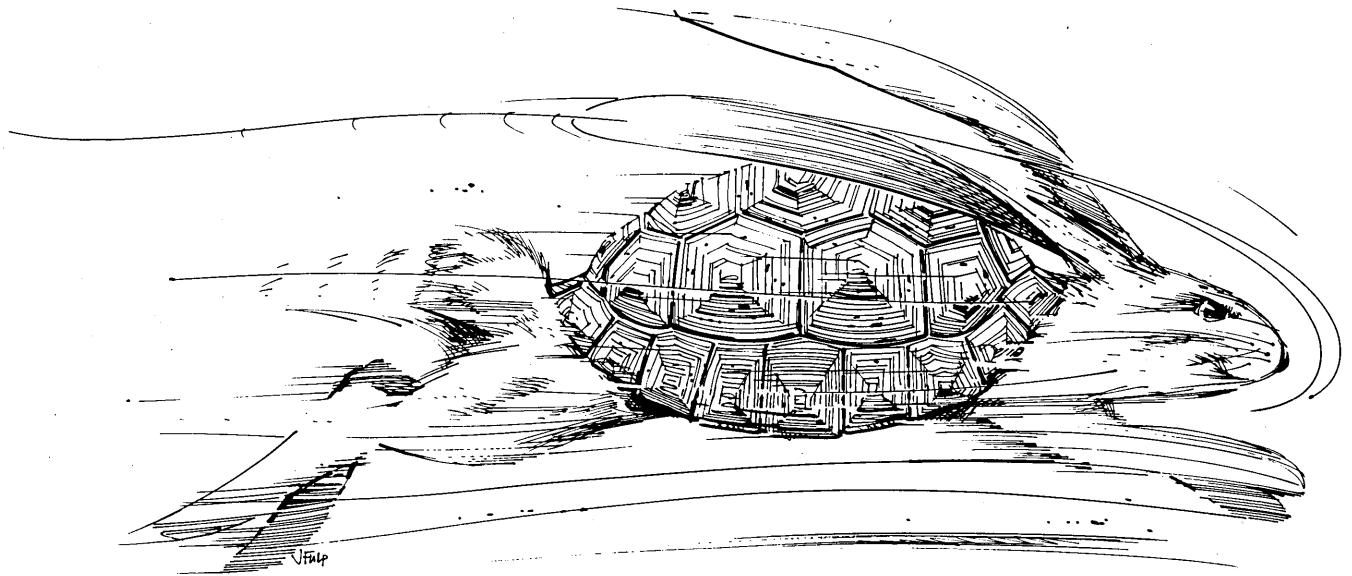

OUR NEW 4800 TAPE ACCELERATOR CAN BOOST DATA TRANSFER SPEEDS TO 3 MB/SEC.

Problem: your system's performance is being hindered by the speed of your tape subsystem. Each tape control unit locks up an entire processor/tape channel capable of much higher speeds.

Solution: our new 4800 Tape Accelerator enables two or more tape units to operate concurrently on the same channel; in multi-CPU situations, it also dynamically balances processor workload. Once "channel busy" signals are minimized, your existing tape system's performance can improve two or three fold; in some cases, using fewer channels.

No software or operating modifications are required. The device plugs straight into the Storage Technology 3600 series tape subsystems, and can increase total cable length to over 500 feet.

To find out more, call your local Storage Technology office, clip the coupon, or call (303) 673-4063.



Storage Technology

Show me how to triple my tape subsystem performance.

Name _____

Function _____

Company _____

Address _____

Mail to: Storage Technology Corporation
Product Marketing, Mail Drop 3K
Louisville, Colorado 80028

22

Take the rough spots out of software conversions.

There can be hidden snags, even in simple conversions. But DASD is prepared to bring you in on time and within budget with a comprehensive library of proven conversion software. And we back up our products with a staff of conversion specialists ready and able to aid your conversion—whatever it may be. So pave the way for your smooth software conversion. Choose DASD.

Circle the appropriate number on the Reader Service Card and return it today.

Conversion Programs Available

RPG/RPG II to COBOL
Circle No. 370

NEAT/3 to COBOL
Circle No. 371

DIBOL to COBOL
Circle No. 372

COBOL to COBOL
Circle No. 373

FORTRAN to FORTRAN
Circle No. 374

DOS ALC to OS ALC
Circle No. 375

MAP to COBOL
Circle No. 376

COBOL ISAM to
COBOL VSAM
Circle No. 377

CCP to CICS
Circle No. 378



PEOPLE/PRODUCTS/RESULTS

DASD Corporation
Corporate Services Center
9045 North Deerwood Drive
Dept. 239
Milwaukee, WI 53223
(414) 355-3405

ADVERTISERS' INDEX

Alpha Micro Systems54,55
Amdahl.....175
American Bell.....20,21
Ampex.....Cover 3
Ampex.....282-33
Anaconda Ericsson.....190
Anderson Jacobson.....4
Apollo Computers.....248,285
Apple Computer, Inc.....16,17
Arthur Andersen & Co.....85
AT&T Longlines.....102,103
Auerbach.....350
Automatic Data Processing.....323
Anadex.....105

B. Dalton Books.....198
Boole & Babbage.....258,259
BASF Systems.....133
Braegan Corp.....59
Burroughs.....301
Business People.....136
Bytek.....304

Cado Systems Corp.....181
*California Software.....282-17
Cambridge Systems Group.....308
Candle Corporation.....2
C&D Batteries.....185
*Centronics.....282-24
CGA.....153
*CIE Terminals.....282-20,282-21
Cincom Systems.....254,255
*Cipher Data.....282-37
Codex.....274,275
Compaq Computers.....138
Compugift.....96
Computer Associates.....108
Computer Associates.....263
*Computer Automation.....282-7
Computer Corp of America.....53
Computer Parts Exchange.....99
Computer Security.....300
*COMTAL Corp.....282-13
Comtech Data.....28
Continental Resources.....86
Control Data Corporation.....98
Control Data Institute.....136
Convergent Technologies.....6,7
Cullinet.....172,173
Cybernex.....63
Cyborg Systems.....78

Dansk Data.....324
DASD.....312
Data General.....230,231
Data General.....292,293
Datagraphix.....288
Data Kinetics.....222
Datapoint.....327
Dataproducts.....19
Dataram.....196
Datasources.....264
Datastream.....154
Datswitch.....76,77
Dataware.....256
Decision Data.....223
Digital Communications
Associates.....22
Digital Engineering.....191
Digital Equipment.....236,237,286,287,340
Digital Research.....345
Digitec Software Design.....104
*DMA Systems.....282-23
Dolan Consulting.....118
Durango.....135
Dylakor.....222
Dysan.....87

EF Information Systems.....349
Elxsi.....38,39
EMC.....183
Emulex.....199
*Epson America.....282-35
Exxon.....33-36

Four Phase Systems.....203

General Data Comm.....244,245
General Electric Terminet.....283
Graham Magnetics.....229
Graphic Laminating.....312
Group Operations.....213

Hal Communication.....338
*Hewlett Packard.....269
Hewlett Packard.....282-19
Hughes Aircraft.....168

IBM-Modems.....129
IBM-Series 1.....65,66,67
IBM-ISG.....142-143
IDA-Ireland.....333
Industrial Computer
Controls.....343
Infodata.....302
Infodyne.....265,282-40
Infotron.....141
Innovation Data
Processing.....319
Integrated Technologies.....195
Intel.....10,11
*Intel.....282-8,282-9
*Intermec.....282-30
C. Itoh.....15
ITT Courier.....147
ITT Worldcom.....331

Kennedy Co.....Cover 2

The Leading Edge.....43
Lear Siegler.....337
Lee Data.....297
Liebert.....178,179
Lor Tec Power Systems.....84
Lynch Communications.....80

M/A Com DCC.....233
MAI Sorbus.....311
Mathematica.....209
Manager Software Products.....93,95,97
Martin Marietta.....145
Maxell.....277
Mc Cormack & Dodge.....60,61
MDS.....79,81,83
Megatek.....307
Memorex.....130,131
Merlyn Corporation.....119
Micom.....1
Micom.....84
Microcom.....30
Moore Business Forms.....339
MPI.....206
MSA.....166,167

NCR.....49,50,51
NCSS.....282
Nichols.....104
Nixdorf.....112,113
Northern Telecom.....176,177

On Line Conferences.....267
On Line Software.....180
Onyx.....246
Optical Coating Labs.....151
Oxford Software.....210
Ozalid.....32

Perception Technology Corp.....	334
Perkin Elmer.....	107
Persyst.....	26,27
Phalo Systems.....	127
Phaze Information Machines.....	82
Philips Information System.....	101
*Plessey Peripheral Systems.....	282-2,282-3
Polaroid.....	148,149
Popom.....	250
Precision Visuals.....	89
Prentice.....	235
Printronix.....	186
Protocol.....	45
*Qantex.....	282-12
Qume.....	221
*Racal Vadic.....	282-4
Radio Shack.....	159
Ramtek.....	299
Rixon.....	193
Rusco Electronic Systems.....	46-47
SAS Institute.....	5
Kingdom of Saudi Arabia.....	198
*Software Microsystems.....	282-29
Software AG.....	9
Software International.....	12
Software Results.....	332
Southern Systems.....	137
Specialized Products.....	136
Sperry Univac.....	280,281
SPSS.....	206
Storage Technology.....	313
Symbolics.....	279
Sytek.....	116
Tab Products.....	334
T Bar.....	291
Tandem.....	69-74,74A&B
*Teac.....	282-38
*Tekelec.....	282-11
Teletype.....	Cover 4
Teletype.....	204,205
*Teletype.....	282-14
Televideo.....	160,161,270,271
Telton.....	124
Texas Instruments.....	30,31
Three M.....	100,188,189,249
Timeplex.....	226
Tower Systems.....	171
Trans Net.....	250
*Triumph Adler.....	282-36
*TRW.....	282-39
TSI International.....	214
Tymnet.....	194
UCC.....	224,225
Ungermann Bass.....	200,201
United Telecom Computer Group.....	295
Uniq Computer.....	157
US Postal Service.....	111
U3S.....	251
VM Software.....	8
*Western Peripherals.....	282-31
*Zilog.....	282-26
Wang Labs.....	257
Witesmith Ltd.....	29
Wrightline.....	272
Xerox Computer Services.....	120,121
Xerox Printing Systems.....	347

Are your backups running into your prime shift?



Incremental Backups can reduce your backup time by 50 to 80%.

User can specify that ABR is to backup changed data sets only until a limit count is reached. At that time, ABR will interpose a full volume dump. This technique greatly reduces backup time while providing a periodic image of the entire volume.

- Automatic Volume Reconstruction
- Automatic Tracking of Backups
- Preallocation
- Unlike Device Support

FDR™

AUTOMATIC BACKUP & RECOVERY™

Available for IBM OS/VS & MVS
90 Day Free Trial



**INNOVATION
DATA PROCESSING**

970 Clifton Ave., Clifton, NJ 07013 • 201-777-1940

CIRCLE 217 ON READER CARD

The Marketplace... SOFTWARE SERVICES

ADVERTISERS' INDEX

SOFTWARE SERVICES

Amcor Computer Corp.	320
Applied Information Systems, Inc.	321
Beemak Plastics	321
Dataware, Inc.	320
Dataware, Inc.	320
Dataware, Inc.	320
Evans Griffiths & Hart, Inc.	320
Raymond G. Lorber, Incorporated	320
Mitchell & Gauthier Associates	321
Octal Incorporated	321
Plycom Services, Inc.	320

DP MARKETPLACE

Data Supplies, Inc.	321
Downtown Book Bazaar	321
TKE Electronics	321

BUY, SELL, LEASE

Eurodata Inc.	321
Genstar Rental Electronics, Inc.	322
International Computer Remarketing	321
Thomas Business Systems, Inc.	322

JOB MARKETPLACE

Wallach Associates, Inc.	322
-------------------------------	-----

PERSONAL COMPUTING

Pan American Electronics	322
--------------------------------	-----

IBM SERIES/1 VAR

- Customized Programming
- Message Switching
- Telex/Teletype Interface
- Freight Forwarding
- General Business Applications

Raymond G. Lorber, Incorporated
Systems & Programming Design
101 California Street Suite 3325
San Francisco, Ca. 94111
(415) 434-2607

CIRCLE 500 ON READER CARD

DEC RSTS APPLICATION SOFTWARE

BUSINESS CONTROL SYSTEMS:
• ORDER PROCESSING/BILLING
• INVENTORY CONTROL
• SALES ANALYSIS

ACCOUNTING SYSTEMS:
• ACCOUNTS RECEIVABLE
• ACCOUNTS PAYABLE
• PAYROLL
• GENERAL LEDGER
• FINANCIAL MANAGEMENT

DEC GOLD STAR RATED
TOP MILLION DOLLAR AWARDED

amcor computer corp. an amcor company
1900 Plantside Dr., Louisville, KY 40299 502/491-9820
Regional Offices - Atlanta, GA / Campbell, CA

CIRCLE 502 ON READER CARD

RSTS/E & RSX-11M SOFTWARE PACKAGES

- KDSS** multi-terminal key-to-disk data entry system
TAM multi-terminal screen-handling facility for transaction-processing applications
FSORT3 very fast record sort for RSTS/E
SELECT convenient, very fast extraction of records that meet user-specified criteria (RSTS/E only)
BSC/DV a DV11 handler for most bisynchronous protocols (RSTS/E only)
COLINK links two RSTS/E systems using DMC11s
DIALUP uses an asynchronous terminal line to link a local RSTS/E system to a remote computer system

Evans Griffiths & Hart, Inc.
55 Waltham Street
Lexington, Massachusetts 02173
(617) 861-0670

CIRCLE 501 ON READER CARD

FIXED ASSETS SYSTEM

Calculating depreciation got you down? Know where all your assets are at? Use PLYCOM's Fixed Assets System for software that is easy to use, yet effective. Gives you a complete solution. Includes all the forms, procedures and programs necessary to give management full control over the asset reporting function. Includes excellent documentation and complete support. Features:

- Easy to use menus
- Book and tax depreciation
- Multi-division or multi-company
- Disposal reporting
- Property tax reporting
- Depreciation forecasting
- Acquisition reporting
- Interfaces to General Ledger
- For PDP-11's using RSTS/E

Plycom * services, inc.
P.O. Box 160
Plymouth, IN 46563
(219) 935-5121

CIRCLE 503 ON READER CARD

COBOL to COBOL

One of the many successful Translators offered by Dataware is our COBOL Converter, a table-driven conversion system designed to convert COBOL programs from one vendor or operating system to another.

This converter plus our other conversion tools meet the needs of a changing computer industry.

Our conversion approach provides the major solution to management's conversion problems and facilitates the recovery of the initial capital investment in systems development.

For more information, call or write today.

The Conversion Software People
Dataware, Inc.
2565 Elmwood Avenue
Buffalo, New York 14217
(716) 876-8722 • TELEX: 91519

CIRCLE 504 ON READER CARD

PL/1 TO COBOL

Dataware's Software Translator automatically converts from IBM PL/1 to ANS COBOL (DOS or OS). The Translator is capable of handling IBM OS or DOS (48 or 60 character set) source programs as input.

For more information on this translator or the others listed below, please write or call today.

- EASYCODER/TRAN to COBOL
- BAL/ALC to COBOL
- AUTOCODER/SPS to COBOL
- COBOL to COBOL

The Conversion Software People
Dataware, Inc.
2565 Elmwood Avenue
Buffalo, New York 14217
(716) 876-8722 • TELEX: 91519

CIRCLE 505 ON READER CARD

Dataware Software Translators

RPG to COBOL

Converts RPG and RPG II programs to the industry standard ANS COBOL (DOS or OS). The translator achieves an extremely high percentage of automatic conversion (approaching 100%) of the source code.

RPG to PL/1

Converts RPG and RPG II programs to an optimized PL/1 (DOS or OS). The translator achieves an extremely high percentage of automatic conversion (approaching 100%) of the source code.

For more information, call or write today.

The Conversion Software People
Dataware, Inc.
2565 Elmwood Avenue
Buffalo, New York 14217
(716) 876-8722 • TELEX: 91519

CIRCLE 506 ON READER CARD

TKE
ELECTRONICS

A DIVISION OF
TECH-KNOWL ENTERPRISES
EMI/EMC
TESTING, CONSULTING
AND TRAINING
FCC-MILITARY
ALAN A. JONES
(215) 844-0907
P.O. BOX 512
NARBERTH, PA 19072

CIRCLE 507 ON READER CARD

Tabcard Holders
supplying holders for
all types of D.P. systems

Vinyl envelopes
available with adhesive back or magnets. Special sizes

SINCE 1951
BEEMAK™ PLASTICS
7424 Santa Monica Boulevard
Los Angeles, Ca. 90046 • (213) 876-1770
Outside California—call our Toll Free number:
1 (800) 421-4393

CIRCLE 508 ON READER CARD

PDP-11 & VAX Software

EasyEntry
Quick form design
and data entry system

AIS-PLI
ANSI Subset G
PLI Compiler

BURCOM-11
PDP-11/Burroughs
Communications System

1-800-334-5510

applied information systems

500 Eastowne, #207
Chapel Hill, NC 27514
(919) 942-7801

CIRCLE 509 ON READER CARD

**ARE YOU TIRED
OF FILE
PROTECTOR
RINGS ALL OVER
YOUR COMPUTER
ROOM? BECAUSE
OF IMPROPER
STORAGE. WE
HAVE THE
ANSWER!**

SEND \$2.50 FOR A BROCHURE ON OUR
NEW LINE OF RING HOLDERS

Data Supplies Inc.
P.O. Box 26392 Dept. B
St. Louis MO. 63136

CIRCLE 510 ON READER CARD

ACSL

The Advanced Continuous Simulation Language is a powerful but easy to use program designed for modelling the behavior of dynamic systems. Applications range from control system analysis to chemical plant models to urban dynamics.

- Interactive or Batch Graphics
- Unlimited Problem Size
- FORTRAN Compatibility
- Stiff Integration

ACSL reduces program development time by factors of two to ten: ACSL is available for CDC 6000/7000, IBM 360/370, UNIVAC 1100, SEL 32, PDP 10/20, VAX II, PRIME 50 and HARRIS computers. Access through BCS, CYBERNET and other national networks.

MITCHELL AND
GAUTHIER ASSOCIATES, INC.
P.O. Box 685, Concord, Ma. 01742
(617) 369-5115

CIRCLE 511 ON READER CARD

**COMPLETE 68000
DEVELOPMENT TOOLS
FOR VAX/VMS***

MOTOROLA PASCAL → 68000 optimizing cross-compiler \$2995
MOTOROLA 68000 relocatable cross-assembler \$ 995
MOTOROLA cross-library builder \$ 995
MOTOROLA cross-linker \$ 995
VMS ↔ VERSADOS† file transfer \$ 695
VMS → VERSABUG downloader \$ 395

All products run in VAX native mode.
Developed in cooperation with Motorola for
guaranteed Motorola compatibility.
*tm Digital Equipment Corp. †tm Motorola

octal
INCORPORATED

1951 Colony Street, Mountain View, CA 94043
(415) 962-8080 Telex: 172933

CIRCLE 512 ON READER CARD

**Save \$ on
Computer Books!**

We offer a 10% discount on
computer books from several
publishers.
Fast, reliable service and low
shipping charges for mail orders.
Write for FREE catalog.

**DOWNTOWN
BOOK
BAZAAR
INC.**

DOWNTOWN
BOOK BAZAAR,
Dept. D
P.O. Box 2490
Brooklyn, N.Y.
11202

CIRCLE 513 ON READER CARD

BUY, SELL, LEASE

HEWLETT-PACKARD*

New & Used

Computers • Terminals
Peripherals

Buy & Sell Worldwide

EURODATA INC.
1673 Carling Ave. Ste. 110
Ottawa, Canada K2A 1C4
613-725-9485
Telex - 0533025

* Trade Mark Reg'd.

CIRCLE 514 ON READER CARD

Buy Sell Lease Trade

Data General
Digital Equipment
Hewlett Packard

INTERNATIONAL COMPUTER REMARKETING
A Division of Pinzone & Associates, Inc.

807 South Main Street
Duncanville, Texas 75137
214-780-1600 TELEX 73-0121 Pinzone DCVJ

3000 Research Road
Champaign, Illinois 61821
217-357-7882

CIRCLE 515 ON READER CARD

Like-new products



For free catalog, phone toll-free (800) 225-1008 in Massachusetts (617) 938-0900

Genstar REI Sales Company

6307 DeSoto Ave., Suite J
Woodland Hills, CA 91367

CIRCLE 516 ON READER CARD

SYSTEMS • PERIPHERALS • PARTS

DG

Phil Thomas
305/392-2006

DEC

Bryan Eustace
305/392-2005

Jennifer Eustace

305/392-2007
TELEX 568-670

BUY • SELL • TRADE • LEASE

THOMAS BUSINESS SYSTEMS, INC.

CIRCLE 517 ON READER CARD

People of all ages die of heart disease and stroke.



American Heart Association

WE'RE FIGHTING FOR YOUR LIFE

JOB MARKETPLACE

LET US PLACE YOU IN A BETTER JOB NOW

Put our 20 years experience placing technical professionals to work for you. Client companies pay all fees; you get our expert advice and counsel FREE. Nationwide opportunities in Communications, Defense, Intelligence, Computer, Energy and Aerospace Systems. If you earn over \$25,000, we have a better, more rewarding job for you . . . right now. Send your resume in confidence to: Dept. DM-B

WALLACH associates, inc.

Washington Science Center
6101 Executive Boulevard, Box 6016
Rockville, Maryland 20852

Technical and Executive Search

Wallach . . . Your Career Connection

CIRCLE 518 ON READER CARD

Save On
TRS-80™ Computers

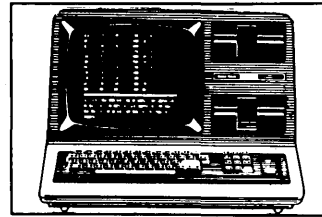

For the best deals on TRS-80 Computers, we have **SPECIAL DISCOUNTS, FREE SHIPPING** and a **TOLL FREE ORDER NUMBER**

Pan American Electronics

Dept. 22 • 1117 Conway • Mission, TX 78572
Telex Number 767339

Toll Free Order Number 800/531-7466
Texas & Principal Number 512/581-2766
TM - Trademark of Tandy Corporation

CIRCLE 519 ON READER CARD

"THERE IS AN ANSWER TO EVERY RIDDLE IN THE UNIVERSE, EXCEPT ONE."

I know the secrets of the stars and the mysteries of the moon. But the origin of The Common Cold baffles even a great thinker like myself. That's why I rely on the Consumer Information Catalog.

It's published by the Federal Government and lists over 200 booklets you can send away for. Over half are free. And all are wise. With tips on everything from repairing a flat tire to relieving a cold.

So send for this free catalog. Write: Consumer Information Center, Dept. B, Pueblo, Colorado 81009. After all, it's hard enough deciphering the mysteries of this planet, without the handicap of an earthshaking sneeze.

THE CONSUMER INFORMATION CATALOG

A catalog of over 200 helpful publications.



USE THE DATAMATION MARKETPLACE ADVERTISING SECTION

CALL KATHY 800-223-0743 OR SHIRLEY

Every payday, ADP pays 6,000,000 people at 80,000 companies nationwide.



Stan Domalewski is Director of Management Information Systems for Brinks, Inc. He's been around computers and payrolls long

enough to know what's worthwhile. And what isn't.

"The best thing in the world is to put your payroll on somebody else's computer.

"There is absolutely no benefit to processing payroll in-house. The deadlines can kill you. The data entry load is unbelievable. And if you don't have redundancy in your hardware, and it goes

down, you have real trouble with a capital "T."

"ADP comes through every time. They do the collection. They do the consolidation. The closest my computers get to payroll these days are after-the-fact-audits.

"ADP delivers a finished product. They can go from worksheet to completed check in less than 24 hours. The balanced quarterly tax information I get is a life saver. And if a glitch or two should pop up, ADP has proven to be very responsive.

"With ADP doing payroll, I can put my computers to better use for Brinks. And I get the chance to do some of the things I like to do."

Stan Domalewski and

Brinks, Inc. are valued clients of ADP. They are also proof that it pays not to process payroll on your own computer.

For more information on how to free your computers from tasks like payroll, accounts payable and receivable, general ledger and financial reporting, and others—call ADP toll free, at 800-526-7474. In New Jersey, call collect at 201-472-2222. Or write to ADP, 405 Route 3, Clifton, NJ 07015.



The computing company®

CIRCLE 220 ON READER CARD

Without tying up anybody's computer department.



Flexibility

DDA's systems are designed to be flexible and adaptable to your needs. They can be configured to meet your specific requirements and can be expanded as your needs change.

Expandability

DDA's systems are designed to be expandable. You can add more users, more data, and more processing power as your needs grow.

DDA's systems are designed to be reliable. They are built with high-quality components and are backed by a strong warranty.

Reliability

DDA's systems are designed to be reliable. They are built with high-quality components and are backed by a strong warranty.

Operating Systems

DDA's systems are designed to be compatible with a wide range of operating systems. This gives you the flexibility to choose the system that best fits your needs.

Languages

DDA's systems are designed to be compatible with a wide range of programming languages. This gives you the flexibility to choose the language that best fits your needs.

Communications

DDA's systems are designed to be compatible with a wide range of communication protocols. This gives you the flexibility to choose the protocol that best fits your needs.

DDA's systems are designed to be compatible with a wide range of hardware. This gives you the flexibility to choose the hardware that best fits your needs.

DDA's systems are designed to be compatible with a wide range of software. This gives you the flexibility to choose the software that best fits your needs.

DDA's systems are designed to be compatible with a wide range of services. This gives you the flexibility to choose the services that best fit your needs.

**If you can't beat us,
Join us.**

It is danish.

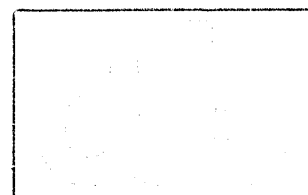
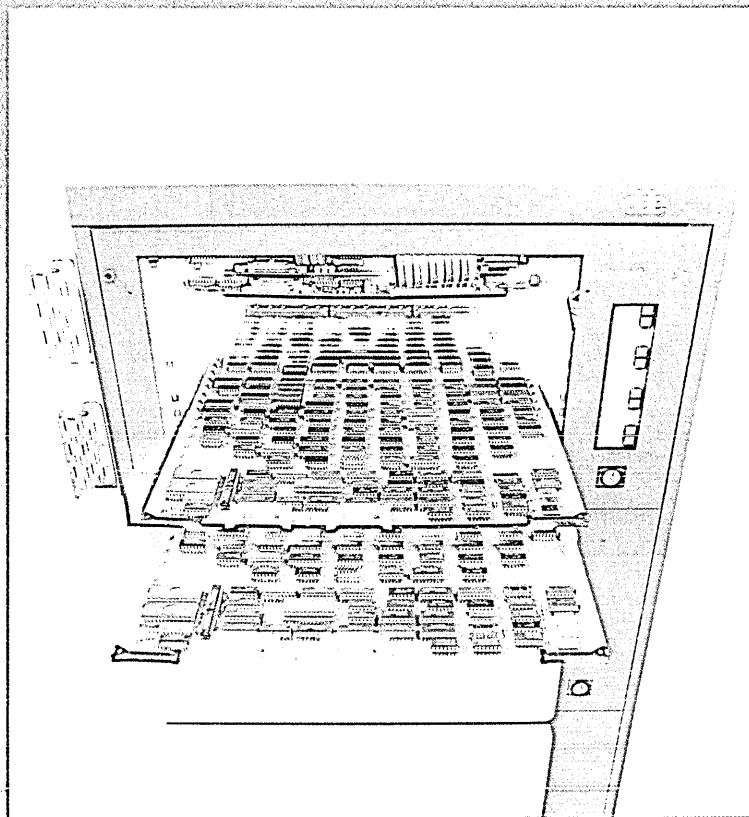

Danish Data Electronics A/S, Herlev Hovedgade 207, 2730 Herlev, Denmark.

Telephone: int. +45 2845011. Telex 35258 dde dk. UNIX is a trademark of Bell Telephone Laboratories

CIRCLE 221 ON READER CARD

SOURCE DATA

BOOKS

BRAINS, BEHAVIOR, AND ROBOTICS by James S. Albus

Technical books are usually delimited by a certain dry precision. Deviations from this form are considered nonanalytical and, hence, nonscientific. So generally, the technologist conforms to this style, no matter how difficult and procrustean it may be.

Fortunately, James Albus didn't feel these constraints when writing his *Brains, Behavior, and Robotics*. The polymathic Albus capriciously carries the reader from neurology through psychology before ultimately arriving at robotics. He drifts a bit, but this isn't a book about robots for managers, or accountants, or even manufacturers. It is a multiform book that exists simply for the exposition of Dr. Albus's many ideas. While its digressiveness might dismay an overly punctilious reader, this book may be the best one yet written about robotics.

Albus is a Kentuckian who heads the National Bureau of Standards' robotics research laboratory. While a student at Wheaton College, Albus designed the antennas and radio-frequency feed network for the Vanguard I satellite. He also directed NASA's artificial intelligence program for 15 years, and his mathematical model of the cerebellum, revealed in his "Theory of Cerebellar Function," was recognized by *Industrial Research* magazine as one of the most significant inventions of 1976. Albus is a fellow of the Washington Academy of Science.

Albus delights. For example, to demonstrate the "enormous complexity of the computation and control problems involved" in shopping at a mall, he includes a photo of his car in a shopping center parking lot and proceeds to describe the way he goes about buying a record, losing his way in the mall, and eventually returning to his car. He thus exhibits the entangled nature of visual perception, motor coordination, and decision making. The reader might ask what is the purpose of the shopping mall?

Albus then offers a formidable spread of facts.

We read of the central nervous system, of subcortical matter, and of the thalamus. The first seven chapters attempt to explain how the brain directs behavior. Albus discusses a sensory-interactive model of the brain to be used for hierarchical control. This is pretty rarefied stuff, so the nomenclature occasionally verges on the sublime. He writes of "behavior trajectories" and blithely informs us that when we daydream, "we allow our hypothesis generators to drift wherever our emotional evaluators pull them." But despite such moments, the exposition is clear and logical. The reader should have little difficulty following the author, although Albus's course might not always be true.

Finally, in the eighth chapter, Albus begins to address robotics specifically. It is here that he really starts to loosen up and show his form. His model for a \$420 hydraulically driven plastic robot conjures up a multitude of applications. He writes of household robots that will mow our lawns and wash our towels which cost almost as much as a Honda Accord. He suggests the future of robots in the construction industry where they would work as apprentices to master craftsmen and thereby eliminate hod carriers, bricklayers, and concrete finishers from the job site. In addition, stonemason robots would quarry and build with granite. "Building with stone," writes Albus with obvious pleasure, "could experience a renaissance."

Albus even prophesies robots equipped with a mechanism analogous to human emotion. Such a device would allow robots to evaluate dangerous situations, writes Albus, though he admits this "survival program" might be disruptive and of questionable human benefit.

These scenarios are all laid out with a matter-of-factness that belies their arduousness. Albus's thought processes are astonishing, and poetic. The poetic mind, wrote T.S. Eliot, is "constantly amalgamating disparate experience . . . [where the ordinary man] falls in love, or reads Spinoza, and these two experiences have nothing

to do with each other, or with the noise of the typewriter or the smell of cooking; in the mind of the poet these experiences are always forming new wholes." So it is with Albus: the models he uses to illuminate his theories parallel the models, or processes, Eliot describes in poetry. Albus can hear a jaybird sing and think of robotics. Whether discussing Thomas Aquinas's *Summa Theologica* or the neurological process of action potential, Albus expresses ideas in a manner commensurate with his awe for the future.

Particularly enjoyable is the ingenuous fashion in which Albus describes and defines the most highfalutin of ideas. When faced with seemingly insurmountable problems, he declares them solvable. In thinking of what could be done with his goal-directed hierarchical program, Albus reminds us:

"To be sure, the addition of complex sensors, sophisticated sensory processing, internal world models, and multiple levels of feedback into the hierarchy produces an exponential increase in the complexity of possible behavior patterns; but this is not magic. It is predictable and deterministic."

For Albus, little is impossible. He speaks of a future free from want, of a surplus gross national product, of a revival of ancient lifestyles, and the reader concurs. Even at his most visionary, Albus is compelling. He theorizes of giant floating "lily pads" made of plastic which would farm algae to process alcohol while sailing equatorial waters. These computer-controlled pads, up to 10 kilometers in diameter, would produce 42,000 gallons of methanol per hour. There would be no more energy crises.

Albus also reveals an aptitude for contemplation far beyond the ken of many contemporary technologists, when, in chapter 12, he ponders the social significance of robotics. Although this chapter is less polemic than Albus's previous book, *Peoples' Capitalism*, its message is still quite extreme. The present socioeconomic system, he writes, is not structured to deal with the diffusion of robotry. The eventual

SOURCE DATA

deployment of automatic factories will mean a concentration of wealth and power into the hands of a few. If labor is thus removed from the creation of wealth, how will ordinary people buy what is produced? How will diminished work input relate to increased production output? How can the wealth created by robotics technology be used to combat disease and poverty? Such concerns become plausible if, as Albus suggests, the eventual cost of manufactured goods falls to near the cost of their unfinished raw materials.

The Puritan work ethic is not "an indispensable component of human society," says the author. He points out that the rich have flourished for centuries with "little recourse to the work ethic as most of us know it." Albus hopes robotics will "free mankind from wage slavery and the regimentation of the Puritan work ethic central to all economic philosophies born of industrialization." To attain this, he says, industrial productivity must rapidly increase. Albus recommends the institution of mandatory savings bonds (bearing 4% interest) to supply capital for industrial improvement and to control inflation. He envisions a national mutual fund empowered to borrow from the Federal Reserve. Every citizen would be a shareholder in the NMF, which would disseminate those profits resulting from investment in advanced technologies. Where the kingfish hailed every man a king, Albus proposes to make every citizen a capitalist.

Such admittedly Jeffersonian sentiment might not endear Albus to the Hamiltonians of the boardroom or the Commerce Department, but what else is being offered these days? Albus is one of the few to evaluate the social problems of robotics in a coherent fashion. Unlike many others, he does not cynically rely on the tired precepts of social Darwinism. Nor does he delude himself that such change will cause only temporary discomfort. He respects change as part of a historical continuum, and he has some ideas about how to deal with this

change. For that alone, he should be read.

This is a good book for the student of robotics. Its scope is panoptic enough to provoke thought, and it serves to remind the reader that a monomorphic pursuit of one topic makes for a dull lad.

What Albus has created with *Brains, Behavior, and Robotics* is neither dull nor dilettantish. Those who are interested in the field of robotics, and those who are attentive to the capabilities of technology, will find this a serious and perhaps profound book. James Albus deserves more attention, and this is a good place to begin awarding it to him. Byte Books, Subsidiary of McGraw-Hill, New York (1981, 352 pp., \$16.95).

—Leopold Froehlich

THE BUSINESS COMMUNICATIONS REVIEW MANUAL OF PBX'S

by L.F. Goeller Jr. and J.A. Goldstone

DIMENSION* PBX AND ALTERNATIVES

by Economics & Technology Inc.

DATAMATION is running a series of articles on private telephone exchanges (PBXs) that will carry both voice and data traffic (March, April, May, and July 1983 issues). In preparation for this series, we had to educate ourselves in the art of telephony. A short (and admittedly incomplete) literature search yielded two documents that helped us learn the rudiments of the telephone business. Each of these books has strengths and weaknesses, which are described in the paragraphs that follow.

The vocabulary and jargon of the telephone business seem more confusing than those we use in the computer business. Two vendors will describe the same feature using different words, making procurement contracts difficult to write and to understand. Further, the user's statement of re-

quirements is likely to be misunderstood since the vendors may not understand the words as the user intended them.

Since computing and telephone communications are just beginning to work together, it is unlikely that the situation will change in the near future. Thus, a user wishing to procure a new telephone system that fits his or her master plan for computing and office automation must learn telephone jargon.

The first book, *The Business Communications Review Manual of PBX's*, is by L.F. Goeller, a consultant, and J.A. Goldstone, editor of a telephone trade publication. Together they have written a manual to help nontechnical administrators learn enough about PBXs to oversee procurement of an upgraded system. The manual's second edition became available in mid-1982 and provides valuable educational material for the computer specialist making his first foray into the jungles of telephony.

The first 43 pages of this manual provide an excellent description of a traditional PBX and how it works. The approach is from an engineering viewpoint and the prose is supplemented by several good block diagrams. The next 10 pages describe, from the voice telephone point of view, the leading features a PBX should encompass.

Neither Goeller nor Goldstone is strong in computer communications. Their strength is in voice, and you should keep this bias in mind when you read this otherwise excellent manual. You must add to their feature list and question the architectures they discuss based on your built-in understanding of computers and communications.

The third chapter, about 20 pages long and entitled "The PBX in the Office of the Future," also contains good information but lacks a solid foundation in computer communications. Specifically, the authors here do not discuss the new families of terminal systems that are likely to be architected to exploit 56KB signaling, office systems involving multiple protocols, security in the local network, and maintenance features the PBX should offer in a multivendor environment.

The heart of the book is a questionnaire of 400 or so items. The authors contacted vendors and distilled vendor literature to describe 37 PBXs in excruciating detail. There is narrative on each system, an introduction to the vendor, an enumeration of sales outlets, and an enormous computer printout detailing how each product matches the questionnaire.

This manual seems directed to two separate audiences: the introductory material and the educational material is well done for the mature professional who is just getting into telephony. Only those with several years' experience in telephony, however,

*Dimension PBX is a registered trademark of AT&T.



"Alright, Lomax, let's see how tough you are without those desk accessories."

CARTOON BY CHUCK VADUN

"Hyatt was a pioneer of local area networks. When Datapoint introduced the first one, we ordered."

—Bob Regan
V.P. Management Information Systems
Hyatt Hotels Corporation



"Local area networks are the hot topic in data processing these days. But they're nothing new to us," says Hyatt's Bob Regan. "Ours have been up and running for five years."

When Datapoint introduced the first local area network, the ARC® system, in 1977, Hyatt was among the first to install it. Today there are approximately 5,000 ARC local area networks in use, far more than any competing system.

"One reason the ARC network has been so effective for Hyatt is because it's easy to expand," says Regan. "Hyatt has had phenomenal growth, and the ARC has kept up. When more people needed the system to do more work, we simply added to the network."

The ARC local area network can be expanded virtually without limit by simply plugging in additional Datapoint processors, printers, storage disks, and terminals. Each new processor adds power to the

network so new users get the same fast response the original users were getting. Companies can closely match the power of an ARC system to their needs, expanding in small, inexpensive increments instead of buying "more computer than they need" in order to have room for growth.

What's more, Datapoint systems can be expanded or upgraded without replacing software. "We run some programs on ARC networks that were originally written for our first Datapoint computer more than ten years ago," says Regan. "That means we didn't lose any of the money we invested in programming and training. And it made the growth steps easy on our people. The changeover to the ARC network was accomplished in only two days."

No matter how far an ARC system is expanded, all the users can have access to all the data except where security precautions are installed. So even though more and more people are using more and more computers, there's never a

need to duplicate files.

"At present, Hyatt operates forty-five ARC systems," Regan says. "Others are in the planning stages right now. On the operations side we use them for accounting, reservations, and group sales. At Corporate we use them for accounting and for systems development. Obviously, we depend on them heavily. They're like the meters where we check our own financial performance. They simply have to work. And they do."

"Hyatt has stayed with the ARC system because it's been cost-effective. That's the bottom line. I can recommend a certain system to a hotel, but in the end, the system has to sell itself. And keep selling itself after it's installed. Our Datapoint ARC systems have done that."

For more about Datapoint, call (800) 531-5639. In Texas, call (800) 292-5099. Telex 767300 in the U.S.; 06986622 in Canada; or 923494 in Europe (UK). Or write Datapoint Corporation, Marketing Communications T41DM, 9725 Datapoint Drive, San Antonio, Texas 78284.



DATAPOINT

CIRCLE 222 ON READER CARD

SOURCE DATA

can appreciate the questionnaire in all its detail. The individual items enumerated in the questionnaire present an abundance of information that's difficult for the uninitiated to digest.

Although Goeller and Goldstone present the background of the questions in paragraph form, much of the data remains difficult to grasp. The authors should have identified those items of prime importance to help the reader. This type of judgment might be modified by specific installation factors, but the volume of ungraded material presented is difficult to handle.

The remaining section of the manual is a blank RFP. This is a useful educational tool, although it has not been found to be directly applicable in recent procurement situations. Educationally, though, it can be used as a quiz to prove that the reader has digested the jargon and is ready to state his or her requirements and proceed with a procurement. In taking the quiz, ask yourself, do I understand this item? Is it important in my situation? Can I predict the answers I'm likely to get, and am I prepared to interpret the responses from this question?

If you answer yes to all those questions for each item in the sample RFP, then add the computer communication questions they have omitted and proceed with the procurement.

This manual is available in paperback from BCR Enterprises, Inc., Hinsdale, Ill. (1982, 375 pp., \$145).

Dimension PBX and Alternatives*, a 1982 document by Economics and Technology Inc., is pre-Antelope—potential purchasers should be sure to request the fifth edition. The fourth edition is aimed at the administrator who needs an understanding of the telephone trade as a prerequisite to buying a new CBX. The first 30 pages take a nonengineering approach toward defining the words and terms of the trade. These authors evidently shared the same background as Goeller and Goldstone and, hence, succumbed to the same bias; digital data is barely mentioned. Once again, the computer-skilled individual can use this document to pick up the litany and lingo, but he or she will have to be constantly on guard to add the digital data features the authors have omitted.

A 50-page section entitled "CBX Features" provides readable definitions for many of the confusing terms in voice telephony. The definitions are written from the viewpoint of one who either has a Dimension system installed, or has been under heavy selling pressure from Bell. Such a reader would have heard the terms and be hungry for the definitions. While the meanings presented here are useful for their intended purpose, a reader not familiar with the Dimension equipment may find the repetitive references a bit tiresome.

The following 100 pages describe the pre-1983 Bell Dimension offering and

its major competitors. Instead of the massive table of features contained in Goeller and Goldstone's manual, these authors provide narrative highlights of each product. Unfortunately, the narratives are not written from a checklist, so each one seems to say what is known about the product without necessarily touching all the bases.

The last two sections of ETI's book are devoted to pricing a Dimension system and the standard price list for Dimension features. It gives an idea about the depth one must go to in order to get the final prices, and some idea of how the Bell System marketed their product before 1983. Today there is an indication that Baby Bell is a great deal more flexible than this manual implies, and there has even circulated a rumor or two that Baby Bell negotiates prices when faced by tough competition. Economics and Technology Inc., Boston, Mass. (fifth edition published in 1983, 280 pp., \$200).

Neither manual follows an ideal outline, but by reading both, the serious student can begin to get a good appreciation for various PBXs. In addition, the experienced computer person who is contemplating the installation of a third generation PBX can benefit from these manuals; this professional needs to absorb the vocabulary of the established telephone industry.

Both manuals provide an introduction to that vocabulary. However, the appeal of the third generation PBX is its ability to handle voice and data in an integrated manner. Neither manual provides a satisfactory treatment of data traffic. Until a third handbook comes along, computer people will have to use their own ideas to add the data content both these manuals omit.

—R. L. Patrick

BOOK BRIEFS

IDEA TRANSFER, Inside Techniques for Executive Presentations

by Alan W. Boal and T. M. White

Why does getting up before an audience strike fear in the hearts of many? Why do stomachs churn, palms get clammy, butterflies flutter, and beads of perspiration form when someone calls upon us to speak?

Boal and White, in their book *Idea Transfer, Inside Techniques for Executive Presentations*, seek to calm the stomach, get the butterflies flying in formation, and reduce the tension level by likening the speech preparation and delivery process to using a computer.

First of all, say the authors, a speech or presentation is a transfer of ideas. Semantics? You bet, but if it helps you get over your initial fear of the presentation, use it.

Second, these two consultants, who specialize in communications for high technology organizations, break down the idea transfer concept into five phases: data, input, output, printout, and debug. These phases should further calm the nerves of the technically grounded ceo, marketing executive, engineering manager, or software specialist who is called upon to speak. Once the authors have your attention, they describe a deceptively simple recipe book-style attack on developing ideas and presenting them effectively.

In the data phase, you start your topic development process with the audience in mind. The authors, still seeking to calm your nerves, state that the audience is more than monolithic; it is a collection of individuals, each with a different perspective on what will soon and easily become your topic. You will turn them into your source of confidence and information.

Is this possible? Sure it is, say the authors. You are the person who takes all the points of view of the audience members and makes a complete statement out of it. You decide how the audience should use what you give them. You identify what the audience needs to know.

With this revised attitude, Boal and White introduce the essential ingredient in preparing a speech: the cluster system. In their terms, "When you pose a rhetorical question and then answer it, you give your audience a small cluster of information. . . . Speech clusters make your presentation easy to follow and therefore more persuasive."

Now you enter the input phase in which the cluster system is fleshed out and the message is prepared. If there are five clusters, each about four or five minutes long, you've got a 20-25-minute speech. From here on the authors introduce techniques for maintaining interest, such as internal signposts on where the speech is going, summaries of what you've already said, personal stories to accentuate points through example, and the tried-and-true addition of statistics.

The output phase covers delivery and is followed by the printout phase which integrates the entire process into a complete idea transfer system. But no development effort is complete without debugging. The final chapters tell the speaker how to determine if the audience understood what was said and, most importantly, if they're ready to respond to the call for action (there's got to be one or else there's no reason for the speech).

If the book ended at the debugging phase, it would have been complete in its own right. However, the authors take the idea transfer process one step further and provide the reader with a comprehensive bibliography on personal presence, plus special sections on preparing for specific presentations, such as staff meetings, ex-

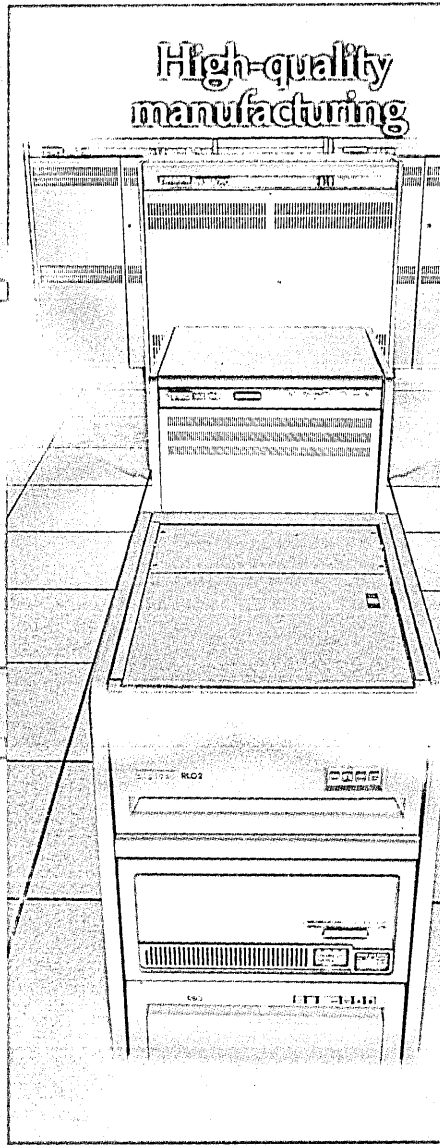
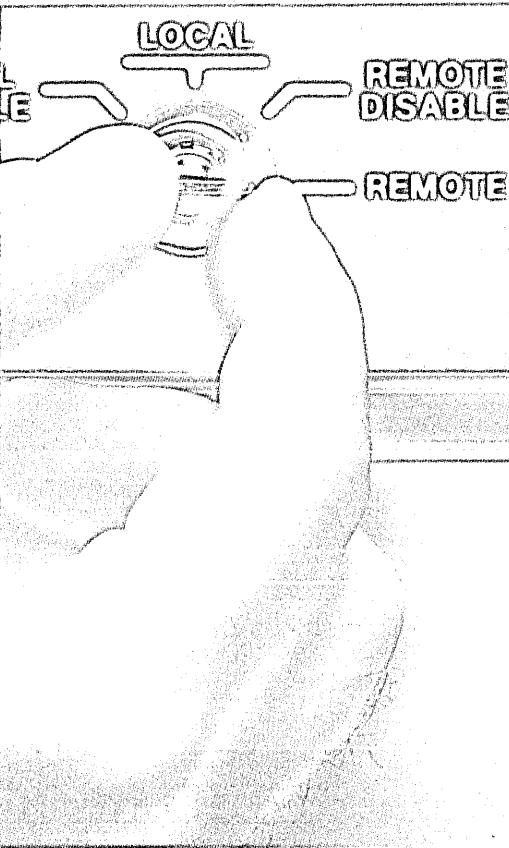

We've brought all our resources together to bring you the first total systems uptime guarantee.

If computer systems reliability is a critical factor in your business, then it's important that you buy a computer made by Digital. Because we'll work with you, to ensure that the reliability we design and build into our products is maintained at your site. In fact, once the necessary service requirements are met, we will guarantee that your VAX Family, DECSYSTEM-10 or DECSYSTEM-20, will be available at an optimum level you can select yourself—up to 99%.

How is Digital able to offer a total system uptime guarantee? It has a lot to do with Digital's company-wide commitment to quality. A commitment evident in the years of engineering and manufacturing focus on reliability and maintainability technology. And

in one of the largest and most capable service forces in the industry—supported by the remarkable power of Digital's proven Remote Diagnosis technology.

One more thing: since high uptime is designed into all of Digital's products, it's not an add-on or an extra-cost option. There's no additional service charge for Digital's Uptime Guarantee. It is an integral part of your Service Contract.

For full details, call your local Digital office or write to: Digital Equipment Corporation, 129 Parker Street, Maynard, MA 01754. © Digital Equipment Corporation 1982

digital

SOURCE DATA

ecutive sales seminars, ceremonial speeches, and technical briefings.

While *Idea Transfer* is short in length, it is long in content. For the first-time speaker or the accomplished pro this book packs usable approaches into a format ready for immediate execution. Comware Publishing, Irvine, Calif. (1982, 133 pp., hardcover \$17.95, paperback \$9.95).

—Jerry Kalman

REPORTS & REFERENCES

DISK COUNTRY

If you'd like to learn a little more about your PC's innards, this 32-page booklet can help. Percom Data Corp. calls it taking a "peek under the hood" to understand what disks and disk drives are and their connection and function within the computer. There is a chapter on Percom Data's products, but other than that section, the booklet is unbiased. It is written fairly simply—nontechnologists will have no trouble comprehending the material. "Inside Personal Computer Disk Storage Systems" sells for \$5. Contact Percom Data Corp., 11220 Pagemill Rd., Dallas, TX 75243, (214) 340-7081.

VISIONARY

There are presently 400 to 500 machine vision systems installed in U.S. manufacturing plants. Tech Tran Corp. expects the installation base to reach 50,000 within the next 10 years. Additionally, the prices for individual machine vision systems will drop from the current \$25,000 to \$30,000 to below \$10,000 by 1982. This information comes from TTC's 162-page report, "Machine Vision Systems—A Summary and Forecast." Written for business and technical specialists, the report was prepared "to provide an assessment of the machine vision system field," including a review of future technology, industrial applications, and industry structure. To purchase the report, contact Tech Tran Corp., 134 N. Washington St., Naperville, IL 60540, (312) 369-9232. The price is \$50 in the U.S., Canada, and Mexico, and \$65 elsewhere.

TEST AID

According to Applied Information Development, Inc., a data processing consulting firm, testing accounts for 40% to 50% of software development costs, but most systems methodologies provide little if any testing guidance. The company has produced the "Applied Information Development Testing Management Handbook" to fill this gap. The handbook is a "unified system of management, organizational, technical, and administrative techniques" developed by AID's Quality Assurance group. The company claims its techniques will show management how much testing is necessary and how to reduce testing and maintenance costs. For further information,

contact AID at 823 Commerce Dr., Oak Brook, IL 60521, (312) 654-3030.

SECONDHAND ROSE

"The Blue Book of Used IBM Computer Prices" is published quarterly (January, April, July, and October) by Computer Merchants, Inc. Their computer price guide provides current market information on many IBM products available from dealers, brokers, and leasing companies. The guide lists current prices; whether price trends are up, down, or stable; and which equipment is nearly obsolete. Cpus, systems, and peripherals are included. The yearly subscription rate for the guide is \$28 in the U.S., Canada, and Mexico; \$40 elsewhere. Contact Computer Merchants, Inc., 75 South Greeley Ave., Chappaqua, NY 10514, (914) 238-9631.

SEMINARS

DOCUMENTATION HELP

A one-day seminar, "Computer-Assisted Manual Writing," is being offered several times during May, June, September, and October by PromptDoc, Inc. The goal of these seminars is to "help attendees gain documentation development insight" so they can produce better systems. The company will demonstrate its documentation development methodology, its automated documentation development software (called Manual Maker), and its computer assisted writing product (FirstDraft). The latter two systems run on any CP/M-based micro. The \$195 fee for the seminar entitles participants to discounts on all PromptDoc software. Contact the company at 833 W. Colorado Ave., Colorado Springs, CO 80905, (303) 471-9875.

SEE YOU IN ST. LOUIS

The Recognition Technologies Users Association (formerly known as the OCR Users Assoc.) Summer Conference will be held concurrently with Expo '83—an exposition of recognition technologies equipment. During July 17–20, in St. Louis, Mo., the conference will cover voice recognition, robotics, video imaging, optical disk technology, and more. The keynote speaker will be Thomas G. Kamp, vice chairman, business and technology, Control Data Corp. Break-out sessions will be addressed by Bill Moore, president and ceo of Recognition Equipment, Inc.; Captain Grace Murray Hopper, USNR; and others. Program information is available from Recognition Technologies Users Assoc., P.O. Box 2016, Manchester Center, VT 05255, (802) 362-4151.

COMMUNICATIONS

The 1983 International Conference on Communications will take place June 19–22 at the Sheraton-Boston Hotel, in Boston, Mass. Under the theme "Integrating Com-

munications for World Progress," this 19th annual gathering will cover AT&T's postdivestiture plans, the U.S. government's point of view on the changing domestic communications environment, international telecommunications cooperation, and other topics. The conference is cosponsored by the IEEE and the Communications Society Conference Board. Registration information can be obtained from Gerald H. Brody, Raytheon Data Systems, 115 Norwood Park South, Route 1, Norwood, MA 02062, (617) 762-6700.

DBMS

As sponsors of the 1983 National Data Base Management Symposium, Digital Consulting Associates Inc. gathered much information on "Fourth Generation Data Management Software" that they've decided to share. They're offering a two-day seminar (named above) in Tarrytown, N.Y., June 20–21 that will explain how DBMS methodologies work with new high-productivity software. Attendees will receive DCA's 400-page workbook, which shares the same title as the course. Registration is \$650, and further information is available from DCA at P.O. Box 97, Lynnfield, MA 01940, (617) 334-5755.

VENDOR LITERATURE

OA SOFTWARE

This vendor has released a catalog of its office automation applications packages containing software for executives, accountants, typists, and secretaries. CMA MICRO COMPUTER, Yucca Valley, Calif.

FOR DATA CIRCLE 350 ON READER CARD

MHI CATALOG

The Material Handling Institute Inc. is offering a 16-page catalog listing over 100 publications and audiovisual materials available from the institute. THE MATERIAL HANDLING INSTITUTE INC., Pittsburgh, Pa.

FOR DATA CIRCLE 351 ON READER CARD

MACS ON PROMACS

This 12-page technical brochure describes the vendor's product, PROMACS, which is an application program generator. MANAGEMENT AND COMPUTER SERVICES INC., Valley Forge, Pa.

FOR DATA CIRCLE 352 ON READER CARD

MAKING MONEY

Because of deregulation in the telecommunications industry, entrepreneurs, interconnect companies, hotels, and just about anyone can earn big bucks by reselling the services of common carriers, satellite networks, AT&T, and others. This booklet, "The Profitable Resale Telephone Network, Defined," will tell you where to begin. HARRIS CORP., Digital Telephone Systems Div., Novato, Calif.

FOR DATA CIRCLE 353 ON READER CARD

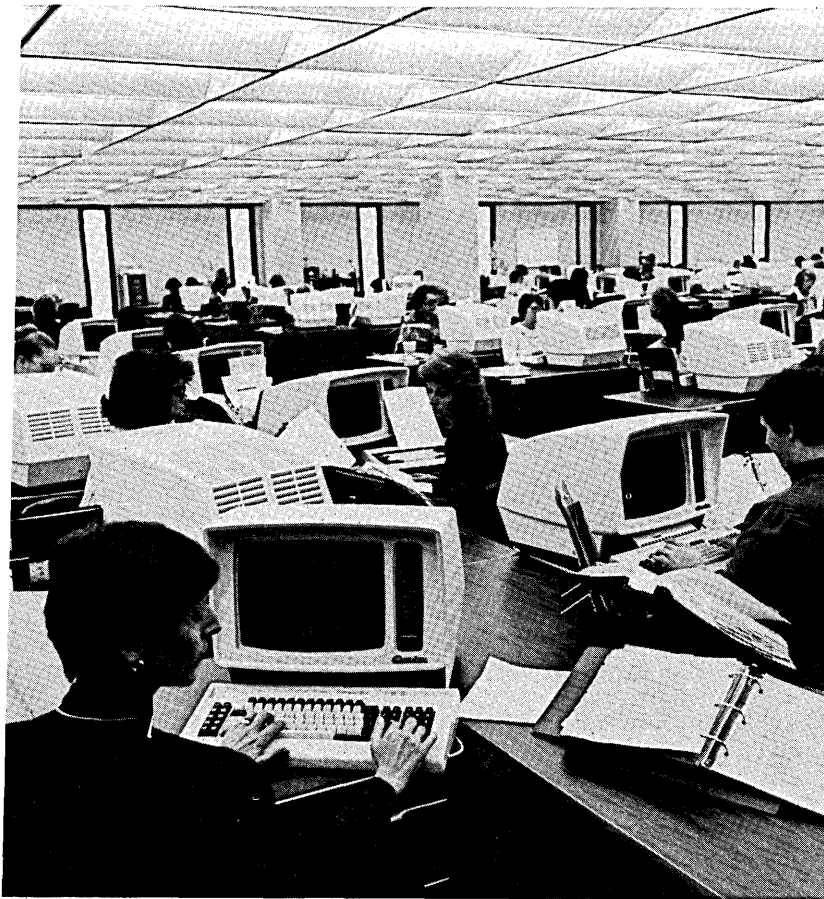

**You have the
information.**

**We have the
way to move it.**

It's extraordinary how far American business has gone in managing information in the office.

And how frustrating it can be to get that information where it's needed, once it leaves the office.

It seems clear that something must be done to bring the movement of information outside the office to the same sophisticated level as inside the office.

Our Communications Spectrum

Improving the movement of this information is precisely what we at ITT Worldcom are doing now with our Spectrum of Communications Services.

Our Spectrum is a new range of worldwide information movement services created specifically to bring together the latest advances in data, record and voice communication.

For example, now your computers and terminals can talk to other incompatible terminals, anywhere in the world. Even those on other networks.

You can even deliver the same information to an unlimited number of terminals, automatically.

And we're continually adding new features with an eye to satisfying your future requirements.

Now throughout the U.S.

Best of all, our Spectrum was created with the same expertise and quality we're known for around the world.

The way we look at it, whatever other productivity problems American business has, it's producing more and more information.

And getting that information where it's needed speedily, reliably, efficiently and economically—that's what ITT Worldcom is all about.

I'd like more information. My area of particular interest is in:

- Communications within the U.S.
 International Communications.

Name _____

Title _____

Company _____

Address _____

City _____ State _____ Zip _____

Marketing Department (A/PR)
 ITT World Communications Inc.

DC-7-82

67 Broad Street
 New York, New York
 10004

ITT

ITT World Communications Inc.

CIRCLE 224 ON READER CARD

COMBOARD™ / HASP

the low
overhead
DEC/IBM
interconnect

■ Your DEC computer has more important things to do than be a processor for your IBM communications. Save valuable computing capacity by handling your interconnect workload with a COMBOARD.

■ COMBOARD is a 16 bit CPU based single board computer that plugs into your DEC UNIBUS™. Then the COMBOARD, not the DEC host, handles all the real-time interrupts and protocol processing associated with data communications.

■ COMBOARD's low overhead means your DEC users still get quick response time at their terminals. Your CPU capacity is used for applications software, yet your data communications throughput remains high.

■ COMBOARD models 631,731 and 1231 support transfer rates from 2400 to 56,000 bps, and are the leaders in DEC to IBM or CDC interconnects.

■ For more details dial toll free --
1-800-SRC-DATA
In Ohio, dial --
1-614-421-2094

SOFTWARE RESULTS CORPORATION

2887 Silver Drive
Columbus, Ohio 43211
TWX 810-482-1631

COMBOARD™ Software Results Corporation
DEC UNIBUS™ Digital Equipment Corporation

CIRCLE 225 ON READER CARD

Employment Scene

ON THE JOB

GROWING YOUR OWN

Good programmers are hard to find. Did you ever think of training non-dp personnel to become entry-level programmers? Lots of companies have done it, as far back as the early '60s and perhaps even earlier.

The Michigan National Corporation Bank, Lansing, Mich., began such a program last May. It offered to train any employees, from tellers to commercial loan clerks, to become programmers. Of its 7,000-plus employees, 206 expressed interest in the program and 199 of them went on to take an aptitude test. The 46 employees who scored in the top 15% were then carefully interviewed by Elena Garcia, training coordinator; Gil Bernard, systems and programming group manager; and Greg Williams, a member of the bank's personnel department. They came up with 10 trainees, seven men and three women, who took the twelve-week training course.

The program was suggested by Michigan National's individual dp departments and by management. After the project got the green light, memos went out to all 30 or so banks within the corporation, informing all employees that the training program was available. Those interested in the training were informed that certain work and educational backgrounds were preferred, and that two years' full-time experience with the bank was required.

According to Elena Garcia, there are many reasons to promote from within rather than hire new programmers. First, it is easier to train bankers to become programmers than to train programmers to become bankers. Second, it offers a promising career path for bank employees. Additionally, the company achieves better relations with end users, because many members of the dp department were once users. Dp managers are also pleased because less on-the-job training is required, and they really know who they're getting when the new programmer has worked two years for the company—it certainly beats a résumé and letter of recommendation.

Michigan National is so happy with the results of its program—all 10 trainees are working out well—that it is doing it again this summer. This was a learning experience for the bank, however, as well as for its employees. To make the transition easier for both, the bank will make some changes in its '83 program.

Last year, for economic reasons, the

bank joined forces with Lansing Community College, and employees enrolled in the program received credits toward a degree. Students were trained by both bank technical support people and by college teachers. Half the day was spent at the bank on the actual equipment they'd soon be working with, and the other half at the college. Garcia said this posed no problem, but the educational tools used did. The two institutions differed on how to teach, which created difficulties. In the '83 program, the students will use textbooks, not manuals.

Michigan National also learned to leave more time for the testing and interviewing procedures. Last year it had only six weeks to select and relocate its programmers (some had to move nearer to the Lansing site). The bank also found that a very definite benefits package had to be worked out for all new programmers before they relocated or began training. Incidentally, the bank gave most of the new programmers raises, starting on their first day of training, to the going rate for entry-level programmers.

But the Michigan method isn't the only way to go. Lehman Brothers, Kuhn, Loeb, an investment banking firm in New York, has used a different approach to solving the programmer shortage. According to Samuel Solomon, vice president of information services, Lehman Brothers hires well-educated non-dp people and teaches them programming.

Solomon, who is responsible for building Lehman's existing training program, said he prefers hiring archaeology and linguistics majors, but someone with an MBA in finance is equally desirable. To date, this company is also very happy with its education program.

According to Joseph Izzo, founder of the JIA Management Group Inc., Santa Monica, Calif., there aren't many of these programs around right now because of the stalled economy. Bill Marks, vice president at JIA, says these programs meet with considerable success, adding that training in-house people to become programmers usually works out better than training non-dp grads. Both Izzo and Marks concur that the major drawback to such programs is that, inevitably, the company is "training for the whole world." Increased loyalty is expressed by the employees, but it is only temporary, say the consultants.

Deborah Sojka

What vital natural resource can the Republic of Ireland offer computer service companies?

The right people.

Dynamic young people. Educated within a system of universities and technical colleges which inculcate the skills so vital to computer software development.

Young people capable of incisive innovative thought and pioneering concepts. They are a natural resource that the Republic of Ireland has in abundance.

Ireland has managed to avoid the attendant disadvantages of industrialisation. It still offers a very special environment: clean air, open spaces, magnificent scenery and the possibility of a lifestyle which is calm and unhurried – yet stimulating.

Meanwhile, you benefit from 100% training grants to new companies, generous employment grants, and the lowest corporate tax structure in Europe.

If people are a key factor in your business the people to talk to are IDA Ireland. Call us or contact us at any of the offices listed.

REPUBLIC OF IRELAND
The new high-tech centre of Europe.

IDA Ireland 
INDUSTRIAL DEVELOPMENT AUTHORITY

New York Tel. (212) 972 1000

Chicago Tel. (312) 644 7474

Cleveland Tel. (216) 861 0305/6

Los Angeles Tel. (213) 829 0081

Menlo Park, Calif. Tel. (415) 854 1800

Houston Tel. (713) 965 0292

Fort Lauderdale Tel. (305) 785 9430

Boston Tel. (617) 367 8225

The Clear Advantage™ of TAB's multi-user computer system

With the new TAB Multifunction Workstation you'll never suffer from computer congestion.

Desk top computers are supposed to make working time more productive. However, a lot of stand alone systems can't go beyond standing alone. They can't grow with your demands. The new TAB Multifunction Workstation not only upgrades with your needs, it has multi-user capability, unequalled communications flexibility, and can tie in with an existing computer network.

Single user 8 bit to multi-user 16 bit. You can start with the TAB System 830 as an entry level, single user station. Then, as your requirements expand, you simply replace its 8 bit processor board with a 16 bit board, and the same workstation becomes a multi-user System 1650. This system can support up to six TAB Terminals and a printer... plus communicate with a central corporate computer.

Maximum memory capacity from the start. The large integrated disk memory of TAB Workstations handles 5 million bytes of information and can be expanded. In addition, an IBM compatible 8" floppy disk provides 256KB to 1.2MB of capacity for data input, output and file backup. And they're both contained in the same space saving cabinet with a large 15-inch display screen.

Total communications capability and the top operating system. TAB Workstations utilize industry standard communications for convenient interface to a host computer—Async, IBM Bisync, and SNA/SDLC. Additional capabilities include ASCII to EBCDIC and Async to IBM Bisync conversions.

By employing the universally popular family of CP/M® and MP/M® operating systems, TAB Multifunction Workstations can access the largest base of applications



packages and programming languages in the world.

So, before you invest in a desk top computer for a small business, or expand the corporate system, compare the Clear Advantage of the TAB Multifunction Workstation. Call or write: **TAB Products**, 1451 California Avenue, Palo Alto, CA 94304, (415) 858-2500 Inside Calif.; 800-672-3109 Outside Calif.

In Europe: **TAB Products Europa B.V.** Ellermanstraat 5, 1099 BW Amsterdam, The Netherlands. Phone: 020-681691. Telex: 15329

In Canada: **TAB Products** 550 McNicoll Ave., Willowdale, Ontario M2H 2E1. Phone: (416) 494-0077

CP/M & MP/M are registered trademarks of Digital Research, Inc.

TAB PRODUCTS CO

Technology And Business
CIRCLE 227 ON READER CARD



READERS' FORUM

ORGANIZATIONAL ISSUES

Today's approach to the organization of the MIS function is an anachronism. It reflects a view of technology that is no longer relevant. It impedes any meaningful examination of how best to satisfy information needs. It does not meet the requirements of businesses today and will not meet their needs tomorrow.

Those are strong words. They are also threatening words because the validity of an organizational approach has a direct impact on career paths. But the questions have to be raised. If the inadequacies of today's approach are not recognized and addressed within the MIS community, they most assuredly will be addressed from without. Enterprises that tolerate anachronisms do not survive.

The factors that are affecting organizational structures have nothing to do with performance. In fact, if performance were the only criterion, there would be no need for significant change. The problem is that today's organizational approach has developed over the years based on a perception of information technology that is no longer valid. If the performance gains of the past are to be repeated, organizational modifications will have to be introduced to reflect what is happening in the worlds of technology, information, and the people who work with information.

The challenge to current organizational strategies has been triggered by three agents of change. The first, the enormous outpouring of new information-oriented technologies, is the best known. A revolution is taking place both in the capabilities of new machines and in the categories of personnel who use them. The second agent of change is the growing importance of information as a corporate resource and the need to manage the resource in a meaningful way. The third agent is the increasing significance of offices (and the people who work in them) to the success of an enterprise. Each of these factors introduces a new management challenge. Operating in concert, they cry out for a reexamination of how enterprises are organized and managed.

The explosion in new office technologies is obvious, as vendors saturate the media with advertising campaigns designed to capture a share of what promises to be an enormous market. The world of technology seems to be in a maelstrom, but a close examination reveals several complementary trends. First, technologies are converging. In the past, the world of dp was quite different from the worlds of word processing and micrographics. Today, dp can be handled on word processing equipment and vice versa, and both technologies interface with micrographics equipment. Similar overlapping is occurring in other technologies as well.

Electronic mail is an important new function in the office that exemplifies today's technology trends. Internal correspondence is created on a terminal, moved over a telecommunications network, received by an addressee on another terminal, and filed electronically. Is electronic mail a word processing application, a telecommunications application, or a dp application? In fact, it is none of these. It is one of a growing number of functions that

cannot be labeled in traditional terms but must be grouped under an umbrella term like office technology or information technology.

The second trend in technology involves the interconnection of all office technologies through telecommunications networks. Eventually, all of the powers of technology will be available wherever one can tap into a network. The trend toward one overall information technology is reinforced by the move toward telecommunications interconnection.

The third trend flows from the first two and introduces a new user community, the entire office. Technology is no longer the exclusive preserve of technologists. It is everywhere: in the workplace, the home, and anywhere else one can tie into a network. In this environment, technological mystique goes by the board. Machines are tools to be used at will in the ordinary course of workday activities.

The fourth trend is the introduction and rapid acceptance of personal computers. While waiting for office networks to be perfected we can find many of their capabilities today in inexpensive personal computers. Resistance to technology by managers and professionals is fading as these devices proliferate in the office and home. And, as personal computer users continue to learn, they begin to demand telecommunications interconnection to central computers and access to the information stored there. There is no holding back the tide.

The significance of those trends has not yet been recognized. Corporations are organized on the basis of technological separateness. Dp departments, word processing centers, micrographics units, and the like have been established to handle individual technologies. Trade associations have been built around specific technologies and their unique infrastructures. If the technologies are converging, however, then organizational strategies and industry affiliations based on technological separateness are no longer valid. New strategies and affiliations will have to emerge that address the trend toward one overall information technology.

The second agent of change is the burgeoning demand for better, more timely, and more comprehensive information. The MIS community already lives with this problem and is in a daily struggle to meet the diversified information needs of management. The whole field of database management is aimed at organizing computer-stored data to permit selective retrieval in response to an information demand.

But the MIS community is primarily concerned with information stored on computers, and it operates within the constraints of computer technology. Substantially more information is stored by other means—paper, word processors, microfilm, books, videotapes, and external databases, with varying capabilities for organized access and retrieval. If information is to provide the competitive edge in the years ahead, more sophisticated approaches must be developed to meet information needs in a timely, cost-effective way.

A new set of disciplines concerned with all information is necessary, i.e., how best to organize and structure information for easy access and use, how best to relate the value of information to its cost, how to meet privacy requirements, how to ensure validity and authenticity, how to minimize redundancies. This need is so important that one can envision a separate organizational compo-

READERS' FORUM

ment concerned with improving management of the information resource. This component, however, should not be allied with technology-based organizations because information comes in many media, some machine-based and some not. Alliance with technology inevitably introduces biases and constraints that limit the ability to address information needs comprehensively.

The third agent of change is both old and new. It concerns offices, the people who work in them, and the impact of both on the bottom line. It is old because the origins of today's MIS world lie in using computer technology to reduce office costs. Much was accomplished in the '60s and '70s along these lines; for example, high-volume, repetitive clerical activities were mechanized and MIS became an important operating function. What was left in the office was nonrepetitive, people-oriented activities. Good control was exercised over the cost of mechanized activities, but the cost of other office operations continued to rise.

This problem has been exacerbated by the changing nature of the work force. Office-based personnel are the fastest growing sector in industry. Even in traditionally blue collar companies, more than half the employees and upwards of 70% of payroll dollars are white collar. Further, as the intellectual demands of business grow, the ratio of managers and professionals to clericals grows. Managers and professionals now account for 75% of all office costs.

Up to now, these statistics have been looked at with only mild concern. The recession, however, has proved to be an eye-opener. In this time of economic adversity, senior management is activating contingency plans, closing marginal plants, trimming product lines, modifying operating objectives, and pursuing many other options. In the office, however, there are no contingency plans, clear-cut operating objectives, or operating plans that relate to business. The office is not subjected to the rigorous disciplines that characterize the management of line operations. In its attempts to cope with the recession, senior management is discovering that the only retrenchment options available for the office are freezing salaries, cutting travel budgets, and reducing discretionary expenses by some arbitrary percentage—bromides that must date back to the Middle Ages. The sophisticated options available in other sectors of business are nowhere to be found in the office.

These facts, which the current economic climate has brought into the open so forcefully, must be addressed. The entire approach to management of offices must be reexamined. The mission of the office must be more clearly defined. Its structure must support that mission; operating goals and plans must be developed, and performance measures and accounting systems devised to track performance. In short, the same kinds of management practices that have worked so successfully in the line side of business must be

introduced in the office. The drive to improve office productivity which triggered early MIS efforts must be revived.

The foregoing raises a number of questions. The first is, how should one manage technology in a world where many different technologies are converging and every office-based employee is a potential technology user? The second is, how can the information resource be best managed? The third is concerned with the office. Since information is the primary product of the office and its workers, and since technology is one of the tools used in producing that product, how can management of both be attuned to the management of the enterprise?

There is no prescribed approach to managing technology. Current approaches oriented to separate technologies are passé. One has to look across the broad spectrum of information-related technologies and identify common requirements. This analysis suggests that there are two such requirements—the need to provide services to users, which is the traditional approach, and the need to provide capabilities that users can employ. The provision of services is an ongoing activity, a vital operating function of the enterprise, to be managed as a line operating unit. The provision of capabilities is a discretionary activity, an investment in new tools and techniques to help people perform better and thus improve the performance of the total enterprise.

The provision of services requirement suggests an amalgamation of today's data centers, word processing centers, micrographics centers, other similar services, as well as units responsible for maintaining existing systems and appropriate software support. Service centers created in this fashion would provide a variety of ongoing benefits and act as a repository for machine-stored information. They should report at a level that allows line management the opportunity to supply the same principles of management used with other operating units. In addition, they should be interconnected through a telecommunications network and together serve as an information utility, providing access from any location to all machine-stored information.

The provision of capabilities requirement suggests an amalgamation of functions whose purpose is to provide technological support to users. They include new systems development, the advanced office systems or office automation team, the decision support systems function, and the information center or similar unit established as an interface between dp and end users. To this grouping should be added several new functions, including one intended to support users of personal computers, a second concerned with planning the physical environment, and a third that addresses behavioral issues. Since all these activities are concerned with the delivery of capabilities to users, the responsibility for telecommunications network design and management should be included with them. The delivery function should be assigned at an organizational level high enough to ensure senior management attention; its forward direction and level of activity must be meshed with business plans.

This new direction challenges long-held traditions in the MIS community. It separates new systems development from systems maintenance and it holds that the two groups should not report to the same individual. The reasons for this separation are inherent in the different nature of each function. A service function is ongoing and ought to be allied with all other service functions. A delivery function, on the other hand, is ad hoc, and is concerned with providing a variety of capabilities to users, not just those associated with a particular technology.

Separating the management reporting relationship of new systems development from equipment operations allows discretionary management techniques to be applied to the former and operating techniques to be applied to the latter. It also eliminates a conflict of interest that has sullied the reputation of MIS managers. Outsiders have charged that the MIS community's zeal in advocating the installation of new systems, which leads to needs for larger equipment, bigger budgets, and ultimately managers' promotions, is self-serving. This conflict will be made moot by separating the

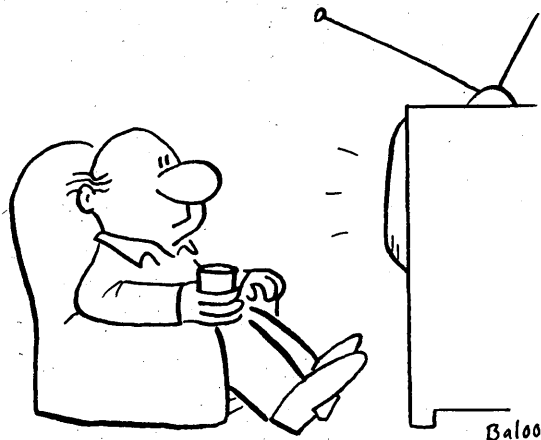

"It's eleven o'clock. Do you know where your interests lie?"

Baloo

CARTOON BY REX F. MAY

	ADM 36	VT 100
DEC Compatible	STANDARD	STANDARD
Graphics (Plot 10 Compatible)	OPTION	NO
15 Inch Display	OPTION	NO
132 X 24 or 80 X 24 Display	STANDARD	OPTION
Full Visual Attributes	STANDARD	OPTION
Printer Port	STANDARD	OPTION
International Character Sets	STANDARD	NO
English Set-Up Legends	STANDARD	NO
Block Mode	OPTION	VT 131 OPTION
User Friendly	STANDARD	?
Price	\$1195	\$1945

THE VT100™ SIMPLY DOESN'T MEET LEAR SIEGLER'S STANDARDS.

We not only engineer our terminals to the highest standards. We give you more standards. (See chart.)

Our ADM 36 DEC™ compatible video display terminal has more standard features. More operator conveniences. Performs faster. And costs less.

Not only that, we give you options DEC doesn't even offer. Like the full point-plotting and vector-drawing capabilities of our sophisticated graphics package. English setup legends. Reduced intensity and protected fields. And a 15-inch display that can come in very handy when you're in the 132 column mode.

On theirs you pay extra for a 132 column by 24-line display. Extra for

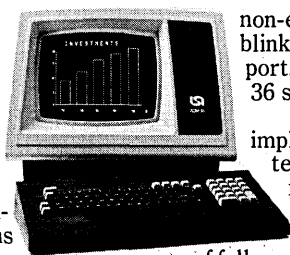

non-embedded attributes like bold, blink, and underline. Extra for printer port. But all these features are ADM 36 standards.

ADM 36. Another innovative implementation of state-of-the-art technology from LSI, the world's favorite manufacturer of reliable, high quality terminals. It's backed by the broadest network of full service centers anywhere, with walk-in Express Depot™ service, on-site service and extended warranty service in 3,000 cities nationwide. No wonder we're the standard others copy.

So before you buy another DEC VT100 terminal, consider the options. Or the absence thereof.

Our easy-to-operate ADM 36 is your logical alternative. Thanks to our standard approach.

Call 800-LEAR-DPD or 714-774-1010 for more information and the name of your nearest distributor.

Please send me further information about the ADM 36.

NAME _____

TITLE _____

COMPANY _____

ADDRESS _____

CITY _____ STATE _____

ZIP _____ PHONE _____

Mail to: Lear Siegler Data Products Division
714 North Brookhurst St., Anaheim, CA 92803
Or Call: 800-LEAR-DPD or 714-774-1010

DM5/83

LEAR SIEGLER, INC.
DATA PRODUCTS DIVISION

EVERYBODY MAKES TERMINALS. ONLY WE MAKE LEAR SIEGLERS.

Sales & Service: Boston (617) 456-8228 • Chicago (312) 279-7710 • Houston (713) 780-9440 • Los Angeles (714) 774-1010, Ext. 219 • Philadelphia (215) 245-4080 • San Francisco (415) 828-6941 • England (04867) 80666 • From the states of CT, DE, MA, MD, NJ, NY, RI, VA and WV (800) 523-5253
OEM Sales: • Chicago (312) 279-5250 • Houston (713) 780-2585 • Los Angeles (714) 774-1010, ext. 582 • New York (516) 549-6941 • San Francisco (415) 828-6941 • England (04867) 80666
Express Depot™ is a trademark of Lear Siegler, Inc. DEC™ and VT-100™ are trademarks of Digital Equipment Corporation. Plot 10™ is a trademark of Techtronix Inc.

EXTEND YOUR PRINTER CABLE



PS3910

Line Printer Controller

The HAL PS3910 Line Printer Controller System allows you to "extend" the cable of your mainframe printer. The PS3910 connects between the printer and mainframe using a standard dial-up telephone line. Data compaction and error correction are used to handle printer speeds up to 600 LPM. Full interactive data exchange is provided on the two-way communications link so that the computer and printer operate just as if they were sitting side-by-side. When you need a remote high speed printer, use the PS3910 and save the cost of an additional mainframe computer. Some of the features of the PS3910 are:

- Manual, automatic-answer dial-up, or dedicated line service
- Data is compacted and error-corrected
- Printer speeds up to 600 LPM
- Full two-way communications between printer and mainframe
- Printer status relayed to mainframe
- Interface to [®] Centronics-compatible printer port
- Optional [®] Dataproducts or [®] HP Universal-Differential interface
- Use one PS3910 at mainframe and one PS3910 at printer
- No change required to existing printer support software
- Local and remote printer testing included
- Switch selection of local or remote printer
- Control multiple printers from one mainframe
- One or more printers may be driven by multiple mainframes
- Economical and efficient

Find out more about the remarkable HAL PS3910 system. Contact us today.



HAL Communications Corp.
P.O. Box 365
Urbana, Illinois 61801
(217) 367-7373
TWX: 9102450784 HALCOMM

[®] Centronics - TM of Centronics Data Computer Corp.
[®] Dataproducts - TM of Dataproducts
[®] HP and Universal-Differential Bus - TM of Hewlett-Packard

READERS' FORUM

reporting relationship of the two functions.

The management of technology, then, focuses on service center functions and delivery functions. The management of information, if it is to be addressed effectively, calls for the creation of a new organizational unit separate from both the service and the delivery functions. Its orientation should not be toward technology. It should be concerned with how best to organize information to support the requirements of the enterprise. The information management unit should combine the policy and planning elements of database management, text management, records management, micrographics, library services, and other information-related functions.

Current MIS literature advocates creation of a chief information officer parallel to other senior corporate officers and promotion of the senior MIS executive to that position. Perhaps someday such a position will emerge and the senior MIS executive may well be one of its candidates. To be chosen, however, he or she will have to give up the MIS responsibility because tying information management to the constraints of computers, or to any other technology, for that matter, will so encumber the function as to make it virtually meaningless. It will also greatly hinder the introduction and acceptance of the principle that concern for the management of information is every manager's responsibility.

This new approach to technology management creates the opportunity for substantially improved control of these activities. Establishment of an organizational component for information management brings better management control over the office's product: information. What else can be done to improve office management? If the effort is serious, then three steps should be taken. The first is to clarify that responsibility for improving the management of office rests with each manager; it should not be transferred to some central agency. Second, senior management should indicate by word and deed the importance placed on improving office performance. Third, an advanced office management program should be set up to monitor the effectiveness of office operations company-wide. Responsibility for the program should be assigned to a senior manager with appropriate staff support from accounting, human resources, and other organizations. The accounting system should be modified to provide comprehensive company-wide performance information on offices, including costs, staffing levels, clerical/professional ratios, capital investment, and similar criteria, along with information on trends. Concepts like critical success factors should be introduced, human resources accounting techniques should be employed, and value-added measures should be developed. Office productivity improvement programs should operate under the aegis of the advanced office management program. Office performance data should be reported to senior management on a regularly scheduled basis. The goal should be to develop increasingly sophisticated, bottom line-oriented approaches to office management.

These, then, are the agents of change operating on the office and the effects they are likely to have on the MIS function. Traditionalists in that field will resist the changes and try to hold on to the heydays of the late '70s when the MIS executive controlled all technology. But those days are over. Distributed processing, office automation, personal computers, and a number of other developments have combined to move technology from the hands of a few to the hands of many.

Initially, the changes will cause traumas as career paths are adjusted. Ultimately, however, the change will be for the better. Rather than resist these changes, the MIS community should lead the effort to bring them about. The real value of technology today is its ability to expand intellectual capabilities. As technology fans out to all those who work in offices, the benefits will multiply manifold. By enhancing the creative power of the whole work force, technology will be contributing in substantial ways to the success of the enterprise, which has been the goal of MIS from the outset.

—John J. Connell
Pasadena, California

CIRCLE 229 ON READER CARD

NEW BOLD IMAGE!

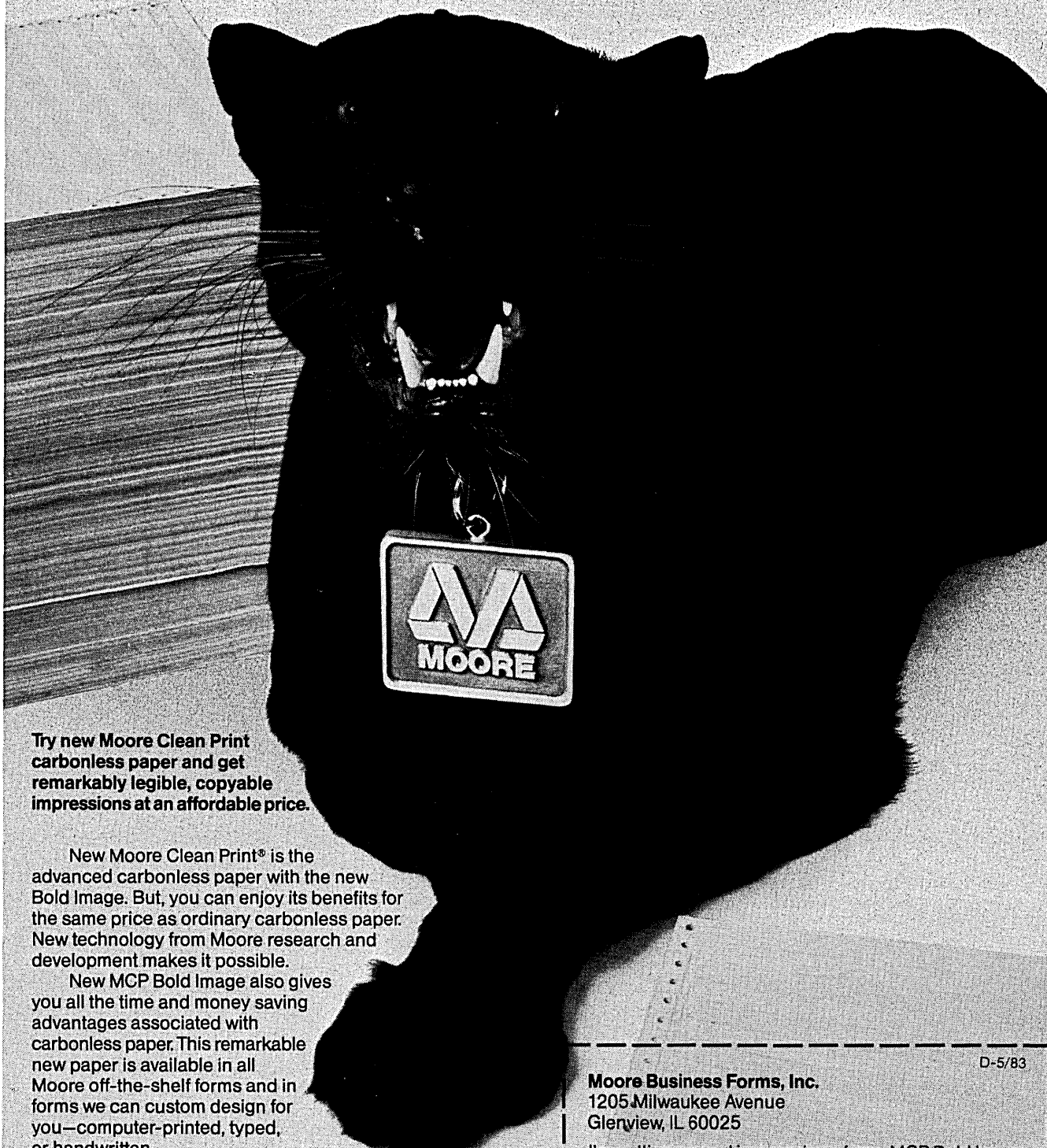

Try new Moore Clean Print carbonless paper and get remarkably legible, copyable impressions at an affordable price.

New Moore Clean Print® is the advanced carbonless paper with the new Bold Image. But, you can enjoy its benefits for the same price as ordinary carbonless paper. New technology from Moore research and development makes it possible.

New MCP Bold Image also gives you all the time and money saving advantages associated with carbonless paper. This remarkable new paper is available in all Moore off-the-shelf forms and in forms we can custom design for you—computer-printed, typed, or handwritten.

New Bold Image does make a big difference in new Moore Clean Print. How big? Return the coupon, or call toll-free 1-800-842-9000, ext. 20, and see for yourself.



**MOORE
BUSINESS
FORMS**

D-5/83

Moore Business Forms, Inc.
1205 Milwaukee Avenue
Glenview, IL 60025

I'm getting a good impression of new MCP Bold Image already. Please tell me more.

Name _____ Title _____

Company _____

Address _____

City _____ State _____ Zip _____

How to get the most popular features of the VT 100 for 30% less.

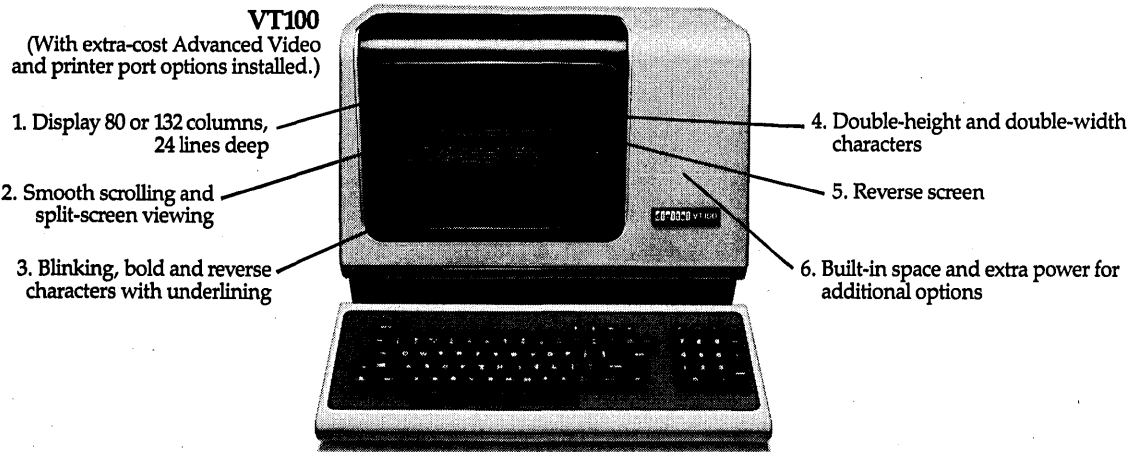

Buy Digital's VT 102.

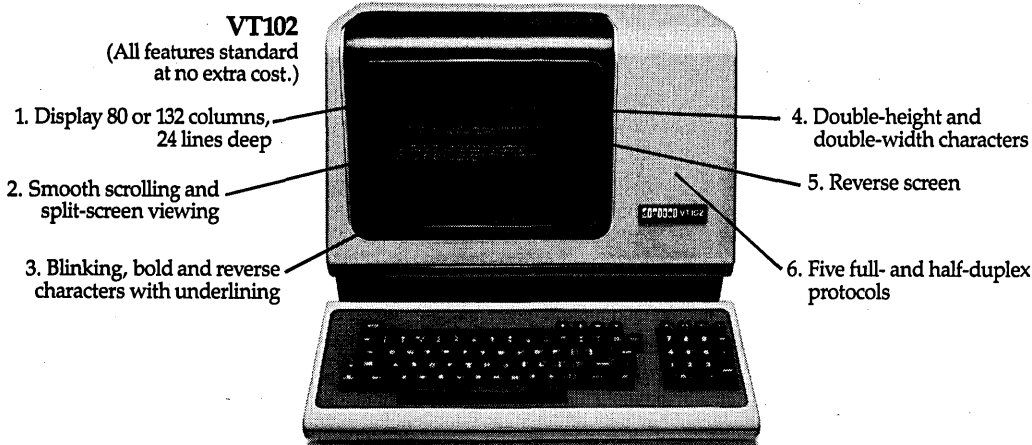

Surprise. Digital's VT102 terminal has all the features and quality that have made the VT100 the industry standard. So what's the difference? The VT102 is designed for people who don't need the extra space or power for expansion and add-ons, which include the graphics and personal computing options. And not getting that expansion capability can save you over 30% on the price. So if you don't need it, why pay for it? Check out the VT102 instead.

See your Digital distributor today or call 1-800-DIGITAL, extension 700. In Canada, call 1-800-267-5250. Or write:
Digital Equipment Corporation,
Terminals Product Group, 2 Mt. Royal
Avenue, UPO1-5, Marlboro, MA 01752.

digital

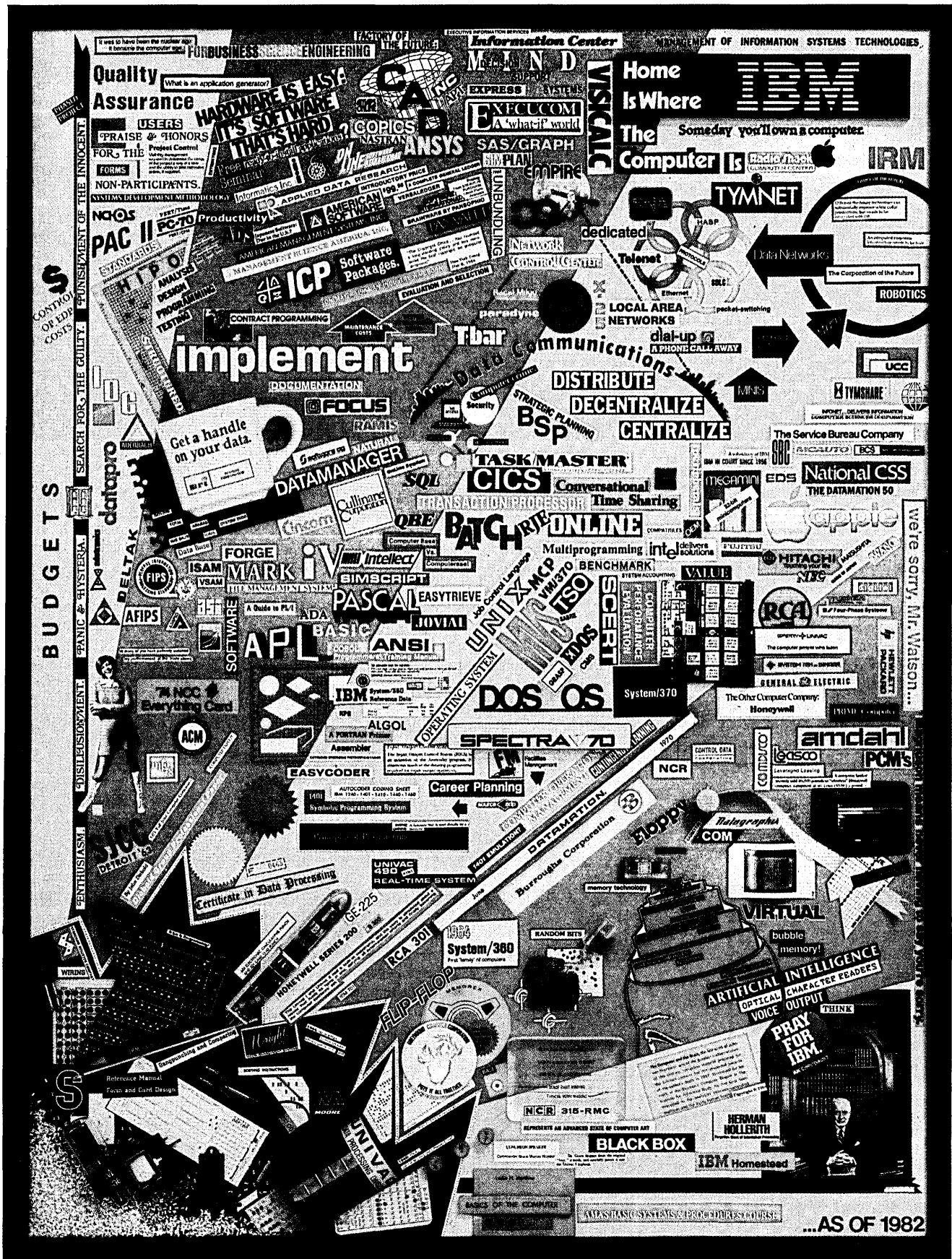

PHOTOGRAPH BY GEORGE ZUEHLKE

EVERY PICTURE TELLS A STORY: During the past 25 years, Ronald T. Brezinski, director, corporate applications and planning, GATX Corp., Chicago, Ill., has been collecting various "pieces" of the computer industry. Finally, in 1982, he completed his project—a 30" x 40" collage, depicting the industry's growth from punch cards to computer chips.

AHA!

The computer is frequently referred to as a problem-solving tool. Whether or not this is true depends largely on how you define problem solving. For example, is an adding machine engaged in problem solving when used to add a column of numbers? Is a car a tool for solving transportation problems?

Perhaps problem solving is one of those mysterious things that we all recognize when we meet it, whatever it is. When it comes to computer problems, at least, solving them involves certain rare skills that some people have in abundance and others seem to lack totally. I have had students spend an entire semester wrestling with a problem that some other student solved in 10 minutes with a 10-line program. There is nothing remarkable about this. To many people, music is a subject beyond all understanding; others cannot cope with foreign languages; still others cannot make intelligent use of a screwdriver. There is no reason why we should expect everyone to become adept at problem solving with a computer.

We have noticed this about good problem solvers: 1) they have solved a lot of problems, and 2) they light up at finding a new challenging problem. It also seems to be true that among those who take to problem solving at all, the range of ability from best to worst is about five orders of magnitude.

There is no shortage of writing on the subject of problem solving. A quarter of a century ago, George Polya wrote *How To Solve It*, which is still the book on the subject. More recently there have been Wayne Wickelgren's *How To Solve Problems* and Martin Gardner's *Aha! Insight*. The very best you can expect from such books is "Hey, let me show you how I solved a bunch of problems." If you expect to discover the secret of that magical step (what Gardner calls "Aha!"), then you will be disappointed. Can the master chess player tell you why, of two seemingly excellent moves, he picks that one? Would you expect a great artist to tell you exactly why the circle is just slightly off center in the abstraction?

Most of us have had the experience of taking a simple problem situation and making a monumental mess out of it, simply because we started in the wrong direction and couldn't get our minds off that direction. Later, we ask ourselves "How could I

have been so stupid?" Even good problem solvers can recall such situations, but not as many of them as the rest of us.

Let me describe an event that occurs regularly when I teach advanced students. By advanced I mean computer science majors who have been exposed to systematic training in our black arts for upwards of two years; who know all about structured programming and can write programs in any one of seven high-level languages; who have, apparently, been trained to be contemptuous of low-level languages, flowcharts, and team approaches; and, most importantly, who have written and run many programs, all of which produced correct results.

Now, I present these advanced students with a well-defined, standard problem, say, the solution of a set of simultaneous nonalgebraic equations. I stack the deck firmly in favor of good computing by outlining a possible mode of attack, and issue the routine warnings against things like intermixing integers and floating point numbers too freely or calculating constants inside the loop.

Any experienced teacher can predict what happens. First of all, everyone gets the correct results, some of them to far greater precision than the problem called for or the data justified. About half of them remember their high school training and check the results against the original equations (which means that the other half don't remember this obvious check).

But what a range of work! The student who understands what computing is all about has written a short, efficient, elegant program of 25 statements. The student who has learned only to get answers at all costs has produced a magnificent mishmash of 250 statements, including over 100 statements that implement the most elaborate possible convergence tests. (The smart student has perhaps been on the machine twice—once to explore the convergence rate and thus establish that 10 iterations will work in all cases, and again for a short, snappy production run.) The 250-liner has comments that simply echo the code itself, and is full of blocks of code that simulate the constructs of structured programming while violating its fundamental principles. Don't get me wrong. The student who has been exposed to the concepts of structured programming generally writes better code than the student who hasn't. His proficiency in coding just doesn't correlate with problem-solving ability.

I submit that we should pay a lot of attention to the situation outlined above and try to find out what causes it. Where, how, and why has the good student learned to be so good? Conversely, what has the poor student been taught (or not been taught) that makes him so poor? Can't we isolate the elements that produce skill in problem solving just as we do with other skills? It may be that we can't, in the same sense that we find it difficult to teach chess playing, but we don't even try. We spend countless hours on the tools of our trade, and little or no time on its essence.

Surely I am not alone in such experiences. The advanced students swear allegiance to structured programming and they generally write convoluted, messy programs. They can pass parameters to and from subroutines in seven languages, but they can't solve simple problems. They profess deep scorn of work done in assembly language, yet they can't solve problems in their high-level languages. They are tolerant of dinosaurs who still work in FORTRAN, and they get ludicrous results (which they don't recognize as ludicrous) in Pascal. They know all about operating systems and link editors and lists, but they can't solve problems.

Is it possible that we are teaching a lot of interesting aspects of computing while neglecting the one aspect at the heart of every task? Can you think of anything we might want a computer to do that isn't made up of many little problems to be solved?

Among number-manipulating problems (as opposed to file problems of indexing, sorting, searching, retrieving; or pattern recognition problems; or problems that are intrinsically embedded in some other discipline, like music), there seem to be two types that demand computer solution, that is, that cannot be attacked by analytic means. These are Monte Carlo problems, which call for



Leo Cullum

CARTOON BY LEO CULLUM

In 3270 Network Development, ICCI is Getting You There.

We set the first generation standard

In 1978, ICCI introduced our CA12™—the *first* protocol converter to support both BSC and SDLC protocols. It set the standard for the first generation of protocol converters. And the CA12™ was only the beginning.

We introduced the second generation

In 1982, ICCI brought you the CA20™—the *first* second generation protocol converter.

Compare our CA20™ with any other protocol converter available

today. You'll see the results of extraordinary attention to engineering detail. Still the most sophisticated product of its type, our CA20™ features:

- True 3270 emulation
- Dual synchronous host support
- Asynchronous switching capability
- Automatic logoff and disconnection
- User selectable port configuration
- Comprehensive hardware diagnostics
- Remote trace and testing capability
- Single card construction

We'll bring you the next generation

In 1983, we're bringing you new products and training programs for network growth. We've always anticipated your network problems. And we're bringing you solutions for today—and tomorrow.

So plan your network growth in new directions. And call or write to ICCI, 196 Broadway, Cambridge, MA 02139, Telephone (617) 864-3270. We'll help you get your network where you want it to be.

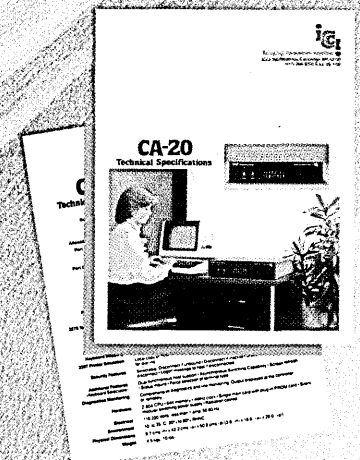
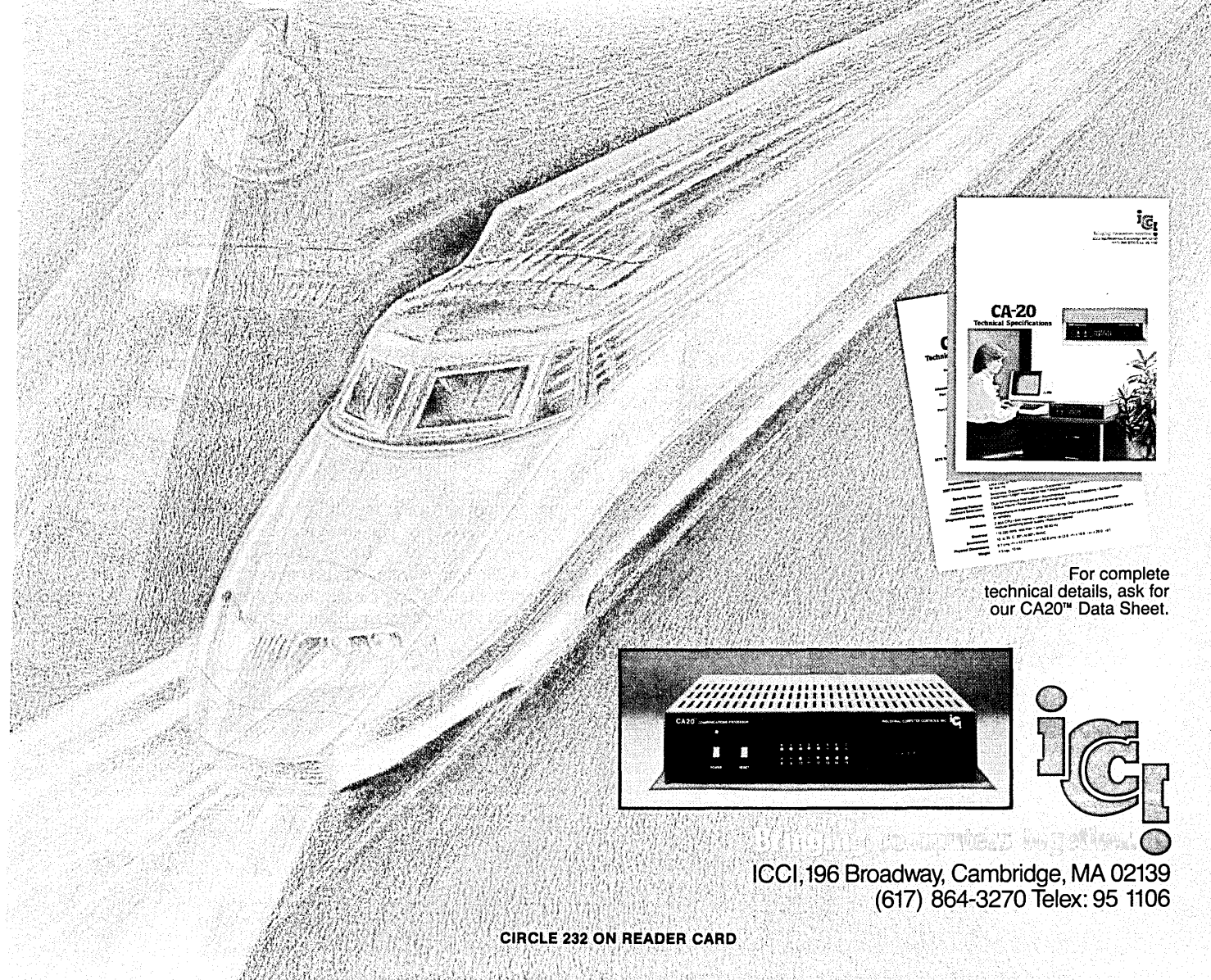

For complete technical details, ask for our CA20™ Data Sheet.

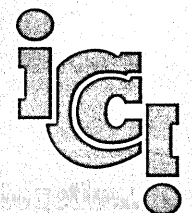
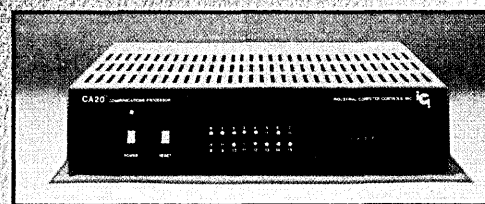

ICCI, 196 Broadway, Cambridge, MA 02139
(617) 864-3270 Telex: 95 1106

CIRCLE 232 ON READER CARD



IBM SERIES 1 PERIPHERAL

Makes any Touch-Tone* Phone a Voice-Response Computer Terminal.



Hitch our BT-II processor to your computer, and any push button telephone becomes a data entry terminal with voice response.

It's the most cost-effective terminal yet. No expensive CRT's. No keyboards. No

teleprinters. Route sales people, field reps, bank tellers . . . any person authorized to access the computer can do it with ease. All they need is a telephone number and an I.D. number.

Applications are unlimited. Automated order entry . . . inventory control . . . payroll data processing . . . financial data collection.

The BT-II is compatible with any existing computer and is lower in cost than other peripheral equipment. Computer communication software is tailored to meet the needs of specific situations. A pleasant, natural-sounding voice provides step-by-step data entry instructions . . . verifies input . . . responds with "retrieved" data. All without special hardware, and with all the security safeguards you'd expect.

Write, call or circle the reader service number to receive full information about this exciting development. Our BT-II processor is easily the most versatile, cost-effective way yet to interface people and computers.

*Registered TM of AT&T

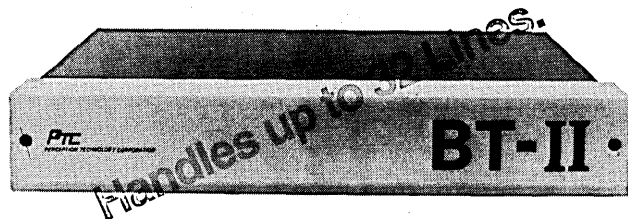

PTC PERCEPTION TECHNOLOGY CORPORATION

The leader in voice response technology

50 Shawmut Road, Canton, MA 02021 Telephone (617) 821-0320

CIRCLE 233 ON READER CARD

READERS' FORUM

FIG. 1
SAMPLE PROBLEM

9	13	15	5	7	14	3	5
1	10	3	11	2	16	12	15
12	16	8	2	10	4	1	9
7	4	14	6	6	13	8	11
3	9	16	6	9	5	15	2
15	11	2	8	12	1	4	7
4	1	14	5	3	10	16	8
13	7	10	12	13	14	6	11

massive sampling, and combinatorial problems, where all the combinations may have to be explored. It might be instructive to examine such a problem, as an illustration of the problem-solving ideas I am promoting.

Fig. 1 shows four sets of 16 squares, one set in each quadrant. In each set of 16 squares, the numbers from 1 to 16 are inserted randomly. Then, the like numbers of each of the four sets are connected (to be precise, the centers of their squares are connected). For example, the centers of the four squares containing the number 12 are connected. The result is generally a quadrilateral, although it may be a triangle. We can list at least 13 distinct figures among these (rhombus, trapezoid, isosceles right triangle, parallelogram, etc.). The problem to be solved is, what is the probability of obtaining each of the 13 distinct types?

As stated, the problem solution could concern something on the order of 10^{50} cases. As with most interesting problems, however, a little study reduces the number of cases to less than 10^5 . The nub of the problem is how to identify, from the set of four coordinates, an isosceles trapezoid, say, one whose parallel sides may be skewed to the axes. This is not the easiest problem in the world, and could well challenge the combined efforts of all the students in a top-notch class. This nonuseful problem is presented simply as an example of something to be done, in which the most superb programming ability is of little consequence; the trick is how to attack and solve the problem. Incidentally, to my knowledge it has never been solved.

Just what do we know about how to solve problems? As nearly as I can determine, the sum total is this:

1. Look for patterns, and similarities to previously solved problems.
2. Make up similar, simpler problems and solve those first: then apply these solutions to solving the original problem.
3. Break the problem into parts, and treat each part as a sub-problem.

The above directives are nothing more than platitudes, of very little help on real, sticky problems. Among the high achievers there is one common element, namely, they have solved hundreds of problems. So we have another instruction.

4. Practice. If you want to be a good problem solver, then a necessary but not sufficient requirement is that you solve lots of problems. If the problems you solve lend themselves to computer solution, then the computer will help you, and the personal computer will let you do it at your desk, in private, and dirt cheap. I figure that my own machine is long past the point where it furnished over 1 billion executed instructions per dollar spent, and each time I use it, the cost goes down still further. I am approaching asymptotically the cost of electric power.

That seems to be a short and quite unsatisfying list. I maintain that we ought to go further than that. We should carefully investigate why there is that five-orders-of-magnitude spread in ability. What do the problem-solving experts do that the rest of us don't do? Conversely, what are the common pitfalls and blunders that most of us make while thrashing around trying to fabricate solutions? Software tool kits are all very fine, but I think we've lost sight of what the computer is meant for.

—Fred Gruenberger
North Ridge, California

CP/M® gives you a new world of PC power

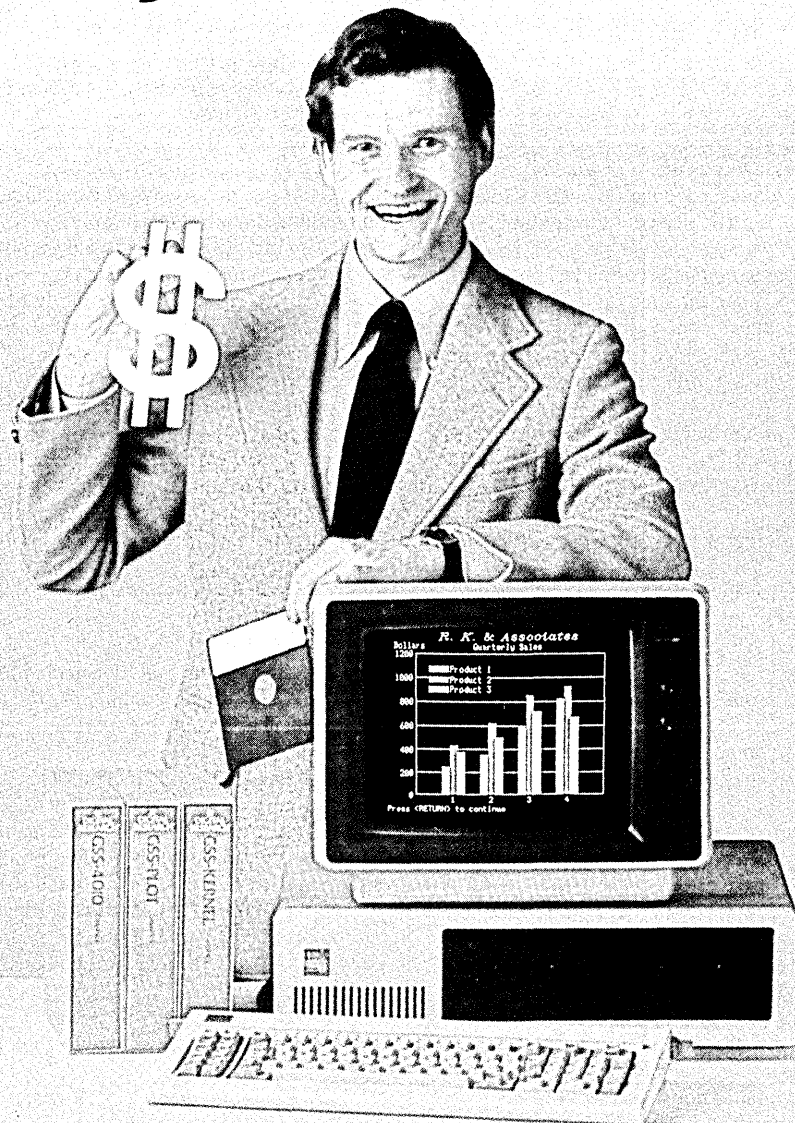

...for a new low price.

Now, for just \$60, you can have the world's most popular operating system for your IBM® PC. Only \$60 for instant access to the largest collection of applications software in existence—literally hundreds of proven, professional software programs for every business and educational need.

New highs in productivity.

New enhanced CP/M-86® comes with print spooling, an exclusive feature that increases the work power of your IBM PC like no other operating system can. With print spooling you can print documents and run applications programs *at the same time*. And, for the ultimate in efficiency, all CP/M-86 programs are upward-compatible to Concurrent CP/M™ the productivity breakthrough that lets your PC run as many as four different programs simultaneously!

New high-performance graphics.

Another unique advantage of enhanced CP/M-86 is GSX™ the new graphics extension that allows CP/M to operate the latest graphics hardware devices.

This lets you choose from a growing array of exciting, sophisticated graphics applications packages which run under the widely-accepted GSX standard.

Great high-level languages.

For programming under CP/M, Digital Research offers the most complete selection of professional-quality languages and utilities for the IBM PC: CBASIC® and CBASIC Compiler™ Pascal/MT+™ CIS™ and Level II COBOL™ "C", PL/I, DR Logo™ and more.

High time to buy!

Before now, you'd pay \$250 for CP/M-86 and another \$75 for GSX. That's what makes new enhanced CP/M-86 such a terrific value. At \$60 it puts PC Power within reach of any budget! You'll find this enhanced CP/M-86 value in The CP/M Library™ a selection

**DIGITAL
RESEARCH™**

The best of everything in software.

of the finest in CP/M software for your IBM PC. Look for it today at your IBM PC dealer. Or contact Digital Research Inc., (408) 649-5500, 160 Central Avenue, Pacific Grove, CA 93950.

IBM is a registered trademark of International Business Machines, Corp. CIS and Level II COBOL are trademarks of Micro Focus, Ltd. The logo and tagline, CP/M, CP/M-86, Concurrent CP/M, GSX, CBASIC, CBASIC Compiler, Pascal/MT+, DR Logo and The CP/M Library are either trademarks or registered trademarks of Digital Research Inc. © 1983, Digital Research Inc.

CIRCLE 234 ON READER CARD

HORACE CHECKS OUT HIS CYCLE

"Why do we hold our annual reviews on April 1?" asked Bartholomew Byte, marketing systems manager for the Potent Toy Manufacturing Co. "Somehow, I have difficulty with the credibility of anything done on that day."

The question was directed to no one in particular, but everyone instinctively turned to Ina Interface, longtime secretary to Horace Heuristic, Potent's MIS manager.

"I asked Horace that last year," said Ina, "and with his normal organization, he went to the flip chart and listed three reasons:

1. When calendar reform was adopted by France in 1564, New Year's was moved from April 1 to Jan. 1. Some people resisted the move and were called "April Fools." So April 1 is really traditional.

2. April is usually the beginning of spring weather, and it's much easier to be optimistic in spring.

3. Everybody is on vacation in December, so it's difficult to spend time coordinating reviews and plans."

"He's weird," muttered Aloysius Access, manufacturing systems manager.

"But lovable," added Portia Partition, finance and administrative systems manager.

"He's also coming," warned Ina. The group pulled up chairs to the conference table as they heard the familiar whistling echoing down the hall.

"Morning, gang," said Horace cheerfully as he came in.

"How can you be so bloody happy on a rainy day like this?" complained Aloysius.

"Well, I didn't say it was a good morning, did I?" replied Horace with a damp grin.

"As you know," he continued, "we've set aside this morning to review our recursive system development cycle, now that we've been using it for several years. Portia, we agreed that you would list the positive features of the cycle."

"Be happy to," said Portia as she gathered her notes and walked to the flip chart. "As you all know," she continued, "we began using system and program prototypes in a formal way several years ago. I'd like to start our discussion by reviewing some of the implications." Then Portia displayed her list.

A software prototype:

1. Is a live, working system.
2. Tests assumed design characteristics.
3. Is created quickly.
4. Is inexpensive to build.
5. Is expected to be iterative.

"Since then, prototyping has become a popular topic," Portia added.

"Yes," Ina interrupted, "the best recent article was in that Edp Analyzer Horace circulated last year."

Portia pulled the list of implications from the flip chart and taped it to the wall. "I agree, and now I'll list what I feel are the advantages we've seen."

Advantages of the Recursive Cycle:

1. Users evaluate a working model—not just a paper description. User involvement increases.
2. Users benefit from partial system solutions much sooner than with classic methods.
3. Neither user nor designer needs to be omniscient about how the system will function in the user environment.
4. Changes are encouraged early in the development cycle.
5. Systems designers can experiment with technical innovations.
6. Code segments can be carried over to final construction.

7. Sometimes the prototype alone will satisfy or eliminate the need for further iterations.

8. Maintenance in the classic sense is decreased.

9. Prototypes force some product documentation back into the development phase.

Portia paused as the group mulled over her presentation.

"I don't know about your first advantage," said Bartholomew. "Users become so involved that they almost get in the way of the programmer/analyst's work."

"I'm afraid I disagree," answered Horace. "After all, users are our customers. Since we charge out our costs, they pay for our work in a very real sense. Furthermore, they will own the system when it is implemented, so as far as I'm concerned, there simply can never be too much user involvement."

Ina was tapping the table gently. Horace smiled and invited her to speak.

"Well," she began, "It's about documentation, Portia's ninth item. We've learned from software vendors that there are two distinct kinds of documentation—development documentation that pertains to the work through initial implementation and product documentation, the words that become part of the final system itself."

"Isn't that really just the user's manual we've always had?" Aloysius blurted.

"Not exactly," Ina continued. "The manuals were usually written after the system was finished and were considered merely necessary evils by the programmers. Product documentation is part of the system itself; it becomes part of the environment in which the system operates."

Horace agreed, and added, "That's why the recursive cycle includes prototype versions of product documentation. By having to write a draft of the product documentation during the design cycle, the system designer must again focus, appropriately I feel, on how the system will operate in the real world."

"Okay, okay," Aloysius said impatiently. "Let me tell you about the problems with this new fangled concept." Portia smiled sweetly, handed him the marker, and taped her list of advantages to the wall.

The room was quiet as Aloysius wrote this list:

1. It's heresy—beware of auditors, consultants, sacrosanct standards.

2. It's seductively easy. Beware of people who don't design or plan at all, stop the cycle too soon, make changes before giving new versions a chance.

3. Resource planning is more complex, for both users and edp people.

4. Iterative retraining is needed.

5. System designers become bored with each iteration or continue iterations only to produce elegant code.

6. Iterative testing is needed.

7. Version control is needed.

8. Complex technology, such as multisite networks, process control, and AI, may be difficult to prototype.

9. It is hard to use when no identifiable user exists at the time of design.

10. It doesn't solve the documentation problem and could make it worse.

"I've added point 10 just for you," said, Aloysius, looking tolerantly at Ina.

Bartholomew chuckled, and said, "I really like your first item. Our auditors were skeptical the first year they saw this. When we called it prototyping they rated us 'unacceptable'; it was only when Horace dignified it by calling it 'recursive development' that they reluctantly let it pass."

"We finally added these concepts to our department standards last year," clarified Portia. "Now that it is in writing, I doubt the auditors will hassle us . . . about this at least."

"Your point on boredom is double edged," said Horace. "Some of our people wanted to drop projects before we felt they

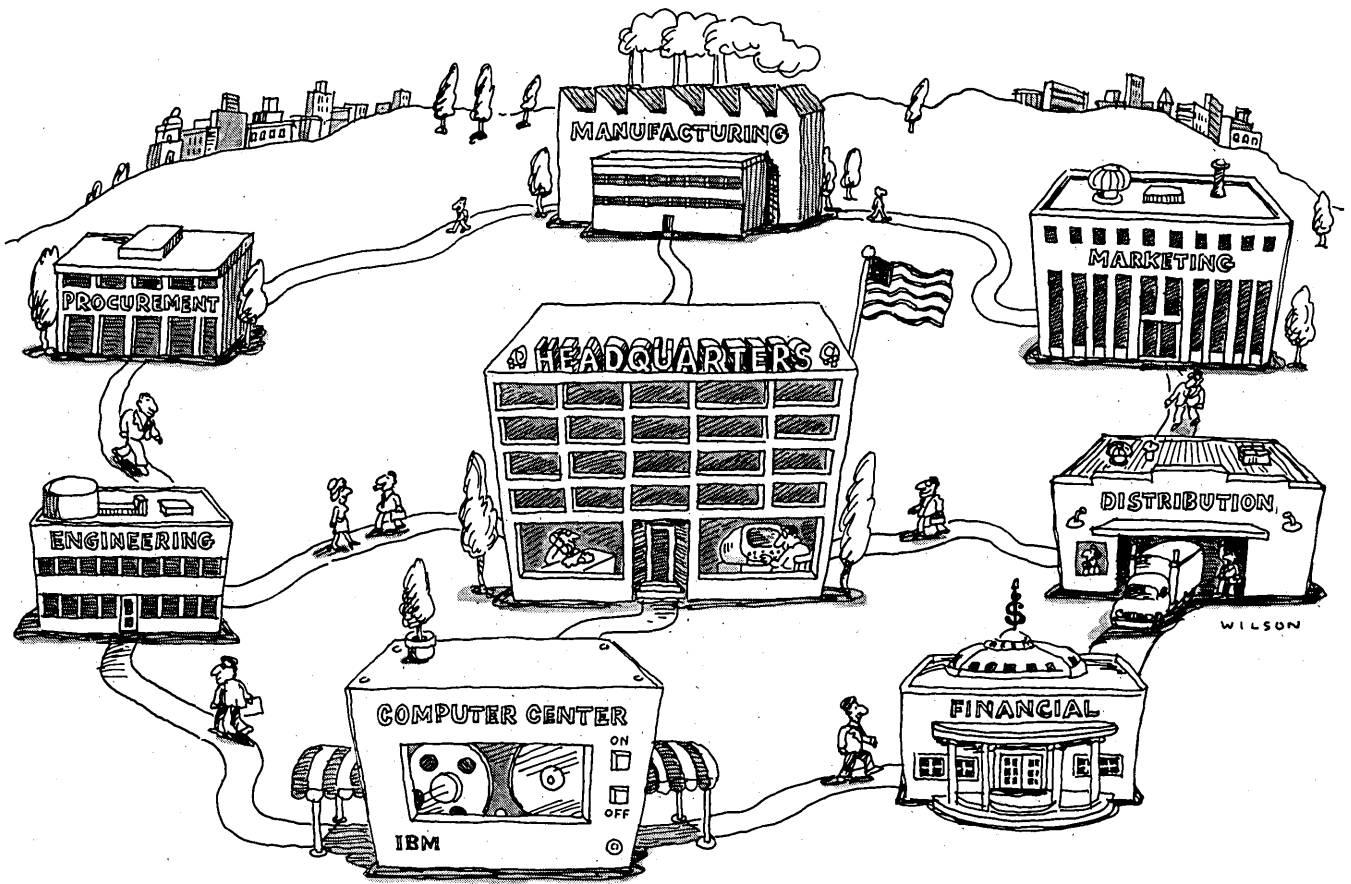

Announcing a complete, unified software system for manufacturers.

Developing a manufacturing planning and control system takes skill and time. You can buy various parts from different vendors and build the interfaces yourself. Then test and implement the software.

Or you can have the Xerox Manufacturing System.

An advanced software architecture from Xerox has done all the work for you. Integrated applications, systems software, analytical tools, and personal computers joined in one complete, unified system.

Every department works with information from the same database. Closed-loop business applications help you plan and execute your priorities and manage costs at optimum levels. Master scheduling, MRP II, inventory, order entry, costing, production control, procurement, receivables, payables, and financial modules are combined in the most powerful operating management tool available today.

Plus, easy-to-use programs for inquiry, reporting, data manipulation, modeling, forecasting, and graphic display. And a personal computer link to your mainframe, the first practical application of its kind.

Xerox software is completely portable across all

IBM 4300, 370, and 3000 computers and operating systems. You can use it on your computer or, as an option, start with our timesharing service. Then, when you're ready, move the software and database in-house. In one weekend. Our systems run on Digital VAX minicomputers, too.

Implementation support, consulting, and education services are available nationwide. For more information, call toll-free (800) 323-2818, Operator 148. In Illinois, call (800) 942-1166. Or return this coupon.

Xerox Computer Services D5/83

c/o Ron Rich, 5310 Beethoven Street, Los Angeles, California 90066

Send me your *Xerox Manufacturing System* brochure.

I'm interested in your software for:

IBM 43XX IBM 370 IBM 30XX Digital VAX

Name/Title _____

Company _____

Street _____

City _____ State _____

Zip _____ Tel. () _____

XEROX® is a trademark of XEROX CORPORATION. VAX® is a trademark of Digital Equipment Corporation. IBM® is a trademark of International Business Machines Corporation.

XEROX

CIRCLE 235 ON READER CARD

READERS' FORUM

were finished, while others didn't want to let go until the system was perfect."

Ina then addressed Aloysius: "I know you'll tell me anyway, so I'll ask first; why doesn't the recursive cycle help the documentation problem?"

"Clearly," he replied smugly, "if we develop several iterations of a system, we need to write several iterations of the documentation. That's more work than doing it the old way. Additionally, if the documentation is not kept consistent with the code, we are likely to mislead the reader, which is worse than no documentation at all."

"You're right, Aloysius," Horace said quietly. "That problem does exist in the recursive cycle, but I suggest that it is no worse than what happened in the classic cycle. We used to go through several iterations, but they were either hidden from the user or performed after the fact by calling it maintenance. We did no better in keeping our documentation current."

"And, frankly," interrupted Ina, "I prefer the recursive cycle—at least the problem is out in the open where we can deal with it by allocating time and people resources appropriately."

"Okay, Aloysius," continued Horace, "please place your list on the wall next to the others, and let's see what we have."

The group stared at the lists for a few moments. Then Bartholomew smiled, and went to the flip chart. "I haven't been up here yet, so let me see if I can summarize all this," and he began to write.

The Bottom Line

Users:

- Become more involved.



Top to bottom: Finston, Jones, Cline, and Parke

- Get usable results sooner.
- Achieve emotional "ownership" of systems.

Edp Systems Developers:

- Become more involved with user concerns.
- See results sooner.
- Learn to use a variety of construction tools.
- Must combat nth generation blues.
- Must still focus on basic construction methodologies.

Development Schedule:

- Much shorter for initial results.
- May be longer to "final" implementation.
- May be much less with classic maintenance and enhancement.
- Must anticipate considerably increased user involvement.

Systems Return on Investment = User Satisfaction/Life Cycle Cost

Using a Recursive Cycle:

- User satisfaction is dramatically increased.
- Life cycle cost probably decreases = development cost which may go up + maintenance/enhancement cost which probably goes down. Result: Systems return on investment is increased.

"See, I took an accounting course once, too," said Bartholomew, as he returned to his seat.

"I guess I can agree with that summary," admitted Aloysius. "There is no question that users are more involved; I just see that, sometimes, as a mixed blessing."

"But how does the recursive cycle blend with advances in data processing technology—you know, personal computers, user programming languages, and database management systems, for example?" asked Ina.

"I can comment on that," responded Portia. "About six months ago, Dan Debit over in accounting asked us to work with him on a budget and planning system he needed for the Space and Soldier Video Game Division—they're planning really explosive growth, you know."

"Anyway, Nathan Nitpick, his boss, wouldn't give the request any priority, and we couldn't help Dan for several months. So Dan brought his personal computer from home and set up what he needed using one of those table calculation programs. It didn't do everything he wanted, mostly because he couldn't read and analyze some files from the main computer, but it did save him a lot of pencil scratching."

"Best of all, when we finally did get to work on the project, he had a good prototype on his personal computer, and it was easy to agree on system specifications."

"Good example," said Horace. "As we've all observed, the key to the recursive cycle is user involvement. Any other tools that also encourage user involvement, such as personal computing and user-oriented programming, can complement and enhance the value of prototyping."

"This was a good session," continued Horace. "Are there any final observations?"

"Only this," piped up Portia. "Usually, when we want to make changes in the way people do things, a need appears and then we find a solution. I think the recursive cycle is best sold by first getting a tool for prototyping and then picking an application on which to apply the tool. The personal computer was a good example. Once Dan brought his to the office, it was easy to get other people to use it to try out their ideas. In fact, Nathan Nitpick finally broke down and bought one for the department, so Dan could take his back home."

"What are we discussing tomorrow?" asked Aloysius, anxious to go to lunch.

"Tomorrow is futures day," answered Ina. "Horace is going to talk about expert application systems."

"What are they?"

"I guess you'll have to come tomorrow and see," replied Horace.

—Joe Podolsky
San Jose, California

CARTOON BY HENRY R. MARTIN

We're the leading IBM/38 software house in Scandinavia.

Share our success in your part of the world.

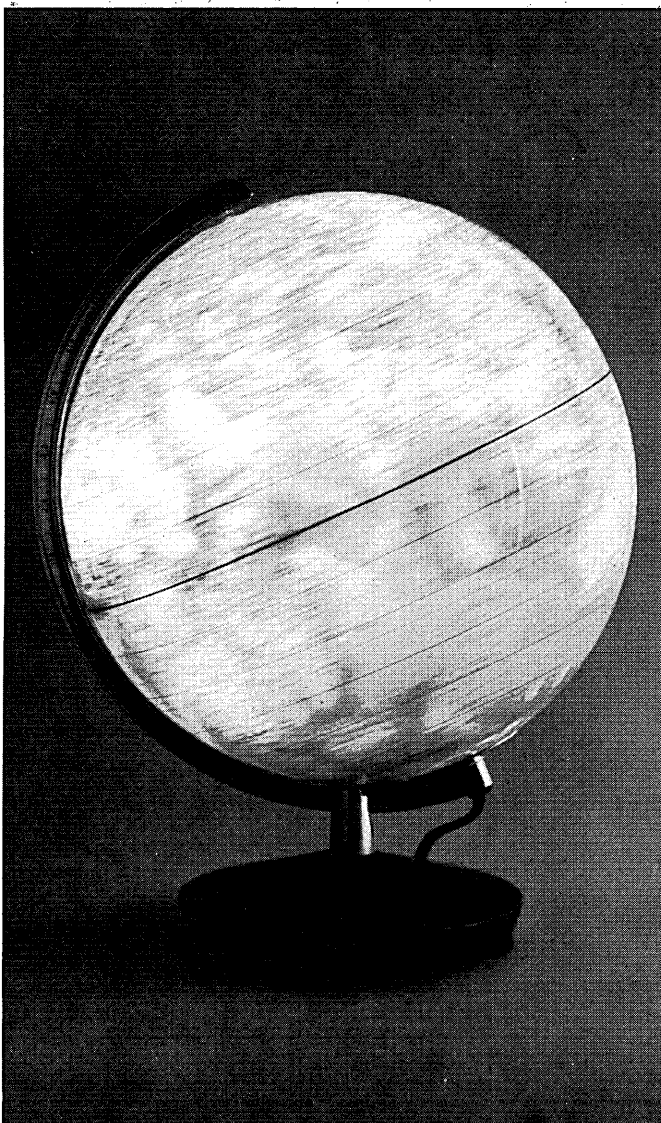

We have developed a range of high quality applications software packages for the IBM/38, covering order processing, invoicing, stock control, purchasing, general ledger, accounts payable, accounts receivable and maintenance.

Some 50 systems have already been installed world-wide, mainly with large multinationals or medium sized companies.

Full documentation and sales material are available in English.

Covering Scandinavia with our own 12 software houses, we are now looking for distributors for our products in other countries.

If you feel you have the financial strength and marketing and technical expertise to adapt, sell and install these products to your local IBM/38 market, get in touch with us.

EF Information Systems Division

Att: Staffan Ahlberg (Managing Director), Box 7813,
S-103 96 Stockholm, Sweden.
Telex: 17837 Consult S. Telephone: +46-8 24 90 20.



ANSWERS IN BLACK & WHITE.

Move more efficiently in the corporate environment. Make decisions more effectively. Get specs fast. Know your options, get results.

Auerbach has brought order to the chaotic schedules, information updating, historically high turnover rates, and critical decisions facing MIS and DP managers. *Auerbach Information Management Series (AIMS)* identifies trends and provides proven management techniques, ideas, and approaches for managing people, technology, and time.

All information services in *AIMS* are "how-to" in nature, logically organized, updated bimonthly, easily referenced, and written by DP specialists. *AIMS* means answers—fast, thorough, and available only from Auerbach, the world's single most authoritative source of DP management information. We answer DP's needs with information services, on-line newsletters, and customized products. With the country's largest DP information bank—accessible to subscribers through our *Telephone/TELEX Information Service*.

Companies like IBM, ITT, Exxon, and General Foods, use Auerbach services. Because when there's a call for information, Auerbach answers.

All Auerbach services are available for a free, 15-day trial, with no obligation.



AUERBACH®

Auerbach Publishers Inc.
6560 N. Park Drive
Pennsauken, NJ 08109 USA

800/257-8162

(In NJ call 609/662-2070)
TELEX 831 464

CIRCLE 237 ON READER CARD

READERS' FORUM

BLUE-COLORED GLASSES

Imagine a candidate for a programming position who graduated in the top 10 of his class and has four solid years of ANSI 68 and 74 structured COBOL programming experience. He's worked on mainframes and minicomputers and has heavy interactive on-line design and analysis experience. His résumé shows rapid promotion and accompanying salary increases into the mid-20s within his four professional years. Imagine this candidate has several letters of recommendation from senior level consultants and ex-employers, expressing the opinion that he can learn anything, assume responsibility, and work without supervision.

You might think this person has it easy finding a good position. In fact, he has been turned down by agencies without even getting an interview. You see, this candidate bears the industry's worst stigma: no IBM experience.

If you are an employer who turns down candidates strictly because they lack IBM experience, you are doing yourself and your company a great disservice.

As the candidate described above, you can imagine my frustration when I see less qualified people get good positions simply because they've been exposed to IBM at some point in their careers.

A large company with over 40 programmers and several levels of bosses does not seem like the best hunting ground to find good programming talent. As a matter of fact, any programmer who remains in this stifling environment for more than a year is already telling everyone that he either lacks confidence in his ability or has developed the bad habits inherent to his surroundings—such as buck passing, acceptance of whatever inefficiencies and frustrations he may face, lack of pride in his work, and the absence of personal initiative.

The tragedy of all this is that with current management attitudes, nothing can change. The only way a large company will hire a non-IBM programmer is at the entry level. This enables the organization to train and condition the person until he or she becomes the stifled programmer described above. In this manner, industry is replenishing the supply of these types.

A more intelligent approach would be to look for a candidate who has a good record of learning new concepts and software along with a parallel rise in promotions and salary. If a person can go from school to learning an operating system like D/G AOS or Honeywell's GCOS in three months, chances are very good he won't have any trouble with OS/JCL, CICS, or any other three-letter systems from IBM. Talent has six letters, not three, and Big Blue hasn't yet cornered the market on good dp professionals.

Before interviewing programming candidates, learn the names of the non-IBM large mainframes that exist. (On three different occasions, I have been interviewed by people who did not know that Honeywell's level 66 computers are considered mainframes.)

If your candidate is being hired as a COBOL programmer, make sure he knows COBOL. ANSI COBOL is a standard, and whether the person knows IBM's COBOL should not be a prerequisite. I've worked with people who have been in the business since the '60s and who did not know what declaratives are or how the perform . . . varying verb works. Big companies whine about the maintenance burden, but never bother to stop the problem by having only the best programmers write programs from scratch. As for the infamous CICS, a sharp programmer who has a record of learning operating systems and software in a short time can learn CICS just as quickly.

The discrimination that exists against non-IBM programmers is not in anyone's best interest.

—William Rice
Central Islip, New York

ONLY AMPLEX

No corporation in the world surpasses the scope of the Ampex commitment to 5 1/4", 8" and 14" Winchester disk drives, disk storage modules, disc recording media, disk controllers, core and semiconductor memories, and video display terminals. Since 1944 Ampex has consistently designed, manufactured and marketed the innovative products and techniques that have helped shape today's computer-oriented society.

Ampex Corporation
Memory Products Division
200 North Nash Street
El Segundo, CA 90245

Call toll-free:

800-421-6868

In California call:

213-640-0150

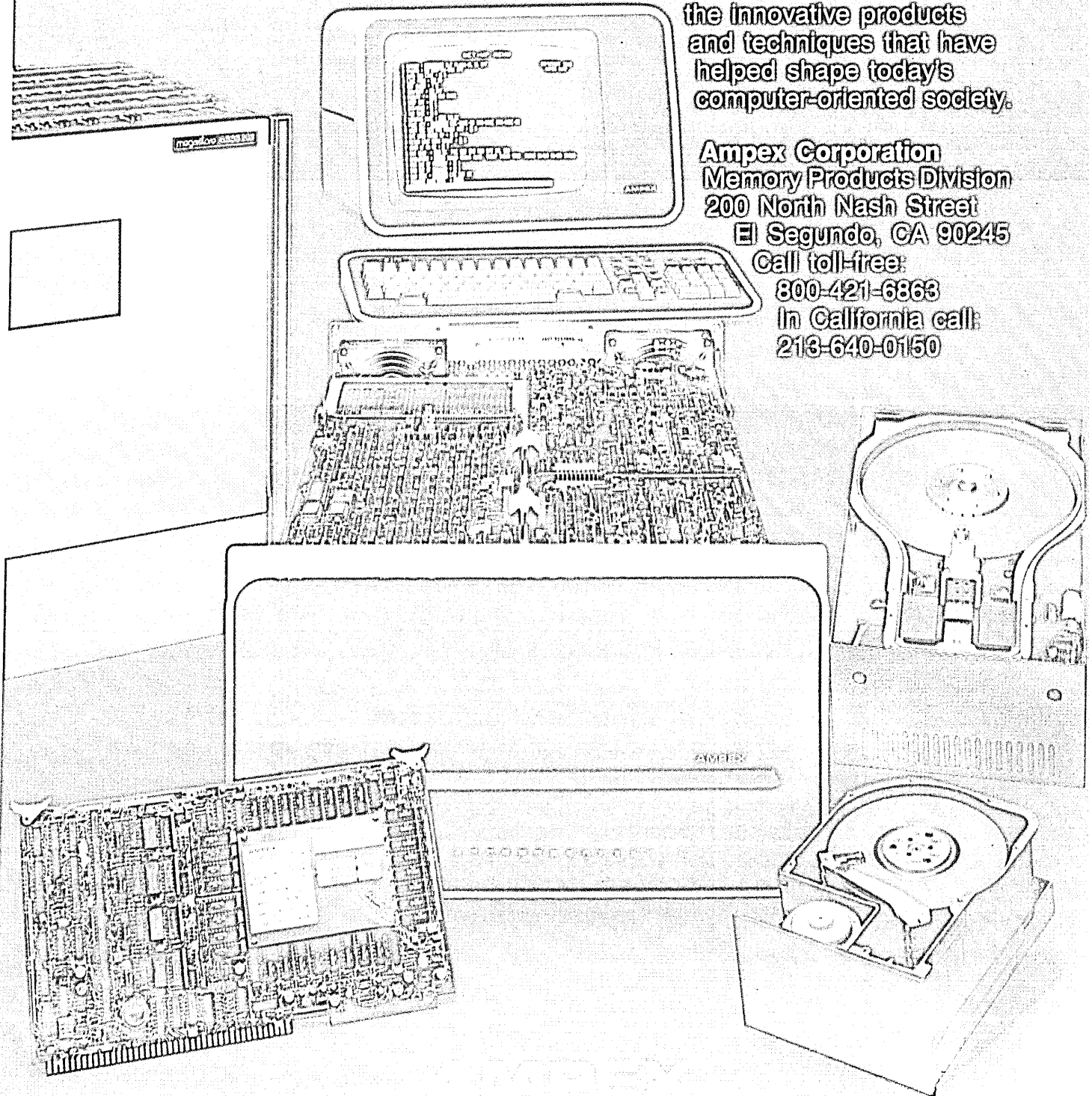

INTRODUCING A CONVERSATIONAL TERMINAL WITH A LOT TO SAY FOR ITSELF.

An attractive low price plus a long list of features make the 5410 terminal from Teletype Corporation a great value. In fact, it's hard to beat this ANSI 3.64 based asynchronous terminal's cost-effectiveness for applications

such as time sharing, inquiry response, data retrieval and software development.

Unlike most terminals in its class, the 5410 lets you change from an 80 to 132 column mode so that you can put more data—even accounting spreadsheets—on the screen. No matter which mode you're in, you'll

get high resolution with crisp, easy-to-read characters.

The 5410 is also surprisingly user-friendly. For starters, it has 8 programmable function keys that can be down-line loaded from a host or entered locally by the operator. These non-volatile keys are easily associated with screen labels. When the operator goes to another application and changes the function keys, the screen labels can change right along with them. There's no need to put plastic strips or messy tape on the screen.

When it comes to optioning, the 5410 features an English menu (see screen above) for fast set up. The operators don't have to flip DIP switches or figure out complicated codes. They'll also appreciate the 5410's character attributes which include blinking, boldfacing, underlining, non-displayed and reverse video.

Of course, we had the operator in mind when we designed the 5410. That's evident in the detachable, low-profile keyboard that's light enough to rest on the operator's lap. And in the tiltable, non-glare screen with brightness control.

The 5410 also stretches to suit your needs as well as the operator's. For example, it features a standard EIA printer port; the internal software to do editing, split screen and line drawing graphics; and on-line speeds up to 19200 bps.

Another nice thing about the 5410 is its ability to diagnose its own problems. And that if service ever is needed, our established nationwide service organization lets us respond quickly to your call.

When you size up conversational terminals, we think you'll find our 5410 speaks for itself.

TELETYPE: VALUE SETS US APART.



Teletype Corporation, 5555 Touhy Ave., Dept. 3223-A, Skokie, IL 60077. Tel. 1 800 323-1229, Extension 104. "Teletype" is a registered trademark and service mark of Teletype Corporation.

CIRCLE 3 ON READER CARD