

EDN[®]

Engineering in Poland
TIGA 340X0-based
intelligent graphics boards
JTAG boundary-scan test
eases pc-board testing
Switched-capacitor filter
subtleties affect design

ELECTRONIC TECHNOLOGY FOR ENGINEERS AND ENGINEERING MANAGERS

Special Report: The right development software brings PLDs to life

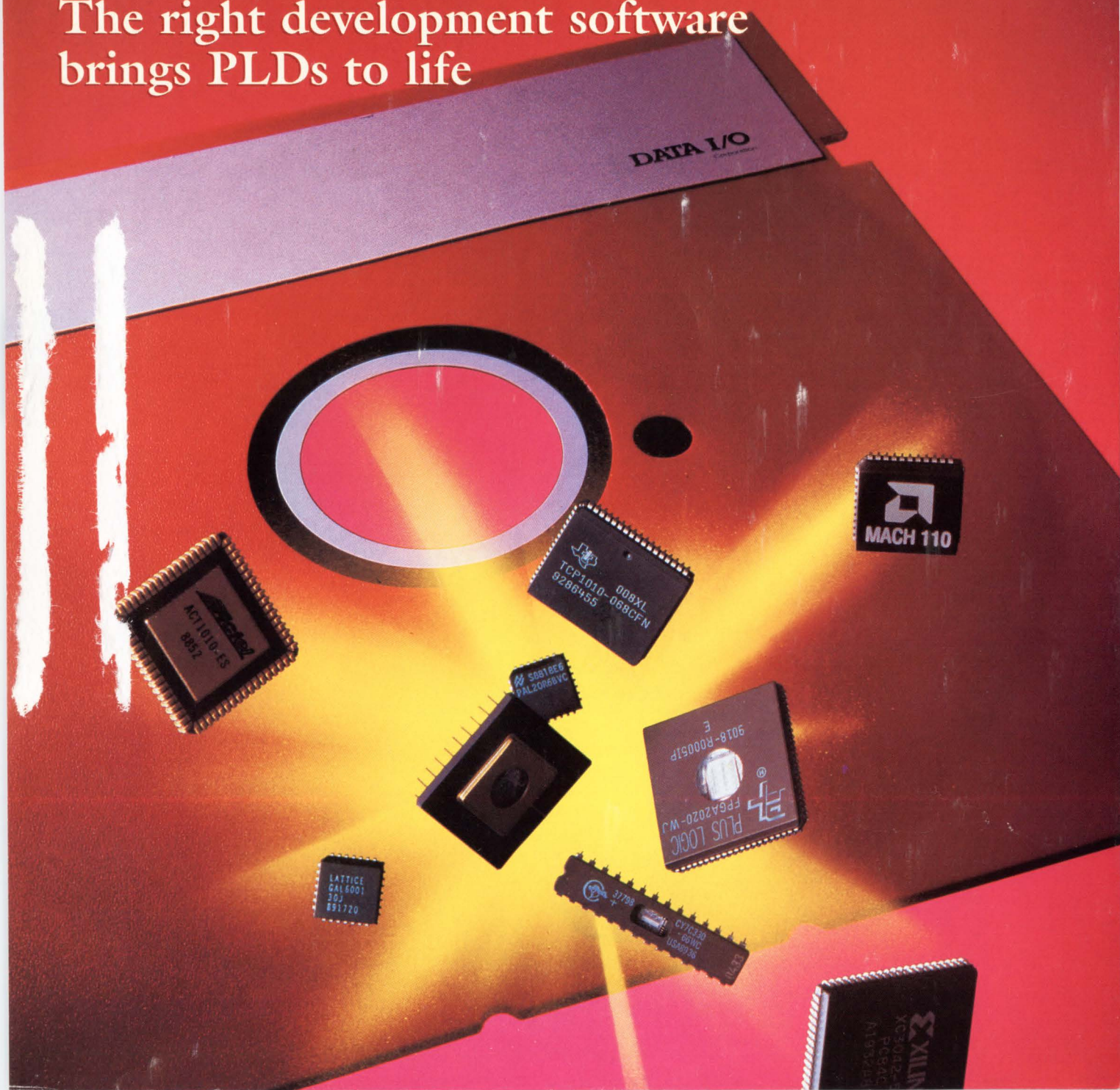

HITACHI'S DK515, 5 1/4", 780 MB WINCHESTER

From any point of view, this 5 1/4" disk drive reflects Hitachi's superior technical expertise, high-performance, and quality.

The DK515 features a fast 2.46 MB/sec. data transfer rate, an average access time of 16 ms, and a choice of ESDI, SCSI, or ESMD interfaces.

Like all Hitachi drives, the DK515 reflects quality, because all critical components—including heads, media, and servo systems—are designed, engineered, and manufactured by Hitachi.

Then, to make sure that Hitachi's strict standards of excellence are maintained, each and every drive is 100% burned-in and tested. The final result: a clear reflection of Hitachi's commitment to providing the very best in reliable, high-quality, high-performance disk storage. All this from a \$48 billion company.

Available now!

For more information about Hitachi disk drives, call your local Hitachi Distributor listed below, or Hitachi at 1-800-283-4080, Ext. 877.

Hitachi America, Ltd.
Computer Division, MS500
Hitachi Plaza
2000 Sierra Point Parkway
Brisbane, CA 94005-1819



Authorized Distributors

CONSAN 612-949-0053
(IA, IL, IN, KS, KY, MI, MN, MO, ND,
NE, OH, Pittsburgh, PA, SD, WI)

R SQUARED 800-777-3478
(AZ, So. CA, CO, NM, UT, WY)

SIGNAL 800-228-8781
(CT, MA, ME, NH, RI, VT)

CIRCLE NO. 109

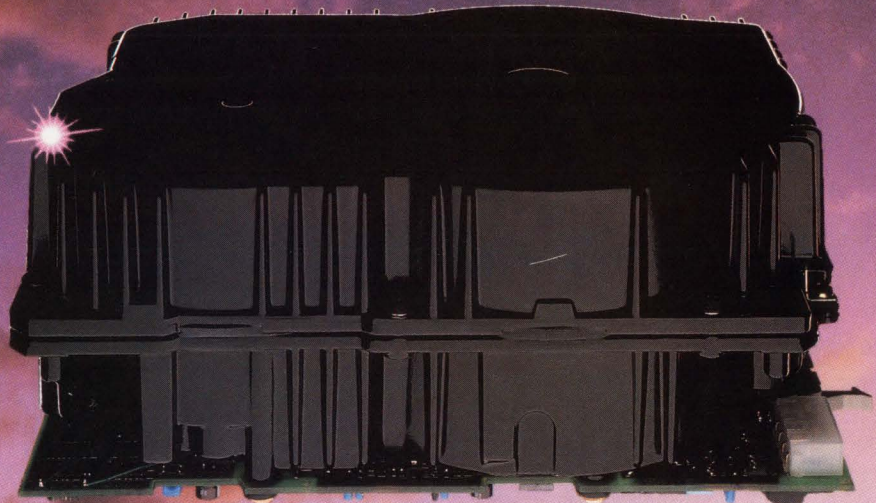

A Reflection of Quality

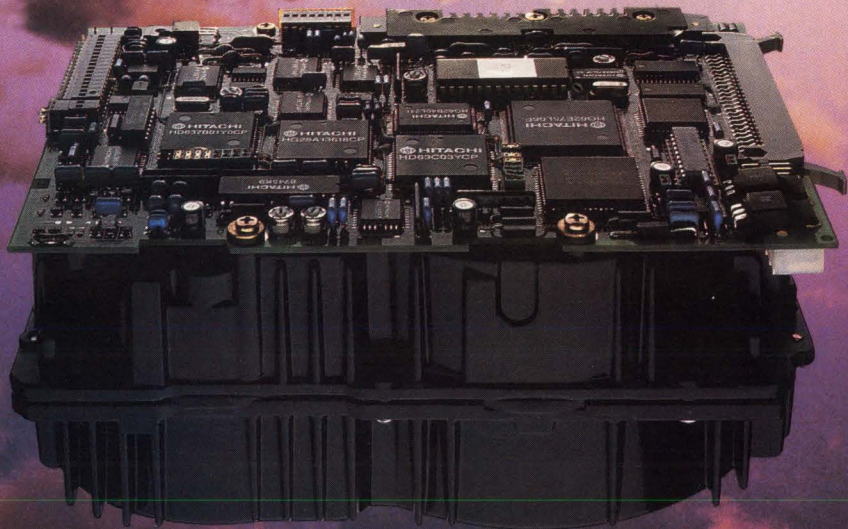

EXAR Fax/Data Combo Breaks the Barrier

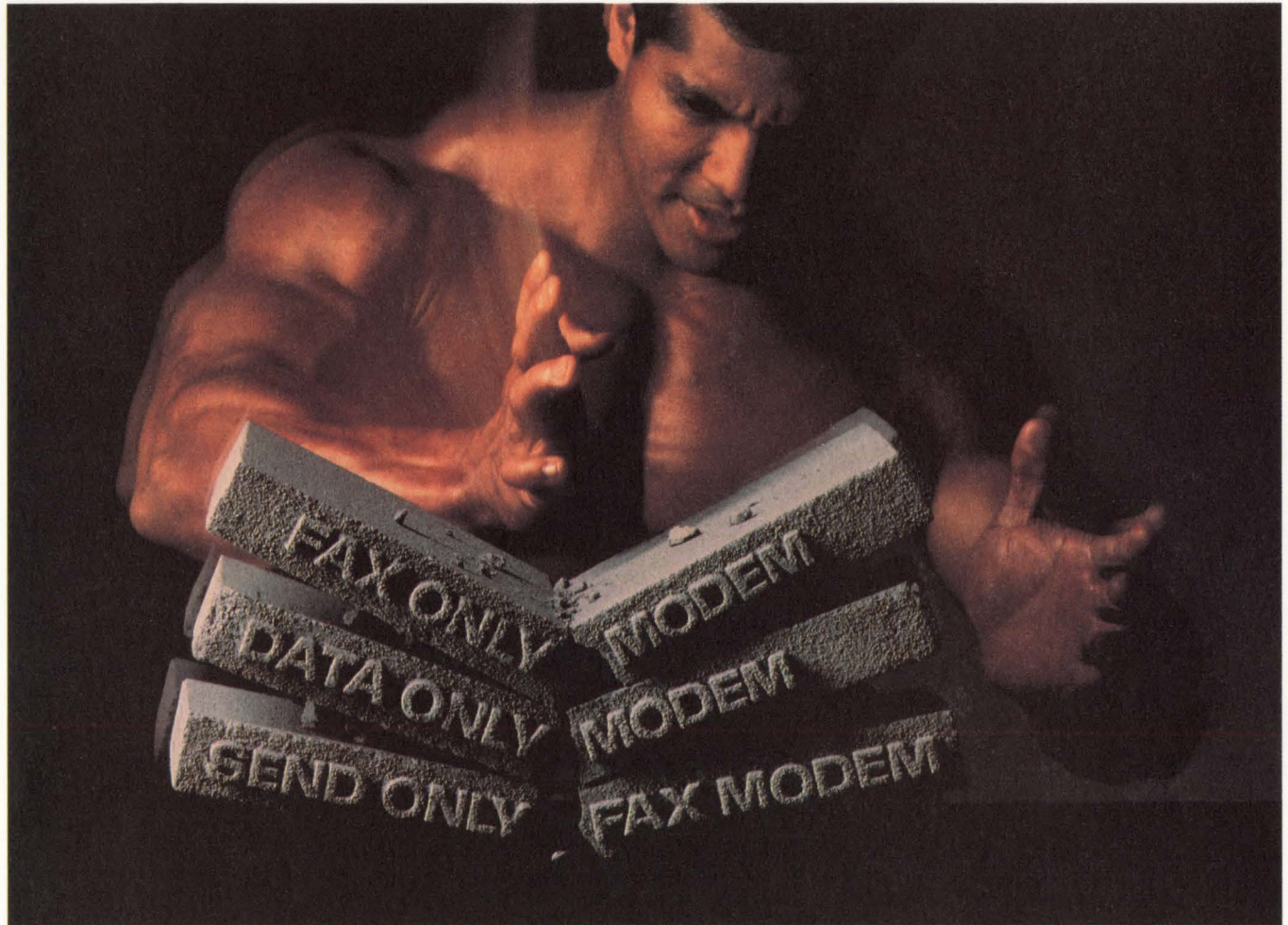

Break away from the competition

Break through the limitations of yesterday's Fax only, Send only Fax, and Data only modem products. With the XR-2900 Fax/Data combo you can offer 9600 BPS send/receive fax with 2400 BPS data modem at a very competitive price. Exar has broken the cost barrier of adding fax capability to 2400 BPS modems. Now, why would anyone want a modem without fax capability?

More features...

For a feature driven market the XR-2900 Fax/Data combo is supported with V.42bis, V.42 and MNP5 protocols, making it simply the most versatile and cost-effective solution on the market today. It is also fully supported with TR29 and T.30 firmware. With a flexible architecture and the "Extended AT" command set provided by Exar, you can easily create your own unique modem solutions.

Less power and space

XR-2900 is the perfect answer for the growing Laptop and Notebook PC markets that have critical space and power requirements. Ever increasing communication needs of these products can only be met by combining fax and data functions.

XR-2900 Fax/Data combo features

- V.29, V.27ter, V.21 (Ch 2) for Fax
- V.22 bis, V.22, 212A & 103 for Data
- Low power CMOS for Laptop & Notebook PCs
- CCITT V.42bis/V.42 support
- MNP5 for data compression in alternate mode
- DTMF generation and CPM (Call Progress Monitor)
- V.23 & V.21
- PLCC/QFP/DIP package options

Call EXAR today at (408) 434-6400 and discuss your new generation modem products with us. We have the most flexible range of modem products, the system knowledge and the application support to assist you in bringing your products to the market.

Put some muscle in your modems

 **EXAR** ...the analog plus[®] company

Analog Plus is a trademark of EXAR Corporation.

Maximum IEEE-488.2 Performance... and the Foundation for the Future

NEW FEATURES

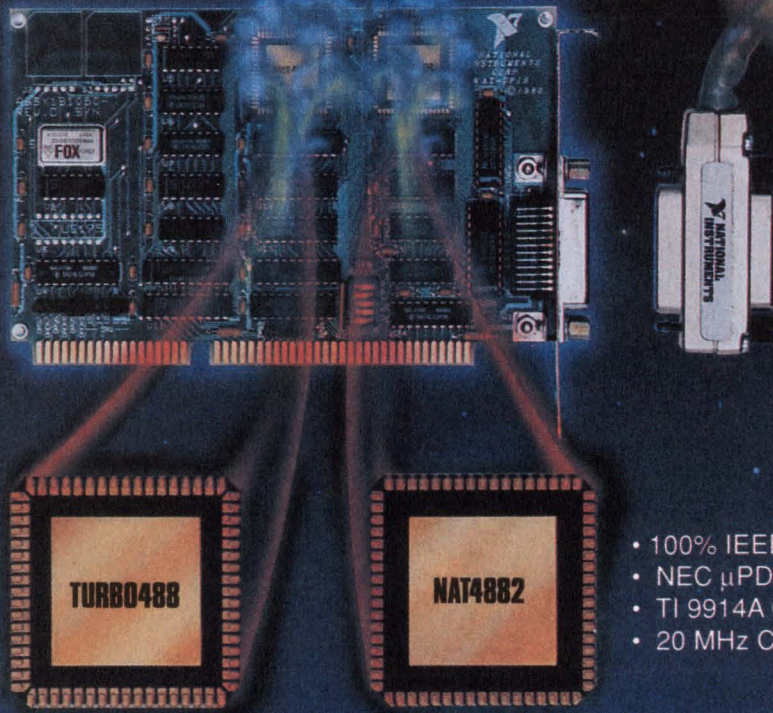

- FIFO Buffers
- Last-Byte Handling
- Byte/Word Packing
- 1 Mbytes/sec Rates

- 100% IEEE-488.2
- NEC μ PD7210 Compatible
- TI 9914A Compatible
- 20 MHz Clock Input

The AT-GPIB

Custom Chips – Bringing state-of-the-art technology to you is why we've been the leader in the IEEE-488 (GPIB) market for over 14 years. Our latest AT-GPIB board for the PC/AT computer combines the functionality of our new IEEE-488.2 controller chip, the NAT4882™, and the performance enhancements of our Turbo488™ ASIC to provide 100% IEEE-488.2 compatibility, 1Mbytes/sec read and write data rates, and significantly reduced software overhead.

Enhanced Software – The performance and functionality of our NI-488 software has made it the *de facto* industry standard. The new NI-488.2 is compatible with NI-488 when using either Hewlett-Packard commands or high-level functions with popular compiled languages. A complete 488.2 controller command set, dynamic configuration, and compatibility with extended memory are but a few of the enhancements.

IEEE-488.2 and SCPI – IEEE-488.2 is the foundation of the new Standard Commands for Programmable Instrumentation (SCPI) and of the new generation of GPIB test systems. The NAT4882, AT-GPIB, and our enhanced NI-488.2 software are the tools of the 90's. But the NAT4882 is also completely compatible with both the NEC μ PD7210 and TI 9914A chips of the 80's.

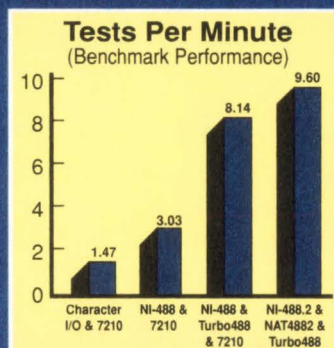

A Sound Investment – You can still run your existing NI-488 programs yet automatically take advantage of the NAT4882, Turbo488, and the streamlined NI-488.2 driver. The state-of-the-art technology of the AT-GPIB with its maximum specified data rates for both reads and writes and its complete 488.2 compatibility ensures that your GPIB investment will not be obsolete because of the new instrumentation standards.

Take advantage of these technologies and standards to make your IEEE-488 control problems a thing of the past.

Nihon National Instruments K.K. (Japan) (3) 788-1922 • National Instruments of France (1) 4865-3370
National Instruments of Italy (2) 4830-1892 • National Instruments United Kingdom (06) 355-23-545

Call for **FREE** Catalog
(800) IEEE-488 (U.S. and Canada)
(512) 794-0100



NATIONAL INSTRUMENTS
The Software is the Instrument[®]

6504 Bridge Point Parkway
Austin, TX 78730-5039

CIRCLE NO. 101

BELL
2000 pts 50 kHz
Sample Rate

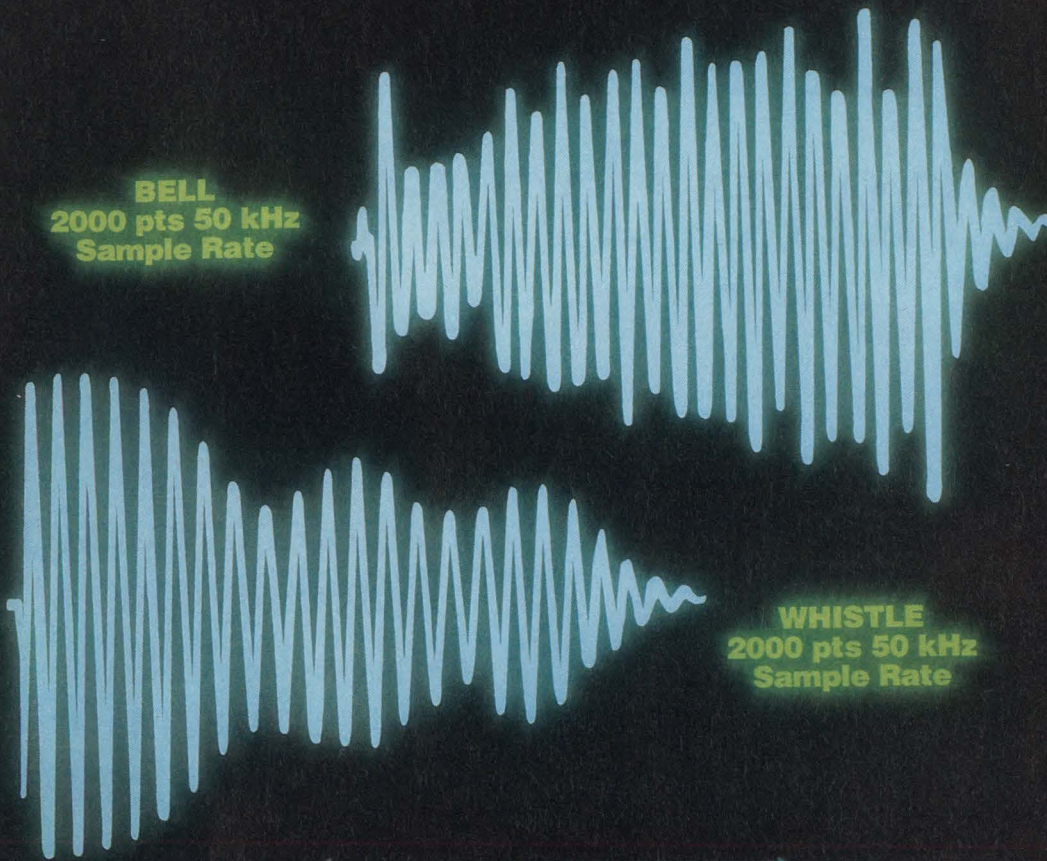

WHISTLE
2000 pts 50 kHz
Sample Rate



Our new function generator has all the bells and whistles.

In fact, it has any kind of waveform you can imagine. Because the Model 95 combines a high performance function generator with a powerful arbitrary generator.

As a function generator, Model 95 produces remarkably pure square waves, triangles and sines, from 1 mHz to 20 MHz with synthesized accuracy up to 0.001%. It has

the power to output 15 Vp-p into 50 Ω , and includes sweep, pulse and modulation modes plus four user-selectable output impedances. There's even an internal trigger generator for trigger, gate and burst.

If you'd rather be arbitrary, Model 95 gives you up to 128k of waveform memory to work with, and a sample rate of 20 MHz. Four different editing

modes help you produce even the most complicated wave shapes quickly and accurately, while analog and digital filters allow you to create the purest output possible.

For information about all the other bells and whistles you'll find on the Model 95, call Wavetek San Diego, Toll Free at **1-800-874-4835** today.

Tucker had the Vision. We have the Power.

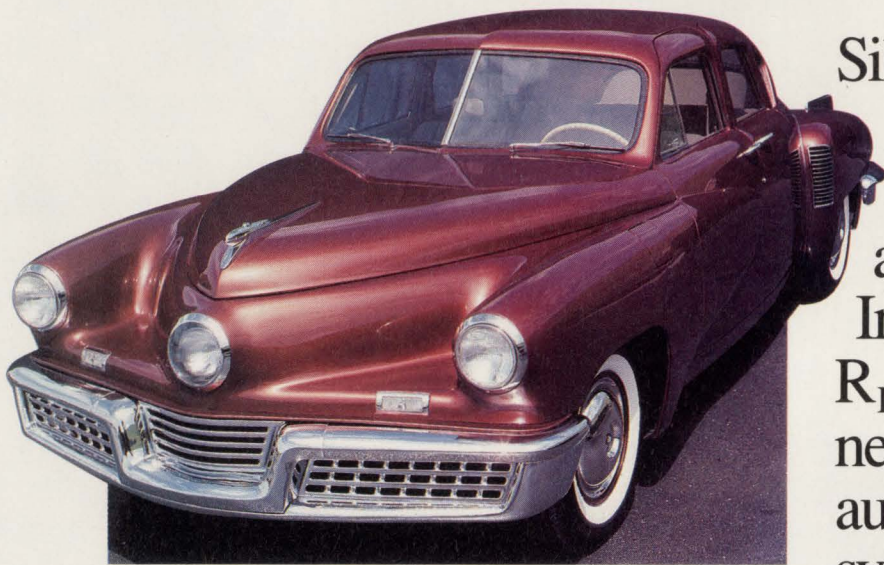

Photo courtesy Behring Auto Museum

Siliconix' power MOSFETs for leading-edge automotive designs. Incredibly low $R_{DS(ON)}$ for the new generation of automotive electrical systems.

Preston Tucker built features into his cars that were far ahead of his time. Now you can have the power that Tucker missed.

Siliconix' new 14-milliohm $R_{DS(ON)}$ power MOSFETs dramatically reduce system size by minimizing part count or shrinking heat sinks. Their higher current handling and cooler running capabilities mean that electro-mechanical relays can be things of the past.

Device	On-Resistance	Voltage	Current	Package
SMP60N06-14	14 m Ω	60 V	60 A	TO-220
SMW70N06-14	14 m Ω	60 V	70 A	TO-247

These MOSFETs are more than tough enough to handle the voltage spikes common in cars. And they have lower gate charge so you can design with smaller drive circuits and fewer components.

Design cooler cars and shrink electrical system size! Ask for a free gift and the SiMOS 2.5 Design Kit. Call our toll-free hotline now! **1-800-554-5565, ext. 953.**

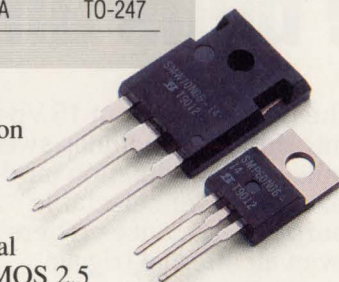

Siliconix
incorporated

2201 Laurelwood Road, Santa Clara, CA 95054

©1990 Siliconix inc.



On the cover: Choosing the right development software is as crucial to PLD-based circuitry design as choosing the right PLDs. See the Special Report on pg 100. (Photo courtesy Data I/O Corp; design by Doug Hansen Design)

SPECIAL REPORT

PLD development software

100

You can't use PLDs in your designs unless you also use the right development software. Choosing that software can be just as important as picking the proper device for your design. The right PLD and the right software will make your job much easier; the wrong choices will stop your project cold.—*Steven H Leibson, Senior Regional Editor*

Electronics in Poland: Learning to cope with capitalism

52

This article is part of an occasional series that examines the electronics-engineering profession in Europe. This installment describes Poland's triumph of gaining democracy and the country's current struggle for economic survival.—*Gary Legg, Special Projects Editor*

INNOVATION[™]
Driving Electronic
Technology Into The
Next Century

DESIGN FEATURE

Knowledge of subtleties aids switched-capacitor filter design

121

Switched-capacitor filters are in essence sampled-data systems. By recognizing the effects—such as aliasing—these systems can have on the filtering process, you'll have a better understanding of your filter's anomalies. THD, clock jitter, and noise are other potential problems you need to recognize and take steps to avoid.—*Richard Markell, Linear Technology Inc*

Continued on page 7

EDN[®](ISSN 0012-7515) is published 49 times a year (biweekly with 2 additional issues a month, except for February, which has 3 additional issues and July and December which have 1 additional issue) by Cahners Publishing Company, A Division of Reed Publishing USA, 275 Washington Street, Newton, MA 02158-1630. Terrence M McDermott, President; Frank Sibley, Senior Vice President/General Manager, Boston Division; Jerry D Neth, Senior Vice President/Publishing Operations; J J Walsh, Senior Vice President/Finance; Thomas J Dellamaria, Senior Vice President/Production and Manufacturing; Ralph Knupp, Vice President/Human Resources. Circulation records are maintained at Cahners Publishing Company, 44 Cook Street, Denver, CO 80206-5800. Telephone: (303) 388-4511. Second-class postage paid at Denver, CO 80206-5800 and additional mailing offices. POSTMASTER: Send address corrections to EDN[®] at the Denver address. EDN[®] copyright 1990 by Reed Publishing USA; Ronald G Segel, Chairman and Chief Executive Officer; Robert L Krakoff, President and Chief Operating Officer; William M Platt, Senior Vice President. Annual subscription rates for nonqualified people: USA, \$109.95/year; Canada/Mexico, \$135/year; Europe air mail, \$165/year; all other nations, \$165/year for surface mail and \$250/year for air mail. Single copies are available for \$10. Please address all subscription mail to Ellen Porter, 44 Cook Street, Denver, CO 80206-5800.

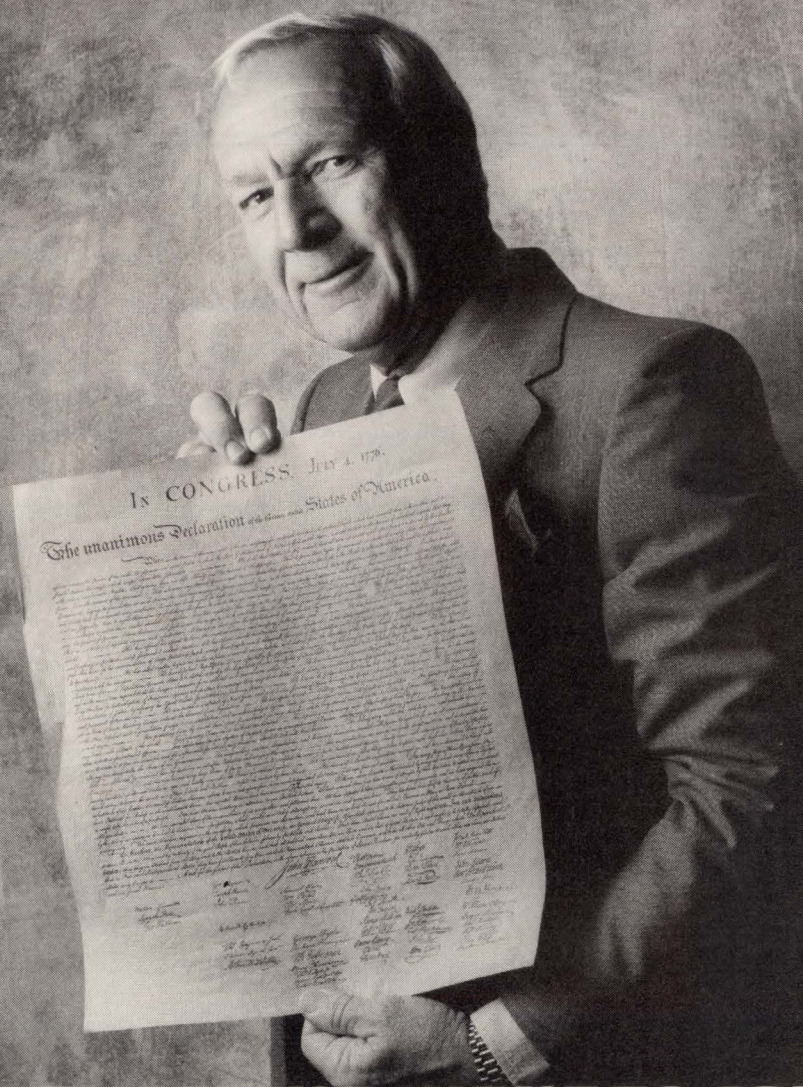

**IF THE RUSSIANS WANT TO COPY THIS,
WE'LL GUARANTEE THAT IT WORKS.**

To ensure life, liberty and the pursuit of happiness in your office, we'd like to propose a system that's guaranteed to work. The Lanier copier system. Lanier copiers are guaranteed to be up and running 98% of the time. You get a loaner for the times it's not.

And you get a 24-hour toll-free Hot Line for any questions you have. So for more productivity, call **1-800-852-2679**. And make a declaration that you want the very best copier system in the USA. Lanier.

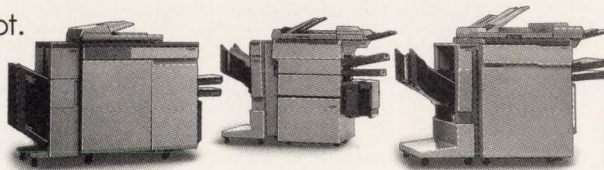

LANIER
COPYING SYSTEMS

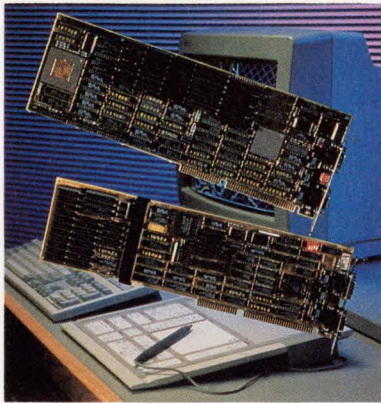

Intelligent graphics boards based on Texas Instruments microprocessors give you workstation-quality graphics on a PC (pg 81).

EDN magazine
now offers
Express Request,
a convenient way
to retrieve product
information by
phone. See the
Reader Service
Card in the front
for details on how
to use this free
service.

Express Request 

TECHNOLOGY UPDATES

JTAG boundary-scan test: Adding testability also aids debugging

67

The JTAG boundary-scan technique makes the testing of pc boards and systems easier. For the knowledgeable designer, the technique also offers benefits during debugging.—*Richard A Quinnell, Regional Editor*

INNOVATION
Driving Electronic
Technology Into The
Next Century

TIGA 340X0-based graphics boards: Intelligent cards display megapixels

81

Boards based on the TI 34010 and 34020 chips offer the performance and compatibility that users of graphics-intensive CAE and business applications need.—*Maury Wright, Regional Editor*

EDITORS' CHOICE

Monolithic single-supply ADC

95

DESIGN IDEAS

- Passive network is totally resistive 135
- Watchdog timer sounds alarm 136
- Single-chip chime sounds pleasant note 136
- Diodes stabilize CMOS circuits 138
- Setup tests crystals 140

Continued on page 9

Cahners Publishing Company, A Division of Reed Publishing USA Specialized Business Magazines for Building & Construction Research Technology Electronics Computing Printing Publishing Health Care Foodservice Packaging Environmental Engineering Manufacturing Entertainment Home Furnishings and Interior Design. Specialized Consumer Magazines for Child Care Boating and Wedding Planning.

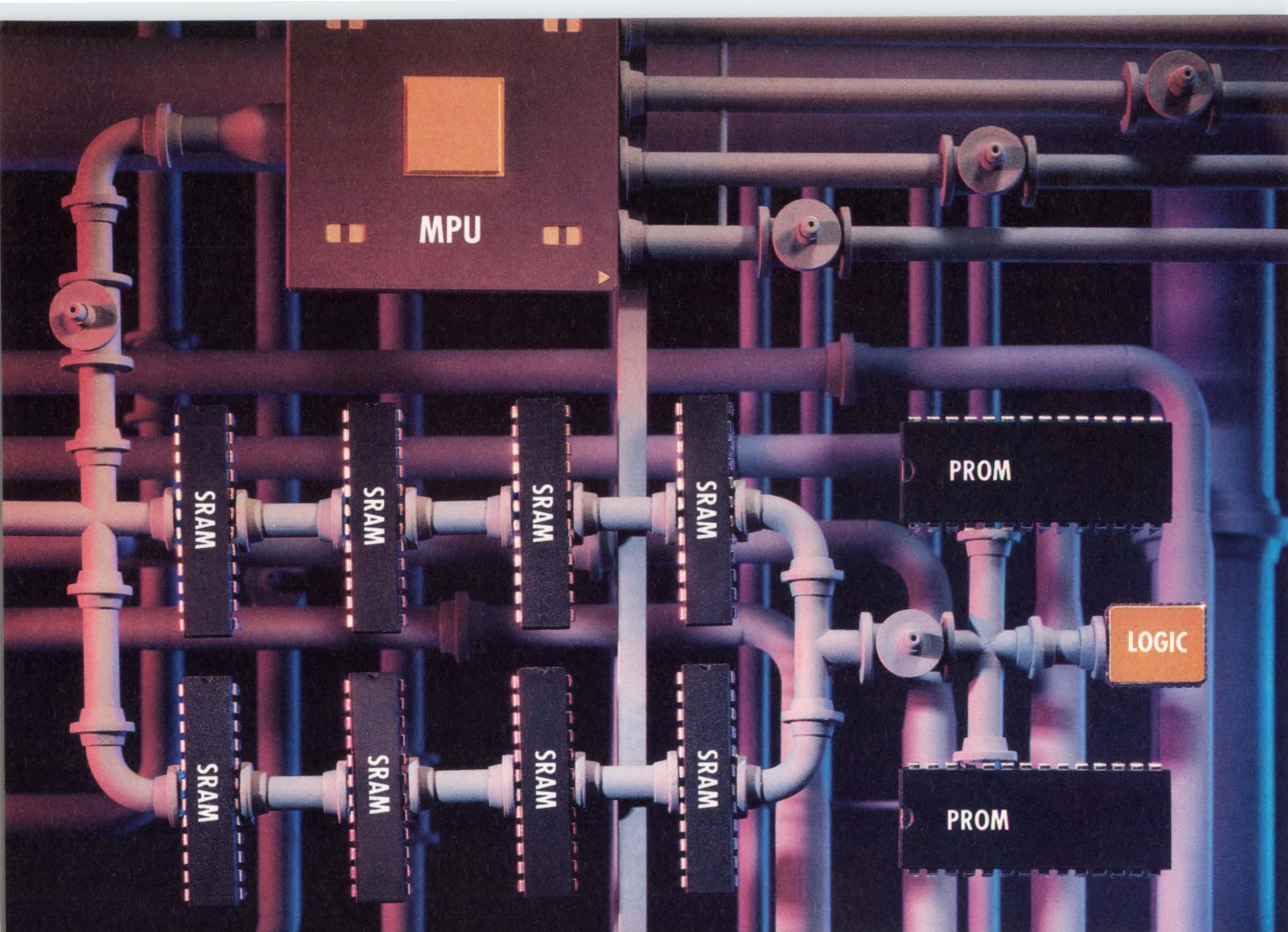

There's a much faster way around all this.

For applications such as embedded control, where space is at a premium, these new high density, high performance PROMs let you build a smaller system, or pack more functions into your existing space.

256K PROM.

You save on more than space and SRAM part costs.

You save on power, because all these PROMs are in our proven, high performance, low power CMOS.

They are available in a wide variety of packaging, including plastic DIP, CERDIP, and PLCC.

They are erasable. That lets us test every part 100% before shipping, and lets you specify windowed, reprogrammable versions.

So if you need more memory in less space with less power, go direct with our ultra-fast 256K PROMs.

New Ultra-Fast 256K PROMs:

At 35 ns, these 300-mil parts are so fast you can run code right from PROM, eliminating SRAM and logic expense. You cut space and cost requirements significantly.

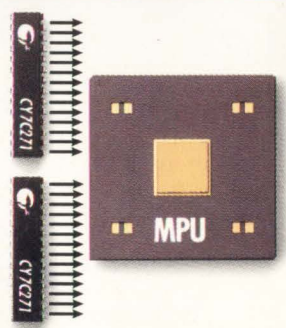

Call the Hotline for your free Data Book and get the full info on all our PROMs. 1-800-952-6300.*
Ask for Dept. C4H



*1-800-387-7599 in Canada. (32) 2-672-2220 in Europe.
©1990 Cypress Semiconductor, 3901 North First Street,
San Jose, CA 95134. Phone: (408) 943-2600, Telex: 821032
CYPRESS SNJ UD, TWX: 910-997-0753.



CYPRESS SEMICONDUCTOR

VP/Publisher
Peter D Coley

VP/Editor/Editorial Director
Jonathan Titus

Managing Editor
Joan Morrow Lynch

Assistant Managing Editor
Susan L Rastellini

Special Projects
Gary Legg

Home Office Editorial Staff
275 Washington St, Newton, MA 02158
(617) 964-3030

Tom Ormond, *Senior Editor*
Charles Small, *Senior Editor*
Jay Fraser, *Associate Editor*
John A Gallant, *Associate Editor*
Michael C Markowitz, *Associate Editor*
Dave Pryce, *Associate Editor*
James P Scanlan, *Associate Editor*
Julie Anne Schofield, *Associate Editor*
Dan Strassberg, *Associate Editor*
Chris Terry, *Associate Editor*
Kathleen M Vejvoda, *Associate Editor*
Helen McElwee, *Senior Copy Editor*
Susan Bureau, *Copy Editor*
Christine McElvenny, *Senior Production Editor*
Gabiella A Fodor, *Production Editor*
Brian J Tobey, *Production Editor*

Editorial Field Offices

Steven H Leibson, *Senior Regional Editor*
Boulder, CO: (303) 494-2233

Doug Conner, *Regional Editor*
Atascadero, CA: (805) 461-9669

J D Mosley, *Regional Editor*
Arlington, TX: (817) 465-4961

Richard A Quinell, *Regional Editor*
Aptos, CA: (408) 685-8028

Anne Watson Swager, *Regional Editor*
Wynnewood, PA: (215) 645-0544

Maury Wright, *Regional Editor*
San Diego, CA: (619) 748-6785

Brian Kerridge, *European Editor*
(603) 630782
(St Francis House, Queens Rd,
Norwich, NR1 3PN, UK)

Contributing Editors
Robert Pease, Don Powers,
David Shear, Bill Travis

Editorial Coordinator
Kathy Leonard

Editorial Services
Helen Benedict, Nicky Woodlock

Art Staff
Ken Racicot, *Senior Art Director*
Chinsoo Chung, *Associate Art Director*
Cathy Madigan, *Staff Artist*

Production/Manufacturing Staff
Andrew A Jantz, *Production Supervisor*
Kelly Brashears, *Production Assistant*
Deborah Hodin, *Production Assistant*
Michele R Weinberg, *Production Assistant*
Diane Malone, *Composition*

Director of Art Department
Joan Kelly
Norman Graf, *Associate*

VP/Production/Manufacturing
Wayne Hulitzky

Director of Production/Manufacturing
John R Sanders

Business Director
Deborah Virtue

Marketing Communications
Anne Foley, *Promotion Manager*
Pam Winch, *Promotion Assistant*

EDITORIAL

47

Conditions in Eastern Europe are bad, but not as bad as you might think.

NEW PRODUCTS

Test & Measurement Instruments	142
Computers & Peripherals	146
Integrated Circuits	156
Components & Power Supplies	164
CAE & Software Development Tools	170

DEPARTMENTS

News Breaks	21
Signals & Noise	32
Ask EDN	35
Calendar	40
Literature	176
Business/Corporate Staff	180
Career Opportunities	190
EDN's International Advertisers Index	195

What's new in EDN

In this issue, EDN Magazine introduces a new department called Ask EDN (pg 35). In this section, EDN's editors help you solve design problems, locate parts and manufacturers, and interpret spec sheets. We'll answer as many of your questions as we can. And if EDN doesn't have the answers, we'll look for experts who can provide them or print your letter and ask our readers for their ideas. If you've got a nagging problem or a difficult question, write to Ask EDN, 275 Washington St, Newton, MA 02158. FAX (617) 558-4470; MCI: EDNBOS.

The newest tw

Finally, a plug and play 10BASE-T network.

With our new ML4650 family of Single Chip 10BASE-T transceivers, you're covered all across the LAN. Because we have single chip twisted pair solutions for both ends, hub to node. Available now. In quantity. Giving you a fast, no hassle 10BASE-T solution.

On the PC side, the ML4651 and ML4652 transceivers incorporate AUI interfaces designed for both Ethernet adapter cards and external MAUs.

On the hub side, the ML4654 is tailor-made for a hub design with TTL or ECL outputs. All are highly integrated

single chip solutions, minimizing

the number of external components required. So your design-in process is much easier. And faster.

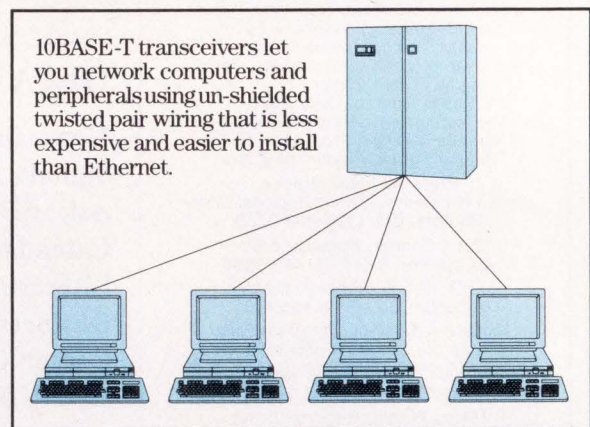

On-chip current driven transmitters are less sensitive to noise and power supply variations. So you get superior jitter performance and low noise outputs that help you easily pass FCC requirements. And the receiver includes an intelligent squelch that rejects cross-talk noise commonly found coupling from the phone wires into the LAN. There's no external crystal oscillator required either, and devices use 5 volts only power supplies.

Parts are available in 20- and

Micro Linear
10BASE-T products
are available in both
adapter card and
external MAU configurations.

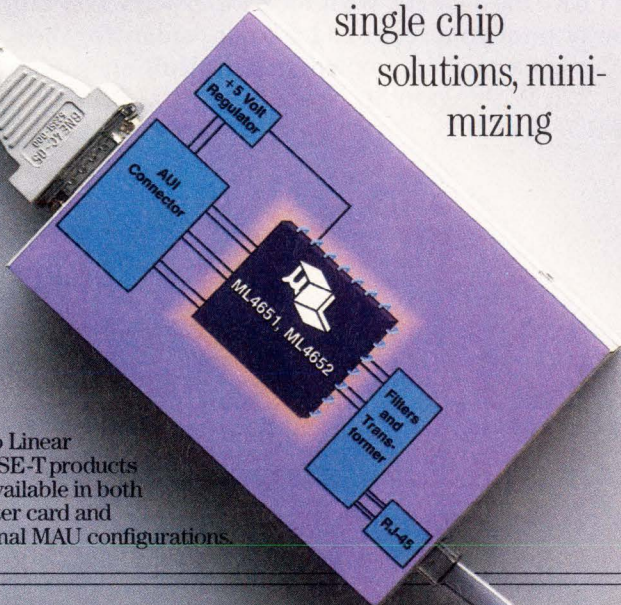

ist in 10BASE-T.

24-pin skinny DIPs and 28-pin PLCCs. There's even an ML4621 Fiber Optic Inter-Repeater Link (FOIRL) receiver available to satisfy 10 Mbps fiber optic Ethernet requirements.

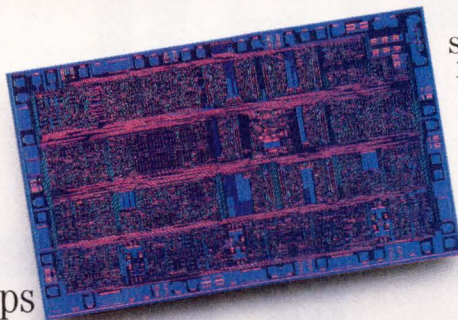

Semi-standard options of the standard 10BASE-T circuits are possible simply by modifying the metal mask on the FB3651 tile array.

functional or performance modifications. Or special screening packaging or reliability

levels to meet your specific network requirements. Whether it's an on-board AUI device. Or a multi-port repeater (MPR) designed to achieve that critical time-to-market advantage you've been looking for.

And, unlike much of the technology you've been hearing about, these are products of experience. We've been shipping twisted pair transceivers since 1987, as part of Synoptics' LattisNet network.

Semi-standard options.

We're one of the first to market for one simple reason. Our 10BASE-T family is based on our standard FB3651 bipolar tile array. So we were able to quickly modify our "standard" product to satisfy the rapidly-emerging IEEE 802 standards.

And, for the same reason, they can be easily modified with semi-standard capability to give you proprietary product advantages. Like

Call us on it.

If you'd like to turn your 10BASE-T idea into a deliverable product, just call Charles Yager today at (408) 433-5200 and ask him for the complete story on our ML4650 family of single chip 10BASE-T transceivers. Or ask for a free sample. It could add a whole new twist to your networking scheme.

Micro Linear, 2092 Concourse Drive,
San Jose, CA 95131



Micro Linear

©1990 Micro Linear Corporation. LattisNet is a registered trademark of SynOptics Corp.

**A GRAPHIC
EXAMPLE
OF WHY
APPLE
CHOSE THE
AMD 29K.**

When you set out to design the most advanced graphics system technology, you have to search for the most innovative microprocessor you can find.

That's why Apple® called AMD. When it came to designing their new Macintosh® graphics accelerator board* they needed AMD's 29K™ RISC microprocessor. At 23 MIPS, only the 29K can boost the speed of 32-bit QuickDraw® graphics routines from five to thirty times. More than enough for photo-realistic images. And for the first time ever, true 24-bit color graphics can be displayed at even faster than monochrome speeds.

29K and Fusion29K are trademarks of Advanced Micro Devices, Inc. Where indicated, product and company names are trademarks/registered trademarks of their respective holders.

*Macintosh Display Card 8 • 24 gc

You can have the same kind of performance with the 29K. And you don't have to wait to get started. Or finished. AMD and over 40 Fusion29K™ partners already have complete hardware and software development tools. Such as the HP® emulator, Microtec® Research and Intermetrics™ cross compilers and debuggers.

Find out everything you need to know. Give us a call at (800) 2929AMD. And don't take any chances when it comes to your RISC design.

Advanced Micro Devices

901 Thompson Place, P.O. Box 3453, Sunnyvale, CA 94088

CIRCLE NO. 69

© 1990 Advanced Micro Devices, Inc.



"I came here because linear leadership. I stay here vision of the linear future."

HOW NATIONAL SEMICONDUCTOR IS HELPING YOU DESIGN HIGH-PERFORMANCE SOLUTIONS WITH ADVANCED LINEAR TECHNOLOGIES.

Dennis Monticelli, National Semiconductor's Design Manager, Analog Division, talks about pushing the performance limits of linear-IC design.

Building the world's first high-speed, high-power monolithic op amp.

"No one in the world has ever done this before. Our LM6313 delivers a 250V/ μ s slew rate, yet can drive a 50-ohm load directly with a 20V swing. Before this, you'd need a separate op amp and buffer or an expensive hybrid. We did it in one device using a unique bipolar technology we call 'Vertically Integrated PNP' or 'VIP.' It's a junction-isolated complementary bipolar process. And we were the first in the industry to do it."

Setting the standard in high-resolution CRT design.

"Today's CRT designs have run out of gas. Only integrated solutions can deliver high speeds without bandwidth losses due to discrete board layouts. So we created the LM1201 video preamp. One chip. 16 pins. Replaces 40 components. Put it with our CRT driver, and you can design a 1280 x 1024 display with a 6ns pixel rate. Without the EMI. Without the real estate."

Delivering bipolar performance in CMOS op amps.

"Single-supply 5V systems need optimized op amps. So we developed a proprietary linearized CMOS process called LMCMOS. We get the ultralow input bias cur-

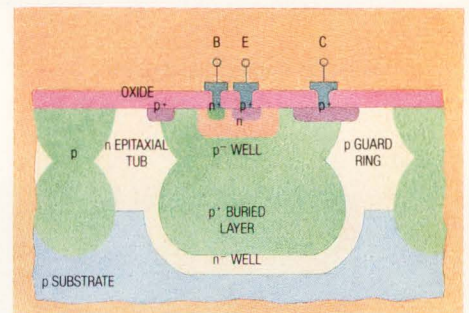

rent and frugal power consumption of CMOS with the driving power and input precision of bipolar. Our new LMC660/662 op amps, for example, can drive 600-ohm loads rail-to-rail. With input bias current of 40 femtoamps. Remarkable!"

Making switching-power-supply design truly simple.

"Switching regulators are efficient and versatile, but you need a PhD in Power Conversion to design one. Not anymore. Our new Simple Switcher family makes it easy. Our free design software even gives you a printed schematic and a manufacturers' parts list. And you get an output voltage that's guaranteed to be within $\pm 5\%$

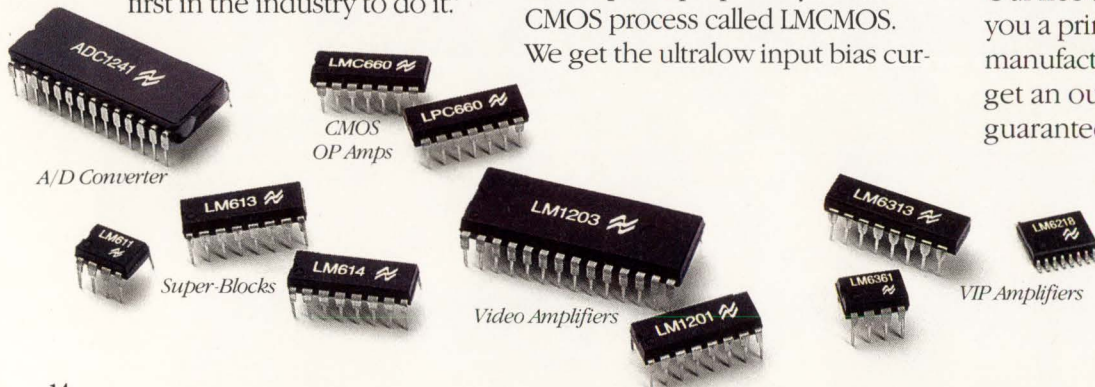

National has a heritage of because we also have a clear

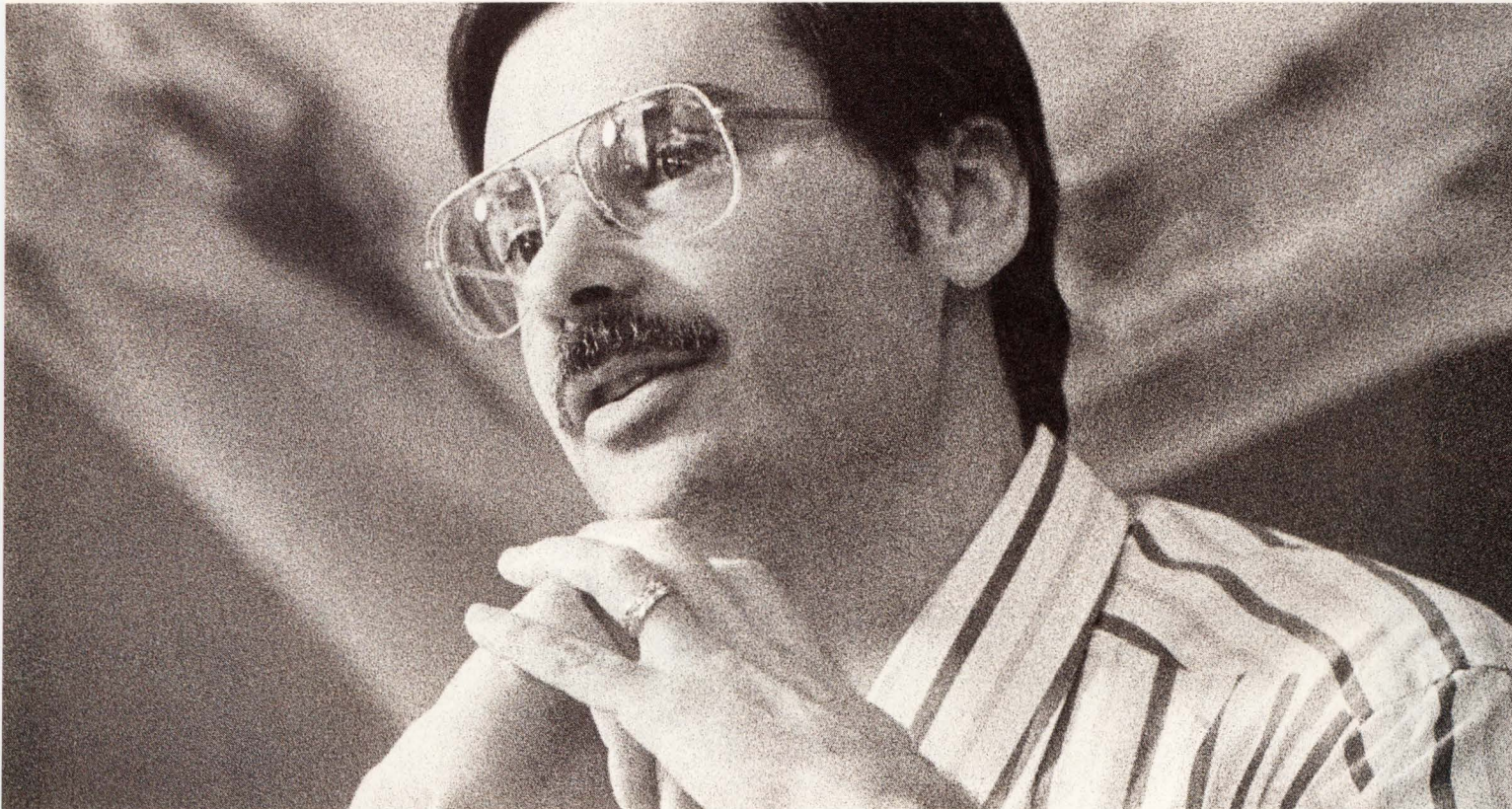

regardless of line, load, temperature, and external component tolerances. Simple, right?"

Integrating three technologies to make power devices smarter.

"We've actually packed CMOS, bipolar, and DMOS onto the same chip in our new LMD18200 H-Bridge. It's rated at 55V at 3A, and delivers 150W continuous and 300W peak power to the load. All

under the command of CMOS-logic-level inputs. And since R_{ON} of each FET is just 0.3 ohms, even if you draw peak current of 6A, that still leaves 50V for the motor. So it's perfect for printers, plotters, industrial controls, whatever. Now that's smart."

Putting the pride of National to work for you.

"I've spent my entire design career here at National. We have a long heritage of linear leadership.

We have a clear vision of the linear future. And we have some of the best linear designers in the world, pardon my modesty. If I were in the market for advanced linear, I'd call National. Period!"

1-800-NAT-SEMI, Ext. 201



©1990 National Semiconductor Corporation
LMCMOS, Simple Switcher, Super Block, and VIP are trademarks of National Semiconductor Corporation.

SAMSUNG
NOW

68040 SYSTEMS EQUIPPED YOU'LL NOTICE A



Systems utilizing the new Samsung 84C31 take off. They run like Triple Crown-winning thoroughbreds. They blaze, scorch, and leave others in their dust.

In a word, they are fast.

And they make even speedy 68040 systems that *don't* use the 84C31, look like they're not in motion.

The 84C31 was designed

with the close cooperation of Motorola. It is the *only* DRAM controller designed

SAMSUNG'S DRAM CONTROLLER FOR THE 68040 AND 68030

Part Number	RAMs Supported	Package
KS84C31-33CL	256K, 1Mb	68-pin PLCC
KS84C32-33CL	256K, 1Mb, 4Mb	84-pin PLCC

Samples and production available now.

specifically for Motorola's powerful 68040 and 68030 microprocessors.

Like the extremely successful earlier-generation

Samsung System Accelerators™, the part is highly integrated and inherently fast. And as the cutting edge in memory control, it can help you simply and economically enhance even 68040 performance.

The 84C31 supports both the burst and non-burst modes of the 68040. It also provides a direct interface

WITH OUR DRAM CONTROLLER: CERTAIN IMPROVEMENT.



WITH

to the microprocessor.
Which saves you dollars,
board real estate, and

68030 PERFORMANCE SUMMARY

Access Clocks	DRAM Speed	Frequency (Mhz)
4-2-2-2	70 ns	20
5-2-2-2	120 ns	20
5-2-2-2	80 ns	25
6-2-2-2	120 ns	25
6-2-2-2	80 ns	33
7-2-2-2	100 ns	33

68040 PERFORMANCE SUMMARY

Access Clocks	DRAM Speed	Frequency (Mhz)
3-2-2-2	80 ns	25
5-2-2-2	100 ns	25
6-2-2-2	120 ns	25
5-2-2-2	80 ns	33
6-2-2-2	100 ns	33

design time, since it means
you don't need additional
glue logic.

Ease of design is another
advantage. As a glance at
our System Design Guides
will show, it's an unusually
simple chip to design in.

All in all, we believe the
84C31 is the best memory
controller solution available
today.

For details on using it to
make *your* designs take off,
contact DRAM Controller
Marketing, Samsung
Semiconductor, 3725 No.
First St., San Jose, CA
95134. Or call 1-800-669-
5400, or 408-954-7229.



© Samsung Semiconductor, Inc., 1990. System Accelerator is a trademark
of Samsung Semiconductor, Inc. Motorola is a trademark of Motorola, Inc.

CIRCLE NO. 71



©1990 Hewlett-Packard Co. TMT&M 020A



“Did you hear about
the car accident we had
in Switzerland?”



There were no serious
injuries.

Not long ago, an HP salesman
turned a routine product demon-
stration into a crash course in
reliability.

Our District Manager in Switzer-
land, Ueli Nussbaumer, had just
given a demonstration of an HP
spectrum analyzer. He set the
analyzer down beside his car,
intending to pack it last.

Well, there was a lot to pack. And
when Ueli backed the car out, an
ear-splitting screech of ripping
metal made him hit the brakes.
The analyzer!

It was trapped under the car.
Ueli jacked up the car, yanked out
the analyzer, and ran back to his
customer's office to test its vital
signs. The spectrum analyzer
worked perfectly. The customer
was incredulous.

Stories like this underscore why
HP rates highest for reliability
among engineering managers.
And we're still not satisfied.
In fact, in 1979 we started our
Total Quality Control program to
increase quality ten-fold in 10
years. A goal we'll reach this year.

It just goes to show that when
design and manufacturing produc-
tivity are at stake, there is no
reliable substitute for HP. Because
you never know what you might
run into.

There is a better way.



What a GaAs.



GaAs beam lead Schottky diodes optimized for 26-60GHz.

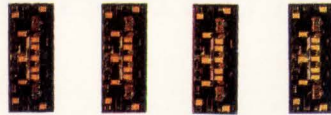

GaAs MMIC DC-50GHz voltage variable attenuator.

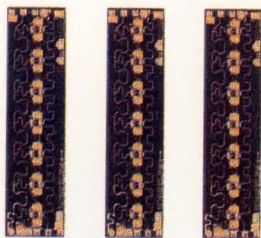

GaAs MMIC traveling wave amplifiers.

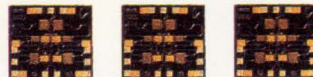

GaAs MMIC SPDT switches.

New Product

New Product

Products shown 10 times actual size.

Want some great news about GaAs? Check into HP. We've got a full line of GaAs high-performance products.

For openers, consider our new GaAs MMIC attenuator. The only device in the world operating from DC-50GHz.

Its wide attenuation range, exceptional bandwidth and fast switching speed make it ideal for automatic gain control, amplitude and pulse modulation switching.

Our line of GaAs Schottky diodes is optimized for 26-60GHz. But they deliver outstanding performance through 100GHz.

Along with low series resistance and low capacitance. Which ensures a high cut-off frequency and solid performance through 100GHz.

If you're looking for the right general-purpose switch, switch to HP. Our new broad-band GaAs MMIC SPDT devices offer low insertion loss and high isolation for improved system performance from DC-6GHz.

Plus they're available in both 8- and 7-lead packages for versatile drop-in replacement.

HP's great GaAs news also includes a family of high-gain, high-power MMIC traveling wave amplifiers.

Designed to operate from 2-26.5GHz. And 100% RF tested to provide guaranteed spec performance. Best of all, our new GaAs products are from HP. Which means you can count on our commitment to excellence in service, support and reliability.

If you'd like to know more about HP's broad line of GaAs performance products, call **1-800-752-0900, ext. 1156**. And tell us it's a GaAs.

There is a better way.

 **HEWLETT
PACKARD**

CG08007

NEWS BREAKS

EDITED BY SUSAN BUREAU

TWO FIRMS OFFER NO-SLOT IEEE-488 INTERFACES

If you need to use an IBM PC-compatible computer to control a group of IEEE-488 instruments, but your PC has no open I/O slot to hold the bus-controller card, you don't have to purchase another PC. Instead, look to Cleveland, OH; two companies in that city offer solutions. IOtech's ((216) 439-4091) LPTalk488 cable plugs into a computer's Centronics-compatible I/O port and couples with the IEEE-488 bus. The \$195 cable uses a parallel-port connector to mate with the connectors on PCs. Keithley Instruments ((216) 248-0400) offers the \$299 500-Serial, a unit no larger than the shell of a DB-25 connector that mates with a standard RS-232C port. This unit, which plugs into and draws power from an RS-232C interface, also connects to the IEEE-488 bus. An adapter lets the device mate with the 9-pin connector used by many PCs. Both vendors include IBM PC-based software with their hardware.

—Dan Strassberg

EEPROMs SHED VOLUME

A pair of slimmed-down EEPROMs from Intel Corp (Santa Clara, CA, (408) 987-8080) should help you fit nonvolatile data storage into very small places. The 1M-bit 28F010 and 2M-bit 28F020 feature surface-mount packages measuring 20×8×1.2 mm. The 200-nsec devices cost \$17.95 for the 1M-bit version and \$45.20 (10,000) for the 2M-bit version.—Steven H Leibson

MILITARY-PRODUCT DATABASE INCLUDES EDIF CAE INFORMATION

Although several component-database systems exist, none except the Component Information System from Expert Views Inc (Waltham, MA, (617) 890-0333) lets you transfer MIL-spec component data to your CAE system. The database supplies graphical-symbol information and specifications to CAE systems in both ASCII format and EDIF 2.0. A symbol compiler lets companies convert graphics information to comply with company-wide graphics standards. The system operates on networked computers running Unix or VMS operating systems and costs \$50,000 for a 1-year license, including quarterly updates. The company provides two \$40,000 software packages for the system. View Master, a parts-access software package, lets users examine components and specifications. A control software package called Component Manager lets managers customize the database by eliminating some products, adding specifications for others, and including special or customized components.

—Jon Titus

CONTACTLESS SENSOR DETECTS MOTION AND POSITION

The Optometer, a contactless detector from Heimann GmbH, a subsidiary of Siemens Corp (Iselin, NJ, (800) 222-2203), provides large-area motion and position detection. The device detects alternating light and dark areas, in either a linear or circular configuration. When activated by a vertical light beam, the photodiodes produce a binary signal that indicates the moving object's position. The sensor is unaffected by noise and irregular signal levels. It offers resolutions of 0.05 to 5 mm and ranges of 50 to 200 mm. Prices are \$60 to \$250, depending on the features you choose.—Susan Bureau

NEWS BREAKS

PLD PROVIDES HIGH-SPEED WIDE-ADDRESS DECODING

Most high-speed PLDs give you the speed you need for address decoders in high-performance systems but not the decoding width you want. The PHD48N22-7 from Philips Components-Signetics (Sunnyvale, CA, (408) 991-2000) offers both these features by providing a 7.5- to 8-nsec propagation delay and 36 dedicated input leads for wide-address decoding. The 68-lead device also has 10 dedicated output leads, so you should be able to satisfy all the chip-enable requirements in your design with one IC. In case you need wider-address decoding or more chip enables, the device has 12 bidirectional lines that you can use as input or output pins. If you use all the lines as inputs, you can resolve a 48-bit address to a single location. The PLD costs \$22 (1000); the company's Amaze version 1.9 software for programming the device is free to qualified customers.—Steven H Leibson

TEST-PROGRAM SYNTHESIS LINKS VENDORS

To automatically create tester-specific test programs, ExperTest Inc (Mountain View, CA, (415) 965-2000) and TSSI (Beaverton, OR, (503) 645-9281) plan to share their technology. ExperTest's Test Design Expert (TDX), scheduled for release in the fourth quarter, will create high-fault-coverage test patterns from behavioral and structural circuit descriptions. TSSI's Test Development Series (TDS) software will use the patterns to produce programs for more than 60 ASIC verifiers as well as component and in-circuit testers. The TDX package price starts at \$150,000, and the TDS software starts at \$20,000.—Michael C Markowitz

GLOBAL HIGH-TECH DEVELOPERS CONVERGE ON HAWAII

Long a melting pot for people from countries rimming the Pacific basin, Hawaii will be the setting for a conference on high-technology development in Pacific-rim countries in the 1990s. The High-Technology Development Corp (Mililani, HI, (808) 625-5293), which is administratively linked with the state's government, is sponsoring its seventh annual Governor's Symposium on High Technology. The 3-day conference will include panels and speakers discussing critical software-industry issues, strategic alliances, displays and imaging, artificial intelligence, competition between Pacific-rim and European countries in 1992, and information ethics. The symposium will take place November 13 to 15 at the Kauai Hilton Hotel.—Steven H Leibson

LOW-SKEW CLOCK BUFFER OFFERS MULTIPLE PHASES

The GA1110 clock buffer from Gazelle Microcircuits (Santa Clara, CA, (408) 982-0222) uses an internal 500-MHz phase-locked loop to match the output clock, which serves as a feedback signal to the incoming clock. You don't need external components to set the loop-filter parameters. The six TTL-compatible output signals can drive as much as ± 24 mA.

If you use an unmodified output signal as the feedback, the input and output clocks will match within 500 psec. You can alter this value by inserting additional logic delays between the output and feedback pins. You can choose from four sets of clock output phases, including combinations of inverted signals and phase shifts of ± 2 and ± 4 nsec. By using different output phases for the feedback, you can obtain phase shifts as great as ± 6 nsec. Available with 25-, 33-, and 40-MHz speeds, the clock comes in a 16-pin DIP and costs approximately \$35 in sample quantities.

—Richard A Quinnell

FOR 75 YEARS WE'VE BELIEVED QUALITY BEGINS RIGHT IN YOUR OWN BACKYARD.

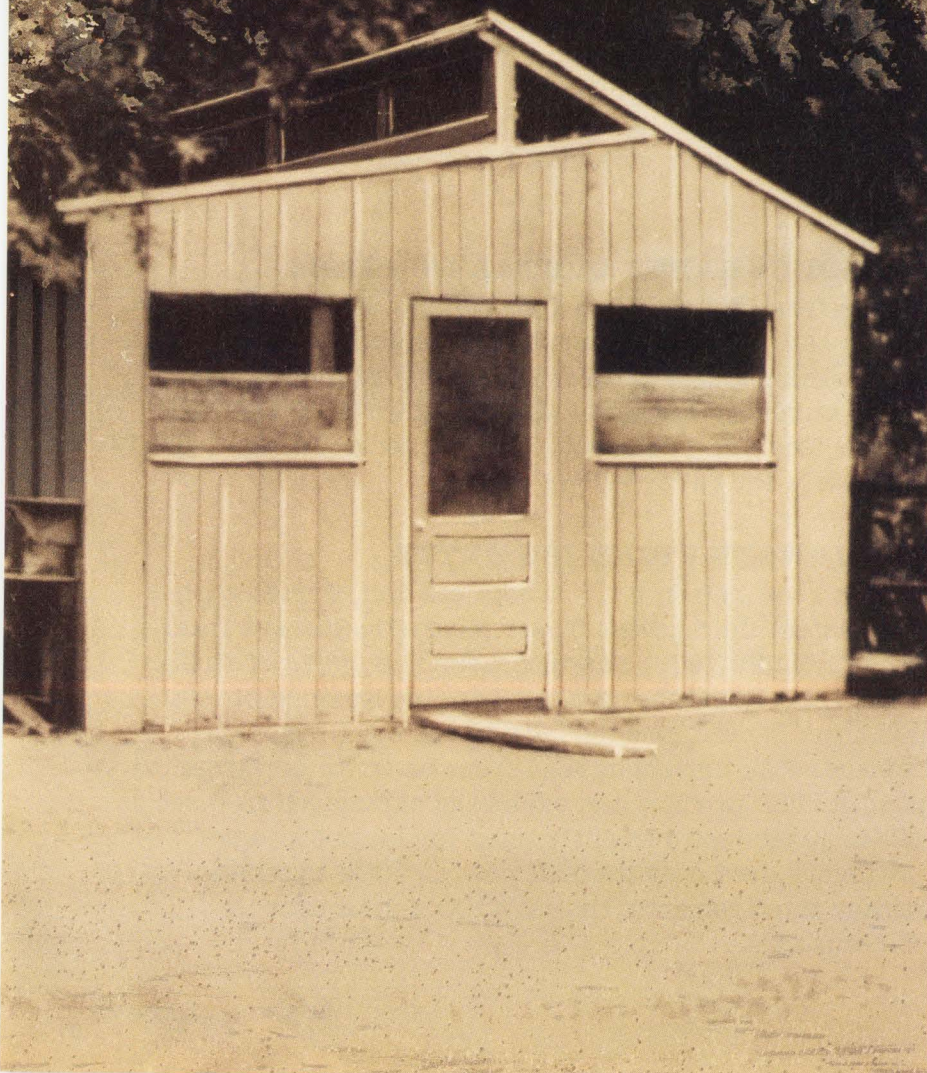

Zero defects. Statistical process control. Total quality management.

When James Cannon founded Cannon Electric in a shed behind his house in 1915, these terms didn't exist.

But the foundations for a solid business did. Because long before built-in quality became the talk of the industry, Cannon was designing quality into all of our connectors.

That commitment to innovative design, dependable products and unsurpassed customer service has paid off. Seventy-five years later, ITT Cannon has become an international supplier of electronic components, with manufacturing operations throughout North America, Europe and Asia, backed by employees dedicated to leading the industry we founded. You see, instead of just paying lip service to quality, we've invested millions of dollars guaranteeing the reliability of our products and service.

On the drawing board, our computer-aided designs create innovative, cost-efficient solutions. On the factory floor, our precision manufacturing equipment employs statistical process controls. And in the testing lab, sophisticated techniques allow advanced material development and environmental performance evaluation.

The result? From commercial avionics and automotive electronics, to computer and medical equipment, our customers get first time, every time performance. From our components. And our people.

So if you expect more than ever from your suppliers, talk to the company that's ready to serve your needs.

ITT Cannon. We discovered the value of quality 75 years ago—right in our own backyard.

1851 East Deere Avenue, Post Office Box 35000
Santa Ana, CA 92705-5300
Phone: (714) 261-5300 Fax: (714) 757-8324/8301
Telex: (714) 655358

CIRCLE NO. 74

ITT Cannon
AN ITT EMC WORLDWIDE COMPANY
Discover our strengths.



NEWS BREAKS

COMBINING FRAMEWORKS TO PROMOTE ORDER

Bringing order out of chaos is the goal of a 3-year agreement between Digital Equipment Corp (Maynard, MA, (508) 467-3589) and Cadence Design Systems (San Jose, CA, (408) 943-1234). The companies are attempting to combine their tool-integration and design-management frameworks with standards such as the CAD Framework Initiative's framework specification, the Open Software Foundation's Motif, and the X Window System. Under the agreement, Cadence can sell the DEC Power-frame framework to its customers immediately.—Michael C Markowitz

ADA DEVELOPMENT SYSTEM RUNS ON PCs

It's not exactly the low-budget language compiler that many programmers have come to expect for PCs, but at \$1815, FirstAda from Alsys Inc (Burlington, MA, (617) 270-0030) is relatively cut-rate for a validated Ada development system. This price gets you an optimizing compiler that generates 8086/8 or 80286 code, a debugger, an automatic-recompilation utility, a cross-reference generator, a source-code reformatter, and a high-speed syntax checker. You also get a text editor and a beginner's guide to Ada. The package runs under DOS and requires a 640k-byte machine with at least 2M bytes of extended memory and 7M bytes of space on your hard disk.—Steven H Leibson

TWO CMOS FAMILIES MEET ESA RADIATION-IMMUNITY SPEC

SGS-Thomson Microelectronics (Phoenix, AZ, (602) 867-6100) supplies two families of rad-hard (radiation absorbed dose) CMOS logic chips for military, aerospace, and similar applications. The 100k-rad CMOS 4000B family meets the European Space Agency's (ESA) 50k-rad radiation-immunity specification for high-speed CMOS logic. The company expects the ESA to approve their second CMOS family, the HSCMOS line, in the first quarter of 1991. Both logic families come in a variety of ceramic packages, including dual in-line and chip-carrier versions. Prices start at \$40 (500).—Susan Bureau

STD BUS CARD OFFERS 144 HIGH-CURRENT DIGITAL I/O LINES

The ZT88CT72 Digital I/O interface from Ziatech (San Luis Obispo, CA, (805) 541-0488) can sink 12 mA on each of its 144 I/O lines. Competing products usually have only 48 channels and 3-mA current-sinking capabilities. The company made these improvements in channel count and current sinking by designing an ASIC instead of using standard off-the-shelf parts. The STD bus card operates over a -40 to +85°C range. The unit is available immediately for \$495.—Doug Conner

12-IN. OPTICAL DRIVE AND CHANGER STORE 28G BYTES

For extremely large on-line storage requirements, 12-in. optical-disk drives with jukebox disk changers provide the fastest data access. Laser Magnetic Storage International Co (Colorado Springs, CO, (719) 599-7900) has increased the speed of these drives further with its 28G-byte LF 4500 RapidChanger, a 12-in., write-once optical-disk drive with a 5-cartridge magazine. Each disk cartridge stores 5.6G bytes on 2-sided media, and the integral optical-disk drive can read from or write on either side of a cartridge without flipping it. The product can exchange cartridges in 3 sec or less—much faster than the 12-in. jukeboxes currently used for large storage applications. The \$16,000 unit transfers data over its SCSI port at 700k bytes/sec. For applications with smaller storage requirements, the LD 4100 1-disk unit is available for \$12,000.—Steven H Leibson



A core, two caps and
Nichrome film can't get you
to market sooner.

Metal film resistance. Lots of people supply it, but at Dale® we have more ways to make it work to your advantage.

From the start, we'll give you more alternatives for fine-tuning resistance to your application — right out of the catalog. Low cost commercial to ultra precision.



Dale Makes Your Basics Better

EDN August 2, 1990

Dale® Can.



High power. Ultra high or low value. Tight tolerance. Matched sets. Thick film chips plus thin film chips and networks for surface mounting. MIL qualifications from MIL-R-22684 through MIL-R-122. All guided

by Statistical Process Control and Just-In-Time delivery systems.

Whether your need is for high performance, high volume or both, Dale has the products and the commitment to meet your exact needs for quality and delivery. Start saving time right now.

Contact your Dale representative or phone 402-371-0080. Dale Electronics, Inc., 2300 Riverside Blvd., Norfolk, NE 68701-2242.

DALE ELECTRONICS, INC.
• • • a VISHAY Company

CIRCLE NO. 75

25

RF TRANSFORMERS

Over 50 off-the-shelf models...

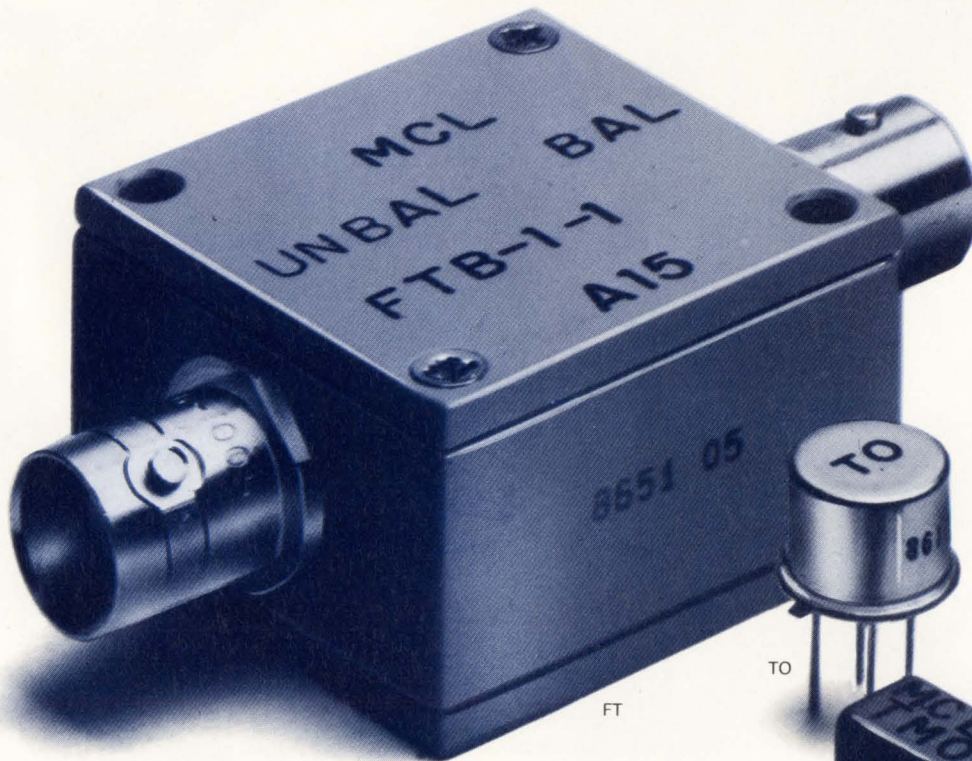

Having difficulty locating RF or pulse transformers with low droop, fast risetime or a particular impedance ratio over a specific frequency range? ... Mini-Circuits offers a solution.

Choose impedance ratios from 1:1 to 36:1, connector or pin versions (plastic or metal case built to meet MIL-T-21038 and MIL-T-55831 requirements*). Ultra-wideband response achieves low droop and fast risetime for pulse applications. Ratings up to 1000M ohms insulation resistance and up to 1000V dielectric voltage. For wide dynamic range applications involving up to 100 mA DC primary current, use the T-H series. Coaxial connector models are offered with 50 and 75 ohm impedance; BNC standard; request other types. Available for immediate delivery with one-year guarantee.

Call or write for 68-page catalog or see our catalog in EEM, or Microwaves Product Data Directory.

*units are not QPL listed

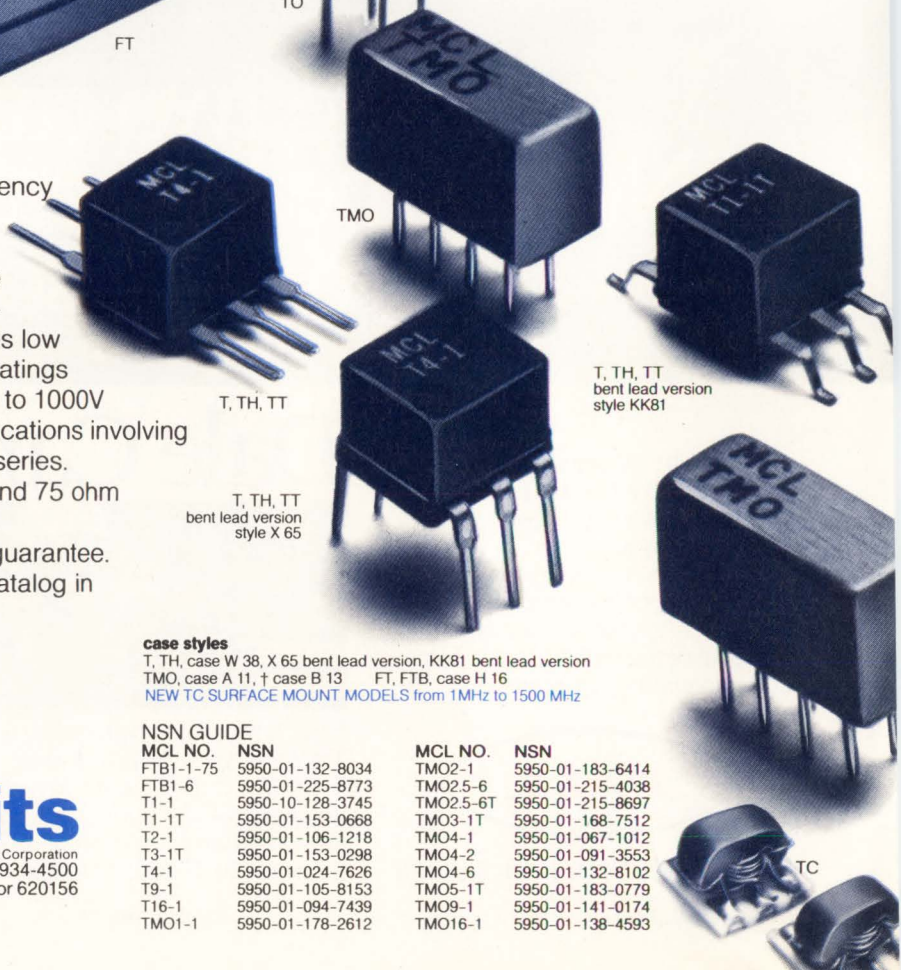

case styles

T, TH, case W 38, X 65 bent lead version, KK81 bent lead version
TMO, case A 11, † case B 13 FT, FTB, case H 16
NEW TC SURFACE MOUNT MODELS from 1MHz to 1500 MHz

NSN GUIDE

MCL NO.	NSN	MCL NO.	NSN
FTB1-1-75	5950-01-132-8034	TMO2-1	5950-01-183-6414
FTB1-6	5950-01-225-8773	TMO2.5-6	5950-01-215-4038
T1-1	5950-10-128-3745	TMO2.5-6T	5950-01-215-8697
T1-1T	5950-01-153-0668	TMO3-1T	5950-01-168-7512
T2-1	5950-01-106-1218	TMO4-1	5950-01-067-1012
T3-1T	5950-01-153-0298	TMO4-2	5950-01-091-3553
T4-1	5950-01-024-7626	TMO4-6	5950-01-132-8102
T9-1	5950-01-105-8153	TMO5-1T	5950-01-183-0779
T16-1	5950-01-094-7439	TMO9-1	5950-01-141-0174
TMO1-1	5950-01-178-2612	TMO16-1	5950-01-138-4593

finding new ways ...
setting higher standards

Mini-Circuits

A Division of Scientific Components Corporation

P.O. Box 350166, Brooklyn, New York 11235-0003 (718) 934-4500
Fax (718) 332-4661 Domestic and International Telexes: 6852844 or 620156

FORMERS

3KHz-800MHz from \$3²⁵

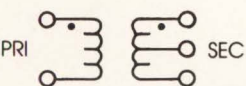
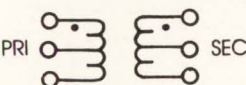
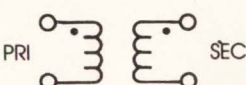
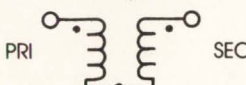
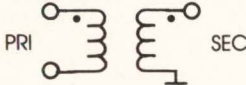
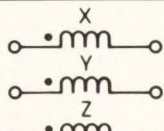
case style number see opposite page	MODEL NO.	Ω RATIO	FREQUENCY MHz	INSERTION LOSS			PRICE \$ Qty. (1-9)		
				3dB MHz	2dB MHz	1dB MHz			
A* 	T	T1-1T	1	05-200	05-200	.08-150	2-80	4.45	
		T1-6T	1	003-300	003-300	01-150	02-50	6.95	
		T2-1T	2	07-200	07-200	.1-100	.5-50	4.95	
		T2.5-6T	2.5	01-100	01-100	.02-50	.50-20	4.95	
		T3-1T	3	05-250	05-200	.1-200	.5-70	4.95	
		T4-1	4	2-350	2-350	.35-300	2-100	3.25	
		T4-6T	4	02-250	02-250	05-150	0.1-100	4.45	
		T5-1T	5	3-300	3-300	6-200	5-100	4.95	
		T8-1T	8	03-140	03-140	.10-90	1-60	7.95	
		T13-1T	13	3-120	3-120	7-80	5-20	4.95	
		T16-6T	16	03-75	03-75	.06-30	1-20	5.65	
		T4-1H	4	10-350	10-350	15-300	25-200	5.95	
		TMO	TMO1-1T	1	05-200	05-200	.08-150	2-80	7.95
		TMO2-1T	2	07-200	07-200	.1-100	5-50	8.45	
		†TMO2.5-6T	2.5	01-100	01-100	.02-50	.05-20	8.45	
		†TMO3-1T	3	05-250	05-250	.1-200	5-70	7.95	
TMO4-1	4	2-350	2-350	.35-300	2-100	6.25			
TMO5-1T	5	3-300	3-300	6-200	5-100	8.45			
TMO13-1T	13	3-120	3-120	7-80	5-20	8.45			
B* 	TT	TT1-6	1	.004-500	.004-500	.02-200	1-50	6.95	
		TT15-1	1.5	075-500	075-500	2-100	1-50	5.95	
		TT2.5-6	2.5	01-50	01-50	.025-25	.05-10	6.45	
		TT4-1	3	05-200	05-200	2-50	1-30	5.95	
		TT4-1A	4	0.1-300	0.1-300	0.2-250	0.3-180	6.95	
		TT25-1	25	02-30	02-30	.05-20	1-10	9.95	
		TTMO	TTMO25-1	25	02-30	02-30	.05-20	1-10	11.95
		TTMO1-1	1	005-100	005-100	01-75	05-40	11.45	
		TTMO4-1A	4	0.1-300	0.1-300	0.2-250	0.3-180	13.95	
		C 	T	T1-1	1	.15-400	.15-400	.35-200	2-50
T1.18-3	1.18			0.01-250	0.01-250	0.02-200	0.03-50	5.65	
T1-6	1			01-150	01-150	02-100	05-50	5.65	
T1.5-1	1.5			1-300	1-300	2-150	5-80	4.45	
T1.5-6	1.5			02-100	02-100	05-50	0.1-25	5.65	
T2.5-6	2.5			01-100	01-100	.02-50	.05-20	4.45	
T4-6	4			02-200	02-200	05-150	1-100	4.45	
T9-1	9			15-200	15-200	3-150	2-40	3.95	
T16-1	16			3-120	3-120	7-80	5-20	4.45	
T36-1	36			03-20	03-20	.05-10	1-5	6.95	
TO	TO-75			1	10-500	—	10-500	40-250	6.95
TH	T1-1H			1	8-300	8-300	10-200	25-100	5.95
T9-1H	9			2-90	2-90	3-75	6-50	6.45	
T16-H	16			7-85	7-85	10-65	15-40	6.45	
TMO	TMO1-02			1	1-800	1-800	2-500	—	9.45
TMO1-1	1			15-400	15-400	.35-200	2-50	6.25	
TMO1.5-1	1.5			1-300	1-300	2-150	5-8	8.45	
†TMO2.5-6	2.5			01-100	01-100	.02-50	.05-20	7.95	
†TMO4-6	4	02-200	02-200	.05-150	1-100	7.95			
TMO6-1	6	3-200	3-200	5-150	5-50	7.95			
TMO9-1	9	15-200	15-200	3-150	2-40	7.95			
TMO16-1	16	3-120	3-120	7-80	5-20	7.95			
D 	T	T2-1	2	050-600	050-600	1-400	5-200	3.95	
		T3-1	3	5-800	5-800	2-400	—	4.45	
		T4-2	4	2-600	2-600	5-500	2-250	3.95	
		T8-1	8	15-250	15-250	25-200	2-100	3.95	
		T14-1	14	2-150	2-150	5-100	2-50	4.95	
		TMO	TMO2-1	2	050-600	050-600	1-400	5-200	7.95
	TMO3-1	3	5-800	5-800	2-400	—	8.45		
	TMO4-2	4	2-600	2-600	5-500	2-250	7.95		
	TMO8-1	8	15-250	15-250	25-200	2-100	7.95		
	TMO14-1	14	2-150	2-150	5-100	2-50	8.45		
	FT	FT1.22-1	1.22	005-100	005-100	01-50	.05-25	35.95	
	FT1.5-1	1.5	1-400	1-400	5-200	1-100	35.95		
E 	FTB	FTB-1	1	2-500	2-500	5-300	1-100	36.95	
		FTB1-6	1	01-125	01-125	05-50	1-25	36.95	
		■FTB-1-75	1	5-500	5-500	5-300	10-100	36.95	
F 	T	T-622	1	0.1-200	0.1-200	0.5-100	5-80	3.25	
		T626	1	0.01-10	0.01-10	0.2-5	.04-2	3.95	

■ Denotes 75 ohm models

* FOR A AND B CONFIGURATIONS

Maximum Amplitude Unbalance
0.1 dB over 1 dB frequency range
0.5 dB over entire frequency range

Maximum Phase Unbalance
1.0° over 1 dB frequency range
5.0° over entire frequency range

CIRCLE NO. 76

C72-2 REV. B

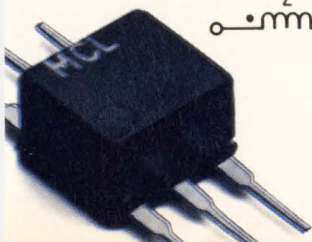

Memory lane.

Introducing the complete line of non-volatile memories from Fujitsu.

Talk about fond memories. With Fujitsu's full line of CMOS and bipolar non-volatile memories, you've got a choice that includes ROMs, EPROMs, EEPROMs and PROMs. Plus all the packaging options you can think of. Now that's worth remembering.

Take our low-power CMOS ROMs, for example. You get densities up to 16Mbits. Plus we're also developing a very high-density 32Mbit device.

But density alone isn't enough. Which is why our ROMs also come in both standard and high-speed versions as fast as 150ns. With blazingly fast 100ns devices just around the corner.

When it comes to EPROMs, we've got the broadest selection in the industry. With densities ranging from 64K to 4Mbits. And speeds up to 150ns.

But the future is always faster. Which is why our 1Mbit device will soon operate at speeds of 55ns and 100ns.

What's more, our 1Mbit and 4Mbit devices are available in x8 and x16 configurations for your most advanced applications.

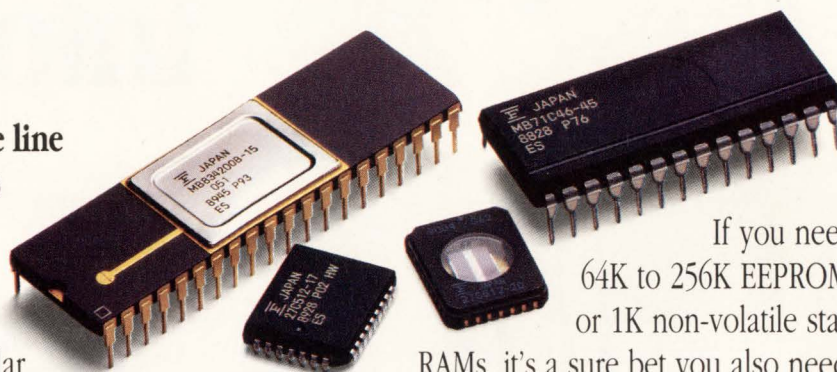

If you need 64K to 256K EEPROMs, or 1K non-volatile static RAMs, it's a sure bet you also need reliability. Which makes Fujitsu the one supplier to always keep in mind.

We've utilized thin-oxide and CMOS technologies in our entire EEPROM product line to provide you with the highest quality and reliability.

Just take a look at the numbers. A failure rate of less than .0004% per 1000 hours. And erase/write cycles of 10,000 minimum and over 100,000 typical. That's reliability.

As for PROMs, it's no secret that Fujitsu devices range from 256 bits to 128K. But now our PROMs are even better. Because our unique new BiCMOS technology increases speed and densities and lowers power consumption.

Both the 128K device, which clocks in at 35ns, and our soon-to-be-announced 256K device, which will run at 25ns, are the fastest PROMs on the market in these densities.

All in all, when it comes to non-volatile memories, only Fujitsu gives you the choice.

If you'd like to know more, call 1-800-642-7616. And take a stroll down memory lane.

FUJITSU

FUJITSU MICROELECTRONICS, INC.

Integrated Circuits Division

3545 North First Street, San Jose, CA 95134-1804. 1-800/642-7616.

Every step of the way.SM

©1990, Fujitsu Microelectronics, Inc.
Every step of the way is a service mark of Fujitsu Microelectronics, Inc.



Signetics. Because into making

WITH OUR FULL FAMILY

To design successful new systems, you need an IC vendor who understands your ever-changing needs. A partner who can match the right device to your application.

That's exactly what you get from Philips Components-Signetics.

As the design world changes, Signetics changes. We're listening to your needs. And designing and enhancing our devices to meet those needs.

Like the growing need for personal communication devices and for ICs in desktop and portable computing. As well as devices for computer networking with compatibility across platforms. And for ICs that meet the need for robotics and automation in manufacturing.

We're also drawing from nearly a century of Philips innovation to apply our consumer technologies to the business world. Including digital video and high-density compact disc storage.

In fact, wherever your design needs take you, Signetics will be there with complete families of devices to meet emerging computing, communications and control needs.

©1990 NAPC

Philips Components

you've put so much it perfect.

OF ICs, YOU GET OUT OF IT WHAT YOU PUT INTO IT.

COMPUTING		COMMUNICATIONS		CONTROL	
APPLICATION	PRODUCT	APPLICATION	PRODUCT	APPLICATION	PRODUCT
Workstations	<ul style="list-style-type: none"> ● Advanced BiCMOS Logic ● High Speed ASICs ● Futurebus Chip Set ● High Speed PAL®-type Devices ● High Performance MCUs ● SRAMs 	Cellular Communications	<ul style="list-style-type: none"> ● Cellular Chip Set ● Frequency Synthesizers 	Automotive Control Systems	<ul style="list-style-type: none"> ● 8-bit 80C51-based MCUs ● OTP EPROMs ● Linear/Digital/Mixed Mode ASICs
Personal Computers	<ul style="list-style-type: none"> ● High Density ASICs/PLDs ● DRAM Controllers ● OTP EPROMs ● FLASH Memory 	Mobile Telephony	<ul style="list-style-type: none"> ● Paging ICs ● Frequency Synthesizers 	Consumer Appliances and Entertainment	<ul style="list-style-type: none"> ● A/D MCUs ● LCD Displays ● Audio Circuitry ● Dolby Noise Reduction ● Frequency Synthesizers
Desk Top Video	<ul style="list-style-type: none"> ● A/D Converters ● Digital Color Decoders 	FAX/Modems/Features Phones	<ul style="list-style-type: none"> ● 8-bit 80C51-based MCUs ● E²PROM ● LCD Drivers ● Dialers ● Speech Circuits ● RF Chip Set 	Industrial Control & Robotics	<ul style="list-style-type: none"> ● Advanced BiCMOS Logic ● UV/OTP EPROM MCUs ● Real-Time Bus Communications Controller
Peripheral Products	<ul style="list-style-type: none"> ● 8-bit 80C51-based MCUs ● Zero Power PLDs ● Programmable Sequencers ● 3-State ECL Transceivers 	DataComm LANs	<ul style="list-style-type: none"> ● Ethernet Chip Set ● 100-Mbit Fiber ● High Speed PLDs ● Advanced BiCMOS Logic 	Portable Instrumentation	<ul style="list-style-type: none"> ● Low Voltage/Power MCUs ● Advanced CMOS Logic ● LCD Drivers
		Multi-Protocol	<ul style="list-style-type: none"> ● Dual Universal Serial Controller ● UARTs and DUARTs 		

As illustrated above, we're listening to customer needs and developing products in three focused areas: computing, communications and control.

This includes products based on our advanced BiCMOS technology, QUBiC. Developed from our strength in bipolar technology and fully integrated with our sub-micron CMOS technology, QUBiC gives you nearly twice the speed of previous-generation bipolar ICs. With CMOS power savings. We're incorporating QUBiC into all our product families, creating a new class of high-performance devices.

Philips Components-Signetics is committed to the military market, with over 80% of our ICs meeting MIL-SPEC certification. This commitment is evident in our Class S domestic assembly plant and DESC-certified wafer fabs.

To learn how Philips Components-Signetics helps you make the perfect design, call today for more information: 800-227-1817, ext. 711D.

PAL is a trademark of AMD/MMI

Signetics

EXTENDING THE DIMENSIONS OF PERFORMANCE



ULTRA-MINIATURE SURFACE MOUNT

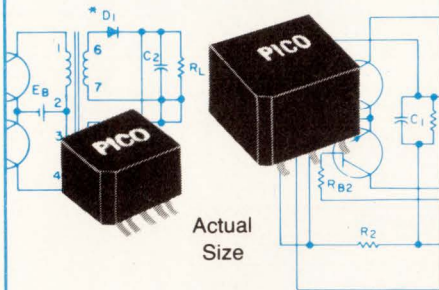

DC-DC Converter Transformers and Power Inductors

These units have gull wing construction which is compatible with tube fed automatic placement equipment or pick and place manufacturing techniques. Transformers can be used for self-saturating or linear switching applications. The Inductors are ideal for noise, spike and power filtering applications in Power Supplies, DC-DC Converters and Switching Regulators.

- Operation over ambient temperature range from -55°C to $+105^{\circ}\text{C}$
- All units are magnetically shielded
- All units exceed the requirements of MIL-T-27 ($+130^{\circ}\text{C}$)
- Transformers have input voltages of 5V, 12V, 24V and 48V. Output voltages to 300V.
- Transformers can be used for self-saturating or linear switching applications
- Schematics and parts list provided with transformers
- Inductors to 20mH with DC currents to 23 amps
- Inductors have split windings

Delivery—
stock to
one week

SEE EEM,
THOMAS REGISTER
OR SEND DIRECT FOR
FREE PICO CATALOG

PICO
Electronics, Inc.

453 N. MacQuesten Pkwy. Mt. Vernon, N.Y. 10552

Call Toll Free **800-431-1064**

IN NEW YORK CALL **914-699-5514**

CIRCLE NO. 1

SIGNALS & NOISE

On abbreviations and communications

The purpose of my discussion of abbreviations is twofold:

1. As EDN and other publications are vehicles to educate and inform engineers, I feel very strongly about keeping communication lines open and uncluttered as our industry grows more diverse daily. Journals keep the industry communication lines open by disseminating information across engineering boundaries.

2. Our young engineers just starting on this exciting road of electronics are confused enough already. This journal should be an example for these engineers to learn and copy from.

The standards we transmit to readers today will shape the future of intercommunication in the industry, bringing understanding to many. [This understanding] may help solve problems today or help bring forward the discoveries of tomorrow.

In Anne Swager's article (EDN, March 29, 1990, pg 59) on analog-to-digital converters (ADCs), I seemed to have gotten tangled in more than 40 undefined or mixed abbreviations. I haven't been a long-time reader of your journal; however, I've been reading technical journals of similar caliber for many years. I note that unexplained abbreviations are usually a professional trait that hides ignorance or tries to impress—and succeeds in doing neither.

Even the military has noted, as a documentary necessity, that there are standards and etiquette for using abbreviations. This etiquette [dictates] writing out the meaning of abbreviations in full at the first occurrence, with the abbreviation following in parentheses. In the article by J D Mosley (EDN, March 29, 1990, pg 79), FDDI was handled in exactly this way.

Anne's article was of interest, but its inconsistency was distracting. Please explain what the first sen-

tence, fourth paragraph on pg 59 was trying to say. Aren't hybrids integrated circuits? Also in the same paragraph, is the "sample-and-hold function" the same as S/H?

On pg 61, I think what was meant is that "The HDAS-75 and -76 75-kHz hybrids typically dissipate 500 mW" [rather than 500 mW typ]. Lastly, I do not think the number of pins determines the interface type (serial or parallel) as the fifth paragraph on pg 64 would suggest. As a magazine dedicated to inform and educate, I am pleased in general with the level of communication your journal offers.

Chris Gidden

Crag Consultants Ltd of St Helier
Jersey Channel Islands
Gardena, CA

(Ed Note: EDN acknowledges that the electronics industry is full of acronyms, and we strive to invent none of our own. However, we do maintain a list of what we believe are commonly understood abbreviations. That "S/H" stands for "sample and hold" and "ADC" for "analog-to-digital converter" are just two examples of abbreviations we expect most of our readers to be familiar with. When we use less common abbreviations, we do spell them out on first use.

Rather than use monolithic IC and hybrid IC throughout the entire article, the author chose the common usage of IC as monolithic and hybrid for a hybrid IC. As far as this article is concerned, the words "sample and hold" simply refer to the function, and "S/H amplifier" refers to the physical device.

Chris Gidden correctly points out that the number of output pins in and of itself does not determine a device's interface type. However, because monolithic ICs are typically smaller than hybrid packages (and therefore don't have the space for a large number of output pins), most manufacturers design these monolithic data-acquisition ICs with serial interfaces.)

EDN



With this Ethernet chip set, your competitors will swear you took a shortcut.

The shortest route to market begins with our three-chip set—the EtherStar™ controller, encoder/decoder, and transceiver—from Fujitsu's Advanced Products Division.

We've engineered this Ethernet set to offer you unparalleled ease of design. With our expert design support and optional manufacturing kit, you have everything you need to get new products out in record time.

EtherStar's unique buffer manager automatically controls buffer memory access and allocation, making application software easier to develop. And EtherStar handles many functions usually performed by the software driver in hardware—boosting system performance. No wonder official Novell certification tests show that products based on our chip set have higher data-transfer rates.

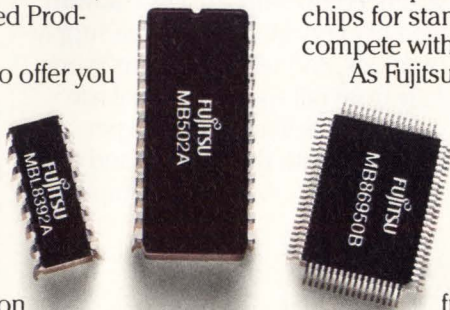

Unlike some of our competitors, we can supply you with complete system solutions, including interface chips for standard bus architectures. And we don't compete with you by selling boards.

As Fujitsu's American arm, we're in close touch with your marketplace and what you need to excel there. So call us at 1-800-866-8608. Learn about the family of high-performance Ethernet solutions from Fujitsu's Advanced Products Division.

And take the shortest, smartest pathway to Ethernet success.

NOVELL LABS
AUTHORIZED
**TESTED AND
APPROVED**
NetWare Compatible™

FUJITSU

EtherStar is a trademark of Fujitsu Microelectronics, Inc. © 1990 Fujitsu Microelectronics, Inc.
FUJITSU MICROELECTRONICS, INC., Advanced Products Division, 50 Rio Robles, San Jose, CA 95134-1806.

National's family of CMOS op amps rises to a new all-time low: 40 femtoamps.

TAKING IT TO THE LIMITS WITH ULTRA-LOW INPUT BIAS CURRENT.

National's new quad/dual CMOS op amps, the LMC660/662 and the LPC660/662, feature an extremely low input bias current of 40 fA typical. You can't go much lower.

FEATURING RAIL-TO-RAIL OUTPUT SWING.

With a newly patented double feed-forward circuit architecture, National's op amps provide an output swing that extends from one supply rail to the other. You can't swing any more than that.

Use the LMC660/662 and LPC660/662 to drive rail-to-rail input A/Ds, or take advantage of the LMC's fully specified 600 Ω load capability to process audio in telecom and cellular radio applications. Other typical applications include:

- Handheld meters
- Medical instrumentation
- Remote sensors
- Electrometers
- Spaceborne/Avionic subsystems

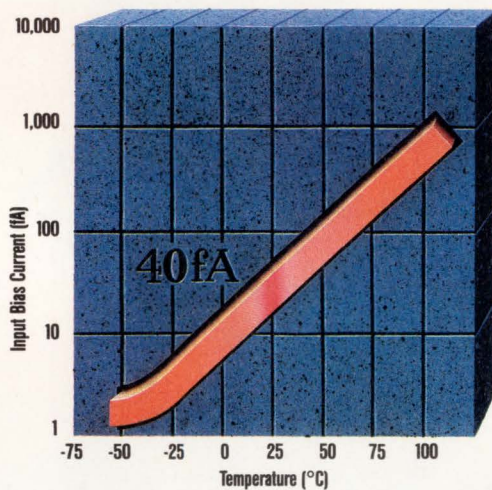
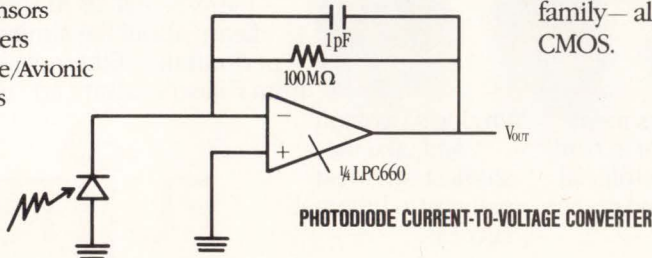

**INPUT BIAS CURRENT VS. TEMPERATURE:
40 fA AT 25°C**

NATIONAL REDEFINES SINGLE-SUPPLY OPERATION.

In the past, a single-supply op amp was an amplifier whose input common-mode range included ground. But in today's +5V systems, you need op amps that take advantage of every last volt that the supply provides, and whose outputs swing fully from rail-to-rail. National was the first to deliver rail-to-rail performance with the LMC660 and now

has a complete family — all in CMOS.

POWER UP WITH LOW POWER AND MICROPOWER.

If you're looking for low power, there's the LMC660/662, which operate at 375 μ A/amplifier. Or if your application calls for 40 μ A/amplifier, we offer the LPC660/662, micropower versions of the popular LMC series. In either case, you get lower power dissipation and a longer lasting battery.

LMC660/LPC660 VS. THE COMPETITION

	LMC660AI	LPC660AI	TLC274AI
Output Swing (V⁺ = +5V)	0.15V to 4.82V	0.03V to 4.97V	0.05V to 3.2V
V _{OS} (max)	3 mV	3 mV	5 mV
I _b (typ)	40 fA	40 fA	600 fA
Supply Current (typ)	375 μ A/amp	40 μ A/amp	675 μ A/amp

GET THE LOWDOWN.

For more information on our new CMOS op amps and growing family of high-performance amplifiers, including VIP™ Bi-FET™ Super-Blocks™ and precision, call or write us today: 1-800-624-9613, Ext. 66. In Canada: 1-800-548-4529, Ext. 66. National Semiconductor Corporation, P.O. Box 7643, Mt. Prospect, IL 60056-7643. And find out how we can help take your designs to new heights.

ASK EDN

EDITED BY JULIE ANNE SCHOFIELD

Have you been stumped by a design problem so long that you don't know who to turn to? Are you having trouble locating parts? Finding companies? Can't interpret a spec sheet? Ask EDN.

This department will serve as a forum to solve nagging problems and answer difficult questions. EDN's editors will provide the solutions. If we can't solve a problem, we'll find an expert who can, or we'll print your letter and ask your peers for help. We can't answer every question, but we'll try to publish the ones that will help you most in your job.

Address your letters to Ask EDN, 275 Washington St, Newton, MA 02158. FAX (617) 558-4470; MCI: EDNBOS.

Reader seeks frequency converter

Can you tell me where I can purchase a 6A frequency converter that will take 120V ac, 60-Hz input and allow 100 to 120V ac, 50-Hz output? My company needs such a converter for the in-house testing of products used in foreign countries.

If you do not know of such equipment, have you published information on an electrical circuit for such purposes?

*I J Rocklin
General Manager
Rocklin Manufacturing Co
Sioux City, IA*

We found more than 20 companies that offer frequency converters with the specs that Mr Rocklin is looking for. The list includes

Abacus Controls Inc
85 Readington Rd
Somerville, NJ 08876
(201) 526-6010

Industrial Test Equipment Co
21 Yennicoock Ave
Port Washington, NY 11050
(516) 883-1700

Power Star Inc
17346 Eastman St
Irvine, CA 92714
(714) 261-5377.

Senior Editor Charles H Small offers this piece of advice:

"As a former engineer at an uninterruptible-power-supply company, I have some simple advice that may surprise you: Make a motor/generator set. Get a 60-Hz motor and a generator rated for 50 Hz. Mount appropriately sized pulleys on the generator and motor shafts and connect the pulleys with a V belt.

"Such a setup is easy to cobble up from readily available components. The generator output will be a clean, isolated sine wave. The setup is robust; if you add properly sized circuit breakers, the setup will survive any conceivable insult. You can't say the same for small solid-state converters."

Reader in the dark about light pens

Where can I find light pens?

*A Banerjee
Research and Development
Engineer
Orphic Systems Inc
Philadelphia, PA*

Among the dozen or so companies that offer light pens are

Design Technology
5710 Ruffin Rd
San Diego, CA 92123
(619) 268-8194

Opto Technology Inc
562 Chaddick Dr
Wheeling, IL 60090
(312) 537-4277

Rehlander Associates
118A Bridge St
Beverly, MA 01915
(617) 922-5961.

Help locate software company

I am hoping that one of your readers can help me locate a software program once advertised in your magazine. The program is "Part-lister" from Livewire Software, Pacific Palisades, CA. I have tried for several months to contact them, but they seem to have either moved or gone out of business.

If anyone can help me find a copy of this program, I would certainly appreciate their help.

*Jon Sanserino
Technical Director
Datawave Inc
Van Nuys, CA*

We called the phone number on the advertisement that Mr Sanserino included with his letter, but the number is now that of a private citizen, to whom we apologize for bothering. If any reader knows the whereabouts of this company, please drop Ask EDN a line.

EDN

You Can Only Go to a

Oki's New 0.8 μ m ASICs

If your ASIC vendor's 1.0 μ m product is at the end of its shrink, your anxieties are justified. When they'll get to the higher speeds and densities you need for next-generation products is a good question.

Oki's there now. Our new family of *true* 0.8 μ m drawn sea-of-gates offers the migration path you need to 0.6 μ m, 0.5 μ m, and beyond. With 200 ps to 400 ps gate delays and 500 MHz flip-flops, these new CMOS 5-Volt SOGs provide the high-speed performance your systems require now — and in the future. Manufactured on a proven, high-volume production line, they also provide the guaranteed quality and reliability your systems demand.

Choose from a range of products — 4K to 92K usable

gates — and JEDEC metric packages, including QFP and PGA. Our automatic test vector generation (ATVG) capability using scan macros allows you to achieve greater than 95% fault coverage. And it's easy to design with Oki ASICs. We support many popular industry-standard platforms and offer industry-standard in-house tools such as Verilog[®] and Explorer Rene.[™]

Start easing your ASIC anxieties today. Call 1-800-654-6994 and schedule a consultation. We'll analyze your ASIC needs and provide the complete design support you need for today's high-density systems — and for those even higher performance systems you've thought about, but couldn't design. Now you can — with Oki.



Transforming technology into customer solutions

Shrink for So Long

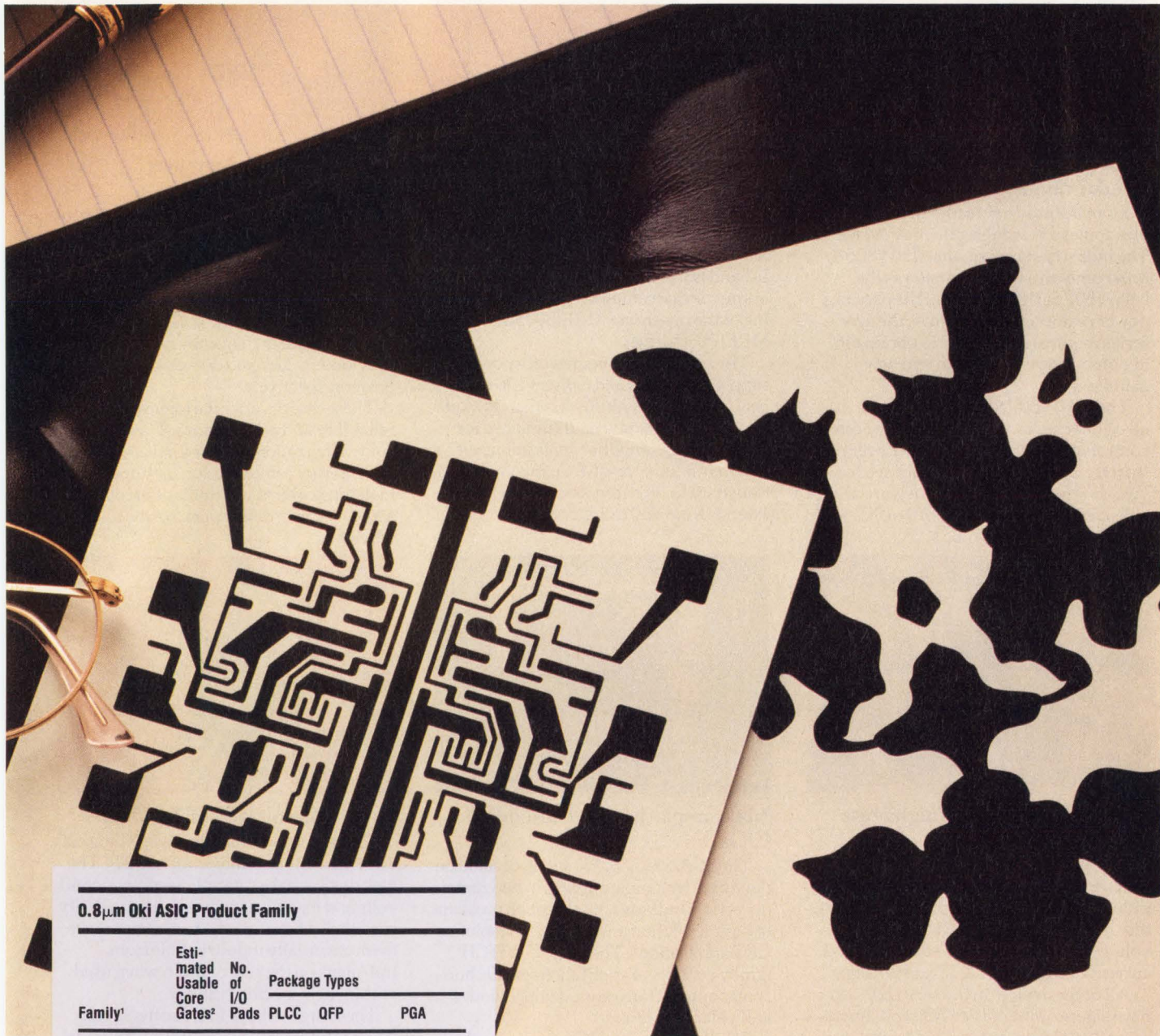

0.8μm Oki ASIC Product Family

Family ¹	Esti- mated Usable Core Gates ²	No. of I/O Pads	Package Types		
			PLCC	QFP	PGA
MSM10S01XX	4K	100	68, 84	60 to 100	88 to 108
MSM10S03XX	12K	160	68, 84	80 to 144	88 to 132
MSM10S05XX	22K	208		120 to 208	108 to 208
MSM10S09XX	36K	272		144 to 272*	108 to 256
MSM10S11XX	47K	304		144 to 304*	132 to 301
MSM10S18XX	72K	384		144 to 304*	208 to 340
MSM10S23XX	92K	424		144 to 304*	240 to 340

¹Other products are under development

²Up to 100% utilization increase with 3-layer metal, memory, and other regular blocks

*JEDEC metric packages



OKI
Semiconductor

785 North Mary Avenue
Sunnyvale, CA 94086-2909
Telephone 1-800-654-6994

*Verilog is a registered trademark of Cadence Design Systems, Inc.
Explorer Rene is a trademark of Mentor Graphics Corporation.*

Motorola Discrete



High gain power modules for mobile cellular radios.

From the industry leader in power modules comes a new high gain improvement. The industry standard, the MHW806A, now comes in a 0-dBm version as the MHW807 Series. Instead of the previous power requirement of 30 mW, the new series requires only 1 mW to obtain 6W of output power, thanks to two new gain stages.

The MHW807 Series is perfect for all cellular radio applications. They offer controllable, stable performance over more than the 35 dB range in P_o that's needed. Two different frequency models are available: 820 to 850 MHz and 870 to 905 MHz.

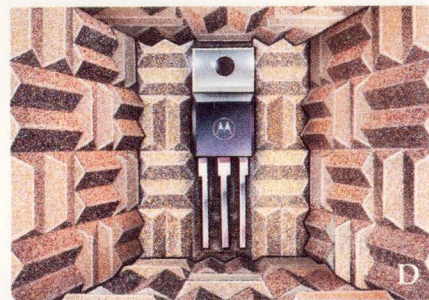

Special TRIACS offer high noise immunity.

The MAC219 series of TRIACS is designed specifically for applications in industrial areas where high noise immunity is required. These TRIACS have voltage ratings from 200 to 800 volts and current ratings of 8, 12, 15 and 20 amps.

All of the devices in the MAC219 series have a noise immunity of 500 volt/microsecond minimum value. This critical rate of rise of off-state voltage is five times that of standard devices with equivalent specifications.

They're perfect for exceptionally demanding applications in AC power control where noise immunity is essential to successful operation of the TRIAC. Use them in appliance controls, industrial controls and AC power circuits involving motors and other inductive loads.

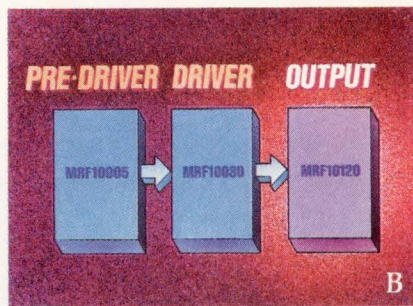

Long pulse microwave power transistor.

Motorola continues to expand its long pulse microwave power transistor portfolio with the introduction of its new 120 watt L-Band transistor, the MRF10120. This output device completes the lineup consisting of the pre-driver MRF10005 and the MRF10030 driver.

The MRF10120 operates on a power supply of 36 volts and delivers 120 watts of peak power for typically less than 15 watts of peak RF input power. It's designed for common base amplifier applications such as JTIDS (military) and Mode S (commercial) transmitters. The frequency of operation extends from 960 to 1215 MHz.

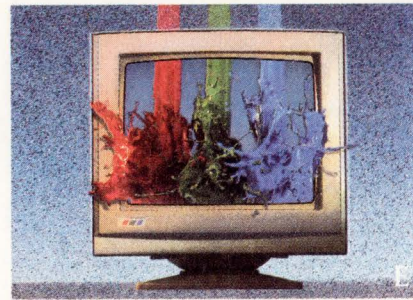

Make a splash in high resolution CRTs.

The SCANSWITCH™ family of semiconductors offer simple answers to horizontal deflection and video amplification problems in high resolution and ultra high resolution CRT applications. The SCANSWITCH family consists of application specific horizontal output transistors, damper diodes and video amplifiers.

Single-chip control ICs are also available for personal computer monitors to reduce design complexity and overall system cost.

All the devices are designed to improve performance in monochrome and color CRT monitors with horizontal scan frequencies of 50 kHz or greater. They offer reduced power dissipation and the ability to work over a wide range of frequencies.

For horizontal output, video amplifiers and multimode horizontal, vertical and video processors, the SCANSWITCH family of semiconductors is the answer.



Satellite microwave power transistors.

Three new microwave power transistors are available for large-signal output and driver amplifier stages for satellite up/down links. The MRA1600-2, MRA1600-13 and MRA1600-30 are designed for Class C, common base amplifiers that operate in the 1600-1660 MHz frequency range. They provide 2.2, 12.7 and 30 watts of minimum power respectively.

These devices offer the highest in reliability and performance. They feature gold metalization, diffused ballast resistors and internal compensation for impedance matching control. All this is offered in a low-cost microwave package for cost efficiency.

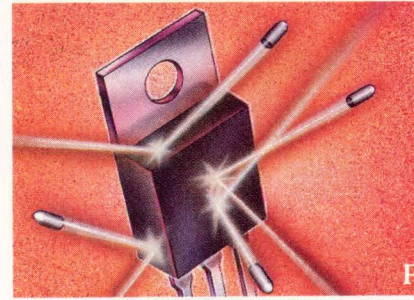

New high-voltage EFETs.

There's some new additions to Motorola's advanced line of Bulletproof™ EFETs. The new devices have gate voltage ratings of 40 volts and have avalanche energy capability specified. These two characteristics make them essentially indestructible from transients on the gate or drain when used within their specified ratings.

These high voltage EFETs offer breakdown ratings from 400 volts to 1000 volts in the industry's standard TO-218 and TO-200 plastic package. They allow the design of line operated circuits such as motor controls, power supplies and lamp ballasts and other high voltage circuits with a higher degree of reliability.

Many other EFETs are available with smaller size die housed in both metal and plastic packages, including isolated Full Paks™.

Design News

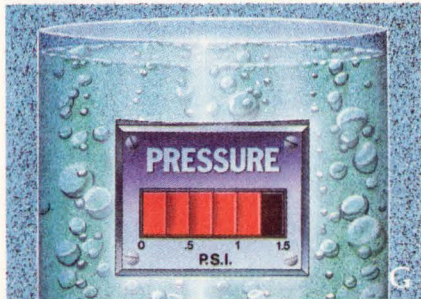

Low pressure transducer for critical applications.

This new low pressure, temperature compensated, fully calibrated sensor provides a very accurate and very linear voltage output directly proportional to pressure differentials. Its accurate range is from 0 to 1.5 PSI.

The MPX2010D pressure sensor is calibrated for a full-scale span of 25 mV, with a linearity error of less than 1.0 percent, due to laser trimming of critical on-chip components. Even with temperature variations from 0 to 85°C, typical span error is only ± 1.0 percent.

A variety of package options make it perfect for applications in automotive, industrial, medical, and many more.

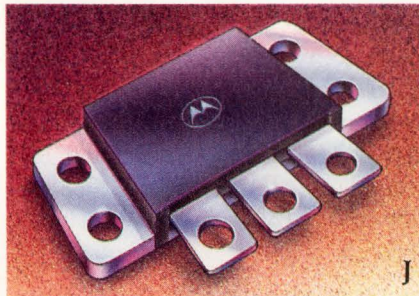

Switchmode power rectifier with dual Schottky barrier.

These new high current, dual Schottky rectifiers are available in an electrically-isolated low profile package. Less hardware and tooling is required for mounting than with conventional stud-mounted rectifiers. Both reverse avalanche energy and dv/dt are specified.

Their low inductive package is of obvious advantage in high frequency switching applications. And the platinum barrier metal technology creates optimum forward voltage drop and low reverse leakage current.

The MBR16035CT, MBR16055CT and MBR16050CT Schottky barrier rectifiers are rated at 160 amps continuous, with a non-repetitive peak surge current of 1200 amps. V_{rrm} is rated at 35, 45 and 50 volts minimum respectively.

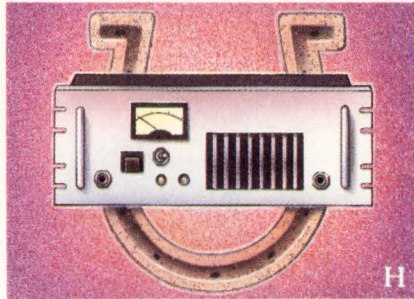

A new breed of workhorse.

Now you can have the same rugged workhorse you've enjoyed for your high-power applications in a medium-power, broadband amplifier. The PAA series of broadband amplifiers are bred to outwork and outlast the competition.

They're ruggedly built with the same power components as our high-power PAA Series including MIL-STD capacitors and resistors, gold-plated connectors, MIL-SPEC plating and painting, EMI/RFI input filter, heavy-duty machined housings with stainless steel hardware, and teflon-coated wire.

For high-reliability performance you can depend on in a medium-power amplifier, Motorola's PAA Series is the answer.



They're here. High volume, small-footed Optoisolators.

There's a new, reliable, UL-recognized optoisolator for designers who need the time and space savings of opto coupling in small outline, surface mount packages—the MOC200 Series.

Motorola supplies all MOC200 devices in the industry-standard SOIC-8, eight pin packages. And, they're available in tape-and-reel option, conforming to EIA standard RS481A. These devices offer a variety of output configurations:

- 30 & 70 volt transistors @ $I_F=10mA$
- 30 volt transistors @ $I_F=1mA$
- PhotoDarlington detectors

Each of the 12 small-footprint types in the series is packaged with a stable, long-life infrared emitting diode, and features high input-output isolation of 2500 vac(rms), minimum.

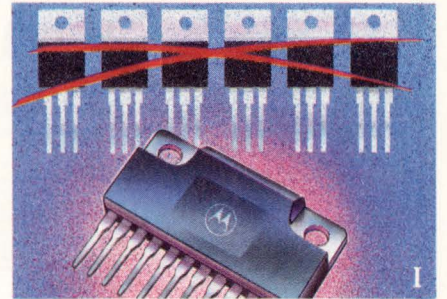

ICePAK™ TMOS Power Modules for brushless motor control.

Just one ICePAK™ power module replaces 6 power MOSFETS in brushless motor applications. Motorola's MPM3003 power module can handle high surge of up to 25 amps at motor startup. It's a complete three-phase bridge with three N-channel MOSFETS in the lower legs and P-channel MOSFETS in the three upper legs.

This power module is rated at 60 volts to 100 volts at 8 to 10 amps. It offers high dissipation capability and a mechanically rugged, isolated, space-saving package.

Get more information.

To get more information on any of the Motorola products shown here, contact your local Motorola sales office, complete and return the coupon below to Motorola Semiconductor Products, Literature Distribution Center, P.O. Box 20912, Phoenix, AZ 85036. Or call toll-free any weekday, 8:00 a.m. to 4:30 p.m. (MST) 1-800-521-6274.



MOTOROLA

To: Motorola Semiconductor Products, Inc.
P.O. Box 20912, Phoenix, AZ 85036

Please send me more information on:

- | | |
|---|--|
| <input type="checkbox"/> A MHW807 Power Modules | <input type="checkbox"/> G Low Pressure Transducers |
| <input type="checkbox"/> B Microwave Power Transistors | <input type="checkbox"/> H PAA Broadband Amplifiers |
| <input type="checkbox"/> C MRA1600 Series Power Transistors | <input type="checkbox"/> I TMOS Power Modules |
| <input type="checkbox"/> D TRIACS | <input type="checkbox"/> J Switchmode Power Rectifiers |
| <input type="checkbox"/> E SCANSWITCH™ | <input type="checkbox"/> K Surface-Mount Optoisolators |
| <input type="checkbox"/> F High-Voltage EFETs | |

Name _____ 438EDN080290

Title _____

Company _____

Address _____

City _____

State _____ Zip _____

Call me (_____) _____

We did it...

10 lbs in a 5 lb sack.

All on a Single ISA Bus Card

CEX500 Multi-Purpose Expansion Cards				
Standard Functions	Optional Function Descriptions			
	COM1, COM2, LPT1 Floppy & IDE	ST506 Interface	SCSI Interface	VIDEO
CEX540				N/A
CEX541				CGA/MONO
CEX542			✓	N/A
CEX543			✓	CGA/MONO
CEX550				N/A
CEX560	✓			
CEX561			✓	
CEX562	✓	✓		
CEX570				VGA*
CEX571			✓	
CEX572	✓	✓		
CEX573			✓	
CEX580		✓		SUPER VGA*
CEX581			✓	
CEX582	✓	✓		
CEX590		✓		FLAT PANEL VGA*
CEX591			✓	
CEX592	✓	✓		



"19 Years of Quality Service"

Diversified Technology

An Ergon Co.

112 E. State St. • Ridgeland, MS 39157

* Downward Compatible W/EGA Monitor

**Call Us About The Configuration
That Best Meets Your Needs.**

1-800-443-2667

CIRCLE NO. 2

Clear Out Your Excess Parts And Earn Tax Benefits Up To 200%

Q: How can my company benefit by donating excess parts, assemblies and products?

A: Your donations could be good for an above cost tax deduction of up to 200% under IRS 170(e)(3).

Q: Who could possibly need my excess parts?

A: Over 700,000 students in community, technical and four-year colleges need thousands of metal, electric, electronic parts and all kinds of equipment for **training**.

Q: How do the colleges get them?

A: We have nine warehouses around the country where members (colleges and other non-profits) come in and select what they need.

Q: Is this a unique service?

A: Absolutely. No one else can match our **network** of warehouses. Fast service for over 900 companies and hundreds of colleges. We are the only **non-profit** 501(c)(3) offering this. So call or write today and we'll reply within 48 hours.

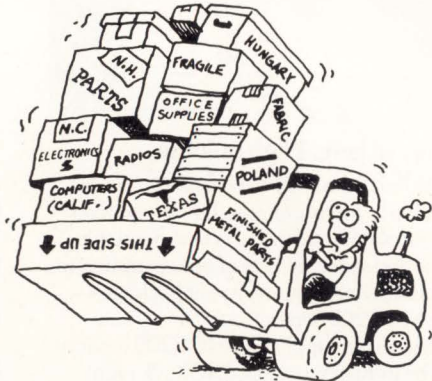

Company/College

Gifts-In-Kind Clearing House

P. O. Box 850 Davidson, NC 28036 704/892-7228

Program expanded to Eastern bloc countries — Hungary, Poland, etc.

CALENDAR

Surface Mount Manufacturing (short course), Bethlehem, PA. National Training Center for Microelectronics, Northampton Community College, 3835 Green Pond Rd, Bethlehem, PA 18017. (215) 861-5486. FAX (215) 861-5060. August 6 to 8.

SIGGRAPH '90: 17th International Conference on Computer Graphics and Interactive Techniques, Dallas, TX. SIGGRAPH '90, Conference Management, 111 E Wacker Dr, Suite 600, Chicago, IL 60601. (312) 644-6610. FAX (312) 938-1232. August 6 to 10.

Upgrading, Troubleshooting, and Maintaining your NetWare LAN (seminar), Newport Beach, CA. Center for Advanced Professional Development, 1820 E Garry St, Suite 110, Santa Ana, CA 92705. (714) 261-0240. August 9 to 10.

Controlling the SMT Process (short course), Bethlehem, PA. National Training Center for Microelectronics, Northampton Community College, 3835 Green Pond Rd, Bethlehem, PA 18017. (215) 861-5486. FAX (215) 861-5060. August 13 to 15.

Transient Voltage: Risk, Principles, and Solutions (seminar), Tampa, FL. GSI Educational Services, 2001 W 10th Pl, Tempe, AZ 85281. (800) 776-8358. August 14.

Software Quality Assurance and Testing (short course), San Diego, CA. Learning Tree International, 6053 W Century Blvd, Los Angeles, CA 90045. (800) 421-8166; in CA, (213) 417-8888. FAX (213) 410-2952. August 14 to 17.

High Volume Electronic Printing: User Needs and Vendor Solutions (conference), Boston, MA. BIS CAP International, Research Publications and Conferences Div, Box

MEGA MEMORY.

SONY HIGH-DENSITY SRAMS				
MODEL	CONFIG.	SPEED (ns)	PACKAGING	DATA RETENTION
CXK581000P*	128K x 8	100/120	DIP 600 mil	L, LL
CXK581000M*	128K x 8	100/120	SOP 525 mil	L, LL
CXK581100TM*	128K x 8	100/120	TSOP	L, LL
CXK581100YM*	128K x 8	100/120	TSOP (reverse)	L, LL
CXK581001P	128K x 8	70/85	DIP 600 mil	L
CXK581001M	128K x 8	70/85	SOP 525 mil	L
CXK581020SP	128K x 8	35/45/55	SDIP 400 mil	
CXK581020J	128K x 8	35/45/55	SOJ 400 mil	

*Extended temperature range available. L = Low power. LL = Low, low power.

MEGA COMMITMENT.



As you can see, Sony's more committed than ever to meeting your high-density SRAM needs.

Just consider the enhancements we've made in a few short months: TSOP and TSOP-reverse packaging. Low data retention current. And extended temperature range.

All based on our unique 0.8-micron CMOS technology, and available in 32-pin DIP and surface-mount plastic packages.

Then consider our ever-increasing production capabilities. We've just added yet another SRAM facility in Japan. And acquired a large AMD facility in San Antonio, Texas.

So you can really count on us in a crunch. Need more proof we're serious about your each and every SRAM need?

Call us. We've got more breakthroughs on the way. Well over 100 SRAM products spanning the performance spectrum. And the desire to meet—or exceed—your toughest performance spec.

Sony high-density SRAMS are shipping now, complete with competitive pricing. So call (714) 229-4190 today. Or write Sony Corporation Of America, Component Products Company, 10833 Valley View St., Cypress, CA 90630, Attention: Semiconductor sales. FAX (714) 229-4285.

SONY®

MORE IN THE SERIES OF DESIGN ADVANTAGES

LOG/iC

THE SHORTEST CONNECTION BETWEEN IDEA AND SILICON!

Design Advantage #3

OPTIMIZATION

By using our own proprietary algorithm which allows for table optimization and 'Don't Cares' on outputs, LOG/iC achieves unparalleled reduction. This allows use of the smallest devices from a wider selection, often preventing the need for partitioning.

Contact ISDATA 1-800-777-1202 for complete details on these and other design advantages of LOG/iC.

Design tools that take your functional descriptions for optimal implementation into semicustom ASICs from PLDs to Gate Arrays.

Design Advantage #7

PARTITIONING

'Interactive' device partitioning keeps you in control of complex designs for the most intelligent design implementation. Works with our PLD Database for architectural reference and aids in automatic device selection.

ISDATA™ 800 AIRPORT RD.
MONTEREY, CA
93940
408 373-7359
INCORPORATED

CIRCLE NO. 4

CALENDAR

68, Newtonville, MA 02160. (617) 893-9130. FAX (617) 894-5093. August 15 to 17.

Image Processing on PCs (seminar), Marlboro, MA. Data Translation, 100 Locke Dr, Marlboro, MA 01752. (508) 481-3700. FAX (508) 481-8620. August 16 to 17.

SMT Workmanship Standards, Inspection, Rework and Repair (short course), Bethlehem, PA. National Training Center for Microelectronics, Northampton Community College, 3835 Green Pond Rd, Bethlehem, PA 18017. (215) 861-5486. FAX (215) 861-5060. August 16 to 17.

ICEC-IEEE Holm Conference on Electrical Contacts, Montreal, Quebec, Canada. IEEE Holm Conference Registrar, Box 1331, Piscataway, NJ 08855. (201) 562-3863. August 20 to 24.

1990 IEEE International Symposium on Electromagnetic Compatibility, Washington, DC. IEEE 1990 EMC Symposium, Box 19342, Washington, DC 20036. (703) 521-6336. August 21 to 23.

Surface Mount '90, Boston, MA. MG Expositions Group, 1050 Commonwealth Ave, Boston, MA 02215. (800) 223-7126; in MA, (617) 232-3976. August 28 to 30.

Adaptive Signal Processing (short course), Garmisch Partenkirchen, West Germany. CEI-Europe/Elsevier, Box 910, S-61201 Finspong, Sweden. +46(0)122-17570. FAX +46(0)122-14347. September 3 to 7.

Second International Connection Congress, Tarpon Springs, FL. Worldwide Convention Management Co, Box 159, Libertyville, IL 60048. (708) 362-8711. FAX (708) 362-3484. September 5 to 7.

NEW
Gated-Oscillator
16 BIT Programmable



PDO-1600-5



E₀

OUT

- Jitter-free
- TTL IN/OUT
- Stable frequency
- V_{co} replacement
- 10 MHz upper frequency
- Reliable & repeatable frequency

(201) 773-2299
FAX (201) 773-9672
Clifton, New Jersey 07013

data delay devices, inc.

CIRCLE NO. 5

ADVERTISEMENT

Standard Grigsby Offers Conductive Metal Domes.

Stainless steel domes for use with membrane products are available from Standard Grigsby, Inc. Used between membrane switch layers, the .375" square domes provide tactile and audible feedback. Life is estimated to exceed 3 million actuations.

These corrosion-resistant domes are priced at \$44.00/1000 in 5,000-piece lots. Delivery: from stock. Contact the company for free samples and additional information. Standard Grigsby, Inc., Aero Park, 88 N. Dugan Rd., P.O. Box 890, Sugar Grove 60554-0890. (708) 556-4200, FAX (708) 556-4216.



CIRCLE NO. 66

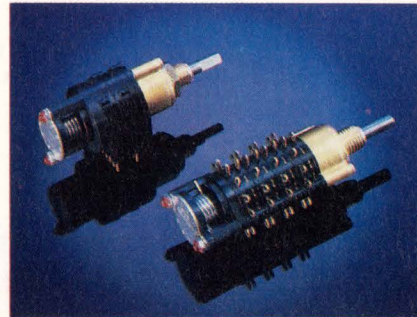

1/2" Switch With Spring Return Option.

Standard Grigsby, Inc. has added a spring return feature to its 1/2" switch family, to provide momentary switch action. The 1/2" family offers fixed or adjustable stops with detent angles of 30° and 36°. Sealed versions may be specified to meet military and commercial requirements. PC mount and solder lug terminations are offered. The switches are priced at \$5.95 each for a single pole, 10/12 position switch in lots of 500. For more information, contact Standard Grigsby, Inc., Aero Park, 88 N. Dugan Rd., P.O. Box 890, Sugar Grove 60554-0890. (708) 556-4200, FAX (708) 556-4216.

CIRCLE NO. 111

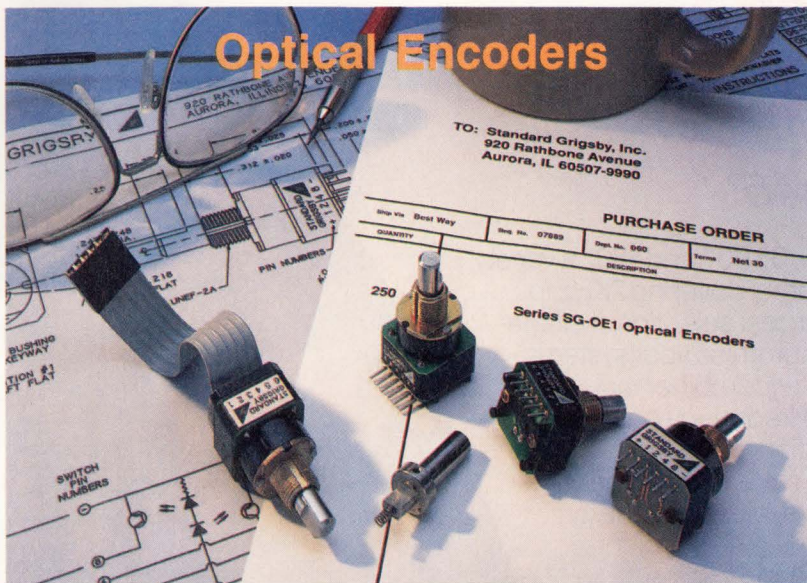

Specify THE Standard In Optical Switching... Standard Grigsby!

Quality Is Standard At Standard Grigsby...

- Vibration-resistant interlock design
- Long life
- Reliable LED optical switching source
- Low power consumption

Customer Satisfaction Is Standard, Too!

- Binary, gray, or custom codes
- High res, 128-152 position option
- Ribbon cable or connectors
- 16, 24, 32, 64 positions
- P.C. lugs and right angle mounts available
- Priced at under \$20 in lots of 100

Raise your switching standards! Call us today for our complete **Optical Encoder** product catalog. 708/844-4320

STANDARD GRIGSBY

88 N. Dugan Road/P.O. Box 890, Sugar Grove, IL 60554-0890
708/556-4200 **FAX 708/556-4216**

CIRCLE NO. 114



TL-360 P.B. Offers Long Life/Compact Size.

Standard Grigsby's TL-360 pushbutton switch offers long life and reliable performance in a micro-miniature package. Life rating is 100,000 cycles (typ.). Terminals are oxygen-free copper and available as silver- or gold-plated. The .156" depth and .360" diameter make the switch ideal for P.C. mounting. The TL-360 is environmentally sealed. Switch travel is .015-.025" with contact bounce a maximum of 5 micro-seconds. Actuating force is 25 oz. max. Priced at \$0.49 in 1,000-piece lots, delivery is from stock. Contact Standard Grigsby, Inc., Aero Park, 88 N. Dugan Rd., P.O. Box 890, Sugar Grove, 60554-0890. (708) 556-4200, FAX (708) 556-4216.

CIRCLE NO. 112

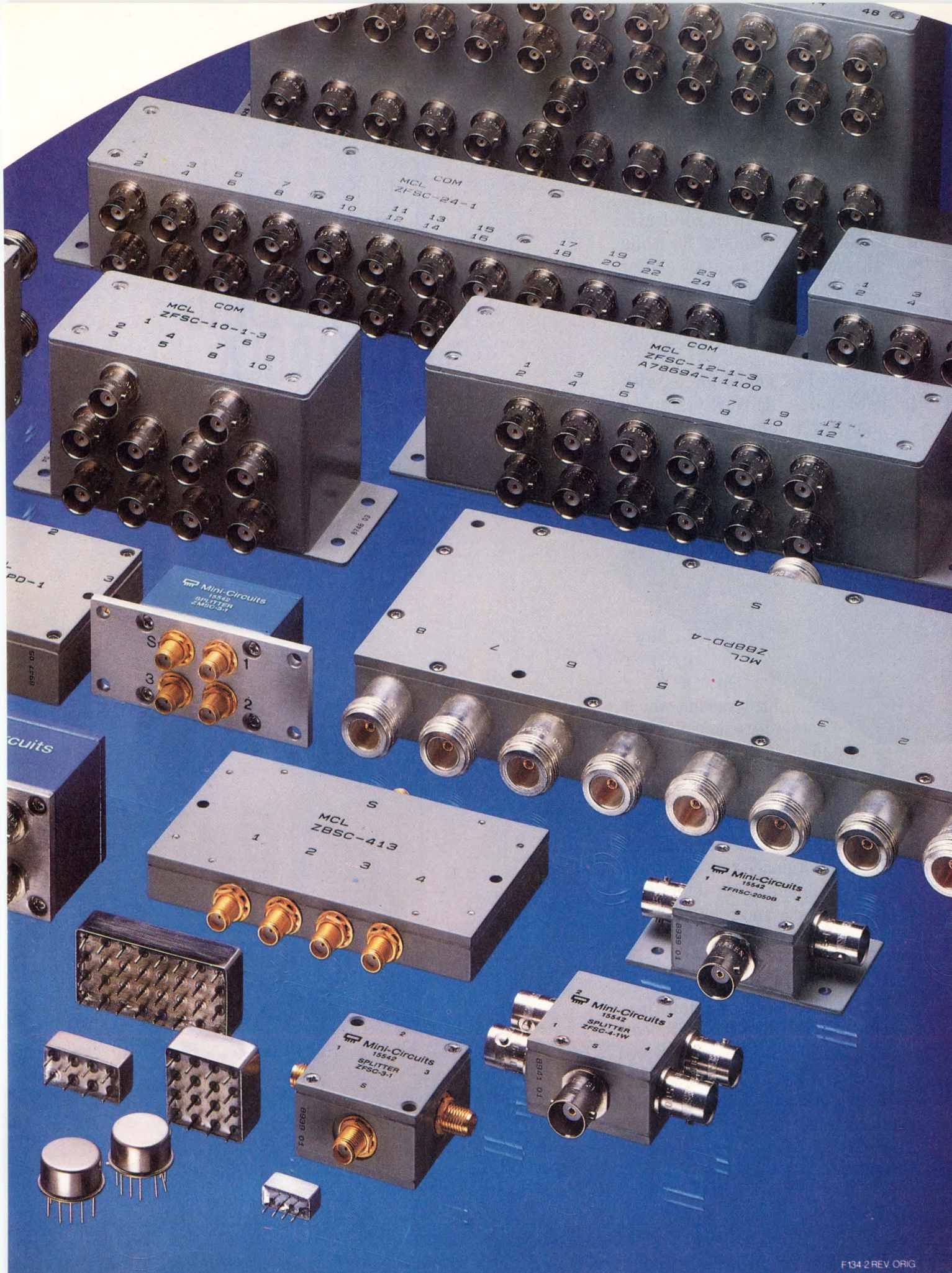



It may not look like one, but it is. You see, even the world's most advanced semiconductor technology means nothing until someone puts it to good use. Someone like Unisys.[®] So while this may look like an ad for the powerful new Unisys A16 computer, it isn't. It's really a testimony to the power of partnerships.

Unisys joined forces with Motorola's ASIC division in applying leading-edge technology to meet customers' needs. An example of our handiwork is the advanced,

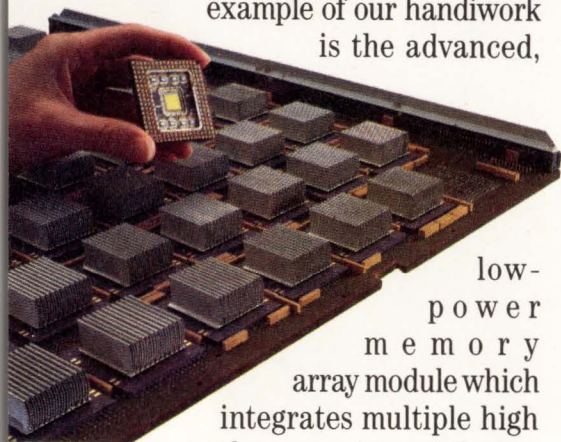

low-power memory array module which integrates multiple high speed memories with our semicustom ECL arrays, dramatically reducing interface delays.

But please, don't get so caught up in the A16's exceptional cost/performance ratio. Don't be overwhelmed by its incredible performance and reliability. Or its environmental efficiencies in electricity and cooling. There's more to life than mainframe performance housed in a unit that requires less than 10 square feet of space. Please, these things are nice, but don't forget about the teamwork and technology that made it possible.

UNISYS

Unisys is a registered trademark of the Unisys Corporation.

YOU'RE READING A MOTOROLA ASIC AD.

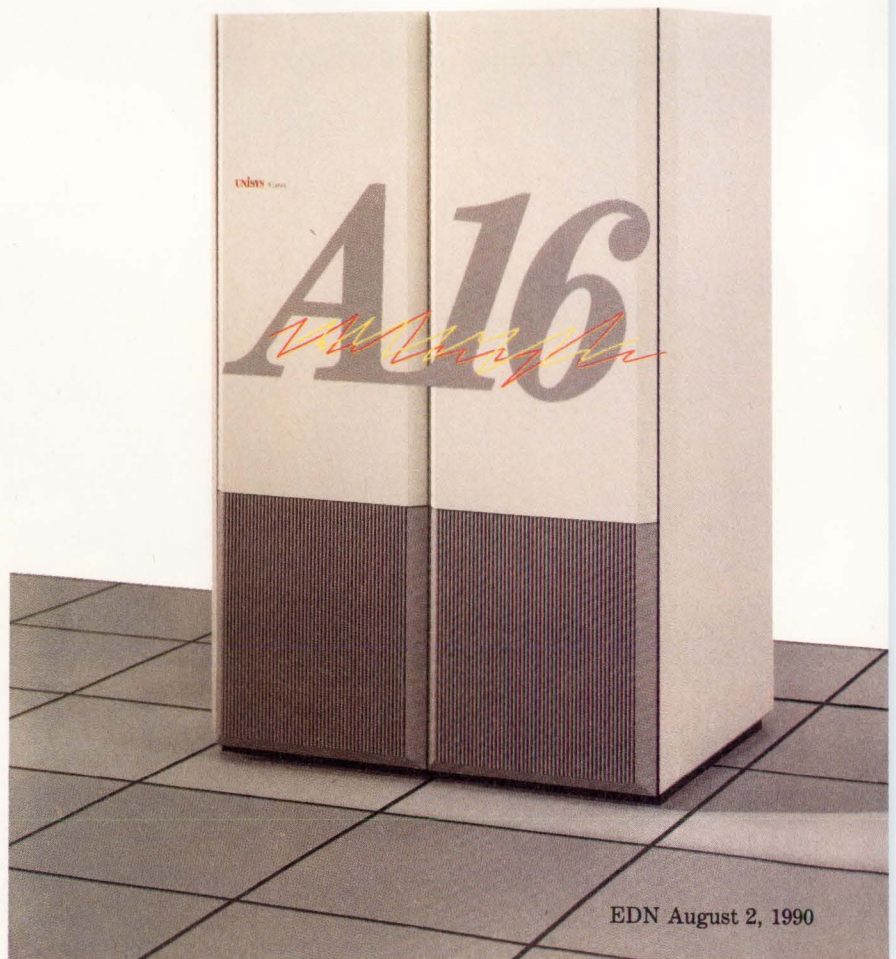

EDITORIAL

The "truth" about Eastern Europe

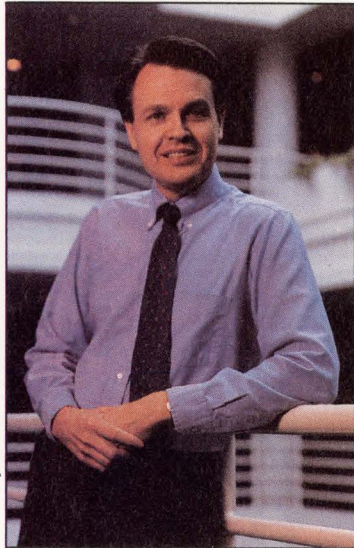

Kevin Bryan

Facts don't always tell the truth. Just consider this popular image of Eastern Europe: The cities are drab and joyless. Nothing works. Incentive has been destroyed by 45 years of socialism. Technology, what there is of it, is terribly outdated.

This image is basically true, but somewhat distorted. I know; I've been to Eastern Europe twice recently, to Poland and to Hungary. My first surprise was that the cities are not all that drab. Warsaw has many beautiful parks, and Budapest has the majestic Danube. Both cities are alive with activity. And most things do work reasonably well. Even the phone systems, with all their well known shortcomings, aren't as terrible as you may have heard or read.

But mostly, I was surprised by the spirit of the people, especially engineers, in Eastern Europe. Socialism has not destroyed incentive. Most people in Hungary work 60 or 70 hours a week; many have built their own homes and small vacation cottages. In both Poland and Hungary, plenty of engineers seek out challenging, creative work for the sheer joy of it. (See page 52 for a report on electronics in Poland. Our next issue features a report on electronics in Hungary, and future issues will concentrate on electronics in other countries.)

Technology in Eastern Europe certainly does lag technology elsewhere, but not by as much as you might think. In Poland, for example, IC design and production trail the state of the art by 10 years or so, but the use of ICs in design is much more up to date. Eastern European countries have well educated work forces, too. In Poland, 98% of the population is literate. In both Poland and Hungary, engineering education stresses a solid grounding in the sciences and lots of hands-on lab experience. Eastern European engineers are actively recruited for high-tech jobs in Western Europe and elsewhere.

Still, the image of Eastern Europe as a sluggish technological backwater lingers on. This image is not without foundation, but it's misleading because it doesn't show the whole picture. To see only the risks of doing business in Eastern Europe—of which there are many, admittedly—is a mistake. A better approach is to carefully consider those risks while looking at the possibilities: a well-educated work force, technical talent, and potentially lucrative markets.



Jesse H Neal
Editorial Achievement Awards
1987, 1981 (2), 1978 (2),
1977, 1976, 1975
American Society of
Business Press Editors Award
1988, 1983, 1981

Gary Legg
Special Projects Editor

From Star Wars



to Price Wars

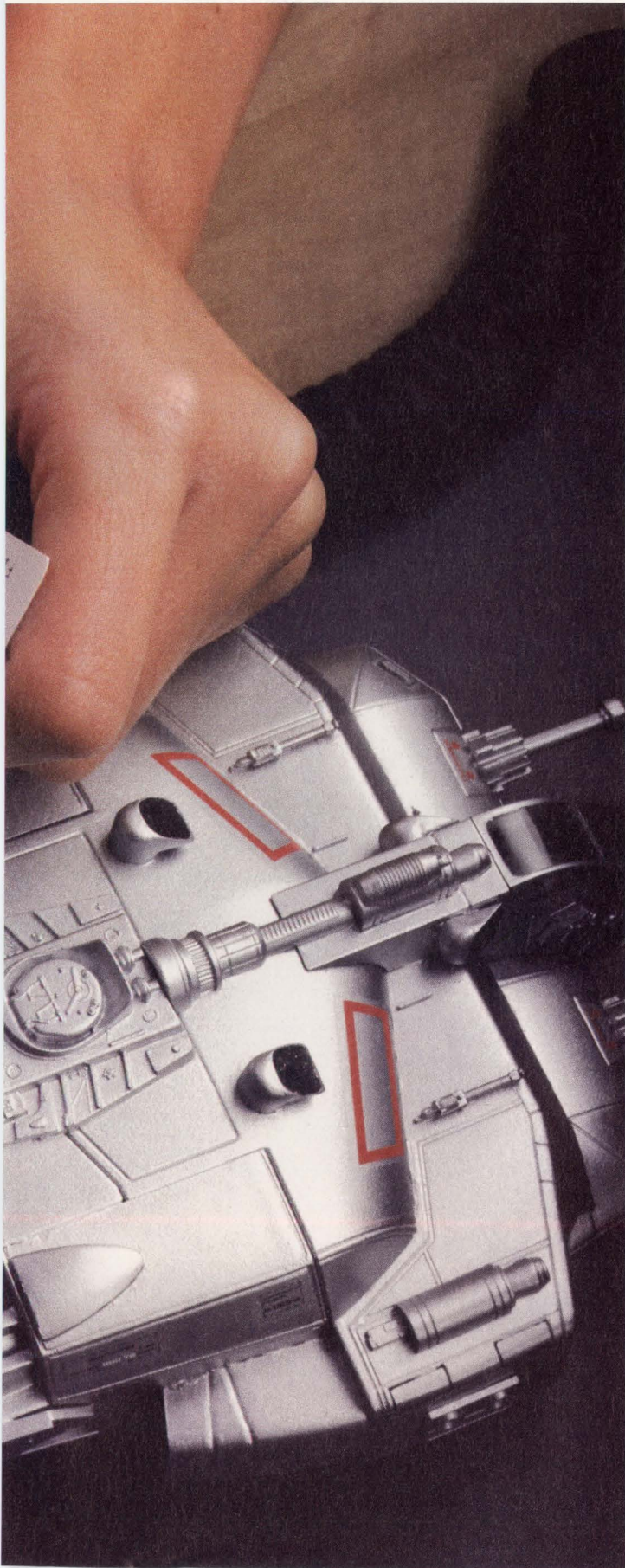

Our High Rel/Aerospace linear array experience is paying off for companies with high-volume, low-cost applications.



Symbol Technologies is a good example. A tiny Raytheon instrumentation amplifier helped them combine both bar code scanner and decoder in a single, lightweight, handheld unit—that's tough enough to take a five foot drop onto concrete.

Symbol also took advantage of our *Win-Win* program. It let them get to market quickly with a semicustom array, then shift to full custom as sales volumes increased.

Win-Win is fast, flexible, and makes good business sense because it eliminates the risk of getting into a full custom array before you're really ready.

Raytheon is committed to analog technology. From our design kits and engineering support to our fab and plastic assembly facility. We have the experience it takes to help you develop creative, cost effective solutions.

Find out how. Call 1-800 722-7074 for our new analog brochure.

Raytheon Company, Semiconductor Division.
350 Ellis St., Mountain View, CA 94039.

CIRCLE NO. 64

Raytheon

Where quality starts with fundamentals

Why do you think they come with racing stripes?

Ladies and gentlemen, start your engines. Because our new 80 and 40 Mb Caviar™ family of intelligent drives is going to give you the kind of system speed you've always wanted.

As you can see on the chart, no one can match our data throughput.

Data Transfer in Kilobytes Per Second*

CAVIAR 280 w/CACHE FLOW	962
COMPETITOR X	814
COMPETITOR Y	773
COMPETITOR Z	648

*CoreTest Sequential reads using a 64K blocksize in a 33MHz AT.

What's more, according to our incredibly conservative attorneys' interpretation of the benchmark data, the 80 Mb drive benchmarked an average access time of less than 18 milliseconds. And according to our engineers'

interpretation, our attorneys are, indeed, incredibly conservative.

So what's the secret behind these high-performance, low-profile, 1-inch, 80 and 40 Megabyte AT compatible intelligent drives?

Some say it's our unique CacheFlow™ caching feature. A new generation design which constantly evaluates the way data is being retrieved from the drive and adapts to the optimum caching method. So disk seeking operations and latency delays are minimized. And throughput is increased.

Others say it's our unique InterArchitecture—the way we design and manufacture all our own chips, boards and drives to work together—that accounts for the speed.

Whatever the reason, the result is dramatically enhanced system performance.

So what are you waiting for?

For more information, call us at 1-800-4 INFO WD.

If it were easy, anyone could do it.

WESTERN DIGITAL
SEMICONDUCTORS • STORAGE • IMAGING • COMMUNICATIONS

Western Digital, Caviar™ and CacheFlow™ are trademarks of Western Digital Corporation. All other marks herein belong to other companies.



the celebrations of democracy are over. The bright Solidarity banners no longer fly above cheering crowds. A year after its populace swept aside a lumbering old Communist regime, Poland still faces the difficult job of installing a workable system in Communism's place. It is not an easy task. It is an especially daunting task for the country's outdated electronics industry.

Accustomed to central planning,

ELECTRONICS IN POLAND

Learning to cope with capitalism

government subsidies, and guaranteed Eastern Bloc markets for

most of its products, Poland's electronics industry hasn't yet learned to think for itself, let alone do for itself.

Warszawski Komitet Obywatelski

Solidarność

Okręg 1 Śródmieście

KANDYDACI

TEXT AND PHOTOGRAPHS BY GARY LEGG, SPECIAL PROJECTS EDITOR

ELECTRONICS IN POLAND



This telecommunications agency building reflects the grim status of Poland's telecommunications system.

When Poland moved from a controlled economy to capitalism in the space of one day—January 1 of this year—the consequences for electronics were enormous.

Suddenly, by government decree, the subsidies were gone. Monopolies were abolished; markets were no longer guaranteed. Managers accustomed to receiving orders from bureaucrats were suddenly responsible for making decisions themselves. All of a sudden the cold reality of capitalism was at hand: Be profitable or perish. Languishing on the trailing edge of technology, electronics in Poland now has no choice but to become competitive.

Almost without exception, plans to restructure Poland's electronics industry involve joint ventures with

This article is part of an occasional series on electronics engineering in Europe.

foreign firms. Industry managers know that much of their technology is not competitive globally, and they hope to improve it through cooperative arrangements. They also realize that impoverished Poland must get its working capital from abroad. Anatol Zmijewski-Szmit, sales manager for Unitra Commercial and Industrial Company, puts it bluntly: "Joint ventures are the future of our country."

What Poland has to offer in return for technology and capital is a well-educated work force accustomed to low wages. The average Polish worker earns about \$75 a month, and the average engineer earns only a little more. Many managers in Polish electronics companies suggest that their industry can do in the 1990s what Taiwan's did in the 1970s and 1980s: start by providing manufacturing services, gradually acquire competitive technology, and finally move into independent design and development.

Barriers stand in this road to progress, however. One is the lack of a

solid commercial infrastructure. Commercial banking, for example, is almost nonexistent in Poland, and without a banking system, foreign investments are slow in coming. Telecommunications is also a problem. Poland's outmoded and inadequate phone system makes even an ordinary business call a questionable proposition.

The Polish economy is another obstacle: Inflation last year was between 700 and 900%. Although the annual rate had dropped to 48% by April of this year and has continually declined since, inflation is still a problem to contend with. The Solidarity-led government hopes for a "normal" rate of approximately 10% by year's end.

For Polish workers, the shift to market economics brings another problem—unemployment. Practically nonexistent under socialism, unemployment is now increasing rapidly as companies trim their staffs or even go out of business. Harvard economics professor Jeffrey Sachs, who advises the Polish government, predicts that between five and ten percent of the work force will be jobless by the end of the year. That would mean between one and two million people out of work in a society that has never really had to cope with unemployment.

A positive—if harsh—effect of unemployment is that Polish workers are motivated like never before to perform well to keep their jobs. Sachs notes that in the first week of "shock therapy" capitalism, worker absenteeism dropped 75%. Soaring prices add to workers' anxiety. Under capitalism, prices of previously subsidized consumer items such as food and energy have floated to their natural levels. In January alone, the price of coal rose 600%. For the few engineers who can afford a car, a tank of gas now costs about a week's salary.

Much of the new unemployment in Poland results from trimming deadwood that would never have accumulated in companies under capitalism. Engineer Grzegorz Marzantowicz claims, for example, that of the 1000 employees at the state-run telecommunications company where he works, some 300 are administrators. Deadwood is not unknown in technical departments, either. Tadeusz Jarosinski, an engineer who left Poland for the United States last year, says he was frequently one of two or three Polish engineers doing all the work on a project, while a dozen or so coworkers did little more than sit around and read newspapers.

If socialism provided little incentive for hard work or innovation, Poland's new market system provides incentive with a vengeance. As soon as capitalism became the official policy, enterprising Poles began selling consumer items that simply weren't available before. On Warsaw's busy Marszalkowska Street, vendors now stand elbow-to-elbow selling everything from clothing to tropical fruit to electronic equipment. Operating right in front of the dreary department stores they compete with, the vendors feature brighter displays, wider selections, and prices that are 10 to 15% lower.

Polish engineers are responding to their country's political and economic changes with a mixture of enthusiasm, optimism, and anxiety. Some now perform engineering work as sidelines to their regular jobs. Others are taking their first look at private companies as possible employers. But many, perhaps most, engineers still fear the uncertainties of a market economy. Their fears are exacerbated by the knowledge that Polish electronics lags state-of-the-art technology by as much as 15 years in some areas. Still, most Polish engineers say



Sidewalk shops now abound in Poland. Last year's consumer goods shortages and long lines have been replaced with plentiful supplies and few people who can afford them.

they are well trained and capable of narrowing the technology gap with experience. Much of the gap, they say, is a result of technology import restrictions, not lack of knowledge or ability.

Poland's economy—not its economic system or the state of its technology—is electronics engineers' biggest concern. The big question is whether the country will regain enough economic health to support private industry, especially

in the mercurial field of electronics.

On a personal level, engineers wonder if they can continue to make ends meet on \$100-a-month salaries while newly freed prices continue to soar. Although they're happy with their country's turn to democracy and proud of its leadership role in Eastern Europe's denunciation of Communism, they're also concerned about their own financial futures. As one Polish engineer says, "We are living in such an interesting time, but it would be so much better to live in such an interesting time with some money."

ELECTRONICS IN POLAND



On most weeknights, the living-room table in the two-room Warsaw apartment of Grzegorz and Zosia Marzantowicz is covered with the documents of a surprisingly capitalistic activity—private business. Since 1984—long before Communist rule ended and capitalism became Poland's official policy—Grzegorz Marzantowicz has been a private engineering consultant.

Making it by moonlighting

Capitalism is nothing new to this Polish couple. His income from a part-time engineering business more than doubles their regular salaries.

The part-time business is a venture that Marzantowicz didn't plan, or even anticipate. In 1981, after earning a master's degree in electronics at the Technical University of Warsaw, he began a career as a telecommunications engineer for a government-owned agency. There, he found that ability and hard work did not bring advancement. "You could only advance with age," he says, "not your knowledge."

The situation led to what Marzantowicz calls a "war" between the older and younger engineers. "The younger designers worked much faster," he says. "I could do a project in a week that other designers would need a month for, and in my free time I would look for more

work." Marzantowicz's boss was only too glad to provide the extra work, but his hands were tied when it came to providing more money. Even now, with nine years of engineering experience, Marzantowicz earns only 1.2 million zlotys a month—about \$125—from his regular job with the telecommunications agency.

So when one of the agency's customers offered him some work on the side, he accepted. Although he had some misgivings about circumventing his full-time employer, "In Poland, I must if I want to make money." Now, six years later, Marzantowicz's income from part-time projects is roughly twice that from his regular job. To earn it, though, he says, "I am working 25 hours in 24."

Long hours are not the only price Marzantowicz pays. Because private customers need to contact him during business hours and he's not yet ready to give up his regular job, Marzantowicz has had to cut his agency supervisor in on the action. "I have to pay my boss money," he says, "and he sleeps on the job." But, by funneling some of his private work through the agency, Marzantowicz makes his supervisor look far more productive than he really is, thus solidifying the supervisor's—and his own—position. Marzantowicz pockets only 20% of the fees for the shared jobs, but there are plenty of other jobs that his boss never finds out about.

Most of those jobs involve designing office-building installations such as burglar alarms, access-control systems, telephone networks, paging systems, and closed-circuit TV. Marzantowicz has arrangements with ten companies that contract for such installations. He usually gets 60% of the contract fee, and the contractor keeps 40% for administration.

The work is relatively low tech. "My projects use very simple techniques," Marzantowicz says. "Mostly, I use a typewriter and a



pen. I also have a small personal computer, an Atari 800 with a disk drive and a printer. I would like to buy a plotter, but it's too expensive."

The greatest difficulties with Marzantowicz's consulting work result from shortages of time and work space. He often works far into the night, sometimes taking short naps on the living-room sofa. He usually spends Saturdays at installation sites. "Sunday," he says, "belongs to God." Every two months, he spends a week in Vienna undergoing training at one of the companies he consults for.

The living-room table where Marzantowicz works also serves as the family dining table, so he can't leave his work spread out for long. Nor is there any other work space; the apartment's two rooms are home not only for himself and his

wife, but also for their four-year-old son, Mateusz, and Marzantowicz's mother. In fact, Marzantowicz's parents lived there when he was born; it's the only home he's ever known.

Marzantowicz and his wife would like more space, but with Warsaw apartments selling for \$10,000 to \$20,000, they're not likely to get it anytime soon. Nevertheless, Poland's turn toward capitalism after 45 years of Communism has started people dreaming—not just of increasing their meager incomes as Marzantowicz has, but also of possessing some modest material objects. For now, the grim economic situation makes many of these goals unrealizable, but still the dreams persist. "My dream," says Marzantowicz, "is to buy a flat with an extra room where I can have a computer and work."

ELECTRONICS IN POLAND



Life has not been easy for Anatol Zmijewski - Szmit. Since his birth in Siberia in 1945, he has faced one challenge after another.

Zmijewski provides few details of his beginnings. He says only that his mother was Polish, his father half German and half Russian, and that if you've read Aleksandr Solzhenitsyn's *Gulag Archipelago*, "then you understand." When he

After another academic job that lasted two years, he became a design engineer for Unitra Unima, a manufacturer of electronic test and production equipment.

Designing test equipment such as multimeters and signal generators gave Zmijewski the greatest fulfillment of his professional life, but the satisfaction lasted only four years. When a new manager at the company wanted his own hand-picked design team in place, he used a combination of firings and harassment to remove anyone in his way. Zmijewski was in his way.

Next, Zmijewski parlayed his facility in languages, particularly Russian, into a job with Unitra Unima's parent company, Unitra. The giant state-owned foreign trading company dealt solely in electronics and almost exclusively in the sphere of the Soviet Union. Zmijewski quickly acquired knowledge of importing and exporting to add to his electronics expertise, and from 1982 through 1986, he and his family—wife, son, and mother—lived in Moscow.

Since returning to Poland, Zmijewski has traveled and conducted business in virtually every country that is, or was, Communist. As an international sales manager with 15 people reporting to him, his career appeared set.

But last year's political upheaval and this year's economic transformation have pushed Poland—and Unitra and Zmijewski—into a state of uncertainty. Under Poland's Solidarity-led government, Unitra no longer enjoys the monopoly on foreign electronics trade that it held for so long. Small companies, much leaner than Unitra, now compete for business. In addition, many companies, such as Unitra, that previously received government subsidies lost all such preferential treatment when Poland implemented a shock-therapy switch to a market-based economy. Now, Unitra must either be profitable or perish.

Making it in tough times

After a long struggle for success under socialism, a 44-year-old engineer ponders an uncertain future in Poland's new market-based economy.

was three, he and his mother made their way to her native Warsaw, which had been almost completely reduced to rubble in the war. He avoids mentioning his father, except to say that he remained in the Soviet Union.

At the age of 19, Zmijewski went to work in a Warsaw electronics factory, where he quickly encountered socialism's dark side. He was working too hard, an older worker told him menacingly, and making everyone else look lazy. If he didn't slow down, he would receive a beating.

Zmijewski went on to earn a master's degree in electrical engineering at the Technical University of Warsaw in 1969. He became a teaching assistant, but quit after a year because the pay was so low.



Unitra's loss of favored status has changed Zmijewski's job. Previously involved only with electronics, Unitra now scrambles to maintain profitability by dealing in everything from butter and potatoes to dresses. "I know electronics," says Zmijewski. "I can sell electronic products. But now I have to learn about everything else." The situation is further complicated by the fact that many of Unitra's new clients are companies much smaller than the old ones. Zmijewski has to maintain many more contacts and participate in many more negotiations just to keep sales figures level.

The new political and business

environment creates opportunities as well as difficulties, but the changes in Poland make new undertakings risky. Changing jobs in a country where many of the companies that exist are new and unproven and the economy is in shambles is a crap shoot. Few job openings are available anyway. And starting your own company requires capital, which is practically nonexistent.

Friends and associates encourage Zmijewski to become an international marketing consultant, applying his knowledge of electronics, trade, and Polish manufacturing and consumption. Thus far, he has

been reluctant. He figures he would need six months of operating expenses just to get started, and even that much money is hard to come by. Worse, the money could easily be lost.

So, Zmijewski works harder and harder and hopes for the best. Unitra is all right for now, he says, so he has some time for things to work out. But just in case, he's taking an advanced course in economics to learn more about marketing, banking, and foreign trade. The extra knowledge, he figures, will help him meet this latest challenge.

ELECTRONICS IN POLAND



"If I had thought that in two or three years the situation in Poland would improve so that I could carry out my projects, my dreams, then I would have stayed, but it obviously wasn't true. I realized I have only one life, and if I lose my best ten years or my energy or my enthusiasm, I will never get them back."

Those are the words of Tadeusz (Tad) Jarosinski, a 32-year-old elec-

Making it in America

Frustrated by limited opportunities, this Polish engineer looked abroad. Now he's working in Maryland.

tronics engineer who left Poland last year to pursue high-tech goals in America. Solidarity-backed candidates had just dominated Poland's first free elections in four decades, but Jarosinski thought the climate for electronics would not be healthy for a long time, maybe ten years or more. He left Warsaw not knowing when he would next see his wife, his three-year-old daughter, and his four-month-old son. He came to the United States without a job and without much money. His English, while passable, still left a lot to be desired.

But what Jarosinski did have when he arrived in America—on the Fourth of July—was an impressive resume and a burning desire to do creative engineering. He started mailing out his resume and

soon had plenty of interviews, although few companies were willing to tackle the paperwork necessary to get him a US work permit. He had a job in Chicago within three or four months, although he soon left it for a better opportunity. He now works as a combination hardware and software engineer for Telecommunications Techniques Corp (TCC) in Germantown, Maryland.

Before he left Poland, Jarosinski had chalked up eight years of electronics experience with one state-owned company and two private ones. He had designed hardware and software for everything from the 8048 microcontroller to the 80286 microprocessor. The work had been frustrating, however, because few designs ever went into production. "The whole infrastructure [in Poland] is so complicated," he says, "that to actually complete an ambitious project is very, very difficult. You can't rely on other contractors. Even if projects are properly done by the hardware and software engineers, they're not completed because of a lack of screws, a lack of boxes, a lack of ABS material, or something like that."

On his own, however, Jarosinski had taken several projects to completion. He designed and built an EPROM programmer and an 8051 emulator. The projects gave him not only good experience, but also engineering tools that he wouldn't otherwise have been able to own. "I couldn't afford to buy even a simple emulator from Nohau for about \$2000," he says. "That's a lot of money in Poland."

Another of Jarosinski's projects was a reverse-engineered computer that was software-compatible with an IBM PC/XT. High component costs forced him to use a noncompatible backplane and, therefore, deviate from the IBM hardware spec. He couldn't afford a hard disk either, so he borrowed floppy-disk drives from the Technical Univer-

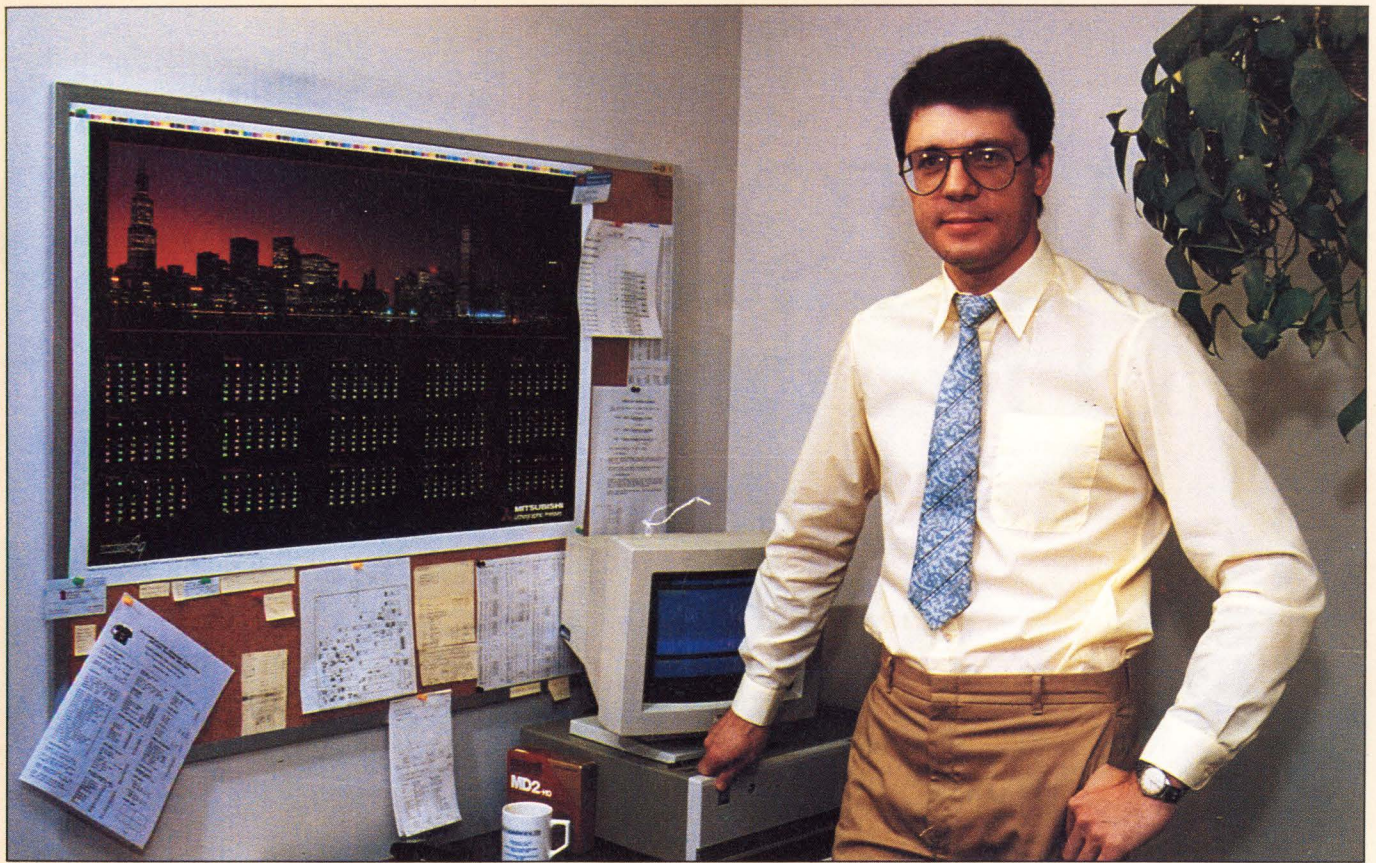

sity of Warsaw. He ordered chips from a company in Jamaica, and when the company stopped supplying the Eastern Bloc under pressure from the Reagan administration, he turned to sources in West Berlin. He eventually finished the computer and used it to run Microsoft's C compiler, design programs from Autocad and OrCAD, and various other software packages.

But Jarosinski's regular employment was becoming more frustrating. Working for Plastomed, a West German firm with an office in Warsaw, he thought for a time that he could actually take a project to completion. However, the company had so many problems dealing with Polish internal affairs that "They had to concentrate more on getting screws than developing software." It was the last straw. "I had bet on this company," Jarosinski says. "It was my last chance to do something real in Poland."

Now, after only a year in the US and barely six months at TTC, Jarosinski is gratified that his hardware and software designs for T1 test equipment are actually going into production. He's also happy to

have development equipment, such as his Hewlett-Packard 9000 workstation, that he didn't have to build himself.

After a nine-month separation from his wife and children, Jarosinski was able to bring them from Warsaw to rejoin him in April. The family plans to stay in America indefinitely, but the thought of returning to Poland is never completely out of mind.

"I think it can be very profitable for my country," Jarosinski says, "if I can go back after ten years or so and give some knowledge to the next generation of electronics engineers." To have stayed in Poland would have been a mistake, Jarosinski says, because in the current economic climate, he would be unable to accomplish anything of significance. "The Polish economy is very weak," he says. "It doesn't profit from people who stay there and do nothing." **EDN**

Article Interest Quotient
(Circle One)
High 515 Medium 516 Low 517

HOW TO TURN 040 WITHOUT LOSING A STEP.

FORCE '030

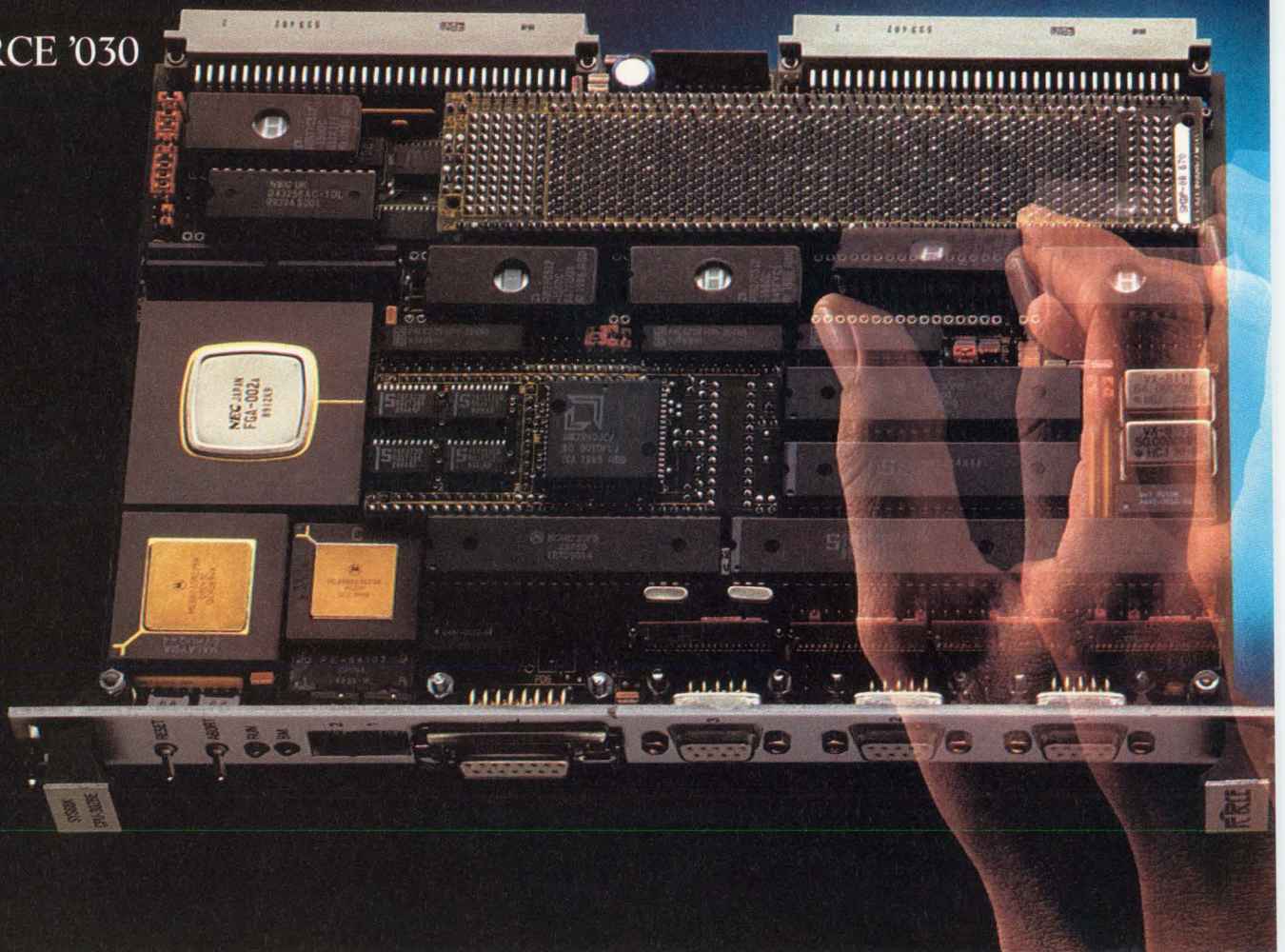

Turning 040 doesn't mean you have to give up the code you lived by when you were 030. Although that's what some manufacturers expect you to do.

But not FORCE. We guarantee that applications written for our 68030 VME boards will run on our 68040 boards. That's because we've built compatibility into our 030 and 040 address maps and on-board device drivers.

In fact, no one makes it easier to move your software from 030 to 040. The competition can't even come close. Just ask them.

Then ask us. We'll keep you from spending months writing new software drivers. So you can spend your time improving performance and functionality. Or getting to market months ahead of the competition.

What's more, you can start today on your 040 applications. Just develop them on a FORCE 030 board. When you're ready, we'll upgrade you to the highest performance 040 board you can buy.

So you can speed up your software without missing a step.

Of course, we have all the tools you need to get started. Choose from the broadest range of real-time operating systems and kernels, including PDOS, OS-9, VxWorks, VRTX32 and pSOS+. We even give you VMEPROM, free of charge.

You can also take advantage of XRAY and the entire Microtec family of software tools. Including cross, native and embedded development environments.

Our performance advantage even extends to UNIX.[®] With the industry's top-rated Unisoft UNIX 5.4.

Finally, you get the industry's best-rated documentation, integration support, regional technical staff and a full one-year warranty.

Here's your next step: call 1-800-BEST-VME ext. 40 for details on our 030 to 040 upgrade offer. Or fax a request to (408) 374-1146 for an immediate response.

Because turning 040 doesn't have to slow you down.

68030 CPU	COMPATIBILITY	68040 CPU
CPU-30	DMA, SCSI, Floppy, Ethernet, Serial I/O	CPU-40 + EAGLE I/O Module
CPU-31	DMA, SRAM, VSB, Serial I/O	CPU-41 + EAGLE I/O Module
CPU-33	DMA, DRAM, Serial I/O	CPU-40



VME at its best.

UNIX is a registered trademark of AT&T. VxWorks is a trademark of Wind River Systems, Inc. pSOS+ is a trademark of Software Components Group. VRTX32 is a trademark of Ready Systems, Inc. OS-9 is a trademark of Microware Systems. PDOS and VMEPROM are trademarks of Eyring Research, Inc. XRAY is a trademark of Microtec Research, Inc. © 1990 FORCE Computers, Inc.

FORCE Computers, Inc., 3165 Winchester Blvd., Campbell, CA 95008-6557, (408) 370-6300 ext. 40

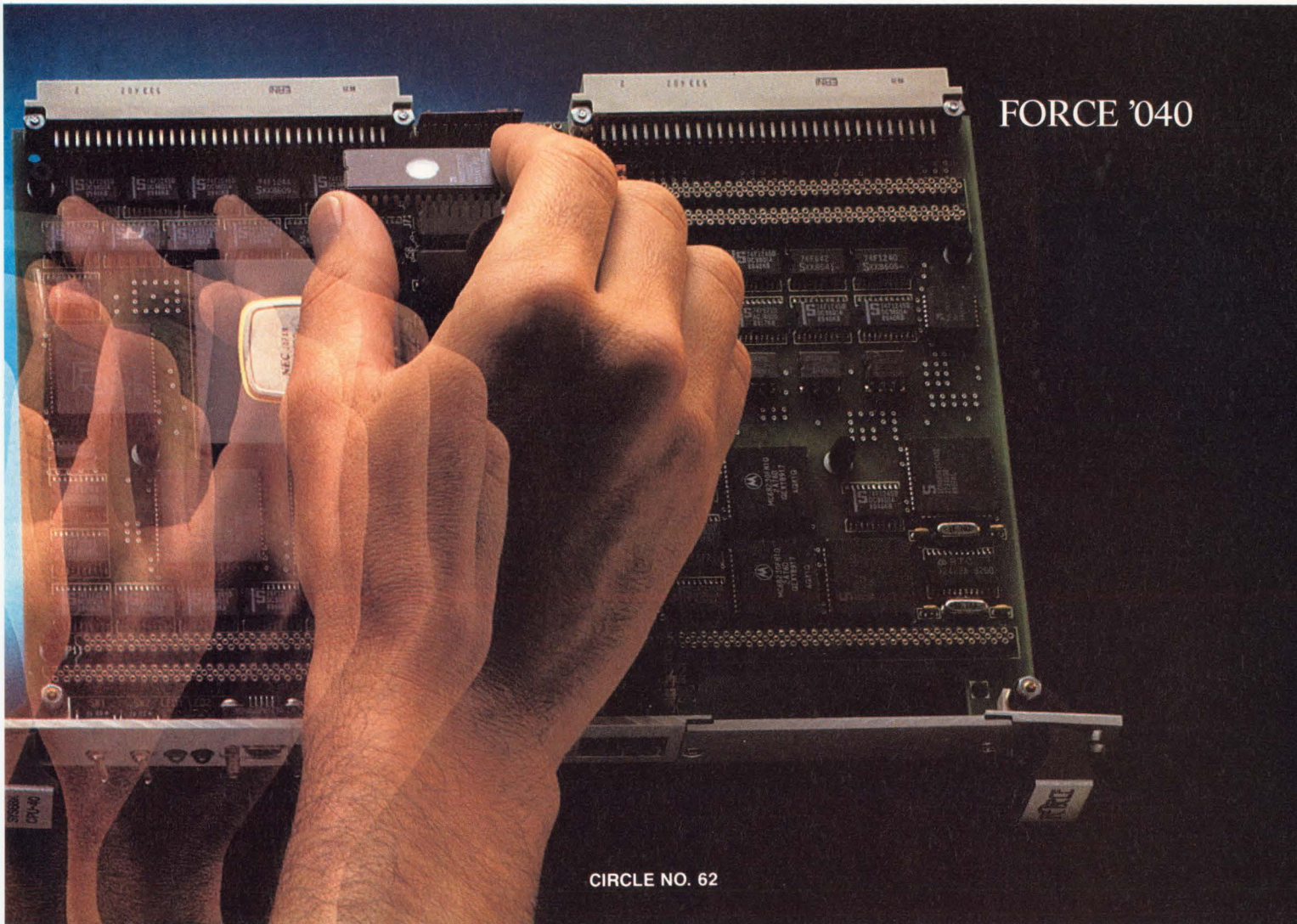



DOUBLE

“...  for

AMP TBC (Twin-Beam Contact) Connectors steal the show for high-density, high-pin-count affordability. Three- and four-row versions deliver compelling performances in 32 to 540 position roles.

The twin-beam receptacle at

the heart of the TBC Connector represents the very best of AMP engineering—the greatest economy of material consistent with design excellence. It provides two-point contact (with gold-over-nickel plating), and the BeCu base assures high normal forces of 50 grams/contact (end of life minimum) for solid dependability.

There's more here than economy, though. Tightly controlled, short point-of-contact geometry allows two levels

of mating for make-first break-last sequencing of power and ground pins. The same design reduces insertion

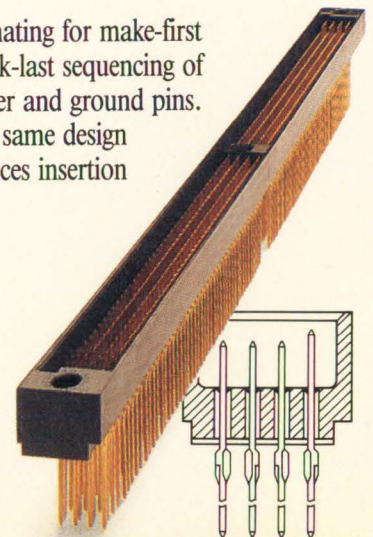

Two levels of sequenced mating allow "hot" connect/disconnect. Compliant pin option for solderless pcb insertion.

FEATURE

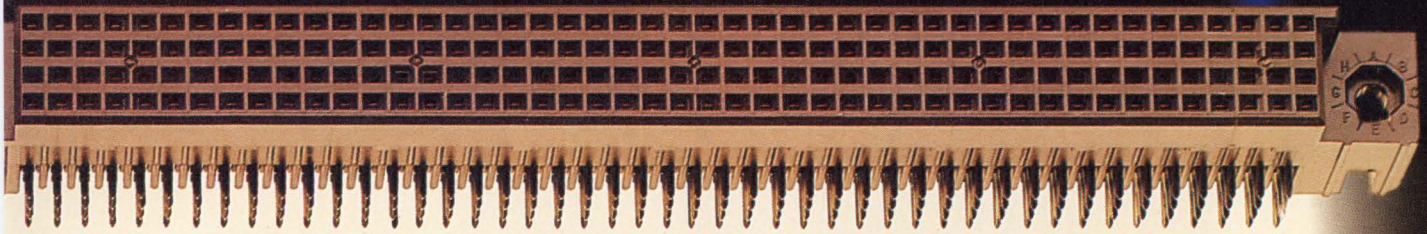

cost reduction.”

force, and provides outstanding contact wiping action: .070" on short pins, and a minimum of .100"



Unique twin-beam receptacle delivers outstanding reliability in an affordable high-density connector.

on long. (Coming soon: TBC Plus Connectors, with six rows of contacts and three levels of sequencing.)

AMP TBC Connectors are fully polarized, with closed-entry design to eliminate stubbing, and they come in high-temp materials ready for vapor-phase and IR reflow soldering.

And TBC receptacle assemblies intermate with our popular AMP-HDI pin header assemblies, to give you immediate daughter card cost-reduction, without redesign.

Call 1-800-522-6752 and ask about the AMP TBC Connector Series. AMP Incorporated, Harrisburg, PA 17105-3608.

AMP Interconnecting ideas

Advanced Pressure Sensors

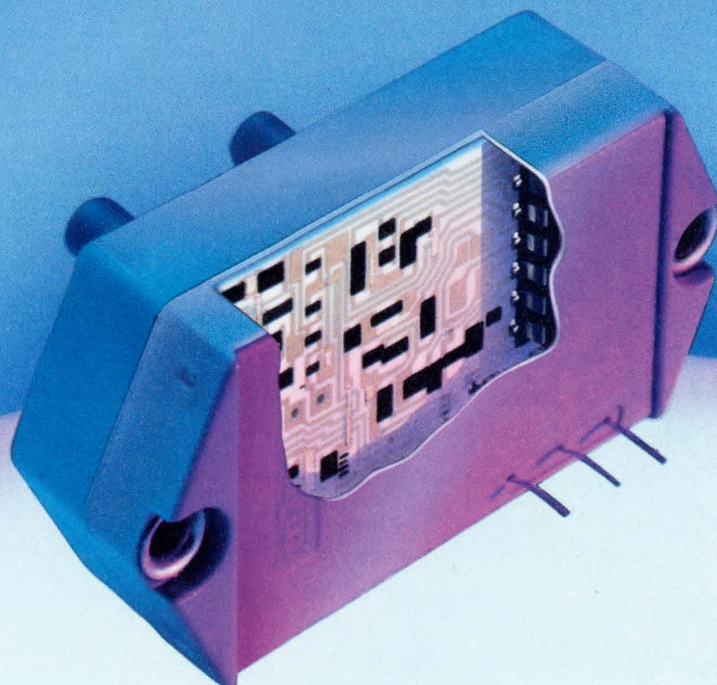

FOR: MEDICAL INDUSTRIAL HVAC

Sensym's 142/163 Series

Features Include:

- Guaranteed precision over temperature: $\pm 1\%$ Max (-18°C to $+63^{\circ}\text{C}$)!
- High level calibrated output:
1.0V $\pm 50\text{mV}$ offset
5.0V $\pm 50\text{mV}$ span
- Linearity: $<0.75\%$ FSO Max

These precision transducers are priced starting at **\$40 ea / 100's. Stock delivery.**

Available parts:

- 163SC01D48** ... -20 to $+120\text{cmH}_2\text{O}$
142SC series ... 0 to 1psi up to 0 to 150psi



Free Handbook



Sensym's new 1990 Sensor Handbook gives complete product specifications plus over 200 pages of application notes and ideas.

Call or fax us today for your free Sensor Handbook.

CIRCLE NO. 60

JTAG BOUNDARY-SCAN TEST

Adding testability also aids debugging



The JTAG boundary-scan technique makes testing pc boards and systems easier. For the knowledgeable designer, the technique also offers benefits during debugging.

*Richard A Quinnell,
Regional Editor*



As circuits continue to increase in complexity and package density, designing for testability will become more than just a good idea—it will become a requirement. One test technique that helps you debug your design as well as aid production testing is the boundary-scan technique developed by the Joint Test Action Group (JTAG). Soon to be issued as IEEE Standard 1149.1, the technique is now gaining industry support in the form of tools and scannable standard ICs.

The roots of the JTAG boundary-scan technique lie in the difficulty of testing surface-mount pc boards. The high component density and fine lead sizes of surface-mount components make testing with traditional bed-of-nails probes difficult at best. When components are mounted on both sides of the board, or when circuit traces lie entirely on internal board layers, probing methods become wholly inadequate.

Anticipating that surface-mount pc boards will get even harder to test, the JTAG committee developed a probeless test technique that requires a 4-wire serial test bus. The test bus comprises four signals: Test Data In (TDI); Test Data Out (TDO); Test Mode Select (TMS); and Test Clock (TCK).

TDI and TMS assume

a logic-high state if not actively driven, ensuring that the test circuitry always receives a known value on these lines. TDO is a 3-state signal that is active when you are shifting data through the IC. At all other times, it is a high-impedance signal.

The test bus allows you to examine or change the state of all I/O pins on a component, hence the name “boundary scan.” By wiring together the TMS and TCK on all ICs and connecting TDO of one IC to TDI on the next, you can test your entire board with a single bus.

Fig 1 gives an overview of the JTAG boundary-scan technique’s circuit architecture. All scannable ICs have the three scan registers shown: the instruction register; the bypass register; and

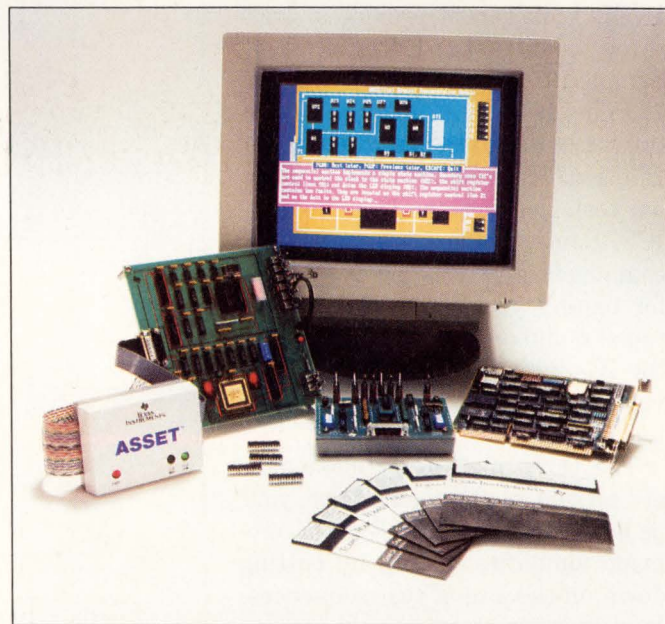

Providing a complete package for testing your boundary-scan design, the Asset system from Texas Instruments includes a scan-test controller, C++ compiler, software tutorials, and debugging utilities.

TECHNOLOGY UPDATE

JTAG boundary scan

the boundary-scan register chain. Data passes through these registers under the Test Access Port's (TAP) control, moving from TDI to TDO. The technique gives the IC designer the option of providing additional scannable registers. These extra registers may provide scan paths for testing internal logic, reading a device-specific ID code, or accessing optional built-in test circuits.

The TAP, a state machine that clocks and controls the various registers and multiplexers, is built into every scannable IC. The TMS signal directs the port's state changes, which occur on the rising edge of TCK. Depending on the TAP's state, the test circuits may sit idle or pass data through a register without affecting the IC's normal operation. They may also execute the test command stored in the instruction register. (See **box**, "Controlling your boundary-scan test.")

Standard defines test commands

Any IC claiming compliance with IEEE 1149.1 must provide at least three commands: External Test; Sample/Preload; and Bypass (**Ref 1**). The IC may, at the manufacturer's option, provide a variety of additional commands, such as internal test, self-test, and reading the IC's identity code. The mandatory commands give you the basic tools for testing your pc board. The optional commands allow you to test the ICs individually as well as give you more powerful pc-board-test tools.

The three mandatory commands are all you really need to test your pc board's wiring. The Bypass command simplifies testing by cutting down on the size of test sequences. It allows you to effectively remove an IC from the test loop, routing test data through the 1-stage bypass register. You can then restrict

the length of your test sequences to that required by only the ICs you're interested in.

You can best understand the operation of the other two commands by referring to the circuit in **Fig 2**. The Sample/Preload command causes register R1 to capture the state of the IC's I/O line while loading register R2 with the data previously held by R1. The multiplexer M2 allows the system data to pass through, so that your circuit's normal operation is unaffected. You can thus use the Sample/Preload command to take a snapshot of your circuit's nor-

mal operation or to prepare register R2 for the next test command.

The External Test command causes the boundary-scan register to behave in one of two ways, depending on the type of signal line the register connects to. A register connected to an IC's output or I/O control line will use R2's output value to replace the IC's normal output signal. A register connected to an IC's input line will capture the line's state on the edge of TCK following the External Test command. The result of this dual function is that you can use a single Ex-

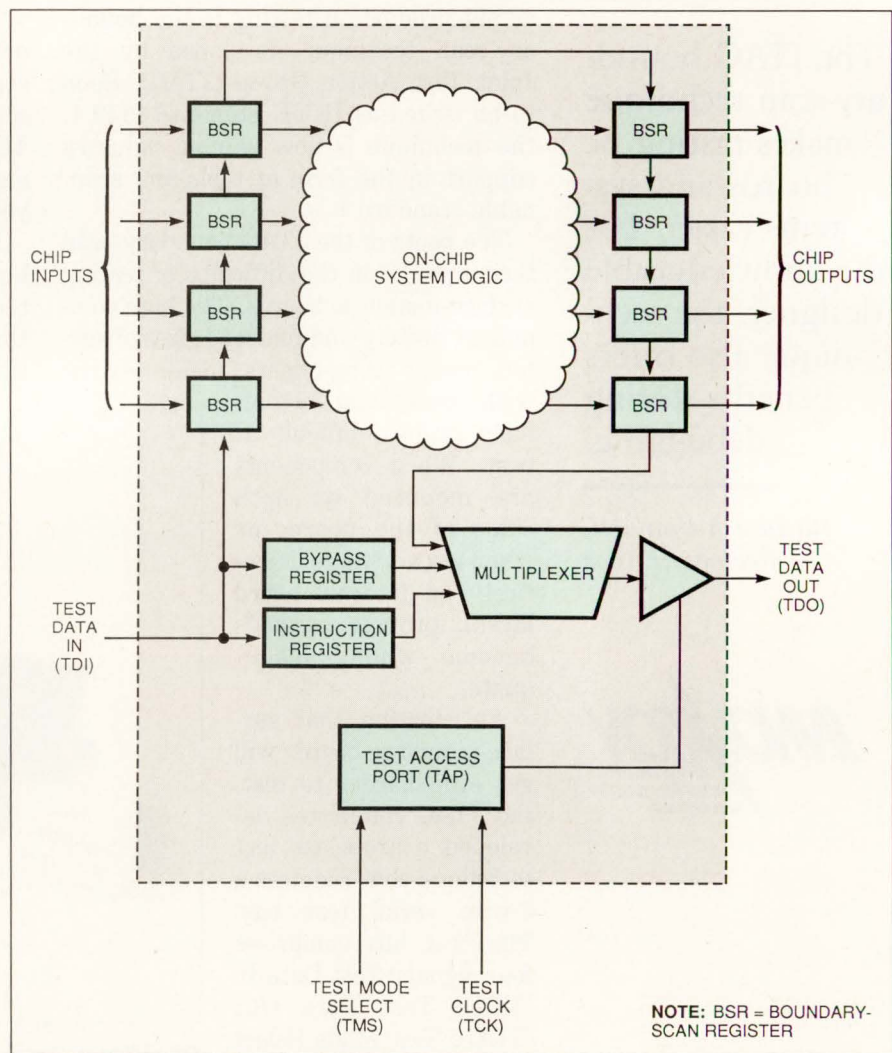

Fig 1—A JTAG boundary-scanable IC allows you to read and control all of the IC's normal I/O signals with only four additional signals.

Controlling your boundary-scan test

To control the boundary-scan test circuits, you must manipulate both the Test Data Input (TDI) and Test Mode Select (TMS) lines. You use the TDI line to enter instructions and data into circuits. You use TMS to control the Test Access Port (TAP). A succession of TMS values moves the TAP through its various states (Fig A.)

A typical test sequence would begin with the TAP at Test-Logic-Reset. The TAP enters this state at power-up. It will also enter and remain in this state following a sequence of at least five "1s" on TMS.

While in the Test-Logic-Reset state, the TAP allows the IC to operate normally; the test logic is inactive. The TAP also forces the current instruction to the Bypass command or, when implemented, the optional ID Code read command. By forcing the instruction, the TAP ensures that a glitch on TMS has no effect on your circuit. The TAP would return to Test-Logic-Reset within three clocks without executing any instructions.

When the TAP clocks in a "0" on TMS, it moves from the Test-Logic-Reset state to the Run-Test/Idle state. In Run-Test/Idle, the test logic remains inactive, but the TAP no longer forces the instruction's value. You can, therefore, safely park the TAP in this state after loading an instruction that you wish to use repeatedly, such as Sample/Preload.

From the Run-Test/Idle state you can move the TAP to the Select-DR-Scan or the Select-IR-Scan state. Both states have no effect on the test logic; they are simply gateways into their respective scan sequences. One sequence controls the boundary-scan and optional data registers; the other routes serial data through the instruction register. The two sequences are otherwise identical, and the corresponding states have similar effects.

The Capture states transfer data into a serial shift register to be clocked out through TDO. In Capture-DR, the test circuits sample the IC's I/O lines if the current instruction is Sample/Preload. If the current instruction specifies one of the optional test registers, the captured data will be device-specific.

In Capture-IR, the captured data represents the status of the IC. All but the two least significant bits of data are device-specific. That is, the IEEE 1149.1 specification does not restrict their value or meaning. The two least significant bits, however, must be "01." Having this known value to shift

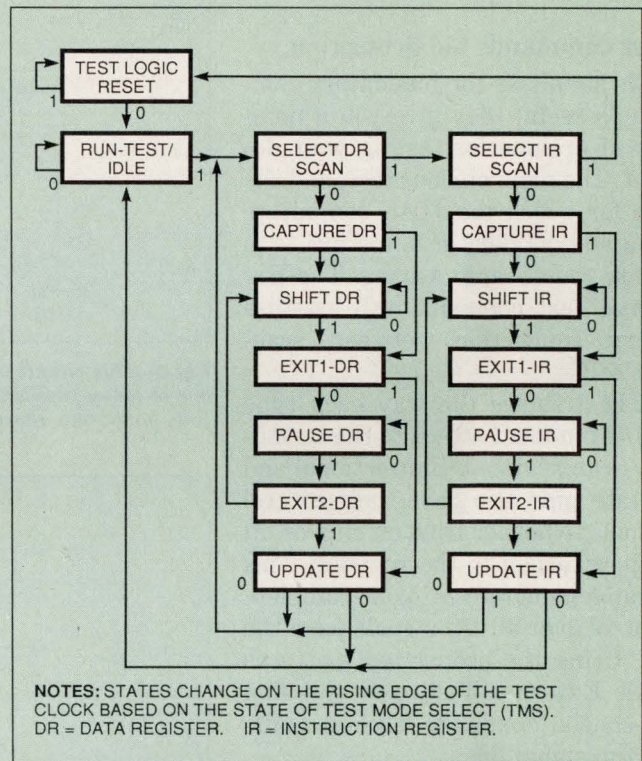

Fig A—The behavior of the JTAG test circuits derives from the Test Access Port's state. Notice that a sequence of five "1s" will move the port to Test-Logic-Reset from any other state.

through the scan path aids you in debugging your circuit.

The Shift states allow the Test Clock (TCK) to move data through the IC from TDI to TDO. The data advances one step each rising edge of TCK while TMS is held low. The instruction register determines which path is active during Shift-DR. Shift-IR always uses the instruction register.

The Exit states simply provide gateways to other states. They do not affect the test circuit's operation. The Pause states do have a function, however. They allow you to suspend data shifting, then resume without altering the data. The Pause state is handy when you must wait in the middle of loading a test pattern to retrieve the rest of the pattern.

The Update transfer stores the newly shifted-in data values into the appropriate register. Changing the current instruction and latching test data into the output lines of the boundary-scan register both occur in an Update state.

TECHNOLOGY UPDATE

JTAG boundary scan

ternal Test command to set an IC's output signals, then verify the receipt of those signals at other ICs.

Test commands aid debugging

As simple as the mandatory commands seem, they give you a number of options for testing your design. The most obvious test, and the one for which the JTAG committee created boundary-scan testing, is to check your board's wiring. The External Test command will exercise every connection between scannable ICs.

Fig 3 shows the way each type of I/O pin must attach to the boundary-scan register. Bidirectional and 3-state pins also have their control signals, whether from on chip or off chip, attached to the register. This arrangement gives you complete control over all I/O signals from the IC. Using the proper test patterns with External Test, you can find all shorts, opens, or stuck-at faults on the signal lines.

To test your entire board's wiring, though, all of the ICs on the board must be scannable. Even then, TMS and TCK signals must be testable by external probing.

A corollary to Murphy's Law warns that the built-in test circuits will be the first to fail, and the JTAG boundary-scan circuits are not immune to failure. Only TMS and TCK will need to be probed, however. If they are properly wired, you can check out the remaining circuits by reading the instruction registers of all devices. The two least significant bits of each IC's instruction register must read "01." If the expected pattern doesn't show up when you scan the instruction registers, you need only count bits backward to find out where the fault occurred.

The Sample/Preload command gives you a picture of your entire register system at a given moment, rather

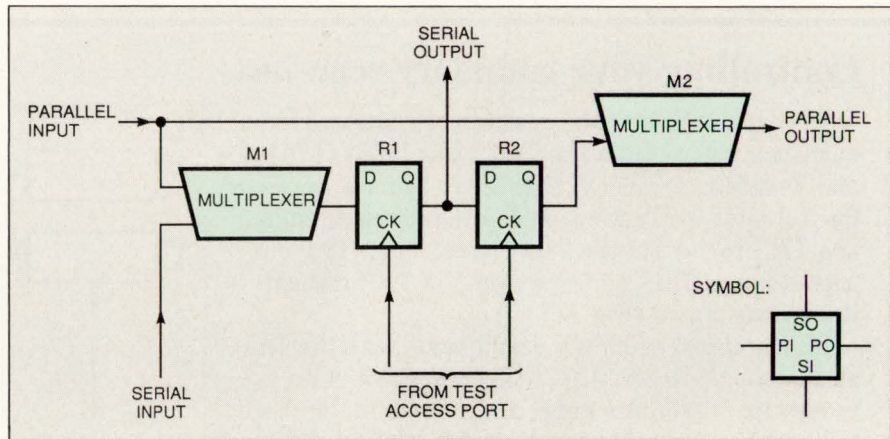

Fig 2—This circuit showing the basic features of a JTAG boundary-scan register cell is one of many possible implementations. The cell can capture the state of its parallel-input line, provide an alternate output signal, and shift data in and out of adjacent cells.

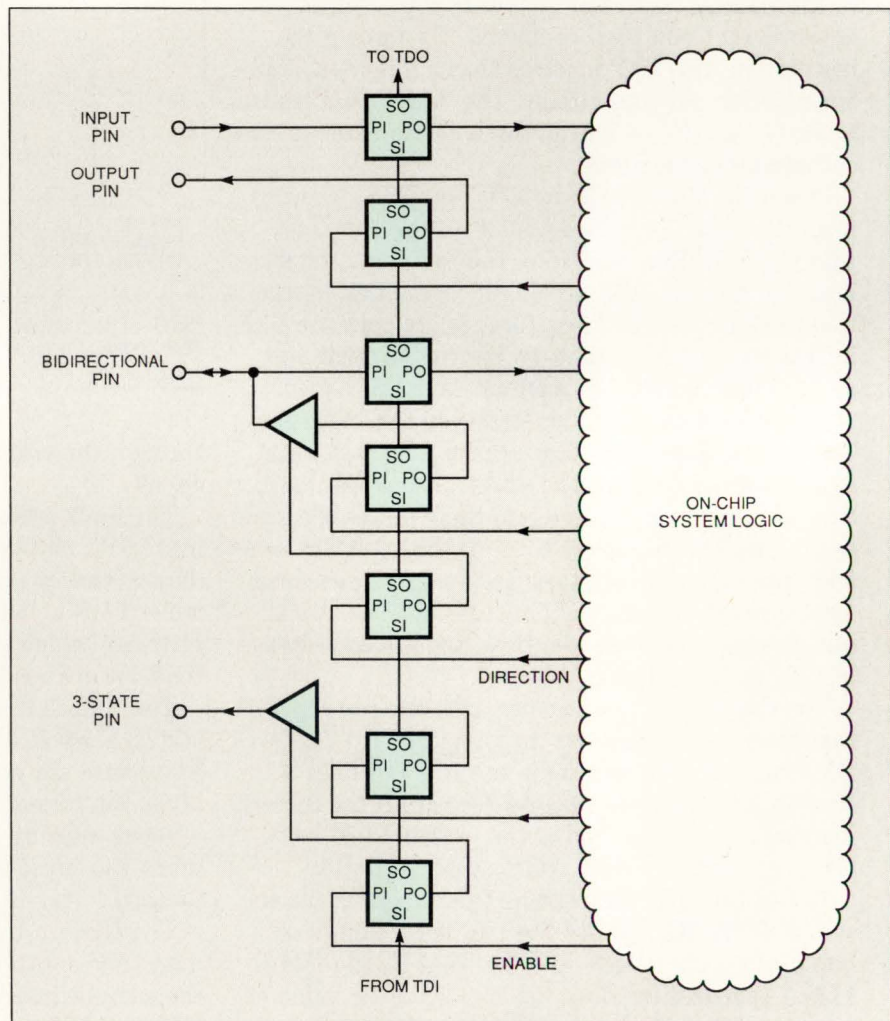
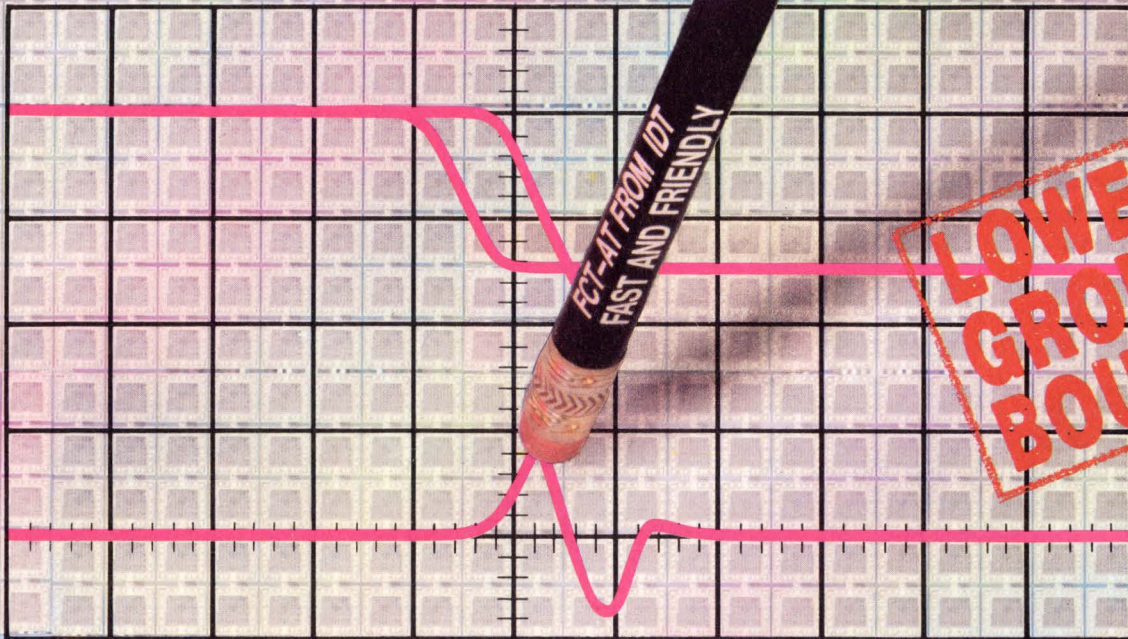

Fig 3—In order to provide complete control over an IC's I/O lines, the boundary-scan registers must connect to I/O control lines as well as signal lines.

FCT-T Logic



Fastest Speed

Fast and Friendly

IDT now offers the fastest and friendliest series 54/74 TTL logic family available. The FCT-T family offers speeds that are twice as fast as those of other logic families with up to 40% less switching noise than previous FCT devices. The reduced output voltage swings and new output circuitry provide high-speed logic designers with the perfect combination of the fastest speed, low power, and ease of use.

True TTL Compatibility

We've designed our FCT-T logic family with outputs that provide direct TTL logic compatibility. Edge rate control structures have also been added to increase noise immunity while maintaining FCT-C speeds.

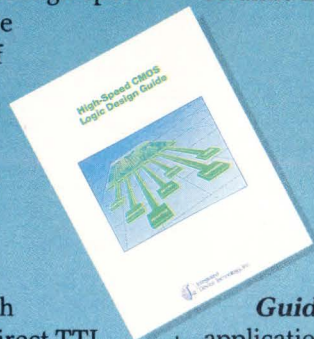

Fastest Speeds Available

The FCT-T family is pin- and function-compatible with FCT logic and is available in FCT-T, FCT-AT, and FCT-CT speed grades — the fastest in the industry. And they're available in all standard package configurations: plastic DIPs, ceramic DIPs, plastic SOICs, PLCCs, and ceramic LCCs in commercial and MIL-STD-883B versions.

Free Design Guide

Call or FAX us today and we'll send you a copy of our new *High-Speed CMOS Logic Design Guide* which contains

application information on reducing ground bounce, series termination, and PC board trace characteristics, as well as an overview of FCT-T logic.

You Can Count On Us

IDT offers a full array of high-performance system building blocks including:

- RISC processors
- Multi-port memories
- Standard logic
- RISC modules
- SRAMs
- Subsystems
- Complex logic
- FIFOs

IDT Corporate Marketing
P.O. Box 58015
3236 Scott Blvd.
Santa Clara, CA 95052-8015

(800) 345-7015
FAX: 408-492-8454

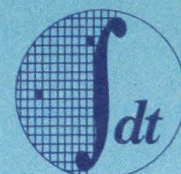

When cost-effective performance counts

Integrated
Device Technology

TECHNOLOGY UPDATE

JTAG boundary scan

like having a many-hundred-bit wide, 1-word-deep logic analyzer. If you can put your system into a repetitive loop, you can then take a succession of such pictures, timed to provide a sequential look at your circuit's operation. Tedious work, it's true, but a lot of capability from a mere four wires.

In large circuits the length of the scan path may become unwieldy. There is, however, nothing restricting you to a single scan path through your circuit. You can just as easily break the test path into multiple paths, running them independently or sharing various signals. Fig 4 shows several possible scan-path configurations.

Using the Bypass command in conjunction with the External Test command also lets you test your board in sections. You can bypass the ICs that you want to function normally, then use the External Test command to set up and read their boundary conditions. The same scheme allows you to perform functional tests on devices or logic blocks that aren't scannable.

At present, ICs that aren't scannable vastly outnumber the ones that are. Any ASICs you create can certainly be made scannable; many ASIC vendors have JTAG boundary-scan circuits in their libraries. Scannable standard logic, on the other hand, is still fairly rare.

There are some exceptions. Texas Instruments has introduced the first four members of its Scope 74BCT8xxx family of JTAG boundary-scannable logic devices. The four members are 20-MHz octal latches and drivers, functionally similar to the industry-standard 74LS244, -245, -373, and -374 devices, but with the addition of the JTAG test bus. They range in price from \$4.33 to \$4.55 (1000).

More complex scannable devices are also available. The TMS320C50

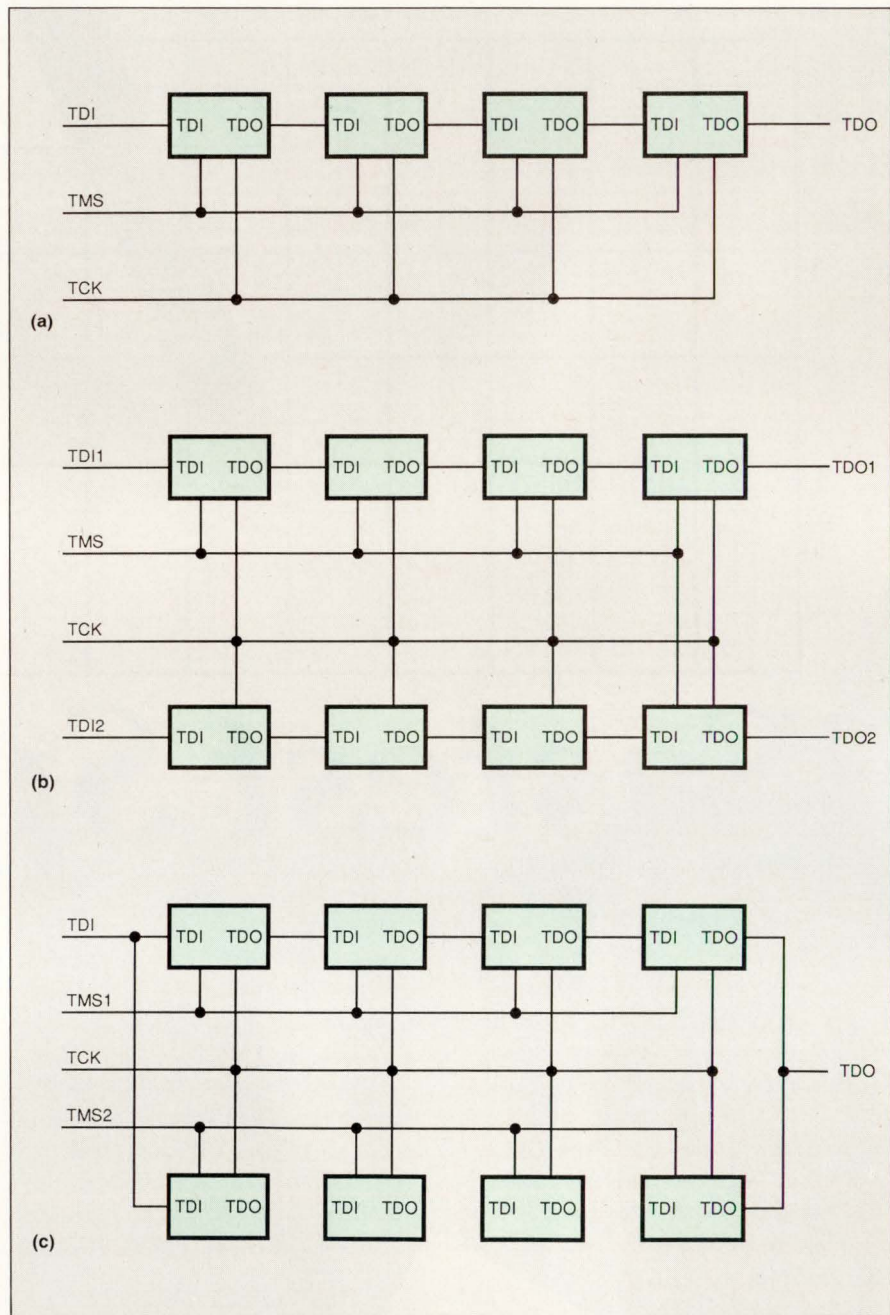
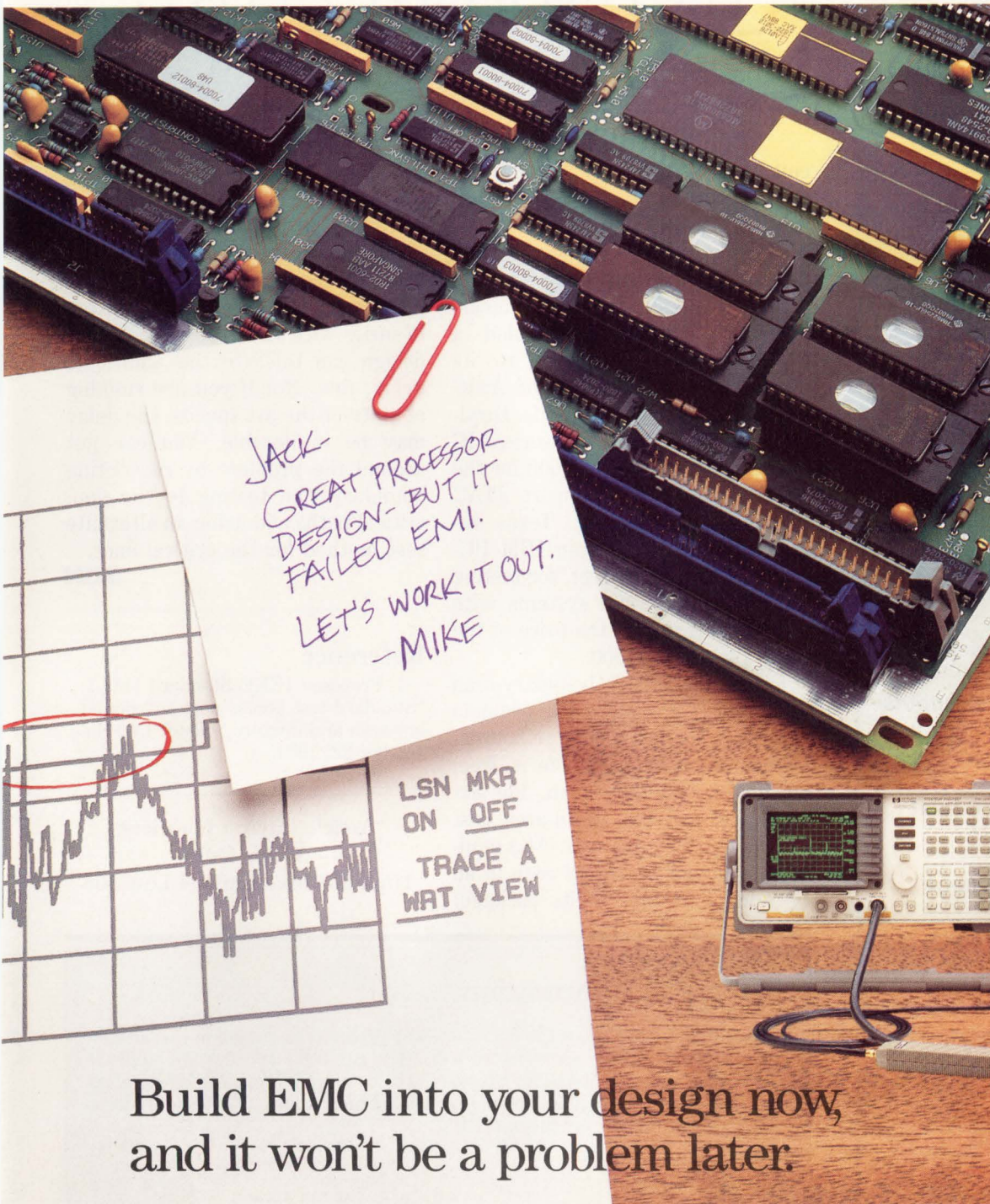

Fig 4—Breaking up is easy to do if a single scan path through your circuit (a) is too long. You can, for example, create parallel scan paths (b) that operate simultaneously. You can also utilize TDO's 3-state nature to parallel paths (c) that operate independently.

fixed-point DSP μ P from Texas Instruments provides the JTAG test bus. The chip costs \$135 in sample quantities. The ADSP21000 floating-point DSP μ P from Analog Devices, which should appear later this year, will also provide the test bus.

For the most part, however, JTAG boundary scan is something you'll have to add to your own ICs. Tools to make that addition easier are already on the market. Racal-Redac's SilcSyn 2.0, for example, offers automatic boundary-scan cir-



Build EMC into your design now, and it won't be a problem later.

With all the new regulations surrounding electromagnetic compatibility (EMC), the best way to avoid costly delays is to locate problems as early as possible. Two new HP EMC solutions make that easy.

The HP 84100A Design Development Solution helps you correct problem areas at the design stage. It pinpoints hot spots on breadboards and prototypes

using a spectrum analyzer with software memory cards that simplify troubleshooting.

The HP 84110A Pre-Production Solution gives you added confidence that your designs will pass compliance. It has all the analysis capability, software and accessories you need to uncover conducted and radiated emission problems before final EMI testing. So, find out how to build EMC

into your designs. For information about HP's full line of EMC solutions and design training programs, call **1-800-752-0900***. Ask for **Ext. 1350**, and we'll send you our EMC Measurement Solutions fact kit.

There is a better way.



See Us at Autotestcon Booth No. 400

Lowest Profile
0.5" ht.,
up to 55 Watts



PICO **AC-DC** **Power** **Supplies**

- **Input Voltage 90 to 130 VAC (47/440Hz)**
- **Single, Dual, Triple Outputs**
- **1200V Rms Isolation**
- **Low Isolation Capacity Available**
- **Continuous Short Circuit Protection**
- **High Efficiency**
- **Fully Regulated Voltage Outputs**
- **Operating Temperature -25°C. to +70°C. with No Heat Sink or Electrical Derating Required**
- **Expanded Operating Temperature Available (-55°C. to +85°C. ambient)**
- **Optional Environmental Screening Available**

PICO manufactures complete lines of Transformers, Inductors, DC-DC Converters and AC-DC Power Supplies

**Delivery—
stock to
one week**

**SEE EEM,
OR SEND DIRECT FOR
FREE PICO CATALOG**

PICO
Electronics, Inc.

453 N. MacQuesten Pkwy. Mt. Vernon, N.Y. 10552

Call Toll Free 800-431-1064

IN NEW YORK CALL **914-699-5514**

CIRCLE NO. 6

TECHNOLOGY UPDATE

JTAG boundary scan

cuit synthesis for your ASIC design. Prices range from \$40,000 to \$50,000.

Tools to help you test your boundary-scan design are also becoming available. Integrated Measurement Systems has added a \$33,000 scan-test module to its Logic Master XL series of ASIC test and verification systems. Hewlett-Packard's HP82000 series IC evaluation systems (\$75,000 for the basic system) also support JTAG boundary-scan testing. Texas Instruments is offering an IBM PC-based tool, called Asset, for testing both pc boards and systems with the JTAG test bus; the price of the basic system is \$7500.

Using the JTAG boundary-scan technique helps solve the problem of testing surface-mount pc boards. Of course, nothing in life is free; neither is boundary scan. For example, there is a board-area cost for the extra signal lines. At a minimum, putting boundary scan in an IC adds four pins to its package.

For large devices the additional pins may not dictate a package size increase, but smaller devices will jump up one size.

There may also be a performance penalty caused by the multiplexers in series with all I/O signals. If your design can tolerate the additional delay, fine. But if you are running at state-of-the-art speeds, the delay may be intolerable. You can get around the problem by restricting boundary-scan testing to the non-critical paths and using an alternate test method for the critical ones.

EDN

Reference

1. Proposed IEEE Standard 1149.1, "Standard test access port and boundary-scan architecture," Draft D6, November 22, 1989.

Article Interest Quotient
(Circle One)

High 503 Medium 504 Low 505

For more information . . .

For more information on the boundary-scan products discussed in this article, contact the following manufacturers directly, circle the appropriate numbers on the Information Retrieval Service Card, or use EDN's Express Request service. When you contact any of the manufacturers directly, please let them know you saw their products in EDN.

Analog Devices
One Technology Way
Norwood, MA 02062
(617) 329-4700
FAX (617) 329-8703
Circle No. 700

Hewlett-Packard
Box 10301
Palo Alto, CA 94303
Phone local office
Circle No. 701

Integrated Measurement Systems
9525 SW Gemini Dr
Beaverton, OR 97005
(503) 626-7117
FAX (503) 644-6969
Circle No. 702

Racal-Redac/Silc Technologies
34 Third Ave
Burlington, MA 01803
(617) 273-1144
FAX (617) 229-8174
Circle No. 703

Texas Instruments
Box 809066
Dallas, TX 75380
(800) 336-5236, ext 700
Circle No. 704

Don't keep your processor in suspended animation.



Introducing the industry's first 20 and 25ns—1 Megabit SRAMs.

History is filled with examples of good architecture gone bad. Elegant designs left hanging because they didn't have the right parts.

As a system designer, you've probably experienced the same thing. Now, Paradigm Technology offers a solution. The industry's first 20 and 25-nanosecond 128K x 8 SRAMs.

Our 1 Mb SRAMs provide significantly enhanced functionality, throughput and performance in a variety of architectures. What's more, a very small cell size allows our chips to fit neatly into packages as small as 400-mils—all made possible by a proprietary dual-well CMOS process.

Best of all, every SRAM is fabricated right here in our own facility in San Jose, California.

Don't keep your processor in a state of suspended animation. To place an order for any of our family of very fast 1 Mb and 256K SRAMs, call Paradigm's Express Chip hotline today.

1 Megabit 128K x 8 Package				
Access Time	400 mil Sidebraze	600 mil Sidebraze	400 mil SOJ	400 mil Cerpack
20 ns	AUG	SEPT	NOV	SEPT
25 ns	NOW	SEPT	NOV	SEPT

Military-grade parts under MIL-STD-883 Class C available in 4th quarter 1990.



Catch the Expresssm
1-800-767-4530

PARADIGM TECHNOLOGY, INC. 71 Vista Montana, San Jose, California 95134
(408) 954-0500 FAX (408) 954-8913

CIRCLE NO. 38

"Have you heard? Toshiba has a full line of high speed

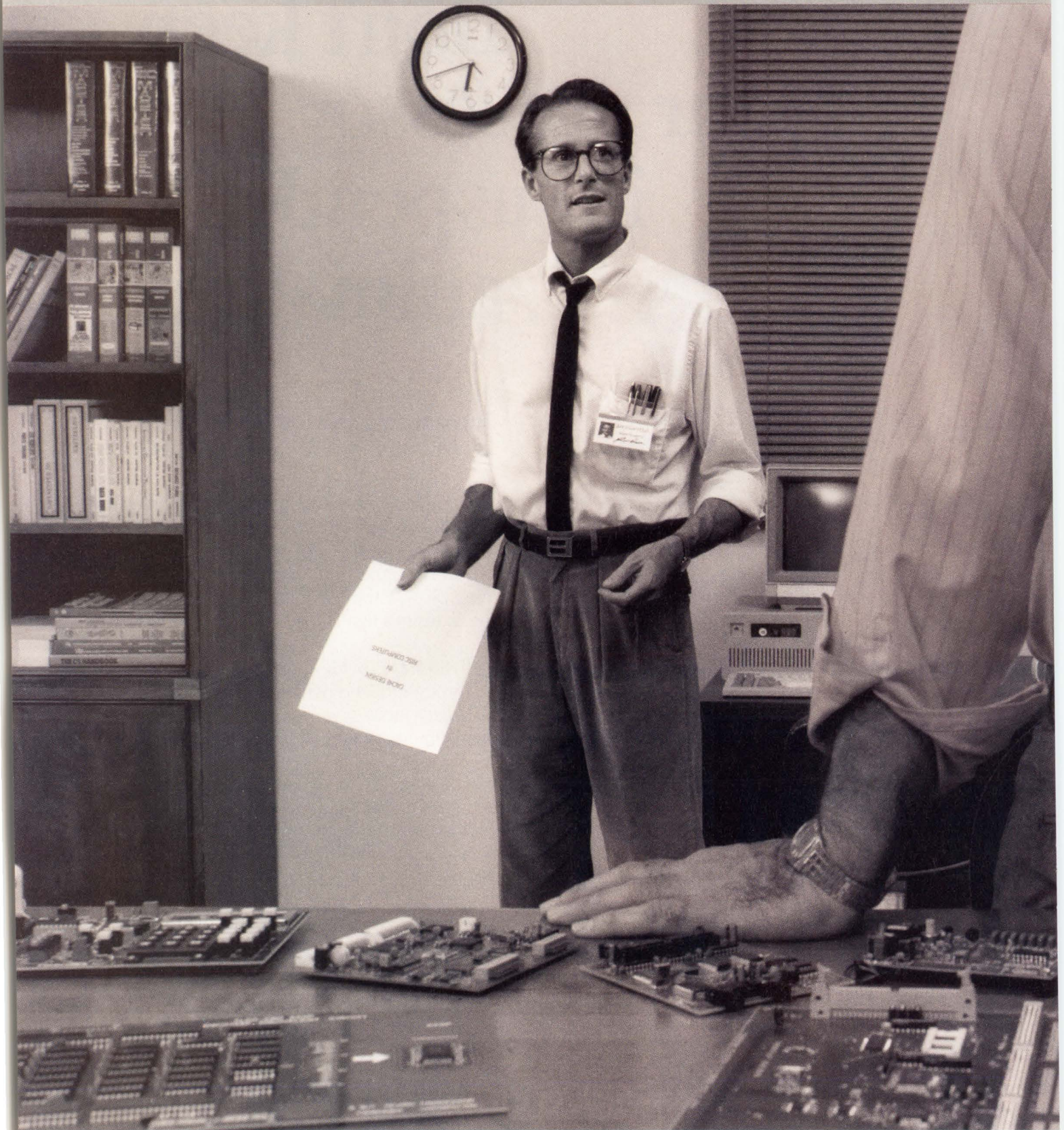

Toshiba semiconductor products are available from a distributor near you. You can reach the distributor of your choice by calling one of the central numbers: Active Electronics, **1-800-388-8731**; Cronin Electronics, Inc., **1-800-5CRONIN**; General Components, Inc., **1-800-524-1463**; Gould Electronics, **1-800-323-6639**; Itt Multicomponents Corp., **1-800-387-3687**; Merit Electronics, Inc., **1-408-434-0800**;

SRAMs."

"How many? How fast?"

"256K for starters. Plus 144K and 64K. And the 144K at 20ns, is the fastest application specific Cache Data RAM available anywhere."

"Great! When can we get our hands on them?"

"They're available immediately. In quantity. Right now."

The addition of these state-of-the-art 256K SRAMs and 144K Cache Data RAM gives Toshiba the broadest line in the industry. More densities. More configurations. More speeds. More choices to fit your design needs.

Toshiba high speed CMOS SRAMs are not only fast, they're reliable. And Toshiba has more than 20 years of CMOS experience.

You can cut qualification costs with Toshiba SRAMs, too. All the devices employ the same 1.0μ CMOS process and aluminum master slice that's common to all configurations within each density. So you can qualify by family.

The 20ns Cache Data RAM is the fastest on the market. (25ns and 30ns versions are also available.) The devices are user configurable to either 4K × 18 × 2, or 8K × 18. The × 18 organization gives you two extra bits to support

Toshiba High-Speed SRAMs						
Configuration	Density	Speed (ns)			Availability	
64K x 1	64K	35	45	55	Now	
16K x 4	64K	15	20	25	35	
16K x 4 (OE)	64K	15	20	25	35	
8K x 8	64K	15	20	25	Now	
8K x 9	72K	15	20	25	Now	
4K x 18 x 2	144K	20	25	30	Now	
8K x 18	144K	20	25	30	Now	
64K x 4	256K	17	20	25	35	
64K x 4 (OE)	256K	17	20	25	35	
32K x 8	256K	17	20	25	35	
32K x 9	288K	17	20	25	35	
16K x 12	192K module	25	35		Now	
16K x 16	256K module	25	35		Now	
PART	CE	A12	t _{acc}	t _{OE}	V _{cc}	PACKAGE
TC55187	unlatched	unlatched	20/25/30	10/10/12	± 10%	PLCC
TC55188	latched	latched	20/25/30	10/10/12	± 10%	PLCC

the parity check required in specific applications like Intel's 80486™. Both devices are provided with byte control, and on-chip address latches are designed to interface directly with the Intel 82385™ cache controller. Pin-out is compatible with other suppliers.

Toshiba high speed SRAMs are ideal for high-end system designs. Anywhere you need top speed and fully static operation, Toshiba has a high performance solution.

They offer a wide range of packaging options, too. Why not call today for a complete set of data sheets? Call 1-800-888-0848, ext. 517. *Service is our key component.*



In Touch with Tomorrow
TOSHIBA

TOSHIBA AMERICA ELECTRONIC COMPONENTS, INC.

© Toshiba America Electronic Components, Inc.

TM Intel, 80486 and 82385 are trademarks of Intel Corporation.

MST-012-88-1

Marshall Electronics Group, 1-800-522-0084; Milgray Electronics, Inc., 1-800-MILGRAY; Marsh Electronics, Inc., 1-800-558-1238; Repton Electronics, Inc., 1-800-282-1360; Rome Electronics, 1-800-366-7663; Nu Horizons Electronics Corp., 1-800-726-7575; Sterling Electronics, 1-713-623-6600; Western Microtechnology, Inc., 1-800-338-1600;

*It's 1992.
Do you know where
your 4-meg DRAMs are?*



*NEC customers
have no cause for alarm.*

The best way to feel good about future DRAM supplies is to buy from NEC today.

Many experts expect DRAM shortages by 1992. Naturally, these predictions make buyers nervous.

At NEC, we take these worries seriously. We're planning ahead now to keep our long-term customers supplied now, and in the future.

That's why we're putting \$400 million more into our Roseville fab. Located on 72 acres near Sacramento, California, this wafer fabrication plant has been in volume production since 1984.

NEC was the first Japanese company to invest heavily in U.S. manufacturing. We're already shipping over five million low-cost, high-quality integrated circuits per month, direct from Sacramento to you.

U.S. Memories, Microprocessors, and ASICs too.

The first 4-meg DRAMs made in the United States will be made by NEC. In fact, our new submicron line will add another five million new units per month by the spring of 1992.

If you are buying 256K DRAMs from us now, you know our American products are of the same unsurpassed quality as our 1-meg and 4-meg DRAMs made in Japan and other worldwide locations.

Our U.S. fab is growing to five times its current size. Soon, we'll be able to meet all your future needs with American-made versions of our most advanced DRAMs, SRAMs, VRAMs, microprocessors and ASICs.

The time is now.

Whatever your IC needs, you can put our local manufacturing clout to work for you immediately.

NEC's California fab already offers ASIC designers the same uncompromising quality found in our standard products along with an important bonus: hands-on local control of production.

Our customers remain loyal to us, because we are loyal to them.

Call 1-800-632-3531 today to learn more about doing business with NEC, your global manufacturing partner. Our complete line of microprocessors, ASICs and memory products is available now.

For even faster service, FAX your literature request to 1-800-729-9288. Ask for Info Pack 393.



Our expanding California facility will produce the first 4-meg DRAMs made in America.

NEC Electronics Inc.
401 Ellis Street
Mountain View, CA
94039-7201
1-800-632-3531/415-965-6158

SBE... At the Core of WAN Interface Solutions

The SBE VCOM-4 Multiprotocol Communications Controller ... *today's high-performance, cost effective WAN interface.* For price-performance in a *single* VMEbus communications controller, nothing equals the new SBE VCOM-4.

This exclusive SBE card features *four* full-duplex, independently programmable serial channels. Yet, it takes up only one VMEbus slot and provides twice the throughput of conventional boards. A complete implementation of X.25 is available ported to the VCOM-4, which speeds your product to market.

The result: an unmatched WAN interface for VME-based hosts, front-end processors, and data/voice networking systems, including:

- Two channels at T1 speeds.
- All four channels can operate with *sustained* throughput at speeds up to 768 Kbps, interfacing to fractional T1 services or 56/64 Kbps lines.
- Each communications channel can be *independently* configured to support HDLC, SDLC, Bisync, Async.

Turn to SBE and the VCOM-4 for the core of your VMEbus WAN product design application. For fast action, contact SBE, Inc., 2400 Bisso Lane, Concord, CA 94520, or call **1-800-347-COMM.**

CIRCLE NO. 47



SBE

*Communications &
Real-time Solutions*

EDN August 2, 1990

TIGA 340X0-BASED GRAPHICS BOARDS

Intelligent cards display megapixels

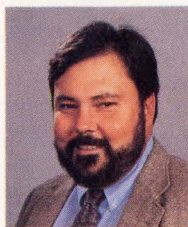

Boards based on the TI 34010 and 34020 chips offer the performance and compatibility that users of graphics-intensive CAE and business applications need.

*Maury Wright,
Regional Editor*

Users of 80X86-based "personal computers" for CAE or other graphics-intensive applications need no longer take a back seat to "workstation users." Intelligent graphics boards based on the Texas Instruments 34010 and 34020 μ Ps can offload graphics responsibility from your host CPU and greatly accelerate graphics applications and graphics environments such as Microsoft Windows. Furthermore, the 340X0 boards offer compatibility with a wide base of software via the TIGA (Texas Instruments Graphics Architecture) and DGIS (direct graphics interface standard) graphics standards.

The lack of graphics standards at and above the megapixel range has certainly hampered the use of graphics-intensive applications on personal computers. Typically, you need to find graphics software that meets your needs and then buy a graphics board that the software supports. What's more, you're often stuck with a system that runs only a specialized application or two, or one that requires multiple monitors and video cards.

IBM's VGA card provides a standard way to

display 640×400 pixels. Subsequently, super and extended VGA cards from third-party vendors now offer a somewhat standard way to achieve 800×600 - and even 1024×768 -pixel resolution. And although the VGA cards depend on the host CPU to perform the graphics manipulations, today's 33-MHz 80386 and 80486 systems have power aplenty.

Graphics-intensive applications require a more elegant video subsystem

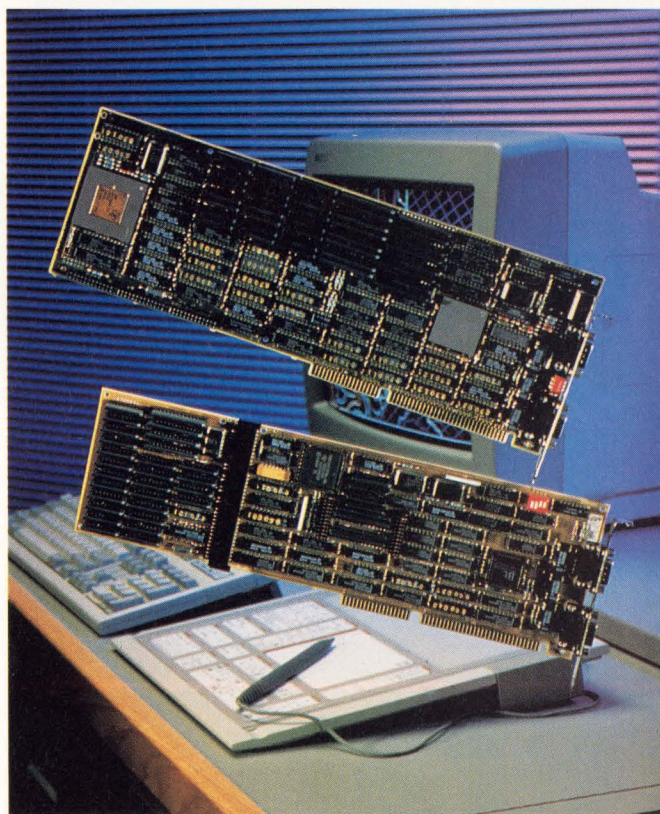

The 50-MHz 34010 and 25-MHz 34020 intelligent graphics controllers from Hewlett-Packard offer users a price/performance choice. The \$2495 Intelligent Graphics Controller 20 is one of the first boards to use the new 34020 processor that implements features such as fast area fills and accelerated text generation. Users on a budget may prefer the \$995 Intelligent Graphics Controller 20.



The Standard for Circuit Simulation Has Expanded

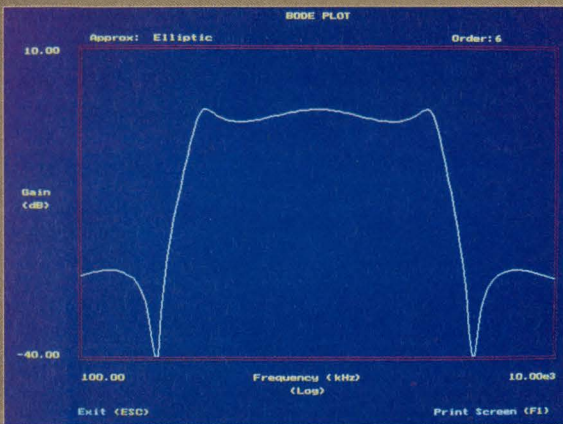

Filter Designer Bode Plot

Filter Designer: New Front End Design Tool

Filter Designer, a member of the PSpice family, is an interactive design aid giving you the ability to design and analyze active filters. Features include a menu-driven interface, hard copy report summaries and plots, cascading multiple designs, and interfaces to PSpice and SWITCAP.

Filter Designer uses a well established methodology in applying classical approximations to your filter specification. Available filter types include low pass, high pass, band pass, and band reject, all of which may be synthesized by Butterworth, Chebyshev, Inverse Chebyshev, and Elliptic (Cauer) functions.

A full editing capability allows you to insert, delete, and reorder stages, and modify coefficient values. These editing features allow a filter expert to fine tune a design, or quickly make a small modification to an existing design.

Filter Designer supports both active RC and switched-capacitor biquad filter structures. The components may be scaled or resized to center the values in preferred ranges.

Both Bode and pole-zero plots are available. Normally, you can determine the acceptability of your design by the inspection of its Bode plot. The Filter Designer plots gain, phase, and delay vs. frequency. For sampled data designs, you can plot your choice of the s - or z -domain transfer function. Pole-zero plots allow you to inspect the roots of the transfer function in either the s -domain or z -domain.

The Filter Designer numerical optimizer is a universal filter design option which allows the user to synthesize arbitrary transfer functions and delay equalization filters.

Filter Designer works with our PSpice circuit simulation package. PSpice and its options form an integrated package for the analysis of electronic and electrical circuits.

Each copy of PSpice and Filter Designer comes with our extensive product support. Our technical staff has over 150 years of experience in CAD/CAE, and our software is supported by the engineers who wrote it. Since its introduction over six years ago, PSpice has sold more copies than all other SPICE programs combined.

For further information about Filter Designer or any other PSpice product, please call us at (714) 770-3022 or toll free (800) 245-3022.

20 Fairbanks • Irvine, CA 92718 USA • FAX (714) 455-0554

TECHNOLOGY UPDATE

Intelligent graphics boards

than that offered by VGA, though. Almost two years ago, IBM started shipping the 8514/A board, which includes some dedicated circuitry, to offload some graphics primitives from the host. Over the summer, third parties began shipping 8514/A clones. Thus far, the 8514/A occupies less than an industry-standard position because there are some compatibility problems that have to be worked out (see **box**, "TIGA 340X0 vs 8514/A: fact and fiction"). The 8514/A boards also fail to offer the performance that a processor-based board can offer in accelerating a graphics application.

Boards become standard

Intelligent graphics boards that support megapixel resolution have been available for as long as five or six years. The 340X0 boards represent the first semblance of an industry standard, however. TI began shipping the 34010 about four years ago and the 34020 last year. Currently, around 50 vendors offer 340X0 boards for IBM-compatible personal computers, including IBM PC/AT, EISA (Extended Industry Standard Architecture), and Micro Channel Architecture (MCA) bus models. Furthermore, the offerings support resolutions ranging from 640×400 to 4M×4M pixels and offer choices from monochrome to 24-bit color.

According to Doug Crawford, marketing manager for computer video products, TI will soon ship its one millionth 34010. Crawford also estimates that between 70 and 80% of the chips sold go into IBM-compatible personal-computer applications. He expects the company to sell half a million chips this year and to double shipments each year afterward.

Much of the 340X0's success can be traced to TIGA. TI defined TIGA to act as a hardware-independent applications-software in-

terface for 340X0-based boards. In fact, TIGA acts as a graphics operating system that runs on such a board. And any software that includes a TIGA driver can run on a board that hosts TIGA. Board vendors license the graphics standard from TI.

About 50 software applications currently support TIGA. Among them are Microsoft Windows and

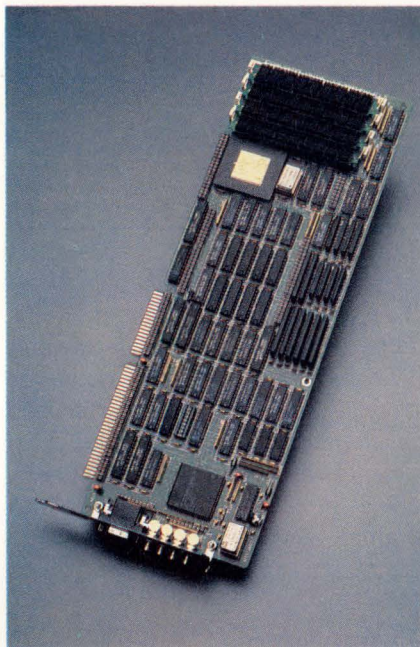

Support for 1600×1200-pixel resolution makes the Artist XJS 34020-based board from Artist Graphics suitable for high-end CAE applications. The board supports 16 colors at its maximum resolution, and you can use the board in a 1280×1024-pixel resolution mode with 256 colors.

OS/2 Presentation Manager. Therefore, the hundreds of Windows applications will also run on TIGA boards. And the performance that 340X0 boards offer help most in graphics environments such as Windows. The graphics environment called Halo from Media Cybernetics (Silver Springs, MD) also includes a TIGA driver. And Halo adds support for a couple of hundred more applications.

To further embellish compatibility, TI developed a version of the

8514/A AI (adapter interface) for TIGA boards. IBM developed the AI to provide software developers with a hardware-independent software interface to 8514/A boards. Currently, all but about a half dozen applications that support the 8514/A do so via the AI and therefore will run on TIGA boards. You can expect more applications in the future, however, that write directly to 8514/A hardware registers.

Third-party vendors have also added compatibility to 340X0-based boards. GSS (Graphics Software Systems), for example, licenses its DGIS graphics standard for use on 340X0 boards. The company includes DGIS with its AT1000 and AT1050 boards. The standard adds support for approximately 50 other packages as well. Other well-known vendors of 340X0 boards that support DGIS include Hewlett-Packard, NEC, and Sota Technology. In all, more than 30 vendors of 340X0 boards offer DGIS.

When you consider buying a 340X0 based board, the most important things to examine are performance, price, compatibility, resolutions and colors supported, and upgradeability.

As you might expect, performance is the toughest criterion to judge. Processor-speed rating could give a clue to performance, but most of the newer 34010 boards include 50-MHz processors. For example, the \$995 AT1050 and \$1495 AT1000 from GSS include 50-MHz μ Ps. GSS actually only sells the boards on an OEM basis; it also sells manufacturing rights and complete manufacturing kits. NEC sells the products to end users under the name Multisync Graphics Engine.

A few companies offer boards with faster processors. Number Nine Computer Corp sells its Pepper Pro 1024 with a 60-MHz processor, but the board costs \$2495. Vermont Microsystems' Cobra family of

TECHNOLOGY UPDATE

Intelligent graphics boards

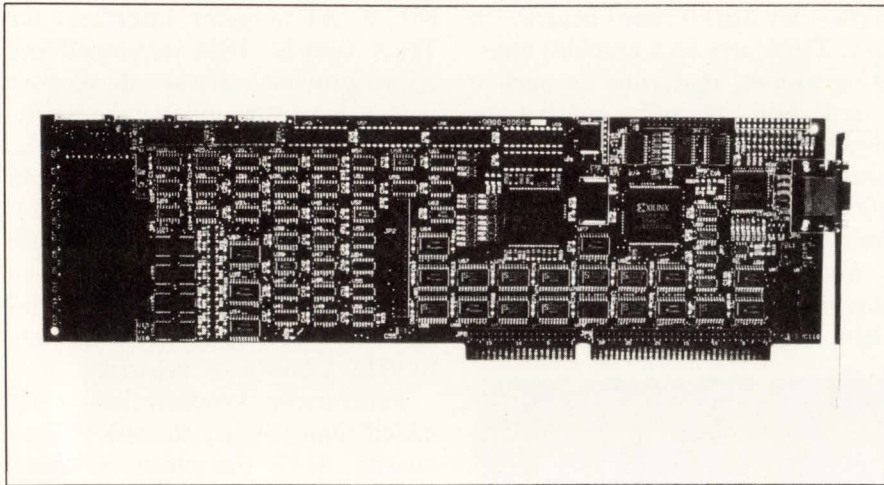

The programmable frequency output of the GSS 34010-based AT1050 video card allows it to support virtually any monitor—including adjusting to nonstandard scanning frequencies. The \$995 board includes software support for Microsoft Windows and all DGIS-compatible applications.

boards also uses a 60-MHz processor. The boards start at a base price of \$3395. Number Nine's newest board, the #9GRX, uses a 60-MHz chip and has a base price of only \$895.

Hewlett-Packard has led the charge to move to the next-generation 34020 μ P in search of performance. Carla Klein, an HP product manager, claims that the \$2495 Intelligent Graphics Controller 20 based on a 30-MHz 34020 offers about triple the performance of a 34010-based board and 15 times the performance of a VGA board. The company also offers the 34010-based \$995 Intelligent Graphics Controller 10.

Jim Cochell, GSS' director of new products, claims GSS achieved 34020-like performance on its boards by designing a custom graphics accelerator IC to complement the 34010. The IC performs fast fills, accelerates text generation, and includes hardware dithering—all enhancements that the 34020 offers. Cochell doesn't think the 34020 is cost effective yet for the mainstream market.

Ultimately, performance depends on a manufacturer's software exper-

tise as much as it does on hardware. TIGA and DGIS implementations affect performance, but you can't measure such effects quantitatively. To find the best performer, you should run your suite of applications on each board you consider.

The price of 34010 boards has dropped considerably in the last

year. In addition to Number Nine's #9GRX, GSS/NEC, Hewlett-Packard, and Sota Technology all have boards priced under \$1000. TI's Crawford expects to see prices approach \$500 by the end of the year. He also thinks that 34020 boards will reach the \$1000 level by year's end.

The cost of 34010 boards compares favorably with 8514/A boards. And your monitor will probably cost you substantially more than the video board. Monitors capable of 1024 \times 768-pixel resolution start at about \$1000. A 19-in. unit capable of displaying 1280 \times 1024 pixels will cost you at least \$2500.

Despite the success of TIGA and DGIS and the growing popularity of Windows, software compatibility is still a problem. You should certainly make sure that your key applications will run on the board you choose. Furthermore, some type of VGA compatibility will ensure that you can run virtually any application as long as you use a

Text continued on pg 88

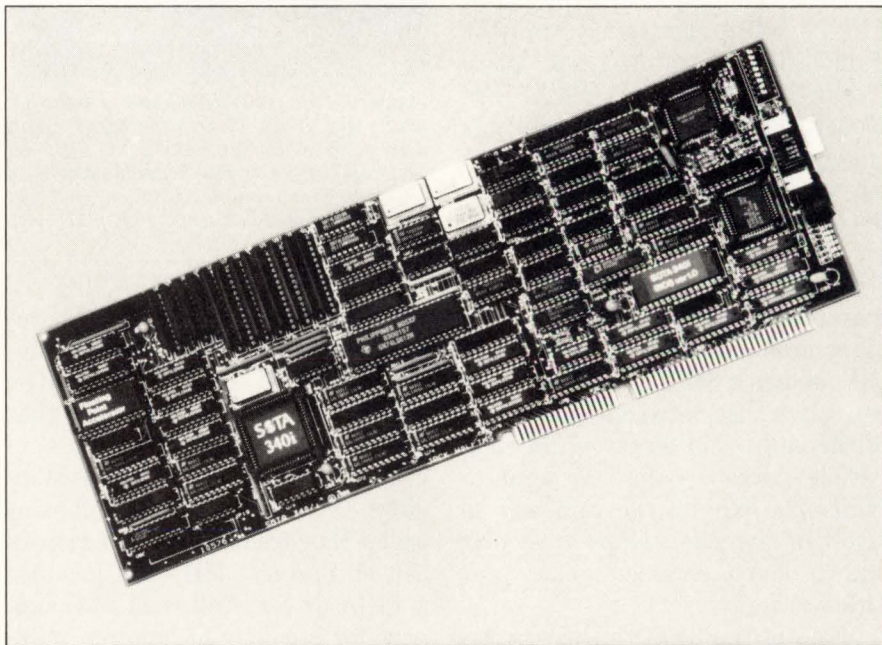

Resolutions to 1280 \times 1024 pixels and support for 256 colors make the Sota Technology 340i a flexible choice. You can buy the basic unit for \$995 and expand the video RAM frame buffer later.

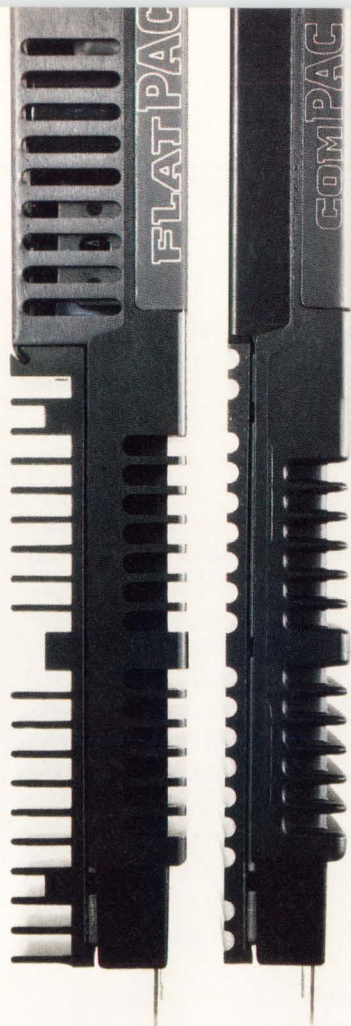

Up To 600 Watts Per Inch

Our expanding family of compact, configurable, power systems combine the flexibility of a custom supply with the availability of standard catalog products . . . in low profile, compact packages that let you pack the most power into the least amount of space. And they meet the specialized input voltage, noise and transient requirements of major worldwide markets. Think of them as a universal solution for most of your system power requirements . . . AC or DC input . . . in computer, telecom or vehicular applications . . . up to 600 Watts. FlatPAC™ is the industry benchmark for power density in off-line applications. And now, CompPAC™ sets the standard for DC input supplies . . . in a package less than one inch tall! Both offer unprecedented flexibility in configuration along with instant availability . . . in a fraction of the space required by conventional switchers. Just define your requirements . . . we utilize our high frequency, high power-density converters to quickly configure a FlatPAC or CompPAC specific to your needs.

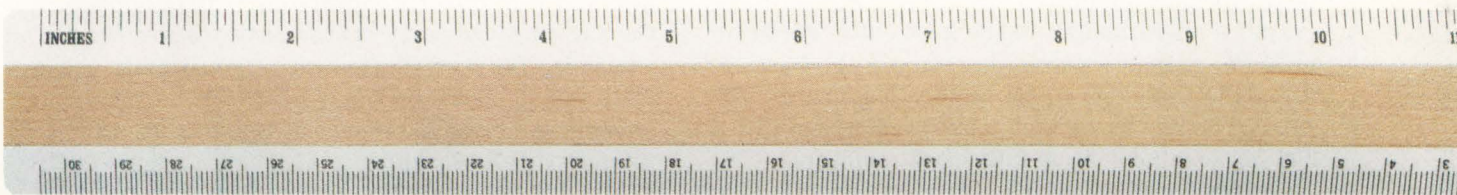

You benefit from the proven field performance, high efficiency and inherently high reliability of our component-level power converters, without sacrificing any of the features you need: off-line inputs for worldwide application; nominal DC inputs from 24 to 300 VDC; surge limiting; safety agency recognition; EMI/RFI to FCC/VDE, British Telecom, Bellcore or MIL-STD-461; totally isolated and trimmable outputs; AC OK and DC OK status signals . . . and more.

You don't have to choose between costly and risky custom development or bulky catalog supplies. Call us to discuss FlatPAC and CompPAC . . . the new standards that make customs obsolete.

Does your power supply measure up?
Call **VICOR EXPRESS** for a free ruler
at **1-800-735-6200** or **508-470-2900** at ext. 265

FlatPAC™ AC Input		CompPAC™ DC Input
110/220 VAC	Voltage Inputs	24, 28, 48, 270, 300 VDC
1, 2, or 3	Number of Outputs	1, 2, or 3
2 to 95 VDC	Output Voltages	2 to 95 VDC
Up to 600 Watts	Output Power	Up to 600 Watts
1.37"	Height	1"
FCC Part 15, Class A VDE 0871, Class A IEEE Std 587-1980	Applicable Specifications	Bellcore (24/48 V) British Telecom (24/48 V) FCC/VDE, Class A (300 V) MIL-STD-461 C (28/270 V) MIL-STD-704A



Component Solutions For Your Power System
23 Frontage Road, Andover, MA 01810

Common Stock Traded on NASDAQ under "VICR"

TECHNOLOGY UPDATE

TIGA 340X0 vs 8514/A: fact and fiction

At the recent Spring Comdex in Atlanta, GA, purveyors of 8514/A-compatible boards waged an all-out verbal war against boards based on the Texas Instruments 34010 and 34020 graphics processor chips. Sifting through the rhetoric, you will find some truths, some half truths, and some outright lies. You should certainly consider both board styles if you need a high-end graphics controller for CAE or other applications on your personal computer. But make sure you compare the technologies on a level playing field.

Designers of IBM-compatible personal-computer graphics boards depend on the competing 8514/A and 304X0 technologies to make a step up in graphics performance from VGA. Vendors offer boards in the 1024 × 768-pixel resolution range (and higher) based on both. Both technologies have merit, and they may eventually coexist in the marketplace. Boards based on the TI ICs have a huge lead in terms of shipments and availability, however.

IBM began shipping the 8514/A video card almost two years ago. Third-party vendors have only begun production shipments this summer. IBM's 8514/A board includes dedicated circuitry to offload some graphics operations from the host CPU. All prior IBM PC graphics standards required the host CPU to handle the video frame buffer. The board offers 1024 × 768 resolution and displays 16 (standard) or 256 (optional) colors on interlaced monitors.

Boards based on the TI 34010 have been available for almost four years; 34020 models have emerged over the last year. The 340X0 ICs are actually full-fledged 32-bit μ Ps with specialized graphics instructions added to a typical μ P instruction set. Code written for the 34010 will run unchanged on the 34020. TI also defined the TIGA (Texas Instruments Graphics Architecture) standard to provide a hardware-independent software interface to 304X0 boards.

Weigh many factors

When you examine boards based on the 340X0 with 8514/A boards, consider compatibility, performance, resolution and display quality, cost, and availability.

Compatibility always proves important in choosing a video board. Standard advice includes the tip to choose your software first and then choose a video board that works with all of it. Traditionally, IBM-invented video standards (MDA, CGA, EGA, and

VGA) have been safe choices because all software developers support the IBM standards. The 8514/A adds a hitch to assured compatibility, however. IBM intended software vendors to write applications compatible with a hardware-independent software interface called the AI (adapter interface), which was defined for the 8514/A and subsequent video boards. The AI would eliminate the problem of supporting many different displays in application software. Software developers, however, like to write code that communicates directly with the graphics hardware and therefore wrings all of the potential performance out of a video board.

IBM refused to release a detailed description of the 8514/A registers, forcing developers to use the AI. Third-party vendors reverse-engineered the IBM board and custom ICs, however, and the hardware is now well defined. Still, only a handful of applications software currently supports the 8514/A at the hardware level. Most applications that include a driver exploit the AI.

Vendors of 8514/A boards other than IBM that tout performance, however, refer to performance achieved with direct hardware support in applications. Such third-party boards have just become available. The level of hardware compatibility they offer, among each other and with IBM, is yet to be determined. Several vendors at Comdex used proprietary drivers to demonstrate the prowess of their 8514/A boards on applications such as AutoCAD. The necessity of hardware-dependent drivers for good performance paints a different picture than the plug-and-play image championed by the 8514/A vendors.

Boards have many applications

TI 340X0-based boards enjoy no status as an IBM standard. However, they work with many more applications than 8514/A vendors would have you believe. Most of the boards support TIGA, which acts as a graphics operating system on a 340X0 board. A TIGA-compliant board can run any software that includes a TIGA driver. TI currently lists almost 50 popular software packages that include TIGA drivers. That list includes the Microsoft GUIs (graphical user interfaces)—Windows and OS/2 Presentation Manager—and a graphics environment called Halo from Media Cybernetics (Silver Springs, MD). Therefore, TIGA boards will run several hundred other applications through these environments.

TECHNOLOGY UPDATE

Other companies, such as GSS, Hewlett Packard, and NEC, support DGIS (direct graphics interface standard) and TIGA on their boards. Between Windows, Halo, and DGIS, you will find few new graphics applications that the 340X0 board can't run. TI also includes an 8514/A AI driver for TIGA. The 340X0 boards also support AI applications as well as any 8514/A board.

Check before you buy

Performance claims will take the most effort to sort out. The IBM 8514/A includes dedicated circuitry to accelerate three basic graphics functions: line drawing; filled rectangles; and bitblts (bit block transfers). Other graphic operations require help from the host. Furthermore, vendors of 8514/A clones must implement similar architectures to provide register-level and AI compatibility with the original. Even Doug Crawford, TI's marketing manager for computer video products, concedes that the dedicated circuitry of an 8514/A can perform such operations on a par with or faster than a 340X0 board.

Effectively running CAE applications or GUIs such as Windows requires much more than executing a couple of graphics primitives, though, and 340X0 boards can accelerate an entire graphics environment. TI and Microsoft, for example, offload the entire "Windows engine" to the 340X0 in the TIGA Windows driver. No 8514/A boards currently come close to 340X0 boards in the overall acceleration of such an environment. TIGA also allows any application to download code into the graphics board, allowing software developers to customize graphics primitives that speed up their applications.

In addition to good performance, users of high-end personal computers demand resolution in the megapixel range. The IBM 8514/A board displays 1024 × 768 pixels, 256 colors, and only supports interlaced monitors that are subject to an annoying flicker. Vendors of 8514/A boards argue that the IBM board included undocumented support for 1280 × 1024 resolution, noninterlaced monitors, and full color. All of the 8514/A clone vendors plan to offer such extended support, but it remains to be seen how the extensions impact hardware or AI compatibility.

TIGA and the 340X0 offer a resolution-independent graphics standard. The board designer can choose to support any monitor type and resolution

desired. In fact, you can currently purchase TIGA boards that range in resolution from 640 × 400 (VGA resolution) to 4M × 4M pixels, and that offer support from monochrome to 16.7 million colors.

Cost of a megapixel display subsystem ranges from \$1500 to more than \$10,000. The 8514/A vendors believe that they will offer boards that cost substantially less than 340X0-based products. In comparing the two types of boards, however, you will find a similar list of components. Both types of boards require similar dynamic RAM or video RAM frame buffers, D/A converters, and look-up tables to support similar resolutions. The 8514/A boards employ a custom chip that implements the graphics functions. The TIGA boards use the TI 34010 or 34020 μ P.

Many factors influence cost

The cost of 8514/A boards will depend on the price of the custom chip and therefore largely on the number of boards each vendor can sell. Currently, no one other than IBM has sold many. TI, meanwhile, has sold almost a million 34010 μ Ps. The chip suits applications ranging from laser printers to workstations. The company expects to ship half a million this year. The TIGA boards, however, do have the added cost of program storage memory because the 340X0 is a μ P.

Currently, a few 8514/A boards have street prices approaching \$500, although retail prices remain around \$1000. TIGA boards feature similar retail prices, and TI's Crawford expects TIGA boards to near the \$500 retail level by the end of the year.

Monitor prices, however, contribute more to the cost of a megapixel display subsystem. Both 8514/A and TIGA offerings require monitors that range from a minimum of \$1000 for an interlaced unit to \$2500 minimum for a 19-in. noninterlaced 1280 × 1028-pixel unit. In fact, the monitor price makes the small difference in video-board price less significant.

Availability of TIGA boards abounds for the IBM PC/AT, EISA, and MCA buses. Approximately 50 vendors currently ship such boards over a price range of \$900 to \$5000. Until recently, only IBM shipped 8514/A boards—and only for MCA bus machines. The 8514/A clone vendors finally began to ship units for IBM PC/AT bus machines over the summer—a year later than originally promised.

TECHNOLOGY UPDATE

Intelligent graphics boards

multiple-frequency monitor.

Most of the boards for Micro Channel systems include a "pass-through" connector to VGA. IBM includes VGA on the mother board of its PS/2 systems and introduced the pass-through concept on its 8514/A board. The pass-through circuit allows the VGA controller to drive the monitor when necessary. It connects two video controllers to the same monitor.

The PC/AT bus boards from Hewlett-Packard, Number Nine, and Sota Technology include pass-through capability that works with standard PC/AT bus VGA cards. GSS includes a similar feature on its AT1050 card and actually includes the VGA circuitry along with the 34010 on its AT1000 offering. Adding a CGA (color graphics adapter) or an MDA (monochrome display adapter) simulator on a 34010 board is another workable, but less desirable, compatibility solution that some manufacturers offer. The Number Nine #9GRX includes a VGA pass-through and MDA emulation.

All of the boards discussed here support 1024×768-pixel resolution and noninterlaced monitors at a minimum. Most also can support

lower resolutions such as 800×600 that are more suitable for 14-in. monitors. Typically, resolution and number of colors are subject to the amount of frame buffer memory a board includes.

Sota Technology's \$995 340i, for example, comes standard with a 512k-byte video-RAM frame buffer and supports 1024×768-pixel resolution and 16 colors. You can upgrade the board for \$200 to 1M-byte of video RAM, in which case the board then supports 1280×1024-pixel resolution and 16 colors, or 256 colors at lower resolutions. Likewise, the #9GRX from Number Nine offers 1024×768-pixel resolution with 16 colors as a base and can be expanded to support 256 colors and 1280×1024 resolution.

The GSS AT1050 includes a programmable-frequency output feature that allows you to adjust the board to support nonstandard resolutions. The board supports 1024×768 pixels maximum, but you can set it to a resolution of 900×700 pixels, for example. Such a feature can come in handy in exploiting the maximum noninterlaced resolution a monitor offers.

For higher-resolution CAE requirements, consider the Artist

XJS board from Artist Graphics. The 34020-based board supports 1600×1200-pixel resolution and costs \$4295. You can also buy a VGA module for the board, and the company plans to offer Micro Channel and EISA versions later this year.

Overall, the boards discussed here certainly offer workstation-level graphics performance—one of the shortcomings pundits believe distinguishes workstations from personal computers. The performance that the 340X0 boards offer certainly can serve the X-Windows market as well as they do Microsoft Windows. You can expect to see widespread X-Windows support emerge for these boards. In fact, expect personal computers equipped with 340X0 boards to completely upstage the demand for dedicated "X terminals"—and industry observers expect a huge demand for X terminals. **EDN**

Article Interest Quotient
(Circle One)

High 518 Medium 519 Low 520

For more information . . .

For more information on the graphics boards discussed in this article, circle the appropriate numbers on the Information Retrieval Service card, or use EDN's Express Request service. When you contact any of the following manufacturers directly, please let them know you saw their products in EDN.

Artist Graphics
2675 Patton Rd
St Paul, MN 55113
(612) 631-7800
FAX (612) 631-8424
Circle No. 705

Hewlett-Packard Co
19310 Pruneridge Ave
Cupertino, CA 95014
(800) 752-0900
Circle No. 707

Number Nine Computer Corp
725 Concord Ave
Cambridge, MA 02138
(617) 492-0999
FAX (617) 864-9329
Circle No. 709

Vermont Microsystems Inc
11 Tigan St
Winooski, VT 05404
(802) 655-2860
Circle No. 711

Graphic Software Systems Inc
9590 SW Gemini Dr
Beaverton, OR 97005
(503) 641-2200
FAX (503) 643-8642
Circle No. 706

NEC Home Electronics Inc
1255 Michael Dr
Wood Dale, IL 60191
(312) 860-9500
Circle No. 708

Sota Technology Inc
559 Weddell Dr
Sunnyvale, CA 94089
(408) 745-1111
FAX (408) 745-1640
Circle No. 710

You can do business in Japan without shelling out a fortune.

For many companies, the biggest barrier to new markets has been the cost of business trips. Restaurants can be expensive, and even the smallest accommodations may carry oversized bills. Yet those willing to be a little adventurous will find that traveling comfortably in Japan doesn't require packing a suitcase full of yen.

Hop on the bus.

A \$20 bus ride from Narita Airport may not strike you as a bargain, but compared to a \$150 taxi, it is. The buses marked "Airport Limousine" stop at all the major hotels in Tokyo.

Sleep cheap.

Business hotels are a fairly new phenomenon. Catering primarily to

Japanese businessmen, they're clean, functional, and conveniently located. Although vending machines replace amenities like room service, at \$40 to \$50 a night these hotels are a sound investment. Two major chains are the Tokyu Inn (tel. 03/406-0109) and the Washington (tel. 03/434-5211).

Food for naught.

It should come as no surprise that you'll save money eating where the locals eat. Good and reasonably priced restaurants can be found in department stores and the basements of office buildings. At lunch, ask for *teishoku*. It means special of the day, and includes rice, miso soup, salad, meat or fish, and dessert—all for around five dollars. *Ramenya* and

sobaya (noodle shops) are perfect places for a quick and tasty meal.

Northwest notes.

Since your time is money too, we make it as quick and easy as possible for you to get to Japan, by offering daily nonstops from the most U.S. cities. So you can count on arriving when you want, rested and ready to do business. And we give you something else no other U.S. airline can: the knowledge, understanding and insight that comes from over 40 years of helping people do business in Asia. For international reservations, call your travel agent or Northwest at 1-800-447-4747. To find out more about doing business in Asia, call 1-800-553-2215, ext. 183.



© 1990 Northwest Airlines, Inc.

NORTHWEST AIRLINES





Drawing a finer line

*The world's most up-to-date production
technology delivers leading-edge ULSI circuits*

Sub-micron production in full swing, bringing the new age of 4M DRAMs

Oki's Miyagi Plant, benefitting from the latest advances in the company's system technology, has already reached mass production and shipment of 1M-bit memories and has recently begun quantity production of 4M DRAMs. At the Miyagi Plant, broad utilization of ultra-fine process technology and state-of-the-art automation combine to assure the high quality of these products. Oki is already well underway with technological innovation enabling production of 16M-bit memories.

High-level automation with ultra-fine process production

Oki's 0.8 μ process technology used in its second-generation 1M- and 4M-bit memories has been integrated into one of the world's most advanced production lines for reliable mass production of over 20,000 6-inch wafers per month.

In 1988 Oki led the world with the first facility dedicated for production of sub-micron devices. Today that lead is being extended with the latest advances in automated manufacturing, such as sophisticated wafer tracking systems for improved quality and production control monitoring.

From the transportation system, driven by linear motors, to individual production equipment in each process machine group, all are computer controlled. To assure products of extremely stable quality, automation and every detail of the production environment are maintained at the world's highest levels.

High performance and packaging flexibility support customers in a wide range of applications

Oki's Advanced System Technologies are dedicated to total customer satisfaction. A comprehensive service system provides flexibility, quality, cost savings and quick turn-around times.

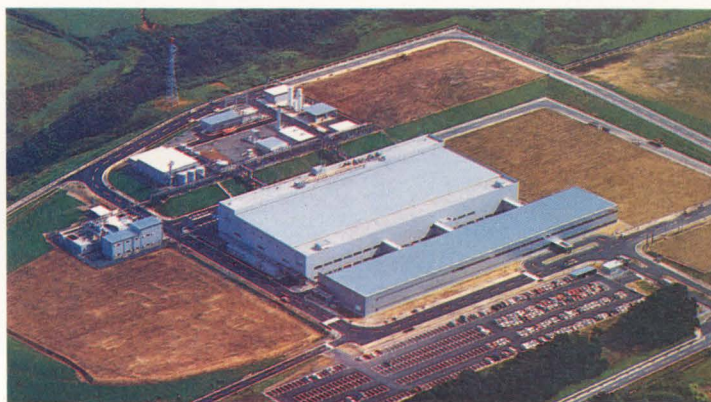

Oki's Miyagi Plant, featuring world-standard process technology and automation.

Oki Electric Industry Co., Ltd.
Electronic Devices Group
Overseas Marketing Group
7-5-25 Nishishinjuku, Shinjuku-ku,
Tokyo 160, Japan
■ Tel: 3-5386-8100 ■ Fax: 3-5386-8110
■ Telex: J27662 OKIDENED

Oki Electric Europe GmbH
Hellersbergstraße 2, D-4040 Neuss
West Germany
■ Tel: 2101-15960 ■ Fax: 2101-103539
■ Telex: 8517427 OKI D

Oki Semiconductor Group
785 North Mary Avenue, Sunnyvale,
CA 94086, U.S.A.
■ Tel: 408-720-1900 ■ Fax: 408-720-1918
■ Telex: 910-338-0508 OKI SUVL

Oki Electronics (Hong Kong) Ltd.
Suite 1801-4, Tower 1
China, Hong Kong City, 33 Canton Road.,
T.S.T. KLN, Hong Kong
■ Tel: 3-7362336 ■ Fax: 3-7362395
■ Telex: 45999 OKI HK HX

OKI
ELECTRONIC DEVICES



OKI

Oki Electric Industry Co., Ltd.
Tokyo, Japan

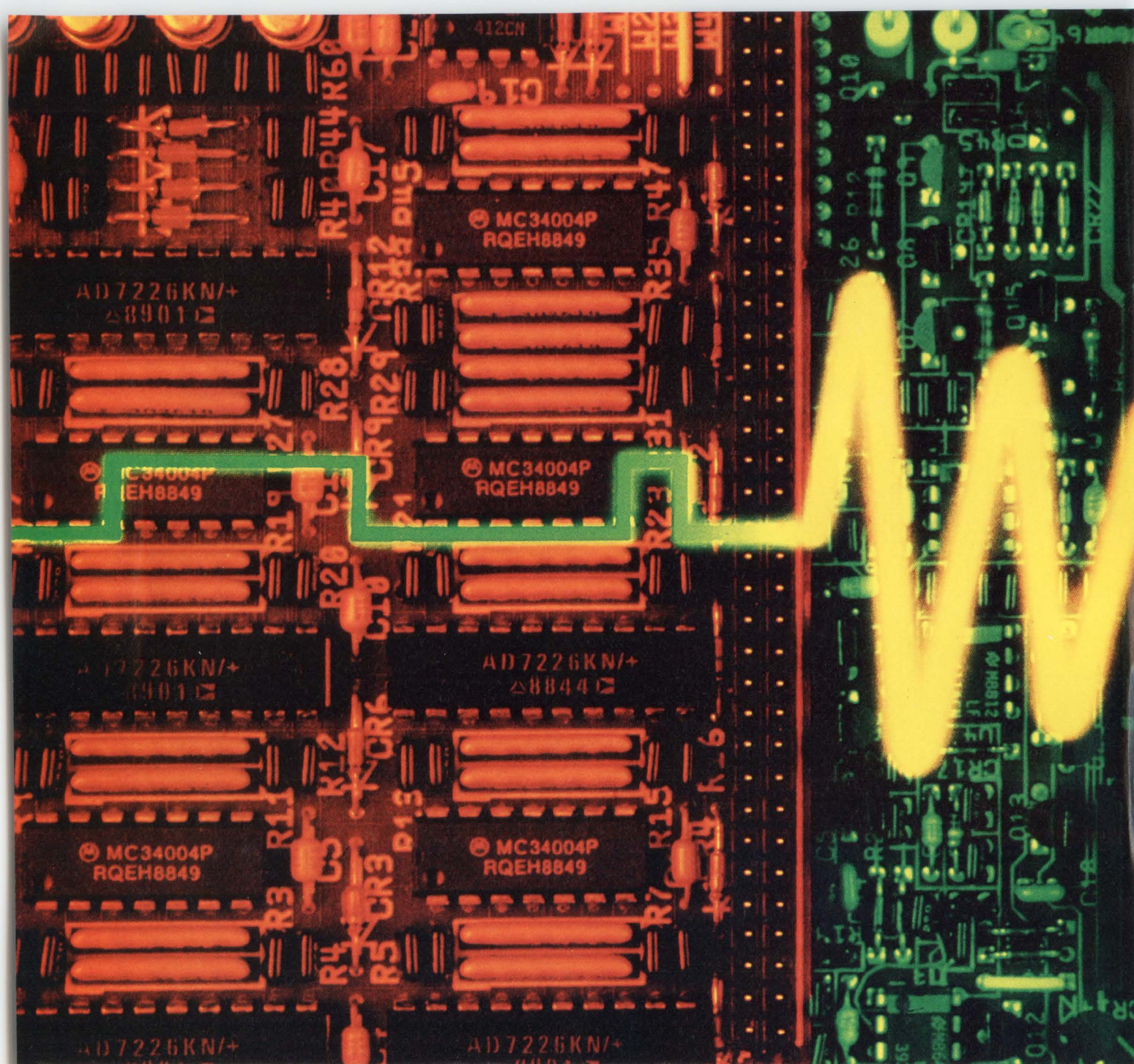

The smart choice in board testing



The L350 combinational board tester.

Now there's a combinational board tester that helps you test the most challenging VLSI technologies – from high-speed VLSI and ASICs to mixed signal and scan. The L350 has 20 MHz digital, SuperFast Analog,[™] and automated boundary scan testing. And over 3,000 test pins.

What's more, you don't have to be a programming whiz to get great test results. The L350 has expert software that reviews PC board testability before you commit to artwork. Its advanced knowledge base generates accurate, repeatable in-circuit and cluster tests. And it analyzes test results, providing one clear repair message per fault.

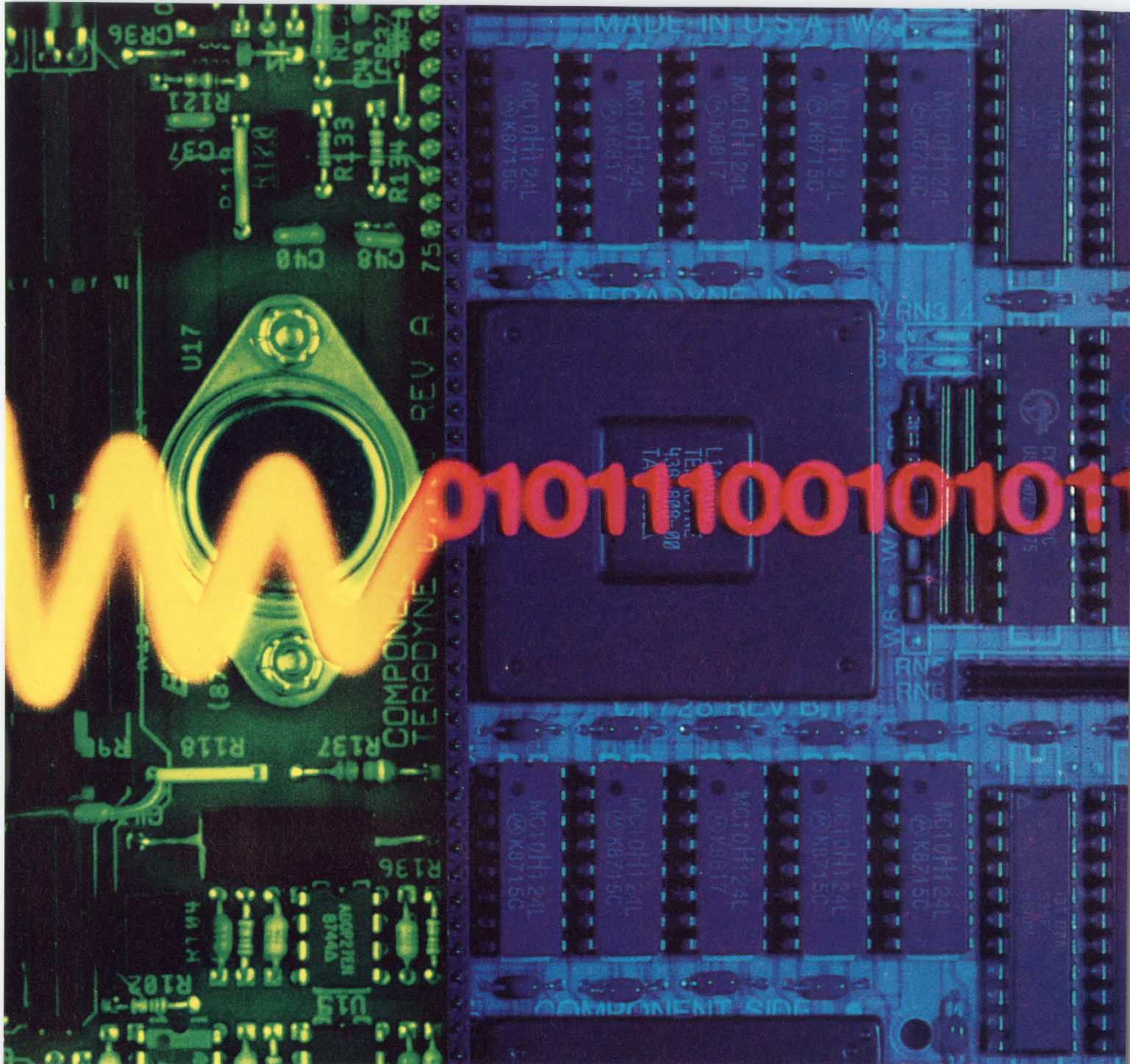

is the smartest board tester.

The L350 gives you smart hardware too, with multiple dedicated processors for highest analog and digital throughput. Now, in thirty seconds or less, you can get 100% interconnect coverage, 100% device coverage, and 100% pin-level fault coverage on dense, complex boards. Just the answer for automated and JIT manufacturing.

Best of all, using the L350 with our BoardWatch® test quality management software is a very smart business strategy. Because by finding VLSI faults fast, diagnosing them accurately, and using the information to eliminate defects at their source, you'll get new,

advanced products to market more efficiently.

With brain power like this, even difficult test problems become easy to solve. You'll start testing fast with low operating costs and highest circuit board yields at system assembly.

So if you're thinking about a new combinational tester, make a smart call. Contact Daryl Layzer at 617-482-2706, Ext. 2808 for more information about the new L350 VLSI Board Test System.

TERADYNE



How To React When Your Customers Send You Mixed Signals.

Big trouble. A customer sends you a mixed signal ASIC design. You simulate it as best you can with your in-house tools. And then cross your fingers. Because guess what happens when your customer plugs it into his system?

That's right. Zippo.

Who's to blame? Who cares? The important thing is you've lost a potentially profitable working relationship.

Here's a way out: Saber, the industry's most popular mixed signal simulator. You provide your customers with accurate Saber behavioral libraries that cover all

your ASIC cells' functionality. They can then use Saber to simulate not only the ASIC, but also the entire digital/analog system that surrounds it (even the non-electrical parts).

When they're satisfied, they send you models of the entire system design along with the completed ASIC design. Now you can run a Saber device-level simulation that interacts with the customer's system as a whole.

The result? Fewer failures. Lower customer costs. Increased customer confidence. No more mixed signals — except those on silicon.

For more information on how Saber can help with your mixed signal designs, phone (503) 626-9700, ext. 39, or FAX (503) 643-3361.

Saber environments include: Cadence, Calay, Computervision/Prime, Daisy/Cadnetix, HP, Mentor Graphics, NCR, Racal-Redac/HHB, Schlumberger, Siemens, Teradyne, Valid/ADT and Viewlogic.

 **Analogy**

Monolithic single-supply ADC converts to 18 bits in 10.4 μ sec

Operating from a 5V supply, the monolithic AT76C120 18-bit A/D converter can convert 96k samples/sec on each of its two channels. The converter includes dual sample-and-hold circuits that sample both channels simultaneously. Using a successive-approximation technique, the chip converts and then outputs the data from both channels serially on a sin-

gle-output port. This data is in 2's complement format.

The converter is unprecedented in its use of nonvolatile memory for factory trimming. The on-chip memory allows the manufacturer to compensate for linearity errors by adding correction factors to the digital values. Trimming is performed by the manufacturer and is transparent to the user.

The converter requires two clocks for operation. The conversion clock (CONV) controls the internal S/H function and initiates the output of data after conversion. You can obtain the conversion clock by dividing the system clock (SCLK) by 64. The system clock regulates the conversion and synchronizes the output of individual data bits at the data-output port.

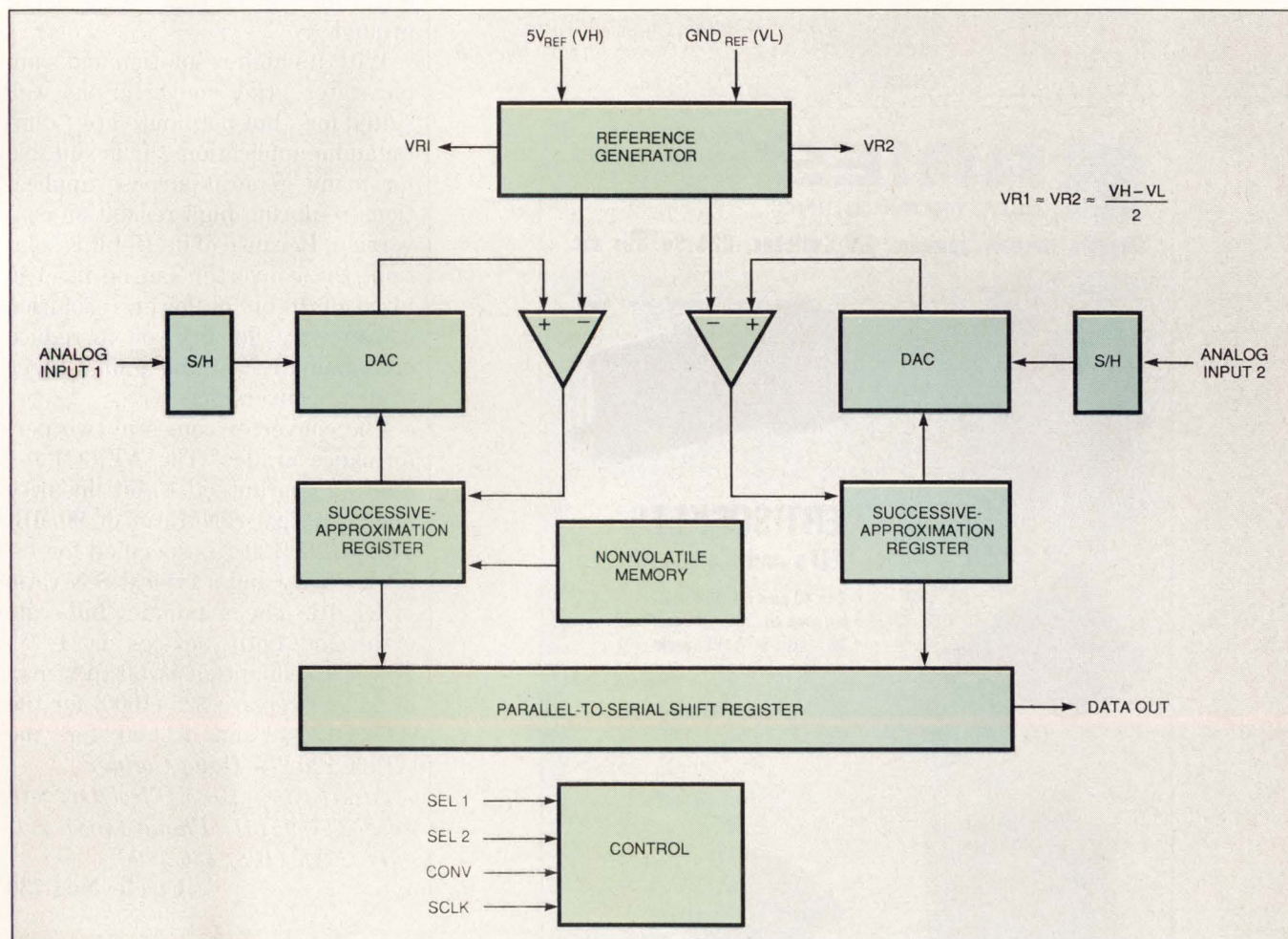

This 2-channel 18-bit A/D converter gets trimmed at the factory when the manufacturer writes values into the on-chip nonvolatile memory.

Quality metal stampings...

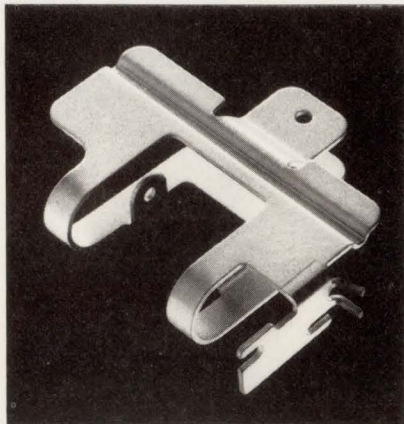

**Premium
priced.
Worth it!**

Ask for
FREE
36-page
booklet

If your product uses stamped components, don't scrimp on parts that compromise performance, durability or appearance. Profit from Dayton Rogers' 60 years of short run stamping experience, plus CAD and SPC.

CALL TOLL FREE **1-800-677-8881** FAX: 612-871-2646



Find us in the Yellow Pages under:



& Federal Stampings, Inc.

2824 - 13th Avenue So., Minneapolis, MN 55407

Minneapolis, MN • Rochester, NY • St. Petersburg, FL
Columbus, OH • Arlington, TX • Eugene, OR • Van Nuys, CA

CIRCLE NO. 7



ARIES[®]
ELECTRONICS, INC.

P.O. Box 130
Frenchtown, NJ 08825
Phone (908) 996-6841
Telex 6974615
FAX 908-996-3891

Headers, Sockets, Jumpers, DIP Switches, .025 Sq. Stix, etc.

For LED's or incandescents

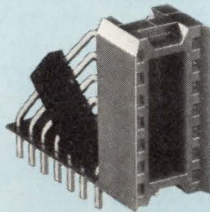

For large .5 and .6 displays

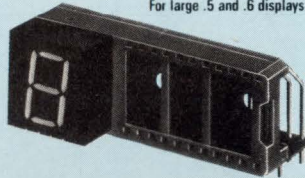

For angle mounting

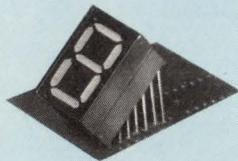

VERTISOCKETS[®]
for LED's and Incandescents

- 2 to 40 pins on .100 centers
- pin rows on .200, .300 and .600
- 30°, 45°, 60°, 90° angle mounting (vertical or horizontal)
- elevator sockets to bring your displays to proper height

For 1/4" to 1-1/4" elevation

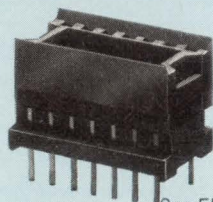

Collet Vertisocket



See EEM Vol. C pgs. 1272-1280 & Vol. A pg. 1733

CIRCLE NO. 8

EDN EDITORS' CHOICE

Two select pins control the converter's operation. The first select pin (SEL1) lets you specify whether channel one or channel two is output first at the single serial-output port. The second select pin (SEL2) controls whether the converter outputs 18 bits or reduces the output to 16 bits. You might select 16-bit operation when extra resolution is not needed so that the data will fit in two bytes instead of three. Sixteen-bit operation does not affect the overall conversion speed.

The converter requires a stable 5V reference for proper operation. A reference-generation block provides ac ground references (VR1, VR2) for signals that swing below ground.

With its high resolution and sample rates, the converter is well suited for—but not limited to—digital-audio applications. It is suitable for many general-purpose applications requiring high-resolution conversion. Because of its 18-bit resolution, the converter can be used in place of 16-bit or lower resolution converters, allowing you to reduce or eliminate variable-gain stages prior to conversion.

The converter comes in two performance grades. The AT76C120-1 offers a guaranteed 15-bit linearity and a typical S/N ratio of 90 dB. The AT76C120-2 is specified for 13-bit linearity and a typical S/N ratio of 84 dB. The maximum full-scale error for both devices is 1.5%. Power consumption is 50 mA max at 5V. Prices are \$25 (1000) for the AT76C120-1 and \$23.50 for the AT76C120-2.—**Doug Conner**

Atmel Corp, 2125 O'Nel Dr, San Jose, CA 95131. Phone (408) 441-0311. FAX (408) 436-4200.

Circle No. 730

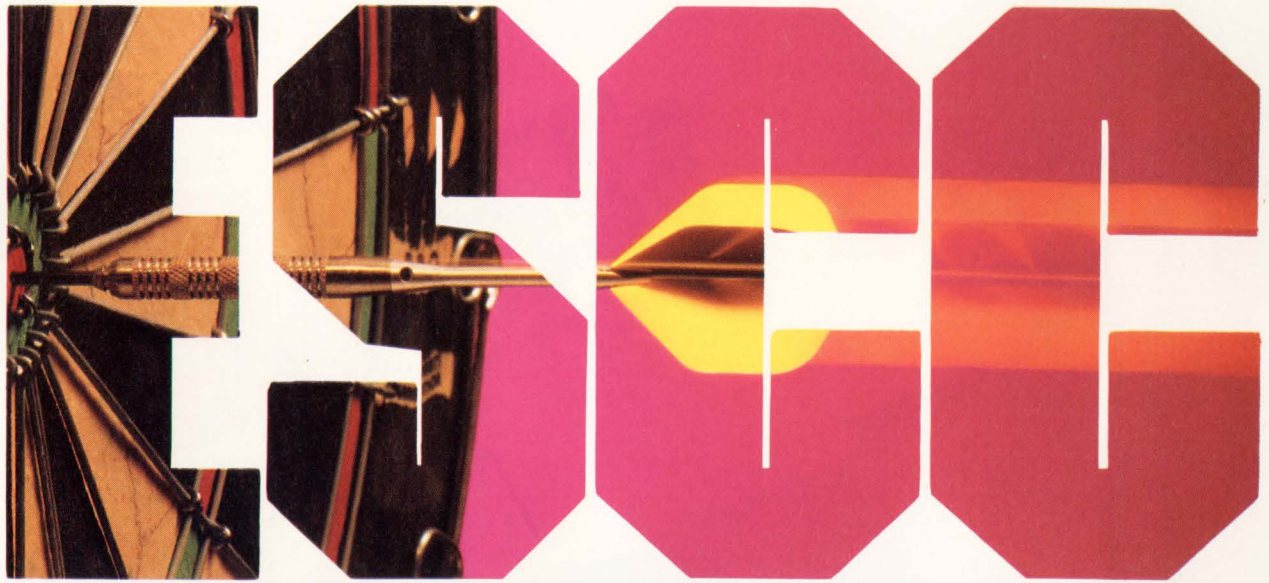

The *ENHANCED* SCC. Smoother operation. Super CPU performance. Same socket.

Introducing Zilog's Z85130™, the enhanced serial communication controller (ESCC) that significantly reduces your CPU overhead, gives you new deep FIFOs, and offers plenty of SDLC support for your 16 and 20 MHz applications. *And* it's pin and function compatible

to the Zilog CMOS and NMOS SCCs you may already be using.

Deep FIFOs improve CPU performance.

The ESCC gives you a 4-byte deep transmit FIFO, an 8-byte deep receive FIFO, with programmable FIFO interrupt and a DMA request level. Since you're manipulating the data in byte strings, you don't have to attend to it as often. This, combined with other features that simplify the CPU interface, means a lot better utilization of CPU horsepower.

Improved status and timing.

The low-power CMOS ESCC is designed for 16 and 20 MHz CPUs. It also gives you improved databus timing, 2 Mb/S with DPPLL and faster interrupt response. DMA timing is the same for transmit and receive. And you can now read WR3, 4, 5 and 10.

Built-in quality and reliability.

The ESCC comes to you off-the-shelf, with all the advantages of Zilog's Superintegration™ technology. And it's backed by the proven quality and reliability that have come to characterize everything we make.

To find out more about the ESCC or any of Zilog's rapidly growing family of Superintegration products, contact your local Zilog sales office or your authorized distributor today. Zilog, Inc., 210 Hacienda Ave., Campbell, CA 95008, (408) 370-8000.

Enhanced SDLC Support

The Z85130 offers some exciting news for SDLC users. We've taken away the necessity of external commands by making a lot of the functions automatic. And that means your CPU doesn't have to be spending valuable time attending to the link layer.

Here are some of the SDLC enhancements to improve link layer support:

- Automatic transmission of the opening flag
- Automatic reset of transmit Underrun/EOM latch
- Deactivation of RTS pin after closing flag
- Complete CRC reception
 - TXD pin automatically forced high with NRZI encoding when using mark idle
 - No CPU intervention or acknowledgement needed between SDLC frames
 - Receive FIFO automatically unlocked for special receive interrupts when using the SDLC status FIFO

Right product. Right price. Right away.



ZILOG SALES OFFICES: CA (408) 370-8120, (714) 838-7800, (818) 707-2160, CO (303) 494-2905, FL (813) 585-2533, GA (404) 448-9370, IL (312) 517-8080, NH (603) 888-8590, MN (612) 831-7611, NJ (201) 382-5700, OH (216) 447-1480, PA (215) 653-0230, TX (214) 987-9987, WA (206) 523-3591, CANADA Toronto (416) 673-0634, UNITED KINGDOM Maidenhead (44) (628) 39200, W. GERMANY Munich (49) (89) 672045, JAPAN Tokyo (81) (3) 587-0528, HONG KONG Kowloon (852) (3) 723-8979, KOREA (82) (2) 552-5401, TAIWAN (886) (2) 741-3125, SINGAPORE 65-235 7155, DISTRIBUTORS: U.S. Antheon Electronics, Hall-Mark Electronics, JAN Devices, Inc., Schweber Electronics, Vargas Electronics, Western Microtechnology, CANADA Future Electronics, SEMAD, LATIN AMERICA Argentina-Yel.-(1) 46-2211, Brazil-Digibyte (011) 501-1945, Semiconductores Profesionales (5) 536-1312.



ZL30A

Power in design
Speed in production

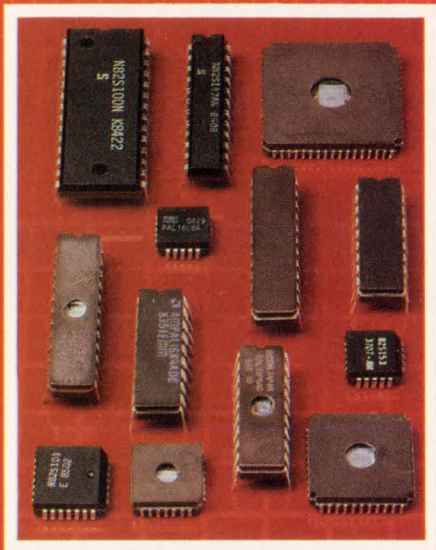

Stag's ZL30A offers total PLD programming support

Stag Microsystem's model ZL30A is the first dedicated Logic Programmer of its kind that not only supports programming of PLDs, EPLDs, and GALs*, in a variety of 20, 24, 28 and 40 pin DIP, but also supports programming of the latest surface mounted PLCC/LCC devices.

Stag's ZL30A contains features that have made it the industry standard in both engineering and production environments. Salient among these are:

- Powerful easy-to-use editing capability
- Super fast programming speed
- Stand alone or remote control operation
- Comprehensive device library
- Handler interface capability to support DIP or PLCC/LCC devices
- I/O formats include JEDEC, Signetics and X-Plot
- Compatible with CUPL* software compiler
- RS232C, IEEE-488 and handler control interface ports standard
- Expansion modules accommodate 40 pin DIP and a range of surface mounted devices
- Stringent in-program checks including continuity and connect tests are automatically performed to guarantee error free stand alone or handler operation
- Supports Test Vectors
- Turn-Key handler interface kits
- Worldwide sales and service support.

Headquarters/

Western Regional Office
Stag Microsystems, Inc.
1600 Wyatt Drive
Santa Clara, CA 95054

Tel: (800) 227-8836
Tel: (408) 988-1118

Eastern Regional Office

Stag Microsystems, Inc.
3 Northern Blvd., Ste. B1
Amherst, NH 03031

Tel: (800) 222-STAG
Tel: (603) 673-4380.



Sophisticated systems for the discerning engineer.
*GAL is a trademark of the Lattice Corp.
*CUPL is a trademark of Assisted Technology.

It's no fluke.



Made in the U.S.A.

Feature	Fluke Model 77	Beckman Industrial RMS225
Digits	3-1/2 Digits	4 Digits
Resolution	3,200 Counts	10,000 Counts
Accuracy	0.3%	0.25%
Automatic Reading Hold	Touch Hold®	Probe Hold™
Analog Bar Graph	31 Segments	41 Segments
Battery Life	2,000 Hrs	1,000 Hrs
10A Range	✓ (Fused)	✓ (Unfused)
Protective Holster	✓	✓
3 Year Warranty	✓	✓
True RMS		✓
Auto Min Max™		✓
Relative Mode		✓
Self-Resetting Fuse		✓ (40mA Input)
Price	\$159*	\$149

® Touch Hold is a registered trademark of the John Fluke Mfg. Co., Inc. * 1990 Fluke and Philips Catalog

Your best auto-ranging multimeter for the money. It doesn't happen by accident. It takes expertise, painstaking R&D, and a solid commitment to provide you with the features you've asked for at a price you can afford. When you add it all up, the new Beckman Industrial RMS225 simply outperforms any meter in its class. And like all the



other multimeters we've built over the years, it's designed for long lasting and trouble-free use. So, go visit your local distributor today and check out the new RMS225 digital multimeter. Once you compare it to the others, the choice will be obvious.



Beckman Industrial™

An Affiliate of Emerson Electric Co.

Instrumentation Products Division
 3883 Ruffin Road, San Diego, CA 92123-1898
 (619) 495-3200 • FAX (619) 268-0172 • TLX 249031
 Outside California 1-800-854-2708 Within California 1-800-227-9781

© 1990 Beckman Industrial Corporation. Specifications subject to change without notice. Fluke is a registered trademark of John Fluke Mfg. Co., Inc.

PLD development software

You can't use PLDs in your designs unless you also use the right development software. Choosing that software can be just as important as picking the proper device for your design. The right PLD and the right software will make your job much easier; the wrong choices will stop your project cold.

Steven H Leibson, *Senior Regional Editor*

PLDs and their associated development software form an inseparable team. You can't design PLD-based circuitry without both. Software-development tools for PLDs comprise three types—compilers, simulation products, and test software—and you need all three to complete the job. PLD compilers convert your design into a PLD fuse map. Simulation products, including simulators and device models, allow you to test your design before programming a PLD to make sure that your design is right. They can also save you precious development time. Test software, which includes fault graders and automatic test-pattern generators, helps you keep things right in production.

Many PLD compilers allow you to create a design without regard to any particular device architecture. Sometimes, though, you may wish to use a specific part. If you always have a particular

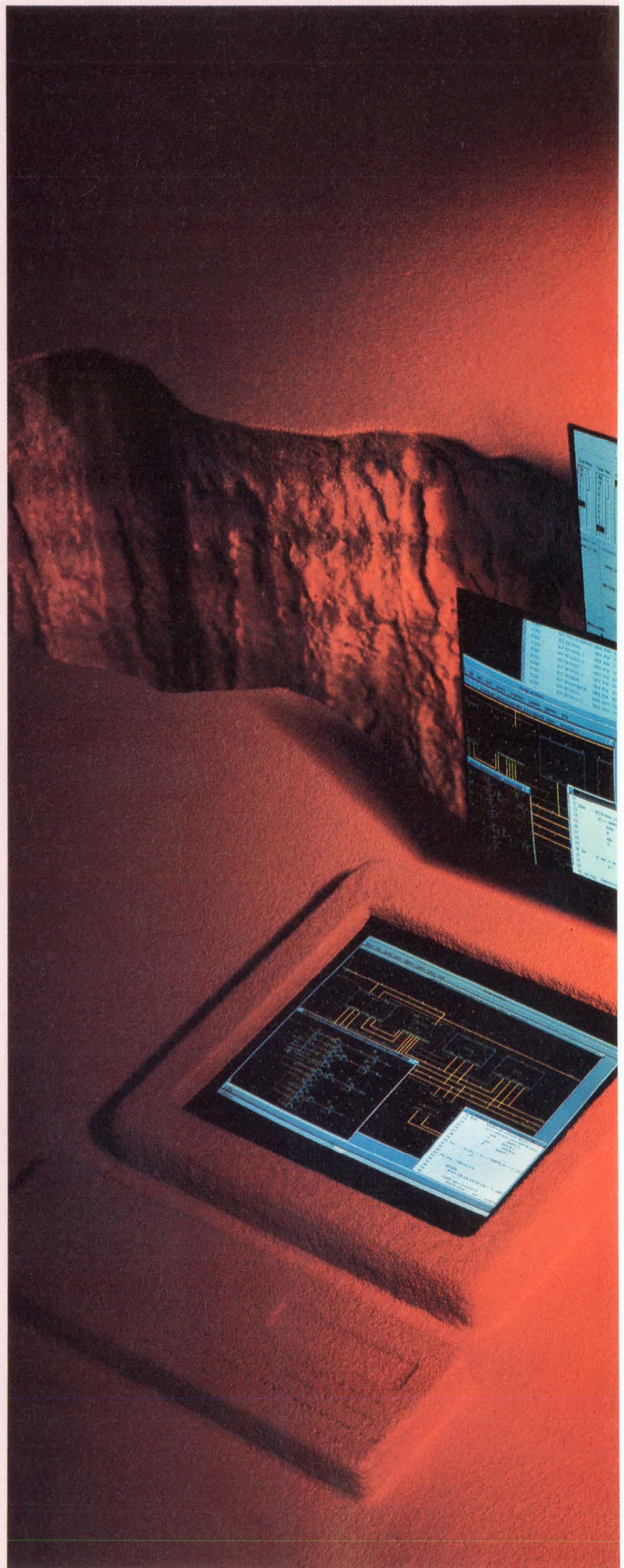



The right PLD development software provides safe passage through PLD circuit design. (Photo courtesy Mentor Graphics Corp)

PLD development software

PLD in mind when you start a design, almost any PLD compiler will suffice. Early PLD compilers required you to specify the target device in the source-definition file, making device-independent design impossible. Many of the compilers now available allow you to postpone device selection until much later. Compilers that allow device-independent design also accept a device

Simulation can save you precious development time. Test software helps you keep things right in production.

specification, so you can be satisfied in all cases. In fact, you may well elect to use both device-specific and device-independent design methods at different times. Sometimes your requirements are sufficiently general, in which case many PLDs will meet your design needs. For other designs, you may wish to use a special feature that is available in only one vendor's PLD. There's little need to postpone device selection in such instances.

Device specificity introduces one of the first criteria you should consider when selecting a PLD compiler: device support. Some vendors offer universal compilers that can generate fuse maps for many PLD types. Other vendors, generally the PLD manufacturers themselves, offer device-specific compilers for their own PLDs. Most PLD programmers accept JEDEC Standard No. 3A fuse-map files, and because most PLD compilers generate such files, you can use most PLD compilers with almost any PLD programmer. **Tables 1 and 2** list several representative universal and device-specific PLD compilers. Note that in each table, only general PLD types are listed under the "PLDs supported" column. Some of these products generate fuse maps for dozens of different PLD architectures and thousands of individual devices, and are therefore virtually impossible to catalog. For an up-to-date, complete device listing, contact the individual compiler vendors.

Do not construe the listing of a supported PLD family in **Tables 1 and 2** to mean that all devices of that family are supported by that compiler. Some of the compilers listed do indeed support every available PLD in the families listed. Other compilers support only a few devices in each family. The list of supported devices for each compiler grows regularly.

You must obtain a compiler that creates fuse maps for all of the PLDs you plan to use. Although that may seem an obvious statement, it has deep implications. Once you select a compiler, you will invest quite a bit

of your time learning the idiosyncrasies of the product you pick; you'll not enjoy adopting another compiler later without a strong reason for doing so. Unlike high-level languages for μ Ps, no standard language exists for PLD source files. Consequently, the source languages for the various PLD compilers vary widely even at the simplest level.

Table 3 demonstrates the diversity among PLD compilers by listing the Boolean, arithmetic, and relational operators for several of the compilers listed in the first two **tables**. If you try to master several PLD compilers, you can easily become confused trying to remember one compiler's symbol for the exclusive-OR operator or whether another compiler supports arithmetic operations. Incidentally, you should not underestimate the value of relational and arithmetic operators for defining PLDs. You can use these additional operators in several applications that formerly used only Boolean operators. For example, if you're defining an address decoder that decodes the address space from hexadecimal address F000 to F7FF, you might write

$$!ENABLE = A15 \& A14 \& A13 \& A12 \& !A11$$

which will work fine. However, using relational operators you can write the same equation as

$$!ENABLE = (ADDRESS \geq F000) \& (ADDRESS \leq F7FF)$$

which generates the same function but gives a much better description of what you're really trying to do.

New PLDs appear all the time. The devices you use

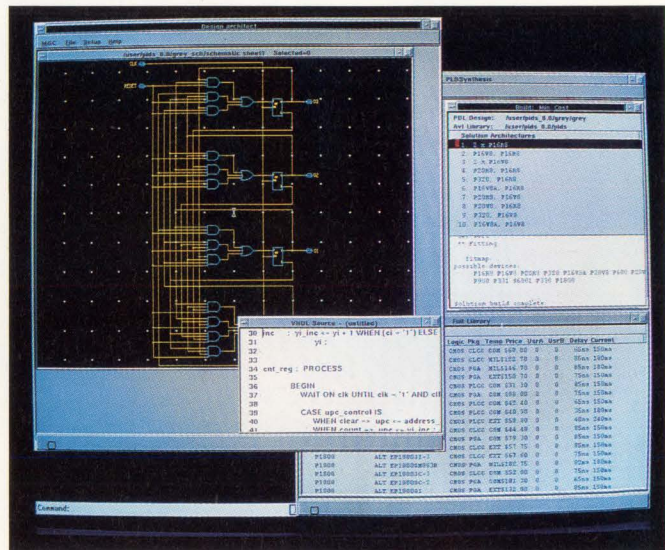

Multiple entry methods for PLD designs, such as schematic drafting, VHDL descriptions, and traditional Boolean equations, allow you to match your design style to the problem. (Photo courtesy Mentor Graphics Corp)

today may not be the parts you'll use next year. Data I/O Corp claims that more than 250 PLD architectures and 3000 individual devices already exist. More are on the way. Many universal compiler vendors, including Data I/O, try to add device support to their products as soon as possible, but the PLD vendors don't always cooperate. Some PLD vendors keep the tools for their architectures as proprietary as their PLDs. If you must use a brand new PLD architecture, then a device-specific compiler such as those listed in Table 2 may be your only choice. All of the PLD vendors that offer development tools for their devices do so to support their IC products. Some fear that the universal compilers won't adequately support the special fea-

tures of their unique PLD architectures.

An example of the potential mismatch between a universal compiler and a PLD arises with flip-flops in some of the newer PLDs, such as Altera's EPLDs (erasable PLDs). You can configure the output registers in some of these devices as JK, T, and SR flip-flops, in addition to the more common D type. But some universal compilers can only create equations for D flip-flops. Your design may work better (fit more efficiently into the PLD) if you use a non-D type flip-flop to create the macrocell equations. The resulting inefficiency in generating product terms may mean the difference between a design that fits in a particular device and one that does not. That's one reason why

Table 1—Representative universal PLD compilers for IBM PC and compatible computers

Manufacturer	Product	Price	Entry Methods					Logic Minimizer	Editor	PLDs Supported (nonexhaustive)
			Boolean Equation	Truth Table	State Machine	Waveform	Schematic			
Accel Technologies	Tango-PLD	\$495	Yes	Yes	Yes	No	Yes	Espresso	Optional	PALs, GALs, PEELs, FPLAs, FPLSs, EPLDs, Atmel ATV
Advanced Micro Devices	Palasm 90	\$70	Yes	No	Yes	No	No	Yes	Yes	PALs, FPLSs
Data I/O	ABEL	\$1995	Yes	Yes	Yes	No	Optional	Presto, Espresso	No	PALs, GALs, PEELs, FPLAs, FPLSs, EPLDs
Inlab	proLogic	\$249	Yes	Yes	Yes	No	No	No	No	EPLDs
ISDATA	Log/iC	\$1480 to \$2280	Yes	Yes	Yes	No	Optional	Fact, Bruno	No	PALs, GALs, PEELs, FPLAs, FPLSs, EPLDs, Atmel ATV
Logical Devices	CUPL	\$1495	Yes	Yes	Yes	No	Optional	Redundancy minimization, Presto, Espresso, Quine-McCluskey	Yes	PALs, GALs, PEELs, FPLAs, FPLSs, EPLDs, Atmel ATV
Minc	PLDesigner	\$1950 to \$4500	Yes	Yes	Yes	Yes	Yes	Sum-of-Products, Espresso, Quine-McCluskey	Yes	PALs, GALs, PEELs, FPLAs, FPLSs, EPLDs
	PGADesigner	\$2500 to \$6000	Yes	Yes	Yes	Yes	Yes	Sum-of-Products, Espresso, Quine-McCluskey	Yes	PALs, GALs, PEELs, FPLAs, FPLSs, EPLDs, Altera MAX, Actel ACT-1, Xilinx
National Semiconductor	Plan II	Free	Yes	No	No	No	No	No	No	PALs, GALs
Omaton	Schema-PLD	\$495	Yes	Yes	Yes	No	Yes	Quick-min, Presto, Quine-McCluskey, proprietary method	No	PALs, GALs
OrCAD Systems	OrCAD/PLD	\$495	Yes	Yes	Yes	No	Yes	Quine-McCluskey, McBoole	No	PALs, GALs, EPLDs
Pistohl Electronic Tool	SP11	\$295	Yes	No	No	No	No	No	Yes	GALs, EPLDs

PLD development software

Altera offers device-specific development tools for its parts.

No matter which compiler type you pick, your next choice is the design-entry method. With early PLD compilers, you had no choice—Boolean equations. You can live with that one technique for virtually any design you can imagine. However, Boolean equations do not

Device specificity introduces one of the first criteria you should consider when selecting a PLD compiler: device support.

provide the best possible entry method in every instance, so compiler vendors introduced many more options. The five most common design-entry methods, which are listed in **Tables 1 and 2**, are Boolean equations, truth tables, state-machine design, schematic entry, and waveform entry.

Boolean equations and truth tables use text files for the design specification. You can use your favorite text editor to create these source files. Also, many compiler vendors provide text editors either as an option or as an integral part of their compiler. One vendor, Accel Technologies, adopted a well-established, PC-based text editor as the preferred mate for its Tango-PLD compiler. The text editor, called Brief, is available for \$199. Brief, a product of Solution Systems (South Weymouth, MA, (617) 337-6963), performs as both text editor and user interface for Tango-PLD.

If you are creating state machines with PLDs, you should seriously consider using a compiler that supports such designs with an entry method tailored to the task. Some PLD compilers that permit you to design using a special state-machine notation support both the Mealy and Moore state-machine models; some support only one model. Unless you are a dedicated advocate of one model, you should be able to build the state machine you want with either form.

All of the state-machine entry methods for the compilers listed in **Tables 1 and 2** employ text-based source files, even though the manuals often illustrate examples with graphic state-machine representations. However, Hewlett-Packard's 74150A PLD Design System and PLD Master from Dazix allow you to draw your state machines. The PLD Design System lets you draw state diagrams with a special editor and troubleshoot those designs with an interactive debugger. The PLD Design System runs on HP's Model 9000 Series 300 workstations and costs \$13,700. The compiler's device library includes PALs, GALs, PEELs, FPLAs, FPLSs, and EPLDs (for an explanation of these abbreviations, see **Glossary**). PLD Master, a \$5000 module, employs a graphic state-machine representation that resembles a software flowchart.

The last two common design-entry methods are schematic entry and waveform entry. Schematic entry is a natural choice for PLD designs. Using schematic representations of gates, flip-flops, and registers, you can easily create a design that will fit into a PLD's primitive elements: gates, flip-flops, and registers. Some of the compilers accept files from several schematic editors; some will accept schematic files with a little help.

Table 2—Representative device-specific PLD compilers for IBM PC and compatible computers

Manufacturer	Product	Price	Entry Methods					Logic Minimizer	Text Editor	PLDs Supported (nonexhaustive)
			Boolean Equation	Truth Table	State Machine	Waveform	Schematic			
Altera	PLDS-Encore	\$9995*	Yes	Yes	Yes	No	Yes	Yes	No	All Altera EPLDs
Cypress Semiconductor	PLD Toolkit	Free to \$395	Yes	No	No	No	No	No	No	Cypress PALs, 7C330 family
Intel	iPLDS II	\$1995*	Yes	Yes	Yes	No	Yes	Espresso	No	Intel EPLDs
International CMOS Technology	Place I	\$695	Yes	No	Yes	No	Yes	Yes	Yes	PEELs
Programmable Logic Technologies	LogicLab	\$499*	Yes	No	No	No	No	Yes	Yes	GALs
Signetics	Snap 1.4	\$795	Yes	Yes	Yes	Yes	Yes	Yes	No	PLC42VA12, PLHS501, PLHS502, PLHS601, PML2552, PLUS105, PLUS405, PLUS153, PLUS173
Texas Instruments	proLogic	Free	Yes	Yes	Yes	No	No	No	No	EPLDs

Note: * = Price includes a device programmer.

For example, Data I/O's \$250 On-CUPL package translates schematic files generated by several PC-based schematic editors into text files containing CUPL equations.

Ideally, you'd like to mark an arbitrary block of circuitry on your schematic and ask the compiler to design the appropriate PLD. Such a feature would allow you to experiment with different design approaches. Unfortunately, the PLD compilers' ability to work with schematic files remains somewhat crude. You must often use an entire schematic to define the PLD, although some compilers allow you to isolate the PLD to one schematic sheet or hierarchical level. If schematic entry is important to you, check to make sure that the compiler you're considering is compatible with your preferred schematic editor.

Very few PLD compilers currently accept waveforms as PLD source files—but this design-entry method is indeed very handy. Many specifications you work with, such as a μ P's bus cycle or the SCSI bus handshake protocol, are specified as waveforms. Using waveform entry, you can copy the waveforms that you plan to apply to the PLD's inputs, add the waveforms you wish to obtain from the PLD's outputs, and then ask the compiler to figure out what circuitry should

go in between. Without waveform entry, you must manually convert the waveforms into some other format so that you can enter the design data using a different entry method. Any sort of mental conversion is subject to translation errors due to human error, so waveform entry is valuable for certain designs. The compilers from Minc and HP support waveform entry. More should.

Other entry methods exist beyond the five mentioned here. For example, OrCAD/PLD version 1.1 introduced an entry method called "streams," which

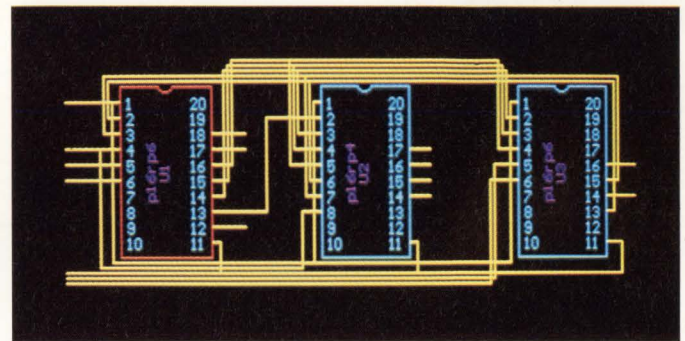

After partitioning your design, Logical Devices' PLPartition software draws a partial schematic to show you how to connect the selected PLDs.

Table 3—Operators for selected universal PLD compilers (noninclusive list)

Product	ABEL	CUPL	LOG/IC	OrCAD/PLD	Palasm 90	PLDesigner	Plan II	Tango-PLD
Boolean operators								
AND	&	&	&	&	*	*	* or &	&
NAND				&'		/*		!&
OR	#	#	+	#	+	+	or +	
NOR				#' or !#		/+		!!
Exclusive OR	\$	\$	\$	## or \$:+:	(+)	^, \$, :+:	^
Exclusive NOR	!\$			##'	:*:	/(+)		!^
NOT	!	!	/	' or !	/	/	! or /	!
Arithmetic operators								
Add	+ +	+		+				
Subtract	- -	-		-				
Multiply	* *	*		*				
Divide	/ /	/		/				
Modulus	% %	%		\				
Exponent	**	**		**				
Relational operators								
Equal	= =	:		= =		=		= =
Not equal	!=			/=	<>	<>		!=
Greater than	>			>	>	>		>
Greater than or equal	> =			> =	> =	> =		> =
Less than	<			<	<	<		<
Less than or equal	< =			< =	< =	< =		< =

PLD development software

allows you to specify output values using an implicit sequence of input states. For example, you could write

```
Stream: Step[3~0] -> Y  
{ 0, 0, 7(0,1) }
```

which defines a 16-state waveform with two states of

Don't underestimate the value of relational and arithmetic operators for defining PLDs.

a low output signal followed by a 14-state square wave. Note that this method gives you a shorthand method for specifying repetitive waveforms. The parameter 7(0,1) specifies seven consecutive groups of the se-

quence (0,1). This method works well if you want to create an arbitrary output waveform using very few characters.

Looking to the future, when more input methods become available, Data I/O has rewritten ABEL so that the front-end design (design specification and minimization) and the back-end design (fitting and fuse-map generation) are separated by a well-defined interface (Fig 1). That interface takes the form of an extended Berkeley Espresso PLA file format, which ASIC vendors commonly use. This de facto standard file format allows other tool vendors to replace ABEL's front-end tools so that you can describe your design using entry methods not supported by ABEL, such as VHDL (VHSIC Hardware Description Language) descriptions or waveforms. ABEL's fitter and fuse-map generator can then create your PLD's JEDEC file.

You can also replace ABEL's back-end tools so that

Glossary

ASIC (application-specific integrated circuit): An IC that is customized for a particular application. The term ASIC usually refers to nonprogrammable devices (devices configured by the semiconductor vendor) but occasionally is used to refer to PLDs as well.

Boolean equations: Behavioral descriptions of a digital circuit's operation using logical (AND, OR, NAND, NOR, exclusive OR, and NOT) notation.

Buried registers: Registers inside a PLD that cannot drive the device's output pins. Buried registers are generally used to implement state machines or to store values.

Design verification: Simulation of the logical operation of a PLD to confirm that a design works properly. You supply the input vectors and the expected output vectors. The design verifier then tells you if you're going to get what you expect.

EPLD: Erasable programmable logic device—a type of PLD. EPLDs are available from Al-

tera, Cypress Semiconductor, Intel, and Texas Instruments.

Fault: A circuit node in the PLD that is stuck high or low so that the attached circuitry cannot operate correctly.

Fault grading: The evaluation of a set of input vectors to determine how many potential faults the vectors can identify. Usually expressed in a percentage, such as 99.9% coverage.

Fitter: A PLD compiler module, program, or subprogram that matches the logical operations of a design to the physical capabilities of a PLD.

FPLS: Field-programmable logic sequencer—a type of PLD.

FPLSs are available from Signetics and Advanced Micro Devices.

Functional simulation: A simulation method that simulates a circuit using logic equations and behavioral descriptions rather than device characteristics. This technique is faster but less accurate than timing simulation.

Fuse map: A description that indicates how the programmable

elements of a PLD are to be programmed. Unlike today's devices, early PLDs used fuses almost exclusively. But today, some PLDs use EPROM or EEPROM cells to program the internal logic. Nevertheless, for historical reasons, the portion of a file that describes the programming of such a PLD is still called a fuse map.

Fuse mapper (mapper): The PLD compiler module, program, or subprogram that generates a PLD's fuse map by matching the desired interconnections and macrocell configurations to the appropriate programmable elements in the device.

GAL: Generic array logic—a type of PLD. GALs are available from Lattice Semiconductor (Hillsboro, OR, (503) 681-0118), National Semiconductor, and SGS-Thomson Microelectronics (Phoenix, AZ, (602) 867-6259).

Initializable circuit: A circuit that can be forced into a known state after power is applied. Initializable circuits are easier to test than circuits that

your PLD design can easily become an ASIC simply by shipping the PLA file to an ASIC vendor. Thus you can prototype a circuit using ABEL to create PLDs and then convert your designs into an ASIC without redesigning the part. Looking at it from another perspective, you can now use ABEL to design ASICs. Data I/O plans to ship this latest version of ABEL (4.0) this month.

Minimization buys you more silicon

Once you've entered your PLD design in some way, your next step is to create the fuse map. Early PLD compilers took this step in one jump. Direct translation of a design file into a fuse map is certainly fast and remains a viable option for simple designs. However, this approach loses its lure for large PLDs. If you want to make efficient use of a PLD, you must use some sort of minimization or reduction algorithm to

compress the design so that it fits the available macrocells. If you don't minimize, you may need to buy a bigger, more expensive PLD.

PLD compilers use a variety of minimization algorithms to perform this task. The most popular minimization algorithms are Espresso, Presto, and Quine-McClusky, all of which were developed originally as ASIC design tools but have been adopted for PLD compilers. Many PLD compilers also reduce terms by using deMorgan's theorem. They try both positive- and negative-true logic and select the approach that uses the fewest product terms. Each minimization method offers some advantage (usually speed or efficiency), and several PLD compilers now offer a choice of several methods, as indicated in **Tables 1** and **2**. Some PLD compilers, such as ABEL, also allow you to apply minimization algorithms on a pin-by-pin basis, in case you want to keep redundant terms in some of your combina-

can't be initialized.

PAL: Programmable array logic—a type of PLD. PALs are available from Advanced Micro Devices and many other alternate sources.

Partitioning: Decomposition of a design into smaller modules that will each fit in one PLD.

PEEL: Programmable, electrically erasable logic—a type of PLD. PEELs are available from International CMOS Technology.

Macrocell: A configurable logic element within a PLD that can perform several different operations.

Minimization: The removal of redundant logic terms from the functional description of a digital circuit or gates from the circuit itself. Minimization and reduction are frequently used interchangeably.

PLD: An all-encompassing term for logic devices that can be configured in a device programmer. Programmable memory ICs such as EPROMs, EEPROMs, and PROMs are not generally considered to be PLDs.

Preloadable device: An IC that can be placed in any desired state, usually by jamming the desired value into the device's internal registers. Contrast this term with the "initializable circuit," which can be initialized, but perhaps not to any desired state but only one state.

Reduction: See minimization.

Simulator: A software program that mimics some facet of a circuit's operation so that you can verify various aspects of your design without building the circuit or programming a PLD.

Test vectors: Sequences of 1s and 0s that describe a stimulus and how a circuit should react to that stimulus. Part of the text vectors constitute input vectors to be applied to the device under test and the remaining portions of the test vectors indicate the expected response from the device.

Timing simulation: A simulation that uses device propagation delays to produce an accurate estimate of circuit performance.

Truth table: A tabular method for describing logical equations.

This method provides a sort of shorthand notation and allows you to simply type the input and output conditions without describing the equations that relate the two. The compiler then generates the equations from your table.

Uninitializable circuit: A logic circuit that cannot easily be placed in a known state after power is applied. Such a circuit is tough to test and should be avoided whenever possible to avoid alienating the manufacturing department.

Unit-delay simulation: A form of idealized timing simulation that uses delay increments of one dimensionless unit instead of nanoseconds or picoseconds. Unit-delay simulation is faster than timing simulation but not as accurate.

Universal PLD compiler: A software product that converts source files to fuse maps for PLDs from a variety of manufacturers.

PLD development software

torial output equations to avoid output glitches. Reduction of state-machine terms usually causes no problems because the clocked nature of the state machine makes it insensitive to the resulting glitches.

The minimization step produces a compacted representation of your design. Until this point, you need not have specified a PLD architecture. Some PLD com-

If you don't minimize, you may need to buy a bigger, more expensive PLD.

pilars allow you to take these first steps without selecting a specific PLD. Other compilers force you to declare a target PLD in your source file up front. One way or another, you need to select a device that has the physical resources necessary to implement your reduced equations. This step is called "fitting." If you've had a specific device architecture in mind all along, you can simply turn the compiler's fitter loose and see if your design fits.

Some compilers, such as Minc's PLDesigner and HP's PLD Design System, will partition your design by trying single- and multiple-PLD solutions to create the "best" fit. PLDesigner allows you to define what is best for your design through a table of weighted parameters. These parameters include propagation delays, power dissipation, and device cost. You select what factors are important and PLDesigner will generate alternatives, rank them according to your values, and then list the ten best solutions. You can pick one of these solutions and generate the appropriate fuse maps or go back and change your weightings to investigate alternative solutions.

Logical Devices offers two separate programs that add a partitioning ability to the company's CUPL compiler. The \$495 PLAdvisor solicits your design criteria and then generates a list of candidates from its PLD library. The \$995 PLPartition accepts the list generated by PLAdvisor or a list of devices that you supply and then partitions your design to fit in one or more of the candidate parts. You don't need PLAdvisor to use PLPartition.

Save time by narrowing the choices

You usually won't want a partitioner to consider every PLD in its library during the partitioning phase. PLDesigner's library manager allows you to create your own device library, which can be a subset of the parts that Minc's compiler supports. For example, you may want to create subset libraries that contain just the PLDs in your lab stock, the PLDs on your com-

pany's approved-parts list, or the PLDs in your manufacturing inventory. Creating a reduced library speeds up partitioning by eliminating obviously useless choices.

Some engineers like automatic partitioning because they aren't familiar with the hundreds of PLD architectures available. They appreciate a compiler's ability to explore alternative design solutions. Other engineers already know what PLDs they want to use; they aren't interested in this feature. Even if you are already familiar with all the devices you wish to consider, partitioning software can explore many more possibilities in far less time than you can by hand. Furthermore, if you want total control over device selection, compilers with partitioning modules usually allow you to pick the target device when you must.

Tables 1 and 2 list PLD compilers that run on IBM PC and compatible computers. These compilers use a variety of user interfaces on the PC, ranging from line-oriented to menu-driven schemes. For Apple

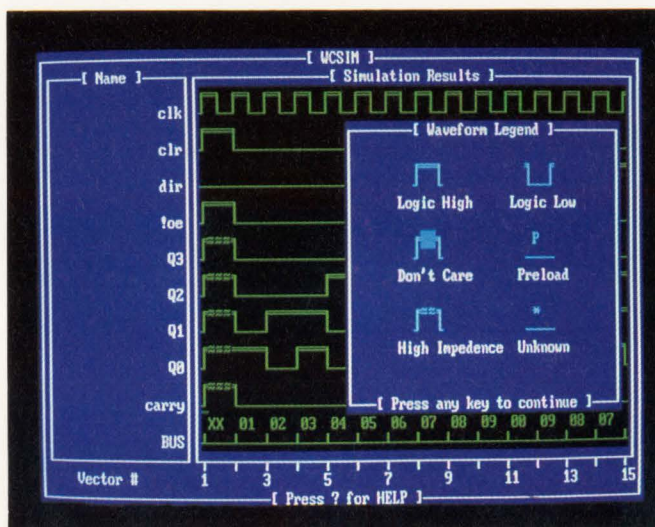

A waveform display from the device simulator allows you to see how your PLD design will perform. (Photo courtesy Logical Devices Inc)

Macintosh fans, Capilano Computing offers MacABEL, a \$2350 version of the ABEL compiler. Macintosh users can also purchase MacABEL in a package with Capilano's schematic editor and simulator for \$2995. Several of the PLD compilers in Tables 1 and 2 are also available for workstations.

Many vendors of workstation-based CAD and CAE products offer PLD compilers as part of their tool sets. Dazix's PLD Master incorporates Advanced Micro Devices' PALASM compiler and works with ABEL and ISDATA's LOG/iC. Intergraph's Synthesis Engineer Series includes multiple compilers such as custom versions of Data I/O's ABEL (\$3000) and Minc's PLDe-

signer (\$14,000). Mentor Graphics and Valid Logic Systems also offer PLD compilers based on PLDesigner. However, these CAE software companies don't just repackage and sell other companies' PLD compilers; they integrate the software into their CAE environments so that you can use the same entry methods and simulation tools for PLD design that you use to design other types of circuitry.

For example, Mentor's \$14,900 PLDSynthesis package uses Minc's compiler, partitioning and fitting, algorithms, and its PLD libraries, but not its user interface. Instead, Mentor changed the compiler's user interface to conform with its Software Release 8.0 framework. Further, it connected its schematic editor, VHDL design tools, and Quicksim II simulator to the PLD compiler and thus integrated PLDSynthesis into the company's entire package of design tools. You can design a circuit board with Mentor's schematic editor and other design tools and define your PLDs within the context of your overall design using either Mentor's

tools or Minc's text-based input methods. (Although it uses much of Minc's design, Mentor has deferred support for waveform entry until it develops a unified waveform editor for all of its CAE tools. Intergraph's version of Minc's compiler supports waveform entry.) Once you have designed all of your circuitry, you can verify the entire design's operation using Mentor's Quicksim II simulator.

Most PLD compilers include some sort of simulation capability. The simulators with the least capabilities accept input and output vectors that you create and simulate your logic equations (independent of the PLD you select) to ensure that the equations produce the results you expect. Vendors sometimes call these programs functional verifiers instead of simulators.

More complex simulators use a model of your target PLD to create a simulation that reproduces the behavior you specify. For this type of simulation, you specify the input vectors, and the simulator generates output vectors or waveforms. You check these results to see

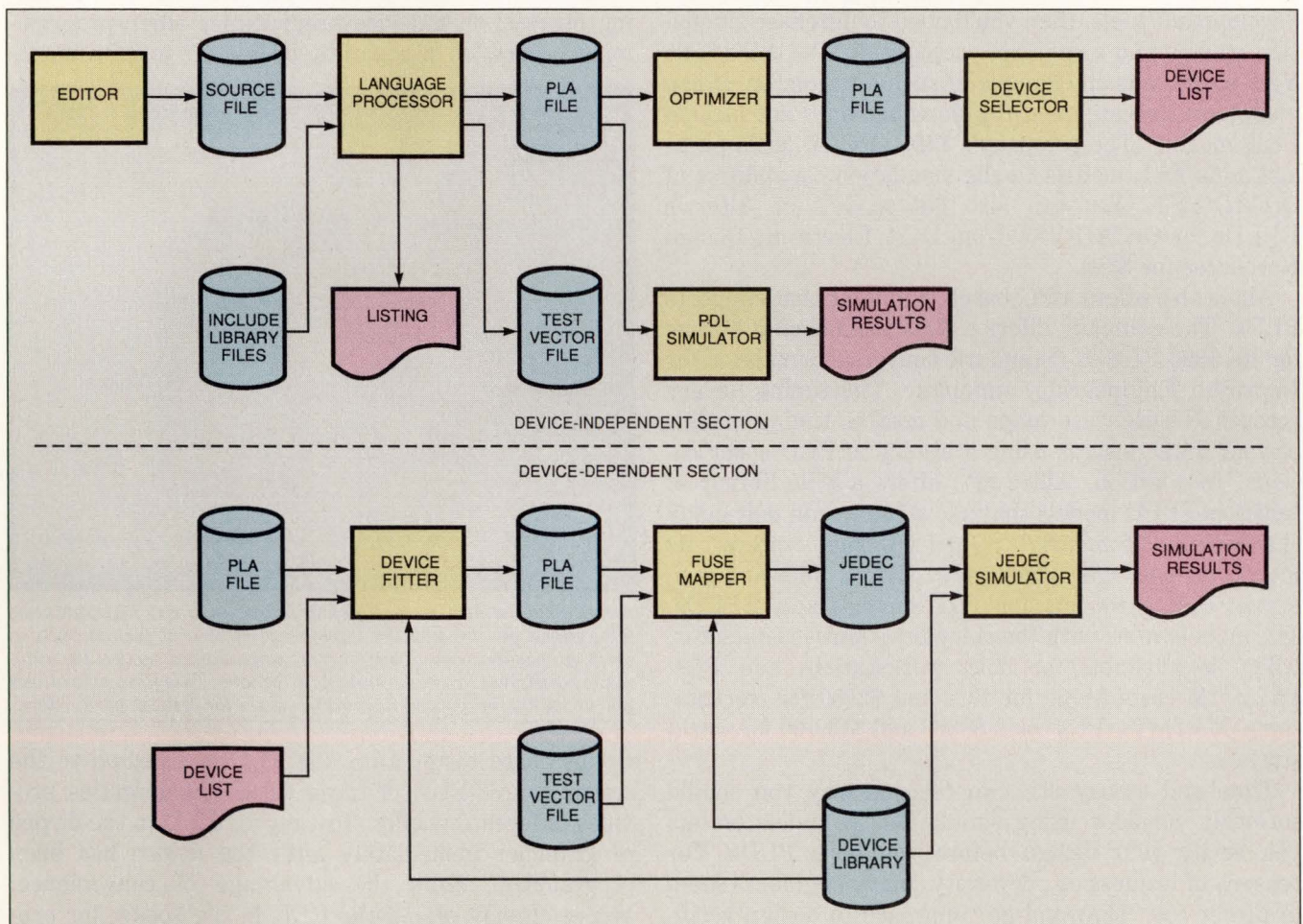

Fig 1—By splitting the latest version of its PLD compiler, CUPL 4.0, into a device-independent design section and a device-specific fitting and mapping section, Data I/O has produced a tool that can accept design information created by other design tools. Because the front-end design section generates files commonly accepted by ASIC vendors, you can use this product to design ASICs as well as PLDs.

PLD development software

if your design works as expected. Thus, you find out how the circuit will behave instead of guessing and then verifying your guess. However, you cannot perform these device-level simulations without models for the PLDs you're using.

If you're using an integrated design environment like Mentor's, then you already have a simulator on

One way or another, you need to select a device that has the physical resources necessary to implement your reduced equations.

hand. All you need is the models. Logic Automation, a company that creates device models, has agreed to supply Mentor with device models for all PLDs that PLDSynthesis supports. If you're using PC-based PLD development tools, then you'll need to purchase simulation models and a simulator separately. OrCAD's \$995 VST package is an example of such a simulator. It can model simple gates and flip-flops but does not include PLD models. The company's \$495 OrCAD/MOD package adds PAL models to the simulation capabilities of OrCAD/VST. You can also get models of Altera's EPLDs for OrCAD/VST from DGA Electronic Design Resources for \$395.

Aldec also offers a PC-based simulator that supports PLDs. The company offers a \$995 PLD timing library for its \$995 SUSIE (Standard Universal Simulator for Improved Engineering) simulator. The timing library accepts JEDEC fuse maps and creates timing models of your PLD designs using a library of PLD specifications. In addition, Aldec also offers a \$795 library of functional PLD models that allow you to run unit-delay simulations. Similarly, Quad Design offers its PAL2TIM package, which takes JEDEC files and generates timing models for PAL devices and EPLDs. The models work with the company's Motive simulator, which is available for both workstations and PCs. PAL2TIM costs \$1760 for PCs and \$2750 for workstations. Motive for PCs costs \$8600 and \$13,000 for workstations.

Time and money are two reasons why you should seriously consider using simulation. A simulator lets you verify your design before you burn PLDs. For reasons of laziness or perversity, many engineers seem to prefer the "blow-and-go" approach to design verification and ignore simulation. Their reward is a pile of useless devices, which are usually heaped on the lab bench in an unceremonious and unsightly pile. With

5-nsec PAL devices selling for more than \$20 in small quantities and complex PLDs costing even more, this approach can become a costly habit in short order. The price for using a simulator for simple PLDs is usually no more than a few minutes to create some input vectors that will verify your design's logical operation. Even for complex PLDs that require many test vectors, you might still save time by using a simulator, because troubleshooting such complex parts also takes a bit of time.

If you've finished your design, verified that your design works by simulating it, and the prototype circuit is built and operating, you may think that your job is finished. Think again. The manufacturing department is going to build that design of yours, and you can help them by creating test programs for your PLDs and your board. Test software specifically created for PLDs can aid you in performing this task. **Table 4** lists a variety of software packages that create PLD test programs.

You can test PLDs at three points in the manufacturing process: on a device programmer when programming occurs; on a separate IC tester; and on an in-

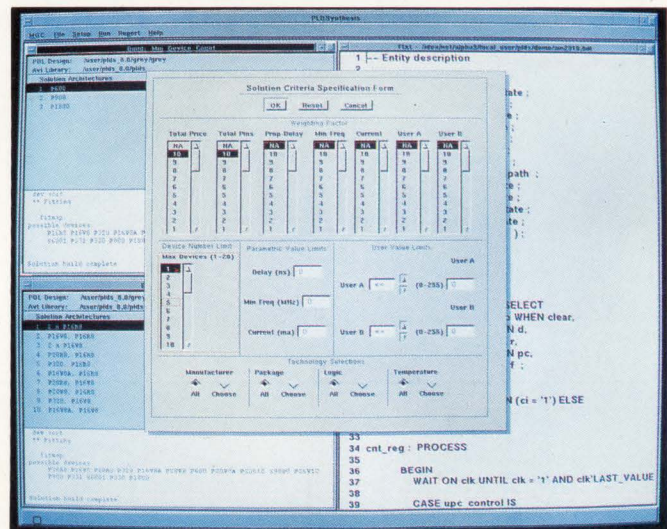

A specification form, part of Mentor Graphics Corp's PLDSynthesis tool, allows you to rank the importance of several factors such as price, propagation delay, and current consumption so that the automatic partitioner can make suitable selections. This form also allows you to set maximum and minimum values for critical parameters.

circuit board tester after the PLD is attached to the circuit board. Each of these three opportunities provides different benefits. Testing the PLD in the device programmer immediately after the device has been programmed offers the advantage of convenience. You've already placed the PLD in the socket for programming, so you need only allocate a few extra seconds for testing.

All device programmers verify that the PLD's fuses,

EPROM cells, or EEPROM cells have been properly programmed. You don't need test vectors for this test. But if the PLD's programming circuits are faulty, your programmer can program the wrong fuse and be unable to detect that problem because the same on-chip circuitry that programs the device also reads and verifies the programmed fuse map. Chances are good that the faulty circuitry that caused the wrong fuse to blow will tell you that everything is OK when you read the fuse's status. This level of testing also does not check the PLD's input and output circuits, which are not used during programming and fuse-map verification. For the same reason, fuse-map testing cannot determine if you've programmed the right part. The fuse maps of PLDs such as the 16L8 and 16R8 look alike to the device programmer.

Most PLD programmers allow you to exercise a PLD's I/O circuitry through test vectors. The JEDEC 3A file format accommodates test vectors, so in one file you can transfer the test data and the programming data to the device programmer. PLD compilers allow you to incorporate your design-verification vectors into the PLD's fuse-map file for use by the device programmer. In addition, PLD test software can often accept JEDEC fuse maps and append additional test vectors to the JEDEC file for more complete tests.

However, device programmers generally cannot perform parametric testing. For example, they can't tell you if your 5-nsec PAL device really meets its 5-nsec propagation delay spec. They also cannot determine the timing skew between a PLD's outputs. For that sort of information, you need an IC tester. Because they're not dedicated to just PLDs, IC testers don't normally accept test vectors in the JEDEC 3A format. So if you're going to create test vectors for an IC tester, you'll need an appropriate piece of software. Similarly, if you want to test the PLD once it has been placed on a circuit board, you'll need to generate test vectors in the appropriate in-circuit board tester format. Testing PLDs on the circuit board provides the advantage of ensuring that the device still works after enduring manufacturing steps such as device placement, soldering, and cleaning.

Test for failure, not success

It's relatively simple to create a few test vectors that only test for a PLD's proper operation. You defined the device's function by designing it, so you know how it's supposed to work. However, creating a set of test vectors to test for all possible device faults can be a much harder problem, because you may need a lot of vectors. Yet you need to test for those faults,

Table 4—Representative automatic test-pattern-generation software for PLDs

Manufacturer	Product	Price	Tester(s) Supported	PLDs Supported (nonexhaustive)
Acugen Software	ATG 510	\$495	PLD programmer	PALs
	ATG 520	\$2495	PLD programmer	PALs plus the 22V10
	ATG 521	\$3300	PLD programmer	PALs, GALs
	ATG 530	\$4950	in-circuit tester	PALs, GALs
	ATG 531	\$6950	in-circuit tester	PALs, GALs, EPLDs
	ATG 540	\$4950	PLD programmer, IC tester	PALs, GALs
	ATG 541	\$6950	PLD programmer, IC tester	PALs, GALs, EPLDs
	ATG 550	\$6950	PLD programmer, IC tester, in-circuit tester	PALs, GALs, PEELs, FPLAs, FPLSs
	ATG 560	\$9950	PLD programmer, IC tester, in-circuit tester	PALs, GALs, PEELs, FPLAs, FPLSs, EPLDs
Data I/O	PLDtest Plus 2000	\$1995	Device programmer	PALs
	PLDtest Plus 6000	\$4995	IC tester	PALs, GALs, PEELs, FPLAs, FPLSs, EPLDs
Hewlett-Packard	74153A Advanced PLD Utilities	\$4100	PLD programmer	PALs, GALs, FPLAs, FPLSs, EPLDs
ISDATA	LOG/iC Functional Verifier ¹	\$995	PLD programmer	PALs, GALs, PEELs, FPLAs, FPLSs, EPLDs, Atmel ATV
Logical Devices	TESTPLA	\$1995	PLD programmer	PALs, GALs, PEELs, FPLAs, FPLSs, EPLDs
Teradyne	Circuit Breaker	\$50,000 ²	IC tester	PALs, GALs, FPLAs, FPLSs, EPLDs

Notes: 1. The LOG/iC Functional Verifier is an optional module for ISDATA's LOG/iC PLD compiler.
2. Price includes a license for Teradyne's Lasar Version 6 simulator.

PLD development software

as they could cause your circuit to operate incorrectly. Unless you plan to make a career out of writing test vectors, you should consider purchasing test software that includes an automatic test-pattern generator. Several software products for creating PLD tests appear in **Table 4**.

PLD test software can start with the vectors you

created to verify your design. Working with those test vectors, a fault grader can evaluate your design-verification vectors to determine how much fault coverage they provide. If your vectors can detect every possible fault in the device, you've achieved 100% fault coverage. More than likely, however, your test vectors will only exercise a small part of the PLD. An automatic

Manufacturers of PLD development software

For more information on PLD development software such as the products described in this article, circle the appropriate numbers on the Information Retrieval Service card or use EDN's Express Request service. When you contact any of the following manufacturers directly, please let them know you saw their products in EDN.

Accel Technologies Inc
6825 Flanders Dr
San Diego, CA 92121
(619) 554-1000
FAX (619) 554-1019
Circle No. 650

Acugen Software Inc
427-3 Amherst St
Nashua, NH 03063
(603) 891-1995
Circle No. 651

Adams-Macdonald Corp
800 Airport Rd
Monterey, CA 93940
(408) 373-3607
FAX (408) 373-3622
TLX 882141
Circle No. 652

Advanced Micro Devices Inc
Box 3453
Sunnyvale, CA 94088
(408) 732-2400
Circle No. 653

Aldec
3525 Old Conejo Rd, #111
Newbury Park, CA 91320
(805) 499-6867
FAX (805) 498-7945
TLX 239447
Circle No. 654

Altera Corp
3525 Monroe St
Santa Clara, CA 95051
(408) 984-2800
FAX (408) 248-6924
TLX 888496
Circle No. 655

Arctos Systems Corp
300 March Rd, 4th Floor
Kanata, Ontario
Canada K2K 2E2
(613) 591-3084
Circle No. 656

Atmel Corp
2125 O'Neil Dr
San Jose, CA 95131
(408) 441-0311
FAX (408) 436-4200
Circle No. 657

Bytek Corp
508 NW 77th St
Boca Raton, FL 33487
(407) 994-3520
FAX (407) 994-3615
Circle No. 658

Capilano Computing Systems Ltd
501-1168 Hamilton St
Vancouver, British Columbia
Canada V6B 2S2
(604) 669-6343
Circle No. 659

Cypress Semiconductor Corp
3901 N First St
San Jose, CA 95134
(408) 943-2600
FAX (408) 943-2741
TLX 821032
Circle No. 660

Data I/O Corp
Box 97046
Redmond, WA 98073
(206) 881-6444
FAX (206) 882-1043
TLX 152167
Circle No. 661

Dazix
Box 7006
Mountain View, CA 94039
(415) 960-0123
FAX (415) 960-6933
TLX 858262
Circle No. 662

DGA Electronic Design Resources
155 West St
Wilmington, MA 01887
(617) 935-3001
FAX (617) 270-3723
Circle No. 663

Exel Microelectronics Inc
2150 Commerce Dr
San Jose, CA 95131
(408) 432-0500
FAX (408) 434-6444
TLX 171339
Circle No. 664

Gould Inc
Semiconductor Div
2300 Buckskin Rd
Pocatello, ID 83201
(208) 233-4690
Circle No. 665

Hewlett-Packard Co
Customer Information Center
19310 Pruneridge Ave
Bldg 49AW
Cupertino, CA 95014
(800) 752-0900
Circle No. 666

Inlab Inc
2100-C W 6th Ave
Broomfield, CO 80020
(303) 460-0103
FAX (303) 469-5565
Circle No. 667

Intel Corp
Box 58065
Santa Clara, CA 95052
(408) 765-8080
Circle No. 668

Intergraph Corp
1 Madison Industrial Park
Huntsville, AL 35894
(205) 772-2000
FAX (205) 730-2461
TWX 810-726-2180
Circle No. 669

International CMOS Technology Inc
2125 Lundy Ave
San Jose, CA 95131
(408) 434-0678
FAX (408) 434-0688
TWX 910-997-1531
Circle No. 670

Manufacturers listing continued on pg 114

88 Pin "DAC-Per Pin" Technology

NEW



From **\$1995⁰⁰***

ALLPRO-88™ Universal Software Driven Device Programmer Supports Virtually Every Device On the Market!

Logical Devices offers you a truly pin driven "DAC-Per-Pin" programmer with electronic ground and Vcc, 4MHz clock, current mode source, high-speed programmable slew rate, and up to 10 amps of peak current on each pin.

All of this starting at \$1995.00 for a 24 pin version with logic configuration. Easily field upgradable to 88 pins. Supports the latest of low to high-pin count devices such as the AMD Mach and Altera Max devices, National "D" PALS, Signetics PLHS Series and all other devices your current programmer cannot program!

Supports programming, verifying, and functional testing for PLDs, EPLDs, GALs, PALs, PROMs, EPROMs, EEPROMs, FPGAs, LCAs, MAX, MACH, ASPL, P-Sequencers, and FPLAs. ALLPRO is certified by key semiconductor manufacturers to provide excellent programming yield and reliable operation.

No copy protection in ALLPRO-88 software and updates. Buy one copy for all your units. Updates are complete and comprehensive, each version includes all supported devices.

ALLPRO-88 is supported by CUPL®, the world's most popular logic design software, with high level behavioral hardware language (CHDL), multiple PLD design, ATVG and simulation capability.

If all of this gives you an upset stomach over your Data I/O* investment, then call us for a FREE DEMO and a generous trade-in offer.

1-800-331-7766

LOGICAL
DEVICES, INC.

1201 NW 65th Place
Fort Lauderdale, FL 33309
Fax: (305) 974-8531 Phone: (305) 974-0967

* Quoted price for US delivery only, F.O.B. Fort Lauderdale, FL. The brands or product names mentioned are trademarks or registered trademarks of their respective holders.

© 1990, Logical Devices Inc.

PLD development software

test-pattern generator can take your test vectors as a seed and create additional vectors to make the test's fault coverage more complete. Automatic test-vector generators can develop test vectors without your verification vectors, but they'll perform more quickly if you give them those clues to your design's operation. Thus, you have yet another reason for using simulation

and verification in the early design stages.

After power is applied to a PLD, it will be in an unknown state, which makes it difficult to test. If you can initialize the part, perhaps using a reset line, your test can proceed immediately. Otherwise, you'll have to somehow put the PLD into a known state. Many PLDs allow a tester to jam a value directly into its

Manufacturers of PLD development software (continued)

ISDATA Inc
800 Airport Rd
Monterey, CA 93940
(408) 373-7359
FAX (408) 373-3622
Circle No. 671

ISDATA GmbH
Haid-und-Neu-Strasse 7
D-7500 Karlsruhe
West Germany
Circle No. 672

Lattice Semiconductor Corp
Box 2500
Portland, OR 97208
(503) 681-0118
FAX (503) 681-3037
TLX 277338
Circle No. 673

Logic Automation Inc
19545 NW Von Neumann Dr
Beaverton, OR 97006
(503) 690-6900
Circle No. 674

Logical Devices Inc
1201 NW 65th Pl
Fort Lauderdale, FL 33309
(305) 974-0967
FAX (305) 974-8531
TLX 383142
Circle No. 675

Mentor Graphics Corp
8500 SW Creekside Pl
Beaverton, OR 97005
(503) 626-7000
FAX (503) 626-1268
TLX 160577
Circle No. 676

Minc Inc
6755 Earl Dr, Suite 200
Colorado Springs, CO 80918
(719) 590-1155
FAX (719) 590-7330
Circle No. 677

National Semiconductor Corp
Box 58090
Santa Clara, CA 95052
(408) 721-5000
Circle No. 678

Omaton Inc
801 Presidential Dr
Richardson, TX 75081
(214) 231-5167
FAX (214) 783-9072
Circle No. 679

OrCAD Systems Corp
3175 NW Alocek Dr
Hillsboro, OR 97124
(503) 690-9881
FAX (503) 690-9891
TWX 910-240-2090
Circle No. 680

Phase Three Logic Inc
1600 NW 167th PL
Beaverton, OR 97006
(503) 645-0313
FAX (503) 645-0207
Circle No. 681

Pistohl Electronic Tool Co
22560 Alcalde Rd
Cupertino, CA 95014
(408) 255-2422
FAX (408) 255-2436
Circle No. 682

Programmable Logic Technologies
Box 1567
Longmont, CO 80501
(303) 772-9059
FAX (303) 772-5617
Circle No. 683

Quad Design
1385 Del Norte Rd
Camarillo, CA 93010
(805) 988-8250
FAX (805) 988-8259
Circle No. 684

Signetics Co
Box 3409
Sunnyvale, CA 94088
(408) 991-2000
Circle No. 685

Teradyne Inc
321 Harrison Ave
Boston, MA 02118
(617) 482-2700
TWX 710-321-1055
Circle No. 686

Texas Instruments Inc
Semiconductor Group (SC-971)
Box 809066
Dallas, TX 75380
(800) 232-3200 x700
Circle No. 687

Valid Logic Systems Inc
2820 Orchard Pkwy
San Jose, CA 95134
(408) 432-9400
Circle No. 688

Viewlogic Systems Inc
313 Boston Post Rd W
Marlboro, MA 01752
(508) 480-0881
FAX (508) 480-0882
Circle No. 689

Xeltek
473 Sapena Ct, Unit 26
Santa Clara, CA 95054
(408) 727-6995
FAX (408) 727-6996
Circle No. 690

VOTE . . .

Please also use the Information Retrieval Service card to rate this article (circle one):

High Interest 500
Medium Interest 501
Low Interest 502

A hand is shown holding a PAL chip that is on fire. The fire is bright orange and yellow, with a thick plume of dark blue smoke rising from the chip. In the background, other PAL chips are visible on a green printed circuit board (PCB). The overall scene is set against a dark, gradient background.

A few words of advice from high-performance μ PLDs.

Chill out, PAL.

Many designers have hot, high-performance designs. Literally.

Fortunately, Intel has a simple way to reduce system heat and still get incredible performance. The μ PLD Family of programmable logic devices.

Take, for example, the 85C220 and 85C224. They operate at 80MHz (100 MHz internally) with only a 10ns total propagation delay.

And since μ PLDs are manufactured using Intel's CHMOS* technology, they require just 1/4 the power of their pin-compatible bipolar PAL* alternatives. Which means they can lower

system heat by 35 percent and help reduce board-level failures, too. So they're certain to give your high-performance system a boost. And send chills up the spine of your motherboard.

Learn more about Intel μ PLDs and receive a μ PLD/PAL heat comparison. Call (800) 548-4725 and ask for Literature Packet #1A28.

Otherwise, you could take some heat over your system design.

The Intel logo, consisting of the word "intel" in a lowercase, sans-serif font with a registered trademark symbol (®) to the upper right of the letter "l".

intel®

registers. This "preload" feature is usually activated by applying a "supervoltage"—substantially higher than 5V—to one of the PLD's pins. Consequently, you probably won't want to use the preload feature on a PLD once it's placed on a circuit board, because the

Testing PLDs on the circuit board ensures that the device still works after enduring manufacturing steps such as device placement, soldering, and cleaning.

supervoltage can easily destroy other circuitry on the board. However, programs that create vectors for IC testers can use a PLD's initialization or preload features to reduce the number of test vectors needed to test the device.

Once the PLD's registers are in a known state, the test can proceed. Be aware that PLDs with the same architecture but made by different manufacturers may use different preload algorithms. That situation may cause problems when your purchasing department switches PLD vendors, because you'll need a different test for the new PLDs. (This same problem arises for PLD programming as well. PLDs from different vendors, and even different-speed PLDs from the same vendor, use different programming algorithms.)

A test program can also place a PLD into a known state by applying a set of initialization vectors to the

PLD's input pins that will force the device into a known state no matter what its initial state is. From there, the test can proceed just as it would if the device's state had been preloaded. This approach requires that the tester apply more vectors than the preload method but it may be the only alternative available to you unless you plan to run your PLD tests on an IC tester.

You can certainly use just a compiler to create PLDs and leave design verification and device testing to the fates. Engineers and their employers take this low-ball approach all the time. One wonders what they're trying to save. They won't save time unless the engineers always create perfect designs the first time. (Those same people probably work crossword puzzles in ink.) Consequently, they don't save money, because time is more valuable than money in the electronics industry. An engineer's time, including overhead, can cost nearly \$100/hour; the time to market is priceless. Even the most expensive development tools can quickly become bargains if you keep these realities in mind.

EDN

References

1. Alford, Roger C, *Programmable Logic Designer's Guide*, Howard W Sams & Co, Indianapolis, 1989.
2. Burton, Von L, *The Programmable Logic Device Handbook*, Tab Books, Blue Ridge Summit, 1990.
3. Conner, Doug, "PLD architectures require scrutiny," *EDN*, September 28, 1989, pg 91.
4. Kops, Peter de Bruyn, "Testability is crucial in PLD circuit design," *EDN*, August 18, 1988, pg 191.
5. Payne, Daniel J, "Build testable ASICs using nonstructured design techniques," *EDN*, March 1, 1990, pg 167.
6. Small, Charles H, "Automatic test generators for PLDs clean up your logic designs," *EDN*, September 17, 1987, pg 59.
7. Small, Charles H, "PLD programmers," *EDN*, March 31, 1987, pg 118.
8. Small, Charles H, "PLD-design software meets the challenge of multiple-device PLD applications," *EDN*, February 18, 1988, pg 61.

Acknowledgment

EDN appreciates the assistance of Lisa D White, an associate editor at Personal Engineering and Instrumentation News magazine, who provided time on her Apple Macintosh to try out Capilano Computing's MacABEL PLD compiler.

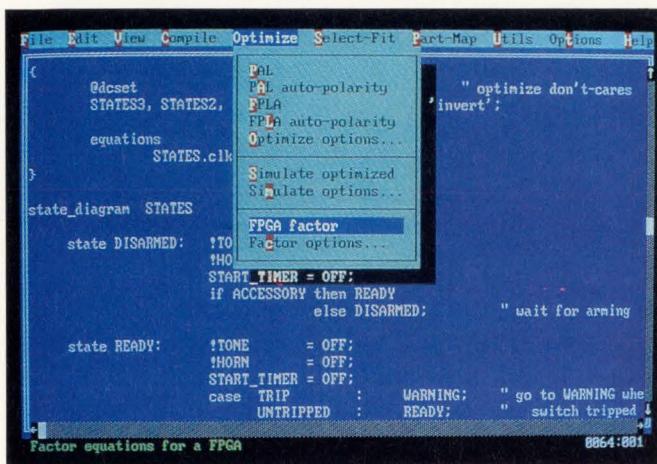

Improved user interfaces for PC-based PLD design tools mark the software products' transition from minimal, batch-oriented implementations to interactive programs that help you refine your design more efficiently. (Photo courtesy Data I/O Corp)

Article Interest Quotient (Circle One)
High 500 Medium 501 Low 502

Finding The Right Embedded Graphics Processor Can Be Harder Than You Think.



Embedded graphics applications can range from PC displays to entertainment systems. So you need a fast graphics system processor that's fully programmable for every high-resolution application.

And you don't need to waste a lot of time trying to find one.

That's why Marshall Industries carries the latest graphics system processor from Texas Instruments. Ready to ship in production quantities.

With a 60 million bit-per-second draw rate, seven and one half million instruction-per-second capacity and the ability to draw open and filled geometric shapes, the TMS34010 is available in 40, 50 and 60 MHz speeds. All these features on a single chip make this the most cost-effective graphics processor on the market.

Even better, thanks to Marshall's leadership, you get the full support of a national distributor. Support which includes developer's kits for 34010-based PC systems, software assemblers, hardware emulators, evaluation boards, and extensive documentation. Not to mention the security that comes from dealing with one of TI's largest distributors.

So if finding a reliable source for your embedded graphics solutions has you on pins and needles, call Marshall today.

We won't stick you with anything but a great graphics processor.

Marshall



(Authorized Locations)
 AL Huntsville (205) 881-9235*
 AZ Phoenix (602) 496-0290*
 Tucson (602) 790-5687*
 CA Irvine (714) 458-5301*
 Los Angeles (818) 407-4100*
 Sacramento (916) 635-9700*

San Diego (619) 578-9600*
 San Francisco (408) 942-4600*
 CO Denver (303) 451-8383*
 CT Connecticut (203) 265-3822*
 FL Ft. Lauderdale (305) 977-4880*
 Orlando (407) 767-6585*
 Tampa (813) 575-1399*

GA Atlanta (404) 923-5750*
 IL Chicago (312) 490-9155*
 IN Indianapolis (317) 297-0483*
 KS Kansas City (913) 492-3121*
 MA Boston (508) 658-0810*
 MD Maryland (301) 622-1116*
 MI Michigan (313) 525-5850*

MN Minneapolis (612) 559-2211*
 MO St. Louis (314) 291-4650*
 NC Raleigh (919) 878-8882*
 NJ N. New Jersey (201) 882-0320*
 Philadelphia (609) 234-9100*
 NY Binghamton (607) 798-1611*
 Long Island (516) 273-2424*

Rochester (716) 235-7620*
 OH Cleveland (216) 248-1788*
 Dayton (513) 898-4480*
 OR Portland (503) 644-5050*
 PA Philadelphia (609) 234-9100*
 Pittsburgh (412) 786-0441*
 TX Austin (512) 937-1991*

Dallas (214) 233-5200*
 El Paso (915) 593-0706*
 Houston (713) 895-9200*
 San Antonio (512) 734-5100*
 UT Salt Lake City (801) 485-1551*
 WA Seattle (206) 486-5747*
 WI Wisconsin (414) 797-8400*

In Canada: G.S. Marshall Co.
 Montreal (514) 694-8142
 Ottawa (613) 564-0166*
 Toronto (416) 458-8046*

TEXAS INSTRUMENTS
 Authorized Distributor

The new performance standard

SNA-6:
The ultimate instrument for applications in systems manufacturing.



SNA-6: 50 Hz to 3.2 GHz

Designed for applications from the audio to the microwave range, the dual-function SNA-6 handles spectrum analysis from 50 Hz to 3.2 GHz. The instrument's excellent dynamic range and accuracy permit analysis of **densely spaced line spectra**. The narrowest analyzer filter (3 Hz bandwidth) allows detection of extremely low amplitude a. c. line interference superimposed **on a 3 GHz carrier**. This is just one benefit of the low-noise synthesizer oscillator. The SNA-6 also sets new standards in scalar network analysis. The 0.1 Hz resolution synthesizer can be tuned across the entire frequency range without skips or phase hits. The same synthesizer also provides the signal for the tracking generator. When testing active two-port networks, the gain/attenuation vs. frequency can be determined from +30 to -140 dBm and 100 kHz to 3.2 GHz with excellent precision.

You can use our bar code reader or your PC with our software for remote control applications on the IEEE 488/IEC 625 bus. You will also be impressed by the versatile evaluation functions and hardcopy capabilities of the SNA-6.

For more information about the state-of-the-art SNA-6 from Wandel & Goltermann, please fill out and send in the coupon below.

USA: Wandel & Goltermann, Inc., 1030 Swabia Court, R. T. P., NC 27709, Tel. (919) 941-5730, Telex II: 810-621-0002, Fax (919) 941-5751.

Canada: Wandel & Goltermann Inc., 21 Rolark Drive, Scarborough, Ontario M1R3B1, Tel. (416) 291-7121. **Worldwide:** Wandel & Goltermann, VMW, Postfach 12 62, D-7412 Eningen, Tel. + (49) 71 21-86-0, Tlx. 729833, Fax + (49) 71 21-884 04.

CIRCLE NO. 52

COUPON

- More information about the SNA-6
- Please arrange for a sales engineer to call

Name

Company

Street

Town/postcode

Telephone no.

E 10.89/VMW/14/4C/NA EDN080290 EM/16

Wandel & Goltermann

Electronic Measurement Technology



Real-Time Software Performance Analysis and Test Coverage



HMI's Performance Analysis Card (PAC) provides real-time software performance analysis and real-time software test coverage for all HMI-200 series in-circuit emulators. This option operates completely transparent to the system under test and collects its data in real-time to establish a true profile of the software execution.

Features:

- Hardware implemented
- Up to eight modules can be defined
- Histograms for each module are displayed
- Minimum, Maximum and Average time duration for each module displayed
- Coverage mode displays which pieces of the code did and did not execute
- Trace data has a time stamp

Benefits:

- More efficient code produces higher performance products for your company
- Better tested code eliminates bugs generated from untested code and creates higher quality software for your company
- The Emulator and Performance Analysis together shorten the design cycle time allowing your company to have its window of opportunity in the marketplace

Available Emulators:

8051 family	8085	68010	6809/6809E	64180/Z180
DS5000	68000	68020	68HC11 including F1	Z80
8096/80196	68008	68302		

68302 Now Available. 68030 and 68332 coming soon. Call HMI for information.



HUNTSVILLE MICROSYSTEMS, INC.
4040 South Memorial Parkway, Huntsville, AL 35802
(205) 881-6005

The way
we build
workstations,
you'd think
we had
to use them
ourselves.

We do.



There's nothing like some real world proof to establish the viability of a product.

Which is why you might find it comforting to know that the Sony NEWS® line of workstations are being used by real designers. On real chip, board, and product development projects. For one of the world's most successful electronics manufacturers: Sony.

In fact, Sony engineers are using NEWS workstations to design everything from SRAMs and other chips to advanced video and audio controllers for the professional broadcast markets.

All of which uniquely positions us to understand your engineering and product development needs. Because here is a case where the supplier is acutely aware of the consumer's needs. And has to meet those needs. On a daily basis.

The result is our very affordable NEWS 3710 desktop workstations—the latest additions to our current workstation line. Fast, powerful, and expandable, these R3000®-based systems offer extensive memory plus high capacity, cost-effective storage options—including Sony's unique magneto optical drives and DAT tapes. Of course, you can choose the black-and-white, grayscale, or high-resolution Trinitron® color monitor that best fits your application.

We even have most of the popular EDA software packages—including applications from vendors such as Cadence, Valid Logic, Data I/O, Synopsys, Racal-Redac, Silvaco and an ever-expanding roster of others.*

To find out more about why Sony's solutions should be your solutions, give us a call at 1-800-624-8999, ext. #96.

Then just sit back and watch the NEWS.

SONY®

Sony Microsystems Company

Sony Microsystems Company, 651 River Oaks Parkway, San Jose, CA 95134 (408) 434-6644 FAX: (408) 954-0849 • Sony of Canada, Ltd., Ontario, Phone: (416) 499-1414 FAX: (416) 497-1774 • Sony Microsystems Europe, Köln, Phone: (0221) 59 30 42 FAX: (0221) 59 35 42 • Sony (Australia) Pty. Ltd., N.S.W. Phone: (02) 887-8666 FAX: (02) 887-4351 • International Sales Division, Tokyo, Phone: (03) 448-4041 FAX: (03) 448-4043 • Sony, NEWS, and Trinitron are registered trademarks of Sony Corporation. R3000 is a registered trademark of MIPS Computers, Inc. © 1990 Sony Corporation of America. Design and specifications subject to change without notice. *Some of the software mentioned herein may not be available for all NEWS models or for worldwide distribution. Call your Sony representative to check for availability.

Knowledge of subtleties aids switched-capacitor filter design

Switched-capacitor filters are in essence sampled-data systems. By recognizing the effects—such as aliasing—these systems can have on the filtering process, you'll have a better understanding of your filter's anomalies. THD, clock jitter, and noise are other potential problems you need to recognize and take steps to avoid.

Richard Markell, *Linear Technology Inc*

Armed with a basic knowledge of switched-capacitor filter design—how to choose filter types and pole/zero locations, for example—you can achieve optimal performance from these filters by recognizing some of their subtleties. The most prominent effect of the sampled-data nature of switched-capacitor filters is the potential for aliasing and imaging of continuous-time signals. Also, recognizing system-level constraints such as clock feedthrough, clock jitter, noise, and filter sensitivity helps you maximize filter performance. If your filter is involved in spectrum analysis, THD is an important specification to evaluate. For any application, layout and power-supply features are critical for getting the best performance out of your switched-capacitor filter (see **box**, "Checklist helps filters work the first time.")

Because the switched-capacitor filter uses a switching capacitor to generate variable filter parameters,

this type of filter is by definition a sampled-data device. Like all other such devices it is subject to aliasing and imaging. The mathematical explanation of these complex effects is the subject of many paragraphs in textbooks (Ref 1). However, the system designer needn't go through rigorous mathematics to get a meaningful handle on the subject. A series of spectrum-analyzer views displays theoretical and measured responses of both switched-capacitor filters and active RC filters.

Fig 1a shows the basic frequency-domain response for both a theoretical eighth-order elliptic filter and a sampled-data system. **Fig 1a's** theoretical sampled-data system's response is the same for any sampled-data system, whether it's a sample-and-hold amplifier, a sampled A/D converter, or a switched-capacitor filter. The switched-capacitor filtering process—a form of sampling—effectively multiplies the theoretical elliptic-filter response by the sampled-data response in **Fig 1a**. The final result of this sampling and filtering process with an input frequency of f_{IN} is the filter response in **Fig 1b**. Notice the image-frequency components around the clock frequency, f_{CLK} . These components aren't the result of aliasing, but are an artifact of the nature of a sampled-data system.

Fig 2 shows two segments of the output spectrum of an 8-pole elliptic switched-capacitor test filter. This test filter's cutoff frequency is 500 Hz, and the ratio of the clock frequency to the cutoff frequency— f_{CLK}/f_{CUTOFF} —is 100:1. **Fig 2a** shows the response from 10 to 510 Hz to a 500-mV (–6 dBV) 100-Hz sine-wave input. **Fig 2a** displays the input signal plus the second harmonic that the filter introduced. The amplitude of the second harmonic is –75 dBV.

The most prominent effect of the sampled-data nature of switched-capacitor filters is the potential for aliasing and imaging of continuous-time signals.

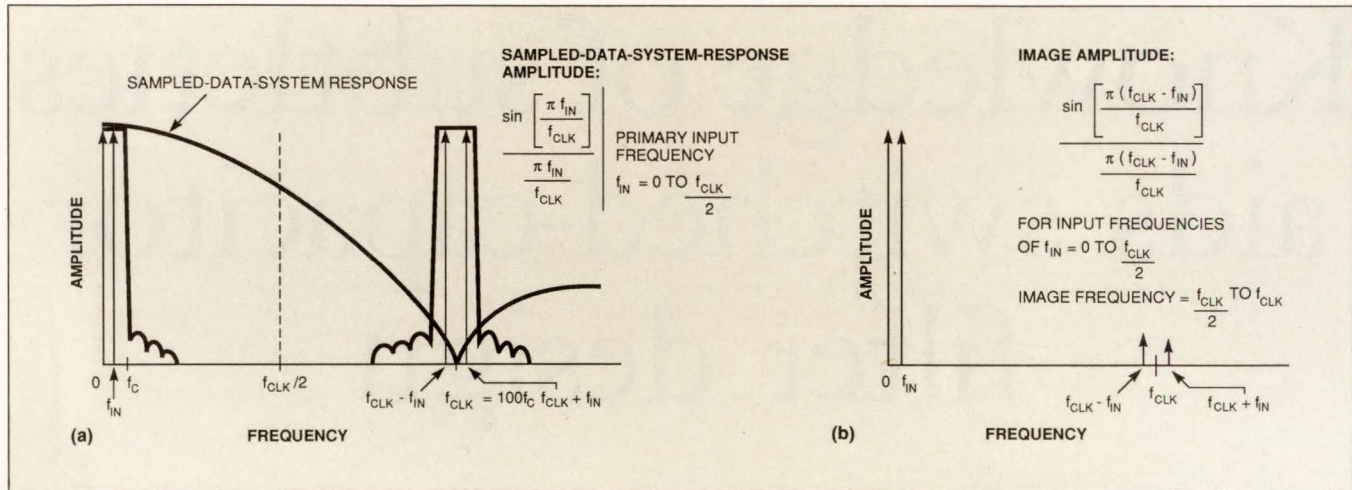

Fig 1—Switched-capacitor filters are a type of sampled-data system. The overall switched-capacitor filter's response in **b** is the product of the theoretical sampled-data-system response and the theoretical elliptic filter's response in **a**. The image components that occur at multiples of the clock frequency result from the filter's sampling nature and aren't an anomaly of the filter.

Fig 2b shows the output spectrum around 50 kHz, which is the clock or sampling frequency. The center signal results from clock feedthrough, which is not affected by the sampled-data system's $(\sin x)/x$ response. This signal's level is about 890 μV rms. The other two signals are the images of the 100-Hz input frequency at about -55 dBV (-61 dBV - the input's -6 dBV) below the input signal. The amplitude of these signals is almost exactly as the theory predicts when you use

the formula in Fig 2a.

These images may not be important if the clock frequency is much higher than the frequency band of interest. However, without prefiltering, aliasing can occur, and worse, it can cause out-of-band signals to show up in the passband. When using switched-capacitor filters, aliasing is something you need to take pains to prevent.

All sampled-data systems are prone to aliasing when

Checklist helps filters work the first time

Standard precautions can steer you clear of most problems when you're testing and using your switched-capacitor filters:

Utilize good breadboarding techniques. Avoid building your filters on protoboard or wire-wrap boards. Instead, build the filter on prototype pc boards or on a piece of double-sided copper-clad board. Treat your filter as an analog component more than a digital one. That is, take layout precautions so that the clock doesn't interfere with the operation of the analog parts of the cir-

cuit. Even though your input frequency may be in the kilohertz range, you should follow RF layout techniques.

Use a linear power supply. If this is impossible, use a clean switcher. Properly bypass the supply.

Be prepared to deal with aliasing. Bandlimit! Pre- and post-filter if necessary.

Check your filter's time- and frequency-domain performance. Although not discussed in detail

in this article, the ultimate response in the frequency domain is often not the ultimate response in the time domain and vice versa. Look at both responses on the bench before committing a filter to either a pc board or silicon.

Evaluate the relative importance of THD and S/N ratio. Understand the cases in which one spec limits the other.

Provide a stable, clean clock to the switched-capacitor filter. This will help you avoid problems caused by too much clock jitter.

input signals exceed one half the clock or sampling frequency. These aliasing effects lead to the ADC user's creed: Don't present signals to the converter at frequencies exceeding one half the clock frequency. If you ignore this warning, aliasing will occur. Remember also that the system can't tell if the signal is an alias or if it's real.

A good way to examine the aliasing phenomena is to imagine that the frequency spectrum folds around one half the clock frequency (the sampling frequency). The spectrum folds back on itself like a piece of paper with the fold representing the sampling frequency. Therefore, a 49.9-kHz input signal to a system whose clock frequency is 50 kHz appears folded back to 100 Hz. Similarly, a 30-kHz input appears folded back to 20 kHz.

The switched-capacitor filter passes or attenuates whatever signal you input to it, whether it's a real or aliased signal. Thus, an input signal of 49.9 kHz aliases into the previous filter's passband and appears at the filter's output unattenuated at 100 Hz. A spectrum plot for this input frequency is identical to the plot in Fig 2a. A 30-kHz input appears folded back to 20 kHz. However, 20 kHz is well out of the passband of this 500-Hz lowpass filter, and this signal is attenuated to the floor of the filter, about 75 dB.

When using switched-capacitor filters, remember that signals above one half the sampling frequency may fold over into your filter's passband. Without any prefiltering, these folded signals would be only slightly attenuated, as dictated by the $(\sin x)/x$ response. As a result, the filter passes signals between 0 and 500 Hz, whether they're real or aliased signals, without attenuating them. The filter attenuates signals at 30 kHz by approximately 75 dB. The moral of the aliasing story is that you must bandlimit your switched-capacitor filter's input signals. A simple RC filter will do.

Small size and other advantages

One of the great advantages of the switched-capacitor filter is the lack of discrete capacitors, which exhibit tolerance and stability limitations. An active RC filter with real-world capacitors that you design using theoretical capacitor values has problems with repeatability and stability. The switched-capacitor filter also has small errors in both the cutoff frequency, f_0 , and Q , but they are easier to deal with than those of the active RC filter.

Manufacturing realities of the semiconductor business also affect the switched-capacitor filter design.

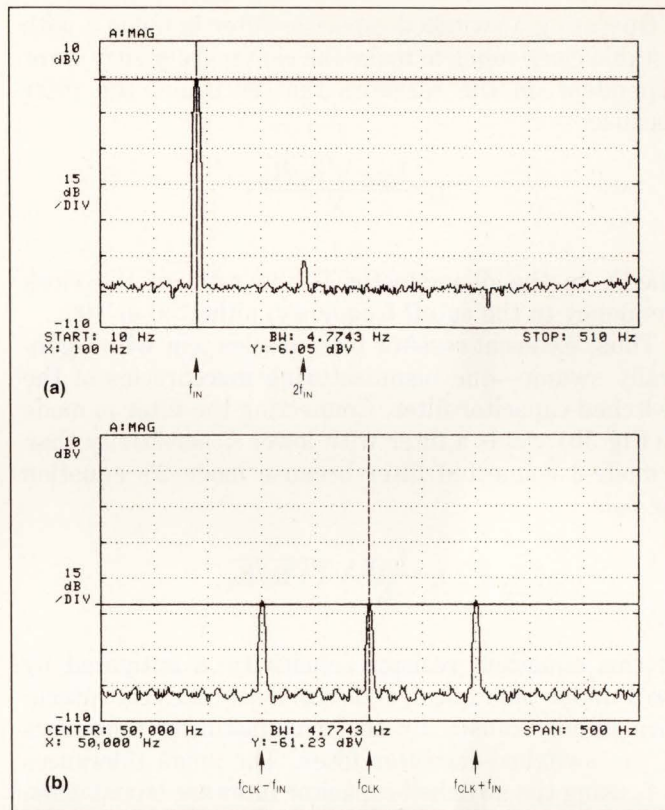

Fig 2—Spectrum-analyzer output plots display the main signal and second harmonic (a) of an eighth-order switched-capacitor filter (LTC1064-1). Image and clock-feedthrough signals appear at the switched capacitor's clock frequency (b).

Although this inaccuracy is much less than the inaccuracy of a comparable active RC filter, it does exist. Switched-capacitor filters are available from manufacturers with center frequency tolerances of generally 0.4 to 0.7%. Be aware that these numbers are only true if you use an accurate and stable clock.

In addition to the effects of the manufacturing process on the filter, the way you use filters also determines many of their characteristics. For instance, if you're using a universal switched-capacitor-filter building block that requires external resistors, the different ways of connecting those resistors (the modes) have various advantages and disadvantages. The state-variable biquad-circuit configuration, known as mode 3 (Fig 3a) allows you to achieve lowpass, bandpass, and highpass filter functions. This configuration also enables you to design high-Q filters that have low sensitivity to component tolerances. (For a strict mathematical analysis of the sensitivity of the state-variable biquad filter, see Ref 2.)

The moral of the aliasing story is that you must bandlimit your switched-capacitor filter's input signals. A simple RC filter will often do.

Operating a switched-capacitor filter in mode 3 with a stable clock tends to make the center-frequency error dependent on the resistors that surround the filter because

$$f_0 = \frac{f_{\text{CLK}} \sqrt{R_2/R_4}}{X}$$

The X in the denominator is the ratio of the clock frequency to the cutoff frequency, either 50 or 100.

Thus, external resistor inaccuracies join with—generally swamp—the manufacturing inaccuracies of the switched-capacitor filter. Connecting the filter in mode 2 (Fig 3b) yields a filter with lower f_0 sensitivity than a mode-3 connected filter because mode 2's equation for f_0 is

$$f_0 = \frac{f_{\text{CLK}}}{X} \sqrt{1 + R_2/R_4}$$

In this equation, resistor sensitivity is mitigated by the 1 under the radical, and so in most cases the inaccuracy is only caused by the manufacturing tolerances of the switched-capacitor filter. The small tolerances in f_0 using the switched-capacitor filter are trivial when compared with an active RC filter. An elliptic filter built with resistors, capacitors, and op amps requires a lot of trimming. Changing the cutoff or center frequency is even more impractical.

One of the most common uses of filters is for antialiasing prior to A/D conversion. Antialiasing filters bandlimit the signal at the input to a DSP system. A critical

concern is the filter's S/N ratio. If a filter has a maximum output swing of 2V rms and noise of 100 μ V rms, it has an S/N ratio of 86 dB. A filter with these characteristics would certainly be a candidate for the antialiasing filter prior to a 14-bit A/D converter, a component which requires an S/N ratio of approximately 84 dB.

S/N ratio isn't the only important consideration, however, especially if you're trying to resolve every spectral component in a band of interest. THD is a measure of the unwanted harmonics that are introduced by nonlinearities in the system. Unfortunately, system and filter designers often ignore the subtleties of THD.

You can understand the effects of S/N ratio and THD, and how they inter-relate, by considering a system whose goal is to digitize a 4-kHz signal to 14 bits of accuracy. In this case, the filter has an S/N ratio of 86 dB, but let's suppose its THD is only -47 dB. Ultimately, both the 4-kHz signal and its harmonics will be digitized. Thus, the 4-kHz pure tone will come out looking like 4 kHz + 8 kHz + 12 kHz, and so on. The A/D converter will digitize these signals, thereby adding errors to the data-acquisition process. Ultimately, you won't be able to tell the real signals from the erroneous harmonics.

Fig 4 illustrates that THD in a real filter is often not as good as the S/N-ratio specification. This figure shows a THD-vs-input-amplitude plot of an 8-pole Butterworth lowpass filter. A second horizontal scale labels S/N ratio. The graph shows that the THD and S/N ratio of 1.5V-rms inputs are below -70 dB and -85

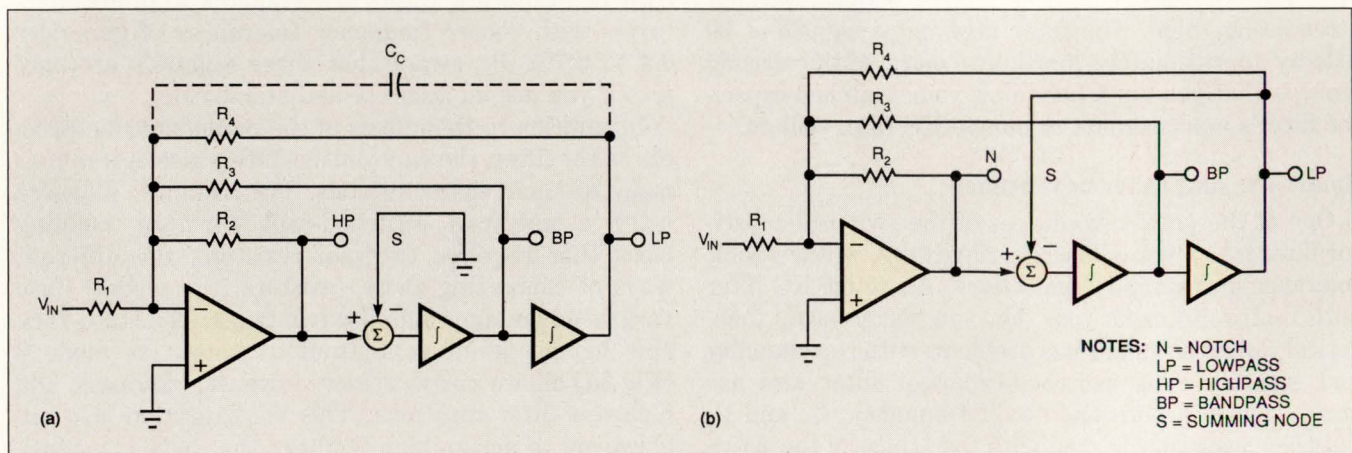
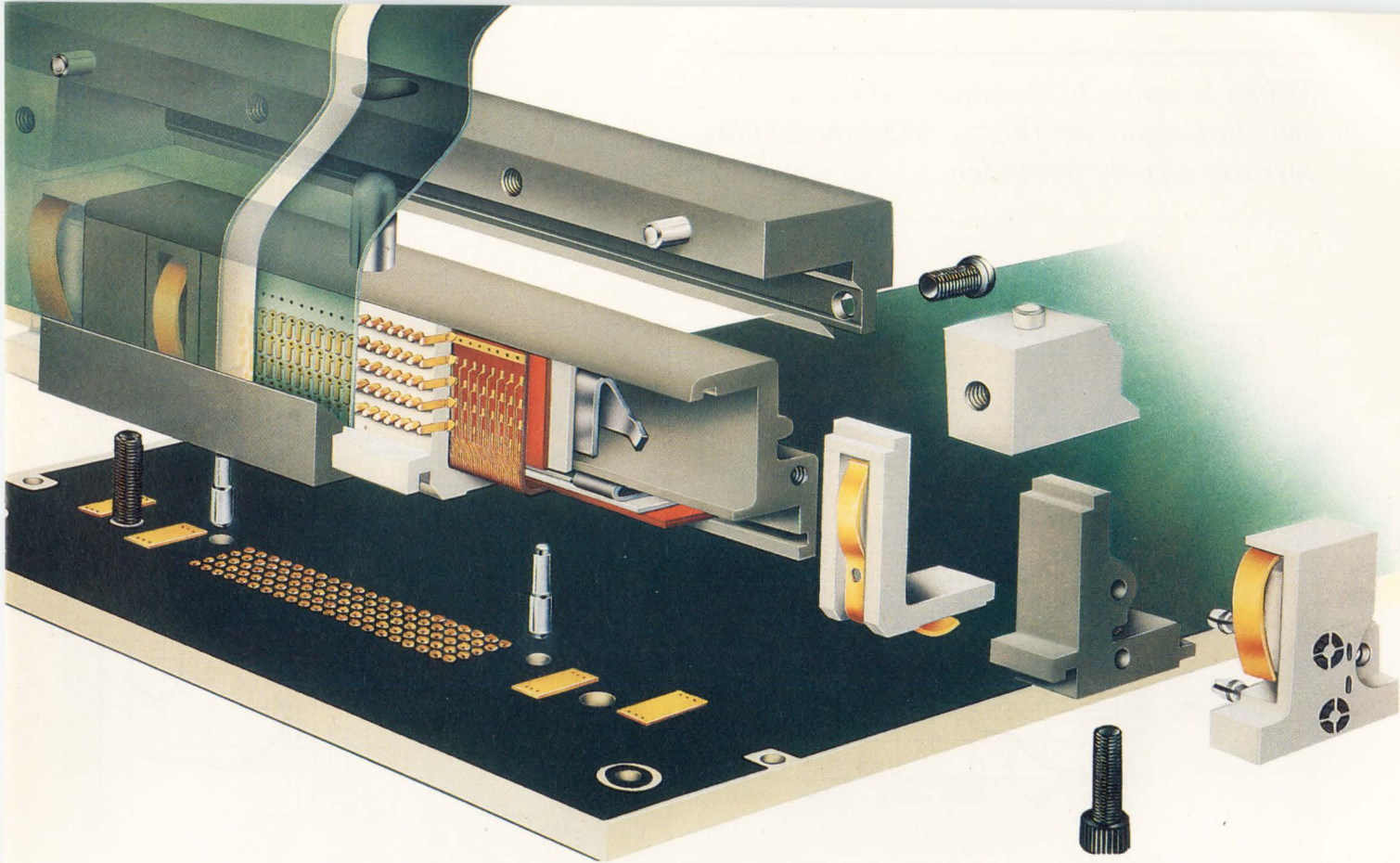
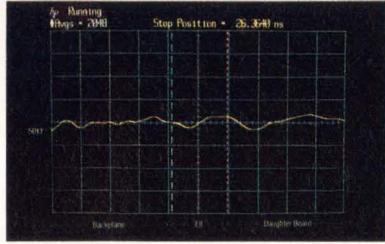

Fig 3—The major sources of a filter's error can depend on the way you configure the filter. Connecting a universal filter building block in mode 3 (a) will produce a filter whose errors stem mainly from external resistors. Filter errors connected in mode 2 (b) depend more on the quality of the part itself.



Out of sight performance!

Introducing the Electronically Invisible Interconnect: transparent to high frequency signals, therefore eliminating connector induced signal distortion. Until now, the limiting factor for signal integrity in high speed electronic circuits has been the connector. The source may be matched to the load, but an impedance mismatch at the connector degrades performance. Signal integrity



EII achieves matched impedance of the connector to the backplane and daughter card.

through EII is maintained because reflection, crosstalk, attenuation, signal skew, and rise-time degradation are reduced to absolute minimums. This unprecedented performance is made possible by a unique flexible microstrip transmission line structure with a continuous ground-plane as the major signal path through the Electronically Invisible Interconnect. Augat, the company known for

quality and innovation, is now setting a new standard of performance – the Electronically Invisible Interconnect. Outta' sight!

AUGAT® Quality and Innovation

Augat Inc., Interconnection Products Division

33 Perry Ave., P.O. Box 779, Attleboro, MA 02703
 (508) 222-2202
 FAX: (508) 222-0693



When it comes to choosing a clock for switched-capacitor filters, 555-type oscillators are strictly forbidden.

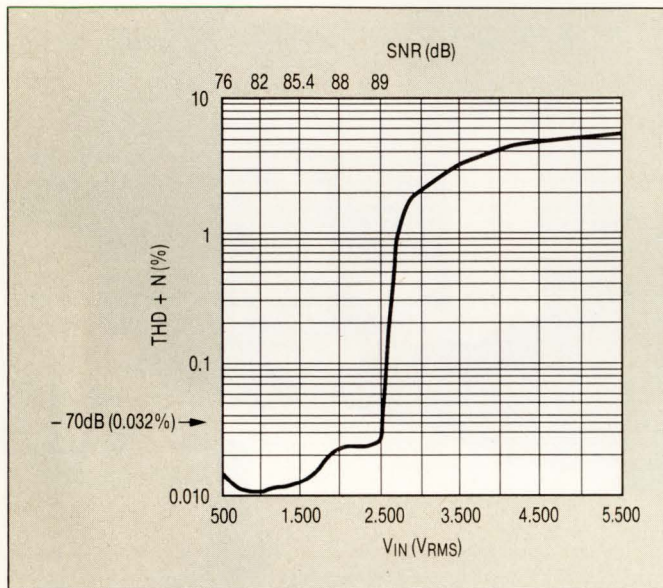

Fig 4—For spectrum-analysis applications, THD is what ultimately limits digitization accuracy. Data from a real switched-capacitor filter reveals that, although the S/N ratio is 85 dB when $V_{IN} = 1.5V_{RMS}$, THD is around -75 dB.

dB, respectively. Thus, all the harmonics of the 4-kHz input signal are below -70 dB. However, your system's real digitization accuracy is now 70 dB and not the dynamic range of 85 dB.

THD generally limits the digitization accuracy of spectrum-analysis applications, not S/N ratio. If your system must be able to resolve multiple-frequency components, don't overlook THD's importance. It does no good to have a filter or any black box that has an 85-dB S/N ratio without the equivalent THD. Distortion is a complicated phenomenon, and its potential causes are not explicitly known. Some possible causes are the charge transfer inherent in the switching capacitors, the output drive, and the swing internal to the switched-capacitor filter.

THD varies with filter type

Many engineers who use filters generally assume that the THD of active RC filters is superior to that of switched-capacitor filters. Traditional filter textbooks seem to lack data on THD, either in a theoretical or a practical sense. The THD-vs-frequency plot data of the eighth-order elliptic RC and switched-capacitor filters (**Fig 5**) shows that the active RC filter has somewhat better THD performance than the switched-capacitor filter. (Note: The elliptic filters have almost the worst THD specifications of all the filter topologies

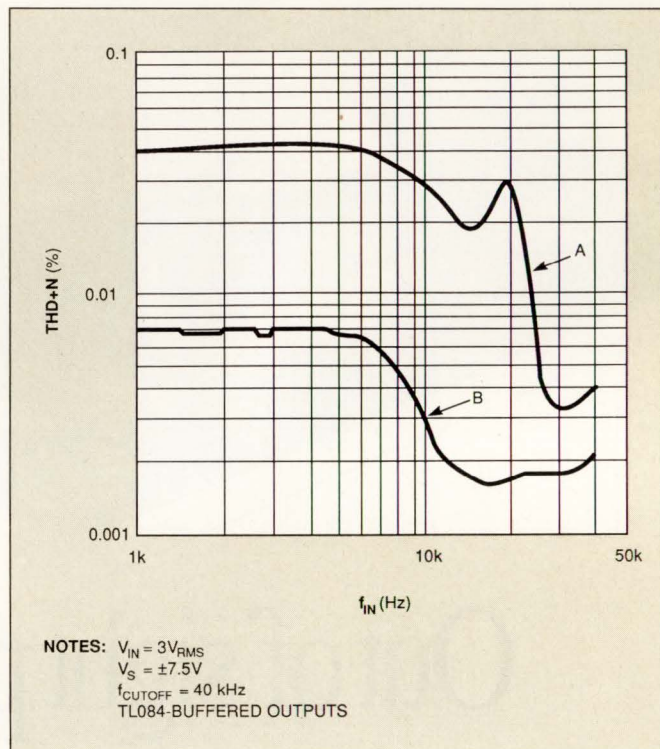

Fig 5—Switched-capacitor filters have many advantages in size and price over active RC filters, but active RC filters have slightly better THD performance (trace B) than do switched-capacitor filters (trace A).

because of their high-Q sections. Butterworth and Bessel filters have very good THD performance.) The performance of the active RC filter comes with the cost of board space: the active RC filter that produced this data includes 16 operational amplifiers, 31 resistors, and eight capacitors on a board that's about 2.5×6 in.

In many cases, you can optimize the THD of a filter by adjusting its design parameters. For example, you can make a large difference in an eighth-order filter's THD simply by changing the cascade order of the four second-order sections. This process is specialized, and data-sheet THD specifications may not reflect the best achievable performance. Bob Pease may be the Czar of Band Gaps (**Ref 3**), but sometimes only a Czar of Filters can tweak the minimum THD from a filter circuit.

Noise in switched-capacitor filters has been on the decline since the invention of the device. Many devices currently have noise levels that compete with active RC filters. The noise of the switched-capacitor filter is nearly constant and independent of bandwidth. For

SIEMENS



Well Received.



Advanced CMOS
Frame Aligner
(ACFA)

**Siemens
is the ISDN
leader. From T-1
to U-Interface.
Murray Hill to Munich.**

Siemens, with the most comprehensive ISDN IC family in the world, has created a technology which is fast becoming a telecommunication standard.

Our ISDN Oriented Modular Architecture (IOM[®]2) eases incorporation of data, speech and picture sources, and offers the adaptability to meet your application-specific requirements, including chip-sets optimized for the requirements



Signal Processing
Codec Filter
(SICOFI)

of terminals, network terminators and switching applications.

We provide a wide array of products supported by our IOM technology. From the T1/CEPT Advanced CMOS Frame Aligner, with a flexible microprocessor interface which meets North American and European standards, to CMOS Microcontrollers and Gate Arrays.

Siemens also offers cost-effective solutions for analog interface, including single and dual channel Digital Signal Processing Codec Filters. Designed with DSP architectures for maximum programmability.

And Siemens invented a unique, all-CMOS monolithic ISDN Echo Cancellation Circuit, the first single chip solution for the standardized



ISDN Echo
Cancellation Circuit
(IEC-Q)

U-interface. With the power to double the traffic-handling capability of any existing telephone line.

It took the leader in the ISDN industry to develop the most advanced telecommunication devices in the world.

Monolithic designs which reduce cost, lower power consumption, and supply you with solutions which are well received, worldwide.

For details, call (800) 456-9229, or write Siemens Components, Inc. 2191 Laurelwood Road Santa Clara, CA 95054-1514. Ask for literature package M12A003.

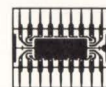

**Siemens
Practical Solutions by Design.**

Active RC filters aren't subject to aliasing, but they require more board area and many more components.

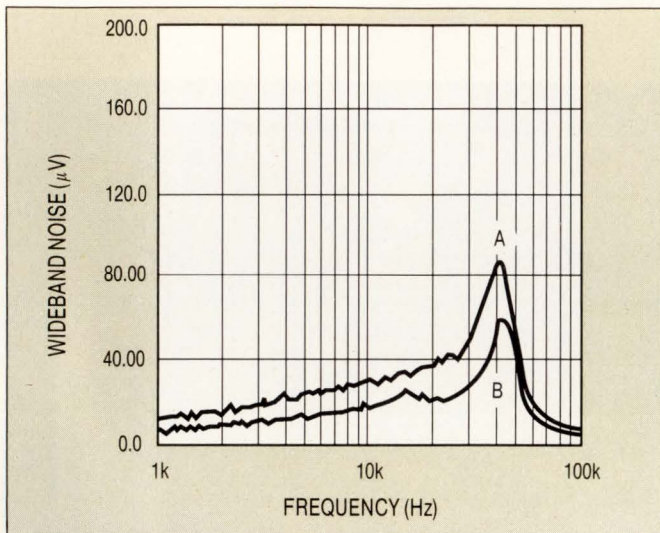

Fig 6—The noise performance of elliptic active RC filters (trace B) and switched-capacitor filters (trace A) is quite close.

example, Linear Technology's LTC1064-2 Butterworth filter has approximately 80- μ V rms noise from 1 Hz to 50 kHz (f_0 equal to 50 kHz). It also has 80- μ V rms noise from 1 Hz to 10 kHz (f_0 equal to 10 kHz). Because the traditional active RC filter has noise specifications based on so many nV per $\sqrt{\text{Hz}}$, the switched-capacitor

filter is a better competitor for active RC filters as the filter's cutoff frequency increases. **Fig 6** compares noise between an active RC filter and a switched-capacitor filter. Both curves show typical peaking at the corner frequency. The active RC filter has slightly better noise performance, but the two filters differ at most by 20 μ V.

When it comes to bandpass filters, switched-capacitor filters have no better or worse performance than other filter types. **Fig 7a** is the frequency response of an eighth-order Bessel bandpass switched-capacitor filter. This filter has a Q of approximately 9, and a very linear phase response in the passband. The Bessel response is very useful when signal phase is important. Of particular interest to the present discussion is that the noise-band shape of this bandpass filter (**Fig 7b**) is identical to the curve in **Fig 7a**. This is not unusual since the bandpass filter is letting only the noise at a particular bandpass center frequency through the filter. Users of switched-capacitor filters sometimes assume the source of this noise is clock feedthrough, but this assumption is wrong. This noise is not the result of clock feedthrough, and it is not peculiar to the switched-capacitor filter. In an active RC filter, or even a passive LC bandpass filter with these characteristics, noise appears like a signal at the center frequency of

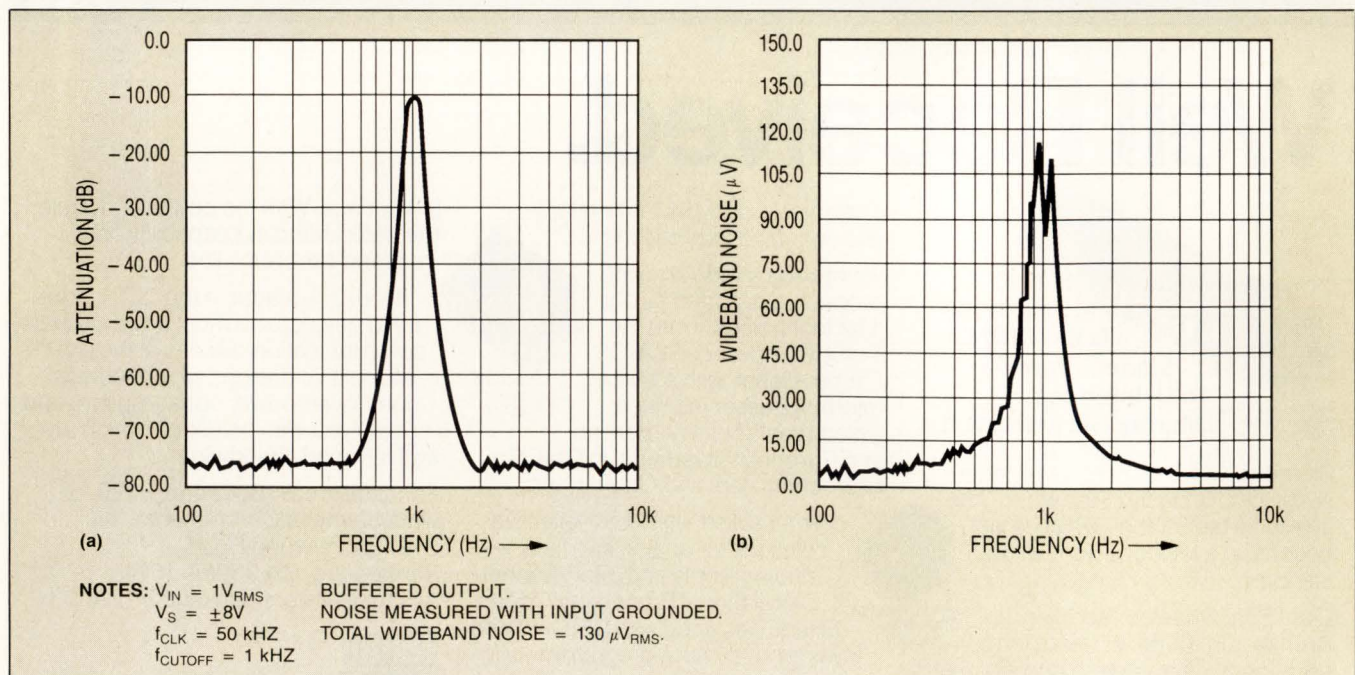

Fig 7—Don't be surprised if you see noise peaks (b) in the pass band of a highly selective, high-Q switched-capacitor bandpass filter (a). Often erroneously attributed to switched-capacitor-filter clock feedthrough, all bandpass filter types, including active RC and passive RC types, exhibit noise responses that closely resemble the filter's frequency response.

8mm.

No other tape measures up.

Considering conventional tape storage products for your customers' data storage needs?

Consider again.

With its superior recording characteristics and unprecedented capacity on a single tape, 8mm data storage has become the *de facto* standard in today's workstation, UNIX[®], and file server environments.

We've shipped over **100,000 EXB-8200 8mm Cartridge Tape Subsystems**, backing up some of the biggest names in the industry such as Bull S.A., Data General, IBM, Motorola, NCR, Norsk Data, Northern Telecom, Prime Computer, Siemens, Sun Microsystems, Texas Instruments, 3Com, and Wang Laboratories, just to mention a few.

At *2.5-gigabyte* capacity, the EXB-8200 makes unattended backup a reality, dramatically reducing manual intervention. Add an integrated SCSI controller and formatter, industry-standard 5¼-inch form factor, and a fast 246 Kbytes/second transfer rate, and you have the field-proven storage system that keeps pace with today's disk capacities.

If you're an OEM, VAR, or systems integrator, call us today at **(303) 447-7359** or write EXABYTE Corporation at 1685 38th Street, Boulder, CO 80301.

And find out why no other tape measures up to 8mm for your customers' backup/restore, data acquisition, data interchange, software distribution, and archiving needs.

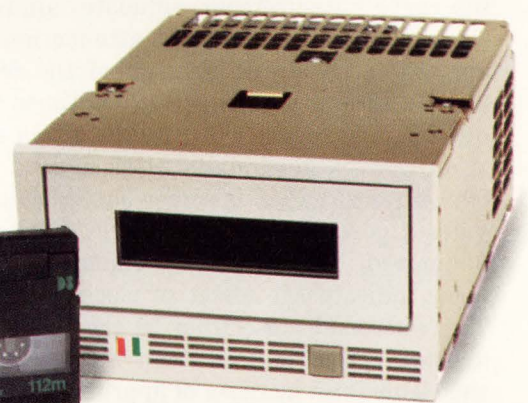

The EXB-8200
2.5-Gigabyte Capacity
246 Kbytes/Second Transfer Rate
Over 100,000 Drives Shipped

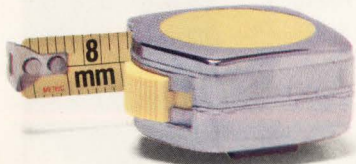

CIRCLE NO. 54

UNIX is a registered trademark of AT&T.
©1990 EXABYTE Corporation.

EXABYTE™
The Capacity to Succeed

Switched-capacitor filters are more analog than digital, and using analog-circuit layout techniques ensures proper performance.

the bandpass filter.

Unlike bandpass-filter noise, effects of the clock signal are unique to switched-capacitor filters. You can never take the act of clocking a switched-capacitor filter for granted. A clean, stable clock is required to obtain device performance commensurate with the data-sheet specifications. This requirement implies that 555-type oscillators are strictly forbidden. Often, what appears as insufficient stopband attenuation or excessive passband ripple is in fact the result of poor clocking of the switched-capacitor-filter device.

Fig 8 shows an eighth-order elliptic lowpass switched-capacitor filter that's set up to provide a cut-off frequency of 500 Hz. Modulating the clock (see the top curve measurement) simulates approximately 50% clock jitter. The stopband attenuation at 750 Hz is approximately 42 dB instead of the 68 dB specified by this filter's data sheet at 1.5 times the cutoff frequency. The second curve on the graph shows the situation when a good stable clock is used. Although the 50% jitter situation is somewhat ridiculous, Fig 8 provides a good base line as to why clock jitter must be minimized. Similar measurements of the wideband noise indicate the effect of clock jitter on the noise. The wideband noise from 10 Hz to 1 kHz rises when a jittery clock is used from 156 μV rms to 173 μV rms. This is an increase of approximately 11% due only to a poor clocking strategy.

Clock feedthrough has been greatly improved in the recent generation of switched-capacitor filters, but some users still want to further limit this anomaly. It is, of course, easier to postfilter clock feedthrough that is 100 times the cutoff frequency of the filter than for a clock-to-cutoff ratio of 50:1. The design aspects of minimizing clock feedthrough—choosing the clock-to-cutoff frequency ratio, for example—deserves your thought and attention.

Previously, Fig 2b showed -61 dB of clock feedthrough at 50 kHz. This is below 0 dB, which in this example was 2V rms. Clock feedthrough here is approximately 890 μV rms. Inserting a simple RC filter whose cutoff frequency is well outside the passband of the filter at the output of the switched-capacitor filter can reduce both the clock feedthrough and the imaging by at least a factor of 10. A simple RC post filter with values of 9.64 k Ω and 3300 pF reduces Fig 2b's clock feedthrough to -82 dB below 1V rms or to 89 μV . If a clock-feedthrough component is out of the band of interest, additional filtering is unnecessary.

Switched-capacitor filters continue to evolve and pro-

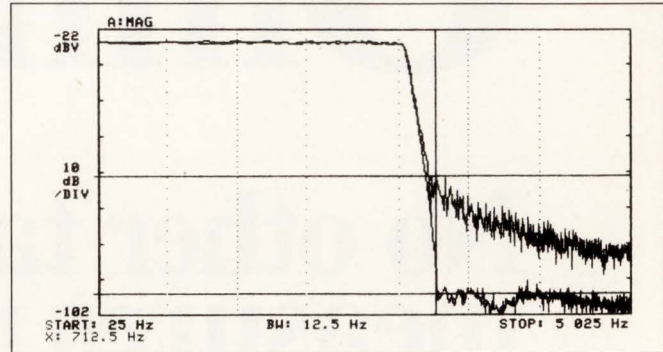

Fig 8—Clock jitter degrades the performance of a switched-capacitor filter. The upper trace shows the filter's performance with 50% clock jitter; the bottom trace shows the improvement with a jitter-free clock.

gress. These filters closely pace the performance of active RC filters and offer the advantages of smaller size, better accuracy, and tunability. To best take advantage of these filters, you must observe good engineering practices and thoroughly understand the types of signals you're filtering, what signals you want to preserve, and finally how much spectral precision is necessary. **EDN**

References

1. Schwartz, Mischa, *Information Transmission, Modulation and Noise*, McGraw-Hill, New York, NY, 1980.
2. Daryanani, Gobind, *Principles of Active Network Synthesis and Design*, John Wiley and Sons, New York, NY, 1976.
3. Pease, Robert, "Preside over power components with design expertise," *EDN*, October 12, 1989, pg 177.

Author's biography

Richard Markell has been an applications manager at Linear Technology Corp (Milpitas, CA) for two years. In addition to writing articles and application notes, Richard recently helped develop switched-capacitor-filter design software. He has a BA in electro-optics from San Jose State University and is a member of the Audio Engineering Society. His hobbies include audio-circuit design, gardening, traveling, and hiking.

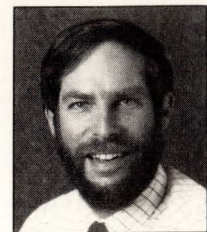

Article Interest Quotient (Circle One)
High 497 Medium 498 Low 499

Applications for a New Micropower, Low Charge Injection Analog Switch

Guy Hoover, William Rempfer, Jim Williams

With greater accuracy for both charge and voltage switching, the LTC201A is a superior replacement for the industry standard DG201A. In addition, the micropower LTC201A operates from a single 5V supply, and has lower on-resistance and faster switching speed. These improvements are critical to the operation of the following three circuits.

Micropower V-F Converter

Figure 1 shows a 100Hz to 1MHz voltage-to-frequency converter. This V-to-F operates from a single supply and draws only 90 μ A quiescent current, rising to 360 μ A at 1MHz. Linearity is 0.02% over a 100Hz to 1MHz range.

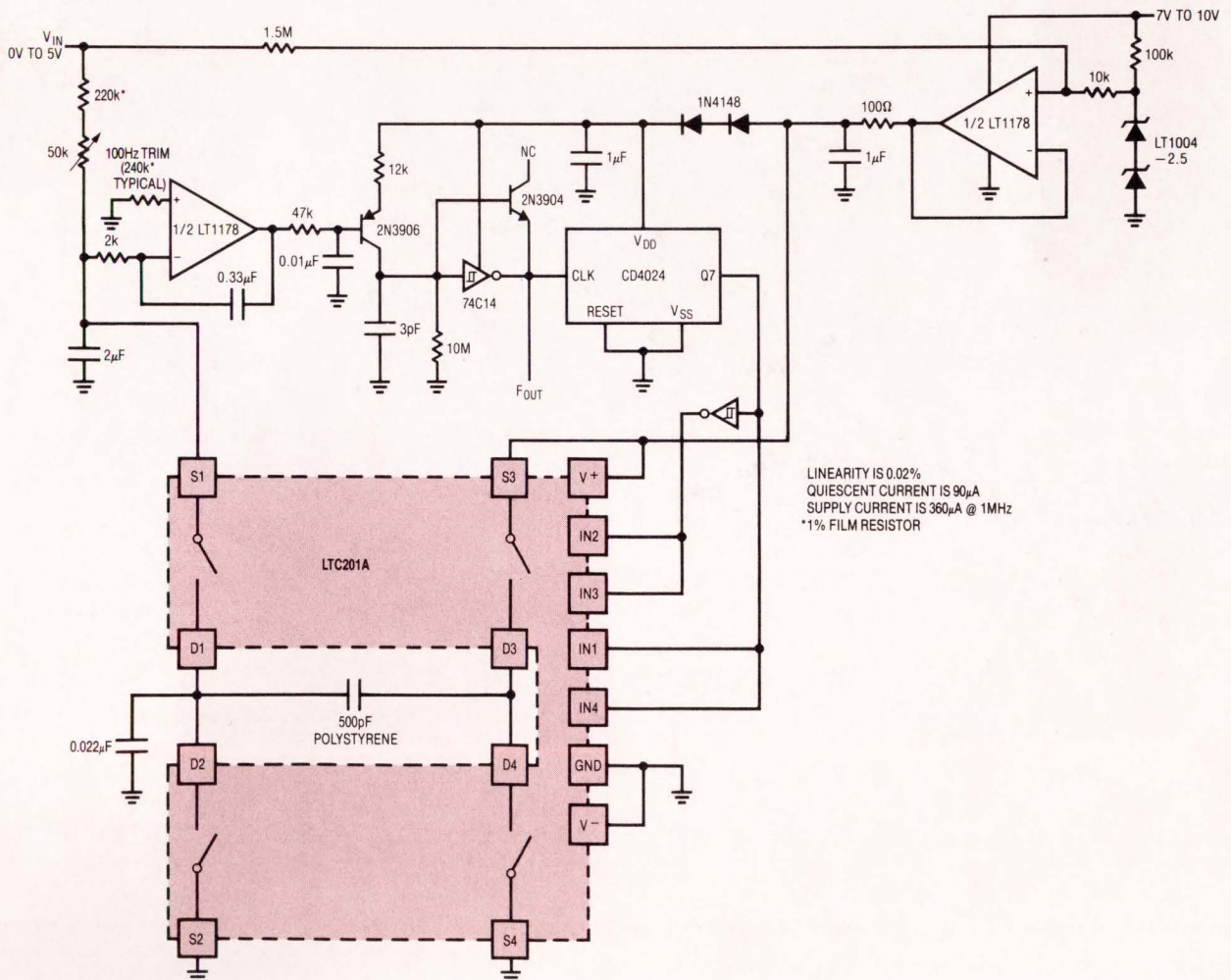

Figure 1. Micropower 100Hz to 1MHz V-to-F Converter

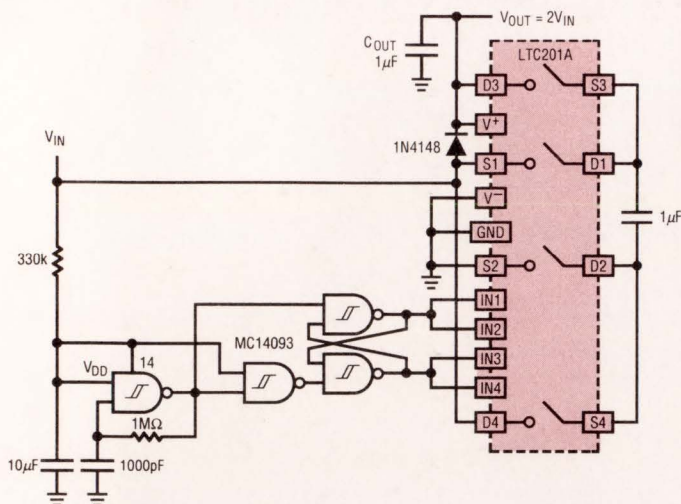

Figure 2. Micropower, 4.5V-15V Input, Voltage Doubler

The circuit consists of an oscillator, a servo amplifier and a charge pump. The oscillator's divided down output is expressed as current (charge per time) by the LTC201A-500pF combination. The input voltage is converted to current by the 220k trimmer pair. The amplifier controls the oscillator frequency to force the net value of the current into A1's summing point to zero.

The 1.5MΩ resistor between V_{IN} and the reference buffer amplifier sums a small input related voltage to the reference, improving linearity. The 0.022µF capacitor prevents excessive negative transitions at LTC201A D1-D2 pins. The series diodes in the oscillator divider supply line lower supply voltage, decreasing current consumption. The 10MΩ resistor at Q8's collector dominates node leakages ensuring low frequency operation by forcing Q8 to always source current.

Precision Voltage Doubler

The precision micropower voltage doubler of Figure 2 has an input voltage range of 4.5V to 15V. The low supply current of the LTC201A allows it to be powered directly from the input voltage. Total no load supply current of the circuit ranges from 20µA at $V_{IN}=4.5V$ to 130µA at $V_{IN}=15V$. Output impedance is only 1.2kΩ at $V_{IN}=4.5V$ and reduced to 600Ω at $V_{IN}=15V$. The accuracy of this circuit is better than 0.2% over the 4.5V to 15V input range.

The MC14093 is used to form an oscillator with complementary non-overlapping outputs. R1 and C1 determine the frequency of oscillation (roughly 1.2kHz at $V_{IN}=4.5V$). The oscillator outputs drive two sets of switches in the LTC201A and ensure that one pair of switches shuts off before the other set turns on. C_{IN} is alternately charged to V_{IN} and then stacked on top of V_{IN} to charge C_{OUT} . R2 reduces the supply voltage to the MC14093 which keeps current drain low. The diode ensures latch-free power-up for any input rise time condition.

Quad 12-Bit Sample and Hold

Figure 3's sample and hold uses the low charge injection of the LTC201A combined with the low offset voltage of the LT1014 to produce a sample to hold offset of only 0.6mV. This makes it accurate enough for 12-bit applications. Acquisition time to 0.6mV is 20µs. Aperture time is 300ns (the off time of the LTC201A). Droop rate is 2mV/ms and is limited by the I_B of the LT1014. The input range is 3.5V to -5V with ±5V supplies.

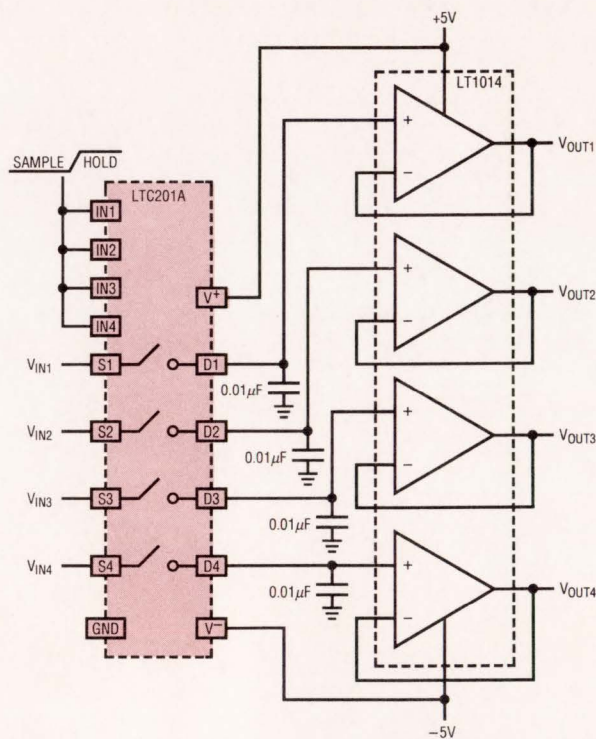

Figure 3. Quad 12-Bit Sample and Hold

For additional literature on LTC201A, call (800) 637-5545.
For applications help, call (408) 432-1900, Ext. 445.

MEGABIT MEMORIES

As Big As Your Imagination

The first time your designs start having density or space problems, we should be talking.

Whether you need a few megabits of SRAM in a 32-pin DIP, or 64-Megabits of Flash PROM in a 2" x 2" flatpack, we can help.

Our newest models, for example, are a series of 4-Megabit (512Kx8) CMOS SRAMs in a rugged 1.6" x 0.6" ceramic 32-pin DIP with JEDEC standard pinouts. They offer read access times from 45nSec to 120nSec, and three temperature ranges. They also feature a typical operating current of just 37mA, and data retention with voltages as low as 2.0 volts. Data retention current at 25°C is typically 10ua. Just right for

those low-power battery-backed applications. As with all our products, Screening to MIL-STD-883C is an available option.

If 4-Megabit isn't enough, we have a new 34-pin 8-Megabit Flash PROM module that measures just 1.93" x 1.14". At 0.41in², it's probably the smallest package available holding that much non-volatile memory. Organized as 1 Megabyte x 8, its eight pages of one megabits each can be erased a page at a time without affecting the other pages. Access time is 150nSec. Programming typically takes just 10uSec/byte and 2

seconds/page. Chip erase also takes 2 seconds/page. We also have a 2" x 2" 64-Megabit Flash PROM flatpack in test now, and still larger capacities to follow.

We have all the building blocks for your tiny systems, the memory and density for your terabit

dreams, and the products to help you anywhere in between. If it's only a 2-Megabit SRAM or EEPROM in a miniature package, or a shoebox-size supercomputer array, we have the technology and the expertise to respond. Your imagination or ours, we'll make it happen.

White Technology, Inc.

A wholly owned subsidiary of Bowmar Instrument Corporation
4246 E. Wood St. • Phoenix, Arizona 85040 • (602) 437-1520
FAX 602-437-9120 • TWX 910-951-4203

CIRCLE NO. 80

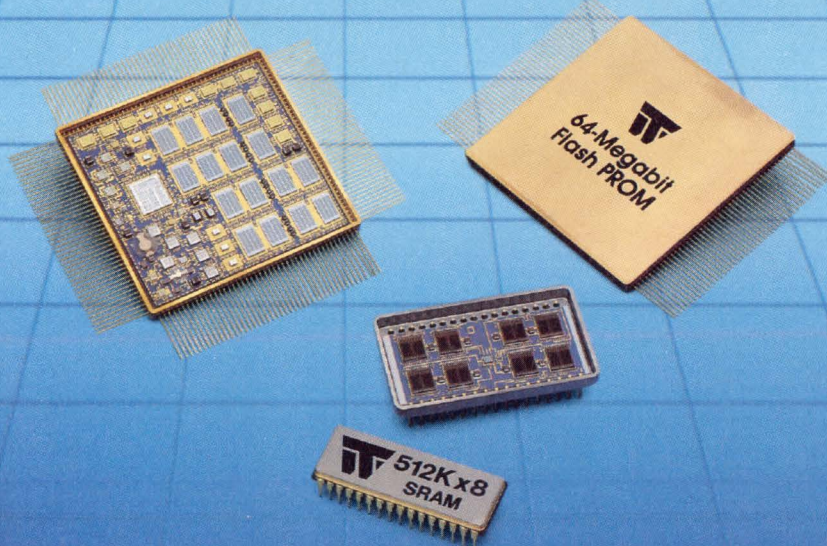
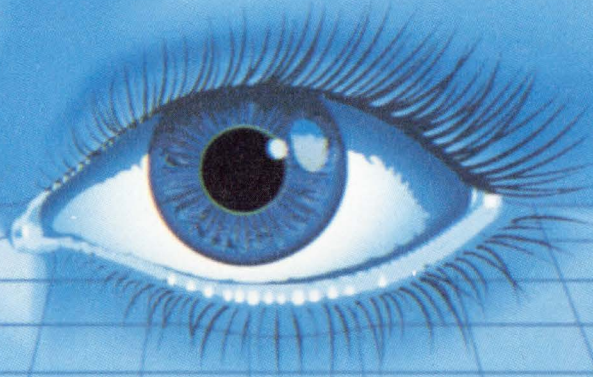

CERTIFIED AND
QUALIFIED TO
MIL-STD-1772

Emulation power without compromise



EZ-Pro™ 1.5 price performance leader for 8-bit in-circuit emulation.

Power in selection—System support for more processors than any other manufacturer in the world. Power in product range to match your needs—from economical basic configurations to fully featured systems.

Power in performance—Completely integrated capabilities include options such as versatile trace, performance analysis, EPROM programming, C source level debugging, over 100 personality modules with a common universal platform for different processors, C cross compilers, cross assemblers and more.

Power without compromise—All invented here. Supported here. And available to rent or purchase now.



EZ-Pro 2.1 industry workhorse for 16-bit and 8-bit designs.

Free Demo Disk!

See how easily you can use these sophisticated development tools. Our marketing department will ship your demo disk today. Please Call:

(714) 731-1661

 **american
automation**

Headquarters: 2651 Dow Avenue, Tustin, California 92680-7207
Telephone (714) 731-1661. European Headquarters: UK Oxford 993 778991. Distributors: Australia 3-5601011, Belgium 2-4681400, France 1-69308050, India 418387, Indonesia 22-71880, Italy 2-50722282, Korea 2-7849942, Spain 1-7291155, Switzerland 1-4354111, Taiwan 2-7368150, West Germany 89-6127087.

DESIGN IDEAS

EDITED BY CHARLES H SMALL

Passive network is totally resistive

Prayson Pate
BNR, Research Triangle Park, NC

The circuit in **Fig 1a** looks trivial, but it isn't. It can provide a resistive termination to a transmission line over a wide bandwidth—much wider than you can achieve with op amps. Further, you can extend the circuit to make multipole lowpass, highpass, and bandpass filters. Note that although the circuit resembles a tank circuit, it doesn't ring. In fact, ringing arising from component mismatch is small for reasonable component tolerances.

To calculate the circuit's impedance, first let $Z_1 = R \parallel L$ and $Z_2 = R \parallel C$. If $\omega_1 = R/L$ and $\omega_2 = 1/RC$, then

$$Z_1 = R/(1 + j\omega/\omega_1)$$

and

$$Z_2 = R/(1 + j\omega_2/\omega).$$

Thus the circuit's input impedance equals $Z_1 + Z_2$, or

$$Z_{IN} = R(1 + (j\omega/\omega_2 + \omega_1/j\omega) + 1)/(1 + j\omega/\omega_2 + \omega_1/j\omega + \omega_1/\omega_2).$$

This expression reduces to simply R if $\omega_1 = \omega_2 = \omega_0$.

You can calculate values for L and C simply:

$$L = \omega_0/R = 2\pi/F_0$$

and

$$C = 1/\omega_0 R = 1/2\pi F_0.$$

The circuit's transfer function is then:

$$H(j\omega) = Z_2/Z_{IN} = 1/(1 + j\omega/\omega_0),$$

which is the same transfer function as a simple LC lowpass filter.

You can realize more elaborate circuits by various combinations of the RL and RC subcircuits. Swapping the subcircuits in the circuit in **Fig 1a** yields a highpass circuit with the same pole. **Fig 1b** shows a 2-pole lowpass filter, and **Fig 1c** shows a bandpass filter. In **Figs 1b** and **1c**, the resistive input impedance of the second filter stage acts as the parallel resistor for the first stage. You can repeat this arrangement many times. The bandpass filter in **Fig 1c** does have the disadvantage of a 3-dB loss in its passband. **EDN**

To Vote For This Design, Circle No. 746

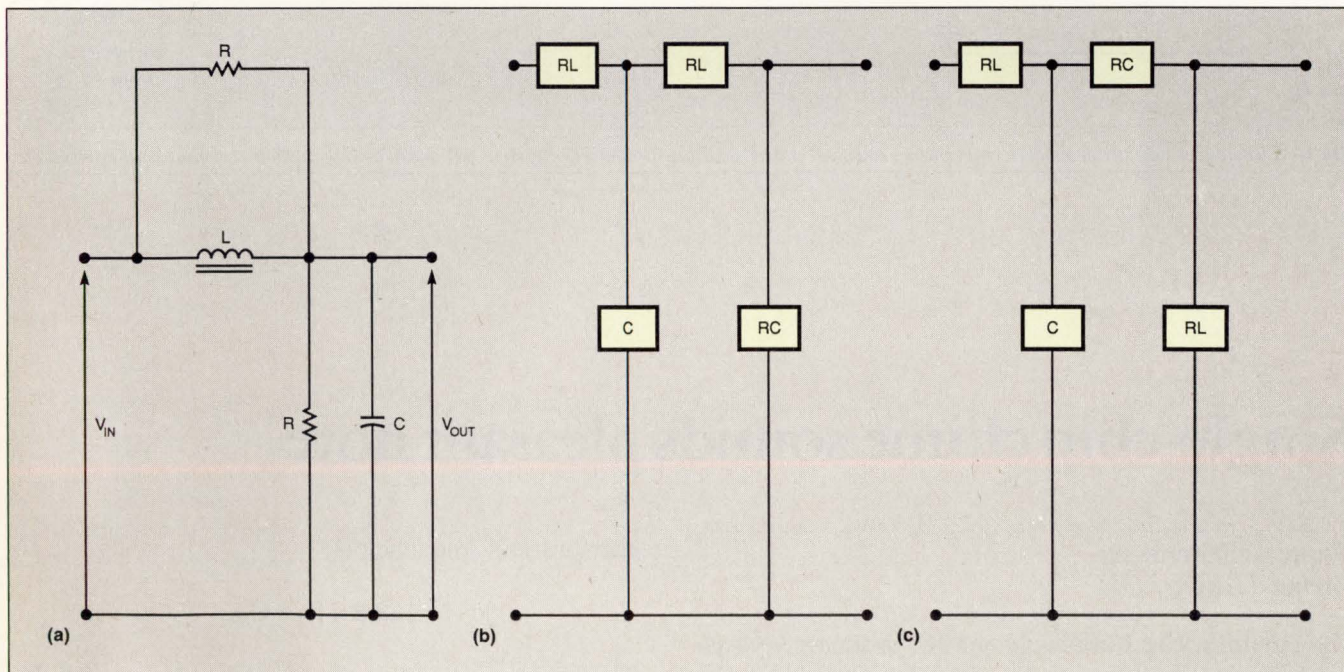

Fig 1—The simple circuit in **a** provides resistive termination at all frequencies. Combining and swapping the circuit's elements yields the 2-pole lowpass filter in **b** and the bandpass filter in **c**.

Watchdog timer sounds alarm

N Kannan
Centre for Development of Imaging Technology
Kerala, India

The watchdog timer in **Fig 1** contains a counter, IC₃, in addition to the usual retriggerable 555 timer, IC₁. The counter will sound an audible alarm if the watchdog timer tries to reset the μ P a certain number of times—eight in the case of the counter in **Fig 1**. The alarm indicates that despite numerous resets, the sys-

tem μ P has failed to restart successfully, and the system is truly dead.

A second 555 timer, IC₂, resets the counter, IC₃, for the duration of a manual system restart. You could easily modify the design so that the system μ P resets the counter. **EDN**

To Vote For This Design, Circle No. 747

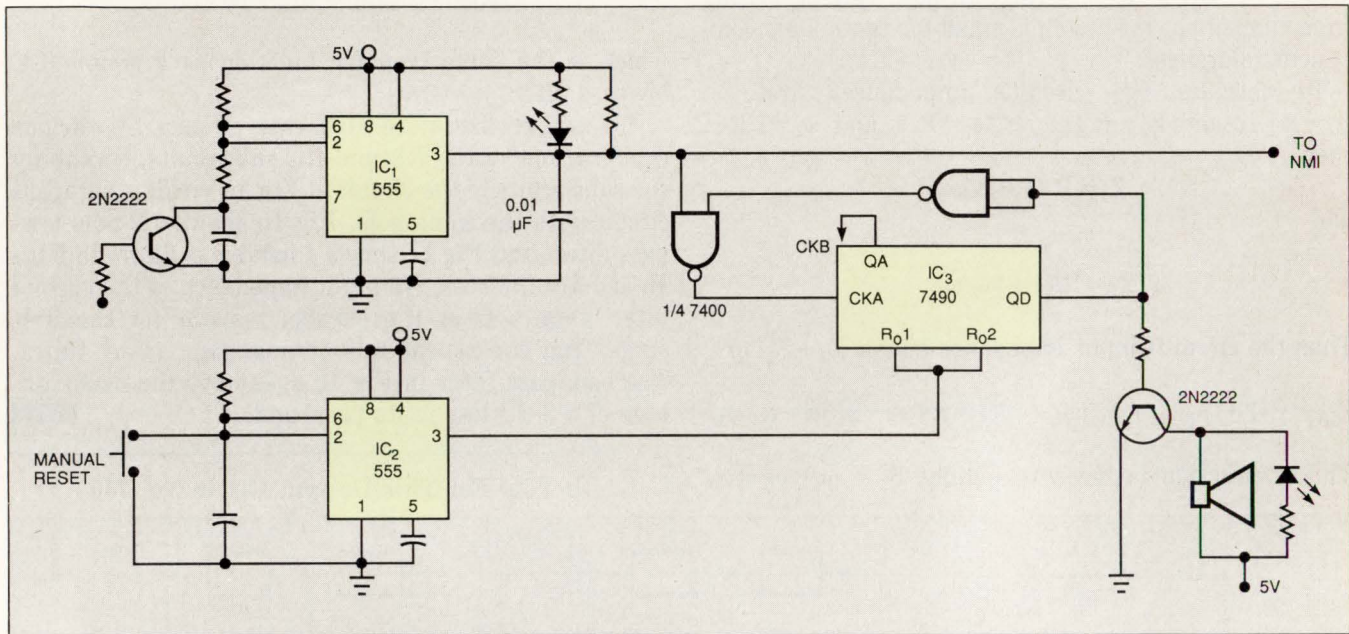

Fig 1—This watchdog timer counts reset pulses and sounds an audible alarm if the system μ P doesn't respond to a certain number of resets.

Single-chip chime sounds pleasant note

Dennis Eichenberg
Parma Heights, OH

The circuit in **Fig 1** uses only one IC, produces a pleasant tone, and sports a single control for adjusting the tone's chiming rate. IC_{1A} and IC_{1B} form an astable multivibrator, which produces the circuit's basic tone. The

multivibrator's frequency is:

$$f = 1 / (2.2 \times R_1 \times C_1)$$

The component values in **Fig 1** produce a 668-Hz tone. IC_{1C} buffers the multivibrator's output to the 8 Ω speaker. Current-limiting resistor, R₂, determines

SPDT & SP4T SWITCHES

WITH BUILT-IN DRIVERS



10 to 3000MHz from \$39⁹⁵

Now, high-speed, high-isolation switches with built-in drivers, tough enough to pass stringent MIL-STD-202 tests. There's no longer any need to hassle with the complexities of designing a TTL driver interface and then adding yet another component to your subsystem... it's already included in a rugged, low-cost, compact assembly.

Available in the popular hermetically-sealed TO-8 package or a small EMI-shielded metal connectorized case, these tiny PIN-diode reflective switches, complete with driver, can operate over a 10 to 3000MHz span with a fast 2 μ sec switching speed.

Despite their small size, these units offer isolation as high as 40dB(typ), insertion loss of only 1.1dB(typ), and a 1dB compression point of +27dBm over most of the frequency range. All models are TTL-compatible and operate from a dc supply voltage of 4.5 to 5.5 V with 1.8mA quiescent current.

Switch to Mini-Circuits for highest quality innovative products... and leave the driving to us.

SPECIFICATIONS

	TOSW-230 ZSDR-230		TOSW-425 ZSDR-425	
	typ.	max.	typ.	max.
Freq. Range(MHz)	10-3000		10-2500	
Insert. Loss (dB)				
10-100MHz	1.3	1.9	1.3	1.7
100-1500MHz	1.1	1.9	1.1	1.7
1500-3000MHz	1.8	2.7	1.8	2.5
Isolation(dB)	typ.	min.	typ.	min.
10-100MHz	60	40	60	40
100-1500MHz	40	28	40	30
1500-3000MHz	35	22	35	22
1dB Compression(dBm)	typ.	min.	typ.	min.
10-100MHz	17	6	17	6
100-1500MHz	27	19	27	19
1500-3000MHz	30	28	30	28
VSWR(ON)	typ.	max.	typ.	max.
	1.3	1.6	1.3	1.6
Switching Time (μ sec) (from 50% TTL to 90% RF)	typ.	max.	typ.	max.
	2.0	4.0	2.0	4.0
Oper. Temp.(°C)	-55 to +100		-55 to +100	
Stor. Temp.(°C)	-55 to +100		-55 to +100	
Price (10-24)	\$39.95		\$59.95	
(1-9)	\$89.95		\$109.95	

finding new ways...
setting higher standards

Mini-Circuits

A Division of Scientific Components Corporation
P.O. Box 350166, Brooklyn, New York 11235-0003 (718) 934-4500
Fax (718) 332-4661 Domestic and International Telexes: 6852844 or 620156

CIRCLE NO. 82

WE ACCEPT AMERICAN EXPRESS

F126 REV.A

DESIGN IDEAS

the speaker's volume. R_2 's minimum value is 220 Ω .

IC_{1D} and IC_{1E} form an asymmetric, astable multivibrator, which adds a chime effect to the circuit's basic tone. The chime effect's frequency is:

$$t_{LO} = 1.1C_2(R_4 || (R_5 + R_6))$$

$$t_{HI} = 1.1C_2(R_5 + R_6).$$

R_7 gives this rate multivibrator a slowly varying output signal to produce a pleasant decay for the chime effect. IC_{1F} is an inverting amplifier for the chime multivibrator.

EDN

To Vote For This Design, Circle No. 748

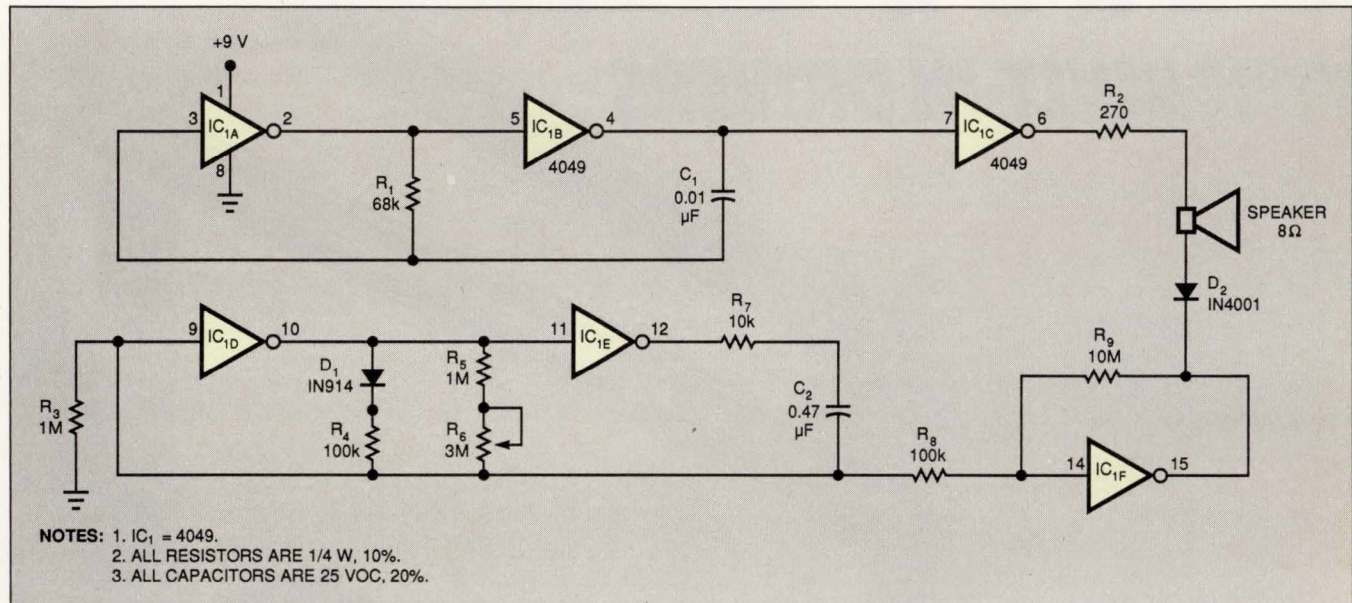

Fig 1—Using only one IC, this dual multivibrator produces a pleasantly decaying, chime-like sound.

Diodes stabilize CMOS circuits

Cezary Rudnicki
 Institute of Electronics, Warsaw, Poland

The simple diode network in Fig 1 can stabilize the voltage supplied to CMOS circuitry from a battery.

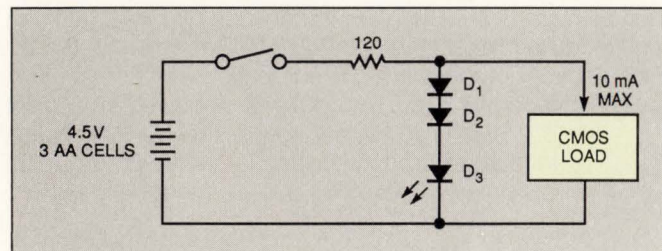

Fig 1—This simple diode network stabilizes the supply voltage for low-power CMOS circuits running at 3V.

Table 1—Voltage regulation

Input	4.5V	4V	3.5V	3.2V	3V	2.8V
Output	3.28V	3.21V	3.14V	3.05V	2.94V	2.8V
LED	on	on	on	on	on	off

D_1 and D_2 must have a combined forward-voltage drop of about 1.5V. And D_3 is an LED with a forward-voltage drop of about 1.7V. Table 1 shows the network's output voltage as the battery's voltage declines.

EDN

To Vote For This Design, Circle No. 749

THE FINE ART OF DISC DRIVES



*Metal sculpture by
Micah T. Curtis
Big Sur, California*

Since their introduction, Wren[®] disc drives have been among the most sought after in the industry. With their high capacity and sterling performance features, it's no wonder we've been hard-pressed to fill all the orders. Fortunately, that's now changed.

These 5.25" half- and full-height drives are ready for immediate delivery in capacities ranging from 43 to 1200 megabytes in a variety of ST412, SCSI, ESDI and AT interfaces. Our unique Zone Bit Recording,[®] used in most models, and low-mass actuator give Wren drives high data transfer rates and average seek times as low as 10.7 msec. These specifications make the Wren family the ideal choice for thousands of high-performance applications.

Like the artist who spends years perfecting his craft, Seagate has spent the past decade mastering the fine art of disc drives. To become further enlightened about Wren and our other disc storage solutions, contact your authorized Seagate distributor, or call Seagate directly: 800-468-DISC, or 408-438-6550.

 **Seagate**

PC/AT is a trademark of International Business Machines Corporation. Zone Bit Recording, Wren, Seagate and the Seagate logo are registered trademarks of Seagate Technology, Inc. © 1990, Seagate Technology, Inc.

Design Entry Blank

\$100 Cash Award for all entries selected by editors. An additional \$100 Cash Award for the winning design of each issue, determined by vote of readers. Additional \$1500 Cash Award for annual Grand Prize Design, selected among biweekly winners by vote of editors.

To: Design Ideas Editor, EDN Magazine
Cahners Publishing Co
275 Washington St, Newton, MA 02158

I hereby submit my Design Ideas entry.

Name _____

Title _____ Phone _____

Company _____

Division (if any) _____

Street _____

City _____ State _____

Country _____ Zip _____

Design Title _____

Home Address _____

Social Security Number _____

(Must accompany all Design Ideas submitted by US authors)

Entry blank must accompany all entries. Design entered must be submitted exclusively to EDN, must not be patented, and must have no patent pending. Design must be original with author(s), must not have been previously published (limited-distribution house organs excepted), and must have been constructed and tested.

Exclusive publishing rights remain with Cahners Publishing Co unless entry is returned to author or editor gives written permission for publication elsewhere.

In submitting my entry, I agree to abide by the rules of the Design Ideas Program.

Signed _____

Date _____

ISSUE WINNER

The winning Design Idea for the March 29, 1990, issue is entitled "Meter quickly measures low-speed rpm," submitted by David Sherman of David Sherman Engineering (Everett, WA).

Your vote determines this issue's winner. All designs published win \$100 cash. All issue winners receive an additional \$100 and become eligible for the annual \$1500 Grand Prize. **Vote now**, by circling the appropriate number on the reader inquiry card.

Setup tests crystals

Jon Dunn

Bertan Associates, Hicksville, NY

Certain crystals aren't suitable for oscillator circuits that use logic gates (**Fig 1**). If a crystal has more than one series-resonant mode, such a circuit can oscillate indeterminately at one of several frequencies.

With the simple test setup in **Fig 2a**, you can quickly identify crystals with spurious modes on your scope (**Fig 2b**). If you identify unsuitable crystals, your crystal supplier may be able to change its manufacturing methods to eliminate the spurious modes. **EDN**

To Vote For This Design, Circle No. 750

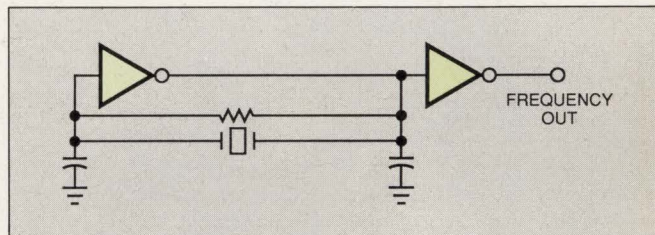
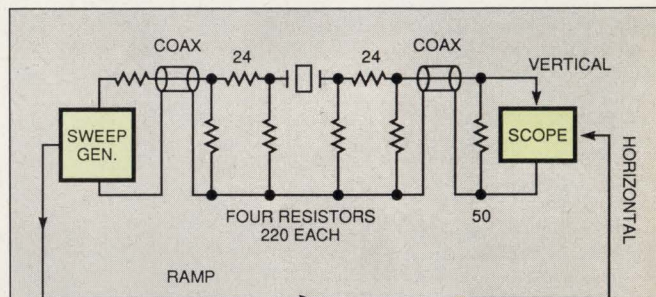
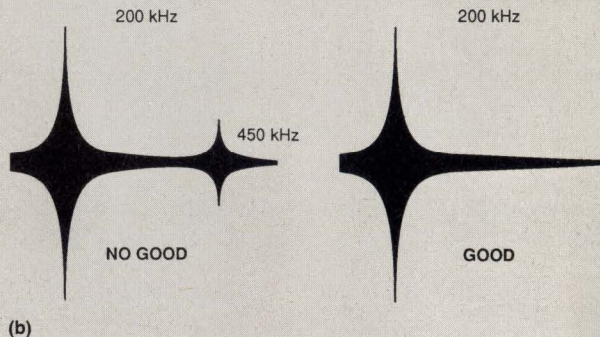

Fig 1—Simple oscillator circuits that employ logic gates depend on the crystal's series-resonant mode, so a crystal that has more than one series-resonant mode is not suitable for such circuits.



(a)



(b)

Fig 2—This simple test setup (a) will quickly ferret out unsuitable crystals (b).