

# EDNI<sup>®</sup>

THE DESIGN MAGAZINE OF THE ELECTRONICS INDUSTRY

February 17, 1994

## TECHNOLOGY UPDATES

**Speech-synthesis  
and -recognition  
chips**  
pg 27

**Shrinking devices  
put the squeeze on  
system packaging**  
pg 41

## DESIGN FEATURES

**PLD-design  
methods migrate  
existing designs to  
high-capacity  
devices**  
pg 77

**Quantify critical-  
timing risks with  
statistical analysis**  
pg 95

**Minimize time  
delays and reduce  
circuit density by  
retiming a design**  
pg 107

**News Breaks**  
pg 13

**Design Ideas**  
pg 55

**New Products**  
pg 113



**Special Report:**  
**Design tools target  
electromagnetic compatibility**  
pg 64



OLD WAVE

**The LMC6001** ~ Input current guaranteed to 25 Femto Amps max. @ 25°C ~ Low voltage offset of 350 $\mu$ V max. ~ Low voltage offset drift of 10 $\mu$ V/°C max. ~ Rail-to-rail output swing ~ Vnoise @ 1kHz of 22nV/ $\sqrt{\text{Hz}}$  ~ Designed and guaranteed to operate over the temperature range (-25°C to +85°C) ~ Available in PDIP and metal can packaging. ~ Call 1-800-NAT-SEMI, Extension 273 for ordering information and a free product sample kit.

 **National  
Semiconductor**



**The same old wave** of analog I/Cs won't arm you to meet the challenges of the digital future. Because, from wireless communications to personal systems to multimedia, today's emerging markets are demanding dramatically different analog thinking. That's why National Semiconductor is introducing a brilliant new generation of analog solutions built for leading edge systems. These solutions deliver world-class integration, functionality and performance to help you to design world-class products. So, the next time you're faced with a really tough analog problem, give us a call. Or simply turn the page. And see for yourself why we're **not the same old wave.**

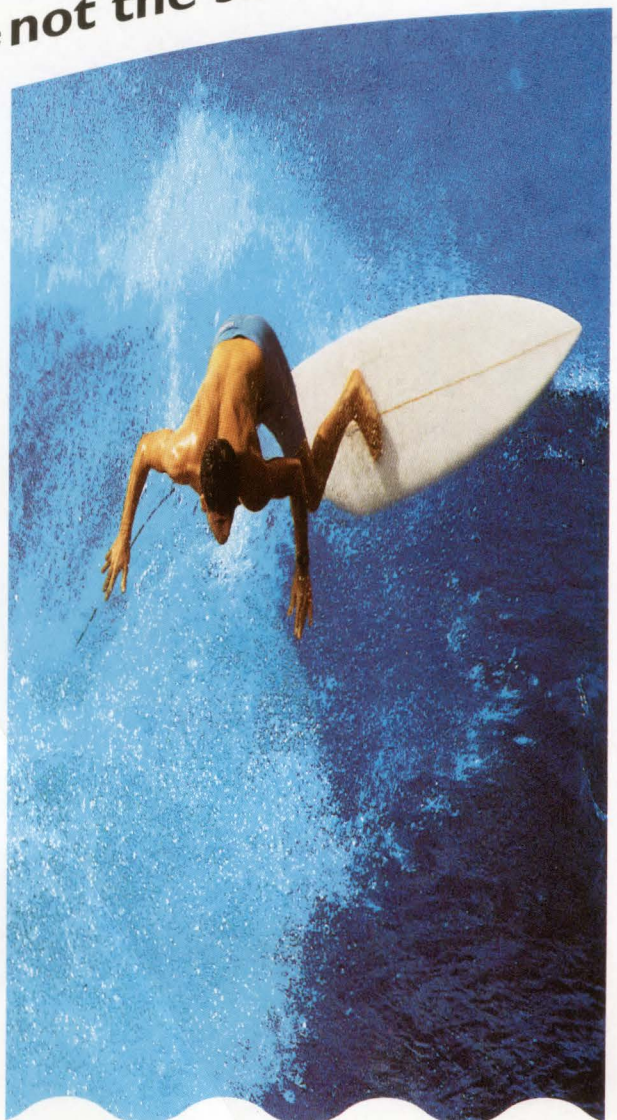



**NOT THE SAME**

**The World's Lowest Input Current Op-Amp**

# YOU DEMAND SERVICE. AT DIGI-KEY YOU GET IT!

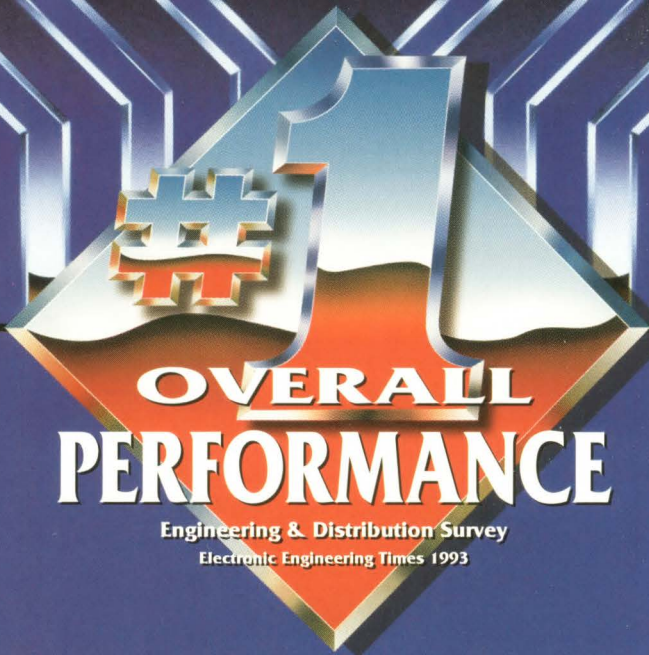

1. DIGI-KEY.....	90%
2. Marshall .....	53%
3. Wyle .....	51%
4. Pioneer .....	50%
5. Arrow .....	48%
6. Hamilton/Hallmark.....	44%
7. Newark.....	43%

In a recent "Engineering & Distribution Survey" conducted by *Electronic Engineering Times*, respondents were asked to evaluate distributors with whom they have done business or were most familiar. The table above reflects the percentage of respondents who rated these distributors as excellent (6&5 responses) on a 6 point scale where 6=excellent and 1=poor in terms of OVERALL PERFORMANCE!

DIGI-KEY is a registered trademark of Digi-Key Corporation and is in no way affiliated with the other distributors evaluated in the survey or listed above.

Look for YOUR FREE Catalog Soon!

## Digi-Key<sup>®</sup>

CORPORATION

Quality Electronic Components, Superior Service

701 Brooks Ave. South, Thief River Falls, MN 56701  
Toll Free: 1-800-344-4539, Fax: 218-681-3380

CIRCLE NO. 1

CIRCUIT BREAKERS FOR EQUIPMENT

# PERFECTLY *on board*

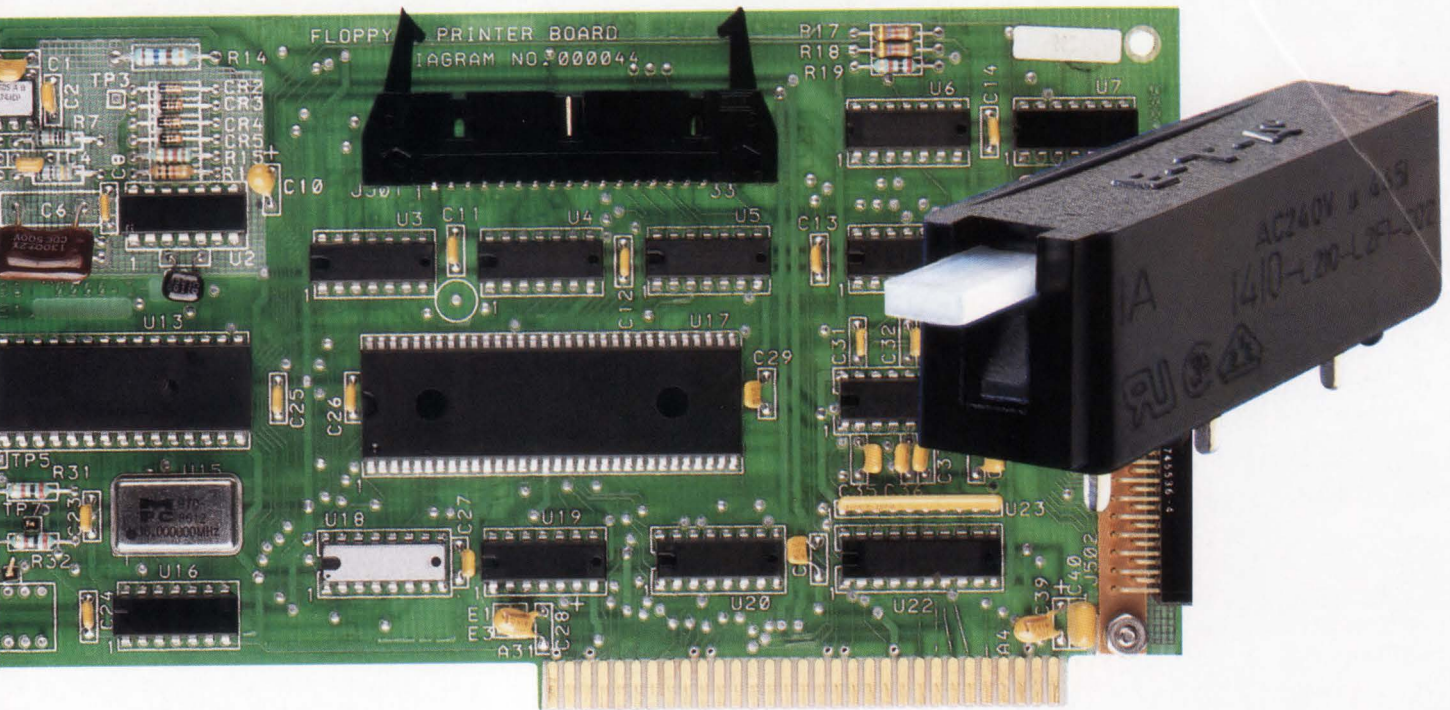

- ▶ Direct PCB or remote mounting
- ▶ Push-button manual reset
- ▶ Solder pin or blade terminal connections
- ▶ Current ratings from 0.63 to 8.0 A



E-T-A Series 1410 Circuit Breakers for Equipment are specially designed to protect printed circuit boards.

The tiny, fast acting 1410 CBE deals with short circuits or current overload quickly and cost-effectively. Because, in the competitive world of electronics manufacturing, extended downtime is unacceptable.

At E-T-A, we believe that protecting circuits allows no compromise. That's why all

our products fit precise application and performance specs. Perfectly.

So, next time you need to protect a PCB, get on board with perfection, choose E-T-A.

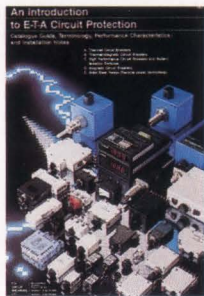

Call or fax for Your free E-T-A Circuit Protection Brochure.

7400 N. Croname Rd.,  
Niles IL 60714-3982  
(708) 647-8303  
FAX (708) 647-7494

E-T-A Circuit Breakers  
236 Hood Rd., Markham,  
Ontario L3R 3K8  
(905) 475-5886  
FAX (905) 475-5889

CIRCLE NO. 2



**WE PROTECT CIRCUITS TO PERFECTION**

# incredible!



## SPDT switches with built-in driver

### **ABSORPTIVE or REFLECTIVE** dc to 5GHz

Truly incredible...superfast 3nsec GaAs SPDT reflective or absorptive switches with built-in driver, available in pc plug-in or SMA connector models, from only \$14.95. So why bother designing and building a driver interface to further complicate your subsystem and take added space when you can specify Mini-Circuits' latest innovative integrated components?

Check the outstanding performance of these units...high isolation, excellent return loss (even in the "off" state for absorptive models) and 3-sigma guaranteed unit-to-unit repeatability for insertion loss. These rugged devices operate over a -55° to +100°C span. Plug-in models are housed in a tiny plastic case and are available in tape-and-reel format (1500 units max, 24mm). All models are available for immediate delivery with a one-year guarantee.

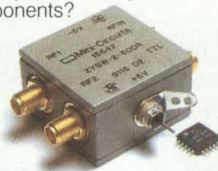

finding new ways...  
setting higher standards

# Mini-Circuits™

WE ACCEPT AMERICAN EXPRESS AND VISA

P.O. Box 350166, Brooklyn, New York 11235-0003 (718) 934-4500 Fax (718) 332-4661

**Distribution Centers** NORTH AMERICA 800-654-7949 • 417-335-5935 Fax 417-335-5945 EUROPE 44-252-835094 Fax 44-252-837010

For detailed specs on all Mini-Circuits products refer to • THOMAS REGISTER Vol. 23 • MICROWAVES PRODUCT DIRECTORY • EEM • MINI-CIRCUITS' 740-pg HANDBOOK

CIRCLE NO. 95

F141 REV. D

EDN February 17, 1994 ■ 3

#### SPECIFICATIONS (typ)

	Absorptive SPDT			Reflective SPDT		
	YSWA-2-50DR	ZYSWA-2-50DR		YSW-2-50DR	ZYSW-2-50DR	
Frequency (MHz)	dc-500	500-2000	2000-5000	dc-500	500-2000	2000-5000
Ins. Loss (dB)	1.1	1.4	1.9	0.9	1.3	1.4
Isolation (dB)	42	31	20	50	40	28
1dB Comp. (dBm)	18	20	22.5	20	20	24
RF Input (max dBm)	20			22	22	26
VSWR "on"	1.25	1.35	1.5	1.4	1.4	1.4
Video Bkthru (mV,p/p)	30	30	30	30	30	30
Sw. Spd. (nsec)	3	3	3	3	3	3
Price, \$	YSWA-2-50DR (pin) 23.95			YSW-2-50DR (pin) \$14.95		
(1-9 qty)	ZYSWA-2-50DR (SMA) 69.95			ZYSW-2-50DR (SMA) 59.95		

# Nothing stacks up like our new interface chip.

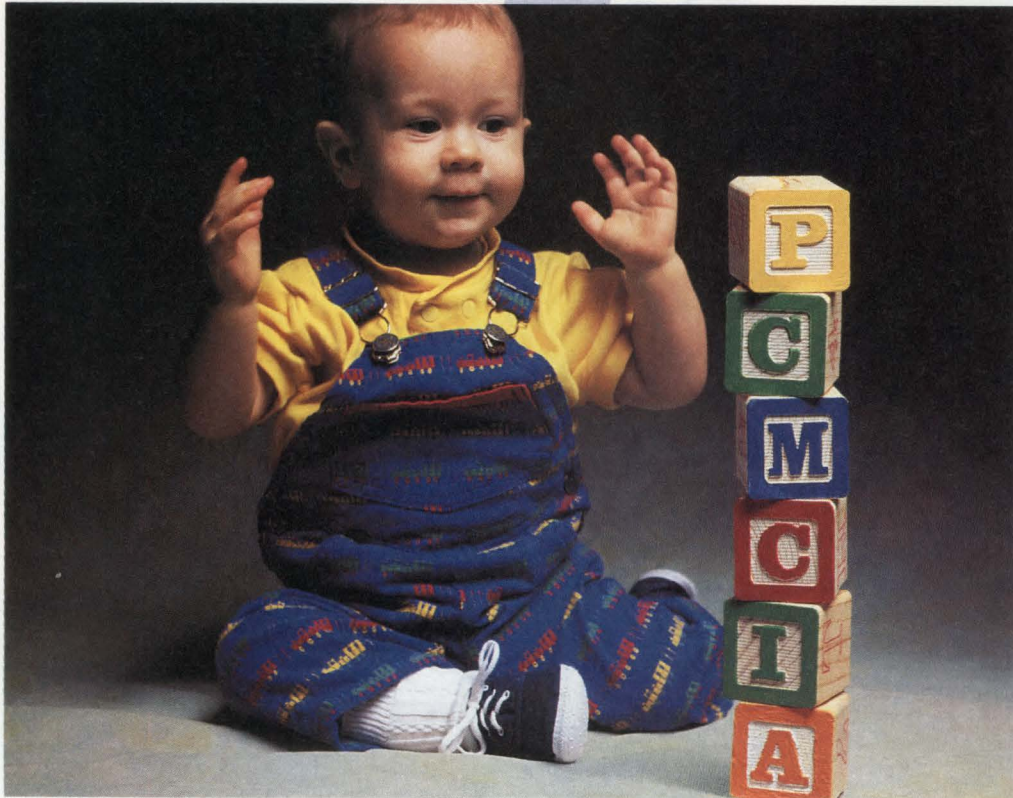

Now computer designers can downsize and simplify PCMCIA power management in all application types.

#### A smaller PCMCIA interface.

Our highly integrated monolithic Si9710CY interface switch eliminates many external components – reducing system size and improving reliability.

size and improving reliability.

#### A more efficient PCMCIA solution.

This PCMCIA rev. 2.1 compatible IC has on-resistance as low as 150 m $\Omega$ , the industry's

lowest, for improved tolerance on the output voltages. And its low 1- $\mu$ A leakage current significantly extends battery life.

#### A simpler Plug and Play design.

The Si9710CY, by eliminating up to seven power discretes and drivers, simplifies the design task and reduces design cycle time.

#### Get more efficient host adapter designs.

Contact your local Siliconix/TEMIC sales office. Or call our toll-free hot line and ask for more technical information. 1-800-554-5565, ext. 915.

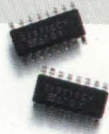
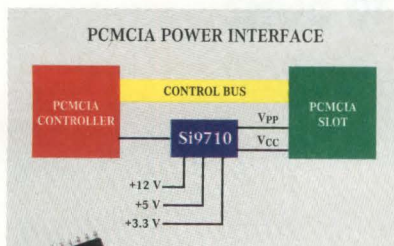

## Siliconix

A Member of the TEMIC Group

2201 Laurelwood Road, Santa Clara, CA 95054  
Fax: 408-970-3995, Attn. 915



FREE INFO, FREE POSTAGE  
Use our postage-paid reader service card  
to get information on this issue's products.

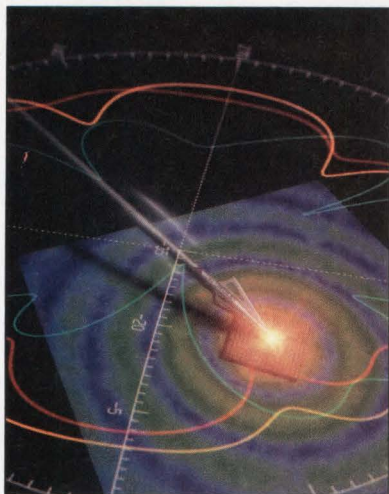

**On the cover:** As system speeds increase, so do electromagnetic-compatibility (EMC) problems. Several kinds of tools for EMC analysis let you address the issues early in the design game. See our Special Report, beginning on **pg 64**. (Photo courtesy Ansoft Corp; creative director, Joy Burd; art director, Rebecca Kinney; photography Caffee/Photosynthesis)

THE DESIGN MAGAZINE OF THE ELECTRONICS INDUSTRY

## SPECIAL REPORT

### EMC-design tools

64

The problem facing designers of high-speed circuits is not just to make sure that products work by themselves. Designers must also make sure that their products fit into a larger community of electronic systems.—*Doug Conner, Technical Editor*

## DESIGN FEATURES

### PLD-design methods migrate existing designs to high-capacity devices

77

Moving to newer higher capacity programmable devices can give you higher density and better performance. But if you use common CAE design tools, transferring your old design's description to the new device's development environment may be difficult.

—*Mike Trapp, Lattice Semiconductor Corp*

### Quantify critical-timing risks with statistical analysis

95

Using statistical methods to quantify the risks associated with critical timing paths lets you trade off technology vs performance and manufacturing goals.—*James J Vorgert, Texas Instruments Inc*

### Minimize time delays and reduce circuit density by retiming a design

107

Timing for initial sequential circuit designs generally is not optimal. By following some retiming procedures, you can add or delete sequential blocks to optimize circuit timing requirements and minimize circuitry.—*Jaap Sondervan, Philips Electronic Design and Tools*

## DESIGN IDEAS

### Priority encoders slip into FPGAs

55

### Off-line power supply requires few parts

55

### VisualBasic does I/O

56

### Motor-drive algorithm saves space and cycles

56

### Spice models CMOS switch

58

Continued on page 7

EDN Magazine offers Express Request, a convenient way to retrieve product information by phone. See the Reader Service Card in the front for details on how to use this free service.

**EXPRESS REQUEST** 

EDN® (ISSN 0012-7515, GST Reg. #123397457) is published 38 times per year, bi-weekly with one additional issue per month, by Cahners Publishing Company, A Division of Reed Publishing USA, 275 Washington Street, Newton, MA 02158-1630. Robert L. Krakoff, Chairman and Chief Executive Officer; Timothy C. O'Brien, Executive Vice President/Finance and Administration; Michael Wisner, Senior Vice President/General Manager, Boston Division; Michael Wisner, Vice President/Publishing Director. Circulation records are maintained at Cahners Publishing Company, 44 Cook Street, Denver, CO 80206-5800. Telephone (303) 388-4511. Second-class postage paid at Denver, CO 80206-5800 and additional mailing offices. **POSTMASTER: Send address changes to EDN®, PO Box 173377, Denver, CO 80217-3377.** EDN® copyright 1994 by Reed Publishing USA. Rates for non-qualified subscriptions, including all issues: US, \$140.00 one year, \$238.00 two year; Canada, \$209.00 one year, \$355.00 two year (includes 7% GST, GST# 123397457); Mexico, \$195.00 one year, \$332.00 two year; Foreign surface \$245.00 one year, \$417.00 two year; Foreign air expedited surcharge add \$152.00 one year, \$304.00 two year. Except for special issues where price changes are indicated, single copies are available for \$10.00 US and \$15.00 foreign. Please address all subscription mail to EDN®, 44 Cook Street, Denver, CO 80206-5800. EDN® is a registered trademark of Reed Properties Inc., used under license.

(Printed in USA)



ULTRA  
L O G I C

**FINALLY.  
PROGRAMMABLE LOGIC  
YOU CAN COMMIT TO  
FOR LIFE.**

Why search for  
a new vendor  
every time you

need a new part? Announcing UltraLogic™

The industry's most comprehensive  
approach to programmable logic.

Complex PLDs and FPGAs that  
top every existing benchmark.



And Warp™  
software – the  
open, industry-

standard VHDL development tool that supports  
the entire UltraLogic family. This is strong stuff.

**Call the Cypress UltraLogic hotline  
today and get the whole story.**

**1-800-858-1810\*, Dept. C4E.**



\*In Europe, fax requests to the above Dept. at (32) 2-652-1504 or call (32) 2-652-0270. In Asia, fax requests to the above Dept. at 1-415-940-4343. UltraLogic and Warp are trademarks of Cypress. © 1993 Cypress Semiconductor, 3901 North First Street, San Jose, CA 95134 Phone: 1-408-943-2600, Telex: 821032 CYPRESS SNJ UD, TWX: 910-997-0753



**Home Office**

275 Washington St, Newton, MA 02158  
EDN Bulletin Board: (617) 558-4241  
MCI: EDNBOS  
Phone (617) 558-plus 4-digit extension below  
Fax (617) 558-4470

To send a message to an EDN editor via Internet, add "@MCIMAIL.COM" to his or her MCI address.

**Publisher**

Jeffrey Patterson -4454

**Editor-in-Chief**

Steven H Leibson -4214

**Managing Editor**

Joan Morrow Lynch -4215

Gary Legg, *Senior Technical Editor* -4404  
Charles Small, *Senior Technical Editor* -4556  
MCI: EDNSMALL

Dan Strassberg, *Senior Technical Editor* -4205  
MCI: EDNSTRASSBERG

John A Gallant, *Technical Editor* -4666  
Frances T Granville, *Senior Associate Editor* -4344  
Erin Haskell, *Associate Editor* -4333

James P Leonard, *Associate Editor* -4324  
Gillian A Caulfield, *Production Editor* -4263  
Patricia Shaughnessy, *Production Editor* -4206

Doug Conner, *Technical Editor*  
Atascadero, CA: (805) 461-9669  
MCI: EDNDCONNER

Richard A Quinell, *Technical Editor*  
Aptos, CA: (408) 685-8028  
MCI: EDNQINNELL

David Shear, *Technical Editor*  
Corvallis, OR: (503) 754-9310  
MCI: EDNSHEAR

Anne Watson Swager, *Technical Editor*  
Wynnewood, PA: (215) 645-0544  
MCI: EDNSWAGER

Ray Weiss, *Technical Editor*  
Woodland Hills, CA: (818) 704-9454  
MCI: EDNWEISS

Brian Kerridge, *Technical Editor*  
22 Mill Rd, Loddon  
Norwich, NR14 6DR, UK  
(508) 528435; fax (508) 528430  
MCI: EDNKERRIDGE

EDN Asia, Mike Markowitz, *Editor*  
Cahners Asia Limited  
19th Floor, Centre Point  
181-185 Gloucester Rd, Wanchai, Hong Kong  
Phone (852) 838-2666; fax (852) 575-1690

**Contributing Technical Editors**

Robert Pease, Don Powers, Dave Pryce, Bill Travis

**Assistant to Editor-in-Chief**

Kathy Leonard -4405

**Editorial Services**

Helen Benedict, Senior Secretary -4681

**Art Staff**

Robert L Fernandez, *Art Department Director*  
Ken Racicot, *Senior Art Director* -4708  
Chinsoo Chung, *Associate Art Director* -4446

**Marketing & Business Director**

Deborah Virtue -4779

**Marketing Communications**

Patricia Tyler, *Director of Marketing Services and Custom Publishing* -4526  
Jean Graham, *Promotion Assistant* -4698

**EDN Products**

301 Gibraltar Dr, Box 650  
Morris Plains, NJ 07950  
Phone (201) 292-5100  
Fax (201) 292-0783

**Group Publisher**

Terry McCoy, Jr

**Associate Publisher**

Steven P Wirth, (201) 292-5100, ext 380

**Editorial Director**

Richard Cunningham, (702) 648-2470

**Editor-in-Chief**

Bruce Bennett, (201) 292-5100, ext 390

**Managing Editor**

Carol Coleman, (201) 292-5100, ext 330

**Production Manager**

Sheila Rodgers, (201) 292-5100, ext 287

**Customer Service Manager**

Jen Brinkman, (201) 292-5100, ext 322

**Design Director, Art Director**

John M Angelini, Beverly Blake



February 17, 1994

Continued from page 5

**TECHNOLOGY UPDATES**

**Speech-processing ICs: Speech-synthesis and -recognition chips personalize consumer products** 27

If speech is the mirror of the soul, then many of today's commercial products will reap their just rewards. Maturation of speech-compression coding algorithms is allowing almost every new device to talk, make audio sounds, and even recognize a human voice.

—John Gallant, *Technical Editor*

**Shrinking devices put the squeeze on system packaging** 41

While solving today's system-packaging puzzles, you can design products that are not only smaller but more reliable.

—Charles H Small, *Senior Technical Editor*

**EDITORIAL**

**Let's get physical (again)** 25

Time's up. The physics of electronics has returned to center stage, and you'd better be ready with the required tools and knowledge.

—Steven H Leibson, *Editor-in-Chief*

**NEW PRODUCTS**

Embedded Systems .....113  
Microprocessors .....116  
Test & Measurement.....118  
Integrated Circuits.....127  
Power Sources .....135  
Computers & Peripherals.....136  
Components .....141

**DEPARTMENTS**

News Breaks.....13  
Signals & Noise .....19  
Career Opportunities.....150  
EDN's International Advertisers Index.....154

LAN

A T M

WAN



# TI's experience in silicon solutions gives you the strength to meet your networking needs.

From LANs to WANs, Texas Instruments has the powerful integrated circuit solutions you need to meet your broadband communications and networking requirements.

**Add more muscle to your LAN.** Select from the market's fastest growing Token Ring commprocessor as well as Ethernet™ and dual-protocol commprocessors. Our new PacketBlaster™ boosts small-packet performance up to 600 percent — in fact, it's on Compaq's NetFlex-2™ network adapter card.

**Sun, SynOptics and TI: Driving powerful ATM products to the desktop.** The industry's first jointly developed two-chip solution for complete ATM physical and adaptation layer processing is now being sampled by TI. Operating at the 155 Mb/s SONET/SDH rate, this cost-effective chipset is optimized for adapter card applications connecting workstations and hubs.





**Heavyweights in the WAN ring.** Soon, most every telephone

connection in the world will pass through an IC from TI. That's because every major carrier system manufacturer uses TI's advanced ASIC products to meet their SONET/ATM switching needs. And some of these customers already have designs under way using TI's next-generation products to meet 622 Mb/s and faster requirements.

**TI and the power of converging multimedia technologies.** TI is a major player in bringing together voice, video, data and cable services based on our experience in SONET/ATM and MPEG IC technology.

**Total Integration: The lift you need to get to market faster.** Silicon technology. Flexible, open hardware and software design tools. Timely technical information. Worldwide service and support. That's Total Integration™. To find out how you can use it and get networked with TI, call **1-800-477-8924, ext. 3920.**

**TI: Helping you build stronger networks.**

	<b>ETHERNET AND TOKEN RING COMMPROCESSORS</b>
	<b>ADAPTATION AND PHYSICAL LAYER SOLUTIONS</b>
	<b>LINE TERMINATION AND PROTOCOL FUNCTIONS</b>
	<b>155-622 MBITS/S ASIC CAPABILITY</b>
	<b>OPTIMIZED DECOMPRESSION DEVICES</b>

EXTENDING YOUR REACH  
WITH TOTAL INTEGRATION™



© 1994 TI  
Total Integration, Extending Your Reach, Extending Your Reach With Total Integration and PacketBlaster are trademarks of Texas Instruments Incorporated.  
Ethernet is a trademark of Xerox Corporation.  
NetFlex-2 is a trademark of Compaq Computer Corporation.

# ANOTHER R

## The truth about interference

### MAX782 Output Noise Spectrum at 1A

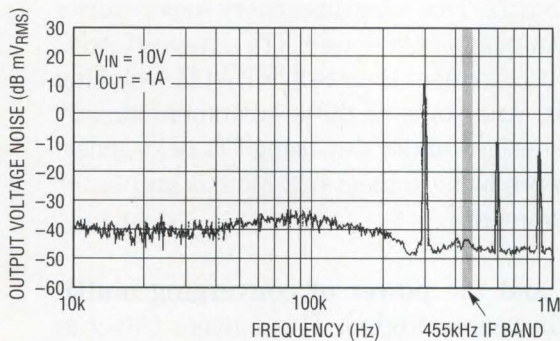

**Figure 1.** The MAX782 evaluation board operates at 300kHz with 1A load current and shows no harmonics in the 455kHz IF band.

### Noise in the New Generation of High Efficiency Switching Regulators.

Switching regulators generate noise. It results from the very nature of their operation, and is something that power supply designers accept to obtain the dramatic efficiency improvement compared to linear regulators. Fortunately, this noise seldom causes interference problems.

The newest battery-powered switching regulators have sophisticated algorithms which operate MOSFET switches intermittently at low load currents. Examples of these regulators are the Linear Technology LTC1148 family and Maxim Integrated Products MAX782.

### MAX782 Output Noise Spectrum at 0.75A

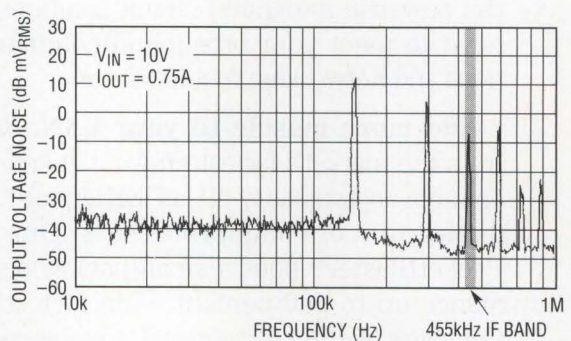

**Figure 2.** Dropping the load current by only 25% halves the operating frequency and shifts the third harmonic into the 455kHz IF band.

While the actual algorithms differ, both can generate fundamental and harmonic frequency components over a wide spectrum.

Figure 1 and 2 above illustrate that a "snapshot" of the frequency spectrum at one load current tells the power supply designer very little. In Figure 3 the operating frequency for two different LTC1148 applications and for the MAX782 evaluation board is plotted versus load current. Figure 3 shows that the LTC1148 reaches the audio band sooner as load current falls, while the MAX782 sweeps a much wider band of frequencies while getting there. Is one better than the other? Maybe the whole issue is just a "red herring".

# ED HERRING

## and switching regulators.

### Lowest Noise Frequency vs Load Current

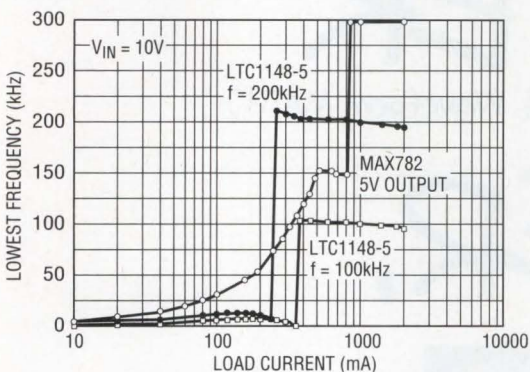

**Figure 3.** A more truthful look at the range of frequencies a switching regulator can generate is to plot the lowest fundamental frequency vs load current.

### Does Noise Equal Interference?

Switcher noise is only a *potential* source of interference, and in this regard the switcher has plenty of company. Figure 4 shows that logic noise is also rich in frequency components extending into the audio range. Fortunately, the same measures which must be taken to prevent interference due to logic noise also work on switcher output noise. These include local RC supply filters for IF and RF noise and linear regulators for audio noise.

Because all high efficiency switching regulators generate wide output noise spectra, and because it can be dealt with in the same manner as logic noise, the

### Noise Generated by a Notebook Computer

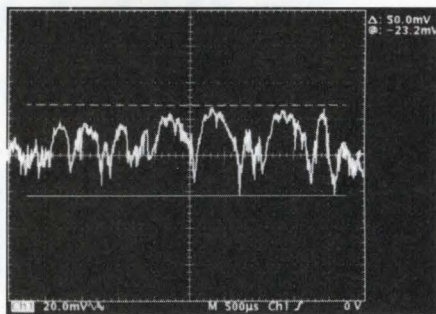

**Figure 4.** This photograph of a notebook computer 5V supply bus shows logic noise exceeding the ripple produced by most switching regulators.

issue of interference is largely a red herring. Claims to the contrary by other vendors serve only to confuse power supply designers looking for the most effective solutions for their battery-powered supplies. It is other concerns such as shutdown current, quiescent current, operating efficiency, dropout voltage, transient response, and design flexibility that should rightly dominate the designer's comparison list.

For real help with switching regulators contact Linear Technology Corporation, 1630 McCarthy Blvd., Milpitas, CA 95035/408-432-1900, Ext. 361. For literature on noise in switching regulators, call 1-800-4-LINEAR.

FROM YOUR MIND TO YOUR MARKET AND EVERYTHING IN BETWEEN.

**LINEAR**  
TECHNOLOGY

# FASTER

(2Gs/s Sample Rate, 500 MHz Bandwidth)

# DEEPER

(8 Mbytes Acquisition Memory)

# SMARTER

(Unsurpassed Triggering, Measurements & Waveform MATH)

# BETTER.

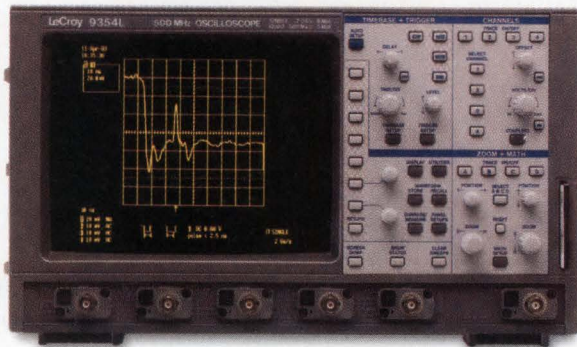

# LeCroy 9354.

(Curious?)

# 800-4-LeCroy





EDITED BY FRAN GRANVILLE

## Codecs lower cost of PC-based audio applications

Two low-cost, 16-bit stereo, CD-quality codecs provide high-performance audio for PC applications. The AD1847 and AD1846, which cost \$7.50 and \$8, respectively (OEM qty), both support the Microsoft Windows Sound System and Compaq Business Audio. Like the company's AD1848 SoundPort, these codecs are single-chip, sigma-delta, stereo digital-audio codecs. The AD1847's serial port allows direct interface to a DSP or system-I/O chip and fits in a low-cost 44-lead plastic leaded chip carrier or thin quad flat-pack instead of the more expensive 64- and 68-pin packages parallel-port codecs require. The AD1846 is a cost-reduced, pin- and register-compatible version of the AD1848K with a dynamic range of 70 dB. Both codecs are complete digital-audio systems (including A/D conversion, D/A conversion, gain control, and mixing of multiple analog and digital data streams) and require minimal support circuitry.

—by Anne Watson Swager

Analog Devices Inc, Norwood, MA, (617) 461-3881. **Circle No. 500**

## Digital-coupler IC replaces optocouplers

The ISO150 uses high-voltage capacitors instead of an LED and photodiode to transmit signals across the isolation barrier. This alternative device to high-speed optocouplers offers faster performance, lower power consumption, and better isolation specifications. The coupler also acts as a transceiver, whereas optocouplers are unidirectional. Primary applications include digital isolation for A/D and D/A conversion, multiplexed data transmission, and I/O-port isolation in instruments. The ISO150 has two bidirectional channels, which you can independently configure to transmit or receive. The IC requires no external components. Key specifications include an 80-Mbps typical data rate, 25-mW max power consumption per channel, 2400V-rms isolated partial discharge, and 16.5-mm creepage distance. The TTL- and CMOS-com-

patible IC comes in a 24-pin DIP and costs \$7.75 (1000).

—by Anne Watson Swager

Burr-Brown Corp, Tucson, AZ, (602) 746-1111. **Circle No. 501**

## Hitachi and Mitsubishi to codevelop flash memories

Hitachi Ltd and Mitsubishi Electric Corp have announced that they will codevelop flash memories. Under the agreement, the companies will jointly develop a 16-Mbit flash memory based on Mitsubishi's DINOR cell-structure technology and a 64-Mbit flash memory based on Hitachi's AND cell-structure technology. The companies will also consolidate their 16- and 64-Mbit product lines.

DINOR and AND feature higher integration and lower power consumption than NOR and NAND cell structures, which are currently the most popular technologies for flash memories. Although NOR offers 100-nsec read time and easy erasability, it requires a large cell size and a 12V external power supply. In comparison, DINOR provides a smaller cell size, single-power-source operation, and shorter access times. Hitachi's AND incorporates NAND and NOR; it also provides smaller cell size than NOR and NAND; single-power-source operation; and the ability to erase small blocks (512 bytes). AND suits nonvolatile-storage and hard-disk-drive-replacement applications; DINOR suits nonvolatile-storage applications.

The two companies expect the new technologies to become the de facto industry standard and are seeking partners with which to establish a DINOR-AND Group. One company that may join the group is SGS-Thomson Microelectronics, Europe's second-largest semiconductor company, which already has an alliance with Mitsubishi for flash-memory development.

—by Fran Granville

Hitachi America Ltd, Tarrytown, NY, (914) 333-2902. **Circle No. 502**

Mitsubishi Electronics America Inc, Sunnyvale, CA, (408) 730-5900.

**Circle No. 503**

## SHORTS

**Correction.** "News Breaks" (EDN, January 6, 1994, pg 15) provided an incorrect phone number for JTAG Technologies, the Dutch company that recently acquired Fluke Corp's boundary-scan test business. The correct information is JTAG Technologies BV, Eindhoven, The Netherlands, 31-40-785739, fax 31-40-785104. **Circle No. 504**

**Rochester Electronics to offer discontinued Intel ICs.** Rochester Electronics has signed an agreement with Intel Corp that lets Rochester sell discontinued Intel parts. The agreement gives Rochester access to current and future discontinued products, tooling, and processes for Intel's military and commercial ICs. Rochester Electronics Inc, Newburyport, MA, (508) 462-9332. **Circle No. 505**

**Conference issues call for DSP papers.** The fifth International Conference on Signal Processing Applications and Technology, scheduled for October 18 to 21, 1994, in Dallas, has issued a call for papers. Topics include DSP machines, software, and technology; instrumentation and testing; speech processing; virtual reality; and more. Abstracts are due by April 15, 1994. DSP Associates, Waltham, MA, (617) 891-6000.

**Circle No. 506**

**Motor uses high-temperature superconducting coils.** Reliance Electric Co has demonstrated a high-efficiency motor using American Superconducting Corp's high-temperature superconducting wire. The motor offers 3730W output power, and the coils rotate at 1800 rpm, compared with the Reliance's earlier prototype, which had stationary coils and 1490W output power. Reliance Electric Co, Cleveland, OH, (216) 266-5809. **Circle No. 507**

American Superconductor Corp, Westborough, MA, (508) 836-4200.

**Circle No. 508**

## LITERATURE

**Scope accessory catalog.** This free, 16-pg, color catalog describes multimeter leads; connector adapters; and scope, differential, and active probes. **Test Probes Inc**, San Diego, CA.  
**Circle No. 509**

**Data sheet for supplies.** This color data sheet describes five single- and multiple-output supplies that produce as much as 165W. **American Reliance Inc**, Arcadia, CA. **Circle No. 510**

**Signal conditioner specs.** A 2-pg data sheet describes a stackable power supply that accepts charge and voltage inputs and a stackable charge amplifier that

includes filters. **Scantek Inc**, Silver Spring, MD.  
**Circle No. 511**

**Catalog lists PLL modules.** A 32-page catalog lists hundreds of standard modules that collectively cover 5 MHz to 3.5 GHz. The catalog includes dimensioned outline drawings and a form for obtaining a quote on a custom unit if no standard unit meets your requirements. Free. **RF Prototype Systems**, San Diego, CA.  
**Circle No. 512**

**Brochure covers IC test system.** A 6-pg full-color brochure describes a test system for VLSI ICs that incorporate such design-

for-test methodologies as  $I_{DDQ}$  scan, and built-in self test. The system tests devices with as many as 768 pins. **Micro Component Technology Inc**, San Jose, CA.  
**Circle No. 513**

**Catalog on interconnect products.** A 260-pg catalog describes more than 10,000 products, including accessories for in-circuit emulators, programmers, and logic analyzers. Free. **EDI Corp**, Patterson, CA. **Circle No. 514**

**Guide describes bioelectric measurements.** The Axon Guide covers topics in neuroscience, cardiovascular research, and plant physiology research. It cov-

ers such subjects as data acquisition and how to minimize noise in laboratory setups. **Axon Instruments Inc**, Foster City, CA.  
**Circle No. 515**

**Book lists industrial I/O products.** This 96-pg free catalog describes such items as ADC boards and arbitrary-waveform generators. **Industrial Computer Source**, San Diego, CA. **Circle No. 516**

**Tutorial on scope probes.** This 36-pg illustrated booklet explains probing basics and how to select scope probes. It also contains a glossary. Free. **Tektronix Inc**, Beaverton, OR.  
**Circle No. 517**

## Intergraph ships Windows NT-based design system

Intergraph Corp, the largest independent application site for Microsoft's Windows NT operating system, is now shipping the VeriBest Design System for Windows NT. The software provides an integrated system comprising a schematic editor, a state-diagram editor, an online electrical-rules checker, an automatic Verilog or VHSIC hardware-description-language generator, a Verilog simulator, and a graphical logic analyzer. The complete VeriBest Design System software costs \$22,000. Unbundled design software costs from \$3500.—by Doug Conner

Intergraph Corp, Huntsville, AL, (800) 837-4237. **Circle No. 518**

## IEEE 802.12 accepts HP draft spec

Hewlett-Packard Co has announced that the IEEE 802.12 working group

voted to accept HP's Demand Priority protocol (100VG-AnyLAN) draft specification, which HP submitted at the IEEE 802.12 interim meeting on January 17 to 19 in Austin. The specification includes Token Ring additions IBM, Proteon, and Texas Instruments proposed.

HP believes this brings the IEEE 802.12 working group one step closer to final approval of a draft standard for transmitting Ethernet and Token Ring information at 100 Mbps. To ensure Ethernet and Token Ring frame compatibility, the IEEE 802.3 (Ethernet) and IEEE 802.5 (Token Ring) committees each have assigned two voting liaisons to the IEEE 802.12 working group.

HP's 100VG-AnyLAN provides users with standard, compatible, and affordable 100-Mbps performance to desktops using Ethernet or Token Ring frames. The Demand Priority protocol supports all of the network design rules, topologies, and cable types of 10Base-T and Token Ring, and it gives users an easy and economical upgrade to higher performance.

—by Fran Granville

Hewlett-Packard Co, Palo Alto, CA, (415) 857-1501. **Circle No. 519**

## ATM network-interface card runs on PCs

In response to increasing demand for Asynchronous Transfer Mode (ATM) communications, Newbridge Microsystems has expanded its Openbus Communications product line by introducing an ATM network-interface card for standard EISA-based PCs.

The NM 121 ATM adapter operates on PCs running Novell NetWare, NetWare Lite, Microsoft MS-DOS, and Microsoft Windows. It also complies with NetWare servers and PC clients. The NM 121 ATM adapter supports up to 100-Mbps throughput over multimode fiber; it complies with ATM Forum specifications; it provides comprehensive remote management using SNMP; and it accommodates industry-standard protocols including IPX and TCP/IP.—by Fran Granville

Newbridge Communications, Ottawa, ON, Canada, (613) 591-3600.

**Circle No. 520**

# THE DESIGN CENTER FAMILY OF PRODUCTS—

The **Design Center** provides the building blocks to form the foundation for your custom desktop EDA system. Whether your needs are analog, digital, or mixed analog/digital, the **Design Center** has a configuration for you. Each product stands on its own strengths, providing you with the most advanced technology for completing the task for which it was designed. Used in any combination, they form a powerful, tightly integrated development environment. To build your custom EDA system, select from the following:

## SCHEMATIC ENTRY

Schematics provides graphical circuit editing and a complete symbol library of over 9,000 devices. All **Design Center** functions are centrally managed from within the schematic editor, thus streamlining the design of your circuit. Layout netlists can be generated and used as input to CADStar, PADS, P-CAD, Protel, or Tango board layout packages.

## CIRCUIT SIMULATION

Includes analog behavioral modeling, Monte Carlo and sensitivity/worst-case analyses, graphical waveform analysis, stimulus generation, device characterization, analog and digital libraries of over 9,000 devices, and digital worst-case timing. With PSpice (analog), PLogic (digital), or PSpice A/D (mixed analog/digital), you are getting the accuracy and reliability that MicroSim Corporation has always maintained.

## PROGRAMMABLE LOGIC SYNTHESIS

PLSyn combines device-independent, mixed-level design capture, efficient min-max timing simulation, optimized logic synthesis, and automated goal-and-constraint directed device selection. PLSyn can even automatically partition a large design to fit in several different types of programmable devices. PLSyn provides designers who are new to programmable logic, as well as the experienced programmable logic designers, with the best route to an efficient, error-free design ever available in the desktop EDA market.

## SIGNAL INTEGRITY ANALYSIS

Polaris automatically extracts parasitics from board layouts and applies transmission line, parasitic capacitance, and coupling values, back to the circuit. After simulation, the circuit's behavior can once again be verified, comparing waveforms showing the effects of crosstalk, reflection, and delay, to the ideal waveforms.

# TECHNICAL SOPHISTICATION IN EVERY FORM

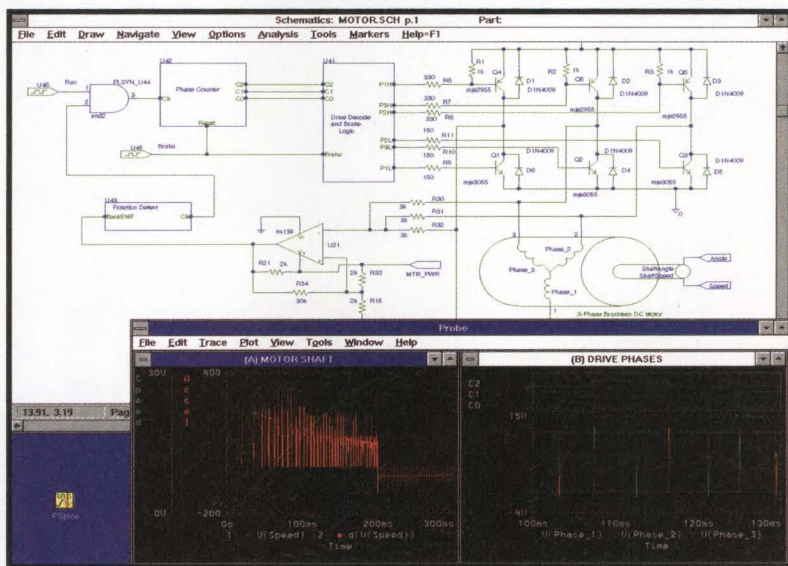

You can count on the **Design Center** for functionality, reliability, and performance, as well as MicroSim's commitment to provide the best in desktop EDA. For more information about the **Design Center** EDA system, call toll free at

(800) 245-3022 or FAX at (714) 455-0554



## MicroSim Corporation

*Providing the Best in Desktop EDA*

20 FAIRBANKS • IRVINE, CA 92718 • USA • (714) 770-3022  
(800) 245-3022 • FAX: (714) 455-0554 • BBS: (714) 830-1550

THE MAKERS OF PSpice



SCHEMATIC CAPTURE



MIXED-SIGNAL SIMULATION



DIGITAL SIMULATION

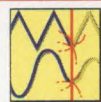

ANALOG SIMULATION

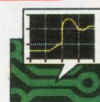

SIGNAL INTEGRITY



PROGRAMMABLE LOGIC SYNTHESIS

Design Center and PSpice are registered trademarks of MicroSim Corporation. All other trademarks are the property of their respective owners.

• Circle No. 150 for IBM • Circle No. 151 for Macintosh • Circle No. 152 for SPARCstation

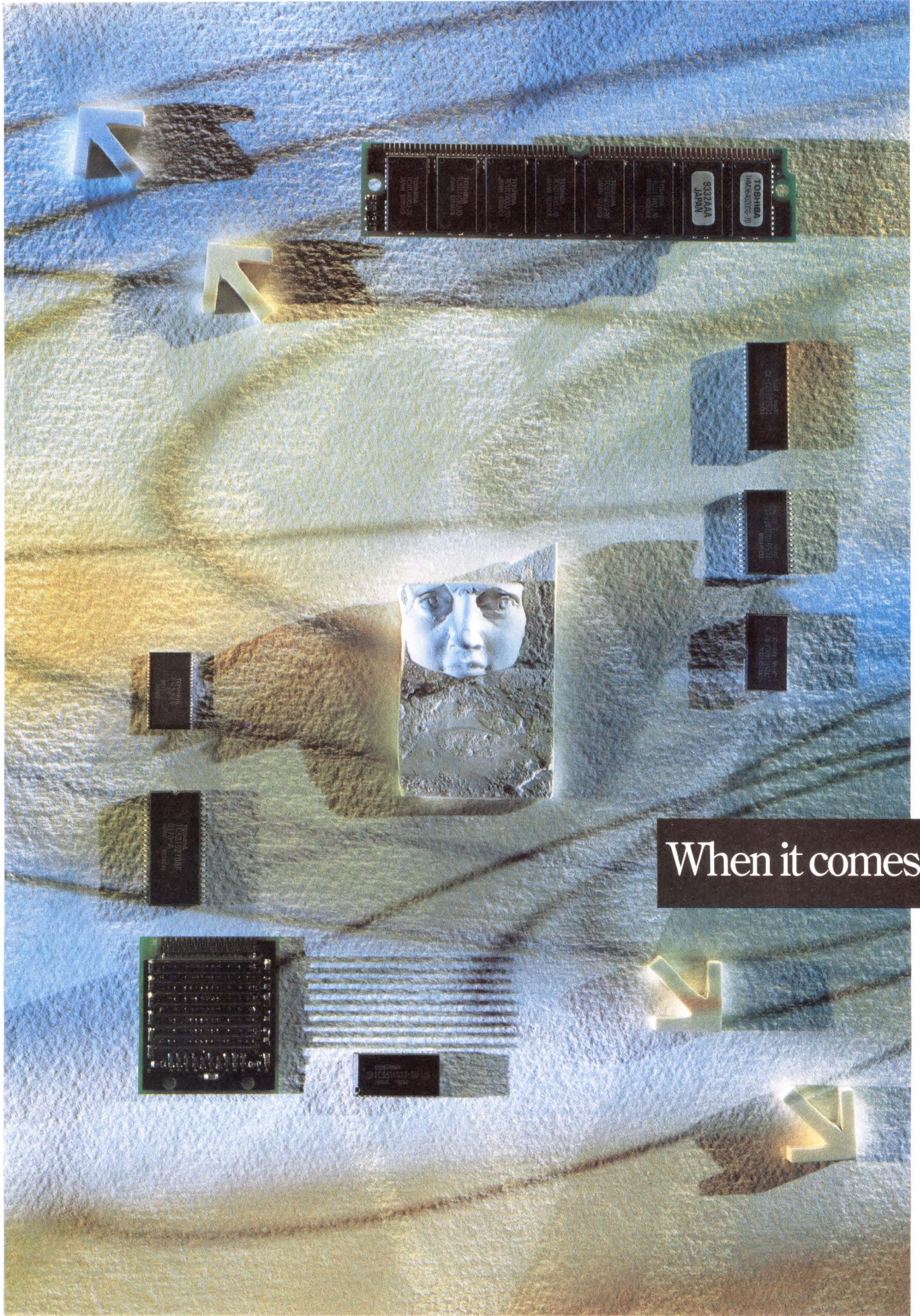

When it comes to

At Toshiba, we sell more memory products than anyone else in the world.

Anyone.

An achievement we're justifiably proud of.

And why no matter where you look, you'll find our DRAM, SRAM, Non-Volatile products and Memory Cards in more places than anyone else.

Naturally, we're in all types of computers, from PCs to workstations, minis to mainframes, Personal Digital Assistants to supercomputers.

But our influence extends much further.

To laser, dot matrix and color thermal printers.

National Semiconductor, Samsung and others, we're helping take technology to places never before dreamed possible — while standardizing it for everyone's use.

All of which translates into more than just the industry's most expansive line

of memory products.

It means consistent supply, due to huge manufacturing capabilities. Performance advantages, from a long history of

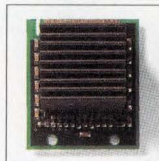

Rambus DRAM



High Speed SRAM

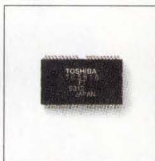

NAND EEPROM

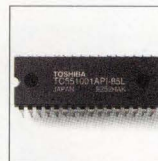

Standard Speed SRAM

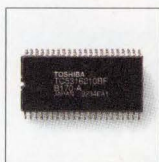

16Mb MROM

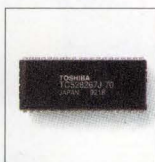

2Mb VRAM

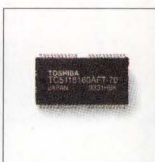

1Mb x 16 DRAM

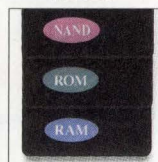

Memory Cards

technological innovation and product quality. Reliable alternate sourcing. And the kind of customer service, financial strength and overall stability you'd expect from one of the world's largest corporations.

That's why more companies the world over depend

on Toshiba for memory. And it's what keeps us in the most important place of all — first.

memory, we're in all the right places.

Modems and digital switches. Handheld instruments.

Consumer products like mobile phones, faxes and copiers. Even automobiles and electric vehicles.

And thanks to strategic partnerships with companies like IBM, Motorola, Siemens, Rambus,

For more information, or a free product guide, just call 1-800-879-4963.

Then follow the lead of systems manufacturers worldwide.

And commit our name to memory.

In Touch with Tomorrow  
**TOSHIBA**

TOSHIBA AMERICA ELECTRONIC COMPONENTS, INC.

Please call me, Circle No. 108

# Sa·ram (Sə-rām')

**Definition:** *noun.* 1. A new innovative Sequential Access/Random Access Memory chip from IDT. 2. The combination of a FIFO and Dual-Port memory on one chip. 3. A real estate saving chip that makes your life easier. 4. The fastest and largest Multi-Port SRAM in the semiconductor industry.

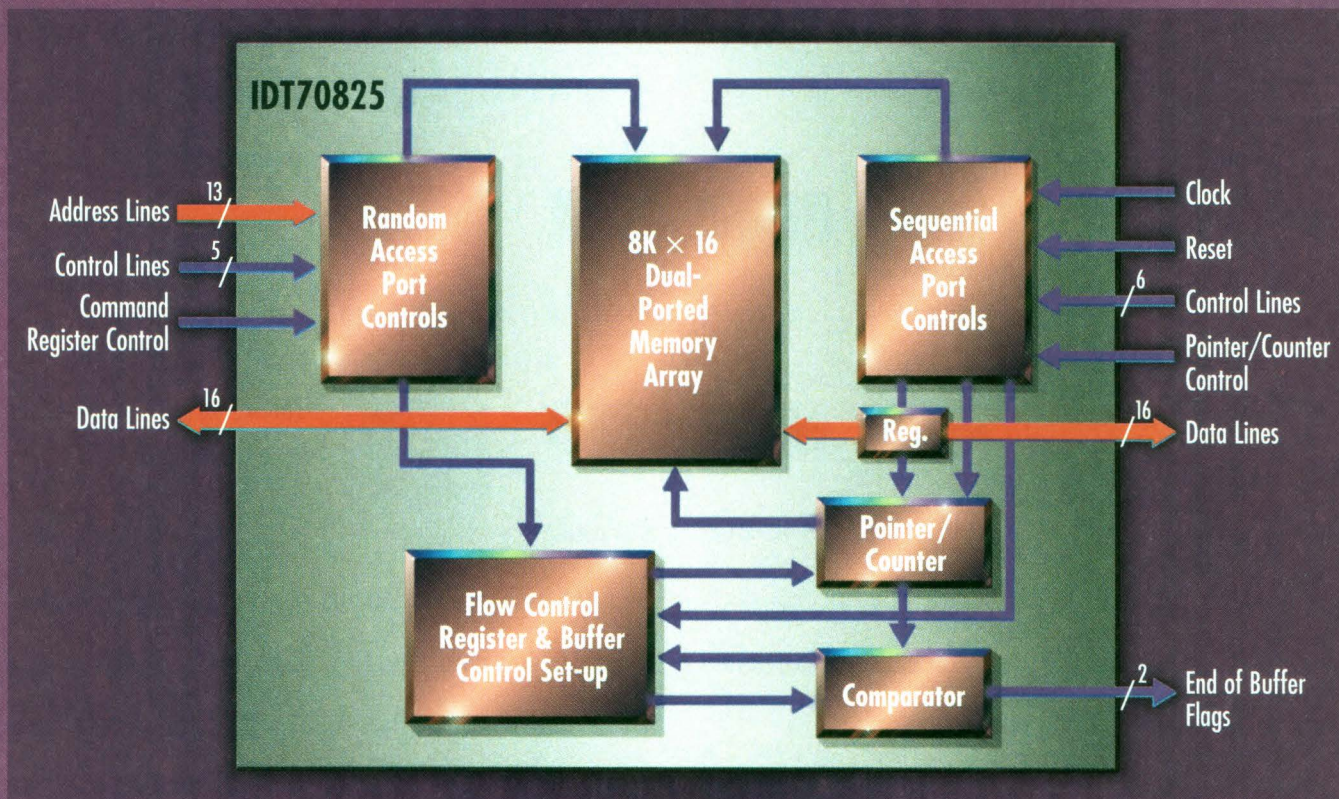

## IDT defines your next specialty memory!

### A Combination FIFO and Dual-Port

IDT's innovative new SARAM™ combines the advantages of a synchronous FIFO and dual-port SRAM in one chip. It offers the functionality of a bidirectional synchronous FIFO on one port and the asynchronous random access capability of an SRAM on the other while maintaining a true dual-port's ability to simultaneously access data in a given memory cell from either port.

### Configurable Buffer

The 8K x 16 SARAM is comparable to the largest dual-port available, so large packets of data can be transported in

SARAM is a trademark of Integrated Device Technology, Inc.

applications such as telecommunication switches, bridges, and routers. SARAM's large configurable buffer allows designers to customize the buffer size on-the-fly for each application.

### 25ns Access Time

IDT's SARAM allows memory accesses as fast as 25ns on either port. At top speed with both ports active, SARAM consumes as little as 1.5W of power; when idling, SARAM consumes as little as 25mW. Best of all, SARAM is packaged in a low-profile 80-pin TQFP package, so you save significant board space both in part count and package size.

### Free Pocket Dictionary

Call or FAX us today and receive a free pocket-size Webster's dictionary and bookmark, SARAM data sheet, application note and a sample request card so you can begin designing with IDT's innovative SARAM dual-port memory now!



**(800) 345-7015 • FAX: 408-492-8674**  
ASK FOR KIT CODE 7071

**Integrated Device  
Technology, Inc.**

## Correct the spec

In the new-product writeup for the LT1413 dual single-supply op amp (*EDN*, November 11, 1993, pg 122), you describe the op amp as having a maximum supply current of 480 mA/amplifier; in fact, the supply current is 1000 times lower than that: 480  $\mu$ A/amplifier. Its drift is 0.5  $\mu$ V/ $^{\circ}$ C, rather than 0.5  $\mu$ C/ $^{\circ}$ C. Please alert your readers.  
*Ron Denchfield, Public Relations  
 Linear Technology Corp  
 Milpitas, CA*

## Equation corrections

Thank you for publishing my article, "Relative-phase modeling speeds Spice simulation of modulated systems" (*EDN*, November 11, 1993, pg 91). Unfortunately, several errors appeared in the equations; the inconsistent math may confuse readers.

- In **Fig 1b** (pg 92), the signal coming from the left-most summer should be labeled  $\Phi_1$
- **Eq 2** (pg 93) should read  $v_0(t) = \sin(\Theta_c(t) + \Theta_D(t)) = \sin(\omega_c t + \Theta_D(t))$
- The equation just below **Eq 2** (pg 93) needs an = just after  $\Theta_D(t)$
- Near the end of the first paragraph on pg 94,  $f_1$  should be  $\Phi_1$
- Also on pg 94, in the lower right corner, the first three of the four equations were typeset as  $\omega @ -1t$  but should have read  $\omega_1 t$ ; the fourth of these equations should have a ) just before the =
- Finally, in **Fig 3** (pg 94), the last signal's label should be  $\Phi_1$ .

*John Kesterson, Sr Engineer  
 Mitsubishi R&D Center  
 Nevada City, CA*

## Innovation is thriving

I cannot resist commenting on your editorial "Innovation is where you find it" (*EDN*, November 25, 1993, pg 33). It seems to me that you are making a "left-brain" analysis of your friend's "right-brain" comment. Is innovation dead? Of course not. We in the United States are as innovative as any group on earth. One serious problem, however, is that our business and political philosophy is not tuned to searching out and rewarding innovative ideas. Perhaps you have noticed, however, that the Japanese do just that.

And now for a specific suggestion: Because so few technical magazines pay much attention to patents, how about publishing a 1-pg feature on electrical patents granted? For example, you might try a review of a publication such as "NASA Tech Briefs."

*Wayne E Hough  
 President, Kryptos Corp  
 Mukilteo, WA*

## Motorola photo lacks text

At the bottom of pg 24 of our "Have a high-tech holiday" feature (*EDN*, December 9, 1993), we ran a photo of a Motorola evaluation board but printed the wrong product writeup under it. Motorola's hands-on kit includes the fully assembled bar-graph pressure-gauge evaluation board, an application note, a sensor brochure, two data sheets, a sensor slide rule, and a sensor pocket conversion card. You need only apply pressure to the MPX2100 pressure sensor to interface with digital systems. The kit costs \$75. Phone (800) 441-2447 and ask for KITDEVB147/D.

## Experiment with floor planning

Regarding Doug Conner's Technology Update "ASIC design tools: Submicron technologies require floor planning" (*EDN*, September 2, 1993, pg 61), I would like to share some experience with floor planning vs flat placement and wiring.

We designed several CMOS processors and I/O chips in an IBM 0.8- $\mu$ m CMOS technology and compared these designs using a flat-vs-floor-planned approach. The following specs show the complexity of a typical design:

- 12.7-mm chip size
- 343,200 available GA/SC cells
- 330,836 (96%) used GA/SC cells
- 13 macros
- 34,935 used circuits
- 3200k transistors.

I agree that flat layout without a timing-driven approach is likely to result in a poor cycle time, but we've seen that in the case of a timing-driven place and route, the flat version is superior to the floor-planned version. (Timing driven in this case means that we automatically generate upper bounds for the wiring length of each net and use this information to drive the placement and wiring.)

To show the strength of this

# LCD Proto Kit

Everything you need to start your LCD application .... create complex screens in just a few hours!

240 x 64 pixel Supertwist LCD mounts directly onto CYB003 prototyping board.

Kit provides serial interface to IBM PC for quick prototyping. Board also supports displays up to 240 x 128 pixels.

Interface to 6 soft keys or 4 x 4 key matrix.

Dial 0-25k ohms for LCD contrast.

\* The CY325 LCD Windows Controller provides parallel or serial high-level control of Instrument-size LCDs. Up to 256 built-in windows support window-relative text, bargraphs, waveforms, and plots. Text and graphics are maintained in separate planes, facilitating special effects. Complete User Manual included.

Wirewrap area for custom circuitry or back-light.

RJ 11 serial jack for Rx/D, Tx/D, CTS, and GND, plus 2 spares.

5 Pin Power DIN.

Alternate Power Connector.

Add your own 8051 CPU for stand alone operation.

## Kit also includes:

Power supply provides +5v and Gnd for board, -12v for LCD, and +12v spare.

Sample routines in 8051 Assembler and QuickBasic.

LCD Paint™ for creating your own graphics images.

4-wire RJ11 style cable with DB25F connector for your IBM PC.

LCD demo

Demo routines preprogrammed into 8751 for immediate gratification.

**\$495 - Kit**  
 Popular LCD Starter Kit.



(\$595 pre-assembled & tested)

\*The CY325 CMOS 40-pin DIP and 44-pin PLCC LCD Controller IC are available from stock @ \$75/singles, \$20/1000s.

## CyberneticMicroSystems

Box 3000 • San Gregorio CA 94074  
 Tel: 415-726-3000 • Fax: 415-726-3003

CIRCLE NO. 3

**Table 1—Postlayout timing analysis**  
(cycle time with zero wiring set to 100)

Cycle time	Number nets with negative slack	Floor plan	Timing-driven place and route
129	3556	No	No
113	2096	Yes	No
114	889	Yes	Yes
109	571	No	Yes

approach, we calculated the possible cycle time with zero wiring length for each net; we used only the capacitance of the inputs of the next stage driven by the net as the actual net capacitance. This yields a theoretical lower bound for the possible cycle time. For this example, we've set this lower bound to 100 and used this as (an unreachable) target for layout.

The results (see **Table 1**) show the possible cycle times for each of the four possible combinations of flat/floor-planned and timing driven/nontiming driven. Column 1 shows the number of nets that do not satisfy the timing requirements; reducing this number

makes the job of incremental logic change (to improve cycle time) much easier.

"Submicron technologies require floor planning" is true for the nontiming-driven approach, but for the timing-driven approach, the flat version is superior. In this case, the actual cycle time is only 9% above the theoretical lower bound of wiring length zero.

We obtained similar results for several test cases and are now using flat, but timing-driven, layout for all of our production chips. Due to very fast place-and-route algorithms, the turnaround time is two to three days.

This is not to say that some type of

early floor planning and feedback of the estimated net length to synthesis isn't useful, but even in this case, I suppose that not using the floor-plan boundaries in the final place and route improves timing. Probably, a combination of both approaches is preferable.

*Dr Jürgen Koehl*  
*IBM Deutschland Entwicklung GmbH*  
*Böblingen, Germany*

## Review of "Hands On!"

I am a very satisfied user of Byte Craft's Fuzz-C preprocessor, which you covered recently in your "Hands On!" column (*EDN*, December 9, 1993, pg 223). Most recently, I used it in an embedded controller based on a Motorola 68HC11 and was pleased with both the performance and code size of the fuzzy-logic functions. I am currently using a beta version of the preprocessor, which incorporates some of the upcoming improvements—specifically the use of variables in LINGUISTIC and CONSEQUENCE blocks. I feel strongly that tools, such as Fuzz-C, that generate standard C code have much greater utility than those that produce assembly language for one (family of) microprocessor.

I am puzzled by David Brubaker's comments toward the end of the review. He suggests an improvement to Fuzz-C would be "...a Windows icon with which a user could open and execute Fuzz-C." Most Windows users know how to create an icon or a PIF file to run a DOS application from Windows. The process is relatively simple and takes just a few minutes. I am really amazed, however, by the statement that the author "had to...temporarily exit Windows, run Fuzz-C under DOS, and then reenter Windows to compile and debug." Even a novice should be able to open a DOS window and run Fuzz-C *without* leaving Windows!

Overall, the review was thorough and accurate, and I encourage *EDN* to present more articles and reviews of embedded-systems development tools.

*Eric B Schuyler*  
*EBS Consulting*  
*Snyder, NY*

Send your letters to Signals and Noise Editor, *EDN*, 275 Washington St, Newton, MA 02158. Or fax us at (617) 558-4470. *EDN* reserves the right to edit letters.

## SIEMENS

For the finest components,  
call toll free . . .

Siemens Components, Inc., Special Products Division

Capacitors/RFI	800-888-7729
Ferrites:	800-888-7728
Thermistors:	800-888-7728
Varistors/ Surge Protectors:	800-888-7728
Saw Products:	800-888-7728
Microwave Ceramics:	800-888-7728
Switches/ Connectors:	800-888-7728

SPD-1



# When it comes to performance, packaging and price, our references are impeccable.

	ADI	LTC	MAXIM
	<u>AD780B</u>	<u>LT1019A</u>	<u>MAX 873AE</u>
<b>•PERFORMANCE</b>			
Output Drift: (-40 to +85°C)	3ppm/°C	Not Specified	7ppm/°C
Output Drift: (0 to +70°C)	3ppm/°C	5ppm/°C	7ppm/°C
Initial Error:	1mV	1.25mV	1.5mV
Noise:	100nV/√Hz	316nV/√Hz	474nV/√Hz
<b>•PACKAGING</b>			
SOIC	YES	NO	YES
PDIP	YES	YES	YES
CERDIP	YES	NO	NO
<b>•PRICE</b>			
1000'S	\$5.50	\$6.25	\$7.67

Our  
References  
Are Impeccable.

Whether you're specifying 2.5V, 5V or 10V, Analog Devices offers an unbeatable family of monolithic, high-precision voltage references available in either surface-mount or through-hole packaging, over the industrial temperature range.

## Introducing the AD780. The world's best performing 2.5V reference.

When it comes to voltage references, the AD780 is truly superlative. It's the highest precision 2.5V voltage reference on the market. In fact, with its temperature coefficient of 3ppm/°C and initial accuracy of 1mV, no other voltage reference comes close to its performance over the industrial temperature range.

It has by far the lowest noise in its category and at just \$5.50 (in thousands) for the B-grade and \$3.30 (in thousands) for the A-grade, it's also the lowest priced. But the AD780 isn't merely superlative, it's



completely unique. It's the only reference capable of providing either a 2.5V or 3.0V output while maintaining the industry standard pinout.

Incidentally, the AD780 also offers the versatility of being available in industrial grade, surface-mount packaging. All of which means if you're

seeking a truly superlative voltage reference, the AD780 is one reference you should check. So call us at 1-800-ANALOG-D (262-5643) for a free sample and datasheet or write to us at the address below.



Introducing the new EPLDs from Xilinx.  
Because products for the next generation  
shouldn't be designed with parts from the last.

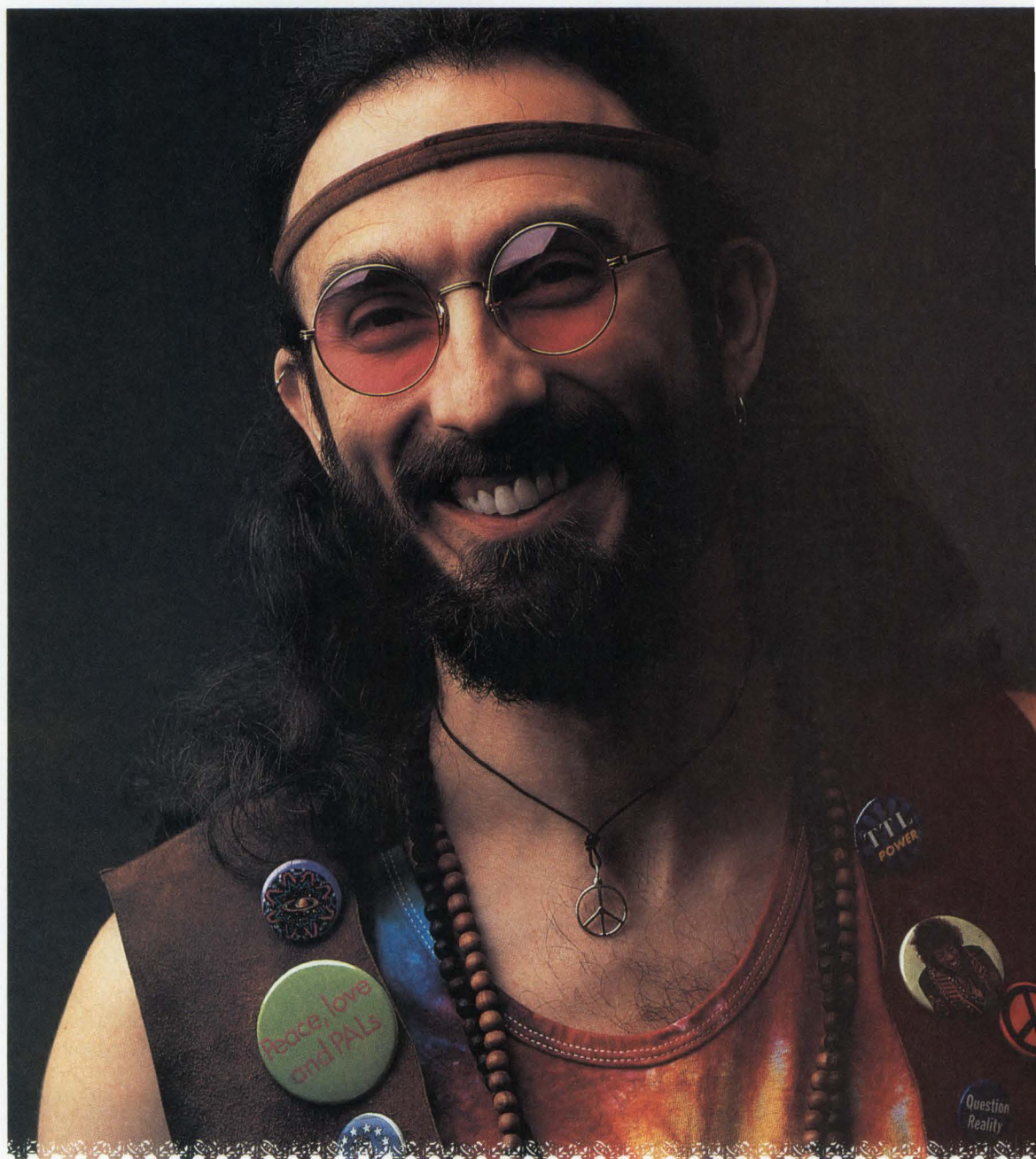

When it comes to design engineering, you only have two choices.

Make history.

Or become history.

So while we have nothing against PALs or TTL, may

we suggest something a bit more up to date?

Something that'll meet the hurry-up-get-it-out-first-and-make-it-smaller-and-faster-with-more-features demands of a whole new

generation of products.

Like the new EPLDs from Xilinx®.

Our XC7300 family can

boosts logic performance.

In addition, our 7300s are the only EPLDs in this day and age with built-in

Arithmetic Logic Units (ALUs, for short), so you can build adders, accumulators, and comparators, easily.

Since they also let you incorporate higher level sys-

tem functions, our EPLDs do everything your PALs or discrete logic can do and then some.

In less space, faster, and with less power.

Just one Xilinx EPLD, for instance, can integrate dozens of devices, very quickly. With interfaces for ABEL™, CUPL™, and PALASM™, and software that directly converts and optimizes PAL files, you can use everything you've ever learned.

And just consider what you'll get to work with: terrific speed, totally predictable timing, and guaranteed 100% routing, thanks to our thoroughly modern Universal Interconnect Matrix.™

This latest advance allows you to engineer even the most complex functions, which along with higher product term utilization,

are perfect for everything from simple controllers to complex synchronous state machines.

You can count on a bright future, too.

Because we're the only company with a simple, straight-forward upgrade path to FPGAs.

So call our 24-hour literature hotline at 800-231-3386 for a copy of our new PAL Conversion Guide and the name of the Xilinx representative nearest you.

Because the times they are a'changin'. And it pays to stay ahead of them.

Xilinx EPLD Benchmarks	
State Machine	83 MHz
Counter	100 MHz
16 bit Accumulator	51 MHz
Memory Decoder	10 nS

*Our EPLDs have short pin-to-pin delays. So they're fast. And since they act just like PALs, your design time is cut down to practically no time.*

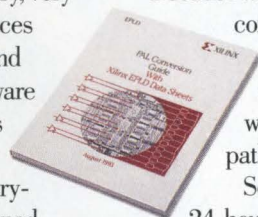

**XILINX®**  
The Programmable  
Logic Company.™

©1993 Xilinx, Inc., 2100 Logic Drive, San Jose, CA 95124. Europe, 44 (932) 349401; Japan, 81 (3) 297-9191; Asia, 852 (3) 721-0990.

Xilinx is a registered trademark, and The Programmable Logic Company is a service mark of Xilinx, Inc. All other trademarks or registered trademarks are the property of their respective holders.



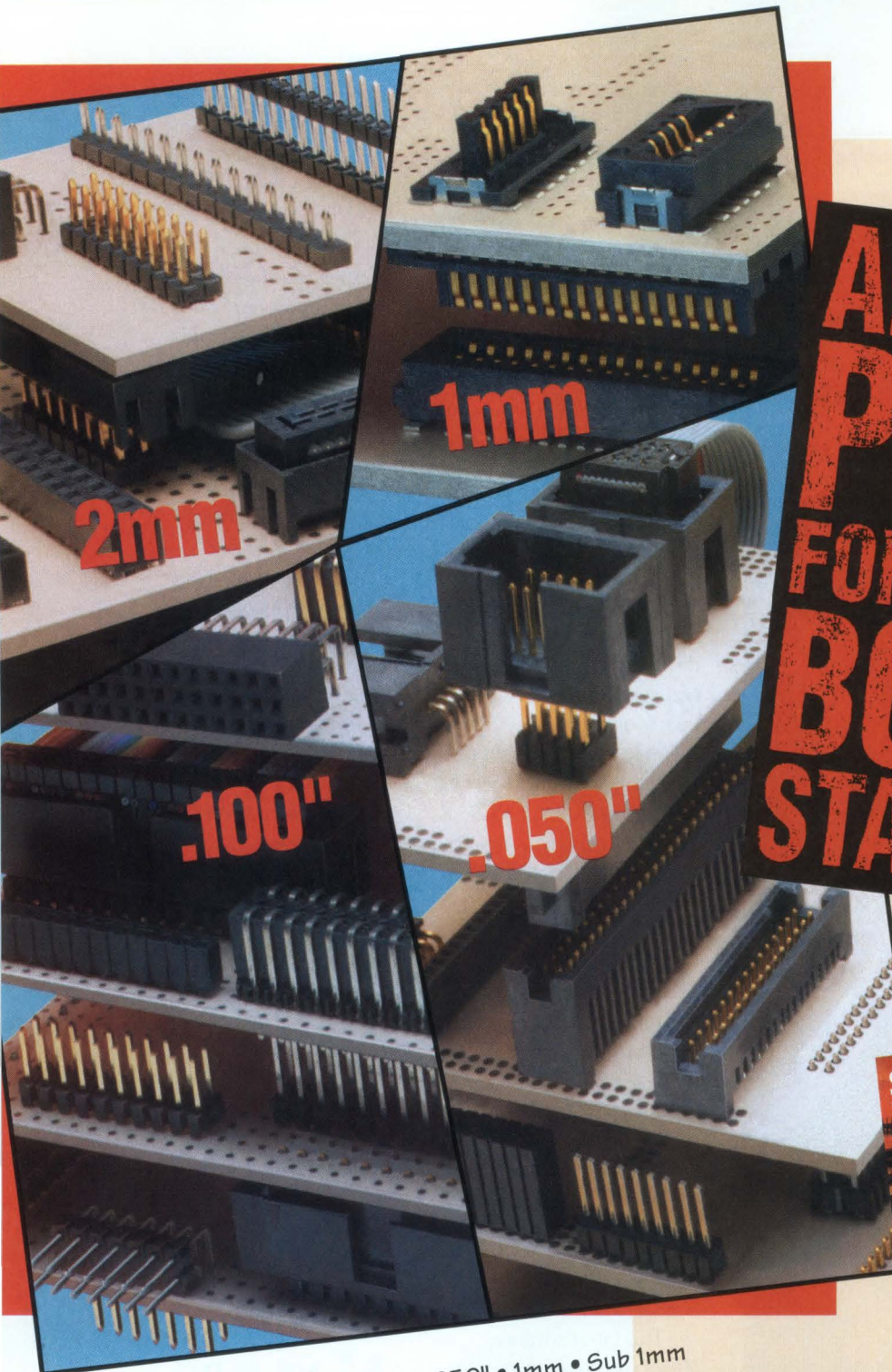

# ANOTHER PITCH FOR SAMTEC BOARD STACKERS

CHOICE OF PITCH: .100" • 2mm • .050" • 1mm • Sub 1mm  
 CHOICE OF TECHNOLOGY: Through-Hole • Surface Mount  
 CHOICE OF DESIGN: Elevated • Low Profile • Shrouded • Bottom Mount

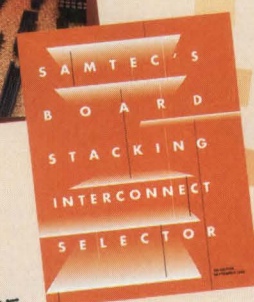
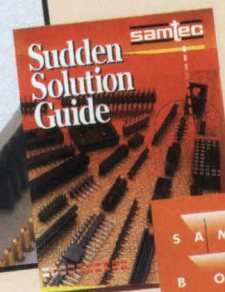

CHOICE OF LITERATURE:  
 • Full-Line Solution Guide  
 • Board Stacking Selector  
 CALL 1-800-SAMTEC-9



## IS SUDDEN SOLUTIONS

New Albany, Indiana USA • Cumbernauld, Scotland UK • Singapore  
 SAMTEC, INC. • P.O. Box 1147 • New Albany, IN 47151-1147 USA • Phone 812-944-6733 • Fax 812-948-5047

CIRCLE NO. 80

## Let's get physical (again)

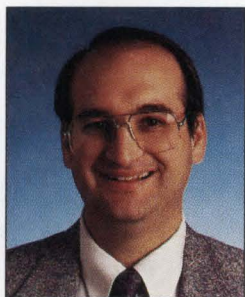

In the days before the world went digital, electrical engineers dealt with physical reality. In fact, their design prowess depended heavily on their ability to subjugate various physical laws armed with little more than a slide rule and a book of engineering formulas. Then came RTL, DTL, HTL, SUHL, ECL, TTL, CMOS, and a host of other abbreviations all translating to one word: digital. Digital electronics threw a lot of physical reality out the window.

For example, in the TTL domain, 2 and 5V mean the same thing. Ditto 0 and 0.5V. Face it; things were sloppy in the digital realm, and we loved it. Recently, Isadore Katz of Meta-Software came by to tell me something that I already knew: The party's over. Physics has returned to electronics. Speeds have increased, and geometries have shrunk to the point where parasitics now have a substantial effect on digital circuit operation.

Katz specifically talked about circuits in deep submicron ICs, but the same is true at the board level. You can't build leading-edge, 0.35- $\mu$ m ICs without seriously sparring with physics, and you can't plop a 200-MHz  $\mu$ P with its support circuitry onto a pc board without a similar analysis. If you want to compete

in today's market, you're sooner or later going to have to work with deep submicron ICs and high-speed pc boards.

In the micron realm, IC designers have been simulating circuit performance for many years. However, to save time, IC circuit simulation has generally coupled linear or piecewise-linear approximations with lumped parasitic elements. Not any more. At 0.35  $\mu$ m, approximations won't get you close to the theoretical maximum clock speeds of the silicon. To really exploit advanced IC-fab processes, you've got to get physical, and that means simulating the real circuit phenomena. Likewise, the era of pc-board design using Kentucky windage has ended; parasitics rule. Wide 64-bit, 200-MHz  $\mu$ P buses present just as many pitfalls as deep submicron ICs.

While Katz's mission was to point out how important his company's HSpice simulator will become for deep submicron IC design, his message really has a much broader scope. No matter which type of design you're doing, if you want to compete, you'd better dust off your physics and sharpen your simulation skills. This time around, however, you're better off leaving the slide rule in its glass display case.

Steven H Leibson  
Editor-in-Chief



Jesse H. Neal  
Editorial Achievement Award  
1990 Certificate, Best Editorial  
1990 Certificate, Best Series  
1987, 1981 (2), 1978 (2),  
1977, 1976, 1975

American Society of  
Business Press Editors Award  
1991, 1990, 1988, 1983, 1981

Send me your comments via fax at (617) 558-4470, or on the EDN Bulletin Board System at (617) 558-4241, 300/1200/2400 8,N,1. From the Main System Menu, enter ss/soapbox and select W to write us a letter.

# Fast 1MHz+ PWMs Control The Current Standard

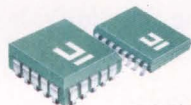

Catch the next generation of PWM control ICs from Unitrode with the UC3823A and UC3825A. Offering the highest speed and greatest protection, these PWMs also eliminate the need for numerous external components.

Rise above the undertow of mediocre performance and take your designs to a higher level with the leader in PWM technology. For literature and free samples contact your Unitrode Representative or call:

**(603) 424-2410**



7 Continental Boulevard, Merrimack, NH 03054  
FAX (603) 424-3460

- ◆ Low start up current
- ◆ Accurate oscillator frequency
- ◆ Leading edge blanking
- ◆ High current totem pole outputs
- ◆ Latched fault logic
- ◆ Full-cycle soft start
- ◆ Restart delay after fault
- ◆ High GBW error amplifier
- ◆ Active low outputs during UVLO
- ◆ Advanced undervoltage lockout

**"THE CURRENT MODE PWM LEADER"**



**INTEGRATED  
CIRCUITS**

**UNITRODE**

## SPEECH-PROCESSING ICs

# Speech-synthesis and -recognition chips personalize consumer products

JOHN GALLANT, Technical Editor

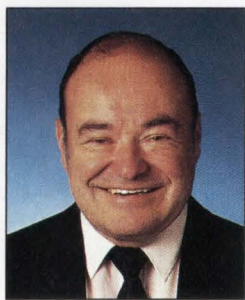

**If speech is the mirror of the soul, then many of today's commercial products will reap their just rewards. Maturation of speech-compression coding algorithms is allowing almost every new device to talk, make audio sounds, and even recognize a human voice.**

Have you ever noticed how virtually every consumer product you buy these days can talk to you? Practically every new toy, learning aid, game, and even some greeting cards can make audible sounds. In addition, multimedia computers, automotive warning systems, appliances, clocks, and equipment for the handicapped all can talk. At the core of these talking devices are speech-synthesis ICs that generate speech from sampled data stored in memory.

The 1980s witnessed a range of technical breakthroughs that enable today's high-quality talking products. Gone are the early days of talking computers, which employed ICs that linked phonemes to generate speech. Although these products could generate unlimited speech, the speech was of very poor quality: At best, it sounded robotic; at worst, it was unintelligible. The techniques that emerged to generate today's high-quality speech are sampled-data systems that take samples of an actual human voice. The systems use data compression for predictive-coding algorithms.

The two most popular predictive-coding algorithms for generating speech are adaptive differential pulse-code modulation (ADPCM) and linear predictive coding (LPC). These algorithms compress speech samples stored in memory while retaining "near-toll-quality" speech. The CCITT defines toll-quality speech as logarithmic PCM-coded data at a sample rate of 8 kHz and a resolution of 8 bits/sample.

The combination results in a bit rate of 64 kbps for toll-quality speech.

## ADPCM has lots of advocates

Oki Semiconductor uses the ADPCM coding system to compress data in the company's speech-synthesis ICs. ADPCM is a variant of DPCM, which reduces the amount of data by quantizing and encoding the differential between speech-signal samples. ADPCM adaptively changes the quantization width, depending on the quantization width of the previous differential sample.

Oki offers synthesizers having internal mask ROM ranging from 128 kbits to 1 Mbit. The company also offers synthesizers with one-time-programmable (OTP) or external ROMs, (Fig 1). The synthesizers have resolutions of 3 or 4 bits/sample and variable

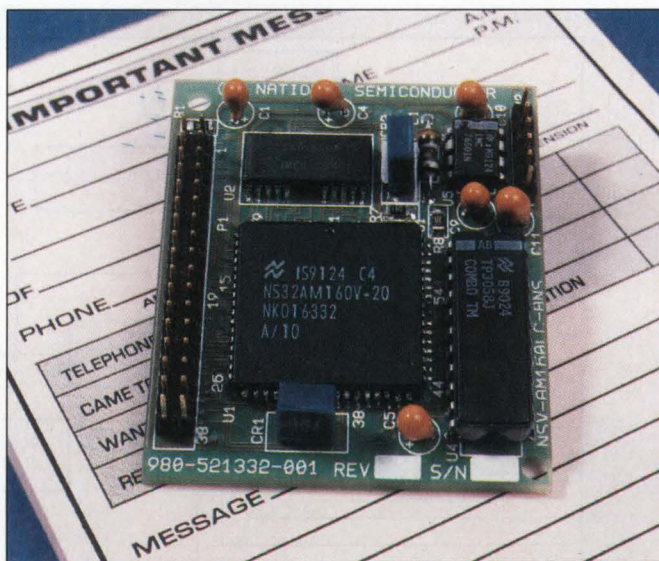

**Cassette answering machines are giving way to digital tapeless answering machines, such as this one from National Semiconductor. The NS32AM160 contains DSP functions, 25 kbytes of ROM, a codec, and 2.1 kbytes of RAM to implement the voice-handling algorithms.**

## SPEECH-PROCESSING ICs

sampling rates from 4 to 16 kHz. A 4-bit ADPCM synthesizer sampling at 4 kHz has a compressed bit rate of 16 kbps. The 4-bit MSM6379 has 512 kbits of OTPROM, which stores 32 sec of speech sampling at 4 kHz. The \$10 (5000) chip comes in a 16-pin DIP and has an internal 12-bit D/A converter and a lowpass filter. You program the device using a dedicated programming tool called Anawriter Mark VII.

Mosel-Vitellic also offers a wide range of speech-processing chips, largely designed into products from Asia, based on ADPCM data compression. The VTV001 has as much as 256 kbytes of memory and variable bit rates from 16 to 32 kbps. The chip also includes a microphone and a preamplifier for voice recording and an 8-bit D/A converter for reproduction.

### LPC models the vocal tract

Texas Instruments employs the other popular coding system, LPC, to compress data in speech-synthesis ICs. LPC attempts to model the human vocal tract. Air from the lungs excites the vocal tract by moving through the vocal chords (two small flaps at the base of the larynx). When producing voiced sounds such as "a" or "e," the vocal chords vibrate to modulate the air from the lungs, thus producing nearly periodic pulses of air. The pitch period determines the sound produced.

## Looking ahead

Speech-synthesis technology has matured through the 1980s and the 1990s. As a consequence, you can purchase powerful speech-synthesis ICs today for only a few dollars or less in OEM quantities. The low added cost of these devices must appeal to commercial-equipment designers because they are including vocal commands in virtually every product under development.

Even speech-recognition technology has made major advances in the past decade. Although the most sophisticated voice recognizers require a computer with megabytes of memory, voice-recognition products designed around DSP chips or embedded processors are powerful subsets of this technology. These speaker-trained devices store a variety of utterances and achieve accuracies greater than 90%, even in the presence of automobile noise. You can expect to see these products in cellular and cordless telephones, handheld personal digital assistants, digital answering machines, and a variety of voice organizers, such as memos, calendars, and to-do lists.

Besides the voiced sounds, generating speech also requires the use of unvoiced—or noise—sounds, such as "s." Turbulent air passing through the open vocal tract produces unvoiced sounds. Above the vocal chords are the pharynx and the oral and nasal cavities, all of which shape the spectrum of the sound. The frequency response of the vocal tract is similar to a tube with constant diameter, which has a number of resonances, or formants.

TI's TSP50C1x family combines an 8-bit  $\mu$ P, a speech synthesizer, ROM, RAM, a D/A converter, and I/O interface ports on a low-cost chip. The chip's LPC model imitates the human vocal tract. The model extracts parameters

from sampled speech to create two excitation generators that model the vocal-chord restrictions for voiced and unvoiced sounds. The model has a gain multiplication stage to model levels of pressure from the lungs and a 12-pole lattice filter that models the shape of the oral cavity. Because the filter has 12 poles, TI calls it LPC-12 (Fig 2).

Because speech changes slowly, the  $\mu$ P accesses parameter samples from memory in frames that are generally 10 to 25 msec long. The device calculates the input parameters to the model as an average of the parameters for the entire frame. The resulting compressed bit rate is effectively 1.5 kbps. The TI devices offer five sizes of internal ROM ranging from 4 kbytes (capable of processing 14 sec of speech) in the \$0.85 TSP50C04 to 32 kbytes (capable of up to 3 minutes) in the \$2.30 TSP50C19. Because the devices are mask programmable, they are available only in minimum-quantity orders of 50,000 units.

TI recommends that external speech-coding services perform speech development for the company's speech-synthesis chips. One external speech developer is Robert Jeffway, who has coded a host of toys and commercial appliances using TI's development tools for speech analysis. You can contact him in Leeds, MA, at (413) 584-0491.

### Toys and games

ESS Technology offers the Sound Magician line of speech- and sound-synthesis chips for the toys and game market. The playback-only chips cost \$0.50 to \$2 in OEM quantities. A customer

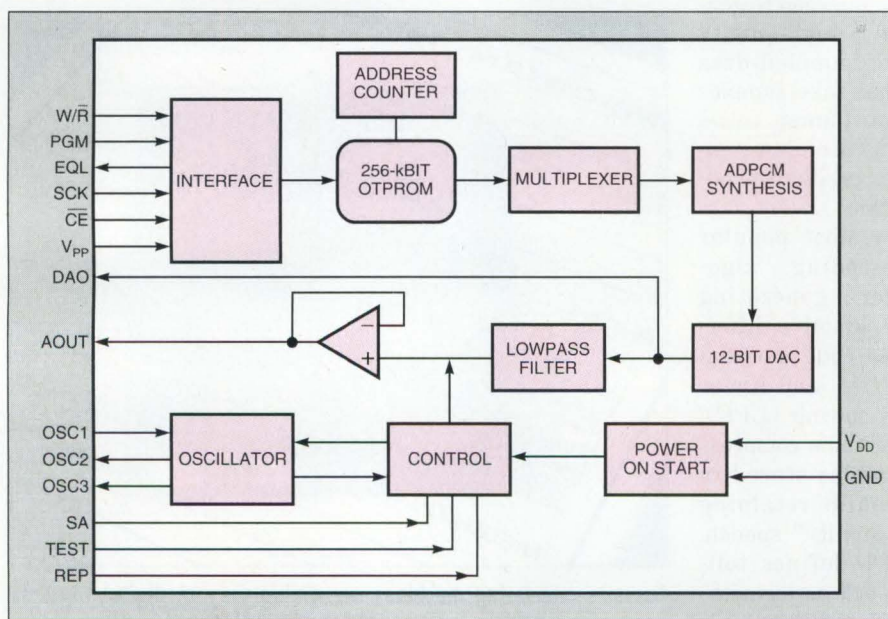

**Fig 1—The MSM6378A chip from Oki Semiconductor is an ADPCM voice synthesizer having 256 kbits of OTPROM. At a 4-kHz sampling rate, the chip stores as much as 16 sec of speech.**



SONY

## VISUALIZE WHAT YOUR PC CAN DO.

Video communications will be the hottest selling feature of tomorrow's PC's. The ingredients for which are available right now in packages as small as 1/4". Just add an optical system to Sony's CCD and supporting Chip Set for a first rate, on-board camera featuring high-quality Hyper HAD<sup>®</sup> technology. Formats are NTSC/PAL color and EIA/CCIR B&W. Supporting IC's for the CCD operating system include video signal processors in either color or B&W. Plus you get Sony's acknowledged expertise in video processing, just by calling 1-800-288-SONY.

It's a nice arrangement: We make the chips, you make the history.

The monitor displays a web browser window titled "Sony CCD News" with the following content:

**Sony A World Leader in CCD Image Sensors.**  
Leading edge technology for CCD Image Sensors

MODEL NO	FORMAT	NTSC	PAL	PIXEL
ICXD260KA	1/2" Color	510H	500H	
ICXD270KA				
ICXD38BNA	1/2" Color	768H	752H	
ICXD39BNA				
ICXD38BNB	1/2" Color	768H	762H	
ICXD39BNB				
ICXD44BKA	1/3" Color	510H	500H	
ICXD45BKA				
ICXD54AK	1/3" Color	510H	500H	
ICXD55AK				
ICXD56AK	1/4" Color	510H	500H	
ICXD57AK				
ICXD58AK	1/3" Color	768H	752H	
ICXD59AK				
ICXD60AK	1/3" Color	768H	752H	

Next to the table is a video communication window titled "Video Communications (CMYK, 1:1)" showing a woman's face.



©1993 Sony Electronics Inc. Sony and Hyper HAD are trademarks of Sony. Sony has a large selection of other CCD's available for immediate application in medical video cameras, surveillance cameras, 2D barcode readers, machine vision and B&W object or character recognition systems.

## SPEECH-PROCESSING ICs

supplies a recording of the desired speech and sound, which the company samples and stores in an on-chip ROM.

In addition, ESS supplies three chips that generate speech and sound for PC applications. The chips employ ADPCM or a patented ESPCM compression coding algorithm. The chips are register compatible with Creative Labs' Sound Blaster board. The \$12 ES488 creates all of the speech and sound of a Sound Blaster board, except music synthesis.

The recently introduced \$18 ES1488 is socket compatible with the ES488 and includes on-chip music synthesis. The \$20 ES688 is a 16-bit stereo chip that features 44.1-kHz sampling for recording and playback of CD-quality music. All of the chips interface with the ISA bus and have drivers for Windows and the Windows Sound System. The chips' audio-application software includes an audio recorder, a talking clock, a calculator, and a volume control. In addition, the chips run on 3.3 or 5V and have power-management fea-

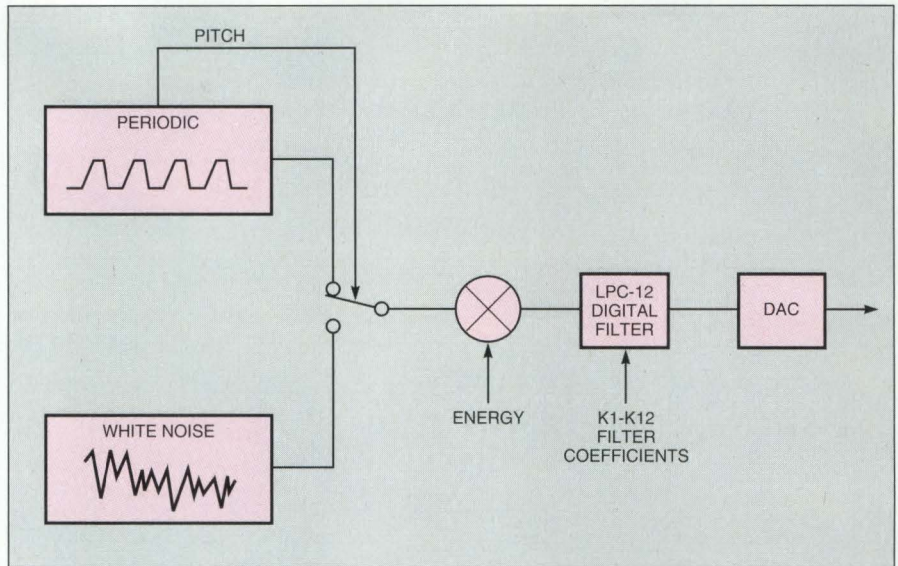

**Fig 2—TI's TSP50C1x family of LPC voice synthesizers model the human vocal tract. Two generators for voiced and unvoiced sounds drive a digital filter, which models the human oral cavity.**

tures for adding sound to portable computers.

National Semiconductor's NS32AM160

and NS32AM161 chips are members of the 32-bit Series 32000/EP family of embedded system processors. Designed for digital answering machines, the \$18 (10,000) chips can also replace microcassettes in dictation machines. The processors integrate the functions of a DSP chip and a system controller. The DSP function compresses and decompresses data using sub-band coding or LPC algorithms.

The processors can execute instructions from on-chip or external ROM. In addition, the chips can detect and generate DTMF tones and provide voice recognition. National supplies the NSvoice algorithmic software to execute the DSP, compression/decompression, DTMF, and tone-generation functions.

Information Storage Devices (ISD) provides a different twist to recording and playback devices for short (10 sec or less) speech applications. The \$5.48 (1000) ISD1100 series stores analog signals directly in single cells as one of 256 levels. Each device provides an oscillator, a microphone preamplifier, automatic gain control, a smoothing filter, and a speaker amplifier on one chip.

Because the ISD chips provide analog storage, they don't require A/D or D/A converters. ChipCoder technology lets you record and rerecord as much as 10 sec of audio without using a special programmer. You can play back the sound through a small external speak-

## For free information...

For free information on the speech-processing products discussed in this article, circle the appropriate numbers on the postage-paid Information Retrieval Service card or use EDN's Express Request service. When you contact any of the following manufacturers directly, please let them know you read about their products in EDN.

### Analog Devices

Norwood, MA  
(617) 329-4700  
Circle No. 320

### AT&T Microelectronics

Allentown, PA  
(800) 372-2447  
Circle No. 321

### Centigram Communication Corp

San Jose, CA  
(408) 944-0250  
Circle No. 322

### Dragon Systems

Newton, MA  
(617) 965-5200  
Circle No. 323

### ESS Technology

Fremont, CA  
(510) 226-1088  
Circle No. 324

### Information Storage Devices

San Jose, CA  
(408) 452-8700  
Circle No. 325

### Mosel-Vitellic

San Jose, CA  
(408) 433-0952  
Circle No. 326

### National Semiconductor Corp

Santa Clara, CA  
(800) 272-9959  
Circle No. 327

### Oki Semiconductor

Sunnyvale, CA  
(408) 720-8940  
Circle No. 328

### Texas Instruments

Denver, CO  
(800) 477-8924  
Circle No. 329

### Vocal Inc

Palo Alto, CA  
(415) 323-5613  
Circle No. 330

### VOTE... . . .

Please also use the Information Retrieval Service card to rate this article (circle one):

**High Interest 592**  
**Medium Interest 593**  
**Low Interest 594**

### Super Circle Number

For more information on the speech-processing products available from all of the vendors listed in this box, you need only circle one number on the postage-paid reader service card.

**Circle No. 331**

## WORLD CLASS D.C. POWER SUPPLIES

**Condor's  
Global Performance®  
switchers offer  
continuous range input,  
full agency approvals  
and more.**

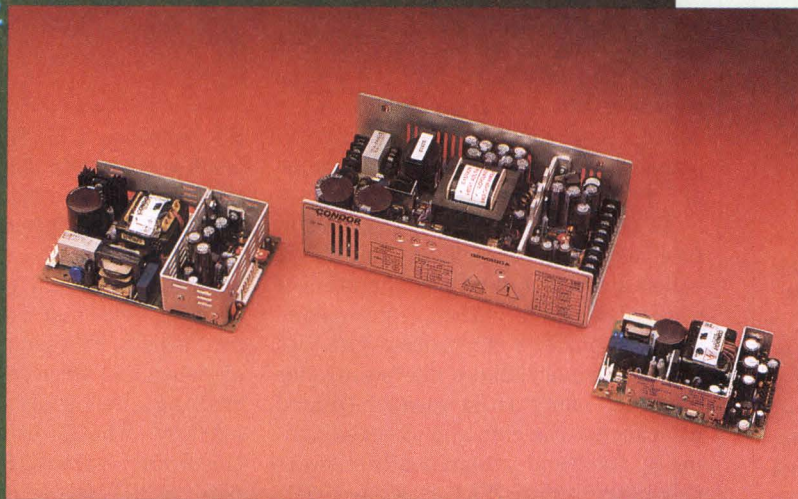

Our Global Performance switchers give you top performance and full agency approvals, including UL1950, CSA22.2 No. 234 Level 3, IEC950, EN60950, VDE0805 Class B EMI and VDE0871 Level B EMI. Medical versions also are available, approved to UL544, IEC601-1, CSA234 Level 3 and VDE0750.

Global Performance switchers have the features you want:

- 71 models (single- and multi-output)
- Industry-standard packages
- 8 power levels (40 to 225W)
- Continuous-input voltage (85-264VAC)
- OVP on all 5V outputs and single-output units
- MTBF 100,000+ hours per Mil Hndbk 217E
- 8-hour burn-in with cycling (24 hours on medical versions)
- Computerized testing (data sheets furnished)
- 2-year warranty
- 30-day FREE evaluation (call us for samples)

If you need world class performance, quick turnaround and competitive pricing, try our Global Performance switchers — the only approval they're missing is yours!

**Call for our  
free catalog,  
or see us  
in EEM!**

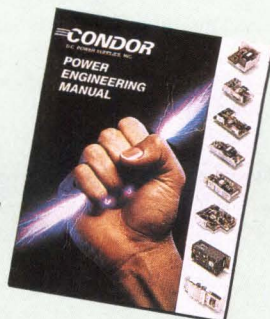

# CONDOR

Condor D.C. Power Supplies, Inc.  
2311 Statham Parkway  
Oxnard, CA 93033  
(805) 486-4565 • FAX (805) 487-8911  
(800) 235-5929 (outside California)

CIRCLE NO. 77

**WE'VE  
EXAGGERATED  
HOW MUCH  
CALCULATING  
POWER IS  
IN NEW  
MATHCAD PLUS 5.0.  
BUT ONLY  
SLIGHTLY.**

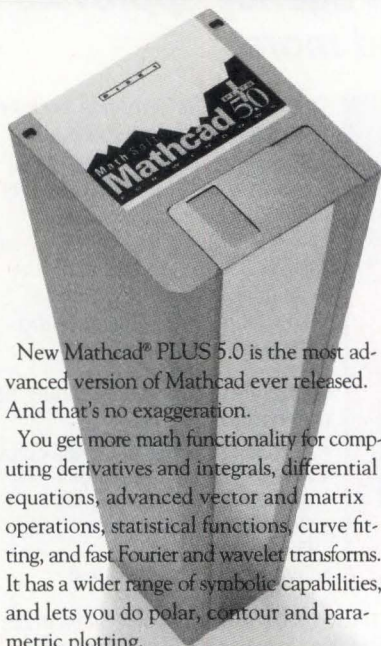

New Mathcad<sup>®</sup> PLUS 5.0 is the most advanced version of Mathcad ever released. And that's no exaggeration.

You get more math functionality for computing derivatives and integrals, differential equations, advanced vector and matrix operations, statistical functions, curve fitting, and fast Fourier and wavelet transforms. It has a wider range of symbolic capabilities, and lets you do polar, contour and parametric plotting.

Simply enter equations in real math notation anywhere in the on-screen worksheet. Add text and graphics, display results in 2-D and 3-D, change variables and instantly update answers. Then print your results in presentation-quality documents.

Best of all, Mathcad PLUS 5.0 is more powerful than spreadsheets or calculators and easier than programming languages. And that's no exaggeration, either.

Mathcad PLUS 5.0 is \$299.95\*. Call now for more information, or mail or fax the coupon below.

Call: 1-800-967-5075 • Fax: (716) 873-0906

**FREE MATHCAD PLUS 5.0 INFORMATION KIT**  
For more information on Mathcad PLUS 5.0,  
mail or fax this coupon. a24a2

Name  Title

Company

Address

City

State  Zip

Country  Phone

MathSoft, Inc. P.O. Box 1018, Cambridge, MA 02142-1519 USA

Phone: 1-800-967-5075 • Fax: 716-873-0906

MathSoft Europe, P.O. Box 58, Livingston, UK EH15 7AE

Phone: +44-506-460373 • Fax: +44-506-460374

© 1994 MathSoft, Inc. TM and ® signify manufacturers trademark or registered trademark respectively. \* Dealer price may vary.

**CIRCLE NO. 4**

## EDN-TECHNOLOGY UPDATE

### SPEECH-PROCESSING ICs

er. The chip is at the heart of Hallmark's recordable greeting cards.

Voice synthesis is only half the story. Many commercial devices can recognize voice commands as well. Because voice-recognition algorithms are more complex than synthesis algorithms, they require the full horsepower of a DSP chip. AT&T has leveraged its expertise based on the DSP16A chip to develop dedicated speaker-trained voice recognizers for telecommunication terminals, such as cellular and cordless telephones. Using ADPCM or code-excited linear-predictive-plus coding, the recognizers store compressed speech that achieves bit rates of 5.2 kbps.

AT&T's latest offering is a hands-free voice processor, called the HVP-S, which provides full-duplex operation of a cellular phone with no microphone suppression. The chip, along with two codecs, memory, and a microcontroller stores as many as 64 speaker-trained utterances. The chip allows speed dialing by voice and automatically answers the phone. The HVP-S with ROM-coded voice-recognizer software sells for less than \$20 (10,000).

Because Analog Devices sells some of its DSP chips for less than \$10, the company is actively recruiting third-party vendors to add speech-processing value to their chips. For example, Centigram Communication adds interactive voice response and text-to-speech value to its 2100 family of DSP chips. You can purchase the product as an adapter card or as integrated chip sets.

Recently, Dragon Systems and Analog Devices received a federal grant to port Dragon's voice-recognition software onto one of Analog Devices' DSP chips. Dragon will develop speech-recognition software to fit available memory and run on a range of DSP chips for handheld personal digital assistants and notebook computers.

#### Voice recognition for faxes

National Semiconductor offers the Dispatch family, which includes three 32-bit embedded processors that incorporate DSP functions and three peripheral controllers. The product permits the use of a single phone line for facsimile and voice communications. It uses software to switch automatically

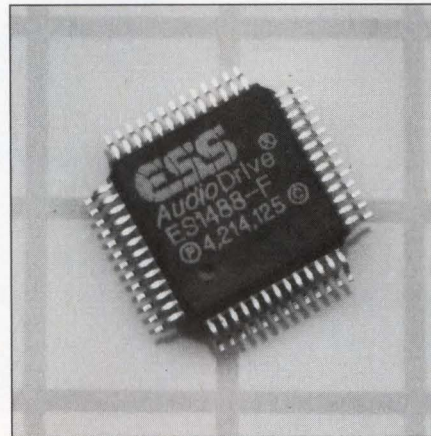

**ESS Technology's ES1488 IC is a complete Creative Labs Sound Blaster board on a single chip. The chip runs on 3.3 or 5V and offers power-management features.**

between send and receive modes or between voice and fax modes. Dispatch uses a set of 25 words to provide speaker-dependent voice recognition for controlling the fax and the answering machine. The lowest configuration of the family—the 32FX161 processor plus the 32X100 peripheral controller—costs \$45 (1000).

Vocal Inc adds voice-recognition software to TI's TMS320C25 DSP chip or National Semiconductor's 32000/EP family of embedded-system processors. The company's TrueWord software stores as many as 100 utterances using a speaker-trained DSP algorithm called Spectral Fit Coding (SFC). SFC compresses sampled audio data to 5 kbps using a minimum-squared error-fitting process.

For systems that already have a TI DSP chip or one of National's embedded processors, Vocal supplies TrueWord as a licensed OEM software product. Otherwise, Vocal offers a 3×6-in. card that contains a processor, a  $\mu$ -Law codec, external RAM, and external ROM. Evaluation units for a TMS320C25 voice computer card cost \$1500. Evaluation units for a voice module card containing a National 3200 family processor cost \$500. EDN

*You can reach Technical Editor John Gallant at (617) 558-4666, fax (617) 558-4470.*

Article Interest Quotient  
(Circle One)

High 592 Medium 593 Low 594

# THE UNIVERSAL DEVICE PROGRAMMER FOR ALL PACKAGE TYPES.

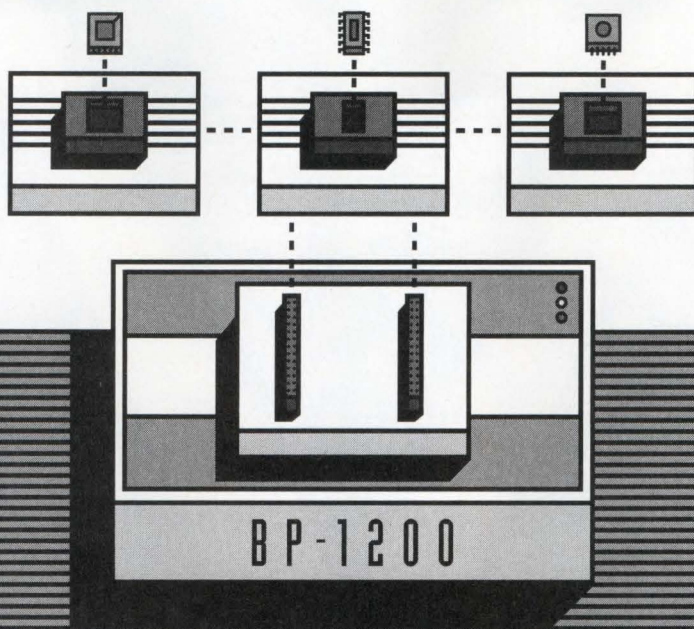

**T**he BP-1200 universal device programmer leads the industry in devices supported, programming speed, ease of use and reliability. With prices starting at \$2495, **free software updates**, and a three year limited warranty,\* the BP-1200 is simply the best choice for those seeking the biggest bang for the buck!

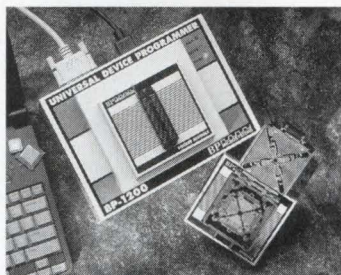

The BP-1200's ability to program virtually every programmable device, including the fastest and largest PLDs, microcontrollers and memories, gives you the freedom to choose the ideal parts for your next design. The BP-1200 also supports all package types. Our full line of interchangeable programming sockets supports DIP, LCC, PGA, PLCC, QFP, SOIC and TSOP devices directly.

The BP-1200 is the first programmer that programs and vector tests devices with up to 240 pins. If you don't need 240 pin support yet, you can start with as little as 32 pin DIP support and upgrade in the field (to 40, 48, 84, 144 or 240 pins) when you need to do so.

The BP-1200 is the fastest universal programmer on the market. Since the BP-1200 connects directly to your PC's printer port, you can program parts in seconds, not minutes. The BP-1200 reads files directly from your hard disk or network, so you won't waste time copying files to a floppy disk or waiting on a serial download.

The BP-1200's high speed, high yields and optional Advanced Feature Software make it ideal for production use, whether you are doing medium volume manual programming or very high volume autohandler production.

Call today for more information about the BP-1200 and a free demonstration disk!

#### DEVICE SUPPORT INCLUDES:

- Altera 7000 series
- AMD MACH parts
- Intel 32M bit flash EPROM
- Intel FX740 and FX780 FPGAs
- Lattice pLSI and ispLSI devices
- Microchip PIC microcontrollers
- Motorola 68HC705 and 68HC711 families
- over 3270 devices from over 66 manufacturers

## BP MICROSYSTEMS

BP Microsystems, Inc. • Houston, TX

1-800-225-2105

\*Only on BP-1200s purchased in the U.S. after September 15, 1993. Some restrictions and exclusions apply. Features and specifications subject to change without notice. Call for details.

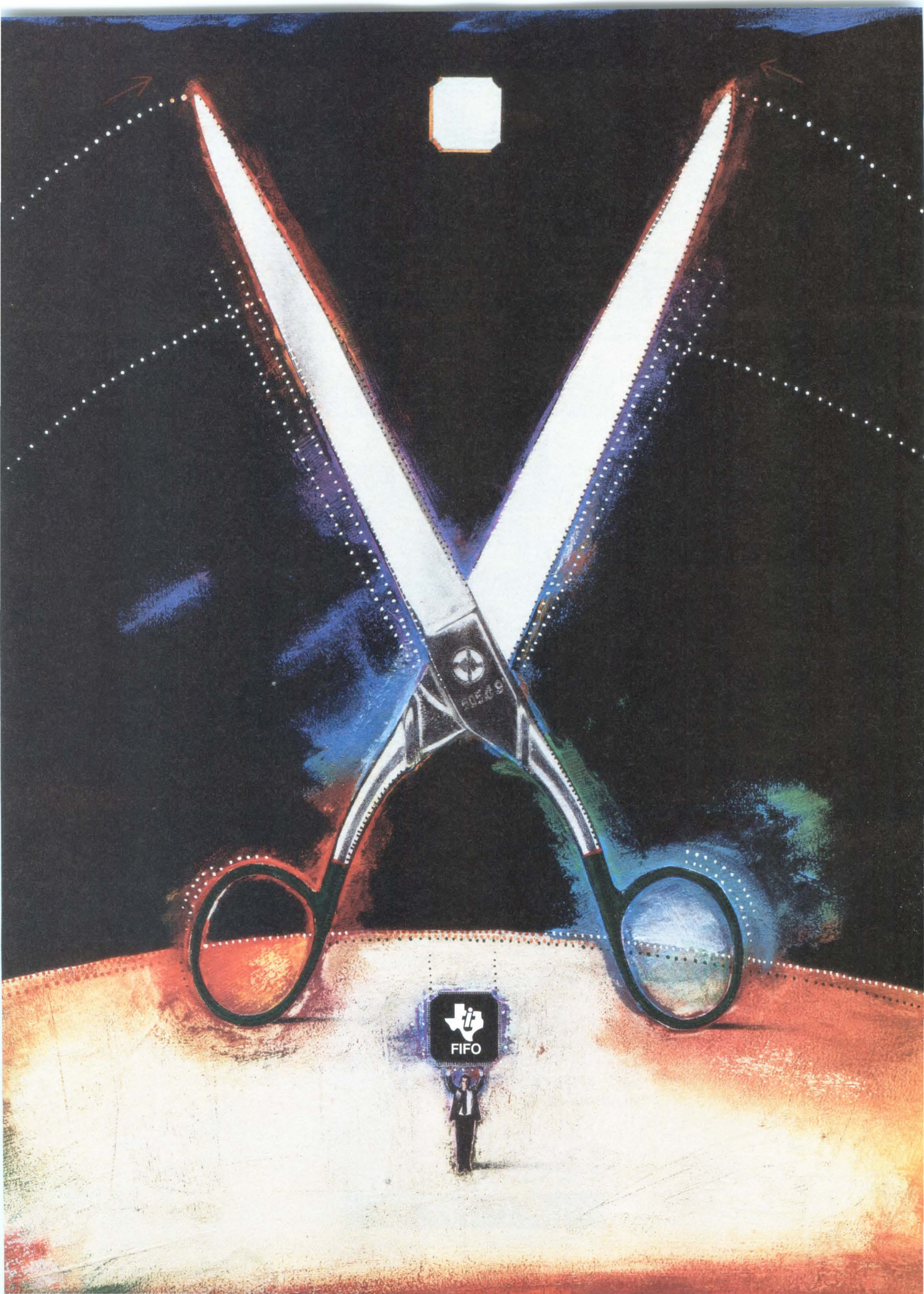

# High-Bandwidth Computing and Internetworking. Most FIFOs just aren't cut out for these applications. TI's are.

Texas Instruments FIFOs fit your applications like they were made for them. Because they are.

## High-bandwidth computing FIFOs.

Parallel processing systems using RISC and X86 CPU architectures demand reduced latency and increased data integrity levels. TI's high-bandwidth computing FIFOs allow faster transfer speeds and higher reliability by providing quick access times, parity generation and checking and bidirectional mailbox registers.



### High-Bandwidth Computing FIFO Features

- Parity generation and checking for data integrity
- Bidirectional mailbox registers allow priority information to bypass FIFO memory for immediate use
- Clocked architecture for improved data throughput and system integration

## Internetworking

**FIFOs.** Internetworking end equipment such as switches, hubs, bridges and routers provides connectivity and interoperability between the various LANs and WANs. Our internetworking FIFOs aid in protocol conversion by incorporating byte swapping and bus matching features to control the flow of information.



### Internetworking FIFO Features

- In addition to high-bandwidth computing features:
- Byte swapping allows you to manipulate byte-wide data to match the different host CPU data requirements of the network
  - Bus matching allows for efficient conversion between differing LAN and WAN protocols

## Why compromise?

These are just a part of TI's application-specific FIFOs. So rather than compromising with

traditional off-the-shelf FIFOs or custom solutions, you can buy an application-specific solution. One that helps you cut design time, reduce board and memory space and increase system performance.

At TI, FIFO means fast in, fast out.

TI's advanced FIFO portfolio offers solutions in standard and fine-pitch packaging. Architectures range from 64 to 4K word depths and 1- to 36-bit widths. High-speed clocked architectures feature multi-stage synchronization circuitry for improved metastability characteristics.

## More than FIFOs.

With our FIFOs you get the Total Integration™ benefits you've come to expect from TI: leading-edge silicon, technical information, design tools and worldwide service and support.

So if you're ready to begin using FIFOs that are really cut out for the job, return the reply card or **call 1-800-477-8924, ext. 3033**, today.

And discover the FIFOs that really fit your applications.

EXTENDING YOUR REACH  
WITH TOTAL INTEGRATION™



# Rides Any Bus.

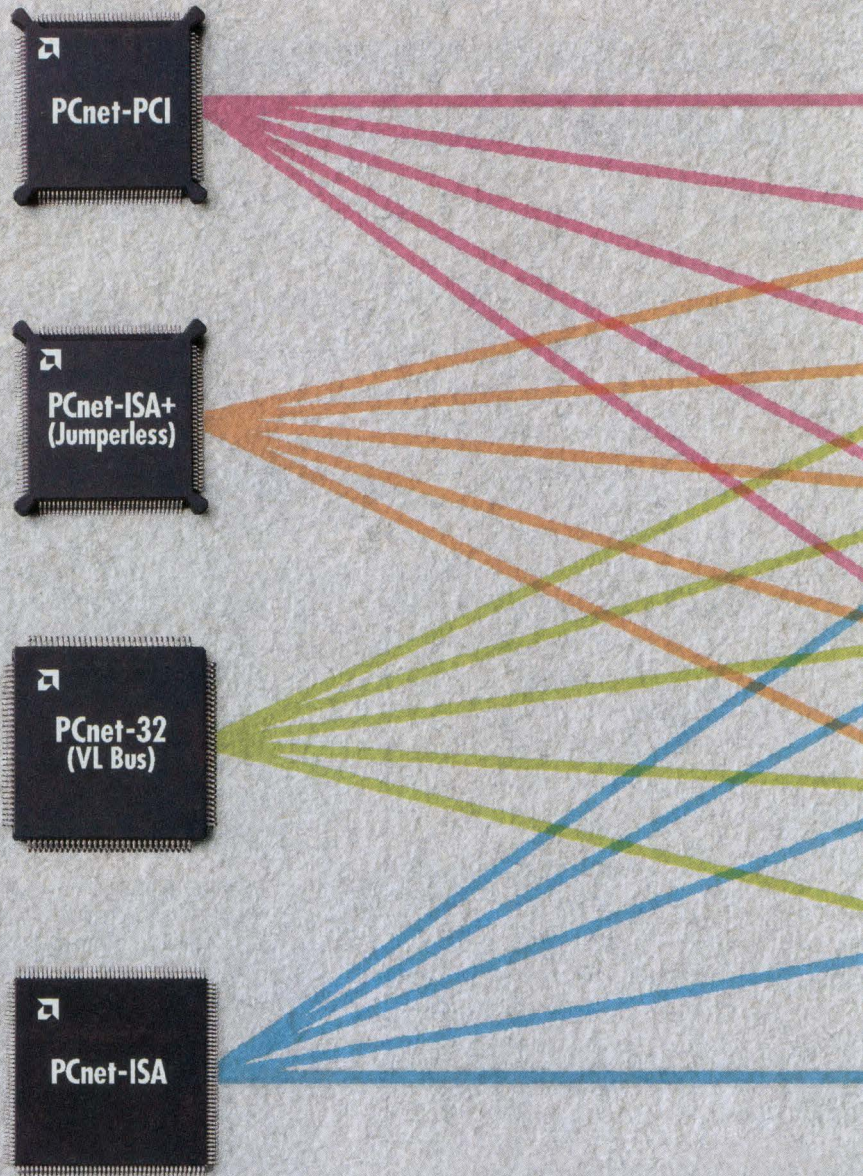

## Presenting The PCnet™ Family: Software-Compatible Ethernet Controllers That Address All Of Your Bus Needs.

Here's a prime example of how to get along with everyone — with the PCnet Ethernet controller family from Advanced Micro Devices. PCnet controllers are compatible with the most popular PC bus architectures, the most popular Network Operating Systems (NOS), and the entire controller family uses the same driver for each NOS.

It's the Ethernet controller family NOS vendors are already quite familiar with. In fact, it's vendor certified as 100% compatible with operating systems like NetWare®, Windows NT™, LAN Manager, and LANtastic®.

What's more, the PCnet family uses a high performance Bus Mastering architecture, for higher throughput and lower CPU utilization.



# Talks To Any Driver.

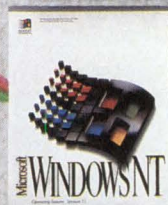
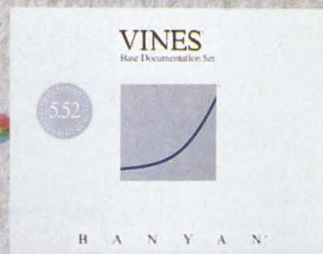

Plus, your designs require no extra memory, saving you board space, money, and power. For additional power savings, PCnet devices support two power-down modes for notebook and green PC designs.

Virtually any design will love the PCnet controllers, since they're available now in VL, PCI, and jumperless Microsoft Plug and Play ISA versions. And our new PCnet-SCSI combines both high performance Ethernet and SCSI capabilities.

For more information on the PCnet family, call AMD® today. Soon your next PC will be talking to everyone.

800-222-9323



Ask for Literature Pack 18S.



**Advanced Micro Devices**

CIRCLE NO. 38

The Network Operating Software displayed in this ad is reprinted by permission from their respective holders.

EDN February 17, 1994 • 39

# CURRENT SHOWCASE

## BiMOS II 32-Bit Serial-Input, Latched Source Drivers with Active DMOS Pull-Downs — 5818-F

Designed primarily for use with vacuum fluorescent displays, the 5818-F is a smart power BiMOS II driver that combines DMOS shift registers, data latches, and control circuitry, with bipolar high-speed sourcing outputs and DMOS active pull-down circuitry.

- 60 V or 80 V Source Outputs
- High-Speed Source Drivers
- Active DMOS Pull-Downs
- Low-Output Saturation Voltages
- Low-Power CMOS Logic and Latches
- 3.3 MHz Minimum Data Input Rate
- Reduced Supply Current Requirements



## BiMOS II Unipolar Stepper-Motor Translator/Driver — 5804

Combining low-power CMOS logic with high-current and high-voltage bipolar outputs, the 5804 BiMOS II translator/driver provides complete control and drive for a four-phase unipolar stepper-motor.

- 1.5 A Maximum Output Current
- 35 V Output Sustaining Voltage
- Wave-Drive, Two-Phase, and Half-Step Drive Formats
- Internal Clamp Diodes
- Output Enable and Direction Control
- Power-ON Reset
- Internal Thermal Shutdown Circuitry

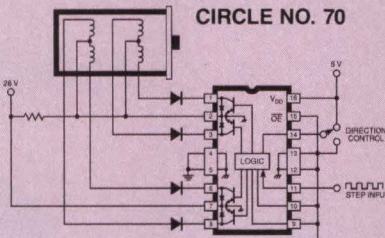

## BiMOS II 32-Bit Serial-Input, Latched Drivers — 5832

Intended originally to drive thermal print-heads, the 5832 has been optimized for low output-saturation voltage, high-speed operation, and pin configurations most convenient for the tight space requirements of high-resolution printheads.

- 5 MHz Typical Data Input Rate
- Low-Power CMOS Logic and Latches
- 40 V Current Sink Outputs
- Low Saturation Voltage

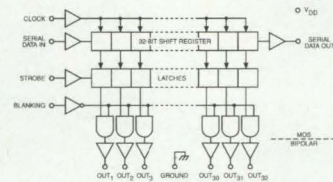

## BiMOS II Latched Drivers — 5801

The 5801 latched-input BiMOS IC merges high-current, high-voltage outputs with CMOS logic.

- 4.4 MHz Minimum Data Input Rate
- High-Voltage, High-Current Outputs
- Output Transient Protection
- CMOS, NMOS, TTL Compatible Inputs
- Internal Pull-Down Resistors
- Low-Power CMOS Latches

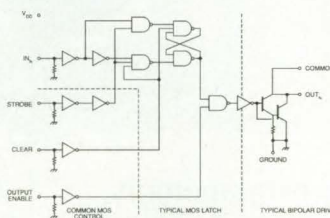

## Take A Test Drive... Call For Samples

Try these Allegro ICs in your breadboard. You'll find that you'll reduce your component count, increase reliability through use of monolithic solutions and protection features, as well as potentially lowering overall manufacturing costs. Samples and detailed technical information are available. Just give us a call.

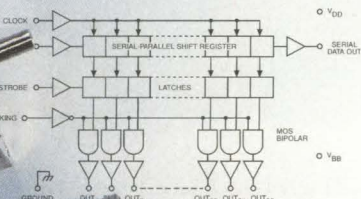

CIRCLE NO. 69

CIRCLE NO. 71

CIRCLE NO. 72

## THE PACE QUICKENS



FORMERLY SPRAGUE SEMICONDUCTOR GROUP

CALL 1 • 508 • ALLEGRO

115 Northeast Cutoff, Worcester, Massachusetts 01615

# Shrinking devices put the squeeze on system packaging

CHARLES H SMALL, Senior Technical Editor



**While solving today's system-packaging puzzles, you can design products that are not only smaller but more reliable.**

The trick to turning today's packaging problems into challenges is to shrink your product's parts count—not just its size—thereby increasing reliability (Ref 1). Simply deleting parts from your system haphazardly (often called “Muntzing”) can lower costs but also can scuttle your system's reliability.

Packaging problems arise simply because electronic devices are simultaneously getting smaller, faster, and more complex. Even inductor makers, such as Pico Electronics and Coiltronics, now offer surface-mount coils and transformers. These developments concentrate heat sources and ordain more connections in a smaller area.

As digital-clock speeds inexorably push beyond 50 MHz, transmission-line effects dominate the signal integrity of such systems. Higher clock speeds tax the signal integrity of pc boards, cables, and connectors.

Consumer demand plays a part, too. Users expect your new products to be more flexible and powerful than your old products were. Yet they also want your new products to fit into smaller, lighter packages and run twice as long as before on battery power.

## New-age packaging

Motorola's new Series 900 VMEbus computers provide several examples of how to reduce costs while increasing reliability. The personnel Motorola employed in the computers' development also provides a lesson for management.

Motorola's computer-system designers ran into an

all-too-common marketing problem: Motorola's customers could not forecast precisely which computers they would need. So the new system needed to be as flexible as possible. “No problem,” you say. “Electronic engineers have always designed modular products.” But Motorola decided that, along with being modular, the new computers would use as few parts as possible. After all, every part provides a chance for error.

The resulting design (Fig 1) required innovative electronic engineering. Where the old line had 600 parts, the new computers have only 190 parts. For example, this VMEbus system has no backplane; instead the cards simply stack using conventional connectors. Unfortunately, Motorola is not

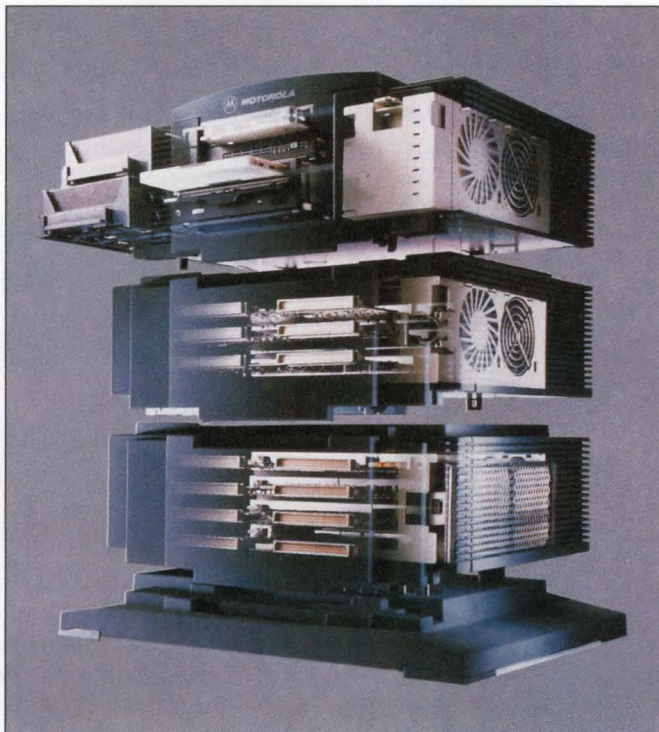

**Fig 1—Innovative packaging has sharply reduced the number of mechanical components in Motorola's Series 900 VMEbus computers.**

## SYSTEM PACKAGING

disclosing how it made the stacking cards meet the VMEbus spec. (Connector manufacturers, such as Augat, happily provide you with Spice models for their connectors so that you can attempt to duplicate Motorola's feat.)

The computer also incorporates clever inputs from novel members of the design team: experts in molding plastic. If you remove the nonstructural plastic case of a conventional PC, you see several sturdy sheet-metal subframes cradling various parts of the computer. Lots of sheet-metal screws fasten this Erector-set assembly together. Wires and cables also abound, as do clamps and brackets to hold them.

In contrast, Motorola's plastics engineers made the plastic cases structural. They also provided molded-in supports wherever possible, dramatically reducing the mechanical parts count. Eschewing nuts, bolts, and screws, the designers made virtually every component snap into place—even the power supply. Simple, light-gauge sheet-metal cabinet liners serve only as RF shielding and also snap into place. Motorola's old line had 300 fasteners and 50 wires and cables. The new computers have only eight fasteners and two cables.

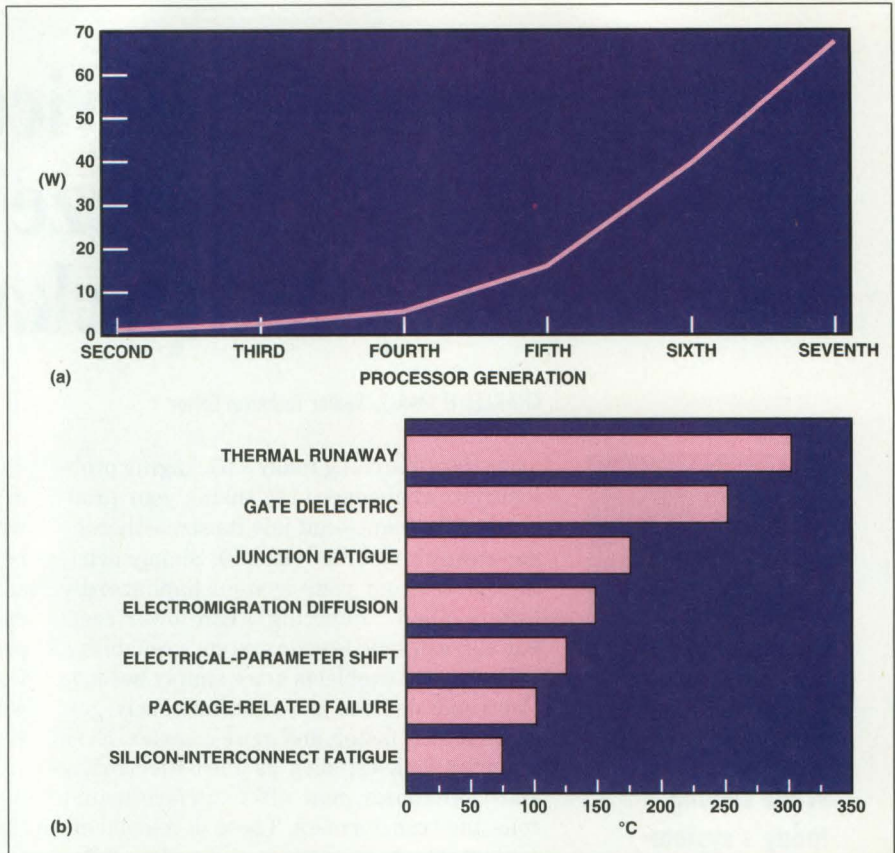

**Fig 2—**The graph in (a) shows that as clock speed climb, so does power dissipation. The graph in (b) shows the relationship between overtemperature and various kinds of failures. (Courtesy of Aavid Engineering)

## Solving the world's toughest electronics packaging problem

A couple of specs tell you more than you would ever want to know about the terrifying packaging problems facing the Cray III's designers: A 4-processor Cray III has 62,738 GaAs ICs running at a clock speed of 480 MHz and dissipating 90 kW in a machine the size of a washing machine.

For starters, the designers did not fasten the custom GaAs ICs to the surface of the supercomputer's petite (25×25-mm) pc boards. Instead, each chip has gold bonding wires that stand vertically to the chip's surface. Then, machinery inserts the wires into holes on the pc board and swages the wires into place, leaving the chip standing on little stilts a tiny bit above the board's surface. This way, cooling can get to both sides of the chips.

After stacking boards into modules, ingenious "pins," rather than conventional connectors, make board-to-board contact vertically within the

module (**Fig A**). The pins provide electrically fast and clean connections. Machinery tightly twists several strands of gold-plated beryllium-copper wire into a diminutive rope, or "pin."

At precise intervals, the machinery then untwists the wires, forming a springy, basket-like lump in the pin. Last, the machinery pulls these pins down through a stack of pc boards where the untwisted sections form a gas-tight seal with plated holes in the pc boards. Preserving signal integrity, flexible circuit boards make I/O connections from module to module. (Contact Rogers Corp for information on flexible circuit boards.)

Lastly, and heroically, designers dunked the entire supercomputer into Fluorinert to provide cooling. Pumps circulate the Fluorinert through the modules and around the ICs to pick up heat. The Fluorinert then goes to a remote chiller before being cycled back to the supercomputer.

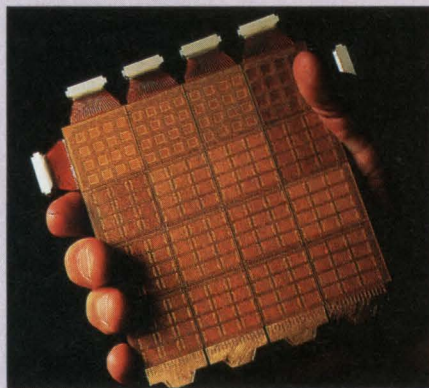

**Fig A—**The Cray III vertically stacks assemblies of 16 tiny, 1-in.-square pc boards into modules. Special "pins" connect the assemblies vertically. Comprising many such modules, the complete computer runs submerged in a cooling bath of Fluorinert.

# AT&T's Distributed Power. Helping Silicon Graphics catch a fast-closing market window.

What do you do when you're building an advanced workstation product...you're approaching your market window...and you can't get the performance you want with the power you've got?

Silicon Graphics

turned to

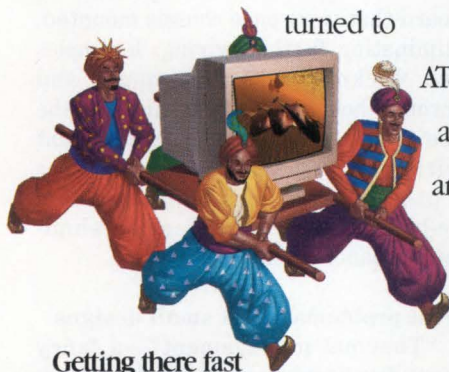

Getting there fast by distributing the load

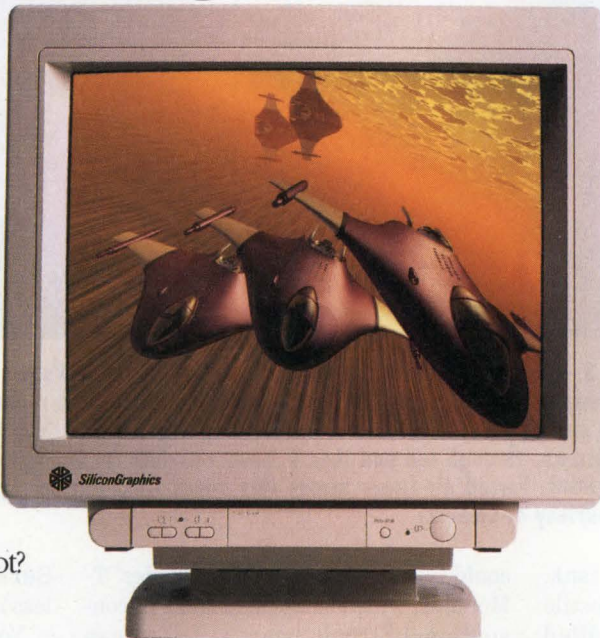

Powerful performance on-time and on-budget

AT&T Power Systems and got an innovative answer. By replacing centralized power with AT&T's Distributed Power Architecture, they were able

to add power to their work-in-progress without costly re-engineering and release delays. To create and



The power of increased functionality

manage different power configurations. To mix 5V, 3.3V and 1.5V outputs. To use one design for multiple platforms. And to power-up-and-down without any problems.

All with the support of an AT&T Power Systems

Team, which included AT&T Bell Laboratories designers, to help them meet their performance and marketing goals.

For more about the advantages of AT&T's Distributed Power Architecture for a wide range

## AT&T Power Systems. The Power To Do More.

of advanced graphics, telecommunications and EDP applications, call AT&T at 1 800 526-7819. For other AT&T Microelectronics literature or information, call 1 800 372-2447, ext. 913. In Canada, call 1 800 553-2448, ext. 913.

Workstation screen image courtesy of Ginkgo Designs, San Francisco. Silicon Graphics and the Silicon Graphics brand and logo are registered trademarks of Silicon Graphics, Inc.



**AT&T**  
Microelectronics

## SYSTEM PACKAGING

Reducing a chassis's parts count doesn't necessarily mean switching to plastic. Triple E Corp's Triple E card cage significantly reduces the number of parts in a card cage without abandoning all-metal construction. The company assembles VMEbus, VXIbus, Multibus II, Futurebus, AT, and EISA card cages from just five pieces: three extrusions and two stampings.

## Powerful or flexible?

Although some soothsayers and pundits envision all-in-one electronics products, such as a combination TV, phone, encyclopedia, and facsimile machine, users have shown themselves willing to customize products themselves. However, other than mucking out your own septic tank, it's hard to imagine a more user-hostile chore than installing a so-called "adapter" into a PC. Yet, PC users have bought an amazing number and variety of add-in pc boards.

You could make your product more flexible by designing with expensive in-circuit-programmable logic. Or you

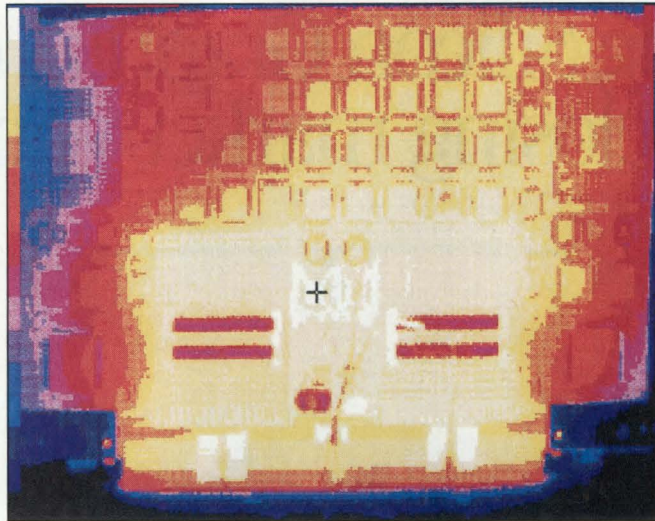

**Fig 3—This pc board contains two heat-sinked Pentium  $\mu$ Ps, which occupy the yellow areas having two red bars. The image renders the coolest parts of the board in blue, dropping down through the spectrum, through red and then yellow, to white for the hottest portions. Forced air flows across this board from left to right. (Courtesy of Compix)**

could try Free Frame Technologies' T-Modules, which comprise stacks of conventional circuit boards. Users can swap T-Modules in and out of small computers without fooling with screws or cables. Cutouts in the case locate one end of the modules, and the other end slips into a mother-board socket. Spring strips on the lid of the comput-

er's case hold the modules in place.

Just like the designers of the T-Module, you can substitute board-to-board "mezzanine" connectors for cables. Connector manufacturers are competing to see who can make the lowest profile connector. Samtec Micro Stripe connectors consist of alternating layers of conductive and nonconductive silicon rubber. The connectors can match 0.020-in. pc-board pad spacing and connect two pc boards that are 0.125 in. apart. Specialty Electronics offers 1-mm receptacles, pin headers, and shunts that rise 0.067 in. above the pc board. Augat's Millipede surface-mount 1-mm connectors rise 0.116 in. (female) and 0.130 in. (male) above the pc board.

Surface-mount connectors are much less noisy than through-hole connectors.

You can also mount components on board that were once chassis mounted, eliminating further wiring. Examples are Wickman's surface-mount and through-hole fuses, which eliminate the use of a fuse holder and its attendant wiring. Oxley's 2-part lamp comprises a panel-mounted lens that mates to a pc-board-mounted LED, again eliminating panel wiring.

## Looking ahead

First and foremost, the so-far inexorable increase in  $\mu$ P clock rates will continue to flog digital engineers, causing them to brush up on their transmission-line theory. And users will demand that PCs provide features such as multimedia and character recognition. Voice I/O and other forms of signal-processing will drive analog engineers into the digital domain. RF engineers will be busy designing the small, portable products that will set the 900-MHz band buzzing with wireless-network traffic.

Packaging will obviously have no choice other than to become denser. Today's peripheral connections to ICs will first give way to 2-D schemes along the lines of IBM's "flip-chip" technology. Ultimately, pc-board designers will have to enter the third dimension by stacking ICs. Or IC makers will have to produce 3-D (multiple-layer) devices.

These high clock speeds and 3-D designs present an interesting challenge to circuit-simulator makers, which have heretofore had to handle only low-speed, planar circuits.

To contend with finer lines and more layers, pc-board makers will have to adopt Star Wars technology. Vacuum deposition of thin-film traces and laser-drilled vias are techniques that could replace today's mechanical and chemical pc-board methods. The methods that a few multichip modules (MCMs) use today will become commonplace throughout the industry.

## Heat problems haunt small designs

"Thermal management"—a fancy term for keeping your product from burning up—is the bugaboo that constantly haunts shrinking designs. Never forget that every 10°C rise in operating temperature roughly doubles your product's failure rate.

**Fig 2a** illustrates the effects of increasing temperature. The new Pentium  $\mu$ P typifies today's high-speed, complex digital devices (**Fig 2b**). Notebook-computer makers would love to ship Pentium-equipped products. Unfortunately for them, a 66-MHz Pentium dissipates more wattage than the notebook computers' thin packages can conduct to the outside world.

**Fig 3** shows a pc-board containing two heat-sinked Pentium  $\mu$ Ps. The image renders the coolest parts of the board in blue, dropping down through

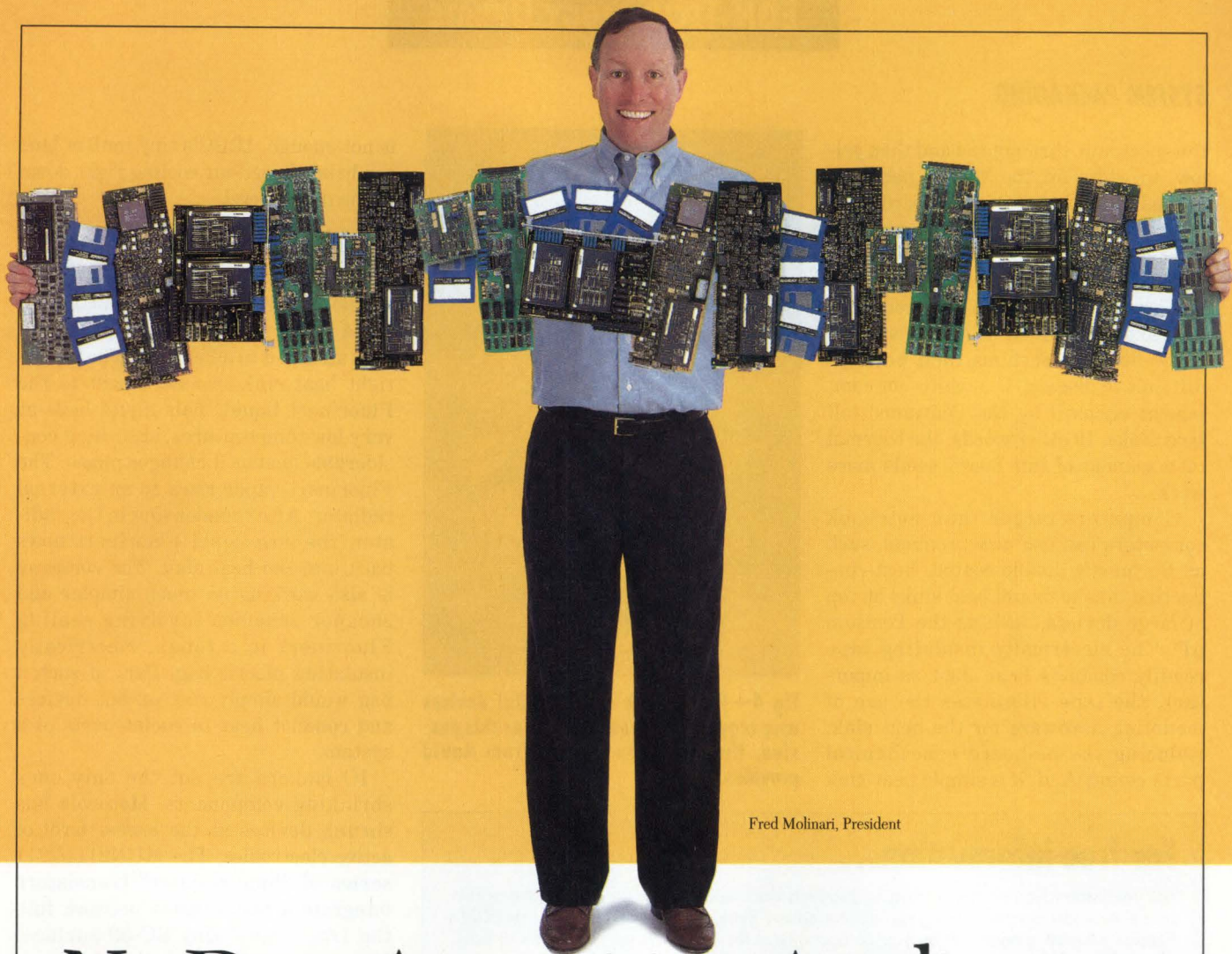

Fred Molinari, President

# No Data Acquisition Application Is Beyond Our Grasp.

Whether you're making scientific measurements to 24-bit resolution, performing FFTs in real time, or looking for a robust yet low cost solution, Data Translation has the right data acquisition solution for you. With more than 300 products, you can easily find exactly what you need.

Using our Windows-compatible software, you'll get your project up and running faster than ever. For immediate application gratification, choose one of our icon or menu-driven packages and you'll be acquiring data within minutes. Develop your applications using one of our DT-Open Layers™ compliant software tools, and rest assured that your code will run any supported board with little or no reprogramming.

DT VEE™ is based on HP VEE for Windows™

#### SOFTWARE

- DT VEE for Windows visual programming package
- Visual Basic Custom Controls for high speed plotting, data acquisition
- Extensive C drivers and DLLs for DOS & Windows

#### HARDWARE

- Up to 224 analog inputs
- Up to 1 MHz throughput
- Highest accuracy in the industry
- Simultaneous sampling
- Onboard DSP

Whatever your needs, call Data Translation first. We have it all: the right hardware, easy-to-use software, and exceptional pre- and post-sales customer support.

And that's quite a handful.

**FOR MORE INFORMATION, CALL 1-800-525-8528, EXT.**

**DATA TRANSLATION®**

UK Headquarters: (0734) 793838, Germany Headquarters: (07142) 95 31-0, France Headquarters: 50.45.95.83, Italy Headquarters: (39) 30242-5696. Sales Offices: Australia 2699-8300; Austria: (222) 36-7660; Belgium (02) 466.81.99; Brazil 11564-6024; Canada (416) 625-1907 or (800) 268-0427; Denmark (45) 4227-4511; Finland (358) 0351-1800; Greece (30) 1361-4300; Hong Kong (852) 515-0018; India (91) 2223-1040; Israel (972) 954-5685; Japan (81) 33502-5550 or (81) 335379-1971; Korea (82) 2718-9521; Malaysia (60) 3248-6786; Mexico (52) 5575-6091, (52) 5575-6098; Netherlands (31) 70399-6360; New Zealand (64) 9415-8362; Norway (47) 22434150; Poland 4822 580701; Portugal (351) 1793-4834, (351) 1793-4934; Singapore (65) 336-4767; South Africa (27) 12803-7680/93; Spain (34) 1555-8112; Sweden (46) 8765-0208; Switzerland (41) 1386-8686; Taiwan (88) 62303-9836; Turkey (90-1) 288-6213 (90-1) 288-6215

## SYSTEM PACKAGING

the spectrum, through red and then yellow, to white for the hottest portions. Forced air flows across this board from left to right.

The two Pentiums occupy the large yellow area. Each Pentium has a pair of horizontal, equals-sign-like red bars (an artifact of their heat sinks). Between the Pentiums (and perhaps difficult to discern) is a white-hot component eclipsed by the Pentiums' tall heat sinks. In other words, the thermal management of this board needs more work.

Computers larger than notebook computers can use new products, such as Berquist's double-coated, heat-conducting tape to mount heat sinks on top of large devices, such as the Pentium  $\mu$ P. The electrically insulating tape readily conducts heat. Just as important, the tape eliminates the use of mounting hardware for the heat sink, reducing the pc-board's mechanical parts count. And, if a simple heat sink

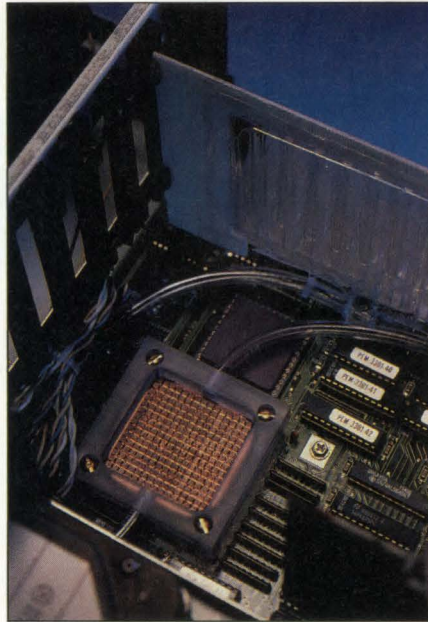

**Fig 4—Future high-speed digital devices may require liquid cooling, such as this passive, thermosiphon system from Aavid provides.**

is not enough, IREC's tiny muffin fans can bring forced-air cooling right down to the device level.

### Sweating the details

For really tight packaging, Aavid is developing liquid-cooled heat sinks. Fig 4 shows such a thermosiphon heat sink attached to a Pentium. The liquid-tight heat sink transfers heat to the Fluorinert liquid. This liquid boils at very low temperatures, absorbing considerable heat as it changes phase. The Fluorinert vapor rises to an external radiator. After condensing in the radiator, the now-liquid Fluorinert flows back into the heat sink. The company is also working on much simpler and cheaper schemes involving sealing Fluorinert in a tough, electrically insulating plastic bag. Part of such a bag would simply rest on hot devices and conduct heat to cooler parts of a system.

IC makers are not the only ones shrinking components. Motorola has shrunk devices at the lowest level of active electronics. The MUN2111/2211 series of "bias-resistor" transistors integrate a bias-resistor network into the transistors' tiny SC-59 surface-mount package. Using these devices brings down the component count and the real estate consumed, but not the heat dissipated.

Ohmite has shrunk even the humble power resistor, providing a compact but concentrated source of heat that you must somehow remove. Ohmite screens some models of its power resistors onto a thermally conductive ceramic substrate. Other models use an even more thermally conductive, enameled, porcelain-coated steel substrate. The ceramic-substrate resistors can dissipate 10W/in.<sup>2</sup>, and the steel-substrate resistors can dissipate 20W/in.<sup>2</sup>. The planar construction results in low inductance (50 nH at 1 MHz typ).

EDN

## For free information...

For free information on the packaging products discussed in this article, circle the appropriate numbers on the postage-paid Information Retrieval Service card or use EDN's Express Request service. When you contact any of the following manufacturers directly, please let them know you read about their products in EDN.

**Aavid Engineering Inc**  
Laconia, NH  
(603) 528-3400  
Circle No. 301

**Augat**  
Attleboro Falls, MA  
(508) 699-7646  
Circle No. 302

**The Berquist Co**  
Edina, MN  
(612) 835-2322  
Circle No. 303

**Coilcraft**  
Cary, IL  
(800) 322-2645  
Circle No. 304

**Cray Computer Corp**  
Colorado Springs, CO  
(719) 579-6464  
Circle No. 305

**Compix Inc**  
Tulatin, OR  
(503) 639-8496  
Circle No. 306

**Free Frame Technologies**  
San Jose, CA  
(408) 254-1462  
Circle No. 307

**IREC**  
Burbank, CA  
(213) 849-2481  
Circle No. 308

**Motorola Computer Group**  
Tempe, AZ  
(800) 759-1107, ext 852  
Circle No. 309

**Motorola Semiconductor Products**  
Phoenix, AZ  
(602) 244-3742  
Circle No. 310

**Ohmite**  
Skokie, IL  
(708) 675-2600  
Circle No. 311

**Oxley Inc**  
Branford, CT  
(203) 488-1033  
Circle No. 312

**Pico Electronics Inc**  
Mt Vernon, NY  
(914) 699-5514  
Circle No. 313

**Rogers Corp**  
Chandler, AZ  
(602) 961-1382  
Circle No. 314

**Samtec Inc**  
New Albany, IN  
(812) 944-6733  
Circle No. 315

**Specialty Electronics Inc**  
Landrum, SC  
(803) 457-2424  
Circle No. 316

**Triple E Corp**  
Lowell, MA  
(508) 453-0600  
Circle No. 317

**Wickman USA**  
Atlanta, GA  
(404) 699-7820  
Circle No. 318

### Super Circle Number

For more information on packaging products available from all of the vendors listed in this box, you need only circle one number on the postage-paid reader service card.

Circle No. 319

## Reference

1. Nordwall, Bruce D, "Companies Reduce Solder to Increase Reliability," *Aviation Week & Space Technology*, December 6, 1993, pg 50.

Article Interest Quotient  
(Circle One)

High 598 Medium 599 Low 600



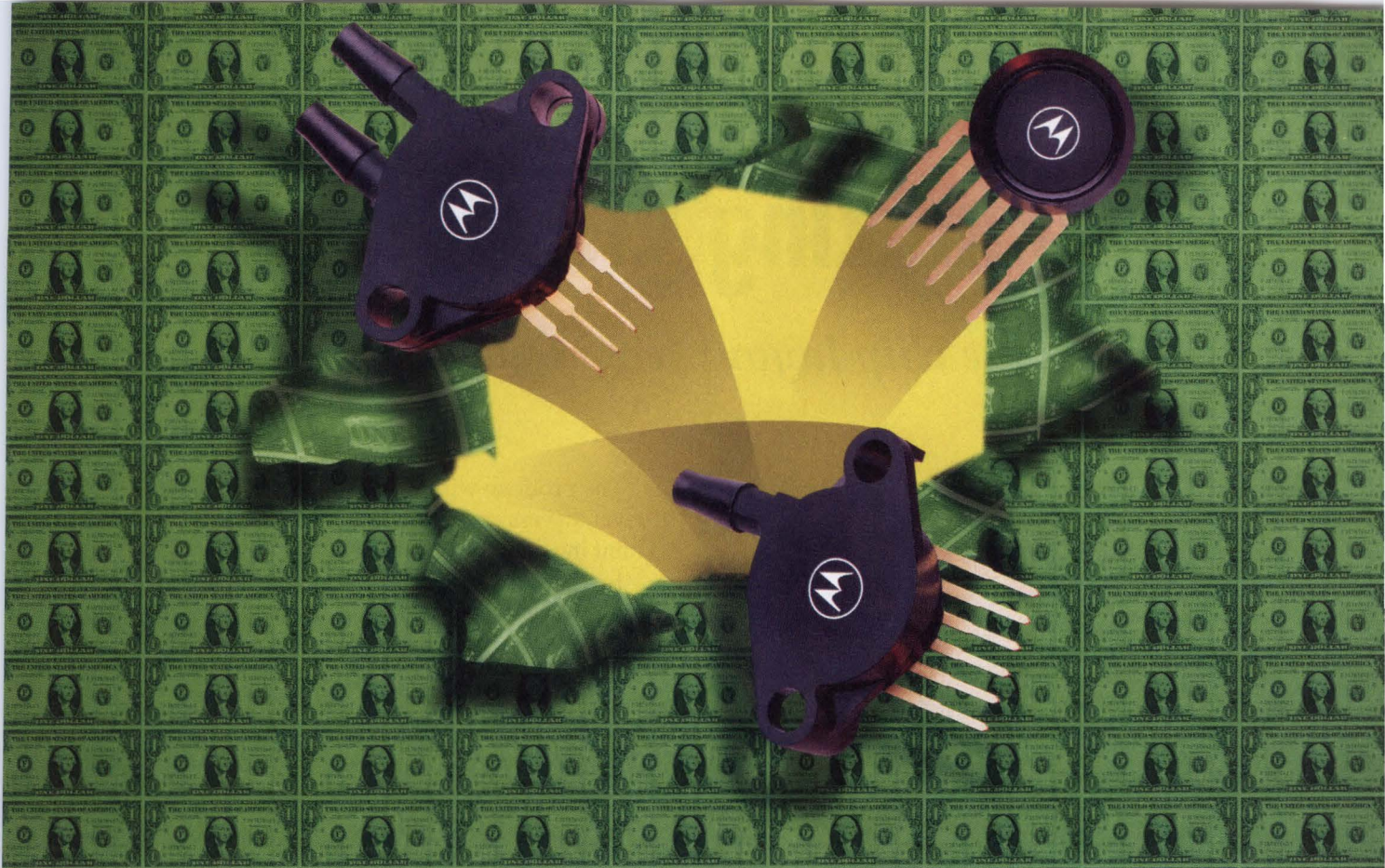

# Less buck for the bang

Motorola introduces new, lower Pressure Sensor pricing for the New Year!

We've made a New Year's Resolution for 1994 to get your sensor business, and to help kick it off we're offering many of our high-quality, high-performance Pressure Sensors at new, lower prices!

## Check Out These Lower Prices

Would you believe an uncompensated sensor for under \$5.00; a new high impedance, temperature compensated sensor for under \$9.00; a signal conditioned sensor for under \$10; and a temperature sensor for under 14¢ — each in a quantity of 5K? Well, believe it! And these are just four examples of the new pricing structure\*.

## A Wide Range of Sensors

Motorola's large portfolio of silicon Pressure Sensors includes devices for differential, absolute or gauge pressure measurements. They are available as the basic sensing element, with temperature compensation and calibration, or with full signal conditioning circuitry included to interface directly to A to D microprocessor or microcontroller-based systems.

Thanks to their patented strain gauge design, the higher sensitivity and excellent long-term repeatability of some of our newest units makes them ideally suitable for such applications as altimeters, pneumatic controls and robotics, liquid level measurement, manifold vacuum control, and HVAC systems.

## Contacting Us Now Makes Sense!

Motorola Pressure Sensors have always given lots of bang for the buck, and now you can get this bang for even fewer bucks. For the latest pricing information, contact your local sales office. For technical information on Motorola's complete family of

Pressure Sensors, including our MPX5000 series, request our Pressure Sensor Data Book #DL200/D Rev. 1 by completing and returning the coupon below, by calling 1-800-441-2447, or by writing Motorola Semiconductor Products, Inc., P.O. Box 20912, Phoenix, AZ 85036. \*Pricing is in US dollars for US delivery only.



The Conference and Exposition of Sensors and Systems  
February 8-10, 1994  
Disneyland Hotel Convention Center  
Anaheim, California  
Visit us at booth 200.



**MOTOROLA**

Motorola and are registered trademarks of Motorola Inc.

To: Motorola Semiconductor Products Inc., P.O. Box 20912, Phoenix, AZ 85036



Please send me Pressure Sensor Data Book #DL200D, Rev. 1.

632 EDN021794

Name \_\_\_\_\_

Title \_\_\_\_\_

Company \_\_\_\_\_

Address \_\_\_\_\_

City \_\_\_\_\_ State \_\_\_\_\_ Zip \_\_\_\_\_

Call Me ( ) \_\_\_\_\_

# Minimizing Clock Skew

*Unique chip layout technique from OKI*

**O**KI Semiconductor employs an integrated development environment in which the positions and sizes of clock drivers and trunk lines are determined by floor plan and flip-flop placement. This innovative approach has allowed the Sunnyvale, CA ASIC manufacturer to take the lead in minimizing RC loading variances. In fact, OKI guarantees a worst-case clock skew of 1.0 ns; 0.5 ns typical.

The OKI technique, which applies to all 0.8  $\mu\text{m}$  ASIC products, lets you balance loading distribution among clock trunk lines at the layout stage plus gives you the flexibility to handle a wide array of design requirements. Such requirements can include multi-phase clocks, mega-macro blocks, a broad choice of floor plans, and more.

## Current practice

Most chip designers still address the clock skew problem using one of two approaches: the multi-level tree method or the clock trunk technique.

The problem with multi-level trees is that the multi-level drivers create unwanted delays and frequently exhibit inconsistent driving capabilities.

In the clock-trunk approach, single-level clock drivers have wired outputs and run all the flip-flops through wide trunk lines. While this can solve the problems of the multi-tree approach, the clock drivers and trunk lines are embedded in the base array, restricting positioning and causing new balance-loading concerns.

## OKI's answer: flexible clock trunks

The OKI solution is an automated layout technique that is entirely transparent to the designer. It centers around a flexible, single-level clock trunk approach in which the positions of the clock drivers and trunk lines are driven by the layout software. The advantages of this approach are twofold...

First, the software generates clock trunk lines on the basis of flip-flop distribution, *after* placement, making easy load-balancing possible among the trunk lines. Second, with the OKI solution, you can work with a large variety of design styles used in IC layouts.

## Clock driver structure

Figure 1 is a layout showing OKI's unique clock-handling structure. A vertical clock driver – composed of a number of output transistors and having a common output terminal from which trunk lines run horizontally – is placed inside the core area. (The *logical* macrocell, as opposed to the physical structure, is a simple, *one-component* logic model in your netlist.) Each flip-flop connects to a clock trunk via short, minimum-width branch wires.

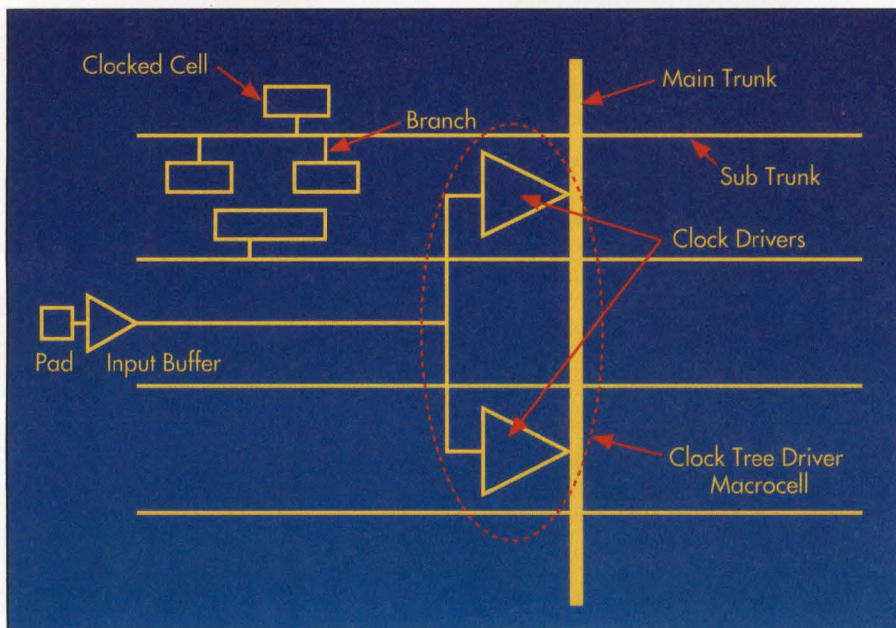

Figure 1. OKI's Clock Tree Structure

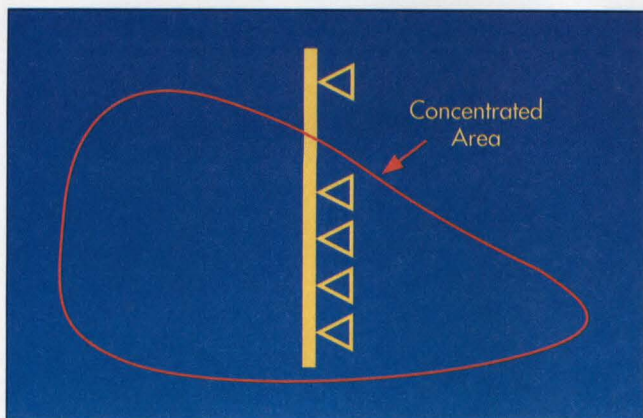

Figure 2. Dynamic Clock Driver Placement

### Floor plan placement & clock trunk generation

After a floor planning session using OKI's floor planning tool, you initiate a layout session in which all the components in the design area are automatically placed without regard for clock nets.

The positions and sizes of clock drivers and the sizes of the clock trunk lines are determined by the particulars of the floor plan. The OKI layout software automatically generates an appropriate number of clock trunk lines based upon flip-flop distribution. A higher concentration of trunk lines is dynamically generated (where the lines are needed most) so that loading capacitance and resistance are equally distributed. [See Figures 2 and 3.]

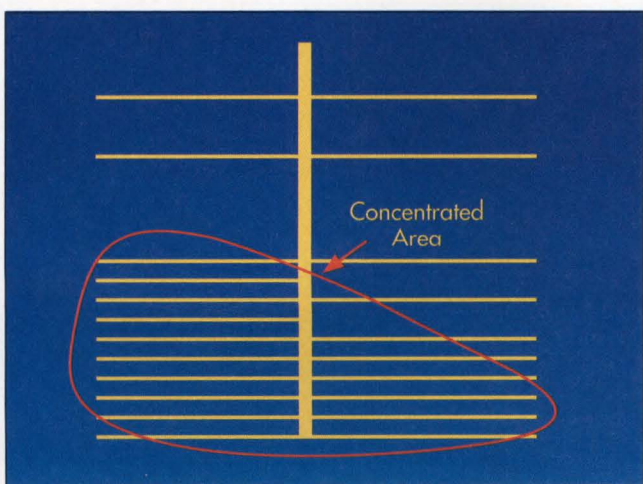

Figure 3. Dynamic Sub-trunk Allocation

Flip-flops are allocated to the trunk lines so that no single line has a greater load. At this point, flip-flop placement is further optimized to reduce layout interconnect. Finally, minimum-length branch nets are routed to each flip-flop, further reducing and balancing clock loading.

### Performance benefits

Several factors influence clock performance (speed and skew). These include the driving capability of the clock driver; the fan-out loading capacitance connectable to each clock line; and the parasitic capacitance and resistance existing in the layout interconnect between the clock driver and the individual flip-flops.

To achieve highest performance, OKI has analyzed the range of capacitance and resistance on given die sizes, defining limits for our clock drivers so that the maximum capacitance and resistance on any one clock trunk are not exceeded. These limits, expressed

in terms of maximum fan-out loading, are automatically implemented in the new OKI layout technique.

To further assure top performance, routing restrictions, minimizing the length of branch wires, are defined. The cumulative effect of these implementations is to minimize all resistance and capacitance variances. In this way, OKI is able to guarantee minimum clock skew.

### Exceptional test results

OKI has conducted numerous studies on 0.8  $\mu\text{m}$  designs using the new layout technique. In each case, the RC circuits of the clock nets were extracted and clock skew checked and verified by an HSPICE\* circuit simulator. The results were excellent. In all the tests, the greatest skew obtained was 0.47 ns – a showing that further confirms the value of the OKI technique in which the positions of clock drivers and clock trunk lines are flexibly generated. ■

\*A trademark of Meta-Software, Inc.

**The cumulative effect of these implementations is to minimize all resistance and capacitance variances. In this way, OKI is able to guarantee minimum clock skew.**



*A significant announcement in*  
**FLASH MEMORY DESIGN**  
*[What it gives the industry is a **STANDARD.**]*

As one of the key companies introducing the new NAND flash-memory technology, we at Samsung are standard bearers for something quite important.

Because the muddled, build-what-you-please world of flash is in desperate *need* of a standard. And

NAND *is* that standard—for three reasons. It's being widely built by not just us but several other major memory companies. It makes for exceptionally high system endurance. And it's the architecture ideally suited to the higher densities needed down the road.

Which is going to give designers what they need: flash chips in a variety of densities that are interchangeable. With no redesigning.

Which—when you think about what flash is used for—ought to be the whole idea.

We're sampling the 16 Mb flash



right now, and will introduce the 32 Mb and 64 Mb in 1995 and 1996.

And we're manufacturing them all with the kind of quality that has won ISO 9001 certification for Samsung.

NAND flash memories are one more way we're advancing our leadership position in memory—

and adding to our remarkable achievement in building the world's first 16-meg DRAM.

All of which is making us something of a standard ourselves. To learn about our NAND flash technology, please call 1-800-446-2760 or 408-954-7229 today. Or write

to Flash Memory Marketing, Samsung Semiconductor Inc., 3655 North First St., San Jose, CA 95134



**SEMICONDUCTOR**

*A Generation AHEAD.*

# Your primary concern is our first order of business.

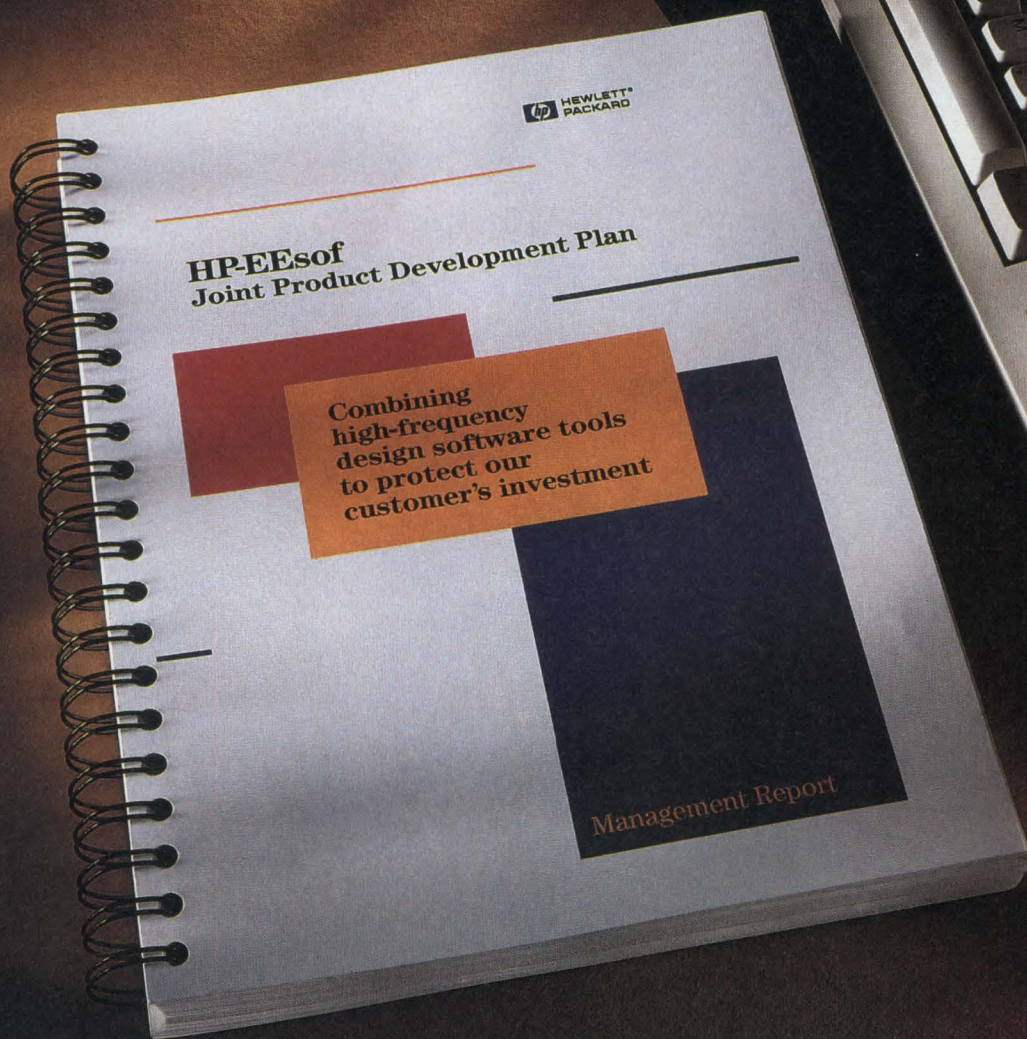

Now that EEsof has merged with HP's high-frequency design software operation, you're probably wondering what's going to happen to your software investment.

Plan on getting the most from it.

Right from the start, HP-EEsof will support and enhance both the MDS and the Series IV product families. So the software you're using today will evolve with your changing needs.

In the future, we plan to combine the best technology from each set of tools, without

sacrificing key features. Your design databases and software customizations will be migrated forward. And simulators, models, and libraries will be retained. All within a design environment that's easy to learn and use.

Of course, whether you've been using HP or EEsof software, you'll benefit from our combined R&D resources, industry knowledge, and global sales and applications support. In fact, you'll have a broader selection of high-frequency

design capabilities to choose from than ever before.

So, plan on getting the most from your software investment. Call **1-800-343-3763**. And we'll mail you more information about HP-EEsof solutions for high-frequency CAE.



**HEWLETT®  
PACKARD**

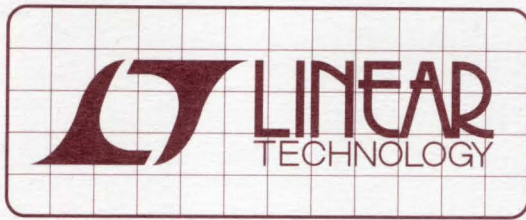

# DESIGN NOTES

## Single 4-Input IC Gives Over 90dB Crosstalk Rejection at 10MHz and is Expandable – Design Note 79

John Wright

### Introduction

Professional video systems need to multiplex between many signals without interference from adjacent video sources that are not selected. Final system crosstalk rejection of all non-selected or "Hostile" signals of 72dB is regarded as "professional quality." This level of isolation is very difficult to achieve because every doubling in the number of inputs degrades the crosstalk by 6dB. In the past because no single IC was good enough, cascades of discrete switches and amplifiers were used to achieve the necessary isolation. An additional requirement of some video multiplexers is the ability to switch quickly and cleanly so the sources can be changed in picture without visible lines or distortion. New emerging multimedia systems require the performance of professional systems in the PC environment.

The new LT1204 four-input video multiplexer IC speeds the design of high performance video selection products. It features easy input expansion, and over 90dB crosstalk rejection on a PC board up to 10MHz even when expanded to 16 inputs. Additionally, this new multiplexer has low

switching transients and includes a 75MHz current feedback amplifier to drive 75Ω cables. Figure 1 shows the LT1204 in a typical application.

### Expanding the Number of Inputs

To expand the number of MUX inputs LT1204s can be paralleled by shorting their outputs together. The Disable feature ensures that amplifier outputs that are not selected do not alter the cable termination. When the LT1204 is disabled (pin 11 low), the output stage is turned off and the feedback resistors are bootstrapped, effectively removing them from the circuit. This has the effect of raising the "true" output impedance to about 25k in Figure 1. The LT1204 disable logic has been designed to prevent shoot-through current when two or more amplifiers have their outputs shorted together. The LT1204 also has a logic controlled shutdown (pin 12 low) that drops the supply current from 19mA to 1.5mA. When shut down, the feedback resistors load the output because the bootstrapping is inoperative. Figure 2 shows this loading effect for a 16-to-1 MUX made with four LT1204s using the Disable feature vs the Shutdown feature.

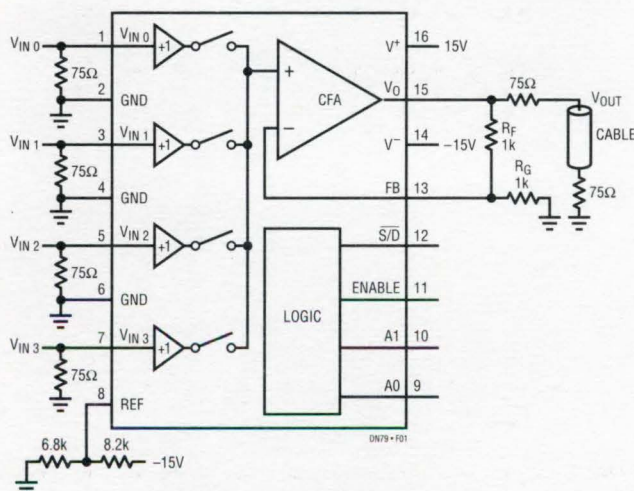

Figure 1. 4-Input Video Multiplexer with Cable Driver

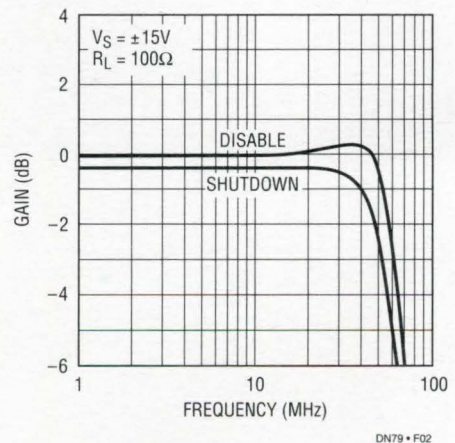
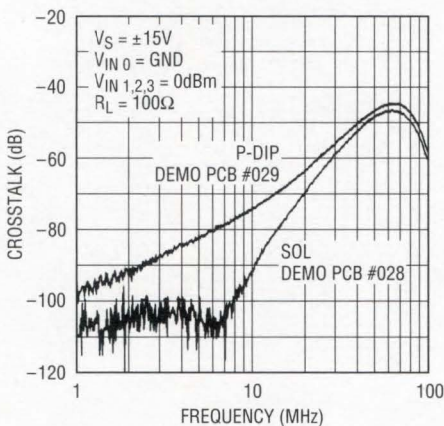

Figure 2. 16-to-1 Multiplexer Response Using Disable Feature vs Shutdown Feature

## PC Board Layouts

Crosstalk is a strong function of the IC package, the PC board layout, as well as the IC design. Layout of a PC board that has over 90dB crosstalk rejection at 10MHz is not trivial. PC boards have been fabricated to show the component and ground placement required to attain this level of performance. It has been found empirically from these PC boards that capacitive coupling across the package of greater than 3fF (0.003pF) will diminish the rejection. Keys to the layout are: placing ground plane between inputs, minimizing the feedback pin trace length, putting feedback resistors on the back side of the surface mount PC board, and guarding pin 13 with ground plane.

### Crosstalk in P-DIP and SOL vs Frequency



LT1204 • A101

## Switching Transients

Multimedia systems switch active video "in-picture" to create special effects and this requires fast clean transitions with low "glitch" energy. In the past video source selection was made during the blanking period and switching transients were not visible. The LT1204 has input buffers that isolate the internal make-before-break switches. These buffers ensure glitches are minimized at the inputs. This is important because loop-through connections send these glitches to other equipment. When two channels are on momentarily the more positive voltage passes through; if both are equal, there is only a

40mV error at the input of the CFA. The time of this 40mV error can be reduced by adjusting the voltage on the Reference (pin 8). The Reference pin is used to trade off positive input voltage range for switching time. On  $\pm 15V$  supplies, settling the voltage on pin 8 to  $-6.8V$  reduces the switching transient to a 50ns duration, and the positive input range reduces from 6V to 2.35V. The negative input range remains unchanged at  $-6V$ . Included are photos of the switching transients for the new LT1204 as well as competitive CMOS and bipolar MUXs.

### LT1204 Output Switching Transients

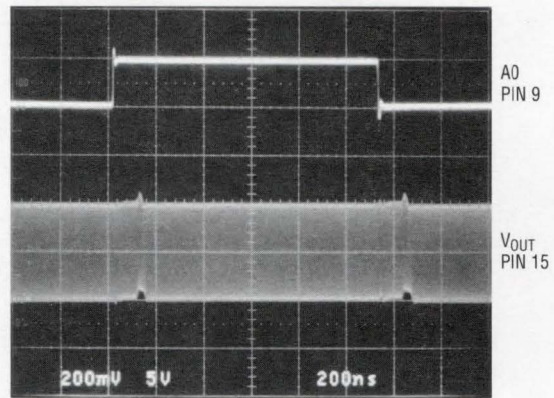

$V_{IN0}$  AND  $V_{IN1}$  CONNECTED TO A 2MHz SINEWAVE  
 $V_{REF} = -6.8V$

DN79 • A102

### Competitive MUXs

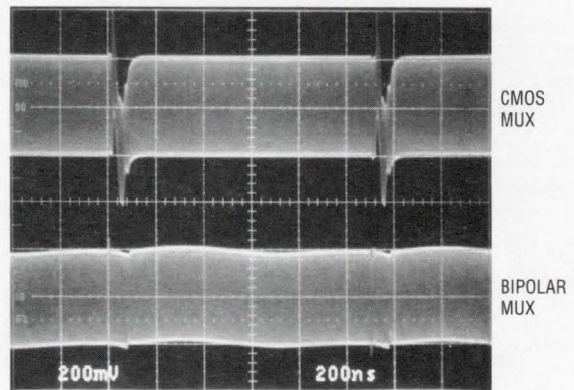

$V_{IN0}$  AND  $V_{IN1}$  CONNECTED TO A 2MHz SINEWAVE

DN79 • A103

For literature on our High Speed Amplifiers, call **1-800-4-LINEAR**. For applications help, call (408) 432-1900, Ext. 456

Linear Technology Corporation

1630 McCarthy Blvd., Milpitas, CA 95035-7487

(408) 432-1900 • FAX: (408) 434-0507 • TELEX: 499-3977

LT/GP 0294 190K • PRINTED IN THE USA

**LINEAR**  
TECHNOLOGY

© LINEAR TECHNOLOGY CORPORATION 1994



## Priority encoders slip into FPGAs

Swapnajit Mitra, Baharat Electronics, Bangalore, India

The standard 8-to-3 priority encoder's design, in maximal canonical form (such as the 74148), suffers from drawbacks when you try to use the design as a macro in a large digital project. The drawbacks are

- The number of inputs to the gates varies from two to nine
- If any of the inputs develops a stuck-at-zero or stuck-at-one fault, such a fault is difficult to detect
- Reconfiguring the design to suit a fault-tolerant design is difficult.

The simplified approach in **Fig 1(a)** shows a 2-to-1 priority encoder, which generates the proper output as well as a signal-present output (SP). SP indicates the presence of any signal at the inputs, simplifying testing. By inspection, you can see that the circuit in **Fig 1(a)** is a priority encoder.

The circuit in **Fig 1b** combines two of **Fig 1(a)**'s basic build-

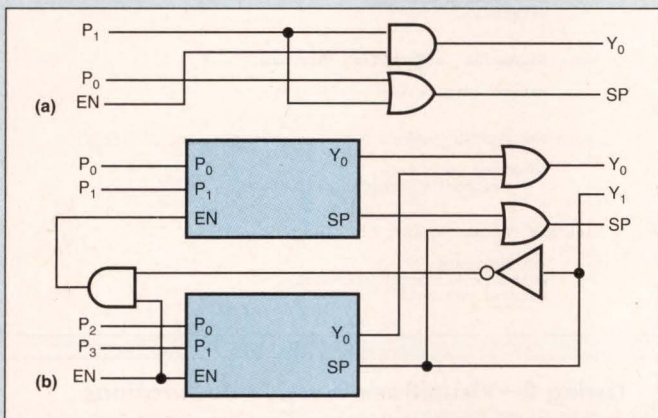
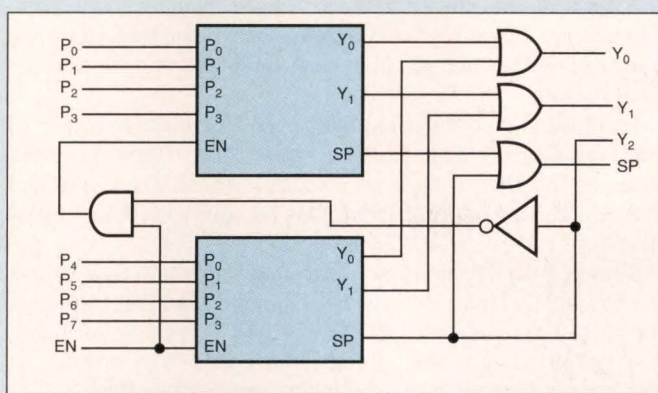

**Fig 1**—The simple 2-to-1 input priority encoder in (a) extends easily to a 4-to-2 priority encoder.

ing blocks into a 4-to-2 priority encoder. And, by extension, **Fig 2** shows an 8-to-3 encoder. Simulations show that this circuit has 98% fewer transistors than the canonical circuit does for cell-based design. Owing to never exceeding the number of inputs to a logic cell, this design also compiles economically over a Plessey gate array.

Extending this design to 16 or more inputs is not advisable. If you extend the design to 16 or more inputs, its critical path increases linearly with the number of inputs; the canonical approach always yields a 3-stage design, giving it superior propagation delay. **EDN BBS /DI\_SIG #1370** **EDN**

To Vote For This Design, Circle No. 341



**Fig 2**—The 4-to-2 priority encoder in 1(b) is the basis for this 8-to-3 priority encoder. This design compiles over gate arrays and FPGAs more economically than does the canonical design.

## Off-line power supply requires few parts

Sam Ochi, IXYS Corp, Santa Clara, CA

The simple off-line power supply in **Fig 1** can provide 150 mA or less and uses only a handful of components. Current regulator, IC<sub>1</sub>, acts as a preregulator for any of the popular 3-terminal regulators (The figure shows a 78L05). Because IC<sub>1</sub> drops most of the voltage in this circuit, the circuit suits only low-current applications.

To get the best possible power factor and simultaneously reduce IC<sub>1</sub>'s power dissipation, choose capacitor C<sub>1</sub> such that the lowest point of its ripple voltage is greater than voltage dropped across IC<sub>1</sub> and IC<sub>2</sub>—even at your application's maximum load. **EDN BBS /DI\_SIG #1364** **EDN**

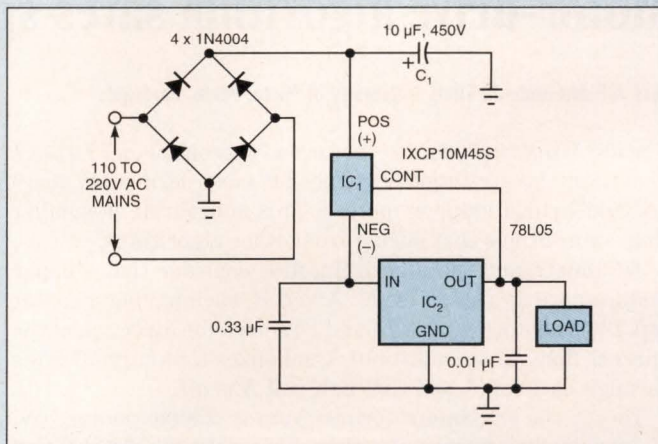

**Fig 1**—A current regulator feeds just the right amount of current to a common 3-terminal regulator, enabling this simple low-current power supply to operate directly from the mains.

To Vote For This Design, Circle No. 342

## VisualBasic does I/O

Jon Titus, *Test & Measurement World*, Newton, MA



Microsoft's VisualBasic—which runs under Windows—cannot operate on a PC's I/O ports. However, you can add dynamic-link libraries (DLLs) to extend the keywords of native VisualBasic (**Listing 1**). The compiled code, listings, and documentation in ZIPfile DI1167Z.ZIP (attached to EDN BBS /DI\_SIG #1367) let you perform I/O operations using the new keywords *Inp* and *Out*. These added keywords operate the same way these keywords do in other Basic dialects.

To use *Inp* and *Out* in VisualBasic, you must tell your program that these operations exist. Use the *Declare* statements, as **Listing 2** shows. Remember that the *Out* operation is a subroutine because it simply outputs a byte; it returns nothing back to your VisualBasic program. The *Inp* operation is a function, because it returns a byte from an input port. You use the *ByVal* keyword to tell VisualBasic that you want it to transfer the actual value, and not a reference or pointer to the value.

In addition, you must explicitly tell VisualBasic where to find the library functions in your DLL. This example assumes the DLL is on a floppy disk in the B drive. You can put the DLL on another drive, but be sure to tell VisualBasic where it is.

Simple VisualBasic program fragments show how to use the *Inp* and *Out* instructions. For example, `Out 771, 130` sends the value 130 to output port 771 of my PC. On the other hand, `A=Inp(769)` assigns the byte at input port 769 to variable A. The syntax is exactly the same as in most other Basics.

EDN BBS /DI\_SIG #1367

EDN

To Vote For This Design, Circle No. 343

### Listing 1—C++ source code for DLL (Borland C++ compiler)

```
#include <d:\borlandc\include\windows.h>
#include <d:\borlandc\include\dos.h>

extern "C" {
int FAR PASCAL _export Test (int) ;
void FAR PASCAL _export Out (int, int) ;
int FAR PASCAL _export Inp (int) ;
}

int FAR PASCAL LibMain (HANDLE hInstance, WORD wDataSeg,
WORD wHeapSize, LPSTR lpCmdLine)
{
hInstance = hInstance;
wDataSeg = wDataSeg;
wHeapSize = wHeapSize;
lpCmdLine = lpCmdLine;

if (wHeapSize > 0)
UnlockData (0);
return 1 ;
}

int FAR PASCAL _export Test (int arg1)
{
return (arg1 + 1);
}

void FAR PASCAL _export Out (int portaddr, int portdata)
{
unsigned char data;
outportb(portaddr,portdata);
}

int FAR PASCAL _export Inp (int portaddr)
{
int portdata;
portdata = inportb(portaddr);
return (portdata);
}
```

### Listing 2—VisualBasic location declarations

```
Declare Function Test Lib "b:\cuser2.dll" (ByVal Numb%) As Integer
Declare Sub Out Lib "b:\cuser2.dll" (ByVal Addr%, ByVal Byte%)
Declare Function Inp Lib "b:\cuser2.dll" (ByVal Addr%) As Integer
```

## Motor-drive algorithm saves space and cycles

José A P Machado da Silva, *University of Porto*, Porto, Portugal

The algorithm embodied in the second subroutine in **Listing 1** generates the excitation sequence for most permanent-magnet and hybrid stepper motors. This subroutine is smaller than subroutines that spring from other algorithms.

To understand the algorithm, first consider that stepper motors have two stator coils, A and B, each having a center tap. Phase notation (A,A,B, and B) shows the direction of the current flow. That is, AA=10<sub>2</sub> symbolizes that current flows through half-coil A and that half-coil A is off.

To get the maximum torque from a stepper motor, you must drive two phases at a time. Using the binary notation developed in the preceding paragraph, the 4-phase drive sequence for all four half coils is 0101<sub>2</sub>, 0110<sub>2</sub>, 1010<sub>2</sub>, 1001<sub>2</sub> or 5<sub>HEX</sub>, 6<sub>HEX</sub>, A<sub>HEX</sub>, 9<sub>HEX</sub>.

### Listing 1—Stepper-motor drive subroutines

Memory Accessing		bytes/cycles	
Begin	MOV Rr,curraddress	2/2	Load adr reg w/current table address
New	MOV Output,@ Rr	2/2	Send drive sig to output
	INC Rr	1/1	Increment adr reg
	CJNE Rr,#lastaddress+1,More	3/2	Rel-cond jump to More
More	...	...	Delay
	JNZ New	2/2	End of motion?
End	MOV curraddress,Rr	2/2	Save adr reg
Accumulator Rotating			
Begin	MOV A,currstate	2/1	Load A w/current drive bytes
Next	MOV Output,A	2/1	Send drive sig to output
	RL A	1/1	Rotate A left twice
	RL A	1/1	
	...	...	Delay
	JNZ Next	2/2	End of motion?
End	MOV curstate,A	2/1	Save drive bytes

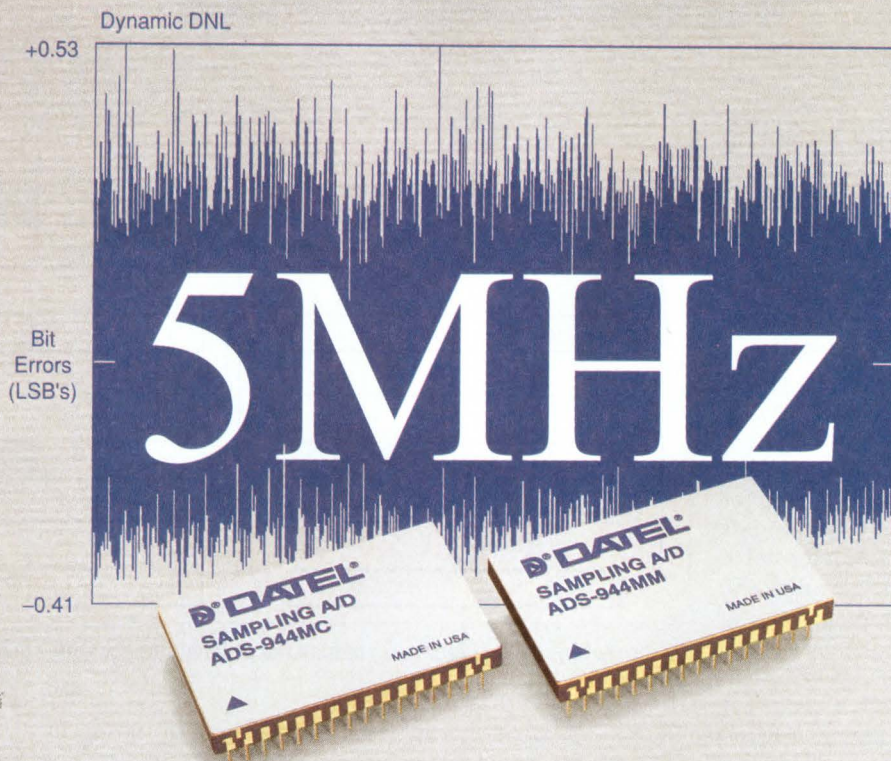

# 14-bit, Sampling A/D's

Incomparable price, performance, size and power!

DATEL's new ADS-944 is without competition ... unless you consider devices with inferior performance, greater power consumption, larger packages and much higher prices competitive. Evaluate an ADS-944 and you'll agree ... there's no comparison.

DATEL offers a complete line of DIP-packaged, 14-bit, sampling A/D's with throughputs from 0.5 to 10MHz. Call today for details.

- No missing codes over temperature
- 76dB SNR, -74dB THD @ Nyquist
- Edge triggered; no pipeline delay
- Small 32-pin TDIP; TTL compatible
- 2.9 Watts power dissipation
- MIL-STD-883 screening optional
- \$479 (OEM, USA)

SPECIFICATIONS	+25°C			0 to +70°C			-55 to +125°C			UNITS
	MIN.	TYP.	MAX.	MIN.	TYP.	MAX.	MIN.	TYP.	MAX.	
Sampling Rate	5			5			5			MHz
Integral Nonlinearity		±3/4			±3/4			±1		LSB's
Differential Nonlinearity	-0.95	±0.5	+0.95	-0.95	±0.5	+1.0	-0.95	±0.5	+1.25	LSB's
No Missing Codes	14			14			14			Bits
Total Harmonic Distortion*		-74	-72		-74	-72		-73	-70	dB
Signal-to-Noise Ratio*	73	76		73	76		72	75		dB

\*  $f_{in} = 2.45\text{MHz}$

DATEL, Inc., 11 Cabot Boulevard, Mansfield, MA 02048 Tel: (508) 339-3000  
 FAX: (508) 339-6356. For immediate assistance 800-233-2765.

**DATEL**  
 INNOVATION and EXCELLENCE

The usual technique for generating this sequence with a  $\mu\text{P}$  is to look up the succeeding phase commands in a table (see the first subroutine in **Listing 1**). This operation requires a multibyte MOV instruction. The new algorithm obtains each phase by rotating the accumulator's contents (**Fig 1**). Thus, the algorithm saves processor cycles and the space needed for the table.

In **Fig 1**, the accumulator begins with  $A5_{\text{HEX}}$ . The accumulator's least-significant four bits are the motor-drive output ( $5_{\text{HEX}}$ ). Two circular-rotate left instructions yield the next motor-drive output,  $6_{\text{HEX}}$ , and so on. To drive the motor in the opposite direction, reverse the sense of the rotation instructions.

Comparing the two subroutines in the **listing**, you can see that the accumulator-rotating algorithm saves 10 memory locations (six in the subroutine plus four in the table) and three  $\mu\text{P}$  cycles for each step.

You can use the same algorithm to generate wave-drive and half-step sequences. Rotate one of the bytes— $48_{\text{HEX}}$ ,  $84_{\text{HEX}}$ ,  $23_{\text{HEX}}$ , or  $12_{\text{HEX}}$ —to obtain wave drive. Obtain the

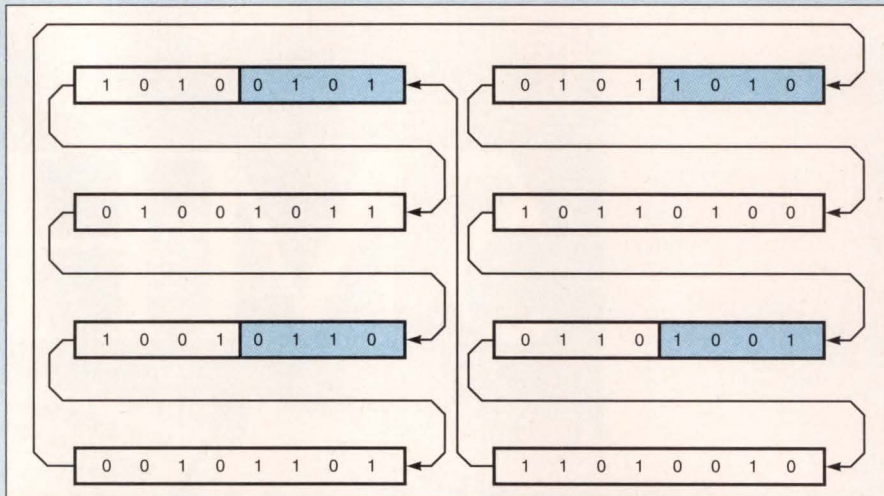

**Fig 1**—Rotating the proper bytes around the accumulator generates drive signals for a step motor.

sequence  $0101_2$ ,  $0100_2$ ,  $0110_2$ ,  $0010_2$ ,  $1010_2$ ,  $1000_2$ ,  $1001_2$ ,  $0001_2$  by alternately rotating both of the full-step sequences to achieve half-step drive, saving even more memory. **EDN**

**EDN BBS /DI\_SIG #1368**

**To Vote For This Design, Circle No. 344**

## Spice models CMOS switch

Paul E Brown Jr, McDonnell Douglas, Santa Ana, CA



The Spice subcircuit in **Listing 1** is a model of an spst CMOS analog switch. Ideal circuit elements such as PMOS and NMOS FETs model the switch (M3 and M4) and the switch's CMOS inverters (M1 and M2). Resistors and capacitors model the CMOS switch's drain-to-source on-resistance (RDS), its source capacitance (CS), and its drain capacitance (DC). An ideal dc-voltage source (VREF) and a voltage-controlled voltage source (E1) model the switch's logic-level voltage shifter.

The model employs parameter passing so that you can use the model for more than one type of switch. You can find the needed parameters on the switch manufacturer's data sheet. If you do not pass your own parameters, the model uses the defaults in the **listing**.

A typical call to this model is

```
XREF N1 N2 N3 N4 N5 N6 SWITCH {IS=xx ID=xx
CS=xx CD=xx RDS=xx},
```

where N1 is the source node, N2 is the drain node, N3 is the control-voltage node, N4 is the positive power-supply voltage node, N5 is the power-supply return node, and N6 is the negative power-supply voltage node. You can find a copy of this **listing** on the EDN Readers' Bulletin Board as DI1366.LST.

**EDN BBS /DI\_SIG #1366**

**EDN**

**To Vote For This Design, Circle No. 345**

### Listing 1—CMOS analog-switch Spice model

```
* IDEAL CMOS ANALOG SWITCH
* S = SOURCE; D = DRAIN; VL = LOGIC CONTROL VOLTAGE
* SWITCH IS OPEN FOR VL = 0V; SWITCH IS CLOSED FOR VL = 1V
*
* PASS THE FOLLOWING PARAMETERS
*
* IS = SOURCE LEAKAGE CURRENT IN AMPERES
* ID = DRAIN LEAKAGE CURRENT IN AMPERES
* CS = SOURCE OFF CAPACITANCE IN FARADS
* CD = DRAIN OFF CAPACITANCE IN FARADS
* RDS = DRAIN TO SOURCE ON RESISTANCE IN OHMS
*
.SUBCKT SWITCH 2 3 1 4 5 6 {IS=1PA ID=1PA CS=1PF RDS=0.1}
* S D VL VCC GND VEE
R1 1 5 1T
R2 7 5 1T
T3 8 5 1T
VREF 7 5 -2.5V
E1 8 5 POLY(2) 1 5 7 5 0 6 6
R4 9 5 1T
C1 9 5 {CS}
RS 2 5 {1/IS}
CS 2 5 {CS}
RD 3 5 {1/ID}
CD 3 5 {CD}
RDS 10 3 {RDS}
M1 9 8 6 6 NMOS
M2 9 8 4 4 PMOS OFF
M3 10 9 2 4 PMOS OFF
M4 10 8 2 6 NMOS OFF
.MODEL PMOS PMOS(KP=10M)
.MODEL NMOS NMOS(KP=10M)
.ENDS
```

# RF TRANSFORMERS

Over 80 off-the-shelf models...

3KHz-1500MHz from \$1<sup>95</sup>



Having difficulty locating RF or pulse transformers with low droop, fast risetime or a particular impedance ratio over a specified frequency range?... Mini-Circuits offers a solution.

Choose impedance ratios from 1:1 to 36:1, in connector, TO-, flatpack, surface-mount, or pin versions (plastic or metal case built to meet MIL-T-21038 and MIL-T-55631 requirements\*). Coaxial connector models are offered with 50 and 75 ohm impedance; BNC standard, other types on request.

Ultra-wideband response achieves low droop and fast risetime for pulse applications. Ratings up to 1000M ohms insulation resistance and up to 1000V dielectric voltage. For wide dynamic range applications involving up to 100mA primary current, use the T-H series. Fully detailed data appear in our 740-pg RF/IF Designer's Handbook.

Need units in a hurry?... all models are covered by our exclusive one-week shipment guarantee. Only from Mini-Circuits.

\*units are not QPL listed.

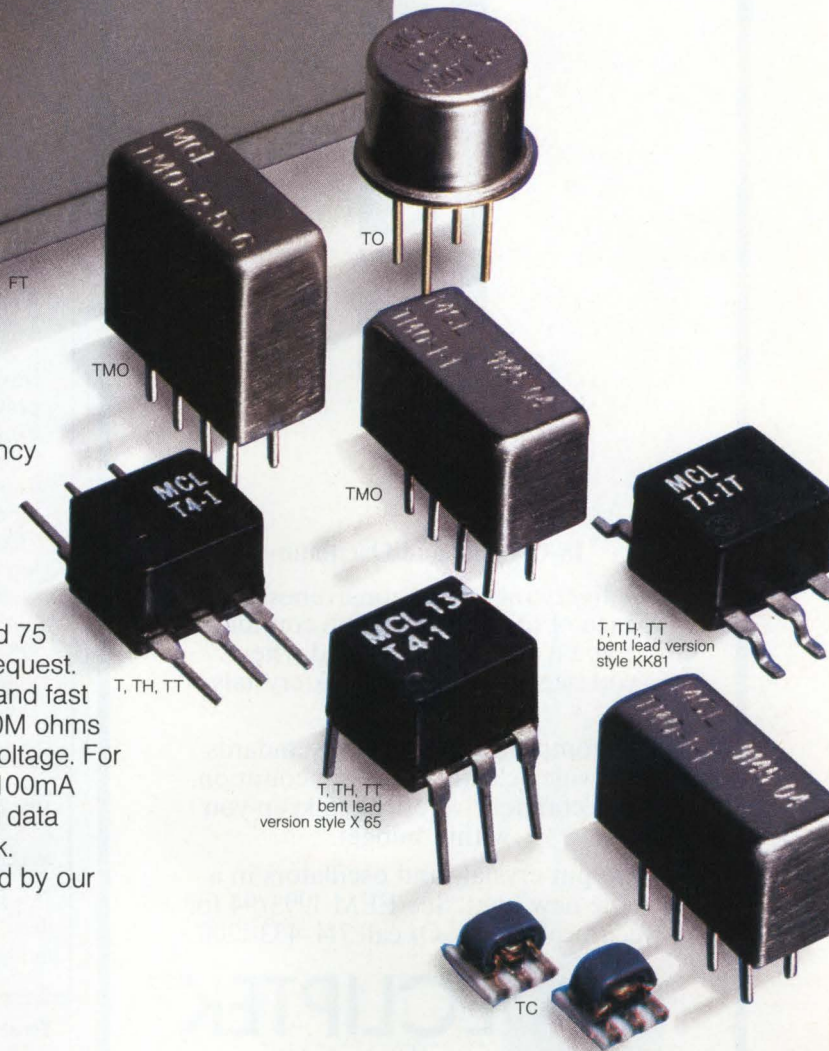

 **Mini-Circuits**<sup>®</sup>

P.O. Box 350166, Brooklyn, New York 11235-0003 (718) 934-4500 Fax (718) 332-4661

For detailed specs on all Mini-Circuits products refer to • THOMAS REGISTER Vol. 23 • MICROWAVES PRODUCT DIRECTORY • EEM • MINI-CIRCUITS' 740-pg HANDBOOK.

CUSTOM PRODUCT NEEDS... *Let Our Experience Work For You.*

CIRCLE NO. 96

F 71-Rev.E

# DELIVERY

## In Crystals and Oscillators.

Delivery means responsiveness and peace of mind. You can be confident you'll get what you need when you need it. With Ecliptek crystals and oscillators.

Uncompromising quality standards and wide selection you can count on. Plus competitive prices to keep you within budget.

We put crystals and oscillators in a whole new light. See EEM 1993/94 for technical details. Or call 714-433-1200.



The Crystal and Oscillator Specialists

CIRCLE NO. 9

### Design Entry Blank

**\$100 Cash Award for all published entries selected by editors. An additional \$100 Cash Award for the winning design of each issue, determined by vote of readers. Additional \$1500 Cash Award for annual Grand Prize Design, selected among biweekly winners by vote of editors.**

To: Design Ideas Editor, EDN Magazine  
Cahners Publishing Co  
275 Washington St, Newton, MA 02158

I hereby submit my Design Ideas entry.

Name \_\_\_\_\_

Title \_\_\_\_\_ Phone \_\_\_\_\_

Company \_\_\_\_\_

Division (if any) \_\_\_\_\_

Street \_\_\_\_\_

City \_\_\_\_\_ State \_\_\_\_\_

Country \_\_\_\_\_ Zip \_\_\_\_\_

Design Title \_\_\_\_\_

Home Address \_\_\_\_\_

Social Security Number \_\_\_\_\_  
(US authors only)

#### Entry blank must accompany all entries.

Design entered must be submitted exclusively to EDN, must not be patented, and must have no patent pending. Design must be original with author(s), must not have been previously published (limited-distribution house organs excepted), and must have been constructed and tested. Fully annotate all circuit diagrams. Please submit software listings and all other computer-readable documentation on a 5¼-in. IBM PC disk in plain ASCII.

Exclusive publishing rights remain with Cahners Publishing Co unless entry is returned to author, or editor gives written permission for publication elsewhere.

In submitting my entry, I agree to abide by the rules of the Design Ideas Program.

Signed \_\_\_\_\_

Date \_\_\_\_\_

The winning Design Idea for the July 22, 1993, issue is entitled "Active filter makes component selection easier," submitted by Michael Wyatt of SSO Honeywell Inc (Clearwater, FL).

The winning Design Idea for the August 5, 1993, issue is entitled "Decoder demonstrates elegant DSP function," submitted by Leonard Schupak of Navitech Consulting (Irvine, CA).

**Your vote determines this issue's winner.** All designs published win \$100 cash. All issue winners receive an additional \$100 and become eligible for the annual \$1500 Grand Prize. **Vote now**, by circling the appropriate number on the reader inquiry card.

# Quick Just Got Quicker



## 4000 Usable Gate FPGA at over 150 MHz.

A new breed of superfast antifuse FPGA's is blowing away the competition in standard PREP™ benchmarks.

The *WildCat* series of FPGA's from QuickLogic introduces its first member - the *WildCat* 4000. With more than 4000 usable gates this cost-effective *WildCat* flies at an astounding 150 megahertz in the PREP DataPath benchmark.

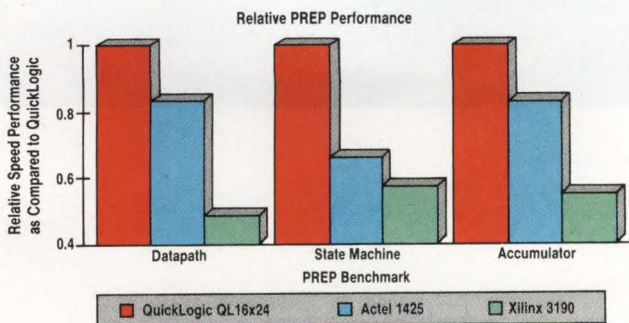

### Free Evaluation Tools

Be one of the first 100 to fax your business card to QuickLogic, and receive our complete suite of powerful software evaluation tools at no cost. This \$3000 value will run simulation and synthesis tests to prove your design and to show off the awesome speed of the *WildCat* 4000.

Look to the company that lives up to its name for fast solutions to today's high speed, high density design requirements. For QUICK response fax us at (408)987-2012 or call 1-800-842-FPGA (3742) to learn more about *WildCat* SuperFast FPGAs.



## QUICKLOGIC

We Live Up To Our Name

2933 Bunker Hill Lane, Santa Clara, California 95054

©1994 QuickLogic Corporation. PREP is a trademark of the Programmable Electronics Performance Company.



Presentations use or include the most recent PREP PLD Benchmark data which was measured according to Benchmark Suite #1, Version 1.2, dated 3/28/93. Any analysis is not endorsed by PREP.

*How to beat the squeeze  
in today's tight design environments.*

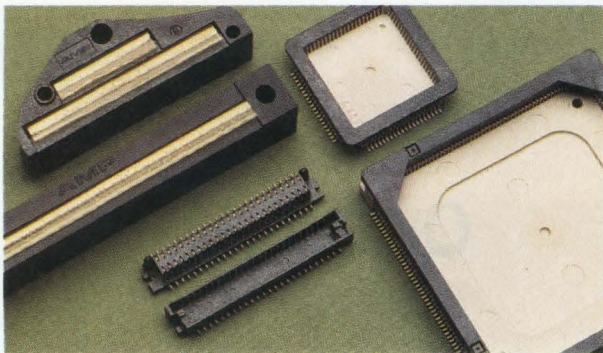

*AMP fine-pitch solutions are available for designs requiring sub-0.050", sub-2mm centers. Metristak board-to-board stacking connectors on 1mm centers; LGA, MCR, and PQFP sockets; FPC connectors on 1mm and 0.5mm centers; AMPLIFLEX elastomeric package- and board-to-board connectors for pitches as fine as 0.025".*



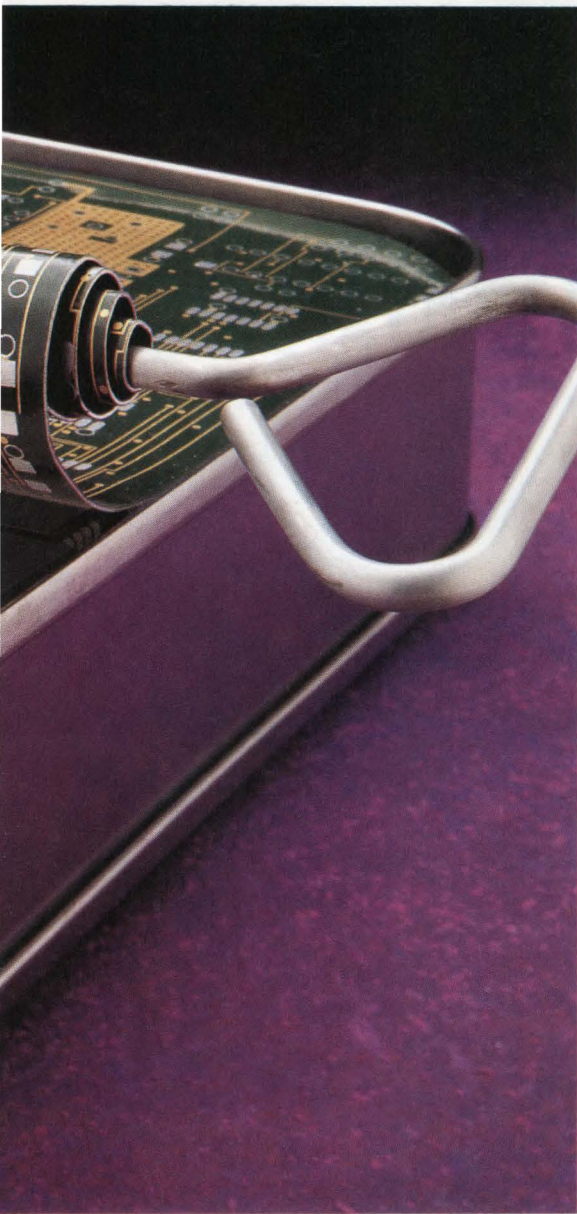

High-density design is a world unto itself — a world with tight corners, low ceilings, and shrinking floors. Living there on today's budgets and schedules can be a lot easier with help from the experts. In interconnects, that's us.

Because every design is unique, we'll show you all the options. We can guide you through the good and bad of each — with an eye on system performance, manufacturability, and cost.

We'll show you all the choices you have, too, in socketing, I/O, and board-to-board interconnects. With systems that range from the conventional (0.050" and 2mm centers) to the sublime (our "finest" connectors offer redundant contact on board pads 0.015" wide, on 0.025" centers, with non-critical alignment). We'll make sure the system you work with can meet tight electrical

characteristics as well as tight space limitations.

And we'll show you how the system you choose will fit successfully into production. With the packaging you need. The tooling and feeder modules you need. And the support you need in training and maintenance.

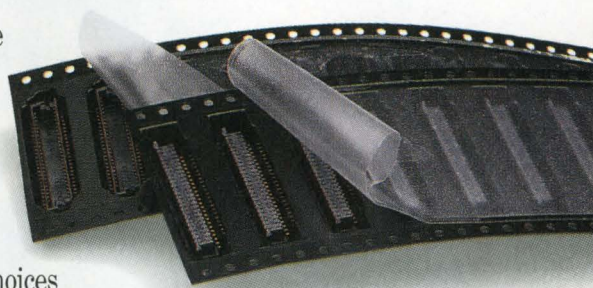

Need more help? We supply full technical information, catalog sheets, and 2D and 3D models of many product lines to shorten your design cycle. And we can provide design services, build your subsystems, or even fabricate all of your product for you.

AMP and AMPLIFLEX are trademarks.

For more information, call our Product Information Center at 1-800-522-6752 (fax 717-986-7575). AMP, Harrisburg, PA 17105-3608. In Canada, call 905-470-4425.

CIRCLE NO. 49

**AMP**

# EMC-design tools

Doug Conner, Technical Editor

**The problem facing designers of high-speed circuits is not just to make sure that products work by themselves. Designers must also make sure that their products fit into a larger community of electronic systems. The issue is electromagnetic compatibility (EMC).**

Photo courtesy Ansoft Corporation

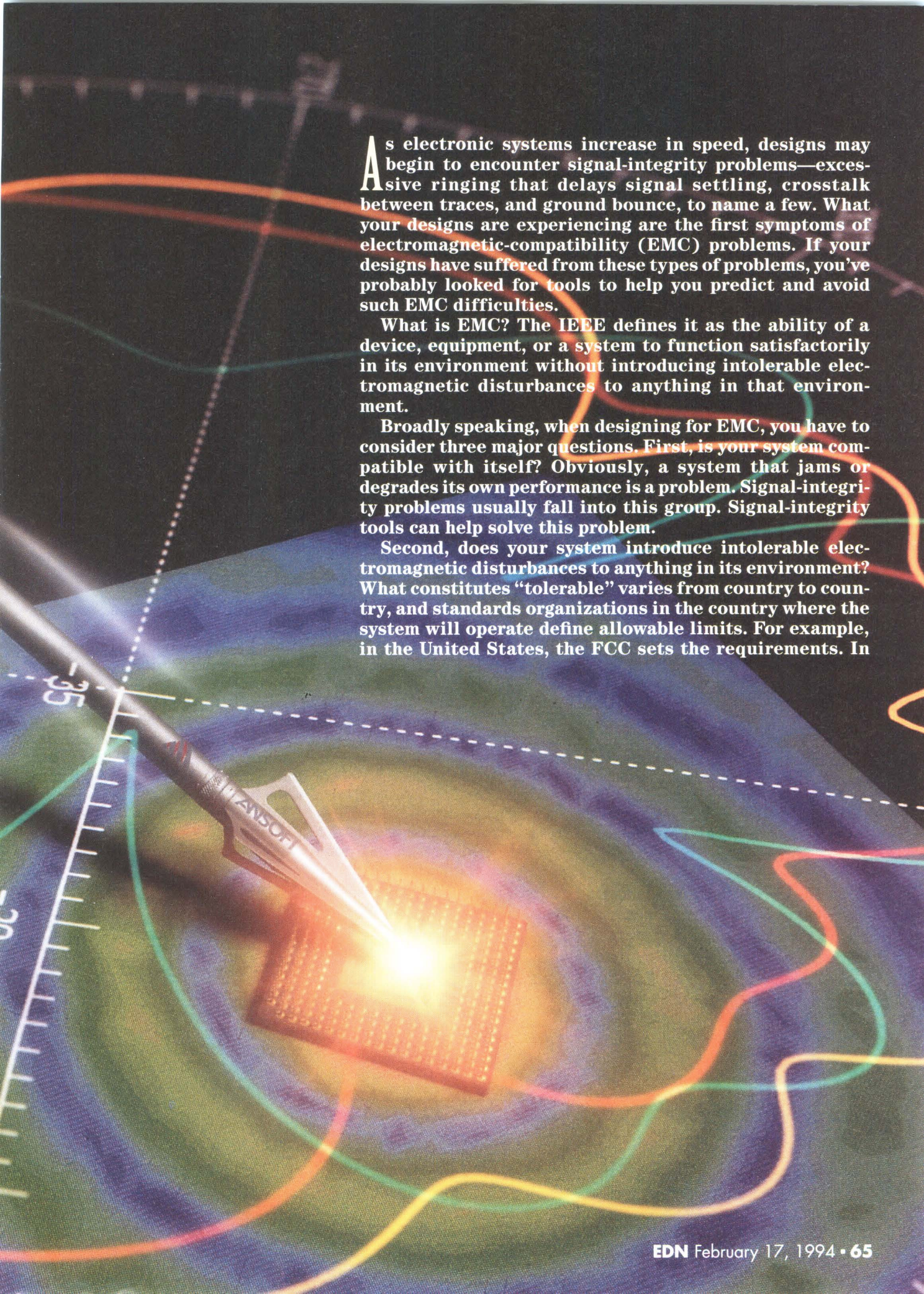

**A**s electronic systems increase in speed, designs may begin to encounter signal-integrity problems—excessive ringing that delays signal settling, crosstalk between traces, and ground bounce, to name a few. What your designs are experiencing are the first symptoms of electromagnetic-compatibility (EMC) problems. If your designs have suffered from these types of problems, you've probably looked for tools to help you predict and avoid such EMC difficulties.

What is EMC? The IEEE defines it as the ability of a device, equipment, or a system to function satisfactorily in its environment without introducing intolerable electromagnetic disturbances to anything in that environment.

Broadly speaking, when designing for EMC, you have to consider three major questions. First, is your system compatible with itself? Obviously, a system that jams or degrades its own performance is a problem. Signal-integrity problems usually fall into this group. Signal-integrity tools can help solve this problem.

Second, does your system introduce intolerable electromagnetic disturbances to anything in its environment? What constitutes "tolerable" varies from country to country, and standards organizations in the country where the system will operate define allowable limits. For example, in the United States, the FCC sets the requirements. In

## EMC-DESIGN TOOLS

Europe, the IEC has instituted a new set of strict EMC standards that will go into effect in 1996. Compliance testing is usually required on most systems to verify that a system doesn't violate the standards. Newly emerging EMC tools attack the emissions problem.

Third, does the surrounding environment adversely affect your system? If so, you have a susceptibility problem, which is typically more difficult to solve than are the other two types because it's difficult to know what the surrounding environment will be for every application. One of the reasons that standards organizations are developing emission standards is to specify an environment for which you can design. Specifying the maximum allowable emissions for a system can also tell you that another system in the vicinity will have emissions less than or equal to the maximum. Currently, none of the EMC-analysis tools effectively addresses the susceptibility problem.

The methods of dealing with the first two EMC considerations differ, depending on which of the issues you are addressing.

The problems of an electronic system's compatibility with itself typically manifest themselves without any special testing when you attempt to operate the system. Signal-integrity tools help you at the design stage by predicting such problems before you build a system. This gives you a chance to change the design and avoid the problem.

Currently, the most common method of handling electromagnetic emissions is through compliance testing of the

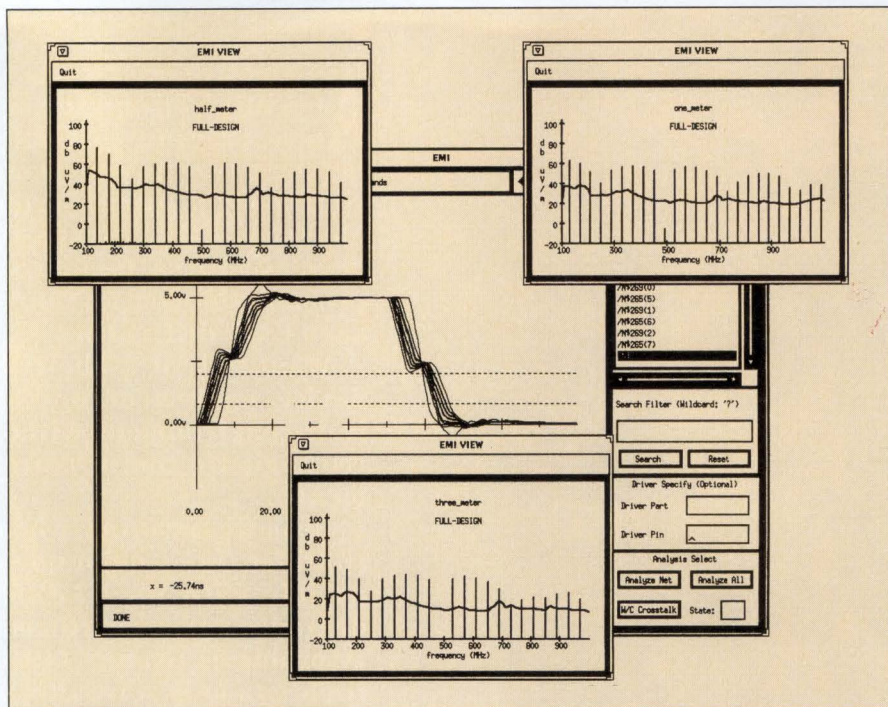

**Quad Design's Quiet predicts EMI radiation at selected points in 3-D space for unenclosed pc boards and subassemblies.**

final product. Although emission testing is necessary and will remain so, finding EMC problems by testing a production system or prototype is undesirable. Product testing usually happens late in the development cycle, and problems may delay your product's completion date. The unit cost of the product may also increase because you typically don't have as many options available for correcting an EMC problem late in the development process.

To make their systems pass emission tests, engineers often try to seal a radi-

ating mess inside a shielding enclosure. Although this technique is often necessary for passing emission testing, a well-designed system inside may reduce the cost of the enclosure.

Correcting an EMC problem earlier in the design stage may be as simple as moving components and traces around on a pc board. **Table 1** lists EMC-design tools that are or soon will be available. EMC tools that can help you at the design stage are of two types.

### Let an expert system help you

The first is an analysis tool that checks your adherence to rules that minimize EMC problems. As this article goes to press, the rule-based EMC tool called EMC Advisor is the only commercial tool that is actually available. EMC Advisor is a part of Racal-Redac's CAD Expert EDA-layout-design System but is an independent application. The tool is an expert system that evaluates a design to measure its relative compliance to a set of EMC-design rules. It is not a simulator, although you might want to use it as a complementary tool with an EMC simulator.

EMC Advisor evaluates a design against a set of 15 rules that focuses on the two categories of emissions: differential mode and common mode. Differ-

**Table 1—EMC-design tools**

Manufacturer	Product	Price	Availability	Description
Ansoft	Maxwell SI Eminence	\$49,900	March, 1994	Simulates emissions of multiple pc boards, cables, and enclosures
Aries Technology	MSC/Aries EMC	\$19,950 \$950/month	Q1, 1994	Simulates emissions of multiple pc boards, cables, and enclosures
Contec	ContecRadia	\$70,000	January 15, 1994	Simulates emissions from a pc board without an enclosure
Quad Design	Quiet	\$60,000	Beta: Q1, 1994	Simulates emissions from a single pc board without an enclosure
Racal-Redac	EMC Advisor	\$15,000	Now	Expert system evaluates compliance to EMC-design rules

ential-mode emissions result from a current flowing around a loop, such as a signal and its return path. Common-mode emissions result from currents on the power-distribution system, such as transients in the ground plane. Poorly designed power-supply decoupling or improper component placement often results in common-mode emissions.

To evaluate a design, EMC Advisor analyzes layer stack, track shielding, impedance profiling, component placement, partitioning, power-supply decoupling, power-plane impedance, and power-plane overlap. You can also add your own rules. Because the tool uses data normally available in the design system, you can run the tool periodically as you perform a layout. Furthermore, you don't have to be an EMC expert to use EMC Advisor. After the tool completes its analysis, it highlights problem areas of the design in red and marginally problematic areas in amber. It also suggests improvements.

Although a rule-based EMC tool still leaves you guessing as to just what your systems electromagnetic emissions are, such a tool can effectively minimize potential EMC problems. For designers with limited knowledge of how to avoid EMC problems, the rule-based tools can help you create a better design that has a much better chance of passing emission tests without problems.

Even if you use an EMC simulator on the design, EMC Advisor may help you create a better design. Another advantage: EMC Advisor runs much faster than analysis tools that perform complete electromagnetic simulations.

#### Simulators help analyze your design

The second type of analysis tool for EMC design is a simulator. The benefit of simulators is well known: You get to see how your design behaves without actually building and testing the hardware. The major concerns with most simulators is how well they represent reality and how difficult it is to obtain or develop the models to use in the simulation. (See **box**, "The ABCs of EMC".)

The simulators in the **table** predict a system's frequency-dependent electric-field intensity at arbitrary points in space. The listed simulators simulate various types of systems.

For example, Ansoft's Maxwell SI

Eminence simulates full 3-D systems, including multiple pc boards, cables, and enclosures. The simulators from Contec and Quad Design do not simulate the effects of enclosures. The EMC tools read physical-design data from a variety of compatible design tools. Make sure the tools you want to use are compatible with your physical-design tools. Such physical-design tools can include tools for pc-board layout, mechanical design, multichip-module (MCM) design, and IC-package design.

Ansoft's Maxwell SI Eminence uses a full-wave finite-element solver to solve the full, unsimplified Maxwell's equations in the frequency domain for characterization of arbitrary 3-D structures. The tool has an adaptive mesh-refinement capability to simplify mesh creation for the analysis of 3-D structures. The software is applicable to EMC and EMI problems in ICs, pc boards, cables, loops, cabinets, apertures, and radiating structures, such as microstrip, wire, slot, and horn antennas. The tool generates a Spice model of a system that runs on Spice simulators.

Aries Technology's EMC tool also analyzes 3-D designs using finite-element analysis. The software automati-

cally generates the finite-element mesh from 3-D physical-design data. It predicts magnetic and electric fields and current densities, induced and applied voltages and currents, and power losses for frequencies from dc to RF. The analysis program provides results for any number of frequencies or in the time domain.

In June, Quantic Design will offer the EMC Greenfield EMC-analysis tool, but the company has not yet set a price for the product. The software models the radiated electromagnetic fields from multiple pc boards within an enclosure, including internal and external cables, using time- and frequency-domain analysis. The tool offers a choice of an approximate-but-fast solution or an exact analysis. Quantic will integrate EMC Greenfield with the company's other Greenfield transmission-line-analysis tools.

Contec's ContecRadia and Quad Design's Quiet model the radiated electromagnetic field of a pc board, MCM, or backplane with no enclosure. As the tools become commercially available, it will be interesting to watch Radia and Quiet. Although less ambitious than some of their competition, will they also

## Manufacturers of EMC-design tools

For free information on the EMC-design tools in this article, circle the appropriate numbers on the postage-paid Information Retrieval Service card or use EDN's Express Request service. When you contact any of the following manufacturers directly, please let them know you read about their products in EDN.

**Ansoft Corp**  
Pittsburgh, PA  
(412) 261-3200  
Circle No. 393

**Aries Technology,**  
a division of MacNeal-Schwendler Corp  
Lowell, MA  
(508) 453-5310  
Circle No. 394

**Contec Microelectronics USA**  
San Jose, CA  
(408) 434-6767  
Circle No. 395

**Hyperlynx**  
Redmond, WA  
(206) 869-2320  
Circle No. 396

**Quad Design,**  
a Viewlogic Co  
Camarillo, CA  
(805) 988-8250  
Circle No. 397

**Quantic Laboratories Inc**  
Winnipeg, Manitoba, Canada  
(204) 942-4000  
Circle No. 398

**Racal-Redac**  
Mahwah, NJ  
(201) 848-8000  
Circle No. 399

#### VOTE . . .

Please also use the Information Retrieval Service card to rate this article (circle one):

**High Interest 583**  
**Medium Interest 584**  
**Low Interest 585**

#### Super Circle Number

For more information on EMC-design tools available from all of the vendors listed in this box, you need only circle one number on the postage-paid reader service card.

Circle No. 400

## The ABCs of EMC

Zoltan Cendes, PhD, President, Ansoft Corp

Many designers may think of electromagnetic compatibility (EMC) as a black art and view its problems as mysterious, counterintuitive, or strange. Solutions to EMC problems tend to be heuristic, based on years of experience with trial-and-error methods. Yet, to understand EMC, you must first understand that the source of the phenomenon is electromagnetic. However, many designers find EMC confusing because they use inappropriate models or simple circuit models to represent complex electromagnetic phenomena.

Maxwell's equations govern electromagnetic fields. These equations predict that time-varying magnetic fields induce electric fields and that time-varying electric fields induce magnetic fields. At low speeds—with leading-edge rise times less than 1 nsec, for example—the induced fields are small, and you may overlook them. In these cases, using traditional lumped-circuit parameters, such as capacitance, inductance, and resistance, you can accurately model the voltages and currents in the components.

However, as computer speeds increase so that signals exhibit subnanosecond rise times, induced fields become significantly larger, and frequencies become higher. In these cases, ordinary circuit theory breaks down. As a result, there is no alternative to full-wave solutions—solving the full set of Maxwell's field equations.

### A spiral inductor's field

The spiral inductor in Fig 1 illustrates how a simple RLC model breaks down at high frequency. This spiral inductor has a three-to-one metalization pattern; that is, the conducting turns are three times as wide as the space between them. As a result, current is readily induced in neighboring turns. A low-frequency solution, assuming the absence of induced currents in the conductors, provides a lumped-parameter response that rises monotonically with frequency (see the green line in Fig 2). Measuring the circuit and providing a

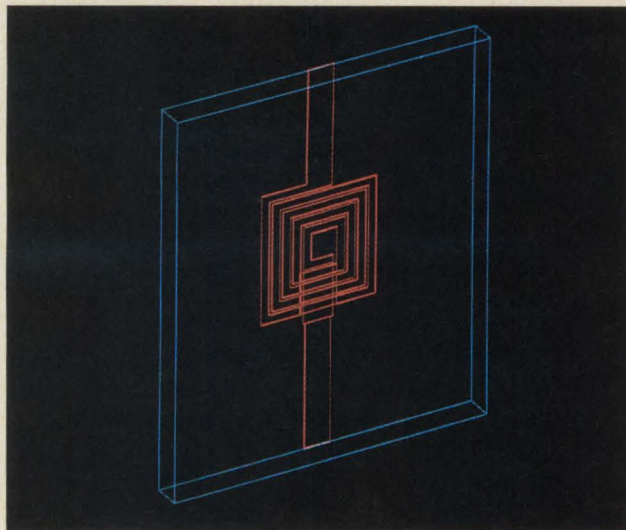

Fig 1—This spiral inductor operates like a classical dipole loop antenna.

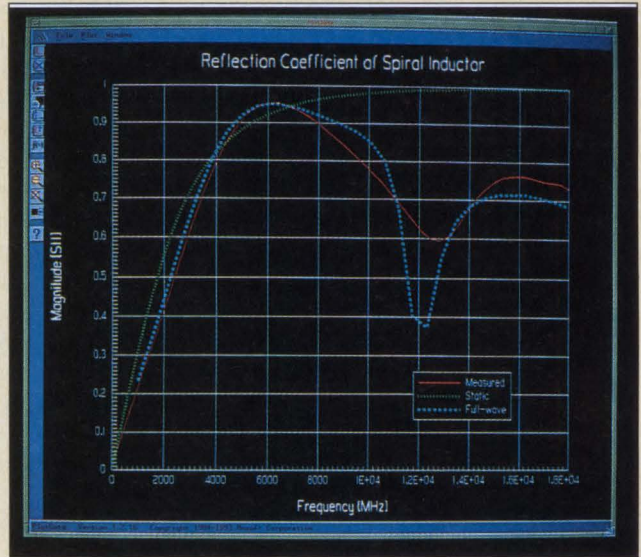

Fig 2—The green line shows the low-frequency analysis of the inductor in Fig 1, ignoring the induced currents. The blue line shows the full-wave solution of Maxwell's equations, and the red line shows the measured response.

full-wave solution of Maxwell's equations determines the actual circuit behavior. This is a much more complicated solution (see the red and blue lines in Fig 2).

In this case, the low-frequency model is accurate to about 5 GHz but breaks down at higher frequencies. Clearly, the low-frequency, lumped-parameter circuit model is useless at high frequencies. Although 5 GHz appears to be a very high frequency, it may not be. For example, a digital circuit operating with a 1-nsec rise time has a significant amount of leading-edge harmonics at this frequency.

What is going on here? Why does the performance of the spiral inductor depart so radically above 5 GHz from the behavior that circuit theory predicts? There are three reasons.

First, as the frequency rises, the current no longer flows in the familiar stream-function patterns common to low frequency. Instead, the current crowds toward the edges of the conductors due to skin effect.

Second, eddy currents are induced in the ground plane below the spiral. These ground-plane eddy currents further alter the inductance and resistance values of the inductor.

Third and most important, high-frequency electronic components set up and radiate electromagnetic waves. These waves establish resonances and standing wave patterns in the inductor, dramatically altering the voltage and current patterns and radiating energy away from the system. In fact, at high frequency, the spiral inductor in Fig 1 operates like and exhibits behavior similar to that of a classical dipole loop antenna. Because the radiation from a loop antenna grows with the square of the frequency, inductor performance deteriorates rapidly following the onset of radiation.

Fig 3 shows the far-field radiation pattern for the spiral

inductor at 10 GHz. At this frequency, 10 to 15% of the energy input to the inductor radiates away.

Solving EMC problems, therefore, involves determining the underlying electromagnetic fields. For low frequencies, you can solve the quasistatic field equations for LCR, and you can use the resulting values and quasi-transverse-electromagnetic analysis to simulate signal-integrity phenomena, such as crosstalk, ringing, and ground bounce. At midrange frequencies, you must model the eddy currents in the conductors by solving the electromagnetic-diffusion equation.

However, at leading-edge rates lower than 0.1 nsec, there is no alternative to solving the full set of Maxwell's equations. The full-wave solution is difficult to compute. However, once you compute it, you can generate a full-wave Spice model to interface directly with circuit simulators.

Fortunately, finite-element methods to compute full-wave solutions have emerged in recent years. In many cases, these methods provide easy and highly accurate solutions to EMC problems. Consider, for example, the layout of the pc-board power and ground traces in **Fig 4a**. Ansoft's Maxwell SI Emission simulated the layout.

The first step in simulating the radiated emissions is to enter the geometry of the structure by using the software's solids-modeling system or by reading the geometry from a CAD file, such as GDSII, Gerber, or AutoCAD. Next, define the materials in the structure and the input signals. Finally, the software creates and refines the finite-element mesh, solves the resulting matrix equations, and determines the frequency response.

After the software completes the solution, you can test the solution in many ways, including having the software compute inductance and reactance as a function of frequency, determine resonances and standing wave patterns, and plot near- and far-field patterns. **Fig 4a** shows a plot from the pc board of the near field at 100 GHz. The plot shows that plac-

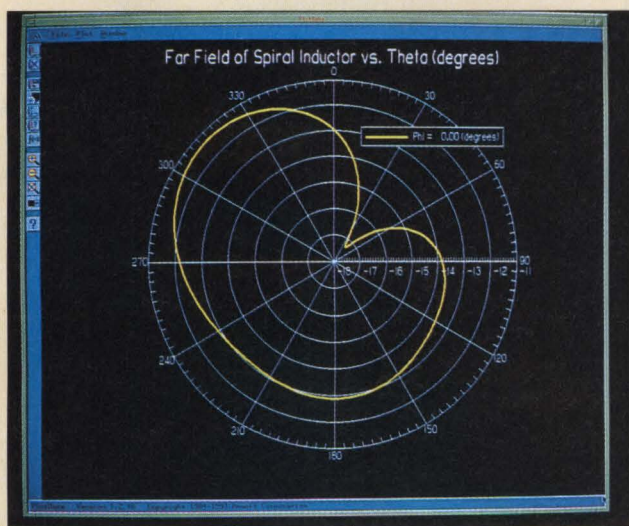
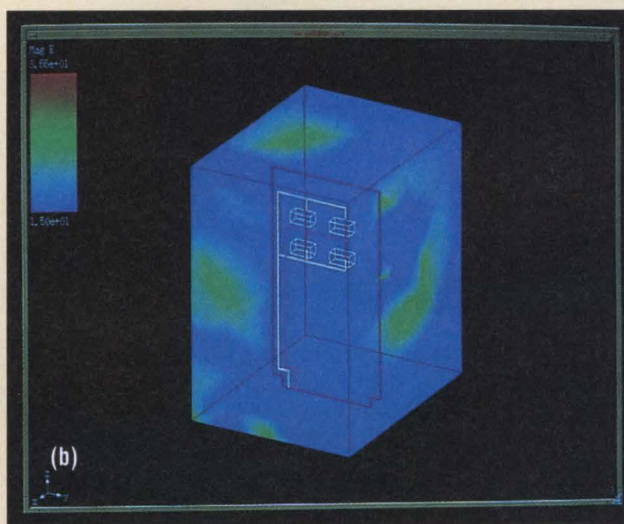
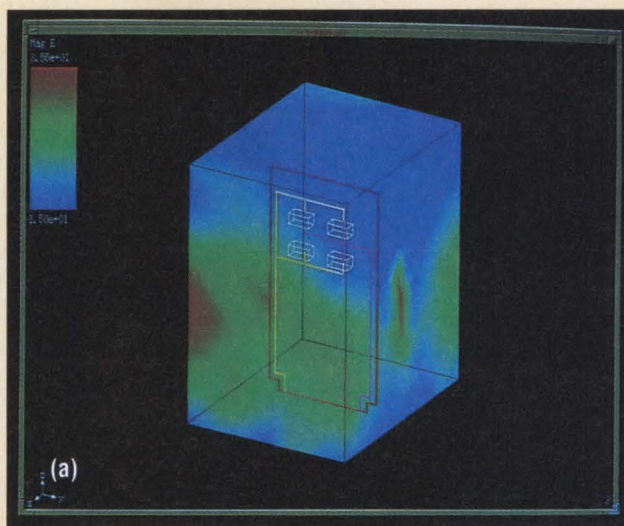

**Fig 3**—The radiation pattern of Fig 1's spiral inductor at 10 GHz shows that 10 to 15% of the energy input to the inductor radiates away.

ing the power and ground leads on opposite ends of the pc board creates a large current loop that emits excessive radiation.

To dramatically reduce the radiated emissions from the pc board, the designer rerouted the ground trace to lie directly under the power trace. **Fig 4b** shows the resulting near field at 100 GHz.

Thus, solving EMC problems is not a black art after all. The electromagnetic fields in electronic components causes these problems. Using full-wave finite-element methods to solve these fields directly, you can perform a precise simulation of EMC phenomena and minimize electromagnetic coupling and emissions.



**Fig 4**—A plot from the pc board of the near field at 100 GHz shows that placing the power and ground leads at opposite ends of the pc board creates a large current loop that emits excessive radiation (a), indicated by red. Reducing the loop area (b) of the power and ground trace significantly reduces the radiated energy.

## EMC-DESIGN TOOLS

prove to be less capable, or more realistic for real-world problems?

ContecRadia calculates radiated-noise and electric-field intensities, including electrical effects, reflection, and crosstalk of transmission lines in high-speed, high-frequency digital, analog, and mixed-signal systems. After extracting the electrical models from layout files, the ContecSpice circuit simulator calculates time-domain current and voltage distributions in the conductor traces. It uses the current distribution on the conductive traces to calculate the radiated electric-field intensities, based on loop-antenna principles.

Quad Design's Quiet uses transmission-line simulation to model the network waveforms and then sums the radiation from each net segment to get the radiation from the entire net relative to one or more specified points in space (the receiving antenna location). By summing the radiation from all nets, the software obtains the full board radiation.

Quiet simulates networks in the time domain using linear and nonlinear dri-

ver, receiver, and terminator characteristics. By accurately modeling the network-signal characteristics of all modern logic families, the software can accurately model the radiated energy. The software lets you specify the characteristics of each signal on every net or just the clock frequencies. It also lets you use pseudorandom signals to simplify the definition of signal activity.

Although the Radia and Quiet simulators handle only pc boards and do not include the effects of an enclosure, don't count them out as useful tools to help you stay out of EMC problems. The shielding effects of a conductive enclosure are useful and often necessary, but reducing radiated energy at its source is usually best.

An analysis tool that lets you work on a single board at a time can help you maintain low emission levels. However, such a tool does not let you obtain accurate data on the radiated energy of the entire system outside its enclosure—something you may want to know if you anticipate problems when you run emis-

sions tests on the completed system.

Also, remember: Tools that help reduce transmission-line and signal-integrity problems typically result in lower emission levels.

Kellee Crisafulli, president of HyperLynx, a manufacturer of signal-integrity-analysis tools, reports that some of the company's customers find that when they clean up their transmission lines, they also reduce EMI and RFI.

The future for EMC-analysis tools for radiated emissions looks promising and competitive. Many of the companies that offer transmission-line-analysis tools expect to have EMC tools available within the next year. With the ever-increasing clock rates of many electronic systems, EMC is likely to become a more familiar acronym. **EDN**

You can reach Doug Conner at (805) 461-9669.

Article Interest Quotient  
(Circle One)

High 583 Medium 584 Low 585

## Find The EMI Source

Down to a Single Trace



With a  
patented  
fine tip  
probe

### PS400 Near Field Set Includes:

- **Tip probe** isolates source of emissions to specific pin or trace.
- **Broadband probe** locates general area of emissions.
- **H-Field probe** detects sources of magnetic noise.
- **Custom storage case** protects probe set.

EMI AND  
SAFETY TEST  
EQUIPMENT



114 Olinda Drive, Brea, CA 92621  
(714)-528-8800

----- OTHER EQUIPMENT IN STOCK -----  
ANTENNAS • PREAMPLIFIERS • LISNS • COMB GENERATORS

CIRCLE NO. 16

## IF AN INDEPENDENT PERFORMANCE STUDY DOESN'T CONVINCE YOU,

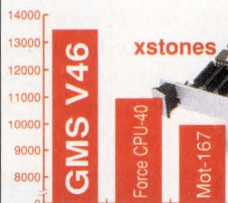

## MAYBE THE PRICE DIFFERENCE WILL.

### WHY PAY TWICE AS MUCH FOR ONLY HALF THE PERFORMANCE?

An independent research laboratory recently compared the New GMS V46 to two leading VME SBCs, the Motorola MVME167 and the Force CPU-40.

We knew our design was superior, but what they discovered surprised us. Not only did the V46 outperform the competition in all seven individual benchmark tests (by 10-50%), the V46 costs substantially less.

Take a look at the above table to see the pricing of all of the boards as tested.

#### AVAILABLE OPTIONS:

- Ethernet/SCSI
- 030/040 CPU
- DRAM/SRAM/EPROM/FLASH
- 32-bit Expansion Bus
- Real-Time OS
- Super VGA • VME64

Product	Processor	ENET/SCSI	DRAM	SRG	Price
GMS V46	68040 25MHz	YES	8MB	8	\$2,575
Motorola 167	68040 25MHz	YES	8MB	4	\$4,995
Force CPU-40	68040 25MHz	No SCSI	16MB	4	\$5,400

CONFIGURATION AND PRICING AS TESTED. PRICING FROM TRADE PUBLICATIONS.

### EXPANDABLE AS YOUR NEEDS CHANGE.

Only the GMS V46 offers up to 32MB of DRAM, 4MB EPROM, 512K SRAM and 8 serial ports standard, all for about half the cost of a similarly configured MVME167 or CPU-40.

With the addition of the New GMS Super VGA controller, the V46 can become a single-slot, real-time embedded workstation with simultaneous support for CRTs and LCDs.

And, the V46 is 100% CMOS.

### SEE FOR YOURSELF.

When it comes time to choose an embedded computer for your application, call (909) 980-4VME for a complete competitive analysis. We're proud of the V46's performance and we think you will also be impressed.

As a matter of fact, we're so sure you'll agree that the new GMS V46 provides the highest-performance and the lowest cost, we'll send you one FREE to evaluate for 30 days.



GENERAL MICRO SYSTEMS  
P.O. Box 3689 • 8358 Maple Pl., Rancho Cucamonga, CA 91730

All names and products mentioned are trademarks of their respective holders.

Please call me, Circle No. 124

Send more information, Circle No. 125



# When Your Design's On The Line...

Turn to TDK for EMI/RFI Suppression.

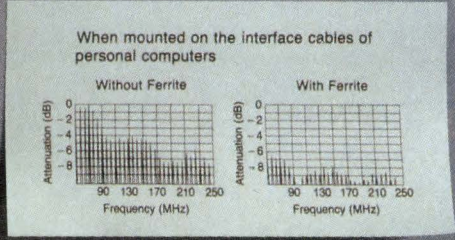

TDK Ferrite Cores for EMI/RFI Suppression come in all shapes and sizes with initial permeability ( $\mu$ iac) ranging from 45-1,500.

Take, for example, TDK Ferrite EMI Suppressors for Cables. Once attached to power or interface cables, these small ferrite cores absorb high frequency EMI without affecting signal transmission. Even large power surges can be absorbed without saturation.

Our singular understanding of ferrite and its properties has enabled TDK to develop products such as ferrite bead cores, ferrite chip EMI suppressors, and multi-hole ferrite plates, to name only a few.

CEL, TDK's Component Engineering Laboratory, can help you with your product selection, or can custom design and test manufacture EMI/RFI suppression components to meet your specific requirements.

Call or write your local TDK office today for more information.



- Ferrite Chip EMI Suppressors
- Ferrite Bead Cores
- Axial Leaded Ferrite Beads
- EMI Suppression Multi-Hole Plates
- Ferrite EMI Suppressors for Cables
- Ferrite Toroidal Cores for EMI/RFI Filters
- Ferrite Plates for Shielding

TDK CORPORATION OF AMERICA 1600 Feehanville Drive, Mount Prospect, IL 60056, USA Phone: 708-803-6100 INDIANAPOLIS Phone: 317-872-0370 NEW YORK Phone: 205-464-0222 GREENSBORO Phone: 919-292-0012 DALLAS Phone: 214-506-9800

GERMANY • FRANCE • ITALY • U.K. • KOREA • TAIWAN • HONG KONG • SINGAPORE • THAILAND • CHINA • BRAZIL

TDK CORPORATION Tokyo, Japan



*Why now?*

## *Our* NEW 4-MEG VRAM.

*[Because its FAST PAGE MODE is so rapid.]*

The new 4-meg VRAM doesn't just give you the most memory any VRAM ever has. If it's a Samsung part, it also gives you the highest *performance* any VRAM ever has.

Thanks to an advanced Fast Page Mode that makes pages

move at unheard-of speeds.

The chip's extended data out feature gives it a Fast Page Mode cycle time of 25 ns. Which gives your customers the ability to build products with increased visual performance. And gives *you* one more reason

to use the 4-meg *now*.

Unlike some lesser-performance 4-megs, this 60 ns chip is a full-SAM VRAM—the design that will be the industry standard. It gives you an 8-column block write.

And like all semiconductor

*The Samsung VRAMs*

PART	ORG.	SPEED
KM4216C256*	256K x 16	6ons
KM428C257	256K x 8	6ons
KM428C256	256K x 8	6ons
KM428C128	128K x 8	6ons
KM424C257	256K x 4	6ons

\*Sampling now; all others in production quantities now.



products from Samsung, it has the kind of quality that has won us ISO 9001 certification.

For us at Samsung, this 4-meg VRAM is one more way we're advancing our leadership position in memory—and adding to our remarkable

achievement in building the world's first 16-meg DRAM.

All of which is why you may want to act fast yourself. To learn about the VRAMs with the blazing Fast Page Mode, please call 1-800-446-2760 or 408-954-7229 today. Or write to VRAM

Marketing, Samsung Semiconductor Inc., 3655 North First Street, San Jose, California 95134.



**SEMICONDUCTOR**

*A Generation AHEAD.*

# SIEMENS

## What Is The #1 Reason To Choose Us For Embedded Control ICs?

### *K<sub>r</sub>\*f<sub>e</sub>(t)<sub>d</sub>*

#### #1 In 16-Bit Microcontroller Math Performance.



The SABC167 16-bit microcontroller gives you unbeatable servo performance, 500ns multiply, context switching, interrupt response, and DMA performance which is 25 times faster than the nearest competitor. *Call and ask for Lit. Pack #M14F039.*

CIRCLE NO. 140

#### #1 In On-Board 8-Bit Peripherals.



The 80C517A features over ten times the amount of RAM of the 80C52 and an extended set of on-board peripherals, which reduces the need for external components, and saves you money and board space in your designs. *Call and ask for Lit. Pack #M14F047.*

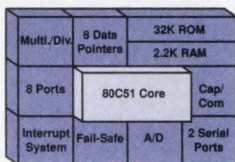

CIRCLE NO. 141

#### Superior Service And Technical Support In The U.S., And Around The World.



We work very closely with you to provide the service and technical support that fits your needs, including Field Application Engineering, Just-In-Time delivery, and the best microcontroller tool support in the industry.

#### #1 Value In 16-Bit Microcontroller Evaluation Kits.



This kit includes everything you need to test the world's fastest real-time controller – the SAB80C166 – with complete functionality. It's a \$5,000 value, for only \$195! *Call for more details on how to order. Call and ask for Lit. Pack #M14F049.*

CIRCLE NO. 142

## You Decide.

Siemens Embedded Control products offer blazing CPU speed and peripheral functionality, for superior performance in any application. And they're complemented by a full suite of development tools, including C, RTOS, fuzzy, Modula 2 and Forth.

Plus, we back all our products with the global expertise and experience you need to build for the world market, right here at home. As well as the technical support and commitment to R&D that have given our customers a competitive edge around the world.

## Announcing Our Latest Reason.

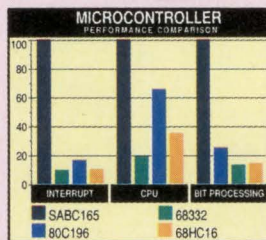

#### #1 In 16-Bit Microcontroller Price/Performance.

The SABC165 offers a 100ns instruction execution rate and a 50ns interrupt sample rate — twenty times better than the competition.

Achieved in a streamlined design, its dynamically programmable bus modes let you reduce system costs by allowing 8-bit and 16-bit wide devices on the same bus. With five times the capabilities of other 16-bit devices, it's ideal for high-volume data transfer applications like EDP, industrial control and telecommunications.

The SABC165's optimization for digital applications makes it the best 16-bit value available. *Call and ask for Lit. Pack #M14F048.*

CIRCLE NO. 143

Whatever your #1 reason might be for choosing an Embedded Control IC supplier, Siemens is the #1 company to call.

**1-800-77-SIEMENS**  
Call Today, And Ask For Extension 3.

# PLD-design methods migrate existing designs to high-capacity devices

Mike Trapp, Lattice Semiconductor Corp

*Moving to newer higher capacity programmable devices can give you higher density and better performance. But if you use common CAE design tools, transferring your old design's description to the new device's development environment may be difficult. PLD-design methods help ensure that your design remains transportable.*

All CAE tools accept PLD-design methods. Thus, using PLD-design methods leads to a very simple method for moving designs to new types of PLDs. Using these methods helps you take advantage of the increased performance and lower cost of newer devices and lets you combine new designs with existing ones.

## Overcoming proprietary databases

Each CAE vendor has developed a proprietary database for sharing circuit-design information among its own tool set. To transfer circuit-design information from one vendor's tool set to another's, you must perform a complex translation. This translation may misinterpret or drop information altogether, yielding an erroneous result.

The ostensible "industry-standard" Electronic Design Interchange Format (EDIF) netlist typifies this problem. EDIF can represent circuits at levels ranging from a complete graphical, functional, and parametric representation to only a primitive functional representation. As a result, one

vendor's EDIF netlist reader may not totally understand another's EDIF netlist. Consequently, using incompatible netlists would make your translation at least incomplete and at worst inaccurate.

However, translation becomes simple and reliable if you use PLD-design methods to express your design. In particular, most designers use Boolean equations to describe their PLDs' functions because of the AND/OR architecture of PLDs. Fortunately, because PLDs have become extremely popular as a "can-do-anything" circuit element, CAE vendors have integrated PLD-development tools into their CAE tools. These tools produce Boolean equations in various formats, which you can easily translate from one to another, giving an accurate and complete functional description of a circuit.

To illustrate, consider the high-level description of a 10-bit, up/down, preloadable counter in **Listing 1** (see *EDN BBS*). This functional description uses ABEL 4.XX, a device-independent language. A device's description at this level does not translate easily to any specific PLD. However, you can use a PLD compiler to transform the

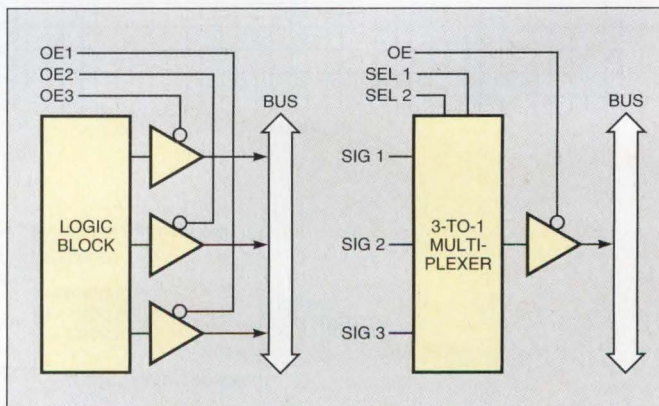
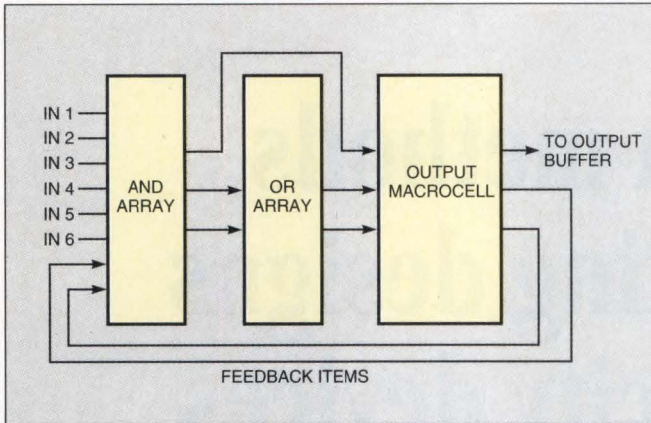

**Fig 1—You can translate 3-state buses into 1-of-N selection functions for implementing in a high-density programmable device.**



The software listings in this article are available on EDN's computer bulletin-board system (BBS). Phone (617) 558-4241 with modem settings 300/1200/2400 8,N,1. Access /freeware SIG and specify /r/read option followed by /k/keyword search for "MS #533."

## PLD-DESIGN METHODS



**Fig 2—Boolean expansion may improve device utilization but can introduce feedback terms.**

high-level ABEL description into reduced Boolean equations (**Listing 2** on *EDN BBS*)—the fundamental description of a 10-bit up/down counter. Now, you can move this Boolean representation of the counter to virtually any development environment with only minor changes.

Because all mainstream PLD compilers produce reduced

equations with virtually identical syntax, migrating these equations from tool to tool is simple. For instance, the PDS tool from Lattice for developing devices in the company's pLSI family has an equation syntax virtually identical to ABEL's reduced-equations syntax. Similarly, the PLA files that ABEL, Minc, and CUPL produce all follow the standard rules for PLA-file syntax.

You can even extend this technique of obtaining reduced, transferable equations from a schematic diagram. Many CAE companies include PLD compilers, with associated PLD libraries, in their design environments. With components from their PLD library, you can use the CAE tools to produce reduced Boolean equations that describe the schematic. You can then integrate these equations with functions expressed in a PLD-description language to form a set of equations that completely describes your circuit. The design tools may produce these equations in the familiar textual form or in an industry-standard format known as PLA (see **box**, "Interpreting PLA files").

If you capture your old designs in the form of these equations, you just follow a series of basic steps to implement them in a new programmable device:

- Define the I/Os.

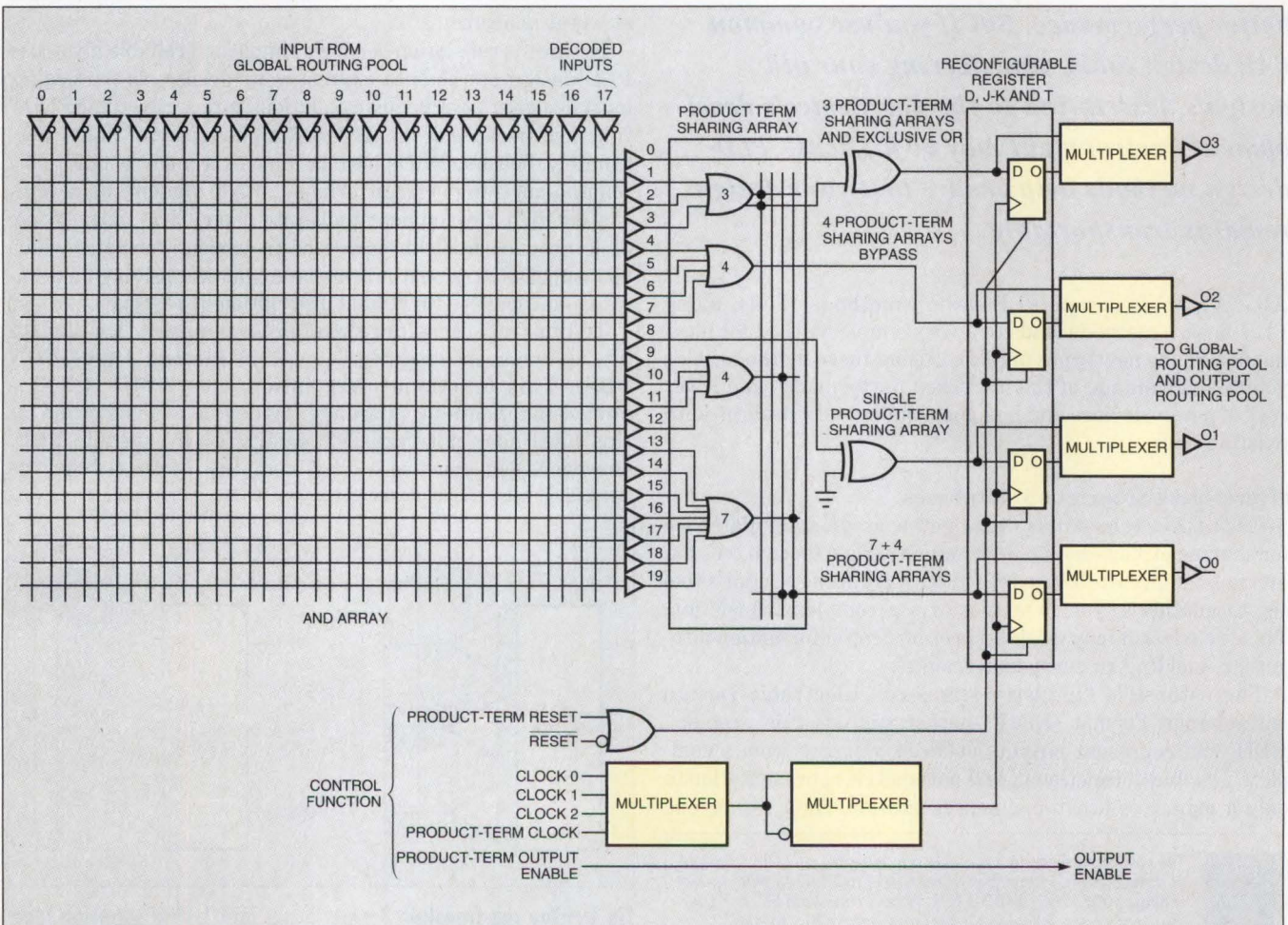

**Fig 3—The pLSI logic block allows different product-term-sharing combinations for implementing various logic functions.**

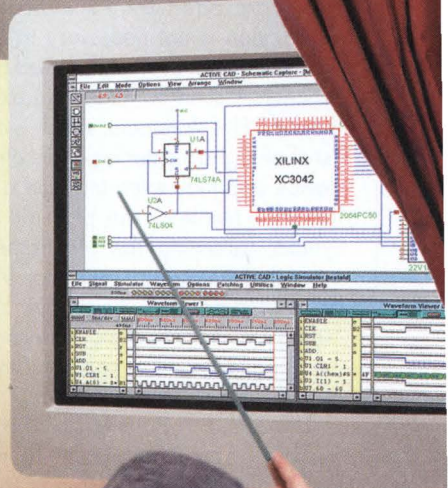
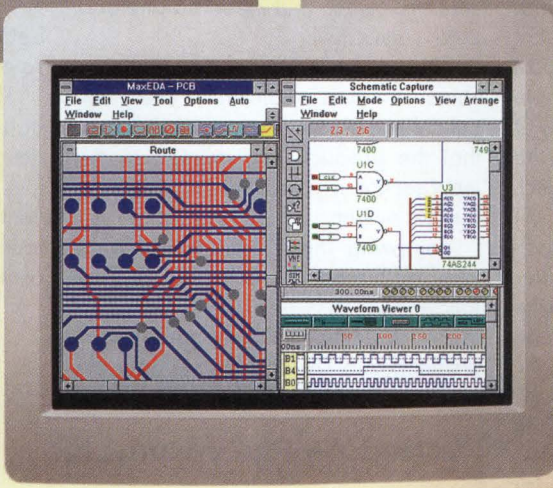
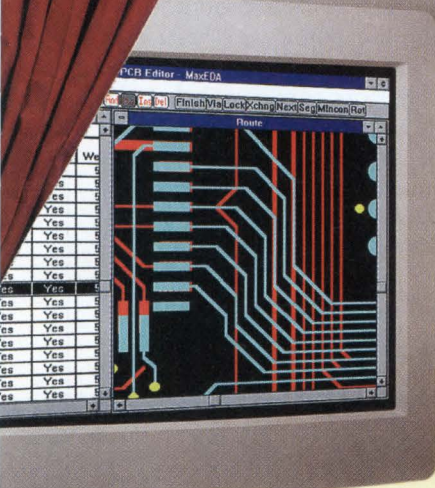
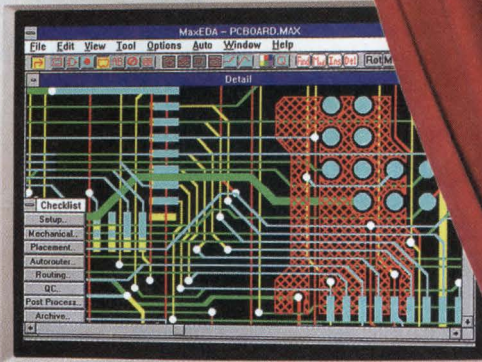
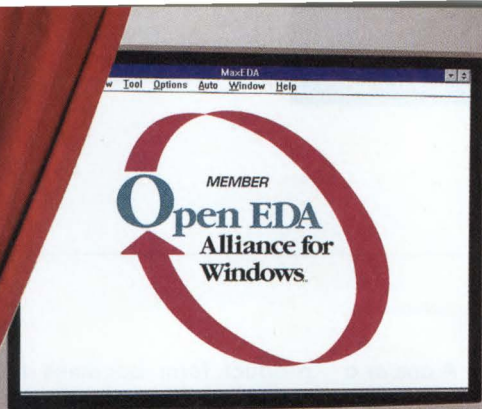

# A Symphony in EDA

*Achieve Superior Performance  
With Interactive EDA Design Tools.*

When you lead the best players in EDA, you lead with **MASSTECK**. We understand the importance of playing together with an entire suite of EDA products. MaxEDA for PCB is integrated with the top players in the Open EDA Alliance for Windows™. With MaxEDA you conduct a design from inception to manufacturing.

Call today for superior EDA design performance

**1-800-MASSTECK**

**1-800-627-7832**



## MASSTECK

**Interactive EDA**



MICROSOFT  
WINDOWS  
COMPATIBLE  
32-Bit Application

## PLD-DESIGN METHODS

### Interpreting PLA files

**Listing A** shows the PLA-format file for the 10-bit up/down counter. The statements preceded by **#\$** indicate that information is not necessary to the circuit description but may be used by post processors such as fitters. An example is the **#\$ PIN** statement, which is an I/O list of all signals entering and exiting the device and may even indicate a specified PIN number. The plus (or minus) symbol following the pin name indicates that the register node has a buffer or inverted between the register and the output pin. Polarity designators have no meaning for inputs or combinatorial outputs.

The **.i** and **.o** statements indicate the number of inputs and outputs, respectively. The number of inputs includes nodes feeding back as circuit inputs. The number of outputs includes actual combinatorial signal outputs and signal outputs controlling the D input, the D asynchronous set, and the output-enable equations.

The **.type f** statement indicates the format of the PLA file. The **F** format shows equations implemented in only positive logic, and the alternative **FR** format shows the equations implemented in both positive and negative logic.

The **.ilb** and **.ob** statements identify inputs and outputs, respectively, of the PLA file. Feedback nodes included as inputs have an **.FB** extension. The outputs also use dot extensions to indicate that the output signal is registered (**.REG**) or part of an exclusive-or equation (**.X1** and **.X2**).

The **.phase** statement indicates if the signal should be complemented (**.phase 0**) or not complemented (**.phase 1**). The **.p** indicates the number of product terms required to define the circuit's function. The table following the **.p** statement defines the product terms.

The table has two sections. The first section defines the inputs to the product term and has a column for every input defined. A minus sign in a row indicates the input for that column is a "don't

care" for that product term. A one or a zero in a column indicates that the product is true when that input is a one or a zero, respectively.

The output section reads similarly. This section has a column for every output defined. A one in a column indicates that the product term defined in the input section is a product term required for that output.

Following these rules, you would interpret the equations for **Q9.REG** as follows (**Q9.FB** is the first output defined in the **.ob** section): When **loadl** is complemented, and **D9** and **clr** are true, the

product term becomes the output **Q9.REG**. When **loadl**, **clr**, **ce**, and **Q9.FB** are true, the product term becomes the output **Q9.FBn**. And so on...

This file looks very cryptic, but it is actually a very compact way to describe large complex circuits. The PLA format is an industry standard; hence, tools that use it as input can interface with tools that produce PLA file as output.

### Listing A—PLA-format file

```

#$ TOOL ABEL 4.10
#$ DATE Mon Oct 5 14:41:38 1992
#$ TITLE 10 bit up down loadable counter
#$ TITLE Michael Trapp Lattice Semiconductor Oct 1990
#$ MODULE _10bitctr
#$ JEDECFILE count10
#$ VECTORFILE _10bitctr.tmv
#$ PINS 26 Osc OE Q9+ Q8+ Q7+ Q6+ Q5+ Q4+ Q3+ Q2+ Q1+ Q0+ loadl D9 D8 D7 D6 D5
  D4 D3 D2 D1 D0 u_d ce clr
.i 26
.o 30
.type f
.ilb Osc OE loadl D9 D8 D7 D6 D5 D4 D3 D2 D1 D0 u_d ce clr Q9.FB Q8.FB Q7.FB
Q6.FB Q5.FB Q4.FB Q3.FB Q2.FB Q1.FB Q0.FB
.ob Q9.REG Q8.REG Q7.REG Q6.REG Q5.REG Q4.REG Q3.REG Q2.REG Q1.REG
Q0.REG Q9.C
Q8.C Q7.C Q6.C Q5.C Q4.C Q3.C Q2.C Q1.C Q0.C Q9.OE Q8.OE Q7.OE Q6.OE Q5.OE
Q4.OE Q3.OE Q2.OE Q1.OE Q0.OE
.phase 11111111111111111111111111111111
.p 131
-01-----1----- 10000000000000000000000000000000
-1-----111----- 10000000000000000000000000000000
-1-----0010000000000 10000000000000000000000000000000
-1-----0-11-----1 10000000000000000000000000000000
-1-----0-11-----1- 10000000000000000000000000000000
-1-----0-11-----1 10000000000000000000000000000000
-1-----0-11-----1 10000000000000000000000000000000
-1-----0-11-----1 10000000000000000000000000000000
-1-----0-11-----1 10000000000000000000000000000000
-1-----0-11-----1 10000000000000000000000000000000
-1-----0-11-----1 10000000000000000000000000000000
-1-----0-11-----1 10000000000000000000000000000000
-1-----0-11-----1 10000000000000000000000000000000
-1-----0-111----- 10000000000000000000000000000000
" "
-1-----001-----00 00000000100000000000000000000000
-1-----0-1-----11 00000000100000000000000000000000
-1-----1-1-----10 00000000100000000000000000000000
-1-----101-----01 00000000100000000000000000000000
-0-----1-1----- 00000000100000000000000000000000
-1-----11-----1 00000000100000000000000000000000
-1-----01-----0 00000000100000000000000000000000
1----- 00000000011111111111100000000000
-0----- 00000000000000000000000001111111111
.e

```



MILITARY POWER COMPONENTS  
OFF THE SHELF  
OVER 1000 STANDARD MODELS



Meet military requirements with flying colors! When it comes to power supplies, over 1000 standard Vicor power components and configurable products fit the bill for military programs seeking the benefits of nondevelopment items (NDI) and commercial off-the-shelf (COTS) equipment.

**Inputs:** 28, 155 & 270 VDC per MIL-STD-704 (A-E), MIL-STD-1275, MIL-STD-1399, and MIL-STD-461.

**Outputs:** 2-95 VDC at 10-100W, expandable to kilowatts.

**Environments:** MIL-STD-202, MIL-STD-810, MIL-STD-2036.

**Quality/Reliability:** MIL-I-45208, NAVMAT P-4855-1A, MIL-HDBK-217.

Shop our line of military power products and find just what you need. Our building-block approach to power supply design cuts time and expense while allowing you to implement virtually any power system solution. Call Vicor today for details.

## Component Solutions For Your Power System

Vicor Corporation 23 Frontage Road • Andover, MA. 01810 USA • TEL: (508) 470-2900 • FAX: (508) 475-6715

Vicor GmbH Carl-von-Linde Strasse 15 D-85748 Garching-Hochbruck, Germany • Tel: +49-89-329-2763 • Fax: +49-89-329-2767

Vicor Far East 293-3 Fu Hsing South Rd., Section 2, 6/F., Suite 3A, Hsin-Tien City, Taipei Hsien, Taiwan • Tel: +886-2-736 4349 • Fax: +886-2-733 7341



## PLD-DESIGN METHODS

- Compile and minimize PLD equations.
- Add MSI and SSI functions.
- Implement 3-state circuits, inversions, and preset/reset.
- Combine all PLD source files into a single file.
- Partition the circuit over the new device's logic blocks.
- Import and verify the design.
- Place and route the design using tools for high-density devices.
- Assign the I/O pins.

An upgraded PLD design begins with defining the I/Os of the new device based on the circuit developed for the old devices. You must first determine if the new design will be pad-limited (the new device does not have enough I/O pins) or gate-limited (the new device does not have enough internal logic).

If the design is pad-limited, you must choose a device with a higher pin count or partition the design among two or more lower-pin-count devices. Using a higher-pin-count device raises the cost of the implementation and typically results in a large amount of unused internal logic. Multiple lower density devices typically incur a lower cost and better utilization of available logic.

A gate-limited design mandates that you select a higher density device. This choice usually leads to unused I/O pins. You can take advantage of the unused pins to introduce additional functions, providing that the design does not become gate-limited again.

### A shotgun approach

As a shotgun approach, you can simply draw a box around a circuit, count the I/O and gate requirements, and select a programmable device meeting this gate and I/O count. However this simple-seeming task can be complex, requiring good engineering judgment of how to best use the high-density device.

Another straightforward method to estimate gate count uses SSI, MSI, and PLD equivalents. By adding the number of these circuit blocks required for a circuit, you can determine if the design fits into a high-density device. For instance, the generic logic block of the pLSI family of high-density devices is roughly equivalent to one-half of a 20V8 PAL device. Extending this approximation, roughly one MSI device or two SSI devices can fit into each logic block.

To partition a circuit implemented with MSI, SSI, and PLDs, look for those nodes that are best suited for interconnection within the new device. These nodes typically travel from one device to only one or two other devices. Assign nodes that connect to many devices to the new device's I/O pins, unless you vacuum all the destination devices into the new high-density device.

This approach eases determining whether you should implement a node within the high-density device or allocate it as an I/O pin. Signals that connect to a device not implemented in the high-density device become I/O pins by default. Naturally, nodes going off-board must become I/O pins of the high-density device.

### Clocking affects partitioning

Clocking can also impact how you partition a circuit. If the circuit requires more clocks than are available in one of the

new devices, for example, you should partition the circuit over multiple devices, such that circuits with common clocks are in the same device.

After defining the circuitry to be placed into the new device, you begin converting the design into the new device's format. A typical design contains many PLDs and a few MSI and SSI devices. Most PLDs have an associated source-equation file, the source for design equations to be imported into the device-specific software for the new high-density device.

You should re-minimize the old equations in the original PLD design before converting them into the high-density device's format. While designing with PLDs, you typically use only Boolean reduction. Advanced reduction algorithms available with standard third-party compilers can further reduce the number of product terms required for a function. These reductions produce a lower gate count and easier implementation into the high-density device.

In some cases, the original design's documentation may not be available. In such a case, you may have only to access a JEDEC fuse map for some PLDs. You must decompile this fuse map into the source equations and re-minimize the equations. The decompilers produce raw equations that have generic names for the equation's variables and parameters:

```
Pin23 := Pin01 & Pin02
# Pin03 & Pin04 & Pin05 .....
# Pin09 & Pin10;
Pin23.OE= Pin06;
```

Although functionally correct, these equations are difficult to read. Using the "search-and-replace" function available on word processors, you can recast the generic signal names to match those on your schematic. Signal naming is important because development software and high-density development software connect signals with common names.

### Add MSI and SSI functions

At this point, you should add any MSI and SSI functions that you want in your revised design. You can easily integrate MSI and SSI functions into the new device by creating a PLD-design file that emulates the functions and importing that file into the device's design software. Most MSI functions fit neatly into a PLD, especially when a designer uses a PLD such as a 22V10 PAL device whose flexible architecture simplifies I/O and product-term allocating. The same procedure for SSI devices is applicable, but combining AND, OR, and INVERTERS into the MSI- or PLD-design equations should be very simple.

By using the same names on the inputs and outputs of the MSI PLD as on the schematic, the resulting file becomes ready for converting and importing.

An alternative method for implementing these functions is to find the closest equivalent circuit to the desired function within the macro library provided with the high-density-device software. Both of these techniques aim to develop functionally correct equations that best utilize the pLSI's architecture.

You can then add PLD files containing MSI and SSI func-

# TRUE $\pm 10\text{kV}$ ESD PROTECTION FROM A CMOS +5V RS-232 IC!

Designed for harsh environments, Maxim's ruggedized MAX211E, MAX213E, and MAX241E are the industry's first RS-232 transceivers to provide true  $\pm 10\text{kV}$  ESD protection per the Human Body Model on all RS-232 I/O pins. And, unlike some bipolar solutions, Maxim's CMOS MAX211E, MAX213E, and MAX241E are immune to latch up!

## TYPICAL BIPOLAR LATCHED BY -2kV TO -10kV ESD

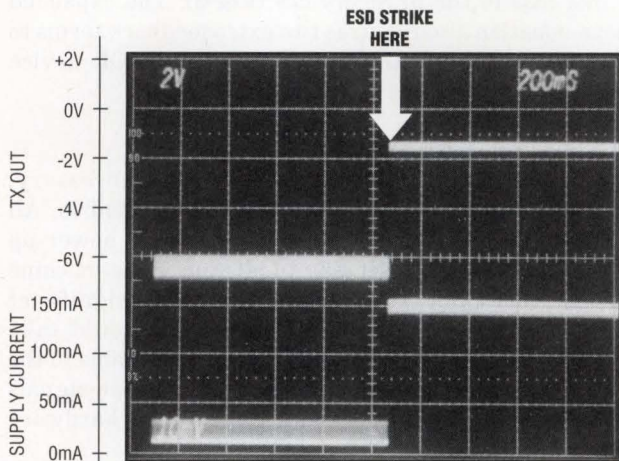

Bipolar Charge Pump Output can collapse, and supply current can increase to 150mA when the receiver input is zapped with -2kV to -10kV, latching the device.

## MAXIM CMOS SURVIVES $\pm 10\text{kV}$ ESD

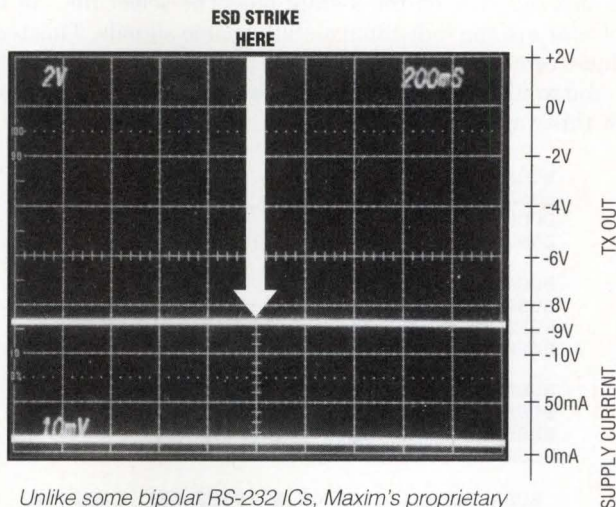

Unlike some bipolar RS-232 ICs, Maxim's proprietary CMOS ESD structure protects RS-232 I/O pins from  $\pm 10\text{kV}$  ESD without latching up.

## Select a Maxim Latch Up Free, $\pm 10\text{kV}$ ESD, RS-232 IC

Part	TX/RX	ESD**	Caps $\mu\text{F}$	Latch Up Free	Data Rate kbps	RX Active	Icc (Shutdown)	Price <sup>†</sup>
MAX211E	4/5	$\pm 10\text{kV}$	0.1	Yes	120		1 $\mu\text{A}$	\$3.62
MAX213E	4/5	$\pm 10\text{kV}$	0.1	Yes	120	2	15 $\mu\text{A}$	\$3.62
MAX241E	4/5	$\pm 10\text{kV}$	1.0	Yes	120		1 $\mu\text{A}$	\$3.62

\*\*ESD testing done on all RX in and TX out pins using Human Body Model waveform detailed in Mil Standard 883 method 3015.7  
<sup>†</sup>1000 up, suggested resale FOB USA.



**FREE Interface Design Guide—Sent Within 24 Hours!**  
**Includes: Data Sheets and Cards for Free Samples**

**CALL TOLL FREE 1-800-998-8800**  
**For a Design Guide or Free Sample**

MasterCard® and Visa® are accepted for Evaluation Kits or small quantity orders.



Maxim Integrated Products, 120 San Gabriel Drive, Sunnyvale, CA 94086, (408) 737-7600, FAX(408) 737-7194.

**Distributed by Arrow, Bell, Digi-Key, Elmo, Hamilton Hallmark, and Nu Horizons.** Authorized Maxim Representatives: **AL**, M-Squared, Inc.; **AZ**, Techni Source Inc.; **CA**, Mesa, Pro Associates, Inc., Infinity Sales, Inc.; **CO**, Component Sales; **CT**, Comp Rep Associates; **DE**, TAI Corporation; **FL**, Sales Engineering Concepts; **GA**, M-Squared, Inc.; **ID**, E.S. Chase; **IL**, Heartland Technical Marketing Inc.; **IN**, Technology Marketing Group; **IA**, JR Sales Engineering, Inc.; **KS**, Delltron; **LA**, BP Sales; **MD**, Micro-Comp, Inc.; **MA**, Comp Rep Associates; **MI**, Micro Tech Sales; **MN**, Mel Foster Technical Sales, Inc.; **MS**, M-Squared, Inc.; **MO**, Delltron; **MT**, E.S. Chase; **NE**, Delltron; **NV** (Reno, Tahoe area only) Pro Associates, Inc.; **NH**, Comp Rep Associates; **NJ**, Parallax, TAI Corporation; **NM**, Techni Source Inc.; **NY**, Parallax, Reagan/Compar; **NC**, M-Squared, Inc.; **OH**, Lyons Corporation; **OK**, BP Sales; **OR**, E.S. Chase; **PA** (Pittsburgh area) Lyons Corporation, (Philadelphia area) TAI Corporation; **SC**, M-Squared, Inc.; **TN**, M-Squared, Inc.; **TX**, BP Sales; **UT**, Luscombe Engineering Co.; **VA**, Micro-Comp, Inc.; **WA**, E.S. Chase; **WI**, Heartland Technical Marketing, Inc.

**Distributed in Canada by Arrow. Authorized Maxim Representative in Canada: Tech Trek.**

Maxim is a registered trademark of Maxim Integrated Products. © 1994 Maxim Integrated Products

## PLD-DESIGN METHODS

tions to the files containing the converted PLD equations. The goal is to derive functionally correct equations in standard compiler format.

### Convert 3-state signals to multiplexers

Trying to implement 3-state buses within an ASIC or high-density devices can create problems, such as causing outputs to go undefined. In fact, many high-density devices can't implement internal 3-state buses at all. As a solution, you can implement 3-state functions with a 1-of-N select function (Ref 1). The inputs to the selector are the signals that would be tied together on the 3-state bus. The select lines of the selector are the individual 3-state enable signals. This technique, commonly used in ASICs, appears in Fig 1.

You would rewrite the 3-state equations for a 1-of-N selector this way:

```
BUSA_SIG1=SIG_1A
BUSA_SIG1.OE=SIG1_OE
BUSB_SIG1=SIG_1B
BUSB_SIG1.OE=SIG1_OE
```

```
BUSA_SIG2=SIG_2A
BUSA_SIG2.OE=SIG2_OE
BUSB_SIG2=SIG_2B
BUSB_SIG2.OE=SIG2_OE
```

```
BUSA_SIG3=SIG_3A
BUSA_SIG3.OE=SIG3_OE
BUSB_SIG3=SIG_3B
BUSB_SIG3.OE=SIG3_OE
```

```
BUSA_OUT= (!SIG1_OE & !SIG2_OE) & SIG_1A
# ( SIG1_OE & !SIG2_OE) & SIG_2A
# ( SIG1_OE & SIG2_OE) & SIG_3A;
```

```
BUSB_OUT= (!SIG1_OE & !SIG2_OE) & SIG_1B
# ( SIG1_OE & !SIG2_OE) & SIG_2B
# ( SIG1_OE & SIG2_OE) & SIG_3B;
```

The six original equations now appear as the two functions of BUSA\_OUT and BUSB\_OUT. Note that you do not need SIG3\_OE.

Assuming that the SIG\_1A and SIG\_2A expressions use typical PAL-type equations, they would have this AND/OR structure:

```
SIG_1A= SIGA1 & SIGA2 & SIGA3
# SIGA4 & SIGA5 & SIGA6;
SIG_2A= SIGB1 & SIGB2 & SIGB3
# SIGB4 & SIGB5 & SIGB6
```

Then the selector equation becomes

```
BUSA_OUT= (!SIG1_OE & !SIG1_OE) & SIG1 & SIG2 & SIG3
# (!SIG1_OE & !SIG1_OE) & SIG4 & SIG5 & SIG6
# ( SIG1_OE & !SIG2_OE) & SIGB1 & SIGB2 & SIGB3
# ( SIG1_OE & !SIG2_OE) & SIGB4 & SIGB5 & SIGB6
# ( SIG1_OE & SIG2_OE) & SIG_3A;
```

The AND function on the output enables (SIG1\_OE, SIG2\_OE) does not increase the number of product terms required to implement the various bus-signal functions. This result holds true for product-term-oriented architectures, such as the pLSI devices.

### Investigate inversions

Given the wide variety of device architectures, you should investigate active-high vs active-low internal signals to

achieve the highest utilization of the device's resources. The following equation is an example:

```
!OUT= IN1 & IN2 & IN3 # IN4 & IN5 & IN6;
```

If you can't implement this equation with a hardware inverter, you can use Boolean expansion to produce an alternative:

```
OUT=!IN1 # !IN2 # !IN3 & !IN4 # !IN5 # !IN6;
```

This equation requires seven product terms as opposed to two when implemented into a PLD-type device architecture like that in the pLSI devices (Fig 2). The expanded Boolean equation also requires two extra feedback terms to implement the OR-AND function in an AND-OR device architecture.

### Define preset/reset mechanism

A frequently neglected, but nonetheless necessary, requirement for digital designs is a reset mechanism. All state-machine designs should have a known power-up state. If you attach a reset line to all your state-machine registers, such a line would unnecessarily use significant routing resources. The reset mechanism should take advantage of the hardware-reset resources available in the new device. You should remove individual reset signals from your design equations and instead use hardware reset.

Many programmable-device architectures provide only reset and no preset mechanism. In these cases, you can complement outputs requiring a preset signal and still use the hardware reset. Alternatively, you can make the preset function synchronous by adding a preset term into the design's equations.

Last, when placing new logic in the high-density device, you should partition that logic into available logic resources. For the pLSI family, you simply write Boolean equations or use the available macros. With the exception of a few keywords, you can enter the equations just as you would using third-party design tools.

### Combining source files and partitioning

The \*.DOC files produced by third-party compilers come in an industry-standard format. These files contain reduced equations derived from the source file, JEDEC maps, high-level state-machine language, truth tables, and standard equations. You should combine all the individual PLD and MSI \*.DOC files into a single source file for partitioning over the high-density device.

Using a pLSI device as an example, you can collect equations into groups of four outputs to partition the PLD equations to fit into the four outputs of the pLSI device's logic blocks (Fig 5). (You must place headers and trailers around the four equations to direct the pLSI design software to partition the equations into a particular logic block.)

The software then maps the equations into the logic block's 18 inputs, 20 product terms, and four registered or combinatorial outputs. Additional logic capacity results from product-term sharing among the four outputs and an optional exclusive-OR gate fed by a product term and an AND-OR term.

# CMOS SWITCHES DELIVER 2Ω CHANNEL MATCHING AND 3Ω RON FLATNESS

Unrivalled Precision—0.012% CMRR without trimming

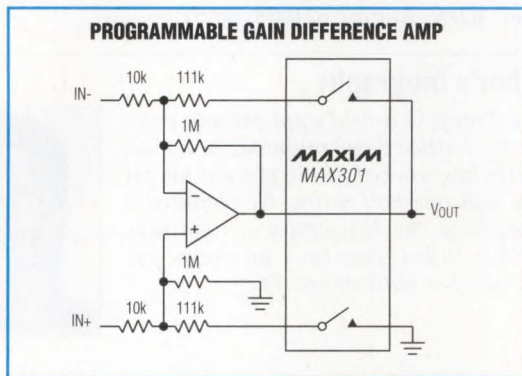

Maxim's new precision analog switches guarantee 3Ω on-resistance flatness and 2Ω channel matching. These ground-breaking specifications assure lower distortion, improved linearity and accuracy, and freedom from trimming for attenuators, tuned filters, and programmable-gain amplifiers. The circuit shown, for example, allows CMRR as low as 0.012% without trimming. All switches operate from single supplies of 10V to 30V, or dual supplies of ±4.5V to ±20V.

Choose the right switch for your design!

PART	FUNCTION	RON (Ω)	MATCH (Ω)	FLATNESS (Ω)	CHARGE INJECTION (PC)	V <sub>LOGIC</sub>	*COST (\$)
MAX301	dual SPST	30	2	3	15	✓	1.23
MAX303	dual SPST	30	2	3	15	✓	2.57
MAX305	dual SPST	30	2	3	15	✓	2.57
MAX317	SPST	30	N/A	3	10	✓	1.05
MAX318	SPST	30	N/A	3	10	✓	1.05
MAX319	SPST	30	2	3	10	✓	1.41
MAX333A	quad SPST	30	2	3	10	N/A	3.60
MAX351	quad SPST	30	2	3	10	✓	1.76
MAX352	quad SPST	30	2	3	10	✓	1.76
MAX353	quad SPST	30	2	3	10	✓	1.76
MAX361	quad SPST	85	2	9	10	✓	1.29
MAX362	quad SPST	85	2	9	10	✓	1.29
MAX364	quad SPST	85	2	9	10	N/A	1.14
MAX365	quad SPST	85	2	9	10	N/A	1.14



**FREE Mux & Switch Design Guide—Sent Within 24 Hours!**  
Includes: Data Sheets and Cards for Free Samples

CALL TOLL FREE 1-800-998-8800  
For a Design Guide or Free Sample

MasterCard® and Visa® are accepted for Evaluation Kits or small quantity orders.

**MAXIM**



Maxim Integrated Products, 120 San Gabriel Drive, Sunnyvale, CA 94086, (408) 737-7600, FAX(408) 737-7194.

Distributed by Arrow, Bell, Digi-Key, Elmo, Hamilton Hallmark, and Nu Horizons. Authorized Maxim Representatives: AL, M-Squared, Inc.; AZ, Techni Source Inc.; CA, Mesa, Pro Associates, Inc.; Infinity Sales, Inc.; CO, Component Sales; CT, Comp Rep Associates; DE, TAI Corporation; FL, Sales Engineering Concepts; GA, M-Squared, Inc.; ID, E.S. Chase; IL, Heartland Technical Marketing Inc.; IN, Technology Marketing Group; IA, JR Sales Engineering, Inc.; KS, Delltron; LA, BP Sales; MD, Micro-Comp, Inc.; MA, Comp Rep Associates; MI, Micro Tech Sales; MN, Mel Foster Technical Sales, Inc.; MS, M-Squared, Inc.; MO, Delltron; MT, E.S. Chase; NE, Delltron; NV (Reno, Tahoe area only) Pro Associates, Inc.; NH, Comp Rep Associates; NJ, Parallax, TAI Corporation; NM, Techni Source Inc.; NY, Parallax, Reagan/Compar; NC, M-Squared, Inc.; OH, Lyons Corporation; OK, BP Sales; OR, E.S. Chase; PA (Pittsburgh area) Lyons Corporation, (Philadelphia area) TAI Corporation; SC, M-Squared, Inc.; TN, M-Squared, Inc.; TX, BP Sales; UT, Luscombe Engineering Co.; VA, Micro-Comp, Inc.; WA, E.S. Chase; WI, Heartland Technical Marketing, Inc.

Distributed in Canada by Arrow. Authorized Maxim Representative in Canada: Tech Trek.

\*1000-up US recommended resale.

Maxim is a registered trademark of Maxim Integrated Products. © 1994 Maxim Integrated Products

CIRCLE NO. 92

## PLD-DESIGN METHODS

The final conversion step is defining the I/O cells. The I/O cell for the pLSI device's definition is

```
SYM IOC IOXX 1;
XPIN XSIGNAME PIN# LOCK#;
IB1/OB1 (SIGNAMEIN/SIGNAMEOUT, SIGNAMEIN/SIGNAMEOUT);
END;
```

(Because the pLSI software routes the pLSI devices according to signal name, it automatically connects all I/O cells to the proper internal nodes.)

### Import, verify, and lay out the design

Once you have partitioned your design over the new device(s), you must import the device's source file into the design software for verifying, placing, and routing. You then follow the steps outlined for the device's development environment.

This technique for creating a design for a programmable device builds upon PLD-design methods. In summary, the following guidelines can simplify your efforts:

- Decide if the design is I/O- or gate-limited.
- Choose the appropriate new device.
- Use as many of the original Boolean functions from low-density source files as possible.
- Convert 3-state outputs to 1-of-N multiplexer outputs.
- For reset functions, use the global reset for the entire device or asynchronous reset for specific logic resources.

- Remain within the logic resources when partitioning the circuit.

Following this method brings you the significant manufacturing benefits of new generations of programmable devices: smaller boards, simpler test procedures, faster development, and fewer parts in inventory and assembly. **EDN**

### Reference

1. Small, Charles H, "Where CMOS rules, multiplexers slave," *EDN*, August 5, 1993, pg 57.

### Author's biography

*Mike Trapp is a field applications engineer for Lattice Semiconductor in Irvine, CA. He has worked at his present job for three and one-half years. He obtained a BSEE from the University of Colorado, Boulder. In his spare time, he enjoys soccer and other outdoor sports.*

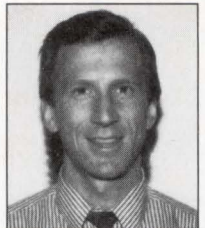

Article Interest Quotient  
(Circle One)

High 589 Medium 590 Low 591

## The Smaller, The Better. Ultra Miniature SMD Crystal Clock Oscillators from Raltron.

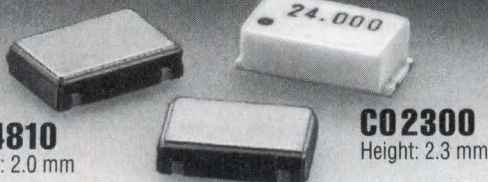

**CO4810**  
Height: 2.0 mm



**CO4910**  
Height: 2.0 mm

**CO2300**  
Height: 2.3 mm

- SMD miniature package
- High stability/reliability
- 3.3V version for battery applications

**Frequency Range:**  
1.8432 to 67 MHz

**Frequency Stability:**  
± 50, ±100 ppm  
(-10° to 70° C)

**Dimensions:**  
(CO4810 / CO4910)  
7.5 mm length  
5.0 mm width  
2.0 mm height

Call or fax your specs to:

**RALTRON**  
ELECTRONICS CORP.

2315 NW 107 AVENUE  
MIAMI, FLORIDA 33172 U.S.A.  
FAX (305) 594-3973  
TELEX 441588 RALSEN  
(305) 593-6033

**ONLY RALTRON HAS IT ALL.**  
Crystals / Crystal Oscillators  
Crystal Filters / Ceramic Resonators

## 12 BIT, 20 MSPS A/D < \$5K

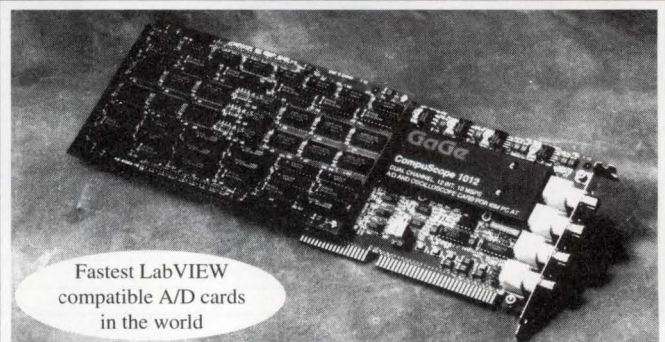

Fastest LabVIEW compatible A/D cards in the world

Gage Applied Sciences Inc., the recognized world leader in ultra-fast PC based data acquisition and instrumentation, presents the CompuScope family:

- 20 MSPS A/D at 12 bit resolution, 65 dB dynamic range
- Up to 100 MHz A/D rate at 8 bit resolution
- On-board memory up to 8 megasamples
- FREE GageScope software. Winner of BEST IN TEST 1993
- Multiple cards can provide up to 32 simultaneous channels
- C, Pascal, BASIC drivers, Windows DLL etc.

<b>CSLITE</b>	8 bit / 40 MSPS / 16K	\$595
<b>CS220</b>	8 bit / 40 MSPS / 256K	\$1,995
<b>CS250</b>	8 bit / 100 MSPS / 32K	\$3,500
<b>CS1012</b>	12 bit / 20 MSPS / 512K	\$4,995

**CALL 1-800-567-GAGE**

Inquire about our D/A cards

Gage Applied Sciences Inc.

5465 Vanden Abeele, Montreal, Quebec, Canada H4S 1S1  
From outside North America, call + 1-514-337-6893  
Fax: (514) 337-8411, BBS: (514) 337-4317

**GAGE**

# REAL VHDL, REAL SYNTHESIS, REAL WINDOWS—STARTING AT THE UNREAL PRICE OF \$1,995.

*PROsim™ delivers 28-state, high-performance, full-timing simulation. PROsim integrated with PROvhdl and PROcapture gives you a powerful, multi-level simulation package, with back-annotation to PROcapture for the fastest design and debug capability available on a PC. PROsim, \$4,995.*

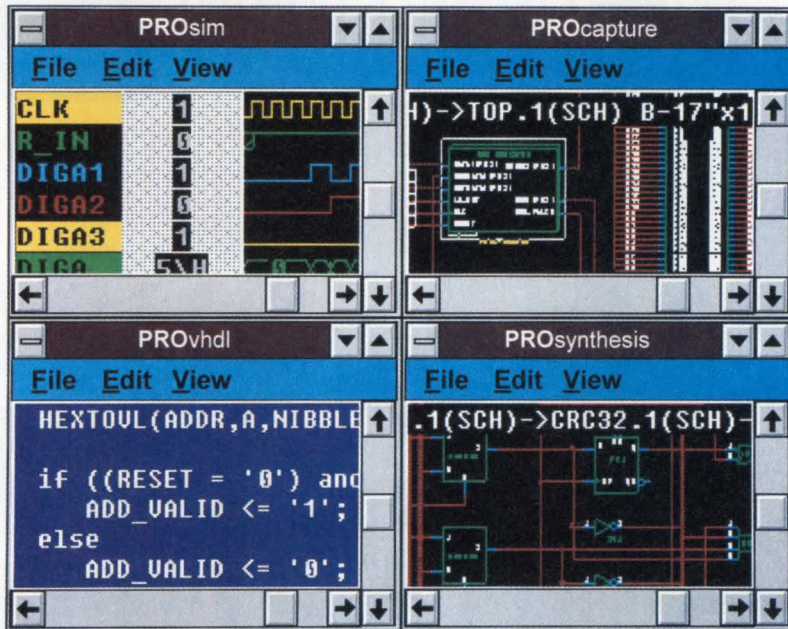

*The newest member of the PRO Series™ family, PROvhdl™ brings the power of high-level design to your PC. Now you can develop more innovative FPGA and CPLD designs faster than ever before. Integrate it with other PRO Series tools for full system-level design. PROvhdl, \$1,995.*

*PROcapture™, our advanced, Windows-based design-entry solution gives you the widest variety of libraries available on the PC platform. EDN Reader's Choice Survey rated Viewlogic tools as the best schematic entry solution. PROcapture, \$1,995.*

*PROsynthesis™ produces gate-level representations from VHDL descriptions in a fraction of the time schematics would take. Create FPGAs and CPLDs in VHDL and have the freedom to target whatever silicon you choose from the broadest set of libraries available today. Incorporating FPGA architecture-specific algorithms, PROsynthesis optimizes silicon utilization in increasingly complex FPGAs. PROsynthesis, \$4,995.*

## VHDL, top-down design, programmable logic— your path to market has never been faster.

Power, integration, performance, product range, the broadest vendor support in design kits and libraries — you can't get a better suite of integrated design tools for the PC at any price, much less one as competitive as this.

Put major-league performance on your PCs. Call 1-800-873-8439 today and ask about the PRO Series.

VIEWlogic

**PRO Series™**



**CALL 1-800-873-8439 NOW FOR A FREE DEMO DISK**

# Our new RF pro to tough standards.

# CDMA

ADJACENT CHANNEL POWER



MI

TDMA (TIME DIVISION)

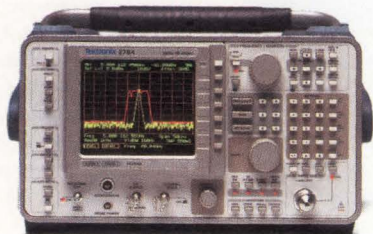

# BURST TRANSITION

# CISPR



# PHASE NOISE

# I/Q IN PHASE/ QUADRATURE

NORT



# ducts measure up Most of all, yours.

# JITTER

STD. 461C  
(MULTIPLE ACCESS)

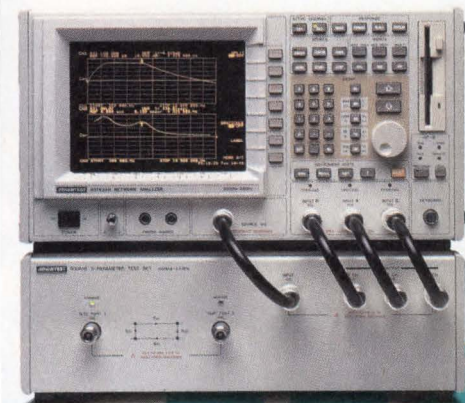

VSAT  
(VERY SMALL  
APERTURE  
TERMINAL)

# MMMC

GMSK (GAUSSIAN FILTERED MINIMUM SHIFT KEY)

PERSONAL  
COMMUNICATIONS  
SERVICE



AMERICAN DUAL MODE CELLULAR

If you're racing to keep pace with new test and measurement requirements, relax. You'll have more time for solving real problems with our new RF lineup. Because we meet your needs like never before.

Here's why. We've partnered with two other leading manufacturers of T&M equipment used worldwide. Rohde & Schwarz in Europe. And Advantest in Japan. We distribute and support each company's microwave and RF instruments here in the USA just like they're our own.

Which means you can now turn to a single reliable source for all the equipment you need. Spectrum analyzers offering unmatched value in every frequency range. Network analyzers combining leading technology with low-cost automation. Signal sources to handle a wide variety of modulation formats. Even EMI solutions to meet all certification as well as pre-compliance testing needs.

These are proven tools in the aerospace, defense and communications industries. In RF test. And in everyday service. Suffice it to say they meet a lot of tough standards. Including yours.

Take the measure of our new RF lineup: return the card for a free selection guide with key specifications. Or call **1-800-426-2200, Ext. 203.**

**Tektronix**

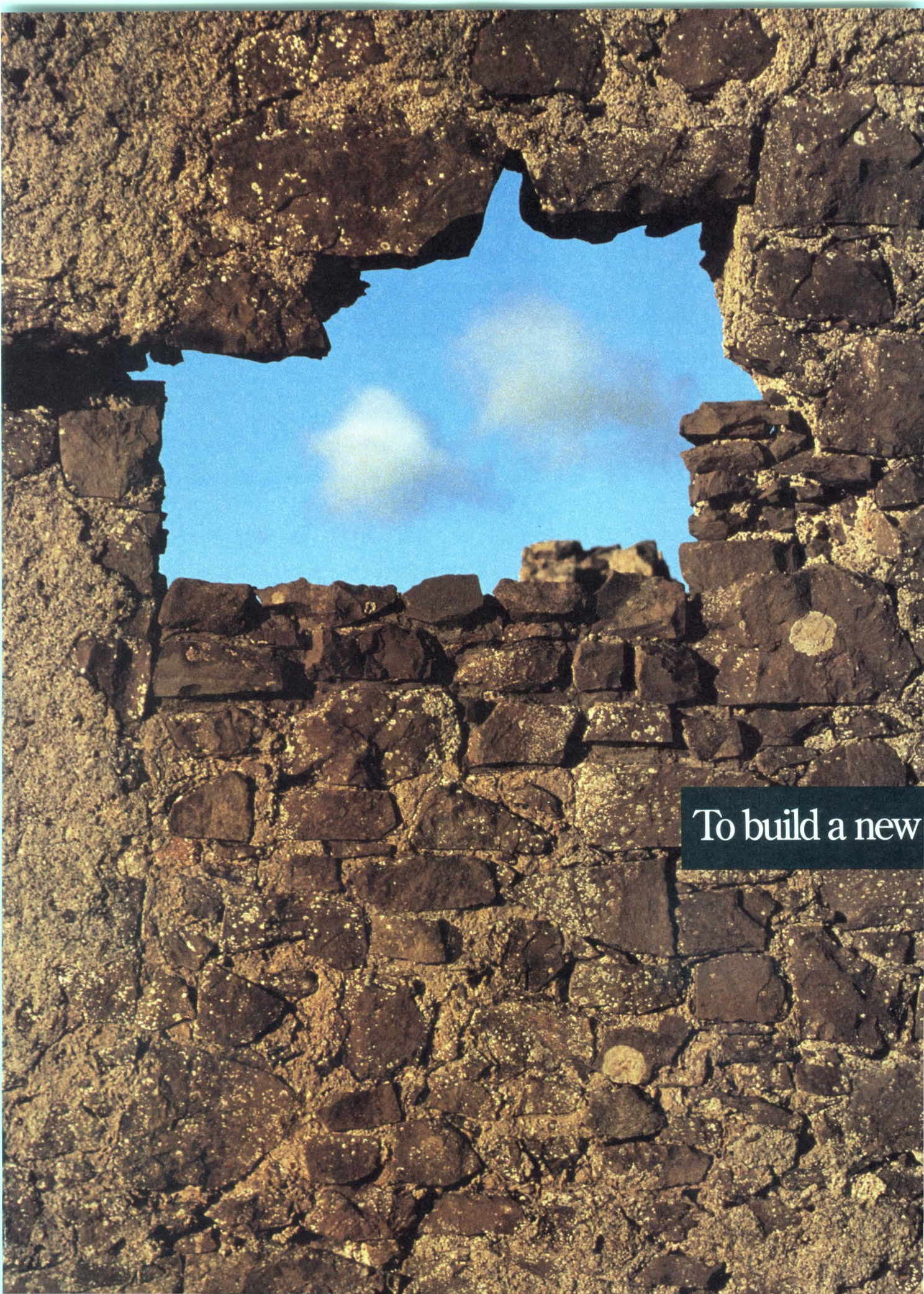

To build a new

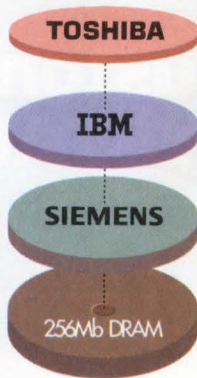

At Toshiba, we see a new kind of tomorrow. One where restrictive corporate borders are transformed into paths of shared innovation. And world-class companies work together for the benefit of all.

A vision that's evident in our recent partnership with IBM and Siemens.

By forming an international alliance with these two industry leaders, we're pushing technology to places never before deemed practical, or even possible.

Together, we're developing an advanced generation of dynamic RAM — a 256 megabit DRAM chip.

By pioneering 0.25 micron technology, electronic

It will accelerate the innovations of our next century — many not even imagined yet — by years.

Enable applications like interactive television, multimedia, mobile computing

and voice recognition to become commonplace.

Drastically reduce the size of computers, Personal Digital Assistants and communications devices.

And establish an important, standardized technological springboard for future generations of highly dense chips.

Remarkable, yes.

But no less than you'd expect from a company with

one of the industry's strongest R&D and patent records.

**future, we had to tear down some old walls.**

pathways 1/1600 the width of a human hair are being used to pack 256 million bits of information — enough to hold 25,000 pages of text — onto a fingernail-sized chip.

The result will push the capacity of semiconductors by over 16 times. But that's only the beginning.

For more information on how Toshiba technology will play a part in your future, please call 1-800-879-4963.

Because at Toshiba, we're working on a world without borders. Cooperation through coalition. And innovation beyond expectation.

In Touch with Tomorrow  
**TOSHIBA**

TOSHIBA AMERICA ELECTRONIC COMPONENTS, INC.

# EPSON The CrystalMaster

## Awards its customers with the latest in CRYSTAL technology

### CRYSTALS

#### THRU-HOLE



##### C-2

- LOW FREQUENCY TUNING FORK TYPE
- 32.768 KHz
- 20 KHz - 100 KHz

##### CA-301

- HIGH FREQUENCY AT - STRIP TYPE
- 4.0 MHz - 67.0 MHz

#### SMD



##### MC-405/6

- HEAT RESISTIVE C-2H INSIDE
- L10.4xW4.06xH3.56mm
- 20 KHz - 100 KHz

##### MA-505/6

- HEAT RESISTIVE CA-303 INSIDE
- L13.46xW5.08xH4.57mm
- 4.0 MHz - 67.0 MHz

#### MINIATURE SMD



##### MC-306

- NEW TUNING FORK CRYSTAL TECHNOLOGY
- L7.9xW3.8xH2.5mm
- 32.768 KHz

##### MA-306

- NEW AT - STRIP CRYSTAL TECHNOLOGY
- L7.9xW3.8xH2.5mm
- 17.7 MHz - 40.0 MHz

### OSCILLATORS

#### THRU-HOLE



##### SG-51/531

- COST EFFECTIVE AUTO INSERTABLE FULL SIZE (SG-51) AND HALF SIZE (SG-531) DIP'S
- CA-301 CRYSTAL INSIDE
- 1.025 MHz - 67.0 MHz

#### SMD



##### SG-615

- SURFACE MOUNTABLE
- HEAT RESISTIVE CA-303 INSIDE
- L14.0xW9.8xH4.7mm
- 1.025 MHz - 67.0 MHz

#### MINIATURE SMD



##### SG-636

- MINIATURE SURFACE MOUNT
- NEW AT - STRIP CRYSTAL TECHNOLOGY
- L10.3xW5.8xH2.8mm
- 2.20 MHz - 40.0 MHz

**EPSON** EPSON AMERICA, INC.  
COMPONENT SALES DEPARTMENT  
TEL: (310) 787-6300, FAX: (310) 782-5320

# Quantify critical-timing risks with statistical analysis

James J Vorgert, Texas Instruments Inc

*Performing a timing analysis using conservative worst-case methods may force you to over design or reduce performance goals unnecessarily. Using statistical methods to quantify the risks associated with critical timing paths lets you trade off technology vs performance and manufacturing goals.*

Timing is critical for a digital system's success. For decades, designers have analyzed circuits' timing using conservative worst-case methods. Such methods ensure reliable systems, but many are overly conservative. They also provide little insight into the risk of retaining a signal path that analysis shows exceeds its timing requirements. Statistical timing analysis can quantify the risk associated with that signal path.

Formally stated, a signal path is "a series of interconnected nodes in a digital design that are defined to begin and end with a constrained device or pin" (Ref 1). Most digital designs have thousands of paths; each path has some inherent delay requirement. These requirements derive from system performance goals, circuit functionality, system clock rates, interface timing constraints, and other considerations.

You can identify signal paths at any number of conceptual levels. A system-level path, for example, comprises a group of similar individual paths. All signals in the group have the same basic structure and requirements. For the system to operate properly, the signals must function within their requirements.

Once you identify a signal path and its requirements, timing analysis can determine if the path will meet its requirement. As with the identification process, you can perform timing analysis at any of several levels. You can scrutinize individual paths or analyze and take one or more paths from a system-level group to represent all of the paths in the group. Likewise, a number of analysis methods are available, depending on information availability and desired accuracy.

## Maxima yield first-order estimates

You can make a good first-order timing estimate by adding the maximum delay values for each component in the path,

which is called worst-case analysis. Most vendors provide data books that specify the maximum output propagation delays and input setup times for their devices. If the results of a worst-case analysis are within 20% of exceeding the path's timing requirement, that path is said to be critical and is usually subjected to more detailed analysis. If a path meets its requirements by 50% or more, it has a "safe margin," and no further analysis is necessary. Paths that fall somewhere between safe and critical may be treated either way but are usually reexamined along with the critical paths.

The worst-case-analysis method is simple to use, and often electrical CAE tools support it, allowing a majority of the signal paths in a design to be subjected to a first-order check. Passing this test does not guarantee, however, that a path will function properly. The estimate does not account for factors such as interchip wiring delays or driver loading effects. Generally, these effects are small, but for critical paths, they may be fatal. For this reason, designers use more rigorous worst-case methods that account for loading effects. Such methods first estimate the physical properties of the inter-

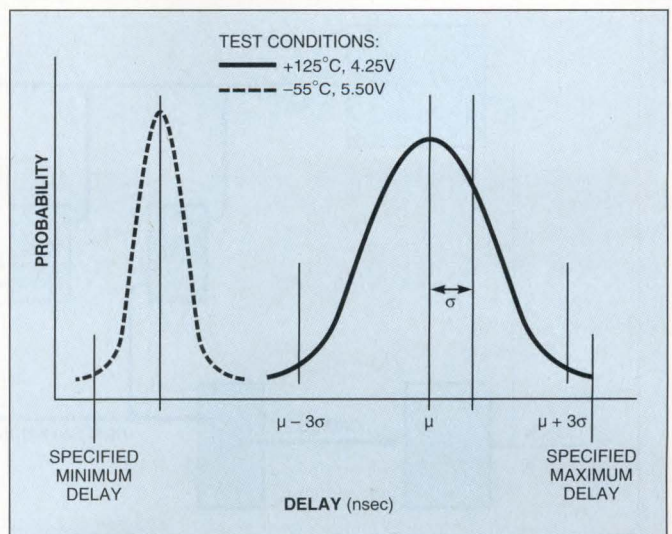

**Fig 1—The delay distributions obtained at extreme operating conditions determine a part's minimum and maximum ratings. Using those distributions instead of maximum values lets you quantify your system's expected performance.**

## STATISTICAL TIMING ANALYSIS

connections (length, capacitance, and inductance), then adjust the timing delays through each component or wiring segment in the path. You can perform the analysis manually using loading information from vendor data books or with the aid of a computer-based circuit-analysis tool.

Early in the design process, usually you do not have enough information to make an accurate estimate of the loading delays for each path. In such cases, the designer must make worst-case assumptions about the characteristics of a "typical node" (eg, all nodes have 35-pF load capacitance). Generally, designers also set a design margin that applies equally to a path in the design (eg, all paths must meet requirements by 10 nsec or more to allow for interchip delays).

For an example of a ROM-circuit analysis using the worst-case approach, see **box**, "A worst-case circuit analysis." In the example, the analysis predicts a delay of 122.2 nsec vs a requirement of 121.2 nsec. If, as in the example, the results of the worst-case analysis indicate that the circuit will not operate reliably over the specified range of operating conditions, conservative design rules dictate that you replace one

or more of the components with a faster device, change the design, or relax performance goals.

This conservative approach can be prohibitive, especially for high-performance systems: System-level requirements usually restrict architectural changes, reducing performance goals is self-defeating, and in many cases, the fastest available parts have already been specified. When you can find faster parts, they are often expensive and available only in limited quantity, which limits the design's producibility.

### Worst-case estimates conceal risk

At this point in the design process, most designers begin to rationalize, thinking it's not likely that all of the components in the path will perform at worst case, or they assume that vendors always pad the worst case specifications. Thus, a design team concludes that a marginal design will work fine in the real world. But how well the design will work is a question often left unanswered. The design team accepts the unknown risk and resolves to work it out on the prototype.

However, it is both possible and practical to quantify risks associated with a critical path. Statistical analysis offers

## A worst-case circuit analysis

**Fig A** shows a typical system-level path in a microprocessor design. The path's starting point is the clock input of the memory-management unit (MMU). The signal path progresses from the clock to the MMU's A(0:16) and CS(0:3) outputs. From there, the signals travel to the address and control inputs of the ROM devices. The path asynchronously propagates through one of the ROMs and dri-

ves the inputs of a standard bus-interface device. The buffer interface in turn drives the microprocessor's data inputs (CPU).

Individual paths include many permutations of the same basic structure, which is a single control output propagating from the MMU clock input through the ROM and data buffers and into the CPU. In this case, 16 address bits and one chip-enable line

traverse through three ROMs with eight data lines for  $(16+1) \times 3 \times 8 = 408$  individual paths. A single system-level path from MMU clock to CPU data input represents all of the individual paths.

**Table 1** shows typical requirements for the microprocessor circuit in **Fig A**. To meet the 4-MIPS requirement at the 33-MHz clock rate, a typical instruction can require no more than  $33/4 = 8$  clock cycles. Instruction execution requires four clocks, so the ROMs must be accessed within four clock periods. Therefore, each of the 408 individual paths from the MMU clock input to the CPU data inputs must propagate in  $<4/33.0E+06 = 121.2$  nsec.

### Figure worst-case delays

In this example, the first-order worst-case analysis is straightforward. We have chosen to implement MMU functions using a field-programmable-gate-array (FPGA) device. Using the postlayout-timing-analysis tools the vendor provided, we find that the expected worst-case address delay is 12 nsec. The chip-select outputs are faster (8 nsec). According to the data book, the chip select to data delay of a ROM (50 nsec) is also faster than the address

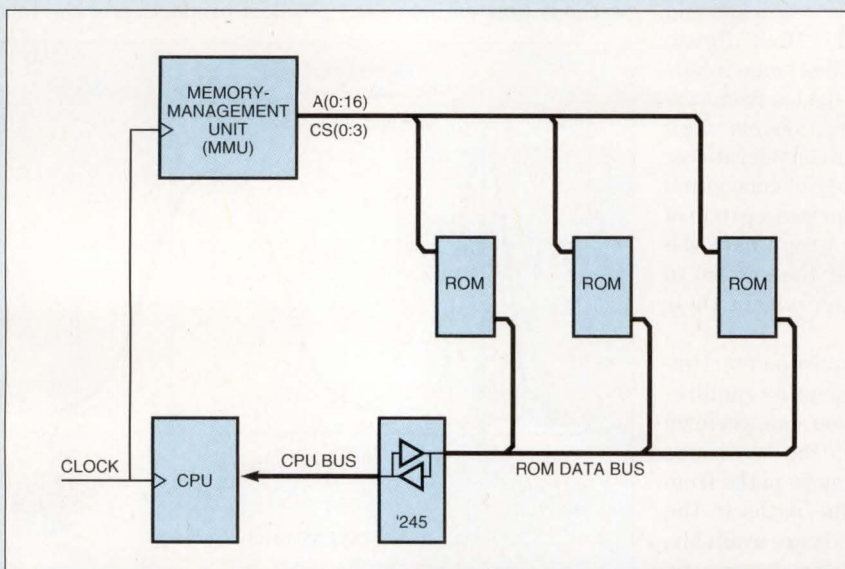

**Fig A**—You can analyze the multiple individual paths in this design example as a single system-level path.

detailed insight into path delays as well as a means for determining how well the design will work. The analysis methods use characterization data for each device—rather than maximum or minimum parameters—to derive a function that describes the probable delay for each device. Combining delay functions forms a joint probability distribution for the path's overall delay, which you then use to compute the probability that the path will either pass or fail its requirements. If all paths in the design receive a statistical analysis, you can estimate the design's expected manufacturing yield with respect to timing.

Few vendors actually publish characterization data for their products, yet this information is generally available through the vendor's technical-support staff. Most vendors collect product-characterization data to generate timing specifications for their parts and to provide metrics for monitoring their manufacturing processes. For military products, vendors must collect delay data to meet Mil-Std-883 requirements. If characterization data is not available from the vendor, however, you can collect it by measuring the delays through a large sample of devices (100 or more) over

the design's desired range of temperatures and operating voltages. Note that such testing is usually expensive, though.

Using characterization data can be risky. Usually, characterization data is short-term data—for example, samples come from a single batch (lot) of devices produced over a short period of time. Short-term data does not account for the possibility that the manufacturer's processes may change over time or that multiple vendors (or multiple foundries owned by the same manufacturer) will produce the same end product with varying results. Also, characterization data can be wildly different from one manufacturer to another; and, currently, no standards exist for collecting this data.

Some vendors provide characterization data in statistical form: the mean ( $\mu$ ) and standard deviation ( $\sigma$ ) or variance ( $\sigma^2$ ) at a number of important temperature and voltage combinations over the specified operating conditions. Other vendors provide a table of measurements for a sample of devices under various environmental conditions. The data may represent either long- or short-term sampling, so the designer must take care to understand what type of information is

delay (90 nsec). Because the chip-select paths will always be faster than the address paths, we simplify the analysis by ignoring chip selects and concentrating on the worst-case address path.

The data buffer has a 7-nsec delay from input to output, and the CPU requires 5 nsec of setup time on data inputs. Therefore, the total worst-case delay is  $12+90+7+5=114$  nsec. Because this is within 20% of the

requirement,  $(121.2-114)/121.2=95\%$ , consider the path critical. Thus, we need to examine wiring delays and loading effects.

In the case of our ROM circuit, the printed-wiring-board (PWB) vendor advertises typical capacitance of 4 pF/in. and inductance of 0.2 mH/in. of etch. An initial board layout suggests that each trace in the path has approximately 18 in. of etch. Computer models

are not available for the CPU or FPGA pins, so you will have to estimate these by hand. The ROM manufacturer provided a Spice analysis of the ROM drivers and the buffer circuit based on our anticipated loading. We estimate the combined worst-case delay through this portion of

the path to be 102.3 nsec, compared with 97 nsec using the first-order estimate.

For the MMU FPGA, the only loading information in the vendor's data book is a chart of delays vs capacitive loads. Inductive effects on these delays are small compared with capacitive loading, so, initially, we can ignore the inductive contribution and account only for capacitive effects. Calculate the load capacitance for a typical address line by adding the input capacitance of the three ROMs ( $12 \text{ pF} \times 3 = 36 \text{ pF}$ ) and the anticipated capacitance of the signal trace ( $18 \text{ in.} \times 4 \text{ pF/in.} = 72 \text{ pF}$ ) for a total of 108 pF.

The vendor-specified maximum delay of the output driver assumed a 50-pF load. The vendor's loading chart recommends adding to this maximum 0.05 nsec/pF over the rated load. The adjustment to the address delay through the MMU becomes  $0.05 \times (108-50) = 2.9$  nsec. Therefore, total address delay through the MMU is  $12+2.9=14.9$  nsec. Because loading doesn't affect input setup delays, they remain at 5 nsec. Thus, total estimated delay for the ROM path is  $14.9+102.3+5=122.2$  nsec. The path fails to meet its requirement.

### System example operating conditions

Average system throughput	>4 MIPS
System clock frequency	33 MHz
Processor software	ROM
Processor operation	(1) Opcodes prefetched during execution of previous instruction; (2) a typical instruction requires 4 internal clocks and makes 1 operand fetch; (3) memory-access cycles begin on the rising edge of a system clock. The MMU is programmed to extend the cycle by up to eight clock periods, and the process latches data inputs on the rising edge after the MMU signals that the cycle is ending.

## STATISTICAL TIMING ANALYSIS

available. From this information, the designer can derive a distribution function for a device delay at a number of important temperatures and operating voltages (Fig 1).

## Calculating the delay distribution

The delay distribution function represents the probability that a randomly selected device will have a given delay under fixed operating conditions. In general, the distribution approximates a Gaussian, or normal, curve. The important statistical properties of the distribution are its mean ( $\mu$ ) and variance ( $\sigma^2$ ). This information is directly available from statistical characterization data. For tabular data, the  $\mu$  and  $\sigma^2$  values must be calculated using Eq 1 and Eq 2 (Ref 2), where  $X$  is the series of delay measurements under the desired operating conditions, and  $N$  is the number of measurements.

$$\mu = \Sigma X / N \quad (1)$$

$$\sigma^2 = \Sigma (X - \mu)^2 / N \quad (2)$$

Note that temperature or voltage variations may affect both the mean and variance values in a nonlinear fashion. Designers, therefore, must recalculate  $\mu$  and  $\sigma^2$  for each desired set of operating conditions rather than simply scaling. Also, it is not generally valid to assume that a typical value in the vendor's data book represents the process mean or that the specified maximum values represent any specific variance from the process mean. Rather than making assumptions, designers should contact the vendor to obtain characterization data.

Most vendor-supplied characterization data is short-term data and does not account for the possibility that the vendor's manufacturing processes may change over time or that multiple factories or vendors may produce the product with varying results. Traditionally, vendors have accounted for such variations by specifying a guard band or design margin. Designers typically also include a design margin in their worst-case timing analysis by limiting the acceptable delay to some fixed value below the actual requirement. The trouble with these approaches is that they are arbitrary; it is virtually impossible to quantify risks associated with these methods.

Statistical analysis provides a more concise approach for

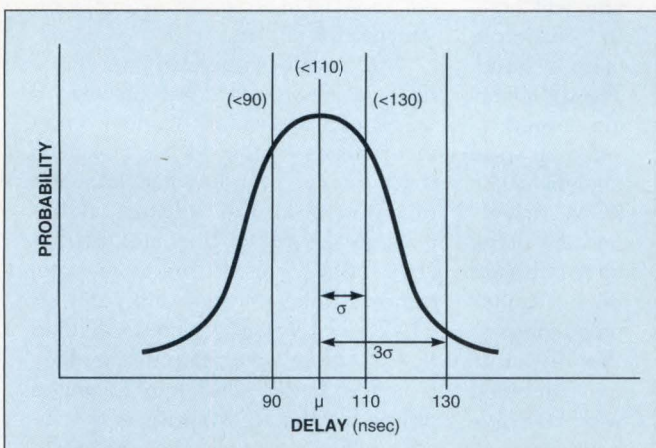

Fig 2—Products such as memories have a Gaussian delay distribution but are sorted into bins for sale by speed rating. Distributions within bins will not be Gaussian.

handling short-term data; Motorola's Six Sigma approach offers two options: You either set the path goals such that the requirement is at least six standard deviations ( $6\sigma$ ) greater than the mean delay for the path, or you account for possible process shifts by shifting the mean delay for each device by a factor of  $1.5\sigma$  and then set the path goals such that no more than three defects are expected per million implementations (3 dpm) (Ref 3).

Some vendors track their processes and collect long-term characterization data. This data includes a large sample of devices from many manufacturing lots, and it accounts for normal process shifts by sampling the process over time. Depending on the vendor's record for controlling its processes, long-term data may provide more insight into the vendor's process shift than simply scaling short-term data. You can use long-term data directly, or, for a more conservative analysis, you can similarly scale it to short-term data.

## Statistics don't always apply

Some devices don't lend themselves to statistical modeling. Memory devices, for example, are produced in the same manner as most other electronic components but differ in how they are tested and sold. Most memory products are binned before shipment, meaning they are individually tested at the factory and sorted into groups that have similar performance characteristics. For example: A vendor manufactures ROMs that have a nominal access time of 100 nsec, and the variance for the process is 10 nsec. The vendor tests each part and sorts them into bins of <90 nsec, 90 to 110 nsec, and 110 to 130 nsec. Finally, the manufacturer marks each group of parts with an appropriate speed grade and sells the lots at different prices, based on market demand.

The delay distribution for each group is a part of the normal process distribution, but delays do not have normal distribution within a group (Fig 2). Because the distribution for a group of binned parts is not Gaussian, assume that the delay for that part will be equal to the vendor's specified maximum delay and that the variance of the group will be zero (ie, worst-case delay).

Field-programmable devices and ASICs offer another twist. Vendors cannot gather characterization information for a device that doesn't yet exist. However, the vendor can characterize the manufacturing process and provide timing analysis based on that characterization, estimating the delay distribution using a static timing analyzer. Most static timing analyzers can be set to determine "best/strong," "nominal," and "worst/weak" process points at minimum, nominal, and maximum temperature and supply voltage. By analyzing a path through the design at each of the process points—and holding the temperature at maximum and the supply voltage at minimum—designers can derive the worst-case delay distribution for the path.

As with other components, the delay distribution for an ASIC will be a Gaussian curve (unless the device is screened or speed-graded). The mean delay for the device is the result of the "nominal-process" timing analysis, and  $\sigma$  is given by

$$\sigma = (W - B) / 2X, \quad (3)$$

where  $W$  is the result of the "worst-process" analysis,  $B$  is



# Simple as 1, 2, 3!

## Configure Your Own Hot-Swap, Fault Tolerant Power Supplies & Systems

PROVIDES  
ZERO SYSTEM  
DOWNTIME!

AC or DC Input  
19" Rack Mount Enclosure Holds up to 6 Plug-In Supplies  
(1/2 Rack Enclosure Available)  
Thumbscrew Retainer



Circuit Breaker Integral to Each Supply (With Automatic Trip-OFF)  
Isolation Diodes Integral to Each Supply  
375-2000 Watts Field Replaceable Hot-Swap Power Supplies (1-5 Outputs per Supply)  
Status Indicators and Test Points

MPS-4 shown  
(up to 550 Watts Per Supply)

### 1. List Your Requirements

List Your Required DC Outputs	Volts	Amps Per Supply	Amps Needed for Total System Load
Output #1:			
Output #2:			
Output #3:			
Output #4:			
Output #5:			

NOTE: Outputs include isolation diodes and automatic current sharing.

### 2. Select Your Plug-In Power Supply



PS-4 Series 7"H x 2.8"W x 19"D	Total Output Power Per Supply*	Input Voltage (Check One)		
		AC 115/230VAC	AC w/ PFC 90-264VAC	DC 48VDC
	375 Watts		NA	
	550 Watts			NA
	1000 Watts			
	1500 Watts			NA
	2000 Watts			NA

\*Prior to isolation diodes



### 3. Call (619) 575-1100 . . . or Fax (619) 575-7185

We make configuring your own Power System as easy as filling in the blanks. Just tell us which DC Outputs and which Input (AC or DC) you need and we'll do the rest. What could be simpler?

ISO 9001  
Certified  
Manufacturer

**LAMBDA**  
Qualidyne Inc. 

Call for your  
free catalog!



3055 Del Sol Blvd. • San Diego, CA 92154 • Tel: (619) 575-1100 • Fax: (619) 575-7185

CIRCLE NO. 85

EDN February 17, 1994 • 99

## STATISTICAL TIMING ANALYSIS

the result of the "best-process" analysis, and  $X$  is the vendor's sigma metric. For most vendors, the sigma metric is 3 (ie, they use  $3\sigma$  data for process corners). Verify the  $X$  value with the vendor.

### Consider output loading

Another consideration when using characterization data is the effect of output loading. Vendors typically perform characterization with a 50-pF test load, which is true for ASIC-timing-analysis estimates as well. If the design loads are significantly more or less than the test load, an adjustment is necessary to account for loading. Like delays, loading adjustments can be modeled either as a worst-case value or as a statistical distribution based on variance in board layout and material properties. Currently, however, it is difficult to obtain statistical data for anticipated loading. To apply a worst-case loading adjustment to a statistical distribution, calculate the correction factor from the vendor's data book (same method as for worst-case analysis) and add this factor to the mean ( $\mu$ ) device delay.

Once you've modeled the delays statistically, you can derive a joint delay distribution for a critical path. Obtain the exact distribution by combining the distributions using the convolution integral: Convolve the distribution function of the first delay in the path with the second, and then convolve the result with the next delay, etc, until you combine all of the delay components. The result is the joint delay distribution for the path. Unfortunately, the mathematics for convolution are very complex.

Fortunately, the analysis can be simpler. For module-level paths that propagate through separate devices, the delay through each device usually can be considered to be independent of the other device delays (an exception would be a design composed of several identical devices that are all from the same manufacturing batch). In addition, each delay is randomly distributed within the delay distribution for that device. In this situation, the "root-sum-of-squares" (RSS) method allows use of the Central Limit Theorem in statistics to determine the joint distribution or overall delay characterization.

The Central Limit Theorem states that the sum of a set of such independent continuous random variables asymptotically approaches a normal distribution. This implies that the total path delay will have a Gaussian distribution with the mean equal to the sum of the individual path-delay means

$$\mu_j = \sum \mu \quad (4)$$

and standard deviation related to the individual delay distributions by

$$\sigma_j = \sqrt{\sum \sigma^2} \quad (5)$$

Because the individual component distributions are considered normal, the error of this approximation is small—even for paths with only three or four components.

### Sample statistical analysis

To reexamine the ROM path example (see **box**) using the RSS method, start by analyzing the memory-management unit (MMU) FPGA design. An initial analysis of all of the

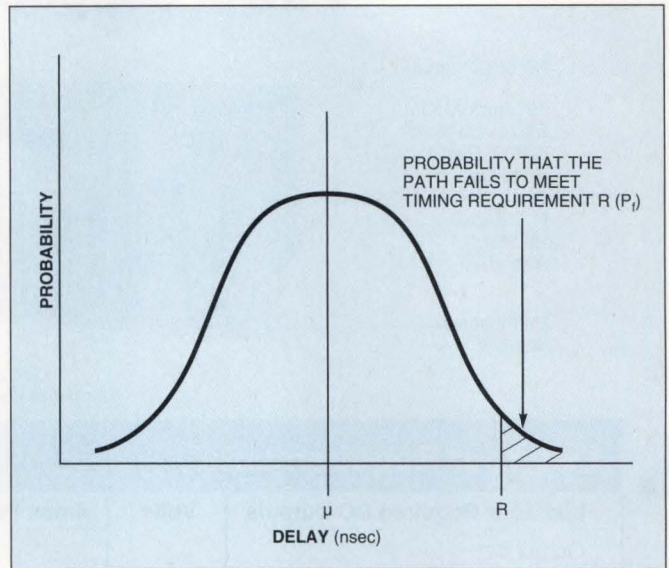

**Fig 3—The probability that a path will fail to meet its timing requirement ( $R$ ) is given by the area under the distribution curve to the right of  $R$ . This value may be calculated or determined from standard tables.**

address- and chip-select paths indicates that the longest path is A(16). Because all of paths within the FPGA are highly correlated, you know that A(16) will always be the longest path, so you need only do detailed analysis on this one path. Rerunning the static timing analysis at 125°C, 4.5V, and all three process points yields 10.2, 11.1, and 12 nsec. Using **Eq 3**,  $\sigma = (12 - 10.2) / (2 \times 3) = 0.3$  nsec. Because the 108-pF loading on the address lines is greater than the 50 pF assumed by the timing analyzer, you must adjust  $\mu$  accordingly. The vendor's data book recommends adding 0.05 nsec/pF for loads greater than 50 pF, so

$$\mu = 11.1 + (0.05 \times 58) = 14 \text{ nsec.}$$

According to the manufacturer, the CPU has a mean setup time of 4.5 nsec and variance of 0.17 nsec; the buffer device is specified to have mean propagation delay of 5.8 nsec and variance of 0.4 nsec. The ROM is a binned part, so use the maximum delay value (90 nsec) as the mean with zero variance. Add 4 nsec to the ROM delay to account for loading, making the mean delay 94 nsec with zero variance. Using **Eq 4** and **Eq 5**, the joint distribution for the path is a normal distribution with

$$\begin{aligned} \mu &= 14 + 94 + 5.8 + 4.5 = 118.3 \text{ nsec} \\ \sigma &= \sqrt{(0.3^2) + (0^2) + (0.17^2)} = 0.53 \text{ nsec.} \end{aligned}$$

Once you know the joint distribution for a path, the probability ( $P_f$ ) that the path delay will be greater than its requirement (ie, the path will fail) is given by the area under the distribution curve and to the right of the requirement ( $R$ ) (**Fig 3**). You can calculate this area by evaluating

$$P = \int_R^{\infty} \left( \frac{1}{\sigma \sqrt{2\pi}} \right) e^{-(X-\mu)^2 / (2\sigma^2)} dX \quad (6)$$

However, because the distribution is considered to be a nor-

# TESTPOINT

**TestPoint is a software tool for building test, measurement, and data acquisition applications for Windows.**

TestPoint lets you build complete applications without drawing, connecting, or wiring icons or writing lines of code.

## **New Capabilities**

TestPoint brings extraordinary capability to instrument control and data acquisition for the benchtop or production line. TestPoint's software functions can replace hardware functions worth thousands of dollars, provide new measurement capabilities and simplify testing.

## **Better Tests**

Sharp graphics and clear indicators eliminate errors and improve accuracy.

## **Cut Through the Paperwork**

TestPoint can "hot link" to your spreadsheets, databases and word processing files so the paperwork is done the instant the test is finished.

**There is no faster, better or easier way to build applications. Guaranteed!**



- **Data Acquisition**  
Multitasking A/D, D/A,  
Digital I/O
- **Instrument Control**  
IEEE-488, RS232, RS485
- **Analysis**  
Mathematics, DDE
- **Presentation**  
Graphics Charts  
Displays File I/O

**Development System \$995**  
**Free Unlimited Runtime License**  
**Literature 1-800-234-4232**  
**Applications 617-273-1818**



Capital Equipment Corp.  
76 Blanchard Road  
Burlington, MA 01803

TestPoint is a trademark of Capital Equipment Corp.

## STATISTICAL TIMING ANALYSIS

mal curve, a simpler method is to use a standard table of area under the normal curve (Ref 3).

Most standard tables of area under the normal curve contain either the area bounded by  $\mu-z$  and  $\mu+z$ ; the tail area remaining below  $\mu-z$  and above  $\mu+z$  (bilateral tail area); the area left of  $\mu+z$  (values of the normal distribution function); or the area remaining to the right of  $\mu+z$  for positive values of  $z$  (unilateral tail area), where  $z$  is the sigma metric value given by

$$z=(R-\mu)/\sigma, \quad (7)$$

where  $R$  represents the value of the paths' required delay. By realizing that the total area under the normal curve is equal to 1, you can calculate the area remaining to the right of  $z$  using any table of area under the normal curve.

For the ROM path,  $z=(121.2-118.3)/0.53=5.47$ . Because short-term data was used to calculate  $\mu$  and  $\sigma$  for the path, the initial Six Sigma goal is  $z>6$ . Although the goal isn't met, you still may be willing to accept the risks for this high-performance design. To better quantify the risk, you can approximate the long-term distribution for the path by adding  $1.5\sigma$  to  $\mu$ . Reevaluation of Eq 7 yields

$$z=(121.2-(118.3+0.795))/0.53=3.97.$$

A standard table of area under the normal curve lists the area remaining to the right of  $3.97\sigma$  as  $3.606E-05$  (Ref 3). The probability that a given ROM address path will fail is  $1/3.606E-05$  or 1 in 27,732 or 36 dpm. Again, you didn't meet the Six Sigma goal of  $\leq 3$  dpm. However, you've quantified the risk. Depending on the expected manufacturing volume and cost of producing a faulty unit, the project may accept the risk for this high-performance system.

Another tool that can help the designer quantify risk is the system-level yield calculation. If you perform an RSS analysis for several independent paths in the design, compute the overall probability that one of the paths will fail ( $P_{SF}$ ) using

$$P_{SF}=1-\{(1-P_F(1))\times(1-P_F(2))\times(1-P_F(3))\dots\times(1-P_F(N))\}. \quad (8)$$

For this type of system-level calculation, it's important to realize that paths are not always independent. There is generally a high correlation between individual delay paths through a single IC (the variances of address to data delays through a ROM will be close to identical). When parallel paths all run through the same devices, if the slowest path passes, it is likely that all of the others will pass. Therefore, the probability that a system-level path will fail is approximately the probability that the slowest path will fail.

When using statistical methods, take care to understand the assumptions of statistical analysis and to know when to apply these methods. In the example, we calculated the probability that the slowest ROM path will fail. Ignoring the faster enable paths, the probability that the system-level ROM path will fail is simply the probability that any one of the 384 permutations of the address paths will fail. If you apply Eq 8 directly, the probability is  $1-(1-0.606E-05)^{384}=0.013$ . You'd expect one in 72 of the boards to fail manufacturing test due to a ROM failure.

This result is incorrect. All of the paths that pass through a single ROM have a strong correlation, so Eq 8 does not apply. The probability that any of these paths will fail is

approximately the probability that the slowest ROM address path will fail, or  $3.606E-05$ . Because the system has three ROMs, the probability that the ROM function will fail is  $1-(1-3.606E-05)^3=1.082E-04$ . You should expect only one in 9244 boards to fail as a result of a ROM-address-path failure.

Use Eq 8 to combine probabilities for separate paths such as the address and chip-select paths. If the probability that a ROM chip-select path will fail is  $1.23E-06$ , the probability the ROM function will fail is  $1-\{(1-1.23E-06)^3\times(1-3.606E-05)^3\}=1.12E-04$ , or one in 8937 boards.

Finally, the probability that all of the paths on the board will pass, called the system-level yield, is given by

$$Y=1-P_{SF}. \quad (9)$$

For the ROM function, the yield with respect to timing is  $1-1.12E-04$  or 0.999888, meaning 99.98% of the boards will operate properly. Of course this doesn't account for other potentially critical paths in the design. Further analysis will establish a good estimate of the system-level yield for the entire design.

When analyzing the entire design, use both statistical and worst-case methods. Worst-case methods provide a fast, simple approach to help identify critical timing concerns. While conservative, they tend to ensure high reliability of the final product. Statistical methods can help quantify risks allowing you to make informed decisions to balance performance, cost, and manufacturability goals. Together, worst-case and statistical methods combine as a powerful design tool. EDN

## References

- Schulz, Steven E, *Introduction to Timing Verification Algorithms for Digital Designs*, A White Paper, Texas Instruments Inc, November 1990, pg 9.
- Papoulis, A, *Probability, Random Variables, and Stochastic Processes*, McGraw-Hill Book Co, New York, NY, 1965, pp 189, 266 to 268.
- Lindgren, B W, G W McElrath, and D A Berry, *Introduction to Probability and Statistics*, Macmillan Publishing Co Inc, New York, NY, 1978, pp 38 to 45, 120 to 126.
- Harry, M J and J R Lawson, *Six Sigma Producibility Analysis and Process Characterization*, Addison-Wesley Publishing Co Inc, 1992, Chapter 6.

## Acknowledgment

*This article originally appeared in the Texas Instruments Technical Journal and is reprinted with permission.*

## Author's biography

*James J Vorgert is an electrical design engineer with the Corporate Venture Products Group of Texas Instruments, where he currently designs both digital and analog circuit boards. For four years, he worked as a CAE-design methodology specialist with TI's Defense Systems and Electronics Group. He has a BSEE from the University of Minnesota and enjoys photography, woodworking, and backpacking in his spare time.*

Article Interest Quotient (Circle One)  
High 586 Medium 587 Low 588

# New Op Amp Delivers 160MHz Bandwidth and 90dB SFDR

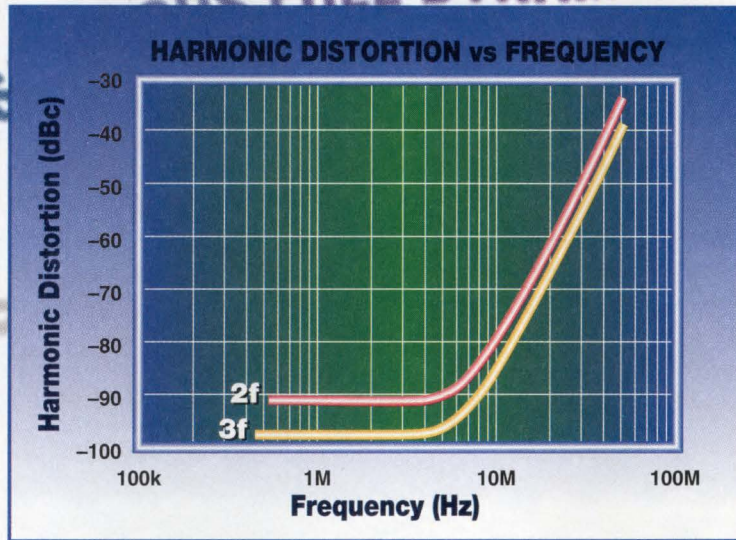

## Designed for Low Distortion

OPA628 is a unity gain stable, voltage feedback op amp that delivers 160MHz bandwidth and 90dB SFDR. Its classic op amp design features high input impedance, high common mode rejection, and symmetrical differential input flexibility. Its 90dB SFDR means excellent linearity—better than 1LSB of 15 bits. And, it's powered by  $\pm 5V$  supplies for low power dissipation. Designed for low distortion, OPA628 is your performance choice.

## Designed for Versatility

OPA628's versatility, performance, and low price make it perfect for precision video, telecommunications, instrumentation, and test equipment applications. It's an ideal precision A/D and D/A buffer. It's a great driver for 12- to 16-bit high speed A/Ds. And, its 30MHz gain flatness and very low differential gain/phase error is super for high end video. Or, try it in any application that needs wide dynamic range. Designed for versatility, OPA628 fits your next application.

## Designed for Less

OPA628 is designed to give you optimum performance at a super price. It's a better solution than any other "make" or "buy" amp out there. Designed for savings plus performance, OPA628 is the best for less.

## OPA628 Key Specifications

- Low voltage noise .....2.5nV/ $\sqrt{\text{Hz}}$
- Low noise figure.....9.3dB
- SFDR.....90dBc
- Two-tone third-order intercept.....60dBm
- Supply range..... $\pm 4.5V$  to  $\pm 6V$
- Unity-gain bandwidth .....160MHz
- Differential gain/phase .....0.015%/0.015°
- Offset voltage.....500 $\mu V$
- Packages.....8 pin-DIP and SOIC

## FREE Samples Fast

For your FREE SAMPLE, detailed data sheet, and *Operational Amplifiers* brochure—just fax **1-602-741-3895**. Or, contact your local sales rep for more information.

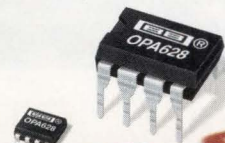

**0.015%/0.015°  
DIFFERENTIAL GAIN/PHASE**



CIRCLE NO. 75



International Subsidiary Offices: Austria (43) 1 602 63 71, France (33) 1 395 43558, Germany (49) 711 77040, Italy (39) 2 580 10504, Japan (81) 33 586 8141, Netherlands (31) 03465 50204, Switzerland (41) 1 7240928, United Kingdom (44) 923 233837.

# 5-volt performance. 3-volt

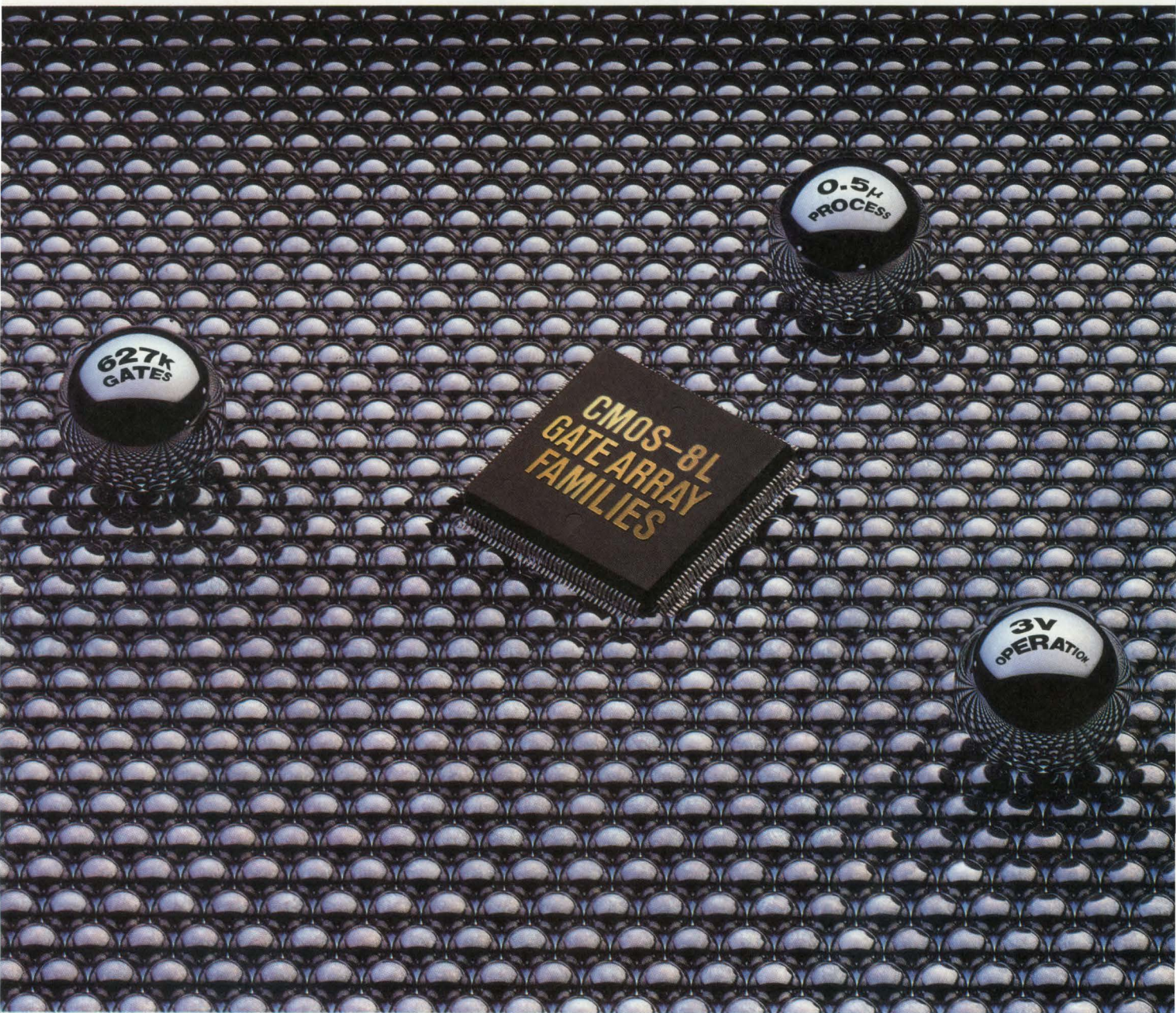

**For fast answers, call us at:** USA Tel:1-800-366-9782. Fax:1-800-729-9288. Germany Tel:0211-650302. Fax:0211-6503490. The Netherlands Tel:040-445-845. Fax:040-444-580. Sweden Tel:08-753-6020. Fax:08-755-3506. France Tel:1-3067-5800. Fax:1-3946-3663. Spain Tel:1-504-2787. Fax:1-504-2860. Italy Tel:02-6709108. Fax:02-66981329. UK Tel:0908-691133. Fax:0908-670290. Ireland Tel:01-6794200. Fax:01-6794081. Hong Kong Tel:886-9318. Fax:886-9022. Taiwan Tel:02-719-2377. Fax:02-719-5951. Korea Tel:02-551-0450. Fax:02-551-0451. Singapore Tel:253-8311. Fax:250-3583. Australia Tel:03-8878012. Fax:03-8878014. Japan Tel:03-3454-1111. Fax:03-3798-6059.

# operation.

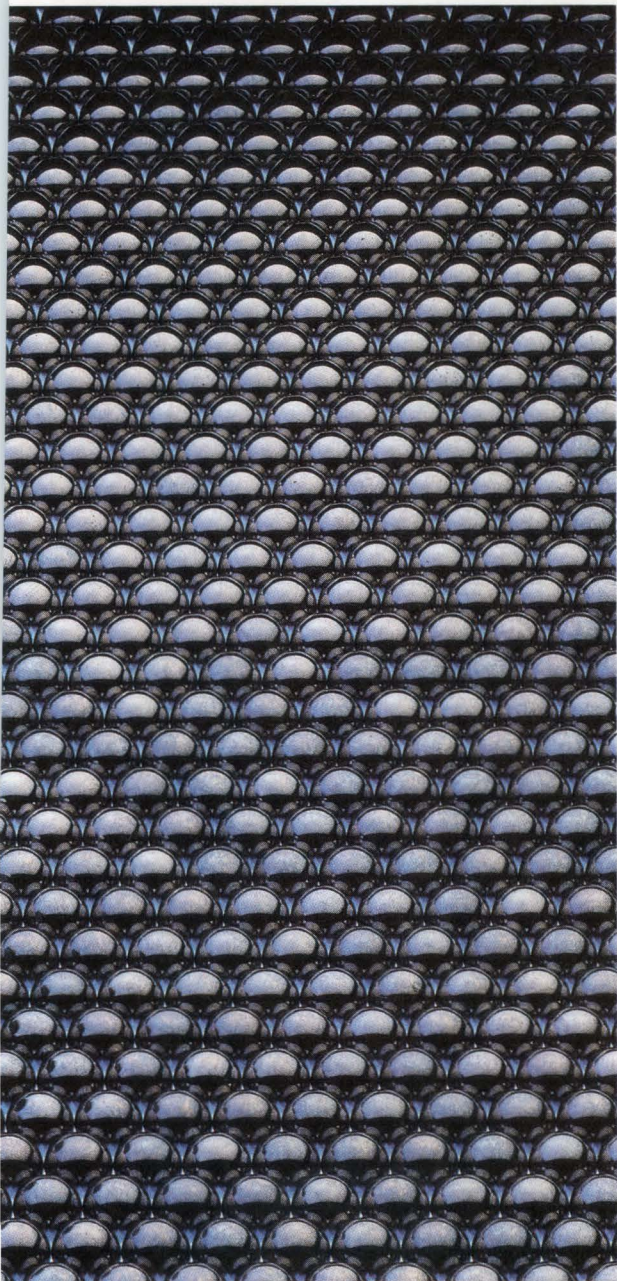

**H**igher performance with lower power consumption. That's what designers need for tomorrow's high-end products. And that's precisely what you get from NEC's new 0.5-micron gate array families.

Our CMOS-8L and CMOS-8LCX families give you 3-volt operation to reduce power consumption, resolve heat and noise problems, and lower packaging costs. Far from sacrificing performance to achieve these benefits, they also offer a wide range of high-end features for portable products, workstations, and multi-processing enterprise systems.

Our new gate arrays give you a loaded speed of 198 picoseconds\*, high integration with up to 627K raw gates, and low power dissipation of 1.24  $\mu$ W/MHz/cell. CMOS-8LCX incorporates CrossCheck® embedded test technology. Other premium-performance features include:

- Compiled RAM with Built-in Self Test (BIST).
- PLL, GTL and clock tree synthesis.
- Combination TAB/QFP packaging.
- 5-volt interface.
- SCAN and JTAG test alternatives.
- OpenCAD® Design System support.

NEC's CMOS-8L and CMOS-8LCX gate array families provide a competitive edge in tomorrow's markets by reducing power consumption without sacrificing performance. For more information on our high-end 3-volt ASICs, call NEC today.

\* F/O=2, W/L=0.5mm

CrossCheck is a registered trademark of CrossCheck Technology Inc.  
OpenCAD is a registered trademark of NEC Electronics Inc.

# WORLD'S HIGHEST BANDWIDTH, LOWEST POWER A/D CONVERTERS

## SPEED DEMONS, POWER MISERS.

Tired of trading off power efficiency for bandwidth? Trade up to this family of high-speed A/D converters, designed for high-speed instrumentation, communications, and professional video applications. As a group, their speed is hard to beat. And when you combine that with their low power consumption, nothing else can touch them. There's a whole range of A/D performance, from 20 MSPS to 500 MSPS – in a variety of configurations and with lots of built-in extra features. So get the performance you need – and give your power supply a break.

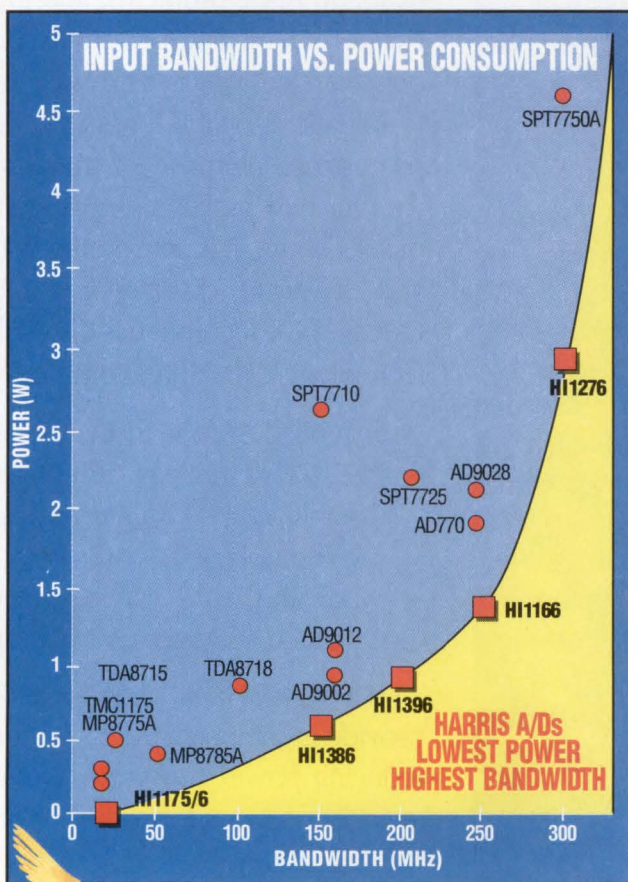

### A/D Family Features

#### HI1276, 8-bit, 500 MSPS

- 300 MHz input bandwidth
- 2.8 W power consumption

#### HI1166, 8-bit, 250 MSPS

- 250 MHz input bandwidth
- 1.4 W power consumption

#### HI1396, 8-bit, 125 MSPS

- 200 MHz input bandwidth
- 870 mW power consumption

#### HI1386, 8-bit, 75 MSPS

- 150 MHz bandwidth
- 580 mW power consumption

#### HI1175/6, 8-bit, 20 MSPS

- 18 MHz bandwidth
- 60 mW power consumption
- Built-in voltage reference

D/As also available:

HI20201, 10-bit, 160 MHz update rate

HI20203, 8-bit, 160 MHz update rate

HI1171, 8-bit, 40 MHz update rate

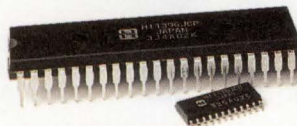

Nothing runs as far and as fast on so little power as a Harris data converter. Except maybe these high-energy in-line skates. On a single kick, they attain a theoretical straight-line speed of 115 mph, and maintain that speed for 45 minutes. (Actual specs will be available following the completion of a 86.25-mile test sidewalk.)



Try our AnswerFax service!

Call 407-724-3818 and request document #7051.

Or call 1-800-4-HARRIS, ext. 7143.





# Minimize time delays and reduce circuit density by retiming a design

Jaap Sondervan, Philips Electronic Design and Tools

*Timing for initial sequential circuit designs generally is not optimal. By following some retiming procedures, you can add or delete sequential blocks to optimize circuit timing requirements and minimize circuitry.*

Retiming is a basic technique for modifying digital circuits' clocking behavior without changing the circuits' functionality. Because the sequential part of many designs involves flip-flops, you can retime a circuit by adding, deleting, or shifting flip-flops in the basic circuit until you achieve desired timing results. The goal of retiming a circuit is to achieve a desired clock rate and simultaneously reduce the circuit density by using a minimum number of flip-flops. In addition, retiming a circuit can create a pipeline architecture by adding or deleting flip-flop stages.

Retiming should change only the timing relationship of signals by advancing or postponing exactly one or more clock cycles. A basic rule for retiming a circuit is that you can freely insert flip-flops into a network or shift a flip-flop through a node within the network (provided timing relationships between branches don't change). If you encounter a fork in the network, you may have to insert more than one flip-flop after the node to maintain the same timing relationship. If multiple network paths join at one node, you can reduce the number of flip-flops preceding the node to one flip-flop after the node.

**Fig 1** illustrates this idea: (a) shows a simple node without a pipeline state; (b) inserts a flip-flop before the node, which creates a pipeline architecture. In this architecture, the flip-flop drives both nodes. However, you can maintain the same timing relationships by shifting the flip-flop

through the node and adding a flip-flop in each branch after the node (c). **Fig 2** illustrates how you can shift flip-flops (or registers) through a node even when the node is connected by combinatorial logic. A vertical bar depicts the flip-flops (or registers) in **Fig 2** and will be a convention throughout the rest of this article.

As a practical application for retiming a circuit, consider the FIR filter in **Fig 3**. The output of the filter is given as

$$O = I + I_{-1} + I_{-2}$$

In the basic circuit of **Fig 3(a)**, two registers delay the input signal ( $I$ ) to develop the  $I_{-1}$  and  $I_{-2}$  signals. The time delays of the two adder blocks are in the critical path of the circuit and create a limit to the maximum-output clock frequency attainable. Using the basic rules for retiming lets you shift the registers through the nodes in the circuit, provided you maintain the equivalent timing relationships between branches.

In **Fig 3(b)**, the rule allows registers FF1A and FF1B to replace register FF1. Register FF2 shifts to a new position

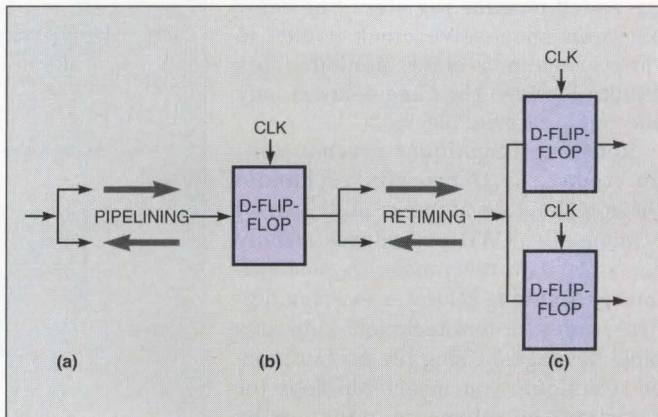
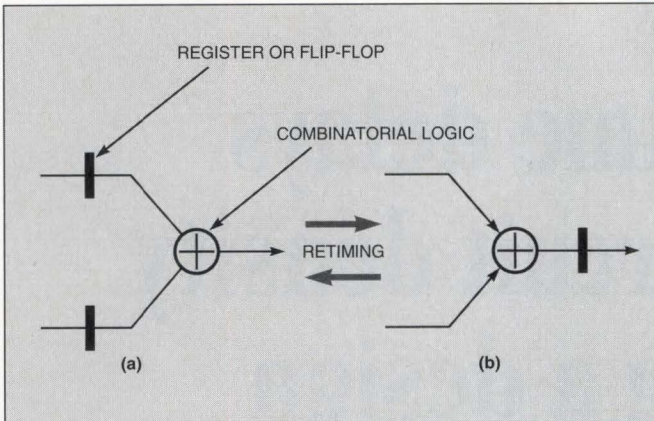

**Fig 1**—Inserting a flip-flop into the path of a circuit creates a pipeline stage. To retime the pipelined circuit, shift the flip-flop through the node to add two flip-flops to the two succeeding branches.



The software listings in this article are available on EDN's computer bulletin-board system (BBS). Phone (617) 558-4241 with modem settings 300/1200/2400 8,N,1. Access /freeware SIG and specify (r)ead option followed by (k)eyword search for "MS #687."

## RETIMING SEQUENTIAL CIRCUITS



**Fig 2—You can shift flip-flops through a node to retime a circuit even though the node consists of combinatorial logic.**

in the same branch. Essentially, the functional operation of the circuit has not changed. The next step in the retiming procedure is to consolidate registers FF1A and FF1B into one register that resides between the adders (c). The final circuit (d) now has only the time delay of one adder in the critical path. The final circuit will operate at twice the frequency of the original circuit. Note that the circuit-performance increase occurs without any increase in circuit density.

Another example of retiming is the pipeline architecture of Fig 4. In Fig 4(b), an additional pipeline stage (FF4 and FF3) is inserted in the positions indicated relative to the original circuit (a). The result of the register addition means the time delay due to combinatorial logic halves, but the output is available one clock cycle later. A timing diagram would show that the time between clock periods for the original circuit could exceed an entire clock period due to the time delays of two combinatorial blocks. Although the output of the final circuit exceeds the clock period by one clock cycle due to the added pipeline registers, the delay between successive clock cycles is shorter than a clock period. This results because the time delay is only one combinatorial block.

Retiming techniques are not new, but today, CAD procedures handle these techniques automatically instead of manually. CAD procedures usually consist of two techniques. A postoptimizer technique relocates existing flip-flops; a design-tool technique allocates pipeline stages. Using the postoptimizer technique, you insert flip-flops (or registers) by schematic entry—or by high-level description language if using synthesis. Often the positioning of the flip-flops is not optimal.

The pipelined architecture in Fig

5(a) could have been created by synthesis or schematic entry. The example has a maximum time delay of four logic gates between the four flip-flops in the branches and the flip-flop in the output path. After design entry, you can postoptimize this design using retiming. The modified design must exhibit the same functionality as the original circuit; therefore, the number of pipeline stages between the inputs and the output must not change. This restriction is called “keeping the latency.”

You have a number of ways to postoptimize this design. Fig 5(b) demonstrates one way, which minimizes chip density but maintains a maximum time delay of six logic gates. Achieve the optimized design by shifting the flip-flops in the branches through the combinatorial node to the output path. The design also achieves a power-dissipation reduction, from five to two flip-flops. Fig 5(c) shows another postoptimized design of the original circuit. By moving the four flip-flops in the input branches through the secondary branch nodes, you achieve a maximum time delay of three logic stages. The number of flip-flops decreases from five to three.

Using CAD procedures, a top-down design comprises the following steps: First, make a behavioral high-level description of the circuit. When the behavior is correct, transform the description into a Register Transfer Level (RTL) description. Manually add logical structure to the RTL description to perform gate-level synthesis; you need the additional structure because state-of-the-art gate-level-synthesis tools cannot synthesize sequential operations (except for the special case of state machines, where flip-flops are implicit in the description). Adding structure man-

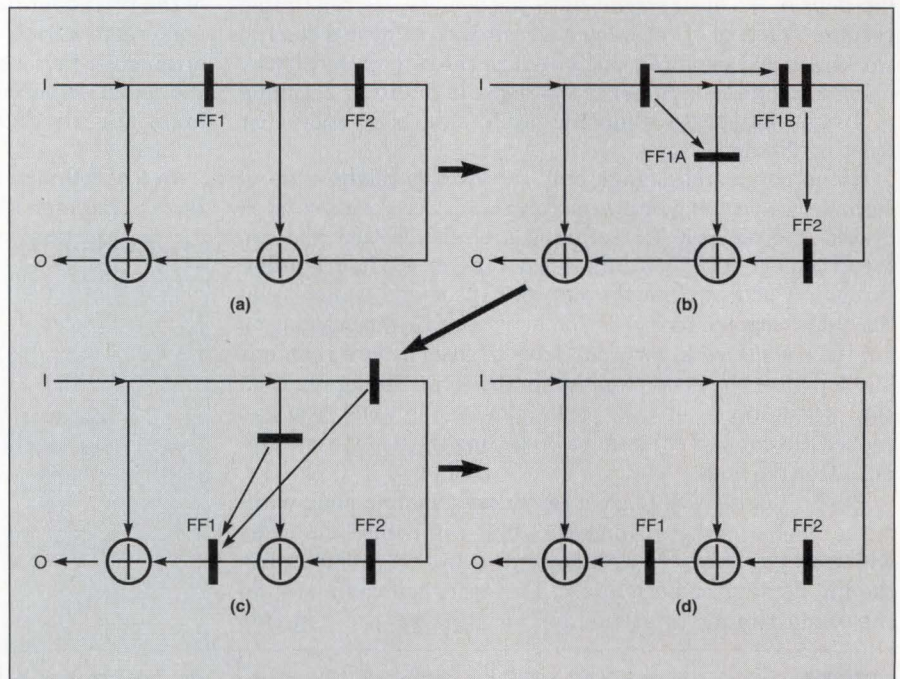

**Fig 3—In this example of an FIR filter, the original circuit (a) suffers the time delay of two adders in the output path. After the circuit is retimed (d), the time delay is reduced to one adder.**

APRIL 19, 1993 • PC WEEK

from page

"...Standard alkaline batteries are available anywhere, while NiCad and NiMH batteries can be purchased – in hundreds of variations – only through computer dealers or the manufacturers of portable PCs. Industry heavyweight Duracell Inc. seeks to lessen that inconvenience."

"...Cellular phone manufacturers can benefit from economies of scale provided by mass-produced battery packs and can then leverage the fact that replacement battery packs are available at mass retail wherever their devices are sold."

36 Cellular Business April 1993

"...Standard battery packs would relieve portable PC manufacturers from having to custom-design their own rechargeable batteries...That should yield savings in both production time and costs."

January 12, 1993 PC MAGAZINE 34

"...As new phones are designed, cellular OEMs are recognizing the increasing need to standardize battery pack configurations...By limiting the number of rechargeable pack sizes needed, Duracell hopes to provide easy, unassisted sales of replacement batteries to consumers at retail."

CELLULAR MARKETING  
December 1992

# We couldn't have said it better ourselves.

We've been talking a lot about DURACELL® Standard Sized Rechargeable Batteries. Now look who's spreading the word about limiting the number of rechargeable battery sizes to fit portable computers and cellular phones.

DURACELL Nickel-Metal Hydride Rechargeable Batteries offer longer life, more convenience, and greater affordability for OEMs, retailers, and consumers alike. Now that's news you can use.

Find out the rest of the story. Call Duracell today at 1-800-422-9001, ext. 443.



**DURACELL®**  
**RECHARGEABLES**

## RETIMING SEQUENTIAL CIRCUITS

ually is tedious because it usually takes one or more iterations to meet design constraints. **Fig 6** depicts the top-down procedure.

Refer to **Listing 1** (see *EDN BBS*) for an example of the behavioral VHDL (VHSIC hardware-description language) code for a 32-bit comparator. Typical synthesis for this design's VHDL code using the LSI Logic LCA100k library results in 426 gates having an overall time delay of 21 nsec. Because the specification requires a maximum time delay of 15 nsec, the design has to be pipelined. To pipeline the design, the RTL description must be changed manually. **Listing 2** (see *EDN BBS*) shows the resulting RTL-VHDL source code. The synthesized design results in a time delay of 11 nsec using two pipeline stages consisting of 20 flip-flops.

You can retime the design using Optima, a retiming tool from Philips Electronic Design and Tools, to create a pipeline that has exactly 15-nsec time delay. Using Optima, you can specify the time-delay constraint to be exactly 15 nsec. Optima produces a design that has one pipeline stage using eight flip-flops, which is fewer than the synthesized manual design. You could also find the optimized design that uses only one pipeline stage to achieve the shortest time delay. This design results in a time delay of 12 nsec using 17 flip-flops. EDN

### Author's biography

*Jaap B Sondervan is a marketing manager for Philips Electronic Design and Tools in The Netherlands. Sondervan specializes in CAD-product marketing and public relations and has been with Philips for nine years. His main interests are in synthesis and test for ASICs. Sondervan has an MSC in Electronic Engineering.*

Article Interest Quotient (Circle One)  
High 595 Medium 596 Low 597

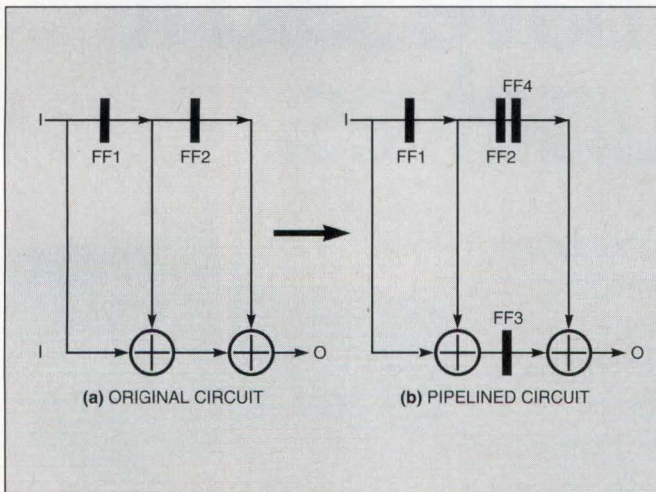

**Fig 4**—The original pipelined circuit (a) suffers the time delay of two adders in the output path. Retiming the circuit (b) creates another pipeline stage but reduces the time delay to one adder in the output path.

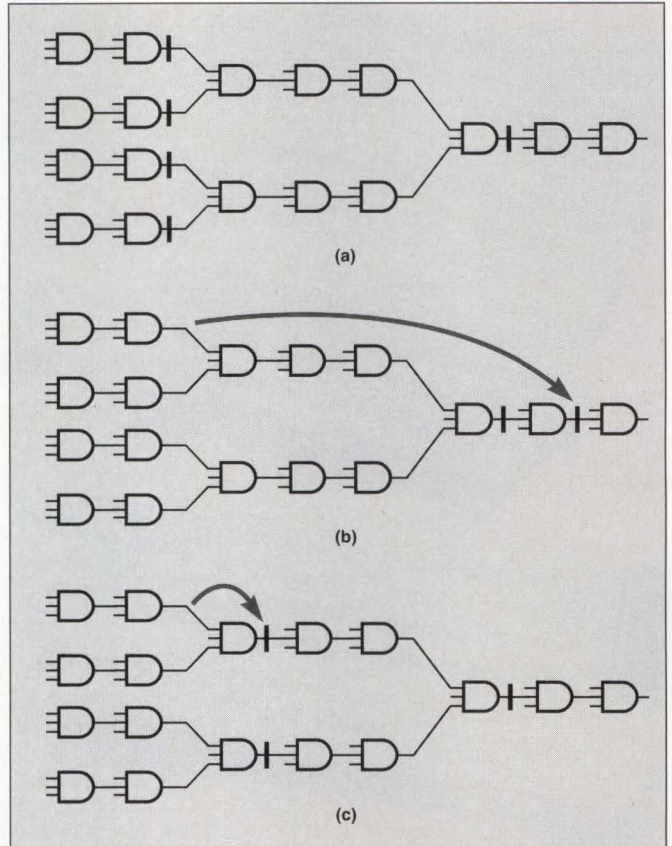

**Fig 5**—You can retime this synthesized circuit (a), which has time delays for four logic gates, in a variety of ways. Two examples appear in (b) and (c).

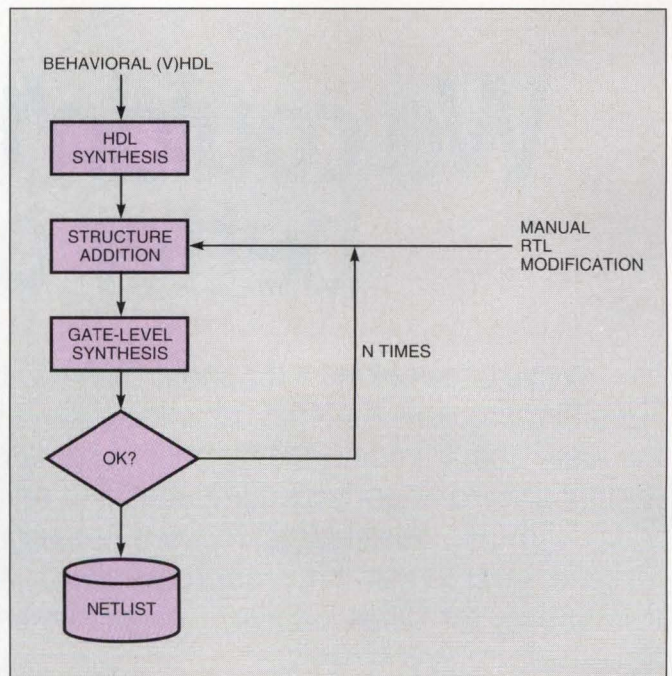

**Fig 6**—A top-down procedure for manually designing a pipelined architecture requires many repetitive modifications.

**XILINX**  
  
**TENTH  
ANNIVERSARY**

**O**ur achievements of the past ten years are the direct result of customer loyalty and employee dedication. The leadership position which we have attained in the Programmable Logic industry could not have been realized without these partnerships and these commitments.

To all of you who have played such a significant role in the company's success, our sincere thanks.

*Bernard V. Vonderschmitt*

Bernard V. Vonderschmitt  
President, Xilinx, Inc.



The Programmable Logic Company<sup>SM</sup>

# Avoid future shock: Transvidiate\* with XTK™

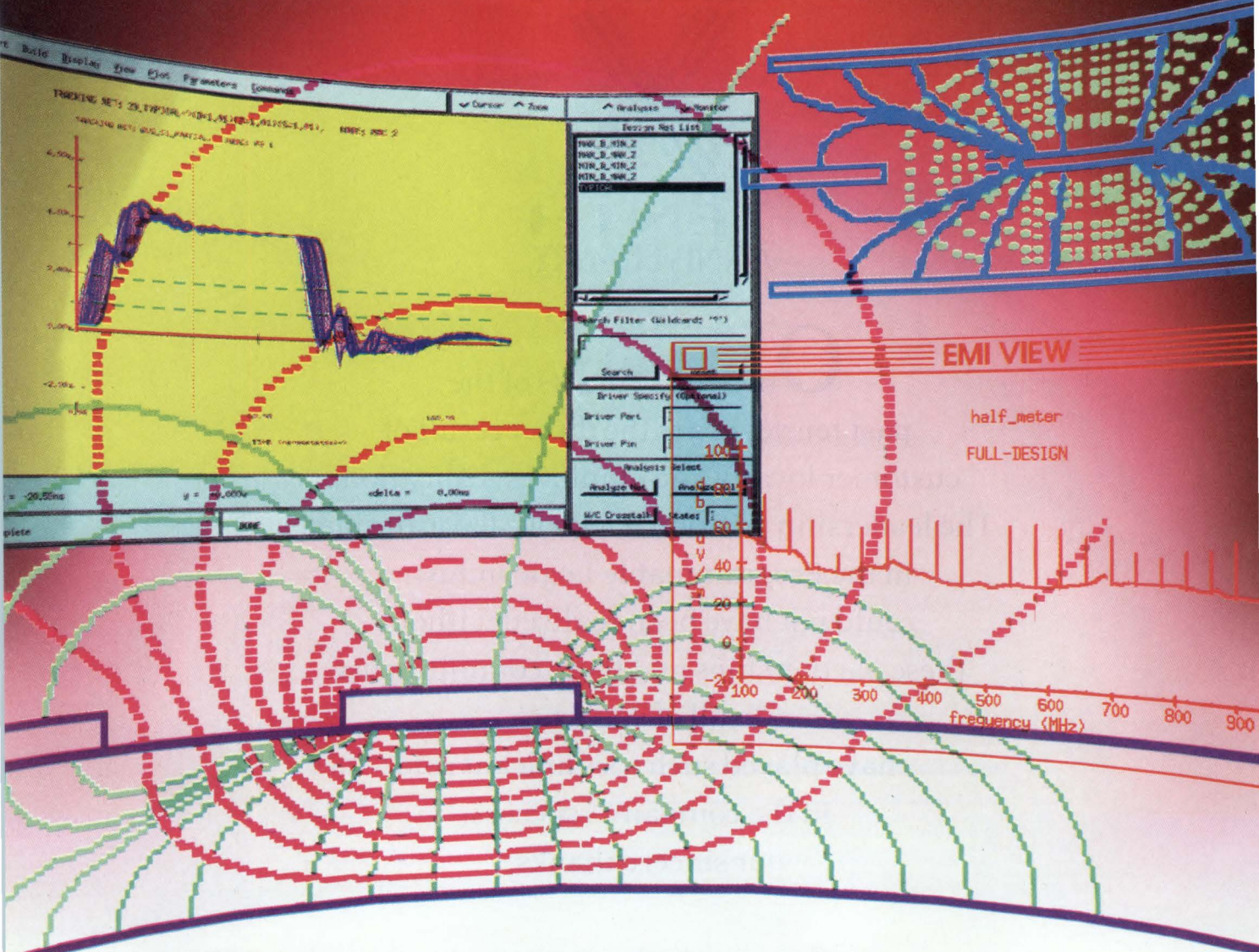

## Identify signal distortions before they occur.

If the rigors of high performance design have you caught up in repetitive prototyping, break away with XTK (Crosstalk Tool Kit) from Quad Design. Simply stated, XTK is the most powerful and comprehensive signal integrity tool money can buy. It speeds your design cycle by pinpointing signal quality problems and predicting the effects of signal distortions prior to prototyping.

XTK automatically extracts topology and electrical parameters from PCB and MCM layout systems, allowing rapid and accurate simulation of lossy transmission line and crosstalk effects for entire digital systems. This, in addition to its speed and accuracy, makes XTK an essential element in increasing the quality of your high performance designs while decreasing product debug time.

For an even greater impact on your design cycle, XTK will soon be augmented by QUIET™, the industry's first integrated EMI tool kit. QUIET will not-so-quietly predict radiated noise from PCBs.

Avoid future shock by transvidiating with XTK. Call Quad Design at (805) 988-8250 and we'll send you a brochure on our whole fleet of predictive tools. 1385 Del Norte Road, Camarillo, California 93010... FAX (805) 988-8259.

**QUAD DESIGN**  
A Viewlogic Company



\* *transvidiate* (trans vid'e at') vt. *-a ted, -a ting* [TRANS (L. across, over) + VID (L. videre, to see) + -ATE] **1.** to bridge the present and future by knowing all signal distortion effects of your digital circuit design before they happen **2.** to avoid future design mistakes while the design is still a vision **3.** to exist in the future presently —*trans-vid'i-a'tion* n.

## Kit evaluates low-power applications

Designing a low-power system is not just a matter of connecting low-power components. To lower power, you make trade-offs between running full speed and reducing performance. You also must ensure that your software takes advantage of the hardware's power-saving capabilities and you should take advantage of a variety of power-saving features on modern  $\mu$ Cs (micro-controllers).

But it isn't easy to decide which features provide the lowest power: How much will lowering the clock speed, placing the  $\mu$ C in standby mode, lowering the voltage, or changing your code affect the battery life of your design?

The M68EPL11KIT evaluation kit helps find answers to these questions. Based on the Motorola 68HC11E9  $\mu$ C, the kit consists of an evaluation board, development code, a low-power-design manual, technical documentation, extra crystals—and yes, even batteries.

The evaluation board contains the  $\mu$ C, a 14-character, 2-line LCD, an RS-232C interface, low-power LCD



**This evaluation kit allows you to learn more about low-power system design; you can play games with clock speeds, supply voltage, and code.**

driver chips, a wire-wrap area, and a battery holder. The 68HC11E9  $\mu$ C has 512 bytes of RAM and EEPROM, 38 I/O lines, and an 8-channel, 8-bit ADC.

A typical application runs from two weeks to a month using batteries. If you often use standby mode, battery life can last up to two months; full out, without any standby, reduces battery life to 30 to 40 hours.

You don't have to use three AA batteries. You can also power the board with a regulated power supply (2.7 to 5.5V dc) or unregulated power (7.5 to 15V dc).

By changing clock frequency, you can experiment with clock-speed tradeoffs. You can find out if your application would benefit from running at a higher clock frequency with longer standby times or a slower clock frequency with less time to sit in standby mode.

Preprogrammed into the 12-kbyte ROM on the  $\mu$ C is a monitor program called BUFFALO, which includes a debugger and a 1-line assembler/disassembler. You can also download assembled code developed on your computer.

Once you figure out your application, enter it in Motorola's Portable Power Design Contest, which offers a chance to win \$511 and a chance to have your entry published by Motorola.

—David Shear  
Motorola, Austin, TX. (512) 891-3465.  
Circle No. 332

## Single-board PC includes onboard development firmware

Often, developing low-end PC-based embedded systems requires that you load various tools into the target to debug your code. In these applications, a keyboard and video display may not exist on the target. Borland's TDREMOTE, a target-resident utility, allows you to use the company's Turbo Debugger on the target system.

The SBC2040 includes firmware that can support Borland's Turbo Debugger. You just connect a cable between the PC and the SBC2040. When you've debugged the program, the unmodified .exe file is burned

into EPROM and plugged into the SBC2040. A flash EEPROM package is available for field upgrades.

The single-board computer suits diskless applications and includes two serial ports, a parallel port, and a watchdog timer. Onboard memory handles four 32-pin memory ICs, for a total of up to 4 Mbytes of memory. A PC/104 interface and a 6-channel 12-bit A/D converter are also included. \$275; \$75 for the A/D option.—David Shear

Micro/Sys, Glendale, CA. (818) 244-4600.  
Circle No. 333

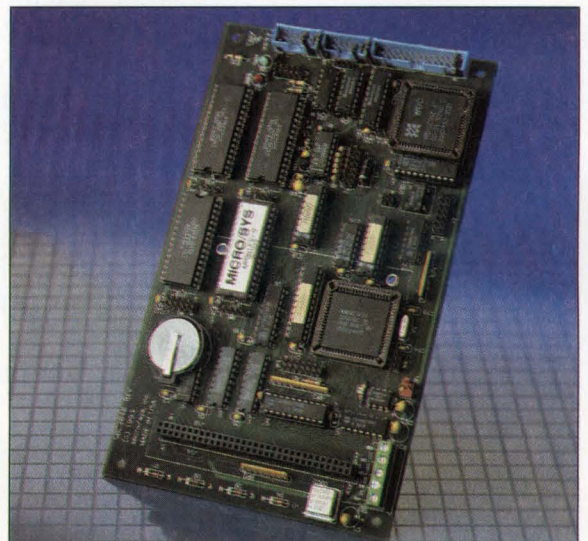

**To get started debugging your code, all you do is connect a serial cable between this PC-based single-board computer and your PC.**

Our  
Power Module  
is Dual...  
theirs is only  
single output!



Patent Pending

- **Low Cost DC-DC Converters**  
Single Outputs \$104 /  
Dual Outputs \$149
- **Dual Isolated Outputs**  
28 Standard Models /  
Special Voltages Available
- **Wide Input Voltage**  
Four Series / 18-380 VDC Input
- **Parallel Operation**  
Fixed Frequency 100kHz  
True Redundancy Operation
- **100 Watts**

The availability of DUAL ISOLATED OUTPUTS creates cost and space savings in many applications.

Fully safeguarded for over voltage, over temperature and continuous short circuit protection, these FIXED Hi-Frequency units minimize technical problems.

With output voltages from 3.3 VDC to 100 VDC, four distinct input ranges and the choice of single or dual outputs plus the capability of Parallel Operation, as standard features, your circuit designs can be optimized.

Assembled in the U.S.A. with PICO quality components, these hi density units allow the most stringent mechanical, electrical and environmental requirements.

See EEM or send direct  
for **Free PICO Catalog**.  
Call toll free **800-431-1064**  
in NY call **914-699-5514**  
FAX **914-699-5565**

**PICO Electronics, Inc.**

453 N. MacQuesten Pkwy., Mt. Vernon, N.Y. 10552

CIRCLE NO. 27

## EDN-NEW PRODUCTS

### EMBEDDED SYSTEMS

#### DSP development board includes integrated SVGA graphics system

The DSP Lab One signal-processing board combines a DSP development system with an SVGA graphics system on one ISA board. The board lets you acquire data, process it, and then display the results on a monitor without impacting the operation of the PC it's plugged into.

By separating the DSP functions (including displaying data) from the PC, you have complete access to the PC for other operations while developing algorithms. You can also use the PC as the human interface and modify the operation of the DSP system while the DSP system runs.

The board contains four Texas

Instruments TMS320C51 DSPs, 16-bit A/D and D/A converters (166-kHz maximum sample rate), a TMS34010-based SVGA graphics controller, and 2.5 Mbytes of onboard memory. The DSPs communicate with the host and each other via global memory and high-speed serial buses.

Tutorials, sample displays, sample applications, a monitor/loader, and high-level graphics functions are also included. The SAL-DL1/28 runs at 28 MHz and costs \$3995; the 20-MHz SAL-DL1/20 costs \$3495.—David Shear

*Standing Applications Laboratory, Kirkland, WA. (206) 453-7855.*

Circle No. 334

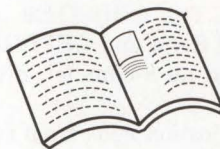

## PUT YOUR BOOK IN OUR LIBRARY

EDN—in collaboration with international book publisher Butterworth-Heinemann—is seeking authors to extend our exciting series of practical books about electronic hardware and software. Titles already in the EDN Series for design engineers include *Analog Circuit Design*, by Jim Williams; *Operational Amplifiers*, by Jiri Dostal; and *Rechargeable Batteries Applications Handbook*, by Gates Energy Products.

We have room in the series for many more professional titles. Whether you have an idea for a book or a completed manuscript, contact us. Developing an idea for a full-fledged book might be a lot easier than you think. Let EDN help you get published.

**Contact:**  **Frank Satlow**, EDN Series  
Butterworth-Heinemann  
80 Montvale Ave  
Stoneham, MA 02180  
Phone (617) 438-8464, ext. 241  
Fax (617) 438-8103



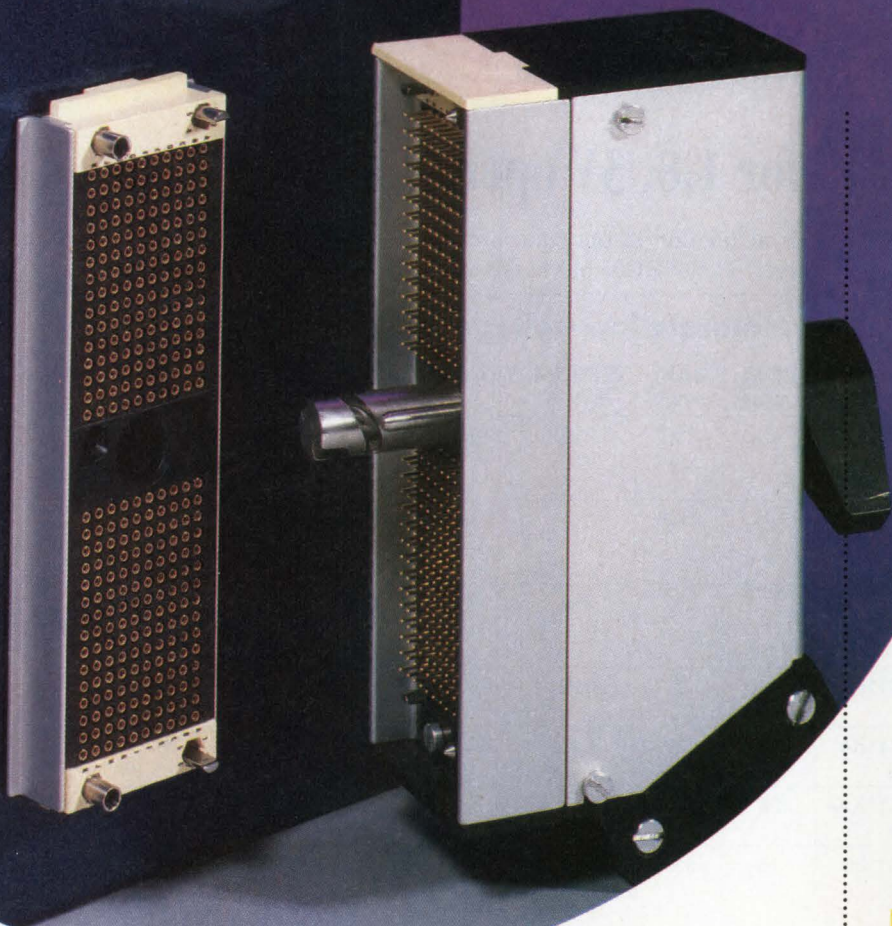

*Less than 2 second operation*

*Wiping action pin and sockets*

*60-300 low insertion force contacts*

## END THE CONNECTOR COMPROMISE

*with quick disconnect  
connectors...for test  
equipment*

Only Hypertronics ends the connector compromise — for heavy duty test and measuring equipment applications — by replacing zero insertion force (ZIF) with low force, high cycle reliability. The 180° quick turn coupling shaft provides fast action coupling for over 15,000 mating cycles

Our NBY Series provides 60-300 contacts with Crimp, printed circuit board, wire wrap® and solder cup terminations. And the wipe action of each Hypertac® contact maintains electrical continuity under corrosive conditions and extremes of shock and vibration...ending the intermittence problems of ZIF contacts.

The NBY Hypertac® contacts provide low insertion force, exceptional cycle life, contact resistance of under 5 milliohms and virtual immunity to shock and vibration. The reliability and density of the NBY connectors makes it ideal for ATE, Medical, test and process equipment applications.

Now you can have it all...in connectors for applications in test equipment requiring up to 300 contacts. End the connector compromise by calling 1-800-225-9228, toll free.



**HYPERTRONICS  
CORPORATION**

16 Brent Drive, Hudson, MA 01749  
(508) 568-0451 FAX (508) 568-0680

**HYPERTAC®: Inserting pin into hyperboloid sleeve.**



Wire sleeve before insertion of pin.

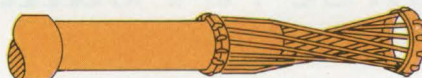

Pin partially inserted into sleeve.



Pin completely inserted into sleeve.

### Motorola 8-bit $\mu$ Cs head for 1.8, 3V operation

A tidal wave of low-power applications is crashing against engineering shores. Burgeoning applications include remote controls, pagers, cellular and portable phones, video games, cameras, handheld audio and video, notebook computers, and handheld digital assistants. Low-power 8-bit  $\mu$ Cs supply the smarts to control these products. Motorola's 8-bit controllers, the popular 68HC05 and 68HC08 families, are available in low-power versions.

Motorola's low-end 68HC05 now comes in low-power 1.8V versions. Initially, seven members of the 8-bit 68HC05 family can operate at 1.8V, running with a 500-MHz clock. These  $\mu$ Cs cut power significantly for power-limited applications over 5V—or even 3V parts.

(Power is a function of the square of the voltage.) The 68HC05 has handled 3 and 5V operation since its introduction in 1984. Bus clock rates for 5V

Motorola low-voltage 68HC11 8-bit $\mu$ Cs							
Part	ROM (kbytes)	RAM (bytes)	EEPROM (bytes)	I/O pins	A/D (8 bit)	Bus speed (MHz)	Package type
68HC11A8 series	8	256	512	38	Yes	0 to 2	52-pin PLCC 48-pin DIP 64-pin QFP
68HC11D3 series	4	192	N/A	32	Yes	0 to 2	40-pin DIP 44-pin QFP 52-pin TQFP
68HC11E9 series	12	512	512	38	Yes	0 to 2	52-pin PLCC 52-pin TQFP 64-pin QFP
68HC11F1	N/A	1	512	30	Yes	0 to 3	68-pin PLCC 80-pin TQFP
68HC11K4 series	24	768	640	62	Yes	0 to 3	84-pin PLCC 80-pin QFP
68HC11KA4 series	24	768	640	51	Yes	0 to 3	68-pin PLCC
68HC11L6 series	16	512	512	46	Yes	0 to 2	68-pin PLCC 64-pin QFP

What has seven bright colors...  
 is thin yet rugged...  
 flexible...  
 with an easy-to-use  
 graphic interface...  
 ...and runs all day on  
 three AA batteries?

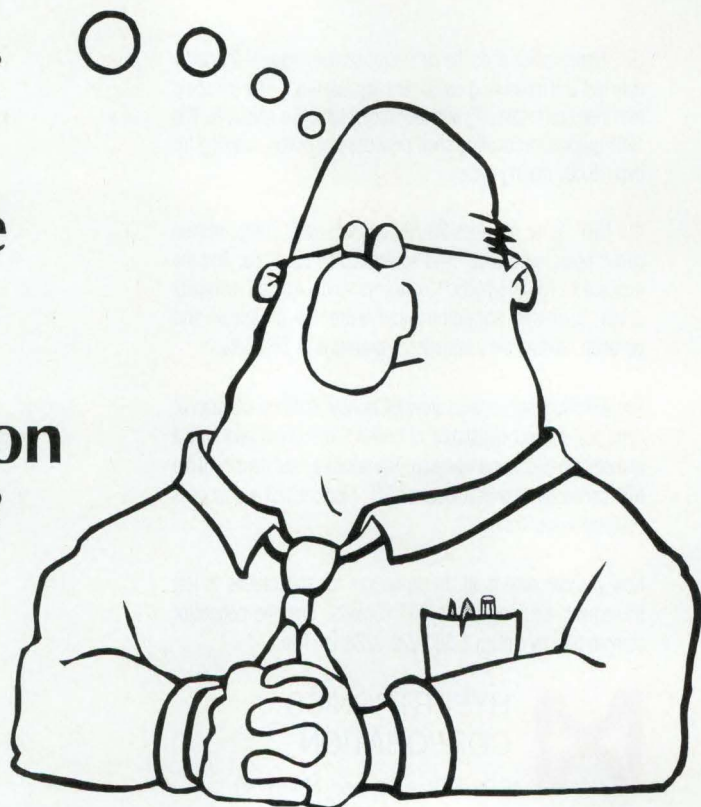

# EDN-NEW PRODUCTS

## MICROPROCESSORS

parts go to 2 MHz (1 MHz for 3V parts).

Motorola has also reinforced the low-power ranks of its mainline 68HC11

with new parts. These include a ROM-less part (the 678HCF1) and three ROM/EPROM parts, with up to 24 kbytes of on-chip ROM. All these chips have an 8-bit A/D converter and 512 or 640 bytes of EEPROM to hold application-specific constants and codes. All the 3V 68HC11 parts run at the same bus clock rates as the higher-voltage, 5V chips.

For the 68HC11 low-voltage parts, Motorola supplies a battery-powered development board and kit, with a tutorial and development software. The 3V 68HC11 family: D3, \$4.34; A8, \$7.52; E9, \$8.57; L6, \$10.86. For the lower-level 1.8V 68HC05 line, prices start at \$1.07 for a K0; 3 to 5V K0 parts cost \$0.98 (50,000).—Ray Weiss

Motorola Inc, Austin, TX.  
(512) 891-2000. **Circle No. 579**

Motorola 1.8V 68HC05 8-bit $\mu$ Cs						
Part	ROM (kbytes)	RAM (bytes)	Timer (bits)	I/O pins	Bus speed (kHz)	Package
68HC05C4	8	176	16	28	0 to 500	40-pin DIP 44-pin PLCC/QFP 42-pin SDIP
68HC05C8	4	176	16	28	0 to 500	40-pin DIP 44-pin PLCC/QFP 42-pin SDIP
68HC05C12	12	176	16	28	0 to 500	40-pin DIP 44-pin PLCC/QFP 42-pin SDIP
68HC05J1A	1	64	Multi	14	0 to 500	20-pin DIP 20-pin SOIC
68HC05K0	0.5	128	Multi	10	0 to 500	16-pin DIP 16-pin SOIC
68HC05P1	2	768	16	20	0 to 500	28-pin DIP 28-pin DIP 28-pin SOIC
68HC05P4	4	768	16	20	0 to 500	28-pin DIP 28-pin SOIC

## THE PERFECT DISPLAY OF FORM AND FUNCTION

IEE's REFLECTIVE SYMBOLIC VISUAL PANEL is a unique LCD technology providing outstanding design flexibility in a fully integrated flat panel color display.

- ◀ SEVEN BRIGHT COLORS for visual impact and style
- ◀ THIN YET RUGGED construction is ideal for portable and industrial applications
- ◀ EASY TO USE in your design, with fully integrated switches and interfaces available
- ◀ FLEXIBLE design to create displays and switches in a variety of shapes and sizes
- ◀ GRAPHIC INTERFACE using icons, colors and integrated switches for customized menu-driven applications
- ◀ RUNS ALL DAY ON THREE AA BATTERIES.

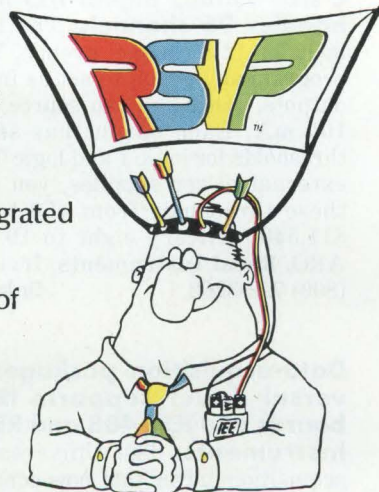

INDUSTRIAL ELECTRONIC ENGINEERS, INC. • Tel: (818) 787-0311 Ext. 418 • Fax: (818) 901-9046  
Immediate, Circle No. 28      Reference, Circle No. 29

Contact us for a free brochure

**Generator produces 100V or 2A pulses with 100-psec timing resolution.** The 8114A generator (\$9600) produces pulses to 15 MHz. It provides a variable duty cycle and 7-nsec transitions. Amplitude resolution is 10 mV, and amplitude error is <1%. A \$1700 variable-baseline option lets you offset the output up to  $\pm 25V$ . **Hewlett-Packard Co**, Santa Clara, CA. (800) 452-4844. **Circle No. 346**

**Monitor displays NTSC, PAL, and SECAM waveforms.** The Model 5222 monitor handles composite and component waveforms simultaneously. The monitor has two groups of four inputs. It derives sync from two inputs in each group plus an external reference. The unit produces overlay, parade, and picture displays. A white phosphor is optional. Cursors control on-screen signal-parameter readouts. Menus control the instrument setup; the unit stores and recalls 10 of these setups. \$3665. **Leader Instruments Corp**, Hauppauge, NY. (516) 231-6900. **Circle No. 347**

**IEEE-488 interface runs under MS-Windows V3.1.** The 82341A occupies one ISA- or EISA-bus slot. The software that accompanies the board enables you to write C or C++ programs that import data into Windows applications from any instrument that has an IEEE-488.2 interface. \$495. Version for Windows NT, \$845. Upgrade from Windows to Windows NT version, \$350. **Hewlett-Packard Co**, Santa Clara, CA. (800) 452-4844. **Circle No. 348**

**C-size VXIbus digital I/O module handles 96 channels.** The 1277-5A includes 12 8-channel groups. You can program any group to act as inputs or outputs. Each line can source or sink 100 mA. Each output has separate thresholds for logic 1 and logic 0. Using external power supplies, you can set these thresholds from +50 to -50V. \$11,540; delivery eight to 10 weeks, ARO. **Racal Instruments**, Irvine, CA. (800) 722-3262. **Circle No. 349**

**Data-acquisition packages' universal driver supports ISA-bus boards and IEEE-488 and RS-232C instruments.** The Universal data-acquisition driver that now comes with Labtech Notebook and Labtech Control provides the same flexibility as the universal printer drivers that have been a staple of PC word processors for many

### FREE INFO, FREE POSTAGE

Use our postage-paid reader-service cards to get more information on any of these products.

years. With the Windows versions of the data-acquisition and -control packages, you can intermix instruments from multiple vendors. With the DOS versions, memory limitations restrict you to hardware from one vendor at a time. The packages' prices start at \$995. **Laboratory Technologies Corp**, Wilmington, MA. (508) 657-5400. **Circle No. 350**

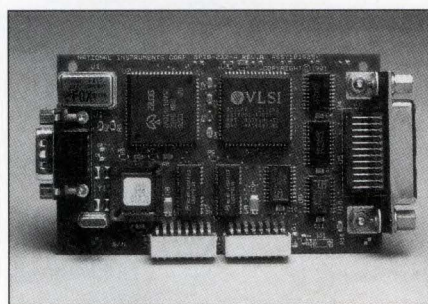

**Cards that mount within instruments convert between IEEE-488 and RS-232C.** The GPIB-232CV-A (OEM) lets you connect an instrument that has an RS-232C port to the IEEE-488 bus. The GPIB-232CT-A (OEM) lets a controller or terminal that has an RS-232C port act as a full-functioned IEEE-488.2 controller. This unit implements normal and extended talker and listener modes, serial and parallel polling, service requests, passing and receiving of control functions, and remote programming. Each board costs \$495 (one). **National Instruments Corp**, Austin, TX. (512) 794-0100. **Circle No. 351**

**Benchtop power supply provides up to 35V and 1.7A.** The E3616A power supply has 10-turn potentiometers that control output voltage and current. A pair of digital meters monitors both quantities simultaneously. Line and load regulation are each 0.01%. Remote sensing compensates for I-R drops in external wiring. Output noise is <200  $\mu V$  rms. \$500. **Hewlett-Packard Co**, Santa Clara, CA. (800) 452-4844. **Circle No. 352**

**PC-based fax protocol analyzer displays T.30 handshakes as well as T.4 image data.** The GD-Fax 14.4 passively monitors a phone line and captures all data traveling in both direc-

tions between a pair of fax machines or fax boards. It then displays the data and a detailed analysis of timing information, deviations from CCITT standards, and data or format errors. \$4495, including a year of software updates. **Gray Associates**, Truckee, CA. (916) 582-8623. **Circle No. 353**

**IEEE-488-programmable resistance calibrators limit error to 0.002% from 100 $\Omega$  to 1.9 M $\Omega$ .** You can operate the 6201 and 6202 calibrators from their front panels or via the IEEE-488 bus. The 6201 (\$2600) provides decade values from 1 $\Omega$  to 10 M $\Omega$ . The 6202 (\$3500) provides all of these values as well as values 1.9 $\times$  as great. (In other words, the 6202 provides twice as many values as the 6201, the highest being 19 M $\Omega$ .) The units allow you to make 2- or 4-wire connections. **Electronic Development Corp**, Boston, MA. (617) 268-9696. **Circle No. 354**

**Programmable linear power supplies produce single and dual outputs to 240W.** The single-output PM 2831 (\$2095) and the dual-output PM 2832 (\$3595) power supplies operate as voltage or current sources with automatic crossover. Each output provides up to 8V dc at up to 15A. You can program the overvoltage and overcurrent limits separately from the output values. Output voltage resolution is 2 mV; output current resolution is 0.75 mA. The units operate in two quadrants; that is, their outputs can source or sink current. Programming is via IEEE-488.2; the command set conforms to the SCPI syntax. The units store 99 output settings and can automatically step through them. **Fluke Corp**, Everett, WA. (800) 443-5853. **Circle No. 355**

**VXIbus interface software runs under LynxOS real-time OS.** The NI-VXI software for LynxOS includes a resource manager, a VXI resource editor, a library of routines for VXI programming, and an interactive control program for debugging the VXIbus. The software can configure and control VXI systems that comprise single or multiple mainframes. \$995. **National Instruments Corp**, Austin, TX. (512) 794-0100. **Circle No. 356**

**ISA-bus card houses 12-MHz direct digital synthesizer.** The DDS3, which resolves 2 Hz, plugs into an 8-bit ISA bus. It generates sine

# Your clock has the jitters? We can help!



AKM's Stereo DACs don't mind a little jitter. Or even a lot! Up to 100ns is no problem. AKM's unique architecture provides high tolerance to clock jitter, ideal monotonicity and low distortion — all without trimming.

Choose AKM's low cost, easy-to-use DAC products for any application — digital CATVs, satellite receivers, digital audio systems, digital music keyboards, digital sound recording systems, CD players, etc.

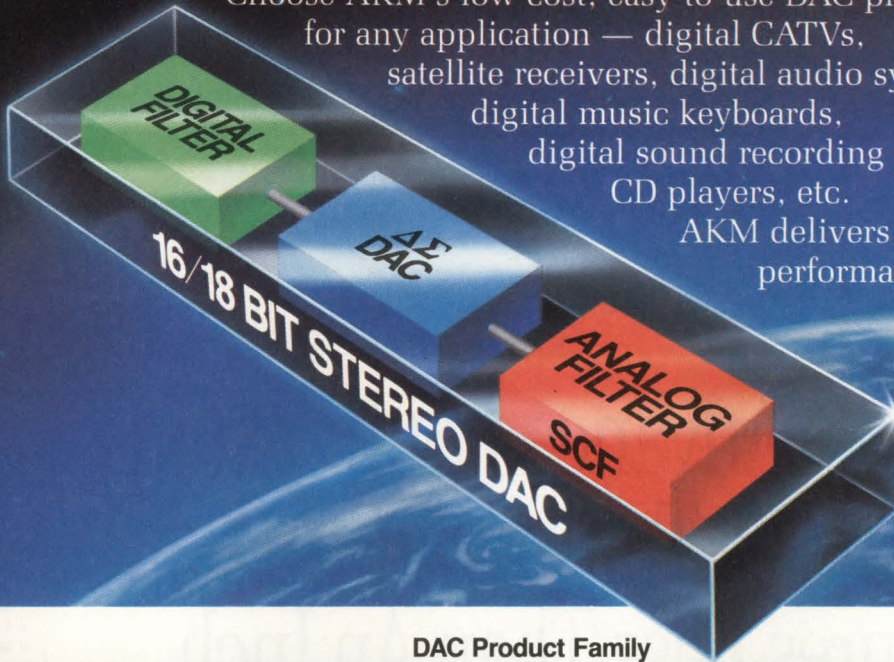
AKM delivers — price, performance, quality.



DAC Product Family

Device	# of bits	DR	S/N	THD + N	Special Features	Voltage
 <b>AK4316</b>	16	90dB	90dB	0.01%	• High tolerance to clock jitter	+5V
 <b>AK4318</b>	18	97dB	97dB	0.0025%	• High tolerance to clock jitter • De-emphasis control circuit • Soft mute function	+5V
 <b>AK4313</b>	18	93dB	93dB	0.004%	• High tolerance to clock jitter • De-emphasis control circuit • Soft mute function • Low voltage	2.7 ~ 4.0V



## Asahi Kasei Microsystems Co.,Ltd.

JAPAN — TS Bldg. 24-10, Yoyogi 1-chome, Shibuya-ku, Tokyo 151, Japan Phone: (03) 3320-2067 / Fax: (03) 3320-2072  
 USA — 2055 Gateway Place, Suite 415, San Jose, CA 95110 Phone: (408) 436-8580 / Fax: (408) 436-7591  
 EUROPE — Avenue Louise 326, Bte 056, 1050 Brussels, Belgium. Phone: (32) 2-649-7831 / Fax: (32) 2-640-1809

**For more information, contact:**

- (U.S.A.)**
- WA, OR, MT (Western); CANADA-BC, Alberta ..... Quest Marketing, Inc. .... Phone (206) 228-2660 Fax (206) 228-2916
  - CA (Northern), NV (Northern), ID, UT, CO ..... Pinnacle Sales ..... Phone (408) 453-7500 Fax (408) 453-7667
  - CA (Southern) ..... Solutech, Inc. .... Phone (714) 374-0130 Fax (714) 374-0131
  - NV (Southern), AZ, NM, MEXICO-Sonora, Chihuahua ..... Fred Board Associates ..... Phone (602) 994-9388 Fax (602) 994-9477
  - IA, WI, IL, IN ..... Richmar Electronics Corp. .... Phone (708) 968-0118 Fax (708) 968-0197
  - NY (Upstate) ..... Interactive Component Sales ..... Phone (315) 445-9600 Fax (315) 445-8700
  - NY (Southern), CT, NJ, PA, DE ..... WD-TMI ..... Phone (914) 779-8738 Fax (914) 779-8840
  - MD, VA, DC ..... Eltron Sales, Ltd. .... Phone (703) 635-7201 Fax (703) 635-1933
  - TN, NC, SC, GA, AL, MS ..... E-Squared Marketing ..... Phone (205) 430-3000 Fax (205) 430-3350
  - FL, Puerto Rico ..... Micro Concepts, Inc. .... Phone (407) 830-8889 Fax (407) 834-0649
- (EUROPE)**
- Austria, Germany, Italy, Spain, Switzerland, Greece ..... Austria Mikro Systeme International AG ..... Phone (43) 3136/500-267 Fax (43) 3136/500-491
  - Other European Countries ..... AKM Europe ..... Phone (32) 2-649-7831 Fax (32) 2-640-1809

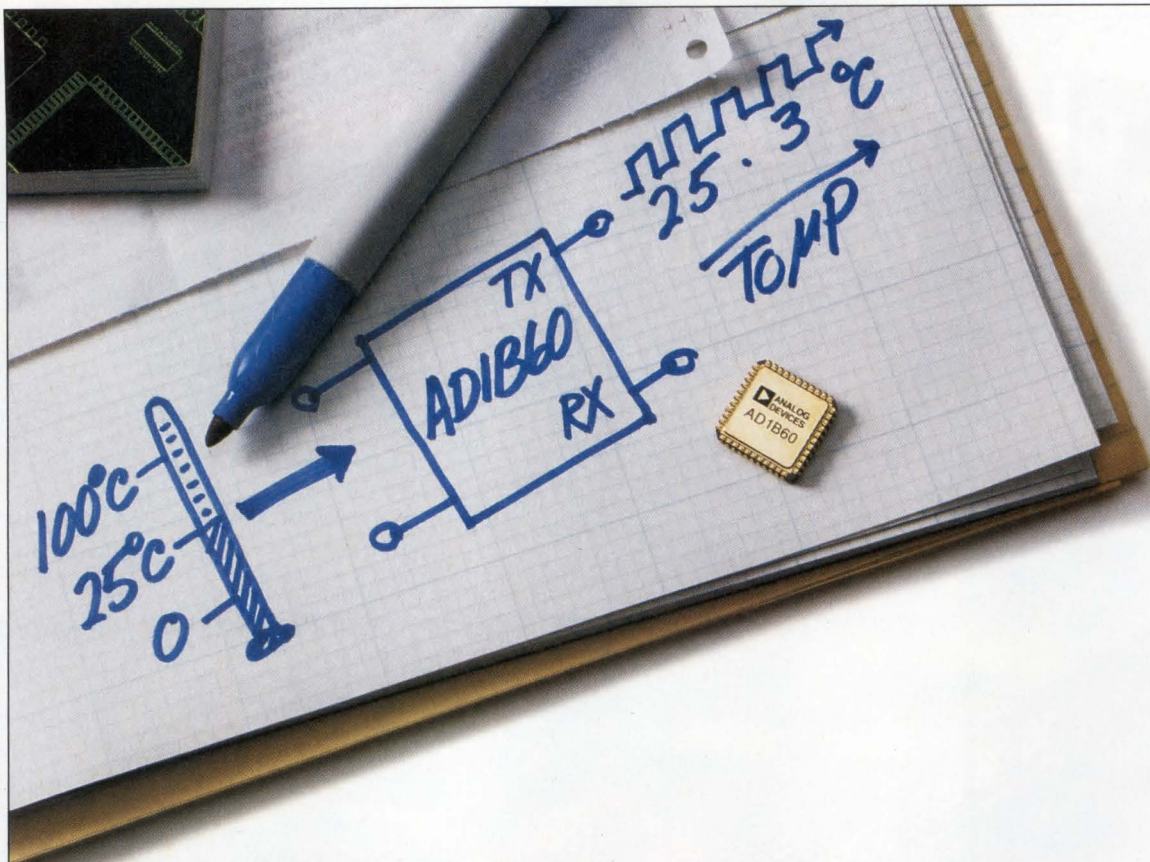

# The Most Advanced Subsystem To Measure Temperature Also Measures Less Than An Inch.

Introducing the AD1B60. The only intelligent digitizing signal conditioner component.

When we say there's nothing like the AD1B60, it isn't advertising hype, it's fact. Not only does it provide excitation, linearization, compensation, scaling and self-calibration for thermocouples and RTD's, it does so in just one small surface-mount package. And since it eliminates the need to write and debug linearization software, the AD1B60 is incredibly easy to use. So if you're looking to cut design costs, get to market faster

and reduce inventory requirements, there's only one thing to do. Call Analog Devices at 1-800-ANALOG-D (262-5643).

We'll send you a datasheet on the AD1B60 and a brochure detailing our full line of industrial components.

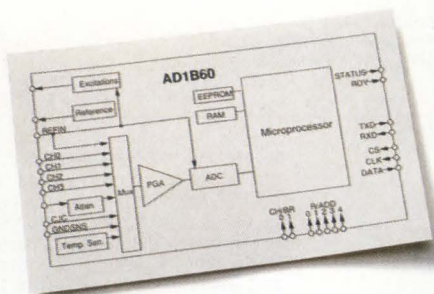

- Direct connect to sensors
- Configurable inputs
- Max error of 0.2°C over temp. range
- Linearized serial output

Analog Devices, Inc., One Technology Way, P.O. Box 9106, Norwood, MA 02062-9106.



## TEST & MEASUREMENT

waves and TTL/HCMOS signals whose frequency is accurate to within 5 ppm. Phase noise is  $<-90$  dBc at a 1-kHz offset. Spurious signals are  $<-45$  dBc, and harmonics are  $<-40$  dBc. Output amplitude is 12V p-p into an open circuit. An attenuator reduces the output up to 70 dB in 10-dB steps. An accompanying C program, which runs under DOS, lets you set attenuation and frequency. The program can sweep the output through various settings and dwell at points you choose for programmable intervals. \$399. **Novatech Instruments Corp.**, Seattle, WA. (206) 328-6902. **Circle No. 357**

**Logic-analyzer probe minimizes wiring messes.** Using a 24-in. controlled-impedance cable, the \$395 ActivCable provides a high-density, high-impedance,  $>200$ -MHz-bandwidth connection to logic-analyzer probes or a breakout box from a 48-point connector. The connector occupies  $<0.5$  in.<sup>2</sup> on a board. Active circuits in the cable hold the loading on any line to 4 pF and 30  $\mu$ A. The circuits draw no power from your board and allow you to set separate threshold voltages ( $-5$  to  $+5$ V) on two groups of 24 channels. The \$1950 breakout box terminates as many as 192 signals. **Biomation Corp.**, Milpitas, CA. (408) 435-7800. **Circle No. 358**

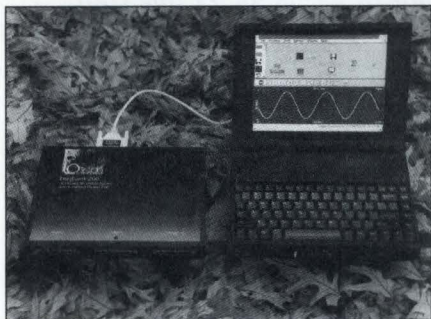

**I/O unit for notebook PCs communicates at 500 kbytes/sec.** The  $8\frac{1}{2} \times 11 \times 1\frac{3}{8}$ -in. DaqBook/200 connects to a PC via a bidirectional enhanced-parallel-port (EPP) interface that also works with standard parallel ports. The unit, whose ADC resolves 16 bits at 100 ksamples/sec, acquires 16 analog signals (expandable to 256 signals) and includes 16 high-speed digital inputs, 24 general-purpose digital I/O lines, five counter/timers, and two 12-bit DACs. The vendor supplies DOS and Windows drivers for C, Basic, Visual Basic, and Visual C++. With these drivers, the unit emulates several industry-standard ISA-bus data-acquisition cards. \$1995. **IOtech Inc.**, Cleveland, OH. (216) 439-4091. **Circle No. 359**

**Tools add joint time-frequency analysis to graphical programming system.** The \$495 Joint Time-Frequency Analysis (JTFA) Toolkit is a virtual-instrument library for the vendor's LabView graphical programming system, which runs on Macintosh and Windows PCs, and Sun SPARCstations. JTFA is a technique for analyzing signals whose frequency content varies over time. For users who do not have LabView, a JTFA executable program, which runs on any computer that can

run LabView, reads files of time signals, transforms the signals into the time-frequency domain, and displays the results in a spectrogram. **National Instruments Corp.**, Austin, TX. (512) 794-0100. **Circle No. 360**

**ISA-bus boards take 2M 12-bit or 1M 14-bit samples/sec.** The PC-414F (2M samples/sec/channel, 12 bits, \$1995 (one) with 1k-word FIFO) and the PC-414G (14 bits, 1M samples/

## Need Top Performance and Reliability in a Subminiature Film Capacitor? You Need IC's MSR!

Illinois Capacitor's MSR radial lead metallized film capacitors have what it takes to handle the most demanding applications. Their construction utilizes the latest in metallized Mylar® polyester film dielectrics for compact size and high performance. The self-healing metallized-film design prevents shorting due to high-voltage arc-over. Their construction makes them ideal for transient suppression and EMI reduction as well as for coupling and bypass applications.

- Non-inductive, self-healing.
- 0.01 mfd to 10 mfd.
- 100 wvdc to 1000 wvdc.
- Capacitance tolerance  $\pm 10\%$  (K) standard;  $\pm 5\%$  (J) optional.
- Wide operating temperature range:  $-55^\circ\text{C}$  to  $+125^\circ\text{C}$ .
- Excellent for telecommunications and audio applications.

MSR capacitors are in stock for immediate delivery. For complete details, contact your local IC distributor or IC.

Ask for our FREE Capacitor Engineering Guide.

**ic**®  
**ILLINOIS CAPACITOR, INC.**

Mylar is a registered trademark of DuPont.

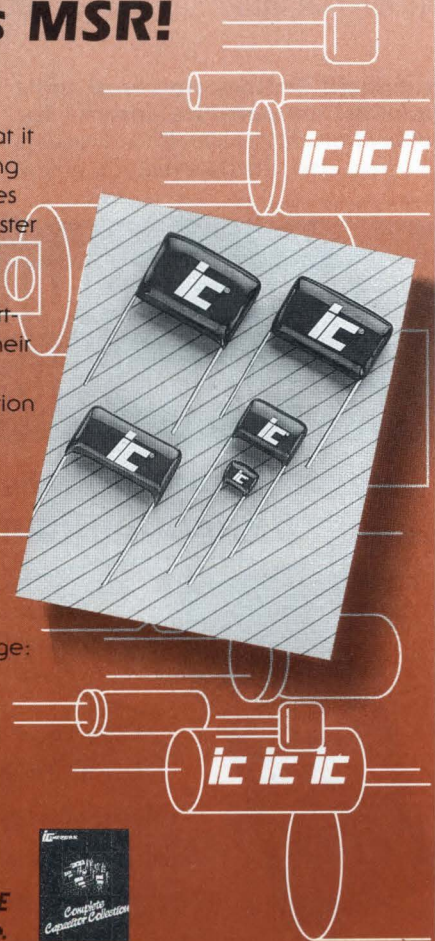

3757 West Touhy Avenue  
Lincolnwood, IL 60645  
708 675-1760  
Fax: 708 673-2850

CIRCLE NO. 30

# EDN-NEW PRODUCTS

## TEST & MEASUREMENT

sec/channel, \$2195 (one) with 1k-word FIFO) include level-sensitive trigger circuits. You set the trigger levels using a 12-bit DAC that also provides an analog output. The units transfer data via the ISA bus or a 10-MHz parallel port that connects directly to many array processors. **Datel Inc**, Mansfield, MA. (508) 339-3000. **Circle No. 361**

**\$495 ISA bus board acts as auto-calibrating 3¾-digit DMM.** The autoranging DMM-100 takes as many as 10 samples/sec or waits more than an hour between samples. The board performs alarm-state monitoring and averaging functions. Ready-to-use software for DOS and Windows logs data to disk; the Windows version also graphs acquired data. Drivers allow you to write your own applications in high-level languages. **Quatech Inc**, Akron, OH. (216) 434-3154. **Circle No. 362**

**Handheld battery-powered units simulate temperature sensors for calibration.** Model 473 (\$795) produces an output that simulates that of a type J,

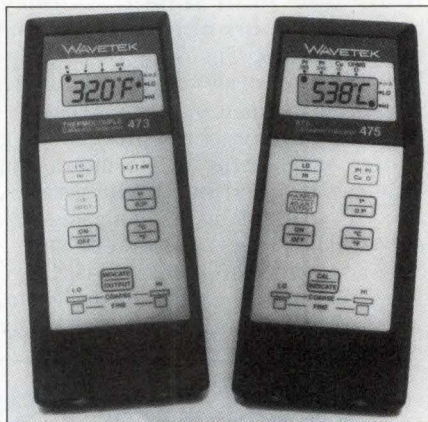

K, or T thermocouple while simultaneously converting the output of a 4- to 20-mA transmitter into a corresponding temperature display. You calibrate a transmitter by supplying it with a simulated sensor output and adjusting the transmitter until its displayed output agrees with its input. Model 475 (\$895) performs a similar function, except that it simulates 100Ω platinum or 10Ω copper RTDs. Both units also accept sensor outputs directly and display the corresponding temperature. **Wavetek Corp**, San Diego, CA. (619) 279-2200. **Circle No. 363**

**PC-based software simplifies creation and editing of arbitrary waveforms.** AnyWave works with the vendor's instruments. The software lets you draw or edit waveforms using a mouse and transfer them to an arbitrary-waveform generator (ARB). You can also transfer the waveforms to the vendor's DSOs for use as templates in comparison testing. The software lets you load and modify waveforms acquired by DSOs, including waveforms acquired by the handheld Scopemeter. \$395. **Fluke Corp**, Everett, WA. (800) 443-5853. **Circle No. 364**

**225-MHz counter/timer offers optional 2.4-GHz channel.** The 10-digit half-rack-size Model 776 (\$1995) has two independent channels. Besides a third 2.4-GHz channel, the 776/2.4G (\$2495, available spring 1994) includes a temperature-compensated crystal oscillator stable to 0.1 ppm/month. The units incorporate an IEEE-488 interface that transfers 100 ASCII-formatted readings/sec. **Keithley Instruments Inc**, Cleveland, OH. (216) 248-0400. **Circle No. 365**

## DUMB TERMINALS ... for smart engineers

**Better Ergonomic Features,  
Better Configurability.**

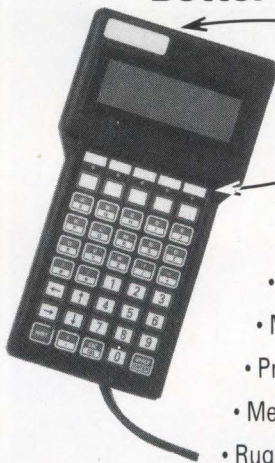

**FREE Logo and  
Top Key Customizing**

- Every key configurable
- More hardware options
- Multi-drop interface available
- More powerful command set
- Programmable indicator LEDs
- Metal snap-dome keys for crisp feel
- Rugged, attractive, comfortable case

**QSI**  
CORPORATION

QSI Corporation  
2212 South West Temple #46  
Salt Lake City, UT 84115-2648 • USA  
Phone 801-466-8770 (Fax 801-466-8792)

CIRCLE NO. 31

122 • EDN February 17, 1994

## One Stop Shopping!

*All your circuit board needs under one roof.*

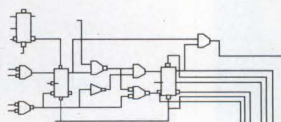

### PCB MANUFACTURING

- 2 day turn on multi-layers
- Prototype and production
- Gerber Data Test
- FR4, Polyimide
- Turnkey assembly
- PCMCIA up to 6 layers

### PCB DESIGN LAYOUTS

- Layouts for Economical manufacturing
- Backplanes
- Impedance Control
- Analog and ECL
- Surface Mount
- 3 CAD Workstations

### TECHNICAL SUPPORT

- Free Design Layout Tips
- Free MFG Cost Cutting Tips
- We accept Gerber Data Via Modem

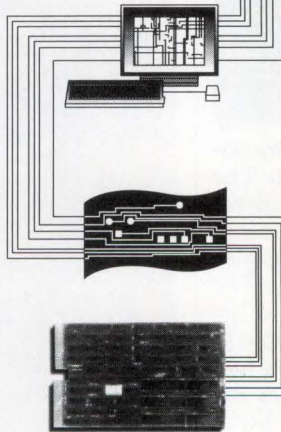

**Call For A Quote!**

**MC** **Murrietta  
Circuits**

Phone: (714) 970-2430  
FAX: (714) 970-2406  
MODEM: (714) 970-5015

4761 E. Hunter Ave., Anaheim, CA 92807

CIRCLE NO. 32



# 486 VMEbus PC Performance and Power from VMIC

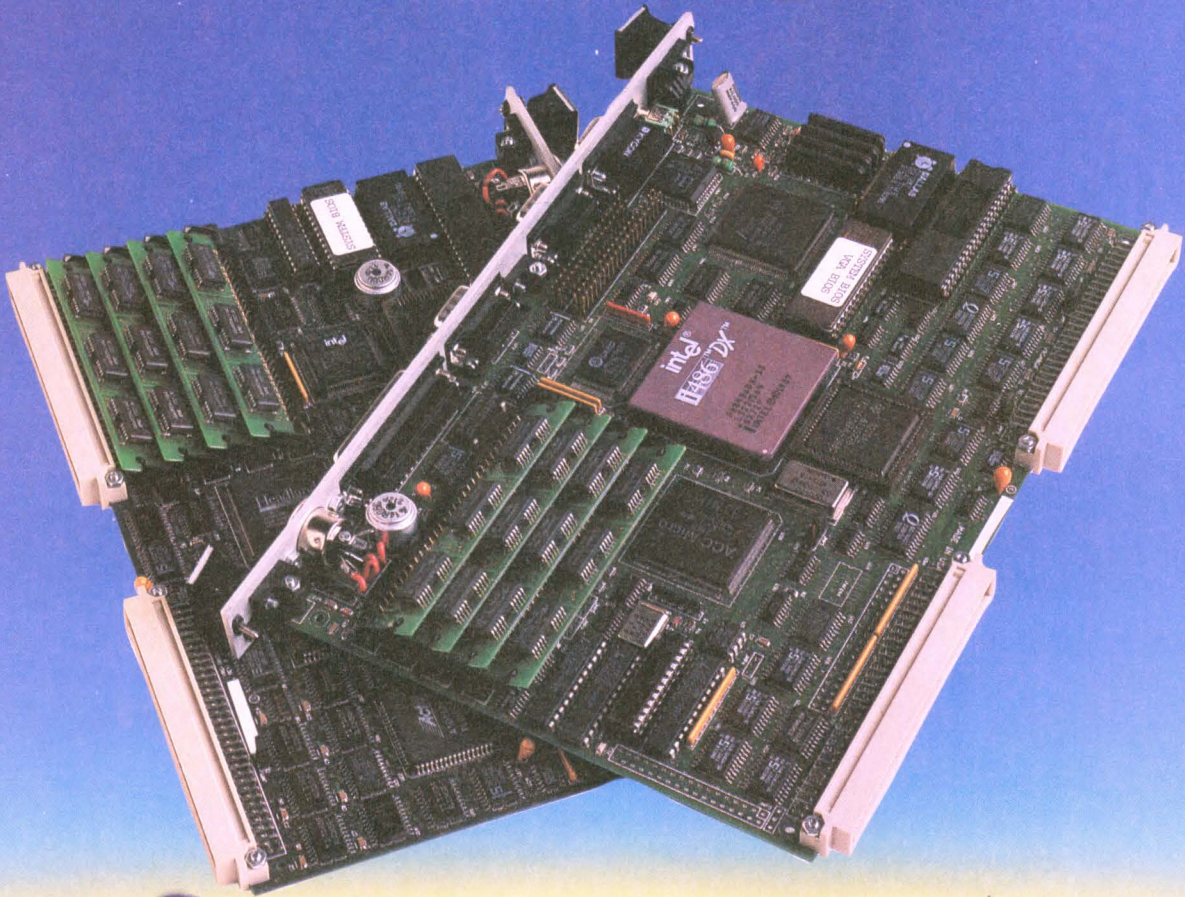

## PC/AT VMEbus Products from VMIC bring the best of both worlds together.

Now the flexibility and low cost of the PC can be coupled with the performance and power of VMEbus products from VMIC. Our product line includes the 486 CPU's, disks, FLASH disk, adapter boards, ISA bus I/O boards and more.

PC/AT VMEbus Systems from VMIC may be ordered and configured ready to operate as a complete turnkey PC/AT computer system.



*The CPU, a floppy and hard disk, VGA compatible monitor, power supplies with a complete operating system including MS-DOS and Windows, keyboard and mouse is shipped with VMIC's VMEManager™ software utilities ready for operation within a VME chassis/Enclosure.*

## FREE PC/AT and VMEbus Catalog from VMIC now available. Call Toll-Free!

VMIC is your ONE-STOP SOLUTION FOR PC/AT VMEbus CPU's, VMEbus I/O Products and Systems. Not only do you get VMIC's TWO YEAR WARRANTY, but the best service and technical support in the industry. Pick up the phone and VMIC will configure your VMEbus PC with performance and power!

**VMIC** VME

VME Microsystems  
International Corporation

1-800-322-3616

12090 S. Memorial Parkway • Huntsville, AL 35803-3308 • (205) 880-0444 • FAX (205) 882-0859  
VMIC products are internationally represented by distributors throughout the world. Call or fax VMIC for complete information.

CIRCLE NO. 113

# Calibrate All Your Handheld Multimeters With One Instrument!



Now there's a way to test every function of your handheld multimeters quickly, easily, and affordably. That's voltage, current, resistance, capacitance, conductance, temperature—even pulse and logic functions. All fully traceable.

The new Wavetek Model 9000 Multifunction Calibrator not only provides *continuously variable active impedance* and test signals, but can also lead unskilled operators through the calibration

Calibrator Functions	
DC Voltage	±1050 V
AC Voltage	1050 V, 10 Hz - 100 kHz
DC Current	1 $\mu$ A - 20 A
AC Current	20 $\mu$ A - 20 A
Resistance	0 $\Omega$ - 400 M $\Omega$
Conductance	2.5 nS - 2.5 mS
Capacitance	0.5 nF - 40 mF
Frequency	0.5 Hz - 10 MHz
Temperature:	
"K Type" T/C	-250°C - +1350°C
PRT100	-200°C - +850°C
Pulse:	
Duty Cycle	0.05% - 99.95%
Pulse Width	0.30 $\mu$ s - 1999.9 ms
Logic	TTL, ECL, 5V CMOS

procedure and produce certificates of calibration. And it does it in half the time of most other methods!

The fully variable output and "% Deviation" function let you read and record

percentage error on every scale of the meter under test. An optional trackball speeds function selection and output setting. Best of all, the Model 9000 can pay for itself in a remarkably short time.

## Easy ISO 9000 Certification.

With new ISO 9000 directives requiring documented calibration of all test equipment, Wavetek's new Model 9000 Multifunction Calibrator is the solution for all your handheld meters. Now you can meet all these new requirements, test every function of your multimeters, and save calibration time as well.

To make fast work of your handheld meter calibration, start by calling Wavetek at **1-800-223-9885** now!

## Clock-IC family takes building-block approach

### Synergy Semiconductor's SY10xxx/SY100xxx clock ICs

Part No.	Function	Price (1000)
SY10EL34	Clock generator	\$7.85 (+2, 4, or 8)
SY10S834	Clock generator	\$8.75 (+1, 2, or 3)
SY10E111	1:9 differential driver	\$15.75
SY10H841	1:4 translating driver	\$8.75
SY10H842	1:4 translating driver	\$8.75
SY10H843		\$8.75
SY10H641	1:9 translating driver	\$11.50
SY10H645	1:9 TTL driver	\$11.50
SY10H646	1:8 translating driver	\$11.50
SY69401	Master/slave clock distribution (150 MHz)	\$19.85
SY10E195	2-nsec delay, 20 psec/step	\$18.45
SY10E196	Analog-tuned delay line	\$19.55
SY89424	1-GHz PLL clock synthesizer	\$17.85
SY89429	25- to 400-MHz synthesizer	\$18.75

Before high-speed CMOS became available, designers turned to ECL to handle clock frequencies above 10 MHz. Now that circuits run at frequencies above 50 MHz, designers may again want to use ECL in clock distribution, but not just for its speed. ECL's low-voltage-swing differential-I/O interface generates less EMI and is less sensitive to noise than the TTL interfaces of high-speed CMOS. Synergy Semiconductor's ClockWorks ICs offer designers this ECL feature for clock signals and provide a TTL interface to the rest of the circuit.

The family provides a range of product types for clock generation and distribution: frequency synthesizers, clock generators, clock drivers, delay lines, and phase-locked loops. Family members interconnect using positive-referenced ECL (PECL) to reduce noise. They continue using differential sig-

nals internally to maintain precise duty-cycle control.

Low-skew TTL interfaces drive the rest of the circuit. All family members have part-to-part skew specified as less than 1 nsec. The SY10/100H842 1:4 driver IC, for example, offers a maximum skew of 400 psec pin-to-pin and 500 psec part-to-part. In addition to low skew, the TTL interfaces provide drive where needed, typically 24 mA.

All ClockWorks family members interconnect without buffers or translators, allowing designers to use a building-block approach to clock-subsystem design while maintaining low skew levels. The SY10xxx parts use 10,000 ECL levels; SY100xxx parts using 100,000 ECL levels are also available.

—Richard A Quinell

*Synergy Semiconductor, Santa Clara, CA. (408) 730-1313.*

**Circle No. 335**

## Chip replaces Ethernet/SCSI boards

The PCnet-SCSI IC from Advanced Micro Devices is a single-chip replacement for Ethernet and SCSI adapter boards in systems that use the PCI bus. By combining the functions onto a single

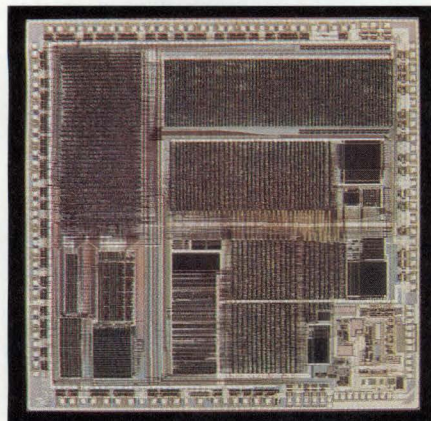

Combining Ethernet and SCSI functional cores, the PCnet-SCSI offers adapter-board functions with a single PCI load.

IC, the device allows designs to offer both capabilities while using only one PCI load. The 132-pin plastic quad flatpack is part of a pin- and software-compatible family of I/O chips for creating multiple-capability, common-design systems.

The PCnet-SCSI device (Am79C974) is a PCI bus master with two functional cores: SCSI and Ethernet. The SCSI core offers an 8-bit single-ended SCSI-2 interface with a 10-Mbyte/sec data-transfer rate, a DMA with a 96-byte FIFO buffer for burst transfers, and a 32-bit PCI-bus interface. The Ethernet core includes a media-access-control (MAC) unit, an attachment-unit interface (AUI), and a media-attachment unit (MAU) for 10Base-T (twisted-pair) Ethernet. The core is compatible with the Novell NE2100/1500T adapter cards.

A wide range of software drivers for the device is available for unlimited distribution with a single startup fee. The SCSI drivers include support for Windows 3.1 and NT, MS-DOS 5.0/6.0, IBM OS/2 2.x, and SCO Unix. The Ethernet drivers work with Novell NetWare 2, 3,

and 4; Microsoft LANManager, Windows NT, and Windows for Workgroups; IBM LANServer, Artisoft LANtastic, Banyan Vines, and SCO Unix. Advanced Micro Devices maintains and upgrades all drivers.

Two other family members are pin- and software-compatible with the Am79C974 but offer reduced capability. PC-SCSI offers just the SCSI capability, and PCnet-PCI offers just the Ethernet capability. Because the devices are pin-compatible, designers can produce one board design that offers varying capabilities, depending on the parts installed.

The PCnet-SCSI (Am79C974) costs \$39.95 (1000). Samples are available now, and the company plans to begin shipping production quantities during the second quarter. The other two devices are also available, and production will begin in the first quarter. The Ethernet-only device, the PCnet-PCI, costs \$29.95. The PC-SCSI (Am53C974) costs \$24.95.—Richard A Quinell

*Advanced Micro Devices, Sunnyvale, CA. (408) 749-5703.*

**Circle No. 336**

### 16-bit DAC drives current loops

The AD420 16-bit DAC from Analog Devices provides a single-chip interface between a  $\mu$ P and industry-standard 4- to 20- and 0- to 20-mA current loops. You can also configure the IC to provide output voltages of 0 to 5V, 0 to 10V, or  $\pm 10$ V using a single external buffer amplifier. The device is available in 24-pin DIP and SOIC packages.

The sigma-delta DAC is monotonic to 16 bits, and has a maximum integral nonlinearity of  $\pm 0.006\%$ . You can trim the offset and gain error, which are a maximum of  $\pm 0.1\%$  and  $\pm 0.2\%$ , respectively, using two external potentiometers. Settling time to 0.1% of full scale is typically 3 msec.

The device supports several processor-interface choices. The serial inter-

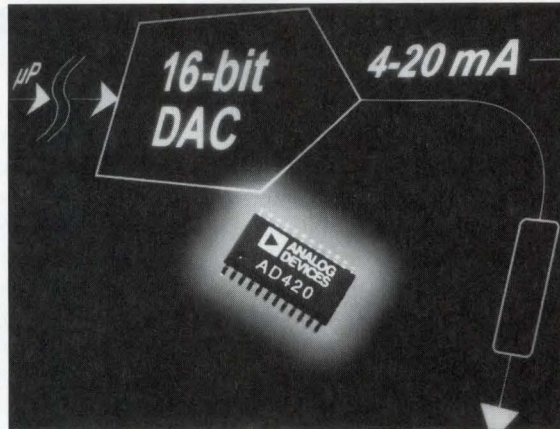

By directly driving 4- to 20-mA current loops, the 24-pin AD420 replaces a separate DAC and loop-current driver.

face is compatible with both the SPI and MicroWire family of  $\mu$ Ps. The DAC also has an asynchronous interface option, which reduces the number of interface wires from three to two. The DAC includes peripheral circuitry, such as a precision 5V reference with a

maximum drift of 30 ppm/ $^{\circ}$ C and fault-detection circuitry that warns of an open circuit in the loop.

Additional features include an asynchronous reset to the low end of the range, a 0- to 24-mA over-range capability, the ability to daisy-chain multiple devices using a 3-wire interface, and provision for an external output transistor. Using an external transistor shifts the power dissipation outside the device for high-temperature operation. Typical quiescent current is 3.5 mA; maximum is 4 mA.

The \$10 (1000) IC operates from a single power supply between 12 and 36V. Loop compliance is from 0 to within 2.5V of the supply voltage. The operating temperature range is  $-40$  to  $+85^{\circ}$ C. —Anne Watson Swager

Analog Devices Inc, Wilmington, MA. (617) 937-1428. **Circle No. 337**

### Op amps drive 10,000-pF loads

Linear Technology's LT1354 through LT1365 family of 12 single, dual, and quad op amps use a circuit topology that prevents oscillation with capacitive loads up to 10,000 pF. The circuit topology of these stable op amps—which combines true voltage feedback with the slewing behavior of current feedback—provides them with 400- to 1000-V/ $\mu$ sec slew rates and 1.25- to 7.5-mA max supply currents (see table).

As the capacitive load increases of what the company calls its "CLOAD" op amps, both the bandwidth and phase margin decrease, so peaking occurs in the frequency domain and in the transient response. All the amplifiers are unity-gain stable and include specifications for operation from  $\pm 15$ ,  $\pm 5$ , and  $\pm 2.5$ V supplies.

Maximum offset voltages range from 0.8 (LT1354/5/6) to 1.5 mV (LT1363/4/5), maximum input bias currents range from 300 to 2000 nA, maximum input offset currents range from 70 to 350 nA, and settling time to

within 0.01% of a 10V step ranges from 280 to 80 nsec. Respective specifications for the LT1357/8/9 and LT1360/1/2 amplifiers are within these ranges. The input noise voltage for all amplifiers is between 8 and 10 nV/ $\sqrt{\text{Hz}}$ .

The amplifier family suits a wide variety of applications—from active filters to video. The two amplifiers of the LT1355 and external components can implement a 100-kHz fourth-order Butterworth Filter. Video specifications of the LT1363 include differential gain and phase of 0.06% and 0.04 $^{\circ}$ , respectively.

Prices range from \$2.25 and \$2.50 for the single LT1360 in 8-pin DIP and SOIC packages, respectively, to \$6.80 and \$7.35 for the quad LT1359 in 14-pin DIPs and SOICs, respectively (1000). Samples are available. —Anne Watson Swager

Linear Technology Corp, Milpitas, CA. (408) 432-1900. **Circle No. 338**

#### Linear Technology's high-speed op amps

Part No. (single/dual/quad)	Gain bandwidth (MHz)	Slew rate (V/ $\mu$ sec)	Supply current (mA: maximum/amp)
LT1354/55/56	12	400	1.25
LT1357/58/59	25	600	2.5
LT1360/61/62	50	800	5
LT1363/64/65	70	1000	7.5

### Cache memory fits onto single chip

Developed on a memory-intensive ASIC foundation, Sony's CXK784862Q is the first in a planned family of integrated cache-memory devices for 80x86- and Pentium-based computer systems. The 160-pin device contains a complete level-two cache-memory subsystem, including memory, a controller, and tag RAM.

The device provides a 256-kbyte, 2-way set-associative cache. Its main memory is organized as two 32k $\times$ 36-bit memory blocks. It also includes two 4k $\times$ 20-bit tag RAMs and a cache controller. The memory uses a write-through protocol and is designed for connection to 486 logic-core chip sets.

The cache subsystem chip comes in 33- and 50-MHz speeds. It operates in a look-aside configuration, allowing burst access (2-1-1-1) with zero-wait-state performance. You can cascade chips to form cache subsystems as large as 1 Mbyte that offer the same performance as the basic device.

The CXK784862Q comes in a 160-pin plastic quad flatpack and uses less than 2W when operating at 50 MHz. Samples, \$125 (100); OEM qty, <\$100 (5000).

—Richard A Quinell

Sony Component Products Company, Cypress, CA. (800) 288-7669. **Circle No. 339**

# WORLD'S GREATEST POWER SUPPLY ICs FOR NOTEBOOK COMPUTERS

Maxim's industry-leading MAX782/MAX783/MAX786 dual-output 3.3V & 5V notebook power supplies provide:

- ◆ **Longest Battery Life:**
  - 95% efficiency at high load current; 85% at 10mA
  - 70 $\mu$ A I<sub>STANDBY</sub> for static RAM or real-time clock
  - 25 $\mu$ A I<sub>SHUTDOWN</sub> (MAX783/MAX786)
- ◆ **Smallest Size:**
  - 25cm<sup>2</sup> area, 5mm height (complete circuit)
  - 30 $\mu$ F/A filter capacitors; 10 $\mu$ H inductors
  - 300kHz master oscillator
- ◆ **Most Complete Solution:**
  - Replaces 6 or more ICs
  - Dual PWM, 3.3V and 5V buck regulators
  - Dual PCMCIA V<sub>PP</sub> outputs (MAX782/MAX783)
  - Precision voltage monitors
- ◆ **Lowest Noise and EMI:**
  - Excellent transient response
  - Fixed-frequency for noise-sensitive RF-wireless systems

MAX782 and MAX783 are \$5.95\*, and the MAX786 is \$4.15\*. For quick evaluation, order a pre-assembled demo board (order MAX782EVKIT-SO, MAX783EVKIT-SO, or MAX786EVKIT-SO).

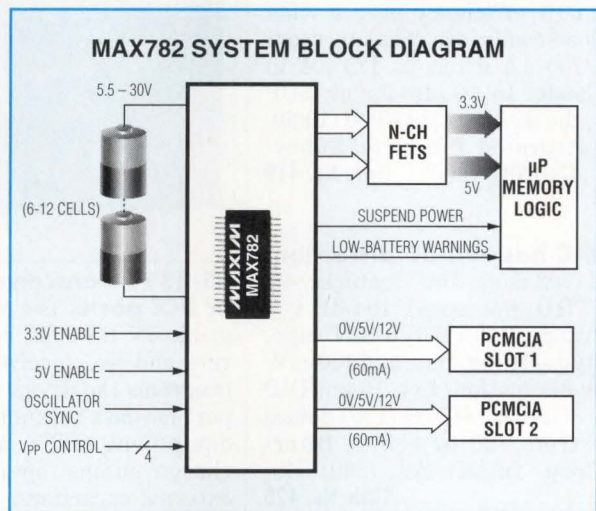
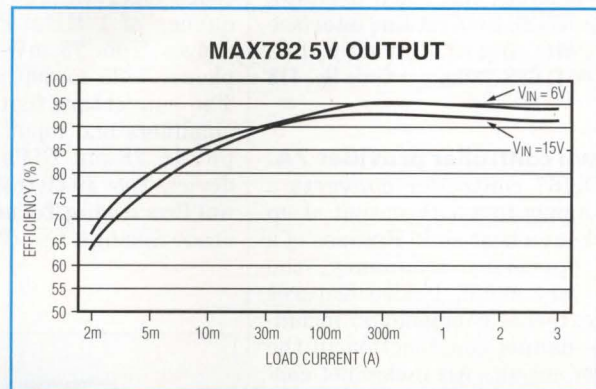

**FREE Notebook Design Guide—Sent Within 24 Hours!**  
Includes: Data Sheets and Cards for Free Samples

CALL TOLL FREE 1-800-998-8800

For a Design Guide or Free Sample

MasterCard® and Visa® are accepted for Evaluation Kits or small quantity orders.



Maxim Integrated Products, 120 San Gabriel Drive, Sunnyvale, CA 94086, (408) 737-7600, FAX(408) 737-7194.

**Distributed by Arrow, Bell, Digi-Key, Elmo, Hamilton Hallmark, and Nu Horizons.** Authorized Maxim Representatives: **AL**, M-Squared, Inc.; **AZ**, Techni Source Inc.; **CA**, Mesa, Pro Associates, Inc., Infinity Sales, Inc.; **CO**, Component Sales; **CT**, Comp Rep Associates; **DE**, TAI Corporation; **FL**, Sales Engineering Concepts; **GA**, M-Squared, Inc.; **ID**, E.S. Chase; **IL**, Heartland Technical Marketing Inc.; **IN**, Technology Marketing Group; **IA**, JR Sales Engineering, Inc.; **KS**, Delltron; **LA**, BP Sales; **MD**, Micro-Comp, Inc.; **MA**, Comp Rep Associates; **MI**, Micro Tech Sales; **MN**, Mel Foster Technical Sales, Inc.; **MS**, M-Squared, Inc.; **MO**, Delltron; **MT**, E.S. Chase; **NE**, Delltron; **NV** (Reno, Tahoe area only) Pro Associates, Inc.; **NH**, Comp Rep Associates; **NJ**, Parallax, TAI Corporation; **NM**, Techni Source Inc.; **NY**, Parallax, Reagan/Compar; **NC**, M-Squared, Inc.; **OH**, Lyons Corporation; **OK**, BP Sales; **OR**, E.S. Chase; **PA** (Pittsburgh area) Lyons Corporation, (Philadelphia area) TAI Corporation; **SC**, M-Squared, Inc.; **TN**, M-Squared, Inc.; **TX**, BP Sales; **UT**, Luscombe Engineering Co.; **VA**, Micro-Comp, Inc.; **WA**, E.S. Chase; **WI**, Heartland Technical Marketing, Inc.

**Distributed in Canada by Arrow.** Authorized Maxim Representative in Canada: **Tech Trek.**

\* 1000 PC, FOB USA, suggested resale.

Maxim is a registered trademark of Maxim Integrated Products. © 1994 Maxim Integrated Products  
CIRCLE NO. 93

EDN February 17, 1994 ■ 129

## INTEGRATED CIRCUITS

### ATM chip set handles 622 Mbps.

Comprising three ICs and a multichip module, the PM53xx ATM chip set implements the physical-layer interface for SONET and SDH transmission media. The set includes the PM5312 transport-terminating transceiver (\$170), the PM5318 serial-to-parallel conversion chip (\$120), the PM5345 Saturn user-network interface (\$47.60), and the PM5712B SONET line interface (\$1100). **PMC Sierra**, Burnaby, BC, Canada. (604) 688-7300. **Circle No. 418**

### Step-down controller provides 7A.

The MAX767 controller converts a fixed 5V supply to a 3.3V output at up to 7A without a heat sink. Because of a 300-kHz operating frequency, the device is very small. It also features low-cost external components, including all n-channel construction in the application circuit. All n-channel construction and synchronous rectification result in 90% efficiency over a wide range of load conditions. The quiescent power of 750  $\mu$ A drops to 125  $\mu$ A in standby mode. In 20-pin shrink SOP packages, the device costs \$3.40 (1000). **Maxim Integrated Products**, Sunnyvale, CA. (408) 737-7600. **Circle No. 419**

### 20-bit DAC has -96-dB distortion.

The PCM1702 audio DAC features -96 dB max THD plus noise, 104-dB typ dynamic range, 110-dB typ S/N ratio, 200-nsec typ settling time, and 150-mW typ power dissipation. In a 16-pin DIP or 20-pin SOP, the \$17.08 (100) device operates from -25 to +85°C. **Burr-Brown Corp**, Tucson, AZ. (800) 548-6132. **Circle No. 420**

### Analog engine conditions instrumentation signals.

The 4301 IC combines three general-purpose op amps with characteristics in the 4558 class, an exponentially controlled voltage-controlled amplifier, and a log-responding rms-level sensor. The IC permits remote programming of front-end gain while sensing true-rms signal levels. The dynamic range is 115 dB, and THD does not exceed 0.01% at unity gain. In a 20-pin DIP or 24-pin surface-mount package, the device operates up to 75°C. \$4.39 (1000). **That Corp**, Marlborough, MA. (508) 229-2500. **Circle No. 421**

**10-bit CMOS ADC converts 40M samples/sec.** The SPT7860 is part of a family of 10-bit CMOS ADCs that range from 5 to 40M samples/sec. All of

### FREE INFO, FREE POSTAGE

Use our postage-paid reader-service cards to get more information on any of these products.

the converters feature differential linearity of  $\pm 1/2$  LSB, integral linearity of  $\pm 1$  LSB, and guaranteed no missing codes. S/N ratio is 56 dB at an input frequency of 1 MHz. Power dissipation ranges from 75 mW for the 5M-sample/sec 7835 to 200 mW for the 7860. The converters feature on-chip T/H amplifiers and input capacitances of 5 pF. In 28-pin DIPs and SOICs, the devices cost \$9.60 to \$43.50 (1000). **Signal Processing Technologies Inc**, Colorado Springs, CO. (719) 528-2314. **Circle No. 422**

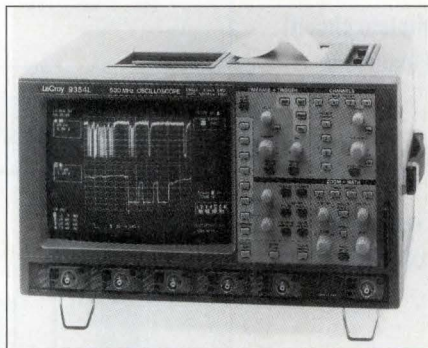

**RS-232C transceiver serves as DTE or DCE ports.** The MAX214 programmable 5V RS-232C contains three drivers and five receivers. A control pin programs the device as an 8-line serial port for data-terminal and data-circuit equipment (DTE and DCE). Dual charge pumps, operating with 1- $\mu$ F external capacitors, generate the voltage to produce minimum  $\pm 5$ V transmitter-output levels. Data rates are as high as 116 kbps. A shutdown mode reduces the quiescent supply current from 20 mA to 20  $\mu$ A. \$3.99 (1000). **Maxim Integrated Products**, Sunnyvale, CA (408) 737-7600. **Circle No. 423**

### Fax and voice chip suits portable applications.

The 73D2950 datafax/voice chip set integrates the transformerless Data Access Arrangement (DAA). An optional T version uses the TrueSpeech audio-compression algorithm, which the company recently licensed with the DSP Group. The 3-chip set includes a microcontroller, the DSP, and an analog front-end line-interface circuit. The set and associated RAM, ROM, and DAA components consume <150 mW of power. The components suit 3.3 and 5V systems and

incorporate power-down features. The set costs around \$22 (OEM); T version, \$29.50. **Silicon Systems**, Tustin, CA. (714) 573-6200. **Circle No. 424**

### Video RAMDAC incorporates clock generators.

The ICS5340 merges a triple 8-bit video DAC with a color-palette RAM and two timing generators. The device handles 24-bit color through 8-bit pseudocolor at clock rates to 135 MHz. Its timing generators provide a selection of eight video clocks and two memory clocks. Samples and demonstration boards are available. Prices begin at \$6.95 (50,000). **Integrated Circuit Systems Inc**, Valley Forge, PA. (215) 630-5300. **Circle No. 425**

### Op-amp outputs swing rail to rail.

The TLC2262 and TLV2262 single-supply op amps consume 0.4 mA. The C2262 operates from one 5V supply or up to a  $\pm 8$ V supply. The V2262 works best on 3V systems but also runs off 5V systems. Typical noise at 1 kHz is 12 nV/ $\sqrt$ Hz, and input-bias current is typically 1 pA. Both op amps are available in DIP, SOIC, and thin-shrink SOP packages. The SOP package occupies half the space of a standard surface-mount SOIC package. In DIPs, the TLC2262 and TLV2262 cost \$0.82 and \$0.99 (1000), respectively. **Texas Instruments**, Denver, CO. (800) 477-8924 ext 4500. **Circle No. 426**

### Gate array addresses military needs.

The FX150KM gate array has more than 150,000 raw gates and 256 signal I/O pins. The vendor manufactures the chip in a 0.6- $\mu$ m H-GaAs III process featuring a sea-of-gates architecture. Typical gate delays are 60 psec, and gate power dissipation is 0.18 mW unloaded. The device withstands dose radiation >100 MRADs. The arrays comply with MIL SPEC 883-C standards and cost \$0.005 to \$0.03/gate. **Vitesse**, Camarillo, CA (805) 388-3700. **Circle No. 427**

### Quad analog switch matches on-resistance.

The MAX333A CMOS IC has four independent switches with 35 $\Omega$  max on-resistance, 2 $\Omega$  matching between the channels, and 5 $\Omega$  variation over the analog signal range. Charge injection is less than 5 pC, ESD tolerance is greater than 2000V, break-before-make action is typically 10 nsec, and turn-on and -off times are less than 175 and 145 nsec, respectively. Quies-

# ±18-BIT SERIAL ADC USES ONLY 60µA

**Interface Directly to Your Transducer for only \$8.00\*!**

Maxim's new MAX132 ADC delivers 2µV resolution, dissipates only 1mW max over temperature, and saves even more power with its 4µA sleep mode. A serial interface reduces board space and allows for inexpensive isolation. And if your application calls for multiple input channels or programmable gain, the MAX132's four digital outputs remotely control a MUX or PGA via the serial interface, eliminating extra "glue" logic and serial control lines.

- ◆ 2µV Resolution at ±500mV Full-Scale
- ◆ Supply Current Over Temperature:  
Operating Mode: 60µA 125µA Max  
Sleep Mode: 4µA 10µA Max
- ◆ Up to 100 Conv/sec Throughput
- ◆ 4 Serially Programmed Digital Outputs for Remote Control of MUX/PGA
- ◆ ±10pA Input Current
- ◆ 50/60 Hz Rejection
- ◆ Space-Saving 24-Pin DIP and SO
- ◆ Parallel Interface Version Available – MAX135

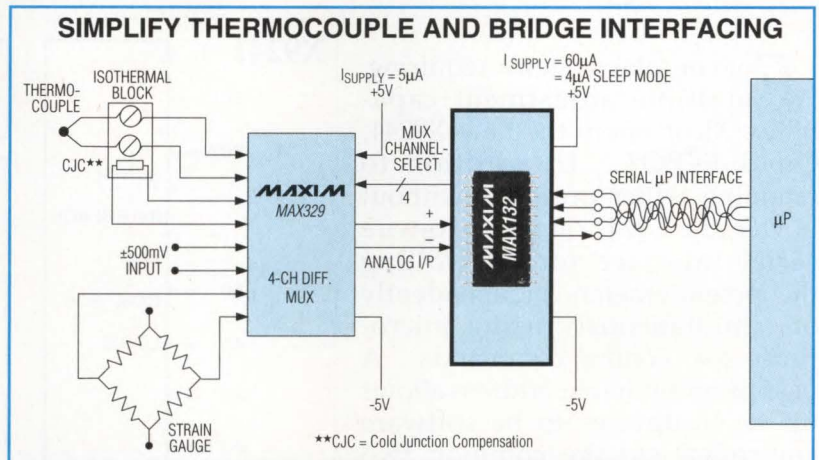

Benefit from the MAX132's high resolution, low noise, and 10pA input current by interfacing directly to transducers and other low-level signals.

## Complete Kit Speeds Evaluation, Reduces Design Time

A pre-engineered MAX132 Evaluation Kit and your personal computer can save you hours of component gathering, board assembly and evaluation time. The kit contains a pre-drilled board and all the components needed to build a complete, high-resolution ADC circuit plus application-specific software and an RS-232 interface for your PC.

**Call 1-800-998-8800 and order MAX132EVKIT, for \$95<sup>+</sup>.**

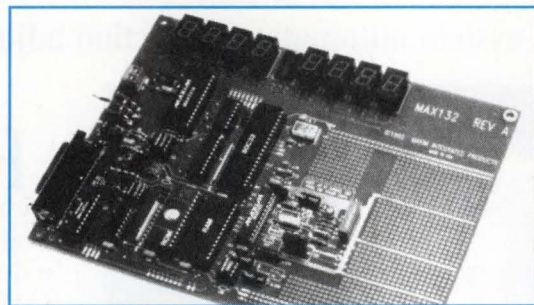

**FREE A/D Converter Design Guide—Sent Within 24 Hours!**  
**Includes: Data Sheets and Cards for Free Samples**

**CALL TOLL FREE 1-800-998-8800 ext. 6444**  
**For a Design Guide or Free Sample**

MasterCard® and Visa® are accepted for Evaluation Kits or small quantity orders.

# MAXIM



Maxim Integrated Products, 120 San Gabriel Drive, Sunnyvale, CA 94086, (408) 737-7600, FAX(408) 737-7194.

Distributed by Arrow, Bell, Digi-Key, Elmo, Hamilton Hallmark, and Nu Horizons. Authorized Maxim Representatives: AL, M-Squared, Inc.; AZ, Techni Source Inc.; CA, Mesa, Pro Associates, Inc., Infinity Sales, Inc.; CO, Component Sales; CT, Comp Rep Associates; DE, TAI Corporation; FL, Sales Engineering Concepts; GA, M-Squared, Inc.; ID, E.S. Chase; IL, Heartland Technical Marketing Inc.; IN, Technology Marketing Group; IA, JR Sales Engineering, Inc.; KS, Delltron; LA, BP Sales; MD, Micro-Comp, Inc.; MA, Comp Rep Associates; MI, Micro Tech Sales; MN, Mel Foster Technical Sales, Inc.; MS, M-Squared, Inc.; MO, Delltron; MT, E.S. Chase; NE, Delltron; NV (Reno, Tahoe area only) Pro Associates, Inc.; NH, Comp Rep Associates; NJ, Parallax, TAI Corporation; NM, Techni Source Inc.; NY, Parallax, Reagan/Compar; NC, M-Squared, Inc.; OH, Lyons Corporation; OK, BP Sales; OR, E.S. Chase; PA (Pittsburgh area) Lyons Corporation, (Philadelphia area) TAI Corporation; SC, M-Squared, Inc.; TN, M-Squared, Inc.; TX, BP Sales; UT, Luscombe Engineering Co.; VA, Micro-Comp, Inc.; WA, E.S. Chase; WI, Heartland Technical Marketing, Inc.

Distributed in Canada by Arrow. Authorized Maxim Representative in Canada: Tech Trek.

Maxim is a registered trademark of Maxim Integrated Products. © 1994 Maxim Integrated Products

CIRCLE NO. 94

EDN February 17, 1994 ■ 131

# Design Engineers Bulletin

New Product and Applications Information for Design Engineers

## Xicor's New X9241 Quad Potentiometer Allows Factory Automation of 64 Potentiometer Adjustments via a Digital Two Wire Serial Bus

For complex systems requiring multiple adjustment capability, Xicor offers the new X9241, Quad E<sup>2</sup>POT. In addition to retaining wiper positions without power, the X9241 offers a two-wire serial interface for controlling the potentiometers independently or simultaneously using micro-processor control commands. A user programmable address allows up to 16 devices to be software controlled via the common two wire serial bus.

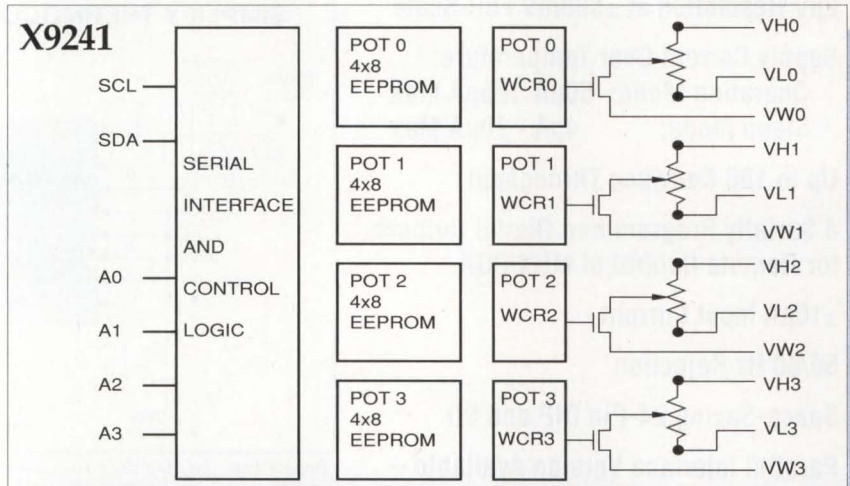

## QUAD E<sup>2</sup>POT Development System

PC based system automates production adjustments of system potentiometers



The XK9241 can be used in a production environment to optimize the settings of the E<sup>2</sup>POT.

Faster analog circuit checkout and calibration is made possible by Xicor's new XK9241W Quad E<sup>2</sup>POT Development System. This system consists of an X9241 evaluation board, interface cables and software which allows a design engineer to control all functions of the Xicor X9241 Quad E<sup>2</sup>POT from a menu driven system on a IBM PC Compatible computer. The XK9241W Development System allows the design engineer to place the X9241 in a target analog system and perform all adjustments and configuration needed to recognize the features and benefits of the Quad E<sup>2</sup>POT. The XK9241 PC based development system can also be used in production environments to automate potentiometer adjustments for initial system calibration.

The XK9241 supports all versions of the X9241 family. It can simultaneously control up to 16 different Quad E<sup>2</sup>POTs on the same two-wire bus to effectively allow adjustment of 64 individual E<sup>2</sup>POTs. Orders for the XK9241W can be placed with any authorized Xicor distributor. Suggested resale price is \$188.00.



# EDN-NEW PRODUCTS

## INTEGRATED CIRCUITS

cent power consumption is 35  $\mu$ A. Price starts at \$3.46 (1000). **Maxim Integrated Products**, Sunnyvale, CA. (408) 737-7600. **Circle No. 428**

**Interface IC handles scanner image sensors.** The M62490FP works with contact image sensors and CCDs, converting the analog scanner signals to digital. It includes ADC, S/H, gain-control, and black-level-control circuits on chip, offering an 8.5-dB gain with a 5-MHz bandwidth. The 42-pin device costs \$3.50 (10,000). **Mitsubishi Electronics America**, Sunnyvale, CA. (408) 730-5900. **Circle No. 429**

**Palette DACs operate as fast as 250 MHz.** The RGB series of palette DACs comes in 170- and 250-MHz speeds. The RGB561 (\$103, \$194) handles 1600 $\times$ 1280 $\times$ 27-bit images with overlay and independent gamma correction. The RGB530 (\$71, \$116) includes 8-bit overlay and underlay with 24-bit color. The RGB525 (\$52, \$83) uses pixel packing to achieve 1280 $\times$ 1024 $\times$ 24-bit color with 4 Mbytes of VRAM. **IBM Microelectronics**, Hopewell Junction, NY. (800) 426-0181. **Circle No. 430**

**Stereo codecs offer reduced-cost options.** Alternatives to the AD1848 codec standard in Windows Sound System audio cards, the AD1846 and AD1847 feature lower cost than the Windows cards. The 1846 is pin and register compatible with the 1848 but has reduced dynamic range (70 dB). The 1847 offers a serial interface to reduce pin count from 68 to 44 pins. Production will begin in March, and prices will be \$8 and \$7.50, respectively. **Analog Devices**, Norwood, MA. (617) 329-4700. **Circle No. 431**

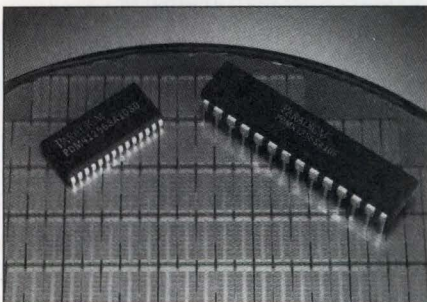

**256-kbit SRAMs have 10-nsec access time.** These 256-kbit CMOS SRAMs, additions to the vendor's Paramount series of SRAMs (part

no.'s PDM4151SA10, PDM41256SA10, PDM41257SA10, PDM41258SA10, and PDM41298SA10), feature a 10-nsec access time. Three of the devices have 64k $\times$ 4-bit architectures. The other two offer organizations of 32k $\times$ 8 and 256k $\times$ 1 bits. The 64k $\times$ 4-bit PDM-41298SA10 features an output-enable pin. The 5V parts have an active current of 135 mA and a standby current of 2 mA. Prices range from \$11.25 to \$12.10 (100). **Paradigm Technology Inc**, San Jose, CA. (408) 954-0500. **Circle No. 432**

**Self-timed SRAM has 10-nsec access time.** The CXK77910A family of self-timed SRAMs has a 10- or 12-nsec access time. The SRAM can act as cache memory in Pentium and RISC SPARC  $\mu$ Ps. The SRAM has a 128k $\times$ 9-bit organization, and an external clock triggers input and output registers. The chip comes in a TSOP or SOJ package and has a 945-mW power consumption. \$100 (100). **Sony Corp of America**, Cypress, CA (714) 220-9100. **Circle No. 433**

# DESIGN IN THE ULTIMATE POWER SOURCE

ULTRALIFE<sup>®</sup> 9-Volt lithium batteries significantly outlast alkalines – up to four times longer – in products powered by 9-Volt batteries. Because ULTRALIFE lasts longer, battery replacement is reduced and product reliability is enhanced. Designing superior ULTRALIFE batteries into your products is a smart move. For proof, call for our white paper on the ULTRALIFE battery's performance in specialty products. And, the next time, specify long-lasting ULTRALIFE batteries.

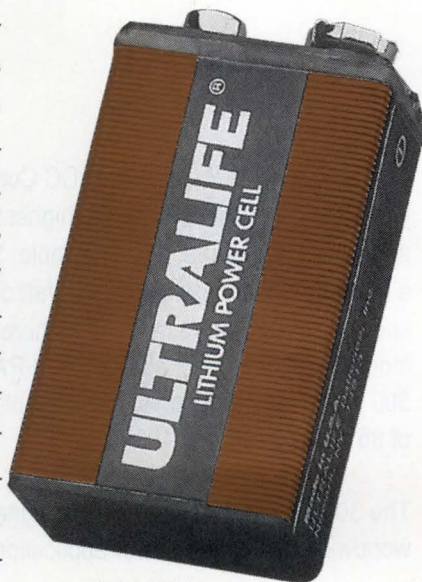

Made in U.S.A.



100% mercury-free.

# ULTRALIFE

BATTERIES INC.

Phone: 800-332-5000  
315-332-7100

Fax: 315-331-7800

©1993 Ultralife Batteries, Inc.

CIRCLE NO. 33

# Stands Alone

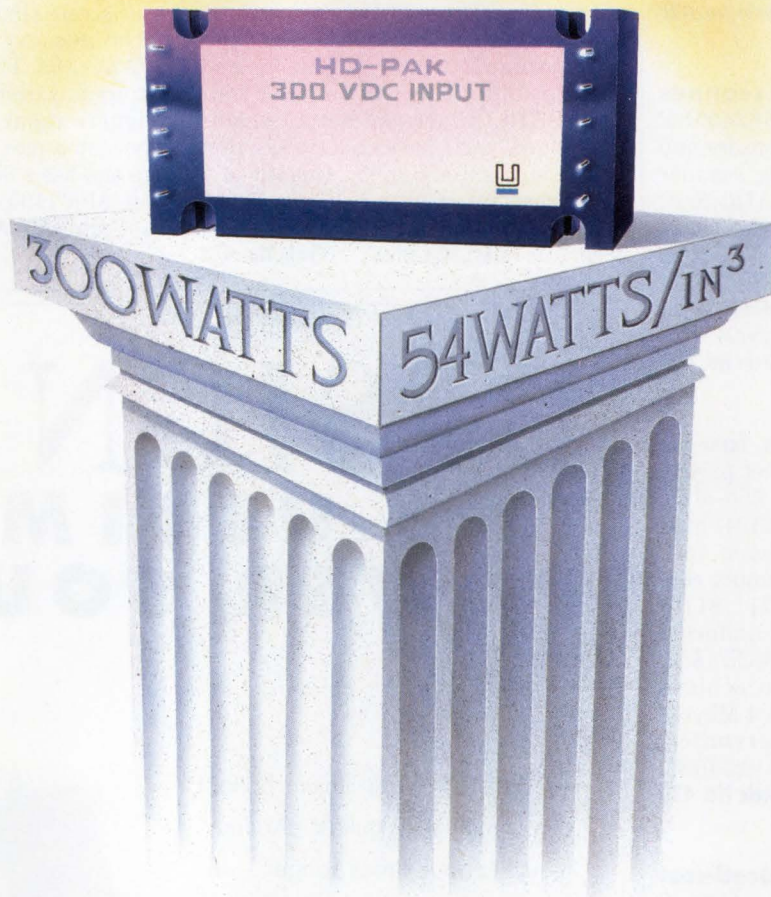

Our new HD-PAK™ Series DC/DC Converters give you the most output power, the highest performance and the best features. It's that simple. You won't find a true 54 Watts/in<sup>3</sup> density (300 Watt output) over the specified temperature range anywhere else in an industry standard package. The HD-PAK is rated for 300 Watts of output power at a baseplate temperature of 85°C (225 Watts at 100°C).

The 300 VDC input HD-PAK is designed specifically for worldwide distributed power applications.

Call, FAX or write us today for more information.

## **HD-PAK Features**

- ◆ Fixed 350 Khz operation
- ◆ -40°C to +100°C baseplate temperature
- ◆ Low output ripple
- ◆ Parallel capability
- ◆ Outputs 2.6, 3.3, 5, 12, 15, 24, 28 and 48VDC
- ◆ Synchronization (300-400 Khz) from internal or external source
- ◆ Up to 90% efficiency
- ◆ UL, CSA and VDE (in process)

## (508) 667-9500

Powercube Corp., 8 Suburban Park Drive, Billerica, MA 01821 Fax (508) 667-6280



## **POWERCUBE**

A SUBSIDIARY OF UNITRODE CORPORATION

# EDN-NEW PRODUCTS

## POWER SOURCES

**Quad-output 100W switchers measure 5×3.3×1.5 in.** The US100 series quad-output 100W switchers accept 90 to 264V-ac inputs. The units have onboard FCC class B and VDE class A line filters. Each of the four outputs is available in voltages ranging from ±2 to ±48V. (Modifications take three weeks.) Multiple-output models, \$93 (100). **Digital Power**, Fremont, CA. (510) 657-2635. **Circle No. 561**



**8W converters run for 1 million hours.** The 800 series of 8W dc/dc converters offer 1000V-dc isolation and 2:1 input-voltage ranges. The units measure 1×2×0.375 in. Models are available in single-, double-, and triple-output versions. The converters have remote-on/off and converter-synchronization pins. Line- and load-regulation specs are ±0.2%. All units undergo a 72-hour burn-in under a cycled load. Prices range from \$58.80 to \$66.50 (100). **Conversion Devices Inc**, Brockton, MA. (508) 559-0880. **Circle No. 562**

**200W dc/dc converter accepts 300V input.** The BASIX dc/dc converters meet VDE0871 Class A requirements without external filtering. Outputs range from 3.3 to 48V. The units measure 4.6×2.4×0.5 in. \$160 (OEM quantities). **Computer Products/Power Conversion America**, South Boston, MA. (617) 268-1170. **Circle No. 563**

**Regulated 14W dc/dc converters have 4:1 max-input range.** The KWx series dc/dc converters accept 9 to 36V or 20 to 72V inputs. Regulated outputs span 5 to ±15V dc. The units measure 3×2.56×0.83 in. \$53 (100). **Polytron Devices**, Paterson, NJ. (201) 345-5885. **Circle No. 564**

**External supply meets medical specs.** The MED 115 external supply meets UL 544. The supply outputs 5V at 0.75A and ±15V at 0.25A. Input is via a hospital-approved line cord, and output is via a 6-ft. cable and DIN connec-

### FREE INFO, FREE POSTAGE

Use our postage-paid reader-service cards to get more information on any of these products.

tor. \$40 (OEM quantities); delivery, stock to 10 weeks ARO. **Elpac Power Systems**, Irvine, CA. (714) 476-6070.

**Circle No. 565**

**Rectifier blocks withstand 5- to 30-kV pk reverse voltages.** The 3HG series rectifier blocks handle currents from 2 to 5A. The blocks are available in half-wave, positive and negative center-tap, and doubled configurations. Resistance- and capacitor-compensated blocks are also available. A 20-kV, 2.25A unit costs \$62 (25). **HV Components Associates Inc**, Farmingdale, NJ. (908) 938-4499. **Circle No. 566**

**5W dc/dc converters meet MIL-H-38534 Class B.** MSA series dc/dc converters measure 1×1×0.27 in. The units handle continuous input voltages from 16 to 40V and meet the power-bus-surge standards of MIL-STD-704A through E. Outputs range from 5 to ±15V. \$630 (100); delivery, stock to six weeks ARO. **Interpoint**, Redmond, WA. (206) 882-3100. **Circle No. 567**

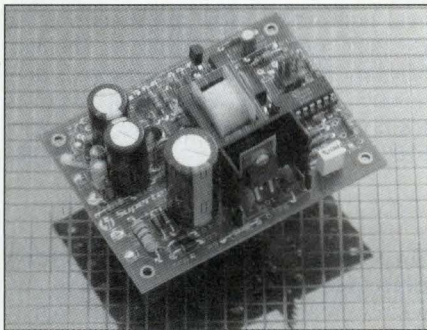

**Demo board exercises power-supply-controller IC.** The model HV9120DB-1 demo board comes with an information packet and an application note explaining the company's PWM switching-supply controller ICs. The demo board is a functional high-voltage off-line supply. \$95. **Supertex Inc**, Sunnyvale, CA. (408) 755-0100. **Circle No. 568**

**1000W supply sets outputs at factory.** You can instruct the company to set the secondary outputs of the

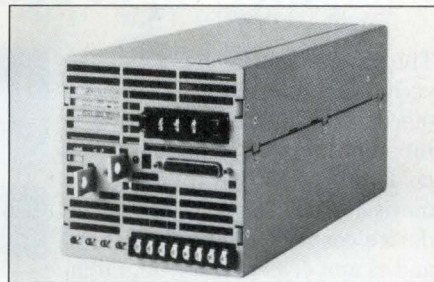

PM3386B multiple-output power supply to any voltage between 2 and 24V dc. As many as five secondary outputs are available. The supply's main output provides 750W at 5 or 24V dc. The supply measures 5×5×11 in. The unit corrects its input-power factor to 0.99% and accepts 96 to 264V-ac inputs. Line and load regulation for the main output are ±0.25%, and ripple and noise are 50 mV p-p. \$1095 (small quantities); delivery is from stock. **Pioneer Magnetics**, Santa Monica, CA. (310) 829-6751. **Circle No. 569**

**Solid-state fuse carries 4A.** The CS310 solid-state fuse trips in microseconds. Units having voltage ratings as high as 30V are available. You reset the unit by killing power. \$4.53 (1000). **Inresco**, Manasquan, NJ. (800) 684-6330. **Circle No. 570**

## MAIL

Send all new product information to:

**EDN MAGAZINE**  
Cahners Publishing Co  
275 Washington St  
Newton, MA 02158  
(617) 964-3030  
Fax (617) 558-4470  
EDN Bulletin Board System:  
(617) 558-4241  
MCI: EDNBOS

**EDN ASIA**  
Michael Markowitz, Chief Editor  
Cahners Asia Ltd  
19th Floor, Centre Point  
181-185 Gloucester Rd  
Wanchai, Hong Kong  
(011) 852 838-2666  
Fax (011) 852 575-1690

**EDN PRODUCTS**  
Gordon Publications  
Bruce Bennett, Editor  
301 Gibraltar Dr, Box 650  
Morris Plains, NJ 07950  
(201) 292-5100  
Fax (201) 898-9281

## Computer-input device conveys 3-D position and orientation

The Immersion Probe, a penlike stylus mounted on a lightweight mechanical linkage, provides 3-D information to a computer. You hold the stylus like a pencil and move it freely in 3-D space. The device conveys 3-D position (x, y, and z) and orientation (roll, pitch, and yaw) via a standard serial port. Applications include 3-D CAD, graphic design, digitizing 3-D objects, and 3-D virtual-reality interfaces.

The mechanical linkage supports the stylus, reducing operator fatigue during extended use. The linkage also provides physical resistance, to improve control of fine motions. The self-calibrating device uses mechanical sensor ele-



**Immersion Probe provides 3-D position and orientation information to a computer via a serial port.**

ments that do not suffer from the noise, interference, or shadowing problems of magnetic and ultrasonic tracking devices.

Immersion Probe is available in two models, IC and IX, which vary only in precision. IC measures with 0.05-in. accuracy in a central region and with 0.10-in. accuracy in outer regions; IX improves those figures to 0.025-in. and 0.05-in. accuracy, respectively. Angular resolution of the IC version is 0.7°; with IX, it's 0.3°. IC costs \$999; IX is \$1495. A developer's programming library—for Macintosh, PC, or SGI systems—sells for \$139.—**Gary Legg**

*Immersion Corp, Palo Alto, CA. (415) 960-6882. Circle No. 401*

**Rewritable optical disk boosts storage capacity.** The 3.5-in. RMD-5300-S magneto-optical disk drive reads and writes ISO-standard 128-Mbyte cartridges and proprietary 256- and 384-Mbyte cartridges. The drive senses which type of cartridge you insert. Sustained data rate is as high as 1.528 Mbytes/sec, and average seek time is 35.2 msec. <\$1000 (OEM). **Mass Optical Storage Technologies Inc**, Cypress, CA. (714) 898-9400. **Circle No. 402**

**CD-ROM drive doubles speed.** The CDU-33A entry-level addition to the vendor's line of double-speed CD-ROM drives reads multisession disks. Thus, it is compatible with Kodak's Photo CD format, and it can play audio CDs. Average access time is 320 msec; sustained data-transfer rate is 300 kbytes/sec. \$200. **Sony Electronics Inc**, San Jose, CA. (800) 352-7669. **Circle No. 403**

**Transceivers support FDDI over twisted pairs.** The PE-6852X series of 100-Mbyte/sec TP-PMD transceivers supports FDDI over data-grade, unshielded, twisted-pair copper wire. MLT-3 encoding and data scrambling control EMI, and adaptive equalization compensates for signal distortion caused by varying cable lengths (to 100m). \$40 (1000). **Pulse Engineering Inc**, San Diego, CA. (619) 674-8100. **Circle No. 404**

### FREE INFO, FREE POSTAGE

Use our postage-paid reader-service cards to get more information on any of these products.

**Wireless data link connects computer equipment.** A pair of transceiver units known as Comrad enable a computer to communicate wirelessly with another computer or with peripheral equipment. The units connect to RS-232C ports and operate on the 900-MHz radio band. No FCC license is necessary. \$429.95. **Communications R&D Corp**, Indianapolis, IN. (317) 290-9107. **Circle No. 405**

**Tiny video system transmits long distances.** The PC-7 video system, which comprises three small boards and a 2.7-oz color video camera, fits in small spaces and can transmit without wires as far as 10 mi. The boards are connected by flexible ribbon cable and can be arranged in different configurations. The smallest configuration is a 2.25-in. cube. Camera, \$370; transmitters start at \$50. **Supercircuits**, Austin, TX. (512) 335-9777. **Circle No. 406**

**Solid-state disk holds 536 Mbytes.** The MegaRam-35 solid-state disk stores as much as 536 Mbytes in a 3.5-in. form factor. It transfers data at 10

Mbytes/sec via its SCSI-2 interface, and its access time is 35  $\mu$ sec. An RS-232C port allows diagnostic testing. Price depends on capacity—approximately \$100/megabyte. **Imperial Technology Inc**, El Segundo, CA. (800) 451-0666. **Circle No. 407**

**Stereo displays boost brightness and contrast.** Two 19-in. color stereo displays provide higher contrast and brightness than earlier models. The SGS19U works with normal vertical sync or external frame sync; the SGS19C works with stereo-ready workstations or computers that provide a 50- to 152-Hz frame sync signal. Both have a liquid-crystal modulator and work with passive stereo glasses. \$8995 each. **Tektronix Inc**, Wilsonville, OR. (800) 835-9433, ext 5000. **Circle No. 408**

**Digitizer works with touch or pen.** The TouchPen digitizer provides both touch and pen input for flat-panel displays. It draws 60 mA while operating and 2 mA in sleep mode. \$795. **Micro-Touch Systems Inc**, Methuen, MA. (508) 659-9000. **Circle No. 409**

**Touchscreen controller fits on half-sized PC card.** The E281-4035 touchscreen controller fits on a half-sized card for the ISA or EISA bus. Touch-response time for a 19-in. monitor is 22 msec. Onboard diagnostics test the

# ***Pentek Quad 'C40 VME***

***There are other Quad 'C40 VME boards. They don't come with half the I/O, software, and DSP experience as the Pentek 4270.***

Go ahead. Check out the competitors.

Then call Pentek.

Ask us about

- Data acquisition boards
- Parallel, serial and SCSI interfaces
- Telecom interfaces and digital receivers
- Our other 'C40 and 'C30 DSP processors
- Our SwiftTools™ development environment, SwiftNet™ network protocol for distributed VMEbus systems, DSP libraries, real-time OS, and device drivers.

You'll soon know about our DSP experience and what we mean when we say,

***When it comes to DSP...  
Pentek has the whole solution***

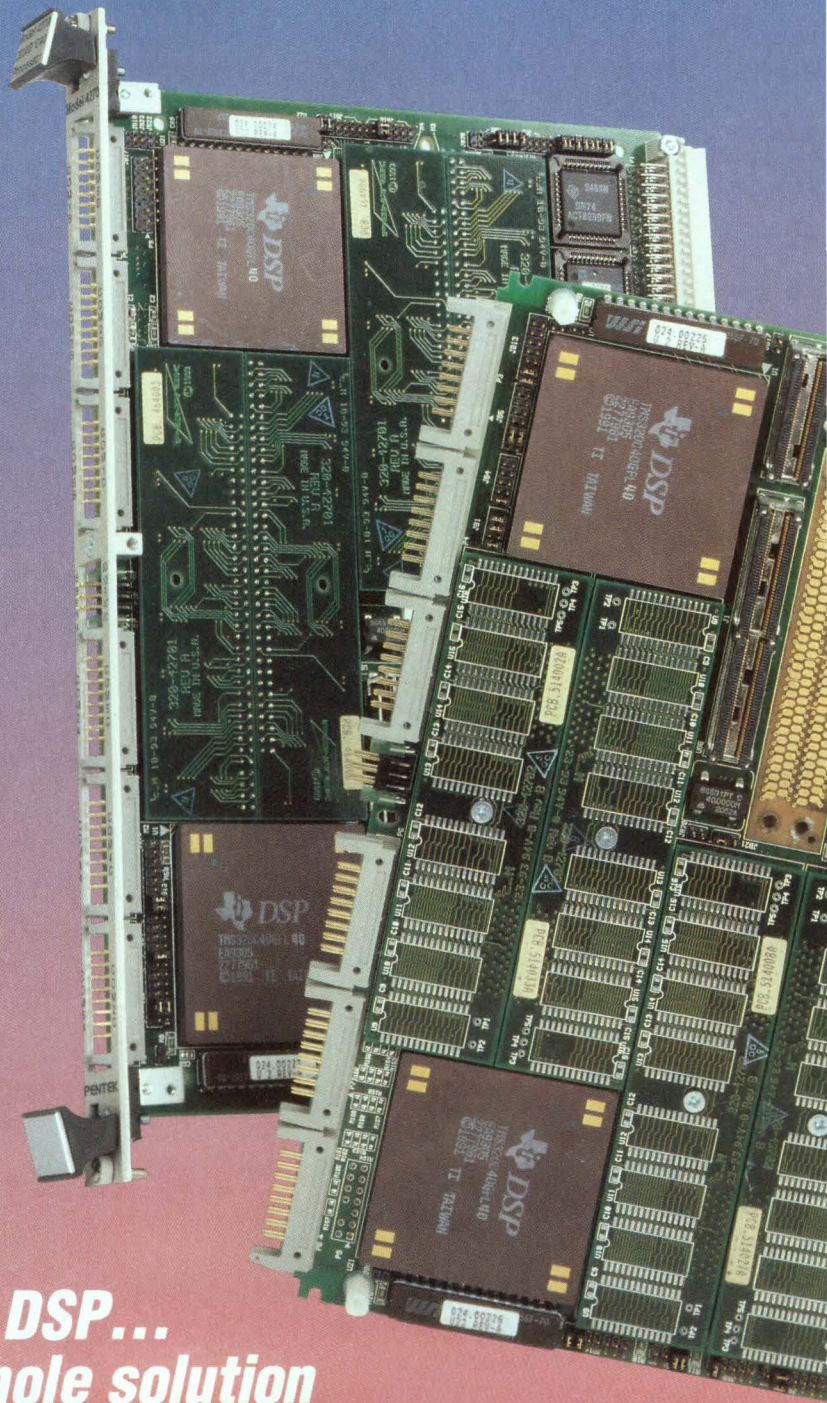

**PENTEK**

***Innovative DSP systems***

55 Walnut Street • Norwood, NJ 07648 • Tel: 201-767-7100 • Fax: 201-767-3994 • BBS: 201-767-8733

© 1993 Pentek, Inc.

CIRCLE NO. 99

EDN February 17, 1994 • 137

# 80C196

## In-Circuit Emulators

Microsoft Windows 3.1 based user interface

Pull-down Menus

Speed bar (point and click)

On line help

Disassembler,  
in-line  
assembler  
Window

Watch  
Window  
for high level  
variables

Register  
Window

Source  
Window

Data  
Window

Call Stack  
Window

Shadow RAM  
shows data  
changes in  
real-time

Inspect  
Window

Context sensitive help line

Trace Buffer Window

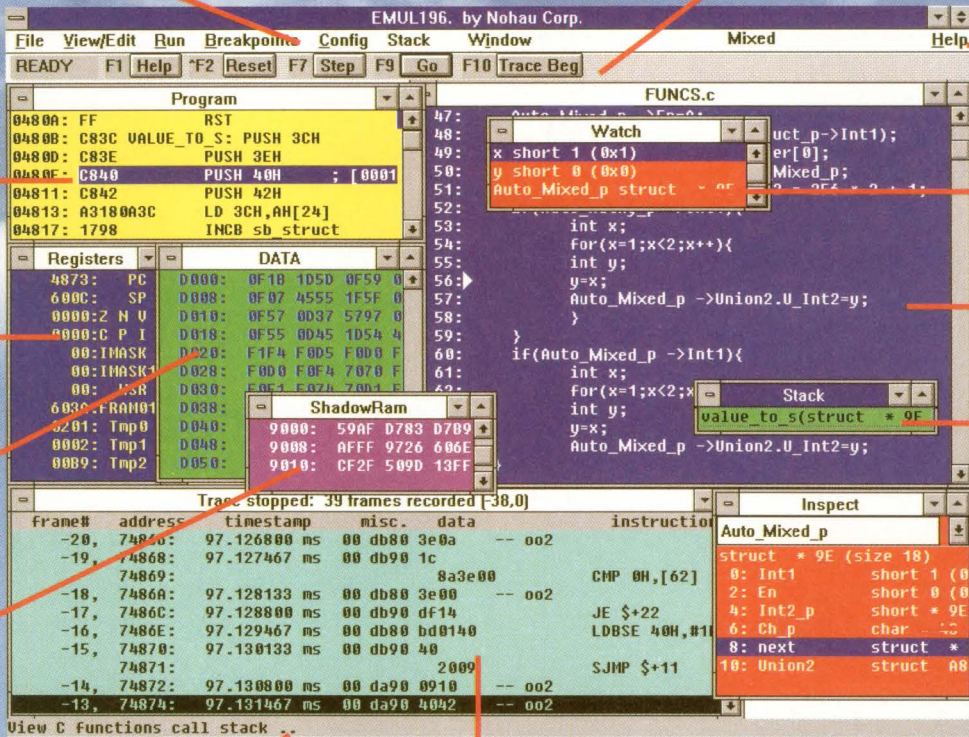

### FEATURES:

- Support for 80C196: KR/Q/T/C/D, JR/Q, NQ/T & more.
- Real-time emulation at maximum chip speeds.
- Use of bond-out chips for accurate emulation.
- Hosted on PC's and workstations.
- High Level support for popular C-compilers.
- Unlimited hardware breakpoints.
- Break in real-time on Internal Access, both on data value and address.
- Trace board up to 512K deep, 104 bits wide, with 40 bit timestamp. Triggering and filtering with full instruction queue decoding.
- Memory contents shown during real-time emulation (Shadow RAM).
- Code Coverage and Program Performance Analysis.
- CCB's controlled from user interface. (Wait states, timing mode, bus width and more.)

Also supported:

# 8051 68HC11 68HC16 683xx

To learn more, please call (408) 866-1820 for a FREE Demo Disk. For more information via your Fax, call our 24-hour Information Center at (408) 378-2912.

**NOHAU**  
CORPORATION

51 E. Campbell Avenue  
Campbell, CA 95008-2053  
Fax. (408) 378-7869  
Tel. (408) 866-1820

Argentina 1 312-1079, Australia (02) 654 1873, Austria 0277 20-0, Benelux (01858) 16133, Brazil (011)-458-8755, Canada 1-514-689-5889, Czechoslovakia 0202-2683, Denmark 43 44 60 10, Finland 90-4526-21, France (1) 69 41 28 01, Germany 49-7043-40247, Great Britain 0962-733140, Greece 1-924 20 72, India (0212) 422164, Israel (03)-491202, Italy (011) 437 15 51, Korea (02) 784-7841, New Zealand 09-3092464, Norway 22-67 40 20, Portugal 01-80 95 18, Romania 961-30078, Singapore 749-0870, Slovenia 061-445-526, S.Africa (021) 23-4943, Spain (93) 276 22 69, Sweden 040-92 24 25, Switzerland 01-740 41 05, Taiwan 02 7640215, Thailand (02) 281-9596.

# EDN-NEW PRODUCTS

## COMPUTERS & PERIPHERALS

touchscreen, controller, and cabling. From \$255. **Elographics Inc.**, Oak Ridge, TN. (800) 868-6824. **Circle No. 410**

### X terminals lower entry-level cost.

The ECX series of color X terminals perform better and cost less than their predecessor models. Three models—with 1024×768 resolution in 14-, 15-, and 17-in. monitors—perform at 52,000 Xstones. Prices, respectively, are \$1795, \$1995, and \$2595. **Network Computing Devices Inc.**, Mountain View, CA. (415) 694-0650. **Circle No. 411**

### Touch frame fits flat-panel displays.

The Modular/1LP touch frame mounts on all 200×150-mm flat-panel displays, including many from Hitachi, Panasonic, Sharp, and Toshiba. The device includes a sealable scanning IR screen with circuitry that compensates for water, dust, and airborne particulates. The unit is available with a software- or hardware-based controller, a PC/104 controller, or an RS-232C controller. \$380. **Carroll Touch**, Round Rock, TX. (512) 244-7040. **Circle No. 412**

### ISA parallel interface meets MIL specs.

The NTDS-4610, an NTDS/AT half-length adapter for ISA-bus systems, complies with MIL-E-16400/MIL-STD-2036 and MIL-STD-1397B standards. It features stress screening and conformal coating; it can operate in all four Naval Tactical Data Systems parallel environments. \$4589. **S T Research Corp.**, Newington, VA. (703) 550-7000. **Circle No. 413**

### Flat-panel VGA monitor is useful in hospitals.

The ELM-VGA electroluminescent flat-panel display suits hospital information and point-of-care systems. The 10-in. display is 2.7 in. thick; it can mount on a wall, a desk stand, or a bedside swing arm. Users can view its monochrome images from any angle. \$1395. **Planar Systems Inc.**, Beaverton, OR. (503) 690-1100. **Circle No. 414**

### Pocket-sized book is PC reference.

The 94-pg *PC Technical Source Book* provides a quick-reference compendium of the most commonly needed facts and figures from myriad PC hardware and software manuals. Contents include diagnos-

tic error codes, CPU summaries, XT and AT add-on card dimensions, BIOS entry points, DOS keystrokes, keyboard scan codes, and ASCII control codes. Free. **Industrial Computer Source**, San Diego, CA. (619) 271-9340. **Circle No. 415**

### SBus card lowers graphics cost.

The TGX260 graphics frame buffer for the SBus accelerates 2- and 3-D vector rendering for a lower price than Sun products, according to the manufacturer. The single-slot, 8-bit-color, double-buffering card is compatible with all SPARC workstations. It has programmable resolution and refresh rates as high as 76 Hz for 1024×768 resolution. \$3495. **Integrix Inc.**, Newbury Park, CA. (805) 375-1055. **Circle No. 416**

### PCMCIA card holds SCSI controller.

The SCSI2GO PCMCIA Type II card contains a SCSI controller. An interface cable to the 16-bit device provides a 50-pin SCSI-2 connector. Supplied software automatically reconfigures your system when you plug the card into a PC. \$329. **Future Domain Corp.**, Irvine, CA. (714) 253-0400. **Circle No. 417**

## HIGH POWER FACTOR

### Custom Switching Power Supplies

for ●Engineering work stations

- Computer main frames
- Computer peripheral equipment
- Business equipment
- Telecommunications
- etc.



- High power factor 0.99
- Design, manufacturing in Japan
- Repair center in U.S.A.

FDK also specializes in DC-DC converters, hybrid ICs, memory cards, ferrite cores, lithium batteries, stepper motors, optical isolators, etc.

**FDK** Your Best Strategic Partner  
**FDK AMERICA, INC.**

A Division of Fuji Electrochemical Co., Ltd.  
San Jose Office: 3099 North First Street, San Jose, CA 95134, U.S.A.  
TEL: 408-432-8331 FAX: 408-435-7478

Dallas TEL: 214-650-7742 FAX: 214-650-7792  
Boston TEL: 617-487-3198 FAX: 617-487-3199

CIRCLE NO. 34

## Die cut components for pagers, cellular phones & computers

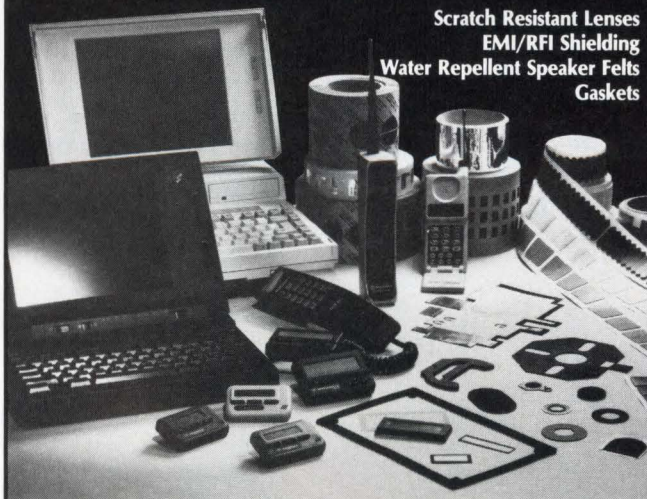

Scratch Resistant Lenses  
EMI/RFI Shielding  
Water Repellent Speaker Felts  
Gaskets

Parts from prototype through production • Rolls or individual pieces  
With or without adhesive • JIT delivery worldwide • Quality parts on time

### the hirol company

1170 West McNab Road • Fort Lauderdale, Florida 33309 U.S.A.  
001 (305) 974-4900 • Fax 001 (305) 975-4734

**Read Cosine Limited** (London)  
0202 632274 or 632275  
0202 623338 Day Fax  
0202 600674 Night Fax

**Dynamar Computer Products**  
**Pte Ltd.** (Singapore)  
(65) 2813388  
(65) 2813308 Fax

CIRCLE NO. 36

139

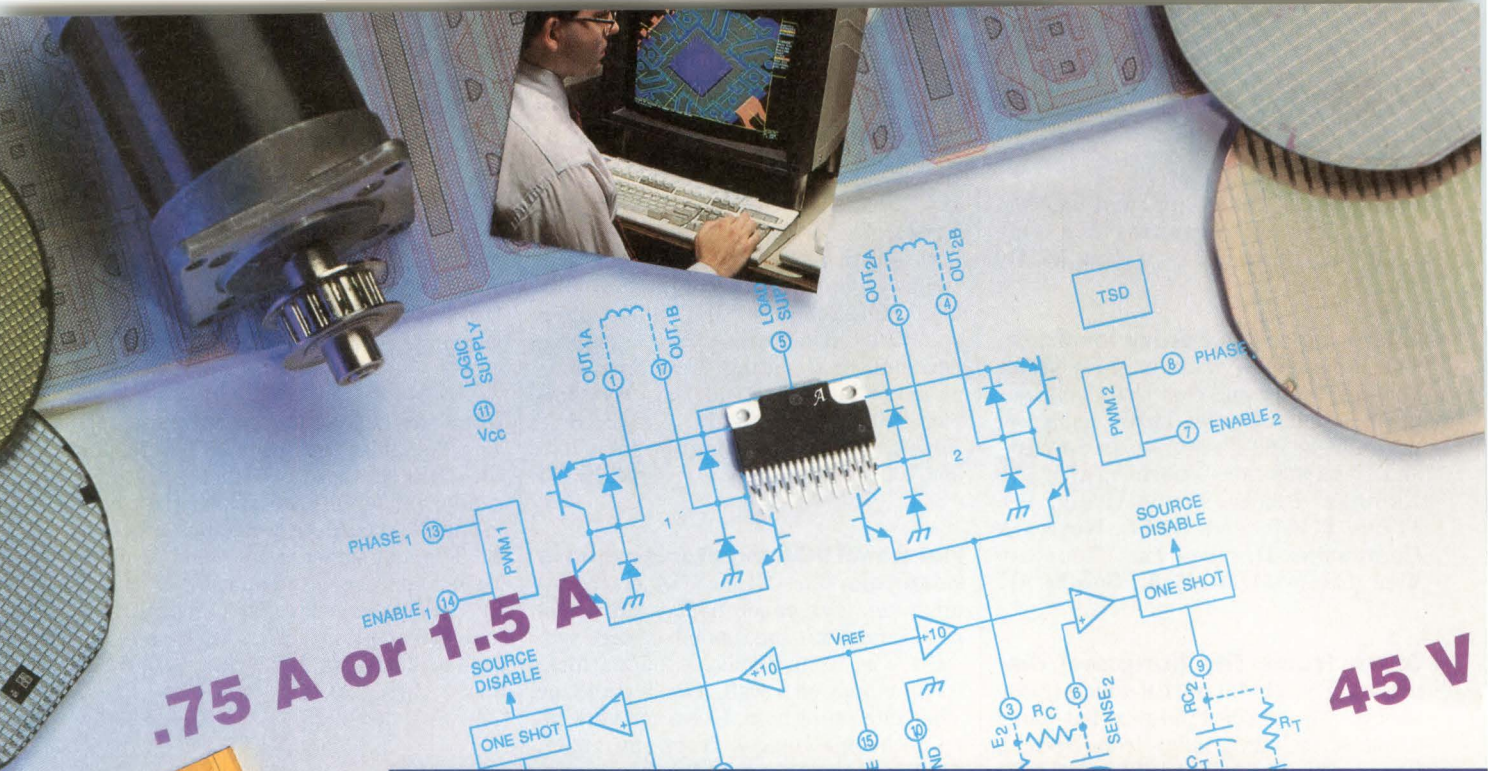

**.75 A or 1.5 A**

**45 V**

**THE POWER TO DRIVE 2 WINDINGS WITH ONE IC**  
**2916, 2917, & 2918 Dual Full-Bridge PWM Motor Drivers**

**FEATURES**

- For Bipolar Stepper Motors or For Two DC Motors
- $\pm .75$  A or  $\pm 1.5$  A Continuous Output Current
- 45 V Output Sustaining Voltage
- Internal PWM Current Control
- Internal Clamp Diodes
- Internal Thermal Shutdown

**Circuitry Elegantly Engineered To Meet Your System Requirements**

Containing two full bridges, the Allegro's 2916, 2917, & 2918 motor drivers are designed to drive both windings of a bipolar stepper motor or bidirectionally control two dc motors. Each bridge is capable of sustaining

45 V and includes internal pulse-width modulation (PWM) control of the output current to  $\pm .75$  A (2916) or  $\pm 1.5$  A (2917, 2918). Current is determined by the user's selection of a reference voltage and sensing resistor. Included on chip are ground clamp and flyback diodes for protection against inductive transients. Internally generated delays prevent cross-over currents when switching current direction. Thermal protection circuitry disables the outputs if the chip temperature exceeds safe operating limits.

**Designed For Manufacturability**

Allegro's ICs are "designed-for-manufacturability" under stringent standards of Total-Quality. Design/Production teams, under our

PACE (Product And Cycle-time Excellence) program, work closely with our customers to meet their time-to-market and quality/reliability objectives.

Headquartered in Worcester, Massachusetts, Allegro operates two Wafer-fabrication plants as well as assembly/test facilities. Design centers are located worldwide, sharing common cell libraries and design tools.

**Take A Test-Drive... Call For Samples**

Samples are available now. Just give us a call at 1•508•ALLEGRO and we'll have our Sample Pack in the mail to you the same day. After all, the measure of our success can only be *your total satisfaction.*

**THE PACE QUICKENS**



Formerly Sprague Semiconductor Group

**CALL 1 • 508 • ALLEGRO**

115 Northeast Cutoff, Worcester, Massachusetts 01615  
 CIRCLE NO. 39



## COMPONENTS

**Micromachines regulate gas flow.**

The MiniPR family of gas-pressure regulators employs silicon micromachines to regulate gas pressures from 0 to 30 or 0 to 100 psig with an accuracy of  $\pm 1\%$  FS. The regulators handle gas-flow rates from 0.1 to 1500 cc/min. The hybrid units operate over 0 to 50°C and consume significantly less power than electromechanical regulators. A 0 to 10V signal controls the unit, and power consumption is 2.5W typ. A typical application would be a portable, battery-powered gas chromatograph. \$275 (10). **Redwood Microsystems**, Menlo Park, CA. (415) 617-1209.

Circle No. 367

**R-2R network is integrated.**

The IPEC R-2R precision resistor network combines 16 resistors in the usual ladder configuration. The unit comes in 25- or 50-mil pitch, surface-mount packages. Standard values are 10, 25, and 50 k $\Omega$ . \$1.35 to \$2. **California Micro Devices Co**, Milpitas, CA. (408) 263-3214.

Circle No. 368

**Right-angle LEDs are surface mountable.**

The SIDELED right-angle, surface LEDs come in hyper red, super red, orange, yellow, blue, green, and pure green. The units are 4 mm high. Two emitter versions and one phototransistor version are available for IR applications. \$0.24 to \$1.82 (1000). **Siemens Components Inc**, Cupertino, CA. (408) 297-7910.

Circle No. 369

**Heat-resistant compound fills many electronics niches.**

You can mold the Flamehold heat-resistant compound into prototype heat sinks. The compound also replaces machined fixtures during prototype production runs. The material withstands the heat of wave soldering and holds shields, coils, brackets, and other components in place. The material is dimensionally stable, does not deform or swell under heat, does not soil or corrode parts, and is simple to apply and remove. The compound is safe and nontoxic. You can reuse the material indefinitely by adding water. \$30 (5 lb). **Nassau Research Corp**, Aliquippa, PA. (412) 375-3300.

Circle No. 370

**Probe measures surface resistance.**

The model 850 surface-resistance probe measures point-to-point and point-to-ground resistance to EOS/ESD standards 4.1 and 7.1, NFPA

## FREE INFO, FREE POSTAGE

Use our postage-paid reader-service cards to get more information on any of these products.

99, ASTM F150, and applicable DoD standards. The probe weighs 5 lbs and uses a 2.5-in.-diameter, conductive-rubber electrode having 65-durometer hardness. The probe will work with common voltmeters. With it, you can measure floors, mats, workbenches, and a variety of other surfaces. **Electro-Tech Systems Inc**, Glenside, PA. (215) 887-2196.

Circle No. 371

**Test probe grips large test points.**

The KLEPS 280 test probe has a steel, spring-loaded jaw that opens to 0.86 in. Like its smaller cousin's jaws, this probe's jaws simultaneously extend and

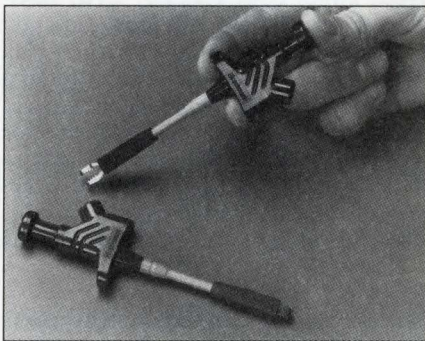

open when operated. The probe accommodates 4-mm banana plugs having fixed or retractable sleeves. Thus, the probe meets DIN VDE 0110 electric-shock requirements for 1000V connection. The probe comes in red or black. KLEPS 280: \$19; delivery stock to six weeks ARO. **Richard Hirschmann of America**, Riverdale, NJ. (201) 835-5002, ext 230.

Circle No. 372

**Transistors with integrated bias resistors save space.**

The MUN 2111/2211 series of transistors has bias resistors, a single transistor, and monolithic-base and base-emitter resistors. NPN and PNP devices are available in SC-59 surface-mount packages. \$0.12 (3000). **Motorola Inc, Semiconductor Products Sector**, Phoenix, AZ. (602) 244-3742.

Circle No. 373

**Connector family lowers insertion force.**

New members of the MicroStrip family of high-density, controlled-impedance, board-to-board and cable-to-board connectors boast 25% lower insertion forces than previous members

of the family offered. The connectors have 40 high-speed signal lines/in. \$0.15 to \$0.25 per line. **AMP Inc**, Harrisburg, PA. (717) 564-0100.

Circle No. 374

**Heat sinks cool multiwatt devices.**

Two heat sinks slide onto multiwatt devices, requiring no mounting hardware. The model 566010 is 1.22-in. tall, has four mounting clips, and suits medium-power devices. The model 530510 is 0.62-in. tall and suits low-power applications. PC-board soldering tabs are available for increased sturdiness. \$0.44 (5000). **Aavid Engineering**, Laconia, NH. (603) 528-3400.

Circle No. 375

**Custom membrane-switch panel drops in.**

The Series 70 custom membrane switches feature a drop-in panel. The switch panel has an accompanying pc board that is 9 to 22.5 mm behind the front panel, depending on switching functions. LED-illuminated switches are optional. \$8 to \$10 per function. **EAO Switch Crop**, Milford, CT. (203) 877-4577.

Circle No. 376

**IGBT modules shoulder greater amperages.**

The H-Series IGBT modules now handle 300 and 400A at 600V using the same-sized package as did the previous 200 and 300A units, respectively. Despite the greater current-carrying capacity, case temperatures have not increased. The modules include a soft-recovery diode. \$177.73 to \$231.04. **Powerex Inc**, Youngwood, PA. (412) 925-4422.

Circle No. 377

**Connectors mate to miniature valves.**

The GDS series connectors mate with DIN 43650 Form C miniature valves used for industrial control. Female cable-mount and male panel-mount versions are available with solder or screw-wire attachments. The connectors have an IP 65 rating (suitable for hose-down and spray environments). \$1.32 (1000). **Richard Hirschmann of America**, Riverdale, NJ. (201) 835-5002, ext 230.

Circle No. 378

**Aluminum capacitors deliver peak currents to high-power audio amplifiers.**

The Boomer-Cap line of aluminum capacitors suits professional audio amplifiers have outputs as high as 10 kW pk. The 1.2F units measure 3 $\times$ 8 $\frac{5}{8}$  in., and 1F units measure 3 $\times$ 5 $\frac{5}{8}$  in. Rated for 10-kA pk cur-

rents, the capacitors are an outgrowth of Strategic Defense Initiative research. Their voltage rating is 20V. \$35. **Cornell Dubilier**, Pickens, SC. (803) 878-6311. **Circle No. 379**

**Touch screen plugs into multimedia players.** The Crystal Clear touch screen for multimedia players connects using either an 8- or 9-pin "RS-232-C" connector. Versions are available for Philips Consumer Electronics CD-I 220 and 604 CM135 monitors and other popular multimedia monitors. \$495. **Interaction Systems Inc**, Watertown, MA. (617) 923-6001. **Circle No. 380**

**Fuseholders meet IEC requirements.** The FPG series fuseholders for 5×20-mm fuses meet the power-dissipation requirements of IEC 127-6, PC2. Panel-mount versions handle 4W; pc-board versions handle 2.5W. The series also meets the shock-safety requirements of IEC 529. The units' materials meet UL94V-O with an oxygen index of 31% and a comparative tracking index of 275. The series is insert molded for a complete seal at its base, suiting potted applications. Tab or solder connections are available. Panel-mount versions also have a front seal. UL and CSA rate the fuseholders for 16A at 250V (10A at 250V by VDE, SEMKO, and SEV). Fuseholders, \$0.82 (500). Delivery is from stock. **Schurter**, Petaluma, CA. (707) 778-6401. **Circle No. 381**

**Micromachined accelerometers feature response to 2 kHz.** A family of micromachined, surface-structure accelerometers comes in 10, 25, 50, and 100g versions. The units come in 20-pin leadless chip carriers (LCCs). The model 1010 outputs a digital pulse stream whose rep rate is proportional to acceleration. The model 1210, operating from 5V, provides a ±3V analog output. The unit has a 100-dB range. The model 1100 threshold accelerometer generates a logic output when acceleration exceeds a threshold. Operational temperature range is -55 to +125°C. Model 1010 LCC, \$59; J-lead, \$64 (1000). **Silicon Designs Inc**, Issaquah, WA. (206) 391-8329. **Circle No. 382**

**Data-access arrangement meets Japanese specs.** The CH1817J family of data-access arrangements (DAAs), meets Japan Approvals Institute of Telecommunications Equipment

(JATE) and Ministry of Posts and Telecommunications specifications. The units are compatible with modem and fax chip sets, including V.32bis through V.TURBO and V.FAST. Single-ended and differential models are available. \$15. **Cermetek Microelectronics**, Sunnyvale, CA. (408) 752-5000. **Circle No. 383**

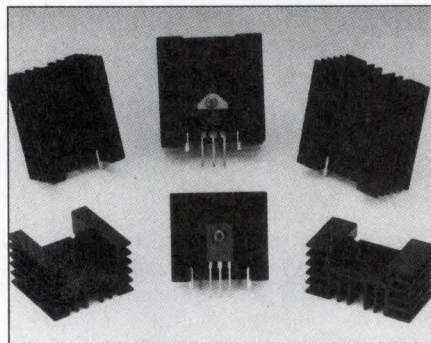

**Heat sinks cool TO220, 218, TO3-P, and multiwatt devices.** A family of 1.65 and 2-in.-wide heat sinks mounts vertically and provides a threaded mounting hole. You can mount the heat sinks with tin-plated solderable studs or screws. \$1 (1000); delivery is three to four weeks ARO. **International Electronic Research Corp**, Burbank, CA. (213) 849-2481. **Circle No. 384**

**Space-rated, battery-cell-bypass switch prevents power loss after individual cell's failure.** The model 1176 cell-bypass switch senses a cell's failure in a battery, automatically bypassing the failed cell. The switch detects cell-leakage current and uses one or two electromechanical actuators to handle as much as 300A. Switch operation occurs without shock, vibration, or debris. Model 1176, \$1950 typ (50); delivery, 12 weeks ARO. **G&H Technology Inc**, Camarillo, CA. (805) 484-0543. **Circle No. 385**

**Semiconductor laser's emission matches HeNe gas lasers'.** The HL6312G solid-state laser diode produces a 5-mW, 630-nm output, which is the same wavelength as HeNe gas lasers'. Typical operating specs are 2.7V at 65 mA, suiting battery-powered applications. The unit's operating lifetime is 1000 hr at 5 mW and 50°C. \$79 (1000). **Hitachi America Ltd**, Brisbane, CA. (415) 589-8300. **Circle No. 386**

**500-MHz solid-state switch has 8Ω on-resistance and 10-pF on-capacitance.** The DG643 single-pole,

double-throw analog switch handles 75 mA. The units come in small-outline, surface-mount packages. 16-pin plastic DIP, \$1.80; SO-16, \$1.96 (1000). **Siliconix**, Santa Clara, CA. (408) 988-8000. **Circle No. 387**

**Electrolytic-capacitor mountings protect capacitors and facilitate pc-board cleaning.** The ECM series of electrolytic-capacitor mountings allow venting and proper draining during pc-board cleaning. The units are made from UL-rated 94V-2 nylon per ASTM D4066 PA111 and raise the capacitor 0.050 in. above the pc board. The mountings ease inspection and protect the caps from shock, vibration, and accidental lead bending. \$44.50 per 1000 (10,000). **Bivar Inc**, Irvine, CA. (714) 951-8088. **Circle No. 388**

**High-brightness green, amber, and red LEDs illuminate large-area displays.** High-brightness LEDs radiate in a 60°-horizontal and 30°-vertical pattern, which is twice the viewing angle of conventional high-brightness LEDs. The 570-nm, 270-mcd HLMP-V500 costs \$0.28; the 592-nm, 460-mcd HLMA-VL00 costs \$1.07; and the 644-nm, 1000-mcd HLMA-V100 costs \$0.72 (1000). All versions come in T-1<sup>3/4</sup> untinted, nondiffused packages. **Hewlett-Packard Co**, Santa Clara, CA. (800) 537-7715, ext 7939. **Circle No. 389**

**Telecommunications-relay series meets 2500V Bellcore specification for voltage-surge isolation.** The FBR10 telecommunications-relay series measures 0.2×0.1 in. and consumes 140 mW when energized. The units switch 220V dc or 250V ac max at 2A max. The units perform 200,000 operations at 30V dc, 1.5A resistive. The devices come in a 12-pin DIP with two form-C contacts. \$3.47. **Fujitsu Microelectronics Inc**, San Jose, CA. (408) 922-9000. **Circle No. 390**

**PCMCIA connector is smaller and thinner than its predecessors.** The IC7 series of 68-pin connectors suits PCMCIA Type I, II, and III memory cards. The units are through-hole or surface mountable (either side of a pc board) and offer a choice of left or right eject buttons. The units have 1.27-mm contact spacing. They measure 85×65×5.4 mm. \$4.50 (1000). **Hirose Electric Inc**, Simi Valley, CA. (805) 533-7958. **Circle No. 391**

# Tomorrow's Technology... Today



"With the convergence of computing and communications technologies, consumer demand for computerized wireless products is gaining momentum. Stanford Telecom has developed a high-performance solution that is cost-effective for the commercial, high-volume OEM market.

To achieve optimum performance in terms of cost-efficiency, quality, and customer service, we have partnered with Zilog to offer the STEL-2000. It is designed for a large number of high speed burst data applications such as wireless LANs and data acquisition systems including inventory control systems and medical telemetry systems.

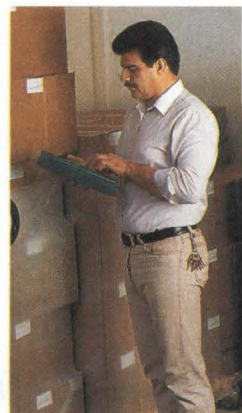

Our relationship with Zilog will continue to provide a strong alliance to accommodate the increasing demand for the STEL-2000."



Hatch Graham,  
Vice President and General Manager  
- Stanford Telecom ASIC &  
Custom Products Division

Contact your nearest Zilog sales office or  
authorized distributor for more information.



210 E. Hacienda Avenue  
Campbell, CA 95008-6600  
(408) 370-8000  
FAX (408) 370-8056

# For \$995 you can have a great function generator from SRS ...



**... or half of an  
HP or Wavetek.**



Direct Digital Synthesis (DDS) is the innovative function generator architecture pioneered by SRS. First introduced in the ground-breaking 30 MHz DS345, DDS is now available in two NEW products, the DS335 and DS340. All three instruments have the advantages of DDS - one microhertz frequency resolution, low distortion outputs, linear and logarithmic frequency sweeps, and outstanding frequency accuracy. Optional computer interfaces provide complete control for remote or ATE applications.

## • DS335 — \$995

3.1 MHz Function Generator  
Sine, Square, Triangle and Ramp Waveforms  
Low Distortion Outputs, -70dB (.1%THD)  
Available GPIB and RS-232 Interfaces

## • DS340 — \$1595

15.1 MHz Function Generator *Plus*  
FSK and Arbitrary Waveforms with  
12 bits, 16k points and a 40MS/s clock  
Available GPIB/RS-232 with Arb Software

Two new function generators with the performance, features and quality you need—at half the price. For more information or to arrange a demonstration call our applications engineers at (408) 744-9040.

## **Affordable Performance. Only from SRS.**



STANFORD RESEARCH SYSTEMS

1290-D Reamwood Avenue • Sunnyvale, CA 94089  
TEL (408)744-9040 • FAX 4087449049

CIRCLE NO. 106

# EDN PRODUCT MART

This advertising is for new and current products.

Please circle Reader Service number  
for additional information from manufacturers.

## ROM-IT

### EPROM EMULATION SYSTEM



**The Most Flexible EPROM Emulator You Can Get Today**

- Emulates up to eight 4-Megabit EPROMs through one standard serial port.
- Downloads 2-Megabit programs in less than 23 seconds
- Examine and modify individual bytes or blocks.
- Accepts Intel Hex, Motorola S-Record and Binary files.
- Software available for IBM PC and compatibles.
- Base 27256 EPROM System \$395.00. Other configurations available.

**Incredible Technologies, Inc.**  
Visa, Mastercard and American Express Accepted

Order Now - It's Easy  
Call (708)870-7027 Or Fax (708)870-0120  
For More Information

CIRCLE NO. 230

## 68HC16 683xx

### BACKGROUND MODE DEBUGGER



- C Source Level Debugger.
- Fast Downloads over PC-ISA Bus.
- Windows 3.1 Interface.
- Source level support for most assemblers.
- In-depth high level support for HiWare, Intermetrics, Introl, Microtec Research, Sierra and SDS.

**\$1495**  
BDM with C Debugger!

SLD available at \$995.  
Call for a Free Demo Disk.  
**(408) 866-1820**

US Pricing Only  
**NOHAU**  
CORPORATION

51 E. Campbell Avenue  
Campbell, CA 95008  
Fax (408) 378-7869

CIRCLE NO. 231

## Relex

### Reliability Software

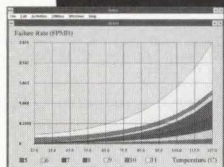

**Mac! DOS! Windows!**

Relex Reliability Software, long known for its power and flexibility, is now available for Windows, the Mac, and DOS! With features such as a powerful CAD interface, system modeling, impressive graphics, and unmatched user-friendliness, Relex is the ultimate, intuitive solution!

- MIL-HDBK-217
- Bellcore
- Parts Count
- Mechanical
- CNET
- FMECA
- more

Call 410-788-9000 Today For a Free Demo!

**INNOVATIVE SOFTWARE DESIGNS, INC.**  
Two English Elm Court  
Baltimore, MD 21228 USA

410-788-9000  
FAX 410-788-9001

CIRCLE NO. 232

## PROTO EXPRESS

### Best Value in the World for POLYIMIDE & FR4 1 to 5 DAY TURN 1 to 12 Layers

#### PRINTED CIRCUIT PROTOTYPES

##### 2 PIECE PRICES FOR FR4 .062 Th.

LAYERS	1	2	3&4	5&6	7&8
15	\$233	\$292	\$639	\$787	\$935
SQUARE INCH UP TO	30	264	330	724	891
	60	311	389	853	1049
	90	358	448	980	1207
	120	385	486	1044	1311

5 PIECES x 1.34    5 DAY PRICES ABOVE  
10 PIECES x 1.67    UL LISTED

EXTRAS	CAPABILITIES	DISCOUNTS
Photo Plotting	Buried & Blind Vias	5%
Testing	Polyimide Multilayer	
Gold Contacts - \$50	Full Body Gold	10%
25% - Below 8 Mil Hole	Carbon Paste	
- Below 15 Mil Hole	Tin nickel burn-in boards	COD
SMOBC & LPI - \$50	SMT-SMOBC	
	Up to 22 layers	10%
	Impedance control boards	

FOR MORE INFORMATION CALL OR FAX  
Ken Bahi ■ 1108 W. Evelyn Ave., Sunnyvale, CA 94086  
Phone (408)735-7137 FAX (408)735-1408 Modem (408)735-9842

CIRCLE NO. 233

## UNIVERSAL/GANG PROGRAMMERS



**FLEX-700**  
40 pins from \$845  
48 pins from \$945

**TUP-400/300**  
\$745/\$575

As FLEXible as your needs are:

- Supports EPROM, FLASH, PLD, FPGA, GAL, MPU, ...in DIP, PLCC, SOP, QFP, PGA ...
- Expandable from 40 pins to 256 pins and to 4 or 8 sockets for gang programming.
- Universal 44, 68, & 84 pin PLCC modules.
- Free software updates via BBS.
- Programming algorithms approved by IC Manufacturers.

**Tribal Microsystems Inc.**  
44388 S. GRIMMER BLVD., FREMONT, CA 94538  
Tel: (510) 623-8859  
Fax: (510) 623-9925

CIRCLE NO. 234

## Low Cost Miniature Controllers



Save time. Save money.

Our wide range of C-programmable miniature controllers are ideal for control applications, data acquisition, and test and measurement. Compact and low in price (the Little PLC™ above is 2"x3" and \$195), these controllers are programmed with our easy-to-use Dynamic C™ development system. Our controllers feature digital I/O, ADCs and DACs, relays and solenoid drivers, RS232 and RS485 serial ports, battery-backed memory and time/date clock, LCDs, keypads, enclosures and more!

1724 Picasso Ave.  
Davis, CA 95616

24-Hour AutoFax 916.753.0618. Call 916.757.3737  
from your FAX. 916.753.5141 FAX

**ZWORLD**  
ENGINEERING

CIRCLE NO. 235

To advertise in Product Mart, call Joanne Dorian, 212/463-6415

# Now—PSpice Quality at an Affordable Price

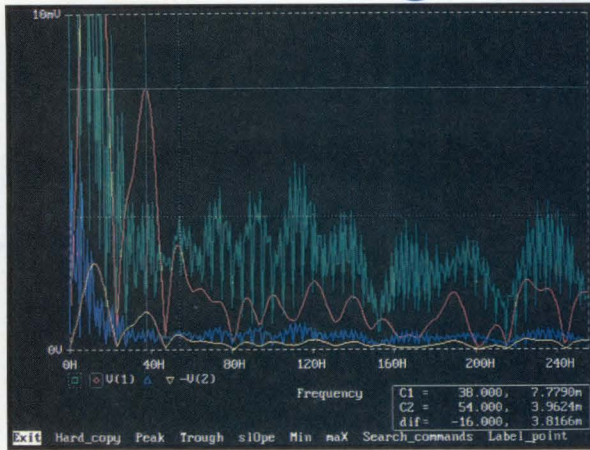

For those small circuit analog designers who want the technical sophistication of PSpice, we now have a low cost solution for you!

Small-circuit PSpice is now available at an unprecedented price of **\$1,495**

The PSpice circuit simulator comes complete with:

- Analog library of over 7,200 devices.
- Analog Behavioral Modeling.
- Monte Carlo & sensitivity/worst-case analyses.
- Enhanced graphical waveform analyzer.
- Device characterization.
- Stimulus generation.



**MicroSim Corporation**

20 FAIRBANKS • IRVINE, CA 92718 • USA  
(800) 245-3022 • (714) 770-3022 • FAX (714) 455-0554

CIRCLE NO. 236

## Gang, Set & Match

- ◆ PP42 - the total solution for Gang/Set programming of EPROMs and EEPROMs
- ◆ 8, 16 or 32-bit programming of device sets in a single operation (24 to 32 pins)
- ◆ Optional modules for ganging Micros, Masked ROM pinout EPROMs, 40-pin DIP/16-bit or 32-PLCC EPROMs
- ◆ 4 Mbits RAM standard - expandable to 64 M
- ◆ Serial and parallel ports
- ◆ 'Stand-alone' or PC operation

Stag Microsystems, Inc.  
Tel: (408) 988-1118 Fax: (408) 988-1232

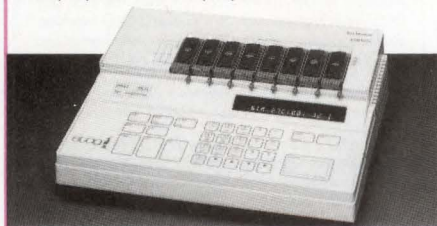

CIRCLE NO. 237

## HIGH VOLTAGE PULSE GENERATORS FOR BEAM BLANKING AND GATING

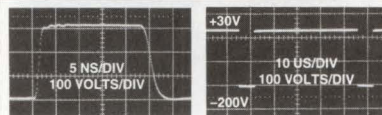

Avtech's extensive line of AVR, AVL and AVRL pulse generators includes over 75 standard models covering the following ranges:

- 100, 200, 350, 400, 700 and 2000 Volt models
- Pulse widths from 5 ns to 10 ms
- Rise times of 0.5, 2, 10 and 60 ns
- Propagation delays as low as 15 ns

Call us for your special requirements and a copy of our 113-page general catalog.

**AVTECH**  
ELECTROSYSTEMS

P.O. Box 265, Ogdensburg  
New York 13669  
(315) 472-5270

P.O. Box 5120, Station F  
Ottawa, Canada K2C 3H4  
(613) 226-5772  
Fax: (613) 226-2802

CIRCLE NO. 238

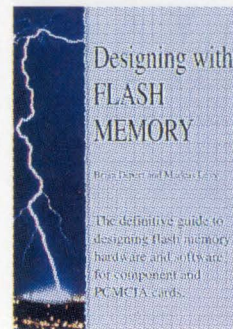

## HOT FLASH

Announcing the immediate availability of "Designing with Flash Memory", by Dipert and Levy! This reference is destined to be the flash memory bible for years to come.

It covers components and cards, both hardware and software, including PCMCIA and ExCA!

Written by the experts! 422 pages, soft cover, \$49.95. Unconditional 30-day money-back guarantee. Call now!

## Annabooks

1-800-462-1042

619-673-0870

619-673-1432 FAX

MasterCard, Visa,  
American Express, and  
Company POs  
accepted

CIRCLE NO. 239



## Schematic Capture for Windows and Macintosh®

### DESIGNWORKS™

The universal schematic capture front-end is now available for Windows. DesignWorks™ for Windows has all the same workstation functionality as its Macintosh counterpart, including full hierarchy with unlimited levels, automatic gate packaging and comprehensive symbol libraries. DesignWorks is built to work with PCB, FPGA, ASIC, and SPICE packages from any vendor. Custom netlist/report generation, back annotation, EDIF schematic support and a custom programming interface free your designs from being locked into one layout package or one simulator.

CALL (800) 444-9064 FOR YOUR FREE DEMO!

CAPILANO COMPUTING  
(604) 522-6200 Fax (604) 522-3972

CIRCLE NO. 240

## LEDs and Switches Stack together On PC Board Edge

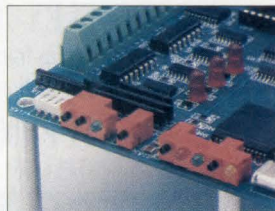

Companion LED indicator lamps available in choice of red, yellow and green, interlock with miniature, SPDT push button switches to create status/reset stations at the edge of a PC board.

The Series 32 maintains 0.200" between centers of the lamps and the switch buttons. The assembly measures only 0.272" off the board. It is 0.400" deep. Many operational functions can be monitored in a very small space. The switches are priced at \$1.37 in lots of 100 and \$1.00 in lots of 1000.

Request your free copy of Bulletin #609 from Thomas L. Menzenberger, GRAYHILL, Inc., 561 Hillgrove Ave., La Grange IL 60525, or call (708) 482-2132.

CIRCLE NO. 241

**NEW**

**ChipLab**

- Programs PLDs, PROMs, and EPROMs and microcontrollers up to 48 pins
- Algorithm updates available via electronic bulletin board

**Special Introductory Price**  
32-pin version: **\$895**  
48-pin version: **\$1495**

To order, call: **1-800-3-DataIO, Ext. 901**  
(1-800-332-8246)

Also distributed by:  
**Promark Technology West**  
(1-800-227-3345)  
**JDR Microdevices**  
(1-800-538-5000)

**DATA I/O**

CIRCLE NO. 242

To advertise in Product Mart, call Joanne Dorian, 212/463-6415

**4-Color  
Product Mart Ads  
Are Available in  
EDN Magazine and  
Products Editions!**

For an additional \$340,  
you can run your  
Product Mart Ad in color.  
For more information, call  
Joanne Dorian at (212) 463-6415.

CIRCLE NO. 243

**PLCC PROBING**



**IN SOCKET**

- Probe socketed PLCC chips
- Lowest profile socketed PLCC PROBE
- Mechanically and electrically reliable connection
- Choice of PLCC, PGA, LCC, cable (top socket)
- Sizes from 20 to 84 pins
- Optional height extender
- Custom design services



**IRONWOOD ELECTRONICS**  
P.O. BOX 21151, ST. PAUL, MN 55121  
(612) 431-7025; FAX (612) 432-8616  
CIRCLE NO. 244

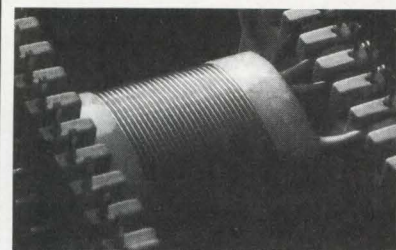

**POWER TRANSFORMERS AND INDUCTORS  
CUSTOM SWITCHING MAGNETICS**

- ISO 9001 Certified
- Cost effective designs
- 100% Electrical testing for critical parameters
- Surface mount packages available
- UL, IEC, VDE, CSA compliance
- Various footprints and mounting options
- Custom, precision core grinding

GFS Manufacturing, Inc.; Dover, NH. Telephone:  
603/742-4375, Fax: 603/742-9165.

CIRCLE NO. 245

**PCB RUSH SERVICE  
Proto Manufacturing**

- ☀ 24 hour Multi/Rigid
- ☀ 10 day std delivery
- ☀ Design & CAM
- ☀ Laser Plotting
- ☀ LPI/DFSM
- ☀ Mil GF & GI
- ☀ Nice People

Dial (800) PCB-RUSH  
Sun Circuits Incorporated  
5124 Calle del Sol  
Santa Clara, CA 95054  
(408)727-7784 fax (408)727-0347  
BBS/Modem (408) 988-3591

CIRCLE NO. 246

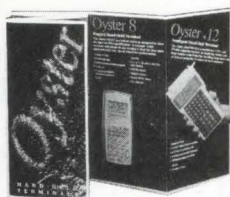

Oyster's new catalogue and data sheets contain detailed information on a wide range of hand-held terminals. The terminals interface with a spectrum of microprocessor-controlled equipment in a variety of applications. The literature specifies terminal use, and a special chart allows a choice of specification to suit your requirements. So for the essential hand-held reference, it's got to be Oyster.



Every hand-held terminal you'll ever need.

CIRCLE NO. 247

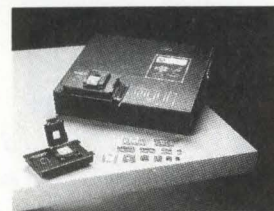

**PILOT-U84 Universal Programmer  
The Leader in New FPGA Support**

- Altera MAX 7064, 7128 • Xilinx 1736D, 1765D etc
- Intel FX-740, FX-780; 87C196 KD, KR, JR, MC etc
- Moto 68HC711D3, E9; 68HC705 C8, C9, P9 etc
- WSI PSD-4XX, -5XX, PAC, SAM • Atmel 29C040 etc
- AMD MACH435, 29F040, 16R8-4 • Lattice pLSI etc
- All packages to 256-pin: PLCC, PGA, QFP, TQFP, SOIC

For immediate support, please call  
800-627-2456 FAX: (408) 736-2503

CIRCLE NO. 248

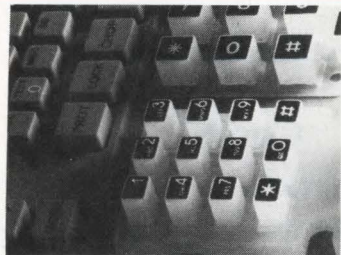

**Only a Specialized Keypad  
Manufacturer Could Provide  
Versatile and Economic Products.**

With more than 11 years of experience in this field, we proudly offer you various types of conductive silicone rubber pads, rubber pads with multicolor keys and multicolor printing, translucent parts for backlighting. Please contact us early for design assistance and information.



**GENERAL SILICONES CO., USA**  
650 W. Duarte 401 Arcadia CA 91007, USA  
Tel: (818) 445-6036 Telex: 3716189 GSCUI  
Fax: (818) 445-6084

CIRCLE NO. 249

*You Don't Have  
To Burn Your  
Devices Like This!*



**LOGICAL**



**Has a Full  
Range of  
High Quality  
Universal & Gang  
(EEPROMS, FLASH, PLD,  
& MICRO CONTROLLER)  
Programmers**

**LOGICAL  
DEVICES, INC.**  
TEL: (305) 428-6868  
FAX: (305) 428-1811 **digelec**

1 800 331-7766 Ext: 103

CIRCLE NO. 250

To advertise in Product Mart, call Joanne Dorian, 212/463-6415

## HAND HELD TERMINALS & COMPUTERS

Industry Proven Reliability

- RS-232, RS-422, RS-485
- 5 VDC, Extended 8-24 VDC or Battery Powered
- 4x20 or 8x24, 16x32 Supertwist Liquid Crystal Displays
- Rugged Ergonomic Housing
- Full Range of Models Available
- Off The Shelf or Quickly Customized To Suit Your Needs



**Two Technologies**  
419 Sargon Way  
Horsham, PA 19044  
Tel: (215) 441-5305  
Fax: (215) 441-0423

CIRCLE NO. 251

## TCP/IP & SNMP NETWORKING PROTOCOLS

Add them to your System Designs with:  
**FUSION Developer's Kit**

- ▼ FUSION TCP/IP protocol suite
- ▼ FUSION SNMP agent MIB 2 + Ver.2
- ▼ Flexible architecture - C source code
- ▼ Used in hundreds of process control, embedded systems, and end-user designs
- ▼ Full support, training, consulting and porting services

For More Information Call  
**(800) 541-9508**

(805) 484-2128 • Fax (805) 484-3929



**Pacific Softworks**

CIRCLE NO. 252

# Consistency is key



## to the power of EDN Product Mart

CIRCLE NO. 253

## Speed Your Product to Market

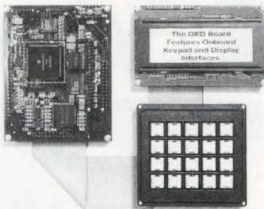

**With The QED Board™**

Ready-to-Use Computer Saves You Time and Effort

- Onboard hardware and software control dozens of analog and digital I/O lines, serial ports, keypad and LCD display
- High level programming language includes hundreds of useful functions for data analysis and instrument control
- Complete QED Product Design Kit is available to provide quick hassle-free instrument prototyping

Call or fax now for a complete QED catalog!  
Phone 510 / 790 - 1255 • Fax 510 / 790 - 0925

**Mosaic Industries, Inc.**  
5437 Central Ave., Suite 1 • Newark, CA 94560

CIRCLE NO. 254

BEST PRICE FOR PROTOTYPE CIRCUIT BOARDS

**FR-4 • FLEX • POLYIMIDE**

**24 HOUR TO 120 HOUR**

2 PIECES, FR-4, 062 THICK, 8/8 DESIGN, 5 DAYS

LAYERS	TOTAL SQ. IN. AREA				
	16	32	64	96	120
SINGLE	\$230	\$ 260	\$ 300	\$ 350	\$ 380
DOUBLE	\$290	\$ 320	\$ 380	\$ 440	\$ 480
FOUR	\$630	\$ 720	\$ 850	\$ 980	\$1,040
SIX	\$780	\$ 880	\$1,040	\$1,200	\$1,300
EIGHT	\$930	\$1,050	\$1,130	\$1,420	\$1,540

DISCOUNT 10%

- |                       |                    |  |
|-----------------------|--------------------|--|
| <b>CAPABILITIES :</b> | <b>MATERIALS :</b> | <b>EXTRAS :</b>                              |
| • S.M.O.B.C.          | • FR-4 & FR-5      | • ARTWORK                                    |
| • TIN LEAD            | • FLEX             | • ELECTRICAL TEST                            |
| • TIN NICKEL          | • POLYIMIDE        | • SMOBC WITH LPI \$50                        |
| • GOLD BODY           | • DUROID           | • GOLD CONNECTOR \$50                        |
| • BLIND-BURIED VIAS   | • TEFLON           | • BELOW 8 MIL TRACES & 15 MIL HOLES 25% MORE |
| • ELECTRICAL TEST     |                    |  |
| • 4 MIL TRACES & GAPS |                    |  |
| • 8 MIL THRU HOLES    |                    |  |

PLEASE CALL OR FAX :

MODEM (408) 988-3415



**TEL. (408) 988-3980 • FAX (408) 988-4534**  
3391 KELLER STREET • SANTA CLARA • CALIFORNIA 95054

CIRCLE NO. 255

Universal Programmers

**SUPERPRO® \$549**  
**SUPERPRO II \$699**

Call now for limited time special offer and a free demo disk!!



These high performance & low cost desktop programmers support more than 2,500 devices with free software updates via BBS. The support includes E(E) PROM, FLASH, BIPOLAR, PLD, GAL, EPLD, PEEL, MICRO, etc. Adapters are available upto 84 pin PLCC, PGA, & SOIC package.

ROM MASTER programs upto 4MB EPROM. \$129.

**XELTEK** (408) 524-1929  
757 N. Pastoria Avenue (408) 245-7084 FAX  
Sunnyvale, CA 94086 (408) 245-7082 BBS

CIRCLE NO. 256

## 486 Single Board Computers & Rack Units

3 YEAR WARRANTY

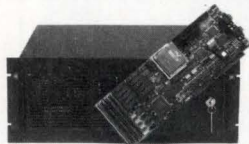

14 Slot 486DX2-50 4MB 120MB HD .. \$2,295  
486SX-25 Single Board Computer .... \$ 575  
486DX-33 Single Board Computer .... \$ 775

**ORDER DESK 1-800-777-4875**

**US LOGIC** Made In U.S.A.

7004 Convo Court, San Diego, CA 92111  
(619) 467-1100 • FAX (619) 467-1011

The Intel Inside Logo is a registered trademark of Intel Corporation.  
3 year warranty applies to Falcon-II Single Board Computer.

CIRCLE NO. 257

## NICHICON ELECTRONIC COMPONENTS CATALOG

Now available from Nichicon (America) Corporation is the company's 184 page '94 Electronic Components Catalog. Inside are detailed performance specifications and dimensions for Nichicon's lines of aluminum electrolytic capacitors, tantalum capacitors, plastic film capacitors, positive thermistors, and hybrid ICs. Complete ordering information includes a part numbering system, cut or formed leads, taped leads and taping for chip type capacitors.



**Nichicon (American) Corporation**

927 E. State Parkway, Schaumburg, IL 60173  
(708) 843-7500 • FAX: (708) 843-2798

CIRCLE NO. 258

Combine your Product Mart ads in EDN Magazine and Products Editions for higher impact and a lower rate!

CIRCLE NO. 259

To advertise in Product Mart, call Joanne Dorian, 212/463-6415



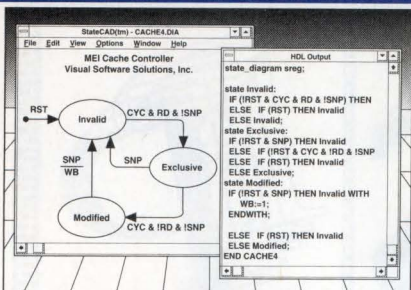

**Wouldn't you rather draw HDL?  
With StateCAD™ you can!**

StateCAD enables you to draw state diagrams and automatically analyze them for design flaws. From state diagrams StateCAD produces synthesizable ABEL HDL and professional documentation.



**Visual Software Solutions**

3057 Coral Springs Dr. Suite 203  
Coral Springs, FL 33065

Ph: (800) 208-1051 Fax: (305) 346-9394

StateCAD is a trademark of Visual Software Solutions, Inc.  
ABEL is a trademark of Data IO Corporation.

CIRCLE NO. 260

**IMAGINE IF YOUR  
PRODUCT COULD TALK!**

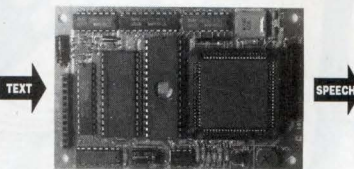

V8600 text-to-speech synthesizer

- Converts plain ASCII text into speech ("talking printer")
- Requires only a single 5V supply and speaker
- Unlimited vocabulary—no custom recording necessary
- Programmable pitch, rate, tone, volume, etc.
- Text, character, phonetic, tone and PCM modes
- Microprocessor, serial and printer interfaces
- Use in telecom, robotics, monitoring systems, etc.
- Less than \$100 in OEM quantities
- ISA, PC/104 and stand-alone versions available

**FREE V8600 DATA BOOK**

USA Ph: 206 355-3800 Fax: 355-1098  
UK/Europe Ph: +4481 539 0285

**RC SYSTEMS**  
INCORPORATED

RC Systems, Inc. • 1609 England Avenue • Everett, WA 98203 USA

CIRCLE NO. 261

**Talk Is Cheap,  
Even Digitally.™**

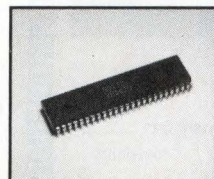

MODEL: VP1410

- \* QuikVoice™ technology
- \* Plays up to 10 messages stored in external EPROM
- \* 10 direct-trigger pins
- \* CVSD encoding
- \* 3 - 6V single supply
- \* DIP or surface-mount
- \* Low cost

**Let your product speak for itself!**

Our QuikVoice family of digital voice boards and IC chips give your product the competitive edge by letting them talk in real voice. Imagine how much more "user friendly" your product will become! Conventional voice technology requires high tooling cost and long turn-around time, while QuikVoice technology allows you to create a voice EPROM in just minutes with low-cost in-house equipment! Change messages easily or customize messages for each of your customers!

**ELETECH ELECTRONICS, INC.**

16019 Kaplan Ave, Industry, CA 91744 (818) 333-6394

CIRCLE NO. 262

**Communicate  
Weekly  
to the  
electronics OEM  
through EDN Magazine  
and Products Editions'  
Product Mart sections.**

CIRCLE NO. 263

**PathFinder  
Intelligent In-Circuit Emulation**

**80188 80186**

EA EB EC XL

- Windows Debugger!
- 131K Hardware Breakpoints
- Real Time Trace - 4K!
- Trace While Emulating
- Trace Triggers
- 256K Overlay RAM
- No Slots Required
- CMOS and NMOS



**\$4,995**

Low price no longer means low performance. Softaid's new PathFinder is the only emulator under \$7k that includes real-time trace triggering, to help you debug time-critical code. No other inexpensive emulator gives you the resources needed to debug both software and hardware. Only the PathFinder troubleshoots even ROMed code via its extensive hardware breakpoints. Call today!

**Softaid**

800-433-8812 Or 410-290-7760

\*EC version requires additional adapter, call for details

CIRCLE NO. 264

**FASTEST ALL PACKAGE-TYPE  
GANG & SET PROGRAMMER**

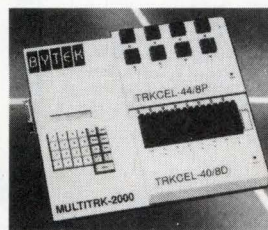

- \* Prices from \$895. (USD)
- \* Duplicate E/PROMs 8, 16 or 32 at a time.
- \* Set Program to 8, 16 or 32 devices each with different data.

- \* All Packages: DIP, PLCC, LCC, PSOP, PQFP.
- \* Gang Motorola Micros (68xxx or 68HCxxx)
- \* Free Lifetime Library Updates via 24 hr. BBS
- \* Rapid Programming Speeds (Gang or Set)
- \* 32 1Meg Devices: 17 seconds, 2Meg: 30 sec.

Call now: 800-523-1565

**BYTEK Corporation**  
Boca Raton, Florida - USA  
Tel: 407-994-3520  
Fax: 407-994-3615

CIRCLE NO. 265

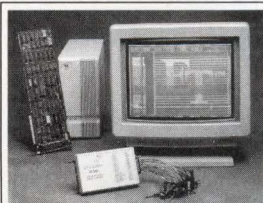

**Rated #1  
for  
Ease-of-use  
by OEMs  
& end users**

**Expandable  
Logic Analyzer plus**

- ✓ 50 MHz and 25 MHz state and timing
- ✓ 32K sample depth, up to 192 channels
- ✓ Professional features in PC-based product
- ✓ Easy-to-use, windows-like interface
- ✓ PC-based desktop and ISA bus versions
- ✓ Digital/analog pattern generator option



EMULATION TECHNOLOGY, INC.  
**800.995.4381**

CIRCLE NO. 266

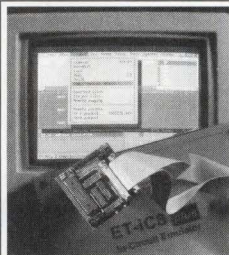

**Supports:**

- Z8/80/180...
- 8031/51/52...
- 68HC11...
- 80C166...
- 80186EA/B/C

**PC-based Emulators**

- ✓ Easy-to-use, windows-like interface
- ✓ Powerful project manager
- ✓ 24-hour, 7-day technical support
- ✓ Wide range of processors supported
- ✓ Free demos & software updates via BBS 408-982-9044



EMULATION TECHNOLOGY, INC.  
**800.995.4381**

CIRCLE NO. 267

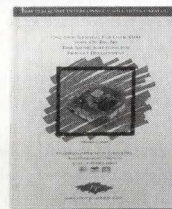

**#1 in  
Adapter  
Solutions  
for over  
10 years**

**FREE 1994 Interconnect  
Solutions Catalog**

- ✓ Over 3,500 devices for one-stop-shopping
- ✓ 120 "Off-the-shelf" items available for overnight delivery
- ✓ Unlimited application consulting
- ✓ Time saving solutions for product development
- ✓ Ask about our custom designs
- ✓ Leading edge technology -- over 500 PQFP solutions



EMULATION TECHNOLOGY, INC.  
**800.995.4381**

CIRCLE NO. 268

To advertise in Product Mart, call Joanne Dorian, 212/463-6415

## EDN-CAREER OPPORTUNITIES

IOWA MIDWEST  
MIDWEST OPENINGS

### RF DESIGN ENGINEERS

MSEE/BSEE. Experience levels to 10+ years. RF/Microwave circuit design. HF to 3.0 GHz. Areas of interest are: receivers, transmitters, power amplifiers, frequency synthesizers, modulation/demodulation, spread spectrum, DSP implementation of radio functions. Multiple openings with several of my Midwest client companies.

**DON GALLAGHER, MSEE**

Gallagher & Brei Associates  
1145 Linn Ridge Rd., Mount Vernon, IA 52314  
(319) 895-8042 • Fax (319) 895-6455

**ELECTRICAL ENGINEER:** Analyze, design, test Signetics 83C552 microprocessor integrated automatic control systems. Design & develop hardware configuration of microprocessor control systems realtime control & communication software for multi-processor systems & develop control communication & graphics software for systems. Req. M.S.E.E., 2 yrs. of exp. in microprocessor integrated automatic control, & skills/abilities in data structures & communications; non-linear, FUZZY & adaptive control theories; analog, digital, & hybrid control; ASM51 assembly & Microsoft C compiler; laser & ultrasonic detecting systems. 9-5, 40 hrs/wk. \$39,773.65/yr. 2 resumes to P.O. Box 8968, Case #40134, Boston, MA 02114.

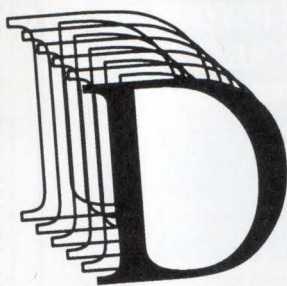
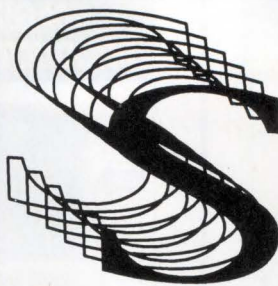
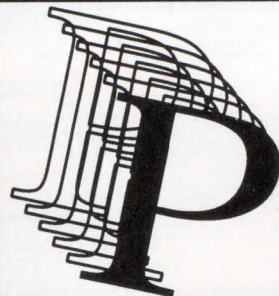
# Without Tears™

Learn DSP  
and Put your  
Knowledge to  
work  
immediately!

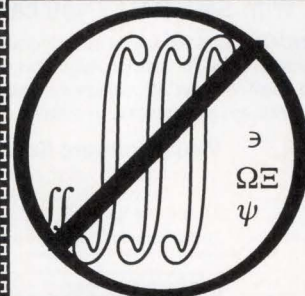

Coming to a  
Place Near You

Boston,  
Salt Lake City  
Washington D.C.  
Chicago, Dallas  
San Jose

Call Z Domain Technologies, Inc.  
(800)-967-5034  
(404)-587-4812

Call 9-5 EST. Ask for  
brochure.

Our 2-Day Advanced  
Course is ready. Call for  
more info

By Taking This  
3-Day Course  
You will really  
learn DSP.  
**Guaranteed!**

APPLIED TECHNOLOGY DIVISION

## Computer Scientists/ Software Engineers

Computer Sciences Corporation (CSC), a leader in information systems technology support to government and industry, has immediate opportunities at NASA's Software Engineering and Ada Lab (SEAL) at the Langley Research Center in Hampton, VA.

We are looking for top-notch computer professionals with complete life cycle S/W development backgrounds using DOD-STD-2167A or equivalent. Requires experience with Object Oriented principles and solid Ada development backgrounds implemented on real-time embedded systems, preferably 80X86-based. In addition, experience with metrics collection and analysis, testing procedures, V&V, Q/A, CASE tools, and Configuration Management is preferred.

Candidates must also have a BS in Computer Science or Computer/Electrical Engineering (MS preferred) and 8 years experience to include 2 years of task/project leadership. Software development in a PC environment is a must.

CSC offers competitive salaries and benefits. Please mail resumes in confidence to: CSC/ATD/Langley, 3217 North Armistead Ave., Hampton, VA 23666-1379. FAX: (804) 865-1725. An Equal Opportunity Employer M/F/D/V.



Computer Sciences Corporation

*Looking for Qualified  
Engineering Professional?*

Turning to

**EDN**

will Make

**Your Search Easier.**

*call:*

**Kim Fogarty**

**Recruitment**

**Account Executive**

**1-800-603-4860**

Don't Miss your Chance  
**MAKE A CONNECTION**  
with Jabil Circuit, Inc.

*A leader in High Technology  
Automated Manufacturing of printed  
Circuit Board Assemblies*

**Jabil**  
CIRCUIT, INC.

Let Jabil Circuit, Inc. connect you with a great job in a priceless location! We are a leading contract manufacturer of PCB assemblies based in St. Petersburg, Florida, where residents enjoy freedom from a state income tax, and the additional benefits associated with a cost of living far below that of other metropolitan centers of similar size. In addition, our central location gives the comfort of a small community with all the amenities of the big city just a short drive away.

### TEST ENGINEER

Utilize your circuit design and software development experience to assume total engineering project responsibility in a fast paced, team oriented environment. Test Engineers at Jabil Circuit are expected to perform the full range of activities related to the design, development and implementation of In-Circuit, Functional, ESS and customer supplied test programs. This includes the design of a wide variety of test fixtures, as well as reducing the cost and improving the functionality of assigned assemblies. The successful candidate will possess a BSEE and related software experience in "C" and Assembly level programming. Strong communication skills are a must.

### SYSTEMS TEST ENGINEER

Develop and implement network based system level diagnostic test processes. Provide technical leadership to identify and resolve complex hardware/software/firmware system anomalies. Customize system level testing and reporting to accommodate various customer and business requirements.

In return for your expertise, we provide a competitive salary and benefits package along with a state-of-the-art work environment. For confidential consideration, please call or send resume to the **Human Resources Department at 10800 Roosevelt Boulevard, St. Petersburg, FL 33716. (813)576-5091.**

**Jabil**  
CIRCUIT, INC.

Equal Opportunity Employer M/F/H/D/V

## GPS SOFTWARE ENGINEERS

Rockwell  
International  
Corporation's  
Collins  
Avionics &  
Communications  
Division, a world  
class leader in

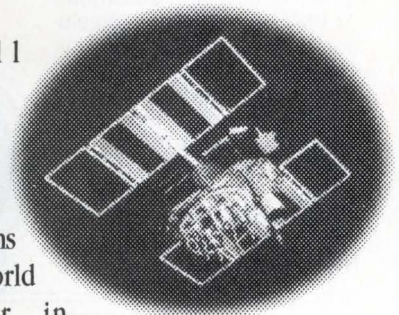

electronics and technology for communications, guidance and control has a number of challenging engineering opportunities at our Cedar Rapids, IA facility.

### Software Engineering Requirements

- Embedded real-time avionics software development experience
- Design, code, test, verification experience
- High-level languages
- BSCS/BSEE required
- A minimum of two years GPS experience preferred
- Must be able to work in a team-oriented environment

U.S. citizenship is required. Applicant selected will be subject to security investigation and must meet eligibility requirements for access to classified information. Successful candidates will be required to pass a drug screen test.

Rockwell International offers an excellent salary and complete benefits package. For consideration, please send your resume with salary history in confidence to: **C.C. Boardman, Rockwell International, Collins Avionics & Communications Division, 350 Collins RD. NE, Cedar Rapids, Iowa 52498 or FAX to (319) 395-2001.** An Equal Opportunity Employer.



**Rockwell International**

*...where science gets down to business*

# THE WORLD IS WATCHING WHAT WE DO.

The new generation in digital television has triggered a revolution in telecommunications. At the forefront of this revolution is General Instrument Corporation, the world's largest supplier of access control, scrambling and descrambling equipment used by cable and satellite television programs, such as CNN, HBO, superstations and sports channels. We are a leader in the next generation



of multi-channel digital and television technology High Definition Television (HDTV) and an integral part of the "Grand Alliance", which is combining technologies to become the U.S. broadcast standard for HDTV.

We have the following career opportunities for qualified professionals with the vision to enhance our future...and change the way the world sees itself.

## SYSTEMS ENGINEERS

Will design advanced digital communications systems for satellite, cable and broadcast TV. Requires an MSEE plus at least 5 years' experience in the following areas: communication system design, system architecture, data communication protocols, telephony and networks, encryption and access control, digital signal processing, communication networks, digital video compression, satellite communications or system test/evaluation. (CODE PMN)

## TEST ENGINEERS

Will develop test strategy and dedicated equipment used in production of complex consumer audio/video gear, and work from design phase through production start to optimize product design-for-test, test equipment design and product quality. Requires BSEE with 3-7 years' experience designing and/or programming dedicated test equipment and associated products. Exposure to Boundary-Scan, NTSC/PAL testing and GenRad test equipment is highly desirable. Openings exist in hardware and firmware; must have skills in both. (CODE MMN)

## FIRMWARE ENGINEERS

Will design, develop and integrate embedded real-time code for complex video scrambling/compression systems. Requires a BSEE with experience in firmware design and microprocessor/controller real-time programming. Familiarity with communication theory and firmware test development is a plus. (CODE JPN)

## DIGITAL DESIGN ENGINEERS

Will design a variety of digital compression boards and perform signal processing developmental tasks encompassing field programmable gate arrays and microprocessor-based systems. Duties will also include system integration/concept and involvement from product conception to production. Requires a BSEE (MSEE desirable) and 3+ years' experience, along with strong skills in UNIX, Viewlogic and FPGA (XILINX, ACTEL, MAX). (CODE LTN)

## ANALOG/RF DESIGN ENGINEERS

Will design analog/RF circuits and systems for video/audio hardware. Detail design includes op-amp, transistor circuits, oscillators, A/D, D/A, filters, PLL and amplifiers. Requires analog/RF design experience (DC thru UHF); MSEE and video/audio circuit design a plus. (CODE HSN)

## PRODUCT DEVELOPMENT ENGINEERS

Will design sophisticated products for DigiCipher-II video systems. Positions are available for Project, Lead and Design Engineers. All products encompass a broad range of technologies including digital demodulation, error correction, video and audio decomposition, advanced GUI, and DES-based access control. Transmission is via MPEG-2 compatible packet bit stream. Requires BSEE (minimum) with 4+ years' experience in analog/digital hardware design, hardware/firmware integration and communications systems. (CODE BDN)

## SOFTWARE ENGINEERS

Will design, develop and integrate program modules utilizing "C" on VAX/VMS platforms, Record Management Services (RMS) and low-level screen interface routines to handle Man Machine Interface (MMI) transaction processing and file management for satellite TV applications such as access authorization, feature control, on-screen text, etc. Requires a BSCS or related degree with software engineering design/code experience in a multi-tasking environment. (CODE NLN)

The world is watching what we do. Be part of this new wave of technology. Send your resume including salary history/requirements, referencing appropriate code to: Human Resources, General Instrument Corp., 6262 Lusk Blvd., San Diego, CA 92121. On-site gym. Smoke-free facility. EOE.

DESIGN ENGINEER  
\$17.35/hr

8 am to 5 pm  
40 hours per week

Design and development of embedded controller software. Research and design of signal processing algorithms. Master of Science degree, major in Electrical Engineering or equivalent. Two (2) years experience in job offered or two (2) years experience as engineer/scientist. Experience must have included 12 months of "C" language usage and real time system programming and graphics programming. Contact LA Office of Employment Security, Job Order 093762, 1991 Wooddale Blvd., Baton Rouge, LA 70806.

1. THIS NOTICE IS PROVIDED AS A RESULT OF THE FILING OF AN APPLICATION FOR PERMANENT ALIEN LABOR CERTIFICATION.

2. ANY PERSON MAY PROVIDE DOCUMENTARY EVIDENCE BEARING ON THE APPLICATION TO LOUISIANA DEPT. OF LABOR, ALIEN LABOR CERTIFICATION UNIT, RM. 110, P.O. BOX 94094, BATON ROUGE, LA 70804-9094 and/or REGIONAL CERTIFYING OFFICER, U.S. DEPARTMENT OF LABOR, 525 GRIFFIN STREET, ROOM 314, DALLAS, TX 75202.

## TECHNOLOGY UPDATE

April 25-29, 1994

Monterey, CA 93943-5110

POC: Dr. R. Panholzer,

Naval Postgraduate School

408-656-2948, Fax # 2816

For  
information  
on placing your  
advertisement in  
CAREER  
OPPORTUNITIES  
for

# EDN

## Magazine

call:

## Kim Fogarty Recruitment

## Account Executive

# 1-800 603-4860

**GI** General Instrument

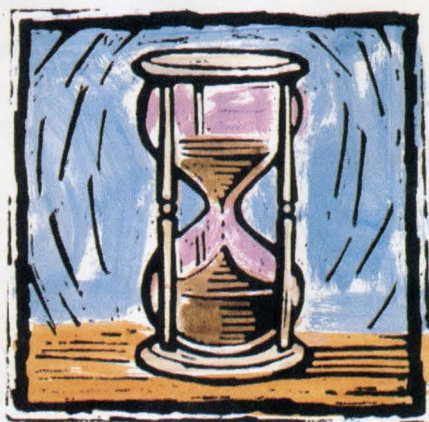

*“Do not squander time*

**OUR ADVANCED LASER AND COMPUTER**

*for that is*

**TECHNOLOGIES CREATE SYSTEMS THAT EXAMINE**

*the stuff*

**THOUSANDS OF CELLS PER SECOND.**

*life is made of.”*

*-Franklin*

By giving physicians the means to diagnose disease in a matter of minutes and initiate treatment, Coulter's instruments and technologies impact the lives of thousands of people all over the world.

Understanding the challenges and potential of the biomedical environment, Coulter continues to excel at matching technology to the needs of medicine. Today's breakthrough techniques, a result of innovative brilliance

and dedicated teamwork, are a source of tomorrow's promise in the triumph over diseases such as cancer and AIDS.

If you're interested in working with this leader in the rapidly growing industry of biomedicine, send your resume to: Coulter Corporation, Dept. HR/TK, 11800 SW 147th Avenue, Miami, Florida 33196-2500, or fax your resume to 305-380-3689. An Equal Opportunity Employer, M/F/D/V.



**COULTER**  
SCIENCE SERVING HUMANITY

# PICO

ULTRA-MINIATURE

## Surface Mount Audio Transformers

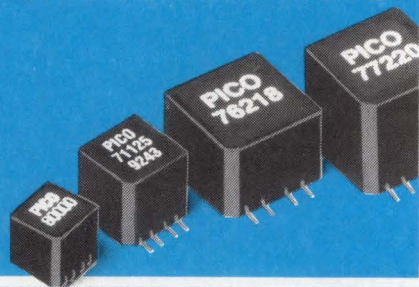

Low Profile  
.2" Ht.

- **Manufactured and tested to MIL-T-27**
- **Frequency range 20 Hz to 250 KHz**
- **Available from 100 milliwatts to 3 watts**
- **Impedance from 20 ohms to 100 K ohms**
- **Operating temperature -55°C to +130°C**
- **Low profile .2" ht.**

PICO surface mount units utilize materials and methods to withstand extreme temperature (220°C) of vapor phase, I.R., and other reflow procedures without degradation of electrical or mechanical characteristics.

Delivery—  
stock to one week

See EEM  
or send direct  
for **Free PICO Catalog.**

Call toll free **800-431-1064**  
in NY call **914-699-5514**  
FAX **914-699-5565**

**PICO Electronics, Inc.**

453 N. MacQuesten Pkwy., Mt. Vernon, N.Y. 10552

CIRCLE NO. 27

154 • EDN February 17, 1994

## EDN-INTERNATIONAL ADVERTISERS INDEX

Company	Page	Circle	Company	Page	Circle
Advanced Micro Devices	38-39	38	Murrietta Circuit Design	122	32
Advin Systems	147	248	National Semiconductor	C2 A-C	
Allegro MicroSystems	40	69-72	NEC Corp	104-105	97
	140	39	Nichicon	148	258
AMP Inc	62-63	49	Nohau Corp	138	98
Analog Devices Inc	21	64		145	231
	120	65	Oki Semiconductor	48-49	12
Annabooks	146	239	Oyster Terminal	147	247
Asahi Kasei			Pacific Softworks	148	252
Microsystems Co Ltd	119	73	Pentek Inc	137	99
AT&T Microelectronics	43	47	Pico Electronics	114	27
Avtech	146	238		154	27
BP Microsystems Inc	33	74	Power Trends Inc	155	100
Burr-Brown Corp	103	75	Powercube	134	101
Bytek Corp	149	265	QSI Corp	122	31
Capilano	146	240	Quad Design	112	102
Capital Equipment Corp	101	76	Quicklogic	61	103
Cirrex	148	255	RC Systems	149	261
Com-Power Corp	70	16	Raltron Electronics	86	19
Condor Inc	31	77	Samsung Semiconductor	50-51	37
Cybernetic MicroSystems	19	3		74-75	104
Cypress Semiconductor	6		Samtec	24	80
Data I/O Corp	146	242	Siemens Components Inc	20	
Data Translation	45	46		76	140-143
Datel Inc	57	78	Sierra Circuits	145	233
Digi-Key Corp	1	1	Signal Transformer Co	C4	89
Duracell Inc	109	79	Siliconix	4	
Ecliptek Corp	60	9	Softaid Inc	149	264
EESof Inc	52	48	Sony Semiconductor	29	105
Eletch Electronics	149	262	Stag Microsystems	146	237
Emulation Technology	149	266	Stanford Research		
	149	267	Systems Inc	144	106
	149	268	Sun Circuits	147	246
Epson America Inc	94	81	TDK Corp	71-72	
E-T-A Circuit Breakers	2	2		73	107
FDK America	139	34	Tektronix Inc	88-91	35
GFS Manufacturing	147	245		89-90	
Gage Applied Sciences	86	26	Texas Instruments	8-9	
General Micro Systems	70	124-125		34-37	
General Silicones	147	249	The Hirol Company	139	36
Grayhill Inc	146	241	Toshiba America		
Harris Semiconductor	106	82	Electronic Components	92-93	110-111
Hypertronics Corp	115	83		16-17	108-109
IEE	116-117	28-29	Tribal Microsystems	145	234
Illinois Capacitor Inc	121	30	Two Technologies	148	251
Incredible Technology	145	230	US Logic	148	257
Innovative Software			Ultralife Batteries	133	33
Design Inc	145	232	Unitrode Integrated Circuits	26	112
Integrated			VME Microsystems	125	113
Device Technology	18		Vicor Corp	81	114
International Rectifier	C3	84	Viewlogic Systems Inc	87	115
Ironwood Electronics	147	244	Visual Software Solutions	149	260
Keithley Instruments Inc	123-124		Wavetek Corp	126	116
Lambda Qualidyne Inc	99	85	Wolfram Research Inc	156	117
LeCroy Corp	12	86	Xeltek	148	256
Linear Technology Corp	10-11	87	Xicor Corp	132	118
	53-54		Xilinx	22-23	121
				111	122
Logical Devices	147	250	Zilog Inc	143	123
Massteck	79	88	Zworld	145	235
Mathsoft	32	4			
Maxim Integrated					
Products Inc	83	91			
	85	92			
	129	93			
	131	94			
MicroSim Corp	15	150-152			
	146	236			
Mini-Circuits	3	95			
	59	96			
Mosaic	148	254			
Motorola Semiconductor					
Products Inc	47				

**Recruitment Advertising 150-151**

This index is provided as an additional service. The publisher does not assume any liability for errors or omissions.

# INTRODUCING THE WORLD'S SMALLEST 15 WATT ISOLATED DC-DC CONVERTER.



## Advancing the State-of-the-Art for Board-Mounted Converters.

Throwing out all the old design concepts, Power Trends has advanced the state-of-the-art again. This time it's for board-mounted DC-DC converters. By using switching frequencies greater than 650 kHz, planar magnetics and surface-mount construction—we have now produced the industry's smallest and most reliable 15 Watt isolated DC-DC converters.

Not only are the new products much smaller than competitive designs, but—with fewer components—they also significantly advance product reliability.

### FEATURING

- Smallest footprint: 1.45" x 1.64" x 0.38"
- Wide input voltage range: 36V to 72V
- 80% efficiency
- Temperature range: -25°C to +70°C
- 500 VDC isolation
- Planar magnetics

Three products are initially available—the PT3101A, a 48V-to-5V unit; the PT3102A, a 48V-to-12V unit; and the PT3103A, a 48V-to-15V unit. All three products operate over an input voltage range of 36 to 72 VDC and provide their rated power up to 70°C without additional heatsinks. They provide 80% efficiency, 500 VDC isolation, and are ideally suited for telecom, industrial, computer, medical, and other distributed-power applications requiring input-to-output isolation.

Send for a spec-and-applications brochure, or call and ask about samples.



**POWER TRENDS®**

Power Trends, Inc. 1101 North Raddant Road, Batavia, IL 60510 • (708) 406-0900 • FAX (708) 406-0901

CIRCLE NO. 100

EDN February 17, 1994 • 155

Mathematica

New! Electrical Engineering Pack

"A Must for Electrical Engineers..."

Call 1-800-441-MATH

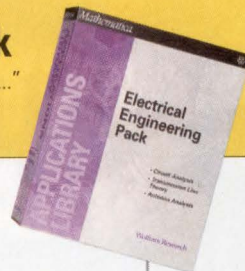

# OTHER SYSTEMS CAN GET YOU ONLY SO FAR ...



Engineers and scientists who start with other technical software programs soon reach a point they can't get past. The project isn't finished, but the software is. What can they do then but buy and learn yet another program for the next leg of the project, or return to pencil and paper to finish it out.

Fortunately, many engineers and scientists start with *Mathematica*. And they just keep going.

*Mathematica* helps them past the standard calculations, and on to the more complex. Thousands of algorithms are at their fingertips to help them solve all kinds of technical problems. And nearly a hundred special-purpose packages are included free with *Mathematica* to take you even further. Add to that a revolutionary user interface, graphical

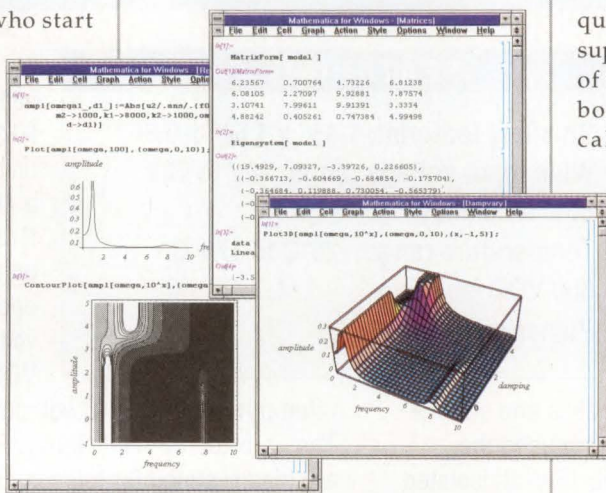

Only *Mathematica* notebooks enable users to create interactive documents combining text, live formulas, and graphics that can be modified within the document at any time and easily organized into a hierarchical outline.

abilities beyond comparison, and a symbolic programming language that makes it unprecedentedly easy to translate ideas into programs—and your possibilities are endless.

The award-winning guide that comes with the program gets you started

quickly and easily. For even more support, you can always turn to one of the over 30 *Mathematica*-related books, tutorials, and journals, or call on one of our user support staff for personal assistance. So you see, *Mathematica is the complete system* that never leaves you stranded.

To get the latest information call:

**1-800-441-MATH**

(U.S., Canada)

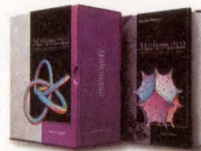

## Wolfram Research

Wolfram Research, Inc.

+1-217-398-0700; fax: +1-217-398-0747; email: info@wri.com

For European inquiries:

Wolfram Research Europe Ltd.

+44-(0)993-883400; fax: +44-(0)993-883800

email: info-euro@wri.com

Representatives in over 30 countries; contact main offices.



# Power-full tiny inverter.

Or how to shrink a 1hp, 3-phase motor control inverter to fit your pocket...book.

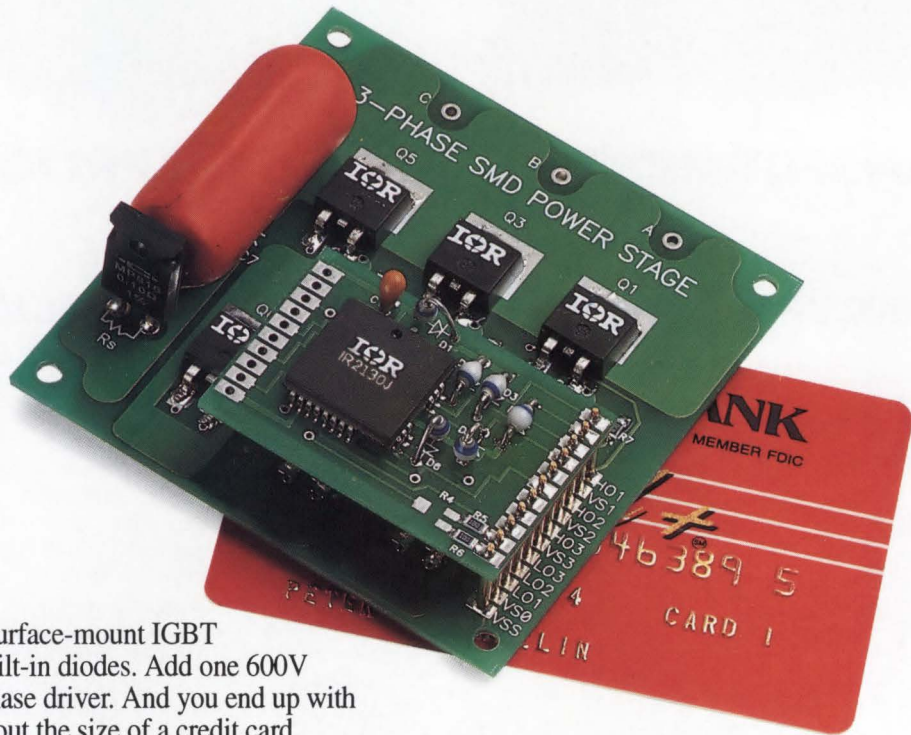

Take six IR surface-mount IGBT CoPacks with built-in diodes. Add one 600V IR2130J three-phase driver. And you end up with a 1hp inverter about the size of a credit card.

The lower part count, size and weight reductions bring added value to your end product. Your customers benefit from the pass-along savings. And you gain the competitive edge.

Thanks to the most compatible line of power devices ever. Value-priced to save you money. In stock to save you delivery time. Send for our data "Shrink Pak." Quicker yet, call. 1-800-245-5549.

You'll see how small your inverters can get.

*This motor control inverter is 3" x 3" sq. and features six SMD-220 surface-mount CoPack UltraFast IGBTs driven by a single 600-volt, 3-phase driver (IR2130J) with current-sensing.*

*Available now at key IR distributors.*

**IR** International Rectifier

WORLD HEADQUARTERS: 233 KANSAS ST., EL SEGUNDO, CA 90245, USA 310-322-3331, FAX 310-322-3332, TELEX 66-4464. EUROPEAN HEADQUARTERS: HURST GREEN, OXTEY, SURREY RH8 9BB, ENGLAND, (0883) 713215, FAX (0883) 714234

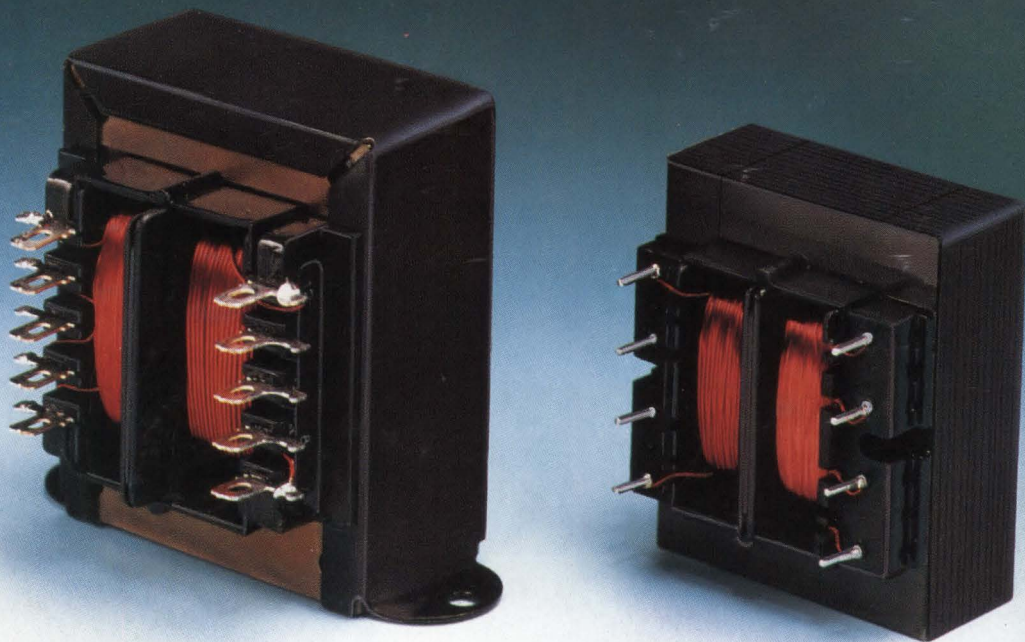

## TRANSFORMERS FOR CLASS 2 APPLICATIONS

DUAL BOBBIN DESIGNS FEATURE  
4000 VRMS PRIMARY AND SECONDARY ISOLATION.

\*INHERENTLY LIMITED  
\*\*NON-INHERENTLY LIMITED  
MAXIMUM FUSE VALUE SPECIFIED  
ALL PRIMARIES ARE 115/230 VOLT 50/60 HZ

PART NO.	SECONDARY RMS RATING	FUSE REQ.	PRICE
CL2-25-12	12V @ 2.10A	2.5A**	14.50
CL2-25-24	24V @ 1.05A	N/A*	14.50
CL2-40-12	12V @ 3.33A	4.0A**	18.50
CL2-40-24	24V @ 1.66A	2.0A**	18.50
CL2-80-24	24V @ 3.33A	4.0**	25.25

PART NO.	SECONDARY RMS RATING	FUSE REQ.	PRICE
CL2-2.5-12	12V @ .20A	N/A*	9.00
CL2-2.5-24	24V @ .10A	N/A*	9.00
CL2-5.0-12	12V @ .42A	N/A*	9.75
CL2-5.0-24	24V @ .20A	N/A*	9.75
CL2-10-12	12V @ .83A	N/A*	10.90
CL2-10-24	24V @ .42A	N/A*	10.90
CL2-20-12	12V @ 1.66A	N/A*	13.25
CL2-20-24	24V @ .833A	N/A*	13.25
CL2-30-12	12V @ 2.50A	3.0A**	15.25
CL2-30-24	24V @ 1.25A	N/A*	15.25
CL2-50-12	12V @ 4.20A	5.0A**	18.65
CL2-50-24	24V @ 2.10A	2.5A**	18.65

Signal's "Class 2" transformers feature the same dual high-temperature bobbin construction and insulating shroud originally developed for the company's very successful International Series. Available in both PC and chassis mount versions, they offer a choice of inherently limited or non-inherently limited designs and feature 4000 VRMS primary and secondary isolation.

Signal's insulation system results in very high isolation between the primary and the secondary windings, and between either winding and the core. The dual bobbin design reduces capacitance and eliminates the need for an electrostatic shield. This dual bobbin series is UL recognized to UL 1585 Class 2 (File # E116583). It also satisfies CSA safety and performance standards.

For additional technical data, contact Signal Transformer, 500 Bayview Avenue, Inwood, NY 11696-1792.

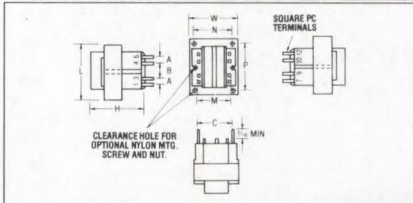
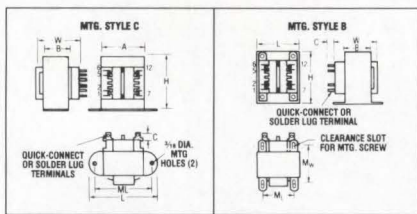
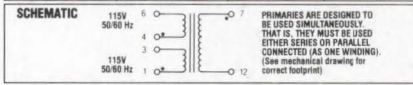
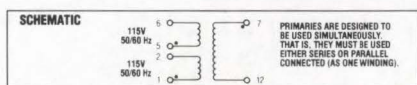

DIMENSIONS							Terminals	Mtg. Style	Mtg. ML	Mtg. MW	Mtg. Screw	Lbs.
VA	L	W	H	A	B	C						
25	2 <sup>13</sup> / <sub>16</sub>	1 <sup>1</sup> / <sub>8</sub>	2 <sup>1</sup> / <sub>8</sub>	2	1 <sup>1</sup> / <sub>8</sub>	3 <sup>1</sup> / <sub>16</sub>	C	2 <sup>1</sup> / <sub>8</sub>	-	#6	1.25	
40	3 <sup>1</sup> / <sub>8</sub>	2 <sup>1</sup> / <sub>8</sub>	2 <sup>1</sup> / <sub>8</sub>	2 <sup>1</sup> / <sub>8</sub>	1 <sup>1</sup> / <sub>8</sub>	3 <sup>1</sup> / <sub>16</sub>	C	2 <sup>1</sup> / <sub>8</sub>	-	#6	1.8	
80	2 <sup>1</sup> / <sub>2</sub>	2 <sup>1</sup> / <sub>8</sub>	3	-	1 <sup>1</sup> / <sub>8</sub>	3 <sup>1</sup> / <sub>16</sub>	B	2	2 <sup>1</sup> / <sub>8</sub>	#6	2.8	

DIMENSIONS							Pin Dimensions	Mtg. M	Mtg. N	Mtg. P	Mtg. Size	Mtg. Quantity	Lbs.
VA	L	W	H	A	B	C							
2.5	1 <sup>1</sup> / <sub>8</sub>	1 <sup>1</sup> / <sub>8</sub>	1 <sup>1</sup> / <sub>8</sub>	.200	.250	1.000	0.025SQ	1 <sup>1</sup> / <sub>16</sub>	-	-	#4	2	0.25
5.0	1 <sup>1</sup> / <sub>8</sub>	1 <sup>1</sup> / <sub>8</sub>	1 <sup>1</sup> / <sub>8</sub>	.200	.400	1.000	0.025SQ	1 <sup>1</sup> / <sub>16</sub>	-	-	#4	2	0.37
10.0	1 <sup>1</sup> / <sub>8</sub>	1 <sup>1</sup> / <sub>8</sub>	1 <sup>1</sup> / <sub>8</sub>	.200	.400	1.140	0.038SQ	1 <sup>1</sup> / <sub>8</sub>	-	-	#4	2	0.53
20.0	2 <sup>1</sup> / <sub>4</sub>	1 <sup>1</sup> / <sub>8</sub>	1 <sup>1</sup> / <sub>8</sub>	.400	.400	1.460	0.038SQ	1 <sup>1</sup> / <sub>2</sub>	-	-	#4	2	0.90
30.0	2 <sup>1</sup> / <sub>8</sub>	2 <sup>1</sup> / <sub>8</sub>	1 <sup>1</sup> / <sub>8</sub>	.550	.275	1.680	0.045SQ	-	1 <sup>1</sup> / <sub>8</sub>	2 <sup>1</sup> / <sub>8</sub>	#6	4	1.15
50.0	3	2 <sup>1</sup> / <sub>8</sub>	1 <sup>1</sup> / <sub>8</sub>	.600	.300	1.900	0.045SQ	-	2	2 <sup>1</sup> / <sub>2</sub>	#6	4	1.70

**signal**  
TRANSFORMER

The American  
Original.™

BUY DIRECT

24  
HOUR  
PRONTO  
SHIPMENT

TEL: (516) 239-5777  
FAX: (516) 239-7208