

# Electronic Design 19

VOL. 18 NO.

FOR ENGINEERS AND ENGINEERING MANAGERS

SEPT. 13, 1970

RECEIVED  
SEP 17 1970

CALMA CO.

**Liquid crystals** — material with an unlimited future. New uses are pointing toward alphanumeric readouts that could operate on millimicrowatts, pilot lights that

cost about one-hundredth of a cent, a flat-screen color TV, an inexpensive thermal mapper and a cancer detector. For details on this unique material, see p. 76.

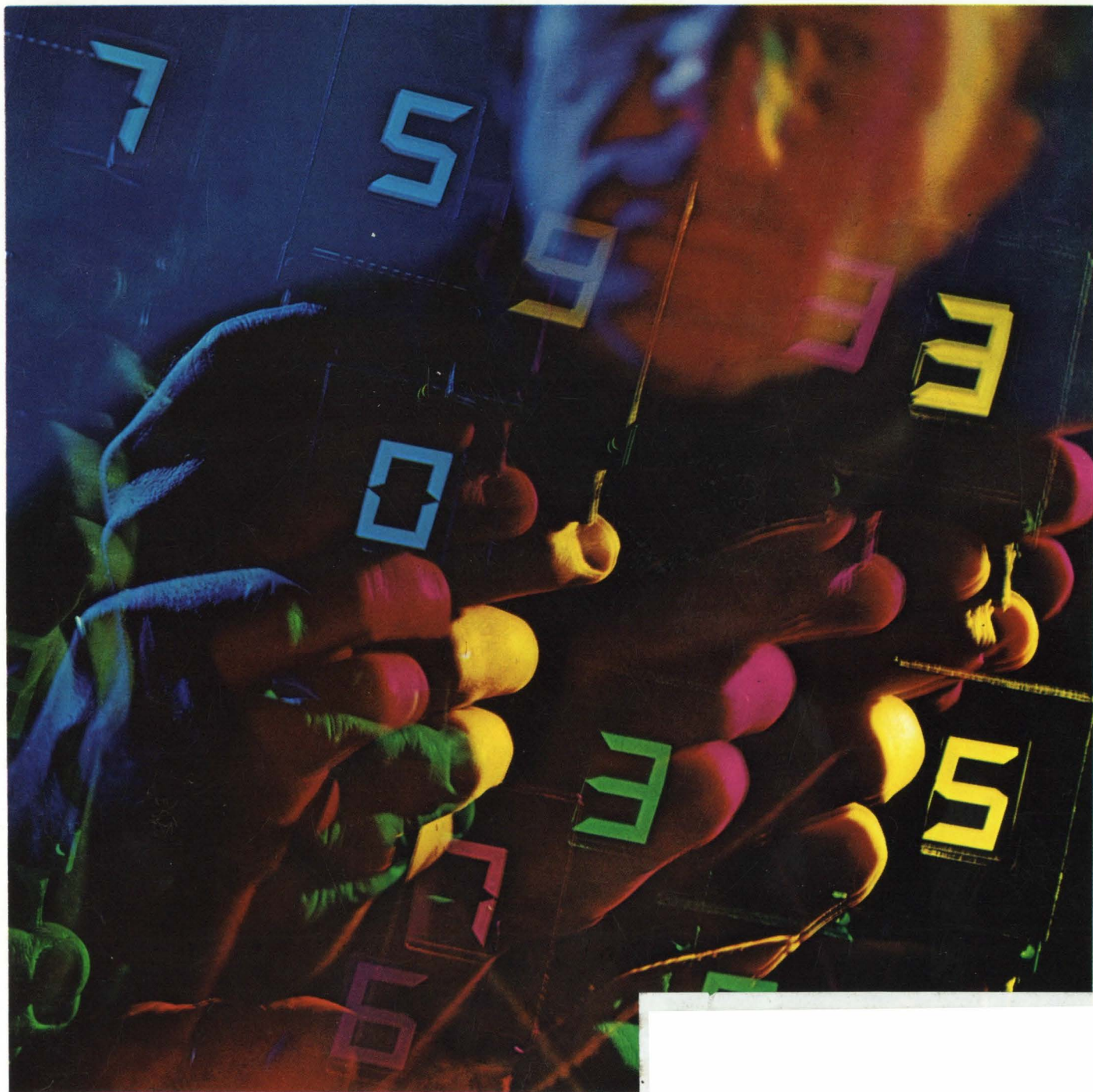

# DALE Metal Film Resistors

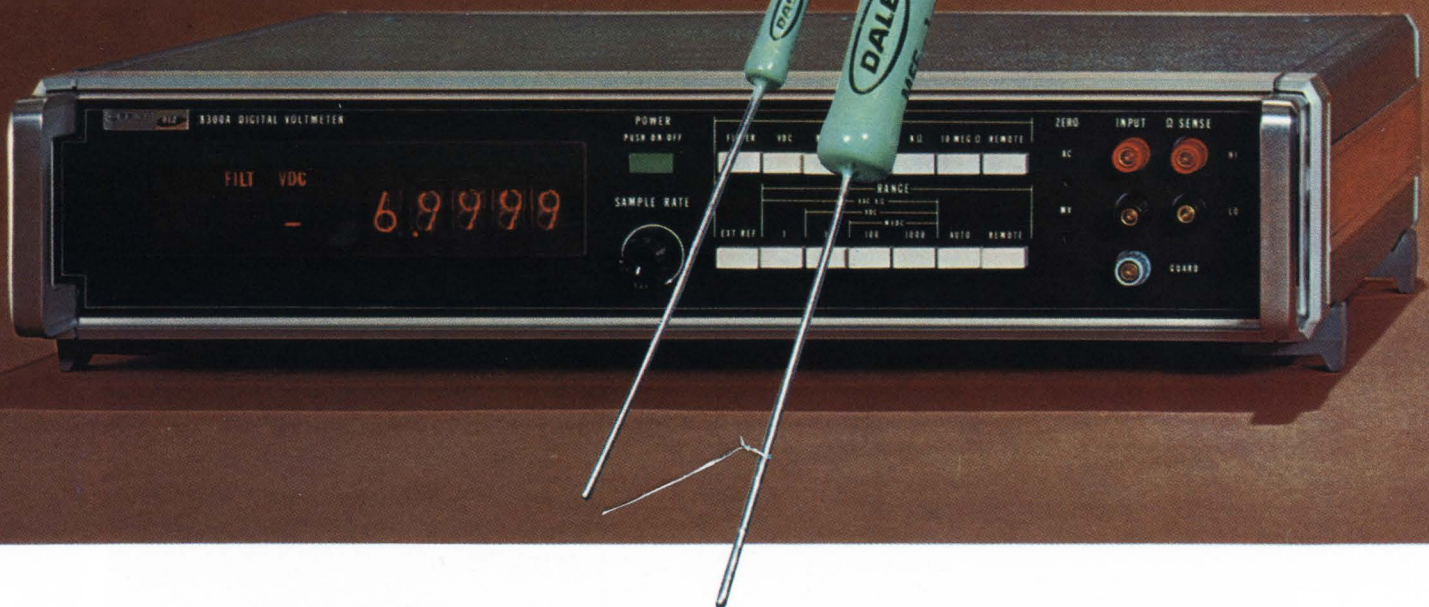

## where stability and low noise are important

Fluke uses Dale Metal Film Resistors in a host of circuit applications... primarily where stability and low noise are important. These conformal coated units combine small size and excellent reliability with low cost and economy of installation. Typical applications in the versatile 5-digit Fluke 8300A DVM are: Current sources for zener diodes • Feedback pairs around operational amplifiers • Secondary ladder networks • Timing circuits and input filters.

### Take advantage of Dale's Metal Film versatility.

From one quick source you can... choose epoxy coated (MFF) or molded (MF) styles... meet MIL-R-55182, MIL-R-10509 and MIL-R-22684... specify extreme high and low resistance values without sacrificing stability.

Phone 402-564-3131 for details

### DALE ELECTRONICS, INC.

1352 28th Avenue  
Columbus, Nebraska 68601  
In Canada: Dale Electronics Canada Ltd.  
A subsidiary of The Lionel Corporation



### DALE MFF—CONFORMAL COATED METAL FILM RESISTORS

Mil. Spec.: Conform to all requirements of MIL-R-10509, except dimensionally smaller. MIL-R-22684 = RL-07, RL-20.

**Size Range:** 1/10 thru 2 watts

**Resistance Range:** 10 ohms to 11 megohms\*

**Tolerances:** MIL-R-10509 = 1%, .5%, .25%, .10%;  
MIL-R-22684 = 2%, 5%.

**Temperature Coefficient:** 11 standard T.C. codes,  
± 200 ppm/°C to ± 25 ppm/°C in -55°C to +175°C range.

\*Extended value ranges, 1 ohm to 50 megohms available in MF series.  
Write for complete specifications.

### FLAME RETARDANT COATINGS...

are standard on all Dale 1/10 thru 1/2 watt conformally-coated metal film resistors.

These resistors have excellent color stability when subjected to short time overloads and prolonged high temperature operation. They have withstood 100 times rated power for as long as 10 minutes without exhibiting flame.



# You can load up on X-Y recorders.

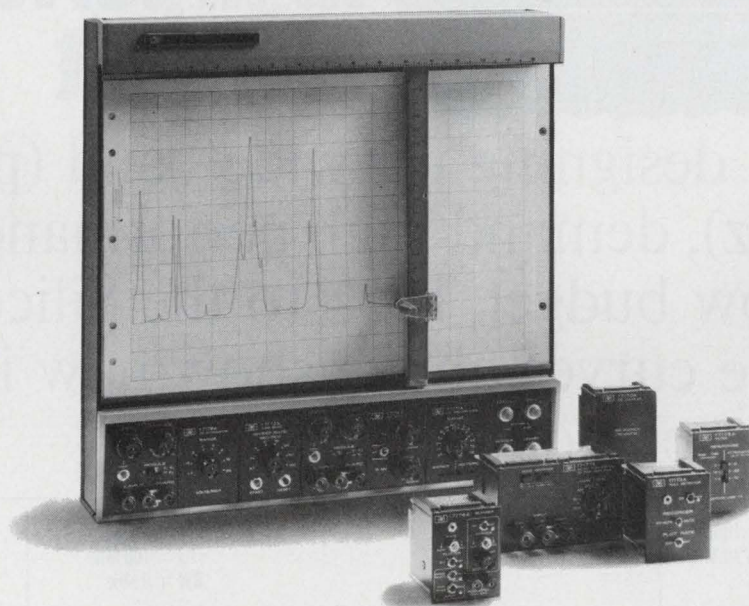

## Or get an X-Y recorder you load up.

The world's first plug-in X-Y recorders let you buy modules, not mainframes, when you want to change applications. So you can order a single workhorse instrument to handle any analog and almost any digital job you have in mind. With the best dynamic performance on the market.

There are eight plug-ins for Hewlett-Packard's 7034A and 7004B X-Y's. You can use two plug-ins per axis. Besides taking care of all the routine tasks, they'll let you plot X-T, Y-T, single channel and discrete analog data. Extract signals superimposed on steady-state DC. Record AC from 5 Hz to 100 kHz. Plot two channels independently. And handle high-speed point plotting, too. You can specify the capability you want now and add to it later.

Dynamic performance is state-of-the-art. There's acceleration of better than 1500 in/sec<sup>2</sup> and slewing speed of 30 in/sec to catch all the transients that most recorders miss. Guarded circuits eliminate the effects of common mode voltages, and IC construction keeps your recorder running perfectly day after day. Autogrip electrostatic paper holddown and mess-free disposable

ink pens are standard.

The 8½" x 11" 7034A costs just \$1295 and the 11" x 17" 7004B is only \$100 more. Modules start at \$25. To lighten your load in X-Y recording, call your local HP field engineer. Or write to Hewlett-Packard, Palo Alto, California 94304; Europe: 1217 Meyrin-Geneva, Switzerland.

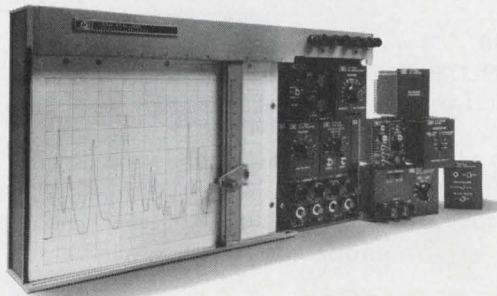

**HEWLETT**  **PACKARD**

GRAPHIC RECORDERS

11904

INFORMATION RETRIEVAL NUMBER 2

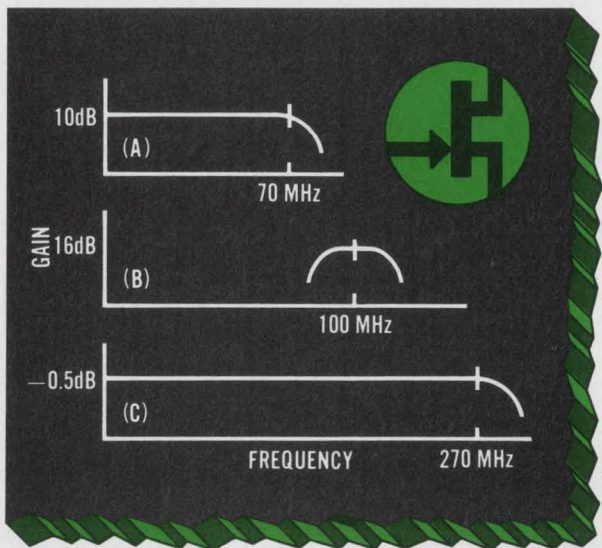

# EPOXY VHF FETS

high performance  
low cost

If you're designing for wide band (pushing 300 MHz), demand high performance but stuck with a low budget, look to the Siliconix E300. The three curves above show how ideas (a.), (b.) and (c.) prove out:

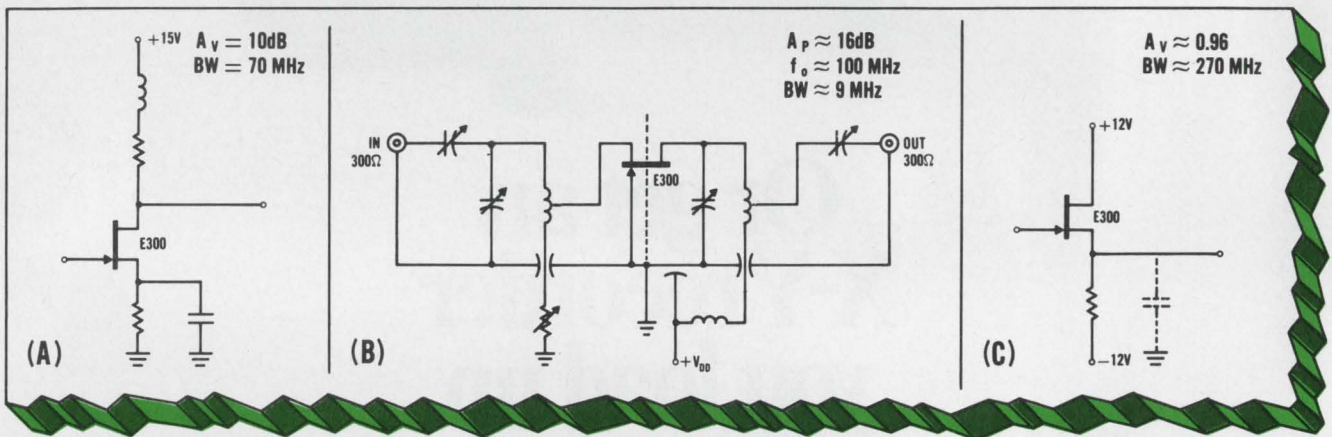

You can also use the E300 for  Ultra-stable oscillators  High dynamic range mixers  High isolation VHF switches  Etc.

If you're not sure of the Etc. part, our applications people are ready to help. For complete data, write or call any of the offices below.

**New York:** Sy Levine (516) 796-4680  
**New England:** Al La Croix (617) 769-3780  
**Ft. Worth/Dallas:** Charlie Williams (214) 231-8151  
**St. Louis:** Jim Spicer (314) 291-3616  
**Minneapolis:** Ed Koelgen (612) 920-4483  
**Southern California:** Dave Ferran (213) 420-1307  
**Northern California:** Chuck Brush (408) 246-8000



**Siliconix incorporated**

2201 Laurelwood Road • Santa Clara • California 95054  
 Telephone (408) 246-8000 Extension 201 • TWX: 910-338-0227  
 In Europe: Siliconix Limited, Saunders Way, Sketty, Swansea, Great Britain

INFORMATION RETRIEVAL NUMBER 3

# Electronic Design 19

FOR ENGINEERS AND ENGINEERING MANAGERS

VOL. 18 NO.

SEPT. 13, 1970

---

## NEWS

- 23 **News Scope**
- 27 **Microminiaturization is forcing inductors out**  
Designers are using electronic micro-equivalents that are competitive in performance and cost
- 32 **Computer constructs 3-D castles in the air**
- 34 **Device gives doctors speedy lab reports**
- 43 **Technology Abroad**
- 46 **Navy simulates deep sea for man and sub**  
New facility is being built to test man and components down to 2250-foot depths
- 48 **New laser quadruples color-range emissions**
- 55 **Washington Report**
- 

## TECHNOLOGY

- 76 **Liquid crystals: Material with a hot future.** Unusual properties of the substance are proving ideal in display, medical and other uses.
- 84 **Feedback analysis can be speeded** by these techniques for calculating driving-point impedance.
- 90 **Be logical—consider unfamiliar gating.** The eight canonical forms of two-stage logic are interchangeable.
- 94 **Precision op amps can be wasted** if they're not used in the right configuration. Here's how to match circuit to application.
- 100 **How do we compete with 'Japan, Inc.?'** The threat is real, says this electronics observer, who offers strategies to meet the challenge.
- 104 **Ideas for Design**
- 113 **Product Source Directory: Rack-and-Panel Connectors**
- 

## PRODUCTS

- 119 **Components: CRT** uses a matrix grid to generate many beams.
- 122 **ICs & Semiconductors: MOS character generator** is bipolar compatible.
- 126 **Instrumentation: Shaft-encoder knob** data-logs instruments.
- |                              |                           |
|------------------------------|---------------------------|
| 132 Data Processing          | 137 Microwaves & Lasers   |
| 133 Modules & Subassemblies  | 138 Packaging & Materials |
| 136 Tools & Engineering Aids | 154 Product Index         |
- 

## Departments

- 75 **Editorial:** A new growth area—recycle engineering
- |                        |                        |
|------------------------|------------------------|
| 13 Designer's Calendar | 142 Annual Reports     |
| 53 Letters             | 143 Application Notes  |
| 59 Sidelights          | 144 New Literature     |
| 140 Evaluation Samples | 149 Bulletin Board     |
| 141 Design Aids        | 152 Advertisers' Index |

Information Retrieval Service Card inside back cover

**Cover Photo:** Courtesy of RCA laboratories, Princeton, N. J.

---

ELECTRONIC DESIGN is published biweekly by Hayden Publishing Company, Inc., 850 Third Avenue, New York, N.Y. 10022. James S. Mulholland, Jr., President. Printed at Brown Printing Co., Inc., Waseca, Minn. Controlled circulation postage paid at Waseca, Minn., and New York, N.Y. Copyright © 1970, Hayden Publishing Company, Inc. 82,501 copies this issue.



If your time-share  
bill runs over  
\$2,300 a month  
you're being had!

Forget about mounting rental bills. You'll save hard cash with your own HP 2000A System.

You can have up to 16 terminals going simultaneously. Your users can program the computer in simple conversational BASIC... and unlike most computers it checks every entry step-by-step. No busy signals, no wait messages. And you can even forget about expensive reports and computer down-time. The 2000A System keeps on working... while others are being worked on. *Time and money saved, that's what you can count on with the extraordinary HP 2000A System.*

Sound good so far? Here's one better. HP can have your 2000A Time-Share System installed and running in a matter of months — not years. So give your local HP computer specialist a call. He's got all the details. Or write Hewlett-Packard, Palo Alto, California 94304. Europe: 1217 Meyrin-Geneva, Switzerland.

HEWLETT  PACKARD  
DIGITAL COMPUTERS

Circle 75 on read



**Last year this ad offered you  
the best time-share buy  
on the market.**

**Now we've got an even  
better deal. Our new system  
handles twice the users  
for just \$2667 a month.**

Last year, we had one Time-Share system that made a lot of sense to a lot of people. Now, we've got two! Our new HP 2000B System does an even better job of holding the line on rising time-share costs. It handles 32 users simultaneously. Twice as many as its "little brother" (HP 2000A) — for only a third more cost.

Of course, if you already have a 2000A (or only need a 16-terminal system right now), you can upgrade to 32 terminals any time you're ready. Either way, you'll still have the best time-share buy on the market.

Both systems provide the advantages of HP BASIC, easiest programming language around. More scientists, engineers, educators and businessmen are using it every day. To make the 2000B even more useful, some new language features have been added. Like chaining (where one program calls in another automatically). Common storage for simplified programming. And doubled data file capability, for access to 16 files simultaneously.

Sound good so far? Here's more. Our 2000B, complete with custom software, control teleprinter and all 32 terminal interfaces, costs just \$124,050. Or \$2667 a month on our new five-year lease plan. And if you want to start with a minimum investment, our HP 2000A is only \$93,750. And don't forget what we said about upgrading!

For all the details, contact your nearest HP computer specialist. Or write to Hewlett-Packard, Palo Alto, California 94304; Europe: 1217 Meyrin-Geneva, Switzerland.

INFORMATION RETRIEVAL NUMBER 4

HEWLETT  PACKARD

DIGITAL COMPUTERS

what!



really!

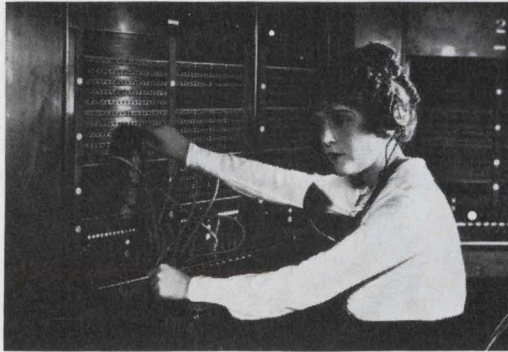

yes, mag  
tape  
terminals



TELETYPE?

It's true.

After helping a jillion feet of paper tape wind and unwind its way through communications systems everywhere, Teletype announces the addition of magnetic tape data terminals.

There are some basic advantages in both mediums. But as you are well aware, the medium that's right for a system depends a lot on the application criteria.

The new magnetic tape data terminals have many operational features that make life less complicated for the operator.

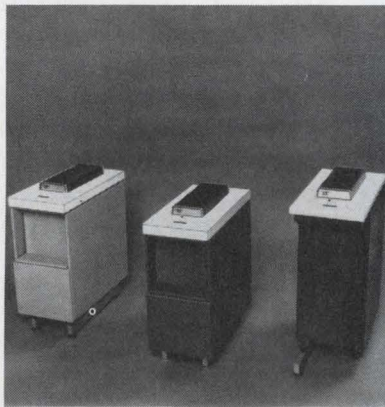

*New, modular line of Teletype® 4210 magnetic tape data terminals.*

For example, take a look at the tape cartridge, which was specifically designed for reliability required for data transmission.

Its vital statistics are: 3" x 3" x 1".

It contains 100 feet of 1/2" precision magnetic tape.

It will hold 150,000 characters of data, recorded at a density of 125 characters per inch. The equivalent of a 1000 foot roll of paper tape.

This means that your data is easier to store, easier to handle, easier to work with than ever before. And it's reusable.



# DATA COMMUNICATIONS

equipment for on-line, real-time processing

The units have a "fast access" switch which will move tape forward or reverse at a speed of 33 inches per second. A digit counter provides a reference point to help locate various areas of the tape.

Four ASCII control code characters can be recorded in the data format to aid character search operations. When the terminal's "search" button is pressed, tape moves at the rate of 400 characters per second

Also magnetic tape adds high speed on-line capability to low speed data terminals.

You can zip data along the line at up to 2400 words per minute. For example: Take a standard speed Teletype keyboard send-receive set, and a typical typist. Add a new magnetic tape unit to this combination and the on-line time savings can pay for the magnetic tape terminal in short order.

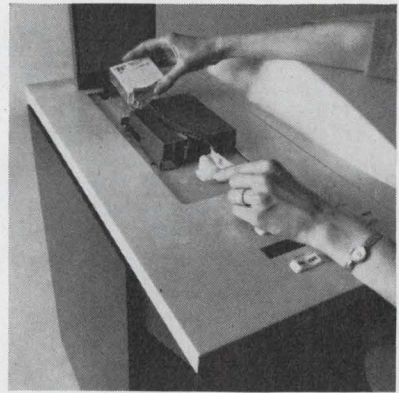

*Straight-through threading makes tape loading and unloading exceptionally easy.*

They can send or receive at high or low speed. Or can be used independently as stand-alone terminals on-line.

If you would like to know more about this new line of Teletype magnetic tape data terminals, please write Teletype Corporation, Dept. 89-15, 5555 Touhy Avenue, Skokie, Illinois 60076.

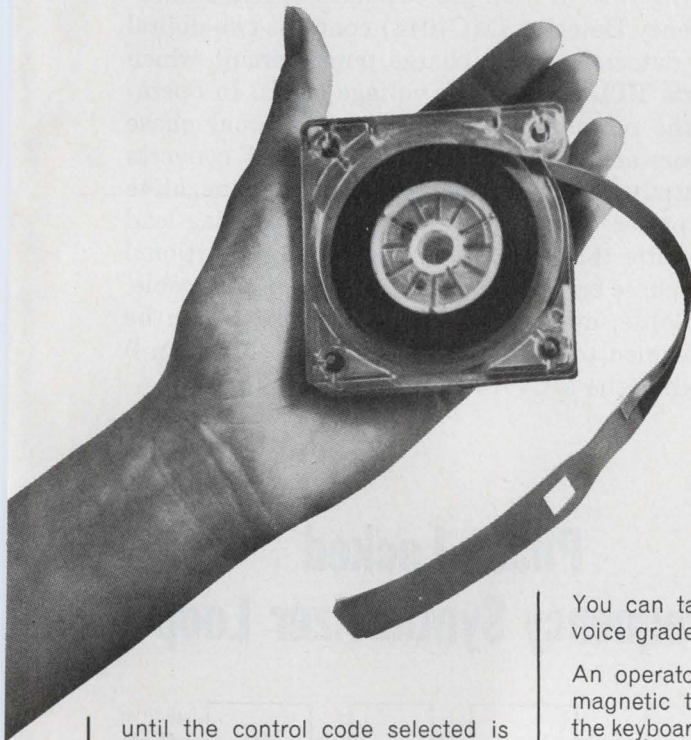

until the control code selected is detected. Then the terminal stops the tape automatically.

A "single step" switch is also provided which enables you to move the tape forward or backward one character at a time. In editing or correcting tape, you can send a single character using this feature.

You can take better advantage of voice grade line speed capabilities.

An operator can prepare data for magnetic tape transmission using the keyboard terminal in local mode. Then send it on-line via the magnetic tape terminal up to 2400 words per minute.

These new modular magnetic tape data terminals offered by Teletype are perfectly compatible with model 33, model 35, model 37 and Inktronic® keyboard send-receive equipment.



*Teletype 4210 magnetic tape data terminal with 37 keyboard send-receive set.*

**machines that make data move**

INFORMATION RETRIEVAL NUMBER 5

ELECTRONIC DESIGN 19, September 13, 1970



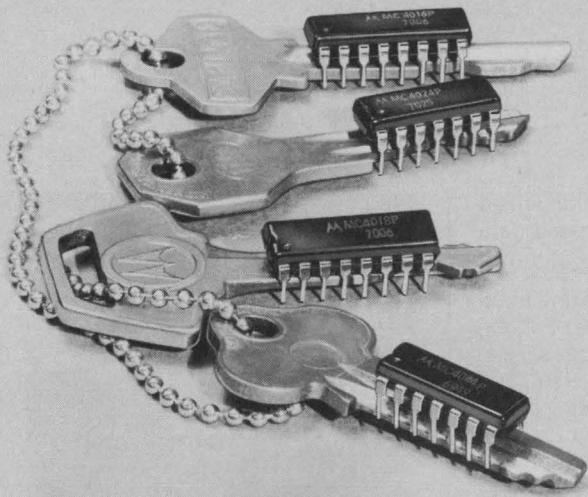

# Four IC Keys To Phase-Locked Loops

Unlock your phase-locked loop and frequency synthesizer design problems with Motorola's DUAL VOLTAGE-CONTROLLED MULTIVIBRATOR (MC4024), PHASE-FREQUENCY DETECTOR (MC4044) and either of two PROGRAMMABLE MODULO-N COUNTERS (MC4016 and MC4018). The new digital concept replaces from 8 to 15 packages in conventional phase-locked loop systems and offers additional benefits of lower design costs, higher performance and decreased power consumption.

The MC4024 VCM generates a digital output waveform whose frequency range is linearly dependent upon a dc input voltage (+3.0 to +5.0 volts). Frequency control is accomplished through the use of voltage-variable current sources which control the charging rate of a single capacitor. The Phase-Frequency Detector (MC4044) contains two digital phase detectors and a charge pump circuit which converts TTL inputs to dc voltage levels. In operation, the outputs of either of two internal phase detectors are fed to a charge pump that converts the outputs to fixed amplitude positive or negative going pulses. These pulses are applied to a lag-lead active filter that provides a dc voltage proportional to the phase error. The counters are programmable, cascadable, modulo-N devices. MC4016 can be programmed to divide by any number (N) from 0 through 9, the MC4018 from 0 through 15.

## Phase-Locked Frequency Synthesizer Loop

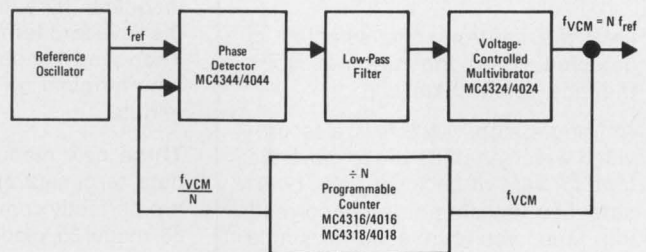

The loop achieves a stable state when  $f_{VCM} = N f_{ref}$ . When this condition does not exist the VCM searches through its frequency spectrum until it finds the frequency at which the stable state occurs. At this point the loop locks. This system allows the generation of many discrete frequencies from a single, highly stable source ( $f_{ref}$ ).

# Use Them To...

## Control Motor Speeds

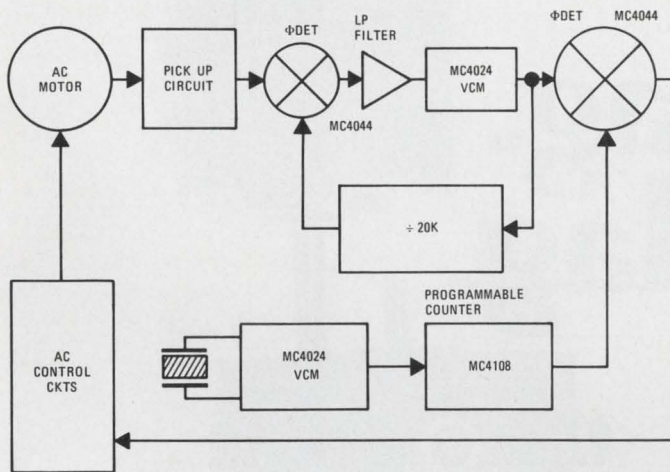

countless other applications requiring phase-locked loop and frequency synthesis IC solutions. In instrumentation apply them for variable time base generators; in computers, to synthesize multiple clock frequencies from a single source, and to lock data together from multiple information tracts. And the communications, industrial control and FM fields will find prime applications waiting.

# Or...

# Or...

## To slave two computers together

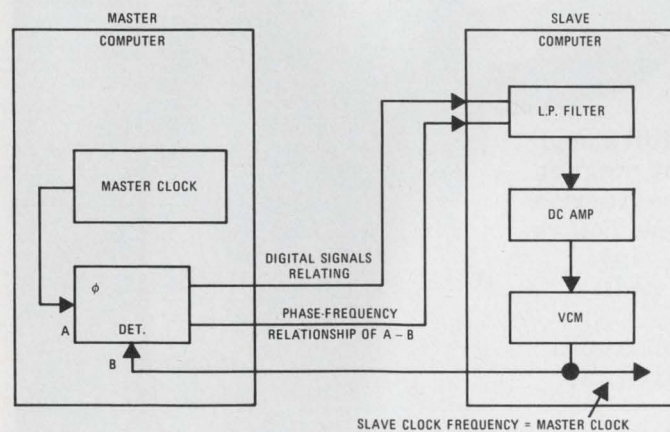

Now is the time to evaluate these "application-oriented" circuits. Call your local Motorola distributor for samples at low 100-up (DIP) prices of: MC4024/\$2.20, MC4044/\$2.20, MC4016/\$5.50, and MC4018/\$5.50. The devices are available in  $-55^{\circ}\text{C}$  to  $+125^{\circ}\text{C}$  (4300 series) and  $0^{\circ}\text{C}$  to  $+75^{\circ}\text{C}$  (4000 series) versions with packaging configurations to meet your requirements.

For complete specifications and applications data write to P. O. Box 20912, Phoenix, Arizona 85036. These devices could be the key answer to your design.



**MOTOROLA DIGITAL**  
IC Systems For The 70's!

# No drag. No lag.



Our new High Performance DC Motors get to full speed 100 times faster than conventional permanent magnet motors. Because the drag caused by excessive inertia has been practically eliminated by our unique hollow rotor design. And with low drag, you have little lag.

This can mean accelerations up to 900,000 radians/second<sup>2</sup>.

These features make our motors ideal for such applications as tape capstan drives, line printer drives and machine tool positioning.

There are 5 sizes available and options include: Integral low ripple tachometers, special shaft lengths and shapes and forced air cooling adaptations.

For more information on our low-inertia, High-Performance DC Motors, contact your MICRO SWITCH Branch Office (in the Yellow Pages under "Switches, Electric"). Or write for our special literature.

## MICRO SWITCH

FREEMONT, ILLINOIS 61032

A DIVISION OF HONEYWELL

HONEYWELL INTERNATIONAL—Sales and Service offices in all principal cities of the world. Manufacturing in Australia, Canada, Finland, France, Germany, Japan, Mexico, Netherlands, Spain, Taiwan, U.K. and U.S.A.



## The globetrotting 417 goes wherever the data is. (Even on a roller coaster.)

When you can't bring the data to the recorder, bring the 417 to the data. It's light (28 lbs.). Small (17" x 15" x 7"). Rugged (works under vibration and in any position). And accurate (equals large rack machines).

Made in wideband or intermediate models, it measures vibration, speed, air speed, G forces, shock, all kinds of physical data. On up to seven channels at once, IRIG compatible. Within the 417 series, direct frequency response ranges from 100 Hz to 375 KHz. FM

frequency response, DC to 100 KHz at 30 inches per second.

For power (normally 13w) the 417 can use its self-contained battery. Or, with accessories, it can use any power: 12 to 28v DC, 110 or 220v AC, 50 to 400 Hz.

You'll spend your time recording, too, not tweaking. Because the 417 is simple to use. And it needs less maintenance than any other recorder you can carry. If you should ever have a problem, there are thirty-five helpful

417 offices throughout the U.S.

You can take off with a 417 for as little as \$7,000. Around the lab, around the campus, or around the world. It's a go-getter.

For more intermediate and wide-band specs, write: Mr. Bob Mei, Dept. 413-10, Lockheed Electronics Company, Plainfield, New Jersey 07061. Or call him at (201) 757-1600.

**Lockheed Electronics**  
A Division of Lockheed Aircraft Corporation

Consider the GaAsLITE opto isolator.

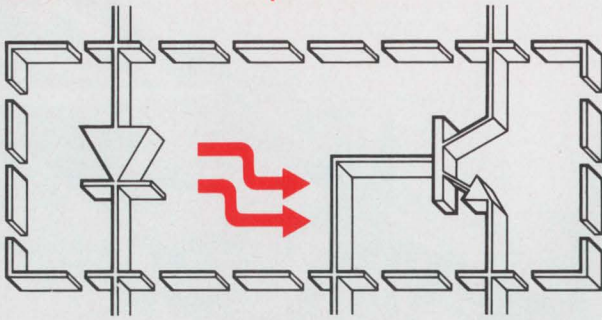

Couple a GaAsLITE to a silicon detector, and you get almost perfect isolation between input and output; 100,000,-000,000 ohms. Our opto isolators listed here do just that, and more. They give high performance at great speeds for very low cost. Scan the details. Each is packaged for mass production handling, and each is priced to suit quantity applications.



**MCT 2:**

**a GaAsLITE/phototransistor opto isolator compatible with semiconductors in digital or linear circuits.**

High current transfer ratio (35%) and isolation characteristics make the MCT 2 an ideal isolation transformer, pulse transformer, or relay. It can transmit a complex signal between subsystems without noise feedback.

The MCT 2 is a planar GaAs diode optically coupled to an NPN silicon planar phototransistor. It delivers hundred-billion-ohm isolation resistance and voltage isolation in excess of 1500 V, with coupling capacitance of 1.3 pF. New ISO-DIP six-lead plastic dual-in-line package makes it easy to work with and gives maximum economy.

Characteristics:

Max. emitter forward voltage 1.5 V @  $I_F = 100$  mA  
 Detector  $H_{FE}$  typ. 150 @  $V_{ce} = 5$  V,  $I_c = 100$   $\mu$ A  
 Bandwidth 300 kHz @  $I_c = 2$  mA

Price: 1,000 quantities, \$3.55. (All prices quoted are suggested resale price.)



**MCD 2:**

**if you need a really fast GaAsLITE opto isolator, this is it.**

In the MCD series, we've coupled a GaAsLITE to a diffused planar Si PIN photodiode. The new MCD 2 gives you a turn-on time of 5 nanoseconds, yet offers the high voltage (1500 V) and resistance ( $10^{11}$  ohms) isolation you need for amplifiers, isolation transformers, pulse transformers, relays, feedback circuits or logic switches. Its coupling capacitance is very low, too; 1.3 pF. It will perform beautifully in linear or digital circuits. And the ISO-DIP packaging makes pc board stuffing a snap.

Characteristics:

Max.  $V_F$  1.5 @  $I_F = 100$  mA  
 Typ. DC transfer ratio 0.2%  
 Bandwidth 8.5 MHz  
 Price: 1,000 quantities: \$3.95.

# GaAsLITE Update

How Monsanto GaAsLITEs, optically coupled to light detectors, become ideal switches for digital or linear circuits.

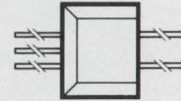

**MCS 1:**

**a new opto isolator — GaAsLITE/photo SCR—a SPST relay with no contact bounce, microsecond response and solid state reliability.**

High input-output isolation ( $10^{11}$  ohms with 2500 V breakdown) and 3 pF coupling capacitance make the MCS 1 perfect for high speed switching or relay functions where an IC is looking at AC line voltages or any application that now uses an equivalent SCR. A bi-stable device, with a built-in memory, it can be used as a latching relay in DC circuits and carry 200 V across the anode.

Characteristics:

$V_{AX} \geq 200$  @  $R_{GK} = 27K$   
 $V_{AK} = .9$  V (typ.) @  $I_A = 200$  mA  
 $I_F = 4$  mA } @  $V_{ce} = 50$  V,  $R_{GK} = 27K$   
 $I_H = .1$  mA }  
 Price: \$11 ea., 1,000's.

**Coupled pairs are in stock world wide**

You know that all of our products are available in the U.S. through Schweber (516) 334-7474; Semiconductor Specialists (312) 279-1000; K-Tronics (213) 685-5888; or Kierulff. You can get them overseas as easily:

- United Kingdom: SEMICONDUCTOR SPECIALISTS, West Drayton 6415
- France: YOUNG ELECTRONIC, 604-10-50
- West Germany: Alfred Neye, ENATECHNIK, (04106) 4022
- Denmark: SCANSUPPLY, AEGIR 5090
- Belgium: TECHMATION, 384078
- Netherlands: TECHMATION, 020-173727
- Norway: ARTHUR F. ULRICHSEN A/S, 21 6510
- Switzerland: OMNI RAY A.G., 051-478200
- Italy: SILVERSTAR LTD., 46.96.551
- Sweden: GP-INGENJOERSFIRMAN, 08/930280
- Japan: NEW METALS AND CHEMICALS LTD. CORP., (201) 6585-7
- Australia: HAWKER DE HAVILLAND AUSTRALIA PTY., LTD., 93-0221
- Israel: MONSEL

# Monsanto

For additional technical information write Monsanto Electronic Special Products, 10131 Bubb Road, Cupertino, California 95014. (408) 257-2140.

# Designer's Calendar

## OCTOBER 1970

S	M	T	W	T	F	S
				1	2	3
4	5	6	7	8	9	10
11	12	13	14	15	16	17
18	19	20	21	22	23	24
25	26	27	28	29	30	31

For further information on meetings, use Information Retrieval Card.

Oct. 26-28

Electronic & Aerospace Systems Convention (EASCON), (Washington, D. C.) Sponsor: IEEE. Richard Marsten, NASA Hdqs., Code SC, Washington, D. C. 20546.

CIRCLE NO. 401

Oct. 28-30

International Electron Devices Meeting (Washington, D. C.) Sponsor: IEEE. E. O. Johnson, RCA, 415 S. 5th St., Harrison, N. J. 07029.

CIRCLE NO. 402

## NOVEMBER 1970

S	M	T	W	T	F	S
1	2	3	4	5	6	7
8	9	10	11	12	13	14
15	16	17	18	19	20	21
22	23	24	25	26	27	28
29	30					

Nov. 15-19

Engineering in Medicine & Biology (Washington, D. C.). Sponsor: IEEE. Richard Johns, 522 Traylor Bldg., Johns Hopkins School of Medicine, Baltimore, Md. 21205.

CIRCLE NO. 403

Nov. 17-19

Fall Joint Computer Conference (Houston, Texas). Sponsor: IEEE. L. E. Axson, IBM Scientific Center, 6900 Fannin, Houston, Texas 77025.

CIRCLE NO. 404



## Abbott Offers Dependable Power Supplies at Reasonable Prices

*Are you tired of buying electronic power supplies that don't work... don't meet specifications... don't operate for very long? Are you concerned about the long term operation of your system? Then take a long look at Abbott's power supplies. They are built to operate trouble free for many years.*

Abbott is pleased to announce its new line of dependable 60 Hertz to DC power supplies. Abbott engineers spent two years developing this model "R" family. Their performance and reliability characteristics were "designed in" from the start. With a choice of any output voltage from 5 to 100 volts DC and output currents from 15 milliamperes to 20 amperes, their principle specifications are:

**INPUT:** 105-125 VRMS, 50-420 Hertz, 1 phase  
**LINE REGULATION:**  $\pm 0.05\%$  or 10 mv (whichever is greater) for input change of 105-125 VRMS  
**LOAD REGULATION:**  $\pm 0.05\%$  or 10 mv (whichever is greater) for change from no load to full load  
**RIPPLE:** 0.02% or 5 mv RMS (whichever is greater)  
**TEMPERATURE:** Operating:  $-4^{\circ}\text{F}$  ( $-20^{\circ}\text{C}$ ) to  $+160^{\circ}\text{F}$  ( $+71^{\circ}\text{C}$ ) without derating, forced air, or heatsinking. Storage:  $-67^{\circ}$  to  $+185^{\circ}\text{F}$ .  
**TEMPERATURE COEFFICIENT:** 0.03% per degree Centigrade

**SHORT CIRCUIT PROTECTION:** Each unit is completely protected against an overload or short circuit of any duration.

**SERIES OPERATION:** Two or more power supplies can be operated in series.

**RELIABILITY:** The mean time between failure (MTBF) per MIL-HDBK-217 under worst case operating conditions of full output current, maximum input voltage and  $+160^{\circ}\text{F}$  ambient, is 22,026 hrs. for 20 amp. models, increasing to 47,281 hrs. for 0.15 amp. models. At  $+104^{\circ}\text{F}$  ambient, the MTBF increase to 63,898 hrs. and 141,243 hrs., respectively. (Complete reports available on request.)

Abbott also manufactures 3,000 other models of power supplies with output voltages from 5.0 to 10,000 volts DC and with output currents from 2 milliamperes to 20 amperes. They are all listed with prices in the new Abbott catalog with various inputs:

28 VDC to DC, regulated  
 28 VDC to 400 Hz, 1 $\phi$  or 3 $\phi$   
 28 VDC to 60 Hz, 1 $\phi$

400 Hz to DC, regulated  
 60 Hz to DC, hermetically sealed  
 60 Hz to 400 Hz, 1 $\phi$  or 3 $\phi$

Please write for your FREE copy of Abbott's new catalog or see EEM (1970-71 ELECTRONIC ENGINEERS MASTER Directory) Pages 930-939.

**abbott transistor**

LABORATORIES, INCORPORATED

5200 W. Jefferson Blvd./ Los Angeles 90016  
 (213) WEBster 6-8185 Cable ABTLABS

To: Abbott Transistor Labs., Inc., Dept. 91  
 5200 West Jefferson Blvd.  
 Los Angeles, California 90016

Sir:  
 Please send me your latest catalog on power supply modules:-

NAME \_\_\_\_\_ DEPT. \_\_\_\_\_  
 COMPANY \_\_\_\_\_  
 ADDRESS \_\_\_\_\_  
 CITY & STATE \_\_\_\_\_

INFORMATION RETRIEVAL NUMBER 10

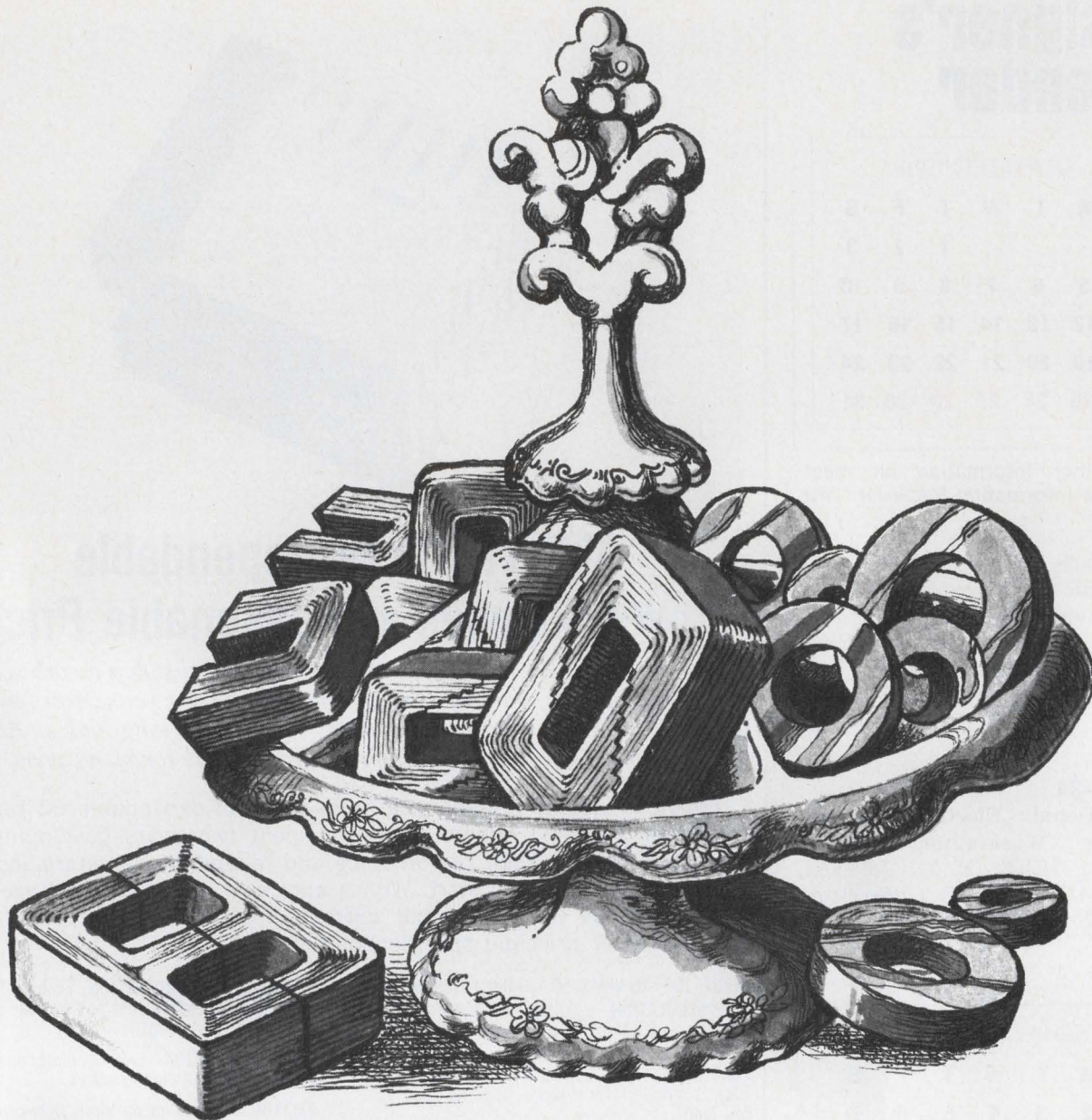

## Silectron selection.

**What you want, when you want it—Arnold's rugged family of cut, toroid, and DG Silectron cores.**

The choice is yours. For power or control transformers, saturable reactors, inductors, magnetic amplifiers, and pulse transformers—our Silectron C- and E-cut cores. For power current transformers, and circuit breakers—our Silectron toroidal cores. For reducing watt loss and exciting current in distribution transformers—our distributed gap (DG) Silectron cut cores.

All bear the stamp of consistently high quality. Backed by 100% inspection. Plus our fast, responsive delivery.

Rugged, compact Silectron cores from Arnold. In a wide variety of thicknesses (1, 2, 4, and 12 mil) and shapes. Easy to assemble into your finished product. Now's the time to call or write.



**ARNOLD**  
SPECIALISTS IN MAGNETIC MATERIALS

The Arnold Engineering Co., Dept. D-1, Marengo, Illinois 60152 • Member Company of Allegheny Ludlum Industries • Branch Offices and Representatives in Principal Cities

INFORMATION RETRIEVAL NUMBER 11



# Price Breakthru!

Now, on FET switches, drivers for industrial use ( $-20^{\circ}\text{C}$  to  $+85^{\circ}\text{C}$ )

\$3/channel\* buys you 6 channels of MOS switching complete with DTL/TTL compatible drivers.

Package is hermetic seal, ceramic dual-in-line.

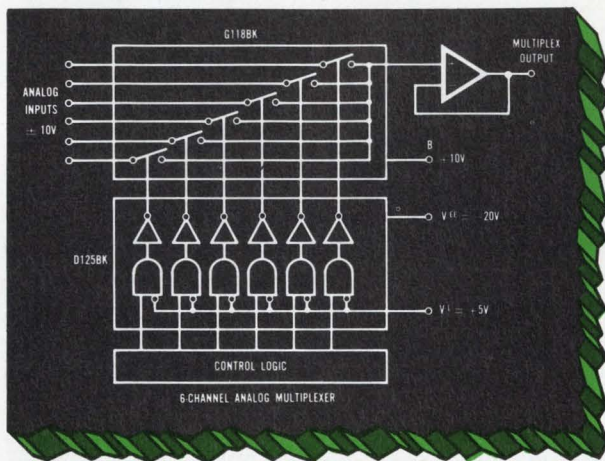

Use them for:

- Multiplexing 1 mV-10 V
- Sample-and-hold
- D/A converters
- General switching
- Interfacing low level logic to MOS or JFET switches

\* 100 piece price

For complete information on the D125BK, G118BK or others in this series, call any of the offices listed below.

**New York:** Sy Levine (516) 796-4680  
**New England:** Al La Croix (617) 769-3780  
**Ft. Worth/Dallas:** Charlie Williams (214) 231-8151  
**St. Louis:** Jim Spicer (314) 291-3616  
**Minneapolis:** Ed Koelfgen (612) 920-4483  
**Southern California:** Dave Ferran (213) 420-1307  
**Northern California:** Chuck Brush (408) 246-8000



**Siliconix incorporated**

2201 Laurelwood Road • Santa Clara • California 95054  
Telephone (408) 246-8000 Extension 201 • TWX: 910-338-0227  
In Europe: Siliconix Limited, Saunders Way, Sketty, Swansea, Great Britain

INFORMATION RETRIEVAL NUMBER 12

# OUR ANGLE: four frequency phase angle voltmeters

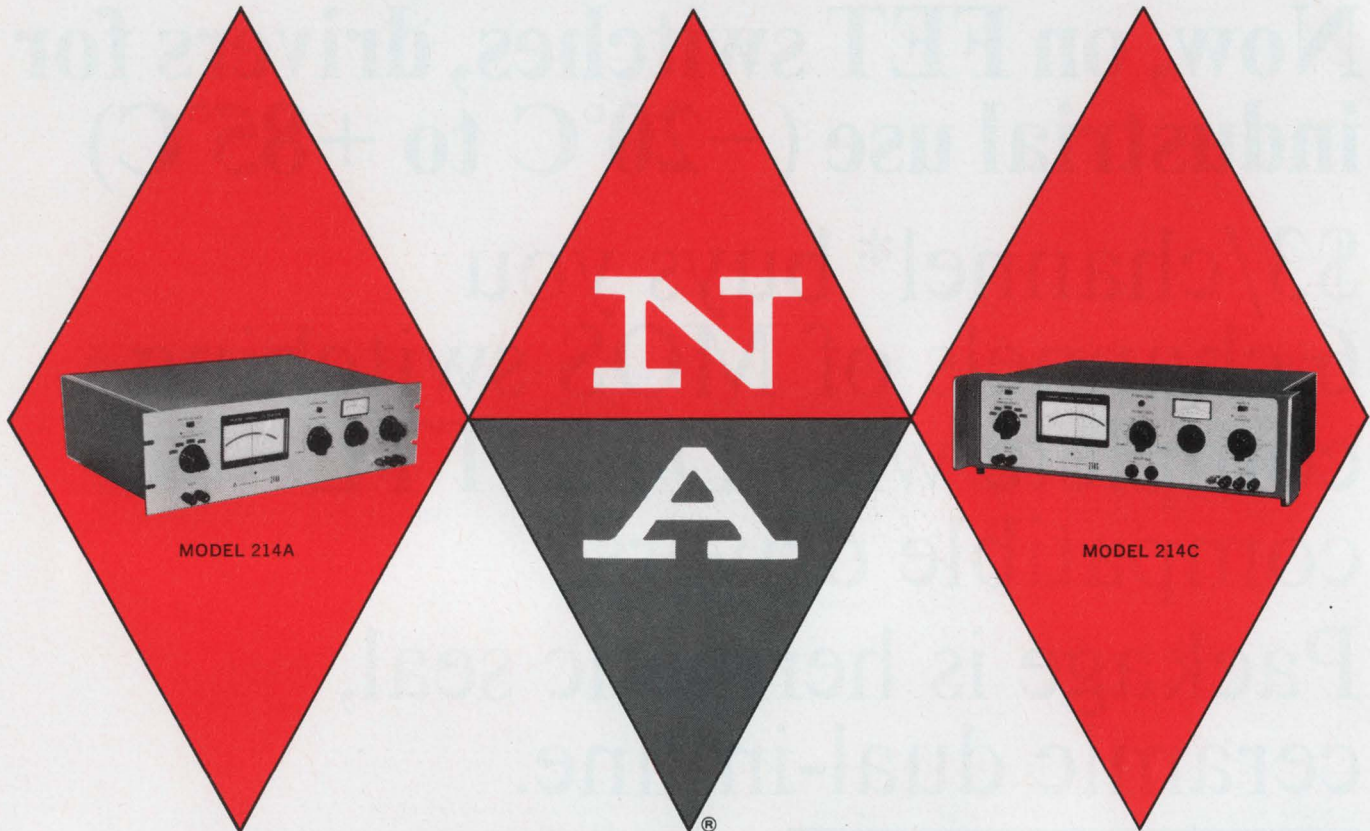

## CAN YOU THINK OF A BETTER ANGLE TO AVOID OBSOLESCENCE?

North Atlantic's 214 FOUR-FREQUENCY PHASE ANGLE VOLTMETER introduces a new flexibility in AC voltage measurements. It enables direct reading of null balance, total voltage, fundamental voltage, in-phase voltage, quadrature voltage, and phase angle.

It's also pre-wired to handle four operating frequencies from 30Hz to 20kHz, which means extended longevity and broader application. Even if you only need one frequency, there are three extra spots to add other frequencies later. Frequency changes can be made rapidly and conveniently in the field with plug-in modules. The 214 can be completely recalibrated at the installation site by a single rear-panel adjustment.

Harmonic rejection and high signal overload design of the unit screens out conventional distortion and errors in measurement and calibration. The all solid-state Model 214 offers full accuracy over  $\pm 5\%$  bandwidth,  $1^\circ$  phase measurement, adjustable meter scaling for go/no-go testing, and  $300 \mu\text{V}$  full-scale sensitivity. Priced from \$1215.00.

Options? Other models offer  $0.25^\circ$  phase accuracy, lower-cost single frequency operation, broadband phase-sensitive performance from 10Hz to 100kHz.

Whether your AC measurements are large or small, contact your North Atlantic sales engineering representative today. He'll show you a new angle to your AC voltage measurements.

**NORTH ATLANTIC**  
*industries, inc.*

200 TERMINAL DRIVE, PLAINVIEW, NEW YORK 11803  
cable: noatlantic / twx: 510-221-1879 / phone: (516) 681-8600

INFORMATION RETRIEVAL NUMBER 13



# Let there be light

Optoelectronics is on the move.

In card and tape readers. In star trackers. In computer peripherals and light-actuated switching. In spectrophotometry and burglar alarms. In optical logic drives, shaft encoders and movie projectors. In test and inspection equipment. In visual displays and autos and home appliances. In just about everything.

The day is even seen when optoelectronics may give us the much-talked about picture-frame or flat-screen TV receiver where thousands of multi-colored LED's are excited by many sets of lines driven by integrated circuits.

Opto offers a degree of control not possible through other methods. It is virtually "the perfect switch." It has the speed of light. It furnishes sensitivity acute enough to detect infrared and ultraviolet luminance. It has no moving parts and life expectancy is in excess of 100 years. Its prices are down to a universally-desirable, dollar-and-less range.

You may interface with optoelectronics sooner than you think.

So you're prepared for what's coming, we've prepared a special, basic design guide containing application notes, selector and cross-reference lists, data sheets and where-to-get-it-now information. You'll find out about theory and characteristics of photodevices, static and dynamic conditions, switching parameters, geometric considerations, area sources and lens systems, fiber optics and applications, definitions (like Nits, Luxes and Candelas) plus several circuits suited to dc, low and high-frequency applications.

And, if you're looking for complete data on the best devices to evaluate and design in, complete specs on the bright new introductions on the next page, as well as Motorola's complete capability in emitters, detectors and arrays, will be included to help show you the way.

Send to Box 20912, Phoenix 85036 for our "Let There Be Light" brochure. It's a good start.

**Begin with  
Motorola Optoelectronics**

# Your light source... Optoelectronics from Motorola

## Light Emitters

Compactness, reliability and compatibility with integrated circuits keynote light-emitting diode advantages — as well as perfect spectral-matching of IR units to

silicon detectors. Six Motorola red and infrared, fast-switching types now offer flexibility in package, performance — and price!



LED BRIGHTNESS/POWER OUTPUT vs FORWARD CURRENT

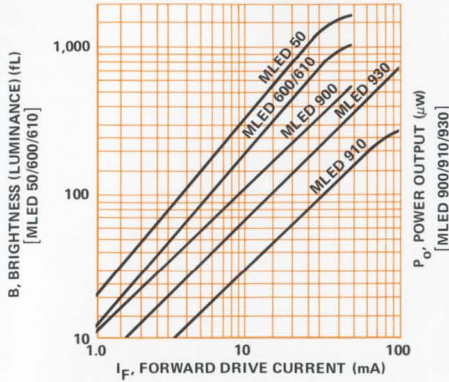

LED	Color	Application Advantage	Package	Peak Emission Wavelength (nm)	Brightness (typ.)	Price 100-up
MLED50	Red	Tiny, Bright, Plastic Performer	Plastic Micro-T	6,600	750 fl @ 20 mA	\$1.50
MLED610	Red	High Density Reliability	Pill	6,600	450 fl @ 20 mA	\$2.60
MLED600	Red	Fast, Low-cost, Visibility	Plastic Mini-T	6,600	450 fl @ 20 mA	\$1.95
MLED900	IR	Economical Power Output	Plastic Mini-T	9,000	550 μW @ 50 mA	\$1.50
MLED910	IR	Direct, PC Board Matrix Assembly	Pill	9,000	150 μW @ 50 mA	\$2.40
MLED930	IR	Rugged Match for Any Detector	TO-18	9,000	650 μW @ 100 mA	\$3.30

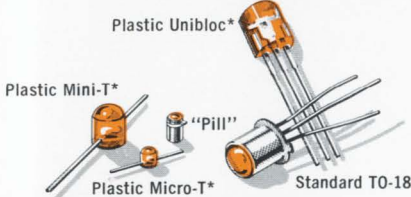

## Light Detectors

Control light-to-current flow with 23 different diodes, PIN's, transistors and Darlingtons for optimized optical performance in dc to high-frequency designs. Sensitive, fast and rugged, Motorola detectors are 100-up-priced low as 80¢ in metal hermetic packages!

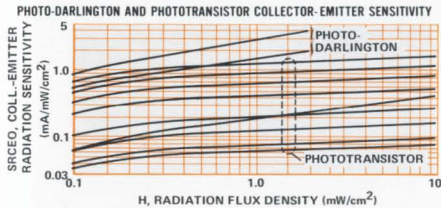

Detector	Type	Application Advantage	Package	Sensitivity (mA/mW/cm²)	Dark Current (max) nA	Switch Time = tr + tr (max) μs	Price 100-up
MRD100	Transistor	Smooth, Clean Arrays/ Matrices	Plastic Micro-T	0.04 (min)	100	6.5	\$1.00
MRD150	Transistor						\$ .80
MRD200	Transistor	2 Subminiature Lenses, Multiple Sensitivities	Pill	0.25 (min) 0.05 (min) 0.1 (min) 0.04 (min)	25	6.5	\$2.60
MRD210	Transistor						\$2.30
MRD250	Transistor						\$2.40
MRD600	Transistor						\$2.10
MRD300	Transistor	Control Flexibility, Angular Reliability	TO-18	0.8 (min) 0.2 (min)	25	6.5	\$7.00
MRD310	Transistor						\$3.00
MRD450	Transistor	Uniform Sensitivity through Unique Lens	Plastic Mini-T	0.2 (min)	100	6.5	\$ .75
MRD500	PIN Diodes	Fast, Low-Light Reaction	TO-18	1.2 (min)† 0.3 (min)†	2	1 ns (typ)	\$7.25
MRD510	PIN Diodes						\$6.60
MRD810	Transistor	Optimum Optical Performance	TO-18	0.2 (min)	50	11	\$4.00
MRD3050	Transistor	Plastic-Priced Metal Package	TO-18	.02 (min) .04 (min) .02 to .08 .05 to 0.2 .125 to 0.5 .3 (min) .4 (min)	100	5.5 (typ)	\$ .80
MRD3051	Transistor						\$ .90
MRD3052	Transistor						\$1.20
MRD3053	Transistor						\$1.20
MRD3054	Transistor						\$1.30
MRD3055	Transistor						\$1.40
MRD3056	Transistor						\$1.60
2N5777	Darlington Amplifiers	Ultra-High Sensitivity, 5,000 h <sub>FE</sub>	Clear Plastic Unibloc	2.0 (typ) 2.0 (typ) 4.0 (typ) 4.0 (typ) 1.0 (typ)	100	400	\$ .50
2N5778	Darlington Amplifiers						\$ .55
2N5779	Darlington Amplifiers						\$ .70
2N5780	Darlington Amplifiers						\$ .80
MRD14B	Darlington Amplifiers						\$ .40

39-Element Diode Array

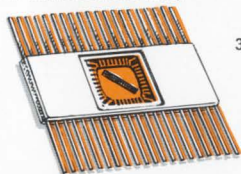

31-Element Transistor Array



## Arrays

The challenges in character recognition are rapidly being met with the introduction of the industry's first standard, 39-element monolithic diode array in a ceramic flat-pack plus a new transistor array with 5-mil spaced elements . . . as well as Motorola's recognized leadership in customizing individual requirements. Cost-cutting, finished packaging and optimized performance matching are the advantages when you go "the Motorola array way" for your OCR applications!

LED/DETECTOR SPECTRAL MATCHING CHARACTERISTICS

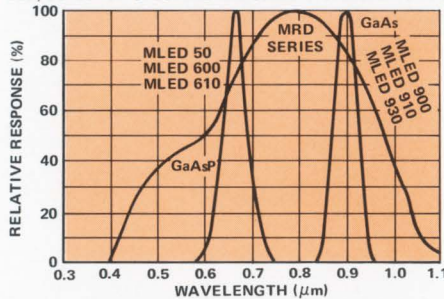

100-Element, 1.4" Custom Diode Array

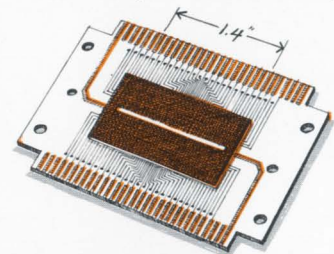

Array	Type	Application Advantage	Package	Sensitivity @ H = 5mW/cm² (nA/mW/cm² min.)	Dark Current (max) nA	Price 100-up
MRD6039D	39-Element Diode	State-Of-The-Art Resolution	(Ceramic Flat-Pack)	14	2	\$100.00
MRD6039T	39-Element Transistor	Super-Sensitivity in a Standard Package	(Ceramic Flat-Pack)	300	10	\$116.50

\*Trademark Motorola Inc.

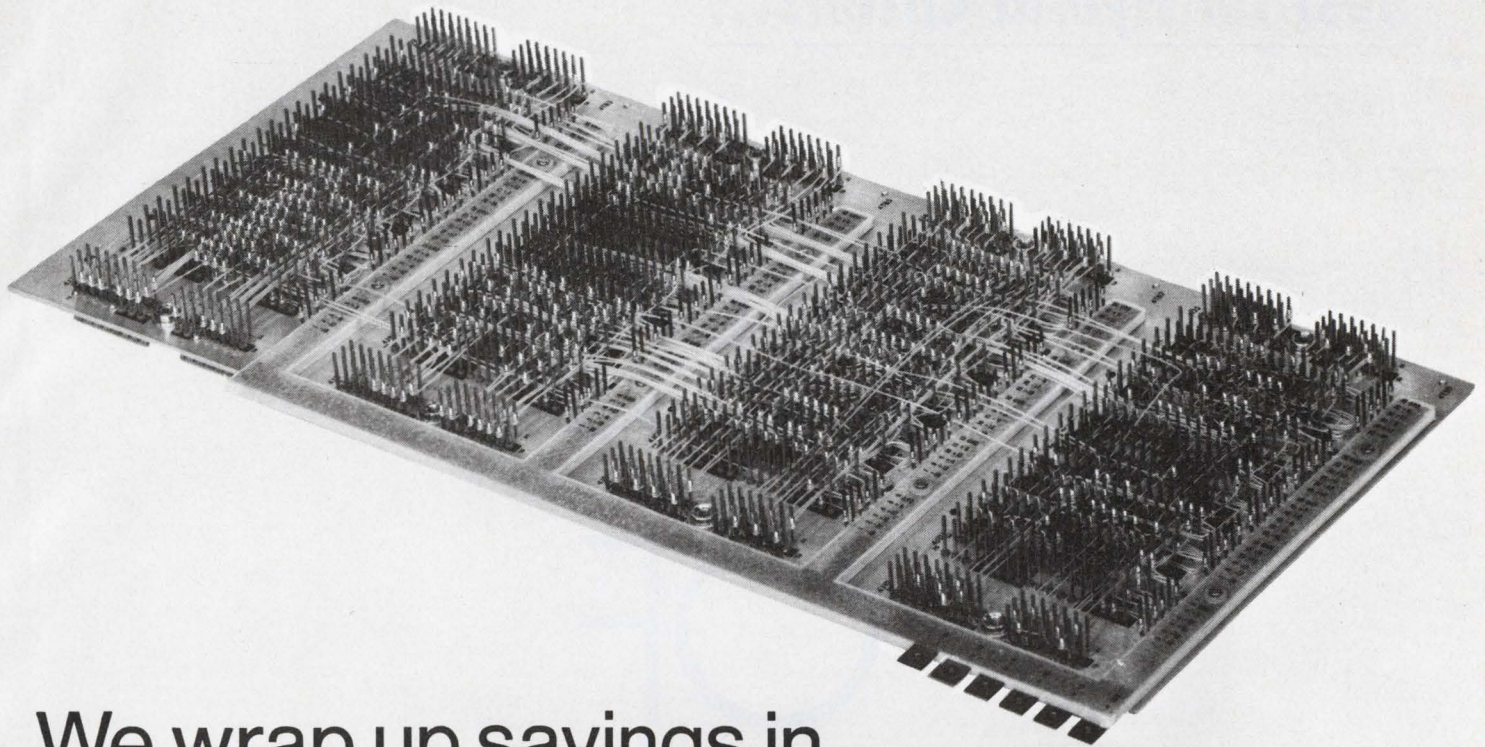

## We wrap up savings in interconnection packages three important ways.



*Hand wrapping*



*Semi-automatic machine wrapping*



*Fully automatic Gardner Denver machine wrapping*

Our "Total Packaging Service" has helped a lot of our customers save a lot of time and money. And it's helped make us the largest manufacturer of metal plate back panel interconnection systems.

It's complete interconnection system packaging from design to wire wrap termination.

We deliver in six weeks.

That's it in a nutshell. Now, here's how it works:

You can call us in on the design stage. We'll sit down with you and help design a p.c. board or frame or metal plate back panel system to do exactly what you want it to do. With our experience we can save you problems. And problems cost money.

Next come the connectors. We have all you're likely to require; several hundred thousands of them. All standard. Maybe they used to be special, but now they're standard. You save again. For square or offset grids. On .100", .125", .150", or .200" centers. Or non-standard configurations if you need them.

And, finally, your wire termin-

ations. (You could send us your back panels and your wire list even this late in the game and we could still save you enough money to make it worth your while.)

You have three choices here: hand wrapping, semi-automatic machine wrapping, or fully automatic Gardner Denver machine wrapping. We handle the computer programming for the automatic and semi-automatic wire wrapping so you get not only accuracy, but minimum wire lengths and densities, too. You save again.

Add it up: three important ways you can save on your back panel interconnection systems. And we haven't even mentioned the remote possibility (perish the thought) of something not being quite right with the final package. Single source responsibility can save you all kinds of time and money.

For the rest of the details, call our Interconnections Manager, Jim Scaminaci, at (213) 675-3311, Ext. 235. Collect. Or write Elco Corporation, Willow Grove, Pennsylvania. 19090. (215) 659-7000. TWX 510-665-5573



**ELCO** Interconnection Systems

**Best for Hybrid Circuits...**

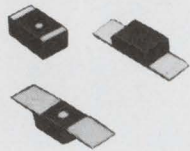

# PIPS OF CHIPS

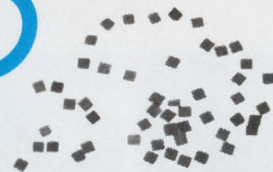

## **DOMINO<sup>®</sup> Molded Solid-electrolyte Tantalum Capacitors**

Designed for hybrid circuit and low-profile flatpak printed circuit board applications. Fully-molded construction for superior mechanical and humidity protection. Excellent stability. Compatible with automatic insertion equipment. Available with and without extended tab terminals.

*Write for Engineering Bulletin 3532.*

## **MONOLYTHIC<sup>®</sup> Chip Ceramic Capacitors**

Offer a unique combination of high volumetric efficiency, wide selection of capacitance ranges and body formulations, and moderate cost. Excellent adherence of metallized terminations eliminates problems often encountered with other chip ceramic capacitors. Available in four EIA-preferred chip sizes.

*Write for Engineering Bulletin 6200.*

Technical Literature Service  
Sprague Electric Company  
347 Marshall Street  
North Adams, Mass. 01247

45-0148



**THE BROAD-LINE PRODUCER OF ELECTRONIC PARTS**

INFORMATION RETRIEVAL NUMBER 16

# Highlighting

THE ISSUE



Imagine an alphanumeric read-out that requires only microwatts of drive power and is totally insensitive to ambient light level. Consider a transducer that can take an image transmitted at any frequency and convert it to an optical image. Or how about a pilot light that costs one-hundredth of a cent, an inexpensive thermal mapping device, a cancer detector, a smog sniffer or a flat-screen color TV set?

These are a few of the present and envisioned applications of a state of matter called liquid crystals.

Incorporated into the experimental digital volt-ammeter shown above are seven-segment liquid-crystal displays.

**Page 76**

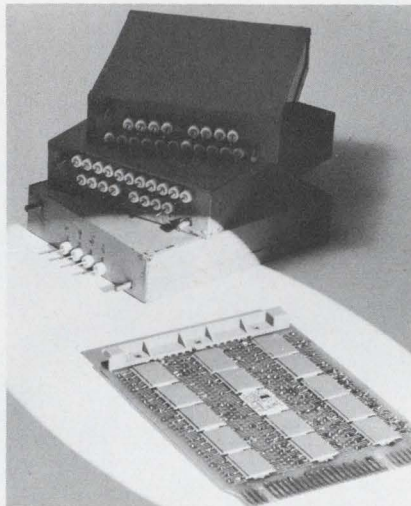

For designers of microminiaturized circuits, the inductor, as we know it today, is dead. It's simply too large to fit into the design. If it's shrunk too much, its performance deteriorates. As a result, there has been a "falling domino" effect in the design of low-level signal and communications circuits.

In place of the old inductor, an ingenious substitute has turned up: the capacitor-loaded gyrator. And in place of inductor-capacitor (LC) electromagnetic filters, further substitutes have been devised, such as active operational amplifier filters that simulate simple or complex filter networks.

The photograph above shows the microelectronic equivalent of three conventional LC filters.

**Page 27**



Using a matrix ( $M_x$ ,  $M_y$ ) electrode between its first and second grids, a new multibeam CRT allows the direct display of any numeral, character, symbol, sketch or diagram on its fluorescent screen by simply changing the applied voltages to its 7 by 5 matrix electrode.

At each of 35 crosspoints formed by the intersection of the horizontal and vertical bars of the matrix, a hole is present. By applying a positive voltage with respect to the cathode to both  $M_x$  and  $M_y$  bars, the CRT's electron beam is passed through only those crosspoint holes where a positive voltage is simultaneously present at both  $M_x$  and  $M_y$  bars.

**Page 119**

**TI's quiet  
revolution in  
optoelectronics**

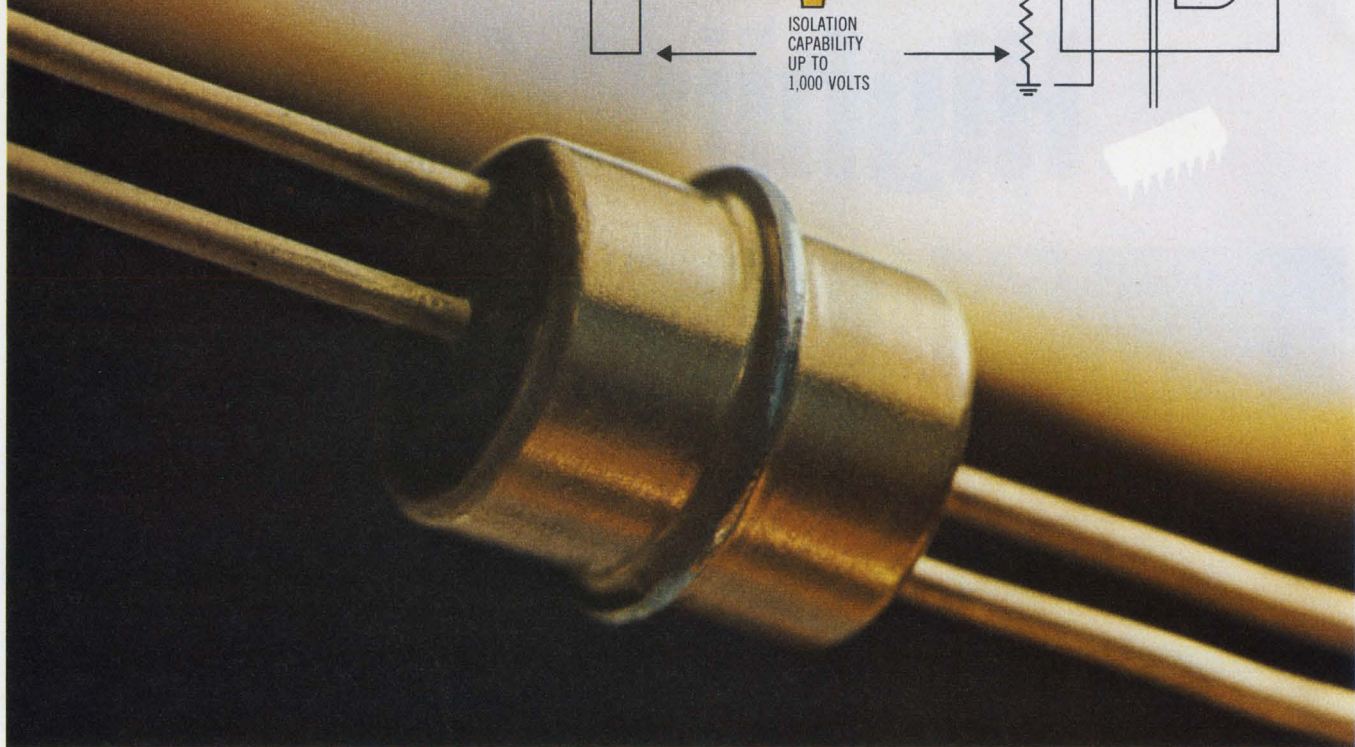
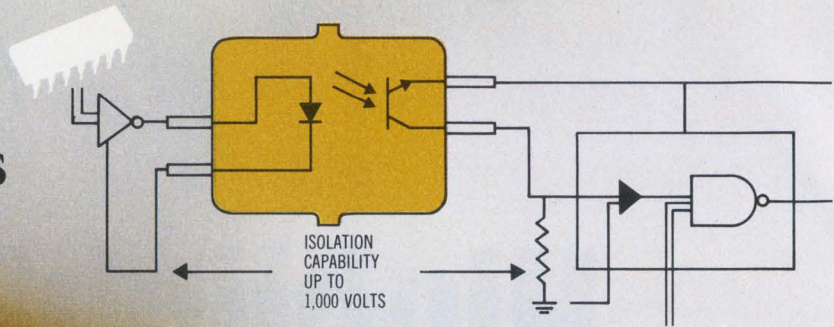

## Volume is up, prices are down on TI's optically-coupled isolators.

**Now get all the advantages of optical interfacing – and economy, too.**

Big demand has increased our production...and brought prices down more than 50% on TI optically-coupled isolators (OCIs).

TIL 107 is \$2.95; TIL 108 is \$3.50 (both 100-999 quantities).

That's how little it takes to gain these new benefits for your interface circuit design.

### Isolation to 1000 volts.

Input/output isolation of up to 1000 volts allows for the simple interface of different voltage levels and suppresses troublesome high voltage transients.

### Greater noise immunity.

Electrical isolation of the input diode and output transistor eliminates ground loops and noise signal transmission.

### Lower design costs.

TI OCIs handle the job alone. You don't need complex circuits to pass noise-free signals between input terminals and computers and along transmission lines.

Plus, you get these advantages over relays and pulse transformers: Response from dc to 100 kHz. High shock and vibration immunity. Bounceless action. Speeds to 5  $\mu$  sec. Wide operating temperature range. Longer Life.

### Smaller size.



TI OCIs fit into high density situations with ease. The twin TO-18 metal can is just 0.206" x 0.220" diameter.

Performance is improved, too. A more efficient emitter guarantees a 1.6 mA output for a 15 mA input. Enough to drive DTL/TTL logic without additional components. You cut space, weight, power and system costs.

Both OCIs are available now. Call your TI sales office or authorized distributor. For a data sheet, write Texas Instruments Incorporated, PO Box 5012, MS 308, Dallas, Texas 75222.



**TEXAS INSTRUMENTS**  
INCORPORATED



## Tiny laser hailed as key to communications system

MURRAY HILL, N.J.—A practical laser communication system capable of carrying millions of telephone channels may be in the offing, once development is completed on a semiconductor laser recently announced here by Bell Telephone Laboratories.

"This is the laser we have been waiting for," says Rudolph Kompfner, associate executive director of communications research at Bell Laboratories. "One could build a laser communication system now [with previously available lasers] but it wouldn't be efficient."

The new semiconductor laser, invented by Izuo Hayashi, a physicist, and Morton Panish, a chemist, is the result of interdisciplinary research that Bell Laboratories has emphasized for years.

The pinhead-size laser is a gallium-arsenide and aluminum-gallium-arsenide sandwich that is doped with tin, silicon, zinc and germanium. When forward bias is applied to the p-n junction formed with these materials, the hole-electron recombination is confined to a very narrow strip at the junction. Milliwatts of light can be emitted with an ordinary flashlight battery as a power source.

Previously semiconductor lasers operating at room temperature had to be pulsed to prevent them from burning out. To operate them continuously, they had to be cooled. The critical balance in developing the new laser was to come up with a material and a structure that would operate at a low enough energy level so the temperature threshold would not vary with power input.

Kompfner says his organization is working on a communication system that will use this laser to transmit a beam of light through pipes that are filled with gas or partially evacuated. Gas lenses or



**New semiconductor laser makes a penny look big.** This is the first of its kind to run continuously at room temperature. The power source is no larger than a flashlight battery.

conventional optics are being considered to focus the beam.

In announcing the development at a press conference here Kompfner emphasized that much exploratory work had to be done. But the laser does combine the characteristics needed for use in a large system. It is simple, efficient, inexpensive and compact—and it operates continuously at room temperature.

### Hologram color maps suggested for fliers

Holographic films of color maps, stored in a cassette, may one day be used by pilots of military aircraft, according to RCA's Defense Electronic Products Div. in Moorestown, N. J.

Such maps would be displayed to a pilot and moved in synchronism as the aircraft flew over the terrain. The advantages of hologram over ordinary film techniques, RCA says, include:

- Inherent redundancy that makes such systems immune to dust scratches.
- Low relative cost.
- Faster access to a given image.
- Elimination of complex optical equipment.
- Ability to store new information in a smaller area.

The map display, being studied for the Navy by RCA, would draw upon technology similar to that used in RCA's SelectaVision TV tape player.

### System warns pilots against aquaplaning

A system to warn airline pilots against the possibility of aquaplaning—skidding along on a thin film of water on the runway—has completed successful operational trials at London's Gatwick Airport.

Flight tests have shown that on untreated runways only 0.05 inch of water can cause aquaplaning. The new system—called Aquaplaning Risk Indicator for Landing—uses sensing heads placed at selected points in the runway to measure the depth of water—from 0.6 to 0.006 inch—with an accuracy of  $\pm 0.001$  inch.

Although cables are currently used to transmit data from the runway to the control tower, a radio telemetry link is to be installed later to send the data to a computer on board the aircraft.

### Electronics industry seen headed for a leveling-off

The U. S. economy will start to bounce back this winter and will grow substantially during the next two to three years, but the electronics market will not show any appreciable rise for at least two and probably three years, Dr. John V. N. Granger, president of IEEE, predicts.

In addressing 650 electronic manufacturers at a Wescon-sponsored luncheon meeting in the Los Angeles Hilton, he attributed the lag in growth to several reasons. One, he said, is tight money.

"Any technological industry needs continued infusions of capital to stay alive," Granger said.

A second reason for the lag, he said, is that Government support for electronics will be out of political favor for the next few years. And a third reason he cited is growing competition from abroad. Foreign competition has already overtaken us in the consumer area, the IEEE chief said, and is spreading to such other areas of electronics as instrumentation.

But when the electronics upturn does come in about three years, Granger predicted, it will be sharp, sparked partly by renewed defense contracts and partly by growth in industrial electronics.

The main thrust of electronics growth, Granger said, will come from the industrial market. EDP, transportation, avionics, highway traffic control, automotive and marine electronics, and telecommunications studies made by Stanford Research Institute economists, he said, indicate that the electronics market will rise faster than the Gross National Product during the years following 1973. From 2.5% of the GNP in 1970, the electronics market will jump to 3% in 1975 and to about 3.4% in 1980, Granger said.

## U.S. science post going to Bell Labs executive

Senate confirmation of Dr. Edward E. David as the new Science Adviser to the President is expected this month.

David, a 45-year-old executive director at Bell Telephone Laboratories in Murray Hill, N. J., is an adviser to the National Science Foundation, the Dept. of Defense and a number of other governmental and engineering organizations. He has received awards as an "outstanding engineer" from his alma mater, the Georgia Institute of Technology, and from Eta Kappa Nu. He brings to Washington a unique blend of computer specialist and humanist.

"Many of the great problems of our society are the products of technology and call for technological

solutions. I am thinking here of environmental pollution and invasions of privacy," David noted in a recent speech on education.

## First cartridge-TV plant starts operating in West

The first facility in the United States for the manufacture of magnetic tapes for cartridge television has begun operation. Being built by Cartridge Television, Inc., in San Jose, Calif., the plant—a subsidiary of Avco Corp.—cost \$2-million, covers 145,000 square feet and employs 250 technicians and electronics specialists. Mass production of blank and pre-recorded tapes for the company's new home cartridge color TV system, called Cartrivision, will begin this year.

## NASA plans to monitor earth's carbon monoxide

In an effort to bring space work down to earth, NASA has awarded a contract for the development of a satellite-borne sensor to measure atmospheric pollution.

The sensor, which is to keep track of carbon monoxide concentrations over the earth, will be developed by the General Electric Co.'s Space Div. in King of Prussia, Pa., under a contract with NASA's Langley Research Center in Norfolk, Va.

GE will first develop and demonstrate a laboratory version and then an engineering model that it will test-fly in a balloon or an aircraft. The 30-month effort is valued at \$1,077,000.

The main subcontractor is Barringer Research Ltd. of Toronto, which developed the main ingredient of the sensor—a correlation interferometer capable of detecting very small amounts of gas constituents in the air.

The device is to make global measurements of carbon monoxide over a period of a year. The end result will be a map showing those portions of the earth's atmosphere with high, low and average concentrations of the poisonous gas. In this way scientists hope to pinpoint where the gas is mysteriously converted to another compound and how it is done. Evidence that

such a natural conversion takes place is based on the fact that despite the 200 million tons of carbon monoxide generated in the world every year, the earth's atmosphere remains at a level of approximately five million tons.

## New 'voiceprint' system uses a minicomputer

A system to identify a person by comparing his voice with a "voiceprint" previously stored in a minicomputer is under development at Voiceprint Laboratories, Somerville, N.J. Useful for companies or agencies with tight security systems the new Speaker Recognition System provides positive identification, according to William E. Hughes, vice president of Voiceprint Laboratories.

The system uses a Varian 620/i computer that is linked to a 16-channel multiplexing converter. The voice input is applied to a special filter bank that separates the speech into complex spectral components—this over the telephone range of 200 to 3000 cycles.

Positive identification can be obtained, according to Hughes, because no two voices are alike.

## Satellite communications seen facing competition

Satellite communications will not be able to compete economically with conventional communications media for at least a decade, according to one of President Nixon's top technical advisers. Speaking in New York City at a conference on the Revolution in Transmission of Business Information, Ralph L. Clark, associate director of the Presidential Office of Telecommunications Policy, explained that decreases in the cost of conventional long-haul transmission were making it very hard for satellites to compete.

Even for transoceanic communications, where most people agree that satellites have a distinct advantage over cable, Clark said, "Based on hard, cold economics, the new transoceanic telephone cables can give satellites a tough run for their money in international service."



**THEY'RE MOLEX EDGE CONNECTORS. "Straight-on" or "right-angle" types for printed circuit boards. Terminals crimped to wires automatically. Reliable? And how! Connector terminals are bifurcated. Provide a really solid contact. Yet you can slip the connector on and off time after time without any damage to the printed circuits. And it's not a preload unit. Carries only contacts required. From six to twenty-four. Comes in white or six other colors. Terminals available in tin-plated brass with gold plating or selec-**

**tive gold plating. ■ A good example of how Molex helps create high-speed low-cost devices that simplify circuitry. If you want to save assembly time, steps and money, take a close look at these Molex edge connectors. For free samples write: Molex Incorporated, Downers Grove, Illinois 60515. Or you can make connections by calling (312) 969-4550.**

*...creating components that simplify circuitry*





When you're adding a new "twist" to tornado tracking...

Symbolic representation of global weather as plotted by Burroughs ILLIAC IV computer.

## bring ERIE in early.

Cyclone off Ceylon. 17-inch snow at Salem. Tropical storm in Trinidad. World-wide weather reports? No, forecasts! Made four days in advance... with the same accuracy as present one-day predictions. That's just one of the superscale jobs possible with the incredible new ILLIAC IV computer designed by the University of Illinois and built by Burroughs Corporation. Unlike conventional computers that process serially, ILLIAC IV utilizes parallel processing... crunching numbers on many matrix problems or differential equations simultaneously, and at super speeds. From the start, ERIE engineers have worked closely with Burroughs to develop the highly-sophisticated resistor/capacitor and resistor modules at the heart of ILLIAC IV. Proof, once again, that it pays to bring ERIE in early.

**ERIE TECHNOLOGICAL PRODUCTS, INC.**  
644 West 12th Street, Erie, Pennsylvania 16512  
(814) 453-5611

# Microminiaturization is forcing inductors out

## Designers are using electronic micro-equivalents that are competitive in performance and cost

**Jim McDermott**  
East Coast Editor

For designers of microminiature circuits, the inductor, as we know it today, is dead. It's simply too large to fit into the design; if it's shrunk too much, its performance deteriorates. As a result, there has been a "falling domino" effect in the design of low-level signal and communications circuits.

In place of the old inductor, an ingenious substitute has turned up: the capacitor-loaded gyrator. And in place of the inductor-capacitor (LC) electromagnetic filters, further substitutes have been devised: active filters that simulate simple or complex filter networks; ceramic filters that substitute for i-f transformers; and monolithic quartz filters providing super-selectivity.

The substitute devices are finding use in circuits that operate over frequency ranges from a few hertz to tens of megahertz. And they are reported to produce filter networks that work better than the old networks did.

### The 'ideal' proves elusive

The ideal microelectronic substitute for an inductor would be a two-port microcircuit fabricated on a silicon monolithic chip and having an equivalent inductive reactance and Q. But, as yet, there is no such micro-sized monolithic substitute.

"As far as the complete realization of monolithic active filters is concerned," Dr. George Moschytz, supervisor of the Active Filter Group, of Bell Laboratories, Holmdel, N.J., told ELECTRONIC DESIGN, "I don't think there's too much hope in the near future. But we can combine thin-film passive components, such as tantalum resistors and capacitors, with monolithic structures, like gyrators or operational amplifiers, and produce a hybrid element that has the neces-

sary temperature stability. This temperature stability, incidentally, is much higher than that of the passive inductor or LC network."

The capacitive-loaded gyrator is proving to be the simplest and most logical microcircuit substitute for an inductor. Comprised of active devices, resistors and capacitors, it has the electrical characteristics of an inductor.

It is a two-port device that transforms its load admittance by interchanging the roles of voltage and current. This feature converts a capacitive load into a simulated inductive reactance at the gyrator's input terminals (Fig. 1).

The feasibility of the concept has been demonstrated by Dr. John Gerig, president of Reaction Instruments, Inc., Vienna, Va., designer of a currently available gyrator—the SG-20—made of discrete components. It simulates an inductance of up to 25 kH with stable Qs up to 1800 over a frequency range from dc to 20 kHz.

"With the SG-20, and similar gyrators," Dr. Gerig says, "it is practical to realize fix-tuned or

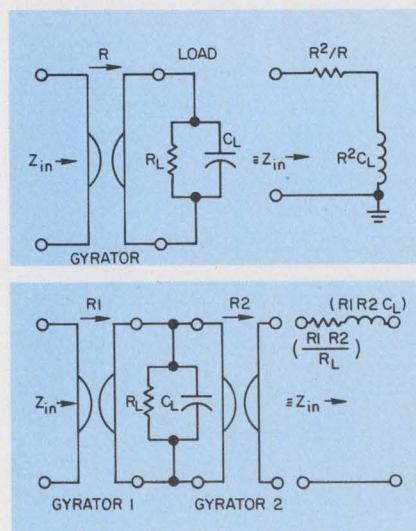

1. A grounded inductor is simulated by one gyrator (top) and a floating inductor, by two (bottom).

voltage or resistance-tuned filters, including high-Q and bandstop designs, where real inductors are very large or very lossy."

According to Dr. T. N. Rao, supervisor, Exploratory Integrated Electronics Group, Bell Laboratories, Holmdel, N.J., experimental Bell designs have verified that the capacitor gyrator can be used up to 100 MHz with more than adequate temperature stability and Q. But for widespread application, Dr. Rao says, it will have to be developed as a low-cost monolithic structure.

According to spokesmen at the Motorola Semiconductor Div. in Phoenix, Ariz., the basic design work has been done for such a device, but as yet the market has failed to materialize. Probably the biggest single factor retarding further development of the capacitor-gyrator is overwhelming success in the use of low-cost operational amplifiers in active filters.

Active-filter technology is advancing rapidly with operational

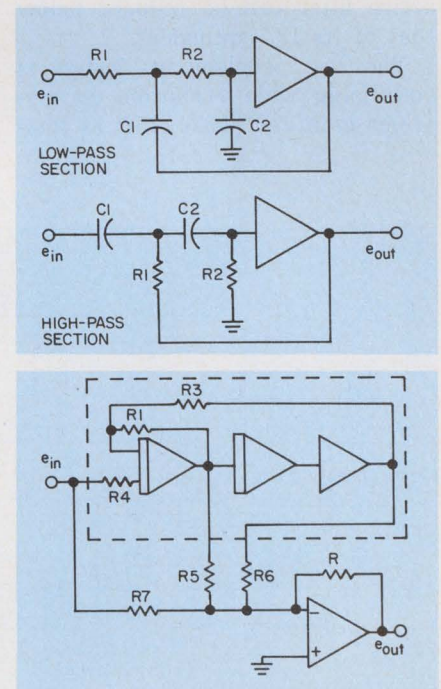

2. Basic building blocks for active filter design (top), and design example of three-stage filter (lower).

(Micro-filters, continued)

amplifiers, according to Bell Laboratories' Dr. Moschytz. This type of linear active filter is much better than its discrete-component counterpart in terms of both temperature stability and selectivity, he points out. Also, it's cost-competitive, particularly in lower-frequency communications circuits, up to about 100 kHz. This is because operational amplifiers are cheap, mass-produced ICs widely used in many applications.

**Op-amp filters are versatile**

Active op-amp linear filters are not direct substitutes for inductors, but instead are designed so that their transfer function is essentially identical to that of a desired single or multi-section LC filter. The active filters are comprised of building blocks of two-pole, (second order) feedback amplifiers that are cascaded to form multiple-pole filters (Fig. 2).

Each section is designed with high input and low output impedances, and as a result, the sections can be cascaded without buffer stages. Because interaction between them is minimal, the separate sections can be independently tuned. It has also been found, Dr. Moschytz says, that the order of an active filter can be reduced below that of its LC equivalent.

The big problem in design is stabilizing wide variations in amplifier gain and phase shift as tem-

perature changes and the amplifier ages. The solution, Dr. Moschytz points out, is to match carefully the tracking and temperature coefficients of the external resistors and capacitors. This is accomplished by using either thick-film resistors and ceramic chip capacitors with off-the-shelf silicon op amps, or thin-film tantalum resistors and capacitors with beam-leaded monolithic silicon amplifier chips.

Active op-amp filters may be built with one or more feedback loops. The single-loop filter may use either negative or positive feedback. But the single-loop, two-pole filter is generally useful only in low-Q applications, Dr. Moschytz says.

To provide Qs on the order of a few hundred, more than one amplifier must be used within the feedback loop. Several design methods are available, but, in general, the three-amplifier configuration is the optimum, providing a six pole filter, Dr. Moschytz says.

The Bell scientist points out that an all-purpose filter building block that provides any second-order transfer function has a fourth amplifier outside the pole-generating loop. The particular function obtained depends upon the particular output terminal, or combinations of terminals used (Fig. 2c).

With this configuration, known as the Biquad, a change in the value of a frequency-governing resistor changes the response frequency without varying the bandwidth.

A major new low-cost monolithic

active filter currently available is a phase lock-loop system produced by Signetics, Inc., Sunnyvale, Calif. (Fig. 3). It is not, however, a linear filter, like the op-amp units. Instead, the phase-lock loop circuit is designed as a frequency-selective IC suitable for filter, demodulator and signal conditioner applications, primarily with FM inputs. However, one version is also suitable for AM demodulation.

The strong point of the phase lock-loop system, according to Dr. Allan B. Grebene, manager of linear circuit research at Signetics, is that it is useful over a range of

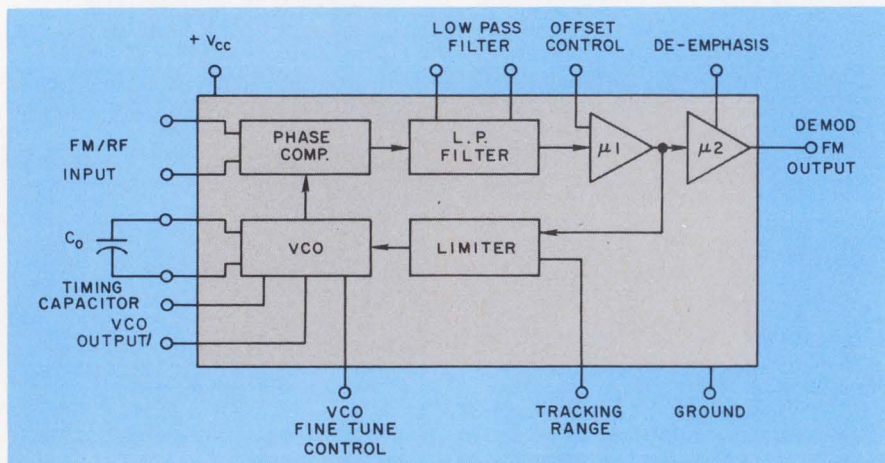

3. Phase-lock loop system on a monolithic chip provides a tracking filter. It can also be used as the electronic equivalent of an FM (or AM) i-f section, with corresponding demodulation. Bandwidth is adjustable.

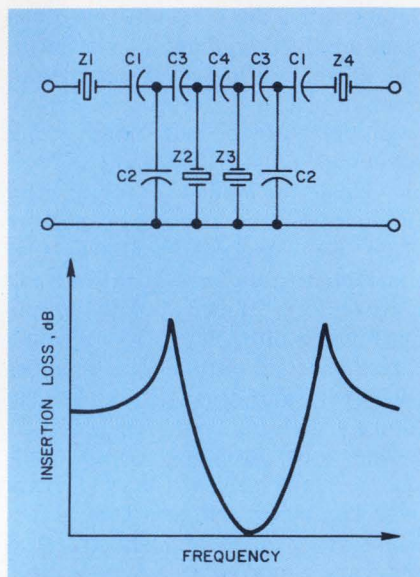

4. Typical filter of ceramic elements and capacitors (top), with representative response (bottom).

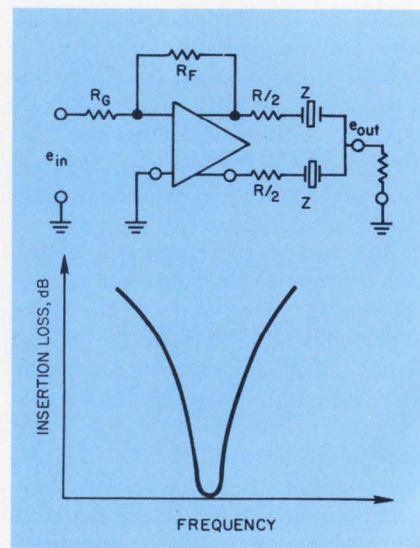

5. A hybrid lattice filter uses an op amp driving two piezo-ceramic resonators. Response shown at bottom.

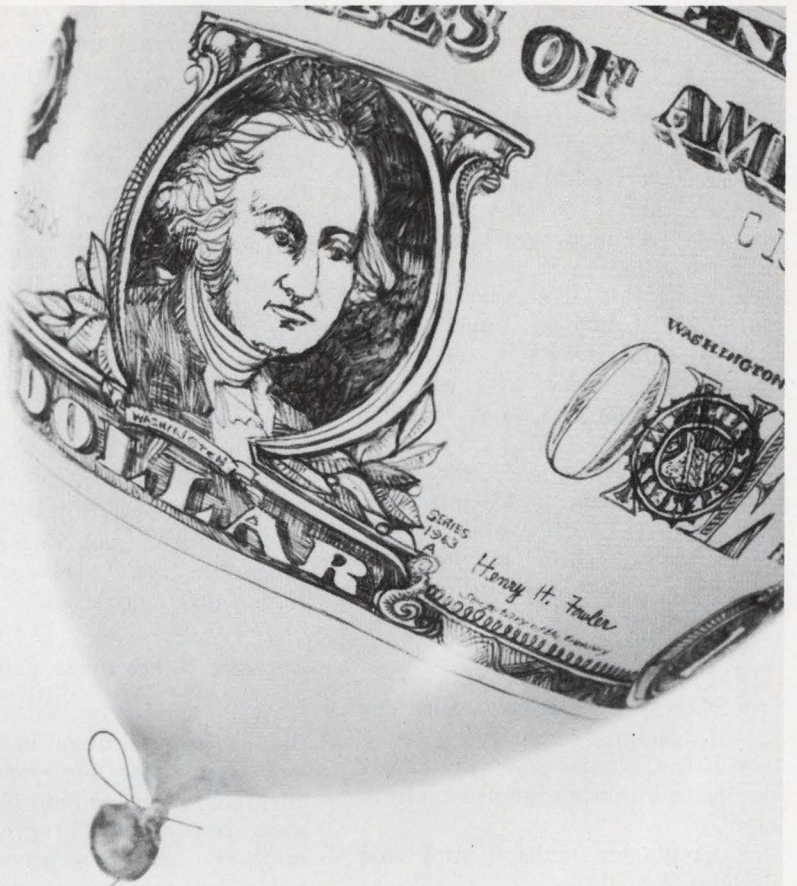

## Introducing: The anti-inflation circuit breaker.



The new Heinemann Series AM1.

A direct replacement for our own Series AM12.

Costs less, all along the line. A single-pole model with an auxiliary switch, for example, will save you 17 percent over a comparable AM12 model. A three-pole, 400-Hz model with auxiliary switch will save you about 34 percent.

And the AM1 offers the bonus of UL recognition. In any current rating up to 50 amp, at 240 Vac or 65 Vdc.

The Series AM1 is available with all the usual Heinemann options. Choice of time delays or instantaneous trip. And special-function internal circuits.

If you're tooled up to use AM12-type breakers, you could start using our Series AM1's immediately, without modifying a thing.

But, on second thought, there is one major change you'll have to contend with.

You'll have to revise your present component-parts cost.

Downwards.

Get in touch with your local Heinemann representative or write us for a copy of Bulletin 3306. Heinemann Electric Company, 2616 Brunswick Pike, Trenton, N.J. 08602.

**HEINEMANN** 

4625

**(Micro-filters, continued)**

frequencies from less than 1 Hz to more than 15 MHz, with an adjustable frequency tracking range of from  $\pm 1\%$  to  $\pm 20\%$ .

Within this frequency range, the circuit provides a tunable narrow-band filter with a selectivity comparable to that of three conventional tuned i-f stages, according to Grebene.

The center frequency and selectivity of the circuit are independently adjusted with a capacitor and a resistor-capacitor network. In operation, these devices can provide, without tuned circuits:

- FM demodulation.
- AM demodulation.
- Narrow bandpass adjustable to 1% tracking range.
- Exact, noise-free frequency duplication in a high-noise environment.
- Frequency multiplication and division.

The principal applications are in tone decoders, FM (or AM) i-f strips, telemetry decoders, tracking filters, modems and signal conditioners.

**Phase-lock loop IC is new**

The phase-lock loop is comprised of a voltage-controlled oscillator (VCO), a phase comparator, a low-pass filter and an amplifier (Fig. 3). The center frequency is determined by the adjustable free-running frequency of the VCO.

The VCO is set to run at approximately the desired incoming signal frequency, and its output is applied to the phase comparator, or mixer, which combines both the incoming signal and oscillator output to provide a dc error signal whose polarity and magnitude are dependent upon whether the VCO frequency is higher or lower than the incoming signal.

The low-pass filter, which is adjustable, restricts just how far the incoming signal can be from the oscillator to have the latter lock in step. This, in effect, provides the adjustable bandpass.

The error signal from the phase comparator passes through the filter, is amplified and applied to the VCO, and the VCO tracks the

incoming signal in frequency.

For FM intermediate frequency demodulation, the VCO error voltage is a direct, filtered and demodulated output voltage. For these applications, the band rejection is typically comparable to three tuned stages, according to Signetics' Dr. Grebene. For AM demodulation, a synchronous multiplier is added to the chip.

The phase lock-loop system is of silicon monolithic structure, and consequently the temperature stability of the IC circuits is poor, compared with that of other types of active filters. But the temperature factor is not important, because the VCO locks onto and tracks the input signal.

**Ceramic filters make gains**

As a solid-state substitute for the i-f transformers in AM, FM and communications receivers of all kinds, piezo-ceramic filters have made considerable progress. While military and aircraft receivers have for some time used fixed-tuned ceramic resonant filters in their i-f stages, the designers of consumer equipment have recently begun to use them, according to Antonio Lungo, project engineer at the Piezo Electric Div. of Vernitron (formerly Clevite), Bedford, Ohio.

These solid-state i-f filters made of piezo-electric ceramic elements tailored to provide a mechanical resonance at i-f frequencies of 455 kHz, 4.5 MHz and 10.7 MHz. The mechanical resonance of the ceramic element is translated by the piezo-activity of the device into an electrical output (Figs. 4

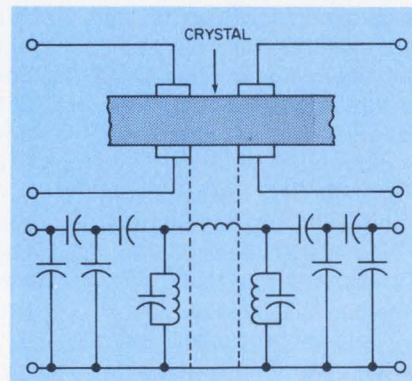

6. One section of a monolithic crystal filter (top) with its equivalent circuit (bottom).

& 5). The bandwidths, typically between 1% and 10% of the center frequency, depend upon the mechanical modes of vibration of the ceramic material.

Insertion losses, according to Lungo, depend to a great extent on the bandwidth. Losses may run from 1 to 8 dB, with the latter figure typical.

"These devices," Lungo told ELECTRONIC DESIGN, "can be made for operation anywhere between 1 kHz and 10 MHz. We use combinations of essentially two-terminal devices in series and parallel to provide a required bandwidth.

"As the frequency changes, the shape changes. If you want to make a smaller filter, you move to a higher frequency for a particular mode."

Above 1 MHz, Lungo points out, certain types of ceramic elements are small enough to be packed within an IC can. And so far as impedance is concerned, they are generally more compatible with ICs than with discrete transistor circuits.

**Micro-crystal filters useful**

For micro-sized filters of extremely high stability and with ultra-narrow bandpass (0.1%), monolithic quartz filters provide the only current solution, according to Dr. William Beaver, president of Comtech Laboratory, Mission Viejo, Calif. Such a filter consists of a small quartz plate onto which an array of metal electrodes is deposited. Operating frequencies range from 1 up to 100 MHz (Fig. 6).

As yet, monolithic crystal fabrication technology is only a few years old, says Dr. Beaver, one of the early researchers in this field. And, as a result, the devices are still available only in limited quantities and are relatively expensive.

The reduction in size over conventional quartz filters is high—10 to 20 to 1. But design of the monolithic versions is difficult. It incorporates the theory of frequency selection as related to filters with the theory of piezo electric devices. And because of this, Dr. Beaver feels that it will be 1973 or 1974 before monolithic crystal filters go into mass production. ■■



# ¢-LINE SCRs 24¢



**moisture protection  
doesn't  
cost you more...**

**and it's nice to know it's there.**

Unitrode offers you hermetically sealed SCRs in metal packages at plastic prices. The bonus in reliability you'll get is performance protection in all types of environmental conditions, wherever your end products may be used. Electrically, these SCRs are equivalent to the most widely used plastic devices, but none in this price range offer the high reliability and parameter stability made possible by Unitrode's unique combination of oxide passivated junctions in hermetic packages. Unitrode SCRs range from low-voltage, low-current sensing models to high-voltage, medium current control types. All offer the versatility of lead-mounted design for easy interchangeability in hundreds of applications. The low-price, high reliability of ¢-line SCRs make them ideal for lamp or relay driving and as sensors, for use in pulse generators, timing circuits, motor controls and process controllers. (Sensing types are as low as 24¢ ea. in 100K lots.) They're in stock now, ready for immediate delivery.

Can you afford not to use them? For fast action, call Sales Engineering collect at (617) 926-0404

Unitrode Corporation,  
580 Pleasant Street, Watertown, Mass. 02172

**Send for your free samples and complete specs today.**

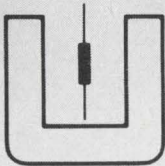

**UNITRODE** quality takes the worry out of paying less.

	ID 100 Series	ID 200 Series	ID 300 Series
Anode current rating	500mA @ 100°C Case	1.6A @ 70°C Case	1.6A @ 70°C Case
Voltage ratings	to 200V	to 200V	to 400V
Max. gate trigger current	200µa	200µa	200µa
Peak On-voltage	1.7V max. @ 1 Amp.	2.2V max. @ 4 Amps.	2.5V max. @ 4 Amps.
Package	TO-18 can, 0.5" leads	TO-5 can, 0.5" leads	TO-5 can, 1.5" leads

# Computer constructs 3-D castles in the air

## Display system lets architect view his line drawings in three dimensions

Elizabeth de Atley  
West Coast Editor

An architect has just designed a new building. He feeds the descriptive data into a computer, puts on a headset, and sees a three-dimensional line drawing of the computer-generated data displayed in mid-air a few feet in front of him. The building appears to stand still as he moves around it and even inside of it. If he doesn't like something, he changes the descriptive data and tries again.

A dream? No. It's a new head-mounted display system developed by Dr. Ivan E. Sutherland of the University of Utah, Salt Lake City, and associates. As shown in Fig. 1, the system consists of a head-position sensor, a general-purpose computer and supplementary memory, a matrix multiplier, a

clipping divider and a head-mounted display.

According to Don Vickers, a graduate student working on the project, the head-position sensor is a mechanical device that is connected through a universal joint to a pivot in the ceiling. It measures the position of the viewer's head and feeds the information to the general-purpose computer, which is a PDP 10 with a supplementary Ampex core memory.

### Matrix multiplier used

The computer builds a matrix defining the head position in three dimensions. The matrix multiplier, a specially built piece of computer hardware, multiplies the matrix that defines head position by another matrix that defines the object

to be viewed. This multiplication of matrices rotates and translates the object so that it appears to be stationary as the observer moves around it. After the object has been transformed by matrix multiplication, the data is sent to a clipping divider, which computes the perspective the viewer is used to seeing and then clips the object to eliminate those parts that he would not see if he were actually standing in that relation to a real object. For example, if he gets too close to the object, the edges will disappear from view.

According to Vickers, this job could be done by software in the digital computer but not nearly as fast. The clipping divider is designed to process a picture consisting of up to 3000 lines without causing the image to flicker, Vickers says.

The head-mounted display consists of a miniature 1/2-inch-

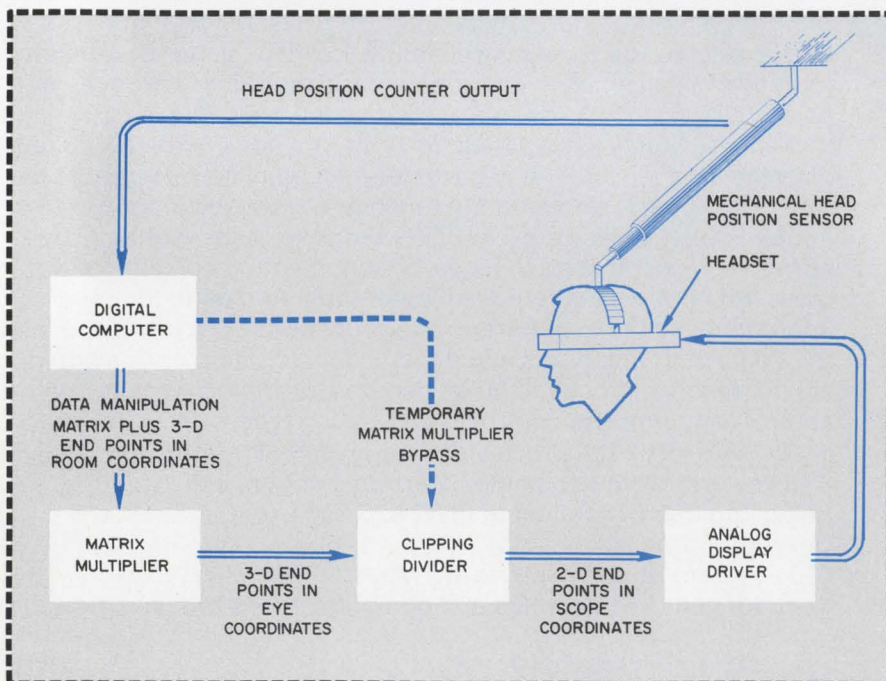

1. The head-mounted display device shown is used in computer graphics research at the University of Utah. Computer-generated pictures begin as information transmitted from the mechanical head-position sensor into the computer and end as analog display data entering the headset. The viewer can walk around or inside a 3-D virtual image projected in mid-air in front of him. Line drawings of up to 650 points can be displayed.

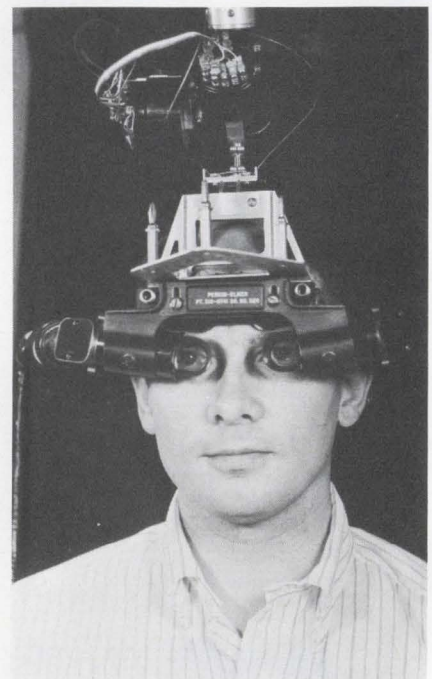

2. A miniature CRT screen on each side of the viewer's head and an optical system that projects the scene on each screen to a position a few feet in front of the viewer comprise the display.

# IRIS

(Instant Response Information System)



## Another Allen-Bradley First.

**Now, A-B distributors offer the fastest order handling in the industry.**

Your business is too important for procurement delays. That's why your local Allen-Bradley electronics distributor is now equipped to talk directly to our factory computer. He can order instantly. Respond quickly to your emergency needs. Provide better day-to-day service, too. On-line computer communications, a first in electronics distribution.

The top names in electronic distribution are part of the program: ALMO. CRAMER. ELMAR. KIERULFF. NEWARK. SCHWEBER.

Allen-Bradley has always been recognized for the quality of its electronics components. Equally important, however, is service to customers. Now, Allen-Bradley's IRIS program brings a new higher standard in customer service to the industry. It's all part of A-B's whole new dimension in electronics.

NEW DIMENSION ELECTRONICS

# ALLEN-BRADLEY

Milwaukee, Wisconsin 53204



EC70-19 © Allen-Bradley Company 1970

INFORMATION RETRIEVAL NUMBER 22

## NEWS

### (3-D displays, continued)

square CRT screen on each side of the viewer's head and an optical system that magnifies the pictures on each screen and projects them to a position several feet in front of the observer, forming a stereoscopic view of the picture on the screens. Half-silvered mirrors in the optical system permit the viewer to see the stereo image projected into the real world around him, says Vickers. Thus, displayed material can be made to hang disembodied in space or to coincide with actual objects.

"For example," says Vickers, "a

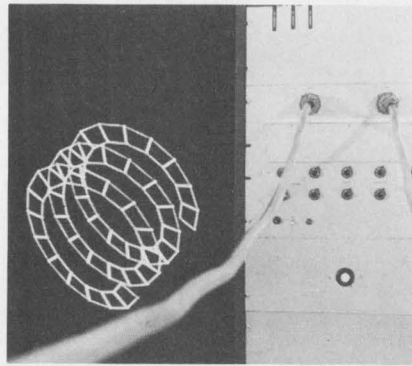

3. This computer-generated object (left) and the surrounding room are a photographic simulation to illustrate the perspectives a user sees when he looks into the head-mounted display.

computer-generated display of tanks could be superimposed onto an actual map of the battle territory."

### A limit of 650 points

The present system is limited by the speed of the matrix multiplier to line drawings consisting of up to 650 points. However, computer-generated half-tone pictures have been successfully displayed on a CRT screen at the University of Utah, and researchers there say that the logical next step will be to project images of solid three-dimensional objects into space. ■■

## Device gives doctors speedy lab results

At 2 a.m., the telephone rings in a doctor's office in New York City. An electronic answering device closes a circuit, connecting the caller to a facsimile machine, and emits a go-ahead beep over the line. The caller—an operator at the United Medical Laboratory, Portland, Ore.—hears the tone and transmits a detailed lab analysis report, which the doctor's nurse tears off the facsimile machine when she comes in the next morning.

The laboratory receives mail requests for lab analyses from all over the country and, thanks to the unattended terminals in the doctors' offices, can get results back within two days from the time the request is received.

### Here's how it works

The answering device, called the Telanalysis 240 (TA 240), works this way: When the telephone rings, a magnetic transducer in the control box under the phone (see photo) detects the magnetic field around the ring coil and emits a signal that is amplified and used to command a solenoid that lifts the telephone button. The control box contains circuitry that senses whether (1) there is paper in the facsimile, (2) the facsimile is in the RECEIVE mode, and (3) the data coupler is enabled (that is, resting in it).

If these conditions are all met, the device emits a go-ahead beep, and the operator on the other end of the line transmits the data. As long as a carrier signal is present on the line, the control holds the telephone open, but 15 seconds after the carrier disappears, it hangs up. If the carrier does not appear within 15 seconds after the phone rings and is "answered," the device also hangs up.

According to Gilbert Springer, manager of electrical systems at the United Medical Laboratory and designer of the device, even while the telephone is hooked up to the

TA 240 it can be used for ordinary voice communications.

"When you take the receiver off the coupler," he says, "a switch sends a signal to the Telanalysis unit, telling it to lift the solenoid and open the telephone."

The TA 240 will connect digital as well as analog peripheral equipment—such as teletypewriter, printer or computer—to the telephone line via any type of data modem, regardless of the bit rate. Thus it can be used wherever unattended service is necessary.

Springer says he designed this device to save money. It is much less expensive, he says, than the standard Bell Telephone data set that offers unattended service. A single TA 240 unit costs \$275 to purchase and \$15 per month to lease, including line charges.

In July, 1970, the Bell System made available its data access arrangement (DAA), an unattended answering unit that is considerably less expensive than its complete data set. The DAA is a hardwired answering device into which the customer plugs his data modem. A Bell System representative told ELECTRONIC DESIGN that, if the customer supplies electrical power, the unit costs \$40 to install and \$3.30 per month rent. However, it is a permanent fixture, whereas the TA 240 can be used with any telephone and acoustic coupler. ■■



An unattended answering device, the Telanalysis 240, "answers" the telephone in a doctor's office, and an operator at the United Medical Laboratory—a large mail-order laboratory in Portland, Oregon—transmits the results of a lab analysis at any time of day or night to any part of the U.S. It rents for \$15 per month.

**Component and  
Circuit Design**

# IDEAS

FROM  
**SYLVANIA**

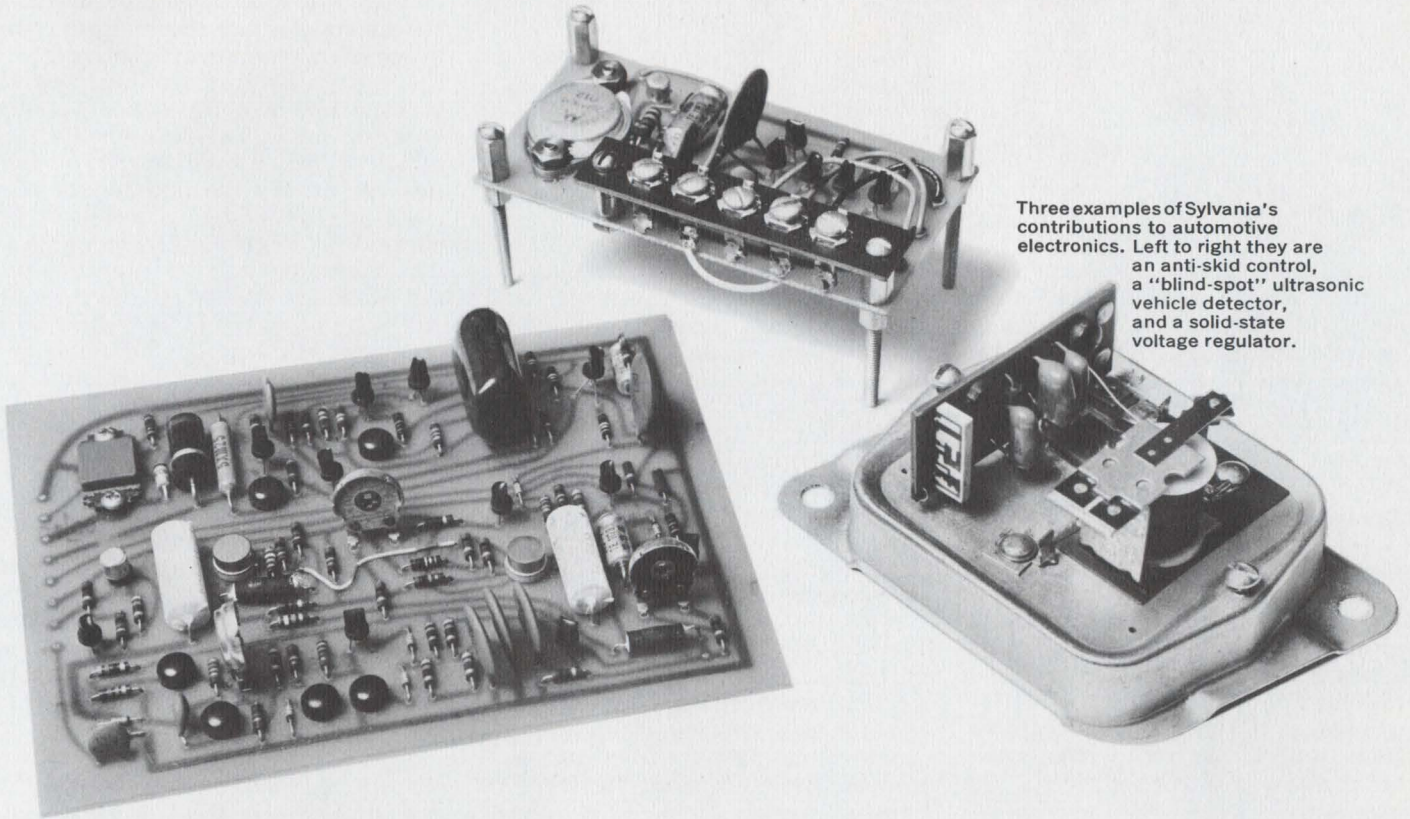

Three examples of Sylvania's contributions to automotive electronics. Left to right they are an anti-skid control, a "blind-spot" ultrasonic vehicle detector, and a solid-state voltage regulator.

## CIRCUIT MODULES

### **Zeroing in on transportation electronics.**

Our new development laboratory, geared specifically to transportation electronics, is closely tied in to our high-volume production facilities.

One area of great potential for the electronics industry is the transportation systems field. Trucks, subway trains and passenger vehicles are foremost in this area.

Our new Wakefield Development Laboratory facility has been set up with the specific charter of meeting these needs from system concept to volume production.

Today's automobiles are using more and more electronics, and over 100 potential electronics applications have been identified. As of now, more than twenty functional systems are either in use or are undergoing field testing. These range from clocks, turn signals, voltage regulators and automatic temperature controls to electronic fuel injection and anti-skid braking systems.

Other potential applications include electronic monitoring units for oil, water and fuel levels, electronic ignition, electronic speedometers and, eventually, total electronic control by a small on-board computer.

So far, in its short existence, the Wakefield Laboratory has come up with a number of interesting practical systems for cars, including an ultrasonic "vehicle" detector, an anti-skid control system and an electronic voltage regulator.

The ultrasonic "vehicle" detector was designed to meet the requirements of a large automobile manufacturer. System requirements were tough. Wanted was a system that would detect vehicles in the blind zones within 30 feet of the rear of the car and would cover an area

## **This issue in capsule**

### **CRTs**

Silicon target storage tube gives high resolution.

### **Integrated Circuits**

How to design a character generator for ASCII address decoding.

### **CATV**

Our cable communications equipment spans a wide spectrum.

### **Hybrid Microcircuits**

Interface circuits solve TTL-MOS matching problems.

### **Microwaves**

We're bringing beamleads to microwaves.

### **Manager's Corner**

A philosophy for the future of cable communications.



Passive ultrasonic "blind-spot" detector with directional horn.

only slightly larger than a single lane. The system had to ignore such things as tunnels, fences, signposts and billboards while also being impervious to rain, snow, dust, salt, shock and vibration over a broad temperature range. On top of that, the system had to be inexpensive.

Our Wakefield engineers investigated radar, active ultrasonic and infrared approaches and discarded them because of their inability to discriminate. A simple active system cannot distinguish between a real target vehicle and a stationary object.

Needed was a system that could respond to a characteristic inherent in the operation of a moving vehicle. The characteristic we picked was noise. We decided on a passive ultrasonic detection system to give us control over range and directivity as well as discrimination. The system, illustrated in the diagram and photograph, responds only to those sounds generated by a moving vehicle, such as its engine and tire noise.

With a detector horn mounted in each rear taillight assembly, a vehicle approaching from either side will cause a small bulb to light on the appropriate side of the rearview mirror.

To avoid nuisance display in bumper-to-bumper traffic, the system is designed to respond only at speeds above 35 mph, which makes it especially useful in high-speed traffic on multiple-lane expressways.

We can't claim original design for the anti-skid systems we've made, but we can claim fast delivery and drastic system improvement. One customer brought us a six-card, 600-component, hand-wired, prototype of his anti-skid system. He needed the six cards in printed circuit form within three months. Our elapsed time, from receipt of schematics to delivery of hardware, was only two months.

Now this same customer has asked us to redesign and cost-engineer his original system. With this effort nearing completion, it appears that we will have reduced the component population by

30% and the system cost by 50%.

Another customer requested redesign and cost engineering of their anti-skid module. Within three months, component population was halved and cost was cut by two-thirds. This same customer has now requested assistance in the basic design and engineering of a more advanced system.

These examples highlight the technical competence and fast response this group offers to serve our customers.

Although electronic voltage regulators are not new, most existing ones have drawbacks. The electromechanical regulator has proved unreliable and just can't carry the higher field currents of the newer, more powerful alternators. Regulators using germanium transistors require extensive finned packages for heat sinking and still won't take present underhood temperatures. Microcircuits have not been able to meet the severe automotive environment and be cost competitive.

In addition, all previous solid-state regulator designs were subject to catastrophic failure if the battery was disconnected while the engine was running. This could happen during routine servicing or as the result of a loose battery cable.

Our design is able to withstand the transients caused by battery disconnect. In addition it has passed severe testing in the field and is going into volume production.

These are only a few of the new developments that are coming out of our Wakefield Lab and entering production at our custom module facility. If you need an electronic system for anything that moves on tracks, road, water, or in the air, we've got the people who can design and produce your system at the lowest cost and with the shortest lead time.

CIRCLE NUMBER 300

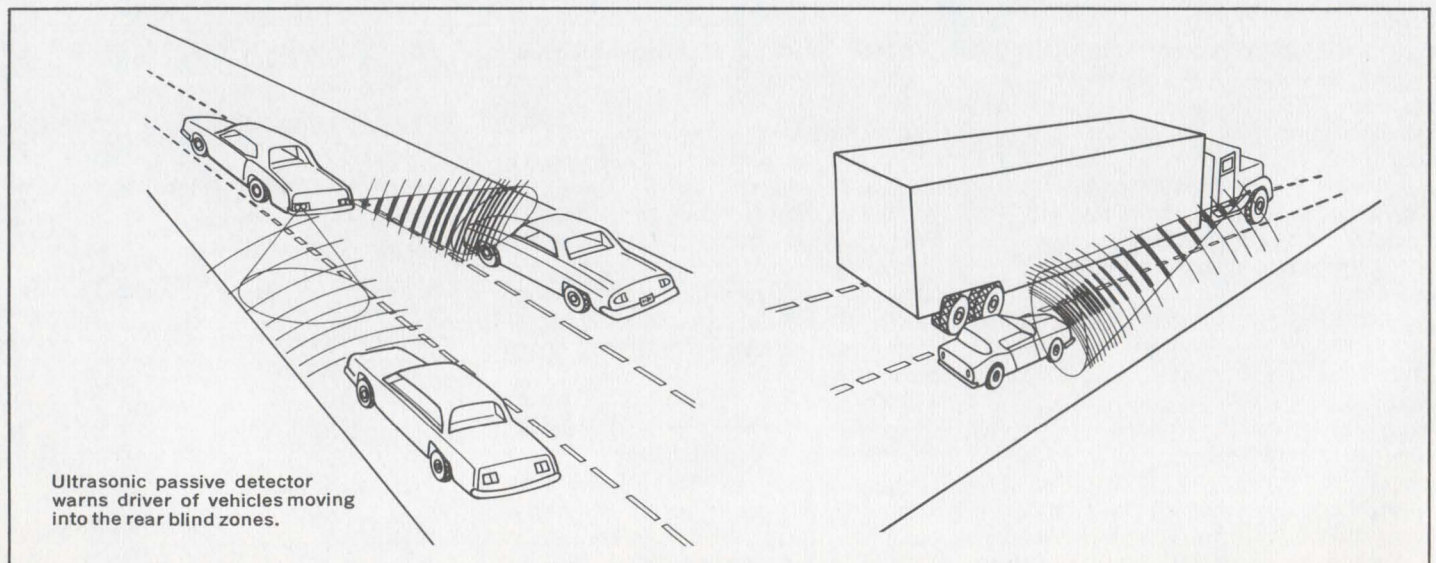

Ultrasonic passive detector warns driver of vehicles moving into the rear blind zones.

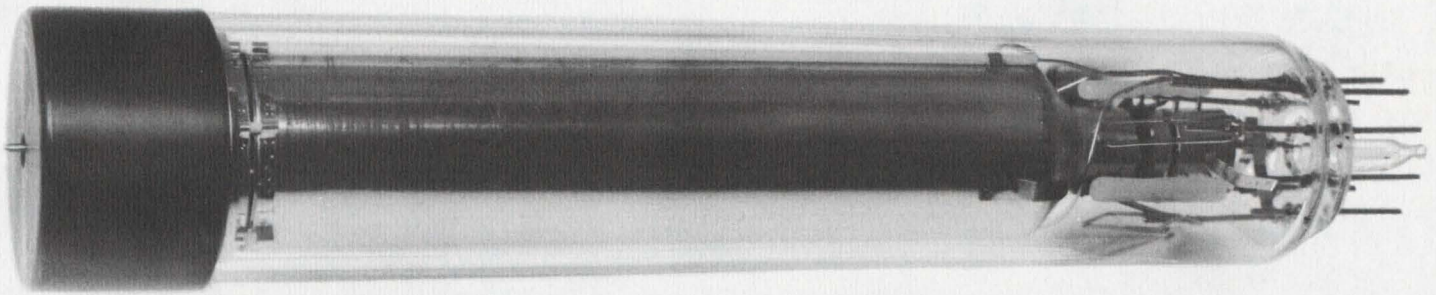

## CRTs

### Silicon target storage tube gives high resolution.

Mosaic target of silicon oxide storage islands provides resolution better than 1,000 TV lines/diameter with high writing speed and long retention times.

A new 1½" silicon mosaic target storage tube, developed by our Advanced Technology Laboratory, is ideally suited for scan conversion, video frame storage, computer output buffers and display refreshing. It may be selectively updated, thus requiring only that changes in information be transmitted from the source. Low speed transmission systems, such as those for facsimile printers, can advantageously use this device. The tube will find applications in many information processing and data display systems.

Advantages of the new 1½" silicon storage tube include: resolution of better than 1,000 TV lines/diameter, retention times of over 15 minutes with gray scale capability, high writing speeds, and low cost. Images can be held for several days or longer with the beam turned off.

The structure of the tube is shown in the diagram. It is similar to a magnetically focused and deflected vidicon. The storage target is a mosaic of insulating SiO<sub>2</sub> islands, as shown in the photograph. In operation, a charge pattern established on the islands during writing is used to control the landing of the primary beam current at local areas dur-

ing reading.

During the erase cycle the target is held at +15V and scanned. The beam charges the insulating islands to cathode potential (0 V), since the secondary emission ratio is less than one. The charge storing islands are now at -15V with respect to the n-type substrate.

For writing, the target is held at +250V, and the beam current is modulated by applying the signal to control grid G<sub>1</sub>. Where the beam strikes, the high-energy incident electron beam creates a secondary emission ratio greater than unity. Thus, the islands become less negative in proportion to the beam current striking them. Islands not struck by the beam remain at -15V with respect to the substrate.

In the readout mode, target voltage is reduced to +5V. With respect to the beam potential of 0V, the oxide islands will range from -10V (if not written upon) and will approach 0 V (if maximum "white" signal was applied to G<sub>1</sub>).

The reading beam is split into two components: *i<sub>r</sub>*, current "reflected" to the collector mesh, and *i<sub>i</sub>*, the current landing on the substrate. The landing current, *i<sub>i</sub>*, through the output resistor, provides the required output signal.

Since the reading beam is prevented from landing on the islands because of their negative potential relative to the cathode, the target can be scanned repeatedly without appreciable deterioration of the stored information. Operation is possible with both conventional raster scanning, or random X-Y addressing.

Our 1½" silicon mosaic storage tube is now available in prototype form. We are presently designing complete storage modules to meet specific customer applications. These will be self-contained units requiring only an input signal and line power.

CIRCLE NUMBER 301

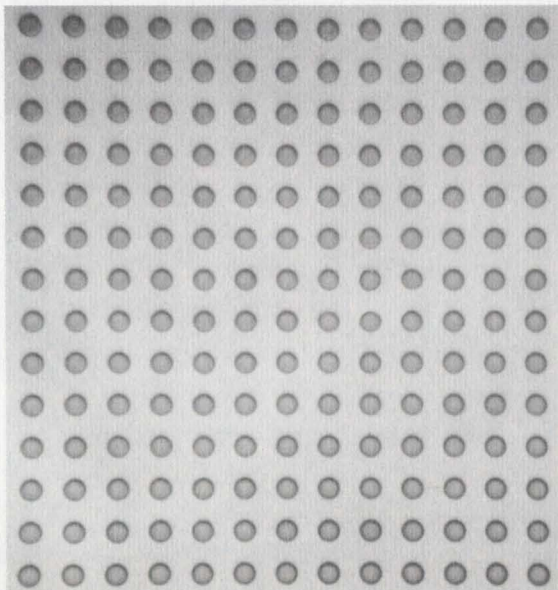

Enlarged section of silicon mosaic island pattern.

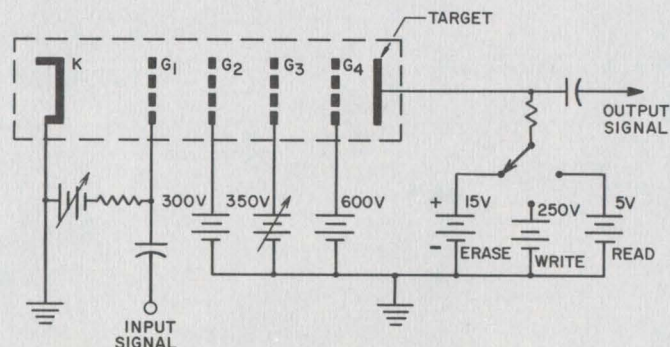

Circuit diagram of silicon mosaic target storage tube.

## INTEGRATED CIRCUITS

### How to design a character generator for ASCII address decoding.

Here's how to use read-only memories as code converters for addressing a memory containing the 64 characters of the popular ASCII code.

In a typical character display using a 5 x 7 pattern, as shown in Fig. 1, each character is made up of 5, 7 or 8-bit words. There are available so-called character generators with bit patterns for storing the alphabet, numerals and other characters. Actually they use 256-bit read-only memories (ROM) containing 32 eight-bit words with binary addresses from 0 to 32. Numeral 1 would be stored in locations 0 to 4 and numeral 2 would be stored in locations 5 to 9, etc. Thus, to generate the numeral 2, a binary 5 is used as the starting address and is positively incremented four times by one until the value reaches nine.

These ROM's would be very easy to use if the code for 1 is 0 and the code for 2 is 5. However, most codes do not follow this pattern. In fact, there is an unlimited number of address codes that can be used for character generation.

One of the simplest ways to over-

come this problem is to use additional ROM's as code converters. Here is a simple method for applying this technique to the popular ASCII code.

Figure 2 shows the ASCII code with its associated characters arranged in ascending numerical order without regard to the most significant character of the code. Also, for this discussion each character will be stored in five adjacent locations in a memory which must be large enough to handle the full 64 characters. Thus,  $64 \times 5 = 320$  storage locations must be available which can be provided by ten 32 x 8 ROM's.

The ASCII code is converted to binary numbers which incremented by five for each unit change in the ASCII code. This conversion can be done in two ROM's where the five lower order bits of ASCII are used as the address and the sixth bit is used to select which ROM's are used.

For example, the six-bit value in ASCII for the letter A is 000001 which will decode to 00000101, or five, while the letter B, 000010, will decode to 00001010 etc. The eight bits from the decoder ROM's are then preset into a counter whose output is used to select the locations in the 320 x 8 bit memory. Four clock pulses can then be added to the counter to advance the character generator through the five desired locations. Figure 3 shows the logic to do this.

This technique makes optimum use of the character generator for all locations that are used. That is, although each ROM contains 32 locations or can store 6-2/5 characters, the 2/5 of a character can be used. This means that some characters are split between ROM's but only 10 ROM's are required instead of 11 for the character generator.

This method is very straightforward but a reduction in logic can be achieved by putting some constraints on the character locations in the character generator.

An examination of the least significant bit of the ASCII code shows that one-half of the characters have an even-number code and the other half have an odd-number code. This would imply that it is only necessary to decode

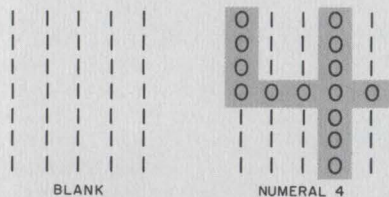

Fig. 1. Typical ASCII address for numeral four.

300	@	320	P	240	SPACE	260	Ø
301	A	321	Q	241	!	261	1
302	B	322	R	242	"	262	2
303	C	323	S	243	#	263	3
304	D	324	T	244	\$	264	4
305	E	325	U	245	%	265	5
306	F	326	V	246		266	6
307	G	327	W	247	'	267	7
310	H	330	X	250	(	270	8
311	I	331	Y	251	)	271	9
312	J	332	Z	252	*	272	:
313	K	333	[	253	+	273	<
314	L	334	]	254	,	274	<
315	M	335	^	255	-	275	=
316	N	336	^	256	.	276	>
317	O	337	←	257	/	277	?

Fig. 2. ASCII code and its numerical equivalents.

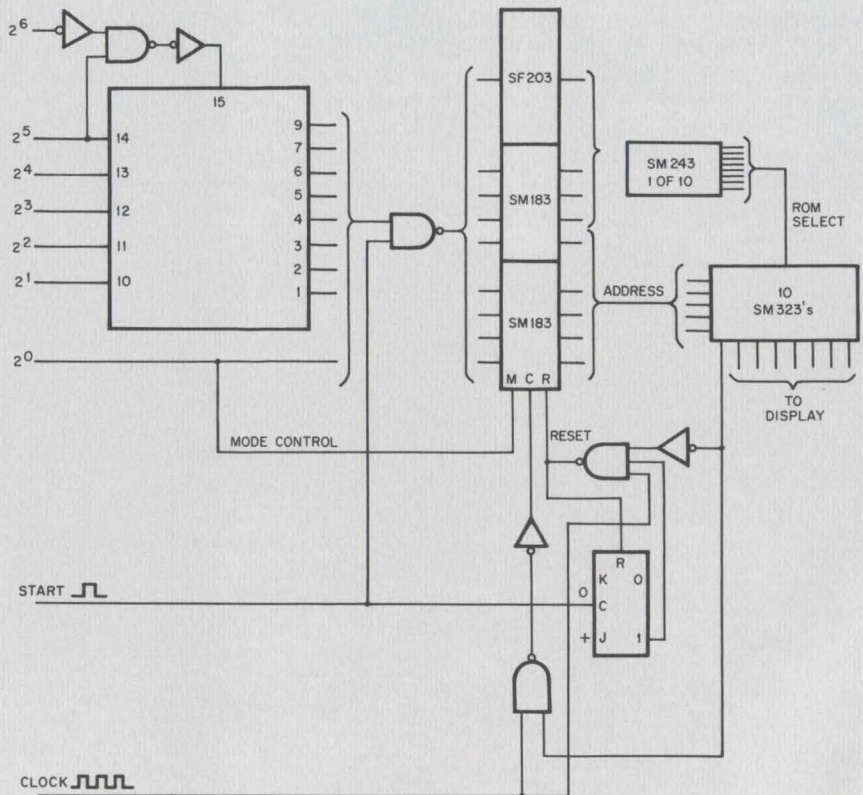

Fig. 3. Logic system for decoding ASCII code using ROM's.



32 values of the ASCII code if in each pair of characters one will start in an odd location and the other will start in an even location. Since each ASCII character requires five locations in memory, adjacent characters will always have one even and one odd address.

For example, B has an ASCII code 02 and C has a code of 03. If B has a starting address of ten and C has a starting address of fifteen, then one is even and one is odd. However, the remaining bits of the address are not the same. This problem is easily overcome if B has a starting address of fourteen, 1110, and the address counter counts down to ten on four count pulses, and if C has a starting address of fifteen, 1111, and the address counter counts up to nineteen on the four count pulses.

Figure 3 also shows the logic to do this where bit 2<sup>0</sup> controls the mode of the up/down counter. In addition if a 5 x 7 format is used for each ASCII character, then the eighth level or line can be used to control the count pulses. This is also shown in Fig. 3 where, for the letter B with a starting address of 14, there will be a one stored in the 8th line for locations 14, 13, 12, and 11 which will enable clock pulses to the up/down address counter. The eighth line for location 10 will have a zero stored in it which, when inverted and NANDed with the clock, will reset the address counter to zero and reset flip-flop A. Since the zero location in memory will contain a zero in the 8th line, it is necessary to inhibit additional reset pulses to the address counter to avoid a race condition. Flip-flop A does this function and holds the character generator in the "off" condition until the next start pulse. The gating to the chip enable for the address decoder is to inhibit the character generator for commands such as tab, line feed, return, etc.

This technique of address decoding for ROM's and also for random access memories can be used where more than one word out of a memory is required for a given address. If, for example, one address is to call out four successive words, the first address could call location four in the memory and then count down to one while the next address could call out location five and count up to eight. In this case the zero location of the memory would not be used but the simplified decoding would more than justify this method. It is not necessary that each address call out the same numbers of words, or sets, to use this method. However, the starting address for each set in a pair must only differ by one.

CIRCLE NUMBER 302

## CATV

### Our cable communications equipment spans a wide spectrum.

Family of amplifiers, power supplies and ancillary equipment features sub-VHF, bi-directional, and other special transmission capabilities.

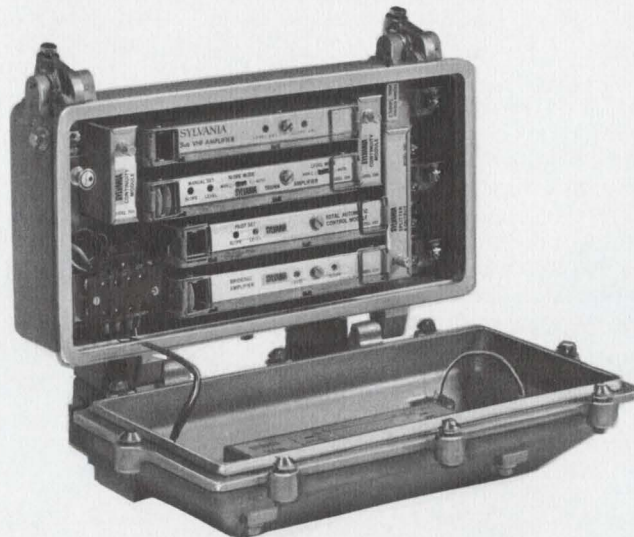

Our new, growing line of rugged equipment for cable television has the design flexibility to solve many systems applications problems and assure long operating life with minimum downtime.

Take, for example, our fully modularized trunk amplifier station. It has a wide bandwidth from 50 to 270 MHz. A dual-pilot feature gives totally automatic 16-dB level control, and 16-dB slope control ranges over wide temperature excursions. High overload-to-noise capability of the Sylvania equipment enables cascading up to 80 amplifiers satisfactorily. The amplifier is available with manual or automatic control and with or without a bridging amplifier. An optional feature designs you into the future—permitting addition of an extra-service module that can provide a number of other functions, including bi-directional operations in the 6 to 30 MHz band. You can also have sub-VHF for long-haul forward transmission or split-band trunking (54 to 110 MHz and 140 to 270 MHz) for multiplexing of octave bandwidths.

Our line extender amplifier comes in two different models. One provides for manual control of gain and slope; the other is totally automatic. Both units are otherwise identical. They complement our trunk amplifier with their wide 50 to 270 MHz bandwidths. High overload-to-noise capability and superior VSWR allow these units to be used as economy trunk amplifiers.

The dual pilot control feature of the fully automatic model allows higher operating levels in distribution and tighter control of these levels at the subscriber drop. The level and slope control functions are achieved through use of current-sensitive solid-state control elements to minimize distortion products.

Both amplifier models use plug-in attenuation pads and equalizers. The high-signal level stages employ stud-mounted transistors with stable current bias for reliable operation over a wide temperature range.

Like the trunk amplifier, the line extenders are housed in rugged, cast housings for EMI shielding and protection against weather.

Our outdoor multi-tap/directional coupler allows up to 8-way distribution. Provision is made for use of a variable 8-dB cable-equivalent equalizer. Various splitter combinations and plug-in couplers may be inserted after installation of the multi-tap housing.

Also included in the cable television equipment family are a balun for 75 to 300-ohm transformation, an outdoor directional coupler with high directivity and power passing capability, an outdoor splitter and a power coupler. All Sylvania passive devices provide the same wide bandwidth as our amplifiers. An AC power supply package provides a well regulated output for 30 or 60 V AC operations.

CIRCLE NUMBER 303

## HYBRID MICROCIRCUITS

### Interface circuits solve TTL-to-MOS matching problems.

Translating current-oriented TTL outputs to voltage-sensitive MOS inputs is a job that hybrid circuits can easily handle.

One of the main advantages of hybrid microcircuits is design flexibility, and one of the major places where this flexibility is of value is in interfacing between two different types of logic systems. Translating between TTL and MOS circuitry is one important place this flexibility can be used.

For example, our MS-303 interface driver, shown in Fig. 1, will accept a TTL input and translate it to a signal capable of driving MOS circuitry with output currents of +500 mA with voltage swings of up to 30 V.

Figure 2 shows the MS-303 with the external circuitry required to give two typical rates of  $t_{on}$  and  $t_{off}$ . If these don't meet your needs, we'll be glad to help you design a circuit that will.

And that is one of the advantages that we offer in hybrid

circuit design. If you can't meet your requirements with our off-the-shelf devices, we'll be glad to give you a custom design that will do the job. Don't let the phrase "custom design" turn you off. Because we know these circuits inside out, we can make a custom design at a cost comparable to off-the-shelf designs.

Another hybrid microcircuit that can solve interface problems is our MS-302 dual-phase clock driver shown in Fig. 3. By connecting external capacitors, you can control clock pulse widths over a wide range. Figure 4 shows two typical configurations and the table shows the circuit characteristics operating at two different frequencies using different values of capacitance.

Like all Sylvania hybrid microcircuits, these units are available to meet both industrial and military specifications. They use thick film and hybrid techniques and are packaged in hermetically sealed enclosures for high reliability.

Of course, neither of these circuits may solve your interface problems, but don't let that worry you. We have off-the-shelf designs, but we know how to customize them at minimum cost. If you have an interface problem, we're willing to face it.

CIRCLE NUMBER 304

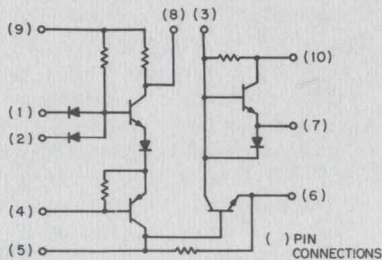

Fig. 1. Basic circuit of MS-303 interface driver.

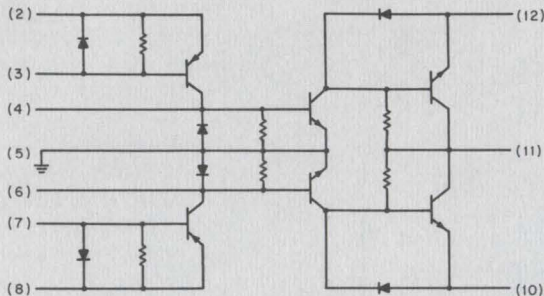

Fig. 3. Circuit of MS-302 dual-phase driver.

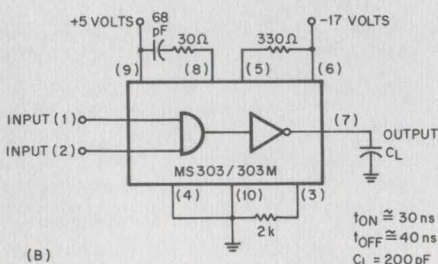
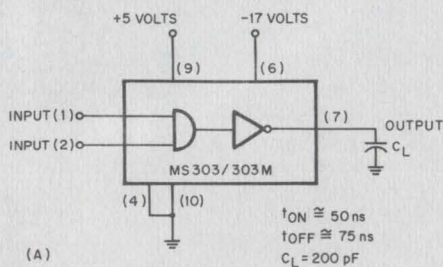

Fig. 2. External circuitry for MS-303 for different operating speeds.

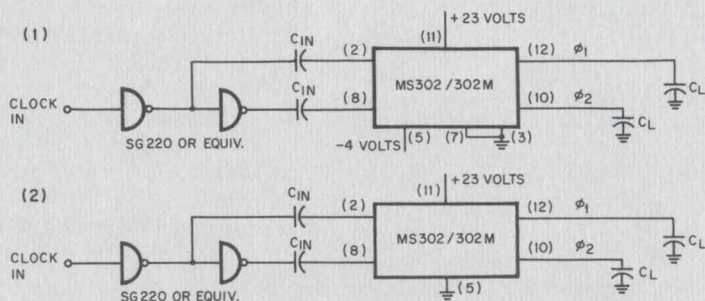

Fig. 4. Two configurations for using MS-302 dual-phase driver. Table shows typical characteristics for both configurations using specific values for frequency and capacitance.

	Configuration 1		Configuration 2	
	Condition 1	Condition 2	Condition 1	Condition 2
$t_r$ (ns)	77	30	59	23
$t_f$ (ns)	55	21	41	17
$t_d$ (ns)	50	27	41	22
$t_{pw}$ (ns)	440	134	363	125
Power (Mw)	815	495	680	444

Condition 1,  $f=0.5 \text{ MHz}$ ,  $C_L=1000 \text{ pF}$ ,  $C_{in}=2200 \text{ pF}$

Condition 2,  $f=1.0 \text{ MHz}$ ,  $C_L=200 \text{ pF}$ ,  $C_{in}=600 \text{ pF}$

## MICROWAVES

### We're bringing beamleads to microwaves.

Our full family of beamlead devices offers a lot of advantages to designers of microstrip circuits.

Capacitors, tunnel diodes, PIN diodes and Schottky diodes are now available from Sylvania in both beamlead and chip form.

The SC-9001 beamlead capacitors are high-temperature thermally grown, silicon devices. Their very high Q and small size makes these devices ideal for microwave applications. Units are available in a capacitance range from 0.5 to 100 pF at 1 MHz.

The beamlead tunnel diode family, DTB-5724, 5725, is designed for use as low-level amplifiers and oscillators in microstrip systems. They are also used in satellite and phased-array antenna systems. The tunnel diode, itself, consists of a circular, passivated, germanium substrate with two metal leads. The lengths of the leads are different to allow identification of the cathode as the shorter lead. Overall length is 30 mils and the substrate is 8 mils in diameter. The cathode beamlead contributes less than 0.1 pf to the total capacitance.

Our beamlead microwave PIN diodes are essentially voltage-dependent variable resistances, which makes them valuable for switching, limiting and controlling microwave

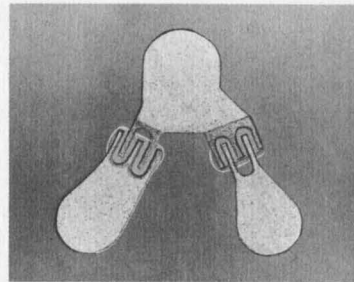

Photomicrograph of dual Schottky diode.

power. The D5840 PIN diodes are surface-oriented beamlead silicon devices consisting of a p+ type and an n+ type separated by an intrinsic layer. Breakdown voltage is 60V, and forced minority carrier lifetime is typically 15 ns. The graph shows change of resistance with forward current for a typical PIN diode.

Beamlead Schottky diodes are available in three frequency ranges: S-band, X-band, and Ku-band. Although used primarily as mixers, Schottky diodes can also be used as detectors, modulators, low-power limiters and high-speed switches.

Our beamlead Schottky diodes are made by depositing a suitable metal on an epitaxial silicon substrate to form a junction. The process and choice of materials results in low series resistance, and a narrow spread of capacitance values for close impedance control. These devices also feature a low forward-voltage knee which makes possible efficient operation at low local-oscillator drive levels, or for low-level detection.

All of these beamlead microwave devices are also available in mounted or unmounted chip form. We have the most complete line of microwave beamlead and chip device diodes in the industry. So why look further? Just talk to us.

CIRCLE NUMBER 305

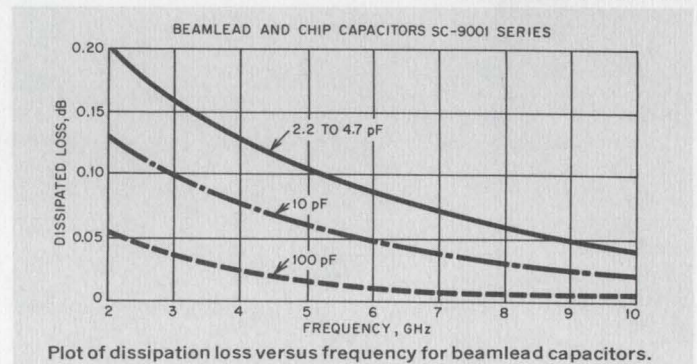
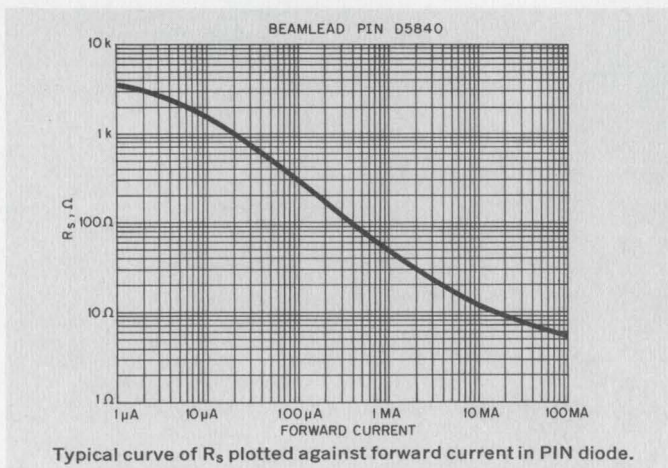

Use Sylvania's "Hot Line" inquiry service, especially if you require full particulars on any item in a hurry. It's easy and it's free. Circle the reader service number(s) you're most interested in; then fill in your name, title, company and address. We'll do the rest and see you get further information by return mail.

### BUSINESS REPLY CARD

No Postage Stamp Necessary if Mailed in the United States

FIRST CLASS  
Permit No. 2833  
Buffalo, N.Y.

POSTAGE WILL BE PAID BY

Sylvania Electric Products Inc.  
Advertising Services Center  
70 Empire Drive  
West Seneca, New York 14224

Dept. E 5 5 5 5

\_\_\_\_\_

\_\_\_\_\_

\_\_\_\_\_

\_\_\_\_\_

\_\_\_\_\_

\_\_\_\_\_

\_\_\_\_\_

## MANAGER'S CORNER

### A philosophy for the future of cable communications.

Cable television is a booming industry. At the present time there are over 2,000 systems in operation and an equal number under construction. In addition, there are over 2,300 applications under consideration in various cities throughout the United States.

All of this means big business for cable equipment suppliers, but it poses problems for the equipment buyers. The problem is not what type of equipment to buy for operation today, but what type of equipment to buy that will be usable in the future.

And the future of cable television is as exciting as it is unpredictable. Visionaries of the industry predict completely wired cities with all television programming coming over cable. They see the next logical step as interconnection of the wired cities to form a network throughout the nation. With this growth they predict an expansion of the use of cable television beyond the usual entertainment programming. Data transmission, facsimile transmission, educational and special interest programming (such as courses for doctors) are among the exciting possibilities of the future.

For the CATV operator, all of this means that the future will demand greater channel capacity. And that is where the Sylvania design philosophy comes in. We have designed our complete line of cable TV electronics, amplifiers, directional couplers and baluns, to meet the needs of the

future. All of these units are broad spectrum equipment, covering the entire range from 50 to 270 MHz with "hands off" total automatic control. For bi-directional service, the Sylvania equipment also covers the sub-VHF 6 to 30 MHz band.

This broad spectrum capability means that Sylvania equipment won't have to be replaced to meet the changing needs of the future. Regardless of the future direction cable television may take, you can be sure our equipment won't become obsolete.

Our Components Group is applying this same advanced engineering philosophy in the design of other equipment for cable television. You can get the cable system of tomorrow from Sylvania, today.

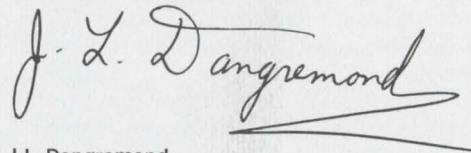

J.L. Dangremond  
Product Marketing Manager, CATV-Special Products.

This information in Sylvania ideas is furnished without assuming any obligations.

# SYLVANIA

## GENERAL TELEPHONE & ELECTRONICS

NEW CAPABILITIES IN: ELECTRONIC TUBES • SEMICONDUCTORS • MICROWAVE DEVICES • SPECIAL COMPONENTS • DISPLAY DEVICES

E5

NAME \_\_\_\_\_

PLEASE PRINT

TITLE \_\_\_\_\_

COMPANY \_\_\_\_\_

ADDRESS \_\_\_\_\_

CITY \_\_\_\_\_ STATE \_\_\_\_\_ ZIP \_\_\_\_\_

#### Circle Numbers Corresponding to Product Item

300    301    302    303    304    305

Please have a Sales Engineer contact me.

Visit    Phone...Phone No. \_\_\_\_\_ Area Code \_\_\_\_\_



#### HOT LINE INQUIRY SERVICE

Need information in a hurry? Clip the card and mail it. Be sure to fill in all information requested. We'll rush you full particulars on any item indicated.

You can also get information using the publication's card elsewhere in this issue. Use of the card shown here will simplify handling and save time.

# Technology Abroad

A new Swedish satellite ground station will be built by Italy's Consorzio di Telecomunicazioni via Satelliti SpA. The installation will be constructed at Tanum, Sweden, near Gothenburg, at a cost of \$2.8-million.

Indium-phosphide microwave oscillators are being investigated by the British Royal Radar Establishment (BRE). 'Experimental production techniques for liquid-encapsulated indium-phosphide single crystals have already produced encouraging results. These oscillators operate in a complex three-level mode, which resists the formation of domains and thus—at least theoretically—performs better than those based on the Gunn effect. Initial results have indicated an unusually smooth waveform, and most of the crystals have been found to provide strong oscillations. Though device work is still only in the initial stages, the BRE says it has achieved 7% efficiencies.

A full-scale telemetry system is in operation at Pirelli's new Vizola vehicle test-track facility near Milan, Italy. Transducers located at critical points on each test vehicle feed acceleration, vibration and strain data to two eight-channel TM transmitters.

Data is received in a control-tower complex, where it is recorded on tape for computer processing. Pen recorders and oscilloscopes provide information on a real-time basis. The computer-aided system condenses test-data reduction time from several months to a few days.

An electronic braking system that senses when auto brakes are about to lock and responds by reducing hydraulic pressure has been developed by Britain's Mullard organization. Toothed rings are fitted to the car's wheels so

that velocity is sensed by timing the passage of each tooth with a magnetic coil. When a characteristic deceleration occurs, the hydraulic pressure is reduced to prevent a skid. It is immediately restored so that it will respond properly to the brake pedal.

A zener-diode pressure gauge, comprised of an unusual combination of zener diodes, has been used at the Technical University of Warsaw for a 114,000-psi hydrostatic pressure gauge. The gauge has a temperature coefficient of pressure close to zero. The diode can be used either as a zener or as an avalanche breakdown device, depending on the working direction; in addition, the pressure sensitivity coefficient remains negative in either mode.

**Industry briefs:** The French aerospace industry reported \$707-million in exports for the first half of 1970; it predicts \$900-million for the entire year compared with the best previous figure (1968) of \$510-million . . . . Britain's Ministry of Technology and National Research Development Corp. will underwrite a comprehensive story of British microelectronics for the 1970-80 period . . . . Telesat Canada Corp. is planning a \$40-million construction program for 34 ground stations, to be finished in time to service Canada's first communications satellite in late '72 or early '73 . . . . Siemens Ag of Munich expects sales to climb 18 or 19% for the year ending Sept. 30, over the same period a year ago; it will sink \$13.7-million into an electronic components plant at Bordeaux; and it will hand over U. S. manufacturing and marketing concessions for utility and industrial customers to Allis-Chalmers of Milwaukee . . . . IBM World Trade Corp. plans a new plant in West Berlin for manufacture of electric typewriters and dictating equipment.

# The big difference between chip capacitors and our 505 series

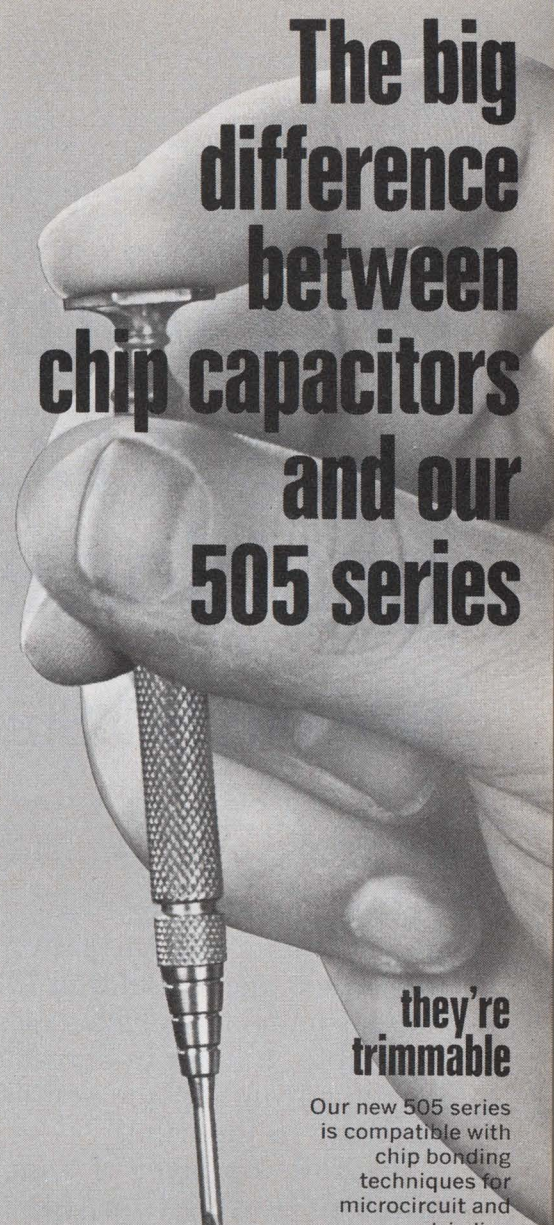

## they're trimmable

Our new 505 series is compatible with chip bonding techniques for microcircuit and strip line applications . . . and they're trimmable in ranges from .1 to 100 pF!

But trimmability is only one of the plus advantages of this new series, they feature high Q (self-resonant into X band),  $\Delta C$ 's of 1 to 15 pF, and low temperature coefficients ( $0 \pm 20$ PPM/ $^{\circ}$ C).

When your application calls for high Q chips, be sure to check the 505 series, they do everything a chip does — plus. Send today for full details.

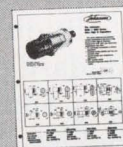

*Johanson*

MANUFACTURING CORPORATION

400 Rockaway Valley Road, Boonton, N.J. 07005  
(201) 334-2676 TELEX: 13-6432

Electronic Accuracy Through Mechanical Precision

# end your signal pollution problems

## Beldfoil® ISO-Shielded™ Cable

It's the cable with virtually perfect shielding. It's a Belden exclusive. Beldfoil ISO-Shield is like a continuous metal tube enclosing each pair of conductors in a cable. It locks out crosstalk or interference . . . whether from outside sources or between shielded elements in the cable.

Beldfoil is a layer of aluminum foil bonded to a tough polyester film (for insulation and added strength.) To form an ISO-Shield, we apply it in any one of several unique ways to meet the requirements of different applications. (See Figures 1 and 2, for example). Each gives more physical shield coverage than braided wire or spiral wrapped (served) shields. And greater shield effectiveness . . . even after repeated flexing.

Beldfoil ISO-Shielded Cables are small, lightweight. They terminate easily. They're modest in price. Your Belden Distributor stocks a wide variety of standard Beldfoil shielded cables as listed in the "Belden Electronic Wire and Cable Catalog" (ask him for the latest edition). And, should you have specifications no standard product can meet, ask him to quote on a specially engineered design. Or, if you choose, contact: Belden Corporation, P. O. Box 5070-A, Chicago, Ill. 60680. Phone (312) 378-1000.

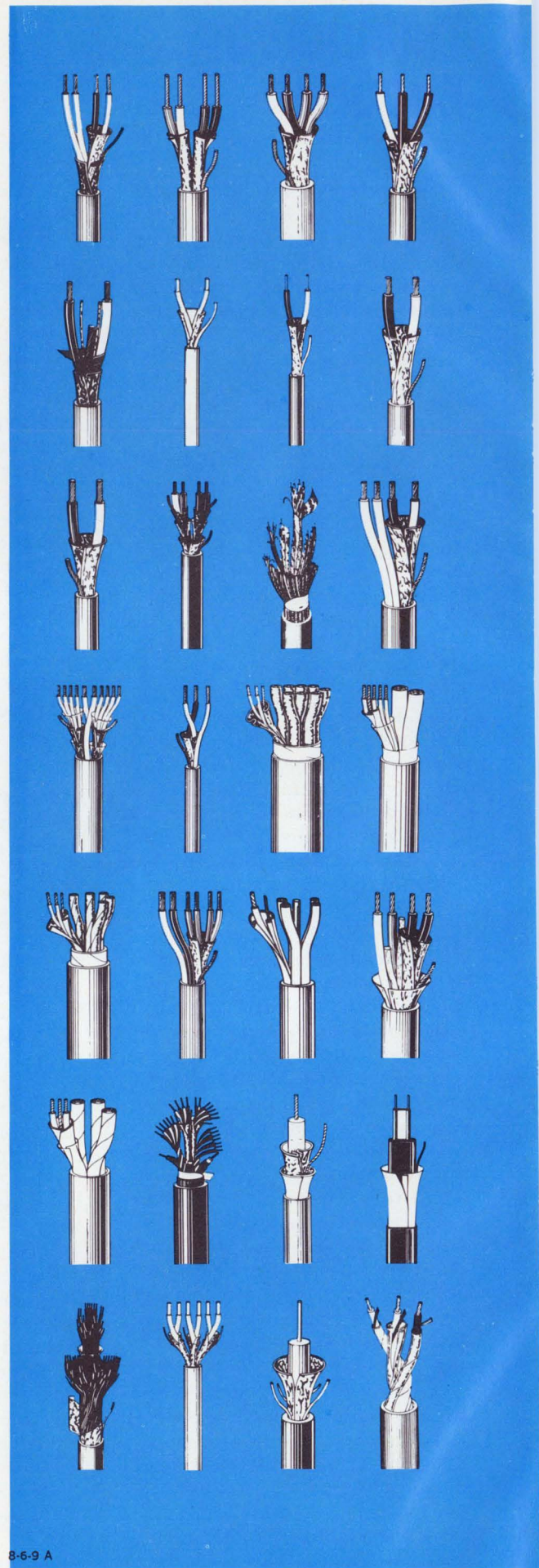

8-6-9 A

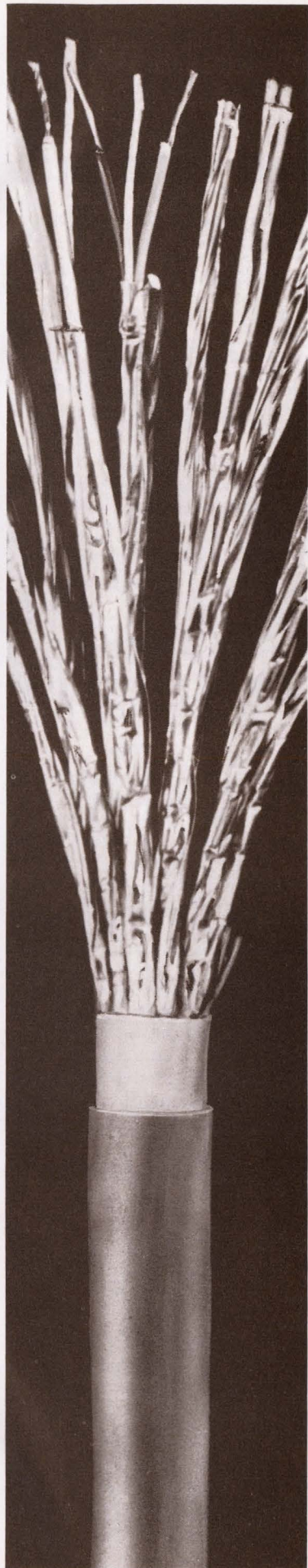

Metal (shield) foil, folded to assure metal-to-metal contact.

FIGURE 1

Polyester insulating layer folded to assure isolation between shields.

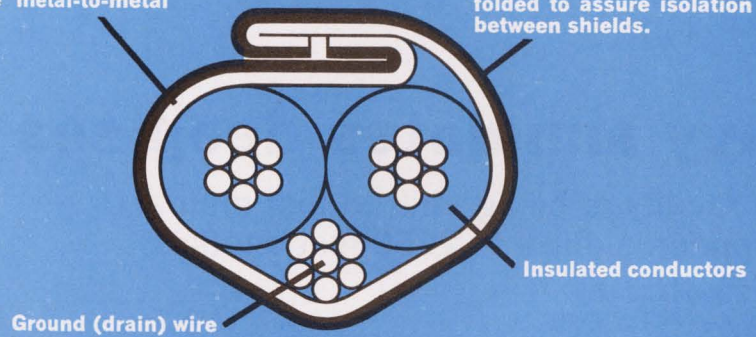

### Beldfoil Multiple Pair Individually Shielded Cable

The Figure 1 cross-section shows Belden's exclusive Z-folded Beldfoil ISO-Shield. Note the metal-to-metal contact between the two edges of the aluminum foil. In essence, you have a continuous aluminum tube. And the polyester layer on the outside of the fold assures the isolation between shields so necessary for best performance in the field.

#### Technical Data

Nominal values for multiple pair individually shielded cables containing 3 to 27 pairs (including 8769 and 8773 through 8778 Series cables)  
 Suggested working voltage: 300 volts rms max.  
 Working voltage between adjacent shields: 50 volts rms max.  
 Capacitance between conductors in a pair: 30 pf per ft. nom.  
 Capacitance between one conductor and other conductor connected to shield: 55 pf per ft. nom.  
 Capacitance between shields on adjacent pairs: 115 pf per ft. nom.  
 Insulation resistance between shields on adjacent pairs: 100 megohms per 1000 ft. nom.

Metal (shield) foil, folded to assure metal-to-metal contact.

FIGURE 2

Polyester insulation layer folded to provide bonus insulation between conductors and shield.

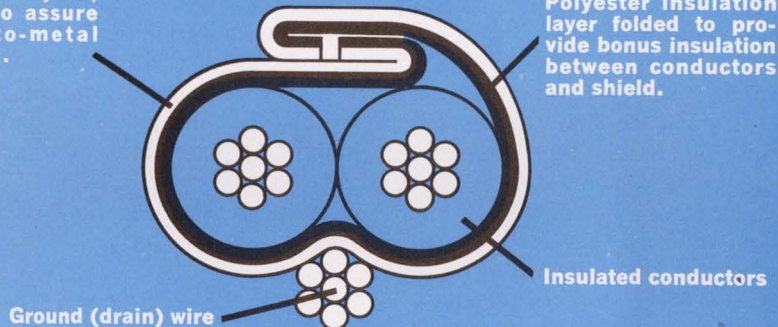

### Beldfoil Shielded Single Pair Cable

The Figure 2 cross-section shows the exclusive Belden Z-fold with the polyester insulating layer inward. This makes use of the high dielectric strength of the polyester film as bonus insulation between the conductors and the shield. (The cable jacket provides the primary insulation of the shield from outside objects or adjacent cables.)

#### Technical Data

Nominal values for 8451 Shielded Pair Cable  
 Suggested working voltage: 200 volts rms max.  
 Capacitance between conductors: 34 pf per ft. nom.  
 Capacitance between one conductor and other conductor connected to shield: 67 pf per ft. nom.

**BELDEN**

*new ideas for moving electrical energy*

# Navy simulates deep sea for man and sub

**New facility is being built to test man and components down to 2250-foot depths.**

**John F. Mason**  
Military-Aerospace Editor

A Navy electronics engineer, a doctor and a submarine designer watch, by closed-circuit television, as a diver tries to attach an acoustic antenna to the top of a small, manned submarine.

The sea depth is 1000 feet according to a dial on a console next to the TV screen. The water is 33°F, salty, and the illumination is poor.

The diver's pulse is normal, however, according to another console. His breathing mixture is correct, and his heated suit is functioning as it should.

Other TV screens with consoles show aquanauts in dry chambers, in locks between chambers, and one slipping from a dry shelter into the dark, cold water.

The difference between this operation, which will take place in mid-1972, and the Navy's Sealab experiments of the past is that this one will be in a simulator instead of the sea.

The advantage this facility will have over existing simulators is its unique capacity to accommodate both man and his equipment at the same time. The water-filled chamber that can hold divers and a submersible is 47 feet long and 15 feet in diameter. Two dry chambers are 14 by eight feet each.

The chambers will be able to produce pressure equivalent to sea depths of 2250 feet. However, until life-support equipment and electronic components can function effectively that deep, the operations will be less ambitious.

The simulator will be used for research and development, test and certification of equipment and systems, and for simulation and rehearsal of complete missions to be carried out at the bottom of the sea. It will be available for use by government, educational and in-

dustrial groups.

Some of the larger programs that will benefit from the facility include those for rescue and salvage, underwater construction, deep-ocean technology and oceanography.

## Facility to go on display

The chambers are being readied now for installation in a three-story brick structure being built at the Naval Ship Research and Development Laboratory in Panama City, Fla. Total cost will be approximately \$7.4-million.

The partially-built simulator will be on display for the first time at the IEEE International Conference on "Engineering in the Ocean Environment" in Panama City, Sept. 21 through 24.

Instrumentation and data-acquisition sensors will be partially controlled by a small digital computer, yet to be selected. For mission simulation, the laboratory's computer complex will be used. This consists of two Applied Dynamics

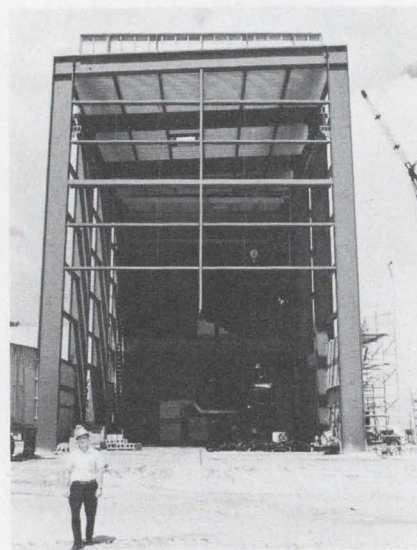

**The deep-sea simulator** to accommodate both man and submersible will go into this three-story structure at the naval base in Panama City, Fla.

AD 256 analog computers, under the control of a digital executive XDS 9300 computer, and a Burroughs 5500 digital computer.

Conditions monitored will be turbidity, salinity, absolute pressure, differential pressure, temperature, humidity, gas flow, fluid flow, oxygen level and gas composition.

The computer will also calibrate the system, check out its reliability, and sound an alarm when undesirable conditions are found.

For gas analysis and management, several infrared analyzers are available, two gas chromatographs, and a mass spectrometer. Biomedical instrumentation will record and display heart rate, respiration, body temperature, blood pressure and oxygen consumption.

## Trouble with components

Work is needed on a number of electronic components if they're to operate under pressure, the facility's project manager, Rolf R. Mossbacher, told ELECTRONIC DESIGN.

Certain power transistor cases, for example, collapse at about 500 feet, Mossbacher says, thus shorting the pins. Of the materials used now—aluminum, copper and stainless steel—Mossbacher says stainless steel seems to be the best. He also suggests that greater pressure can be sustained with a spherical case rather than one with a flat top. For further protection, he says it might be a good idea to pot the entire inner vacuum with a plastic potting compound.

The rubber seal used in some electrolytic capacitors ruptures in cold, wet, high-pressure environments. "So we changed to solid tantalum capacitors," Mossbacher says. "And when tantalum capacitors don't give us the voltage we need, we ask for a capacitor potted in a hard compound. Perhaps there is a better solution," he adds.

Everything needs miniaturizing,



# The compatible DATA-PAC family performers proudly present their new memory act.

Introducing the ICM-161, an integrated-circuit core memory system. It's fully field expandable in 4K-word modules to more than 16K words. It's field reconfigurable, too. With 7 different word lengths— from 8 to 32 bits per word—in 4-bit increments.

That adds up to 60 different memory systems. Systems you put together on the job. Easily. With an interchange of core storage and memory control modules. We provide complete documentation and

30-day delivery.  
Your imagination does the rest.

The ICM-161 is just part of the build-it-yourself digital systems we call the DATA-PAC family.

Four other core memory systems. Logic modules. Controllers. Minicomputers. Analog interface modules. Hardware. Power supplies. Accessories. All with common documentation.

Perform feats of design with DATA-PAC products. Enhance your act with the ICM-161. Our literature will expand your knowledge. We expand your alternatives. Write Honeywell, Computer Control Division, Framingham, Massachusetts 01701.

The Other Computer Company:  
**Honeywell**

**HONEYWELL INTERNATIONAL**—Sales and Service offices in all principal cities of the world. Manufacturing in Australia, Canada, Finland, France, Germany, Japan, Mexico, Netherlands, Spain, Taiwan, U.K. and U.S.A.



**(SIMULATOR, continued)**

he says, "especially transducers and signal conditioning equipment used for physiological monitoring.

"Resistors have presented no problem at 1275-foot depths we've subjected them to in the small pressure simulator (less than 1 cubic foot in size) we have here for testing components. But we can't know how they'll behave at 2000 feet.

"Underwater connectors leak," Mossbacher adds, "and thermal circuit breakers don't work in a helium atmosphere since helium carries off heat six times faster than air does.

"For a circuit breaker," he says, "we have tried magnetic devices. We've tested these at 1275 feet in helium for 10 days and they worked well." The device was made by Airpax Electronics, Inc.

Another problem is making TV cameras heliumproof. The helium

ruined the TV cameras used in the Sealab II habitat off the coast of California, and new ones had to be installed outside the habitat in sea water.

One company has promised the Navy, by spring of 1971, a TV camera that will operate in a helium atmosphere at a depth of 2250 feet for 30 days. The image orthicon tube in present "helium-resistant" TV cameras begins to break down in about five days, says a laboratory spokesman. ■■

## New laser quadruples color-range emissions

A unique chemical reaction has been found that causes a laser to emit light in colors that cover nearly half the visible spectrum—a range four times broader than tunable emissions from any other single dye laser.

The reaction, termed "exciplex" or excited-state complex, occurs in certain lasing materials known as organic dyes.

When a dye such as 4-methylumbelliferone is used, the tuning range, which includes colors from the near ultraviolet to yellow, is 1760 Å (angstroms) wide. Previously known organic molecules exhibit a tuning range less than 400 Å wide.

Ability to tune such a wide range is "one of the most significant advances since the introduction some four years ago of organic molecules or dyes as lasing materials," says Bell Telephone Laboratories, Murray Hill, N. J. The discovery was made there and reported by three scientists, Andrew Dienes, Charles V. Shank and Anthony M. Trozzolo.

The new laser will be "an ideal laboratory tool for investigating the interaction of light with various forms of matter," and it will pave the way for "extremely versatile laser communications," a spokesman for the labs says.

The key to the exceptional laser tunability—it takes a dozen or so conventional dyes to cover the entire visible spectrum—lies in a reversible chemical reaction that forms the exciplex.

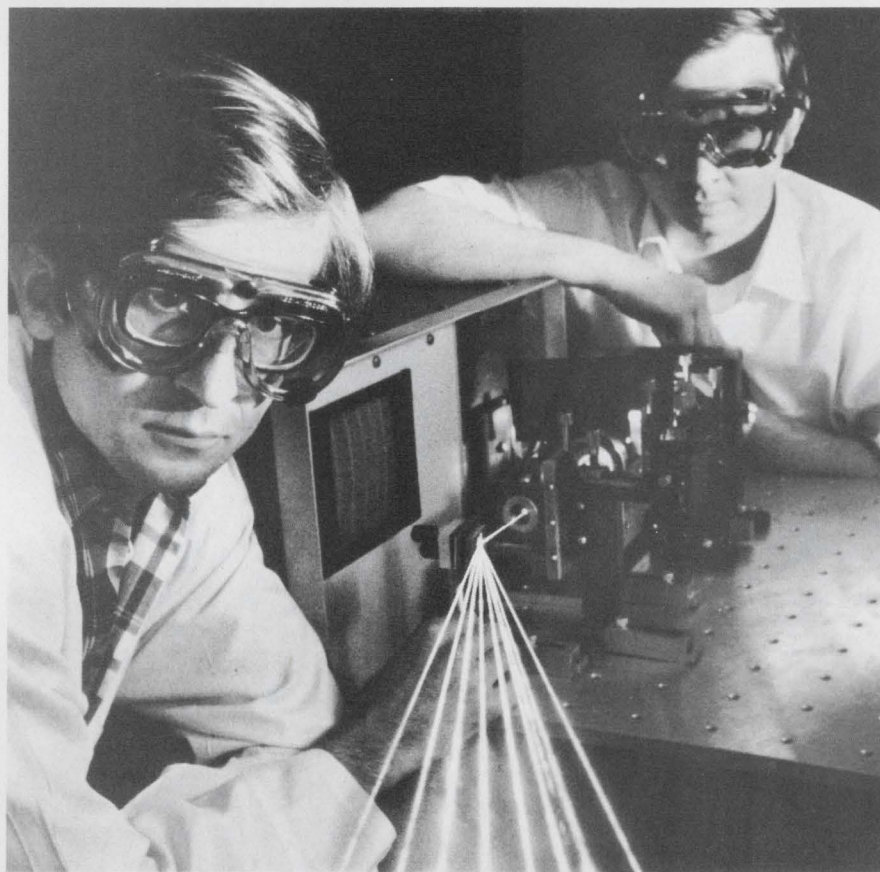

**Two of the three scientists** at Bell Labs who devised the new dye laser, called an exciplex laser, demonstrate its range of colors from ultraviolet to yellow. They are Andrew Dienes (left) and Charles V. Shank.

Unlike normal chemical reactions, an exciplex reaction takes place only when the molecules of the dye are in an electronically excited state, just prior to the emission of light. The molecules are excited by directing light pulses into the dye solution. This

is called optical pumping, and it can be provided by a flashlamp, a gas laser, or a solid-state laser. Once excited, the molecules of the dye react with a chemical present in the solution, and another form of the dye is created. It is an excited-state complex or exciplex. ■■



## Bodine helps data devices tell it like it is...

Bodine fractional horsepower drives. Small. Quiet. A complete line designed to power information-handling devices precisely, accurately, dependably. Motors built with all the integrity you've designed into your product—that deliver as specified with fewer callbacks and service problems. If this is the kind of power you're looking for, you'll find no better source.

Over 3,500 standard specifications to choose from. Bodine also builds custom fhp motors to meet design requirements. Our engineers will be happy to help you pinpoint the right one for your particular application need. Computers, business machines, instrumentation, copiers—whatever your product, specify Bodine fhp drives. We've been the power behind the leading products for some 63 years. Write for bulletin. Bodine Electric Company, 2500 W. Bradley Place, Chicago, Illinois 60618.

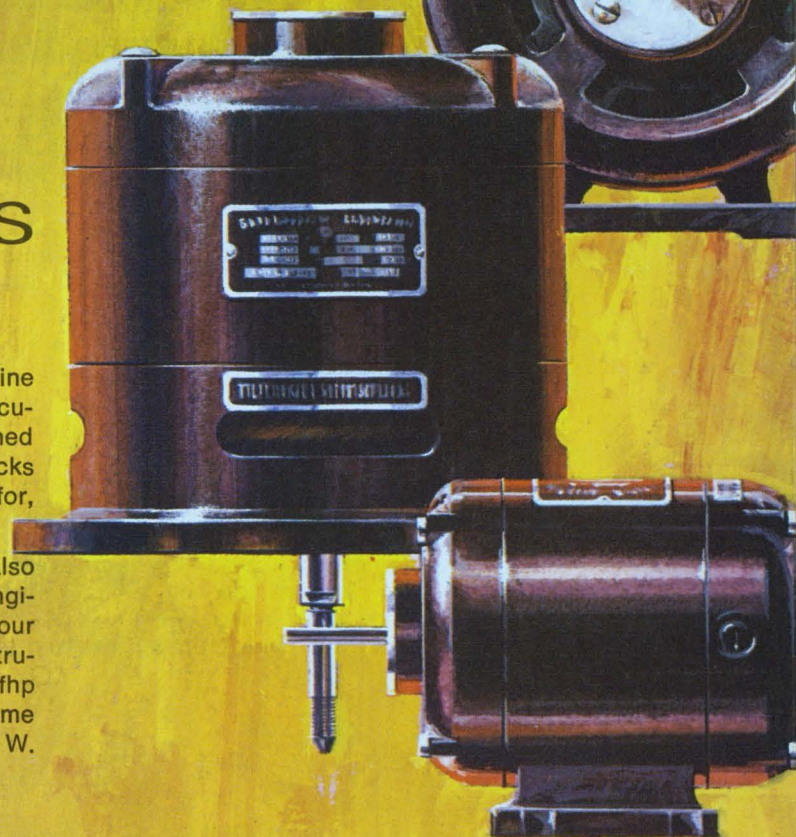

*Bodine Motors Wear Out—It Just Takes Longer*  
**BODINE MOTORS/CONTROLS**

Ask about Bodine SCR motor speed controls



**POLYCELL + CAD = Custom MOS**

## Motorola's "New Math" Formula Works Fast For Accurate, Economical Logic Design

Call it "New Math" or old fashioned common sense, Motorola's POLYCELL LSI brings you custom MOS arrays today. The design accuracy, speed, and efficiency of Motorola's POLYCELL approach are realized through the use of optimum sized "building block" cells and an advanced computer aided design facility.

Motorola's POLYCELL LSI for Custom MOS is a total system, starting with the performance specification and logic drawing, and working through design, artwork, fabrication, and testing. With a library of predesigned MOS logic cells at the heart of the system, circuit requirements are quickly and accurately reduced to working arrays. Design errors are quickly identified and corrected through the use of logic and circuit simulation programs proven over a full year of handling customer requirements. Total

design costs are only 40% to 60% of those in lengthy "hand-wrought" methods.

To make the system work, Motorola has developed a flexible Customer-Motorola interface arrangement for complete, clear communications insuring full recognition of customer interests and needs — and his understanding of his responsibilities, too.

A completely detailed 88 page manual, "MOS POLYCELL LSI," describes the entire POLYCELL program.

You may obtain a copy by addressing a request on your company letterhead to Motorola Semiconductor Products, Inc., Technical Information Center, P. O. Box 20912, Phoenix, Arizona 85036.

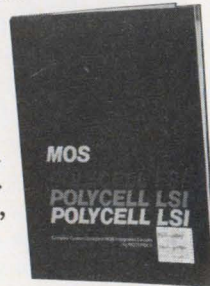

 **MOTOROLA MOS**  
... LSI The POLYCELL Way!

# 7 new stocking locations

## for Allen-Bradley components

**CLEVELAND** Schweber Electronics Corporation  
23880 Commerce Park Drive, BEACHWOOD, Ohio 44122 (216) 464-2970

**DETROIT** Newark-Detroit Electronics, Inc.  
20700 Hubbell Avenue, OAK PARK, Michigan 48237 (313) 548-0250

**SEATTLE** Kierulff Electronics  
5940 Sixth Avenue South, SEATTLE, Washington 98134 (206) 763-1550

## and in Canada...

**MONTREAL** Cesco Electronics Ltd.  
4050 Jean Talon, MONTREAL, Quebec, Canada (514) 735-5511

**OTTAWA** Cesco Electronics Ltd.  
1300 Carling Avenue, OTTAWA, Ontario, Canada (613) 729-5118

**QUEBEC** Cesco Electronics Ltd.  
98 Rue St. Vallier, Ouest, QUEBEC, P. Q., Canada (418) 524-4641

**TORONTO** Cesco Electronics Ltd.  
24 Martin Ross Avenue, DOWNSVIEW, Ontario, Canada (416) 638-5250

### Expanding this network of appointed distributors:

**San Francisco** Elmar Electronics, Incorporated  
2288 Charleston Road, Mountain View, California 94040  
(415) 961-3611

**Los Angeles** Kierulff Electronics, Incorporated  
2585 Commerce Way, Los Angeles, California 90022  
(213) 685-5511

**Chicago** Newark Electronics Corporation  
500 North Pulaski Road, Chicago, Illinois 60624  
(312) 638-4411

**Boston** Cramer Electronics, Incorporated  
85 Wells Street, Newton, Massachusetts 02159  
(617) 969-7700

**New York** Schweber Electronics  
Jericho Turnpike, Westbury, New York 11590  
(516) 334-7474

**Philadelphia** Almo Electronics Corporation  
A Sterling Electronics Company  
Roosevelt Blvd. at Blue Grass Rd., Philadelphia, Pa. 19114  
(215) 676-6000

NEW DIMENSION ELECTRONICS

**ALLEN-BRADLEY**

Milwaukee, Wisconsin 53204



Cores on degaussing table being demagnetized.



**The reason our core memories are in big demand is a small matter.**



**The small matter.**

A core memory system is only as reliable as the cores that go into it. When you make 20-million-bit mass memories like our Large Core Store (LCS), you need the highest reliability. So we've invented an exclusive way of making cores uniform in quality, density and size. We have a way of testing every core for mechanical and electrical reliability before it's strung. Quality control all the way. All the way from cores to stacks, and from intermediate

systems to the LCS (20,000,000 cores worth of quality...that's no small matter). We'll make a compatible memory for any system you have, or any you have on the board. One with built-in economies. We specialize in specials, so buy only as much memory as you need. Just make your demands.

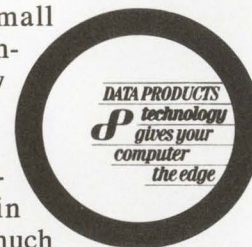

**DATA PRODUCTS**

**OEM marketing** 16055 Ventura Blvd., Suite 419, Encino, California 91316

Acton, Massachusetts (617) 263-3961; Bethesda, Maryland (301) 652-8120; Cherry Hill, New Jersey (609) 667-7355; Dallas, Texas (214) 231-2240; Detroit, Michigan (313) 354-5858; Los Altos, California (415) 941-5485; Los Angeles, California (213) 981-9600; Melbourne, Florida (305) 723-0720; Minneapolis, Minnesota (612) 927-8747; Amsterdam, The Netherlands 020-156-297; London, England 01-579-2917; Vienna, Austria 34 53 61, 34 44 16

## Our core memory systems...

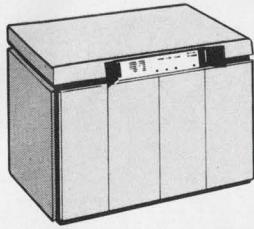

**CM 1700 Large Core Store**—An advanced high-speed random access mass memory providing up to 20 million bits

in either 40 or 80 bit configurations. A 2-wire, 2½D system with 2.0 microsecond cycle time; 1.25 microsecond access time.

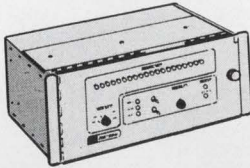

**Store/33**—Buy only as much memory as you need: 4K x 6 to 16K x 24.

A flexible plug-in system with a full choice of cycle times. Built for easy maintenance and field expansion, with 2½D cycle times at 3D cost.

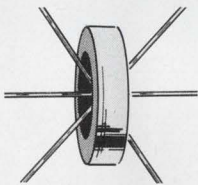

**Ferrite Memory Cores**—Our exclusive process gives you uniform quality at a greatly reduced price (as little as \$2.50/K).

Cores are cookie-cut from continuous ferro-plastic tape. A full range of diameters and electrical characteristics.

**Remember them for speed and reliability. And for the matter of quality.**



**DATA PRODUCTS**  
OEM marketing

16055 Ventura Blvd., Suite 419  
Encino, California 91316

# Letters

## Power crisis stresses need for new ideas

Sir:

While observing the recent "brown-outs" through New York's murky atmosphere, I reflected back on my own experience with electrical engineering at CCNY. Like everyone else I sheepishly went down the electronics trail. All the creative action (and the money), we were sure, was in radar, communications, computers, and so on, and the Con Ed guys were sort of union-help types.

Well, we can now see at least some of the results. Those guys who got us to the moon were a bunch of dedicated, terrifically creative types. Their energy did not go into solving the set of engineering problems that have led to the present power crisis. But there is still lots of creative effort left there, and more than one of those guys would be happy to plunge into a new, high-priority project right now.

Here's what I have in mind. While mulling over the problems cited earlier it occurred to me that there might be creative ways to help solve both at once. Our present method of generating power is oriented heavily toward cyclical operation. Turn on everything for a hot summer weekday and shut down most of it when power consumption is low. This is related to the pollution problem, since by general engineering principles turning things on and off results in periods of inefficiency when heat and waste products are dispelled until the plant adjusts to new operating levels.

So why not concentrate efforts on short-term energy-storage technology? This could reduce peak-load energy requirements, and smooth the fluctuations in operating levels.

There are many possibilities that might be explored. A simple one is to pump a lot of water up at night and let it fall during daytime hours. Another is to spin heavy masses like steel wheels on low-friction bearings—perhaps in-

tense, balanced magnetic fields. This idea is used on a small scale in some gyroscopes. Another is the use of capacitors like those developed for nuclear fusion projects such as Princeton's Stellerator. They could be charged at night and slow-charged during the day.

These methods might prove more expensive, at least initially, than simply building more generators and power plants. But I hope whoever is doing the calculating adds in the cost of present power-company public-relations programs to "sell" nuclear power—and the legal battles when power planners insist that the heart of Queens or a beautiful scenic spot next to the Hudson are the only available places to put their new nuclear plants.

Why not a national engineering effort to quickly provide this energy-storage technology?

*Robert C. Haavind*

Editor  
Computer Decisions  
New York, N. Y.

## 'Gremlins' finish job that is just begun

Sir:

In your article in the July 19 issue (ED 15), p. 21, on Honeywell's expendable remote weather stations (EROWS), the type gremlins appear to have accomplished our developmental job for us when you reported that EROWS had already been "designed and built" by Honeywell's Aerospace Division-Florida, in St. Petersburg.

EROWS development, under the sponsorship of the Air Force Cambridge Research Laboratories, Bedford, Mass., has just begun. Our first delivery is still about a year off. In addition, it will use vhf, not uhf for its telemetry system.

*Larry R. Lubenow*

Honeywell, Inc.  
Aerospace Div.  
St. Petersburg, Fla.

# Real Time saver.



## Now you can record 1,000 high accuracy readings per second without breaking guard.

Cimron found an answer to the speed vs. isolation problem that's been putting a damper on digital data gathering. Now our 6653A Multimeter can digitize up to 1,000 readings per second and record the data on continuous magnetic tape or store the information in a computer for real-time processing.

Our unique high-speed capability is achieved by a plug-in option which increases the thrupt rate threefold. This option is compatible with any new or existing 6653A.

Ultimate common mode rejection is maintained which prevents loss of accuracy due to noise in low level signals. The 6653A can't be matched for its overall measurement capability, accuracy and stability in its price range. You get the greatest number of options including sample and hold, AC, millivolt and ohms. With the autorange and combined ohms-millivolt converter plugged in, it can autorange through all six DC ranges.

For systems applications, Cimron

offers five buffered or unbuffered printout plug-ins.

Engineered with all IC logic and modular construction, the basic 6653A with accuracy of  $\pm 1$  digit is just \$1,740.00. And it all adds up to Cimron *customer concern*.

Write to Cimron, Department E-101, 1152 Morena Blvd., San Diego, California.

# CIMRON



LEAR SIEGLER, INC.

CIMRON DIVISION



# Washington Report

DON BYRNE, WASHINGTON BUREAU

## **Microwave landing system contracts expected by Jan. 1**

The Microwave Landing System National Planning Group expects to let contracts for the development of a microwave scanning-beam instrument landing system by the first of the year. The group, composed of NASA, Federal Aviation Administration and Defense Dept. representatives, has held two meetings to date in Washington and has agreed to support the scanning-beam principle and the signal format recommended by Special Committee 117 of the Radio Technical Commission for Aeronautics. The international commission has been considering an improved landing system for more than two years. The special committee expects to meet in Washington on Oct. 12, at which time formal recommendations are to be made to all interested parties—both domestic and foreign—for development of a common microwave ILS.

## **AT&T urges balance between cable and satellite**

American Telephone and Telegraph has urged that a balance be maintained between overseas cable and satellite facilities in the future. Filing comments in the Federal Communication Commission's future broad inquiry into overseas communications, it stated that a new transatlantic cable was urgently needed now to keep up with demand in the early 1970s. To maintain a proper "mix" AT&T said, 10 submarine cables will be needed in the present decade—three transatlantic, three in the Pacific area and four in the Caribbean-South American area.

## **Intelsat IV program on schedule, Comsat says**

The Intelsat IV communications satellite program is on schedule and meeting all objectives, the Communications Satellite Corp. (Comsat) has assured the Federal Communications Commission in a status report. In 22 months of work by Hughes Aircraft Co., the prime contractor, the prototype spacecraft has been assembled and four test elements completed. The report also spelled out some of the steps taken to prevent the errors that occurred in the Intelsat III program. A Comsat vice president, George P. Sampson, says that unless unexpected difficulties are encountered, the first flight craft will be at the launch site by November for a scheduled launching in December.

## **Commerce Dept. sponsoring computer show in Japan**

The Bureau of International Commerce of the Commerce Dept. will sponsor a computer and peripheral equipment show in Tokyo Oct. 12-17 in an effort to increase U. S. penetration of the Japanese computer market. The federal bureau says that last year U. S. companies sold \$92-million worth of computers and computer equipment to the Japanese and that sales this year are expected to exceed \$105-million, making

Japan one of the world's largest markets for U. S. manufacturers. The Commerce Dept. sees large-scale digital computers, character-recognition equipment, optical character readers, electronic handwriting systems, keyboard encoders, numerical control units and selected software and services as products with the highest sales potential in the Japanese market. More than half of Japan's imported digital computers come from the U. S. and the demand for imported software is expected to reach \$28-million by 1972, the Commerce Dept. says.

## FAA to begin automatic vhf position reporting tests

The Federal Aviation Administration's experimental vhf automatic position reporting system is expected to go into test operation on the first half of the San Francisco-Hawaii run this month. U. S. air carriers are strongly supporting this data-link system for trans-ocean flights, as opposed to an over-ocean uhf satellite radar system.

The vhf system derives aircraft positions from the planes' own inertial navigation systems. They are data-linked back to a large cathode-ray tube display in Oakland, Calif. If the system becomes operational, a satellite will be used to relay the signals.

The ground system, called Idiiom, was developed by Information Display, Inc., of Mt. Kisco, N. Y., under a \$210,000 contract with the FAA. Three airlines will participate in the nine-month test.

## 8 file as would-be operators of domestic satellites

Eight applicants have told the Federal Communication Commission that they want to be considered, along with the Western Union Telegraph Co., as a potential operator of a domestic satellite system. After Western Union filed the first application, the commission invited comments by any other parties who wished to file.

Replying with varying degrees of certitude were the three major radio-television networks filing as one group; the Data Transmission Co.; AT&T; Comsat; General Telephone and Electronics Corp.; RCA Global Communications, and its subsidiary, RCA Alaska Communications, filing jointly; the Microwave Communications, Inc. group; and Teleprompter Corp. and Hughes Aircraft together.

**Capital Capsules:** The Electronic Industries Association's communications terminals and interface section has endorsed a **report of the National Academy of Sciences favoring connection of customer-owned systems with the nation's telephone network.** The EIA agrees there should be a nationwide certification program of such user-owned equipment, with specification limited to guarding the public switching network from possible harm . . . . NASA's Lewis Research Center is **seeking a contractor to study, design, construct and test CRTs in microwave high-power transmitters . . . .** The U. S. Tariff Commission says its recommendation on what to do regarding **Item 807 of the Tariff Code will be submitted to the White House "not later than Sept. 30."** The report was originally scheduled to be completed by Aug. 31. (Item 807 waives the import duty on electronic components made in the U. S., assembled abroad and returned here for sale.) Labor groups want the item repealed; industry groups support it.

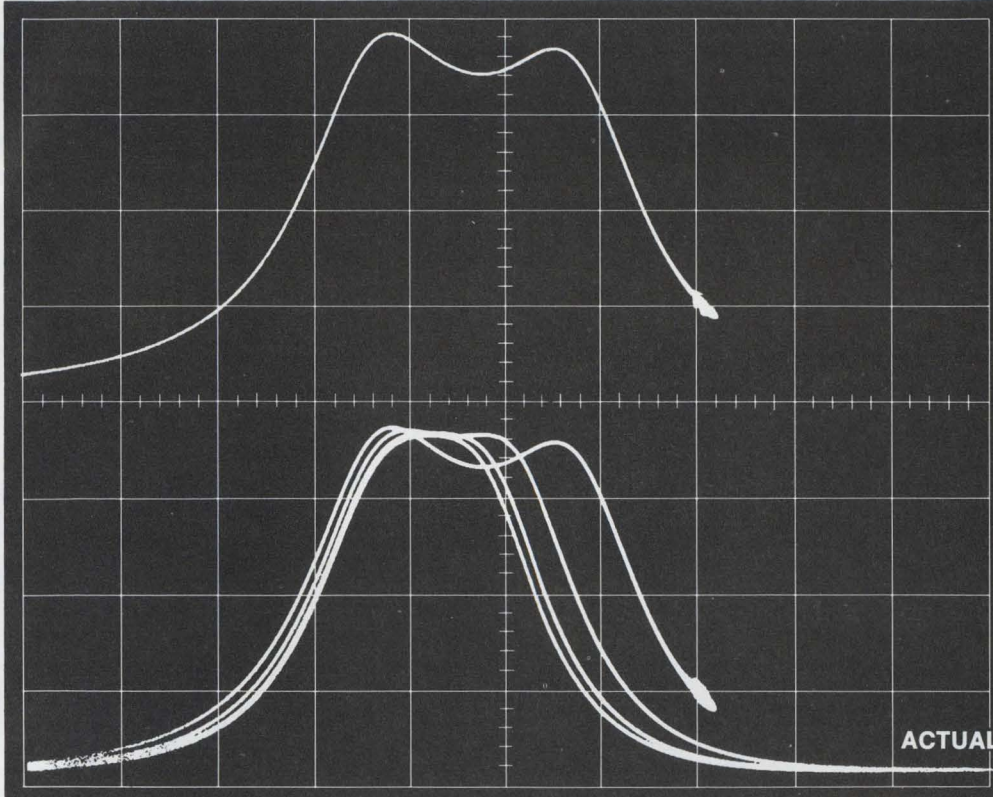

CH1  
> 100  
mV

CH2  
> 100  
mV

HORIZ  
200  
mS

ACTUAL SCREEN SIZE

# A DUAL-BEAM FAMILY

Performance in a Configuration to fit YOUR individual application

Big performance . . . in a compact size! Performance characteristics of this dual-beam oscilloscope family include high-gain, wide-bandwidth amplifiers with 19 calibrated deflection factors from 10  $\mu$ V/div to 10 V/div. The voltage inputs (differential or single ended) have a bandwidth of DC to 1 MHz at all deflection factors. Current probe inputs are also provided for each beam with 10 Hz to 1 MHz bandwidth and eight calibrated deflection factors ranging from 1 mA to 200 mA/div. A wide sweep range is provided in 21 steps from 1  $\mu$ s/div to 5 s/div. The convenient direct reading magnifier provides sweep magnification ratios of up to 50 times. Bright fiber-optics automatically read out scale-factors adjacent to the extra large 8 x 10 div (1.27 cm/div) CRT.

This big display area is available in a 6 $\frac{1}{2}$ " conventional or rugged bistable storage CRT; both have internal graticules. Three instrument configurations are available, each at the same price. They are: a 5 $\frac{1}{4}$ " high rackmount, a 6" high x 17 $\frac{3}{4}$ " wide low-profile cabinet and a 10" wide upright cabinet. Save space without compromising your measurements!

Ask your Tektronix Field Engineer for a demonstration. For complete specifications consult your 1970 Tektronix Catalog or write: P.O. Box 500, Beaverton, Oregon 97005.

5031 (Storage) . . . . . \$2500    5030 (Conventional) . . . . . \$1850

These oscilloscopes are available through our new Leasing Plan.  
U.S. Sales Prices FOB Beaverton, Oregon

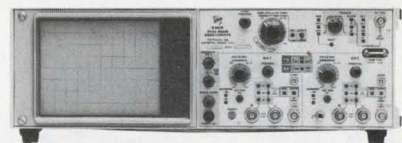
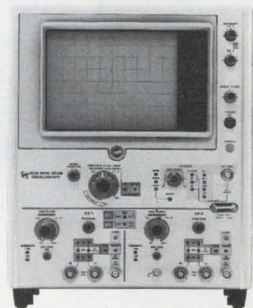

**Tektronix, Inc.**



*committed to progress  
in waveform measurement*

# From Microdot, of course

We present, for your pleasure and profit, a sampling of the superb in electronics and aerospace products. Engineered by divisions and companies of Microdot Inc. Designed to solve specific problems. For lack of space, your particular problem may not be discussed here. Don't fret. Call us. For some very, very interesting solutions.

## For coupling: a very dense bayonet.

Here's a new bayonet coupling series of multi-pin connectors from Microdot that features the highest contact density on the market. They're also lighter and smaller than any comparable type. The MARC 63 series meets performance requirements of MIL-C-38999, MIL-C-81511 and MIL-C-38300. Accommodates all insert layouts used in the MARC 43, MARC 53 and RMD series.

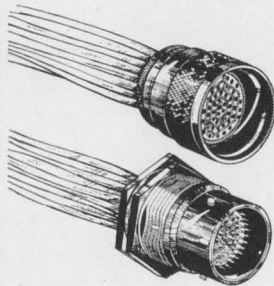

## Decisions. Decisions.

You now have a choice in helically coiled threading inserts. Plus good reasons for deciding on Perma-Thread from our Kaynar Manufacturing Division. Available in Std. 208 Free-running and Pitch-Lok 209 Locking series. Inserts increase assembly reliability, eliminate thread failures, stay securely in place. They're the lightest, smallest inserts on the market. Interchangeable with all other coiled inserts.

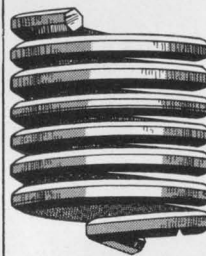

## Able cable.

"Mini-Noise" coaxial reduces noise voltage magnitude by a factor of 100 to 1 compared with other cables. Reason: Our Cable Division's proprietary process of coating cable with specially treated Teflon\* or polyethylene dielectrics. A great solution to audio noise problems encountered by electronic component manufacturers and users. \*Du Pont Trademark

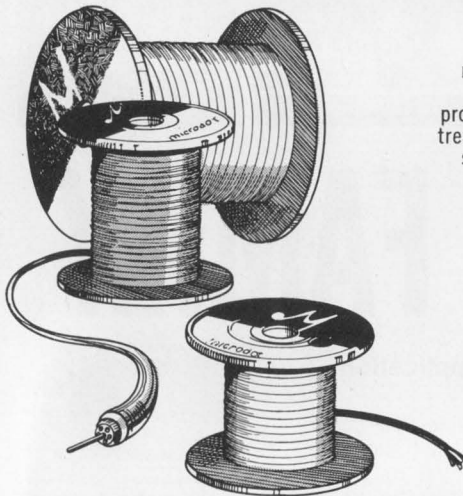

## First things first.

Like "Minimate." It's the first connector to meet MIL-E 5400 K on 0.050" centers. Ideal miniature edgeboard connector for tape recorders, computers — wherever disconnect and connect occur often. Edgeboard connector normally used on mother/daughter board concept.

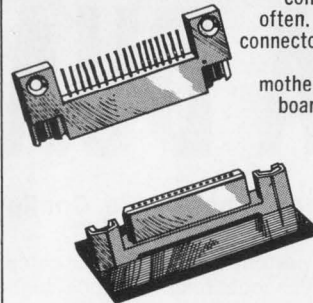

## Testing: 1-2-3-4-5.

Microdot's Instrument Division is offering a new line of general test oscillators and waveform generators. Five in each series. Waveforms cover frequency spectrum of .005 Hz to 3 MHz. Output signals: sine, square, triangle, ramp and sync pulse. Oscillator frequencies range from 10 Hz to 10 MHz. Each has an output signal monitor. Amplitude is controlled by precision step attenuation.

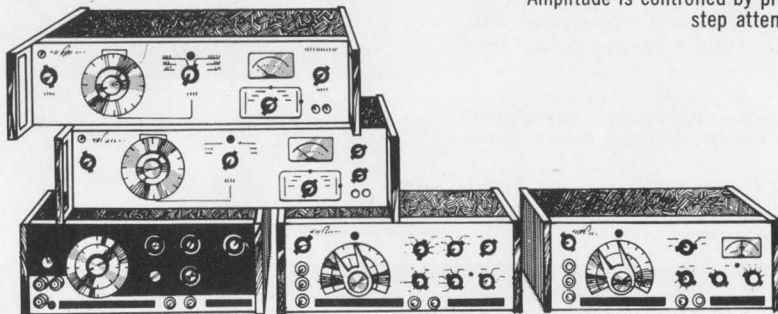

## How low can we get?

Plenty low, if handling costs are high on an assembly line for electronics products. We streamline the operation with Speed-Feed system vibratory parts feeders, storage hoppers and inline feeders. From Speed Feed Systems, a division of Microdot's Kaynar Company.

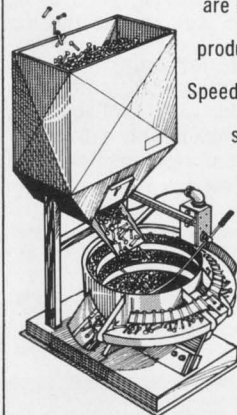

**MICRODOT INC.**

220 Pasadena Ave., South Pasadena, Calif. 91030

# ditto

## Watts the difference?

Microdot's Model 445 oscillator, of course. A 50-watt plug-in performer from our Instrument Division. With VHF-UHF power. Choice of heads for 6 frequency ranges. From 2-2500 MHz.

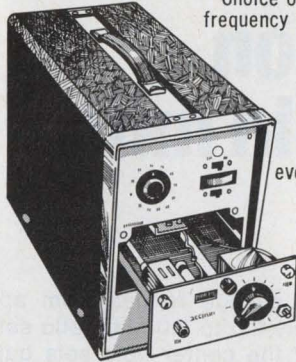

Has positive no-load protection. Must equipment for everything from power meter calibration to antenna pattern measurements.

## Fasten it fast. And fast to unfasten.

Kaylock miniature fasteners — from Microdot's Kaynar, Inc. — are especially suited to today's sophisticated electronic system packaging. These lightweight fasteners are easy to use, reliable and highly reusable. Kaylock nuts feature the thin-wall self-locking device for uniform locking torque. Available in carbon steel, A286 stainless and other high temperature alloys.

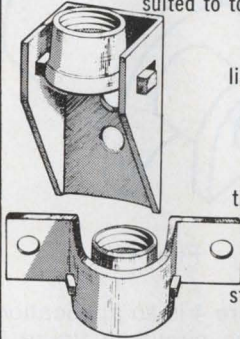

Available in carbon steel, A286 stainless and other high temperature alloys.

## Easy reader.

4

All the news that's fit to print about these products can be yours. Free. (Unless you're upset by the price of postage stamps.) Check the items you're interested in. Mail this coupon. And we'll send literature.

- Testing equipment
- Model 445 oscillator
- Perma-Thread inserts.
- Cable
- MARC 63 connectors
- Minimate connector
- Speed-Feed system
- Kaylock self-locking nuts

Name & Company \_\_\_\_\_

Address \_\_\_\_\_

City \_\_\_\_\_

State \_\_\_\_\_ Zip \_\_\_\_\_

SIDELIGHTS

## 'Combat' coverage of liquid crystals

Although violence on college campuses is not uncommon these days, West Coast Editor David Kaye didn't expect to get part of his story on liquid crystals (p. 76) under combat conditions. The day was May 4, the place was Kent State University in Kent, Ohio, and as Dave sat down to interview James L. Ferguson, associate director of the Liquid Crystal Institute, shots rang out across the campus.

There had been rumblings of trouble. During the previous two days, store windows had been broken in Kent, and the ROTC building on campus had been burned down. Armored personnel carriers rolled through the streets as Dave headed for the university adjacent to Kent's downtown area, and upon arriving at the campus he found the National Guard occupying the site. He had to get special clearance to enter the institute.

A rally had been called at 12 noon, by the students, to protest the presence of the Guard on campus. And then, into this tinderbox of emotion, burst the sound of shots.

Guardsmen came into the Liquid Crystal Institute and asked that it be evacuated; it was an avowed target because of the military-contract work carried out there. No sooner had Dave and Jim Ferguson cleared the border of the city of Kent than martial law was declared, and the borders were closed to all traffic, in and out.

Dave got his liquid-crystal interview—at Jim's home near town. It wasn't until later, when truth sifted through the wild rumors, that they learned four students had been killed by the shots they heard.



West Coast Editor Dave Kaye had to get special clearance to enter the Liquid Crystal Institute at Kent State University.

# Linear actuators: Positioning systems that offer high speed, high resolution and positional accuracy within mils.

The drive system in a pm loud-speaker is a familiar example of the linear actuator principle. It consists of a coil mounted in the annular gap of a permanent magnet assembly. When you introduce a current, the coil moves with force proportional to the product of the current and the magnetic field.

Your particular application may require the coil to move a precise amount, apply a precise force or simply advance to a specific position. Coil travel can be several inches or a few thousandths of an inch depending on your need. Positional accuracy within mils is possible when high resolution sensing equipment is used.

## The magnetic circuit. 3 basic types.

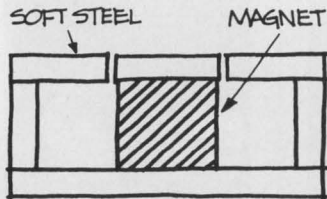

FIG. 1

Figure 1 shows the magnetic circuit with highest efficiency. The magnet forms the center pole with a soft steel plate on the gap end. Leakage is 1.5 to 1.8. Operating density of the

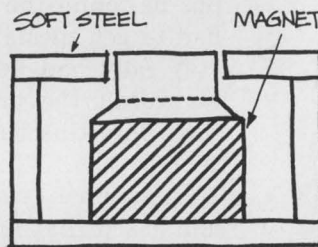

FIG. 2

magnet controls gap density. Magnet length determines coil excursion.

Greater gap density for a given gap size is possible when you design the type of circuit in figure 2. The soft steel center pole operates near magnetic saturation, which may be 50% greater than the magnet  $B_d$  in figure 1. Leakage in the figure 2 circuit is 1.8 to 2.2. Short center pole length establishes coil excursion in this type of circuit.

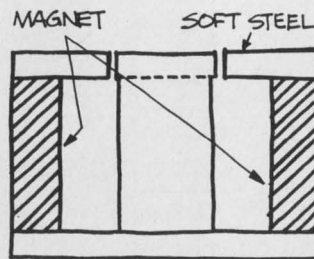

FIG. 3

The circuit in figure 3 provides long coil excursion, high gap density —

or both. Leakage ranges from approximately 2.5 to 3.0. Magnetic saturation of the center pole sets gap density.

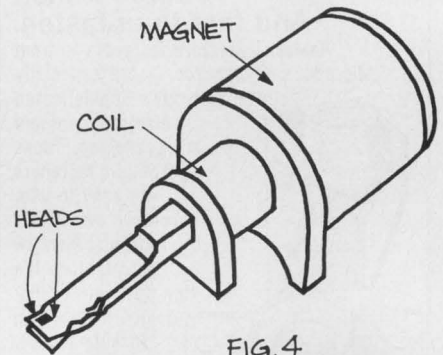

FIG. 4

The unit in figure 4 is an application of the magnetic circuit in figure 3 above. It positions magnetic heads in computer disk drive systems. Both electrical and optical position sensing are employed to achieve extremely high resolution.

## We offer design assistance.

If your design problem concerns high speed or high resolution linear motion, you can get the magnetic circuit information you need at Indiana General. Our engineers are always ready to work with you. Just write Indiana General, Magnet Products, Valparaiso, Indiana 46383.

**indiana general** 

a division of Electronic Memories & Magnetics Corporation

INFORMATION RETRIEVAL NUMBER 34

**"ZERO" Reaction Time**

**clip transients...**

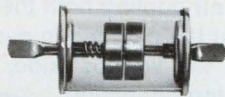

**with the New Uni-Imp  
Voltage Surge Protector**

- Impulse Ratio ..... 1.1 to 1
- Trip Voltages ..... 550V to 15kV  
(constant up to 50 kV/microsec.)
- Life ..... greater than 5,000 shots  
@ max. rating
- Follow-on Current ..... Compatible with normal  
relay closure times

Now it is possible to protect sensitive components, even semi-conductor equipment, against voltage transients without concern for the rate of voltage rise. The "zero" reaction time of Signalite's new Uni-Imp is only one of its many unique features. Others including its Bi-Polarity, immunity to di/dt restrictions, infinite leakage resistance, are described in a new data sheet.

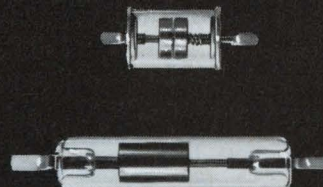

**AVAILABLE UPON  
REQUEST** Detailed  
Data Sheet ... on  
Signalite's Uni-Imp  
Zero Reaction Time  
Voltage Surge Pro-  
tectors.

**Signalite** 

Division of  
General Instrument

1933 HECK AVENUE, NEPTUNE • NEW JERSEY 07753  
(201) 775-2490

Malco presents Dip-Mates, another great moment in mating.



## Man discovers something better.

Some guys are never satisfied with their mates. They're always looking for something new. Something a little more . . . uh . . . reliable. And preferably, something with a little less resistance.

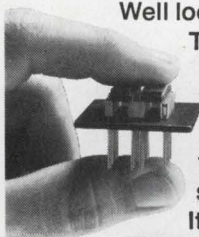

Well look no further.

The newest Malco-Mate was specifically designed for the guy who wants something better. It's DIP-MATE.

The most advanced, most reliable dual-in-line circuitry interconnection system available.

The not-so-secret secret of Dip-Mates is the newly designed fork type contact plus the low resistance ground and power connections. Now you can plug in thin DIP leads and maintain a consistently reliable connection. In Dip-Mates, the base plate functions as the ground while a thin, insulated aluminum power plate is attached under the module board.

The new Dip-Mate design keeps thermal problems to a

minimum by air cooling both the top and bottom of the plugged-in package. And on the wrapost side, a low profile interconnection design allows for a maximum area available for wire wrapping.

But let's get to the best part. Dip-Mates are the most versatile dual-in-line (MSI and LSI, too) connectors because they can be used as both a flat I.C.

board or in a cubic configuration using a mother plate with daughter plates inserted at right angles. In fact, you can even stock spare modules.

Not only does this configuration

save gobs of space, but it lets you add as many modules as you need. Reliably.

To make it even more tempting,

INFORMATION RETRIEVAL NUMBER 57

Dip-Mates used in the cubic configuration can have built-in heat sinks installed, so you can stuff the entire mating system into a tiny space without worry. And Dip-Mates accept everything from the standard 14-pin I.C. up to an infinite number of contacts. Almost.

Naturally, you can order Dip-Mates to meet your unique design specifications. In fact, we'll even provide wire-wrap for you. Or, you can order any of our off-the-shelf Dip-Mates in standard configurations. And even not so standard configurations.

If you're looking for a new mate that can offer you some very interesting variations, discover Dip-Mates. They're something better.

**We solve your mating problems.**



**MALCO**  
MALCO MFG COMPANY INC  
5150 WEST ROOSEVELT ROAD  
CHICAGO, ILLINOIS 60650  
(312) 287-6700

Send for your free copy of  
**Dip-Mates Exposed.**  
**A Guide To Reliable Mating.**

INFORMATION RETRIEVAL NUMBER 36 ►



# RCA Linear IC Arrays: performance, dependability, and versatility in application.

Here are ten important answers to some of your most pressing circuit design problems. These monolithic, active-device arrays combine the attributes of integrated circuits with the design flexibility and accessibility of discrete devices.

In this series of transistor and diode arrays, you get the economy and availability of mature devices. But you are in no way locked into a circuit config-

uration which may not meet the requirements of your application.

RCA IC Arrays offer four, five or six transistors in three package styles; six diodes in bridge configuration or as an array of independent diodes.

For new design freedom, for excellent device matching and temperature tracking, for significant savings—look into these RCA IC Arrays.

For further information, see your

local RCA Representative or your RCA Distributor. For a copy of RCA's Integrated Circuit Product Guide (or a specific technical bulletin by File No.) write RCA, Commercial Engineering, Section 571-13/CA37, Harrison, New Jersey 07029. International: RCA, 2-4 rue du Lièvre, 1227 Geneva, Switzerland, or P.O. Box 112, Hong Kong.

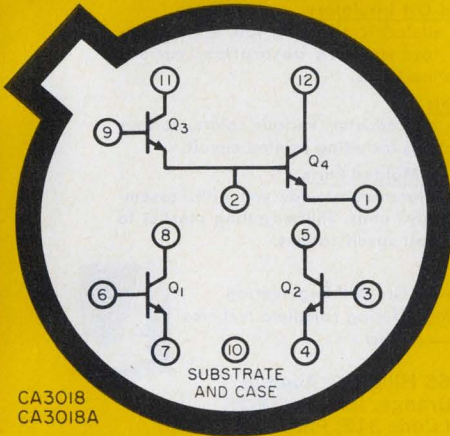

CA3018  
CA3018A

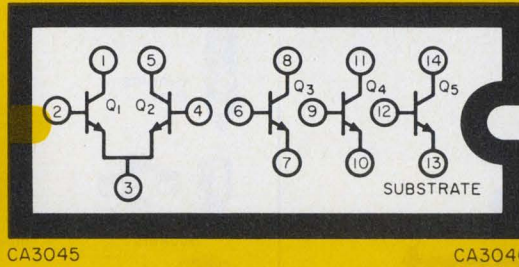

CA3045

CA3046

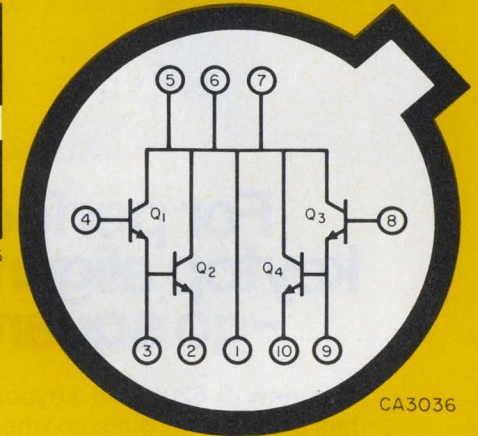

CA3036

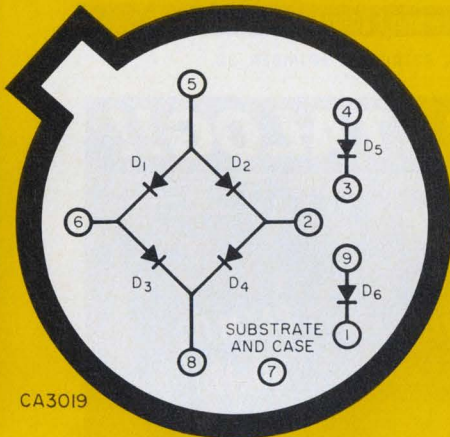

CA3019

Device Type	Package	Description	Technical Bulletin File No.	Price (1000-unit level)
CA3018	12-lead TO-5	Two isolated transistors and Darlington-connected transistor pair	338	\$ .98
CA3018A	12-lead TO-5	Premium version of CA3018 (performance controlled)	338	1.35
CA3019	10-lead TO-5	One diode-quad, two isolated diodes	236	.98
CA3026	12-lead TO-5	Dual differential amplifier	388	1.25
CA3036	10-lead TO-5	Dual Darlington array	275	.89
CA3039	12-lead TO-5	Six matched diodes	343	.98
CA3045	14-lead DIL ceramic	Differential amplifier and three isolated transistors	341	1.50
CA3046	14-lead DIL plastic	Differential amplifier and three isolated transistors	341	.98
CA3049	12-lead TO-5	Dual independent differential RF/IF amplifiers	378	1.95
CA3054	14-lead DIL plastic	Dual independent differential amplifiers	388	1.25

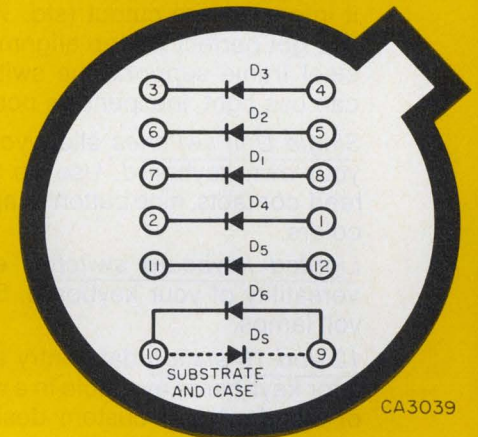

CA3039

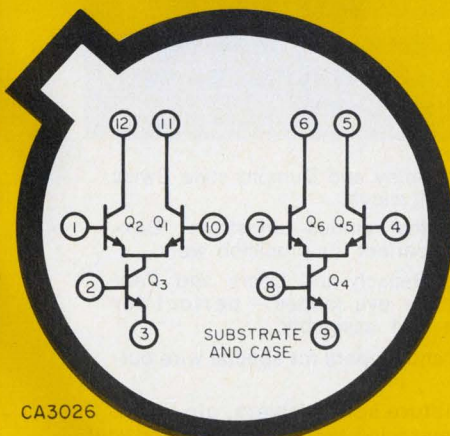

CA3026

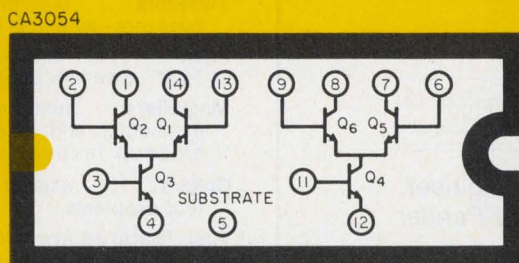

CA3054

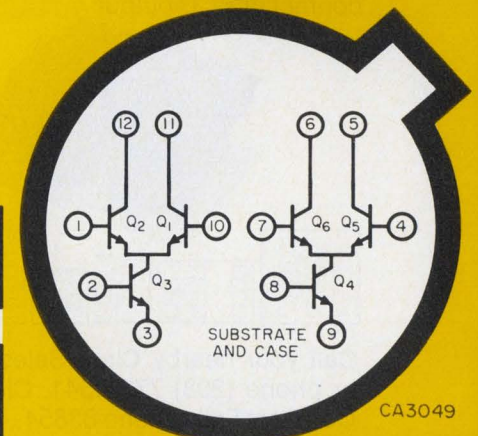

CA3049

**RCA**  
Integrated Circuits

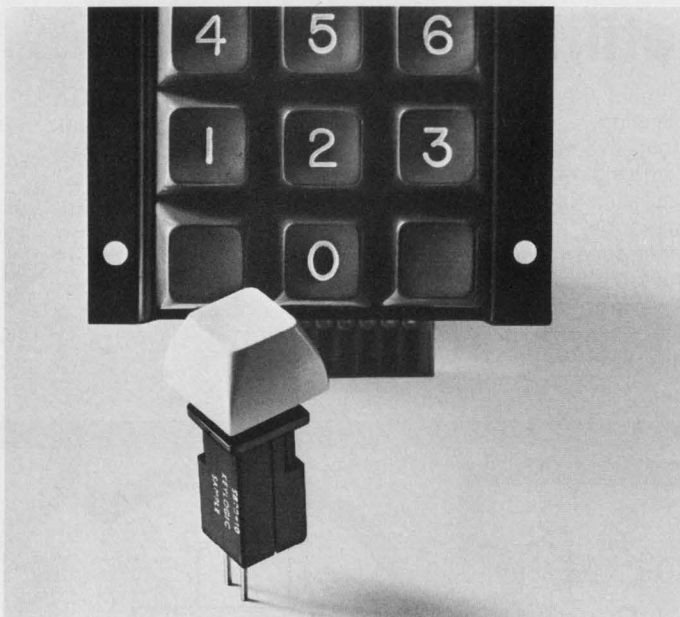

## For perfect keytop alignment -go square!

The new S-820 reed keyboard switch has a square housing, so when you drop it into a square cutout (std. 1/2" punch) you get perfect keytop alignment. And a steel frame supports the switch so you can use light, inexpensive pcb's.

*Single Unit switches* allow you to make your own keyboard. Use up to 2 N. O. reed contacts, nine button shapes, seven colors.

*Lighted keyboard switches* extend the versatility of your keyboard. 5, 12 or 28 volt lamps.

*12 and 16-station data entry and calculator keyboards* available in a wide range of standard and custom designs, hard contact or BCD output.

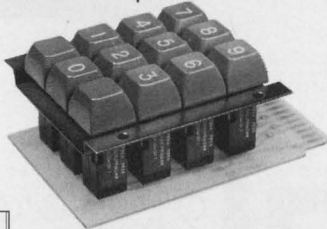

Call your nearby Clare Sales Engineer, or phone (208) 773-4541. Clare-Pendar Co., Post Falls, Idaho 83854.

**CLARE-PENDAR™**  
The Other Keyboard Company!

INFORMATION RETRIEVAL NUMBER 37

## FOR EXCELLENCE IN TERMINATION HARDWARE SPECIFY GRAYHILL



Test Clips



Push Posts

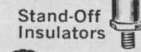

Stand-Off Insulators



Binding Posts



Sockets



Plastic Molded Parts

### Test Clips

Adjustable tension, threaded studs or plug in bases, various sizes.

### Push Posts

Plunger action lets you connect and disconnect quickly and easily, assures positive contact.

### Binding Posts

Screw type or spring loaded, banana plug or stud mounting, single or multiple units, with various colors for circuit identification.

### Stand-Off Insulators

High dielectric strength, low loss insulation, low moisture absorption, various mounting styles.

### Sockets

Lamp or transistor, various colors, various mountings including printed circuit.

### Custom Molded Parts

Tight tolerances provide you with "assembly ready" units. Thermosetting plastics to meet most specifications.

For your Grayhill Engineering Catalog offering complete technical data—contact



565 Hillgrove Avenue  
LaGrange, Illinois 60525  
Area Code 312, Phone 354-1040



... the Difference Between Excellent and Adequate

INFORMATION RETRIEVAL NUMBER 38

## FREE CATALOG!!

*NEW 32-page Hand Tool and Magnifier Catalog...*



... features the finest tools for miniature and sub-miniature applications.

Included are such brand names as Peer, Dumont, Lindstrom and Bausch and Lomb.

**Tweezers** . . . . .featuring Boley and Dumont style Swiss tweezers—available in all alloys.

**Pliers** . . . . .featuring the famous Lindstrom "Box-Joint" Swedish pliers—perfect for precision work.

**Magnifiers** . . . . .featuring Bausch and Lomb and Peer monocular and binocular eye loupes— perfect for closeup inspection and assembly.

**Cutters** . . . . .scissors and nippers for special wire cutting problems.

Also featured are miniature screwdrivers, pin vises, knives, etc. Let these money-saving tools go to work for you!

Ask for Catalog No. 170

**HAMMEL, RIGLANDER & CO., INC.**  
435 Hudson Street • New York, N.Y. 10014

INFORMATION RETRIEVAL NUMBER 39

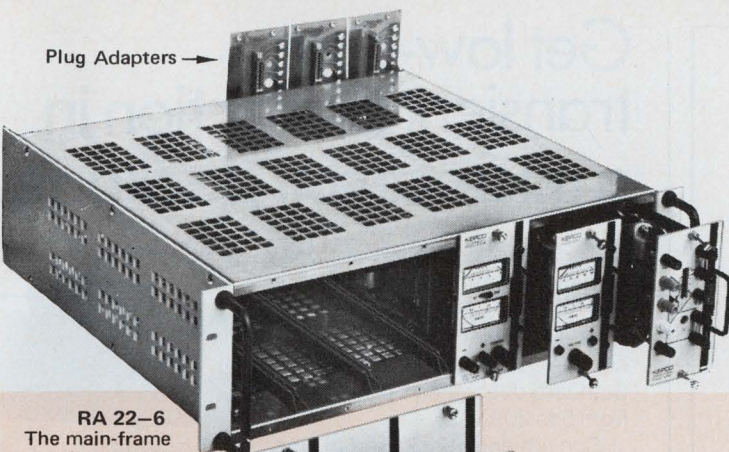

**RA 22-6**  
The main-frame takes any six modules or combinations.

**FILLER PANELS**  
To fill up slots temporarily left empty.

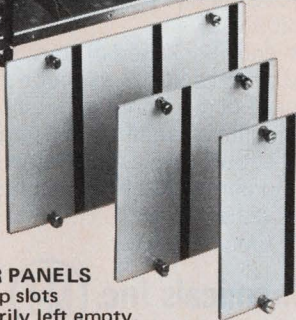

# KEPCO

## 6-in-a-RACK

### FAMILY OF PLUG-IN POWER SUPPLIES

The unique one-sixth rack size for regulated voltage and current sources, and power amplifiers, provides exceptional packaging density and enormous flexibility in intermixing the eighteen available models. Models plug into housings that accommodate one, two, three or six units.

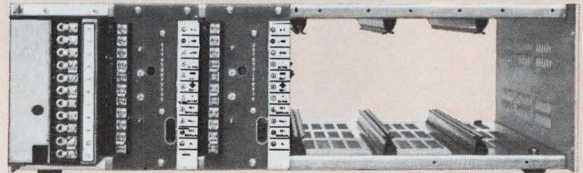

This is the rear of the 6-unit, rack mountable housing, RA 22-6, showing the location of the plug adapters, PC-2, which interface each model's male PC connector to an easy-to-use barrier strip. There is space for a bolt-on overvoltage protector (shown mounted on the left-hand slot). If you look carefully, you can see the coding pins which you can use to uniquely encode each slot so that no one can get the supplies mixed-up.

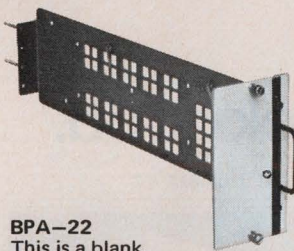

**BPA-22**  
This is a blank slide assembly which you can use to mount your own circuits—or the lower-cost, unmetered Kepco power modules.



**CA-3**  
Use this single unit housing to convert any of the plug-in supplies and amplifiers to a self-contained bench model.



**CA-4**  
This dual housing will permit you to custom-make your own dual supplies. No tools or soldering; just plug in the supplies and plug-in the line cord!



**CA-5**  
A 3-unit housing provides you with considerable flexibility in your choice of voltage or current regulators or, perhaps, a three amplifier manifold.

## CC

### CURRENT CONTROLLERS

Kepeco's CC Series programmable current regulators feature a capacitorless output circuit that responds to load changes at speeds up to  $2 \mu\text{sec}/V$ . A 10-turn current control with dual range sensing, operate a low-noise integrated control amplifier to provide exceptional stability and resolution. Regulation is 0.0005% for line, 0.005% for load.

MODEL	AMPS	VOLTS
CC 7-2M	0-2	0-7
CC 15-1.5M	0-1.5	0-15
CC 21-1M	0-1	0-21
CC 40-0.5M	0-0.5	0-40
CC 72-0.3M	0-0.3	0-72
CC 100-0.2M	0-0.2	0-100

PRICE: \$209.00

## OPS-BTA

### OPERATIONAL POWER

The OPS modules, with the suffix BTA are equipped with an operational patch panel for summing and feedback components. Gain is in excess of  $0.5 \times 10^6 V/V$  with an offset voltage coefficient  $< 20 \mu V/^\circ C$ . The fast-slewing unipolar amplifier is perfect for digital control or any rapid-fire programmed testing.

MODEL	VOLTS	AMPS
OPS 7-2BTA	0-7	0-2
OPS 15-1.5BTA	0-15	0-1.5
OPS 21-1BTA	0-21	0-1
OPS 40-0.5BTA	0-40	0-0.5
OPS 72-0.3BTA	0-72	0-0.3
OPS 100-0.2BTA	0-100	0-0.2

PRICE: \$192.00

## PCX-MAT

### VOLTAGE REGULATORS

The PCX module, with the suffix MAT, sports a metered front panel with a 10-turn, high resolution voltage control. The low-noise integrated control amplifier regulates the output to better than 0.0005% for line, 0.005% for load. A multiterminal rear barrier-strip, interfaced with the printed circuit plug, provides access for remote control facilities.

MODEL	VOLTS	AMPS
PCX 7-2MAT	0-7	0-2
PCX 15-1.5MAT	0-15	0-1.5
PCX 21-1MAT	0-21	0-1
PCX 40-0.5MAT	0-40	0-0.5
PCX 72-0.3MAT	0-72	0-0.3
PCX 100-0.2MAT	0-100	0-0.2

PRICE: \$180.00

For complete specifications and application notes — Write Dept. DH-05

# KEPCO®

KEPCO, INC. • 131-38 SANFORD AVENUE • FLUSHING, N.Y. 11352 • (212) 461-7000 • TWX # 710-582-2631 • Cable: KEPCOPOWER NEWYORK

INFORMATION RETRIEVAL NUMBER 40

# NEW!

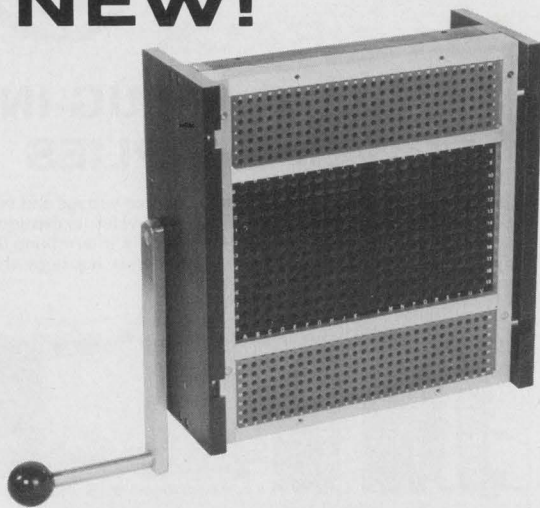

**A True-Thru shielded coaxial cable lets you pre-program removable patchboards.**

Now you can plug in hundreds of pre-programmed coaxial cables simultaneously and instantly. The combination of a newly designed cable receptacle plus precise machining of rack camming action make it possible to program removable panels with as many coaxial cables as you need — at present, up to 2,448.

“True-through shielded” means that each cable has its own separate shield, isolated from other shields, carried through the system. It also means that cross-talk is down 120 to 150 db from ordinary commoned systems.

High frequencies present no problem. At 100 megacycles, VSWR is 1.02. And you don't destroy this by crimping the outer shield: the connection is held by a screw-on collar. This collar also lets you rewire the cable as often as needed—and rewire with maximum speed. VSWR has remained constant after more than 10,000 cycles.

A 50-ohm matched impedance and .002-ohm contact resistance are two more reasons why you may want to telephone in your order rather than just writing for our complete brochure on this new development. But the main reason is change-over speed. By using a panel programmed with these new through-shielded coaxial cables, you can switch a computer from one program to another in less than 30 seconds.

Let us tell you more—including how little all these advantages are going to cost you. Write to VPC in Waynesboro, Virginia, or telephone (703) 942-8376. We're looking forward to working with you.

That's why we developed the new True-Thru shielded coaxial cable programming system in the first place.



VIRGINIA PANEL CORPORATION WAYNESBORO, VA.

INFORMATION RETRIEVAL NUMBER 41

## Get low-cost transient protection in a microcircuit package.

Capable of deflecting overvoltage transients in 50 nano-seconds or less, the new TRANSTECTOR\* Circuit Protector Hybrid Crowbar can operate in circuits carrying up to 10 Amps. Standard overvoltage trip points from 5 to 200 VDC.

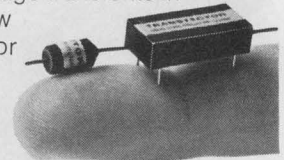

Conveniently packaged in standard dual in-line integrated circuit and DO-27 diode cases — it permits you to save space on your printed circuit or multi-layer boards by 3 to 1 over the old method of using discrete components.

Find out about Transtector Systems from M&T Chemicals Inc., 532 Monterey Pass Road, Monterey Park, Calif. 91754. Tel. (213) 283-9278.

\*Trademark of M&T Chemicals Inc.

**M&T Chemicals Inc.**   
SUBSIDIARY OF AMERICAN CAN COMPANY

## M&T can make you look good.

INFORMATION RETRIEVAL NUMBER 42



### THE CHILLER

Cold. Calculating. Mechanically refrigerated. Yet, at times, warm . . . even hot. Called by those who know . . . Tenney Jr. Inside 1¼ cu. ft. of emptiness waiting for you and yours. Get it. Sit it on your bench-top. Watch it pull down from ambient 75°F to -120°F in 55 minutes. Or, if heat is your hang-up, watch it zoom to +350°F in 35 minutes. Either way with ±¼°F control and no RFI. Write or call us about Tenney Jr. today. We'll see that you get yours.

**T Jr. \$1080** — Available immediately from stock. Also ask about the Tenney SST, only \$890.

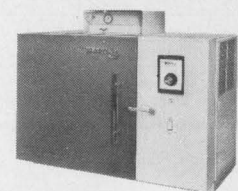

**Tenney**  
ENGINEERING, INC.

1090 Springfield Rd., Union, New Jersey 07083 • (201) 686-7870  
Western Division: 15721 Texaco St., Paramount, Calif. 90723

606

INFORMATION RETRIEVAL NUMBER 43

ELECTRONIC DESIGN 19, September 13, 1970

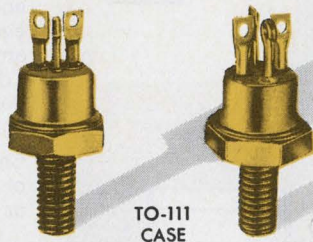

TO-111  
CASE

# JAN-TX

# POWER TRANSISTORS FROM PIRGO

**six JAN and six JAN-TX 5-amp types  
available from stock now!**

Type	$BV_{CEO}$ (sus)	$h_{FE}$ @ 1A	$V_{CE}$ (sat)
JAN-TX 2N2880 / JAN 2N2880	70	40-120	2 @ 5A
JAN-TX 2N3749 / JAN 2N3749*	70	40-120	2 @ 5A
JAN-TX 2N3996 / JAN 2N3996*	80	40-120	2 @ 5A
JAN-TX 2N3997 / JAN 2N3997*	80	80-240	2 @ 5A
JAN-TX 2N3998 / JAN 2N3998	80	40-120	2 @ 5A
JAN-TX 2N3999 / JAN 2N3999	80	80-240	2 @ 5A

\*isolated collector

Get them off-the-shelf  
by calling your Sprague semiconductor distributor.  
Or call Gil Levy at Pirgo. (516) 694-9880

PIRGO ELECTRONICS, INC., 130 CENTRAL AVE., FARMINGDALE, N.Y. 11735  
A SPRAGUE ELECTRIC CO. AFFILIATE



INFORMATION RETRIEVAL NUMBER 44

the  
problem  
solver...

THE ALL NEW **PREMIER**  
TRIMLINE SERIES OF  
ELECTRONIC ENCLOSURES

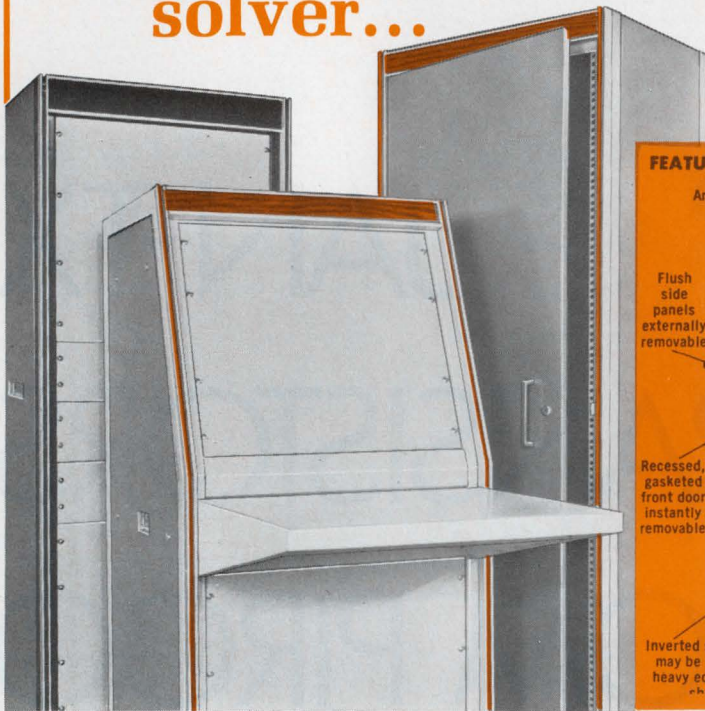

**FEATURES**

- Anodized aluminum trim bolted to frame
- Choice of black or walnut grained inlay
- Full length magnetic door catch
- Flush side panels externally removable
- Recessed, gasketed front door instantly removable
- Available in 19", 25" and 31" depths
- Inverted solid base may be used for heavy equipment
- Provisions for leads and concealed casters

Problems involving styling, utility and costs of enclosures for electronic systems are minimized by using the new Trimline Series. By engineering as "standard", new customized designs in a large variety of sizes, configurations, styles, trims and colors, the new line features easier equipment mounting and accessibility. Because the Trimline Series is stocked in depth, lead time and costs are greatly reduced.

*Call the Premier Representative or Distributor in your area or write for Catalog T.*

**PREMIER METAL PRODUCTS CO.**

A Division of Sunshine Mining Co.  
**337 Manida Street,  
Bronx, N. Y. 10474, (212) 991-6600**  
Metal Housings for the  
Electronics Industry since 1946

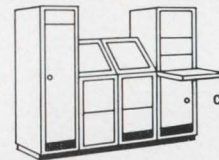

Wide  
variety  
of  
configurations  
possible

INFORMATION RETRIEVAL NUMBER 45

**Scotchpar**<sup>®</sup>  
BRAND POLYESTER FILM

WE WANT OUR NAME  
ON THE TIP  
OF YOUR TONGUE!



INFORMATION RETRIEVAL NUMBER 46

INFORMATION RETRIEVAL NUMBER 47 ►

*were*  
Photocells ~~are~~ too expensive  
for my application

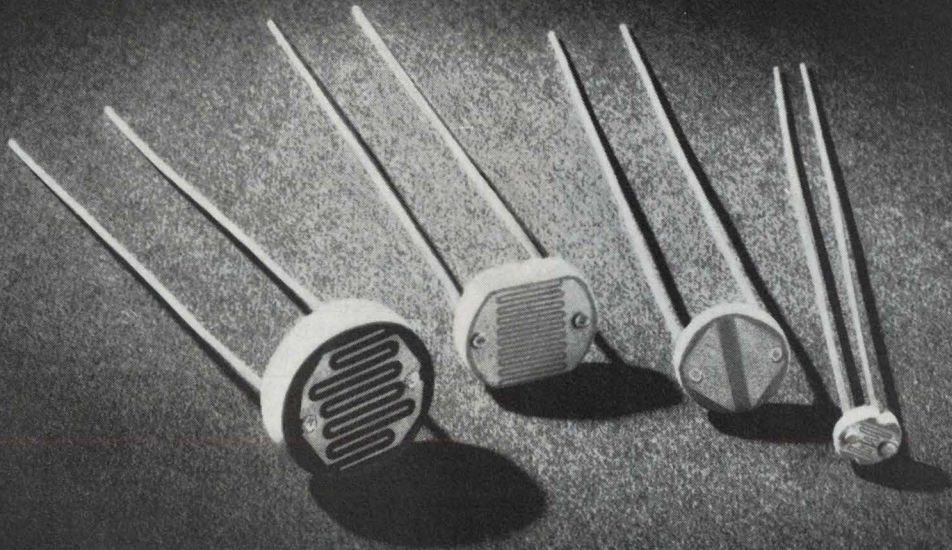

## New low-cost design offers many new application possibilities

Plastic encapsulated cells are now readily available in 4 sizes from .170 inches to .435 inches in diameter... and they're as rugged and nearly as reliable as hermetically sealed cells for many applications.

Look again at the applications where you thought photocells were too expensive. We'll send you free samples if you'll tell us why you need them: Call (914) 664-6602 or write Clairex®, 560 South Third Avenue, Mount Vernon, New York 10550.

**CLAIREX ELECTRONICS**  
A DIVISION OF CLAIREX CORPORATION

We've put together a push-on, push-off snap-acting switch with a pilot light indicator in a very small package, at a very small price.



- **HIGH RATING** — 5 amps at 125 volts a-c or 28 VOLTS d-c.
- **SMALL SIZE** — mounts in a 9/16" hole.
- **INDEPENDENT LAMP CIRCUIT** — accepts all standard T-1 3/4" midget-flanged incandescent or neon lamps.
- **ALTERNATE ACTION** — push-on, push-off.
- **CHOICE OF 6 COLORS**, in transparent or translucent lenses.
- **RELAMPABLE WITHOUT TOOLS** from the front of the panel.

For complete information, send for Bulletin 512.

## LPB Series 2

LIGHTED PUSHBUTTON SWITCH



# Unimax Switch

Division of Maxson Electronics Corporation,  
A Riker-Maxson Subsidiary, Ives Road, Wallingford, Conn. 06492.  
Phone 203-269-8701.

INFORMATION RETRIEVAL NUMBER 48

## 10-500 MHz TUNABLE RF POWER AMPLIFIER

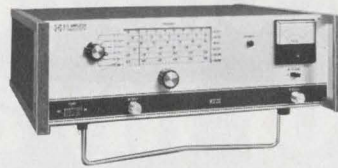

MODEL RF-815

- Up to 8 Watts into 50 ohms
- > 35 DB Gain
- Bandwidth 1-5 MHz
- Low Distortion
- Small, Lightweight

Tunable in six bandswitched ranges from 10 to 500 MHz, the RF-815 provides up to 8 watts of RF power into a 50 ohm load. With about 40 db of gain the 3 db RF bandwidth is 1.0 MHz at the low end of the frequency range, increasing to 5 MHz wide at 500 MHz. Accurate output metering and overload protection is provided.

Applications include amplification of signal generator outputs up to 20 volts, selective amplification of RF signals as provided by a receiver preselector, exciter driver stage for transmitters, RFI testing, attenuator measurements, harmonic amplification, and many others. All solid state except for the one tube output stage. Simple mechanical design provides for easy maintenance. Light weight of 25 pounds makes the unit portable for bench use. Optional rack mounting uses 5 1/4" rack height.



**R F COMMUNICATIONS, INC.**

Electronic Instrument Sales Dept.

1680 University Avenue • Rochester, N. Y. 14610  
Phone 716-244-3850 TWX: 510-253-7469

INFORMATION RETRIEVAL NUMBER 49



## EMI/RFI SHIELDING GASKET CONDUCTIVE SILVER/SILICONE

CONSIL® • Highly conductive pure silver/silicone • Produced as sheets, cut gaskets, strips and custom molded parts • Wide range of compressability: 30 to 60 + durometer • Volume resistivity: 0.001 ohm-cm • Operating temperature: -65°F. to +450°F. • Patent pending • Write for data #850



CONSIL® — FOR  
EMI/RFI Shielding,  
Sealing, Grounding  
and Static Dis-  
charge.



**TECKNIT** TECHNICAL WIRE PRODUCTS, INC.

East Division • 129 Dermody St., Cranford, N. J. 07016 (201) 272-5500  
West Division • 427 Olive St., Santa Barbara, Calif. 93101 (805) 963-1867

INFORMATION RETRIEVAL NUMBER 50

ELECTRONIC DESIGN 19, September 13, 1970



# Our 5000 and 7500 permeability Ceramag<sup>®</sup> ferrite materials can pack a terrific amount of inductance into a small size.

And the higher the perm, the fewer turns required. Results. Lower distributed capacity. Material savings. Improved performance.

Ceramag<sup>®</sup> 24H offers the designer a true 5000 permeability. New, Ceramag<sup>®</sup> 24K is also a true 7500 permeability. Both materials hold their permeability over a wide range of sizes.

Ceramag<sup>®</sup> 24H and 24K are production materials, ready for immediate use in your design. Stock available in some sizes.

Precisely engineered, Stackpole ferrite materials are produced by exact processing, density checks, rigid kiln controls and accurate sintering. You get more out of Stackpole Ceramag<sup>®</sup> materials simply because we put more into them.

Study the characteristics of 24H

	$\frac{L}{N^2}$ (nh) TOROID SIZE: 0.230" O.D. 0.120" I.D. 0.060" L.	MAXIMUM PERMEABILITY	SATURATION FLUX DENSITY @ 1.5 OERSTED	RESIDUAL MAGNETISM	COERCIVE FORCE	CURIE POINT	TEMPERATURE COEFFICIENT OF $\mu_0$	
							-25° to 25° C.	25° C. to 75° C.
CERAMAG <sup>®</sup> 24K	1485	9700	4100	700	0.05	175	+1.000	-0.450
CERAMAG <sup>®</sup> 24H	990	6900	3800	850	0.1	175	+0.700	-0.450
2500 PERM REFERENCE	495							

and 24K, then consider how you might use these ferrites.

For more information, samples and applications, contact:

Stackpole Carbon Company,  
Electronic Components Division,  
St. Marys, Pa. 15857. Ph: 814-834-1521. TWX: 510-693-4511.

Disaccommodation factor for both materials is  $1.4 \times 10^{-6}$ , typical.



**STACKPOLE**  
Electronic Components Division

Producing high quality Ceramag<sup>®</sup> ferrite components for the home entertainment, industrial electronics and computer industries for over twenty-two years.



# Sensitrode<sup>®</sup>

A new glass rectifier with four advances in the state-of-the-art.



1. Junctions defined by etching, not ultrasonic dicing or scribing – no mechanical damage.
2. Etch solution touches only silicon slices and inert wax – no chance for contamination.
3. The etched junction is protected by high purity, high temperature glass fused on at 1000°C – not subjected to soldering operations or coating by organic materials.
4. The rectifier chip is diced out **after** glassing and is a complete hermetically sealed rectifier in itself – the exterior package affords further protection and convenience for use

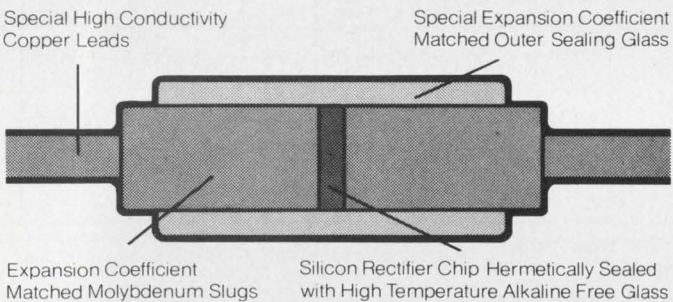

Sensitrode meets MIL-S-19500E for one and three ampere rectifiers to 1500 volts and above. Recovery times as low as 70 nanoseconds for one ampere, and 140 nanoseconds for 3 amperes. Surge currents to 225 amperes. Thermal cycling from – 196°C to 300°C.

Offered in five series: 1N3611, 1N4245, 1N5059, 1N5415 (including fast recovery) and 1N5614. All in double glass slug packages. Quality Assurance Procedures include high temperature storage, seal testing, temperature cycling, and 100% electrical testing.

Send for FREE descriptive literature.

**Sensitron Semiconductor**  A Sensitron Company

Dept. EDN-7 West Industry Court, Deer Park, New York 11729 (516) 586-7600

INFORMATION RETRIEVAL NUMBER 52



**Now! Fast Installation**  
on any JEDC case with  
**FEATHERWEIGHT 360° COOLERS**



**NO MORE BEEFSTEAK THUMBS!**

Just slide a Wakefield 200 Cooler down the special tapered tool and onto the case. Its unique fin design permits horizontal or vertical orientation for natural convection. Similarly for forced convection, the axis of the semiconductor may be oriented either parallel or perpendicular to air flow. Resilient design with precision manufacturing assures excellent thermal contact over 75% of circumference. Send for Bulletin #200.

Priced at \$25/M and up in quantity.



**WAKEFIELD**

DELTA DIV.

ENGINEERING INC., Wakefield, Mass. 01880 • 617-245-5900

INFORMATION RETRIEVAL NUMBER 53

## NEW FROM DURANT



## Modular electronic count/control saves money

Buy the count/control capability you need with Durant's new Series 2000. Save money by *not* buying features you don't require. Specify two to six decades with 7-line display BCD readout, or no display at all. Select one or two levels of pre-determining and order single stage or two-stage output control with prewarn. And there's a wide choice of other options to match your exact needs.

Series 2000 count/control is compact and modular. Operates at speeds to 20,000 cps. Advantages include remote reset, built-in time delay and automatic recycling. Priced below similar competitive units.

For information, write! 622 N. Cass St., Milwaukee, 53201.

**DURANT**  
DIGITAL INSTRUMENTS



A CUTLER-HAMMER COMPANY

622 N. Cass St., Milwaukee, Wisconsin 53201

783R

See us at the Production Engineering Show—Navy Pier 2109

INFORMATION RETRIEVAL NUMBER 54

ELECTRONIC DESIGN 19, September 13, 1970

# Only from Clare... Ultraminiature Picoreed® Relays.

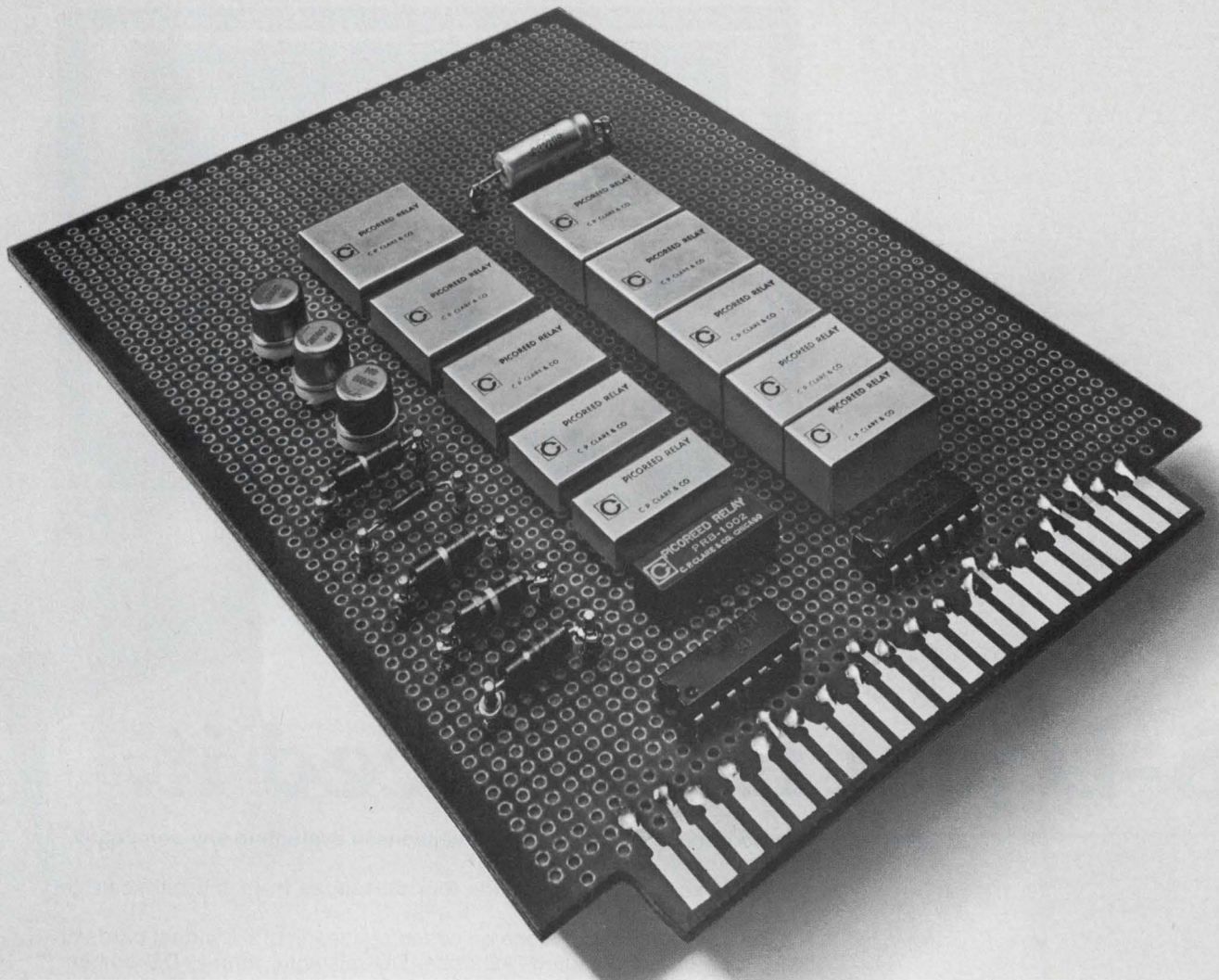

**Widest choice of contact configurations. High density packaging. Low profile metal covers. High sensitivity.**

Ultraminiature Picoreed relays in a wide range of contact configurations. If you want a 6 form A relay you get just that from Clare—not six 1 form A relays from somebody else.

Need a low profile Picoreed relay? Choose from 1 to 6 form A in our

Type PRB line. They allow 0.375" pc board mounting centers. Need a high sensitivity Picoreed relay? Choose from 1 to 5 form A in our Type PRBH line. They allow 0.500" pc board mounting centers.

Now, observe the performance. Up to 100 million operations at signal levels (5V, 10mA) and 5 million operations at tough 28 Vdc, 125mA loads. Power requirements as low as 50 mW nominal. Fast operate times as low as 500 microseconds including bounce.

One last point: You can order Clare Picoreed relays with electrostatic

shielding. For full information, circle the Reader Service number now. Also available at your nearest Clare distributor. Take your pick.

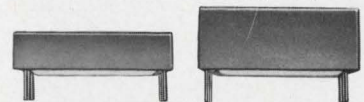

PRB Low Profile: 0.225" high  
PRBH High Sensitivity: 0.350" high

**And we're delivering now!**



C. P. Clare & Co.  
Chicago 60645 and worldwide.  
A General Instrument company.

# Which 5-digit multimeter is your best buy?



The new S-D 7005 offers five-digit resolution and accuracy. Designed for top performance in actual laboratory use.

**Price: \$1,295.**

## S-D just introduced it.

Prove it to yourself. Ask these questions in evaluating any competitive DVM:

Does the basic DVM include **four dc ranges** from 1 V full scale to 1,000 V full scale?

Can all **optional functions** be added by means of individual cards at any time? (Auto-ranging, AC volts, DC millivolts, ohms, DC current and digital outputs?)

Is the **input impedance** greater than 10,000 megohms on 1 V and 10 V ranges? Is **feedback noise** at the input terminals less than 1 mV? Is full scale **response time** less than 400 milliseconds?

Does the unit use **dual slope integration** for max noise immunity at line frequencies? Are **plug-in cards** used for easy maintainability of all measurement circuitry?

Does it have an **annunciator** to remind you what measurement you're making? Are its **digital outputs** compatible with both IC logic and discrete component logic?

The S-D 7005 offers all these features and more for just \$1,295. Request technical data or a demonstration from your local Scientific Devices office or contact: Concord Instruments Division, 888 Galindo St., Concord, California 94520. Phone: (415) 682-6161. TWX: 910-481-9478.

**SYSTRON**  **DONNER**

**Another S-D instrument first!** Electronic counters/Digital voltmeters/Pulse generators/Data generators/Time code generators/Sweep generators/Spectrum analyzers/Digital panel meters/Digital clocks/Signal generators/Oscillators/Laboratory magnets/Precision power supplies/Analog & analog-hybrid computers/Data acquisition systems.

## Publisher

Hugh R. Roome

## Editors

New York Office  
850 Third Ave.  
New York, N.Y., 10022  
(212) 751-5530

Editor: Frank Egan

Managing Editor: Ralph Dobriner  
Managing Editor: Raymond D. Speer  
Microelectronics, Steven A. Erenburg  
Computers, Milton J. Lowenstein  
Microwaves, Michael J. Riezenman  
Management, Richard L. Turmail  
News, John N. Kessler  
Military-Aerospace, John F. Mason  
New Products, Roger Allan  
New Products, Lucinda Mattera  
Copy, Marion Allen

## Field Offices

### Massachusetts

Jim McDermott  
P.O. Box 272  
Easthampton, Mass. 01027  
(413) 527-3632

### San Francisco

Elizabeth de Atley  
2051 Wellesley St. (Suite D)  
Palo Alto, Calif. 94306  
(415) 321-7348

### Los Angeles

David Kaye  
2930 Imperial Highway  
Inglewood, Calif. 90303  
(213) 757-0183

### Washington

Don Byrne  
1425 N St. NW  
Washington, D.C. 20005  
(202) 667-6568

## Editorial Production

Dollie S. Viebig  
Richard D. Grissom

## Art

Art Director, Clifford M. Gardner  
Assistant, William Kelly  
Rita Jendrzejewski  
JoJo Miskimmon  
Jack Weissman

## Production

Manager, Thomas V. Sedita  
Helen De Polo  
Kathleen McConkey  
Leslie Stein

## Circulation

Manager, Nancy L. Merritt

## Information Retrieval

Peggy Long

## EDITORIAL



## A new growth area — recycle engineering

A new multibillion dollar market is waiting to be developed. The market is pollution control—and it calls for new and imaginative engineering.

The price tag of \$71.3-billion, over the next five years, has been placed, in a recent study by the Economic Unit of *U.S. News & World Report*, on the work required to clean up the nation's air, water and land. The magazine quotes one expert: "What for years was the concern of only a handful of scientists and conservationists suddenly has become a national obsession."

But to combat pollution in its many forms, we must find something to do with the pollutants. The most obvious solution is to convert them from destructive to constructive elements. And recycling is the term that best describes this process.

Past examples of recycling have included such things as the system, developed for the astronauts, that recycles urine into drinking water. TRW has developed an experimental "garbage engine" that burns most anything and turns it into useful work. With further development, it could lead to the conversion of garbage into electric power or some other type of energy.

Floyd Goss, chief engineer in the Los Angeles Dept. of Water and Power, tells of another recycling procedure. Electrostatic precipitators are being used to remove particulate matter from smoke when oil is burned to generate electric power. The dust contains vanadium, which is filtered out and sold back to companies that use vanadium.

A study at Oregon State University has shown that the heat output from atomic power plants might be used for something besides the thermal pollution of our oceans. The fishing industry could set up oyster beds in the warm effluent waters; the result might be super oysters that could not otherwise grow in the normally cold regions of northern coastlines.

Over the next several years pollution control will call for the development of many recycling devices. It's becoming a matter of survival. And recycling devices will unquestionably use large quantities of electronics.

It's a tremendous challenge to electronic engineers. Like to try your hand?

DAVID N. KAYE

Imagine an alphanumeric readout that requires only microwatts of drive power and is totally insensitive to ambient light level. Consider a transducer that can take an image transmitted at any frequency and convert it to an optical image. Or how about a pilot light that costs one-hundredth of a cent, an inexpensive thermal mapping device, a cancer detector, a smog sniffer or a flat-screen color TV set?

These are a few of the present and envisioned applications of a state of matter called liquid crystals.

Dr. George H. Heilmeyer, head of device concepts research at RCA Laboratories in Princeton, N.J., describes a liquid crystal as an organic material that has the physical properties of a liquid. It pours as a liquid does and assumes the shape of its container as a liquid does. But over specific temperature ranges liquid crystals possess a degree of molecular order that is more characteristic of solid state. The molecules have a definite spatial relationship to each other.

Liquid crystals change their optical properties when subjected to certain stimuli. Depending on the particular molecule, the stimuli can include heat, an electric or magnetic field, shear force, pressure, ultraviolet light, acoustic energy and certain gases. The optical property most often considered is the ability of the liquid crystal to reflect light. Heilmeyer notes:

"With liquid crystals, we see, for the first time, the ability to control the reflection of light by electronic means."

### Brighter the day, brighter the display

Liquid crystals are expected to have their greatest impact on displays. Although three different phases of liquid crystals exist, it is the nematic phase which will be used in most displays. The nematic phase is a condition where the molecules, which are roughly shaped like a cigar, tend to line up in a random fashion, with their long axes all parallel to one another. The optical effect that allows nematic liquid crystals to be used in displays is called dynamic scattering. Dynamic scattering is an effect in which the application of an electric field makes all of the molecules align parallel to a pair of electrodes. A controlled flow of ions is then generated by the applied voltage from electrode to electrode. The ions disrupt the crystal alignment, causing a scattering of light that impinges upon the liquid crystal film. Scattering turns the normally transparent film white and causes light to be reflected off it. The amount of light reflected can be controlled by the voltage across the electrodes.

## Liquid crystals:

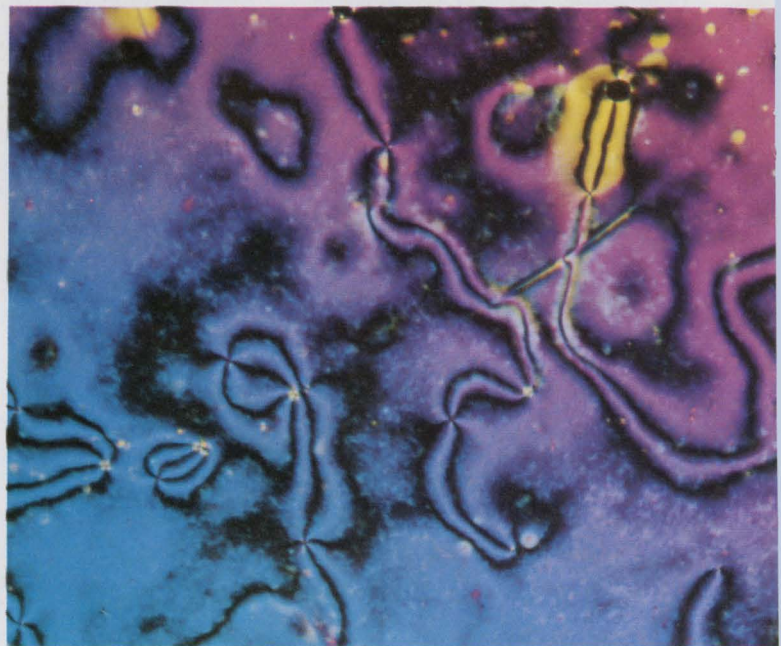

Heated nematic liquid crystal viewed through a polarizing

According to Heilmeyer: "Since the effect is reflective, contrast is independent of ambient light level. Hence the brighter the light, the brighter the display."

A display (see illustration) can therefore be constructed by:

- Depositing transparent conductive electrodes on two pieces of glass.

- Sandwiching a 1-mil-thick layer of nematic liquid crystal between the two panes of glass and holding it there by capillary action.

Voltage then applied appropriately across the electrodes can yield a visible pattern, determined by the physical configuration of the electrodes. Tin oxide is the most popular electrode material. About 25 V is typical of the required voltage.

In addition to the constant-contrast feature, liquid-crystal displays are also small, flat, light, inexpensive and users of very little power.

James L. Fergason, associate director of the Liquid Crystal Institute at Kent State University in Kent, Ohio, explains the power requirements this way: "There is very little force involved in reorientation of liquid-crystal molecules. For

# Material with a hot future

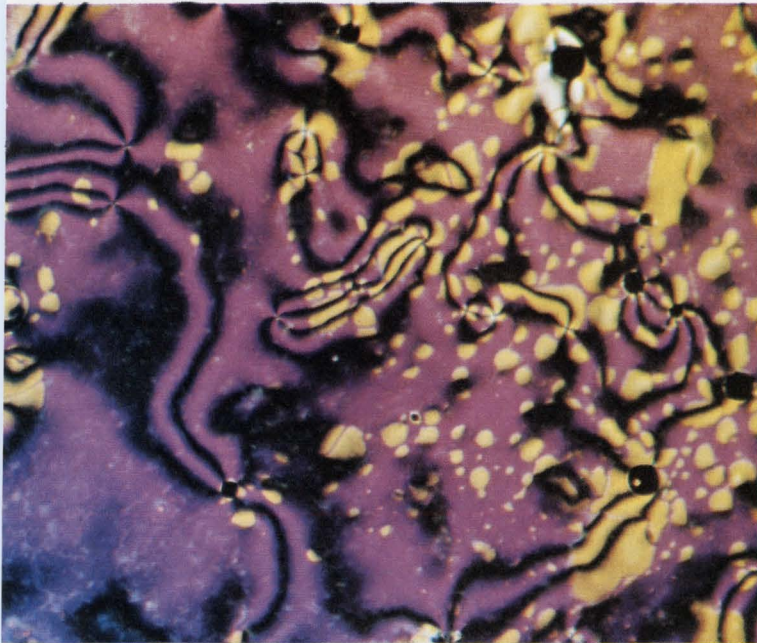

microscope. Colors respond to variations in thickness.

comparison, you could think of mosquitos doing pushups or leaves fluttering on a tree. Nematic liquid crystals require energy on the order of microwatts per square inch."

Dr. H. Barry Bebb, director of the Advanced Technology Laboratory at Texas Instruments in Dallas, says: "You can drive a liquid crystal display directly from the logic without an additional driver." Bebb notes that the "turn-on time of the display is about 2 milliseconds, and the turn-off time is about 20 milliseconds."

Texas Instruments has built seven-segment numeric readout displays. However, Bebb feels that "most people prefer a display which is a 5 x 7 dot matrix type rather than a seven-segment type." TI sees no reason why a 5 x 7 dot matrix display could not be made easily with liquid-crystals.

If the constant-contrast feature is not considered a major consideration, dynamic scattering displays can be back-lighted. They then operate in a transmissive mode, where most of the light is scattered forward rather than backward. Dynamic scattering always results in more light

being scattered forward than backward. For reflective operation, the rear electrode is made reflective rather than transparent.

Dr. Richard A. Reynolds, manager of the applied optics branch of the Advanced Technology Laboratory at Texas Instruments, says: "We have been able to make more pleasing displays in the transmissive mode than in the reflective mode. However, it is necessary to provide a light bulb behind the panel."

RCA uses the reflective mode in its displays. Thomson-CSF in France has made alphanumeric displays in the transmissive mode. Collins Radio in Cedar Rapids, Iowa, is also building back-lighted liquid-crystal displays. The Collins displays are for aircraft cockpits.

## Only a few problems remain

Only two major areas of study remain before liquid-crystal readouts find their way to the marketplace. One is temperature stability and the other lifetime or reliability.

Liquid-crystal displays must operate within a fairly limited temperature range. At limits of the particular range, contrast tends to drop off a bit. Materials research is currently going on at many different companies to extend the usable temperature range.

Due to the newness of the developmental displays, a sufficient amount of time has not yet been spent studying failure mechanisms. Donald C. Batesky, a technical associate in new product development with Eastman Kodak in Rochester, N.Y., notes:

"The main failure mechanism in most nematics is that over a period of time the electric field can break a carbon-nitrogen double bond in the liquid-crystal molecule. However, there are nematics that don't have the double-bond problem. The carbon-nitrogen materials are, however, the easiest to manufacture."

Life-testing in the industry to date has shown that 5000 to 6000 hours of constant dc operation can be achieved with liquid-crystal displays.

Dr Frederic J. Kahn, a member of the technical staff at Bell Telephone Laboratories, Murray Hill, N.J., points out some other areas of cur-

rent study: "They include organic molecule instability, photochemical deterioration and electrochemical deterioration."

When a display is desired with more than just letters and numbers, liquid crystals can fill the bill. Werner Haas, senior scientist at Xerox in Rochester, N.Y., points out: "Liquid crystals can be thought of as image converters. Images transmitted at any frequency can be converted into optical images."

Imaging can be accomplished with either the nematic phase or the cholesteric phase. There is disagreement among scientists as to what constitutes the cholesteric phase. It can be thought of as a stack of discrete layers of molecules in which all of the molecules in each layer are aligned in the same direction, and the direction of each layer is offset from the direction of the adjacent layers. If one were to plot the angular direction of the molecules as they moved in a vertical direction through the stack, a helix would be traced out.

Cholesterics reflect light at different wavelengths when they are stimulated. Each type of stimulus tends either to wind or unwind the helix. When the helix winds, the colors that are reflected move from red towards blue. When it unwinds,

the reflection wavelength gets longer. Therefore, while nematics yield a white display, cholesterics yield a color display.

Although images can be transmitted at any frequency, the mechanism of imaging is frequency-dependent. Haas of Xerox notes: "Different wavelengths have different effects upon liquid crystals. At light frequencies, you have heating and can detect a color change. Acoustics will change the birefringence or the reflection colors as well, by changing the angular pitch of the cholesteric molecules. Ultraviolet produces a chemical decomposition, resulting in a color change."

Experiments in imaging have been varied. According to Dr. James E. Adams, a scientist at Xerox, ultraviolet imaging can be done by shining the light through a mask onto a plane of cholesteric liquid crystals. Where the ultraviolet gets through, chemical bonds are broken, resulting in a color change of the plane at those points.

The difference in reflectivity between those areas that were shielded from the ultraviolet and those areas that were not shielded creates the image.

Dr. James H. Becker, manager of exploratory device development at Xerox, describes another imaging experiment.

"We place a liquid-crystal layer on top of a photoconductor [selenium]," he reports. "The combination of liquid-crystal layer and photoconductor is uniformly charged. Light is reflected off the object to be copied and imaged onto the photoconductor. Where the light is incident on the photoconductor, electron-hole pairs are generated. These migrate in the influence of the original electric field. The motion of the electrons and holes is such that where the light hits, the original field is removed—that is, the voltage goes down to practically zero. In the regions where the light does not hit—the dark line that you are trying to copy—the voltage pattern remains on the photoconductor. This voltage pattern on the photoconductor is the same as the image pattern. A large voltage exists where the original image is dark, and a small voltage where it is light. This latent image field pattern then interacts with the liquid crystal to cause a rearrangement of molecules. As a result of this rearrangement of the liquid-crystal molecules, a visual pattern is created."

A somewhat similar experiment is by Dr. J. David Margerum, head of the photochemistry section of the Chemical Physics Dept. at Hughes Research Laboratories, Malibu, Calif.

"We have a liquid-crystal cell that is photosensitive," he notes. "You can record an image on it which can be displayed, by either reflection or projection techniques, on a large screen. The cell consists of a layer of zinc sulphide photocon-

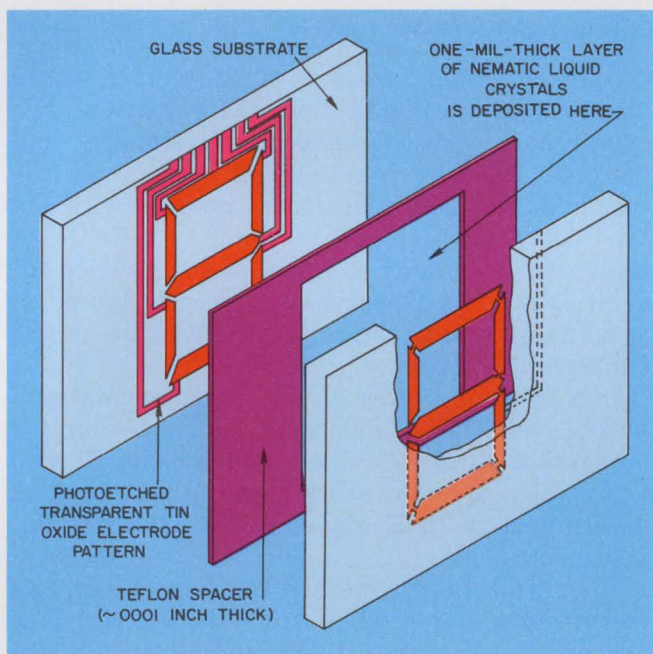

**Liquid-crystal displays** can be constructed very simply. Etch the desired electrode pattern—in this case a seven-segment numeric readout—in transparent conductive material that has been deposited on two pieces of glass. Using a spacer of about one mil in thickness to confine it, deposit some nematic liquid crystal on one of the pieces of glass. Complete the sandwich by covering the liquid crystal with the other piece of glass. Now, when an electric field is impressed across any segment of the display, the liquid crystal will be stimulated into a dynamic scattering mode, and that segment of the display will reflect light.





Seven-segment liquid crystal displays from Texas Instruments are incorporated into an experimental digital volt-ammeter. These readouts are back-lighted. Turn-on time is about 2 milliseconds.

ductor and a layer of nematic liquid crystal, sandwiched between a pair of transparent electrodes. The electrodes are deposited on a pair of glass plates, which complete the sandwich.

"When a voltage is applied across the cell in the absence of ultraviolet light, there is no occurrence of dynamic scattering. This is because the ZnS is a high resistivity material, and it holds off the transport of current to the liquid crystal. When the ultraviolet light falls upon the photoconductor, it opens the circuit and allows current to flow at the point at which it is activated. In this way an image is impressed on the liquid-crystal layer in the form of dynamic scattering. If white light is now reflected off the cell onto a screen, the UV image is seen as a visual image.

"Variable persistence can be achieved in the display by adding a little bit of cholesteric material to the nematic. Although ultraviolet was chosen and ZnS used, any wavelength can be imaged using the appropriate photoconductor."

Cholesteric imaging in the infrared has been achieved by Ferguson at Kent State. "We are focussing an infrared image through an optical system onto a liquid-crystal film. We use very highly temperature-sensitive cholesteric liquid crystal. By controlling the temperature of the film, we get an image of the object that is being viewed. It has the following advantages over other techniques:

"It works at room temperature rather than at liquid nitrogen temperature. It has a field imaging capability—that is, it takes a total image and converts it to a visible pattern. It has much higher sensitivity than other room-temperature bolometric devices. And there is no need for an electronic readout such as an electron gun.

"This device can be used for medical thermal mapping of a subject. There are also some military applications."

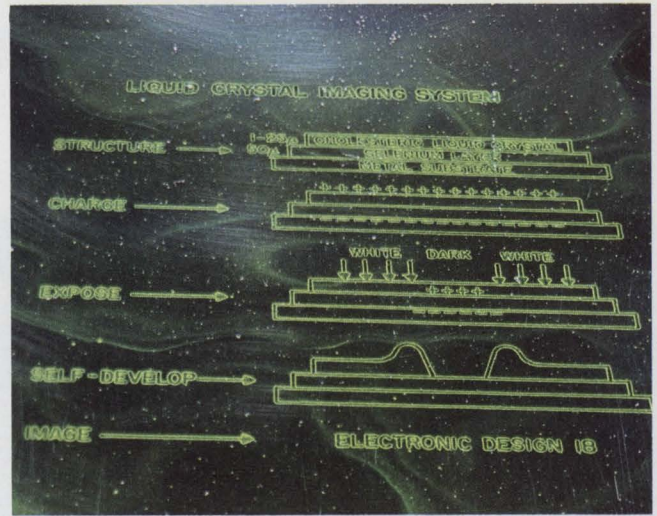

Imaging with cholesteric liquid crystals is achieved by Xerox. The liquid crystals are coated on a layer of selenium. After exposure, the crystals take on a permanent image.

A new liquid-crystal display element has been developed at Bell Laboratories. It uses the polarization properties of cholesterics and was developed by Dr. Kahn.

"Cholesteric materials," says Kahn, "are sensitive to the polarization of the incident light. Incident light of different polarizations result in different colors being reflected.

"We have made a passive, polarization-switched, two-color display element. It is called cholophor. The cholophor is composed of one or more layers of room-temperature cholesteric liquid crystals and one or more layers of photoluminescent phosphors. This element is of particular interest for large-screen, optically scanned, laser applications.

"The color of the cholophor element is determined by the sense of circular polarization of the illuminating light. For example, a typical cholophor, which appears blue-green when illuminated with 4880 Å of right circularly polarized light, turns red [the color of the illuminated phosphor] when the sense of polarization is switched to left circular."

### Flat-screen applications sought

Peering into the future, liquid-crystal experimenters see such things as flat-screen or even 3-D TV. But Heilmeyer of RCA points out that this will be a long time in coming. It's not the liquid crystals' fault though. "Flat-screen TV," says Heilmeyer, "requires a 500-by-500-line matrix. The problem is: How do you address a quarter of a million elements? It's an electronics problem, not a liquid-crystal problem."

Ferguson believes that a flatscreen oscilloscope may not be too far off. "I believe that it will be possible to make a flat-screen oscilloscope many years before a flat-screen TV," he says. "In an

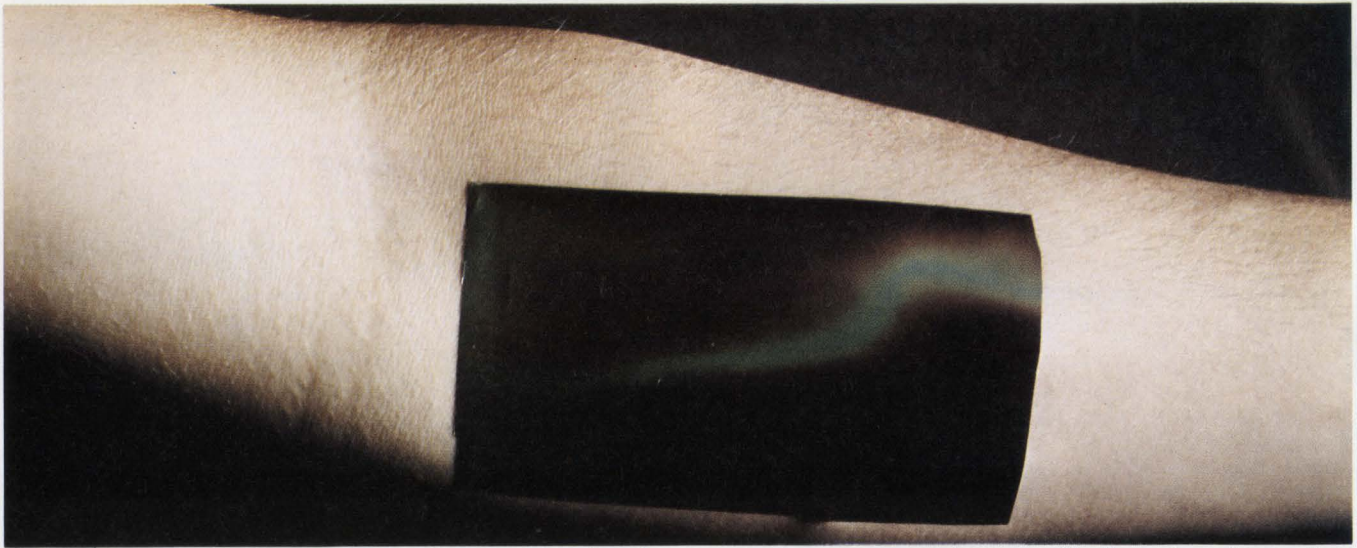

**Tape film containing liquid crystals** has been developed by Hoffman-La Roche for thermal analysis. In this case the main vein in an arm can be seen. Since the blood is hotter than the surrounding medium, it shows up blue. Similar techniques have been used to determine breast

cancer more accurately than with X-ray techniques. It is through monitoring of thermal patterns on the breast that abnormalities can be observed. Estimated cost of one breast-cancer check using liquid crystals is \$1. No side effects have been found.

oscilloscope you can use a cross-grid drive rather than having to address every element in a large matrix."

Ferguson dreams of the day of the 3-D home display. "You can write," he says, "the information that's in a hologram, with an infrared laser, on a liquid-crystal screen and get a truly three-dimensional display. Instead of using a regular optical system, you use a laser-illuminated scene. You convert your camera tube so that instead of seeing a normal image, it sees a phase modulation, due to the laser light. It transmits the phase information to a liquid-crystal screen, which in turn modulates a source in the home, and you have a projected three-dimensional image."

Ferguson expects liquid crystals to find wide use first as indicators or pilot lights. A small cell constructed of two pieces of glass coated with transparent electrodes, and a drop of nematic material sandwiched in between, is all that is required. The pilot light or indicator would be a dynamic scattering device. One industry source feels that in large quantities these indicators could be produced for a fraction of a cent a unit.

### **Thermal maps come in pretty colors**

Beyond displays and readouts, most other applications of liquid crystals make use of the temperature-sensing capabilities of the cholesteric phase. A coating of liquid crystals on any surface can give an immediate thermal map of that surface. Dr. Kahn at Bell Laboratories notes: "You can make liquid crystals which would

change from red to blue in about  $0.1^{\circ}\text{C}$ ."

Ferguson says it's even possible to do better. "Cholesterics," he reports, "can change state with temperature changes on the order of one-tenthousandth of a degree." As the temperature increases, the helix winds, and the reflected color moves from red towards blue.

Nondestructive testing is an important application of liquid crystals. They have been used to test integrated circuits—looking for hot spots, checking thermal gradients, etc. And they have hunted the structural imperfections in such things as honeycomb structures. In any situation where a thermal pattern is important, liquid crystals can play a role.

Dr. Paul L. Garbarino, a project engineer with the Components Div. of International Business Machines in Hopewell Junction, N. Y., is using liquid crystals to check integrated circuits. To see the colors, it is necessary to provide a black background that will absorb any extraneous incident light.

"We spray on a 2 or 3-micron amorphous carbon coating for our black background," says Garbarino. "Carbon gives better uniformity and stability over a period of time than any other method. The layer of carbon is so thin that, even though it is somewhat conductive, it doesn't seem to change the circuit's electrical performance.

"We are interested in studying failure modes in ICs, such as electro-migration and shorts. Electro-migration in a stripe of aluminum occurs when a high current density bombards the metal atoms, sweeping them away and causing vacancies. Ultimately an open circuit can occur.

"Thermal mapping has been done at IBM on

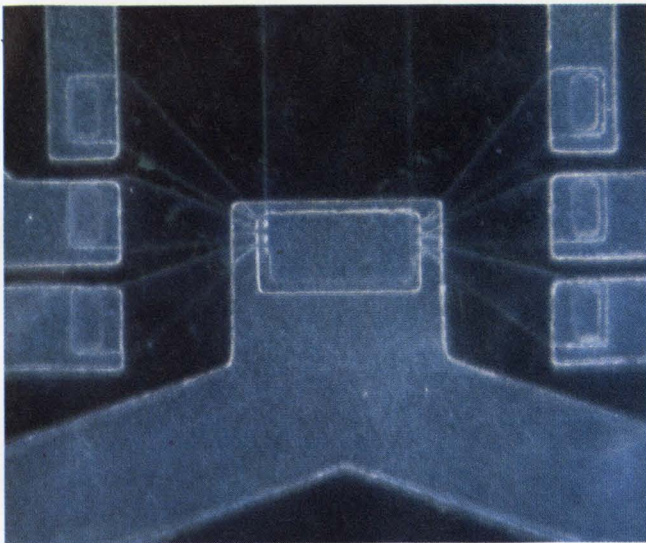

**Thermal analysis of monolithic and hybrid integrated circuits** can be done with cholesteric liquid crystals. Temperature gradients will show up as color changes, thus allowing faults or hot spots to be located easily. For the colors to be easily seen, the surface of the circuit

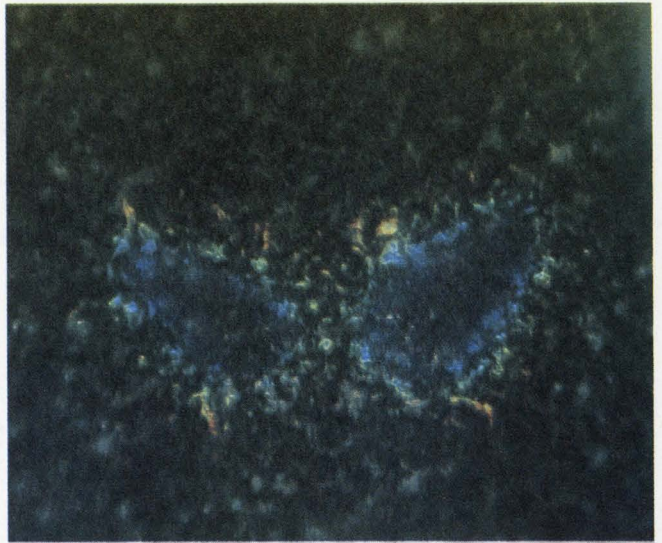

is first darkened before the liquid crystal is coated on. IBM uses a thin layer of amorphous carbon that does not allow the circuit to be seen any longer, but it brings out the color pattern well (left). At the right is the circuit coated, but with no black background.

both bipolar and MOS structures.”

Garbarino admits to the following limitations:

- Thickness of the liquid-crystal film causes a good bit of light dispersion.
- Variations in the crystal thickness cause inconsistent color coverage.

Elliott Philofsky, head of the metallurgy and analytical services section at Motorola Semiconductor in Phoenix, Ariz., is skeptical about using liquid crystals instead of infrared microscopy in thermal mapping. “As I see it,” he says, “liquid crystals have a couple of great disadvantages over IR microscopy. Since one usually has to provide a black background for the crystal coating and since the liquid crystal solvent may damage the device under test, liquid crystals may not be a totally nondestructive method of testing. Then there’s the time involved in setting up a liquid-crystal test. In addition the ultimate resolution of liquid crystals doesn’t appear to be that much better than IR microscopy is now. In time IR microscopy may give even better resolution than liquid crystals.

“Offhand, I can’t see where liquid crystals will ever be used on a production-line basis. They will be more used for troubleshooting and as a design tool.”

### A boon for diagnostic medicine

Since the human body is a mass of thermal patterns, doctors have found that liquid crystals can help them in their diagnoses. Ferguson at Kent State notes:

“We are doing studies of breast-cancer detection. Out of 65 patients, we have determined

malignancy more accurately than X-ray techniques. It costs us only about \$1 to do a breast-cancer check. We have found no side effects yet in all of our experimentation. It is through monitoring of thermal patterns on the breast that abnormalities can be observed.

“We have also seen some relation of thermal patterns on the breast to the degree of fertility of the subject. The effect is in preliminary investigation at present.”

When used as a simple liquid, liquid crystals are difficult and messy to handle. A great deal of work is going on at several companies to develop a convenient way of working with the crystals. At Hoffman-LaRoche, Inc., in Nutley, N. J., Peter G. Pick, head of the liquid crystal chemistry section, has developed a good approach. He explains:

“The key to the whole thing is the delivery system. The liquid crystals are contained within a multilayer film, which can be easily applied to a surface. The film has a useful lifetime of years. It can be torn, bent or twisted and still be usable.”

This tape can be applied to a person’s skin to observe the patterns of the blood vessels near the surface. It can be used as a body-temperature monitor. Or it can be used to monitor the temperature in an electronic enclosure.

Kahn at Bell Laboratories, sums up the potential of liquid crystals by saying:

“Research is in such an early stage that it is not yet quite clear which effect will prove to be most useful. Liquid-crystal research is at about the same stage today that solid-state physics was at 20 years ago.” ■■

# To make the lowest-cost arithmetic logic unit with carry lookahead built-in,

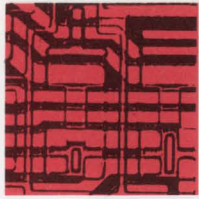

Fairchild's new 9340 is the perfect arithmetic logic unit for almost every application. It's a high-speed device that can perform two arithmetic operations (ADD or SUBTRACT) and any of six logic operations on two 4-bit binary words in parallel. To handle 16 bits, just hook up four 9340s.

And nothing else.

The 9340 can ADD two 4-bit words in 28ns and SUBTRACT two 4-bit words in 33ns. The addition of two 16-bit words takes only 42ns.

The new ALU has full internal carry lookahead, and provides either a ripple carry output or carry lookahead outputs. The speed and flexibility of the 9340 make it ideal for other applications like multipliers, dividers and comparators.

Input clamp diodes are used on all inputs to limit high speed termination effects in the 9340. Input/output characteristics provide easy interfacing with all Fairchild DT $\mu$ L, TT $\mu$ L and MSI families.

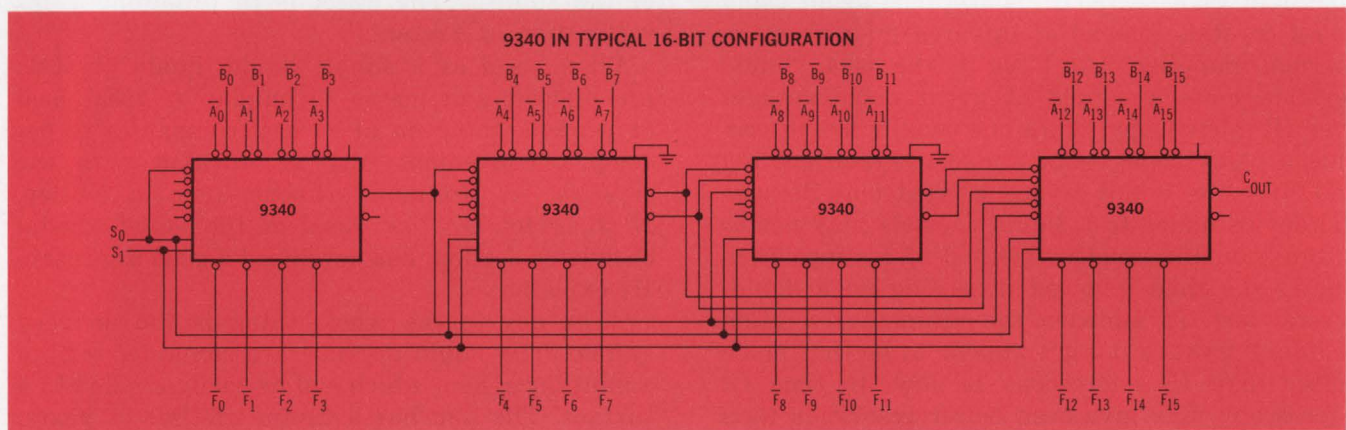

To order the 9340, call your Fairchild Distributor and ask for:

PART NUMBER	PACKAGE	TEMPERATURE RANGE	PRICE (1-24)	PRICE (25-99)	PRICE (100-999)
U6N934059X	DIP	0°C to + 75°C	\$20.90	\$16.70	\$14.00
U6N934051X	DIP	-55°C to +125°C	41.80	33.40	28.00
U4M934059X	Flat	0°C to + 75°C	23.00	18.40	15.40
U4M934051X	Flat	-55°C to +125°C	46.00	36.80	30.80

# you have to get serious about MSI family planning.

We put together a family plan by taking systems apart. All kinds of digital systems. Thousands of them.

First we looked for functional categories. We found them. Time after time, in a clear and recurrent pattern, seven basic categories popped up: Registers. Decoders and demultiplexers. Counters. Multiplexers. Encoders. Operators. Latches.

Inside each of the seven categories, we sifted by application. We wanted to design the minimum number of devices that could do the maximum number of things. That's why, for example, Fairchild MSI registers can be used in storage, in shifting, in counting and in conversion applications. And you'll find this sort of versatility throughout our entire MSI line.

Finally, we studied ancillary logic requirements and packed, wherever possible, our MSI devices with input and output decoding, buffering and complementing functions. That's why Fairchild MSI reduces—in many cases eliminates—the need for additional logic packages.

The Fairchild MSI family plan. A new approach to MSI that's as old as the industrial revolution.

It started with functional simplicity, extended through multi-use component parts, and concluded with a sharp reduction in add-ons. Simplicity. Versatility. Compatibility. Available now. In military or industrial temperature ranges. In hermetic DIPs and Flatpaks. From any Fairchild Distributor.

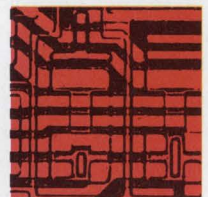

**OPERATORS**  
9304 - Dual Full Adder/  
Parity Generator  
9340 - Arithmetic  
Logic Unit

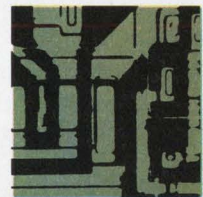

**LATCHES**  
9308 - Dual 4-Bit Latch  
9314 - Quad Latch

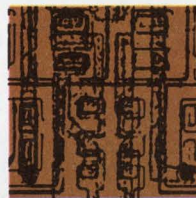

**REGISTERS**  
9300 - 4-Bit Shift  
Register  
9328 - Dual 8-Bit  
Shift Register

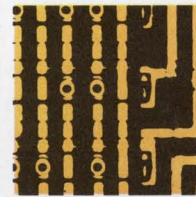

**MULTIPLEXERS**  
9309 - Dual 4 Input  
Digital  
Multiplexer  
9312 - 8-Input Digital  
Multiplexer  
9322 - Quad 2-Input  
Digital  
Multiplexer

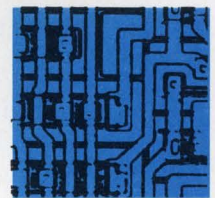

**DECODERS AND  
DEMULTIPLEXERS**  
9301 - One-Of-Ten  
Decoder  
9315 - One-Of-Ten  
Decoder/Driver  
9307 - Seven-Segment  
Decoder  
9311 - One-Of-16  
Decoder  
9317 - Seven-Segment  
Decoder/Driver  
9327 - Seven-Segment  
Decoder/Driver



**COUNTERS**  
9306 - Decade Up/  
Down Counter  
9310 - Decade Counter  
9316 - Hexadecimal  
Counter



**ENCODERS**  
9318 - Priority 8-Input  
Encoder

**FAIRCHILD**  
SEMICONDUCTOR

# Feedback analysis can be speeded

by these techniques for calculating driving-point impedance. The formulas also help determine the network's return ratio.

The critical factor in analyzing feedback networks is the driving-point impedance. Any procedure that can ease the job of calculating that impedance will greatly simplify the over-all analysis.

Classical approaches such as loop equations and the two-port technique work, of course, but the algebraic manipulations are cumbersome, and they obscure system performance. A more practical way is to use Blackman's and Bode's formulas.

These formulas not only facilitate the analysis but also describe the general behavior of the feedback network as the amount of feedback is changed. They also make it possible to determine the return ratio (closed-loop feedback factor) of such networks.

Furthermore, the use of Blackman's formula for circuits with multiloop feedback is a step toward simplifying the analysis of such networks. In unusual cases, where Blackman's formulas become impractical, it is possible to use a hybrid solution.

## Review of the classical methods

To analyze the single-stage common-emitter feedback amplifier of Fig. 1, one can begin by writing three loop equations and solving them for the driving-point impedance  $Z_{DR} = v_{in}/i_{in}$ . The solution of even this relatively simple circuit requires a good deal of manipulation.

Some simplification results if the circuit is considered instead as a linear two-port with  $R_L$  hung onto port 2. The two-port network is described by

$$v_1 = i_1 Z_{11} + i_2 Z_{12} \quad (1a)$$

and

$$v_2 = i_1 Z_{21} + i_2 Z_{22}. \quad (1b)$$

Since  $v_2 = i_2 R_L$ , Eq. 1b can be rewritten as

$$0 = i_1 Z_{21} + i_2 (Z_{22} - R_L). \quad (2)$$

Eq. 2 can be solved for  $i_2$  yielding

$$i_2 = -i_1 Z_{21} / (Z_{22} - R_L) \quad (3)$$

and the result can be plugged into Eq. 1a to determine  $Z_{DR}$ , thus:

$$Z_{DR} = Z_{11} - \frac{Z_{21} Z_{12}}{Z_{22} - R_L} = \frac{Z_{11} Z_{22} - Z_{12} Z_{21} - Z_{11} R_L}{Z_{22} - R_L}. \quad (4)$$

This same result can be obtained more easily by evaluating the impedance matrix:

$$Z = \begin{bmatrix} Z_{11} & Z_{12} \\ Z_{21} & Z_{22} - R_L \end{bmatrix}. \quad (5)$$

In this case

$$Z_{DR} = \Delta / \Delta_{11} \quad (6)$$

where  $\Delta$  is the determinant of the network and  $\Delta_{11}$  is the determinant when the row and the column of the loop in question are eliminated. That is,

$$\Delta = Z_{11} (Z_{22} - R_L) - Z_{21} Z_{12} \quad (7a)$$

and

$$\Delta_{11} = Z_{22} - R_L. \quad (7b)$$

If  $Z_{DR}$  is the driving-point impedance with feedback ( $Z_{DRF}$ ), Eq. 6 must be slightly modified. For example, since the circuit shown in Fig. 1 uses shunt feedback,  $Z_{DRF} = (\Delta + \Delta_y) / (\Delta_{11} + \Delta_y)$  where  $\Delta_y$  indicates the y-determinants of the feedback network. If the circuit had used series feedback, we would have to add the z-determinants to the original  $\Delta$ .

## Use Blackman's approach

The use of Blackman's<sup>1,2</sup> formula gives a clear understanding of the behavior and variations of the driving-point impedances with varying parameters and feedback forms. The derivation of the formula helps to demonstrate its importance. The network shown in Fig. 2 will be used,<sup>3</sup> and the assumption is made that the entire network, including vacuum tubes, is a linear system. This means that superposition is applicable.

Consider that  $e_1$  is applied in series with terminals 1 and 1'. Also let a second emf,  $e_2$ , be applied between the grid and the cathode of the tube. Voltages  $v_1$  and  $v_2$  will be linearly related to  $e_1$  and  $e_2$ . If voltage source  $e_1$  has a non-zero internal impedance, the coefficients in these relations will depend upon it. However, if the input

Vasil Uzunoglu, Chief Engineer, Allied Research Associates, Inc., P.O. Box 536, Baltimore, Md. 21203.

current  $i_1$  is used as an independent variable in place of  $e_1$ , the coefficients will not depend upon the impedance of the source.

It is also convenient to use the potential difference,  $e_2 - v_2$ , developed between terminals 2 and

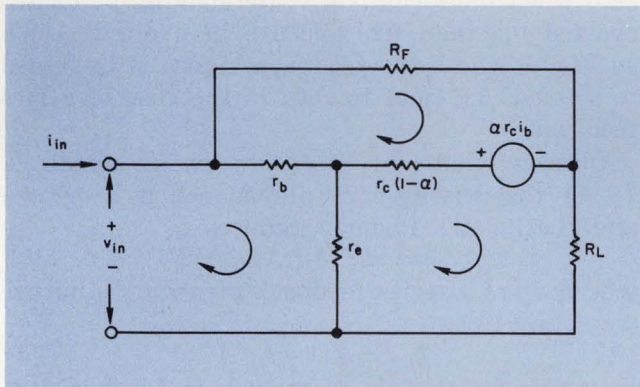

1. Classical methods may be used to analyze this common-emitter feedback amplifier, but Blackman's and Bode's techniques are easier and more informative.

2' as one of the dependent variables instead of  $v_2$ . This leads to:

$$v_1 = Ai_1 + Be_2 \quad (8a)$$

$$e_2 - v_2 = Ci_1 + De_2 \quad (8b)$$

where the coefficients are all independent of  $Z$ .

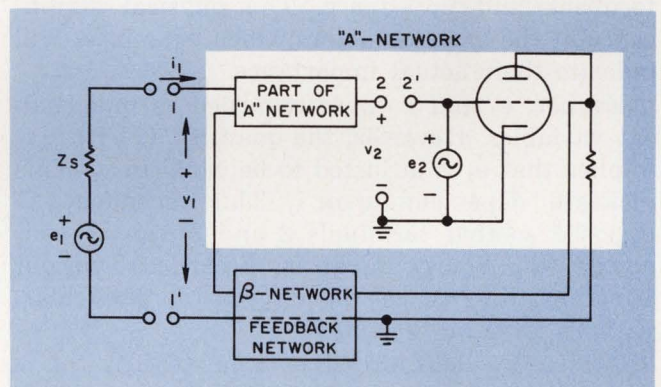

2. Blackman's formula is derived by using this amplifier, which employs both series and shunt feedback.  $Z_s$  is the output impedance of voltage source  $e_1$ .

## Comparison of Blackman's and Bode's methods

### Blackman

The first step in applying Blackman's method is to find  $Z$ —the input impedance with all active elements set equal to zero. For the circuit of Fig. 3, this means that the controlled voltage source is replaced by a short. This yields:

$$Z = r_b + r_e(r_c' + R_L)/(r_e + r_c' + R_L). \quad (a)$$

To find  $\beta_o$ , the fraction of the output signal fed back to the input must be found. It is given by

$$\beta_o = \frac{r_b}{r_b + r_e(r_c' + R_L)/(r_e + r_c' + R_L)} \cdot \frac{r_e}{r_e + r_c' + R_L} \quad (b)$$

The voltage gain,  $A$ , is given by

$$A = -\alpha r_c / r_b \quad (c)$$

Substituting Eqs. (a) through (c) into Blackman's formula for series feedback (Eq. 14), we obtain:

$$Z_{in} = Z[1 + (r_c/Z)(r_e/(r_e + r_c' + R_L))]. \quad (d)$$

### Bode

The  $\Delta_o$  determinant is given by

$$\Delta_o = \begin{vmatrix} r_b + r_e & r_e \\ r_e - \alpha r_c & r_c' + r_e + R_L \end{vmatrix} \quad (a)$$

To calculate  $\Delta_o$  REF, the driving source must be shorted. In this case, the term  $\alpha r_e$  becomes zero.

Thus:

$$\Delta_o \text{ REF} = \begin{vmatrix} r_b + r_e & r_e \\ r_e & r_c' + r_e + R_L \end{vmatrix} \quad (b)$$

Using Bode's formula for series feedback (Eq. 15a) and simplifying the result, we obtain:

$$Z_{in} = Z[1 + (r_c/Z)(r_e/(r_e + r_c' + R_L))]. \quad (c)$$

From these equations we obtain

$$(v_1/i_1)_{e_2=v_2} = (AD-BC)/D \quad (9a)$$

$$(v_1/i_1)_{e_2=0} = A \quad (9b)$$

$$((e_2-v_2)/e_2)_{v_1=0} = (AD-BC)/A \quad (9c)$$

and

$$((e_2-v_2)/e_2)_{i_1=0} = D. \quad (9d)$$

Hence

$$\frac{(v_1/i_1)_{e_2=v_2}}{(v_1/i_1)_{e_2=0}} = \frac{1 - (v_2/e_2)_{v_1=0}}{1 - (v_2/e_2)_{i_1=0}} \quad (10)$$

Equation 10 expresses the relationship between feedback and impedance. The physical significance of the various factors, when examined, will indicate their actual importance.

Earlier,  $e_2$  and  $v_1$  were regarded as independent variables. However, the quantity  $(v_1/i_1)_{e_2=v_2}$  implies that  $e_2$  is adjusted to be equal to  $v_2$ . This makes  $e_2$  dependent upon  $i_1$ . This dependence is imposed so that terminals 2 and 2' can be connected (and source  $e_2$  can be discarded) without affecting the rest of the circuit—in particular, without affecting  $v_1$  and  $i_1$ .

Obviously, therefore, the ratio  $(v_1/i_1)_{e_2=v_2}$  is the impedance seen between terminals 1 and 1' when terminals 2 and 2' are connected and the only source of emf acting on the network is the external circuit connected to terminals 1 and 1'. This impedance will be symbolized by  $Z_A$ .

The ratio  $(v_1/i_1)_{e_2=0}$  implies that no voltage is applied between the grid and the cathode of the tube. However, it is immaterial whether or not a voltage is applied to the grid of the tube if the amplification of the tube is nullified. Therefore, this ratio is the impedance that will be seen at terminals 1, 1' when terminals 2, 2' are connected and the amplification of the tube is nullified. This ratio is  $Z_p$ .

Finally, the ratios  $(v_2/e_2)_{v_1=0}$  and  $(v_2/e_2)_{i_1=0}$  are recognized to be the feedback to the vacuum tube with terminals 1, 1' connected (shorted) in the first case, and left open in the second. These ratios will be symbolized by  $F_{sh}$  and  $F_{op}$ , respectively.

Hence, Eq. 10 may be written in the more significant form

$$Z_A/Z_p = (1-F_{sh})/(1-F_{op}) \quad (11)$$

and when written as

$$Z_{DR} = Z[1 - (A\beta)_o]/[1 - (A\beta)_\infty] \quad (12)$$

it is Blackman's formula.  $Z$  is the driving-point impedance with all active elements eliminated (set equal to zero).  $(A\beta)_o$  is the return ratio or

feedback factor when the terminals at the driving point are shorted together  $(A\beta)_\infty$  is the return ratio when the driving-point terminals are left open.

The feedback factor is the gain around the complete loop from the input of the amplifier back to the input again. If the driving-point terminals incorporate only one type of feedback, that is shunt or series; either  $A\beta_o$  or  $A\beta_\infty$  is zero. For example, for shunt feedback,  $\beta$  goes to zero when the terminals at the driving point are shorted together. This occurs in a circuit such as Fig. 1 where the feedback signal is bypassed to ground.  $\beta_\infty$  goes to zero in the case of series feedback.

Observe that for negative shunt feedback  $(-A)$  the driving-point impedance is decreased, and Blackman's formula reduces to

$$Z_{DR} = Z/(1+A\beta_\infty) \quad (13)$$

whereas for a series feedback of negative nature we obtain

$$Z_{DR} = Z(1+A\beta_o) \quad (14)$$

in which case  $Z_{DR}$  is increased. If feedback becomes positive for the above cases, then the input impedance for the shunt case increases, and that for the series case decreases. This is true only as long as the system is stable. Thus, Blackman's formula furnishes a powerful tool for determining the effect of feedback on impedance.

### Bode offers other simplifications

Bode's formulas for the driving-point impedance are derived from Blackman's formula. They are given as

$$Z_{DR} = Z\Delta_o/\Delta_{o\text{ REF}} \quad (15a)$$

and

$$Z_{DR} = Z\Delta_\infty/\Delta_{\infty\text{ REF}} \quad (15b)$$

where  $\Delta_o/\Delta_{o\text{ REF}}$  is the return difference of the network with the driving source short-circuited, and  $\Delta_\infty/\Delta_{\infty\text{ REF}}$  gives the same quantity with the input terminals left open. The return difference,  $F$ , is related to the return ratio,  $T$  (note that  $T = A\beta_\infty$ ) by

$$F = 1 + T. \quad (16)$$

The return difference for any element in a complete circuit is equal to the ratio of the values assumed by the circuit determinant when the specified element has its normal value and when the specified element vanishes. One can see that



Eq. 13 corresponds to Eq. 15b and also that Eq. 14 corresponds to Eq. 15a.

Using Blackman's formula to determine  $A\beta_0$  or  $A\beta_\infty$  requires that the user have a good circuits background. The analysis depends not only on mathematical manipulations but on circuit insights as well. In particular, one has to be able to define  $\beta$  for a given feedback setup, and this takes experience.

On the other hand, Eqs. 8 and 10 require the evaluation of the determinants in question, so

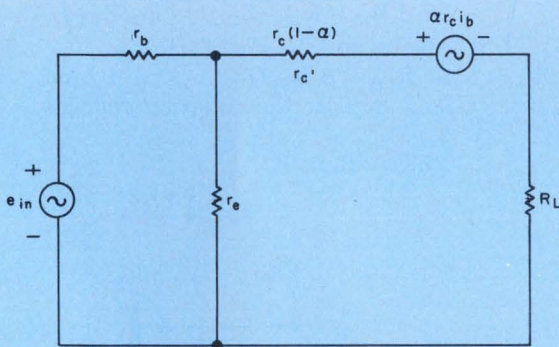

3. The emitter resistance is the feedback element in this simple common-emitter configuration.

that the user is faced with the problem of determining the reference condition. Determining the reference condition requires both kinds of experience. One has to be able to combine the practical circuit and the matrix to see what makes the forward transmission in the circuit go to zero.

The reference condition is a mathematical quantity that, when inserted in the determinant, will make the forward transmission zero. It is a function of the properties of the driving point.

### Compare these techniques

Since familiarity with powerful tools is best obtained by first using them at a relatively simple level, let's examine the common-emitter circuit of Fig. 3—an example of series feedback. It is analyzed for driving-point impedance using

both Blackman's and Bode's methods (see comparison box).

If one wants to determine the return ratio itself (the feedback factor) using Bode's method, one observes that

$$A\beta = 1 - \Delta / \Delta_{\text{REF}} \quad (17)$$

This indicates that the reference condition has to be evaluated with the driving point including  $e_{in}$ , as there is no restriction in the driving point. This is different from the illustrative example in which the reference conditions (a and b of Bode's method) were evaluated with  $e_{in}$  shorted. Hence, there will not be any forward transmission to the output load,  $R_L$ , when  $\alpha r_c$ , the output generator, is shorted.

Therefore, as far as the return ratio is concerned, the determinant must be evaluated with  $e_{in}$  in the circuit. Upon examining the determinant, we see that to make the forward transmission zero, it is not enough to make  $\alpha r_c = 0$ . The only way to prevent any signal from appearing at the output is to set  $\alpha r_c = r_e$ . In this case  $\Delta$ , the total determinant of the circuit, is given by

$$\Delta = \begin{vmatrix} r_b + r_e & r_e \\ r_e - r_c & r_e + R_L + r_c' \end{vmatrix} \quad (18)$$

The reference condition is given by

$$\Delta_{\text{REF}} = \begin{vmatrix} r_b + r_e & r_e \\ r_e - r_e = 0 & r_e + R_L + r_c' \end{vmatrix} \quad (19)$$

Note that  $\Delta_{\text{REF}}$  refers to the input condition including  $e_{in}$ . One sees that in this case the reference condition is satisfied when  $\alpha r_c$  is set equal to  $r_e$  making the second row and first column zero. In both cases, the condition is satisfied, resulting in zero forward transmission. Substituting Eqs. 18 and 19 into 17 provides the expression for the return ratio.

### Extend to multiple feedback paths

Blackman's formula (Eq. 12) as it stands applies only to networks with a single feedback loop. For multipath feedback networks, the formula becomes<sup>1</sup>

$$Z_{\text{DR}} = Z \left[ \frac{(1 - T_{10})}{(1 - T_{1\infty})} \right] \left[ \frac{(1 - T_{20})}{(1 - T_{2\infty})} \right] \dots \quad (20)$$

where  $T_{10} = (A\beta)_{10}$  is the return ratio with all of the elements in their reference condition;  $T_{20}$  is the return ratio with all elements except the

## Analyzing a network with two feedback paths

This two-transistor amplifier has two feedback paths: shunt feedback to the input through  $R_F$  and series feedback caused by the emitter degeneration of  $R_E$ .

Normally, for shunt feedbacks at the input it is appropriate to deal with current gain, whereas series feedback demands the use of voltage gain for practical reasons. One can use both. By breaking into the feedback circuit, the return ratio can be determined experimentally.

The feedback path is broken at the  $X$ , and a network with impedance  $Z_M$  is connected at point  $A'$ .  $Z_M$  is the impedance that one sees by looking into the circuit at point  $A$ . In this example it's just the resistance of the forward-biased base-emitter junction of  $Q_1$ ,  $Z_B$ , in parallel with  $R_B$ .

An input current applied at  $A$  will cause a current to flow through  $Z_M$ . The ratio of the current through  $Z_M$  to the input current is the return ratio, assuming that forward transmission through  $R_F$  can be ignored. The return ratio ( $A\beta$ ) is a complex number, so both magnitude and phase must be measured.

At this point we should note the distinctions between the three input impedance levels under discussion:  $Z_B$  is the open-loop input impedance,  $Z_{IN}$  is the closed-loop input impedance and  $Z_M$  is the impedance seen by the feedback current—it is given by  $Z_M = R_B Z_B / (R_B + Z_B)$ . Note that  $R_B$  must be added to  $Z_B$  and  $Z_{IN}$  to get the actual impedance seen by the driving voltage source.

For effective shunt feedback,  $R_B$  is chosen to be much greater than  $Z_B$ . Also,  $R_F$  is chosen to be much larger than  $R_E$  to prevent forward transmission through the feedback path. When these design criteria are satisfied, the feedback current is given by

$$i_F = i_{e2} R_E / (R_E + R_F)$$

from which we obtain  $\beta(s) = R_E / R_F$ . The cur-

rent gain of the first stage is then given by  $A_1(s) = \beta_1 R_{L1} / (R_{L1} + Z_{IN2})$  where  $\beta_1$  is the current gain of  $Q_1$ . The total forward gain is given by  $A(s) = \beta_2 A_1(s)$ , and the return ratio is given by

$A(s)\beta(s) = [\beta_1 \beta_2 R_{L1} / (R_{L1} + Z_{IN2})] [R_E / R_F]$  where  $\beta_1$  and  $\beta_2$  are frequency dependent.

For this circuit, Blackman's formula yields:

$$Z_{IN} = \frac{Z[1 + A_2(s)\beta_\infty]}{1 + A_1(s)\beta_\infty}$$

because both  $A_1(s)$  and  $A_2(s)$  are negative. The denominator represents the feedback through  $R_F$ , and the numerator represents the feedback due to emitter degeneration. If we assume that  $R_F \gg Z_B$  and  $r_c \ll r_c' + R_{L1} || Z_{IN2}$ , we get:

$Z = r_b + r_e$        $\beta_\infty = R_E / R_F$   
 $A_2(s) = -\alpha r_c / r_b$  and  $\beta_\infty = r_b r_e / (r_b + r_e) r_c'$ .

The input impedance of the amplifier is given by

$$Z_{IN} = \left( \frac{r_b + r_e}{1 + [\beta_1 \beta_2 R_{L1} / (R_{L1} + Z_{IN2})] [R_E / R_F]} \right) (1 + (\alpha r_c / r_b) + r_b r_e / (r_b + r_e) r_c')$$

If  $Z_{IN2} \gg R_{L1}$ ,  $(\beta_1 R_{L1} / R_E) \gg 1$  and  $(\alpha r_c r_e / (r_b + r_e) r_c') \gg 1$ , the equation reduces to

$$Z_{IN} = R_F r_e / R_{L1}$$

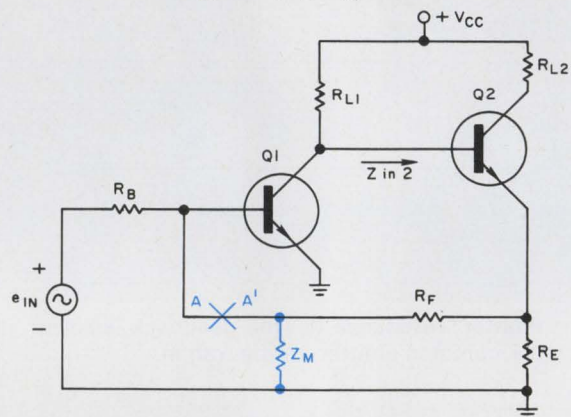

first in their reference condition;  $T_{30}$  is the return ratio with all elements except the first and second in their reference condition; and so on.

An example that shows how mathematics combines with physical reality in a multipath feedback situation is worked out in the box at the top of the page. ■■

### References

1. Blackman, R. B., "Effect of Feedback on Impedance," *Bell System Technical Journal*, Oct., 1943, Vol. 22, No. 3, p. 269.
2. Uzunoglu, Vasil, *Semiconductor Network Analysis and Design*, McGraw-Hill Book Co., 1964, Chapt. 8.
3. Blackman, R. B., Private communication.
4. Mulligan, J. H., Jr., "Signal and Transmission in Nonreciprocal Networks and Feedback Systems," *Proc. Symp. Adaptive Networks and Feedback Systems*, Polytechnic Institute of Brooklyn, 1960, p. 125.

### Test your retention

Here are questions based on the main points of this article. Their purpose is to help you make sure you have not overlooked any important ideas. You'll find the answers in the article.

1. What four methods can be used to find  $Z_{IN}$ ?
2. What is the basis of Blackman's formula?
3. What is meant by return ratio?
4. What is the distinction between return ratio and return difference?
5. How are multiple feedback circuits analyzed using Blackman's formula?

## Quality business machines and equipment deserve the best in toggle switches. Cutler-Hammer's.

Whether it's the switch for a printout machine at the bank or the bank of switches at a recording studio, when you specify Cutler-Hammer toggle switches you can bank on the performance.

Top-quality equipment—from commercial-grade appliances to computers—deserves the finest in switches. The finest quality. And the finest in design flexibility, distinctive appearance, and performance.

You get all this from Cutler-Hammer in the broadest line of toggle switches available.

AC-rated. AC/DC. Low energy.

Dry-circuit capability, or up to 25 amps. One, two, and four poles. The greatest selection of ratings, terminations, hardware, toggle shapes, materials, and colors. You name it. We have thousands of varieties ready for delivery—and we'll build one more to your specifications if you don't find what you want in stock.

So, for the next piece of quality equipment you design, specify Number 1. Cutler-Hammer toggle switches. The performers you can bank on. Call your C-H Sales Office or Stocking Distributor. Or write for full-line catalog LD-110-217.



Quality switches for quality products. See your C-H Distributor for immediate service.

**CUTLER-HAMMER**   
SPECIALTY PRODUCTS DIVISION, Milwaukee, Wis. 53201

# Bank on them.

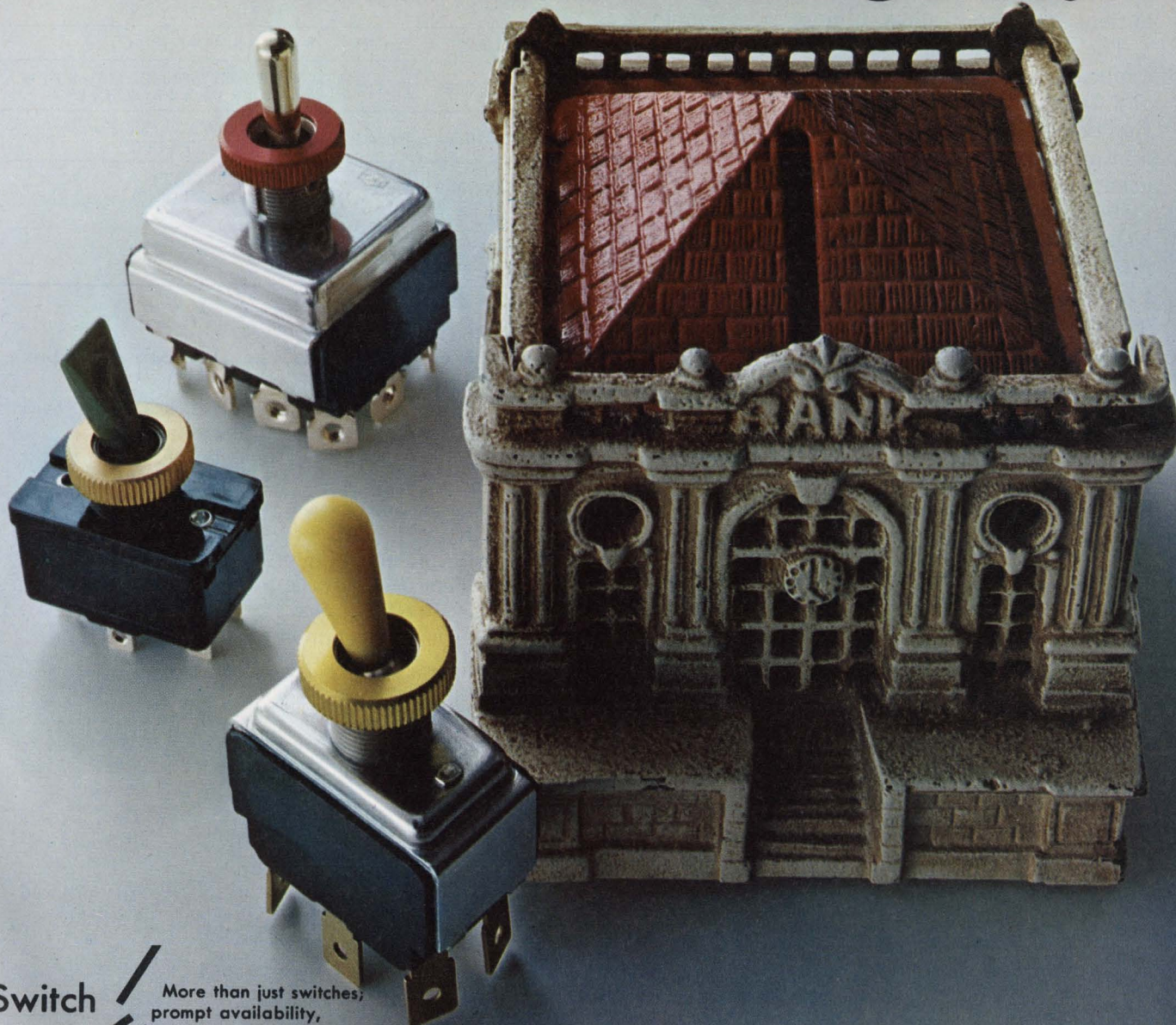

Switch  
to No. 1

More than just switches,  
prompt availability,  
field help, innovation,  
quality assurance, too.

INFORMATION RETRIEVAL NUMBER 59

# Be logical—consider unfamiliar gating.

The eight canonical forms of two-stage logic are interchangeable. Any one can simplify a design.

Most engineers are familiar with AND/OR and OR/AND two-stage logic. However, many do not realize that there are six additional equivalent forms of two-stage logic that can be useful in many applications. In all, there are eight canonical nondegenerate gate combinations of two-state logic. Four can be derived from a minimum-sum statement of the problem and four from the minimum-product statement. These structures give the engineer additional design options, and may allow him to save money.

The choice of canonical form for a particular application is usually dependent on the number and types of gates required to implement that function. The designer usually tries merely to minimize gate count. But the availability of unused gates on a circuit card may make other logic forms attractive. If, for example, several NOR gates are left over, the designer can economize by using them to implement an additional function with NOR/NOR logic. All that is required is an awareness of the logic forms and their equivalence.

## Set up the canonical forms

To illustrate the eight canonical forms, equivalent minimum expressions are used. The sample equation is

$F = A'B + AB'C'$  as a minimum sum and

$F = (A' + B')(A + B)(B + C')$  as a minimum product.

The minimum sum is directly represented by AND/OR and the minimum product by OR/AND logic. The other minimum-sum forms are NAND/NAND, OR/NAND and NOR/OR. For NAND/NAND

$F = [(A'B)'(AB'C')']'$ ,

or

$F = (A'|B)|(A|B'|C')$  in stroke notation.

The remainder of the minimum-sum forms are listed in the Table of Canonical Forms.

---

Gilbert Starr, Systems Analyst, QED Systems, Inc., 515 Washington Ave., Pleasantville, N.Y. 10570.

## Table of canonical forms

Logic Form	Minimum Expression	See Figure	Sample Equation
AND/OR	Sum	1	$A'B + AB'C'$
NAND/NAND	Sum	2	$[(A'B)'(AB'C')']' = (A' B) (A B' C')$
OR/NAND	Sum	3	$[(A+B')(A'+B+C)]' = (A+B' )(A'+B+C)$
NOR/OR	Sum	4	$(A+B')' + (A'+B+C)' = (A \nabla B') + (A' \nabla B \nabla C)$
OR/AND	Product	5	$(A'+B')(A+B)(B+C')$
NOR/NOR	Product	6	$[(A'+B')' + (A+B)' + (B+C)']' = (A' \nabla B') \nabla (A \nabla B) \nabla (B \nabla C')$
AND/NOR	Product	7	$[(AB) + (A'B') + (B'C)]' = (AB) \nabla (A'B') \nabla (B'C)$
NAND/AND	Product	8	$(AB)'(A'B')'(B'C)' = (A B)(A' B')(B' C)$

## Definitions

**Degenerate network:** one that can be implemented using a single gate.

**Minimum expression:** a logic expression that contains no redundant literals or terms.

$AB + A'C + BC$  is not minimum because it can be reduced to  $AB + A'C$ .

**Minimum sum:** a sum of products based on AND/OR gates such as  $AB + A'C$ , which is a minimum expression.

**Minimum product:** a product of sums based on OR/AND gates such as  $(A+B)(C+D)$ , which is a minimum expression.

## Notation

**Stroke (|)** represents the NAND, AND followed by inversion.  $A|B = (AB)'$ ;  $A|B|C \dots = (ABC \dots)'$ .

Since  $(AB)' = A' + B'$  by DeMorgan's theorem,  $A|B = A' + B'$  is an alternate expression.

**Dagger (∇)** represents the NOR, OR followed by inversion.  $A \nabla B = (A+B)'$ ;  $(A \nabla B \nabla C \dots) = (A+B+C+\dots)'$ .

By DeMorgan's theorem  $A \nabla B = A'B'$ .

Minimum-product forms include the familiar OR/AND as well as NOR/NOR, AND/NOR and NAND/AND. As an example, NOR/NOR uses the equation

$$F = [(A'+B) + (A+B) + (B+C)']'$$

or

$F = (A' \downarrow B') \downarrow (A \downarrow B) \downarrow (B \downarrow C')$  in dagger notation. The other minimum-product forms are listed in the table. Note that any of the forms

can be converted into any other by using the basic operations of Boolean algebra and DeMorgan's theorem. ■■

**Bibliography**

Givone, Donald D., *Introduction to Switching Circuit Theory*, McGraw-Hill Book Co., New York, 1970.

Mayley, G., and Earle, J., *The Logic Design of Transistor Digital Computers*, Prentice-Hall, Inc., Englewood Cliffs, N. J. 1963.

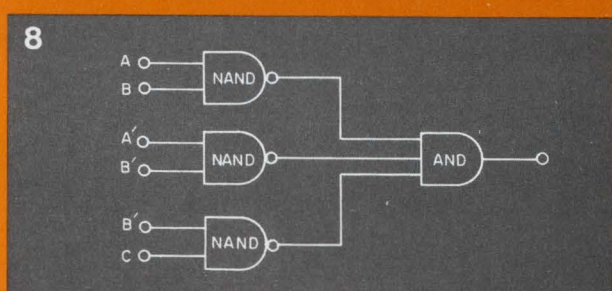
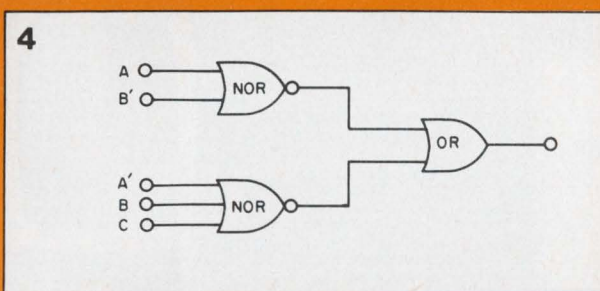
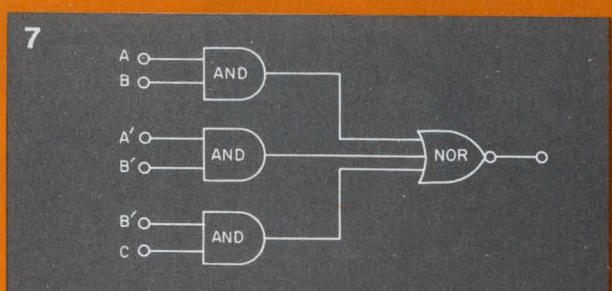
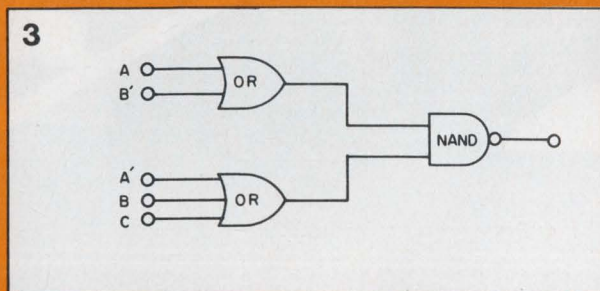
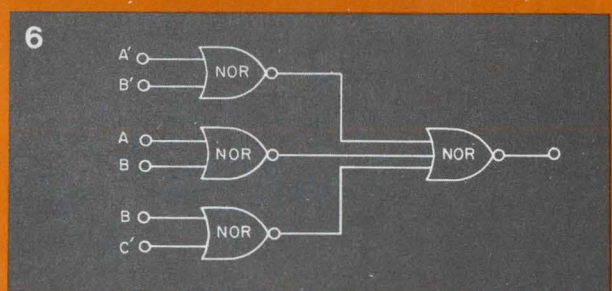
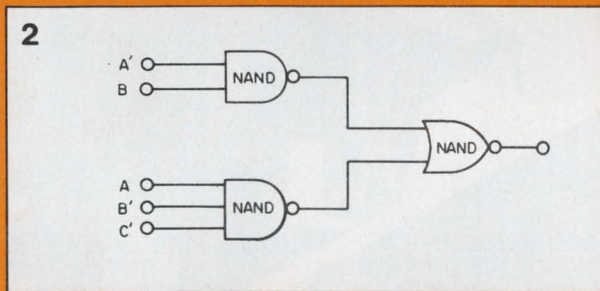
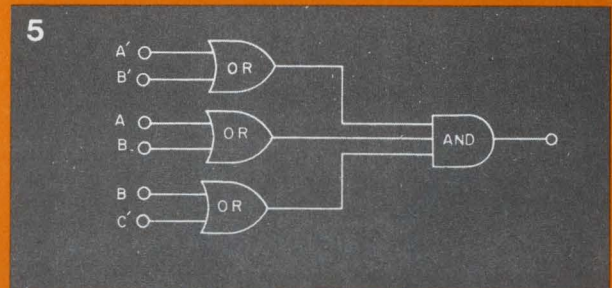
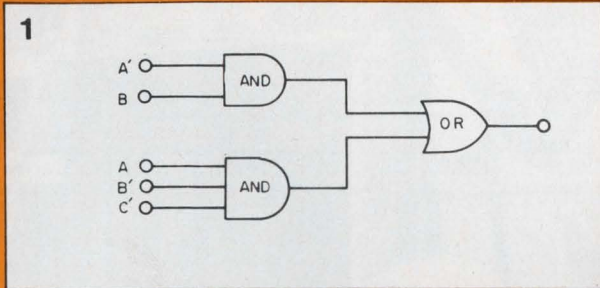

1-8. These two-stage logic circuits illustrate the eight canonical forms for a sample equation. The Table of canonical forms lists each of the circuits and its logic equation using AND, OR, stroke, dagger and inversion notation. Figures 1-4 are minimum sum; Figs. 5-8 are minimum product. The input literals for Figs. 3, 4, 7, 8 are the inversions of those for Figs. 1, 2, 5, 6.

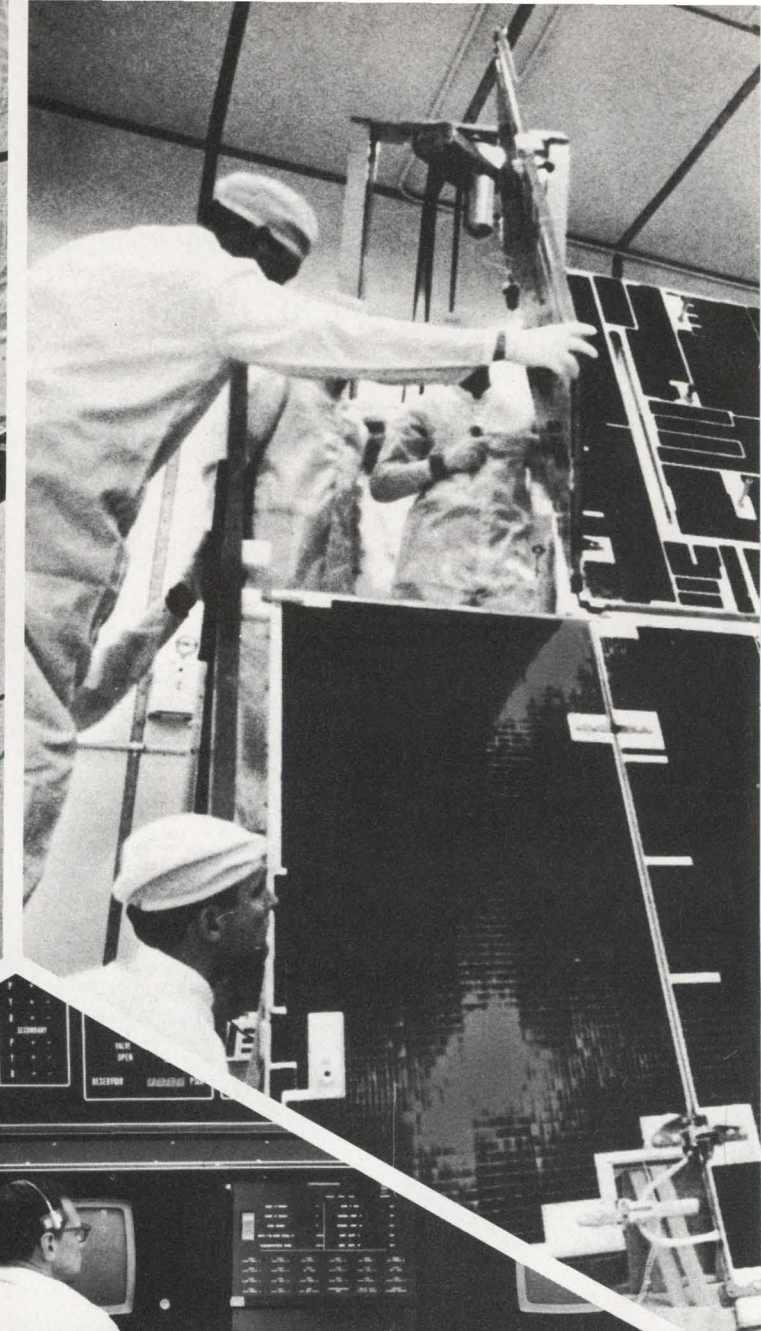
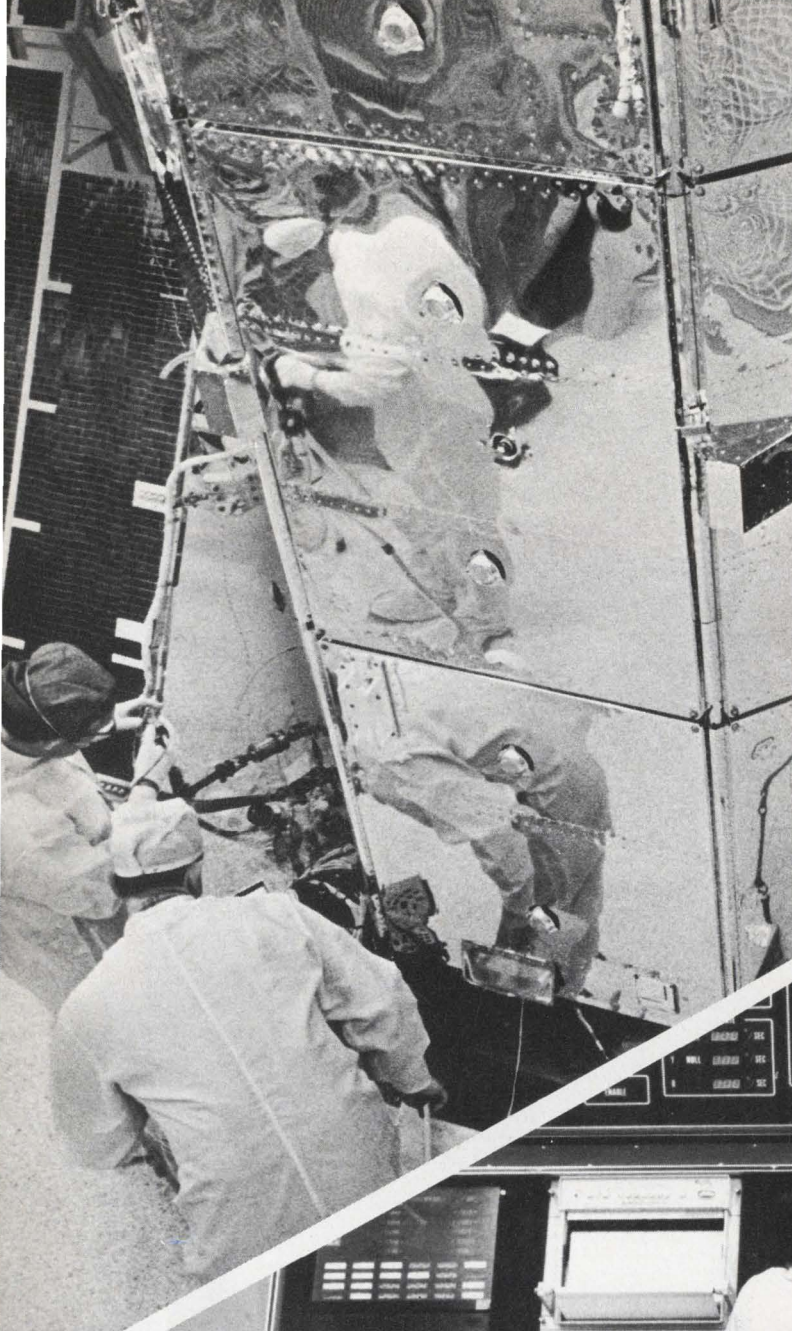

# When the Goddard Space Flight Center wrote their specs for a hardcopy printer, they wound up with a choice of one.

They didn't mean to. It just turned out that way.

Because of all the printers around, the Gould 4800 was the only printer which could give the Goddard people all they asked for.

**Speed** Goddard asked for 1000 lines per minute. The 4800 will whip out 4800.

**Silence** Goddard planned to put their printer right in their on-line control room. And weren't about to put up with a noisy impact printer. With the Gould 4800, they don't have to. It's electrostatic. And very quiet.

**Printout Width** Goddard wanted a full 80 columns wide. The Gould 4800 provides it.

On convenient 8½" wide paper.

The Goddard people also were impressed by several other important factors:

*alphanumerics and graphics* — the Gould 4800 delivers words and pictures,

simultaneously, direct from computer output; *permanent paper* — special,

high-contrast, won't curl, get yellow or brittle . . . you can write on

it with anything; *reliability* — smooth, quiet, impact-free operation means less wear and tear on parts, less maintenance, little downtime; *versatility* — Gould 4800 generates wide variety of fonts, from smallest matrix on up, in many weights, sizes and faces. It can be integrated into a console set-up (see Goddard installation photo on opposite page) or used independently as shown below.

One more thing: The Gould 4800 is priced at or below printers that can't come close to the performance. So the Goddard people not only got quite a lot more than they bargained for. They also got quite a bargain.

**Talk to your computer people about the Gould 4800. Then talk to us about a demonstration.**

**We're ready whenever you are.**

Gould Inc., Graphics Division, 3631 Perkins Avenue, Cleveland, Ohio 44114.

 **GOULD**

Gould 4800. The next generation of high-speed printers.



# Precision op amps can be wasted

if they're not used in the right configuration.

Here's how to match the circuit to your application.

## Part two of a two-part article

After going to the trouble of carefully selecting the best operational amplifier for a precision measurement, you certainly wouldn't want to throw away its capabilities by using it in an inappropriate configuration. Fortunately, almost all op-amp circuits boil down to variations of either the basic inverting or noninverting configurations, so it's not too difficult to choose the right one. (The differential circuit—but not the differential op amp—is omitted from this discussion because it usually requires very high-performance instrumentation amplifiers rather than ordinary op amps.)

The inverting configuration, which is very widely used, not only permits accurate voltage measurement but, with the introduction of various feedback components, can perform such other useful functions as integration, differentiation and filtering.

Ideally, the inverting configuration (Fig. 1a) has a closed-loop gain of  $R_f/R_{in}$ , but this is reduced in practice because the amplifier's open-loop gain,  $A$ , is not infinite. The actual closed-loop gain is

$$G = \frac{R_f}{R_{in} + (R_f + R_{in})/A} \quad (1)$$

Variations in the open-loop gain produce scaled-down variations in the closed-loop gain according to the relationship

$$\Delta G/G \cong (G/A) (\Delta A/A) \quad (2)$$

An op amp with an open-loop gain of  $10^6$ , connected in an inverting circuit with a closed-loop gain of 100, would undergo only a 0.002% closed-loop gain variation for a 20% change in the amplifier's open-loop gain.

An important inverting-amplifier limitation is the fact that the source resistance,  $R_s$ , influences the closed-loop gain. So long as the source resistance remains constant, either the input or the feedback resistor can be trimmed to make  $R_f/(R_{in} + R_s)$  equal to any desired value. Un-

fortunately,  $R_s$  is not always constant, and will introduce errors if changes in its magnitude are an appreciable fraction of  $R_{in}$ . Efforts to reduce the effect of  $R_s$  by raising the value of  $R_{in}$  will aggravate current-drive errors, and they may create the need for very large values of feedback resistance to maintain a particular gain level. A modified inverting-amplifier configuration (Fig. 1b) can be used to sidestep the need for high values of  $R_f$ , but only at the price of worsened voltage drift.

The source resistance forms part of the inverting circuit's total input resistance, so this configuration cannot be used successfully for high-impedance voltage measurements.  $R_{in}$  would have to be made impossibly high to avoid loading down the source and to make the circuit gain relatively independent of  $R_s$ . If a large closed-loop gain were needed,  $R_f$  would have to be made even higher so that the ratio  $R_f/R_{in}$  would provide the necessary gain.

## Inverting increases voltage drift

In the inverting configuration the input signal is not applied to the amplifier's input terminal. Only the fraction  $E_{in}R_f/(R_f + R_{in})$  is applied. Thus, the amount of drift, as a percentage of the input signal, is increased by a factor  $(R_f + R_{in})/R_f$  relative to the scaled-down input voltage.

Usually an amplifier's drift is referred to the circuit's input terminals instead of referring the circuit's input signal to the amplifier's terminals. In this way the drift at the circuit's input terminals can be compared directly with the input voltage for an estimate of measuring error. When the amplifier offset,  $E_{os}$ , is translated to the circuit input, the effective drift is then  $(\Delta E_{os}/\Delta T) (R_{in} + R_f)/R_f$ , which is also equal to  $E_{os} (1 + 1/G)$ . For high-gain circuits, therefore, the voltage offset at the circuit's input terminals is very nearly the same value as the offset figures listed in the manufacturer's specification.

For unity-gain inverting configurations, however, the voltage drift is effectively doubled. Similarly, drift translated to the output is very

Robert I. Demrow, Manager, Applications Engineering, Analog Devices, Inc., 221 Fifth St., Cambridge, Mass. 02142.



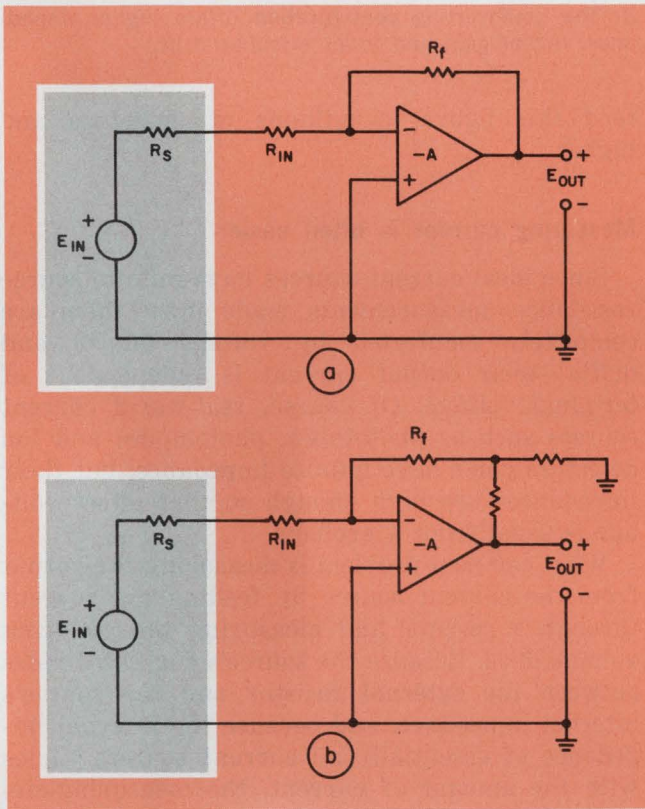

1. The standard inverting configuration (a) has a closed-loop gain of approximately  $R_f/R_{in}$ . One way to obtain high gain without using extremely large feedback resistors is to tap off only a fraction of the output voltage for use as a feedback signal (b).

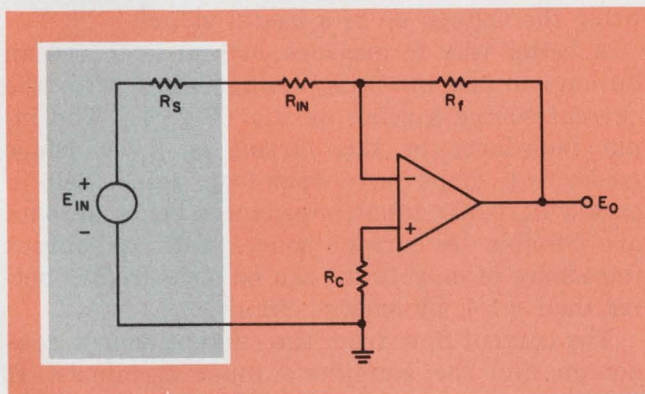

2. Current drift is reduced by the temperature-compensating resistor  $R_c$ . If  $R_c = (R_s + R_{in}) || R_f$ , the current drift will depend upon the difference-current drift between the two input terminals.

nearly equal to  $GE_{os}$  for large gain values, but for lower gains, the output drift,  $E_{os}(1 + G)$ , becomes magnified relative to the output signal. (Signal gain is  $G$  and the drift gain is  $G + 1$ .)

When the drift curves of Part One of this article<sup>1</sup> are used for inverting-amplifier selection, the scaled-up offset voltage effect should be taken into account. Thus, an op amp with  $3 \mu V/^\circ C$  maximum voltage drift has an effective drift of  $6 \mu V/^\circ C$  when used in a unity-gain inverting configuration. The horizontal drift axis for the amplifier's combined drift curve must be raised by  $3 \mu V/^\circ C$ . A unity-gain inverting amplifier is perhaps an extreme example of drift magnification, but even the 10% drift increase for a 10:1 gain circuit may shift the selection from one amplifier type to another.

The inverting circuit is used for measuring very low-level voltage signals. Among its positive attributes is its natural compatibility with chopper-stabilized op amps. Thus, in low-impedance applications, an inverting configuration based on a state-of-the-art chopper-stabilized op amp permits fractional millivolt signals to be resolved, and signals as low as  $10 \mu V$  to be measured with approximately 1 to 10% accuracy. (At this signal level, noise, rather than drift, limits the resolution and the achievable accuracy is primarily determined by the bandwidth used.)

The inverting amplifier generates current-drift errors two ways. Changes in the bias current drawn through the source resistance,  $R_s$ , create an error,  $R_s \Delta I_b$ . In addition, the bias current is drawn through input resistor  $R_{in}$ , creating a further bias-current error,  $\Delta I_b R_{in}$ .

Actually, the bias current is supplied by the amplifier's output through  $R_f$  but the net current-drift error is identical to the error that would be created by  $I_b$  flowing through  $R_{in}$ .

### Reduce the current-drift error

It is possible to reduce the effect of bias-current drift by introducing a compensating resistor in series with the amplifier's noninverting terminal (Fig. 2). Provided the two bias currents track properly, the technique can enhance cur-

rent stability by a factor of five or better. In addition, the technique lifts both amplifier input terminals away from ground potential and may introduce common-mode errors.

The inverting configuration is clearly not suitable for high-impedance voltage measurements. A much better choice for that application is the noninverting circuit, which uses feedback to multiply the input impedance of the op amp.

### Noninverting circuit has less drift

Input signals for the noninverting configuration (Fig. 3) are applied directly to the op amp's noninverting input terminal. Consequently, there is no input-signal attenuation (as in the inverting circuit) and no relative magnification of voltage drift.

Also, the absence of series resistor  $R_{in}$  eliminates current drift within the actual circuit, leaving only the  $I_b R_s$  drift produced by bias current flowing through source resistance  $R_s$ . These simplifications enable the drift curves to be consulted directly without any allowances for increased amounts of drift—so long as the resistance values in the divider are small compared with  $R_s$ , or are much smaller than  $E_{os}/I_b$ .

The noninverting circuit's closed-loop gain,  $G = (R_1 + R_2)/R_2$ , is higher than the inverting amplifier's gain for the same resistance values. Its gain stability, calculated from the more accurate gain equation,

$$G = \left( \frac{R_1 + R_2}{R_2} \right) \left( \frac{1}{1 + 1/AB} \right) \quad (3)$$

is given by  $\Delta G/G = (\Delta A/A) (G/A)$ . The quantity  $B = R_2/(R_1 + R_2)$  in Eq. 3 is the fraction of the output signal fed back to the input.

Because the noninverting configuration employs bootstrapping feedback, its input impedance is very high. The feedback raises the op amp's differential input impedance by a factor of  $AB$ , where  $A$  is the open-loop gain of the op amp. Even for modest levels of amplifier gain, such as  $A = 50,000$ , the effective input impedance to ground can be made many orders of magnitude greater than the differential input impedance. An economy op amp with a 1-M $\Omega$  input resistance can theoretically be boosted to about 10,000-M $\Omega$  input resistance when connected in a gain-of-5 circuit.

Unfortunately, the enhancement of differential input impedance is not the whole story; the amplifier's common-mode impedance (the impedance between the input terminals and ground) sets a maximum limit on the input impedance. Nevertheless, many inexpensive amplifiers are available with 10,000-M $\Omega$  common-mode impedances, and when input impedance becomes crucial, the FET and varactor-bridge amplifiers can ex-

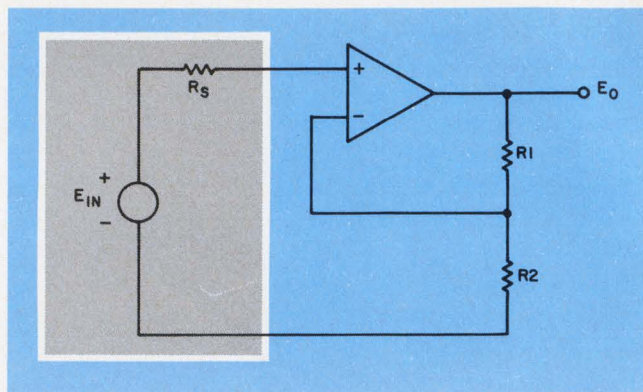

3. The noninverting configuration offers higher impedance, higher gain and lower effective drift.

tend this figure to millions of megohms and higher.

### Measuring current is often easier

Since ideal current sources have infinite source resistance, measurements made upon them are completely unaffected by voltage offsets and drifts—their output current is independent of terminal voltage. Of course, real-world current sources such as phototubes, photodiodes and ion detectors don't have infinite impedance, but their impedances are high enough so that offset voltage is usually not a problem.

What can be a problem is measuring the output from the current source by feeding the current through a resistor and measuring the resulting voltage drop. Because the source's current divides between the external resistor and the source's internal impedance, and because the internal impedance of essentially all current sources varies with the amount of current, the measuring-circuit's share of the total current will vary as the current varies. To make current measurements as accurate as possible, therefore, the measuring resistor should be made very small. This, in turn, will result in a very small voltage drop, requiring an extraordinarily high-gain voltage amplifier to bring the voltage up to a useful value.

A better way to measure current is to use an op amp in the inverting configuration with the current source serving as  $R_{in}$  (Fig. 4). The input impedance of this circuit is  $R_f/A$ . Since modern op amps have open-loop gains well in excess of 10,000, input impedances below an ohm are possible. A current source with an output impedance of only 10 k $\Omega$  can be measured to better than 0.1% by such a circuit.

The current flow from the current source does not go into the amplifier's input terminals. It returns to ground through the feedback resistor and the amplifier back through the power supply. This is important because both the amplifier and power supply must be capable of supplying

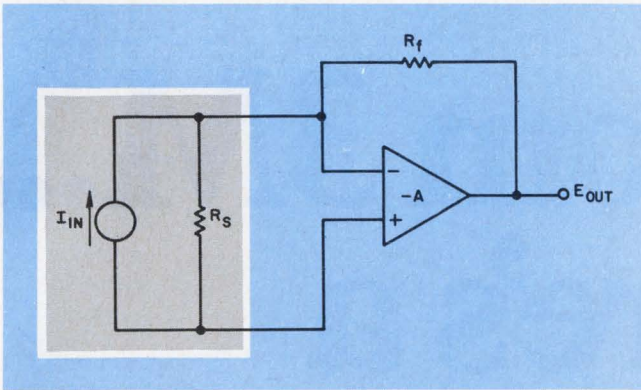

4. The extremely low impedance ( $R_f/A$ ) of this inverting circuit makes it ideal for current measurements.

the value of the current to be measured. To measure a 20-mA current source, you could not use an amplifier with a capability of only 5 mA, since the amplifier would saturate and the feedback would no longer be effective in maintaining the input terminal voltage at a low value.

#### Current drifts are the big problem

As in the case of voltage measurements, temperature drifts are largely responsible for the errors in current measurements. We stated earlier that voltage drift would not be a problem in most cases; let's see why.

Suppose the output resistance of a current source is 1 M $\Omega$  and the current is 1  $\mu$ A with an acceptable measuring error due to voltage effects of 0.1% at 25°C and 0.1% for a 10°C temperature range. If we consider the Thevenin equivalent of the current source, we see that the allowable voltage error is 0.1% of  $1 \mu\text{A} \times 1 \text{M}\Omega = 1 \text{mV}$ . The allowable voltage error due to the 10°C temperature range would also be 1 mV. An amplifier with less than a 1-mV offset and 100- $\mu\text{V}/^\circ\text{C}$  voltage drift coefficient would be adequate. Since nearly all amplifiers can meet these specifications, there are no problems in meeting the voltage requirements on the amplifier.

However, suppose we allow the same errors for the bias current and bias-current drift. In this case, 0.1% of 1  $\mu$ A, is 1 nA, so an amplifier must be selected that has a bias current of less than 1 nA and a bias-current drift of less than 100 pA/°C. These specifications can be met with nearly all FET, varactor and chopper-stabilized amplifiers, but they are too stringent for the majority of bipolar types.

Some of the lower-bias-current bipolar units might be current-compensated down to less than 1 nA from another current source, such as a resistor tied to a fixed voltage. The higher-bias-current units would probably not meet the current-drift requirement even though they, too, could be current-compensated.

When the inverting op amp is used for current measurement in a voltage circuit, then the voltage offset and voltage drift may be very important. For example, suppose one wanted to measure the current to 1% at 25°C and within 1% over a 10°C temperature range in a circuit where the open-circuit voltage is only 1 mV. The amplifier offset must be less than 1% of 1 mV or 10  $\mu$ V and the temperature coefficient of voltage drift must be less than 1  $\mu\text{V}/^\circ\text{C}$ . The only type of amplifier that could reasonably be expected to accomplish this would be a chopper-stabilized unit.

In summary, therefore, op amps used for current measurements from current sources generally do not have stringent requirements on voltage offset or voltage drift, although it is always wise to verify the errors attributable to current loss in the source impedance due to these voltage effects. Errors in current measurements from current sources are generally attributable to bias current and bias-current drift, and the amplifier to be chosen would normally be the one whose bias current or bias-current drift just meets the requirements. The chopper-stabilized amplifier would not normally be used unless voltage effects were significant.

Op amps used for current measurement from voltage sources normally require closer scrutiny of voltage offset and voltage drift, since the errors in these applications are generally more dependent on these parameters than the bias current and bias-current drift. However, again, it is always wise to check the errors due to bias current and bias-current drift to verify that they actually are insignificant. ■■

#### Reference

1. Demrow, Robert I., "Pick the Right Op Amp to Make Your Precision dc Measurement," *Electronic Design*, ED 18, Sept. 1, 1970, p. 54.

#### Test your retention

Here are questions based on the main points of this article. Their purpose is to help you make sure you have not overlooked any important ideas. You'll find the answers in the article.

1. What is the gain of the inverting circuit? Of the noninverting circuit?
2. How can a compensating resistor be used to reduce current drift?
3. Why is the inverting circuit not suitable for high-impedance voltage measurements?
4. What type of circuit is recommended for use in making current measurements?

**Now from 3M...  
there's a  
thermoplastic  
that withstands  
500° F.**

**What do you make**

# of that?

"Astrel" Brand 360 Plastic is a unique new engineering thermoplastic. What you make of it depends on your needs. It may be any device that must endure prolonged exposures at high temperatures (to 500° F.) and remain structurally useful. Electrical connectors and IC test sockets made of "Astrel" 360 Plastic have already proved increased reliability under severe temperature conditions. Others are making use of this new material in bobbins, relays, tube sockets and terminals.

Parts from "Astrel" 360 Plastic also display excellent chemical and solvent resistance and dielectric properties. A true thermoplastic, it can be readily fabricated on most conventional injection, extrusion, or compression molding equipment. Structurally sound without reinforcing fillers, it is self-extinguishing.

If lesser plastics aren't making it for you, fill out the coupon below, telling us about your application problem. We will send you complete information along with a sample. Or better still, call direct to Lou Cove, Commercial Development Department, 612-733-7376.

## ASTREL<sup>®</sup> 360 PLASTIC 3M<sup>COMPANY</sup>

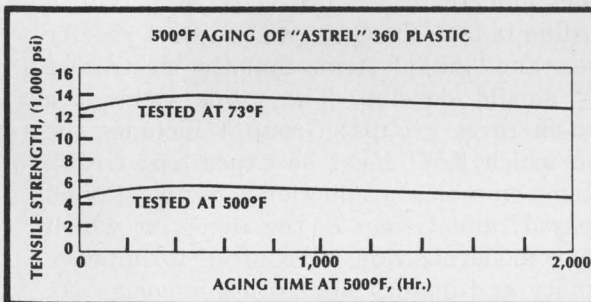

TENSILE STRENGTH CHART

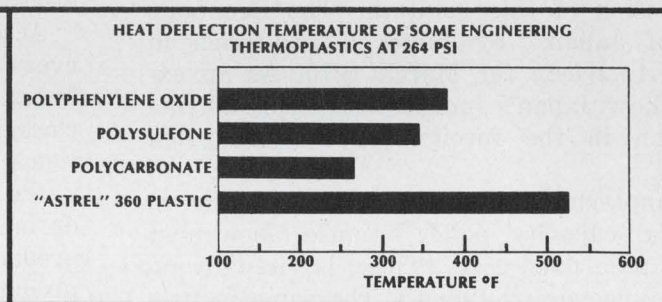

HEAT DEFLECTION CHART

Chemical Division, 3M Company, 3M Center,  
St. Paul, Minnesota 55101  
Please send me information and a sample of "Astrel"  
Brand 360 Plastic; I'm thinking of using it for:

\_\_\_\_\_

\_\_\_\_\_

NAME

COMPANY

STREET

CITY

STATE

ZIP

# How do we compete with 'Japan, Inc.'?

The threat is real, says this electronics observer, who offers strategies to meet the challenge.

The challenge of Japanese competition to electronics consumer manufacturers may soon be a problem of the industrial electronics and computer industries as well. If top industrial electronics operating management can be made fully aware of the impending challenge, perhaps the experience of the U. S. consumer electronics industry will not be duplicated.

One of the most serious problems of the challenge however, is that top U. S. management is not convinced that a competitive threat exists. Therefore, before discussing the steps to combat the challenge it would be well to look at what the Japanese have done in the consumer area (see box on p. 102), and what the Japanese Government and the Japanese electronics industry have done to make their challenge possible.

## Japan thrives on full-capacity policy

Industrial electronics management will no doubt question the reasons for the success of Japan's competitive challenge. There is an excellent discussion of this point in "The Economic Growth of Japan," by James C. Abegglen in *Scientific American* for March 1970. As an example of how Japan's industry structure affects its position in the foreign market, Abegglen wrote:

"The employment system leads indirectly to Japan's 'full-capacity' policy because labor must be viewed as a fixed cost. (There is virtually no employee turnover in Japan.) The same is true of the carrying charges associated with heavy debt. The only remaining variable of any consequence is the cost of raw materials, and so there is extreme pressure on the Japanese company to operate at capacity as long as revenues can cover raw-material costs. This pressure can make export prices that are quite low seem attractive to the producer."

The strong support of the Japanese Government has also had a significant impact on the



competitive position of Japanese companies. An "electronic industry development law," passed in 1957 and extended in 1964 to March, 1971, is designed to promote development of the Japanese electronics industry.

According to law, the Government must specify every year the "guide" items that the electronics industry should develop. The guide items are classified in three groups: Group 1 includes the items on which R&D must be expedited; Group 2, the items on which production must be started or increased; and Group 3, the items on which production modernization is required to improve productivity and quality and to lower costs.

The Japanese Government supports up to 50% of the R&D expenditures for Group 1 items. It is estimated that Government R&D support of the electronics industry totaled \$1.5 million in 1968 and about \$1.7 million in 1969. In themselves these are not significant amounts; however, it appears that Japanese firms under this type of control do not duplicate R&D programs to any great extent, thereby multiplying the effect of the funding. To support Group 2 and 3 items, the Government gives a special long-term loan at 6-1/2% interest and allows special depreciation on capital equipment involved.

Three items included in Group 1 for 1970 should be of specific interest to U. S. industrial

---

**John P. Thompson**, Senior Research Associate, Arthur D. Little, Inc., 25 Acorn Park, Cambridge, Mass. 02138.

electronics companies:

- Large-scale multiprocessing computers with over 524,000 words of memory and a cycle time of less than 0.2  $\mu$ s.
- Input/output character readers.
- Long-distance information-processing equipment.

### Strategies for combating the challenge

Now, let's take a quick look at the steps the U. S. electronics industry can take to combat the Japanese challenge.

- Improve management.
- Cooperate within the Electronics Industry Association, and other industry associations.
- Support individual EIA members.
- Strengthen antidumping laws.
- Evaluate duplication of U. S. R&D efforts.
- Investigate foreign manufacturing sites.
- Communicate with EIA-Japan.
- Develop new U. S. electronic business.

**Improve management.** Most of the major Japanese electronics firms have excellent first-generation top management. Many of you will agree that some U. S. electronic firms could be far better managed. We must be more concerned with competence in management than with connections.

**Work together within EIA.** EIA must act as a unit to develop strategies and to propose these strategies to the U. S. Government, labor, and other industrial organizations such as the Business Equipment Manufacturers Association and IEEE. For example, in early May of this year, George Butler and others presented U. S. arguments for retention of Item 807 of the tariff schedules to the U. S. Tariff Commission. Our proposal will probably be successful, in part, because it reflects a coordinated industry view, not the interests of selected industry participants.

**Act as a unit to support individual EIA members.** For example, the Department of Justice has filed an action against Westinghouse Electric, charging it and two major Japanese companies with illegally conspiring not to sell certain products in the other's country. The industry is intensely concerned at this time because tens of thousands of jobs are being lost in consumer electronics, partly as a result of import competition. Yet the Justice Department is suing Westinghouse because it has taken what appears to be an action to protect the U. S. domestic market.

**Support the Fannin Bill to strengthen antidumping laws.** Sen. Paul Fannin (R-Ariz.) is expected to introduce a bill soon to strengthen the antidumping laws. Since Japan considers both interest on debt and labor as fixed cost, the industry definitely needs such protection.

**Evaluate the extent and effect of duplication of R&D efforts on the U. S. electronics industry.** If we determine that intra-industry cooperation in the area of R&D would have a significant impact on the U. S. industry, we should decide on a course of action and present the industry's views to the U. S. Government, asking for suggestions on what action must be taken to allow such cooperation.

**Investigate foreign manufacturing sites.** EIA should have detailed information on countries where electronics manufacturing facilities might be established, particularly low labor cost areas such as Singapore, Korea, and Taiwan. The data should include, among others, historical trends and forecasts of productivity, trade incentives, and tariff schedules.

**Establish routine communications between EIA and EIA-Japan to facilitate the exchange of information.** We may learn something from Japan, and it is just possible that parallel programs of some types may be beneficial to both.

**Develop major new U. S. electronic business.** The major source of industry growth from 1960 to 1969 was the computer and associated equipment and software operations. Development of a comparable business or businesses in the 1970-1980 decade would have the same effect. The following are only a few of the significant businesses the industry could consider developing:

1. First, consider the amount of electronic equipment sales that would result if AT&T *Picturephones* were installed in just half of the business telephone terminal installations by 1980. On the basis of their public announcements, the common carriers expect to install only 1 million Picturephone terminals (with a total system value of about \$4 billion) by 1980. Keen competition among U. S. companies could increase the number of installations to 10-to-15 million by 1980.

Taking the market development one step further, the companies could provide a complete system, including not only the video receiver but also an alphanumeric terminal with options for high-speed (8 second/page) facsimile. The common carriers' revenues would rise substantially because of the increased use of the 1-MHz bandwidth; and, since AT&T is giving the user the option of purchasing his own terminals, the door is open for our industry to benefit from increased equipment sales.

2. The potential of *interactive TV and home facsimile* terminals was discussed in the EIA filing on FCC docket 18397 Part V (October 29, 1969) and most recently in "The Wired Nation," *The Nation* (May 19, 1970). To spread development costs, 20 companies could fund the necessary planning to form a company like Comsat

## Proof of penetration in the U.S. consumer electronics market

*The untenable position of the U. S. consumer electronics product and component companies was accurately described by Herbert Rowe, chairman of the World Trade Committee of the Parts Division of the Electronics Industry Association (EIA), in testimony before the Committee on Ways and Means of the U. S. House of Representatives. The data that follows is based on Rowe's presentation.*

Of the 10.7 million home radio sets sold in the United States in 1958, 77% (8.2 million) were U. S. brands and 23% (2.5 million) were foreign brands. By 1969 only 26% (10.4 million) of the total 39.4 million sets sold were U. S. brands; furthermore, of this 10.4 million, 54% (5.6 million) were manufactured overseas by U. S. companies. Therefore, imports actually accounted for 88% (34.6 million) of total U. S. home radio sales in 1969. By 1975, it's likely that there will be so few home radios manufactured here that U. S. production will hardly show up in the statistics.

The same pattern is reflected in the black-and-white television market. In 1968 foreign-label imports and domestic-label imports (1.2 million units and 850,000 units, respectively)

accounted for about 29% of the total 7.0 million black-and-white units shipped from the factory to retail channels. In 1969 this percentage rose to about 41%, while total sales remained about level. By 1975 it is anticipated that very few black-and-white units will be made in the U. S.

The same situation already exists in resistors, capacitors, and speakers, and recent market figures indicate that the trend is starting in the color-television market.

Many people in the consumer-products industry said as recently as three years ago that foreign manufacturers could not significantly penetrate the U. S. color-television market, primarily because of the freight, technological, and service requirements associated with these units. But they *are* penetrating the market. Sales of color-television imports in the U. S. market increased in the first quarter of 1970 compared to the same period in 1969. In the first quarter of this year, imports (split about 50% foreign-label and 50% domestic-label) accounted for 16% of total unit sales of 1.16 million, up from about 10% of total first-quarter 1969 sales. Action must be taken before 1971 to reverse the trend to imports in this market.

that would implement a 10,000-terminal marketing experiment. If successful, this experiment, which will probably cost \$15-to-\$20 million, could lead to a \$1-billion/year market for the electronics industry.

3. *High-speed facsimile* is another area that should be studied. A network might be set up that is similar to the present TELEX and domestic TWX networks, but whose bandwidth is wide enough to provide national and international 8-second/page facsimile. The market implications of such a development for the total industry, as well as many individual companies, are substantial.

4. The developing *videoplayer* (a generic term to describe a class of products—EVR, SV, HVTR, and CTV) market is a good example of how we might cooperate to meet the challenge of foreign suppliers. Chase Morsey of RCA estimated, at the time RCA's Selectavision videoplayer was introduced, that the total videoplayer market would reach \$1 billion by 1980. Unless U. S. manufacturers cooperate to produce a standardized product, we may lose this market. Magnavox has announced that it is talking to Philips about sales of Philips' HVTRs in the United States. Also, Philips, Matsushita, SONY, and others are trying to standardize on one HVTR. If each of the U. S. firms that plan to market a videoplayer in 1972—CBS, Avco, and RCA—goes his own way, which company would you bet on to get the largest

share of the U. S. and world market: the foreign manufacturers that are offering a standardized product, or an individual U. S. company with a product that is compatible with no other product? The cassette should have taught us a lesson here.

### Japan is tipping the trade scale

Despite the fact that we have lost most of the home radio market and a considerable share of the black and white television sales, and were completely preempted from the cassette player business, the U. S. electronics industry is growing. EIA estimates electronics industry employment in 1960 at 500,000-600,000 and 1969 employment at 1,136,000, an increase of about 100%.

Also encouraging are the industry import/export figures for the first quarter of this year, recently announced by EIA. Electronics industry exports in the first quarter of 1970 were \$819.2 million (up 30% over the comparable 1969 period), while imports were \$468.5 million (up only 34%), giving the industry a good balance of trade. However, these figures would be even more reassuring were it not for the trade deficit with Japan. According to EIA data, in 1969 U. S. electronic product imports from Japan totaled \$1.03 billion, while U. S. exports to Japan were only \$264.5 million. Consider what the total industry trade balance would be if exports to Japan were brought up to the level of imports. ■■



# Buckbee-Mears took a 60-year-old technique and created parts for a rocket engine chamber.

*Pratt & Whitney Aircraft is mighty happy we did.*

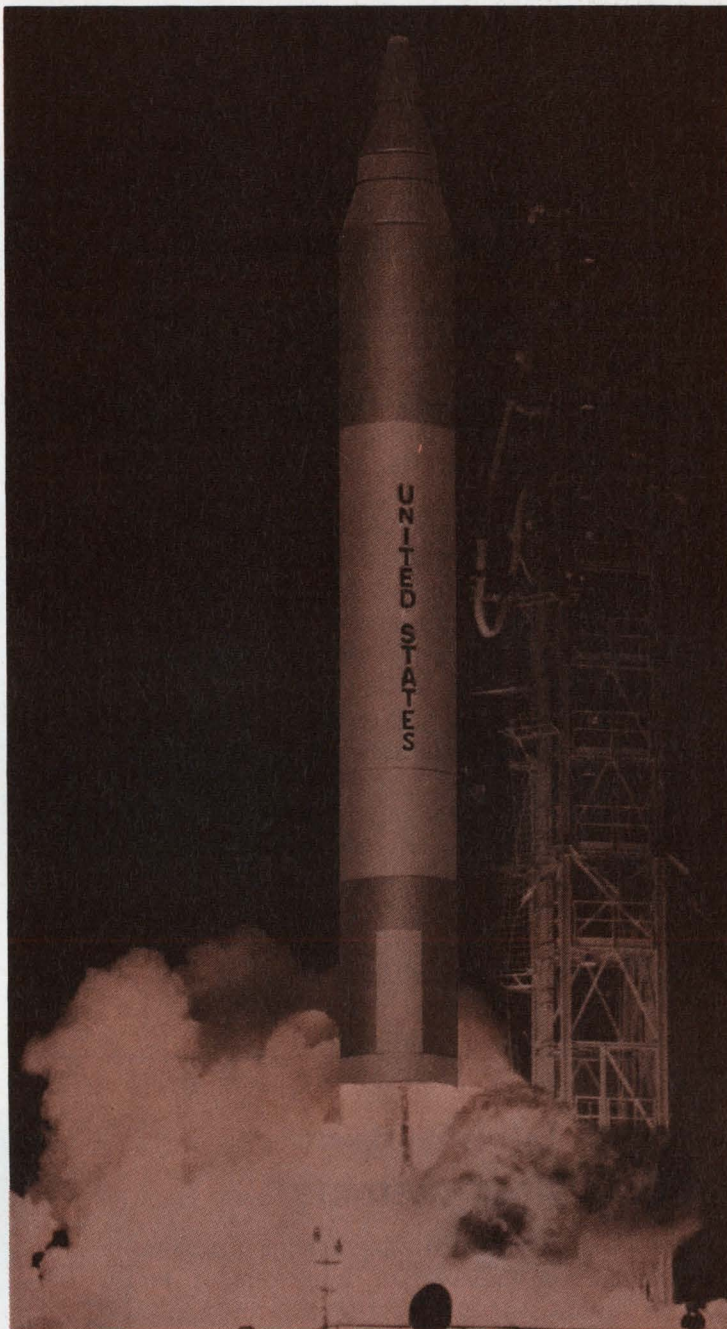

The original technique was photoengraving. But it took Buckbee-Mears ingenuity to refine it for etching passages in a Pratt & Whitney Aircraft advanced rocket engine thrust chamber. The movement of fuel through the passages also serves as a coolant.

Today we call the process chemical machining. Buckbee-Mears can chemically machine on metal any design that can be drawn in a line. In the case of Pratt & Whitney Aircraft, the design was precisely machined on duplicate pieces of metal and then joined to create the thrust chamber for a propellant.

Buckbee-Mears offers chemical machining to very close tolerances. Depth of the etch can be up to one half the

width of the groove. Tolerance on groove width is  $\pm 10\%$  of the depth of etch.

Because chemical machining is such a versatile technique, the applications are many. You might be able to use it for weight removal, grooves for guiding wires for automatic core loading, print out devices, or etching channels in a surface.

At Buckbee-Mears, your special problems or needs are given personal attention. That's why Buckbee-Mears is the world leader in photomechanical reproduction. If you have a problem that might be solved by precision chemical machining, call or write Bill Amundson, industrial sales manager in St. Paul. The number is 612-227-6371.

PRECISION METAL AND GLASS ETCHING • ELECTROFORMING • AUTOMATED DESIGN  
**bmc** BUCKBEE-MEARS COMPANY  
SAINT PAUL, MINNESOTA 55101

INFORMATION RETRIEVAL NUMBER 62

# Ideas For Design

## Extra transistor speeds response of phototransistor

The switching speed of a phototransistor can be increased more than 50 times, without sacrificing output signal level, by using a second transistor as a common-base load (see drawing). Usually, the switching speed of a phototransistor is limited by the charging rate of its internal capacitance.

To maximize the charging rate, the load resistance should be as low as possible. Unfortunately, since the phototransistor,  $Q_1$ , is a current source, the output voltage is proportional to the load resistance. Thus the designer is faced with a trade-off between speed and voltage.

The extra transistor,  $Q_2$ , solves the problem by providing a low-resistance charging path for the phototransistor, even when a large load resistor is used. Since the common-base circuit has almost unity current gain, the output voltage is almost the same as would be produced if the load were in the emitter leg of  $Q_1$ .

With a load resistance of 10 k $\Omega$ , the two-transistor circuit has a switching time slightly below

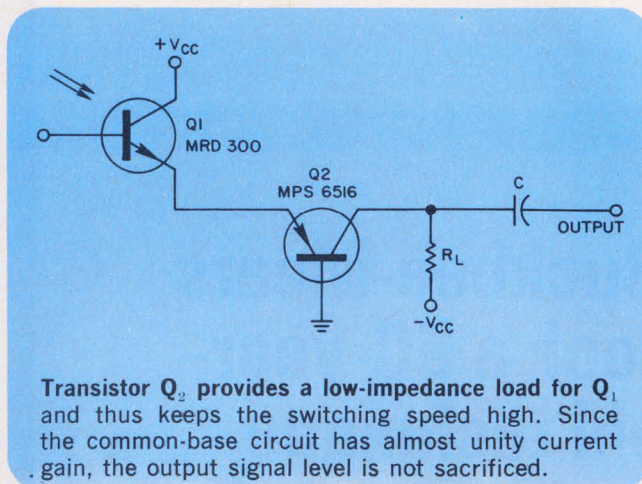

1  $\mu$ s, compared with 50  $\mu$ s for the phototransistor alone.

In an amplifier application, the same technique increases the bandwidth with a 10-k $\Omega$  load from 10 kHz to 300 kHz.

*John Bliss, Applications Engineer, Motorola Semiconductor Products, Inc., 5005 E. McDowell Rd., Phoenix, Ariz. 85008.*

VOTE FOR 311

## Tristable latch makes multiple-input memory

A common digital-systems design problem is implementing a memory to store one of many possible inputs and preserving this information until another input updates the system. This scheme simplifies the array of flip-flops normally employed.

The gate pairs (1A1, 1A2), (2A1, 2A2) and (3A1, 3A2) each form a latch, which has added into it the output information of the other two latches. Assume that input A, normally high, goes to ground for an instant. This condition forces the 1A2 output to ground, which in turn forces the 2A1 and 3A1 outputs to go high. Since inputs B and C are normally high, the 2A2 and 3A2 outputs are high. When 2A2 and 3A2 outputs are applied simultaneously to 1A1, they force its output to ground. This action latches the 1A2 output low, and the 2A2 and 3A2 outputs high. The system will stay locked until either input B or input C goes low.

This latch uses an MC3000 for A1 and an MC3001 for A2. If more storage is necessary, the

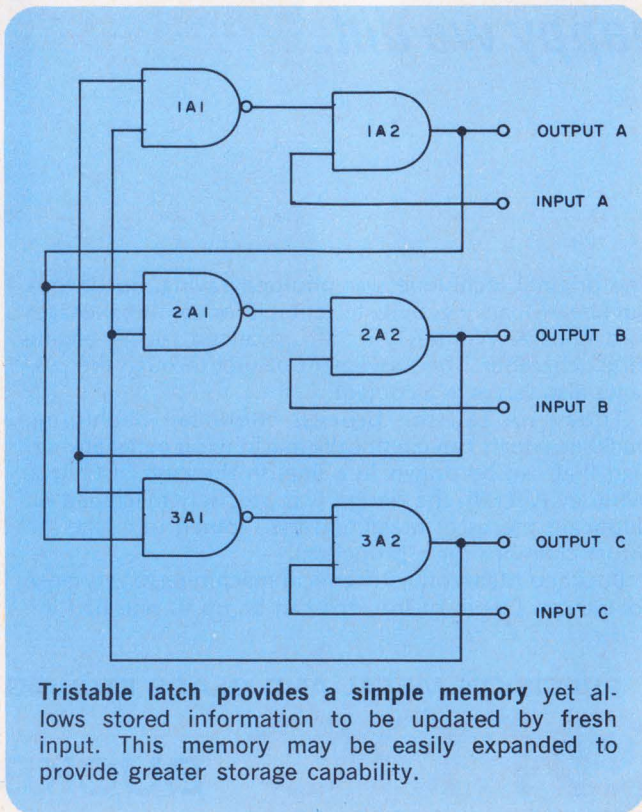

## Helipot Trims Price & Profile

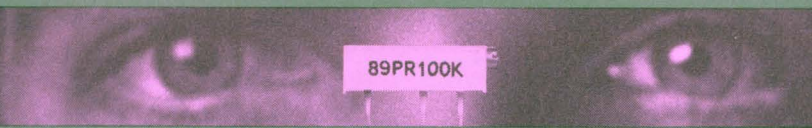

89PR100K

The new Helipot Series 89 industrial  
cermet trimmers feature:

**Low Cost:**

\$1.35 each in 1-9 quantities;  
less than \$1.00  
in quantities over 1,000.

**Low Profile:**

Maximum height of .250 inches  
allows for closer p-c board stacking.

Series 89 trimmers with two different pin spacings  
are available "off-the-shelf"  
from 17 locations across the country.

**Beckman®**

INSTRUMENTS, INC.  
HELIPOT DIVISION  
FULLERTON, CALIFORNIA

INTERNATIONAL SUBSIDIARIES: AMSTERDAM; CAPE TOWN; GENEVA; GLENROTHES,  
SCOTLAND; LONDON; MEXICO CITY; MUNICH; PARIS; STOCKHOLM; TOKYO; VIENNA.

configuration shown may be replaced by (n) NAND gates having (n-1) inputs, and an equal number of two-input AND gates. Thus, a five-state latch would require five four-input NAND gates and five two-input AND gates.

C. H. Doeller III and Aaron Mall, *Design Engineers, Bendix Corp., Communications Div., E. Joppa Road (Towson), Baltimore, Md. 21204.*

Inputs			Outputs		
A	B	C	A	B	C
0	1	1	0	1	1
1	0	1	1	0	1
1	1	0	1	1	0
1	1	1	Same as above; last low input causes low output.		
Any other			Outputs identical to inputs.		

VOTE FOR 312

## Proportional oven control is low-cost and precise

This precise temperature control will hold a small heated chamber at  $60 \pm 0.1^\circ\text{C}$  over an ambient temperature range of  $-20$  to  $+50^\circ\text{C}$ . By selecting the proper thermistor and heating element, the controlled temperature can be established at any desired point from  $+40$  to  $+80^\circ\text{C}$ .

Tight temperature control is maintained through the use of high-gain dc feedback. Transistors  $Q_1$ ,  $Q_2$  and  $Q_3$  provide high open-loop dc gain;  $Q_3$  is the control transistor that varies the current through the heater element. The thermistor, which is the feedback sensing element, has its operating point set with  $R_1$ .

The heating element used is a low-cost Watlow silicon-rubber heater pad, 1 inch wide by 3 inches long, with an operating temperature of  $60^\circ\text{C}$ . Its maximum ratings are 30 V and 6 W dissipation. The thermistor has a resistance of  $5 \text{ k}\Omega$  at  $25^\circ\text{C} \pm 10\%$  and a resistance ratio from 0 to  $50^\circ\text{C}$  of 9.1:1. Maximum input power for the controller is 6.6 W, while the nominal input power required to maintain  $60^\circ\text{C}$  in the oven used is 3.6 W.

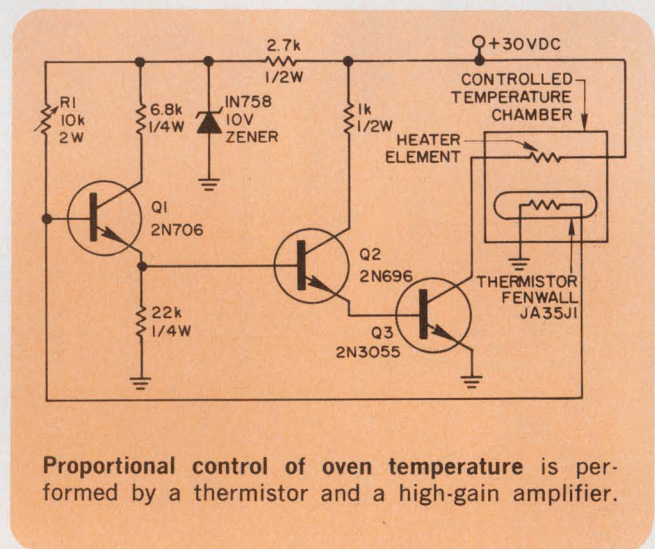

Proportional control of oven temperature is performed by a thermistor and a high-gain amplifier.

William Ress, *Engineer, Zeta Laboratories, Inc., 616 National Ave., Mountain View, Calif. 94040.*

VOTE FOR 313

## Integrated current controls UJT-oscillator frequency

The unijunction-transistor oscillator is a handy circuit, but it is awkward to control. With the conventional circuit, the UJT valley (turn-off) current and peak (firing) current characteristics limit the range of capacitor charge current. But peak-current effects can be reduced with a simple feedback amplifier. This amplifier not only increases the controllable range of the oscillator but also improves the charging linearity and al-

lows more variation of input or control interface.

An inverting amplifier,  $Q_1$  and  $Q_2$ , and feedback capacitor  $C_1$  perform an integrating function. The input is maintained at a virtual ground by the feedback current. Integrated input current appears as a voltage across  $C_1$ . When the voltage is sufficient, the UJT fires and discharges  $C_1$ . During the capacitor discharge, the amplifier is inactive and the discharge current will flow through the collector-base junction of  $Q_1$ . Each output pulse represents a quantity of charge or integrated current. Therefore, the circuit will generate an output pulse rate proportional to the

**New from TRW**

**300 VOLTS**

**30 AMPS**

**$f_t > 100$  MHz**

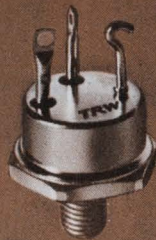

**...a new concept in power supply design**

The high switching speed and high operating voltage of TRW's new PT6905 transistor provides a major forward step in power supply performance.

You can do away with the bulky 60 Hz transformer and work directly from rectified ac power lines. Switching above 20 kHz will assure your circuit is free from audio noise.

Consider these outstanding

PT6905 characteristics:

- $V_{CE0}$  300 V
- Sat. switching time  $< 900$  ns.
- Triple diffused double oxide construction for superior second breakdown characteristics.
- Hard-solder construction and welded interconnections.

Available from stock in TO-63 or TO-3 non-isolated and TO-61 isolated collector packages.

For details and application as-

sistance contact TRW Semiconductors Inc., 14520 Aviation Blvd., Lawndale, Calif. 90260. Phone: (213) 679-4561, TWX: 910-325-6206, TRW Semiconductors Inc., is a subsidiary of TRW Inc.

**TRW**<sup>®</sup>

INFORMATION RETRIEVAL NUMBER 64

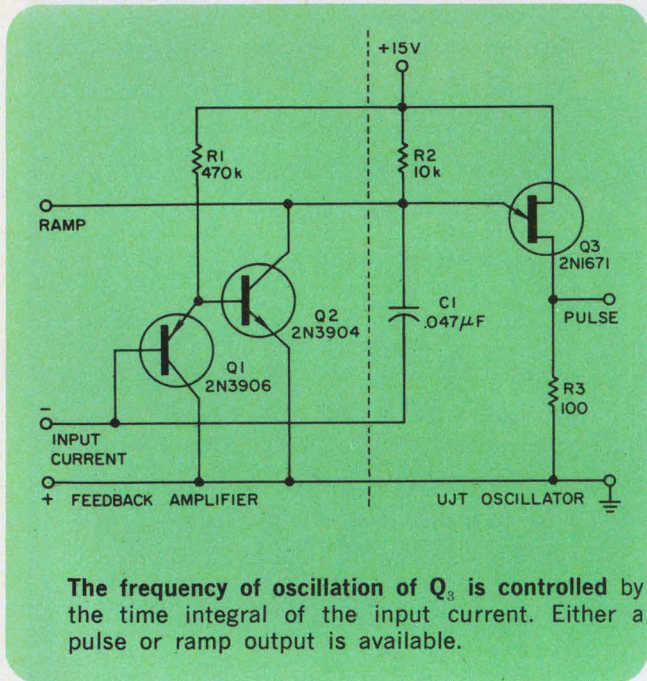

average input waveform, the algebraic sum of several input currents, or a simple dc current.

When the input current is constant, a linear ramp is available at the RAMP terminal. External RAMP load resistances greater than 25 k $\Omega$  are not part of the feedback and do not affect the integration.

The frequency to current conversion factor for a circuit with the components shown and corrected for offset current is: 3.24 Hz/ $\mu$ A within 0.5% from 0.4 to 100  $\mu$ A and within 5% from 0.05 to 500  $\mu$ A. The conversion factor temperature coefficient varied from minus 0.2 to plus 0.07%/°F for 0.4 and 400  $\mu$ A input current, respectively. The offset current, which varies with transistors and can be the source of non-linearity and instability with small input currents, is 0.2  $\mu$ A minus 0.3%/°F. As an illustration of time-delay capability, a 47  $\mu$ F capacitor for  $C_1$  and 0.4  $\mu$ A input current produced a 33-minute period.

*Richard W. Fergus, Argonne National Laboratory, Bldg. 14, Rm. 16, 9700 S. Cass Ave, Argonne, Ill.*

VOTE FOR 314

## Measure low resistances with an inexpensive DVM

Most inexpensive digital voltmeters either have no provision for measuring resistance or else they have minimum full-scale readings of 1 k $\Omega$  or higher. Quite often it's necessary to be able to measure resistors around 100 ohms or less while maintaining full-scale resolution. The circuit shown allows measurements in this range with any DVM. Accuracies are determined primarily by the ratios of precision resistors.

The operation of the circuit is straightforward. Operational amplifier  $Z_1$  is connected in the well-known Howland circuit so that it can supply a constant current through the unknown resistor,  $R_x$ . The current  $I_r$  is given by  $V_1/R_3$  where  $V_1$  is the reference voltage supplied by op amp  $Z_2$ . For the values shown in the diagram,  $V_1 = 1.0$  V and  $I_r = 1.0$  mA.

Since  $I_r = 1.0$  mA, a 100-ohm unknown resistor will produce a voltage of 0.1 V at the input to  $Z_1$ . Because  $(R_2/R_1) = (R_4/R_3) = 10$ , the output is then 0.1 V  $\times$  10 = 1.0 V. This is a scale factor of 0.01 V/ohm.

Amplifier  $Z_2$  is connected as a unity-gain buffer. It prevents errors that would be caused by loading of the voltage divider across the refer-

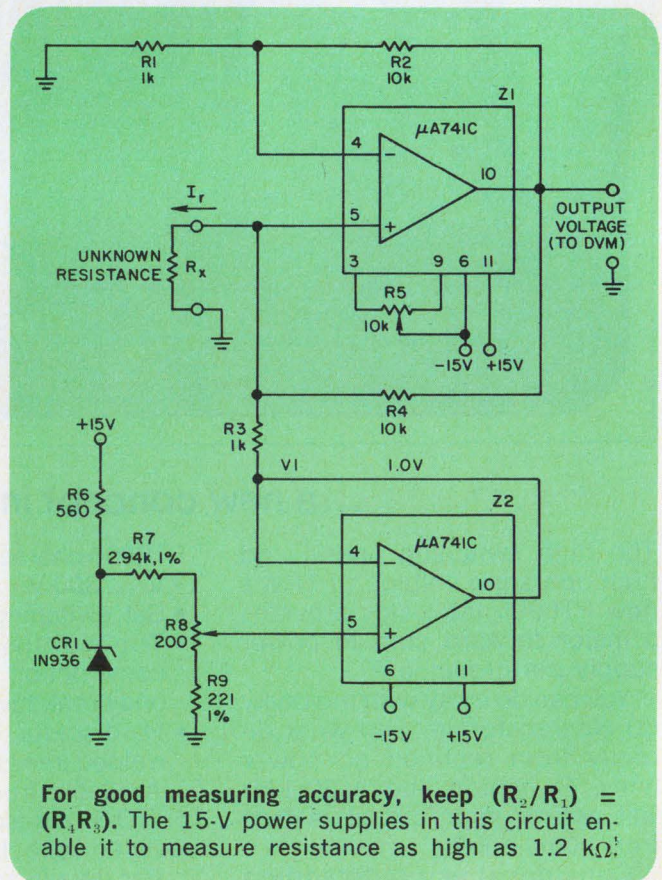

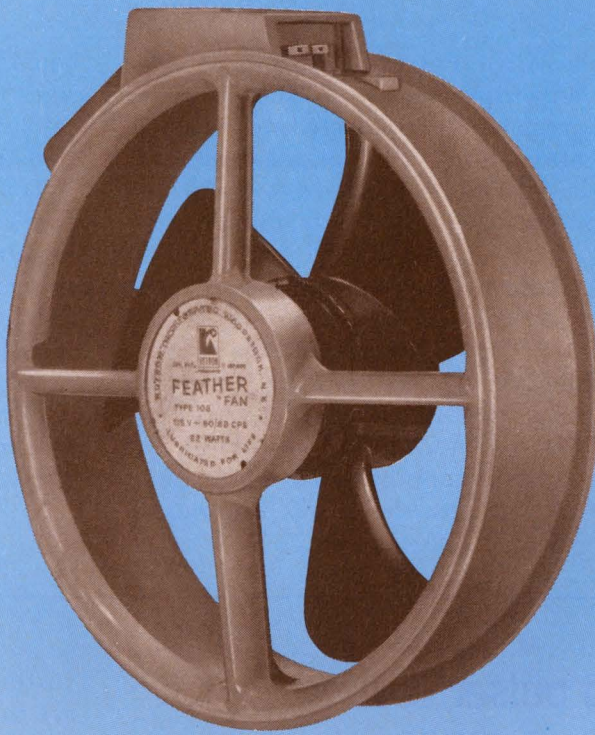

# a fan for all reasons

270 CFM at Free Delivery  7" Diameter by 2.44 Axial Depth  Reversible Air Flow  Maintenance Free  Draws Only 22 Watts — Less Than Several 100 CFM Fans  115 VAC, 50-60 Hz, 1 Phase  Strong, High Impact Plastic  Recognized Under U.L. Components Program  In Stock for Immediate Delivery

## the Rotron Feather<sup>®</sup> Fan



For complete technical details  
call 914-679-2401 or write

Rotron Incorporated, Woodstock, N. Y. 12498  
INFORMATION RETRIEVAL NUMBER 65

ence zener diode, CR<sub>1</sub>. Potentiometer R<sub>8</sub> is adjusted to give an output of 1.0 V when a 100-ohm reference resistor is connected to the R<sub>x</sub> terminals. Potentiometer R<sub>5</sub> compensates for any voltage offset in Z<sub>1</sub> and is adjusted to provide zero output voltage when the R<sub>x</sub> terminals are shorted.

The tracking accuracy is determined by the accuracy of the match between the ratios R<sub>2</sub>/R<sub>1</sub> and R<sub>4</sub>/R<sub>3</sub>. If 0.1% resistors are used, the tracking will be within 0.5% for values of R<sub>x</sub> from 10 to 1000 ohms. For better tracking, R<sub>2</sub> can be replaced by a potentiometer and a resistor.

Almost any power supply can be used. The higher the supply voltages, the larger the maxi-

imum resistance that can be measured. For voltages of ±15 V, the maximum output voltage is ±12 V, corresponding to a maximum unknown resistance of 1.2 kΩ.

Different scale factors can be obtained by varying V<sub>1</sub> or R<sub>3</sub> while keeping R<sub>3</sub>/R<sub>4</sub> constant. For resistances below 100 ohms, care must be taken to keep the circuit resistances in the R<sub>x</sub> path as low as possible. A contact resistance of only 0.1 ohm, for example, will cause an error of 1% in measuring a 10-ohm resistor.

*Seymour N. Rubin, Senior Engineer, Systron-Donner Corp., Datapulse Div., 10150 W. Jefferson Blvd., Culver City, Calif. 90230.*

VOTE FOR 315

## Calibrated pulser covers one-to-ten-μs range

It is often desirable to set pulse width or delay by adjusting a panel-mounted helipot. The circuit shown accomplishes this by connecting the 100-kΩ helipot R to a fairly high voltage, V<sub>R</sub> = 14 V, thus approximating a constant current recharge. The formula  $\Delta t = CR\Delta V/V_R$  now applies, where  $\Delta V$  is the voltage swing of the IC and  $\Delta t$  is the width of the pulse. C in this case is 0.001 μF.

To calibrate, the helipot is set to 1.00 when R = 0, and the pulse width is set to 1 μs by ad-

justing R<sub>T</sub> (about 12 kΩ). Then the helipot is set to 10.00, and the pulse width is adjusted to 10 μs by varying V<sub>R</sub>. The pulse width will track the helipot readings to ±5% over a 10:1 control range.

A transistor output is used instead of a NOR gate to avoid the NOR-gate input resistance that affects calibration accuracy.

*Ralph R. Fullwood, Los Alamos Scientific Laboratory, University of California, Los Alamos, N.M.*

VOTE FOR 316

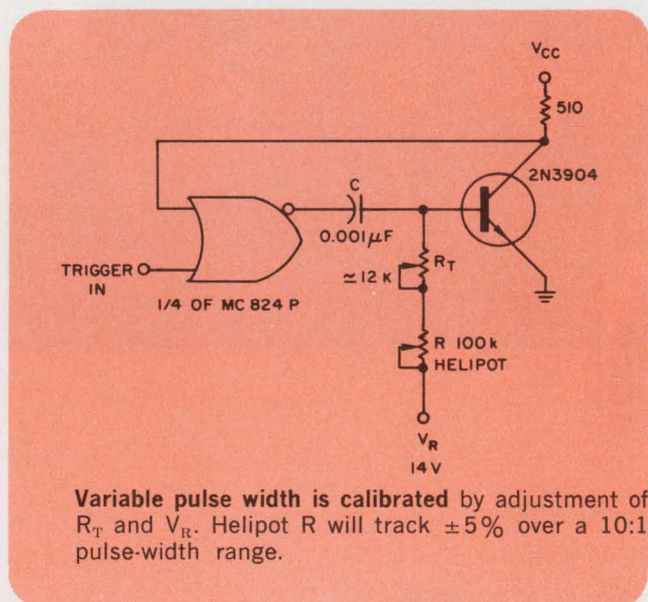

**VOTE!** Go through all Idea-for-Design entries, select the best, and circle the appropriate number on the Reader-Service-Card.

**SEND US YOUR IDEAS FOR DESIGN.** You may win a grand total of \$1050 (cash)! Here's how. Submit your IFD describing a new or important circuit or design technique, the clever use of a new component or test equipment, packaging tips, cost-saving ideas to our Ideas-for-Design editor. You will receive \$20 for each accepted idea, \$30 more if it is voted best-of-issue by our readers. The best-of-issue winners become eligible for the Idea Of the Year award of \$1000.

### IFD Winner for May 10, 1970

**John T. Hannon, Jr.,** Design Engineer, Brown Engineering, Huntsville, Ala. His Idea "Pre-settable Up/Down Counter Needs No Inhibits Or One-Shots" has been voted the Most Valuable of Issue award.

**Vote for the Best Idea in this Issue.**



# We've added a little something to the Burr-Brown line of computer interface and data acquisition modules

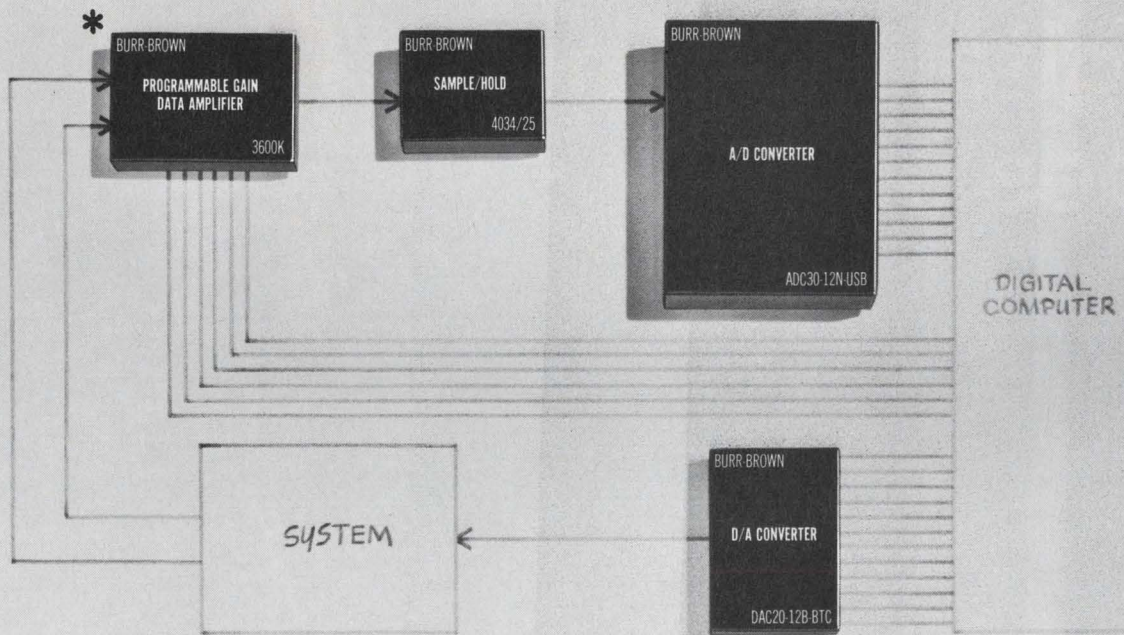

## \* a small, programmable gain data amplifier

Our new Model 3600K programmable gain data amplifier has a distinct advantage over its big, rack-mount counterparts in high-performance data acquisition applications. The low price (just \$245) coupled with the small size (3.0" x 2.1" x 0.4") makes it feasible to assign amplifiers to smaller groups of signals and locate them closer to the signal source for better resolution. Designed to operate on multiplexed low-level signals under computer control, the 3600K rejects common mode noise and provides proper scaling prior to A/D conversion. Naturally, it's compatible with Burr-Brown's other interface and data acquisition modules.

For help with your Analog/Digital conversion and interface problems phone (602) 294-1431, collect, and ask for your Regional Applications Engineer.

<b>PROGRAMMABLE GAIN DATA AMPLIFIER</b> Model 3600K Size: 3.0" x 2.1" x 0.4" Price (1 to 9 units): \$245	Gain accuracy: $\pm 0.1\%$ Linearity: $\pm 0.01\%$ Common mode rejection: 100 dB Voltage drift: $\pm 1 \mu\text{V}/^\circ\text{C}$ Settling time: 500 $\mu\text{sec}$	
<b>A/D CONVERTERS</b> Size: 3.4" x 4.4" x 0.8" Price (1 to 9 units): 8-bit \$195.00 10-bit \$225.00 12-bit \$295.00	High speed: Low drift: Optional input buffer amplifier. Four popular digital codes	30 $\mu\text{sec}^*$ 20 ppm/ $^\circ\text{C}^*$ *10-bit unit.
<b>D/A CONVERTERS</b> Size: 3.0" x 2.1" x 0.4" Price (1 to 9 units): 8-bit \$ 95.00 10-bit \$125.00 12-bit \$155.00	High speed: Low drift: Four popular input codes	1.5 $\mu\text{sec}^*$ 20 ppm/ $^\circ\text{C}^*$ *10-bit unit.
<b>SAMPLE/HOLD</b> Model 4034/25 Size: 2.4" x 1.8" x .60" Price (1 to 9 units): \$110.00	Gain accuracy: Input impedance:	50 M $\Omega$ $\pm 0.01\%$ Three other catalog units also available.

**BURR-BROWN**  
RESEARCH CORPORATION

International Airport Industrial Park • Tucson, Arizona 85706  
TELEPHONE: 602-294-1431 • TWX: 910-952-1111 • CABLE: BBRCORP



Operational Amplifiers  
Instrumentation Amplifiers  
Active Filters  
Multiplier/Dividers  
A/D-D/A Converters

# When the lights go out, the only really portable Digital Multimeter goes on



## ...and on.

**Run the Fluke 8100A 0.02% digital multimeter anywhere, anytime up to 8 full hours off the rechargeable battery pack. Printer output now available.**

There are twenty or thirty digital multimeters around that lay claim to portability. The only one you can move around easily and use without a nearby wall plug is ours. It's the only portable machine that works where you need a portable machine.

True portability is just part of the story. The Fluke 8100A, with an accuracy of 0.02% and a selling price of \$795, with rechargeable battery option, gives you nine times the accuracy of three digit instruments for half the price of comparable four digit multimeters. We've used a new A to D technique to give you an instrument with low power drain for eight-hour continuous battery operation without recharging. (line operation only \$695)

The Fluke 8100A measures ac and dc volts in four ranges to 1200 volts and ohms in five ranges to twelve megohms. Readout is four full digits plus "1" for 20% overranging. Features include an active 2-pole switchable filter and automatic polarity indicator. All functions are push-button selectable.

Also available are RF and high voltage probes, switched ac-dc current shunts, a ruggedized case, and data output (line operation only).

John Fluke Mfg. Co., Inc., P.O. Box 7428, Seattle, Washington 98133. Phone (206) 774-2211. TWX: 910-449-2850 / In Europe, address Fluke Nederland (N.V.), P.O. Box 5053, Tilburg, Holland. Phone: (04250) 70130. Telex: 884-50237 / In the U.K., address Fluke International Corp., Garnett Close, Watford, WD2 4TT. Phone: Watford, 27769. Telex: 934583.



# Product Source Directory

## Rack-and-Panel Connectors

The rack-and-panel connectors covered in this Product Source Directory are arranged alphabetically according to manufacturer.

Manufacturer identification is shown in the

Master Cross Index below. The following abbreviations apply:

ina—information not available

n/a—not applicable

Abbrev.	Company	Information Retrieval No.
AMP	Amp Inc. Box 3608 Harrisburg, Pa. 17105 (717) 564-0101	453
Airborn	Airborn, Inc. 2618 Manana Dr. Dallas, Tex. 75220 (214) 357-0274	454
Amphenol	Amphenol Corp. Industrial Div. 1830 S. 54th Ave. Chicago, Ill. 60650 (312) 242-1000	455
Bendix	Bendix Corp. Electrical Components Div. Sidney, N.Y. 13838 (607) 563-9511	456
Burndy	Burndy Corp. Richards Ave. Norwalk, Conn. 06852 (203) 838-4444	457
Cinch	Cinch Manufacturing Co. Div. of TRW Inc. 1500 Morse Ave. Elk Grove Village, Ill. 60007 (312) 439-8800	458
Continental	Continental Connector Corp. 34-63 56th St. Woodside, N.Y. 11377 (212) 899-4422	459
Dale	Dale Electronics Inc. Box 609 Columbus, Neb. 68601 (402) 564-3131	460
Elco	Elco Corp. Maryland Rd. & Computer Ave. Willow Grove, Pa. 19090 (215) 659-7000	461
Hughes	Hughes Aircraft Connecting Devices Box H Newport Beach, Calif. 92663 (714) 548-0671	462
ITT	ITT/Cannon Electric 3208 Humboldt St. Los Angeles, Calif. 90031 (213) 225-1251	463

Abbrev.	Company	Information Retrieval No.
Malco	Malco Manufacturing Co. 5150 W. Roosevelt Rd. Chicago, Ill. 60650 (312) 287-6700	464
Microdot	Microdot Inc. 220 Pasadena Ave. S. Pasadena, Calif. 91030 (213) 799-9171	465
Milross	Milross Controls Inc. 511 2nd St. Pike Southampton, Pa. 18966 (215) 355-0200	466
Molex	Molex Products 5224 Katrine Ave. Downers Grove, Ill. 60615 (312) 969-4550	467
North	North Electric Electronics Div. 553 S. Market St. Galion, Ohio 44833 (419) 468-8100	468
Positronic	Positronic Industries, Inc. 1906 S. Stewart Springfield, Mo. 65804 (417) TU 3-3434	469
Sealectro	Sealectro Corp. 225 Hoyt St. Mamaroneck, N.Y. 10543 (914) 698-5600	470
Switchcraft	Switchcraft, Inc. 5555 N. Elston Ave. Chicago, Ill. 60630 (312) 774-1515	471
Transitron	Transitron Electronics 168-182 Albion St. Wakefield, Mass. 01880 (617) 245-5640	472
U.S.C.	U.S. Components 1320 Zerega Ave. Bronx, N.Y. 10462 (212) 824-1600	473
Winchester	Winchester Electronics Div. of Litton Industries Main & Hillside Aves. Oakville, Conn. 06779 (213) 274-8891	474

Manufacturer	Series	Contacts (Min-Max)	Contact Size (AWG, Min-Max)	Wire Size (AWG, Min-Max)	Maximum Insertions	Contact Resistance (mΩ, Min-Max)	Insulation Resistance (MΩ)	Sea-Level Test Voltage (V rms)	Notes
AMP	22	15-105	22	28-22	ina	7	5000	1000	1a; A
AMP	Ampeez	7-14	G	18-14	ina	ina	ina	ina	1a; 2f
AMP	Amp-Lok	3-12	G	22-14	ina	2	500,000	ina	1a; 2f
AMP	Arinc	32-124	20-16	24-16	> 500	2	5000	2000	1a; 2e; 3j; A
AMP	Combo-Line	7-36	G	26-18	ina	ina	ina	ina	1acg; 2f
AMP	D	45-78	20-10	30-10	> 500	2	5000	1500	1ac; 2e; 3bfh; A; G
AMP	DD	90-156	20-10	30-10	> 500	2	5000	1500	1ac; 2b; 3bfh; A; G
AMP	Dualatch	32-396	G	32-16	10,000	2-4	10,000	1000	1acmn; 2bd; 3bdfhimp
AMP	Fastin-Faston	1-8	G	22-10	ina	2	500,000	ina	1a; U
AMP	G	4-69	16-12	30-8	ina	2	5000	1500	1ac; 2df; 3bfhmp; A; G
AMP	HDR	12-106	20	30-20	> 500	7	5000	1000	1amn; 2b; 3b
AMP	M	14-160	20-16	32-8	> 500	2	50,000	1500	1amn; 2b; 3bdhik; A; G
AMP	Mate-N-Lok	1-15	G	30-14	ina	2	ina	ina	1acg; 2f
AMP	W	26-45	20-16	30-16	> 500	2	5000	1500	1ac; 2e; 3b; A; G
AMP	WW	52-90	20-16	30-16	> 500	2	5000	1500	1ac; 2e; 3b; A; G
Air Born	EK	34-104	16	30-14	2500	2	5	2000	1a; 2b; 3cdr
Air Born	EP	14-104	16	30-16	5000	2	5	2000	1d; 2b; 3dr
Air Born	K	18-104	16	30-14	2500	2	5	2000	1a; 2b; 3dr
Air Born	P	14-104	16	30-16	5000	2	5	2000	1d; 2b; 3dr
Air Born	WK	34-104	16	30-14	2500	2	5	2000	1a; 2b; 3cqr
Air Born	WP	14-104	16	30-16	5000	12	5	2000	1d; 2b; 3cqr
Amphenol	17	3-98	24-20	28-20	500	ina	ina	500	1abdp; 2bcd; 3eq; B; P; Q; R
Amphenol	26 Blue Ribbon	8-42	N	16	20,000	ina	ina	750V dc	1eg; 2f; 3cj
Amphenol	57 Micro-Ribbon	14-64	N	24-22	20,000	ina	ina	700V dc	1dg; 2c; 3c
Amphenol	93	34-50	20	22-18	500	2.26	> 10 <sup>4</sup>	500V dc	1a; 2bg; 3e
Amphenol	94	15-63	20-16	22-14	500	1-2.66	> 100	600	1ac; 2h; 3df; A; B
Amphenol	115	2-100	16	20-16	500	ina	ina	125 min	1bdeh; 2b; 3e; K; M; V
Amphenol	126	1-34	22-12	24-12	500	ina	ina	60 min	1de; 3e
Amphenol	126 CN1	13-113	20-12	24-10	500	0.87-2.66	> 5000	600V dc	1c; 2h; 3aq; A; B
Amphenol	213	57-134	20-16	24-16	500	1.2-2.5	> 500	1500	1a; 2h; 3j
Amphenol	217	18-102	20-12	24-12	500	0.63-2	5000	1500	1a; 2h; 3s; A; B; (1)
Amphenol	220	52-104	26-22	28-24	500	ina	ina	1500	1bc; 2b; 3e
Amphenol	221	60-80	28-24	32-24	500	ina	ina	500	1bc; 2g; 3hi
Amphenol	223	5-33	26-22	28-24	500	ina	ina	1500	1bc; 2f; 3f
Amphenol	305	1	G	18-10	500	ina	ina	ina	1de
Bendix	Arinc	106	22	26-22	ina	6	100,000	1300	1a; 2j; 3stu
Bendix	LB	9-104	22-20	28-20	ina	4-6	5000	1000	1a; 2j; 3dhmqtstu; C
Bendix	PCB	28-80	24-20	28-20	250	30-40	5000 min	1300 min	1ac; 2ab; 3a
Burndy	DTD	40-156	16	26-10	500	2	50	2000	1ch; 2b; 3d
Burndy	MS-M, MSB, MSD	14-152	16	30-16	500	2	50	2000	1bm; 2bgj; 3dgi; A
Cinch	D-Subminiature	9-50	20-18	20	ina	2.67	5000	1250	1ad; 2bk; 3dfq
Cinch	Blue Ribbon	8-32	N	18	ina	3	100,000	800V dc	1c; 2k; (6)
Cinch	Micro Ribbon	14-50	N	20	ina	3	5000	500,000	1ch; 2k; (6)
Cinch	Hinge	15-100	n/a	18	ina	20	1000 min	930	1ch; 2bd; V; (14)
Cinch	Jones	2-33	n/a	18-10	ina	ina	ina	730 min	1c; 2k; (15)
Cinch	Mini-Jones	19-68	n/a	20	ina	6.5	1000	830	1a; 2bk; (16)
Continental	18	7-75	18	18	500	5	> 5000	2000	1d; 2b; 3bc
Continental	20	5-104	20	20	500	4	> 5000	2000	1df; 2b; 3bc
Continental	25	7-104	16	30-14	500	ina	> 5000	2000	1a; 2b; 3bc
Continental	250	7-75	16	16	500	5	> 5000	1350	1df; 2b; 3bc
Continental	MM, MMM	5-104	22	22	500	7	> 5000	1325	1adf; 2b; 3bc
Continental	SM	5-104	20	20	500	6	> 5000	1325	1df; 2b; 3bc
Dale	M14	19	14	20-14	ina	ina	ina	3600	1dj; 2a; 3i
Dale	M20	7-75	20-16	22-16	ina	ina	ina	2250	1d; 2b; 3cin
Dale	MM	5-44	24-22	24-22	ina	ina	ina	1500	1d; 2b
Dale	S20	17-41	18-16	20-16	ina	ina	ina	1875 min	1d; 3c; A
Dale	SM	5-75	20	22-20	ina	ina	ina	1500	1d; 2b
Elco	01	2-44	n/a	30-18	2x10 <sup>6</sup>	7	25,000	2000	1c; 2b; 3dj; (8)
Elco	6501	3	n/a	18-14	ina	2	5000	3500	1a; 2c; (9)
Elco	8016	20-120	n/a	30-18	2x10 <sup>6</sup>	6	25,000	2000	1acm; 2b; 3dj; (7)
Elco	8017	75-130	n/a	30-18	2x10 <sup>6</sup>	6	25,000	2000	1acm; 2b; 3dj; (7)
Elco	8018	80-140	n/a	30-18	2x10 <sup>6</sup>	6	25,000	2000	1acm; 2b; 3dj; (7)
Elco	8024	12	n/a	30-18	2x10 <sup>6</sup>	6	5000	1800	1acm; 2k; 3r; (7)
Elco	8026	33-117	n/a	30-22	2x10 <sup>6</sup>	8	25,000	1000	1a; 2b; 3dj; (5)
Elco	8125	32	n/a	30-18	2x10 <sup>6</sup>	6	25,000	1350	1c; 2c; 3dj; (6)
Elco	8129	6-15	n/a	30-18	2x10 <sup>6</sup>	6	25,000	1350	1c; 2k; 3j; (6)
Hughes	B	14-102	22	30-22	ina	25	5000	1500	1a; 2c
Hughes	D	18-138	20	24-20	ina	25	5000	2000	1a; 2c
Hughes	M	10-212	16	30-16	ina	30	5000	2000	1a; 2c; 3ce
Hughes	W	38-244	22	30-22	ina	25	5000	1500	1a; 2c; 3ce
Hughes	WSS	14-244	22	30-22	ina	25	5000	1500	1a; 2c; 3ce
ITT	DPA	2-32	20-4	26-4	500	0.5-8	5000	1000 min	1ac; 2k; 3fq; A
ITT	DPA, DPGM	8-32	20-16	24-16	500	3-8	5000	1000 min	1ac; 2k; 3st; A
ITT	DPD, DPD2	2-256	20-0	20-0	500	0.1-2	5000	540 min	1c; 2bk; 3cf; A; E
ITT	DPDMA, DPD2MA	2-224	20-4	26-0	500	0.1-2	5000	540 min	1a; 2bk; 3fr; A; E; F
ITT	DPJ, DPJM; DPJMB	21-64	20-8	24-8	500	3-8	5000	1000 min	1ac; 2k; 3fs; A
ITT	DPK	18-161	22-8	30-8	500	3-8	5000	1500	1a; 2bk; 3rt; A; B; D
ITT	DPSRC	4-42	16-8	20-8	500	3	5000	1000	1a; 2k; 3s; A
ITT	DPX, DPX2, DPXMA, DPX2MA	2-212	22-4	26-4	500	0.5-8	5000	1000 min	1ac; 2bk; 3fs; A; F
Malco	Mini-Wasp	26-52	n/a	30-22	500	< 2	1,000,000	300	1a; 2fk; 3e; H; J; (5)

# Burndy gives you the Compact Bantam in all shell styles.



Lightweight, low-silhouette subminiature cylindrical connectors to meet Mil C-38999 are here. Ready to assemble in sizes 8 through 24. Available in arrangements from 3 to 128 rear release crimp contacts, with a bayonet-type, quick disconnect and 5 alternate polarizations. Burndy is making all shell styles

shown above in Series IIA and IIB. The former operates continuously within a temperature range of  $-65^{\circ}\text{C}$  and  $150^{\circ}\text{C}$ , and the latter takes up to  $200^{\circ}\text{C}$  continuously. Intermateable, and interchangeable with all connectors made to this Mil spec in these series.

Burndy also offers improved,

easy-to-use insertion and extraction tools and a highly reliable ratchet-controlled hand tool conforming to Mil T-22520.

Send for our unique wall chart catalog which shows all the connectors and tools and has charts detailing the insert arrangements, contacts and the available finishes.

# Burndy gives you immediate delivery on the Compact Bantam in all shell styles.

 **BURNDY**  
Bantam Products/Norwalk, Connecticut

INTERNATIONAL SALES HEADQUARTERS & MANUFACTURING FACILITIES:  
CANADA/ENGLAND/BELGIUM/MEXICO/BRAZIL/JAPAN/Sales Offices in Major Cities

Manufacturer	Series	Contacts (Min-Max)	Contact Size (AWG, Min-Max)	Wire Size (AWG, Min-Max)	Maximum Insertions	Contact Resistance (mΩ, Min-Max)	Insulation Resistance (MΩ)	Sea-Level Test Voltage (V rms)	Notes
Malco	Wasp	20-100	n/a	26-16	500	< 2	1,000,000	800	1a; 2k; 3e; H; J; (10)
Micradot	Combo-Mate	9-51	24	28-24	> 2000	4	5000	1000	1ac; A
Micradot	Flat Strip	1-120	24	28-24	> 2000	4	5000	1000	1ac
Micradot	Flex-Mate	9-51	24	(2)	> 2000	4	5000	1000	1ck
Micradot	Micro-Con MCDA, MCDB, MCDC	9-51	24	28-24	> 2000	4	5000	1000	1ac; S
Micradot	Micromate MCDM	9-51	24	28-24	> 2000	4	5000	1000	1ac
Milross	500	14-500	22-14	24-12	ina	ina	ina	ina	1a; 2st; 3dej; W
Milross	M	7-104	20	20	ina	2	ina	2100	1dhi; 2b; 3cdir; X; Y; Z
Milross	MA	14-50	16	16	ina	ina	ina	4700	1dhi; 2b; 3cdir; X; Y; Z
Milross	MM	5-44	22	22	ina	ina	ina	18,000	1dhi; 2b; 3cdir; X; Y; Z
Milross	SM	5-75	20	20	ina	ina	ina	1950	1dhi; 2b; 3cdir; X; Y; Z
Molex	1261, 1292, 1360, 1375, 1396, 1490, 1545, 1619, 1653	1-15	12	30-14	100	< 2	ina	250	1a; 2m
Molex	1625, 1649, 1772	1-36	16	30-18	100	< 2	ina	250	1a; 2m
Molex	1991	3-15	12	30-14	100	< 2	ina	250	1a
North	D	40-100	n/a	18 max	4000	7-14	500,000	2000	1ch; 2n; K; (5)
North	E	40-100	n/a	18 max	4000	7-14	500,000	2000	1ch; 2a; K; (5)
North	F	40-100	n/a	18 max	4000	7-14	500,000	2000	1ch; 2p; K; (5)
Positronic	GH	4-9	18	26-18	200	8	1000	1000	1cf; 2r; 3dr; (3)
Positronic	GM	7-50	18	26-18	200	8	1000	1000	1cfm; 2qr; 3cdr; (3)
Positronic	GMCT	14-104	18-16	24-14	200	6-8	1000	1000	1acm; 2qr; 3cdr; (3)
Positronic	MGH	3	20	24-22	200	10	1000	1000	1c; 2r; 3dr; (3)
Sealectro	ConheX	1-9	18	14-16	1000	6	1000	1500	1c; 2aj; 3ew
Switchcraft	PREII	2-7	16	22	500	50	1000	1000	1c; 2ku; (4)
Switchcraft	Q-G	3-5	18-12	18-14	500	50	1000	1000	1d; 2f; (4)
Transitron	1530, 1540	7-75	22-20	30-20	500	2	5000	1800	1b; 2gv; 3d
Transitron	5040	7-104	22-20	30-20	500	2	5000	1800	1df; 2gv; 3d
Transitron	7030, 7025	5-50	24-22	30-22	500	8	5000	1000	1df; 2gv; 3d
U. S. C.	IMI	7-104	20	20-18	5x10 <sup>8</sup>	4	10x10 <sup>6</sup>	1200	1dfi; 2b; 3bedx; X; (13)
U. S. C.	MI	7-225	20	20-18	5x10 <sup>8</sup>	4	10x10 <sup>6</sup>	2250	1di; 2b; 3bedx; X; Z; (11); (12); (13)
U. S. C.	REMI	7-225	20	30-18	5x10 <sup>8</sup>	4	10x10 <sup>6</sup>	2250	1b; 2b; 3bedx; X; Z; (12); (13)
U. S. C.	SMI	5-104	20	20	5x10 <sup>8</sup>	4	10x10 <sup>6</sup>	1460	1d; 2b; 3bedx; (11); (13)
U. S. C.	UMI	5-50	22	22	5x10 <sup>8</sup>	7	10x10 <sup>6</sup>	1350	1d; 2b; 3bdx; (11); (13)
U. S. C.	URC	9-104	20-16	30-16	5x10 <sup>8</sup>	4	10x10 <sup>6</sup>	2210	1b; 2b; 3bed; X; (12); (13)
Winchester	40	81-108	G	ina	ina	ina	ina	2000	2b; 3d
Winchester	42	50-74	22	22	ina	ina	ina	1200	1df; 2gv; 3d
Winchester	A, SA	7-19	16	16 max	ina	ina	ina	2100	1d; 3d
Winchester	CAC	104-152	G	ina	ina	ina	ina	2000	2gv
Winchester	EA, EE	14-104	20-16	20-16	ina	ina	ina	1000	1d; 2v; 3qrv
Winchester	MRA	9-104	16	16	ina	ina	ina	1000	1df; 2grv; 3d
Winchester	MRAC	9-104	G	ina	ina	ina	ina	200	1a; 2grv; 3dr; T
Winchester	MRE	7-104	20	20	ina	ina	ina	1200	1df; 2grv; 3d
Winchester	QRE	6-34	16	16	ina	ina	ina	3150	1d; 2gv; 3dr
Winchester	SLE, SME, SRE	4-50	24-20	22	ina	ina	ina	1000	1df; 2gv; 3d
Winchester	SQC	100	22	28-24	ina	ina	ina	1400	1a; 2v; 3dr; T
Winchester	SRD	32	22	24	ina	ina	ina	1200	1df; 2b
Winchester	SREC	7-260	22	28-20	ina	ina	ina	1400	1a; 2gv; 3d; T
Winchester	SRM	5-104	20	20	ina	ina	ina	1500	1d; 2gv; 3cd
Winchester	XAC	9-104	G	ina	ina	ina	ina	2000	1a; 2gv; 3cdrv; T
Winchester	XMRA	9-104	16	16	ina	ina	ina	1000	1df; 2gv; 3cd
Winchester	XMRE	7-104	20	20	ina	ina	ina	1200	1df; 2gv; 3cd

- Contact termination
  - crimp
  - removable crimp
  - solder
  - solder cup
  - solder eyelet
  - dip solder
  - PC pin
  - tapered pin
  - turret
  - twin turret
  - weld
  - wire-wrap
  - Termi-Point
  - removable solder
- Locking method
  - none
  - screws
  - clips
  - springs
  - external
- Accessories
  - none
  - shields
  - shells
  - hoods
  - housings
- molded-in latch
  - guide pins
  - panel
  - by accessory
  - quick-disconnect
  - contact retention
  - holding tabs
  - lock-stud/floating nut
  - lock-stud/cam-lock
  - thread locks
  - vibration locks
  - lever clamp
  - control collar
  - lock ring
  - jacks
- clamps
  - skirts
  - strain reliefs
  - guide pins
  - polarization keying
  - keying plug
  - latching devices
  - locking latch
  - modular inserts
  - potting forms
  - mounting hardware
  - float-mount hardware
  - clinch-nut mounting
  - through-hole mounting
  - gaskets
  - shorting terminations
  - brackets
- Coaxial-cable contacts available
  - Shielded contacts available
  - Thermocouple contacts available
  - Filter-type contacts available
- Twinax contacts available
  - High-voltage contacts available
  - Special contact sizes available
  - Mating female contact can be any size
  - Any number of contacts available
  - Customized configurations available
  - Flat-blade male contacts available
  - Spring-type socket contacts available
  - Ribbon-type contacts
  - Fixed contacts available
  - Encapsulated contacts available
  - Power/coax-combination contacts available
  - Twist-pin contacts available
  - Removable contacts
  - Modular units lock together
  - Hinged-type connectors available
  - Hermaphroditic modular connectors
  - Closed-entry connectors
  - Meets MIL-C-5015
  - Meets MIL-C-8384
  - Meets MIL-C-26518
- Flat cable on 50-mil centers
  - Ten-day delivery on cataloged connectors
  - Audio connectors
  - Contacts rated at 3 A
  - Contacts rated at 5 A
  - Contacts rated at 8.5 A
  - Contacts rated at 9 A
  - Contacts rated at 20 A
  - Contacts rated at 6 A
  - Meets MIL-C-008384
  - Meets MIL-C-22857
  - Meets MIL-C-28748
  - Contacts rated at 4.5 A
  - Contacts rated from 4.5 to 25 A
  - Contacts rated at 4 A

## microcircuit reliable, these new opto-hybrids

offer nominal light sensitivity thresholds of 7.0 ("A" version 1.5) mW/cm<sup>2</sup> • maximum channel matching ratios of 2.0 or 1.2 to 1 • minimum high output of 4.5 Vdc and maximum low output of 0.4 Vdc; inverted logic also available • speed of response 1 microsecond or less.

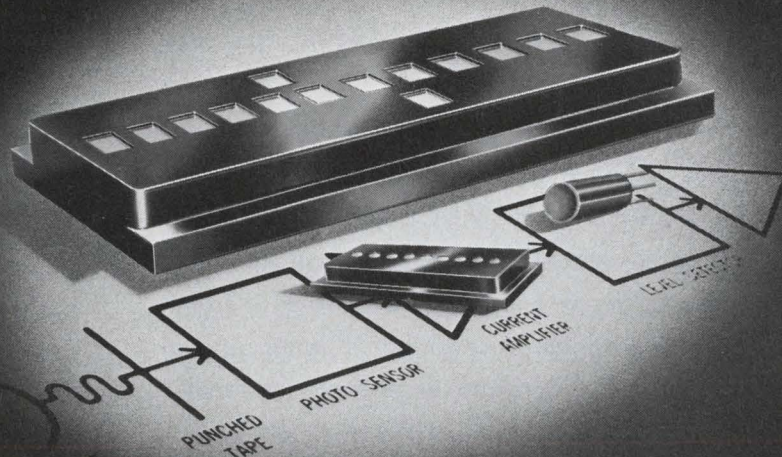

actual size

## ready for market opto-hybrid™ readers

These standard Centralab Semiconductor products, complete subsystems with "built-in" light sensors, amplifier/digitizer, provide DTL/TTL-compatible output without the noise problems associated with low signal levels. About 1/10th the size of discrete component layouts and cost competitive with discrettes, these "opto's" are now available in 1, 9 and 12-channel configurations for position sensing and for reading punched cards and tape. Let us show you how to fit a Centralab Semiconductor opto-hybrid to your particular application. Write for all the facts about this newest Centralab Semiconductor family. ☐ Copies of our brochure "Hybrids . . . Practical answers to circuit improvement" are also available upon request. Write Centralab Semiconductor, Dept. H, 4501 N. Arden Dr., El Monte, Calif. 91734.



**CENTRALAB  
SEMICONDUCTOR**

Division • GLOBE-UNION INC.  
4501 NORTH ARDEN DRIVE  
EL MONTE, CALIFORNIA 91734

zeners, temp.-compensated devices, tunnel diodes, rectifiers, scr's, semiconductor chips, hi-rel hybrids and photovoltaic products

# DON'T LET THIS LOW PRICE FOOL YOU

Triplett's new 3½-digit Model 5020 digital panel meter is a complete, self-contained instrument ready for panel-mounted or bench-top use.

Available in 6 ranges from 10.00 mV to 1000 V DC and 7 ranges from 1.000  $\mu$ A to 1.000 A DC, the bipolar Model 5020 features accuracies of 0.1% of reading  $\pm 1$  digit as a voltmeter and 0.15% of reading  $\pm 1$  digit as an ammeter through 100% over-range. Its seven-bar, fluorescent readout gives a single-plane display for accurate, wide-angle readability.

Priced at only **\$240** (\$265 with BCD output) suggested USA user net, this new Model 5020 allows even the budget-minded to enjoy the accuracy and easy reading of a digital display. For a free demonstration, see your Triplett distributor or call your Triplett sales representative right now. Triplett Corporation, Bluffton, Ohio 45817.

**TRIPLETT**  
Manufacturers of the World's  
most complete line of V-O-Ms

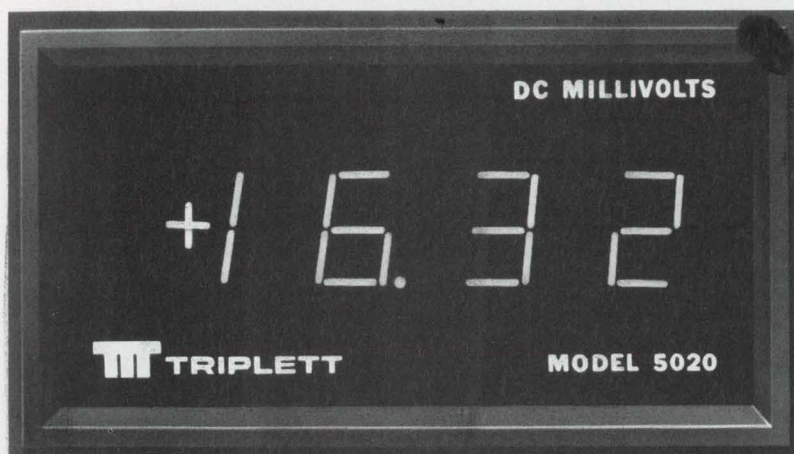

Shown actual size

1. Low-cost, bipolar 3½-digit instrument reads to 100% over-range.
2. Dual-slope analog/digital conversion gives high noise rejection, stability and accuracy.
3. Single-plane, seven-bar readout for accurate wide-angle readability.



# New Products

## CRT with matrix grid generates many beams



Legi Electronics Corp., 3118 W. Jefferson Blvd., Los Angeles, Calif. Phone: (213) RE3-4508. P&A: \$90; 1 to 2 months.

Using a matrix ( $M_x$ ,  $M_y$ ) electrode between its first and second grids, the new Matrix multi-beam CRT allows the direct display of any numeral, character, symbol, sketch or diagram on its fluorescent screen by simply changing the applied voltages to its  $M(x, y)$  matrix electrode.

The 7 by 5 matrix electrode consists of seven vertical bars ( $M_{x1}$ ,  $M_{x2}$ , . . . ,  $M_{x7}$ ) and five horizontal bars ( $M_{y1}$ ,  $M_{y2}$ , . . . ,  $M_{y5}$ ) that are electrically insulated from each other.

At each of 35 crosspoints formed by the intersection of the horizontal and vertical bars of the matrix, a hole is present. By applying a positive voltage with respect to the cathode to both  $M_x$  and  $M_y$  bars, the CRT's electron beam is passed through only those crosspoint holes where a positive voltage is simultaneously present at both  $M_x$  and  $M_y$  bars.

In this manner, complicated digital displays such as numerals, characters, symbols or sketches, can be made on the CRT with the proper application of pulse voltages to the matrix crossbars.

To determine the position of the character display, a step-form current is passed through the CRT's deflection coil, and upon completion of one horizontal step-form wave, all parts of a single character are scanned as if the vertical step-form wave had changed for one step.

CIRCLE NO. 250

## Three-pole relay switches at 75 $\mu$ s

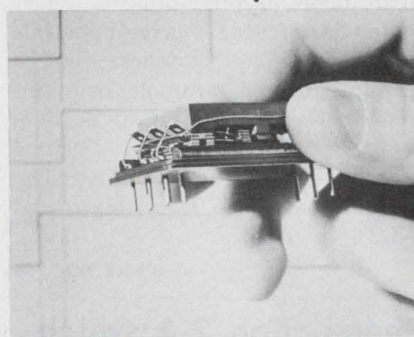

James Electronics, Inc., 4050 N. Rockwell St., Chicago, Ill. Phone: (312) 463-6500. P&A: from \$16; stock to 6 wks.

The new 6200 relay has three-pole switching circuits, one which shield-switches a two-wire low-level signal circuit at 75  $\mu$ s. It has a switching rating of 50 V at 2 mA continuous. The relay is packaged on a 2.5 by 0.85 by 0.63-in. PC board. It is available in drive voltages of 6, 12 and 20 V.

CIRCLE NO. 251

## Flatpack transformer measures 1/8-in. high

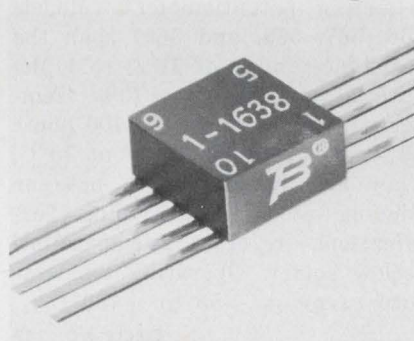

Bourns Pacific Magnetics Corp., 28151 Highway 74, Romoland, Calif. Phone: (714) 657-5195.

Model 4210-1638 miniature transformer is a low-profile flatpack measuring only 0.25 by 0.25 by 0.125 in. It operates from  $-55$  to  $+125^\circ\text{C}$  with rise and fall times of 10 ns for a 5-V-peak pulse and meets Mil-T-21038, grade 7 specifications. Primary inductance is 320  $\mu\text{H}$  and leakage inductance is 0.25  $\mu\text{H}$ . Dc resistance is 0.65  $\Omega$  and interwinding capacitance is 25 pF.

CIRCLE NO. 252

## 1-1/2-in.-dia motors give 1250-oz-in. torque



TRW Inc., Globe Div., 2275 Stanley Ave., Dayton, Ohio. Phone: (513) 228-3171.

Type CMM and CLL dc permanent-magnet planetary gearmotors develop 1250 oz-in. of continuous-duty torque yet measure only 1-1/2 in. in diameter. They are available in 83 standard speed reduction ratios from 4:1 to 46,656:1. CMM units operate from 4 to 50 V dc sources, while CLL units operate from 6 to 75 V dc sources.

CIRCLE NO. 253

## 1/8-W carbon trimmers lower price to 33¢

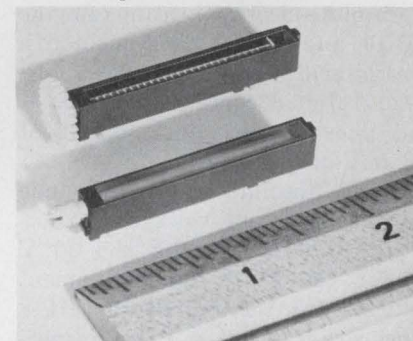

Amperex Electronic Corp., Components Div., 35 Hoffman Ave., Hauppauge, N. Y. P&A: from 33¢; stock.

Offering resistances from 1 k $\Omega$  to 2.2 M $\Omega$ , a new line of 20-turn trimmer potentiometers that dissipate 1/8 W at 70 $^\circ\text{C}$  retails for as low as 33¢ each. Tolerance is  $\pm 20\%$  and repeatability is 0.1%. Only 1-7/8-in. long, they are suited for mounting on PC boards and are available in two styles: one for hand adjustment and one for screwdriver adjustment.

CIRCLE NO. 254

## Multi-segment tubes give 500 foot-lamberts

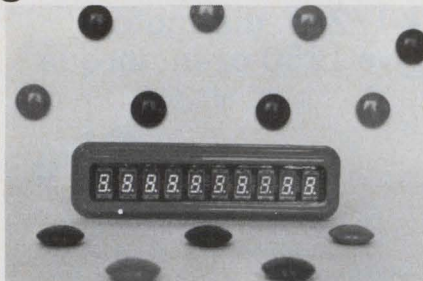

Legi Electronics Corp., 3118 W. Jefferson Blvd., Los Angeles, Calif. Phone: (213) RE3-4508. P&A: \$60; 1 to 3 months.

The new Legi multi-numerical indicator tubes feature a multiple number of digits in a single metal envelope with a brightness of 500 foot-lamberts per digit.

The DP-10 (10 digits) and DP-8 (8 digits) tubes are easy to assemble into instruments since they employ dual-in-line integrated-circuit sockets.

The use of center-tapped filaments on each digit allows for equal brightness. Another feature is the lack of display reflection from the front glass.

The same segments for each digit are connected in parallel with each other to decrease the number of lead pins.

Absolute electrical ratings for the DP-10 and DP-8 tubes include a control-grid voltage of 20 V dc, a control-grid current of 3 mA dc and phosphor-segment current of 0.8 mA dc per digit.

Other absolute ratings include phosphor-segment voltage of 20 V dc for the DP-10 tube and 30 V dc for the DP-8 tube. Filament voltages for the DP-10 and DP-8 tubes are 7.5 and 6 V dc, respectively. Both tubes have a filament current rating of 50 mA dc.

For pulse operations, the duty cycle is 1/16 for the DP-10 and 1/20 for the DP-8. Control-grid and phosphor-segment voltages are 50 and 57 V pk-pk, respectively, for the DP-10 and DP-8.

Prices for the Legi indicator tube are \$60 for the DP-10 and under \$60 for the DP-8.

Availability for quantities under 100 units is 1 month, and for quantities over 100 units is 1 to 3 months.

CIRCLE NO. 255

Interswitch, 770 Airport Blvd., Burlingame, Calif. Phone: (415) 347-8217.

The new series K miniature thumbwheel switches with wire-wrap terminations, pins, or short solder lugs features large numerals in 3/8-in.-wide switches. Switch formats include two-pole two-position; one-pole 10-position or one-pole 11-position versions. Decimal or BCD outputs are available. The switches are 1-5/6-in. high and 2-3/16 in. deep.

CIRCLE NO. 256

## 3/8-in.-wide switches display large numerals

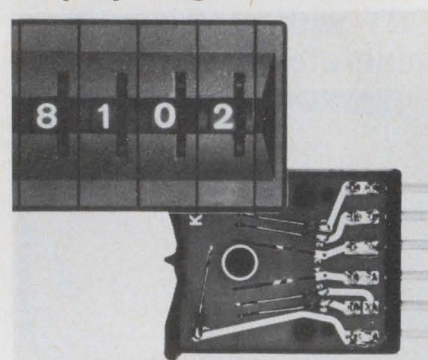

## Snap-action 2-A switch measures 0.0075 in.<sup>3</sup>

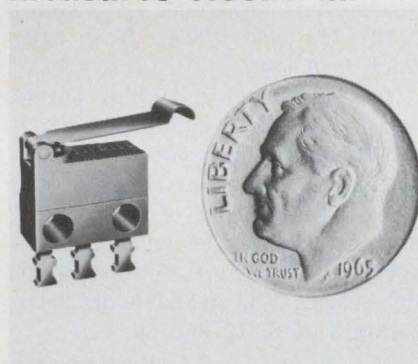

McGill Manufacturing Co., Inc., Electrical Div., Valparaiso, Ind. Phone: (219) 462-2161.

Rated at 2 A for 125 to 25 V ac, the new Mini-Mite snap-action switch measures 0.25 by 0.3 by 0.10 in. It meets MIL-S-8805 specifications and is available with four types of terminals: single-turret, double-turret, quick-connect spade and wire-wrap. Models are also available with pin plungers and with a variety of lever styles.

CIRCLE NO. 258

Weston Components Div., Archibald, Pa. Price: \$1.55.

A family of four cermet 1/4-in. trimming potentiometers (Models 566, 567, 568, and 569) span the resistance range of 10  $\Omega$  to 1 M $\Omega$  with a tolerance of  $\pm 10\%$ . Temperature coefficient is  $\pm 100$  ppm/ $^{\circ}\text{C}$ , and rating is 1/2 W at 70 $^{\circ}\text{C}$ . They are available with base or edge-mounted PC-board pins. Terminations are of high-temperature reflow solder. Operating temperature range is  $-55$  to  $+150^{\circ}\text{C}$ .

CIRCLE NO. 257

## 1/4-in cermet trimmers span 10 $\Omega$ to 1 M $\Omega$

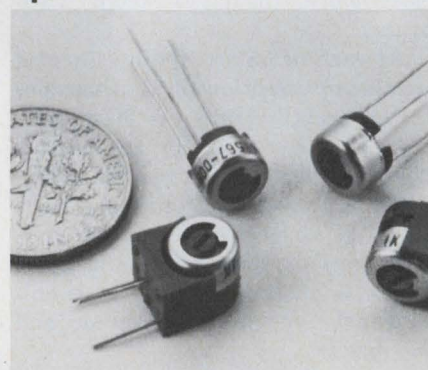

## Crystal oscillators stabilize to 1 x 10<sup>-6</sup>



Accutronics, Div. of Gibbs Mfg. and Research Corp., 628 North St., Geneva, Ill. Phone: (312) 232-2600. P&A: \$325 to \$575; 6 wks.

Providing frequencies between 1 and 200 MHz, the series 190 voltage-controlled crystal oscillators have frequency tolerances of less than  $\pm 1 \times 10^{-6}$  over a temperature range of 0 to  $+60^{\circ}\text{C}$ . Various logic-compatible output voltages and waveforms are available. Frequency deviation is  $\pm 0.02\%$  and linearity is 15%.

CIRCLE NO. 259

# WHERE

can you get a time delay relay that won't false operate, that will give you  $\pm 3\%$  repeatability, will switch 10 amperes and costs only \$16.50?

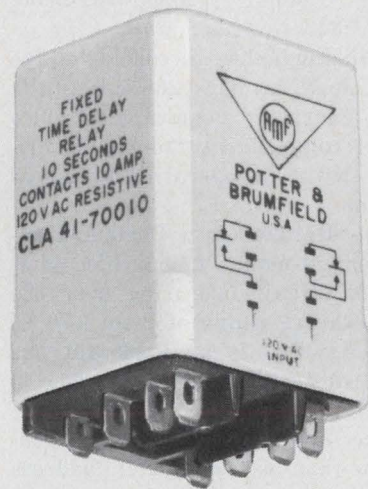

# HERE

This compact time delay, our CL Series, provides a delay on operate. Its reliable solid state circuit will time as little as 0.1 second and as much as 120 seconds. Three types are offered in AC or DC versions: fixed delay on operate, resistor adjustable and knob adjustable.

An integral part of the package, our field-proven KU relay handles the DPDT output switching up to 10 amperes. Transient protection is provided up to twice the rated input voltage for 8 milliseconds. Reset and recycle times are 150 milliseconds. Polarity reversal protection is provided.

A wide variety of mountings give you many design options. Nylon sockets

are available with solder, quick-connect or printed circuit terminals. Also, cases with brackets for mounting the CL time delays directly to a chassis can be provided. Manual push-to-test buttons are also available. The plain case measures 1.53" x 1.40" x 1.90" high.

The CL Series is but one in a large family of solid state/relay time delays. Some have screw terminals and will switch 30 amperes. Others are combined with dry reed relays in an exceptionally compact package. Delays on operate, on release, or "interval on" may be ordered. Nearly 1300 listings are shown in our catalog.

For complete information, call your local P&B sales engineer. Or, call or write Potter & Brumfield Division of American Machine & Foundry Company, Princeton, Indiana 47570. Telephone 812/385-5251.

STANDARD P&B TIME DELAYS ARE AVAILABLE FROM LEADING ELECTRONIC PARTS DISTRIBUTORS.

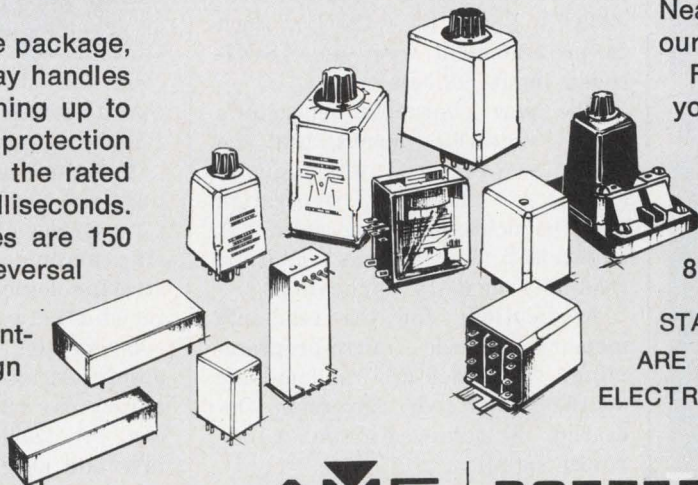

**AMF | POTTER & BRUMFIELD**

# At Last...

## The Right Digital Printer... At the Right Price

### SCM now offers the Model M-120 Digital Printer

featuring

- Serial Entry
- Numeric
- BCD Input
- 16 Columns

The SCM M-120 Printer is American made and sells for less than \$200.

```

1 1 1 1 1 1 1 1 1 1 1 1 1 1 1 1
2 2 2 2 2 2 2 2 2 2 2 2 2 2 2 2
3 3 3 3 3 3 3 3 3 3 3 3 3 3 3 3
4 4 4 4 4 4 4 4 4 4 4 4 4 4 4 4
5 5 5 5 5 5 5 5 5 5 5 5 5 5 5 5
6 6 6 6 6 6 6 6 6 6 6 6 6 6 6 6
7 7 7 7 7 7 7 7 7 7 7 7 7 7 7 7
8 8 8 8 8 8 8 8 8 8 8 8 8 8 8 8
9 9 9 9 9 9 9 9 9 9 9 9 9 9 9 9
0 0 0 0 0 0 0 0 0 0 0 0 0 0 0 0
    
```

```

1 1 1 1 1 1 1 1 1 1 1 1 1 1 1 1
4 3 2 1 0 9 8 7 6 5 4 3 2 1
    
```



**SMITH-CORONA MARCHANT**  
DIVISION OF SCM CORPORATION

**Industrial Products**

3210 Porter Drive  
Palo Alto, California 94304  
(415) 326-9500 TWX 910-373-1777

INFORMATION RETRIEVAL NUMBER 73

## ICs & SEMICONDUCTORS

### MOS static generator is bipolar-compatible

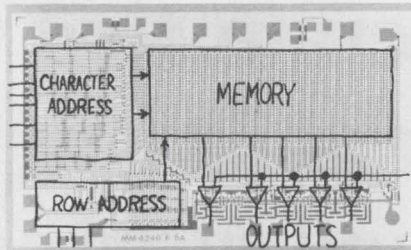

National Semiconductor Corp., 2900 Semiconductor Dr., Santa Clara, Calif. Phone: (408) 732-5000. P&A: \$45 to \$144; stock.

Utilizing a low-threshold-voltage technology, a new 2560-bit static MOS character generator provides direct compatibility to bipolar devices with an operating speed of 600 ns.

The MM5240 is a P-channel enhancement-mode monolithic integrated circuit operating over the temperature range of 0 to +70°C. The MM4240 is available for the temperature range of -55 to +125°C.

The new static character generator has six character address and three row address input lines which provide access to an organization of 64 by 8 by 5 characters.

Programming to any desired character font or input address code is easily accomplished by simply completing a standard pattern sheet that is provided by the manufacturer, or by providing the data in a pre-arranged punch-card or paper-tape format.

A standard generator is available with a 7 by 5 dot-matrix character-font output in the MM-5240AA (0 to 70°C) and the MM-4240AA (-55 to +125°C). Each is programmed with an ASCII-coded input address.

The new character generator's static operation means that no clocks are required which allows lower-cost character generation and asynchronous operation. A chip-select line allows multiple read-only memory applications.

Applications for the read-only memory include micro-programming, table look-up, random-logic synthesis and code conversion. Operation is achieved from ±12-V power supplies.

CIRCLE NO. 260

### Fast 12.5-kV diode recovers in 1.5 μs

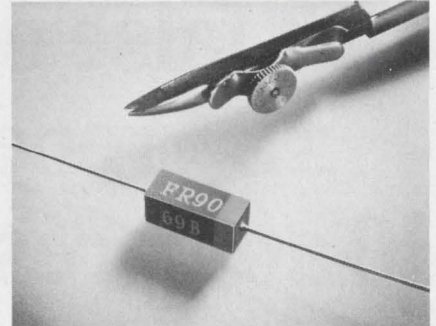

Sarkes Tarzian, Inc., Semiconductor Div., 415 N. College Ave., Bloomington, Ind. Phone: (812) ED2-1435.

Capable of reverse-voltage operation at 12.5 kV dc, type MW-20FR90 low cost diode features a recovery time of 1.5 μs. Other specifications include leakage at rated voltages of less than 5 μA and maximum average current of 20 mA. The diode is epoxy encapsulated and measures 0.187-in. square by 0.5-in. long.

CIRCLE NO. 261

### Six-bit d/a converter fits on a single chip

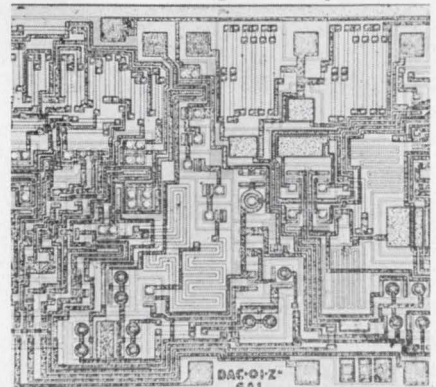

Precision Monolithics Inc., 1500 Space Park Dr., Santa Clara, Calif. Phone: (408) 246-9222. Price: \$40.

Designed as a high-speed 6-bit unit, the monoDAC-01 d/a converter consists of a voltage reference, six current sources, six current-steering logic switches, a diffused resistor network, and an internally compensated output operational amplifier, all on a single chip. Accuracy is ±1/2 the least significant bit, power consumption is 250 mW and slew rate is 25 V/μs.

CIRCLE NO. 262

## IC set for calculator consists of 6 DIPs

*Electronic Arrays, Inc., 501 Ellis St., Mountain View, Calif. Phone: (415) 964-4321. P&A: \$158.46; 2 wks.*

A set of 6 MOS LSI circuits, each a 24-pin DIP, form all the electronics for a 16-digit calculator with 8-digit display. These include a control array which utilizes a 1920-bit read-only memory, an input array, a control logic array, a register array, an arithmetic array and an output array. The circuits are p-channel enhancement-mode MOS ICs.

CIRCLE NO. 263

## LSI 256-bit memory accesses in 120 ns

*Intel Corp., 365 Middlefield Rd., Mountain View, Calif. Phone: (415) 969-1670. P&A: \$80, \$20; stock.*

Type 3102 256-bit bipolar random-access LSI memory operates with the 3202 decoder for a maximum access time of 120 ns. It stores up to 4096 words of any length, is TTL-compatible and dissipates 1.5 mW/bit. Both memory and decoder units have 10  $\mu$ A input leakage current. Load current is 0.25 mA for the decoder and 0.5 mA for the memory unit.

CIRCLE NO. 264

## Dual 100-bit register dissipates 0.4 mW/bit

*Texas Instruments Inc., 13500 N. Central Expressway, Dallas, Tex. Phone: (214) 238-2011. P&A: \$6.50; stock.*

The TMS3406LR dual 100-bit shift register features operation to 2 MHz and power dissipation of 0.4 mW/bit at 1 MHz. It uses thick-oxide silicon-nitride MOS P-channel enhancement-mode circuitry. Propagation delay is 120 ns. One power supply and two clock phases are needed for operation. It is available in an 8-pin TO-100 metal can.

CIRCLE NO. 265

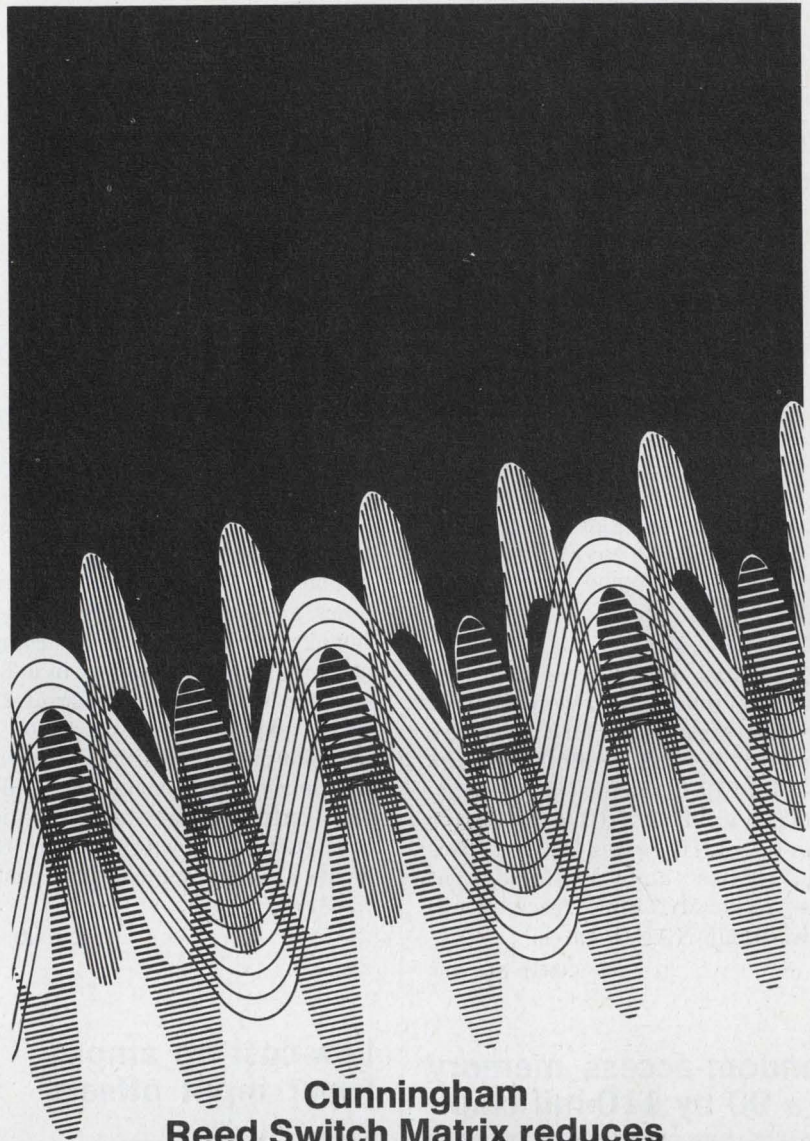

## Cunningham Reed Switch Matrix reduces high-frequency crosstalk to a new low.



Isolation does it. Through an unusual "sandwich" design, matrix-mounted reed switches are sealed, shielded and separated from their controls, achieving maximum open circuit isolation and negligible crosstalk.

The matrix is ideal for interconnecting video channels, broadband data switching, test systems for nano-second digital pulses, telemetry equipment for multiple data channels, antenna switching, and medical data monitoring. Proven reliability up to 100 million operations. The whole story about

the Cunningham Reed Switch Matrix's excellent signal characteristics, 100% random access, computer compatibility, single package design and dual coaxial connectors for multiple expansion is told in Data Sheet No. 500. Write or phone Cunningham Corporation, 10 Carriage St., Honeoye Falls, New York 14472. Phone (716) 624-2000.

## Cunningham Corporation

SUBSIDIARY OF GLEASON WORKS

INFORMATION RETRIEVAL NUMBER 74

## Quad line modem ICs meet RS-232-C standard

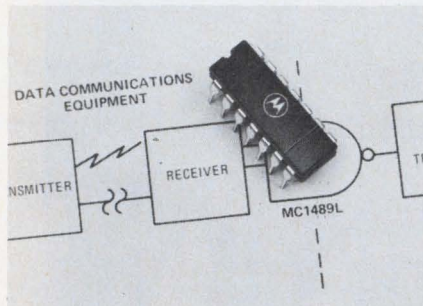

Motorola Semiconductor Products Inc., P.O. Box 20912, Phoenix, Ariz. Phone: (602) 273-6900; P&A: \$7, \$6; stock.

Two new Modem ICs, the MC1488L quad line driver and the MC1489L quad line receiver, meet the requirements of EIA interface standard RS-232-C. Both circuits are DTL/TTL-compatible monolithic ICs. The MC1488L driver has 4 NAND gates (three two-input gates and a single-input gate). The MC1489L receiver has 4 two-input NAND gates.

CIRCLE NO. 266

## Random-access memory is a 90 by 110-mil chip

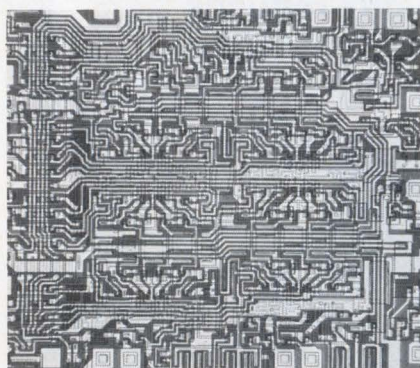

Texas Instruments Inc., 13500 N. Central Expressway, Dallas, Tex. Phone: (214) 238-2011. P&A: \$5.94; stock.

Designated SN54/74170, a new monolithic TTL random-access memory has a 4 by 4 register file with 98 equivalent gates on a single 90 by 110-mil silicon chip. It is organized as four 4-bit words and provides separate on-chip decoding to simultaneously write-in and retrieve data. Write time is 45 ns and access time is 30 ns.

CIRCLE NO. 267

## Hybrid TO-8 op amp supplies 2-W output

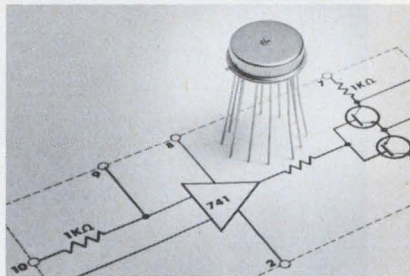

Dickson Electronics Corp., P.O. Box 1390, Scottsdale, Ariz. P&A: \$14.50; 2 wks.

The new DPA500 hybrid IC combines a standard monolithic operational amplifier with a complementary emitter follower in a TO-8 package with output power of 2 W. Other significant features of the DPA500 hybrid IC include internal frequency compensation, and a wide output-voltage range. Unique construction allows maximum flexibility in accommodating custom circuits.

CIRCLE NO. 268

## Low-cost op amps lower input offsets

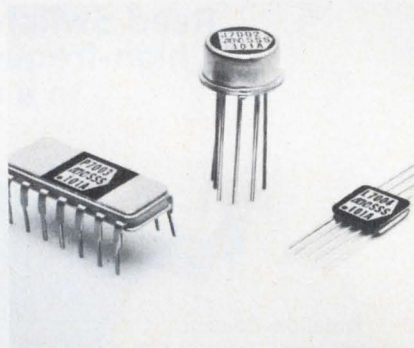

Precision Monolithics, Inc., 1500 Space Park Dr., Santa Clara, Calif. Phone: (408) 246-9222. P&A: \$30, \$12; stock.

The new SSS101A and SSS201A low-cost operational amplifiers offer input offset voltages of 1.8 and 2 mV, offset currents of 5 and 10 nA and large-signal voltage gains of 100,000 and 50,000, respectively. Operating temperatures are  $-55$  to  $+125^{\circ}\text{C}$  and  $-25$  to  $+85^{\circ}\text{C}$ , respectively. Both are available in 14-lead DIP and 10-lead flatpack cases.

CIRCLE NO. 269

## The Signetics Challenge.

Here are the distributors who back it up:

<b>ALABAMA</b>	
Huntsville: Compar Corp.	(205) 539-8476
<b>ARIZONA</b>	
Scottsdale: Compar Corp.	(602) 947-4336
<b>CALIFORNIA</b>	
Burbank: Compar Corp.	(213) 843-1772
Burlingame: Compar Corp., (National)	(415) 347-9501
Culver City: Hamilton Electro Sales	(213) 870-7171
El Monte: G. S. Marshall	(213) 686-1500
Los Angeles: Wesco Electronics, Inc.	(213) 685-9525
Palo Alto: Wesco Electronics, Inc.	(415) 968-3475
San Diego: G. S. Marshall	(714) 278-6350
San Diego: Wesco Electronics	(714) 279-3471
<b>CANADA</b>	
Downsview, Ontario: Cescio Electronics, Ltd.	(416) 638-5250
Montreal, Quebec: Cescio Electronics, Ltd.	(514) 735-5511
Ottawa, Ontario: Cescio Electronics, Ltd.	(613) 729-5118
Quebec: Cescio Electronics, Ltd.	(418) 524-3518
<b>COLORADO</b>	
Englewood: Compar Corp.	(303) 781-0912
Denver: Hamilton/Avnet Electronics	(303) 433-8551
<b>CONNECTICUT</b>	
Hamden: Compar Corp.	(203) 288-9276
<b>FLORIDA</b>	
Orlando: Hammond Electronics	(305) 241-6601
<b>ILLINOIS</b>	
Elmhurst: Semiconductor Specialists, Inc.	(312) 279-1000
Des Plaines: Compar Corp.	(312) 775-0170
Schiller Park: Hamilton/Avnet Electronics	(312) 678-6310
<b>MARYLAND</b>	
Baltimore: Compar Corp.	(301) 484-5400
Hanover: Hamilton/Avnet Electronics	(201) 796-5000
Rockville: Pioneer Washington Electronics, Inc.	(301) 427-3300
<b>MASSACHUSETTS</b>	
Burlington: Hamilton/Avnet Electronics Corp. of Mass.	(617) 272-3060
Newton Highlands: Compar Corp.	(617) 969-7140
Watertown: Schley Electronics Corp.	(617) 924-1500
<b>MICHIGAN</b>	
Detroit: Semiconductor Specialists, Inc.	(313) 255-0300
Southfield: Compar Corp.	(313) 357-5369
<b>MINNESOTA</b>	
Minneapolis: Compar Corp.	(612) 922-7011
Minneapolis: Semiconductor Specialists, Inc.	(612) 866-3434
<b>MISSOURI</b>	
St. Louis: Compar Corp.	(314) 542-3399
<b>NEW JERSEY</b>	
Cherry Hill: Hamilton/Avnet Electronics	(609) 662-9337
Cedar Grove: Hamilton/Avnet Electronics	(201) 239-0800
Haddonfield: Compar Corp.	(609) 429-1526
<b>NEW MEXICO</b>	
Albuquerque: Compar Corp.	(505) 265-1020
<b>NEW YORK</b>	
Albany: Compar Corp.	(518) 489-7408
Buffalo: Summit Distributors, Inc.	(716) 884-3450
Deerpark: CIE Northeast, Inc.	(516) 586-7800
New York: Terminal-Hudson Electronics	(212) 243-5200
Woodbury: Compar Corp.	(516) 921-9593
<b>NORTH CAROLINA</b>	
Winston-Salem: Compar Corp.	(919) 723-1002
<b>OHIO</b>	
Cleveland: Pioneer Standard Electronics	(216) 432-0010
Fairborn: Compar Corp.	(513) 878-2631
<b>PENNSYLVANIA</b>	
Philadelphia: Milgray-Delaware Valley, Inc.	(215) 278-2000
<b>TEXAS</b>	
Dallas: Hamilton/Avnet Electronics	(214) 638-2850
Dallas: Compar Corp.	(214) 363-1526
Houston: Hamilton/Avnet Electronics	(713) 526-4661
Houston: Universal Electronics	(713) 781-0421
<b>WASHINGTON</b>	
Kirkland: Compar Corp.	(206) 882-4191
Seattle: Hamilton/Avnet Electronics	(206) 624-5930

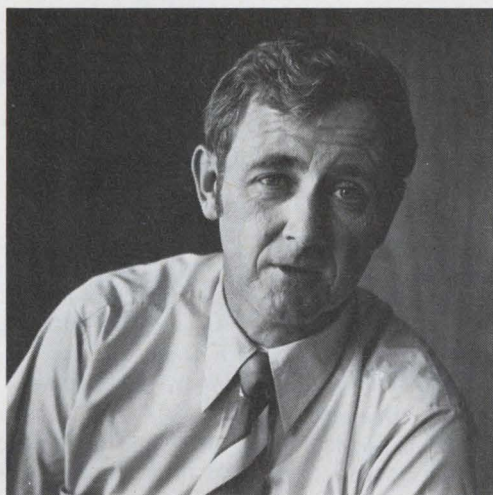

**“If I told you Signetics really delivers MSI, you’d tell me to prove it.**

**“So-effective Sept. 15 to Oct. 15—Signetics makes this challenge:**

**“If you order MSI from stock—and we don’t ship them to you within ten working days—you get up to 100 units free.”**

**“I guarantee it. Personally.”**

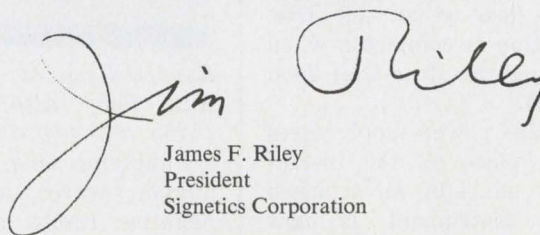
  
James F. Riley  
President  
Signetics Corporation

**The Signetics Guarantee.** We guarantee shipment of MSI from stock within ten (10) working days ARO, or customer will receive, without charge, the first 100 units or the quantity ordered, whichever is less, of each delinquent device type. This guarantee applies to all new single orders placed between September 15 and October 15, 1970 with Signetics' distributors for immediate shipment of quantities up to 4,999 of N8200 and N8T00 products in silicone DIP. Void if order is cancelled or reduced. Signetics Corporation, 811 East Arques Avenue, Sunnyvale, California 94086 / A subsidiary of Corning Glass Works

INFORMATION RETRIEVAL NUMBER 76

## Shaft-encoder knob data-logs instruments

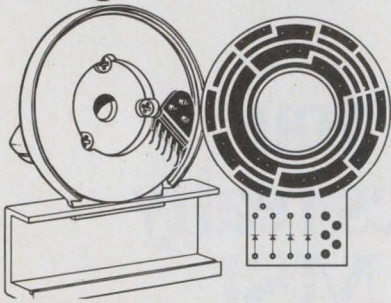

*Electro Scientific Industries, Inc., 13900 N. W. Science Park Dr., Portland, Ore. Phone: (503) 646-4141. Price: \$50 to \$60.*

The Data-Dial knob is an easy-to-install device that provides a link between older manual instruments and computer-compatible recording devices to allow inexpensive conversion of most calibration instruments to automatic data-logging equipment.

By replacing an instrument's existing knob with the Data-Dial knob, the instrument's ordinary decimal output is converted to a BCD output.

Essentially, the Data-Dial is a decimal-to-BCD shaft encoder that fits on the front panel of any instrument's 12-position switch having a 0.25-in.-diameter shaft. All that is needed after that is a +5-V power supply for the Data-Dial's operation.

Installation of the Data-Dial is quick. Indicators on it and on the instrument are placed at a 12-o'clock position. The instrument's knob is then removed and the Data-Dial knob is placed over the control's shaft and pressed firmly into place. Attachment to the instrument panel is maintained through the use of an adhesive. The installation is completed when screws holding the Data-Dial knob are tightened.

The logic and power-supply wires are held in place on the instrument's front panel by an attached cover. The instrument is now ready for connection to a data coupler.

The Data-Dial switch is mounted on a glass-epoxy printed-circuit board. Hard gold-on-nickel is used as the plating material for increased reliability and long life.

CIRCLE NO. 270

## 90-MHz 4-plug-in scope displays stored data

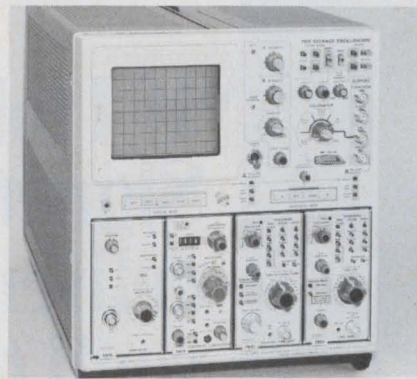

*Tektronix, Inc., Box 500, Beaverton, Ore. Phone: (503) 644-0161. P&A: \$3200; 4th quarter, 1970.*

The 7514 is a 90-MHz four-plug-in split-screen storage oscilloscope designed to use all the 7000-series plug-ins. A write-through mode of operation allows stored and conventional displays in the same area of the CRT. By operating the CRT at 18 kV, a writing speed of 450 cm/ $\mu$ s is achieved. A new auto-focus circuit eliminates manual focusing once initial focusing is done.

CIRCLE NO. 271

## Function generator varies cycle mode

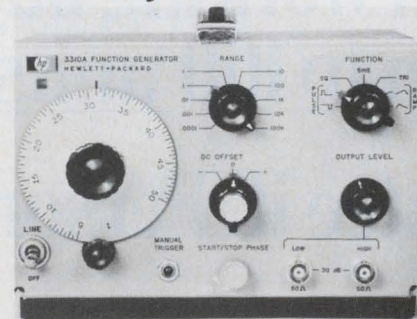

*Hewlett-Packard, 1501 Page Mill Rd., Palo Alto, Calif. Phone: (415) 326-7000. P&A: \$735; 1 wk.*

Supplying sine, square, and triangular waves, and positive and negative ramps and pulses from 0.0005 Hz to 5 MHz, the model 3310A Opt. H10 function generator offers single-cycle, multiple-cycle or free-run operation. Output amplitude can range from 15 mV to 15 V peak-to-peak into a 50- $\Omega$  load. Dc offset is  $\pm 5$  V into 50  $\Omega$ .

CIRCLE NO. 272

## Compact oscilloscope reaches up to 18 MHz



*B&F Instruments, Inc., Cornwells Heights, Pa. Phone: (215) 634-7100. P&A: \$1195; stock.*

Incorporating many new features in a compact size, the SM111 dual-channel oscilloscope covers the bandwidth of dc to 18 MHz. Other features are sensitivity of 2 mV/cm to 50 V/cm, a timebase of 200 ns/cm to 1 s/cm (5X magnifier extends time base to 40 ns/cm), and a 10 by 8-cm CRT with type 31 phosphor trace. Over-all dimensions are 10-in. high by 10-in. wide by 14-in. deep.

CIRCLE NO. 273

## DIP IC checker doubles tests

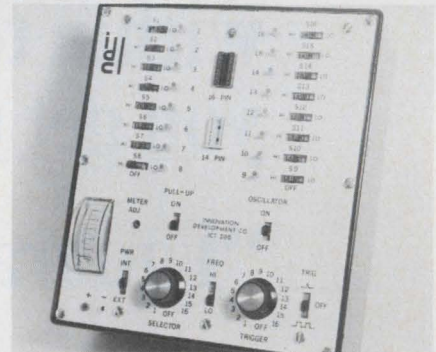

*Innovation Development Co., P.O. Box 7, Azusa, Calif. Phone: (213) 966-9275.*

A new and portable integrated circuit tester allows both dc component testing and functional verification of the device's operation. Model ICT-200 accepts 16-lead DIPs and checks them on-the-spot. Test points are provided at each pin for oscilloscope monitoring. The instrument measures 7.375 by 8.375 by 3 in. and weighs 2.51 pounds.

CIRCLE NO. 274



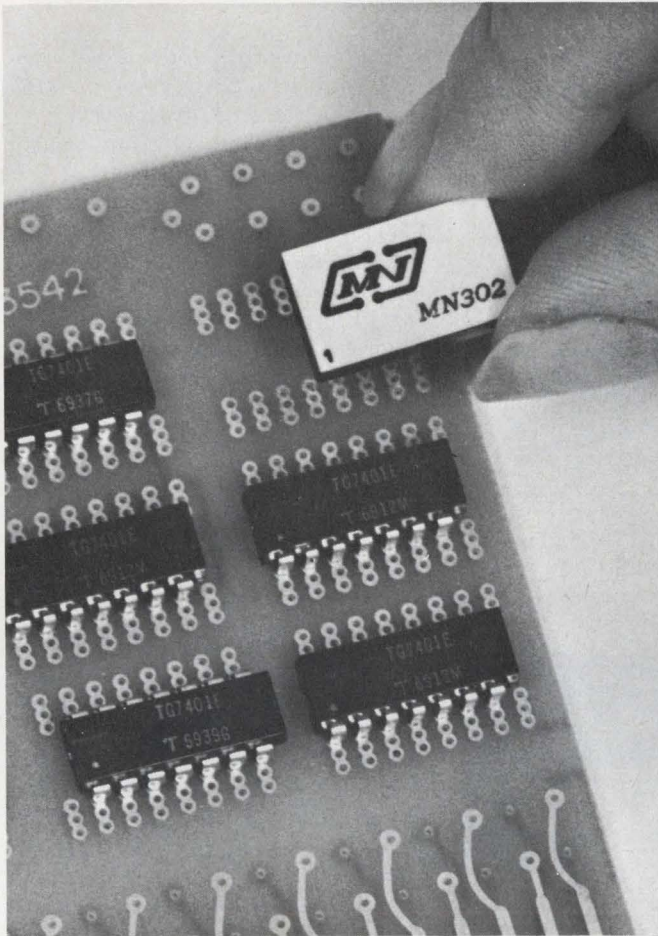

# complete

including precision ladder network and op amp

# low priced

\$79 (1 to 24 quantity), \$53 (100 quantity)

## 8 BIT D/A CONVERTER

in dual-in-line package

Micro Network's MN302 thin film hybrid digital to analog converter fits a standard 14 lead dual-in-line socket and includes a precision ladder network and op amp output. The 0.45 x 0.75 x 0.14 inch package is the electronic industry's smallest complete 8 bit D/A converter. Accuracy is 0.2 percent and maximum power consumption is only 400 mW.

Also available in BCD (MN303).

For more complete information write or call Robert Jay at:



**Micro Networks Corporation**

5 Barbara Lane • Worcester, Mass. 01604 • (617) 756-4635

INFORMATION RETRIEVAL NUMBER 77

## The power supply you plan to build is built!

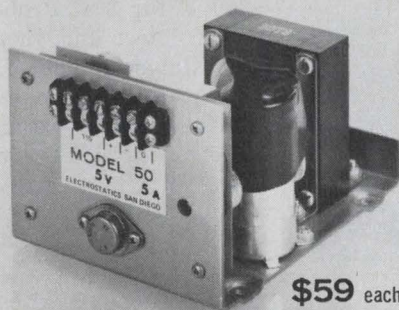

**\$59** each

OTHER MODELS 3 to 50 V available

It's on the shelf, ready for immediate delivery from Electrostatics. With specs proven in service. Low cost. Brief specs on our Model 50:

- 5V 5A Power Supply
- Input 105-125V, 47-420 Hz
- Regulation: Line 0.01% Load 0.1%
- Ripple: 500  $\mu$ V max.
- Temp: -20 to +70°C
- Foldback current limiting
- Size: 5" W x 4.13" H x 7" L

(\$69 with overvoltage protection)

For full information call Robert McCartney, Manager of Application Engineering, (714) 279-1414. Or circle the number below for our latest data sheet.

### Electrostatics, inc.

7718 Clairemont Mesa Blvd., San Diego, California 92111 DEPT. 102

INFORMATION RETRIEVAL NUMBER 78

ELECTRONIC DESIGN 19, September 13, 1970

## DESIGNERS' KEYBOARD

Standard 10-12 keyboards use reed switches for long life. Mechanical lockout feature allows simplified circuitry. Also momentary types available. With or without PC connections.

**SWITCH BANK**

SB-030 Series



**ALCOSWITCH®**

DIV. OF ALCO ELECTRONIC PRODUCTS, INC., LAWRENCE, MASS.

INFORMATION RETRIEVAL NUMBER 79

## DESIGN YOUR OWN KEYBOARD

A reliable reed switch is actuated by a permanent magnet. Close tolerance is maintained in operating pressure; and operating points are standard. Optional keytops similar to electric typewriters.

**STEP-UP FORMATION**



**ALCOSWITCH®**

DIV. OF ALCO ELECTRONIC PRODUCTS, INC., LAWRENCE, MASS.

INFORMATION RETRIEVAL NUMBER 80

# THE QUIET LAMP

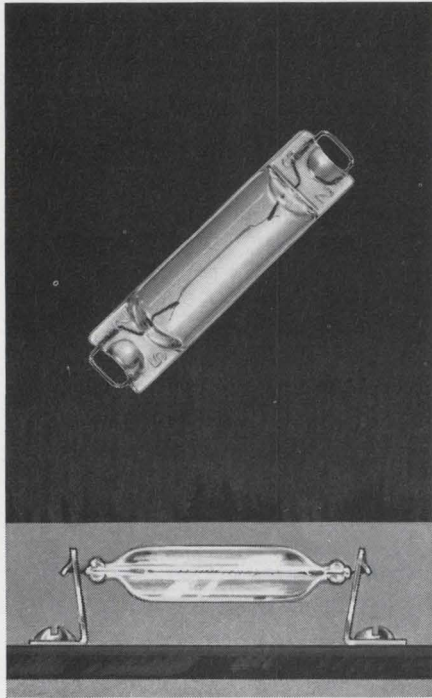

The design of this lamp makes it ideal for all audio-related applications where freedom from noise is desirable. There are no anchors, a principal source of noise. The lamp has no soldered connections and no soldered-on base. The clip-type mounting bracket is inexpensive and provides a low silhouette that conserves space. Can be supplied in 6 v. and 12 v. types. Write for catalog A-21. Tung-Sol Division, Wagner Electric Corporation, 630 W. Mt. Pleasant Avenue, Livingston, N.J. 07039; TWX: 710-994-4865, Phone: (201) 992-1100; (212) 732-5426.

## TUNG-SOL® BASELESS CARTRIDGE LAMP

TUNG-SOL—WHERE BIG THINGS ARE DONE WITH SMALL LAMPS

© Trademark TUNG-SOL Reg. U.S. Pat. Off. and Marcas Registradas

INFORMATION RETRIEVAL NUMBER 81

## INSTRUMENTATION

### Storage-scope plotters respond up to 1 MHz

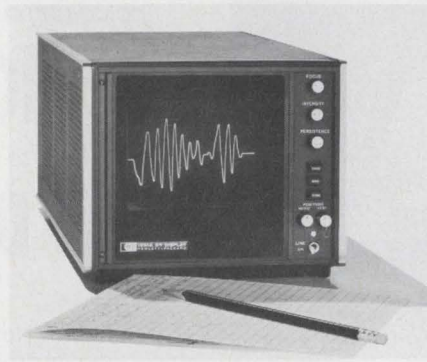

Hewlett-Packard, 1501 Page Mill Rd., Palo Alto, Calif. Phone: (415) 326-7000. P&A: \$1575; stock.

Displaying and plotting analog or digital data, models 1331A/C X-Y plotters with 5-in. storage CRTs respond at 1 MHz. Displays light up in 4  $\mu$ s, and the trace storage retains on-screen information for 15 minutes and erases it in 1 s. Shades of gray data can be written and stored. Trace writing speed is 20 cm/ms and full-screen deflection is at 1 V.

CIRCLE NO. 275

### Linear tester checks most ICs



Microdyne Instruments, Inc., 203 Middlesex Turnpike, Burlington, Mass. P&A: from \$7850; August 1970.

A new linear IC tester, model 735, is designed to check most operational amplifiers, comparators, regulators, and analog multipliers automatically. After test limits are set, it sequences through as many as 14 tests. Tests include offset voltage, bias and offset current, open-loop gain and power-supply and common-mode rejection ratios.

CIRCLE NO. 276

### Low-cost logic probes withstand 200-V inputs

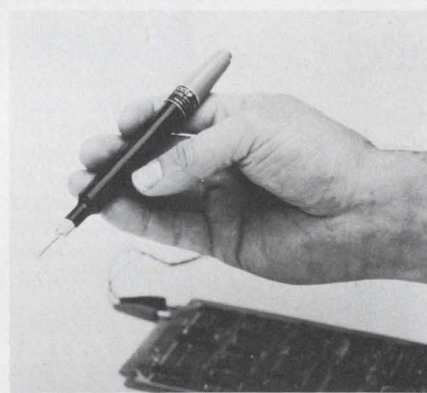

Automated Control Technology, Inc., 745 Distel Dr., Los Altos, Calif. Phone: (415) 964-4860. Price: \$30.

A new series of low-priced logic probes feature input overload protection up to 200 V continuous and -200 V for 3 s. Probe models 30 and 40 detect and visually display logic states 1 and 0. A visible lamp at each probe end indicates quiescent logic levels and identifies single pulses as narrow as 30 ms. Pulse repetition rates up to 30 pps can be detected.

CIRCLE NO. 277

### Spectrum analyzer displays 3 dimensions

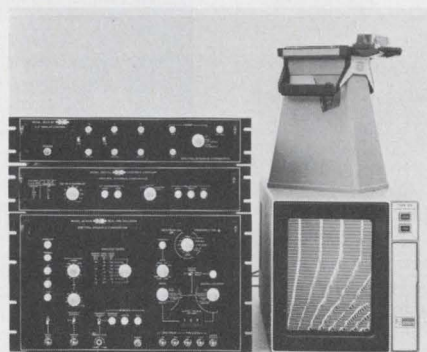

Spectral Dynamics Corp., P.O. Box 671, San Diego, Calif. Phone: (714) 287-2501. P&A: \$1250; 4 wks.

Three-dimensional spectrum displays are presented in real time with the SD25-80 3-D display control and the SD301B real-time analyzer. Changes in amplitude vs frequency vs time can be viewed directly on a long-persistence oscilloscope. Phenomena from 0.03 Hz to 20 kHz can be analyzed at rates as high as 20/s.

CIRCLE NO. 278

## DMM and counter units are scope plug-ins

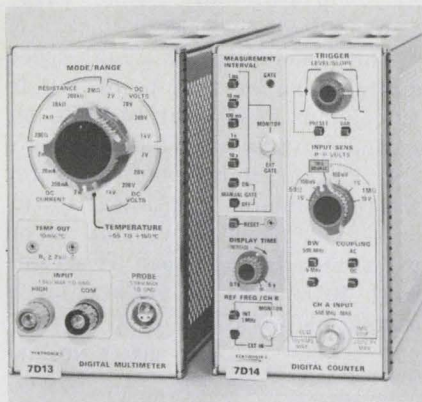

Tektronix, Inc., Box 500 Beaverton, Ore. Phone (503) 644-0161. Availability: 4th quarter, 1970.

Two new plug-ins expand the use of the 7000-series oscilloscopes. The 7D13 digital multimeter measures dc currents to 2 A, dc voltages to 1000 V, resistances to 2 M $\Omega$  and temperature from  $-55$  to  $+150^{\circ}\text{C}$ . The 7D14 counter measures up to 500 MHz by a gated technique without prescaling. Its accuracy is 0.00005%. Both units display an alphanumeric readout on the CRT.

CIRCLE NO. 279

## 54-range multimeter has $\pm 1\%$ dc accuracy

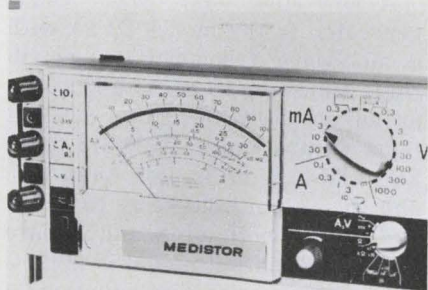

Medistor Instrument Co., 4503 8 Ave. N. W., Seattle, Wash. Phone: (206) SU4-8141. P&A: \$135; 35 days.

The new model N-3 multimeter features 54 ranges, a mirror-scale taut-band meter and dc accuracy of  $\pm 1\%$  of full scale on all ranges. Ac accuracy is  $\pm 1.5\%$ . Dc currents are measured from 40  $\mu\text{A}$  to 10 A and ac currents from 0.3 mA to 10 A. Both ac and dc voltages are measured from 0.3 to 3000 V full scale. Four resistance and two capacitance ranges are included.

CIRCLE NO. 280

# WHEN WILL COMPUTERS REPLACE PEOPLE?

## RIGHT NOW!

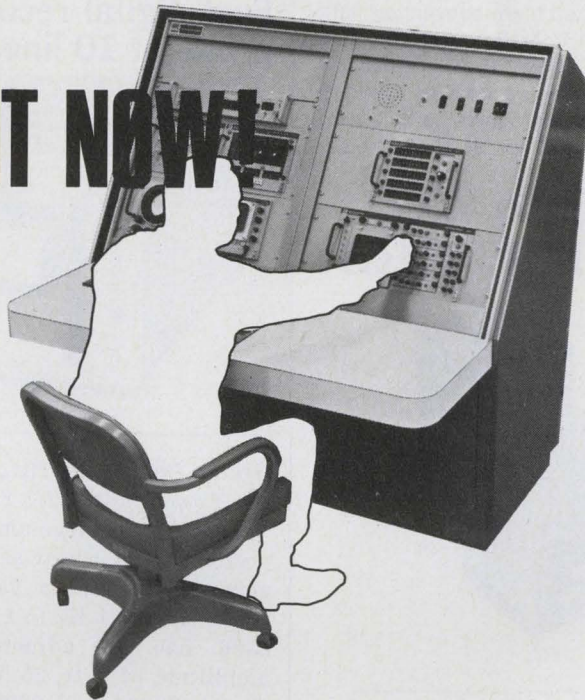

as a matter of fact, in W-J's new

## COMPUTER-CONTROLLED ECM SURVEILLANCE SYSTEM!

Just a short time ago, it took one flesh-and-blood operator to run the Watkins-Johnson ECM Surveillance System.

Things have changed.

Now a computer does the job, and it provides several advantages in the process:

**One**, digital organization makes the equipment compact and lightweight for airborne applications.

**Two**, prior programming provides fast reaction.

**Three**, unattended operation reduces manpower requirements.

For a demonstration of the W-J Capability, Send Your Specs Today!!!



WATKINS-JOHNSON

3333 HILLVIEW AVE., PALO ALTO, CALIFORNIA 94304 • TELEPHONE: (415) 326-8830

INFORMATION RETRIEVAL NUMBER 82

Premium-engineered ERA Transpac® Inverters convert low voltage DC to 115 VAC, 60 or 400 cps. Solid-state designs assure high shock and vibration resistance, high conversion efficiency, stable operation and minimum maintenance. New ERA Transpac® Frequency Changers convert any 115 VAC, 50-1000 cps source to 115 VAC output, 60 or 400 cps at power levels.

## DC to AC INVERTERS

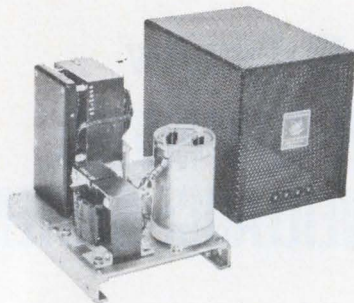

## AC to AC FREQUENCY CHANGERS

These highly stable Inverters or Frequency Changers are ideal for the exacting requirements of AC-operated equipment in lab, military or industrial applications, providing high reliability at moderate cost. *Types available:* non-regulated square-wave output; regulated square-wave output; regulated sine-wave output.

Write Today for Catalog #138



**ERA TRANSPAC  
CORPORATION**

A Subsidiary of  
Electronic Research Associates, Inc.  
67 Sand Park Road, Cedar Grove, N.J. 07009  
(201) 239-3000

INFORMATION RETRIEVAL NUMBER 83

## INSTRUMENTATION

### Fast digital recorder prints at 10 lines/s

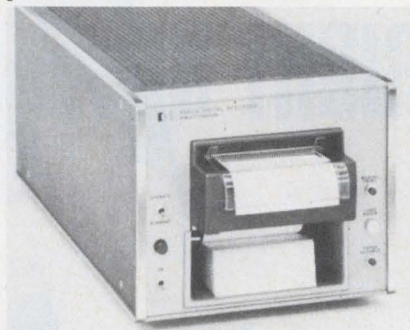

Hewlett-Packard, 1501 Page Mill Rd., Palo Alto, Calif. Phone: (415) 326-7000. P&A: \$1150; stock.

The model 5055A is a high-speed digital recorder that prints up to 10 columns of data at 10 lines per second. It has individual changeable 16-character print wheels for the ten columns. Printing is in ink on regular paper or without ink on pressure-sensitive paper. It accepts 8421 BCD data at voltage levels compatible with TTL ICs.

CIRCLE NO. 281

Gralex Industries, Inc., 155 Marine St., Farmingdale, N. Y.

Providing large-amplitude bipolar outputs, a new series of pulse generators offers a variable repetition rate of 1 Hz to 1 MHz. Model 2306 has an adjustable output amplitude of 0 to 25 V into 50 Ω. Models 2306A and 2306B have outputs of 0 to 40 and 0 to 50 V, respectively. Rise and fall times are 1 or 1.2 ns. Repetition rate can be varied from the front panel.

CIRCLE NO. 282

### Pulse generators give 50-V output



### Sine/square generator is accurate to ±1%

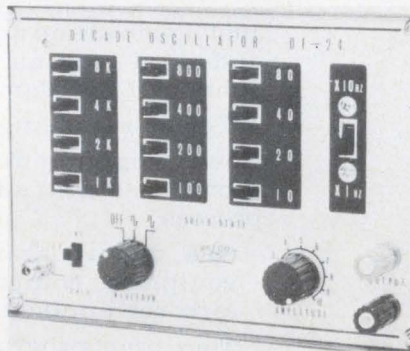

Hollywood Instruments, Inc., P. O. Drawer 1400, Hollywood, Fla. Phone: (305) 983-6453. Price: \$60.

A new sine/square-wave decade generator is the model DF24 with a sine-wave frequency range, in three bands, of 10 Hz to 166.5 kHz at an accuracy of  $\pm 1\% \pm 1$  Hz. Square-wave range is 20 Hz to 30 kHz. Distortion is less than 1% and the output voltage is 10 dB at 10 kΩ for both sine and square waves. The output signal is adjustable with a variable attenuator.

CIRCLE NO. 283

Medistor Instrument Co., 4503 8th Ave., Seattle, Wash. Phone: (206) 784-8141. P&A: \$1125; 20 days.

Model A-72A is a differential voltmeter with  $\pm 0.002\%$  accuracy and 2 ppm/day stability which can detect a 0.1-μV charge. It has six readout dials and five ranges from 110 mV to 1100 V full scale. Its smallest voltage step is 0.1 μV and it uses a zener oven that operates from the line voltage or from internal rechargeable batteries.

CIRCLE NO. 284

### Differential voltmeter is accurate to ±0.002%

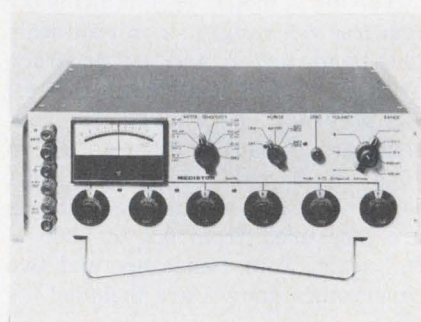

## Low-cost pulse source covers 1 Hz to 1 MHz

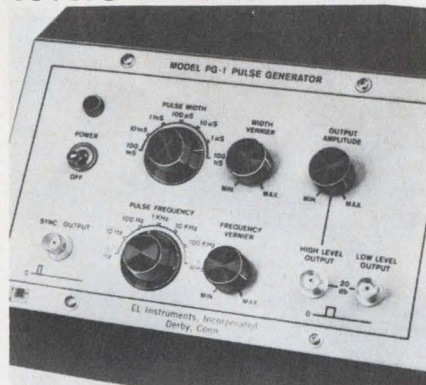

El Instruments Inc., 61 First St., Derby, Conn. Price: \$150.

The PG-1 is a low-cost digital signal source with frequency and pulse width ranges of 1 Hz to 1 Mz and 100 ns to 100 ms, respectively. Output impedance is 50  $\Omega$ , and rise and fall times are 20 ns. The PG-1 is compatible with RTZ, DTL and TTL integrated circuit modules as well as discrete-component circuits. Maintenance and calibration procedures are minimized by the extensive use of high-speed digital and linear ICs.

CIRCLE NO. 285

## Deviation calculator reads out five digits

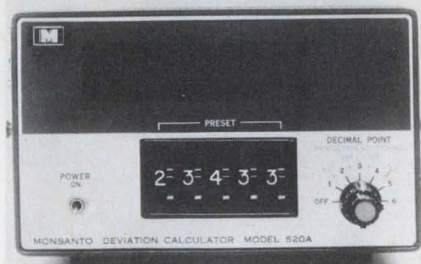

Monsanto Electronic Instruments, 620 Passaic Ave., West Caldwell, N. J. P&A: \$650; September, 1970.

The model 520A five-digit programmable deviation calculator automatically computes and displays the sign and difference between any measured BCD variable and a reference value. The reference value can be set manually with a five-digit thumbwheel switch or programmed externally. Maximum calculating time is 200  $\mu$ s.

CIRCLE NO. 286

## Fast custom design hybrid microelectronics

... like a 2 amp integrated circuit interface, driver circuit

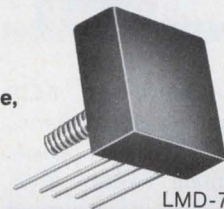

LMD-7 DRIVER

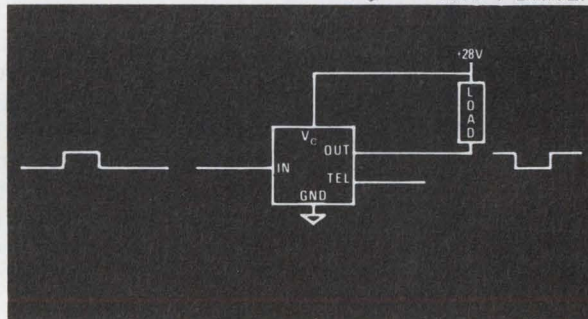

Typical Application and Connection Diagram

### Absolute Maximum Ratings

Parameter	Symbol	Min.	Typ.	Max.
Applied voltage	V <sub>c</sub>	22V	28V	32V
Output voltage	out	3V		45V
Input threshold	in	1.5V	3.0V	32V
Output current	I <sub>out</sub>			2A
Surge current	I <sub>surge</sub>			5A
Max. "ON" voltage drop	V <sub>on</sub>		1.4V	2V

Our microelectronics engineers developed this circuit to convert a low level input control signal into a high level output signal.

It drives solenoids, stepping switches, lamps and peripheral equipment associated with integrated logic levels.

We're equipped to give you fast design and prototype service on any custom hybrid microelectronics package. Our engineers will come to you, if that's what you need.

You'll find our delivery dependable and our production standards among the highest in the industry.

The circuit described above is now stocked. Ask for catalog sheet. Or, for the whole story on our capability, write for brochure, "Custom Hybrid Microcircuits."

Specialists in hybrid microelectronic circuits



LEDEX MICROELECTRONICS, LEDEX INC.  
123 Webster Street, Dayton, Ohio 45401 phone (513) 222-6992

INFORMATION RETRIEVAL NUMBER 84

### Low-cost \$88 keyboard mounts on a PC board



*Mechanical Enterprises, Inc., 5249 Duke St., Alexandria, Va. Phone: (703) 751-3030. P&A: \$88; stock.*

The new tri-mode 65-key Mercuronic coding keyboard mounted on a PC board features low cost of \$88 (quantities of 1000). Its output is ASCII-coded and it can be supplied with any special code using up to 10 bits. The \$88 price includes shift control, and strobe-signal-inhibit circuits. Individual keys are attached to the PC board with ordinary screws.

CIRCLE NO. 287

### Plated-wire memory fits on 2 PC boards

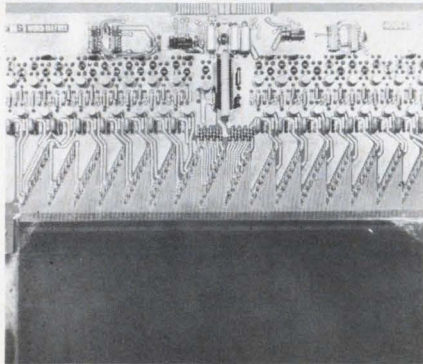

*Memory Systems, Inc., 3341 W. El Segundo Blvd., Hawthorne, Calif. Phone: (213) 772-4220. P&A: 5¢/bit; 60 days.*

The system/300 is a generic family of plated-wire memories comprised of two 12 by 15-in. circuit boards: a word board and a sense-digit and timing and control board. Each word board contains a 256 word by 80-bit plane driven by a 16 by 16 diode matrix. Single-turn word straps intersect two crossover-per-bit digit lines to form each bit location.

CIRCLE NO. 288

### Magnetic-tape transport read/writes at 5 in./s



*Compucord, Inc., 225 Crescent St., Waltham, Mass. P&A: \$980; 30 days.*

The CompuDette 1210 is a serial-in/serial-out digital magnetic-tape transport with a read/write speed of 5 in./s. It also features bi-directional read and write, variable packing density to 1600 bits/in. and remote and manual control. Start/stop time is less than 20 ms and a self-contained power supply is included. A standard 4 by 2-1/2 by 3/8-in. cassette is used.

CIRCLE NO. 289

### 16-digit calculator has two memories

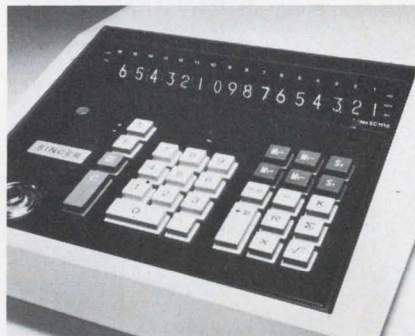

*Singer Co., Friden Div., 2350 Washington Ave., San Leandro, Calif. Phone: (415) 357-6800. P&A: \$1195; 30 days.*

Model 1116 16-digit calculator contains two direct-access memory registers and features square-root capability. By using its memory-plus and memory-minus keys, an operator may directly add to or subtract from the contents of either memory register. The registers may be used to retain constants or intermediate answers.

CIRCLE NO. 290

### Low-cost I/O terminal costs only \$2315



*KSW Controls Inc., 340 Post Rd., Fairfield, Conn. Phone: (203) 255-3483. P&A: \$2315; 30 days.*

The new Terminal/900, a low-cost I/O modified Selectric-type-writer terminal compatible with 2741 software, is priced at only \$2315. It is available with EBCD and BCD codes and operates in full and half-duplex modes by means of a keyboard. Unique features include computerized tab set capability and a low-cost plotting option made possible by reverse line feed and half spacing.

CIRCLE NO. 291

### Transmission scrambler codes and decodes data

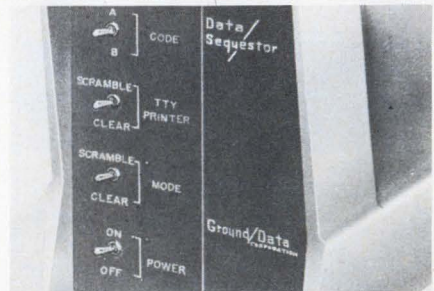

*Ground/Data Corp., 4014 N. E. 5th Terr., Fort Lauderdale, Fla. Phone: (305) 563-2527. P&A: \$1400; 90 days.*

The Data Sequestor provides privacy for users of teleprinters or other data terminals by scrambling the text prior to transmission and unscrambling the signal at the receiving station in accordance with a pre-arranged code. Without the exact code setting, no intelligence can be discerned from the scrambled output.

CIRCLE NO. 292

**14-bit cermet ladder tracks to 1 ppm/°C**

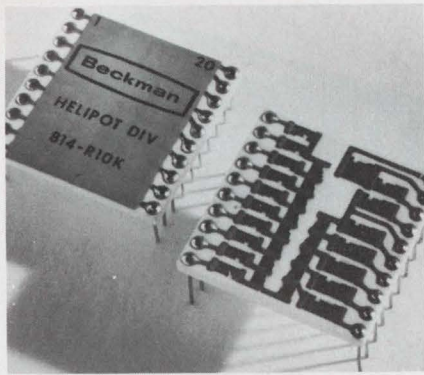

Beckman Instruments, Inc., Helipot Div., 2500 Harbor Blvd., Fullerton, Calif. Phone: (714) 871-4848. P&A: \$70; stock.

Featuring a settling time to 100 ns and an output-voltage-ratio error as low as 33 ppm, the 814 14-bit binary cermet thick-film ladder network tracks to within 1 ppm/°C. Its operating temperature range is from -20 to +80°C and it is available with resistance values of 10 kΩ. Its low profile makes it compatible with flatpacs and DIPs.

CIRCLE NO. 293

**Power servo op amp supplies 1000 watts**

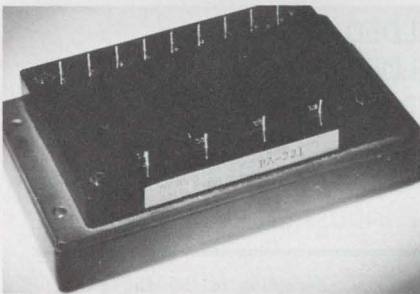

Torque Systems Inc., 225 Crescent St., Waltham, Mass. Phone: (617) 891-0230. Price: \$385.

With an output of ±25 A at ±40 V, the new PA-221 operational amplifier for driving dc servo motors supplies 1000 W of class B output power. Open-loop gain is 300,000 and reference power requirements are -15 V at 1 mA. Other features include built-in current limiting for full servo gain and compensation, and short-circuit protection. Size is 2.75 by 4.68 by 1.16 in.

CIRCLE NO. 294

# LED

**New low cost LED Vactrol photon isolator**

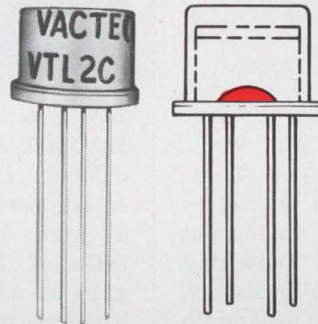

**as low as \$4.20 each in 1,000 quantities**

- all solid state
- 4 types of photoconductors combined with LEDs
- hermetically sealed TO-5 enclosure
- unlimited life—no filaments
- ideal for environments where shock and vibration are a problem
- applications include photochoppers, linear isolators, noiseless switching, SCR and triac turn-on, audio level controls, etc.

Part Number	LED	PHOTOCELL		
	Current (ma) (1.65v typ.)	Max. Cell Resistance	Typical Rise Time (ms)*	Decay
VTL2C1	40	10 KΩ	.5	3.5 ms **
VTL2C2	40	500 Ω	3.5	500 ms †
VTL2C3	40	2 KΩ	2.5	35 ms †
VTL2C4	40	75 Ω	6.0	1.5 sec †

\* To 63% conductance

\*\* To 1 meg

† To 100 K Ω

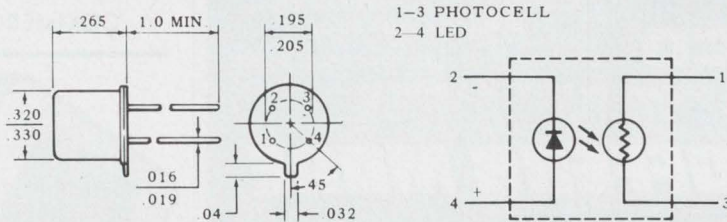

Vactec confines its production activities entirely within the United States. Advanced mechanized techniques provide highest quality at prices competitive with other manufacturers **anywhere** in the world.

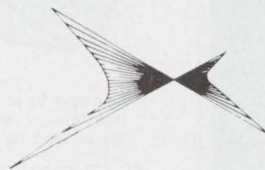

## VACTEC, INC.

2423 Northline Ind. Blvd.  
Maryland Heights, Mo. 63043  
Phone: (314) 872-8300  
Write for Bulletin VTL2C

Specializing in standard Cds, Cdse, and Se sells; custom engineering for every photocell need. Listed in EBG under "Semi-Conductors" and in EEM Sec. 3700.

INFORMATION RETRIEVAL NUMBER 85

### Tiny d/a converter mounts on PC board

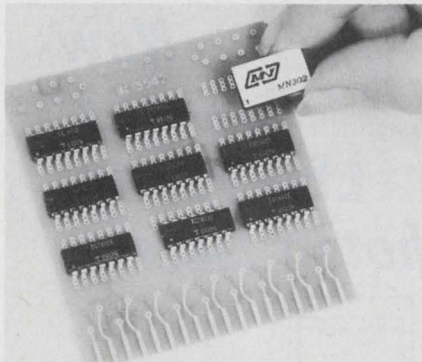

Micro Networks Corp., 5 Barbara Lane, Worcester, Mass. Phone: (617) 756-4635. P&A: \$79; stock.

Only 0.45 by 0.75 by 0.14 in., the MN302 8-bit d/a converter comes complete with an output operational amplifier, switching network and precision resistors, and is designed to be used with DIP sockets on standard printed-circuit boards. Its slew rate is 0.5 V/ $\mu$ s, temperature coefficient is  $\pm 10$  ppm/ $^{\circ}$ C and power consumption is 400 mW.

CIRCLE NO. 295

### High-gain op amp has $1.5 \times 10^6$ CMRR

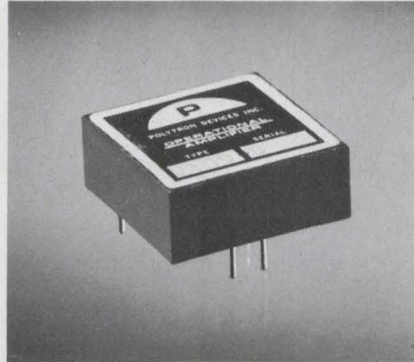

Polytron Devices, Inc., P.O. Box 398, Paterson, N. J. Phone: (201) 523-5000. P&A: \$68; stock.

Model P209-9 high-gain differential operational amplifier exhibits a high common-mode rejection ratio of 1.5 million and voltage gain of 1.5 million. Dc resistance between inputs is  $10^{12}\Omega$  with an input capacitance of 4 pF. Gain-bandwidth product is 2 MHz and full-power output frequency is 50 kHz. Offset voltage is 1 mV and offset current is 2.5 pA.

CIRCLE NO. 296

### Negative-bias supply converts positive input

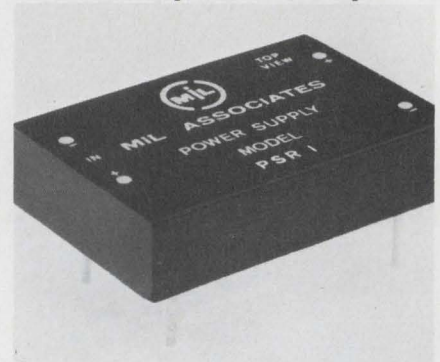

Mil Electronics, Dracut Rd., Hudson, N. H. Phone: (603) 889-6671. P&A: \$15.60; stock to 1 wk.

The low-cost PSR-1 plug-in negative-bias supply converts a +12-V dc source to -10 V dc without the use of a transformer. Its output power is 150 mW and output ripple is less than 20 mV pk-to-pk. Output resistance is less than 100  $\Omega$  and typical efficiency is 70%. Because of its high efficiency, excessive current drain is minimized. The PSR-1 is only 0.37-in. high.

CIRCLE NO. 297

## ALCO LITE OFFERS MORE

Miniature assembly has unbased T-1 #680 incandescent lamp replaceable from front of panel without tools. Rated 5V @ 60mA. Choice of lens color. Model BFK-5. 77¢ ea./per 100.



REPLACE-A-LAMP PILOT

**ALCO** ELECTRONIC PRODUCTS, LAWRENCE, MASS.  
INFORMATION RETRIEVAL NUMBER 86

## ALCO LITE OFFERS MORE

Ideal for space limitations. BNE's lens appears slightly above panel. BNF lens is higher for greater illumination. BND square lens projects from panel for max. light intensity. With and without internal resistor.

### MODERN NEON PILOTS

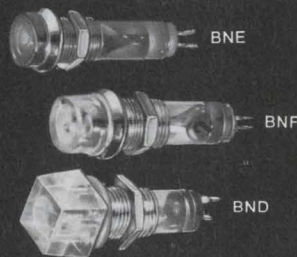

**ALCO** ELECTRONIC PRODUCTS, LAWRENCE, MASS.

INFORMATION RETRIEVAL NUMBER 87



# JAMES

THE NATION'S PRIME SOURCE FOR—

- SHIELDED SIGNAL
- SHIELDED POWER
- SOLID STATE POWER

## TRANSFORMERS

COMMERCIAL • INDUSTRIAL • MILITARY

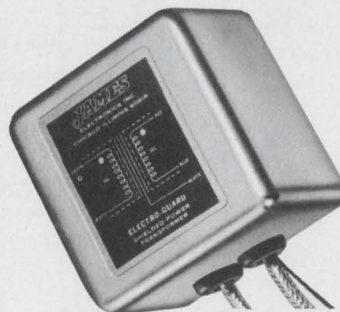

Shielding to 150 db  
Power Ratings 1 watt to 1 kw  
Flat Pack, Open Frame,  
Sealed—A model for every use



215 Standards In Stock

One may fit your needs or use the simplified "Transformateria" technique of ordering a special. Delivery in ten days to your specs. Send for your "Menu" today.

## JAMES ELECTRONICS, INC.

4050 N. ROCKWELL AVE., CHICAGO, ILL. 60618 • PHONE: 312 463-6500

INFORMATION RETRIEVAL NUMBER 88

ELECTRONIC DESIGN 19, September 13, 1970



## Constant-current unit has 100-M $\Omega$ output

California Electronic Mfg. Co., Inc., Box 555, Alamo, Calif. Phone: (415) 932-3911. P&A: \$78; stock.

The model 925 constant-current module supplies an output of 10 to 50 mA and 0 to 10 V with a current regulation of 0.001% and an output impedance greater than 100 M $\Omega$  at a 10-mA output. Isolation at a 10-mA load is 0.01%/V. The model 925 module measures 1.5 by 1.5 by 0.7 in., has a temperature stability of 0.01%/°C, and meets MIL-E-5272 requirement provisions.

CIRCLE NO. 298

## Monolithic regulators hold 38 V to $\pm 5.5$ mV

Transitron Electronic Corp., 168 Albion St., Wakefield, Mass. Phone: (617) 245-4500.

Series TVR2000 monolithic voltage regulators maintain an output voltage in the range of 0 to 38 V to within  $\pm 5.5$  mV. The new regulators operate with a constant output impedance and dissipate only 800-mW of power. They can operate at output load currents up to 200 mA and are available in hermetic cerdip, TO-100 and 14-pin plastic DIP cases.

CIRCLE NO. 299

## Lin/log amplifier is sensitive to -80 dBm

Hallicrafters Co., 600 Hicks Rd., Rolling Meadows, Ill. Phone: (312) 259-9600.

Model 58-588 is a thick-film logarithmic i-f amplifier that provides linear-to-logarithmic conversion over a 60-dB signal range at 4.5 MHz and at a sensitivity of -80 dBm. It operates from a +12 and a +5-V supply with a 70-dB gate-off feature and a voltage-control option that provides several decades of gain adjustment. Multiple detectors provide 50 and 500- $\Omega$  outputs.

CIRCLE NO. 340

# If you'd like to make your FM radio 20 times smaller, we've got just the filter for you.

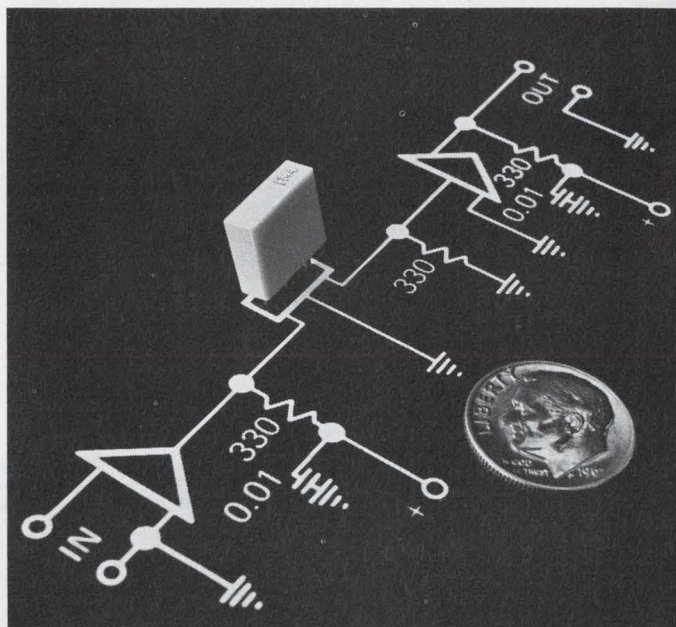

Our new 10.7 megahertz FM filter — the FM-4 — measures only 0.016 cubic inches in volume. But it replaces four tuned circuits more than twenty times its size. Price is competitive with IF cans, and it saves additional dollars by reducing the number of components and interconnections in your IF strip. It's just a sample of what Vernitron can do in piezoelectric filters — in which we've done the lion's share of development.

The FM-4 is based on the coupled-mode monolithic technique developed for our quartz filters. Result is a new level of performance — higher adjacent channel rejection, distortion less than 1/2 percent, bandwidths characteristically 235 kHz at 3 dB and 825 kHz at 40 dB. Insertion loss about 3.5 dB. It's just a sample of what we can do in piezoelectric filters — in which we've done the lion's share of development.

So, if you're on a size-reduction kick — or a cost reduction kick — our neat little FM-4 is a good place to start. In fact, for high-quality filters for almost any kind of communication equipment — military, commercial or consumer — get in touch.

Vernitron Piezoelectric Division, 232 Forbes Road, Bedford, Ohio 44146. Or: Vernitron (U.K.) Limited, Southampton, England.



**Vernitron Piezoelectric Division**

232 Forbes Road / Bedford, Ohio 44146 / (216) 232-8600

INFORMATION RETRIEVAL NUMBER 89

## Pencil-sized hand tool bends leads easily

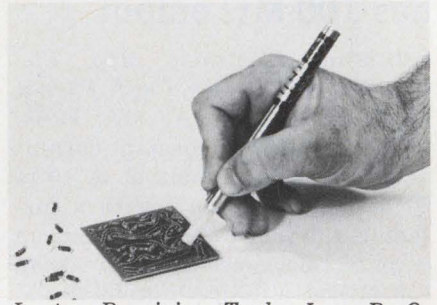

Lectro Precision Tools, Inc., P. O. Box 1360, Minnetonka, Minn.

Approximately the size of a pencil, a new tool measuring 5-1/2 in. long and 3/8 in. in diameter simplifies component-lead bending. It is portable, handy, weighs only 1 oz and is easy to use. It will bend any kind of lead with its sturdy nylon tip quickly and easily without disturbing components. The tip is replaceable and can be reshaped or sharpened with a file. Its barrel is made of aluminum.

CIRCLE NO. 341

## Heat-gun attachments shrink tubing fast

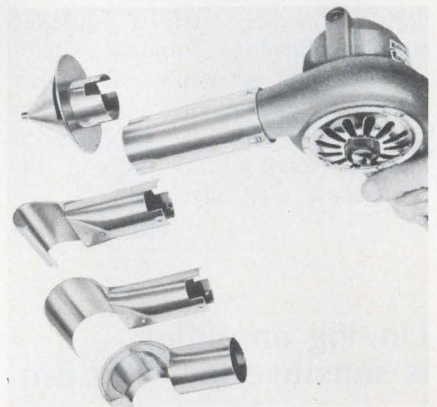

Master Appliance Corp., 1745 Flett Ave., Racine, Wis.

Two new chrome-plated accessory baffle attachments for flameless heat guns provide fast and positive shrinking of plastic tubing. One is an 8-in.-wide baffle for shrinking long-length plastic tubing up to 3/4-in. in outside diameter. The other is a 2-in.-wide baffle for shrinking plastic tubing up to 1-3/4-in. in outside diameter. The two baffles snap easily into place on heat guns which provide 1000°F temperatures.

CIRCLE NO. 342

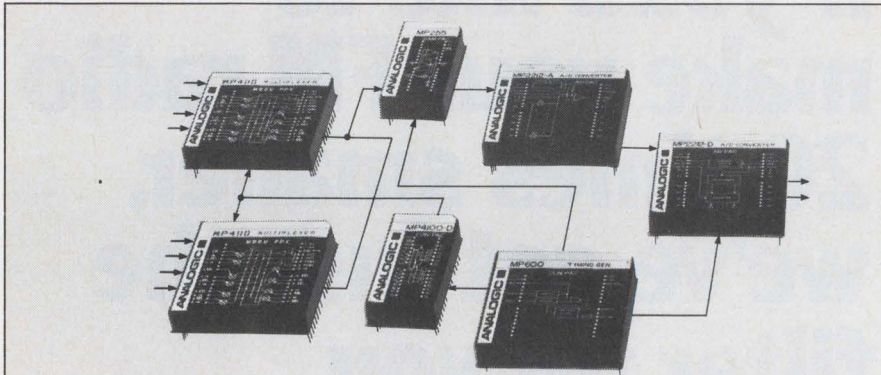

ANALOGIC INTRODUCES

# the first family

**ANALOGIC** ■  
...The Digitizers

Audubon Rd., Wakefield, Mass. 01880  
Tel. (617) 246-0300, TWX (710) 348-0425

Analogic's new **Modupac™** line is the first **complete** family of analog-digital-analog signal conversion modules. They're available as independent single units, or in any combination, and easily interconnected to form all or part of a limitless range of systems. However you specify them, Analogic **Modupac™** modules offer you the following advantages:

- Pre-system engineered for maximum performance and high M.T.B.F.
- Both electrostatically and electromagnetically shielded . . . yet easily repairable.
- Standardized terminal arrangement.
- 0.10" pin spacing . . . for P.C. or "DIP" socket mounting.
- 3 plan sizes: 1" x 2", 2" x 2", and 2" x 4"; most are 0.39" high.

Function for function, the best price-performance ratio available.

INFORMATION RETRIEVAL NUMBER 90

# Vector

## Vector systems help you CUT BREADBOARDING TIME

SOLDERLESS U-CLIP TERMINAL

Choose the type that meets your needs.

1. Mount D.I.P.'s, Transistors, Round Can Integrates, directly to board or in sockets. Patch cord hook-up available.
2. Solderable push-in terminals for .042", .062" or .093" holes.
3. Handsome new extruded aluminum rails that make into expandable circuit cases or chassis in virtually any size and shape. Hardware for mounting in plug-in racks or chassis.
4. Pre-punched Copper-Clad Cards for do-it-yourself etching. Also solderless spring terminals.

May we send you complete information including sample Vectorbord® and terminals? There is no obligation.

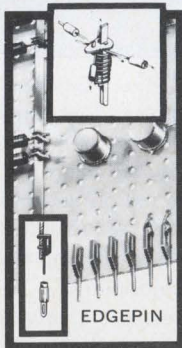

EDGE PIN

4 WAYS

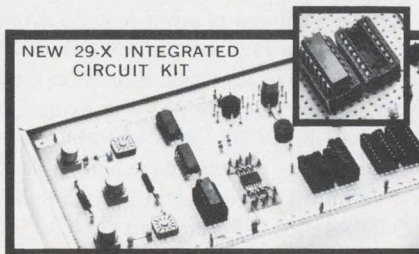
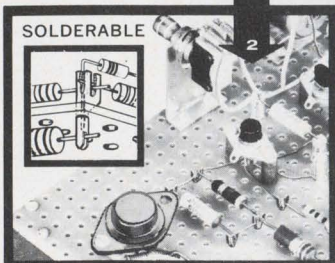
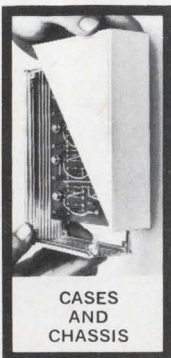

**Vector ELECTRONIC COMPANY, INC.**  
12460 Gladstone Ave., Sylmar, Calif. 91342

INFORMATION RETRIEVAL NUMBER 91

### Broadband switches swing out to 18 GHz

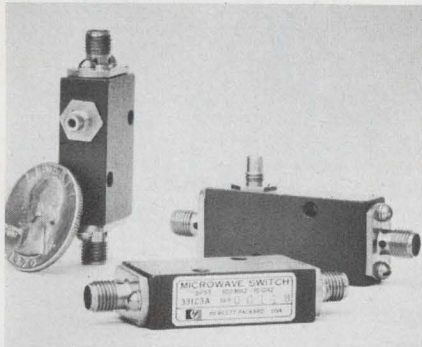

Hewlett-Packard, 1501 Page Mill Rd., Palo Alto, Calif. Phone: (415) 326-7000. P&A: \$125 to \$130; 2 wks.

New spst microwave switches with bandwidths as broad as 0.1 to 18.0 GHz are now available at prices ranging from \$125 to \$175. With this bandwidth, users can standardize on a single switch style for simplified systems designs. Models 33102A, 33103A, and 33104A have switching speeds of 50 ns. Models 33122A, 33123A, and 33124A have 15-ns switching speeds.

CIRCLE NO. 343

### Small 50-W amplifier spans 115 to 400 MHz



Microdot Inc., 220 Pasadena Ave., S. Pasadena, Calif. Phone: (213) 682-3351.

The model 207 50-W power amplifier covers the range of 115 to 400 MHz in an instrument only 19 by 7 by 15 in. It utilizes a proprietary cavity design with distributed-constant transmission lines for good heat-sink cooling and high efficiencies. The cavity measures only 3 by 4 by 11 in. and is easily removed from the main chassis to permit servicing.

CIRCLE NO. 344

### Gunn-effect oscillators operate to 60 GHz

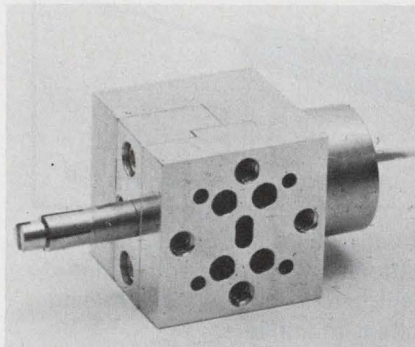

Varian, Solid State Div., 611 Hansen Way, Palo Alto, Calif. Phone: (415) 326-4000.

The VSE-9020 series of Gunn-effect oscillators deliver a 5-mW cw output over a 200-MHz range for operation at 50 to 60 GHz. They are tunable with a single screw and are designed to operate over the temperature range of 0 to 50°C. Bias voltage is 3.2 V dc and operating bias current is 500 mA dc. The output is exceptionally free of spurious and harmonic signals.

CIRCLE NO. 345

### Silicon phototransistors cover 0.2 to 3 mA

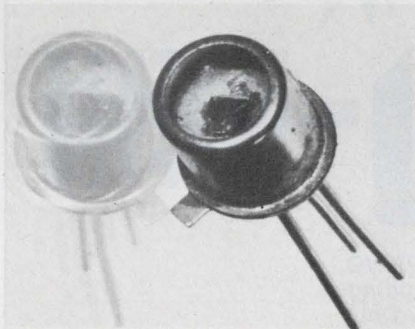

Clairex Electronics, 560 S. Third Ave., Mount Vernon, N. Y. Availability; stock.

Three new silicon phototransistors cover a light sensitivity range from 0.2 to 3 mA at 5 mW/cm<sup>2</sup> and at maximum collector-to-emitter voltages of 15 to 50 V. Type CLT2010 ranges over 0.2 to 0.6 mA, type CLT2020 ranges over 0.4 to 1.2 mA and type CLT2030 has a range of 1 to 3 mA. Sensitivity tolerance is 3:1. All units are supplied in three-lead TO-18 packages.

CIRCLE NO. 346

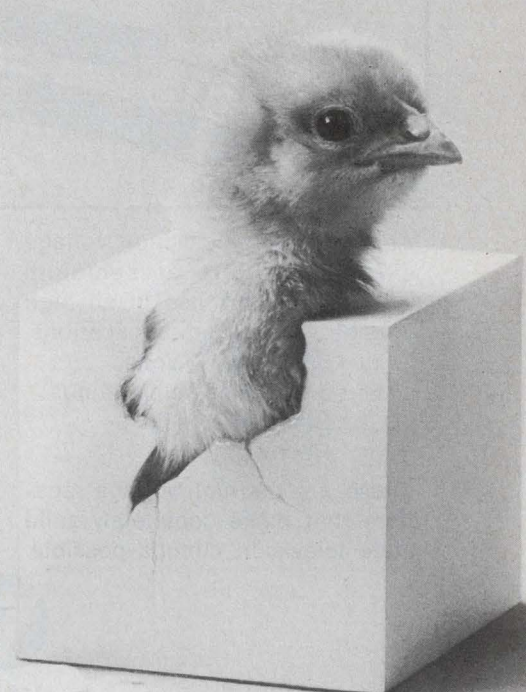

One of the  
unique qualities  
of Electro Cube  
is to produce  
non-standard  
packages readily

electro cube  
capacitors

We also make 4,000 or more standard capacitors with wound dielectrics. If case style is a problem, ask. We'll help. Electro Cube, Inc., 1710 South Del Mar Road, San Gabriel, California 91776. (213) 283-0511

## Varo High Voltage Rectifiers: Silicon Performance at Selenium prices.

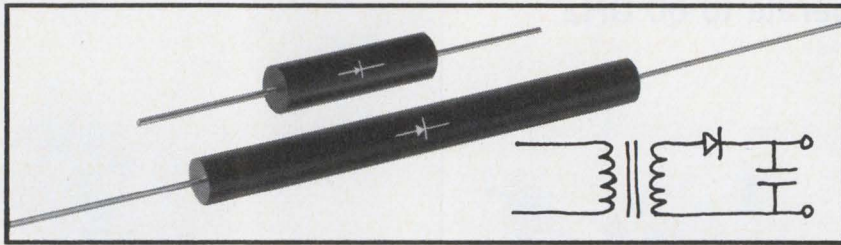

At last, economical high voltage silicon rectifiers at selenium prices! Ideal for use in all high voltage, low current applications.

- 5,000-40,000 Volts
- 5, 10, 25 milliamp ratings
- Standard and Fast Recovery

These are the high voltage rectifiers that make completely solid state television circuits possible.

Equally well suited for use in other cathode ray tube applications, electrostatic power supplies and voltage multipliers.

10,000v, 5mA rating. Quantity of 1,000. Complete details, applications, and price list available.

ONLY **\$1.32**



SEMICONDUCTOR DIVISION, 1000 N. SHILOH ROAD, GARLAND, TEXAS 75040 (214) 272-4551  
INFORMATION RETRIEVAL NUMBER 93

## PACKAGING & MATERIALS

### Coaxial connectors simplify assembly

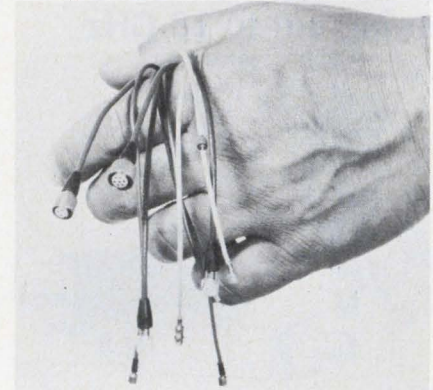

Microtech, Inc., 777 Henderson Blvd., Folcroft, Pa. Phone: (215) 532-3388.

A new line of low-cost ultra-miniature coaxial and multi-contact connectors simplify cable assembly. To fabricate a coaxial cable assembly, the cable is simply threaded into a plug. To fabricate a multi-contact connector assembly, a special four-conductor cable is easily soldered to a socket assembly and snapped into the plug body. Connectors are available in outer-diameter sizes of 1/8 to 1/4 in.

CIRCLE NO. 410

# the Mighty - mini



Schrack's NEW MINIATURE STEPPING SWITCH, Type RTM, is the smallest stepping switch available on the market today. Only 1/4 the size of comparable steppers, it combines high performance with economy of space and cost.

The RTM is equipped with 2 x 10 or 2 x 12 gold-plated contacts and mates with our socket which meets standard printed circuit spacings. Unique hold-down spring enables mounting in any position.

Write for free catalog today. Schrack also manufactures all types of relays, stepping switches and accessories. Catalogs upon request.

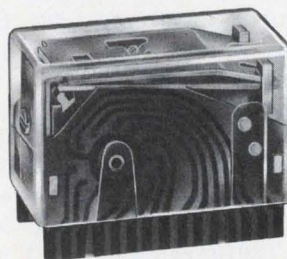

1 41/64" L x 13/16" W x 15/16" H

Selected territories available for representation.  
**SCHRACK** ELECTRICAL SALES CORP.

1140 Broadway, New York, New York 10001  
tel: (212) 683-0790

INFORMATION RETRIEVAL NUMBER 94

### PC board for discretes takes DIPs and TO-5s

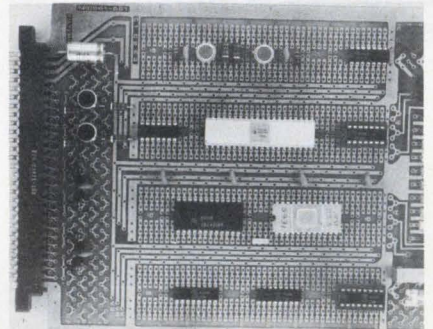

Progress Electronics Co., 5160 N. Lagoon Ave., Portland, Ore. Phone: (503) 285-0581. Price: under \$20.

Designed for integrated and discrete-circuit prototyping, a new PC board with a 56-pin gold-plated-finger connector can accommodate combinations of: 8, 14 and 16-pin DIPs with 0.3-in. spacing; 24, 36 and 40-pin DIPs with 0.6-in. spacing; 4, 8 and 10-pin TO-5 cans; transistors; diodes; potentiometers and test points. It is double-sided with plated-through holes.

CIRCLE NO. 411

## Interconnections emphasize density

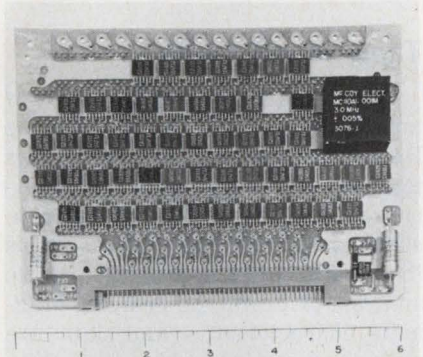

Micro Technology, div. of Sterling Scientific Industries, 5388 Sterling Center Dr., Westlake Village, Calif. Phone: (213) 889-1470.

Providing high-density circuit board packaging for digital and analog information systems, the Micropoint circuit interconnections are said to handle all configurations and combinations of integrated circuits and discrete components. Density is only limited by the physical size of the components used.

CIRCLE NO. 412

## Flat-cable jumpers have DIP sockets

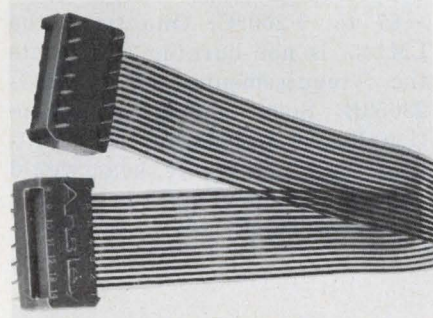

Thomas & Betts Corp., Ansley Div., Old Easton Rd., Doylestown, Pa.

A new line of low-profile flat-cable jumpers use 14-pin DIP sockets. The sockets are molded of glass-filled nylon and have gold-plated-over-nickel brass pins spaced on a standard dual-in-line pattern of 0.1 by 0.3 in. Cables can be ordered to any desired length with vinyl, polyester, Teflon or Kapton dielectrics. Other features include a low profile lightweight cable, flexibility and fixed electrical characteristics.

CIRCLE NO. 413

## IC heat dissipators fit 0.55-in.-dia TO-8s

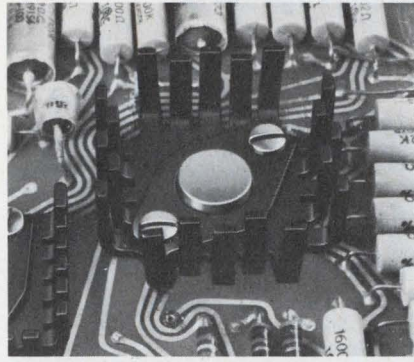

International Electronic Research Corp., 135 W. Magnolia Blvd. Burbank, Calif. Phone: (215) 849-2481.

A new series of heat dissipators accommodate ICs packaged in TO-8 cases having diameters up to 0.55 in. Series UP heat dissipators accept square or circular IC lead patterns up to 0.4 in. Power dissipation ratings of multi-lead TO-8 IC packages can be increased on the order of eight times that of bare-case operation by using the new series of heat dissipators.

CIRCLE NO. 414

## Printed-circuit hood holds 28 connectors

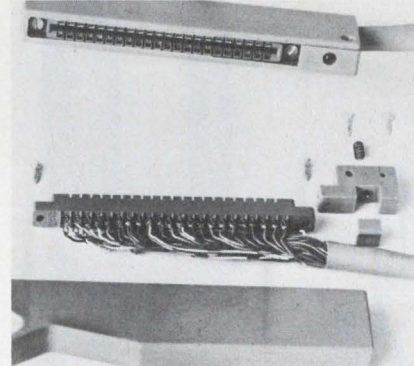

Stanford Applied Engineering, 340 Martin Ave., Santa Clara, Calif. P&A: 71¢ to \$1.90; stock.

Holding either single or dual types, the 8030-28 hood can accommodate up to 28-contact PC-board connectors. It can accept connectors with 5.093-in. center-to-center mounting holes and has variable entries to handle cables with diameters to 1/2 in. It is molded from high-impact plastic. The hood complements a connector line with 15, 18 and 22-contact connectors.

CIRCLE NO. 415

# Mini frequency analyzer mates with Mini computer

for automatic testing in real time on line.



Real time calibrated frequency domain measurements are interpreted *automatically* by a mini-computer mated with the new Mini-Ubiq™. The 200-line Mini-Ubiq, latest in Federal Scientific's line of Ubiquitous® Spectrum Analyzers, can be expanded to 400 lines at any time by the addition of one circuit card.

- Automatic comparison of vibration or acoustic signatures of good/bad products for accept/reject decisions in production or QC.
- Automatic scaling and equalization of the response characteristics of a pickup transducer.
- Ensemble averaging and storage of many spectra.
- Detection and location of peaks.
- Automatic analysis with thousands of resolution elements.

Write for free bulletin on techniques.

**federal scientific**

**Federal Scientific Corporation**

Originators of the Ubiquitous® Spectrum Analyzer  
Subsidiary of Elgin National Industries, Inc.  
615 West 131st Street, N.Y., N.Y. 10027.  
(212) 286-4400

# 10% OFF Call Now



## Digital Panel Meters 3½ and 4½ digits

All of the high quality DPM's listed below are specially priced with a 10% discount in quantities of 1-9. If you call or write within 7 days as a result of this ad (you must mention this publication), you will receive a 10% discount card good for one month.

If you require specials for OEM applications such as ratiometers, comparators, or customs (mechanical/electrical) we would like to quote it and give you the best price.

**Take off 10% from these  
Published 1-9 Prices**

3½ digit Model 510 Unipolar	\$195. Now \$175.50
3½ digit Model 520 Autopolarity	\$225. Now \$202.50
4½ digit Model 720 Autopolarity	\$370. Now \$333.00

I need complete specifications and information. Send literature!  
 Send me a 10% discount card. No obligation. It's good for 30 days.  
 Model:  510      Quantity \_\_\_\_\_  
            520      \_\_\_\_\_  
            720      \_\_\_\_\_

Name \_\_\_\_\_  
 Title \_\_\_\_\_  
 Company \_\_\_\_\_  
 Address \_\_\_\_\_  
 City \_\_\_\_\_  
 State \_\_\_\_\_ Zip \_\_\_\_\_

### Datascan Inc.

1111 Paulison Avenue, Clifton, New Jersey 07013  
 (201) 478-2800

913

INFORMATION RETRIEVAL NUMBER 96

## Evaluation Samples

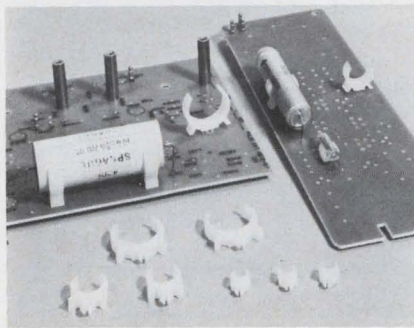

### Component clips

A new line of component clips feature grip-fast split-bulb bases to lock into printed-circuit boards and to insulate components from the boards. Their snap-in installation permits the use of boards to hold capacitors, resistors, lamps, batteries and fuses firmly into place. Clips are available in four holding sizes of 1/8, 3/8, 1/2 and 3/4 in. Samples are available. Lorain Tool & Mfg. Co.

CIRCLE NO. 347



### Metal spacers

Free samples are available of new low-cost aluminum and steel BUTTite spacers. The new spacers are inventoried in a range of sizes designed to accommodate bolt sizes #4 through bolts 1-in. in diameter. Standard lengths range from 3/16 to 4 in. They feature burr-free edges and square ends. C.E.M. Co.

CIRCLE NO. 348

### Tape-wound cores

A new concept in packaging of tape-wound cores is known as Datapac. This new package allows tape-wound cores to be blister-packed individually with detachable permanent data records. It is intended to aid the designer in the analysis of prototype designs. Magnetic characteristics and data are presented on the blue-and-white permanent-record Datapacs. The fact that individual cores and their pertinent hysteresis data cannot be separated results in considerable savings of both engineering time and money. Sample Datapacs are available. Magnetic Metals Co.

CIRCLE NO. 349

### Shrinkable tubing

Free samples are available of a line of very flexible shrinkable tubing in nine different sizes. The tubings shrink 50% in diameter upon application of moderate heat and can be used at operating temperatures that range from -67 to +250°C. One type, the LM145, is non-burning and meets the requirements of MIL-I-23053B. Some shrink at exceptionally low temperatures, permitting their use where heat would damage components. L. Frank Markel & Sons.

CIRCLE NO. 350

### PC board supports

The assembly of electronic equipment is simplified with the use of new plastic circuit board supports. They snap into a 3/16-in. hole on a chassis and automatically lock in position. The PC board slips onto a spring-locking pin at the upper end of each support. The supports are readily removable. They are made of nylon and measure 3/16 to 7/8-in. long. Free samples are available. Richlok Plastic Co.

CIRCLE NO. 351

# Design Aids



## Lens calculator

A new calculator speeds up lens calculations while designing microfilm/microfiche rear-projection and office-copier optical systems. This time-saving pocket-sized calculator enables the designer to easily determine the relationship between three basic lens parameters — focal length, magnification and object-to-image distance. Complete instructions are included on the calculator. Bausch & Lomb

CIRCLE NO. 352

## Conductive elastomers

A new guide lists three types of a new conductive elastomer for use in emi shielding and pressure gasketing. The three types of elastomers are the XECON CS-1, CS-2 and CS-3. They are constructed of a silver conductive element on an inert substrate in a matrix of highgrade silicone. Flexing, stretching, compression or continuous exposure to 200°C will not change their conductivity. Metex Corp.

CIRCLE NO. 353

## Conversion table

A new conversion table helps engineers and designers convert wind pressure to wind velocity data. Wind velocity is given in miles per hour, kilometers per hour and knots. A comprehensive checklist for engineering considerations in the purchase and installation of microwave transmitting towers is provided as well as guidelines for writing tower specifications. Wind velocity, icing and rigidity as they apply to microwave tower specifications are also described. Microflect Co.

CIRCLE NO. 354

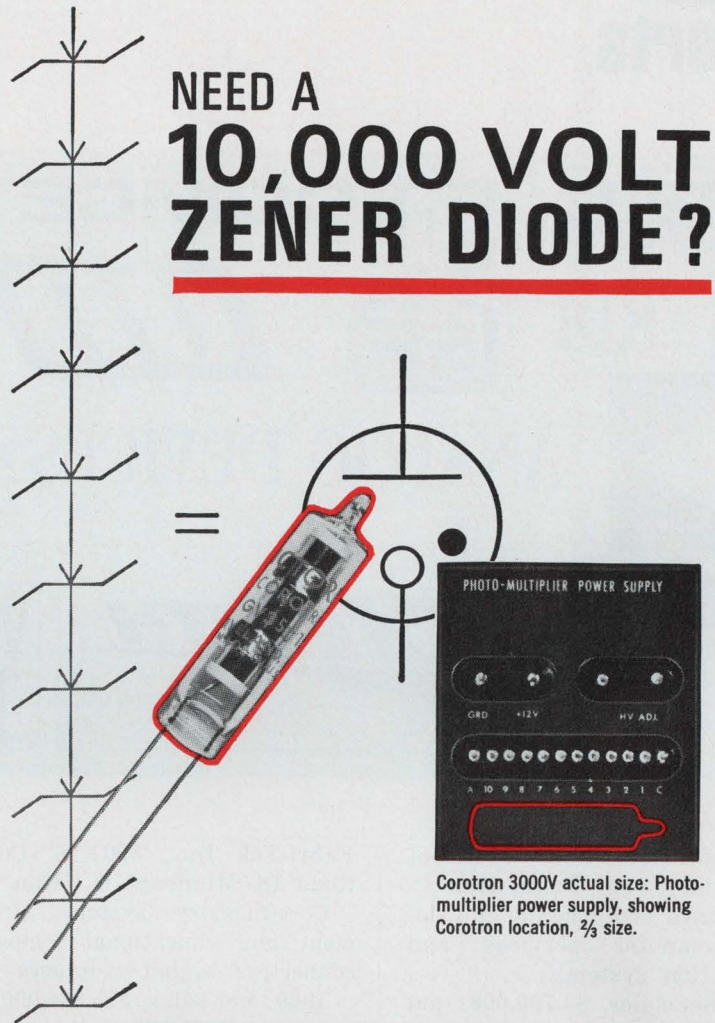

Corotron 3000V actual size: Photo-multiplier power supply, showing Corotron location,  $\frac{2}{3}$  size.

You *could* string together several hundred zeners. Or you could specify *one* Victoreen Corotron. It is the gaseous equivalent of the zener with all the advantages of an *ideal* HV zener diode.

For space research and other rugged applications requiring absolute power supply stability, GV3S Series, shown, provide the ideal reference voltage anywhere in the range of 400 to 3000 volts. They enable circuitry to maintain constant high voltage regardless of battery source voltage or load current variations. Cubage and weight (GV3S Corotron weighs only 4 gm.) are important considerations. So is temperature variation (Corotrons operate from 200°C down to -65°C). Ruggedized versions withstand shock to 2000 G, vibration 10 to 2000 cps.

If you're trying to simplify circuits . . . to cut cost, size and weight . . . to upgrade performance—you need Corotron high voltage regulators. Models are available now from 400 to 30,000 volts. A consultation with our Applications Engineering Dept. will speed up the countdown.

DMA 525



**VICTOREEN INSTRUMENT DIV. of VLN**  
10101 WOODLAND AVENUE • CLEVELAND, OHIO 44104  
EUROPE: ARNDALE HOUSE, THE PRECINCT: EGHAM, SURREY, ENGLAND • TEL: EGHAM 4887

INFORMATION RETRIEVAL NUMBER 97

# Annual Reports

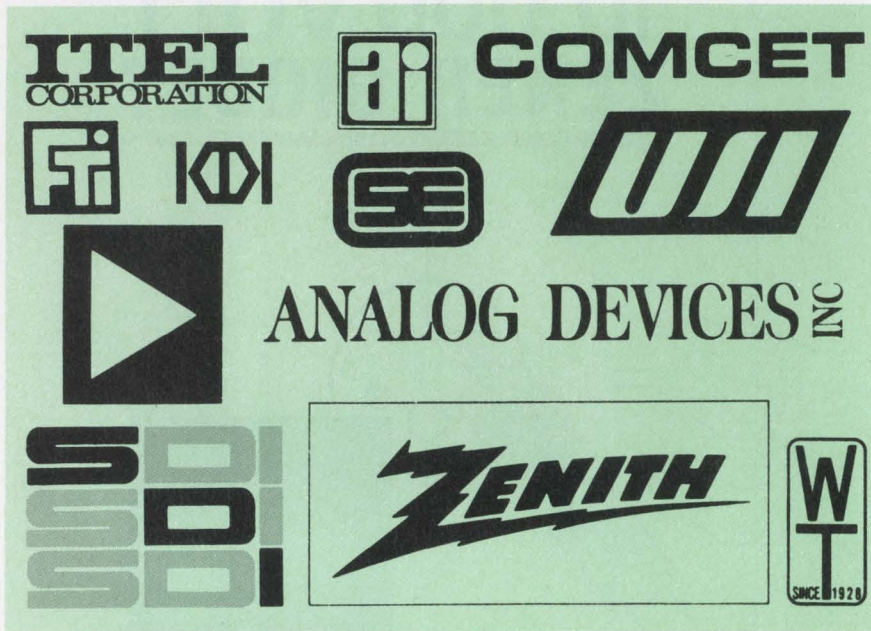

**Alpha Industries, Inc.**, 381 Elliot St., Newton Upper Falls, Mass.

Microwave components and devices, computer services and identification systems.

1969: net sales, \$4,705,008; net income, \$323,997.

1970: net sales, \$3,458,230; net income (loss), (\$38,190).

CIRCLE NO. 355

**Analog Devices, Inc.**, 221 Fifth St., Cambridge, Mass.

A/d and d/a converters, operational amplifiers, comparators, ladder networks, power supplies.

1968: net sales, \$5,749,590; net income, \$500,903.

1969: net sales \$8,764,933; net income, \$615,692.

CIRCLE NO. 356

**Computer Communications Engineering Technology**, 2 Research Court, Rockville, Md.

Computer communications systems and services.

1968: net income (loss), (\$606,797).

1969: total revenues, \$388,169; net income (loss), (\$4,117,238).

CIRCLE NO. 357

**Fabri-Tek Inc.**, 5901 S. County Road 18, Minneapolis, Minn.

Core-memory systems, instrument and educational computers, connectors, signal averagers.

1969: net sales, \$15,824,000; net earnings, \$369,000.

1970: net sales, \$21,205,000; net earnings, \$562,000.

CIRCLE NO. 358

**Intel Corp.**, 1 Bush St., San Francisco, Calif.

Data processing services, mass-memory devices, computer peripherals, commercial containers.

1968: revenues, \$9,761,303; net income, \$488,728.

1969: revenues, \$40,437,516; net income, \$3,288,682.

CIRCLE NO. 359

**KDI Corp.**, 5721 Dragon Way, Cincinnati, Ohio.

Computer keyboards, software, chemicals, environmental sciences, educational systems.

1968: net sales, \$84,266,309; net income, \$4,228,794.

1969: net sales \$139,573,137; net income, \$5,350,288.

CIRCLE NO. 360

**Sterling Electronics Corp.**, 4201 S.W. Freeway, Houston, Tex.

Microwave components, panel-meters, marine services.

1968: net sales, \$54,598,658; net income, \$2,318,268.

1969: net sales, \$66,557,116; net income, \$1,825,667.

CIRCLE NO. 361

**Symbolic Displays, Inc.**, 118 N. Batavia St., Orange, Calif.

Display and lighting systems for aviation and computers.

1968: net sales, \$1,552,134; net income, \$127,350.

1969: net sales, \$1,842,923; net income, \$147,915.

CIRCLE NO. 362

**Ultrasonic Systems, Inc.**, 405 Smith St., Farmingdale, N.Y.

Ultrasonic motors and converters, plastics assembly equipment, contractual research.

1969: total current assets, \$656,408; total current liabilities, \$135,433; net sales, \$71,302; net income (loss), (\$362,070).

CIRCLE NO. 363

**Winslow Tele-Tronics, Inc.**, 607 Industrial Way West, Eatontown, N.J.

High-frequency sources, test and measurement instruments.

1968: sales, \$6,825,893; net income, \$615,207.

1969: sales, \$8,150,689; net income, \$158,242.

CIRCLE NO. 364

**Zenith Radio Corp.**, 1900 N. Austin Ave., Chicago, Ill.

Televisions, radios, stereo systems, tape recorders, hearing aids, integrated circuits.

1968: net sales, \$705,404,738; net income, \$47,315,200.

1969: net sales, \$676,577,184; net income, \$39,620,527.

CIRCLE NO. 365



# Application Notes

## Active notch filters

The use of active notch filters in electronic circuits is described in a new application note. It shows how narrow bands of frequency can be eliminated with notch filters. Problems such as amplitude and phase distortion, overshoot, ringing and sensitivity are discussed at length and experimental results are shown. Discussions start with an introduction to the notch filter and proceed through its development to design and practical considerations. Equations, sketches and typical waveforms are included. A. P. Circuit Corp.

CIRCLE NO. 366

## Thermistors

The properties and applications of negative-temperature-coefficient thermistors is the subject of a new eight-page technical booklet. The basic operating principles of thermistors are discussed along with characteristic curves, charts, circuit configurations and equations. Included are discussions on thermistor terminology, voltage-current characteristics, current-time relationships, dissipation constant power rating and time constant. Also discussed are applications for temperature measurements, differentials, compensation and control. Sensitron, Inc.

CIRCLE NO. 367

## Low-inertia servo motors

A new performance and applications guide outlines the various applications information for low-inertia permanent-magnet dc servo motors. Discussed are their use with disc storage drives, line printers, tape transports, card readers and optical-character readers. The guide contains definitions, formulas and temperature calculations designed to simplify the correct selection of a servo motor for any application. Control Data Corp., Cedar Div.

CIRCLE NO. 368

## Dc power supplies

A new 80-page dc power supply handbook contains discussion of the operating principles of dc power-supplies, descriptions of circuit principles, operating features, methods of checking power-supply performance, and a section on applications that contains a selection guide to help in choosing the proper power supply for each application. Circuit principles are clearly illustrated with diagrams and schematic outlines. Equations are used throughout the discussions to show the various circuit relationships. The handbook also contains a catalog of over 100 models of several types of power supplies. Hewlett-Packard.

CIRCLE NO. 369

## Digital thermometers

The pros and cons of various methods of digital thermocouple measurement are described in a 16-page booklet. The typical problems and solutions encountered in thermocouple thermometry are graphically illustrated. Problems include noise, drift with time, scaling and linearization, and temperature. Included are a two-page table of base and noble-metal thermocouple characteristics and a checklist of thermometer specifications. The noble and base metals shown include iron constantan (J) and (YBS), chromel alumel (K) and copper constantan (T). Doric Scientific Corp.

CIRCLE NO. 370

## Heated sensors

A new handbook describes the theory of operation and applications of heated sensors for measuring mean velocity, high-frequency velocity turbulence, mass flow, mean temperature and high-frequency temperature fluctuations in gases and liquids. CGS/Datmetrics.

CIRCLE NO. 371



# Iridium Platinum

Iridium Platinum is probably the best known alloy in the Platinum metal family. By varying the Iridium content from 5% to 40%, a very wide range of physical and electrical properties is obtained.

Diameters available range from rod sizes down to 0.0005" and, in some alloys, to 0.0002". With alloys high in Iridium, fantastic tensile strength can be obtained particularly in the smaller diameters. All of the alloys have excellent corrosion resistance and are not affected by any single acid.

Resistivity, temperature coefficient and tensile strength graphs are available. Write for complete data.

## Sigmund Cohn Corp.

121 S. Columbus Ave.  
Mount Vernon, N.Y. 10553  
(914) 664-5300

INFORMATION RETRIEVAL NUMBER 98

## WORKHORSE!



### TYPE 9750

Nothing fancy, and not expensive. Just a good old 10 stage photo-multiplier but: It has a superb bi-alkali cathode with excellent collection efficiency (which is fundamental for good S/N ratio), highly stable CsSb dynodes which provide a gain of  $10^6$  at just over 1,000 volts, and a dark current of  $10^{-10}$  A. at that voltage (50 A/L).

As usual EMI has provided a number of variations: 9750QB with a spectroil window for UV and low level counting applications, (liquid scintillation) 9750B with Pyrex window for visible applications, and finally 9750KB for those who prefer the B-14A overcapped base. In the "K" configuration, it is directly interchangeable with our 9656KB or a number of competitive types.

The 9750 with its high quantum efficiency and low dark current gives excellent resolution for low energy gamma rays. When used with a thin two inch sodium iodide crystal with a beryllium window, the resolution for  $Fe^{55}$  is of the order of 40%.

Flying spot scanners, photometers, thermoluminescent dosimeters, low level scintillation counting are all applications for which the 9750 is highly suitable. Detailed specifications on request from:

### GENCOM DIVISION varian/EMI

80 EXPRESS STREET, PLAINVIEW, N. Y. 11803  
TELEPHONE: (516) 433-5900

## New Literature

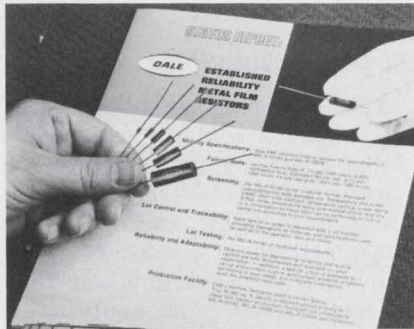

### Resistors

Reliability studies of metal-film resistors are detailed in a new report. The report lists complete electrical and physical specifications, summarizes testing data and the types of screening available. Dale Electronics Inc.

CIRCLE NO. 372

### Diodes

Featured in a product brochure are four voltage-variable capacitance diodes. Their highlights are high Q varactor diodes, pill diodes designed for use in waveguide or stripline circuits, and high-voltage high-capacitance high-Q epoxy types designed for applications requiring broad tuning. Teledyne Crystallonics.

CIRCLE NO. 373

### PC card cages

An eight-page bulletin provides a method for specifying custom-designed cages for plug-in printed-circuit boards. Also described is a line of off-the-shelf cages. National Metalcrafters, Inc.

CIRCLE NO. 374

### Filters

The 12-page "Dual-In-Line LC Filters Series" brochure gives specifications, attenuation, phase-shift and group-delay characteristics, and time-response for low-pass, linear-phase and high-pass phase filters. The frequency range of these filters is 1 kHz to 10 Mhz and impedance ranges are 50 to 5000  $\Omega$ . ESC Electronics.

CIRCLE NO. 375

### Sales training

The "Smooth Selling Sales Training Program" is a series of 12 stimulating sales training articles. They include the following: "The Salesman is a V.I.P.," "Are You a Salesman?," "Get Acquainted with Your Company," "You're on Stage," "You Can't Fire without Ammunition" and "You are a Goodwill Salesman, Too." The other six articles are "Closing the Sale," "How to set up an Interview," "Relaxing between Rounds," "The Competition," "Taking a Risk" and "Playing the Short Game." George N. Kahn Co.

CIRCLE NO. 376

### Power-supply catalog

Power supplies from 11 different categories are described in the new "High/Low-Voltage Power-Supply Catalog." Included are mobile power inverters, specialized power supplies for traveling-wave tubes, ion pumps, cathode-ray tubes, and customer-designed system power supplies. Capatron Division of AMP Inc.

CIRCLE NO. 377



### Transistors

Available in limited quantities, the 92-page "Radiation Hardened Silicon Power Transistor Manual" outlines information on neutron irradiation effects relative to transistors. Included are data sheets, photographs, curves, and specification charts. Solitron Devices, Inc.

CIRCLE NO. 378

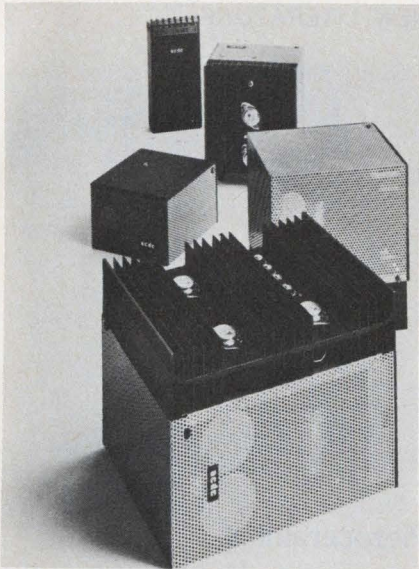

### Power supply modules

A short-form catalog describes a complete line of dc power supply modules and rack assemblies. It also includes all the necessary specifications and prices for easy and proper power-supply selection. ACDC Electronics Inc.

CIRCLE NO. 379

### Electronic keyboards

A four-page applications brochure describes standard and custom electronic keyboards for the computer terminal market. The brochure contains "do-it-yourself" worksheets on which a customer can design his own custom keyboards. Controls Research Corp.

CIRCLE NO. 380

### Thumbwheel switches

Described in an eight-page catalog of industrial-grade thumbwheel switches are 12 new codes as well as double-width model switches, and wave soldered interconnection circuit boards. Electronic Engineering Co. of California.

CIRCLE NO. 381

### SCR controls

Highly informative, a 16-page brochure describes and illustrates adjustable motor speed-drive systems. Diagrams show the functional relationships of the three principal controls—speed, torque and regulation. Maurey Mfg. Corp.

CIRCLE NO. 382

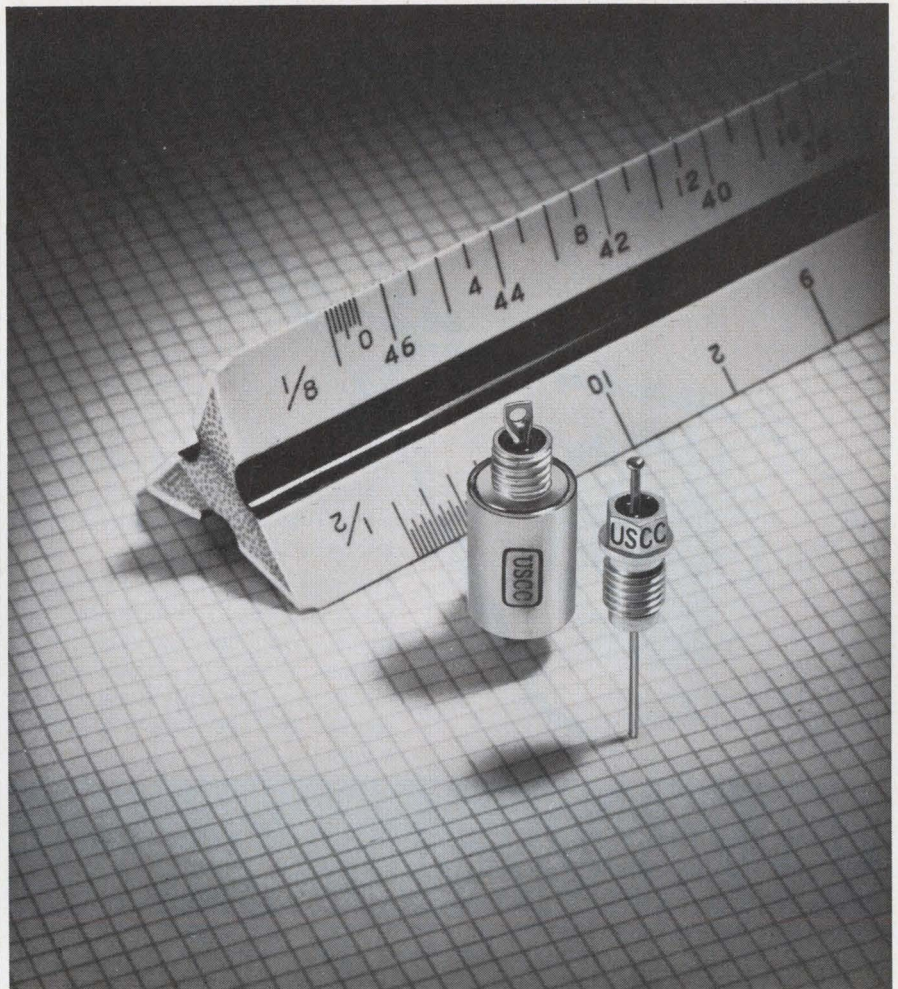

## How small are your EMI problems?

An EMI/RFI problem used to be one of the least appealing facts of circuit life. Add the requirements for a small unit with high attenuation characteristics and you were in trouble. Not anymore. Today, you'll find lasting happiness with two proven USCC series of miniature filters. Both provide up to 70 dB of attenuation.

Series 2000 suppresses conducted noise from SCR's, switches, relays, motor commutators, etc., in low voltage dc lines from 10 kHz to 10 GHz. Available in Pi, L or T section units for 50/100/200/300 WVdc and 115/230 Vac in 10 current ratings and 2 thread lengths.

Series 3000 subminiature units are for use where size, weight and reliable performance are critical as in microwaves, communications and airborne equipment. Available in Pi or multi-section units for 50/100/200 WVdc from 10 MHz to 10GHz.

Send for the complete details in a series of technical catalog sheets: U.S. Capacitor Corporation, 2151 No. Lincoln Street, Burbank, California 91504. Phone: (213) 843-4222. TWX: 910-498-2222.



Other reliable USCC EMI/RFI products: general purpose filters, signal line/communications filters, power line filters and cabinet assemblies, data processing filters, and special/custom filters.

INFORMATION RETRIEVAL NUMBER 102

# Service... Engineering... Experience

MAKE THE **BIG** DIFFERENCE  
BETWEEN A YOKE SPECIALIST  
AND A YOKE SUPPLIER



Syntronic Yoke Specialists have more yoke knowledge and provide more engineering assistance than anyone else in the field.

The most extensive line of deflection yokes available is offered by Syntronic... in production quantities or custom designed to special requirements. See the BIG Difference for yourself the next time you specify a yoke.

1" ID 12 oz. Single Gap  
Shielded Dynamic/Static  
Focus Coil

***syntronic*** INSTRUMENTS, INC.  
100 Industrial Road, Addison, Illinois Phone 312, 543-6444

INFORMATION RETRIEVAL NUMBER 103

## Bulova has the answer to your crystal requirements

Whether it be for military communications or for data transmission, Bulova can satisfy your crystal needs. Advanced production techniques provide an accurate, stable and reliable frequency source to assure minimal frequency shift and low error rate for use in — Radio sets (military or commercial) • Facsimile • CATV • CCTV • Modems • Data Terminals • Multiplexers • Telemetry.

Bulova has a complete line of crystals from 2KHz to 150MHz in solder-sealed, precision glass and coldweld enclosures. For military users, Bulova supplies standard "CR" types to meet the latest MIL-C-3098 specs.

Contact your Bulova man to match your economic needs with your technical requirements. Call (212) 335-6000, See EEM Section 2300, or write —



**BULOVA**

FREQUENCY CONTROL PRODUCTS

Electronics Division of Bulova Watch Company, Inc.  
61-20 Woodside Avenue, Woodside, N. Y. 11377 / (212) 335-6000

INFORMATION RETRIEVAL NUMBER 104

## NEW LITERATURE

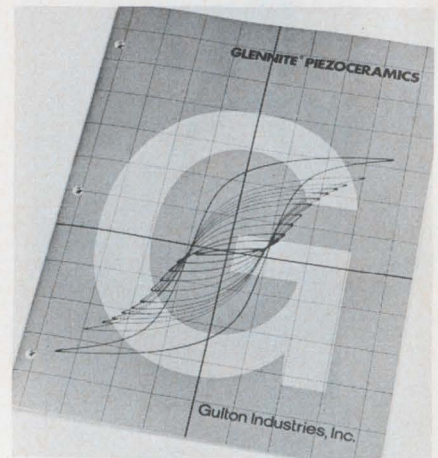

### Piezoceramics

A 28-page catalog begins with a summary of electrical and mechanical specifications for 10 ceramic compositions offered, and goes on to describe the various piezoceramic shapes which are available, and contains complete information on temperature and time characteristics for each material. Gulton Industries, Inc.

CIRCLE NO. 383

### Rotary solenoids

This 32-page catalog lists complete information characteristics of rotary solenoids. There are eight basic sizes, ranging from 1 in. in diameter by 5/8 in. to 3-3/8 in. in diameter by 2-5/16 in. Standard rotary strokes are 25, 35, 45, 67-1/2 and 95 degrees. Ledex Div., Ledex Inc.

CIRCLE NO. 384

### Indicator lights

Illustrated with photographs and schematic drawings, the "Product Lighting Guide" furnishes complete specifications for an extensive line of indicator and pilot lights. An index enables users to quickly match lights to their needs. Leecraft Mfg. Co.

CIRCLE NO. 385

### Carbon film resistor

A four-page, illustrated brochure, describes specifications and dimensional data of carbon film resistors. Among the types listed are high-voltage, high-frequency, and precision resistors. Beman Manufacturing, Inc.

CIRCLE NO. 386

## GaAs lasers and emitters

A concise description of a line of solid-state gallium-arsenide lasers and emitters is contained in a new 12-page catalog. Devices listed include infra-red emitters and single and multiple-diode lasers. Characteristic curves and a glossary of terms are included. RCA

CIRCLE NO. 387

## Electronic components

Containing 100 pages, a guidebook featuring sections on counters, flow meters, servo mechanisms, test equipment and timers introduces a transducer selection guide which describes popular types, functions and applications of transducers. Electronics Div., American Relays.

CIRCLE NO. 388

## Power supplies

A 32-page catalog contains engineering data on modular and laboratory power supplies. A power supply locator chart is provided so the user can easily decide which supply series will best fit his needs. Deltron, Inc.

CIRCLE NO. 389

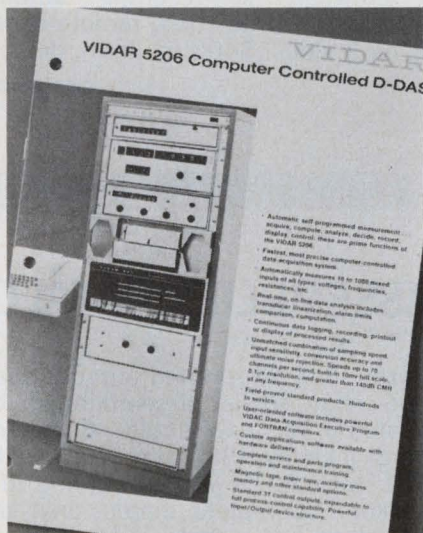

## Data acquisition

A new brochure reviews areas of application for a programmable data-acquisition and control system which scans data in random-access or sequential modes. Vidar Corp.

CIRCLE NO. 390

# JFD

**TINY. . . .  
BUT—MVMs  
CAN TAKE IT!**

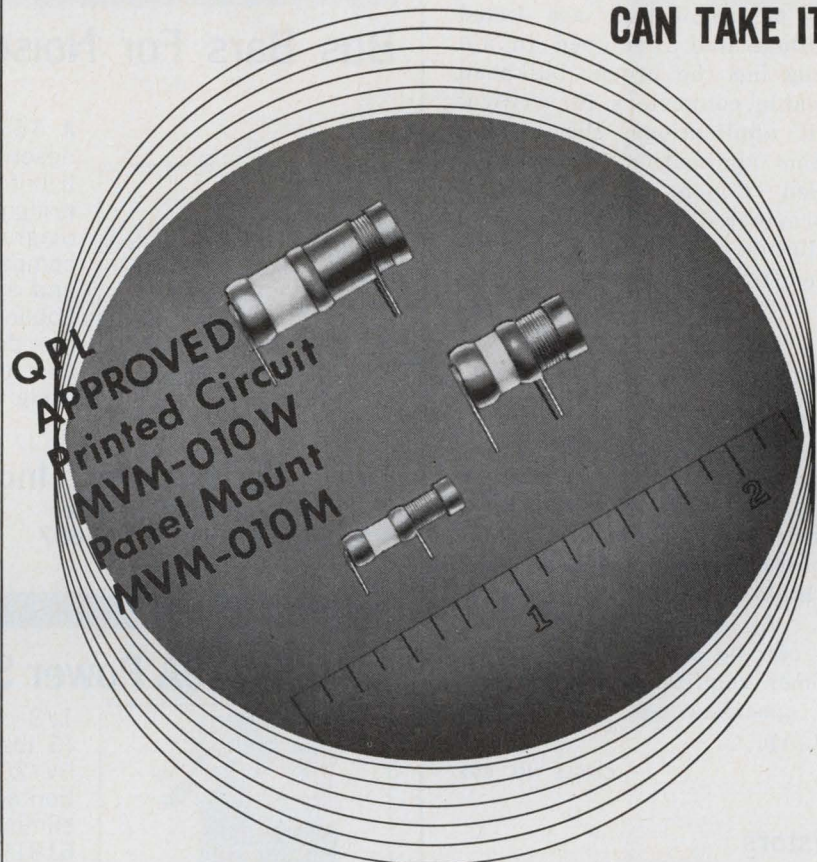

## THESE NEW HIGH Q AIR VARIABLES ARE RUGGED

JFD has developed three sizes of unusually rugged air variable capacitors. All three feature a unique internal guiding mechanism with a positive stop. The result: concentricity is constant and these capacitors can withstand conditions of extreme shock and vibration.

Further, newly developed metal biasing elements provide smoother, more constant torque during and beyond life cycling.

Other unique features of the series are:

- Engineered to withstand heat — during soldering.
- Internal air meshing shells are silver plated to provide best surface conductivity and long life.

All MVM's are completely interchangeable with competitive models.

Write for MVM catalogs.

**MVM-003** — Microminiature in size. Capacitance range is 0.35 pf to 3.5 pf. The Q factor measured at 3.5 pf and 100 MHz is 5,000. Available in 2 models.

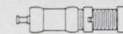

**MVM-010** — Adjustable from 0.8 pf to 10 pf. Q greater than 3,000 measured at 10 pf and 100 MHz. Available in 4 models.

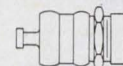

**MVM-020** — Adjustable from 1 to 20 pf. Q ranging from 3,000 at minimum capacitance, to 1200 at maximum capacitance. Available in 4 models.

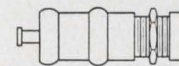

Illustrations actual size.

# JFD

"TODAY'S COMPONENTS BUILT FOR TOMORROW'S CHALLENGES"

**JFD ELECTRONICS CORP. / COMPONENTS DIVISION**

15th Avenue at 62nd Street / Brooklyn, New York 11219 / Phone 212-331-1000

SUBSIDIARY OF RIKER-MAXSON CORPORATION

## Connectors

In this 16-page catalog, 73 basic styles of connectors are listed and illustrated. Designed to aid in selecting the proper bulkhead and cable connectors for critical circuit applications, the catalog contains application information, detailed dimensional drawings, performance characteristics, and installation instructions. Cinch-Nuline Div. of TRW.

CIRCLE NO. 391

## Power sources

Covering technical information on transformers, magnetic devices and power sources, a new catalog features rectifier plate-supply transformers, filament heater transformers, saturable reactors and high-power magnetic amplifiers. A self-addressed reply form can be used to list special customer requirements and technical specifications. Light Electric Corp.

CIRCLE NO. 392

## Resistors

A complete line of tin-oxide resistors is described in a 16-page resistor design guide. Reliability claims are presented in the text with tables and charts that give the results of a continuing life test of 600 resistors. Corning Glass Works.

CIRCLE NO. 393

## Nondestructive testing

A 14-page booklet explains six training courses in nondestructive testing. Included are magnetic particle inspection, ultrasonic testing, radiographic technician, and X-ray interpretation courses. Magnaflux Corp.

CIRCLE NO. 394

## Mini-power converters

Described in an eight-page catalog are the features, specifications, modifications and mounting dimensions for miniature and subminiature power conversion equipment. Arnold Magnetics Corp.

CIRCLE NO. 395

# Design Data from

## Bus Bars For Noise Reduction

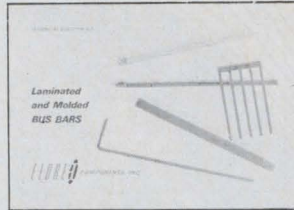

A 16 page Technical Bulletin is now available, describing a new concept in power or signal distribution. Basic mechanical and electrical design principles, along with descriptive pictures and diagrams, are included in this bulletin. These compact buses can replace bulky cable harnesses and repetitive wiring for computer or modular application. This method of construction satisfies the demanding requirements of low inductance and resistance of high speed, solid state systems, while controlling electrical noises.

Send For Free Sample CIRCLE NO. 171

## Eldre Components, Inc.

1239 University Avenue  
Rochester, New York 14607

## Now 5V/20A Power Supplies Fit Microcircuitry



1/3 smaller (3.25"x6.50"x7.50"), 1/4 lighter (6 lbs.), cooler, more reliable than conventional 5V/20A supplies, Series 600 utilizes size-reduction advantages of the switching regulator — but eliminate its RFI (input & output meet MIL-I-6181). Single, dual, triple outputs at 3VDC to 30VDC; efficiencies 65-90%. Continuously deliver full regulated power at  $-20^{\circ}$  to  $71^{\circ}\text{C}$  without derating, heat sinking, air cooling; maintain full-load storage for 30MSEC after AC power drop-out. Also: IC regulating amplifier, automatic overvoltage crowbar, self-resetting automatic overload, short-circuit protection, remote sensing, mountability on 3 sides. \$400 ea. Imm. del.

## Trio Laboratories, Inc.

80 Dupont Street  
Plainview, N. Y. 11803

CIRCLE NO. 172

## NEW RELAY SOCKET ASSEMBLIES CATALOG

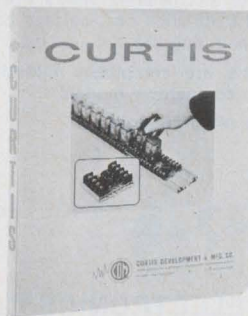

The new Curtis line of printed circuit snap-in track-mounted relay socket assemblies is completely illustrated in this new 2-color, 6 page catalog. Variations include RS8 octal relay sockets, as well as RS11 and RS15 with eleven and fifteen pin relay sockets. Complete dimensional drawings and list prices are included. All units snap in or pop out vertically from prepunched vinyl track and feature Curtis barrier terminal blocks. CSA approved. Send today for your free copy.

SEE US AT BOOTH 6058, PE SHOW

## Curtis Development & Mfg. Co.

3236 North 33rd Street  
Milwaukee, Wisconsin 53216

CIRCLE NO. 173

# Manufacturers

Advertisements of booklets, brochures, catalogs and data sheets. To order use Reader-ServiceCard (Advertisement)

## Modulated Time Code Handbook

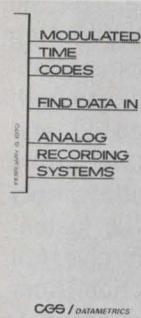

A practical engineering guide for the engineer involved in instrumentation recording. The illustrated handbook presents a complete precise on the theory of time code indexing and automatic data retrieval for magnetic tape, oscillographs, and camera film data recording. The handbook also covers many **do's** and **don'ts**, as well as outlined time error accumulation, time synchronization, weighted code recognition, and error filtering for playback and Automatic data Search. Request Technical Bulletin MTC.

CIRCLE NO. 174

Datametrics Division  
**CGS Scientific Corp.**  
Watertown, MA. 02172 Tel. (617) 924-8505

## SELF-SEALING FASTENERS



For positive seal against air, gas, fluids. These APM-HEXSEAL products are designed to conform to all Fastener Handbook dimensions and standards, and applicable Military Specifications. The unique feature is a captive O-ring underneath the head (patented). This O-ring guarantees positive sealing against most liquids and gases. Other beneficial features: • Reusable • Pre-assembled • Vibration-resistant • Positive metal-to-metal contact • Seals standard clearance holes • Withstand in excess of 6000 psi internal and external pressures. Available in screw, rivet and bolt version. Write today for free samples, and detailed information.

CIRCLE NO. 175

**APM Hexseal Corporation**  
44 Honeck Street, Englewood  
New Jersey 07631 (201) 569-5700

## New PC Drafting Aids Catalog

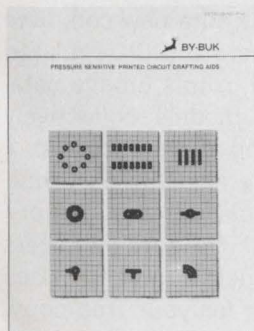

The By-Buk 1970-71 catalog of pressure sensitive printed circuit drafting aids is now available. With thousands of ideas to promote accuracy and efficiency in printed circuit master artwork layouts. Featured are new artwork patterns for: TO cans, multi-pads, dual in-lines and flat packs. Also the most comprehensive listings of conductor line tapes, pads, donuts, connector strips, elbows, corners, etc. Available in opaque black, transparent red and transparent blue materials. Send for your free catalog and samples.

CIRCLE NO. 176

**By-Buk Company**  
4326 W. Pico Blvd.  
Los Angeles, California 90019  
(213) 937-3511

## Bulletin board

of product news  
and developments



A compact **color-slide television studio** which transmits 35-mm slides to standard TV sets over CATV or closed-circuit facilities has been developed by Sylvania Electric Products. It can also transmit black-and-white information. The studio uses a circular tray to house and advance the slides and operates unattended for extended periods of time. Prices range from \$2750 to \$4500.

With the new **43-minute video-tape #800338**, a theoretical three-pole Chebyshev filter can be designed and constructed. The actual filter's response is compared with the theoretical model using a Hewlett-Packard model 675A or 676A network analyzer. Reasons for differences in filters are clearly shown and complete characterization of one and two-port networks is demonstrated. The new tape is a development of Hewlett-Packard.

**Price reductions** have been announced by Fairchild Semiconductor on linear ICs and plastic transistors. The  $\mu A723$ ,  $\mu A725$ ,  $\mu A735$ ,  $\mu A740$ ,  $\mu A741$ ,  $\mu A748$  and  $\mu A749$  ICs have been reduced in price by as much as 61% in quantities of 100 to 999. For example, the  $\mu A748$  operational amplifier has dropped its price from \$3.25 to \$1.25. Micro-Pak transistors will undergo price reductions up to 86% for 185 models. The price reductions apply to quantities of 1 to 99.

ELECTRONIC DESIGN's function is:

- To aid progress in the electronics manufacturing industry by promoting good design.
- To give the electronic design engineer concepts and ideas that make his job easier and more productive.
- To provide a central source of timely electronics information.
- To promote two-way communication between manufacturer and engineer.

**Want a subscription?** ELECTRONIC DESIGN is sent free to qualified engineers and engineering managers doing design work, supervising design or setting standards in the United States and Western Europe. For a free subscription, use the postfree application form inside the back cover. If none is included, write to us direct for an application form.

If you do not qualify, you may take out a paid subscription for \$25 a year in the U.S.A., \$35 a year elsewhere. Single copies are \$1.50 each.

**If you change your address,** send us an old mailing label and your new address; there is generally a prepaid postcard for this inside the back cover. You will have to requalify to continue receiving ELECTRONIC DESIGN free.

**The accuracy policy of ELECTRONIC DESIGN is:**

- To make reasonable efforts to ensure the accuracy of editorial matter.
- To publish prompt corrections whenever inaccuracies are brought to our attention. Corrections appear at the end of the Letters column.
- To refuse any advertisement deemed to be misleading or fraudulent.

Microfilm copies are available of complete volumes of ELECTRONIC DESIGN at \$19.00 per volume, beginning with Volume 9, 1961. Work is now in process to complete the microfilm edition of Volumes 1-8. Reprints of individual articles may be obtained for \$2.00 each, prepaid (\$.50 for each additional copy of the same article) no matter how long the article. For further details and to place orders, contact the Customer Services Department, University Microfilms, 300 North Zeeb Road, Ann Arbor, Michigan 48106; telephone (313) 761-4700.

**Want to contact us?** If you have any comments or wish to submit a manuscript or article outline, address your correspondence to:

Editor  
ELECTRONIC DESIGN,  
850 Third Avenue,  
New York, N.Y. 10022.

# Design Data from

## Quality Fasteners For All Designs

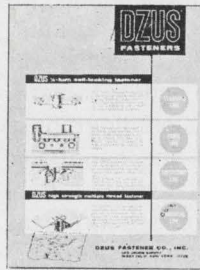

This 8-page catalog provides design data on the complete group of DZUS 1/4-turn self-locking fasteners for standard, high speed and panel applications, as well as universal high strength multiple thread fasteners for high tensile and shear stresses. Dzus stud assemblies, wire forms and receptacles offer an exceptional, wide variety of combinations from stock to fit specific fastening requirements. Diagrams and tables give full details for rapid, unlimited design selection. Condensed or complete Catalog available on request.

CIRCLE NO. 177

**Dzus Fastener Co., Inc.**  
425 Union Boulevard  
West Islip, L. I., N. Y. 11795

## FREE ... New 76-Page Components Catalog



If you're a component specifier you'll want this all-new catalog from Sprague Products Company. Hot off the press, it's bulging with information on electronic components. Catalog C-560 contains up-to-the-minute listings of Sprague's full line of 148 types (22,764 items) of capacitors, transistors, resistors, filters, and pulse transformers available as standard stock items through Sprague industrial distributors. Write for a copy today and stay in the know.

CIRCLE NO. 178

**Sprague Products Company**

347 Marshall Street, North Adams, Mass. 01247

## New Low Cost Mini Power Supplies



Power/Mate Corp. has introduced a new complete line of 119 models of miniature DC regulated power supplies—now described in this 6-page catalog. These 119 Mini Mate models collectively cover from 3.6 to 48 vdc and currents up to 2 amps. The Mini Mates feature adjustable DC outputs, low cost, high performance and Power/Mate's full five year warranty. The catalog covers complete specifications, model numbers, sizes and prices. Write, call or twx for your free copy.

CIRCLE NO. 179

**Power/Mate Corporation**  
514 South River Street  
Hackensack, New Jersey 07601  
(201) 343-6294 TWX (710) 990-5023



# Manufacturers

Advertisements of booklets, brochures, catalogs and data sheets. To order use Reader-ServiceCard (Advertisement)

## Mini-Frequency Analyzer with Mini-Computer for Automatic Testing



Real-time calibrated frequency domain measurements are interpreted automatically by a mini-computer easily interfaced with the new 200-line MINI-UBIQ™, latest Ubiquitous® Spectrum Analyzer. It can be upgraded to 400 lines at any time by the addition of one circuit card. • Automatic comparison of vibration or acoustic signatures of good/bad products for accept/reject decisions in production or QC • Automatic scaling and equalization of the response characteristics of a pickup transducer • Ensemble averaging and storage of many spectra • Detection and location of peaks • Automatic analysis with thousands of resolution elements.

CIRCLE NO. 180

**Federal Scientific Corporation**  
a subsidiary of Elgin National Industries, Inc.  
615 West 131st Street, New York, N. Y. 10027

## Plastic Parts



CUSTOM production to your specs from patented, low-cost tooling. Any size, any quantity in Nylon, Delrin, other thermoplastics. Let us quote. We have 20 years experience.

STANDARD gears, racks, bearings, sprockets, pulleys, washers, insulators, many other components available quickly from stock tools. Over 2,500 items described in our 48-page catalogue. Write today for a free copy.

CIRCLE NO. 181

## Nylomatic

28 Nolan Ave., Morrisville, Pa. 19067

## BISHOP CIRCUIT ZAPS



**PRE-ETCHED, PRESSURE-SENSITIVE COPPER COMPONENT PATTERNS FOR INSTANT PC BOARDS.** Circuit Zaps® are 1 ounce copper circuit components patterns, pads, and conductor paths, precision-etched on 5 mil (.005") glass epoxy base material, backed by a special pressure-sensitive adhesive. Circuit Zaps® completely eliminate the artwork, photography, photoprinting, touch up, etching, stripping, and other time-consuming steps in PC board development. Circuit Zaps® provide maximum flexibility.

Now you can save time and money in making designs, proving theories, checking circuits and densities — for all prototype PC work. Write today for the **FREE TECHNICAL BULLETIN 1003** with **FREE SAMPLE**.

CIRCLE NO. 182

## Bishop Graphics, Inc.

7300 Radford Avenue  
North Hollywood, California 91605  
(213) 982-2000 Telex: 674672

# Electronic Design

## Advertising Sales Staff

Keith Aldrich  
Sales Manager

## New York 10022

Robert W. Gascoigne  
Samuel M. Deitch  
Daniel J. Rowland  
850 Third Avenue  
(212) Plaza 1-5530  
TWX: 867-7866

## Philadelphia 19025

Mort Sullivan  
P.O. Box 126  
Dresher, Pa.  
(215) 884-6880

## Boston 02154

Joseph F. Palmer  
1268 Main Street  
Waltham, Mass.  
(617) 894-2700

## Chicago 60611

Thomas P. Kavooras  
Berry Conner, Jr.  
200 East Ontario  
(312) 337-0588

## Cleveland

Thomas P. Kavooras  
(Chicago)  
(312) 337-0588  
(call collect)

## Los Angeles 90303

Stanley I. Ehrenclou  
W. James Bischof  
2930 Imperial Highway  
Inglewood, Calif.  
(213) 757-0183

## San Francisco 94022

Arthur R. Shields, Jr.  
95 Main Street  
Los Altos, Calif.  
(415) 941-3084

## London W. 1

For United Kingdom and Holland  
Brayton C. Nichols  
44 Conduit Street  
Tel: REGent 4714

## Verviers, Belgium

For Continental Europe  
Andre Jamar  
1, Rue Mallar, 1  
087) 253.83 Telex 41563

## Tokyo

Haruki Hirayama  
Electronic Media Service  
5th Floor, Lila Bldg.,  
4-9-8 Roppongi  
Minato-ku  
Phone: 402-4556  
Cable: Electronicmedia, Tokyo



**AMERICAN BUSINESS PRESS, INC.**

## PIN/TERMINAL HEADACHES?

We can ship  
**FROM STOCK**



The  
**CONCORD**

equivalent of almost any: LERCO • USECO, or  
**CAMBION BRASS SOLDER TERMINALS and  
PINS PLUS...PRINTED CIRCUIT, MS STD.,  
Mil-T-55155, Fed. Spec. Nos. & Crack Proof  
Terminals.**

"We completely manufacture everything we sell."  
Certified Plating to ALL MIL-Specs.

**CONCORD ELECTRONICS CORPORATION**

37 GREAT JONES STREET • NEW YORK, N.Y. 10012  
(212) 777-6571 TWX 710-581-4930

INFORMATION RETRIEVAL NUMBER 106

# Micro-Miniature Reed Relays

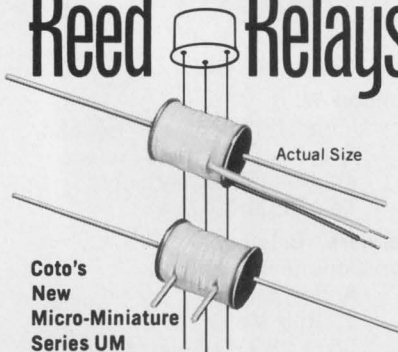

**Coto's  
New  
Micro-Miniature  
Series UM**

- Extremely small size: .400" x .300"OD
- Occupies less than 0.03 cu. in.
- Ultra-high speed 100 Microseconds operate time excluding bounce
- Stock voltages 3, 6, 12 and 24 volts
- Available with either leads or pins with 0.2" spacing

Special voltages, resistances, electrostatic and/or magnetic shields available. Write for new Data Sheet MR-9.1



**COTO-COIL COMPANY, INC.**  
59 Pavilion Avenue, Providence, R. I. 02905  
Tel: (401) 941-3355

INFORMATION RETRIEVAL NUMBER 107

# Advertisers' Index

Advertiser	Page	Advertiser	Page
AMP-Hexseal Corporation .....	149	Fairchild Semiconductor, A Division of Fairchild Camera and Instrument Corporation .....	82, 83
AMF Incorporated, Potter & Brumfield Division .....	121	Federal Scientific Corporation .....	139, 151
Abbott Transistor Laboratories Incorporated .....	13	Fluke Mfg. Co., John .....	112
Alco Electronic Products, Inc. ....	127, 134	Gencom Division, Varian/EMI .....	144
Allen-Bradley Co. ....	33, 51	Gould, Inc., Graphics Division .....	92, 93
Analogic Company .....	136	Grayhill, Inc. ....	64
Arnold Engineering Company, The .....	14	Hammel Riglander & Co. Inc. ....	64
Augat, Inc. ....	153	Hayden Book Company, Inc. ....	122B
Beckman Instruments, Inc., Helipot Division .....	105	Heinemann Electric Company .....	29
Belden Corporation .....	44, 45	Hewlett-Packard .....	1, 4, 5
Bishop Graphics, Inc. ....	151	Honeywell, Computer Control Division .....	47
Bodine Electric Company .....	49	Indiana General, A Division of Electronic Memories & Parts Corporation .....	60
Buckbee Mears Company .....	103	JFD Electronics Corp./Components Division .....	147
Bulova Frequency Control Products .....	146	James Electronics, Inc. ....	134
Burdny Corporation .....	115	Johanson Manufacturing Corp. ....	43
Burr-Brown Research Corporation .....	111	Kepeco, Inc. ....	65
By-Buk Company .....	149	Lear Siegler, Inc., Cimron Division .....	54
CGS Scientific Corp., Datametrics Division .....	149	Ledex Microelectronics, Ledex Inc. ....	131
Centralab Semiconductor Division, Globe-Union, Inc. ....	117	Lockheed Electronics, A Division of Lockheed Aircraft Corporation .....	11
Clairex Electronics, A Division of Clairex Corporation .....	69	3M Company, Chemical Division .....	98, 99
Clare & Co., C. P. ....	73	3M Company, Scotchpar .....	68
Clare-Pendar Co. ....	64	M & T Chemicals, Inc. ....	66
Cohn Corp., Sigmund .....	143	Malco Manufacturing Company, Inc. ....	62
Concord Electronics Corporation .....	152	Microdot, Inc. ....	58, 59
Coto Coil Company, Inc. ....	152	Micro Networks Corporation .....	127
Cunningham Corporation .....	123	MicroSwitch, A Division of Honeywell .....	10
Curtis Development & Mfg. Co. ....	148	Molex Incorporated .....	25
Cutler-Hammer .....	89	Monsanto Company .....	12, Cover III
Dale Electronics, Inc. ....	Cover II	Motorola Semiconductor Products, Inc. ....	8, 9, 16, 17, 50
Data Products Corporation .....	52, 53	North Atlantic Industries Inc. ....	16
Datascan, Inc. ....	140	Nylomatic Corporation .....	151
Durant Digital Instruments, A Cutler-Hammer Company .....	72	ERA Transpac Corporation .....	130
Dzus Fastener Co., Inc. ....	150	Eastman Chemical Products, Inc. ....	153
Elco Corporation .....	19	Eldre Components, Inc. ....	148
Eldre Components, Inc. ....	148	Electro Cube, Inc. ....	137
Electro Cube, Inc. ....	137	Electrostatics, Inc. ....	127
Electrostatics, Inc. ....	127	Erie Technological Products, Inc. ....	26
Erie Technological Products, Inc. ....	26	Pirgo Electronics, Inc. ....	67
AMP-Hexseal Corporation .....	149	Potter & Brumfield Division of AMF Incorporated .....	121
AMF Incorporated, Potter & Brumfield Division .....	121	Power/Mate Corp. ....	150
Abbott Transistor Laboratories Incorporated .....	13	Premier Metal Products Co., Inc. ....	68
Alco Electronic Products, Inc. ....	127, 134		
Allen-Bradley Co. ....	33, 51		
Analogic Company .....	136		
Arnold Engineering Company, The .....	14		
Augat, Inc. ....	153		
Beckman Instruments, Inc., Helipot Division .....	105		
Belden Corporation .....	44, 45		
Bishop Graphics, Inc. ....	151		
Bodine Electric Company .....	49		
Buckbee Mears Company .....	103		
Bulova Frequency Control Products .....	146		
Burdny Corporation .....	115		
Burr-Brown Research Corporation .....	111		
By-Buk Company .....	149		
CGS Scientific Corp., Datametrics Division .....	149		
Centralab Semiconductor Division, Globe-Union, Inc. ....	117		
Clairex Electronics, A Division of Clairex Corporation .....	69		
Clare & Co., C. P. ....	73		
Clare-Pendar Co. ....	64		
Cohn Corp., Sigmund .....	143		
Concord Electronics Corporation .....	152		
Coto Coil Company, Inc. ....	152		
Cunningham Corporation .....	123		
Curtis Development & Mfg. Co. ....	148		
Cutler-Hammer .....	89		
Dale Electronics, Inc. ....	Cover II		
Data Products Corporation .....	52, 53		
Datascan, Inc. ....	140		
Durant Digital Instruments, A Cutler-Hammer Company .....	72		
Dzus Fastener Co., Inc. ....	150		
Elco Corporation .....	19		
Eldre Components, Inc. ....	148		
Electro Cube, Inc. ....	137		
Electrostatics, Inc. ....	127		
Erie Technological Products, Inc. ....	26		
Fairchild Semiconductor, A Division of Fairchild Camera and Instrument Corporation .....	82, 83		
Federal Scientific Corporation .....	139, 151		
Fluke Mfg. Co., John .....	112		
Gencom Division, Varian/EMI .....	144		
Gould, Inc., Graphics Division .....	92, 93		
Grayhill, Inc. ....	64		
Hammel Riglander & Co. Inc. ....	64		
Hayden Book Company, Inc. ....	122B		
Heinemann Electric Company .....	29		
Hewlett-Packard .....	1, 4, 5		
Honeywell, Computer Control Division .....	47		
Indiana General, A Division of Electronic Memories & Parts Corporation .....	60		
JFD Electronics Corp./Components Division .....	147		
James Electronics, Inc. ....	134		
Johanson Manufacturing Corp. ....	43		
Kepeco, Inc. ....	65		
Lear Siegler, Inc., Cimron Division .....	54		
Ledex Microelectronics, Ledex Inc. ....	131		
Lockheed Electronics, A Division of Lockheed Aircraft Corporation .....	11		
3M Company, Chemical Division .....	98, 99		
3M Company, Scotchpar .....	68		
M & T Chemicals, Inc. ....	66		
Malco Manufacturing Company, Inc. ....	62		
Microdot, Inc. ....	58, 59		
Micro Networks Corporation .....	127		
MicroSwitch, A Division of Honeywell .....	10		
Molex Incorporated .....	25		
Monsanto Company .....	12, Cover III		
Motorola Semiconductor Products, Inc. ....	8, 9, 16, 17, 50		
North Atlantic Industries Inc. ....	16		
Nylomatic Corporation .....	151		
ERA Transpac Corporation .....	130		
Eastman Chemical Products, Inc. ....	153		
Eldre Components, Inc. ....	148		
Electro Cube, Inc. ....	137		
Electrostatics, Inc. ....	127		
Erie Technological Products, Inc. ....	26		
Pirgo Electronics, Inc. ....	67		
Potter & Brumfield Division of AMF Incorporated .....	121		
Power/Mate Corp. ....	150		
Premier Metal Products Co., Inc. ....	68		

# HIGH DENSITY IC PACKAGING PANEL

Increase flexibility — save time, space, money

**HIGH PERFORMANCE  
FAST DELIVERY  
LOW COST**

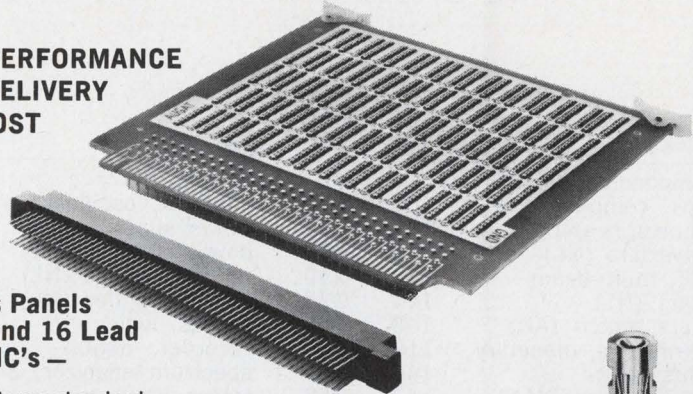

## R-Series Panels For 14 and 16 Lead Plug-In IC's —

- 60 patterns standard
- Mates with Augat's new 120 contact edge connector with Wire Wrap terminations on .100 inch centers. Connector supplied separately.
- 1/8" double-sided board has power and ground planes connected to each IC pattern.
- Machined contacts assure high reliability and retention.
- Wire Wrap terminations on IC patterns.

**AUGAT** INC.

Request Complete I. C. Folder  
Tel: 617-222-2202  
31 Perry Ave., Attleboro, Mass. 02703



INFORMATION RETRIEVAL NUMBER 108

Advertiser	Page
RCA Electronic Components and Devices	63, Cover IV
R F Communications, Inc.	70
Rohde & Schwarz	122A
Rotron, Incorporated	109
Schrack Electrical Sales Corp.	138
Sensitron Semiconductor, A Sensitron Company	72
Signalite, Division of General Instruments	61
Signetics Corporation	124, 125
Siliconix Incorporated	2, 15
Smith-Corona Marchant, Industrial Products	122
Sprague Electric Company	20, 67
Sprague Products Company	150
Stackpole Carbon Company	71
Sylvania Electric Products, Inc., Electronic Components Group	35, 36, 37, 38, 39, 40, 41, 42
Syntronic Instruments, Inc.	146
Systron-Donner Corporation	74

TRW Semiconductor Division of TRW Inc.	107
Technical Wire Products, Inc.	70
Tektronix, Inc.	57
Teletype Corporation	6, 7
Tenney Engineering, Inc.	66
Texas Instruments Incorporated, Components Group	22
Trio Laboratories, Inc.	148
Triplett Corporation	118
Tung Sol Division, Wagner Electric Corporation	128

Unimax Switch, Division Maxon Electronics Corporation	70
U. S. Capacitor Corporation	145
Unitrode Corporation	31

Vactec Inc.	133
Varo Semiconductor Division	138
Vector Electronic Company Inc.	136
Vernitron Piezoelectric Division	135
Victoreen Instrument Division	141
Virginia Panel Corporation	66

Wakefield Engineering, Inc.	72
Watkins-Johnson	129



it's HELPED A LOT OF PEOPLE GLUE THINGS THEY THOUGHT COULDN'T BE GLUED.

For example, how do you bond neoprene to fluoroelastomer? (Eastman 910® Adhesive does a great job if you etch the fluoroelastomer with sodium before you apply the adhesive.) Or rubber to polyacetal? (Pretreating the polyacetal with chromic acid increases bond strength 500%.)

Questions like these come from a lot of big companies. And from a lot of smaller ones. The answers come from our technical service laboratory. And from our more than ten years of experience with cyanoacrylate adhesives. (We invented them.)

And we have more answers. Like how to make Eastman 910 set faster, or slower. How to make

your bonds stronger, or more heat-resistant, or more impact-resistant, or whatever.

So if you're trying to glue something, and you're having a problem, we may be able to help. Contact your Eastman 910 distributor, or call Dick Blair at (615) 246-2111 at Eastman Chemical Products, Inc. in Kingsport, Tennessee.

He and our lab people are pretty good at finding what's wrong and setting it right.

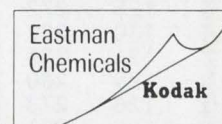

INFORMATION RETRIEVAL NUMBER 109

# Product Index

**Information Retrieval Service.** New Products, Evaluation Samples (ES), Design Aids (DA), Application Notes (AN), and New Literature (NL) in this issue are listed here with page and Information Retrieval numbers. Reader requests will be promptly processed by computer and mailed to the manufacturer within three days.

Category	Page	IRN	Category	Page	IRN	Category	Page	IRN
<b>Components</b>			plotter, X-Y			Tools & Engineering Aids		
clips, component (ES)	140	347	plug-ins, oscilloscope	129	279	attachment, heat-gun	136	342
connectors (NL)	148	391	power supplies (AN)	143	369	bender, lead	136	341
converters (NL)	148	395	power supplies (NL)	144	377	calculator, lens (DA)	141	352
CRT, multi-beam	119	250	power supplies (NL)	145	379	conversion, table (DA)	141	354
filters (NL)	144	375	power supplies (NL)	147	389	training, sales (NL)	144	376
filters, notch (AN)	148	366	probes, logic	128	277	<b>New Literature</b>		
gearmotors, planetary	119	253	recorder, digital	130	281	cages, PC card	144	374
lights (NL)	146	385	spectrum analyzer, 3-D	128	278	components	147	388
motors, servo (AN)	143	368	tester, IC	126	274	connectors	148	391
oscillators, crystal	120	259	tester, IC	128	276	controls, SCR	145	382
PC cages (NL)	144	374	testing (NL)	148	394	converters, mini-power	148	395
potentiometers, cermet	120	258	voltmeter, differential	130	284	data acquisition	147	390
potentiometers, trimmer	119	254	<b>Microwaves &amp; Lasers</b>			diodes	144	373
relay, switching	119	251	amplifier, power	137	344	filters	144	375
resistors (NL)	144	372	calculator, lens (DA)	141	352	keyboards, computer	145	380
resistors (NL)	146	386	diodes (NL)	144	373	lasers, GaAs	147	387
resistors (NL)	148	393	lasers, GaAs (NL)	147	387	lights, indicator	146	385
sensors, heated (AN)	143	371	oscillator, Gunn-effect	137	345	modules, power supply	145	379
solenoids (NL)	146	384	phototransistors	137	346	nondestructive testing	148	394
sources, power (NL)	148	392	switches, spst	137	343	piezoceramics	146	383
switch, snap-action	120	257	transistors (NL)	144	378	power supplies	144	377
switches (NL)	145	381	<b>Modules &amp; Subassemblies</b>			power supplies	147	389
switches, thumbwheel	120	256	amplifier, logarithmic	135	340	power supplies	148	392
thermistors (AN)	143	367	controls, SCR (NL)	145	382	power supplies	144	372
thermometers (AN)	143	370	converter, 8-bit d/a	134	295	resistors	144	372
transformer, flatpack	119	252	converters (NL)	148	395	resistors	148	393
tubes, readout	120	255	DIP filters (NL)	144	375	resistors, carbon	146	386
<b>Data Processing</b>			indicators (NL)	146	385	sales training	144	376
calculator, 16-digit	132	290	keyboards (NL)	145	380	solenoids, rotary	146	384
cores, tape-wound (ES)	140	349	ladder, 14-bit binary	133	293	switches, thumbwheel	145	381
data acquisition (NL)	147	390	module, current	135	298	transistors	144	378
keyboard, low-cost	132	287	modules, power (NL)	145	379	<b>Application Notes</b>		
keyboards (NL)	145	380	motors, servo (AN)	143	368	filters, active notch	143	366
memory, plated-wire	132	288	op amp, differential	134	296	motors, servo	143	368
scrambler, data	132	292	op amp, servo	133	294	power supplies, dc	143	369
terminal, I/O	132	291	power sources (NL)	148	392	sensors, heated	143	371
transport tape	132	289	power supplies (AN)	143	369	thermistors	143	367
<b>IC &amp; Semiconductors</b>			power supplies (NL)	144	377	thermometers, digital	143	370
converter, d/a 6-bit	122	262	power supplies (NL)	147	389	<b>Design Aids</b>		
diode, high-voltage	122	261	regulators, voltage	135	299	calculator, lens	141	352
diodes (NL)	144	373	sensors (AN)	143	371	conversion table	141	354
diodes, laser (NL)	147	387	solenoids (NL)	146	384	elastomers	141	353
driver & receiver, line	124	266	supply, negative-bias	134	297	<b>Evaluation Samples</b>		
generator, character	122	260	thermistors (AN)	143	367	clips, component	140	347
IC set, calculator	123	263	thermometers (AN)	143	370	cores, tape-wound	140	349
memory, LSI	123	264	<b>Packaging &amp; Materials</b>			spacers, metal	140	348
memory, random-access	124	267	cages, PC card (NL)	144	374	spacers, metal	140	348
op amp, hybrid power	124	268	connectors (NL)	148	391	supports, PC-board	140	351
op amps, low-cost	124	269	connectors, coaxial	138	410	tubing, shrinkable	140	350
shift register, MOS	123	265	cores, tape-wound	140	349			
transistors (NL)	144	378	dissipators, IC heat	139	414			
<b>Instrumentation</b>			elastomers (DA)	141	353			
calculator, deviation	131	286	hood, connector	139	415			
coupler, decimal-to-BCD	126	270	jumpers, flat-cable	139	413			
generator, decade	130	283	PC boards	139	412			
generator, function	126	272	piezoceramics (NL)	146	383			
generator, pulse	130	282	printed-circuit card	138	411			
generator, pulse	131	285	spacers, metal (ES)	140	348			
multimeter	129	280	supports, PC (ES)	140	351			
oscilloscope, 18-MHz	126	273	tubing, shrink (ES)	140	350			
oscilloscope, storage	126	271						

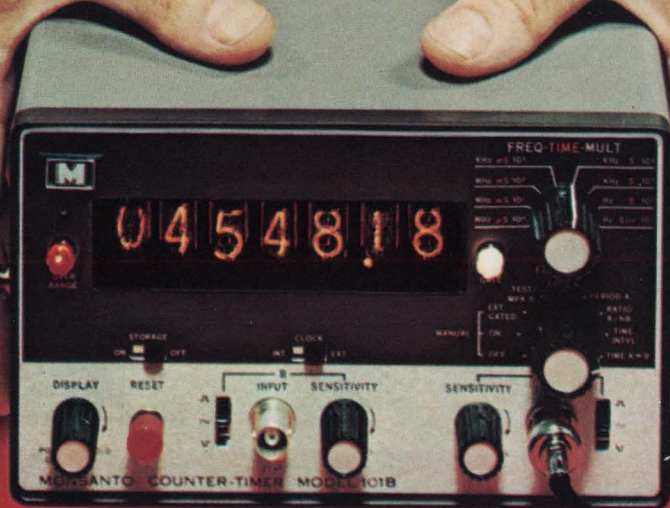

MSI construction; 50 MHz counting range; BCD output (TTL compatible); Full complement of counter/timer functions (including true time interval and multiple period average). These are some of the advantages that make this latest "Small Wonder" the most wonderful of all.

## Will <sup>small</sup> wonders never cease?

In the beginning was the Model 100A . . . the original "Small Wonder." Others quickly followed to make the Monsanto 100 Series the most popular line of counters in the industry.

And now there is a new breed, led by the Model 101B. It features wider performance ranges through ex-



tensive use of MSI and other design innovations that enhance its performance, reliability and serviceability. In addition to the advantages highlighted above, the Model 101B also offers dual inputs with individual trigger controls, adjustable display time with storage, crystal controlled clock, plus built-in

interfacing with the rest of Monsanto's line of compact, half-rack instruments.

And—Wonder of Wonders—Model 101B prices begin at \$695. Others of the new breed begin at \$420. Get complete details from your Monsanto Field Engineering Representative or from Monsanto Electronic Instruments, West Caldwell, New Jersey 07006.

# SEE BRIGHTER, MORE COLORFUL DIGITAL DISPLAYS WITH NUMITRON DEVICES

DR2100 NUMITRON Digital Display Devices

DR2000 NUMITRON Digital Display Devices



Your enthusiastic acceptance of RCA's DR2000 family of NUMITRON Digital Display Devices led to a decision to broaden the NUMITRON line with a new DR2100 family of smaller-size devices.

Both NUMITRON families give you the same unlimited filter-color selection for their sharp, bright and clean numerals. The DR2000 types are now available in production quantities. And, the new compact DR2100 types, which may be mounted on one-half inch centers, are only available in sample quantities.

Both families of NUMITRON Digital Display Devices feature:

- High contrast display ratio—bright segmented digits against a dark background
- Controllable high brightness
- Up-front planar numerals for wide viewing angle
- Rugged construction—high reliability

Here's another big benefit! Both NUMITRON families are designed for low voltage operation—4½ volts—and they are fully compatible with RCA's CD2500E and CD2501E 7-Segment Decoder Drivers.

Type numbers of RCA's NUMITRON Digital Display Devices:

- |  |         |        |
|--|---------|--------|
| <input type="checkbox"/> Numerals 0 through 9                  | DR2000, | DR2100 |
| <input type="checkbox"/> Numerals 0 through 9,<br>with decimal | DR2010, | DR2110 |
| <input type="checkbox"/> Plus-Minus and numeral 1              | DR2020, | DR2120 |
| <input type="checkbox"/> Plus-Minus                            | DR2030, | DR2130 |

For further information on RCA's NUMITRON devices, see your RCA Representative or your local RCA Distributor. Also ask for information on RCA's 7-Segment Decoder Drivers especially designed for use with NUMITRON devices. For information on both of the two NUMITRON families and the Decoder Drivers, write to RCA Electronic Components, Commercial Engineering\*, Harrison, N. J. 07029.

In Europe: RCA International Marketing, S.A.,  
2-4 rue du Lièvre, 1227 Geneva, Switzerland.

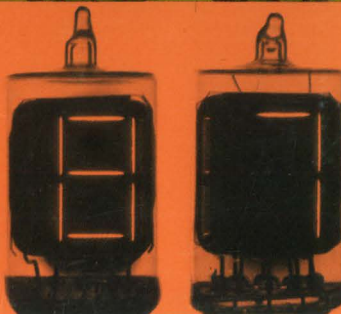
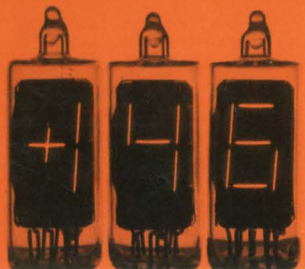
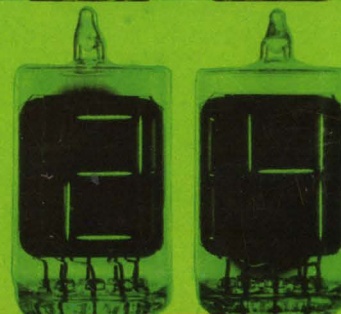
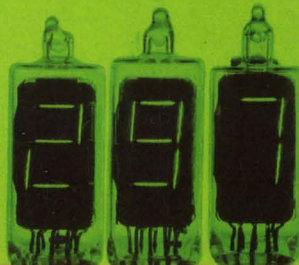
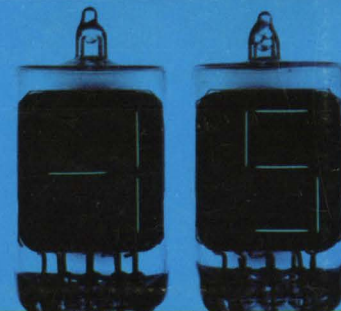
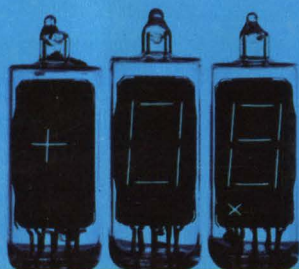
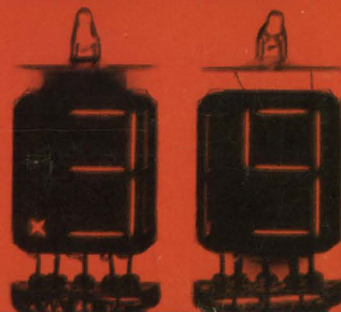
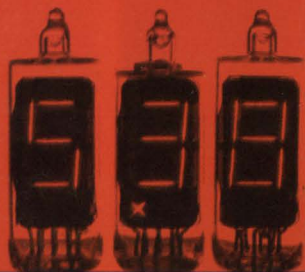
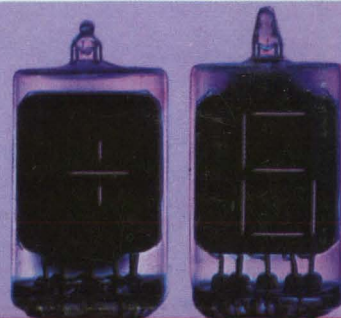

## RCA