

# Electronic Design<sup>®</sup> 20

VOL. 24 NO.

FOR ENGINEERS AND ENGINEERING MANAGERS

SEPT. 27, 1976

**RFI and EMI** are rapidly racing out of control. Major sources are new citizens-band sets, industrial fabricating equipment, switching power supplies and consumer

devices. The FCC's response is to make stricter regulations. But these tougher limits will make EMI/RFI-proofing a major design task. For the story, see p. 24.

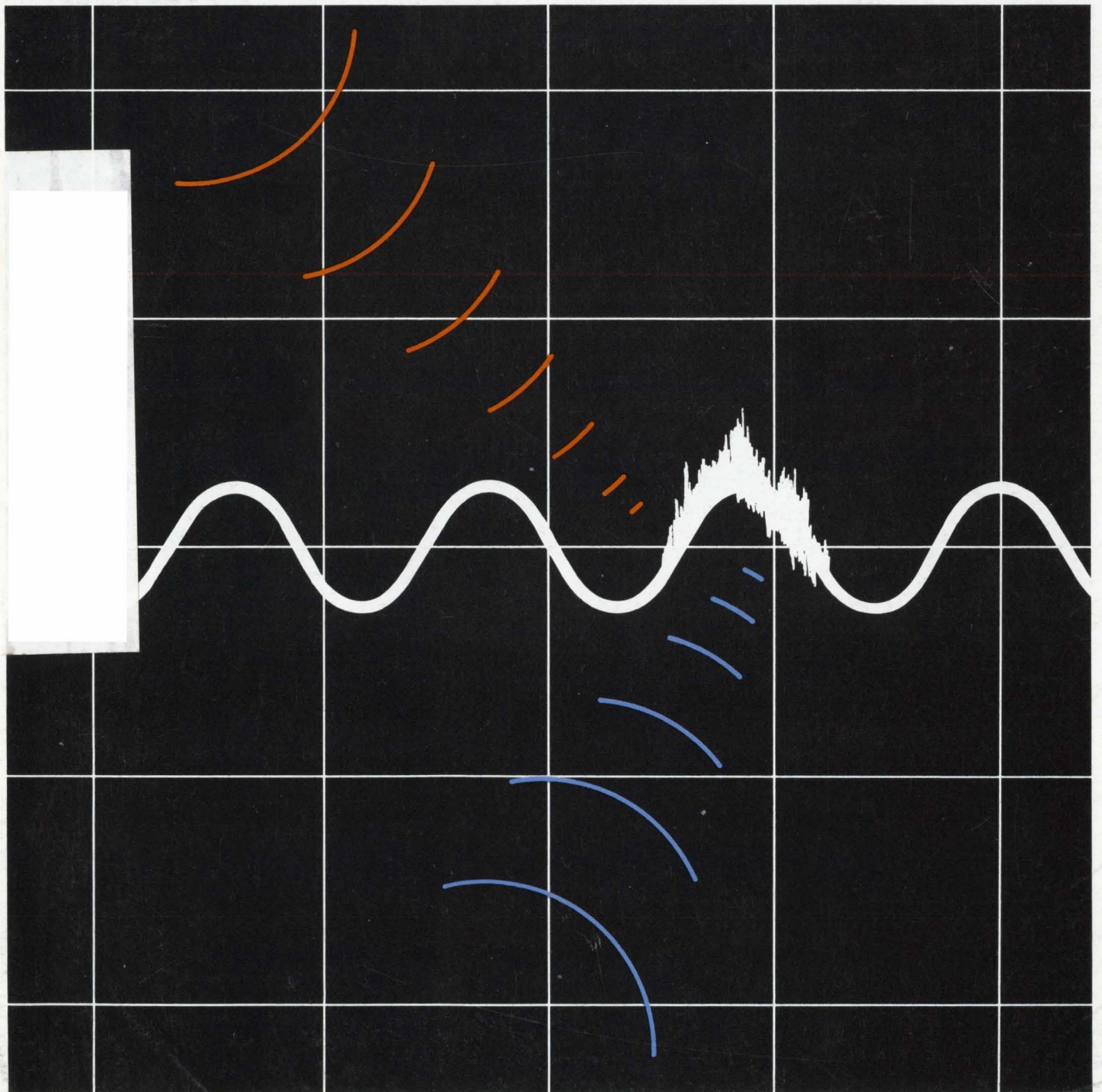



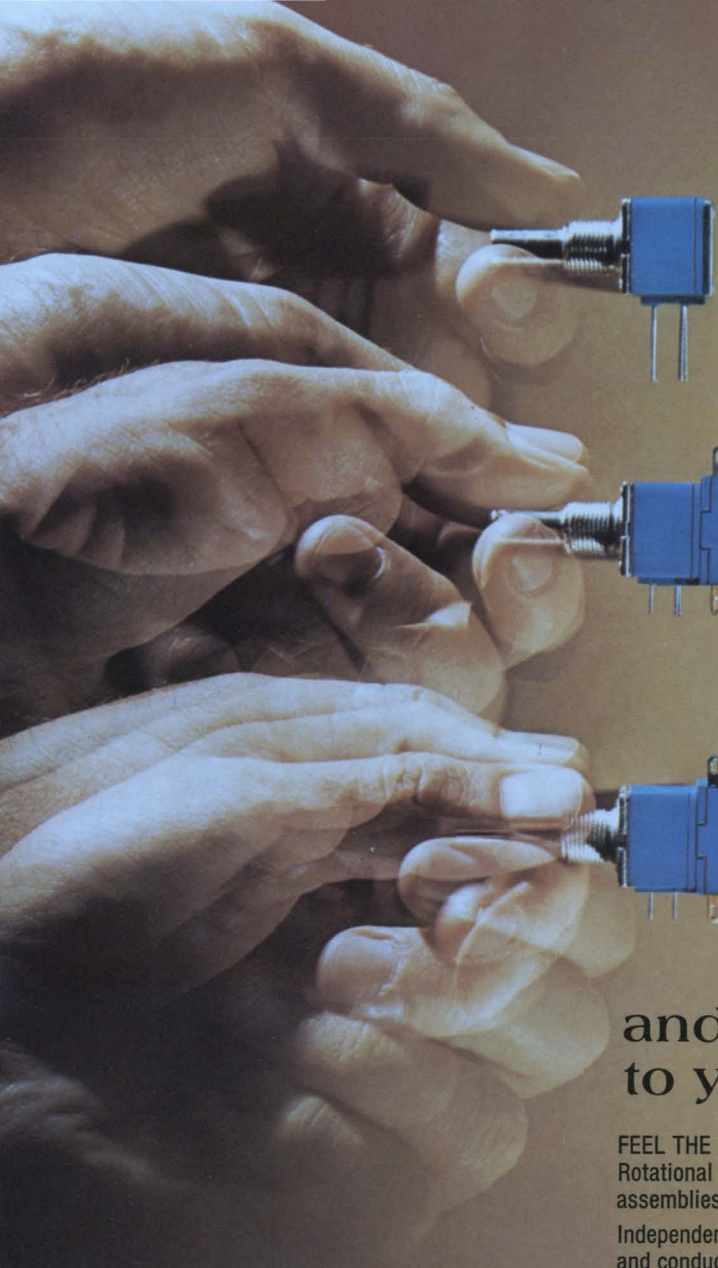

**FEEL**  
the pot . . .

**CLICK**  
the switch . . .

**GANG**  
the modules . . .

and add "quality-touch" appeal  
to your product.

**FEEL THE POT . . .** a smooth, quality feel, only from Bourns® 81/82 Model Potentiometers. Rotational torque range, only .3 to 2.0 oz. inch, is consistent for one, two, three or four cup assemblies.

Independent linearity of  $\pm 5\%$  and low 1% CRV provide exceptional setability in both cermet and conductive plastic element types.

**CLICK THE SWITCH\*** . . . one that really clicks, with positive action detent at either CW or CCW end. The Bourns Model 85/86 potentiometer/switch combination is rated at 2 amps in DPST style and 1 amp in DPDT. Contacts are constructed of fine silver with gold overlay. This provides exceptionally low contact resistance, for reliable operation at low level analog or logic signal levels — or any application requiring an "on-off" function.

**GANG THE MODULES . . .** potentiometers and switches. Up to 4 modules can be ganged on the same single or dual concentric shaft, without sacrifice to the satin-smooth feel or the sure-fire click. Other options include a wide choice of bushing and shaft styles, P.C. pins or solder lugs. Think of the possibilities! Now you can specify custom pots and switches assembled from "off-the-shelf" modules — at standard cost and leadtime.

Add "quality-touch" appeal to your equipment with BOURNS Model 80 Family of Modular Potentiometer/Switches. Write or call today for complete technical information, direct or through your Bourns distributor.

**FEEL, CLICK, GANG . . . BEAUTIFUL!**

**TRIMPOT PRODUCTS DIVISION, BOURNS, INC.,** 1200 Columbia Avenue, Riverside, California 92507, Telephone (714) 781-5122 — TWX 910 332-1252.

\*Patent pending

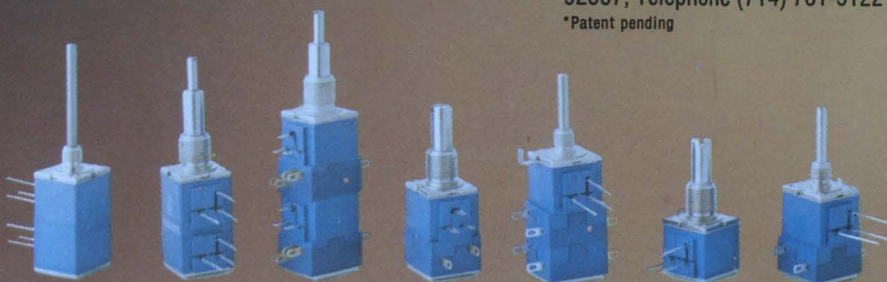

Int'l Sales Offices: European Hdqtrs. — Switzerland, 042/23 22 42 • Belgium 02/218 2005 • France 01/2039633 • Germany 0711/24 29 36  
• Italy 02/32 56 88 • Netherlands 070/88 93 18 • United Kingdom 01/572 6531 • Japan 075 92 1121 • Australia 86 9410 • Brazil 257-3535

CIRCLE NUMBER 252



The instruments on the left are our good old Models 152 and 159 programmable function generators—the ones that are ASCII coded and compatible with the GPIB.

And at right is our new Model 583 Autoprogrammer, designed to be used only with our programmables. By means of its plug-in memory, the Autoprogrammer can store

commands for up to 100 separate tests. Test sequencing can be manual as well as automatic. Size of the memory is 1024 eight-bit words. You can program the memory supplied with the blank plug-in cartridge, or we can furnish you EROMs that are pre-programmed to your specs.

The Model 583 Autoprogrammer goes for just

\$995; the blank plug-in EROM cartridge is \$150; a custom-programmed plug-in is \$250. But none of these will do you any good unless you have one of our programmables. So get one. WAVETEK, P.O. Box 651, San Diego, CA 92112. Phone (714) 279-2200, TWX 910-335-2007. U.S. prices only

**WAVETEK**<sup>®</sup>

CIRCLE NUMBER 2

**If you have  
one of these,**

**you  
ought to  
have one  
of these.**

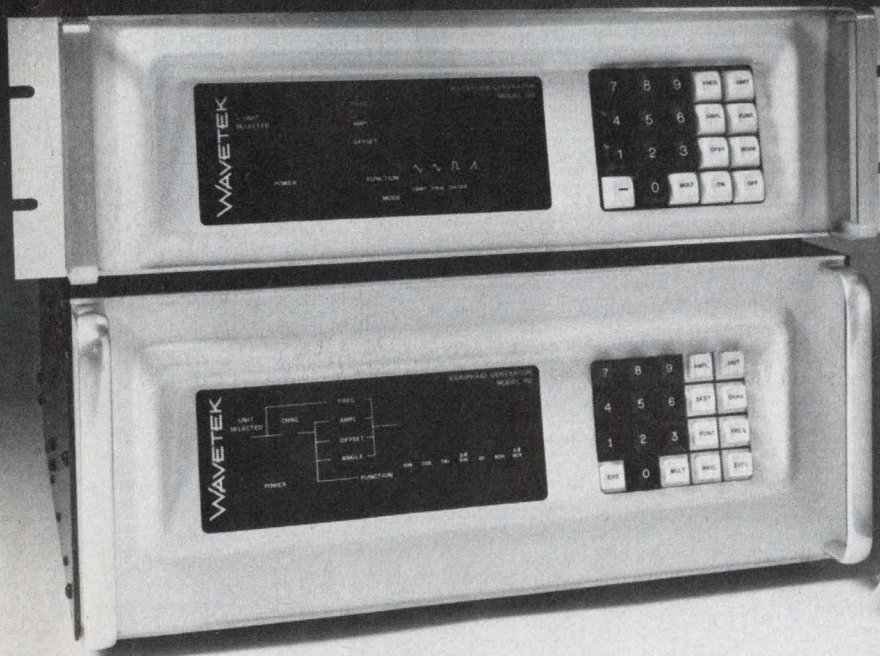



# Surprise! \$2.95

(10-49)

# Wideband Transformers

**SURPRISE! Wide bandwidths, .015-600 MHz**  
**SURPRISE! Low insertion loss, 0.5 dB**  
**SURPRISE! Microminiature, .230" x .270" x .300"**  
**SURPRISE! One week delivery**

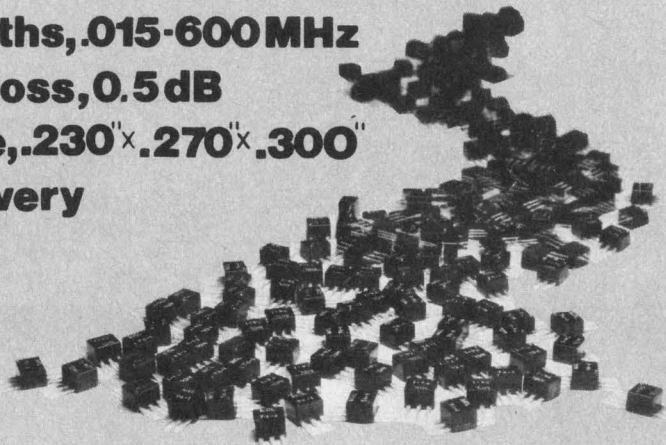

**DESIGNERS KIT AVAILABLE:**  
 2 TRANSFORMERS OF EACH TYPE  
 T1-1, T2-1, T4-1, T9-1, T16-1  
 KIT # TK-1... \$32.00

NO "MAKE OR BUY" DECISION HERE... it costs less to buy Mini-Circuits wideband transformers and there's no delivery delay. Impedance levels from 12.5 to 800 ohms with insertion loss typically less than 0.5 dB

MODEL	T1-1	T2-1	T4-1	T9-1	T16-1
Impedance Ratio (50 Ω pri. imp.)	1	2	4	9	16
Bandwidth (MHz)	1db loss	2-50	.05-200	2-100	2-40
	3db loss	.15-400	.015-600	.2-350	.15-200
Price (10-49)	\$2.95	\$3.45	\$2.95	\$3.45	\$3.95

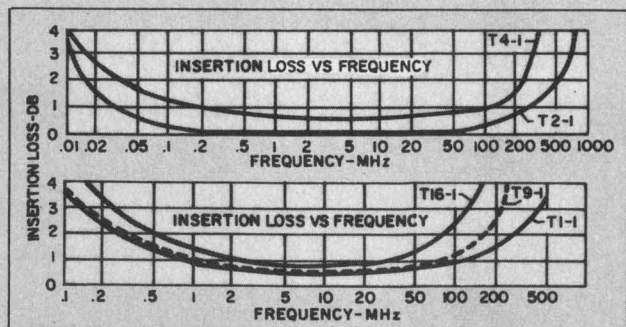

For complete specs, performance curves and drawings, see pgs 192-193 of the 1976-77 MicroWaves Product Data Directory.

World's largest supplier of double balanced mixers

**Mini-Circuits Laboratory**  
 A Division Scientific Components Corp

837-843 Utica Avenue, Brooklyn, NY 11203  
 (212) 342-2500 Int'l Telex 620156 Dom. Telex 125460

**International Representatives:**  AUSTRALIA General Electronic Services, 99 Alexander Street, New South Wales, Australia 2065;  ENGLAND Dale Electronics, Dale House, Wharf Road, Frimley Green, Camberley Surrey;  FRANCE S. C. I. E. - D. I. M. E. S., 31 Rue George - Sand, 91120 Palaiseau, France;  GERMANY, AUSTRIA, SWITZERLAND Industrial Electronics GMBH, Klüberstrasse 14, 6000 Frankfurt/Main, Germany;  ISRAEL Vectronics, Ltd., 69 Gordon Street, Tel-Aviv, Israel;  JAPAN Denso Kaisha, Ltd., Eguchi Building, 8-1 1 Chome Hamamatsucho Minato-ku, Tokyo;  EASTERN CANADA B. D. Hummel, 2224 Maynard Avenue, Utica, NY 13502 (315) 736-7821;  NETHERLANDS, BELGIUM, LUXEMBOURG: Coimex, Veldweg 11, Hattem, Holland.  NORWAY Datamatik AS, Ostensjoveien 62, Oslo 6, Norway

**US Distributors:**  NORTHERN CALIFORNIA Cain-White & Co., Foothill Office Center, 105 Fremont Avenue, Los Altos, CA 94022 (415) 948-6533;  SOUTHERN CALIFORNIA, ARIZONA Crown Electronics, 11440 Collins Street, No. Hollywood, CA 91601 (213) 877-3550



---

## NEWS

- 21 **News Scope**
- 24 **The Federal Communications Commission is being swamped** with thousands of complaints as the sources of RFI and EMI are increasing dramatically —An Electronic Design special report.
- 43 **Washington Report**

---

## TECHNOLOGY

- 49 **MICROPROCESSOR DESIGN**
- 62 **FOCUS on Digital Voltmeters:** When you're specifying these instruments a casual approach can be disastrous. Careful analysis may show that a DVM with an accuracy spec of 0.1% is actually worse than 1% under some conditions.
- 74 **Cancel 60-Hz and other noise** with adaptive filters. Other benefits include less signal distortion than with conventional techniques.
- 82 **Reduce the noise output** of linear rf amplifiers. High degeneration in the emitter of a grounded-base circuit reduces the noise figure to 2 dB, 10% from the carrier.
- 88 **Model your ROM and NAND gates** when using computer-aided design to check a digital system. This program models large ROMs, with minimal circuitry.
- 96 **Ideas for Design:**  
Preselector/mixer alignment circuit uses receiver's balanced mixer as a load.  
Temperature-measuring bridge uses constant-current FET circuits.  
Pulse-width modulator produces an output of same polarity as input.
- 102 **International Technology**

---

## PRODUCTS

- |                           |                             |
|---------------------------|-----------------------------|
| 107 Instrumentation       | 125 Modules & Subassemblies |
| 110 Components            | 132 Integrated Circuits     |
| 114 Power Sources         | 136 Data Processing         |
| 117 Microwaves & Lasers   | 140 Discrete Semiconductors |
| 120 Packaging & Materials |                             |

---

## DEPARTMENTS

- |   |                                |
|---|--------------------------------|
| 57 <b>Editorial:</b> The great anatomical anomaly |                                |
| 5 Across the Desk                                 | 148 Advertisers' Index         |
| 141 Application Notes                             | 150 Product Index              |
| 142 New Literature                                | 150 Information Retrieval Card |
| 144 Bulletin Board                                |                                |

**Cover:** Cover designed by Art Director, Bill Kelly.



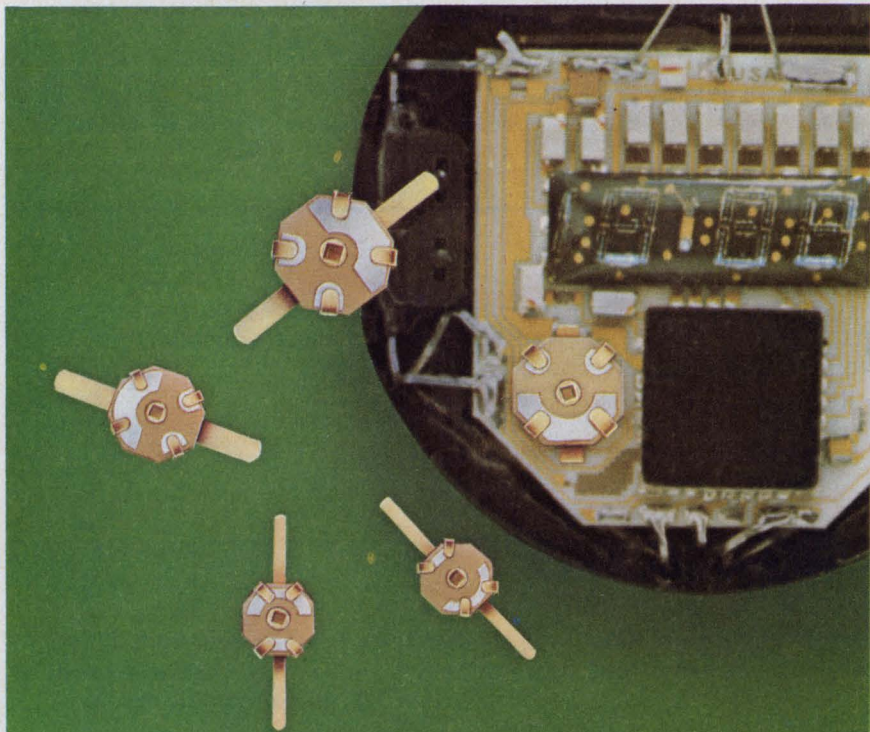

# Thin-Trim<sup>®</sup> capacitors

Tucked in the corner of this Pulsar Watch is a miniature capacitor which is used to trim the crystal. This Thin-Trim capacitor is one of our 9410 series, has an adjustable range of 7 to 45 pf, and is .200" x .200" x .050" thick.

The Thin-Trim concept provides a variable device to replace fixed tuning techniques and cut-and-try methods of adjustment. Thin-Trim capacitors are available in a variety of lead configurations making them easy to mount.

A smaller version of the 9410 is the 9402 series with a maximum capacitance value of 25 pf. These are perfect for applications in sub-miniature circuits such as ladies' electronic wrist watches and phased array MIC's.

Johanson Manufacturing Corporation  
Rockaway Valley Road  
Boonton, New Jersey 07005  
(201) 334-2676 TWX 710-987-8367

**Sr. Vice President, Publisher**  
Peter Coley

## Editors

Editorial Offices  
50 Essex St.  
Rochelle Park, NJ 07662  
(201) 843-0550  
TWX: 710-990-5071  
Cable: Haydenpubs Rochellepark

**Editor-in-Chief** George Rostky

## Managing Editors:

Ralph Dobriner  
Michael Elphick

## Senior Associate Editor:

Stanley Runyon

## Associate Editors:

Sid Adlerstein  
Dave Bursky  
Samuel Derman  
Jules H. Gilder  
Morris Grossman  
John F. Mason  
Michael Shunfenthal

## Contributing Editors:

Peter N. Budzilovich, John Kessler  
Alberto Socolovsky, Nathan Sussman

## Editorial Field Offices

### East

Jim McDermott, Eastern Editor  
P.O. Box 272  
Easthampton, MA 01027  
(413) 527-3632

### West

David N. Kaye, Senior Western Editor  
8939 S. Sepulveda Blvd., Suite 510  
Los Angeles, CA 90045  
(213) 641-6544  
TWX: 1-910-328-7240

Jim Gold, Western Editor  
1537 Shasta Ave.  
San Jose, CA 95128  
(408) 279-8588

## Editorial Production

Marjorie A. Duffy, Production Editor  
James Keane, Copy Editor

## Art

**Art Director**, William Kelly  
Richard Luce, Anthony J. Fischetto

## Production

**Manager**, Dollie S. Viebig  
Helen De Polo, Anne Molfetas

## Circulation

**Director**, Barbara Freundlich  
Trish Edelman

## Information Retrieval

Peggy Long

## Advertising Promotion

Susan G. Apolant



# Across the Desk

## A better model for phonograph cartridges?

I liked the article, "Hold Noise Down With JFETs . . ." (ED No. 4, Feb. 16, 1976, p. 146), especially the design example for the phonograph preamplifier. It bears mention, however, that B. I. Hallgren of the Institute of Physics at the University of Stockholm has proposed a different circuit for a phono cartridge:

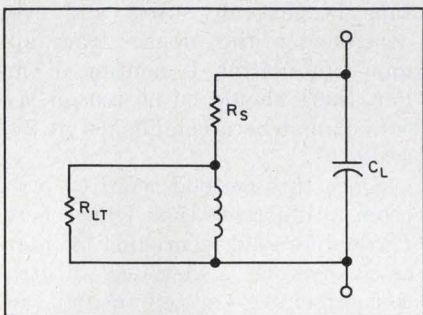

In this version,  $C_L$  is mostly cable capacitance and  $R_{LT} = R\omega^k$ , where  $\omega$  is the angular frequency, and  $R$  and  $k$  are constants determined by the specific pickup cartridge. Typical values for popular cartridges are as follows: for the ADC 27,  $R = 53.8 \Omega/\text{rad}$  and  $k = 0.67$ ; for the Shure M75,  $R = 272 \Omega/\text{rad}$  and  $k = 0.51$ .

This model was published in the Journal of the Audio Engineering Society (Vol. 23, No. 7, September, 1975). Its accuracy appears to have been confirmed by Tomlinson Holman of Advent Corp., who commented on it at the convention of the AES (New York City, October, 1975).

*Richard W. Bowser*

Custom Electronics, Inc.  
4448 S. 84 St.  
Omaha, NE 68127

## The author replies

I read Mr. Hallgren's article

with much interest when it was published. He used 83 third-octave bands (from 8.8 Hz to 114 kHz), a complex model and a computer for noise calculations. For the two phono cartridges (with specific loading) the RIAA equalized noise was  $0.772 \mu\text{V}$  for an ADC 27 and  $0.709 \mu\text{V}$  for a Shure M75.

I used the ADC 27 cartridge loaded with 250 pF and  $47 \Omega$  (the same conditions as Mr. Hallgren) as an example. I used the following equation for the noise calculation:

$$V_{EQ} = \frac{(|A_1|^2 V_{N1}^2 + |A_2|^2 V_{N2}^2 + \dots)}{(|V_n|^2 V_{Nn}^2)^{1/2}}$$

where  $V_{EQ}$  is the equalized noise,  $|A_n|$  is the magnitude of reflected gain at the center of each frequency band and  $V_{Nn}^2$  is the noise of each frequency band.

With octaves starting at 20 Hz and ending at 20 kHz, the RIAA equalized noise worked out to  $0.75 \mu\text{V}$ . This is within 3% of the value of Mr. Hallgren's example; if the same frequency range had been used, the difference would have been less. I don't believe that the addition of  $R_{LT}$  to the model would significantly change the calculated noise value; there is no need to further complicate an already complex problem.

Complete details of this example will appear in National's upcoming audio handbook.

On rereading my ELECTRONIC DESIGN article, I've discovered several small errors that I overlooked earlier. On p. 151, the equation should read:

$$V_{MAX} = \left[ \frac{(\text{min. signal})^2}{\text{min S/N}^2} - V_N^2 \right]^{1/2}$$

$$V_{GS, \text{typ}} = V_{P, \text{typ}} \left[ 1 - \left( \frac{I_D}{I_{DSS}} \right)^{1/2} \right] = 2.1 \text{ V}$$

$$R_s = \frac{15 \text{ V} + V_{GS, \text{typ}}}{I_{D, \text{max}}} = 17 \text{ k}\Omega$$

*(continued on page 6)*

Electronic Design welcomes the opinions of its readers on the issues raised in the magazine's editorial columns. Address letters to Managing Editor, Electronic Design, 50 Essex St. Rochelle Park, N.J. 07662. Try to keep letters under 200 words. Letters must be signed. Names will be withheld on request.

## Marcoflex. The switch that turns people on.

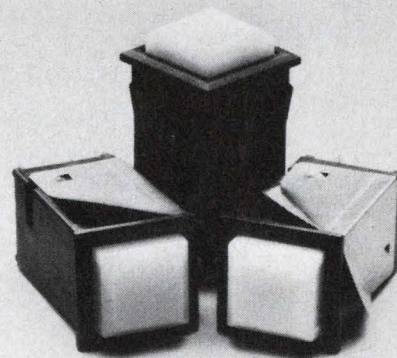

"... amazingly simple and reliable."  
"Why didn't I think of it?"

People are really getting turned on by our new Marcoflex 650 switches.

Which doesn't surprise us. After all, its patented flexing spring action is something of a *breakthrough*.

An incredibly simple design gives you electrical and mechanical characteristics associated with larger switches in a miniature, .625-inch package at an economical price.

Features include wiping action, multiple-point (bifurcated) contact, true snap action, high contact force, and positive tactile feel.

Plus alternate or momentary action, and excellent reliability.

Get turned on by Marcoflex yourself. Contact us today for full details.

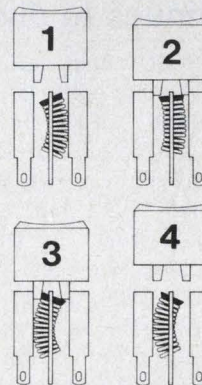

**The patented Marcoflex mechanism.**

### ILLUMINATED PRODUCTS INC.

A subsidiary of OAK Industries Inc.  
2620 South Susan St., P.O. Box 11930  
Santa Ana, CA 92711  
Telephone: 714/540-9471 TWX 910-595-1504

**OAK COMPONENTS GROUP**



## ACROSS THE DESK

(continued from page 5)

Also, on p. 152:

$$V_{GS(max)} = 2.8 \text{ V}$$

and,

Final S/N =

$$\frac{2 \text{ mV}}{1.73 \mu\text{V}} = 1150 (61.2 \text{ dB})$$

John Maxwell

Senior Application Engineer

National Semiconductor Corp.

2900 Semiconductor Dr.

Santa Clara, CA 95051

## Microprocessors—a topic of limited interest?

Microprocessors are indeed wonderful machines, but must 90% of each issue be devoted to them?

Quite frankly I am bored with reading three-page articles each time a microprocessor manufacturer changes a resistor value on his chip.

Would you consider articles on the other 90% of the electronics field that microprocessors have not revolutionized?

Larry W. Fort  
Engineering Dept.

Progressive Electronics, Inc.

432 South Extension

Mesa, AZ 85202

## Editorial on advisors continues to divert

I couldn't help noticing the protests of your editorial, "The Czar's Consulant" (ED No. 1, Jan. 5, 1976, p. 75). However, the worst taste of all was not shown by the editorial itself, but by the letter "Success Story" by Dan Sheingold of Analog Devices (ED No. 8, April 12, 1976, p. 14).

To describe as a "sales force" a political organization guilty of murdering 10 million human beings in the drive to collectivize agriculture alone is reprehensible and deserves no place in the discourse of decent men. The figure is Stalin's own estimate. See, for example, p. 345 of *The World Since 1939* by Carroll Quigley (Collier Books, New York, 1965).

There can be no excuse for call-

ing the abhorrence of mass murder, political purges, and slave labor (*ibid*, pp. 345-346) "foolishly cutting off . . . sources of information and tools for their sales force." The United States is a country founded on the right of each man to live his life by his own choice, free from arbitrary compulsion. Should it ever wind up "undercut" by the "competition," it will be because of the abandonment of individual liberty, and not the failure to betray it.

Dick Bowser

Custom Electronics, Inc.

4448 South 84 St.

Omaha, NE 68127

## Misplaced Caption Dept.



How come the other kids get to use their pocket calculators?

Sorry. That's Jean-Baptiste Simeon Chardin's "The Young School Mistress," which hangs in the National Gallery in London.

## Improve your PC artwork with three-layer method

I am writing in response to an article "Improve Your PC Artwork Techniques" (ED No. 25, Dec. 6, 1975, p. 72). My general feeling is that the techniques described are definitely not "state-of-the-art."

With today's technology of high-density packaging, it is common practice to design PC boards using 0.013-in. traces with 0.013-in. air gaps. However, IC pads have 0.060-in. pads to allow traces to run between pins of the same row. This practice therefore requires both

designer and board manufacturer to maintain a degree of high-quality workmanship.

While there were numerous items I could comment on, one of the most critical centers around front-to-back registration, especially for boards that have been modified several times, and for large boards in general. This can be overcome by using the red and blue taping system, but for most applications that technique is costly, time consuming, and demands very careful handling and storage.

The benefits of the red and blue system can be obtained by using the "three-layer" method, which uses a pad master common to both front and back, and therefore ensures positive registration. Crepe tape is generally used, and even considering the dense trace/air-gap combination I mentioned earlier, there should be no reason layouts cannot be accomplished at 2:1 scale.

Since this method requires more room to illustrate than I have here, I would be glad to provide to interested persons a detailed illustration brochure—a new design aid that Masters has just published.

Darryl Lindsey  
Administrator

Masters PC Design School

40386 Loro Place

Fremont, CA 94538

## 'Terrific' article points up the value of experience

"Nick Tagaris of Datel . . ." is a terrific article. Hard hitting and concise. It takes guts for ELECTRONIC DESIGN to print it, considering some 95 to 98% of your readers do not pass Nick's minimums of 10 years experience and a generalist.

However, it is refreshing to find someone who hires working EE's based on their maximums not their minimums. So often, we see the golden 2 to 5 ads with the resultant minimum monofunctional experience as the only allowable qualifications. And they truly mean 5 years maximum.

David W. Weigand  
Consulting Engineer

904 Tyson Drive

West Chester, PA 19380





# MEASUREMENT COMPUTATION

innovations from Hewlett-Packard

# NEWS

SEPTEMBER 1976

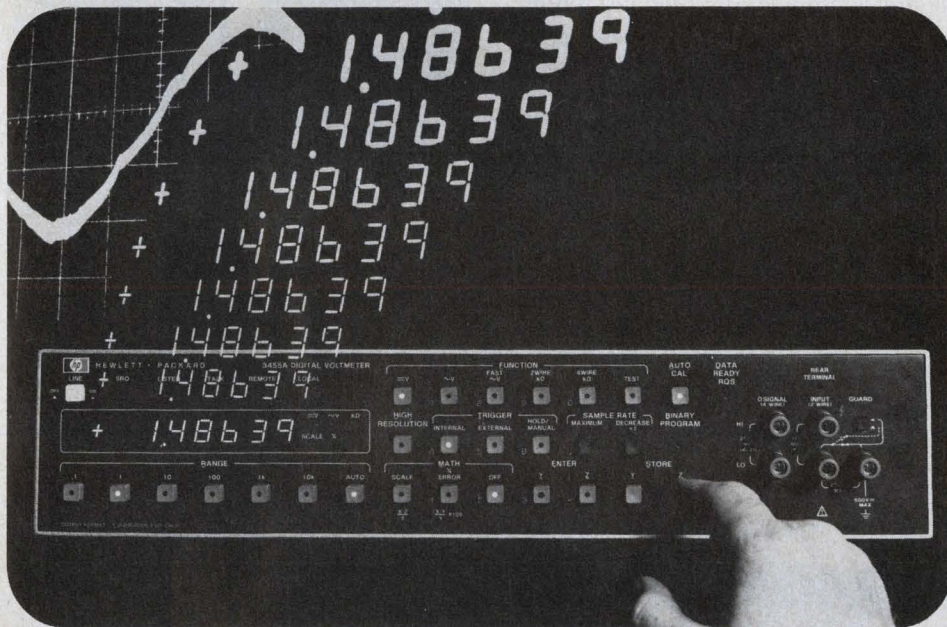

New 5½, 6½-digit DVM checks its dc and ohms circuits for accuracy and then makes corrections. One microprocessor controls the Auto-cal process; the other is for computation of the math functions and remote programming via the HP-IB.

## NEW HP microprocessor-controlled DVM makes 24 readings/sec in presence of noise

Hewlett-Packard's new Model 3455A DVM has high speed and good noise rejection for systems use and high resolution and computational capability for bench applications.

Dc measurements from 1 microvolt to 1 kilovolt can be made at 24 readings per second with 5½ digits; 6½ digits are used for greater than 1 ppm resolution measurements at six readings/second. Greater than 60 dB normal mode noise rejection and greater than 160 dB common-mode noise rejection is obtained on all dc ranges. Best dc accuracy is  $\pm 0.0023\%$ .

True rms measurements are made up to 13 readings per second above 300 Hz. True rms is measured with best accuracy of 0.1% over a 30 Hz to 1 MHz bandwidth. Signal crest factors as high as 7:1 full scale can be measured.

Four or two-wire resistance measurements can be made from 1 milliohm to 15 megohms. Maximum current through the unknown is less than 1 milliamper.

Math functions built into the 3455A let the user offset, take ratios or scale readings so that readouts are in physical units. A % ERROR mode converts read-

**in this issue**

Special edition:  
**HEWLETT-PACKARD  
INTERFACE BUS**

World's first  
rectangular lamp

Three new personal  
calculators

ings into percent change compared to a predetermined reference.

Use of a plug-in precision reference enables the instrument to check itself against the reference. Under control of a microprocessor, it makes its own error corrections. This reference unit can be easily removed from the 3455A for periodic calibration. A self-test feature verifies operation of dc circuits. If a problem is found, it is easily diagnosed using the front panel display.

Standard on the 3455A is an HP-IB (Hewlett-Packard's implementation of IEEE 488-75) I/O for systems operation. Front panel indicators on the 3455A display range, function and HP-IB status during remote operation.

For more information, check 1 on the HP Reply Card.



# Automatic system speeds transceiver testing to 1000 MHz

Productivity is the watchword in receiver manufacturing. Radio maintenance shops are striving to improve throughput, test quality, and turn-around-time. R&D and incoming quality labs need to provide accurate, consistent, and comprehensive testing of today's sophisticated transceivers.

To help solve these requirements, Hewlett-Packard is introducing its 8950A Transceiver Test System. The combination of these mostly off-the-shelf instruments provide capability of testing AM and FM transceivers up to 1000 MHz and 100 watts. System control is via the HP 9825A calculator providing self-contained operation.

Amplitude modulation characteristics are measured from 1 to 95% depth and an accuracy of  $\pm 5\%$ . FM deviation is measured to 20 kHz with an accuracy of  $\pm 3\%$ . Audio measurements on the transmitter provide  $\pm 5\%$  accuracy on sensitivity, with audio response indicated to 25 kHz for AM and 20 kHz for FM. Audio distortion is measured to  $< 2\%$  at 400, 1000 or 3000 Hz using the THD (total harmonic distortion) technique. Squelch tone frequency is indicated to  $\pm 0.1$  Hz.

Receiver test capabilities include sensitivity tests at 12 dB SINAD for 1 kHz or

with 20 dB quieting and can also be made at squelch threshold. Audio power output is measured to  $\pm 0.5\%$  with a frequency response to 50 kHz; accuracy and audio distortion to  $\pm 1\%$  at 1 kHz tone.

Model 8950A achieves maximum throughput and testing speed with a special interface and signal switch adapter panel mounted at the operator shelf. Automatic testing can improve test times by 10 to 1 over manual tests. Throughput of course depends on the particular test sequence, but a Citizen Band transceiver test can be run in 3 minutes including a printed test report.

Hewlett-Packard furnishes software test modules as sub-routines, segmented by type of test; for example, transmitter power, transmitter frequency, etc. The user then writes simple programs to access the tests as appropriate and compare test data against programmed limits or print out a test card.

*For additional technical information, check Q on the HP Reply Card.*

## New, easy-to-use storage controls make your measurements faster, less complicated

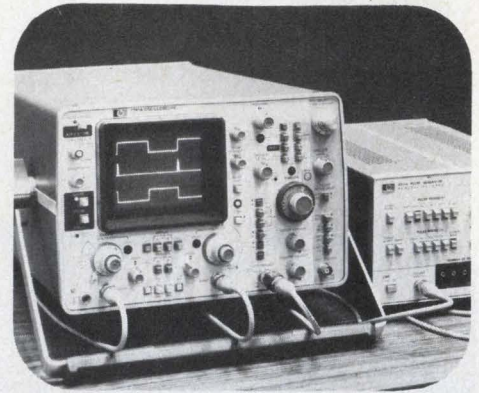

*For viewing low-rep-rate/fast rise-time signals, the variable persistence mode of the 1741A storage oscilloscope allows you to adjust the trace for an optimum display.*

A newly-designed storage/variable-persistence CRT, used for the first time in Hewlett-Packard's new 1741A oscilloscope, produces exceptionally clean traces, and excellent trace-to-background contrast ratio.

New automatic storage controls make it easier than ever before to capture low-rep-rate, single-shot waveforms common in today's digital circuits.

As a dual-channel, 100 MHz general purpose scope, it has a writing speed of at least  $100 \text{ cm}/\mu\text{s}$  which allows single shot capture of glitches 1 division high and less than 20 ns wide.

The variable persistence mode allows you to adjust the trace for an optimum display. The third-channel trigger view lets you observe an external trigger signal simultaneously with channel A and B traces.

A  $\times 5$  magnifier permits two channel measurements as low as  $1 \text{ mV}/\text{div}$  to 30 MHz, without cascading.

The 1741A is suited not only to the laboratory and the computer room, but also to the more rugged situations common with communications and process control equipment.

*For more information on this easy-to-use storage/variable persistence oscilloscope, check G on the HP Reply Card.*

HP-IB

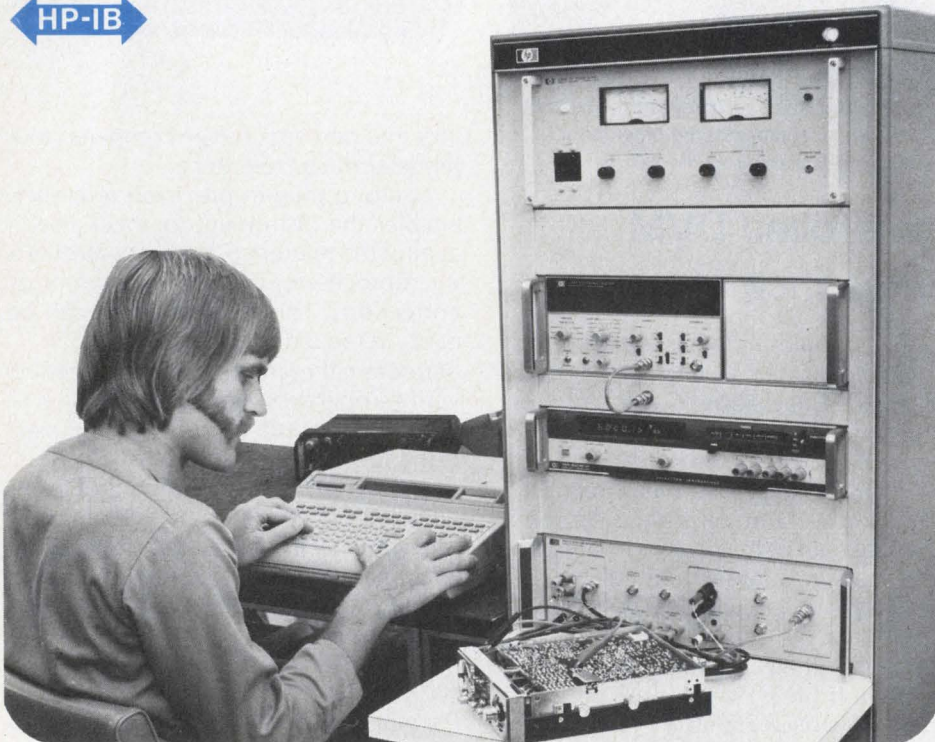



Capture that unique digital event at the press of a button!

The handy HP 1230A Logic Trigger increases the usefulness of any scope in the data domain by providing a digitally-delayed jitter-free trigger just at that point in the data stream you require.

When digital delay is added to word recognition, it is possible to select a unique word because the trigger pulse can be released on any preset number of clock cycles after recognition. The scope will display the data stream from any desired point after the trigger word without multi-triggering. Subsequently, this point may be shifted either direction simply by pressing the Up or Down button—continuously for fast shift, or successively for step-by-step.

In addition to the 1230's clock and eight-bit word recognition (HI/LO/OFF) inputs, a gate input allows further qualification. Delay (between 1 and 9998 clock pulses) is indicated on a 4-digit LED display.

The 1230A can be operated in a synchronous or asynchronous manner for maximum measurement flexibility.

For additional technical data, check O on the HP Reply Card.

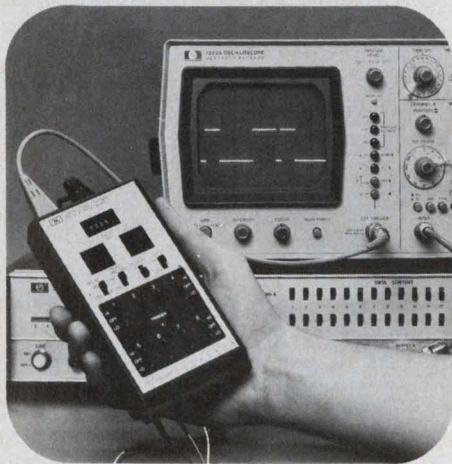

Compact 8-bit trigger probe generates a trigger output pulse from parallel digital pattern recognition with digital delay capability for oscilloscopes, logic analyzers, or other externally triggered test equipment.

## NEW automatic phase noise system simplifies difficult measurements



The 5390A Frequency Stability Analyzer specializes in phase spectral density measurements made very close to the carrier. Offset frequencies from below 0.01 Hz out to 10 kHz can be analyzed with extremely narrow bandwidths.

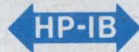

With tightening bit error rate requirements in satellite communications, shrinking bandwidths in ground communications links and greater resolution requirements in many radar systems, the ability to characterize precision frequency sources has been meeting increasing demands. In many cases specifications for close-in phase noise have been limited by the capabilities of existing test equipment rather than by the need for the information.

Although the 5390A frequency stability analyzer is a complimentary device to today's high performance spectrum and wave analyzers, it excels in the difficult close-in measurements (e.g. 100 Hz and below) where such devices become inadequate. Frequency offsets well below 1 Hz can now be analyzed with sub-millihertz bandwidths and excellent sensitivity.

Data is automatically collected by a high performance counter in the time domain. Under calculator control, the system operates as a frequency selective digital filter and converts the data to the frequency domain. Since the system measures zero crossings, elaborate amplitude calibration schemes are unnecessary. Data is automatically reduced and the single sideband phase noise-to-carrier ratio, normalized to a 1

Hz bandwidth, is presented in terms of dB below the carrier (dBc) in both tabular and graphical form using the 9871A printer/plotter.

The system will take measurements on carrier frequencies from 500 kHz to 18 GHz. Observations of phase noise may be made at offset frequencies from below 0.01 Hz out to 10 kHz with typical sensitivities of greater than  $-150$  dBc at 1 Hz away from the carrier.

Measurements are usually made by comparing two similar sources slightly offset in frequency from each other. Measurements can also be made on non-offsettable sources by using an additional mixer/amplifier module.

Besides the difficult phase noise measurements, the 5390A also makes long term drift measurements and can monitor short term stability in the time domain using an improved version of the Allan Variance technique.

The basic system includes the 5390A analyzer, a 9825A calculator and 9871A printer/plotter, software for frequency stability and phase noise measurements, diagnostics, and a technical handbook.

For a technical data sheet, check K on the HP Reply Card.



## New HP-IB/21MX Minicomputer controls multiple instrument clusters, accesses data and develops new programs—all at the same time



### HP-IB

In the past, interfacing instrumentation systems for measurement and test applications has been complex and costly. Not any more. With the HP-IB/21MX Minicomputer, automatic test systems for production, laboratory research, and automatic data acquisition systems can be implemented more easily and simply. HP offers for the first time a minicomputer with a multi-programming operating system as a controller for instruments which conform to the IEEE-488 standard.

Take the simplicity of HP-IB\* interfacing. Add HP's 21MX Minicomputer and Real-Time Executive (RTE) software for the power and control. Choose from over 100 HP and non-HP IEEE-488 compatible instruments, calculators and peripherals to handle test and measurement. Within hours, flexible and powerful measurement and test systems can be up and running. OEM's can focus resources on customer interfacing.

**Controls multiple instrument clusters.** Because the Real-Time HP-IB Minicomputer supports multi-

programming, it can simultaneously control several HP-IB clusters of up to 14 instruments each. Test/measurement equipment can be organized into multiple physical or functional groups—each connected to the HP-IB/21MX Minicomputer by its own HP-IB Interface Bus.

New instrument clusters can be added or reconfigured without downtime or effect on existing clusters.

Systems can grow as needs grow. And, because of the new Real-Time HP-IB Minicomputer's speed as an HP-IB controller, throughput is increased in high volume or production testing.

**Consolidates data.** The Real-Time HP-IB Minicomputer's multi-priority program scheduling allows highest priority to run immediately and then later devote time to such operations as correlating and analyzing data, and producing timely management reports.

HP's new IMAGE/1000 data base management software adds a complete set of "software tools" for consolidating

files into a single data base. Once the data base is established, IMAGE/1000's English-like QUERY language allows users to interactively find any stored information by searching under multiple "key values" such as a part number, vendor code or failure type. IMAGE/1000 permits easy report generation with automatic sorting, summation, pagination and averaging.

**Allows concurrent program development in multiple languages.** While the Real-Time HP-IB/21MX Minicomputer is busy controlling instruments and consolidating data, it can also be used for program development.

For the first time, engineers can readily access instruments and devices via the IEEE-488 and with the popular scientific language FORTRAN IV. HP's Multi-User Real-Time BASIC, which can be learned in a few hours, and HP's assembly language are available. This multi-lingual approach brings the utilization of HP-IB to a wider cross section of users.

**Supports multiple terminals.** The Real-Time HP-IB Minicomputer also offers multi-terminal accessibility. Several people can use the system immediately and simultaneously—for program development, data entry or system control. As a result, testing and production data such as quality assurance information is available when needed for decisions.

**Augments data networks.** Finally, the Real-Time HP-IB/21MX Minicomputer extends the data gathering capabilities of today's computer networks. Off-the-shelf hardware/software data communications packages make it easy to connect the HP-IB/21MX Minicomputer to other HP 21MX computers or to link it upwards to a central computer.

For a video tape demonstration of the HP-IB/21MX, check the  on Item A of the HP Reply Card.

\*HP-IB is Hewlett-Packard's implementation of IEEE Standard 488 and identical ANSI Standard MC1.1—Digital Interface for Programmable Instrumentation.

For more information on how these systems can help you gain management control over your automated testing, check A on the HP Reply Card.



# Build your own automated test system easier and faster with the HP-IB

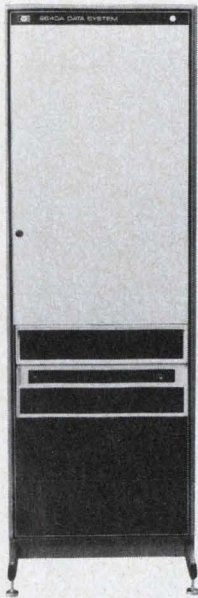

## Multiple Instrument Clusters

Each independent cluster of up to 14 instruments is connected to the 21MX Minicomputer via a separate HP-IB interface cable.

## Add New Clusters Easily

With on-line configuration capability, new independent instrument clusters can be added or changed without downtime or effect on existing clusters. Programming test procedures are simple BASIC "PRINT/READ" or FORTRAN "WRITE/READ" statements.

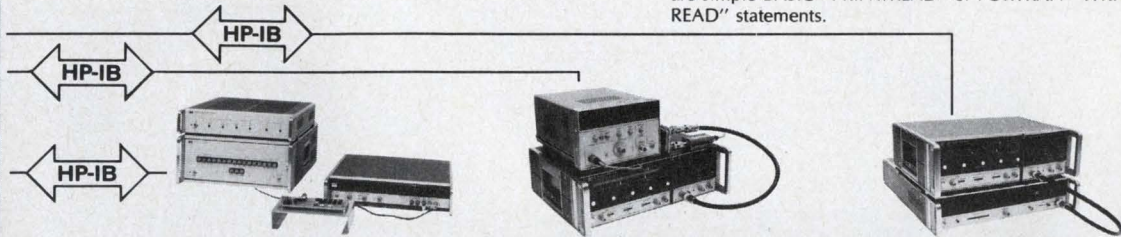

### Component Test Clusters

A monolithic DAC is tested with an HP multiprogrammer and digital voltmeter.

### Subassembly Test Cluster

At the same time, C-band microwave amplifiers can be tested with a sweep oscillator and an RF power meter.

### Instrument Test Cluster

And, at the same time, a sweep oscillator can be tested with a frequency counter.

## New Real-Time HP-IB/21MX Minicomputer

The HP-IB/21MX Minicomputer which automates test/measurement procedures, and permits concurrent program development and data retrieval consists of a 21MX Minicomputer and cartridge disc memory, managed by HP's RTE-II or RTE-III Real-Time Executive software.

For more information on the Real-Time HP-IB/21MX Minicomputer, check A on the HP Reply Card.

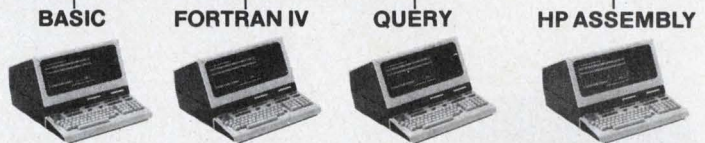

## Multiple Terminals for Concurrent Program Development or Data Base Access

The Real-Time HP-IB/21MX Minicomputer, with new IMAGE/1000, permits fast multi-lingual program development or data access by several users simultaneously.

## Computer Network Connections

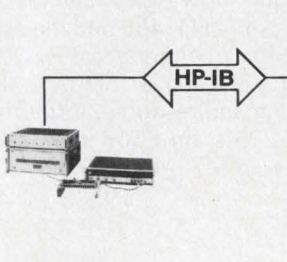

### Incoming Inspection Satellite

A remote HP-IB/21MX Minicomputer in the nearby Incoming Components Inspection Department consolidates test data via the network connection system.

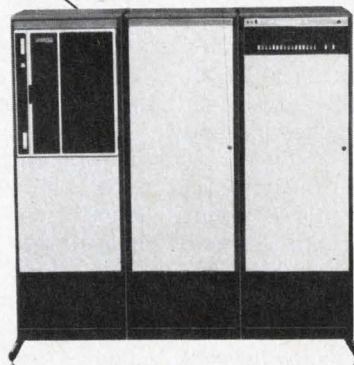

### Central EDP

HP supported hardware and software connect the HP-IB/21MX Minicomputer to other 21MX Minicomputers or IBM 360/370 in a distributed management information network.



## HP computers, calculators and the Interface Bus aid in the analysis of samples from Mars

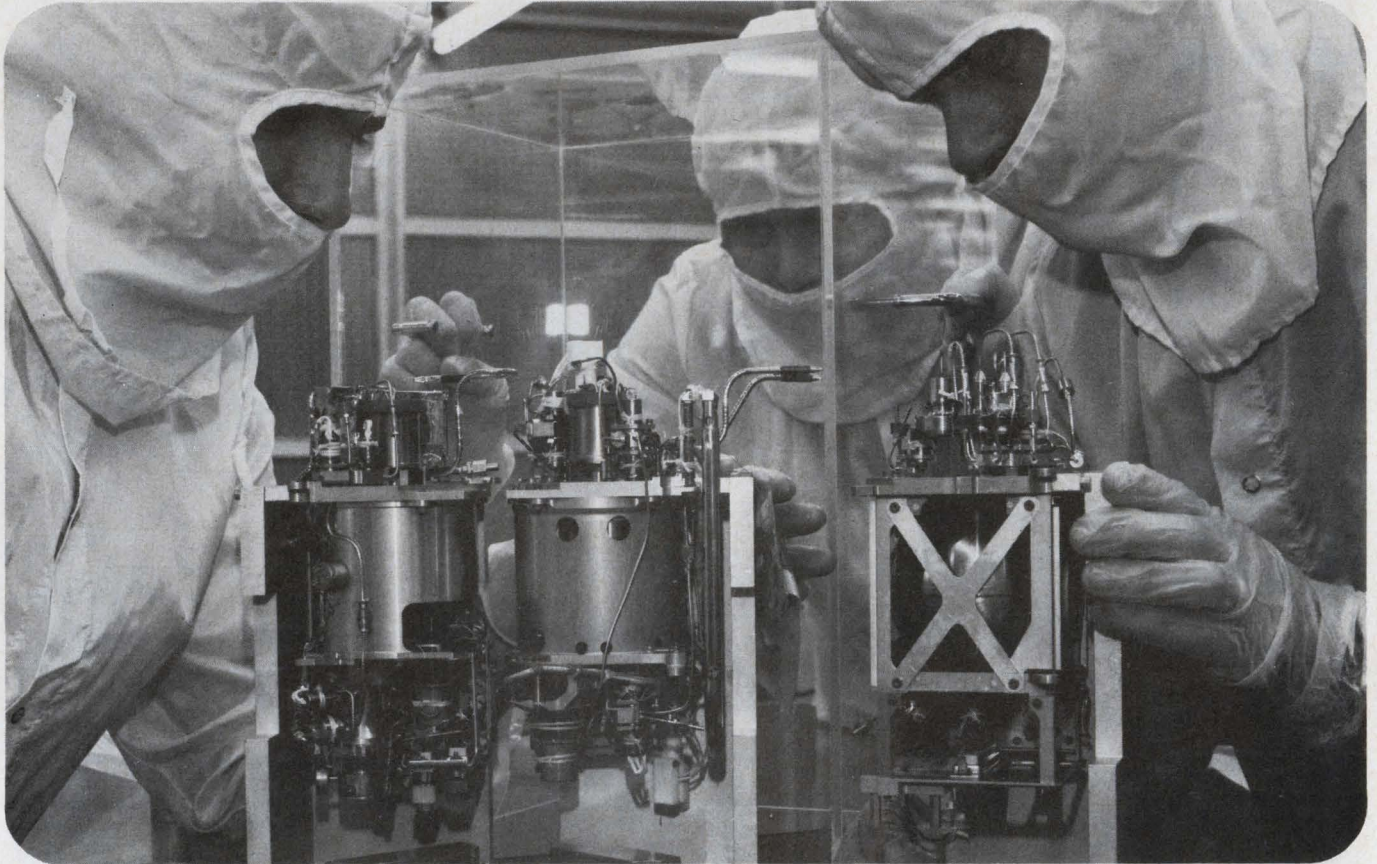

### HP-IB

TRW's advanced technology is being applied this summer when a computerized life detection instrument package probes for life on Mars. The HP Interface Bus has contributed significantly to the development of testing programs at TRW.

At the TRW Space Park facility in Redondo Beach, California, precise measurement and testing is a critical aspect of the company's activities. As a designer and manufacturer of scientific military and commercial spacecraft systems, the Defense and Space Systems Group relies on 25 HP 2100/21MX computer-based Scientific and Measurement Systems for engineering and manufacturing testing.

Don Broutt, manager of TRW's automatic test systems department, adopted the Hewlett-Packard Interface Bus (HP-IB) to link numerous test instruments to his HP computers and HP calculators.

"Many of our programs involve extremely limited production runs . . . some products, for example, are one of a kind. Before adopting the interface bus, our efforts to reestablish test stations for

each program was like reinventing the wheel. Now, when setting up a new test station with the HP-IB, we can easily add or reconfigure instruments in a computerized network with minimal set up time," explains Broutt.

With improved flexibility comes cost savings, according to Broutt. Prior to adopting the HP-IB, testing required specially engineered printed circuit board interfaces for each unique test device. If a device served as both a "listener" and "talker," it required two boards. Now, one board within a computer allows interfacing with up to 14 devices that meet the IEEE-488 standard. A single standard cable now replaces specially-engineered cables formerly required for each test instrument.

"In our pre-HP-IB testing, we wrote special driver software for each unique device. This consumed excessive

amounts of computer memory. Now our engineers simply use a subroutine for each device to access an HP-IB standard driver. Gone is time-consuming reference to handbooks for device translation. Once a subroutine is written, the device interface is transparent to our engineers," relates Broutt.

With the growing availability of test devices using IEEE-488 and the expanding use of the HP Interface Bus, TRW has reduced the cost of interface design. Manpower and resources formerly allocated to this function can now be applied to other priority projects.

*For more information on how HP computers in conjunction with the HP-IB can help you, check A on the HP Reply Card.*



## New HP display station: extensive stand-alone capability plus data communications flexibility

The HP 2645 display station is the latest and most powerful addition to Hewlett-Packard's growing family of general-purpose, interactive display terminals.

Keyboard use is simplified by eight user-defined soft keys, each of which can be set up to issue a string of up to 80 characters or several control sequences stored in the terminal. You can simply press a key to trigger file searches, issue operator or computer instructions, dynamically configure the terminal, or perform other specialized tasks.

The 2645 is compatible with a wide variety of computer systems. It can operate at selectable speeds of up to 9600 baud, and has the optional capability of asynchronous or synchronous (BISYNC) multipoint polling with up to 32 terminals on the same line. This makes possible the sharing of modems, data lines, and computer I/O channels with significant savings in data transmission costs. Built-in self test ensures proper operation within a network.

Up to four 128-character sets can be viewed concurrently on the high-resolution display.

Optional, highly reliable cartridge tape transports provide 220,000 bytes of mass data storage, allowing the 2645 to batch information and to perform many operations on a stand-alone basis that normally require connection to a computer.

*For more information on these products, check J on the HP Reply Card.*



Data handling capabilities of new terminal include protected fields, numeric/alpha field checking and off-screen storage up to 12 kilobytes.

## NEW Digital Test System enables production testing and test programming concurrently

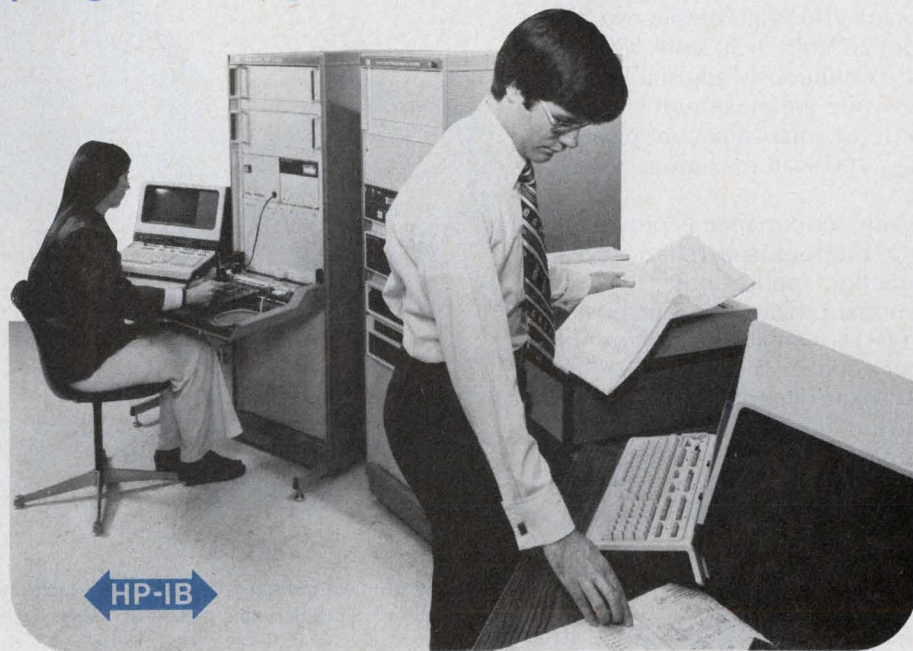

Because of their increasing complexity and density, testing of logic circuit boards today is a major element in manufacturing costs. The use of manual or semi-manual fault location techniques on loaded logic boards costs precious troubleshooting hours.

The new Hewlett-Packard Digital Test System, DTS-70, offers printed circuit logic board manufacturers versatile capabilities that will result in improved test quality and high throughput.

A system consists of three elements, an HP 9571A Test Station, a 21MX minicomputer-based controller, and the HP 91075B TESTAID-III Test Generation Software. The HP 9571A test station handles logic assemblies to 200 MSI-type IC's (10,000 gate equivalents).

Go/no-go testing on the DTS-70 is fast—typically a few seconds for moderately large boards. Fault isolation using the computer-assisted FASTRACE guided probe is accurate and quick, typically locating the fault in less than a minute. When the fault is located, the fault data is automatically displayed on the CRT terminal and printed on hard copy by an optional repair ticket printer. The test operator attaches the repair ticket to the PC board so the fault data is

available at the rework/service area.

An important feature of the DTS-70 is the ability to *concurrently* write and edit test programs at the test preparation station while production testing continues on the HP 9571A test station. Test programs are prepared using TESTAID-III, an advanced digital logic simulator. In addition to interactive program preparation on-line, TESTAID-III can have all controls preloaded into it for unattended or overnight operation, thus maximizing personnel and computer efficiency.

Designed to accurately test large numbers of complex logic assemblies, up to three HP 9571A test stations can be operated from one controller in the system. Add-on stations can usually be installed in less than two hours.

The system uses the Hewlett-Packard Interface Bus to provide control for analog functions: dc voltage measurements, frequency, time interval, power supply programming for units under test, and to control other system devices.

*For more information, check D on the HP Reply Card.*



## New 200 Watt extended range DC power supply

The new HP 6002A power supply can provide a full 200 Watts output over the range from 20 Volts to 50 Volts. Output voltage is continuously adjustable from 0 to 50V while the maximum current available is automatically controlled to maintain a 200 watt maximum power boundary.

Lab grade performance is provided for general purpose research, design, and production applications.

An optional programming feature (Option 001) is available for controlling the output voltage (or current) via the Hewlett-Packard Interface Bus—either by calculator or computer. Switches on the rear panel of the 6002A allow either local front panel control, HP-IB controlled voltage, or HP-IB controlled current. A programmable range allows a  $5 \times$  improvement in resolution when the 6002A is operated below 10 volts.

The power supply operating status is continuously shown by front panel indicator lights which reduce the need to interpret meter readings. Additional lights also identify overrange and over-voltage conditions. The overvoltage protector is a front-panel adjustable SCR type "crowbar". Ten-turn controls permit accurate adjustment of output voltage and current when the supply is operating under local control.

For more information, check N on the HP Reply Card.

With HP-IB option, the new 6002A power supply can be digitally controlled using your calculator, computer or other controller.



HP-IB

## Highest power yet for microwave sweepers



High power output sweepers are especially useful in such applications as local oscillator driving mixers or for stimulating antennas when making pattern measurements.

Close-up of 5.9 - 12.4 GHz GaAs MESFET Amplifier used in new Hewlett-Packard sweeper plug-ins to deliver 50 mW leveled RF output.

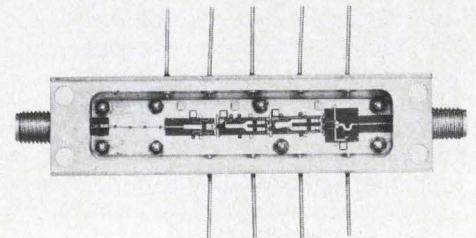

Two new RF plug-ins for the HP 8620C Sweep Oscillator capitalize on Gallium-Arsenide technology to deliver at least 50 mW of leveled power in the frequency ranges, 5.9 - 9.0 GHz and 8.0 - 12.4 GHz. These are highest power levels ever offered in solid-state sweepers—and higher than most backward wave oscillator (BWO) tube-type sweepers as well. Key to this achievement is a broadband power amplifier developed by Hewlett-Packard that typically delivers 100 mW output over a 5.9 - 12.4 GHz range with 10 dB nominal gain. The amplifier employs  $1 \mu\text{m}$  Gallium-Arsenide Schottky-Gate Field Effect Transistors (GaAs MESFET).

The extra power is achieved without sacrificing other RF performance characteristics (such as frequency accuracy, linearity, stability, and residual FM). Harmonics are at least 30 dB below full rated output, non-harmonic spuri-

ous  $>60$  dBc, and optional internal leveling to  $\pm 1/2$  dB is offered.

Using high power sweepers, it is often possible to eliminate additional amplification when performing saturation tests or high loss measurements. Higher power also permits padding to isolate test devices from source and detector for better matching leading to more accurate measurements. The new plug-ins accept direct modulation from the HP 8755 Frequency Response Test set which allows a full 60 dB measurement dynamic range even with padding for best match.

Model 86242C covers 5.9 - 9.0 GHz and HP 86250C covers 8.0 to 12.4 GHz.

For additional data, check P on the HP Reply Card.



## The world's first rectangular solid-state lamp

Rectangular solid-state lamps in three colors (high efficiency red, yellow and green) are now available from Hewlett-Packard. This is the first solid-state lamp in this configuration to be offered to the market place. The configuration of this lamp makes it ideal for lighted mechanical switches, flush-mounted panel indicators, backlighting, bar type scale indicators, or minus indicators in digital displays.

The 5082-4570, 4670, and 4970 are encapsulated in an axial lead rectangular epoxy package. They utilize a tinted epoxy with a thin, uniform segregated diffused layer at the emitting surface to provide a high on/off contrast plus a uniform light emitting area.

Dimensions of the flat light emitting surface are 2.54 mm (0.10") by 7.49 mm (0.295"). The axial luminous intensity for the red lamp is 1.0 mcd typical; for the yellow and green, it is 1.2 mcd

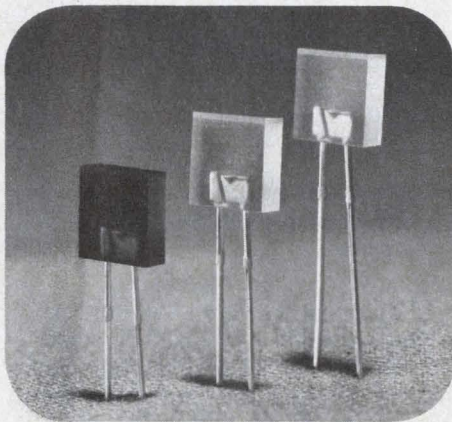

New rectangular LED lamps are ideal for flush mounted panel indicators.

typical. The typical operation forward current is 15 mA for the red and yellow; and 20 mA for the green.

For technical information, check L on the HP Reply Card.

## Fastest microwave switch-guaranteed 5 ns rise time

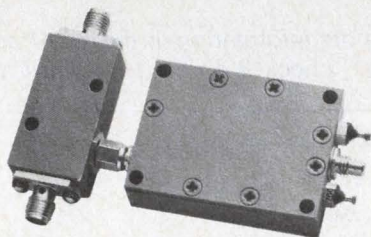

Output connector of new fully TTL compatible switch driver (right) mates with the SMC connector on the new HP fast PIN diode switch.

HP offers the new 33140/33640 series SPST switches for operation from 0.1 to 18 GHz. Rise time is 5 ns; fall time is 7 ns. Isolation up to 80 dB is available.

Designed especially to drive these 33140 series switches, the HP 33190A TTL compatible switch driver can be used to improve the switching time of any SPST diode switch.

For further information, check H on the HP Reply Card.

## 670 nm high intensity emitter simplifies optical alignment

Now available from Hewlett-Packard is a visible, near-IR, source using a GaAsP on GaP LED chip which has been optimized for maximum quantum efficiency at 670 nm. The emitter's beam is sufficiently narrow to minimize flux problems, yet broad enough to simplify optical alignment.

The HEMT-3300 is designed for consumer and industrial applications such as optical transducers and encoders, smoke detectors, assembly line monitors, small parts counters, paper tape readers and fiber optic drivers.

This device comes in a standard T-1 $\frac{3}{4}$  configuration with an undiffused, untinted plastic lens. The axial radial intensity is typically 500 mW/sr at 10 mA.

For further specifications, check M on the HP Reply Card.

IR emitter in a T-1 $\frac{3}{4}$  package optimized for 670 nm emission.

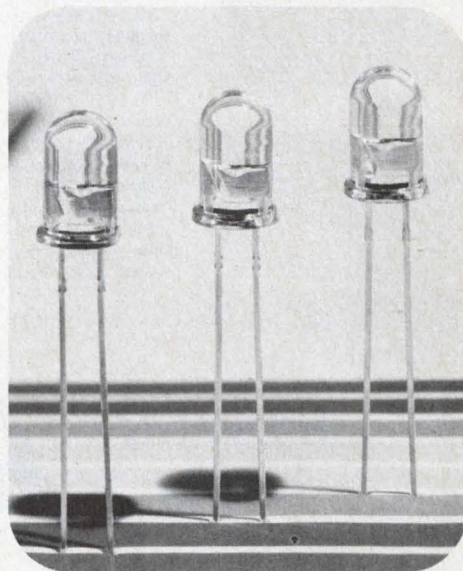

## New rugged one micron GaAs FET chip

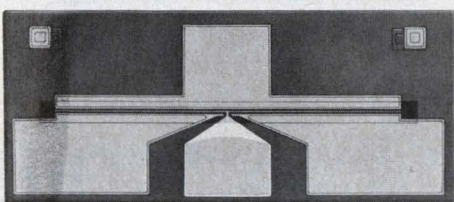

New chip available for applications in telecommunications, radar and EW amplifiers in the 1-12 GHz frequency range.

The HFET-1000 is a GaAs FET chip designed for low noise figure (3.6 dB typical); high gain (11.0 dB); and a high dynamic range of 14.5 dBm linear power output at 10 GHz.

The .065 x .028 mm chip is provided with a dielectric scratch protection layer over the active area. Gate width is 500 micrometers resulting in a typical linear output power greater than 25 mW.

For additional technical data, check E on the HP Reply Card.



## Now, more memory—for less money



The HP-67 and HP-97 are the most powerful personal calculators Hewlett-Packard has ever built. The HP-67 (left) gives you shirt-pocket portability. The battery-powered HP-97 (right) gives you attaché case compactness plus a quiet built-in thermal printer.

Two new HP calculators, the HP-67 and the HP-97, have more than three times the program capacity of the first HP magnetic card-reading calculator—the HP-65—and at a lower cost. But there's more to evaluating programming capacity of a calculator than just merely comparing the 100 steps of the HP-65 to the 224 steps in both the HP-67 and the HP-97.

The factor of three times the *increase in capacity* is specified because *all* functions, whether one, two, or three keystrokes long, use only one step of program memory.

Now, for the first time, you can transfer information from either side of the magnetic card into the data registers, or record data from the registers to the magnetic card.

A significant operational improvement of the HP-67/97 is the "smart" card reader. In addition to data recording and reading, the card reader serves as a prompter for proper operation. It automatically checks and retains the display mode, angular mode setting and status of the four flags. It also detects whether information on the card consists of data for the storage registers or program steps. You will find it virtually impossible to improperly load programs or data from the cards.

There are many more powerful features including 10 user-definable functions, 10 conditional/decision functions and three types of addressing.

For more information on the HP-67 and HP-97, check B on the HP Reply Card.

## Calculator that remembers, even when turned off

The HP-25C is the first HP scientific programmable pocket calculator that retains stored programs and data even when it is turned off. The HP-25C with continuous memory is otherwise identical in performance to the HP-25A.

With the keystroke programmability of the HP-25A or HP-25C, you can solve automatically the repetitive problems faced by scientists and engineers.

Both have 49 steps of program memory with merged keycodes and 72 built-in scientific, engineering and mathematical functions and operations, including full editing capability, register arithmetic and several conversions.



For further details on both calculators, check C on the HP Reply Card.

East-4 Choke Cherry Road, Rockville, MD 20850  
Ph. (301) 948-6370.

South-P.O. Box 10505, Atlanta, GA 30348  
Ph. (404) 434-4000.

Midwest-5500 Howard Street, Skokie, IL 60076,  
Ph. (312) 677-0400.

West-3939 Lankershim Blvd, North Hollywood, CA  
91604, Ph. (213) 877-1282.

Europe-7, rue du Bois-du-lan, P.O. Box, CH-1217, Meyrin-2,  
Geneva, Switzerland, Ph. (022) 41 54 00.

Canada-6877 Goreway Drive, Mississauga, Ontario,  
L4V 1M8, Ph. (416) 678-9430.

Japan-Yokogawa-Hewlett-Packard Ltd., Ohashi  
Bldg., 1-59-1 Yoyogi, Shibuya-ku,  
Tokyo 151, Ph. 03-370-2281/92.

**HEWLETT**  **PACKARD**

Sales and service from 172 offices in 65 countries.

**MEASUREMENT COMPUTATION NEWS**  
innovations from Hewlett-Packard

September/October 1976

New product information from  
**HEWLETT-PACKARD**

Editor: Iona M. Smith

Editorial Offices:  
1507 Page Mill Road  
Palo Alto, California, 94304 U.S.A.



*If you buy  
a prom programmer  
before you read this  
you're making a  
big mistake!*

You can spend a lot of money and get practically nothing if you aren't careful.

**Here's what to test for:**

1. Is the programmer universal? Does it equip you for "tomorrow?" Will it program every available PROM type? (At last count there were over 165.)

2. Are programming techniques approved by the semiconductor manufacturers?

3. Can the programmer be calibrated? By you? Can performance be verified to PROM manufacturers' current specifications?

4. Is the programmer supported by direct sales, installation, training and service?

If the programmer is from Data I/O, it passes the test. Today, more than 1500 companies use Data I/O programmers. We build a complete range of machines including the Programmer V which has outsold every other automatic programmer in the

world (including the former world champ, the Data I/O Programmer I).

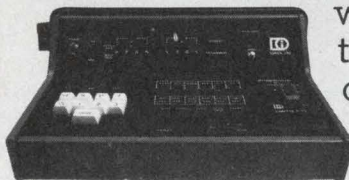

**Data I/O total three point service.**

1. Every Data I/O customer receives a quarterly update on currently available PROMs.

2. Through our direct (computerized) mailing program, Data I/O customers are kept constantly up-to-date on PROM specification changes and technological innovations.

3. Nine field offices in the U.S.A. and 22 distributors worldwide provide our customers with direct sales support, installations, operator training and service.

**Get the facts**

If you would like to know more about our products, or want copies of our quarterly PROM Comparison Chart and PROMBiTS (our periodic technical bulletin on PROM applications and innovations), mail this coupon or call one of our offices. Data I/O Corporation, P.O. Box 308, Issaquah, Washington 98027.

Name \_\_\_\_\_

Title \_\_\_\_\_

Company \_\_\_\_\_

Address \_\_\_\_\_

City/State/Zip \_\_\_\_\_



**Data I/O**

CIRCLE NUMBER 6



# Are you buying wire and cable from memory?

**Call Blake  
for a new concept in  
quality, service and delivery.**

Blake sales engineers treat your wire and cable requirements as a unique problem that demands an individual, immediate and economical solution.

Just tell us what you need.

A single conductor hook-up wire? A special UL-approved computer cable? A complex multi-conductor molded cable assembly?

Blake manufactures and stocks the broadest possible line of electronic wire and cable products. We have the facilities and the know-how to meet your exact requirements. With consistent quality. And prompt delivery.

So don't buy wire and cable from memory. Contact a Blake sales engineer for a new concept in quality, service and delivery.

Call us at (213) 776-3303. Or write:

**BLAKE WIRE & CABLE**

5740 Arbor Vitae Street

• Los Angeles, California 90045

CIRCLE NUMBER 7





SEPTEMBER 27, 1976

## New standard clears up DMM/DVM accuracy specs

Users and vendors of digital multimeters and voltmeters might finally talk the same language when a new ANSI standard for their instruments appears some time next year.

The standard—an update of ANSI C39.6, the seven-year-old standard now in effect—defines terms and provides test methods for many of the important DMM performance characteristics.

The format includes both mandatory and optional procedures and ways to specify DMMs, says William Nichols, chairman of the ANSI Committee working on the standard and chief electronic engineer at Keithley Instruments, Cleveland, OH.

One source of confusion the standard attacks is the method of specifying accuracy. DMM vendors currently specify accuracy in terms of the readings, full range, full scale, overrange, or some combination of

these. Since the terms mean different things to different people, and since each vendor uses his own method, there's no way to really compare competing instruments.

The C39.6 eliminates the doubts by limiting the accuracy statement to one method and by dropping the word "overrange" from the DMM lexicon. Accuracy is spelled out as a percentage of reading plus a number of digits.

Vendors who will use the standard are required to specify accuracy over a 10-degree span near room temperature. A  $\pm 1$ -degree range can be stated, if desired, or a wider range, say 0 to 50 C, can be given.

Other DMM or DVM specifications covered by C39.6 include resolution, linearity, and tempo. But one difficult area that probably won't be covered is EMI specs. They will have to wait for future standards.

## New, stronger battery powers electric car

A new battery that will enable an electric car to travel 150 miles at a speed of 55 miles per hour is being developed by Argonne National Laboratory in Illinois.

A prototype lithium-sulfur battery with a power density of 150 W/kg has already been fabricated, according to Bill Walsh, leader of the advanced engineering group. This density is two and a half times greater than the power density of current automotive lead-acid batteries. With a little more effort, notes Walsh, the power density of the lithium-sulfur battery can be raised to over 200 W/kg.

The components of the new battery, a lithium alloy and iron sulfide, make it more powerful than

the conventional lead-acid battery because the components have a higher specific energy than the components of the lead-acid system.

To prove the feasibility of the battery in electric-car applications, Argonne engineers plan to contract with industry to build and test a prototype car that would be powered by the battery. The prototype is expected to be operational by late 1978 or early 1979. It will weigh about 2500 pounds, 880 of which will belong to the batteries.

Walsh notes that by 1985 the weight of the batteries will be reduced to only 550 pounds. To provide the same capability with lead-acid batteries, 2600 pounds worth of them would be needed, he adds.

In addition to its use in electric

vehicles, the lithium-sulfur battery promises to become an important energy and money-saving tool for electric utility companies. The reason Walsh points out, is that during heavy consumer demand, many utilities must operate extra turbines. Power-generating efficiency could be increased if these extra generators, which are only used during peak loads, could be replaced by a large bank of lithium-sulfur batteries. They could store excess electricity generated during low-demand hours and release it during high load hours. In addition, Walsh says, energy-transmission costs could be cut by locating the batteries at substations that are closer to load centers.

## Fortran compiler offered for $\mu P$ design system

A resident Fortran compiler, just what microprocessor users have been waiting for, is finally available. Developed by Motorola, the compiler is designed to operate on the company's Exorciser development system.

Designated M6800FTNRO-10D the compiler uses a Fortran language that is a subset of the standard Fortran IV. Like the standard Fortran, the Motorola  $\mu P$  version accommodates variable names that consist of two to five alphanumeric characters. It also features implicit type designation, with variables starting with letters I to N denoted as integers, and all variables as real numbers.

The 6800-based Fortran can handle arrays with a maximum of three dimensions and accepts formatted and unformatted input data. Intrinsic functions include square root, exponential, sine, cosine, log and absolute value.

The minimum hardware configuration needed to use the 6800 Fortran compiler is an Exorciser, 16-k of memory, a disc memory and a terminal. The compiler is available for delivery and sells for \$500.

CIRCLE NO. 316

## New mini features high density memory

The new Eclipse C/330 computer from Data General incorporates the



highest-density main memory in the company's computer line.

The C/330 has new 64-k bytes of semiconductor and 32-k bytes of core on single-board memory modules. Its memory allocation and protection unit (MAP) doubles main-memory capacity to 512-k bytes and provides hardware protection for user programs in dual programming applications.

The new Eclipse MAP and memory modules enable users to be more flexible when configuring main memory and peripherals into their systems. In addition, the dense memory results in fewer connections and interface components, so the reliability of the computer system is increased.

The C/330's interactive data-entry and access (Idea) system is the first produced in the mincomputer industry to permit users with limited programming knowledge to implement data-entry and data-management applications. The system uses Idea software that includes an easy to use, English-like language.

The MAP unit provides hardware protection for programs and data in multi-user systems and permits programs to operate concurrently. The unit also provides write protection so that several users can share memory blocks without altering data and procedures. The unit has four data-channel MAPs, so the number of peripherals that can operate concurrently on the data channel is increased. A new look-ahead algorithm in the MAP's memory-access logic markedly decreases system-mapping overhead.

The new Eclipse's 64-k-byte, semiconductor memory modules (NMOS) quadruple the 16-k bytes of NMOS memory previously available only on a single board. In addition, memory speed has been increased to 500 ns for read cycles compared to 700 ns read cycle time for the 16-k module.

Memory-error checking and correction is standard on the semiconductor modules.

The 32-k-byte, core-memory module doubles the density of already available 16-k core modules. The 32-k-byte memory has an 800-ns cycle time. Data General uses a split-sense memory technique that increases the traditional 1- $\mu$ s speed to 800 ns. Core and semiconductor

modules can be interleaved up to eight different ways to reduce effective cycle time.

The new interactive data-entry-access software is supplemented by other software that includes a multitasking, real-time, disc-operating system; an ANSI-74 Cobol language system, an INFOS database-oriented file management system; RPGII sort/merge utilities and RJE/HASP communication emulators. The Eclipse commercial instruction set gives the computer data handling capability for commercial data processing applications. The instructions handle word-byte and word-bit addressing, code translation, and full editing for formatting functions and move and compare character string. An Extended Arithmetic Processor provides fast operations on packed and unpacked numeric data. For large file handling, the C/330 supports over 700 M/byte on line disc storage.

CIRCLE NO. 317

## Promising optical fibers developed by Corning

Electro-optical communications equipment that can offer not only a 50% improvement in source coupling but also a significant reduction in signal attenuation is now feasible, thanks to improved optical fibers from Corning Glass Works.

Called Corguide, the new fibers promise better transmission than was previously possible in the 800-to-1100-nm range. They also offer a higher numerical aperture (0.2) and decreased water-ion (-OH) absorption at 950 nm.

The four fibers now available combine 200 or 400-MHz bandwidths with 6 or 10-dB/km-attenuation levels. Such attenuation has previously been available only in the 820-nm range.

The standard length of the new fibers is 1 km, but longer runs are available on request. Multikilometer lengths of new fibers should withstand loads of 10,000 psi for 20 years, according to Corning, which conducted screen tests at 25,000 psi.

The fiber improvements stem from Corning's deposition process, which allows the introduction of controlled quantities of dopants.

So far, the process has produced fibers with attenuations down to 1 dB/km, bandwidths wider than 1500 MHz and continuous lengths to over 10 km. Such performance isn't commercially available as yet.

CIRCLE NO. 318

## High efficiency achieved with organic photocells

The highest efficiency to date of any organic photovoltaic material has been obtained at the IBM Watson Research Center. V. Y. Merritt, a researcher at the Yorktown Heights, NY laboratory, has converted hydroxy squarylium, a derivative of square acid, into thin films that have an energy-conversion efficiency of about 0.2%, roughly 10 times better than any previously obtained efficiency for a photovoltaic organic semiconductor.

Although inorganic photovoltaic semis have a better 4% efficiency, researchers at IBM indicate that it is possible to make the organic semis competitive with the inorganic by doping the organic film.

## Minifloppy cuts cost of disc storage—maybe

A new floppy-disc memory that features a smaller disc and reportedly reduces the cost of disc memories by one-third has been introduced by Shugart Associates. Sunnyvale, CA. The Minifloppy sells for \$390 in unit quantities, compared to \$600 for the standard-size floppy.

Although the cost of owning a Minifloppy appears cheaper than owning a regular floppy, the Minifloppy is really much more expensive. In fact, on a per-byte basis, the Minifloppy is almost twice the price of a standard floppy.

The reason for the greater cost is the new unit uses a smaller 5-in. disc that holds between 80 and 90 k-bytes of data, depending on the coding format used. The standard floppy's 8-in. disc holds 250 k-bytes of formatted data. Thus, in unit quantities, the Minifloppy costs 0.43¢/byte for the drive, while the standard floppy costs only 0.24¢/byte.

CIRCLE NO. 319



# Five hundred million thumbwheel

switches  
can't be wrong.  
Theoretically  
we could ship you  
500,000,000  
thumbwheel switches  
without duplicating  
any one.  
If you need  
any thumbwheel switch  
you can probably find it  
among that 500,000,000.  
Our four big sellers are:

**Stripswitch.**

PC board mounted  
with coded outputs,  
less than \$2.

**Series 1776.**

Standard miniature,  
general purpose,  
low price.

**Series 1976.**

Miniature slimline,  
same features as 1776,  
also low price.

**Series 2000.**

Full size,  
general purpose,  
low price.



Stripswitch

1776

1976

2000

Believe it or not,  
those four switches  
give us the broadest line  
of industrial thumbwheel switches  
of any company  
in the world.

Send for  
our free Switch Products Guide.  
We've got your switch.



**SWITCHES/READERS/PACKAGING**

1441 East Chestnut Avenue, Santa Ana, California 92701  
Phone 714/835-6000

Also stocked and serviced in North America by G. S. Marshall, Hall · Mark, Schweber, R-A-E, Zentronics.



# FCC swamped with complaints as sources of RFI/EMI increase

Radio-frequency and electromagnetic interference from a phenomenally growing number of sources, such as CB sets, consumer electronic devices, video games, computers, switching power supplies, ignition systems, and industrial, scientific and medical equipment has reached proportions beyond the effective control of the understaffed Federal Communications Commission.

Complaints of interference from the public—not including military and government agencies—have been pouring into the FCC at the rate of 100,000 per year. Currently, 87% of all complaints of interference to home electronic entertainment equipment—televisions, high-fidelity sets, FM receivers, electronic organs—involves Citizen's Band (CB) transceivers.

The CB units have interfered with nearly every mobile and fixed-communication service, including business, industrial, law enforcement, utilities, aircraft and other public safety devices.

While the problem of CB interference has received wide publicity and attention, it is, for the FCC only the tip of an interference iceberg, admittedly a big tip.

Aircraft navigation and communications equipment has been seriously interfered with from a wide variety of other RFI sources, including garage-door-opener transmitters, industrial rf heating, medical diathermy equipment, community-antenna television systems, super-power FM stations, and auto ignition systems.

In fact, electronic automotive systems for the control of braking

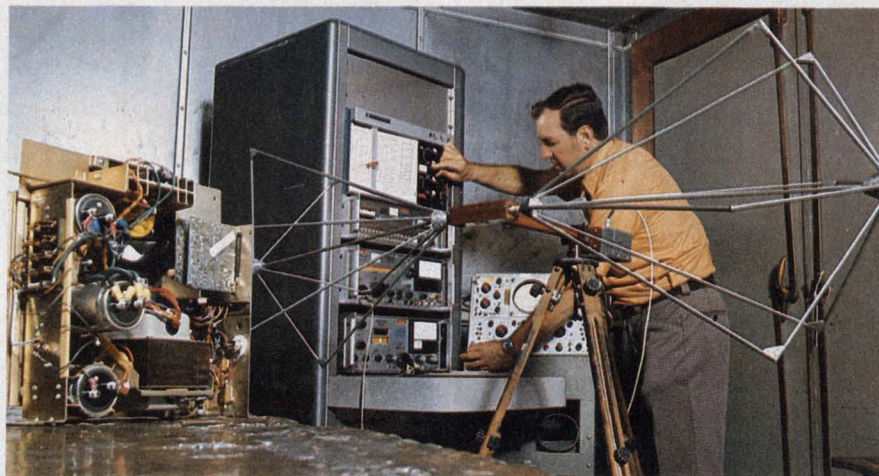

Radiated interference from a display-terminal power supply being measured for a customer at Sanders Associates, Nashua, NH, electromagnetic-compatibility test facility. Measurements are being made between 20 and 200 MHz.

and fuel injection have been disabled by transmissions from mobile equipment in passing vehicles.

Sensitive medical equipment in hospitals has been made inoperative by the radiation from nearby television or broadcast-station transmitters as well as by broadband EMI from surgical cauterizing equipment.

Further compounding the radio frequency interference (RFI) and electromagnetic interference (EMI) problems for the FCC is the appearance of literally millions of potential sources of interference in consumer devices. These devices include the familiar coin-operated electronic games with video monitors, consumer TV games with the outputs attached to the antenna terminals of the home receiver, switching power supplies, computers, and other devices incorporating clocks driving digital circuitry.

Confronting the problem of controlling RFI/EMI emissions, the

FCC finds its task further encumbered by the continued development and proliferation of highly sensitive receivers in the consumer entertainment field, in mobile communications and in medical instrumentation.

## 'David' responds

Faced with the Goliath of RFI/EMI from licensed and regulated as well as unregulated sources, the public's David—the FCC—has taken two approaches to the problem that unfortunately will add to the design requirements and costs of millions of future products incorporating any kind of electronic source of interference.

In the first place, the FCC has adopted stricter regulations for RFI emitters like CB equipment, even though the regulations are not completely satisfactory to anybody involved: the CB manufacturers; their principal adversary, the TV industry; even the FCC.

**Jim McDermott**  
Eastern Editor



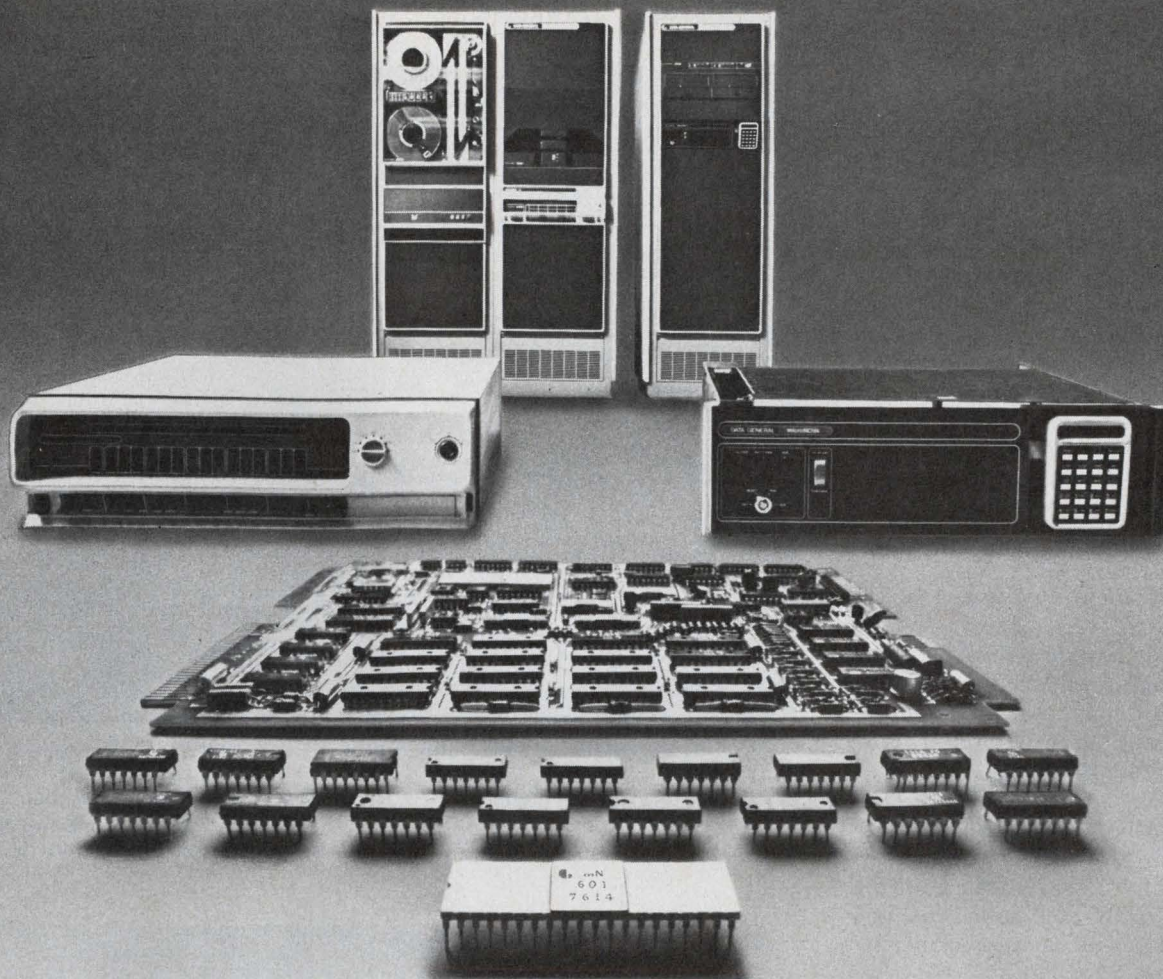

# With a line of minis and micros like ours, we don't have to push any one of them.

With other companies, you might set out to buy a microprocessor chip and end up with the whole chassis. Or get a box when all you need is a board.

But Data General doesn't work that way. We don't have to push you into buying something you weren't really looking for. Because we can let you choose from microprocessor chip sets, microcomputer boards, completely packaged MOS minis and full-blown NOVA 3 systems. All four are compatible. And they give you a range of performance with a range of prices.

So, if you're a component user, there are both high-performance microNOVA chip sets and microcomputer boards that feature Data General's mN601 microprocessor. The mN601 is a full 16-bit NOVA-on-a-chip. And the microcomputer is a full 4K-word computer-on-a-board. You package them yourself, for greatest economy. (Speaking of economy, the board costs only \$589 in OEM quantities of 100.)

And if you're not ready for components yet, there's our fully-packaged microNOVA MOS minicomputer. It's available with up to 32K words of MOS memory and peripherals like

our diskette subsystem. And it's supported by our Real-Time Operating System and diskette-based Disc Operating System. You can get our mini with 4K words of MOS memory for only \$1995. Or as a complete development system with the diskette.

If you need bigger systems capabilities, take a look at our NOVA 3 computer. It's compatible with our microNOVA family. And it runs with high-performance peripherals, sophisticated software like Real-Time Disc Operating System, high-level languages like FORTRAN 5 and BASIC, and memory expansion to a full 128K words.

We've got it all. But we won't try to sell it all. Unless it's what you really need. If you don't believe that line, call us. Dial 800-225-9497 (in Massachusetts, 1-617-485-9100, extension 2509) and ask for information on microNOVA and on the free half-day microNOVA seminars that happen this fall all over the country.

Or write for our microNOVA and NOVA 3 brochures. And see for yourself.

## DataGeneral

Data General, Route 9, Southboro, Mass. 01772 (617) 485-9100. Data General (Canada) Ltd., Ontario.  
Data General Europe, 15 Rue Le Sueur, Paris 75116, France. Data General Australia, Melbourne (03) 82-1361  
NOVA is a registered trademark of Data General Corp.



In addition, the FCC has proposed revisions which will strengthen two crucial sections of its regulations, Parts 18 and 15. The former regulates industrial, scientific and medical equipment. The latter covers devices with low-power intentional radiation, such as wireless intercoms, and devices with unintentional radiation, such as electronic games.

New regulations and standards are also being considered where none now exist, such as for gasoline-engine ignition systems.

### A change in philosophy

A development with far-reaching implications is a change in the Commission's basic philosophy that will strongly influence future designs of all communications equipment susceptible to RFI/EMI. Historically, the FCC has considered the emitters of interfering radiation the villain. But with emitters growing by the millions, the FCC—apparently motivated by the philosophy, "If you can't beat 'em, join them,"—is now considering imposition of regulations requiring the manufacturers of consumer-entertainment electronic equipment to make their products RFI/EMI-proof.

Currently, the FCC has no legal authority to do this. But this authority would be granted under bills filed in Congress by Senator Barry Goldwater and Congressman Charles Vanik to amend Section 302 of the Communications Act.

Key provisions of the Goldwater Amendment, introduced Feb. 25, 1976, include the following (proposed changes italicized): "SEC. 302. (a) The Commission may, consistent with the public interest, convenience and necessity, make reasonable regulations governing (1) the interference potential of devices which, in their operation, are capable of emitting radio-frequency energy by radiation, conduction, or other means in sufficient degree to cause harmful interference to radio communications, and (2) the use of protective components in audio and visual electronic equipment which are capable of reducing interference to such equipment from radio frequency energy.

(b) No person shall manufacture, import, sell, offer for sale, or

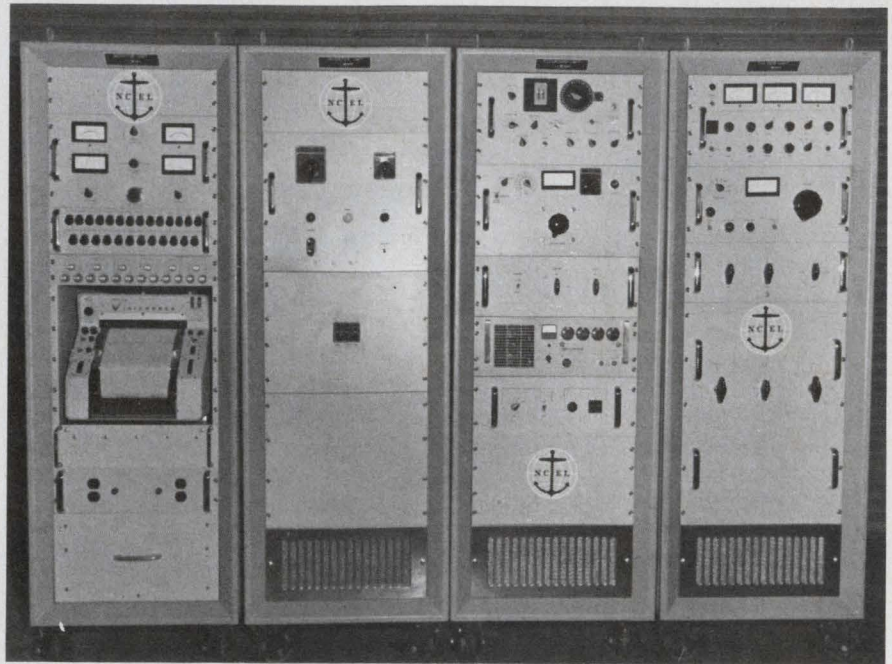

**Power-line transients disrupt computers.** To test digital-system susceptibility, the power-line transient synthesizer was developed by the Navy Civil Engineering Laboratory, Port Hueneme, CA. The synthesizer can superimpose 2- $\mu$ s-to-1000- $\mu$ s pulses of 10 to 4000 V on both ac and dc lines. Sine waves from 400 to 10 kHz and up to 75 V can also be impressed on ac and dc.



**Vehicles are isolated from external environmental noise** to define and reduce their EMI in the anechoic chamber at Aeronutronics Ford, Palo Alto, CA. The EMI is pin-pointed and measured from 20 to 1000 MHz.

*ship devices and electronic equipment* or use devices which fail to comply with the regulations . . ."

A survey of the electronics industry's consumer-entertainment-product manufacturers failed to turn up any proponents of mandated regulations on consumer equipment.

"We don't like to see any regulation on susceptibility," says Robert Grant, chief engineer for government compliance at Magnavox and chairman of the Electronic Industries Association (EIA) Interference task force. "The big problem we have now is the fact that there are no good test methods and



# Greater RFI/EMI shielding in new, narrow-width contact strips from Instrument Specialties

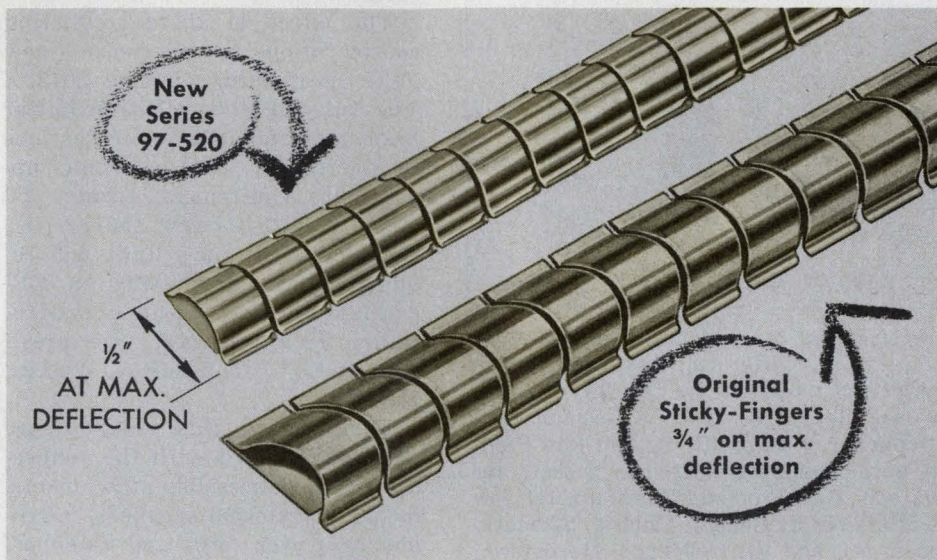

## Latest addition to *stickyn fingers*® line!

Instrument Specialties now offers Sticky-Fingers self-adhesive, beryllium copper contact strips in three variations to solve your most critical RFI/EMI problems.

Comparable to the shielding effectiveness of the original Sticky-Fingers, our newest series 97-520\* offers shielding effectiveness of 92 dB at 10 GHz plane wave or greater than 92 dB at 1 MHz magnetic, and has a dynamic range of 0.10". Yet, it measures a scant 3/8" wide, and 1/2" at maximum deflection.

Supplied in standard 16" lengths, series 97-520 is ideal for metal cabinets and electronic enclosures where variations exist in the space to be shielded, and where high shielding effectiveness must be maintained in narrow spaces, even with frequent opening and closing of the cabinet.

Select the exact series that fits your application best. Write today for a complete catalog, list of finishes available, and our latest Independent Shielding Evaluation Report. Address: Dept. ED-68.

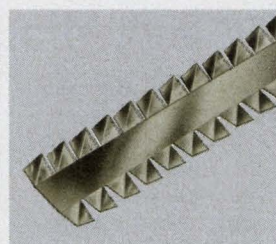
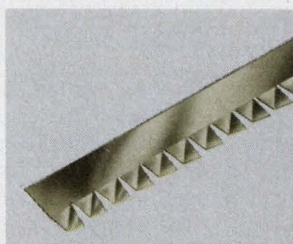
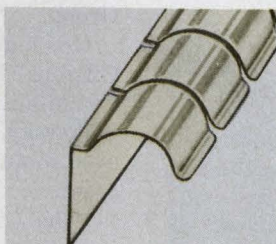
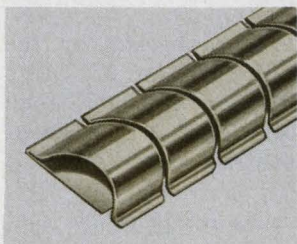

Series 97-500\*—the original 3/4" wide Sticky Fingers. For greatest possible shielding and where space permits. Also available: Series 97-505—90° configuration of Series 97-500; same shielding effectiveness.

For those all-purpose applications where economy and space are both factors, specify the 3/8" wide single-twist series 97-555, or 1/2" wide double-twist series 97-560 Sticky-Fingers.

*Specialists in beryllium copper springs since 1938*

\*Patented

CIRCLE NUMBER 10

ELECTRONIC DESIGN 20, September 27, 1976



INSTRUMENT SPECIALTIES CO., INC.  
Little Falls, New Jersey  
Phone 201-256-3500



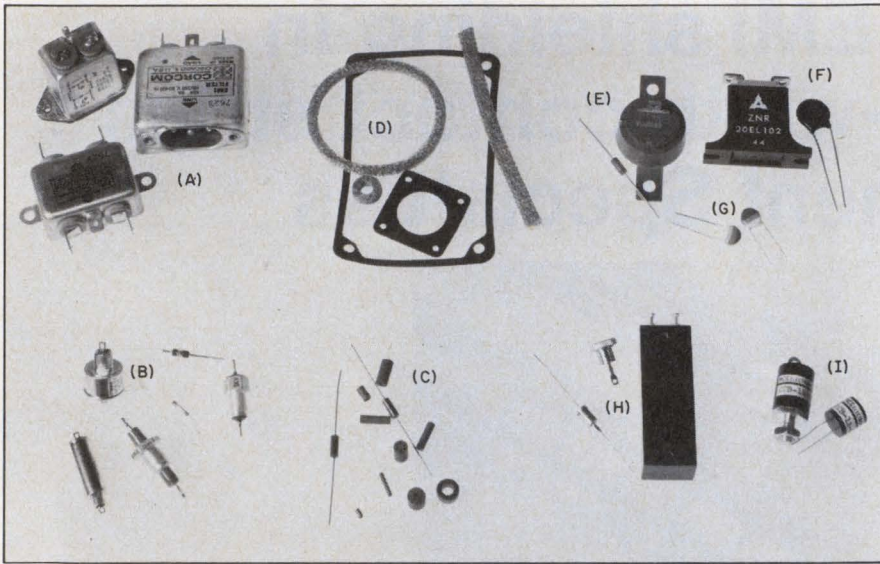

The growth of EMI/RFI sources and receivers by the millions mandates a design emphasis on the use of components to minimize electrical noise and its effects. These components include: power-line filters (A) by Corcom, Chicago, IL; hermetically sealed, ceramic low-pass filters (B) by Erie Technological Products, Erie, PA; ferrite beads for reducing rf noise (C) by Fair-Rite Products, Wallkill, NY; knitted-wire mesh and conductive-elastomer gaskets for sealing enclosures against EMI (D) by Tech. Wire Products, Cranford, NJ; low and high-power transient-absorbing varistors (E) by General Electric, Syracuse, NY, (F) by Matsushita Electric, Secaucus, NJ, and (G) by Mepco, Morristown, NJ; and fast-acting clamps and crowbars (H) by General Semiconductor, Tempe, AZ, and (I) by MCG Electronics, Deer Park, NY.

equipment to measure susceptibility in order to comply with any regulations."

Grant did point out the considerable efforts of the National Bureau of Standards and various industry technical groups to develop susceptibility-measurement techniques.

### No more design afterthoughts

As a result of the rule tightening and the forecast of even greater

restrictions, interference control in emitters and suppression in susceptible receivers will no longer be an afterthought of design. Instead, they will substantially increase total development time.

Experts in the EMC field predict imminent shortages of EMC specialists for in-house development of new electronic devices and systems because for years interference control as an element of design has been neglected.

By adopting tougher require-

ments and rules to alleviate interference the FCC has found itself in the impossible position of trying to satisfy the technical requirements of opposing parties with conflicting economic interests. A classic case is the controversy between the CB and the TV manufacturers.

The effect of these conflicting considerations can be seen in a new FCC rule making (Docket 20120). The rule tightens CB-transmitter harmonic radiation specifications by increasing the harmonic-suppression requirement from -50 dB to -60 dB below the carrier. To achieve this new limit will require additional filtering in CB-transmitter antenna circuits, claims Hugh Barnes, vice president of E. F. Johnson Co., Waseca, MN.

Furthermore, this tougher spec must be satisfied with the connection of all permissible attachments, including external speakers, microphones, power cords and antennas.

Another new requirement: If insufficient harmonic suppression causes interference on TV channels 2, 5 and 6 of a neighbor's set, the guilty CB owner must insert a low-pass filter between the antenna rf-output jack and the antenna feedline.

### Battle lines drawn

The new spec naturally has aroused strong differences of opinion between the CB and TV-set makers. As originally proposed by the FCC, the requirement was -70 dB, but the Commission softened its stand by -10 dB despite the TV-set manufacturers' united request for -112 dB, submitted by the EIA's Consumer Electronics Group.

CB makers are backed by the Citizens Radio Station of EIA's Communications Division. John Sadowsky, EIA staff vice president of communications, states the CB case:

"The Citizens Radio people contend that legally operated citizen's radio sets don't cause interference to TV sets. And when such interference does happen, it's the fault of the wide-open front end of the TV receiver."

Joseph DeMarinis, director of engineering for GTE Sylvania, Batavia, NY disagrees:

## FCC's EMC authorization programs

**Type Approval**—The manufacturer must submit his device to the Commission's Laboratory for evaluation of its interference potential. If prescribed emission limits are not exceeded the manufacturer is given a Grant of Type Approval.

**Type Acceptance**—The manufacturer conducts his own EMI emission-limit testing. Based upon the FCC's evaluation of the manufacturer's engineering-test report a Grant of Type Accept-

ance may be issued for equipment that can be expected to comply with the applicable FCC rules when operated by the end consumer. Type-accepted devices require a station or operator's license.

**Certification**—This follows the type acceptance procedure conducted by the manufacturer. But certificated equipment is operable without any license. For example, radio and TV receivers are certificated.



# PRECISION.

The mark of a Pro. Like P&B.  
Time delay relays with up to  $\pm .05\%$  repeatability.  
And delay times to a year or more.



That's the kind of precision you get with Potter & Brumfield **CG Series** relays. And there are many more P&B time delay relays to meet virtually any requirement. Including . . .

**R12, R13, R14, R15 Series.** Sophisticated circuitry usually found in more expensive relays. Repeatabilities to  $\pm 3\%$ ; time delays to 600 sec.

**Low cost R16 Series.** Easily mounted p.c. board module. Delay on operate ranges: 0.2 to 2, 2.0 to 30, 5.0 to 100 sec. Potentiometer or resistor adjustable.

**R52 modules.** Inexpensive way to make all but a few 6, 12 or 24 VDC P&B relays into time delays. Resistor adjustable timing ranges from 0.2 to 100 sec.

Also low profile, solid state hybrid, adjustable and non-adjustable—even dry reed. With every type of termination, too!

Design for precision. Specify P&B. See your P&B sales representative, or P&B Pro Shop Distributor. Or, contact Potter & Brumfield Division AMF Incorporated, Princeton, IN 47671. Telephone: 812-386-1000.

European address: Electrical Products Group, AMF International Limited, AMF House, Whitby Road, Bristol BS4 4AZ, England. Telephone: (0272) 778383, Telex: 449481, AMMAFOCO, BRSTL.

Go with the Pros and you can't go wrong.





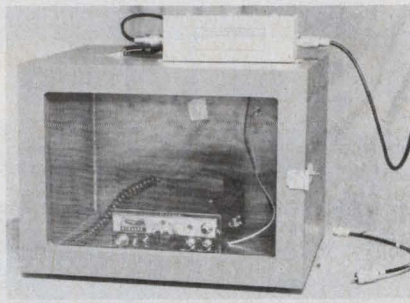
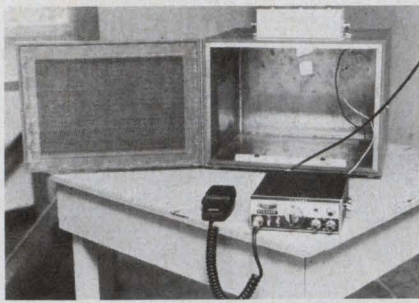

## Proposed Part 15 radiated limits

Frequency f, kHz	Distance of measurement, m	Field strength, $\mu\text{V}/\text{m}$
10 to 500	300	2400/f
500 to 1600	30	24,000/f
above 1600	3	100

## Proposed Part 15 conducted limits

Frequency, MHz	EMI Voltage (see text)	
	Microvolts	dB above 1 $\mu\text{V}$
0.1 to 0.45	1000	60
0.45 to 1.6	200	46
1.6 to 25	100	40

The feasibility of eliminating TV interference by RFI-proofing a CB set is demonstrated by GTE Sylvania at test site. With bare CB the RFI is objectionable (upper and lower left). When CB unit is shielded and filtered, the RFI on TV channel 2 is below the perceptible level (upper and lower right).

"The filtering and shielding of a TV set is an order of magnitude, or more, better than the state of the art of CB transmitters. Further improvements in the TV set will not be noticeable until the harmonic radiation levels of the transmitters are further reduced."

The principal obstacle facing the TV-set designers is that CB transmitter harmonics fall within the bandpass of TV channels. Hence, the recommended  $-112$  dB level from the TV industry.

"Traps can't be used for in-band CB interference," explains DeMarinis. "And in order to even notice the fundamental of a nearby CB transmitter overload the TV receiver, the harmonics must first be lowered substantially."

"If the TV set is overloaded with a fundamental, harmonics are generated inside the tuner, and traps can be put in for that. We've taken a CB transmitter and added the filtering we think it should have. In tests on our 100-ft radiation site the TVs perform well."

For those CB makers pleased with the new  $-60$  dB requirement, the FCC has added a warning to its ruling: "We believe that further tightening of the harmonic-suppression limit in the future will be necessary."

While CB transmitters have been

widely recognized as sources of interference, less known is the fact that the radiation from oscillators of CB receivers has been creating interference problems for three public services: the Power Radio Service used by electric, gas, water and steam utilities in the 37-MHz band; the aircraft services band, 100 to 135 MHz; and the Forestry Conservation Service operating on 151.205 and 151.400 MHz.

### Synthesizers cause interference

Interference to Power Radio Services stems from the heterodyne type of frequency synthesis used by many 23-channel CB receivers. To minimize the number of crystals the 23 oscillator frequencies are obtained by heterodyning the outputs of two oscillators. One uses crystal at 37.6, 37.65, 37.7, 37.75, 37.8 and 37.85 MHz. The other has crystals at 10.180, 10.170, 10.160, and 10.140 MHz. The combined total is 10 crystals for 23 channels.

The 37.6, 37.7 and 37.8 MHz frequencies happen to be those used by the Power Radio Service. To alleviate interference of all three services, the FCC amended Part 15C by adding a new Section 15.59 that requires the certification of

CB receivers to new, low limits of oscillator radiation.

The limit of receiver oscillator radiation within a band of 25 to 500 MHz was reduced to 2.0 nW at the antenna terminals for receivers produced after Jan. 1, 1977. The lower level of 0.2 nW will be effective for receivers produced after Jan. 1, 1978.

With the CB receiver's antenna terminals connected to a shielded resistor equal to the rated input impedance, the emission at any frequency from 20 to 500 MHz is limited to a maximum of 5  $\mu\text{V}/\text{m}$ , measured at a distance of 3 m, for those receivers produced after Jan. 1, 1977. The measurements must be made with the microphone and all other options attached to the set.

If the CB receiver can be connected to ac power lines, the conducted interference fed back into the lines must not exceed 100  $\mu\text{V}$  at any frequency between 0.45 and 25 MHz. This requirement also applies to a battery-operated CB receiver that can be connected to the power line through a battery charger.

The manufacture of CB receivers not certified to meet these requirements must cease no later than Aug. 1, 1977, while the sale of noncertified units must end by Jan. 1, 1978.

Interestingly enough, the great majority of the new 40-channel CB equipment will employ a phase-locked-loop synthesizer using two IC chips and a single crystal. This



**Who provides the industry's broadest line of electronic packaging hardware ... including Thumbwheels or Bit Switches?**

SAE does! We're the only manufacturer that is DIRECTLY INTERCHANGEABLE with other popular switch series such as: 8000; 23000, 29000, 1776, 1976; T20, T60, T70; and Types M, H and P. You'll find us a very competitive and readily available second source!

Our switches feature five housing sizes; 8, 10, 11, 12 and hexadecimal position wheels; large wheel characters; custom-markings; colored wheels; and a unique contact spring that can produce *any present* or custom switching code. Additionally, you can choose PC pins; component mounting boards; switch assemblies with "mother boards"; and complete circuits on PCBs. In other words—name it ... we'll deliver!

And don't overlook our diminutive, behind-the-scene BIT SWITCH™. This new DIP programming device comes in two through ten SPST switches, plugs into an IC socket, or mounts directly onto a PCB on .300" by .100" centers. You'll find it ideal for switching circuits or BCD coding in computer peripherals, communications equipment, traffic signal controllers, etc.

Our new 128 page packaging handbook gives complete details, and also describes our entire line of electronic packaging and interconnection hardware.

™-Stanford Applied Engineering, Inc.

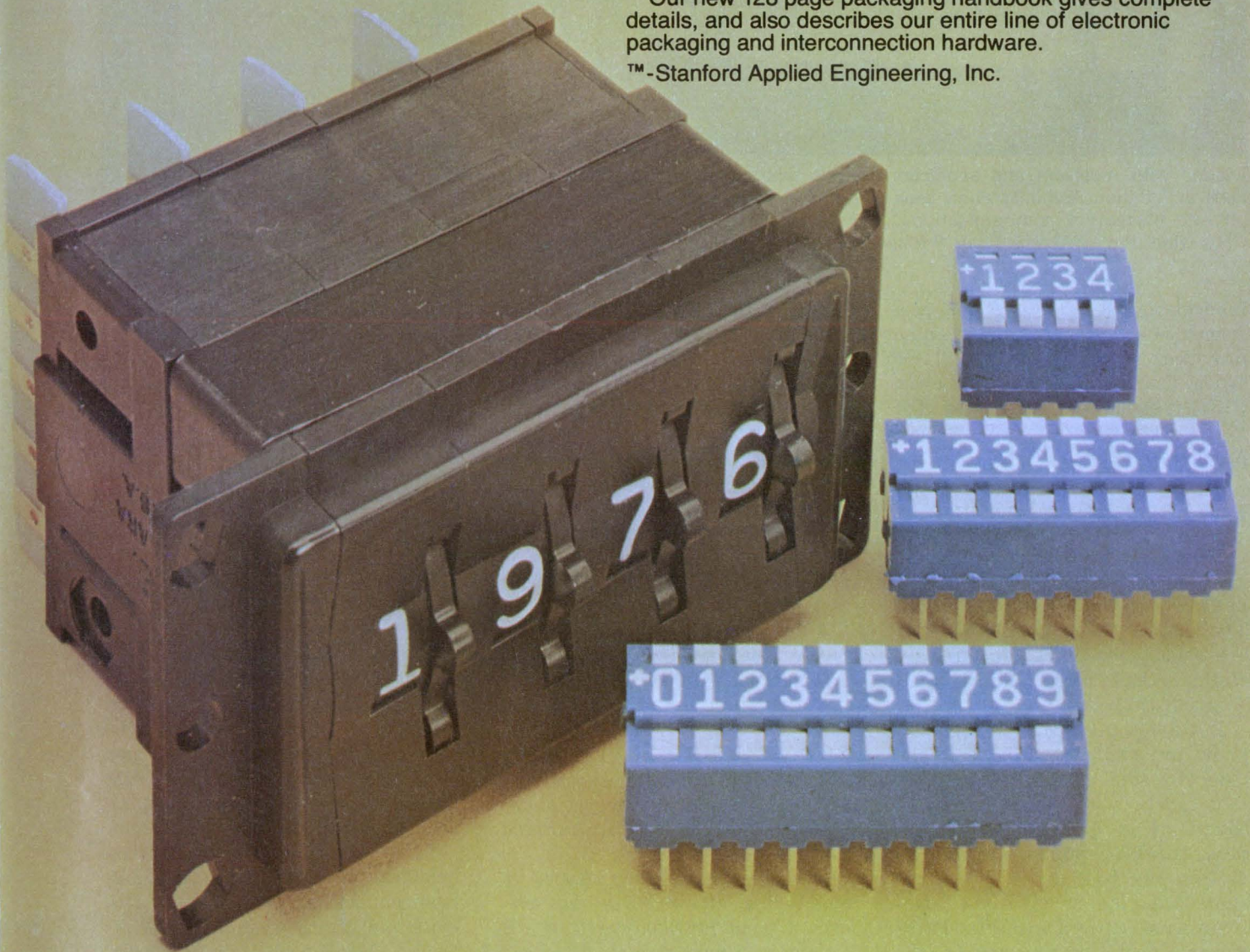

For an immediate reply, call the following toll-free "ZIP QUOTE" number at the factory ... 800-538-6843.



**Stanford Applied Engineering, Inc.**

840 Martin Ave., Santa Clara, CA 95050  
(408) 243-9200 TWX 910-338-0132



## Consumer devices and FCC rules

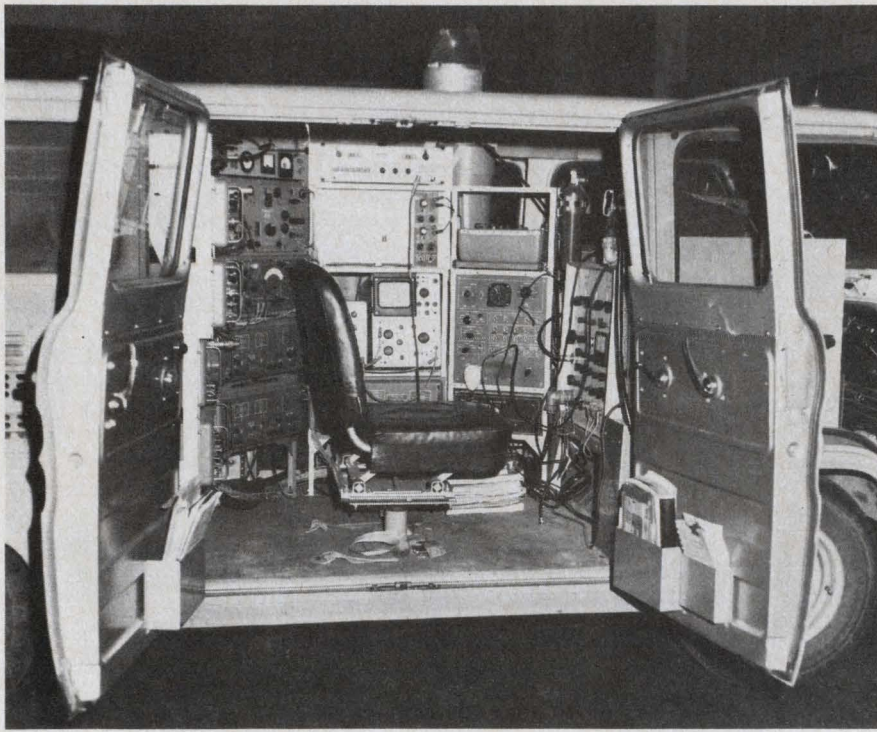

Loaded with receivers and spectrum-analysis equipment, mobile vans of the Federal Aviation Administration seek out and identify signals interfering with aircraft navigation communications. Receivers tune from 10 kHz to 10.5 GHz, while the analyzers cover the spectrum from 1 kHz to 40 GHz.

innovation provides a better performance at lower cost than can be provided with the two-oscillator synthesizer. In addition, using the PLL system will eliminate the Power Radio Service's interference problem.

### FCC vs bootleggers

Illegal or bootleg rf amplifiers increase the CB-transmitter output many times its legal 4-W limit. The sale of these amplifiers—they are usually discovered in CB base stations—has been banned since August, 1975.

But a few irresponsible CB suppliers are making available to the Cber broadband linear amplifiers that can be sold legally for use in the amateur band. These amplifiers, the FCC points out, can be driven only by 3 or 4 W, so the subterfuge is obvious. Few amateurs have exciters with that low a power; most exciters are in the 100-W class.

To help combat bootleg operations and other sources of CB interference, the FCC's Field Operations Bureau is investigating a random selection of TV-interference complaints. The bureau is engaged in the following activities:

- Monitoring a CB station unannounced to determine if a linear amplifier or other illegal accessories, such as a variable-frequency oscillator or a power microphone, are part of the CB setup.

- Inspecting CB-station equipment for spurious emissions through the use of spectrum analyzers. New test procedures for measuring such parameters as radiation from the CB cabinet are also being used.

- Inspecting a complainant's TV receiver for received signal levels and antenna quality.

- Installing high-pass filters on the TV receiver and low-pass filters on the offending CB set.

- Making a neighborhood survey to determine the impact of interference on the local area around a CB set.

One result of the stepped-up monitoring activity was the seizure of over \$10,000 worth of CB equipment used by eight unlicensed operators in Northern New Jersey. The culprits were engaged in illegal operations that interfered with police, fire, and aircraft communications as well as with AM, FM and TV reception. The operators face a fine of \$500 a day for every day they engaged in illegal

Type of consumer device	Part
Wireless intercom	15.7
Walkie-Talkie (under 100 mW)	15.119
Wireless microphone	15.161
Security transmitter	15-D
Intrusion detector	15-F
Field disturbance sensor	15-F
Door opener transmitter	15-E
CB transmitter	95
Model remote control transmitter	95
Amateur radio transmitter	97
Microwave oven	18
Electronic games	15.7
Class I TV device (couples to TV set with modulated rf oscillator)	15-H
Master antenna system	15.13
Electronic equipment	15.13
Radio receivers (above 30 MHz)	15-C
Electric motors	15.25
Home appliances	15.25
Ignition system	15.25
Light dimmer	15.25

operations plus a year in jail, and a maximum \$10,000 fine for unlicensed operation.

Most of the FCC regulations governing consumer electronics devices and equipment appear in Parts 15 and 18 of the Commission's Rules. But Part 15 has not been amended since 1948, and the basic technical specs of Part 18 have remained the same since 1946.

Since then, however, vast technological advances have occurred. Semiconductors, integrated circuits and digital systems have appeared. Many new devices, operating at frequencies substantially higher than in the late 40s, present new interference problems.

Consequently, the FCC has proposed overdue changes to Part 15 (Docket 20780) and Part 18 (Dockets 20718).

*(continued on page 34)*



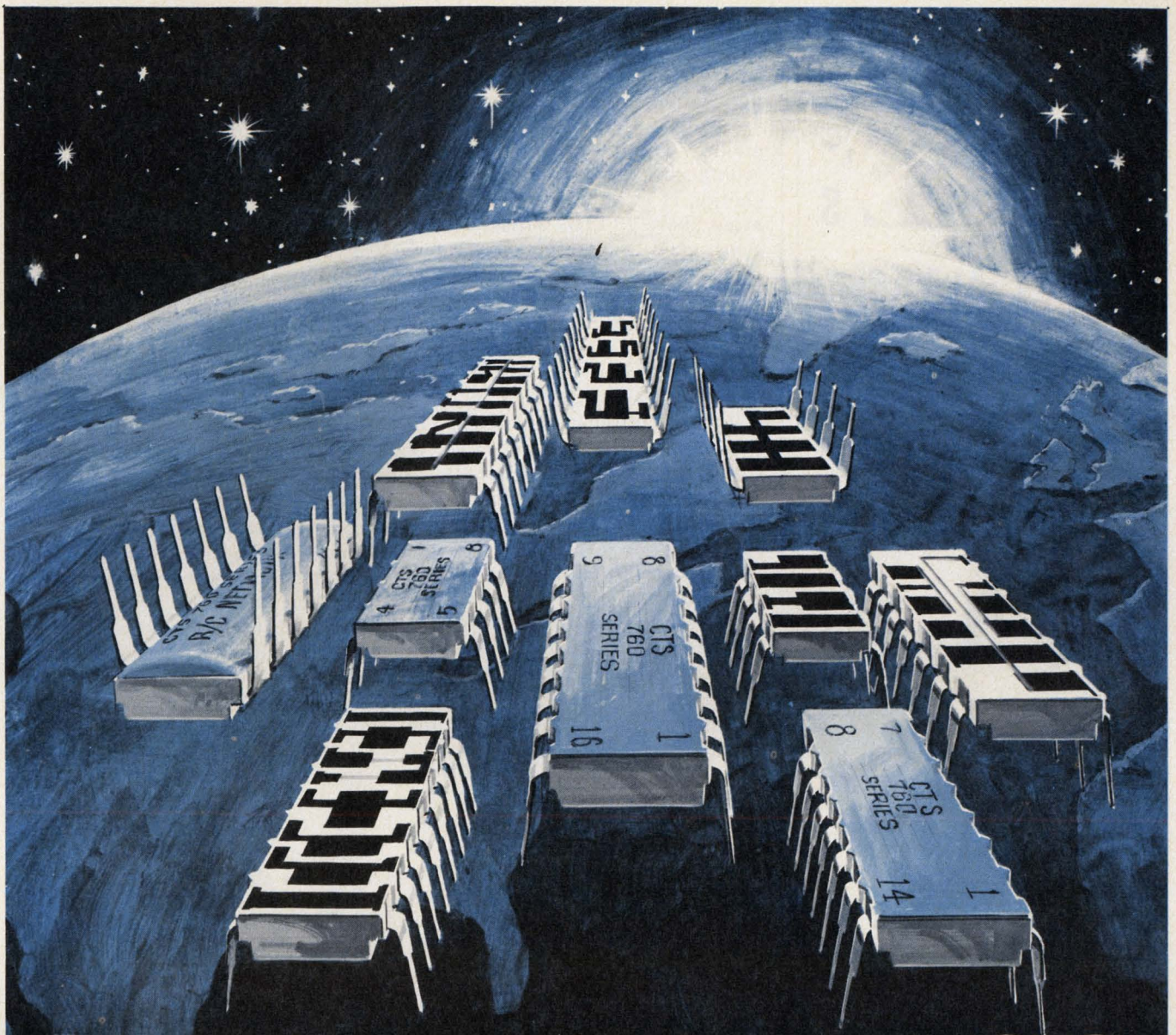

## Down to earth economy from CTS

Overall cermet resistor network economy is what CTS has been putting into modern systems for well over a decade. For example, Series 760 DIP cermet networks, purchased in quantity, can cost less than 30¢ each.

And on the PC board, they offer still more economy by saving valuable space. Quick, automatic installation lets you cut handling costs and inspection time. You eliminate many separate components. And CTS production methods assure not only the highest quality product, but the fastest delivery, too.

Where one of our more than 210 standard off-the-shelf 14-pin and 16-pin DIP cermet resistor networks won't meet your circuit requirements, we'll custom design the network you need in either

8, 14, 16 or 18 pin package configuration.

CTS Series 760 DIPs' stability and reliability are remarkable. Over 900 million hours of test data on CTS cermet resistor networks prove CTS reliability with an established failure rate of only 0.00051% per 1000 hours @ 95% confidence level — considerably superior to military failure level S of established reliability specs. With failure so low, you enjoy the ultimate in long-range system economy.

See for yourself the many ways CTS reliable, economical DIPs can benefit you. Write for your copy of our reliability report and complete 12-page cermet resistor network catalog. **CTS OF BERNE, INC.**, 406 Parr Road, Berne, Indiana 46711. Phone (219) 589-3111.

**CTS CORPORATION**

Elkhart, Indiana

A world leader in cermet and variable resistor technology.



CIRCLE NUMBER 13



# RELIABILITY is RCL's FIRST NAME!

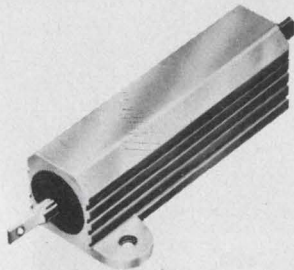

## RCL...

The  
Prime  
Source  
For  
RE's and  
RER's

*The finest Wire-Wound Resistors designed, manufactured and quality controlled, employing the ultimate in modern technology and priced to sell competitively.*

**Call our hotline for prompt service and delivery.**  
**(603) 627-3831**

**AMF**

**RCL Electronics**

195 McGregor St.  
Manchester, N.H. 03102

One proposed change in Part 15 is the certification of restricted-radiation devices with relatively high interference potential that are being widely distributed to the public. These include electronic (coin-operated) games that use rf energy, rf switching supplies operating above 10 kHz, wireless intercoms, and any other restricted radiation device that uses rf energy for the purpose of communications. Other devices will be added to the list as the need arises.

To certify these devices, the FCC proposes to discard its 1948 maximum-emission standard of 15  $\mu\text{V}/\text{m}$ , measured at a distance of  $\lambda/2\pi$ . The Commission wants to substitute a table of radiated and power-line-conducted emission limits, with the latter measured between each power line and ground (see tables).

Switching-power-supply manufacturers claim that to conform to the new proposed emission limits would, in many cases, call for costly re-designing, a preview of the coming mandated emphasis on electromagnetic compatibility (EMC).

Wally Amos, chairman of the Computer and Business Equipment Manufacturers Association (CBEMA) subcommittee on EMI/RFI, differs with the FCC's proposed switching-supply standards:

"The FCC proposes to decrease the conducted limits of noise voltage measured with frequency while we would increase it. In the 10-MHz range, our limit is 70 dB above 1  $\mu\text{V}$  (3 mV), while the FCC's is 40 dB (100  $\mu\text{V}$ ). This is a stringent and costly limit that is not necessary to protect communications services.

"Even more expensive is the FCC's extension of frequency limits down to 100 kHz, where filter components become large and costly. CBEMA advocates a lower limit of 450 kHz."

A real headache for the FCC is the TV game that can be connected to the antenna terminals of the owner's set. About 30 were announced at June's Consumer Electronics Show (ED, No. 15, July 19, 1976, p. 21).

"These games are potentially as popular as CB sets," says Milton Moble, chief engineer in charge of the FCC's testing laboratory in Maryland. "We've had more applications for TV-game type approval

in the second quarter of '76 than we had in the past four years.

"Toy firms with little or no expertise in EMI or RFI jumped onto the TV-game bandwagon. Rejection rate for new companies is more than 50% at the present time because the technical regulations are very strict for these Class I TV devices."

### Even your hand drill

A number of interference sources producing random broadband electrical noise can be just as disruptive to communications as the narrow-band emitters, such as CB sets.

These broadband sources, called incidental-radiation devices, include electric motors, hand drills, home appliances, light dimmers, electric-tool speed controls, and ignition systems.

As yet, these devices are unregulated by the Commission. However, complaints of interference from these products have increased.

For one of these broadband sources—ignition systems—the FCC has initiated a Notice of Inquiry (Docket 20654) to examine the advisability of establishing EMI-emission limits. The Commission has already conducted both in-house and outside studies on different facets of the problem. For example, the FCC measured the ignition-radiation levels of 10,000 vehicles at land-mobile communication frequencies. The Commission decided that objectionable degradation of communications had occurred, particularly in high-density urban traffic.

The Motor Vehicle Manufacturers' Association of the United States responded to the FCC's inquiry by questioning the validity of the FCC's test program of the 10,000 vehicles.

The U.S. automakers oppose mandatory FCC standards because, for one thing they abide by the voluntary Society of Automotive Engineering (SAE) Standard J551C. Nonetheless, the Detroit manufacturers have been working overtime for months to bring the ignition noise of their 1977 models within mandatory limits established by Canada's Dept. of Communications effective as of Sept. 1. These limits are required for cars manufactured or imported by Canada, parallel J551C. ■■



# The Only COMPLETE Microprogram Controller

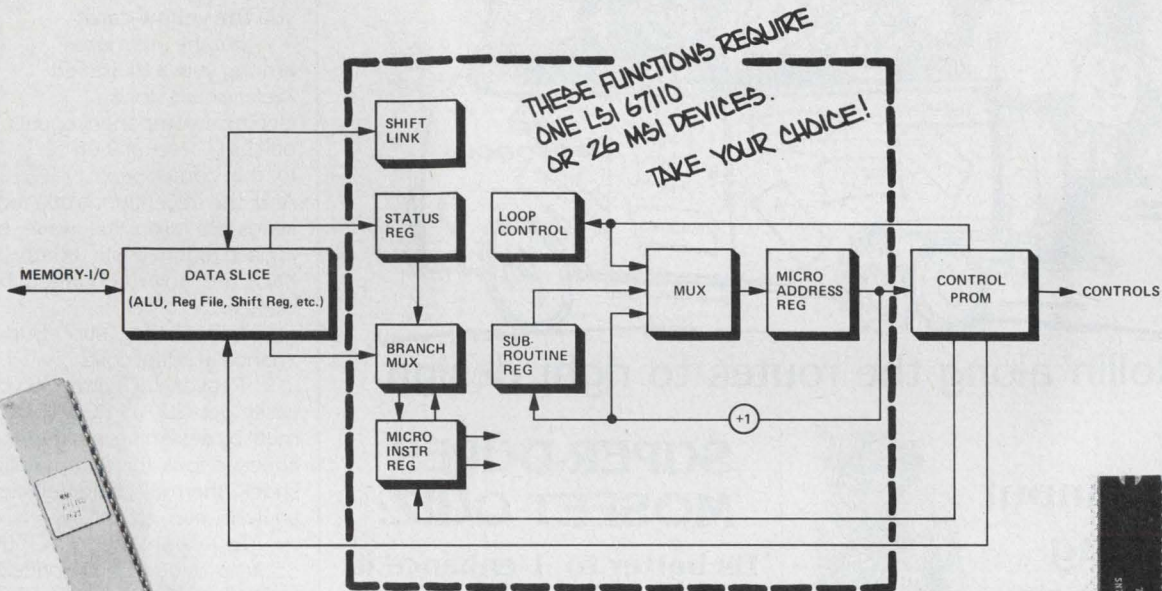

Handles every control application from discs to CPUs.

And replaces 26 or more MSI devices.

## Applications

CPU  
Process Control  
Disc Control  
High Speed Printer Control  
CRT Controller  
Signal Processing Control

## Features

- Works with any bit slice microprocessor such as MMI 6701, 2901, 3002.
- Works as a stand alone non-arithmetic controller
- Directly addresses 512 words of microprogram storage
- On-chip five bit counter for program looping routines
- Data shift linkage for arithmetic and logic shifting with 4 bit slices
- Microsubroutine and four way branch capabilities
- Very High Speed — 33 MHz

For more information about this revolutionary microprogram controller and about other members of our growing family of LSI logic devices that will eventually replace all MSI logic, call, TWX or write:

In the United States,  
Ed Barnett or John Birkner.  
In Europe, Bernd Kruse

DEVICE	TEMPERATURE	100 QUANTITY PRICE
67110J	Commerical	\$25.00
57110D	Military	\$55.00

**United States**  
Monolithic Memories, Inc.  
1165 East Arques Avenue  
Sunnyvale, CA 94086  
Tel: (408) 739-3535  
TWX: 910-339-9229

**Europe**  
Monolithic Memories, GmbH  
8000 Munich 80  
Mauerkircherstr. 4  
West Germany  
Tel: (089) 982601, 02, 03, 04  
Telex: (841) 524385

**Far East**  
MMI Japan KK  
Parkside-Flat Bldg  
4-2-2, Sendagaya Shibuya-Ku  
Tokyo 151, Japan  
Tel: (3) 403-9061  
Telex: (781) 26364

# Monolithic Memories

CIRCLE NUMBER 15



# MOTOROLA OMNIBUS



Rollin' along the routes to right design

## Kiss input polling routines goodbye



Bon Voyage and good riddance to input polling routines for your microprocessor systems. Send them packing first class at strictly coach fares with the new MC8507/MC6828 Priority Interrupt Controller.

What's that? Why two different numbers for one LSI device? No, not a split personality. We just want you to know this PIC is bipolar LSI (MC8507) designed to work in any processor system, but its first and foremost function (MC6828) is serving M6800 systems as if it were a member of that renowned NMOS family. Either number can be used for ordering.

Basically, the purpose of the PIC is to generate a modified address to ROM in response to prioritized inputs. Each interrupting device is assigned a unique ROM location with the starting address of the appropriate service routine. After the MPU responds to an interrupt, the PIC directs it to the proper memory location. The PIC also generates a Stretch signal, so the interrupt structure can be designed to accommodate the faster operations anticipated with improvements in processor speeds.

You'll just love it.

## SUPER-DUPER MOSFET QUIZ:

'Tis better to **1 enhance it**  
**2 deplete it**  
**3 tube it**



If you're into #3, this isn't for you (or maybe it is). But if you're after the best in MOSFETs for present and future VHF two-ways and TVs, receive this message:

Good 'ol Motorola now supplies the popular 'ol 3N201-03 family of N-channel, depletion mode dual gates plus the new DMOS enhancement mode MFE521.

The '201s, of course, offer typ common-source  $G_{PS}$  of 20 dB and typ NF of 1.8 dB. The '203, generally used for IF, has 25 dB  $G_{PS}$  typ.

And if you promise not to tell TI, the series duplicates theirs—for which you may be thankful—and is priced comparably—for which they won't be.

For your next generation of amplifiers/mixers, we present MFE521 in all its super-duper enhancement mode and ion-implanted splendor for just 60¢. It has 0.02 pF max reverse transfer capacitance and diode protected gates. At 200 MHz, common-source  $G_{PS}$  is 25 dB and NF 1.7 dB typ. Input and output capacitance, at 1 MHz, are 3.3 pF and 1.1 pF typ.

All are in hermetic TO-72's and can be had just by quizzing our super-duper salesmen. Don't ask about tubes—they know FETs, not filaments.

Advance and be **RECOGNIZED**, said UL, so we did.

And we are.

To prove it, we'll send you the **yellow card!**

For the amazed among you, a UL-issued "yellow card" for an electrical component equals official UL recognition for that component.

And the recently introduced MDA3500 series 35 amp full wave bridges that caused such a stir among you awhile back are now recognized by UL (what else!?!).

Reason for stir? Superior performance at equal cost.

Reason for card? So you can more easily get UL APPROVAL on your equipment by designing in components already checked out for flammability, electrical shock, thermal characteristics, chemical analysis, etc., etc.

To refresh, the MDA3500 series is a 35 amp bridge family priced at 25 amp levels. Besides furnishing 10 extra current-handling amperes, it offers 100 extra amps of surge current protection. And super-efficient, 70-watt Pb. And low AQL. And low  $\theta_{JC}$ . And fast turnaround.

And a price tag of just \$2.35, 25-99, for a 200-volter.

Customers are ordering it by the thousands and competition is mumbling under its breath.

And all we wanted was a little recognition.

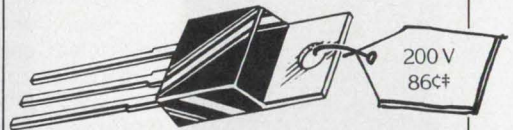

And now a new Triac, plastic, with 15 amp, 800 volt kick. Its glass passivation is just a sensation; its price tag sends studs up the crick.

That price tag runs about 30% less than for comparable studs—a bottom-line advantage that ought to make this very first of its TO-220 kind an irresistible choice for many commercial/industrial designs.

The 15 A(RMS) MAC15/15A is designed for full wave ac control in solid state relays, light dimmers, motor and heating controls and power supplies or

#10,000 PCS.



wherever full-wave thyristors are needed. Reliability? Coming right up in 150 A surge protection, all-diffused and glass-passivated junctions, gate cathode passivation, improved copper piece parts, void-free encapsulant, in-process and outgoing QC and reliability verification.

The small, rugged Thermowatt\* package offers low thermal resistance, high-heat dissipation and durability.

Gate triggering is guaranteed in two or four modes.

Use it everywhere you need to cost-reduce comparable metal parts.

Get it from a supplier who knows triacs, reason and rhyme, all the time. Motorola.

## The case of the pooped-out powertab



**OR, GE whiz, man, your wattage is missing.**

Don't take the rap for that nemesis of the honest engineer, that rapscallion of purloined performance — Skimpy Power Dissipation. It can kill you with a feeble 1.67 watts of  $P_D$ .

Turn to the only savior you have . . . Motorola's dynamic D40/41 Duowatt\* plug-in replacements with 2 watts of free-air power dissipation, and a better price.

Our powertab units eclipse theirs by 20% in power-handling and in the lowest  $\theta_{JC}$  in the industry: 62.5°C/W for lower-junction stress and a real edge in reliability and long life.

Plus, Duowatts offer second-generation epoxy molding with lower resistance to heat, higher resistance to moisture and greater strength.

Here's the run-down:

Series	Application	P <sub>D</sub> — Watts	
		GE	Motorola
D40C	NPN Darlington	1.67	2
D40D/41D	NPN/PNP 30-75 V Hi-gain Ampl.	1.67	2
D40E/41E	NPN/PNP 30-85 V Hi-gain Ampl.	1.67	2
D40K/41K	NPN/PNP Darlington	1.67	2
D40N	NPN HV Ampl.	1.67	2
D40P	NPN HV/Hi-gain Ampl.	1.67	2

Motorola Duowatts solve the power problem. Elementary, Watson, elementary.

## How does a tuning diode army march in one set of tracks?

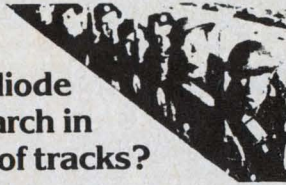

**Abruptly, of course.**

The new MV210 is an abrupt junction varactor diode inherently capable of tracking and matching the capacitance of the one in front of it, and behind it, over the entire voltage range.

In the past, painstaking, expensive testing and matching was required when using more than one varactor diode in a tuning system, plus costly tuning circuit adjustment once you got it all together.

The '210 plastic TO-92 solves all that by requiring just one voltage level check. All the diodes that match each other at that level, will match at any other chosen voltage level in the spectrum.

It's also got 100 min Q at 100 MHz, controlled, uniform ratio of  $C_1C_{25}=3.4$  min 3.7 max and a low 90¢ price.

Use the '210 in FM, TV, CB-VCO synthesizer control and general frequency control to count a better cadence and cut design and testing involvement.

Forward, march.

## Nail down voltage transients with unique crowbar IC

If nasty little gremlins run around in your circuit playing havoc with voltage limits, and your nerves, pin 'em to the wall with the MC3423.

This one-of-a-kind linear unit protects sensitives from transients or regulator failure. It senses overvoltage immediately and quickly crowbars, or short circuits, the supply forcing it into current limiting or opening the fuse or CB.

It's used with an external SCR, such as the new TO-220 25A 2N6504 capable of surge protection to 300A. Protection voltage threshold is adjustable and the circuit can be programmed for minimum duration of overvoltage condition before tripping. This feature prevents false tripping in noisy environments which would normally not harm the load.

It also offers additional output for use as OVP indication as an open-collector transistor when the OVP is activated. Just a buck-and-a-half, friends.



**(Coupon Missing?)** Send inquiries to Dept. LDC, Motorola Semiconductors, Box 20912, Phoenix, AZ 85036

## ALL ABOARD!

For complete itinerary, fill out and send to: Motorola Semiconductors, Box 20912, Phoenix, AZ 85036

Please have salesman call. Phone: \_\_\_\_\_

Name \_\_\_\_\_ Title \_\_\_\_\_

Company \_\_\_\_\_ Address \_\_\_\_\_

City \_\_\_\_\_ State \_\_\_\_\_ Zip \_\_\_\_\_

- MHW594/580 CATV Modules
- 3N201/MFE521 MOSFETS
- MDA3500 Bridges
- MAC15/15A Triacs

- MC8507/6828 PIC
- D40/41 Duowatts
- MV210 Tuning Diode
- MC3423 OVP Linear IC

## CATV's out of the bag

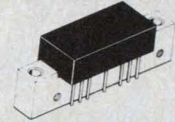

**Motorola Modules Play Better!**

Spec for spec, Motorola's new 17 and 34 dB CATV modules outplay anything else, even West Coast re-runs.

Same package, mind you, just better performance — like 35 channel instead of 32 guaranteeing low-distortion limits and a 7.0 db max noise figure tested at 300 MHz, not channel 13.

And if long term reliability's your major suit, they've got that too. This series incorporates a unique state-of-the-art transistor with emitter metal current densities and MTTF figures that challenge comparison. Tests on the geometry have accumulated over 750,000 operating hours at 90-100°C case. And we're still waiting for the first failure.

You don't have to design them into CATV. Any low-noise, low-distortion, flat-gain application from 40-300 MHz will do.

Just call and ask for the MHW594 & 5 and MHW580.

Or send us a cable.

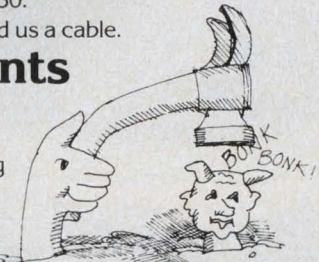



**CHAMP mass-termination connectors  
you can use anywhere with low power.  
Affordable technology  
from AMP.**





A complete connector terminated at one stroke—  
that's mass-termination. Fast. Reliable. Low cost.  
That's AMP.

CHAMP connectors handle unstripped solid and stranded  
wire, multi-conductor cable, even woven and laminated  
cable without costly wire preparation. They're especially  
useful for cable-to-cable, cable-to-panel and cable-to-  
printed circuit board connector applications. And are  
available in 14, 24, 36, 50 and 64 positions, with a  
broad variety of mounting accessories.

With all this versatility, you'll find CHAMP connectors  
at work in a wide range of equipment such as  
instrumentation, test equipment and business machines.

So come to AMP, the Company which believes  
professional engineers deserve support. We will work  
with you from the laboratory to your production line.  
At AMP, our goal is to make sure you get the most  
from our products—and from yours.

For more information on CHAMP mass-termination  
connectors, just call Customer Service at (717) 564-0100.  
Or write AMP Incorporated, Harrisburg, PA 17105.

# AMP

INCORPORATED

CIRCLE NUMBER 18

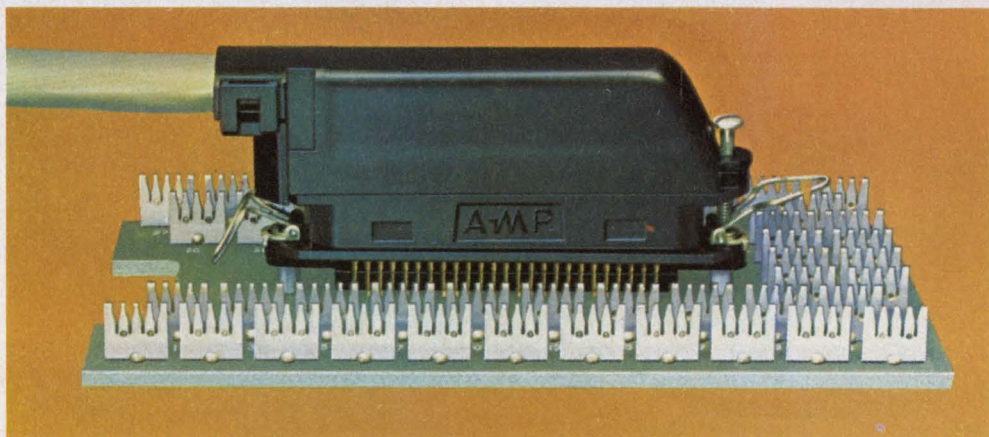
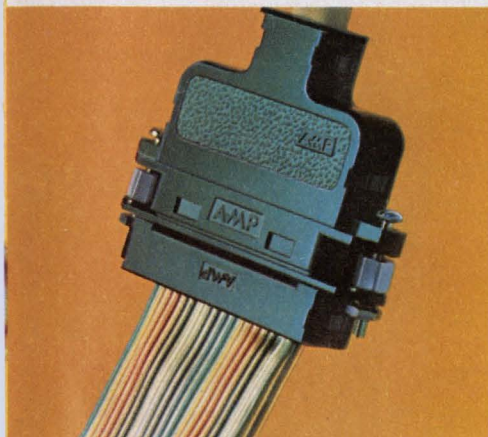
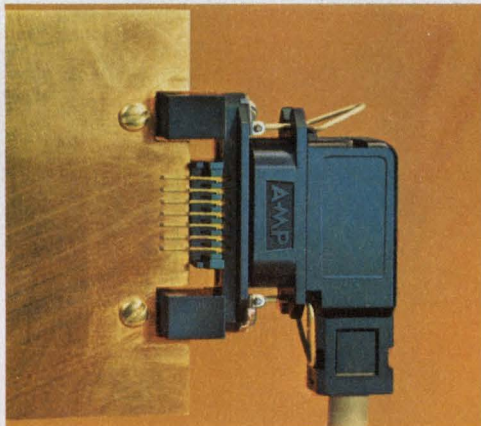
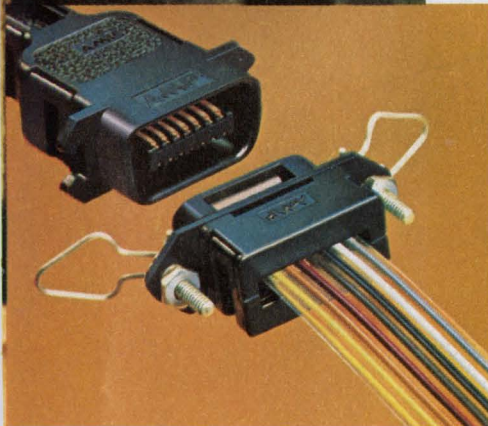



# NEW FROM KEITHLEY: TWO "BEST BUY" DMMs.



Model 173



Model 172

**4½ DIGITS. 30000 COUNTS.  
UNDER \$500.**



Advanced features are found in both these general-purpose DMMs:

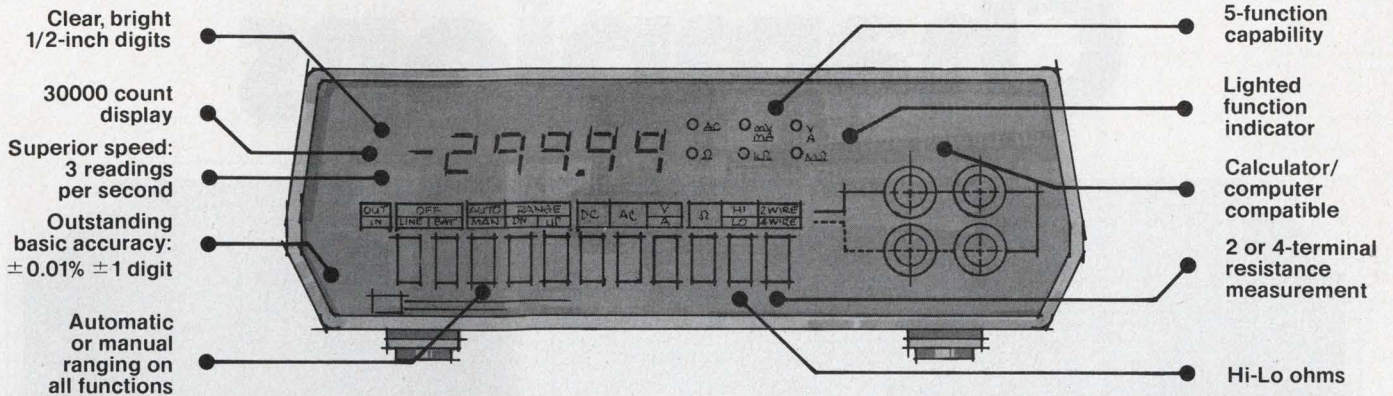

Take a look at the remarkable features of the new Keithley Digital Multimeters. They're unmatched in the industry.

Now consider price. At \$499 we think you'll agree the Keithley 172 is the best buy in a general purpose 4½-digit DMM.

There isn't another 4½ that matches the price-performance value of the 172. Except for its higher-rated companion, the Keithley 173.

**For \$499: the exceptional 172.**

To begin with, you get a dependable, durable, portable, easy-to-use, autoranging instrument with five functions. Designed for research, engineering or production applications.

Measure from 10 microvolts to 1200 volts dc, 10 microvolts to 1000 volts ac, 10 milliohms to 300 megohms, 10 microamps to 2 amps, ac or dc. DC accuracy is  $0.01\% \pm 1$  digit.

There's more: 3 month recal cycle. No-nonsense, full-year guarantee on parts, workmanship, and specs. 30000-count display yields maximum accuracy for 15, 18, 24 and 28-volt measurements.

**For \$625: the even more exceptional 173.**

The Keithley 173 is our top-rated 4½-digit DMM. It gives you all the performance and accuracy of the 172 plus superior autoranging current measurements from 10 nanoamps to 3 amps. This makes the 173 the most complete and versatile general purpose 4½-digit DMM in the world — at any price.

**More versatility. Now or later.**

Options and accessories expand the 172 or 173 to your specific needs: Rechargeable battery pack you can buy now or add later. Digital output/control. RF probe. 50-amp shunt. Clamp-

on ammeter. High-voltage probe. Rack mount kits. Test lead sets. Carrying case. IEEE 488 interface.

**Make this easy decision.**

For most 4½-digit DMM applications, the new Keithley 172 is your best buy. When you require more current measuring capability, the 173 is.

For convincing proof, send for detailed specs or request a demonstration. Or if you're already convinced, send your order to: Keithley Instruments, 28775 Aurora Road, Cleveland, Ohio 44139. (216) 248-0400. Europe: Heighhofstrasse 5, D-8000 München 70, West Germany. (089) 7144065.

**DMMs for all your needs.**

We know you have a variety of measurement requirements. So we offer a growing family of DMMs to meet your application and price objectives. Send for details.

3½ digits	4½ digits	5½ & 6½ digits
<p><b>Model 168</b> General purpose. Low cost.</p> <p><b>Model 160B</b> 1 <math>\mu</math>V and 10 pA sensitivity.</p> <p><b>Model 616</b> Super-sensitive. 0.1 pA full-scale.</p>	<p><b>Models 172 and 173</b> Two "Best-Buys!"</p> <p><b>Model 171</b> 1 <math>\mu</math>V sensitivity. 5-functions.</p> <p><b>Model 174</b> 0.1 <math>\mu</math>V sensitivity. (coming soon)</p> <p><b>Model 180</b> 30 nV sensitivity.</p>	<p><b>Model 190</b> Multi-function. Low cost.</p> <p><b>Model 5900</b> 0.001% accuracy. High stability.</p> <p><b>Model 6900</b> Accuracy, stability and sensitivity measured in ppm.</p>

**KEITHLEY**  
The measurement engineers.

FOR DEMONSTRATION, CIRCLE #19  
FOR TECHNICAL DATA, CIRCLE #20



# LED Champions



## Cost, performance and delivery winners!

If you're looking for the perfect cost and power saving replacements for incandescents, look to Data Display Products! Our LED's are super bright champions (50 MCD @ 20 mA—typical clear red). You can choose from an almost unlimited variety of shapes, styles and sizes . . . available with built-in resistors for all popular voltages . . . ready for quick delivery!

**PCB LED's**—Horizontal or vertical viewing . . . optional built-in resistor for 5V applications.

**Bi-Pin (T1- $\frac{3}{4}$ ) LED's**—Ideal for dead front panel applications, e.g. DEC's PDP Series computers.

**Slide Base LED's**—Direct replacements for incandescent types.

**Subminiature Panel LED's** (also suitable for PCB mounting)—available in hundreds of sizes, shapes and styles.

**Midget-Flanged (T1- $\frac{3}{4}$ ) LED's**—Direct replacements for incandescents in panel light and switch applications.

**Replacement Lenses**—Specifically designed for use with Midget-Flanged LED's.

There's lots more too, and they're all Champions! Send for our Catalog today: Data Display Products, P.O. Box 91072, Los Angeles, Ca. 90009, (213) 641-1232.

Produced by the original "little light" people.

**Data DISPLAY PRODUCTS**



# Washington Report

## **FCC to seek comsat regulation**

The U.S. Position at the next World Administrative Radio Conference on 11.7-to-12.2-GHz broadcast satellites will be that orbits and frequencies should be subject to minimum regulation, the Federal Communications Commission announced.

The U.S. position is based on a 15-month study in which U.S. companies took part. If the position is adopted, participating countries will be permitted to move their communications satellites in orbit only one time each for a maximum distance of 10 degrees of longitude. The satellites would also have to be stable in orbit to within  $0.1^\circ$  of longitude. The study did not recommend a figure for antenna accuracy, but the FCC will propose  $0.2^\circ$ , which is a feature of the upcoming Intelsat V satellite and the current 6.4 GHz U.S. domestic communications satellites.

The conference will convene in Geneva, Switzerland, Jan. 10.

## **Navy testing new ship electronic defenses**

The Naval Electronics Systems Command is due in October to complete operational evaluations of a new low-cost electronic-warfare suite for its patrol frigates and destroyer escorts, and possibly for a new anti-submarine warfare helicopter as well.

The system is known as the Design-to-Price Electronic-Warfare Suite (DPEWS), and the Navy is testing prototype hardware submitted by Hughes and Raytheon. Each firm has been asked to submit cost proposals for 285 production systems. The production contract will be awarded early next year.

Under the design-to-price restrictions, the unit cost of the basic DPEWS, which provides only threat warning, will be limited to \$300,000 in production. The top-of-the-line system, which incorporates threat warning, surveillance and defensive electronic countermeasures, will be limited to \$1.4 million in production.

Although initial production will cover only shipboard installations, the DPEWS has been specified for the Navy's planned Light Airborne Multi-Purpose System (LAMPS) ASW helicopter. Approval for at least 200 of those helicopters is expected next spring.

## **Soviets favor U.S. microwave landing system**

The United States is picking up support from an unexpected quarter in its bid for worldwide adoption of the time-reference, scanning-beam



(TRSB) microwave landing system: the Soviet Union. Except for Australia, which has also proposed a TRSB system, all other countries favor the doppler system. The International Civil Aviation Organization (ICAO) will choose one as the global standard.

The Soviets are building TRSB hardware but have not put it into operation yet, according to Jeff Cochran, associate administrator for engineering and development at the Federal Aviation Administration, who recently returned from a tour of Soviet air-traffic-control facilities in Moscow and Leningrad.

Cochran said the Soviets were interested in increasing cooperation with the United States in such air-traffic-control areas as collision avoidance and discrete-address beacon systems (DABS). The Soviet Union has an automated terminal air-traffic-control system, which Cochran considered "roughly equivalent" to the U.S. ARTS III (air-terminal) system. The Soviet equivalent contains alphanumeric displays with altitude-encoding capability.

## Drone aircraft contract protested

Teledyne Ryan, the losing bidder in the Air Force's competition for the Compass Cope multipurpose drone aircraft, has protested the selection of Boeing on the grounds that Teledyne, not Boeing, was the low bidder and the Air Force overestimated its cost proposal.

The protest was filed with the General Accounting Office after the Air Force awarded Boeing a \$77.2-million engineering-development contract to refine electronic subsystems and deliver three prototype vehicles. Only \$2.75-million of that contract was actually obligated, however, pending Defense approval of a mission for the drone aircraft. Congress voted \$6 million to the program for the coming fiscal year but directed the Air Force to spend not more than \$3 million until the mission could be defined.

Compass Cope is envisioned as a replacement for manned aircraft used to pinpoint the location of enemy anti-aircraft missile radars behind battle lines. The Air Force plans to procure up to 100 of the drones, and might also use them to carry side-looking airborne radars, communications relay systems and ocean-surveillance sensors.

The principal aim of the subsystem program is to develop a more reliable dual-digital flight-control system. Honeywell, a Boeing subcontractor, will deliver a brass board system to replace the analog system used in the initial flight tests. Univac, another subcontractor, is developing a continuous-wave (CW), frequency-modulated command guidance system to replace the pulsed microwave system also used in those tests. Since the initial system used vacuum-tube technology and had to be multiplexed for the down link, it was susceptible to multipathing problems.

**Capital Capsules:** Dr. Richard C. Atkinson, on leave from Stanford University, has been named acting director of the National Science Foundation following the appointment of Dr. H. Guyford Stever as presidential science advisor (ED, Washington Report, Sept. 1). . . . The National Oceanic and Atmospheric Administration will use an airborne infrared doppler lidar (light radar) this September to measure the velocity of water particles in waterspouts off Key West, FL. By measuring the doppler shift of the particles, the researchers will be able to keep the aircraft (hearing the lidar), a T-28, a safe distance from the storm.



# Sprague puts more passive component families into dual in-line packages than any other manufacturer.

**Call Sprague First!**

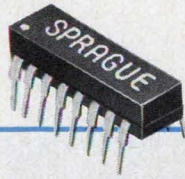

plus improved performance and compatibility with DIP microcircuits

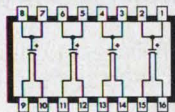

**DIP  
MULTIPLE  
TANTALUM CAPACITORS**

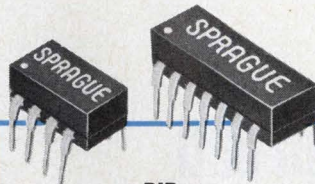

Solid-electrolyte tantalum capacitors with 2 or 4 sections per package. 8- or 16-pin configurations. Standard ratings are 6.8  $\mu\text{F}$  @ 35V, 15  $\mu\text{F}$  @ 20V, 22  $\mu\text{F}$  @ 15V, 33  $\mu\text{F}$  @ 10V. Capacitance tolerance,  $\pm 20\%$ . Operating temperature range,  $-55\text{C}$  to  $+85\text{C}$ . Write for Bulletin 3542 or circle 151 on reader service card.



**DIP  
MULTIPLE  
CERAMIC CAPACITORS**

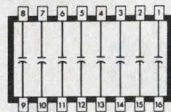

Monolithic<sup>®</sup> construction . . . alternate layers of ceramic dielectric material and metallic electrodes are fired into a solid homogenous block. 2, 4, 7, or 8 capacitor sections per package. Standard ratings, 18 pF to 0.1  $\mu\text{F}$  @ 100V. Capacitance tolerance,  $\pm 20\%$ . Write for Bulletin 6242 or circle 152 on reader service card.

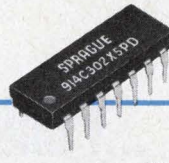

**DIP  
TANTALUM/CERAMIC  
CAPACITOR ASSEMBLIES**

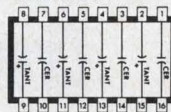

Solid tantalum and Monolithic<sup>®</sup> ceramic alternating isolated sections. Choice of 4 or 8 sections per package. Standard tantalum ratings, 6.8  $\mu\text{F}$  @ 35V, 15  $\mu\text{F}$  @ 20V, 22  $\mu\text{F}$  @ 15V, 33  $\mu\text{F}$  @ 10V. Ceramic ratings, 18 pF to 0.1  $\mu\text{F}$  @ 100V. Cap. tol.,  $\pm 20\%$ . Write for Engineering Bulletin 6642 or circle 153 on reader service card.

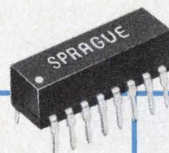

**DIP  
RESISTOR/CAPACITOR  
NETWORKS**

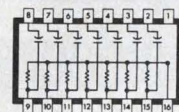

(1 of 3 designs)

Metanet<sup>®</sup> metal-film resistors and Monolithic<sup>®</sup> ceramic capacitors in bypassed pull-up, R-C coupling, speed-up, and active terminator networks. Resistor ratings, 100 to 6800  $\Omega$  with 125mW power dissipation. Capacitor ratings, 100 pF to .01  $\mu\text{F}$  @ 100V. Write for Engineering Bulletin 154 on reader service card.

**DIP  
MULTIPLE  
METAL-FILM RESISTORS**

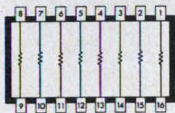

Noble metal film resistors encased in protective glass. Choice of 7 or 8 resistors per 14- or 16-pin package. Resistance values, 50  $\Omega$  to 100,000  $\Omega$ . Power dissipation, 125mW. Standard resistance tolerance,  $\pm 5\%$ . Operating temperature range,  $-55\text{C}$  to  $+70\text{C}$ . Write for Bulletin 7042 or circle 155 on reader service card.

**DIP  
PRECISION RESISTOR  
NETWORKS**



(1 of 5 designs)

Noble metal film resistors in pull-up, pull-down, interfacing, and terminating configurations, for applications requiring repetitive resistance patterns. 14- or 16-pins. Up to 28 resistors per package. Individual resistors from 50 to 100,000  $\Omega$ . Dissipation, 125 mW. Write for Bulletin 7042 or circle 156 on reader service card.

**DIP  
MULTIPLE  
PULSE TRANSFORMERS**

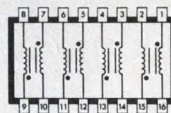

(1 of 2 designs)

Four transformers in 16-pin package. All cores have exclusive protective coating. Inductance values from 10 to 1000  $\mu\text{H}$ . ET product values of 5 volt- $\mu\text{sec}$ . Choice of four turns ratios . . . 1:1, 2:1, 3:1, 4:1. Operating temperature range, 0 C to  $+70\text{C}$ . Write for Engineering Bulletin 40400 or circle 157 on reader service card.

**DIP  
TAPPED  
DELAY LINES**

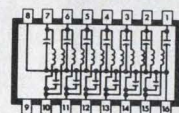

Lumped constant delay lines . . . ideal for timing and pulse synchronization circuits. 14- or 16-pin packages with delays of 50, 100, or 150 nanoseconds at a characteristic impedance of 100  $\Omega$ . Working voltage, 50 VDC. Operating temp. range, 0 C to  $+70\text{C}$ . Write for Bulletin 45004 or circle 158 on reader service card.

**Popular Types Now Available OFF-THE-SHELF From Your Sprague Industrial Distributor.**

For complete technical data, write for any of the above-mentioned Engineering Bulletins to: Technical Literature Service, Sprague Electric Company, 347 Marshall Street, North Adams, Mass. 01247.

**THE BROAD-LINE PRODUCER OF ELECTRONIC PARTS**





# What makes The faster and easier?

## ...Rapidograph, Rapidometric, Rapidograph SL

Finest precision, highest quality Technical Pens offer the most complete range of line widths. Points available in hard chromed stainless steel, sapphire jewel and tungsten carbide.



## ...Pelikan and Koh-I-Noor Drawing Inks

Specially formulated for the most exacting requirements.



## ...Rapidraw Drafting Film

A virtually indestructible film with a fine-toothed surface for maximum precision and reproducibility in engineering drawings.

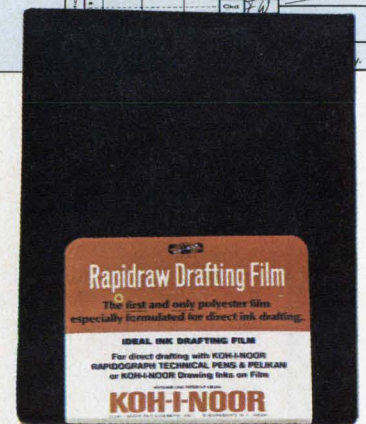
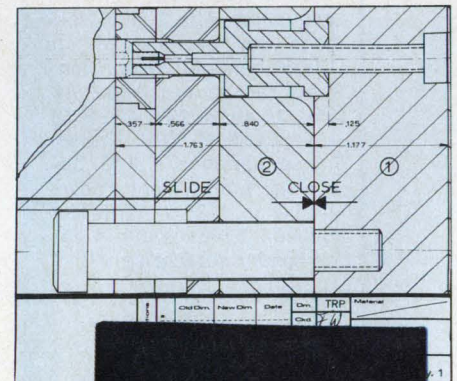



# "RAPIDRAW" System

To learn how The "Rapiddraw" System can help you save money and achieve highest quality engineering drawings, call Koh-I-Noor on our toll-free number 800-631-7646 or collect 201-479-4124.

## ...Koh-I-Noor Ink Erasing System

Erasures can be made on the film with confidence and ease without marring the film surface, as often as required.

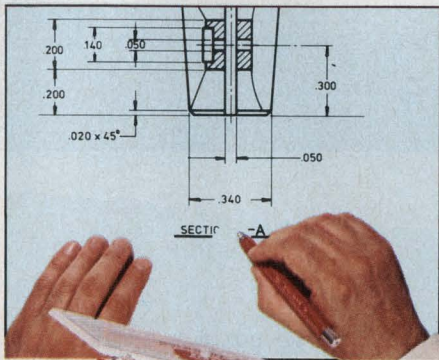

## ...System accessories

Designed to make drafting with ink on film even easier than you might suppose.



## What makes us the authority?

Koh-I-Noor has developed Rapiddraw, a System of totally integrated instruments and materials, providing a remarkable simplification of drafting techniques. This System makes direct ink drafting on film the most practical method to achieve precision engineering drawings, as confirmed by leading industries. We would like to give you a free manual completely describing our System.

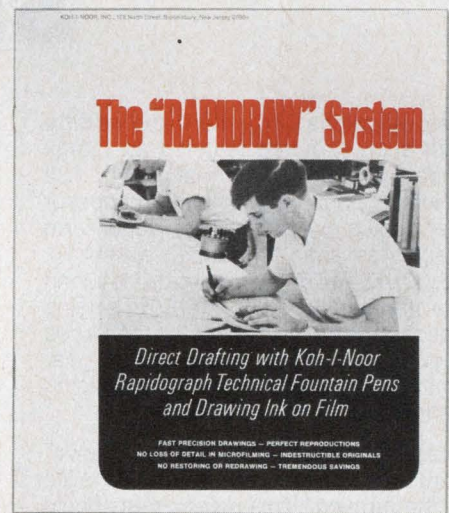

YOU GET MORE FROM  
**KOH-I-NOOR**<sup>®</sup>  
The "Breakthrough" Company

Koh-I-Noor Rapidograph, Inc., 100 North Street, Bloomsbury, N.J. 08804  
In Canada: Koh-I-Noor/Canada/Ltd., 4180 Ave. de Courtrai, Montreal, Quebec H3S 1C3.

CIRCLE NUMBER 23



# Gotcha, DEC!

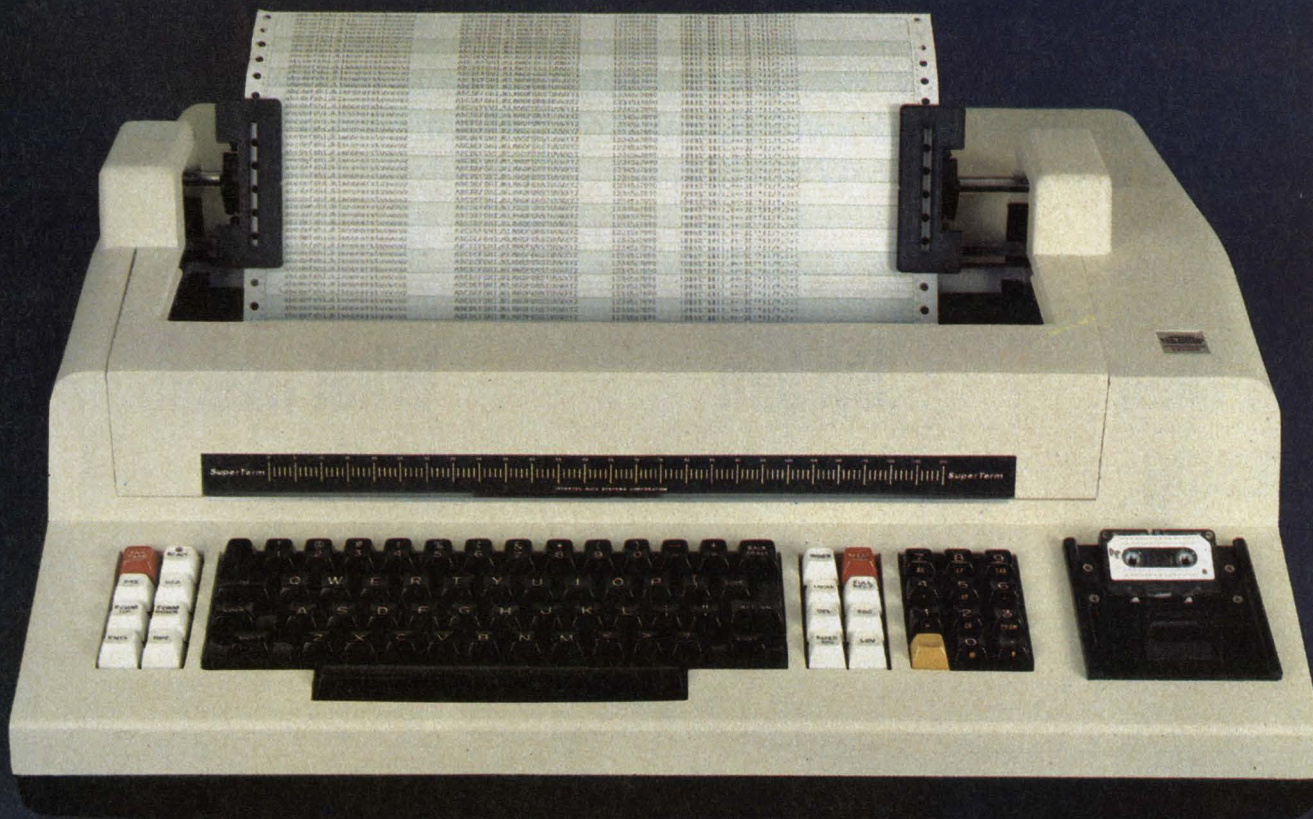

## SuperTerm

Yes, we gotcha DECwriter II and we did it with such standard features as: matrix impact printing (no thermal paper!), 132 column print width, microprocessor electronics, portability (SuperTerm weighs less than 45 lbs), high speed (10, 15, 30, 45 and 60 characters per second are standard with 120 and 180 cps being optional), an IBM Selectric configured keyboard, a 33 key alphanumeric "gear shifted" key pad and a quick loading cartridge ribbon system.

In addition, SuperTerm's unique "anvil" printhead design is warranted for the life of the terminal! This means that should you ever encounter defects in printhead workmanship, Intertec will replace or repair the defective component(s).

OEM's will be pleased to learn that the Intertec SuperTerm provides all of this capability and more at an OEM price of only \$1,400.

Low cost options available on every SuperTerm include: Super and sub-scripting, horizontal and vertical tabs, variable vertical pitch, forms control, pagination, direct X/Y addressing, adjustable left and right margins, reverse printing, double width characters, automatic CR on end of line, and a font programmable character set.

If your application calls for APL/ASCII, SuperTerm has that too. In fact, SuperTerm has got just about everything—except competition.

Want more? You've got it! A built-in micro-cassette (Supercette) is available to end users at only \$700 in single quantities with OEM discounts available.

In addition to unparalleled price and performance, every SuperTerm is backed by Intertec's nationwide factory trained service network with over 160 service centers strategically located coast to coast.

For more information on the total performance and unparalleled low price that make the Intertec SuperTerm the very best buy for your terminal dollar, just call Intertec Data Systems, the only company with international sales, service and revolutionary SuperTerm.

## **INTERTEC DATA SYSTEMS**

1851 Interstate 85 South • Charlotte, North Carolina 28208

Telephone (704) 377-0300 • TWX: 810-621-7831



# Microprocessor Design

## Instrument analyzes $\mu$ P systems in both data and time domains

The first  $\mu$ P analyzer geared for work in both the data and time domains in Davco's DM 230. Connect the unit's 40-pin squeeze clip across your  $\mu$ P, and you can look at the real-time waveforms of 32 input lines eight at a time on your own scope. Then flip some switches, and look at addresses and data on the 230's built-in hexadecimal readout.

With the analog capability, you can check rise and fall times, pulse timing, glitches and noise. The analog bandwidth of the 230 goes beyond 50 MHz, and its transition times are specified at less than 20 ns. Differential time delays stay below  $\pm 8$  ns.

With the digital capability, you can record events that occur before or after an address that you set on thumbwheel switches. Up to



128, 32-bit words can be so captured. You can observe addresses and data side-by-side or hit a switch to see status registers along with a count of  $\mu$ P clock cycles.

Four LEDs on the Davco unit tell you that

*(continued on page 51)*

## A low-cost EPROM programmer kit works under software control

Program and verify erasable, programmable, read only memories (EPROMs) under the control of your  $\mu$ P development system. Normally, transferring corrected programs that are in a RAM to a more permanent form of storage in EPROM may be done several ways. You can manually key in data on some programmers, or you can transfer RAM data to paper tape and then use that to drive a programmer, or you can output the RAM data, directly into another kind of programmer.

The first two methods are time-consuming and error-prone, requiring you take the intermediate step of reading out the RAM data into some other form to drive the programmer. The third method is most direct and least susceptible to error.

This method has been available on the Intel MDS system, at a system cost of several thousand dollars.

The Model 8700 kit, on the other hand, connects directly to a peripheral interface IC, the Intel 8255 PIA, for example, that is hooked into any development system. Under that system's control, you write contiguous bytes of RAM from the development-system memory into any manually selected starting address in an EPROM, then verify its contents. The EPROM must be a type 2708 or 2704, which are  $1\text{ k} \times 8$  and  $512 \times 8$  EPROMs, respectively. The supervisory program that does the housekeeping functions is not supplied. Flow charts are given, however, so you can write such a program.

*Engineering Resources, 1903 Alameda Padre Serra, Santa Barbara, CA 93103. (805) 963-3801.*

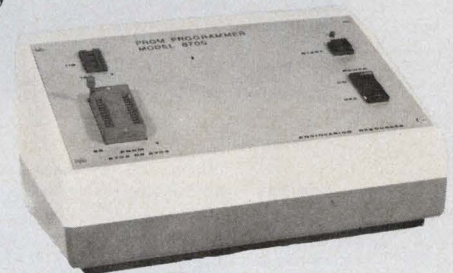

CIRCLE NO. 504



# Ise introduces five new ways to make the competition turn green.

Your competition probably already thinks they're using the perfect display in whatever it is they make. Let them keep thinking it. While you prove them wrong with a new Itron display. They're designed to make the competition turn green. Which also happens to be the color of the segments.

All 17 of them on the 17-digit Itron. All 5 on the FG-512A1. Next comes an Alfa-Numerical Itron. A Linear-Analog Itron. And a Digital Clock Itron. Five ways to be heartless if you put a little heart into it.

## *itron*<sup>®</sup>

Alfa-Numerical Display



FG209M2

ef=10V  
ec=eb=40Vp-p  
ic=10mA-p-p  
ib=8mA-p-p  
Wd. 205mm  
Lg. 40mm  
Segment 9mm

Instruments & Large Calculator Display

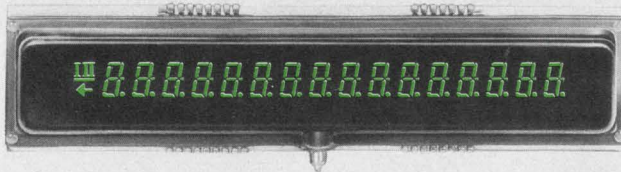

FG179F2

ef=7V  
ec=eb=35Vp-p  
ic=7mA-p-p  
ib=5.5mA-p-p  
Wd. 170mm  
Lg. 40mm  
Segment 9.5mm

Instruments & Terminal Units Display



FG512A1

ef=3.5V  
ec=eb=24Vp-p  
ic=4mA-p-p  
ib=3mA-p-p  
Wd. 100mm  
Lg. 40mm  
Segment 12mm

Digital Clock Display



FG425A1

ef=5.5V  
ec=eb=35Vp-p  
ic=8mA-p-p  
ib=6.5mA-p-p  
Wd. 140mm  
Lg. 59mm  
Segment 25mm

Linear Analog Display

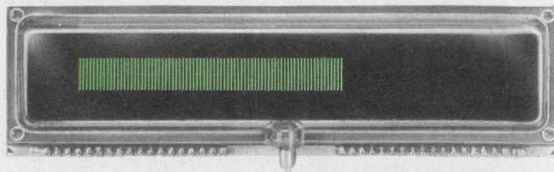

FG120S1

ef=5.5V  
ec=eb=35Vp-p  
ic=4mA-p-p  
ib=0.2mA-p-p  
Wd. 140mm  
Lg. 40mm  
Segment 8mm

### NORITAKE CO., LTD.

#### Electronics Office (U.S.A.)

22410 Hawthorne Blvd. Torrance California 90505.  
U.S.A.  
Phone: (213) 373-6704.  
Telex: "230674910"

#### Electronics Division

1-1, Noritake-Shinmachi, Nishi-ku, Nagoya-City,  
Japan.  
Phone: NAGOYA (052) 561-7111.  
Telex: J59738 NORITAKE

### ISE ELECTRONICS CORP.

#### London Office

c/o NORITAKE (U.K.) LTD  
Noritake House 2, York Street W1H 1 Be, England.  
Phone: (01) 935-7543 Cable: "LUCTUAL" LONDON

#### Muenchen Office

c/o NEUMULLER GmbH 8 Muenchen 2, Karlstrasse 55,  
West Germany. Phone: 592-421 Telex: 522106

#### Hong Kong Office

Room 1403 Shing Loon Bldg.  
24-26 Stanley Street, Hong Kong.  
Phone: 5-232420 Telex: HX83151

#### Taipei Office

72-9 SEC. 2, JEN AI RD., Taipei.  
Phone: 351-0293 Telex: 11176



# Burndy's GTH™ connectors deliver good-as-gold reliability at a fraction of the cost.

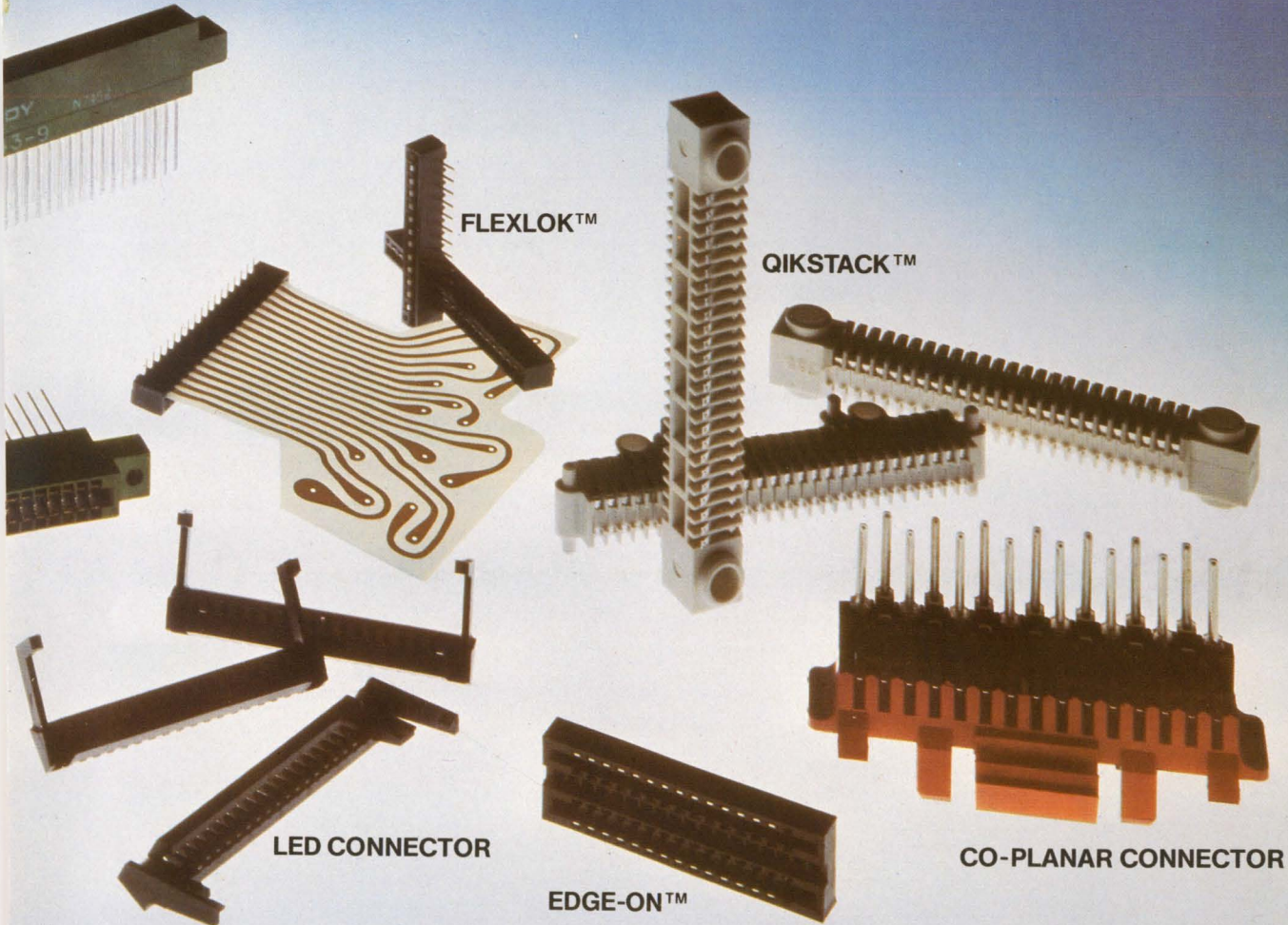

FLEXLOK™

QIKSTACK™

LED CONNECTOR

EDGE-ON™

CO-PLANAR CONNECTOR



## FIELD PROOF

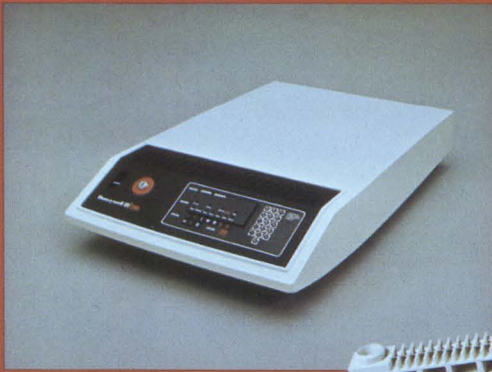

For high reliability and economy, GTH QIKSTACK connectors are used in Honeywell's new Series 60, Level 6 minicomputer.

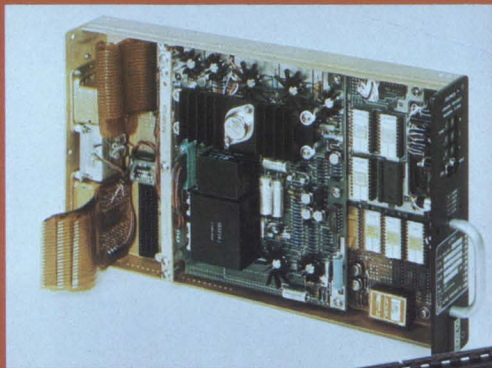

For design flexibility and reliability, GTH FLEXLOK connectors are used by Aero Products Division of Litton Industries in the DIGIPROX™ ground proximity warning system.



For closer packaging density and high reliability, the GTH chassis Co-Planar connectors are used in Quasar's remote control television.

With Burndy GTH connectors, you enjoy the performance characteristics of gold—without suffering its high cost. If that's too hard to believe, just study the performance comparison chart.

The secret behind the amazing performance of GTH is the use of high pressure plastic deformation to achieve a gas-tight, corrosion-free contact, and a contact geometry that provides an ingenious mechanical interlock to insure good metal-to-metal contact despite vibration or thermal expansion.

Burndy GTH contacts not only eliminate the need for gold in the connector, they eliminate gold in the mating component as well. You save both ways—without sacrificing performance or reliability.

# Here's

## Burndy's exclusive GTH gas-tight, corrosion-free

High-pressure plastic deformation forms gas-tight, corrosion-free contact without the use of gold.

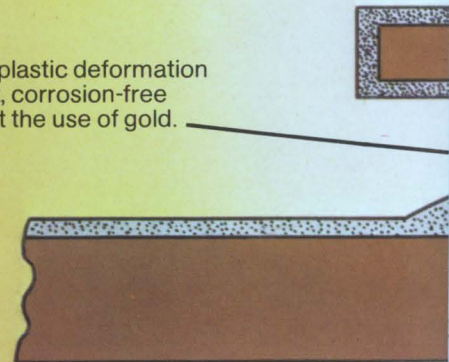

### ADVANTAGES OF GTH CONNECTIONS

- **Low cost, high reliability:** Helps you cut interconnection costs up to 33% and more—without sacrificing reliability.
- **Interchangeability:** May be used with existing gold, tin or solder-plated components with no loss in reliability.
- **Design Flexibility:** Compact design for close packaging densities, simplified handling, installation and field serviceability.
- **Ease of Installation:** Requires no special tooling or operator training. Installs like any ordinary connector.

Unbelievable? Send for more proof. Simply check the convenient Quick Response Card and we'll send you documented test data.



# proof!

concept insures high-pressure, contact without the use of gold.

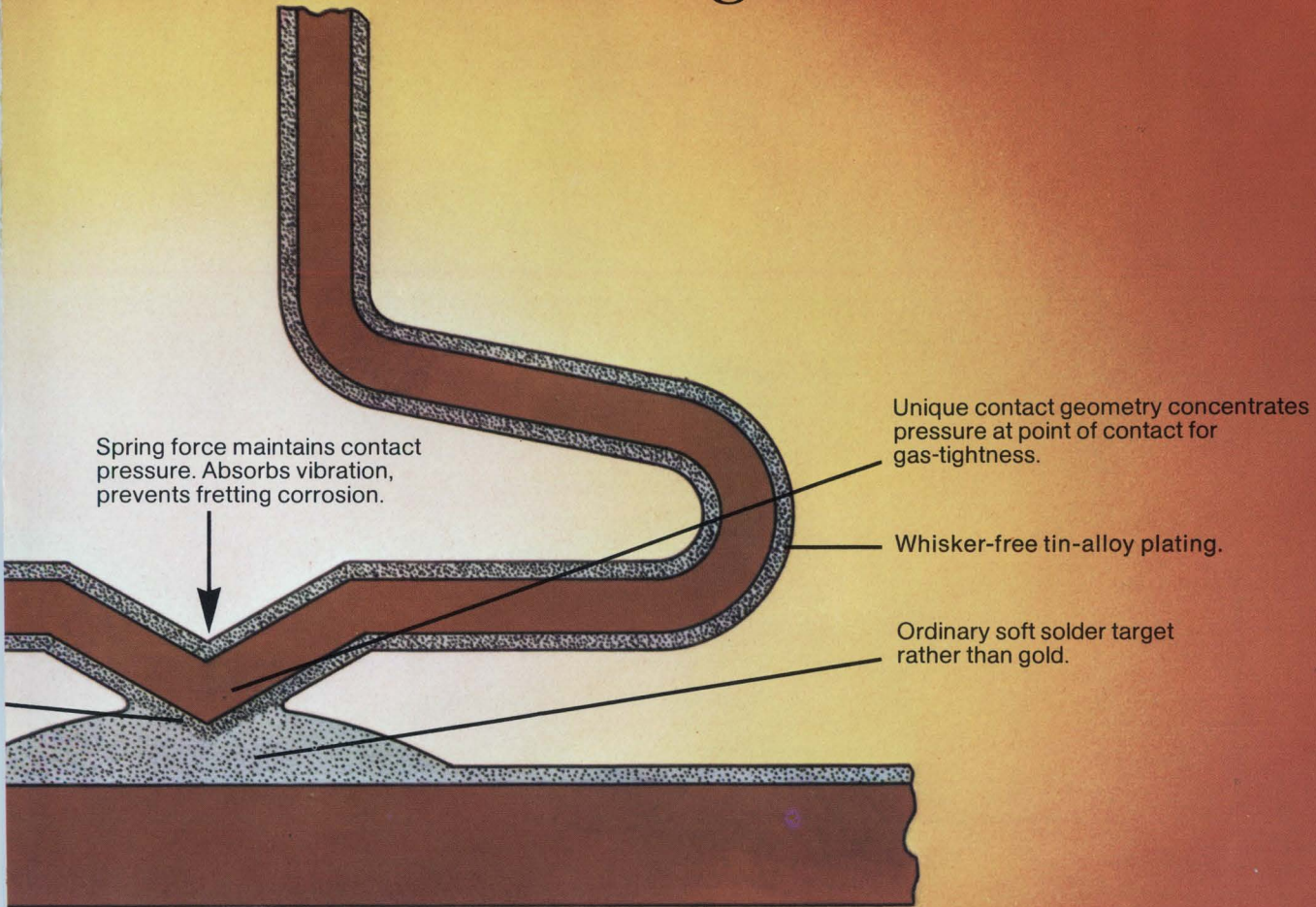

## LABORATORY PROOF

### TYPICAL CONTACT RESISTANCE VALUES (Milliohms)

After Environmental Test, at Dry Circuit Levels.  
(Range of Values Within 99.9% Confidence Level)

Environmental Test	GTH Contacts	Conventional Geometry Contacts			
	Tin-Alloy Plate	15 Microinch Gold Flash	30 Microinch Gold Plate	50-100 Microinch Gold Plate	Tin or Tin-Alloy Plate
Initial	4.0 - 6.0	4.5 - 13.3	4.5 - 8.6	4.4 - 8.3	4.1 - 12.0
Thermal Shock	4.0 - 8.6	6.0 - 15.0	5.0 - 8.0	5.2 - 7.2	6.0 - 15.0
Humidity	4.5 - 7.0	10.1 - 31.8	5.0 - 9.0	4.9 - 8.8	5.3 - 75.1
Industrial Atmosphere	4.0 - 6.0	10.9 - 20.3	5.0 - 20.0	5.0 - 13.0	28.7 Open Circuit
Gas Tightness	4.0 - 6.5	Not Applicable	Not Applicable	Not Applicable	4.0 Open Circuit
Thermal Cycling	4.0 - 7.0	8.5 - 15.5	5.0 - 10	4.6 - 9.0	4.0 Open Circuit
Durability	4.0 - 5.5 100 cycles	10.1 - 12.2 100 cycles	5.0 - 9.0 100 cycles	5.3 - 9.3 500 cycles	13.9 - 57.9 100 cycles
Vibration	4.0 - 5.5 5-500-5 Hz	9.0 - 15.0 10-55-10 Hz	4.0 - 8.0 10-2000-10 Hz	5.3 - 9.3 10-2000-10 Hz	4.0 - 15.0 10-55-10 Hz

### IMMUNITY TO FRETTING CORROSION

Relative Lifetimes Under Accelerated Fretting Conditions  
Without Lubrication

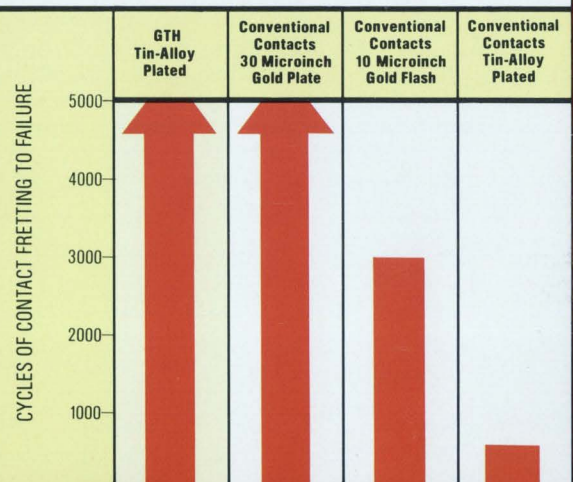



# Burndy GTH connectors: Your golden opportunity to cut connector costs up to 33%.

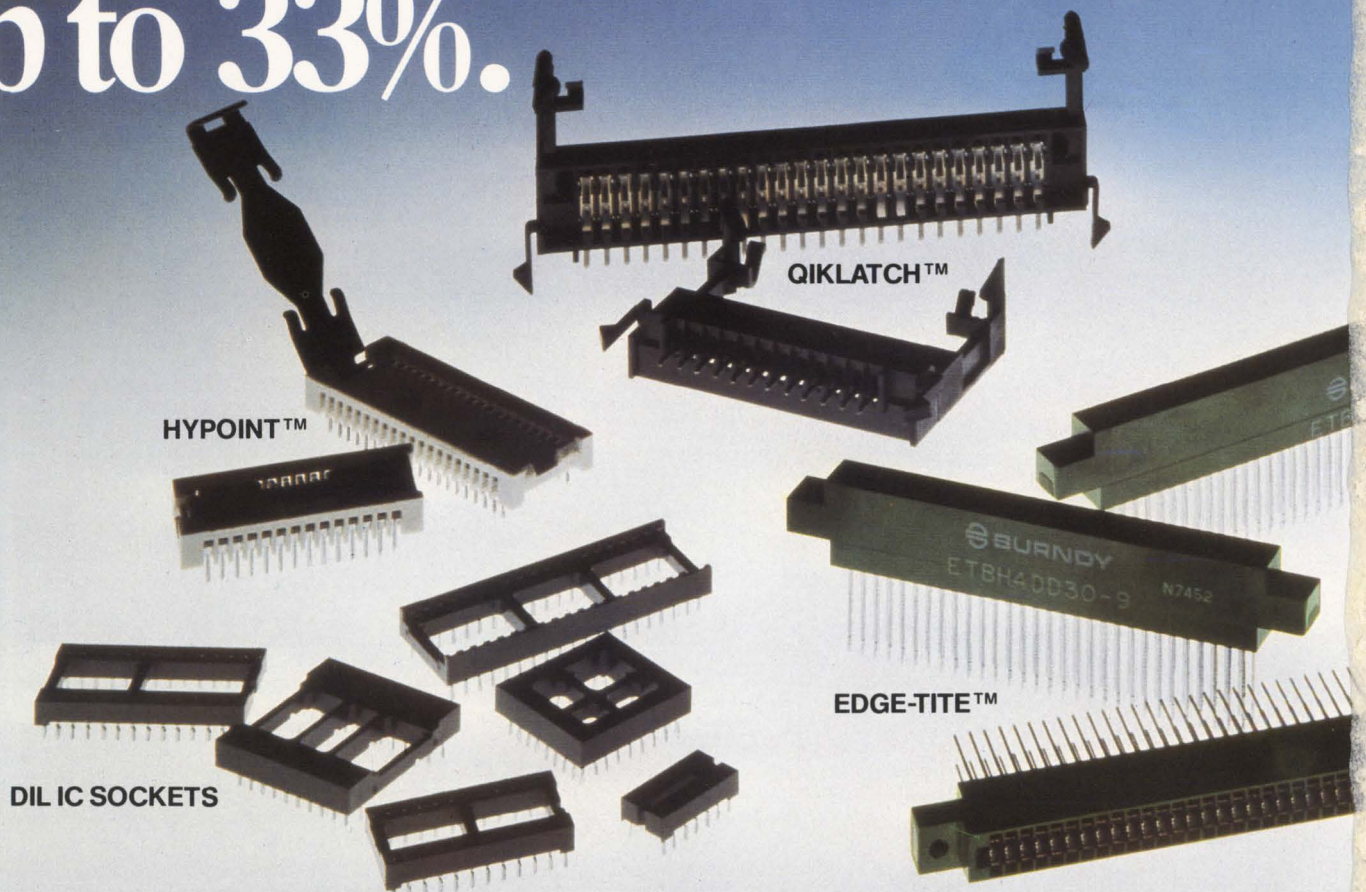

Burndy GTH connectors are available in all types of designs for all types of applications. All of them are currently being used to help control connector costs by some of the best known names in the electronics field. Names like Quasar Electronics, Litton Industries, Honeywell, National Semiconductor, Dictaphone, and Wang Laboratories to name just a few. Use the convenient Quick Response card for more information on how GTH can help you keep your competitive edge. We'll send you data that's worth its weight in gold.

**QIKLATCH™** zero-entry Mother/Daughter PC connectors in sizes from 8 through 24 positions on .156" centers.

**EDGE-TITE™** PC connectors in sizes from 10 through 50 positions on .100" centers.

**QIKSTACK™** feed-thru connector. Board-to-board spacing from .250" to .625". Up to 30 contact positions.

**EDGE-ON™** board-to-board receptacle. Up to 15 positions on .100" centers.

**DIL IC SOCKETS** for leaded packages, in sizes from 8 through 42 positions.

**LED CONNECTOR** board-mounted PC receptacle in a wide range of sizes and viewing angles on .100" centers.

**FLEXLOK™** connectors for flexible circuitry and flat conductors in sizes from 6 through 21 positions on .100" centers.

**CO-PLANAR** solderless-wrap chassis connector in 15 positions on .156" centers.

**HYPOINT™** leadless IC receptacles in sizes from 24 through 48 positions.

 **BURNDY**  
Norwalk, Connecticut 06856



## MICROPROCESSOR DESIGN

(continued from page 49)

selected address lines are active. To use this feature, turn the four hexadecimal address thumbwheels through all 15 positions, starting with the MSD, until all the LEDs light. When used with the 230's recorded information, the LEDs let you chart the system's program flow.

With another feature, a reset timer, you can weed out bad  $\mu$ P chips before the chips go into the system under development. To use the reset timer, set the thumbwheels to the address, or location, of the  $\mu$ P's reset vector (e.g., FFFE or FFFF for the 6800). Then throw

a toggle switch, and the DM 230 will continuously cycle the  $\mu$ P, so that you can get a scope display of bus information.

Or you can single-pulse the  $\mu$ P to latch data into the 230's memory, then use the instrument's digital modes for analysis.

The Davco unit's \$2900 price includes one probe buffer: electronics used to match the 230 in the  $\mu$ P under test. Buffers are now available for either the 8080 or 6800  $\mu$ Ps. Additional buffers cost \$750. A printer option is also available. Delivery of the DM 230 takes 60 days. *Davco Manufacturing Co., 169 Ridgedale Ave., Morristown, NJ 07960. (201) 267-4990.*

CIRCLE NO. 505

## PC board does floating point BCD functions for 8-bit systems

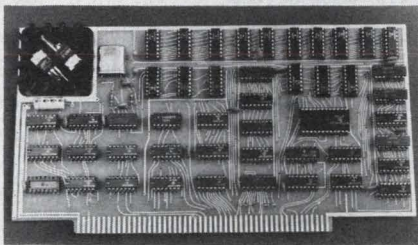

The Model A Floating Point Board performs add, subtract, multiply, and divide with up to 14 BCD digit accuracy, in record time. With a typical add/subtract time of 20  $\mu$ s and multiply/divide time of 100  $\mu$ s, your 8080 system operates at speeds, claimed by the manufacturer, to surpass most minis.

If floating point arithmetic were done by software routines in an 8080 system, it would take milliseconds to complete. Furthermore, such routines would take about 1-k bytes of memory. This card takes only about 30 bytes of your system's memory for the numbers. Extended Basic software accessing the board, in development systems, is available.

The Model A Floating Point Board costs \$499 and is available on 30 days delivery. *North Star Computers, Inc., P.O. Box 4672, Berkeley, CA 94704. (415) 527-6760.*

CIRCLE NO. 506

## Evaluator eases testing of 6800-based microprocessor systems

With the User System Evaluator just introduced by Motorola Semiconductor, manufacturers of products containing the 6800 microprocessor can now test them in a production environment.

Known as the M68USE, the evaluator consists of an M6800 processor module, an intercept module and a cable-and-buffer assembly. These modules make it possible to connect the Exorciser, Motorola's  $\mu$ P development system, to user-designed systems.

The interface between the Exorciser and the external system can be changed at will and modular options of the Exorciser—such as memory and I/O—can be incorporated into the external system during emulation. It is thus possible to compare simulated functions with actual functions performed by the external system.

In use, the processor module of the M68USE replaces the original MPU module in the Exorciser and is connected to the external system by the cable-and-buffer assembly. The intercept module connects a system analyzer to the processor module of the M68USE. *Motorola Semiconductor Products, P.O. Box 20294, Phoenix, AZ 85036. (602) 244-4556.*

CIRCLE NO. 507

## Two $\mu$ P's are used to make development system 'crash proof'

The first "crash proof" prototyping and development unit has been developed for microprocessor applications.

Two  $\mu$ Ps keep programs under development completely separate from the operating system in this new Signetics unit—dubbed TWIN from "testware instrument." In other such devices, application-program malfunctions or operator errors can destroy or radically

(continued on page 52)



(continued from page 50)

alter the resident operating system. But in TWIN, errors made in the development process cannot alter system integrity or software that has already been completed.

One microprocessor—a Signetics 2650—controls the whole system and is called the master; the second  $\mu$ P, a slave, is used for developing programs and for interfacing prototype devices. The slave CPU must match the one that will be used in the product being developed. This separation of central processors relieves the user of the housekeeping required to distinguish user programs from internal operations, and reportedly results in substantial savings in development time.

TWIN uses an assembler language with a syntax typical of minicomputer languages, and comes with a full range of supporting software . . . including a disc-based operating system, a text editor, a resident assembler and extensive debugging and diagnostic capabilities.

*Signetics, 811 E. Arques Ave., Sunnyvale, CA 94086. (408) 739-7700.*

CIRCLE NO. 508

### A/d and d/a cards plug into popular development systems

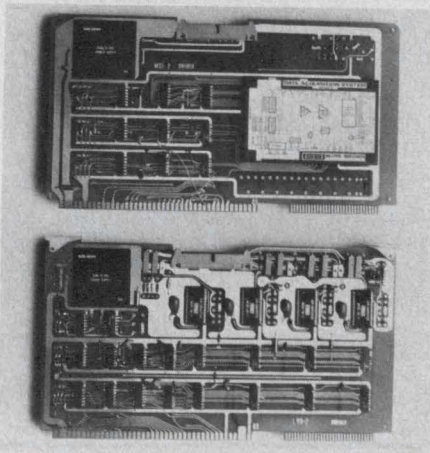

Analog interface cards plug directly into Motorola's Exorciser (6800)  $\mu$ P and Intel's MDS800 and SBC80 series of single-board computers. The cards, made by Burr-Brown, consist of separate a/d and d/a converters.

The a/d cards take either 8-differential or 16 single-ended channels, designated MP7208 and MP7216 for the Motorola system, and MP8408 or MP8416 for the Intel system. They output 12 bits into two words of the 8-bit wide data busses of the host systems.

The cards are resistor programmable, and have  $\pm 10$  V to  $\pm 10$  mV full scale ranges; with throughput accuracy of .1% on the most sensitive, down to .025% for the least sensitive (10 V) range. Conversion time ranges from 100  $\mu$ s to 33  $\mu$ s over the same full scales.

The d/a cards take 12-bit inputs and convert them to analog outputs, with strap-selectable unipolar or bipolar outputs, up to 10 V. Accuracy is .025% and output-settling time is 10  $\mu$ s on all ranges. Model numbers are MP7104 for Motorola and MP8304 for Intel.

All boards in the series cost \$695 (1-4).

*Burr-Brown, Airport Industrial Park, P. O. Box 11400, Tucson, AZ 85734. (602) 294-1431.*

CIRCLE NO. 509

### A mobile-telephone-service control unit is given intelligence with a $\mu$ P



A mobile-telephone control head using a microprocessor has been introduced by Secode Electronics of Dallas. The control head is used in a system called IMTS—for improved mobile telephone service—and consists of a control head and transceiver. The control head generates and receives audio control frequencies that are used in these communications, and selects UHF or VHF-frequency pairs for full duplex (sending on one frequency, receiving on the other), service.

A Rockwell International PPS-4 4-bit  $\mu$ P was selected for the brains of the control head since only 4 bits are needed as input for dialing and as output for transceiver control. Previous control heads used only SSI and MSI logic. A  $\mu$ P was selected because the control head could be easily modified for use in non-IMTS systems, using different audio control frequencies and protocols, and reduced the unit's size and chip count. The unit is also able to redial the last telephone number keyed in.

*Secode Electronics, Div. of Communications Industries, Inc., Dallas, TX. (214) 742-7231.*

CIRCLE NO. 510



# extraordinary...



## even for Data Precision.



# Here's a miniature 3½ digit portable multimeter that delivers extraordinary performance and value for only \$189.



Data Precision proudly presents a 0.1% accuracy multimeter that brings the same high performance and value to 3½ digit portable instruments that our Model 245 brought to 4½ digit multimeters. The same levels of reliability, the same small size, the same great convenience and flexibility. The Model 175 has it all... and more for just \$189.00.\*

## High performance

The Model 175 gives you 32 ranges of measurement capability, six functions, 0.1% DCV accuracy guaranteed for one year, and 100 microvolts resolution. You can measure DCV from ±100 microvolts to ±1000V, ACV from 100 microvolts to 500V with a frequency response of 30Hz to 50kHz, DC Current from ±100 nanoAmps to ±2A, AC Current from 100 nanoAmps to 2A with a frequency response of 30Hz to 50kHz, Resistance from 100 milliohms to 20 Megohms in two excitation voltages.

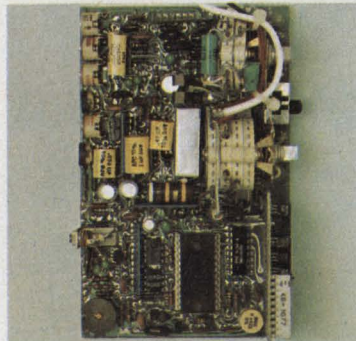

\*Price U.S.A.

## Real miniature portability

Here is true miniature portability that delivers lab performance wherever you take it. And you can take it anywhere. The 175 operates from AC line, or rechargeable NiCad batteries for 6 hours of in-spec operation. Add this to the remarkably small size 1¾"H x 5½"W x 3½"D, 34 cu. in., weight 22 oz. (4.45 x 13.97 x 8.89cm, 552cc, .63kg.) exceptional operating temperature characteristics, rugged construction... and you can see that this is real portability.



## Right at home in the lab

Connect the 175 to an AC line and you have a great bench instrument. It's always recharging when line connected and ready to go into the field whenever you need it.

## And the Model 175 gives you a lot more.

• **Easy to Read, Big, Bright Display:** 0.43" LED display for easy reading in dim light or bright light.



• **Hi/Lo Resistance Measurement:** Measure resistance in two modes. Hi excitation 2.5V (exceeds semiconductor forward threshold) and Lo excitation 300mV (below silicon junction threshold), for in-circuit resistance measurement without turning on semiconductor junction. No need to unsolder resistor.

• **Automatic Zero:** TriPhasic™ conversion eliminates need for any front panel zero control.

• **Tells You When To Recharge:** Blinking decimal point advises up to 10 minutes in-spec battery operation remaining.

• **Overload Protected:** It's forgiving. All DCV ranges can take ±1000V, all ACV ranges to 500V, all resistance ranges up to 250V... continuously—without loss of calibration or damage to the instrument. Current ranges are protected by 2A fuse easily accessible in a test lead.



Actual size, front view.



**And Much More:** Auto Polarity, 100% Overrange, Overload Indication, Internal DC and AC Current Shunts, LSI/CMOS Reliability, Exceptional Common and Normal Mode Rejection, Complete Documentation including NBS traceability and **individually** calibrated data sheet. Simple and precise calibration.

### You get a complete package.



Everything you need to use the 175 is supplied with the instrument. Nothing else to buy. No extra costs. Standard accessories include the rechargeable NiCad battery module, line cord with recharger, a pair of fused test leads, alligator clips, carrying case and documentation.

### Optional accessories that make the Model 175 even more versatile.



High voltage probe, AC current clamp, pedestal stand, rack mount, deluxe leather case and mini- to-standard banana adaptor.

### The competition just isn't competitive.

The Model 175 is an extraordinary value offering the performance, size and price you want. Judge for yourself. The following is a comparison based upon manufacturers' data.

	Data Precision Model 175	HP 3435	HP 3176B	Fluke 8000 A
Digits	3½	3½	3½	3½
Size	34 cu. in.	395 cu. in.	123 cu. in.	212.5 cu. in.
Display Size	0.43" LED	0.30" LED	0.25" LED	0.25" LED
Basic Accuracy for 1 Year ±1 Digit	0.1%	0.1%	0.3%	0.1%
DCV Sensitivity	100µV	100µV	100µV	100µV
AC Frequency Response	30Hz-50kHz	30Hz-100kHz	45Hz-10kHz	45Hz-20kHz
Functions	6	5	5	5
Ranges	32	27	19	26
Hi/Lo Excitation	Yes	No	No	No
Calibration Accuracy Guaranteed	1 year	1 year	1 year	1 year
Overrange	100%	100%	10%	100%
Ranging	Manual	Manual & Auto (except current)	Auto	Manual
Rechargeable Batteries	Yes	Yes	Yes	Optional (\$50.00)
Recharges Batteries While Operating	Yes	Yes	No	Optional
Full Scale Voltage Drop Measuring Current	100 millivolts (EIA STANDARD)	220-400 millivolts	100 millivolts	100 millivolts
Price With Batteries	\$189.00	\$400.00	\$275.00	\$349.00

All Model 175 specifications are covered by a one year warranty. Service is available from our worldwide service centers.

For complete information or a demonstration, contact your local Data Precision representative or Data Precision Corporation, Audubon Road, Wakefield, MA. 01880, (617) 246-1600. TELEX (0650) 949341.



**DATA PRECISION**<sup>®</sup>  
...years ahead



# FREE

292 PAGES

# Designer's Handbook

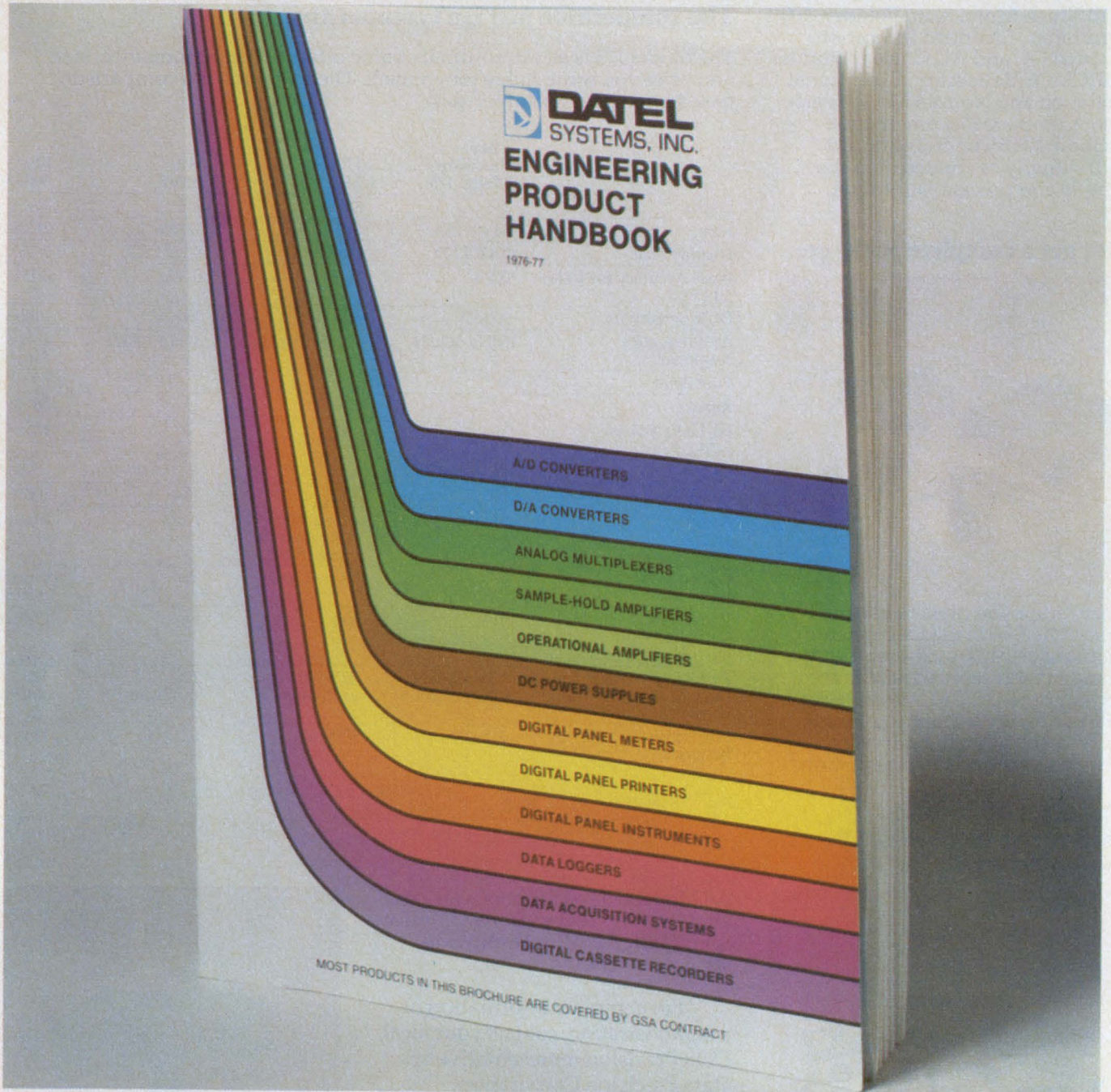

1020 Turnpike St., Canton, Ma 02021 • Phone (617) 828-8000  
• Santa Ana, Calif. (714) 835-2751 • Santa Ana (L.A. Exchange) (213) 933-7256  
• Sunnyvale, Calif. (408) 733-2424 • Gaithersburg, Md. (301) 840-9490

#### FRANCE SUBSIDIARY

**DATEL SYSTEMS SARL**  
11 Avenue Ferdinand Buisson  
75016 Paris, France  
Tel: 603-06-74  
Telex: (842)204280

#### JAPAN SUBSIDIARY

**DATEL KK**  
Kobayashi Building  
3-26-3 Higashi  
Shibuya-ku, Tokyo 150  
Tel: Toyko 499-0631  
Telex: 2422389  
Yachiyo Bldg. Higashikan  
33 Daikucho  
Kita-Ku, Osaka 530  
Tel: (06) 354-2025

#### UNITED KINGDOM SUBSIDIARY

**DATEL (U.K.) LTD.**  
Sealine House  
Priestley Road  
Basingstoke  
Hampshire, RG-24 9NT, U.K.  
Tel: Basingstoke (0256) 66721  
Telex: (851)858845

#### WEST GERMANY SUBSIDIARY

**DATELEK SYSTEMS GmbH**  
8 MUENCHEN 71  
BECKER-GUNDAHLSTRASSE 1  
Postf. 71-03-04  
Tel. (089) 78-40-45  
Telex: 5212855



## The great anatomical anomaly

I think it was in some correspondence with Sigma Instruments many years ago that a long-forgotten sage put forth the observation that there are more horses' asses in the world than there are horses. Being an engineer, he expressed this in the form of an equation. It translates, roughly, to: the sum between the limits of zero and infinity of the horses' asses, greatly exceeds the sum of the horses.

As we read this expression, most of us chuckle and think of somebody we know. We think of Joe, who fell in love with the tunnel diode in 1960, and still wants to use it wherever possible. Or we think of Jack, who wants to run a Fourier analysis on every waveform he encounters. Or Frank, the frustrated football coach, who likes to give his engineers a pep talk every morning. Or Charlie, who's still trying to use up the supply of tantalum capacitors he was lucky enough to buy during the last parts shortage.



But we never think of ourselves. We never see that the anatomical anomaly may be a universal truth that applies to us, too. We don't see that, in the eyes of our colleagues, we may be Joe or Jack or Frank or Charlie. And that's good and bad.

It's good because that blindness protects some of us from seeing what's ugly or ludicrous in ourselves. It helps us overlook behavior that might be arbitrary, officious or arrogant; capricious or hypercritical; crochety, mean, rude, willful or stupid. It helps many of us avoid what we might be unable to bear.

But the blindness is bad, too. It conceals from many of us the personal flaws we might be able to correct.

All of us could be better with some flaw correction. We could become better engineers, better managers and better humans.



RECOGNIZED BY  
AMERICAN REVOLUTION  
BICENTENNIAL  
ADMINISTRATION

ELECTRONIC DESIGN is deeply honored to have received official recognition as a participant in the American Revolution Bicentennial Celebration, with authority to display the Bicentennial Symbol.

GEORGE ROSTKY  
Editor-in-Chief



# The CMOS You Want

We're introducing new products. Some are new developments we're proud to take the credit for, and others we're simply alternate sourcing. Some have broad areas of application and some are highly specialized, but they all have one thing in common. Somebody wants them.

That's why our line of standards is so broad. That's why we work so hard to offer you the best in reliability. That's why we led the way with CMOS MSI and LSI. Motorola innovates . . . Motorola produces.

That's the way it's been at Motorola since we put our CMOS technology in gear, that's the way it is now, and that's the way we intend to keep it. By doing what you want, we get what we want.

## PRECISION MAKES IT THE SUPER ONE-SHOT

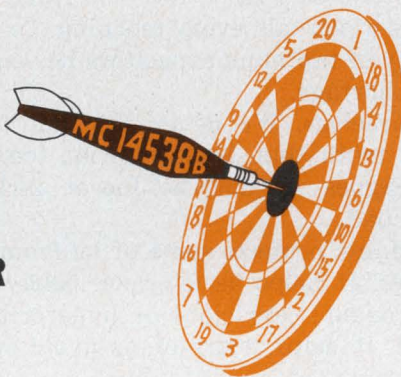

Our new MC14538B is like our industry standard MC14528B Dual Monostable Multivibrator, with one great improvement. We added PRECISION, and made it the Super One-Shot. Pulsewidth variation from part-to-part and over the temperature range is a mere  $\pm 0.5\%$ . Not RCA, nor National, nor anyone else can match it.

You'd naturally expect that kind of precision to cost a bundle, so maybe the best part of the Super One-Shot is actually the \$1.76 price.

Join the swelling ranks of Super One-Shot users today.

For information circle 241.

## ANALOG SWITCHES? PICK THE HOT ONES



Our Austin, Texas "Silicon Ranch" is popping out great volumes of analog switches, and we've lined up some hot ones. The MC14066B quad analog switch/quad multiplexer is now generally preferred to the older MC14016 because it has significantly lower ON resistance at higher voltages. Try it at \$.70. MC14051B, 14052B, and 14053B are, respectively, 8-channel, dual 4-channel, triple 2-channel analog multiplexer/demultiplexers. All three pin-for-pin replacements for the CD4051B, 4052B, 4053B can control analog signals over the full supply voltage range, and each is priced at \$1.15.

For information circle 242.



# MOTOROLA



# Is The CMOS You Get

## UPGRADE GATE PERFORMANCE WITH CMOS SCHMITT TRIGGERS.

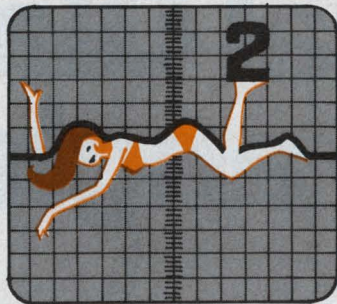

**NOW THE PRICE IS RIGHT.**

Now it's practical to upgrade gate performance with Schmitt Triggers. The MC14584B Hex Schmitt Trigger and MC14093B Quad 2-Input "NAND" Schmitt Trigger eliminate race problems associated with gate and inverter functions like the MC14011 and MC14069 by squaring up slow changing waveforms. There's no need to change PC boards; they're direct plug-in replacements. Noise immunity also is superior. The kicker is price, and you never saw CMOS Schmitt Trigger prices like these. Each is \$.54.

For information circle 243.

## HELLO BUTTONS - GOODBYE DIALS



Both the MC14408 and MC14409 MSI subsystems are binary-to-phone pulse converters. Either pairs beautifully with the MC14419 keypad-to-binary code converter in a smooth, efficient, cost effective keypad pulse dialing system with the last number stored for one-push redialing. Add more memory and a little circuitry and it remembers more numbers. No tones required, just push the buttons and get controlled dial pulses. That's Motorola innovation in CMOS LSI. The 408 and 409 are each \$6.98. The keypad encoder is just \$2.25.

For information circle 244.

## HAPPINESS IS A PLL APPLICATION FOR THE MC14568B



Can a CMOS MSI Phase Comparator with Programmable Counters find happiness in PLL applications? Judge for yourself. The MC14568B is barely introduced, yet more than a million units are already sold into PLL bliss. Programmable divide-by-N counters like the MC14522B and 14526B extend its counting range and coming soon is a dual BCD/binary counter (MC14569B), specially designed for operation with the 14568B. The plastic MC14568B is an MSI bargain at \$2.61.

For information circle 245.

## CMOS TRANSMITTER SENDS... TO REMOTE NMOS RECEIVERS

Start with a 22-channel CMOS LSI remote control transmitter, the MC14422, select the appropriate receiver from either the MC6525 or the MC6526, and you have the essentials of a versatile remote control transmitter-receiver system.

Transmission is by time multiplexing five frequencies over widely spaced transmitter channels, precluding doppler effect interference.

Use it for TV or radio, industrial controls, security systems, electronic games and toys, and anywhere low-power remote control is the object. The MC14422 carries a \$6.10 price tag.



For information circle 246.

©McMOS is a trademark of Motorola Inc.

Note: All prices are based on plastic package and 100-999 quantity.

# Semiconductors

*-CMOS reliability at its best.*



# It pays to look into Metal Glaze™ from all angles.

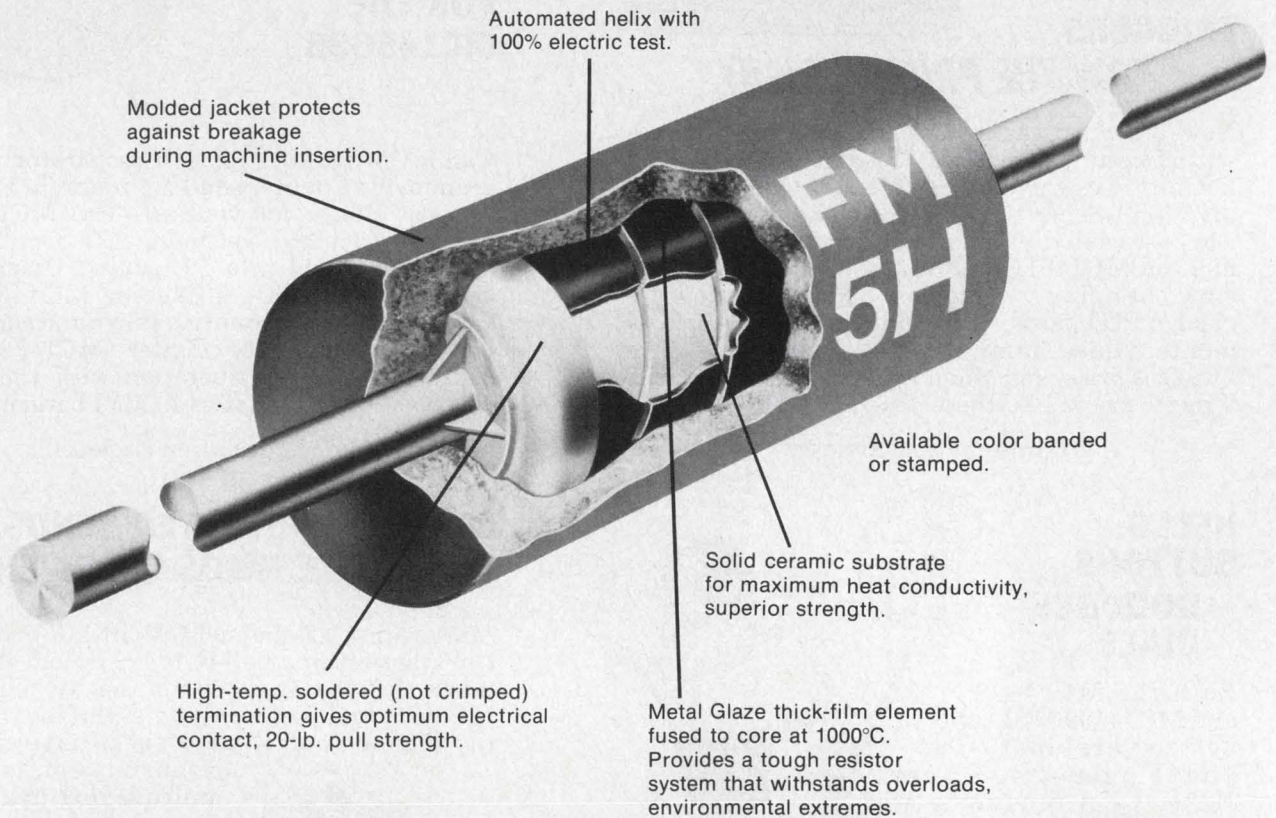

\*™Metal Glaze is TRW trademark for its thick-film resistors.

We have designs on you. Especially if you're designing any type of low-power circuitry and need resistors with excellent load life stability and cost effectiveness.

TRW/IRC Metal Glaze resistors can take the heat. For instance, their thermal characteristics are outstanding, resulting in lower operating temperatures, greater reliability.

Another advantage, you can often double-rate our Metal Glaze resistors so you can use smaller resistors, saving board space.

The ability and toughness of Metal Glaze to withstand heat with minimum drift has been proven billions of times in all types of electronic equipment, worldwide. And they're available in ratings  $\leq 3$  watts,  $\geq 1\%$  tolerance, with ranges as low as 1 ohm.

For complete resistor choice including Metal Glaze, carbon comp., thin-film, wirewound and networks, contact your local TRW authorized distributor or sales representative. Or TRW/IRC Resistors, an Electronic Components Division of TRW, Inc., 410 N. Broad St., Philadelphia, Pa. 19108, (215) 922-8900.



**RG PULSE OR SURGE POWER RATING:  
MAXIMUM APPLIED POWER/PULSE ON TIME**

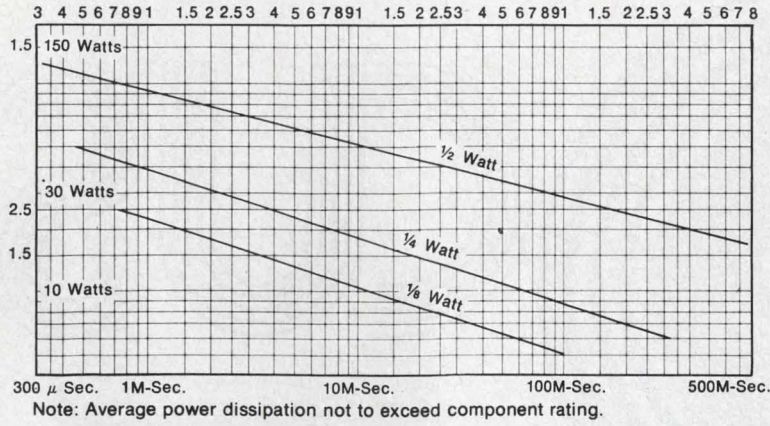

**Overload Protection**

Rugged Metal Glaze construction provides excellent power surge capability. A 1/4w unit will conservatively operate within specifications when exposed to 18w, 10msec pulses, provided average power, and max voltage ratings are not exceeded. Ask us about your applications, including those requiring steady state conditions exceeding mil rated power.

**TYPICAL TO-55 DESIGN TOLERANCE**

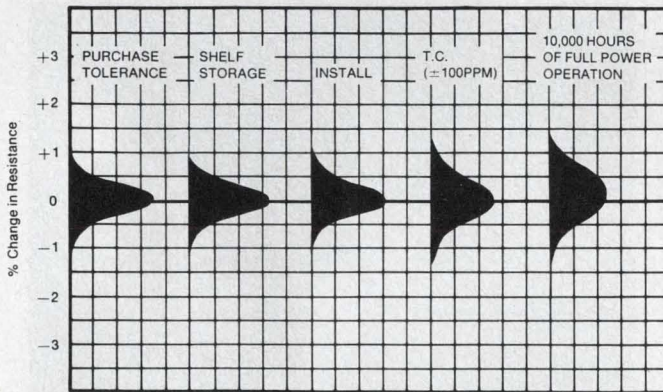

**Minimum Design Tolerance**

(Design tolerance = a statistical summation of various parameters including load life, TCR, installation, and moisture resistance) All the features of Metal Glaze Resistors result in tight, predictable design tolerances which can be as low as ±1.5%, depending upon your application.

**TYPICAL DISTRIBUTION OF TEMPERATURE COEFFICIENT OF RESISTANCE**

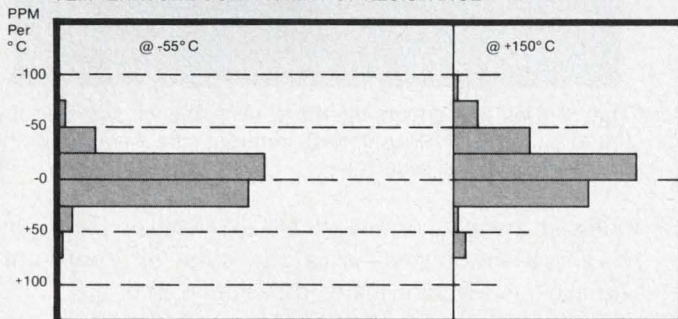

**Absolute, Linear TCR**

T.C.'s of 50, 100, or 200ppm are specified across the entire resistance range from 1Ω to 1MΩ. Our TC characteristic is essentially linear with temperature, and is a normal distribution centered near zero.

**AVERAGE RESISTOR TEMPERATURE RISE VS. APPLIED POWER**

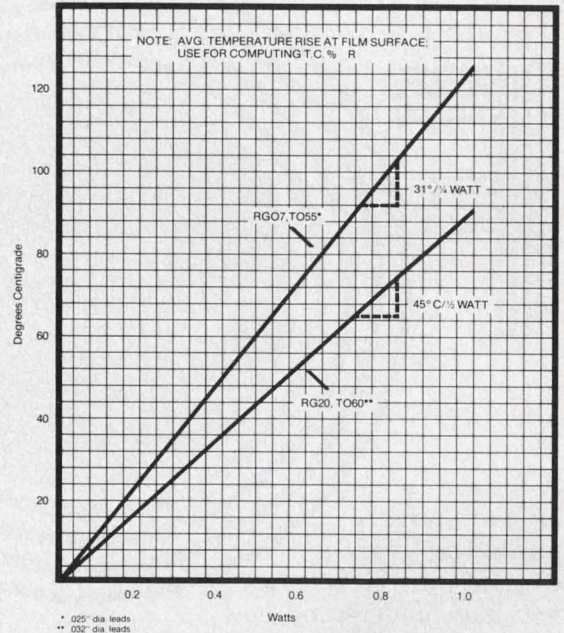

**High Thermal Conductivity**

A solid alumina substrate and other design features efficiently transfer heat from the resistor element. As an example, a 1/4w unit at full load has a hot spot temp rise of only 30°C, half the rise experienced in some other types. Cooler operation means stability and reliability are optimized.

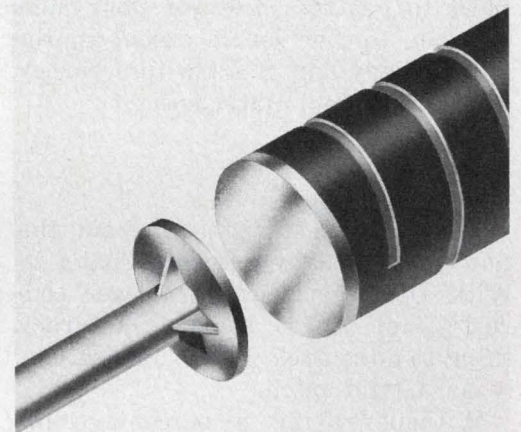

**Capless Terminations**

All Metal Glaze resistors have our exclusive high temperature soldered terminations. This capless construction means excellent pull strength and prevents substrate damage during assembly. With the additional protection of a molded jacket, 1/4w Metal Glaze resistors withstand a 20lb pull test.

**TRW IRC RESISTORS**  
ANOTHER PRODUCT OF A COMPANY CALLED TRW

CIRCLE NUMBER 30



# FOCUS

## on Digital Voltmeters

After a short while shopping for a digital multimeter, you may understand how a championship diver feels during competition: From the ground the board may be only 30 feet up, but from the board the water seems 300 feet down.

To keep the job of selecting a DMM within reasonable bounds, you must first brush aside the flotsam and jetsam of coined terms and short-changed specs.

Then you must plunge deeply into the spec sheet to get the most for your money and the best box for the job; a casual approach can end up as a belly flop. Start with accuracy, one of the most fluid of all DMM specs.

### Too good to be true

For any measuring equipment the first question you'll usually ask is: What's its accuracy? With DMMS, when the answer comes back as "0.1%" or "0.1% basic dc accuracy," the first thing to do is duck. Both numbers can be as deadly as a wild pitch.

Without saying a percentage of what, the 0.1% spec is meaningless. The "basic" spec might be OK. That is, if you lived in Utopia.

In reality, no one-number spec can qualify a DMM's errors. Each range, each function, each set of environmental conditions carries its own inaccuracy handicap. Which does the DMM vendor highlight? Why the lowest, of course.

A DMM's inaccuracy should be spelled out for all conditions: as a function of time, temperature, line voltage, humidity, range, function, and more.

By the time you run down all the inaccuracy terms, that solid 0.1% basic accuracy has been



That DMMS are becoming more versatile is signaled by the Digitec 2180, a unit that includes the measurement of decibels in its repertoire.

chewed away to a shaky 1% or worse. How you combine the terms—straight sum or root-sum-square—can make a big difference, too.

Items like operating temperature range and accuracy tempco might be listed, all right. There's just one problem—the stated tempco doesn't hold or isn't linear over the full specified range. Or accuracy is specified over such a narrow range, you don't dare take the DMM out of the air-conditioned lab (which is kind of unfortunate if the DMM claims to be "portable").

The hedging over specs for temperature and

**Stanley Runyon**  
Senior Associate Editor





Pocket portables are getting smaller. Sencore's DVM 35 illustrates the trend toward lighter and more compact meters. The 3-digit 35 sells for only \$124.

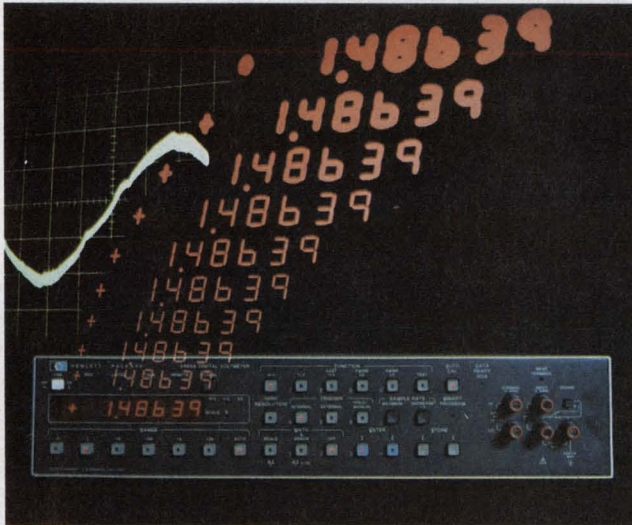

With internal  $\mu$ Ps and memories, systems DMMs are growing in sophistication. This Hewlett-Packard unit is the first to offer a removable reference module.

time (how long the unit holds the stated accuracy) not only hides true performance, it makes it rather difficult to compare competing DMMs—something a few vendors would rather you didn't do anyway.

#### Ignore and suffer

Ask the manufacturer why he ignores tempco, and you may get a simple answer: "Why, we assume users will just readjust the zero to compensate for drift."

It's a good bet that the same vendor writes his accuracy spec in disappearing ink. Or perhaps he'll give you accuracy as a percentage of full scale, alone or with other terms linked on. You can be sure he juggled the various terms so that no one term looks too poor.

For example, suppose a DMM's accuracy is given as  $\pm 0.5\%$  of reading  $\pm 0.5\%$  of range  $\pm 1$  digit. What accuracy you'll get in practice now depends on where you are in what range scale and what  $\pm 1$  digit means—in terms of the measured parameter, volts, amps or ohms.

On the low end of the range, errors can easily shoot past 5% of the reading. And that doesn't include the effects of temperature, humidity and other factors. Where is the DMM's advantage over the analog VOM now?

Don't forget that with a percentage-of-range spec, you must recalculate the possible error at every reading. And even though you can always switch ranges to get on to the more accurate portion of the next range, you might have to give up resolution to do so.

Another problem: when an autoranger switches its own ranges, will it do so for the best accuracy or resolution? Maybe not.

The percentage-of-range spec for fixed errors has long been a thorn in the sides of those who must specify meters. With the adoption some time next year of a new ANSI DMM standard (C39.6), accuracy will be stated uniformly as a  $\pm \%$  reading  $\pm$  a number of digits at a standard temperature or range. Perhaps C39.6 will finally remove the thorn.

Another deception the ANSI standard may squelch is the "overrange chop," a deft maneuver that neatly snaps errors in half—on paper, at least.

#### Don't count on your digits

To effect the chop, all a vendor need do in overranging DMMs is to define full scale with overrange included. Thus instead of dividing a fixed error by a full scale of, say, 1000 counts, the vendor divides by 2000 counts. Presto: half the error.

The word "overrange" would be well gotten rid of in any case for other reasons: 1. It's often confused with accidentally going off scale, which is not what it means; 2. Overrange is usually specified in terms of a fractional digit, which tells you nothing about how many "extra" counts you get. (The new ANSI standard does drop the word, "overrange.")

Consequently, a 3-1/2-digit DMM may read to 1999 or perhaps even higher, but then again it may stop at 1100. There's no way of knowing since there's no agreed-upon convention. Best

*(continued on page 64)*





**Liquid-crystal displays are another trend in DMMs.** The one used in the Danameter series of pocket portables draws so little power, the battery lasts for a year.

bet: ask what the top count is.

Still another source of confusion is the practice of mixing percentages and digits. Sure, you can easily convert from one to the other. But then the onus is on you—not the vendor—to come up with the right answer. You'll have to worry about what to count as full scale, and do so for all ranges on each function. Sound exciting?

Is there any easy solution to the problem of specifying accuracy? Perhaps not, though some have suggested an over-all, worst-case number for accuracy.

No matter how vendors specify accuracy, they must judge where to place both fixed and variable errors (offset, gain and linearity are the major errors), how to account for all the nibbling factors and what calibration cycle to specify. And this must be done for each function and for all ranges within the function. All in all, making the decisions is a tough job.



**Representative of many of the advances in DMMs** is Systron-Donner's 7003. With LSI circuitry, the unit offers true-rms measurements for less than \$300.

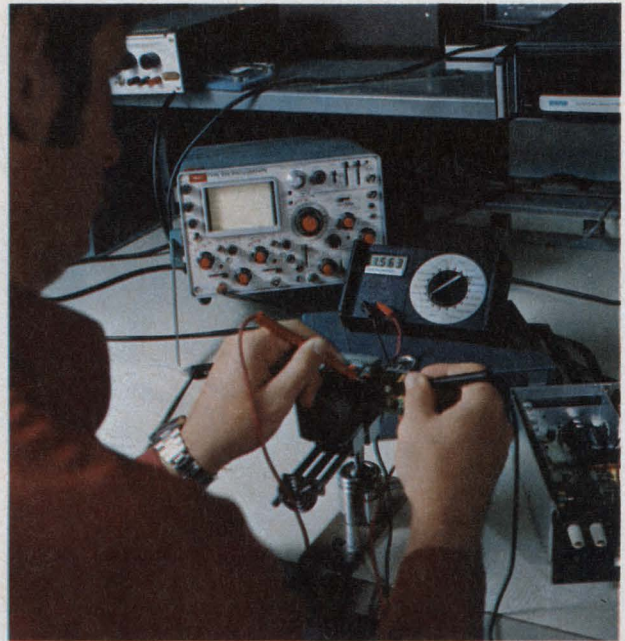

**This DMM lives up to the name "multimeter."** The unit is also a 27-MHz counter. Battery operation lets you take the Valhalla 4440 into the field.

For the ac functions, the job gets even trickier. Not only does ac accuracy suffer from the same ailments as the dc functions, it's got an additional problem—ac accuracy depends on the input frequency.

### The rut-lined path to ac accuracy

If ac measurements are important to you, do more than casually glance at the DMM's ac specs. First, ac accuracy is almost always worse than the dc spec. Second, you can be certain that ac accuracy is given over a limited bandwidth to keep the number low.

Outside the stated bandwidth, accuracy plunges. You may have started out with 2% of reading at 1 kHz. By the time you get to 10 kHz, the 2% has dropped headlong to a poor 20%.

If there's no cliff in the spec to drop over, there may be local potholes, where accuracy dips at certain frequencies. You may find the holes on one range but not another. Where can you not find them? On the data sheet, naturally.

Beware when ac specs are given at spot frequencies, like 10 or 100 kHz. What happens in between is anybody's guess.

Remember, most DMMs use average detection and calibrate the readout for an rms reading. That calibration works for only one input—a perfect sinusoid. If your sine wave is distorted—and most are—reading accuracy degrades.

For a harmonically distorted sine wave, the error depends not just on the amplitude of the harmonic, but also on the phase and order. With a 3rd harmonic, for example—the one likely to give the worst reading—maximum error occurs



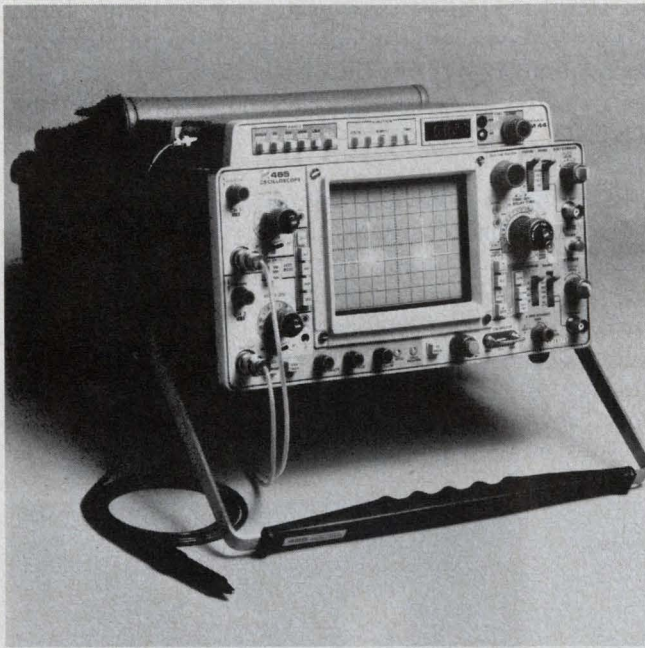

**Add a DMM to a portable scope** and boost measuring power. The Tektronix DM44 reads not only resistance and voltage, but time intervals and temperature too.

at 0° or 180° phase, and can go as high as 14% at 30% distortion.

With more than one harmonic present, the situation becomes complex and pinning down errors isn't a trivial task. The answer here is to pay more money, and get a true-rms-responding DMM.

After you decide to do so, approach your favorite DMM supplier and ask: What do you mean by "true"?

### To tell the truth

Like beauty, true rms is in the eye of the beholder. When it comes to DMMs, the truths being held aren't always self-evident.

There are those who believe that the only "true" true-rms converter is the one that responds to the equivalent heating value of the input signal. And there are those who stand with the mathematical approach, one that the heating group labels "quasi-rms."

In the latter technique, active and passive circuit elements square the input components, take the average of the square and then find the square root of the average.

Which technique is best? Both have strong and weak points in terms of performance and cost. Generally, heating values are used in more expensive laboratory DMMs, while the mathematical calculation is common in lower-priced bench and portable models.

Which to choose depends on the bandwidths and waveshapes of the signals to be measured. Pin those down first, then see if the DMM in question can handle the inputs and still give the

needed accuracies.

Check the range of the expected signal crest factors—the ratio of peak to rms value—then look up the DMM's crest-factor rating. Most signals found in practice don't carry crest factors greater than about 5. But gaussian noise and signals with long, narrow pulses can go much higher.

If the factor exceeds ten, you'll have to look for a unit with 1-MHz bandwidth or more.

After all is said and done, how important is accuracy anyway? How fully should it be specified? How much should you pay for it?

### Too much of a good thing?

The answers to all three questions pivot on one key point: Know your job exactly, then match the DMM to the application.

By overstressing accuracy, you may overlook items of greater importance for the job at hand—items like protection or display brightness. Bear in mind that you'll probably pay dearly for high accuracy under wide temperature, time and frequency requirements.

Some observers see detailed, lengthy specs as cover-ups for inherent nonlinearities or inaccuracies. The argument goes that the vendor counts on the several noncorrelated effects to merge statistically—rather than to add up linearly—and so produce a better over-all spec. The counter argument: "Short, misleading specs border on the criminal."

Whatever accuracy you decide on, be it 0.01% or 1%, realize that that number is ephemeral: Resistors drift with time. Trimmer pots and capacitors can shift with vibration. Insulation can deteriorate under attack by humidity, dust or air pollution. All of which means you must recalibrate a DMM periodically.

How often should you do so? As infrequently as possible, naturally. If you must recalibrate every 24 hours to keep 0.01% accuracy, forget it. The DMM literature should tell you what accuracy you'll get for various time intervals.

In fact, most DMMs are so specified. Unfortunately, not all units are specified alike. Thus you'll find numbers for 24 hours, 30 days, 60 days, 90 days, 6 months and 1 year. You may even get all six, or some other periods, on any one DMM. As a result of the nonstandardization, you can't always compare competing units.

If your Q.C. or cal lab dictates a recal period, then, of course, that's the interval to look for. However, you should also know both the short and long-term accuracies (whatever "short" and "long" mean to you). And you should know some other things, like:

Are all ranges calibratable? If not, how long does it take before those ranges drift out of spec? What must be done to get back into spec?



In your understandable concern for accuracy, burn one other thing into your mind: More digits buy more resolution, not more accuracy. And, sometimes, more digits don't even get you resolution.

### Down for the count

On DMMs—or any digital-readout instrument for that matter—5 digits may not be more accurate than 4 digits, which may not be more accurate than 3 digits. That's because no matter how many digits a machine boasts, the reading can still be incorrect.

The last or last few digits may constantly roll around like so many wheels on a slot machine. (In this case, the payoff isn't three lemons, it's one—the DMM.) Or there's a dead zone around zero and the last digit stays glued in stubborn immobility.

Stability and accuracy must therefore be compatible with resolution. If the theoretical resolution outstrips the stated accuracy of the box, drop it. Thus a 3-digit DMM's over-all reading accuracy shouldn't be worse than 0.1%, a 4 digit's worse than 0.01% and a 5 digit's worse than 0.001%.

Now a 4-1/2-digit unit may not be more accurate than one with 3-1/2 digits. Does it at least guarantee more resolution? Nope.

Suppose both machines have 100% overrange. Suppose the "smaller" box reads 199.9 mV full scale on its most sensitive range, while the "bigger" unit goes to 1.9999 V on its most sensitive. Resolution of both DMMs: 100  $\mu$ V.

Take another case. Suppose you mostly want to know the exact levels of some common power sources—12, 15 and 24 V dc, 115 or 230 V ac. Will two different 3-1/2-digit units give the same resolution on these measurements? Will 5-1/2 digits on one box give better resolution than 4-1/2 digits on another? Not necessarily.

If one 3-1/2-digit meter has only 10% overrange—1100 counts—you'll have to use the 100-V range to measure 12 V, the 1000-V range to measure 115 V. Resolution? Barely 1%.

If the 4-1/2 gives 200% overrange—30,000 counts—and the 5-1/2 counts to just 120,000 with 20% overrange, then the two are equivalent between 12,000 and 30,000 counts, the region that includes the common source levels.

### Filtering your way through noise specs

Even when a DMM seems to check out as far as your required sensitivity, resolution and accuracy, you're not OK yet... remember stability? On top of that, you've got to worry about the unit's noise-rejection characteristics.

It's rare to find a clean dc signal these days,

so DMM designers take pains to counteract hum, ripple or noise riding on the signal or lurking in ground loops. How well the designers succeed is reflected in a DMM's normal-mode rejection (NMR) and common-mode rejection (CMR) specs.

The more common countermeasures include various forms of signal integration to cancel unwanted signals at line-related frequencies; active or passive filters in the front end to cope with broadband noise; and floating inputs or guarded construction—two techniques that boost CMR by increasing the impedance (isolation) between the low input and ground.

How much rejection is enough can be answered



Diminutive in size, yet big in performance, the Data Precision 175 follows in the footsteps of the older 245, a pace setter in miniature meters.

only in terms of your needs. To make sure that normal-mode errors from 50 or 60 Hz stay below 1 count in a 3-digit DMM, you'll need at least 1000:1 attenuation, or a 60-dB NMR.

Common-mode interference is a more insidious problem, since the source—or sources—of the trouble isn't easily spotted. In selecting a DMM for systems use, a high CMR is crucial and a guarded DMM is practically a must.

Remember three things when you look into NMR and CMR: 1. Filtering slows a unit down; 2. A CMR spec should be given for some imbalance—preferably 1 k $\Omega$ —between the high and low leads; and 3. Small "differences" in noise-rejection specs can mean the difference between a good reading and one in which the last digits are useless.

On the first item, find out if you can get both the impressive reading speed and the high NMR at the same time.

On the second item, every factor-of-10 reduction in the imbalance resistor "improves" the



CMR by 20 dB. Insist on a 1-k $\Omega$  spec. (While you're at it, see what the CMR is on the current ranges, too.)

If you are slowed down in trying to determine just how fast a DMM can operate, you're not alone. This is another DMM area that needs some standardization, and about the only way out of the quandary is to ask for definitions.

### The shortness of it all

What does a vendor mean when he talks about "settling time," "response time," "reading rate," "digitizing time"? Settling time to what value—the rated accuracy or what? How does response time relate to the input waveform?

Speaking of relations, keep questioning and you may uncover a few black sheep—specs that should be attached to other specs but are kept closeted by the DMM vendor, probably to hide embarrassing behavior. Input impedance is a likely interrogative target.

High input impedance ( $Z_{in}$ ) is something to be desired. If  $Z_{in}$  isn't high enough compared with the source impedance then rated DMM accuracy can be swamped. Even a 10-M $\Omega$   $Z_{in}$  isn't enough to prevent a loading error of 0.1% with a 10-k $\Omega$  source.

So vendors promote lofty 1000-M $\Omega$  and 10,000-M $\Omega$  input  $Z_s$  in large, bold print. Completely missing—or buried inconspicuously—is another figure, without which any impedance spec is incomplete. The truant is bias current.

Almost all DMM input amplifiers need bias. When the current passes through the source impedance, you get a voltage drop—and a reading error. When the ambient temperature changes, so does the bias current. The hotter it gets, the bigger the error.

Although a 1-nA bias at 25 C sounds low, it really isn't when you realize that bias current roughly doubles every 7 C. In the field, when temperatures reach 35 C, accuracy melts away.

The input impedance you started with can also dissolve under certain other conditions—when you change a range or function; in the middle of the unit's analog-to-digital conversion; during or after an overload. Oh yes, input capacitance does its share in eating into  $Z_{in}$  with ac inputs. Make sure you know what the  $C_{in}$  is.

Linger a bit longer at the DMM's input terminals, and you'll learn even more.

### Is it a DMM or a power supply?

You may not realize it, but a DMM can be a two-way street. That is, the meter can pump energy out the input terminals. Few spec sheets tell you that such kickback signals exist, much less what the amplitudes are.

Even on the ohms function, where you expect output current, surprises may await. In some cases, the surprise is especially unpleasant—like 100 mA to 1 A coming out on the lower ranges, or 22 V of open-circuit voltage. Resistors may not wince at such levels, but what about fuses, diodes and base-emitter junctions?

You can try to extract vengeance on a troublesome DMM if you are so disposed. Just do deliberately what is often done quite inadvertently: apply a high voltage to the input while you're on ohms. If nothing burns out, you'll have at least learned something: how good the DMM's protection is.

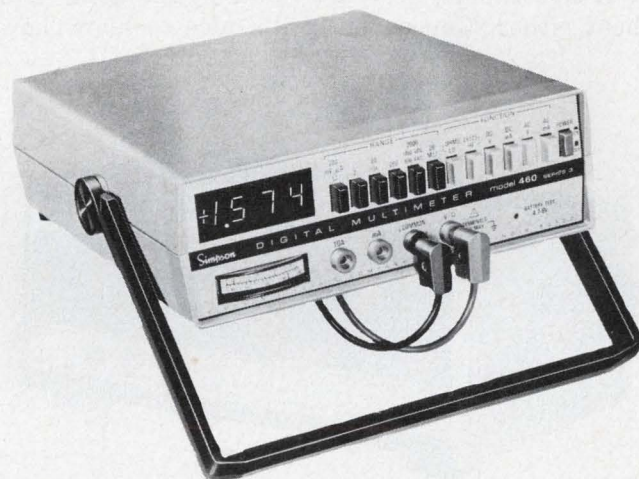

A useful feature in digital meters is . . . an analog meter. Thus you can use units like Simpson's 460-3 for nulling, peaking and watching trends.

Often forgotten in selection—but sometimes more crucial than specs like accuracy—is a DMM's ability to withstand such abuse. All the accuracy in the world won't help you much if someone blows up the instrument unintentionally by applying 115 or 230 V to a sensitive scale.

That won't happen if the meter is adequately protected. What you'd like to know about protection is: how much, what kind, on which ranges? What you may not like are some of the answers.

### Ohm is where the art is

Any DMM that can't handle at least the common line voltages on the ohms function is begging for a knockout. Those units that can measure 1000 V or higher had better be able to take that level, too—without damage, and on all ranges and functions.

Don't sigh with relief when a spec sheet does in fact say "protected to 1000 V." Remain cautious and ask, "for how long?" Any answer other than "continuously" spells trouble.

What form the protection takes is also significant. Three kinds prevail today—fuses, circuit



breakers and electronic circuits. A given DMM may use all three, one for each function (resistance, voltage, current).

When fuses form the line of defense, find out how easy they are to change. Must you open the box and get out your soldering iron? How many different types of fuses must you stock or carry around just in case? Even more annoying: Must the box go back to the cal lab because it's been opened?

Circuit breakers and electronic protective measures avoid these problems but can bring their own nuisances and limitations.

In a line-operated instrument, fuses don't care about brownouts, blackouts or low-line conditions. But circuits may. Circuitry doesn't get along with heat either. Consequently it's nice to know how



**Low-power ohms measurement** is a feature that's appearing more frequently in low-cost DMMs. The 283, from B&K Precision, offers a switchable Hi/Lo ohms.

overload protection is affected by temperature, line voltage or other conditions. The data sheet ought to tell you. It should also reveal whether an overload knocks the DMM out of calibration.

There are some other not-so-obvious considerations in protection. What happens to a DMM when you shuffle across a plush carpet and zap the function switch with a crackly spark? Or suppose you hit two buttons at once by mistake? What about an overload that catches an autoranger just between ranges?

### Sometimes knob twiddling pays off

One test you can make: apply 115 V to the input, and punch all combinations of buttons, both range and function. A good DMM won't be bothered.

With floating inputs, another number that's important is the one that spells out the maximum common-mode voltage (CMV). When it's listed, the CMV should be compatible with the unit's rated CMR.

Most line-operated DMMs can't stand more than a few hundred volts of CMV. If you need more CMV protection than that, look into battery-operated meters, which can tolerate CMVs in the kilovolt region.

Suppose a meter's defenses do crumble somehow, or the overload exceeds the unit's rating. If, say, an input op amp blows, can you change it yourself? Do you have to change five other matched components as well? Are the parts commercial or custom? Study the unit's manual—it may be an eye opener.

Related to any discussion of protection is the two-lead vs. three-lead question. Those that offer one jack for both voltage and resistance measurements are quick to point out the convenience of the feature, and how it finally does away with irritating lead changing.

Those that keep the three inputs counter with a valid argument—what happens when voltages are applied to the ohms circuits? Can the unit suffer? How much can it take?

For that matter, while you're worrying about safety, perhaps you'd better ask yourself: how much can I take? Sometimes a DMM can also dish out what it receives.

### Danger: High voltage

Danger lurks not just in the high voltages found within some units but in careless use of the DMM. Leads have been known to pull out rather easily from banana jacks. If the other end of a dangling lead happens to be attached to a kilovolt or so . . . .

If you expect to work with dangerous levels, you can avoid this hazard by looking for binding posts rather than banana jacks. Some DMMs offer them. Other units offer recessed male terminals as the input.

After you've satisfied yourself as to a unit's basic performance and protective measures, you'll probably look for other things—for features that make life easier or that speed measurements. Even esthetic qualities can be important.

It's OK to want your field rep to carry a good-looking unit, but remember: while you're worrying about the color of the pushbuttons, you can get zoned somewhere else. Autoranging is a likely spot.

Recently the cost of autoranging has come down so sharply that you can get this feature even in \$200 DMMs. But don't say yes to autoranging just because it's readily available. Say yes because you don't need what the vendor may have traded off for autoranging—things like accuracy, stability, ac bandwidth, and more.

Tight specs and autoranging aren't necessarily mutually exclusive, but to get both together you'll





**True rms, autoranging, autozero, compact size:** The 8040A, latest from Fluke, gives all that in a compact package. The unit works from rechargeable or throw-away batteries, or from the line.

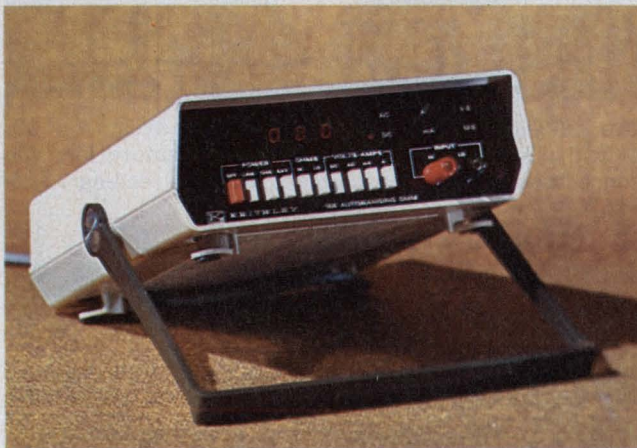

**For \$315, you can buy a DMM** with autoranging, high or low ohms, lighted function indicators and more. The unit shown is the Keithley 168.

usually have to pay the price. And even in more expensive units, autoranging can have drawbacks. Continual ranging with noisy signals or with signals near a DMM's switching points are two annoying aspects of any autoranger. If you're looking for maximum resolution, you can't be sure you're getting it with autoranging, especially in the overrange regions. For these reasons, many autoranging DMMs have a manual mode.

Another point: several DMMs today offer a touch-and-hold feature, a switch or button that freezes a reading so you don't have to watch the display while poking around under a chassis. Nice feature, yes? Yes, until you think about it and realize how touch-and-hold affects autoranging.

If your application calls for autoranging, the feature can save many man-hours. And, as one vendor points out, relays can far outlast manual switches in lifetime.

Other features appearing in DMMs with increasing frequency include analog nulling or trend meters, low-power ohms, diagnostic indicators and even temperature or capacitance meters. If any of these are useful, fine. Just be

sure the "extras" don't hide the performance of the DMM proper.

Buzzwords can also disguise performance. Lift the camouflage by asking, "Does 'autozero' really improve zero stability?" "What does 'quadrislope-matic integration' really do to help a unit?"

Don't get caught up in the numbers game either. You may end up with 75 ranges—but only two functions. What good are a fistful of ranges and functions, anyway, when all you need are a few? In still another area—internal design—vendors may reverse and try to convince you that less is better.

In the highly competitive war to sell DMMs, the parts-count skirmish has become an all out firefight. The argument goes that the fewer the number of parts, the better the reliability. With major DMM functions being put today on one or just a few LSI chips, the parts count has plunged. Lift many of the newer DMMs, and you'll swear the box is empty.

### Getting by on less

Does the reliability argument hold water? Maybe. But if a vendor really believes in his argument, or in his published MTBF, why does he warranty his unit for only 90 days?

Remember: It's not the parts that "count," it's the final performance.

The kind and size of display are often stretched out of proportion in a sales tug-of-war between rival vendors. Things like quality and brightness are subjective in a display, but current drain and life aren't.

Whether you prefer LEDs, LCDs, gas discharge or whatever, each type has merits and drawbacks—none can be all things to all men. What circuitry the designer has built around the display and how the display is packaged count too.

Because of LSI, the size, weight and price of portable and bench DMMs continue to drop. Alternately, you can get more in a DMM for the same price. In systems and laboratory units, the latest trends include built-in  $\mu$ Ps and ROMs and capabilities like self-diagnosis and the IEEE-488 interface standard for programmability.

Thus DMMs today can do more than measure. They can calculate, linearize, watch for high/low limits, and more. Some units just about calibrate themselves; others watch for ailments and can almost, but not quite, repair themselves.

### The new breed: thinking DMMs

DMMs with high IQs include Systron-Donner's 7115—the forerunner in  $\mu$ P meters—and the month-old Hewlett-Packard 3455A, the first unit with a removable reference.

One system DMM, from Dana, uses a  $\mu$ P to provide practically any desired interface. An-



other new systems unit, the Data Precision 7500, emphasizes speed, with 1000 conversions per second available to speed up one of the slowest links in a computer-controlled network.

There are even DMMs that count (or counters that measure, if you prefer) like Valhalla Scientific's 4440, a 4-1/2-digit DMM and 27-MHz counter (a \$50 option). And if that's not enough, look into Vu Data's triple combination, the 975, which marries a DMM to a counter and an oscilloscope. Tektronix also offers several DMM options—the DM44 is the latest—for its portable scopes, as well as a bunch of DMMs for its TM500 line of modular test instruments. The 44 displays time intervals and temperature along with voltage and resistance.

Unusual units can turn up in unexpected places. Peek into your co-worker's shirt pocket and you may find a super-miniature, probe-like affair with digital readout, autoranging and more. Two such units exist—the HP 970A and the Logical Technical Services 12T, a DMM that also measures temperature.

Need long-term averaging of slowly fluctuating, random signals? Check out the Thermo Systems 1076, which measures rms, mean-square, or mean, at 10:1 crest factors.

Another group of meters specializing in rms measurements is offered by Yokogawa Corp. of America. The line includes models that measure power as well as voltage and current.

Specialized DMMs are the forte of California Instruments, makers of the Cimron product line. The company's broad line includes the DMM 42, a unit that spans the super wide resistance range of 100  $\mu\Omega$  to 200 M $\Omega$ . Other Cimron models include a counter/DMM and an ATE unit that, among other things, takes ac/ac ratios.

In general-purpose DMMs, the action today is mostly in 3-1/2-digit portables and 3-1/2 and 4-1/2-digit benchtoppers. Packaging of the portables runs from tiny pocket models resembling hand-held calculators, to the tilt-bail configuration popularized by the Fluke 8000A. Prices of 3-1/2-digit units today have plummeted to the \$100 mark.

### Those remarkable portables

What should you look for in a portable? Ruggedness is a prime consideration. A portable is sure to suffer through whacks, drops, vibration, coffee spills, smoke and other miseries. Can your unit "tough it out"?

What about EMI susceptibility? Plastic cases aren't known for resistance to EMI. Does your vendor provide for this? Some do.

How easy is it to retrofit a battery-operated DMM to line operation or vice versa? Can the unit work off the ac line without a battery? Are

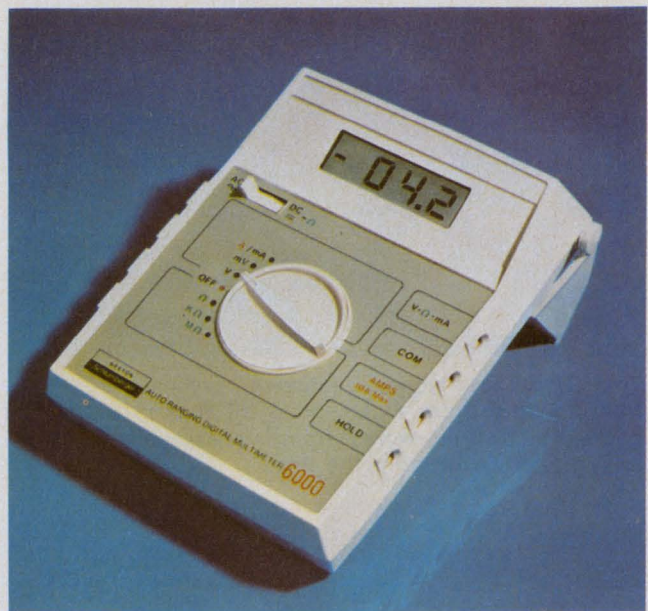

Over 200 hours of battery life marks the Weston 6000, a field unit that uses LCDs. A "hold" feature lets you concentrate on the measurement, not the reading.



Wide true-rms bandwidth is the hallmark of the Ballantine 3028A. You can make ac measurements from 15 Hz to 110 kHz with the 3028.

batteries easily replaced? How long do they last? Are they rechargeable? How long to recharge? What's optional?

Will you use the unit in sunlight or other high ambient lighting? If so, look into display contrast. You might have to hide in a closet to read some units.

Don't overlook the physical features: shape, how it's carried or stored, where the controls and display are located. Lightweight units are fine—that is, until you push a button and send the DMM sliding across the bench. What's good for the field isn't necessarily good for the bench.

Remember, some DMMs sacrifice a lot to squeeze size or price. Accuracy of these units can fall far behind that of the analog multimeter.

Among the smaller portables, the standouts in-



clude units from Dana, IET Labs, Non-Linear Systems and Sencore. The Danameter A features LCDs, one-year operation on a single 9-V battery, and once-a-year recalibration.

IET's pocket portable is the DM-50, a 3000-count unit with protection on all three functions, V, I and R. Non-Linear's midget line packs up to four digits, plus an active filter in the 3-1/2-digit unit, into a 1.9 × 2.55 × 4-in. case. And Sencore's two pocket units feature 30-MΩ input impedance when you hit an X 2 probe button.

Moving up to the more traditionally sized portables, you'll find units like Simpson's 360-2 and Weston's 6000. The dash 2 inherits the "look" of the familiar 360 VOM in a digital "update," with such features as low-power ohms and a built-in analog meter.

The 6000 is a sleek DMM using LCDs for 200 h of battery life. Other features: autoranging, autopolarity, ability to hold readings, and more.

Compact benchtoppers have arrived with increasing frequency lately, no doubt sparked by the success of the Fluke 8000A, a unit that, with others, has catapulted Fluke to the leadership position in DMMs.

Frontrunners in these and other DMMs include Hewlett-Packard and Data Precision, with significant roles being played by Ballantine Laboratories, B & K Precision, Dana, Digitec, Keithley, Philips and others.

### The 3-1/2-digit battle

Ballantine's 3028A, introduced at Electro '76, offers 3-1/2-digit rms response from a low 15 Hz to a top of 110 kHz. The B & K 3-1/2er, the 283, lights up with 0.41-in-high digits.

Data Precision's "miracle" of packaging, the 4-1/2-digit 245, has recently gained a younger brother, the 3-1/2-digit 175. Also boasting a very compact case, the 175 sells for \$189.

Digitec's 2100 series of DMMs stand out with low bias current. One unit, the 2180, reads out directly in decibels.

The prize for the most prolific producer may go to HP, which has turned out four new DMMs within the last year. The imaginatively packaged HP 3476A typifies much of the advanced technology going into today's crop of DMMs.

Another unit wearing the "new look" is Keithley's 168, a 3-1/2-digit box with autoranging, high or low ohms, two-terminal inputs and lighted function indicators.

Two units from Philips deserve attention: the portable PM 2514 autoranger and the PM 2523 tilt-bailer. Accuracy of the 23 is guaranteed for life—no recalibration is necessary.

Fluke isn't sleeping, of course. Hot off the assembly line at Fluke are the 8030A and the 8040A, with 3-1/2 and 4-1/2 digits, respective-

ly. Virtues of the 30A: true rms for both voltage and current, plus a diode-test function. The 40A autoranges and reads true rms.

Newcomers and overseas vendors are also quite active in DMMs. De Forest Electronics, a new arrival, startled the industry recently with its \$100 offering, the 3-1/2-digit MM 200. Takeda-Riken, a Japanese manufacturer, markets the TR-6355, a 3-1/2-digit unit with 10-μV resolution.

And Viz Test Instruments Group has acquired the old RCA line of equipment, and has added the WD750A—a 3-1/2-digit box with rf shielding, low-power ohms, an analog meter, and other features. ■■

## Need more information?

The products cited in this report don't represent the manufacturers' full lines. For additional details, circle the appropriate number on the Reader Service Card. For data sheets and more vendors, consult ELECTRONIC DESIGN'S GOLD BOOK.

- Ballantine Labs., P.O. Box 97, Boonton, NJ 07005. (201) 335-0900. (M. Lichtenstein). **Circle No. 450**  
 B&K Precision, 6460 W. Cortland, Chicago, IL 60635. (312) 889-8870. (G. Rose). **Circle No. 451**  
 California Instruments Div. (Cimron), 5150C Convo St., San Diego, CA 92111. (714) 279-8620. (P. Muller). **Circle No. 452**  
 Dana Labs Inc., 2401 Campus Dr., Irvine, CA 92713. (714) 833-1234. (C. Everett). **Circle No. 453**  
 Data Precision Corp., Audubon Rd., Wakefield, MA 01880. (617) 246-1600. (R. Scheinfein). **Circle No. 454**  
 Data Tech, Penril Corp., 2700 S. Fairview Rd., Santa Ana, CA 92704. (714) 546-7160. (W. Miller). **Circle No. 455**  
 De Forest Electronics, 40 Fairfield Pl., West Caldwell, NJ 07006. (201) 575-8670. (P. Zagaria). **Circle No. 456**  
 Dynascan Corp., B&K, 1801 W. Belle Plaine Ave., Chicago, IL 60613. (312) 327-7270. **Circle No. 457**  
 John Fluke Mfg. Co., Inc., P.O. Box 43210, Mountlake Terrace, WA 98043. (206) 774-2211. (C. Newcombe). **Circle No. 458**  
 Hewlett-Packard, 1501 Page Mill Rd., Palo Alto, CA 94304. (415) 493-1501. **Inquire direct**  
 Hickock Electrical Instrument Co., 10514 Dupont St., Cleveland, OH 44108. (216) 541-8060. **Circle No. 459**  
 IET Labs, Inc., 335 Bear Hill Rd., Waltham, MA 02154. (617) 890-5105. (S. Aisenberg). **Circle No. 460**  
 Julie Research Labs, 211 W. 61 St., New York, NY 10023. (212) 245-2727. (D. Komoroff). **Circle No. 461**  
 Keithley Instruments Inc., 28775 Aurora Rd., Cleveland, OH 44139. (216) 248-0400. (M. Moore). **Circle No. 462**  
 Logical Technical Services Corp., 71 West 23 St., New York, NY 10010. (212) 741-8340. (M. Norris). **Circle No. 463**  
 Non-linear Systems Inc., Box N. Del Mar, CA 92014. (714) 714-1134. (P. Akin). **Circle No. 464**  
 Philips Test & Measuring Instruments Inc., 400 Crossways Park Dr., Woodbury, NY 11797. (516) 921-8880. (S. Rauch). **Circle No. 465**  
 Schneider Electronique 27-33 Rue D'Antony 94533 Rungis-Cidex L 165, France. **Circle No. 466**  
 Sencore Inc., 3200 Sencore Dr., Sioux Falls, SD 57107. (605) 339-0100. (B. Bowden). **Circle No. 467**  
 Simpson Electric Co., Div. of AGM, 853 Dundee Ave., Elgin, IL 60120. (312) 697-2260. (J. Rothenbach). **Circle No. 468**  
 Systron-Donner Corp., Instruments Div., 10 Systron Drive, Concord, CA 94518. (415) 676-5000. (C. Bishop). **Circle No. 469**  
 Tektronix, Inc., P.O. Box 500, Beaverton, OR 97077. (503) 644-0161. (K. Arthur). **Circle No. 470**  
 Takeda-Riken, 646-A Santa Cruz Ave., Menlo Park, CA 94025. (415) 323-3039. (H. White). **Circle No. 471**  
 Thermo-Systems Inc., 2500 Cleveland Ave. N., St. Paul, MN 55113. (612) 633-0550. (J. Lerich). **Circle No. 472**  
 United Systems Corp. (Digitec), P.O. Box 458, Dayton, OH 45401. (513) 254-6251. (M. Elovitz). **Circle No. 473**  
 Valhalla Scientific, 7707 Convo Court, San Diego, CA 92111. (714) 277-2732. (H. Clark). **Circle No. 474**  
 Viz Test Instruments Group, 335 E. Price St., Philadelphia, PA 19144. (215) 844-2626. (R. Liska). **Circle No. 475**  
 Weston Instruments, 614 Frelinghuysen, Newark, NJ 07114. (201) 243-4700. (P. Rehnberg). **Circle No. 476**  
 Yokogawa Corp. of America, 5 Westchester Plaza, Elmsford, NY 10523. (914) 592-6767. (J. Stegenga). **Circle No. 477**



# How can you guarantee your product for ninety days if the parts that go into it aren't guaranteed for ninety seconds?

When you're in the business of marketing information systems and modems that sell from \$500 to \$50,000 it doesn't help to have your customers think of you as anything less than a really solid operation.

Of course, you're only as solid as the products you sell.

The best way to get your customers believing in you and your product is to make that product better than anyone else—and to guarantee it.

But how can you be sure nothing will go wrong with the machines you make if you can't be sure of the parts you put into them?

The answer is you can't, unless you're using guaranteed parts.

At MF Electronics, we make molded crystal oscillators the best way anyone knows how to make them. Since we feel they're the best, we're able to guarantee them for one full year.

## The difference between oscillators.

What separates good oscillators from bad is space. Space is one thing there shouldn't be any of inside an oscillator. But the way most oscillators are made, space is one thing you can count on.



## The hollow truth about crystal oscillators.

Look at this oscillator. The fact that we can lift the cap to show you what's wrong with it shows you what's wrong with it.

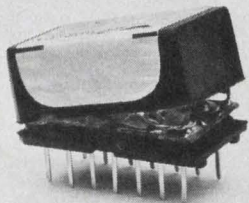

## The MF Guarantee

MF Electronics warrants this molded crystal oscillator to be free from defects for one year from date of purchase.

Any oscillator found to be defective during this period may be returned to the factory, postage paid, for repair or, at our option, replacement without charge.

MF Electronics limits its liability to the repair and/or replacement of the returned MF oscillator.

**MF ELECTRONICS CORP.**

118 E. 25th St., New York, N.Y. 10010 (212) 674-5360 TWX: 710-581-4109

After the crystal and other parts are attached to the base, the cap is glued on, creating a bond that's tenuous at best.

Air seeps through this bond, allowing dirt and moisture to collect. You've got a leaky oscillator, one that's prone to loose parts and electrical shorting. That's how deadly a breath of fresh air can be to the inside of an oscillator.

## The un-hole-y oscillator: It's molded. What a blessing.

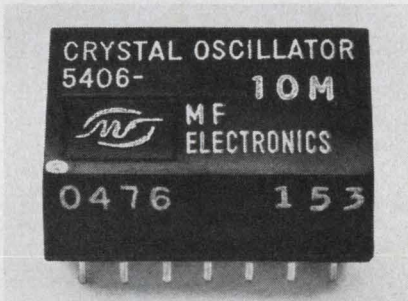

A molded oscillator, on the other hand, has no holes, no open spaces, nothing to hide and nowhere to hide it. Its crystal is hermetically sealed and set in a monolithic block of solid black plastic. There are no spaces for air to penetrate, no room for dirt or moisture to accumulate. Wave soldering can't even deteriorate the unit, so there's no danger of loose pins or joints.

## A test that rings true.

One of our customers, who is also one of the country's largest users of crystal clock oscillators, tested the performance of

various oscillators. He found that MF's molded oscillator lasted 3000 hours in an 85°C/85% relative humidity test. If you've ever done any oscillator testing yourself you know how remarkable that is.

## Two more solid reasons to use MF Crystal Oscillators.

3rd overtone crystals are used in MF's molded oscillators to provide greater electrical and mechanical stability in frequencies exceeding and including 20 MHz.

And an MF molded oscillator is the only one made that meets the UL oxygen index guideline of 28%.

## Because we're solid, your product is more solid.

So when you use MF molded crystal oscillators, you're giving your product a more efficient component, a heart that will beat longer. And your customers will be giving you fewer complaints and service calls.

MF Electronics is the only company that makes molded crystal oscillators. We invented them.

We make what we think are the best crystal oscillators you can buy. And we guarantee them, so your product can be "the best you can buy."

Guaranteed!

## THE MF GUARANTEE

MF Electronics warrants this molded crystal oscillator to be free from defects for one year from date of purchase.

Any oscillator found to be defective during this period may be returned to the factory, postage paid, for repair or, at our option, replacement without charge.

MF Electronics limits its liability to the repair and/or replacement of the returned MF oscillator.

# MF ELECTRONICS CORP.

118 E. 25th St., New York, N.Y. 10010 (212) 674-5360 TWX: 710-581-4109

CIRCLE NUMBER 32



# I.F. A-to-D, P.D.Q.

We may have just come up with the triple play of the century, an instant IC IF-to-video-to-digital system.

And we've done it with proven, plug-in Plessey products.

The Plessey SL550 is a low-noise, high-gain AGC-able front-end amplifier that's not only unique, but superb.

The SL1521 is the simplest, easiest-to-use and least expensive wideband amp you can buy for your log IF strips.

And the SP750 is the world's fastest IC comparator, with a bonus batch of features that reduce your hardware count and increase your reliability.

They all plug together as if they were made for each other and they're available now, so send for all the details.



We'll get back to you, P.D.Q.

## PLESSEY SEMICONDUCTORS

1674 McGaw Avenue, Irvine, CA 92714  
Tel: (714) 540-9945. TWX: 910-595-1930  
Represented world-wide.

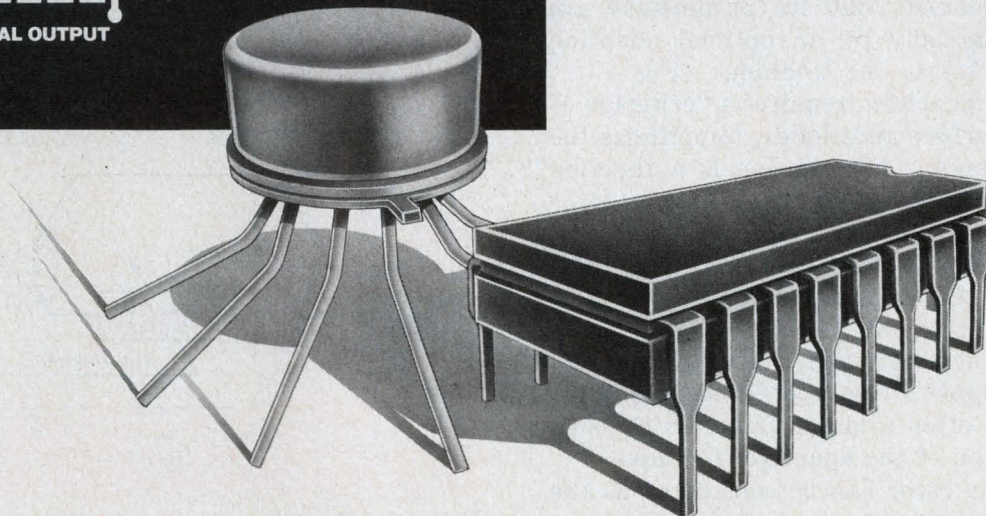
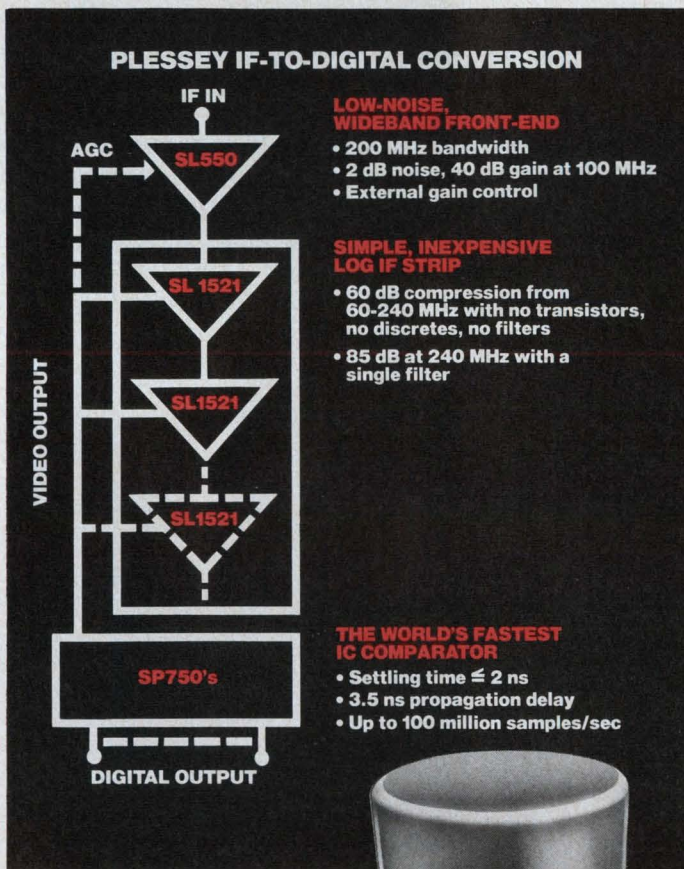

## State-of-the-art brought down to earth

Limiting wideband amplifiers  TV, radio & telephone communications circuits  High-speed dividers

CIRCLE NUMBER 33



## Cancel 60 Hz and other noise with adaptive filters. Other benefits include less signal distortion than with conventional techniques.

How would you like to build filters that design their own parameters, provide excellent noise reduction, and give less signal distortion than conventional filters? The secret: adaptive cancelling of noise or interference.

Adaptive filtering and noise cancelling work best when:

- You can find a reference noise source in which the information-carrying signal is weak or undetectable (noise-cancelling case).
- The signal is nonstationary—that is, its statistical properties vary with time.
- Little or no beforehand statistical information is known about the input signals. In such cases, Wiener or Kalman-Bucy filters generally aren't feasible and the adaptive method may be the only reasonable approach.
- In many cases, conventional, fixed filters efficiently attenuate noise but distort the signal. With adaptive noise cancelling, when applicable, you can reduce noise to levels that would be difficult or impossible with conventional filtering—with little risk of signal distortion.

### What are adaptive filters?

Unlike conventional filters, an adaptive filter is fixed in structure, but its parameters are adjusted automatically by an optimal adaption algorithm—the key to the technique (Fig. 1).

The adaption algorithm requires a "criterion of goodness," or performance index, to optimize the filter's performance. The criterion is a function of an error signal, called the mean-square error (MSE):

$$(MSE) = E \{ (\text{Error})^2 \}, \quad (1)$$

where E means the expected or average value of the quantity in brackets.

To generate the error, many methods are possible, and a designer's resourcefulness in producing the error is often a major factor in the successful application of the adaptive technique.

In general, the error can be considered as the

difference between an actual and a desired response, or:

$$\text{Error} = (\text{what you have} - \text{what you want}). \quad (2)$$

However, the error signal isn't always so simply visualized, that is, d cannot always be thought of as a desired output. Sometimes d is just a signal used to generate an appropriate error. The goal of the adaption algorithm is to adjust the filter parameters to minimize the MSE.

In adaptive noise cancelling, a variation of adaptive filtering, a reference input is derived from sensors located in a noisy environment in which the signal is very weak or undetectable (Fig. 1b). Thus, the reference noise,  $n_1(t)$ , is uncorrelated with the signal,  $s(t)$ , but is correlated in some way with the input noise,  $n_0(t)$ .

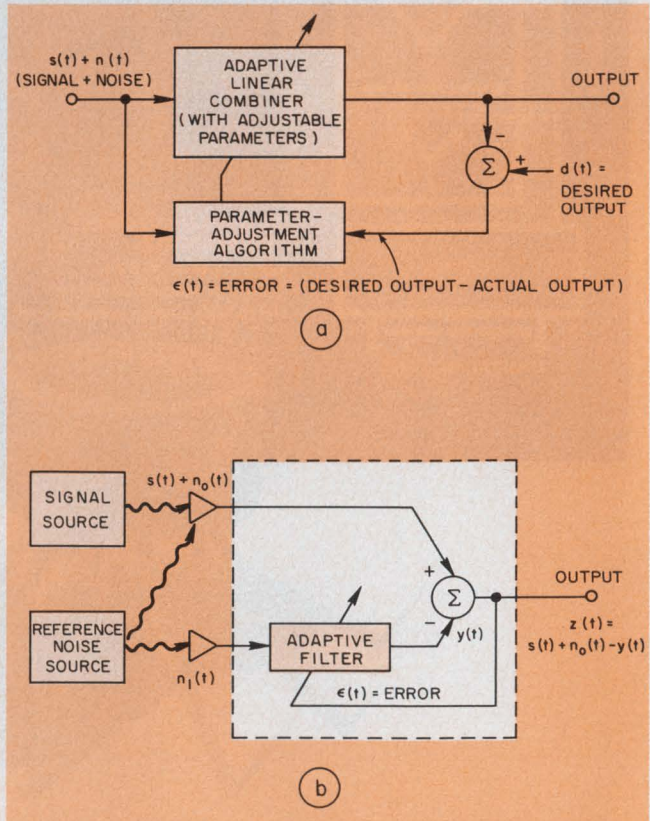

1. An adaptive filter adjusts itself for optimum performance through an algorithm that incorporates a built-in performance criterion (a). One use of the filter is to cancel noise (b).

**Gregory A. Clark**, Electrical Engineer, Electronics Engineering Dept., Lawrence Livermore Laboratory, Livermore, CA 94550.



The adaptive filter conditions the reference noise,  $n_1(t)$ , so that  $y(t)$  is as close a replica as possible of  $n_0(t)$ . Then  $y(t)$  subtracts from  $s(t) + n_0(t)$ , leaving approximately  $s(t)$ :

$$z(t) = s(t) + n_0(t) - y(t) \quad (3)$$

Notice that the error in this case is identical to the output, and you really can't consider the error as the difference between a desired and an actual output.

### One tradeoff: Speed

Note that when the signal plus the noise forms the input to an adaptive filter or noise canceller, the device does not deliver the correct result immediately. The system needs time to adapt to the incoming data, as illustrated by the MSE learning curve (Fig. 2). To quantify the adaption time, an analytical expression for  $\tau_{MSE}$ , the MSE time constant, can be derived.<sup>1,2,3,4</sup>

In typical feedback systems, the "plant," so to speak, is fixed and the plant input is the error between the system input and a weighted value of the output. Thus feedback modifies the input signal to accommodate the plant.

In adaptive systems, the plant changes to accommodate the input signal—a profound difference.

Most practical adaptive-filter designs include the Widrow-Hoff adaptive linear combiner (ALC) shown in Fig. 3. The ALC simply forms a weighted sum of the inputs  $x_j$  to give the output  $y_j$ , which is then compared with some desired response  $d_j$  to form the error signal  $\epsilon_j$ . A linear mean-square algorithm (LMS) uses  $\epsilon_j$  and  $x_j$  to optimally adjust the weights and so minimize the error.

When the ALC first begins to work, or if a change in the input statistics occurs,  $\epsilon_j$  is usually large. The LMS algorithm then adjusts the weight values  $W_j$  (where  $W$  is a vector quantity) to minimize the mean-square error. In the algorithm, the constant  $\mu$  affects the rate of convergence to the minimum MSE.

To guarantee that the algorithm will converge and be stable,  $\mu$  must be greater than zero and

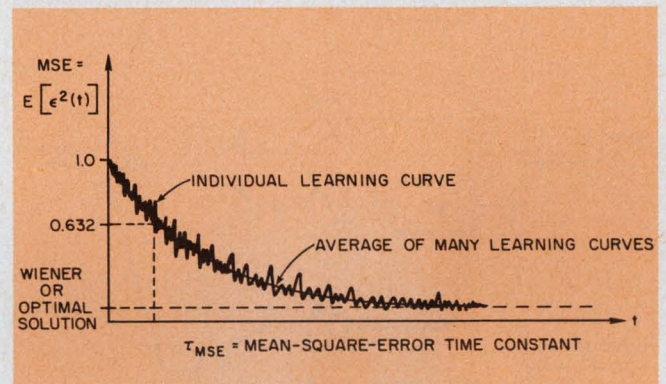

2. Time is needed for an adaptive system to "learn" the most effective solution. A time constant,  $\tau_{MSE}$ , quantifies the adaption time.

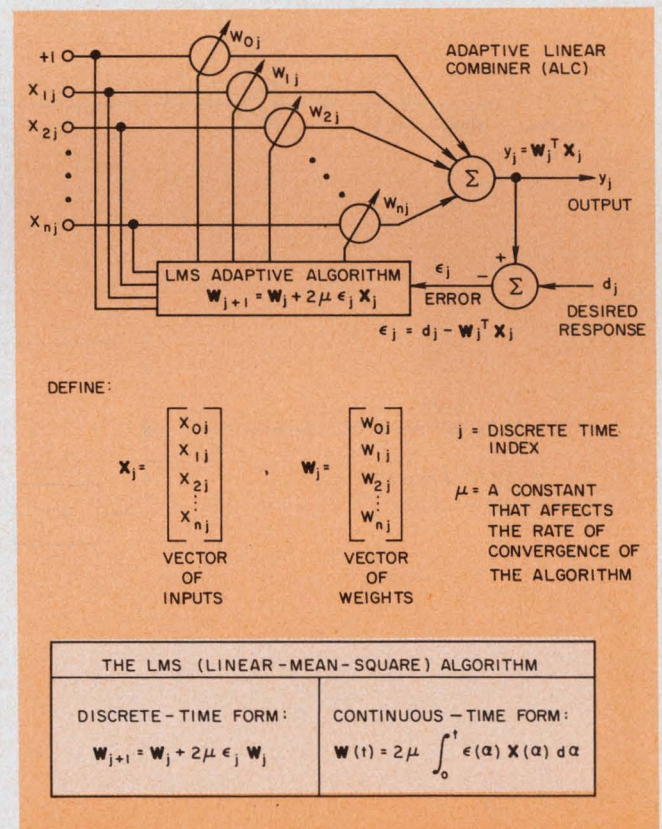

3. An adaptive linear combiner (ALC) forms the heart of the adaptive design. The ALC's output is a weighted sum of the inputs.



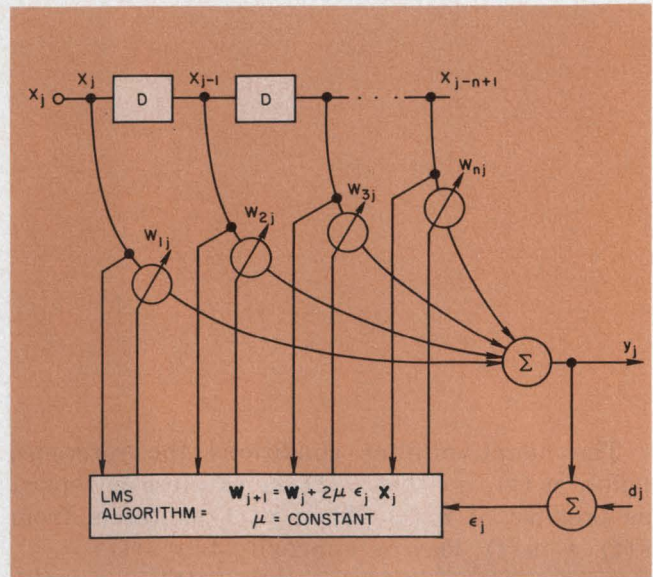
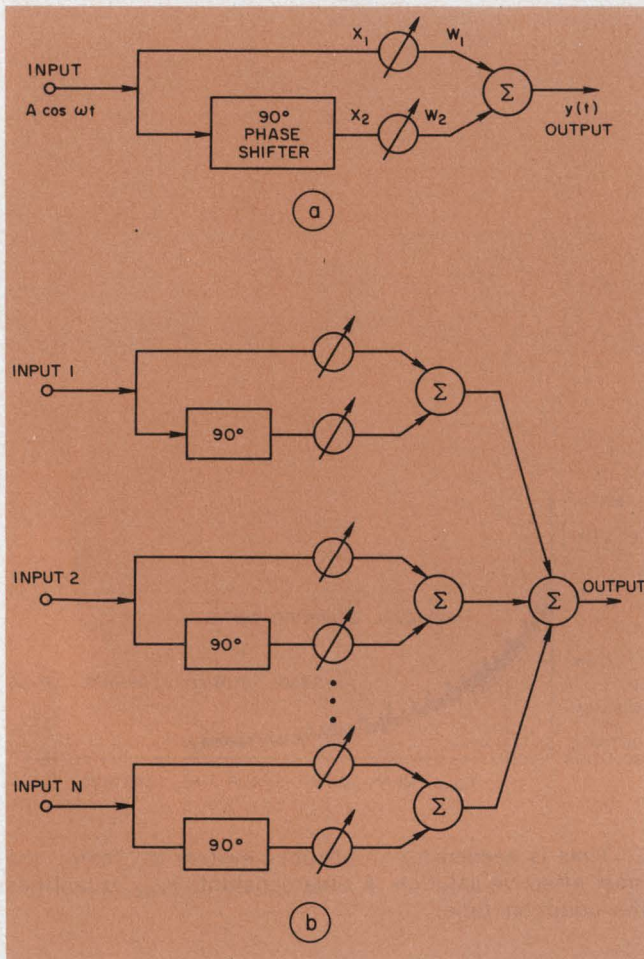

5. For broadband signals, the adaptive technique takes the shape of a tapped delay line, or variable-weight transversal filter.

4. Various filters require different configurations. To filter a single frequency, use the configuration in "a." Another arrangement can handle several frequencies (b).

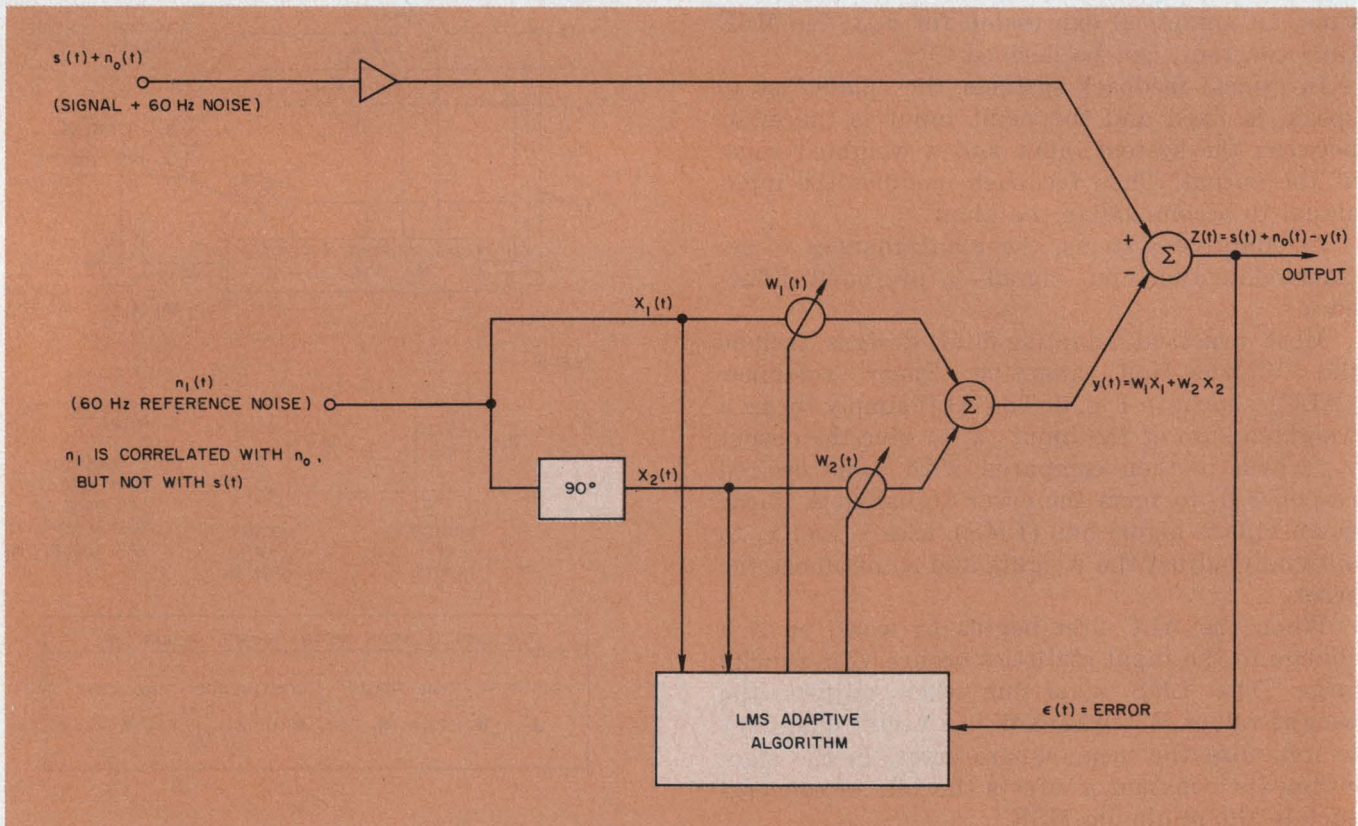

6. To cancel 60-Hz noise, the reference source comes right out of the wall socket. Other frequencies can also

be cancelled by the technique, in which filtering is provided by an ALC.



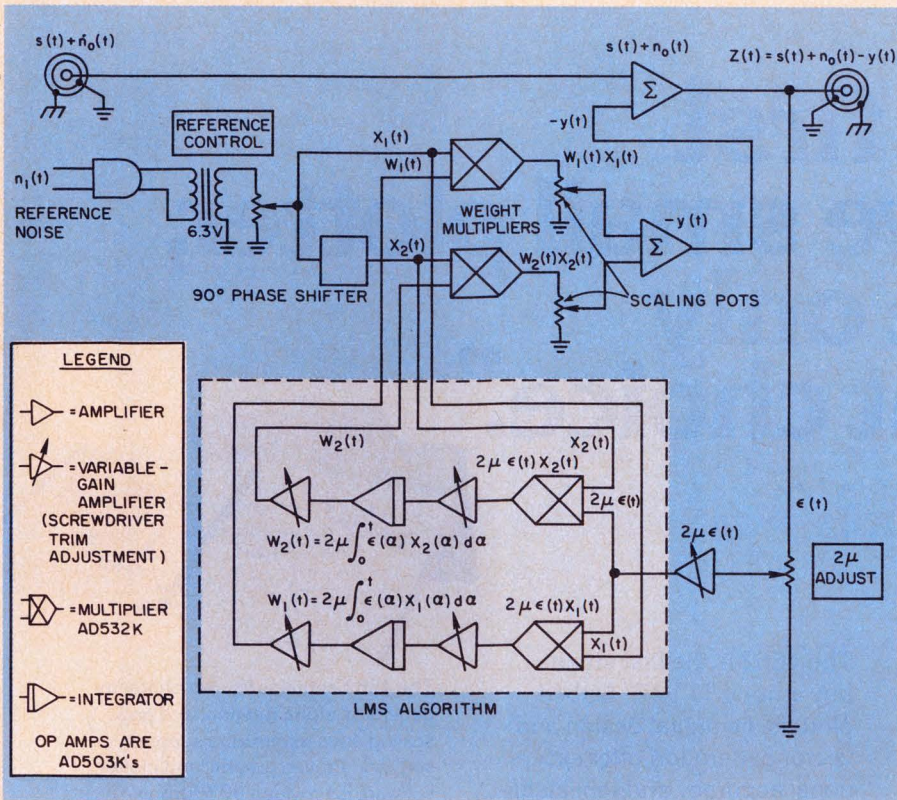

7. A two-weight, analog, 60-Hz canceller is built up from standard commercial op amps and other building blocks. Scaling amplifiers adjust signal levels to prevent saturation.

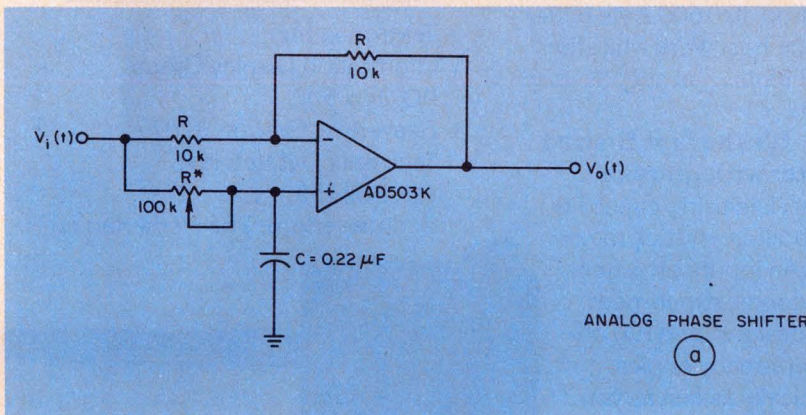

$$G(s) = \frac{V_o(s)}{V_i(s)} = \frac{1 - sCR^*}{1 + sCR^*}$$

$$\text{PHASE SHIFT} = \begin{cases} 0^\circ, & \text{IF } R^* = 0 \\ 180^\circ, & \text{IF } R^* = \infty \end{cases}$$

less than a theoretical value determined by the input statistics. However, in most cases the input statistics are not precisely known, and  $\mu$  must be determined empirically.

Several configurations for the ALC exist for different filtering problems (Figs. 4, 5). For single-frequency filtering, use the configuration in Fig. 4a. With this arrangement adjust  $W_1$  and  $W_2$  to give any desired magnitude and phase at the frequency  $\omega$ .

If several individual frequencies are to be filtered, use the arrangement in Fig. 4b. Finally, Fig. 5 shows the configuration for a variable-weight, tapped-delay-line (transversal) filter for use in broadband signal processing.

Perhaps the simplest example of a noise canceller is a 60-Hz unit in which the reference noise is taken directly from a wall plug (Fig. 6). The 60-Hz line is usually correlated with the 60-

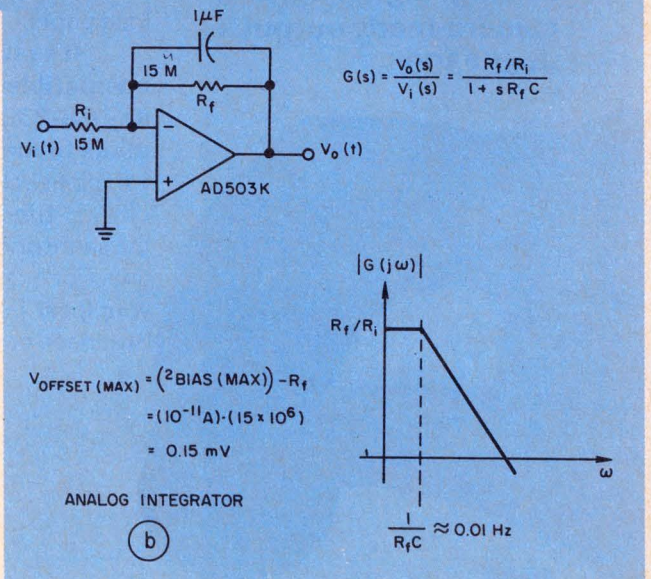

8. Details of the canceller's phase shifter (a) and integrator (b) show typical component values, design equations and circuit performance.

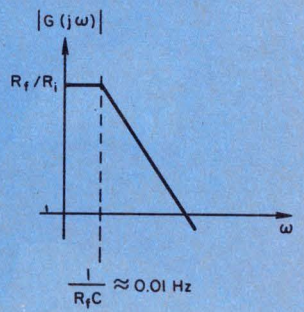

$$V_{\text{OFFSET (MAX)}} = (2 \text{BIAS (MAX)}) - R_f$$

$$= (10^{-11} \text{A}) \cdot (15 \times 10^6)$$

$$= 0.15 \text{ mV}$$



# "As the first interactive small plotter, it was the only intelligent choice."

## Problem: Until now, no small plotter could carry on an intelligent conversation.

Because most B-sized plotters have been pretty much the same: slow, unreliable, and dumb. Even with large off-line plotters you can wait hours, even days, for results... and if there's a mistake—start over.

**Solution: Tektronix' new microprocessor-based 4662. For interactive plotting, page scaling, digitizing, and camera-ready output. Just \$3995.†**

The 4662 is the first smart buy among 11"x17" flatbed plotters. Its digital design and vector generation offer exceptional accuracy and repeatability without drift or slidewire dirt build-up. Its 1600-byte buffer lets the host work while the 4662 plots... at speeds up to 22 ips.

**It's the first B-sized plotter with graphic input.** Digitizing capability and built-in joystick mean you can input corrections in seconds, experiment with designs, and run off camera-ready copies practically as fast as you load paper.

**It's plug-to-plug compatible with virtually any RS-232 system... from minis to mainframes.** You can plot circles around any other B-sized plotter, for about the same price as the competition. For a demonstration, call your local Tektronix Sales Engineer, or write:

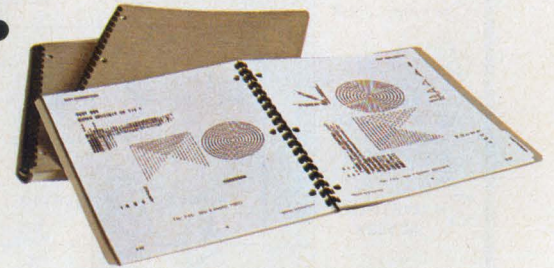

The 4662 contains its own character generator, alpha rotation, and page scaling, thus minimizing support software. Proven graphic and plotter software is provided by Tektronix.

**Tektronix, Inc.**  
Information Display Group  
P.O. Box 500  
Beaverton, Oregon 97077  
**Tektronix Datatek NV**  
P.O. Box 159  
Badhoevedorp, The Netherlands

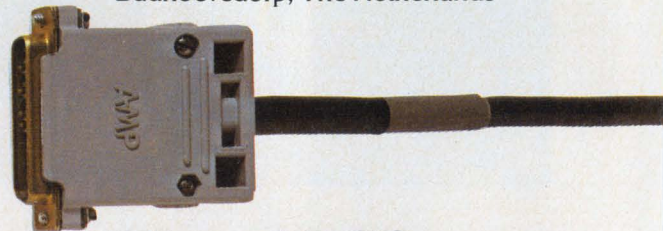

## The 4662. Plug it in. It speaks for itself.

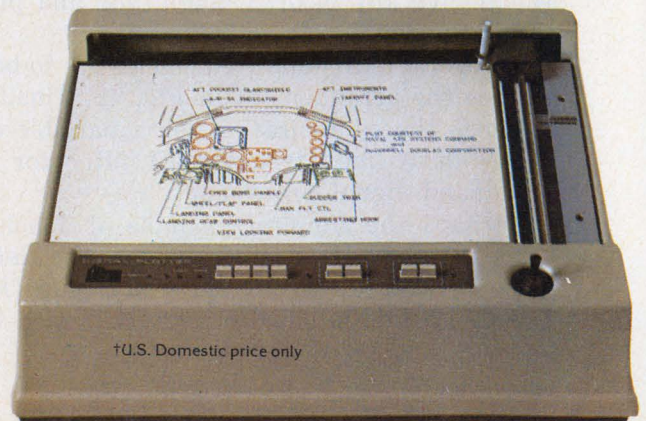



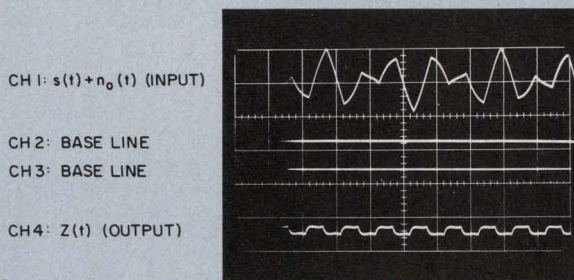

CH1:  $s(t) + n_o(t)$  (INPUT)  
 CH2: BASE LINE  
 CH3: BASE LINE  
 CH4:  $Z(t)$  (OUTPUT)

$s(t) = 100\text{-Hz TRIANGLE}$   
 $n_o(t) = 60\text{ Hz}$   
 SCOPE CAL: 0.2 V/cm, 0.018 s/cm

(a)

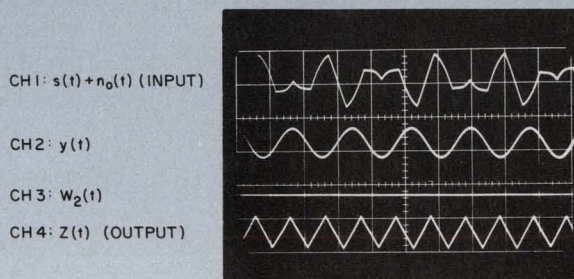

CH1:  $s(t) + n_o(t)$  (INPUT)  
 CH2:  $y(t)$   
 CH3:  $W_2(t)$   
 CH4:  $Z(t)$  (OUTPUT)

$s(t) = 100\text{-Hz TRIANGLE}$   
 $n_o(t) = 60\text{ Hz}$   
 SCOPE CAL: 0.2 V/cm, 0.018 s/cm

(b)

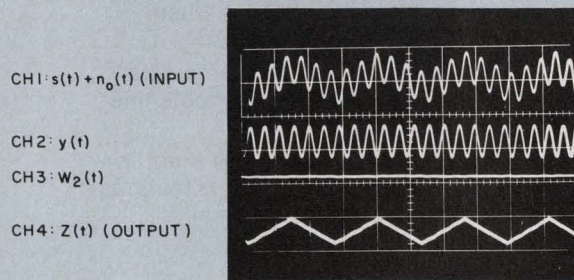

CH1:  $s(t) + n_o(t)$  (INPUT)  
 CH2:  $y(t)$   
 CH3:  $W_2(t)$   
 CH4:  $Z(t)$  (OUTPUT)

$s(t) = 10\text{-Hz TRIANGLE}$   
 $n_o(t) = 60\text{ Hz}$   
 SCOPE CAL: 0.2 V/cm, 0.038 s/cm

(c)

9. Scope photos show relative performance of a standard 60-Hz notch filter (a) and of the adaptive filter (b,c). Note the low signal distortion obtained with the adaptive filter compared with that of the notch type.

Hz noise causing the problem. Here, an ALC serves as the adaptive filter, with two weights.

Note that one ALC input comes directly from the wall plug and the other from a 90-degree phase shifter. With this arrangement, you can adjust the weights to give a 60-Hz sine wave of any magnitude and phase at point y. Note also that the ALC configuration is applicable to any single frequency.

The LMS adaption algorithm, using the error signal, adjusts the weights to make  $y \approx n_o$  so y can be subtracted from  $s + n_o$  to leave approximately s at the output.

Today, with inexpensive, high-quality op amps and multipliers, analog, two-weight cancellers are economical to design (Figs. 7, 8). Op amps make it easy to produce the mathematical functions required by the LMS algorithm. These include 90-degree phase shifting, integration, weight multiplication and scaling. In analog form, the LMS algorithm is given by:

$$W(t) = 2 \mu \int_0^t \epsilon(\alpha) X(\alpha) d\alpha \quad (4)$$

Scaling amplifiers, with screwdriver-adjustable gains, carry a good deal of the "workload" because all of the canceller's internal signals fall between  $-10$  and  $+10$  V—the dynamic range of the op amps and multipliers. Adjust the gains so that none of the op amps saturate with reasonable input magnitudes, roughly:  $0 \leq |\text{signal}| \leq 5$  V and  $0 \leq |\text{noise}| \leq 1$  V.

Additional input and output scaling amplifiers are usually necessary in practical circuits. A pot scales the amount of reference signal entering the adaptive filter.

In relative performance a typical 60-Hz notch filter effectively attenuates the 60-Hz, but distorts the signal (Fig. 9a). With the noise canceller, distortion is low (Fig. 9b,c).

A final note: Although adaptive filters are usually implemented with digital techniques, good analog delays are now possible with charge-coupled devices (see ELECTRONIC DESIGN, Vol. 24, No. 6, March 15, 1976, p. 70). This means that tapped-delay-line transversal filters can now be built economically in analog form. ■■

#### Acknowledgement

The author wishes to thank Charles Pomernacki for his helpful suggestions and John Elliott for constructing the noise canceller.

#### References

1. Widrow, B., et al., "Adaptive Noise Cancelling; Principles and Applications," *Proceedings of the IEEE*, Vol. 63, No. 12, December, 1975.
2. Widrow, B., et al., "Adaptive Antenna Systems," *Proceedings of the IEEE*, Vol. 55, No. 12, December, 1967.
3. Widrow, B., "Adaptive Filters I: Fundamentals," *Technical Report No. 6764-6*, Systems Theory Laboratory, Stanford Electronics Laboratories, Stanford University, December, 1966.
4. Widrow, B., "Adaptive Filters," from *Aspects of Network and System Theory*, Edited by Kalman, R. E. and DeClaris, N., Holt, Rinehart and Winston, Inc., New York, 1970.



# NEW 3½ Digit Multimeter from B&K-PRECISION



**B&K PRECISION** MODEL 283—\$170

...you'll want it for its features  
...but it's the price that will sell you!

- High intensity LED display is easily read from at least 6 feet in the brightest room
- 0.5% DC accuracy
- 100% overrange (1000 scale reads to 1999)
- Automatic polarity
- Automatic decimal point
- Flashing overrange indication on display
- Four ranges each for voltage and current
- Six resistance ranges to 10 meg.
- Reliable In-circuit resistance measurements
- Overload protection on all ranges

Complete new circuitry makes the Model 283 the most dependable and versatile 3½ digit multimeter you can buy. The extra-bright display allows you to use it where other units would cause reading problems. The selectable "low ohms" function permits accurate measurement of semiconductor shunted resistors.

An optional, internal battery pack (BP-83, \$50.00) provides 8 hours of continuous use on one overnight charging and charges when the Model 283 is in use on 115/230VAC.

Thoughtful, convenience features like a side carrying handle, tilt stand and detachable line cord add to its usefulness.

Your B&K-PRECISION distributor has them in stock and will be glad to demonstrate its features to you. Call him, or write for additional information.

**B&K PRECISION**  
PRODUCTS OF DYNASCAN

6460 West Cortland Avenue  
Chicago, Illinois 60635 • 312/889-9087

In Canada: Atlas Electronics, Toronto

FOR PRODUCT INFORMATION CIRCLE NUMBER 238  
FOR PRODUCT DEMONSTRATION CIRCLE NUMBER 239



# IF YOU DON'T USE OUR 16-PIN 4K RAMS, YOU'VE GOT 18 HOLES IN YOUR HEAD. (OR EVEN 22.)

Compared with 18-pin designs, Fairchild's 16-pin 4K RAMS burn less power. Give you more sources. And conform with the 16-pin package planned for 16K RAMS of the future.

Above all they deliver greater reliability. First, because they employ derated design rules. Second, because they're *100% tested* to the tightest criteria in the industry before we release 'em.

**You're ahead with systems design, too.**

With Fairchild 16-pin 4K RAMS you have less add-on parts, fewer interconnects, reduced power dissipation, lower voltage clocks and less susceptibility to noise related failure. So you get a better performing system, using less board

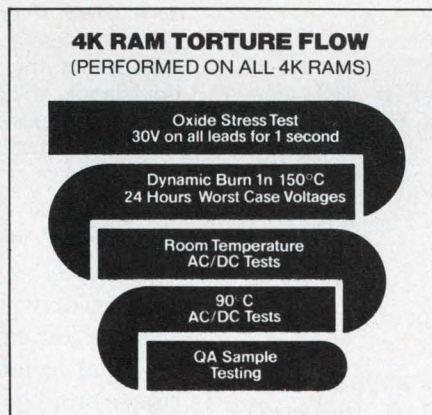

area, for less cost than 18 or 22-pin alternatives.

Our 16-pin format is now the highest volume 4K RAM in production. And from your Fairchild Sales Office, Rep or

Distributor, you get off-the-shelf quantity delivery in plastic or CERDIP—along with complete 4K RAM data pack and app note.

Fairchild Camera & Instrument Corp., MOS Division, 464 Ellis Street, Mountain View, CA 94042. Telephone (415) 962-3941. TWX: 910-379-6435.

Fairchild 16-pin 4K RAMS. They'll help you keep ahead.

**FAIRCHILD**

**WHO ELSE?**



# Reduce the noise output of linear rf amplifiers.

High degeneration in the emitter of a grounded-base circuit reduces the noise figure to 2 dB, 10% from the carrier.

Because of the use of relatively high power in solid-state broadband transmitters, it's generally not recognized that keeping output noise low is a serious problem. Noise output can easily jam nearby sensitive receiver inputs in adjacent channels. The major source of such noise is the high noise level generated by the usual driver stage of a transmitter's final broadband Class B or C amplifier.

To improve the over-all noise figure it is first necessary to provide a cleaner drive, so noise-output reduction is a major objective in the 2-W linear, rf, driver amplifier shown in Fig. 1. It has an equivalent noise figure (NF) of only 2 dB at a frequency 10% removed from a 50-MHz carrier. This low NF is achieved by means of a series-tuned input that also serves as the emitter-degeneration element in a common-base configuration. The degeneration in the emitter circuit reduces the output noise (mainly transistor noise) by about 18 dB.

### Series tuning has high off-resonance Z

In the amplifier's input circuit (Fig. 1a), capacitor  $C_2$  transforms the source impedance,  $R_g$ , to match the load presented by the amplifier input;  $L_1$  and  $C_1$  form a series-tuned circuit to resonate at the carrier frequency. The emitter-base series-resonant circuit presents a comparatively high impedance ( $Z$ ) to off-carrier noise frequencies; thus it provides the impedance needed for emitter degeneration.

Resistor  $R_1$  together with the bias supply,  $V_{EE}$ , sets the collector bias current at 0.5 A. Inductor  $L_2$  serves as an rf choke between the supply,  $V_{CC}$ , and the collector, and the paralleling resistor,  $R_2$ , suppresses any parametric oscillations.

Fig. 1b shows how the rf transistor's dual emitters are coupled to the circuit with a minimum of lead inductances. A semicircular 1/4-in.-wide copper stripline, on 1-mil paper for insulation, produces approximately a 1- $\Omega$  characteristic

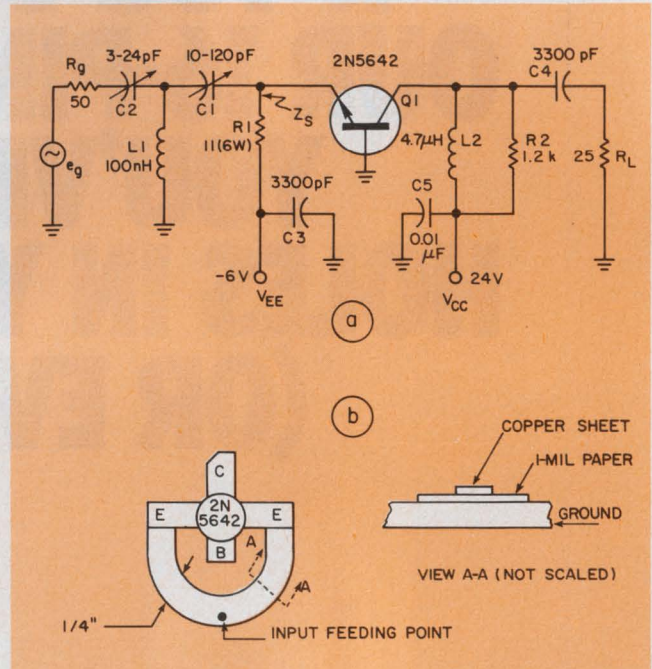

1. A linear rf amplifier in a common-base configuration (a) provides a substantial reduction of output noise because of the degenerative action of the series-tuned impedance of  $L_1C_1$  in its emitter circuit. A special coupling arrangement (b) feeds the input equally to the transistor's two emitter terminals.

impedance, which matches the transistor's input impedance.

This driver amplifier stage, when used in a transmitter rf chain, provides a "clean" drive to the final broadband stage and 16-dB of gain. Because input power is only 50 mW, the input can be tuned with varactor diodes.

A linear noise model of the 2N5642—the rf power transistor used in the amplifier—provides a basis for calculating the amplifier's theoretical noise output. The measured values of the circuit are within 2 dB of the theoretical calculations.

### Measuring the performance

To test the amplifier's noise performance, you may use a test set-up as shown in Fig. 2a.<sup>1</sup> Measurements of amplifier noise-power output in dBm and carrier-to-noise ratio in dB made with

Dr. Dieter R. Lohrmann, Harry Diamond Lab, Adelphi, MD 20783 and Kyung S. Son, Electrical Engineer, U.S. Army Electronics Command, Fort Monmouth, NJ 07703.



such a set-up are plotted in Fig. 3 for several frequencies,  $f_n$ , on both sides of a 50-MHz carrier.

For each  $f_n$ , you must first establish a noise reference. With no rf drive adjust the bias,  $V_{EE}$ , to make the collector current,  $I_c$ , equal to zero when  $V_{cc}$  is 10 V. Then set the output level,  $F$ , of the calibrated noise source at zero;  $F$  is calibrated in terms of excess  $BkT_o$  above the thermal reference ( $k$  is Boltzman's constant,  $T_o$  is room temp in  $^\circ K$  and  $B$  is bandwidth).

Finally, the cw-generator tuned to  $f_n$  must be

of  $f_n$  that you want to plot.

The plotted values of measured noise output  $P_n$  (Fig. 3) in dBm are calculated from the following relationship:

$$P_n = -129 \text{ dBm} + 10 \log F + 12 \text{ dB.}$$

The 12-dB value accounts for a 6-dB loss in the attenuator, a 3-dB loss in the bandpass filter and an additional 3-dB loss because the amplifier's output is split between two 50- $\Omega$  leads (Fig. 2a). The -129 dBm represents the log form of the reference level,  $BkT_o$ , where  $B$  is the band-

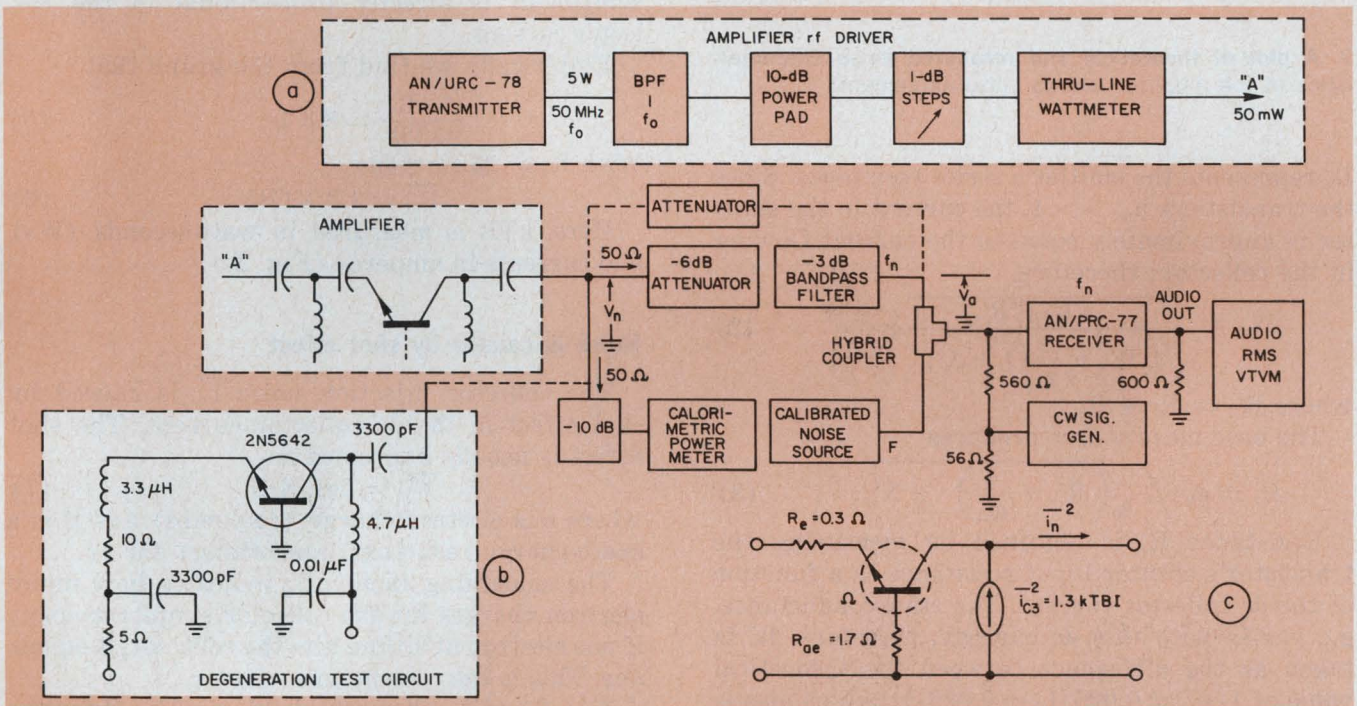

2. The test set up (a) measures the noise performance of the amplifier. Replacement of the 6-dB attenuator and the bandpass filter with an adjustable attenuator allows the measurement of noise in the degeneration test circuit (b). This circuit simulates the amplifier to determine the degenerative effect of a high impedance in the emitter. A Thevenin equivalent (c) shows the noise sources of the transistor.

set at an output level sufficient to "quiet" noise output from the AN/PRC-77 FM receiver by 10 dB. The AN/PRC-77 can be tuned over the range of 30 to 76 MHz.

With the receiver output at this -10-dB reference level, you may now apply rf drive to the amplifier, and then increase  $V_{cc}$  to the normal working voltage, which is 24 V. (This sequence—rf drive first, then the 24 V—is safest for the transistor.)

At this point the reduction in "quieting" provides a measure of the amplifier's noise output. To obtain a measurement, remove the rf drive and restore the reference conditions again. Now, increase the calibrated noise generator's output until you get the same reduction in "quieting" as obtained with the rf drive, and note the  $F$  reading on the noise generator's scale.

This procedure must be repeated for each value

width estimated as 32 kHz and  $T_o$  is room temperature ( $297^\circ K$ ), and calculated as follows:

$$10 \log [kT_o B / 10^{-3}] = 10 \log [1.4 \times 10^{-23} \times 297 \times 32 \times 10^3 / 10^{-3}] = -129 \text{ dBm.}$$

### Measurements agree with theory

The noise components in the collector current can be attributed to three sources (Fig. 4). Assume the sources are uncorrelated so that their mean-square values can be added.

- First source is  $R_e + R_s \rightarrow \overline{i_{c1}^2}$  (emitter and source resistances).

- Second source is  $e_B \rightarrow \overline{i_{c2}^2}$  (base noise source).

- Third source is base-collector junction noise  $\rightarrow \overline{i_{c3}^2}$ .

$$\text{Thus, } \overline{i_n^2} = \overline{i_{c1}^2} + \overline{i_{c2}^2} + \overline{i_{c3}^2} \quad (1)$$

Resistance  $R_s$  represents the Thevenin-equivalent source resistance that the emitter "sees," and



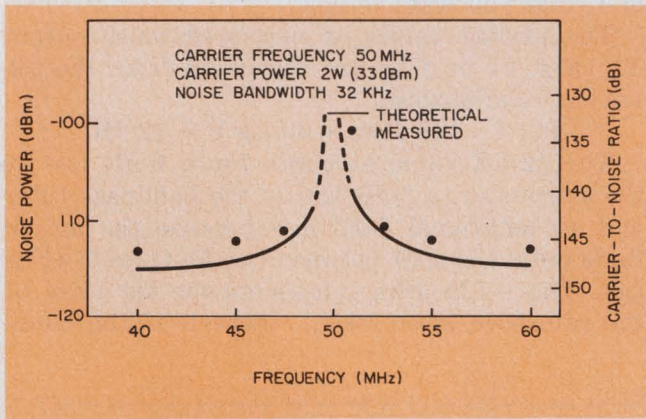

3. A plot of theoretical and measured noise characteristics of the amplifier shows close agreement.

$R_e$  represents the emitter's series resistance. Since the transistor's  $h_{fe} \gg 1$ , the current in the emitter is approximately equal to the current flowing in the collector; therefore,

$$i_{c1} = \sqrt{\frac{4 kTB R'_s}{\left(R'_s + \frac{1}{g_m}\right)^2 + X_s^2}}, \quad (2)$$

where  $R'_s = R_e + R_s$ .

The base noise source produces

$$i_{c2} = e_B / \sqrt{\left(R'_s + \frac{1}{g_m}\right)^2 + X_s^2} \quad (3)$$

Resistance  $R_e$  is obtained by measuring the transistor's emitter input resistance as a function of the dc collector current. The transconductance,  $g_m$ , varies with this dc current; therefore,  $R_e$  is taken as the difference between the theoretical value of  $1/g_m = 0.026/I_c \cong 0.026/I_c$ , which also is plotted, and the measured input resistance where the  $1/g_m$  plots "flatten" out. At high  $I_c$  current, the  $1/g_m$  term becomes small relative to the value of  $R_e$ , allowing the emitter input resistance to approach approximately  $0.3 \Omega$ .

To find  $i_{c3}$  (the third noise component), the amplifier is modified by a large reactance placed in the emitter to minimize the noise from emitter

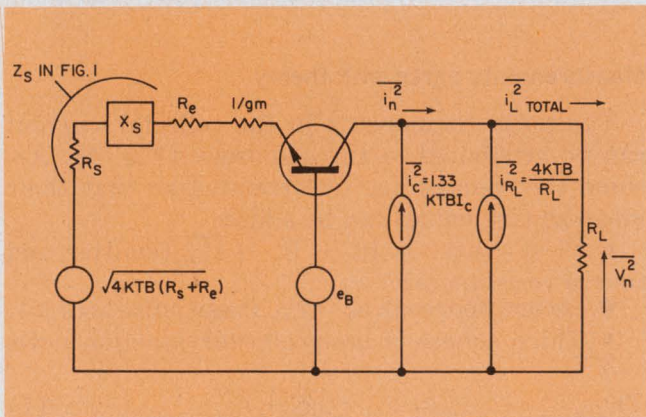

4. An equivalent circuit of the amplifier identifies the theoretical sources of noise in the rf amplifier circuit.

and base sources (Fig. 2b). For this measurement, the 6-dB attenuator is replaced by a step attenuator,  $a_s$ , and the bandpass filter is removed. Because of strong emitter degeneration,  $i_n^2 \cong i_{c3}^2$ . Then,

$$p_n = \overline{i_{c3}^2} R_L = \frac{R_o}{R_L} a_s^2 kTBF, \quad (4)$$

where  $R_o = 50 \Omega$ , the standard reference impedance level.

The graph (Fig. 6) shows measured values of this collector noise of the third kind, as a function of the collector dc current. Clearly, this noise component is directly proportional to the collector current.

Empirically we find from the graph that

$$\frac{\overline{i_{c3}^2} R_L}{4kTB} = 8.3 I_c. \quad (5)$$

With  $R_L = 25 \Omega$ , then

$$\overline{i_{c3}^2} = 1.3 kTBI_c \quad (6)$$

Here,  $kTB$  is measured in watt-seconds (Ws) and currents in amperes (Fig. 2c).

### Noise is caused by shot effect

The collector injection noise  $\overline{i_{c3}}$  is caused by shot effect in the dc collector current. The shot effect is usually expressed as

$$\overline{i_{c3}^2} = 2eI_c S^2 B, \quad (7)$$

where  $e$  is electron charge (coulombs) and  $S$  is a space-charge reduction (smoothing) factor.

The smoothing factor,  $S$ , indicates how many electron charges hit the collector simultaneously: if one electron at a time hits the collector,  $S$  equals one. This is the case in noise diodes.

Eqs. 6 and 7, when combined, yield an  $S$  for the 2N5462 transistor of

$$S^2 = 0.017,$$

which is a characteristic of the transistor; it is determined by the transistor's charge density.

### Evaluating base noise

To evaluate the base noise,  $e_B$ , the emitter in Fig. 2b is bypassed. From Eqs. 1, 2, 3 and 6,

$$\overline{i_n^2} = \frac{4 kTB R'_s}{Z} + \frac{e_B^2}{Z} + 1.3 kTBI_c, \quad (8)$$

where  $Z = \sqrt{\left(R'_s + \frac{1}{g_m}\right)^2 + X_s^2}$ .

If we now introduce an equivalent noise resistor,  $R_{ae}$ , that creates equivalent noise as if it were in series with the base junction (Fig. 4), then

$$e_B = \sqrt{4 kTB R_{ae}} \quad (9)$$

$R_{ae}$  is equal to zero for all signals other than noise. Substituting Eq. 9 into Eq. 8, we obtain the power ratio

$$\frac{\overline{i_n^2} R_L}{4 kTB} = \frac{R'_s R_L}{Z} + \frac{R_{ae} R_L}{Z} + \frac{1.3 I_c R_L}{4} \quad (10)$$

The power ratio is measured as before and the



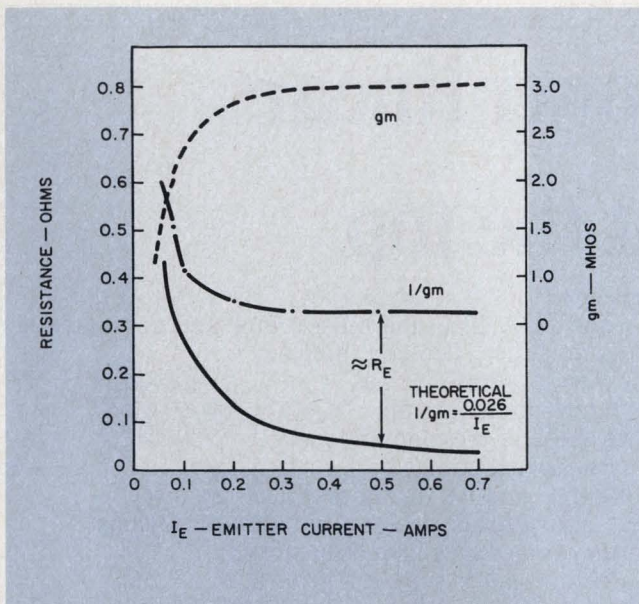

5. The emitter equivalent resistance,  $R_e$ , established from plots of  $1/g_m$ , is approximately  $0.3 \Omega$ .

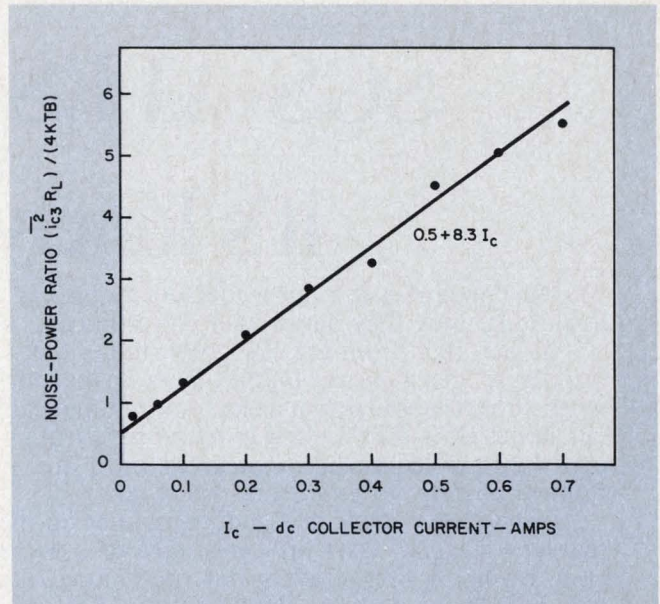

6. An empirical straight line can be fitted to represent the transistor's noise-power ratio vs its collector current.

logs of the ratios are plotted as a function of collector current,  $I_c$ , with the emitter both bypassed ( $X_s = 0$ ) and unbypassed, to show the effect of degeneration.

With the left side of Eq. 10 known from measurements,  $R_{ae}$  can now be calculated by substituting measured value for the loss resistance of  $L_1$ — $R_s = 0.1 \Omega$ ; the equivalent emitter resistance— $R_e = 0.3 \Omega$ ; and for  $1/g_m$ —an “average” value,  $0.05 \Omega$  taken at an  $I_c = 0.5 \text{ A}$  from Fig. 5. When these values are taken together with the measured value of the power ratio at  $I_c = 0.5 \text{ A}$ , we find that Eq. 10 yields  $R_{ae} = 1.7 \Omega$  (Fig. 2c).

Impedance  $Z$  and the coil's  $Q$ , when measured for frequencies between 40 and 60 MHz at 1-MHz intervals, provide the value of  $R_s$  and also allow calculating the theoretical noise power as a function of frequency.

### Calculating the theoretical noise

The total theoretical noise power in the load according to Eq. 10 can be calculated as a function of frequency because now all the noise-source parameters have been determined. Plotted values of these calculations in Fig. 3 show good agreement with the experimentally determined values, thus validating the accuracy of the noise model of Fig. 4.

If we define the noise figure of the amplifier as

$$NF = 10 \log_{10} \frac{P_n}{(\text{Power Gain})(kTB)}$$

we find  $NF = 2 \text{ dB}$ , at a point 10% away from the carrier.

Eq. 10 shows clearly the relative contribution

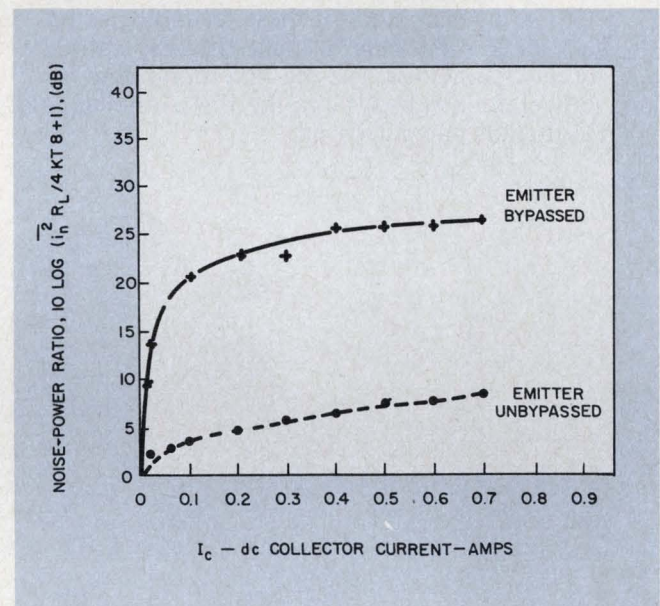

7. Plots of noise-power ratio, with and without emitter degeneration, show that an improvement of about 18 dB results with degeneration.

of the three noise sources to the total noise output. For frequencies close to the carrier, where emitter degeneration is weak, the base noise source,  $R_{ae}$ , dominates the output noise. At frequencies away from the carrier, the base and emitter sources are strongly degenerated, and the collector shot-noise component dominates. Fig. 7 shows that as much as 18-dB improvement in noise output is achieved with full emitter degeneration. ■■

### Reference

1. Lohrmann, D. R., “Determine Transmitter Noise Figure,” *Electronic Design* No. 13, June 21, 1975, pp. 86-89.



# SGS-ATES power linears or it's lonely at the top

Our loneliness and our leadership go back a long, long time; they began with power linears.

In fact, right from the start we've done it all ourselves; paving the way for the others. So that now, when you talk about power linears you automatically talk about SGS-ATES. And in all senses - from experience to technological progress, from the fullness of range to production know-how.

In 1968 we put the first audio amplifier on the market - the 2 W TAA 611 - and since then we've gone on being first at every new step along the way. In 1970 we were the first to achieve 5 W with the TBA 641 and TBA 800; in 1972 the first circuit with thermal protection - the 7 W TDA 810S.

In 1973 the first amplifier to achieve 10 W with full protection - the TCA 940.

In 1974 the first real Hi-Fi, the TDA 2020 - 20 W with 1% distortion.

The development of these technologies has also made it possible to make the first complete sound-channel for TV; the first monolithic vertical deflection system; the first complementary Darlington integrated pair.

## And now?

The TDA 2002: the most robust and compact audio amplifier. The very best of our design experience has gone into producing the TDA 2002: in the chip and the package. It comes in Pentawatt® and it's highly protected against thermal overloads; against short-circuits; against supply overvoltages including spikes.

With a 14.4 V supply it gives 8 W on 2  $\Omega$ . It is ideal for car radios and saves 50% on external components and even more on space.

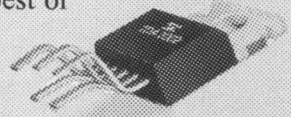

## And that's why



SGS-ATES SEMICONDUCTOR CORPORATION  
Newtonville, Mass., tel: 617-9691610

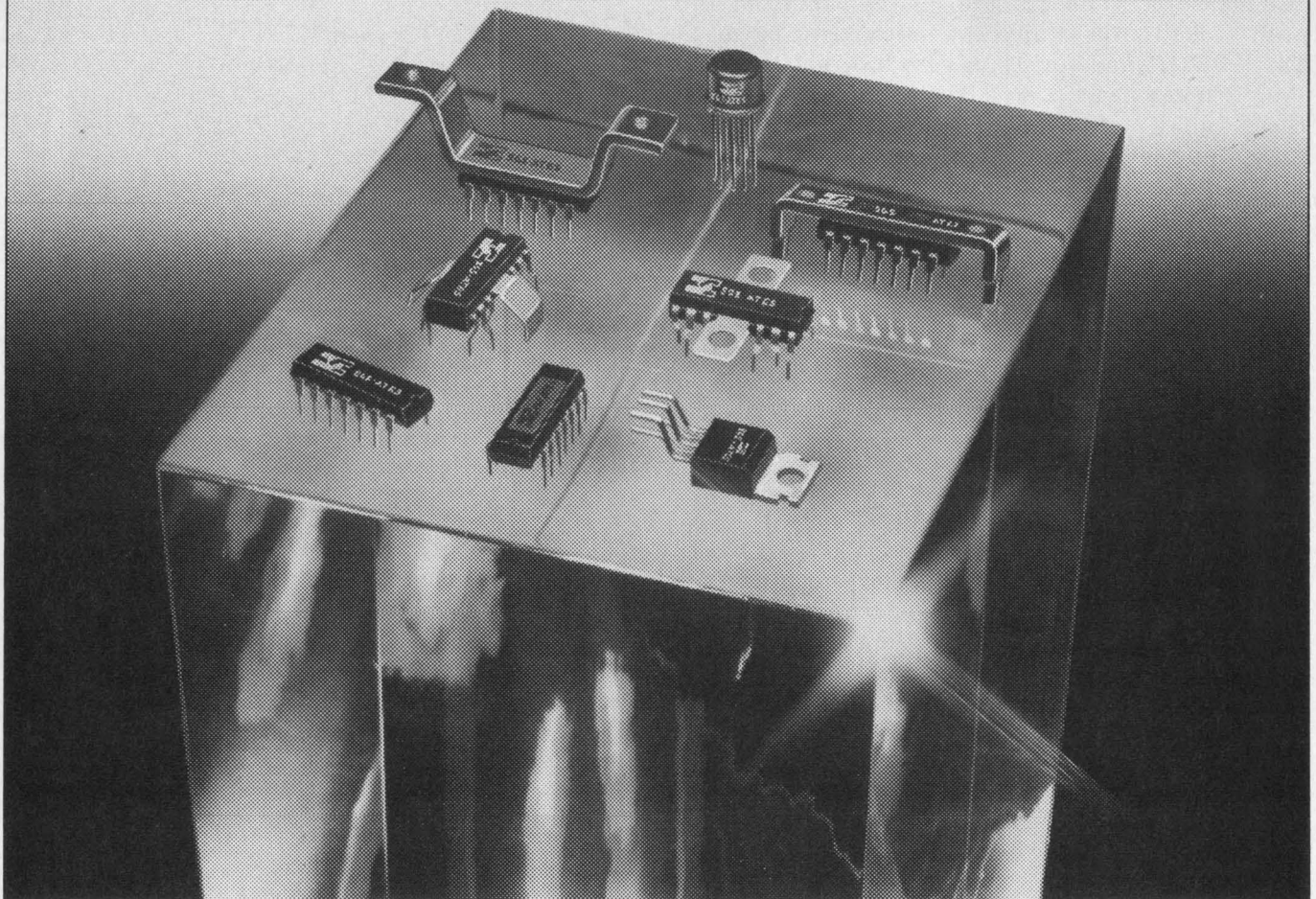



# Microprocessing becomes a buyer's market.

If you're a MOS microprocessor customer, the last few years haven't been a whole lot of laughs.

One supplier had all the good stuff, made all the rules, told you what you could buy. And when. And for how much.

But something happened to change all that: Advanced Micro Devices.

We make the best microprocessor in the world, the Am9080A, and we make all the support circuits you need. They're yours now, off the shelf, at competitive prices. That's right. Competitive.

But we make more than microprocessor products. We make you a promise:

We'll sell you any part, in any quantity, bundled or unbundled. You're the customer.

So, if you suddenly find yourself having an easier time buying microprocessors, just remember why. And who.

If you're shy, and you're just not sure how to say thank you, an order would be really nice.

Write or phone Advanced Micro Devices, The Buyer's Market.

## Ours and Theirs. (The 9080A & 8080A)

Specification	AMD	Intel
Minimum Instruction Cycle Time	1 microsecond	1.3 microseconds
Maximum Power Dissipation (at 1.3 microsec. 0-70°)	829 milliwatts	1307 milliwatts
Output Drive	3.2mA @ .4V	1.9mA @ .45V
Minimum Input High Voltage	3.0V	3.3V
MIL-STD-883	Standard	Special

## Ours and Ours. (Am9080A System Circuits)

AMD Part Number	Description	Availability
<b>CPU</b>		
Am9080A/-2/-1/-4	Speeds to 250 nsec. 0 to 70°C	In Dist. Stock
Am9080A/-2	Speeds to 380 nsec. -55 to +125°C	In Dist. Stock
<b>Static Read/Write Random Access Memories</b>		
Am9101A/B/C/D	256 x 4, 22 Pin Speeds to 250 nsec.	In Dist. Stock
Am91L01A/B/C	256 x 4, 22 Pin Speeds to 300 nsec.	In Dist. Stock
Am9102A/B/C/D	1K x 1, 16 Pin Speeds to 250 nsec.	In Dist. Stock
Am91L02A/B/C	1K x 1, 16 Pin Speeds to 300 nsec.	In Dist. Stock
Am9111A/B/C/D	256 x 4, 18 Pin Speeds to 250 nsec.	In Dist. Stock
Am91L11A/B/C	256 x 4, 18 Pin Speeds to 300 nsec.	In Dist. Stock
Am9112A/B/C/D	256 x 4, 16 Pin Speeds to 250 nsec.	In Dist. Stock
Am91L12A/B/C	256 x 4, 16 Pin Speeds to 300 nsec.	In Dist. Stock
Am9130A/B/C/D/E	1024 x 4, 22 Pin Speeds to 200 nsec.	In Dist. Stock
Am9140A/B/C/D/E	4096 x 1, 22 Pin Speeds to 200 nsec.	In Dist. Stock
<b>Dynamic Read/Write Random Access Memories</b>		
Am9050C/D/E	4K x 1, 18 Pin Speeds to 200 nsec.	In Dist. Stock
Am9060C/D/E	4K x 1, 22 Pin Speeds to 200 nsec.	In Dist. Stock

AMD Part Number	Description	Availability
<b>Mask Programmable Read-Only Memories</b>		
Am9208B/C/D	1K x 8 Speeds to 250 nsec.	Factory Stock
Am9216B/C	2K x 8 Speeds to 300 nsec.	Factory Stock
<b>Erasable Read-Only Memories</b>		
Am1702A	256 x 8, 1.0 μsec.	In Dist. Stock
Am2708	1024 x 8, 450 nsec.	4th Q. 1976
<b>Processor System Support Circuits</b>		
Am8212	8-bit I/O Port	In Dist. Stock
Am8216	Non-Inverting Bus Transceiver	In Dist. Stock
Am8224	Clock Generator	In Dist. Stock
Am8226	Inverting Bus Transceiver	In Dist. Stock
Am8228	System Controller	In Dist. Stock
Am8257	Direct Memory Access Controller	2nd Q. 1977
Am8259	Priority Interrupt Controller	2nd Q. 1977
Am9551	Programmable Communications Interface	4th Q. 1976
Am9555	Programmable Peripheral Interface	In Dist. Stock
Am25LS138	1-of-8 Decoder	In Dist. Stock
Am25LS139	Dual 1-of-4 Driver	In Dist. Stock
*Am25LS240	8-bit Inverting Bus Driver	4th Q. 1976
*Am25LS241	8-bit Non-Inverting Bus Driver	4th Q. 1976
*Am25LS273	8-bit Common Clear Register	4th Q. 1976
*Am25LS374	8-bit 3-state Register	4th Q. 1976
*Am25LS377	8-bit Common Enable Register	4th Q. 1976

\*All combine high performance and low power in space saving 20-pin package

CPU: 9080A = 480 nsec. - 2 = 380 nsec. - 1 = 320 nsec. - 4 = 250 nsec.  
MEM: A = 500 nsec. B = 400 nsec. C = 300 nsec. D = 250 nsec. E = 200 nsec.

# Advanced MOS/LSI



Advanced Micro Devices • 901 Thompson Place, Sunnyvale, California 94086 • Telephone (408) 732-2400 •  
Distributed nationally by Hamilton/Avnet, Cramer and Schweber Electronics.

CIRCLE NUMBER 38



## Model your ROM with NAND gates when you are using computer-aided design to prove out a digital system. This program models large ROMs, with minimal circuitry.

Digital circuitry is becoming so complex that it is quite difficult to design. For this reason, computer-aided-design (CAD) programs for verification and circuit simulation of digital circuits are becoming popular for pinpointing errors.

Digital simulators for logic circuitry use gates and flip-flops as the basic building blocks. From these building blocks, the MSI and LSI components are modeled for computer simulation of the circuit.

MSI components, such as ROMs, can be modeled using combinational circuitry. However, arriving at a minimal circuit representation for a large ROM by hand is a time-consuming job. A Fortran IV program described here generates that minimal circuitry for ROMs by using NAND gates.

This program is written for IBM 360 and 370-series machines that use the Fortran IV G-Level-20 compiler. The program requires 300-k words of core for a ten-input, eight-output ROM. Larger ROMs may be modeled on computers with larger memories.

### A short review of switching theory

Three concepts from switching theory should be understood in order to describe the program flow. Let's take a quick look at them before going on.

*Minterms.* A minterm is an input pattern for which a function is true, and has all its input variables included. For example, in a function of four input variables—called A, B, C and D—the term  $A\bar{B}CD$  is a minterm.  $AD$  is not, because B and C have not been defined. A minterm corresponds to a unique square in a Karnaugh map.

*Prime implicants.* Prime implicants correspond to groupings of ONEs (minterms) on a Karnaugh map.

*Essential prime implicants.* Essential prime implicants are prime implicants that contain a minterm contained in no other prime implicant.

James J. Hanratty, Electronics Engineer, Automatic Test Equipment Engineering Div., NARF Alameda, Alameda, CA 94501.

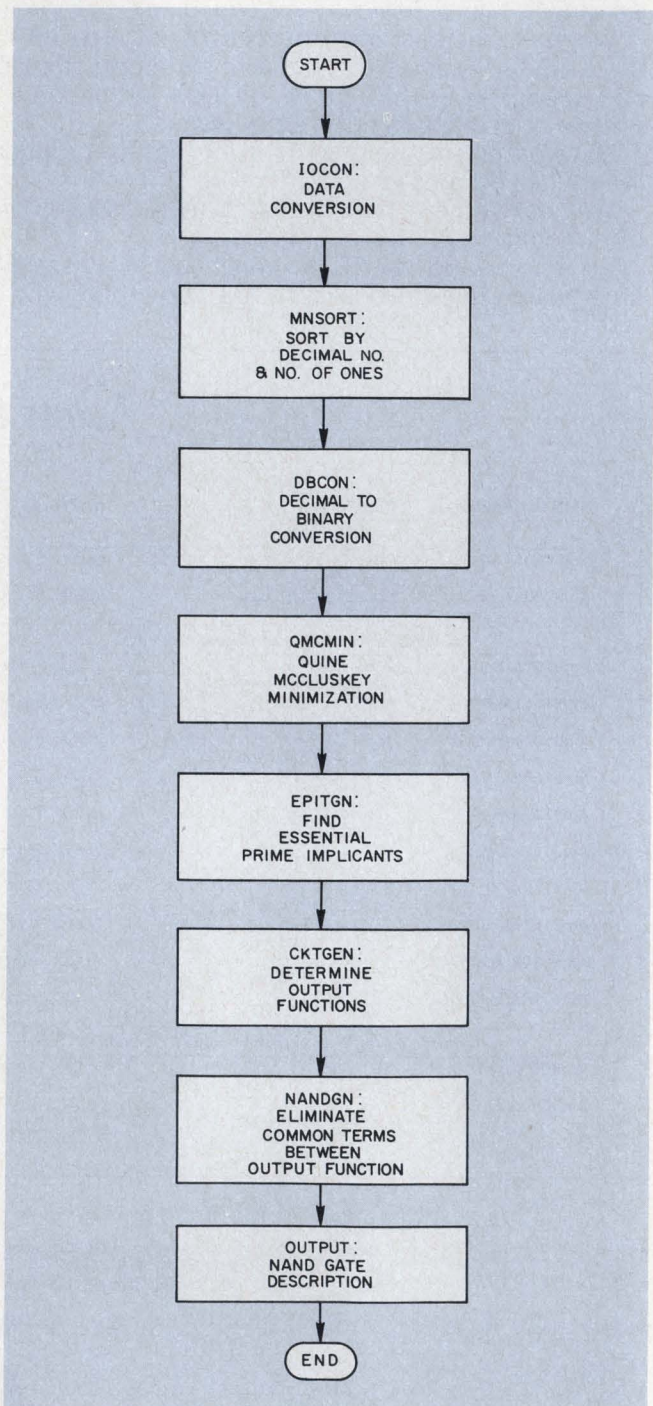

1. The ROMGEN program sequentially steps through subroutines to input the data, minimize the minterms and generate output descriptions of the NAND gates.



Inputs				Outputs		
1	2	3	4	11	12	13
0	0	0	1	0	0	1
0	0	1	0	1	0	1
0	1	0	0	1	1	0
0	0	1	1	0	0	1
0	1	0	1	0	1	0
1	0	1	0	1	1	1
1	1	0	0	1	0	1
1	0	1	1	1	1	1
1	1	0	1	1	1	0

2. The truth table for the ROM used in our example is rather small, but ROMs of any size can be modeled providing your computer has enough memory.

Previous CAD programs<sup>1</sup> have generated single-output combinatorial circuitry that could be used in the modeling of ROMs. This approach requires rerunning the program for each of the ROM outputs, a time-consuming process that results in circuitry that is not minimized.

### Model ROMs with minimal circuitry

ROMGEN, the approach shown here, uses classical techniques and results in near-minimal circuitry. The program is an easy-to-read NAND-gate description of the ROM.<sup>2,3</sup>

As the flowchart shows (Fig. 1), the main program calls the eight subroutines serially. The first subroutine is called IOCON, which reads in the truth table containing the minterms for the ROM, and also converts the binary input to decimal.

The next subroutine called is MNSORT. It performs two sorts on the input data, first by the ascending decimal value of the minterm and then by the number of ONEs in the minterm. This sorting speeds up execution time.

The following subroutine is DBCON, which converts the results of MNSORT back to binary.

QMCMIN, the next subroutine, minimizes the Karnaugh maps generated from the input data. The minimization is done by a tabular technique

known as the Quine-McCluskey method,<sup>2,3</sup> and results in a table of prime implicants corresponding, as usual, to the grouping of adjacent ONEs (minterms) on Karnaugh maps.

Following QMCMIN, the main program calls EPITGN. EPITGN takes the result of QMCMIN, the prime implicant table, and finds the essential prime implicants. After all the prime implicants that cover singular minterms have been found, any remaining minterms are covered by selecting an appropriate prime implicant.

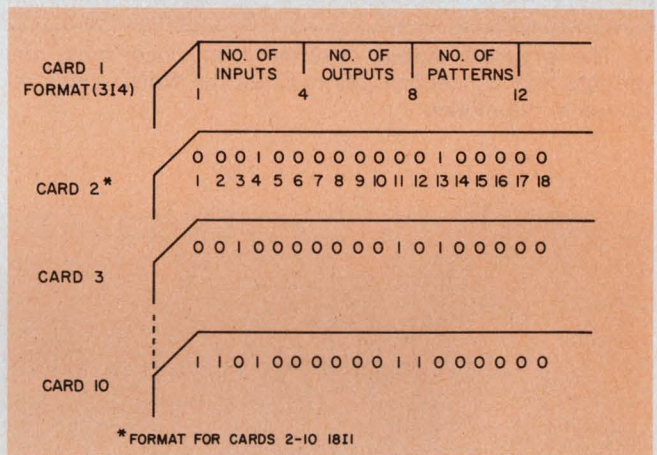

3. The program input consists of a format card first. Each of the following cards contains the address and corresponding data for every location in the ROM.

The next subroutine is CKTGEN. This subroutine selects sets of essential prime implicants to implement each ROM output.

The main program then calls NANDGN. This subroutine eliminates any redundant terms shared by the output functions. Finally, the subroutine OUTPUT is called. This subroutine produces the NAND gate description of the ROM.

### Modeling a four-input, three-output ROM

Let's use the program to generate a model for a four-input, three-output ROM. The first step is to define the ROM truth table (Fig. 2). Next, enter the ROM data onto cards, formatted as shown in Fig. 3. The first data card contains the number of inputs, number of outputs and number of patterns. Following the first card, enter the input-output patterns, one pattern per card.

Fig. 4 shows the program output. The format is the same as that used in Digitest's D-Laser,<sup>4</sup> a digital circuit automatic stimulus generation and response simulation CAD program. As an example of how to interpret the output, take 19NA/990,3,991//.

Here, gate no. 19 has its inputs connected to output nodes 990,3, and 991. The // indicates that the output-node number of gate no. 19



```

19NA/990,3,991//      11NA/19,20,21,22,23,//
20NA/992,2,993,991//  12NA/24,21,23//
21NA/1,990,3//       13NA/27,19,21,22//
22NA/1,2,993,991//   990NA/2//
23NA/1,2,993,4//     991NA/4//
24NA/992,2,993//     992NA/1//
27NA/992,990,4//     993NA/3//

```

4. The program output describes, in coded form, the outputs and connection points of all the NAND gates required in the model.

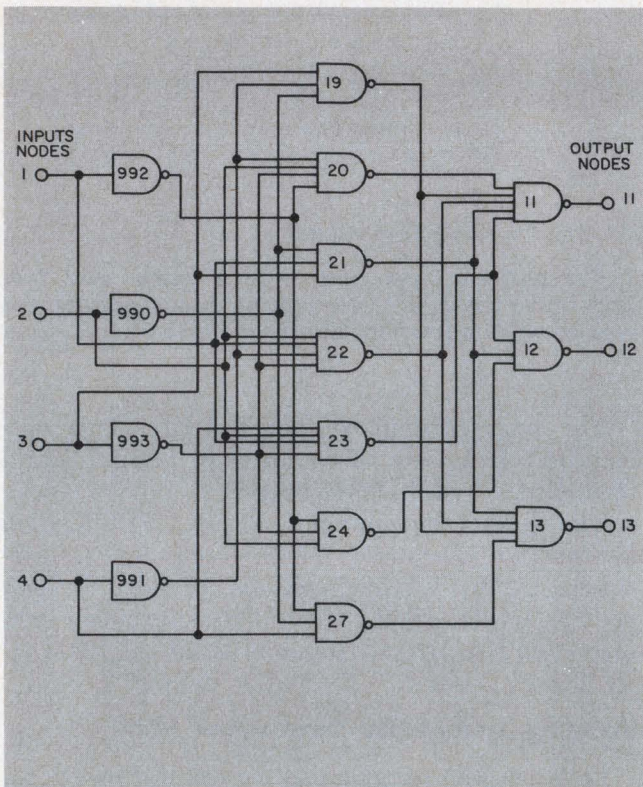

5. The NAND gate equivalent circuit for the ROM is drawn directly from the listing in Fig. 4. Single digits are the input nodes.

is also 19. Interconnecting these NAND gates forms the ROM model (Fig. 5). This ROM model requires only 14 gates. ■■

#### References

1. Shiva, S. G. and Nagle, H. T. Jr., "Bypass Multi-variable Karnaugh Maps," *Electronic Design*, No. 21, Oct. 11, 1974.
2. Hill, J. F. and Peterson, G. R., *Introduction to Switching Theory and Logical Design*, John Wiley and Sons, New York, 1968, Chapter 7.
3. Kohavi, Z., *Switching and Finite Automata Theory*, McGraw-Hill, New York, 1970, Chapter 4.
4. D-Laser User's Guide, University Computing Company, Dallas, TX, Nov., 1973.

## ROMGEN program listing

```

C
C          ROMGEN
C THE FUNCTION OF THIS PROGRAM IS TO GENERATE COMBINATIONAL
C CIRCUITRY TO MODEL A ROM (1024X8) MAX.
C PROGRAM INPUT CONSISTS OF INPUT PATTERNS,MSB FIRST,OUTPUT
C PATTERNS FOR EACH INPUT PATTERN,MSB FIRST,THE # OF ADDRESS
C LINES,THE # OF DATA LINES,TOTAL # OF I/O CARDS.
C PROGRAM OUTPUT CONSISTS OF A NAND GATE DESCRIPTION OF THE ROM
C LASAR GATE FORMAT IS USED (9NA/1,2,3//).
DIMENSION IFUNC(10240,19),IPIT(1024,19),EPIT(1024,18)
RFAID(5,1) NI,NO,NC
FORMAT(3I4)
1 CALL IOCON(NI,NO,NC,IFUNC)
WRITE(6,2)
2 FORMAT(' ','IOCON COMPLETED')
CALL MNSORT(IFUNC,NC)
WRITE(6,3)
3 FORMAT(' ','MNSORT COMPLETED')
CALL DBCON(IFUNC,NC,NI)
WRITE(6,4)
4 FORMAT(' ','DBCON COMPLETED')
CALL QMCMIN(IFUNC,NC,NO,NI,LPIT,IPIT)
WRITE(6,5)
5 FORMAT(' ','QMCMIN COMPLETED')
CALL EPITGN(IPIT,IFUNC,LPIT,EPIT,NI,NO,LEPIT)
WRITE(6,8)
8 FORMAT(' ','EPITGN COMPLETED')
CALL CKTGEN(EPIT,IFUNC,IPIT,LEPIT,NI,NO)
WRITE(6,6)
6 FORMAT(' ','CKTGEN COMPLETED')
CALL NANUGN(IFUNC,IPIT,NI,NO,LX,LEPIT)
WRITE(6,7)
7 FORMAT(' ','NANUGN COMPLETED')
CALL OUTPUT(IFUNC,LX)
STOP
END

SUBROUTINE IOCON(I,NO,NC,IFUNC)
DIMENSION IOBS(16),IRITS(10),OBITS(8),IFUNC(10240,19)
INTEGER OBITS
20 FORMAT(' ','THIS ROM HAS',I2,1X,'INPUTS',I1,1X,'OUTPUTS,AND IS DE
ISCRIBED BY THE FOLLOWING TRUTH TABLE:')
M=0
ICC=0
DO 15 MM=1,10240
DO 16 N=1,19
IFUNC(MM,N)=0
16 CONTINUE
15 CONTINUE
RFAID(5,1) (IOBS(I),I=1,16)
WRITE(6,21) (IOBS(LA),LA=1,16)
21 FORMAT('0',26X,'P11')
1 IFUNC(1811)
ICC=ICC+1
M=M+1
N=0
N=N+1
I=1
L=NI
IRITS(I)=IOBS(I)
I=I+1
IF(I.GT. 10) GO TO 3
GO TO 2
3 OBITS(I-10)=IOBS(I)
I=I+1
IF(I.GT. 16) GO TO 4
GO TO 3
4 I=1
IC=0
ID=0
8 IF (IBITS(I) .EQ. 0) GO TO 6
IC=IC+1
ID=ID+IBITS(I)*2**(L-1)
6 I=I+1
L=L-1
IF(L.GT. NI) GO TO 7
GO TO 8
7 J=1
IFUNC(M,N)=ID
N=N+1
IFUNC(M,N)=IC
N=N+9
11 IF (OBITS(J) .EQ. 1) GO TO 9
J=J+1
IF(J.GT. NO) GO TO 10
GO TO 11
9 IFUNC(M,N)=J
J=J+1
N=N+1
IF(J.GT. NO) GO TO 10
GO TO 11
10 IF (ICC.EQ.NC) GO TO 12
GO TO 13
12 RETURN
END

SUBROUTINE MNSORT(IFUNC,NC)
DIMENSION IFUNC(10240,19)
N=2
M=1
MC=0
4 IF (IFUNC(M,N).EQ. IFUNC(M+1,N)) GO TO 1
IF (IFUNC(M,N).LT. IFUNC(M+1,N)) GO TO 1
DO 3 N=1,19
ITEMP=IFUNC(M,N)
IFUNC(M,N)=IFUNC(M+1,N)
IFUNC(M+1,N)=ITEMP
3 CONTINUE
MC=MC+1
N=2
M=M+1
IF (M.EQ.NC) GO TO 19
GO TO 4
19 IF (MC.EQ.0) GO TO 8
GO TO 7
8 N=1

```



```

L=2
M=1
16 MC=0
IPT=0
12 IF(IFUNC(M,N).GT,IFUNC(M+1,N).AND,IFUNC(M,L).EQ,IFUNC(M+1,L))GO TO
19
IF(IFUNC(M,L).EQ,IFUNC(M+1,L)) GO TO 10
IF(MC,EQ,0) GO TC 11
M=M-IPT
9 GO TO 12
IPT=IPT+1
DO 13 N=1,19
ITEMP=IFUNC(M,N)
IFUNC(M,N)=IFUNC(M+1,N)
IFUNC(M+1,N)=ITEMP
13 CONTINUE
MC=MC+1
N=1
11 IPT=IPT+1
10 M=M+1
IF(M,EQ,NC) GO TC 14
GO TO 12
14 IF(MC,EG,0) GO TC 15
M=M-IPT
GO TO 16
15 RETURN
END

SUBROUTINE DECON(IFUNC,NC,NI)
DIMENSION IFUNC(10240,19),ITEMP(10)
I=NI
N=1
M=1
6 K=IFUNC(M,N)
4 INIV=K/2
NDIV=FLOAT(K)/2.0
IF(IDIV,EG,RDVI)CC TO 1
ITEMP(I)=1
II=I-1
IF(II,EG,0)GO TO 7
K=IUIV
GO TO 4
1 ITEM=ITEMP(II)=0
II=II-1
IF(II,EG,0)GO TO 7
K=IUIV
GO TO 4
2 M=M+1
IF(N,GT,NC)GO TO 5
II=II
GO TO 6
7 IFUNC(M,19)=IFUNC(M,2)
DO 8 N=1,NI
IFUNC(M,N)=ITEMP(N)
8 CONTINUE
N=1
GO TO 2
5 RETURN
END

SUBROUTINE QMTRM(IFUNC,NC,NO,NI,LPIT,IPIT)
DIMENSION IPIT(1024,19),IFUNC(10240,19),LTEMP(18)
DO 65 LA=1,1024
DO 66 LB=1,19
IPIT(LA,LB)=0
66 CONTINUE
65 CONTINUE
DO 804 LA=1,18
LTEMP(LA)=0
804 CONTINUE
IFND=NC
MPTR=0
IFLAG=0
M=1
ISPTR=5120
LL=1
LLL=1
22 MMM=-4
DO 900 LA=1,10240
IFUNC(LA,19)=0
900 CONTINUE
GO TO 15
23 MMM=-5
DO 26 LA=1,10240
IFUNC(LA,19)=0
26 CONTINUE
15 N=11
MM=11
ITM=0
NN=11
4 IF(IFUNC(M,N).EQ,IFUNC(M+LL,NN))GO TO 1
GO TO 2
1 LTEMP(MM)=IFUNC(M,N)
N=N+1
ITM=1
IF(N,GT,NO+10,OR,IFUNC(M,N).EQ,0)GO TO 5
MM=MM+1
NN=11
GO TO 4
2 NN=NN+1
IF(NN,GT,NO+10,OR,IFUNC(M+LL,NN).EQ,0)GO TO 3
GO TO 4
3 N=N+1
NN=11
IF(N,GT,NO+10,OR,IFUNC(M,N).EQ,0)GO TO 5
GO TO 4
5 IF(ITM,EG,0)GO TC 6
N=1
MM=1
IRM=0
NN=1
9 IF(IFUNC(M,N).EQ,IFUNC(M+LL,NN))GO TO 7
GO TO 8
7 LTEMP(MM)=IFUNC(M,N)
N=N+1
MM=MM+1
NN=NN+1
IF(NN,GT,NI)GO TC 11
GO TO 9
8 LTEMP(MM)=-1

```

```

N=N+1
MM=MM+1
IBM=IBM+1
IF(IBM,GT,1)GO TC 6
NN=NN+1
IF(NN,GT,NI)GO TC 11
GO TO 9
11 IF(IRM,GT,1)GO TC 6
N=1
IF(MMM,EG,-4)GO TC 30
NNN=ISPTR
ISPTR=1
GO TO 31
30 NNN=ISPTR
ISPTR=5120
31 IF(LTEMP(NN).EQ,TFLNC(ISPTR,NN))GO TO 32
ISPTR=ISPTR+1
IF(ISPTR,GT,NNN)CC TO 33
N=1
GO TO 31
32 N=N+1
IF(N,GT,NI)GO TO 9A
GO TO 31
98 MM=11
91 IF(LTEMP(MM).FQ,IFUNC(M,MM))GO TO 90
93 MM=11
95 IF(LTEMP(MM).FQ,IFUNC(M+LL,MM))GO TO 94
GO TO 97
90 MM=MM+1
IF(MM,GT,NO+10)CC TO 92
GO TO 91
92 IFUNC(M,19)=1
GO TO 93
94 MM=MM+1
IF(MM,GT,NO+10)CC TO 96
GO TO 95
96 IFUNC(M+LL,19)=1
97 ISPTR=NNN
GO TO 6
33 ISPTR=NNN
MM=11
71 IF(LTEMP(MM).EQ,IFUNC(M,MM))GO TO 70
84 MM=11
81 IF(LTEMP(MM).FQ,IFUNC(M+LL,MM))GO TO 80
GO TO 83
70 MM=MM+1
IF(MM,GT,NO+10)CC TO 72
GO TO 71
72 IFUNC(M,19)=1
GO TO 84
80 MM=MM+1
IF(MM,GT,NO+10)CC TO 82
GO TO 81
82 IFUNC(M+LL,19)=1
83 GO 13 N=1,18
IFUNC(ISPTR,NN)=ITEMP(N)
13 CONTINUE
DO 40 MM=1,18
LTEMP(MM)=0
40 CONTINUE
IFLAG=1
ISPTR=ISPTR+1
MPTR=MPTR+1
6 LL=LL+1
DO 50 MM=1,18
LTEMP(MM)=0
50 CONTINUE
35 IF(M+LL,GT,IEND)CC TO 16
GO TO 15
16 IF(IFUNC(M,19).FQ,1)GO TO 20
GO TO 17
20 M=M+1
LI=1
IF(M,GT,IEND)GO TC 18
GO TO 15
17 DO 19 N=1,18
IPIT(LLL,N)=IFUNC(M,N)
19 CONTINUE
LLL=LLL+1
GO TO 20
18 IF(IFLAG,EG,0)GO TO 21
IF(MMM,EG,-4)GO TC 24
M=1
ISPTR=5120
IFND=MPTR
IFLAG=0
MPTR=0
LL=1
DO 1002 LA=5120,10240
DO 1003 LB=1,19
IFUNC(LA,LB)=0
1003 CONTINUE
1002 CONTINUE
GO TO 22
24 M=5120
802 ISPTR=1
IFND=MPTR+5119
IFLAG=0
MPTR=0
LL=1
DO 1000 LA=1,5119
DO 1001 LB=1,19
IFUNC(LA,LB)=0
1001 CONTINUE
1000 CONTINUE
GO TO 23
21 LPIT=LLL-1
RETURN
END

SUBROUTINE EPITCA(IPIT,IFUNC,LPIT,EPIT,NI,NO,LEPIT)
DIMENSION IPIT(1024,19),IFUNC(10240,19),EPIT(1024,18),
LTEMP(18)
INTEGER EPIT
LPIT=0
LR=1
IX=0
LN=1
DO 1 M=1,10240

```

(continued on page 92)



(continued from page 91)

```

      DN 2 N=1,19
      IFUNC(M,N)=0
      CONTINUE
1     CONTINUE
      DO 92 LA=1,1024
      DO 93 LB=1,18
      EPIT(LA,LB)=0
93    CONTINUE
92    CONTINUE
      LL=1
13   DO 3 KK=1,18
      LTEMP(KK)=IPIT(LL, KK)
3     CONTINUE
      CALL MINGEN(IFUNC,LTEMP,NI,NO,IMC,IOC)
      MM=1026
7     IADR=1+(IFUNC(MM,19)-1)*1025
      M=1
5     IFUNC(IADR+IFUNC(M,19),1)=-1
      IFUNC(IADR+IFUNC(M,19),2)=IFUNC(IADR+IFUNC(M,19),2)+1
      M=M+1
      IF(M.GT.IMC)GO TO 4
      GO TO 5
4     MM=MM+1
      IF(MM.GT.1025+IOC)GO TO 6
      GO TO 7
6     LL=LL+1
      IF(LL.GT.LPIT)GO TO 12
      GO TO 13
12   M=1
10   IF(IFUNC(M,2).EQ.1.AND.IFUNC(M,3).EQ.0)GO TO 8
      M=M+1
      IF(M.GT.LN*1025) LN=LN+1
      IF(M.GT.NO*1025)GO TO 9
      GO TO 10
8     LL=1
      IFUNC(1025,18)=M-1-(LN-1)*1025
      IFUNC(1026,18)=LA
90   DN 100 KK=1,18
      LTEMP(KK)=IPIT(LL, KK)
100  CONTINUE
      MM=1026
      IF(LTEMP(1).EQ.-2)GO TO 42
      CALL MINGEN(IFUNC,LTEMP,NI,NO,IMC,IOC)
40   IF(IFUNC(1026,18).EQ.IFUNC(MM,19))GO TO 41
      MM=MM+1
      IF(MM.GT.1025+IOC)GO TO 42
      GO TO 40
42   LL=LL+1
      IF(LL.GT.LPIT)GO TO 900
      GO TO 90
41   MM=1
81   IF(IFUNC(1025,18).EQ.IFUNC(MM,19))GO TO 43
      MM=MM+1
      IF(MM.GT.IMC)GO TO 42
      GO TO 81
43   DN 44 N=1,18
      EPIT(LR,N)=IPIT(LL,N)
      CONTINUE
      DO 904 LA=1,6
      IFUNC(LA,17)=0
904  CONTINUE
      LFPIT=LFPIT+1
      LR=LR+1
      MM=1026
      MMM=1
48   IADR=1+(IFUNC(MM,19)-1)*1025
46   IFUNC(IADR+IFUNC(MM,19),3)=2
      MMM=MMM+1
      IF(MMM.GT.IMC)GO TO 45
      GO TO 46
45   MM=MM+1
      IF(MM.GT.1025+IOC)GO TO 47
      MMM=1
      GO TO 48
47   IPIT(LL,1)=-2
      IF(IX.EQ.1)GO TO 11
      M=M+1
      GO TO 10
9     M=1
      IX=1
      LN=1
15   IF(IFUNC(M,3).EQ.2.OR.IFUNC(M,1).EQ.0)GO TO 11
      GO TO 14
11   M=M+1
      IF(M.GT.LN*1025) LN=LN+1
      IF(M.GT.NO*1025)GO TO 16
      GO TO 15
14   III=LN
      KKKK=0
32   KKKK=KKKK+1
      IFUNC(1025+KKKK,18)=III
30   III=III+1
      IF(III.GT.NO)GO TO 33
      NOP=M+(III-1)*1025
      IF(IFUNC(NOP,1).EQ.-1)GO TO 32
      GO TO 30
33   IFUNC(1025,18)=M-1-(LN-1)*1025
      KK=1
54   IF(IPIT(KK,1).EQ.-2)GO TO 53
      DO 50 LA=1,18
      LTEMP(LA)=IPIT(KK, LA)
50   CONTINUE
      CALL MINGEN(IFUNC,LTEMP,NI,NO,IMC,IOC)
      DO 51 NN=1, KKKK
      IF(IFUNC(1025+NN,19).NE.IFUNC(1025+NN,18))GO TO 53
51   CONTINUE
52   IF(IFUNC(1025,18).EQ.IFUNC(NN,19))GO TO 55
      NN=NN+1
      IF(NN.GT.IMC)GO TO 53
      GO TO 52
53   KK=KK+1
      IF(KK.GT.LPIT)GO TO 57
      GO TO 54
55   IF(IMC.GT.IFUNC(1,17))GO TO 56
      GO TO 53
56   IFUNC(1,17)=IMC
      IFUNC(2,17)=KK
      IFUNC(3,17)=IOC
      GO TO 53
57   IF(IFUNC(1,17).EQ.0)GO TO 58
      IMC=IFUNC(1,17)
      LL=IFUNC(2,17)
      IOC=IFUNC(3,17)
      DO 905 LA=1,18
      LTEMP(LA)=IPIT(LL, LA)
905  CALL MINGEN(IFUNC,LTEMP,NI,NO,IMC,IOC)
      GO TO 43
58   KK=1
63   IF(IPIT(KK,1).EQ.-2)GO TO 62
      DO 59 LA=1,18
      LTEMP(LA)=IPIT(KK, LA)
59   CONTINUE
      CALL MINGEN(IFUNC,LTEMP,NI,NO,IMC,IOC)
      NN=1
      MM=1
60   IF(IFUNC(1025+MM,19).EQ.IFUNC(1025+MM,18))GO TO 64
      MM=MM+1
      IF(MM.GT.IOC)GO TO 61
      GO TO 60
61   NN=NN+1
      MM=1
      IF(NN.GT.KKKK)GO TO 62
      GO TO 60
62   KK=KK+1
      IF(KK.GT.LPIT)GO TO 67
      GO TO 63
64   NN=1
68   IF(IFUNC(1025,18).EQ.IFUNC(NN,19))GO TO 65
      NN=NN+1
      IF(NN.GT.IMC)GO TO 62
      GO TO 68
65   IF(IOC.GT.IFUNC(5,17))GO TO 66
      GO TO 62
66   IF(IMC.GT.IFUNC(3,17))GO TO 69
      GO TO 62
69   IFUNC(4,17)=IMC
      IFUNC(5,17)=KK
      IFUNC(6,17)=IOC
      GO TO 62
67   LL=IFUNC(5,17)
      IMC=IFUNC(4,17)
      IOC=IFUNC(6,17)
      DO 906 LA=1,18
      LTEMP(LA)=IPIT(LL, LA)
906  CONTINUE
      CALL MINGEN(IFUNC,LTEMP,NI,NO,IMC,IOC)
      GO TO 43
900  WRITE(6,901)
901  FORMAT(' ','IPIT SCANNED WITHOUT FINDING A MATCH')
16   RETURN
      END

      SUBROUTINE CKTGEN(EPIT,IFUNC,IPIT,LFPIT,NI,NO)
      DIMENSION EPIT(1024*18),IPIT(1024*19),IFUNC(10240*19),
      SLTEMP(18)
      INTEGER EPIT
      MN=1
      LN=1
      DO 1 M=1,1024
      DO 2 N=1,19
      IPIT(M,N)=0
      CONTINUE
      DO 3 M=1,10240
      DO 4 N=2,19
      IFUNC(M,N)=0
      CONTINUE
      CONTINUE
      LI=1
11   DO 5 KK=1,18
      LTEMP(KK)=EPIT(LL, KK)
      CONTINUE
      CALL MINGEN(IFUNC,LTEMP,NI,NO,IMC,IOC)
      MM=1026
      IADR=1+(IFUNC(MM,19)-1)*1025
      M=1
6   IFUNC(IADR+IFUNC(M,19),2)=IFUNC(IADR+IFUNC(M,19),2)+1
      M=M+1
      IF(M.GT.IMC)GO TO 7
      GO TO 6
7     MM=MM+1
      IF(MM.GT.1025+IOC)GO TO 8
      GO TO 9
8     LL=LL+1
      IF(LL.GT.LFPIT)GO TO 10
      GO TO 11
10    M=1
14    IF(M.GT.LN*1025)GO TO 12
29    IF(IFUNC(M,2).EQ.1.AND.IFUNC(M,3).NE.2)GO TO 13
      M=M+1
      GO TO 14
13    IFUNC(1025,18)=M-1-(LN-1)*1025
      IFUNC(1026,18)=LA
      NN=1
19    MM=1026
      DO 15 KK=1,18
      LTEMP(KK)=EPIT(MM, KK)
15    CONTINUE
      CALL MINGEN(IFUNC,LTEMP,NI,NO,IMC,IOC)
18    IF(IFUNC(1026,18).EQ.IFUNC(MM,19))GO TO 16
      MM=MM+1
      IF(MM.GT.1025+IOC)GO TO 17
      GO TO 18
17    NN=NN+1
      IF(NN.GT.LFPIT)GO TO 999
      GO TO 19
16    MM=1
22    IF(IFUNC(1025,18).EQ.IFUNC(MM,19))GO TO 20
      MM=MM+1
      IF(MM.GT.IMC)GO TO 21
      GO TO 22
      NN=NN+1
      IF(NN.GT.LFPIT)GO TO 999
      GO TO 19
20   DO 23 N=1,18
      IPIT(MN,N)=EPIT(MN,N)
23   CONTINUE

```



```

MN=MN+1
MMM=1
IADR=1+(LN-1)*1024
25 IFUNC(IADR+IFUNC(MMM,19),3)=2
MMM=MMM+1
IF(MMM.GT.IMC)GO TO 26
GO TO 25
26 M=M+1
GO TO 14
12 LN=LN+1
IPIT(MN-1,19)=1
IF(LN.GT.NO)GO TO 28
GO TO 29
999 WRITE(6,900)
900 FORMAT(' ','EPIT SCANNED WITHOUT FINDING A MATCH')
28 RETURN
END

```

```

SUBROUTINE NANDRN(IFUNC,IPIT,NI,NO,LX,LEPIT)
DIMENSION IPIT(1024,19),IFUNC(10240,19),LTEMP(18)
INTEGER OPN
LCC=NI+1
MM=2
NN=1
OPN=1
N=0
LL=1
DO 1 M=1,10240
DO 2 NM=1,19
IFUNC(M,MM)=0
2 CONTINUE
1 CONTINUE
8 IFUNC(LL,1)=LL+1E
6 N=N+1
IF(N.GT.NI)GO TO 3
IF(IPIT(LL,N).EQ.0)GO TO 4
IF(IPIT(LL,N).EQ.0)GO TO 5
GO TO 6
4 IFUNC(LL,MM)=N
MM=MM+1
GO TO 6
5 IFUNC(LL,MM)=N
MM=MM+1
GO TO 6
3 IF(IPIT(LL,19).FC.1)GO TO 7
10 IFUNC(LL,13)=OPN
99 LL=LL+1
N=0
MM=2
GO TO 8
7 IFUNC(LL,13)=OPN
OPN=OPN+1
IF(OPN.GT.NO)GO TO 9
GO TO 99
9 LN=LL
LL=LL+1
KK=1
N=2
15 ITEMP=IFUNC(KK,13)
13 IFUNC(LL,1)=IFUNC(KK,13)+10
IFUNC(LL,N)=IFUNC(KK,1)
KK=KK+1
IF(KK.GT.LN)GO TO 14
IF(IFUNC(KK,13).NE.ITEMP)GO TO 11
N=N+1
IF(N.EQ.19)GO TO 12
GO TO 13
12 IFUNC(LL,19)=-5
LL=LL+1
N=1
98 IFUNC(LL,N)=IFUNC(KK,1)
KK=KK+1
IF(KK.GT.LN)GO TO 14
IF(IFUNC(KK,13).NE.ITEMP)GO TO 11
N=N+1
IF(N.EQ.19)GO TO 12
GO TO 98
11 LL=LL+1
N=2
GO TO 15
14 DO 16 M=1,1024
DO 17 N=1,19
IPIT(M,N)=0
17 CONTINUE
16 CONTINUE
LKN=1
LLL=1
MM=1
N=2
20 IF(IFUNC(LLL,N).LT.0)GO TO 18
N=N+1
IF(N.GT.NI+1)GO TO 19
GO TO 20
19 LLL=LLL+1
N=2
IF(LLL.GT.LL)GO TO 21
GO TO 20
18 DO 22 NML=1,MM
IF(IFUNC(LLL,N).EQ.IPIT(NML,1))GO TO 23
22 CONTINUE
IPIT(MM,1)=IFUNC(LLL,N)
IPIT(MM,2)=989+LKN
IFUNC(LLL,N)=989+LKN
IFUNC(LL+LKN,1)=989+LKN
IFUNC(LL+LKN,2)=IARS(IPIT(MM,1))
MM=MM+1
LKN=LKN+1
GO TO 24
23 IFUNC(LLL,N)=IPIT(NML,2)
GO TO 24
21 Lx=LL+LKN-1
MM=1
JJ=1
JJJ=1
KKK=1
903 DO 900 II=1,LCC
LTEMP(II)=IFUNC(JJ,II)
900 CONTINUE
KKK=KKK+1

```

```

II=2
911 IF(IFUNC(JJJ,II).EQ.LTEMP(II)).AND.JJJ.NE.MM)GO TO 912
JJJ=JJJ+1
II=2
IF(JJJ.GT.LX)GO TO 909
GO TO 911
912 II=II+1
IF(II.GT.NI+1)GO TO 904
GO TO 911
909 JJ=JJ+1
MM=MM+1
IF(JJ.GT.LX)GO TO 910
JJJ=KKK
GO TO 903
904 III=IFUNC(JJJ,1)
DO 905 LL=JJJ,LX
DO 906 KK=1,19
IFUNC(LL,KK)=IFUNC(LL+1,KK)
906 CONTINUE
905 CONTINUE
LX=LX-1
DO 907 LL=1,LX
DO 908 KK=1,18
IF(IFUNC(LL,KK).EQ.III) IFUNC(LL,KK)=LTEMP(1)
908 CONTINUE
907 CONTINUE
II=2
GO TO 911
910 RETURN
END
SUBROUTINE OUTPUT(IFUNC,LX)
DIMENSION IFUNC(10240,19)
WRITE(6,401)
401 FORMAT('0',18X,'THE LASAR DESCRIPTION OF THIS ROM IS:')
M=1
IFSN=1
400 IF(M.GT.LX)GO TO 599
WRITE(6,100) IFUNC(M,1),IFUNC(M,2)
N=3
200 IF(IFUNC(M,N).EQ.0)GO TO 300
IF(IFUNC(M,N).EQ.-5)GO TO 500
600 GO TO(900,901,902,903,904,905,906,907,908,909,910,911,912,
$913,914,700),IFSN
601 N=N+1
IFSN=IFSN+1
GO TO 200
300 GO TO(1000,1001,1002,1003,1004,1005,1006,1007,1008,1009,1010,
$1011,1012,1013,1014,1015,1016),IFSN
501 M=M+1
N=3
IFSN=1
GO TO 400
M=M+1
N=1
IFSN=1
WRITE(6,38)
GO TO(915,916),N
502 N=N+1
IF(IFUNC(M,N).EQ.0.AND.N.EQ.2)GO TO 1900
IF(IFUNC(M,N).EQ.0.AND.N.EQ.3)GO TO 1901
IF(N.GT.2)GO TO 200
GO TO 501
100 FORMAT(' ',13,'A',' ',13)
1 FORMAT(' ',10X,' ',13)
2 FORMAT(' ',14X,' ',13)
3 FORMAT(' ',18X,' ',13)
4 FORMAT(' ',22X,' ',13)
5 FORMAT(' ',26X,' ',13)
6 FORMAT(' ',30X,' ',13)
7 FORMAT(' ',34X,' ',13)
8 FORMAT(' ',38X,' ',13)
9 FORMAT(' ',42X,' ',13)
10 FORMAT(' ',46X,' ',13)
11 FORMAT(' ',50X,' ',13)
12 FORMAT(' ',54X,' ',13)
13 FORMAT(' ',58X,' ',13)
14 FORMAT(' ',62X,' ',13)
15 FORMAT(' ',66X,' ',13)
16 FORMAT(' ',70X,' ',13)
38 FORMAT(' ',74X,' ',13)
17 FORMAT(' ',10X,'//',13)
18 FORMAT(' ',14X,'//',13)
19 FORMAT(' ',18X,'//',13)
20 FORMAT(' ',22X,'//',13)
21 FORMAT(' ',26X,'//',13)
22 FORMAT(' ',30X,'//',13)
23 FORMAT(' ',34X,'//',13)
24 FORMAT(' ',38X,'//',13)
25 FORMAT(' ',42X,'//',13)
26 FORMAT(' ',46X,'//',13)
27 FORMAT(' ',50X,'//',13)
28 FORMAT(' ',54X,'//',13)
29 FORMAT(' ',58X,'//',13)
30 FORMAT(' ',62X,'//',13)
31 FORMAT(' ',66X,'//',13)
32 FORMAT(' ',70X,'//',13)
33 FORMAT(' ',3X,13)
34 FORMAT(' ',6X,' ',13)
35 FORMAT(' ',6X,'//',13)
36 FORMAT(' ',10X,'//',13)
37 FORMAT(' ',14X,'//',13)
900 WRITE(6,1) IFUNC(M,N)
GO TO 601
901 WRITE(6,2) IFUNC(M,N)
GO TO 601
902 WRITE(6,3) IFUNC(M,N)
GO TO 601
903 WRITE(6,4) IFUNC(M,N)
GO TO 601
904 WRITE(6,5) IFUNC(M,N)
GO TO 601
905 WRITE(6,6) IFUNC(M,N)
GO TO 601
906 WRITE(6,7) IFUNC(M,N)
GO TO 601
907 WRITE(6,8) IFUNC(M,N)
GO TO 601
908 WRITE(6,9) IFUNC(M,N)

```

(continued on page 94)



# EMC's New Computerized IC Panel Design Service

In a hurry? EMC can shorten your need time with a computer-aided Design/Drafting Package for your new Wire-Wrap® IC Panel . . . Often within a week! And you're getting the unequalled NURL-LOC® terminal with 5 times the gripping surface that prevents twist and keeps your panel from warping. For fast action phone (401) 769-3800 or write Electronic Molding Corp. 96 Mill Street, Woonsocket, R.I. 02895.

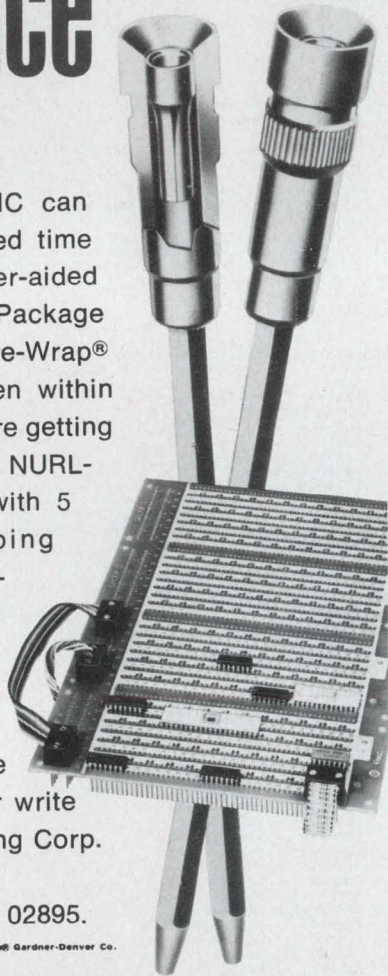

Wire-Wrap® Gardner-Denver Co.



## for need-it-now requirements

See EMC at WESCON, Booth # 136

(continued from page 93)

```

909 GO TO 601
    WRITE(6,10) IFUNC(M,N)
    GO TO 601
910 WRITE(6,11) IFUNC(M,N)
    GO TO 601
911 WRITE(6,12) IFUNC(M,N)
    GO TO 601
912 WRITE(6,13) IFUNC(M,N)
    GO TO 601
913 WRITE(6,14) IFUNC(M,N)
    GO TO 601
914 WRITE(6,15) IFUNC(M,N)
    GO TO 601
915 WRITE(6,33) IFUNC(M,N)
    GO TO 502
916 WRITE(6,34) IFUNC(M,N)
    GO TO 502
700 WRITE(6,16) IFUNC(M,N)
    GO TO 601
1000 WRITE(6,17)
    GO TO 301
1001 WRITE(6,18)
    GO TO 301
1002 WRITE(6,19)
    GO TO 301
1003 WRITE(6,20)
    GO TO 301
1004 WRITE(6,21)
    GO TO 301
1005 WRITE(6,22)
    GO TO 301
1006 WRITE(6,23)
    GO TO 301
1007 WRITE(6,24)
    GO TO 301
1008 WRITE(6,25)
    GO TO 301
1009 WRITE(6,26)
    GO TO 301
1010 WRITE(6,27)
    GO TO 301
1011 WRITE(6,28)
    GO TO 301
1012 WRITE(6,29)
    GO TO 301
1013 WRITE(6,30)
    GO TO 301
1014 WRITE(6,31)
    GO TO 301
1015 WRITE(6,32)
    GO TO 301
1016 WRITE(6,37)
    GO TO 301
1900 WRITE(6,35)
    GO TO 301
1901 WRITE(6,36)
    GO TO 301
999 RETURN
    END

SUBROUTINE MINGFN (IFUNC,LTEMP,NI,NO,IMC,IOC)
DIMENSION LLTEMP(2,10),NNN(18),IFUNC(10240,19),LTEMP(18)
DO 75 LA=1,2
DO 76 LB=1,10
LLTEMP(LA,LB)=0
76 CONTINUE
75 CONTINUE
IMC=0
IOC=0
DO 7 N=1,18
NNN(N)=LTEMP(N)
CONTINUE
MN=1
N=1
II=0
3 IF(LTEMP(N),EQ,-1)GO TO 1
N=N+1
IF(N,GT,NI)GO TO 2
GO TO 3
II=II+1
LLTEMP(1,MN)=N
MN=MN+1
GO TO 4
2 IF(II,EQ,0)GO TO 8
DO 6 MN=1,10
LLTEMP(2,MN)=0
6 CONTINUE
LM=1
11 MN=1
NNN(LLTEMP(1,MN))=LLTEMP(2,MN)
MN=MN+1
IF(MN,GT,II)GO TO 8
GO TO 9
8 L=NI
IDEC=0
DO 10 MN=1,NI
IDEC=IDEC+NNN(MN)*2**(L-1)
L=L-1
10 CONTINUE
IFUNC(LM,19)=IDEC
IMC=IMC+1
IF(II,EQ,0)GO TO 16
LM=LM+1
DO 71 IN=1,11
IF(LLTEMP(2,IN),EQ,0)GO TO 72
CONTINUE
GO TO 16
72 LMN=II
12 LLTEMP(2,LMN)=LLTEMP(2,LMN)+1
IF(LLTEMP(2,LMN),GT,1)GO TO 17
LMN=II
GO TO 11
17 LLTEMP(2,LMN)=0
LMN=LMN-1
GO TO 12
16 N=11
19 IFUNC(N+1015,19)=LTEMP(N)
N=N+1
IOC=IOC+1
IF(IOC,EQ,NO,OR,LTEMP(N),EQ,0)GO TO 70
GO TO 19
88 LM=1
GO TO 8
70 RETURN
    END

```



# MEMORY AT WORK

## Retail Sales

The point of sale terminal is

just one application where data integrity and ease of maintenance are vital. The SEMI 4104A static

4K RAM answers both problems perfectly. It is static; that means simpler, faster field maintenance.

And just 15 mw will protect data. The 1K x 4 organization is ideal for small capacity systems,

and the 200 nsec access (350 nsec cycle) time makes it fast enough for any 8080A class

microprocessor on the market. Get full details from

your local EMM SEMI distributor, or

call us today.

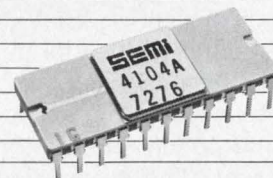

**EMM SEMI**  
A subsidiary of

Electronic Memories & Magnetics Corp.  
3883 N. 28th Ave., Phoenix, Ariz. 85017  
(602) 263-0202





## Preselector/mixer alignment circuit uses receiver's balanced mixer as a load

Sensitivity variations across the band are excessive when the bandpass of an rf preselector is adjusted in a test fixture with the use of a nominal 50-Ω load (Fig. 1a). The problem is that the 50-Ω load doesn't sufficiently correspond to the load presented by the mixer usually fed from the preselector of a receiver system.

On the other hand, the direct use of a mixer (usually a double-balanced circuit) as a load would provide a distorted response to the test circuit's rf-sweeper input and not allow proper adjustment, because of the mixer's feedthrough-rejection characteristics. However, if a dc-bias current is introduced into the mixer's i-f port, rf input would be properly detected by the mixer.

With an rf-sweeper input, the recovered bandshape is found to be essentially independent of this bias current. The mixer-diode impedance remains reasonably constant and the circuit of Fig. 2, by alternately biasing the diodes  $\pm 300 \mu\text{A}$ , can produce a meaningful scope display, be-

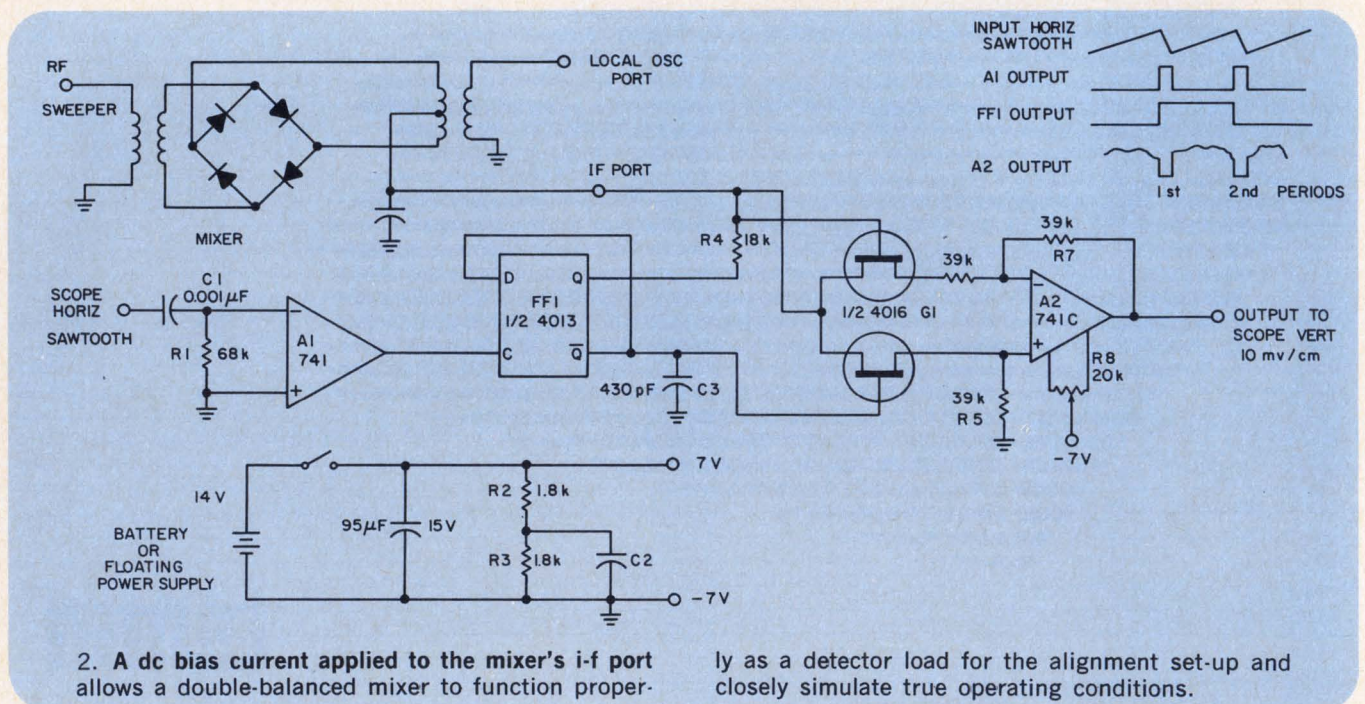
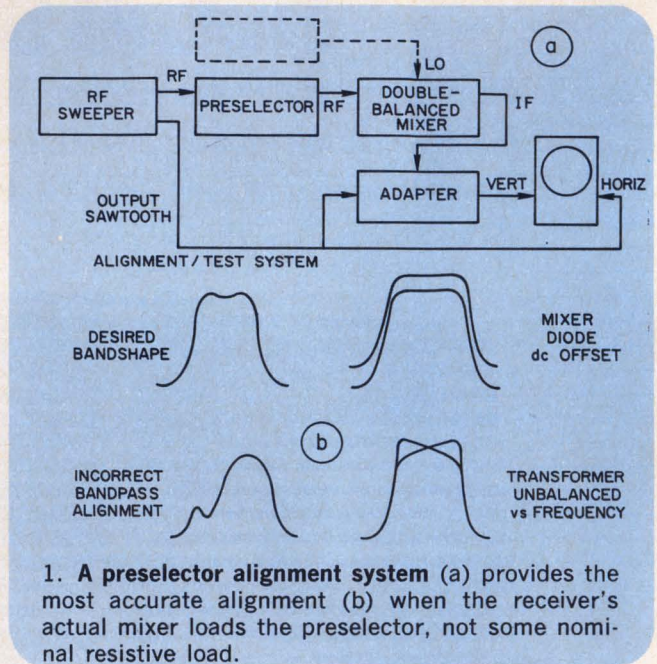



# Simpson®

## NEW PORTABLE DIGITAL MULTIMETER



### 460-3

- 0.1% DC V Accuracy
- 3½ Digits • 32 Pushbutton Ranges
- IC reliability
- All in a Compact State-of-the-Art Instrument



**Lab quality in a portable instrument for general electronic servicing and industrial testing.**

- High accuracy  $\pm$  (0.1% of reading + 1 digit) on all DC voltage ranges
- Large bright 0.43" LED readout
- 32 ranges: 5 DC voltage ranges to 1000V  
5 AC voltage ranges to 600V  
5 Lo-power ohms ranges to 2M $\Omega$   
5 Standard ohms ranges to 20M $\Omega$   
6 DC current ranges to 10 amps  
6 AC current ranges to 10 amps
- Rugged, high-impact case with adjustable tilt-view handle
- Calibrated analog meter included for nulling and peaking as well as scanning trends
- Choice of battery and AC line operation or AC line operation only

**460-3A** for 120/240 VAC (50-400 Hz) power line operation; with test leads, line cord, and operator's manual..... **\$285.00**

**460-3D** for battery operation (batteries not included) and 120/240 VAC (50-400 Hz) power line operation; with test leads, line cord, operator's manual **\$322.00**

#### ACCESSORIES

- RF Probe, Catalog No. 00433 ..... **\$25.00**
- 40kV High Voltage Probe, Catalog No. 00432 **\$35.00**
- AC Amp-Clamp Adapter, Model 154 ..... **\$29.50**
- Rugged Carrying Case, Catalog No. 01617 ..... **\$25.00**

**In stock at your local electronics distributor**

**Simpson**  
INSTRUMENTS THAT STAY ACCURATE

**SIMPSON ELECTRIC COMPANY**

853 Dundee Avenue, Elgin, Illinois 60120 • (312)697-2260  
CABLE: SIMELCO • Telex: 72-2416

KATY INDUSTRIES



INDUSTRIAL EQUIPMENT GROUP



## IDEAS FOR DESIGN

cause the preselector's load is now the load actually used in the receiver (Fig. 1b).

Capacitor  $C_1$  and resistor  $R_1$  differentiate the scope's sawtooth horizontal sweep to toggle the CMOS flip-flop. When the flip-flop's Q output is high, positive bias is applied to the mixer via  $R_4$ . Amplifier  $A_2$  acts as an inverter with unity gain to provide a positive-going bands'hape display on the scope. On alternate horizontal sweeps, the flip-flop Q output applies negative bias to the mixer, and the input to  $A_2$  is switched by  $G_1$  to produce noninverted unity gain to keep the bands'hape positive-going.

Resistors  $R_6$  and  $R_7$  should be matched within  $\pm 1$  percent to ensure that unity gain is maintained for both inverting and noninverting inputs to  $A_2$ . Adjustment of  $R_8$  is required only if the mixer diodes must be selected within about 20 mV dc.

The alignment is performed with the local oscillator (LO) OFF. Also, it is possible to introduce

the sweep into the LO system and align or check its bands'hape.

Offset between the alternate sweep traces results from unbalance in the mixer, and the presence of defective transformers or diodes becomes obvious from observation of this offset and the relative shapes of the sweeps (Fig. 1b).

The diode bias current of approximately 300  $\mu\text{A}$  determined by the series 18-k $\Omega$  resistor and the  $\pm 7\text{-V}$  output from the flip-flop is not critical, but is about the same as that flowing when the LO drives the mixer in normal receiver operation. Detector overload occurs at about 200-mV peak, so only 10 to 20 mV/cm, ac-coupled, vertical scope gain is recommended.

Resistors  $R_2$  and  $R_3$  serve to split the supply voltage into  $\pm 7\text{ V}$ . Absolute voltage is not critical, but symmetry is important, so the divider resistors should match within  $\pm 1$  percent.

*F. Patterson Smith, Research & Development, Narco Avionics, Commerce Dr., Fort Washington, PA 19034.*  
CIRCLE NO. 311

# Temperature-measuring bridge uses constant-current FET circuits

Using a constant-current source instead of the conventional constant-voltage configuration avoids problems with unwanted voltage drops in measuring bridges.

In the temperature-measuring bridge of Fig. 1, a 1-k $\Omega$  thermistor (Corning) serves as the current-regulating element for a FET constant-current generator. This current generator is the active arm of the bridge. The thermistor controls the FET's gate-source resistance.

The passive arm of the bridge uses a trimming pot in a similar FET circuit to null the bridge. The gate-source resistances of both active and passive FET circuits should be equal at the desired nulling temperature.

Remotely mounting the thermistor causes no problems, because lead resistance can be easily kept small compared with the thermistor.

The current drawn by this constant-current bridge is only about 20% of that drawn by a corresponding constant-voltage bridge, resulting in considerable savings on battery-operated equipment.

*Ivar A. Dybvik, Engineer, River & Harbour Lab., Klaebuwn 153, N-7000 Tr. heim, Norway.*

CIRCLE NO. 312

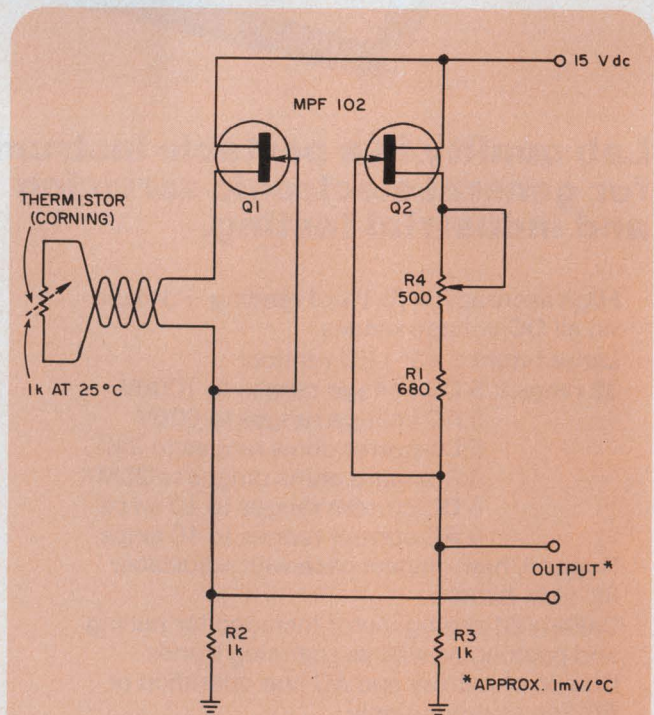

Two arms of this temperature-measuring bridge are constant-current FET circuits. The active arm contains a temperature-sensitive resistor and the other arm balances the bridge with trimmer,  $R_4$ .



# The Raytheon 2900 family gains five new members

**Whereas:** Raytheon is the established alternate source for the Am2901 and Am2909, (franchised distributors stocked), and,

**Whereas:** Raytheon brought you RAYASM, the powerful micro-assembler available on the NCSS computer network,

**Now Therefore:** Raytheon announces five additional 2900 family components, giving us a total of seven, To Wit:

**2901** A 4-bit Microprocessor Slice—the fastest, most powerful LSTTL microprocessor in the world. With its cycle-saving two-address architecture, the 2901's speed can't be touched.

**2905** A 4-bit Bus Transceiver— general purpose open collector bus interface device. Data to the 100 milliamper bus drivers is provided by a 4-bit register with a two-way multiplexer at its inputs. Data from the bus receiver may be held in the 4-bit receiver latch on its way to the three state receiver outputs.

**2906** A 4-bit Bus Transceiver with parity —is equivalent to the 2905 but with the addition of an on-chip parity generator/checker.

**2907** A 4-bit Bus Transceiver—similar to the 2906 with the two-way multiplexer at the input to the bus driver register elimi-

nated to allow the device to be packaged in the space saving 20-pin DIP.

**2909** A Microprogram Sequencer—that can branch anywhere in memory, perform sub-routines, then return with up to four levels of sub-routine nesting. The device is a cascable 4-bit slice which allows addressing of up to 4K words of microprogram with three devices.

**2918** A General Purpose 4-bit Register—with two sets of outputs: TTL and three state. This useful combination can reduce your package count for those status, command, and instruction registers which must drive both your control logic and a data bus.

**93415** A 1024 × 1-bit Fully Decoded Random Access Memory—for your high-speed data and control stores.

Raytheon LSI is on the move. More 2900 family components soon to come include PROM's, sequencers, look-ahead carry generators, additional RAM's, and other goodies now in process.

For complete details, contact your local distributor or Raytheon Company, Semiconductor Division, Dept. 2900, 350 Ellis Street, Mountain View, CA 94042, (415) 968-9211.

# Am 2900 SOLD & SUPPORTED HERE



**SEMICONDUCTOR DIVISION**

CIRCLE NUMBER 42



# Special-purpose pulse-width modulator produces an output of same polarity as input

In some applications—such as in hardware simulation, or in instrument-and-control applications that use pulse-width modulated hydraulic valves, pressure regulators or actuators—the pulse-width modulator's output must have special characteristics. The output must consist of a train of positive pulses if the input modulating signal is positive, and negative pulses, if the modulating signal is negative. No pulses should be present when the signal amplitude is zero.

Such a modulator can be designed with two op amps, two 555 (or one 556) timers and a few passive components (Fig. 1).

If a 555 timer, connected in the monostable mode, is triggered by continuous clock pulses (at pin 2), and the timer's threshold input (pin 3) is modulated by an applied signal, the circuit behaves as a pulse-width modulator. However, the modulator works only on positive input signals.

A second timer handles the negative part of the input-modulating signal. Its modulating signal is first inverted by an op amp. A second op amp then combines the outputs of both timers. This op amp inverts the output of the second modulator, and thus provides both negative and positive pulse-modulated waves, as required.

Diodes  $D_1$  and  $D_2$  automatically separate the positive and negative parts of the modulating signals to  $T_1$  or  $A_1$ . The  $A_2$  op amp should be fast enough to handle the expected rise time of the output of the timers. Diodes  $D_1$  and  $D_2$  can be any general-purpose signal diodes.

*M. P. Srinivasan, Design Engineer, Systems Group, Engineering Design Centre, Indian Institute of Technology, Madras 600 036, India.*

CIRCLE NO. 313

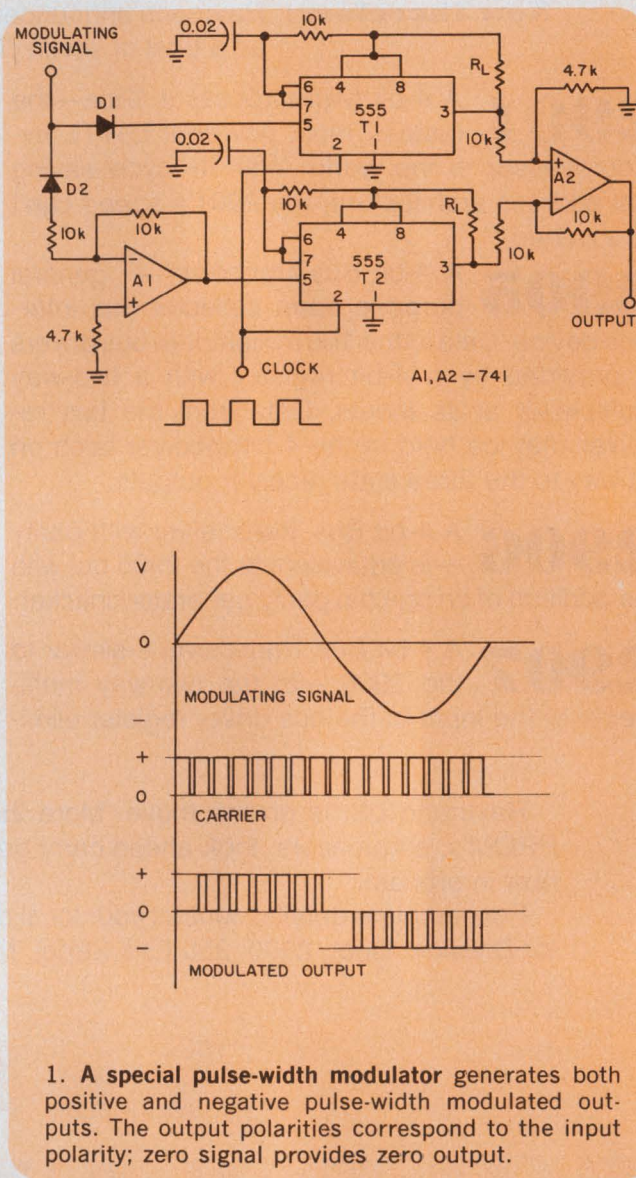

1. A special pulse-width modulator generates both positive and negative pulse-width modulated outputs. The output polarities correspond to the input polarity; zero signal provides zero output.

### IFD Winner for May 24, 1976

**Peter H. Alfke**, Manager, Digital Systems Application, Fairchild Semiconductor, 464 Ellis St., Mountain View, CA 94042. His idea "Accumulate and Trap Data in Counters while Their Outputs Remain Constant" has been voted the most valuable of Issue Award.

**Vote for the Best Idea in this issue** by circling the number of your selection on the Reader Service Card at the back of this issue.

**SEND US YOUR IDEAS FOR DESIGN.** You may win a grand total of \$1050 (cash)! Here's how. Submit your IFD describing a new or important circuit or design technique, the clever use of a new component or test equipment, packaging tips, cost-saving ideas to our Ideas for Design editor. Ideas can only be considered for publication if they are submitted exclusively to ELECTRONIC DESIGN. You will receive \$20 for each published idea, \$30 more if it is voted best of issue by our readers. The best-of-issue winners become eligible for the Idea of the Year award of \$1000.

ELECTRONIC DESIGN cannot assume responsibility for circuits shown nor represent freedom from patent infringement.



# We got the order a few hours ago. The relays will be there a few hours from now.

Our customers think we're 'bout the fastest there is when it comes to shipping relays. This order was extra hot so we got it out in a matter of hours. But we frequently ship orders in 24 hours. And, we can generally promise production and shipment of any order is 360 hours (3 weeks).

We're fast—but we're also something else—good. We make our own switches so we know what our relays will do. But just to make sure,

we run over 3 billion test cycles every day! We make over 6000 variations of dry reed relays so we undoubtedly have what you need. And the cost? Well, you better call and get a quote to believe it! Here in Wabash, money goes a lot further than it does in the big city. We know because we get to the city every so often—though not as frequently or as fast as our relays do.



*Coils, Relays & Transformers*  
**wabash**  
of  
**Wabash, Indiana**  
and Huntington, Indiana; Farmington, Missouri;  
Tipton, Iowa and South Boston, Virginia  
For information and quotes write or call:  
Wabash, Inc., Dept. RB-1, 810 N. Cass St., Wabash, Ind. 46992 Tel: 219/563-2191 TWX 810-290-2722



The Econo-Miser. The most automatically manufactured dry reed relay available. 1 and 2 pole standard types. Less than one dollar in quantity.



## GaAlAs laser used in fiber-optic system

A buried-channel GaAlAs laser for use in long-distance fiber-optic communication systems is ideally suited for the application because its emission is confined to a small area whose dimensions are of the order of the wavelength of the laser light.

According to Standard Telecommunications Laboratories in Harlow, England, who developed the new laser, the ideal injection-laser source for optical-fiber systems and integrated optics has carrier and optical confinement—not only in the plane perpendicular to the pn junction, but also in the plane parallel to the junction.

Standard Telecommunications has

developed a method of fabricating such devices by using liquid-phase epitaxy. The buried active channel is sandwiched between continuous n and p-type passive layers, and has a parabolic profile, tapering gradually to zero at the edges.

The n-type GaAs substrate has a channel laser etched in the top surface; then an active layer is grown over the entire surface. The active layer naturally levels out the structure, providing an isolated active channel. The channel width in devices produced to date is about 10  $\mu\text{m}$ . A 1  $\mu\text{m}$ -wide device is being developed.

Analysis of the spectrum of the device's laser emission has shown

that the modes of emission are limited by the width of the active channel. According to Standard Telecommunications Laboratories, a device with a 1  $\mu\text{m}$ -wide channel would produce a single-mode laser.

## Plastic thermal sensor has improved sensitivity

A low-cost plastic thermal sensor with substantially better sensitivity than similar metallic or semiconductor devices has been produced by a research team at the Marconi Research Laboratories in England.

The Marconi sensor is a thin film of polyvinylidene fluoride (PVF) that is sensitized by heating the film to 100 C and exposing it to an electric field of 1 mV/cm.

Metallic contacts are deposited and the film then acts as a perma-

## POWER FOR YOUR $\mu$ PROCESSOR



Single, dual, and triple output power supplies in a broad selection of output voltage combinations. Output current ratings from 30 ma to 60 amps. Various package styles suitable for virtually every application. Any module you select will be shipped within 3 days; rack mounting models, within 9 days.

Acopian

Corp., Easton, Pa. 18042 Tel: (215) 258-5441

## MULTIPLE VOLTAGES FOR PCB'S

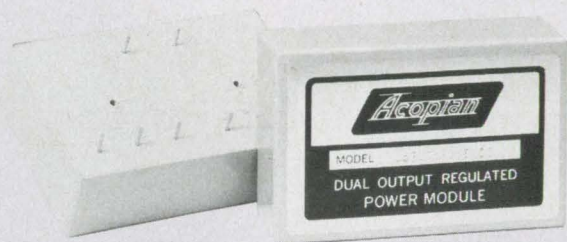

Simplify pc board layout with multiple output power mini's. Duals supply two isolated like or dissimilar outputs, 1 to 28 volts each. Op amp supplies provide  $\pm 12$  or  $\pm 15$  volts. Triples have two balanced, tracking outputs, a third for powering other circuits. Guaranteed 3-day shipment.

Acopian

Corp., Easton, Pa. 18042 Tel: (215) 258-5441



nently charged capacitor. A change in the film thickness due to thermal expansion varies the effective capacitance of the device.

Laboratory prototypes have detected human body heat at 100 yards. A wide range of medical applications is seen, in addition to applications in security systems.

Because changes in air pressure also modify the sensor thickness, the transducer can function as a microphone. A prototype high-impedance condenser microphone built by the research team had a sensitivity of 10 mV at 1 kHz. It responded to frequencies ranging from below 30 Hz to above 4 kHz.

## New microwave devices boost flight safety

Two new microwave developments by AEI Semiconductors Ltd., Lincoln, England, may advance flight safety by reducing the cost of navigation beacons and improving the reliability of radar equipment.

The first development is a pulsed Gunn oscillator that AEI says is the key element of a transponder

that has a fundamental oscillator operating at 9.4 GHz. Output power is 250 mW minimum for a pulse length of 25  $\mu$ s over a  $-20$  C to  $+60$  C range. The Gunn oscillator can be electronically tuned over a 200-MHz band. The pulse chirp is limited to 7 Hz and the temperature coefficient of frequency is 0.25 MHz/ $^{\circ}$ C.

The second AEI development is a gallium-arsenide mixer diode that has increased tolerance to burnout. Use of this device improves the reliability of 8 to 11-GHz radar-microstrip mixer circuits. The spike-burnout limit is 100 nJ. The CW burnout occurs at 500 mW, while the peak-pulse rf burnout is at 1 W input.

The noise figure is 6 dB with a VSWR of 1.5:1 and an i-f impedance of 400  $\Omega$ .

## Researchers develop crystal for hot cathode

An electron-gun hot cathode with 10 to 100 times the beam intensity of the best previous cathodes uses a single crystal of lanthanum borate for the electron

source. The borate crystal, developed by the Japanese National Institute of Researchers in Inorganic Materials, is an artificially synthesized material with a hardness about one third that of diamond and a melting point between 2300 and 2400 C. The material is powdered and heated by rf induction to produce single crystals 7 to 8 mm in diameter and 5 cm long. An electric discharge tool reduces the single crystals to needle-like crystals 0.2 mm in diameter and 5 mm long. Electrolytic grinding further sharpens the tip to submicron size.

Hot cathodes are extensively used as electron beam sources in electron-beam machining tools, electron microscopes, cathode ray tubes and, more recently, in replacing optical beams used in semiconductor manufacturing where very high packing densities are required. Tungsten, barium and strontium oxide crystals have been used, as well as sintered lanthanum borate. The radius of curvature of the LaB<sub>6</sub> crystal is about 0.2  $\mu$ m, compared to the 10-micron radius of sintered LaB<sub>6</sub>, and causes a more stable beam.

## NEED A POWER SYSTEM?

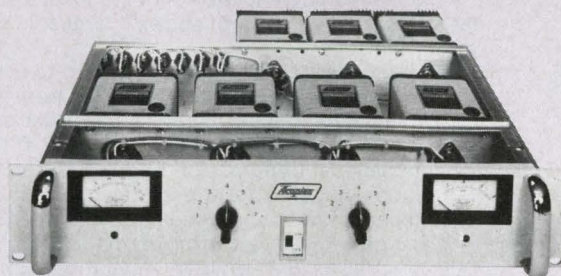

Order multiple output power systems without searching through a catalog, preparing mechanical layouts, item-by-item pricing and detailed purchase requisitions. Instead, call Acopian. We'll listen to your needs, quote a firm price, and then ship your built-to-order system, fully wired and tested, in just 9 days.



Corp., Easton, Pa. 18042 Tel: (215) 258-5441

## GUARANTEED 3 DAY SHIPMENT

### ACOPIAN

POWER  
SUPPLY  
CATALOG  
1976-1977

Every power module listed in the Acopian 48-page catalog is shipped within 3 days of order. Guaranteed! Miniaturized supplies, narrow profile and plug-in modules, premium performance models, and a wide choice of other types are described in detail. Ask for your copy.



Corp., Easton, Pa. 18042 Tel: (215) 258-5441



# Electronic Design in cooperation with ~ electronica 76

announces a special Oct. 25 preview issue of

**the World's Largest  
Electronics Show — EVER!**



**MUNICH**  
GERMANY. NOV. 25 — DEC. 1, 1976  
20 EXHIBITION HALLS PACKED  
WITH 1,600 EXHIBITS AND STANDS  
FROM OVER 2,500 ELECTRONICS  
FIRMS FROM 23 NATIONS.

This year's ELECTRONICA is going to be a stellar event. It's the "show of shows," largest in the world.

Our editors are already deeply involved to bring you a special preview of ELECTRONICA from the design engineer's point of view...the news and products to be unveiled (including those at the 7th International Congress on Microelectronics).

If you're planning to attend, take advantage of our special low-cost package tours to MUNICH — see right. If you're staying home, watch for ELECTRONICA 76 PREVIEW — October 25 in *Electronic Design*.

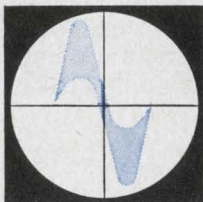

## Note: Alert your Sales & Marketing People

October 25 can be your company's opportunity to sell at ELECTRONICA, in Europe, to the U.S. and the world! It's going to have the largest circulation in our history — 10,000 bonus distribution at Munich, 24,000 international, 103,500 in all. Tell them about the low cost tours to Munich, too. They can save a bundle!

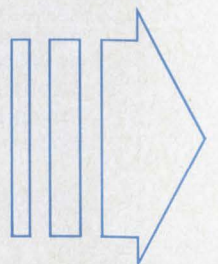



# Electronic Design in cooperation with

## electronica 76 announces 1976

# Travel Tours to Munich

departing from New York, Boston or Chicago



A FULL WEEK OR TWO-WEEK STAY FOR ONLY SLIGHTLY MORE THAN REGULAR AIR FARE ALONE

### 8 DAYS/7 NIGHTS

Included: **Air travel**, economy class via Swissair regularly scheduled flights with complimentary meal service aloft.

**Transfer** by deluxe motor coach from airport to hotel, and return, including baggage handling.

**First class hotel accommodations** (double occupancy) at Eden Hotel Wolff — one of Munich's finest — within walking distance of the fair grounds; all rooms with bath, breakfast and service.

**Champagne reception** co-sponsored by *Electronic Design* and ELECTRONICA 76 management.

**Admission** to the ELECTRONICA Exhibition.

**Tour** accompanied by U.S. representative of the Munich Fair Authority.



### 14 DAYS/13 NIGHTS

Included: All features of shorter tour except accompaniment by U.S. rep. Half-day sightseeing tour of Munich.

All tours are predicated on 10 or more participants; air fares are subject to change. All participants must depart and return with the group to qualify for this low group airfare. Regular airfare for less than 14 days is \$748.00!

### 8-DAY PACKAGE

## \$698<sup>00</sup>

From N.Y.  
or Boston

(\$819 from Chicago.)  
Subject to change.

DEPART: NOV. 24, 1976

RETURN: DEC. 2, 1976

Rates based on double occupancy.  
Single supplement: \$40.

### 14-DAY PACKAGE

## \$938<sup>00</sup>

From N.Y.  
or Boston

(\$1059 from Chicago.)  
Subject to change.

DEPART: NOV. 19, 1976

RETURN: DEC. 3, 1976

Rates based on double occupancy.  
Single supplement: \$90.

### RESERVE NOW DEPOSIT REQUIRED

## \$100<sup>00</sup>

Returnable before  
October 1, if cancelled.

DEADLINE FOR FINAL  
PAYMENT:

**OCT. 30**

(for both tours)

NAME \_\_\_\_\_

TITLE \_\_\_\_\_

COMPANY \_\_\_\_\_

ADDRESS \_\_\_\_\_

CITY, STATE, ZIP \_\_\_\_\_

PHONE \_\_\_\_\_ DEPART FROM: NEW YORK  BOSTON  CHICAGO

Specify ELECTRONIC DESIGN/ELECTRONICA 1976 TOUR TO MUNICH. Make checks payable to "Kallman Associates" (U.S. Electronica representatives). Tel: 201-653-3304. Mail to: Kallman Associates, 30 Journal Square, Jersey City, New Jersey 07306.



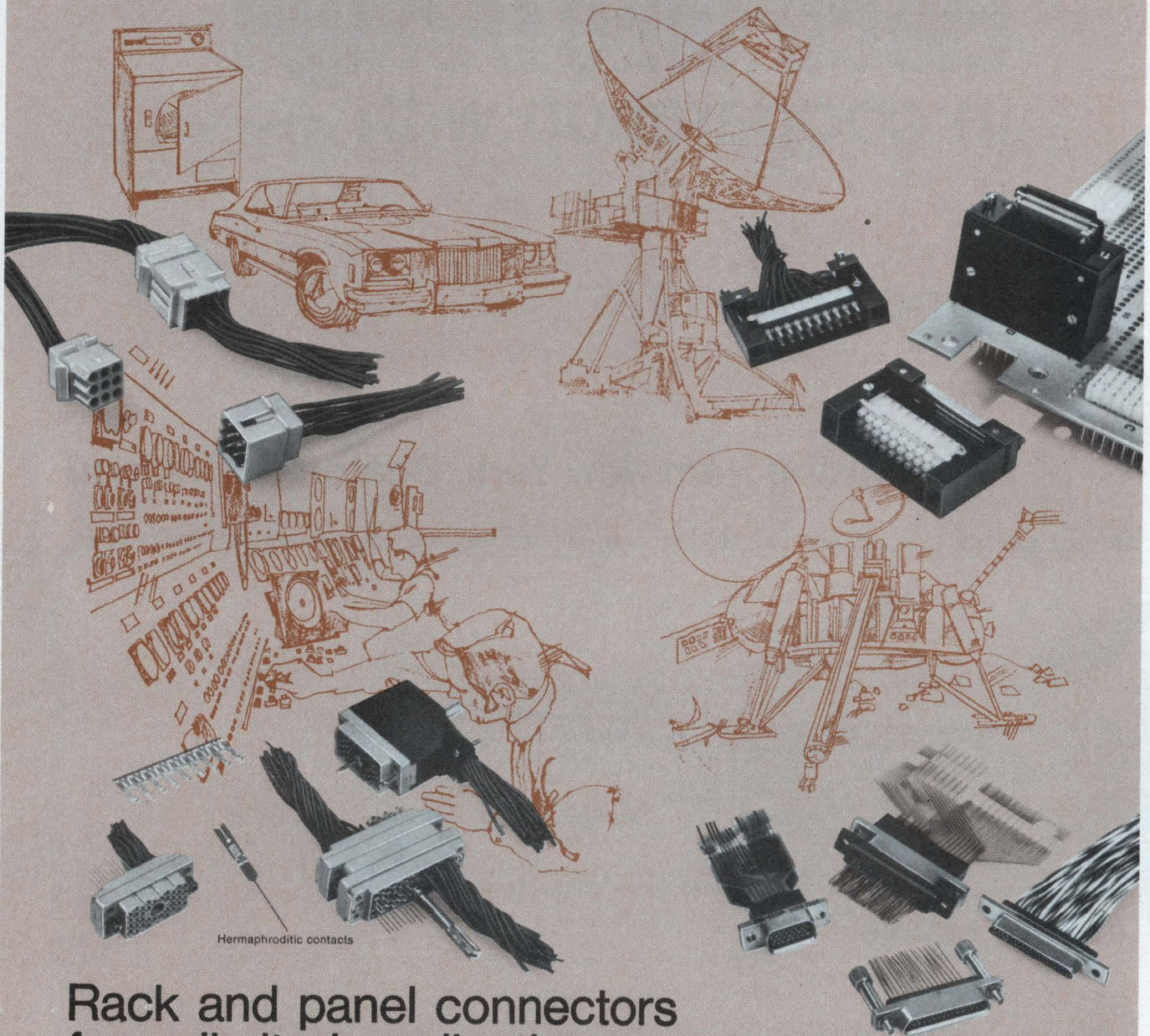

## Rack and panel connectors for unlimited applications... **only from Malco**

You can get some of these connectors from other manufacturers, but *only* Malco offers a complete line of rack and panel connectors for any design situation. It's the broadest line of rack and panel connectors in the industry. Everything from high density spacing of .050 to our Thrift-Mate™ with spacings of .200 and .250. All with the dependability and quality you demand for superior performance. Whether your application is commercial, military or industrial, Malco has rack and panel connectors for you. Whether

your designs call for pin and socket, blade and tuning fork or hermaphroditic, Malco has it. Only Malco has it all. Write for prices and information. Malco, 12 Progress Drive, Montgomeryville, PA 18936. Phone: (215) 628-9800

 **MALCO**  
A Microdot Company



# New Products

## Analyzer excites, then measures response

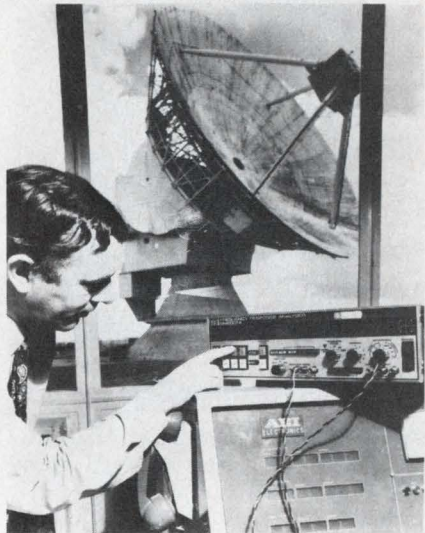

EMI Technology, 20 Old Ridgebury Rd., Danbury, CT 06810. (203) 744-3500. Start at \$6700; stock to 30 days.

Series SM2001A digital transfer-function analyzer provides sinusoidal excitation and measures response in coordinate values. Range is 0.00001 to 999 Hz, extendable to 1 MHz. The unit analyzes the dynamic transfer function of any system or component, from an electronic filter to a battleship gun turret. Display is cartesian, polar or log/polar. Measurement accuracy is  $\pm 0.5\%$  of reading  $\pm 1$  count, and results are displayed on 4-digit panel readouts.

CIRCLE NO. 301

## Stroboscope reads rpm digitally

Power Instruments, 7352 N. Lawn-dale Ave., Skokie, IL 60076. (312) 676-2300. \$395.

Digistrobe is said to be the first digital stroboscope. The unit reads revolutions per minute on five LEDs, 3/8-in. high. Accuracy is  $\pm 1$  rpm (quartz controlled) and the range varies from 200 to 12,000 flashes, or rpm. The unit operates from 115 V ac, optionally 230 V or 12 V dc. There are no range switches on the unit.

CIRCLE NO. 302

## Two monitors offer small spot, storage

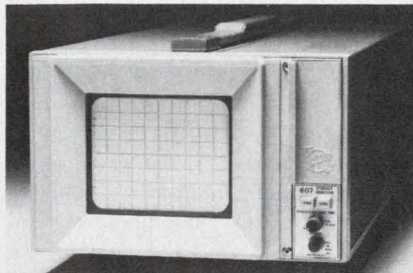

Tektronix, P.O. Box 500, Beaverton, OR 97077. (503) 644-0161. 607, \$1800; 4-6 wks.

Two display monitors are targeted for OEMs. The 606 produces a very small dot size—6.0 mil at normal intensity and 5.0 mil at low intensity—which is uniform across and  $8 \times 10$ -cm CRT. Electronic correction provides optimum focus over a  $7 \times 9$ -cm area. The 607 features variable-persistence storage and spot size of 20 mils stored, 12 mils nonstored. Image persists up to 50 minutes.

CIRCLE NO. 303

## Small counter measures 60-MHz frequencies



Non-Linear Systems, P.O. Box N, Del Mar, CA 92014. (714) 755-1134. \$195; stock.

A frequency counter joins the company's line of miniature, battery-powered test instruments. The FM-7 measures only  $1.9 \times 2.7 \times 4$  in. It monitors frequencies from 10 Hz to 60 MHz and displays the results to seven digits using 0.25-in. LEDs. Input sensitivity is 30 mV rms from 50 Hz to 30 MHz, 100 mV rms from 10 Hz to 60 MHz.

CIRCLE NO. 304

## Preamp boosts instrument sensitivity

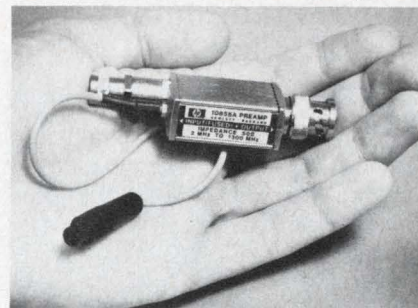

Hewlett-Packard, 1501 Page Mill Rd., Palo Alto, CA 94304. (415) 493-1501. \$225; 30 days.

Designed to enhance measurements of low-level signals, Model 10855A preamplifier increases sensitivity of scopes, counters and analyzers by more than 10 times. Minimum gain is 22 dB (24 dB typical) 2 to 1300 MHz  $\pm 1$  dB. It operates from a power supply of +15 V at 40 mA or with those HP instruments with a probe power output. Other features: 50- $\Omega$  input and output impedances, fuse protection, and reverse isolation of greater than 45 dB.

CIRCLE NO. 305

## PROM programmer is fully interactive



International Microsystems, 122 Hutton St., Gaithersburg, MD 20760. (301) 840-1078. \$1295; 4 wks.

Series 1000  $\mu$ P controlled PROM programmer offers fully interactive operation in any of three programming modes—keyboard entry, terminal control or remote computer control. A 32 k bit buffer RAM memory allows the user to edit the data in RAM from the keyboard of the programmer prior to the actual programming operation. A 14-digit hex display gives 4 digits each of address, copy PROM data, and master PROM data, plus a 2-digit entry and error code.

CIRCLE NO. 306



## Ac-powered units join DPM line

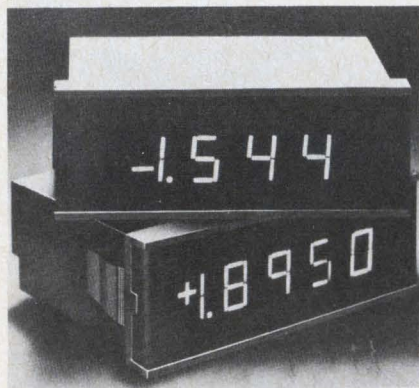

Fairchild Instrumentation Operation, 1725 Technology Dr., San Jose, CA 95110. (415) 962-3816. 3-1/2 digit, \$75; 4-1/2 digit, \$117 (100 up); stock.

Two models of ac powered DPMs—one with 3-1/2 and the other 4-1/2 digits—displays expand the company's DPM line. There are 12 units with ranges from 199.9 mV to 199.9 V for the 3-1/2 digit unit, and 1.9999 V to 199.99 V for the 4-1/2-digit unit. Range selection is accomplished by changing two resistors. Total power consumed is 2.5 W at 115 V ac  $\pm 15\%$  or 240 V ac  $\pm 15\%$ , 47-63 Hz. All units are readable and accurate to 150% of the selected range, with valid BCD data supplied during over-range.

CIRCLE NO. 307

## Chart receiver gives 24-h field operation

Kay Elemetrics, 12 Maple Ave., Pine Brook, NJ 07058. (201) 227-2000. \$1895.

Model 9021 digital chart receiver and recorder provides a built-in timer (0.25, 0.5, 1 and 2-hour intervals) for portable, unattended CATV measurements. You can get 24-hour unattended operation from one fully charged automotive battery. The unit can also be operated from an external source or from ac. Specs include a frequency range of 5 to 400 MHz; minimum signal input for 1/2-scale deflection of 0 dBmV; vertical and horizontal resolution of 8 bits; and a memory size of 2000-bits.

CIRCLE NO. 308

## Transient recorder features 20-MHz ADC

Data Laboratories Ltd., 28 Wates Way, Mitcham, Surrey CR 4 4 RH, England.

A transient waveform recorder made in Britain features a 20-MHz a/d converter which takes a measurement every 0.05  $\mu$ s. Two versions are available: the single-channel DL920 and the twin-channel DL922. The latter samples simultaneously on both channels at a rate up to 10 MHz per channel, but can also be used as a single-channel instrument. Elusive signals, such as one-shots, are recorded in a 2048-word memory (a 4096-word option available) and may be reproduced on an oscilloscope or as hard copy on a pen recorder.

CIRCLE NO. 309

## 'Nude' DPM mounts behind panels

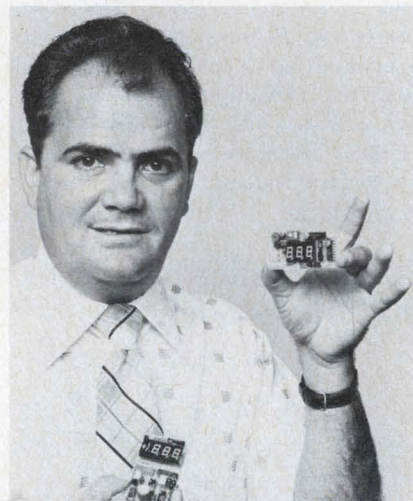

International Microtronics Corp., 4016 E. Tennessee St., Tucson, AZ 85714. (602) 748-7900. \$47; stock-4 wks.

Model 325, called the "Naked DPM," is built on a single PC board measuring  $2.9 \times 1.4 \times 0.35$  in. Display is orange LEDs, 0.4-in. high. Features include automatic-polarity indication, external decimal-point selection, 1000-M $\Omega$  input impedance,  $\pm 0.1\%$  accuracy and linearity, 7-pA typical input bias current, tempo of  $\pm 0.005\%/^{\circ}\text{C}$  and power consumption of 550 mW. Ranges available are 1, 10, 100 and 1000 V dc with up to 1200-V overvoltage protection.

CIRCLE NO. 310

## Current calibrator works to 1 A

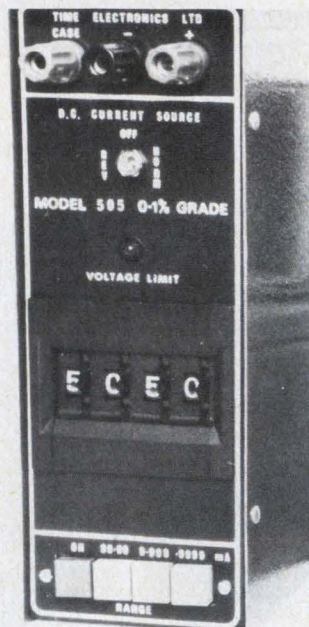

Zi-Tech Div., 223 Forest Ave., Box 26, Palo Alto, CA 94302. (415) 326-2151. \$340; stock.

TE505 compact dc current source offers 0.1% accuracy. The unit has three ranges: 1 mA, 10 mA and 100 mA full scale. An optional 1-A range-extender unit is available. Four decades of thumb-switches are provided for the current setting. The internal reference is a precision zener, aged and selected for performance. The instrument is overload protected and a front-panel indicator shows if drive voltages greater than 10 V are called for.

CIRCLE NO. 320

## Digital meter reads capacitance in 250 ms

GenRad, 300 Baker Ave., Concord, MA 01742. (617) 369-4400. \$2785; 2 wks.

Measurement of capacitance and dissipation can be made automatically with the GR 1686-A digital capacitance meter. Capacitance can be measured from 0.01 pF to 200,000 pF at test frequencies of 120 Hz and 1 kHz with 250-ms measurement time. Basic accuracy is 0.1% for 1-kHz measurements and 0.5% for 120-Hz measurements. A measurement-mode switch allows either single or repetitive measurements at rates ranging from four per second to one every 10 s.

CIRCLE NO. 321



# Compare our SOA and $E_{S/b}$ to theirs and you'll understand why our high current/voltage transistors work.

**High voltage and high current specs aren't enough.**

If you've ever specified transistors above 50 amps, only to find they fail on the job, you know how high-current specs may actually be misleading.

The truth is, unless you see the SOA and  $E_{S/b}$  specs, there's no way of knowing whether a high-current device has the guts to withstand a surge, and not blow out.

That's why we publish both our Safe Operating Area and  $E_{S/b}$  specs.

We want you to see precisely the kind of super-ruggedness you can expect from PowerTech—and only PowerTech—high-current transistors. Compare our  $E_{S/b}$  ratings, from 1.5 to 6 joules, against the millijoules or unpublished ratings of other high-voltage/current devices.

**Copper makes the difference.**

We use extra-heavy copper-metalizing on our bigger, beefier chip:—thereby assuring maximum thermal

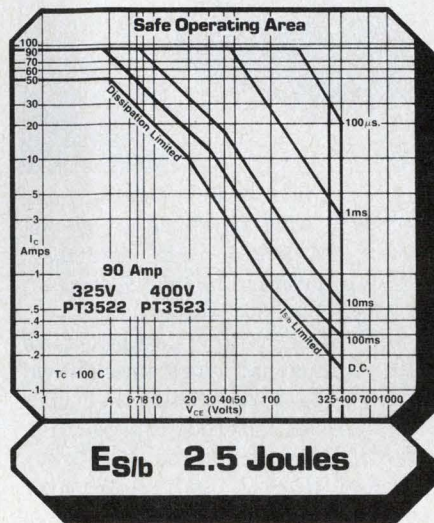

and electrical conductivity and yielding the highest resistance to second breakdown with the lowest  $V_{CE(sat)}$ . Their smaller chips use thin aluminum-metalizing with fragile, current-limiting wires (ours have solid copper posts).

Which would you rather have your circuit depend on? And we don't stop there. To guarantee rapid delivery, we pre-mount our chip on an integral moly-copper heat sink so we can categorize and pre-test the module at high currents to insure maximum reliability prior to mounting in the package of your choice (again 100% tested to the most stringent MIL/AERO specs).

They, on the other hand, must first mount their chip on the package, then test to determine if it's shippable.

**Delivery and prices.**

Our catalogs come complete with prices... we don't believe in secrets.

While our initial device cost may be slightly higher, in the long run we believe you'll find that it's less expensive to use transistors that keep on working.

We rely on direct factory-to-customer contact to ensure 100% responsiveness, backed up by the flexibility of chips already built, pre-tested and ready for whatever electrical/packaging requirements you may have.

But see for yourself: call for further information and applications assistance: Sales Engineering, PowerTech, Inc., 9 Baker Court, Clifton, N.J. 07011; (201) 478-6205.

TYPICAL PRODUCTS			
$I_C$	$V_{CE}$	$E_{S/b}$	Part No.
1200A	80V	6.0J	MT-5007
400A	120V	6.0J	PT-9503
150A	200V	1.5J	PT-4500
90A	400V	2.5J	PT-3523
40A	600V	2.5J	PT-3526

JAN-TX Types Also Available  
Guaranteed SOA

**PowerTech, Inc.**  
"BIG IDEAS IN BIG POWER"

CIRCLE NUMBER 49



# What's the right price for this 1 Form A dry reed relay?

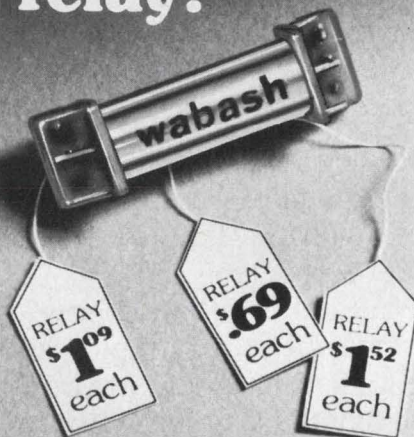

If we told you it has a premium quality switch and precision pins (not bent switch leads) would that help? Or that it's magnetically shielded, U/L listed and meets NARM/EIA proposed standards?

Would it help if we told you it's available in both Form 1A and 2A with .1" and .15" pin spacing, is the most automatically manufactured dry reed relay in the whole world and is available from stock... from Wabash? The right price? All the prices are right. They're the under 25, 100 or MORE and 25,000 prices respectively.

Hard to believe, but true. And we have many other types available, handsomely priced, to fit your needs and budget. So if you'd like to know more, write us (on your letterhead) for a free sample, or call us for a high volume price quote and let us show you how, at Wabash, the price is always right.

*Relays*  
**wabash**

of  
Wabash, Indiana

Wabash, Inc., 810 N. Cass St., Wabash, Ind. 46922  
TEL: (219) 563-2191 TWX: 810-290-2722

CIRCLE NUMBER 50

## COMPONENTS

### \$5 solid-state relays retain all features

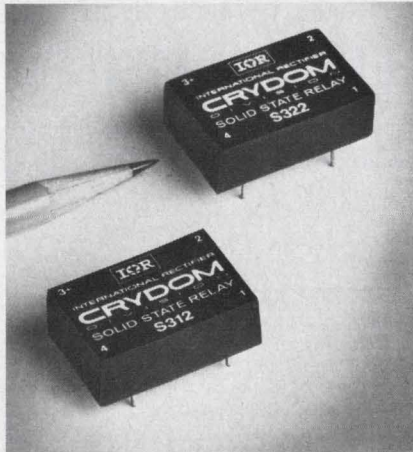

Crydom Controls, Div. International Rectifier, 1521 Grand Ave., El Segundo, CA 90245. (213) 322-4987. 1000-up prices: \$5.45 (Series 2), \$4.95 (Series 3); stock.

Solid-state relay competition with traditional electromechanical relays gets hotter with the Challenger series, offered in production quantity for as low as \$5. Power is rated to 8 A and all features associated with solid-state relays are available. Among features in the Challenger series that other low-cost units lack, according to Crydom, are zero-voltage turn-on, internal snubbers for the triac, half-cycle response and a firm bi-stable turn-on action. In addition, competitive units require higher control current, says Crydom and they don't accept spade-type quick-connect terminals as the Challenger units do. The Challenger series comes in two styles: a miniature unit for PC mounting and a unit with an integral heat-sink mounting surface and push-on connectors for direct-panel or external-finned heat-sink mounting. Series 2 units can handle 8 A rms, when mounted on a heat sink and a one-cycle surge current to 80 A. Isolation, output-to-base and output-to-input is 1500 V ac or 2100 V dc. Blocking voltage is 500 V and rate of rise (dv/dt) is 100 V/ $\mu$ s minimum. Series 3, a PC mount version has a very flat profile and is rated for 2 A rms, 90 to 280 V ac with a surge current rating to 40 A rms. Blocking voltage is also 500 V and dv/dt is 100 V/ $\mu$ s. The units are SPST NO switches.

CIRCLE NO. 322

### Circuit breakers clear in 9 ms

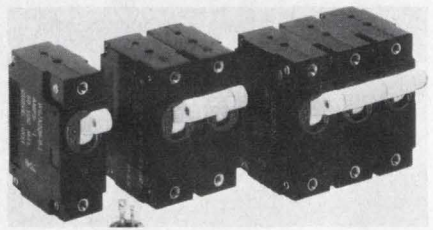

AMF Inc., 200 Richland Creek Dr., Princeton, IN 47671. (812) 386-1000. From \$3: single pole (OEM qty), stock.

The Mini-Mag Series W67 single-pole, W68 double-pole and W69 triple-pole breakers feature circuit-clearing time as fast as 9 ms on moderate to heavy overloads. In addition, the slight inductance of the breaker coil helps limit  $I^2t$  on steeply rising fault currents. Available in trip-current ratings from a fraction of an amp to 30 A, these compact breakers will interrupt fault currents to 2000 A. All standard models are UL recognized as appliance components, and CSA recognized as appliance component protectors. The breakers feature wipe-on-make contacts and a trip-free mechanism, which allows the contacts to open an overload even if the toggle is held in the ON position. On double and triple pole models, an overload in any circuit opens all circuits. Maximum operating voltages are 250 V ac, 60 or 400 Hz, and 50 V dc. All models are temperature stable between -40 and 85 C.

CIRCLE NO. 323

### Illuminated PB switch meets MIL specs

Control Switch, A Cutler Hammer Co., 1420 Delmar Dr., Folcroft, PA 19032. (215) 586-7500. \$11.92 (unit qty).

An illuminated momentary-action pushbutton DPDT switch (part number A20267) meets all requirements of MIL-S-22885/18-01. It's environmentally sealed and shock and vibration resistant. Temperature range is -55 to 85 C. The switch maintains stable contact resistance, especially at minimum current as specified in the MIL spec. It's rated at 28 V dc or 115 V ac, 2-A resistive, 1.5-A inductive and 0.5-A lamp load. Its operating force is  $2 \pm 1$  lb.

CIRCLE NO. 324



## Keyboard designed to clean easily

Datanetics Corp., 18065 Euclid St., Fountain Valley, CA 92708. (714) 549-1191. \$2.90 (10,000 up); stock to 45 days.

Low-cost touch keyboards can be used in both home appliances and industrial systems. The Series 700 is thin (0.15-in. thick), waterproof and completely sealed. Units are available in an unlimited choice of sizes, styles and colors, with or without both bezel and tactile feedback. The standard keyboard interconnects through connectors, or it can be hard wired. Because the keyboard has no cracks or pockets, it is easy to clean.

CIRCLE NO. 325

## Rotary switches provide 60 positions

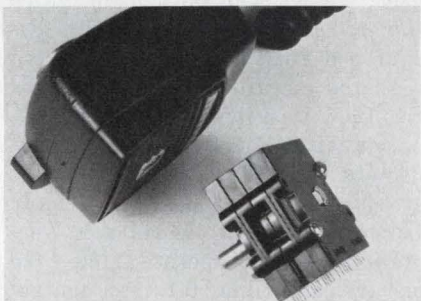

Oak Industries Inc., Crystal Lake, IL 60014. (815) 459-5000. \$2.30: single section, \$3.60: double section (1000 up); limited production.

A rotary switch with a capacity of up to 60 positions, designated the Communication-Series switch, has three rotary-switch design innovations: contacts never touch the laminate, thus eliminating scraped-off particles and intermittent opens; dead and live metal areas on the rotor are separated by grooves that clean each contact as it passes over them; a PC rotor has an integral cam that functions as a precision detent, eliminating functional backlash from loose rotors and stack-up tolerance problems. Oak guarantees switching accuracy for the life of the switch on all applications received by Oak to date. A single section can accommodate two 7-bar readouts or two 8-bit binary codes with separate commons. Plastic materials used have a 94 VO UL flammability listing, and terminals are designed for PCB insertion.

CIRCLE NO. 326

# A NEW GENERATION OF IMAGE SENSORS

## SIMPLICITY OF USE -

Requiring less than a dollars worth of circuitry to drive—and barely more than that for video processing—is just one of the key features of our new “G” series image sensors. Compare the non-critical single TTL clock needed for the “G” device to the complex multi-phase clocks prescribed by others.

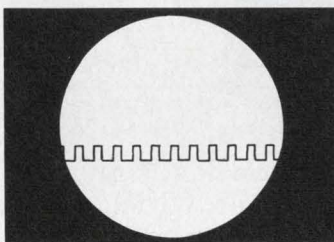

You need only this for Reticon

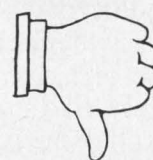
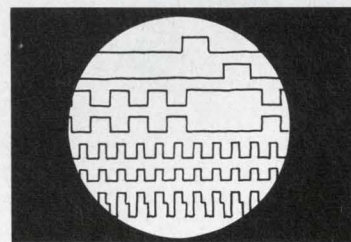

You need all these for others

## HALF THE PRICE -

Or even less will bring you 256, 512, 768, or 1024 sensor elements on 25 $\mu$  centers or up to 1728 elements on 15 $\mu$  centers in our “H” series.

## SUPERIOR PERFORMANCE -

Low dark current allowing low light level operation, on-chip noise cancellation, and smooth spectral response from visible through infrared makes this new generation the unquestionable choice.

## APPLICATIONS -

Page readers, facsimile, OCR, point of sale readers, non-contact measurements and inspection and many others.

# RETICON®

910 Benicia Avenue, Sunnyvale, California 94086  
PHONE: (408) 738-4266 TWX: 910-339-9343

CIRCLE NUMBER 51



# Ledex Linear Solutions... off-the-shelf or tailor-made.



Whatever your linear actuation needs, check with Ledex for the answer. Over 100 design variations are waiting on the shelf to insure 48 hour delivery of your prototypes.

Models range from a space saving  $\frac{1}{2}$ " x  $\frac{1}{2}$ " tubular solenoid to a hefty  $3\frac{3}{8}$ " pancake solenoid that will develop up to 350 pounds of force. You'll probably want something in between and we've got it with our full line of Tubular, D-Frame and Pancake Solenoids.

If your application calls for something special, we'll put over thirty years of solenoid experience to work for you to find the optimum solution.

The optimum solution could be something other than a linear solenoid. That's why we make a full line of Rotary Solenoids, Stepping Motors and Electro Proportional Solenoids. And that's an option no other manufacturer can give you!

Write or call today for our 36 page Linear Actuation Line catalog and price sheet.



Ledex Inc.

123 Webster Street, Dayton, Ohio 45401 (513) 224-9891

CIRCLE NUMBER 52

## COMPONENTS

### Reed relay handles 1 GHz with 1.2 VSWR

*Fifth Dimension Inc., 707 Alexander Rd., Princeton, NJ 08540. (609) 452-1200. \$11.13: RF 1603, \$18.44: RF 1606 (250 up); stock to 6 wks.*

A new rf reed relay, featuring a totally shielded dry-reed switch, is capable of switching low-level signals to 1 GHz and pulse signals with rise times to 150 ps. The relay is small occupying only 0.1 in<sup>3</sup>. At 1 GHz the VSWR is less than 1.2; isolation, 25 dB; loss, 0.4 dB. At 100 MHz the VSWR is 1.03; isolation, 47 dB; loss, 0.08 dB. Distortion of a pulse with a 150-ps rise time is not detectable. The relay is available in two models. Both have a 50- $\Omega$  characteristic impedance. Model RF 1603 is designed for rf PC-board mounting. It's equipped with tabs for commencing with the circuit ground plane. The RF 1606 is suited for cable termination with SMA/OSM coaxial connectors. On both models coil leads are pigtailed for locations remote from rf path. Life is rated at one-million cycles; operate time, 0.5 ms; release time, 0.1 ms; contact bounce, 0.3 ms. Coils are designed for 5, 12 and 24-V-dc operation. TTL drive is possible.

CIRCLE NO. 327

### Smoke detector saves lives

*Mountain West Alarm Supply Co., 4215 N. 16th St., Phoenix, AZ 85016. (602) 263-8831. \$49.50 (unit qty).*

A solid-state smoke detector, the B6 ionization unit, can save lives by detecting smoke at the very early stages of a fire. A single unit can protect a maximum of 900 ft<sup>2</sup>. A LED indicates proper operation. Fire indications are sensed long before visible smoke, flames or elevated temperatures can be detected by other devices. An attention-getting alarm (85 dB) is loud enough to waken heavy sleepers through closed bedroom doors. The unit meets FHA, HUD and California requirements, is listed by UL, weighs 8 oz, measures only 6-in. dia and uses 120 V ac.

CIRCLE NO. 328



## Ironless-rotor motors cog less, make less noise

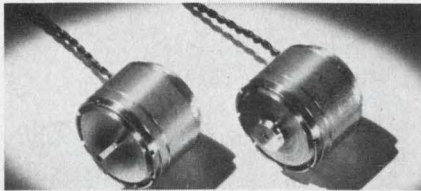

North American Philips Controls Corp., Cheshire Industrial Park, Cheshire, CT 06410. (203) 272-0301. \$6.52 (500 up); prototypes from stock, production 12 to 14 wks.

Low noise levels, rapid acceleration, low cogging and compact size are advantages claimed for the Series 4322-010-77000 dc ironless-rotor motors. Designed for 9-V-dc operation, the motor has a 0.76-g-cm<sup>2</sup> moment of inertia, 8.5-g-cm starting torque and a motor constant of 50 ms, typical. A gold-plated five-segment commutator and silver-plated brushes are used for optimal commutation. This permits the use of accurate electronic control for servo motor or tachometer service.

CIRCLE NO. 329

## Low-profile relay fits 0.6-in. spacing

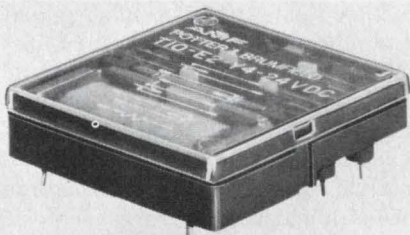

AMF, Potter & Brumfield Div., 200 Richland Creek Dr., Princeton, IN 47671. (812) 386-1000. \$4 (100 up).

A lightweight 6-form-C relay, series T10, permits PC-board spacing on 0.6-in. centers and accepts drive directly from ICs. Coil voltages of 6, 12, 24 and 48 V dc are available, and permissive-make contacts are rated 0.1 to 3 A at 28-V-dc or 120-V-ac resistive. Bifurcated contacts are rated low-level to 1 A at 60 V dc or 12 V ac resistive. The permissive-make arrangement gives all T10s long operating life because of minimal contact bounce. Life expectancy is a minimum of 50-million operations mechanical to 50,000 operations at full load. Initial contact resistance is 50 MΩ or less.

CIRCLE NO. 330

# Be a Genius in your own time!

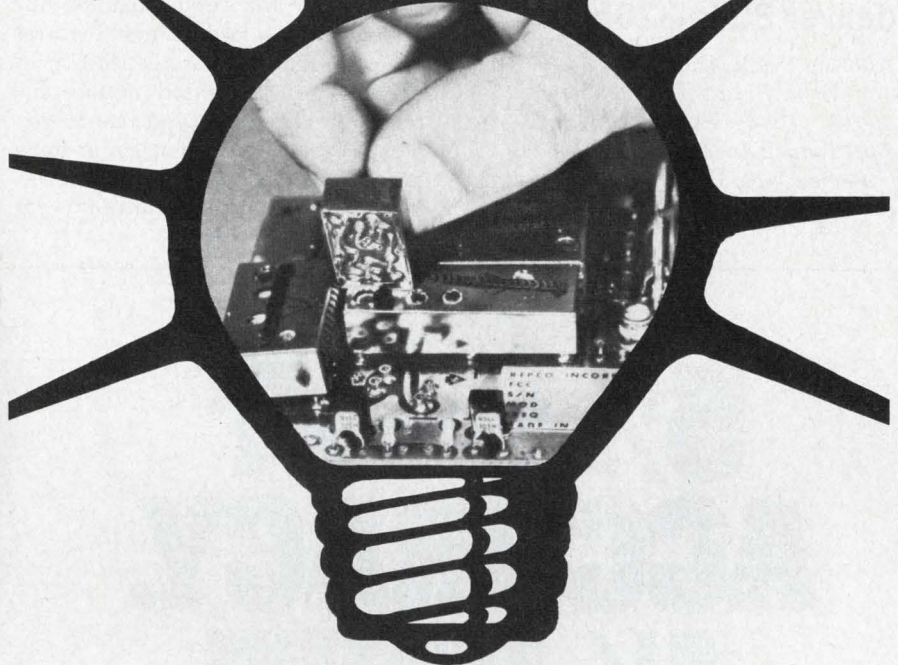

## Join the hundreds who have already discovered the versatility of Repco's modular RF links.

**How versatile?** The overwhelming response to our Undiscovered Genius contest proves the true versatility of Repco's modular RF links. Prizes were awarded for these winning ideas:

- Hospital data system
- Bank teller alarm
- Remote drone fire fighter
- Cardiac rate alarm
- Mine roof failure alert
- Portable ticket vending system
- Silo inventory control
- Boat security system
- Remote timer/counter
- Porpoise communicator
- Radio controlled shark
- Remote corrosion monitoring

**What can you do with RF links?** While building a remote-control shark may be a little too zany for you, consider some of the innovative and commercially proven applications now utilizing Repco modular RF links:

- Air to ground communication
- Alarm systems
- Electric power line monitoring
- Fire nozzle pump operator
- Mine pollution monitoring
- Ocean monitoring buoy system
- Remote crane control
- Repeater link
- Seismic monitoring
- Small craft emergency beacon
- Traffic emergency assistance
- Water flow monitoring

**Repco's modular RF links are designed for voice, low-speed digital, or tone operation. Frequencies available are 25-50 Mhz, 72-76 Mhz, 132-174 Mhz, and 450-470 Mhz ranges (66-88 Mhz for overseas usage). All units are built to stringent FCC & EIA specifications.**

Be a Genius . . . design Repco's RF links into your system. Write or call for free specs brochure.



# Repco

A subsidiary of Scope Inc

Special Products Department  
1940 Lockwood Way, P.O. Box 7065  
Orlando, FL 32804  
(305) 843-8484 TWX 810-850-0120

CIRCLE NUMBER 53



## POWER SOURCES

### Low-cost inverters deliver 30 to 320 VA

Abbott Transistor Labs, 5200 W. Jefferson Blvd., Los Angeles, CA 90016. (213) 936-8185. \$262 to \$361; stock to 8 wk.

Series KN, PN and LN are said to be the lowest cost dc to sine-

wave inverters, in the 30-to-320-VA range, you can buy. They operate from a dc input of 11 to 15, 22 to 30, or 29 to 38 V, producing ac at either 115 V at 60 Hz or 220 V at 50 Hz. Their maximum distortion is 5% and regulation for line or load is 3%. Additional features are: a surge-current capability of three times the rated output and the ability to withstand input transients of 45 V dc for 0.1 s. A magnetic circuit-breaker provides overload protection. **CIRCLE NO. 331**

### HV supply is stable and analog-controlled



Spellman High-Voltage Electronics Corp., 1930 Adee Ave., Bronx, N.Y. 10459. (212) 671-0300. \$580 up, 8-12 wks.

The SEM25N6000X stable high-voltage dc power supply has a continuously-variable output of 0 to 25 kV at 0.25 mA. It is a completely solid-state unit with an encapsulated high-voltage section. The supply features line and load regulation of 0.001% from 10% to its maximum rated voltage, max ripple of 10 ppm from 2.5 to 25 kV and 50 ppm from 1 kV to 2.5 kV, max drift of 10 ppm in four minutes or 50 ppm per hour and a tempo of 0.005% per °C. Either an external resistance or voltage can control the supply's output. For safety, the control circuits are referenced to ground and, the HV return is floated above ground and clamped not to exceed 15 V. This feature lets you use independent grounding of the load-return circuit to eliminate a possible ground loop. The floating HV return is also an aid in the measurement of load current. The unit is protected against arc-over and overloads and has automatic recovery.

**CIRCLE NO. 332**

### Dc/dc converters deliver 140 W

Wilmore Electronics, P.O. Box 2973, Durham, NC 27005. (919) 489-3318. \$320 (10); stock-30 days.

Designed to power equipment such as mobile-radio base stations, data processing and process-control equipment, the Model 1295 dc/dc converter feature efficiencies of greater than 80%. Standard input voltages are 24 and 48 V dc; standard output voltages are 12, 24, 26, 48 and 125 V dc. Each unit can provide 140 W continuously. Model 1295 comes in a 5-1/4 × 12 × 19-in. rack-mount or smaller enclosure. All versions weigh less than 12 lb.

**CIRCLE NO. 333**

# 5½ DIGIT ACCURACY. 4½ DIGIT PRICE.

The 4600 is our brand new 4½ digit multimeter. It gives you the accuracy and resolution of typical 5½ digit multimeters. At half the cost.

And the 4600 stays accurate longer than other DVM's. DC accuracy stays within 0.01% ± one digit for six months at a time. We guarantee it.

80dB normal mode noise rejection produces a 10,000:1 reduction of excess noise. A full decade better than the 1,000:1 reduction of comparable instruments.

Loading errors are virtually eliminated by the 4600's 10,000MΩ input impedance on the two lowest DC voltage ranges.

There's a lot more. Send for a free catalog on our new 4½ digit 4600 multimeter. And find out how to get 5½ digit accuracy without paying for it.

Dana Laboratories, Inc.,  
2401 Campus Drive, Irvine,  
California 92715. 714/833-1234.



**DANA**

**Others measure by us.**

FOR PRODUCT DEMONSTRATION  
CIRCLE # 54

FOR LITERATURE ONLY  
CIRCLE # 55



## Rugged inverters run off 10 to 400 V dc

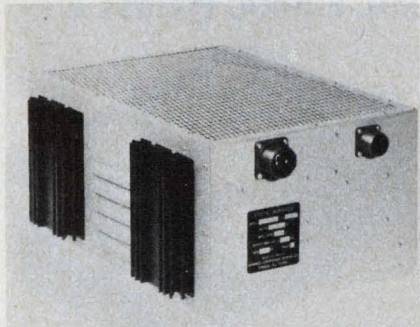

Advance Conversion Devices, 109 Eighth St., Passaic, NJ 07055. (201) 778-0707. From \$285; stock to 90 days.

These ruggedized inverters feature 50,000 hours guaranteed MTBF. They operate from 10-to-400-V-dc inputs with efficiencies in excess of 80%. Outputs of 36 VA to 15 kVA are available at 50 (series D), 60 (series A), or 400 Hz (series C). All units withstand high-voltage spikes and ripple on the input and provide a true sine-wave output with distortion limited to 5% rms.

CIRCLE NO. 334

## 375 W packed into small dual-output switcher

LH Research, Inc., 1821 Langley Ave., Irvine, CA 92714. (714) 546-5279. \$525; 8-9 wks.

The MMX-720 is a two-output switching-regulated power supply in the Mighty Mite series. Its package is 3 × 9.5 × 13 in. The main output delivers 5 V at up to 75 A, while the other output can be any one of the following: 2 V at 24 A, 5 V at 24 A, 12 V at 20 A, 15 V at 20 A, 18 V at 16 A, or 24 V at 10 A. Note that the maximum combined power of both outputs is 375 W. Other operating characteristics include: efficiency of up to 80%, ripple of 1% or 50 mV pk-pk, noise output of 1% pk-pk, or 50 mV, line regulation of 0.4% over the entire input range, load regulation of 0.4% from no-load to full-load and response time of 200 μs to 1% after a 25% load change. Its operating range spans 0 to 70 C. Full rating is maintained to 40 C but must be derated to 60% at 70 C.

CIRCLE NO. 335

## 48-V input operates 5-V dc switching regulator

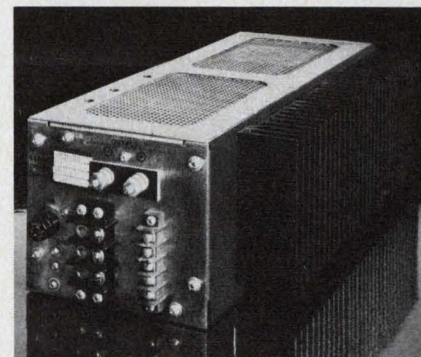

ACDC Electronics, 401 Jones Rd., Oceanside, CA 92054. (714) 757-1880. \$672, stock to 4 wks.

The model JD5N100 dc-to-dc supply accepts inputs from 42 to 60 V, and delivers 5 V at up to 100 A. It has an efficiency of 70%, measures approximately 5 × 7 × 15 in. and weighs 19 lb. Overvoltage, thermal and reverse-voltage protection is standard. Provisions are made for remote-sensing, remote-shutdown and remote-control. These supplies also can be paralleled.

CIRCLE NO. 336

**MODULAR SWITCHING POWER SUPPLIES**  
built for reliability by  
CONTROL DATA CORPORATION

## OEM DESIGNERS

# Get this FREE Design File

on CDC's new modular switching power supplies

These compact, modular power supply switchers simplify design in 300-600 watt applications and keep costs down too. (They're priced at less than 90¢ per watt!) Benefits to the end user include **low EMI noise levels** (we are designed to meet VDE STD 0875) and **highly reliable operation** plus convenient maintenance and easy add-on capability up to 1200 watts in a single, 19 in. rack. Get specs, prices and feature details today from:

## Magnetic Components Group

# CONTROL DATA CORPORATION

7801 Computer Avenue South, Minneapolis, MN 55435  
(612) 830-5800 TWX 910 576 2978

CIRCLE NUMBER 56

ELECTRONIC DESIGN 20, September 27, 1976

MICROPROCESSOR SERIES NO. 1

## OUR EASIEST-TO-USE 2650: NOW MULTI-SOURCED.

All the 2650's you need, in stock at Signetics, authorized distributors, Advanced Memory Systems (AMS) and Philips, too.

Clip coupon to letterhead. Or call (408) 739-7700, Ext. 2982/3. Please rush me my FREE 2650 Short Form Catalog.

Name _____	Title _____
Tel. _____	M.S. _____

811 E. ARQUES, SUNNYVALE, CA. 94086

# THINK

# Signetics μP

a subsidiary of U.S. Philips Corporation

CIRCLE NUMBER 57



## POLA™: THE ULTIMATE IN VERSATILITY IN EMI/RFI PRESSURE-SEAL GASKETING

In strip form, it's Polastrip®. For magnetic-field shielding, Pola-HTM™. When you cut it out yourself, it's Polasheet®. With pressure-sensitive adhesive backing, Polastick®. Whatever form you specify, it's the first family of composite EMI/RFI pressure-seal gasketing—a silicone elastomer matrix with embedded conductive wires that provides high-resilience shielding/sealing efficiency with maximum conductivity between mating surfaces.

More? Metex also makes annular Polaring® in a wide variety of standard and custom sizes. Or, factory-fabricated gaskets are made of Polasheet® or Polastick® gasketing for standard AN, RF or other popular connectors. And, for the optimum in EMI/RFI shielding with pressure seal, Xecon® Polastrip offers a wide variety of hollow, channeled or user-defined cross-sections produced from silicone containing a uniformly dispersed conductive filler.

For full data, samples and application engineering consultation on Pola and other composite shielding/pressure seal solutions, call or write: Metex Corporation, Edison, N. J. 08817, (201) 287-0800; or Cal-Metex Corp., Inglewood, CA. 90301, (213) 641-8000.

# POLA

## METEX

ELECTRONIC SHIELDING GROUP

CIRCLE NUMBER 58

## POWER SOURCES

### High-current supply drives ECL circuits

ACDC Electronics, 401 Jones Rd., Oceanside, CA 92054. (714) 757-1880. \$720; stock to 5 wk.

You get the two voltages needed to power ECL logic—5.2 V at 16 to 80 A and 2.2 V at 0 to 50 A—from the Model JF102. These voltages can be remotely programmed  $\pm 5\%$  for system margin-checking. The unit operates from 115/230 V ac  $\pm 15\%$ , 47-to-63-Hz single-phase. Either can be selected by using the appropriately marked input terminal. Measuring  $5 \times 8 \times 10.5$  in. and weighing less than 20 lb, the unit contains a replaceable fan that permits full output at 50 C, derating linearly to 70% at 70 C. Overload, thermal and overvoltage protection is standard.

CIRCLE NO. 337

### Four-output dc supplies are not custom-priced

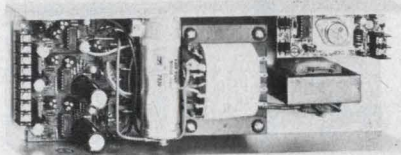

Deltron, Wissahickon Ave., North Wales, PA 19454. (215) 699-9261. \$96-\$109, 1 wk.

The "Quad" series of four-output power supplies consists of standard modules mounted in a single chassis. You can thus bypass the usual engineering charge when you need a custom supply. The Model 888 consists of a QT-2 triple-output power supply (rated: 5 V at 6 A,  $\pm 12$  to  $\pm 15$  V at 1 A) assembled in a common chassis with any of the three QPS series single-output supplies. The Model 8899 consists of an MPS-2 triple-output power supply (rated: 5 V at 7 A, 12 V at 1 A, and 9 V at 1.2 A or 5 V at 0.75 A) assembled in a common chassis with any of the three QPS series single output supplies. Specifications for the "Quad" series are the same as those of the MPS, QT and QPS models they are derived from.

CIRCLE NO. 338

### 25-W regulator meets MIL-E-5400 P class 2

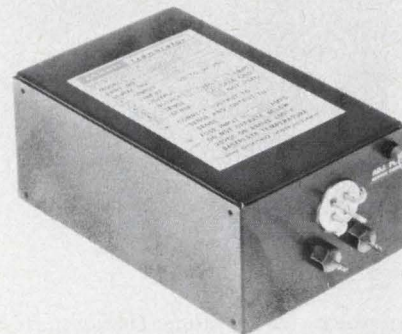

Abbott Transistor Labs, 5200 W. Jefferson Blvd., Los Angeles, CA 90016. (213) 936-8185. \$355 (1-4); 10 wks.

The UN25 series of switching regulators is fully encapsulated and hermetically sealed to meet the environmental requirements of MIL-E-5272C and MIL-E-5400P class 2 and the EMI requirements of MIL-STD-461. The units operate from 115 V, 400 Hz. They output from 5 to 50 V dc at 25 W. Output current is full rated from  $-55$  to  $+85$  C derated 80% at 100 C. Regulation is  $0.3\%/^{\circ}\text{C}$ . Other standard features include short circuit protection, input transient protection, remote error sensing, input to output or case isolation is 250 V dc and output to case is 50 V dc. MIL connectors and overvoltage protection are available as options. Case size is  $3.5 \times 5.5 \times 2.5$  in. They weigh 2.8 lb.

CIRCLE NO. 339

### Cabinet mounted UPS series spans 3 to 15 kVA

Topaz Electronics, 3855 Ruffin Rd., San Diego, CA 92123. (714) 279-0111. \$5000 and up, 1-4 wks.

Standard models of the 81000 series of uninterruptible power supplies (UPS) are single-phase output units with 3, 5, 10 and 15 kVA ratings. They are mounted in NEMA type-2 front-access cabinets. On all standard models, continuous display of the system's operational status is provided by a status-monitor and control panel. Options available include: static-transfer switch, audible-alarm and acknowledgement switch, output-frequency meter, battery-float equalize capability with timer, and battery ammeter.

CIRCLE NO. 340



MICROWAVES & LASERS

Delay line is switched in discrete steps



Allen Avionics, 224 E. 2nd St., Mineola, NY 11501. (516) 248-8080. Start at \$62; 3 wks.

The Nanno Switch is a switch-variable delay line designed for the nanosecond range. The units consist of individual delay lines each with its own switch. Time delay is changed by switching one or more individual delay lines in series with the input and output connections. Units are available in 50 and 75-Ω impedances with eight switches, including 1, 2, 4, 8, 16, 32, 64 and 128-ns delays.

CIRCLE NO. 341

Need a compact, remote multiposition switch?

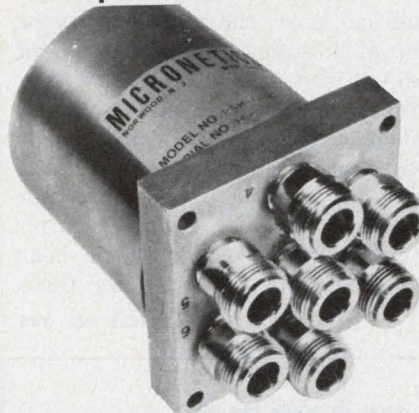

Micronetics, Inc., 36 Oak St., Norwood, NJ 07648. (201) 767-1320. Start at \$195; stock-4 wks.

Model RS series of remote miniature multiposition coaxial switches covers a frequency range of dc to 18 GHz and has an rf power rating of 50 W average. Isolation is 60 dB min., insertion loss is 0.5 max., VSWR is 1.6 max. Impedance is 50 Ω.

CIRCLE NO. 342

Power divider splits input five ways



Sage Laboratories, 3 Huron Dr., Natick, MA 01760. (617) 653-0844. \$250; 45 days.

Model FP1835-24 is the forerunner of a new series of five-way power dividers. The unit has an operating frequency range of 2 to 4 GHz, over which it features maximum VSWR of 1.5:1 at all ports, 15-dB min. isolation, 0.6-dB max. insertion loss (0.3 dB typical), and 0.5-dB max. imbalance. Size is 3.25 × 3.00 × 0.50 in.

CIRCLE NO. 343

tiny trimmers...  
tiny price!

MuRata's new line of subminiature trimmers has established a standard of performance in the economical trimmer field second to none . . . Alumina-base, non-combustible design, extreme resistance to solvents, and a wide 100 ohm to 2 megohm range of resistances. What's more, they are backed by MuRata's world-wide reputation for quality you can count on. Find out how these new pots can be put to work for you. Send for complete technical information today.

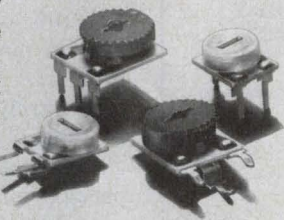

**muRata**  
CORPORATION OF AMERICA  
Rockmart Industrial Park, Rockmart, Georgia 30153  
Phone: 404-684-7821/Telex: 54-2999/TWX: 810-766-1340

CIRCLE NUMBER 59

ELECTRONIC DESIGN 20, September 27, 1976

MICROPROCESSOR SERIES NO. 2

**2650**  
**DEVELOPMENT HARDWARE**  
**FOR ALL**  
**COST/CAPABILITY LEVELS.**

Here now:

- PC1001 Prototyping Card
  - PC2000 4K Byte RAM Card
  - DS2000 Demo Base with P.S.
  - PC3000 Smart Typewriter Democard
  - KT9000 Prototyping Kit
- More Soon!

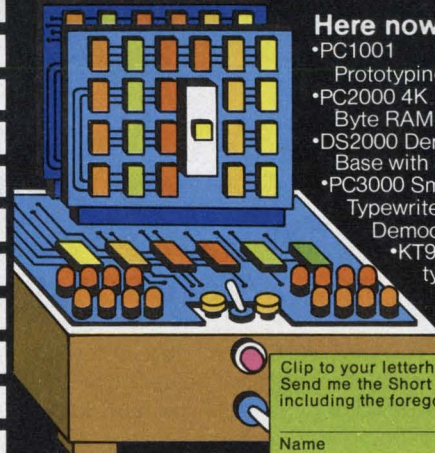

Clip to your letterhead. Send me the Short Form Catalog including the foregoing data sheets.

Name	Title
Tel.	M.S.
811 E. ARQUES, SUNNYVALE, CA. 94086	

THINK  
**Signetics μP**  
a subsidiary of U.S. Philips Corporation

CIRCLE NUMBER 60



**Laser claims mini title**

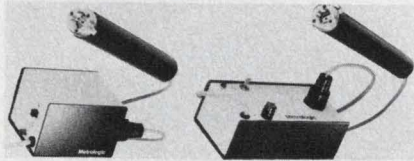

*Metrologic Instruments, 143 Harding Ave., Bellmawr, NJ 08030.*

(609) 933-0100. \$180.

Only 8-5/8 in. long and 1-3/8 in. in diameter, this new 0.8-mW cylindrical laser, the ME-620, may be the world's smallest mass produced helium-neon laser. Front and rear rings are locked in place with an Allen wrench. The beam can be positioned concentric with these rings or can be aimed off-center according to the user's requirements. The output power is near the maximum permitted for Class II lasers.

CIRCLE NO. 344

**Gunn oscillators claim low AM noise**

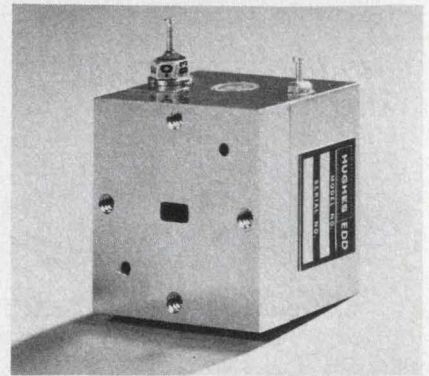

*Hughes Aircraft, 3100 W. Lomita Blvd., Torrance, CA 90509. (213) 534-2121. \$805 to \$1750; 30 days.*

A new series of mechanically tuned Gunn-effect oscillators covers the 18-to-60-GHz frequency range and features inherently low AM noise characteristics. Each unit is factory adjusted to one of eight specific center-frequency ranges. Minimum power outputs range from 10 to 250 mW, although not all outputs are available in all frequency ranges. Mechanical tuning range is from  $\pm 250$  MHz in the lower frequency models to  $\pm 150$  MHz in the higher frequency units.

CIRCLE NO. 345

**Need answers on rechargeable power sources?**



**Call the guys who've been there**  
**800-433-2684**  
**in Texas 800-792-8767**

Call our Hot Idea-Hotline toll-free and we'll help you design a nickel-cadmium sealed cell power package to fit your specific needs. In addition, we'll give you hard facts on sizes, ampere hours, configurations, prices, delivery. Chances are, all the applications we've done on hand tools, appliances, calculators, toys, and communication equipment will provide some short cuts for you. Call us. We'll deliver. Marathon Battery Company, P.O. Box 8233, Waco, Texas 76710. A division of Marathon Manufacturing Company.

**marathon battery company** 

CIRCLE NUMBER 61

**Blue laser lives for 4000 hours**

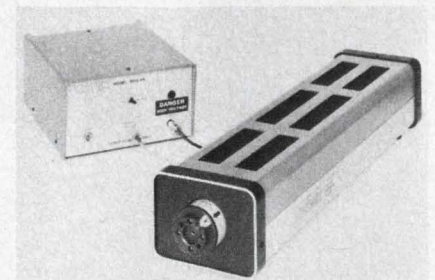

*Liconix, 1400 Stierlin Rd., Mountain View, CA 94043. (415) 964-3062. \$3200.*

This helium-cadmium laser, Mod-4100, offers a tube life expectancy of more than 4000 h. Previous tube life in blue lasers is said to have rarely exceeded 2000 h. Range of operation has also been increased from 0 to 50 C, and the laser package eliminates complicated mirror-adjusting plates, springs and straps. In addition, the resonator structure has environmental shielding for maintenance-free operation.

CIRCLE NO. 346



## TWT amplifier offers protection features

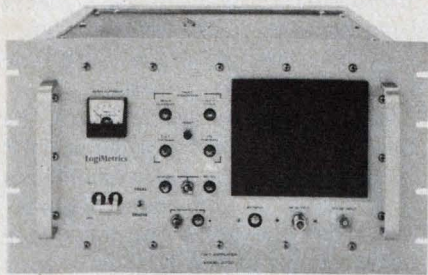

Logimetrics, 121-03 Dupont St., Plainview, NY 11803. (516) 681-4700. \$16,000; 120 days.

The A700 series of traveling-wave-tube amplifiers offers a minimum rf output of 1 kW over the frequency range 1.0 to 16.0 GHz. All models use solid-state power supplies protected by a front-panel circuit breaker. All controls are front-panel mounted. The tubes are protected by helix current and voltage sensors, filament surge limiting and thermal overload sensors. Minimum gain is 35 dB.

CIRCLE NO. 347

## Couplers feature stripline construction

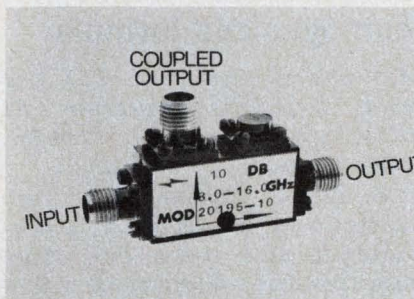

Omni Spectra, 21 Continental Blvd., Merrimack, NH 03054. (603) 424-4111. \$35 to \$175; 3-8 wks.

All fourteen models in new coupler series 20190 feature stripline construction. Standard available frequency ranges are 1.0 to 2.0, 2.0 to 4.0, 4.0 to 8.0 and 7.0 to 12.4 GHz. Mean coupling values of 6, 10 and 20 dB are offered in each frequency range. Temperature range is  $-54$  to  $125$  C. The 20190 incorporates three OSM jack connectors. Isolated port is terminated with  $1/2$ -W,  $50$ - $\Omega$  load.

CIRCLE NO. 348

## GaAsFET amplifier shows noise figure of 2.6 dB

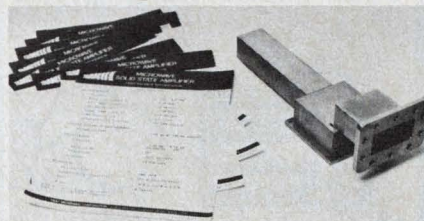

Trak Microwave Corp., 4726 Eisenhower Blvd., Tampa, FL 33614. (813) 884-1411. \$2150; 30-40 days.

Model 8040-1030 is the first in a family of GaAsFET solid-state amplifiers. Designed to operate in the 3.7-to-4.2-GHz region, the low-noise amplifier has a gain of 50 dB min and a noise figure of 2.6 dB max. Gain variation is  $\pm 0.25$  dB max, with a gain slope of 0.1 dB per 20 MHz max. Intermodulation intercept is  $+23$  dBm min and VSWR (input/output) is 1.25:1 max. The 8040-1030 operates from  $-40$  to  $60$  C, weighs only 14 ounces and measures  $3.6 \times 3.9 \times 11.25$  in.

CIRCLE NO. 349

## Guess the number of caps in the jar and win one. Free.

Right—we'd like to give you a free sample.

Just to show you how easy it is to get the right film capacitor for your high energy pulse discharge, communications and instrumentation circuits.

Our line includes metallized film and film-and-foil capacitors with polyester, polycarbonate, polystyrene, polysulfone and polypropylene dielectrics. Values from 0.001-25  $\mu$ F, voltages to 900 V and higher, with tolerances as tight as  $\pm 0.5\%$ . And they're available off-the-shelf from our distributors or in 4 to 5 weeks ARO for production quantities.

Ask for details and your free sample today. You can't lose.

**In film caps, it's no contest.**

**ELPAC COMPONENTS**  
ELPAC 714/979-4440

CIRCLE NUMBER 62

ELECTRONIC DESIGN 20, September 27, 1976

MICROPROCESSOR SERIES NO. 3

## 2650 HIGHER LEVEL LANGUAGE SPEEDS YOUR DEVELOPMENT.

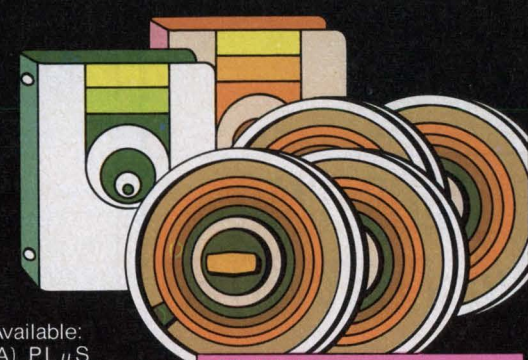

Available:  
(A) PL  $\mu$ S Compiler for 16- & 32-bit computers and on Time-share, (B) 16- & 32-bit Assemblers and Simulators.

Clip to letterhead. Send me quickly the 2650 Short Form Catalog including data sheets on the foregoing software.

Name \_\_\_\_\_ Title \_\_\_\_\_

Tel. \_\_\_\_\_ M.S. \_\_\_\_\_

811 E. ARQUES, SUNNYVALE, CA. 94086

**THINK**  
**SYNOPTICS  $\mu$ P**  
a subsidiary of U.S. Philips Corporation

CIRCLE NUMBER 63



We squeeze time

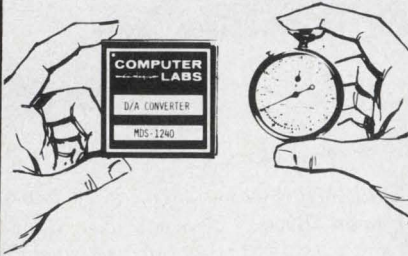

...in our new...

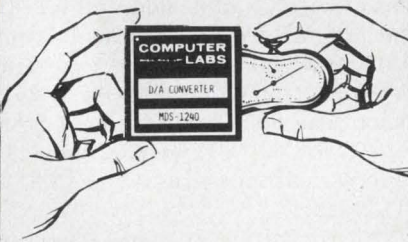

12-bit D/A!

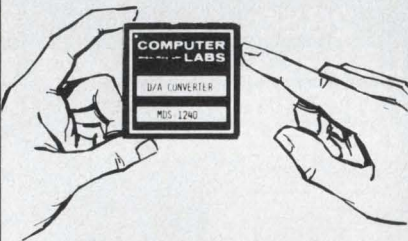

**MDS-1240**  
**D/A CONVERTER**

12-Bits, 40NS

**\$149**

**COMPUTER LABS**

505 EDWARDIA DRIVE  
GREENSBORO, N. C. 27409  
(919) 292-6427

CIRCLE NUMBER 64

## PACKAGING & MATERIALS

### Solder cream comes in homogenized formula

Assembly Systems, Inc., P.O. Box 9084, Dept. S, Providence, RI 02940. (401) 331-9154. \$1.50/oz. (20 oz.-up).

A solder cream, called Tech Solder 6000, comes in a homogenized formula. It combines a fine-mesh powdered-solder metal with a noncorrosive flux and vehicle system. The formula flows at 374 F for use in all standard soldering applications. It contains no cadmium or fluorides. Tech Solder 6000 can be used with either automatic dispensing equipment or a manual syringe.

CIRCLE NO. 350

### Plastic boxes come with divider slots

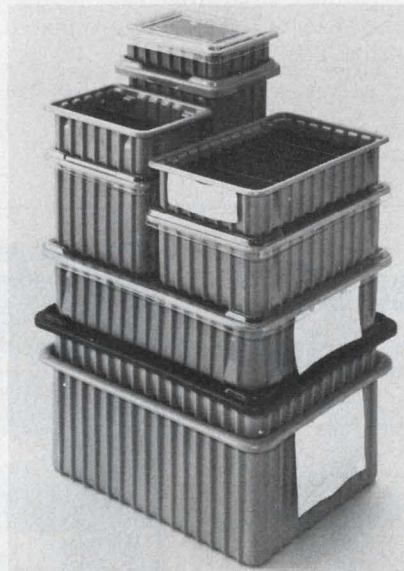

W. D. Adam Co., Inc., 630 W. 27th St., Costa Mesa, CA 92627. (714) 646-4488.

These units, called Modular Tote Boxes are available in 42 sizes. Plastic dividers allow each box to have compartment widths of multiples of 1.125 in. They have dust proof snap-on lids and identification ticket holders. A special circuit board holder is also available.

CIRCLE NO. 351

#### Filler

*Thanks to advances in medical electronics, researchers have discovered that insanity is inherited. You get it from your children.*

### Dummy DIPs stand in for the real ones

Micro Electronic Systems, 8 Kevin Dr., Danbury, CT 06810. (203) 746-2525. 14-pin; \$3.00; 16-pin; \$3.65 (small qty); stock.

Skip-A-Dip is inserted into the holes of a PC board when a DIP is missing due to parts shortages or missing components. Skip-A-Dip keeps the holes free of solder for insertion of the DIP at a later time. The PC board is then wave soldered. The unit is simply removed at the end of the wave solder machine and reused over and over again. It comes in two sizes, 14 and 16 pin. Teflon coated units also are available for water-soluble fluxes.

CIRCLE NO. 352

### Three breadboards come in Eurocard size

Vero Electronics Inc., 171 Bridge Rd., Hauppauge, NY 11787. (516) 234-0400. \$50 each; stock.

Three different boards—a CPU, a memory and an interface board—suitable for the evaluation and production of microprocessor-based systems conform to the single-width Eurocard size. The 100 × 160-mm cards can be put together into a full system using the manufacturer's card-frame system and case-frame parts. The boards are produced on a high-grade, fiber-glass laminate and are totally wire-wrappable. They are preassembled with mini-wrap DIP sockets of the correct size and number for the specific function of the particular board, together with additional test point and component mounting pins. They are also fully decoupled by means of solid tantalum capacitors (0.1  $\mu$ F, 35 V) and fitted with a 64-pin connector with mini-wrap terminations. The CPU board is fitted with a range of sockets to accommodate the microprocessor chip and the minimum memory, clock and interfacing chips. Space is also available for the addition of discrete components and potentiometers. The memory board has eight 28-pin sockets fitted to accommodate 8-k words of additional memory. The interface board contains, in addition to the IC sockets, space for adding discrete components and a crystal.

CIRCLE NO. 353



## Solder alloy melts at 293 F



Multicore Solders, Inc., South Service Rd., Westbury, N.Y. 11590. (516) 334-7450. \$5-7/lb.

A solder alloy has a much lower melting point than standard alloys. The melting point of this alloy is 294 F, compared to standard 60/40 solder, which melts at 380 F. The alloy, called TLC, is a composition of tin, lead and cadmium and is completely non-toxic in use. The alloy is furnished as a wire core solder with 5-cores of rosin flux, or in solid wire form.

CIRCLE NO. 354

## Polyethylene bags prevent static buildup

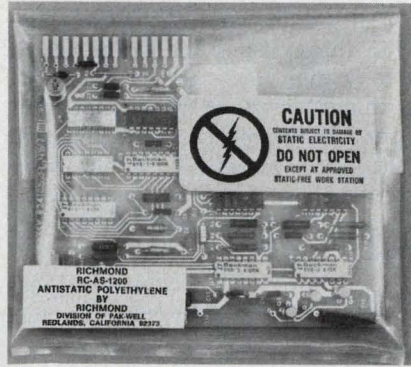

Richmond, Div. of Pak-Well, Box 1129, Redlands, CA 92373. (714)-794-2111. 5.4¢ (1000-up).

Electrostatic damage to CMOS and other sensitive circuits can be prevented by using transparent pink bags made of antistatic polyethylene film. Containing no free-carbon particles, the 6 mil thick RC AS-1200 film is qualified for military use. The bags allow static-safe assembly and handling of static-sensitive circuitry, without the need for conductive floors, seat covers, or air ionizers.

CIRCLE NO. 355

## Cable clips adhere to any smooth surface

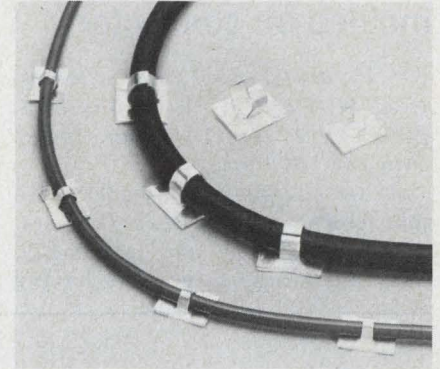

Richco Plastic Co., 5825 N. Tripp Ave., Chicago, IL 60646. (312) 539-4061. SK-3: 9.5¢; SK-6: 12.9¢ (100-999).

Two cable clips, called Sticky-Klips, require no installation tools to mount on a smooth surface. They have a polyethylene adhesive backing and are made of aluminum. The cable is inserted and the clip snaps shut over the wire. Sticky-Klips are available in two models: SK-3 holds cable with diameters up to 5/32 in., while SK-6 accommodates cable sizes to 3/8 in.

CIRCLE NO. 356

# PHOTO ETCH™ PRINTED CIRCUIT KIT

Makes circuits **THREE WAYS**

- 1 FULL SCALE ARTWORK MASTER
- 2 MAGAZINE ART ILLUSTRATION → FILM POSITIVE → NEGATIVE → DEVELOPED PHOTO RESIST IMAGE ON COPPER CLAD CIRCUIT BOARD → ETCHED CIRCUIT BOARD
- 3 DIRECT ETCH DRY TRANSFERS APPLIED TO COPPER CLAD BOARD

**NO** CAMERA DARKROOM FILM CUTTING TRACING

**USES DATAK'S POS-NEG PROCESS**  
The revolutionary photographic way that makes **PERFECT** printed circuits from original art or a printed page.

KIT CONTAINS: 5" x 6" steel printing frame; 4 sheets 5" x 6" photocopy film; yellow filter; chemicals for 1 pint film developer and 1 pint film fixer; 5" x 6" copper clad board; 3" x 4" copper clad board; spray can of photo etch resist; 1 pint resist developer; 2 sheets 8 1/2" x 11" layout film; 1 roll 1 1/8" printed circuit tape; 1 roll 1 3/8" printed circuit tape; 8 sheets dry transfer direct etch PC patterns including pads; transistors; round can and flat pack ICs; DIP ICs; edge card connectors; lines; circles; jogs; etc. 1/2 lb anhydrous ferric chloride to make 1 pint etchant; instructions.

ER-4 COMPLETE PHOTO ETCH SET	.....	\$26.95
ER-2 PC patterns and tapes — refill	.....	3.95
ER-3 1/4 pound dry etchant — refill	.....	1.49
ER-5 6 sheets photocopy film — refill	.....	3.95
ER-6 Film process chemicals — refill	.....	1.95
ER-7 Photo resist spray, 2.5 oz. — refill	.....	2.95
ER-8 Resist developer, 16 oz. can — refill	.....	2.95

AT YOUR DISTRIBUTOR OR DIRECT

the **DATAK** corp.  
65 71st St. • Guttenberg, N. J. 07093

CIRCLE NUMBER 65

ELECTRONIC DESIGN 20, September 27, 1976

MICROPROCESSOR SERIES NO. 4

## 2650 SUPPORT CKTS ARE ALL MULTI-SOURCED.

Available:  
interface, ROM, RAM, PROMs/EROMs. Coming:  
PPI, PCI, A-D Converters, SDLC. Specials from AMS, too.

Attach to your letterhead.  
Put me on your reservation list for the first mailing on upcoming 2650 Interfacing Circuits.

Name	Title
Tel.	M.S.

811 E. ARQUES, SUNNYVALE, CA. 94086

**THINK**  
**Signetics**  $\mu$ P  
a subsidiary of U.S. Philips Corporation

CIRCLE NUMBER 66

121



### Flat cables come with molded-on connectors

AP Products, Box 110-P, Painesville, OH 44077. (216) 354-2101. \$4.01, 50 wires, 1-ft long, socket each end (500 up).

A line of flat ribbon cables with connectors, called Great Jumpers, comes assembled and pre-tested. They are available in cables having

20, 26, 34, 40 and 50 conductors. They come with the three connector types; card edge, PC board, and socket. The connectors are molded directly onto the vinyl ribbon cable with integral molded strain reliefs. The cable has either solid or stranded #28 AWG conductors. Great Jumpers are front and rear coded to identify both the wire number (in repeating decimal sequence) and the wire group (in groups of 10).

CIRCLE NO. 357

### Busses for socket pins act like 18-AWG wire

Rogers Corp., Electro Components Div., Rogers, CT 06263. (203) 774-9605. \$1.31/ft (100 ft up).

To connect selected pins on PC boards, Strip/Bus has a current carrying capacity in excess of 18 AWG copper wire. The strips work with staked-in wire-wrappable pins or with DIP sockets having wire-wrappable tails. They can be used with solder preforms. A low profile keeps Strip/Bus from interfering with subsequent wire-wrapping or with the lay of wires. Models are available for 0.025 and 0.045 in. square pins, and for 0.031 x 0.062 in. rectangular pins, with center-to-center spacings of 0.100, 0.187, 0.200 and 0.250 in.

CIRCLE NO. 358

### Flux-cored wire solder comes as fine as 34 AWG

Multicore Solders, Inc., S. Service Rd., Westbury, NY 11590. (516) 334-7450. \$2.50-\$6.50 (1/2-lb spools); stock.

Flux-cored solder comes in standard gauges as fine as 34 (0.009 in. dia). It also comes in No. 22 (0.028 in. dia), 24 (0.022), 28 (0.014) and 32 (0.010 in.) gauges; either in 60/40 or 63/37 tin/lead alloys. The cores are noncorrosive, nonconductive RA and RMA rosin flux. Multicore fine-gauge solders are on the QPL list and meet Federal Specification QQ-S-571e. They come in 1/2-lb spools.

CIRCLE NO. 359

### Desoldering tools don't clog up

Hunter Associates, 729 Partridge Dr., Bridgewater, N.J. 08807. (201) 526-8440. \$29.95 (unit qty).

Two desoldering tools, models ESS or GSS, use a suction principle that prevents tip clogging. A source of continuous air pressure is applied through a tube and creates pressure in the tool through a venturi principle. The tools require only infrequent emptying of a stainless-steel solder catcher. The Model ESS is fitted with a 4-mm dia tip for standard radio and television applications. The Model GSS is fitted with a 2.4 mm dia. tip.

CIRCLE NO. 360

**LTS**  
**3 1/2 digit**  
**multimeter**  
**thermometer\***  
**in the palm of your hand.**

**Only \$198.**

Model 12: DMM  
w/o temperature

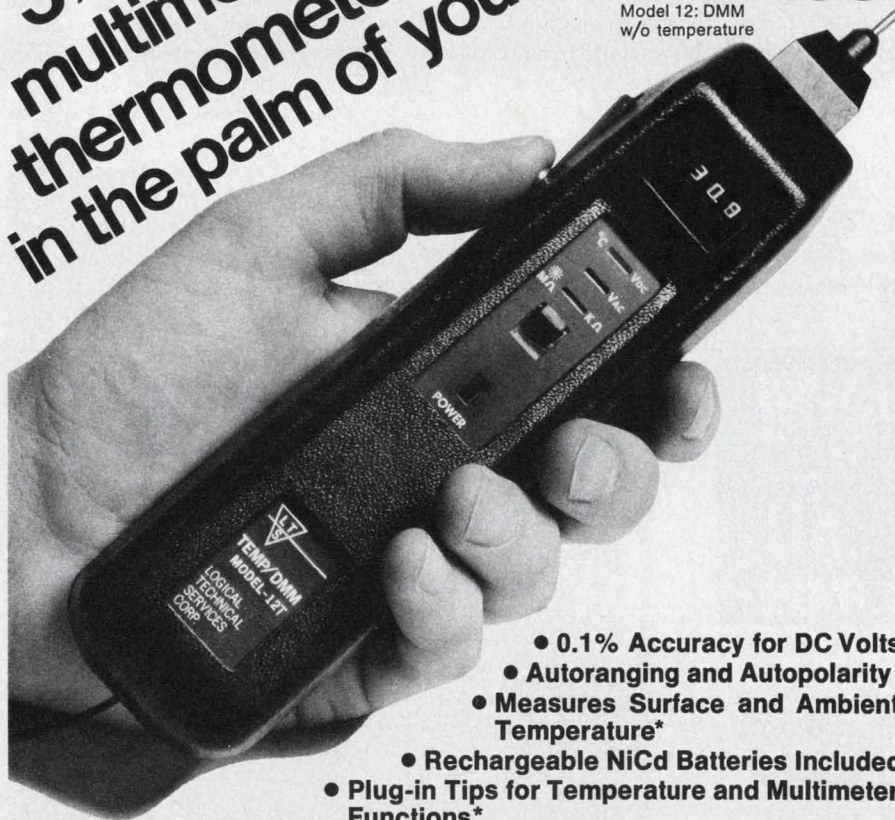

- 0.1% Accuracy for DC Volts
- Autoranging and Autopolarity
- Measures Surface and Ambient Temperature\*
- Rechargeable NiCd Batteries Included
- Plug-in Tips for Temperature and Multimeter Functions\*

**Temperature:** -55° to 153.5°C, ±1°C from 0° to 100°C\*

**DC Voltage:** 1 mV to 750 V, input impedance 10 megohms

**AC Voltage:** 200 mV<sub>rms</sub> to 750 V<sub>rms</sub>, input impedance 10 megohms shunted by 14 pF

**Resistance:** 1 ohm to 19.99 megohms

Both models include ac adaptor/charger, carrying case and operator's manual.

**Model 12T: Combined Thermometer/DMM. \$259.\***



**LOGICAL TECHNICAL SERVICES CORP.**

71 West 23rd Street, New York, N.Y. 10010  
(212) 741-8340      Telex #12-7698

Representative and dealer inquiries invited.

CIRCLE NUMBER 67



## Coil winding machine sells for \$269

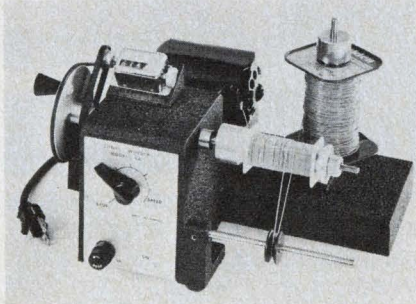

Innes Instruments, Box 3216, Pasadena, CA 91107. (213) 796-3288. See text.

The Coil Winder costs \$269 and comes with a built-in dereeler, SCR motor drive, mechanical counter, and a detachable universal mandrel. The mandrel will hold bobbins with inside diameters of from 3/16 to 1 in. and lengths up to 3 in. Special mandrels and chucks are also available. In use, semi-skilled personnel make set-ups and feed wire by hand. The machine is built on a cast aluminum frame and weighs 8 lb.

CIRCLE NO. 361

## System does interactive PC board design



Redac Interactive Graphics, Inc., 225 Great Rd., Littleton, MA 01460. (617) 486-8751. \$90,000; 90 days.

A computer system that helps you design PC boards is claimed to cost less than most others. Called the Mini-PCB-Designer, the system has interactive capabilities. The Mini system uses the DEC PDP-11/34 computer system with a 17-in. refresh-graphics terminal. It has automatic component placement, auto-routing, design rules-checking and multilayer wiring ability.

CIRCLE NO. 362

## Screw-terminal strips can be cut to length

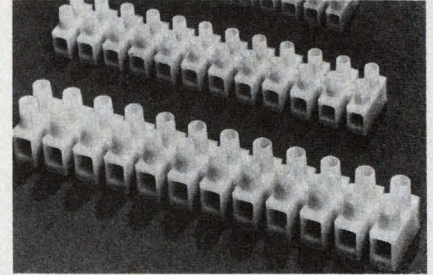

Electrovert Inc., 86 Hartford Ave., Mt. Vernon, NY 10553. (914) 664-6090. 6.8¢ (100-up).

A series of terminal strips, called the EDS series, are flexible and can be easily cut to size. Twelve poles come on one strip. The insulating body is molded of nylon, and can be shaped to the mounting surface. The strips can be cut with a knife or saw blade. The EDS series is made in three sizes for use with 16, 12 and 8 AWG wire. The screw connectors are made of nickel plated brass. All metal parts are either deeply recessed or completely enclosed.

CIRCLE NO. 363

# LOOKING FOR A DISTRIBUTOR NEAR YOU?

Electronic Design's GOLD BOOK lists 5,700 distributors with access both **alphabetic**, by distributor name, and **geographic** by location.

When you need  
information . . .

**Electronic Design's  
GOLD BOOK  
IS THE PLACE  
TO LOOK**

MICROPROCESSOR SERIES NO. 5

## 2650 CRASHPROOF DEVELOPMENT SYSTEM: TWIN WITH DUAL FLOPPY DISKS.

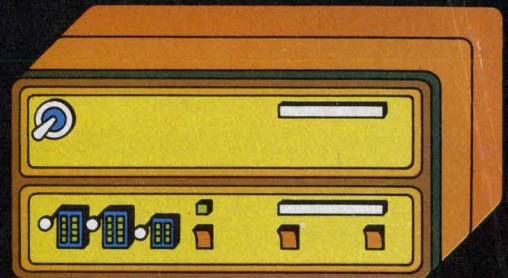

TestWare INstrument (TWIN) lets you develop software and hardware *together* in an actual environment.

Clip to letterhead. Mail now. Please send me 2650 Short Form Catalog full data on TWIN.

Name  Title

Tel.  M.S.

811 E. ARQUES, SUNNYVALE, CA. 94086

THINK

**Signetics  $\mu$ P**  
a subsidiary of U.S. Philips Corporation

CIRCLE NUMBER 69



## PACKAGING & MATERIALS

### Conductive adhesives don't settle on curing

*Electro Kinetic Systems, Inc., 2500 E. Ridley Ave., Chester, PA 19013. (215) 876-6192. \$15-25/lb.; stock.*

A series of three copper-filled adhesives is claimed to be nonsettling and electrically conductive. The adhesives are Conduct-X 5031, 5032 and 5033. Number 5031 is a

general-purpose, heat curable type; 5032 is suited for screen printing and 5033 is a two-part room-temperature curing type. All of the materials exhibit volume resistivities of 0.001  $\Omega$ -cm or less and may be applied by syringe dispensing, screen-printing or drawdown. They may be diluted for brush or spray application with common solvents. An evaluation kit containing 0.5 lb of each of the three types is available for \$25.

CIRCLE NO. 364

### Push mounts hold cable ties to a flat panel

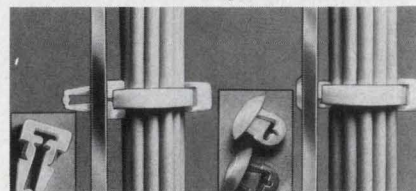

*Panduit Corp., 17301 Ridgeland Ave., Tinley Pk., IL 60477. (312) 532-1800. PM2H25-M, 3.4¢; PBMS-H25-M, 3.8¢; (1000-up).*

Two types of push mounts hold cable ties, which secure wire bundles to panels, cabinets or equipment frames. One push mount, the PBMS-H25, is used wherever access to both sides of the mounting surface is available. The mount is pushed through the mounting hole from the side opposite the wire run, and an appropriate cable tie is inserted to secure the bundle. The PBMS-H25 comes in either natural-nylon or telephone-gray colors. The other push mount, PM2H25, is used where access is available only on the side of the mounting surface to which the wires are being attached. The cable ties can be inserted through the mount and fastened around the wire bundle either before or after the mount is pushed through the panel hole.

CIRCLE NO. 365

# DANA INTRODUCES THE SMART COUNTER.

## Series 9000: World's First Microprocessing Timer/Counter.

The Dana Series 9000 is smart enough to make your work a lot easier. Microprocessing controls provide all the features of a premium timer/counter, a reciprocating counter and a calculator. Plus interfacing options and operating capabilities never before available in one instrument.

The Dana Series 9000 Microprocessing Timer/Counter goes so far beyond all other counters it takes a whole brochure just to explain its capabilities. Ask for it. It's the smart thing to do.

Dana Laboratories, Inc., 2401 Campus Drive, Irvine, California 92664, 714/833-1234.



FOR PRODUCT DEMONSTRATION CIRCLE #70 FOR LITERATURE ONLY CIRCLE #71

### Hot-air tool solders and shrinks tubing

*Swan Manufacturing Co., Shaw House, Blackmore, Ingatestone, Essex CN4 ORN, England.*

A dual-purpose tool solders connections and shrinks plastic sleeves. The Thermopencil, as it is called, features a plug-in power pack that provides 24 V to the tool and to the low-pressure air supply. An alternative power pack, omitting the air pump, is available for customers who already have a suitable air-supply system. Air flow is directed on the connection or sleeve by a slim pencil-type nozzle. A 6-ft cable and air tube is supplied as standard. The MK 1 power/air pack measures 14.5  $\times$  8.75  $\times$  10 in. and is bench mounted. It incorporates an integral air-supply pump with an air flow controller that can be set to supply air at a pressure from 2 to 8 psi. A fail-safe power cutoff is included.

CIRCLE NO. 366



### Delay-on-operate timer now MIL qualified

Hi-G Co., 580 Spring St., Windsor Locks, CT 06096. (203) 623-2481. 1-to-9 prices: \$21 (6100); \$45 (6150); \$50 (6001); stock.

Qualified to MIL-R-83726/13, the Model 6001 thick-film timing modules provide a delay-on-operate function. The modules weigh less than 12 grams, but provide delays of 50 ms to 60 s. There are 30 preset qualified models from which to choose. They are hermetically sealed, operate from -55 to +125 C and are housed in 14-pin metal DIPs. Model 6150 is the commercial version of Model 6001 and can be ordered for any delay period from 50 ms to 60 s. An industrial version, the 6100, is a less expensive but similar device, housed in a plastic, epoxy filled enclosure. It is temperature rated for -55 to +85 C.

CIRCLE NO. 367

### Fast s/h amp acquires signals in under 350 ns

Datel Systems, 1020 Turnpike St., Canton, MA 02021. (617) 828-8000. \$189 (1 to 9); 4 wks.

The SHM-5 modular sample-and-hold amplifier can acquire a signal in only 200 ns to 0.1% or 350 ns to 0.01%. When used with a 12-bit, 2  $\mu$ s, a/d converter, sampling and conversion at up to a 400-kHz rate is possible. The s/h amp has a 5-MHz tracking bandwidth, a 25-V/ $\mu$ s slew rate and an input impedance of  $10^8 \Omega$ . Hold-mode droop is 20  $\mu$ V/ $\mu$ s, maximum, and hold mode feedthrough is 0.005% of input signal, max. The SHM-5 operates in the inverting mode with a gain of -1 and has a 15 ppm/ $^{\circ}$ C temperature coefficient of gain. Its output offset voltage drift is  $\pm 30 \mu$ V/ $^{\circ}$ C and the sample to hold offset step is  $\pm 5$  mV. A 2  $\times$  2  $\times$  0.375-in. epoxy package holds the SHM-5, which has  $\pm 15$  V dc at 75-mA power requirements. The operating range spans 0 to 70 C.

CIRCLE NO. 368

### LVDT signal conditioner delivers 4 to 20 mA

Schaevitz Engineering, US Rte. 120 and Union Ave., Pennsauken, NJ 08110. (609) 662-8000. \$281.10 (unit qty.); stock.

The CTM-401, a fully encapsulated two-wire LVDT signal conditioning module, delivers a 4 to 20 mA dc signal. The signal is directly proportional to a change in LVDT core position. The CTM module does not require any additional external power since it operates from the dc current of existing process controller, recorders, or readout devices. It delivers a nominal 1 V rms excitation to an LVDT. The CTM has an intrinsically-safe design because the current can be limited to 50 mA even with accidental over-voltage of internal short circuiting. Performance features include a frequency response of dc to 100 Hz (within  $\pm 1$  dB), nonlinearity and hysteresis of less than 0.1% full scale and stability (after 15 minutes) of 0.25% full scale.

CIRCLE NO. 369

# #1 Power Supply

## Choice for OP-AMPS

15LBA-1 Wide Range Bi-polar DC  
Tracking Supplies: compare performance, style, price . . .

- $\pm 0.05\%$  regulation
- 500  $\mu$ V RMS ripple
- TC  $\pm 0.02\%/^{\circ}$ C
- 3-way mounting
- Open frame

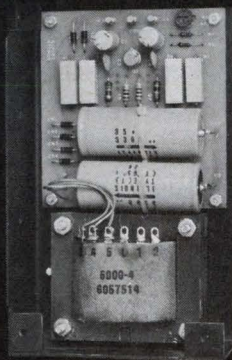

# \$32<sup>95</sup>

100 Quantity

Power supplies are adjustable from  $\pm 12$  Vdc to  $\pm 15$  Vdc using a single output control. Rated for 1 Amp load current @ 50 $^{\circ}$ C ambient. Over 200 other standard models also available. We also specialize in super high efficiency power supplies. For your current and future requirements please call

# Century Electronics

A Division of Chen Industries, Inc.  
2688 So. La Cienega Blvd., Los Angeles, CA 90034  
(213) 838-1806; 870-1083

CIRCLE NUMBER 72

MICROPROCESSOR SERIES NO. 6

# 2650.

## APPS ENGINEERS: IN STOCK NOW.



Dozens of people to support systems, hardware, testware, devices in USA and Europe. More coming.

Attach to your letterhead. Mail. Send me the list of 2650 Applications Engineers with addresses & phone numbers.

Name	Title
Tel.	M.S.

811 E. ARQUES, SUNNYVALE, CA. 94086

# THINK

# Signetics $\mu$ P

a subsidiary of U.S. Philips Corporation

CIRCLE NUMBER 73



# ALONE AGAIN

in low cost 1-watt Zener Diodes

# SCHAUER

## "Z" SERIES ZENERS

DO-41 epoxy molded case

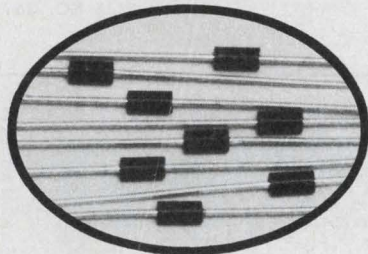

**ANY VOLTAGE**  
2.6 to 34.0  
**ANY TOLERANCE**  
1% 2% 5% 10%  
**At Any Test Current**  
**Compare These Prices**  
**On 1% Tolerance Diodes**

Quantity	Price each
1-99	91¢
100-499	83¢
500-999	77¢
1000 up	73¢

**LARGE STOCK**  
**GOOD DELIVERIES**  
Send for complete rating data and other tolerance prices.

Semiconductor Division

# SCHAUER

MANUFACTURING CORP.

4511 Alpine Ave., Cincinnati, OH 45242  
Telephone 513-791-3030 Telex 21-4576

CIRCLE NUMBER 74

## MODULES & SUBASSEMBLIES

### Signal delay modules provide 5 delay times

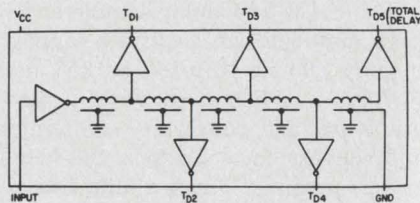

*Technitrol, 1952 E. Allegheny Ave., Philadelphia, PA 19134. (215) 426-9105. Prices start at \$20; stock to 4 wks.*

Dynamic time delay circuits in the TTLDL series offer five delayed outputs. The TTLDL025 has delays of 5, 10, 15, 20 and 25 ns; the TTLDL050, delays of 10, 20, 30, 40 and 50 ns; the TTLDL75, delays of 15, 30, 45, 60 and 75 ns; the TTLDL100, delays of 20, 40, 60, 80 and 100 ns; the TTLDL250, delays of 50, 100, 150, 200 and 250 ns; and the TTLDL500, delays of 100, 200, 300, 400 and 500 ns. Signal rise time (at a  $V_{CC}$  of 5 V, 25 C and no load) is  $\leq 1$  ns for Models 025 and 050;  $\leq 2$  ns for Models 075 and 100;  $\leq 5$  ns for Model 250; and 9 ns for Model 500. The delay circuits come in 14-pin DIPs and may be cascaded in any combination without deteriorating the rise time. Fanout for each model is 10.

CIRCLE NO. 370

### Data-acquisition system has 125 kHz throughput

*Data Translation, 109 Concord St., Framingham, MA 01701. (617) 879-3595, 0750 (unit qty.); stock.*

Offering 12-bit resolution, the DT5710A data-acquisition module, has a throughput rate of 125 kHz. The circuit, is an extension of the DATAX II series. It offers 16 input channels and three-state output for compatibility with the latest microcomputers in either 8-bit bytes or a single 16-bit word. System accuracy is  $\pm 0.03\%$  of FSR, linearity is  $\pm 0.5$  LSB and selectable full scale ranges of 0 to +10,  $\pm 10$ , 0 to +5, and  $\pm 5$  V are available. Within the DT5710A is a 16-channel CMOS multiplexer signal, conditioning amplifier, sample/hold amplifier and 12-bit a/d converter.

CIRCLE NO. 371

### Step attenuators handle 15-to-220-MHz signals

*Diaco Industries, 2351 E. Del Amo Blvd., P.O. Box 5225, Compton, CA 90224. (213) 631-1143. \$174 (10 to 24); stock.*

The DA0051 dual-section step attenuator has an input frequency range of 15 to 220 MHz. It can switch attenuation levels in 5  $\mu$ s. Attenuation levels of 2, 8, 1, 3, 10, 0.7 or 0.25 dB are available for pad A and levels of 4, 16, 32, 6, 20, 1.5 or 0.5 dB are available for pad B (for the -1, -2, -3, -4, -5, -6 and -7 suffix models, respectively.) The 14-pin DIP modules require 5 to 15 V and draw 6 mA, nominal at 15-V bias or 1.6 mA at 5 V. VSWR is 1.25:1 and the input or output impedance is 50  $\Omega$ .

CIRCLE NO. 372

### Motor speed controllers handle up to 1 hp

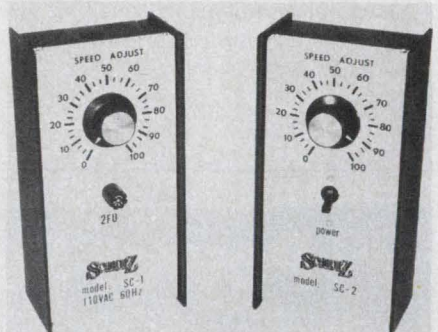

*Schulz Controls, 300 East St., New Haven, CT 06511. (203) 865-2186. From \$130; stock.*

The SC-1 and SC-2 adjustable-speed motor drives can control dc shunt wound or permanent magnet motors with power ratings from 1/70 to 1 hp. Model SC-1 operates from any single phase 50/60 Hz, 110-V-ac  $\pm 10\%$ , power line. It has a speed range of 10:1 and both its maximum and minimum speed settings are adjustable. Regulation is  $\pm 3\%$  but current limit, acceleration and IR compensation are fixed. Model SC-2 is similar to the SC-1, except that regulation is  $\pm 2\%$  and current limit, acceleration, IR compensation, minimum speed and maximum speed are adjustable. Both models have overload protection and will operate over  $-12$  to 122 F (10 to 50 C). Units are designed for wall mounting and measure 10  $\times$  5  $\times$  3 in. (254  $\times$  127  $\times$  76.2 mm).

CIRCLE NO. 373



## A/d converter delivers 16 bits in only 8 $\mu$ s

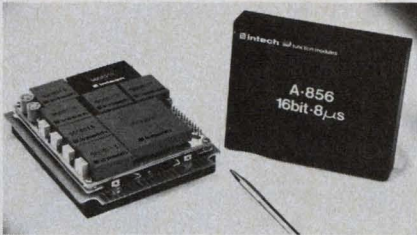

Intech/FMI, 282 Brokaw Rd., Santa Clara, CA 95050. (408) 244-0500. \$1300 (unit qty.); stock.

The A-856 16-bit a/d converter can deliver a data word every 8  $\mu$ s. The unit has a gain tempo of 7 ppm/ $^{\circ}$ C max. and a nonlinearity tempo of  $\pm 2$  ppm/ $^{\circ}$ C. The built-in sample-and-hold amplifier that's mounted on the converter's  $4.5 \times 5.5 \times 1.75$  in. circuit board increases the conversion time by only 2  $\mu$ s when switched into the hold modes. Input impedance of the s/h amp is  $10^9 \Omega$ . The over-all converter requires  $\pm 15$  V at 150 mA and +5 V at 300 mA and operates over 0 to 50 C.

CIRCLE NO. 374

## Pressure converter made for critical locations

Amtek, 860 Pennsylvania Blvd., Feasterville, PA 19047. (215) 355-6900. From \$190; 6 to 8 wks.

The Model 58 pressure-to-electric converter has its own power supply and can operate from a 115 V, 60 Hz line. It is available in a four-wire version with a Factory Mutual approved explosion-proof for Class II, Div. 1, Groups E, F and G. The converter comes in a cast-aluminum housing that also meets requirements of NEMA Type 4 Watertight specifications. The two-wire version, Model 56, is certified by Factory Mutual as Intrinsically Safe for Class I, Division 1, Groups B, C and D when used with approved barriers. The Model 56 operates from 16 to 80 V dc lines and is available with either 4 to 20 or 10 to 50 mA dc outputs. The Model 56 has a nickelplated steel housing suitable for control room type environments. The Models 56 and 58 both have 0.25% FS accuracy.

CIRCLE NO. 375

## Current output d/a's settle in under 85 ns

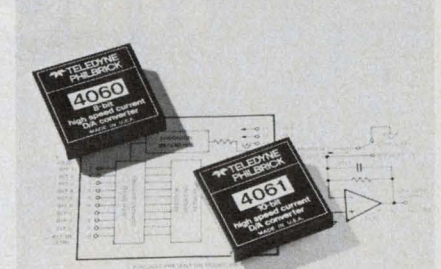

Teledyne Philbrick, Allied Dr. at Rte. 128, Dedham, MA 02028. (617) 329-1600. From \$119 (unit qty.); stock.

The Models 4060 (8-bit) and 4061 (10-bit) high-speed d/a converters are monotonic from 0 to +70 C. They have both unipolar and bipolar outputs of 0 to +10 mA and  $\pm 5$  mA. Both models have a maximum settling time to within  $\pm 1/2$  LSB of 85 ns, with 40 ns typical for the 4060 and 60 ns typical for the 4061. The converters only need  $\pm 15$ -V supplies but are directly TTL compatible.

CIRCLE NO. 376

## MODEL SP-G11 SPEEDEX RECORDER

Model SP-G11 is equipped with a built-in A/D converter in addition to common analog recorder functions. Since output terminals are also provided. It can be readily used in computation and for connection to a printer or paper tape punch.

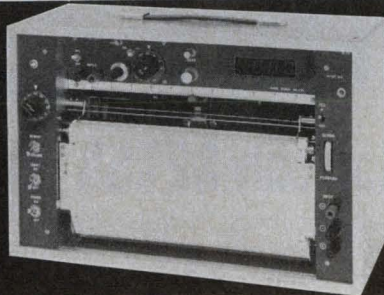

### FEATURES

1. Digital output terminal (10-bit binary or 3-digit BCD)
2. External clock terminal permits chart drive by external clock.

### SPECIFICATIONS

1. Chart width ..... 250mm
2. Pen speed ..... 0.8 secs full scale
3. Measurement voltage ..... 0.5, 1, 5, 10, 50, 100, 500mV, 1, 5, 10, 50, 100V full scale
4. Chart speed ..... 10, 20, 50, 100, 300, 600mm/hr  
20, 50, 100, 300, 600mm/min
5. Digital output (A or B) ..... A...10-bit binary full scale at 1000 digit.  
1 digit 0.1%  
B...3-digits BCD  $10^2 10^1 10^0$  full scale 999

Please write us on your letterhead for detailed information.

**Riken Denshi Co., Ltd.**

5-5-2, Yutenji, Meguro-ku, Tokyo, Japan.  
TEL: 711-6656 TELEX: 0246-8107

CIRCLE NUMBER 75

ELECTRONIC DESIGN 20, September 27, 1976

MICROPROCESSOR SERIES NO. 7

## BY SEPTEMBER THE 2650 IS OVER 30% FASTER.

Your system's features can be extended with the speedier 2650. Current 2650 software will apply.

Clip to your letterhead. Put me on your reservation list for the first mailing of the faster 2650 data sheet.

Name	Title
Tel.	M.S.
811 E. ARQUES, SUNNYVALE, CA. 94086	

**THINK**  
**Signetics  $\mu$ P**  
a subsidiary of U.S. Philips Corporation

CIRCLE NUMBER 76

127



# The easiest-to-use microprocessor

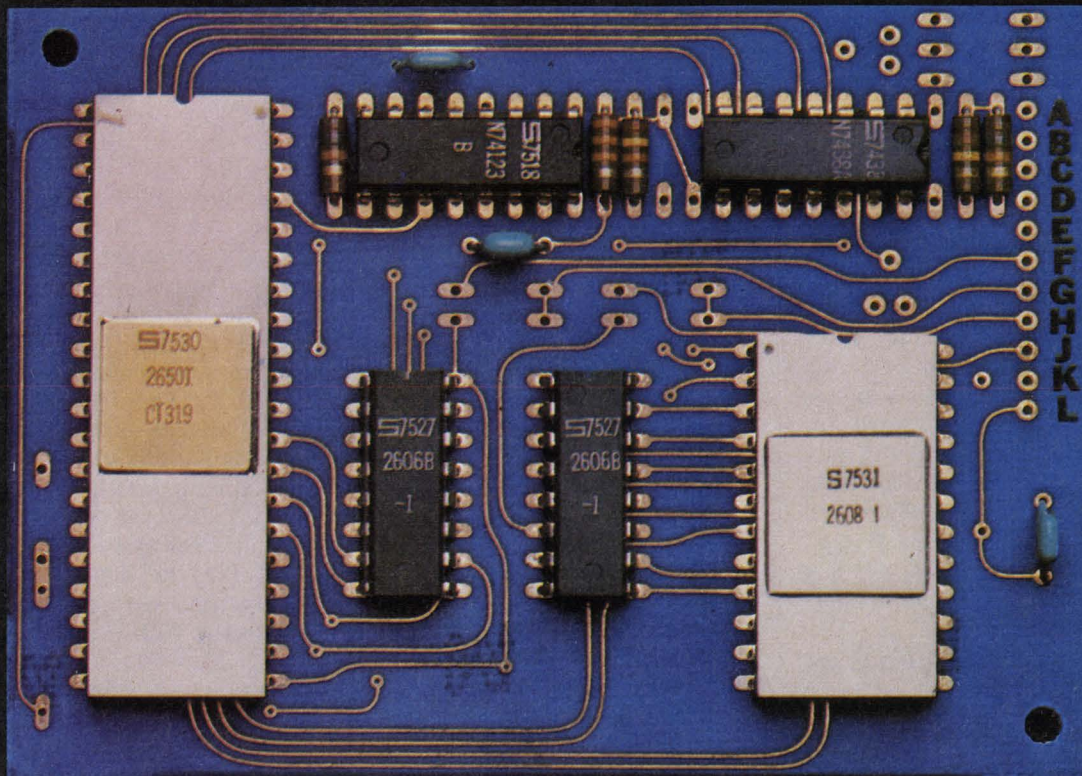

(Photograph approximately 2x actual size.)

## The single-chip 2650 is easiest-to-buy, too. Now only \$21.50 (100-up).

Full support of customer and product is the key to ease of development with the 2650. Applications engineers in the U.S. and abroad are at your beck and call at every stage. Software for almost anyone's requirements and machines. Development hardware is versatile and inexpensive. All circuits are multi-sourced.

**Flow Chart: How to travel safely and quickly from spec sheet to your  $\mu$ C.**

- 1 Applications Engineers — in the field now, more coming. Specific assistance to you is available around the USA, and in Belgium, Holland, Germany, France, Sweden, Britain, Italy, etc.
- 2 Multi-sourced 2650 — available in any quantity from Signetics, at the unprecedented low price of \$21.50. Also available from AMS and Philips, and from Signetics' authorized distributors.

- 3 Development Software — includes the PL  $\mu$ S, an extremely efficient High Level Language (compiler) that reduces programming effort and cuts development time. ANSI standard Fortran IV executes on most machines without alteration. 2650AS1000/1100 Assembler and 2650SM1000/1100 Simulator are available in both 32- and 16-bit, on GE and NCSS time-sharing.

- 4 Multi-sourced Support Circuits — You'll need MOS and/or Bipolar Memories, Interface and Logic. Signetics has *everything* for a complete system. Back up any item from other sources. Coming soon from Signetics are: Programmable Peripheral Interface and Communications Interface, A-D Converters, Synchronous Data Link Controller, 16k NMOS & Bipolar ROMs, 4k & 8k NMOS EROMs, and 8k Bipolar PROMs.



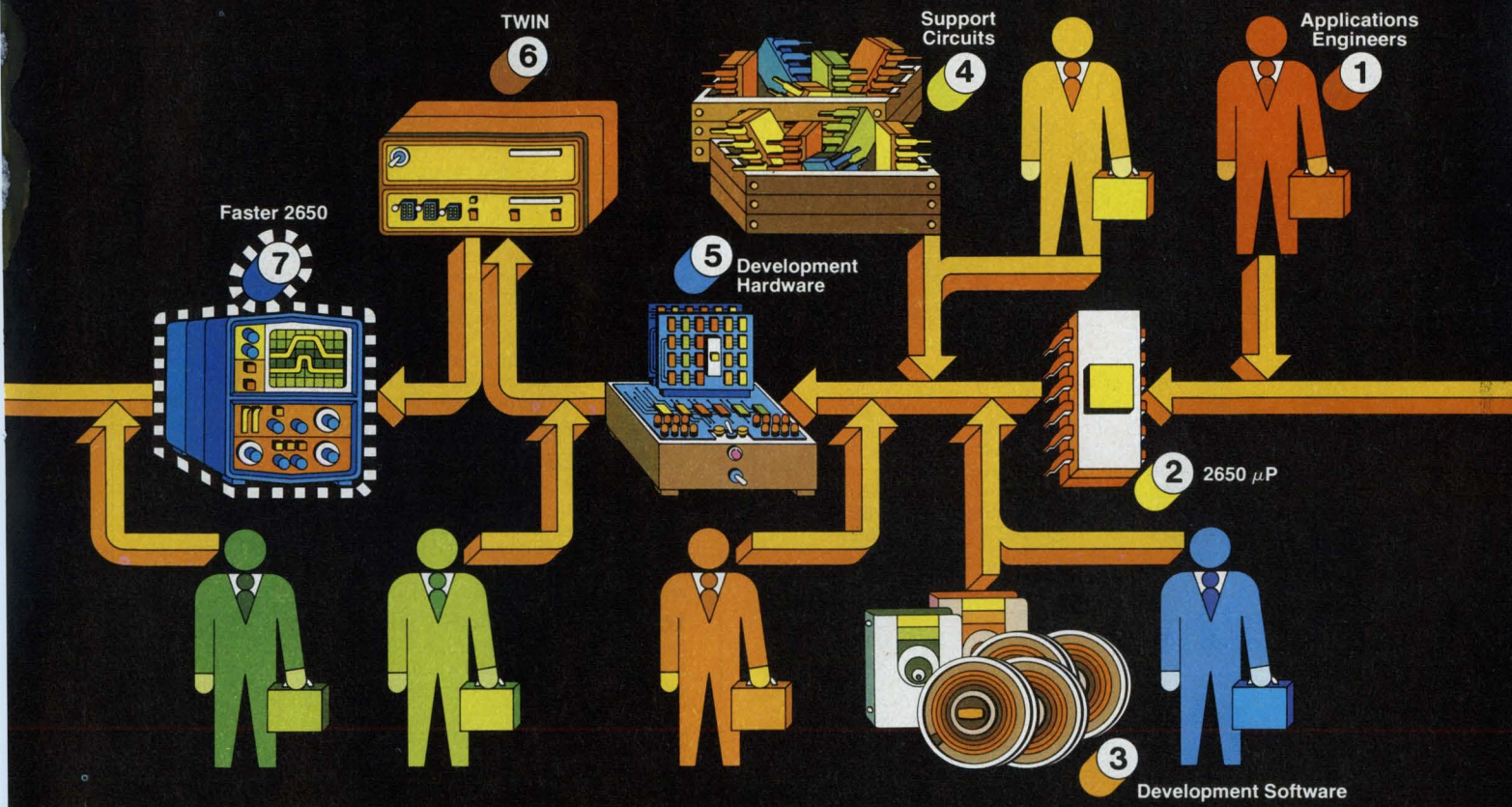

# makes the easiest-to-develop microcomputer.

- 5** Development Hardware — Design/develop/prototype with a variety of cost/capability levels of hardware support. Including prototyping cards and kits, smart typewriter demo card, 4k-byte RAM card, and more. Applications help if you need it.
- 6** TWIN With Floppy Disks — “crashproofs” your system checkout. With DOS, Resident Assembler, and Text Editor. You develop programs and circuits together in an actual system environment with TWICE (*TestWare In Circuit Emulator*). PROM programming, too.
- 7** Over 30% Faster 2650 — By the time you’ve proven out your  $\mu C$ , you’ll have available a faster 2650 if you want it. Uses the same software. For still higher speeds, call Signetics Bipolar Microprocessor Marketing about our 2650 emulator using 3000 series  $\mu P$ .

You go from gleam-in-your-eye to proven prototype in less time for less cost, and the  $\mu C$  you develop is easier and cheaper to produce in quantity, when you start with the 2650. Start now by mailing the coupon.

Attach this to your letterhead for fast response.

Send me complete 2650 short form catalog.

Have a Field Applications Engineer call me for appointment.

My need is:  immediate  6 months  information only

My application is \_\_\_\_\_

\_\_\_\_\_  
Name Title

\_\_\_\_\_  
Telephone Mail Stop

**THINK Signetics  $\mu P$**   
a subsidiary of U.S. Philips Corporation

811 E. Arques Ave., Sunnyvale, Ca. 94086



# Dialight LED Displays

The widest choice for your every application.

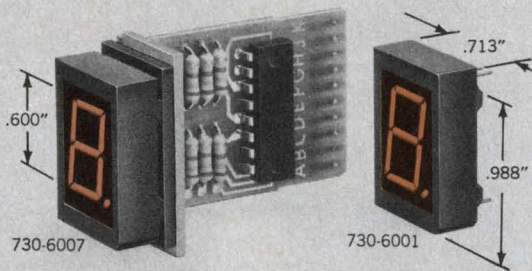

**730 SERIES A** new 0.600" LED character in super bright red, seven-segmented readout . . . low power . . . draws 10mA/segment or less . . . operates with standard IC power supply levels. Very high contrast ratio . . . visible from 40'. Available with or without on-board decoder/driver, plus or minus bar, and with bezel mounting. In 1000-lot quantities each LED **730-6007 . . . . \$6.05. 730-6001 . . . . \$2.55.**

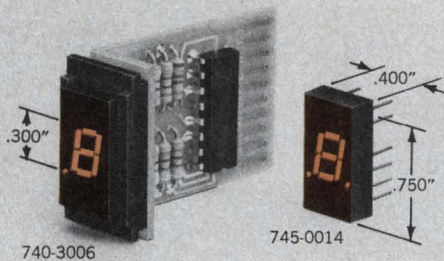

**745 SERIES A** new 0.300" LED character in a very bright red, seven-segmented readout . . . low power requirements. Standard 14-pin DIP . . . available with left and right decimal with  $\pm 1$ , and with and without on-board decoder/driver. Compatible with most TTL and DTL circuits. In 1000-lot quantities each **740-3006 . . . . \$6.43. 745-0014 . . . . \$2.10.**



Dialight, the company with the widest choice in switches, LEDs, indicator lights and readouts, looks for needs . . . your needs . . . and then they develop solutions for your every application. No other company offers you one-stop shopping in all these product areas. And no other company has more experience in the visual display field. Dialight helps you do more

with these products than any other company in the business, because we are specialists that have done more with them. Talk to the specialists at Dialight first. You won't have to talk to anyone else. Send for your free new copy of Dialight's current catalog.

## DIALIGHT

Dialight, A North American Philips Company  
203 Harrison Place, Brooklyn, N. Y. 11237  
(212) 497-7600

# See Dialight.

CIRCLE NUMBER 78

## ENGINEERS & DESIGNERS

**Kearfott's success and stability offers a continuing pattern of growth — yours and ours!**

KEARFOTT's long and continuing role as an innovator and leader in aerospace navigation and computer technology has never been more filled with promise than it is today.

Career opportunities are available for experienced engineers who can participate in advanced development work on challenging avionic projects such as F-16, MRAALS, Space Shuttle, TALONS and others. Our current backlog of assignments offers excellent career advancement opportunities and long-term stability.

If you're seeking new challenges and steady growth with a highly successful organization, where your contributions are recognized, let's get together.

*Immediate positions available in the following areas:*

### LOGIC DESIGNERS

Opportunities involving sequential, high-speed and I/O interface logic and microprocessor applications in digital, signal processing, communication and aerospace systems. Familiarity with MS1/LS1 desirable. Requires several years experience in progressively more challenging logic design. BS/MSEE.

### MAGNETIC MEMORY DESIGN ENGINEER

Needs extensive background in core memory organization, circuits and magnetics, and familiarity with logic design. Experience in the design of precise high current, high frequency digital circuits essential. BS/MSEE.

### COMPUTER ENGINEER

Requires BS/MSEE and 10 years diversified experience in design & application of digital computers to airborne applications; customer liaison experience; ability to formulate responses to customer requirements as well as satisfactory execution of contractor requirements in a computer development program.

### SIGNAL PROCESSING ENGINEERS

Involves analysis and design of Signal Processing-Digital Communications Equipment for avionics plus TDMA and ICNI applications. Requires BSEE degree, Master's preferred, plus 2-5 years experience in communications theory, digital filters, coding theory, signal processing techniques, A/J analysis, error correction, phase locked loops, and related digital and RF hardware design.

### SIMULATION ENGINEER

Requires BS/MSEE and 2-5 years experience with the development of FORTRAN programs to simulate electronic systems for signal processing of RF, Baseband, noise, etc.

*Additional openings for experienced, degreed engineers in the following areas:*

- ANALOG CIRCUIT DESIGN
- COMPUTER SYSTEMS DESIGN
- AIRBORNE ELECTRONIC PACKAGING
- NAVIGATION SYSTEMS DESIGN & ANALYSIS

Please forward resume specifying position for which you are applying, and include salary requirements, to: **D. DeGennaro, Singer Co., 1150 McBride Avenue, Little Falls, New Jersey 07424.**

## SINGER

AEROSPACE & MARINE SYSTEMS

*An equal opportunity employer, m/f  
Who creates opportunities*

CIRCLE NUMBER 250



## Speech compressor has 56 dB dynamic range

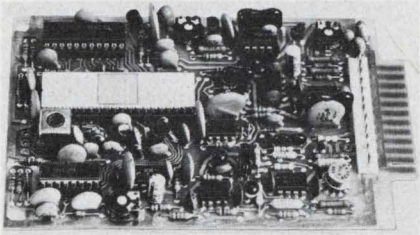

Lexicon, Inc., 60 Turner Street, Waltham, MA 02154. (617) 891-6790. \$100 (lge. qty.); stock.

The Varispeech Model 20 is a real time pitch shifter and speech compressor/expander. All circuitry, including a 4-k RAM, 8-bit d/a converter and pitch computer chip are mounted on a 3.5 × 5 in. PC card. All units shift pitch in real time from two times higher than normal to 0.4 times lower than normal. The device corrects the pitch of rate-altered speech, thus permitting the listener to listen at his own rate of comprehension between one-half and two and one-half times original speed. The Model 20's have a dynamic range of greater than 56 dB, a distortion and noise (total) of 0.6%, and a frequency response of 100 to 5000 Hz (+0/-3 dB). The circuit requires +12 V at 150 mA and -12 V at 50 mA.

CIRCLE NO. 379

## Multiplying DACs accept 15-bit digital inputs

ILC Data Device Corp., Airport International Plaza, 105 Wilbur Pl., Bohemia, NY 11716. (516) 567-5600. From \$270; stock.

The DAC-M is a high-performance multiplying d/a converter. It handles 15 bits and works in all four quadrants. The converter is housed in an encapsulated module, 2.625 × 3.125 × 0.42 in. and weighs only 5 oz. Accuracy grades between ±0.024% and ±0.0031% are available. Power and analog signal grounds are isolated to minimize the effects of intersystem ground noise and common-mode interference. The DAC-M has a short-circuit-protected output of ±10 V at 10 mA and dissipates less than 2 W. Its output slew rate is 5 V/μs, minimum, and it has a CMRR of 70 dB. Digital setting time is 5 μs, maximum.

CIRCLE NO. 380

# If you've got a complicated problem with EMI we've got a simple solution

Electromagnetic Interference. It shows up as static on radio and snow on TV. It can make computer terminals register input error. Make a pacemaker or an EKG malfunction. And interfere with sensitive navigation equipment.

Obviously, you've got to shield your equipment against EMI. You can use sheet metal. Or foil. Or a plating process. These are fine for small enclosures with flat surfaces. But when it comes to large cases and complex shapes, you need a better solution.

And here it is. Electrodag® coatings. We've engineered a whole range of them. To give you from 10-70 dB attenuation, from 1 MHz to 10 GHz. With varied physical properties that let you apply them to almost any material.

This means that you can build your enclosures out of light plastic, coat them with Electrodag, and still get perfect skintight shielding. Even on honeycomb structures and flexible parts made from foamed resins.

And you can forget about expensive techniques like plating, metallizing and vacuum deposition. With Electrodag, all you need is a spray gun, a simple dipping technique, or a paintbrush.

You can use these new coatings for everything from CB radios and EKG units to data terminals and microphones.

This is a new field, but we're the oldest company in it. With the greatest experience, the biggest R&D staff and the most EMI coatings. For technical advice on specific applications, write: Acheson Colloids Company, Electrical Products, Port Huron, Michigan 48060. Or call (313) 984-5581.

 **Acheson**  
high technology coatings

© AC Co., 1976

CIRCLE NUMBER 79



## Dual, low noise preamp has s/n ratio of 76 dB

*Exar Integrated Systems, 750 Palomar Ave., Sunnyvale, CA 94086. (408) 733-7700.*

The XR-4739 is a pin-for-pin replacement for Raytheon's 4739 dual low-noise op amp. It is available in a molded-plastic 14-pin DIP, and operates over a 0 to +75 C range. The dual amp has a signal-to-noise ratio of 76 dB (RIAA, 10 mV ref.), a channel separation of 125 dB, a unity-gain bandwidth of 3 MHz, output short-circuit protection, and only 0.1% distortion at an 8.5-V-rms output into a 2-k $\Omega$  load.

CIRCLE NO. 381

## BCD to phone pulse converter stores number

*Motorola Semiconductor, 3501 Ed Bluestein Blvd., Austin, TX 78721. (512) 928-2600. From \$6.98 (100-up); stock.*

The MC14408 CMOS circuit accepts BCD or binary inputs from control logic, memory, or the MC-14419 keypad-to-binary converter and delivers a string of dial phone pulses. An internal memory holds a 16-digit number that will remain stored until replaced by another entry. A re-dial input eliminates the need to re-enter a number if a call cannot be completed. Four other control inputs: Hold, Call Request, Interdigit Time, and Make-Break Ratio add to the flexibility of this part. On-chip circuitry combined with an external capacitor and inductor provide the clock frequency. The phone system normally uses a 16-kHz clock frequency but the part will operate over a frequency range of 4 to 80 kHz. A variation of the MC14408 is the MC14409—identical in function with the exception of the signal output at the dial rotating output. In the MC14408, DRO remains high during continuous outpulsing of all digits and in the MC14409, DRO is low between each digit pulse burst. Both circuits operate over a range of 3 to 6 V and are available in either ceramic or plastic 16-pin DIPs.

CIRCLE NO. 382

## CMOS clock circuit operates from 1.5 V

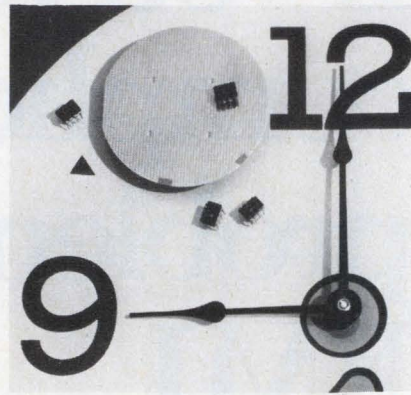

*Intersil, 10900 N. Tantau Ave., Cupertino, CA 95014. \$3.15 (100 up); stock.*

The ICM7038B CMOS clock circuit operates from a 1.5-V battery. The circuit performs the function of oscillator, frequency divider and output driver for miniature synchronous motors. Inside the circuit are an oscillator and 16 binary dividers. The ICM7038D version has the final output from a 17th binary divider. The ICM7038E and ICM-7038G have 18 and 19-stage binary divider options. The total output driver impedance is typically 350  $\Omega$ . An alarm output also has a low resistance, making it suitable for driving a transducer buffer. The circuit, housed in an 8-pin DIP, typically consumes 105  $\mu$ W at 1.5 V and operates over a -20 to +70 C range. Current drive is 1 mA, minimum.

CIRCLE NO. 383

## 8-channel multiplexers have overload protection

*Hybrid Systems, Crosby Dr., Bedford, MA 01730. (617) 275-1570. From \$19 (1 to 9); stock to 4 wks.*

The MUX 202-M and MUX 203 multiplexers are eight-channel, single-ended units. They are housed in 16-pin hermetic DIPs and have overvoltage protection on both the analog and digital inputs. The multiplexers are also protected against channel interaction when the power is removed. The MUX 202-M is fully processed to MIL-STD-883. Key specifications of both units are: accuracy to 0.01%, cross talk of 0.01% at 10 kHz and an address time of 0.5  $\mu$ s. The units are TTL/CMOS compatible and will operate from  $\pm$ 15-V supplies.

CIRCLE NO. 384

## CB synthesizer IC provides all 40 channels

*Nitron, 10420 Bubb Rd., Cupertino, CA 95014. (408) 255-7550. \$2.50 (10,000-up); stock.*

A low-cost 40-channel frequency synthesizer can be built based on the NC6402 digital phase-locked-loop circuit. The circuit synthesizes all 40 CB channels while positively locking out all other frequencies. A logic-level input selects the transmit or receive mode of operation and seven-segment-coded switch closures to ground select the channel and simultaneously operate a two-digit display. In addition to the 16-pin DIP NC6402, all that is required to complete a minimum cost synthesizer is a crystal reference oscillator, a VCO, a one-wafer rotary switch, a mixer, a dual-D flip-flop and an optional two-digit display.

CIRCLE NO. 385

## Design your own logic with 158 gate array

*TRW, One Space Park, Redondo Beach, CA 90278. (213) 536-1500.*

Configurable gate arrays offer logic designers many custom LSI options without the expense and time required for a complete custom circuit design. A logic designer can configure a wide variety of circuit elements using the 158 gates (3-input TTL NAND gates) available on a single array. Turn-around time from a completed logic interconnection program to fully tested arrays is typically six weeks. Standard and driver 3-input, TTL NAND gates with open collectors or active pull up can be configured on the array, along with 3-input gate expanders. The designer can choose from 5 to 25 k $\Omega$  pull-up resistors and isolation diodes. Logic designers can also select a three-diode excursion clamp. There are 38 pads available for signal I/O and two are required for the +5 V supply and ground. Typically, the arrays require about 100 mW and have a propagation-time delay of 40 ns per gate, average. Due to the custom nature of the circuit, costs depend on interconnect complexity and quantity, so contact the company for a quote.

CIRCLE NO. 386





The Industry's Most Complete Line of  
**EPOXY BRIDGE RECTIFIERS**

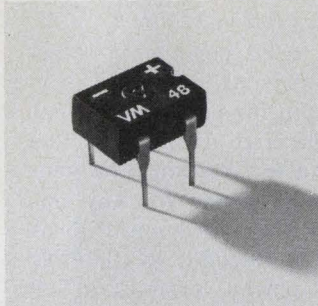

1 AMP

**DIB**

- 1 Amp Dual-in-Line Bridge**
- 4 pin, low-profile DIP
  - 25V to 1000V ( $V_{RRM}$ )
  - 25A 1/2 cycle surge, ( $I_{FSM}$ )
  - Standard .10" grid DIP lead spacing
  - Compatible with automatic handling, testing, inserting.

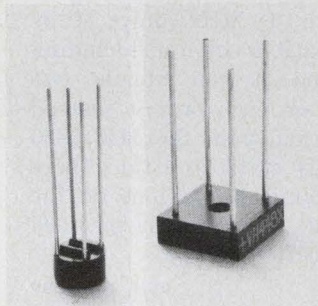

1 AMP    2 AMP    6 AMP

**1 AMP ( $I_O$ ) EBR**

- 25V to 1000V ( $V_{RRM}$ )
- 25A 1/2 cycle surge ( $I_{FSM}$ )
- Controlled avalanche series (250V to 850V min  $V_{BR}$ )
- Fast recovery series

**2 AMP and 6 AMP ( $I_O$ ) EBR**

- 50V to 1000V ( $V_{RRM}$ )
- 2A has 50A surge ( $I_{FSM}$ )
- 6A has 100A surge ( $I_{FSM}$ )
- Controlled avalanche series (250V to 850V min  $V_{BR}$ )
- 2A Fast Recovery Series

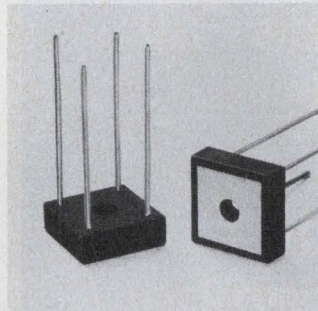

10 AMP

**10 AMP ( $I_O$ ) EBR**

- 50V to 1000V ( $V_{RRM}$ )
- 100A surge ( $I_{FSM}$ )
- Controlled Avalanche series (250V to 850V min  $V_{BR}$ )
- 200 nsec ( $t_{rr}$ ) series
- 1500V min circuit-to-case insulation.

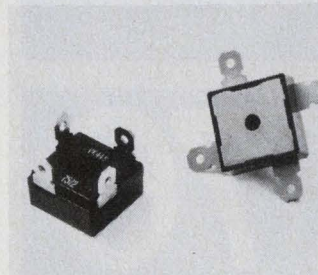

15 & 30 AMP

**15 AMP & 30 AMP ( $I_O$ ) EBR**

- 50V to 1000V ( $V_{RRM}$ )
- 15A has 100A surge ( $I_{FSM}$ )
- 30A has 300A surge ( $I_{FSM}$ )
- 200 nsec ( $t_{rr}$ ) series
- 1500V min circuit-to-case insulation.
- 1.5 °C/W max  $R_{\theta JC}$

Call Mike Hawkins  
214/272-4551  
for more information



Design us in . . . we'll stay there **VARO SEMICONDUCTOR, INC.**

P.O. BOX 676, 1000 N. SHILOH, GARLAND, TEX. 75040  
(214) 272-4551 TWX 910-860-5178

EUROPEAN OFFICE: UK: VARO SEMICONDUCTOR INTERNATIONAL, INC.  
Deeppene House, Bellegrove Road, Welling, Kent, England DA163PY, 01-304-6519/0

CIRCLE NUMBER 81

ELECTRONIC DESIGN 20, September 27, 1976

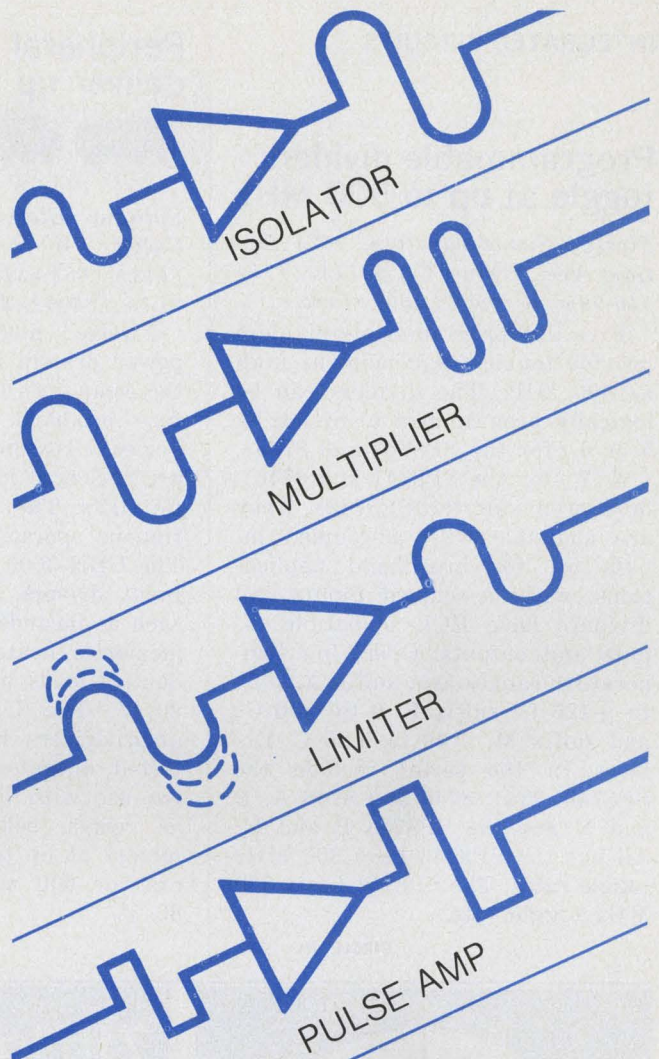

# FROM A SINGLE LOW COST\* AMPLIFIER

Model	Frequency Response (MHz)	Gain (dB)	Flatness (dB)	Noise Figure (dB)	VSWR	Input Power	Current
	Min.	Min.	Typ.	Typ.	In & Out	VDC	mA
GPD-401	5-400	13	±1.0	4.5	2.0	15	10
GPD-402	5-400	13	±1.0	6.0	2.0	15	24
GPD-403	5-400	9	±1.0	7.5	2.0	24	65

Weight, 1.0 Gram

\* PRICED AS LOW AS \$18  
DELIVERY FROM STOCK



**Avantek**

write or call for applications literature and data sheets  
3175 Bowers Avenue, Santa Clara CA 95051 (408) 249-0700

\*In quantities of 50-99 or as low as \$27 in quantities of 1-9.

CIRCLE NUMBER 82



## INTEGRATED CIRCUITS

### Programmable dividers toggle at up to 500 MHz

Plessey Semiconductors, 1674 McGaw Ave., Irvine, CA 92714. (714) 540-9945. From \$11.50; stock.

Five uhf programmable dividers provide toggle frequencies as high as 500 MHz. The dividers can be logically programmed to divide by 5 or 6 (for the SP8740 and 8745), 6 or 7 (for the SP8741 and 8746), or 8 or 9 (for the SP8743). They are available with ac-coupled inputs or, for broadband applications, with dc-coupled inputs. All dividers have ECL-compatible inputs and outputs. Operating temperature ranges are: suffix A, -55 to +125 C; suffix B, 0 to +70 C; and suffix M, -40 to +85 C. Devices in the series include the SP8740, 8741, 8745 and 8746 A, B and M and the SP8743 B and M. All but the SP8743 have 300 MHz toggle rates. The SP8743 has a 500 MHz toggle rate.

CIRCLE NO. 387

### Peripheral drivers deliver up to 1.2 A



Sprague Electric, 115 Northeast Cutoff, Worcester, MA 01606. (413) 664-4411. 100-up prices: \$1.75 (3600), \$1.87 (5700); stock.

Twelve monolithic peripheral power drivers have been added to the company's line of digital interface products. The new devices, Series UDN-3600 and UDN-5700, are packaged in 8 and 16-pin plastic DIPs. They are rated for continuous operation over 0 to 85 C. The UDN-3600 units are dual two-input drivers, designed for loads such as incandescent lamps, LEDs, memories, heaters and other noninductive loads of up to 600 mA at 80 V. The UDN-5700 dual and quad drivers have transient protected outputs and are designed for use with inductive loads such as relays, solenoids or stepping motors at up to 1.2 A (four drivers) or 600 mA (one driver) at 80 V.

CIRCLE NO. 388

### Pin replacement for 6820 offers benefits

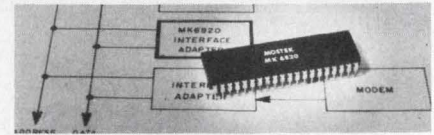

Mostek, 1215 W. Crosby Rd., Carrollton, TX 75006. (214) 242-0444. From \$5.50 (100-up); stock.

The MK 6820 peripheral interface adapter is an improved performance, pin-for-pin replacement for Motorola and AMI 6820. The circuit can also function as a generalized input/output for any microprocessor bus. Advantages of the MK 6820 include: availability in two, low-power versions, a 300 and a 400 mW max model; operation at a 2 or 1 MHz max rate rather than 1 MHz only; fully TTL compatible inputs including Enable; and it can handle two TTL loads on each output instead of one. In addition, the MK 6820 is completely static and thus there are no dynamic limitations on the Enable input. Operation is specified for the 0-to-70-C range.

CIRCLE NO. 389

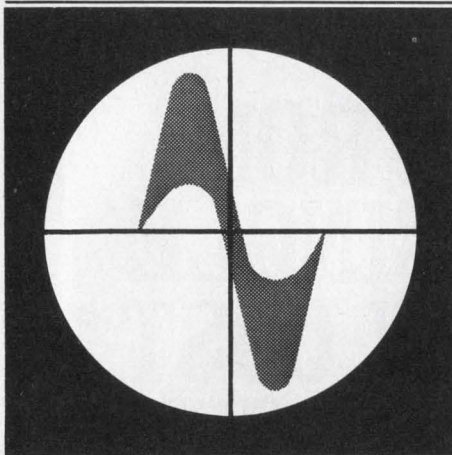

7th International Trade Fair  
for Components and  
Production Facilities  
Munich - Fair Grounds  
25 November - 1 December  
1976

# electronica 76

7th International  
Congress  
on Microelectronics  
29 November -  
1 December 1976

electronica 76 - Coupon  
Please submit further information

Name

Address

Münchener Messe- und Ausstellungsgesellschaft mbH, Postfach 12 10 09,  
D-8000 München 12, Tel. (089) 51 07-1

CIRCLE NUMBER 83



# TEN-FOUR, CB-LAND, DO YOU COPY?



... Hammer up and lay an eyeball on this copy for a minute. We don't want to overmodulate, but we've got four handbooks that, for not much lettuce, can have you doing your thing in the left lane in no time.

How to get your license from Uncle Charley. How to select and set up a rig. How it works. How to fix your set when something's dusting your ears. Do you copy ... it's all here!

Whether you're a green apple or a trucking guy, even if you drive a pregnant roller skate and want help the next time you get bubble trouble, here's the information, tips and techniques you need.

Use the coupon and put down your handle (name) and 10-20 (address) to order the book(s) you want. They come with a 15-day money back guarantee. And keep the wheels spinning and the beavers grinning.

## **HAYDEN BOOK COMPANY, INC., 50 Essex St., Rochelle Park, N. J. 07662**

**MOST OFTEN ASKED QUESTIONS AND ANSWERS ABOUT CB RADIO**  
*CB Magazine Staff*

Everything from "WHAT DOES CB MEAN?" to "HOW DO RG-58 and RG-59 CABLE DIFFER?" Over 160 questions sent in to *CB Magazine* cover all you need to know to really enjoy your rig. 5747-4, \$3.95.

**PRACTICAL CB RADIO SERVICING Revised 2nd Edition**  
*R. R. Freeland*

How to handle just about every problem you'll ever face. Step-by-step instructions, including spot-testing and troubleshooting. Filled with charts, diagrams, illustrations. 0869-4, \$6.95.

**CITIZENS BAND RADIO Revised 2nd Edition**  
*Allan Lytel*

Compares different types of equipment ... how they work ... maintenance and repair ... the FCC and you. 5737-7, \$4.90.

**CBers' HOW-TO BOOK**  
*Leo G. Sands*

How to select and install equipment, including mobile and base stations ... codes and channels ... how to modify your rig for greater convenience and performance. 0718-3, \$4.95.

Please send the books checked on 15-day examination. Enclosed is my check for \$\_\_\_\_\_—Include your state sales tax (NJ-5%, CA-6%, FLA-4%) and 65¢ per book for postage & handling. I understand that I may return the book(s) within 15 days for a complete refund if not satisfied.

Name \_\_\_\_\_

Address \_\_\_\_\_

City \_\_\_\_\_

State/Zip \_\_\_\_\_

76-47



## CRT terminal features programmable baud rate



Omron Corp. of America, Information Products Div., 432 Toyama Dr., Sunnyvale, CA 94086. (408) 734-8400. \$2750; 60 days.

A programmed CRT terminal, the 8030, allows user programming of communications functions from its keyboard. The operator can set up transmission baud rate, parity, bits per word and stop/start bits. The end-of-block terminating character is also user programmable. The terminal contains a two-page refresh memory with a total of 3840 characters, permitting the operator to edit the data before transmitting it to the host computer. The 8030 terminal has a 15-in., diagonally measured, 1920-char display.

CIRCLE NO. 393

## 150-line/min printer available for \$900

Epson America, Inc., 2990 W. Lomita Blvd., Torrance, CA 90505. (213) 530-6533. \$900.

The model 2610 prints 150 lines/min with a 64-character set, or 84 line/min with a 128-character set, both in an 80-column format. The \$900 price of the 2610 includes ASCII control logic and column buffering in addition to electronic and mechanical chassis. A belt-impact printing method is employed. The standard 256-character belt contains four sets of 64 characters. An optional belt provides the same character count in two sets of 128 characters. Paper widths of up to 10-in. with up to three carbons may be accommodated. The 2610 line printer measures  $6.2 \times 17 \times 15.5$  in. and weighs 33 lb.

CIRCLE NO. 394

## PC-board video digitizer sends data to a computer

Echolab, Inc., 213 Middlesex Turnpike, Burlington, MA 01803. (617) 273-1512. \$975 (PC board).

A video digitizer converts 60-k picture elements/s, allowing connection to the programmed I/O ports of most computers. The digitizing technique uses a semi-random access method. The computer specifies an x-axis address via a 9-bit binary number. The video picture is digitized beginning at this address, and continues for four picture elements. The digitizer converts the analog voltage of each picture element into 4-bit words. Four 4-bit words are then packed into a 16-bit word and transmitted to the host computer's parallel I/O port. This process repeats for each video line. The analog video signal is quantized at a 12-MHz rate. The digital word is converted to an analog voltage so that a TV monitor can be used to view the reconstructed picture. The PC board measures  $7.5 \times 8$  in.

CIRCLE NO. 395

## Tape drive is compact, uses 3M cartridge

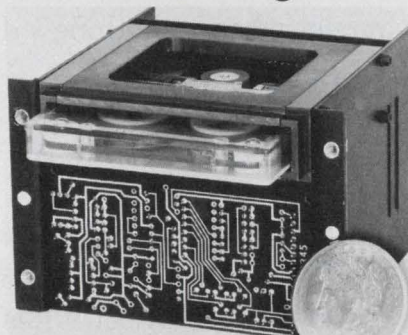

Instrumentation Technology Corp., 18333 Eddy St., Northridge, CA 91325. (213) 886-2034. \$470 (100 up); 30 days.

The Micro-Drive tape transport, Model 101, takes the 3M DC100A data cartridge. The unit's dimensions are  $4\frac{1}{2} \times 4 \times 3$  in. Read/write tape speed is 25 in./s, and the rewind/search speed is 75 in./s. Recording density is 1600 bit/in. The unit requires only one supply voltage of 15 V dc at 700 mA for running current and stand-by current is 15 mA. The cartridge can store up to 1.3 Mbit and the Micro-Drive can transfer data at the rate of 20-k bit/s.

CIRCLE NO. 396

## Graphic plotter talks via RS232

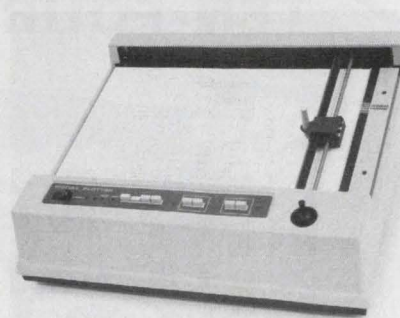

Tektronix, Information Display Group, P.O. Box 500, Beaverton, OR 97077. (503) 644-0161. \$3995.

An interactive digital plotter, called the model 4662, can communicate with alphanumeric terminals through a modem using RS232C compatible lines. Additionally, the plotter can couple with other systems over its built-in General Purpose Interface Bus. Up to a  $10 \times 15$  in. image size can be produced. The 4662 has a hardware character generator, digitizing capability, 22 in./s pen speed, 0.005 in. accuracy and  $\pm 0.0025$  in. repeatability as standard features. It also has a 1600-byte input buffer. Data can be transferred at 110, 150, 300, 600 or 1200 baud. Digitizing is made easy through the use of the joystick control. By moving the pen to the desired position and pressing the call key, the X-Y data points can be sent out to the host. Character-size change is possible through program control, as is character rotation in 1-deg increments.

CIRCLE NO. 397

## Cache memory speeds up DEC PDP-11/45

Minntronics Co., 2975 Furness St., St. Paul, MN 55109. (612) 770-5247. \$9240; stock to 30 days.

The Model-45 cache memory plugs into the DEC PDP-11/45 and 11/50, speeding up program execution by 50 to 100%. The Model 45 consists of three PC boards and an optional power supply. The cards are installed in about 20 min by plugging them into DEC Fastbus slots. No hardware or software modifications to the host computer are required. An on-off switch for the cache memory eases benchmarking and troubleshooting.

CIRCLE NO. 398



# Rose enclosures. New. Beautiful. Quality. Standards.



Rose Enclosures, made specifically for electronic use, culminate years of design, engineering and production experience. Extra high quality, precision-finished units provide functional protection, easy access, excellent esthetics. Available materials: Lexan, Aluminum, Polyester and ABS. Clear plastic covers with Lexan and ABS. A competitively-priced stock of Rose Enclosures is maintained in Belding, Mich. for immediate shipment. Contact us at (616) 794-0700.

**STAHLIN**  
BROTHERS, INC.  
Belding, Michigan 48809

Visit Booth 653 — ISA-76 International Conference and Exhibit - Houston  
CIRCLE NUMBER 85

## New Heyco<sup>®</sup> Nylon Cable Clamps



New from Heyman Manufacturing—nylon clamps for standard and heavy duty cable applications. Tough, lightweight nylon resists abrasion, aging and most chemicals. And provides excellent insulation. Standard clamps range from 1/8" thru 1/2" in 7 sizes. Heavy duty clamp holds 19 different diameter cables, from 1/8" thru 1 1/2". Both have standard locking holes. Both have full radiused inside edges that won't cut into wire insulation—and are open ended for easy entry. U.L. recognized.

**FREE SAMPLES on request from:**

### HEYMAN MANUFACTURING COMPANY

KENILWORTH, NEW JERSEY 07033 WAUKESHA, WISCONSIN 53186  
(201) 245-2345 • TWX: 710-996-5986 (414) 542-7155 • TWX: 910-265-3668  
CALL TOLL-FREE (800) 558-0917 • IN WISCONSIN CALL (800) 242-0985



CIRCLE NUMBER 86

ELECTRONIC DESIGN 20, September 27, 1976



## MEPCAPS<sup>®</sup> FOR THE LITTLE "EXTRAS"

### THAT WIN BIG FRIENDS ON THE PRODUCTION FLOOR

Mepcap<sup>®</sup> radial leaded ceramic capacitors are designed for the guys in the board room—the PC Board Assembly Room. Where helpful product features, no matter how small, can save time and money.

Such as the higher range of values—1 pf to 10 $\mu$ f—available in just six Mepcap sizes. Then there's the controlled meniscus; a big help in getting good electrical contacts the first time, every time.

Easy part identification is appreciated, too. Mepcaps are light gray, against which part markings really pop out. And the unique Mepcap part numbering is the clearest, easiest to understand system going.

Mepcap ceramic capacitors. With the meaningful little "extras" that measure up where it counts the most!



Mepco/Electra, Inc.

A North American Philips Company

111 North Street Canandaigua, N.Y. 14424 (315) 394-1900

**MEPCO/ELECTRA, INC.**  
A NORTH AMERICAN PHILIPS COMPANY

CIRCLE NUMBER 87



# Have you read Electronic Design's ACCURACY POLICY?



We have been printing it in every issue of *Electronic Design* for the past 24 years and adhering to it every business day of the year.

The accuracy policy of *Electronic Design* is:

- To make diligent efforts to ensure the accuracy of editorial matter.
- To publish prompt corrections whenever inaccuracies are brought to our attention. Corrections appear in "Across the Desk."
- To encourage our readers as responsible members of our business community to report to us misleading or fraudulent advertising.
- To refuse any advertisement deemed to be misleading or fraudulent.

## Electronic Design

50 Essex Street, Rochelle Park, NJ 07662

### DATA PROCESSING

#### Two calculators store 224 steps on mag cards

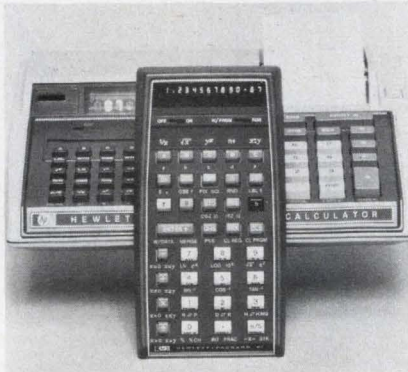

Hewlett-Packard, 1501 Page Mill Rd., Palo Alto, CA 94304. (415) 493-1501. HP-65: \$450; HP-97: \$750.

Two programmable calculators can store 224 steps on magnetic cards; three times more than the company's first magnetic-card calculator, the HP-65. The 11-oz HP-67 is the same size as the 65. Both calculators perform identical computing functions, and have identical program and data storage register capacity. Both models run on rechargeable batteries or line current. The 2.5 lb HP-97 additionally has a built-in thermal printer and a buffered keyboard. The models feature more programming power than the HP-65. Each has 26 data storage registers, 20 user-definable functions, three levels of sub-routines, and label, indirect and relative addressing.

CIRCLE NO. 399

#### Terminal printers come in four models

Data General, Southboro, MA 01772. (617) 485-9100. \$2650 (single qty).

The 6040 series of terminal printers comes in four models: a 30 and a 60 char/s printer are each available in keyboard or receive only versions. Keyboard models can also be used as typewriters. All models print full 132-column lines on paper widths of from 4 to 15 in. They interface with all Eclipse and Nova minicomputers. The printers can interface to 20-mA current loop and EIA RS232-C devices, using asynchronous controllers or multiplexers.

CIRCLE NO. 400

#### Acoustic phone coupler works at 450 baud

Omnitec Corp., 2405 S. 20th St., Phoenix, AZ 85034. (602) 258-8244. \$300 (single qty).

The Model 401C acoustic coupler operates in both full and half duplex, switch selectable, at a data rate of 450 baud. It offers EIA (RS232) interface. The unit has a receive sensitivity of -50 dBm, and a transmit level of -10 dBm. The "sound-seal" cushions of the coupler have a non-linear response to various energy levels to provide maximum acoustic shielding. The 401 also is made of an impact resistant material in 27 different colors.

CIRCLE NO. 401

#### Paper-tape reader sends at 16 baud rates

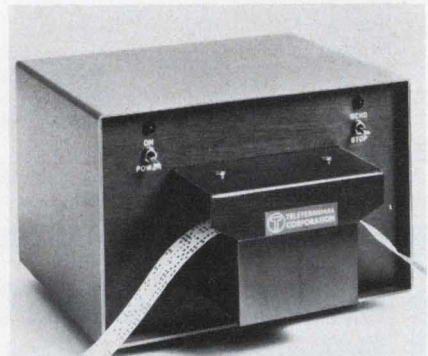

Teleterminal Corp., 12 Cambridge St., Burlington, MA 01803. (617) 272-8504. \$695; stock, 30 days.

The Fly Reader 232 reads paper tape at a rate of 300 char/s. The reader has a bank of programming switches located on the back panel. The switches allow the user to easily select any one of 16 different baud rates. The character length, parity, number of stop bits and the inhibiting or enabling of the RS232 control signals can also be switch-controlled. In addition to RS232, the Fly Reader transmits using current loop or serial TTL interface. It will read any standard one-in.-wide tape that has a transmissivity of less than 60%. The 232 allows remote start/stop of the reader either in a continuous reading mode or in a character at a time (step) reading mode. In addition, the current-loop (TTY) interface can be jumpered as either passive or 20-mA active.

CIRCLE NO. 402



## Noise sensitivity problems go away—we guarantee it!

Topaz Ultra-Isolation Transformers provide an inexpensive and reliable way to supply clean, noise-free AC power to sensitive equipment such as computers, instrumentation, communication and process control equipment.

Ultra-Isolation Transformers offer the industry's best noise attenuation:

- Common-mode noise rejection greater than 145 dB.
- Transverse-mode noise rejection greater than 125 dB at 1 kHz.
- Standard models 125 VA to 130 kVA.
- Priced from \$64.



**Our guarantee:** A Topaz Ultra-Isolation Transformer will solve your noise sensitivity problems to your complete satisfaction or we'll take it back—no questions asked.

**TOPAZ** SOLUTIONS TO POWER PROBLEMS  
ELECTRONICS

3855 RUFFIN ROAD, SAN DIEGO, CA. 92123 • (714)279-0831 • TWX (910)335-1526

CIRCLE NUMBER 89

## AUTHOR'S GUIDE



If you've solved a tricky design problem, if you have developed special expertise in a specific area, if you have information that will aid the design process... share it with your fellow engineer-readers of *Electronic Design*.

Articles you have authored not only raise your own professional status, but help build your company image as well. The readers benefit, your company benefits.

To help you prepare material that meets *Electronic Design's* high editorial standards, our editors have prepared a special author's guide entitled "Writing for *Electronic Design*." It covers criteria for acceptability, form, length, writing tips, illustrations, and payment for articles published. It's available without cost.

It's easy to write for *Electronic Design*, but it's often hard to get started. Send for your copy of our Author's Guide today.

Circle No.  
150

## YEW's POWERFUL FAMILY!



### AC WATTS

And, that's a lot of accuracy, even with low power factors and distorted waveforms. The YEW 2885 is renown throughout the world as the AC power measuring instrument. YEW's APR-2, on the right is used as a standard by many countries in the world.

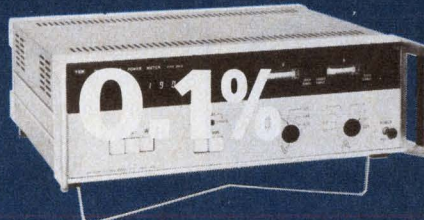

### TRUE RMS V-A-W

Accuracy and versatility have generated a reputation for the YEW 2503 True RMS V-A-W instrument that's hard to beat. Distorted waveforms and low power factor hardly phase it at all.



### TRUE RMS V-A-W

If 0.25% accuracy with 0.01% resolution fills your True RMS requirements, YEW's new 2504 can't be beat for pure dollar efficiency. It takes low power factors and distorted waveforms in stride, too.

### PORTABLE WATTMETERS

YEW has made more precision analog portables than anyone else in the world... and they're usable to 2 KHz and not expensive.

Write for our technical information package.

**YEW** YOKOGAWA CORPORATION OF AMERICA

5 Westchester Plaza, Elmsford, N.Y. 10523  
Tel. 914/592-6767 TWX: 710-567-1256

"Visit us at ISA Booth 547"

CIRCLE NUMBER 90



DIRECT FROM STOCK

# 5V3A

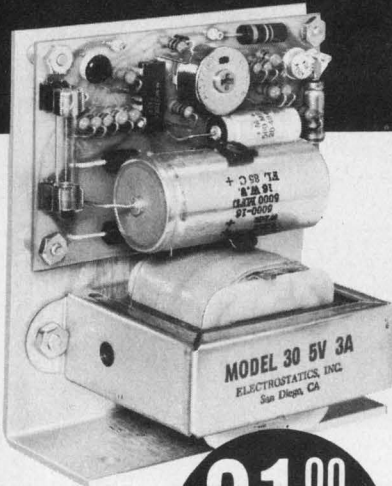

**31<sup>00</sup>**  
(1-9)  
\$23.70 · 100 pcs.

**Excellent regulation and ripple.**

### SPECIFICATIONS

Size: 4 x 4.5 x 2.75 overall  
 Input: 105-125V, 47-420 Hz  
 Output: Any DC voltage 3 to 30  
 Regulation: Line — 0.005%  
                   Load — 0.05%  
 Ripple: Less than 250 Microvolts  
 Temp: Operative —40 to +71°C  
       Storage —65 to +85°C  
       Coefficient —0.01%/°C Max.  
 Current Limiting: Fixed Foldback Type  
 Overvoltage: Optional

MODEL	VOLTAGE	AMPS
30-5	5.0	3.0
30-10	10.0	1.8
30-12	12.0	1.5
30-15	15.0	1.2
30-24	24.0	1.0
30-28	28.0	1.0

### ORDERING INFORMATION

QUANTITY	PRICE	WITH O.V.
1-9	\$31.00	\$36.00
10-24	29.20	33.70
25-49	26.60	29.90
50-99	25.10	28.20
100-	23.70	26.90

CALL (714) 279-1414 FOR DELIVERY

**Electrostatics, Inc.**  
 7718 CLAIREMONT MESA BLVD. • SAN DIEGO, CA 92111

CIRCLE NUMBER 92

## DISCRETE SEMICONDUCTORS

### GaAsFET provides 25 mW at 10 GHz

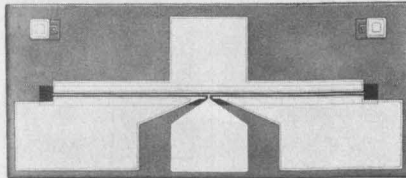

Hewlett-Packard, 1501 Page Mill Rd., Palo Alto, CA 94304. (415) 493-1501. \$135 (1-9); stock.

First of a new family of gallium-arsenide Schottky-barrier field-effect transistors, the Model HFET-1000 chip features a 14.5-dBm (25 mW) linear-power output at 10 GHz. Noise figure at 10 GHz is 3.6-dB typical, with 6.9-dB associated gain; maximum available gain at that frequency is 11 dB. For general use in low-noise amplifiers in the 2-to12-GHz range, this GaAsFET has a 1-by-500- $\mu$ m gate. The chip allows easy wire bonding and die attaching. A scratch and dust-resistant layer covers the active device area.

CIRCLE NO. 403

### SCR hybrids available in nine circuit types

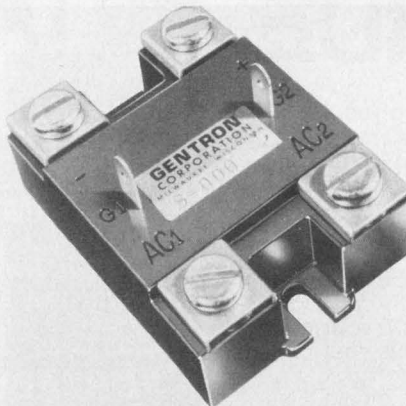

Genatron Corp., 6667 N. Sidney Pl., Milwaukee, WI 53209. (414) 351-1660. From \$20 (100 up); 3 to 4 wks.

The S series of Powertherm SCR hybrids offers nine basic circuit types with voltages to 1200 V and currents to 110 A. Advantages include a low thermal resistance of 0.4 C/W maximum, isolation, and internal interconnects.

CIRCLE NO. 404

### Varactor diodes cover 10:1 cap range

MSI Electronics Inc., 34-32 57th St., Woodside, NY 11377. (212) 672-6500. \$5 (100 to 999); 2 wks.

The 10:1 capacitance tuning ratio provided in the MSI type MV1405 varactor diode assures at least 3:1 coverage in frequency. This tuning diode has a nominal capacitance at 2 V bias of 250 pF, which goes to less than 25 pF at 10-V bias. The breakdown rating of 12 V provides a sufficient safety margin for rf signals of up to 2 V pk-pk. The Q of 200, minimum, at 2-V bias measured at 1 MHz makes the diode particularly suitable at the lower rf frequencies. Furnished in a JEDEC DO-7 glass package, which is hermetically sealed, the diode meets or exceeds MIL-S-19500 environmental specifications.

CIRCLE NO. 405

### High-speed diodes handle 2 to 3 amps

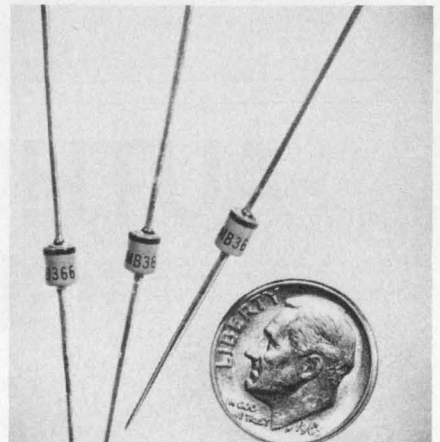

Microsemiconductor Corp., 2830 S. Fairview St., Santa Ana, CA 92740. (714) 979-8220. \$5.45 (100 to 999); stock to 30 days.

A new line of high-speed, switching, 2 and 3-A silicon rectifiers combine miniature size, high surge capability, low thermal resistance and rugged mechanical design. The rectifiers feature a hermetic-seal hard-glass case, solderable silver leads and an opaque painted body that is insensitive to ambient light. Solvent-resistant cathode bands in contrasting color are provided and type number is printed. The rectifiers are designed and manufactured to meet or exceed the requirements of MIL-S-19500.

CIRCLE NO. 406



## Application Notes

### Microwave freq counter

Written to help the microwave engineer understand the capabilities and use of frequency counters, a 10-page ap note covers three common down-conversion techniques: prescale, heterodyne and transfer oscillator. Hewlett-Packard, Palo Alto, CA

CIRCLE NO. 407

### Tape transports

A 55-page OEM Users Manual contains data for the design, preparation, and installation of an interface for Pertec's T5000, T6000, T7000, T8000A and T9000 digital magnetic tape transports. Pertec, Chatsworth, CA

CIRCLE NO. 408

### Modal analysis processor

A six-page brochure on a modal analysis processor shows why and how modal analysis makes vibration easier to understand. Nicolet Instruments, Northvale, NJ

CIRCLE NO. 409

### BiMOS op amp

The CA3140 op amp, which features a high-voltage PMOS input stage and a high-voltage bipolar output stage with a wide output range, is described in a 12-page application note. The brochure contains a business reply card that the reader can use to order a free sample of the CA3140 op amp. RCA Solid State Div., Somerville, NJ

CIRCLE NO. 410

### Coil winders

"The Coil Winders' Idea Book" is a sketchpad of production and testing systems that can help boost productivity for manufacturers of coils, solenoids, relays, and so on. The sketches show how to apply readily available components for limited automation in production and testing operations. Nationwide Electronic Systems, Streamwood, IL

CIRCLE NO. 411

# MAGNETIC SHIELDS

Magnetic shields manufactured in any size from small components to large vacuum chambers. **CO-NETIC AA** alloy has high permeability that provides maximum attenuation. Shields are fully hydrogen annealed after fabrication. We offer material and custom shields. Applications range from shielding earth's field to high intensity AC and DC fields.

Send For Application Notes

MAGNETIC SHIELD DIV.



PERFECTION MICA CO.  
740 North Thomas Drive  
Bensenville, Ill. 60106, USA  
Phone 312 / 766-7800  
TWX 910-256-4815



Please Call or Write  
For Design Assistance

CIRCLE NUMBER 93



## Use them with confidence.

The Hamlin line of stock displays is long—one of the longest in the industry. Selection from distributor or factory stocks includes:

- 12 and 24 hour watch
- 12 and 24 hour clock
- 8 digit calculator
- 3½ and 4½ digit instrument
- 16 Segment Alphanumeric
- 2 and 4 digit numeric

Features include: Transmissive or reflective modes, 5 Vrms input, CMOS compatibility, 250 Ms operate time,

and a wide viewing angle. Edge-mount connector or dual-in-line termination.

Custom displays? Hamlin offers complete design and production services for displays with special format, electric or environmental requirements. For technical and pricing information, call your Hamlin distributor or representative. Hamlin Inc., 614 Lake St., Lake Mills, Wisconsin 53551 414/648-2361 TWX 910/260-3740

**HAMLIN**

glass experts since 1949



# 1 Relay Miss every 2-Billion Cycles

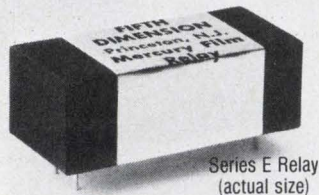

Series E Relay  
(actual size)

We tested 129 of our new Series E Relays at loads from dry circuits to 3 Amps. After 35-billion operations, only 10 single-cycle misses were monitored.

#### Series E Relays offer:

- Indefinite life
- No contact bounce
- Operation in all positions
- Contacts stable to  $\pm 0.015$  ohms over life
- Reliability at dry circuit or power loads
- Self-healing contacts
- Hermetically sealed contacts
- 1250V rms contact breakdown
- Low cost

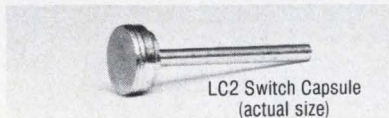

LC2 Switch Capsule  
(actual size)

Series E Relay uses a rugged LC2 welded capsule rather than a fragile glass reed switch. This patented design holds a film of mercury securely to the metal walls of the capsule. With every operation, the mercury film renews the switch contacts. You get the reliability of mercury relays, but with complete freedom of mounting orientation. LC2 welded capsule reliability is proven by hundreds-of-thousands of units in the field, as well as billions of cycles under stringent laboratory conditions.

Send for a FREE SAMPLE of the LC2 welded capsule on your letterhead. Circle the reader service card number for Series E Relay information.

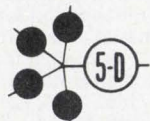

### Fifth Dimension, Inc.

P.O. Box 483  
Princeton, N.J. 08540  
Tel: (609) 452-1200

CIRCLE NUMBER 95

## New Literature



### Power amplifiers

Specifications and data for solid-state rf power amplifiers, wideband power multicouplers and transformers are provided in a 24-page catalog. Electronic Navigation Industries, Rochester, NY

CIRCLE NO. 412

### Test accessories

A 25th-anniversary catalog of electronic test accessories includes charts, photos and a new-products section. The 76-page catalog also has a cross reference of UG number, and an alphanumeric index. ITT Pomona Electronics, Pomona, CA

CIRCLE NO. 413

### Regenerative blowers

Performance and application data on regenerative blowers are given in a six-page brochure. Rotron, Woodstock, NY

CIRCLE NO. 414

### Solid-state databooks

The SSD-200D two-volume, 1232-page set of solid-state databooks for RCA Solid State Div's complete line is now available. The volumes contain complete technical data on all standard types plus abstracts of all application notes relating to those devices. \$6 each or both for \$10. Box 3200, Somerville, NJ 08876

INQUIRE DIRECT

### Screened-image displays

Screened-image displays that incorporate gas-discharge technology with design flexibility are described in a new bulletin from Beckman Instruments, Fullerton, CA

CIRCLE NO. 415

### Fuller's earth

Uses for Fuller's earth and its high adsorptive capabilities in filtering, reclaiming and purifying industrial oils, are described in a 16-page brochure from Carborundum Co., Lebanon, IN

CIRCLE NO. 416

### Power-supply catalog

A 34-page catalog on 28 families of line-operated power supplies and dc/dc converters is available. It includes application notes. Semiconductor Circuits, Haverhill, MA

CIRCLE NO. 417

### Laser products

The latest news on laser products and applications from one company is available in a quarterly newspaper that also covers sophisticated optics and accessories. Coherent Radiation, Palo Alto, CA

CIRCLE NO. 418

### Rf, microwave filters

Rf and microwave filters, components and subassemblies are described in a 40-page catalog. Telonic Altair, Laguna Beach, CA

CIRCLE NO. 419

### Plasma etching

An 8-page bulletin describes the use of low-temperature plasma to etch metals, semiconductor materials and dielectrics in the production of microelectronic devices. International Plasma Corp., Hayward, CA

CIRCLE NO. 420

### Servo recorder

A four-page catalog features the Rustrak 400, 4-in. servo recorder line. Photos of each recorder style, electrical and mechanical specifications, complete list of accessories and plug-in range cards and ordering information are included. Gulton Industries, East Greenwich, RI

CIRCLE NO. 421



# Beat Cost Problems With Continental's Standard Connectors! Call Our Fly Guy.



Guy Palmquist. When you need any special help or advice on connectors, get in touch with Guy. He's flown hundreds of thousands of miles working with people just like you to solve their connector problems. At a real competitive price. In back of Guy is a Continental team of design, manufacturing and molding specialists who can give you exactly the connector you require. So next time a connector bugs you - call our Mr. Palmquist. He's your kind of guy. (212) 899-4422.

*For the Sales Representative Nearest You, See Our Listings in EEM and Gold Book Directories*

# CONTINENTAL CONNECTORS

CONTINENTAL CONNECTOR CORPORATION ■ WOODSIDE, NEW YORK 11377

CIRCLE NUMBER 94



## classified ad

### ELECTRONIC DESIGN ENGINEERS

Challenging work on state of the art television and related equipment, including color, black and white, low light level and video processing. Strong analog and math required. Circuit Design - BS/MS - EE/Physics 2-5 years experience  
Sr. Design - BS/MS 3-10 years experience

Send resume to:

D. O'Connell, Personnel Manager  
Cohu Inc.  
Electronics Division  
P. O. Box 623  
San Diego, CA 92112

Equal Opportunity Employer (M/F)

### Protect Your Heart HAVE REGULAR MEDICAL CHECK UPS



Give Heart Fund 

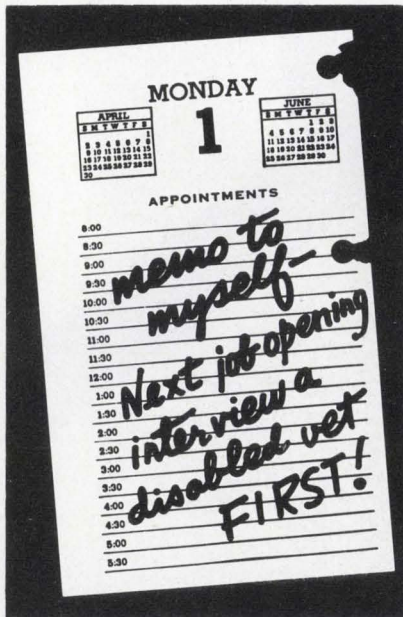

The President's Committee  
on Employment of the Handicapped  
Washington, D.C. 20210

## Bulletin Board

Three-day, in-depth courses on applications of National Semiconductor's SC/MP are now being offered as follows: Sept. 28, 29, 30 in Pittsburgh, PA and Syracuse, NY; Oct. 5, 6, 7 in Houston and Dallas, TX; Oct. 12, 13, 14 in Minneapolis, MN; Oct. 19, 20, 21 in Detroit, MI and Charlotte, NC; Nov. 2, 3, 4 in Cleveland, OH; and Nov. 9, 10, 11 in Detroit, MI. The fee for the course is \$325 and includes an SC/MP chip, three technical manuals, flow charts and software subroutine lists.

CIRCLE NO. 422

Philips Test & Measuring Instruments has cut prices from 12 to 20% on their PM6610 series universal frequency counters for telecommunications and field-service applications.

CIRCLE NO. 423

SGL Waber Electric has been granted Underwriters Laboratories listings for 98 new models of multiple-outlet strips. Special features include a 14/3 jacketed cordset, a 15 A circuit breaker and a new mounting plate. All units are rated at 15 A, 125 V and 60 Hz.

CIRCLE NO. 424

Ferroxcube Corp. has added thermal ferrites to its line of professional-grade ferrite products. Thermal ferrites are suitable for use in temperature-sensing applications where reliability is important.

CIRCLE NO. 425

Computer Automation now offers a Fortran IV compiler to support the firm's LSI-3/05 series of millicomputers.

CIRCLE NO. 426

Data Base Management Systems has a new version of their BIS/3000 system for the HP-3000CX and the HP-3000 Series II. The Release 2 is 30 to 50% faster than the earlier version.

CIRCLE NO. 427

## Electronic Design

ELECTRONIC DESIGN's function is:

- To aid progress in the electronics manufacturing industry by promoting good design.
- To give the electronic design engineer concepts and ideas that make his job easier and more productive.
- To provide a central source of timely electronics information.
- To promote communication among members of the electronics engineering community.

**Want a subscription?** ELECTRONIC DESIGN is sent free to qualified engineers and engineering managers doing design work, supervising design or setting standards in the United States and Western Europe. For a free subscription, use the application form bound in the magazine. If none is included, write to us direct for an application form.

If you do not qualify, paid subscription rates are as follows: \$30.00 per year (26 issues) U.S., \$40.00 per year (26 issues) all other countries. Single copies are \$2.00 U.S., \$3.00 all other countries. The Gold Book (27th issue) may be purchased for \$30.00 U.S. and \$40.00 all other countries.

**If you change your address,** send us an old mailing label and your new address; there is generally a postcard for this bound in the magazine. You will have to requalify to continue receiving ELECTRONIC DESIGN free.

**The accuracy policy** of ELECTRONIC DESIGN is:

- To make diligent efforts to ensure the accuracy of editorial matter.
- To publish prompt corrections whenever inaccuracies are brought to our attention. Corrections appear in "Across the Desk."
- To encourage our readers as responsible members of our business community to report to us misleading or fraudulent advertising.
- To refuse any advertisement deemed to be misleading or fraudulent.

Microfilm copies are available of complete volumes of ELECTRONIC DESIGN at \$19 per volume, beginning with Volume 1, 1952 through Volume 20. Reprints of individual articles may be obtained for \$3.00 each, prepaid (\$5.00 for each additional copy of the same article) no matter how long the article. For further details and to place orders, contact the Customer Services Department, University Microfilms, 300 North Zeeb Road, Ann Arbor, Michigan 48106 telephone (313) 761-4700.

**Want to contact us?** If you have any comments or wish to submit a manuscript or article outline, address your correspondence to:

Editor  
ELECTRONIC DESIGN  
50 Essex Street  
Rochelle Park, N.J. 07662



# Electronic Design

## Advertising Sales Staff

Tom W. Carr, Sales Director  
Jean Bunfield, Sales Coordinator

## Rochelle Park, NJ 07662

Robert W. Gascoigne  
Daniel J. Rowland  
Thomas P. Barth  
50 Essex St.  
(201) 843-0550  
TWX: 710-990-5071

## Philadelphia

Thomas P. Barth  
(201) 843-0550

## Boston 02178

Gene Pritchard  
P.O. Box 379  
Belmont, MA 02178  
(617) 489-2340

## Chicago 60611

Thomas P. Kavooras  
Berry Conner, Jr.  
200 East Ontario  
(312) 337-0588

## Cleveland

Thomas P. Kavooras  
(312) 337-0588

## Los Angeles 90045

Stanley I. Ehrenclou  
Burt Underwood  
8939 Sepulveda Blvd.  
(213) 641-6544

## Texas

Burt Underwood  
(213) 641-6544

## San Francisco

Robert A. Lukas  
3579 Cambridge Lane  
Mountain View, CA 94040  
(415) 965-2636

## London

Constance McKinley  
50 Essex St.  
Rochelle Park, N.J. 07662  
Phone: (201) 843-0550

## Amsterdam, Tokyo, Oslo

Sanders, W. J. M.  
Raadhuisstraat 24  
Graft-De Ryp, Holland  
Phone: 02997-1303  
Telegrams: Euradteam-Amsterdam

## Haruki Hirayama

Electronic Media Service  
5th Floor, Lila Bldg.,  
4-9-8 Roppongi  
Minato-ku, Tokyo, Japan  
Phone: 402-4556  
Cable: Electronicmedia, Tokyo

## Mr. O-kyu Park, President

Dongbo Intl Corp.—  
World Marketing  
C.P.O. Box 4010  
Seoul, Korea  
Tel. 76-3910/3911  
Cable: DONGBO SEOUL  
Telex: EBKOREA K27286

ABP

BPA

NEW! NOW IN STOCK FROM

**CML  
MACARR**  
POWER SUPPORT EQUIPMENT

THE LEADER IN SOLID STATE WIDE BAND POWER AMPLIFIERS!

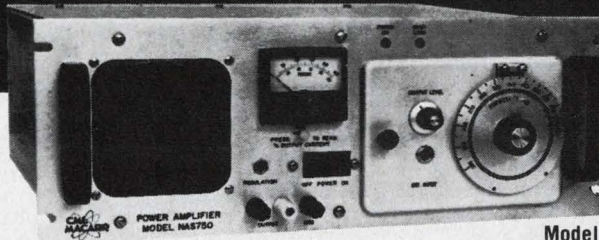

Model NAS-750-1

- Single & Three-Phase Models
- Full Rated Power @ 105-130/210-260V with .7 Pf. Loads
- Current Overload Protection with Automatic Reset
- Harmonic Distortion less than 0.5%
- Modular Plug-In Construction

**FREE!** Send for "How to Apply & Specify Wide Band Power Amplifiers and Frequency Converters."

A Product Line Of

**MARINE ELECTRIC RAILWAY PRODUCTS DIVISION**

166 NATIONAL RD., EDISON, NJ 08817  
Telephone No. 201-287-2810 • TWX 710-998-0560



CIRCLE NUMBER 96

## MICROPROCESSOR CORE MEMORIES

FOR THE LSI-11, 8080, 6800, IMP-16P

- NON-VOLATILE.
- PIN-TO-PIN COMPATIBILITY.
- POWER MONITORING FOR DATA PROTECTION.

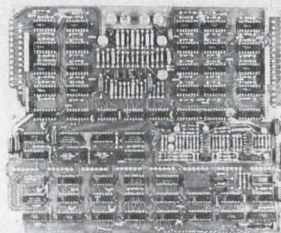

MM-16P 8K x 16

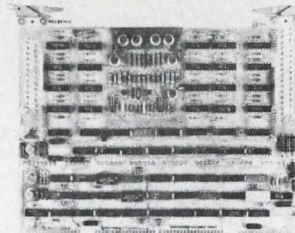

MM-1103 8K x 16

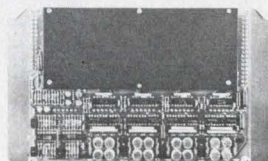

MM-6800 8K x 8

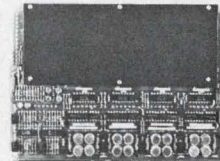

MM-8080 8K x 8

MM-1103 — Plugs directly to DEC. LSI-11 and PDP11-03 computer.

MM-8080 — Plugs directly to Intel's MCS 8 and compatible with SPC80 & MDS800.

MM-6800 — Plugs directly to Motorola's EXORciser and compatible with the Evaluation Modules.

MM-16P — Plugs directly to National's IMP-16P Microcomputer.

micro  
memory  
Inc

9438 Iroindale Ave., Chatsworth, California  
Tel: (213) 998-0070

CIRCLE NUMBER 97



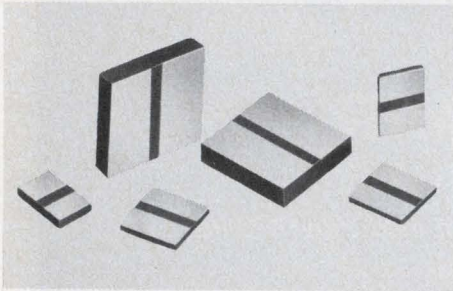

**CERAMIC CHIP CAPACITORS. SPLIT-CHIP**, is a new concept in ceramic chip capacitor technology. These new units have two broad electrodes on one face and eliminate conventional wrap-around end terminations. This new concept provides lower cost and easier assembly. SPLIT-CHIPS are available in five standard sizes from .040" x .030" to .130" x .090" and .015" thick and in all popular dielectrics and capacitance ranges. JOHANSON DIELECTRICS, INC., Box 6456, Burbank, Ca. 91510 213-848-4465

CERAMIC CHIP CAPACITORS

181

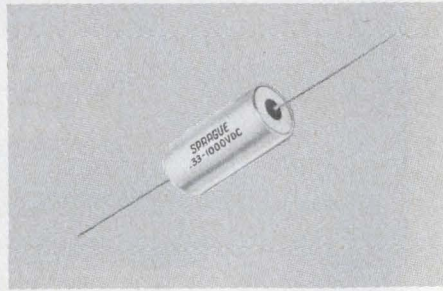

**A natural for SCR snubber applications.** Type 196P Vitamin Q® metal-clad paper capacitors for high-current, high-voltage, high-repetition-rate a-c applications. Built to take 600-to-800 volts peak a-c. Write for Bulletin 2110D to Sprague Electric Co., 347 Marshall St., North Adams, MA 01247. (413) 664-4411.

PAPER CAPACITORS

184

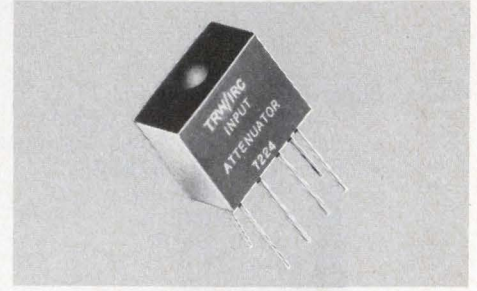

**AR Ultra-Precision Resistor Networks** from TRW provide maximum environmental protection. They feature lower effective cost, high density packaging, and all-welded construction. And, the AR Matched Resistor Sets provide ultra-precision performance at the lowest possible cost. TRW/IRC Resistors, an operation of TRW Electronic Components, 401 N. Broad St., Phila., Pa. 19108. (215) 922-8900.

AR MODULES

187

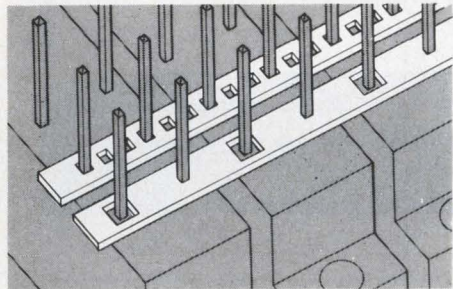

**STRIP/BUS BY ROGERS.** Low Cost Bussing Systems; easy installation, reliable solder joints; greater pin exposure. Write or call for details. Rogers Corporation, Chandler, AZ 85224. Phone (602) 963-4584. (EUROPE: Mektron NV, Ghent, Belgium; JAPAN: Nippon Mektron, Tokyo)

STRIP/BUS

182

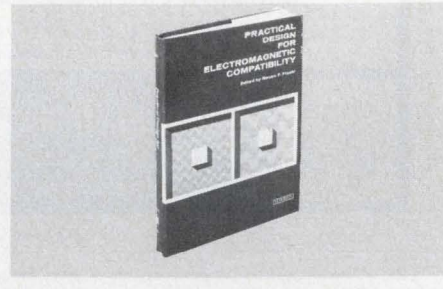

**PRACTICAL DESIGN FOR ELECTROMAGNETIC COMPATIBILITY**, ed. by R. Ficchi. A complete guide to elec. compatibility for electronic systems and equipment, including semiconductor, microelectronic, and digital computer equipment. Numerous charts, graphs, and nomographs. #5685-0, 272 pages, \$17.20. Circle the Info Retrieval Number to order 15-day exam copy. When billed, remit or return book with no obligation. Hayden Book Co., 50 Essex Street, Rochelle Park, N.J. 07662.

DESIGN GUIDE

185

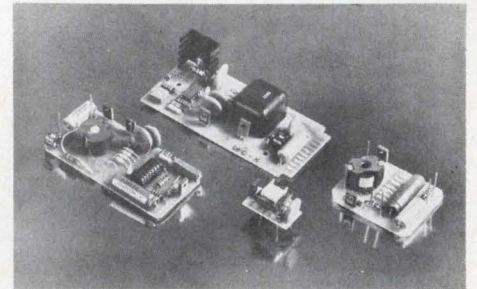

**Activate gas discharge readouts!** Custom designed and produced DC-to-DC power supplies to activate gas discharge displays, or for other applications. Regulation I/O options, packaging (encapsulated, aluminum shell or open frame), size and configuration, heat dissipation, mounting (PC board pins, edge connectors), etc., can be tailored to meet individual specifications. Price and delivery discussed after specifications are submitted. Endicott Coil Co., Inc., 31 Charlotte Street, Binghamton, N.Y. 13905 (607) 797-1263.

CUSTOM DESIGNED POWER SUPPLIES 188

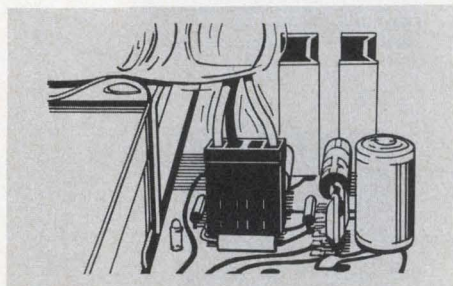

**VIBRATION PROOF** The more you vibrate the contacts or the harder you pull on their termination wires, the greater their grasp on the mated posts. To disconnect — just give the housing a gentle pull straight up. For both solid state and power applications, the AMP Locking Clip Connector adds integrity and reliability to your product. Call (717) 564-0100, or write: AMP Incorporated, Harrisburg, PA 17105. AMP is a trademark of AMP Incorporated.

LOCKING CLIP CONNECTOR

183



The TELCON TM-1200 is a quality FSK data Modem designed for asynchronous operation up to 1800 PBS. The Modem is available as a low profile desk top unit, in rack mount or in basic card configuration for OEM applications. All units comply with EIA standard RS-232 and are compatible with existing WE-202D models. Active integrated filter networks are used with excellent long term stability. All units are 100% burned-in. Price 1-9 \$365.00. Telcon Industries, Fort Lauderdale, Florida 305-971-2250.

MODEM

186

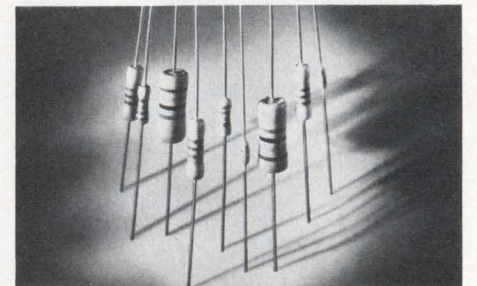

**RCA FLAMEPROOF FILM RESISTORS.** Design engineers prefer them because they won't flame or short under the most severe conditions. These resistors have a 2% tolerance, and are available in 1/4 watt, 1/2 watt, 1 watt, and 2 watt ratings. Resistance values range from 10 Ohms to 1.5 Megohms, depending on wattage rating. 475 film resistors to choose from. RCA Distributor & Special Products Division, Sales Promotion Services, Cherry Hill, N. J. 08101.

FILM RESISTORS

189



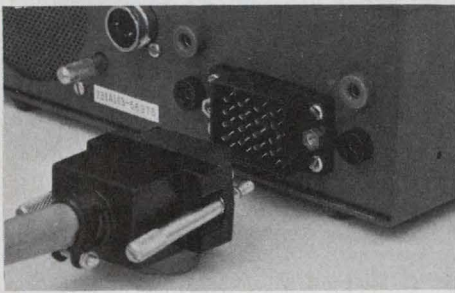

**Rugged and low-cost 36-pin connector.** Superbly designed and produced with simplified construction. Cut your costs up to 50%. Moisture-resistant glass-filled nylon insulator. Recessed contacts in both male and female housings. Hood provides positive cable strain relief. Interchangeable. E. F. Johnson Co., Waseca, MN. (507) 835-2050.

CONNECTOR

190

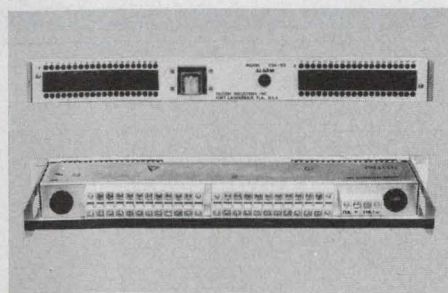

The CDF-90 offers 40 fused lines. It is designed for mounting in a standard 19 inch rack and takes only 1-3/4 inches of vertical space. Mounting flanges adjustable. If a fuse blows, a front panel alarm lights and external alarm output is energized. The fuse panels are compatible with all commonly used battery-supply voltages 24, 48, 60 and 130 volts. Available with 2 alarm indicators and 2 relays for split voltage applications. From stock—two weeks \$275. Telcon Industries, Inc., Fort Lauderdale, Florida 305-971-2250.

FUSE PANELS

193

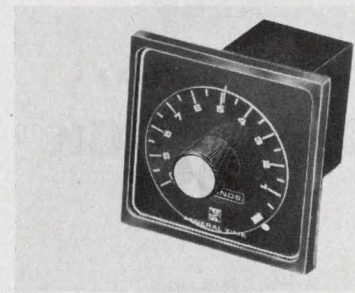

**CMOS DIGITAL TIMERS** by General Time. Low prices enable their use in lieu of both low and high accuracy analog timers and many electromechanical timers.  $\pm 0.5\%$  typical repeat accuracy. On-delay, off-delay, and interval modes available in four different packages; AC and DC. Short reset, recycle and abort times; fast startup. From the industrial control specialists at Industrial Controls Division, General Time, Main Street, Thomaston, CT. 06787. Tel. (203) 283-5881. Telex 96-2445. Helpful literature available on request.

CMOS DIGITAL TIMERS

196

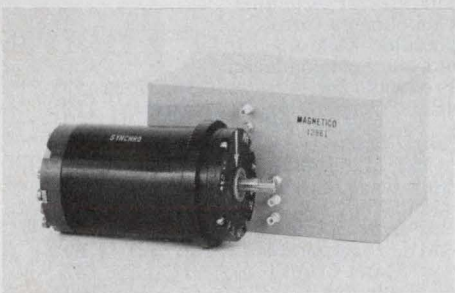

**Synchro Driver, 25 and 100 VA, SCOTT T.** converts 9 volt resolver to 90 volt synchro power. 3 x 4-3/4 x 2-1/4 hi. Model 12961 for 25 VA 60 HZ, #52454 for 100 VA 400 HZ. Gives isolation, 2 arc minutes acc. No system adjustments, age/temp. effects, or common mode problem. 516-654-1166. 182 Morris Ave., Holtsville, N.Y. 11742 - MAGNETICO, INC.

SCOTT T

191

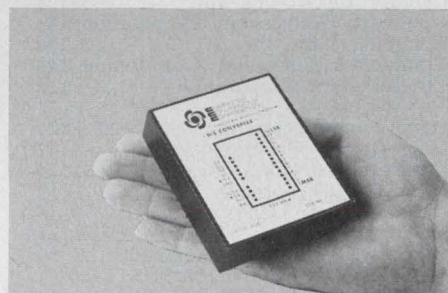

**DIGITAL TO SYNCHRO CONVERTERS—** 14, 12 or 10 bit input, 11.8/90V, 400 or 60Hz transformer isolated output, accuracy  $\pm 4$ ,  $\pm 15$  or  $\pm 30$  min. Driving 1VA, 2VA (2.6" x 3.1" x 82"H module) or 5 VA loads (4 1/2" x 9 1/4" PC card). Price from \$350 in qty. Other CCC products are Synchro to Digital or DC, and DC to Synchro Converters, Solid State C.T.'s or CDX's, and Absolute Encoders. Send for Free Catalog & Application Notes. Computer Conversions Corp., East Northport, N.Y. 11731 (516) 261-3300.

DIGITAL TO SYNCHRO

194

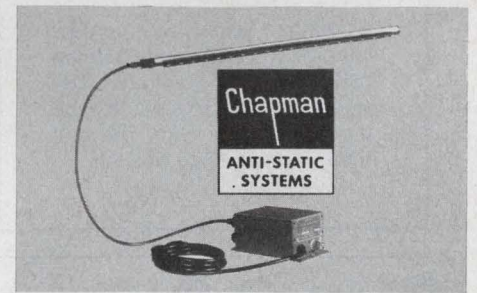

**ANTI-STATIC SYSTEMS FOR PRINTERS, OCR COM and other machines.** Static causes rapidly moving paper and film to jam. . . cause arc tracks on undeveloped film. . . attract and hold dust to photographic negatives causing imperfections on printed circuit boards. Numerous products, of interest to both OEM and user, are detailed in new 32 page catalog to solve these problems quickly, reliably and economically. Chapman Anti-Static Div., Portland Co., 58 Fore St., Bx 427, Portland, ME 04112. (207) 773-4726

ANTI-STATIC SYSTEMS

197

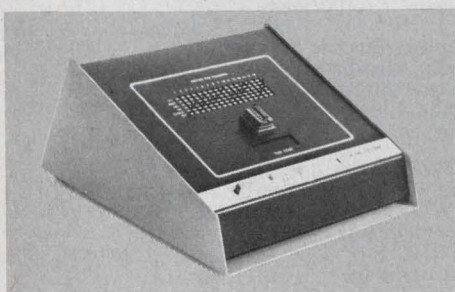

**Inexpensive DIGITAL IC TESTER** performs  $2^{20}$  inspections per test in 1-5 secs. Covers 14/16-pin TTL, DTL and CMOS @ 5V. Employs fixed pattern functional test, requiring no "good" IC for comparison. 4-digit display gives absolute results. Can also check continuity of resistor network. Model 1248: \$630. Electro Scientific Industries, 13900 N.W. Science Park Dr., Portland, Oregon 97229. Sister instrument tests at two added voltages and also covers HTL and offers automatic handler interface.

DIGITAL IC TESTER

192

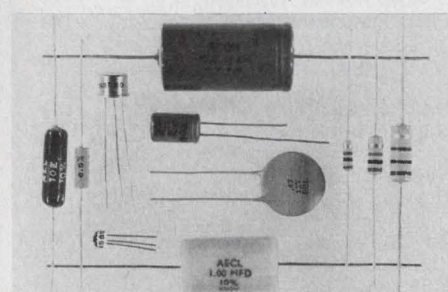

**IMPORTED COMPONENTS. 100% TESTED.** CAPACITORS - Electrolytic to 2200 $\mu$ F and to 50V, 3.5 $\phi$  - 35 $\phi$ ; 100 $\mu$ F/25V - 6.8 $\phi$ . Ceramic Disc, Polyester and Polystyrene. RESISTORS - Carbon Film 1/4W-2W, 10%-1%, \$6/M - \$40/M. Metal Film MIL-R-10509F & Wire Wound. TRANSISTORS - JEDEC Style, TO5, 18, 92, 105 and 106. 2N720 - 19 $\phi$ , 2N2270 and 2N-3053 - 16 $\phi$ , 2N5138 - 8.5 $\phi$ . All prices in 10K lots. Save up to 40%. Write for catalog and prices. Electronents Inc., Box 625, Eatontown, N.J. 07724. (201) 542-8464.

ELECTRONIC COMPONENTS

195

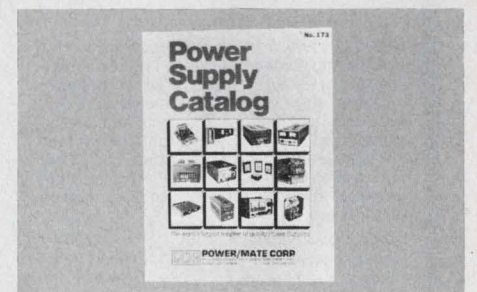

**Free New '76 catalog** contains over 34,500 quality power supplies from the world's largest manufacturer, Power/Mate Corp. Power Supplies for every application including submodulars, open frame, variorated, encapsulated, laboratory & system. All units UL approved and meet most military and commercial specs for industrial and computer uses. Power/Mate Corp., 514 S. River St., Hackensack, NJ 07601 (201) 343-6294

POWER SUPPLIES

198



**KEEP**

Electronic Design's

**GOLD BOOK  
HANDY**

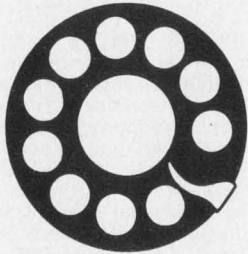

**When You Call**

Save time when you contact suppliers. Check their catalog pages first in *Electronic Design's* GOLD BOOK. Maybe the information you need is right at your fingertips.

# Circuit Savers

**NEW**  
**SIGNAL/DATA/TELEPHONE  
PROTECTION**

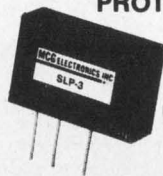

The SLP protectors were expressly designed to protect signal/data/telephone lines from transient overvoltages caused by lightning, heavy machinery, elevator motors, generators, etc. The SLP interfaces between the signal lines and the sensitive circuit to provide a sophisticated blend of high speed (nanoseconds) voltage limiting and brute force protection. The SLP's recover automatically to standby when the need for protection has passed.

Output Clamp Voltage Level  $\pm 5V$  to  $\pm 200V$   
Input Voltage Level (max) to  $\pm 35KV$  (10 US)  
Energy Handling to 50 joules and higher

**BULLETIN 301**

Full line of protection modules for every hi-lo voltage/current requirement. Write or call for data.

279 Skidmore Rd., Deer Park, N.Y. 11729  
Telephone: 516-586-5125

# MCG Electronics

CIRCLE NUMBER 99

# Advertiser's Index

Advertiser	Page	Advertiser	Page
AMP, Incorporated	38, 39, 148	MCG Electronics	148
Acheso Colloids Company	131	MF Electronics Corporation	72
Acopian Corp.	102, 103	Magnetic Shield Division, Perfection Mica Company	141
Advanced Micro Devices	87	Magnetico, Inc.	147
Avantek, Inc.	133	Malco, A Microdot Company	106
B & K Products of Dynascan	80	Marathon Battery Company	118
Blake Wire & Cable Corp.	20	Marine Electric Railway Products Div. Inc.	145
Bourns, Inc., Trimpot Products Division	Cover II	Mepeco/Electra, Inc.	137
Burdury Corporation	50A-F	Metex Corporation	116
CTS Corporation	33	Micro Memory, Inc.	145
Century Electronics, Inc.	125	Mini-Circuits Laboratory, A Division of Scientific Components Corp.	2
Computer Conversions Corporation	147	Monolithic Memories, Inc.	35
Computer Labs, Inc.	120	Motorola Semiconductor Products, Inc.	36, 37, 58, 59
Continental Connector Corporation	143	MuRata Corporation of America	117
Control Data Corporation	115		
Dana Laboratories, Inc.	114, 124	*Philips Electronic Components and Materials	112
Data Display Products	42	Plessey Semiconductors	73
Data General Corporation	25	Portland Co., Inc.	147
Data I/O Corporation	19	Potter & Brumfield, Division of AMF, Incorporated	29
Data Precision Corporation	53, 54, 55	Power/Mate Corp.	147
Datak Corporation, The	121	PowerTech, Inc.	109
Datel Systems, Inc.	56		
Dialight, A North American Philips Company	130	RCA Distributor & Special Products Division, Sales Promotion Services	146
EECO	23	RCA Solid State	Cover IV
Electro Scientific Industries	147	RCL Electronics, Inc.	34
Electronics Inc.	147	Raytheon Semiconductor	99
Electronic Design	104, 105, 138, 139	Reader Service Card	150A-B
Electronic Design Survey Card	114A-B	Repeco, Incorporated	113
Electronic Memories & Magnetics Corp.	95	Reticon	111
Electronic Molding Corporation	94	Riken Denshi Co., Ltd.	127
Electronica	134	Rogers Corporation	146
Electrostatics, Inc.	140		
Elpac Components	119	SGS/Ates Semiconductor Corporation	86
Endicott Coil Co., Inc.	146	Schauer Manufacturing Corp.	126
Fairchild Camera & Instrument Corp., MOS Division	81	Signetics Corporation	115, 117, 119, 121, 123, 125, 127, 128, 129
Fifth Dimension, Inc.	142	Simpson Electric Company	97
Gold Book, The	123, 149	Singer Aerospace & Marine Systems	130
Hamlin, Incorporated	141	Sprague Electric Co.	45, 146
Hayden Book Company, Inc.	*103, 135, 146	Stahlin Bros., Inc.	137
Hewlett-Packard	7 thru 18	Stanford Applied Engineering, Inc.	31
Heyman Manufacturing Company	137		
ISE Electronics Corporation	50	TRW/IRC Resistors, an operation of TRW Electronic Components	146
Illuminated Products Co.	5	TRW/IRC Resistors, an Electronic Components Division of TRW, Inc.	60, 61
Industrial Controls Division, General Time	147	Tektronix, Inc.	78
Instrument Specialties Company	27	Telcon Industries	146, 147
Intertec Data Systems	48	Teledyne Semiconductor	Cover III
Johanson Dielectrics, Inc.	148	Topaz Electronics	139
Johanson Manufacturing Corp.	4		
Johnson Company, E. F.	147	*U. S. Department of Commerce	102
Keithley Instruments, Inc.	40, 41	Valhalla Scientific	150
Koh-I-Noor Radiograph Inc.	46, 47	Varo Semiconductor, Inc.	133
Lexed, Inc.	112	Wabash, Inc.	101, 110
Logical Technical Services Corp.	122	Wavetek San Diego, Inc.	1
		Yokowaga Corporation of America	139

\*Advertisers in non-U.S. Edition



# Q

WHICH OF THE  
ANNUALS DO  
ELECTRONICS ENGINEERS  
CONSULT MOST?

# A

■ Electronic Design's  
■ **GOLD BOOK**

# 83%

OF THE ENGINEERS WHO RESPONDED TO  
A TECHNICAL TRENDS ANALYSTS SURVEY SAY  
THEY CONSULTED THE GOLD BOOK  
WITHIN THE PAST MONTH

(Survey date: February, 1976)

***IF IT'S ELECTRONIC...IT'S IN THE***  
**GOLD BOOK**

(91,000 copies of the 1976/77 edition are now off the presses  
and are being used throughout the U.S.A. and overseas!)



# Product Index

**Information Retrieval Service.** New Products, Evaluation Samples (ES), Design Aids (DA), Application Notes (AN), and New Literature (NL) in this issue are listed here with page and Information Retrieval numbers. Reader requests will be promptly processed by computer and mailed to the manufacturer within three days.

Category	Page	IRN	Category	Page	IRN
<b>Components</b>			timebase, digital	132	383
capacitors	4	4	<b>Microprocessor Design</b>		
capacitors, ceramic	137	87	development system, $\mu$ P	51	508
capacitors, film	119	62	microprocessors	99	42
displays	50	25	microprocessors	115	57
linear actuators	112	52	microprocessors	117	60
motors, ironless rotor	113	329	microprocessors	119	63
passive components	45	151	microprocessors	121	66
potentiometers	11	252	microprocessors	123	69
relay	113	330	microprocessors	125	73
relay, dry reed	110	50	microprocessors	127	76
relays	101	43	microprocessors	129	77
relays	142	95	$\mu$ P system evaluator	51	507
relays, delay	29	11	<b>Microwaves &amp; Lasers</b>		
relays, solid-state	110	322	couplers	119	348
resistors	61	30	GaAsFET amplifier	119	349
resistors, wire-wound	34	14	Gunn oscillators	118	345
sensors, image	111	51	laser	118	346
switch, PB	110	324	TWT amplifier	119	347
switch, rotary	111	326	<b>Modules &amp; Subassemblies</b>		
switches	5	5	amplifier, s/h	125	368
switches, thumbwheel	23	8	amplifiers	133	82
transformers	139	89	conditioner, signal	125	369
trimmers	117	59	converter, a/d	127	374
<b>Data Processing</b>			converter, a/d	III	253
calculators,			converter, d/a	120	64
programmable	138	399	converter, multiplying	131	380
graphic plotter	136	397	converters, d/a	127	376
plotter	78	34	front-end amplifier	73	33
printers, terminal	138	400	microprogram controller	35	15
rf links	113	53	oscillator, low profile	130	377
recorder	127	75	power amplifiers	145	96
terminal, data	136	393	power linears	86	37
$\mu$ P core memories	145	97	system, data-acquisition	126	371
<b>Discrete Semiconductors</b>			<b>Packaging &amp; Materials</b>		
LED displays	130	78	bus strips	122	358
rectifiers, bridge	133	81	cable clamps	137	86
transistor, GaAsFET	140	403	cable tie mounts	124	365
zeners	126	74	connectors	39	18
<b>Instrumentation</b>			contact strips	27	10
analyzer	107	301	designer's handbook	56	28
capacitance meter	108	321	drafting supplies	47	23
chart receiver	108	308	EMI coatings	131	79
counter	124	71	elec. pack. hardware	31	12
DMM, portable	97	41	gripper	94	39
DMM, 3-1/2-digit	80	238	kit, printed-circuit	121	65
DMM, 4-1/2-digit	150	98	magnetic shields	141	93
DMM, 5-1/2 digit	114	55	PC board design sys.	123	362
DPM	108	307	solder, low melting pt.	121	354
display monitors	107	303	substitute DIP	120	352
PROM programmer	19	6	terminal strip	123	363
preamp	107	305	<b>Power Sources</b>		
thermometer/DMM	122	67	dc/dc converter	114	333
wattmeters	139	90	power supplies	103	44
<b>Integrated Circuits</b>			power supplies	115	56
array, custom	132	386	power supplies	116	338
converter, BCD-to-pulse	132	382	power supplies	140	92
converter, d/a	135	390	power supply	114	331
dividers, programmable	134	387	power supply	115	335
drivers, peripheral	134	388	power supply	115	336
gold chip LICs	IV	254	power supply	116	337
multiplexers, 8-channel	132	384	rechargeable power		
PIA	134	389	sources	118	61
RAMs, 4-k	81	37	regulators, switching	116	339
reference, precision	135	392			

**A PORTABLE  
4 1/2 DIGIT  
MULTIMETER  
FOR \$299.  
A 27 MHZ  
COUNTER OPTION  
FOR \$50.**



**VALHALLA  
SCIENTIFIC**  
7707  
CONVOY COURT  
SAN DIEGO,  
CALIF. 92111  
714-277-2732  
**WHAT MORE  
CAN WE SAY?**



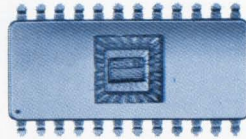

# There is no more accurate 12-bit A/D converter on the market ... and it's monolithic.

Differential and overall linearity within  $\frac{1}{2}$  LSB. Inherently monotonic operation (and no missing codes). Immunity to noise transients. They all add up to unusually high accuracy for our 8702, a single chip, 12-bit CMOS A/D converter.

The 8702 has some other important advantages, too. CMOS technology means very low power dissipation — typically less than 20 mW. It is easy to use; no active auxiliary components are needed. And its latched parallel outputs are

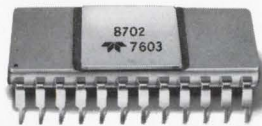

ideal for inputting to microprocessors.

Compared to modules, the 8702 offers immediate significant cost savings plus the prospect of even greater future economies due to its monolithic construction. And the savings in PCB real estate go without saying.

The 8702 comes in a 24-pin ceramic DIP. Other versions include 8 and 10 bit devices in ceramic, and an 8 bit unit in plastic for commercial environments. Call or write for full details.

## TELEDYNE SEMICONDUCTOR

1300 Terra Bella Avenue, Mountain View, California 94043 Tel: (415) 968-9241 TWX: 910-379-6494 Telex: 34-8416  
SALES OFFICES:  
DOMESTIC: Salem, N.H. (603) 893-9551; Stony Brook, N.Y. (516) 751-5640; Des Plaines, IL (312) 299-6196;  
Los Angeles, CA (213) 826-6639; Mountain View, CA (415) 968-9241 • INTERNATIONAL: Hounslow,  
Middlesex, England (44) 01-897-2503; Tiengen, West Germany 7741-5066; Wiesbaden, West Germany  
06121-39171; Kowloon, Hong Kong 3-240122; Tokyo, Japan 03-405-5738.



What's new in solid state ...

# Gold CHIP LICs pile up 18 million hours with near-zero failure rate.

Test results from 18.2 million unit-hours and 1.5 million unit-cycles are in—and the verdict is unanimous. RCA Gold CHIP LICs are *significantly* more reliable than their counterparts with aluminum metalization. Here is a summarized report based on testing by three different kinds of users, plus—perhaps our severest critic—ourselves.

## U.S. Army jungle/salt air tests

In Panama, the Electronics Technology and Devices Laboratory of the U.S. Army Electronics Command tested 63 Gold CHIP LICs to 1,479,000 unit-hours. The tests were done under conditions designed to reveal potential electromigrative shorts and metal corrosion: 27°C, 90-98% R.H., 4.5 V reverse bias. Result: zero failures. Or a failure rate of 0.062%/1000 hrs. at 60% confidence level.

## OEM reliability tests

A major OEM systems manufacturer has completed extensive testing of Gold CHIP bipolar ICs. These were operated at high power and high junction temperature. After 15,000,000 unit-hours: 2 degradational rejects not related to metalization. That's a 0.02% failure rate.

## U.S. Navy plastic IC program

The Naval Electronic Systems Command has awarded RCA Solid State Division a \$1.44 million contract to apply Gold CHIP technology to plastic packaged ICs for military use. MIL-M-38510 specifications will be used.

## RCA reliability tests

In a continuing program, RCA has run the following tests under industry accepted testing conditions.

- Operating Life: 332 units, 376,500 unit-hours.
- Temperature/Humidity Bias: 314 units, 1,244,000 unit-hours.
- Thermal Fatigue: 30 units, 750,000 unit-cycles.
- Pressure Cooker: 510 units, 92,460 unit-hours.
- Thermal Shock: 673 units, 214,760 unit-cycles.
- Temperature Cycle: 1,630 units, 510,000 unit-cycles.

Results: 1 failure in the pressure cooker test. It was caused by a bond wire break at the frame and was not chip related.

You can buy these Gold CHIP LICs from your local RCA Solid State distributor and evaluate them yourself: CA101AG, CA107G, CA124G, CA139AG, CA139G, CA201AG, CA207G, CA224G, CA239AG, CA239G, CA301AG, CA307G, CA324G, CA339AG, CA339G, CA741CG, CA741G, CA747CG, CA747G, CA748CG, CA748G, CA1458G, CA1558G, CA3401G, CA3724G, CA3725G.

# RCA

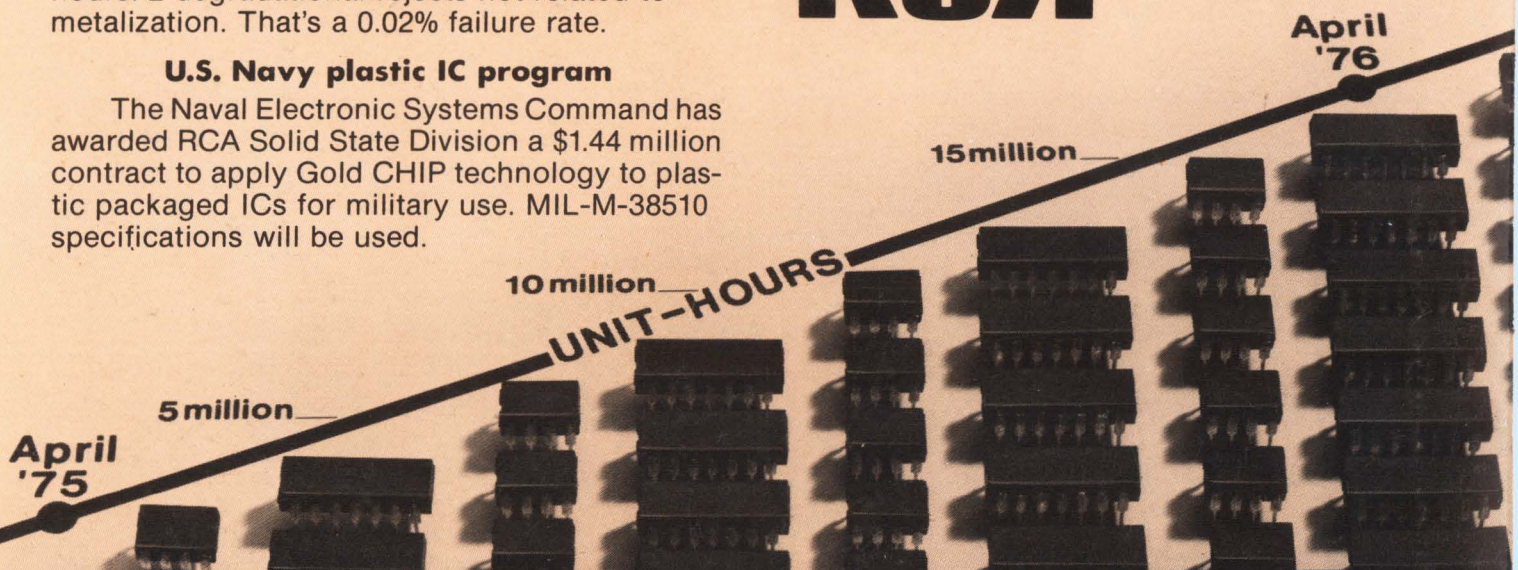

## RCA. Full house in Linear ICs.