

Electronic Design[®] 22

VOL. 25 NO.

FOR ENGINEERS AND ENGINEERING MANAGERS

OCT. 25, 1977

Sidestep stepping-motor hassles.

Although they offer performance features not available with servo motors—direct digital drive, fast start and stop, and a wide speed

range—stepping motors tend to have very confusing specs. And crucial ratings for torque, inertia and accuracy are not defined clearly. Get in step on p. 48.

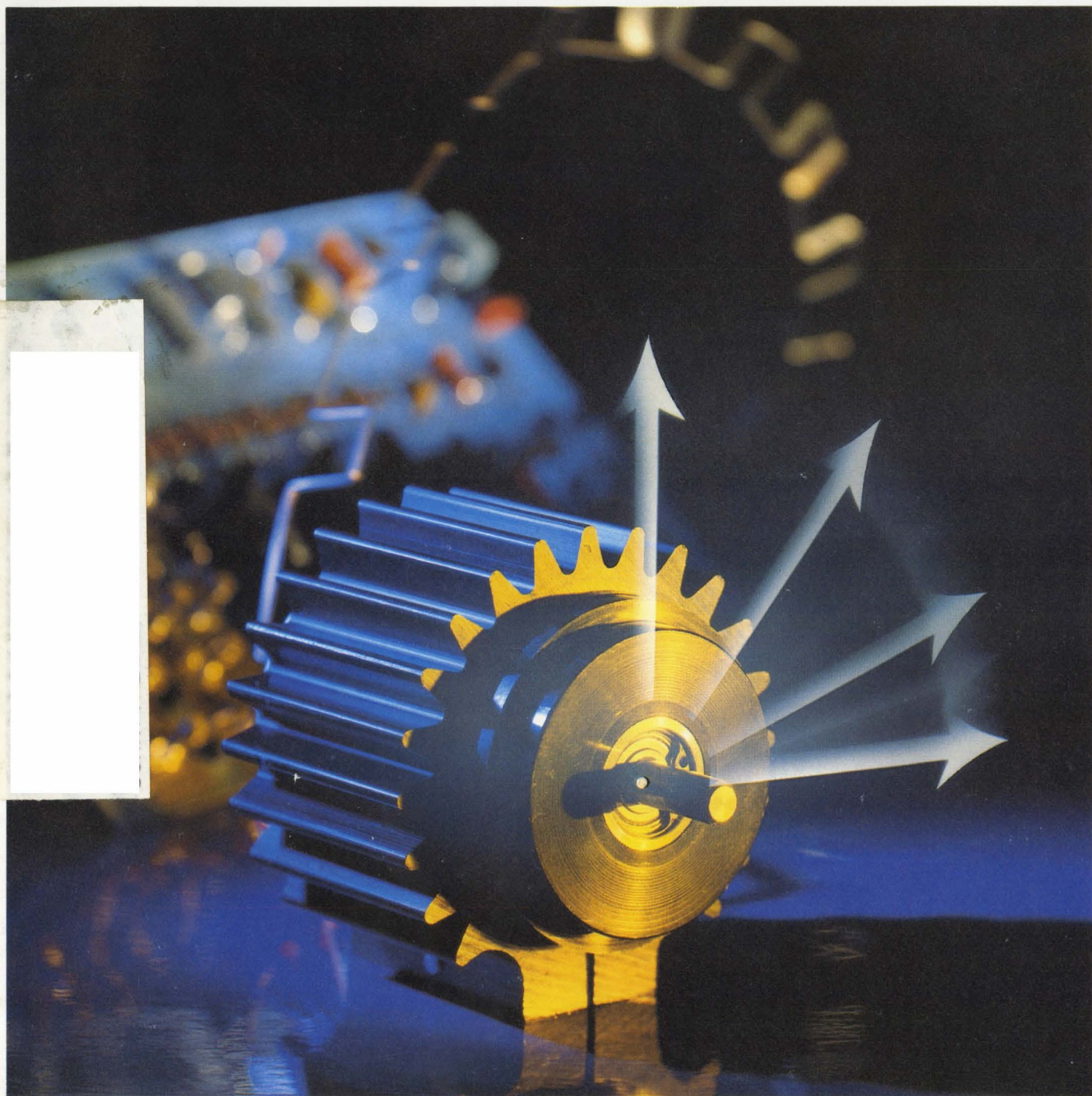

The \$2 Pot with the \$5 Linearity...

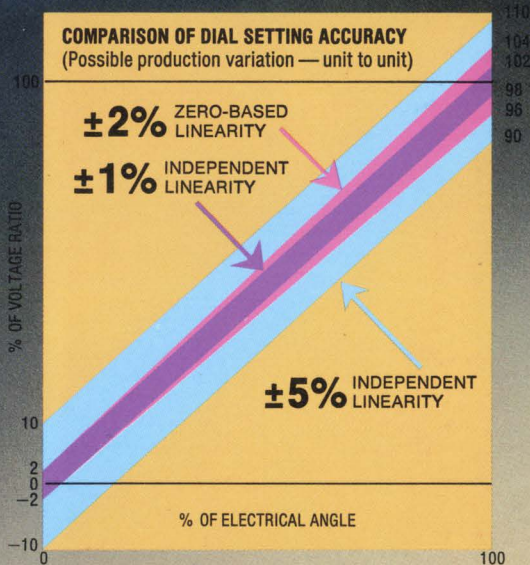
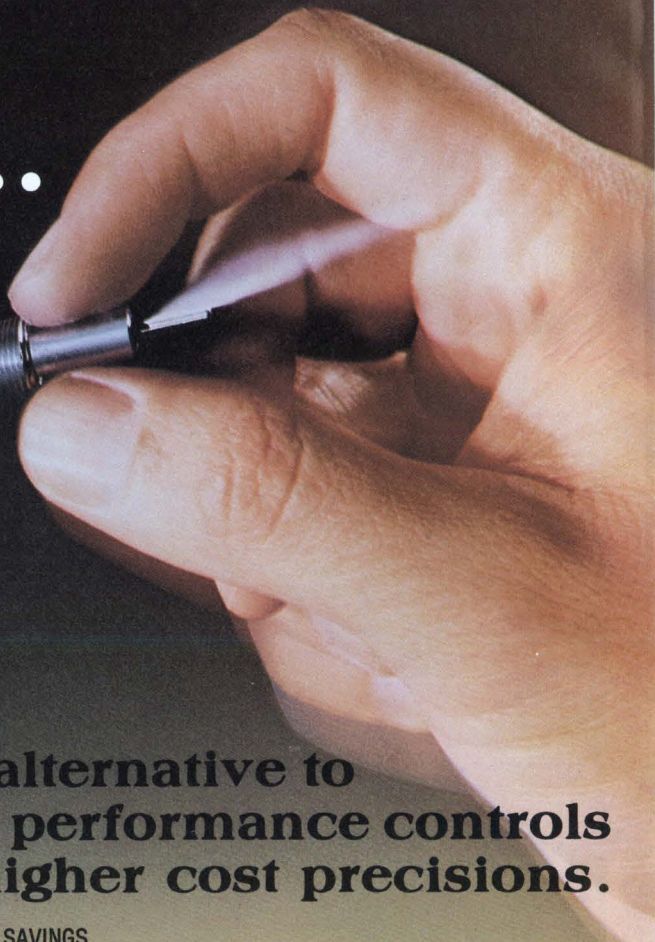

Your alternative to lower performance controls and higher cost precisions.

LASER-TRIMMED SAVINGS

Now, for about \$2*, the Bourns® Model 87/88 semi-precision, single-turn potentiometer delivers $\pm 2\%$ zero-based linearity. Compare the accuracy to the \$5 precision pot with $\pm 1\%$ independent linearity that you're buying now . . . especially the performance at the low end setting, where dial setting accuracy is most critical. Laser trimming and advanced element design† deliver performance and savings in a $\frac{5}{8}$ " square modular package.

MOVE UP FROM INDUSTRIAL GRADE CONTROLS

Again, for about \$2, the Model 87/88 offers 200-300% greater panel setting accuracy over industrial grade controls. They're perfect for applications requiring close, consistent calibration of output-to-panel setting and versatility of design.

MODEL 87/88 — THE ALTERNATIVE

Don't compromise your application with lower performance controls or pay a premium for precision pots. Specify the alternative — Bourns Model 87/88. Write or call today for complete technical information.

\$2 SEMI-PRECISION MODULAR POTS . . . BEAUTIFUL!

TRIMPOT PRODUCTS DIVISION, BOURNS, INC., 1200 Columbia Avenue, Riverside, California 92507, Telephone (714) 781-5122 — TWX 910 332-1252.

* Production quantities, Domestic U.S.A. price, Single cup unit only.
† Patent Pending

PERFORMANCE/COST COMPARISON			
Type	Element	Linearity	Approx. Cost
HIGHER COST PRECISION POTS	Conductive Plastic	$\pm 1\%$ Independent	\$5.00
BOURNS 87/88 SEMI-PRECISION POTENTIOMETERS	Conductive Plastic	$\pm 2\%$ Zero-Based	\$2.00
	Cermet	$\pm 2.5\%$ Zero-Based	
LOWER PERFORMANCE CONTROLS	Conductive Plastic/Cermet	$\pm 5 - 10\%$ Independent	\$1.00

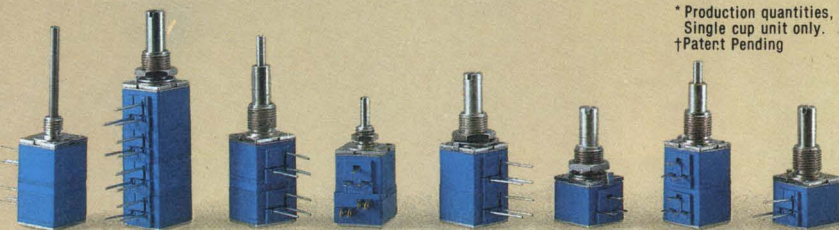

International Marketing Offices: European Headquarters — Switzerland 042/23 22 42 • Belgium 02/218 2005 • France 01/2039633 • Germany 0711/24 29 36 • Italy 02/32 56 88 • Netherlands 70/87 44 00 • United Kingdom 01/572 6531 • Norway 2/71 18 72 • Sweden 764/20 110 • Japan 075/921 9111 • Australia 02/55-0411 03/95-9566 • Israel 77 71 15/6/7

For Immediate Application — Circle 130
For Future Application — Circle 230

Here's what you get in our new Model 802 pulse generator: four simultaneous outputs over the frequency range of 5 Hz to 50 MHz — fixed level sync, TTL and TTL, plus a variable 5-volt output. The upper and lower pulse levels are independently adjustable, and so are width and delay. For operational modes, the 802 gives you continuous, triggered, gated, and double

pulse. You won't find features like these anywhere else for under \$600. Now if you need even more versatility, we've got that, too. The Model 801 (top left) does everything the 802 does, and more — including adjustable rise/fall from less than 7 nsec. It goes for \$995. Our Model 145 (bottom left) is a full-fledged pulse generator and a function generator

as well for just \$895.

So if you're looking for high performance, low price, and top quality in pulse generators, the only name you need to remember is ours. WAVETEK, 9045 Balboa Ave., P.O. Box 651, San Diego, CA 92112, Phone (714) 279-2200, TWX 910-335-2007. U.S. prices only.

WAVETEK®

CIRCLE NUMBER 2

At \$595, our newest pulse generator is no bargain.

It's a steal.



Introducing the SMALLEST

BROADBAND MIXERS

in the world - 40 kHz - 2 GHz

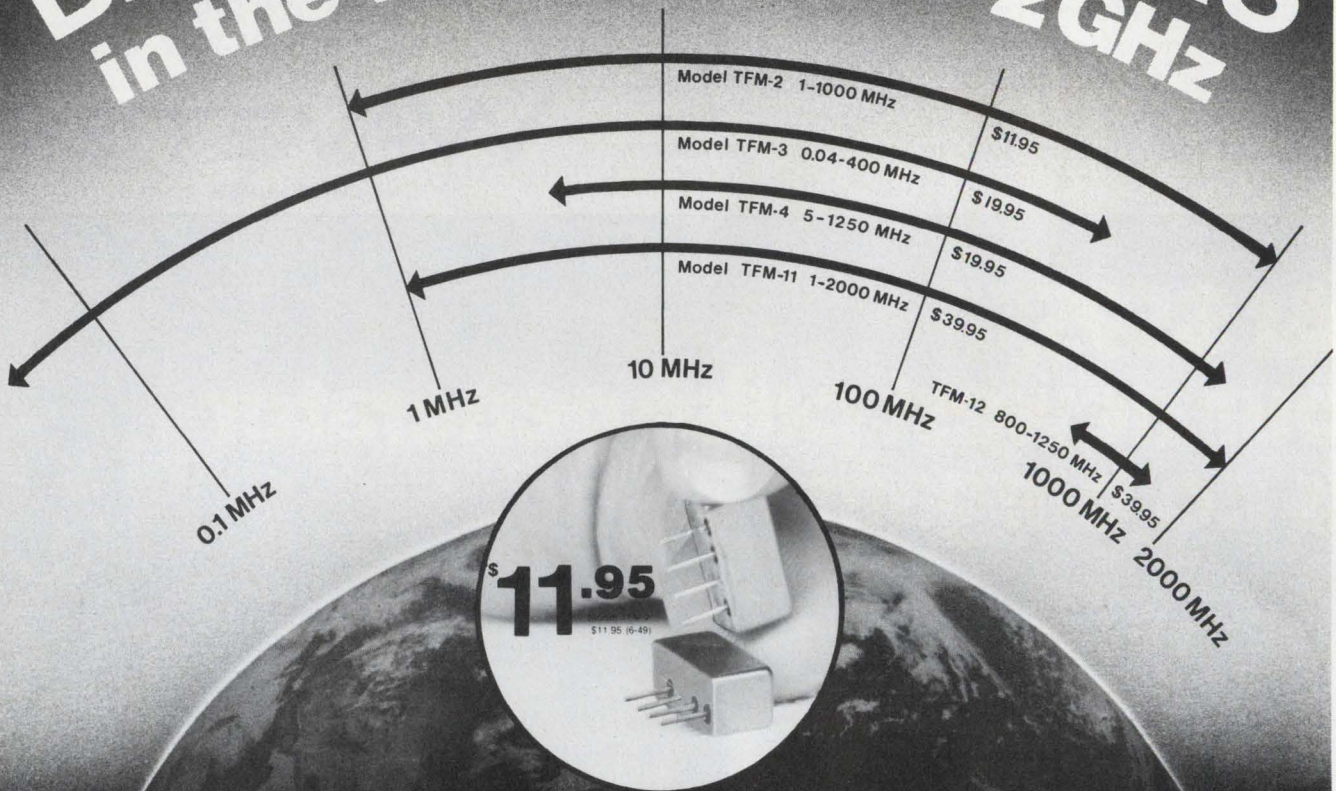

Act now to improve your system designs, increase your packaging density, and lower your costs... specify Mini-Circuits new microminiature TFM series. These tiny units, the smallest off-the-shelf Double Balanced Mixers available today, cover the 40 kHz - 2 GHz range and offer isolation greater than 45 dB and conversion loss of 6 dB. Each unit carries with it a 1-year guarantee by MCL. Upgrade your new system designs with the TFM, rapidly becoming the new industry standard for high performance at low cost.

Model No.	Frequency Range, MHz		Conversion Loss, dB				Isolation, dB								Quantity	Price					
	LO	RF	IF	Typ	Max	Lower Band Edge To one Decade Higher				Upper Band Edge To one Decade Lower											
	LO-RF	LO-IF	LO-RF	LO-IF	LO-RF	LO-IF	LO-RF	LO-IF	LO-RF	LO-IF	LO-RF	LO-IF									
TFM-2	1-1000	1-1000	DC-1000	6.0	7.5	7.0	8.5	50	45	45	40	40	25	35	25	30	25	25	20	6-49	\$11.95
TFM-3	0.04-400	0.04-400	DC-400	5.3	7.0	6.0	8.0	60	50	55	40	50	35	45	30	35	25	35	25	5-49	\$19.95
TFM-4	5-1250	5-1250	DC-1250	6.0	7.5	7.5	8.5	50	45	45	40	40	30	35	25	30	25	25	20	5-49	\$19.95
TFM-11	1-2000	1-2000	5-600	7.0	8.5	7.5	9.0	50	45	45	40	35	25	27	20	25	20	25	20	1-24	\$39.95
TFM-12	800-1250	800-1250	50-90	—	—	6.0	7.5	35	25	30	20	35	25	30	20	35	25	30	20	1-24	\$39.95

Signal: 1 dB compression level -1 dBm. Impedance: all ports 50 ohms. Total input power 50 mW. Total input current peak 40 mA. Operating and storage temperature: 55°C to -100°C. Pin temperature 510°F (10 sec).

Simple mounting options offer optimum circuit layout.

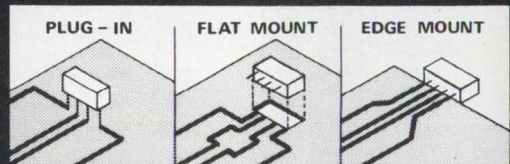

Use the TFM series to solve your tight space problems. Take advantage of the mounting versatility—plug it upright on a PC board or mount it sideways as a flatpack.

WE'VE GROWN

Customer acceptance of our products has been so overwhelming, we've been forced to move to larger facilities — THANKS.

International Representatives: **AFRICA:** Afitra (PTY) Ltd, P.O. Box 9813, Johannesburg 2000, S. Africa. **AUSTRALIA:** General Electronic Services, 99 Alexander Street, New South Wales, Australia 2065. **ENGLAND:** Dale Electronics, Dale House, Wharf Road, Framley Green, Camberley Surrey. **EASTERN CANADA:** B.D. Hummel, 2224 Maynard Avenue, Utica, NY 13502. (315) 736-7821. **FRANCE:** S.C.I.E. - D.I.M.E.S., 31 Rue George, Sand 91120 Palaiseau. **GERMANY, AUSTRIA, SWITZERLAND, DENMARK:** Industrial Electronics GmbH 6000 Frankfurt, Main Klüberstrasse 14 West Germany. **INDIA:** Gaekwar Enterprise, Kama Mahal, M.L. Dananukar Marg, Bombay 400 026, India. **ISRAEL:** Vectronics, Ltd., 69 Gordon Street, Tel-Aviv, Israel. **NETHERLANDS, BELGIUM, LUXEMBOURG:** Cormex Veldweg II, Hattem, Holland.

OUR NEW ADDRESS AND PHONE NO. IS:

Mini-Circuits

MINI-CIRCUITS LABORATORY
A Division of Scientific Components Corp.

2625 East 14th Street Brooklyn, New York 11235 (212) 769-0200
Domestic and International Telex 125460 International Telex 620156

NORWAY: Datamatik AS, Ostensjoveien 62, Oslo 6, Norway. **SINGAPORE & MALAYSIA:** Electronics Trading Co. (PTE) Ltd, 87 Bukit Timah Road, Singapore 9, Malay Peninsula. **SWEDEN:** Intergerad Elektronik AB, Box 43, S-18251, Djursholm, Sweden.

U.S. Distributors: **NORTHERN CALIFORNIA:** PENNY-STOCK CO., Foothill Office Center, 105 Fremont Avenue, Los Altos, CA 94022 (415) 948-6533. **SOUTHERN CALIFORNIA, ARIZONA:** Crown Electronics, 11440 Collins Street, No. Hollywood, CA 91601 (213) 877-3550. **NEW YORK:** NEW YORK MICROWAVE DISTRIBUTORS COMPANY, 61 Mall Drive, Commack, N.Y. 11725, 516-543-4776.

24 Rev/A

Electronic Design 22

VOL. 25 NO.

FOR ENGINEERS AND ENGINEERING MANAGERS

OCT. 25, 1977

NEWS

- 19 **News Scope**
- 24 **Smoke detectors are coming on strong** and they're looking to integrated circuits.
- 28 **Tape transport is small**, but its bit-storage capacity is big.
- 30 **Look out bipolar power transistors:** Here come the power FETs.
- 37 **Washington Report**

TECHNOLOGY

- 48 **FOCUS on stepping motors:** One of the most versatile of rotating components, the stepper is also one of the hardest to specify. Torque, alone, takes on 16 different forms on data sheets. How to step around the problem is the essence of this report.
- 60 **Modern data acquisition is complex.** The DVM and clipboard era has given way to measuring and processing technology, often with a computer at its core.
- 68 **Solid-state-relay applications** require more than just basic relays to be widely useful. Amplifier, pulse and timing circuits can broaden SSR use.
- 76 **Optimize circuit overload protection:** Eight simple steps help determine the best device. Choose from fuses and thermal or magnetic circuit breakers.
- 82 **Solve dc current-source design equations** with a nomograph and ease current-mirror design. Determine the parameters with a straight-edge and pencil.
- 88 **Ideas for Design:**
Convert unipolar CMOS signals into analog bipolar outputs. Graph provides easy solution for choosing a preferred-number sequence. Flyback-inverter efficiency increases when the transformer is loaded properly.
- 95 **International Technology**

PRODUCTS

- 99 **Instrumentation:** Graphics unit drives four different X-Y displays.
- 100 **Data Processing:** Thermal printer delivers full pages in less than 20 s.
- 114 **Modules & Subassemblies:** Multichannel 12-bit data acquisition in a tiny plug-in.
- 105 Micro/Mini Computing
- 112 Power Sources
- 118 ICs & Semiconductors
- 122 Packaging & Materials
- 125 Components

DEPARTMENTS

- 45 **Editorial:** The double standard
 - 7 Across the Desk
 - 126 Design Aids
 - 127 Application Notes
 - 128 New Literature
 - 131 Vendors Report
 - 142 Advertisers' Index
 - 144 Product Index
 - 144 Information Retrieval Card
- Cover:** Photo by Ferderbar Studios, courtesy of Warner Electric Brake & Clutch Co.

ELECTRONIC DESIGN is published biweekly except 3 issues in July by Hayden Publishing Company, Inc., 50 Essex St., Rochelle Park, NJ 07662. James S. Mulholland Jr., President. Printed at Brown Printing Co., Waseca, MN Controlled circulation postage paid at Waseca, MN and New York, NY, postage pending Rochelle Park, NJ. Copyright© 1977. Hayden Publishing Company, Inc. All rights reserved. POSTMASTER: Please send form 3579 to ELECTRONIC DESIGN, P.O. Box 13803, Philadelphia, PA 19101.

Finally.

**A self-locking connector that's
classified UL 94V-0 for flame resistance
and UL 498 for 600 volts.**

And recognizes that people aren't.

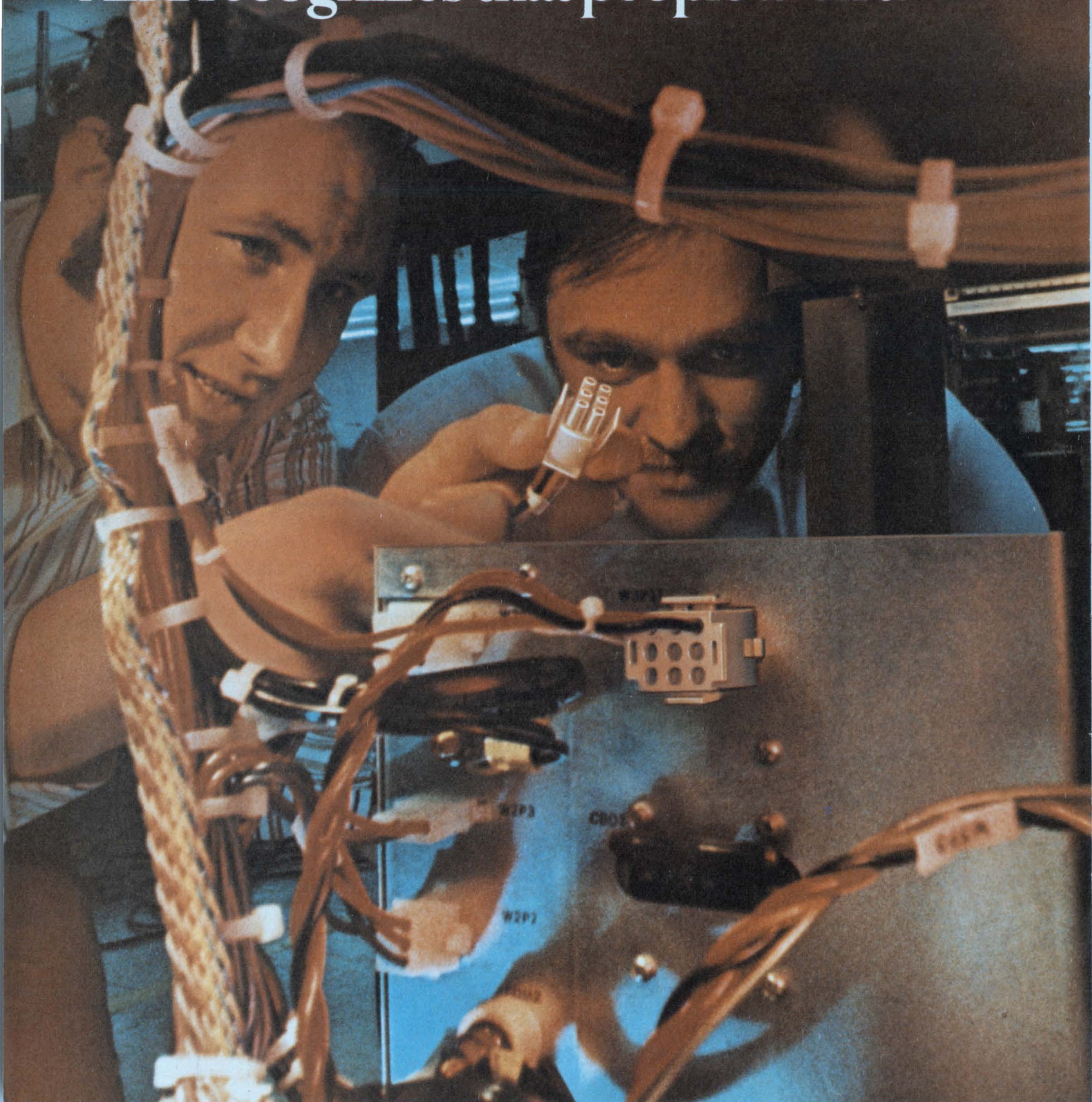

Our flame retardant Universal MATE-N-LOK series can take up to 600 volts with ease.

But people can't.

That's why, along with all the UL, CSA, and VDE/CEE credentials you need for worldwide and flame-retardant use, Universal MATE-N-LOK connectors offer you an exclusive safety feature:

A unique silo-design housing that makes it virtually impossible for you, or anybody else, to touch or mismatch the pins and sockets.

So, in addition to reducing the potential of a fire, you're eliminating the chance of a short—or a shock.

With Universal MATE-N-LOK connectors, you get versatility too. Wire-to-pc board or wire-to-wire. Panel mount or free hanging. Mix pins and sockets in either half, for all types of keying combinations. And no matter how you apply them, Universal MATE-N-LOK connectors are greedy for power—with dual-wire capabilities and other features that let you pack more action into less space.

Of course, Universal MATE-N-LOK connectors, for sophisticated through non-critical applications, are backed by AMP technical service. Not just ordinary service, but the kind that says we'll help you with design problems. Application tooling. Training for your people. And troubleshooting. Just call us.

Find out more about how Universal MATE-N-LOK connectors—and AMP—can help you get more power to your products.

Without getting power to the people who use them.

Call Customer Service at (717) 564-0100, or write:
AMP Incorporated, Harrisburg, Pa. 17105.

AMP has a better way.

AMP
INCORPORATED

CIRCLE NUMBER 4

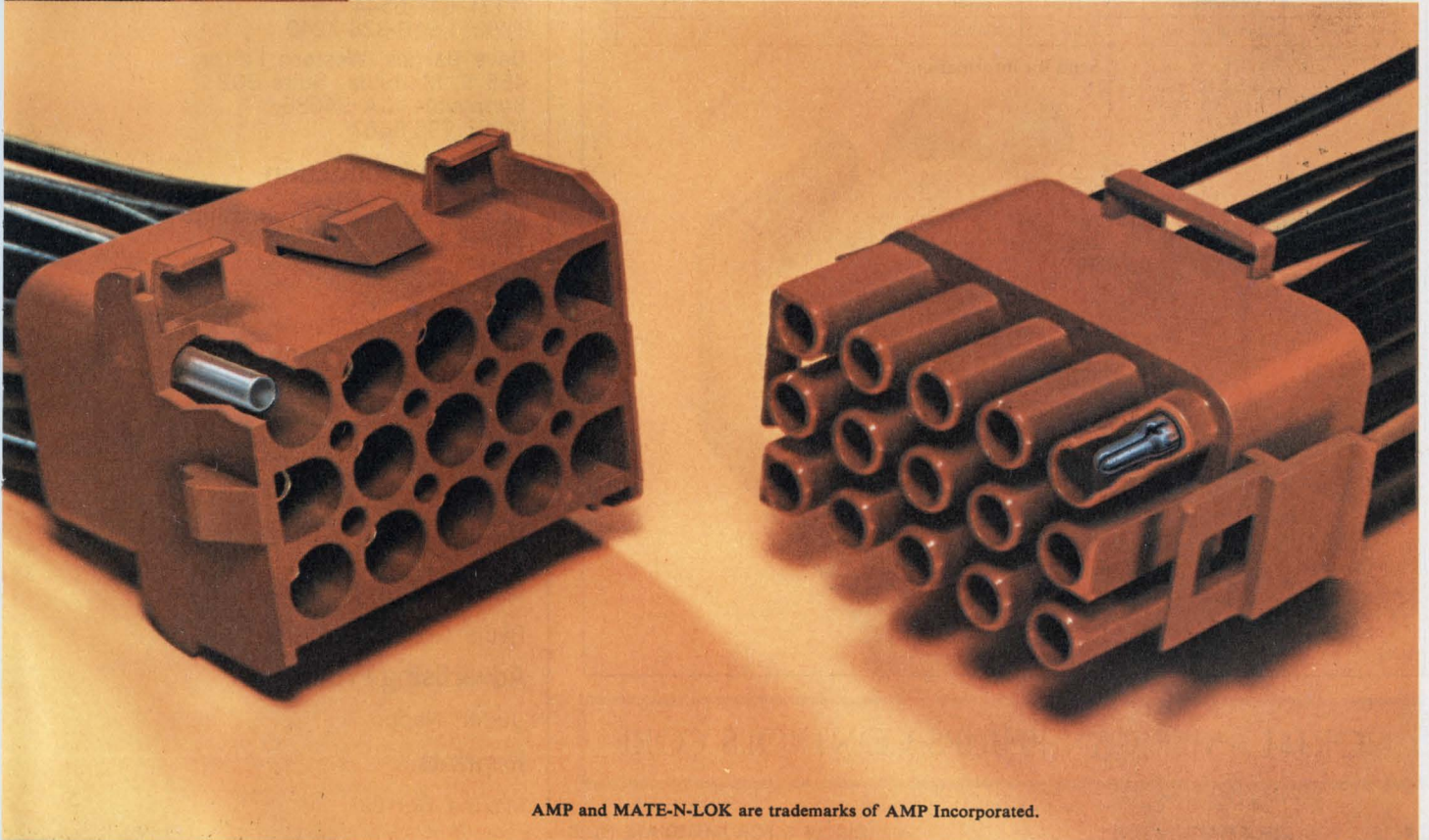

AMP and MATE-N-LOK are trademarks of AMP Incorporated.

The stepper motor/driver duo that cuts stepper motor systems costs to the bone!

And reduces circuit complexity and space requirements.

Imagine! The major components for an incremental drive stepper system for only \$12.60! That's all it costs for our K82701-P2 12-volt stepper motor and SAA1027 IC driver in 100 piece quantities. Using our 16 pin dual-in-line driver saves design time, too, since you don't need to work out the attendant electronic circuitry to operate the motor. It saves space, too.

You're not limited to just one motor, either. The SAA1027 IC is capable of driving a number of different 4-phase stepper motors offering a variety of formats and operating characteristics. They are listed in the accompanying table. Take your pick.

North American Philips Controls stepper motors provide many design advantages, particularly in analytical instrumentation, business machines and computer peripherals. Using 4-phase stators and permanent magnet rotors, they are low in

cost, rugged and precise and offer long-term reliability. Size for size, pull-in rates and stepping accuracy are tops. Another advantage is a low temperature rise, considerably lower than comparable VR stepper motors operating on similar duty cycles. Gear boxes can also be furnished to meet varying torque and speed requirements.

Special offer... FREE driver chips!

We want to make it easy for you to prototype our stepper motors. Thus, for a limited period of time, when you order any of the steppers listed below, specify a chip, "NO CHARGE", with each motor requisitioned. Limit is five chips. Write or call for details.

Offer expires November 1, 1977

USE THE SAA1027 IC DRIVER WITH ANY OF THESE STEPPER MOTORS

Series	Description	Step Angle	Voltage	Max. Pull-in Rate (Steps/sec)	Max. Working Torque (oz-in)
K82102-P2	Low-cost, light duty	15°	12Vdc	700	.16
K82201-P1		7°30'	5Vdc	540	.67
K82201-P2		7°30'	12Vdc	350	.78
K82401-P1		7°30'	5Vdc	400	2.7
K82401-P2		7°30'	12Vdc	200	2.5
K82601-P2	Low-cost, medium duty	15°	12Vdc	150	5.3
K82801-P2		7°30'	12Vdc	180	8.2
K82701-P2	Industrial type	7°30'	12Vdc	200	6.0

Send for information.

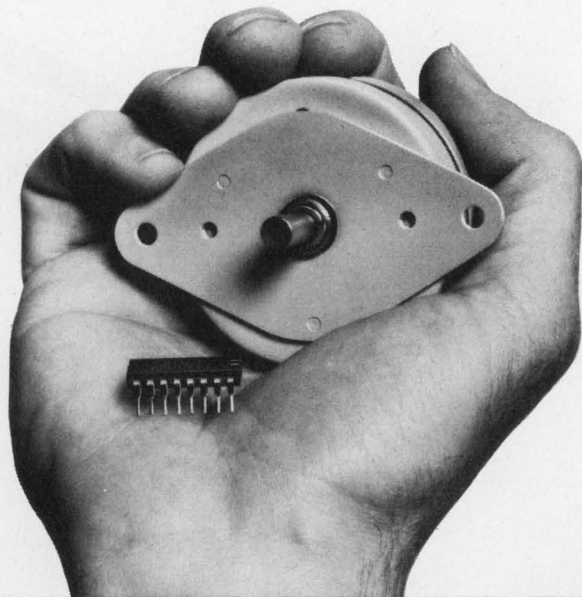

NORTH AMERICAN PHILIPS CONTROLS CORP.

Cheshire, Conn. 06410 • (203) 272-0301

CIRCLE 5 FOR INFORMATION ONLY

CIRCLE 6 FOR IMMEDIATE NEED

6

Sr. Vice President, Publisher

Peter Coley

Editors

Editorial Offices
50 Essex St.
Rochelle Park, NJ 07662
(201) 843-0550
TWX: 710-990-5071
(HAYDENPUB ROPK)
Cable: Haydenpubs Rochellepark

Editor-in-Chief George Rostky

Managing Editors:

Ralph Dobriner
Michael Elphick

Senior Associate Editor

Stanley Runyon

Associate Editors:

Sid Adlerstein
Dave Bursky
Morris Grossman
Gene Heftman
Andy Santoni
Max Schindler

Contributing Editors:

Peter N. Budzilovich, Jules H. Gilder,
Sidney Moskowitz, Nathan Sussman

Editorial Field Offices

East

Jim McDermott, Eastern Editor
P.O. Box 272
Easthampton, MA 01027
(413) 527-3632

West

Dick Hackmeister, Western Editor
8939 S. Sepulveda Blvd., Suite 414
Los Angeles, CA 90045
(213) 641-6544
TWX: 1-910-328-7240

Dave Barnes, Western Editor
465 S. Mathilda, Suite 302
Sunnyvale, CA 94086
(408) 736-6667

Editorial Production

Marjorie A. Duffy, Production Editor
James Keane, Copy Editor

Art

Art Director, William Kelly
Richard Luce, Anthony J. Fischetto

Production

Manager, Dollie S. Viebig
Helen De Polo, Nancy Hurey

Circulation

Director, Barbara Freundlich

Information Retrieval

Paula Greenleaf

Advertising Promotion

Judith Nappo

Reprints

Maxine Correal

Across the desk

Writing about us?

I look forward to reading the editorial in each issue of *ELECTRONIC DESIGN*. So much so, that I keep a separate folder of them for reference.

I want to commend you on your ability to leave a clear and concise message that is not restricted to engineering groups, but can be used throughout the business world.

Though I realize that you have never visited my company, I get the uncanny feeling that you walk through prior to writing your editorials. After reading one of your editorials, I can only conclude that the management of the business world must really have its problems. Is this so?

The company I work for is plagued by many of the things in your editorials, such as "One Plus Six Makes One" (Mar. 15, 1975), "Listening With Both Ears" (July 5, 1975), "The Czar's Consultant" (Jan. 5, 1976), "Company Policy" (Dec. 6, 1976), "Teamwork" (Mar. 1, 1977), and "The Paper Mountain" (Mar. 29, 1977).

These editorials attack my company's effectiveness more from an internal-management tangle that an engineering standpoint. I'm sure others apply.

I enjoy working here, but several of us middle managers can see the poor planning, wrong decisions, and general confusion. We are not in a position, however, to present logical solutions to the "powers that be." Employee morale is low, and several employees have voiced their opinions about the frustrating situations that occur on a continuing basis.

Generally, over-all planning, scheduling, and purchasing seem the most prevalent causes of frustrations among us. This situation has existed over the past 10 years and seems impossible to escape. Yet each month closes with an overwhelming rush that pulls us up by

our bootstraps so effectively that most eyes are closed to problems that continue to exist, but aren't recognized.

It's a shame that the proper people cannot digest or recognize the problems that you so effectively point out in each issue.

Name withheld

Case of a reversed diode:

While reading the Idea for Design on a bicycle-lighting system (ED No. 14, July 5, 1977, p. 92), I noticed a small problem with the schematic. The bridge is drawn like the following:

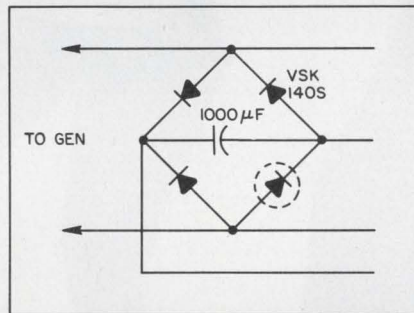

I'm sure that it was an oversight that the generator is shorted out for a half-cycle, and opened for the other half-cycle.

The bridge should look like the following:

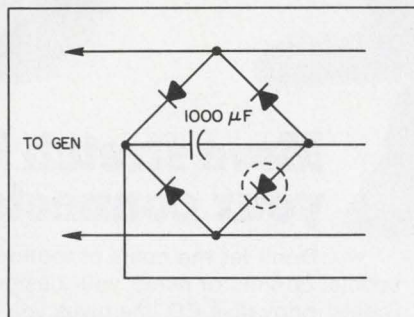

(continued on page 132)

Electronic Design welcomes the opinions of its readers on the issues raised in the magazine's editorial columns. Address letters to Managing Editor, Electronic Design, 50 Essex St., Rochelle Park, NJ 07662. Try to keep letters under 200 words. Letters must be signed. Names will be withheld upon request.

BUILDING YOUR OWN POWER SUPPLY?

Think Twice!



Think "DESIGN-AS-YOU- ORDER"

Think of the expense and time involved in designing and building your own power supply, and how those resources can be applied to designing and building other components.

Now think about the exclusive Arnold Magnetics "Design-As-You-Order" system. You simply order your **custom** power supply from proven "off-the-shelf" sub-modules . . . no engineering charges, no lost design time. Just fill in our "easy-to-use" specification form, we'll do the rest. Your miniaturized, high efficiency power supply arrives encapsulated and pre-tested.

See if these parameters meet your needs:

- Inputs: Single or dual; 60Hz, 400Hz, 12VDC, 28VDC, 48VDC and 115VDC.
- Regulated Outputs: single or isolated multiple; 5 to 300VDC.
- Line and load regulation to 0.1%.
- Power: 3—160 watts (up to 3.9 watts/in³).
- Other catalog power supplies with outputs to 5000VDC and power to 200 watts.
- Capability to design and build to your special needs.

Send for a free "Design-As-You-Order"
Power Supply Kit today!



ARNOLD MAGNETICS CORPORATION

11520 W. Jefferson Blvd.
Culver City, Ca. 90230 • (213) 870-7014

CIRCLE NUMBER 7

Dale makes your basics better.



More muscle in your resistors

Wirewound, metal film, carbon film, tin oxide... Dale's resistor line is stronger than ever. To match expanded capacity, we've installed a network of computer terminals to speed shipments and aid you in production planning. In addition, we've upgraded our quality assurance programs so that one out of every 10 Dale employees is directly involved with quality control. As a result, the Dale resistors you order are the best we've ever made...and the most efficient for you to buy.

CIRCLE NO. 351

More stretch in your connectors

Don't let the costs of tooling a special connector scrap your design. Dale's innovative ED line gives you dual readout .050" and .100" edgeboards that expand in length and number of contacts without tooling charges. This "stretchability" is also available in a line of digital display connectors. In addition, Dale can provide a variety of .156" edgeboards plus dip solder and rack and panel models. To find out more about the advantages of Dale connectors, circle the reply number or call 605-665-9301 today.

CIRCLE NO. 352

More punch in your trimmers

A trimmer's power rating should give you leeway to derate for assured long-term stability. Dale trimmers do. Our low profile 700 Series provides 1 watt at 70°C in both wirewound and cermet models and cermet models give you 1% CRV in the bargain. In single-turn square trimmers Dale's 3/8" 100 Series gives you a half watt clear up to 85°C in a choice of 5 top adjust and 3 side adjust models. Compare. We're the new source you've been looking for.

CIRCLE NO. 353



Higher Q in your inductors

Dale is steadily growing as a source for a wide range of inductors including: Flame retardant coated chokes with performance and durability comparable to molded models at a much lower price; filter inductors with a wide selection of Q vs frequency; trigger transformers interchangeable with 11Z types. In addition, we offer a versatile line of transformers including low power, converter and pulse models. Get complete price and delivery information by calling 605-665-9301 today.

CIRCLE NO. 354

More versatility in your networks

Dual-in-line, single-in-line standard or special circuits... Dale has what you need in thick film resistor networks. For custom circuits our SDP and SSP Series offer two ceramics with space for up to 28 resistors. New low profile SIP models and machine insertable DIP's solve packaging problems. We were the first to qualify to MIL-R-83401 and now offer 10 models meeting this spec. For network help, call 402-371-0080 today.

CIRCLE NO. 355



Your man from Dale has a lot of ways to help you ...call him today.

DALE ELECTRONICS, INC.
1300 28th Avenue,
Columbus, Nebraska 68601
A subsidiary of The Lionel Corporation
In Canada: Dale Electronics Canada Ltd.
In Europe: Dale Electronics GmbH,
8 Munchen 60, Falkweg 51, West Germany

Our complete product line can be found in Electronic Design's GOLD BOOK.

Overprotection can affect a CMOS switch for life.

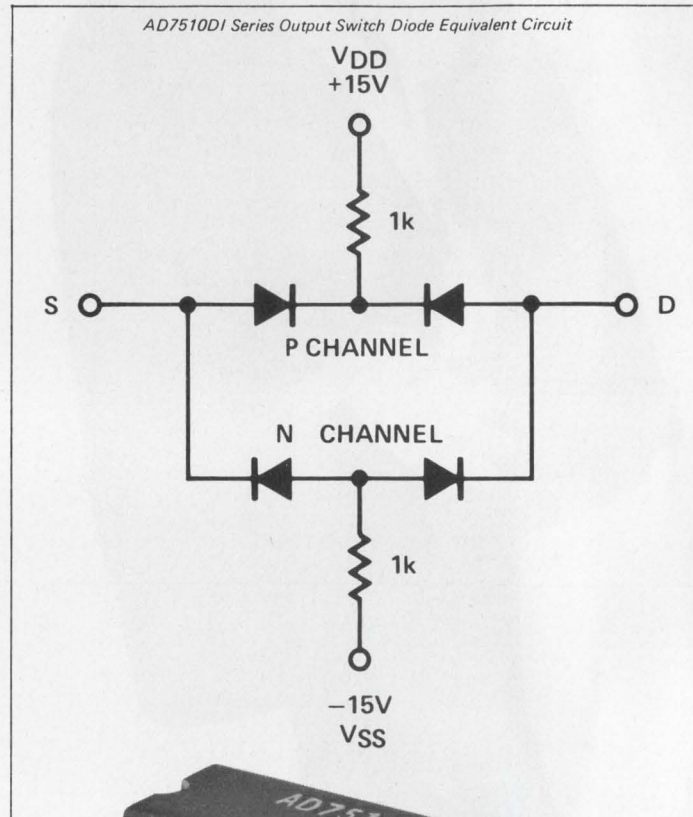

But not Analog Devices' AD7510 family of DI CMOS analog switches. They belong to a whole new generation. With positive overvoltage protection, but without any inhibition on performance.

We accomplished it through a unique design, utilizing "on-chip" resistors in series with the power supply. It provides as much as $\pm 25V$ overvoltage protection. But the resistors only switch in when an overvoltage condition occurs. So normal performance never suffers. And you get both the main assets of an analog switch: a low "ON" resistance of 75Ω and a low leakage current of $400pA$.

The equivalent circuit of the output switch element shows that, indeed, the $1k\Omega$ limiting resistors are in series with the back-gates of the P- and N-channel output devices — not in series with the signal path between the S and D terminals.

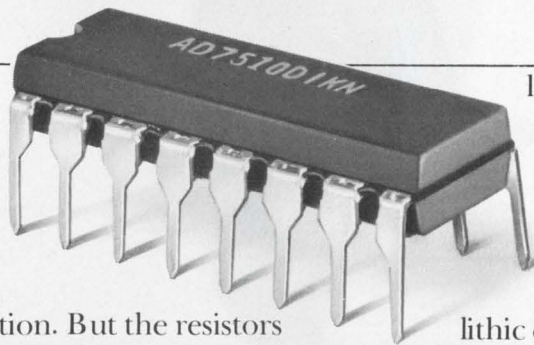

This design, combined with our dielectrically-isolated CMOS fabrication process, prevents

latch-up. And allows TTL/CMOS direct interfacing.

We also included two other measures of security. Silicon nitride passivation to ensure long term stability and monolithic construction for reliability.

Now when it comes to protecting CMOS switches so they can survive in the real

world, Analog Devices knows best. Write for our 8-page technical bulletin on the entire family of DI CMOS protected analog switches, to Analog Devices, the real company in precision measurement and control.

**ANALOG
DEVICES**

The real CMOS switch company

Analog Devices, Inc., Box 280, Norwood, Massachusetts 02062. East Coast: (617) 329-4700, Midwest: (312) 894-3300, West Coast: (213) 595-1783, Texas: (214) 231-5094. Belgium: 03 38 27 07, Denmark: 97 95 99, England: 01/94 10 466, France: 686-7760, Germany: 089/53 03 19, Japan: 03/26 36 826, Holland: 076-879251, Switzerland: 022/319704 and representatives around the world.

Intel delivers SDK-85. It's the quickest way to sink your teeth into 8085 design.

Intel wants you to prove to yourself why the 8085 has become the new industry standard microcomputer. To make it easy for you to do that, our System Design Kit for the 8085 is available now for only \$250.

SDK-85 is the best way we know for you to evaluate MCS-85™ and develop prototypes of 8085-based designs, because it gives you a hands-on look at this important new microcomputer's capabilities.

And to simplify your evaluation, we've designed SDK-85 as a stand-alone kit. It comes complete with an integral keyboard for system control and data/program entry, and LED display output. To simplify programming, debugging and operation we've incorporated an on-board, ROM-resident software monitor.

The 8085 family of components provides you with unprecedented design flexibility. The basic three-chip, high level integration MCS-85 system is included in SDK-85. It includes the 8085 CPU, 8155 256-byte RAM with I/O and timer and 8355 2K-byte ROM with I/O. And there's an on-board single-chip keyboard/display interface, the 8279. Sockets are provided for easy RAM and ROM/EPROM expansion. And there's ample free space laid out for easy wire wrap expansion using Intel's

complete family of programmable peripheral controllers and your own prototype logic and special circuitry.

SDK-85 makes an excellent teaching aid for both microprocessor design and programming courses, for microcomputer design seminars and as a project for the progressive hobbyist. Because the 8085 is the most advanced microcomputer, SDK-85 is the key to state-of-the-art knowledge.

SDK-85 can be assembled in just a few hours with a soldering iron and a few basic tools. Hook it up to your 5V power supply and it's operational the same day you receive it. You can get your SDK-85 from any of Intel's distributors for \$250 in single unit quantities.

To order SDK-85 or any of the MCS-85 components, contact: Almac/Stroum, Components Specialties, Cramer, Hamilton/Avenet, Harvey Electronics, Industrial Components, Pioneer, Sheridan, L.A. Varah, Wyle Liberty/Elmar or Zentronics.

Or, for more information, use the reader service card or write: Intel Corporation, 3065 Bowers Avenue, Santa Clara, CA 95051. Telephone: (408) 246-7501.

intel delivers.

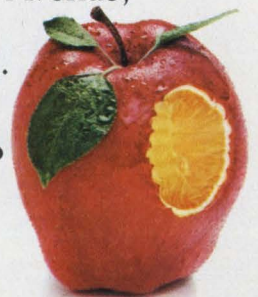

990 OEM minicomputers.

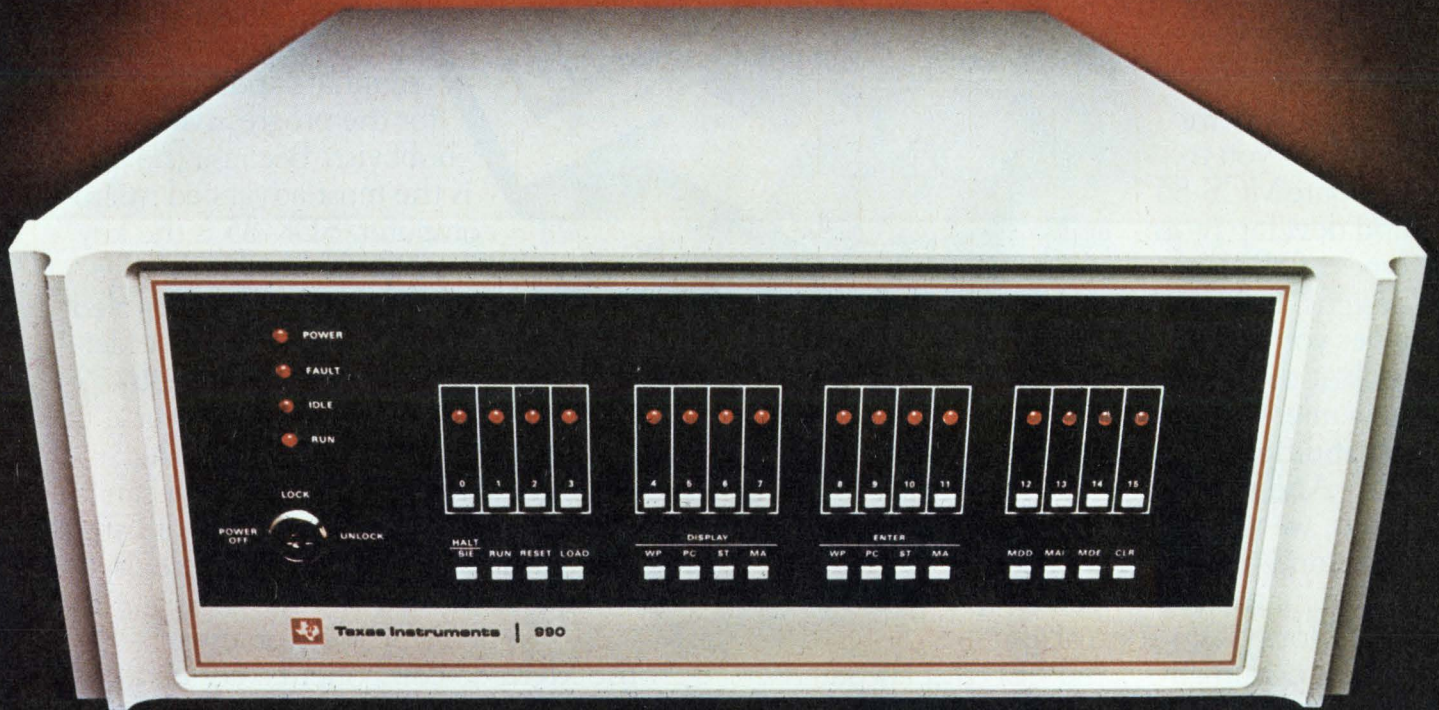

Built, backed and priced to sharpen your competitive edge.

TEXAS INSTRUMENTS.

The 990/10 minicomputer from TI brings superior value to both you and your customers.

Starting with field-proven hardware, the 990/10 delivers the reliability you expect from TI. And all the off-the-shelf support you need for user applications. You get standard software languages, a broad choice of peripherals and nationwide service.

Built for more processing power.

The 990/10 is the most powerful member of the 990 computer family. Its architecture provides features that give you maximum processing power for your money. Like hardware multiply and divide. A 16-level hardware



Peripheral Interface Modules

interrupt structure. 16 registers arranged in a workspace concept. I/O that's directly programmable through the Communications Register Unit (CRU) and autonomously through a high-speed data bus. And bit, byte and word addressing of memory.

Built for system flexibility.

In small or large configurations, the 990/10 design provides surprising flexibility for a small investment.

The CRU, with up to 4096 I/O lines, reduces interfacing costs by keeping controller complexity to a minimum. The TILINE* asynchronous high-

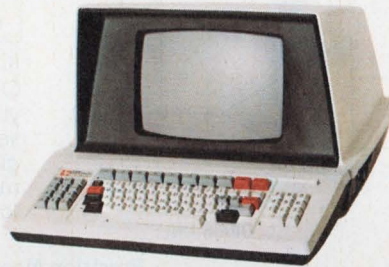

Model 911 Video Display Terminal

speed data bus can support both high- and low-speed devices and takes advantage of design simplicity for simultaneous data transfer between peripherals, the CPU and memory.

With the 990/10, you get a powerful instruction set with an extended operating feature that allows hardware to take over operations that software would normally execute. An optional mapping feature provides memory protection and memory expansion to 2 million bytes. And, optional error-correcting memory corrects single-bit errors for increased system reliability.



DS 25/50 Disc Drives

Full peripheral support.

As well as a range of standard peripherals, disk storage to 180 million bytes and magnetic tape with 800 and 1600 bpi options are available for low-cost mass storage and back-up.

A choice of software.

With common higher level languages, FORTRAN IV, COBOL and Multiuser BASIC, plus the 990/10 assembly language, you have all the tools you need for an efficient application program.

Both the disk-based and memory resident operating systems give you modularity and flexibility for system generation to meet application de-

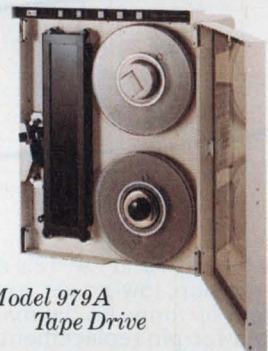

Model 979A Tape Drive

mands. We offer program development aids for creating and testing software, and communications software to support synchronous or asynchronous data transmission.

Backed with nationwide service.

Our responsibility to you doesn't end with the sale. We follow through with complete system training, plus a nationwide factory service network.

The TI 990/10 minicomputer. We build it, back it and price it the way you and your customers want it. You can start configuring a system now with our 990 Computer Systems Handbook on the upward-compatible family of the TMS 9900 microprocessor, 990/4 microcomputer and 990/10 minicomputer. For your free copy, send a letterhead request to Texas Instruments Incorporated, P.O. Box 1444, M/S 784, Houston, Texas 77001.



TEXAS INSTRUMENTS
INCORPORATED

CIRCLE NUMBER 10

*Trademark of Texas Instruments

Copyright © 1977, Texas Instruments Incorporated

The world's only precision low-power op amps: PMI's OP-08 and OP-12.

When you have one of those demanding applications—like a piece of precision portable or space-bound equipment—you've probably hankered for an op amp that would give you lower offset voltage and lower offset voltage drift than the 108A. And, while we're at it, better overall specs.

By George, we've got it.

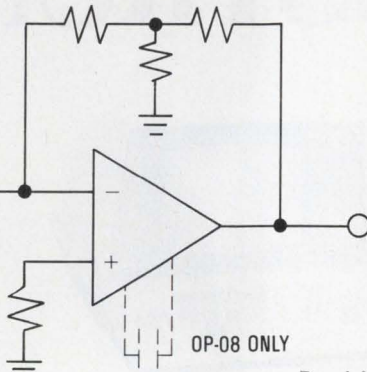
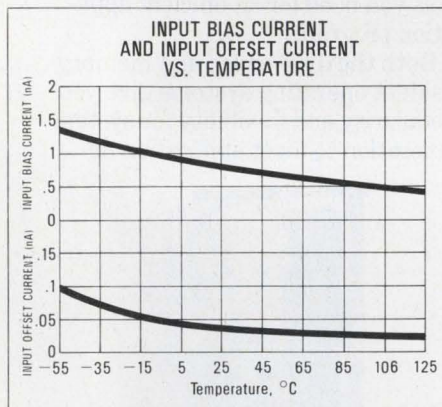

How did we come up with the OP-08 and OP-12?

How did we do it? By being fussier. By using our proprietary ion-implantation and zener-zap trimming processes. By careful design: completely balanced input stage and second stage, and proprietary output design to drive a 2Kohm load. By careful fabrication. And by QA like nobody else in the industry.

When you have to go quality and performance all the way, it's good to know that PMI's OP-08 and OP-12 are available—on your distributor's shelf—right now.

Hybrid Designers: You can order the OP-12 in chip form.

If you'd like to get your hands on an OP-08 or an OP-12, just write us (on your company's letterhead) and we'll send a sample and a data sheet. Be glad to, in fact. After all, when you make the only chip of its kind, it pays to advertise.

Precision Monolithics Incorporated
1500 Space Park Drive
Santa Clara, California 95050
Telephone: (408) 246-9222
TWX: 910-338-0528
Cable: MONO



PMI's new OP-08's and OP-12's are the **only** precision, low-power, low-input-current op amps on the market. They are pin-for-pin replacements for 108A's and 308A's in all applications to give you even better performance. Here are the key specs:

Offset voltage of the OP-08 and OP-12 is three times lower than the LM108A. Voltage drift is two times lower. CMRR and PSRR are at precision levels.

And for battery and solar-powered systems, the OP-08 and its internally-compensated twin, the OP-12, each drive a 2kohm load—**five times** the output current capability of the 108A and 308A.

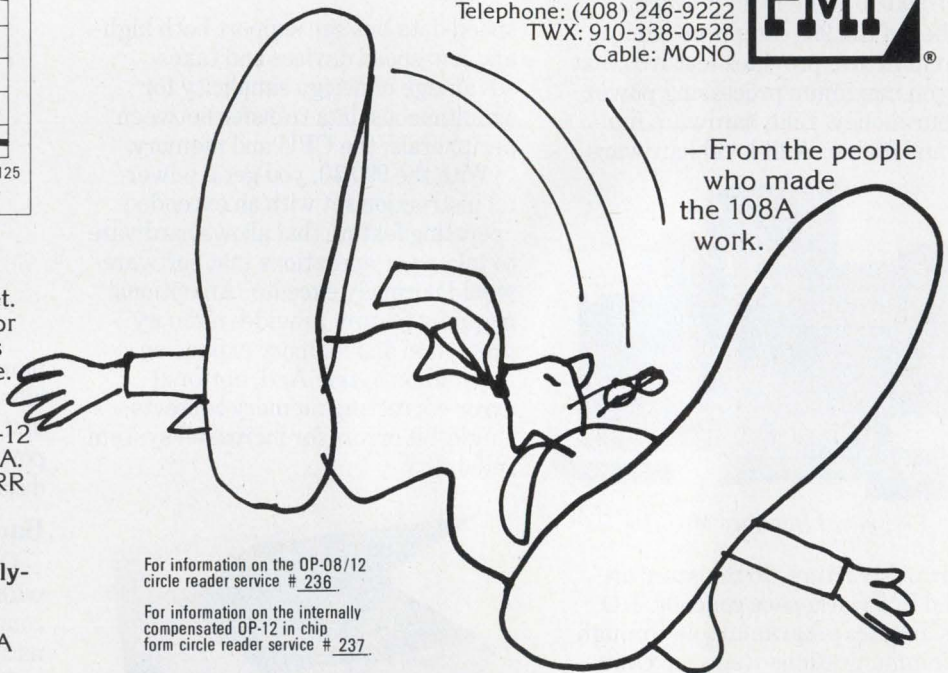

For information on the OP-08/12 circle reader service # 236

For information on the internally compensated OP-12 in chip form circle reader service # 237

Electrical Characteristics $V_S = \pm 15V$	OP-08A/OP-12A OP-08E/OP-12E			OP-08B/OP-12B OP-08F/OP-12F			OP-08C/OP-12C OP-08G/OP-12G			Units
	Min	Typ	Max	Min	Typ	Max	Min	Typ	Max	
Input Offset Voltage	—	0.07	0.15	—	0.18	0.30	—	0.25	1.0	mV
Offset Voltage Drift	—	0.5	2.5	—	1.0	3.5	—	1.5	10	$\mu V/^\circ C$
Input Offset Current	—	0.05	0.20	—	0.05	0.20*	—	0.08	0.50	nA
Input Bias Current	—	0.80	2.0	—	0.80	2.0*	—	1.0	5.0	nA
Output Voltage Swing $R_L = 2K$	± 10	± 12	—	± 10	± 12	—	± 10	± 12	—	V
Common Mode Rejection Ratio	104	120	—	104*	120	—	84	116	—	dB
Power Supply Rejection Ratio	104	120	—	104*	120	—	84	116	—	dB
Power Consumption	—	9	18	—	9	18	—	12	24	mW

*For OP-08B/08-12B

CIRCLE NUMBER 11

Here's how Data General's NOVA 3/D system stacks up against the competition.

Systems Software:
Multitasking Real-time Disc Operating System, FORTRAN IV, Extended BASIC, ALGOL, and Utilities.

NOVA 3/D Processor:
Hardware-protected dual partitions, 700-nanosecond arithmetic operations, 48K-word MOS memory with parity, RTC, and APL.

DASHER Video Display:
1920-character screen, upper/lower case characters, detached keyboard, numeric keypad, programmable function keys and character highlighting, display rotates on two axis.

Cabinet:
72-inch high, holds all rack mounted components.

DASHER Terminal Printer:
60/30 cps; 132-columns; typewriter keyboard, upper/lower case.

Diskette Subsystem:
315KB for program/data interchange, diagnostics and software distribution; convenient, industry-standard offline storage.

Cartridge Disc Subsystem:
10 megabytes (5 fixed, 5 removable); 50 ms. average access time, shares controller with diskette.

\$37,260
List*

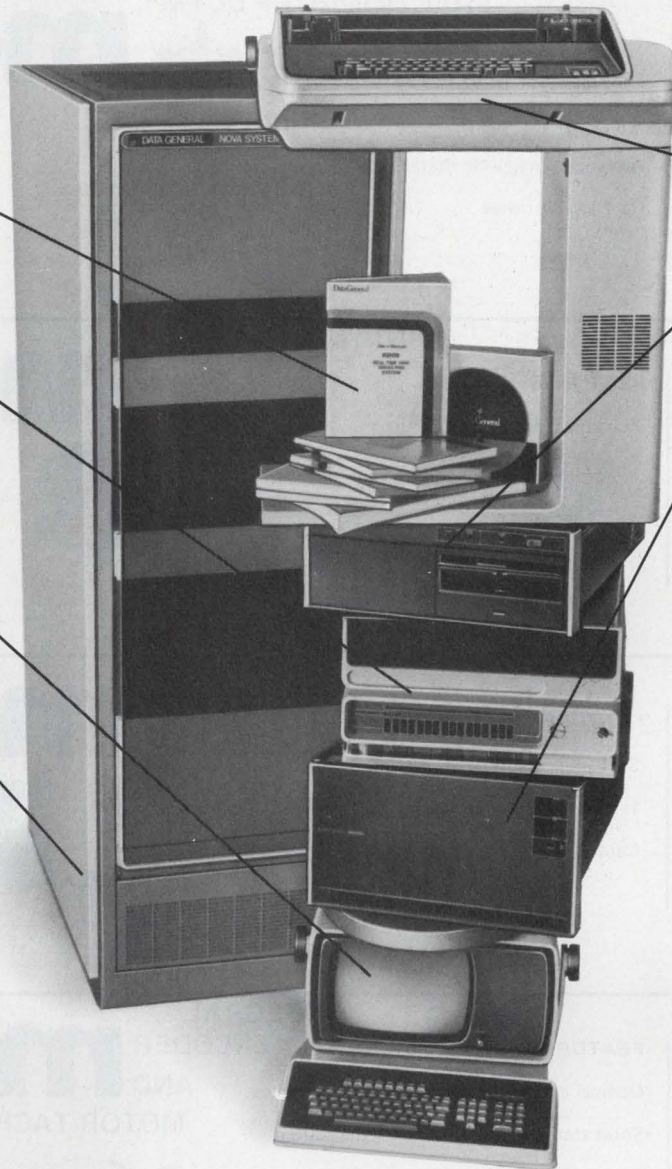

The facts speak for themselves. For \$37,260, Data General's new NOVA 3/D gives you more system, software and support than any comparable computer.

Any way you look at it, it all stacks up in your favor. For more information and our brochure, call or fill out and return the coupon.

*Quantity and OEM discounts available.

Data General, Westboro, MA 01581 ED1025
Sounds like smart business. Send me more information.

NAME _____

TITLE _____

COMPANY _____

ADDRESS _____ TEL. _____

CITY _____ STATE _____ ZIP _____

NOVA is a registered trademark of Data General Corporation.
DASHER is a trademark of Data General Corporation.

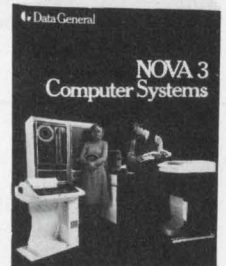

Data General
It's smart business.

Data General, Westboro, MA 01581, (617) 366-8911. Data General (Canada) Ltd., Ontario. Data General Europe, 15 Rue Le Sueur, Paris 75116 France. Data General Australia, Melbourne (03) 82-1361.

CLIFTON PRECISION

More and more O.E.M.'s are changing to Clifton. They know that Clifton offers the finest motor technology, versatility and a responsiveness to customer's needs that is unmatched

in the industry. Clifton designers have demonstrated an ability to solve seemingly impossible problems. Why not put Clifton technology to work for you?

APPLICATIONS

TAPE TRANSPORT DRIVES
DISK MEMORY DRIVES
PRINTER CARRIAGE DRIVES
MACHINE TOOL DRIVES
CONVEYOR DRIVES

FEATURES

Torques from 10 to 120 lb-ft
2 inch to 5.5 inch O.D.
Advanced magnetic materials
Cartridge brushes

FRACTIONAL HP DC PM

motors

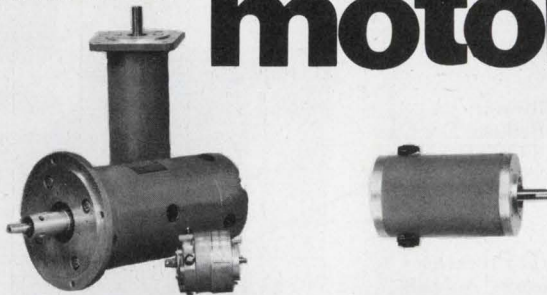

APPLICATIONS

DAISY WHEEL DRIVES
PRINT HEAD DRIVES
INSTRUMENT RECORDERS
LABORATORY INSTRUMENTS

FEATURES

Torques from 2 to 50oz-in.
.75 inch cube to 1.25 inch O.D.
Cartridge brushes
Alnico or rare earth magnets

MINIATURE DC PM INSTRUMENT

motors

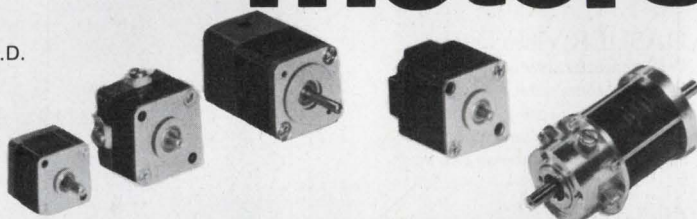

APPLICATIONS

PRINTER RIBBON DRIVES
PRINTER PLATTEN DRIVES
CARD SORTERS
OFFICE COPIERS

FEATURES

Step angles 7.5°, 15°, 30°, 45°, 90°
1.1 inch to 2.8 inch O.D.
Ceramic or rare earth magnets

PM STEPPER

motors



APPLICATIONS

PRINTER CARRIAGE DRIVES
COPYING MACHINES
SPEED CONTROLS
MACHINE TOOL CONTROLS

FEATURES

Optical encoder resolution to 1000 cycles
Solid state gallium arsenide light source
Integral assemblies — no assembly or alignment necessary
Single source for motor/encoders eliminates costly assembly & simplifies service

INTEGRAL ENCODER AND

motors

MOTOR-TACHOMETER ASSEMBLIES

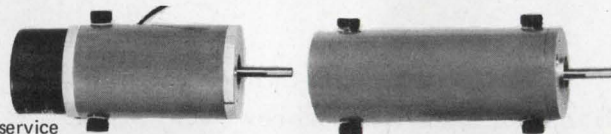

APPLICATIONS

INERTIAL NAVIGATION
PLATFORMS
AIRCRAFT INSTRUMENTS
AIRCRAFT CONTROLS

FEATURES

Torques from 6 to 500oz-in.
1.1 inch to 5.2 inch O.D.
Precision tolerances
Gold commutators
High reliability

DC PM HOLLOW SHAFT TORQUE

motors



CLIFTON PRECISION

for further information, call John Staiber,
(215) 622-1000
MARPLE & BROADWAY, CLIFTON HEIGHTS, PA. 19018

Dialight is your second source to C&K for miniature rockers and toggles...



Come to the people who've always been specialists in having more good ways to solve problems: Dialight. What we've done in indicator lights, illuminated switches, readouts and LEDs, we're doing now in miniature rockers and toggles.

This new Dialight family of switches, which comes in a full range of sizes is, we're proud to point out, all-American made.

When you consider all the configurations of styles, sizes, life and safety ratings, colors and mountings, you'll find there are literally hundreds of thousands of design combinations. Such a number of possibilities

can in itself be a problem, except that the new Dialight catalog is specifically designed to prevent confusion and help you quickly and easily find the most advantageous combination of features for your applications.

If you'd like to see what Dialight quality rockers and toggles can do for the looks, durability and economics of your products, contact us today for the Dialight "Meets Your Need" Book. Your free copy will include a list of stocking distributors in the U.S. and Canada.

DIALIGHT
A North American Philips Company

Dialight meets your needs.

Dialight, 203 Harrison Place, Brooklyn, N.Y. 11237 (212) 497-7600

CIRCLE NUMBER 14

No other conformal coating can make this statement.



Dow Corning 3140 RTV silicone coating is the only conformal coating that has UL recognition to 180 C and also meets the requirements of Mil Spec MIL-I-45608. But, there's more.

Dow Corning 3140 silicone coating stands up to the toughest environments. It is a one-part coating that is non-corrosive to copper and other sensitive materials. Its high tear strength allows you to use it anywhere you need good shock insulation. Dielectric properties are excellent. 3140 really performs when the heat is on. As we said, it's UL-listed to 180 C.

Dow Corning 3140 is fast and easy to apply or repair. You can brush, dip, flow coat or spray it on at room temperature. It goes on clear, so you can easily identify coated components. It can be handled in 24 hours or less, and a little goes a long way.

If you have an application that requires proven durability, toughness and resistance to heat and corrosion, you just can't afford less.

Decide for yourself. Write for literature and a how-to-apply brochure to Dow Corning Corporation, Dept. A7-512, Midland, Michigan 48640.

DOW CORNING

DOW CORNING

New CCDs: the least power and the highest density

A family of LSI logic devices based on charge-coupled technology promises to yield integrated circuits that use 30 times less power than CMOS and have very high density. Known as direct charge-coupled logic (DCCL) devices and developed by TRW, Redondo Beach, CA, they operate at speeds comparable to those of competing technologies.

Except for serial CCD memories that are formed from digital shift registers, all other CCD circuits developed to date have been for analog applications. But now, according to Dr. Tom A. Zimmerman, manager of TRW's charge-transfer LSI products department, several digital CCDs, the DCCL devices, have finally been produced in a project started three years ago.

In the DCCL devices a full charge packet of minority carriers in the semiconductor material represents a binary ONE while an empty charge packet represents a binary ZERO. As in conventional CCDs, charge packets are stored in potential wells in the material and are moved from one well to an adjacent one by clock voltages that are applied to the gates located over the wells. The area of a potential well is only $103 \mu\text{m}^2$ and the energy required to move a packet of charge is very small. The result is a high-density, low-power logic element.

To illustrate the advantages of DCCL, Zimmerman compared the power dissipation and active-area figures for an 8×8 multiplier fabricated with several technologies. DCCL requires only 8 mW of power, and an active chip area of 3.1 mm^2 . The next-lowest power technology, integrated injection logic, dissipates 36 mW of power and requires an active area of 26.2 mm^2 . CMOS, generally considered a low-power technology, requires 820 mW of power and an active area of 19.5 mm^2 . NMOS, considered the densest IC technology, at 7.65 mm^2 requires more than twice the area of the DCCL devices and dissipates 559 mW of power.

All the basic logic functions, such as AND, OR, exclusive-OR, shift and latch have been implemented with

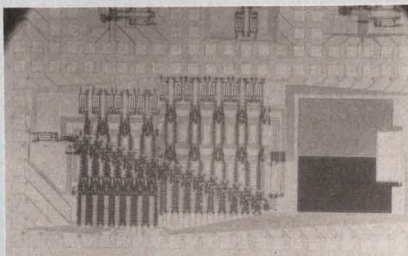

A full adder that sums two 16-bit words to produce a 17-bit result was fabricated with digital charge-coupled logic.

DCCLs, Zimmerman reports. In addition, arithmetic devices such as adders, subtractors and multipliers have been made. The adders and subtractors use 16-bit words to produce a 17-bit output, while the multiplier uses 8-bit words to produce a 16-bit result.

Unlike arithmetic units produced with other technologies, those made with DCCL do not have a ripple-through logic capability. Thus, arithmetic functions must be implemented in a pipeline manner.

The pipeline approach has a big plus, notes Zimmerman—a very high throughput rate. It also has a disadvantage, he admits—it is not suited for calculations on random data. It is best used for signal processing functions that operate on blocks of data.

While DCCL LSI chips are now being developed for speech-processing applications for the Navy, Zimmerman notes that it will probably be a few years before DCCL devices reach the commercial marketplace.

Fiber-optic cables tough enough for heavy sea use

Super-rugged fiber-optic cables have been developed—one type for long-distance undersea optical communications, the other for both communications and power between a ship and hydrophone arrays under tow.

On a "smaller" scale, the need for a standard, low-cost connector, which inhibits the use of small, single-fiber cables, may be in the process of being

filled.

Both fiber-optic cable types have been developed at the ITT Cable Hydrospace Div. in San Diego. The undersea-communications cables, designed to withstand 10,000-psi pressure, should eventually replace coaxial cables now used for undersea-communications links between islands and continents. Prototype cables 300 and 400 m long have been wound with three fibers in a helical-layer configuration, according to William Caton, manager of fiber-optics development at Hydrospace.

The lengths produced to date have been fabricated without a single fiber breaking. The process was described by Caton and Joseph Gatt, manager of systems studies, in a paper, "Fiber Optic Cables in the Undersea Environment" at the Tenth Annual Connector Symposium in Cherry Hill, NJ, Oct. 19 and 20.

The next step will be to produce cables with six fibers wound around the central element.

A prototype undersea system is also being built for testing. It will consist of a 1-km cable, a repeater, and another 1-km link. Optical transmitters and receivers capable of 30 MBaud operation are being adapted to the system. Already, the repeater housing has been tested to 10,000 psi, and the feed-throughs for the fibers into the housing have passed 15,000-psi requirements.

Multimode, graded-index fibers from ITT's Electro-Optics Products Div. in Roanoke, VA, will be used in the undersea system. With the cable lengths limited so far to 300 and 400 m, 6-dB/km fibers are employed.

The fiber-optic ship tow cable, produced for the Navy's Ocean Systems Center in San Diego, has a working strength of 33,000 lb. Tested by the Navy, the cable is 550 m long and is wound with six fibers. Copper conductors capable of carrying 3 kVA of power are also wound into the cable, which is supported by contrahelically woven steel strength members.

Meanwhile, a standard, low-cost connector for single fibers is the target of the Amphenol Division of Bunker Ramo. A connector design from the Danbury, CT, firm, though suitable for 125, 150, or 175- μm fibers, will be supplied initially for the 125- μm Siemens-Corning 1352/53 cable.

Maximum mating loss is spec'd at 1.75 dB, according to John A. Makuch, technical product development manager who, with John Esposito, project manager described the new line at the

Cherry-Hill symposium in "A New Simple Connector for Single Fiber Optic Cables."

The connector is dry—it uses no index-matching fluid, and will mate with Amphenol's 905 series of precision receptacles. A multiple-pin arrangement within a stainless-steel housing keeps the ends of the fiber aligned.

Rear dimensions of the connectors can be adjusted to suit the sizes of different cable jackets.

Prices for the initial 125- μ m connectors will be \$36.75 per termination in 1 to 9 units, and \$81.50 per pair, which requires an adapter.

Video terminal combines graphics, text processing

Combined alphanumeric and graphics can be scrolled with a new computer-display terminal. Not only that, but a complete page for a proposal or report can be prepared on screen, then directly converted to an 8-1/2 \times 11-in. page, or readied for printing with a plotter.

Developed by Tektronix' Information Display Group in Beaverton, OR, the 4025 has a 12-in.-diagonal (30-cm) screen that accommodates 34 instead of the more usual 24 lines, with 80 characters per line. A section at the bottom of the screen can be used as a monitor, for communicating with the host computer; this segment can be scrolled separately.

The 4025 can integrate alphanumeric and graphics largely because of the way it stores graphic data. Tektronix calls this method a virtual-bit map. When the terminal scans the display list, it is directed to fetch dot patterns from separate alphanumeric and graphic memories. When the alphanumeric information is scrolled, the graphics display is scrolled right along with it.

With the bit map, memory is assigned only to areas of the screen that



With built-in routines, the Tektronix 4025 creates pie or bar charts in a few seconds.

will have a graph: If a graph is to occupy, say, one-quarter of the display screen, then only one quarter of a full screen's worth of memory is designated for that graph.

Hard copy can be produced with the 4631 copier which plugs into the 4025's controller. Because the memory image is larger than the screen image, copy size is the normal typed-report format of 8-1/2 \times 11 in. In fact, the length of the graph can stretch even beyond the length of one page, and can be read in its entirety by scrolling through it.

Another new model, the 4024, lacks the 4025's graphics capability, but has most of the other features, such as a typewriter-style keyboard, augmented with 16 function keys. Options for both models include a range of interfaces, additional memory, and expansion of the 64/96 upper and lower case ASCII character set.

In single quantities, the 4025 starts at \$3595, the 4024 at \$2995. The 4642 hard-copy unit goes for \$2250. The 4020 series will be available November 21.

CIRCLE NO. 315

Logarithmic a/d delivers like a 23-bit unit

Although it outputs a 15-bit digital code, the 8020L a/d converter can provide the effective resolution of a 23-bit linear a/d. Based on a new logarithmic-conversion technique developed by Analogic, Wakefield, MA, the log a/d converter has a quantization error of 0.022% of peak input value (or 0.013% of rms).

Built around the company's 15-bit linear a/d converter, the 8020L replaces binarily weighted switch currents with a product of gains based on successive square roots. The analog input signal is multiplied by an amount set by internal control logic while the reference voltage of the converter is divided by another controlled amount. The two results are compared and adjusted until the inequality is less than 1 LSB.

For small signals, the converter provides resolution equivalent to a 20 to 23-bit linear a/d converter. The converter's dynamic range spans six decades of voltage (120 dB) over the full bandwidth, and seven decades over a reduced bandwidth. Conversion for a full-step input takes 33 μ s, assuming an 800-kHz clock rate. However, for maximum accuracy, a clock rate of less than 750 kHz should be used. (Conversion time increases to 41.67 μ s for

a 600-kHz clock.)

The entire converter is housed on a palm-sized circuit card, requires just slightly more than 4 W from +5-V and \pm 15-V supplies, and can reach specified performance 10 minutes after turn-on.

Capable of replacing entire racks of equipment with just a single module, the logarithmic converter was originally designed for medical imaging systems used in 3-D X-ray systems, where many converters are simultaneously used to create a digital image.

National group stumps for U.S. technology

A national task force formed at the National Symposium on Technology is being funded by industry and staffed to promote an understanding of technology's contributions to American society and free enterprise.

"We're concerned that technology is getting an excessively negative and undeserved reputation that threatens America's technological leadership," said task force chairman Edward David, President of Exxon Research and Engineering. "Our country has been built on know-how and yet we see technological decisions increasingly negated by people in the government and industry without an appreciation of the technological contributions." As a matter of fact, David added, America's technological superiority is not only being rivaled, but in some cases it is even being surpassed by foreign countries.

"We feel strongly that it is up to free enterprise to meet this challenge," David observed, "and we've established the task force to give purpose and direction to this need." Joining David, who also served as science advisor to President Nixon, are other leading executives of industry and education: Donald M. Alstadt, President of Lord Corp.; Lewis Branscomb, Vice President and Chief Scientist of IBM; Dr. William S. Kiser, Chairman of the Board of Governors of the Cleveland Clinic Foundation; Henry C. Londean, Public Relations Manager of Getty Oil Co.; and Thomas Van der Slice, Group Vice President, Special Systems and Products, of General Electric.

The technology symposium was held at Villa Maria College, Erie, PA, and sponsored by Lord Corp. and WQLN, the public broadcasting station for northern Pennsylvania.

The Choice In Laboratory & Systems Measurement

Data Precision provides for precision laboratory or Automatic Test Equipment and Data Acquisition requirements by offering a selection of multimeters encompassing a wide range of specifications, features, and options . . . a selection that will meet almost all precision laboratory and monitoring control needs.

MODEL 7500

Model 7500 is a 5½ digit multi-speed instrument that will perform a full conversion 1000 times per second! It is completely programmable in function, range, mode, timing, and conversion speeds. DCV accuracy is $\pm 0.007\%$ of input $\pm 0.001\%$ range ± 1 l.s.d. for 6 months; sensitivity is $1\mu\text{V}$ DC and AC and $1\text{m}\Omega$; DCV and ACV measurement from $1\mu\text{V}$ to 1000V . As a true universal ratiometer, the 7500 also enables the user to choose both the numerator and denominator independently, and every measurement—DC Volts, AC Volts, and Resistance—can be made on a ratio basis to any other if desired.

Model 7500 provides for full incorporation into any computer-based, high-speed, multi-channel automatic test or data acquisition

system. In addition, a broad range of standard options are available, including built-in micro-processor-controlled IEEE 488 BUS or RS232/TTY Output. Base price is \$2995.00.*

MODEL 3500

Model 3500 is a full-function, autoranging, 5½-digit instrument with 6 months basic accuracy of $\pm 0.007\%$ of reading $\pm 0.001\%$ of range ± 1 l.s.d. All important control and state signals are brought to rear panel connectors for use in automated control, test, and computing systems. Voltage ratio is included.

Time-buffered isolated BCD Output, brought out through Standard DTL/TTL interface circuits, permit asynchronous printing, recording, and/or display. In addition, Model 3500 features measurement of DC volts, AC volts, Resistance, Ratio and local/remote Ranging and Triggering plus excellent common-mode and normal-mode rejection. Base price is \$995.00.*



MODEL 3400

Model 3400 is the world's most accurate systems/lab 4½ digit multimeter. It is a fully programmable system multimeter and a highly versatile stand-alone, autoranging laboratory multimeter.

Full 100% overranging, basic DCV accuracy of $\pm 0.007\%$ of input ± 1 l.s.d. for 6 months, measures from ± 10 microvolts to $\pm 1,000$ VDC, ACV from 10 microvolts to 750V , resistance from 10 milliohms to 20 Megohms, AC/DC, DC/DC voltage ratio and full remote control up to 12 conversions per second. It has complete capacity, and its BCD output is fully printer-compatible. IEEE Standard 488 BUS is optional. Base price is \$795.00.* With true RMS AC Volts—\$895.00.*



Data Precision Corporation
Audubon Road
Wakefield, MA 01880 USA
(617) 246-1600, TELEX (0650) 949341.

*Price USA.

 DATA PRECISION[®]
...years ahead



CIRCLE 16 FOR DEMONSTRATION

CIRCLE 104 FOR ADDITIONAL INFORMATION

Designers'

Toggle Switches
Bat, lever lock, Designer
Line, sealed. Big, broad
choice.

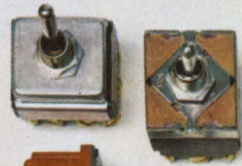

Rocker Switches
Singles and multiples.
Wide, colorful selection
range. Legends, too.

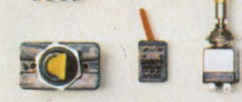
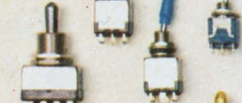
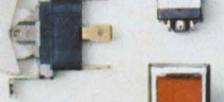
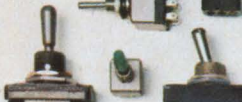
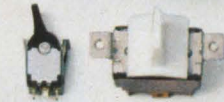
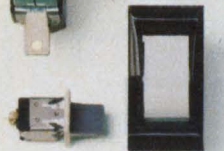
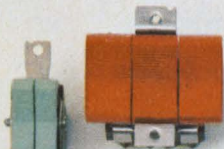
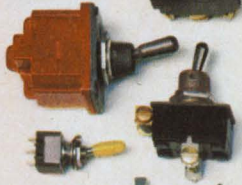

Cutler-Hammer, of course! The broadest
line. Styled to meet today's and tomorrow's
requirements. They're solid quality, look
great, work long and hard. Carried in stock
for local availability by Switch Distributors.
Backed by Cutler-Hammer sales engineers
who can deliver innovative design help for

Pushbutton Switches
Choice of sizes, colors,
circuits, ratings. Styled
to "turn you on".

**Tool Handle &
Slide Switches**
Variable speed, reversing.
Double insulated.

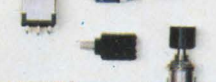
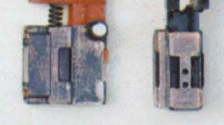
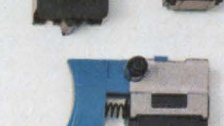
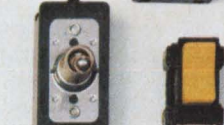

 **Switch to No.1**

Choice.

the exact switch or relay you need—
when you need it.

It's no wonder so many designers specify
Cutler-Hammer. For quality, reliability,
availability, and style. For commercial,
industrial, and military applications.

We simply offer more—of everything!

Snap Switches

Lever, roller, leaf, and
pushbutton actuators.
Four terminal styles.



Switch Accessories
Guards. Boots. Seals.
Caps. Decorator
facenuts. And much
more to protect, code
or customize.



Rotary Switches

Precision and general
purpose. Single and
multiple wafer.



Illuminated Switches

Rockers, paddles,
pushbuttons, indicators.
Snap-in and bushing.

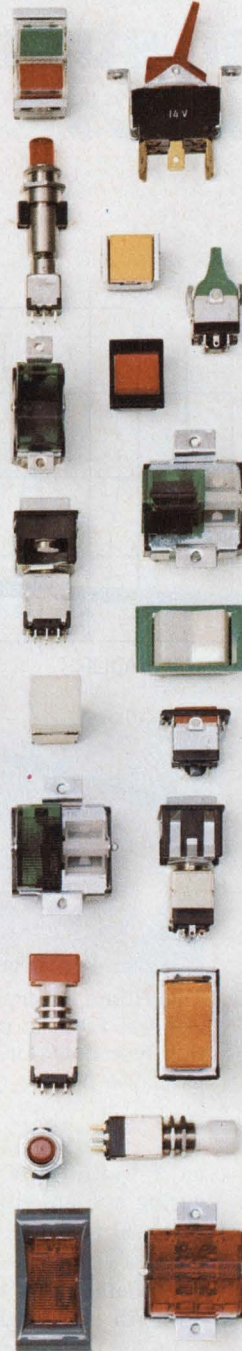

Relays

Hermetics, non-sealed,
potted. Power, latching,
and timing functions.



CUTLER-HAMMER

SPECIALTY PRODUCTS DIVISION, Milwaukee, Wis. 53201



Smoke detectors coming on strong — look for ICs

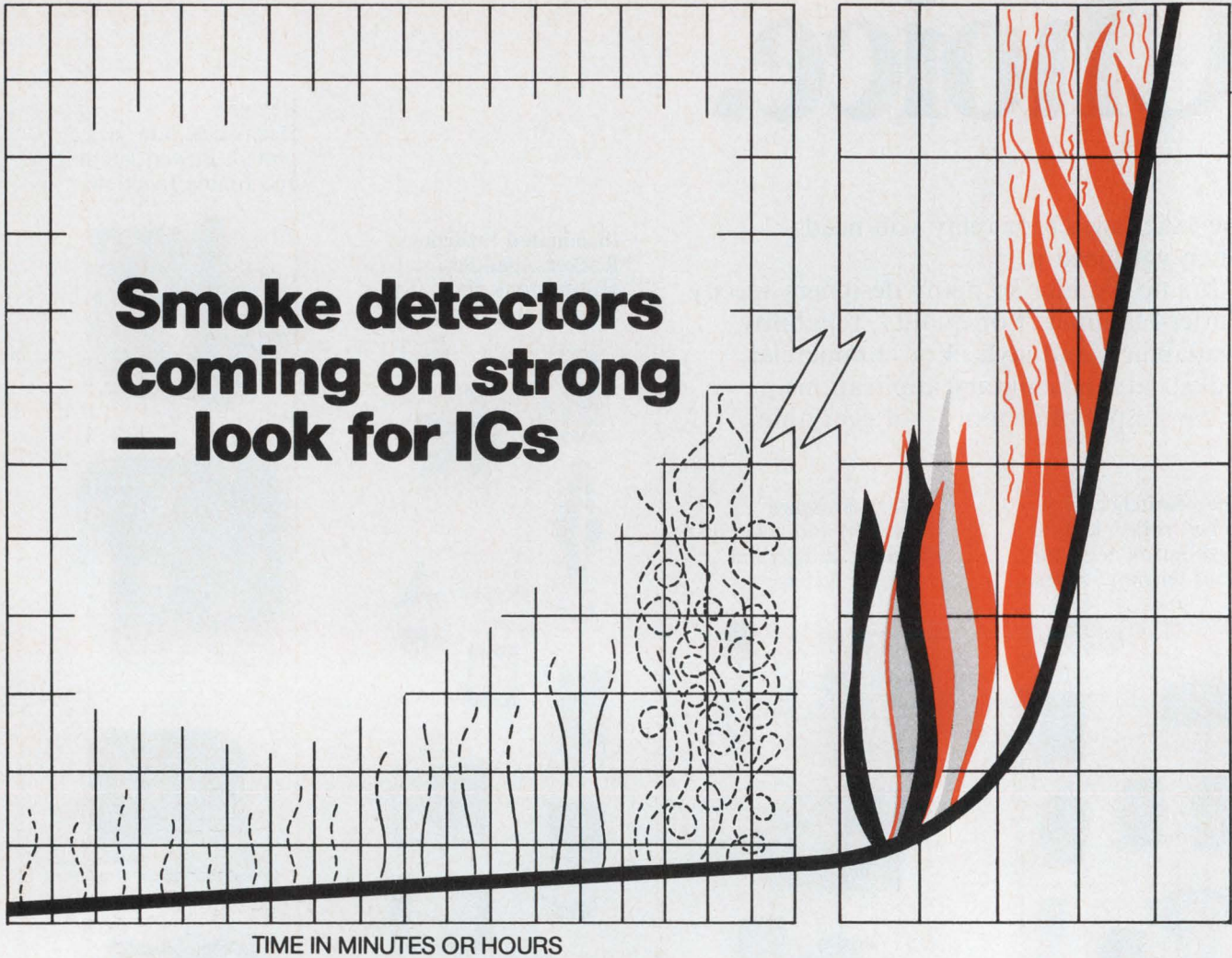

The hottest area of consumer electronics these days is *not* video games, is *not* calculators, and is *not* digital watches. It's smoke detectors. By putting the electronics on small circuit boards and making the smoke sensing chamber smaller, companies have simplified manufacturing and reduced size and price. Now, detectors list from about \$30 to \$65. But spurred on by stringent industry-wide standards and increasing competition, manufacturers are looking to lower costs even more while improving performance and reliability.

Next year should see many units with integrated circuits instead of discrete components, electronic horns instead of electromechanical types, batteries with longer life, and other features.

Most smoke detectors on sale today are "single-station" units—independent boxes mounted on a ceiling or high

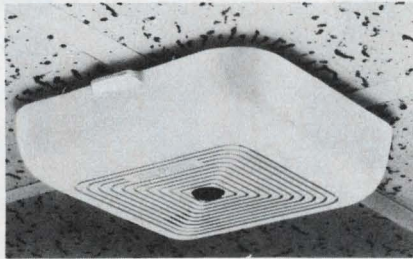

This Home Sentry smoke alarm from General Electric contains an ionization-type detector. The center button tests the alarm.

on a wall. These require no special wiring and are either plugged into an ac outlet or battery-powered. The two types of smoke detectors are ionization and photoelectric units, each with its strength and weaknesses.

In an ionization detector a radioactive source (Americium 241) emits radiation—mainly alpha particles—that ionizes air particles. These, in turn, are attracted by a voltage charge on the collector electrode. The result is a minute flow of less than 1 μ A.

If smoke particles from .01 to 1 micron diameter enter the chamber, the ionized air particles attach themselves readily to these smoke particles to produce heavier particles. Since these new particles move more slowly than the lighter air particles, fewer reach the electrode. Current flow within the chamber decreases, and this decrease is converted into an alarm signal.

Since ionization detectors require very little current, they can be powered effectively by batteries that must be replaced periodically.

In a photoelectric detector a beam of light is projected roughly at right angles to the face of a photocell in a darkened chamber. When smoke particles as small as .5 micron and as big as 1000 microns enter the chamber, light from the particles is scattered and reflected onto the photocell. Since the photocell current is increased and amplified, a voltage for signaling the alarm results.

While ionization detectors respond particularly well to smoke generated

by a flaming fire, photocell detectors react quickly to smoke from smoldering fires. Except for one model, photoelectric detectors must be connected to an electrical outlet, which of course makes them useless during a power failure.

While there is some disagreement as to which type is better—some believe both should be in the home—the number of ionization smoke detectors to choose from is growing more rapidly than the number of photoelectric types. Among them are the Home Sentry from General Electric, plug-in and wire-in units from Honeywell, and ionization models from Scoville Manufacturing Co.'s NuTone Div.

Other ionization-type units are the battery-powered Smokey from Nor-elco, the plug-in and wire-in Fire Alert series from Fenwal, battery and ac line-powered units from Pittway Corp.'s Smoke Alert Div., the battery-powered Pyr-A-Larm from Pyrotronics, and the SmokeGard, powered by 1.5-V AA batteries, from Statitrol.

Among the available photoelectric types are models from Rittenhouse that can be plugged or wired into household ac, the Smoke Sentinel from Pyroprotector and the Captain Kelly's from Gillette, one ac-operated and one dc-operated by a 12.6-V mercury battery. The light source of these Gillette units is a light-emitting diode that is claimed to have a life expectancy of more than 30 years.

No matter what type, smoke detectors have some sort of check-test to assure that the detector is functioning. Some models provide a test button or lever, while others can be checked by blowing smoke—say, from a cigarette or snuffed candle—into them. A few detectors provide a pulsing pilot light that indicates that the batteries are installed and functioning.

All battery-operated models provide a warning when batteries run low—an intermittent chirp that can continue for as long as 30 days. The chirp, a pulsed version of the alarm, is usually initiated when battery resistance falls below a predetermined threshold level or when the voltage level drops below a predetermined value. Right now, batteries last about one year.

First one chip, then two

Meanwhile, looming just over the smoke-detector horizon is an invasion of integrated circuits. As a matter of fact, General Instrument, Siliconix, Micro Components, Motorola Semi-

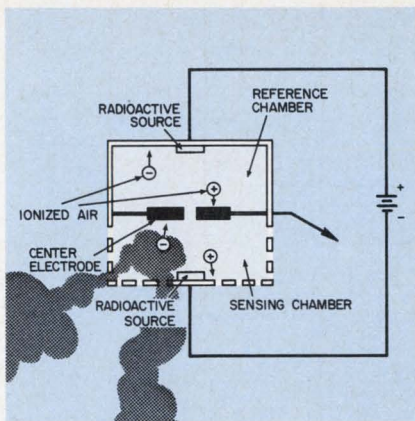

In an ionization detector, radiation from the radioactive source ionizes air particles that are then attracted to the collector electrode. The resulting minute current flow is reduced when smoke enters the chamber, and triggers the alarm circuitry.

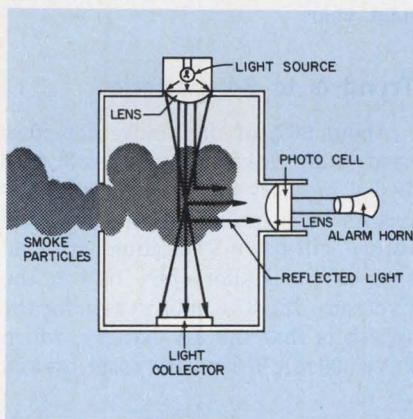

In this photoelectric detector, light from a source is directed through a lens and across a darkened chamber. Smoke particles entering the chamber, deflect some of the light onto the photocell, and trigger the alarm.

conductor, National Semiconductor, RCA and Supertex already offer or are close to announcing single-chip smoke-detector ICs.

But these single-chips are just the beginning. As one smoke alarm manufacturer puts it, "These ICs really don't offer any added sensitivity and improved performance, but they do offer increased reliability, and, of course, lower manufacturing costs." The greatest effect of LSI technology on smoke alarms, however, will be the advanced types that will emerge, such as the dual-detector alarm (photocell and ionization types combined) and specialized features, such as multi-alarm signaling.

The functional diagram of a two-chip battery-operated ionization-type smoke detector is shown on the next

page. A high-impedance comparator, sensing any current reduction through the ionization chamber resulting from smoke, triggers the gate, which activates the sounder continuously until the smoke dissipates. The comparator, an RCA BiMOS op amp, operates in the pulsed mode with the output from a recycling timer. Battery voltage is monitored by a section, RCA's CA3097 array, that contains another comparator, a reference-voltage source, and the recycling timer. When battery voltage decreases to a prescribed level, a pulsed on and off signal is initiated through the recycling timer. Differing sounds enable the user to distinguish between smoke and low-battery conditions.

Powered by a 9-V alkaline battery like the Mallory MN-1504, the circuit operates at 5- μ A battery drain and consumes 45 μ W.

One smoke-detector IC whose components have been recognized by Underwriters Laboratories is the Siliconix SM 110, a 50 \times 58 square-mil monolithic bipolar-PMOS IC designed for 9-V or line-powered systems. With its high-impedance MOSFET input, it can work with both ion-chamber and photoelectric smoke detectors.

A complete ionization smoke-detector circuit on a chip is available from General Instrument. The MEM 4962 features an input MOSFET, an on-board horn driver, a low-battery indicator and an on-chip output driver. It works off a 9-V battery.

An even more capable General Instrument circuit is in the final stages of development. The MEM 4963 is designed to accept ionization or photocell inputs, or both at the same time. Pulse-mode battery testing and an interconnect capability are also featured. If several smoke detectors are connected to a bus and one is triggered, the 4963 can identify which one, then trigger the others.

GI plans to introduce next year the MEM 4964 and MEM 4965, which are similar to the company's other two smoke detector chips, except that their outputs are designed to work with the newer electronic-sounding devices.

Over at Motorola Semiconductor, two low-power complementary MOS ICs, the MC 14461P and MC 14462P, are in production. Both designed for ionization detectors, they are equivalent except that the MC 14461P comes with an on-board FET (the input has standard CMOS protection). Both operate at 9 V but are readily adaptable to 12.6-V smoke detector operation.

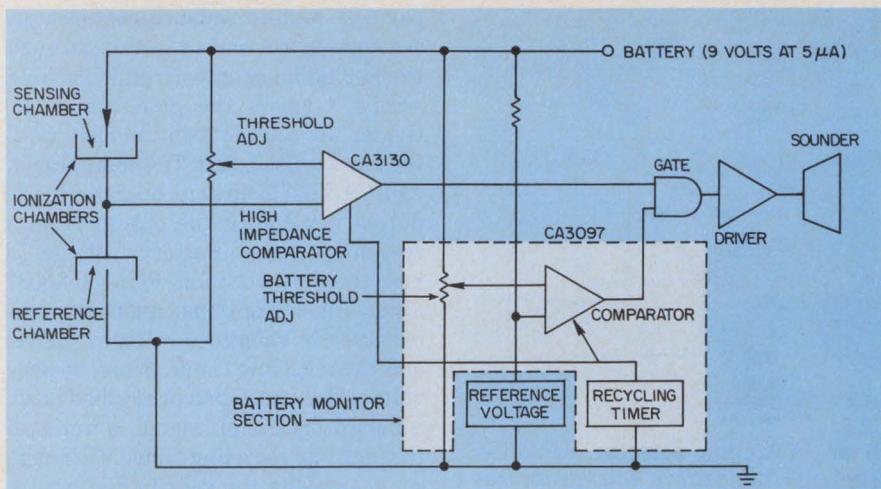

This battery-operated ionization-type smoke detector consumes 45 μ W.

Internal latching makes the Motorola circuits insensitive to transients due to battery testing, horn blowing and alarm beeping—in other words, when the battery is loaded down.

Supertex of Sunnyvale, CA, is offering its SD1A, a low-power CMOS circuit designed for ionization-type detectors. Next spring, the company plans to introduce a CMOS chip for photocell detectors, the SD2.

Meanwhile, the LM 1801, a bipolar IC for ionization units, is in production at National Semiconductor. The com-

pany plans to introduce CMOS versions next year.

Trend is to 9-V batteries

About 90% of the smoke detectors used today are powered by a 3L4116 12.6-V mercury battery. But most detectors being produced now or in the future will use 9-V alkaline batteries, such as the Mallory MN 1604 or the Eveready 522. The main reason for the switch is that the 9-V battery, which has a 500 mA/h capacity, costs less and

is more readily available than the 1000-mA/h 12.6-V unit.

Opinion is divided, however, over what type of 9-V battery to use in smoke detectors. One camp leans to the commonly available types that are used in calculators and transistor radios, and sold in many stores. Another camp leans to the non-standard type, such as Mallory's flatpack alkaline unit currently being tested for UL approval for use in smoke detectors.

One advantage of such a special battery is that it cannot be inserted incorrectly. And it can't be replaced by an inferior standard battery. But unfortunately 9-V alkaline batteries are interchangeable with carbon-zinc types, which aren't UL-approved for smoke detector use. A customer may unwittingly purchase a carbon zinc type and his smoke detector may work improperly or not at all.

Most major battery manufacturers are also looking to much longer-life batteries for next-generation smoke detectors. One type under consideration is the lithium battery that presumably can be packaged into a throw-away smoke detector stuck up on a ceiling or whatever, and replaced, say, every 10 years.

A future trend is to replace the inexpensive electromechanical horns used as the sounding alarm in most detectors with electronic horns. (Underwriters Laboratories Standard UL 217 requires a sound output of 85 dBa at 10 feet.)

Most manufacturers are considering electronic horns, such as the piezoelectric transducer produced by Gulton Industries in Fullerton, CA. Not only does this type of horn have no moving parts, it requires only 20 mA to start and run—electromechanical types require 200 to 300 mA to start and 150 mA to run. One objection to the piezoelectric type is that it puts out a fairly high frequency, which may be hard for elderly persons to hear. Other electronic horns being considered have a built-in oscillator that varies the sound output over a frequency range.

Because of the importance of smoke alarms a lot of agencies, including Underwriters Laboratories and the National Bureau of Standards, are stepping in to set performance and reliability standards. The most comprehensive standard to date is "Single and Multiple Station Smoke Detectors," UL 217, available from Underwriters Laboratories Inc., 333 Pfingsten Road, Northbrook, IL 60062. ■

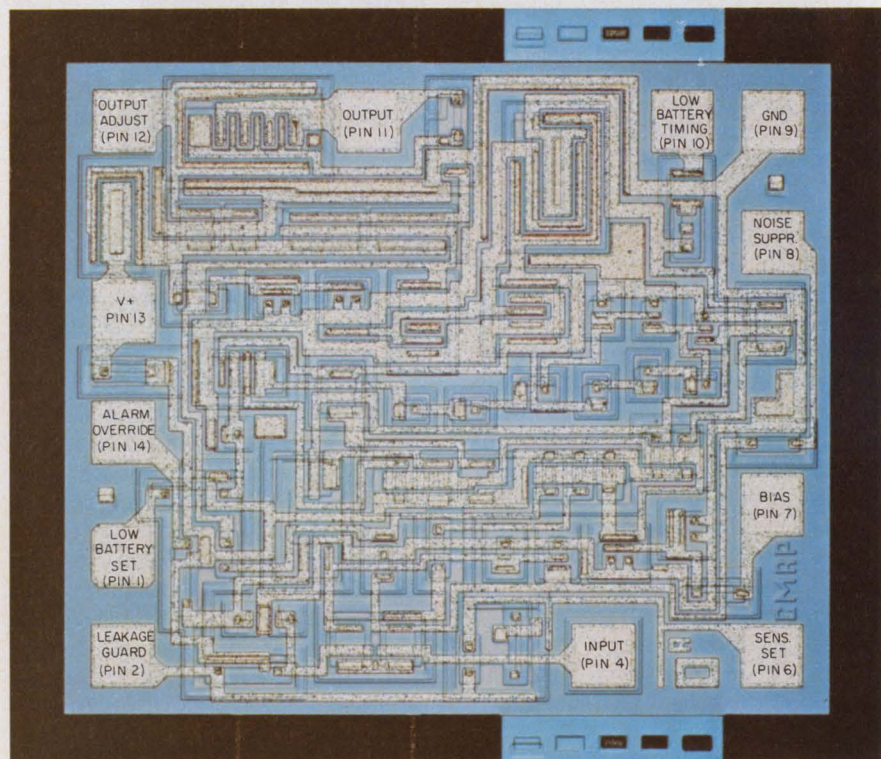

A monolithic bipolar-PMOS chip from Siliconix, the SM110, can be used with a 9-V battery or line-powered smoke detectors.

THE BEST VOLTMETER YOU CAN BUY ISN'T A VOLTMETER.

The Fluke 8500A is an advanced measurement system, but most people buy it because it's the finest high speed 10 ppm voltmeter built.

So why make a distinction?

Simply because all other digital voltmeters have been nothing more than that, voltmeters. As quickly as technology advanced or needs changed, the unit became obsolete. Not so with the 8500A.

The 8500A employs a unique analog/digital bus in conjunction with an internal micro-processor to control measurement and interface modules. The function modules, such as resistance, current, IEEE-488 interface, etc., can be plugged into any available slot in the bus by the user.

The controller then senses the module and measures the new parameter or performs the new function.

So as technology or your needs change, so does the 8500A. You won't be stuck with a dead-ended instrument.

All for a basic system price of \$2,695*.

Obviously, there's a lot more to tell. For data out today, dial our toll-free hotline, 800-426-0361.

**U.S. price only.*

Interface modules plug in.

A current measurement module plugs in.

An isolator module plugs in.

A calibration memory module plugs in.

An ac measurement module plugs in.

A dc measurement module plugs in.



The 8500A can be whatever you want it to be, so it's never obsolete.

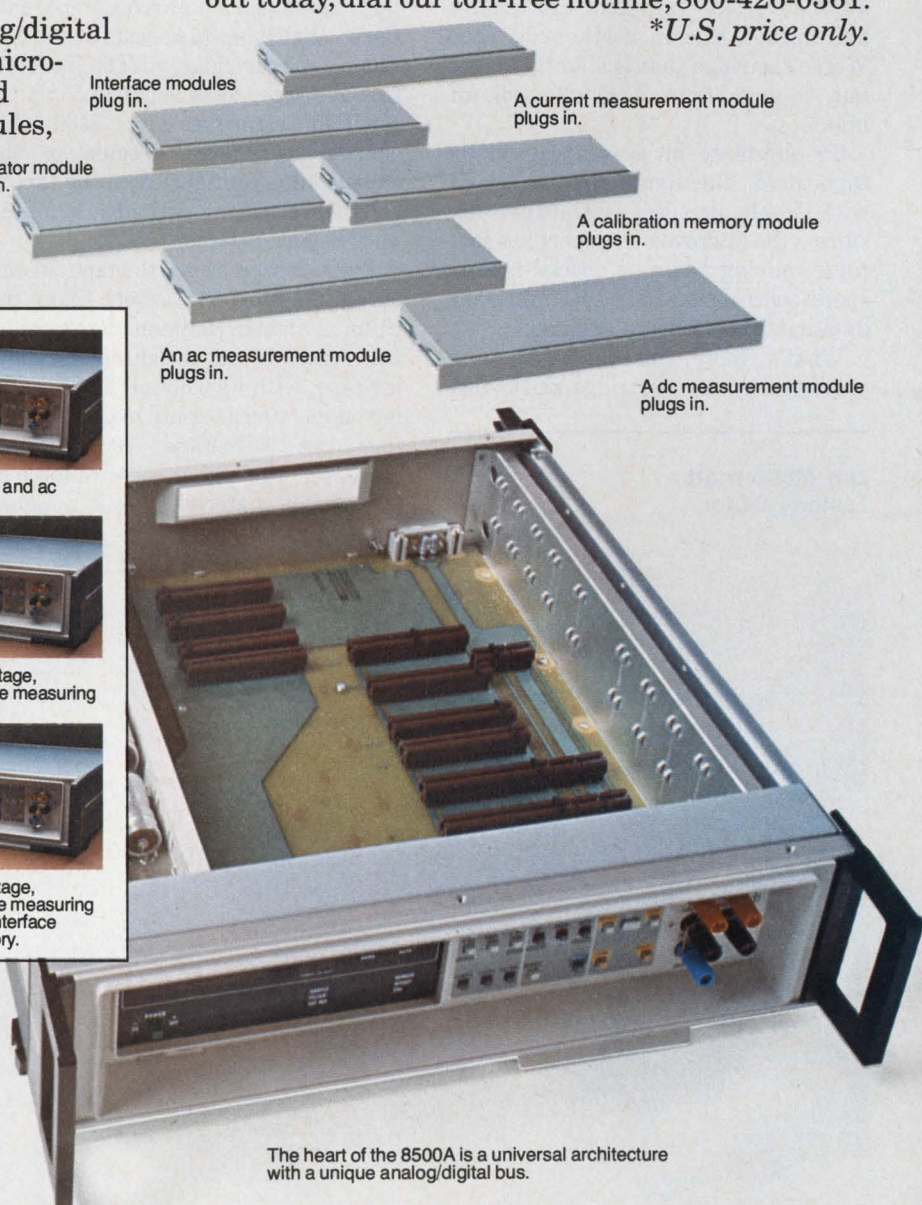

The heart of the 8500A is a universal architecture with a unique analog/digital bus.

Tape transport is small, but its bit-storage capacity is big

A special magnetic-tape transport system answers the need for a small, low-cost means of loading and storing data in microprocessor-controlled consumer products, such as program-mable games. Only 1 in. high \times 1.5 in. wide \times 3 in. long, the transport uses an endless-loop tape that can store a half-million bits in a Microvox Tape Wafer cartridge that is slightly longer but thinner than a small book of matches.

To eliminate bit errors caused by tape-speed fluctuations encountered with simple, inexpensive transport designs—the Microvox transport has just three moving parts—a special motor-speed-control chip and a speed-tolerant data-encoding scheme are used.

What's more, mechanical keying provisions in the cartridge and trans-

port inhibit the illegal duplication of program tapes.

Cartridge is error-free

In high-volume quantities, the transport mechanism of the Microvox system, developed by Micro Components Corp., Waltham, MA, costs about \$15. The plastic cartridge, with 50 ft of 0.07-in.-wide tape, costs about \$1.55 and is certified error-free for 2400 flux changes per inch. Because of the endless-tape configuration, the tape is certified after the cartridge is loaded and welded together.

For several reasons, the tape is 1-mil chromium-dioxide rather than the thinner, more common ferric-oxide. One reason is that the chromium-dioxide tape, with its 0.83-mil Mylar backing supporting a 0.2-mil magnetic coating, can withstand 2000 passes. Moreover, the higher coercive force of the dioxide material gives it a higher

packing density and a higher immunity to demagnetization when being used and handled. In addition, its higher remanent magnetism produces a higher output signal. And a special low-friction coating on the back surface minimizes the friction between tapes that rub in endless-loop operation.

The Microvox cartridge holds a maximum 50 ft of tape. With an 800-bpi recording format, which is compatible with the speed-tolerant ratio recording used with the system, 480,000 bits can be impressed on single-track tape, and with high reliability. Even higher bit density can be achieved with Manchester, or biphasic, recording.

Because the bit capacity of the Wafer is larger than that of game programs, several programs can be stored on one cartridge. And in an interactive game program, several program branches can be recorded so that the next portion of the program to be loaded depends

Jim McDermott
Eastern Editor

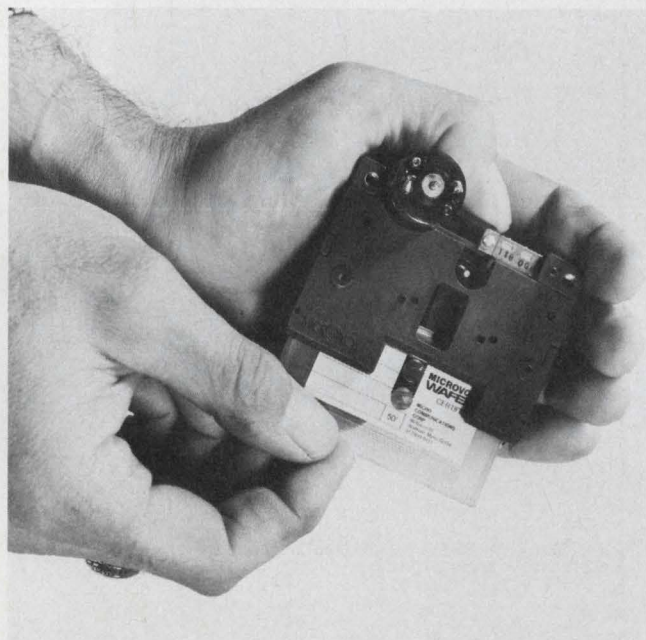

A half-million bits of program data can be stored in the Microvox cartridge (left) and loaded by the tape transport

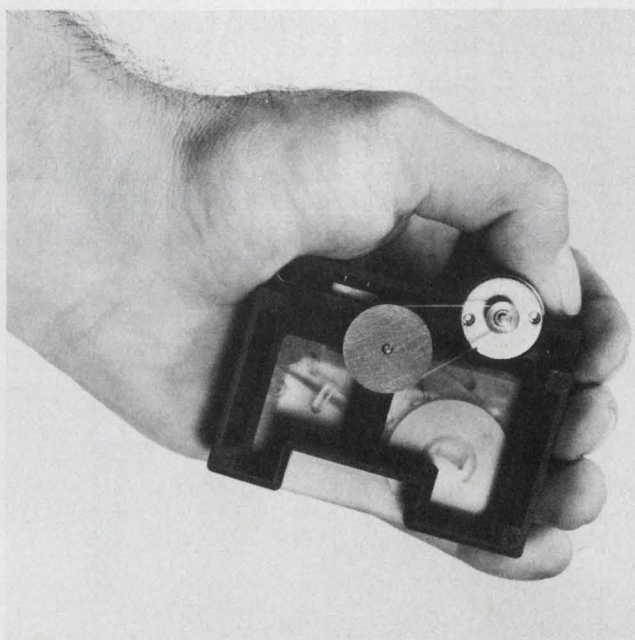

(also at left) into video games and other microprocessor-controlled consumer products. Bottom is shown at right.

Fluke Sponsors New Series: "One Great Family"

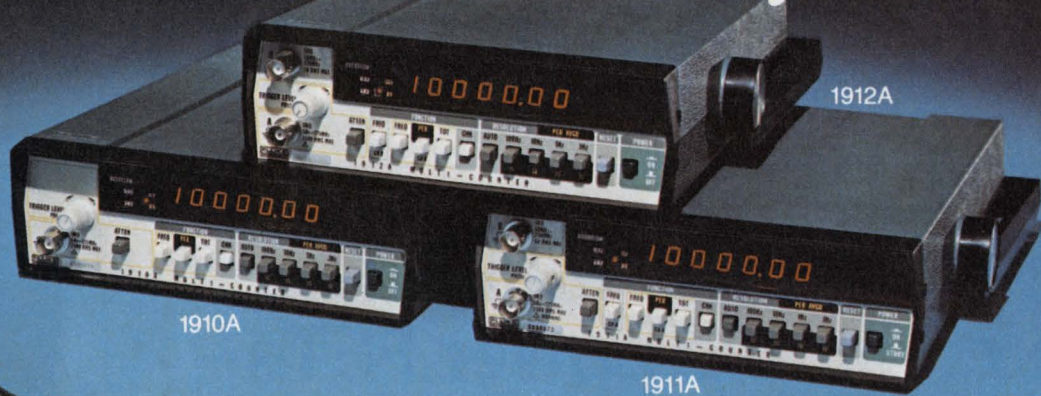

Tired of Reruns?

Fluke counters with a new series in the 5 Hz-520 MHz/time slot.

If you're paying over \$345 for a counter and getting frequency only, tune in on our new 1900-series of priced-right multimeters.

Five different models offer both time *and* frequency, with award-worthy performance and features; the ratings are terrific!

New Time and Frequency.

Last year's hit, the model 1900A, set the stage for this new series of multimeters by offering frequency, period, period average and totalize *standard* in one great counter.

Now all models in the series offer comparable features and value, with autoranging and autoreset as well.

Most models feature a trigger level control and battery option for reliable field use or line-cord-free bench operation. All typically have a 15 mV sensitivity (guaranteed on most!), plus a 0.5 ppm/month time base for long-term stability.

The Price is Right.

From this shared base of solid performance features,

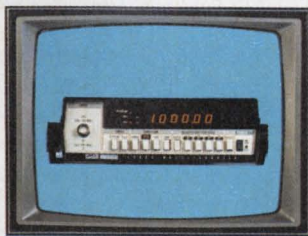

1900A

we've built a series of counters with one model just right for your needs.

The new **1912A**, with a 520 MHz range and an extensive package of standard features, offers more capability for \$620* than you're likely to find anywhere. For 250 MHz measurement perfection, the **1911A** multimeter is a best-buy for only \$495.*



1925A

For lower frequency (125 MHz) applications, specify the **1910A** for \$395.* The **1900A**, years ahead in value, has been reduced to \$345* for even more

cost-effective 80 MHz measurement.

For rugged environment applications in the 125 MHz area, you'll want the **1925A** with its RFI shielding and dust-resistant steel case. \$750.* (For only \$225* more, a special prescaler option extends the 1925A's range to 520 MHz.)

Tune In and Count.

Call (800) 426-0361, toll free, for the location of the closest office or for complete technical literature. Then stop in for the great family picture, and review the extensive option list for better TCXOs, data outputs, and more. John Fluke Mfg. Co., Inc., P.O. Box 43210, Mountlake Terrace, WA 98043.

*U.S. price only.

Command Performance: Demand Fluke Multimeters.



CIRCLE NUMBER 19

on previous game results.

One factor that makes the system useful for mass-consumer distribution is that the cartridge is also thin enough, light enough and tough enough to be mailed for 13¢ and passed through post office canceling machinery without being harmed.

The transport has a die-cast aluminum frame (see photo). Its tape-drive capstan is belt-driven by the speed-controlled motor. A custom motor-control chip monitors the back EMF of the motor and compares this to a zener-voltage reference on the chip. Variations of the back EMF, which is linearly proportional to speed, provide an error signal that maintains speed within $\pm 0.6\%$.

With this motor-control system, the

transport can be operated from a 4 to 18-V-dc source.

The standard Microvox tape head has a single track for data playback. But both single and double-track record-playback heads are also available.

Data errors eliminated

Should the motor speed change unexpectedly, data integrity is maintained with the system's ratio recording, a self-clocking, speed-insensitive data-encoding technique that provides timing information, along with data, in the single-tape channel. A positive-going transition on each bit cell's leading edge corresponds to the clock. The bit is identified as a ZERO if the negative-

going edge occurs in the first half of the bit cell, usually at the one-third point. It is identified as a ONE if the negative edge is in the second half of the bit period, usually the two-thirds point.

In theory, bit-to-bit speed changes as high as 50% can be compensated for, says Clark E. Johnson, Micro Communications president and one of the transport-system designers. But for better noise immunity, only 30% speed changes are tolerated.

Initially, the Microvox system costs more than a ROM, because of its drive and auxiliary electronics—plus an auxiliary RAM into which the tape data are loaded. But the ultimate cost per bit is much lower, simply because the Microvox tapes can be mass-produced. ■■

Look out, power transistors: Here come the power FETs

Bipolar power transistors and Darlington transistors are in for some stiff competition from a new kid on the block, the VMOS power FET. Introduced two years ago by Siliconix, power FETs are expected to take over a large portion of the power devices market in 1978.

Anticipating this power play, major semiconductor manufacturers are investing considerable time and money to bring out power FETs in short order. Siliconix is following its initial act with several more products, and Fairchild is getting ready to announce an entire line of power FETs next month. RCA, Texas Instruments and Motorola are not offering anything yet, but should have something out some time next year.

No second breakdown

The biggest advantage of power FETs and the reason why so many manufacturers are predicting that it will eat into the bipolar power-transistor market in a big way is that no safe operating area (SOA) restricts their power-dissipation curve. Fabricated with VMOS technology, power FETs don't suffer from the second-break-

down characteristic common in bipolar devices.

Without a second breakdown, system design can be cheaper and less complex. Cost comes down because it is not necessary to use more expensive high breakdown-voltage devices to accommodate inductive spikes. And circuits are simplified because capacitors and free-wheeling diodes that are generally used with inductive loads are eliminated.

Another big advantage of power VMOS FETs is that they don't burn themselves out easily because their ON resistance has a positive temperature coefficient that automatically causes the resistance to increase with heat. Thus, the amount of current FETs will pass is limited.

FETs are faster

Switching speeds for power FETs are as much as 10 times faster than those for bipolar power transistors—power FETs aren't slowed down by minority carrier storage time.

Power FETs also have higher gain and input impedance, Gary Hess of Siliconix points out. VMOS power FETs typically exhibit a current gain of several million to several tens of millions and power gains in the hun-

dreds of millions. On the other hand, bipolar power devices have current gains ranging from tens to thousands and power gains ranging from thousands to tens of thousands.

The high input impedance of VMOS FETs results in two more advantages. For one thing, only very low input power signals—on the order of microwatts—are required to drive them. Bipolar rivals require input power signals on the order of hundreds of milliwatts to several watts. What's more, VMOS devices are directly compatible with CMOS circuits.

There are problems, too

While it is easy to interface the VMOS power FETs to CMOS logic circuits, doing the same with TTL may present a slight problem, says Hess. The FETs are designed to operate with voltages that are higher than the conventional 5-VTTL logic supply. So when TTL is used to drive a FET, it will operate, but not as efficiently.

For example, if a FET that is designed to handle a 1-A load is operated at 5 V, its current-handling capability will be reduced to only 600 mA—a 40% drop.

Another problem—soon to be minimized, according to Hess—is that

Jules H. Gilder
Associate Editor

VACTEC Photodetectors

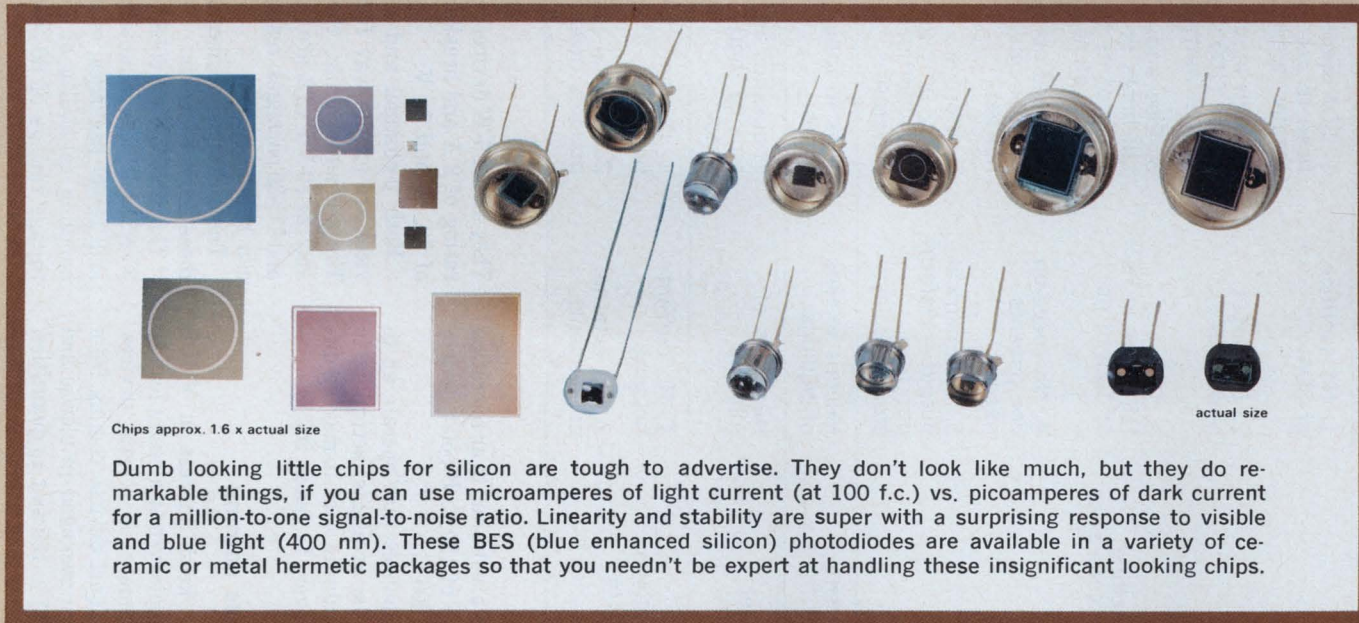

Chips approx. 1.6 x actual size

Dumb looking little chips for silicon are tough to advertise. They don't look like much, but they do remarkable things, if you can use microamperes of light current (at 100 f.c.) vs. picoamperes of dark current for a million-to-one signal-to-noise ratio. Linearity and stability are super with a surprising response to visible and blue light (400 nm). These BES (blue enhanced silicon) photodiodes are available in a variety of ceramic or metal hermetic packages so that you needn't be expert at handling these insignificant looking chips.

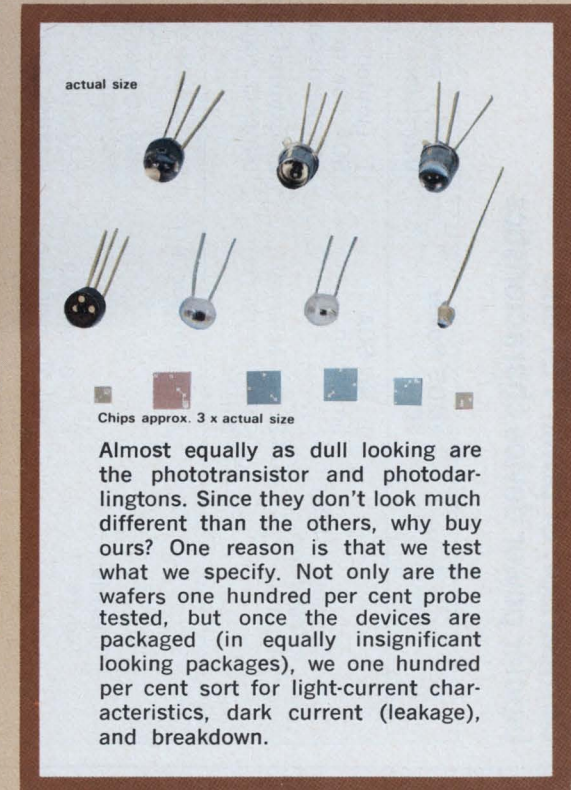

actual size

Chips approx. 3 x actual size

Almost equally as dull looking are the phototransistor and photodarlington. Since they don't look much different than the others, why buy ours? One reason is that we test what we specify. Not only are the wafers one hundred per cent probe tested, but once the devices are packaged (in equally insignificant looking packages), we one hundred per cent sort for light-current characteristics, dark current (leakage), and breakdown.

Even though our devices are as good as we say and reasonably priced, so what is different? Our dedication to this industry is remarkable for a small company. We have technology normally found at only the giants of the semi-conductor industry. At this one facility in Maryland Heights, Missouri, we not only make photodiodes and phototransistors but custom LSI light actuated CMOS IC's for the new Kodak cameras. Even more remarkably, we not only process these chips in entirety, we design the circuits. When you can do such processes as silicon gate CMOS, and epitaxy for bipolar, you learn a lot about silicon chemistry that necessarily spills over to the production of photodiodes and phototransistors. Coupling this with our photometric expertise gained through seventeen years of experience makes an unbeatable combination. We even assemble our own special purpose computers for testing both IC's, transistors, and diodes as well as making many of our own parts handlers to feed the parts into position for automatic testing with a calibrated light source. We don't just brag about "planar" processing, we do all types of silicon processing. This high level of silicon technology plus our exclusive dedication to photodetection must inevitably make our phototransistors and photodiodes a little better than the rest.

So that our CDS, selenium, silicon solar cell, and coupler departments won't feel left out, we make the best of those devices also. It's just that they have had their share of our advertising dollars in the past.

Talk to us but better yet, visit us and we think you'll not only be impressed but amazed. We'd like to work closely with your applications people, and making custom photodevices of any kind is no big deal for us at Vactec.

Write today for catalogs and more information: 2423 Northline Industrial Blvd., Maryland Heights, Mo. 63043 • (314) 872-8300

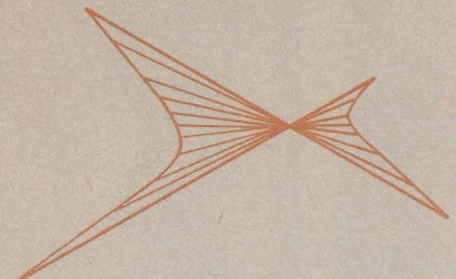

VACTEC, INC.

giga-trim capacitors for microcircuit designers

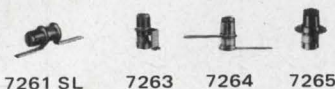
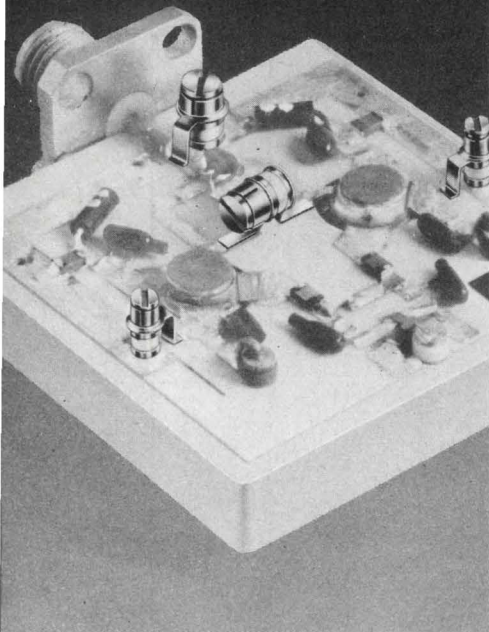

Giga-Trim[®] (gigahertz-trimmers) are tiny variable capacitors which provide a beautifully straight forward technique to fine tune RF hybrid circuits and MIC's into proper behavior. They replace time consuming cut-and-try adjustment techniques and trimming by interchange of fixed capacitors.

Applications include impedance matching of GHz transistor circuits, series or shunt "gap-trimming" of microstrips, external tweaking of cavities, and fine tuning of crystal oscillators.

Johanson

MANUFACTURING CORPORATION

BOONTON, NEW JERSEY 07005

201 / 334-2676

CIRCLE NUMBER 24

Comparison of power FET and bipolar power device characteristics

	VMOS Power FETs	Bipolar power transistors
Second voltage breakdown failure	<ol style="list-style-type: none"> 1. No SOA limitation. 2. No external components required. 	<ol style="list-style-type: none"> 1. Limited SOA due to voltage derating. 2. External components required.
Thermal failure	<ol style="list-style-type: none"> 1. No hot spots. 2. Inherent current sharing due to the positive tempco. 	<ol style="list-style-type: none"> 1. Subject to thermal runaway caused by hot spots. 2. Current-limiting components required.
Switching characteristics	<ol style="list-style-type: none"> 1. No sacrifice of SOA. 2. Low input power (μWs). 3. Rise and fall times in ns to 10's of ns. 4. No speed-up components needed. 5. Symmetrical output waveform due to no storage delay. 	<ol style="list-style-type: none"> 1. SOA sacrificed to get greater speed. 2. High input power (100's of mW to watts). 3. Rise and fall times in 100's of ns to 1000's of ns. 4. Speed-up components needed. 5. Storage delay time gives asymmetrical waveforms.
Current gain	Millions to tens of millions.	Tens to thousands.
Power gain	Hundreds of millions.	Thousands to tens of thousands.
Paralleling devices	<ol style="list-style-type: none"> 1. No current hogging. 2. No external components. 	<ol style="list-style-type: none"> 1. Current hogging. 2. External components needed.

power FETs are limited to an operating temperature of 150 C. Bipolar devices can attain 200 C.

Shortly, devices that operate up to 175 C will be available, according to Hess, who admits that it may be difficult, however, to reach 200 C.

New entries coming

Still, the keen interest in VMOS power technology has already lead to the development of several devices. Three n-channel devices coming from Siliconix are packaged in plastic and cost about \$1 in 100 and up quantities.

They are 12.5-W devices with a current rating of 2 A and breakdown voltages of 40, 60 and 80 V.

Both p-channel and n-channel devices are on the way from Fairchild. The p-channel units, the 60-V FVT1 and the 80-V FVT2, are housed in TO-3 and TO-39 packages, respectively. Both can handle 1 A.

The n-channel devices are similar to those from Siliconix.

The 2N6657, 2N6658, 2N6661 and FVN2 will be available in both TO-3 and TO-39 packages, with a current-handling capability of 1 to 2 A and voltage ratings of 60 to 80 V. ■■



Our family gives you a flat answer.

Our new flat cable connector family has both standard and stackable sockets, PCB connectors and headers, all designed for lowest total applied cost.

In socket connectors our BA Series gives you a low profile package with the option of either open or closed cover design for both end-cable and through-cable applications.

Our BD Series stackable socket line concept permits stacking two connectors on a wire-wrappable post.

For direct solder applications our BC Series handles PCB connector needs.

Featured with the product family is a simple universal termination system designed for minimum tooling cost.

For your header applications our low profile BB Series line is available for both vertical and right-angle mounting in solder or wire-wrappable designs.

Contact GTE Sylvania, Connector Products Operation, Box 29, Titusville, PA 16354. Phone: 814-589-7071.

Remember, good connections run in our family.

GTE SYLVANIA

CIRCLE NUMBER 21

The Cube widens the gap...

In Power-Ferrite EC cores for switching power supply chokes

Now available from Ferroxcube are standardized gapped EC cores in four sizes: 35, 41, 52 and 70 mm. The gap lengths have been optimized to prevent saturation of the core due to a high DC field while simultaneously providing maximum impedance to the AC ripple current.

For worst case DC bias, two gapped cores should be used. Under less stringent conditions, one gapped and one ungapped core in combination may be used. The chart below shows the DC ampere-turns which can be supported for both 2-gapped and gapped/ungapped combinations that will not decrease incremental permeability more than 10%.

EC Core	2 Gapped Cores	1 Gapped + 1 Ungapped Core
35 mm	325 AT	200 AT
41 mm	370 AT	220 AT
52 mm	540 AT	330 AT
70 mm	860 AT	570 AT

For complete specifications on gapped EC cores, bobbins and hardware, call on The Cube.

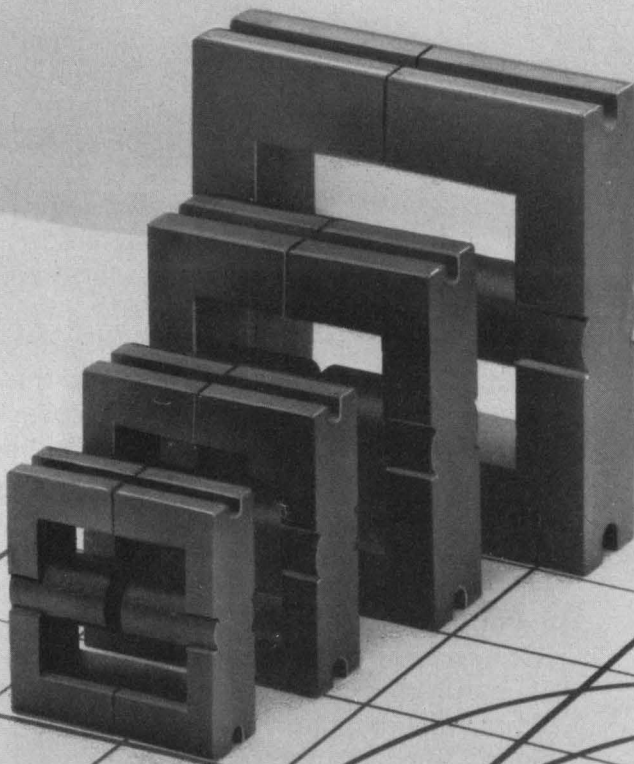

Call
on the
cube



FERROXCUBE Division of Amperex Electronic Corporation,
Saugerties, New York 12477 (914) 246-2811
A North American Phillips Company

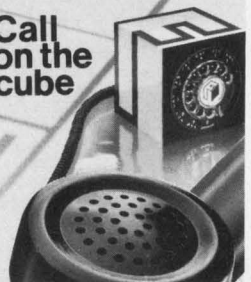

Elmwood makes Sense

Why overspecify? Choose the fast-response snap-acting Elmwood thermostat model that just fits your needs. Choose the levels of tolerance and differential that are right for your product, without wasted details or dollars.

For worldwide sales many Elmwood models meet CSA and European requirements (and DIN norms), as well as U.L. Ratings are to 15 amps, for exposures -65°F to 550°F (-54°C to 288°C), and each unit is factory pre-set, tested and tamperproof. Doesn't Elmwood make Sense? Ask for prototypes.

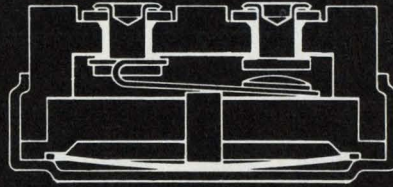

Elmwood Sensors, Inc. 1655 Elmwood Avenue, Cranston, R. I. 02907
PH 401/781-6500. Twx 710-381-6413.

European Div., Elmwood Sensors, Ltd.,
North Shields, Tyne and Wear, NE29 8SA
England Ph (089) 45-82821. Telex: 53284



Elmwood Sensors
Precision Controls

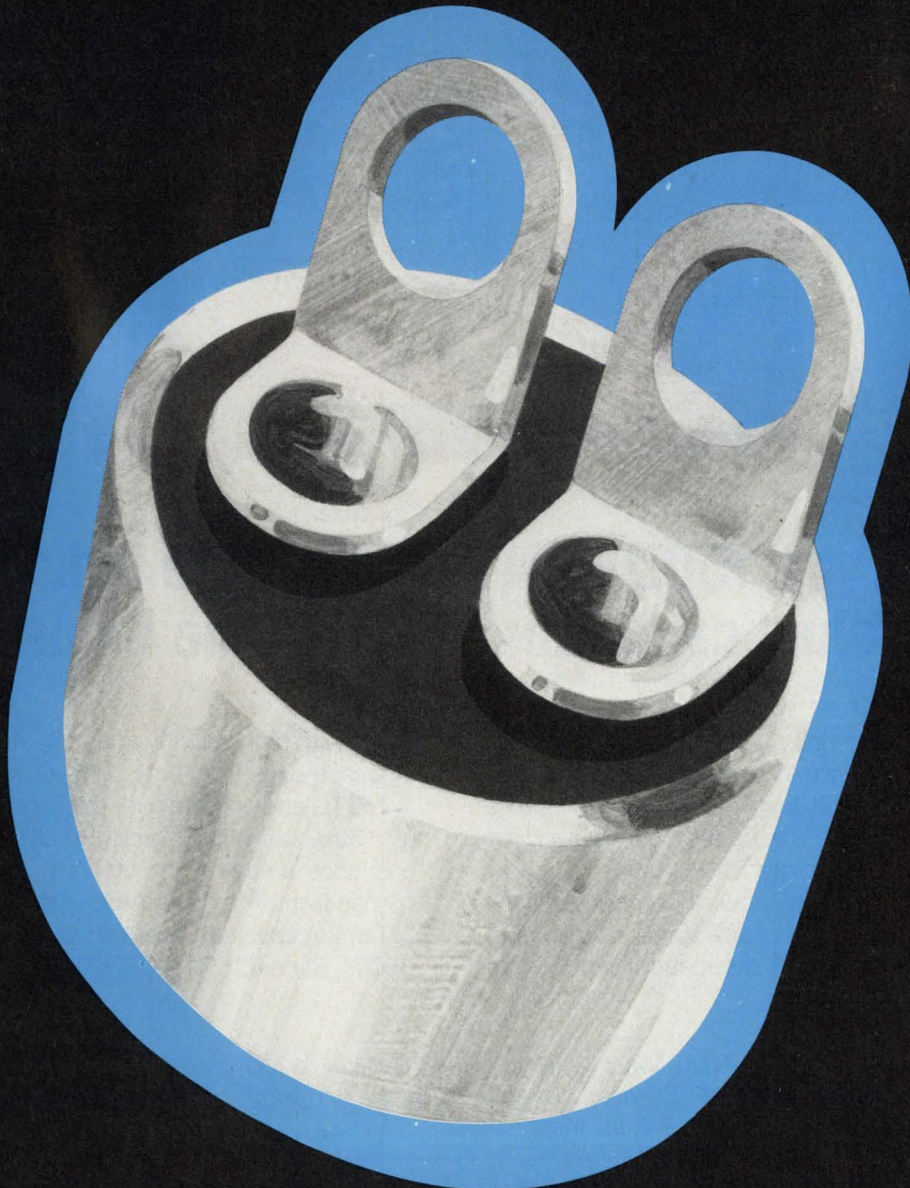

HALL OF FAME CANDIDATE



Sprague Type 150D TANTALEX[®]... the industry's first solid tantalum capacitor... is still the industry leader

If there were a Capacitor Hall of Fame, the Sprague Type 150D would be a shoo-in. The "old reliable" of solid tantalum capacitors is still tough to match . . . particularly with its extended capacitance ratings and outstanding performance characteristics.

As most circuit designers know, these hermetically-sealed capacitors offer high capacitance, small size, low leakage current, and low dissipation factor, com-

bined with high stability and long life. They're furnished in 4 case sizes from only .125" D. x .250" L. to .341" D. x .750" L. and operate over the broad temperature range of -80°C to +85°C or to +125°C with derating. Capacitance values from .0047 to 1000 μ F and voltage ratings from 6 to 125 WVDC are available as standard.

These capacitors are also available to meet MIL-C-39003, Styles CSR13, CSR23, CSR33, and CSR91.

For complete technical data, write for Engineering Bulletin 3520G to: Technical Literature Service, Sprague Electric Company, 347 Marshall Street, North Adams, Mass. 01247.

THE BROAD-LINE PRODUCER OF ELECTRONIC PARTS

CIRCLE NUMBER 25



4SE-7120

Washington report

Navy compromises on Seafarer ELF

Due to local opposition on Michigan's Upper Peninsula, the Navy is seeking a compromise solution to building an extremely low-frequency (ELF) communications system there for real-time control of submerged submarines.

The original plan called for an underground 2400-mile-long cable capable of one-way transmission at 76 Hz, but residents of the area protested on environmental grounds (see ED No. 18, Sept. 1, 1977, p. 19). Now the Navy proposes only a 130-mile buried antenna near the preferred site south of Marquette, MI, which would be linked electronically with an existing 28-mile-long buried antenna at a test site at Clam Lake, WI, 165 miles away.

The two sites should be linked by leased commercial telephone lines, Seafarer proponents recommend in a supplemental environmental-impact statement prepared by the Navy. The two sites are so close together (about 0.08 wavelength) that the propagation paths to any field are essentially the same.

If both systems are operated in phase, the greatest interference or signal reduction will occur when the path difference is maximum. But even when that happens, field strength will be reduced only 0.3 dB, according to the Navy.

Air Force seeks modular avionics test units

The Air Force's Aeronautical Systems Div. expects industry responses by the end of October to its request for proposals on a new family of modular equipment to check out avionics subsystems.

The Modular Automatic Test Equipment (MATE) program is aimed at developing a single family of test equipment able to handle such diverse equipment as radio, radar, inertial navigation and electronic countermeasures. Unlike present systems, MATE is to be usable with all types of Air Force aircraft and at any level of maintenance.

The modular system, which the Air Force claims will save the \$700-million now spent annually on operating individual test systems, is supposed to be operating by the mid-1980s. Two contractors will be chosen, perhaps by the end of this year, for parallel development before the Air Force decides on a single firm to produce hardware.

Firms eye custom LSI for new spacecraft computer

Hughes Aircraft, RCA and Harris Semiconductor are competing to produce the necessary custom LSI circuits for the prototype of a "fault tolerant" spacecraft computer. Designed by Raytheon, the computer boasts a 95% probability of operating for five years without losing any performance—even when subjected to heavy radiation.

All three companies are fabricating test chips for 25 custom circuits for which Raytheon has completed the logic designs and partitioning. The CMOS/SOS circuits will use the silicon-gate process to achieve radiation hardness. Specifications include a density of 750 gates per 250-mil² chip, gate delays of 6 to 8 ns

and packages with up to 84 pins.

Besides providing radiation hardness, the custom LSI circuits are needed to meet the spacecraft size requirement (up to 1 cubic foot and 50 pounds per computer) and power limitations (35 W). Raytheon expects to select two vendors next March.

The basic concept of the fault-tolerant, or "self-healing" computer is that even if some of its data lines become inoperable it has enough redundancy to keep on working. A "rippling" switch transfers the data stream from an inoperable line to an operable one in case of a malfunction.

The Raytheon computer will be used in Air Force surveillance satellites to be launched around 1983 to serve as an early warning of enemy aircraft and missiles attacking the United States. The computer was developed under contract to the Air Force Space and Missile Systems Organization, which has been bothered by the high failure rates of its spacecraft due to computer malfunctions.

A-10 missile-warning system is up for bids

The Air Force is looking for an electronic solution to the problem of protecting its low-flying, subsonic A-10 attack aircraft from enemy missiles. An industry competition is under way.

The A-10 is just going operational and will soon be deployed to Europe, but there have been fears that enemy heat-seeking missiles can home in on the infrared spectral signature of the A-10's huge twin engines. The Air Force Avionics Laboratory proposes that a dual-mode sensor (the Air Force won't say which modes) be installed on the aircraft to warn the pilot of an impending missile attack in time to take evasive action.

The program is in exploratory development at this point, but the Air Force hopes to award an advanced development contract in October or November. Bidding as teams are ITT and Motorola, Sanders Associates and Texas Instruments, and AIL and Aerojet-General. Honeywell and Cincinnati Electronics are bidding individually. If a system is approved for the A-10, the Army may consider it for its helicopters, which are also threatened by heat-seeking missiles.

Capital Capsules: Boeing and Vought are the finalists in the Army competition to develop the General Support Rocket System (GSRs), **a non-nuclear tactical rocket system to be used against enemy airfields.** The Army's Missile R&D Command had solicited 31 firms for prototype development, but only those two submitted bids. . . .Martin Marietta's Orlando (FL) Div. has been selected by the Army to develop a **laser seeker for the Hellfire helicopter-launched anti-tank missile.** The seeker is expected to be developed in three years. . . .**The General Accounting Office has criticized NASA for cost overruns and technical problems encountered in the Seasat A ocean-surveillance satellite program. GAO cited subpar performance of the synthetic-aperture radar antenna and deficiencies in the tape recorder.** In addition, costs have risen from the original estimate of \$58.2-million to nearly \$90-million. NASA has launched a redesign effort on the antenna to achieve the planned launch date of May, 1978. . . .Westinghouse is upgrading some 1000 airborne computers in the F-4E and F-4F fighters of the U.S. and West German air forces. **The present analog unit used in the aircraft's radar will be replaced by a digital one to control the Sidewinder air-to-air missile.** The new computer, designated the LRU-1, is an outgrowth of Westinghouse's Millicomputer family used in other aircraft such as the F-16. . . .**The defensive electronic countermeasures system for the canceled B-1 bomber is being considered for use not only on B-52 bombers carrying cruise missiles, but also on a new version of the FB-111 bomber that is slated to fill the B-1 gap.** But the ALQ-161, made by the AIL, Div. of Cutler Hammer, will face competition from the F-111's ECM system, the ALQ-137 from Sanders' Associates.

Only one 100 MHz portable STORES a 100 MHz single-shot waveform

Almost storing isn't enough. If you want to capture and retain glitches in a data system, pulsed rf sinewaves in a radar system, or any other non-repetitive phenomena at 100 MHz, you need a scope that stores pulses at very fast speeds. That's a tough job for all portable storage scopes except the TEKTRONIX 466.

With 3000 div/ μ s (1350 cm/ μ s) stored writing rate, the 466 is the only 100 MHz portable that stores pulses at its full bandwidth and deflection. And this makes it a valuable test instrument to carry in the field.

The 466 is not only fast, it's versatile. To study fast-rise, high-speed or single-shot waveforms, use the fast-mesh transfer mode. Or if you need to study sharp, non-flickering displays of slow-moving or low-rep-rate signals, use variable persistence storage.

In either mode, a SAVE feature will retain the signal for extended periods of time.

To add even more speed and accuracy to storage measurements made with the 466, the DM44 with a built-in digital multimeter is now available as a factory-installed option. The DM44 also adds differential time measurement capabilities to the 466.

Take the lab-type performance of the 466 into the field for on-site testing. It weighs less than 30 pounds. And when line power isn't available or when you want to isolate the 466 from

noisy or intermittent power sources, use the snap-on 1106 Dc Battery Pack. (Option 07 required.)

For more information or a demonstration of the 466, contact a Tektronix Field Engineer near you. Or write Tektronix, Inc., P.O. Box 500, Beaverton, OR 97007. In Europe write Tektronix Limited, P.O. Box 36, St. Peter Port, Guernsey, Channel Islands.

Tektronix[®]
COMMITTED TO EXCELLENCE

FOR TECHNICAL DATA, CIRCLE 26
FOR DEMONSTRATION, CIRCLE 27

A 100 MHz single-shot waveform before there was a portable that could store at its full 100 MHz bandwidth.

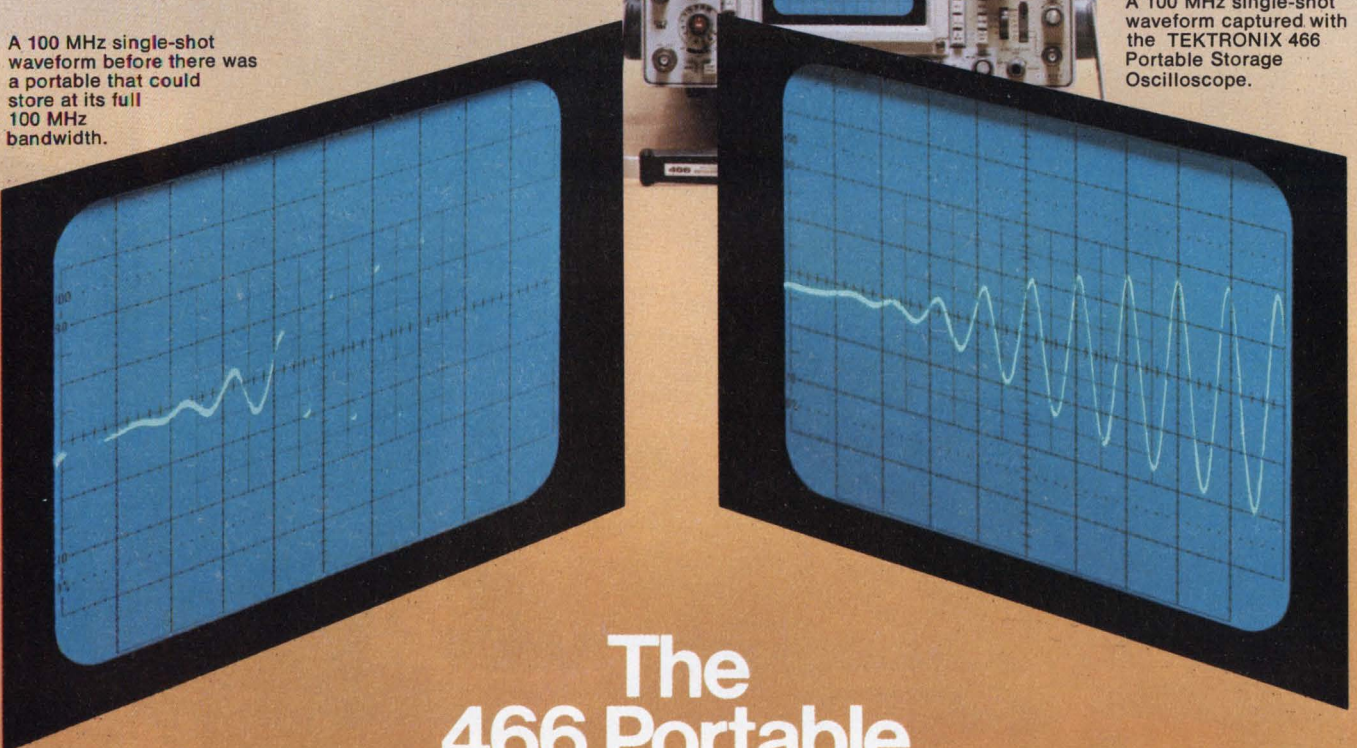

A 100 MHz single-shot waveform captured with the TEKTRONIX 466 Portable Storage Oscilloscope.

The
466 Portable
from Tektronix

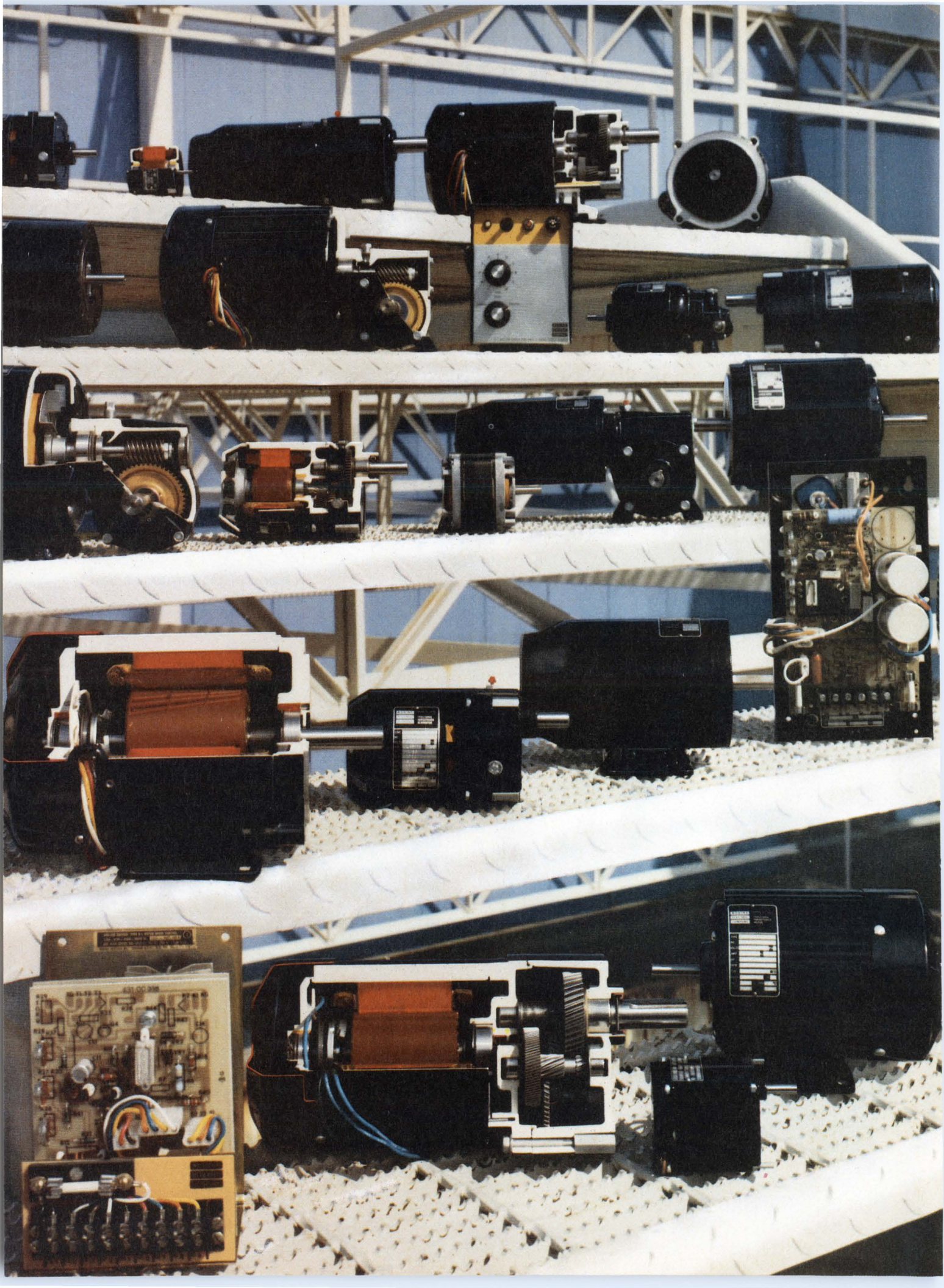

BODINE

delivers

multi-dimensional
drive capabilities

hardware/software/service

Quality Bodine motors are driving the leading products worldwide. Doing it quietly. Efficiently. And economically. Because leading manufacturers know Bodine hardware is built to last—and perform as specified.

But there's another side to Bodine's fhp drive capabilities—the software and service side. Bodine people are constantly creating new power and control capabilities. Helping OEMs find new solutions to highly specialized application requirements. Engineering and manufacturing greater value into existing hardware. Delivering more motor for your money than you might believe possible. Backing our motors—and you—with a total commitment to service.

Talk to Bodine about your fractional horsepower needs. With a comprehensive selection of standard fhp motors, gearmotors and speed controls—plus the ability to make modifications and provide completely new designs—we have the drive you're looking for. And then some. Since 1905. Bodine Electric Company, 2500 W. Bradley Place, Chicago, Illinois 60618. Phone: 312/478-3515. Telex: 25-3646.

Over 4000 catalog specifications.
More than 425 items stocked by distributors.
Ratings from 1/2000 through 1/2 hp.
Torques from 0.3 Oz.-in. through 350 Lb.-in.
Speeds from 0.6 through 10,000 Rpm.
68 distributors in the U.S. and Canada.

For office machines / machine tools / industrial equipment / processing apparatus / electronic equipment / electrical control devices / medical apparatus / data processing equipment / recording instruments / graphic arts equipment / scientific apparatus / and many other uses.

BODINE

ELECTRIC

COMPANY

BODINE MOTORS
GEARMOTORS
SPEED CONTROLS

CIRCLE NUMBER 28

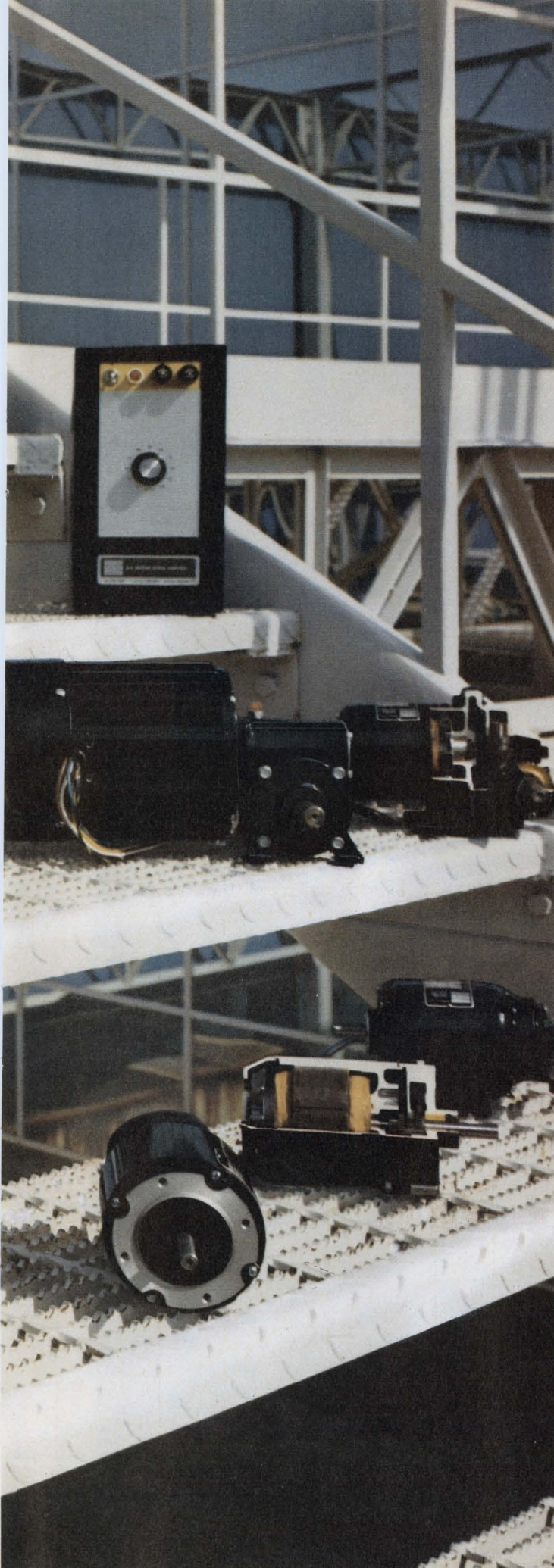



U.L. and C.S.A. approved

MALCO'S THRIFT-MATETM

...cuts your price
not your performance

Thrift-Mate is a high-performance, hard-shell plug and receptacle, perfect for low-cost, rapid assembly applications. You can get Thrift-Mate immediately for cable-to-cable, free hanging or panel mount applications. Also in strip form for automatic or semi-automatic crimping of wires to terminals. Thrift-Mate is intermateable/interchangeable with hard shell connectors available from other manufacturers.

Let Malco help you save money without sacrificing performance. Write Malco, 12 Progress Drive, Montgomeryville, Pennsylvania 18936.

Phone: (215) 699-5373.

Adjustable for free hanging and panel mount applications.

Available in 1, 2, 3, 4, 6, 9, 12 or 15 contact layouts. Other sizes on request.

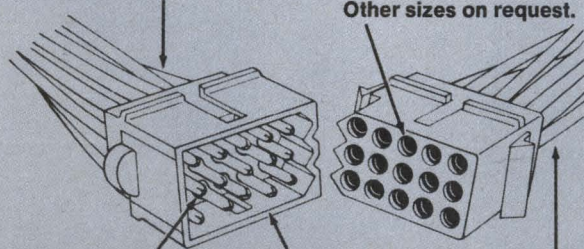

.093" diameter contacts of tin plated brass.

16 to 26 AWG

Contacts can be inserted and removed from insulators easily for changing, repair or replacement.



MALCO
A Microdot Company

A software development breakthrough.



FORTTRAN compiler and relocatable macro assembler in a new custom software system for micros.

Now it's easier than ever to create smooth running custom software for PCS SuperPac 8080 A-*based microcomputers. And it takes less time, too. With SPDS. The SuperPac development system.

SPDS has resident software you'd expect to find only in minis. Like a FORTRAN compiler option for fast, easy programming in a language your programmers already know (look for BASIC soon). A cross-reference generator that lists constants, labels and addresses and really saves time when you're moving segments around. A relocatable assembler with full macro capability. And an up-down loader for directly loading software into a target system up to 1,000 feet away and calling it back to the development system

whenever you need it.

Choose the hardware tools you need. A desk console and dual floppy are standard. From there it's up to you. EPROM programmer, CRT terminal, choice of two line printers and paper tape reader are optional.

SPDS for SuperPac microcomputers. It's a software development breakthrough. From Process Computer Systems, of course. The full service microcomputer manufacturer.

* And, soon, for our new Z-80 based micros.

Tell me more. SPDS SuperPac Please have salesman call.

Attach your business card here.

pcs

Success is PCS.

Process Computer Systems, Inc.
750 North Maple Road, Saline, Michigan 48176
313-429-4971 TWX 810-223-8153

Meet the first Serial Data Generator with 2048-bit memory and broad pattern generation flexibility

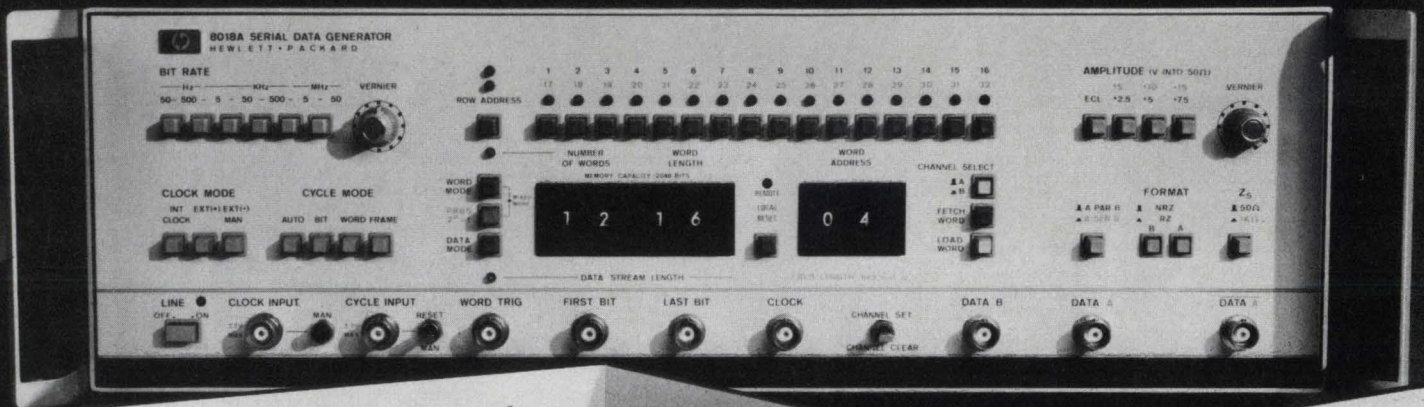

word 1 -PRBS- word 2

word 3 -PRBS- word 4

...word N-1 -PRBS- word N

In MIXED MODE, HP's 8018A alternately generates PRBS and word information, simulating preamble-data message-postamble patterns.

Instrument is shown with optional handles.

HP's new 8018A, for faster, easier serial system testing.

This new 50 Hz to 50 MHz Serial Data Generator greatly simplifies simulation of complex serial data such as disc and telecommunications patterns. You can easily program the 8018A with up to 2048 bits to design and troubleshoot serial interfaces and bus systems. The number of words, word length and PRBS length are conveniently set with thumbwheel switches letting you program the 8018A to generate a frame of words with selectable word length; a data stream with bit-by-bit variable length; a WORD-PRBS-WORD sequence; or a PRBS only. And you can select from AUTO, BIT, WORD and FRAME cycle modes.

Pushbutton selection of amplitude up to 15V (including fixed ECL) and bit rate also speeds setups. And data can either be programmed manually, or, with the HP-IB** option (\$425*), under calculator or computer control or with HP's 15263 Card Reader (\$600*).

A look at the front panel shows that you can choose between a single 2048-bit channel or dual 1024-bit channels that are clocked simultaneously. You can also select either NRZ or RZ formats; internal or external clocking. You have outputs for word trigger, first and last bit, and clock.

Priced at \$3475*, the 8018A gives you simulated serial data that used to require a computer. But it has the flexibility and high quality output needed for a variety of lab or production serial data-testing needs. Ask your local HP field engineer for all the details.

*Domestic U.S.A. price only.

**HP's implementation of IEEE Standard 488-1975.

HEWLETT  PACKARD

1507 Page Mill Road, Palo Alto, California 94304

For assistance call: Washington (301) 948-6370, Chicago (312) 255-9800, Atlanta (404) 955-1500, Los Angeles (213) 877-1282

CIRCLE NUMBER 31

087/11

The double standard

To know Charlie was to love him. Unless you worked for him. But if you were one of Charlie's customers, or just a social acquaintance, you would never see a trait you could describe as less than admirable. He was witty, charming, and solicitous of mankind's welfare and yours.

But if you worked for him, he was a sadistic terror. His sole concern was to satisfy his own ego. If that made your job more difficult and less rewarding—well, too bad. After all, he was the boss, and that gave him special privileges.

The amateur psychologists who knew him said that his behavior was due to a terrible self-image and deep inferiority feelings. To build himself up, he had to tear others down.

But his engineers had no interest in psychological analyses. Their response to his abominable treatment was a powerful and deep-seated prejudice against being degraded and humiliated. So they put as little effort into their work as they could get away with while they looked for employment elsewhere.

In time, it became apparent to everybody that the engineering in Charlie's products ranged from poor to abysmal. Soon the customers, though they still found him delightful, couldn't justify purchasing his products. Business declined, profits declined, and Charlie had to reduce the salary levels that had been just high enough to keep some otherwise unhappy engineers with him. So it came as no surprise that more engineers than usual began to leave the company—then still more. Word got around, of course, so it became increasingly difficult for Charlie to find good engineers—or any engineers. And that made it impossible to develop products he could sell.

"You can't find good engineers anymore," Charlie moaned as, with all the charm he could muster, he applied, some months later, for a job.

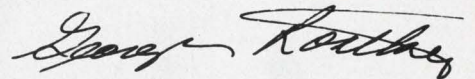
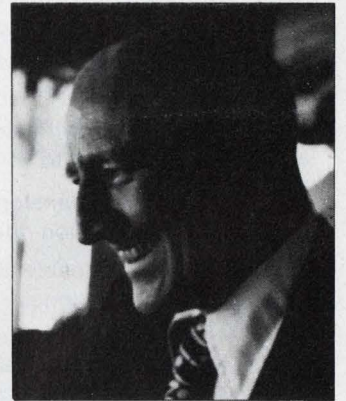

GEORGE ROSTKY
Editor-in-Chief

SABRE X is Here!

Your ten best reasons for buying it are benefits no other tape recorder/reproducer provides

1. Programmable microprocessor control of tape speeds, operating modes, monitor/alarm and other diagnostic testing functions
2. Tape transport with ten speeds from 240 to 15/32 ips
3. 2⁹ time base expansion and/or contraction ratios
4. 10-speed switchable all-band Direct channel electronics
5. 10-speed switchable all-band FM channel electronics
6. 6 megabit digital data processing per track
7. Usable Direct/FM/Digital channel electronics at 240 ips
8. 88.8 hour record time per tape reel — the industry's longest
9. 4.0 MHz/Track direct Record/Reproduce system
10. The same manufacturing excellence that has made Sangamo a leader in tape recorders for over 16 years

IRIG tape recording/reproduction was never like this. But then, that's the whole point of SABRE X: pushing back the horizons of our technology to help you push back yours. We know your needs. So we've given you still more features, including serial

and/or parallel high density electronics, vacuum tape tensioning and modular design. We've made it easy to customize the unit with options ranging from coded computer control, data monitoring and a voice/time code to a tape servo and remote control. We've freed you for virtually unlimited applications, including data reduction, deep space, satellite and space networks, mass data storage and security. We've got your number: SABRE X.

For additional information, call or write:

Sangamo Weston, Inc.
Sangamo Data Recorder Division
P.O. Box 3347
Springfield, Illinois 62714
TEL (217) 544-6411

SANGAMO WESTON

Schlumberger



SABRE X

Berg Interconnection System sews up the electronics in the Athena 2000 machine by Singer.

Berg supplied 80% of the low voltage interconnect system for the Athena 2000 sewing machine by Singer—world's first electronic push button home sewing machine.

Singer likes its new electronic design which eliminates more than 350 mechanical parts while assuring reliable performance. Singer has found it can rely on Berg . . . to supply the products and the application machines that precisely meet its interconnection needs.

Berg is experienced. We read interconnection needs like Singer reads patterns. We have the products, the background, and the back-up to do the job. Your job. Let's work on it, together. Berg Electronics Division. E. I. du Pont de Nemours & Co., New Cumberland, PA 17070—Phone (717) 938-6711.



BERG ELECTRONICS

CIRCLE NUMBER 33

We serve special interests—yours!

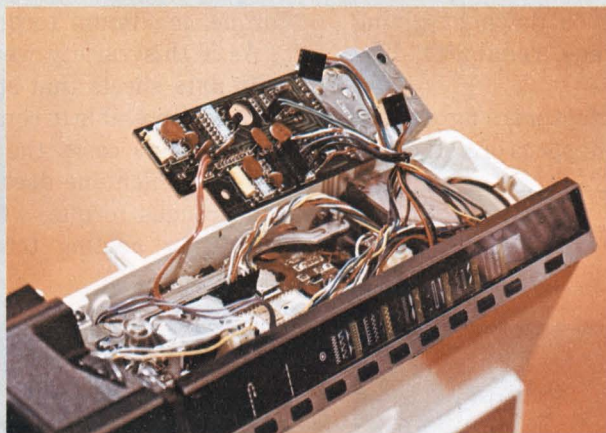

FOCUS

on Stepping Motors

Choosing a stepping motor, let alone deciding to use one, shouldn't be as difficult as it is. Stepping motors are being used more widely now than ever before because control signals are increasingly available in digital, rather than analog, format. And they are more reliable than clutch-and-brake assemblies for incremental-motion applications.

But manufacturers can slow you down by giving unclear specs for torque, accuracy, reliability, lifetime, and speed.

For example, almost all manufacturers agree that torque is one of the most important specs of a stepping

motor. It must be—it's referred to on data sheets by at least 16 different names, including rated torque, holding torque, detent torque, static torque, static stall torque, starting torque, running torque, friction torque, dynamic torque, pull-in torque, pull-out torque, maximum torque and working torque.

As if this variety weren't enough, you must cope with data sheets that specify different torques. It is almost impossible to compare competing units. Worse yet, in some cases the manufacturer just specifies torque. Which one does he mean? Is he referring to synchronous torque, which is greater than starting torque, or holding torque, which is greater than

Jules H. Gilder
Associate Editor



Stepping motors, such as these from American Electronics, are used to provide incremental motion. Motor size varies with the torque required.



A stepper motor should be considered a system, not just a component. Electronic driving circuitry is needed and can significantly affect performance.

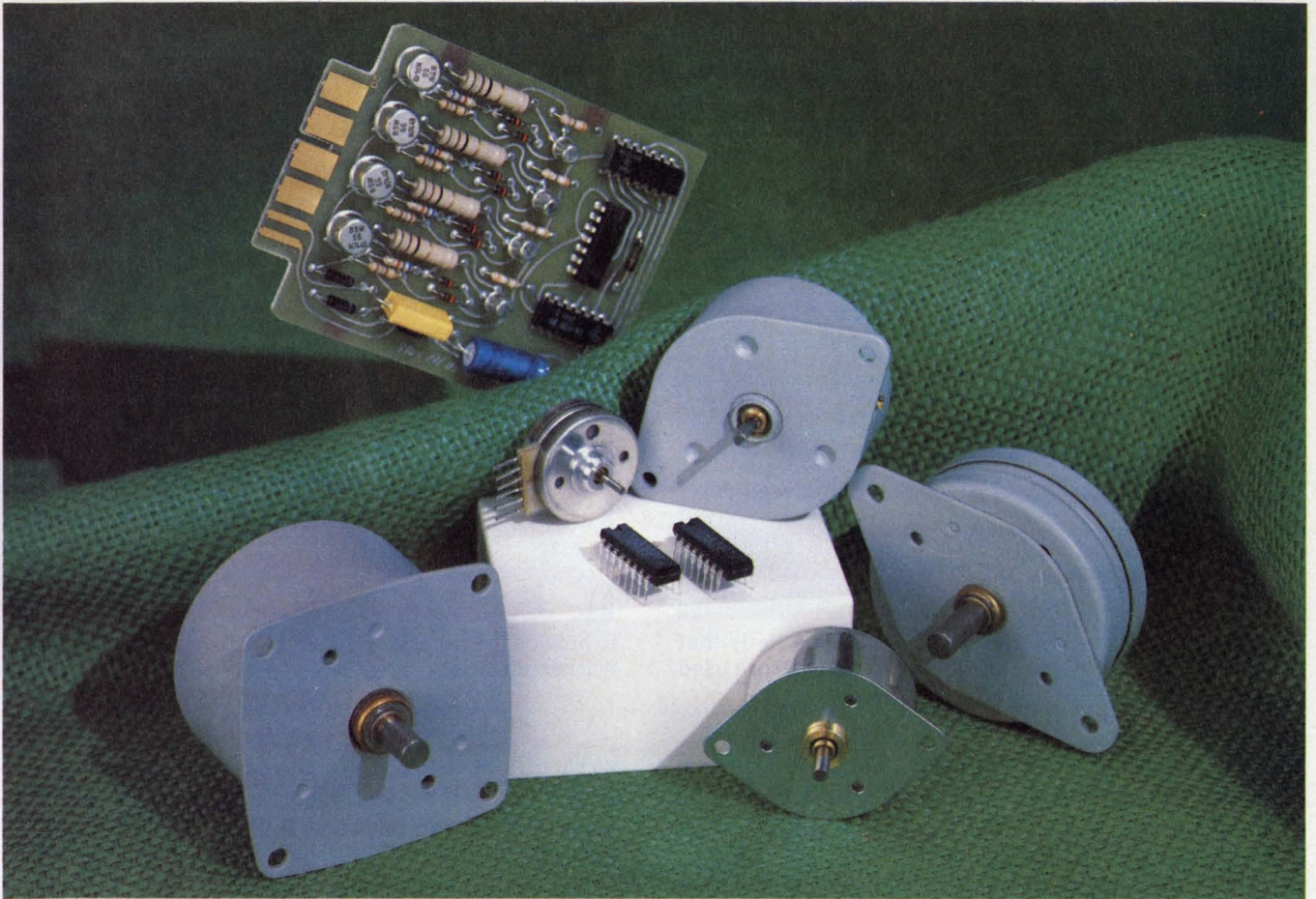

Drive circuits for steppers can be quite complex. Special integrated circuits such as the SAA1027 developed by

North American Philips Controls greatly reduce the size and complexity of the circuitry.

running torque and detent torque? Who knows?

Torque specs are clouded even more because the available torque depends on the speed of the motor, and each manufacturer tends to specify torque at a different speed. Worse, some vendors don't even identify that speed. Even when speeds are listed, you're not out of the woods yet: Identical motors operating at the same speed may not produce the same torque. This seeming paradox occurs because torque also depends on the drive electronics. A motor driven by unipolar circuitry will have one torque; driven by bipolar circuitry at the same speed, that motor will have a higher torque. And an even higher torque is developed by a bipolar chopper circuit.

Even if you fight your way through these torque specs, you're still not in the clear. Many stepping-motor makers use a mixture of English and metric units to specify torque. Some use in.-oz, others in.-gm and still others mm-gm. In some cases, you'll find different torque units for the same motor under different conditions.

Remember: The established way of specifying torque is with force-length units and not vice versa. Thus, oz-in. or gm-mm should really be used. The length-force units that pervade the stepper-motor industry are really units of work or energy.

To sidestep some of the torque ambiguities, at the

very least know which torque the manufacturer means at what speed. A much better solution, however, is to get a torque-speed curve for the motor and drive electronics in which you're interested. Be careful here, too. Since a stepper is a start-stop device, you should be interested in the basic start-stop torque curve. This is not given by all manufacturers. Some give a slew curve, which can make the motor look more efficient than it really is. After you've twisted your way through the torque specs, brace yourself for those dealing with accuracy.

Sidestepping inaccurate accuracy specs

First, many stepper-motor manufacturers do not even list accuracy. Of those who do, hardly anyone gives the absolute accuracy. Almost all specify stepper accuracy as a percentage of step. But different stepper motors have different size steps. For example, a motor that has a stepping angle of 1.8° and an accuracy of half a step will be accurate to 0.9° , whereas a motor with a stepping angle of 0.18° and an accuracy of half a step will be accurate to within 0.09° .

To define performance more clearly and to make comparing easy, manufacturers should provide absolute-accuracy specs in terms of minutes of arc.

An important point that should be noted is that

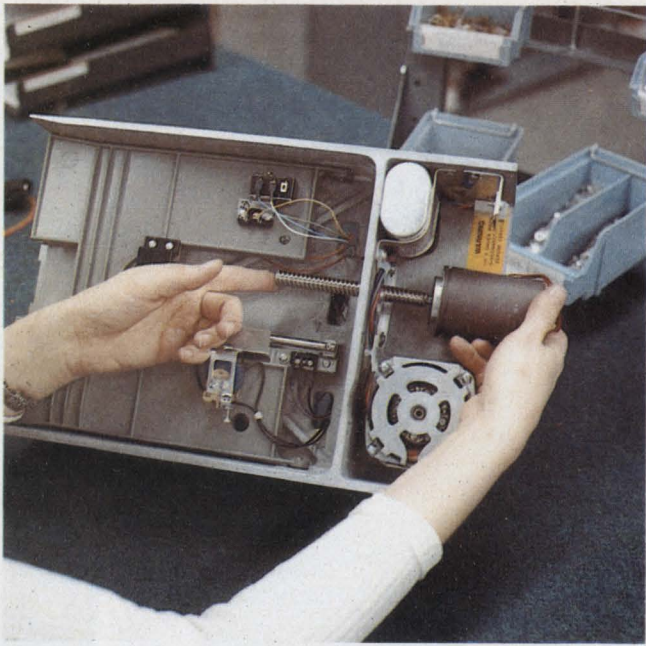

Disc drives are one of the many applications (left) that require stepping motors. Translator cards (right) are used

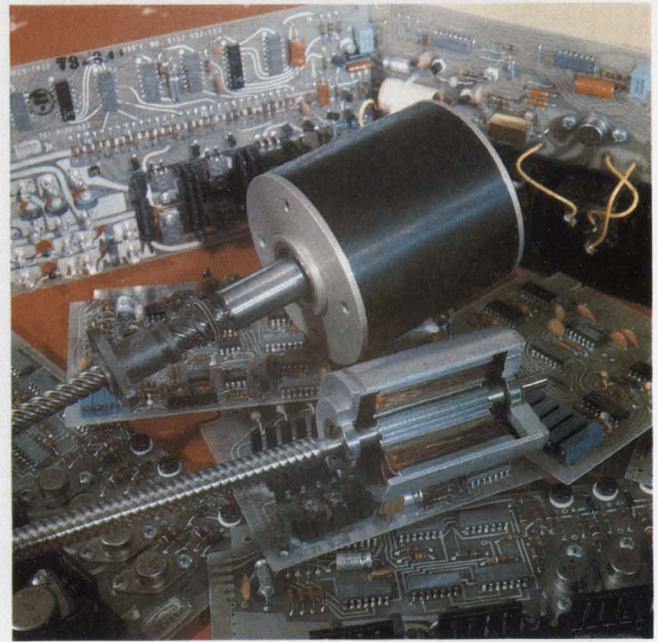

to provide the necessary pulses to drive these motors from Warner Electric.

accuracy specs are not cumulative. Thus the accuracy for a series of steps is better than that for a single step. If a motor has an accuracy of 3 minutes of arc, after 20 steps it will still have an accuracy of 3 minutes of arc. So, from an accuracy viewpoint, it is much better to design a stepper-motor system to accomplish a desired rotation in several small steps rather than in one big one.

The fact that positioning errors are noncumulative results from the stepper's inherently symmetrical construction and magnetic averaging over many poles. Nevertheless, where accuracy is crucial, the designer must be alert to problems traceable to two basic causes: motors with insufficient stiffness or winding-current imbalance.

Accuracy is complex

Unfortunately, accuracy can't be expressed by a single number. It depends on the load, on whether damping is used to reduce step overshoot, on the amount of overshoot, on whether single or dual-phase drive circuitry is used and on the motor itself. To "simplify" matters, vendors give the accuracy spec under no-load conditions—exactly the conditions the motor never sees. Closer scrutiny reveals that, in fact, accuracy specs are useless because, as some stepper makers note, once a motor has a load, results are not repeatable.

How long will they last?

Stepping motors may be very reliable, but data sheets seldom provide reliability specs or life-time information. When such information is offered, it can sometimes be virtually useless. One spec sheet says that life in continuous operation is three to four years

at rated torque and up to 10 years at reduced torque. But the sheet modestly omits definitions of "continuous" or "reduced," and fails to add other critical information.

Does continuous mean 24 hours a day, 365 days a year? What's the load? What kind of drive electronics is used? What means end of life? Is that when the motor stops moving altogether? Or when it starts missing steps? And how much must the torque be reduced to get the 10-year life?

What stepper manufacturers will tell—but only if you ask—is that there are two major failure modes. The first occurs when a phase winding shorts out. This generally takes place only when the motor is operated outside its rated temperature range. The second failure mode results from excessive wear between the rotor and bearing.

Unlike other specs, those for speed are easy to find. Even so, the information seems designed to make comparisons difficult. Some data sheets express speed in revolutions per minute, others in degrees per second, and still others in steps per second. Insurmountable problem? No. Annoyance? Yes.

The kinds of speeds listed vary from manufacturer to manufacturer. Some give maximum speed for a short period of time (generally one minute or less), others give a "normal" speed for greater periods. Still others list both. What you're not always told, however, is what drive electronics were used to obtain these results. Sometimes a manufacturer will use sophisticated drive electronics for rating motors when common practice is to use normal electronics. As you've seen, the same motor can often go an order of magnitude faster with one drive circuit compared with another.

The data most frequently omitted from spec sheets

Step motor application problem

A computer printer manufacturer wants a step motor to drive his printer carriage. The linear motion required is 0.1 in., in start-stop intervals 20 ms apart. A fast tab/rapid carriage return feature at a speed of 25 in./s is required. The positional accuracy required is 0.003 in. combined for the stop motor, lead screw, and print wheel. The print wheel error is 0.0010. Paper width in the printer is 8½ in. The carriage itself weighs 32 oz. Friction is 5 oz-in. due to the screw.

The first step in selecting a stepping motor for this application is to calculate the average force required to move the 32-oz load. The formula is $F = f(S \times M)/t^2$, where S is linear distance moved in inches, M is the mass of the load (32/386), and t is the start-stop time interval in seconds. Thus $F = 4(0.1 \times 0.083)/0.0004 = 83$ oz.

The next step is to select a device to convert the rotary torque of the step motor to the linear torque required by the application. For best efficiency, a high-helix screw and nut are chosen; the highest practical is a screw with a 1.2-in. lead. This screw yields a linear movement of 0.1 in. (the typespacing that is desired) for a rotation of 30°.

The formula is screw lead = $360 \times S/\theta$, where S is the linear motion required and θ is the angular movement of the screw during one incremental motion. Screw lead = $360 \times 0.1/30 = 1.2$ in.

A step motor with 5° step angle is chosen, so that six steps are necessary to produce the 30° rotation. The six 5° steps give a higher accuracy than one 30° step. The efficiency of the screw is 60%, taken from manufacturer's data.

Next, determine the torque necessary to move the 32-oz load with the screw. The formula is $T = F(L/2\pi E)$, where F equals the force required to move the load, L equals the lead of the screw, and E is the screw's efficiency. Thus, $T = 83 \times 1.2/6.2832 \times 0.6 = 26.4$ oz-in.

Rotor inertia must also be accounted for. The step motor tentatively selected has a rotor inertia of 3.53×10^{-4} oz-in s². The torque necessary to overcome that inertia is found from $T = \pi \theta J/45t^2$, where θ is the angular displacement of the screw in degrees, J is the inertia of the rotor in oz-in s², and t is the start-stop time interval in seconds. Thus $T = 3.1416 \times 30 \times 0.000353/45 \times 0.02^2 = 1.85$ oz-in.

To this torque must be added the torque necessary to overcome the inertia of the screw. The formula is $T = \pi \theta J_s L/45t^2$, where J_s is equal to screw inertia per inch of length in oz-in. s², and L is the length of the screw. Thus $T = 3.1416 \times 30 \times 0.000012 \times 12.5/45 \times 0.02^2 = 0.78$ oz-in.

Total torque is the sum of that required to move the load (26.4 oz-in.), to overcome rotor inertia (1.85 oz-in.), to overcome the inertia of the screw (0.78 oz-in.), and to overcome the system friction (given as 5.0 oz-in.). Total torque required is thus 34.3 oz-in.

To design parameters with motor specifications, find the operating speeds required of the motor. Since the motor turns 30° (six steps) in 20 ms, the average

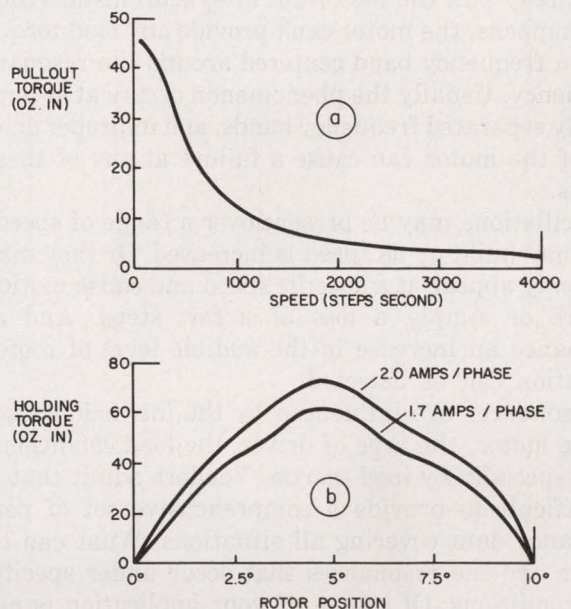

speed of the motor is 300 steps/s. Is the torque at this speed sufficient to move the load? The curve in Fig. A shows that the motor tentatively selected (Warner Electric's SM-072-0060-RA&RS) gives a torque of about 35 oz-in. at 300 steps/s. This curve is obtained with the MCS-1825 driver, two phases on, 24 V dc at 2 A per phase.)

Next, see if this motor can also handle the fast tab/rapid carriage return at 25 in./s, or 1500 steps/s. Fig. A shows that at 1500 steps/s, the motor provides about 9 oz-in. of torque, more than enough to overcome the 5 oz-in. of friction in the carriage during rapid carriage movement.

Does the combined error of the step motor, lead screw, and print wheel lie within the positional accuracy requirement of 0.003 in. The 3/8-in. dia, 12½-in.-long screw has an error of 0.001 in./in. With a frictional load of 5 oz-in., the worst angular error is 0.25%, as determined from the holding torque vs. rotor displacement curve in Fig. B.

The positional accuracy of the step motor itself is $\pm 0.25^\circ$, for a total error of 0.50° , due to friction and step error, both noncumulative. Translating this to linear positional error, $LPE = \ell \times \theta/360$, where ℓ is the lead of the screw in inches, and θ is angular positional error in degrees. Thus $LPE = 0.0017$ in. Adding this to the print wheel error of 0.0010 in. gives a total positional error of 0.0027 in.

Although not a critical parameter in this application, holding torque can be important in other applications. It can be determined for any rotor position of the motors selected for this example by using Fig. B, which comes from Warner Electric's data sheet. For this example, the holding torque is approximately 60 oz-in. at 1.7 A, and approximately 70 oz-in. at 2 A.

concern motor-resonance conditions. A stepper motor is a spring-mass system and, as such, has a natural frequency of oscillation. If resonance is reached, oscillations of increasing magnitude occur, which eventually pull the motor out of synchronism. When this happens, the motor can't provide any load torque over a frequency band centered around the resonant frequency. Usually the phenomenon occurs at several widely separated frequency bands, and improper driving of the motor can cause a failure at any of these points.

Oscillations may be present over a range of speeds and may build up as speed is increased. Or they may suddenly appear at a specific speed and cause motion failure or simply a loss of a few steps. And at resonance an increase in the audible level of motor operation can be detected.

Resonances are influenced by the intrinsic design of the motor, the type of driver, the load conditions, and especially by load inertia. Vendors admit that it is difficult to provide a comprehensive set of performance data covering all situations. What can be shown are the resonances that occur under specific test conditions. Of course, if your application is not identical to the test conditions, the information is not too helpful. However, resonance can be reduced signif-

icantly, note vendors, by use of a driving technique known as half-stepping.

Drive carefully

Most engineers using stepper motors develop their own electronic drives. Often, precious time is wasted and many difficulties are encountered in what amounts to reinventing the wheel. Although manufacturers try to help by designing drive circuits to operate with their motors, many an engineer thinks he can do a better job, cheaper. Unfortunately, not all users fully understand what is required of drive circuits.

Basically, the drive circuitry accepts a digital signal and converts it to the format required by the motor windings. A power-return system removes the current from the windings at the end of a step.

Of the two major formats, one is called the wave drive, in which only one set of stator poles is energized at a time, and the other is called a two-phase drive, in which both sets of stator poles are energized simultaneously. The two-phase drive offers a 20% gain in the available torque per watt over that of the wave drive. And two-phase logic is simpler.

A third driving technique, the half-step drive, combines both the wave and two-phase methods. Basically, the technique alternates between the two major methods, and the resulting torque output is halved. Bear an important point in mind when using a half-step drive system with constant current per winding: At one moment, two windings may be energized; at the next, only one may be.

When two windings are energized, both the motor power and the available torque are at maximum. When only one winding is energized, the motor power is reduced by half. Thus the motor may exhibit a strong step followed by a weak step.

If the load torque is less than 30 to 40% of the maximum, the difference between the steps isn't important. But at higher-load torques and at low pulse-drive frequencies, the weak step shows up as a loss of stepping torque. At high frequencies, of course, you don't need as much torque anyway. The difference between the strong and weak steps can be reduced by designing the drive to change the current in the windings so the motor get its rated power at every step.

A common way of driving stepping motors, called unipolar resistance current limiting, is to simply add one or more resistors in series with the motor windings and raise the supply voltage to yield the normal motor current under steady-state conditions. Such drives are simple, reliable and adequate when speed and torque requirements are low.

There are problems, however. When voltage is raised to improve the high-speed performance, the system efficiency drops. Also, the motor windings are not in continuous use, since the current duty cycle is only 50%. Continuous use of the windings—as would be the case with a bipolar drive—considerably in-

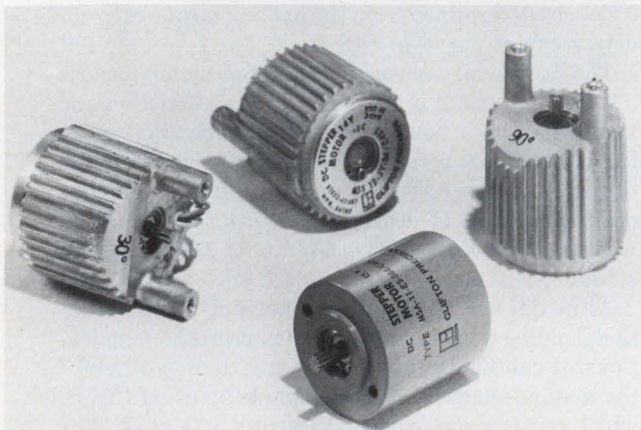

Computer printers also use stepper motors, such as this one from Clifton Precision, to drive paper feed and platen mechanisms (top). The ribbon in a printer is also controlled by a small stepping motor (bottom).

What is a stepping motor?

A stepping motor translates electrical pulses into fixed mechanical movements. Whereas conventional motors rotate continuously when energized, a stepping motor—when pulsed—rotates, or steps, in fixed angular increments.

There are three broad classes of stepping motors available today: permanent-magnet motors, variable-reluctance motors and hybrids.

Permanent-magnet types

The permanent-magnet motor contains a stator having a number of electromagnetic poles. Each pole of the stator may have a number of teeth as part of its flux-distributing member. The rotor is cylindrical and toothed, and contains a permanent magnet.

This motor operates through the interactions between the rotor magnet biasing flux and the magnetomotive forces generated by the applied current in the stator windings. If the pattern of winding energization is fixed—as it is in a stepping motor—there are a series of stable equilibrium points generated around the motor. The rotor moves to the nearest of these and remains there.

If the windings are then excited in sequence, the rotor follows the changing point of equilibrium and hence rotates in response to the changing pattern.

By virtue of the permanent magnet, a detent torque develops in the motor, even when the stator windings are not excited. A restoring torque is generated whenever the rotor moves from the position of minimum reluctance. This torque is much weaker than the energized torque, and is typically only a few percent of the maximum torque.

Variable reluctance steppers

Like permanent-magnet motors, variable-reluctance steppers have a stator with a number of electromagnetic poles. But unlike the rotors in permanent-magnet units, there is no magnet on the variable-reluctance rotor.

When a current passes through the appropriate winding in a variable-reluctance stepper, a torque develops that turns the rotor to a position of minimum

magnetic-path reluctance. This position is stable in that an external torque is required to move the rotor out. But the position is not an absolute one in that there are many such stable points in the average motor.

When another set of windings is energized, the minimum reluctance point occurs at a different set of poles and rotor teeth, causing the rotor to move to a new position. By proper selection of the energizing sequence, the stable positions can be made to rotate smoothly around the stator poles, giving rise to rotational speed at the rotor. When the energization sequence becomes fixed, so does the rotor position. Thus the shaft position is stepped by changing the pattern of winding energization.

Since the rotor teeth in a variable-reluctance motor have little residual magnetism, as is found in permanent-magnet types, there is no force on the rotor when the stator is not energized and, hence, no detent torque exists. The variable-reluctance motor operates in the same way as an ac electromagnet, in which magnetic attraction occurs regardless of the direction of the magnetic flux.

Hybrid motors

There are a number of hybrid devices that convert electrical pulse trains to motion. In addition to the stepping motor proper, these devices usually include some additional component to amplify torque or power.

One type of hybrid motor uses gears to provide internal torque amplification. The gears reduce the step angle and increase the torque at no power gain. In this design, the motor consists of a relatively large stepping-angle device with an integral gear system, and it delivers a small stepping angle, typically 0.18 to 0.45°.

A second method is to follow a low-power, low-torque stepper with a linear power amplifier. Here, a relatively small stepper drives a hydraulic motor. Where the cost of the system and its associated hydraulic supply can be justified, the power gain is considerable. Hybrids of this type come in ratings of several horsepower.

creases the motor output.

Another problem: The voltage applied to the windings is a decaying exponential, while the current is a rising exponential. Thus for a given supply voltage, the rate of rise of the current—and hence the high-speed performance—is considerably reduced over the case in which the full supply voltage is available until the desired current is reached.

A 25 to 30% improvement in available torque can be achieved with bipolar drives in which all four windings are continuously energized. Other drive

alternatives include the bi-level, current-fed and chopper drives. Whichever you choose, consult the vendor.

Lone wolves get bit

Vendors say the most serious mistake an engineer makes in designing with stepping motors is trying to do it alone. Don't. Give the manufacturer as much information as you can. Include the planned drive method, limitations in the drive circuitry, the friction levels to be encountered at the motor drive shaft, and

Dc motors compete with steppers

A controversy is beginning to blossom between some manufacturers of steppers and those who make dc motors. In particular, PMI Motors of Syosset, NY, claims that for many incremental-motion applications, a dc motor is better than a stepper. In reply, stepper makers note that dc motors require a more complex applications interface. PMI contends that this is not always so. In fact, notes Hans Waagen, chief applications engineer for PMI, the interface for

steppers in a closed-loop system—where many applications for the dc motor lie—has the same or greater complexity as that for a dc motor.

Below is a comparison of key specs for open-loop stepper motors and closed-loop dc motors. The major advantage of open-loop steppers over the closed-loop dc motors is low cost and simpler interface. If the loop for stepping motors is closed, this advantage disappears.

the inertia of the load.

If there are any special requirements for transfer time, overshoot and oscillation, settling time, or mechanical concentricity, let the vendor know. Remember, however, that some parameters are useless and don't reflect system usage. Specs should always parallel your desired system performance, rather than copy someone else's characteristics.

Another error engineers often make is not paying attention to all of the available technical literature. A great deal of information has been published concerning such characteristics as ringing at the end of a step. Unfortunately, many designers ignore ringing until their system gets into trouble. By that time, the cure is bound to be expensive.

Bigger steps are not better

It is a common misconception that if a little bit of something is good, a lot is better. This idea has been carried over to stepper motors in that many people think that a larger angle per step produces more—torque at a given shaft speed. Not so. Smaller angles produce as much—if not more—torque. Also, the smaller the angle, the greater the stiffness of the shaft at rest and the smaller the overshoot of the final step.

A common mistake is the use of gear reduction to provide higher resolution than possible with the motor

alone. This adds cost, results in backlash and lost motion, and reduces efficiency.

Just which stepper specs are important is determined by the load and the driving circuit. For example, if a system has lots of time to move a small load from position 1 to position 2, then the maximum start-stop rate is unimportant. However, if the load is large and must be moved from position 1 to position 2 in a short time interval, then the maximum start-stop rate becomes extremely important.

With variable-reluctance step motors driven by translator cards, several questions must be answered. What sort of pulses will reach the translator card? Separate clockwise and counter-clockwise pulses? Or single pulses with separate directional signals? Are separate power supplies necessary for the motor and the translator card? If so, who is going to supply them?

Does the driver circuit provide single phase for maximum response rates and maximum slew speeds? Or does it provide a two-phase signal for faster settling and better damping? Can it do both? Does the driver provide conventional single-voltage operation, or is it a dual-voltage type, with initial overexcitation to boost acceleration at the beginning of each step? Knowing the answers can eliminate unforeseen problems.

New ideas improve performance

A major problem of stepping motors is their tendency to overshoot with loads having a high inertia-to-friction ratio. Schemes devised to correct the overshoot often result in increased rotor-stepping time, reduced dynamic torque and loss of speed.

A new method to control overshoot, developed by Warner Electric Brake and Clutch, uses permanent magnets between pole pieces on the motor stator. The magnets' poles are oriented toward stator poles of the same polarity, thus reducing leakage flux between pole pieces and increasing rotor/stator flux. The result is reduced single-step transit time, reduced overshoot and oscillation, improved dynamic torque and the development of a static torque that holds the motor in position after the current is switched off.

New improvements in step-motor control have further broadened the scope of open-loop operation. Fractional stepping, also called ministepping or micro-

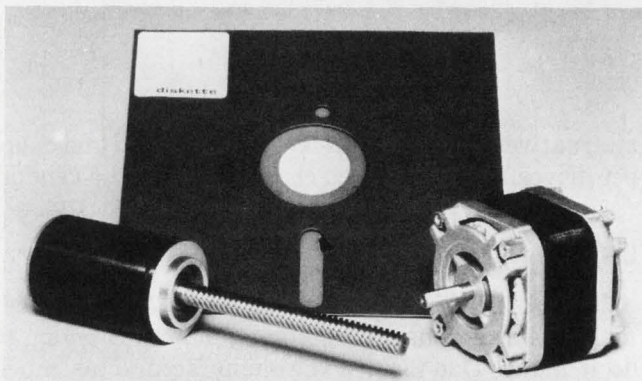

A lead screw attached to the motor shaft in these steppers from Eastern Air Devices is used to convert rotary motion to linear motion for floppy-disc applications.

	Stepper motor (open loop)	Moving-coil motor (closed loop)
1. Displacement	Limited to one fixed-angle θ in a given configuration. With appropriate drive can step $\theta/2$, but torque capability is reduced.	Can traverse any size angular increment on command. Step angle can be varied from step to step with appropriate position information.
2. Repetition rate a) Start-stop step by step	Variable. Inverse function of load inertia, friction ambient temperature and stator drive mode (constant voltage or constant current). Oscillatory pockets at rotor resonant frequency (or harmonics) causes instability at certain repetition rates.	Variable. Inverse function of load inertia, friction, motion time, displacement and ambient temperature. System resonances (armature-to-feedback) limit servo gain, but generally occur at higher frequencies due to stiffer mechanical coupling.
b) Slew mode	Variable up to 10,000 steps/s (equivalent to 3000 rpm with a 200 step/rev device) with careful programming of the acceleration and deceleration rates.	Variable up to 6000 rpm with no restrictions (except for power dissipation) on the acceleration and deceleration rates.
3. Motion time a) Single step	Single pulse step is highly underdamped (i.e. settling time is long) without appropriate compensating techniques. Constant current drive, damping, increasing friction, reverse pulse damping, and reducing the load inertia minimize the problem but response time suffers accordingly.	Single pulse step is adjusted for critical damping in external circuitry to provide minimum settling time.
b) Multiple step	Essentially the same comments as 2 a) above.	Same as 2 a) above.
4. Load inertia	Ideally, the stepper requires light load inertias as increasing inertia will increase the settling time. Problem is minimized by damping, but over-all response time is reduced.	Will accelerate any load inertia to speed provided the drive amplifier has been programmed to supply the necessary drive current. Settling time problem is minimized by stiff mechanical coupling to load.
5. System friction	If high, damps out rotor resonance to an acceptable level. Motor will not step if friction exceeds 0.707 of maximum torque.	For fixed amount of servo gain, tends to increase servo deadband. Increasing the gain will minimize the error but systems resonances will affect performance (i.e. introduce instability) if too high.
6. Accuracy	Error is noncumulative and independent of number of steps taken. Typically, accuracy is $\pm 3\%$ of the intrinsic angular displacement.	Error (in a velocity loop) is a function of the area under the decelerate portion of the velocity profile. Profile must be shaped properly to minimize error caused by tachometer ripple, varying friction, motor resistance changes, B supply variations and positional inaccuracy of optical encoder. Typically, noncumulative error is $\pm 8\%$ of the decelerate displacement. If position loop is added around velocity loop, error is reduced to $\pm 1\%$.
7. Holding torque	When energized, holding torque of stepper is high. Useful in systems where external load disturbances tend to displace load from equilibrium position.	Very little holding torque available in velocity loop. Position loop must be added around velocity loop to provide this function. This will increase cost due to circuit complexity.
8. Ambient temperature	Repetition rate decreases with increasing ambient temperature.	Same comment with regard to stepping rate.
9. System reliability	Similar in analysis to a transformer (since it is brushless) and generally a function of internal heat rise. Only other mode of failure is bearings, which is a function of radial and thrust loads and average speed.	Limited by brush life of motor and tachometer. In general, brush life at rated torque and speed is approximately 10,000 hrs due to low inductance (typically, 100 microhenries). Same comments hold true for bearings.

stepping, is now practical because of microprocessors and improved integrated circuits.

Fractional stepping provides very smooth low-speed performance and the ability to reduce the size of the motor step electronically. For example, with a motor having a step angle of 1.8° , the step angle can easily

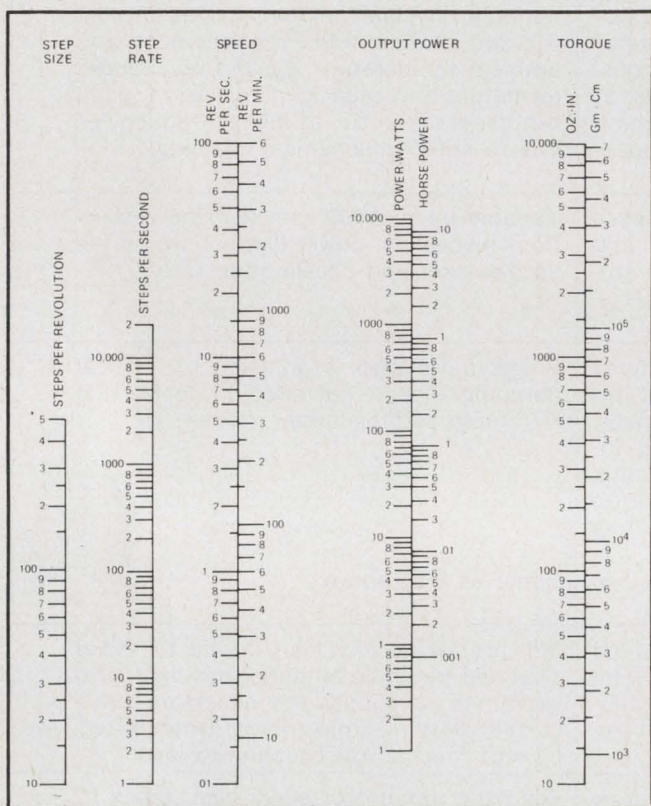

To find speed in rpm or rps, find appropriate values for steps/revolution and steps/s. A straight line extended from these two points will indicate the correct rpm or rps value. To find output power in horsepower and watts, find appropriate values for speed and torque. A straight line between these points will intersect at the correct output power value.

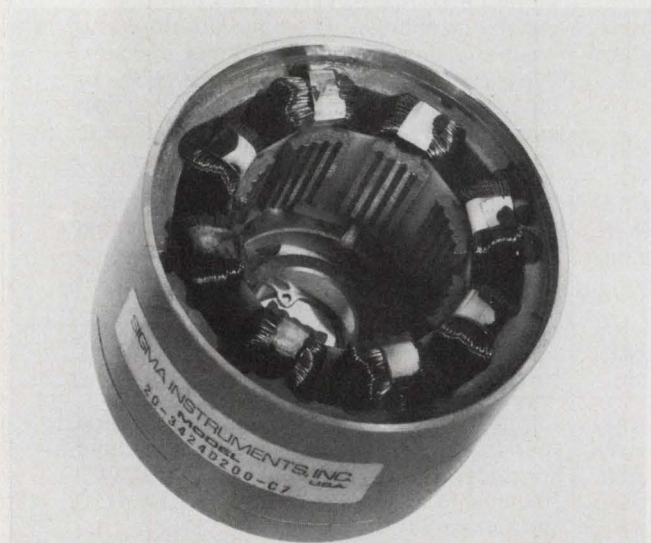

Permanent-magnet stepping motors contain stators with a number of wound poles. Each pole has several teeth as part of its flux distributing member.

be divided into nine separate steps of 0.2° each.

The elimination of conventional heavy rotors and the use of rotating magnetic fields have resulted in low inherent inertia and the ability to start and stop quickly. The improvements have resulted in motors of lighter weight, smaller size, lower backlash, simplified lubrication and easier packaging. Hundreds of designs exist in many shapes and performance ranges, including a few unusual kinds.

For example, if you need a motor that rotates 360° for each pulse applied to it, there's one available from Haydon Switch and Instrument. Known as the 31300 Big Inch Stepper, it is billed as the only permanent-magnet-bias, single-phase, unipolar-drive two-wire stepper on the market. In operation, the motor rotor turns 180° when power is applied, and another 180° when power is removed. The power-removal rotation is accomplished by use of a positive detenting, permanent-magnet bias that turns the rotor when the motor coil is de-energized.

A novel motor with one of the highest torque-to-size-and-weight ratios is the NuSyn line from Mesur-Matic Electronics. These also offer some of the highest

Need more information?

The products cited in this report don't represent the manufacturers' full lines. For additional details, circle the appropriate number of the Reader Service Card. For data sheets and more vendors, consult **ELECTRONIC DESIGN'S GOLD BOOK**.

- Aeroflex Laboratories Inc., South Service Rd., Plainview, NY 11803. (516) 694-6700. (N. Russell) **Circle No. 501**
- Amerace Corp., Controls Prod. Div., 2330 Vauxhall Rd., Union, NJ 07083. (201) 964-4400. (J. Spanos) **Circle No. 502**
- American Electronics Inc., P.O. Box 3070, Fullerton, CA 92634. (714) 871-3020. (B.G. Guy) **Circle No. 503**
- Barber-Colman Co., Industrial Instrus. Div., 1317 Rock St., Rockford, IL 61101. (815) 877-0241. (L.F. Smith) **Circle No. 504**
- Barber Corp., Box 271, Waynesville, OH 45068. (513) 897-2926. (C.M. Barber) **Circle No. 505**
- CP Clare & Co., 3101 W. Pratt Blvd., Chicago, IL 60645. (312) 262-7700. (R.E. Axthelm) **Circle No. 506**
- Computer Devices of California, 11901 Burke St., Santa Fe Springs, CA 90670. (213) 723-6593. (A. Cardwel) **Circle No. 507**
- Conrac Corp., NJ Div., 32 Fairfield Pl., West Caldwell, NJ 07006. (201) 575-8000. (Robert Ullman) **Circle No. 508**
- Control Data, Magnetic Components Div., 7801 Computer Ave., Minneapolis, MN 55435. (612) 830-5800. (J.F. Lucy) **Circle No. 509**
- Dale Electronics, 1376 28 Ave., Columbus, NE 68601. (402) 564-3131. (I.E. Gates) **Circle No. 510**
- Eastern Air Devices, Motor Div., Washington St., Dover, NH 03820. (603) 742-3330. (L. Westerfield) **Circle No. 511**
- Electric Indicator Co., 272-F Main Ave., Norwalk, CT 06851. (203) 847-5861. (W.L. Sly) **Circle No. 512**
- ElectroSyn Corp., 480 Neponset St., Canton, MA 02021. (617) 828-2840. (M.D. Altfillisch) **Circle No. 513**
- Guardian Electronic, 1550 W. Carroll Ave., Chicago, IL 60607. (312) 243-1100. (G.F. Ewmett) **Circle No. 514**
- Haydon Switch & Instrument, 1500 Meriden, Waterbury, CT 06705. (203) 756-7441. (John J. Dean) **Circle No. 515**
- IMC Magnetics Corp., 6058 Walker, Maywood, CA 90270. (213) 583-4785. (E.W. Blair) **Circle No. 516**
- Kollmorgen Corp., Inland Motor Div., 501 First St., Radford, VA 24141. (703) 639-3973. (J. Walnes) **Circle No. 517**

direct resolutions at the shaft with no external gearing required. The smallest step angle available is 0.07°, which yields a resolution of 5000 steps.

In the area of driver circuitry, North American Philips Controls has come up with a new IC driver chip labeled the SAA1027. This chip greatly reduces the size and complexity of the circuitry required to operate stepping motors. The 16-pin DIP device also lowers the cost of building drive circuits.

A complete line of stepping motors, including permanent-magnet and variable-reluctance types, is available from Superior Electric. Trademarked Slo-Syn, the motors are available in a wide range of static torques starting at 15 oz-in. and going up to 2000 oz-in.

Standard as well as custom stepping motors are available from Warner Electric. Building prototypes is Warner's specialty and special stepping angles, as well as high-detent-torque models, are available.

Another company that does not limit itself to a standard line of motors is Sigma Instruments. In addition to customizing a stepper for your application the company also offers custom motor drivers. ■■

With MINI BUS®

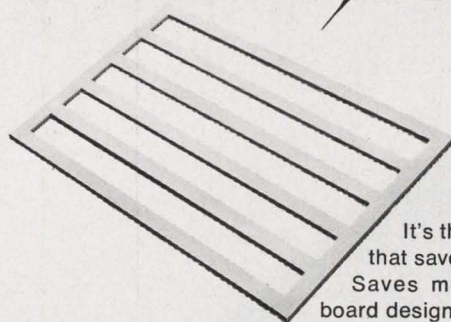

It's the PC card bus bar that saves space on a PCB. Saves money too. Makes board design and layout easier.

all these DIPs

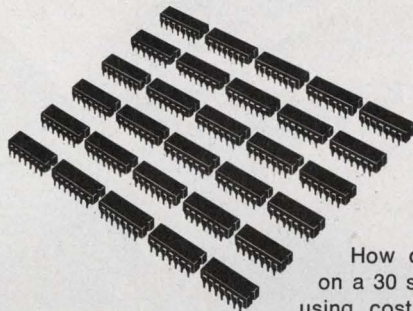

How can you put 30 DIPs on a 30 sq. inch board without using costly multi-layer PCBs?

go on a 5" x 6" 2-sided PCB

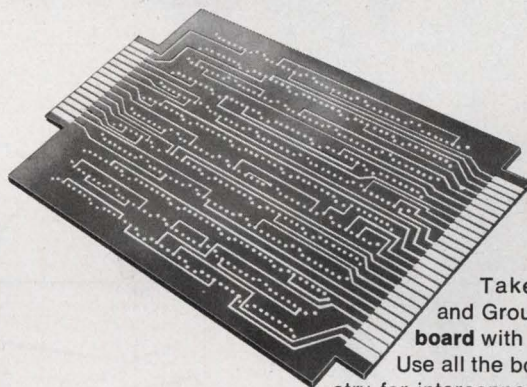

Take Voltages and Grounds **off the board** with MINI/BUS. Use all the board geometry for interconnecting DIPs.

like this

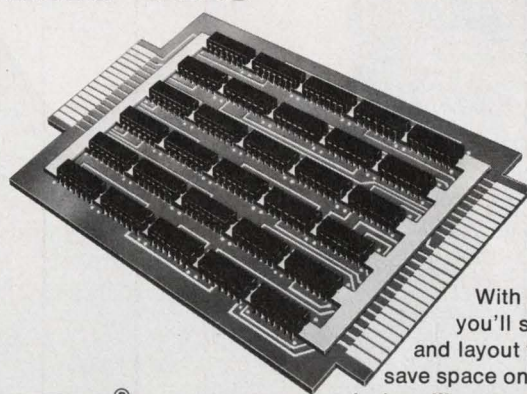

With MINI/BUS, you'll save design and layout time. You'll save space on the board. And **you'll save money** — up to half the cost of a typical 4-layer PCB.



Rogers Corporation Chandler, Arizona 85224
Phone: (602) 963-4584

EUROPE: Mektron NV, Ghent, Belgium JAPAN: Nippon Mektron, Tokyo

CIRCLE NUMBER 34

Kollmorgen Corp., Printed Motors Div., 31 Sea Cliff Ave., Glen Cove, NY 11542.
(516) 938-8000. (A.C. Danzig) **Circle No. 516**

Landis & Gyr Group Headquarters, Gubelstrasse, 6301 Zug, Switzerland.
042-241-124. (P. Lusser) **Circle No. 517**

Ledex Inc., 123 Webster St., Dayton, OH 45401. (513) 224-9891. (J. Leland)
Circle No. 518

Litton Systems Inc., Clifton Precision, Marple At Broadway, Clifton Heights,
PA 10018. (215) 622-1000. (John Staiber) **Circle No. 519**

Mesur-Matic Electronics Corp., 50 Grove St., Salem, MA 01970. (617) 745-7000.
(P.F. Dolan) **Circle No. 520**

Molon Motor & Coil Corp., 3737 Indl., Rolling Meadows, IL 60008. (312)
259-3750. **Circle No. 521**

Nippon Pulse Motor Co., Ltd., 13-16 2-Chome Hongo Bunk yo-ku, Tokyo 113.
Japan. 03-813-8841. (N. Azumi) **Circle No. 522**

North American Philips Controls Corp., Chesire Indl. Pk., Chesire, CT 06410.
(203) 272-0301. (R. Rock) **Circle No. 523**

Omron Corporation of America, 1051 State Pkwy., Schaumburg, IL 60172.
(312) 885-9500. **Circle No. 524**

Philips Inds., Electronic Components and Materials Div., Eindhoven, Nether-
lands. **Circle No. 525**

Portescap US, 730 Fifth Ave., New York, NY 10019. (212) 245-7716. (P.J.
Thornton) **Circle No. 526**

Potter & Brumfield Inc., 1200 E. Broadway, Princeton, IN 47671. (812)
385-5251. (D. Morrow) **Circle No. 527**

Shigoto Industries Ltd., 350 Fifth Ave., New York, NY 10001. (212) 695-0200.
(I. Weinstein) **Circle No. 528**

Sigma Instruments Inc., Motion Control Div., 170 Pearl St., Braintree, MA
02184. (617) 843-5000. (Russell Minkwitz) **Circle No. 529**

Singer Co., Kearfott Div., 1150 McBride Ave., Little Falls, NJ 07424. (201)
256-4000. (Ken Buess) **Circle No. 530**

Struthers-Dunn Inc., Lambs Rd., Pitman, NJ 08071. (609) 589-7500. (W.L.
Capewell) **Circle No. 531**

Superior Electric Co., 3000 Middle St., Bristol, CT 06010. (203) 582-9561. (J.J.
Murray) **Circle No. 532**

Transicoil Inc., Trooper Rd., Worcester, PA 19490. (215) 277-1300. (E.F. Hall)
Circle No. 533

TRW/Globe Motors, 2275 Stanley Ave., Dayton, OH 45404. (513) 228-3171.
(J. Bourque) **Circle No. 534**

USM Corporation (of MA), Route 128, Wakefield, MA 01880. (617) 245-7802.
(H. Hemenway) **Circle No. 535**

Warner Electric Brake, MCS Div., Beloit, WI 53511. (815) 389-37771. (Ken
Kordik) **Circle No. 536**

What's beyond Saturn?



MODCOMP computers are helping bring back the answers.

On August 20, the National Aeronautic and Space Administration launched the first of two Voyager spacecraft atop a Titan Centaur rocket for man's most extensive reconnaissance to date of the outer planets. In September, the second Voyager was launched. Both vehicles were placed in trajectories that will take them to Jupiter and Saturn and past several moons of both planets. The spacecraft will arrive at Jupiter in March and July of 1979, and at Saturn in November, 1980 and August, 1981. One of the Voyagers may then be targeted for the first encounter with Uranus, some 1.7 billion miles from Earth, and possibly Neptune. The decade-long journey could take the vehicles to as many as 15 different planets and satellites.

The success of the Voyager projects will be measured by the ability of scientists to track and monitor the activities of the spacecraft and process the vital data returned to Earth. These critical functions are primarily performed for Voyager and other ongoing space missions, including Pioneer, Viking and Helios, by a series of MODCOMP computers in the Deep Space Network of Jet Propulsion Laboratories in

Pasadena, California, which includes tracking stations throughout the world.

Meeting or exceeding exacting specifications for performance and reliability such as those required by NASA/JPL to help guarantee the success of these missions, is not unusual for MODCOMP. In fact, it has become a way of life.

When it comes to solving problems with computers, MODCOMP leads the way. Whether your application calls for a single, stand-alone system, or a full-blown network of computers.

To learn more about how we can help you, contact Modular Computer Systems, Inc., 1650 West McNab Road, Ft. Lauderdale, FL 33309, Phone: (305) 974-1380.

MODCOMP®

Solving Tomorrow's Problems Today

European Headquarters:
Export House, Woking, Surrey, England
Phone: (04862) 71471

CIRCLE NUMBER 35

Artist's concept of Voyager Spacecraft passing Saturn—courtesy of NASA/Jet Propulsion Laboratory

Modern data acquisition is complex.

The DVM and clipboard era has given way to measuring and processing technology, often with a computer at its core.

To design or even specify a modern data-acquisition system (DAS) for process control and monitoring, laboratory instrumentation or the on-line testing that characterizes today's factories, you must know at least six parameters:

- The number of input channels.
- The data bandwidth of each channel.
- The duration of the test event.
- The volume of the data.
- The dynamic range of the data.
- The required accuracy of the data.

Armed with this knowledge, you can assign appropriate limits to DAS components—the transducers, the signal-conditioning units, the a/d converters and the sample-and-hold (s/h) circuits.

Once you've pinned down the front-end requirements of your system, you can establish its calibration, data-transmission, data-distribution, data-compression and computer-interfacing needs.

How do you specify speed?

Perhaps the two most important DAS parameters are the data bandwidth of each channel and the number of channels. The product of the data bandwidth and the number of channels defines system speed. In sampled-data systems, speed is usually expressed as the product of the sampling rate of each channel and the number of channels. This product is the throughput rate.

Data-acquisition systems are often categorized, albeit somewhat arbitrarily, in terms of their throughput rates: Data loggers (Fig. 1) have throughputs from dc to 25 samples-per-second (sps). Low, mid, and high-frequency systems have throughput rates ranging from 25 to 200, 200 to 50,000, 50,000 to 1-million sps and beyond, respectively.

A DAS test may last from milliseconds to years. For short-term transient testing, data are often recorded on analog tape or stored in a digital memory for subsequent playback, processing and display.

S. Kent Morgan, Formerly Product Line Manager for Data Acquisition, EMR Telemetry, Box 3041, Sarasota, FL 33579. (Currently VP and General Manager, Data Recorder Div., Sangamo Weston, Inc., Box 3347, Springfield, IL 62714).

Limiting parameters of typical data-transmission links

Medium	Typical Distance	Bandwidth
Parallel bus	50 feet	250 kHz
Twisted pair	1000 feet	100 kHz
Coaxial cable	1 mile	10 MHz
Telephone	100 miles (+)	3 kHz
Telephone (modem)	100 miles (+)	10 kbps
Radio link (voice)	10 miles	5 kHz
Radio link (broadband)	1 mile	200 kHz
Microwave link (broadband)	5 miles (+)	5 MHz
Analog tape	—	2 MHz
Digital tape	—	1 Mbps
High density digital recording (HDDR) tape	—	50 Mbps

Long-term data, such as meteorological history, are usually recorded on digital-cassette tapes at timed intervals and collected periodically (e.g., monthly) for processing. But a typical application involves real-time monitoring and quick-look display of events lasting no more than an hour, with off-line processing and analysis performed as part of a one-day turnaround.

When designing the processing and storage sections of your DAS, bear in mind that systems often gather more data than they can process. Usually, though, the volume can be reduced, without losing any information, by compressing the data.

Dynamic range and accuracy differ

“Dynamic range” and “accuracy” are sometimes used to mean the same thing, but they shouldn't be. Dynamic range is the ratio of the maximum-input signal, for which a DAS is linear, to the noise floor of the system. Although the accuracy figure for a DAS includes the noise floor imposed by the dynamic range, it has other factors, including nonlinearity, temperature, time and power-supply-related instabilities, and crosstalk.

Contrary to popular misconception, system ac-

curacy isn't due solely to the resolution of the system's a/d converters. Of course, encoding into 8, 10 and 12 bits does preclude greater accuracy than 0.4, 0.1 and 0.025%, respectively. But if a transducer and signal conditioning with only 1% accuracy precede a converter, 10 or 12-bit resolutions aren't much more beneficial than 8-bit.

Start with the transducers

Having determined parameter values, select transducers with accuracies appropriate to your system.

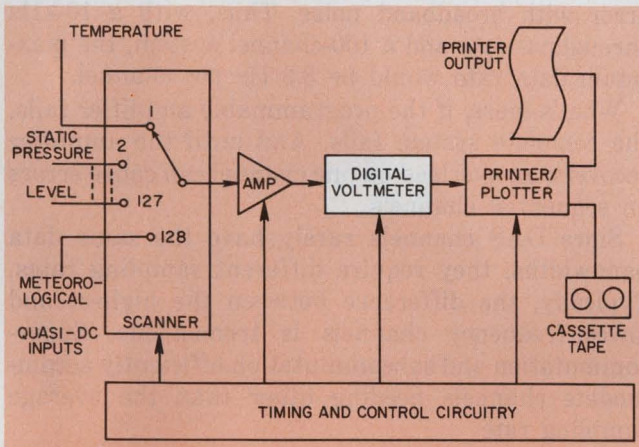

1. This data logger, which incorporates a digital voltmeter, is one of the simplest (and slowest) of DAS's. Today's data loggers offer front-end signal conditioning, autoranging gain, output scaled to engineering units, and magnetic and paper-tape outputs. Control and processing is μ P-based in some units.

For example, spending \$100,000 for a 0.1%-accuracy DAS when you're using $\pm 5\%$ -accuracy transducers is overkill.

In addition, be prepared to interface with conventional transducers for a long time to come. Don't expect the instrumentation engineer's dream, "the universal digital transducer," to become a reality in time to benefit your system. The elements for digital transducers exist, but only as separate chips. They have yet to be put together economically.

Since raw transducer outputs often don't make suitable inputs for a DAS, the signal-conditioning section of a DAS converts them to signals that the DAS can handle. Signal conditioning includes

- Excitation.
- Completion networks.
- Calibration.
- Amplification.
- Filtering.

Except for self-generating elements, such as thermocouples, most transducers require excitation. The source can be either a constant ac or dc current or a voltage. While constant voltages are the most popular sources for powering strain gauges, constant-current excitation offers better transfer-function linearity. Dc excitation usually gives acceptable ac

but for long leads, where dc offsets are expected, ac excitation often improves accuracy.

Completion networks add flexibility for selecting different types of transducers. For instance, changing a completion network can accommodate one, two or four active arms in a strain-gauge network. Completion networks mounted on plug-in cards ease changes.

The output of many transducers is in the low-millivolt range. For further processing, these low levels need amplification. In addition, the ambient common-mode-voltages (CMV) are often much higher than the signal level. Here, differential-input amps

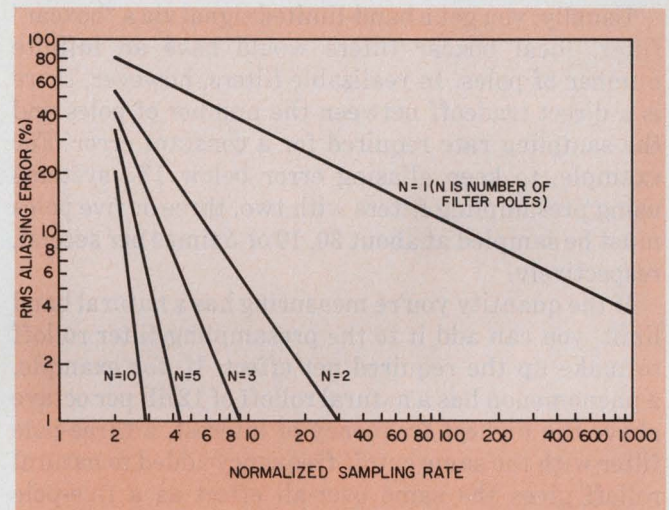

2. Filtering limits aliasing errors when the sampling rate isn't high enough for the bandwidth of the channel's data. With more poles, the antialiasing (presampling) filter's characteristics approach those of an ideal boxcar filter.

curacy, become essential.

You really can't predict an installation's exact CMV environment. Typical values can be anything from 1 to 100 V pk—usually at 60 Hz. But some situations run into kilovolts.

Amplifiers with CMVs greater than the DAS power-supply voltage are expensive. Most amps use ± 15 -V input power—and this falls within the lower common-mode bounds. Unfortunately, a CMV, even slightly past the limit—say, 20 V—can make the amp useless.

Filtering reduces aliasing errors

In broadband sampled-data systems, you can't avoid aliasing errors without input filtering, which must take place between the signal source and the sampler input. Once an unfiltered signal passes through the sampler, the aliasing error becomes so imbedded into the signal that there is no method known that is capable of separating the signal from the error at the output.¹

Fig. 2 shows a plot of aliasing error vs sampling frequency for a flat-amplitude-signal input with 1, 2, 3, 5 and 10-pole low-pass filters. The curve shows that for as many as five samples per data cycle, a filter with at least 5 poles must be included to hold the aliasing error to less than 1% rms. Note that this error

is independent of the number of bits encoded by the a/d converter.

Don't sample too slowly

"How fast must I sample?" is probably the most frequent question asked about multiplexed DAS's. According to Nyquist's sampling theory, an ideally band-limited signal can be reconstructed perfectly from samples taken at a uniform rate equal to or greater than twice the highest signal frequency. Unfortunately, ideal band-limited signals are hard to come by.

Usually, you get a band-limited signal via a "boxcar" filter. Ideal boxcar filters would have an infinite number of poles. In realizable filters, however, there is a direct tradeoff between the number of poles and the sampling rate required for a constant error. For example, to keep aliasing error below 1%, systems using presampling filters with two, three or five poles must be sampled at about 30, 10 or 5 times per second, respectively.

If the quantity you're measuring has a natural band limit, you can add it to the presampling-filter rolloff to make up the required net effect. If, for example, a phenomenon has a natural rolloff of 12 dB per octave above the highest frequency of interest, a three-pole filter with the same cutoff frequency added to natural rolloff gives the same over-all effect as a five-pole filter. Rule of thumb: A five-times sampling rate plus a five-pole filter yields 0.5% of aliasing error. Obviously, if appropriate band-limiting is available, the highest sampling rates available should be used.

Both manual and computer-controlled signal-conditioning equipment is available. For a simple dedicated system, the manual approach is the most cost-effective. In more complex systems, computer control leads to setups that are flexible and adaptable during testing. In large systems, computer control can reduce the time for both setup and test throughput.

Multiplexing puts it all together

After conditioning, the analog signals are ready to be multiplexed into an a/d converter. They can be multiplexed either before or after amplification. Before, the multiplexing is low-level; after, high-level. Both high and low-level-multiplexing schemes are shown in Fig. 3.

The low-level system uses differential switching to sample the analog inputs, and presents these signals to a single programmable-gain amp before they are converted to digital code. The high-level multiplexer uses one amplifier per channel to raise each signal level before high-level, single-ended analog multiplexing and conversion.

The low-level approach is less expensive because it uses only one amplifier. However, this cost advantage carries two major performance penalties: The throughput rate is low, and the presampling filters

must be passive.

When switching among input signals, both the multiplexer and the programmable-gain amp need time to allow switching transients to settle out. So for a system with wide-range gain control, the throughput rate is typically limited to 10 ksp/s. With an amp in each channel, the rate would exceed 1 Msp/s.

Active filters would introduce unacceptable dc errors into the low-level inputs. In practice, this usually limits the input filters to about two poles.

With only a two-pole filter (see the curves in Fig. 2), the normalized sampling rate must be at least 30 times the data rate to ensure less than 1% aliasing error with broadband noise. Thus, with a 10-kHz throughput rate and a 100-channel system, the maximum data rate would be 3.3 Hz per channel.

What's more, if the programmable amplifier fails, the complete system fails. And until the amplifier recovers, an overload on one channel can cause errors on sequential channels.

Since DAS channels rarely have the same data bandwidths, they require different sampling rates. Typically, the difference between the highest and lowest-frequency channels is tremendous. Supercommutation and subcommutation efficiently accommodate channels needing other than the average sampling rate.

With supercommutation, several slots in the commutation cycle are strapped together to provide the increased sampling that a fast channel needs. With subcommutation, one slot is divided into several subslots. During each commutation cycle, only one subslot is sampled. As a result, more channels are

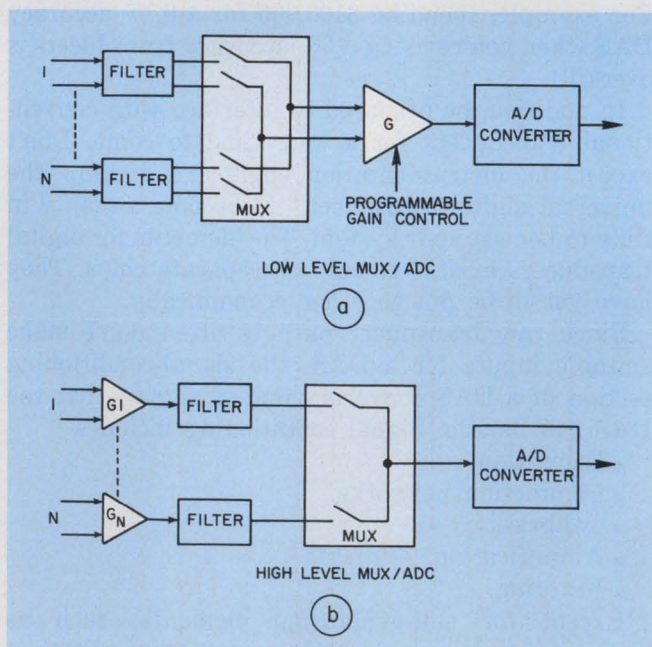

3. Either high or low-level signals can be multiplexed into an a/d converter. Low-level systems (a) contain a programmable-gain amp that boosts the signal from the multiplexer to the level most appropriate for the converter. High-level units need an amp in each data channel, between the signal source and the presampling filter.

sampled but, of course, at less than the average rate.

The wheel diagram in Fig. 4 illustrates both sub and supercommutation. Each of the shaded channels will be sampled at the mainframe rate, say 10,000 frames per second. With 32 channels in the mainframe, the throughput rate is 320,000 channels per second. The two subcom wheels provide reduced sampling-rate factors of 8 and 16, respectively. Strapping channels provides two supercoms, one with four and one with eight times the mainframe-sampling rate.

For sampling at five times the highest frequency of interest, the plan in Fig. 4 provides the number of channels with associated data bandwidths as follows: 1 at 16 kHz, 1 at 8 kHz, 17 at 2 kHz, 8 at 250 Hz and 16 at 125 Hz. There is also one channel for frame synchronization.

Now, make the data digital

After multiplexing, you encode the sampled analog signals digitally. When selecting the encoding resolution (number of bits), remember that greater resolution reduces quantization error at the expense of speed and, of course, money.

If the circuits preceding the converter keep the signal near the full-scale-input value, the quantization error is only $\pm 1/2$ of the least-significant bit (LSB). By contrast, a $1/8$ -full-scale signal encodes with no less than a ± 4 -bit error.

A similar problem occurs when a relatively small dynamic signal is superimposed on a large static offset, as is common in strain-gauge systems. If the

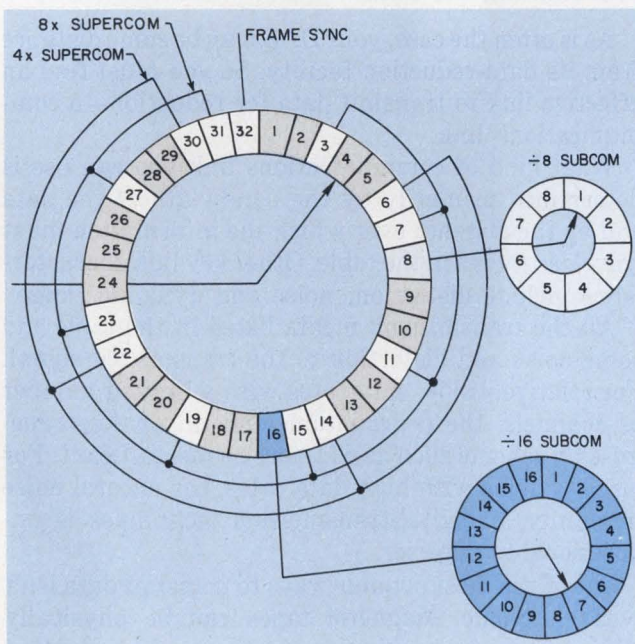

4. Fast data need sampling more often than slow data. Supercommutation, by strapping channels 3, 7, 11, 15, 19, 23, 27 and 31, provides sampling at eight-times the frame rate. Joining 6, 14, 22 and 30 quadruples the sampling rate. Subcommutating channels 8 and 16 lowers sampling to $1/8$ and $1/16$ the frame rates, respectively.

signal-conditioning amp doesn't have a programmable-offset feature, the a/d converter needs extra resolution to deliver a low quantization error.

For example, with a full-scale input of ± 5 V, a 12-bit a/d converter, operating with a ± 3.75 -V offset and only a ± 1.25 -V dynamic signal, has the same quantization error as a 10-bit unit operating at the same ± 5 V full-scale with no offset.

As noted before, an a/d converter's resolution is only one of the components of a system's total accuracy. However, the accuracy and resolution of most a/d converters themselves are consistent. For most uses, 10 or 12-bits are adequate; errors of ± 1 LSB represent ± 0.1 and $\pm 0.025\%$ of full scale, for 10 and 12 bits, respectively.

For systems that can display selected snatches of data on the fly ("quick-look" capability) or for high-speed systems, 8-bit converters are often adequate. The 14-bit (and finer) devices are usually reserved for slow-speed or wide dynamic-range systems. For a given price, the more bits, the slower the a/d converter. For a given throughput rate, the cost of the converter increases sharply with the number of bits.

Static and dynamic accuracies differ

Although a multiplexer-a/d converter block may deliver $\pm 1/2$ -LSB accuracy with static inputs at low-throughput rates, accuracy degrades with dynamic data and higher throughput rates. For example, a multiplexer using solid-state switches has many dynamic-error sources that increase with the throughput rate, including

- Turn-on or turn-off time of the multiplexer switches.
- "Pump back," or charge injection.
- Multiplexer settling time.
- Output-amplifier settling time.
- Crosstalk.

S/h adds its errors

Many multiplexed input a/d-converter systems use an s/h circuit at the multiplexer output. The s/h stores the output of one channel while the multiplexer sequences to the next channel. The s/h module, like the multiplexer also has time-sensitive errors, the three most notable of which are

- Aperture (or uncertainty).
- Acquisition-time.
- Settling-time.

Each of these errors has a fixed time value. So as the throughput rate increases, these errors can become significant.

After the sampled analog signal is captured as a voltage on the s/h circuit's capacitor, it is presented to the a/d converter, which has a "brick wall" limit for throughput. This limit is usually specified in the form of a minimum time required for conversion. Don't allow less time.

The sequential sampling in a DAS produces a definite but predictable time skew of the sampled values of different channels. Though usually negligible, this accurate time correlation among channels is sometimes important. For example, time skew must be avoided to preserve the phase relationships among channels measuring vibration.

Simultaneously gated s/h's between the presampling filter and the multiplexer solve the time-skew problem. To be most effective, these s/h circuits should operate from a common command signal so that they provide samples from all channels as simultaneously as possible.

Computers can also deskew sampled channels. But the process is off-line and complicates DAS programming. An on-line-hardware solution is preferable, because it correlates straightforwardly in real time.

Calibration isn't only zeroing

Most DAS's need calibration. Calibration capabilities in current DAS's range from zeroing and full-

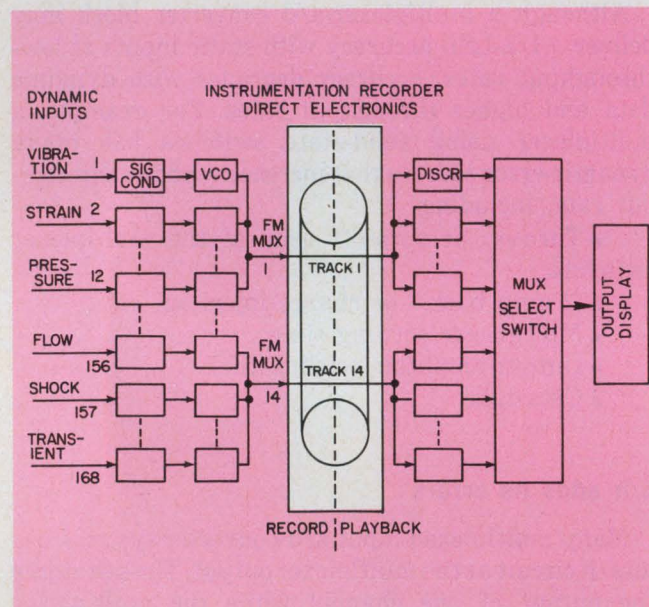

5. Each track records many data channels in a frequency-division multiplexed DAS. Frequency subcarriers from voltage-controlled oscillators are collected on a single recording track. Although in theory, up to 30 subcarriers can be multiplexed together, practical equipment usually limits each track to between 10 and 15 channels.

scale calibration manually to zeroing and gain correcting fully automatically.

Don't underestimate the complexity required in a calibration system. A simple drift correction requires two points.

Although the linearity of state-of-the-art amps is on a par with the tolerance of calibration resistors,

multipoint calibration assures you that the entire system is operating properly over its full dynamic range. A calibration system verifies the total DAS operation before, during and after a test event.

Recording the data

Often, you'll need to record your data on magnetic tape for either off-line analysis or archival purposes. For recording raw analog data, standard single-channel-per-track instrumentation recorders offer 7, 14 and 28 tracks. The data channels on these tracks can be encoded using direct, FM or high-density-digital-record (HDDR) schemes. Additional channels can be squeezed onto a track (Fig. 5) by either frequency-division-multiplexing (FDM) or time-division-multiplexing (TDM). Both these methods require that you pay the price of higher tape speed or reduced channel bandwidth.

For digital data that have been preprocessed, you can use digital-tape drives. But check your throughput rates. Often, these drives have difficulty keeping up with the data. For example: with 33% overhead, a 1600-bpi drive, whose tape moves at the respectable rate of 45 ips, can record only 27,000 12-bit words per second. Contrast this with the very-high-throughput instrumentation recorders, using HDDR encoding, that handle 4,000,000 words per second (Fig. 6).

Before your DAS can receive data, you may have one more problem to clear up.

Transmitting the data

As is often the case, your DAS may be some distance from its data-reduction facility. So you must find an effective link to transmit data for reduction—a communications link.

What kind of communications link you can use is determined primarily by the bandwidth of the data and by the distance over which the information must travel, as shown in the table. Other key link characteristics include distortion, noise and dynamic range.

All the transmission media listed in the table add some noise and distortion to the transmitted signal. For relatively slow data rates with a limited number of channels, the degradation with an analog-transmission scheme such as FM may be insignificant. For large systems with high data rates, the natural noise immunity of digital-transmission techniques is unquestionably superior.

One of the most popular ways to transmit data isn't even electronic. Magnetic tapes can be physically carried from the acquisition location to the reduction facility.

The simplest of all electronic-communication links—and widely accepted—is serial transmission over a pair of single conductors. However, for up to a few hundred feet, a parallel link using a multiconductor

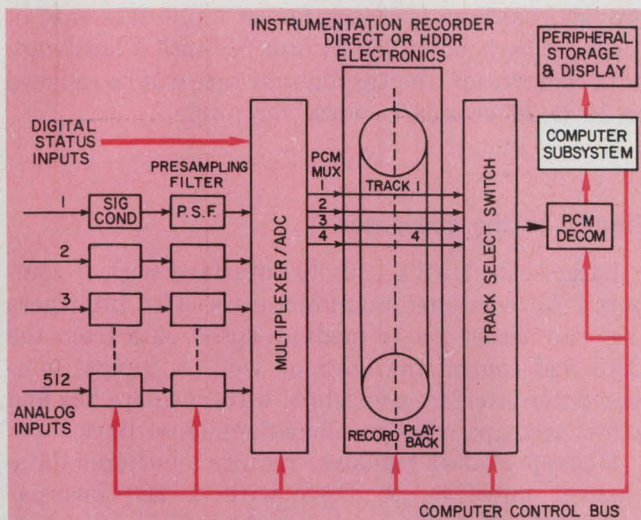

6. Pulse-code-modulated DAS's are more than "souped-up" data loggers. Once the input-data stream has been digitized, the information is virtually free from noise and drift errors. High throughputs, flexibility in selecting sampling rates and sequences, and easy computer operation are all PCM features.

bus can handle data faster.

From the various bus structures used by parallel systems, two standards have recently emerged: the CAMAC and the IEC/HP/IEEE-488. The latter will probably become the more common. Although originally intended only for communication among instruments, this bus can serve for set-up and control as well as for data transmission.

Greater than a few hundred feet, multiconductor buses become impractical. Then, you must use a two-wire communication link. But except for on-site data loggers and recorders, DAS's are configured for a single-channel-per-track mode of data transmission or storage. So with these, multiplexing will be needed to transmit their multiple-data channels over a single serial-transmission link.

For a few medium-accuracy channels, use frequency-division multiplexing (FDM). For highly accurate large systems, use time-division multiplexing (TDM). FDM systems employ either frequency or amplitude modulation, TDM systems either phase-shift-keying or frequency-shift-keying modulation.

For fixed-point links as long as a mile, use either twisted-shielded-pair or coaxial cable. Over this distance, both the bandwidth and signal-to-noise ratio are high. But for longer distances, use either an rf or a telephone-line link. These band-limited-carrier systems require the use of some form of modulator-demodulator (modem) at each end.

Untangling the multiplexed data

Whatever link you use, the data channels must be sorted out at the receiving end—demultiplexed. For FDM, each channel has a unique assignment. For

TDM, each channel has a specific time-slot assignment relative to the start of each frame.

In FDM systems, such as the multiplexed FM DAS shown in Fig. 5, frequency-to-voltage converters, called frequency discriminators, do the demultiplexing. Using bandpass filters, these discriminators select each channel from the transmitted subcarrier-frequency spectrum and convert the selected frequency to an analog voltage proportional to the instantaneous frequency of the subcarrier. Once the subcarrier frequency is selected, it is limited, detected and filtered. The output is an analog voltage that is typically within 1 or 2% of the original voltage from the data source.

At the receiving end of the link, TDM offers notable advantages over FDM, such as improved accuracy, direct digital outputs and lower costs in large systems. To extract each data channel from the serial-TDM stream, the demultiplexer and the incoming data must be synchronized. The popular pulse-code-modulation (PCM) version of TDM shown in Fig. 6 requires

- Bit synchronization to derive the bit clock accurately.
- Frame synchronization to determine the start of each frame of data.
- Word counting to identify each data word within the frame.

The PCM demultiplexer (decommutator or decom) comes in fixed-frequency, manually tunable or computer-controlled versions. You can use a computer instead for decommutating TDM, but speed and cost usually dictate dedicated hardware. This hardware should include a direct bit-parallel, word-serial, computer-interface output and displays (analog and/or digital) for quick-look capability. Many DAS's can select data channels at random for quick-look display of the data.

Where do the data go?

Usually, distributing all incoming data to your acquisition system's complement of recording, computing and display units is neither necessary nor desirable. Most data are recorded on mass-storage devices for off-line analysis and archival history. Usually, just a few critical values must be monitored in real time for out-of-limit conditions. Some others must be directly displayed in pseudo-real time.

At any rate, the various data channels must be routed to the proper parts of the DAS. Again (as in decommutating TDM), although a computer can do the routing, the computer's throughput and other processing functions will suffer. So a dedicated data distributor is often a wise choice. Essentially, this is a hard-wired special-purpose computer designed to distribute data efficiently from a single (or multiple) input port(s) to various output devices. Distributors also tag the data for subsequent processing.

What to do with all the data received? For example, even a medium-speed CAS (sampling 50,000 times a second) will accumulate almost 1.5-billion data words in just one 8-hour day. Rather than store all of them, you can compress them—and reduce storage requirements between 10 and 100 times.

Data can be compressed under software or hardware control. Although software is more flexible, it has a lower throughput rate. In either case, the data compressor passes only those data that represent changes from previous values. All other data are redundant and are rejected. The more redundant data received, the more useful the reduction process becomes.

But data compression can be two-edged. To reconstruct data completely, each point must be accompanied by the channel identification and the time corresponding to the sample. Because of the overhead associated with time and identification tagging, data compression can actually reduce throughput—for example, if the input changes continually at the maximum rate.

There are many data-compression algorithms to set criteria for whether or not a data word passes or fails. One stratagem, for example, is to pass a word whose value is outside two preset limits. Another is to pass a word if the difference between it and the previous word is greater than a set number.

Still, data compression can be crucial to real-time

analysis at high throughput rates. For example, most computers cannot ingest and process all the data, and provide real-time feedback for an input-data rate in the neighborhood of 250 kwords/s. With a hardware data compressor, the throughput rate can be reduced to 10 to 20 kwords/s—ideal for minis.

Finally, to the computer

Large-scale DAS's usually interface with a computer. All computer manufacturers offer interfaces that can accept low-to-medium-speed data from the DAS and control the DAS as well. A typical minicomputer interface consists of a 16-line data bus and a few accompanying handshaking-signal lines.

High-speed data transfers require a buffered data-channel interface. A DAS with a 200 kwords/s/throughput, for example, needs a high-speed buffered channel that can directly load either the computer's RAM or its disc storage.

These buffered data channels absorb short data bursts at a high throughput rate, then retransmit blocks of data to the computer at a reduced average rate. Multiple ports on these buffered channels permit program-controlled switching of sources. ■■

References

1. Crask, G.J., "Snare Those Elusive Aliasing Errors," *Electronic Design*, May 24, 1977, p. 186.



BIG INCH[®] MOTORS

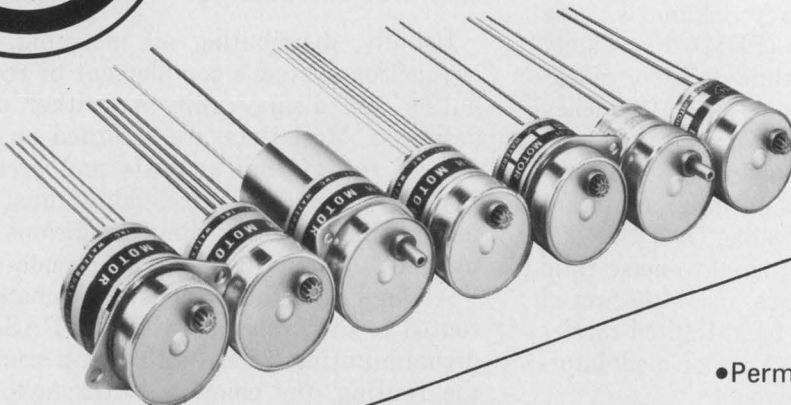

- Dependable • Compact
- High Torque • Low Wattage
- Instant Start-Stop

- Timing
- Synchronous • Stepping
- Capacitor • Instrument
- Permanent Magnet • Miniature

For more detailed information and application data send for catalog on HSI BIG INCH Precision Motors.



HAYDON SWITCH & INSTRUMENT, INC.

1500 Meriden Road, Waterbury, Conn. 06705 (203)756-7441

Who put long-track stability into a ceramic trimmer no larger than this?



CENTRALAB!

Centralab, a leading producer of ceramic-based trimmer resistors, now offers the long-track stability of full-size trimmers with a resistor element measuring .750" in a unit only .475" x .640" . . . and with terminals which meet IEC requirements of 0.100" spacing.

We call it "Series R".

Despite its miniature size, this new trimmer provides set-stability of 0.2% total voltage, thanks to its long-track resistor element which permits 300° mechanical and 260° electrical rotation.

In addition to big-trimmer stability, the new Series R retains all the most-wanted quality features of the Centralab Series S. See the cutaway view and listing of features at right.

Shown above are prices for both series of Centralab trimmer resistors.

For full specifications and complete pricing for the Series R, talk to your Centralab Technical Representative, or call (915) 779-3961.

PRICING (1,000 lot quantities)

	Series S Vert. Mount	Series S Horiz. Mount	Series R
CERBON™	.17	.19	.20
CERMET	.26	.28	.29

Products you need from people who care.



CENTRALAB
Electronics Division
GLOBE-UNION INC.
7158 MERCHANT AVENUE
EL PASO, TEXAS 79915

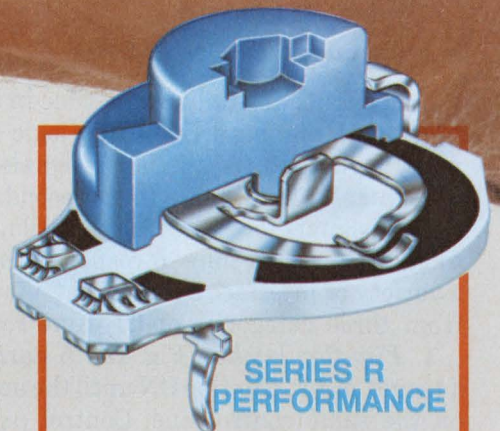

SERIES R PERFORMANCE

Set-stability, Adjustability, Low Noise

- Long-track resistor element.
- Dual tine contacts.
- Mechanical ruggedness.

Reliability

- Ceramic substrate.
- Rigid soldered terminals with hold-in option.
- "Fluxgard" environmental protection.

Flexibility

- CERBON and cermet resistor systems.
- 1-¼ watts cermet, ¾ watts CERBON.

- Hex hole/screwdriver and screwdriver/finger adjust knobs.

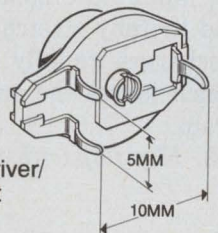

Solid-state-relay applications

require more than just basic relays to be widely useful. Amplifier, pulse and timing circuits can broaden SSR use.

You can get plenty of information on the characteristics and specifications of solid-state relays (SSRs),¹ but data for practical designs that use SSRs are hard to come by. Seldom are auxiliary circuits that allow SSRs to operate on narrow input pulses or low-level input signals mentioned—nor are time-delay and feedback circuits that broaden the range of SSR applications. Also, sequential-closure techniques, multicontact multithrow SSR configurations and proportional-control regulators get short-changed.

To fill this data gap, start with some tips on how to energize SSRs with narrow-pulse inputs.

Narrow pulses can drive SSRs

Many SSRs are fully compatible in level and sensitivity with standard DTL/TTL logic circuits. But in many logic systems, the pulse signals are very short—frequently less than a microsecond. Consequently, control signals for SSRs must be held, or “stretched,” to give the relays time to respond. The following are a variety of interface circuits that allow you to choose from three categories of ON-time requirements:

1. *Flip-flop latches* (Fig. 1a). A narrow pulse turns a toggle, or j-k, flip-flop ON until the next pulse arrives on the same control line. Control pulses fed to the complementing input of the flip-flop cause the flip-flop to set on the first pulse, reset on the next, and so on. Components C_1 and R_1 force the flip-flop into the reset state when the control-circuit power supply is first switched ON.

2. *One-shot, or monostable, flip-flops* (Fig. 1b). A narrow pulse is “stretched” for a length of time determined by timing components R and C . The one-shot is normally OFF until triggered ON by the incoming pulse. The ON-state voltage coupled back to the input via C holds the flip-flop ON until C charges and thereby stretches the applied pulse. Capacitor C discharges rapidly when the one-shot turns OFF, which leaves the one-shot ready to be triggered ON again.

3. *Flip-flop with cycle-counter control* (Fig. 1c). The

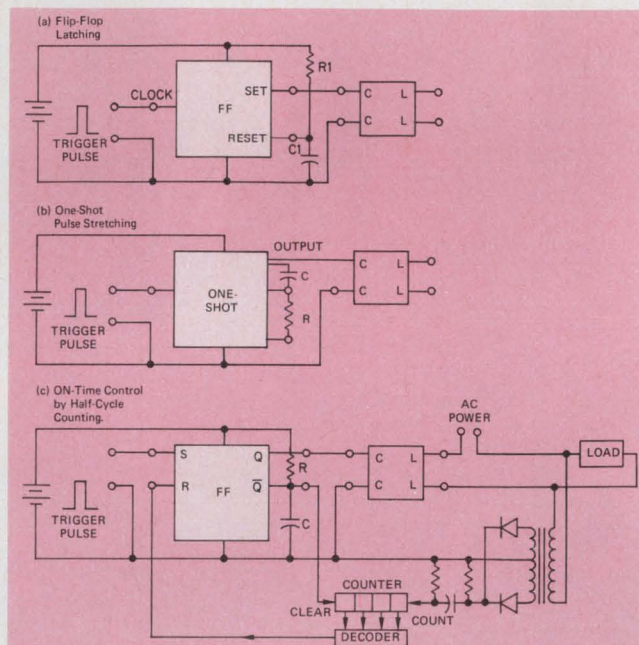

1. Many approaches can be used to hold or “stretch” narrow pulses for properly operating SSRs from logic-system inputs. A set-reset latch flip-flop (a), a one-shot multivibrator (b) or a binary counter (c) are some of the more common methods.

SSR remains energized for a predetermined number of power-line half-cycles. When a control pulse appears, the flip-flop sets, which energizes the SSR and causes ac voltage to appear on the load. The counter counts a predetermined number of half-cycles that when decoded into a reset pulse, reset the flip-flop and turn off the SSR. The reset output of the flip-flop then clears the counter and makes it ready for the next control cycle. This circuit is often used for integral-cycle control of a burst-controlled load, such as a spot welder.

Amplifying signals for SSRs

Not only can logic circuits like flip-flops, monostables and counters enable SSRs to handle narrow-pulse input signals, but with simple and inexpensive preamplifying circuits you can also increase the sensitivity of an SSR as much as 1000 times to handle high-impedance and low-level signals. Three

Paul Bachman, Applications Manager, Gordos/Grigsby-Barton, Inc., 1000 N. Second St., Rogers, AR 72756.

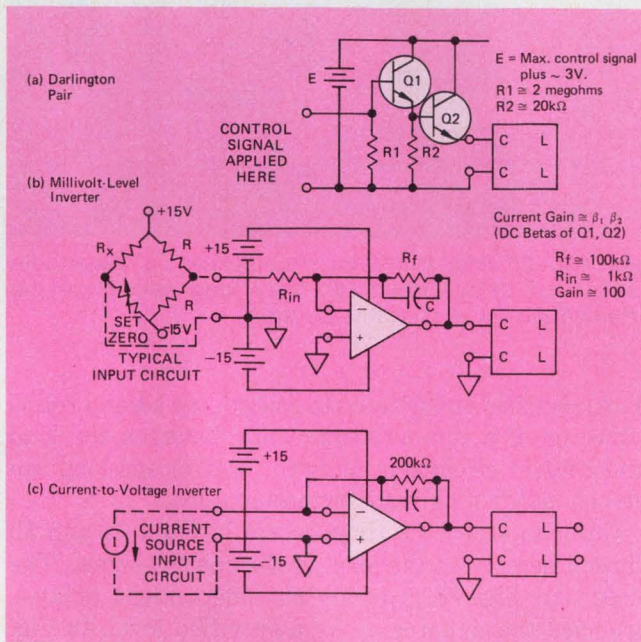

2. SSRs can be controlled from a high-impedance source with a Darlington input (a), from a millivolt level with an op amp preamplifier (b) or from a current source with a current-to-voltage converter (c). But note that in the circuits b and c the signal is inverted.

approaches to implementing preamplifiers enable you to choose according to the needs of your application: a Darlington circuit, a millivolt-input op amp and a current-input op amp.

The simplest way to increase the input impedance of an SSR substantially employs two emitter-followers cascaded in a Darlington configuration (Fig. 2a). But each transistor increases the control-voltage ratings—Must-operate and Maximum-rated inputs—by a base-emitter voltage drop, V_{be} , which is about 0.5 V for each. Thus, an SSR with its control voltage rated between 5 and 25 V needs a corresponding input to the Darlington pair of about 6 to 26 V.

However, the current drawn from the signal source is decreased by the product of the current gains of the two transistors—generally several thousand times. The input impedance of a 1000-Ω SSR can easily go to about 1 MΩ. Of course, the parallel impedance of bias resistor R_1 , which is necessary to ensure transistor cutoff, must be included in the input-

impedance calculation and acts to reduce the impedance. Since the Darlington pair draws virtually no collector current until an input signal is applied, the circuit is highly efficient.

A millivolt-level preamplifier for an SSR uses an op amp connected as a conventional inverter (Fig. 2b). Note that the op-amp input terminals should be connected so that the proper input-signal polarity is applied to the SSR. As shown, the output polarity is inverted relative to the input.

Capacitor C across feedback resistor R_f prevents parasitic oscillation and reduces the bandwidth so that the SSR isn't too responsive to high-frequency noise. A large C makes the circuit integrate the input signal, which averages out hum and random perturbations. The SSR then responds only to sustained input signals without chattering. But, of course, its response to control signals is appreciably slowed.

When choosing an op amp, check its input offset-drift rating. When multiplied by the gain, input drift can produce false input signals to the SSR that are large enough to shift the control range excessively, or even cause false turn-on or turn-off. Low-offset-drift op amps should be used in critical applications, particularly for a wide ambient-temperature range.

Note that the power supply for the op amp needn't be the ±15 V shown. For example, single-ended op amps can be operated from a single positive supply provided that the op amp's output doesn't have to go negative. Of course, when using an inverter input, the input, then, never goes positive.

A highly sensitive current-to-voltage preamplifier, useful for operating SSRs from current sources like photomultipliers, leakage detectors and gas monitors, can develop from input currents of only about 25 μA at the 5 V of drive needed for a typical SSR (Fig. 2c). However, op amps with very low bias-current ratings must be used. Inexpensive op amps are available that have both very low bias-current ratings and low bias-current drift. Low-drift performance is necessary to prevent shifting of the control range, or in extreme cases, even false operation of the SSR.

Controlling the timing of SSRs

Besides handling narrow-pulse, low-level and high-impedance inputs, SSRs must often be timed, or

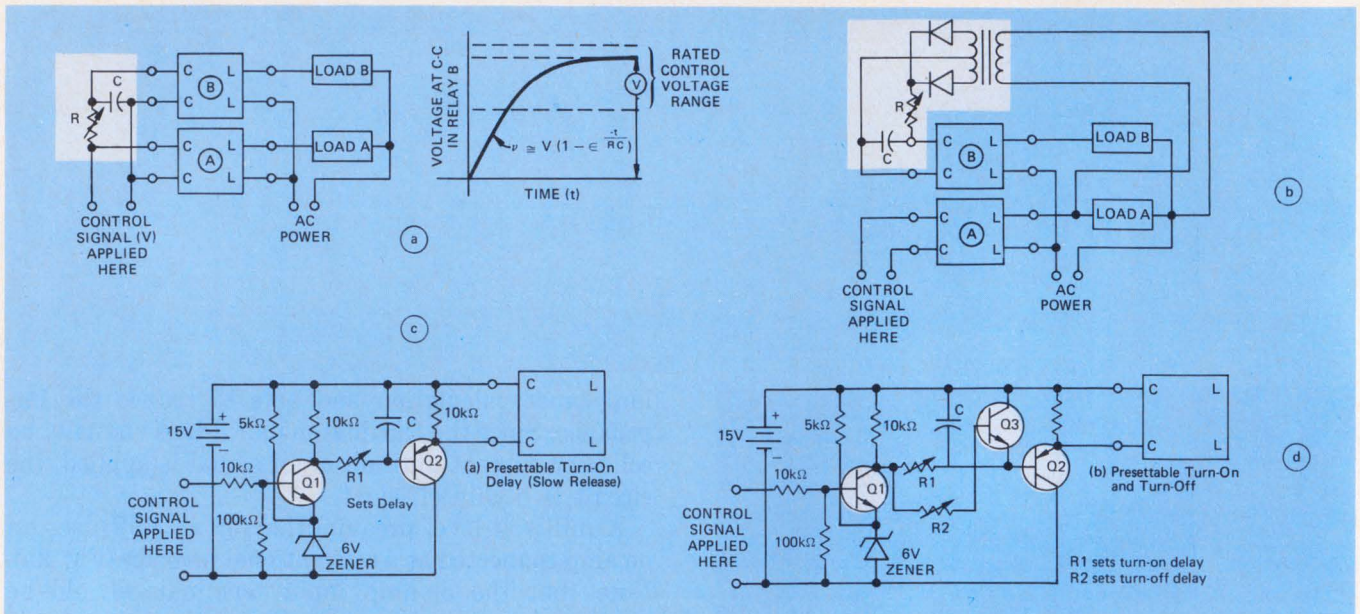

3. Time delay and sequencing in SSRs can be obtained with a simple RC circuit (a) or a fail-safe feedback arrangement (b). Other delay techniques include a preset-

table turn-on delay transistor circuit (c) and a presettable turn-on/off delay circuit (d). Very long delays can be attained with a presettable counter.

synchronized, with specific circuit events. A requirement frequently imposed on the SSR—and the simplest—is that it operate at a preset time after application of an input signal.

Sometimes this delay ensures that one circuit closes before another. The easiest way to implement staggered SSR actuation is to apply the control signal directly to the first SSR and delay the signal with an RC network before applying it to the second. Clearly, the method can be extended to several SSRs in sequence.

A one-shot delay circuit, although more complex and expensive than the simple RC network, has greater delay stability and isn't affected by the SSR's input resistance, especially when SSRs that use input-isolating reed relays are used. The relatively low input resistance of the electromechanical reed-relay input of these SSRs, called hybrids, forces you to use large capacitors and low resistances, which limit the range of attainable delay times.

Charge stored in the capacitor in Fig. 3a also causes a delay of the relay's release. However, circuits are available for eliminating this constraint, and even for reversing the order of turn-off. Another problem with Fig. 3a is that a smaller voltage is applied to the delayed relay than to the undelayed one. However, a resistor inserted in series with input to the undelayed relay, and having the same value as the delayed unit, will equalize the control signals.

Fig. 3b shows how to implement a fail-safe feedback interlock that prevents a control signal from energizing a second relay until the first load has been energized. Thus, if for any reason the first relay doesn't operate, the second can't be energized. The voltage across the first load is transformer-coupled

back, rectified and filtered to control the second relay. However, if a common connection between the load and control circuits is allowed, this closed-loop approach needn't be transformer-coupled.

Unfortunately, the time delays in Figs. 3a and 3b depend heavily on the level of the control signal. The circuit in Fig. 3c provides an independent delay—provided the signal is above a specified level. In Fig. 3c, before application of a control signal, transistors Q₁ and Q₂ are both nonconducting. Transistor Q₁ saturates when the control signal exceeds 7.5 V by a few tenths of a volt. The voltage at its collector then drops sharply by about 7 V and capacitor C charges through R₁. Now, Q₂ starts to conduct.

When the capacitor charges to about 4.5 V, the voltage at the SSR input is sufficient to operate it, if its Must-operate rating is, say, 4 V. The time to operate the SSR is, therefore, controlled by the time constant R₁C, and not affected by circuit-input voltages above about 7.5 V. A typical range of values for R₁ is 25 to 250 kΩ. And for delays of about 0.25 to 2.5 s, C should be a 10-μF, low-leakage tantalum capacitor.

If the SSR turns off at, say, 1.5 V, then the delay on turn-off, after removal of the control voltage, is somewhat more than the turn-on delay. To turn off, the capacitor must discharge to about 2 V from about 7 V, which takes slightly more than one time constant.

To make the turn-off time independently presettable, the circuit in Fig. 3d adds R₂ and Q₃. Initially, Q₃ is cut off and remains so while C is being charged. But when the control voltage is removed, the collector of Q₁ rises to +15 V and saturates the Q₃ base so that its emitter/collector path "shorts" across the charged capacitor. The capacitor then discharges at a rate

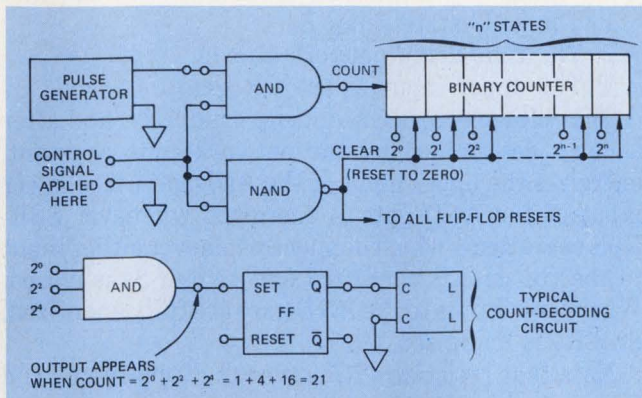

4. Any combination of time-on sequences can be obtained with a counter and an appropriate count decoder for each SSR in the sequence.

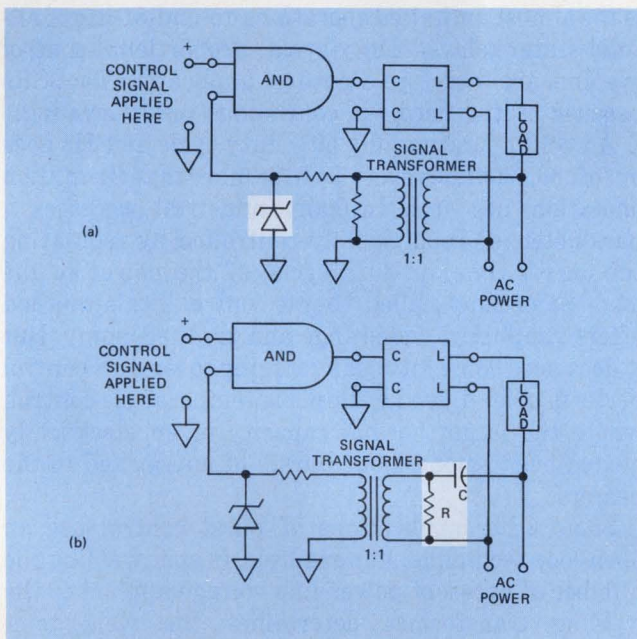

5. Power to the load can be synchronized to start only when the ac line has a particular polarity (a). A phase-advance network (b) can compensate for delay in the SSR.

determined by R_2 . If Q_3 's current gain is β , it will discharge the capacitor in about CR_2/β seconds.

Fig. 4 shows how to operate a group of SSRs in a predetermined sequence after a control signal is applied. Once the control signal is removed, all SSRs turn off simultaneously. The circuit employs a pulse generator whose repetition rate establishes the shortest time interval in the sequence. A 10-Hz rate provides an interval definition of 0.1 s, but almost any other rate can be used. A lower repetition rate provides less resolution, but then fewer counter stages are required for long time intervals.

With a 10-Hz pulse generator, if you wish to turn on a particular SSR at, say, 2.1 s after the control signal is applied, connect an AND gate to decode the

three counter outputs— 2^0 , 2^2 and 2^4 —that represent the number 21. Once this count is detected, a holding flip-flop actuated by the decoding AND is set and the SSR is turned ON.

Any number of such decoding AND circuits within the loading capability of the counter may be connected to the counter to actuate separate SSRs. Where necessary, the counter may be buffered to drive larger loads.

When the control signal is removed, the output of the NAND gate clears the counter to zero and resets all SSR-holding flip-flops. All the SSRs at this time also return to the OFF state.

Synchronizing SSRs to the power line

Very often, an SSR with dc input control and an ac power load must be prevented from going ON unless the power line is about to go positive, no matter when the control signal is applied.

In Fig. 5a, a small signal transformer drives a low-voltage zener diode through a resistor. The nearly rectangular wave developed across the zener, which alternates between +6 V and -0.5 V, is synchronized with the power line. When a control signal is applied, the AND gate turns on the SSR only when the line voltage has the desired polarity. The turn-on polarity depends on the transformer-winding connections.

Fig. 5b adds a phase-shift network, R and C, to advance the rectangular wave across the zener by a few degrees. In this way, the AND gate can be enabled somewhat early to account for on-time delay in the SSR. This phase advance avoids cutting off any of the power cycle that a slow SSR might produce.

Multipole and multithrow configurations

When multipole action is implemented with several hybrid SSRs, variations in input reed-switch response times can cause staggered "closure," which can be either equalized or purposely sequenced by the time-delay circuits in Figs. 4 and 5. However, when timing isn't important, polyphase loads like motors, resistances or power supplies can be controlled with either parallel or series input control of the SSRs (Figs. 6a, 6b).

Note: In Figs. 6a and 6b zero-voltage-turn-on relays are not recommended for polyphase-motor applications where the neutral wire is not available. Hybrid relays, because of their relatively slow-acting inputs, aren't usually used in a zero-turn-on arrangement.

Not only multipole, but also multithrow action can be achieved by SSRs. "Double-throw" contacts, as on an electromechanical relay, are shown in Fig. 6c. Although SSRs basically provide only single-pole, single-throw behavior, the "normally closed" action is created simply with a transistor serving as an inverter. When a control signal is applied, transistor Q is biased OFF; when it is removed, Q conducts and

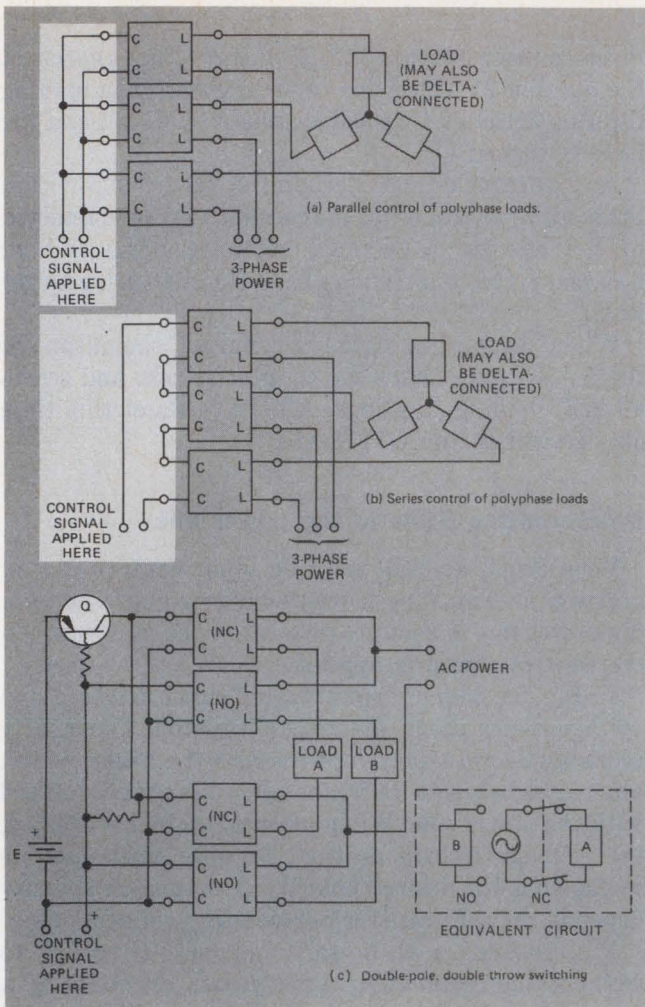

6. Multipole performance can be obtained with SSRs. The control signal can be applied either with the SSR inputs in parallel (a) or series (b). Also, you can get double-throw action by using a transistor to invert the signal to the "normally closed" SSR (c).

keeps the SSR ON. The control signal should be at least 1 V larger than the collector voltage, E.

Ladder diagrams easily implemented

Ladder and relay-tree circuits are easy to implement with SSRs, because SSRs can be controlled by almost any kind of digital logic—from simple diode arrays to TTL and computer-generated commands. Fig. 7 illustrates a general approach to converting a conventional electromechanical-relay (EMR) ladder (Fig. 7a) into an SSR equivalent (Fig. 7b).

The logic configuration in Fig. 7b is only one of many ways the EMR ladder of Fig. 7a can be implemented with SSRs. The simplest approach uses an open-loop technique, where no feedback occurs between loads and control inputs.

In Fig. 7b, pushbutton switch PB₁ sets a flip-flop, and the set output of the flip-flop energizes SSR-K₁. (Thereafter, pushbutton PB₂ resets the flip-flop and de-energizes K₁.)

When the flip-flop is set, closing switch S₁ energizes

three things:

1. The solid-state relay K₂.
2. The time-delay network R₁R₂C.
3. The upper input of the OR gate.

The voltage across C builds up gradually, and after a delay determined by the network time constant, energizes the upper input of the AND gate. The lower input of the AND gate is energized whenever SSR-K₃ is energized—which happens whenever either input to the OR gate is energized and switch S₂ is closed. When both inputs to the AND gate are fully energized, SSR-K₄ is energized.

Note that resistance R₂ serves to discharge C, and both R₁ and R₂ are assumed to be small compared with the input resistance of the AND gate.

Duty-cycle control natural for SSRs

One characteristic that attracts engineers to SSRs is the almost unlimited operations-to-end-of-life of all-solid-state relays. Duty-cycle proportional-control systems are therefore a natural application for SSRs because of the need for continuous on-off cycling.

An SSR operating in a 50% duty cycle at 1 Hz goes on/off 86,400 times every 24 h, or more than 31-million operations per week. In many industrial processes, a parameter is proportionally controlled by regulating the on/off time, or duty cycle, of the power to the load. Sometimes called "burst control," this method offers simplicity, wide range and great economy. But it does need some form of averaging to smooth control performance. A good example is temperature control, where the large thermal capacity of an electrically heated oven smooths out bursts of energy fed to the heaters.

Some other applications of burst control use an open-loop technique. For example, in spot welding the number of cycles of power-line voltage applied to the welding transformer determines the weld temperature. The material welded supplies the thermal-averaging effect.

However, it's more accurate to use a closed-loop feedback approach. Fig. 8 shows a closed-loop, burst-control, temperature-regulating scheme that depends on averaging a high number of on/off power cycles. The system is more complex than a simple open-loop thermostatic control; however, it provides closer regulation and much less hunting and overshoot over a wider range of temperatures.

The multivibrator in the on/off controller operates at about 1 Hz with a duty cycle of 50%, when the voltage across R₁ is approximately equal to the voltage across R₆. Consequently, heater power is on half the time. If the temperature in the oven falls below the level set by R₁, the resistance of a negative-thermal-coefficient thermistor, R_t, rises and the voltage across R₁ falls. And, now, Q₂ conducts longer than Q₁.

The greater the temperature drop, the longer the SSR, energized by Q₂, conducts to supply more power to the heater and drive the temperature up. The circuit

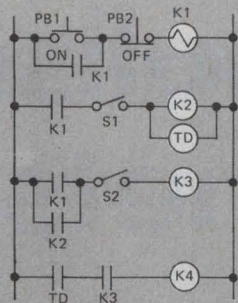

(a) EMR ladder.

If PB1 is pressed, K1 is ON until PB2 is pressed.
 If K1 is closed, and S1 is closed, K2 and time-delay TD are energized.
 If either K1 or K2 is energized (or both), closing S2 energizes K3.
 After time delay TD completes its cycle, if K3 is energized, K4 is operated.

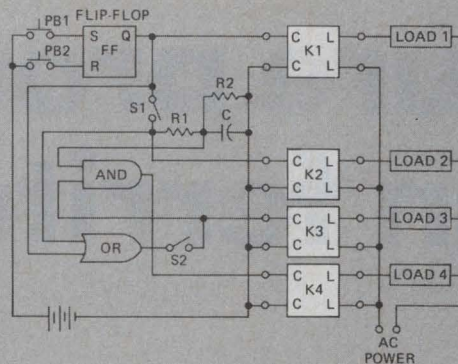

(b) SSR equivalent.

7. Because SSRs easily interface with common DTL/TTL circuits, SSRs can be used to "replace" electro-

mechanical-relays in a ladder circuit (a) and provide equivalent behavior (b).

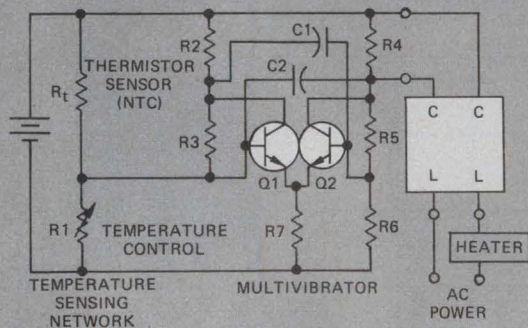
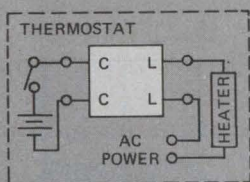

8. Because proportional on/off control systems require relays with large cycling lifetimes, SSRs are a natural choice for such applications.

can respond to relatively fast transients and provide tight static regulations with minimal hunting.

In on/off proportional-control applications, where the load is a transformer primary, a motor winding, a solenoid or some other magnetic device, the circuit can drive the magnetic core of the device into saturation, if the positive and negative cycle halves aren't equal in number. Such a condition corresponds to a dc component in the load current, which becomes most pronounced when the ON period is very short. The worst case, clearly, is a single half-cycle. A saturated transformer not only operates inefficiently, but has very low impedance, so the SSR may be damaged by excess current and fuses may blow repeatedly.

Some SSRs have internal circuitry to ensure whole-cycle control. But if the SSR isn't designed this way, to prevent saturation in short duty-cycle burst controls, add a circuit as in Fig. 9. Saturation of the load

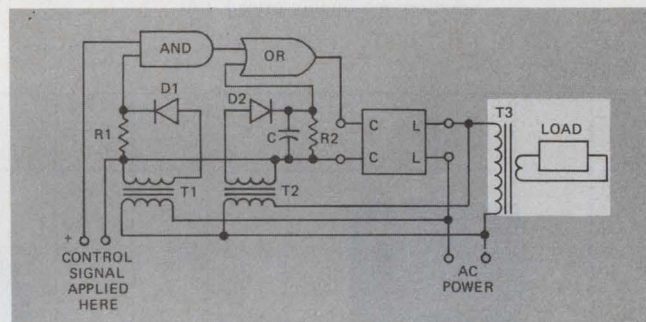

9. When short power bursts can result in unequal positive and negative power-line half cycles, a magnetic-core load can saturate and damage the control SSR. But this simple circuit can eliminate the problem by ensuring that the power to the load has an even number of half cycles.

transformer T_3 is prevented by a two-part control strategy:

1. The small signal-level transformer T_1 , together with D_1 , R_1 and an AND gate, forces the SSR to begin its burst on a specific polarity of the power line—say, the positive half-cycle. However, some SSRs are designed to start conducting on a specific power polarity, which can eliminate the need for this part of the circuit.

2. The small signal-level transformer T_2 , when excited from the load voltage, charges capacitor C through D_2 on every positive half-cycle of the load voltage. Resistor R_2 discharges C after the peak of the positive half-cycle. But C retains charge long enough to ensure that the SSR will conduct for the next negative half-cycle, should the control signal be removed during a positive half-cycle.

Consequently, every power burst contains an equal number of positive and negative half-cycles. Note: If a common connection between the load circuit and the control circuit is allowed, transformers T_1 and T_2 may be eliminated. ■■

Reference

1. Grossman, M., "Focus on Solid-State Relays," *Electronic Design*, Dec. 20, 1976, pp. 48-56.

Pure professionalism in ferrite magnets.

Take your pick between barium ferrites and strontium ferrites. You'll find that as far as conserving resources is concerned, these materials have a great advantage over cast magnets and they are more reasonably priced, too.

You'll go for our ferrite magnets in a big way because of their high coercive force and superb magnetic stability. You'll find that their powerful anisotropic energy will work wonders for micromotors and other motors by helping to improve their performance and making them more compact.

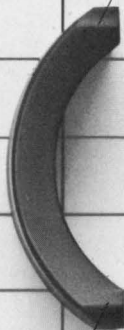
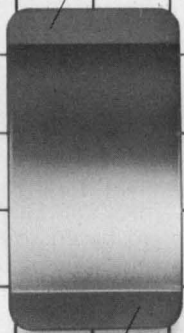

We can make ferrite magnets for you in just about any shape, big or small. But if you want them in the standard form of rings and segments for motors, we'll be just as happy to oblige you.

We have our own production lines that are geared to supply mass quantities of ferrite magnets with a quality that is always high. Our manufacturing process is vertically integrated since we oversee every single stage from the treatment of the raw materials to the final finishing and processing.

We rely on a unique processing technique for our finishing and processing. This allows us to meet requirements for high-level dimensional precision. Behind this technique stand years of experience and proven all-round expertise as a specialist manufacturer.

You have probably deduced by now that we at TDK are specialists when it comes to making ferrite magnets. We have our own plants and the latest in streamlined facilities which are finely tuned to guarantee steady supplies of magnets in large volumes. Our production know-how, forged in the heat of constant innovation, has helped us to gain the position we hold today. It is the same expertise that is responsible for creating our REC (rare earth cobalt) magnets with a maximum energy product of 30 MGOe. When it comes to making ferrite magnets, we are pure professionals.



TDK CORPORATION OF AMERICA 2041 Rosecrans Avenue, Suite 365, El Segundo, California 90245 U.S.A. Phone: (213) 644-8625

CHICAGO BRANCH 2906 West Peterson Avenue, Chicago, Illinois 60659 U.S.A. Phone: (312) 973-1222

NEW YORK BRANCH 755 Eastgate Blvd, Garden City, N.Y. 11530 U.S.A. Phone: (516) 248-5230

EL PASO BRANCH 3501 Frutas Street, El Paso, Texas 79905 U.S.A. Phone: (915) 533-5799

TDK DE MEXICO S.A. de C.V. Carr. Juárez-Porvenir, Parque Ind. A.J. Bermúdez, Cd. Juárez, Chin, Mexico Phone: 3-88-27

TDK ELECTRONICS CO., LTD. Tokyo Japan

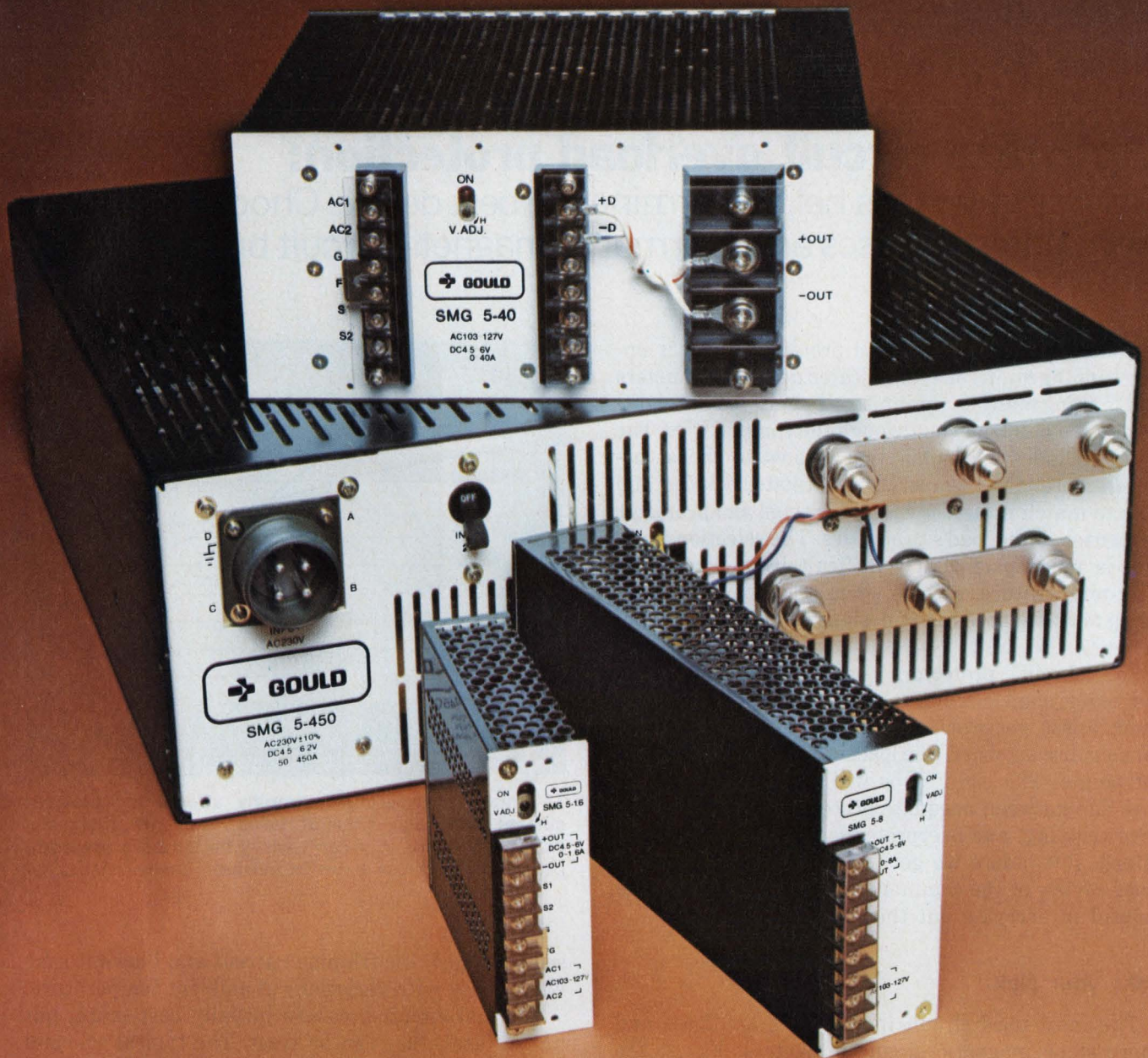

Gould introduces a new range of switching power

Gould's new SMG series lets designers switch to smaller, lighter, more efficient switching power supplies without buying more specs than are needed.

Eighteen new SMG models give the Gould line both wider wattage and a lower price range while maintaining the reliability demonstrated by more than 32,000 Gould units now in use.

The SMG series offers outputs

from 8 to 2,250 watts in a wide selection of voltage/current combinations. Units rated above 500 are fan cooled and are front panel selectable for 110 or 220 VAC.

All SMG units have short circuit and over-voltage protection. Temperature stability and voltage regulation are outstanding. Brownout margins are as high as 63-milli-seconds. There's even an LED "on" indicator on the front panel of every unit.

For complete information contact Gould Inc., Electronic Components Division, 4601 N. Arden Drive, El Monte, CA 91731 or phone (213) 442-7755. TWX 910 587 4934.

Gould.
The power in switching power supplies.



Optimize circuit overload protection:

Eight simple steps help determine the best device. Choose from one-shot fuses and thermal or magnetic circuit breakers.

Choosing a circuit overload protector involves understanding numerous complicated design parameters and making many compromises. To help you, an eight-step guide will lead you through the complexities. The guide includes an explanation of how to choose between current and temperature-activated devices, and how to match protector current ratings and protector responses to the load's properties. The selection problem is made particularly difficult by modern high wire-temperature ratings, dense component packaging and advanced motor designs, which push components to the limit.

So, circuit protectors need close tolerances. Moreover, some circuits must have high tolerance for short pulses, yet provide sharp trip points with instantaneous breaks when overloads exceed predetermined set points. The eight steps will help you travel the fine line between adequate protection (without nuisance tripping) and overprotection—a luxury few can afford. But before we get to the eight-step guide, a brief review of the commonly used protectors will be helpful in carrying out the suggestions.

Take your pick

The most used circuit interrupters are fuses and thermal or magnetic circuit protectors. Fuses, the oldest of the circuit protectors, are one-shot throw-aways that are simply constructed and the least expensive. They cover a very wide range of ratings and can provide blowout delays from milliseconds to hours. But low initial cost ceases to be an advantage when fuses blow. The expense of replacing them plus the equipment downtime when a fuse is not immediately available quickly offset this advantage. Furthermore, equipment is often damaged when the replacement fuse has a higher rating than the original—a practice often resorted to when an exact replacement can't be quickly found.

A fuse element melts and blows because of the heat generated by its resistance to current flow. The precise current at which this happens depends upon ambient temperature, the size and mounting of the fuse clip and the length and size of attached conductors. As

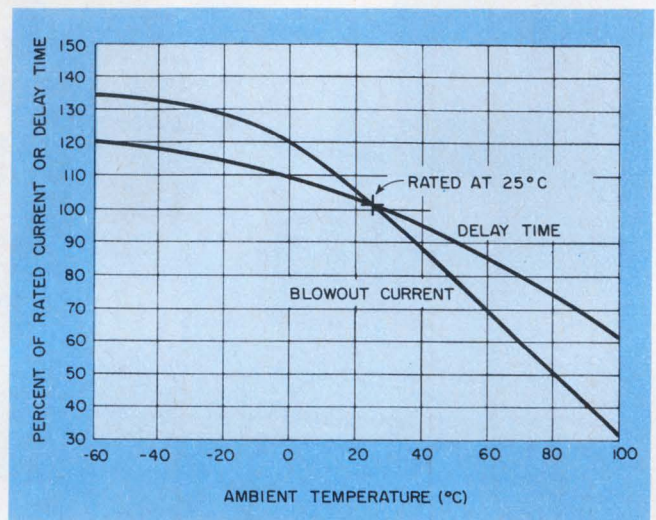

1. Ambient temperature strongly affects the blowout current and delay time of fuses. They are thermally activated devices that can't easily be temperature compensated: don't use them in extreme environments.

seen in Fig. 1, the tripping current and blowout time vary widely with variations in ambient temperature.

Thermal circuit breakers initially cost more, but unlike fuses, they can be reset. The typical thermal circuit breaker employs a bimetal or trimetal element that actuates a trigger latch. Like fuses, most thermal protectors are affected by ambient temperature. However, unlike fuses, thermal breakers can be ambient-compensated by adding complementary bimetal elements to cancel out the influence of ambient temperature. As shown in Fig. 2, a thermal devices can be tailored to match the safe temperature limits of insulated wire, an important market for thermal protectors.

Magnetic protectors mechanically trip a circuit roughly the same way as thermal breakers; however, they respond to ampere turns rather than temperature. While magnetic protectors are the most expensive of the three types, special capabilities can make them cost-competitive in many applications.

A magnetic protector has a definite trip point related directly to current and is only secondarily affected by heat factors. Consequently, magnetic breakers can carry full rated current without the nuisance of repeated tripping when the ambient tem-

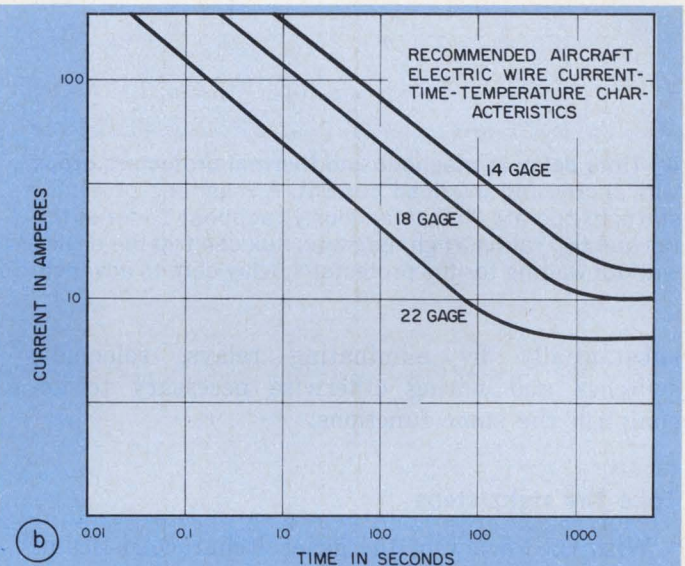
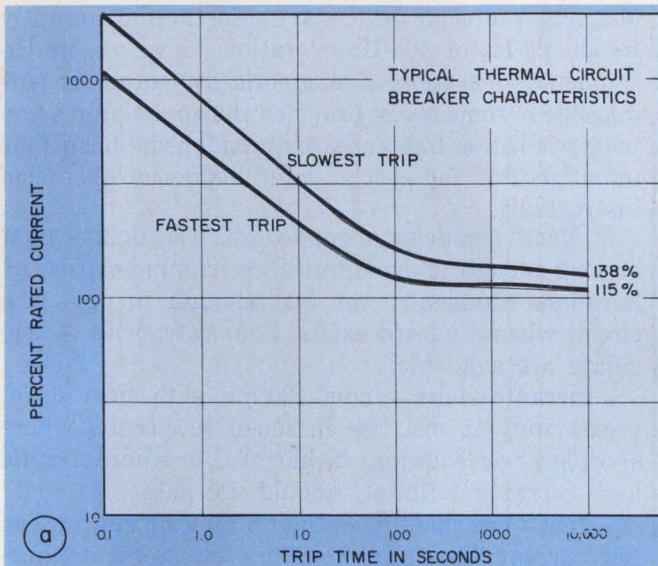

2. The trip-delay characteristics of thermal protectors can match the safe operating time of insulated wires and

ensure that current is interrupted, without unnecessary tripping, before the wires are damaged.

perature rises. Magnetic protectors easily handle a range of -40 to 85 C.

Time delays in magnetic units are usually provided by moving an iron core in a hydraulic dash-pot (Fig. 3). Trip time, which is determined by the speed of the core movement, depends on the amount of overcurrent and the viscosity of the dashpot oil. Current ratings and trip curves are easily adapted by manufacturers to match wiring, printed-circuit boards, motors, transformers, lights and other components.

In addition, magnetic protectors often act as on-off switches for the equipment they protect. They may be equipped with auxiliary or alarm switches, shunt taps, relay poles, dual-coil poles, tapped coils, "no voltage" trip poles and voltage trip poles. Secondary functions include remote electrical shutdown, safety interlocking, and shutdown from loss of ventilation, overheating and improper sequence of operation.

By using electrically isolated actuating coils, magnetic circuit breakers can combine as many as nine poles in one device. The extra contacts and coils combine to form a multipole protector in which a fault in any one circuit automatically trips all circuits.

Obviously, these additional built-in features cost more than a simple protector. However, you can save

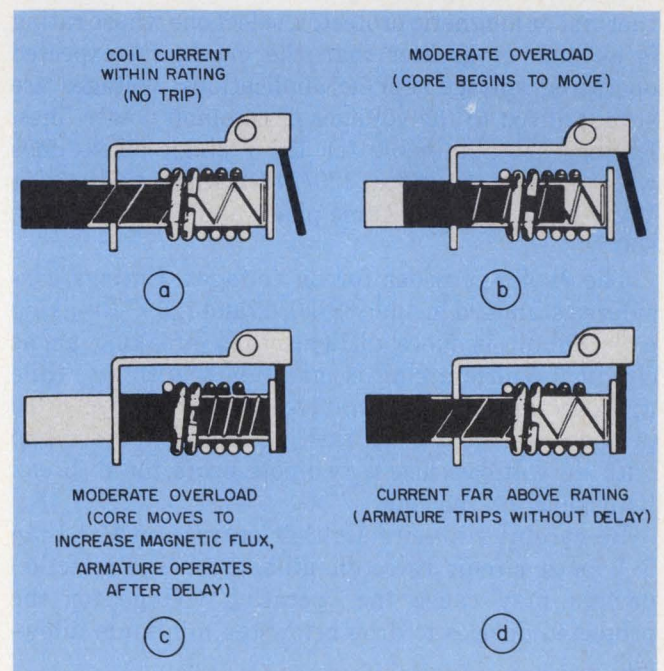

3. Time delay in magnetic protectors is often obtained by moving an iron core in a hydraulic fluid. The viscosity of the fluid provides most of the control over delay. But, at high overloads tripping occurs without delay.

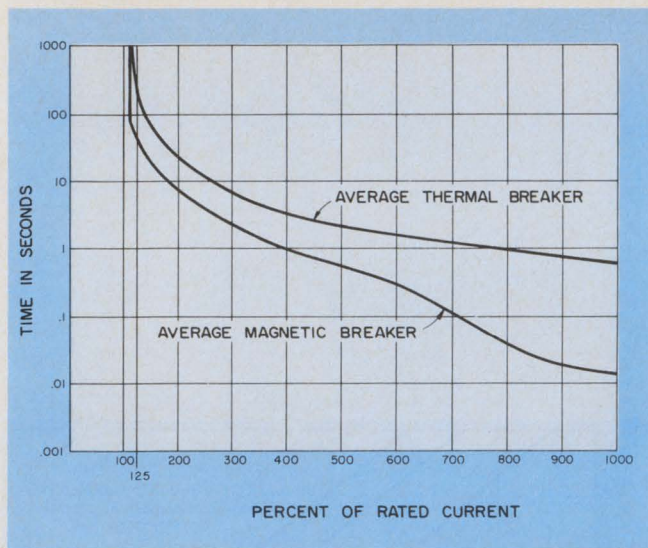

4. Time delay in magnetic and thermal protectors drops with increasing overload current. A magnetic protector starts to operate "instantaneously" at about 10-times the normal trip rating. High magnetic flux can trip the device without waiting for the protector's delay core to advance.

substantially by eliminating relays, solenoids, switches and wiring otherwise necessary to accomplish the same functions.

Take the right steps

With the review of the general characteristics of fuse, thermal and magnetic protectors behind us, you can now concentrate on the eight steps needed to evaluate your particular circuit-protection requirements:

1. *Select voltage rating.* In all cases, whether fuse, thermal or magnetic protector, select one whose rating is as high or greater than the maximum expected operating voltage. For ac applications, voltages are standardized to the voltages of common power lines. Ratings are obtainable for 120-V single-phase lines with one side grounded, 120/240-V single phase, 208-V three-phase, 480-V three phase and, in some cases, 600 V.

The choice is wider for dc voltages. Ratings considered standard include 32, 50, 65 and 125 V. Breaking a dc circuit is more difficult than breaking an ac circuit, because arcing is maintained with dc, while ac goes through zero voltage every half cycle. To provide a longer, more easily extinguished arc gap with dc voltages, use a two-pole protector to break both sides of the line.

Be careful with circuits that operate on less than 5 V or a circuit rated in milliamperes. Protection devices may cause the operating voltage for the protected devices to drop below the minimum allowable.

2. *Select the right trip-current rating.* The current rating of your protector should be approximately 20% higher than the full-load current of the protected device. This allows leeway for manufacturing toler-

ances and voltage fluctuations of the power mains.

3. *Allow for maximum available fault current.* Circuit protectors must be capable of interrupting the maximum available fault current safely. Examine the worst-case fault condition. For example, a 600-A fault current can occur on a 120-V line that normally carries only 30 A, because the line resistance, which is 0.2Ω , is the sole current-limiting element. In this case, you should use a circuit breaker having a nominal 30-A current-carrying rating, but a minimum current-interrupting capability of 1000 A.

4. *Consider power-line frequency.* Magnetic protectors are frequency-sensitive, thermal devices are not. Magnetic-protector devices are structured differently for dc, 60-Hz or 400-Hz operation. However, multi-frequency operation of magnetic protectors is permissible in some cases, provided the application's trip points and other tolerances are broadened. Consult the manufacturer for special multifrequency operation instructions.

5. *Match trip delay to application.* Trip delays must be long enough to avoid nuisance tripping caused by harmless transients, yet fast enough to open the circuit when a hazard exists. Four categories of trip delays are available:

- **Instantaneous**—under 100 ms, with most at approximately 15 ms. Use in sensitive circuits where short low overloads may be harmful, or where specific high currents definitely should not pass.

- **Fast**—less than 10 s at their minimum guaranteed trip current. Use for circuits and electronic applications where temporary overloads of 200% can't be tolerated for more than a few seconds.

- **Slow**—10 to 100 s at their minimum guaranteed trip current. Use for most large transformer-coupled loads where brief overloads can be tolerated without damage. Slow delays allow turn-on surges of most applications to pass without tripping.

- **Very slow**—more than 100 s at their minimum guaranteed trip current. Use where a limited overload will not cause damage—for example, with motors that have starting-current surges that last for several seconds and draw as much as 600% of their running-current rating.

As overloads increase, time delays decrease (Fig. 4). This is usually desirable because protection then comes faster. When the overload is over 10 times rated, magnetic protectors operate in the instantaneous mode.

6. *Learn how to tolerate pulses.* Special features can be built into magnetic protectors to handle short, high-overload pulses. They are the biggest source of nuisance tripping. Transformers or other highly inductive loads can easily generate peaks up to 20 times the rated current and last for a half-cycle (Fig. 5). Observing and measuring these short, high-amplitude pulses is difficult. Often, oscilloscope current probes get saturated and give a false, low-valued picture of such pulses.

Protectors with short delays have poor pulse tolerance. They trip when subjected to just two or three

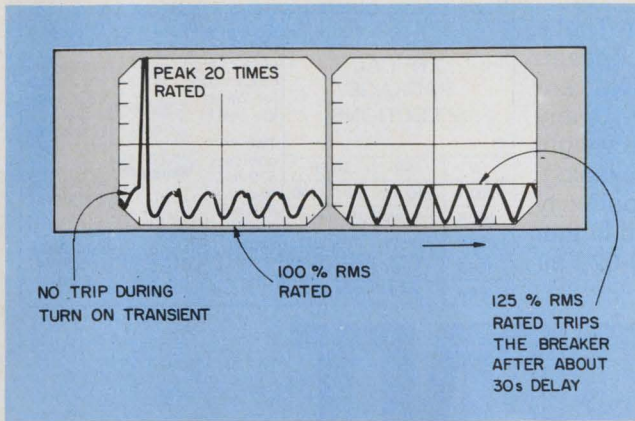

5. **Inductive loads require protectors with high pulse tolerances.** Pulses of 20-times the rated trip current that last for a 60-Hz half cycle must not cause tripping.

times the nominal trip current. Delay protective devices can easily handle peaks 10 to 20 times the trip point; some long-delay protectors handle about 30 times.

Special magnetic protectors with damping mechanisms, often called inertial wheels or flux busters, provide high-pulse tolerance up to 50 times the nominal trip current for severe inrush-current equipment such as variable-ratio and ferroresonant transformers.

7. *Check out the environment.* Operational environment plays havoc with protectors. Recognize ultra-

high or ultra-low temperatures, vibration and shock, among the conditions, before selecting the protector.

Extreme temperatures change both the current trip point and delay time of both fuses and uncompensated thermal devices. They are susceptible to nuisance tripping because of shock and vibration, especially when the current is near the trip rating. A hot fuse becomes fragile, and the latch in most thermal breakers tends to be sensitive to vibration. However, though delay time in magnetic protectors varies with temperature, magnetic trip mechanisms can usually tolerate severe vibration and shock conditions, and they are quite insensitive to wide temperature changes.

But no matter what type of protector you choose, use sealed protectors for explosive atmospheres. Protectors that are not hermetically sealed are sensitive to altitudes above 10,000 ft, where arc quenching is impaired. For high-altitude applications, you must derate both the nominal voltage and current-interrupting capacity of a chosen unsealed protector.

8. *Determine if certification is necessary.* Certification from Underwriters Laboratory, the Canadian Standards Association or even a military QPL listing, among many others, is often required. Many low-cost commercial protectors are uncertified, even though they meet the requirements, because testing and the paper work to obtain approval is expensive. But if the manufacturer's reputation is insufficient and you really need certification, or approval, you'll have to pay the price.■

Cermet Reliable Variable Resistor
(versatility + long life)



CTS 550 Series $\frac{3}{4}$ " dia. variable cermet resistor. MIL-spec reliability plus wide resistance range: 50 ohms through 5 megohms (linear taper). 2 watt power @ 70°C. Features low noise, high overload capacity and excellent hf characteristics. Single, dual or concentric pots with lug or U/L approved power switch. Get CTS cermet quality at low prices. Write: CTS of West Liberty, Inc., 6800 County Road 189, West Liberty, Ohio 43357. Phone: (513) 465-3030.

CTS CORPORATION
ELKHART, INDIANA



CIRCLE NUMBER 40

ELECTRONIC DESIGN 22, October 25, 1977

Mini Round Trimmer
(at low competitive prices)

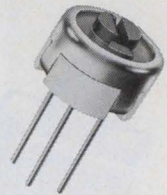

NEW CTS 345 Series single-turn cermet trimmer. Top performance in tiny $\frac{1}{4}$ " ROUND design. Wide 50 to 500K ohm range: $\frac{3}{4}$ watt @ 25°C power rating. Excellent TC, ± 100 ppm/°C. Low .180" profile with 0.03% settability and positive stops. Sealed element; completely enclosed housing. Compact CTS design, proven CTS cermet quality, and low CTS price give you the edge. Get our quote: CTS of West Liberty, Inc., 6800 County Road 189, West Liberty, Ohio 43357. Phone: (513) 465-3030.

CTS CORPORATION
ELKHART, INDIANA



CIRCLE NUMBER 41

Chances are, we already have the packaging you want. That's the beauty of our single-chip design and packaging concept: freedom of choice. Because our ultra-low $V_{CE(SAT)}$ modules are pre-rated, pre-tested and inventoried, we can put them in any package to meet any need...help you optimize size, weight and performance *without* long lead times for custom packaging. Whether you need 5 or 500 pieces, we'll welcome the opportunity to discuss your special needs. For application notes and further information, call Sales Engineering, PowerTech, Inc., 0-02 Fair Lawn Ave., Fair Lawn, N.J. 07410; (201) 791-5050.

TYPICAL PACKAGE SELECTIONS		
I _c	P _b	TYPE
1200A	2100W	PPS 1200
500A	625W	PP 500
250A	325W	PPS 250
150A	325W	TO-114
90A	325W	TO-63

Copper grid distributes current most efficiently for lowest $V_{ce(sat)}$.

Two choices: 570 mil diam. or 820 mil diam. single chips!

Integral solid copper leads and heat sink make pre-bond chip tests and inventory possible.

Void-free bonding techniques eliminates hot spots.

All packages are solid copper.



HIGH CURRENT TRANSISTOR PACKAGING UNLIMITED



PowerTech, Inc.
 "BIG IDEAS IN
 BIG POWER"

FASCO THE ENERGY SAVER!

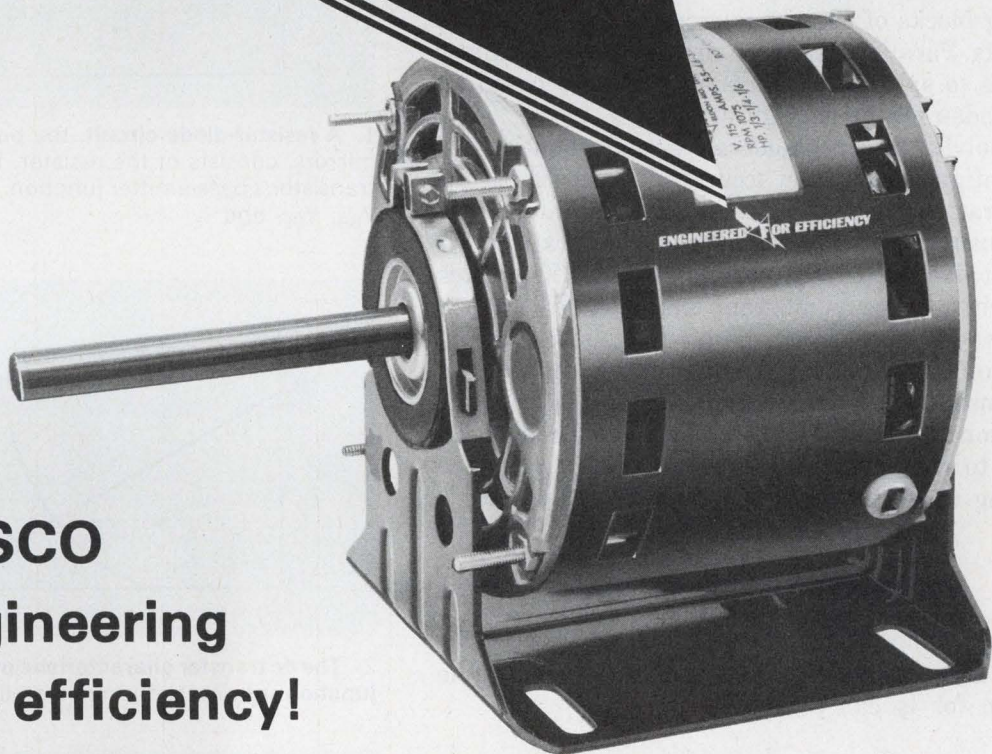

**At FASCO
... engineering
means efficiency!**

FASCO has long been a leading manufacturer of quality fractional horsepower electric motors . . . motors that provide maximum performance, durability and efficient operation.

Your product's power specifications will be carefully analyzed by Fasco engineers to provide the proper size, type, speed, torque, starting requirements and other construction characteristics so necessary in producing the optimum "Energy/Efficiency/Ratio" at the lowest cost.

Fasco's full line of shaded pole, permanent split capacitor, or split phase fhp motors . . . as well as a wide selection of centrifugal and

Transflo® blowers in ranges from 1/500th to 1 H.P. are readily adaptable to your most demanding requirements.

Let Fasco's efficiency experts assist you in solving your product power problems with motors that are "Engineered For Efficiency". Sales offices located in major cities are staffed by factory-trained personnel . . . call now for an energy saving discussion.



FASCO® INDUSTRIES, INC.

MOTOR GROUP HEADQUARTERS
1600W. Jackson Street, Ozark, Missouri 65721

CIRCLE NUMBER 43

Solve dc current-source design equations

with a nomograph and ease current-mirror implementation. You can determine all design parameters with a straight-edge and pencil.

You can determine parameters of "current mirror" circuits on a simple nomograph. With no more than a straight-edge and a pencil, you can derive voltages across components, currents, values of resistors and reverse-saturation currents of transistor base-emitter circuits.

So-called diode and resistor pairs, made up of base-emitter diode junctions and emitter resistors, are the building blocks of current-mirror dc-current sources and sinks. Parallel-transistor circuits that use emitter resistors to split the load equally are also based on such diode-resistor configurations.

But solving the nonalgebraic circuit equations of such configurations to get accurate designs is difficult. And iterative or linear-approximation techniques are time-consuming, cumbersome and inaccurate.

The diode-resistor configuration in Fig. 1 illustrates the variables the nomograph can handle. Voltage V_{BB} is the voltage across both the resistor and the transistor's base-emitter junction diode, and V_{BE} is the transistor's base-emitter voltage. The reverse-saturation current, I_S , of the base-emitter diode is related to the emitter's forward current, I_E , by the following diode law:

$$I_E = I_S \left[e^{V_{BE} \cdot q/kT} - 1 \right]$$

At room temperature (300 K), kT/q is 25.9 mV. Since in most forward-biased applications $V_{BE} \gg kT/q$, the equation for I_E can be reduced to

$$I_E \cong I_S e^{V_{BE} \cdot q/kT}$$

Suppose I_S is 1×10^{-15} A, V_{BB} is 0.80 V and R is 200 Ω . A loop equation based upon this data,

$$200I_E + 0.0259 \ln \left[\frac{I_E}{1 \times 10^{-15}} \right] = 0.80 \text{ V,}$$

can be solved iteratively. You evaluate the equation for incrementally increasing values of I_E until you obtain a suitably accurate value. A computer or programmable calculator can do the job.

If you have a plot of the base-emitter diode's

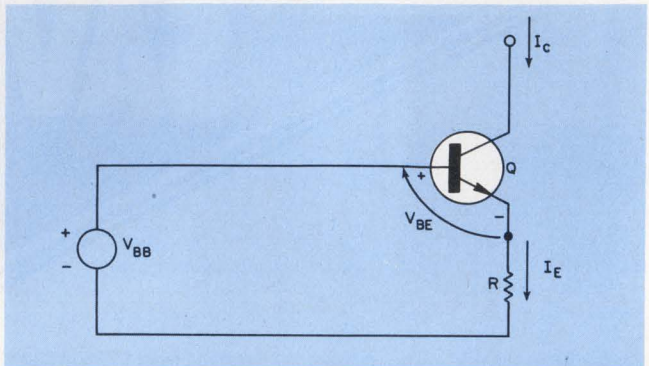

1. A resistor-diode circuit, the building block of current mirrors, consists of the resistor, R , and the diode of the transistor's base-emitter junction. Important variables are V_{BB} , V_{BE} , and I_E .

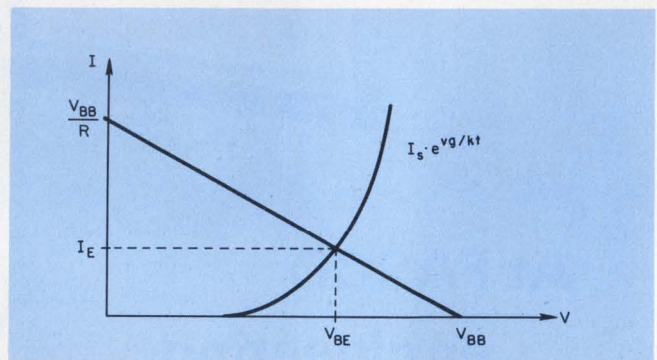

2. The dc transfer characteristic of the base-emitter diode junction intersects the resistor line at I_E and V_{BE} .

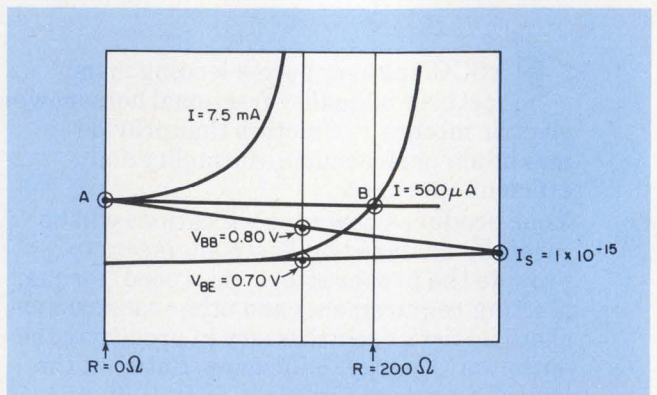

3. The nomograph determines V_{BE} and I_E more accurately than other methods because straight lines run through known points.

Michael L. Rieger, Project Engineer, Tektronix, Inc., P.O. Box 500, Beaverton, OR 97077

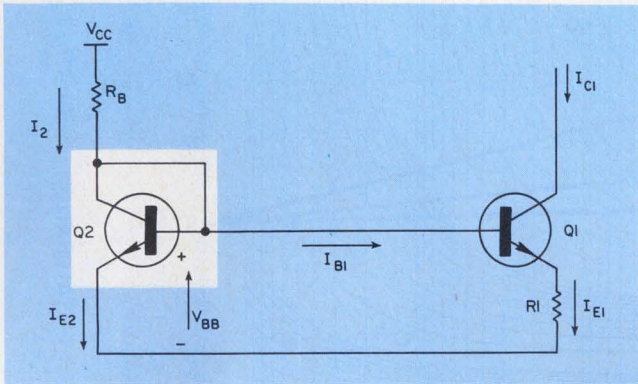

4. Transistor Q_2 , configured as a diode, provides bias for Q_1 . As a result, I_{E2} depends little on I_{E1} , especially when $I_{E2} \gg I_{E1}$ and Q_1 and Q_2 have identical characteristics.

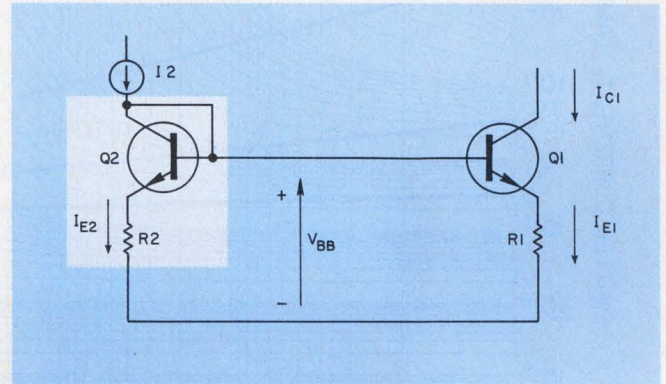

5. The so-called current mirror is the most popular current-source (or sink) configuration. It is designed around a resistor-diode-biased transistor pair.

transfer characteristic, you may use a load-line approach instead (Fig. 2). Draw a straight line representing the transfer characteristic of the resistor from V_{BB} on the voltage axis to V_{BB}/R on the current axis. The intersection of the two transfer curves determines V_{BE} and I_E .

Straight lines do it all

To solve the problem with the nomograph, locate $I_S = 1 \times 10^{-15}$ A on the right-hand border, and $V_{BB} = 0.80$ V on the voltage line in the graph's center. As done in detail in Fig. 3, draw a straight line through these points to establish point A on the left-hand border. Then draw a horizontal line from point A to intersect the vertical $R = 200 \Omega$ line at point B. Point B lies on the $500\text{-}\mu\text{A}$ constant-current line, which is the value of I_E . Finally, draw a straight line from the $I_E = 500 \mu\text{A}$ and $R = 0$ point to $I_S = 1 \times 10^{-15}$ A, which intersects the voltage line at a V_{BB} of 0.7 V.

Emitter current I_E from the nomograph is related to collector current by a forward-current transfer parameter, α_F , as follows:

$$I_C = \alpha_F I_E,$$

where

$$\alpha_F = \frac{h_{fe}}{h_{fe} + 1}.$$

Note: When $h_{fe} \gg 1$ then $\alpha_F \cong 1$ and $I_C \cong I_E$.

In a diode-biased current source (Fig. 4), the bias voltage is obtained from a known current through a diode. The diode is made from a transistor, Q_2 , that is identical to Q_1 . In Fig. 3, the current I_{E2} needed to produce 0.8 V across Q_2 is found to be 25 mA at the intersection of line A-B and the $0\text{-}\Omega$ line. Since bias current I_2 flowing through R_B is equal to $I_{E2} + I_{B1}$,

$$R_B = \frac{V_{CC} - 0.8}{I_{E2} + I_{B1}}.$$

One advantage of such a diode-biased current source is that I_{E1} depends very little on I_{E2} , especially when $I_{E1} \gg I_{E2}$. For example, suppose I_{E2} drops to 1/10 of 25 mA, or 2.5 mA, because the V_{CC} drops. Using the nomograph, you will find that the intersection of a horizontal line from 2.5 mA and 0Ω with 200Ω shows that $I_{E1} = 280 \mu\text{A}$. Note that I_{E1} has dropped by less than half of $500 \mu\text{A}$.

Probably the most popular current-source configuration is the resistor-diode-biased "current-mirror" scheme shown in Fig. 5. The circuit's resistor values, R_1 and R_2 , can be selected from a wide range to produce a large variety of current combinations. With appropriate resistor relationships, the effects of temperature differences between the transistors can be substantially minimized. When $I_{E2}R_2$ is much greater than V_{BB} , then $I_{E1}R_1 \cong I_{E2}R_2$, and the emitter currents can be calculated easily. Often, however,

DIODE-RESISTOR CURRENT-SOURCE NOMOGRAPH

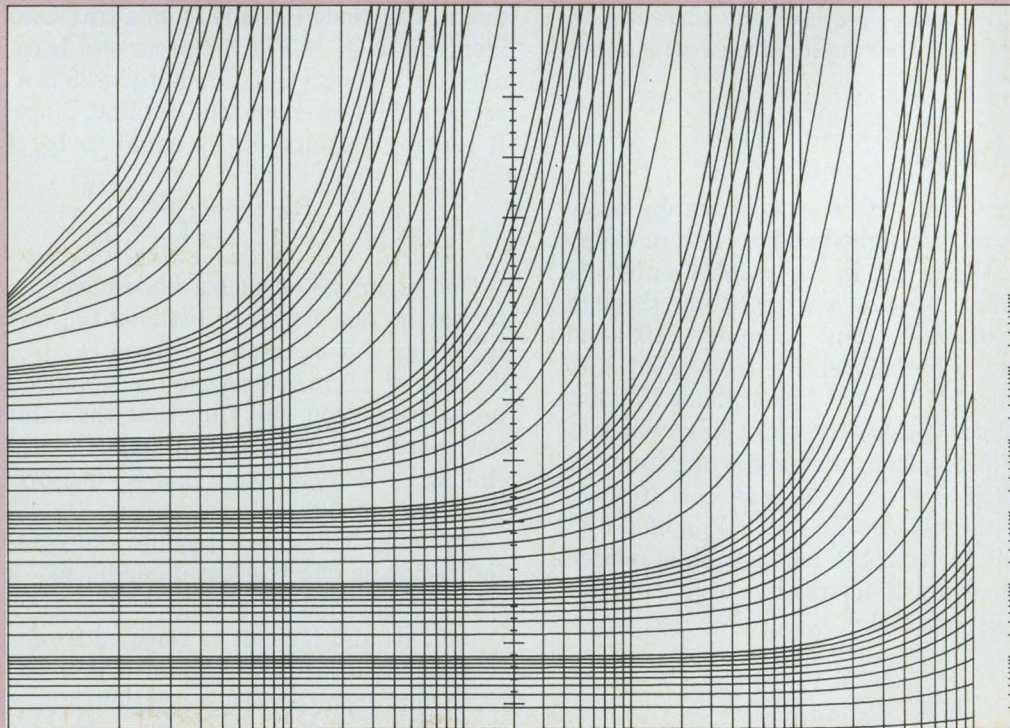
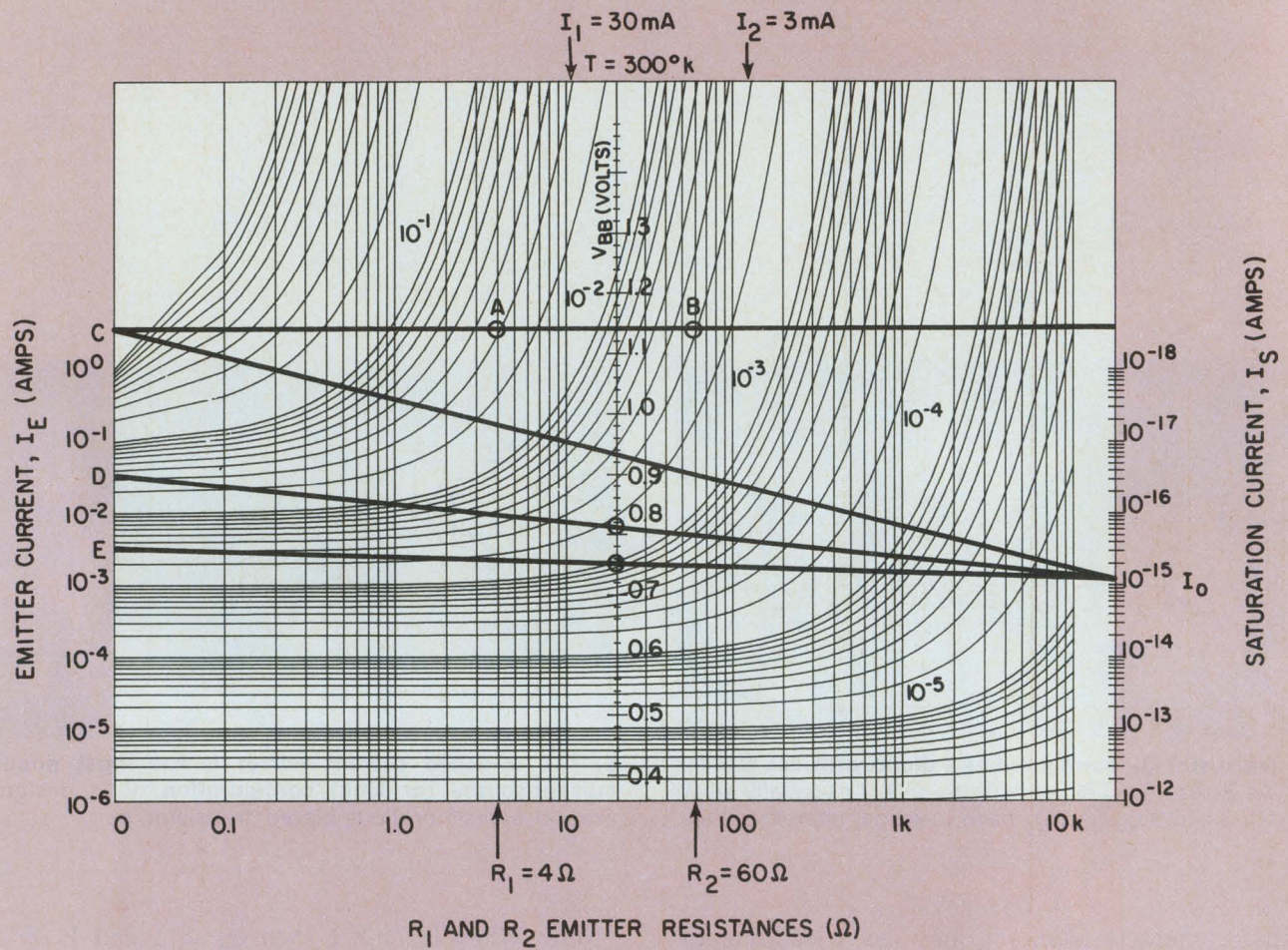

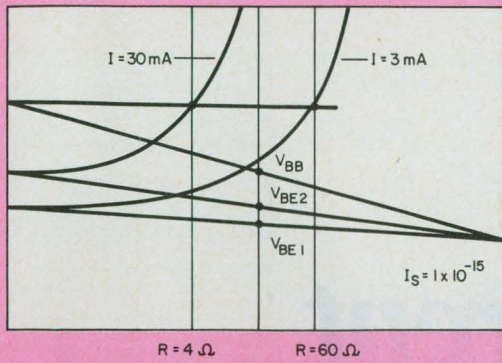

6. You need only a few construction lines to determine the emitter-resistance values for a desired I_{E1} .

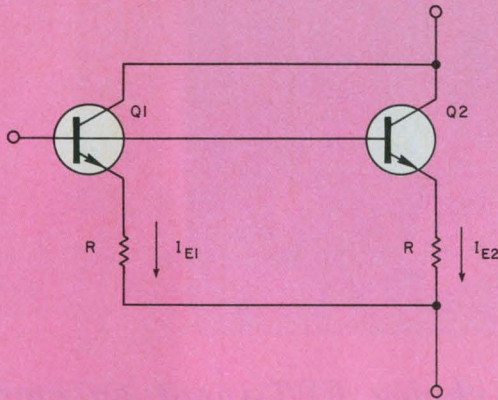

7. By paralleling transistors, you can increase output-current capability. However, any mismatch can cause unequal power dissipation.

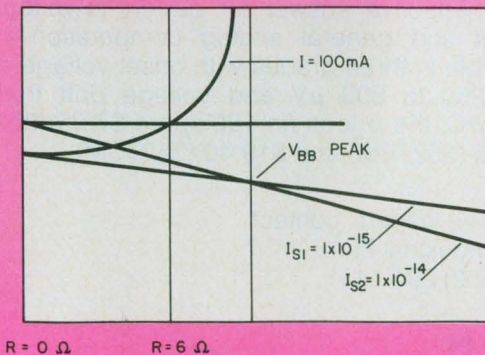

8. Emitter resistances of 6 Ω equalize emitter currents at 100 mA for unequal transistors in parallel.

there is not enough supply voltage, and $I_{E2}R_2$ must be less than V_{BE} .

For example, assume that Q_1 and Q_2 in Fig. 5 are identical devices. You would like to determine a family of resistance and emitter-current values that yield the same base voltage, V_{BB} , on Q_1 and Q_2 , given $I_{E2} = 30$ mA and $R_2 = 4$ Ω. First, draw a horizontal line through the intersection of I_{E2} and R_2 (Fig. 6). The intersection of the horizontal line with the current you want locates the resistance required. For example, the 3-mA line intersects the horizontal line at $R_1 = 60$ Ω.

To determine V_{BB} , draw a straight line from I_S to intersect the horizontal line at $R = 0$ Ω. With $I_S = 1 \times 10^{-15}$ A, $V_{BB} = 0.924$ V. Similarly, lines to $R = 0$ Ω at $I_{E1} = 3$ mA and $I_{E2} = 30$ mA determine V_{BE1} and V_{BE2} to be 0.744 V and 0.804 V, respectively.

Parallel transistors to increase current

The nomograph can also be used to design paralleled power transistor circuits to handle large output currents. But normal device mismatch causes power to be dissipated unequally among the transistors. Small resistances in the emitter circuits of the paralleled transistors, however, can help the transistors distribute the load equally. Unfortunately, these resistances reduce the effective transconductance of the transistor cluster, so of course, the resistor values should be as small as possible.

The nomograph enables you to choose the minimum resistance, given the transistors' saturation currents. For example, in Fig. 7, assume that Q_1 and Q_2 are unmatched, with reverse-saturation currents of 1×10^{-15} A and 1×10^{-14} A, respectively. Also, assume that the pair conducts a peak current of 200 mA. The resistance needed in the emitter of Q_2 to make each transistor conduct 100 mA at the peak input voltage is found with the nomograph as in Fig. 8.

Draw a line from I_{S1} to 100 mA and 0 Ω and find the peak V_{BB} on the voltage axis. Then, draw a line from I_{S2} through the peak V_{BB} to $R = 0$ Ω, followed by a horizontal line from this point. Note that the horizontal line intersects the I_{E2} curves at 100 mA and $R = 0.6$ Ω.

Temperature variations within these configurations can produce undesirable effects. But good thermal coupling among the transistors will minimize the problem. Also, resistors with a temperature coefficient of 3300 ppm/°C can help reduce temperature dependence, when thermally coupled to the transistors. ■■

Bibliography

- Allen, Phillip E., "Graphical Analysis of Matched Transistor Current Sinks/Sources," *IEEE Journal of Solid-State Circuits*, Vol. SC-9, No. 1.
- Buhler, Otto R., "Use Equations to Parallel Transistors," *Electronic Design*, Feb. 15, 1977, pp. 94-96.
- Getreu, Ian, "Modeling the Bipolar Transistor," Tektronix, Inc., Beaverton, OR, 1976, pp. 133-135.
- Grebene, Alan B., "Analog Integrated Circuit Design," Van Nostrand Reinhold Company, New York, 1972, pp. 113-119.

Choice Op Amps from Burr-Brown...

Low Cost

Low Drift

Low Bias Current

Low Offset Voltage

Bipolar

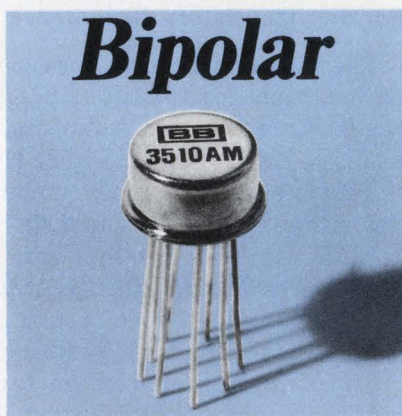

The choice bipolar op amp is Burr-Brown's new 3510. The 3510's low $0.5 \mu\text{V}/^\circ\text{C}$ voltage drift and less than $\pm 15 \text{ nA}$ bias current provides the performance you need for high-accuracy systems at low cost.

The 3510's total performance over the -25°C to $+85^\circ\text{C}$ temperature range surpasses many competitive units rated for only 0°C to $+70^\circ\text{C}$. It's ideal for high-accuracy analog circuits and instrumentation designs. Three grades give you voltage offset from 60 to $150 \mu\text{V}$ and voltage drift from 0.5 to $2 \mu\text{V}/^\circ\text{C}$. Maximum open-loop gain and CMR specs are 120 dB and 110 dB respectively. Prices (in 100's) are only \$4.95 (3510AM), \$5.95 (3510BM) and \$10.00 (3510CM).

FET



The choice FET-input op amp is Burr-Brown's 3527. With bias current of less than 5 pA and low voltage drift of $2 \mu\text{V}/^\circ\text{C}$, the 3527 is your best buy.

Burr-Brown's 3527 comes out a winner when you compare the three most important FET op amp features—input bias current, offset voltage drift and price. And low laser-trimmed offset voltage means no further adjustment in most applications. Here's a cost-effective answer for current-to-voltage converters and general analog computation circuits. Available in three grades with offset voltage ranging from 250 to $500 \mu\text{V}$ and voltage drift from 2 to $10 \mu\text{V}/^\circ\text{C}$, the prices (in 100's) are \$7.95 (3527AM), \$10.35 (3527BM) and \$19.40 (3527CM).

To get details on these price/performance leaders, contact Burr-Brown, International Airport Industrial Park, Tucson, Arizona 85734. Phone (602) 294-1431.



*Performance,
Reliability, Economy*

ROYTRON™ PROVEN DEPENDABLE

HI-SPEED SERIES PAPER TAPE UNITS

Combination Reader/Punch — Punch Only — Reader Only — Optional Interfaces

The Roytron family of desktop readers, punches and combination units are completely self-contained with integral electronics, power supply and optional interfaces. The punches are designed to operate at speeds up to 60 characters per second, punching all varieties of normally utilized commercial tape, including oiled paper, dry paper, metallized mylar, sandwich paper/mylar/paper, polyester and others. The readers are 150/240 characters per second photoelectric units with highly reliable stepping motor tape transports.

The tape sensing systems utilize a trouble-free LED Phototransistor combination.

The housings are designed to completely enclose the paper tape punches, producing a very low noise level even while punching tape!

MODEL 1560-AS READER/PUNCH

Desktop combination reader/punch with serial asynchronous RS-232C compatible interface. Designed to operate with a terminal device on the same serial data lines or alone on a dedicated serial line. Reader will generate data at all standard baud rates up to 2400 baud.

Punch accepts data at all standard baud rates up to 600 baud continuous or 4800 baud batched, utilizing a 32 character buffer.

Two modes of operation are provided: *Auto Mode* — Simulates Model ASR 33 Teletype using ASCII defined data codes (DC 1, 2, 3 and 4) to activate/deactivate the reader or punch; *Manual Mode* — Code transparent mode. Panel switches control activation/deactivation of reader or punch and associated terminal device.

Tape duplication feature is provided by setting unit to LOCAL mode.



MODEL 1060-AS PUNCH

Desktop punch with serial asynchronous RS-232C compatible interface. Designed to utilize ASCII defined control codes and operate with a terminal device on the same serial data lines. Punch accepts data at all standard baud rates up to 600 baud continuous or 4800 baud batched, utilizing a 32 character buffer.

Two modes of operation are provided: *Auto Mode* — Simulates Model ASR 33 Teletype punch using ASCII defined data codes (DC 2 and DC 4) to activate/deactivate the punch; *Manual Mode* — Code transparent mode. Panel switches control activation/deactivation of punch and associated terminal device.

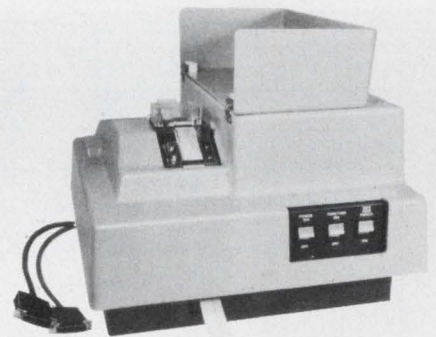

MODEL 1250-AS READER

Reader with serial asynchronous RS-232C compatible interface. Designed to utilize ASCII defined control codes and operate with a terminal device on the same serial data lines or alone on a dedicated serial line. Reader will generate data at all standard baud rates up to 2400 baud.

Four modes of operation are possible: *Auto Mode I* — Simulates ASR 33 Teletype Reader using ASCII defined data codes DC 1 and DC 3 to activate/deactivate the reader; *Auto Mode II* — Utilizes RS-232C defined Clear-to-Send Signal to activate/deactivate the reader; *Auto Mode III* — Reader is activated/deactivated by DC code or the Clear-to-Send Signal; *Manual Mode* — Code transparent mode where panel alone activate/deactivate the reader.

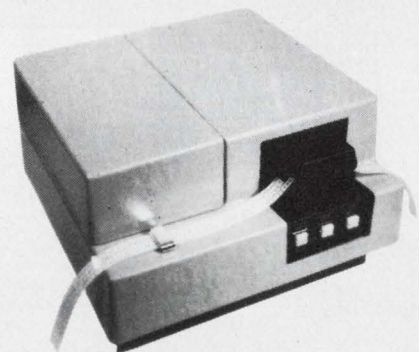

for full details, write or call

SWEDA INTERNATIONAL, INC.
OEM Products

34 Maple Avenue, Pine Brook, N.J. 07058/(201) 575-8100

IN U.K. — ADLER BUS. SYSTEMS/OEM PRODS., Airport House, Purley Way, Croyden, Surrey, England

IN FRANCE — SWEDA INTERNATIONAL/OEM, 103-107 Rue de Tocqueville, 75017 Paris, France

CIRCLE NUMBER 46

Convert unipolar CMOS signals into analog bipolar outputs

CMOS CD4000 series analog switches like the 4016 and 4066, although they normally need bipolar logic control for bipolar analog signals, can also be interfaced with standard unipolar CMOS logic levels. The circuit shown in the figure uses an op amp as a unipolar-to-bipolar analog-level shifter that can be controlled by CMOS logic signals of 0 to 10 V. The op-amp output is suitable as a lab source of bipolar square waves.

The 4016 analog switch (RCA), driven by an input clock, connects the noninverting (+) input of an NE530A (Signetics) op amp to either the output arm of potentiometer R_5 or ground. At the same time, the arm of R_5 is continuously presented to the op amp's inverting (-) input. The op-amp circuit has a gain of -1 for the dc voltage from R_5 when the (+) input goes to ground, and +1 when the (+) input goes to R_5 .

Although the signal from the 4016 is always a

positive voltage V_x set by R_5 , the op amp translates this ground-referenced square wave into a bipolar and symmetrical output square wave of $\pm V_x$.

Symmetry—specifically control of the negative output peak amplitude—is governed by the match between R_1 and R_2 . Resistor R_3 provides bias-current compensation for the op amp to minimize dc offset, and capacitor C_2 reduces the settling time of the circuit.

The circuit employs an NE530A op amp because it slews and settles fast and thus produces sharp-cornered square waves with a rise time of $1 \mu\text{s}$ or less over the full range of $\pm 10 \text{ V}$. An NE535 (Signetics) or MC1741S (Motorola) can also be used in the circuit, but they are slightly slower.

Walter G. Jung, Consultant, Pleasantville Laboratories, Forest Hill, MD 21050.

CIRCLE NO. 311

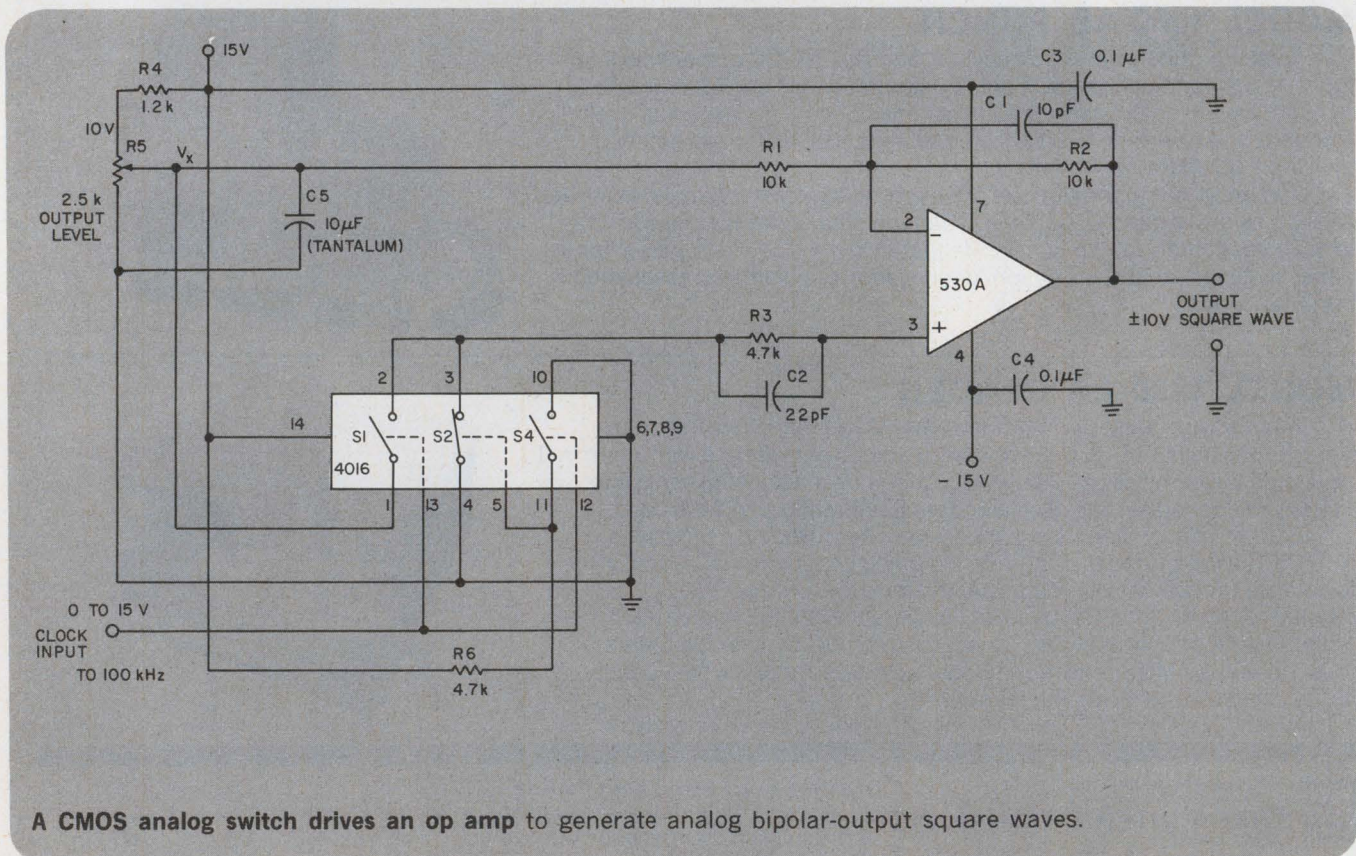

A CMOS analog switch drives an op amp to generate analog bipolar-output square waves.

1/8 oz. to 1/2 oz. electrodeposited thin copper foil?

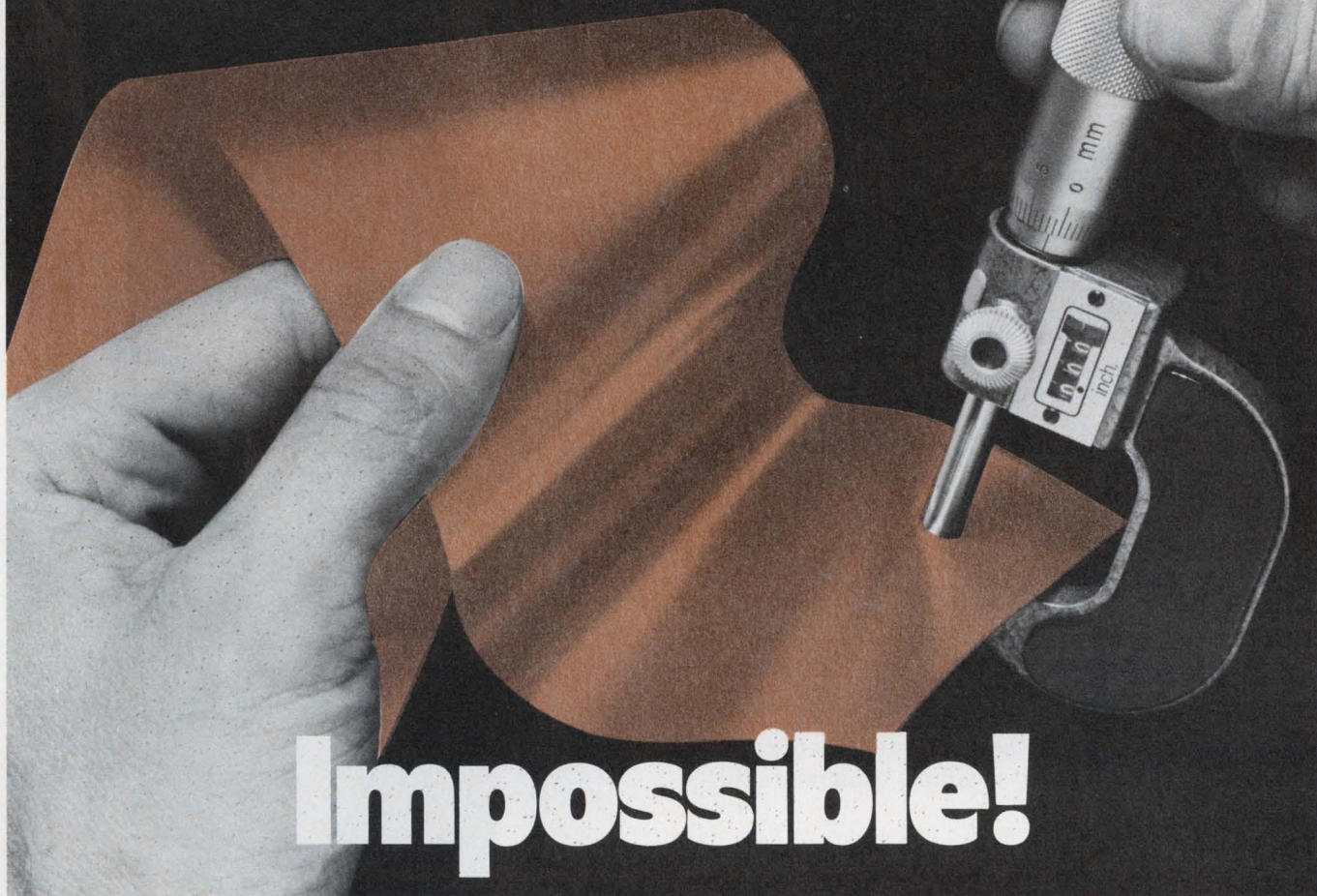

Impossible!

Not impossible if you're Gould — the world's leader in electrodeposited copper foil production.

We anticipated the trend towards more complex, denser circuit board configurations. Last year, we perfected thin foil and delivered over 30 million sq. ft. of TC treated 1/2 oz. to our customers. And Gould was the *only* company that could produce a consistent quality product.

Now we're producing 3/8 oz., 1/4 oz. and 1/8 oz. foil.

With the miniaturization of electronic products, even thinner foils are needed. The new Gould Thin Copper (GTC) product line

includes foils ranging from 1/2 oz. (153 gr/M²) to 1/8 oz. (38 gr/M²).

These thinner foils give you even more freedom of design and allow much finer definition of circuits. And they are available *now*.

Proven performance.

When Gould says a new product is available that product has been proven against tough quality control standards. *Before* it reaches you. *Before* you incorporate it into your design. So count on these advantages in every square foot of GTC you order!

- reduced etching time
- less undercutting

- reduced pollution
- finer lines, more control
- increased production yields
- cost reduction.

Send for GTC Data.

We've just given you the bare facts on the new GTC line. Send for a technical folder, showing the physical characteristics of Gould Thin Copper circuit grade foils. Write: Gould Inc., Foil Division, 17000 St. Clair Ave., Cleveland, Ohio 44110.

 **GOULD**

Graph provides easy solution for choosing a preferred-number sequence

To efficiently cover an entire range of product parameters, like wire size or capacitor and resistor values, with a minimum number of sizes, a good solution can be found in a "Preferred Number System." The size sequence in the system can easily be determined with a simple graphical technique.

The idea of preferred numbers can be traced to the Frenchman Charles Renard.¹ In 1879, he established a rational basis for grading cotton rope. In this country, number tables were first published by the American National Standards Association (ANSI) in 1927. The ANSI standards in "ratios" of 5, 10, 20, and 80 are usually recommended, but any ratio can be used.

Examining a specific problem is the best way to understand how preferred numbers work. Consider the problem of designing a line of meandering-path film resistors.

The final-resistance value is equal to the product of the film resistivity and a geometrical "gain factor." For least-cost manufacturing, the number of "gain factors" (pattern designs) should be kept to a minimum. Each pattern represents design and tooling cost. In addition, a large number of patterns cause a significant amount of lost production time because of the need for frequent tooling changes. If we wish to limit the number of gain factors to five steps per decade, the preferred number system provides us with the "best" distribution of gain factors.

The relationship for dividing a decade (1 to 10 or 10 to 100) into efficiently distributed steps is

$$R = \sqrt[x]{10},$$

where R is the "ratio" between steps and x is the number of steps desired. A simple example is the 5-step series,

$$R = \sqrt[5]{10} = 1.584893,$$

which expands into a sequence of numbers between 10 and 100 as follows:

Calculated	ANSI rounded numbers
10	10
15.849	16
25.119	25
39.811	40
63.096	63
100	100

These are relative numbers, not tied to any system of units.

The graph shows a simple approach to obtaining such a sequence, even when nonstandard ratios are needed. Merely annotate the number of required steps and preferred numbers on the axes of a single-cycle

semilogarithmic graph paper as shown in the figure. The graph shows lines drawn for 3, 4, 5, and 6-step sequences. An examination of the 5-step line, on which five equidistant segments have been marked off, results in the number sequence

1
1.6
2.5
4.0
6.3
10

This sequence is almost identical to the calculations of the previous table.

Reference

1. American National Standard for Preferred Numbers (ANSI 217. 1. 1973).

Oscar Tischler, Research Development Manager, KDI Pyrofilm Corp., 60 S. Jefferson Rd., Whippany, NJ 07981.

CIRCLE NO. 312

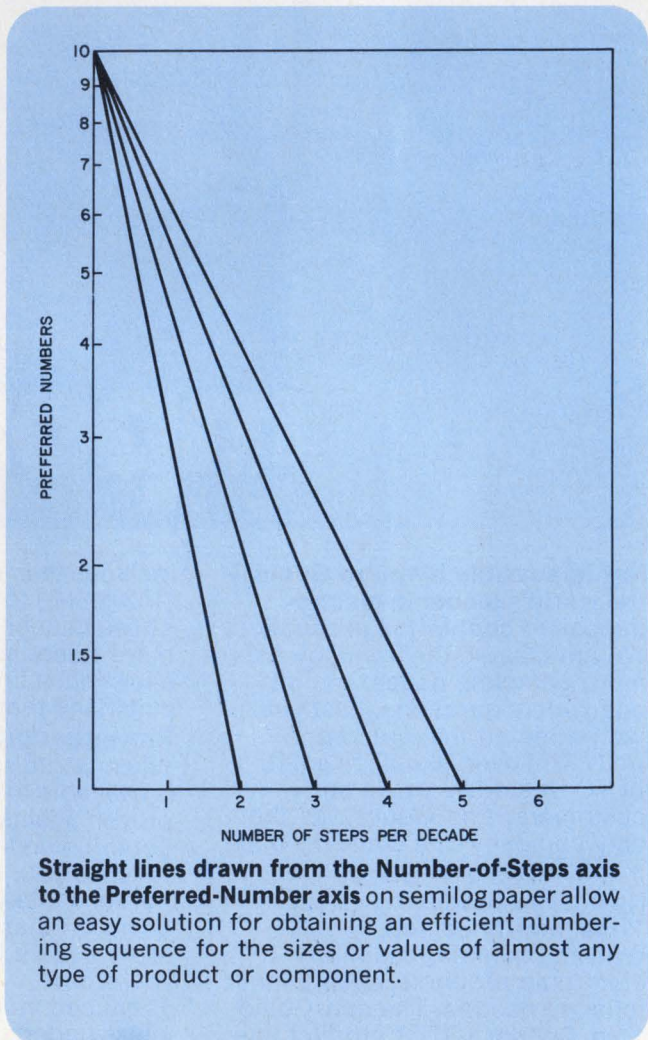

**Uncle Sam and you want
non-PCB capacitors now.
Mallory has them now.**

Mallory non-PCB Bionol™ capacitors are in production and are available now. We've been producing them for two years, using material of the ester family. They are fully tested and we've developed an internal protector to meet UL requirements. This interrupter device is standard on motor-run applications.

Bionol non-PCB's are available in standard configurations or as specials. We're ready now for large or small orders.

We'll be completely finished with PCB production by the end of 1977. Until then our proprietary processes will go on providing the lowest PCB discharge of any company.

Mallory motor-run and power supply capacitors are further examples of our line of high performance products which makes it easier than ever to get the capacitors you need.

Available direct, or through authorized Mallory distributors in U.S. and overseas. Call your local Mallory sales representative for the complete story, including life-test documentation.

Mallory Capacitor Company, a division of P. R. Mallory & Co. Inc., Box 1284, Indianapolis, Indiana 46206 (317) 856-3731.



MALLORY

Flyback-inverter efficiency increases when the transformer is loaded properly

For efficient flyback-inverter dc-to-dc conversion, substantial energy should be transformed only during the transformer's primary conduction period, and high voltages at low-energy, should be transformed during the flyback period. Use the flyback energy to take advantage of the high volt/turn generated by a rapidly collapsing magnetic field. Flyback energy, which is stored and then released from the transformer's air gap, undergoes a diabatic process that produces high losses, if energy is transformed.

A simplified flyback inverter (Fig. 1a) shows two secondaries with diodes that properly connect the windings to loads during different portions of the switching cycle (Fig. 1b). Upon closure of the interrupter switch S, current I_p builds up in primary W_p , and voltage appears across the secondary windings, W_1 and W_2 , which (neglecting copper losses and leakage-reactance drops) is equal to the input voltage E times the respective turns ratios.

During this closure interval, the polarity of W_1 causes diode D_1 to conduct to its load, but W_2 is blocked by its diode D_2 . When the switch opens, the sudden current interruption and rapidly collapsing magnetic field produces a high reverse-voltage swing, called the flyback. But now, D_1 blocks its load and D_2 conducts.

In the voltage waveform of an unloaded transformer (Fig. 1b), the switch ON interval determines the time t_1 . Time t_2 equals half a cycle of the resonant frequency, determined by the inductances and distributed capacitances of the windings.

The magnitude of the flyback voltage e , under no load, where I_p is the primary current each time the switch opens, is

$$e = k \sqrt{\frac{L_m I_p^2}{C_e}}$$

The number k is slightly less than one; it accounts for core hysteresis. Inductance L_m is the mutual

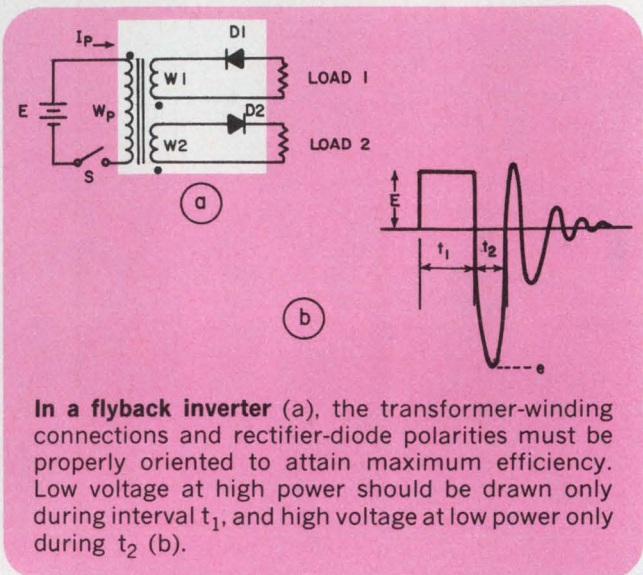

inductance in henries between the primary and the flyback winding, W_2 , in henries, and C_e is the transformer's equivalent winding capacitance in farads referred to W_2 .

When only the flyback winding is loaded, and the transformer has no means for flux reset such as with a permanent magnet, the magnetic core is used less than one-half as efficiently as in conventional inverters. This problem is overcome when a low-voltage winding is loaded during t_1 . For example, if the load is a heater for a cathode-ray tube, the resulting loss from the use of the diode D_2 , may be offset by the transformer's more efficient performance. Thus, you should use a diode even though the heater doesn't require a diode for its operation.

Tom Gross, T.A.O Gross & Associates, Lincoln MA 01773.

CIRCLE NO. 313

IFD Winner of June 21, 1977

Donn Soderquist, Precision Monolithics Inc., 1500 Space Park Dr., Santa Clara, CA 95050. His idea "Digitally Programmed Oscillator Is Suitable for μ P Control" has been voted the Most Valuable of Issue Award.

Vote for the Best Idea in this issue by circling the number of your selection on the Reader Service Card at the back of this issue.

SEND US YOUR IDEAS FOR DESIGN. You may win a grand total of \$1050 (cash)! Here's how. Submit your IFD describing a new or important circuit or design technique, the clever use of a new component or test equipment, packaging tips, cost-saving ideas to our Ideas for Design editor. Ideas can only be considered for publication if they are submitted exclusively to ELECTRONIC DESIGN. You will receive \$20 for each published idea, \$30 more if it is voted best of issue by our readers. The best-of-issue winners become eligible for the Idea of the Year award of \$1000.



Need hustle on conv./charger orders?

Dormeyer's Converter/Charger team keeps moving . . . on application assistance . . . prompt deliveries . . . service after-the-order. We can ship standard units from stock, furnish your company name on the label, or design a converter/charger to meet your special requirements.

When you need fast action on power Converter/Chargers, filtered converters, battery chargers or AC/AC plug-in transformers (all U/L Listed or recognized), just whistle for Dormeyer.

Make it easy on yourself. Write or call today for the new Dormeyer "Coach's Kit" with complete catalog to help you with your requirements.

DORMEYER INDUSTRIES, A Division of A.F. DORMEYER MFG. CO., INC.
3418 N. Milwaukee Avenue Chicago, IL 60641
(312) 283-4000 TWX: 910-221-3831



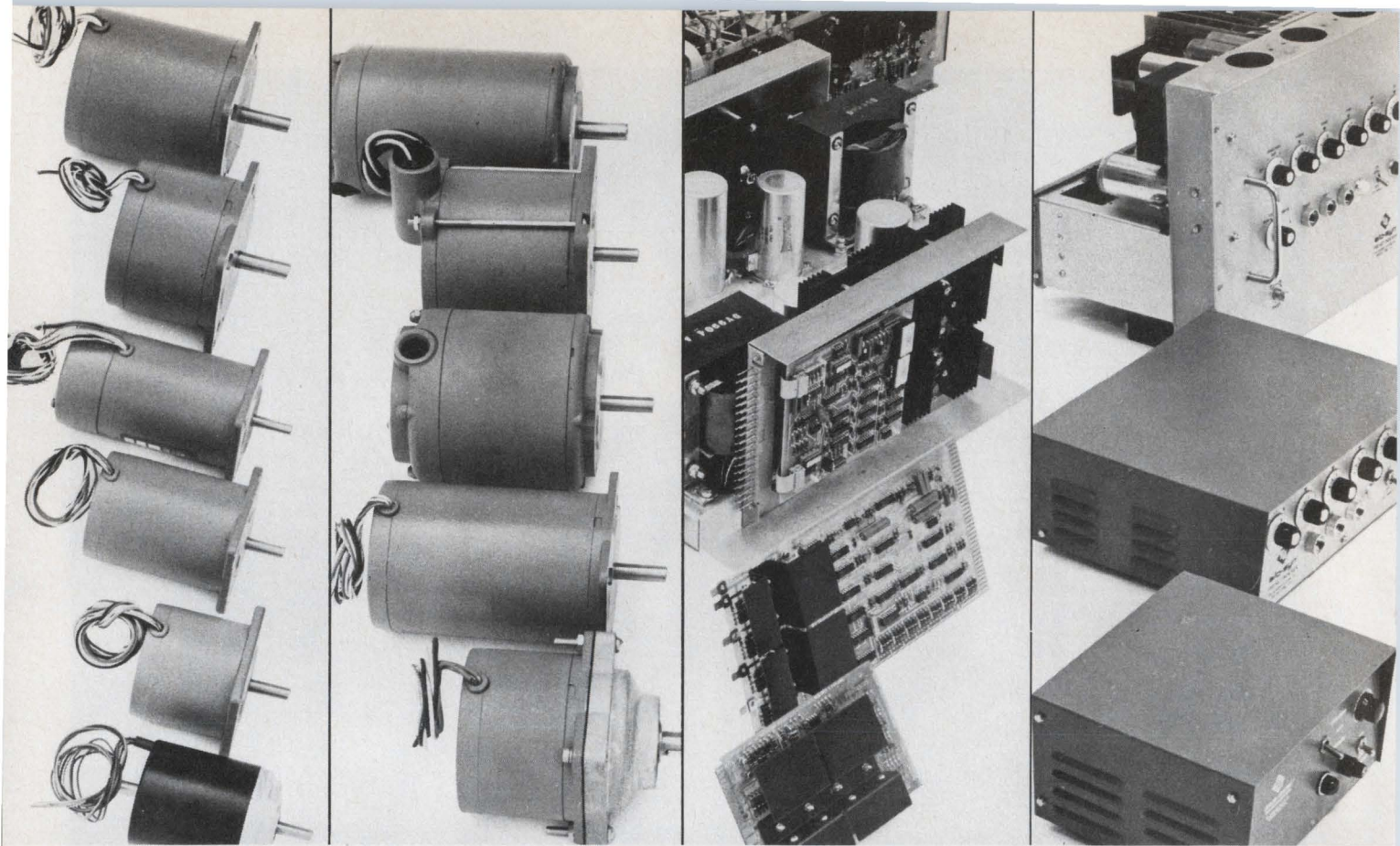

Stepping just came of age.

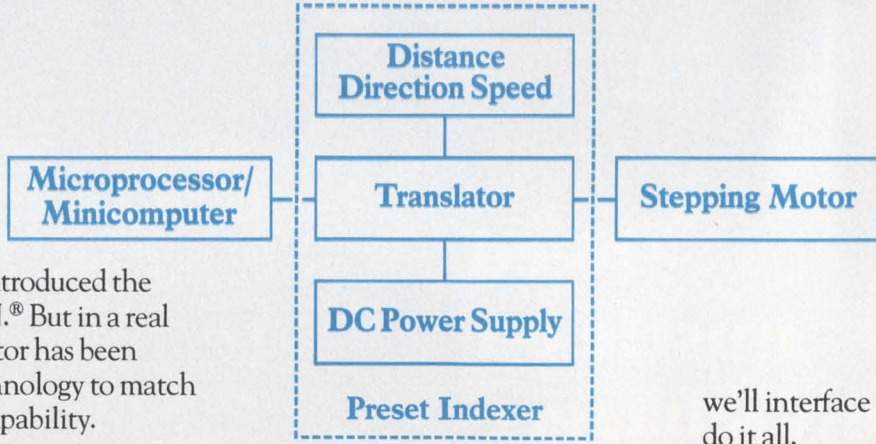

Fifteen years ago, we introduced the first stepper. SLO-SYN.[®] But in a real sense, the stepping motor has been waiting for today's technology to match circuitry with motor capability. Converting electronic input into mechanical output.

For starters. From 0 to 2,000 steps per second in 4 msec with our M060 series (up to 150 oz-in of static torque).

Mid-range. From rest, 12 steps in 12 msec, damped; or 12 steps in 15 msec start — stop — damped, with 100 oz-in of frictional load and 1.2 lb-in² inertia.

High Performance. At 5,000 steps/sec (10,000 half-steps/sec), output torque of 400 oz-in, shaft power 450 watts (.6 hp).

The stepper's logical companion is the Slo-Syn translator or preset indexer. The power for moving loads, controlling distance, speed, direction. Velocity control means motion/time efficiency for a wide range of inertial loads.

Drives interface with microprocessors and minicomputers. Design modularity prevents over-design. You control the options: 1) Modular or packaged drives. 2) If you want to provide the logic,

we'll interface to motor. 3) Or we can do it all.

Whatever the manufacturing move, see the company that's in the best position to help. Write The Superior Electric Company, Bristol, CT 06010. Or call us direct (203) 582-9561.

**A step ahead
in positioning.**

 **Superior Electric**

Light beams moved easily across waveguide array

An optical equivalent of a multipoint selector switch requires just a few volts to deflect a light beam back and forth across a 20-channel waveguide array. What's more, its bandwidth of more than 40 MHz gives 25 ns for random-access switching and 1.6 ns for sequential-access switching.

Besides the multichannel array, this optical IC deflector developed at the University of Glasgow, Scotland, has an interdigital electrode (see Fig. 1).

The waveguide pattern is formed in a 100-Å-thick layer of titanium on lithium niobate (LiNbO_3) with photolithographic techniques. The pat-

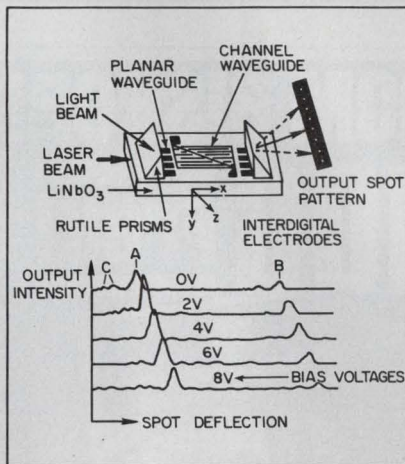

tern includes input and output planar waveguide regions as well as the channels, which are 18 mm long and typically 8 μm wide. Center-to-center channel spacing is 40 μm .

A 0.633-nm helium-neon laser excites the planar waveguide. A second signal-carrying light beam is coupled into and out of the device by a pair of rutile prisms, with the beam propagating in the long, or X, direction.

When the waveguide channels are excited, the signal-beam output becomes a series of spots that are deflected by applying a voltage to the device. The output pattern obtained for different-bias voltages is shown in Fig. 2. The main and secondary peaks are marked A and B.

Peaks of the output pattern move linearly with applied potential, with a 2-V increase shifting the beam one resolvable position. Currently, the output can be shifted five beam positions by 10 V before waveguide non-uniformities severely distort the output pattern.

Future improvements should bring shifts of 16 beam positions for bias potentials between -16 and +16 V. Furthermore, if the width and spacing of the channel waveguide and the electrode gap are halved, the voltage needed to shift by one beam position can be reduced to 1 V.

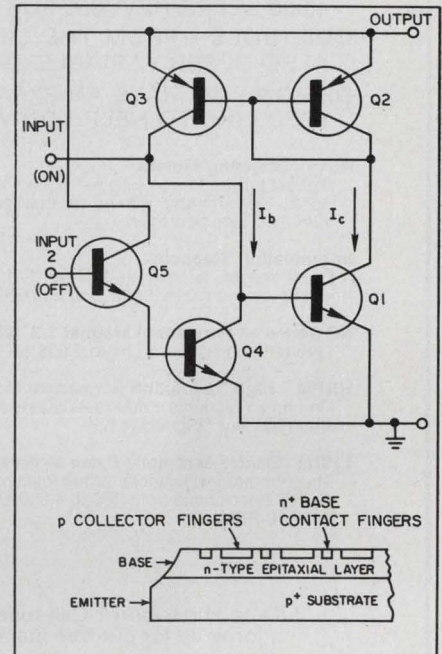

circuiting the remaining collector fingers to the base fingers, an over-all current gain of 0.2 is easily achieved.

Two control inputs are used to turn the switch on and off (Fig. 1). To switch the device on, a 5-V, 100-ns pulse is applied to input 1 via a 1-k Ω resistor. Switch-off is accomplished by applying a 10-V, 2- μs pulse to input 2. The regenerative action can be inhibited simply by inserting a resistor between the Q_5 collector and the supply voltage.

Power switch possible thyristor alternative

A specially fabricated, simple regenerative power-switch may become an alternative to thyristors in many applications if its ratings of 30 A and 70 V can be substantially increased.

Developed at the Rand Afrikaans University in Johannesburg, the circuit consists of commercially available transistors for Q_1 , Q_4 , and Q_5 and a specially fabricated structure (Fig. 2) for Q_2 and Q_3 . These last two transis-

tors form a single pnp transistor whose β is 0.2 to give a 5:1 ratio of I_c to I_b , which ensures that Q_1 and Q_3 saturate.

To minimize the base-voltage drop, I_c does not flow laterally as in a conventional transistor but vertically, as in Fig. 2. An n-type epitaxial layer has a pattern of collector fingers interleaved with a pattern of base fingers diffused into it. By using two of the collector fingers as the collector of Q_3 and short-

Remote-control vehicle removes explosive duds

A remotely controlled vehicle which can safely approach, dig out and dismantle unexploded shells, land mines and other explosive devices has been developed by Forenade Fabriksverken of Sweden. Attached to the front of the armor-plated wheeled vehicle, dubbed FFY Minotaur, is an excavator device incorporating a remotely controlled defusing and dismantling mechanism. Monitoring, defusing or removal operations are accomplished by the vehicle's two operators who are seated at a console inside an antishrapnel shelter.

Nu Syn[®]

EFFICIENT SOLUTION TO YOUR MOTION CONTROL PROBLEM

WHATEVER YOU NEED - WE'VE GOT IT!! AND THAT INCLUDES STEPPING MOTORS WITH TORQUES THAT RANGE FROM 2.5 OZ. IN. UP TO 3,000 OZ. IN. WITH RESOLUTIONS FROM 4 STEPS/REV. UP TO 4,000 STEPS/REV. SPEEDS UP TO 100,000 STEPS/SEC. EVEN EHP MOTORS.

CONTROLS - FROM THE SINGLE DRIVER CARD TO MICROPROCESSOR CONTROL SYSTEMS. WE ALSO OFFER VARIABLE SPEED DRIVES, PRESET INDEXERS AND PROGRAMMABLE SEQUENCERS.

DESIGN - WE HAVE AN EXPANDING REPUTATION FOR SOLVING MOTION CONTROL PROBLEMS — WE'D LIKE TO HELP YOU WITH YOURS - EVEN THOUGH IT MAY BE ONLY ONE OF A KIND.

NuSyn Stepping Motors

Highest torque to size ratio — Highest direct resolution, .45° to .09° per step with no external gearing. Zero backlash — true open loop operation.

Interpolating Steppers

These models interpolate between 1.8° steps to a resolution of .18° or even .09°. Speeds to 200,000 steps/sec.

NP Series — Permanent Magnet 1.8° steppers

Torque handling: 35 oz. in. to 3,000 oz. in.

HRPM - High Resolution Permanent Magnet steppers

Fine angle steppers - 400 to 4,000 steps/rev. 0.9° step to 0.09° step (with our MSD drivers).

EHPM (Electro-Hydraulic Pulse Motors)

These motors will handle torque loads ranging from 5 HP up to 40 HP. Resolutions from 200 to 4,000 steps/rev. Speeds up to 1,500 RPM.

DMC Series Control Systems

Manual or remote control of any stepper - Index preset steps - Interface with computer.

SMC Series Control Systems

Programmable controller for all stepper motors - Simple diode programming to fit your operation.

DD Series Driver Cards

For driving any type of stepper. Interface with TTL pulses. Will operate motors without need of load resistors.

ILA-1, SIP-2 Accelerator Cards

Connect between source of drive pulses and motor driver to provide automatic acceleration and deceleration of motor. TTL level pulses.

MSD Driver Cards

To drive fine angle HRPM motors - up to 4,000 steps/rev.

Like to know more? Call today at (617) 745-7000 or write for our free literature.



MESUR-MATIC

Electronics CORP.
50 Grove Street
SALEM, MASSACHUSETTES 01970

CIRCLE NUMBER 50

ALCOSWITCH[®]

MULTI-POSITION SLIDE SWITCHES FOR INDUSTRIAL APPLICATIONS

A most versatile switch family designed specifically for printed circuit applications featuring a unique wiping action to assume a low contact resistance— This is called our MSSA Series.

- 1,2,3, or 4 POLE OPTION
- CHOICE OF 3 or 4 POSITIONS
- VERTICAL PC OR RIGHT ANGLE MOUNTING
- GOLD OR SILVER PLATED CONTACTS AND TERMINALS
- PC LEVELLING TABS FOR ADDED STABILITY
- EPOXY SEALED TERMINALS
- QUALITY AT ECONOMY PRICING

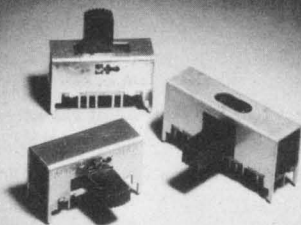

Ask Customer Service for a sample and copy of our 76 page switch catalog.

ALCO ELECTRONIC PRODUCTS, INC.
1551 OSBORN STREET NORTH ANDOVER, MA 01845 U.S.A.

Tel: (617) 685-4371

TWX: 710 342-0552

A SUBSIDIARY OF

AUGAT[®] INC.

CIRCLE NUMBER 51

NEW FROM BISHOP! TECHNICAL MANUAL & CATALOG 106 Free!

Featuring The World's Largest Selection of PC Drafting Aids

- NEW Expanded & Separate Technical Reference Data Manual
- Hundreds of Work-Saving Tips & Ideas
- Over 15,000 PC Drafting Symbols & Tapes
- Custom PC Patterns & Symbols Made To Your Specifications
- NEW Precision Slit PC Artwork Tape
- NEW Precision Grid Line
- NEW PUPPETS[™] PC Layout System Patterns & Sizes
- NEW PreKut Tape Shapes
- NEW Precision Slit PC Artwork Tape Color Core Width Coding
- NEW Dual In-Line Patterns
- NEW Continuous Connector Patterns
- NEW "TO" Symbols
- NEW Reduction Marks
- NEW Prespaced Pad Patterns
- NEW Reference Designation, Letter & Number Kits



Over 120 Pages!
Includes Product Samples

Call Or Write For Your Free Copy



Bishop Graphics, Inc.

5388 STERLING CENTER DRIVE, P.O. BOX 5007
WESTLAKE VILLAGE, CALIFORNIA 91359
PHONE: (213) 991-2600 / TELEX: 66-2400

CIRCLE NUMBER 52

ELECTRONIC DESIGN 22, October 25, 1977

need a precision drawn metal enclosure?



How about an **ALUMINUM** instrument cover...



or a **TITANIUM** component housing...



maybe a **MU-METAL** magnetic shield...



or a pure **NICKEL** battery container...



perhaps a pie shaped **COPPER** enclosure...



or a **BRASS** housing for micro-circuits....



even a **.010 STAINLESS STEEL** detector case.

These are only a few of the more than **1600 SPECIAL** shapes we draw in addition to over **7000 STANDARD ROUND, SQUARE** and **RECTANGULAR** sizes we stock. Write for a copy of our new 84 page catalog today. Yours for the asking.



symbol of quality since 1940

CIRCLE NUMBER 53

Hudson

Tool & Die Company, Inc.

Main Office: 36 Malvern Street, Newark, New Jersey 07105
(201) 589-1800 TWX 710-995-4445

Florida Division: Post Office Box 2613, Ormond Beach, Florida 32074
(904) 672-2000 TWX 810-832-6216

Arrow-M R Relays

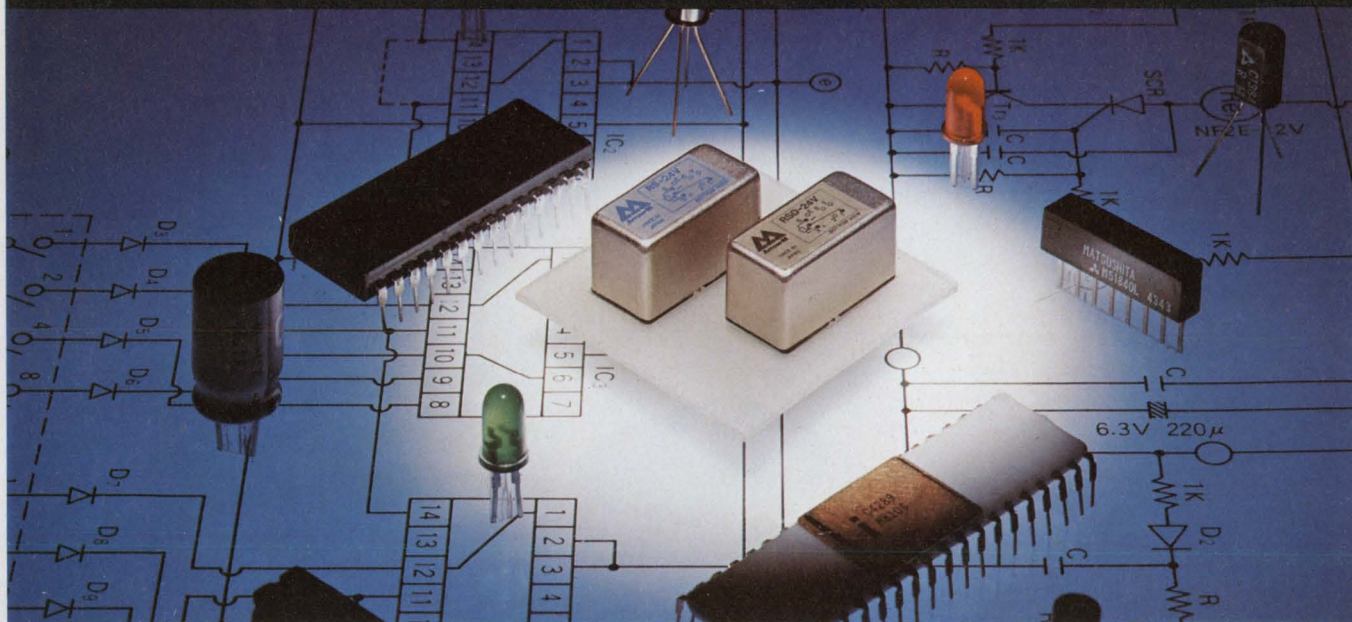

The many advantages and unique capabilities of Arrow-M's R Relays are far too extensive to be covered here. Therefore, we'd like to whet your creative appetite with a few outstanding facts:

1. Arrow-M R Relays are available in 1 Form C contacts which can carry a high current capacity of 1 Ampere 20 watts, and are capable of resisting welding at higher inrush currents. The dry circuit type which can switch current as low-level as 100uA is available in addition to the power type.

2. *High Speed:* Arrow-M R Relays can be operated at 500 cycles/sec.

The tiny power memory reed

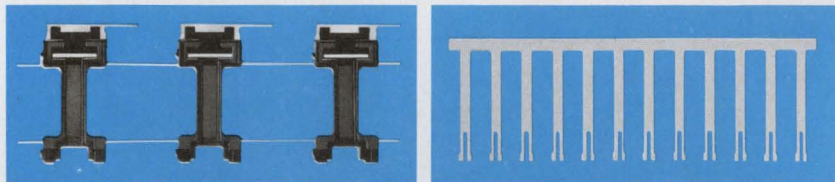

3. Greater reliability and lower cost, due to simultaneous automatic fabrication of coil bobbin, contact and terminal.

4. In addition to the standard there are 1 coil and 2 coil latching types, which are useful for logic circuit design as a memory component.

5. Not only can they be automatically wave soldered on PC boards with a high density of electronic parts, but they are simple to clean with most degreasers and detergents without affecting maximum contact reliability.

6. *High Sensitivity:* Minimum operating power: Single Side Stable 80 mw/Bistable 40 mw

7. *Longer Life:* Mechanical: More than 10^9 operations.
Electrical: More than 10^6 operations.
(1A 20vdc, 0.3A 110vac)

Hungry for more information?
For exact specifications on all of our relays, write or call your nearest Arrow-M office.

Arrow-M Corporation
250 Sheffield Street
Mountainside, NJ 07092
(201) 232-4260

Mid-Western Office:
600 E. Higgins Rd.
Elk Grove Village, Ill. 60007
(312) 593-8535

Western Office:
22010 So. Wilmington Ave.
Suites 300 & 301
Carson, Calif. 90745
(213) 775-3512



Relays for Advanced Technology

CIRCLE NUMBER 54

New products

Graphics unit drives four different X-Y displays

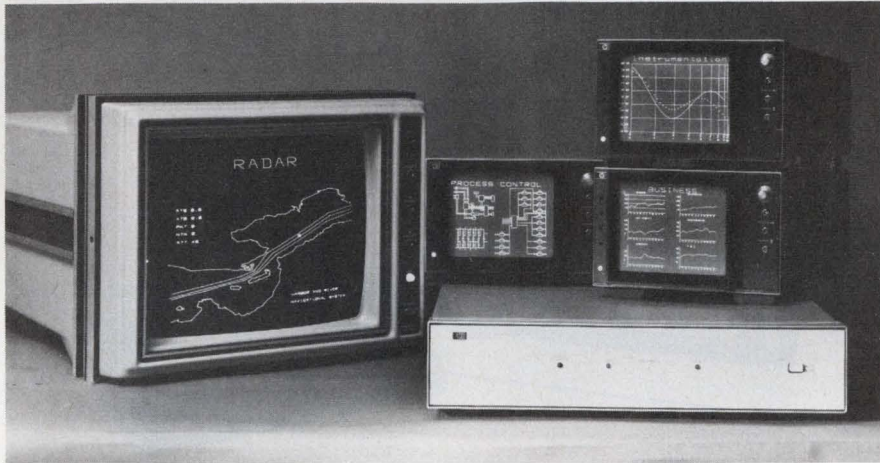

Hewlett-Packard, 1501 Page Mill Rd., Palo Alto, CA 94304. (415) 493-1501. P&A: See text.

The 1350A graphics translator is the first to drive four electrostatic displays —each carrying different information. The HP unit has no display of its own, but provides TTL, 50- Ω outputs for large or small-screen displays.

A 2048-word refresh RAM is the key. Divided into 32 individually addressable files, the memory is continually accessed to generate high-resolution, refreshable vectors or ASCII characters, instead of the raster scans found on most low-cost (under \$10,000) graphics terminals.

The 1350A takes its information from either an RS232C or IEEE 488 bus, and stores the data in its memory. Acceptance takes 2 μ s/character. Since each of the 32 memory files can be erased, blanked or blinked by a simple command, the first file can store a graticule, the second a waveform, the third another waveform, and so on. And different files can be assigned to different displays.

ROM plug-ins in the 1350A hold the 128-character ASCII set. Or 512 user-definable vectors can be drawn from an optional ROM for special symbols.

Only one word in RAM and a single software command are needed to take care of the latter.

Since the 1350A is compatible with electrostatic displays with typical 3-MHz bandwidths, vectors can be written quickly. The maximum refresh rate is 300 Hz, but the actual rate depends on the total length of the drawn vectors. The shortest vectors can be drawn at 1.5 μ s, the longest vectors at 48 μ s. In all, six different speeds are available. Whatever the length, the combination of six vector speeds and 32 intensity levels ensures that all vectors have uniform intensity.

Up to 80 characters per line and 51 lines can be drawn with the $\times 1$ character size. Three other programmable sizes are also standard: $\times 2$, $\times 4$, and $\times 8$. Characters can be rotated 90° under program control.

In addition to selective refresh, electrostatic displays offer five times more light output than the storage CRT used in most low-cost terminals. And a replacement CRT costs about a third less.

The HP 1350A sells for \$3000. Add another \$2400 to \$4200 for an HP display, and the total cost is still way under the cost of most refreshed-vector terminals. Delivery takes 8 to 9 weeks.

CIRCLE NO. 302

Measure HV with wideband probe

Micro Instrument, 2250 Micro Pl., Escondido, CA 92025. G. Acquavella (714) 746-2010. \$695-\$895; stock.

Models P-30D and P-100D probes are ceramic-capacitance, high-voltage divider probes having ratings of 60 kV and 120 kV. They present input loading of less than 10 pF and are provided with 100 ft of dual-shield coax cable. Frequency range is 30 Hz to 3 MHz, with an accuracy of 3%.

CIRCLE NO. 305

Measure low impedance from 0.0003 to 10 Ω

Gotham Audio, 741 Washington St., New York, NY 10014. Russ Hamm (212) 741-7411. \$1291; 4-6 wks.

The EMT Micro-Impedance Meter permits measurement of low impedances in the range of 0.0003 to 10 Ω . It also measures both real and reactive components of complex impedances, small inductances or large capacitances. Values of L and C are obtained from tables in the manual. There are 10 measuring ranges, with an output connector provided for a pen recorder.

CIRCLE NO. 306

Speed up PC board fault location

GenRad, 300 Baker Ave., Concord, MA 01742. Brendan Davis (617) 369-4400.

The 2220 Bug Hound simplifies the process of locating a short, open, bad IC or other faults on PC boards. A key feature is its current-tracing probe. Two LEDs located at the tip of the probe and an audible signal guide the probing. When the probe moves off center to the left, the left LED lights and a tone is heard. Movement to the right causes the other LED to go on and a different tone is heard. The device also contains a microvoltmeter, a 10-mA dc current source and a connectivity tester.

CIRCLE NO. 307

Industry's First Companing A/D In a DIP

- 7 Bits plus sign
±72 dB dynamic range
- Follows Bell μ 255 law
- ±5V input range
- Low Power
660 mW
- Adjustment free
- Small
18-pin hermetic DIP

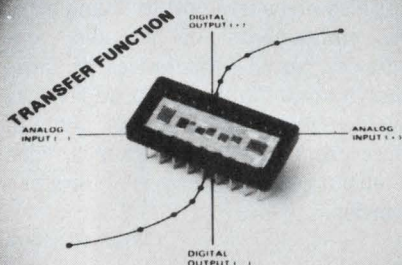

MN 5110
\$55.00*

* in 100 quantity



Micro Networks Corporation
324 Clark Street, Worcester, MA 01606
(617) 852-5400 TWX 710-340-0067

CIRCLE NUMBER 55

DATA PROCESSING

Thermal printer delivers full pages in less than 20 s

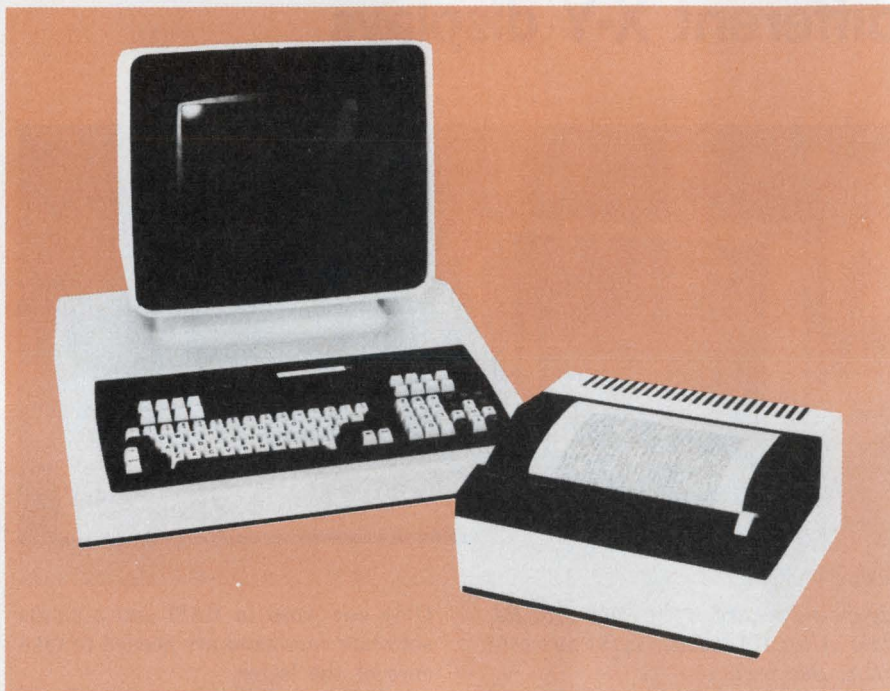

Perkin-Elmer Data Systems, Route 10 and Emery Ave., Randolph, NJ 07801. Jim Folts (201) 366-5550. P&A: See text.

Not only does the Model 650 "Pussycat" print a full page of data in no more than 20 s, it provides a low-cost hard-copy output for CRT terminals. For just \$795 in quantities of 100, the unit prints up to 1920 characters—each made from a 9 × 12 dot matrix—per page.

The Pussycat can accept data from any RS232 interface, while operating at switch-selectable rates of 300 to 9600 baud. Normal interactive dialogues can continue with the terminal while the previous screen of data is being printed. Up to 100 characters per second can be printed on a standard 11-in.-wide roll of paper.

That's right, 11 inches wide. The printer produces characters sideways on a page so that the print time of the entire page depends on the longest line of data on the CRT screen. This sideways capability reduces the cost of internal circuitry—only a row of 288 dots is needed. And, since the Pussycat

has a 1920-character buffer memory, the terminal can quickly dump a page of data into the unit and do other work while the 650 is printing.

If the buffer is empty, the print cycle can be bypassed and the next block of data can be accepted from the terminal. Each page of data is set up as 24 lines of 80 characters, and the printer can produce the full 96-character ASCII set.

With but one moving part, the platen, the printer is controlled by a 6800 microprocessor. When the 650 is used with Perkin-Elmer's 1100 or 1200 CRT console, the screen's data can be dumped into the printer by depressing the terminal's print key.

Up to a 250-ft (76.2-m) roll of thermal paper can be held in the printer's cabinet, and a paper-tear-off edge is built into the case. Housed in a 4 × 12 × 12 in. (10.16 × 30.48 × 30.48 cm) cabinet, the 650 weighs only 15 lb (6.8 kg). Operation calls for just one 115-V ac, 60-Hz supply. Delivery is from stock.

CIRCLE NO. 301



Mi chiquita, si...mi C-Meter, no.

Don't ask. This man isn't going to compromise. He knows that the pushbutton speed, high accuracy (0.1%), compact size and versatility (0.1 pf to 0.2 farads) make him faster on the draw than any reactionary still shaping up circuits by measuring resistors.

With the C-Meter®, you'll measure capacitors as standard operating procedure. You'll waste no time twiddling and nulling, and you'll cut the need for

costly tight-tolerance capacitors or tweak pots. You'll be as speedy as Gonzales...and popular too. People just can't keep their hands off the C-Meter. You owe it to yourself to try one. Our reps are friendly and stock them at \$289.

Capacitors supplied by Apollo Electronics, Inc.

ECD CORP.
196 Broadway, Cambridge
Mass. 02139 (617) 661-4400



CIRCLE NUMBER 56

SALES OFFICES: AL, Huntsville (205) 533-5896; AZ, Scottsdale (602) 947-7841; CA, Costa Mesa (714) 540-7160; CA, Sunnyvale (408) 733-8690; CO, Denver (303) 750-1222; FL, Winter Haven (813) 294-5815; GA, Chamblee (404) 457-7117; IL, Elk Grove Vill (312) 593-0282; IN, Indianapolis (317) 293-9827; MD, Silver Spring (301) 622-4200; MA, Wakefield (617) 245-5940; MN, Minneapolis (612) 781-1611; MO, Kansas City (816) 358-7272; So. NJ/Philadelphia (215) 674-9600; NM, Albuquerque (505) 299-7658; NY, Great Neck (516) 482-3500, (212) 895-7177, Syracuse (315) 446-0220; NC, Raleigh (919) 787-5818; OH, Centerville (513) 433-8171; TX, Houston (713) 688-9971; TX, Richardson (214) 231-2573.

DATA PROCESSING

Black box eliminates errors on data link

Micom Systems, 9551 Irondale Ave., Chatsworth, CA 91311. Roger Evans (213) 882-6890. \$795; 6 wk.

Providing automatic-retransmission-on-error, the 520 Error Controller works with teletypewriter-compatible data terminals that communicate over

telephone lines. A unit is installed at each end of the link: between the data terminal and modem at one end, and between the computer port and modem at the other end. The unit works with CRTs and printing terminals that operate asynchronously at speeds to 2400 bps. The controller transmits all data in a block format with a powerful check character to detect block errors. Any error detected causes automatic retransmission.

CIRCLE NO. 308

A/d converter has programmable amps

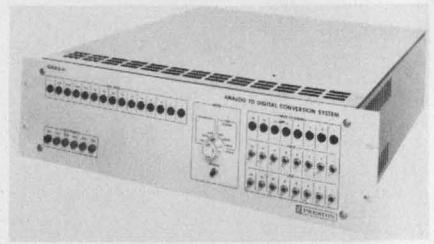

Preston Scientific, 805 E. Cerritos Ave., Anaheim, CA 92805. Bernard Spear (714) 776-6400. \$3933.

A high-resolution a/d converter, GMAD-4A for interfacing minicomputers and controllers, has modular card-mounted analog amplifiers whose gain can be controlled from unity to 16. The gain is controlled by a 3-bit digital signal from a computer or controller. The wide range of gain can permit digital resolution of input-signal changes as small as 38 μ V. Modular construction permits the addition of card-mounted multiplexers with room for 128 differential multiplexer channels in a 5 $\frac{1}{4}$ -in. rack-panel height.

CIRCLE NO. 309

If you have trouble isolating your inputs from your outputs read this book.



This FREE book shows you how to stay out of trouble with low cost Analog Devices isolation amplifiers. Including our latest version, the 286J which offers improved performance for applications in instrumentation, industrial and bio-medical applications. This new design features multi-channel capability for applications in multi-channel data acquisition systems ranging from 2 to over 1000 isolated data points. (\$37 in 100's)

Visual display terminal stores 4 kwords



Megadata, 35 Orville Dr., Bohemia, NY 11716. John Hill (516) 589-6800. \$1950-\$2950; 8 to 12 wks.

Intelligent stand-alone functions with storage requirements of 4 kwords can be performed by the MC77 visual display terminal. The terminal has a keyboard with up to 84 keys, a 12-in. diagonal display, and transmits at data rates from 50 baud to 38.4 kbaud serial, or 10,000 characters parallel. The MC77 is PROM pre-programmed, supporting up to 3k of internal program, 1k of program storage and 4k of internal data storage. Computer interfaces are available, including synchronous, asynchronous, and asynchronous data exchange.

CIRCLE NO. 310

ANALOG DEVICES

P. O. Box 280 Norwood, MA 02062

Please send me your FREE "Isolation and Instrumentation Amplifiers Designers Guide" and 286J data sheet.

Name _____

Title _____ Telephone _____

Company _____

Address _____

City _____ State _____ Zip _____

ED1025

CIRCLE NUMBER 57

Pretty face

Sound design

REPEAT

UP
DOWN

COMP

STOP
YES NO

OUT

A B
C D

1 2

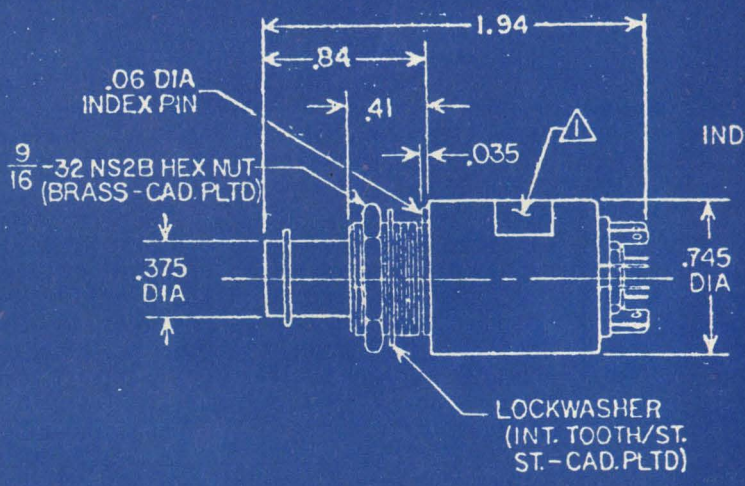
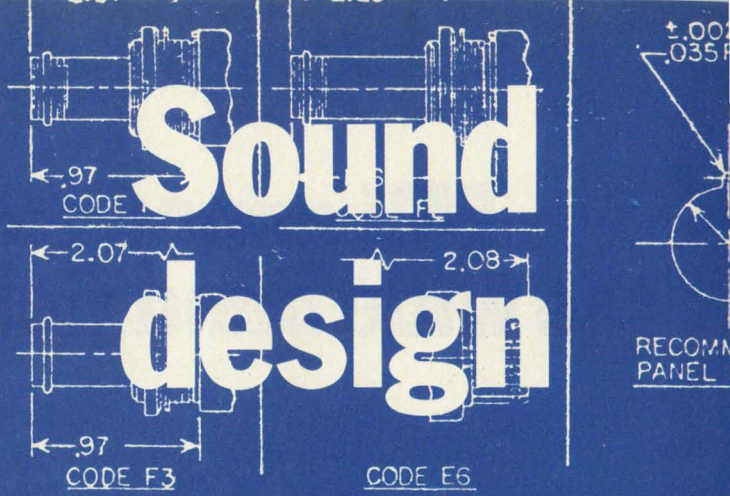

CODE	MODIFICATION DESCRIPTION
*D4	O-RING (ETHYLENE PROPYLENE) ON PLUNGER, EPOXY SEALED BASE.
*D5	SILICONE RUBBER BOOT, SEALED AT CASE NECK, BEARING EPOXY SEALED BASE.
E3	SWITCH CONTACTS AND TERMINALS GOLD PLATED FOR SURFACE RESISTANCE APPLICATIONS AND GREATER SOLDERABILITY.
E4	PROVIDES LAMP CIRCUIT WITH MAKE & BREAK CONTACTS. LAMP GOES ON WHEN PLUNGER IS PRESSED, GOES OFF WHEN PLUNGER IS RELEASED.
E5	ALL NORMALLY OPEN SWITCH CONTACTS CLOSE BEFORE NORMAL CLOSED CONTACTS OPEN.
B6	PROVIDES SWITCHLIGHT TERMINALS THAT ACCEPT AMP RECEPTACLES (0.016 TAB STYLE A).
F1	SINGLE LIGHT GANGSWITCH MOUNTING (MECHANICALLY INTERLOCKED). PROVIDES PLUNGER LENGTHENED 0.125 IN.. PLUNGER SPANNER NUT FOR MOUNTING.
F2	MULTI-LIGHT GANGSWITCH MOUNTING (MECHANICALLY INTERLOCKED). PROVIDES PLUNGER LENGTHENED 0.312 IN.. PLUNGER SPANNER NUT FOR MOUNTING.
F3	GANGSWITCH (NON-INTERLOCKED). PROVIDES PLUNGER LENGTHENED 0.125 IN. AND SPANNER NUT FOR MOUNTING.
F4	SWITCHLIGHT FURNISHED WITH ROUND SPANNER NUT IN PLACE OF STANDARD HEX NUT.
G2	SWITCHLIGHT SUPPLIED WITH LOWER (16 OZ) OPERATING FORCE.

Just what you'd expect from CLARE.

Bright. Handsome. And functional.
Clare switchlights and gangswitches offer wide versatility to the front panel designer to meet most human engineering requirements. And behind the visual esthetics are the reliability, practical design and manufacturing skills that mean quality that is usually found only in custom switchlights. Just what you'd expect from Clare. Write

or call for complete details on the Pendar series switchlights and gangswitches. C. P. Clare & Company
3101 W. Pratt Avenue, Chicago, IL 60645. (312) 262-7700.

We help you compete

C. P. CLARE & COMPANY
GENERAL INSTRUMENT CORPORATION



EMI announces the wide band field lab.

The latest addition to the EMI 7000 family of portable tape recorders is the SE7000M which brings 2MHz direct and 500KHz FM recording ability to the user who has exacting field requirements. The unit has eight-speed capability (up to 120 ips) with equalizers and filters completely built-in for each tape speed. No more filter changing.

And you will bring back the data because the SE7000M is designed for simple and error-free set up. It includes a unique calibration system which permits alignment of data electronics, channel by channel. And it also has the unique ability to actually perform all channel FM electronics-to-electronics checkout without running the tape to assure that you are recording data correctly before running your test.



The SE7000M is truly a rugged field unit which rivals the versatility, fidelity and performance of the most expensive lab recording systems.

Other SE7000 models come with midband capability (600KHz direct and 80KHz FM) and a range of recording track options from seven to 42 tracks.

Send for specifications on the complete line of EMI recorders by checking the reader service number, or contact EMI Technology, Inc., Instrumentation Division, 55 Kenosia Avenue, Danbury, Connecticut, 06810. (203) 744-3500, TWX: 710-456-3068.



EMI Technology, Inc., Instrumentation Division.
A member of the EMI Group.
International leaders in music,
electronics and leisure.



CIRCLE NUMBER 59

Get graphics and imaging for Nova and Eclipse

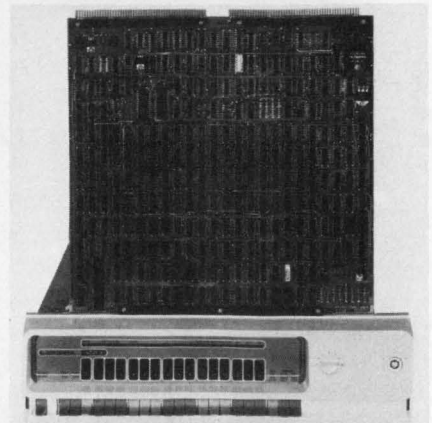

Lexidata, 215 Middlesex Tpk., Burlington, MA 01803. Martin Duhms (617) 273-2700. See text.

Model 200-D graphics and imaging video processor is self-contained on a 15 x 15-in. board that fits into any standard Data General Nova or Eclipse series computer. It generates raster scanned, refresh graphics and imaging displays up to 512 x 512 pixels in 16-level gray scale or color. An important feature is a "writable control store" which enables all the image processing and data formatting routines to be modified under program control from the host computer. The unit uses a high-speed, bipolar, microprocessor with a cycle time of 100 ns. Either the host computer or resident 32 kbytes of memory is used to refresh the display. Prices begin at \$4900 for a b&w system and \$5300 for a color version.

CIRCLE NO. 320

High-resolution CRT takes 8½ x 11 format

DataCopy, 3408 Hillview Ave., Palo Alto, CA 94304. Armin Miller (415) 493-3420. \$5000; 12 wks.

100 line/in. displays of standard 8½ x 11 page formats are presented by a CRT image consisting of a 908 x 1152 dot matrix, which can be placed under full control of a host processor. The full matrix is stored within the terminal's dynamic RAM. An additional 65,376 bits of memory provide unlimited cursor capability. By mixing cursor data with image data on the CRT, the user can configure any cursor shape at 1/16 the image resolution.

CIRCLE NO. 321

Enter data directly into hand-held calculator

Science Accessories, 970 Kings Hwy W., Southport, CT 06490. Rolf Kates (203) 255-1526. \$750.

SAC stand-alone interfaces can connect any standard BCD output device directly to a TI hand-held, programmable calculator by means other than the keyboard. Standard interface packages provide the interface cabling, plug-in connector, necessary calculator modification, and power supply.

CIRCLE NO. 322

Cassette interface operates at 2400 baud

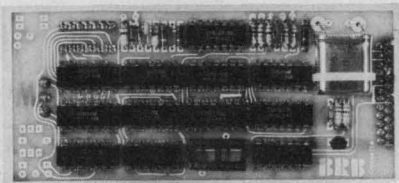

Wintek, 902 N. 9th St., Lafayette, IN 47904. (317) 742-6802. \$139.

Microprocessor programs and data can be loaded and dumped from an audio cassette eight times faster than the standard 300-baud with the Wince cassette interface. The interface also supports 300-baud Kansas-City-Standard operation. It interfaces directly to the Motorola 6850 ACIA. The 2½ × 5 in. module also contains an RS-232 interface for standard baud rates from 150 to 9600.

CIRCLE NO. 323

Small computers can use this 74-Mbyte hard disc

Ohio Scientific, Hiram, OH 44234. (216) 569-7905. \$6000.

The C-D74 disc unit provides a 35-ms average access time to any of 74 Mbytes of information. It provides 12 tracks on a cylinder without reseeking, and can access any of 220,000 bytes of information in 5 ms. With a 10-ms single-track seek, the drive has a transfer rate of 7.3 Mbits per second. A nonremovable, sealed chamber drive with a rotary arm positioner is used in the drive.

CIRCLE NO. 324

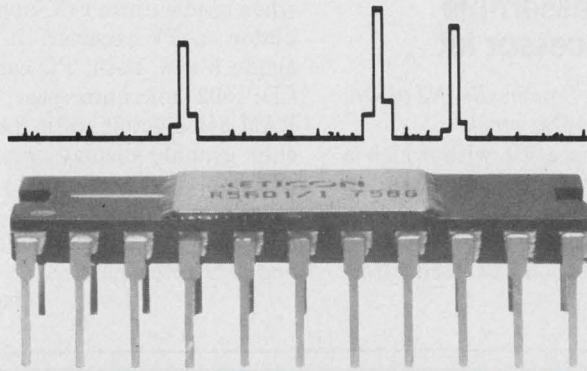

The spectrum analyzer on a chip.

Where else but from Reticon.

What was previously thought impossible will now be an everyday occurrence. Moving up to the next stage of complexity in CCD devices has resulted in the Reticon R5601, a 512 point Discrete Fourier Transformer. This technology offers a spectrum analyzer with small size, light weight, low power, high reliability, and a remarkable low cost. Along with its associated circuitry, it performs the Chirp Z algorithm to give a 256 spectral line display in less than 250 μ sec. It's small enough to fit into your system, yet powerful enough to have a signal-to-noise ratio in excess of 70db. The numerous applications possible include speech recognition, target identification, vibration analysis, bandwidth compression, communications, and general signal analysis.

Currently available is a self-contained evaluation module on two printed circuit cards just 80 square inches. Just hook up your ± 20 volts, display and you're on the air. Use the on-board oscillator or externally control the sampling rate.

The R5601 is the latest in our growing family of discrete time analog signal processing devices. All available through our worldwide network of over 20 distributors and more than 70 salesmen.

Discover the IC that does it all.

RETICON®

AN  COMPANY

910 Benicia Ave • Sunnyvale, California 94086
(408) 738-4266

CIRCLE NUMBER 60

MICRO/MINI COMPUTING

It's easy to assemble μ C with processor kit

RCA, Route 202, Somerville, NJ 08876.
(201) 685-6423. \$275; stock.

Cosmac VIP is a kit with which a microcomputer can be assembled to generate graphics and develop microprocessor control functions. It is a complete computer on a PC card, offer-

ing an operating system in 4 kbits of ROM. Its output directly interfaces with a monochrome CRT display or, when used with an FCC-approved modulator, a TV receiver. It features a single $8\frac{1}{2} \times 11$ -in. PC card with the CDP1802 microprocessor, 2048 byte RAM using 4-kbit static RAMs, single-chip graphic display interface, hexadecimal keyboard, 100-byte/s audio-tape interface, wall-plug power supply, and easy expandability for memory and I/O interfaces.

CIRCLE NO. 325

Flexible disc system improves PDP-11

Ex-Cell-O, Remex Div., 1733 Alton St., Irvine, CA 92713. (714) 557-6860.

An integrated hardware/software unit, the Remex-11 flexible disc system, allows users of PDP-11 computers to improve the efficiency of their equipment. Software modules of the system allow it to operate in an RT-11 environment, using either the standard DEC RX-01 26-sector format or a 16-sector format to increase the disc storage capacity by at least 25%. Efficiency is also enhanced by a single two-instruction command used to transfer up to 65 kwords, stored in multiple sectors and tracks.

CIRCLE NO. 326

Device adapts RS-232 signal to current loop

Connecticut Microcomputer, Pocono Rd., Brookfield, CT 06804. \$24.50 to \$29.50.

The CMC ADAPTER consists of two circuits. The first converts an RS-232 signal to a 20-mA current-loop signal, and the second converts a 20-mA current-loop signal to an RS-232 signal. With this device, a computer's teletypewriter port can be used to drive an RS-232 terminal, or vice versa, without modification of the port. ADA can also be paralleled to drive a TTY or RS-232 printer while still using the computer's regular terminal. It does not alter the baud rate. Size is $3 \times 3\frac{1}{2} \times 1$ in.

CIRCLE NO. 327

Improve on mini ability with extended memory

Monolithic Systems, 14 Inverness Dr. E., Englewood, CO 80110. Reed Ahlquist (303) 770-7400. \$23,795; 6 wk.

EMU is a solid-state, plug-replacement memory unit for the DEC RF/RS-11 fixed-head disc. It eliminates the 8.5 to 17 ms pure rotational latency of the fixed-head disc. The access time of the EMU, 2.1 μ s, is required to set up its control registers and initiate the transfer of information to and from the main memory. This enables it to operate 4000 to 8000 times faster than the fixed-head disc with respect to latency. Also, it transfers data at a 1- μ s rate, which is 16 times faster than the RF/RS-11 and four times faster than the RJS-04 disc.

CIRCLE NO. 328



There are scores of uses for Bud's new Contempo Series, the versatile mini-enclosures. Well engineered, solidly constructed, clean and contemporary. Four styles, 22 sizes in either woodgrain and eggshell, or black pebble and smooth gray finish. The Contempo Series, the newest idea for your ideas. From Bud! For literature, phone Bud toll free: (800) 321-1764; in Ohio, (800) 362-2265.

Complete manufacturing facilities at two locations:

BUD

Bud Industries, Inc.
4605 East 355th Street
Willoughby, Ohio 44094

Bud West, Inc.
3838 North 36th Avenue
Phoenix, Arizona 85019

CIRCLE NUMBER 62

Datel's A/D-D/A I/O Peripheral Boards for the DEC PDP-11 Minicomputers

MODEL ST-PDP

- ▶ Slides directly into DEC's PDP-11 Minicomputer housing
- ▶ Includes 64 Single-ended or 32 Differential A/D Channels plus 2 D/A Channels on one BB11 Connector Block
- ▶ Expandable up to 768 single-ended or 384 Differential Channels.
- ▶ Powerful paper tape diagnostic software included!
- ▶ DMA, Interrupt or Program Control
- ▶ Prices from \$795.00

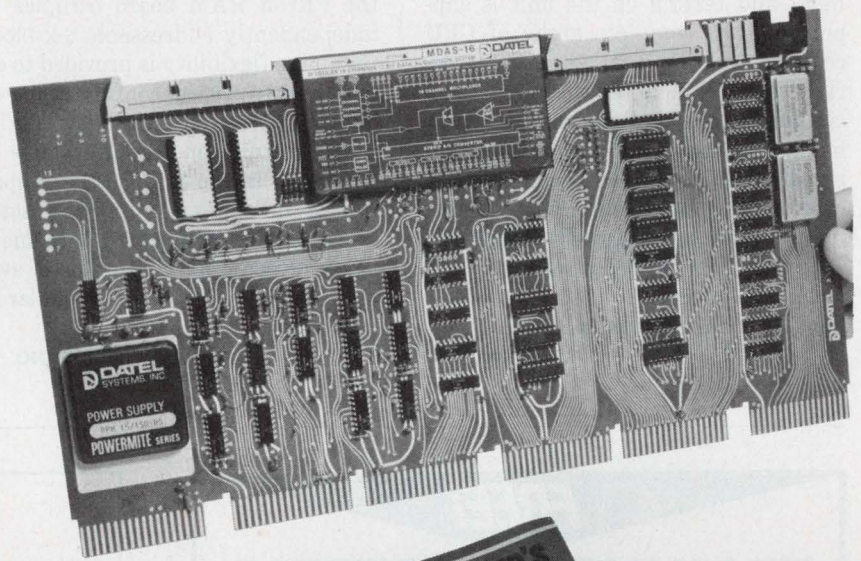

You'll find more specifications on this product and more than 300 data conversion circuits and systems in Gold Book.

Just check Gold Book's Volume 3. That's Datel's complete Engineering Product Handbook, in its own separate volume. More than 290 pages of D/A & A/D Converters, Multiplexers, Sample-Holds, Op Amps, Power Supplies, Digital Panel Meters and Printers, Digital Panel Instruments, Data Loggers, Digital Cassette Recorders, and Data Acquisition Systems. Each fully detailed on individual data sheets. And it's available to you in Gold Book.

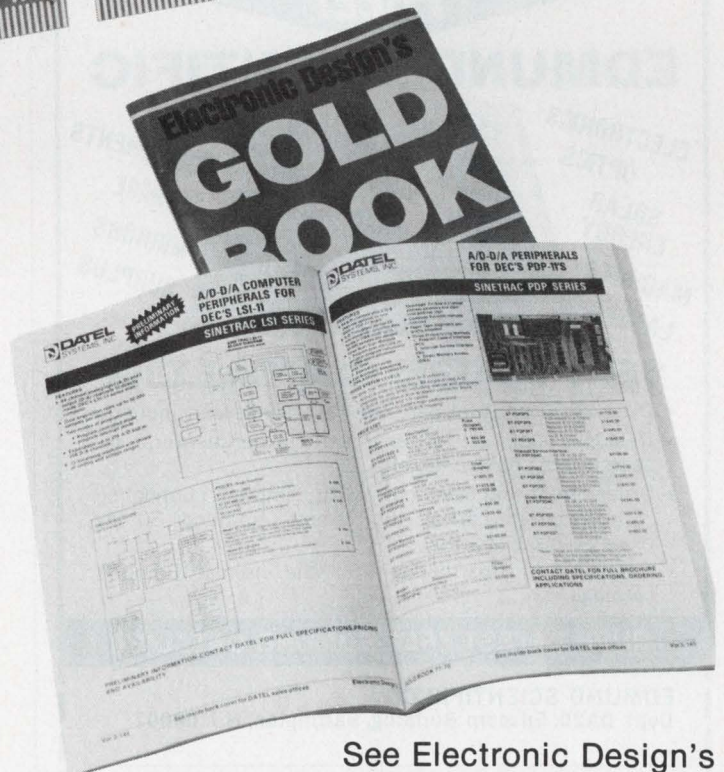

1020 Turnpike St., Canton, MA 02021
Phone: (617) 828-8000

See Electronic Design's
1977-78 "Gold Book"-Vol. 3, page 145

Santa Ana, CA (714) 835-2751, (L.A.) (213) 933-7256 • Sunnyvale, CA (408) 733-2424 • Gaithersburg, MD (301) 840-9490 • Houston, TX (713) 932-1130
OVERSEAS: DATEL (UK) LTD—TEL: ANDOVER (0264) 51055 • DATEL SYSTEMS SARL 620-06-74 • DATELEK SYSTEMS GmbH (089) 78-40-45

CIRCLE NUMBER 63

Build a 16-bit μ C with full kit of parts

Cramer Electronics, 85 Wells Ave., Newton, MA 02159. (617) 969-7700. \$595; stock.

TMS 9900 Cramerkit is a complete package of components, software, and design documentation for building a full capability microcomputer based on TI's TMS 9900, 16-bit, one-chip microprocessor. Custom software development and testing on the unit is supported by a complete array of CPU controls and displays, a variety of peripheral interfaces, special debugging circuits and a system monitor that handles all software-development peripherals. With the on-board EPROM programmer, the monitor will transfer programs directly into EPROMs. The system has a master clock. All CPU buses are buffered so that extra RAM, ROM and I/O can be added.

CIRCLE NO. 329

PROM/RAM board has flexible addressing

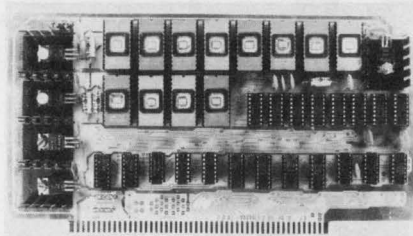

Vector Graphic, 790 Hampshire Rd., A+B, Westlake Village, CA 91361. Carole Ely (805) 497-0733. \$135 (kit), \$175 (assembled).

With a 1-k on-board RAM and capacity for up to 12-k of 2708 type EPROMs, the PROM/RAM board occupies two independently addressable 8-k blocks. Complete flexibility is provided to conform to any system configuration with a minimum of address jumpers. Video boards or disc operating systems can be nested in the 3 k of unused space. MWRITE logic and jump-on-reset allow operation without a front panel. A 24-command PROM monitor is available to interface with most popular I/O boards.

CIRCLE NO. 330

Drafting is automatic with μ C-based machine



Information Displays, 150 Clearbrook Rd., Elmsford, NY 10523. (914) 592-2025.

System 150 is a minicomputer-based turnkey, refresh-graphics, drafting and design system. It has the capability to project 3-dimensional moving displays to show dynamic relationship between parts and to test alternative designs. Geometric and attribute information generated by the system serves as an input to manufacturing and reduces design-to-manufacturing time.

CIRCLE NO. 331

FREE!

EDMUND SCIENTIFIC

ELECTRONICS

OPTICS

SOLAR ENERGY

MAGNETS

LASERS

O.E.M. COMPONENTS

LABWARE

MIRRORS

SURPLUS

164 PAGE CATALOG

- Over 4,000 unusual bargains for science and industry
- In-stock supplies for engineers, experimenters, research labs, hobbyists, etc.
- Order direct and save—buy with complete confidence... every item carries the famous Edmund 30-day money-back guarantee.
- Simply mail this coupon for the newest Edmund catalog.

RUSH LATEST FREE EDMUND CATALOG

EDMUND SCIENTIFIC CO.
Dept. DA20, Edscorp Building, Barrington, N.J. 08007

Name _____

Address _____

City _____ State _____ Zip _____

CIRCLE NUMBER 64

PLENTY OF POWER PACKS

Small size, hermetically sealed. Promise long life, low ripple, withstand vibration and shock. AC input, DC output. Wide variety of electrostatic and solid state applications. Standard and custom designs available. Off the shelf delivery up to 75 KVDC. Just send your specs.

Write for Technical Data.

Plastic Capacitors, Inc.
2623 N. Pulaski Road
Chicago, Illinois 60639
(312) 489-2229

"Serving industry for 25 years"

CIRCLE NUMBER 65

Datel's A/D-D/A I/O Peripheral Boards for the NOVA Minicomputers

MODEL ST-NOVA

- ▶ Slides directly into Data General's NOVA Series Minicomputers
- ▶ Includes 64 Single-ended or 32 Differential A/D Channels plus 4 D/A Channels on one board
- ▶ Expandable up to 256 Channels
- ▶ Powerful paper tape diagnostic software included!
- ▶ DMA, interrupt or program control
- ▶ Prices from \$1445

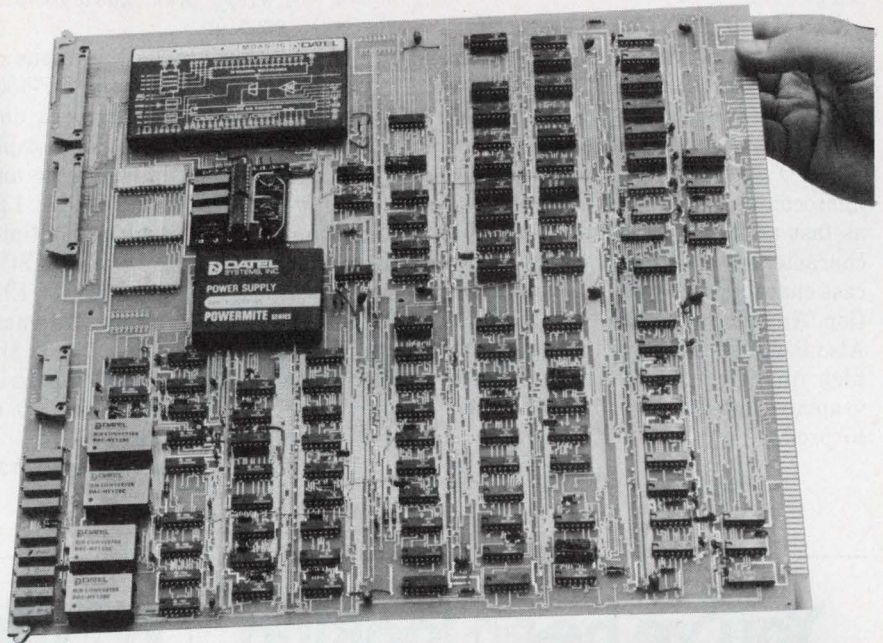

You'll find more specifications on this product and more than 300 data conversion circuits and systems in Gold Book.

Just check Gold Book's Volume 3. That's Datel's complete Engineering Product Handbook, in its own separate volume. More than 290 pages of D/A & A/D Converters, Multiplexers, Sample-Holds, Op Amps, Power Supplies, Digital Panel Meters and Printers, Digital Panel Instruments, Data Loggers, Digital Cassette Recorders, and Data Acquisition Systems. Each fully detailed on individual data sheets. And it's available to you in Gold Book.

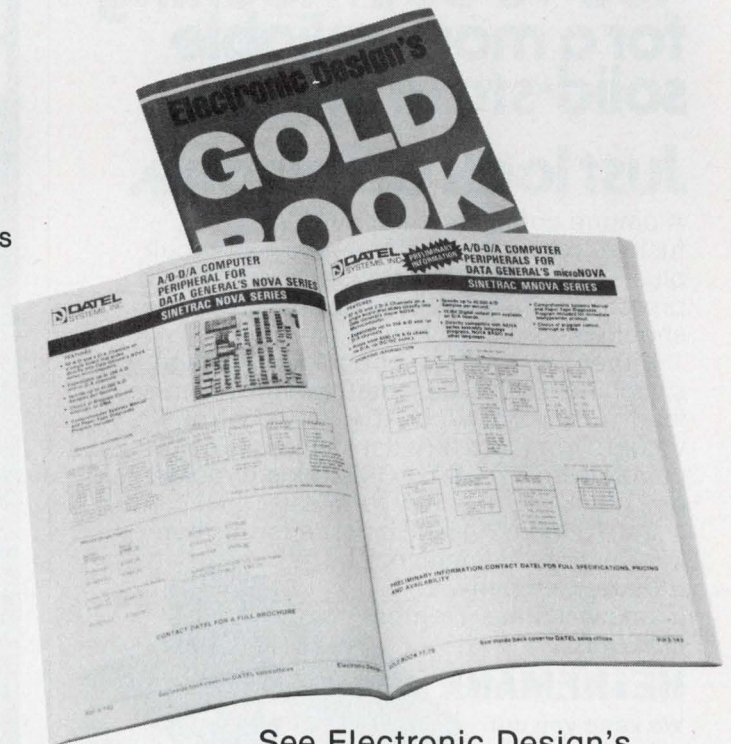

D **DATEL**
SYSTEMS, INC.

1020 Turnpike St., Canton, MA 02021
Phone: (617) 828-8000

See Electronic Design's
1977-78 "Gold Book"-Vol. 3, page 142

Santa Ana, CA (714) 835-2751. (L.A.) (213) 933-7256 • Sunnyvale, CA (408) 733-2424 • Gaithersburg, MD (301) 840-9490 • Houston, TX (713) 932-1130
OVERSEAS: DATEL (UK) LTD—TEL: ANDOVER (0264) 51055 • DATEL SYSTEMS SARL 620-06-74 • DATELEK SYSTEMS GmbH (089) 78-40-45

CIRCLE NUMBER 66

Video display system works with S-100 bus

Micro Systems Development, 2765 S. Colorado Blvd., Denver, CO 80222. George Mensik (303) 758-7411. \$285 (kit); stock.

The MSDV-100 video display system is an 80-character, 24-line device for the S-100 bus. Internally it is a two-board S-100 based system, which occupies 2 k of RAM address space and two I/O ports. Being a bus device, the microcomputer can write to the screen as fast as it can to any memory. The character set includes upper and lower-case characters as well as full punctuation. Any character can be underlined. Also included is the ability to generate high quality forms overlays. Charts, graphs, or order entry forms are easy to produce on the video screen.

CIRCLE NO. 332

Printer works with most mini/micro computers

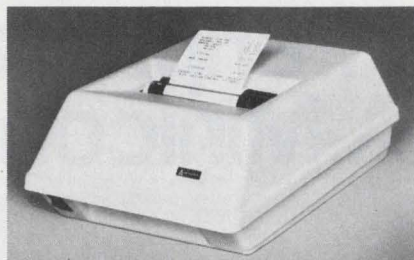

Anadex, 9825 DeSoto Ave., Chatsworth, CA 91311. Ken Mathews (213) 998-8010. \$700 up.

Either for terminal applications or as stand-alone printers, the DP-1000 series digital printers feature a dot-matrix impact printing element capable of printing 64 alphanumeric and special symbols in 40 char/line at 1.25 lines/s on standard single or multiple-copy paper rolls. Three basic ASCII configurations, conforming to EIA RS232-C, allow interfacing to most minicomputers, modems, and the current-drive mode of teletypewriter/printers. Baud rates from 110 to 2400 baud are available.

CIRCLE NO. 333

16-bit μ C has dual floppy disc

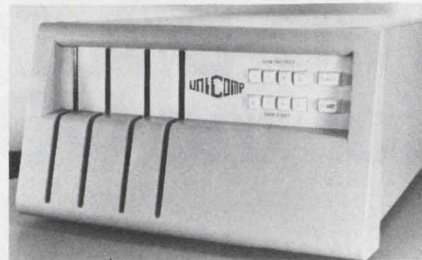

Unicomp, 8950 Westpark, Houston, TX 77063. Joe Lill (713) 782-1750.

SS-11/15 is a 16-bit microcomputer that is a floppy-disc-based system packaged in a 10½-in. rack or tabletop enclosure. It is compatible with operating system software such as RT-11 and RSX-11/S. Hardware includes a 15-quadrant backplane, integral switching-mode power supply, dual or quad floppy disc, CPU with EIS/FIS MICROM, 20 to 28 kword RAM, console interface, diagnostic/bootstrap PROM, bus terminator, console switch register, distributed refresh controller, and complete front-panel controls and displays.

CIRCLE NO. 334

You've been looking for a more reliable solid-state relay.

Just look at this one.

A unique combination of dv/dt snubber, fusible-link protection in the trigger circuit, plus an oversized triac—all combine to protect against catastrophic system failure should the triac fail to turn on.

Either zero-voltage or non-zero-voltage switching, both types rated for maximum ac load currents of 5A or 10A. Any control voltage from 3 to 32V dc; all models compatible with TTL, DTL, CMOS logic. Solder-pin, quick-on, or screw terminals.

Call (609-882-4800) or write for further information. Heinemann Electric Company, Brunswick Pike, Trenton, NJ 08602.

HEINEMANN

We keep you out of trouble.

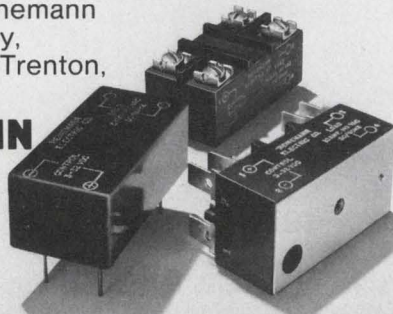

© Heinemann 6961

CIRCLE NUMBER 67

MINI-STEPPERS MAXI-STEPPERS

PM and VR steppers—responsive and precise—with slewing rates to 20,000 steps/sec.

and higher. We offer an unlimited range of step angles, frame sizes and configurations. And high torque/size ratios.

Options include: dampers, heat sinks, encoders, pulse sources, drivers, preset indexers, gearheads, and more. Standards and specials—the best of both.

Send for literature.



Eastern Air Devices Motor Division
Electro Audio Dynamics, Inc.
Dover, N.H. 03820 • (603) 742-3330 • TWX (510) 297-4454

CIRCLE NUMBER 68

ELECTRONIC DESIGN 22, October 25, 1977

Datel's New Low Priced Digital Panel Meter

MODEL DM-3100

FEATURES

- ▶ Miniature case with 0.5" LED display
- ▶ Bipolar, differential ± 2 VFS input
- ▶ 3½ Digit resolution with Autozeroing
- ▶ LCD display available at additional cost
- ▶ Additional ranges — customer programmable
- ▶ 4½ digit resolution also available — \$59 (100's)
- ▶ Additional current and ohmmeter capability — customer programmable

\$29*

*\$35 (1-99) \$29 (100-499)



You'll find complete specifications on this product and more than 300 data conversion circuits and systems in Gold Book.

Just check Gold Book's Volume 3. That's Datel's complete Engineering Product Handbook, in its own separate volume. More than 290 pages of D/A & A/D Converters, Multiplexers, Sample-Holds, Op Amps, Power Supplies, Digital Panel Meters, and Printers, Digital Panel Instruments, Data Loggers, Digital Cassette Recorders, and Data Acquisition Systems. Each fully detailed on individual data sheets.

And it's available to you in Gold Book.



1020 Turnpike St., Canton, MA 02021
Phone: (617) 828-8000



See Electronic Design's 1977-78
"GOLD BOOK"—Vol. 3, page 226

Santa Ana, CA (714) 835-2751, (L.A.) (213) 933-7256 • Sunnyvale, CA (408) 733-2424 • Gaithersburg, MD (301) 840-9490 • Houston, TX (713) 932-1130
OVERSEAS: DATEL (UK) LTD—TEL: ANDOVER (0264) 51055 • DATEL SYSTEMS SARL 620-06-74 • DATELEK SYSTEMS GmbH (089) 78-40-45

CIRCLE NUMBER 69

POWER SOURCES

Increase packing density with 7.2-W solar cells

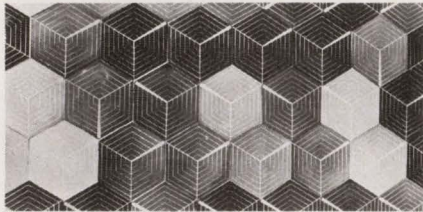

Sensor Technology, 21012 Lassen St., Chatsworth, CA 91311. K. Van Der Pool (213) 882-4100. \$216; 8 wks.

A 7.2-W solar-power module using hexagonal cells increases packing density of panels from 60%, for conventional panels using circular cells, to over 90%. The use of the hexagonal cells provides an output of 8.5 W/ft². A tempered glass cover is included. When operated between -65 and +125 C and protected from mechanical forces, life of the modules is virtually limitless.

CIRCLE NO. 335

Converters deliver up to four dc outputs

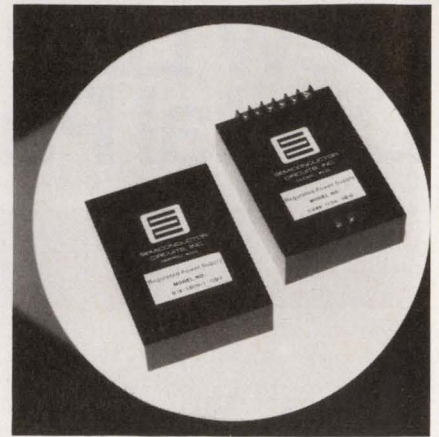

Semiconductor Circuits, 306 River St., Haverhill, MA 01830. Ted Brewster (617) 373-9104. From \$135 (10 qty); 6 to 8 wks.

The U and CU series of modular dc/dc converters feature quadruple, as well as triple and single-output units that deliver up to 25 W total. These converters maintain efficiency of between 70 to 73% in the face of load changes from 15 to 100% of the full-rated load. Input-reflected ripple is 20-mA pk-pk max. Input-to-output isolation is 2500-V-dc min, isolation between the outputs is 300-V-dc min. All units operate from -25 to +71 C without derating. The output-voltage tempo over this range is typically 0.02%/°C. These devices operate from inputs of either 9 to 36 V or 28 to 90 V. The sole difference between the U and CU series is package style. U-series converters are for PC boards while the CPU series is for chassis mounting. They both are 5.5 × 3.5 × 1.25 in. A single-output 25-W dc/dc converter is the primary-output source. In multiple-output models, this also powers dual or triple-output converters—the derived sources. Both series contain two single-output models that deliver 5 V at 5 A or 12 V at 2 A. Three triple-output models offer: a primary output of 5 V at 1 A with derived outputs of -5 V at 1 A and 12 V at 600 mA; a primary output of 5 V at 1 A with derived outputs -5 V at 100 mA and 12 V at 600 mA; or a primary output of 5 V at 2 A with derived outputs whose currents are limited to 300 mA each. Two quadruple-output models combine either a primary output of 5 V at 1 A with derived outputs of -5 V at 1 A and ±12 V at 300 mA each, or a primary output of 5 V at 2 A with derived outputs or -5 V at 100 mA and ±12 V at 300 mA each. CIRCLE NO. 336

MCC builds custom ICs using I²L to provide Consumer Product Prices

With I²L designs both linear and digital functions can be combined in a single chip. This means fewer external components, lower costs and improved reliability. Also, they permit interface power output capability not available with CMOS. Micro Components Corporation is ready to discuss your requirements for custom ICs demanding high performance and consumer product pricing.

Call us at: (401) 463-6000

Successfully being used in:

- Peripheral Microprocessor ICs
- Electronics in Cameras
- Electronic Photo-Flash
- Smoke Detectors
- Ground Fault Interrupters
- Motor Speed Control
- Mobile Communications
- Dynamic Microphones
- Toys & Games
- Automotive Systems
- Opto-Electronic Interface
- Dust & Particle Detection
- Security & Intrusion Alarm Systems
- Electromagnetics
- Timers for Appliances

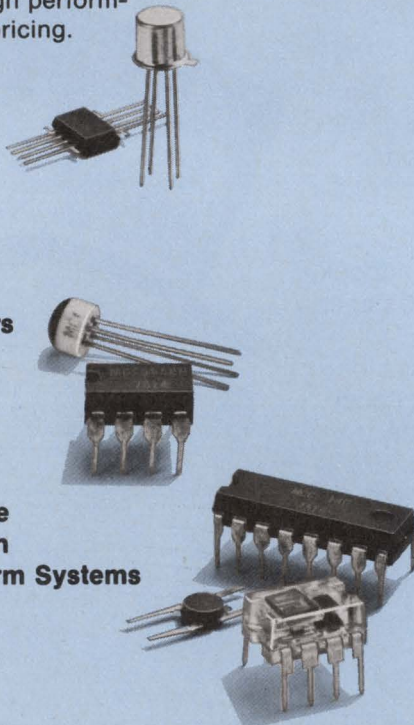

MICRO COMPONENTS CORPORATION

99 Bald Hill Road • Cranston, R.I. 02920

CIRCLE NUMBER 70

Type A 1/4" trimmers. A reliable cure for cramped PCB's.

Our Type A 1/4" cermet trimmer gives you low profile, lowest TCR for a tiny package of high performance... and an ideal solution for cramped printed circuit boards. 10 ohms to 2.5 megs. 0.5 watt at 85°C. -55°C to +150°C temperature range. You get great variety plus greater savings, too. \$0.96 each—1000 piece lot. We have what you need; our distributors have it when your need is now. Ask for Publication 5238.

Multi-finger contact
for low CRV and fine adjustability.

Immersion sealed
for safe board washing.

Exclusive cermet resistance material
on alumina substrate results in TCR of 35 PPM/°C typically.

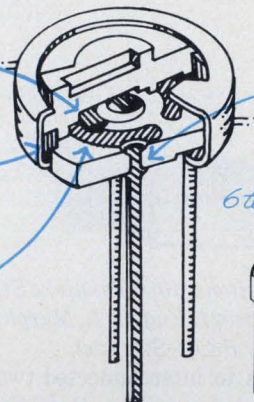

Surged terminals
securely anchored with redundant connections.

6 terminal options

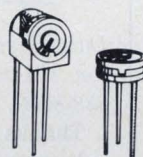

Actual size

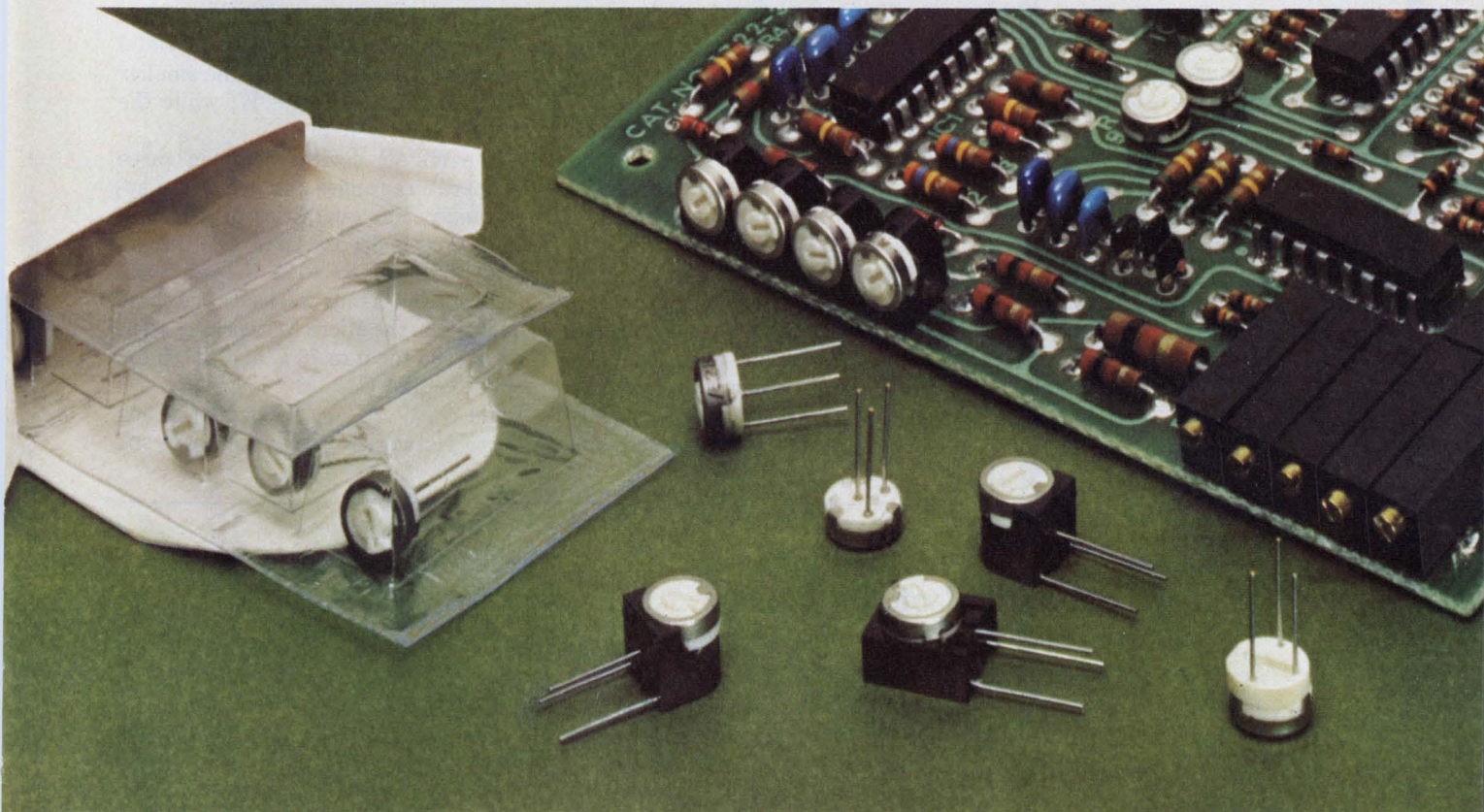

Quality in the best tradition.



ALLEN-BRADLEY
Milwaukee, Wisconsin 53204

CONTACT YOUR
ALLEN-BRADLEY DISTRIBUTOR OR
WRITE TO ELECTRONICS DIVISION

EC159

CIRCLE NUMBER 71

MONOLITHIC CRYSTAL FILTERS

the
State
of the
Art

FIVE THINGS TO DO WITH VHF MONOLITHIC FILTERS ON A RAINY DAY

- 1) Make a paging receiver or other single-channel receiver, (models 2133F & 4171F).
- 2) Reduce IM and front-end overloading in a VHF mobile or base station receiver, (models 2131-33 VBP and 4131-33 VBB).
- 3) Make an up-conversion HF receiver or exciter (custom models).
- 4) Clean up the spectrum in your frequency synthesizer, (custom models).
- 5) Make a 900 MHz mobile receiver (Models 4371F & 2372F, 45 MHz first IF filters).

If one of these projects turns you on, or if you've got a project of your own, don't wait for a rainy day — turn us on right now. Just call or write. We offer a rain barrel full of monolithic crystal filters — from 5 MHz to 180 MHz, including over 60 stock models at 10.7 and 21.4 MHz.

NEW KID ON THE BLOCK...

45 MHz is a popular first I-F for the new 900 MHz mobile radio band. We've got the filters for it — two poles (Model 2372F) and four poles (Model 4371F). And they're in stock. Just write or call for data sheets and quantity pricing.

Pi

Piezo Technology Inc.

2525 Shader Road, Orlando, FL 32804
(305) 298-2000

The standard in
monolithic crystal filters.

CIRCLE NUMBER 72

MODULES & SUBASSEMBLIES

Multichannel 12-bit DASs packed into tiny plug-ins

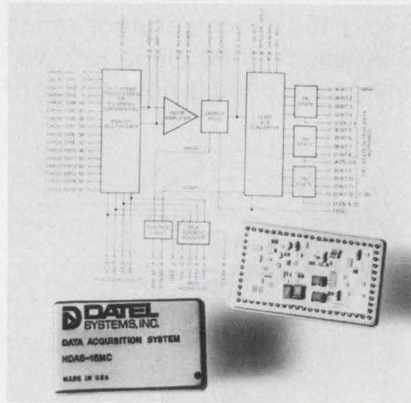

Datel Systems, 1020 Turnpike St., Canton, MA 02021. Eugene L. Murphy (617) 828-8000. P&A: See text.

Thanks to interconnected two-piece substrate construction, Datel Systems has crammed complete 12-bit data-acquisition systems into $2.3 \times 1.4 \times 0.24$ -in. metal packages. Two models are available: the HDAS-16, with 16 single-ended inputs, and the HDAS-8, with eight differential-input channels.

Both thin-film hybrids are miniaturized versions of Datel's MDAS-16 and MDAS-8 data-acquisition systems. The small DASs each contain a CMOS multiplexer, a programmable-gain amp, a sample-and-hold circuit including the capacitor, a 10-V buffered reference, a 12-bit a/d converter, an address register, control logic and tantalum power-supply bypass capacitors. Only one external resistor programs the in-

strumentation amp's gain from 1 to 1000.

Digital-output data have three-state outputs for direct interfacing to a μ C data bus and can be transferred in 4-bit nibbles. Both HDAS-16 and -8 operate in one of three modes: free-running with sequential addressing, triggered with sequential addressing, and random addressing.

The 62-pin HDASs are much smaller and less expensive than other single-unit DASs with similar characteristics such as the MN 7002, from Micro Networks, Worcester, MA. This $2.9 \times 4.5 \times 0.35$ -in. open PC-card module, converts either eight or 16 single-ended analog input channels into 12-bit digital data that can be interfaced directly to μ C data buses.

While the Micro Networks device has a throughput rate of 40 kHz, the Datel devices boast 50 kHz. And the smaller units consume only 2.8 W, while the board requires 3 W.

The HDAS devices come in three temperature ranges and are priced accordingly: For quantities of 1 to 9, 0 to 70 C costs \$295, -25 to +85 C costs \$395, and -55 to +125 C costs \$695. Delivery takes four weeks. In the same quantities, the Micro Networks system costs \$595 for 0 to 70 C and \$1195 for -55 to +125 C.

Datel
Micro Networks

CIRCLE NO. 303
CIRCLE NO. 304

Preset six digits on electronic counter

Kessler-Ellis Prod., Atlantic Highlands, NJ 07716. Richard Laird (201) 291-0500. \$300; stock.

Model SCPS electronic counter has six digits of preset and six 0.4-in., orange LED displays. One preset or two presets can be provided in the same package. The device counts up to the number, down from the number or between two numbers. The input circuit accepts switch closure inputs or voltage pulses from 3 to 30 V dc at speeds up to 2 MHz. Size is $5 \times 1.7 \times 3$ in.

CIRCLE NO. 337

Remote station monitors alarm systems

Hubbell Pulsecom Div., 5714 Columbia Pike, Falls Church, VA 22041. Nelson Boyd (703) 820-8000.

The Datalok 10A remote station provides flexible alarm monitoring, supervision and control. It features static alarm memory and front-panel display, latching control outputs with external reset, built-in modem, ASCII data format with parity checking, and data rates from 37.5 to 2400 baud. Optional boards allow operation in 4 to 8 or 8 to 12 kHz bands of microwave communication systems.

CIRCLE NO. 338

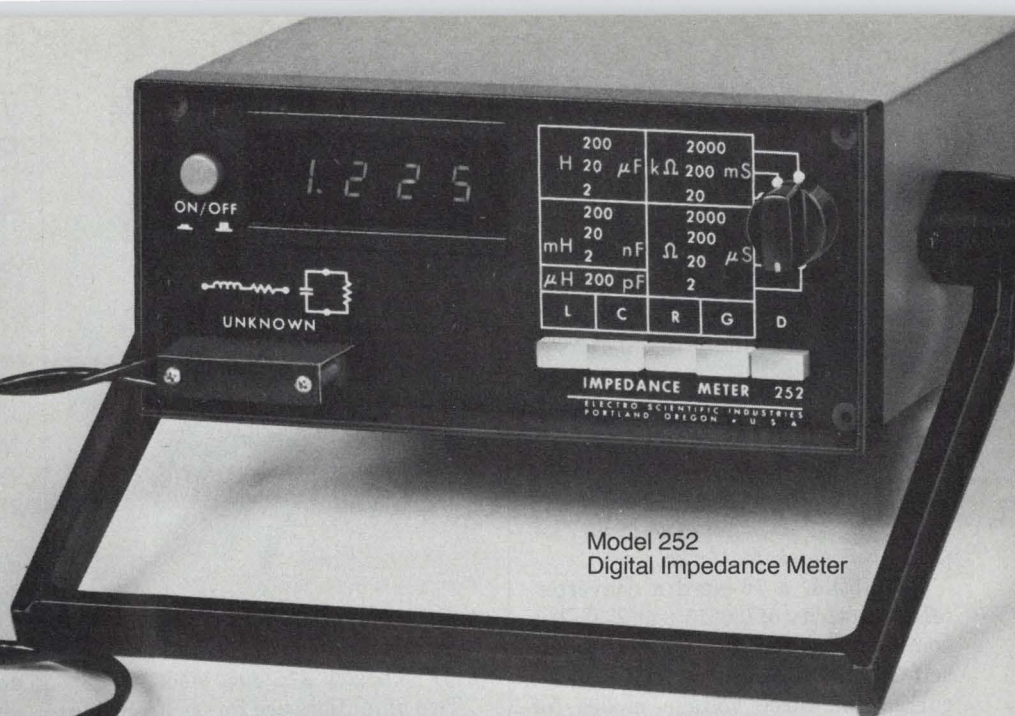

Model 252
Digital Impedance Meter

L-R-C Gotcha! ...and for only \$695

(U.S.A. only)

Newest ESI "weeder" does it all - even Dissipation Factor.

At \$695, incoming inspection and evaluation of passive components becomes easily affordable. You not only measure L, R, C and G with high accuracy over wide ranges, but the dissipation factor reads out also. Check these features in this light, compact, easy to transport tester:

- Measures D as well as L, R, C, G, automatically.
- Light weight; tilt stand handle.
- 0.25% basic accuracy.
- Wide ranges.
- 1 kHz test frequency.
- 2 measurements/sec.
- External bias.
- 4-terminal connection.
- Analog outputs.
- Low power design.

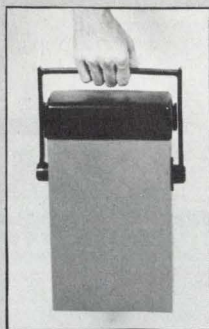

- Large 3½-digit display.
- Front panel dust cover (option).
- Input protection.

Measurements are simple, fast and accurate . . . Set the range and connect to unknown. Four-terminal KELVIN KLIPS® are included, and a front panel dust cover is optional. The Model 252 can also be combined with ESI's Model 1412B Limits Comparator for go/no-go testing.

Handy tiltstand handle completes this value buy, along with the assurance of our precision measurement name: Electro Scientific Industries, 13900 NW Science Park Dr., Portland, Ore. 97229. Units will be available in November, so request a demo today. Telephone 503/641-4141.

esi
ELECTRO
SCIENTIFIC

MODULES & SUBASSEMBLIES

Convert 16 bits with mini module

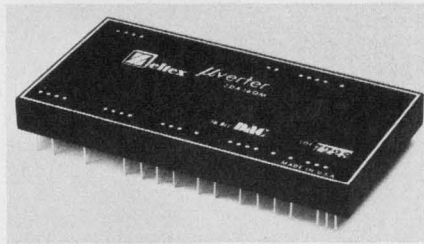

Zeltex, 940 Detroit Ave., Concord, CA 94518. Dick Terry (415) 686-6660. \$596 (100 qty); stock to 4 wks.

ZDA16QM, a 16-bit d/a converter, offers linearity of 0.0015% at 25 C. The compact modular unit is completely self-contained and is usable in two current or three voltage modes for unipolar or bipolar operation. Gain, unipolar and bipolar offsets are externally adjustable. Pre-selected and screened analog switches and 1 ppm/°C thin film resistors ensure stable, accurate performance. Epoxy encapsulated case is 2 x 4 x 0.4 in.

CIRCLE NO. 339

Amplifier for 5-500 MHz is in flatpack or TO-8

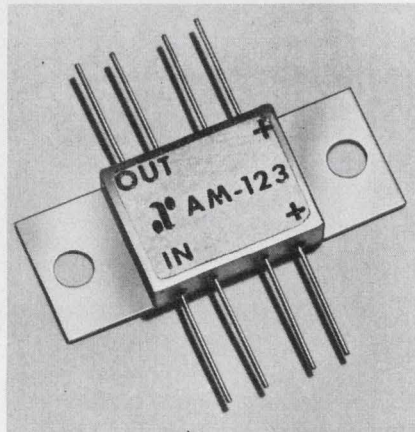

Anzac Electronics, 39 Green St., Waltham, MA 02154. James Leonard (614) 889-1900. \$75/\$95; stock.

Two amplifiers are for use from 5 to 500 MHz with 10-dB gain and ± 0.7 -dB frequency response. AM-123 is in a flatpack and AM-131 has a TO-8 package. Power output is over +19 dBm, third-order intercept at midband is +42 dBm, and noise-figure at midband is 3.5 dB.

CIRCLE NO. 340

Transducer display has control/alarm options

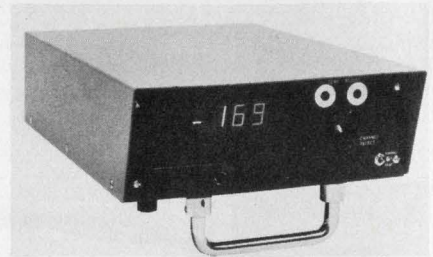

Neutronics, 450 Drew Ct., King of Prussia, PA 19406. Terry Halpern (215) 275-3800. \$600.

Measurement systems can be simplified with the use of the built-in options of the Model-TDI1000 transducer digital indicator. Standard features include power supply for transducers, instrumentation amplifier, 3½-digit bipolar digital display in engineering units, zero and gain controls, self-calibration check and circuit overload protection. Options include peak hold, valley hold, direct differential reading, square root extraction, high/low alarms, 4½-digit display, control and/or recording outputs.

CIRCLE NO. 341

NEW!

From

CAPITOL

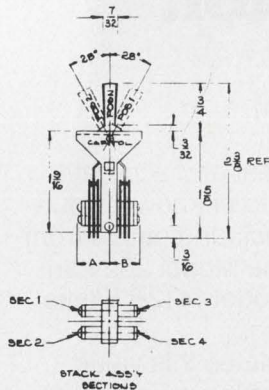
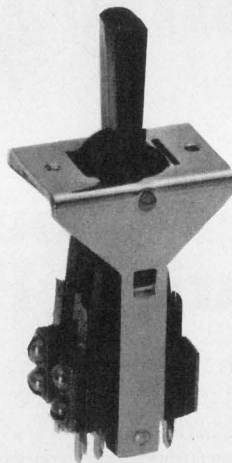

MODEL MLA LEVER SWITCH

A panel-mount switch with one-piece molded cam and handle. It extends only 1 5/8" behind panel. Extremely smooth operation with positive detent action.

COMPLETE SPECIFICATIONS IN NEW BROCHURE

CAPITOL

The Capitol Machine & Switch Co.
87 Newtown Road,
Danbury, CT 06810
203-744-3300

Join the IMC Book Club*



Free Catalog features Tormax® Steppers and Controls

This catalog contains chapters on the Theory of Operation, Excitation Modes and Application along with the Glossary and Specifications of standard models from size 5 thru 34 of the IMC Tormax® stepper motors. The catalog also has a full listing of IMC Tormax® controllers recommended to drive Tormax® steppers.

For immediate service please call Bill Blair, Sales Manager—213/583-4785



*Product Literature Broadside and request card will be sent to you along with this catalog.

SERVING INDUSTRY OVER 25 YEARS

imc

25
Motors
Fans
Blowers

IMC MAGNETICS CORP.

WESTERN DIVISION
6058 WALKER AVE., MAYWOOD, CALIF. 90270

CIRCLE NUMBER 75

ELECTRONIC DESIGN 22, October 25, 1977

Our KH series. Nobody satisfies your 4PDT relay needs any better.

P&B gives you more contact, terminal, socket, rating, enclosure choices than anyone else.

With all the available options, you can virtually design your own KH relay. Need bifurcated crossbar contacts for low-level switching? PC board terminals? Push-to-test button? No problem. These options and dozens more are tooled, ready for production.

KH relays are rated up to 3 amperes at 30V DC or 120V AC, resistive. Contact arrangements include DPDT and 4PDT. KHU relays are UL recognized and CSA certified. KHX relays are UL recognized for opposite polarity ratings.



This is an original Potter & Brumfield design. No wonder we've made more, with more variations for special applications, than anyone. KHU and KHS (hermetically sealed) relays are available from authorized P&B distributors.

Complete specifying information is available from your local P&B representative or call Potter & Brumfield, 200 Richland Creek Drive, Princeton, Indiana 47671. 812/386-1000.

AMF
Potter & Brumfield

Potter & Brumfield

CIRCLE NUMBER 76

Four op amps are on single chip

Sprague Electric, North Adams, MA 01247. (413) 664-4411. \$1.62 to \$1.95.

A series of quad op amps is available, with four internally compensated op amps on a single chip. Type ULN-

4136A specifications meet or exceed those of the industry-standard μ A741 individual devices. The monolithic construction allows close thermal tracking of the four amplifiers on the chip. A low-power, pin-compatible version is available as Type ULN-4236A. The ICs are supplied in 14-lead DIP packages (TO-116). They are also available as 88-mil-square chips for use in hybrid circuits.

CIRCLE NO. 342

30-A power transistor switches fast

International Rectifier, 233 Kansas St., El Segundo, CA 90245. (213) 322-3331.

IR3773 and IR6302 power transistors are rated for a peak collector current of 30 A and a gain-bandwidth product of 1 MHz. Other features are: rise time of 1.5 μ s, storage-time of 2.0 μ s, fall time of 1.8 μ s, and power dissipation of 200 W at 25 C.

CIRCLE NO. 343

Need a second source on optically coupled isolators?

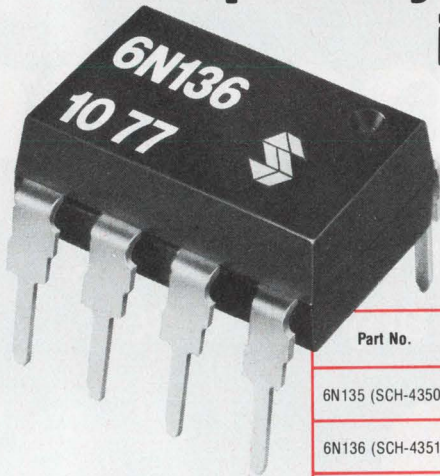

HIGH SPEED ISOLATORS
Spectronics 6N135-6N139 are pin-for-pin replacements for respective HP6N135-139 devices.

3000 VDC Isolation!

Part No.	Input Current	Data Rate	CTR
6N135 (SCH-4350)	16 ma	1 Mbit/sec	7% (min)
6N136 (SCH-4351)	16 ma	1 Mbit/sec	19% (min)
6N137 (SCH-4360)	5 ma	10 Mbit/sec	700% (typ)
6N138 (SCH-4370)	1.6 ma	300 Kbit/sec	300% (min)
6N139 (SCH-4371)	0.5 ma	300 Kbit/sec	400% (min)

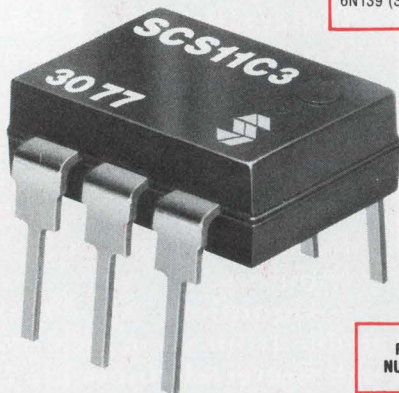

PHOTO SCR ISOLATORS
Spectronics SCS11C1-C3 are pin-for-pin replacements for respective GE H11C1-C3 devices.

5000 VDC Isolation!

PART NUMBER	TURN ON CURRENT (MAX) (I _T)	FORWARD BLOCKING VOLTAGE (V _{DM} @ R _{OK} = 10 Kohm)
SCS11C1	11mA	200V (Min)
SCS11C3 (4N39)	14mA	200V (Min)

For more details and delivery information, contact Commercial Component Marketing, 830 E. Arapaho Road, Richardson, Texas 75081, (214) 234-4271.



Spectronics
INCORPORATED

CIRCLE NUMBER 77

Op amp features low drift and offset

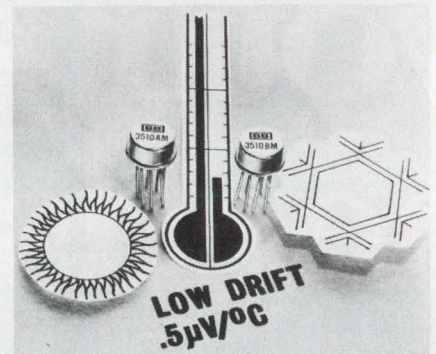

Burr-Brown, Intl. Airport Industrial Park, Tucson, AZ 85734. Dennis Haynes (602) 294-1431. \$5.95 to \$14.75; stock.

Production trimming ensures a low input offset-voltage drift, of less than $\pm 0.5 \mu$ V/C, in the 3510 op amp. Trimming also provides initial input offset of less than $\pm 60 \mu$ V. Specs include: open-loop gain of 120-dB min, common-mode rejection at ± 10 V of 110 dB, and input bias current less than ± 15 nA. Another feature is the circuit's low thermal feedback. Input impedance is 1 M Ω paralleled with 3 pF; input noise (0.1 Hz to 10 Hz) is 0.8 μ V pk-pk.

CIRCLE NO. 344

Hybrid IC is voltage-follower/current-booster

Optical Electronics, P.O. Box 11140, Tucson, AZ 85734. Pete Suozzi (602) 624-8358. \$35.50 to \$44.00; stock.

The 9963 voltage follower and current booster is electrically similar to National's LH0063 and is available in a 24-pin DIP. Features are: ± 6000 -V/s slewing rate; ± 10 -V output swing into 50- Ω load; dc to 200 MHz small-signal bandwidth; single or dual power-supply operation; 55 to +125 C operating temperature range.

CIRCLE NO. 345

Coming through...

with a vital part in product design

It's what's up front that counts. That's why it pays off to involve Belden in the early stages of a project.

We know the codes, specs and electrical/environmental parameters you're faced with. We've come through with answers to some extraordinary new applications.

As much as any component, wire, cable and cord, can make a critical difference in your product's performance. And your costs. By drawing on thousands of high-quality standards—and a wealth of custom engineering knowhow—we can tailor an answer to fit your needs. Exactly.

We can even help you cope with the economics of wire processing, assembly and installation. Our problem solving experience ranges from innovative

packaging to total manufacturing analysis.

Whether you need cord sets, special harnesses, shielded cable construction, flat cable—or help putting it all together, involve a Belden Wire Specialist. He'll come through with everything we've got. For answers right now, phone:

317-966-6661 Electronic Division or mark 400 on reader service card.

312-986-1600 Electrical Division or mark 401 on reader service card.

312-887-1800 Transportation Division or mark 402 on reader service card.

Or write Belden Corporation, 2000 S. Batavia Ave., Geneva, IL 60134

BELDEN



Coming through...
with new ideas for moving electrical energy

Voltage regulator supplies 1.5 A

National Semiconductor, 2900 Semiconductor Dr., Santa Clara, CA 95051. Dave Whetstone (408) 737-5856. \$0.78 up; stock.

An improvement over standard 78XX type voltage regulators, the positive 3-terminal, 1.5-A units, LM140A/140/340A/340, provide better ripple rejection and line/load regulation. They can be used for 15-W outputs and have a current limiting feature, are protected to limit internal power dissipation, and include a thermal shutdown circuit. Output-voltage tolerance is 2% at 1 A.

CIRCLE NO. 346

Power rectifiers handle high surges

Edal Industries, 4 Short Beach Rd., East Haven, CT 06512. Ed Pagano (203) 467-2591.

Series F, an improved line of stud-mounted DO-5 power rectifiers, has silicon junctions fitted within a glass-to-metal sealed case assuring corrosion resistance and operation under severe environmental conditions. Featured are low leakage currents and high surge capability. Standard, bulk-avalanche and fast-recovery types in voltage ratings from 50 to 1500 V PIV are available. They are also available in reverse polarity.

CIRCLE NO. 347

A/d converter gives BCD output

Teledyne Semiconductors, 1300 Terra Bella Ave., Mountain View, CA 94043. (415) 968-9241. See text; stock to 4 wk.

Using low-power CMOS and contained on a single chip in a 24-pin DIP, the 8750 a/d converter operates on the integrating principle and completes 100 conversions per second. At the end of the conversion, the count is latched into the digital outputs as a 3½-digit BCD signal. The circuit is available in plastic for 0 to +70 C operation at \$9.75 in 100 quantity and in ceramic for 40 to +85 C at \$14.85.

CIRCLE NO. 348

Optoisolators have controlled gain

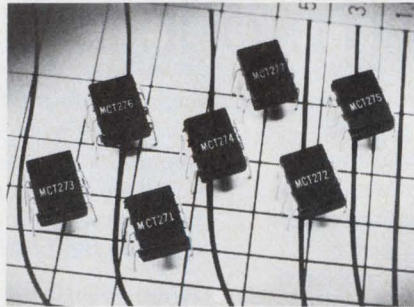

Monsanto, 3400 Hillview Ave., Palo Alto, CA 94304. (415) 493-3300. See text.

A series of optoisolators is available and has various key design parameters. The types include units having controlled gain, high voltage output, high speed, and TTL/temperature compensation. The controlled gain Models MCT271 to 274 have current transfer ratios controllable from 45 to 90% to 225 to 400% at speeds of 7 to 25 μ s. Isolation voltage is 2500 V rms. The HV Model MCT275 has a transfer ratio of 70 to 210%, speed of 15 μ s and isolation of 2500 V rms. High-speed Model MCT276 has a transfer ratio of 15 to 60%, 2.5- μ s speed and 2500 V rms isolation. Model MCT277 has 100% min transfer ratio, 15- μ s speed and 1500 V rms isolation. Prices are from \$0.90 to \$1.65 depending on model and qty.

CIRCLE NO. 349

Power transistor has low switching loss

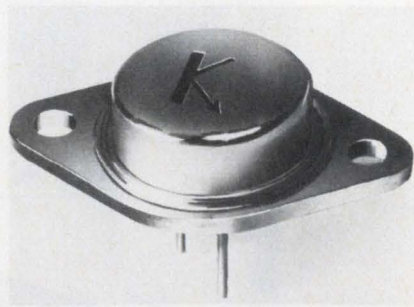

Kertron, 7516 Central Industrial Dr., Riviera Beach, FL 33404. (305) 848-9606. \$8.25 to \$9.75; stock.

A series of npn power transistors for industrial switching applications is packaged in TO-3 cases. The KP3946 has a BV_{ce0} rating of 100 V and the KP3948 is rated at 80 V. Each device has a current gain of 30 with 15-A collector current. The fall-time is less than 500 ns when the device is switched at 10 A.

CIRCLE NO. 350

Isolate 5 kV with optically coupled SCR

Spectronics, 830 E. Arapaho Rd., Richardson, TX 75080. (214) 234-4271. \$1.10 to \$2.50; stock.

Featuring isolation voltages of 5 kV, a line of optically coupled SCRs is being offered as types SCS 11C1, 11C3 and 4N39. Available in 6-pin DIP packages, the couplers are manufactured with planar SCR chips for the outputs.

CIRCLE NO. 411

Rectifier assemblies handle up to 100 A

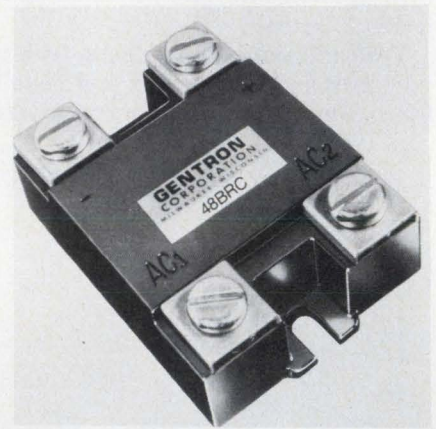

Gentron, 6667 No. Sidney Pl., Milwaukee, WI 53209. Lance Kaufman (414) 351-1660. From \$8 (100 qty); stock.

The Powertherm line of 100-A diode bridge rectifier circuits has units with breakdown voltages of up to 1200 V. All diodes are isolated from the base mounting plate to the terminals. The modular assemblies are available in single-phase center tape, doubler, single-phase full-wave, three-phase half-wave, three-phase full-wave and six-phase star configurations.

CIRCLE NO. 412

Use diodes as high-speed variable rf attenuators

Crown Microwave, 6 Executive Park Dr., North Billerica, MA 01862. (617) 667-4165. \$3.50; 2 wk.

A line of NIP attenuator/switching diodes offer improved performance over comparable PIN or NIP diodes. The diodes are used for high-speed variable attenuators since they have a wide variable resistance range from 0.6 to 10 k Ω while maintaining fast switching speeds from 5 to 10 ns. They operate over the frequency range of 10 MHz to 1 GHz for broadband use and up to 18 GHz in narrow-band switching circuits.

CIRCLE NO. 413

Opening new frontiers with electro optics

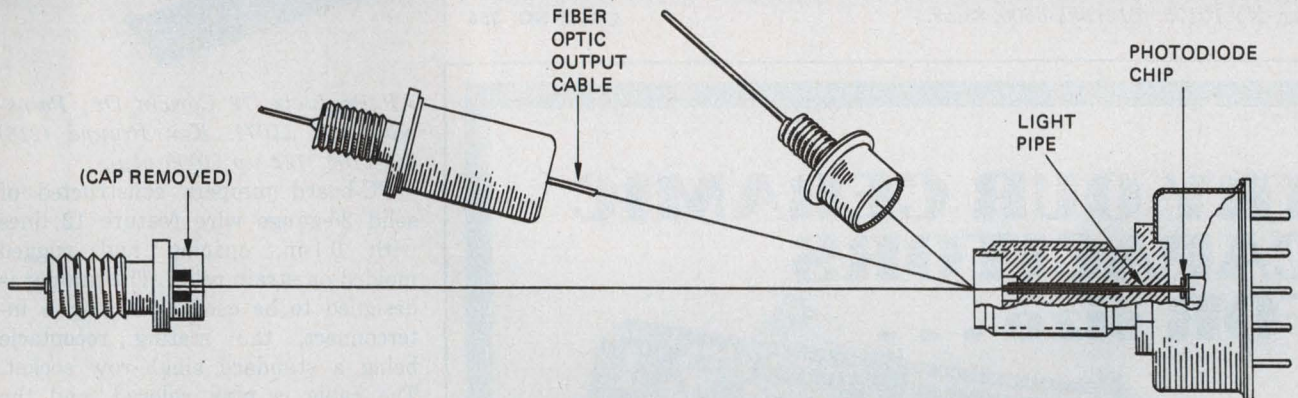

In optical communications, RCA helps you at both ends of the line.

Hi-speed IR emitters with removable caps for low-loss coupling.

With the cap off, you can bring your fiber or bundle right down into very close proximity to the 6-mil GaAlAs edge emitter to maximize coupling efficiency. Along with very high collection efficiency, you get 100 MHz min. analog bandwidth (C30119) or 40 MHz min. (C30123). Rated at up to 200 mA forward current for continuous operation and 1.5 A peak forward current for pulse operation, these devices are available from stock. Hermetically sealed version also available.

Circle 81

IR emitters with output "pigtailed." We've done the coupling for you.

Here we've made your job even easier. You can now couple your fiber or bundle to a fiber optic cable extending 5 inches from the source. At the source end, we've already made an extremely efficient internal optical connection. Like the C30119, the C30133 emitter gives you 100 MHz min. analog bandwidth. It's rated at up to 200 mA forward current for continuous operation, 1 A peak forward current for pulse operation.

Circle 82

Solid-state CW lasers: high power output for better coupling efficiency.

It takes less than a watt to get at least 5 mW of continuous lasing from these breakthrough solid-state lasers, which operate at room temperature. They have a rise time of less than 1 ns—allowing modulation rates well beyond 100 MHz. This plus small source size (13 x 2 μ m typical) and 820 nm wavelength make them especially well suited to single fibers as well as bundles. Choose either the C30130 (OP-12 package) or the C30127 (OP-4A package).

Circle 83

Avalanche detectors now with integral light pipes for efficient coupling.

At the receiving end too, we make efficient coupling easy. With our silicon avalanche photodiodes you secure the fiber or bundle through a hole in a mating connector (also available from RCA) and screw down the sleeve. Our detectors C30903E through C30908E give you a choice of light-pipe diameters, .25mm to 1.25mm, providing broad spectral response ranges, 400 to 1100 nm typical. All offer fast response time (0.5 to 2 ns typical) and high quantum efficiency (typically 77% to 85% at 830nm). Also available: detector preamp modules and temperature compensation units.

Circle 84

If electro optics can solve your problem, remember: EO and RCA are practically synonymous. No one offers a broader product spectrum. Or more success in meeting special needs. Call us for design help or product information. RCA Electro Optics, Lancaster, PA 17604. Phone 717-397-7661. Sunbury-on-Thames, Middlesex TW16 7HW, England; Ste. Anne-de-Bellevue, Quebec, Canada; Sao Paulo, Brazil; Hong Kong.

PACKAGING & MATERIALS

DIP insertion tool also straightens pins

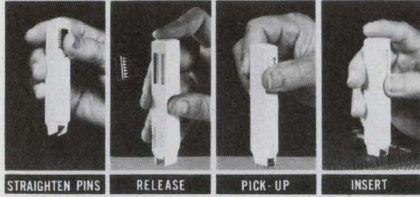

OK Machine & Tool, 3455 Conner St.,
Bronx, NY 10475. (212) 994-6600. \$3.49.

Model INS-1416 DIP insertion tool inserts both 14 and 16-pin IC packages into sockets or predrilled boards. A narrow profile permits the tool to work on densely spaced patterns, while the insertion mechanism assures accuracy as well as "feel." It also includes a pin straightener built into the handle. Insert the IC, rock it on the straightening saddle, and push down on the tool. An automatic ejector delivers the IC ready to be placed in the insertion end for installation.

CIRCLE NO. 356

PC-board jumpers come ready-made

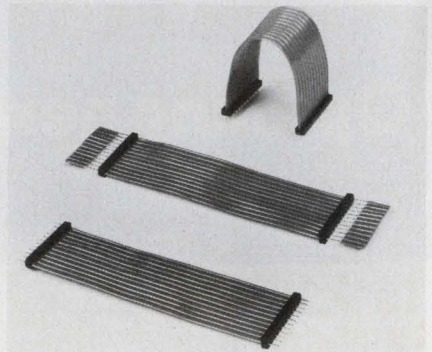

AP Products, 72 Corwin Dr., Painsville, OH 44077. Ken Braund (216) 354-2101. 72¢ up (1000 qty).

PC-board jumpers constructed of solid 26-gauge wire feature 12 lines with 0.1-in. spacing and rugged molded-on strain relief. The jumper is designed to be used as a plug-in interconnect, the mating receptacle being a standard single-row socket. The cable is pink colored, and the individual cable conductors are the pins. These jumpers are shipped with the insulation tabs intact to preserve contact spacing. Each pin has a chisel point for easy socket insertion.

CIRCLE NO. 357

TRY OUR CERAMIC CAPACITORS FOR size . . .

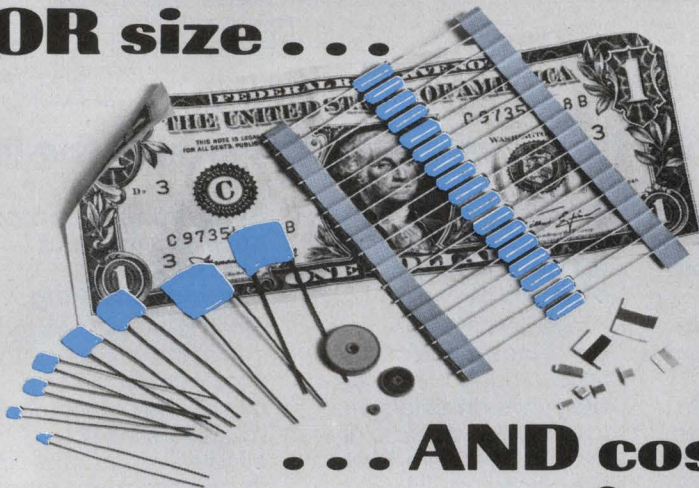

. . . AND cost savings

Need a subminiature or standard ceramic capacitor? Try us for size. With over 40 formulations, we offer the widest range of ceramic capacitors within the industry and off-the-shelf and custom capacitors are available with a capacity range of 1 pf to 10 mfd. Multi-layer, single-layer chip capacitors, conformal-coated leaded devices, glass sealed ceramic capacitors and discoidal

ceramic capacitors are available as small as .050" x .040" or as large as .500" x .500" . . . try us for size.

What about cost savings? Try us for cost. Our modern equipment and technological advances have enabled us to manufacture ceramic capacitors in high volume for low cost applications . . . try us for cost savings.

Write today for our free catalog.

 **CENTRE ENGINEERING**

2820 E. COLLEGE AVE., STATE COLLEGE, PA 16801

814-237-0321 ■ TWX 510-670-3517

CIRCLE NUMBER 85

Mounting spacers keep LEDs parallel

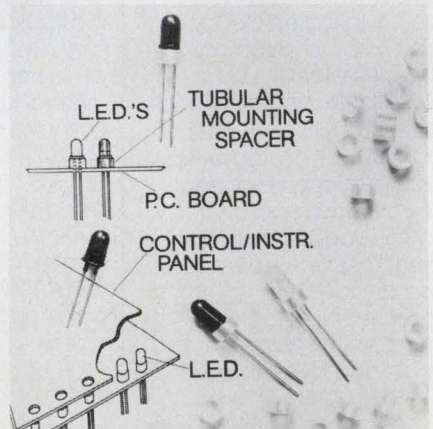

Bivar Inc., 1617 E. Edinger Ave., Santa Ana, CA 92705. (714) 547-5832. \$12/1000 (10,000 qty); stock.

Tubular spacers that elevate LEDs from 0.08 through 0.38 in. in 0.005-in. increments are available in a total of 61 standard sizes. Made from nylon per MIL-M-20693A, Composition A, Type 1 and UL-rated 94V-2 material, these 905 series mounts maintain the bases parallel to a mounting surfaces and keep them from being bent or tilted during handling or final assembly.

CIRCLE NO. 358

Flex Circuit Connector

Our Model M-1255 offers the convenience of a detachable connector for easy field maintenance of modular type building.

- Contacts are available in a continuous strip with easy manual break off.
- Contacts cut to specified lengths at no extra charge.
- Pricing: Less than \$.007 per line.
- Available material & finish: Copper based alloys, pre-tinned.

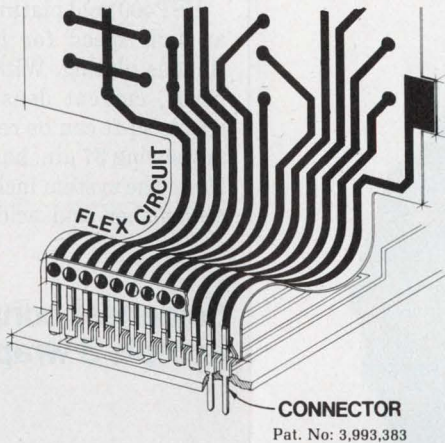

Delivery from stock; samples upon request. For your special design problems, please consult our engineering department.

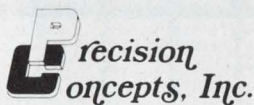

1595B Ocean Avenue
Bohemia, New York 11716
(516) 567-0995

CIRCLE NUMBER 86

small wonders

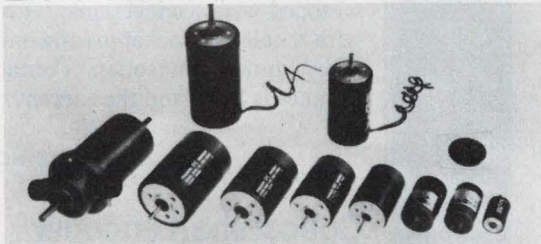

HICO-maxon

MINIATURE PRECISION DC MOTORS

MAXON DC MOTOR

MAXON DC MOTORS DIFFER FROM CONVENTIONAL PERMANENT MAGNET MOTORS. THEY ARE CONSTRUCTED ON THE IRONLESS ROTOR PRINCIPLE PATENTED IN MANY COUNTRIES, IN WHICH A HOLLOW CYLINDRICAL WINDING ROTATES AROUND A DIAMETRICALLY POLARISED PERMANENT MAGNET.

THIS FEATURE HAS A HIGH POWER TO VOLUME RATIO, GIVES A VERY LOW MOMENT OF INERTIA AND A HIGH EFFICIENCY OF MORE THAN 80% ACCORDING TO APPLICATION AT MINIMAL ELECTRICAL ENERGY LOSS.

THE HIGH QUALITY COMMUTATOR HAS UP TO 13 SEGMENTS AND IS OF MINIMAL DIAMETER. THE BRUSHES ARE MADE OF SPECIAL PRECIOUS METAL ALLOYS, WHICH ENSURE LONG LIFE.

HICO Horizons International

716 Willow Rd, Menlo Park, Ca. 94025 Ph: 415-328-1111

MAXON DC MOTORS OFFER ULTRA SMOOTH TORQUE, FAST RESPONSE, QUIET RUNNING, LOW STARTING VOLTAGE AND A WIDE VOLTAGE RANGE. THEY ALSO HAVE LINEAR VOLTAGE, SPEED AND TORQUE CHARACTERISTICS, ENABLING THEM TO BE CONSIDERED IN A VERY WIDE FIELD OF APPLICATIONS.

THE RANGE ALSO INCLUDES MOTOR-TACHOGENERATOR ASSEMBLIES, AND A CHOICE OF GEARHEADS.

IN ADDITION TO THE STANDARD RANGE, AN EXTENSIVE PROGRAM OF SPECIALS HAS BEEN DEVELOPED TO CATER FOR SPECIFIC NEEDS. OUR CONSULTING ENGINEERS ARE ALWAYS AVAILABLE TO ASSIST YOU WITH AN OPTIMUM SOLUTION TO YOUR REQUIREMENTS.

CIRCLE NUMBER 87

ELECTRONIC DESIGN 22, October 25, 1977

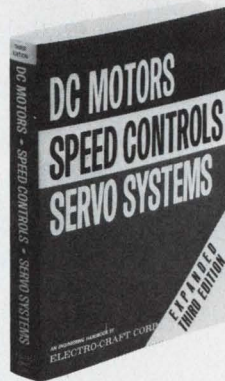

almost
**FREE
BOOK
OFFER**

First and second editions sold out! New expanded third edition of this authoritative engineering handbook now has 500 pages containing more theory, more applications. The book offers basic background in DC motors, speed controls and servo systems, and covers new developments in this fast changing field. It is aimed at the designer and user in industry, with emphasis on the many practical problems from specifying and testing to applications engineering. This \$10 book is available at no charge to qualified engineers sending \$1 to cover postage and handling.

TO GET YOUR COPY, MAIL \$1 ALONG WITH YOUR CARD OR COMPANY LETTERHEAD TO: DEPT. DN
ELECTRO-CRAFT CORPORATION
BOX 664, HOPKINS, MN 55343

P.S. We not only wrote the book,
we make the products, too.

CIRCLE NUMBER 88

SOLID STATE RELAYS

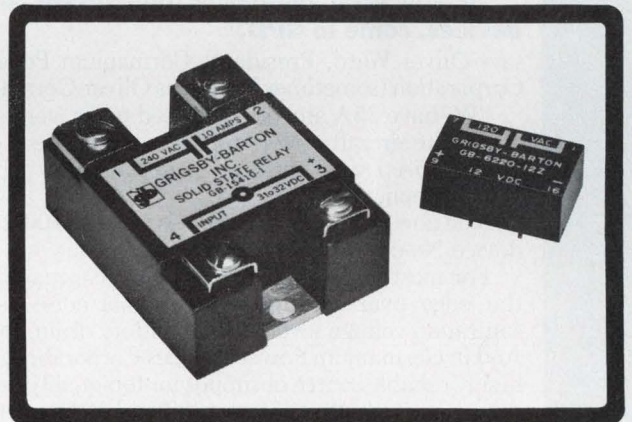

- .5 to 40 AMP RMS Outputs
- Photo Coupled all Solid State
- Zero Voltage or Random Turn-On
- 24 to 280 VRMS Line Ratings
- 3 to 32 VDC or 90 to 270 VRMS Inputs
- Internal RC and MOV Protection
- Panel, Socket or PCB Mount
- 600 V Blocking Available
- 3750 VRMS Isolation Available
- U.L. Recognized & CSA Certified

For more details on our line of SSRS, contact



GORDOS/GRIGSBY-BARTON INC.

1000 N. Second Street, Rogers, Arkansas 72756, U.S.A. • Telephone (501) 636-5000; TWX: 910-720-7998

CIRCLE NUMBER 89

BIG.

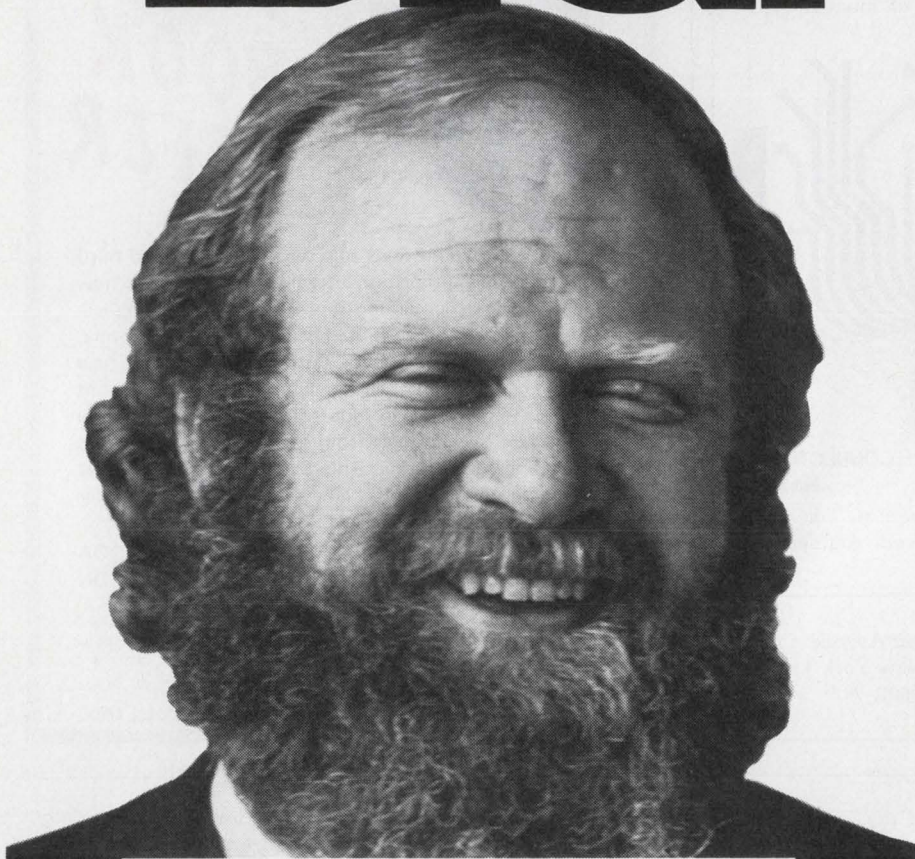

"If you want big-power, big-current, single-chip devices, come to GPD,"

says Oliver Ward, President, Germanium Power Devices Corporation (sometimes known as Oliver Germanium).

"We have 25A and 50A diffused types, very suitable for things like aircraft power supplies or motor-speed controllers.

Our 75A power transistors have long been popular for all sorts of applications.

And now, we announce the world's first 100A single-chip device. No-one's ever done that before.

For most high-power applications, Germanium still has the edge over Silicon. Better signal/noise ratio, lower saturation voltage levels, lower battery drain, for example. And in Germanium Power Devices Corporation, you have a highly reliable source of supply, for top-quality devices.

For example, 2N4276 to 4283 and 4048 to 4053, which used to come from Motorola, or DTG-MP600 to 603 and 2000 to 2400A, which replaces the T0-3 series which Delco have just pulled out of.

We make devices to meet JAN, EIA, PRO-ELECTRON AD, ADY, ADZ, ASZ and AUJ.

We see a big future for Germanium. Make sure you read about it in our latest catalogue."

GPD, PO BOX 65, SHAWSHEEN VILLAGE STATION, ANDOVER, MASS 01810
TELEPHONE (617) 475 5982. TELEX 94-7150 GPD ANDR.
AGENTS THROUGHOUT THE WORLD.

**GERMANIUM
BIG POWER**

CIRCLE NUMBER 90

PACKAGING & MATERIALS

Reduce gold-plating time with high-speed system

Engelhard Electro Metallics, 2655 US 22, Union, NJ 07083. (201) 589-5000.

ESP400 gold plating system operates at high speed for high volume continuous plating. With proper jet-spray heads, current densities approaching 600 A/sq ft can be realized. Gold plate measuring 37 μ in. has been obtained in 2½ s. The system includes concentrate, replenisher and acid.

CIRCLE NO. 359

Solderless connector accepts 3 wrapped wires

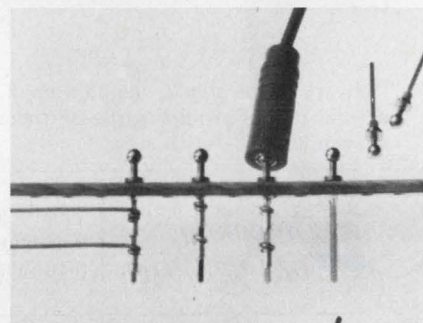

Oxley, 3250 Wilshire Blvd., Los Angeles, CA 90010. (213) 383-8270.

Solderless connections can be made on the lead-through terminal type 050/WR/B2, which will accept three wrapped-wire connections. Designed with a ball and socket arrangement, it allows quick connection. Contact resistance is 2 m Ω and the current rating is 7 A.

CIRCLE NO. 360

Optical shaft encoder in ruggedized version

Vernitron/Vernitech, 300 Marcus Blvd., Deer Park, NY 11729. (516) 585-5100.

A ruggedized incremental optical shaft encoder, the VOE-25 is designed to meet the need for units sealed against dust and moisture. Counts of up to 2540 pulses per revolution are available from the unit which uses LEDs as its light source. High accuracy is provided by the chrome-on-glass code disc. The units can be supplied with a side or end MS connector, and are available with either TTL or HTL compatible outputs. Multipliers, line drivers and extended-temperature-range units are also available.

CIRCLE NO. 361

COMPONENTS

5/8-in. pots go on PC boards

Centralab Electronics, 5757 N. Green Bay Ave., Milwaukee, WI 53201. A. J. Koschnick (414) 228-2751. \$0.50 (production qty).

Terminal-mounted 5/8-in. potentiometer, Model 320, adapts to many PC-board configurations and can be automatically soldered. The pots are available in either carbon-composition or wire-wound. Power rating is 1/4 W at 40 C (for CC) and 2 W at 70 C (for WW). Operating torque is 2.5 oz-in.

CIRCLE NO. 362

Switch assembly has optional interlock

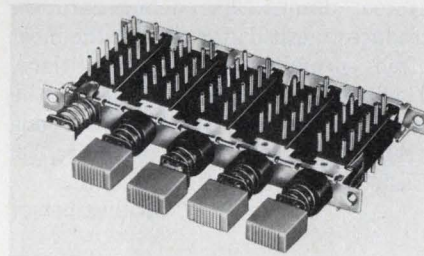

Centralab, P.O. Box 858, Fort Dodge, IA 50501. (515) 955-8534.

While retaining the momentary feature, engaging the "master-on" switch changes a switch assembly to an optional interlocking mode. In the "master-on" mode, previously engaged switches remain engaged until another switch is depressed. Releasing the "master-on" returns all switches to the momentary action mode. The assemblies are available lighted or non-lighted, 2 to 20 stations and "master-on" anywhere along the assembly.

CIRCLE NO. 363

System shut-off delayed by adjustable relay

Struthers-Dunn, Lambs Rd., Pitman, NJ 08071. (609) 589-7500.

An off-delay relay that plugs into octal sockets is available with spdt or dpdt contacts. It transfers contacts immediately when an external switch is closed. When the switch is opened, the contacts return to normal position after a preset delay. Fixed, adjustable, or remote timing is available in seven ranges from 0.1 to 300 s. Standard coil-voltage ratings are available and the contacts are rated for 10 A.

CIRCLE NO. 364

Capacitor pairs stay matched within 0.001%

PFC, 100 Community Dr., Great Neck, NY 11022. (516) 487-9320.

Multiple capacitor modules, mounted in a special honeycomb structure, make it possible to produce capacitor pairs that will stay within 0.001% of each other, long term, despite temperature variations. A typical 0.5-0.5 μ F pair would use 100 identical 0.01 μ F capacitor modules in parallel. Each group of 50 is uniformly dispersed with respect to the other in the honeycomb. Using extremely stable polystyrene capacitors as the modules, random fluctuations of individual units have statistically little effect on the total capacitance. Matched pairs from 0.1 to 10 μ F are available in voltage ratings of 100 to 600 V dc.

CIRCLE NO. 365

Fan operates from 48-V line

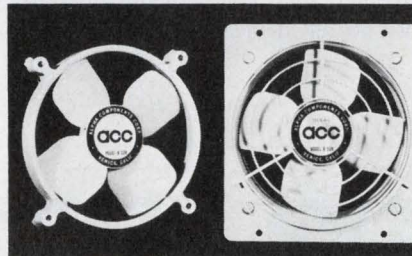

Alpha Components, P.O. Box 306, El Segundo, CA 90245. J.T. Cataldo (213) 322-7780. \$45; stock.

When connected to a filtered, nominal 48-V line, the Model D-48 axial fan delivers 150 cfm and requires less than 1 A to drive it. As no arcing contacts are used, no interference is generated. It weighs 20 oz with grille and venturi. Size is 5-in. diameter by 2-3/8-in. deep.

CIRCLE NO. 366

Pressure transducer transmits 1.5 to 300 psi

Robinson-Halpern, 1 Apollo Rd., Plymouth Meeting, PA 19462. (215) 825-9200. \$175.

Model 152C pressure transmitter/transducer is offered in full scale ranges from 1.5 to 300 psi, differential or absolute. Static-error band is $\pm 0.5\%$ of full scale. The 2-wire, 4-to-20-mA output will drive loads up to 1200 Ω and may be operated from supply voltages of 12 to 38 V. Size is 2-1/8 \times 2-1/8 \times 4 in.

CIRCLE NO. 367

SMALL.



"And on top of all that big stuff," says Oliver Germanium, (otherwise known as Oliver O. Ward, President, GPD), "we can also offer you a brand-new source for small signal Germanium transistors, which we have just taken over from GE.

Immediately, we can offer common-base types such as 2N319-324, 524-526, 1370-1381, 1413-1415 and 1924-1926. Later we'll be making isolated lead types.

We aim to be a totally reliable source for ex-customers of GE, and we are always happy to accept somewhat smaller orders than the giant corporations can easily cope with.

By small-signal device we mean dissipation typically of the order of 225 mW, with applications in low-current computer and switching functions; oscillator, pre-amp and driver circuits.

If you have existing circuits that use Germanium devices, don't redesign.

Ask Germanium.

And you'll find that for many applications, it's still smart to design-in Germanium."

Send for latest data.

GPD, PO BOX 65, SHAWSEEN VILLAGE ST
ANDOVER, MASS. 01810
TELEPHONE (617) 475 5982.
TELEX 94-7150 GPD ANDR
AGENTS THROUGHOUT THE WORLD

**GERMANIUM
SMALL SIGNAL**

CIRCLE NUMBER 91

Design aids

Density conversion

A density-conversion chart provides an easy means of converting material density to other units of measurement. Tecknit.

CIRCLE NO. 368

ASCII code

All 128 ASCII characters, the alphanumeric name, octal, hex and alternate code designations are presented in a wall-mountable chart. Termiflex.

CIRCLE NO. 369

Gases

Specific data for gases used in semiconductor manufacturing are shown on a wall chart. Matheson.

CIRCLE NO. 370

Photoelectric controls

A comparison guide helps you select the proper photoelectric control for distances ranging from 6 to 700 ft. Micro Switch.

CIRCLE NO. 371

Electrical fittings

Electrical fittings, connectors, and clamps for IMC rigid and liquid-tight-conduit applications are presented on a 22 x 28-in. wall chart. Gould, Electrical Components Div.

CIRCLE NO. 372

Solid-state sensors

A four-page solid-state proximity-sensor guide helps to select the most cost-effective no-touch sensors and controls. The guide is divided into three major categories: magnetic field (Hall effect); all-metals responsive (Eddy current), and magnetically operated reed-switch devices. Micro Switch.

CIRCLE NO. 373

Conversion chart

On a two-color chart, saturation pressures are given for refrigerants 12, 13, 14, 22, 502, and 503 at temperatures from -250 to +130 F (-156.7 to 54.4 C) except where critical points are exceeded. On the reverse side, the altitude table converts feet of altitude to ARDC standard temperature (°F) and pressure expressed as torr. Range is 0 to 2,320,000 ft. (8.3×10^{10} torr). Tenney Engineering.

CIRCLE NO. 374

Debug card

A guide to CICS debugging and architecture enables the programmer to review CICS (OS/V, DOS/VS) and system dumps. The debug card introduces methods for solving the most often encounteredabend conditions. The card is available for \$3 each for the first four copies. Telecommunications Technology, 200 Park Ave., Suite 303 East, New York, NY 10017

INQUIRE DIRECT

NEW CATALOG! POWER ROTARY SWITCHES



- Complete line of switches for Industrial Control Applications
- 17 basic switch models
- Ratings from 10A to 200A . . . from 240V to 600V
- Up to 75 poles! up to 16 positions!
- Myriad of standard & optional features

Request Catalog E-4

ELECTRO SWITCH
Weymouth, Massachusetts 02188

Telephone: 617/335/5200 • TWX: 710/388/0377

CIRCLE NUMBER 92



Tough! Flexible! Protective! Inexpensive! Shrinks down in hot water above 140°F. Good electrical and mechanical strength. Resists corrosion and chemicals and will not support a flame. Used for electrical insulation on wires, mechanical protection for pipes and fittings. Effective as scuff resistant jacketing for electrical cables and harness . . . and much more. Sizes 1/4" to 4". Black only.

PENNTUBE
PENNTUBE PLASTICS CO.
Division of Dixon Industries
A Bundy Company
Clifton Heights, PA 19018
(215) 622-2300

SEND FOR
FREE SAMPLE
and Bulletin #71SN-B

CIRCLE NUMBER 93

ELECTRONIC DESIGN 22, October 25, 1977

Application notes

Photometers

Various applications for researching, designing, installing, and maintaining optical-communications equipment using the J16 digital photometer/radiometer are described in a brochure. Tektronix, Beaverton, OR

CIRCLE NO. 404

Spectrum analyzer

How diagnostic and performance measurements on frequency-division-multiplex basebands can be made more simply and quickly using a spectrum analyzer and tracking generator are discussed in a brochure. Marconi Instruments, Northvale, NJ

CIRCLE NO. 405

Tantalum capacitors

What is meant by "silver migration" in wet-tantalum capacitors and why NASA sponsored the development of tantalum-cased, wet-tantalum capacitors is covered in a 12-page catalog. Sprague Electric, North Adams, MA

CIRCLE NO. 406

Chip capacitors

"Understanding Chip Capacitors" covers all phases of ceramic-chip-capacitor technology. The catalog is illustrated with performance graphs and comprehensive tables. Johanson Dielectrics, Burbank, CA

CIRCLE NO. 407

Hand crimping

How to hand crimp standard terminals onto 14 through 26-size wire is described in a two-page flyer. Molex, Lisle, IL

CIRCLE NO. 408

Slide controls

"Design Guide for Custom Slide Control Elements," a four-pager, describes how to match resistive-strip elements to almost any slide-control application. TRW/IRC Resistors, Boone, NC

CIRCLE NO. 409

Before you buy another filter, consider our moveable passband.

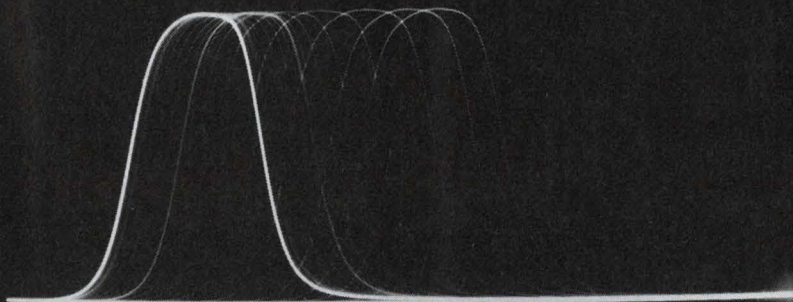

Our tunable bandpass filters provide two big benefits for anyone working in RF and microwave up to 4 GHz.

First, just one of our tunables replaces a whole drawer full of fixed bandpass filters. Less costly, more convenient, faster test set-ups.

Secondly, our tunables are calibrated directly—you get the center frequency you see on the dial—no interpolation or charts needed.

With over 50 standard versions in stock, we can supply a unit for frequencies as low as 48 MHz all the way up to 4 GHz. Each one covers a full octave, and comes with 3% or 5% 3 dB bandwidths. We even stock special purpose units for the

military band (210-420 MHz) and many telemetry bands (210-2310 MHz). And if one of those standards doesn't meet your needs, we'll be glad to quote on special designs for any lab or OEM situation.

Our new Filter Catalog gives complete data on all Telonic Tunable Filters as well as other

types we produce—tubulars, cavity, interdigital, comb-line—all the way to 12 GHz. If you wish a copy, write on your letterhead. If you need immediate information, call us

TOLL FREE (except CA) at 800-854-2436.

Telonic Altair, 2825 Laguna Canyon Road, Box 277, Laguna Beach, CA 92652, 714/494-9401 TWX 910-596-1320 Cable: TELENG Toll Free: (800) 854-2436

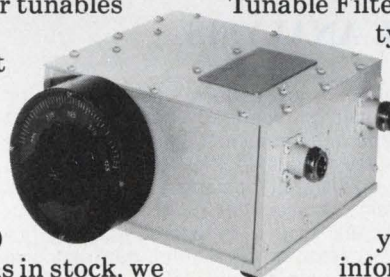

TelonicAltair 

CIRCLE NUMBER 94

New literature



Power amplifiers

Detailed specifications and engineering data for solid-state rf power amplifiers, wideband power multi-couplers, and transformers are provided in a 24-page catalog. Electronic Navigation Industries, Rochester, NY

CIRCLE NO. 375

Potentiometers

A short form describes the Series 400 Slideline conductive-plastic straight-line controls. They are designed for critical audio and instrumentation applications and available optionally with two wipers for upper/lower limit setting. Duncan Electronics, Costa Mesa, CA

CIRCLE NO. 376

Liquid-level transmitter

An ultrasonic continuous liquid-level transmitter is featured in a six-page bulletin that provides sections on the design concept, a list of features, start-up and calibration procedures, maintenance and service, dimensions and specifications. Envirotech, Hauppauge, NY

CIRCLE NO. 377

Terminals

An eight-page brochure describes the Dasher printer and display terminals. Data General, Westboro, MA

CIRCLE NO. 378

Precious-metal powders

A broad line of precious-metal powders, flakes and sponges for application in the electronics industry is described in a catalog, which lists platinum, palladium, gold, ruthenium dioxide, silver and binary/ternary powders, as well as silver flakes and screened-metal sponges. Matthey Bishop, Malvern, PA

CIRCLE NO. 379

Relays, solenoids

Over 350 relays, solenoids, timers, clappers, buzzers and accessories are covered in a 12-page brochure. Deltrol Controls, Milwaukee, WI

CIRCLE NO. 380

Ac and dc motors

An 100-page ac-and-dc-motor catalog contains technical information and illustrations along with sections on connection diagrams and dimensional drawings. IMC Magnetics, Westbury, NY

CIRCLE NO. 381

new from Hayden!

"... well-organized, extremely well written . . . highly recommended for practicing engineers..."

IEEE Transactions

DIGITAL SIGNAL ANALYSIS

Samuel D. Stearns

This is an ideal master handbook on today's signal processing procedures and systems, containing recent advances, new design material, and a comparison between continual and digital systems that's extremely helpful to newcomers to the field. Featuring a foreword by Richard Hamming, the book contains a review of linear analysis; sample-data systems; analog-to-digital and digital-to-analog conversion; the discrete Fourier transform and the fast Fourier transform algorithm; spectral computations; non-recursive and recursive digital systems; computer simulation of continual systems; analog and digital filter designs, and more. 288 pages

"Jacobi's book is great . . . a new, original, readable, usable book on writing for business and professional people. . . ."

Jim Lufkin, Mgr. Professional Publications, Honeywell.

WRITING AT WORK: Dos, Dont's, and How Tos

Ernst Jacobi, Xerox Corporation.

This guide to better writing follows its own principles by being lively, informative, and easy to read. More than a collection of pat rules and formulas, the book is a storehouse of practical advice for business and professional people to make their writing sharper, more interesting, and more informative. It shows you how to overcome procrastination and change your entire attitude toward writing, making it easier and more enjoyable for you! 208 pages.

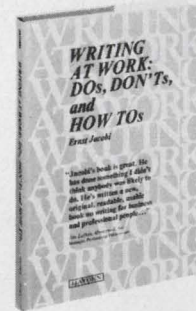
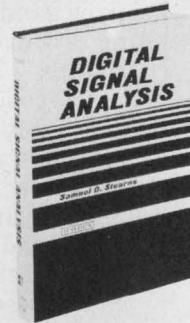

HAYDEN BOOK COMPANY, INC.
50 Essex Street, Rochelle Park, New Jersey 07662

Order today—15-day examination!

Please send me the following book(s) to read and use FREE for 15 days. At the end of that time, I'll either send the amount indicated, plus postage and handling, or return the book(s) with no obligation.

- DIGITAL SIGNAL ANALYSIS, #5828-4, \$19.95
 WRITING AT WORK, #5730-X, \$11.95

Name _____

Company/Institution _____

Address _____

City/State/Zip _____

SAVE MONEY! Payment Enclosed. Publisher will pay all shipping and handling charges. Same 15-day return privilege and full refund if not satisfied.

Design aids

Circuit-design and educational aids, from breadboards and textbooks to a microcomputer-development station, are shown in a 24-page booklet. Specifications, prices and ordering information are included. E & L Instruments, Derby, CT

CIRCLE NO. 382

Panels

Data Sheet 600 describes panels manufactured as aluminum honeycomb media gasketed in an aluminum frame and used on electronic equipment to EMI-shield, allow cool air in to maintain a temperature control, and prevent overheating. Tecknit, Cranford, NJ

CIRCLE NO. 383

Power monitoring

The electronic Power Monitoring Idea Booklet is a sketch pad of tried and tested ideas for monitoring and controlling power use. Nationwide Electronic Systems, Streamwood, IL

CIRCLE NO. 384

Packaging equipment

A 16-page catalog lists 354 packaging products along with complete part nomenclature and an order form and price list. Vector Electronic, Sylmar, CA

CIRCLE NO. 385

Emitters, lasers

Tabulated data and outline configurations for RCA's standard line of IR-emitters and injection lasers are provided in a 24-page catalog. RCA, Somerville, NJ

CIRCLE NO. 386

Accelerometers

Internally preamplified piezoelectric accelerometers are examined in an eight-page catalog that includes discussions of each model, applications data, frequency-response curves comparing these accelerometers with other accelerometers, and a two-page chart with complete electrical, mechanical and physical data for each accelerometer. BBN Instruments, Cambridge, MA

CIRCLE NO. 387

Get hold of the new TO-220 Triac, SCR from Hutson.

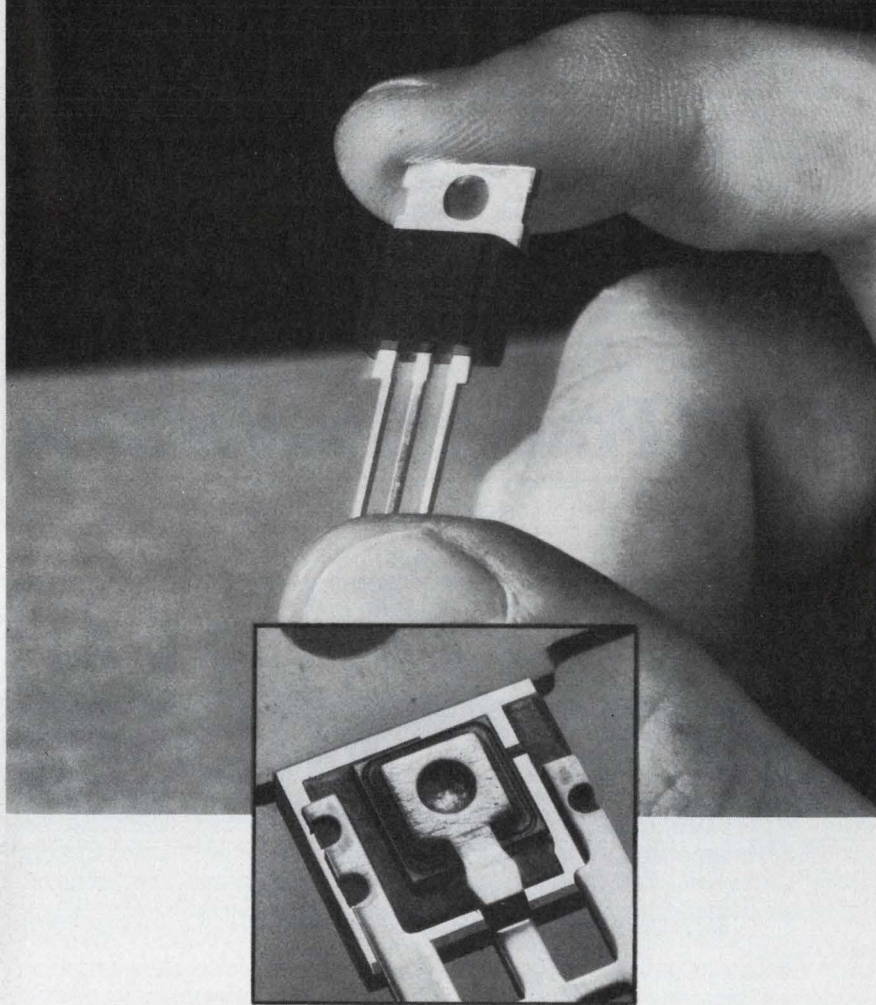

... the first with a face down chip for high volume production!

Hutson is first with the TO-220 isolated device with face down chip that gives you improved thermal, electrical and mechanical performance. Hutson can produce more devices per day than ever before.

So call Hutson for your needs and remember . . . you got it first from Hutson . . . a leader in thyristor applications technology and one of the largest manufacturers of thyristors!



HUTSON INDUSTRIES

2019 W. VALLEY VIEW LANE
DALLAS, TEXAS 75234 (214) 241-3511
TWX 910-860-5537

EUROPEAN OFFICE: 30 RUE PIERRE SEMARD. YERRES, 91, FRANCE
TEL: Paris 948-8258 TELEX 21311

CIRCLE NUMBER 96

ETERNACELL®

The only complete line of Lithium Primary Batteries

There's a new technology in primary batteries. It's called the Eternacell Lithium Battery. Or Eternacell for short.

- Operating voltage 2.8 volts per cell
- -65°F to 160°F performance
- Up to 10 years shelf life
- Highest energy and volume density of any battery system
- 1/2 to 30 ampere-hour cell sizes in production quantities
- Stable voltage output

Reliable, proven in memory standby, communications, underwater power, instrumentation, alarm systems... to name a few. Delivery, stock to 4 weeks.

Eternacell. The highest energy, longest life battery. For information write: Power Conversion, Inc., 70 MacQuesten P'kway South, Mt. Vernon, N.Y. 10550. Or call (914) 699-7333.



Power Conversion

CIRCLE NUMBER 97

ION IMPLANTED Tuning Diodes 2 to 500 pF

Design in Implion® hyperabrupt and abrupt tuning diodes which offer superior capacitance swings, reproducibility and reliability. Tailored for octave or linear tuning in communications and test equipment.

Send for our catalog including selection guide and electrical characteristics as well as information on PIN diodes and low avalanche zener diodes or call 617-273-1730.

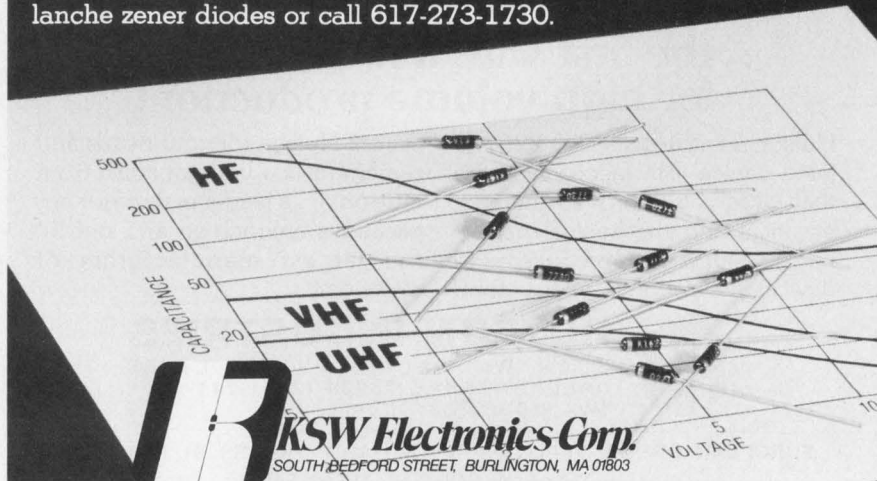

KSW Electronics Corp.
SOUTH BEDFORD STREET, BURLINGTON, MA 01803

CIRCLE NUMBER 98

NEW LITERATURE

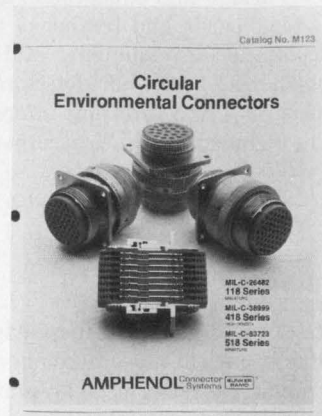

Connectors

Three lines of miniature and high-density environmental circular connectors are described in a 44-page catalog. Amphenol North America, Oak Brook, IL

CIRCLE NO. 388

Components and systems

A comprehensive 700-page catalog describes electronic components and systems, including μ Ps and μ C-development systems. Cramer Electronics, Newton, MA

CIRCLE NO. 389

Electronic hardware

Spacers, standoffs, handles, captive panel screws and fasteners are described in a 30-page catalog. Norelcom Industries, Farmingdale, NY

CIRCLE NO. 390

Custom LSI

The A to Z of custom-LSI micro-circuits for OEMs is given in a 24-page brochure. Subject matter includes case histories, tradeoffs, costs and risks, computer-aided design, comparison of circuit types, and details of design and production. American Microsystems, Santa Clara, CA

CIRCLE NO. 391

Peripheral systems for μ Cs

Electrical and mechanical parameters and programming considerations for SineTrac 800 data-acquisition cards are described in a 16-page catalog. Datel Systems, Canton, MA

CIRCLE NO. 392

Vendors report

Annual and interim reports can provide much more than financial position information. They often include the first public disclosure of new products, new techniques and new directions of our vendors and customers. Further, they often contain superb analyses of segments of industry that a company serves.

Selected companies with recent reports are listed here with their main electronic products or services. For a copy, circle the indicated number.

Burroughs. Computer systems and equipment; terminals; peripheral products; business machines; office products, and components.

CIRCLE NO. 393

Franklin Electric. Motors and inverters.

CIRCLE NO. 394

EG&G. Instruments; components; environmental services; biomedical services; custom services and systems, and ERDA support.

CIRCLE NO. 395

Conrac. Telecommunications; broadcast communications; data handling and display; and aerospace.

CIRCLE NO. 396

Fairchild Camera and Instruments. LSI; components; instrumentation and systems; consumer products, and Federal systems.

CIRCLE NO. 397

Memorex. Information storage and communication products.

CIRCLE NO. 398

TRW. Electronics and computer-based services; spacecraft and propulsion products; fasteners, tools and bearings; energy products and services, and automotive products.

CIRCLE NO. 399

General Semiconductor Industries. Diodes and transistors.

CIRCLE NO. 403

The Servo-Tek World of DC Servomotors

Wide range of permanent-magnet dc models available.

Servo-Tek's Permanent-Magnet DC Servomotors are precision made to give highly reliable performance. Their stability, high output-to-size ratio and speed range from 0-10,000 rpm with output torques to 2.0 oz-in make them ideal as prime movers in servomechanisms. Diameter 1.135 in. lengths up to 3.253 in. A unique field structure of Alnico VI results in minimized cogging (slot lock), a prerequisite to optimum servo performance. Models are available with a variety of operating voltages and with various mountings and integral gearing. Moderately priced with quantity discounts.

Be Selective,
Turn To...

SERVO-TEK®
PRODUCTS COMPANY

1086 Goffle Road, Hawthorne, NJ 07506 · 201-427-3100

Servo-Tek of California, Inc.
8155 Van Nuys Blvd., Van Nuys, CA 91402 · 213-786-0690

FREE CATALOG of rotating
components available.

SERVO-TEK®
ALL AMERICAN
ENGINEERED

CIRCLE NUMBER 99

NEW! INSTANT FREQUENCY DIFFERENCE!



Tracor Model 527A measures frequency difference instantly, precisely. For precisely \$3,150. Front-panel meter reads directly to parts per 10^{11} . Allows adjustment of two oscillators to the same frequency, adjustment to a specific offset, determination of offset — all instantly. Plus both short-term and long-term stability analysis. Internal oscilloscope extends precision to 1×10^{-12} . Reference and signal frequencies need not be the same. Write or call for full technical and application information.

Tracor Industrial Instruments

6500 Tracor Lane • Austin, Texas 78721 • AC 512/926-2800

CIRCLE NUMBER 100



QUALITY AND RELIABILITY

ELINCO ball bearing equipped, fractional horsepower rotary units are crafted to the highest quality standards. To assure reliability and efficiency of operation, every ELINCO motor is carefully inspected—electrically and mechanically. For complete information, request appropriate catalogs below.

AC & DC GENERATORS



over 150 permanent magnet, sine wave, tachometer, and other type generators and alternators.

AC & DC COMMUTATOR MOTORS

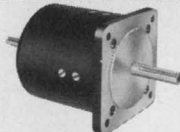

over 200 different models including universal, series, split field, shunt, permanent magnet and governor types.

AC INDUCTION & TORQUE MOTORS

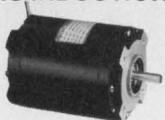

over 100 designs of one, two, or three-phase induction and torque motors for standard or special frequencies and voltages.

SYNCHRONOUS MOTORS



over 200 hysteresis, salient pole, and special types for 50 to 400 cycles, one to three phases. Also multispeed and variable speed units.

AC SELF-SYNCHRONOUS MOTORS



differential motors and one, two, or three-phase and phase-shifting rotary transformers.

GEARMOTORS

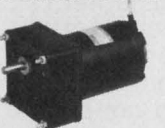

7 types of motors with interchangeable gearheads for face or base mounting. 3 gearhead sizes. Available in ratios 5:1 to 1800:1. Torque to 1500 oz. in.

ELINCO

Electric Indicator Company, Inc.

272A Main Ave. • Norwalk, CT 06851

(203) 847-5861 Telex: 96-5945

Precision products, crafted with pride since 1926

CIRCLE NUMBER 101

ACROSS THE DESK

(continued from page 7)

Mike Tuuri

Tektronix, Inc.
Lawrence Livermore Laboratory
c/o Instrument Services Bldg.
141/1194
P.O. Box 808
Livermore, CA 94550

Ed. Note: We apologize for allowing the author to suffer such embarrassment. We should have caught his error.

How about the Cramerkit?

I recently read your review of PROM programmers. I was surprised that you did not even mention the Cramerkit Prom Programmer, which has to be the most cost-effective device of its kind now available. The Cramerkit Prom Programmer is not a brand-new device. Several hundred have been sold over the past 18 months.

C.L. Grant
Manager,

Marketing Services

Cramer Electronics, Inc.
85 Wells Ave.
Newton, MA 02159

CIRCLE NO. 317

We erase, too

As I was reading the sidebar, "Don't forget the UV light box," in your article, "PROM Programmers Have Grown..." (ED No. 12, June 7, 1977, p. 58), I said to myself, "Don't forget Turner Designs." Turner is a leading manufacturer of EPROM erasers, with the unique ability to hold up to 60 PROMs. Interested readers may want to see our ad on page 169 of that issue or write for more details.

John E. Griffin

Turner Designs
2247A Old Middlefield Way
Mountain View, CA 94043

CIRCLE NO. 318

The wrong K

The ELECTRONIC DESIGN report on choosing a microprocessor in the July 5 issue (ED No. 14, p. 26) was very interesting and of immediate use to us in evaluating processors for spacecraft use. However, I must point out an error in Table 1, p. 30:

The TMS 9900 can only address 32-

k words, not 64-k. It can address 64-kbytes.

Also, the IMP-8 by National (Table 3, p. 30) is rare and no longer supported by National. This entry is good historically, but not good for a selection matrix.

Patrick Stakem

OA Corporation
50/50 Powder Mill Rd.
Beltsville, MD 20705

Stable voltage references we failed to mention

I read with great interest Walter Jung's article, "Voltage References Determine Accuracy" (ED. No. 16, Aug. 2, 1977, p. 84). I was, however, disappointed to find that CODI Corporation's lines of precision voltage-reference modules and diodes weren't mentioned. CODI has been manufacturing these devices since 1970, and they exceed all of the long-term stability ratings mentioned in the article. They include Certavolt (10 ppm/yr), Certacell (20 ppm/yr) and PRD reference diodes (5 ppm/yr).

William C. Henderson
Sales Engineer

CODI Corporation
Pollitt Drive S.
Fair Lawn, NJ 07410

CIRCLE NO. 319

Misplaced Caption Dept.



O.K., O.K., so I won't go to any more conventions.

Sorry. That's Sir Joshua Reynolds' "Garrick between Tragedy and Comedy," which hangs in a private collection in England.

ELECTRONIC DESIGN 22, October 25, 1977

Electronic Design

ELECTRONIC DESIGN's function is:

- To aid progress in the electronics manufacturing industry by promoting good design.
- To give the electronic design engineer concepts and ideas that make his job easier and more productive.
- To provide a central source of timely electronics information.
- To promote communication among members of the electronics engineering community.

Want a subscription? ELECTRONIC DESIGN is circulated free of charge to those individuals in the United States and Western Europe who function in design and development engineering in companies that incorporate electronics in their end product and government or military agencies involved in electronics activities. For a free subscription, use the application form bound in the magazine or write for an application form.

If you do not qualify, paid subscription rates are as follows: \$30.00 per year (26 issues) U.S./Canada/Mexico, \$40.00 per year (26 issues) all other countries. Single copies are \$2.50 U.S. and all other countries. The Gold Book (27th issue) may be purchased for \$30.00 U.S./Canada/Mexico, and \$40.00 all other countries.

If you change your address, send us an old mailing label and your new address; there is generally a postcard for this in the magazine. You will have to requalify to continue receiving ELECTRONIC DESIGN free.

The accuracy policy of ELECTRONIC DESIGN is:

- To make diligent efforts to ensure the accuracy of editorial matter.
- To publish prompt corrections whenever inaccuracies are brought to our attention. Corrections appear in "Across the Desk."
- To encourage our readers as responsible members of our business community to report to us misleading or fraudulent advertising.
- To refuse any advertisement deemed to be misleading or fraudulent.

Individual article reprints and microfilm copies of complete annual volumes are available. Reprints cost \$6.00 each, prepaid (\$1.50 for each additional copy of the same article), no matter how long the article. Microfilmed volumes cost \$23 for 1976 (Vol. 24); \$30 for 1973-75 (Vols. 21-23), varied prices for 1952-72 (Vols. 1-20). Prices may change. For further details and to place orders, contact Customer Services Dept. University Microfilms, 300 N. Zeeb Rd., Ann Arbor, MI 48106. (313) 761-4700.

Want to contact us? If you have any comments or wish to submit a manuscript or article outline, address your correspondence to:

Editor
ELECTRONIC DESIGN
50 Essex St.
Rochelle Park, NJ 07662

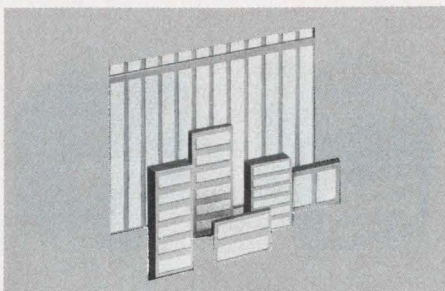

MULTIPLE CAPACITOR ARRAYS are single-plate multiple capacitance elements and serve as replacements of individually bonded chips in hybrid circuits. They are perfect for multiple circuit coupling, filtering, by-pass and high voltage meter multiplier circuits. They are easy to install and provide savings over the assembly of individual capacitors. Multiple capacitor arrays available in a variety of dielectric characteristics to meet specific requirements. JOHANSON DIELECTRICS, INC., Bx 6456, Burbank, Ca. 91510 213-848-4465.

CAPACITOR ARRAYS

181

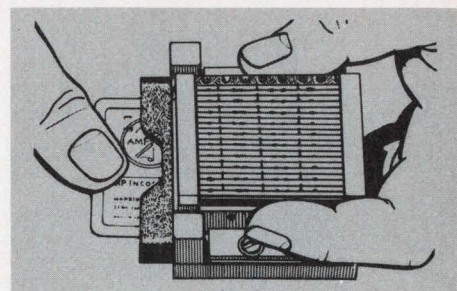

ELECTRONIC SECURITY AT LOCK AND KEY PRICES. The AMP 130 Security Card Reader. Ideal for large-volume access control. No external power. Operates with standard punched identification card. 80-data-bit capacity. Proven high reliability. Compact. Rugged. Withstands temperatures down to -40°F . Needs no adjustment or preventive maintenance. Call (717) 367-1105, or write AMP Incorporated, Capatron Division, Elizabethtown, PA 17022. AMP is a trademark of AMP Incorporated.

SECURITY CARD READER

184

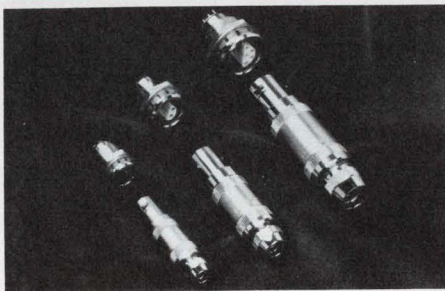

LEMO CONNECTORS are perfect for front panel applications. Superb design and craftsmanship complement any front panel design. The Quick Lock mechanism allows easy connection & disconnection. Panel space is saved because finger clearance is required on only two sides. The all metal shell is rugged and an effective strain relief grips the cable securely. Coax & multipin types from 2-18 pins are available from stock. Lemo U.S.A. Inc., 2015 2nd St., Berkeley, Ca 94710. Tel: 415/548-1966, Tx 335-393.

CONNECTORS

182

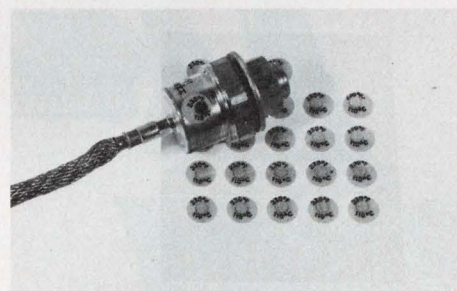

CELSIPOINT® temperature recording dots and strips do indicate by irreversible colour change (white→black) that a specific rated temperature was exceeded in the past of a component, equipment or any other item. Ideal for control of guarantee claims against overheating damages. Range from 100°F in 10° steps to 500°F . Accuracy $\pm 1\%$. Distributors required. Spirig-Signalarm, PO Box 3128, Springfield, Mass. 01101, (413) 788-0224. Internat: Spirig PO Box 160, CH8640 Rapperswil, Switzerland Tx 75400

TEMPERATURE INDICATORS

185



HIGH SPEED RECORDER FOR MICRO-PROCESSORS Model 764 has a patented constant speed tape drive using only 2 moving parts. No capstans, tachometers or clock tracks are necessary. Records up to 32,000 bits per second. Searches at 100 inches per second. Can store up to 5 megabits per 300 foot cassette. ANSI/ECMA compatible. Priced under \$500.00/OEM quantities. MEMODYNE CORPORATION, 385 Elliot Street, Newton Upper Falls, MA 02164. Telephone (617) 527-6600.

MICROPROCESSOR RECORDER

183

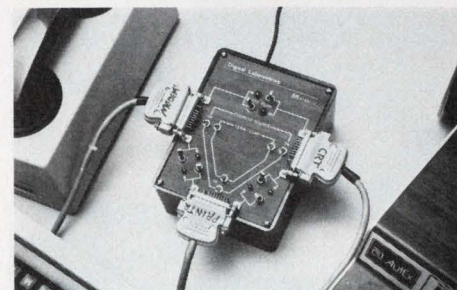

UNIVERSAL JUNCTION UNIT . . . for three devices, RS232C or current loop.

. . . Six switches provide all 63 interconnects that are possible between three I-O devices. LED's indicate data flow. . . . Designed to provide circuit compatibility and easy data routing between different manufacturer's devices. . . . \$350 (1-4) from DIGITAL LABORATORIES, 600 Pleasant St., Watertown, MA 02172 (617) 924-1680

3 PORT RS232 & 20 MA LOOP

186

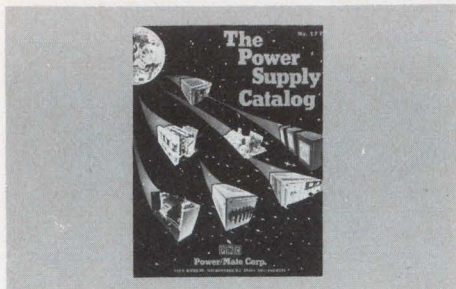

Free New '77 catalog contains over 34,500 quality power supplies from the world's largest manufacturer, Power/Mate Corp. Power Supplies for every application including submodulars, open frame, varigated, encapsulated, laboratory & system. All units UL approved and meet most military and commercial specs for industrial and computer uses. Power/Mate Corp., 514 S. River St., Hackensack, NJ 07601 (201) 343-6294

POWER SUPPLIES

187

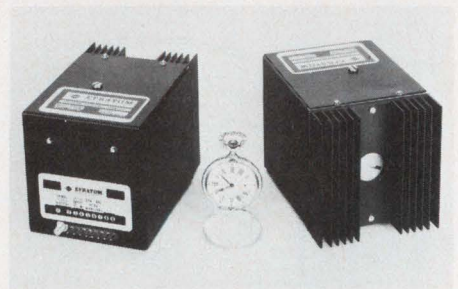

RUBIDIUM OSCILLATORS Series FRK are ultra stable, reliable, light (2.9 lb) small (4x4x4.5") and ideal for navigation/position location and communication systems. The unit provides 10 MHz; 5 and 1 MHz optional. Long-term stability 1×10^{-12} /month, short term 1×10^{-12} /100 sec avg. times and extremely low noise. Available commercial and MIL (radiation hardened) EFRATOM CALIFORNIA, INC., 18851 Bardeen Ave., Irvine, CA 92715 - (714) 752-2891

OSCILLATORS

190



LOW COST QUARTZ CRYSTALS Use Statek 10 to 300 kHz quartz crystals in TO-5s . . . they eliminate count down for oscillators, filters, tone generators, timers . . . They're rugged, accurate & resistant to high vibration and shock. Prices low as \$1.70 ea. in 1000 qty. Send your written application & we'll send you a sample. Call or write for literature. Details in Gold Book and EEM * STATEK CORP. * 512 N. Main, Orange, Ca. 92668 * (714) 639-7810 * Telex 67-8394

QUARTZ CRYSTALS

193

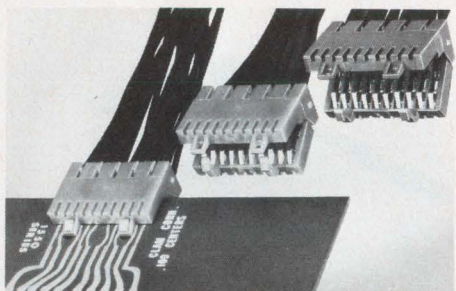

New "Clam" Miniature Connectors offer gas-tight interconnects with zero insertion force. Connectors snap closed over PC board edge exerting 3-4 times normal gram loading. Permits highly reliable interface even with solder plated edge connectors. No abrasive forces during insertion or removal . . . unique retaining dog actuates or releases swivel-clamp action. Contacts are brass tin plate on .100 centers. METHODE ELECTRONICS, INC., Dept. PR., 1700 Hicks Road, Rolling Meadows, Ill. 60008. (312) 392-3500. ZERO INSERT.-FORCE CONNECTORS. 188

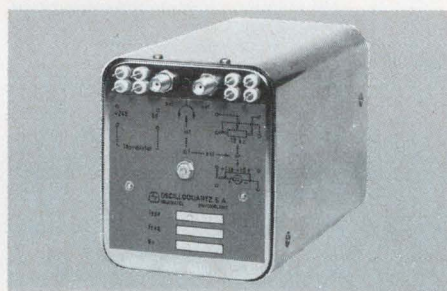

1 X 10⁻¹⁰ CLASS OSCILLATOR. The best oscillator available for ion phase noise and overall performance the Model B-5400 has a typical phase noise of less than 115 dB, 1 Hz from Carrier. The Model B-5400 also features Short Term Stability of 1×10^{-12} and aging of 1×10^{-10} per day. Voltage controlled adjustment permits phase-lock operation. Frequency and Time Systems, Inc., 182 Conant Street, Danvers, MA 01923 (617) 777-1255 Telex: 94-0518

OSCILLATOR

191

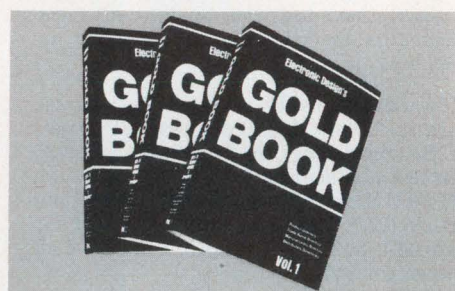

THE '77-'78 GOLD BOOK IS NOW OFF THE PRESS. Contains 2,496 pages of up-to-the-minute information about the entire electronics industry. Complete with Product, Trade Name, Manufacturers, Distributors Directories and Catalogue Compendium. Price: \$30-U.S., Canada and Mexico. Other countries \$40-Overseas postage included. To order, send check or company purchase order to GOLD BOOK, Dept. #437-R, Hayden Publishing, 50 Essex St., Rochelle Park, NJ, 07662.

'77-'78 GOLD BOOK

194

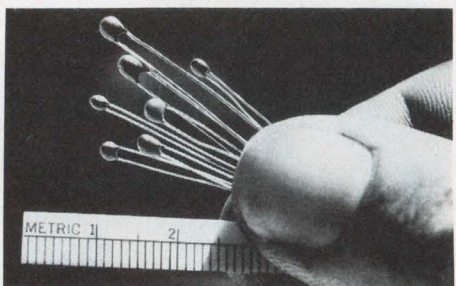

THERMISTORS with leads and coating are highly reliable low cost components in small dimensions more compatible with modern circuit design. R @ 25°C 100Ω to 1 meg Ω ±10% to ±1%. CURVE MATCHED INTERCHANGEABLES to ±.25°C. POINT MATCHED INTERCHANGEABLES to ±.2°C. Call or write for HP97 or TI SR52 THERMISTOR LINEARIZATION PROGRAM. WESTERN THERMISTOR CORPORATION, 354 Via Del Monte, Ocean-side, CA 92054. (714) 433-4484.

THERMISTOR

189

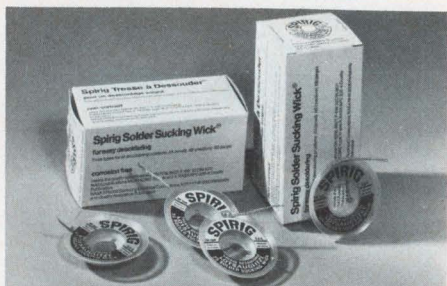

3S-WICK® De-solder Braid. Spirig produces the vacuumized (pat. pend.) solder removal wick in unequalled technology to meet any standards worldwide. 3S-Wicks unique three dimension combination solves all electronics desoldering problems. 3S-Wick pat. pend. Spirig also produces pencil soldering irons. Dealers and distributor inquiries welcomed. USA: Spirig-Signalarm, PO Box 3128, Springfield, Mass. 01101, (413) 788-0224 Internat: Spirig, PO Box 160, CH-8640 Rapperswil, Switzerland TX 75400

3S-WICK DE-SOLDER BRAID

192

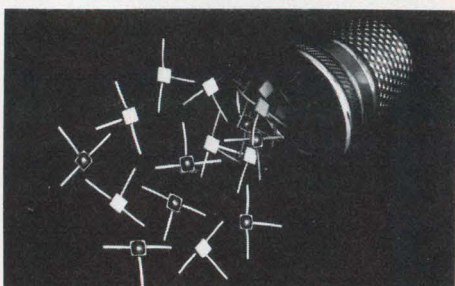

TanFilm™ precision subminiature resistor networks from TRW, the world's smallest 1/4-watt resistor, has proven its performance, reliability and space-saving design in ultra-high-speed computers, line terminations and microwave attenuation. Useful at frequencies up to 2 gigahertz, the network offers low noise and excellent high-frequency characteristics for RF or high-speed switching operatins. TRW/IRC Resistors, an operation of TRW Electronic Components, 4222 S. Staples St., Corpus Christi, TX 78411. (512) 854-4872.

RESISTOR NETWORKS

195

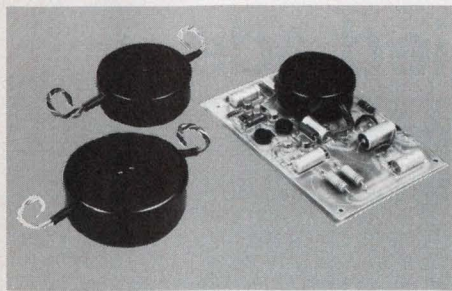

Off-the-shelf, in any quantity, toroidal line transformers are available with 75 most commonly used (6 to 40V) secondaries, 2 x 115V primaries, in 15, 30, 50, 90 and 130VA ratings. Toroids can solve your problems – they have an 8:1 smaller hum field – are 50% lighter – with 50% smaller volume over electrical equivalents – and fully encapsulated in resin filled tough thermoplastic shells. High efficiency saves power, cuts temperature. Sager Electrical Supply Co. 60 Research Rd. Hingham MA 02043 Tel: 617 749 6700

TOROIDAL TRANSFORMERS 199

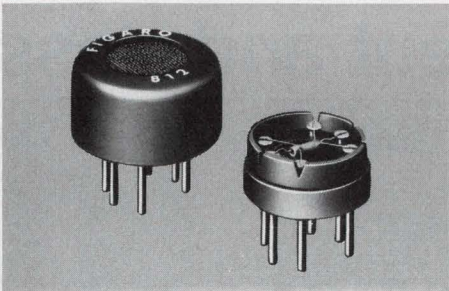

FIGARO GAS SENSOR TGS is a gas sensitive semiconductor. When combustible gas is absorbed on the sensor surface, a marked decrease of electrical resistance occurs. Major features of the sensor include high sensitivity, long term reliability and low cost. The applications are: GAS-LEAK ALARM, AUTOMATIC FAN CONTROL, FIRE ALARM, ALCOHOL DETECTOR, etc. Figaro Engineering Inc., North America Office-3303 Harbor Boulevard, Suite D-8, Costa Mesa, Calif. 92626 Tel: (714) 751-4103 Telex: 678396

GAS SENSOR 199



PROGRAMMING PROVERBS FOR FORTRAN PROGRAMMERS, H. F. Ledgard. These 26 unique "proverbs," or rules and guidelines, are specially designed to help FORTRAN programmers upgrade the quality of their work. Comes with many sample programs. #5820-9, 144 pages, \$6.95. Circle the Info Retrieval Number to order 15-day exam copy. When billed, remit or return book with no obligation. Hayden Book Co., 50 Essex Street, Rochelle Park, N.J. 07662.

PROGRAMMING PROVERBS 197

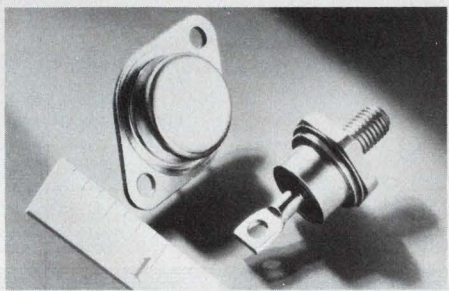

50-WATT SILICON ZENER VOLTAGE REGULATORS. Full Line of 38 nominal voltages ranging from 6.8 to 200 VDC in two package styles. DO-5 (50T Series) and C5a (50Z series) packages available. Std. tol. is $\pm 10\%$, with $\pm 5\%$ and $\pm 20\%$ optional. Five other series with max. DC power dissipation 10 w with the same voltage range are available in a variety of cases. For complete information write to: ST-Semicon, Inc. (formerly Sarkes Tarzian) 415 N. College, Bloomington, IN 47401; (812) 332-1435.

ZENER VOLTAGE REGULATORS 200

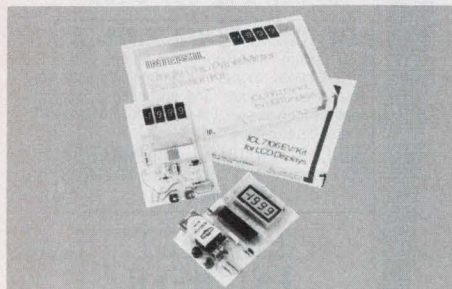

A WORKING DPM IN 1/2 HOUR. Complete evaluation kits. Test these new parts for yourself with Intersil's low-cost prototyping kits, complete with A/D converter and LCD display (for the 7106) or LED display (for the 7107). Kits provide all materials, including PC board, for a functioning panel meter. Available from stock. Energy Electronic Products, 6060 Manchester Ave., L.A., Ca. 90045. (213) 670-7880. TWX: 910-328-6161. Kit No. ICL71-06EV/KIT (LCD) \$29.95. Kit No. ICL71-07EV/KIT (LED) \$24.95.

WORKING DPM 198

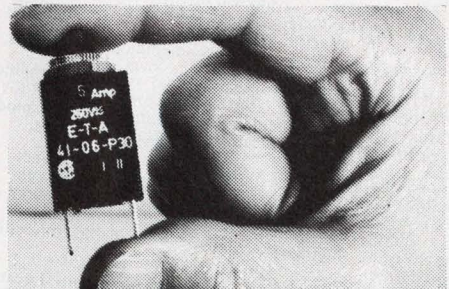

Overcurrent Protector, manual reset eliminates fuse replacement. Convenient panel mounting. 19 fractional ratings from 0.1 to 5 amp. Other models up to 400 amp. Trip-free and fool-proof, UL and CSA approved. High quality, low cost \$1.39 ea. in 1000 lots. E-T-A Products Co. of America, 7400 N. Croname Rd., Chicago, Ill. 60648. Tel: (312) 647-8303. Telex: 253780.

CIRCUIT BREAKER 201

Electronic Design

Advertising Sales Staff

Susan G. Apolant
Sales Coordinator

Rochelle Park, NJ 07662

Robert W. Gascoigne
Thomas P. Barth
Stan Tessler
Constance McKinley
50 Essex St.
(201) 843-0550
TWX: 710-990-5071
(HAYDENPUB ROPK)

Philadelphia

Thomas P. Barth
(201) 843-0550

Boston 02178

Gene Pritchard
P.O. Box 379
Belmont, MA 02178
(617) 489-2340

Chicago 60611

Thomas P. Kavooras
Berry Conner, Jr.
200 East Ontario
(312) 337-0588

Cleveland

Thomas P. Kavooras
(312) 337-0588

Los Angeles 90045

Stanley I. Ehrenclou
Burt Underwood
8939 Sepulveda Blvd.
(213) 641-6544

Texas

Burt Underwood
(213) 641-6544

San Francisco

Robert A. Lukas
465 S. Mathilda, Suite 302
Sunnyvale, CA 94086
(408) 736-6667

England

Constance McKinley
50 Essex St.
Rochelle Park, N.J. 07662
Phone: (201) 843-0550

Europe

Sanders, W. J. M.
Raadhuisstraat 24
Graft-De Ryp, Holland
Phone: 02997-1303
Telegrams: Euradteam-Amsterdam
Telex: 13039-SIPAS

G. Nebut

Promotion Presse Internationale
7 ter Cour des Petites Ecuries
75010 Paris, France
Telephone: 5231917, 1918, 1919

Dieter Wollenberg

Erikastrasse 8
D-8011 Baldham/Muenchen
Germany
Telephone: 0 8106/4541

Tokyo

Haruki Hirayama
EMS, Inc.
5th Floor, Lila Bldg.,
4-9-8 Roppongi
Minato-ku, Tokyo, Japan
Phone: 402-4556
Cable: EMSINCPERIOD, Tokyo



Electronic Design

recruitment and classified ads

PLACE YOUR AD AT ONLY \$45 PER COLUMN INCH IN

Electronic Design

— GET A REPEAT AD FREE!

With our 2 for 1 plan, your net cost in *Electronic Design* is only \$22.50 per column inch, lowest among all the national newspapers and electronics media. You get a total of 165,402 exposures to OEM engineers and engineering managers (not counting 10,600 more among general or corporate managers) at only 27¢ per thousand! You can't beat the price. You can't beat the coverage and you can't beat the quality.

YOU REACH ENGINEERS WITH TITLES LIKE THESE:

- Chief Engineer • Development Engineer • Design Engineer • Project Engineer • Electronic Engineer • Engineer-Supervisor • Section Leader • Staff Engineer • Systems Engineer • Test Engineer • Standards Engineer • Master Engineer

Electronic Design RECRUITMENT ADVERTISING RATES

15% commission to recognized agencies supplying offset film negatives. 2% 10 days, net 30 days. Four column makeup. Column width 1-3/4" x 10".

SPACE	DIMENSIONS		COST
	Wide	Deep	
One column inch	1-3/4"	x 1"	\$45.
2 col. in.	1-3/4"	x 2"	\$90.
1/16 page (1/4 col.)	1-3/4"	x 2-1/2"	\$112.
1/8 page (1/2 col.)	1-3/4"	x 5"	\$225.
1/4 page (1 col.)	1-3/4"	x 10" Vert.	\$450.
	3-1/2"	x 5" Hor.	
1/2 page (2 cols.)	3-1/2"	x 10" Vert.	\$900.
	7"	x 5" Hor.	
3/4 page (3-cols.)	5-1/4"	x 10"	\$1350.
1 page	7"	x 10"	\$1800.

NOTE: EACH RECRUITMENT AD YOU PLACE WILL BE REPEATED FREE OF CHARGE!

LATE CLOSING DATES

Electronic Design is mailed every two weeks. Because of its timeliness, personnel recruitment advertising closes only two weeks before each issue's mailing date.

1977 Mailing Date	Recruitment Closing Date	Issue Date on Cover
Oct. 21	Oct. 7	Nov. 8
Nov. 4	Oct. 21	Nov. 22
Nov. 18	Nov. 4	Dec. 6
Dec. 2	Nov. 18	Dec. 20



HOW TO PLACE YOUR AD

CALL THE RECRUITMENT HOT LINE 201-843-0550

Camera-ready film (right reading negatives, emulsion side down) or camera-ready mechanicals must be received by deadline. Or, if you wish us to set your ad (typesetting is free) simply pick up the phone and call our RECRUITMENT HOT LINE — (201) 843-0550. Ask for:

Constance McKinley
RECRUITMENT ADVERTISING MANAGER
ELECTRONIC DESIGN

50 Essex Street, Rochelle Park, New Jersey 07662

R&D ENGINEERS

MICRO/MINI/COMPUTER

Computer Memory	\$18-28K
Minicomp Arch	\$26-31K
Minicomp CPU	\$19-28K
Minicomp Progmng	\$18-30K
Intel 8080 or M6800	\$18-30K
Non Impact Printers	\$18-25K
ASSEMBLER/FORTRAN	\$16-26K
Microprocessor Apps	\$20-26K
Microprogramming	\$20-26K
A&D Circuit Design	\$20-27K
TV Receiver Design	\$20-26K

Partial List
Openings in 35 States

Call toll free 1-800-821 2270 X605
(IN Mo. 1-800-892-7655) or send resume

RALPH STEVENSON, Partner

JIM KING
438 GULF LIFE TOWER
JACKSONVILLE, FLA 32207

MANAGER ADVANCED PRODUCT DEVELOPMENT

Outstanding opportunity for creative supervisor of Commercial Business Equipment Development Group. Microprocessor experience and electromechanical paper handling devices appropriate. Salary starts to 35k.

Brucks Personnel Corp.
2541 Monroe Ave., Rochester, N.Y. 14618
716-442-5400

TEXAS POSITIONS

Engineering, EDP & technical openings throughout Texas & the U.S. 100% fee paid. Send your resume in confidence to ENGINEERING/EDP SEARCH (Agency) 84 N.E. Loop 410, Suite 124E San Antonio, Texas 78216

Manager Electronic Technology

Are you ready to lead one of the most advanced operations in the telecommunications industry?

If you are, Stromberg-Carlson will offer you the chance to direct a highly skilled engineering team involved in applying the latest semiconductor, power and related electronic technologies to innovative, new telecommunications systems.

As our Manager of Electronic Technology you'll make visible contributions to an important part of our System CENTURY® — a family of digital switching products meeting the exploding demand for state-of-the-art telecommunications systems.

Position requires BSEE or MSEE and 3-5 years experience in analog or digital circuit design. You should also have in-depth knowledge of such areas as microprocessor selection — both evaluation and application, solid-state component characteristics and selection; and analog to digital conversion circuit design.

We offer commensurate salary and excellent benefits. Location is in Rochester, N.Y., an area noted for its broad variety of cultural, recreational and educational attractions. Send resume, including salary history, to: Mr. Steve Peters, Stromberg-Carlson, 100 Carlsson Road, Rochester, N.Y. 14603.

Stromberg-Carlson

A SUBSIDIARY OF GENERAL DYNAMICS CORPORATION

An equal opportunity employer m/f
U.S. Citizenship or permanent visa required.

NATIONAL to 35K

Electrical/Electronic placement specialists.

Design _____ Test _____
Production _____ Project _____
F/S _____ Mfg. _____ Analog _____
Digital _____ RF _____ Radar _____
UHF _____ VHF _____ Power _____

Instructors _____

Various positions at all levels.
Forward resume to:

Gilbert Lane, Dept. 2
505 Fifth Avenue
N.Y., N.Y. 10017
or call 212 867 8100

SWITCHING POWER SUPPLIES

Outstanding opportunity for Senior Electrical Engineer to work in Magnetic Circuits, pot cores, solenoids and switching power supplies for high speed mechanisms in Matrix Printer development. To 23K.

BRUCKS PERSONNEL CORPORATION
2541 Monroe Ave., Rochester, NY 14618
(716) 442-5400

PROJECT ENGINEER

A nationally-known, highly regarded manufacturer of electrical/mechanical automotive switches is seeking men to build prototype samples of new products and related assignments. Plant located in northern Indiana college and resort town, boating - fishing abundant. Liberal financial and fringe package. Reply to:

BOX 000

Equal Opportunity Employer M/F

Please send box replies to:

ERIC C. BAUM & ASSOC.
510 N. Dearborn, Chicago, IL. 60610
Attn: Mr. Kenneth Alpers, Vice Pres.

1

ADVANCED
TECHNICAL
DIVERSIFI-
CATION

2

PROFESSIONAL
GROWTH

3

OUTSTANDING
CAREER
PACKAGE

Engineers — Software Design

3 Reasons Why You Should Look Into the Career Opportunities at GTE Automatic Electric!

Career challenge: the opportunity to make significant contributions at the beginning of a new era in a major industry.

The technical evolution in telecommunications is underway. We're working in many areas of software design in an on-line, real-time environment. Definition, design and implementation projects include CAD, Data Base Systems, Simulation, Fault Recovery, Diagnostics, and very complex switching networks using distributed control system technology. These are the forerunners of even more advanced systems that will be designed for the next generation.

SOFTWARE DESIGN

We're looking for an indepth background in the development of systems software and a minimum of 3 years' experience in structured design, testing and documentation of programs running on large data base, multi-file systems in real-time. Familiarity with HIPO design documentation, TSO usage and software simulation techniques as well as PL1, Fortran and assembler languages for the 8080 and PDP 11 programming is also important.

DATA BASE DESIGN

This position requires a minimum of 5 years' experience in the planning development, design and implementation of data base software, including data base management systems administration. Your primary responsibilities will be the development of data base system for a large on-going project including the implementation, support and administration of systems.

Call now and let us fill-in more details. . .

CALL (800) 323-1966

In Illinois call (800) 942-0491 Sunday thru Friday, from 8 am to 4 pm cdt

If you have current experience in one of these areas, a BS, MS or PhD in Electrical Engineering, Computer Sciences, Math, or other appropriate discipline, let us count out more of the benefits and challenges you receive as a member of the GTE family.

**If unable to call, please send your resume to:
Manager of Technical Employment, Dept. 471 A6**

COMPUTER AIDED DESIGN

We are looking for an extensive background in the design of CAD/CAM systems and the development of Interactive access by the users of CAD/CAM functions. Required is 5-10 years' experience in both hardware and software aspects; DA systems operations, and design, and systems engineering. Your initial responsibilities will include evaluation of existing systems, and working with a project team in the Architectural Planning of a major new system.

MINI-COMPUTER PROGRAMMERS

We have specific assignments available on project development teams responsible for the design implementation of various telecommunication processing systems utilizing mini-computers as the processing element. Responsibilities will include the development of software programs for real-time operating systems as well as unique hardware elements incorporated into the systems.

**GTE AUTOMATIC ELECTRIC
LABORATORIES**

400 N. Wolf Road
Northlake, Ill. 60164

An Equal
Opportunity
Employer
M/F

ELECTRICAL ENGINEERS TEST EQUIPMENT DESIGN

ANALOG - Engineers to design test stands and associated electrical/electronic controls and data acquisition systems. Experience in solid state closed loop analog control systems is desired.

DIGITAL - Engineers to design the hardware and software of digital computer based equipment used in the testing of high speed rotating machinery and mechanical actuating equipment. Experience in Assembly and Fortran programming of minicomputers is required.

Responsibilities include the design, construction, installation and checkout of test stands, instrumentation and control systems. Engineers will be exposed to a broad variety of our aerospace and commercial products. Technical exposure is "total concept" without specialization. Sundstrand, a Fortune 500 advanced technology company, designs, manufactures and markets a variety of aircraft accessory products. Sundstrand offers an excellent benefits package including 14 paid holidays plus vacation and an extensive medical and dental plan. Our headquarters are in Rockford, Illinois, located 90 miles from Chicago.

Send Resumes to:

SUNDSTRAND CORPORATION
Peter L. Arthurs
4751 Harrison Avenue
Rockford, Illinois 61101

An Equal Opportunity Employer
M/F

You're a Microprocessor Professional And You Have a Problem!

Certainly, the problem is not marketability nor is it money. But how will you differentiate genuine professional growth from those companies that will treat you like just another hired hand.

If you're better than your present employer acknowledges and wish to confidentially explore special situations worldwide, contact:

Management Recruiters

Attn: Ed Murphy, National Accounts Manager, 607 Boylston Street, Boston, MA 02110 (617) 262-5050

or Attn: Rick Keane, General Manager, 1500 Main Street, Springfield, MA 01115 (413) 781-1550

or Attn: Al Keleher, Senior Associate, 10 Industrial Park Drive, Nashua, NH 83060 (603) 883-3323

DEVELOPMENT ENGINEERS

Our growth as a leading manufacturer of measuring and controlling instrumentation, computers and systems for the process industry, provides outstanding career opportunities for exceptional individuals interested in contributing to the advance design and development of our electronic instrumentation and computer systems.

We are looking for talented professionals with experience in the following areas:

- Microprocessor/Computer based systems with applications to process control
- LSI design and manufacturer
- Programmable logic circuitry
- Digital logic design and firmware development
- Design of data transmission systems establishing protocol, formatting and error checking
- Specification, design and development of software for computerized process control systems
- Application of computers for process control and data acquisition in the process industries

Qualified individual may forward resume and salary requirements in confidence to:

Technical and Professional Personnel

Taylor Instrument Company
SYBRON | Taylor

95 Ames Street
Rochester, N.Y. 14601

An Equal Opportunity Employer M/F

Constance McKinley
RECRUITMENT ADVERTISING MANAGER
ELECTRONIC DESIGN

50 Essex Street, Rochelle Park, New Jersey 07662

(201) 843-0550

I'm interested in placing recruitment
advertising in *Electronic Design*

Issue _____ Size of ad _____

My copy is enclosed

I need more information

Name _____

Title _____

Company _____

Address _____

Engineers... are you pigeonholed?

We won't keep you pigeonholed in the same old assignment, year after year. After all, variety is the spice of a life's work. And we have a commitment to it. We make our living selling variety: command and control systems, complete air defense systems, radar systems, sonar systems, computer systems and much more. We're part of a company of 36,000 people, active in more than 550 major product areas in 80 technologies. Plenty of room for developing interests, plenty of room for growth.

Our Systems Division engineers enjoy technical diversity because of our program variety, and growth opportunities that we're steadily expanding. They benefit from the technically oriented management which put us on our strong growth curve. And they enjoy a good professional environment, where many of our people wear 10, 15, and 20 year service pins.

Any more good news? Well, yes. We're hiring now.

For quick action, reach for your phone instead of your resume... call M. F. Duggins collect (714) 871-4080, Ext. 5410 between 8 A.M. and 4 P.M. Monday through Friday. Or send your resume to: Professional Employment—Ground Systems Group C, 1901 W. Malvern, Fullerton, CA 92634.

U.S. citizenship required • Equal opportunity M/F/H/C employer

HUGHES

HUGHES AIRCRAFT COMPANY

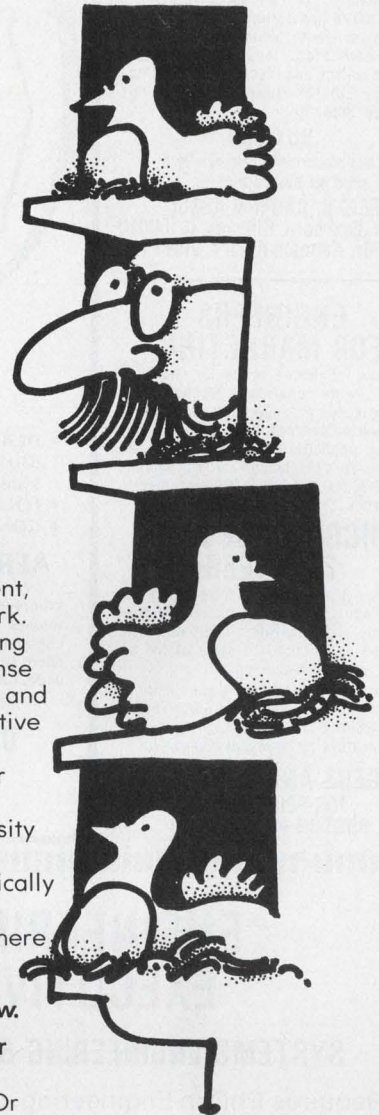

Communications System Engineers. Must understand hardware/software interaction, signal processing, spread spectrum.

Senior Systems Engineers. Tactical, strategic system application of radar, sonar communications, electro-optical software, data processing and command and control technologies.

Communication Analysts. Lead/direct application of systems theory, applied math, estimation, probability to communication system problems.

Data Processing and Software Analysts. System level data processing architecture analysis, design, performance evaluation for multisensor systems.

Display System Engineers. Long term opportunity to lead display product definition/selection for military C&C Systems.

Radar Systems Engineers. Lead/direct radar system conceptual design/analysis. Integration of radar, weapon, command and control systems.

Senior Air Defense Engineers. BSEE, Math or Physics, project management experience in real-time hardware software systems.

Hardware System Engineers. Large scale data processing, peripheral, display systems design, specification, integration checkout.

Systems Analysts. Systems Theory, applied math background. Variety of problems requiring modern analysis techniques.

DESIGN DRAFTSMAN

Well-known, highly regarded national manufacturer of electrical/mechanical automotive switches is seeking an innovative electrical/mechanical design draftsman. Plant located in northern Indiana college and resort town - boating - fishing. Liberal financial and fringe package. Reply to:

BOX 000

Equal Opportunity Employer M/F

Please send all box replies to:

ERIC C. BAUM & ASSOC.
510 N. Dearborn, Chicago, IL. 60610
Attn: Mr. Kenneth Alpers, Vice Pres.

ENGINEERS FOR MARKETING

We have immediate needs for engineers familiar with component technology to provide technical support in marketing. The work will involve technical promotion sales training, publicity, some applications and supervision of technical writers. Salaries are \$27-30,000 and \$16-20,000 depending on experience.

MICROPROCESSOR ENGINEER

Will play a major role in introducing this technology for a leading manufacturer of materials characterization instrumentation. Must be experienced in state of the art microprocessor technology.

For more information on these positions contact Dennis Fitzgerald or Steve Ford at (617) 426-4180 or send resume including salary history to *Technical Department*.

ROGERS AND SANDS INC.
100 FEDERAL ST.
BOSTON MASS. 02110

PLUG INTO A NATIONAL NETWORK

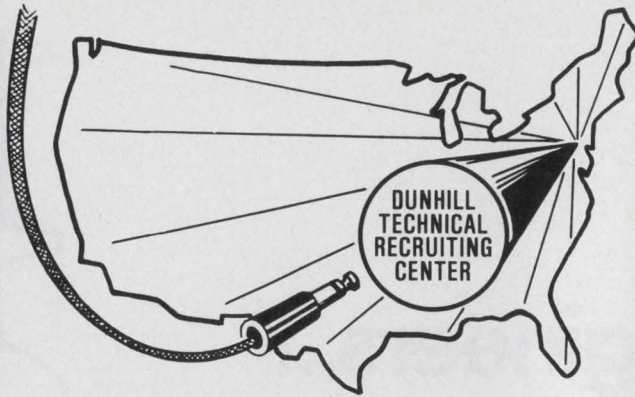

HARDWARE AND SOFTWARE

- DESIGN ENGINEERS (Digital, Microprocessor, RF, Video, Analog)
- LOGIC
- COMPUTER ARCHITECTURE
- SYSTEMS ENGINEERS
- REAL TIME PROGRAMMERS (Assembler and/or Fortran)
- SOFTWARE DEVELOPMENT
- I C DESIGNERS

AEROSPACE, INDUSTRIAL, SOLID STATE

Wherever you are or want to go Dunhill Technical Recruiters have growth opportunities. We will prepare a professional presentation of your background and confidentially present it to growth oriented electronic companies searching for talent such as yours. We will do this directly or through one of 200 offices nationwide. Client companies assume all fees including relocation expenses.

Contact: Allen I. Frank

DUNHILL TECHNICAL RECRUITING CENTER

1009 W. 9th AVENUE - Suite F
King of Prussia, PA 19406
215-337-3355 (agency)

WELLS ELECTRONIC SEARCH, INC.

NATIONWIDE

SYS ARCHITECTURE - HARD/SOFTWARE
Mini, Micro, Terms From Concept 38,000
SR SYS ENG/ANALYST - Elnit, Sigmnt, Comint 25-35,000
BIOMED - Ultra Sound, X-Ray, CT Scanner
Gamma Camera, Pacemakers, Implantables,
Sensors, Fluid Handling, Computer based
Analyzers 16-32,000
ADV-DEV - PhD/MS Programmable
Controller 18-32,000
SR SOFTWARE ENG Process Control
25-35,000
DIR DIAGNOSTIC ENGR programming/
design automation 43,000
R&D & DESIGN - Video Games - Analog
Video circuits, Modems, CRT displays,
Micro computer Syst. 18-35,000
DIGITAL COMM DES ENGRS - Signal
Processing, Info Theory, Phase Locked
Loops, Digital filters, Coding Switching
Syst 18-33,000
MINICOMPUTER, Programmers,
Nationwide 18-32,000
CONTACT
D.L. Sweeny 212-949-8498 Dept. F
WELLS RECRUITING SYSTEMS, INC.
545 5th Ave., NYC, NY 10017 (AGENCY)

ELECTRONIC design project management ENGINEERS

fee paid nationwide

F-O-R-T-U-N-E

- 2200 Century Center
Atlanta, GA 30329
404/325-1600
- 11 Beacon St.
Boston, MA 02108
617/523-3530
- 500 N. Michigan Ave.
Chicago, ILL 60611
312/467-9130
- 2720 Stemmons Freeway
Dallas, TX 75207
214/630-9411
- 301 Fifth Ave. Bldg.
Pittsburgh, PA 15222
412/261-1826

KEEP Electronic Design's GOLD BOOK HANDY

ENGINEERING EXECUTIVE

SYSTEMS ENGINEERING & ANALYSIS

Requires PhD in Engineering, or Sciences and 10-15 yrs. experience in Systems Engineering and Analysis. Technical expertise will probably be in sophisticated aero-space systems technology, or the design of complex petrochemical processes via computer techniques. Individual must have strong managerial credentials. Successful candidate will plan, staff and direct a new department for their NYSE client engaged in commercial products. Compensation \$40-50K (perhaps more), plus unparalleled benefits and professional growth. All search expenses are paid by our client. In complete confidence, contact C. B. Baker, Executive Search Div., CORPORATE STAFFING, Professional Recruiters, Executive Plaza, Ft. Washington, Pa. 19034. (215) 643-3310.

PLACE YOUR AD AT ONLY \$45 PER COLUMN INCH IN

Electronic Design

Electronic Design

BRINGS YOU THE HIGHEST NUMBER OF QUALIFIED OEM ENGINEERS AND ENGINEERING MANAGERS ANYWHERE . . . AT THE LOWEST COST ANYWHERE!

SPECIAL 2 RECRUITMENT ADS FOR THE PRICE OF 1!

Double the coverage . . . double the effectiveness of every ad you place!

— GET A REPEAT AD FREE!

How they work on the job is the ultimate test

Use these fine books for 15 days
without charge!

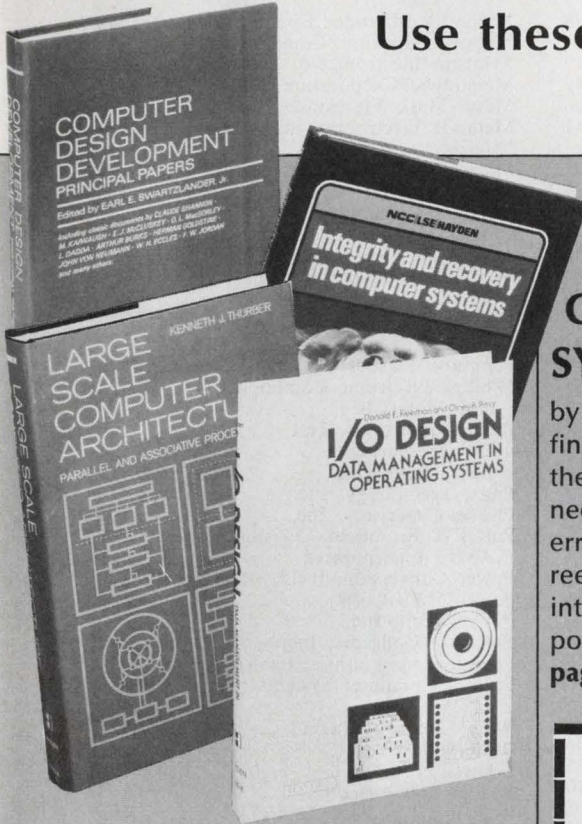

INTEGRITY AND RECOVERY IN COMPUTER SYSTEMS

by T. K. Gibbons. Places at your fingertips in step-by-step fashion all the techniques and strategies you need for locating and correcting errors and failures and for reestablishing complete system integrity and reliability as quickly as possible. #5454-8, cloth, 144 pages, \$9.95

COMPUTER DESIGN DEVELOPMENT: Principal Papers

edited by Earl E. Swartzlander. Gathers together the original papers that heralded the major achievements in logic design, arithmetic algorithms, and computer arithmetic. The coverage progresses from basic design concepts to small subsystems to complete computing systems. #5988-4, cloth, 320 pages, \$13.95

I/O DESIGN: Data Management in Operating Systems

by Donald E. Freeman and Olney R. Perry. Details the many I/O system and subsystem designs in use today allowing you to design your systems with more confidence and accuracy. #5789-X, cloth, 384 pages, \$17.50

LARGE SCALE COMPUTER ARCHITECTURE: Parallel and Associative Processors

by Kenneth J. Thurber. A rare and comprehensive reference covering both general theory and practical applications of the main systems currently in operation. #5775-X, cloth, 352 pages, \$18.95

ORDER FORM

15-Day money-back guarantee

Please send me the books checked below to read and use FREE for 15 days. At the end of that time, I will send payment, plus handling and postage, or return the book(s) and owe nothing. On all prepaid orders, publisher pays postage. Prices are subject to change without notice. Offer good in U.S.A. and Canada only.

- #5454-8 **Integrity and Recovery in Computer Systems** \$ 9.95
- #5789-X **I/O Design** 17.50
- #5775-X **Large Scale Computer Architecture** 18.95
- #5988-4 **Computer Design Development** 13.95

NAME _____

COMPANY _____

ADDRESS _____

CITY/STATE/ZIP _____

Send to: **Hayden Book Company, Inc.**

50 Essex Street
Rochelle Park, New Jersey 07662



77-6

**You'll learn a lot from HAYDEN —
your computer science publisher**

ENVIRONMENTALIZED. OUR DIGITAL PANEL METERS ARE RUGGED.

Our IMPAC™ DPMs can withstand extreme temperatures and are totally immersible in water. That's 100% humidity. 15Gs of vibration in any direction and 30Gs of shock is what we call punishment and our tough little DPMs can take it. Available with 3, 3½, 4 and 4½ digit displays. Check our reader service card for more information.

velonex

560 Robert Avenue
Santa Clara, Ca 95050
(408) 244-7370

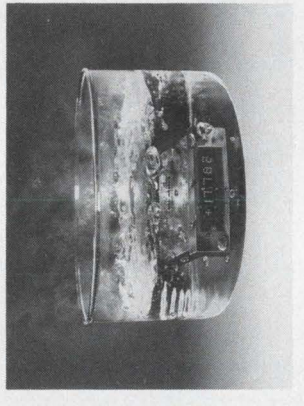

CIRCLE NUMBER 102

MOVING?

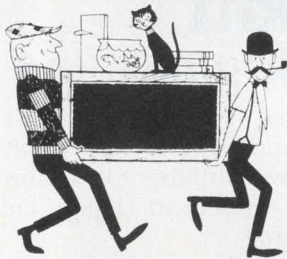

If you've recently moved or plan to in the near future, tell us, and we'll send your issues to you at your new office.

For fast, accurate service:

1. Detach the Change of Address Form bound into the back of this issue.
2. Remove the mailing label from the front cover of this issue and affix it to the designated area on the card.
3. Print your new address in the grid provided.
4. Write date that the change becomes effective. (Please allow 6-8 weeks for processing).
5. Affix proper postage to card and mail today!

Advertiser's index

Advertiser	Page	Advertiser	Page
AMP, Incorporated.....	4, 5	Johanson/Monolithic Dielectrics Division.....	133
AMP, Incorporated, Capatron Division.....	133	KSW Electronics Inc.....	130
Alco Electronic Products, Inc.....	96	Lemo USA, Inc.....	133
Allen Bradley Co.....	113	Malco, A Microdot Company.....	42
Analog Devices, Inc.....	10, 102	Mallory Capacitor Company.....	91
Arnold Magnetics Corp.....	7	*Matsuo Electronics of America, Inc.....	128
Arrow-M Corp.....	98	Memodyne Corporation.....	133
Belden Corporation.....	119	Mesur-Matic Electronics Corp.....	96
Berg Electronics.....	47	Methode Electronics, Inc.....	134
Bishop Graphics, Inc.....	96	*Metrix.....	16
Bodine Electric Company.....	40, 41	Micro Components Corporation.....	112
Bourns, Inc., Trimpot Products Division.....	Cover II	Micro Networks Corporation.....	100
Bud Industries, Inc.....	106	Mini-Circuits Laboratory, A Division of Scientific Components Corp.....	2
Burr-Brown.....	86	Modular Computer Systems.....	58, 59
CTS Corporation.....	79	North American Philips Controls Corp.....	6
Capitol Machine & Switch Co., Inc., The.....	116	Penntube Plastics Co., Inc.....	126
Centralab, The Electronics Division of Globe-Union, Inc.....	67	*Philips Electronic Components and Materials.....	113
Centre Engineering.....	122	Phillips Industries, Test and Measuring Instruments Dept.....	15, 961
Clare & Co., C. P.....	103	Piezo Technology, Inc.....	114
Clifton Precision.....	16	Plastic Capacitors, Inc.....	108
Cutler-Hammer, Specialty Products Division.....	22, 23	Potter & Brumfield, Division of AMF, Incorporated.....	117
Dale Electronics, Inc.....	8, 9	Power Conversion, Inc.....	130
Data General Corporation.....	15	Power/Mate Corp.....	134
Data Precision Corporation.....	21	Power Tech, Inc.....	80
Datel Systems, Inc.....	107, 109, 111	Precision Concepts, Inc.....	123
Dialight, A North American Philips Company.....	17	Precision Monolithics, Incorporated.....	14
Digital Laboratories.....	133	Process Computer Systems.....	43
Dormeyer Industries, Inc.....	93	RCA Electro Optics.....	120*, 121
Dow Corning Corporation.....	18	RCA Solid State Division.....	Cover IV
Dunhill Technical Recruiting Center.....	140	Reader Service Card.....	144A-B
ECD Corporation.....	101	Reticon.....	105
EMI Technology, Inc.....	104	Rogers Corporation.....	57
E-T-A Products Co. of America.....	135	Sager Electrical Supply Co.....	135
Eastern Air Devices.....	110	Sangamo Weston Inc.....	
Edmund Scientific Company.....	108	Sangamo Data Recorder Division.....	46
Efratom California, Inc.....	134	Servo-Tek Products Company.....	131
Electro-Craft Corporation.....	123	*SGS/ATES.....	96J
Electro Scientific Industries.....	115	Signal Transformer Co., Inc.....	Cover III
Electro Switch Corp.....	126	Spectronics, Incorporated.....	118
Electronic Design.....	142	Spirig-Signalarm.....	133, 134
Elinco.....	132	Sprague Electric Company.....	36
Elmwood Sensors, Inc.....	35	ST-Semicon, Inc.....	135
Energy Electronic Products.....	135	Statek Corp.....	134
Fasco Industries.....	81	Sundstrand Corporation.....	138
Ferroxcube Corporation.....	34	Superior Electric Company, The.....	94
Figaro Engineering, Inc.....	135	Sweda International OEM Products.....	89
Fluke Mfg. Co., Inc., John.....	27, 29	TDK Electronics.....	74
Frequency & Time Systems, Inc.....	134	TRW/IRC Resistors, an Electronic Components Division of TRW, Inc.....	134
GTE Automatic Electric Laboratories.....	137	Taylor Instrument Company.....	138
GTE Sylvania, Parts Division.....	33	Tektronix, Inc.....	39
Germanium Power Devices Corp.....	124, 125	Telonic Altair.....	127
Gold Book, The.....	*103, 134, 143	Texas Instruments, Incorporated, Digital Systems Division.....	12, 13
Gordos/Grigsby-Barton, Inc.....	123	Tracor Industrial Instruments.....	131
Gould Inc. Foil Div.....	89	Vactec, Inc.....	31
Gould, Inc. Power Supply Dept.....	75	Velonex.....	142
Hayden Book Company, Inc.....	128, 135, 141, 144	Wavetek San Diego, Inc.....	1
Haydon Switch & Instrument, Inc.....	66	Western Thermistor Corporation.....	134
Heinemann Electric Company.....	110		
Hewlett-Packard.....	44		
HICO Horizons International.....	123		
Hudson Tool & Die Co.....	97		
Hughes Aircraft Company.....	139		
Hutson Industries.....	129		
IMC Magnetics Corporation.....	116		
Intel Memory Systems.....	11		

*Advertisers in non-U.S. edition

The New 1977-1978 **GOLD BOOK** Has Just Been Published

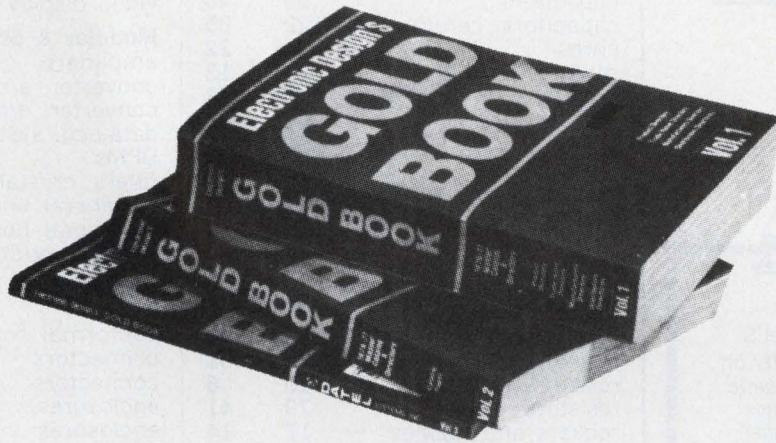

And Completely Outdates Last Year's Edition

If you are currently a subscriber on **ELECTRONIC DESIGN's** qualified circulation file, you need do nothing. You will receive your new **GOLD BOOK** automatically. If you wish additional copies for other members of your company, you may order them now using the convenient coupon form below.

If you are not currently an **ELECTRONIC DESIGN** subscriber on our controlled circulation list, you may order your own multi-section set of the new **GOLD BOOK** by completing the form below. Shipment will be made promptly on receipt of your payment or company purchase order.

**HERE IS WHAT YOU AND YOUR COMPANY
WILL FIND IN THE UPDATED 1977-78**

GOLD BOOK

- **Three sections** containing 2,496 pages of information to quickly locate products used by the electronics industry.
- **A Product Directory** with 5,434 product categories.
- **A Trade Name Directory** of 9,814 listings.
- **A Manufacturers' Directory** listing 8,057 companies in the electronics industry.
- **Two Distributors' Directories** with 2,050 distributors listed.
- **A Giant Compendium of Manufacturers' Data Pages** with specifications.

MAIL TODAY WITH PURCHASE ORDER

Electronic Design's **GOLD BOOK** 449R
Hayden Publishing Co., Inc.
P.O. Box 13803, Philadelphia, Pa. 19101 U.S.A.

Here is our purchase order for _____ sets of the 1977-1978 **GOLD BOOK** at \$30.00 per set—for U.S., Canada and Mexico. (All other countries: \$40.00 per set)

Check enclosed for \$_____. Bill us.

Name (Print) _____

Title _____

Company _____

Address _____

City/Province _____

State/Country _____

Zip or Postal Code No. _____

QUANTITIES ARE LIMITED. PLACE ORDER TODAY!

Available Now!

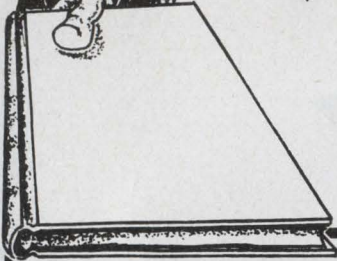

□ MICROPROCESSOR

BASICS, edited by Michael S. Elphick. Here's the nitty-gritty on design selected from *Electronic Design* for the eight currently popular microprocessors: 8080, 6800, F8, PACE, IMP, 2650, 1802, and 6100. Each chapter discusses one model, detailing its advantages, disadvantages, architecture, capabilities, and includes many illustrations of its applications. #5763-6 paper 224 pp., \$10.95

□ ORGANIZING AND DOCUMENTING DATA PROCESSING INFORMATION,

by Thomas R. Gildersleeve. Write sharp, precise DP documents that command attention. This book will show you how to... prepare a first draft... shape your sentences for reading ease... organize a document for quick study. Filled with examples of great DP writing and scores of exercises for practice. #5739-3 paper, 160 pp., \$7.95

Please send the book(s) checked on 15-day examination. At the end of that time, I will send payment, plus postage and handling, or return the book(s) and owe nothing. On all prepaid orders, publisher pays postage. Prices are subject to change without notice. Offer good in U.S.A. and Canada only.

NAME _____

COMPANY _____

ADDRESS _____

CITY _____

STATE/ZIP _____

Send to:

Hayden Book Company, Inc.
50 Essex Street, Rochelle Park
New Jersey 07662

#77-62

Product index

Information Retrieval Service. New Products, Evaluation Samples (ES), Design Aids (DA), Application Notes (AN), and New Literature (NL) in this issue are listed here with page and Reader Service numbers. Reader requests will be promptly processed by computer and mailed to the manufacturer within three days.

Category	Page	RSN	Category	Page	RSN
Components			memory, hard-disc	105	324
capacitors	32	24	printer	110	333
capacitors	36	25	system, kit	108	329
capacitors	95	48	video display	110	332
capacitors, ceramic	122	85	Modules & Subassemblies		
cores	34	22	amplifiers	102	57
motors	16	13	converter, a/d	100	55
motors	41	28	converter, d/a	116	339
motors	66	36	data-acq. system	114	303
motors	81	43	DPMs	144	103
motors	94	49	filters, crystal	114	72
motors	96	50	peripheral boards, I/O	107	63
motors	132	101	peripheral boards, I/O	109	66
motors, dc	123	87	snuffer, dv/dt	110	67
motors, dc	126	92	Packaging & Materials		
potentiometers	11	130	bus	57	34
relays	98	54	conformal coating	21	16
relays, solid-state	123	89	connectors	5	4
resistors	9	351	connectors	123	86
resistors	10	8	enclosures	106	62
resistors	79	41	enclosures	127	94
rockers and toggles	17	14	flat-cable connector	33	21
sensors	35	23	foils	89	46
servomotors, dc	131	99	interconnection systems	47	33
stepper motors	6	5	jumpers, PC-board	122	357
stepper motors	110	68	PC drafting aids	96	52
steppers and controls	116	75	plug and receptacle	42	28
switches	23	17	tool, DIP-insertion	122	356
switches	96	51	tubing	126	93
switches, lever	116	74	wire, cable & cord	119	400
switches, rotary	123	88	Power Sources		
transformers, chokes	113	231	batteries	130	97
trimmer	67	37	converter/charger	91	47
trimmers	79	40	power supplies	7	7
trimmers	113	71	power supplies	75	39
			power supplies	108	65
IC & Semiconductors					
converter, a/d	120	348	new literature		
FET, voltage-follower	118	345	ac and dc motors	128	381
op amp	118	344	components and systems	130	389
op amp, quad	118	342	connectors	130	388
optoisolators	120	349	custom LSI	130	391
rectifier, power	120	347	electronic hardware	130	390
transistor, power	118	343	emitters, lasers	129	386
transistor, power-switching	120	350	packaging equipment	128	385
			panels	129	383
Instrumentation			peripheral systems for μ Cs	130	392
ATE, DAS	18	15	potentiometers	128	376
C-meter	101	56	power amplifiers	128	375
counters	29	19	precious-metal powders	128	379
data generator	44	31	relays, solenoids	128	380
fault-locator, PC	99	307	terminals	128	378
frequency meter	131	100			
graphic unit	99	302	design aids		
instruments	108	64	ASCII code	126	369
oscilloscopes	39	26	conversion chart	126	374
pulse generator	1	2	density conversion	126	368
tape recorder, inst.	104	59	electrical fittings	126	372
tape recorder/reproducer	46	32	gases	126	370
voltmeter	27	18	photoelectric controls	126	371
			solid-state sensors	126	373
Micro/Mini Computing					
adapter, current-loop	106	327			
board, memory	108	330			
computer	110	334			
drafting system	108	331			
interface, calculator	105	322			
memory	106	328			

At signal, we transform custom problems into off-the-shelf solutions.

Next time your needs dictate a transformer design that looks like a sure candidate for a time-consuming, budget-busting "special," contact Signal. Chances are we make something very close if not exactly what you're looking for.

And if we catalog it, we stock it. And if we don't catalog it, we'll make it—and ship it pronto, too.

Signal's unique record of having transformers ready for designers when they need them is no accident. Our R&D department goes to great length to keep pace with new design trends so we can anticipate the needs of circuit designers and packagers.

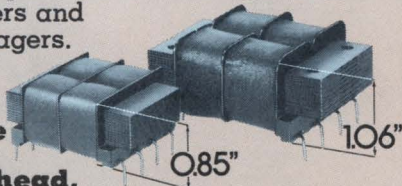

Take our Flathead,

for example. We were first in the industry to develop a "flat" power transformer for high density PC board packaging problems. Our 6 VA units are less than 0.85" high, while our 12 VA units require just 1.06" of headroom.

Need another example? How about 50% savings in weight, size and cost?

Our 2-4-1 series of small power transformers are unbeatable for applications from 2.4 to 100 VA. They use bobbin instead of layer winding to save 40-50% in winding space, and a special "split" bobbin we developed at Signal to eliminate inter-winding insulation and crossover of primary and secondary leads.

For further savings, we made the core out of grain-oriented steel instead of ordinary silicon steel. Result, 40% reduction in the number of required turns and additional weight and cost savings. Not bad.

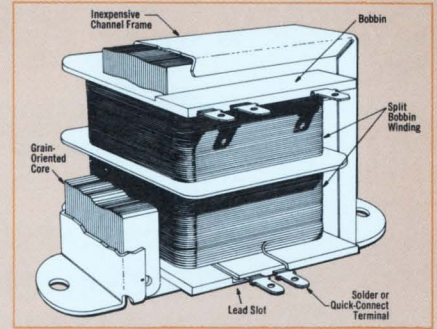

The biggest line, the fastest delivery.

Our complete catalog includes over 1,000 standard transformers and chokes, from 1 to 10,000 VA. All available from stock, with guaranteed shipment of at least four pieces within 48 hours. (Last year we had a 100% record of honoring that guarantee on more than 8,000 orders.)

And all at low, factory direct prices that are made even lower by our enormous volume.

We've moved and doubled the size of our plant and catalog, ask for your new copy today.

Signal Transformer Co., Inc.,
500 Bayview Ave., Inwood, N.Y.
11696, Tel. 516-239-7200

STOCK ROOM

signal

TRANSFORMER

CIRCLE NUMBER 231

ANOTHER PRONTO SHIPMENT FROM SIGNAL

RCA first in CMOS.

Full-temperature protection at low ceramic prices.

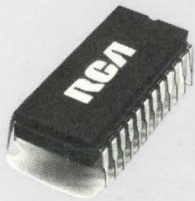

You can add the extra protection of full temperature operation to your B-Series CMOS designs. Without adding to your frit-seal costs.

How? With RCA's frit-seal ceramic package. It offers -55° to $+125^{\circ}\text{C}$ ratings at the same price levels other CMOS manufacturers are publishing for frit-seal product with limited temperature ratings.

What's more, RCA frit-seal ceramic COS/MOS-B is readily available. Most types are on your Distributor shelves. You can order it just by asking for suffix "F."

- **First in CMOS logic.** RCA created the industry standard 4000A-Series and has led the way ever since. And introduced the first high-voltage CMOS circuit.
- **First in CMOS microprocessors.** The RCA 1800 family combines elegant 8-bit COSMAC architecture with CMOS benefits. Result: outstanding performance plus maximum flexibility with minimum parts count.
- **200,000,000th unit.** RCA COS/MOS production capacity has doubled in the last six months and we expect to manufacture our 200,000,000th COS/MOS unit this year.

To fill your needs in CMOS, call your RCA Solid State distributor. Or contact RCA Solid State headquarters in Somerville, NJ; Sunbury-on-Thames, Middlesex, England; Quickborn 2085, W. Germany; Ste.-Anne-de-Bellevue, Quebec, Canada; Sao Paulo, Brazil; Tokyo, Japan.

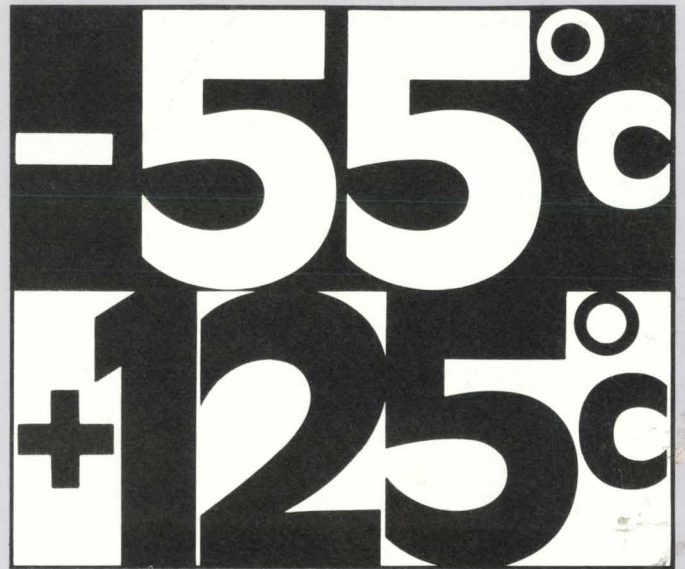

When you say CMOS, say RCA first.

RCA