

# electronics

(Photo at right)

## JAPANESE LOGIC BLOCK

*silicon twin  
NOR circuit, p 58*

## RANGE SIMULATOR

*checks out  
missile guidance  
systems, p 33*

## ENGINE TACHOMETER

*uses passive  
components, p 40*

## LIVE ANTENNA

*new technique  
measures  
admittance, p 50*

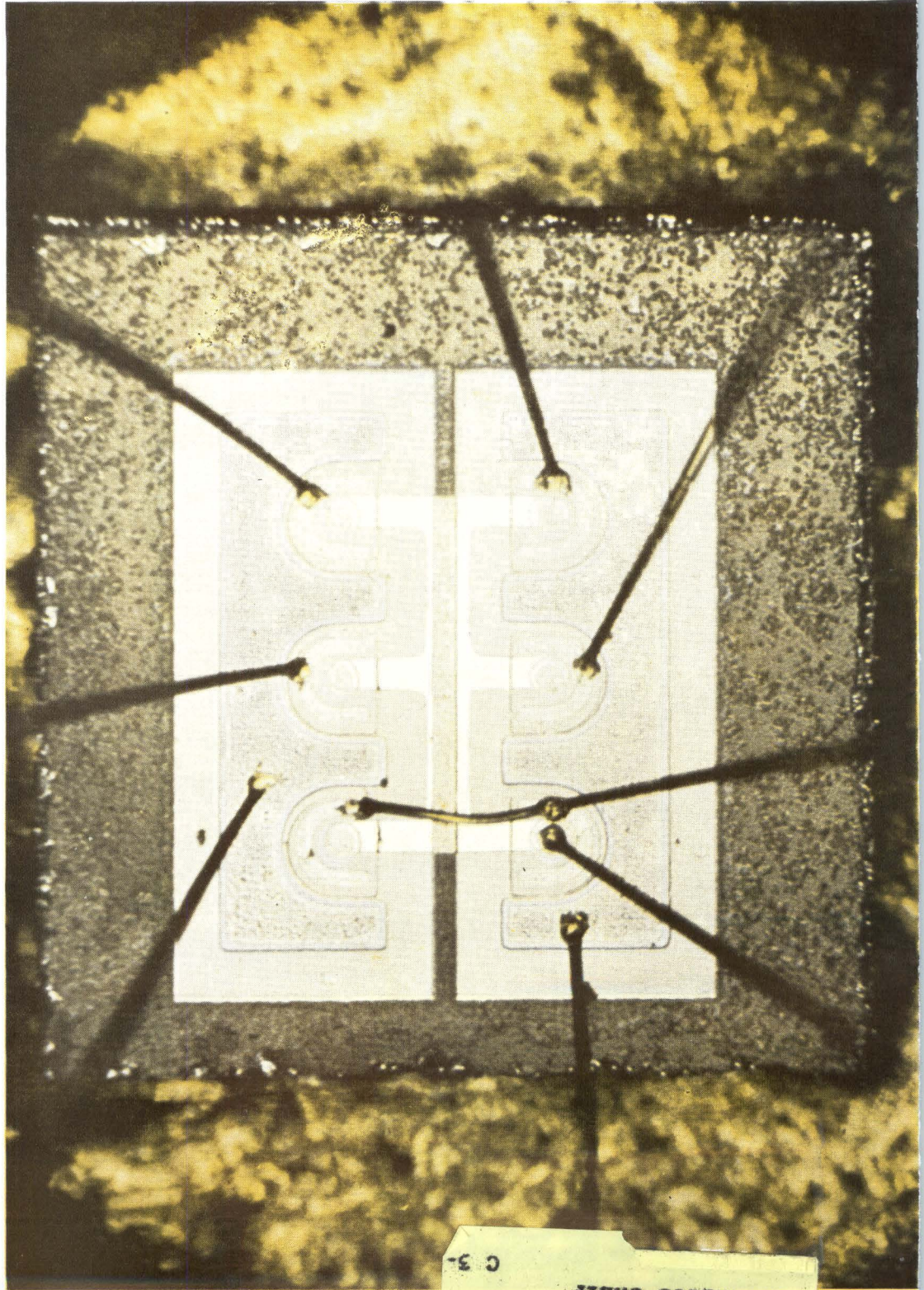

C 3-  
R D SKINNER  
1020 COVINGTON RD  
LOS ALTOS CALIF  
1



# Counter with Plug-ins

## $3/10^9$ /day stability



- Display storage for continuous readout
- Automatic decimal and units indication
- Frequency extender and time interval plug-ins
- BCD outputs
- 8 standard output frequencies
- Modular design—rack, stack or carry

### NEW PLUG-INS INCREASE VERSATILITY AND PERFORMANCE OF BASIC COUNTER

#### hp 5253A Frequency Converter

Increases the range of the 5243L Counter to 512 MC and retains counter accuracy. Plugs in directly and is extremely easy to operate. The stability and accuracy of the basic counter is retained because the converter uses a multiple of the 10 MC signal from the electronic counter to beat with the signal to be measured. So simple to use even non-technical personnel can make frequency measurements to 512 MC quickly and accurately. 5253A Frequency Converter, \$475.00.



#### hp 5262A Time Interval Unit

Converts the 5243L Counter into an accurate time interval counter with a resolution of 0.1 microsecond. Also can measure pulse length, pulse spacing and time between electrical events. Time is read directly on the counter with the units and decimal indicated. Also can be used as an amplitude discriminator for the counter. 5262A, \$300.00.

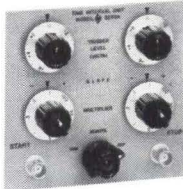

hp 5251A Frequency Converter, 20 to 100 MC and other plug-in units will soon be available to give the 5243L Counter even greater versatility.

Data subject to change without notice. Prices f.o.b. factory.

## SPECIFICATIONS

**Registration:** 8 digits in-line with rectangular Nixie tubes and display storage. Automatic decimal and units indication

**Input Sensitivity:** 100 mv rms, minimum

### FREQUENCY MEASUREMENTS

**Range:** 0 to 20 MC (100 to 512 MC with 5253A plug-in; 20 to 100 MC with 5251A plug-in)

**Gate Time:** 0.1  $\mu$ sec to 10 seconds in decade steps

**Reads-in:** KC or MC with positioned decimal point

**Accuracy:**  $\pm 1$  count  $\pm$  time base accuracy

### PERIOD AVERAGE MEASUREMENTS

**Range:** Single period, 0 to 1 MC; multiple period, 0 to 300 KC

**Reads-in:** Sec, msec,  $\mu$ sec, with positioned decimal point

**Accuracy:**  $\pm 1$  count  $\pm$  time base accuracy  $\pm$  trigger error/periods averaged

### TIME MEASUREMENTS

**Displays:** ( $f_1/f_2$ ) times period multiplier

**Range:**  $f_1$ , 0 to 20 MC;  $f_2$ , 0 to 1 MC in single period, 0 to 300 KC in multiple period; periods averaged 1 to  $10^9$  in decade steps

**Accuracy:**  $\pm 1$  count of  $f_1 \pm$  trigger error of  $f_2$  divided by number of periods averaged

**Scaling:** Factor, by decades up to  $10^5$ , 0 to 20 MC, switch selected on rear panel

**Time Base:** Internal time base frequency, 1 MC

Stability, aging rate less than  $\pm 2$  parts in  $10^5$ /week. Less than  $\pm 3$  parts in  $10^9$ /day

As a function of temperature, less than  $\pm 2$  parts in  $10^{10}$  per  $^{\circ}$ C from  $-20^{\circ}$ C to  $+55^{\circ}$ C

As a function of line voltage, less than  $\pm 5$  parts in  $10^{10}$  for  $\pm 10\%$  change in line voltage from 115 v rms

Short term, less than  $\pm 5$  parts in  $10^{10}$  peak-to-peak with measurement averaging time of one second under constant environmental and line voltage conditions

**Output Frequencies:** 0.1 cps to 10 MC in decade steps, switch selectable at rear panel

**Operating Temperature Range:**  $-20^{\circ}$ C to  $+65^{\circ}$ C

**Size:** 16 $\frac{3}{4}$ " wide x 5 $\frac{1}{4}$ " high x 16 $\frac{1}{2}$ " deep

**Weight:** Less than 40 lbs.

**Price:** \$2,950.00



## HEWLETT-PACKARD COMPANY

1501 Page Mill Road, Palo Alto, California, Area Code 415, DA 6-7000

Sales and service representatives in all principal areas;

Europe, Hewlett-Packard S.A., 54-54bis Route des Acacias, Geneva;

Canada, Hewlett-Packard (Canada) Ltd., 8270 Mayrand Street, Montreal

CIRCLE 900 READERS SERVICE CARD



# NEW hp 5243L Solid State Counter to 500 MC and $\pm$

- All solid state
- Just 5¼" high with plug-ins
- $\pm 3/10^9$ /day,  $\pm 5/10^{10}$ /short term stability
- 0.1 v sensitivity
- $-20^\circ\text{C}$  to  $+65^\circ\text{C}$  operating range
- Remote programming



New  $\text{hp}$  5243L Electronic Counter measures frequency, period, multiple period average, ratio, and multiples of ratio. Unprecedented accuracy is attained through new proportional oven-controlled crystal time base with stability of  $\pm 3$  parts in  $10^9$ /day.

The basic counter without plug-ins offers a maximum counting rate greater than 20 MC, with 8 digit resolution. Plug-in units insert directly into the 5¼" high modular cabinet and extend frequency measurements to greater than 500 MC. Completely solid state, the counter weighs less than 40 pounds with plug-in and can be carried easily in one hand.

Full display storage permits a continuous display of the most recent measured quantity, even while counting. The display changes only if the measured count changes thus permitting faster sample rates. Sample rate is adjustable and is independent of gate time. New, close-spaced rectangular Nixies reduce the 8

digit line length to an easy-to-scan 6", while preserving full digit size.

#### Built-in features of the 5243L include:

Remote programmability of the time base and function controls.

BCD output for printer, systems use.

Display storage that gives a continuous read-out and allows faster sampling.

Multiple period average to  $10^5$  periods for highly accurate low frequency measurements.

Operating temperature range from  $-20^\circ\text{C}$  to  $+65^\circ\text{C}$  for high accuracy under mobile, remote, or extreme environmental conditions.

Signal scaling 0 to 20 MC by decade factors up to  $10^8$ .

8 switch-controlled standard outputs with time base stability, for local standard applications.

Space-saving modular design that racks in 5¼", stacks on your bench, gives full access to removable etched circuit boards.



# Makes more measurements with greater accuracy than any other counter available today. New *hp* 5243L Electronic Counter

Actual size

HEWLETT  PACKARD

24192.119 KC

5243L ELECTRONIC COUNTER

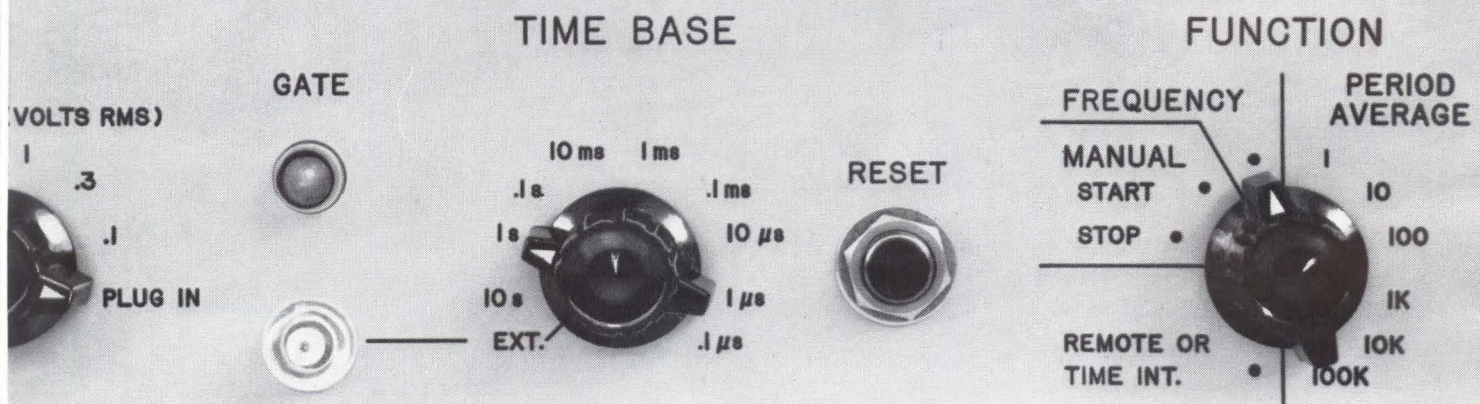

- Measures frequency, time interval, period, multiple period average, ratio, multiple ratio, scales by decades
- Stability: 3 parts in  $10^9$ /day; 5 parts in  $10^{10}$ /short term
- Measures to 500 MC with plug-in, to 20 MC directly
- Solid state, just 5 1/4" high including plug-ins
- Full storage display on easy-reading, close-spaced Nixies



*TURN PAGE FOR DETAILS*



# electronics

A McGraw-Hill Publication 75 Cents



W. W. MacDONALD, Editor

**J. M. CARROLL**, Managing Editor  
 SENIOR EDITORS: Samuel Weber, George W. Sideris. SENIOR ASSOCIATE EDITOR: Michael F. Wolff. ASSOCIATE EDITORS: Michael F. Tomaino, Sylvester P. Carter, William P. O'Brien, John F. Mason, Thomas Emma, Sy Vogel, Leslie Solomon, George J. Flynn, Laurence D. Shergalis. ASSISTANT EDITORS: Nilo Lindgren, Stanley Froud, Stephen B. Gray, Roy J. Bruun, George V. Novatny, Leon H. Dulberger. REGIONAL EDITORS: Harold C. Hood (Pacific Coast, Los Angeles), Thomas Maguire (New England, Boston), Cletus M. Wiley (Midwest, Chicago). ART DIRECTOR: Harry Phillips; Howard R. Berry. PRODUCTION EDITOR: John C. Wright, Jr. EDITORIAL ASSISTANTS: Gloria J. Meurer, Bernice Duffy, Lorraine Rossi, Virginia T. Bastian, Lynn Emery, Bette H. Snyder, Rosemary Abbruzzese, Judy Haskins, Ann Mella, Lorraine Werner. FOREIGN NEWS BUREAU: Director, John Wilhelm, Alyne Elias. LONDON — John Shinn, Derek Barlow, Nicholas Landon. Bonn—Peter Forbath, Silke McQueen. Paris—Robert Farrell, Arthur Erikson. Milan—Marc A. Messina. Mexico City—Bruce Bendow. Rio de Janeiro—Leslie Warren. Moscow — Stewart Ramsey. Tokyo — Richard Halloran, Charles Cohen, John Yamaguchi.

**JAMES GIRDWOOD**, Publisher

**TWO 3-INPUT NOR CIRCUITS**, housed in a single TO-5 case, contain six individual transistors. *Units fabricated by Nippon Electric have cut-off of several hundred megacycles, can obtain clock speeds up to 4 Mc. See p 58* COVER

**PULSE DOPPLER RADAR** Gives Space Trackers New Capability. AN/FPS-16 is modified to determine velocity as well as range and other measurements conventionally made by monopulse radar. *Modifications are relatively inexpensive, can be applied to later versions of the radar* 20

**INFRARED-GENERATING DIODE** Transmits Television Over Modulated Light Beam. Gallium arsenide device is one of several advances reported. *Other researchers are exploiting plasma and ultrasonic phenomena in semiconductors* 24

**VENUS IN 1962? NASA** Gets Set to Launch Another Mariner. Instruments aboard spacecraft will gather scientific data. *The first attempt in the \$142-million program failed* 26

**QUADRUPLE DISH ANTENNA**. Unusual cloverleaf design gives it a bandwidth of 200 Mc to 2,300 Mc. *The array can be used for surveillance as well as communications* 28

**TARGET-RANGE SIMULATOR** Checks Missile Guidance Systems. Part of an automatic diagnostic center, this simulator provides test signals corresponding to either fixed or moving targets. *Tests assure reliable operation of complex weapons systems, minimize failure probability.*

By P. F. Gudenschwager and S. M. Vidulich,  
General Electric Co. 33

**NON-CUTOFF CIRCUITS** Improve Trigger Switching. Arranging a trigger circuit so that neither active element cuts off provides several important advantages. *For example, transistor burnout from base-to-emitter inverse voltage is avoided.*

By H. Inose, Y. Yoshida and H. Tada, University of Tokyo 36

**ENGINE TACHOMETER** Uses Passive Components. Applicable to any four-cycle engine, this device for measuring engine speed uses no transistors or power supply. *Circuit provides unusual reliability at low cost.*

By F. Trainor, Admiral Corp. 40

**DESIGNING TRANSISTOR OSCILLATORS** for Class C Service. Grounded collector Hartley oscillator is attractive in power and stable frequency circuits. *Technique predicts large signal behavior with high accuracy.*

By P. Laakmann, American District Telegraph Co. 42

**ELECTRONIC DIFFERENTIATOR** Has Low Noise Factor. Accurate differentiation in analog computers is beset by transient, saturation and noise difficulties. *New configuration using extra operational amplifier provides at least two-to-one noise improvement.* By N. D. Diamantides, Goodyear Aircraft Corp. 46

Contents continued



Published weekly, with Electronics Buyers' Guide and Reference issue, as part of the subscription, by McGraw-Hill Publishing Company, Inc. Founder: James H. McGraw (1860-1948).

Indexed Annually in Buyers' Guide and Reference issue.

Title ® registered U.S. Patent Office; © copyright 1962 by McGraw-Hill Publishing Co., Inc. All rights reserved, including the right to reproduce the contents of this publication, in whole or in part.

Executive, editorial, circulation and advertising offices McGraw-Hill Building, 330 West 42nd Street, New York 36, N. Y. Telephone Longacre 4-3000. Teletype TWX N.Y. 1-1636. Cable McGrawhill, N. Y. PRINTED IN ALBANY, N. Y.; second class postage paid at Albany, N. Y.

OFFICERS OF THE PUBLICATIONS DIVISION: Nelson L. Bond, President; Shelton Fisher, Wallace F. Traendly, Senior Vice Presidents; John R. Callahan, Vice President and Editorial Director; Joseph H. Allen, Vice President and Director of Advertising Sales; A. R. Venezian, Vice President and Circulation Coordinator; Daniel F. Crowley, Vice President and Controller.

OFFICERS OF THE CORPORATION: Donald C. McGraw, President; Hugh J. Kelly, Harry L. Waddell, Executive Vice Presidents; L. Keith Goodrich, Executive Vice President and Treasurer; John J. Cooke, Vice President and Secretary.

Subscriptions are solicited only from those actively engaged in the field of the publication. Position and company connection must be indicated on orders. Subscription rates: United States and Possessions, \$6.00 one year; \$9.00 two years; \$12.00 three years. Canada, \$10.00 one year. All other countries \$20.00 one year. Single Copies, United States and Possessions and Canada 75¢. Single copies all other countries \$1.50.

THE PUBLISHER, UPON WRITTEN REQUEST FROM ANY SUBSCRIBER TO OUR NEW YORK OFFICE, AGREES TO REFUND THAT PART OF THE SUBSCRIPTION PRICE APPLYING TO COPIES NOT YET MAILED.

Subscribers: Please address all correspondence, change of address notices, subscription orders or complaints to Fulfillment Manager, Electronics, at above address. Change of address notices should provide old as well as new address, including postal zone number if any. If possible, attach address label from recent issue. Allow one month for change to become effective.

Postmaster: Please send Form 3579 to Fulfillment Manager, Electronics, 330 West 42nd Street, New York 36, New York.



Audited Paid Circulation

CONTENTS continued

CONSTANT CURRENT REGULATOR for Testing Relays. In production testing, variations in relay coil parameters require frequent adjustments in test current. *Uniform current is assured by dynamic resistance compensation provided by this transistor circuit.* By D. H. Lien, Western Electric 48

ANTENNA BRIDGE MEASUREMENTS: A New Approach. Ambiguity in null discrimination occurs when making bridge measurements on large-aperture antennas in strong ambient fields. *Standing wave indicator replaces headphones, increases sensitivity and selectivity of tuning.* By W. P. Czerwinski, USASRD 50

DEPARTMENTS

Crosstalk. <i>Standardization and the IEEE</i>	3
Comment. <i>Mechanical Engineers in Electronics</i>	4
Electronics Newsletter. <i>New Family of Rectifiers Are Reversible</i>	7
Washington Outlook. <i>Defense Department Will Cut Overseas Electronics Procurement</i>	12
Meetings Ahead. <i>National Conference on Vehicular Communications</i>	30
Research and Development. <i>Industrial Engines Get Breakerless Ignition</i>	52
Components and Materials. <i>Logic Blocks Offer Design Flexibility</i>	58
Production Techniques. <i>Gas Process Coats Wire with Superconductor</i>	62
New Products Design and Application. <i>Unusual Oscillator Generates Direct F-M</i>	66
Literature of the Week	77
People and Plants. <i>STL Opens \$30-Million Space Center</i>	78
Index to Advertisers	87



## Standardization and the IEEE

STANDARDIZATION is an important activity of both the IRE and AIEE. It has both professional and commercial overtones, inasmuch as use of such standards for measurements, definitions and symbols may be required by both military and industrial contracts.

Within both societies, standards are proposed by technical committees. In both cases these committees are appointed by the president. Both have standards committees to approve proposed standards.

But here the similarity stops.

The AIEE standards committee reviews largely from an administrative point of view, while the IRE standards committee sometimes undertakes major revision during the review procedure.

Publication practices, too, differ for the two societies. The IRE publishes new standards in its Proceedings, and makes additional copies available at nominal cost. The AIEE publishes standards in pamphlet form, sells them to members for \$1.50, and to nonmembers for \$3.00.

How will standards be handled in the IEEE? Several proposals were made during premerger discussions.

It has been suggested that a Standards Committee be constituted as one of the standing committees of the new society. This was not detailed in the merger agreement or in the draft constitution. The special 14-man implementation committee that will actually merge the two societies has broad powers, however.

We urge the committee to use these powers to quickly establish a Standards Committee.

It has also been suggested that the Standards Committee operate along the lines of the AIEE Standards Committee. The presently functioning Joint Standards Committee of the IRE and the AIEE sets such a pattern.

Some observers have voiced fears that there would be too little opportunity under such a setup for the high-level detailed work now done by the IRE Standards Committee, and that the quality of IEEE standards might suffer as a result. To counter these fears, it has been suggested that chairman of society technical committees be

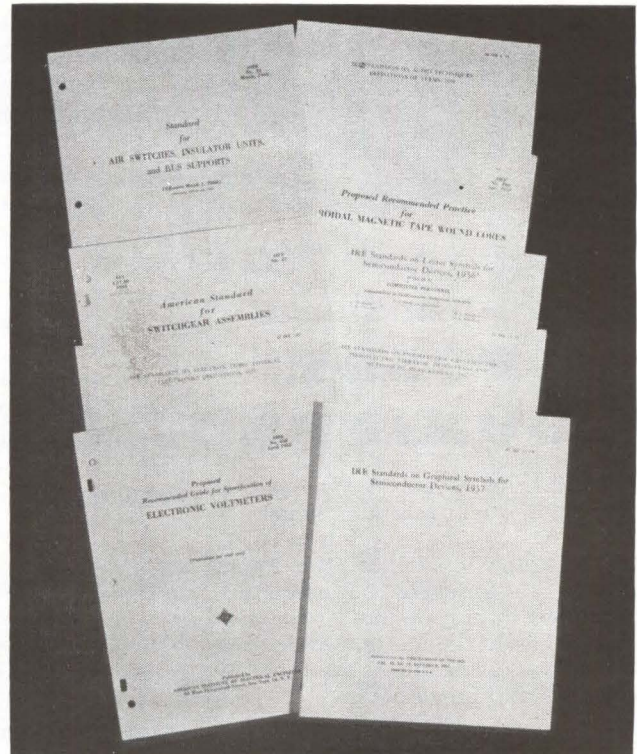

named as liaison representatives to the Standards Committee, and participate in meetings of that Committee. This system is presently used by the JSC.

### Coming In Our August 3 Issue

**PRACTICALITY.** Solid-state display panels are becoming more and more useful as designers press for improvements in resolution and contrast and simpler construction techniques. Next week, a trio of authors from General Telephone and Electronics Labs tell how they improved electroluminescent panels by using nonlinear resistors.

Another report next week gives details of a practical way developed at Bendix to stop transistor failures in magnetic deflection circuits. Also on tap: two articles from Japan, on how varactors may be used to eliminate distortion in klystrons and how to build practical tunnel-diode logic circuits, an English technique for pulse-length discriminators and a report on a new Sola Electric power supply.



Something  
**NEW**  
in counting  
techniques!

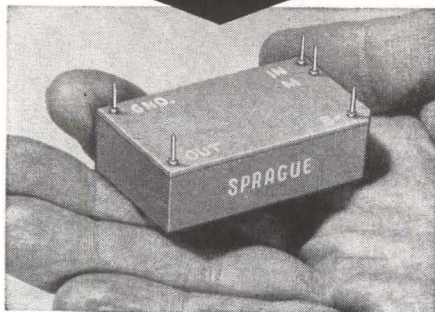

## Sprague type 73Z1 core-transistor **DECADE COUNTERS**

Here is a simple yet versatile, low-cost yet reliable component for counter applications. Counting to speeds of 10 kc, the 73Z1 decade counter provides an output signal for every 10 input pulses, then resets in preparation for the next cycle. For higher counting, two or more counters may be cascaded. Typical characteristics are shown below.

CHARACTERISTIC	INPUT	OUTPUT
Amplitude	1.5 to 8 volts	6.5 volts
Pulse Width	1 $\mu$ sec min.	35 $\mu$ sec
Impedance	100 ohms	20 ohms

Utilizing two rectangular hysteresis loop magnetic cores and two junction transistors to perform the counting operation, the 73Z1 counter is encapsulated in epoxy resin for protection against adverse environmental conditions. It has five terminals —B+ (12v  $\pm$ 10%), input, output, ground, and manual reset.

The 73Z1 counter is available as a standard item. However, "customer engineered" designs can be supplied when other counting cycles, speeds, and package configurations are required for special applications.

For complete technical data or application assistance on the 73Z1 counter or other Sprague components, write to Special Products Division, Sprague Electric Co., 35 Marshall St., North Adams, Mass.

**SPRAGUE**<sup>®</sup>  
THE MARK OF RELIABILITY

4S-301

4 CIRCLE 4 ON READER SERVICE CARD

## COMMENT

### Mechanical Engineers in Electronics

Being a new subscriber to *ELECTRONICS*, and a 15-year subscriber to *Aviation Week*, I find *ELECTRONICS* very informative to an old aircraft engineer. I am in full agreement with the intent of your *Crosstalk* article, What Shortage, in the June 8 issue (p 3).

You mention the truly creative engineer who is well grounded in theory and the technician who can convert a schematic into a breadboard that works, convert it to chassis, handle testing and debugging. But what happened to the electronic packaging engineer? If the electronic engineer is to concern himself with theory and circuits, and the technician is to assemble breadboards, who is to take care of the myriad mechanical problems involved, especially in airborne and space-travelling equipment? Not the technician, but the mechanical (electronic packaging) engineer, backed by the thermodynamicist, the human-factors engineer, the stress engineer, the weight engineer, ad infinitum. The mechanical engineer can handle many of the back-up engineering functions except in critical specialized areas, such as thermal transfer analysis, critical vibration analysis, etc.

The time has come to quit glamorizing the electronic engineer, as the aeronautical engineer was glamorized 25 to 30 years ago, and let it be known that he cannot operate alone. He needs other types of engineers to back him up.

As an old aircraft structure design engineer, converting to an electronic packaging engineer, I feel that an injustice has been done by *Crosstalk* to the many mechanical engineers employed in the electronics industry.

P. J. GRANDE  
Burbank, California

The references to the duties of electronics engineers and electronics technicians were given only as examples, and there was no intention of casting aspersions on the work of engineers other

than electronics engineers. As a matter of fact, the editor who wrote that *Crosstalk* article has degrees in mechanical engineering and physics, and has written a book on mechanical design for electronics production. He says he is well aware of the important contributions that mechanical engineers make in our industry.

### Ultrasound

Your article on page 24 of the June 29 issue, *Medical Researchers Explore Advances in Ultrasonic Diagnosis and Cancer Treatment*, by Cletus M. Wiley, has brought me up to date in the field of ultrasound in medicine. Your article was exceptionally rewarding to read, since my work in medical electronics has been investigating the concept of matching transducers to the brain for study of the waves as a function of the feedback from the human source.

I would appreciate finding out how I could receive the transactions of the symposium on ultrasound in biology and medicine.

THEODORE E. POSCH  
Marine Corps Air Station  
Cherry Point, North Carolina

The University of Illinois, which sponsored the symposium jointly with the Office of Naval Research, made tape recordings of the papers as they were presented and plans to publish a volume of the proceedings next spring. In charge of arrangements is Mrs. Melva Ponton, 212 Biophysical Research Lab., University of Illinois, Urbana, Illinois.

### Transposed Symbols

In the June 1 *Components and Materials* article, *Extending Range Of Controlled Rectifiers*, the symbols on the graphs appearing on page 74 became transposed. In each case, the dot-dash-dot symbol should refer to "normal" while the dash-dash-dash symbol should be "with integrated input circuit."

WARREN R. DAVIDSON  
Transitron Electronic Corporation  
Wakefield, Massachusetts

electronics



# TUNG-SOL HIGH PERFORMANCE

GENERAL PURPOSE  
MINIATURE COMPUTER TRIODE

## 7719

Directly replaces parallel-connected 5965 and 7062 twin-triodes while providing these added advantages for designers of computer circuits:

- Higher transconductance
- Very sharp cut-off
- Much higher plate dissipation
- Linear transfer characteristics
- Very high perveance
- Improved reliability

The Tung-Sol 9-pin miniature 7719 general purpose triode is the latest addition to the Tung-Sol family of top-rated, high-reliability tubes for computer service. Rated at 6 watts plate dissipation, the 7719 incorporates many design and construction features which assure computer users the maximum number of hours of trouble-free peak performance.

### CHECK THESE ADDITIONAL BENEFITS:

- Freedom from cathode interface and reduced electrical leakage . . . Achieved through use of a passive cathode alloy and lower heater power per unit area.
- Minimization of grid emission . . . The 7719 is designed with heavy grid support wire and a double connection to the grid for cooler operation allowing use of 1 megohm grid circuit resistance.
- High stability . . . Use of heavier stock plate material assures more even distribution of heat and lower plate temperature. Cool operation further guaranteed by cool cathode and low bulb temperature (175°C at 6 watt dissipation).
- Very little "island" formation . . . Optimized geometry minimizes island formation thereby providing sharp cut-off, linearity and high perveance.

**Typical applications** of the 7719 are found in totem pole amplifiers to drive function-generating potentiometers, cathode followers, and multivibrators. Full technical details on the 7719 are available immediately on request.

### RATINGS

Heater Voltage (Series)	12.6 ± 0.6	Volts
Heater Voltage (Parallel)	6.3 ± 0.3	Volts
Maximum Plate Voltage	390	Volts
Maximum Plate Dissipation	6.0	Watts
Maximum DC Cathode Current	40	Ma.
Maximum Heater-Cathode Voltage:		
Heater Negative With Respect to Cathode		
Total DC and Peak	200	Volts
Heater Positive With Respect to Cathode,		
DC	100	Volts
Total DC and Peak	200	Volts
Maximum Bulb Temperature	175	°C

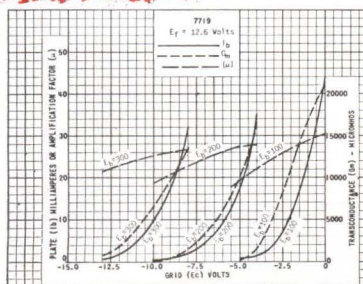

**ts TUNG-SOL®**

Technical assistance is available through: Atlanta, Ga.; Columbus, Ohio; Culver City, Calif.; Dallas, Texas; Denver, Colo.; Detroit, Mich.; Irvington, N. J.; Melrose Park, Ill.; Newark, N. J.; Philadelphia, Pa.; Seattle, Wash. In CANADA: Abbey Electronics, Toronto, Ont.





Today's Highest Precision in  
Power Sources, Power Measurement

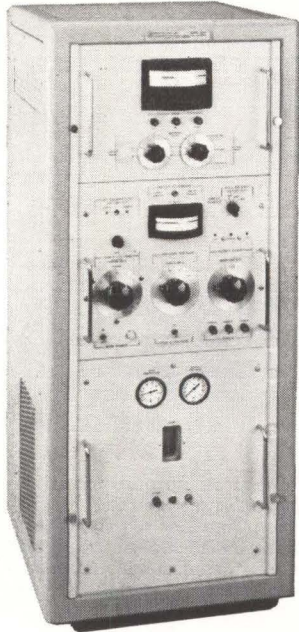

### SIERRA MODEL 290C

#### Calorimetric Test Set

Accuracy: 1% limit of error, 30-1000 watts or 2-3% error 10-1500 watts

Frequency range: DC to 12.4 GC

Null balance mode for accuracy

Direct-reading mode for speed

Differential mode for convenience

Price: \$4,500.00

Dual water loads available for use with Model 290B

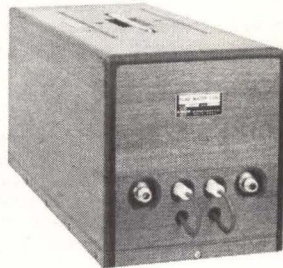

Model	Frequency	Max. VSWR	Price
286B	dc-4 GC	1.25	\$1600.00
287A-C	5.8-8.2 GC	1.10	1600.00
287A-XB	7.0-10.0 GC	1.10	1550.00
287A-X	8.2-12.4 GC	1.10	1500.00

### MODEL 190A CALORIMETER

with associated accessories, constitutes another power measuring system available from Sierra. Ranges 300, 600, 1500, 3000 watts max., water loads available for dc to 12.4 GC. Model 190A, \$860.00

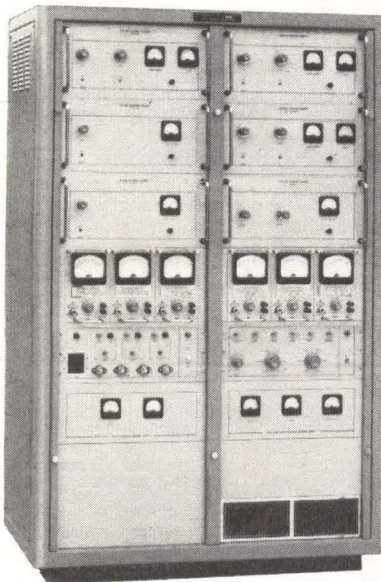

### SIERRA MODEL 1223

#### RF Calibration Test Set

Calibrates power measuring devices to 1% accuracy (probable accuracy 0.5%).

Includes six power sources, six power monitors (i.e., transfer standards), power and frequency selector, and associated units.

Frequencies: 30, 100, 300, 400, 500, 1300 MC

Power ranges: Six ranges for 30 to 500 MC (5, 15, 30, 60, 100, 125 watts)

Four ranges at 1300 MC (5, 15, 30, 60 watts)

Price: \$15,000.00

### SIERRA MODEL 215A

#### VHF-UHF Power Sources

Output continuously adjustable 10% to 100% of maximum

Frequency dial accuracy:  $\pm 2\%$

Reset accuracy: 0.1%

Modulation: External sine or square wave

Frequency stability:  $\pm 0.05\%$

Power output: 50 w nominal, 35 w minimum

Price: \$3,300.00



**PHILCO**  
A SUBSIDIARY OF *Ford Motor Company*



### SIERRA ELECTRONIC DIV.

7697A BOHANNON DRIVE, MENLO PARK, CALIF.  
Phone, Area Code 415, 326-2060

Model	Frequency Range
215A-50	25-50 MC
215A-150	50-150 MC
215A-470	150-470 MC
215A-1000	470-1000 MC



# ELECTRONICS NEWSLETTER

## New Family of Rectifiers Are Reversible

REVERSIBLE RECTIFICATION is provided by a new family of semiconductor devices reported by J. O. Kessler, of RCA Laboratories, at the solid state conference in Durham, N. H. (for other reports, see p 24). Called flexodes, they have highly diffusive dopants which drift and form junctions when electrical fields are applied.

When a flexode, normally a resistor, is warmed by d-c, it becomes a rectifier with forward direction corresponding to the easy flow of the applied current. If the current is reversed, it reverts to a resistor, then becomes a rectifier in the opposite direction. The cycle is repeatable, Kessler said, and signals below breakdown do not affect such switching.

Spontaneous back resistance decay can be halted by intermittent application of current in the appropriate direction or by cooling. Flexodes with decay rates ranging from no change during one month at room temperature to 50 percent in a few minutes have been made. Germanium-base materials and lithium dopes are being used at present.

Among applications suggested by Kessler were adaptive devices whose functions can be changed after installation in circuits, tailor-made devices and, for information systems, multicontact, monolithic learning elements.

## Japanese Negotiate to Produce U. S. Computers

TOKYO—Technical licensing agreements between Nippon Electric Co. and Minneapolis-Honeywell, for manufacture of the U. S. company's computers by the Japanese firm, have been completed. Nippon Electric's contract calls for a minimum royalty payment of \$1.5 million, with five percent of sales as licensing fees.

(Minneapolis-Honeywell announced in the U. S. that both firms will have access to each other's data processing technology.)

Negotiations to manufacture large computers are likely to be concluded soon between Toshiba and GE, and Hitachi and RCA. Toshiba

stated they switched to GE from Sperry Rand because of a disagreement over control of Remington Univac of Japan. Toshiba had wanted to control the joint-venture firm by holding 70 percent of the company stock, split half and half between Toshiba and Mitsui Ampesand Co.

## Germany Begins Building Telstar Ground Station

BONN—The Post Office's Central Communications Division is beginning construction of Germany's first satellite communications transmitting and receiving station, at Raisting, Upper Bavaria.

It will have three revolving antennas. Results with the first, a modified horn 80 feet in diameter, will determine design of the other two. When completed, the station will use two antennas simultaneously for smooth tracking transition from a satellite going below one horizon to a satellite ap-

pearing on the opposite horizon.

The station will transmit on present Telstar tv frequencies. Each antenna will carry 12 tv and 60 telephone channels. Cost is about \$6 million, of which \$2 million will be spent in the U. S. for hydraulic and antenna control systems.

## Congressmen Uphold Navy In Contract Controversy

WASHINGTON—The House Armed Services Committee investigations subcommittee has concluded that the Navy was justified in awarding a production contract to Collins Radio Co. for production of 641 uhf AN/PRC-41 radio sets without seeking competition from other sources (p 7, July 6).

The subcommittee accepted the Navy's claim that urgent need for the radio equipment made it necessary to award the production contract to Collins, which had handled R&D on the project. But it criticized the Navy's policy of withholding specifications for the equipment from competing electronics firms.

## NEMA Is Creating Power Supply Section

NEW YORK—National Electrical Manufacturers Association will organize a new section for electronic power supply manufacturers at a meeting August 23 at the Statler

## Can Nuclear Explosions Melt Cables?

CONCERN SEEMS to be mounting in industry over the possibility of communications, control and power wires being melted by the effects of electromagnetic pulses created by nuclear explosions. The pulses are understood to travel considerable distances.

Some sources believe that current induced in wire by high-yield explosions may have enough amplitude to induce peak currents beyond the carrying capacities of wires and cables normally used. Underground cables might not be immune.

The generation of current pulses in power lines has been observed during ordinary chemical explosions. It is possible that nuclear explosions result in a high-power extension of the same generating principle.

Transients and other effects on electronic equipment are also created by blast radiation. Those hazards have been documented (see, for example, ELECTRONICS, p 62, Feb. 10, 1961; p 40 July 22, 1960, and p 81, Dec. 4, 1959) and are being given increasing attention by component and equipment designers



Hilton Hotel, Los Angeles, during WESCON.

B. H. Falk, secretary of NEMA's Industrial Electronics and Communications division, said that to date 16 manufacturers indicated they will attend. Falk said the new section is being established because of the increasing importance of electronic power supplies, now approaching \$100 million in total sales.

The section is to develop cooperatively statistical and marketing data, standards, definitions, specifications and other common interests.

## Univac Reports 62 Orders For Large New Computer

WHITPAIN TOWNSHIP, PA.—Univac now has orders for 62 of its new large-scale computer, the Univac III, it was announced at a demonstration of the system last week at the Univac Engineering Center. Twenty-two are overseas orders.

First delivery will be to U. S. Steel, Pittsburgh, next month. Fourteen systems are in production for 1962 delivery. Production will be stepped up to four a month in January. Average monthly rental is \$22,000.

Main features of the system are an executive program that allows concurrent programming of several operations, self-generated inputs by peripheral equipment and high processing speeds, such as magnetic tape transfer rate of 200,000 digits a second and memory cycle time of 4  $\mu$ sec.

## Large Core Memories Hit Microsecond Rate

IBM THIS WEEK announced the development of two large core memories that achieve operating rates below a microsecond. One, containing 1,024 72-bit words operates at a rate of 0.7  $\mu$ sec. The other, to contain 16,384 words, has attained a rate of 0.75  $\mu$ sec in tests. Access times are between 0.55 and 0.6  $\mu$ sec.

The smaller memory is operational. The larger one is a full-scale engineering model being used in studies to further advance computer technology. Both are asynchronous core storage units.

Three key techniques are: selec-

tion of cores by single selection rather than by coordinates, partial core switching and the use of new, fast-recovery diodes and magnetic switches in selection, IBM said.

## Soviets Claim Infrared Photography of the Moon

VIENNA—Soviet astronomer N. F. Kuprevich has reportedly made some 20 infrared photographs of the moon by "probing the lunar surface with infrared beams" and using a special "television semiconductor tube" and film.

The photos were made on "white nights" at sunrise and showed details not available in photos made with visible light, reported *Trud*, a Soviet paper. An improved tv telescope is being built.

## Whirlpool of Coolant May Cut Megawatt Tube Sizes

MENLO PARK, CALIF.—Significant size reductions in superpower microwave tubes may result from advanced research into cooling techniques initiated at Stanford Research-Institute for Rome Air Force Base.

One technique being investigated is the use of a boiling coolant to which a helical or vortex motion is imparted as it passes through the cooling system.

L. Feinstein, director of the newly formed Electronic Materials Laboratory, says the method can dissipate power densities up to 6 Kw/cm<sup>2</sup>. This would allow megawatt-range tube elements to be reduced in size by a factor of two or three, he said.

## Tube to Use Extended Interaction Structure

AIR FORCE has awarded Eitel-McCullough a \$1.3-million study contract for the design and development of a new superpower microwave tube. Contract objective is a tube capable of delivering continuously one megawatt of average power at frequencies over 8 Gc. Design will be based on the extended interaction structure proposed by M. Chodorow and T. Wessel-Berg, of Stanford University.

## In Brief . . .

SONAR TRANSPONDER beacons, at the ocean bottom, will be used by Mobile Atlantic Range System ships for positioning. Beacons will be made by Bendix.

S. G. S. FAIRCHILD CO., owned by Fairchild Semiconductor and S. G. S., of Italy, will start making planar and epitaxial silicon transistors in Britain this year.

REPUBLIC AVIATION will develop a nuclear, magnetic induction gyroscope (p 20, Feb. 16) under a Navy contract.

PRAVDA reports that construction will begin soon on the USSR's first magneto-hydrodynamic power plant. Power output is to be in the tens of megawatts.

NAVY has awarded RCA Great Britain Ltd. a \$2-million contract for a U. S. radar station at Thurso, Scotland.

MAJOR MISSILE awards include \$39 million more to Boeing for Minuteman, \$21 million to General Dynamics for continued R&D on Mauler, and \$3 million to Sperry Gyroscope to update Talos radar receivers.

PACKARD-BELL has a \$1-million Navy contract for equipment to be used by early warning planes to interrogate unidentified planes. Melabs reports a \$4.5-million Air Force contract for portable reconnaissance systems.

DOPPLER navigation system contracts include an estimated \$5.5 million to LFE Electronics for AN/APN-131's and \$830,983 to Ryan Electronics for AN/APN-130's and parts.

HAZELTINE has a \$4 million order for AN/APS-95 airborne early-warning radar.

PRODUCTION contracts totalling more than \$7 million have been awarded Hoffman Electronics by Navy for Tacan test sets, sonobuoys and radio transmitters.

NASA HAS ORDERED a Honeywell 800 and two Honeywell 400 computers, costing \$2 million.



**Proven from Sprague!**

# HIGH SPEED

## SILICON CHOPPER TRANSISTORS

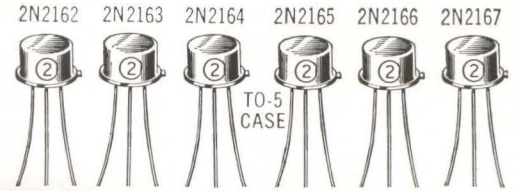

Sprague Surface Precision Alloy Transistors are especially designed for low-level chopper applications. Their specifications have been tailored to meet your actual circuit requirements. Compare these standard Sprague units with ordinary alloy devices for the following characteristics:

- Low Offset Voltage
- Low Output Capacitance
- High Frequency Response
- Low Dynamic Resistance
- Low  $I_{CBO}$
- Matched Pairs Available

TYPE	Min. $V_{CBO}$ (Volts)	Max. $I_{CBO}$ ( $\mu a$ )	Max. $V_{EC}$ (mv)	Min. $h_{FE}$	Max. $C_{OB}$ (pf)	Min. $f_T$ (mc)
2N2162	30	.01	2	20 at 1 kc	10	14
2N2163	15	.01	2	20 at 1 kc	10	14
2N2164	12	.02	1.5	25 at 1 kc	10	24
2N2165	30	.02	3	2.5 at 4 mc	10	10
2N2166	15	.02	3	2.5 at 4 mc	10	10
2N2167	12	.02	2.5	4 at 4 mc	10	16

For application engineering assistance without obligation, write Transistor Division, Product Marketing Section, Sprague Electric Co., Concord, N. H.

For complete technical data, write Technical Literature Section, Sprague Electric Company, 35 Marshall Street, North Adams, Massachusetts.

### SPRAGUE COMPONENTS

TRANSISTORS  
CAPACITORS  
MAGNETIC COMPONENTS  
RESISTORS  
MICROCIRCUITS

INTERFERENCE FILTERS  
PULSE TRANSFORMERS  
PIEZOELECTRIC CERAMICS  
PULSE-FORMING NETWORKS  
TOROIDAL INDUCTORS

HIGH TEMPERATURE MAGNET WIRE  
CERAMIC-BASE PRINTED NETWORKS  
PACKAGED COMPONENT ASSEMBLIES  
FUNCTIONAL DIGITAL CIRCUITS  
ELECTRIC WAVE FILTERS



\*Sprague and (S) are registered trademarks of the Sprague Electric Co.

48-388CR3



Of interest to engineers and scientists

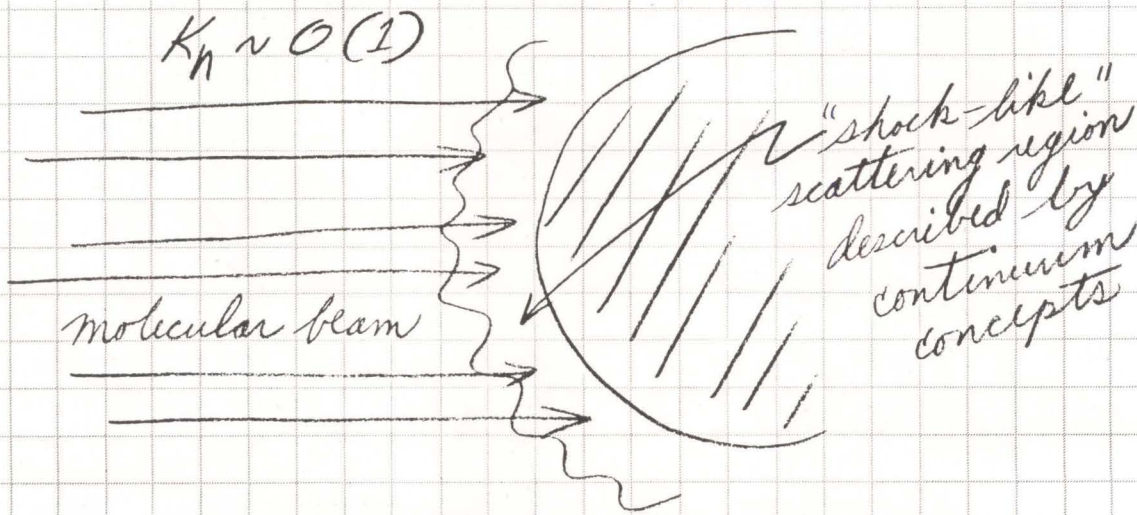

## RAREFIED GASDYNAMICS

...one of more than 500 R & D programs under way at Douglas

In this study, Douglas scientists and engineers are investigating phenomena in the transition region between extremely rarefied and continuum regimes of hypersonic flow.

Included are programs for studying the basis for a two-fluid rarefied flow theory; aerodynamic characteristics of selected configurations in hypersonic rarefied flow; initial establishment of flow fields about objects entering the atmosphere; and the dynamics of vapor generated by the sublimation of the surface of simple shapes in a low density atmosphere.

A "two-fluid" flow model has been successful in aiding the description of shock wave structure and drag coefficients in low density flows.

### Of career interest to engineers and scientists

Expanded Douglas participation in major U.S. missile and space programs has created a stim-

ulating environment in which you can further your career. Sponsors of these projects are Air Force, Army, Navy, NASA, commercial sources, and Douglas. Work areas range from pure research, through applied research, development, manufacture and test of complete systems. Every major engineering and scientific discipline relating to aerospace is involved.

Send us your resume or fill out and mail the coupon. Within 15 days from the receipt of your letter we will send you specific information on opportunities in *your* field at Douglas.

Mr. F. V. Edmonds  
Missile and Space Systems Division  
Douglas Aircraft Company  
3000 Ocean Park Boulevard  
Santa Monica, California

F-5

Please send me full information on professional opportunities in my field at Douglas.

Name \_\_\_\_\_  
Engineering or scientific field \_\_\_\_\_  
Address \_\_\_\_\_  
City \_\_\_\_\_ State \_\_\_\_\_



**MISSILE & SPACE SYSTEMS DIVISION**

An equal opportunity employer



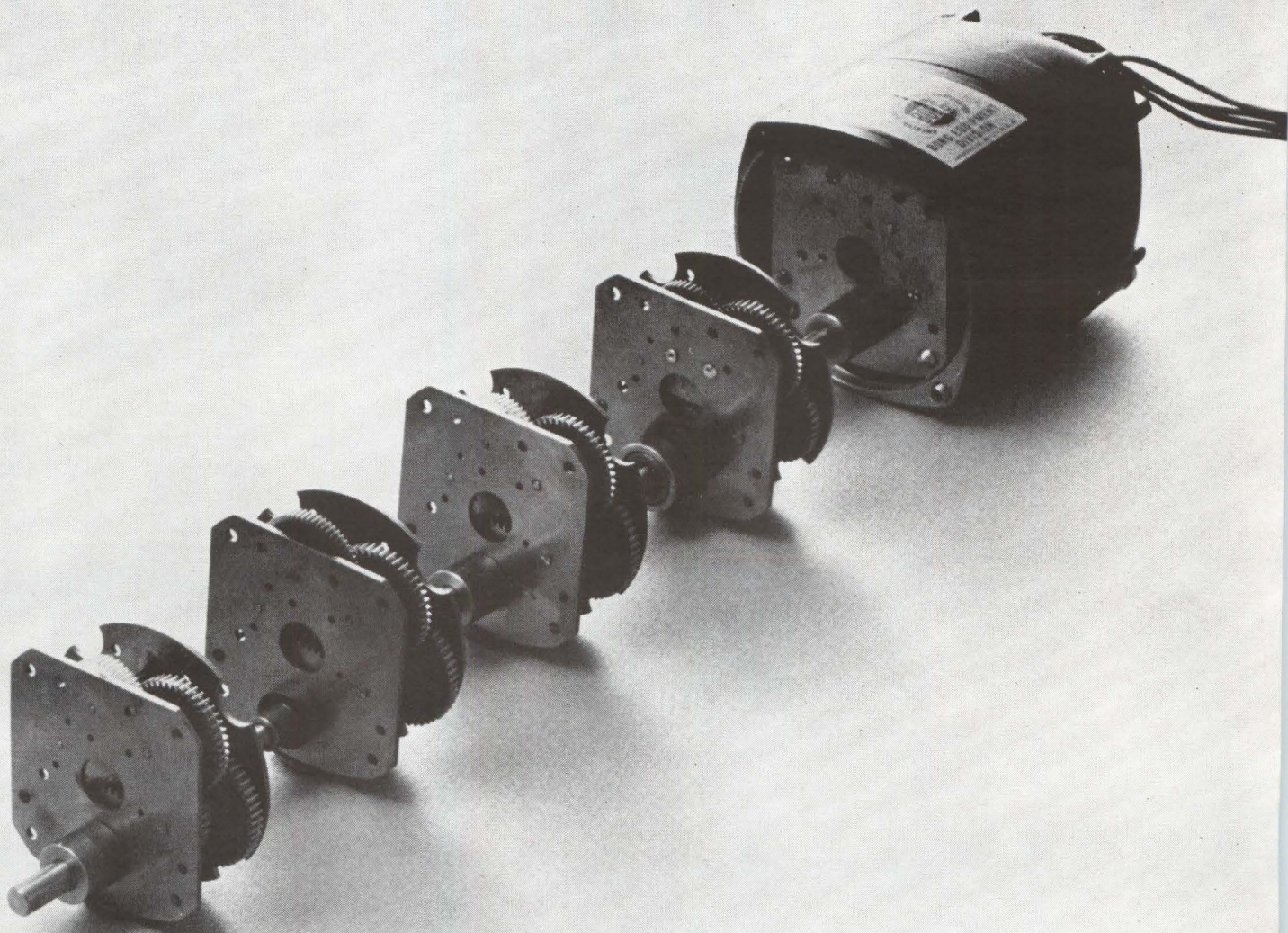

## Why Borg motors let you shift gears

Because you can save money by stocking fewer motors.

Take the new sub-fhp 1060 series\*, for example. You stock one model and several interchangeable gear trains. As the torque requirements of your equipment change, you simply select the appropriate gear train to vary the output speed, gaining the needed torque rating. By stocking spare gear trains—instead of extra motors—you use less shelf space, you save on inventory.

There's more to Borg motors than gear-train versatility and economy. Synchronous, induction, and low-inertia types are available. Their torque speed relationships meet the exacting requirements of instrument and control applications. And you can depend on a Borg motor to outlast any other—it's designed and built for maximum severity service.

Anticipating the problematical, Borg motors offer minimum temperature

rise to counter heat dissipation problems, optional high-speed shaft extensions, special outboard bushings, special length and diameter shafts for gear boxes—and even special paint colors to match your equipment.

If you are snagged by a sub-fhp motor problem, the man to see is your nearby Borg technical representative or Amphenol-Borg Industrial Distributor. Or, if you prefer, write R. K. Johnson, Sales Manager:

*\*The new Borg 1060 series are sub-fhp, four-pole, induction type control motors featuring low-inertia, high-resistance, squirrel-cage rotors.*



**BORG EQUIPMENT DIVISION**  
Amphenol-Borg Electronics Corporation,  
Janesville, Wisconsin.

CIRCLE 11 ON READER SERVICE CARD



# WASHINGTON OUTLOOK

## OVERSEAS ELECTRONICS BUYING TO BE CUT

DEFENSE SECRETARY MCNAMARA'S new drive to slash the Pentagon's share of the U.S. balance of payments deficit—from \$2 billion last year to \$1 billion in three years—will mean a sharp reduction in the growing rate of overseas electronics purchases.

Electronics figures prominently in total procurement overseas of major equipment for U.S. forces. This was scheduled to rise from \$43.8 million last year to \$57.5 million this year. Purchases of materials, supplies and contractual services, involving some electronics, was expected to total \$1.2 billion this year.

McNamara's office will review all proposed new contracts and determine whether foreign procurement is "in the national interest" when foreign producers underprice domestic bids despite the Buy American price differential.

On goods for use abroad, the Buy American percentage is being boosted from 25 to 50 percent. The price differential favoring domestic bids on purchases for delivery in the U.S. is unchanged—six percent, with 12 percent for small businesses and firms in labor surplus areas.

## MILITARY ASSISTANCE PROGRAM CUTS, TOO

OFFSHORE PROCUREMENT under the Military Assistance Program is to be reduced at least 50 percent. Expenditures for this and the Mutual Weapons Development Program had been scheduled to increase from \$108 million last year to \$117.5 million this year, including electronics. Electronics has been playing a more important role in the weapons development program (ELECTRONICS, p 12, June 22). The big drive will be to halt new contracting. The size of this year's cut may be limited since the figures reflect shipments and R&D work on prior contracts.

Grant aid under the Military Assistance Program will not be affected by the new restrictions. These shipments of U.S.-made equipment to allies represent exports and are on the plus side of the balance of payments. Close to \$100 million worth of electronics and communications equipment is scheduled to be shipped to allies this year, mostly to replace obsolete equipment. This is slightly under last year's volume.

Electronic items on the latest military grant aid list: AN/GRC, SCR, VRC and PRC radio series, Navy-type transmitters, AN/TRC-4 and TRC-36 radio relays, AN/TRC-35 radio terminals, AN/TCC telephone terminals and AN/FPS-16 radar.

The U.S. has given its allies \$1.8 billion in military electronics and communication equipment in the last 12 years.

## WE HAVE AN ANTI-ICBM TOO, MR. K

KHRUSHCHEV'S CLAIM that the USSR has an anti-missile rocket that "hits a fly in outer space" does not impress experts in Washington. If U.S. experts have detailed knowledge of Soviet anti-ICBM systems, they are keeping mum, but they do feel that U.S. development in this field is on a par with or even superior to the Soviet's.

They assume Khrushchev meant capability of intercepting a single ICBM. The Army's Nike Zeus system proved it could do that last week, when it intercepted an Atlas nose cone fired from California to Kwajalein. The crucial point is whether an anti-ICBM system can cope with decoys or a salvo attack on a target. The administration doesn't think Nike—nor any Russian system—can do that yet. Nike's success is not likely to affect plans to hold up on production, but continue R&D.





## Amphenol Connectors + Intercon<sup>®</sup> prefabricated circuitry = the first full-scale interconnection service available to the electronics industry

Now one man can give you full-scale interconnection service. He's your Amphenol Sales Engineer.

Reason: he now offers Intercon prefabricated circuitry plus a complete line of Amphenol electrical connectors.

Let's say that you're responsible for the design of an airborne computer which will use micro-miniature components. By contacting an Amphenol Connector Division Sales Engineer, you can now expect these services:

1. You will be provided with recommendations for interconnecting components using weldable and solderable Intercon pre-fabricated circuitry. The Amphenol Sales Engineer will work with you in determining circuit layout, tailoring his recommendations to

your production facilities. He will supply prototype Intercon boards and continue to work with you through test and final approval.

2. If the individual modules are to be pluggable, he will also recommend methods to accomplish this. He may, for example, suggest Amphenol micro-miniature Wire-Form\* contacts and Strip Connectors\* for this purpose.

3. He will also make recommendations for inter-system connections. If your project involves cable harness assemblies, he will work with you in determining and recommending the best and most economical method, utilizing Amphenol's background in the design and manufacture of cable assemblies.

This new full-scale service means that you will be able to conserve time, avoid duplication of effort and be assured of uniform quality levels by dealing with one interconnection specialist rather than many.

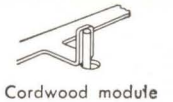
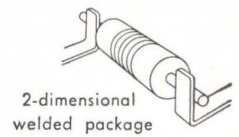
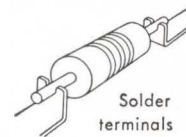

**Tabs make the difference.** Intercon's 3-D tabs allow maximum miniaturization with minimum monkey-business. Circuitry lifts up off the board, making terminations almost easy—especially helpful in multi-layer modules. And, because Intercon saves assembly time (up to 80% or more) costs go down, profits up.

\*T.M. Amphenol-Borg Electronics Corp.



**Connector Division / Amphenol-Borg Electronics Corporation**

CIRCLE 10 ON READER SERVICE CARD



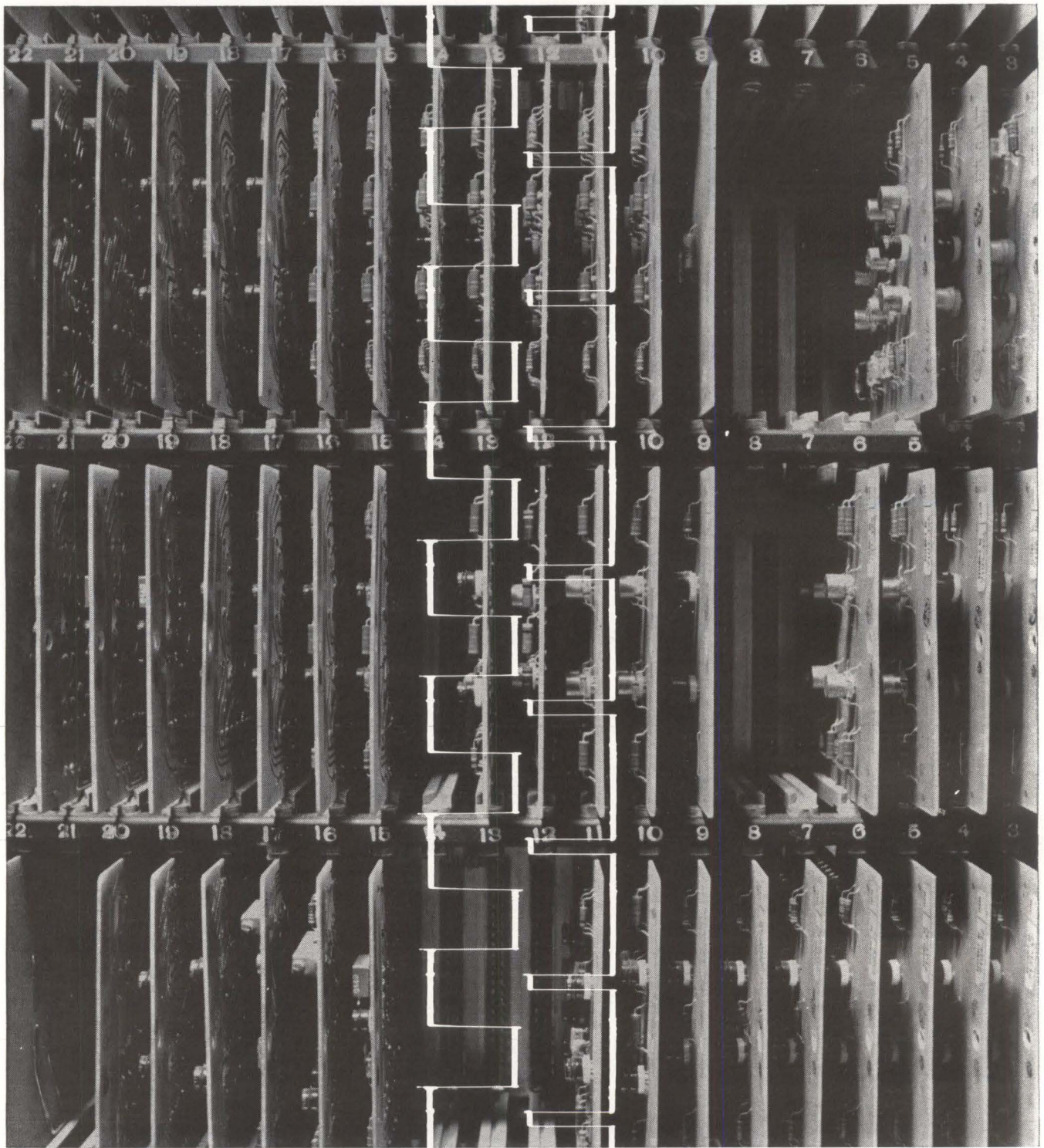

**Now: who has added electronics to the world's most advanced tape unit? AMPEX**

Get set to eliminate interface problems. And cut costs as well. The first Ampex complete tape memory system is here: the TM-4111. This new precision system wraps up an advanced tape transport and new solid state electronics—all in one package. It provides users and manufacturers alike with complete facility for reading, writing and checking digital data in computer formats. The electronics are compatible with the most widely used computers and are designed to operate at

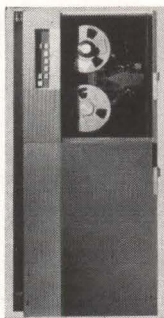

maximum densities up to 600 bpi. The transport provides the fastest start/stop times yet for a medium speed tape unit with special mechanisms to prevent tape abuse. Put the two together: You have a reliable, rugged, remarkably advanced tape memory system. For more data write the only company providing tape and recorders for every application: Ampex Corporation, 934 Charter St., Redwood City, California. Sales and service engineers throughout the U. S. and the world.



# URGENT:

## CLASS OF SERVICE

This is a fast message unless its deferred character is indicated by the proper symbol.

# WESTERN UNION TELEGRAM

W. P. MARSHALL, PRESIDENT

1201 (4-60)

## SYMBOLS

DL = Day Letter

NL = Night Letter

LT = International  
Letter Telegram

The filing time shown in the date line on domestic telegrams is LOCAL TIME at point of origin. Time of receipt is LOCAL TIME at point of destination.

2N1613 USERS WITH DELIVERY PROBLEMS..

¶ WE HAVE IN STOCK FOR IMMEDIATE DELIVERY SUFFICIENT QUANTITIES OF 2N1613 NPN SILICON PLANAR TRANSISTORS TO MEET YOUR URGENT REQUIREMENTS. THESE ARE HIGHEST-QUALITY UNITS, MANUFACTURED AT RAYTHEON/MOUNTAIN VIEW (FORMERLY RHEEM SEMICONDUCTOR), AND ARE AVAILABLE AT OUR REGULAR PRICES. RAYTHEON/RHEEM 2N1613 IS ALSO AVAILABLE PER MIL-S-19500/181 (USN).

¶ CALL OR WIRE SALES SERVICE DEPT. RAYTHEON COMPANY, 900 CHELMSFORD ST LOWELL, MASSACHUSETTS. TELEPHONE 452-8962 AREA CODE 617. TWX LWL 1781X=

THE COMPANY WILL APPRECIATE SUGGESTIONS FROM ITS PATRONS CONCERNING ITS SERVICE

**RAYTHEON**



## **Advertising and Industrial "R & D"...**

# **...An Ominous Contrast In Treatment**

**This year American industry will spend about \$12 billion for industrial research and development, more than half financed by the federal government.** This expenditure, continuing and expanding a tremendous boom in what has been called the industry of discovery, will spawn a veritable flood of new and better products, processes and equipment.

**This year American industry will spend about \$12 billion for advertising of all kinds.** This is roughly the same amount that industry will spend for research and development.

**Without a companion expenditure for advertising, the heavy expenditure for industrial research and development would be, in large part, useless.** Advertising provides a crucial link in the process in getting the results of most of the research and development in the form of new products, processes and

equipment to the companies and people who can make effective use of them.

### **How Advertising & R & D Team Up**

This creative relationship between industrial research and development and advertising has recently been stated by Neil H. Borden, Professor of Marketing in the Harvard University Business School, in this way:

"The pace at which new and improved products are introduced now is far beyond anything we knew in pre-war days. A growing, expanding technology is upon us. This is the era of industrial research. The likelihood of survival of a corporation today depends upon its efforts in research and development of new and improved products and processes . . .

"This increasing emphasis on new products tends to increase the importance of advertising and aggressive marketing in an economy such



as ours. Were industry to be curbed in its opportunity fully to exploit the new products which it is bringing to the market, the urge to develop the new would undoubtedly be decreased and the processes that bring about economic growth would be harmed.”

Of course, the selling role of advertising is by no means limited to the selling of the new products resulting from research and development. It plays a key part in finding the customers for and completing the sales of many long established products and services. But it remains true that it provides an absolutely essential link in the process required to give a large part of our expenditure for research and development practical usefulness.

### **An Ominous Contrast**

**In view of the Siamese-twin economic relationship between industrial research and development and advertising, one might expect to find a comparable attitude of encouragement toward the two lines of endeavor among the policymakers in our National Capital. But here, strangely enough, we encounter a dramatic and ominous contrast.**

**There is virtually universal approval and encouragement of research and development.** Ever increasing governmental appropriations for R & D go sailing through Congress with the greatest of ease. Federal appropriations for research and development have increased fourfold since 1955, topping \$10.5 billion in the fiscal year ending June 30, 1962.

The desirability of tax arrangements which encourage R & D by business firms finds no challenge. There was no opposition to that part of the 1954 revision of the tax code which permitted businessmen to treat R & D expenditures as expenses instead of charging them to their capital account.

Advertising, in contrast, is regarded as a

prime target for the imposition of legislative restrictions and financial burdens. The Washington outposts of the Advertising Federation of America have located in the legislative hopper at this session of Congress no less than 200 proposed bills which, if passed, would place burdens of one kind or another on advertising.

It is contended by some that advertising is in the Washington doghouse because bits of it are conspicuously trivial and also, on occasion, are offensive to high standards of taste and integrity. But the same thing can be said about research and development. It, too, has its sectors — happily limited, as are those of advertising — of triviality and phoniness.

### **Key Steps in Economic Growth**

**What, at root, seems to be the explanation of the differences in attitude toward research and development and toward advertising is a failure to see clearly that they are both essential elements in the same crucially important process of economic growth and expansion. Recognition of this basic economic fact in Washington, and the treatment of both R & D and advertising, accordingly, is a key element in the safeguarding of sustained prosperity in the U.S.A.**

**This message was prepared by my staff associates as part of our company-wide effort to report on major new developments in American business and industry. Permission is freely extended to newspapers, groups or individuals to quote or reprint all or part of the text.**

*Donald C. McGraw*

PRESIDENT

**McGRAW-HILL PUBLISHING COMPANY**



ACCURACIES TO  $\pm 0.01^\circ$   
 FREQUENCIES TO 200 KC  
 SELF CALIBRATING

**ACTON**

Laboratories, Inc.

*Precision Phase Standards*

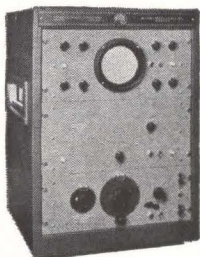

**TYPE 709-A BROADBAND PRECISION PHASE SHIFTER.** With any sine wave input from 20 cps to 20 kc, high stability 709-A supplies two sinusoidal voltage signals whose phase relationship is continuously variable with rotary dial from  $0^\circ$  to  $360^\circ$ ; accuracy,  $\pm 1^\circ$  with any input frequency from minimum rating to 10 kc;  $\pm 3^\circ$  above 10 kc.



**TYPE 7000-B AUDIO PRIMARY PHASE STANDARD.** For calibration of phase meters and phase shifting devices. Supplies two sinusoidal signals at any frequency from 30 cps to 20 kc, with phase relationship continuously variable from  $0^\circ$  to  $360^\circ$  within  $\pm 0.05^\circ$ . Ultimate possible accuracies to  $\pm 0.01^\circ$ . Multiple frequency units available.

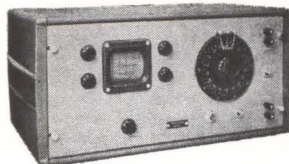

**TYPE 706-A ULTRA-SONIC PRIMARY PHASE STANDARD.** Self-calibrating unit generates two sinusoidal voltage signals with phase difference variable from  $0^\circ$  to  $360^\circ$ ; accuracy,  $\pm 0.1^\circ$  at any single frequency from 20 cps to 200 kc.

**TYPE 714-A PRECISION PHASE STANDARD.** Can utilize nominal 400 cps input signal ( $\pm 5\%$ ) to provide extremely precise ( $0.1^\circ$ ) two-phase outputs from  $0^\circ$  to  $180^\circ$  apart, in all multiples of  $30^\circ$ . Single rotary control selects desired phase angle. Special angles and frequencies can be provided.

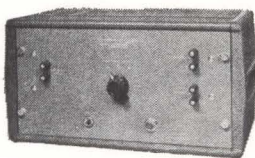

Acton Precision Phase Standards and Phase Shifters are definitive instruments. They are uniquely designed and manufactured to provide the modern laboratory with ultimate reliability as calibrating, measurement and reference devices. These instruments are available as shown or in special rack-mounting enclosures.

Many types of collateral equipment can be supplied for use with these basic instruments.

SEND FOR "PPS" DATA BROCHURE

**ACTON**

Laboratories, Inc.

533 MAIN STREET • ACTON, MASSACHUSETTS  
 A SUBSIDIARY OF BOWMAR INSTRUMENT CORPORATION

PRECISION PHASE METERS AND PHASE/VOLTMETERS, PRECISION PHASE STANDARDS, PRECISION DELAY MEASURING EQUIPMENT, PRECISION MECHANICAL COMPONENTS, ENVIRONMENTAL TESTING.

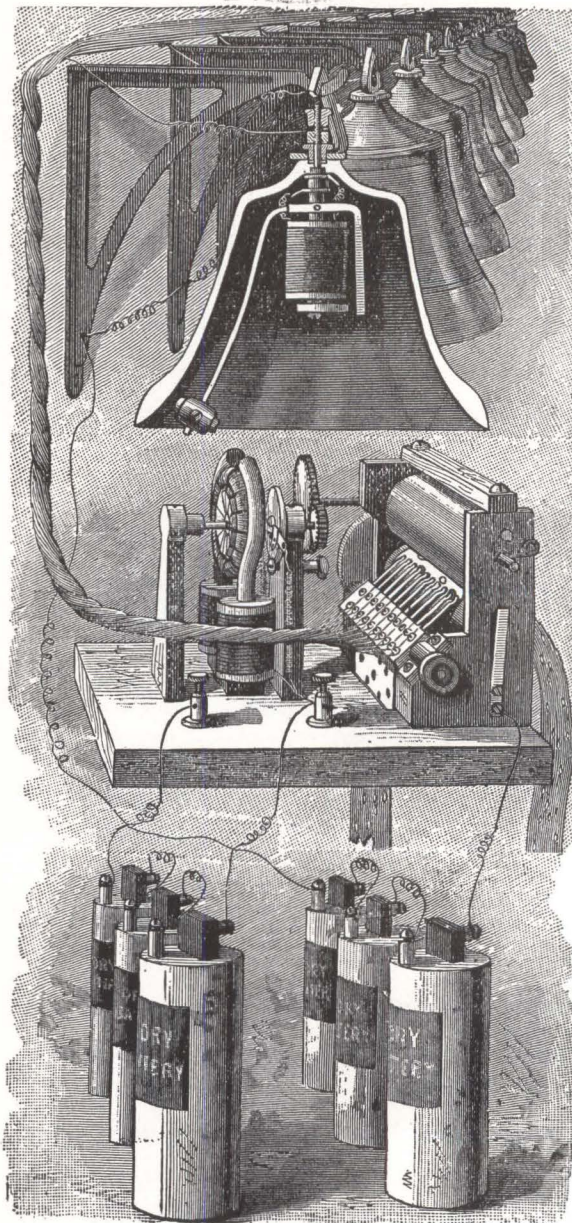

**Is it ancient history  
 by the time you see  
 electronics?**

Get the facts while they're new. Don't wait for **electronics** on a route slip. Look in this issue for the Reader Service Card. Fill out and mail the "for subscriptions" section. Only 71½ cents a week.

**electronics**

A McGraw-Hill Publication, 330 West 42nd St., N. Y. 36



Printed circuit by Mutual Electronics Div. of Robinson Technical Products, Inc.

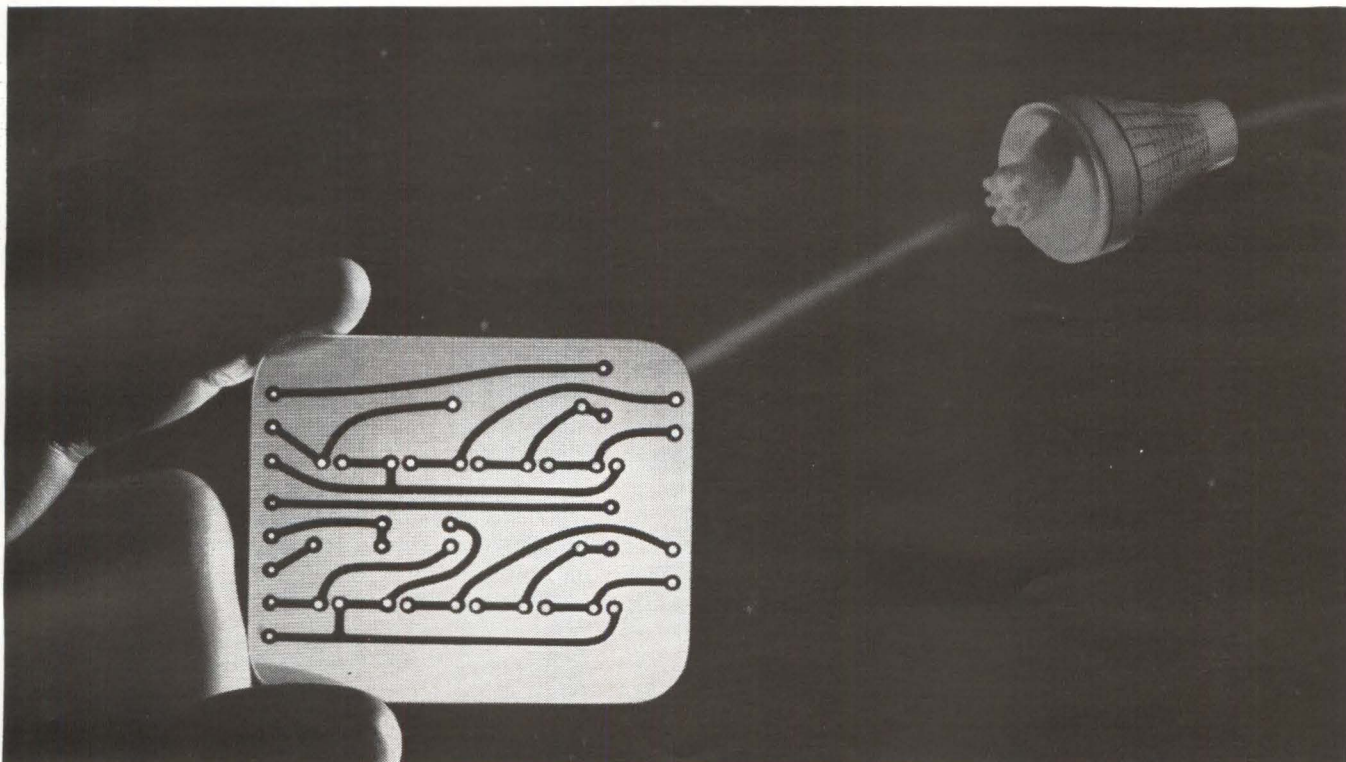

# SHIP IT TODAY USE IT TOMORROW ANYWHERE IN THE U.S.A WITH



*35<sup>th</sup> Anniversary  
1927-1962  
first and finest Air Shipping service*

Vital sub-assemblies and components, small or large, get where they're needed, when they're wanted—faster, surer, safer . . . prime reason to insist on using AIR EXPRESS. As a co-ordinated service of R E A Express and all 37 scheduled U. S. Airlines, this is the only shipping method with air priority everywhere in the U.S.A., Puerto Rico and Canada. On the ground, 13,000 R E A Express trucks give door-to-door service. All this costs you far less than you think. Example—5 lbs. travel 1,500 miles for only \$4.17. Pick up your phone. Call AIR EXPRESS. **CALL YOUR LOCAL R E A EXPRESS OFFICE FOR AIR EXPRESS SERVICE**







# Velocity Measuring Capability

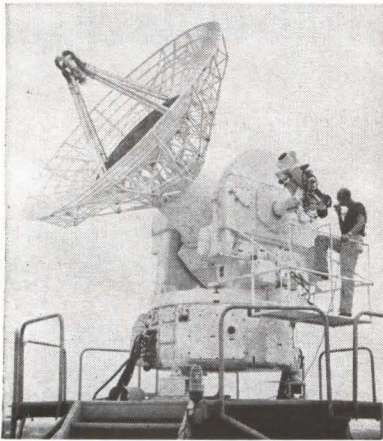

AN/FPS-16 radar is being used for space tracking

ing servo loops have not been affected.

In all, the changes consist of about a 10 percent addition to present equipment. The cost of these changes, it is said, would be far less than the cost of installing short baseline radar setups, which run in the neighborhood of \$20 million to \$25 million each.

Fifty or more FPS-16's are now in use. The "planned" radars shown on the map are those planned by RCA. The ranges have not yet let contracts for all the planned radars shown. The AMR ship, Twin Falls

Victory, and the PMR (Pacific Missile Range) ship, Range Tracker, are in operation. A second PMR ship is under firm contract to RCA. FPQ-6 and TPQ-18 radars, other than the Antigua setup, are being readied for delivery this summer and checkout this fall. It is estimated that a minimum of 10 to 15 additional radars would be needed to cover the equatorial belt if a worldwide system were developed.

**WORLDWIDE NETWORK** — Through time-sharing and triangulation techniques, velocity measurements of vehicles at planetary distances could be made with greater precision than with present short baseline systems because baselines would be of global dimensions. The earth tracking stations could be added or removed, possibly by pre-programming, as a target moved into or out of view. It would be necessary to synchronize very accurately the time base of these installations. This could be done through the use of measurements on a corner reflector satellite placed into a fairly circular orbit. There are some indications, RCA engineers said, that the Russians may have already carried out some such measurement program.

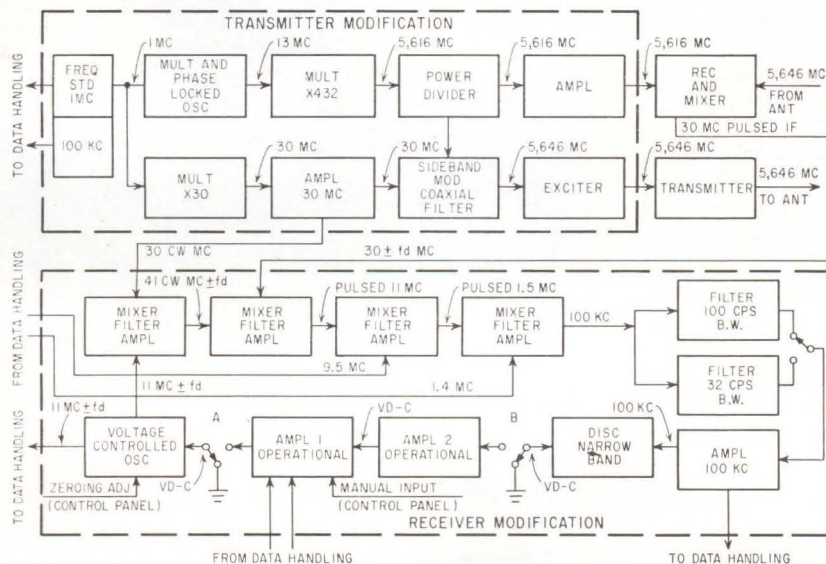

MODIFIED transmitter and receiver of the AN/FPS-16. Other modifications were made in the data-handling system

"Nothing is impossible to diligence and skill"  
Samuel Johnson

These are the trademarks of some of our customers—each an important contributor to a dramatically growing industry. We at Potter pledge our diligence and skills to this growth through a constantly expanding program of research and development.

## POTTER

PHD-1200...  
standardizes  
high-density  
recording

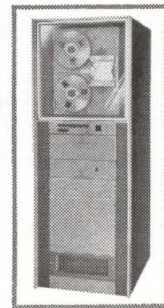

The Potter PHD-1200 solid-state recording system offers computer manufacturers the advantages of high-density recording in an economical standardized package.

The versatile PHD-1200 system is designed around the extremely reliable Potter M906 II Tape Transport. The standard high-density package incorporates a ten-channel dual R/P head, ten-channel read/write amplifiers (nine high-density channels, one block marker), deskewing buffer, manual controls and power supplies. All components are cabled and mounted in a precision transport rack cabinet.

A new brochure describes this system in detail. Simply request "The topic is HIGH DENSITY."



POTTER INSTRUMENT CO., INC.  
Sunnyside Boulevard • Plainview, New York

EUROPE BOUND?  
VISIT US AT Booth 28  
IFIP Interdata Exhibition  
in Munich, Germany  
August 26 to September 2



*Crystallizing Ideas  
Into Products*

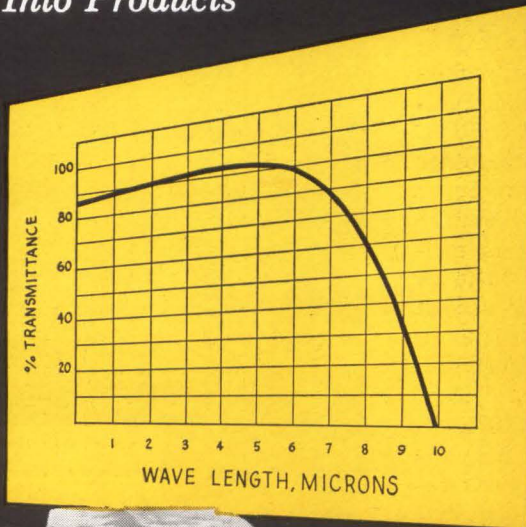

**MAGNORITE\***  
fused MgO crystals  
up to  $\frac{3}{4}$ "...  
for infrared transmission

Single, high purity crystals of Norton MAGNORITE fused magnesia are now available in developmental quantities, in sizes up to  $\frac{3}{4}$ ". Larger sizes, produced experimentally, are available in limited quantities.

The chart shows the infrared transmission characteristics of a 0.05" thick MAGNORITE crystal. Because of their refractoriness, the ability of the new Norton crystals to transmit such radiation at elevated temperatures is outstanding.

In addition, Norton techniques permit the introduction of impurities in controlled percentages, to alter electronic properties.

At present, there is a major interest in the use of doped MAGNORITE fused magnesia crystals for laser and maser applications. For further data write to NORTON COMPANY, Refractories Division, 686 New Bond Street, Worcester 6, Massachusetts.

\*Trade Mark Reg. U. S. Pat. Off. and Foreign Countries.



*Making better products... to make your products better*

22 CIRCLE 22 ON READER SERVICE CARD

# HIGHSPEED PARALLEL ANALOG/DIGITAL CONVERTER

## 10 REASONS TO SPECIFY MODEL AD-350

- Asynchronous
- 100 KC Sampling Rate
- 15  $\mu$ sec/word
- $\pm 0.5$  Bit Resolution
- 0.025% Accuracy
- 11 Bits (Including Sign)
- Highly Reliable
- Solid State Unit
- 100 Megohm Input Impedance (typ)
- No Conventional Sample & Hold Required

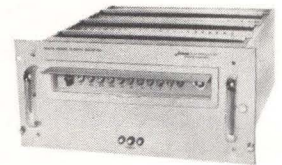

WRITE TO: *Interstate* ELECTRONICS CORPORATION

707 East Vermont Ave. • Anaheim, California • Phone 714-772-2222  
(A subsidiary of Interstate Engineering Corporation)  
NATIONWIDE REPRESENTATIVES

ANOTHER *Interstate* SOLID-*state* INSTRUMENT  
CIRCLE 200 ON READER SERVICE CARD



## How to grow a beard...

Sit back and wait for your copy on that routing list. Okay if you like beards. Otherwise, look in this issue for the Reader Service Card. Fill in the "for subscriptions" section. Mail. Only  $7\frac{1}{2}$  cents a week.

**electronics**

A McGraw-Hill Publication, 330 West 42nd St. N. Y. 36



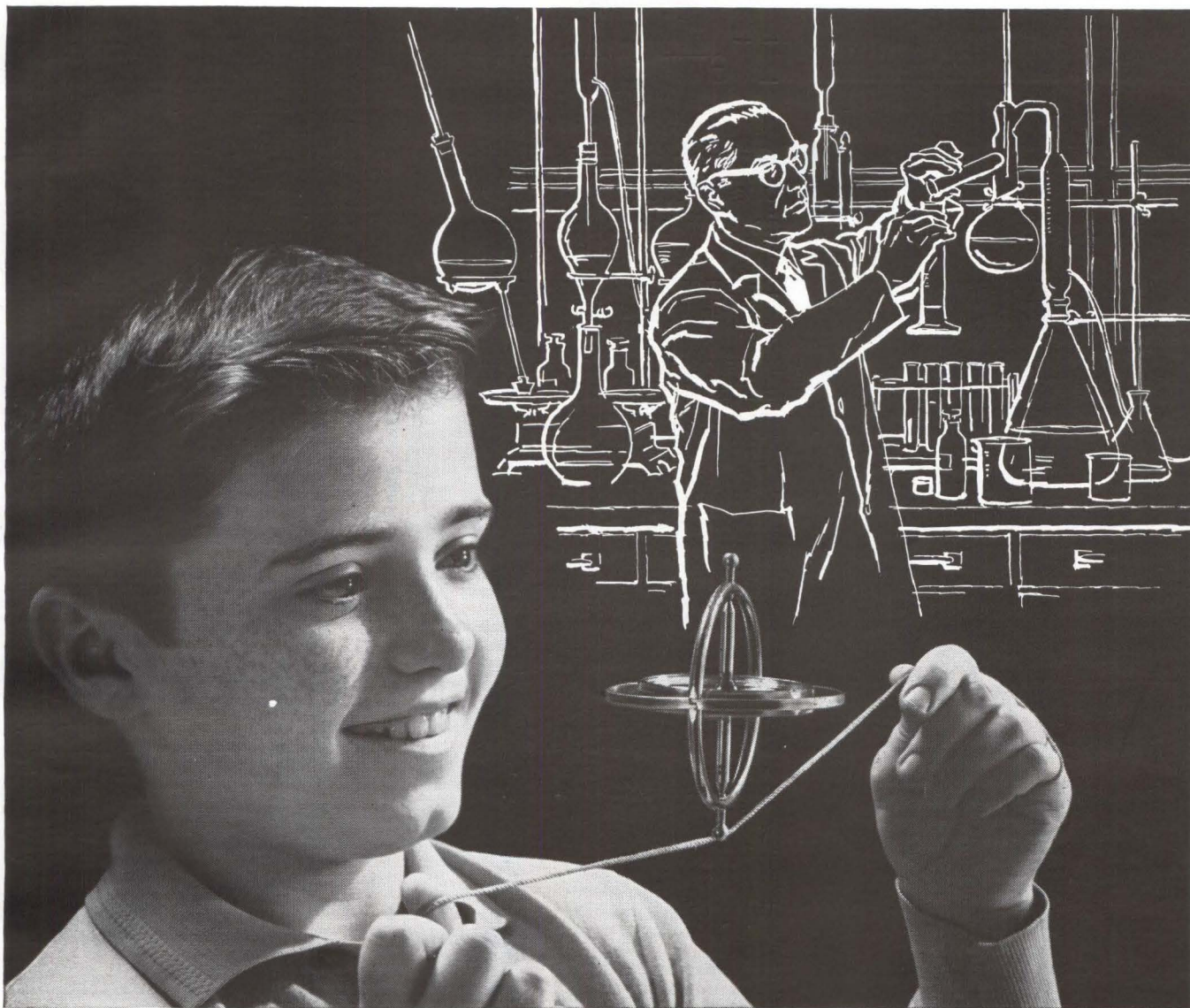

## The Future of Your Business

**MAY DEPEND UPON HIS EDUCATION**

The young mind which today discovers an old principle may someday reveal a new one capable of revolutionizing your business and creating undreamed of growth. But this is possible only if he gets the finest education we can offer.

By the time today's youngsters are ready for college, business and industrial technology will be even more complicated and will require many more trained specialists. To fill this order we must provide our young people with the best possible college educations.

Unfortunately many colleges are already overcrowded. In ten years applications are expected to double. We will need more and better college classrooms and libraries, more efficient college laboratories, and additional top-quality professors. *You can help assure your own future by helping the college of your choice.*

If you want to know what the college crisis means to you, write for a free booklet, "OPEN WIDE THE COLLEGE DOOR," to Higher Education, Box 36, Times Square Station, New York 36, N.Y.



Published as a public service  
in cooperation with The Advertising Council and  
the Council for Financial Aid to Education





# New Infrared-Generating Diode

*Gallium arsenide device  
one of several advances  
in solid-state research*

By THOMAS MAGUIRE  
New England Editor

DURHAM, N. H.—Optical communications through the plasma sheath surrounding reentering space vehicles and optical transmission of television are among potential applications that MIT sees for the zinc-diffused, gallium arsenide diodes recently developed at Lincoln Laboratory (ELECTRONICS, p 7, July 13).

The diodes convert modulated electrical input signals into a beam of modulated infrared light. MIT expects the diode to allow early realization of many applications proposed for optical masers, although the output of present diodes is not coherent.

In the first practical test, last May, the output beam of a diode was used to transmit tv 275 feet. The diodes are now being tested for space communications potential. They are expected to provide a new and improved exciter for optical maser action and there are indications the diode itself may be developed into a new type of optical maser.

A report on the diode was given by R. J. Keyes, codeveloper with T. M. Quist, at this month's 1962 Solid State Device Research Conference, held at the University of New Hampshire.

Other papers reflected extensive research in intermetallics, attempts to exploit plasma and ultrasonic phenomena in solid state devices, and increasing interest in heterojunctions.

OPTICAL TV—The MIT tv experiments were made with rudimentary optical equipment (see photos). Better equipment should increase range to 30 miles. However, to avoid weather interference, optical transmission would probably be at high altitudes, in space or indoors.

Peak beam power in the experi-

ment was 3 w. Larger diodes may yield 15 Kw. Output of the diode, at a temperature of 77 K, is concentrated in a spectral band 100 angstroms wide centered at 8,600 angstroms. Communications bandwidth is at least 100 Mc, enough for 20 tv or 20,000 voice channels.

Keyes said the GaAs diode emits an intense, narrow peak of photon energy at 1.45 electron volts. At an injection current of 1.9 amp, the diode radiates 1.2 Kw/cm<sup>2</sup> power.

Injection luminescence, resulting from recombination of the injected carriers, occurs when the diodes are biased in the forward direction at 77 K. Nearly one photon is emitted per injected carrier, so conversion efficiency is virtually unity. As radiation efficiency approaches unity, more power is radiated than is pumped into the diode at low applied voltages. Heat is extracted from the surroundings.

OPTICAL RELAY—John E. Iwersen, of Bell Telephone Labs, proposed an opto-electronic relay which might provide the four-terminal behavior of electromagnetic relays at electronic speed.

Such devices—not yet practical, he pointed out—show promise of combining advantages in gain, speed and isolation.

In the proposed device, a gallium phosphide diode emitting red and green light would be optically coupled to a reverse-bias silicon diode acting as a photodetector. Iwersen said an experimental device showed a current gain of  $1.8 \times 10^{-4}$  and a total amplifier rise time of 10  $\mu$ sec.

FILM DEVICES—Paul Smith, of A. D. Little, Inc., reported on high-

---

## NEW DEVICE FAMILY

*Devices that employ mobile dopants to create rectifiers that are reversible in their forward direction were reported at the conference by J. O. Kessler, of RCA Laboratories. Details are on page 7*

---

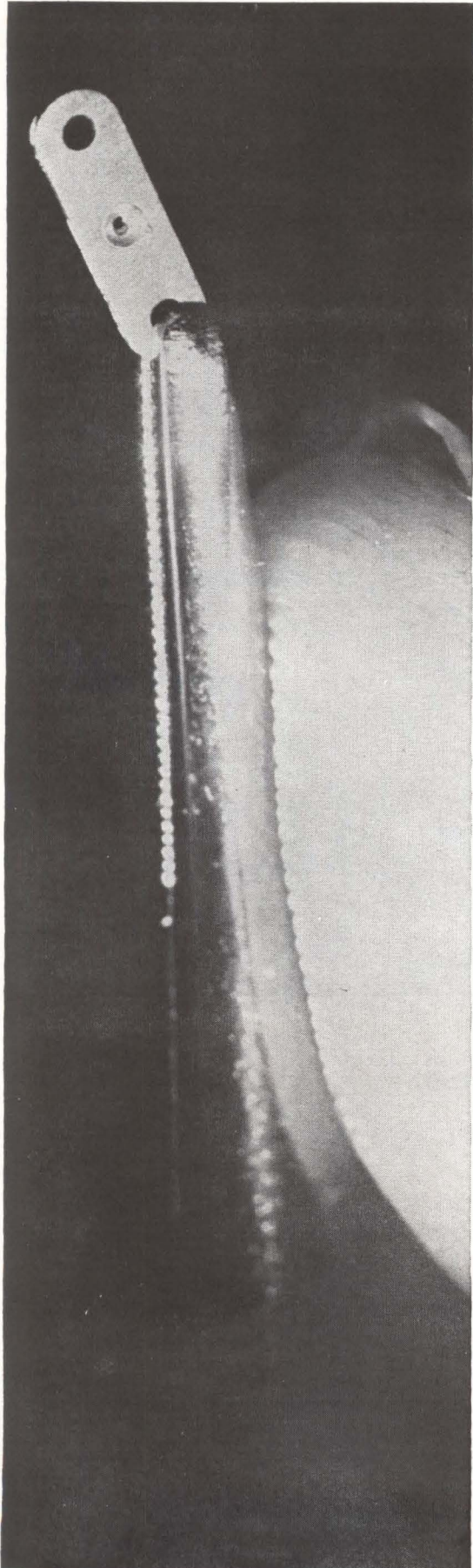

DIODE can be seen just back of the small hole in the center of the mount. Fingertip indicates size



# Transmits Television Over Modulated Light Ray

frequency, superconducting, negative-resistance devices, based on tunneling effects between film-evaporated layers of superconducting and normal metals (ELECTRONICS, p 30, Dec. 15, 1961).

One experimental device, an r-f detector, has been operated as high as 60 Mc. This aluminum-lead device takes advantage of the non-linear nature of the IV curve for a normal metal-superconductor sandwich. An aluminum-tin superconducting tunnel-diode oscillator has operated to 70 Mc.

A 70-Mc amplifier is under development. Smith said it promises good frequency response, time constant of  $10^{-10}$ , bandwidth like an Esaki diode and hopefully a better noise figure than an Esaki diode.

J. P. Spratt, of Philco, who disclosed the Metal Interface Amplifier (MIA) at the 1961 conference, described a modified MIA now under development. Instead of using metal as the source of tunnel electrons, the four-layer device employs an accumulation layer formed in cadmium sulphide as the source.

In the face of controversy during the past year over the MIA mechanism, Spratt said data on the modified structure shows "very clearly that the MIA is a hot electron device and that the effects cannot be explained by edge emission or any other mechanism.

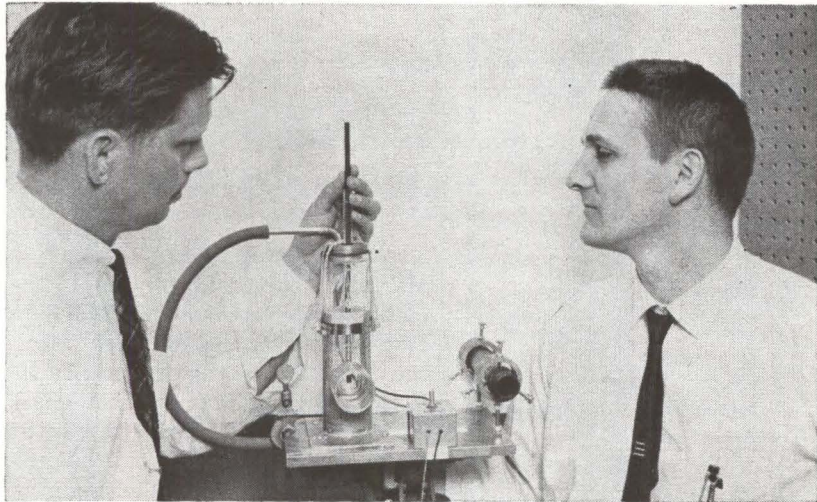

TV TRANSMITTER. Developers examine assembly holding gallium arsenide diode, located at bottom of black rod. Beam is emitted from circular window in lower half of transmitter

OSCILLISTORS—C. E. Hurwitz and A. L. McWhorter, also of Lincoln Lab, reported on a screw-shaped instability first observed in gas plasmas and later applied to semiconductor plasmas to explain the oscillistor effect. The effect, first reported in 1961, is an oscillatory variation in conductivity of a semiconductor containing excess minority carriers and subjected to nearly parallel d-c and magnetic fields.

Oscillators and traveling-wave amplifiers might be built using the screw-shaped density perturbation.

At present, Lincoln Lab is building a traveling-wave amplifier, using a germanium bar and four pairs of vertical probes to detect amplification. When electric and magnetic fields get above threshold values, the wave grows and moves down the bar.

MAGNISTORS—Developments in magnistors, devices that exploit the effects of magnetic fields on injection plasmas (ELECTRONICS, p 27, Feb. 9), were reported by I. Melngailis and R. H. Rediker, of Lincoln Lab. Indium antimonide is the principal material.

To date, highest oscillation obtained with diode magnistors is 450 Kc. Experimental magnetodiodes have been made by mounting a diode in a ferromagnetic toroid's air gap.

Input-output isolation is one of the features of the magnistor. By reducing inductive coupling between output current in the diode and input current in the coil, feedback can be made negligible and the magnistor can be considered essentially a unilateral device.

Melngailis suggested a magnistor stepping switch with plasma rotated to any contact. Various geometries, including transistor-like devices, are being investigated.

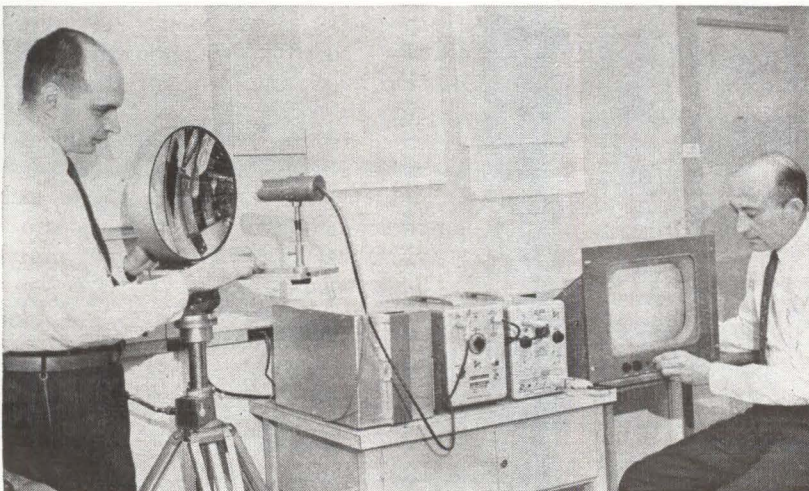

TV RECEIVER has photomultiplier to convert light signal



# VENUS IN 1962? Mariner

## *Microwave and infrared gear to probe planet's atmosphere*

NASA WILL TRY AGAIN to launch a Mariner spacecraft on an interplanetary exploration trip. Mariner I was exploded last Sunday after the Atlas-Agena booster malfunctioned. Mariner II is to be launched by September 10. The craft is to make fly-by infrared and microwave measurements of Venus and is also equipped to obtain data on magnetic fields, solar plasma, cosmic dust and charged particles during its 100 to 140-day trip to Venus.

Original NASA plans called for development of a ship designated Mariner A, to be propelled by a Centaur vehicle. Delays in the Centaur program led NASA to develop a lighter-weight version, Mariner R, to take advantage of favorable launch time. It will be two years before Venus and earth are again in proper alignment.

The 466-pound spacecraft, to be launched from Cape Canaveral, has a planned Venus miss distance of 16,000 miles from the center of the

planet. The Atlas booster will propel Mariner II out of the earth's atmosphere. The Agena will place it in a proper parking orbit, then propel it into deep space. Stabilization during the deep space trip will be by cold nitrogen gas jets, controlled by six light-sensitive diodes (sun sensors) and three gyros, all linked by logic circuits.

**DATA TRANSMISSION**—Two-way digital data transmission over 36 million miles will be attempted with the use of a receiver/transmitter, two transmitting antennas and a command antenna. The command antenna is equipped with an earth sensor to keep it pointed toward the earth at all times.

Synchronizing pulses will provide a reference for the three permanent and one mobile earth stations. The three permanent stations are located approximately 120 degrees apart, in Goldstone, Calif., Woomera, Australia, and Johannesburg, South Africa. The mobile station will be used for tracking until the missile-package is high enough to be acquired by Johannesburg.

Digital instruction data to the ship will be decoded by a central computer and sequencer, then relayed to the spacecraft subsystems. The on-board computer and sequencer, controlled by a crystal oscillator operating at 307.2 Kc, will also provide basic timing for the spacecraft subsystems. This unit also codes experimental information in digital form for transmission to earth. Data will be processed by an IBM 7090 computer at Jet Propulsion Laboratory.

Energy of 148 w to 222 w for control and experiment will be supplied by solar panels containing 9,800 solar cells in 27 square feet of area. Protective filters will absorb heat, but not interfere with energy conversion. A 1,000-wh silver-zinc battery will supply initial power.

**EXPERIMENTS**—The major purpose of the Mariner program is

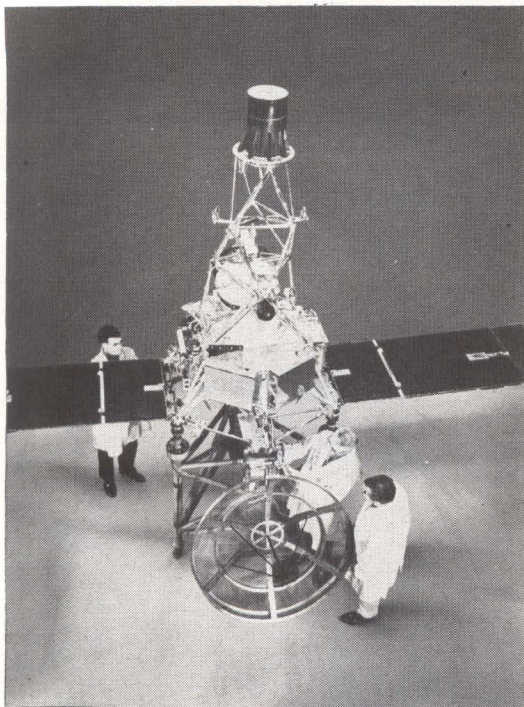

**INSTRUMENT PACKAGES** clustered between the two solar panels will gather scientific data in deep space and near Venus

### **\$142-MILLION PROGRAM**

NASA has authorized a total of \$142 million for Mariner development.

Two-year allotments to Mariner A and Mariner R are \$20.7 million and \$33 million, respectively. Mariners I and II are R types.

Mariner B, an advanced version to be launched by Centaur in 1964 has so far received allotments of \$88.4 million, for a three year period, with more to follow

## Computer Keeps Tabs on Quality Control



Computer-based quality control system in use at IBM's typewriter plant in Lexington, Ky. Factory Data Collection System feeds punched-card inspection data to Rmac data processor. Computer immediately reports abnormal defect levels and also prepares daily and weekly analyses



# to Try Again

to further develop interplanetary spacecraft technology, investigate solar phenomena in the space area between earth and Venus, and gather fundamental knowledge of Venus and its environment.

Microwave radiometer experiments will be carried out by scanning Venus' surface at a wavelength of 13.5 mm, to detect water vapor in the atmosphere, and at 19 mm, to measure surface temperature. Scanning begins 10 hours prior to Venus encounter, rapidly (one degree per sec) until the planet is acquired, then slowly (1/10 degree per sec) for 30 minutes of data acquisition.

An ir radiometer, attached to the microwave antenna, will operate in the 8- $\mu$  to 9- $\mu$  and 10- $\mu$  to 10.8- $\mu$  wave length regions of the electromagnetic spectrum. One optical sensor will scan the surface of Venus, another will obtain reference readings from space. The radiometer will thus obtain information about the atmospheric surface of the planet.

Deep space experiments include a three-axis fluxgate magnetometer to measure interplanetary and Venusian magnetic fields. An ionization chamber, with a group of three Geiger-Mueller tubes, will measure the intensity of high energy particles in space. A cosmic dust detector, a rectangular magnesium sounding board with a crystal microphone in the center, will acoustically measure the impact of cosmic dust. A voltage-sensitive amplifier differentiates between particles of high and low momentum.

A solar plasma detector, open to space instead of sealed in a tube, will measure the flow, density and energy of solar plasma particles. Voltage is changed automatically to 10 different levels, to facilitate measurement of particles.

Spacecraft prime contractor is JPL. Barnes Engineering supplied radiometers. Motorola's Electronics Div. supplied command subsystems. Control equipment was supplied by Northrup's Nortronics Div.

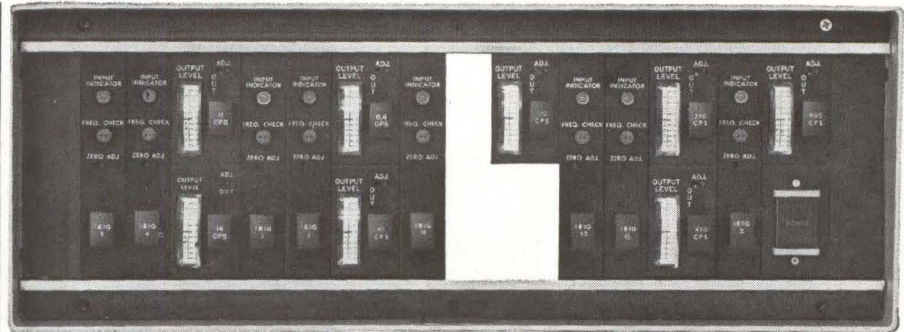

## FULL-SIZE PERFORMANCE IN A MINIATURE TELEMETRY DISCRIMINATOR

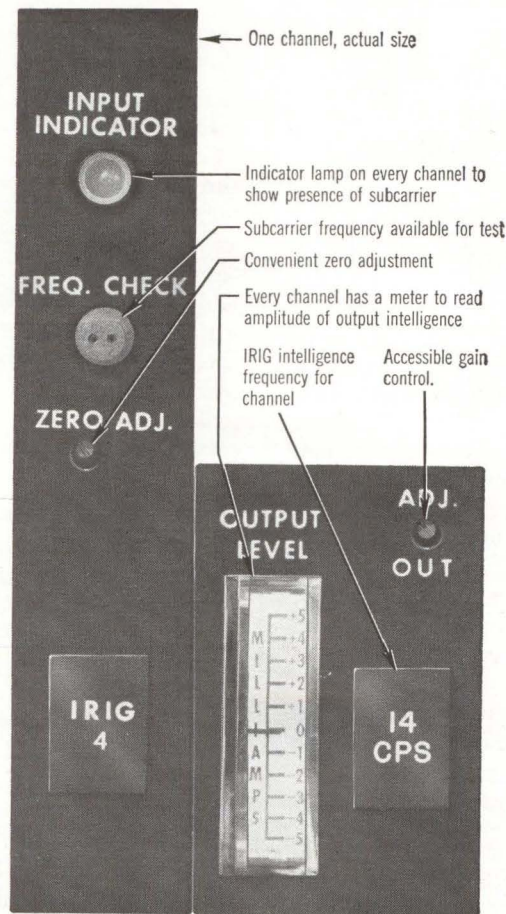

Now you can install 9 IRIG discriminator channels in only 7" of rack space. Advanced solid-state design has packed essential accuracy and reliability into a small package without crowding out the operating refinements that become so important in actual use. The indicators, controls and test points you need are all there — right up front. The output signal is tailored to give you good, clean graphic recordings, with a squelch circuit to eliminate noise traces when no signal is present, and output limiting to protect sensitive recorders. And with zero drift less than 0.2% in 12 hours, you won't be bothered with incessant adjustment.

Accuracy? We can sum it up by saying that data error contributed by the discriminator is so small that you can't detect it on the graphic record. For detailed performance specs — and a look at the superior construction features — send for our new 6-page brochure on TD-109.



**PRECISION  
INSTRUMENT**  
SAN CARLOS, CALIFORNIA / LY 1-4441

P.I. Invites inquiries from senior engineers seeking a challenging future.

31



## FILMISTOR®

METAL FILM RESISTORS  
OFFER 5 TEMP. COEFFICIENTS  
TO MEET ALL CIRCUIT  
REQUIREMENTS

RUGGED END-CAP  
CONSTRUCTION  
FOR LONG TERM  
STABILITY

EXCEPTIONAL  
RESISTANCE TO  
MOISTURE AND  
MECHANICAL DAMAGE

SURPASS MIL-R-10509  
PERFORMANCE  
REQUIREMENTS

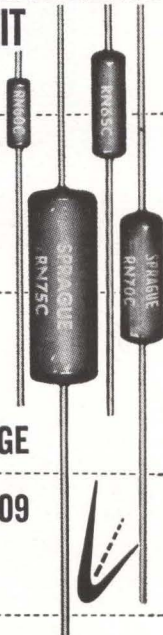

Providing close accuracy, reliability and stability with low controlled temperature coefficients, these molded case metal-film resistors outperform precision wirewound and carbon film resistors. Prime characteristics include minimum inherent noise level, negligible voltage coefficient of resistance and excellent long-time stability under rated load as well as under severe conditions of humidity.

Close tracking of resistance values of 2 or more resistors over a wide temperature range is another key performance characteristic of molded-case Filmistor Metal Film Resistors. This is especially important where they are used to make highly accurate ratio dividers.

Filmistor Resistors, in 1/8, 1/4, 1/2 and 1 watt ratings, surpass stringent performance requirements of MIL-R-10509D, Characteristics C and E.

Write for Engineering Bulletin No. 7025 to: Technical Literature Section, Sprague Electric Co., 35 Marshall Street, North Adams, Mass.

For application engineering assistance, write: Resistor Div., Sprague Electric Co. Nashua, New Hampshire



'Sprague' and '®' are registered trademarks of the Sprague Electric Co.

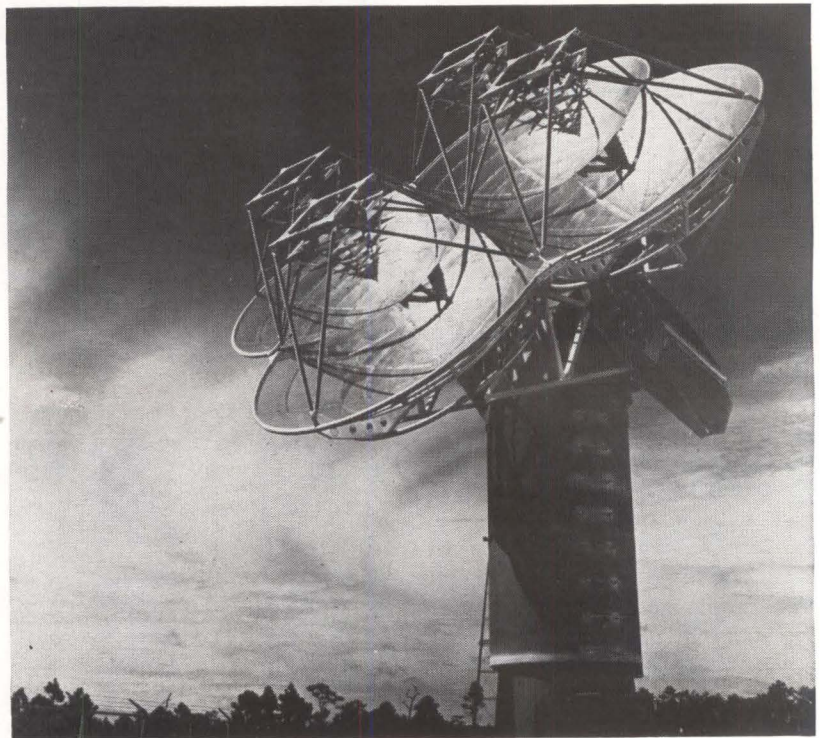

TELSCOM'S UNUSUAL DESIGN gives it bandwidth of 200 Mc to 2.3 Gc. Reflectors have individual log-periodic feeds

## Quadruple Dish Covers 2-Gc Band

PHASE MONOPULSE antenna system developed by Radiation, Inc., combines in a single array four closely spaced reflectors with individual log-periodic feeds interconnected to produce signal information for tracking purposes.

The antenna, with a bandwidth of 200 Mc to 2,300 Mc, can be used for surveillance as well as telemetry and communications. Named Telscom, it is designed for tracking missile launches or low-flying aircraft and can be mounted on ships or large motor vehicles.

The aluminum reflector, resembling a cloverleaf, is 20 feet in diameter and weighs 1,800 lb. It can be rotated in azimuth up to 360 degrees and more than 90 degrees in elevation.

Beamwidth at the sum-channel half-power points is 13 degree at 260 Mc; 1.5 degree at 2,300 Mc. Gain at the sum-channel terminal relative to a like polarized isotropic source is 20 db nominal at 245 Mc; 40 db at 2,300 Mc. Polarization is horizontal, vertical and circular.

The receiving system is designed for over-all or spot frequency range. All servo circuits use transistors.

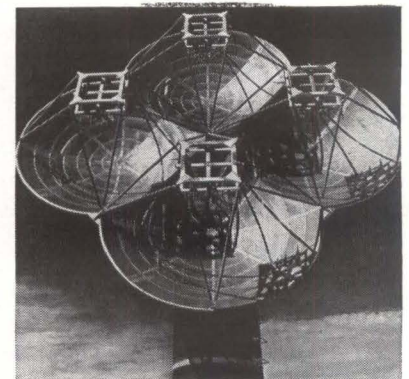

ARRAY of reflectors is about 20 feet in diameter

## Solar Thermionic Power Sources Three Years Off

FLYABLE PROTOTYPE thermionic devices for converting the heat of the sun directly into electrical energy will be available in the low kilowatt range by 1965. Nuclear thermionic systems can be developed by 1970 and by 1975 flyable power systems in the megawatt range should be possible, said E. F. Redden and A. E. Wallis, Wright-Patterson Air Force Base, at the AIEE's Summer General Meeting in Denver.



**EVERYTHING ABOUT  
THE X-15  
IS SPECIAL...**



**EXCEPT THIS**

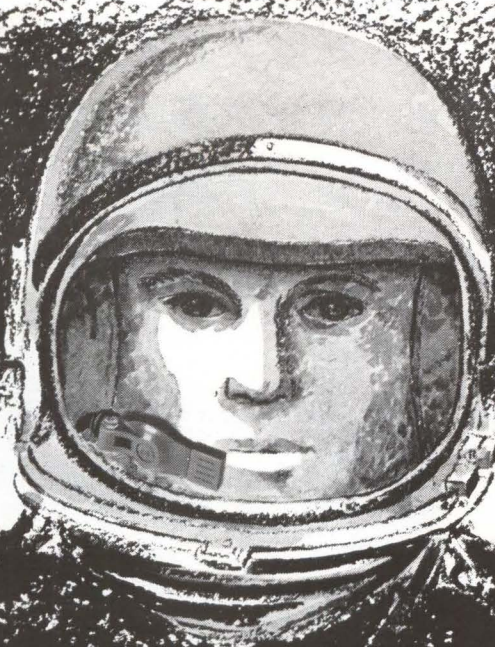

**THE SAME ROANWELL MICROPHONE AND RECEIVERS IN STANDARD AIR FORCE USE MET THE STRINGENT REQUIREMENTS OF THE X-15. HERE'S THE STORY ON HOW THIS REMARKABLE EQUIPMENT IS DESIGNED, MADE AND TESTED:**



**SPECIAL COIL-WINDING AND CEMENTING.** The entire coil assembly, roughly the diameter of a penny, is fastened to the diaphragm and to itself by means of a specially compounded and processed cement. Most other dynamic coil assemblies are wound around and fastened to a cylinder — but that adds mass and weight. Roanwell developed this special winding and cementing technique to produce ultra-light, highly reliable earphones and noise-canceling microphones.

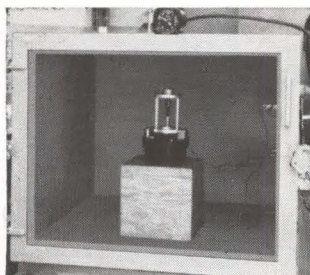

**OUTLASTING THE PILOT.** Roanwell communication equipment will meet test factors that a human being couldn't possibly survive. One such test decompresses the ambient air pressure from an equivalent of 8,000 feet to an equivalent of 35,000 feet, in less than 0.1 second. The delicate diaphragm, approximately .001" thick, and the coil assembly in an ear-piece and in a microphone motor element must withstand this tremendous JOLT and function properly after the test in order to meet specifications.

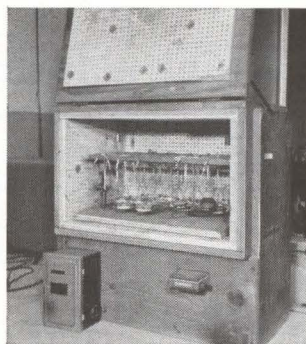

**RESISTING RE-ENTRY SHOCK.** Roanwell drops earphones two inches for 22,000 times onto a hardwood surface. . . . They are then mounted in a headset and dropped six feet onto concrete 20 more times. The units must be manufactured to perform perfectly after this test. Recently, a Roanwell headset was accidentally dropped down a 14 story elevator shaft. It performed to spec even after this unusual "test"!



**100% TESTING.** In addition to some 15 random sample tests in the laboratory, Roanwell puts *all* its equipment through up to 31 separate tests right on the production line. This rigid procedure applies to headsets, handsets, earphones, noise-canceling microphones and all the products in Roanwell's wide line of electro-acoustical devices. Identical standards of quality control are maintained on Roanwell products for missile and space projects as well as on products for industrial and consumer use.

*For reliable terminal communication equipment, contact Roanwell. Write for catalog E-7*

*Prime authority in electro-acoustic devices*

**ROANWELL CORPORATION**

Roanwell Building  
180 Varick Street, New York 14, New York  
(212) YUkon 9-1090 TWX NY 1-478







## What do you use a four-pole breaker for?

The protection of a three-phase power supply and its DC output.  
 The interlocked protection of four separate but related circuits.  
 And almost anything else you can think of that might require four simultaneously switched and tripped circuit breaker poles.

Any ideas? Here's a brief rundown on specs:

Frequency: DC, 60 or 400 cycles AC.

Current Rating: Any integral or fractional value between 0.20 and 50 amperes.

Voltage Rating: 32V DC, 50V DC; 125V AC and 250V AC, 60 cycles; 120V AC and 208V AC, 400 cycles.

Also: a choice of several time-delay characteristics or instantaneous trip. Special internal circuits (e.g., shunt-trip, relay-trip), too.

And: you can have a different frequency, current rating, voltage rating, and circuit construction on each pole, if you like.

All this in a little case just 2.53" high x 3.06" wide x 3.52" deep.

One more thing: the breaker is a Heinemann circuit breaker. Which means that it's hydraulic-magnetic. Which means no derating for high-ambient operation.

Bulletin 3304 will give more detailed information on Heinemann four-pole (and six-pole) circuit breakers. Write for a copy.



**HEINEMANN**  
**ELECTRIC COMPANY**  
 2600 Brunswick Pike, Trenton 2, N. J.

8A2579

## MEETINGS AHEAD

**INDUSTRIAL RESEARCH CONFERENCE**, Columbia University; Arden House, Harriman, N. Y., Aug. 5.

**ENERGY CONVERSION PACIFIC CONFERENCE**, AIEE; Fairmount Hotel, San Francisco, Calif., Aug. 13-16.

**PRECISION ELECTRONIC MEASUREMENTS INTERNATIONAL CONFERENCE**, IRE-PGI, NBS, AIEE; NBS Boulder Labs., Boulder, Colo., Aug. 14-17.

**CRYOGENIC ENGINEERING CONFERENCE**, University of California; at UCLA, Los Angeles, Calif., Aug. 14-16.

**ELECTRONIC CIRCUIT PACKAGING SYMPOSIUM**, University of Colorado, et al; at University of Colorado, Boulder, Colo.; Aug. 15-17.

**AIRCRAFT & MISSILES JOINT WESTERN REGIONAL CONFERENCE**, ASQC; Benjamin Franklin Hotel, Seattle, Wash., Aug. 16-18.

**APPLICATIONS & RELIABILITY SYMPOSIUM**, Precision Potentiometer Manufacturer's Assoc.; Statler-Hilton Hotel, Los Angeles, August 20.

**WESTERN ELECTRONICS SHOW AND CONFERENCE**, WEMA, IRE; Los Angeles, Calif., Aug. 21-24.

**METALLURGY OF SEMICONDUCTORS CONFERENCE**; American Institute of Mining, et al; Ben Franklin Hotel, Philadelphia, Pa., Aug. 27-29.

**BALLISTIC MISSILE & SPACE TECHNOLOGY SYMPOSIUM**, U.S. Air Force and Aerospace Corp.; Statler-Hilton Hotel, Los Angeles, August 27-29.

**MAINTAINABILITY OF ELECTRONIC EQUIPMENT**, EIA Engineering Dept. & Dept. of Defense; U. of Colorado, Boulder, Colo., Aug. 28-30.

**INFORMATION PROCESSING INTERNATIONAL CONFERENCE**, IRE-PGEC, IFIPS, AIFP; Munich, Germany, Aug. 29-Sept. 1.

**INFORMATION THEORY INTERNATIONAL SYMPOSIUM**, PGIT and Benelux Section of IRE; Free Univ. of Brussels, Brussels, Belgium, Sept. 3-7.

**ADVANCED TECHNOLOGY MANAGEMENT CONFERENCE**, IRE-PGEM, AIEE, et al; Opera House on World's Fair Grounds, Seattle, Wash., Sept. 3-7.

**DATA PROCESSING INTERNATIONAL EXHIBIT**, Association for Computing Machinery; Onondaga County War Memorial, Syracuse, N. Y., Sept. 4-7.

### ADVANCE REPORT

**VEHICULAR COMMUNICATIONS NATIONAL CONFERENCE**, IRE-PGVC; Disneyland Hotel, Anaheim, Calif., Dec. 6-7. August 15 is the deadline for submitting a 500-word abstract to: William J. Weisz, Motorola Inc., 4501 W. Augusta Blvd., Chicago 51, Illinois. Topics covered may include the following vehicular communications areas: land vehicular, personal signaling, solid state applications, VHF maritime, air-ground.







# THE MOST COMPLETE LINE of test bench components for all millimeter bands (26-220 Gc) comes from TRG

Pictured here is a test bench setup for W-band. Save for the standing wave indicator it is made up 100% of TRG components. (You'll find all of them listed below.) It remains only to mention that TRG offers the **only** complete line of test bench components for W-band — as well as the most complete line of off-the-shelf millimeter wave test bench components to be found anywhere. Whatever your problem — a single component or complete systems development — TRG has more of everything it takes, including experience to put the answers right in the palm of your hand . . . or on your test bench.



TRG INC., 400 Border Street, East Boston, Mass.

- 1) Universal Klystron Power Supply — Model 940
- 2) Klystron Tube Mount — Model 945A
- 3) Ferrite Isolator — Model W110
- 4) Uncalibrated Attenuator — Model 520
- 5) Directional Coupler — Model W561
- 6) Frequency Meter — Model W550
- 7) Bolometer — Model W990
- 8) Sliding Short Circuit — Model W590
- 9) Slotted Line — Model W740
- 10) Manual Waveguide Switch — Model W540
- 11) Waveguide Termination — Model W580
- 12) Calorimeter RF Head — Model W981
- 13) Calorimeter Control Unit — Model 982

TRG test bench components: the only complete line for W-band — (75-110 Gc) — (WR-10 waveguide)

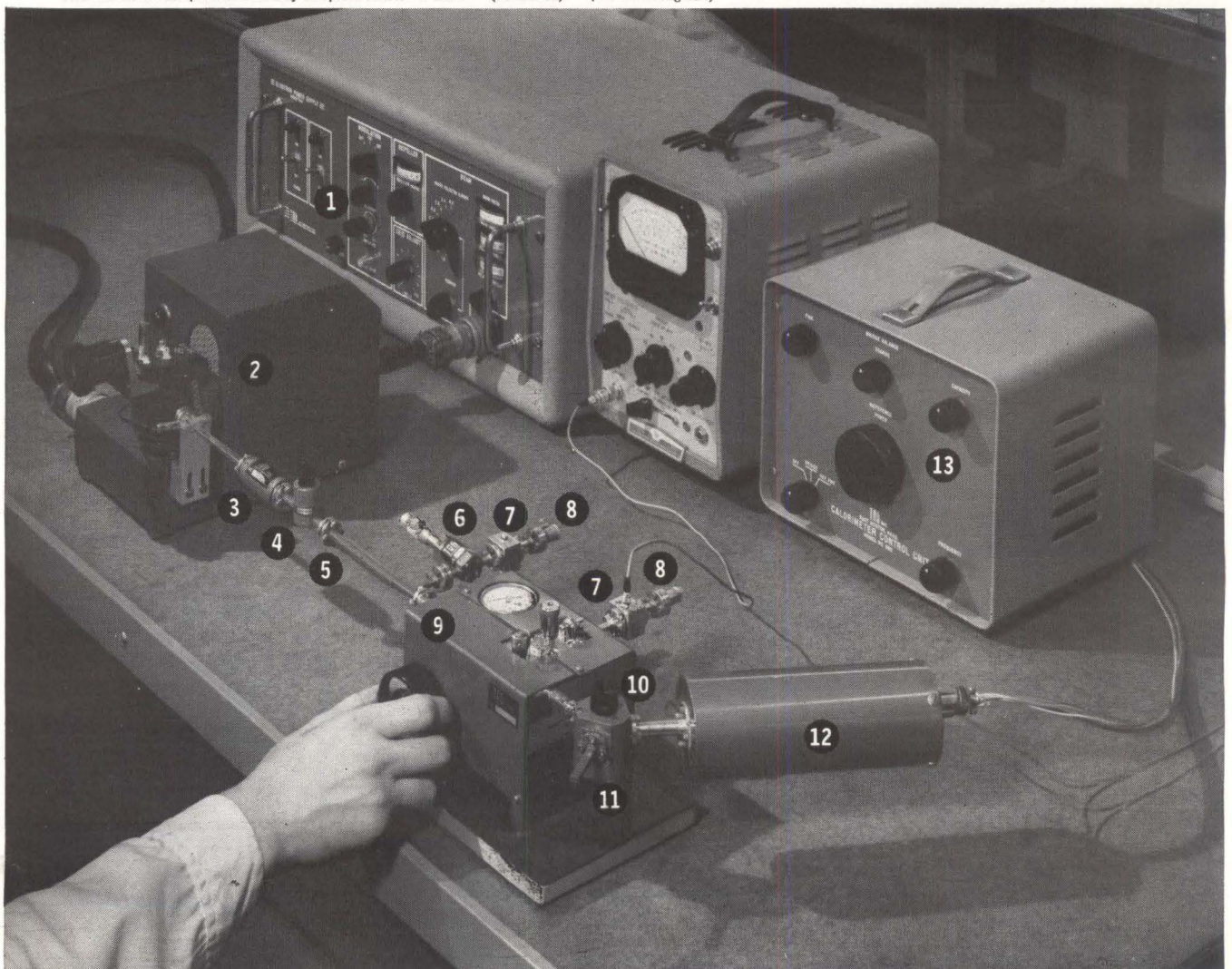



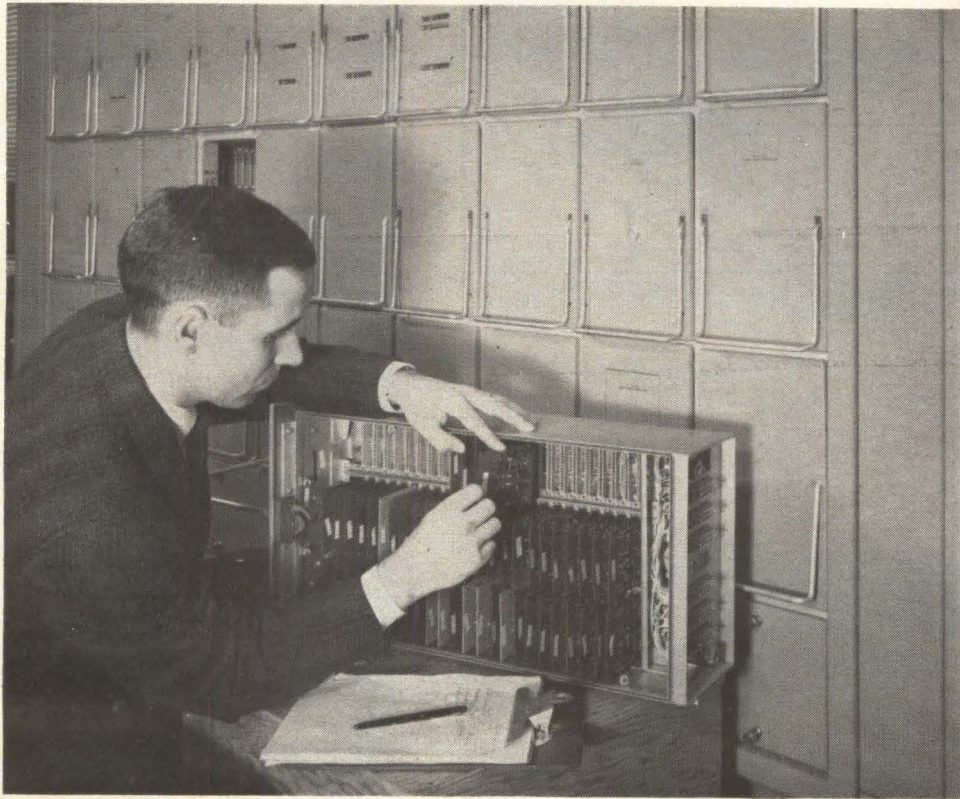

Coauthor Vidulich examines a subunit of diagnostic center cabinet

## Checking Readiness of Missile Guidance Systems

*Target-range simulator is part of a system that checks the operational readiness of the radar tracking portion of a missile guidance system. Test signals provided by this versatile simulator correspond to either a fixed or moving target*

By P. F. GUDENSCHWAGER  
S. M. VIDULICH  
Defense Systems Dept.,  
General Electric Co., Syracuse, N. Y.

THE OPERATIONAL STATUS of the guidance system of an advanced weapons system must be known at all times to minimize the chance of system failure. One way to check the radar tracking section of a guidance system is to exercise it with simulated input signals. If a

failure or degradation of performance below a pre-established threshold occurs, the failure is localized to the faulty sub-assembly by an automatic fault-locating, that is, diagnostic, system; the sub-assembly is then removed and replaced. The range simulator described in this article is part of a diagnostic center that checks the operation of a recently developed pulsed-radar tracker of a guidance system.

The radar tracker measures the range of the launched missile by positioning a range gate about the return video pulse. Positioning of the range gate is called range tracking. Tracking is effected by comparing the time of arrival of the center of the return video pulse with the time of occurrence of the center of the range gate. The difference constitutes an error signal which shows whether the center of



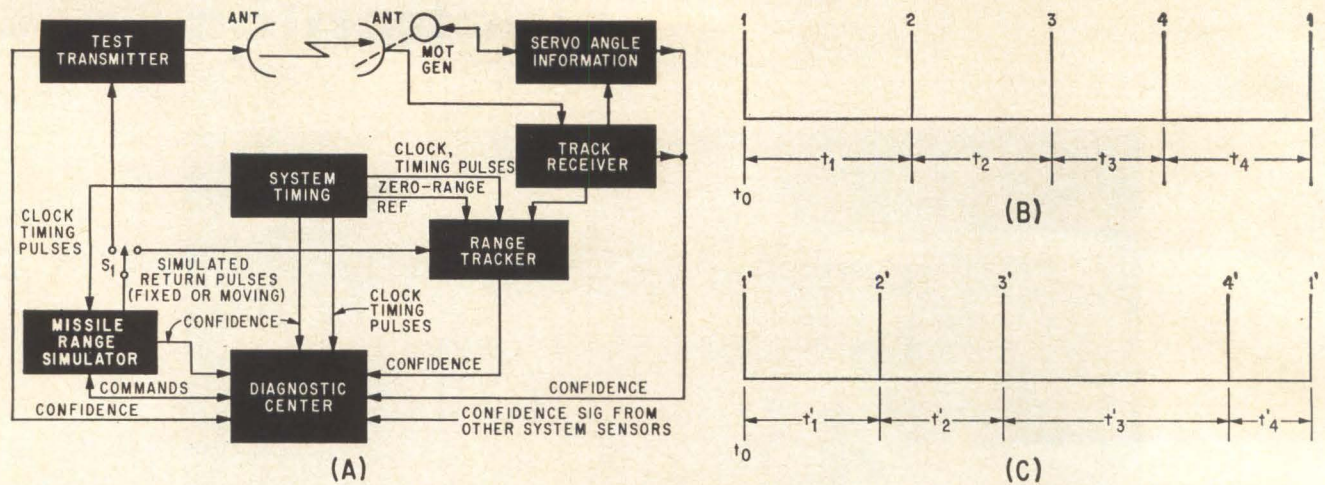

DIAGNOSTIC CENTER (A) commands simulator to send either fixed or moving target pulses to tracking system being checked. Representative staggered pulse periods (B) and (C) provided by simulator—Fig. 1

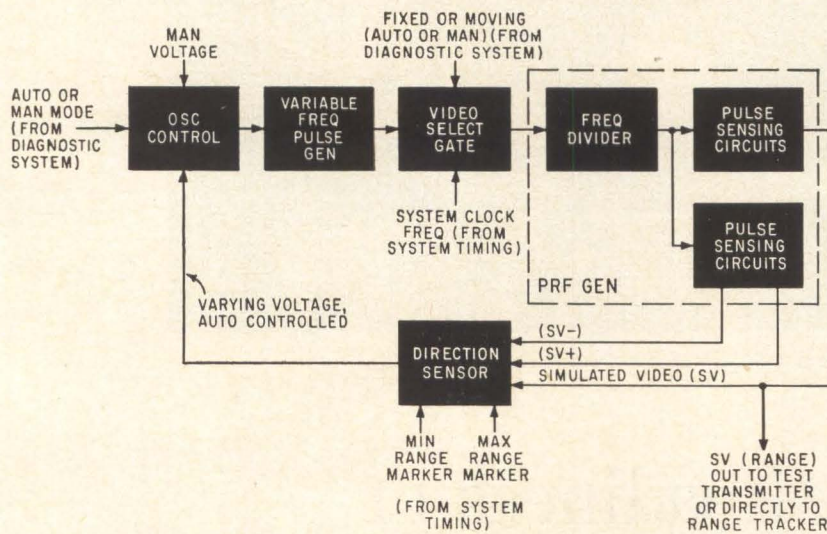

RANGE SIMULATOR output represents missile range. Diagnostic center determines operating mode of this unit—Fig. 2

the gate leads or lags the center of the pulse. The error signal controls a servomechanism within the range tracker that positions the range gate to null the error signal.

**SIMULATOR**—The diagnostic center's simulator provides a return video pulse for exercising the range tracker. During the exercise mode, confidence signals (signals indicating correct or incorrect operation) from the radar are displayed at the diagnostic center console so that system operational conditions can be continuously monitored. Should a loss of confidence from the individual sensors in the radar occur, the diagnostic center enters a programmed fault-locating procedure and determines which sub-assembly has failed. Figure 1A shows the test system, which includes the

range simulator and the diagnostic system, and the radar tracking system being checked. As indicated by switch  $S_1$ , the range simulator can be used to test the tracker with or without its associated antenna and receiving system.

The range simulator provides either fixed-position or moving simulated-return pulses to the range tracking loop. Due to various characteristics of the radar, the range simulator also provides the following. (1) irregularly-spaced return pulses (see Fig. 1B and 1C); (2) adjustable staggered pulse recurrence frequency (Fig. 1B, 1C); (3) change in direction of moving pulse at maximum and minimum ranges; (4) acceleration and deceleration of moving pulses near max. and min. ranges; (5) manual control of moving pulse velocity.

The fixed-position pulse output provides a static test for the range tracker. The change in direction of the moving pulse at the maximum and minimum ranges prevents blocking the receiver during transmission, thus allowing continuous tracking. The moving pulse is accelerated and decelerated at a prescribed rate near the maximum and minimum ranges to compensate for the inertia of the servomechanism within the range tracker (Fig. 1).

The range simulator is shown in Fig. 2. The simulated video (SV) range output pulse is derived from a prf generator having the characteristics of the radar-system timing. The fixed position pulse is developed from the system timing clock and the moving pulse is derived from the variable frequency pulse generator and its control. Standard logic circuits process the input commands that determine the inputs to the prf generator.

The range simulator operates in one of three modes that are controlled by the diagnostic center. These modes are: (1) moving video; (2) fixed-position video; (3) manual. During normal operation, the first two modes are automatically switched by the diagnostic center's program. In the moving-video mode, the range simulator operation is automatic, that is, the output pulse changes directions at the maximum and minimum ranges automatically.

During the automatic moving mode of operation, the simulated video travels back and forth over the guided range. The diagnostic center designates the automatic



mode at the oscillator control, and designates automatic moving video at the video select gate.

To describe the automatic mode it is convenient to start at the time that the prf generator delivers the  $SV-$ ,  $SV$ , and  $SV+$  pulses to the direction sensor; the  $SV-$  is sent at a fixed time before the  $SV$  (simulated video) pulses and the  $SV+$  pulse is sent at a fixed time after. The other inputs to the direction sensor are minimum and maximum range marker pulses from the master system timing (Fig. 1A). The  $SV-$  and  $SV$  pulses set and reset flip-flop 1 of the direction sensor (Fig. 2 and 3A), forming gate 1 (Fig. 3A and 3B). The  $SV+$  and  $SV$  pulses set and reset flip-flop 2, forming gate 2. Gates 1 and 2 ride with  $SV$  as it travels back and forth in time between the minimum and maximum range markers, which are fixed in time. Note that the  $SV$  pulses move in time (see Fig. 3B) with respect to both range markers and the fixed prf reference pulses derived from the system timing reference ( $f_0$ ). This is because the prf generator's repetition rate is derived from  $f_1$  or  $f_2$  (Fig. 3C), which are, respectively, higher and lower than  $f_0$ . In Fig. 3B, the  $SV$  pulses move to the right and the prf is derived from  $f_2$ . Thus, the simulated range denoted by the  $SV$  pulse becomes successively greater as the time of generation of  $SV$  moves closer to the time that a maximum range-marker pulse is generated. When gate 2 and the maximum range markers coincide, the output of coincidence 2 (Fig. 3A) flips the control flip-flop which, in turn, changes the frequency of the variable frequency pulse generator to  $f_1$  (Fig. 3C). When gate 1 and the minimum range marker coincide, the output of coincidence 1 resets the control flip-flop which in turn changes the frequency of the variable frequency generator to  $f_2$ . The gates enclose only one  $SV$  pulse (In Fig. 3B, this is the No. 1 pulse) so that this pulse will travel the entire range.

The control flip-flop output voltage is fed to an integrating network that feeds a voltage-variable capacitor controlling the frequency of an oscillator in the variable frequency generator (Fig. 2). The integrator provides a slowly changing voltage to obtain specified ac-

celeration rates. As the incoming signal to the capacitor swings above and below  $E_0$  (Fig. 3C), the variable capacitance changes and hence varies the frequency of the variable oscillator. The output of the variable oscillator is mixed with the output of a fixed-frequency oscillator and the beat frequency, which is the output of the variable frequency generator, swings above and below the system clock frequency ( $f_0$ ). This output is shaped into pulses and gated through the video select block (Fig. 2) to the prf generator, whose division counter determines the prf. One of the recurring prf pulses resets the counter. The  $SV$  output is confided and then sent to the system range tracker (Fig. 1), either by way of the test transmitter and receiver or directly, depending on the instructions from the diagnostic center.

**AUTOMATIC FIXED MODE**—In this mode of operation, the  $SV$  output is stationary at some predetermined fixed point in range. For this mode, the diagnostic center designates the automatic mode at the oscillator control and automatic fixed video at the video select gate (Fig. 2). At the video select gate, the system clock frequency ( $f_0$ ) is selected as the input to the prf generator and the signal from the variable frequency pulse generator is inhibited. Also, the counter in the prf generator is reset and  $SV$  pulses are generated fixed in time at a predetermined point between the min. and max. range markers.

In the manual mode of operation, velocity and direction of the  $SV$  pulses are controlled by the operator of the diagnostic center. For this mode, the diagnostic center designates the manual mode at the oscillator control and at the video select gate (Fig. 2). A manually controlled voltage is applied through the oscillator control to the variable frequency pulse generator and the oscillator control voltage from the direction sensor is inhibited. The output of the pulse generator is gated through the video select gate to the prf generator.

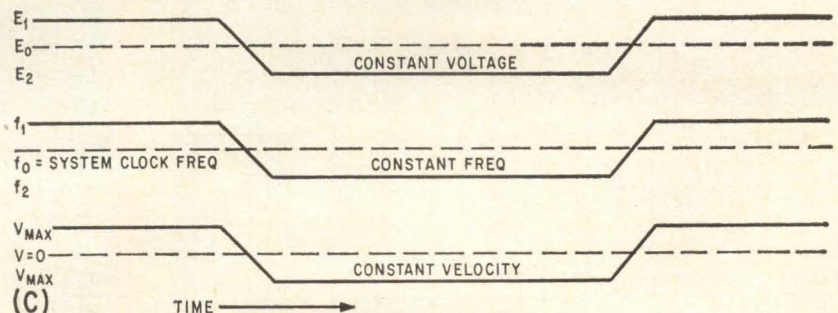
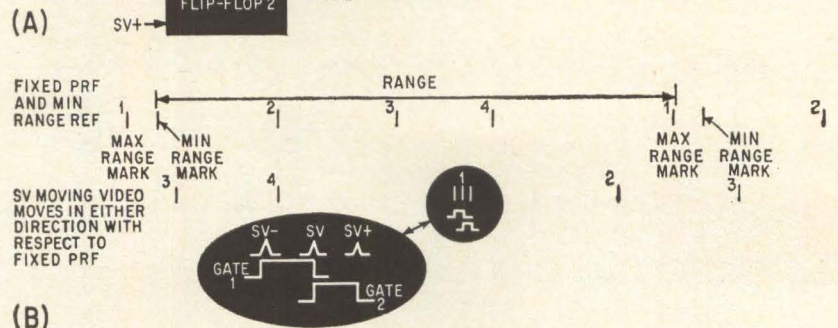
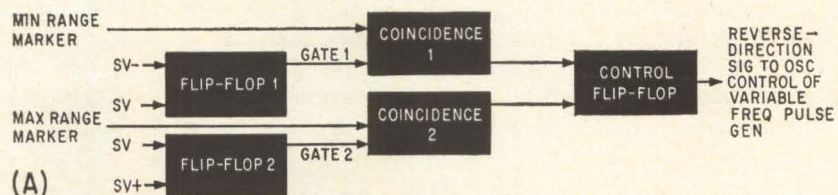

**DIRECTION SENSOR (A)** of simulator. Encircled portions of timing diagram (B) show that only one  $SV$  pulse is enclosed by gates. In (C), voltage  $E$  controls oscillator frequency  $f$ , which produces simulated target velocity  $V$ —Fig. 3



# NONCUTOFF CIRCUITS

## Improve Trigger Switching

*These two types of noncutoff trigger circuits—variations of Schmitt trigger and monostable multivibrator circuits—avoid the drawbacks of cutoff types*

By HIROSHI INOSE, YUICHI YOSHIDA and HISAKO TADA

Dept. of E. E., Faculty of Engineering, University of Tokyo, Japan

POSITIVE CURRENT feedback trigger circuits, in which one of two active elements is generally cut off, have the following drawbacks: the optimum operating regions of the active elements cannot be always achieved, as their operating ranges include cutoff; overdriving is not effective when the active elements are switched towards cutoff; and when transistors are used as active elements, they are subject to possible damage by inverse emitter-base voltage.

Noncutoff trigger circuits have been designed to prevent the active elements from cutting off to avoid these drawbacks. Two types of noncutoff trigger cir-

cuits have been designed—a Schmitt trigger and a monostable multivibrator. The design method and the basic characteristics are shown and the characteristics of the noncutoff Schmitt trigger circuit are compared with those of an ordinary Schmitt trigger circuit, or cutoff type.

TRIGGER CIRCUIT—Operation of the noncutoff trigger circuit is explained in Fig. 1A. Amplifier  $A_1$  operates as a voltage amplifier from  $e \cdot d$  to  $a$ , and as a current amplifier from  $e$  to  $d$ ; amplifier  $A_2$  operates as a voltage amplifier from  $b \cdot c$  to  $f$ , and as a current

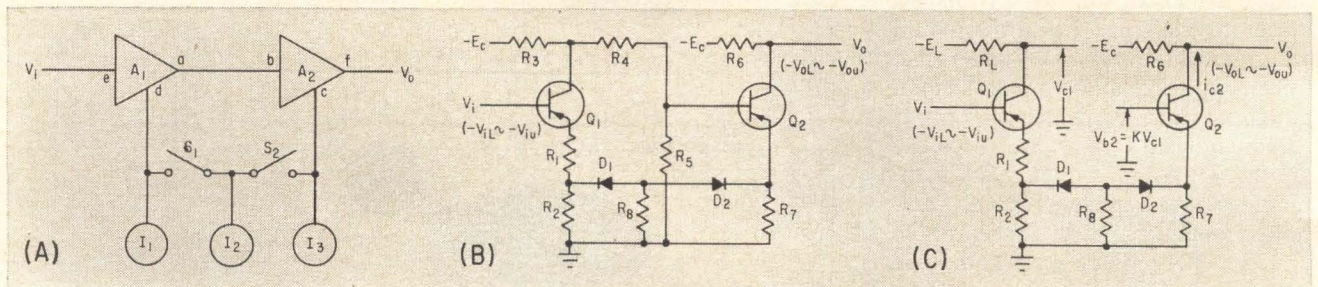

PRINCIPLE OF noncutoff trigger circuit demonstrated in (A), basic circuit in (B) and equivalent circuit in (C)—Fig. 1

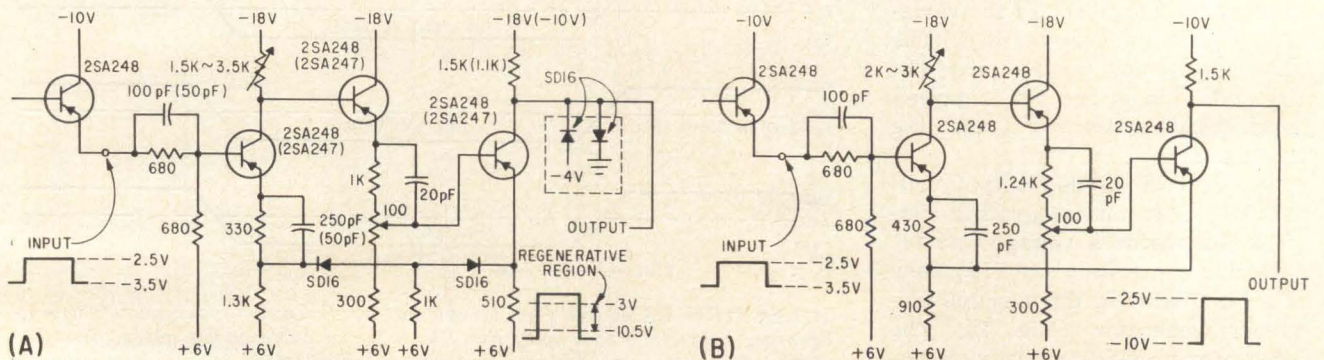

EXPERIMENTAL NONCUTOFF Schmitt trigger circuit (A) compared to cutoff type (B)—Fig. 2



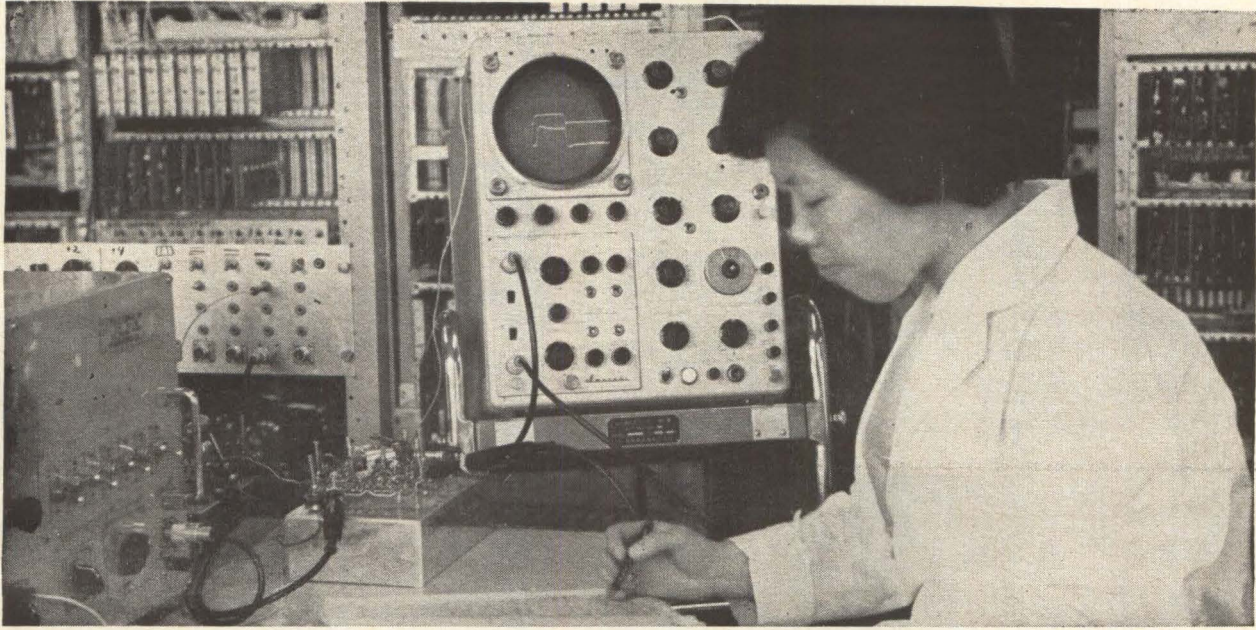

SWITCHING SPEED of noncutoff trigger circuit is measured by co-authoress Tada

amplifier from  $b$  to  $c$ . The currents are supplied to those amplifiers from the current sources  $I_1$ ,  $I_2$  and  $I_3$ . If the switches  $S_1$  and  $S_2$  are both closed, this circuit operates as an ordinary positive current feedback trigger circuit. If the current directional elements  $S_1$  and  $S_2$  are diodes, they will conduct current from  $I_2$  only when  $S_1$  is on,  $S_2$  is off, with the input signal exceeding a threshold level, or when  $S_1$  is off,  $S_2$  is on, with the input signal  $v_i$  exceeding another threshold level in the opposite direction. If the loop gain of the loop  $a \cdot b \cdot c \cdot d \cdot a$  is larger than unity, either  $S_1$  or  $S_2$  must be on and the other off. So whenever  $v_i$  becomes larger or smaller than the threshold level, the current supplied to the output amplifier  $A_2$  changes abruptly from  $I_3$  to  $I_2 + I_3$  or conversely, and its output voltage  $V_o$  jumps from one level to the other level accordingly. However, amplifiers  $A_1$  and  $A_2$  are never cut off, because they are always connected to the current sources, and it is possible to choose the operating point for the active elements used for amplifiers, by designing the current sources. The principle which has been explained with reference to the Schmitt trigger circuit is equally applicable to the monostable multivibrator. However, the input voltage  $v_i$  is kept constant, and when the circuit is triggered, the threshold level varies in accordance with the potential at  $b$  which changes exponentially. When the potential at  $b$  reaches voltage  $V_i$ , the circuit is restored to the original state.

**TRIGGER EQUATIONS**—Consider the basic circuit of the noncutoff Schmitt trigger, Fig. 1B. It is assumed that the characteristics of the transistors and the diodes are ideal: for the transistors, the common-base current gain is assumed to be unity and the base and the emitter resistances are assumed to be zero; for the diodes, the forward resistances are assumed to be zero and backward resistances are

assumed to be infinity. Then the equivalent circuit shown in Fig. 1C is obtained, where

$$E_L = \left( \frac{R_4 + R_5}{R_3 + R_4 + R_5} \right) \cdot (E_c)$$

$$R_L = \frac{R_3 (R_4 + R_5)}{R_3 + R_4 + R_5}$$

$$K = \frac{R_5}{R_4 + R_5}$$

Here are the design conditions: (1) The diode  $D_1$  is turned on when input voltage  $v_i$  becomes more negative than a certain voltage  $-V_{ic}$ . (2) Let  $I_{c2on}$  be  $i_{c2}$  when  $v_i = -V_{ic}$  and  $D_1$  is off. (3) Let  $I_{c2off}$  be  $i_{c2}$  when  $v_i = -V_{ic}$ , and  $D_1$  is on, assuming that the loop gain of this circuit is larger than unity. (4) The transistor  $Q_1$  should not be saturated when the input voltage  $v_i$  assumes the lowest level  $-V_{il}$ . The collector voltage  $-V_{clu}$  of the transistor  $Q_1$  in this case should be chosen as  $V_{clu} > V_{il}$ . (5) The transistor  $Q_2$  should not be saturated when the input voltage  $v_i$  assumes the highest level  $-V_{ou}$ . The base voltage  $-V_{bzL}$  of transistor  $Q_2$  should be chosen as  $V_{bzL} < V_{ou}$ . (6) Ideal loop gain  $G_{Li}$  is

$$G_{Li} = K (R_L/R_1).$$

From these conditions

$$K = \frac{R_5}{R_4 + R_5} = \frac{1 - (V_{bzL}/V_{iu}) (1 - 1/G_{Li})}{1 - (V_{ic}/V_{iu}) (1 - 1/G_{Li})} \cdot \left( \frac{V_{ic}}{E_L} \right)$$

$$R_7 = \frac{K \{ E_L (V_{iL} - V_{ic}) + V_{clu} V_{ic} \}}{I_{c2off} V_{iL}}$$

$$R_8 = \left[ \frac{I_{c2on} V_{iu}}{K \{ E_L (V_{iu} - V_{ic}) + (V_{bzL}/K) (V_{ic}) \}} - \frac{1}{R_7} \right]^{-1}$$



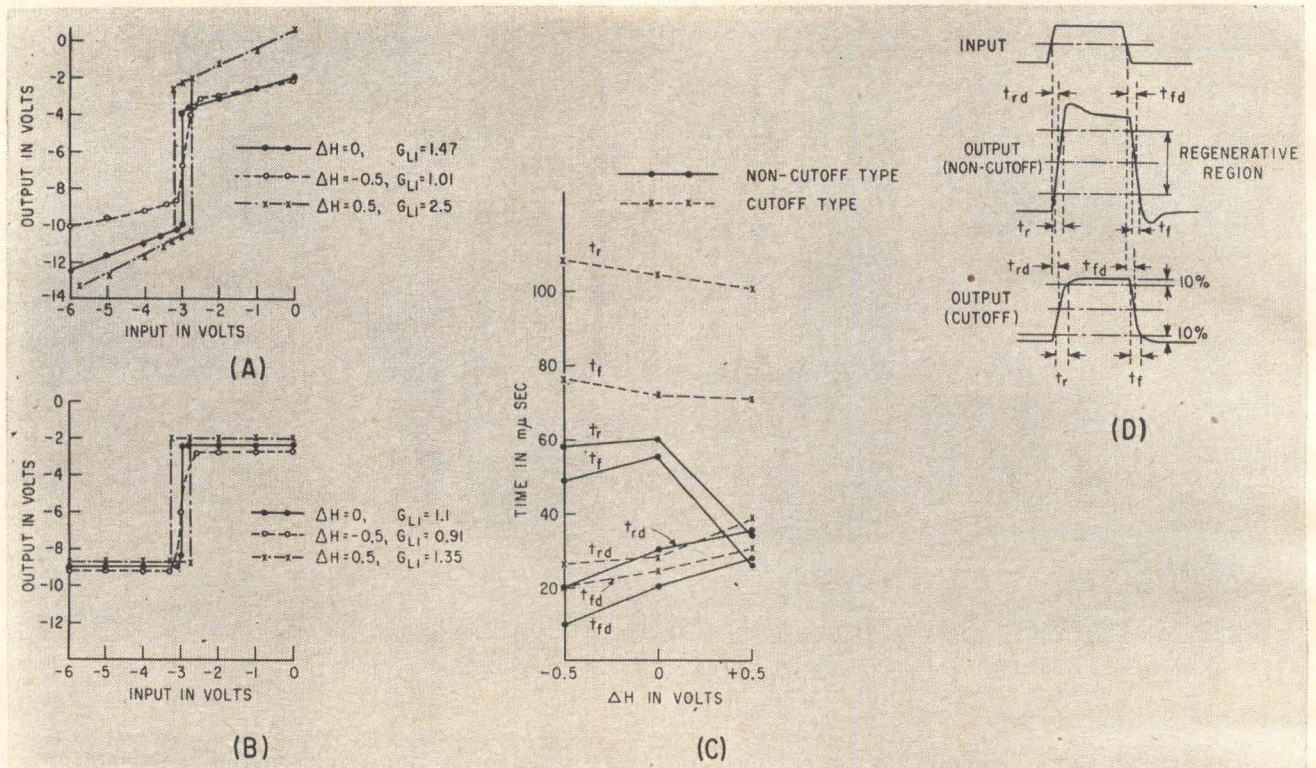

STATIC CHARACTERISTICS of non-cutoff Schmitt trigger (A) and cutoff Schmitt trigger (B); switching characteristics of Schmitt trigger circuits (C) along with definitions of abbreviations (D)—Fig. 3

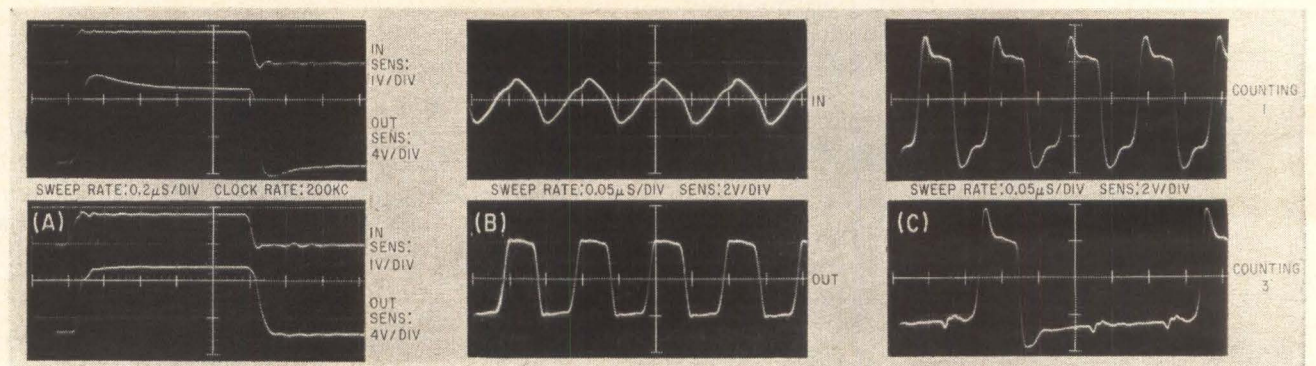

INPUT-OUTPUT WAVEFORMS of noncutoff (top) and cutoff (bottom) types of Schmitt trigger circuits (A); input-output waveforms of noncutoff Schmitt trigger circuit used as pulse shaper at clock rate of 10 Mc (B); output waveforms of noncutoff monostable multivibrator at trigger rate of 10 Mc (C)—Fig. 4

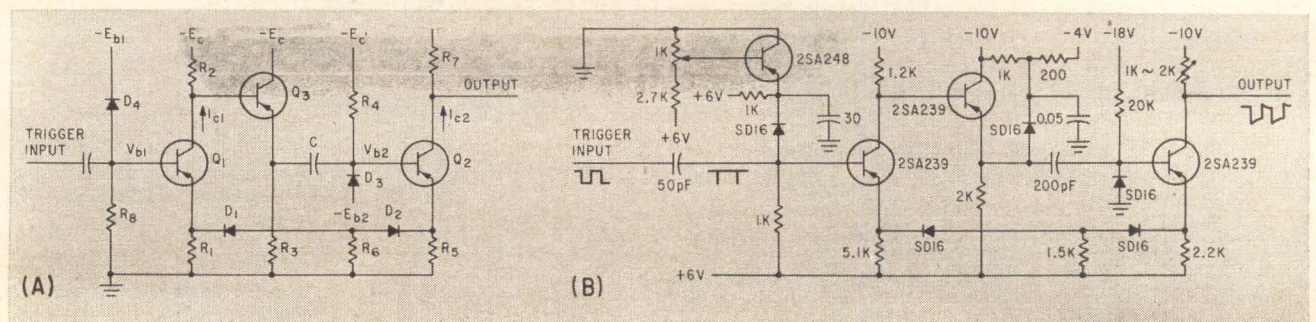

BASIC CIRCUIT of noncutoff monostable multivibrator (A) and experimental circuit (B)—Fig. 5



$$R_1 = \left\{ \frac{K(E_L - V_{clw})}{G_{Li} V_{iL} - K(E_L - V_{clw})} - \frac{K(E_L - V_{b2L}/K)}{G_{Li} V_{iL} - K(E_L - V_{b2L}/K)} \right\} R_8$$

$$R_7 = \left[ \frac{G_{Li} V_{iL} - K(E_L - V_{b2L}/K)}{K(E_L - V_{b2L}/K)} \right] (R_1)$$

$$R_3 = \left( \frac{G_{Li}}{K} \right) \left( \frac{E_c}{E_L} \right) R_1$$

$$R_4 = (1 - K) \left( \frac{E_L}{E_c - E_L} \right) R_3$$

$$R_5 = K \left( \frac{E_L}{E_c - E_L} \right) R_3$$

where  $E_L$  should be chosen to satisfy the inequality

$$E_c > E_L > \frac{V_{b2L}}{K}$$

**COMPARISONS**—Figure 2A shows the experimental noncutoff Schmitt trigger circuit designed with these formulas. For comparison, Fig. 2B shows the experimental cutoff Schmitt trigger circuit designed under the same conditions. In Fig. 2A, the values in parentheses and the elements in dotted lines are for the modified circuit providing higher speed operation.

The static characteristics of these circuits are shown in Fig. 3A and Fig. 3B. In the figures,  $\Delta H$  is related to the loop gain of these circuits, and is defined as the voltage difference between the input voltage by which the regeneration occurs and the input voltage by which the regeneration ceases;  $\Delta H$  is positive when these circuits have hysteresis characteristics.

Pulse responses corresponding to the static characteristics are illustrated in Fig. 3C. Rise time  $t_r$ , fall time  $t_f$ , rise time delay  $t_{rd}$  and fall time delay  $t_{fd}$  in Fig. 3C are defined in Fig. 3D. Figure 4A shows the input-output waveforms when  $\Delta H$  is zero. Figure 4B shows the input and output waveforms of the modified circuit of Fig. 2A, when it is used as a pulse shaper.

**MULTIVIBRATOR**—A monostable multivibrator circuit of the noncutoff type is shown in Fig. 5A. In the figure,  $-E_{b1}$  and  $-E_{b2}$  are base clamping voltages of transistors  $Q_1$  and  $Q_2$  respectively, provided that  $E_{b1} < E_{b2}$ . When the base of  $Q_1$  is triggered (Fig. 6A), the waveform at the base of  $Q_2$  (Fig. 6B) has a duration  $T$  expressed as (Fig. 6):

$$T = R_4' C \left( \log \frac{E_c'' - E_{b2} + (R_2/R_6) E_{b1}}{E_c'' - E_{b1}} \right)$$

where

$$R_4' = \frac{\beta R_4 R_5}{R_4 + \beta R_5}, \quad E_c'' = \frac{\beta R_5}{R_4 + \beta R_5} E_c'$$

and  $\beta$  is the common emitter current gain of  $Q_2$ .

Let  $I_{c1off}$  and  $I_{c2on}$  be the collector currents of the

transistors  $Q_1$  and  $Q_2$  respectively immediately before the circuit is triggered. Let  $I_{c2off}$  be the collector current of the transistor  $Q_2$  immediately after the circuit is triggered neglecting trigger pulse duration. Then the design formulas are

$$R_1 = \frac{E_{b1}}{I_{c1off}}$$

$$R_5 = \frac{(2R_2 E_{b1}) / [(E_{b1}/E_{b2}) R_2 I_{c2on} - E_{b2} + \sqrt{\{(E_{b1}/E_{b2}) R_2 I_{c2on} + E_{b2}\}^2 - 4(I_{c2on} - I_{c2off}) R_2 E_{b1}}]}{1}$$

$$R_6 = \frac{(2R_2 E_{b1}) / [(E_{b1}/E_{b2}) R_2 I_{c2on} + E_{b2} - \sqrt{\{(E_{b1}/E_{b2}) R_2 I_{c2on} + E_{b2}\}^2 - 4(I_{c2on} - I_{c2off}) R_2 E_{b1}}]}{1}$$

Whereas  $R_2$  should be chosen by

$$R_2 < \frac{E_c - E_{b1}}{E_{b1} / R_1 (I_{c2on} - I_{c2off}) / E_{b2}}$$

The results should satisfy the inequality

$$E_{b1} (1 + R_2/R_6) - E_{b2} > 0$$

Figure 5B shows the experimental circuit of the noncutoff monostable multivibrator. Figure 4C shows the output waveforms of the circuit when it is triggered by 10-Mc clock. Count down is achieved by adjusting the clamping voltage of  $Q_1$ .

The design of the noncutoff trigger circuits must take into account the diode characteristics inserted in the feedback loop, to improve the switching speed and protect the high frequency transistors which generally have rather poor permissible values of inverse base-emitter voltage.

The specifications for the transistors used in the experimental circuits were as follows. Transistor 2SA248 has a  $P_{cmax}$  of 125 milliwatts, an  $I_{cmax}$  of 100 milliamperes, a  $V_{EBmax}$  of minus 2 volts, an  $f_{ac}$  of 40 megacycles, and is a drift type. Transistor, 2SA247, which is a Ge-mesa type as is the 2SA239, has a  $P_{cmax}$  of 100 milliwatts, an  $I_{cmax}$  of 30 milliamperes, a  $V_{EBmax}$  of minus 1.2 volts, and an  $f_{ac}$  of 200 megacycles. Transistor 2SA239 has a  $P_{cmax}$  of 75 milliwatts, an  $I_{cmax}$  of 5 milliamperes, a  $V_{EBmax}$  of minus 0.2 volt, and an  $f_{ac}$  of about 300 megacycles.

The authors thank the Bell Telephone Laboratories Inc. for their sponsorship.

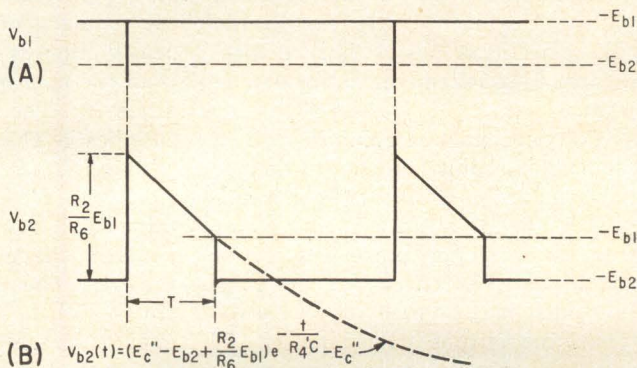

WAVEFORMS at bases of  $Q_1$  (A) and  $Q_2$  (B) in Fig. 5A look like this—Fig. 6



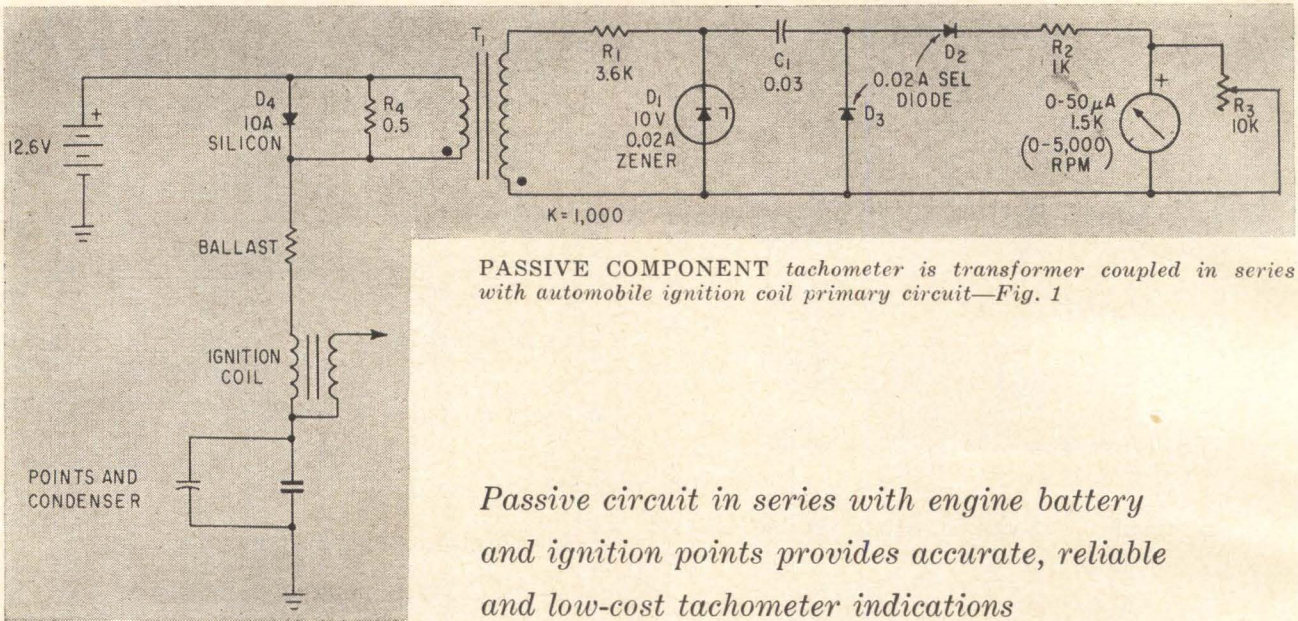

PASSIVE COMPONENT tachometer is transformer coupled in series with automobile ignition coil primary circuit—Fig. 1

*Passive circuit in series with engine battery and ignition points provides accurate, reliable and low-cost tachometer indications*

# Unique Engine Tachometer Uses Only Passive Components

By FRANK TRAINOR  
Engineering Department,  
Admiral Corporation,  
Chicago, Illinois

THE TACHOMETER function for any rotating machine can be obtained without mechanical connection to the shaft if an electrical pulse related to shaft revolutions is available. An automobile engine, depending on the number of cylinders, provides two, three or four ignition pulses for each shaft revolution. These ignition pulses can be integrated by a ratemeter calibrated in rpm.

Conventional ratemeters use a monostable multivibrator to deliver a constant-amplitude, constant-width pulse to an integrating meter for each trigger pulse applied to its input. The energy of the trigger pulse may be many orders lower than the output pulse energy. If enough trigger pulse energy is available, there is no need for the

multivibrator. The essential constant-amplitude, constant-width output pulse can be obtained with passive components.

The simple automobile tachometer circuit of Fig. 1 will provide acceptable accuracy and unusual reliability. Its low cost and small packaging possibilities are attractive.

OPERATION—A sample of primary ignition current is supplied to the primary of  $T_1$ . The secondary peak voltage is several times greater than the operating voltage of zener diode  $D_1$ . The squared wave of  $D_1$  supplies a charging current to  $C_1$  through  $D_2$ ,  $R_2$  and  $M$ , in combination with  $R_3$ . After a time determined by circuit  $C$  and  $R$ ,  $C_1$  is 99-percent charged and remains so until the end of the ignition dwell time. When the ignition points open,  $C_1$  discharges through  $D_3$  and  $D_1$ , the latter now having shifted to its forward conduction charac-

teristic due to the inverse primary wave. The capacitor is now reset and ready for the succeeding ignition event. The meter current is proportional to the average value of the charging current and repetition rate

$$I_o = \frac{[ED_1 - (eD_2 + eD_3)]}{R} A \frac{t_1}{T} \quad (1)$$

where,  $I_o$  = meter plus  $R_3$  current,  $ED_1$  = zener diode voltage,  $eD_2$  = instantaneous peak voltage of  $D_2$ ,  $eD_3$  = instantaneous peak voltage of  $D_3$ ,  $R$  = total meter circuit resistance,  $A$  = form factor of exponential wave equal to 0.3,  $t_1$  = charging time of  $C_1$  equal to  $4.6 RC_1$ , and  $T$  = ignition period (in sec).

The resistance in the discharge path of  $C_1$  is so low that the capacitor could assume a small charge of reverse sign (see Fig. 2). Diode  $D_3$  has a voltage threshold beneath which the discharge rate is slowed abruptly. The net result is that  $C_1$  can never discharge to zero. This residual charge changes with rate



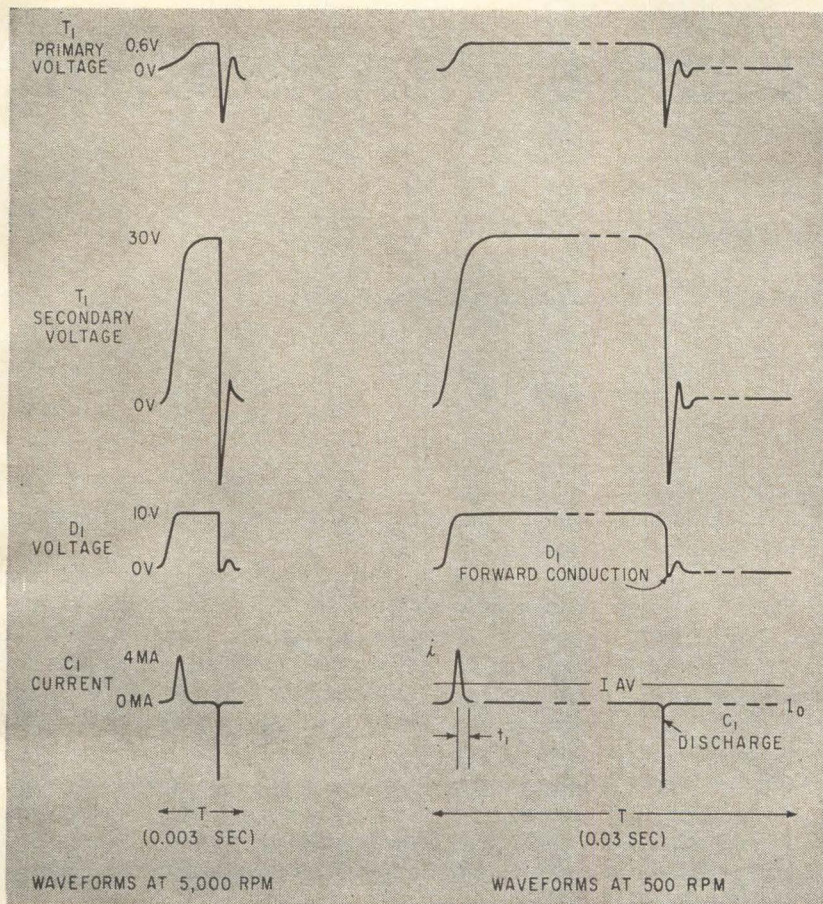

WAVEFORMS for 5,000 rpm and 500 rpm—Fig. 2

source, the engine is accelerated slightly above idle speed until one vertical pulse locks with the horizontal signal. At this point,  $R_s$  is adjusted to give an indication of 900 or 1,200.

The transformer is a 115 v, 6.3 v, 3 A filament transformer with only half of the 6.3 v winding used. Resistor  $R_1$  was necessary because  $T_1$  was not tailored to the application. Diode  $D_1$  keeps the ignition circuit completed even if  $T_1$  becomes open-circuited. It also levels excessive transformer input voltage when ignition coil and ballast are cold. (Manufacturers never put a circuit breaker or fuse in the ignition circuit because failure just as you are passing a truck might prove embarrassing. For this reason,  $D_1$  is recommended. It should be rated to pass the maximum coil current continuously and it should be mounted near the coil, not in the tachometer.) The components were mounted on a board fastened to the fire wall under the instrument panel. The meter was mounted in the space provided for a clock.

**CALIBRATION** — The unit has been checked once since installation and only because a high-pressure car wash got the component board wet. After drying out, recalibration was not required. After all night standing in temperatures as low as  $-10$  F, the tachometer indication at idle was always between 400-500 as soon as the choke dropped the fast idle cam. This is a useful check method because idle speed is usually consistent except in wet weather. The correlation between speedometer and tachometer has been checked several times within the readability of the instruments.

and represents a nonlinear component in the meter indication. In design, this nonlinear component can be minimized.

The forward characteristics of zener diodes are not generally published so it may be necessary to shunt the zener element with a conventional diode that would clamp the inverse wave to the lowest possible voltage. Also, the R-C time and the peak charging current should be held to a minimum consistent with meter current requirements.

Transformer requirements are not critical except that the unidirectional primary current wave makes tape wound or other gapless cores unsuitable. Ordinary silicon iron EI cores have proven best for the application.

**DESIGN FACTORS**—For a typical four cycle engine, the following apply:  $T = 60 (2)/\text{rpm} (N)$ , where  $N$  is the number of cylinders;

$i = ED_1 - (eD_2 + eD_3)/R = \text{peak charging current}$ ; the transformer secondary peak voltage  $eS$  should be three times the zener diode voltage; the transformer primary peak voltage should be no more than 5 percent of the ignition battery voltage; and  $R_1 = eS - ED_1/1.5 i$

Value of  $C_1$  is found from Eq. (1) and its value is independent of  $R$ . Substituting for  $t_1$

$$I_o = \frac{ED_1 - (eD_2 + eD_3)}{R} \quad A \quad 4.6 RC_1/T \quad (2)$$

$$C_1 = \frac{T I_o}{4.6 A (ED_1 - eD_2 - eD_3)} \quad (3)$$

The 60 cps power line may be used as a calibrating reference. If full-scale indication is to be 5,000 rpm, then the line frequency is equivalent to 900 rpm for an eight cylinder engine and 1,200 rpm for a six. With the vertical input of a cro connected to the junction of  $D_2$  and  $R_s$  and the horizontal input connected to a 1 v, 60 cps power line



## NEW TECHNIQUE:

# DESIGNING CLASS-C TRANSISTOR

*Analysis shows grounded-collector Hartley circuit  
has unique advantages in oscillator applications*

TRANSISTOR OSCILLATOR circuits are available to the designer in many configurations. Among these, the grounded collector Hartley is attractive for these reasons: (1) D-c can be applied to the transistor without chokes or resistors, (2) One side of the tank circuit can be grounded, (3) For power oscillators, the collector can be mounted on a heat sink, (4) The design uses a minimum number of components, (5) The circuit is equally well suited for power oscillators used in d-c to a-c converters, as it is for applications calling for essentially no power output but good frequency stability, (6) The circuit can be analysed and synthesised without difficulty, and (7) The output voltage is nearly independent of circuit and load parameters.

Basic circuit configuration, Fig. 1A, can be shown as equivalent circuits, Fig. 1B and 1C, to provide isolation of the tank circuit or transformation of tuning capacitance or load to a desired value.

**CIRCUIT OPERATION**—When d-c is applied, the transistor will be forward biased by current in  $R$ . Loop gain is high and oscillations will start. Capacitor  $C_b$  will be charged due to rectification in the base junction and establish a reverse bias for the base. The bias voltage will increase until it is somewhat smaller than the peak amplitude across  $L_b$ . The transistor will be normally cut-off and conduct only for the interval when the peak voltage across  $L_b$  is slightly larger than the bias voltage across  $C_b$ . Since the voltage across  $L_c$  is in phase with the voltage across  $L_b$ , the transistor will conduct when

the collector to emitter voltage has reached its minimum. The transistor will be driven into saturation and the peak voltage across  $L_c$  will be slightly less than the supply voltage.

The transistor can be viewed as a synchronous switch closing at the peak of each cycle to restore the peak a-c voltage to the level of the d-c supply voltage. This is true, independently of the circuit Q or load. Amplitude of the a-c across  $L_c$  will therefore be approximately equal to the d-c supply voltage. However, as load resistance is decreased, the d-c supply current will increase to furnish the additional power needed to maintain the output voltage.

Frequency will be within a few tenths of one percent of the tank resonance frequency, provided that transistor reactances (mainly collector to base capacitance) can be neglected. Practical oscillator circuits have up to several microfarads appearing in parallel to the junction capacitance. This assumption is therefore valid in most cases.

Another factor in achieving calculated operating frequency is that the transformer material used not show saturation effects, and have a coefficient of coupling close to one. Close coupling between  $L_b$  and  $L_c$  is highly desirable for oscillators requiring good amplitude and frequency stability. If the coefficient of coupling is too small, stray inductances will appear in series with transistor electrodes and cause phase shifts, and consequently frequency shifts. If the coefficient of coupling is one, the real part of the transistor impedance will appear in

parallel with the tank circuit and therefore not cause frequency shifts.

Ferrite cup cores are ideal for oscillator work from audio to several megacycles, since coefficients of coupling above 0.95 can be obtained at good temperature stability of the permeability. Q's up to 800 are possible.

Tank circuit Q must be sufficiently high, at least twenty is recommended, if high frequency stability is desired.

**CIRCUIT ANALYSIS**—Peak voltage across  $L_c$ , Fig. 1A, will be approximately equal to  $V$  after oscillations have started. If all circuit losses, external load resistors, and losses caused by the biasing resistor  $R$  are lumped into an equivalent resistor  $R_L$  across  $L_c$  the power consumed in  $R_L$  will be approximately  $N_{a-c} = V^2/2 R_L$ . The d-c delivered to the oscillator depends upon the efficiency of the transistor as a switch.

Since the exact waveform of the collector current is not known, efficiency is difficult to evaluate. However, power dissipated in the transistor is always smaller than the power delivered to equivalent resistor  $R_L$ , since current flows only when the voltage across the transistor is at its minimum (Fig. 2B). Transistor efficiency will be between 85 and 95 percent. To arrive at useful design equations, the average switching efficiency is at 90 percent; d-c power is then  $P_{a-c} = V^2/1.8 R_L$ , and the d-c supply current is  $I_{a-c} = P_{a-c}/V = V/1.8 R_L$  excluding the bias current in  $R$ . This is average d-c current. Peak collector cur-



# L-C OSCILLATORS

By PETER LAAKMANN,  
American District Telegraph Co.,  
New York, New York

rent is several times average current. Average base current  $I_B$  must be equal to or greater than  $I_{a-c}$  divided by the common emitter current gain at the peak collector current for the transistor to be driven into saturation during the conduction cycle.

Value of biasing resistor  $R$  that will just supply this current is equal to  $1.8 R_{L\beta} (1 + n)$  where  $n$  is the turns ratio between  $L_B$  and  $L_C$  or  $n = \sqrt{L_B/L_C}$ .

Collector to emitter voltage, and collector-current of an oscillator operating with half the maximum permissible  $R$  is shown in Fig. 2B. The desirable excess drive is shown by the dip at the peak of the current pulse, and essentially zero collector to emitter voltage at the current peak. Figure 2A shows the same oscillator, operating with a biasing resistor larger than the permissible value. Note that the collector to emitter voltage never reaches zero, indicating poor efficiency and poor voltage stability.

Equivalent load resistor  $R_L$  is made up of three parts in parallel—the tank circuit resonance impedance, the effect of the biasing network, and the external load. Both the transformed load resistance and the tank circuit resonance resistance can be easily found. The tank circuit resistance is equal to  $Q\omega L_C$ . The external load, as reflected across  $L_C$  can be found from the transformation ratio to the load winding.

The effect of the biasing resistor  $R$  can be evaluated by using conservation of power. Resistor  $R$  reflects in parallel with  $L_C$  with a value

$$R' = \frac{R}{3n^2 + 4n + 1} \quad (1)$$

**COUPLING CAPACITOR**—Many oscillator designs have shown that the exact value of the base coupling capacitor is not critical. The time constant  $C_B R$  should be between 10 and 50 oscillator periods. If  $C_B$  is

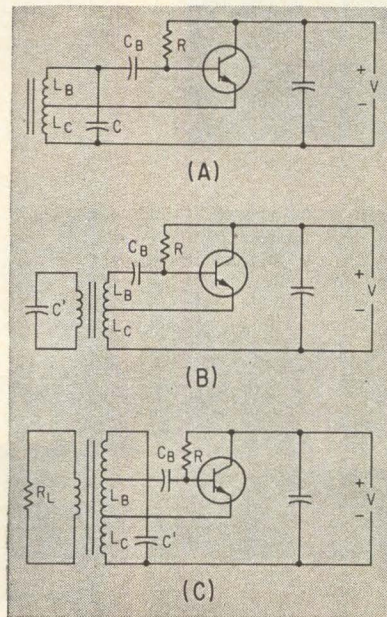

HARTLEY CIRCUIT (A), and method of isolating tank circuit (B) or transforming load to a desired value (C)—Fig. 1

made too large, blocking oscillations can occur. If  $C_B$  is too small, the current pulse leads the collector to emitter voltage. The transistor then becomes reactive and poor efficiency and frequency stability results.

Figure 2C shows collector to emitter voltage and collector current for a small value of coupling capacitance. Figure 2D shows a lagging current pulse for a large coupling capacitor. Voltage and current waveforms for a properly chosen capacitor are shown in Fig. 2B. The capacitor was varied over a 1:4 range.

The exact value of base coupling capacitance depends upon input characteristic of the transistor, leakage inductance and delay time of the transistor. Although it should be possible to calculate the optimum value, such an approach would be more time consuming than an experimental determination of  $C_B$ . For most applications, a value within the indicated range will be

satisfactory. Only for applications requiring maximum efficiency or frequency stability, would an analytical determination be worthwhile, although the improvement is usually small. In any case, it is advisable to check for margin against blocking oscillations, by increasing  $C_B$ .

Of interest for class C oscillator work are alpha cut off frequency, saturation voltage, beta at peak collector current, and breakdown voltages. Minimum diode breakdown voltages should be  $V_{CB} = 2V (1 + n)$  and  $V_{EB} = 2nV$ . A high beta transistor is preferable to a low beta unit, since it permits a larger bias resistor, and consequently, lower loss. Saturation voltage at peak current should be as low as possible for good voltage stability and efficiency. The peak current can be up to one order of magnitude greater than the average current.  $I_{CBO}$  is usually of no significance, except that it provides additional bias margin at high temperatures.

**TANK CIRCUIT**—If the oscillator is to operate into an external load, the designer has a choice of loaded Q. As the total load resistance  $R_L$  is represented by the parallel combination of  $R_L'$  (transformed external load resistance),  $Q\omega L_C$ , and  $R'$  the efficiency increases as  $L_C$  is increased. However, frequency stability is decreased due to a lower total Q. Total collector efficiency (d-c to load resistance) is the product of tank circuit efficiency and switching efficiency.

If the oscillator does not have to deliver power to an external load, but provide maximum frequency stability, the tank circuit design should provide as low a tank circuit reactance as possible. If the d-c supply voltage to the oscillator is given, the available Q of the core material and the power dissipated in the tank circuit will set a lower limit to the tank circuit reactance that can be used. However, if the



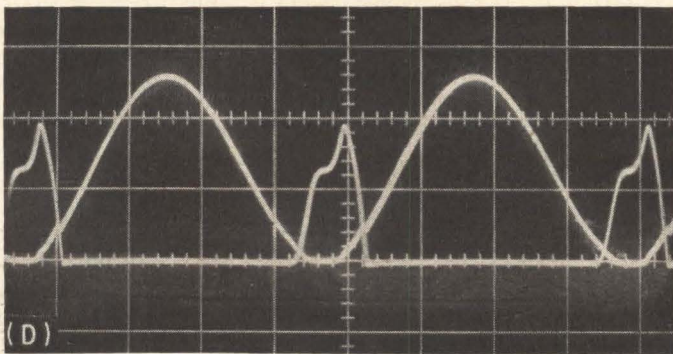
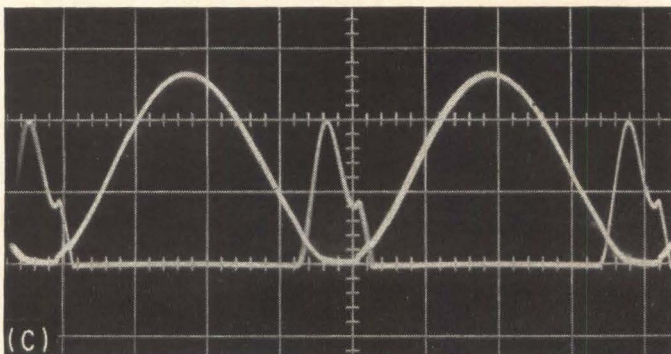
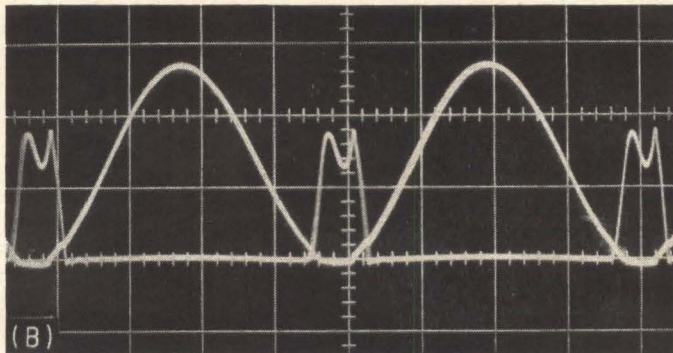
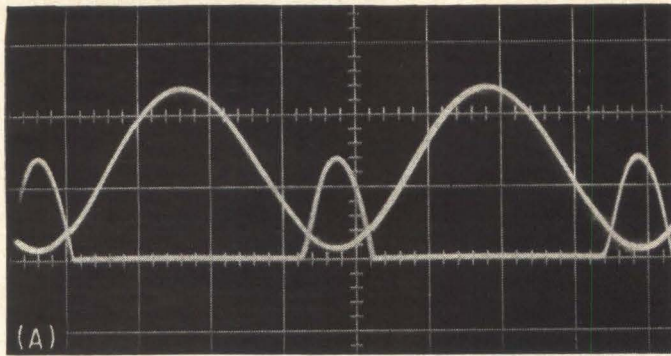

COLLECTOR TO EMITTER voltage and collector current for oscillator operating with insufficient base bias current (A), sufficient bias current with base coupling capacitance chosen for zero phase shift between current pulse and voltage (B), small value of base coupling capacitance shows leading current and poor frequency stability (C), large base coupling capacitance shows lagging current and poor frequency stability (D). Scale is 10 volts per division, 100 ma. per division and 2 microseconds per division—Fig. 2

supply voltage can be chosen, a low voltage is preferable to higher voltage, since it permits a lower tank circuit reactance for a given Q and power limit.

Transformer turn ratio  $n$  determines peak emitter to base voltage and conduction angle of the transistor. It was found experimentally that a peak-to-peak voltage between 5 and 15 v will give conduction angles between 80 and 50 degrees. Conduction angle determines the ultimate efficiency of the transistor switch and the peak current the transistor has to carry. For a conduction angle of 70 degrees, the peak current will be approximately eight times average collector current. As the saturation voltage increases with current, lower conduction angles do not necessarily produce higher efficiencies. It is good practice to design for a conduction angle of approximately 70 degrees, that is, to choose the turn ratio  $n$  to deliver approximately 8 volts peak-to-peak to the base to emitter junction.

DESIGN EXAMPLE—A 122 Kc oscillator was designed to deliver 4.8 volts  $\pm 5$  percent to an rf bridge circuit with a load impedance of 270 ohms at  $\pm 45$  degrees phase angle. Total efficiency of 50 percent and frequency stability of less than  $\pm 2$  percent with respect to load impedance variations were also design requirements that had to be fulfilled.

As the supply voltage is 10 volts, the peak voltage across  $L_c$  will be approximately 9.5 volts (assuming a saturation voltage drop of 0.5 volt for a germanium transistor). Effective a-c voltage across  $L_c$  will therefore be 6.7 volts. The turns ratio, collector to load winding, then becomes 1.39 and the reflected load resistance  $R_L'$  across  $L_c$  is  $(270)(1.39)^2 = 520$  ohms. Tank circuit reactance and loaded Q will be prescribed by the frequency stability required. Reflected load impedance can have a phase angle from  $-45$  to  $+45$  degrees. In the extreme case the reflected load impedance would be 740 in parallel with  $\pm j740$  ohms. To produce less than  $\pm 2$  percent frequency change, the tank circuit reactance should be less than  $(j740)(2)(0.20) = j 29.6$



ohms, since 4-percent reactance change produces 2-percent frequency change.

Tank circuit reactance is chosen as  $j20$  ohms to exceed the frequency stability requirement. Core material to be used has a  $Q$  of 120 at 122 Kc. The tank circuit resonance resistance then becomes  $20 \times 120 = 2,400$  ohms.

The turn ratio will be chosen as 0.4 to deliver 8 volts peak-to-peak to the base to emitter junction.

Neglecting bias resistance, the total load resistance would be 2,400 ohms in parallel with 520 ohms or 420 ohms. From  $I_{a-c} = V/1.8 R_L$ , the average d-c collector current will be 13.3 ma. Peak current for a 70 degree conduction angle will then be approximately 100 ma. A 2N1307 transistor with minimum beta of 30 at 100 ma was chosen. Allowing a safety factor of 2, biasing  $R$  is calculated as 14,200 ohms. A 15,000 ohm resistor is used. This resistor will be reflected as  $R' = 4,900$  ohms in parallel with  $R_L$  (Eq. 1). Since this is approximately an order of magnitude larger than the load resistance, the load resistance is not significantly changed by the reflected bias resistance. Under some circumstances, the transformed bias resistance modifies the load resistance to a larger extent. The calculation of  $R$  would then have to be repeated until the error is minimized.

The reflected bias resistance changes the total load resistance to 386 ohms. Then, d-c collector current becomes  $I_{a-c} = 14.4$  ma.

Since voltage across  $R$  is equal to 14 V (d-c supply voltage plus rectified a-c voltage), the d-c bias current is equal to 0.93 ma. Total supply current is then 15.3 ma, and the d-c power supplied is 153 mw. Since the output power for a 270 ohm resistive load would be 85 mw, the total efficiency is 55.5 percent, which meets the requirement of at least 50 percent efficiency.

The base coupling capacitor is chosen for 20 oscillator periods. A value of  $0.0107 \mu\text{f}$  will give 20 periods, but a  $0.01 \mu\text{f}$  capacitor will work just as well.

Tank circuit reactance is extremely small (20 ohms). Transformation of tuning capacitance is desirable to reduce capacitor size

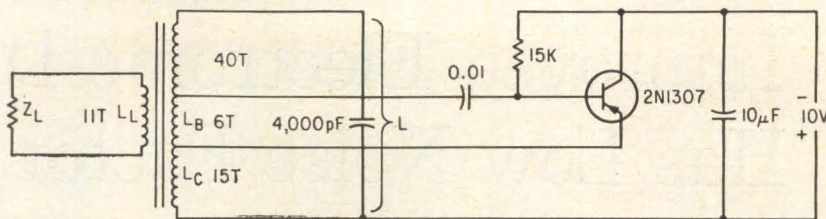

FINAL DESIGN of 122-Kc oscillator. Transformer is No. 30 wire wound on a Ferroxcube core—Fig. 3

(Fig. 1C). A 4,000 pf capacitor is small enough to be practical, and large compared to the winding capacitance of the core (about 50 pf), and therefore a good value to use. The winding data for the transformer can be found from  $N = a \sqrt{L_{mh}}$ , where  $N$  = number of turns and  $L$  = inductance. For the core used,  $a$  was given by the manufacturer as  $93 \pm 2$  percent.

The circuit and all values for this design example are shown in Fig. 3. The oscillator was built and the measured results were practically identical to the calculated values.

ACCURACY—To judge the accuracy of the calculation, the exact value of all components were measured before use in the oscillator. Also, the  $Q$  of the coil, resonating at 122 Kc with a 4,000 pf capacitor was measured, before the value of 120 was used in the calculations. The transistor beta at peak current was measured, to check the formula for the maximum bias resistance. The formula proved to be an accurate prediction of the oscillator behavior, since the transistor ceased to be saturated at the peak of each cycle, when a value of  $R$  greater than the permissible value was used (Fig. 2A). Transformation of load resistance into  $R_L$  is only possible for ratios corresponding to the square of the quotient of integral turns. The design example was written around a realizable transformation ratio.

All of the above mentioned factors combine to explain the extreme accuracy of prediction achieved. In practice, the designer will not know the coil  $Q$  with anything better than perhaps 20 percent accuracy, and a corresponding error will be introduced. The number of turns for the collector winding is the object of

the calculation, hence a restriction is imposed as to physically realizable transformation ratios. This can be significant if proper tank circuit reactance is obtained at 15 turns, as in the design example.

Fortunately, all of these problems can be worked out on paper, with the synthesizing procedure outlined above. The designer is not forced to handle a high number of interacting variables, as is the case in an empirical design of oscillators, with no guaranty of ever achieving an optimized design, or a design that will meet worst case conditions.

From the previous analysis, it appears that a simple method can be used to approximate, with a high degree of accuracy, the large signal behavior of one type of class C transistor oscillator. The analysis could be extended to other circuits, such as the grounded base or grounded emitter Hartley, with only minor modifications. However, the grounded collector Hartley can cover all low and medium frequency requirements with a higher degree of flexibility than many other circuits. The Colpitts oscillator is best suited for high frequency applications, where a coefficient of coupling close to unity between collector and base winding would be difficult to achieve. For lower frequencies, the two capacitors required (one of which is usually extremely large), and the difficulty of applying power to the transistor place the Colpitts at an economic disadvantage.

A number of restrictions, such as for example close coupling between collector and base winding, had to be introduced to facilitate the analysis. This is not only necessary for a simple analysis, but also a requirement for stable performance.



# Improved Electronic Differentiator Has Low Noise Factor

*Time delay of added amplifier smoothes out irregularities caused by h-f noise*

By N. D. DIAMANTIDES, Goodyear Aircraft Corp., Akron, Ohio

DIFFERENTIATION is one of the most basic—and therefore most common—computational operations. It is riddled with more difficulties than any other operation. When electrical quantities are to be used for differentiation, the time derivative of a voltage,  $e_{in}$ , can be obtained as a current,  $i$ , if a capacitor of capacitance  $C$  is charged from the voltage source  $e_{in}$  as

$$i = C \frac{d}{dt} e_{in} \quad (1)$$

Using practical components, the current is totally inadequate as an output because of its low value, except when the rate of change of  $e_{in}$  is high. The difficulty is alleviated through conversion of the output into a voltage by forcing the current through a resistor  $R$ , as in Fig. 1A. If the input is charging at a constant rate and for a time sufficient for the current through  $C$  and  $R$  to assume its steady state, the output voltage is

$$e_o = RC \frac{d}{dt} e_{in} \quad (2)$$

Hence the output has the benefit of an amplifying factor  $R$ .

However the alleviation is not bought without a penalty that manifests itself as undesirable transient effects, particularly when higher derivatives are present at the input. In response to a step increase of the input rate  $de_{in}/dt$ , the output does not follow with perfect fidelity the value  $RCde_{in}/dt$ , but instead approaches this value exponentially with a time constant  $RC$  as

$$e_o = (1 - e^{-t/RC})RC \frac{d}{dt} e_{in} \quad (3)$$

**TRANSIENT EFFECT**—The disturbing transient effect is due to the fact that the input signal is shared between the resistor and the capacitor instead of being applied across the capacitor alone. This can be remedied if junction  $O$  between  $R$  and  $C$  is held at a constant voltage through a monitoring device that demands no current from the junction. Ideally the operational amplifier is such a device, since it has practically zero input current, inverts the voltage polarity between input and output, and has an operating output range that can accommodate the input level.

Assuming that the amplifier has infinite gain

$$i = C \frac{d}{dt} e_{in}$$

and the output becomes

$$e_o = e_o - Ri = e_o - RC \frac{d}{dt} e_{in}$$

By designing the amplifier so that  $e_o$  is at ground potential

$$e_o = -RC \frac{d}{dt} e_{in} \quad (4)$$

If the open-loop gain  $k$  of the amplifier is finite

$$e_o = -\frac{k}{k+1} (1 - e^{-(k+1)t/RC})RC \frac{d}{dt} e_{in} \quad (5)$$

Comparing Eq. 5 and 6, the time constant has been reduced by a factor  $(k+1)$ , a valuable improvement.

**SATURATION**—However, it is common experience that in actual computations the input rate is often so large that the amplifier saturates before the output has the time to reach its required value;  $e_o$  then will no longer be held at ground level by the output action and the amplifier becomes blocked for an appreciable time. This will happen if the input is a step function drawing  $de_{in}/dt = \infty$ . The output will swing to the limit of its range and the grid potential will begin to move back, at a rate equal to this limit value divided by  $RC$ ; when it has assumed a value equal to the step, operation will be resumed. But this is not the only practical malfunction: on account of

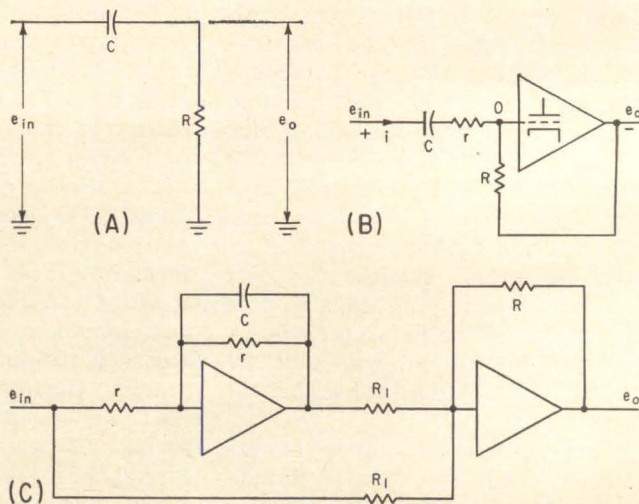

PASSIVE DIFFERENTIATING circuit (A); conventional (B) and improved (C) differentiators—Fig. 1



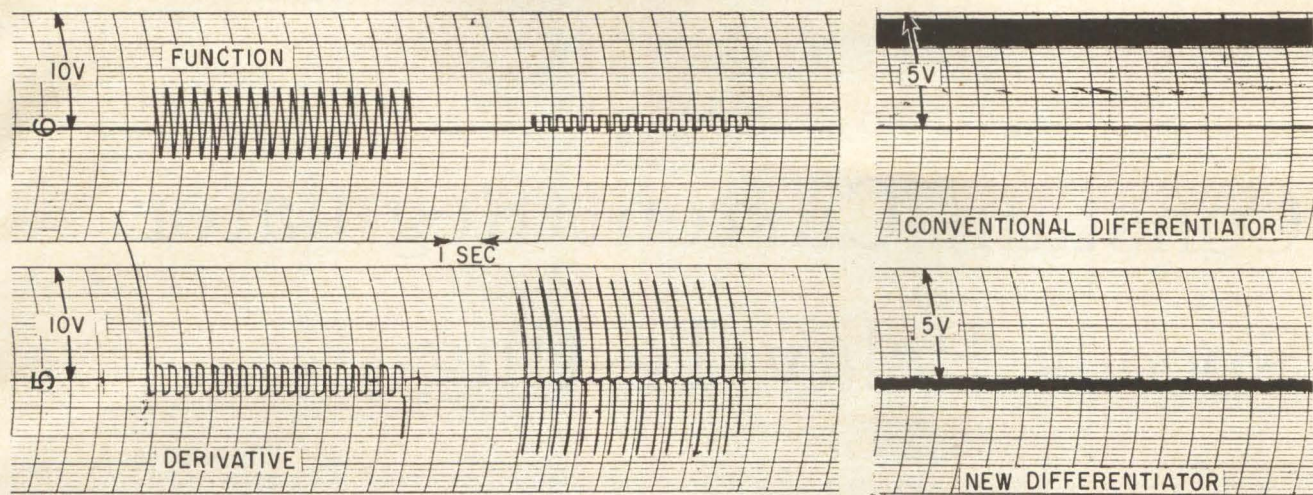

DIFFERENTIATION OF TRIANGULAR and square waves with improved model (left) and comparison of differentiator noise (right)—Fig. 2

the high open-loop gain that operational amplifiers must have, oscillations may follow. The situation may be rectified by inserting a small resistor  $r$  in series with the capacitor, which changes the arrangement to a phase lead circuit that permits a fluctuation of  $e_o$  to cancel itself immediately rather than belatedly with  $R$  and  $C$  acting as a filter. Then, assuming that  $k \cong \infty$ , the result is

$$e_o = -(1 - e^{-t/rC})RC \frac{d}{dt} e_{in} \quad (6)$$

This is a universal characteristic of practically every computer amplifier used as differentiator and can be expressed in a Laplace form (the ordinary notation in analog computation) as

$$e_o(s) = -\frac{RC_s}{1 + rCs} e_{in}(s) \quad (7)$$

where  $s$  is the Laplace operator,  $s = j\omega$  of the frequency domain. Equation 7 is directly obtained from the circuit of Fig. 1B by adding the currents at the junction point  $O$ , assuming infinite amplifier gain and zero grid voltage, and designating resistive impedances by  $R$  and capacitive impedances by  $1/Cs$ .

Equation 7 may be written

$$e_o(s) = \frac{R}{r} \left( \frac{1}{1 + rCs} - 1 \right) e_{in}(s) \quad (8)$$

The form of the computational operation suggested by the right-hand member of this expression is shown in Fig. 1C, which, when the sign-reversing feature of computer amplifiers is considered, is equivalent to a difference amplifier, and has the response function

$$e_o(s) = \frac{R}{R_1} \frac{C_s}{1 + rCs} e_{in}(s) \quad (8)$$

**PEAKING EFFECTS**—The most significant aspect of this setup is the absence of a differentiator, that is, of a capacitor in series with the input of an amplifier; hence no operational unit is subject to the peaking effects of differentiations, that is, to the accentuation of irregularities in the signal being differentiated. Such irregularities are due usually to noise developed internally and tend to be of relatively high frequency. Since the output of a differentiation process is directly proportional to frequency,

the noise output is likely to be out of proportion to the desired signal output and may completely mask this signal. By contrast, the action of the first amplifier, Fig. 1C, featuring a time-delay characteristic, is a smoothing process which tends to iron out irregularities caused by high-frequency noise. If this noise were to be approximated by a sinusoidal  $e_{in} = \sin \omega t$ , then the output of this first amplifier will be

$$e_o(s) = \left( \frac{1}{1 + rCs} \right) \left( \frac{\omega}{s^2 + \omega^2} \right) \quad (9)$$

or in the time domain

$$e_o = \frac{1}{\sqrt{1 + (rC\omega)^2}} \sin(\omega t - \tan^{-1} rC\omega) \quad (10)$$

which predicts greater attenuation the larger  $\omega$  is. To demonstrate the performance of the suggested differentiator, Fig. 1C, the following values of parameters were selected:  $C = 0.05 \mu\text{f}$ ,  $r = 0.10$  megohm,  $R_1 = 0.10$  megohm and  $R_2 = 1.0$  megohm resulting in a transfer function

$$e_o(s) = \frac{0.10s}{1 + 0.005s} \quad (11)$$

In Fig. 2 (left) the results of differentiating a triangular and a squarewave are shown, demonstrating the validity of the analysis.

**COMPARISON**—The new differentiator was also compared to the conventional one as to noise. To do so, the inputs of both were connected to the output of the same computer amplifier whose gain was set equal to unity. The capacitor value in both circuits, Fig. 1B and 1C, was selected as  $C = 1 \mu\text{f}$ , and the value of the resistor  $r$  in the first circuit was lowered to the point where the differentiator output  $e_o$  was a noise signal of 1 volt peak-to-peak as seen in Fig. 2 (right). The differentiator had a transfer function  $s/(1 + 0.003s)$ . Not only noise but also a d-c offset was observed in the output, probably because the amplifier was close to instability. The values of the circuit parameters of the new differentiator were then selected to give the same time constant and gain; that is,  $r = R_1 = 0.003$  megohm,  $R = 1$  megohm, and its output noise recorded with the results shown also in Fig. 2 (right), where a 2-to-1 improvement can be seen.



# Constant-Current Regulator Speeds Relay Testing

*Constant total resistance circuit eliminates manual current adjustments  
and provides uniform conditions for testing production relays*

By D. H. LIEN

Planning Engineer,  
Western Electric Company,  
Indianapolis, Indiana

NO TWO RELAYS from a production run perform exactly alike. They have different electrical resistances, magnetic reluctances, inductances and mechanical pull-in qualities. They can be tested for operation at either a specified minimum current or a minimum voltage.

For telephone relays that are operated at a distance from the source voltage, the minimum current test is practical. In testing large production runs, considerable time can be consumed making current adjustments because of variations in coil resistances. The applied current should not be adjusted downward from above the minimum operating current after the relay has operated, because less current is required to hold the armature than to operate it. Rather, the current should be brought up to the required level from the low side to assure relay operation at the specified minimum. The rate of flux buildup in the relay also becomes important in designing a test circuit. A relay will pull in with the least current if the flux builds up rapidly; therefore, the flux should not be permitted to build up faster in the test circuit than is expected in the operating circuit.

The conventional way to obtain a constant current is to use a high voltage in series with a high dropping resistance. Variations in load resistance are then a small percent-

age of total circuit resistance and cause little change in current. Practically any degree of current regulation can be obtained this way by using a sufficiently high voltage and a high dropping resistance. There are some disadvantages. In addition to the hazard of high potentials and possible arcing, the current and flux buildup is faster, and a relay that just pulls in under these conditions may not operate at all under actual conditions.

A more suitable source would be a voltage of approximately that used in the operating circuit and a series resistance approximately matching that of the relay. Since each relay has a different resistance within a statistical range, part of the circuit must provide dynamic resistance compensation to assure that the same current is conducted through each relay. A series resistor and a transistor will perform this function well. If the source voltage and ambient temperature are constant, no other compensating devices are required.

**CIRCUITS**—The circuit shown in Fig. 1A is a bridge with the base of a transistor as one corner and a potentiometer contact as the opposite corner. Variations in relay resistance shift the balance of the bridge such that variations in the transistor base current adjust the transfer resistance of the transistor in the opposite direction, tending to keep the total resistance constant in the relay arm of the bridge. This is a negative feedback that is greatest when the

potential of the base does not vary with the base current in a direction to minimize the base-current variations. If the base current is a significant part of the potentiometer current, the potential of the divider terminal and the base will be partially affected by the amount of base current and will diminish the feedback.

Adding a second transistor in the cross-arm as shown in Fig. 1B will amplify the change in cross-arm current seen by the controlling transistor and exert a much tighter control.

The circuits of Figs. 1A and 1B are satisfactory if the only variations are in relay resistances. They require a constant-source voltage and a constant ambient temperature. If the source voltage should vary, the potentials of both bridge corners change in the same proportion, and no compensating base-current shift occurs, thus allowing the load current to shift in proportion to the voltage change. A voltage reference zener diode connected as in Fig. 1C will compensate for voltage variations and will also provide tighter current control from load resistance variations than the circuit of Fig. 1A, because variations in base current will cause practically no variations in base potential.

An ambient temperature change will affect the operating point of the transistor and cause the current to be regulated at a different value. This can be counterbalanced as shown in Fig. 1D by placing a temperature-sensitive resistor with a



positive temperature coefficient of resistivity in the emitter circuit where it will affect the operating point of the transistor.

Some relay tests require starting and stopping the test current, which may cause high-voltage surges to be generated in the coil. It may be necessary to protect the circuit from these surges. Figure 1D shows a diode placed across the coil. When the source voltage is interrupted, the collapsing magnetic field in the relay generates a surge in the forward direction through the diode. When the relay is energized, the diode is inversely polarized and does not affect the load current. It will however, prolong the release time of the relay. A further protection is to operate the transistor close to saturation so that its resistance is low and will not absorb a large proportion of the surge energy. This is accomplished by using as much series fixed resistance in the collector circuit as possible because this resistance determines the amount of resistance the transistor assumes to keep the current constant. Although the resistance in the emitter circuit is part of the total series resistance which should match the relay resistance, its value fixes the current level that the transistor will control for a given zener diode voltage. Therefore, part of the series resistance may be placed in the collector circuit to move the transistor toward the low-resistance side.

If the source voltage fluctuates widely, it may be necessary to add a second zener diode and resistor across the first as in Fig. 1D.

**DESIGN**—In designing a constant-current test circuit with matched impedance, a voltage is needed that is just sufficient to drive the test current through twice the expected median relay resistance  $R$ . Practical considerations may require about 10 to 20 percent above this. If the relay resistance range is  $R \pm \Delta R$ , the transistor resistance need operate only from about 0 to  $2\Delta R$ . When a high resistance relay of  $R + \Delta R$  is being tested, the transistor resistance will be near zero. When a low resistance unit of  $R - \Delta R$  is tested, the transistor resist-

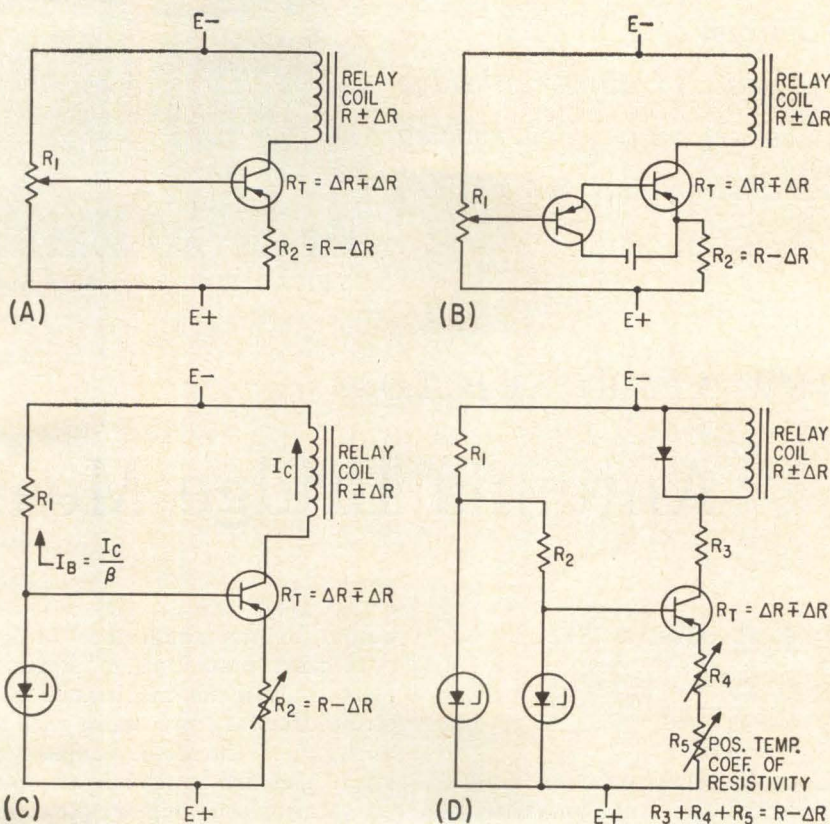

CIRCUITS (A) and (B) compensate for relay resistance variations, circuit (C) for supply voltage variations and (D) for ambient temperature—Fig. 1

ance will be  $2\Delta R$ . The balance of the circuit should be  $R - \Delta R$ , making the total resistance in the bridge relay arm always equal to  $2R$ .

The potentiometer of Fig. 1A may be 40 to 100 times the amount of the relay resistance and up to 200 times for the circuit of Fig. 1B. If it is too low, it will consume considerable power. If it is too high, the fluctuations in base current will alter the base potential and diminish the controlling action of the transistor. This latter effect is less in the circuit of Fig. 1B because of the amplifier in the cross-arm. Only the central portion of the potentiometer is needed, and it may be practical to use a lower-resistance potentiometer with fixed resistors on each end. This will also protect the potentiometer from being overloaded near the negative end.

Since half the potential drop will be across the relay, the collector potential will be less than half the voltage, and the base potential, as determined by the potentiometer or the zener diode, will be less than this.

The resistance in series with the zener diode must carry the base current and the zener current as well as limit the power consumed by the zener diode. Its voltage drop is the source voltage minus the zener voltage.

The temperature-sensitive resistor should have a sufficient power rating to prevent self-heating, particularly if the current is turned on and off frequently. A ratio of temperature-sensitive resistance to fixed resistance of about 1 to 6 in the emitter circuit of a 2N1022 transistor provides close regulation in an ambient temperature varying from 24 to 40 C. If the current increases when the whole unit is heated, increase this ratio.

Since these circuits are practically purely resistive when compared to the relay being tested, the current rise time is limited only by the inductance of the relay and the source voltage. This meets most practical relay test conditions.

#### BIBLIOGRAPHY

Patent—2,751,549 and W. E. Monographs 2281 and 2685.



*Addition of a standing-wave indicator improves bridge measurements when making antenna admittance calculations*

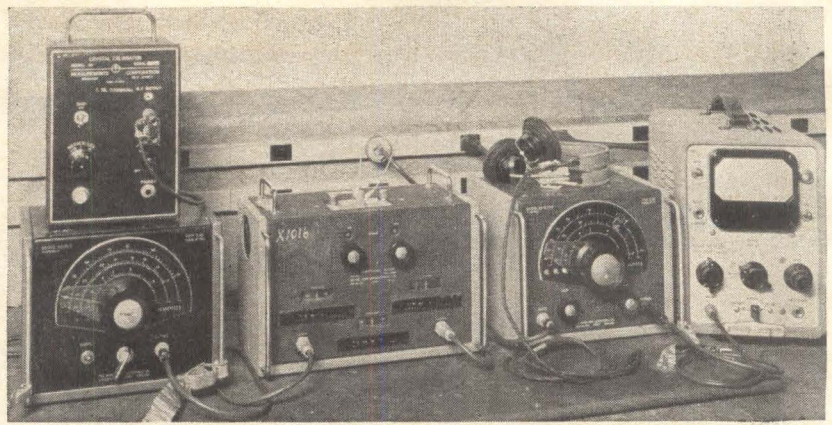

TYPICAL TEST setup with standing-wave indicator at right

## NEW APPROACH TO

# Antenna Bridge Measurements

By W. P. CZERWINSKI  
U. S. Army Signal Research  
and Development Agency,  
Fort Monmouth, New Jersey

BRIDGE measurements of antenna admittance are usually made with a tone-modulated r-f signal (usually 1-Kc audio tone on required r-f) and listening for the audio null on a receiver that is coupled to the

output of the admittance bridge.

In most cases, bridge measurement of antenna admittance is a straightforward procedure with no ambiguity involved. However, large aperture antennas can pick up atmospheric noise plus unwanted signals of sufficient intensity to make the bridge reading ambiguous. This condition can be further aggravated if the test an-

tenna is within the strong field of a nearby transmitting antenna. The signal mixing can override the null, producing either a broad null or no null at all.

**HOW TO MEASURE**—The new approach is to follow conventional methods of measuring antenna admittance until a broad null is located with the admittance bridge tuned to approximate null center. The headphones are then replaced with a standing-wave indicator containing a 1-Kc filter and a high-gain amplifier with meter readout. The indicator is set to its maximum sensitivity and the admittance bridge controls adjusted until the indicator meter dips sharply to its no-signal condition.

With the Smith chart referred to a 600-ohm open-wire transmission line, admittance is normalized to 1/600 or 1.67 millimhos. Test frequency is 12.1 Mc. With the admittance bridge reading conductance  $G = 1.53$  millimhos and susceptance  $B = -3.1$  pf, then  $G/Y_0 = 0.917$ . Therefore,  $-jB = 2\pi fC = -0.236$  millimho and  $B/Y_0 = -j 0.14$ .

The normalized Smith chart admittance values are  $0.917 - j 0.14$ , transferring to impedance becomes  $1.08 + j 0.17$ . As this measurement was made through a 0.164 wavelength, 600-ohm transmission line, the impedance is rotated to the new value of  $0.84 \pm j 0$ . Therefore, the impedance at the feed point is  $600 \times 0.84 = 504$  ohms. The swr then becomes  $600/504 = 1.19:1$ .

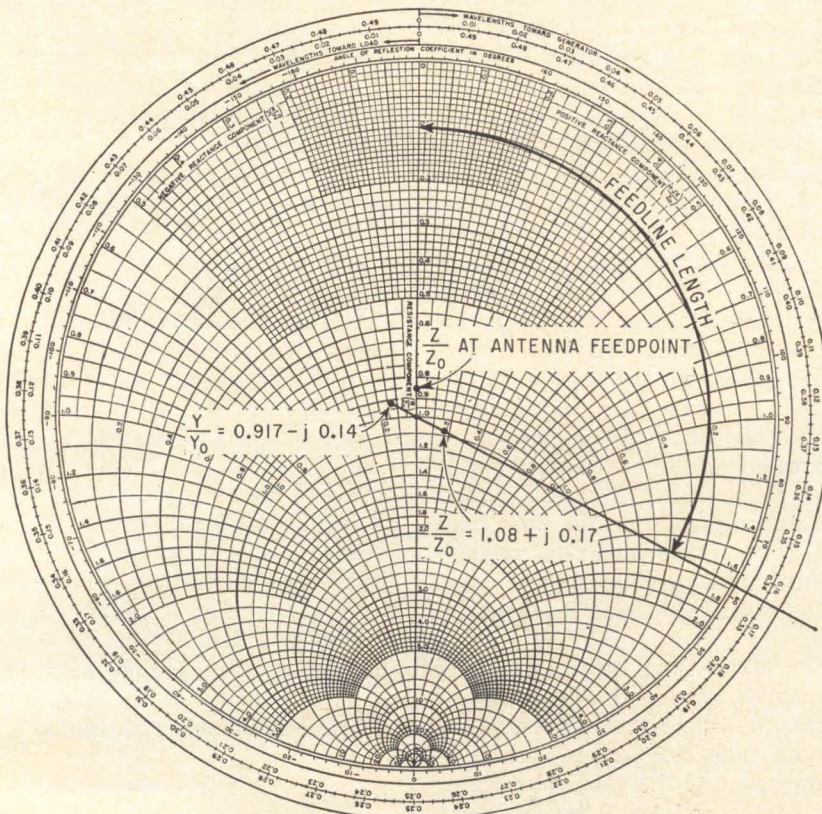

SMITH CHART showing swr calculations



# PRECISION WITH SIMPLICITY

## FROM DELCO RADIO

That's the big feature in Delco Radio's new 175 VA and 250 VA static inverter power supplies. These *all-transistor* units offer increased reliability through simplified circuits. Both static inverters are designed for either airborne or ground applications and will withstand overload and output short circuit conditions indefinitely, delivering at least 110% of rated output before going into overload protection. Units automatically recover to full output upon removal of overload and short circuit. Units are designed to meet the environmental requirements of MIL-E-5272C. For further information on military electronics write Delco Radio's Military Sales Department.

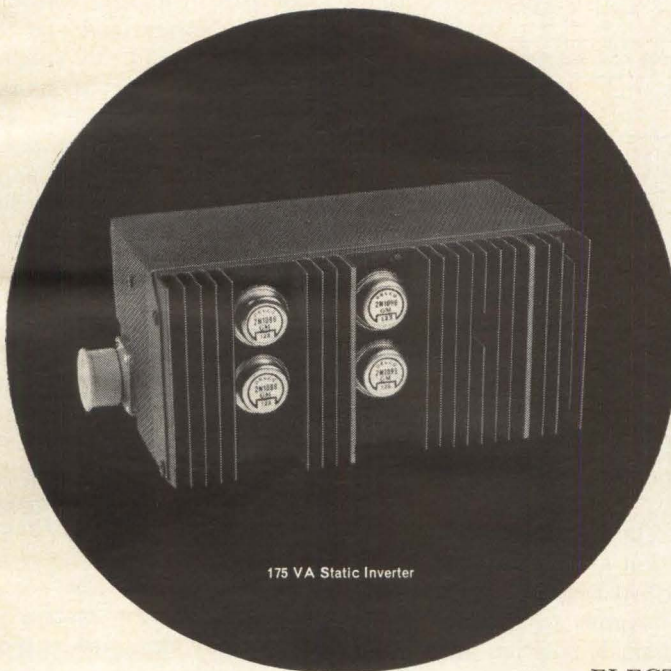

175 VA Static Inverter

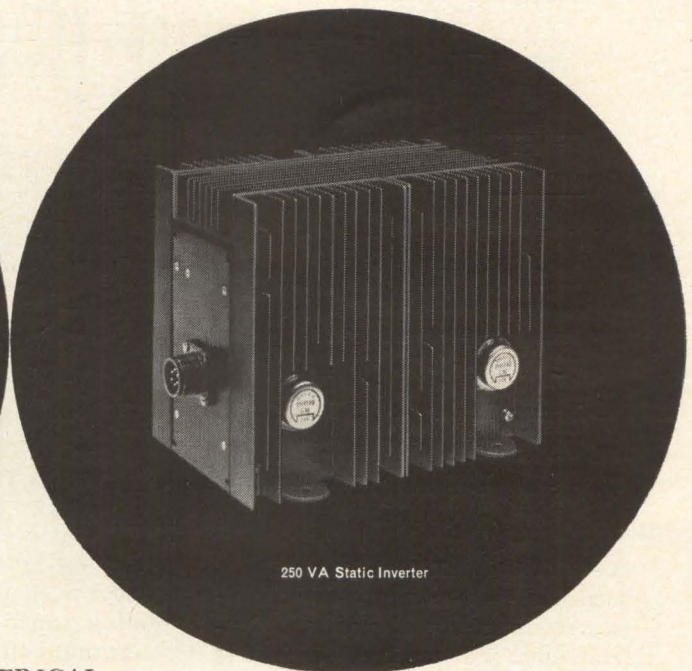

250 VA Static Inverter

### ELECTRICAL SPECIFICATIONS

#### 175 VA STATIC INVERTER

Input  
Voltage: 27.5 VDC  $\pm$  10% per MIL-STD-704

Output  
Power: 175 VA single phase 0.5 lag to 1.0 power factor

Voltage: 115 V adjustable from 110 to 120 volts

Regulation: 1-volt change for any variation of load between zero and 110% of full load, and input voltage between 25 VDC and 30 VDC

Frequency: 400  $\pm$  1 cps.  
Frequency changes less than 1.0 cps. for all environment, load and input voltage variation

Distortion: Less than 5% total harmonic

Efficiency: 80% at full load

#### 250 VA STATIC INVERTER

Input  
Voltage: 27.5 VDC  $\pm$  10% per MIL-STD-704

Output  
Power: 250 VA single phase 0.6 lag to 1.0 power factor

Voltage: 115 V adjustable from 110 to 120 volts

Regulation: 0.7 volt for any variation of load between zero and 110% of full load, and input voltage between 25 VDC and 30 VDC

Frequency: 400  $\pm$  .5 cps.  
Frequency changes less than 1.0 cps. for all environment, load and input voltage variation

Distortion: Less than 5% total harmonic

Efficiency: 80% at full load

**DELCO**  
DEPENDABILITY  
**RADIO**  
RELIABILITY

Division of General Motors • Kokomo, Indiana



# Industrial Engines Get Breakerless Ignition

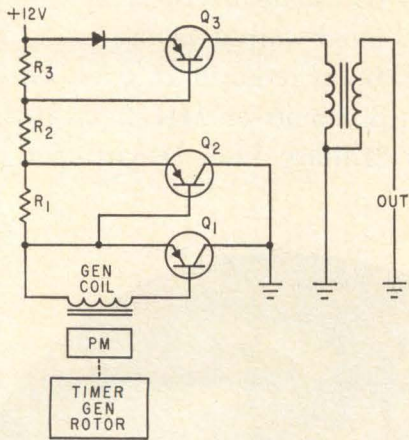

ROTATING permanent magnet switches transistors on and then off, interrupting current in primary of output transformer to generate ignition pulse—Fig. 1

*Specially made transformer allows wide selection of ignition characteristics*

ELECTRONIC IGNITION system has been designed to meet the specialized requirements of modern industrial gasoline engines, including high-pressure turbocharged units. No distributor or breaker points are required in the developmental system. It can provide the high sparkplug voltages required in the new industrial engines, such as those being put into service in processing and pipeline applications.

The electronic ignition system is the culmination of 10 years of design effort and field experience by American Bosch Division of American Bosch Arma Corp. A pulse generator system introduced in 1951 is said to have been successful in principle and practice. A number of them are still operating after more than 50,000 hours of trouble-free service, according to Ralph S. Warner, senior engineer. However, the physical size and initial cost of these systems have limited use to very large engines. These and other factors led to a completely new approach to the de-

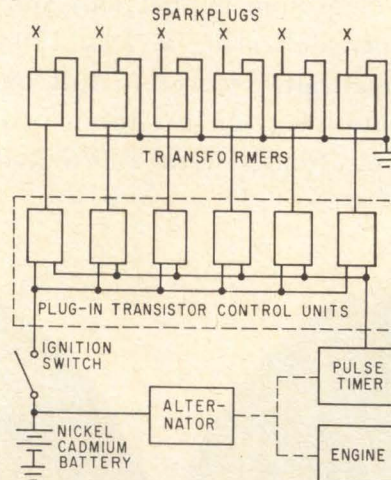

POWER for ignition system will usually be provided by 14-volt d-c battery-rectifier unit supplied by a-c source—Fig. 2

sign of an ignition system to meet the requirements of modern industrial gasoline engines.

**OPERATION**—The basic circuit of the new ignition system for one cylinder is shown in Fig. 1. As the rotating timer magnet passes the generating coil, small positive and negative pulses are produced. Transistor  $Q_1$  is switched off during the half cycle that voltage to the base is positive and on when it is negative. When  $Q_1$  is conducting, current from the 12-volt supply through resistors  $R_1$ ,  $R_2$  and  $R_3$  develops negative bias voltage that switches on  $Q_2$  and  $Q_3$ . When  $Q_3$  is conducting, current flows through the primary of the transformer.

As current in the generating coil reverses polarity, all transistors are switched off. Interruption of current in the transformer primary produces ignition voltage across the secondary in a manner similar to opening the breaker points in conventional ignition systems. According to Warner, the flux reversal is very abrupt, resulting in a spark-timing repetition accuracy of better than  $\pm\frac{1}{4}$  degree. The fast switching characteristics of the transistors are also an important

factor in producing an ignition pulse with a rapid rise rate, which permits secondary energy levels to be reduced without lowering secondary voltage capabilities.

Most electronic ignition systems proposed for automotive engines control a transistor with small currents that pass through conventional breaker points and use a high-tension distributor to supply the ignition pulses from a single transformer to all sparkplugs. Although these systems cost less than the new system, they provide only partial solutions to some of the problems associated with conventional ignition systems.

In the American Bosch system, the control pulses are generated inductively using a single timer magnet with generating coils, switching circuits and output transformers for each cylinder. This arrangement eliminates the breaker points and high-tension distributor and the problems associated with them.

**TRANSFORMER DESIGN** — A key feature of the new system is use of a specially designed output transformer in which the secondary turns are wound in 14 sections or pies. This construction results in low distributed capacitance and net inductance of only 200 microhenries or about 0.05 that of transformers used in conventional systems. These transformer parameters permit wide latitude in selecting ignition characteristics.

For example, in the transformers used in conventional systems, which have a turns ratio of about 60:1, transient peaks of several hundred volts appear across the primary. Only very expensive transformers can withstand these voltages. Transistors could withstand the heavier currents that would result from increasing the turns ratio by adding secondary turns. However, in a conventional transformer, the corresponding increase in inductance and distributed capacitance would reduce voltage rise rate. The low



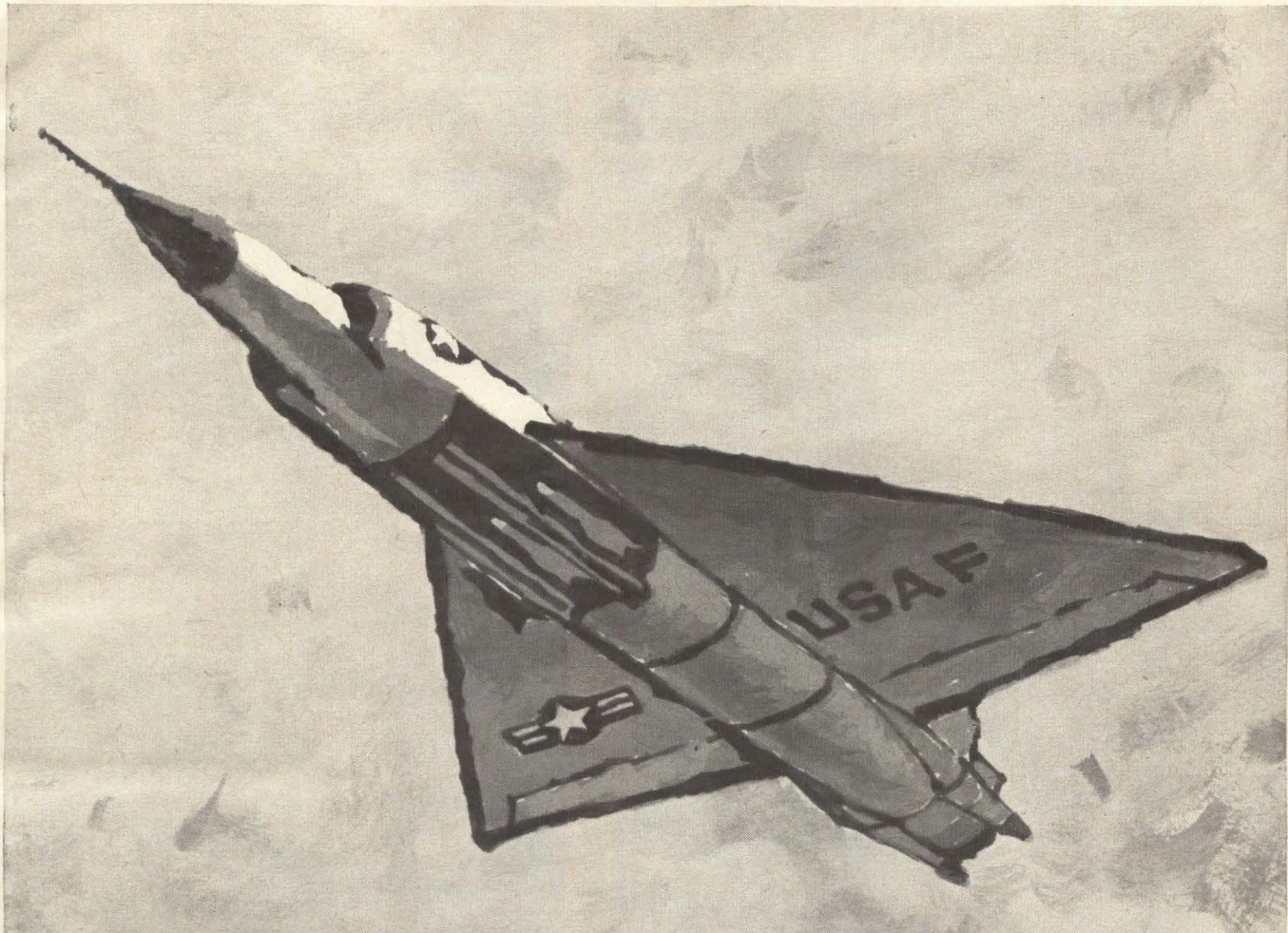

## DO YOU, JOHN DOE, SPECIFY AIRFRAME AND LEAD WIRE?



If you do, John Doe—like me, you're on the prowl for *reliable* wire, cables, and harnesses. Not just the "reliability" claimed for nearly all products but the real McCoy. I found it, John, in Hitemp's Teflon Airframe and Lead Wire—and we can get immediate delivery right out of stock.

Look, John, Hitemp's Airframe and Lead Wire offers so much more, check this list—*Long life and design possibilities* • *Cost savings, space savings, and weight savings* • *Dielectric Constant*—Lowest of all solid materials • *Dissipation Factor*—Lowest of all solid materials • *Insulation Resistance*—Extremely high, will not deteriorate with time, temperature, humidity, or other environmental conditions • *Dielectric Strength*—Extremely high, unaffected by environmental conditions thus allowing reliable operation over a wide variety of conditions.

Those are the things I've been looking for in Airframe and Lead Wire, John—haven't you? Before we specify wire again, we'd do well to examine the Hitemp line—because their kind of *reliability* means RELIABLE. We can write for more information, engineering assistance, and their "Condensed Catalog"—I'm gonna do it now.

### HITEMP WIRES CO.

a Division of Simplex Wire & Cable Co.

1200 SHAMES DRIVE, WESTBURY, NEW YORK  
1532 S. CALIFORNIA AVE., MONROVIA, CALIF.





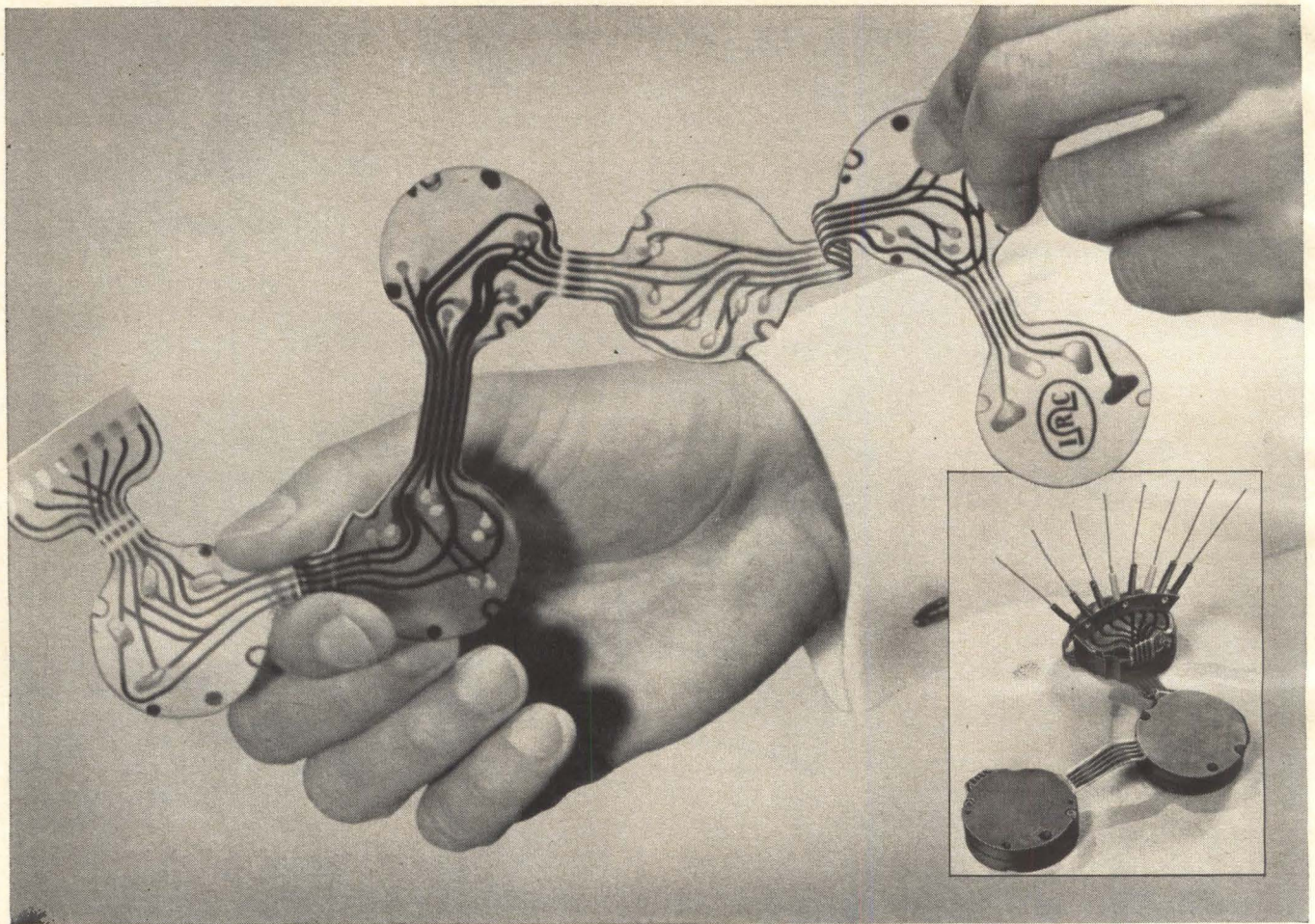

PHOTOS COURTESY, INTERNATIONAL RESISTANCE COMPANY, PLASTIC PRODUCTS DIVISION.

## ABRASION RESISTANCE (plus 8 more KEL-F<sup>®</sup> 81 virtues) helps fold miniaturization problems down to size!

BRAND PLASTIC

More and more, electronics designers rely on KEL-F 81 Brand Plastic for miniaturization answers as circuit complexity grows, available space shrinks. Circuits encapsulated in KEL-F 81 Plastic, for example, save space and weight, speed assembly operations, prevent wiring error. And this plastic insulates etched circuits, other conductors to withstand abrasion, conquer increasingly severe environments.

Consider the switch above. The outstanding abrasion resistance of KEL-F 81 Plastic protects circuitry against severe shock and vibration, even acceleration up to 15,000 times the force of gravity! The circuit, heat-sealed in layers of KEL-F 81 Plastic film, accordion folds into housings, also of KEL-F 81 Plastic. In other electronics applications, this outstanding abrasion resistance is useful in improving "spaghetti" tubing, tube sockets, coil forms, many other components.

**8 MORE PROBLEM-SOLVING PROPERTIES OF KEL-F 81 PLASTIC!** 1) *Dielectric strength*: arc resistance greater than 360 seconds, dielectric strength more than 500 vpm. 2) *Zero moisture absorption*: minimizes surface flash-over, blocks water vapor. 3) *High mechanical strength*: combines excellent tensile, impact and compressive strengths, low cold flow. 4) *800-degree range*: from -400 to +400°F. 5) *Chemical inertness*: resists practically all corrosive media. 6) *Radiation resistance*: retains great strength despite severe exposure. 7) *Optical transmission*: great clarity in thin sections to visible and infrared light. 8) *Reliability*: pin hole free films guarantee operation under critical conditions.

Check the column at right for additional information about circuitry encapsulated in KEL-F 81 Plastic, as well as the authorized processor list.

"KEL-F" IS A REG. TM OF 3M CO.



## KEL-F 81 Plastic

BRAND

...in typical applications

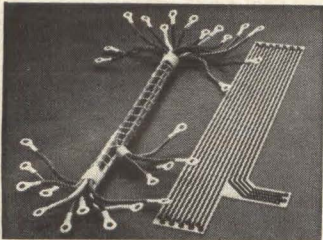

Conventional wiring (left) weighs 14 ounces; circuit that replaced it (right), laminated in KEL-F 81 Plastic, weighs only 2 ounces, takes less space. And laminated circuits usually cost less on an installed cost basis.

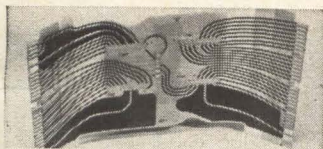

Typical circuits that can be encapsulated with KEL-F 81 Plastic include hookup wiring, multiconductor cables with feeder arms, shielded cables, matrix assemblies, and complex, high-density circuits.

**FOR MORE DATA** about KEL-F 81 Plastic for specific electronics applications, contact 3M Chemical Division Branch Office in Chicago, Cleveland, Los Angeles or Ridgefield, N. J.

### AUTHORIZED PROCESSORS OF KEL-F 81 PLASTIC

Adam Spence Corp.,  
963 Frelinghuysen, Newark, N.J.  
Allied Nucleonics Corp.,  
2421 Blanding Ave., Alameda, Calif.  
Auburn Plastics, Inc., Auburn, N.Y.  
Bonny Manufacturing Corp.,  
146 Main St., Maynard, Mass.  
Carmer Industries, Inc.,  
22 N. 26th St., Kenilworth, N.J.  
The Fluorocarbon Company,  
1754 Clementine, Anaheim, Calif.  
Fluorulon Laboratories, Inc.,  
Box 305, Caldwell, N.J.  
Garlock, Inc., Palmyra, N.Y.  
G-W Plastic Engineers, Inc., Bethel, Vt.  
Gries Reproducer Corp.,  
125 Beechwood Ave., New Rochelle, N.Y.  
Modern Industrial Plastics, Div. of Duriron  
Company, Inc., 3337 N. Dixie Dr., Dayton 14, O.  
Moxness Products, Inc.,  
1914 Indiana Ave., Racine, Wis.  
Penn-Plastics Corp.,  
100 Fairhill Ave., Glenside, Pa.  
Plastic Molded Parts, Inc.,  
1350 Fifth Ave., East McKeesport, Pa.  
Pli-O-Seal Mfg. Co., Sub. of Zero Mfg. Co.,  
1010 Chestnut St., Burbank, Calif.  
Raybestos Manhattan, Inc., Pacific Div.,  
1400 Orangethorpe, Fullerton, Calif.  
L. W. Reinhold Plastics, Inc.,  
8763 Crocker St., Los Angeles 3.  
Saunders Engineering Corporation,  
3012 Spring St., Redwood City, Calif.  
W. S. Shamban Co.,  
11617 W. Jefferson Blvd., Culver City, Calif.  
Thermotech Industries, Inc.,  
3336 Gorham Ave., Minneapolis 26, Minn.  
Timely Technical Products, Inc., Industrial  
Plastic & Engineering Div., Verona, N.J.  
Tube Turns Plastics, Inc.,  
Halochem Products Div.,  
3713 Forest Lane, Garland, Texas

For general technical information about KEL-F 81 Plastic, write Chemical Division, Dept. KAX-72, 3M Company, St. Paul 1, Minn.



CIRCLE 55 ON READER SERVICE CARD

July 27, 1962

overall impedance of the new transformer is achieved with a turns ratio of about 900:1, resulting in a transient of about 34 volts across the primary.

Characteristics chosen for the new ignition system include a secondary output exceeding 30 Kv with peak primary input current of 6 amperes. Since each transistor conducts during about 23 degrees of rotor rotation, average current is only 0.3 amp for each cylinder.

The low transformer inductance and distributed capacitance also contribute to overall secondary rise time of about 100 microseconds, which is import in firing partially fouled sparkplugs. These transformer characteristics also result in less energy storage and thus reduced sparkplug erosion.

**DESIGN PROBLEMS** — Some problems encountered in developing the system are receiving further study. As engine timer shaft speed increases from 0 to 100 rpm, timing is retarded about  $1\frac{1}{2}$  degrees, which can be compensated in initial setting of timing. As speed is increased above 100 rpm, timing is further retarded linearly at about  $\frac{1}{2}$  degree per 100 rpm, which can also be partly compensated in setting of timing. However, this shift is opposite to the desired direction for variable speed en-

gines. The variation in timing is a function of generating coil impedance, which is necessary for low-speed operation, and a compromise must be made. Thus far, attempts to tune this circuit have resulted in resonance or loss problems.

In using germanium transistors, ambient air temperature must be limited to 135 degrees F to prevent thermal runaway. This problem should be solved by the availability of low-cost silicon transistors. The relatively long conduction time of the transistors adds to the thermal problem and increases power consumption. This problem is caused by the strong timer magnet required for low-speed operation, which induces voltage in the generating coil during too large of an arc of rotation. This problem is being corrected by changing the shape of the pole pieces.

An unwanted early pulse of secondary voltage occurs when the transistor is switched on. Although it has been controlled so that it does not fire the sparkplug, it causes confusion in setting timing by producing timer light flashes. This problem is easily remedied by temporarily connecting a diode from the transformer to ground.

A number of the system tested on engines have demonstrated the basic feasibility of the system for low to moderate speed operation.

## Laboratory Supply for Transistors

By FRED W. KEAR

Lytle Corp., Albuquerque, N. M.

VERSATILE power supply has been designed specifically for testing breadboard transistor circuits. It can fulfill rapidly changing requirements for voltages over a wide range of values.

Although a suitable power source is one of the most important test equipment needs of the design engineer, available power supplies often do not meet some of the requirements for testing breadboard transistor circuits. For example, the instrument may not be portable or it may not provide a sufficient selection of output voltages. Fusing

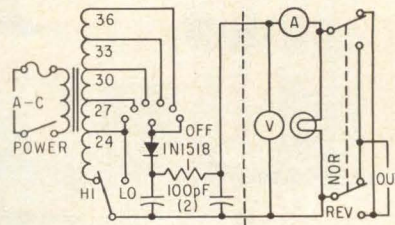

POWER SUPPLY provides wide range of voltages for testing breadboard transistor circuits—Fig. 1

may not be adequate to protect circuits under test, since current overloads of durations that can damage transistors are not prevented by ordinary fusing.

Many of these requirements are



# LAPP STAND-OFF INSULATORS FOR MODERATE OR HEAVY DUTY



For years, Lapp has been a major supplier of stand-off insulators to radio, television and electronics industries. Wide knowledge of electrical porcelain application, combined with excellent engineering and production facilities, makes possible design and manufacture of units to almost any performance specification. The insulators shown on this page are representative of catalog items—usually available from stock—and certain examples of special stand-offs. The ceramic used is the same porcelain and steatite of which larger Lapp radio and transmission insulators are made. Hardware is brass or bronze; brush nickel plating is standard.

Write for Bulletin 301 with complete description and specification data. Lapp Insulator Co., Inc., Radio Specialties Division, 194 Sumner St., Le Roy, N. Y.

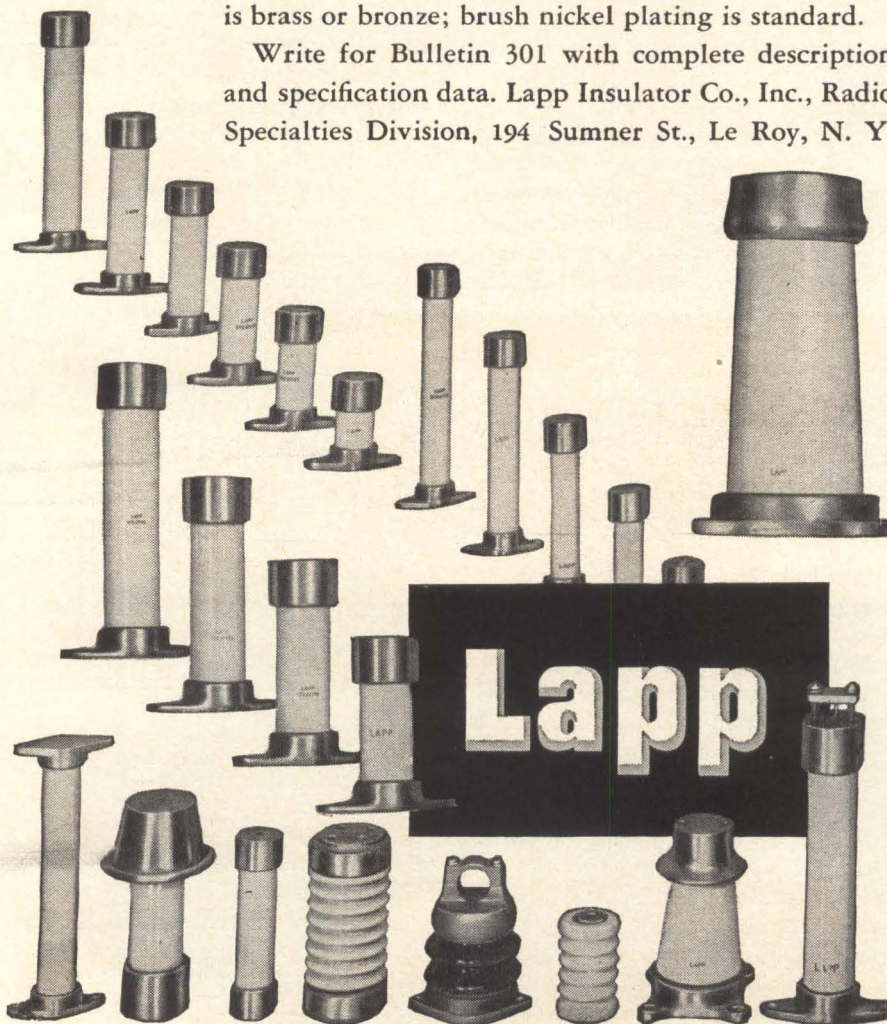

met at a small investment by the basic power supply in Fig. 1. To provide a selection of the most useful d-c voltage levels, the supply is designed to provide constant outputs of 3, 6, 9, 12, 24, 27, 30, 33 and 36 volts d-c. The transformer, which like the rectifier is rated at 5 amperes, has six secondary taps covering a range of 36 volts. A hi-lo switch transfers the negative bus between the ground tap and the 24-volt tap.

Conventional meters are used to monitor output voltage and current, and a switch is provided for output polarity reversal.

**OVERLOAD PROTECTION** — The overload protection circuit for the power supply is shown in Fig. 2 and incorporated at the dashed line in Fig. 1. Transistor  $Q_1$  and the 0.47-ohm resistor are in series with the positive output bus, and  $Q_1$  remains saturated for

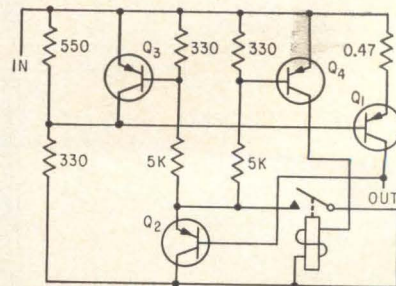

*OVERLOAD protection circuit switches power off rapidly to prevent current overloads from damaging transistors—Fig. 2*

all normal output current levels. Transistors  $Q_2$ ,  $Q_3$  and  $Q_4$  are all reverse biased under normal current loads.

If excessive loading occurs, the voltage drop across the 0.47-ohm resistor and the saturation resistance of  $Q_1$  biases  $Q_2$  in the forward direction, causing it to saturate. As a result, forward bias is applied through the biasing resistors to the bases of transistors  $Q_3$  and  $Q_4$ . Transistor  $Q_3$  immediately switches off  $Q_1$ , which removes power from the load.

A relay coil in the collector circuit of  $Q_4$  closes a set of contacts that maintain the overload circuit in the open condition. After an overload has occurred, the voltage selector switch in Fig. 1 must be



rotated to the off position and then rotated back to one of the voltage positions in order to open the relay contacts and thus reset the overload circuit.

A pushbutton reset switch with normally open contacts connected between the base of  $Q_1$  and the positive bus could be used to restore output power if the overload has been removed. However, it has been noted that requiring the selector switch to be rotated to off and then to a voltage position provides the engineer with better stimulus for checking that the load has been reduced to a proper operating level than simply pressing a pushbutton. Requiring rotation of the selector switch to restore power also reduces the temptation to use the power supply under marginally heavy loads.

**PACKAGING**—Because of its circuit simplicity and the limited need for providing heat sinks, this power supply can be housed in a light-weight portable case for use in the laboratory or for troubleshooting in the field where line voltage is available.

The power supply is also useful for electroplating small objects, such as printed circuits and hardware. A buzzer or light can be connected to a second set of relay contacts in the collector circuit of  $Q_1$  to warn that current has been removed from the bath. This precaution can prevent spoilage of the plating job through no-current immersion in the bath. Current limiting as provided by the overload protection circuit in this power supply is often desirable in electroplating.

The current level at which the overload circuit operates is determined in part by the 0.47-ohm resistor. Increasing resistance causes the circuit to operate with less current. This resistance can be adjusted to provide the desired current limiting, and the resistor used should be as stable as possible. Heat shielding should be provided to protect the resistor from ambient temperature changes and from heat from other components. Some protection is also necessary to prevent temperature excursions in transistor  $Q_1$ .

# AIRPAX



## SERIES 500 MINIATURE MAGNETIC CIRCUIT BREAKERS

- RATINGS FROM 50 MA TO 15 AMPS
- DC, 60 CPS and 400 CPS TYPES
- MINIATURE CASE; SIZE ONLY  
1 3/4" x 1 1/8" x 5/8"
- TRIP LEVEL INDEPENDENT  
OF TEMPERATURE
- REMOTE INDICATING  
TYPE AVAILABLE

- INSTANTANEOUS OR  
DELAY ACTION TYPES
- HERMETICALLY SEALED

- SERIES - SHUNT - RELAY TYPES
- TWO AND THREE GANG  
ASSEMBLIES FOR INTERLOCKING  
CIRCUIT PROTECTION

### Positive Protection

Only slightly larger than a conventional panel switch, the breaker serves as switch, fuse, relay and indicator.

*Bulletin B-41 on request*



CAMBRIDGE DIVISION • CAMBRIDGE, MD.  
TWX: CAMB MD 545      PHONE 228-4600



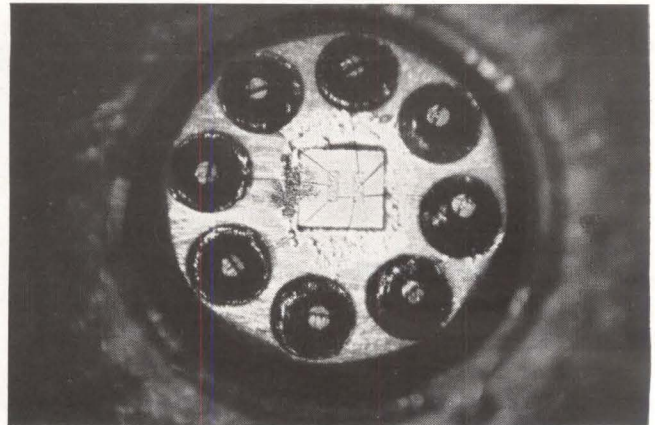
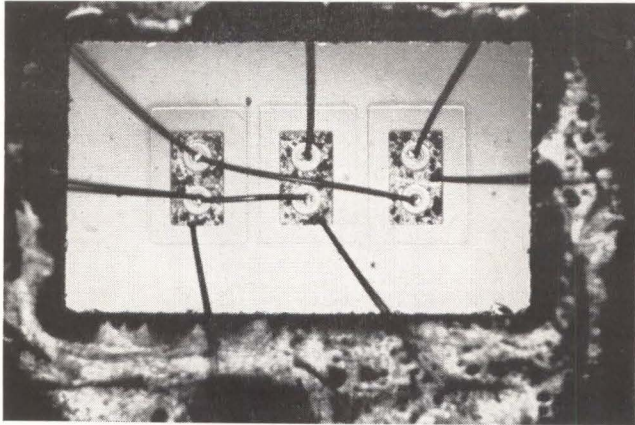

DIODE GATE packages all have six diodes. One type, left, has three two-input OR gates. Silicon AND circuit, right, has diodes of opposite polarity fabricated on silicon of opposite conductivity, has two three-input AND gates

## Logic Blocks Offer Design Flexibility

*Isolate passive elements, use separate diode gates to greater advantage*

TOKYO—Planar transistor and diode logic circuits, fabricated on silicon slices by Nippon Electric Co. Ltd. are designed to compromise between completely integrated circuits and individual components (see *ELECTRONICS*, May 11, 1962, p 52).

Technology used in fabricating the planar units is similar to that used in fabricating completely integrated circuits. However, company chose circuits not having integral passive components in the same package, for its initial effort because they say increased precision is obtained in the passive components at the expense of slight increase in size. Also smaller number of units can be used to greater advantage throughout company's own wide line of electronic equipment.

Packaging the transistor and diode circuits in TO-5 cases will greatly decrease the size and weight of computers and other digital equipment. Flexibility of the designs chosen will also enable company to satisfy a larger number of outside users with fewer types.

First group of Nippon Electric logic packages will consist of six

transistors or six diodes fabricated on a single silicon die. Isolation between individual elements on the same die is achieved by biasing the outermost electrode—the collector for the transistors—backward with respect to the body of the die. Fabrication of diodes and transistors is similar. Main difference is that for diodes the diffusion of the emitter region is eliminated—the region which would correspond to the base of the transistor is one region, that which would correspond to the collector is the other, see diagram, p 61. Also, the allowable free air dissipation of the present units is greater than could be obtained with completely integrated circuits.

HIGHER SPEEDS—Use of diode gating allows higher speed and less heat generation than transistor gating, according to company logic. Direct coupled transistor logic was also considered but company claims it suffers from difficulties in parallel driving, small temperature range of operation, and slow speed. In DCTL circuits investigated to date, company says charge storage in collector or load resistor portions of the circuits is a difficult problem which has been only partially solved.

The transistor NOR circuits produced by Japanese company can be operated at speeds up to 4 Mc clock

rate. Speed of the diode units is so much faster that no slowdown is caused when diodes are used for gating the transistor circuits.

Even when used with standard passive components, circuit densities are more than ten times those using conventional transistors and diodes. Cost is less than one-third that of completely integrated circuits. To further reduce size and increase convenience without greatly increasing prices, Nippon Electric is planning a series of passive circuits to be used with the packs.

Transistor and diode packages are now available on a sample basis, company will start standard production in the fall.

Transistors in the NOR gates have an  $F_T$  of several hundred Mc, which allows their use at clock rates up to 4 Mc in saturated transistor-resistor logic circuits. Six transistors in all NOR packages are available in three types: one six-input NOR gate, two three-input NOR gates, and three two-input NOR gates. Collector connections to the transistors consist of large-area metalized regions common to all transistors in one gate. However, with the exception of the common emitter connection, the individual NOR gates in the multiple units are independent.

Two packages having only two transistors each will also be pro-



# Have you seen these **MOTOROLA** Silicon Rectifier developments?

MOTOROLA  
1N3189-91 series  
Flangeless

**DELIVERS**  
1-AMP @  
100°C

designed to meet the  
high-reliability  
standards of  
MIL-S-19500/155  
(NAVY)



MOTOROLA  
MR-322-6 and  
1N3208-12 series

General Purpose  
**18-AMP**  
**50-400 PIV**

... as low as 46¢  
Heavy Duty 11/16" stud  
**15-AMP**  
**50-400 PIV**  
... as low as 83¢

MOTOROLA  
1N3282-86 series  
Subminiature

**1000-**  
**3000 PIV**

Only 1/10" in  
diameter. Low  $I_R$  of  
.001 mA @ 25°C.

MOTOROLA  
1N1563-6 series  
Single-Ended

**100-400**  
**VOLTS PIV**

Exceptionally high  
surge handling capacity  
... peak one-half cycle  
forward surge current  
60 cps, 25°C ambient  
— 70 Amps.



AND LOOK at the typical advantages you get from each of these  
other types of MOTOROLA silicon rectifiers . . .

MOTOROLA TOP HAT RECTIFIERS  
75 types 50-1000 volts PIV

LOW  $I_R$  — very low reverse current at rated  
DC voltage — as low as 10  $\mu$ A @ 25°C.



MOTOROLA 7/16" STUD RECTIFIERS  
60 types 50-1000 volts PIV

LOW  $I_R$  — maximum full cycle average as half  
wave rectifier (resistive load) as low as  
.0005 mA.



MOTOROLA FLANGELESS RECTIFIERS  
11 types 100-1000 volts PIV

COMPLETE PIV RANGE — 100 thru 1000 volts.  
HIGH  $I_F$  — in addition to 750 mA @ 25°C for  
the standard flangeless line; new types offer  
1-Amp at 100°C.

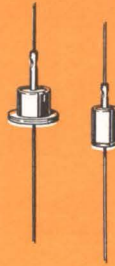

**MIL** type RECTIFIERS

Top-Hats:  
1N538 (JAN) MIL-E-1/1084A  
1N540 (JAN) MIL-E-1/1085A  
1N547 (JAN) MIL-E-1/1083A  
Flangeless:  
1N3189 (USN) MIL-S-19500/155

## FAST SERVICE ON SPECIALS

More than 1,000 special types of silicon rectifiers have been developed and produced by Motorola to meet individual customer needs . . . providing an exceptional special device production capability which assures unmatched service on any "specials" you may require.



For application assistance, Motorola's Silicon Zener Diode and Rectifier Handbook is available from the Motorola Semiconductor Distributor or District Sales Office, or by writing the factory direct. Price — \$2.00.

IMMEDIATE LOCAL AVAILABILITY — For your convenience, all popular types of these top-quality Motorola silicon rectifiers shown above are available from stock at the Motorola Semiconductor Distributor in your area.

THE WORLD'S LARGEST PRODUCER OF POWER RECTIFIERS



**MOTOROLA**  
Semiconductor Products Inc.

A SUBSIDIARY OF MOTOROLA, INC.

1961

5005 EAST McDOWELL ROAD • PHOENIX 8, ARIZONA

CIRCLE 59 ON READER SERVICE CARD 59



You can get them from stock

at OHMITE!

tantalum slug capacitors

up to 125° C.

MIL-C-3965B (Char. C)

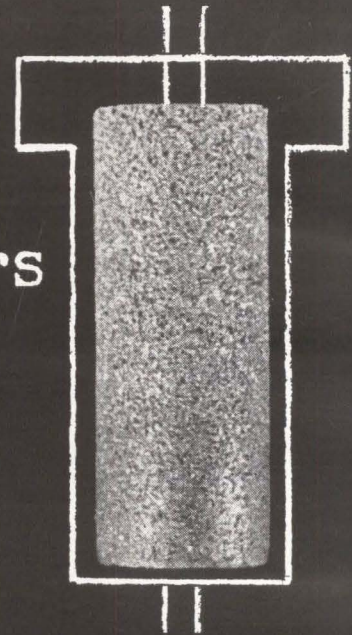

**MIL SIZE T1:** Stocked in values from 1.7 to 68 mfd for 85°C and 125°C operation. Voltages from 4 to 125 volts depending on capacitance and operating temperature. Standard tolerances.

**COM'L SIZE U:** Same as shown above.

**MIL SIZE T2:** Off-the-shelf in values from 9 to 270 mfd for 85°C and 125°C operation. Voltages from 4 to 125 volts depending on capacitance and operating temperature. Standard tolerances.

**COM'L SIZE F:** Same as shown above.

**MIL SIZE T3:** Immediate delivery on values from 25 to 560 mfd for 85°C and 125°C operation. Voltages from 4 to 125 volts depending on capacitance and operating temperature. Standard tolerances.

**COM'L SIZE G:** Same as shown above.

**MIL SIZE T1:** Stocked in values from 1.7 to 68 mfd for 85°C operation only. Voltages from 6 to 125 volts depending on capacitance and operating temperature. Standard tolerances.

**COM'L SIZE SU:** Same as shown above.



**OHMITE**

MANUFACTURING COMPANY  
3610 Howard Street • Skokie, Illinois

RHEOSTATS • POWER RESISTORS • PRECISION RESISTORS • RELAYS • R. F. CHOKES  
GERMANIUM DIODES • VARIABLE TRANSFORMERS • TANTALUM CAPACITORS • TAP SWITCHES



A fine choice, too . . .

# OHMITE Germanium DIODES

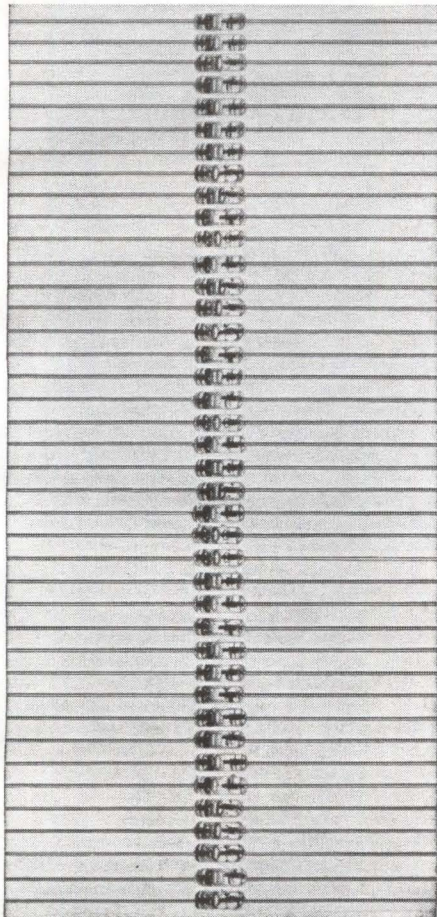

Discover, as other users have, how Ohmite achieves unusual reliability through manufacturing quality control.

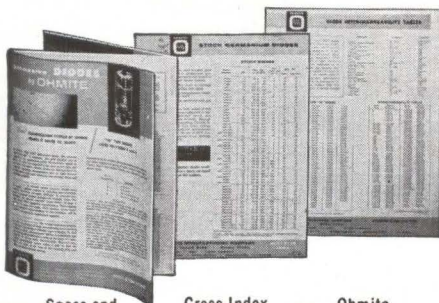

Specs and Listings, BULLETIN 158

Cross Index to 24 Makes, BULLETIN 1002

Ohmite Stock Diodes, BULLETIN 164

**SEND FOR  
A SET**

Ohmite Mfg. Co.  
3610 Howard St.  
Skokie, Illinois



CIRCLE 61 ON READER SERVICE CARD  
July 27, 1962

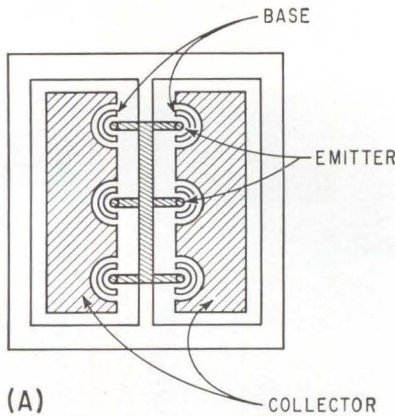

(A)  
PLANAR CONSTRUCTION of six-transistor NOR circuit (A) fabricated on p-type silicon slice. Schematic (B) shows interconnections. Construction of diode package is built upon n-type silicon

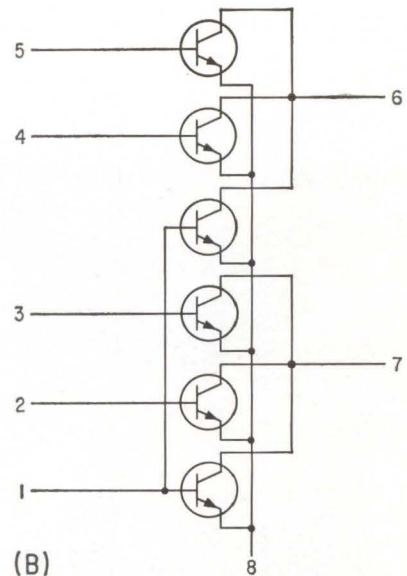

duced for applications including darlington amplifiers, choppers, differential amplifiers, and flipflops. The transistors are similar to those in the NOR gates.

Diode packages all have six diodes, but are available in four types of OR gates and three types of AND gates. Reverse recovery time of all diode units is in the several microsecond range making them suitable for use at high repetition rates.

The OR circuits, fabricated from *n* silicon, have two sets of *np* junctions because gates are isolated from each other and the header by a back biased *np* junction. Four types of OR units are available. For ordinary diode OR gates there are one six-input OR gate, two three-input OR gates with one common input lead, and three two-input OR gates with one common input lead. A package is available for decoupling in computer circuits. This unit has three two-input OR gates in which two of the gates have two independent inputs each—the two inputs of the third gate correspond to one input each of the other two gates. A typical counter circuit uses two OR units and two transistor NOR units.

Silicon AND units differ from OR units mainly in having diodes of opposite polarity fabricated on silicon of opposite conductivity. The AND circuits are fabricated on *p* silicon dice. Each diode actually has two sets of *pn* junctions because gates are isolated from each other and the header by a back-biased *pn*

junction configuration.

**EXPERIMENTAL CIRCUITS** — Nippon Electric has also fabricated other circuits on an experimental basis to demonstrate that they have mastered the technology involved. Company has no immediate plans to produce these circuits, but will manufacture them if sufficient demand exists.

One such unit has three transistors for use as a darlington amplifier; it is fabricated from a single *n* silicon die. The three concentric planar horseshoe-shaped transistors have characteristics that correspond to NEC types 2SC33, 2SC49, and 2SC23. Total device power dissipation is 10 watts with a case temperature of 25 deg C.

Different techniques are used in the fabrication of two direct-coupled-transistor-logic circuits. Both a five-transistor NOR gate, and a three-transistor NOR gate with an additional inverter stage to give OR output, have been developed. The DCTL units differ from the others in using mesa, not planar, transistors. The NOR package is complete, including a diffused load resistor, on a single silicon die. The OR circuit is on two silicon dice, the NOR circuits on one die and the inverter circuit on the other. Both load resistors in the OR circuit are bulk resistors. Construction of each of the two stages in the OR circuit is similar to the DCTL circuit described in *ELECTRONICS*, May 4, 1962, p 20.

C.L.C.



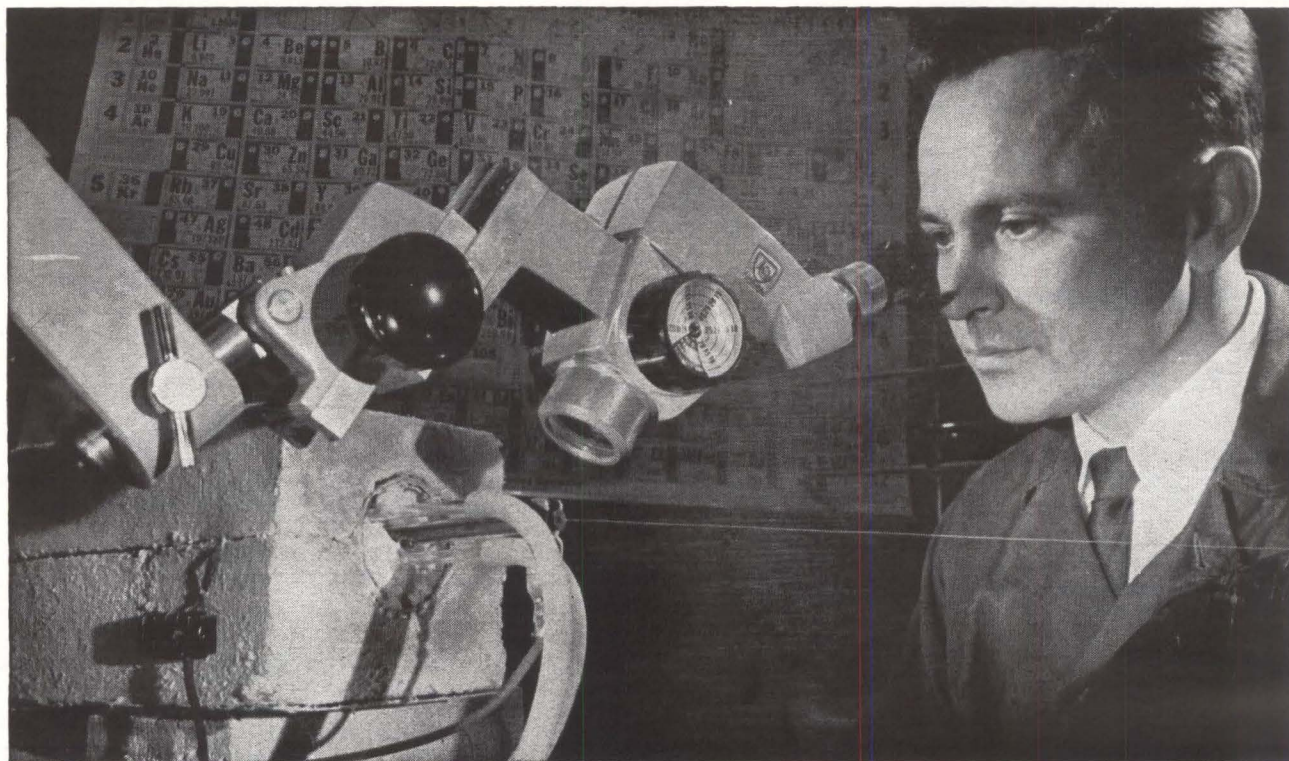

WIRE COVERED with niobium-tin emerges from mass-production process apparatus developed by RCA Laboratories and RCA Electron Tube Division. Production speed is as high as 16.8 meters per hour

## Gas Process Makes Superconducting Wire

*Wire is superconductive at relatively high temperature (near 18 K)*

WIRE COATED with niobium-tin, and used to make superconducting magnets, is being produced by RCA with an irreversible gas-phase transport method. Although the process was announced last fall, no details were then made known. The process has now been perfected to the point where the RCA Electron Tube Division will be making commercial quantities of the wire, according to information made known to **ELECTRONICS**.

The process reportedly solves the low-temperature structural problems of superconducting materials with respect to ductility and the strength to withstand the force of high magnetic fields. Niobium-tin has in the past been prepared chiefly by sintering of the powders of niobium and tin at 1,200 C. At-

tempts were made to melt the sintered masses of  $Nb_3Sn$  at 2,400 C and resolidify the material. Since tin boils well below the melting point of niobium, the resulting solidified material was of unpredictable composition. Powders of the sintered materials, therefore, were pressed and resintered, but while the desired composition was maintained, the resulting material was too porous, resulting in electrical "dislocation" problems even when pressures as high as 17,500 atmospheres were used.

Basis for the gas-phase process is the simultaneous reduction of the mixed gaseous chlorides of niobium and tin to form  $Nb_3Sn$  at temperatures such that predictable compositions are obtained.

In initial attempts, the pairs of chlorides  $NbCl_5-SnCl_2$  or  $NbCl_5-SnCl$  were used as starting materials. Vapor pressures of these chlorides had to be adjusted to obtain the required 3 to 1 ratio of the chlorides

of niobium and tin in a gaseous mixture. In doing this, use was made of a long quartz tube with three distinct temperature zones. In a typical experiment, the first zone was at 120 C and contained  $NbCl_5$ ; the second was at 300 C and contained  $SnCl_2$ ; the third or hot zone was at 1,000 C. The vapors of the chlorides from the first two zones were swept into the hot zone by a slow stream of helium or argon gas. Hydrogen gas was introduced into the hot zone through a thin quartz tube to start reduction of the mixed chloride vapors. Resulting metallic deposits in the hot zone were  $Nb_3Sn$  and a large amount of an unidentified black impurity.

**PROCESS SIMPLIFIED**—By restricting the entire process, including the insertion of the metallic chlorides, to the 1,000 C hot zone, the entire deposition process is considerably simpler, with the ratio of



REMOTE DATA RETRIEVERS, EVENT AND DATA RECORDERS

OPERATION MONITORS, PRINTER PLOTTERS, TIME QUANTIZERS

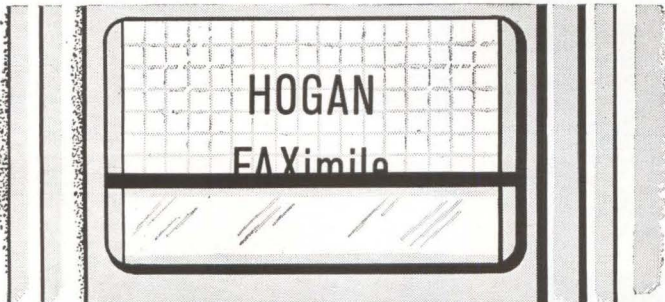

SPECTRUM ANALYSIS, DENSITOMETERS, FACSIMILE RECORDERS

### THE ANSWER TO YOUR RECORDING PROBLEMS...

Whatever your recording problem may be—HOGAN FAXimile recorders are available, or can be designed, to fill your requirements. As many as 2000 simultaneously recording styli—up to 100 styli to the inch for high-speed facsimile—chart widths to 30" and feed rates to 50" per second.

HOGAN specializes in electrolytic techniques for event, spectrum analysis, oscillograph and facsimile recording, frequency time analysis, computer printout, automatic high speed plotting and special purpose binary and gray scale recording applications.

*"Use Hogan design ability!"*

HOGAN FAXimile Corporation • 635 Greenwich St., New York 14, N. Y.  
A SUBSIDIARY OF TELAUTOGRAPH CORPORATION

CIRCLE 201 ON READER SERVICE CARD

## closed-cycle MASER COOLER

- 3/4-watt refrigeration at 4.4°K
- simplified cryostat design
- reliable, unattended operation

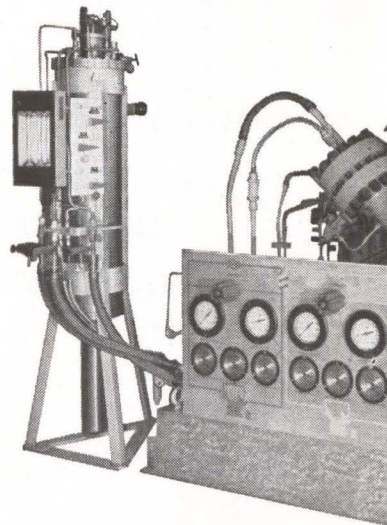

Advanced capabilities in cryogenic design, development, and fabrication, enable Air Products to meet specific customer requirements for closed-cycle electronic coolers.

Cryostat unit pictured here, for example, is part of a cryogenic refrigeration system developed for the Lincoln Laboratory of the Massachusetts Institute of Technology.

System operates on Joule-Thomson principle to provide maser-cooling temperatures as low as -452°F (4.4°K) without cold moving parts... is also adaptable for cooling superconducting magnets and cryogenic computer devices... eliminates handling of cryogenic liquids which boil away in open-cycle systems.

Cryostat, physically separate from compressor unit to make possible remote operation, contains coiled-finned heat exchangers of Air Products design.

Air Products closed-cycle systems maintain temperatures as low as 2.5°K... are ideal for field as well as laboratory applications.

ADVANCED PRODUCTS DEPARTMENT  
DEFENSE AND SPACE DIVISION



*Air Products and Chemicals*  
INC.

Allentown, Pennsylvania

▶ AIR PRODUCTS MANUFACTURES A COMPLETE LINE OF CRYOGENIC ELECTRONIC COOLERS.

CIRCLE 63 ON READER SERVICE CARD 63

## Good parts work best!

Write for our catalogue

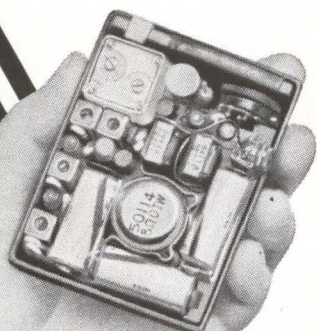

Intermediate Frequency Transformer IFT



POLYVARICON Variable Capacitor



The high standards of MITSUMI electronic components are insured by a fully-automated assembly system, and double-checked by rigid quality controls. Mitsumi Electric Company is Japan's largest manufacturer of components for radio, television and communications equipment.

# MITSUMI PARTS

MITSUMI ELECTRIC CO., LTD.

Komae, Kitatama, Tokyo



CIRCLE 202 ON READER SERVICE CARD



**IMMEDIATE DELIVERY**

**IMMEDIATE DELIVERY**  
**from the TRU-OHM STOCKING DISTRIBUTOR**  
**in your area**



**POWER RHEOSTATS**

from 12½ watt to 300 watt

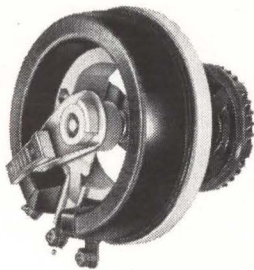
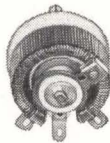

There is a TRU-OHM POWER RHEOSTAT for any and every application . . . with the custom variations for your particular needs. Your Tru-Ohm distributor has stock . . . your Tru-Ohm representative in your area is ready to answer your problems . . . your inquiry is invited.

Write for our latest complete catalog.



Div. of Model Engineering & Mfg., Inc.  
 3426 West Diversey Blvd.  
 Chicago 47, Illinois  
 Factory: Huntington Indiana

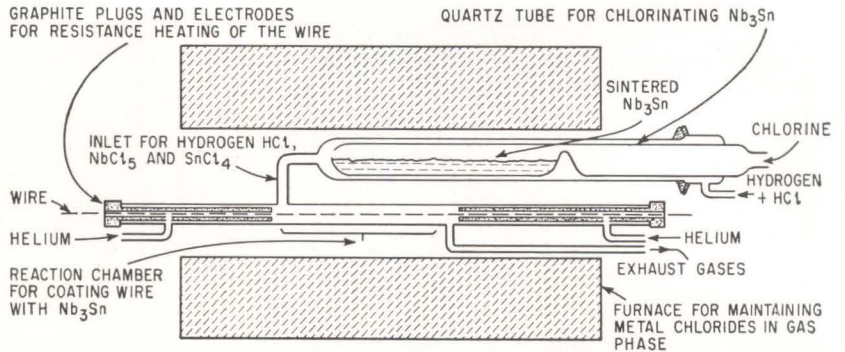

NIOBIUM-TIN is deposited on wire substrate with irreversible gas-phase transport technique. When cooled to superconductivity, wire can carry current at a density of ½ million amps per cm<sup>2</sup> in a 90,000 gauss field

the metal chlorides automatically adjusted to 3 to 1. The metal chlorides are formed by exposing powdered sintered Nb<sub>3</sub>Sn to chlorine gas. The rate of flow of the chlorides and hence the rate of deposition of the Nb<sub>3</sub>Sn is controlled by adjusting the flow rate of the chlorine gas. Temperatures of 1,000 to 1,200 C were maintained with good results: of the Nb<sub>3</sub>Sn converted to chlorides, 50 to 75 percent was re-deposited as Nb<sub>3</sub>Sn with the remainder going into the unknown black impurity.

The final development of the process provided for the deposition of Nb<sub>3</sub>Sn film on refractory metal wire substrate to form usable Nb<sub>3</sub>Sn coated wire, as shown in the sketch.

**CONTINUOUS PRODUCTION** — Considerable changes in experimental procedures were necessary to allow continuous production of wire. Basic to the process is heating the refractory wire to the temperature needed for deposition; this is accomplished by an electric current. The furnace maintains ambient temperatures in a range too low for Nb<sub>3</sub>Sn to form but high enough to keep all metal chlorides volatilized. Thus pure Nb<sub>3</sub>Sn is deposited only on the wire and not on the walls of the apparatus.

As shown, the equipment consists of a gas-phase transport unit made of quartz, and a resistance furnace; the furnace heating element is wound on a Vycor tube to allow an observation window. Both ends of the reaction tube are fitted with graphite plugs with small center holes permitting entrance and exit of the coated wire. The plugs also act as current contacts to resistance heat the wire and they stop react-

ing gases and air; sealing is aided by helium-gas end plugs.

Finding a suitable furnace temperature required experimentation. At low temperature, the apparatus became congested with a dark solid metal chloride (probably NbCl<sub>3</sub>) and at higher temperatures with Nb<sub>3</sub>Sn. Small amounts of HCl added to the hydrogen gas stream retarded concentrations of both of these materials, raising the minimum temperature requirements for the formation of Nb<sub>3</sub>Sn and lowering it for NbCl<sub>3</sub>, which becomes unstable at 900 C. Using this technique, a safe temperature range for the apparatus was found to be 720 to 790 C. Although no accurate determination has been made, deposition of Nb<sub>3</sub>Sn on the wire is effective at wire temperatures between 850 to 950 C.

Other important factors in process efficiency include flow rates of reaction gases, composition of the sintered Nb<sub>3</sub>Sn charge and speed of the wire; wire production has usually been at a speed of 6.5 meters per hour, although good wires have been grown as fast as 16.8 meters per hour.

Selection of refractory substrate is critical in determining the final effective combination of superconductor and substrate. Structurally, it was found that the coefficient of expansion of tungsten was considerably removed from that of Nb<sub>3</sub>Sn; a tantalum substrate was considered more suitable. Platinum-clad substrates gave significant improvement in low temperature properties, with critical temperature of 18 K and current carrying capacity up to 60,000 amps per cm<sup>2</sup> at 7,500 gauss.

According to measurements made



at UCLA's Low Temperature Laboratory, a processed Nb<sub>3</sub>Sn coated wire in the presence of a 93,500 gauss field showed a critical current density of  $1.04 \times 10^5$  amps per cm<sup>2</sup>. Measurements in a 90,000 gauss field at MIT's Lincoln Laboratories and UCLA's Lawrence Radiation Laboratory showed current densities of  $5 \times 10^5$  amps per cm<sup>2</sup>.

### Pressure Seal for Semiconductor Devices

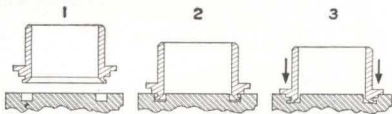
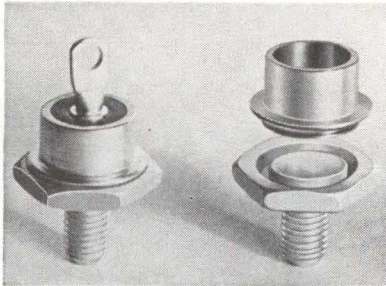

Joining method for dissimilar metals that produces hermetic seals without heat, adhesives, gasketing or sealants is being used in semiconductor manufacture. Standard Pressed Steel Co., developers of the technique, will produce a line of stud-type semiconductor mounts, both caps and bases, and also tools to assemble the two-piece units.

Copper and steel are used in the semiconductor mount but other materials can also be joined. In the semiconductor application, the heatless seal displaces one metal around another under mechanical pressure. As the sketch shows, the cap curls into the base material and residual stresses help hold it. The steel cap allows a glass seal (see photo) and the copper base serves as heat sink and conductor.

Semiconductor assembly costs are lowered by reducing assembly steps, by promoting higher yield, and by producing components with less contaminating elements. With automation techniques, several thousand assemblies per an hour are feasible.

The heatless seal has been successfully tested from -80 to 400 F. It exceeds MIL-STD-202B, method 107A, test condition B.

# NEEDS AN OPERATOR

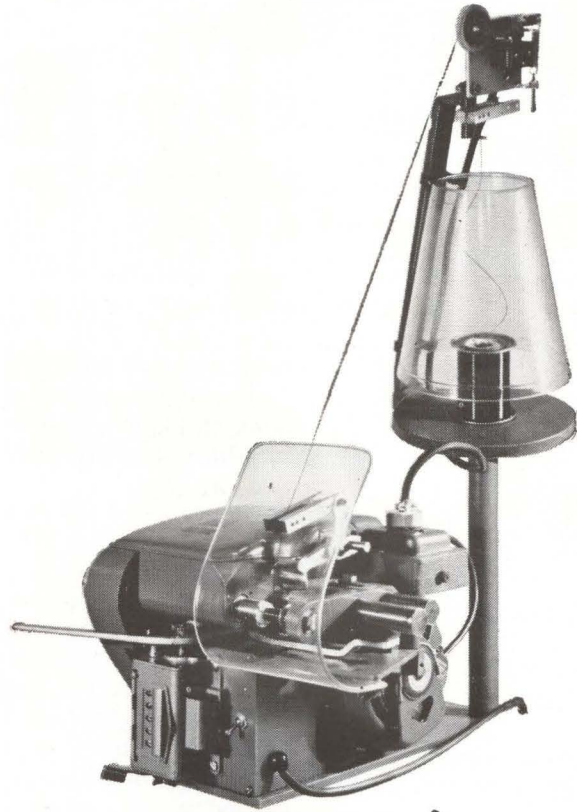

## to start it

Not much else to do. Watch it yourself ... in pleasure. See how the Leesona No. 115 Bachi Bobbin Winder saves an operator's time! See how it helps her change bobbins and start a new coil quickly, easily, accurately. No fumble to place wire in the wire guide—no needless motions. Listen to No. 115 . . . you can hardly hear it. Watch for vibration . . . you won't see any. Even at 10,000 rpm. No. 115 not only saves labor, reduces fatigue. It does more . . . more accurately. For instance: set a dial . . . the machine stops precisely at the number of turns desired. Another instance: turn a dial calibrated in 16ths of an inch, adjust traverse

infinitely from 0 to  $2\frac{3}{8}$  inches (to  $2\frac{3}{4}$  inches with special order machines). Adjust the wire guide pulley microscopically, compensate for differences in bobbin flange thickness. Obtain high speed up to 12,500 rpm, and with certain coils and wires, as high as 15,000 rpm. And this unusual machine not only winds spool wound coils: it also produces layer or form-wound coils. You can see No. 115 is compact. Our fact sheet and illustrated folder will show it has been designed sensibly so it is serviceable, that its components are extraordinarily efficient and durable, and it has the safeguards you want. Call your Leesona agent or write:



Leesona Corporation/Warwick, Rhode Island.



# DESIGN AND APPLICATION

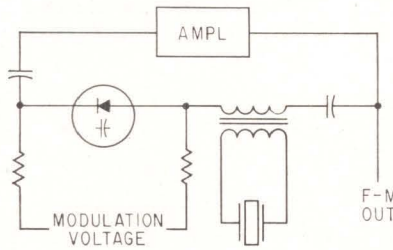
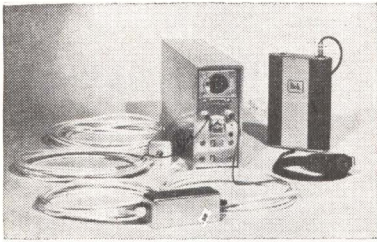

out storage register, serial to parallel converter, or parallel to serial converter. Each stage consists of the basic binary element and the associated gating. Parallel gate and pulse inputs to each stage are provided at the connector, as are the "1" and "0" outputs of each stage. Epoxy glass printed board measures 6 by 4.5 by 0.9 in. (303)

## Unusual Oscillator Generates Direct F-M

*Voltage-controlled crystal oscillator can be modulated between d-c and 45 Kc*

RECENTLY announced by Itek Electro-Products Co., 75 Cambridge Pkwy, Cambridge, Mass., the model VB6000 voltage controlled crystal oscillator is a voltage-to-frequency converter that combines crystal oscillator stability with an ability to linearly and repeatably deviate the oscillator frequency with modulation rates as low as zero (d-c) frequency. This unit generates 10 mw at 60 Mc with  $\pm 45$  Kc deviation with a center frequency stability better than  $\pm 0.01$  percent over 0 to 85 C. Modulation harmonic distortion is less than  $2\frac{1}{2}$  percent with 45 Kc deviation at modulation rates from d-c to 10 Kc. The basic pat-

ented circuit is shown in the sketch. The crystal is coupled to the oscillator through a transformer that introduces another pole into the reactance plot. Slope of crystal reactance in the resonance region is reduced by a factor dependent on transformer ratio. The transformer also tunes out crystal shunt reactance. Result is that reactance curve is symmetrical about oscillator frequency resulting in better linearity and greater deviation. The photograph shows typical application of the oscillator in a wireless microphone system operating at 9 Mc with a frequency response between 30 cps and 15 Kc at 400 mw output. Receiver is diversity and uses a pulse counter discriminator.

CIRCLE 301, READER SERVICE CARD

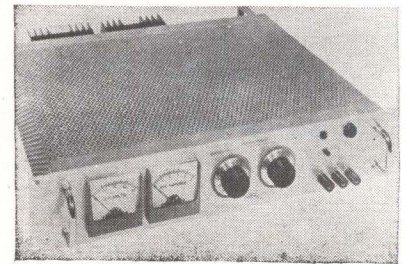

## D-C Power Supply Has Quick Response

SOLA ELECTRIC CO., Elk Grove Village, Ill. The QSA adjustable transistorized d-c power supply is for use in the bench and laboratory as well as in the equipment field. It will afford  $\pm 0.05$  percent static line regulation and provide 0.05 percent static load regulation, and reduces ripple and noise to less than 1 mv rms. Response time is less than 50  $\mu$ sec for 10 percent line change at any load, and less than 50  $\mu$ sec for  $\frac{1}{2}$  may load at any line. (304)

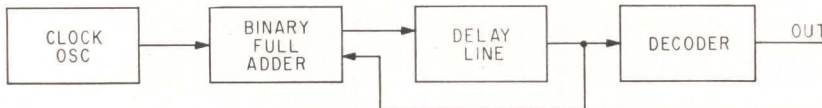

## Delay Line Timer Can Operate for Years

INTRODUCED by Control Electronics Division, 10 Stepar Place, Huntington Station, N. Y., the model ML100 delay line timer is capable of producing extremely long delays measurable in seconds, hours, days or years with quartz crystal oscillator accuracy. Heart of the unit is a magnetostrictive delay line and logic circuits that recirculate a pulse over extremely long time intervals. This process can be carried

on indefinitely. The delay can be used for triggering, timing, range markers, control signals or other sequencing operations. The unit is 50 cu. in., weighs 1 lb and requires less than 1 w power. (302)

## Shift Register CONSISTS OF SIX STAGES

ELECTRONIC MODULES CORP., 1949 Greenspring Dr. Timonium, Md. Usable as a serial read in and read

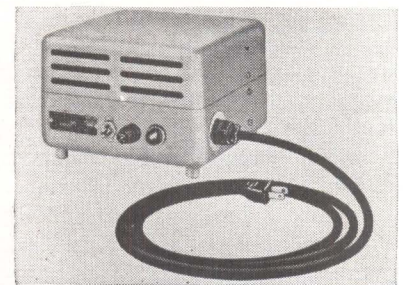

## Translators OFFER VARIETY OF SPEEDS

THE SUPERIOR ELECTRIC CO., Bristol, Conn. Slo-Syn translator types ST-250 and ST-1000 convert low-



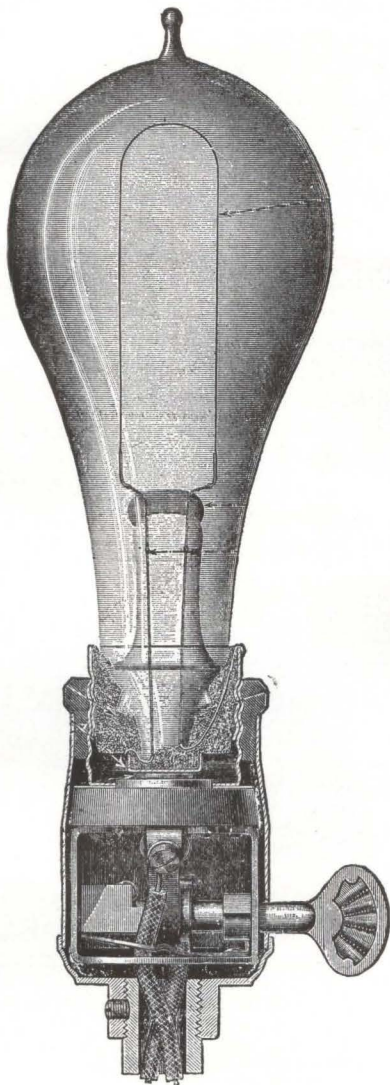

**Is it ancient history  
by the time you see  
electronics?**

Get the facts while they're new. Don't wait for **electronics** on a route slip. Look in this issue for the Reader Service Card. Fill out and mail the "for subscriptions" section. Only 7½ cents a week.

**electronics**

A McGraw-Hill Publication, 330 West 42nd St., N. Y. 36

July 27, 1962

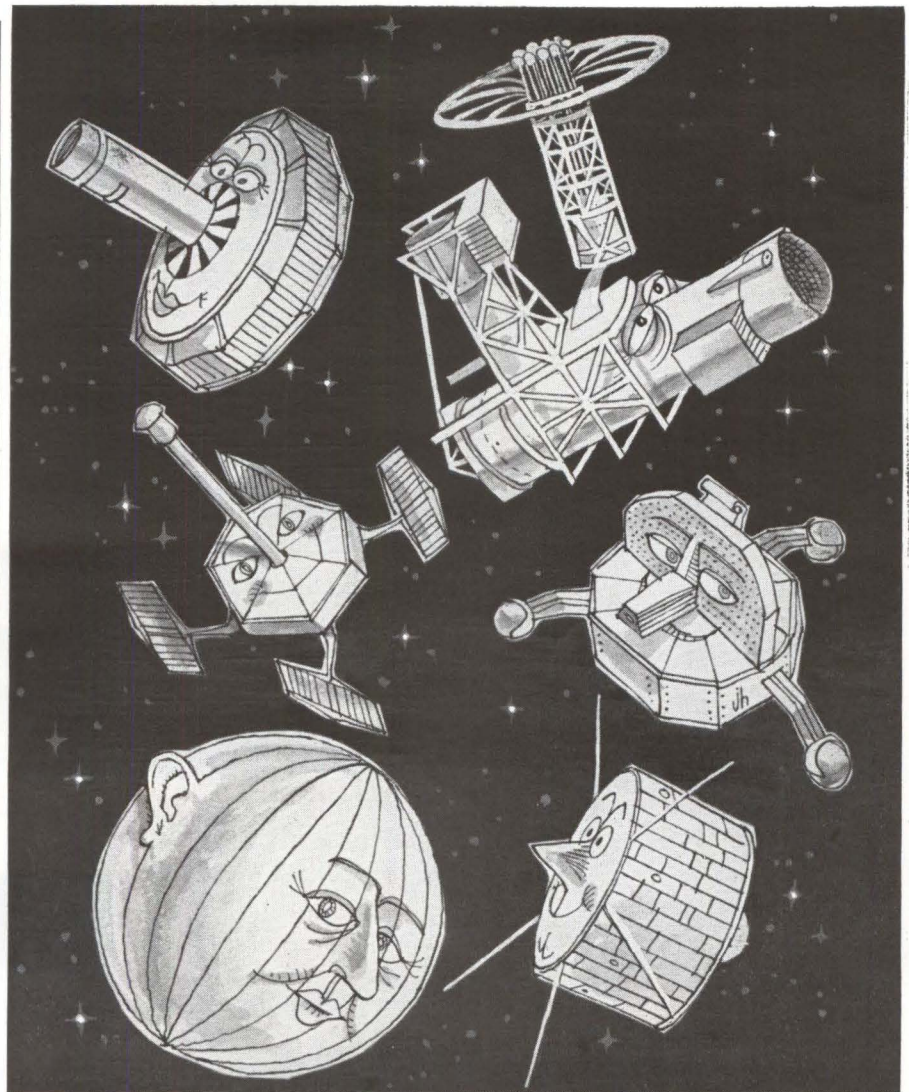

## Six Different Languages... NEMS-CLARKE® 1440 Receiver Interprets Them All!

This hard-working navigational telemetry receiver is already monitoring Transit, Traac, Echo, S3, S16, Stratoscope. It is an exceptionally stable Phase-Lock Receiver with a tuning range of 130-140 mc. The 1440 is particularly suited for the forthcoming S-27 Orbiting Astronomical Observatory.

Nems-Clarke 1440 provides outputs for video, spectrum display, frequency monitor and signal strength recorder. Its four panel mounted meters indicate tuning, output, deviation and signal strength during operation. The receiver is for standard rack mounting.

Write for Data Sheet C-006, Vitro Electronics, 919 Jesup-Blair Drive, Silver Spring, Maryland. A Division of Vitro Corporation of America.

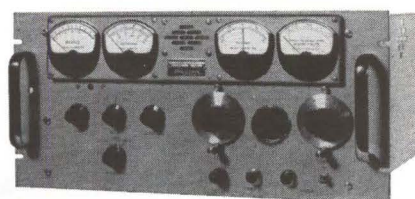

**VITRO ELECTRONICS**

### Specifications:

1. Type of Reception.....FM
2. Tuning Range.....130-140 mc
3. Noise Figure.....6 db maximum
4. IF Bandwidth —  
Wide Band .....100 kc at 3 db points  
Narrow Band ..... 50 kc at 3 db points
5. Phase-Lock Detector.....linear to better than 1% over bandwidth of  $\pm 50$  kc
6. Video Output .....adjustable
7. Video Frequency  
Response.....400 cps to 15 kc
8. Sensitivity.....0.3 v peak to peak per kc of deviation, minimum

CIRCLE 67 ON READER SERVICE CARD

67



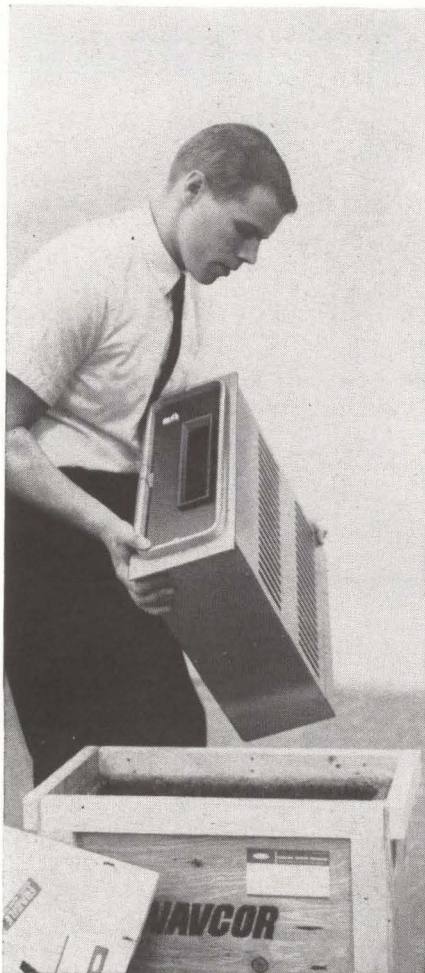

NOW READY:

## ANALOG-TO-DIGITAL CONVERTER

NAVCOR MODEL 2201

LOW PRICE: **\$2935**

ACCURACY: **.05%** ABSOLUTE

DELIVERY: **30 DAYS**

Format: Binary, 10 bits plus sign.  
 Conversion Rate: 10,000 complete conversions per second (9.1 microseconds per bit plus 9.1 microseconds.)  
 Input Range:  $\pm 10.23$  volts; lower or higher ranges available.  
 Input Impedance: 5,000 ohms; high impedance amplifier optional.

Other models start from \$2,775. Both Binary and Binary-Coded-Decimal formats are available. Options include Sample and Hold, Multiplexing, and Over-Range Indication. For more information, write to NAVIGATION COMPUTER CORPORATION, Valley Forge Industrial Park, Norristown, Pennsylvania.



level signal pulses or square waves into the correct switching sequence needed to drive appropriate Slo-Syn synchronous motors at 200 discrete steps per revolution. Speeds up to 400 steps per sec are possible depending on the translator-motor combination used.

CIRCLE 305, READER SERVICE CARD

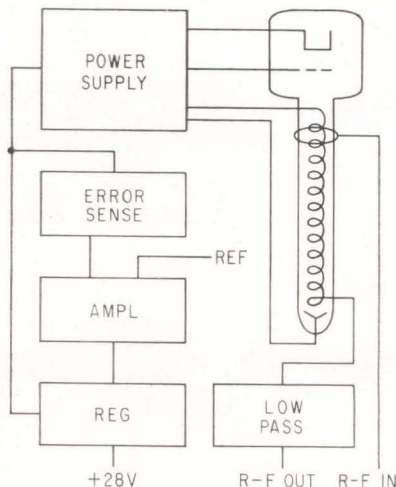

### Microwave Amplifier for 2.0 to 2.4 Gc Band

MANUFACTURED by Watkins-Johnson Co., 3333 Hillview Ave., Palo Alto, California, the WJ-115 microwave amplifier is designed for the 2.0 to 2.4 Gc band and uses a 12 w travelling-wave tube with a solid-state power supply. With an input signal of 3 to 6 mw, nominal output is 12 w. Input power is 81 w maximum. Probability of survival for 1 year in orbit is 90 percent at average baseplate temperature of 25 C and 33-percent duty cycle. Unit may be operated at 100-percent duty cycle if desired. Monitoring circuits are provided for pressure, collector temperature, helix voltage and current and collector current. (306)

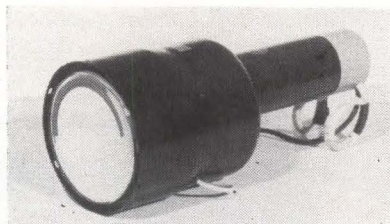

### Storage Tubes Read Out At High Speed

THE MACHLETT LABORATORIES, INC., 1063 Hope St., Springdale, Conn. Writing at full brightness and with

uniform storage characteristics, the ML-8130 offers a read-out capability exceeding 500,000 ips. The similar ML-8139 writes at a rate of more than 150,000 ips. Both tubes are focused electrostatically and offer resolution characteristics up to 80 lines per in. Deflection is accomplished electrostatically in the ML-8130 and magnetically in the ML-8139. (307)

### Waveguide Load Mounts in Any Position

MARCONI'S WIRELESS TELEGRAPH CO. LTD., Chelmsford, Essex, England. Type F1218, designed to provide a good match for radar applications within the 2.7 to 3.4 Gc range, is suitable for use with pressurized waveguide systems. Load consists of carbonyl iron and araldite molded in the waveguide to provide a taper from all four corners for the more rapid dissipation of heat into the fins for natural convection cooling. Plain flange is standard. (308)

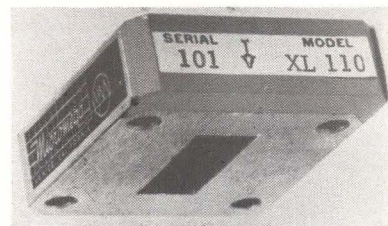

### Miniature Isolator Can Be Preset At X-Band

MICROMEGA CORP., 4134 Del Rey Ave., Venice, Calif. Miniature isolator can be preset for optimum performance at any X-band frequency. Specifications include isolation, 20 db min; bandwidth, 800 Mc for limited temperature range, and 100 Mc for  $-60$  to  $+125$  C; insertion loss, 0.3 db max; vswr, 1.25 max for maximum bandwidth. It measures  $\frac{1}{2}$  in. by  $1\frac{1}{8}$  in. by  $1\frac{1}{8}$  in. weighs less than 2 oz. (309)

### Delay Lines Meet Most MIL Tests

ANDERSEN LABORATORIES, INC., 121 Milbar Blvd., Farmingdale, L. I., N. Y. Series of magnetostrictive delay packages can accomplish delays up to 10,000  $\mu$ sec at a repeti-



tion rate of 1 Mc. Temperature coefficients of 2 ppm from 0 to 50 C. Output levels in the order of 3 to 5 mv at 10 millisecc delay. All can be supplied to meet most military shock and vibration tests. (310)

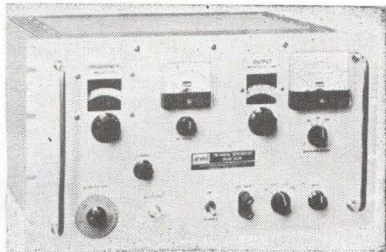

### F-M Signal Generator Gages Modulation Accuracy

ADVANCED MEASUREMENT INSTRUMENTS, INC., 109 Dover St., Somerville 44, Mass. Model 303A features a carrier frequency continuously tunable from 215 to 450 Mc, with frequency stability of  $\pm 0.005$  percent and calibration accuracy of  $\pm 0.5$  percent. It can be modulated with telemetry subcarrier oscillators to check modulation capabilities of telemetry receivers. Three f-m modulation deviation ranges are provided: 0-30, 0-100, and 0-300 Kc, with  $\pm 3$  percent full scale deflection on all ranges and over the entire r-f range. (311)



### Diffusion Furnace Has Controllable Cooling

BTU ENGINEERING CORP., Bear Hill, Waltham, Mass., has developed a small laboratory furnace for the semiconductor and electronics industry. The LD-13-15-1 has an operating range of 650 C to 1300 C and can produce a repeatable thermal flat of 150 mm (6 in.)  $\pm 1$  C or 100 mm (4 in.)  $\pm \frac{1}{2}$  C at 1275 C. Versatile, reliable, and repeatable thermal performance is achieved through the employment of the Power Prop stepless input con-

# 100,000,000 Pulses/Sec from TI

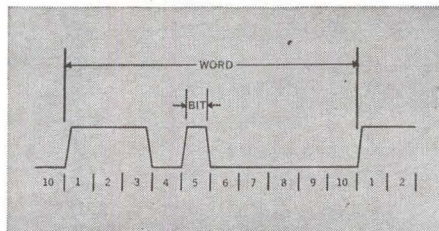
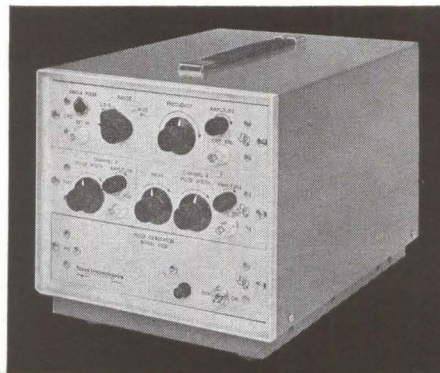

#### PROGRAMMED PULSE GENERATORS

- Bit Rates up to 25 MC
- 10 Bit Programmable Words

#### GENERAL PURPOSE PULSE GENERATORS

- PRF 100 cps to 25 MC
- Variable Pulse Width and Delay
- Variable Rise and Fall Times
- Pulse Mixing
- Plus and Minus Outputs

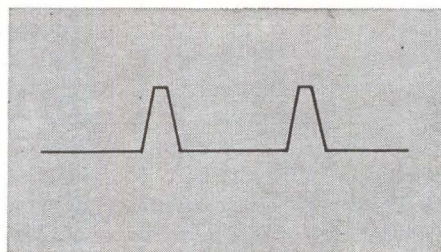
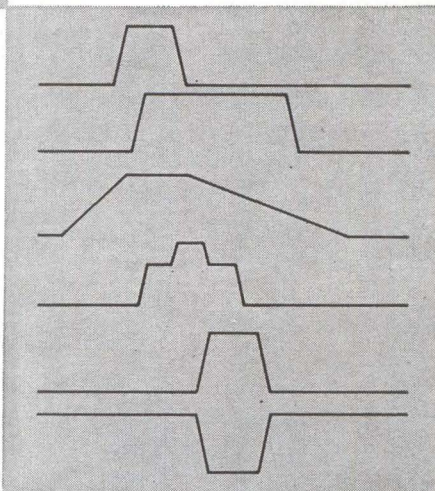

#### CLOCK PULSE GENERATORS

- PRF 100 cps to 100 MC
- Rise and Fall Times—  
Less Than 4 nanoseconds
- Pulse Width—  
Less Than 8 nanoseconds

Texas Instruments complete line of pulse instrumentation features compact design and high reliability through use of all solid state circuitry. Versatile modular construction permits custom combination of desired performance characteristics.

Write for complete information



**TEXAS INSTRUMENTS**  
INCORPORATED  
APPARATUS DIVISION  
3609 BUFFALO SPEEDWAY  
P. O. BOX 66027 HOUSTON 6, TEXAS

501



# NEW FLEXIBLE PERMANENT SEALANT



- seal metal joints, sheet work
- seal leaks
- insulate wiring and terminals
- use as adhesive for pre-fabricated silicone rubber

For a thousand jobs, just squeeze it on and it's on to stay! No pre-mixing or priming. RTV-102 silicone rubber adheres to almost anything — glass, metal, plastics, tile, wood, silicone rubber. Sets in minutes, cures in a few hours, forms a resilient rubber that never dries out, cakes or cracks. Resists moisture, grease, weathering, many chemicals, and temperatures from  $-75^{\circ}\text{F}$  to  $500^{\circ}\text{F}$ .

RTV-102 won't sag on vertical surfaces, can be smoothed over large areas, "gives" with vibration and flexing. For free evaluation sample plus technical data, write on your letterhead describing your application to Section N770, Silicone Products Department, General Electric Company, Waterford, N.Y.

GENERAL  ELECTRIC

troller which utilizes silicon controlled rectifiers.

CIRCLE 312, READER SERVICE CARD



## Fractional H-P Motor Features Fan Cooling

CURVIN DEVELOPMENT CO., 13735 Saticoy St., Van Nuys, Calif., offers a 400 cycle continuous duty motor in single phase capacitor type or with 3 phase windings. Model 131 is conservatively rated at  $\frac{1}{4}$  h-p at 11,000 rpm and features a totally enclosed, fan cooled construction. Either Class F or H insulation can be supplied depending on the operating temperature. It is  $5\frac{1}{4}$  in. long by 3 in. in diameter. (313)

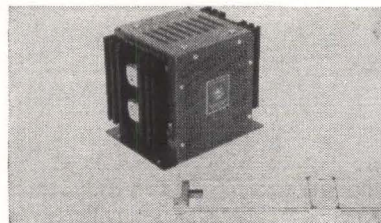

## Static Inverters Offered in 9 Models

ELECTRONIC RESEARCH ASSOCIATES, INC., 67 Factory Place, Cedar Grove, N. J. Series of semi-regulated d-c/a-c static inverters are MOPA designs which provide isolation between the output load and frequency determining elements, and are suitable for use with reactive loads. Nine new models are available which provide outputs of 115 v a-c nominal, 60 or 400 cps, for d-c inputs of 10-14 v d-c or 20-29 v d-c. Power output ratings are in the category of 100 v-a, 250 v-a, and 500 v-a. (314)

## Welding Positioner

RANSOME CO., Scotch Plains, N. J. Model 40 electronically controlled 4,000 lb welding positioner is designed with a single column support which does not extend above

# COMPUTER RESEARCH ENGINEERS & LOGICAL DESIGNERS

Rapid expansion of the Computer Laboratory at Hughes-Fullerton has created several attractive professional opportunities for qualified Computer Research Engineers and Logical Designers. These positions require active participation in broad computer R & D activities in connection with Army/Navy computer systems and new large-scale, general-purpose computers. These multiple processor computers utilize advanced solid-state circuitry, gating and resolution times in the millimicrosecond regions; combine synchronous and asynchronous techniques for maximum speed and reliability.

These professional assignments involve broad areas of logical design, programming and system conception. Fields of interest include:

- Distributed computers
- Advanced arithmetic processing techniques
- Mechanized design
- Asynchronous design techniques
- Utilization of parametrons in computers
- Studies in the utilization of multiple processor computers.

These professional assignments involve such R & D areas as:

- Solid state digital circuitry involving millimicrosecond logic
- Microwave carrier digital circuits
- Sub-microsecond core memory
- Thin film storage techniques
- Functional circuit concepts
- Micro-miniaturization concepts
- Tunnel diodes
- Microwave parametrons
- Circuit organization for maximal-speed computing.

Located in Southern California's Orange County (the nation's fastest growing electronics center), Hughes-Fullerton offers you: a stimulating working environment; private or semi-private offices; long-term stability.

### CALL COLLECT TODAY!

For complete information on these challenging assignments, call us collect today! Ask for:

Mr. J. E. TENNEY at:  
TRojan 1-4080, ext. 3741.

Or, airmail resume to: HUGHES-FULLERTON R & D, P. O. Box 2097, Fullerton 1, California.

An equal opportunity employer.

# HUGHES

HUGHES AIRCRAFT COMPANY



the welding table regardless of vertical adjustment, providing all-around freedom of weldment size, placement and access. (315)

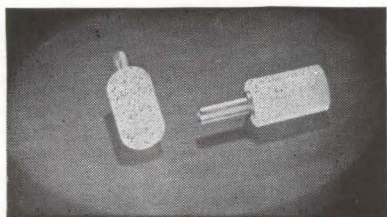

### Variable Probe Connects Into P-C Jacks

SEAELECTRO CORP., 139 Hoyt St., Mamaroneck, N. Y. The PR-300 probe provides test or connection into a 0.080 in. by 0.270 in. deep jack on p-c boards without soldering. The Press-Fit probe has a Teflon body 0.375 by 0.218 in. diameter and is available for color coding. Terminal lug is brass over hard nickel, 0.0003 minimum thickness, and is designed for continuous duty with a current rating of 5.5 amp. (316)

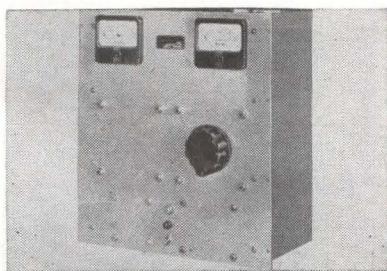

### A-C Power Supply is Distortion-Free

DUNCAN ELECTRIC CO., INC., Davenport Mfg. division, 4363 W. Montrose Ave., Chicago 41, Ill., has available a highly regulated distortionless a-c power supply. Output is continuously variable from 0 to 135 v a-c, at a max current of 50 amp. Regulation is 0.25 percent for 20 v change in input line plus 0-100 percent load change. The supply's amplifiers are all solid state and transistorized for max life and dependability. (317)

### Silicon Rectifier

TUNG-SOL ELECTRIC INC., 1 Summer Ave., Newark 4, N. J. An 18-amp silicon rectifier in press-fit case

from **now**  
**UNITED PROCESS**

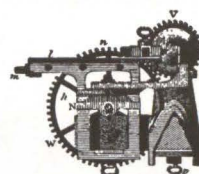

### The Wren epoxy encapsulating machine processes 7200 electronic components per hour!

United Process Machinery Company, leading designers and developers of multi-component plastics processing systems, now offers the electronics industry an epoxy potting and encapsulating machine that meets the most critical requirements.

Recognizing the need for a potting and encapsulating machine expressly designed for the electronics industry, United Process engineers and chemists incorporated the following features in the Wren Machine:

**METERING ACCURACY** to .3 of 1% on all components with full variable output capabilities of from 5-600 gms/min and incorporating complete independent control of all components.

**MATERIALS THOROUGHLY MIXED** under conditions that prohibit the entrapment of air bubbles or dissolved air in the potting and encapsulating compound, and dispensed as a homogeneous material.

**PRECISE DISPENSING** of pre-determined quantities of material as small as 1/25 gm on a manual, semi-automatic or completely automated basis, dispensing up to 7200 shots per hour on a fully integrated production program.

The unit is housed in a durable and compact cabinet (24" x 24" x 12") and is delivered ready to be installed by the United Process technical service engineer in your area.

Write, phone or wire for complete details, specifications and prices.

**UNITED PROCESS MACHINERY COMPANY**

1501 COLORADO AVENUE • EXbrook 5-2719  
SANTA MONICA, CALIFORNIA

REPRESENTATIVES IN MAJOR INDUSTRIAL AREAS

CIRCLE 71 ON READER SERVICE CARD



**Did you swipe this magazine?**

Only 7½ cents a week is the easy way! (\$6 one year, \$9 for two years, \$12 three years.) Just fill in the handy "For subscriptions" section of the Reader Service Card in this issue . . . and you'll get instant subscription.

**electronics:** 330 West 42nd St., N. Y. 36.



# 3-AXIS RATE GYRO TELEMETRY SUBSYSTEM

DEVELOPED BY FAIRCHILD CONTROLS FOR SPIN-STABILIZED MISSILES

Measures pitch, roll and yaw rates  
up to 5000°/second.

DC in, DC out using precision AC Gyros

Temperature . . . . . -60°F to +200°F

Vibration . . . . . up to 50 G's Sinusoidal  
8 G<sup>2</sup>/cycle/second random

Shock . . . . . beyond 200 G's

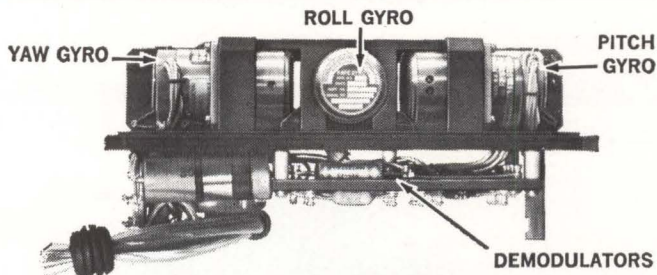

This is one of the many highly sophisticated control and instrumentation packages specifically designed to customer specifications by Fairchild Controls Corporation. Examples of other package applications are control of torpedoes, instrumentation and control of ballistic missiles, and nose cone instrumentation.

A trained staff of experienced engineers is available to consider special problems of design which you may have for instrumen-

Visit our booths #2127-2128 at WESCON

tation and guidance control packages. For more information write Dept. No. 56E.



**FAIRCHILD CONTROLS CORPORATION**  
A Subsidiary of Fairchild Camera  
& Instrument Corporation

225 Park Avenue, Hicksville, L. I., N. Y.  
6111 E. Washington Blvd., Los Angeles, Calif.

withstands overload surges up to 300 amp at 150 C.

CIRCLE 318, READER SERVICE CARD

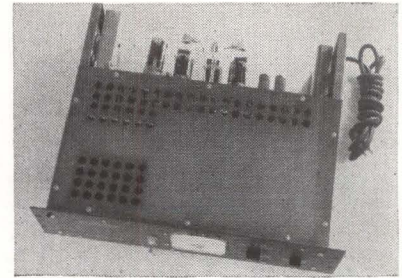

Power Supply Used to Test Capacitors

WALDEN ELECTRONICS CORP., 85 Mystic St., Arlington, Mass. Model 512 constant voltage power supply provides voltage outputs from 3-700 v. Output current, 0 to 50 ma intermittent; 0-35 ma continuous. Unusual line regulation of approximately 0.0001 percent at 700 v output over 105-125 v line range. Load regulation, 0.003 percent no load to full load at 70 v 0.01 percent max. (319)

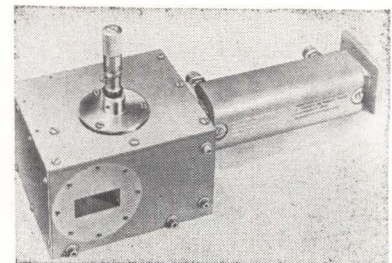

Solid State Limiter  
Replaces TR Tubes

SPERRY MICROWAVE ELECTRONICS CO., Box 1828, Clearwater, Fla., has developed a C-band, long-life solid state limiter designed to replace TR tubes. It operates from 5.4 to 5.7 Gc at power levels up to 300 Kw peak and 450 w average. Insertion loss, including a pressure window, is 1.2 db max. Flat power leakage is nominally 75 mw and spike leakage is nominally 0.15 erg. Peak power in the spike is about 1/2 w. Limiter exhibits preselection characteristics and has a 3 db bandwidth which is nominally 35 Mc. (320)

Charger-Analyzer

SONOTONE CORP., Elmsford, N. Y. Model PCA-130 is a charger-analyzer for sintered-plate, nickel-



cadmium batteries, both military and commercial. (321)

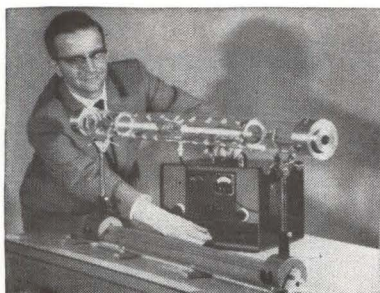

### Helium-Neon Laser Warranted For 1,000 Hr

RAYTHEON CO., Second Ave., Waltham 54, Mass., has introduced a rugged, helium-neon laser, warranted for 1,000 hr of continuous operation. Expected to find wide use in industrial and institutional research labs, model LG-2, employs confocal mirrors spaced 1 meter apart. Output from each end is 1.5 mw. Beam dispersion is 8 min of arc. Price \$7400, complete with r-f supply, magnetic shielding and image converter. (322)

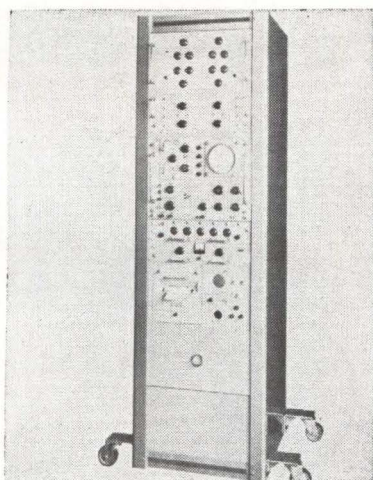

### Transient Monitor Pinpoints Circuit Failure

APPLIED SYSTEMS CORP., 925 East Meadow Drive, Palo Alto, Calif. Series 2500 monitors concurrently up to 6 power buses on a continuous basis; detects and records both positive and negative transient impulses with a minimum time duration of 0.1  $\mu$ sec, and digitally records polarity, relative magnitude and time of occurrence for each transient. Input impedance is 9.0 megohms at 2.5 pf; duration of de-

## We're looking for men who can't let well enough alone

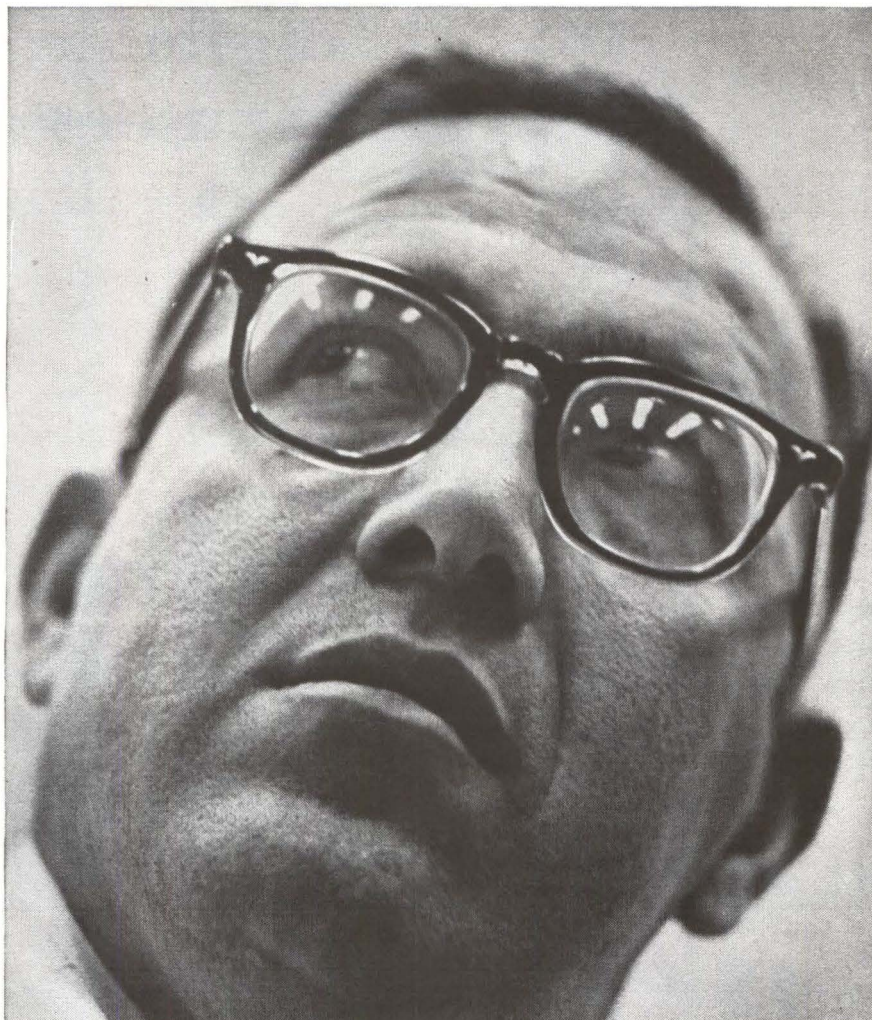

Northrop-Norair needs men who ask questions; men who aren't afraid to rock the boat. In the advanced areas we're exploring at Norair, you don't dare take anything for granted. If this kind of challenge appeals to you, put down the magazine now, while it's on your mind, and write us a letter. Positions are immediately available for:

**Engineers** in electronic checkout systems who have worked with advanced design and program development.

**Engineers** whose background is in supersonic aerodynamics, stability and control, inlet design, ducting, and performance analysis.

**Engineers** familiar with airframe structural analysis.

**Scientists** specializing in infrared, optics, and electronic research.

**Engineers** to work in data reduction.

**Scientists** who know structures research and dynamics.

**Scientists** who have done supersonic aerodynamic research.

**Scientists** experienced in working with information and sensing systems, platforms, infrared, sensors, flight controls, airborne computing and data handling systems.

**Engineers** familiar with programming, operations, and instrumentation for ballistic missile flight test.

**Reliability Engineers** to assess the reliability and to optimize the configurations and mission profiles of space systems.

**Chemical Engineers** to work on the development and applications of structural adhesives for aerospace vehicles.

**Metallurgical Engineers** for research and development on materials and joining.

If you'd like more information about these opportunities and others that may be available by the time you read this, write and tell us about yourself. Contact Roy L. Pool, Engineering Center Personnel Office, **NORTHROP** 1001 East Broadway, Hawthorne, California.

AN EQUAL OPPORTUNITY EMPLOYER



# Shopping for digital computers ?



## ARMA can meet your needs!

**The background:** ARMA's ten years of research, design, and production of computers for inertial guidance have resulted in the development of a new family of advanced digital computers for aerospace, defense, and industrial applications.

**An example:** MICRO, a general purpose, serial, binary, internally programmed, microminiaturized digital computer. MICRO is modular in functional concept, construction and application. Its design concepts have been tested and proved on Air Force programs and is a fully backed-up in-production reality.

**And more:** non-destructive, random access, core memory . . . microminiature logic modules . . . state-of-the-art reliability . . . complete program flexibility . . . a wide range of application-oriented options . . . adaptability to simplified computing devices through the use of selected modules, or expansion to multi-computer systems.

Detailed information, specifications and applications of Arma Computers are contained in the new MICRO folder. Write Arma Division, American Bosch Arma Corporation, Garden City, N. Y. today.

**ARMA** DIVISION  
**AMERICAN BOSCH ARMA CORPORATION**

tectable transients from 0.1  $\mu$ sec to 100 millisecond; transient amplitude range, 5 v min to 250 v max.

CIRCLE 323, READER SERVICE CARD

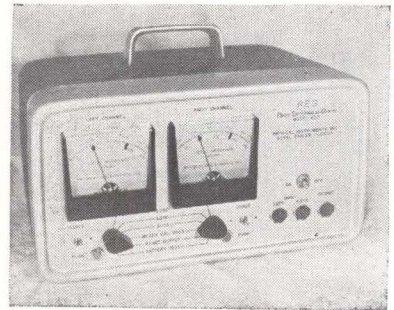

### Blood Flow Sensor Measures Impedance

PHYSICAL INSTRUMENTS, INC., 4565 Ponce de Leon Blvd., Coral Gables, Fla. Model 450 REG (RheoEncephaloGraph) is a two-channel, fully transistorized, clinical and research impedance measurement instrument. Electrical ohmic values obtained are correlative to pulse blood volume. Instrument produces two simultaneous measurements of total patient cranial impedance. An incremental change of 0.05 ohm in the patient will produce a 10 mv output in either channel. Operation is completely automatic. (324)

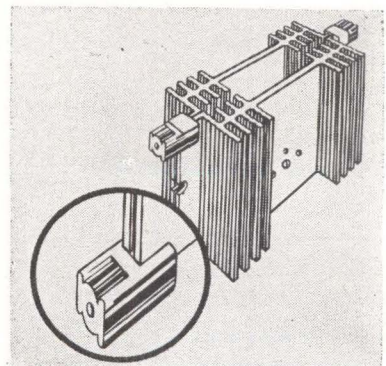

### Mounting Insulator Attaches to Heat Sinks

DELBERT BLINN ELECTRONIC SPECIALTIES, P.O. Box 757, Pomona, Calif. The NH113-IT-1 makes it possible to mount pairs of any standard heat sink in a vertical position while insulating them from two common sides and from each other. It has a dielectric strength of 340 v/mil. Insulators are molded from self-extinguishing material which conforms to MIL-P-20693. Size is 0.906 by 0.500 by 0.500 in. (325)



## PRODUCT BRIEFS

**TNC R-F MONITOR CONNECTORS**, weatherproof. They are composed of a panel receptacle and a cable plug. General RF Fittings, Inc., 702 Beacon St., Boston 15, Mass. (326)

**WIDE SWEEP OSCILLATORS** and attenuator pads. Pads cover d-c to 1,000 Mc. Kay Electric Co., 14 Maple Ave., Pine Brook, N. J. (327)

**PACKAGED SCR POWER UNITS** for industrial use. Operating and storage temperatures are from -40 to +150C ambient. Electrologic Corp., 4165 S.W. 11th Terrace, Fort Lauderdale, Fla. (328)

**TIMING LIGHT GENERATOR** for high speed photo recording. It drives more than 10 neon lamps. Adtrol Electronics Inc., 1437 Vine St., Philadelphia, Pa. (329)

**OCTAVE BAND TUNNEL DIODE AMPLIFIERS** lower the receiver noise figure. Bandwidth is 500-1,000 Mc; gain 13-15 db. Microstate Electronics Corp., 152 Florad Ave., Murray Hill, N. J. (330)

**VIDEO AMPLIFIERS**, fully transistorized. They are designed for use in both color and monochrome systems. Telemet Co., 185 Dixon Ave., Amityville, L. I., N. Y. (331)

**TWIN TETRODE** for ssb applications. It incorporates a very fast heating cathode. Amperex Electronic Corp., 230 Duffy Ave., Hicksville, L. I., N. Y. (332)

**MIDGET POWER AMPLIFIER**, 400-cycle unit. Input impedance is 10,000 ohms (nominal). M. Ten Bosch, Inc., Pleasantville, N. Y. (333)

**MINIATURE SWITCH** has 2 oz max operating force; features 0.062 in minimum overtravel. Cherry Electrical Products Corp., P. O. Box 438-2 Highland Park, Ill. (334)

**ROUND NOSE TAPER PIN** for 0.053 tapered receptacles, Wire sizes No. 16, 18, 20, 22 and 24. Berg Electronics, Inc., New Cumberland, Pa. (335)

**HEAT-SHRINKABLE TUBING** made of irradiated polyolefin; available packaged in small quantity assortments. Alpha Wire Corp., 200 Varick St., New York 14, N. Y. (336)

**SCR D-C POWER SUPPLIES**, high output rating. Panel heights are 3½, 5¼ and 10½ in. NJE Corp., 20 Boright Ave., Kenilworth, N. J. (337)

**SILICON LOGIC MODULES**, low power. Units meet all appropriate military specs. C&K Components, Inc., 103 Morse St., Newton, Mass. (338)

**TEFLON PROBE** for printed circuits. It is available for color coding. Sealectro Corp., 139 Hoyt St., Mamaroneck, N. Y. (339)

**REGULATED POWER SUPPLIES**, environmentalized. Six models are available. Lambda Electronics Corp., 515

## Northrop Space Laboratories needs uncompromising men

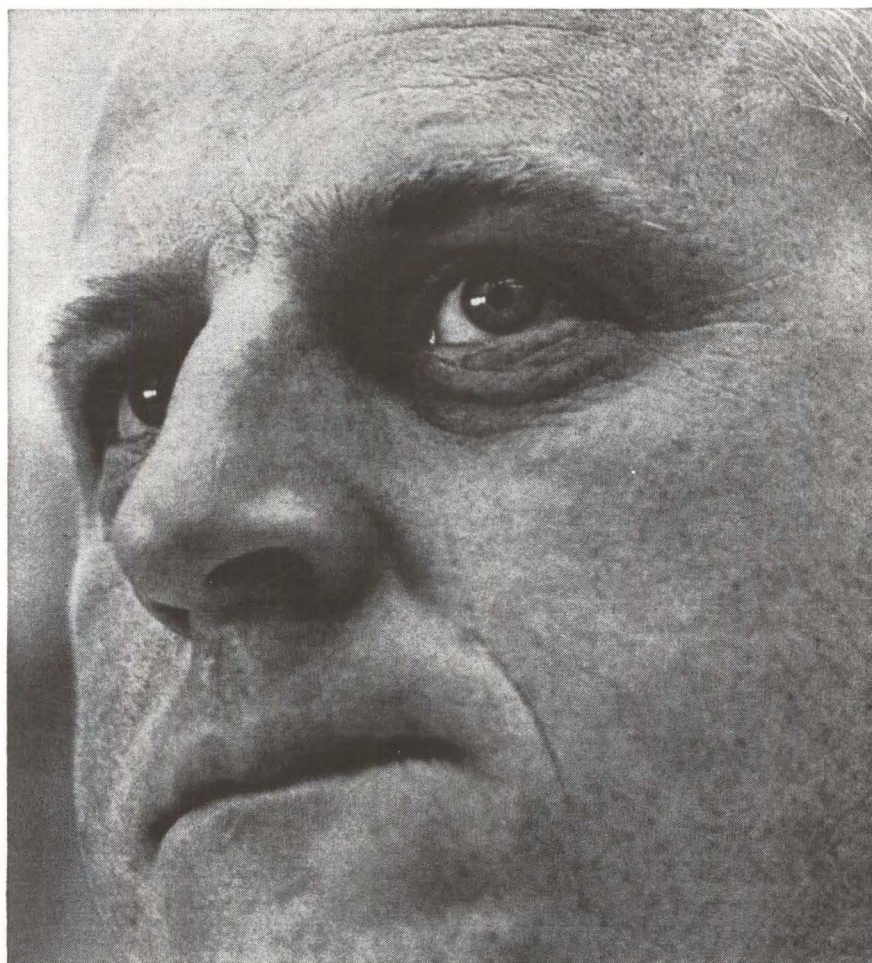

It takes dedicated men to breathe life into a new undertaking. Determined men, to guide and guard its goals through the formative years.

Though newly organized, Northrop Space Laboratories is backed by the full facilities of the Northrop Corporation. It will grow. Yet it needs purposeful men to take up the challenge and grow with it. Will you be one of them? Key spots are now waiting for:

**Solid state physicists**, to conduct fundamental research on many-body problems as applied to an ultra high pressure program. The goals of this program are to study the electrical and physical behavior of materials under ultra high pressure, to investigate the origin, history and structure of the moon and planets, and to find ways to utilize their natural resources.

**Scientists**, to perform research in nuclear and radio chemistry, and to conceive and carry out investigations in the fields of activation analysis, dosimetry, gamma ray spectrometry, surface phenomena, and numerous other areas.

**Stress analysts**, to develop fresh analytical techniques and apply them to new space structural concepts; to do stress analysis and design optimization studies on advanced space vehicle structures.

**A plasma physicist**, to join our growing program in the measurement of plasma properties, spectroscopy, diagnostics, accelerators, and power conversion devices.

**A mathematician-physicist**, to concentrate on systems analysis and operations research applied to military and non-military space systems.

**Physicists** experienced in electro-optical imaging devices and laser theory; **engineering mathematicians** interested in detection theory, reconnaissance and tracking; **electronic engineers** who know their way around statistical communications theory and noise phenomena; for new and original work in satellite detection systems.

For more information about these and other opportunities, write to W. E. Propst, Space Personnel Office, 1111 East Broadway, Hawthorne, California. You will receive a prompt reply.

**NORTHROP**  
AN EQUAL OPPORTUNITY EMPLOYER



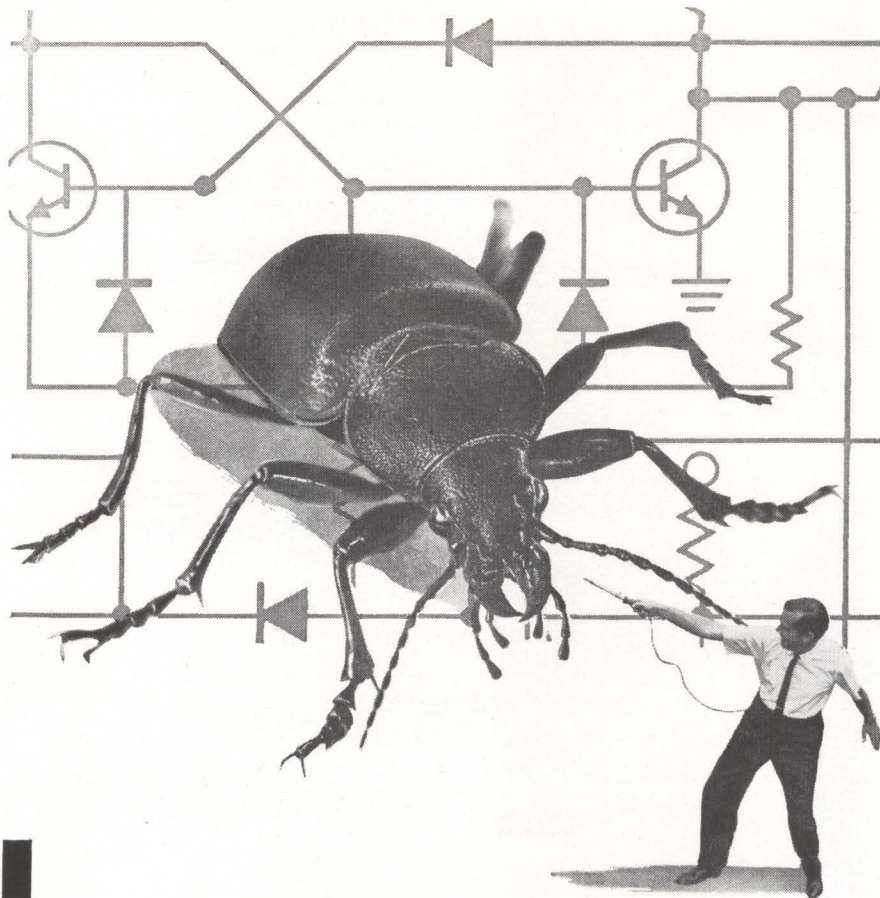

## WHY FIGHT CIRCUIT BUGS?...

use EECo digital circuit modules!

A life test that has already logged over 10 million unit hours with only one degraded failure is proving their reliability more and more conclusively each day.

*Write today for technical data and price information on any of our more than 250 proven catalogued digital circuits.*

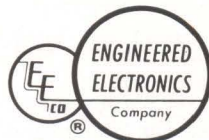

**ENGINEERED ELECTRONICS Company**  
1441 East Chestnut Avenue • Santa Ana, California  
Kimberly 7-5651 • Cable Address: ENGELEX

**EUROPEAN AFFILIATE**  
Electronic Engineering S.A.  
C.P. 142 Fribourg, Switzerland

Broad Hollow Road, Huntington,  
L. I., N. Y. (340)

**AUTOMATIC VOLTAGE REGULATOR** offers wide use flexibility. Unit is small and compact. The Superior Electric Co., Bristol, Conn. (341)

**BICIRCULAR POLARIZED ANTENNA FEED HORNS** span 8.2 to 40 Gc in four bands. General Electronic Laboratories, Inc., 18 Ames St., Cambridge, Mass. (342)

**HIGH-RESOLUTION SMOOTH-SCREEN CRT**, 5-in.-diameter. Westinghouse Electronic Tube Division, Box 284, Elmira, N. Y. (343)

**QUADRATURE PHASE METER**, 20 cps to 40 Kc continuous response. Measures phase angle directly in degrees or in-phase components in volts rms. Ad-Yu Electronics Lab., Inc., 249 Terhune Ave., Passaic, N. J. (344)

**CRT MAGNETIC SHIELDS** have dual layer construction. Price is \$150 to \$300 depending on size and complexity. Magnetic Shield Division Perfection Mica Co., 1322 No. Elston Ave., Chicago 22, Ill. (345)

**CARRIER AMPLIFIER-INDICATOR** displays transducer output. Unit weighs 2 lb, is battery operated. Sanborn Co., Industrial Division, Waltham 54, Mass. (346)

**MULTIPOLE MAGNETIC LATCHING RELAY** saves space and weight. It has high vibration and shock resistance. Allied Control Co., Inc., 2 East End Ave., New York 21, N. Y. (347)

**SSB ANALYZER TEST SET** covers 500 Kc to 50 Mc; features 10 cps resolution. Probescope Co., Inc., 211 Robbins Lane, Syosset, N. Y. (348)

**METAL FILM RESISTORS**, current noise in area of -35 to -40 db. Davenport Division of General Mills, Inc., Livingston, N. J. (349)

**I-F AMPLIFIER** available as welded module. The 10 Mc amplifiers have a 400 Kc bandwidth. Micromodular Components, Inc., 1857 S. Manchester Ave., Anaheim, Calif. (350)

**SUBCARRIER OSCILLATOR SYSTEM** for telemetry or f-m magnetic tape recording. Power requirement is 25 w. Vidar Corp., 2296 Mora Drive, Mountain View, Calif. (351)

**TRIMMER POTENTIOMETERS** have visual indicators. Units have multiple means of adjustment. General Scientific Corp., 1535 First St., San Fernando, Calif. (352)

**60-CHANNEL EVENT RECORDER** features compact design. Response is better than 15 millisecc; resolution, better than 7 millisecc. Techni-Rite Electronics, Inc., 65 Centerville Road, Warwick, R. I. (353)

**ZENER DIODES** are temperature compensated. Standard "Cool Junction" glass package is available in various power ratings up to 1 w. Delta Semiconductors, Inc., 835 Production Pl., Newport Beach, Calif. (354)



## Literature of the Week

**COMMUNICATIONS EQUIPMENT** Manson Laboratories, Inc., 375 Fairfield Ave., Stamford, Conn., has released short form catalog No. 1000 on communications equipment. (355)

**MULTISYN-INDUCTOSYN** Del Electronics Corp., 521 Homestead Ave., Mount Vernon, N. Y., has prepared a manual to acquaint designers with the precision position sensing elements of the Multisyn and Inductosyn. (356)

**LINE VOLTAGE REGULATOR** Sola Electric Co., 1717 Busse Road, Elk Grove Village, Ill. Four-page brochure highlights the Solartron line voltage regulator. (357)

**SPECTROMETER SYSTEM** Varian Associates, 611 Hansen Way, Palo Alto, Calif., has published a 24-page catalog on the V-4502 EPR spectrometer system. (358)

**METER PROTECTOR** Dynatron Laboratories, Inc., 553-E Dawson Dr., Camarillo, Calif. Model 201 meter protector is covered in a two-page bulletin. (359)

**FILTERS** Polyphase Instrument Co., Bridgeport, Pa. Selection guides presents a complete line of lumped constant LC filters covering a range of 5 cps to 500 Kc. (360)

**OSCILLATOR/BANDPASS AMPLIFIERS** Sprague Electric Co., North Adams, Mass. Technical Paper No. 62-10 "Distributed Network Oscillators and Bandpass Amplifiers" covers some recent work on Sprague Ceracircuits. (361)

**PACKAGE CAPABILITIES** Helipot Div. of Beckman Instruments, Inc., 2500 Harbor Blvd., Fullerton, Calif., has published a brochure describing its ability to produce component packages. (362)

**METALS AND COMPOUNDS** The Eagle-Picher Co., American Bldg., Cincinnati 1, O. A 32-page booklet covers a broad range of electronic metals and compounds. (363)

**POWER SUPPLIES** Power Devices, Inc., 8710 Darby Ave., Northridge, Calif. Technical data sheet covers a line of transistor regulated supplies with 0.01 percent regulation. (364)

**TAPE & FILM DEGAUSSERS** Aerovox Corp., Hi-Q Division, 1100 Chestnut St., Burbank, Calif. Bulletin covers three models of tape and film degaussers, each capable of erasing a recorded signal to more than 50 db below saturation. (365)

**GERMANIUM HALL CRYSTAL** Kearfott Division, General Precision, Inc., Little Falls, N. J. Reference sheet KXH-3C covers a germanium Hall crystal intended for multiplier and magnetic field measurement applications. (366)



# start clean!

## with this new ultra-low distortion, stable-amplitude oscillator

When the specs get critical, you need an oscillator that won't add distortion and instability of its own. Here's a stable-amplitude, low-distortion oscillator — Krohn-Hite's new Model 446 — that gives you a *cleaner* sine wave than any other oscillator you've ever worked with!

Amplitude stability is ultra-high: 0.001 db (0.01%), due to a unique infinite-gain AVC circuit (patent pending). Amplitude bounce near line frequency is no longer a problem — less than 0.05%. Distortion — phenomenally low: less than 0.01%.

But that's not all. The 446 push-button oscillator offers continuous frequency coverage from one cycle to 100 kc. Voltage output is continuously adjustable from 0 to 10 volts, with infinite resolution all the way.

And when you need *power* along with stable amplitude and low distortion, team up the Model 446 oscillator with Krohn-Hite's Model UF-101A ultra-low distortion 50-watt amplifier. Here's an amplifier which preserves the stability and distortion-free characteristics, even at a full 50 watts. Frequency response of the amplifier — from 20 cps to 20 kc at full power. A convenient load impedance switch offers a choice of 1, 2, 4, 8 and 225 ohms.

Together, this oscillator and amplifier provide a highly-stable, low-distortion, variable-frequency Power Source (Model LDS-115) — for the most critical meter calibration or measurement needs. Send for technical literature on these new Krohn-Hite instruments.

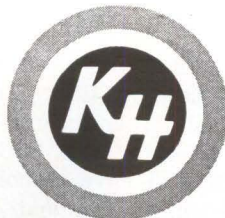

**KROHN-HITE CORPORATION**  
580 Massachusetts Avenue • Cambridge 39, Mass.  
Pioneering in Quality Electronic Instruments





## STL Opens \$30 Million Space Center

FORMAL opening of Space Technology Lab's new \$30 million Space Center in Redondo Beach, Calif., recently marked activation of the 110-acre, campus-like facility with three research buildings, an engineering building and a manufacturing facility. Having a total useable floor area of 638,700 square feet, the buildings used 4,050 tons of steel, 184,280 cubic yards of concrete, and more than 334,000 feet of telephone cable. Completion of the Space Center within eight months was expedited by utilizing STL techniques of concurrent planning, design, and construction employed to lessen time requirements of large research and development projects.

Main feature of the Center is Building M-1, reportedly the first of its kind to be planned, designed and built for the purpose of fabricating and testing spacecraft and space systems. A 12,000 square foot "clean room" almost completely free of dust, moisture and other extraneous matter, is utilized to assemble electronic equipment for space use. Mechanical fabrication takes place in a machine shop consisting of a variety of machines grouped around master machinists. Specialized shops for plating, plastic work, etc., are situated adjacent to the machine shop. The building also contains a 137,000 square foot structure with a 40-

foot overhead bay area and a movable gantry crane for testing and integration activities. Test gear consists of a 30-foot diameter spherical space chamber and other facilities for vibration, shock and radiation testing.

Plans for a second phase of construction scheduled to begin within the next few months will add another five buildings to the complex, two research facilities, a service building, an auditorium/library and an eight-story administration building.



### Transitron Electronic Hires Vallette

WILLIAM J. VALLETTE has been appointed to the new position of director of industrial engineers at Transitron Electronic Corp., Wakefield, Mass. He will have responsibility for administration and di-

rection of industrial engineering in all three plants.

Vallette had been manager of manufacturing of the Special Equipment division at Itek Corp.

### General Kinetics Elects Gutterman

ROBERT P. GUTTERMAN has been elected president of General Kinetics Inc., Arlington, Va. He succeeds William B. Goggins, who continues as chairman of the board. Gutterman was formerly vice president of the firm.

GKI designs and manufactures tape cleaners, testers and controlled-tension winders used in electronic data processing and data recording installations and by tape manufacturers.



### Green Advances At Westinghouse

WILLIAM B. GREEN has been promoted to manager of manufacturing engineering at the Westinghouse Electric Corp. Semiconductor division in Pittsburgh, Pa.

Prior to this appointment, Green was engineering section manager of thermoelectrics and special products at the division.

### Eldre Components Forms Division

ELDRE COMPONENTS, INC., Rochester, N. Y., recently established an Electronic Products division. This division will specialize in the development and production of electronic components, including laminated magnetic shields and bus bar circuitry.

Edward F. Snyder, formerly with The Caledonia Electronics and



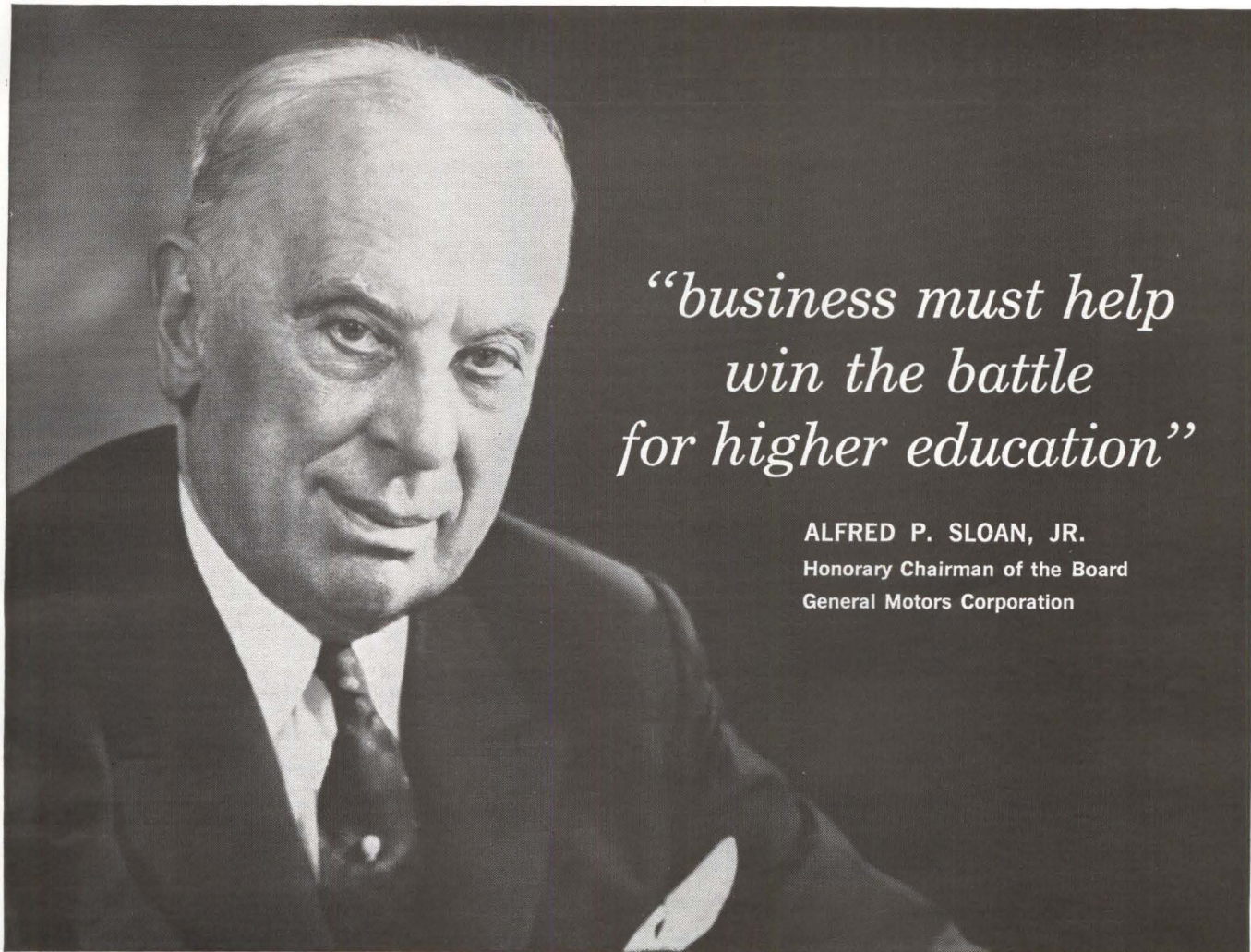

*“business must help  
win the battle  
for higher education”*

ALFRED P. SLOAN, JR.  
Honorary Chairman of the Board  
General Motors Corporation

*“Regardless of the strengths and attributes our nation possesses, if we fall behind in the field of education, we will fall behind as a world power.*

*“Our scientific, cultural and economic growth—and our political strength—will depend largely upon the educational facilities we make available to our youth. We owe it to ourselves as a nation; we owe it to our young people who will inherit this nation to provide the financial aid that will make our institutions of higher learning second to none in the world. This is of vital importance to our business community.*

*“Business must put its support on the line to help win the battle for higher education.”*

Today many of our colleges are overcrowded. In ten years, applications will have doubled and we will be faced with an even more serious crisis in our institutions of higher learning. We will need more and better college classrooms, many more well-equipped college laboratories and thousands more of the most dedicated and well-trained professors.

Only increased financial aid will provide our young people with the best college facilities. Only increased financial aid will keep our finest minds from leaving the teaching profession.

For additional information on the crisis faced by higher education write to: Higher Education, Box 36, Times Square Station, New York 36, N. Y.



Published as a public service  
in cooperation with The Advertising Council and  
the Council for Financial Aid to Education





*"If I can see farther than other men, it's because I stand on the shoulders of giants."*

*Sir Isaac Newton*

It's not that we invite comparison with Newton. But, there's a point to be made. The point is a simple one . . . today, all of us have the shoulders of giants to stand upon—many more than Newton had. Yet, how many of us use this vantage point to see ahead? We at Telerad, do. On this point we welcome comparison with our competitors. At Telerad, creative research is the byword. Whatever your field of interest—systems or component engineering, research and development or straight purchasing of standard components—call us at Telerad. Look ahead with us.

A small reflection of Telerad's capabilities is the recent development of new . . .

## FERRITE LOAD ISOLATORS

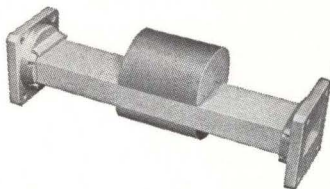

These isolators are of the resonance type. The principal advantages of the resonance isolator in rectangular waveguide are compactness, simplicity of construction, relatively high power handling capacity, and high forward to reverse attenuation ratio. Whether your requirements are for high average power or high peak power, Telerad has the isolator design for your application.

**TELERAD**  
A DIVISION OF LIONEL CORPORATION  
FLEMINGTON, N. J.

Transformer Corp., has been named chief design engineer for the division.



### Barnes Engineering Appoints Kallet

BARNES ENGINEERING CO., Stamford, Conn., has appointed Eli A. Kallet as manager of the space systems department.

Kallet previously served as program manager for the Kearfott division of General Precision, Inc.

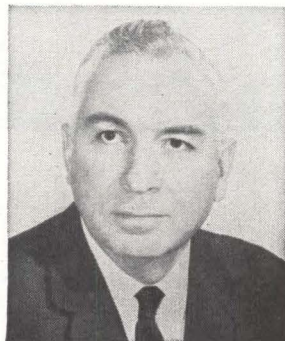

### Radio Receptor Names Paxson

APPOINTMENT of William D. Paxson as vice president-operations of the General Instrument Corporation Radio Receptor division, Hicksville, N. Y., has been announced.

Paxson, formerly assistant general manager of Fairchild Stratos Corporation's Electronic Systems division since 1951, in his new post will be responsible for all Radio Receptor engineering, manufacturing and quality control.

### Eberline Instrument Promotes Moon

JACK L. MOON has been named chief engineer of Eberline Instrument Corp., Santa Fe, N. M. In his new

post, he will direct the research and development of the company's nuclear instruments and other scientific apparatus.

Moon has been with Eberline since 1957.

### Ingersoll Products Elects McLary

MAURICE R. MCLARY has been elected president and general manager of the Ingersoll Products division of Borg-Warner Corp., Chicago, Ill. He succeeds James H. Ingersoll, now on leave of absence from Borg-Warner as director for the U. S. foreign aid mission in the Philippines.

McLary had been executive vice president of Ingersoll Products.

### Packard Instrument Names Sterling

HOWARD T. STERLING has been appointed chief engineer of Packard Instrument Co., Inc., La Grange, Ill. He was formerly chief of nuclear and industrial product engineering at the Curtiss-Wright Corp.

Packard Instrument manufactures instrumentation for the measurement of radioisotopes used in chemical and biological research.

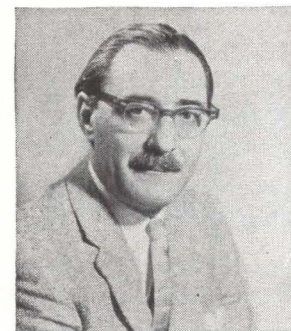

### Manson Laboratories Appoints Radnay

MANSON LABORATORIES, INC., Stamford, Conn., recently appointed Leslie S. Radnay as project engineer and consultant for high frequency communications.

Radnay has been engaged for many years in the design, development and supervision of communication devices both in his native



Hungary as well as in this hemisphere. Prior to joining Manson, he was employed by Reeves Instrument Co. as chief engineer.



Bell Aerosystems Promotes Schlitt

HELMUT SCHLITT has been promoted to the position of director of engineering for the Avionics division of Textron's Bell Aerosystems Co., Buffalo, N. Y.

For the last ten years Schlitt has been manager of Bell's Inertial Guidance Laboratory at North Tonawanda, N. Y.



Cubic Names Walters Products V-P

GLENN A. WALTERS was recently appointed vice president/product research at Cubic Corp., San Diego, Calif.

Walters comes to Cubic from the Dalmo-Victor Co.

James Ladwig Joins Rosemount Engineering

JAMES E. LADWIG, formerly with Minneapolis-Honeywell Aero division and General Electric Ordnance department, has been named to the engineering staff at Rosemount Engineering Co., Minneapolis, Minn.

Firm designs and manufactures

NOW'S THE TIME TO GET THE FACTS!

# DAYTONA BEACH INDUSTRIAL AREAS

Only 30.6 miles to Project Nova Expansion at Cape Canaveral! Strategically situated

IN FLORIDA'S SPACE AGE  
"GOLDEN TRIANGLE"

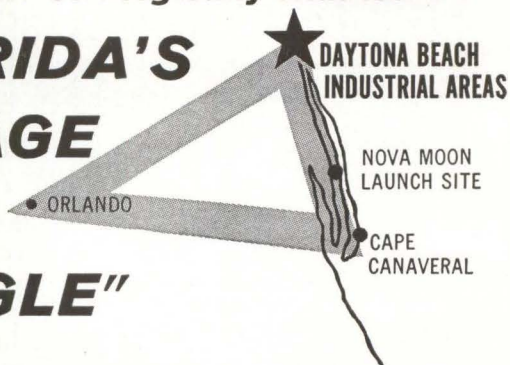

**A red-carpet welcome awaits you in the Daytona Beach Industrial Areas!** Look at the advantages of locating in this friendly METROPOLITAN AREA:

**Ample Manpower**—Skilled labor in abundance; favorable wage rates and living conditions.

**No Labor Problems**—Long record of harmonious management-labor relations. High productivity.

**Mild Year-Round Climate**—The best of Florida's climate keeps absenteeism at an absolute minimum.

**Growing Room**—Ample prime industrial sites at low cost; plenty of room for expansion. No crowding. Sensible zoning.

**Warm Business Climate**—Genuine community interest in industrial development. Full cooperation of local business and government.

**Favorable Taxes**—No local or state personal or corporate income taxes. No state ad valorem taxes on real or tangible property.

**Top Markets**—Florida's expanding \$10 billion-plus market... the surging Southeast... nearby Latin America.

**Excellent Transportation**—Modern highways, airlines, railroads, truck lines, busses, Intracoastal Waterway.

**Ample Power, Water, Fuel**—Limitless water resources. Electric power capacity to keep ahead of all future requirements. Plenty of natural gas, fuel oil.

THE DAYTONA BEACH AREA COMMITTEE OF 100 pledges its complete cooperation in helping you find a profitable site for plant relocation or branch operation. If financing is a problem, **lease-purchase financing is available.** Direct your inquiry to J. Saxton Lloyd, Chairman, who will hold all such inquiries in his personal file IN THE VERY STRICTEST CONFIDENCE.

## DAYTONA BEACH INDUSTRIAL AREAS

Ormond Beach • Holly Hill • Daytona Beach • Daytona Beach Shores  
South Daytona • Port Orange



Mr. J. Saxton Lloyd, Chairman  
Committee of 100, Daytona Beach Industrial Areas  
Dept. E-3, Daytona Beach, Florida

Please send detailed information on the Daytona Beach Industrial Areas.

NAME.....  
TITLE.....  
COMPANY NAME.....  
ADDRESS.....  
CITY..... ZONE..... STATE.....





## SIZE 11 WINDING-COMPENSATED SYNCHRO RESOLVER

Precision, lightweight, high-accuracy components with applications in analog computers and automatic control systems. The compensator winding provides feedback voltage for a resolver isolation amplifier; the feedback loop automatically adjusts to compensate for temperature and frequency variations. Function error of the R980-018 is only 0.1%. A compatible transistorized amplifier, Kearfott number S3100-01A, is available.

CHARACTERISTICS	Part Number	5R980-41	CR9 0980 001 R980-018
	Excitation (volts) (max.)		60
Frequency (cps)		400	400
Total Null Voltage (mv)		25	10
Max. Error from E.Z. (minutes)		5	5
Operating Temp. Range (°C)		-55 to +125	-55 to +125

For complete data write Kearfott Division, General Precision, Inc., Little Falls, New Jersey.

# KEARFOTT



## DUAL- CHANNEL TRANSISTORIZED BUFFER AMPLIFIERS

These high-performance units are designed to drive Kearfott's Size 11 R980 winding-compensated synchro resolvers. The amplifier-resolver combination has stable gain characteristics and negligible phase shift through an ambient temperature range of  $-50^{\circ}\text{C}$  to  $+85^{\circ}\text{C}$ . Extremely high resistance to shock and vibration. Meet environmental requirement of MIL-E-5272.

CHARACTERISTICS	Part Number	S3100-01
	Number of Inputs	
Input Impedance (ohms resistive at $25^{\circ}\text{C}$ )		100,000
Voltage Gain		$1 \pm 0.0005$
Phase Shift (rotor output to input at $25^{\circ}\text{C}$ )		less than 15 min.
Max. Signal Output Voltage		16 volts
Gain Stability Over Operating Temp. Range		$1 \pm 0.05\%$

For complete data write Kearfott Division, General Precision, Inc., Little Falls, New Jersey.



# GENERAL PRECISION

temperature and pressure sensors for use in aircraft and in specialized applications.

## Tesik Transfers to Lockheed Electronics

JAMES J. TESIK has been appointed manager of the quality engineering department of Lockheed Aircraft Corp. He comes to Lockheed Electronics from the Lockheed Missiles and Space Co., Sunnyvale, Calif.

## PEOPLE IN BRIEF

**Edwin Wheeler** promoted to director of international operations by Datex Corp. **Ace Electronics Associates, Inc.**, advances **Vincent DeLaria** to mgr. of production. **A. E. Bennett** moves up to value engineering specialist for Sylvania's Reconnaissance Systems Laboratories. **Howard L. Foote**, formerly with Stromberg-Carlson, named lab mgr. of Chemetron Corp.'s Hilltop Laboratories. **Morton K. Blanchard**, ex-ACF Industries, appointed a senior engineer at Rixon Electronics Inc. **H. Malcolm Ogle** leaves GE to join Applied Systems as asst. to the president. **Joseph J. Sedik**, previously with Raytheon Co., now marketing mgr. for Gabriel Electronics. **American Components, Inc.**, ups **Edward Thompson** to v-p in charge of engineering. **James Franklin Sutton** of Lockheed-Georgia Co. advances to director of research. **Robert M. Thomas, Jr.**, senior v-p, takes the added post of g-m of The Thomas & Betts Co. **John L. Perry** has resigned his regular NAB staff engagement to establish his own Washington consulting service. **Robert Dickholtz** from United Electroynamics Corp. to Arnold Magnetics Corp. as chief engineer. **Winston E. Kock** advances at The Bendix Corp. to v-p of research. **Richard Howe**, ex-Fairchild Camera and Instrument, appointed mgr. of operations for Industrial Control Products, Inc. **General Motors Research Laboratories** elevates **Edward F. Weller, Jr.**, to head of Electronics and Instrumentation dept.



# electronics

## WEEKLY QUALIFICATION FORM FOR POSITIONS AVAILABLE

### ATTENTION: ENGINEERS, SCIENTISTS, PHYSICISTS

This Qualification Form is designed to help you advance in the electronics industry. It is unique and compact. Designed with the assistance of professional personnel management, it isolates specific experience in electronics and deals only in essential background information.

The advertisers listed here are seeking professional experience. Fill in the Qualification Form below.

#### STRICTLY CONFIDENTIAL

Your Qualification form will be handled as "Strictly Confidential" by ELECTRONICS. Our processing system is such that your form will be forwarded within 24 hours to the proper executives in the companies you select. You will be contacted at your home by the interested companies.

#### WHAT TO DO

1. Review the positions in the advertisements.
2. Select those for which you qualify.
3. Notice the key numbers.
4. Circle the corresponding key number below the Qualification Form.
5. Fill out the form completely. Please print clearly.
6. Mail to: D. Hawksby, Classified Advertising Div., ELECTRONICS, Box 12, New York 36, N. Y. (No charge, of course).

COMPANY	SEE PAGE	KEY #
ATOMIC PERSONNEL INC. Philadelphia, Pennsylvania	84	1
DOUGLAS AIRCRAFT CO. Missile and Space Systems Div. Santa Monica, California	10	2
ESQUIRE PERSONNEL SERVICE INC. Chicago, Illinois	84	3
MICROWAVE SERVICES INTERNATIONAL, INC. Denville, New Jersey	84	4
NATIONAL AERONAUTICS AND SPACE ADMINISTRATION Washington, D. C.	84	5
NORTHROP CORP. Norair Div. Hawthorne, California	73	6
NORTHROP CORP. Space Laboratories Hawthorne, California	75	7
REPUBLIC AVIATION CORPORATION Missile Systems Division Mineola, L.I., New York	86	8
SYLVANIA ELECTRONICS SYSTEMS • WEST Mountain View, California	85	9
UNION CARBIDE NUCLEAR CO. Oak Ridge, Tennessee	84	10
WEATHERHEAD COMPANY Cleveland, Ohio	94*	11

\* This advertisement appeared in the 7/20/62 issue.

(cut here)

### electronics WEEKLY QUALIFICATION FORM FOR POSITIONS AVAILABLE

(cut here)

(Please type or print clearly. Necessary for reproduction.)

#### Personal Background

#### Education

NAME .....

HOME ADDRESS .....

CITY ..... ZONE ..... STATE .....

HOME TELEPHONE .....

PROFESSIONAL DEGREE(S) .....

MAJOR(S) .....

UNIVERSITY .....

DATE(S) .....

#### FIELDS OF EXPERIENCE (Please Check)

72762

- |                                              |                                              |                                       |
|----------------------------------------------|----------------------------------------------|---------------------------------------|
| <input type="checkbox"/> Aerospace           | <input type="checkbox"/> Fire Control        | <input type="checkbox"/> Radar        |
| <input type="checkbox"/> Antennas            | <input type="checkbox"/> Human Factors       | <input type="checkbox"/> Radio—TV     |
| <input type="checkbox"/> ASW                 | <input type="checkbox"/> Infrared            | <input type="checkbox"/> Simulators   |
| <input type="checkbox"/> Circuits            | <input type="checkbox"/> Instrumentation     | <input type="checkbox"/> Solid State  |
| <input type="checkbox"/> Communications      | <input type="checkbox"/> Medicine            | <input type="checkbox"/> Telemetry    |
| <input type="checkbox"/> Components          | <input type="checkbox"/> Microwave           | <input type="checkbox"/> Transformers |
| <input type="checkbox"/> Computers           | <input type="checkbox"/> Navigation          | <input type="checkbox"/> Other .....  |
| <input type="checkbox"/> ECM                 | <input type="checkbox"/> Operations Research | <input type="checkbox"/> .....        |
| <input type="checkbox"/> Electron Tubes      | <input type="checkbox"/> Optics              | <input type="checkbox"/> .....        |
| <input type="checkbox"/> Engineering Writing | <input type="checkbox"/> Packaging           | <input type="checkbox"/> .....        |

#### CATEGORY OF SPECIALIZATION

Please indicate number of months experience on proper lines.

	Technical Experience (Months)	Supervisory Experience (Months)
RESEARCH (pure, fundamental, basic)	.....	.....
RESEARCH (Applied)	.....	.....
SYSTEMS (New Concepts)	.....	.....
DEVELOPMENT (Model)	.....	.....
DESIGN (Product)	.....	.....
MANUFACTURING (Product)	.....	.....
FIELD (Service)	.....	.....
SALES (Proposals & Products)	.....	.....

CIRCLE KEY NUMBERS OF ABOVE COMPANIES' POSITIONS THAT INTEREST YOU

1 2 3 4 5 6 7 8 9 10 11 12 13 14 15 16 17 18 19 20 21 22 23 24 25



# NASA

CAREER APPOINTMENTS

## Apollo Manned Lunar Program

**SYSTEM INTEGRATION  
SYSTEM CHECKOUT  
RELIABILITY ASSESSMENT**

Office of Manned Space Flight, Washington, D.C.

The Office of Manned Space Flight has several outstanding career positions available in the Directorate of Integration and Checkout for electronic and aeronautical engineers with B.S. or advanced degrees. Selected applicants will receive permanent appointments as Assistant Directors, Branch Chiefs, and Project Engineers to NASA Headquarters Staff in Washington, D.C.

**Space Vehicle System Checkout** Electronic engineers are required to direct the development of an integrated system checkout equipment for the Apollo Manned Lunar Program. Respondents should have experience in computer, data processing, analog to digital, or computer input-output equipment development. Background in the design, development, and/or project direction of system checkout equipment is desirable.

**System Integration** Electronic and aeronautical engineers are needed to insure the integration of the Apollo space vehicle equipment development program. The assignments require several years experience in electronic or aeronautical missile systems implementation and direction.

**Reliability Assessment** The engineers in this group will develop and direct the comprehensive and unique reliability assessment project for the Apollo Manned Lunar Program. Applicants must be electronic or aeronautical engineers, mathematicians or physicists and should have six to ten years' broad experience in missile system reliability program implementation.

Send brief resume in confidence to:  
Director of Manned Space Flight, Dept. 134-B  
National Aeronautics & Space Administration  
Washington 25, D.C.

All qualified applicants will receive consideration for employment without regard to race, creed, color or national origin.



## EMPLOYMENT OPPORTUNITIES



The advertisements in this section include all employment opportunities—executive, management, technical, selling, office, skilled, manual, etc.

Look in the forward section of the magazine for additional Employment Opportunities advertising.

### — RATES —

**DISPLAYED:** The advertising rate is \$40.17 per inch for all advertising appearing on other than a contract basis. Contract rates quoted on request.

**An advertising inch** is measured  $\frac{7}{8}$ " vertically on a column—3 columns—30 inches to a page.

Subject to Agency Commission.

**UNDISPLAYED:** \$2.70 per line, minimum 3 lines. To figure advance payment count 5 average words as a line.

**Box numbers**—count as 1 line.

**Discount of 10%** if full payment is made in advance for 4 consecutive insertions. Not subject to Agency Commission.

### Electronic Instrument Technicians The Oak Ridge National Laboratory Operated by UNION CARBIDE NUCLEAR COMPANY

at  
Oak Ridge, Tennessee  
Has openings for

Highly skilled electronic instrument technicians to work with electronic engineers in the development, installation and maintenance of electronic systems. Digital data handling, transistorized pulse height analyzers, analog and digital computer systems are only a few examples.

Minimum high school education, with additional training in electronics and at least three years' experience in installation and maintenance of complex electronic systems. Entrance rate \$3.10 per hour; \$3.16 per hour after six months. Reasonable interview and relocation expenses paid by Company.

**Excellent Working Conditions**

and

**Employee Benefit Plans**

**An Equal Opportunity Employer**

Send detailed resume to:

**Central Employment Office  
UNION CARBIDE NUCLEAR COMPANY**  
Post Office Box M Oak Ridge, Tennessee

### COMMUNICATIONS APPLICATION ENGINEER Analysis of advanced electronic communication systems including radio, carrier, telephone, microwave:

Must have design and marketing experience with commercial and military users.

EE degree, 5 yrs. exp. min.

Send Resume to:

**Microwave Services International Inc.**  
Consulting Engineers  
Route 46 Denville, N. J.

### DIRECTOR—SPACE DEVELOPMENT

To head Space and other R&D Projects Lab. Active in Material Analysis and Instrumentation Development. Must be capable of managing all aspects of project. Experience in Radiation, Instrumentation, and Transistor Circuitry. \$20,000. Client assumes all expenses.

**ESQUIRE PERSONNEL, INC.**  
202 So. State St. Chicago 4, Illinois



### E.E.'s

For professional, individualized fee-paid service write for confidential application.

A national employment agency for the Nuclear & Scientific Fields.

**ATOMIC PERSONNEL, INC.**  
Suite 1207L, 1518 Walnut St., Phila. 2, Pa.





**Stimulating career opportunities for Reconnaissance Systems Engineers  
at Sylvania on the San Francisco Peninsula**

**SYLVANIA ELECTRONIC SYSTEMS—WEST**

offers a broad spectrum of challenging problems involved in Reconnaissance Systems Engineering including: Feasibility Studies, Operational Analysis, System Synthesis and Performance Analysis, Application and Development of Advanced Techniques, Specification of Constituent Subsystems, Human Factors Engineering and Operations Research. Typical areas in which openings currently exist include the following:

**DATA ANALYSIS and SIGNAL PROCESSING.** Carry out studies, the objectives of which are the design of new, or the refinement of existing data collection systems. Studies range from the analysis required to develop and define operating requirements compatible with economic and state-of-the-art considerations, through systems conceptual design in block diagram form and including specification of hardware design approach.

**STATISTICAL ANALYSIS.** Perform various statistical analyses at various levels of sophistication, set up mathematical models of stochastic processes. Fields of particular interest include experimental design, theory of queues, theory of mixtures, allocation of resources, search theory, and general operations research.

**INTERCEPT AND DETECTION.** Direct or perform reconnaissance systems operational and technical requirements studies; electronic signal environment studies; synthesis of electronic intercept systems from conception to hardware specification and system block diagram; analysis of system performance and of data related to telemetry, communications, radar and others. Direct or prepare reports and proposals and maintain technical contact with customer representatives.

**ANTENNA AND PROPAGATION.** Perform analyses of electromagnetic propagation aspects of reconnaissance and other systems; analyze direction finding problems and develop direction finding techniques; determine antenna requirements and configuration during synthesis of reconnaissance systems. Activities include report writing, and customer contacts.

These openings exist at all experience levels. Advanced degrees in EE, physics, or mathematics desirable.



*Complete information may be obtained by writing, in confidence to  
Roger Harlan*

**SYLVANIA ELECTRONIC SYSTEMS - WEST**  
P. O. Box 188 • Mountain View, California  
*An Equal Opportunity Employer*



**ELECTRONICS ENGINEERS  
& SCIENTISTS**

**Explore Today's Most  
Advanced Projects in  
Near and Deep**

**SPACE  
COMMUNICATIONS**

( Vehicle-to-Ground )  
( Vehicle-to-Vehicle )

A diversity of advanced communications problems offer you stimulating assignments at Republic's Missile Systems Division. These include communications systems for a number of next-generation satellites and hypersonic vehicles. Emphasis is on applications of new digital techniques in wideband information transmission; multiplexing, security coding and noise reduction. Re-entry blackout communications problems are under study; new concepts in IR cameras are under development.

Openings at all levels on  
Systems and Component  
Design & Development,  
Systems Analysis, &  
Test Programs for

**MICROWAVE ENGINEERS  
RADAR ENGINEERS  
COMMUNICATIONS ENGINEERS  
IR & OPTICS SPECIALISTS  
DIGITAL COMPUTER  
SPECIALISTS**

Also, unusually varied assignments for CIRCUIT DESIGN ENGINEERS with experience in transistorized UHF & microwave systems, including: High Frequency Pulse Circuits, Digital Computer Building Blocks, RF Circuits, Communication Coding Circuits, Feedback Control Circuits.

Write Mr. Paul Hartman,  
Technical Employment Supervisor

**MISSILE  
SYSTEMS  
DIVISION**

**REPUBLIC  
AVIATION CORPORATION**

223 Jericho Turnpike  
Mineola, Long Island, New York  
An Equal Opportunity Employer



**New  
Avenues in  
Space Technology  
at AVCO/RAD**

**Electronics**

Putting "man among the stars" through the design and development of a new generation of space vehicles plus a multitude of advanced space-oriented programs at Avco/RAD have created broad vistas of professional advancement for qualified engineers and scientists.

Openings exist for  
Electronic Engineers and  
Engineering Physicists in:

**Optics & Infrared  
Communications**

**Antenna & Microwave  
Equipment Systems**

**Deep Space & Re-entry  
Communications**

**Component & Circuit Design**

**Sensor Development &  
Telemetry Systems**

**Radar Cross-Section Analysis**

**Airborne Tracking Systems**

The Division is located in a superbly equipped \$23,000,000 laboratory facility in the Boston suburbs. At Avco/RAD you will find a liberal benefits program including educational assistance.

Send resume to  
Mr. J. Bergin, Dept. AW

Avco/RAD is presently associated with Apollo; Titan, Atlas, Minuteman, Nike-Zeus and other classified space projects.

**Avco**

Research & Advanced Development

A Division of Avco Corporation  
201 Lowell St., Wilmington, Mass.

An equal opportunity employer

**SEARCHLIGHT  
SECTION**

(Classified Advertising)

BUSINESS OPPORTUNITIES  
EQUIPMENT - USED or RESALE

**DISPLAYED RATE**

The advertising rate is \$27.25 per inch for all advertising appearing on other than a contract basis. Contract rates quoted on request. AN ADVERTISING INCH is measured 7/8 inch vertically on one column, 3 columns—30 inches—to a page. EQUIPMENT WANTED or FOR SALE ADVERTISEMENTS acceptable only in Displayed Style.

**UNDISPLAYED RATE**

\$2.70 a line, minimum 3 lines. To figure advance payment count 5 average words as a line.

PROPOSALS, \$2.70 a line an insertion. BOX NUMBERS count as one line additional in undisplayed ads.

DISCOUNT OF 10% if full payment is made in advance for four consecutive insertions of undisplayed ads (not including proposals).

**FOR RESEARCH — DEVELOPMENT  
& EXPERIMENTAL WORK**

Over 10,000 different electronic parts: waveguide, radar components and parts, test sets, pulsers, antennas, pulse xmfrs, magnetrons, IF and pulse amplifiers, dynamotors, 400 cycle xmfrs, 584 ant. pedestals, etc.  
PRICES AT A FRACTION OF ORIGINAL COST!  
**COMMUNICATIONS EQUIP CO.**  
343 CANAL ST., N. Y. 13, WO 6-4045  
CHAS. ROSEN (Formerly at 131 Liberty St.)

CIRCLE 950 ON READER SERVICE CARD

**PROFESSIONAL  
SERVICES**

**GIBBS & HILL, Inc.**  
Consulting Engineers

Systems Engineering  
Operations Research • Development  
Field Studies • Design • Procurement  
Power • Transportation • Communications  
Water Supply • Waste Treatment  
393 Seventh Avenue New York 1, N. Y.

**FOR MORE INFORMATION  
About Classified Advertising,**

Contact The McGraw-Hill Office  
Nearest You.

<b>ATLANTA, 9—</b> 1375 Peachtree St. N.E. Trinity 5-0523	<b>HOUSTON, 25—</b> Prudential Bldg. Holcombe Blvd. Riverside 8-1280
<b>BOSTON, 16—</b> Copley Square Congress 2-1160	<b>LOS ANGELES, 17—</b> 1125 W. 6th St. HUNtley 2-5450
<b>CHICAGO, 11—</b> 645 No. Michigan Ave. M0hawk 4-5800	<b>NEW YORK, 36—</b> 500 Fifth Ave. L0ngacre 4-3000
<b>CLEVELAND, 13—</b> 1164 Illuminating Bldg. Superior 1-7000	<b>PHILADELPHIA, 3—</b> Six Penn Center Plaza L0cust 8-4330
<b>DALLAS, 7—</b> 1712 Commerce St. Vaughn Bldg. Riverside 7-9721	<b>PITTSBURGH, 22—</b> 4 Gateway Center EXpress 1-1314
<b>DENVER, 2—</b> 1700 Broadway— Tower Bldg. ALpine 5-2981	<b>ST. LOUIS, 8—</b> 7751 Carondelet Ave. PARKview 5-7285
<b>DETROIT, 26—</b> 856 Penobscot Bldg. W00ward 2-1793	<b>SAN FRANCISCO, 11—</b> 255 California St. DUgلاس 2-4600
<b>WM. H. GINDER, JR.</b>	<b>J. A. HARTLEY</b>



# INDEX TO ADVERTISERS



## Audited Paid Circulation

Acton Laboratories Inc.....	18	Ohmite Mfg. Co. ....	60, 61
Air Express .....	19	Potter Instrument Co., Inc.....	21
Airpax Electronics, Inc.....	57	Precision Instrument Co. ....	27
Air Products & Chemicals, Inc.....	63	Radio Corporation of America.....	4th cover
American Bosch Arma Corp.....	74	Raytheon Company .....	15
Ampex Corporation .....	14	Roanwell Corp. ....	29
Amphenol-Borg Electronics Corp. Connector Division .....	13	Sierra Electronic Corp. ....	6
Avnet .....	87	Sprague Electric Co.....	4, 9, 28
Borg Equipment Division, Amphenol- Borg Electronics Corp. ....	11	TRG, Inc. ....	32
Clairex Corp. ....	88	Telerad Div. of Lionel Corp.....	80
Daytona Beach Industrial Areas.....	81	Texas Instruments Incorporated Apparatus Division .....	69
Delco Radio .....	51	Tru-Ohm Products .....	64
Douglas Aircraft Co. ....	10	Tung-Sol Electric, Inc.....	5
Electrical Industries, Inc. ....	31	United Process Machinery Co. ....	71
Engineered Electronics Co. ....	76	Vitro Electronics .....	67
Fairchild Controls Corp. ....	72		
General Electric Co. Silicone Products Dept. ....	70		
Heinemann Electric Co. ....	30	<b>PROFESSIONAL SERVICES .....</b>	<b>86</b>
Hewlett-Packard Company Inside front cover		<b>CLASSIFIED ADVERTISING</b>	
Hitemp Wires Inc. ....	53	F. J. Eberle, Business Mgr.	
Hogan Faximile Corp. ....	63	<b>EMPLOYMENT OPPORTUNITIES .....</b>	<b>84-86</b>
Hughes Aircraft Co. ....	70	<b>EQUIPMENT</b>	
Interstate Electronics Corp. ....	22	(Used or Surplus New) For Sale .....	86
Kearfott Div. General Precision Inc.....	82	<b>INDEX TO CLASSIFIED ADVERTISERS</b>	
Kintel, A Division of Cohu Electronics Inc. ....	3rd cover	Atomic Personnel, Inc.....	84
Krohn-Hite Corp. ....	77	Communications Equipment Co.....	86
Lapp Insulator Co., Inc. ....	56	Esquire Personnel Service Inc.....	84
Leesona Corp. ....	65	Microwave Services International, Inc....	84
Minnesota Mining & Mfg. Co. Chemical Div. ....	54, 55	National Aeronautics and Space Administration .....	84
Mitsumi Electric Co., Ltd.....	63	Republic Aviation, Missile System Div...	86
Motorola Semiconductor Products Inc....	59	Sylvania Electronic Systems*West.....	85
Navigation Computer Corp. ....	68	Union Carbide Nuclear Company.....	84
Northrop Corp. ....	73, 75		
Norton Company .....	22		

This Index and our Reader Service Numbers are published as a service. Every precaution is taken to make them accurate, but ELECTRONICS assumes no responsibilities for errors or omissions.

**AVNET**  
AUTHORIZED FACILITIES  
PROVIDE ONE QUICK SOURCE

FOR MISSILE  
MILITARY and  
COMMERCIAL  
APPLICATIONS:

**BENDIX**  
"SCINTILLA"  
CONNECTORS

The most trusted name in electrical connectors.

A wide range of types and configurations in the series of MS Standards - Pygmy Types - Rack & Panel - Waterproof - thru - Bulkhead - Ordnance QWL Applications.

Contact Your  
Nearest  
**AVNET**  
Sales  
Engineer

For dependable service  
and immediate delivery



**THE AVNET  
SYSTEM**

**AVNET, New York**  
70 State St., Westbury, L. I., N. Y. ED 3-5800  
**AVNET, Los Angeles**  
5877 Rodeo Rd., Los Angeles 16, Cal. UP 0-6141  
**AVNET, San Francisco Bay Area**  
1262 N. Lawrence St. Rd., Sunnyvale, Cal. RE 6-0300  
**AVNET, Chicago**  
10130 W. Pacific Ave., Franklin Pk., Ill. GL 5-8160  
**AVNET, Boston**  
45 Winn St., Burlington, Mass. BR 2-3060  
**AVNET, Salt Lake City**  
816 S. Main St., Salt Lake City, Utah DA 8-0245  
**AVNET, Seattle**  
11240 Main St., Bellevue, Wash. GL 4-4911  
**AVNET, Phoenix**  
3138 E. McDowell Rd., Phoenix, Ariz., 273-1261



IN THE EXPANDING FIELD OF

## PHOTOGRAPHY

THE UNIQUELY CONTROLLED  
CHARACTERISTICS OF

# CLAIREX<sup>®</sup> PHOTOCONDUCTIVE CELLS

... ARE THE BASES  
FOR A GROWING NUMBER OF  
PRECISION APPLICATIONS

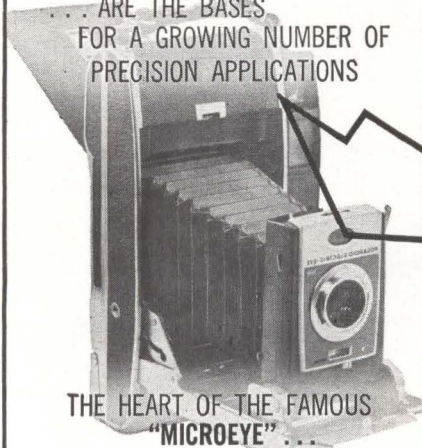

THE HEART OF THE FAMOUS  
"MICROEYE" ...

in the Model 900 Polaroid<sup>®</sup> Land Camera is a Clairex cell of special design, with a sensitivity capable of controlling the precise adjustment of the exposure mechanism over a light range from less than 1/10 of one foot-candle to several hundred foot candles.

Clairex Corporation, through:

- CAREFULLY CONTROLLED CHARACTERISTICS
- CUSTOM DESIGN AND
- ULTRA SENSITIVITY

has pioneered the use of photoconductive cells in the photographic industry. A growing number of high quality still and movie cameras, exposure meters, enlargers and projectors are now using Clairex cells.

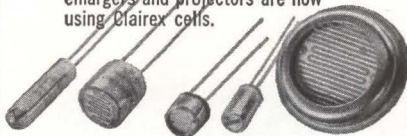

Approximately 1/2 actual size

The broadest standard line —  
**5 Series** in both glass and metal packages plus unique abilities to custom engineer . . . because "Photoconductors are our only business."

**CLAIREX**  
CORPORATION

8 West 30 Street, New York 1, N. Y.  
The Light Touch in Automation and Control



## electronics



Audit Bureau  
of Circulations

Associated Business  
Publications

Audited Paid Circulation

**JAMES T. HAUPTLI**

Advertising Sales Manager

**R. S. QUINT:**  
Assistant Publisher Buyers'  
Guide and Business Manager  
**FRED STEWART:**  
Promotion Manager  
**B. ANELLO:**  
Market Services Manager

**RICHARD J. TOMLINSON:**  
Production Manager  
**GEORGE E. POMEROY:**  
Classified Manager  
**HUGH J. QUINN:**  
Circulation Manager

### ADVERTISING REPRESENTATIVES

**NEW YORK (36):**  
Donald H. Miller, Henry M. Shaw,  
George F. Werner  
500 Fifth Avenue, LO-4-3000  
(area code 212)

**BOSTON (16):**  
William S. Hodgkinson, Donald R. Furth  
McGraw-Hill Building, Copley Square,  
Congress 2-1160 (area code 617)

**PHILADELPHIA (3):**  
Warren H. Gardner, William J. Boyle  
6 Penn Center Plaza, LOcust 8-4330  
(area code 215)

**CHICAGO (11):**  
Harvey W. Wernecke, Robert M. Denmead  
645 North Michigan Avenue, Mohawk 4-5800  
(area code 312)

**CLEVELAND (13):**  
Paul T. Fegley  
55 Public Square, Superior 1-7000  
(area code 216)

**SAN FRANCISCO (11):**  
R. C. Alcorn  
255 California Street, Douglas 2-4600  
(area code 415)

**LOS ANGELES (17):**  
Peter S. Carberry, Ashley P. Hartman  
1125 W. 6th St., Huntley 2-5450  
(area code 213)

**DENVER (2):**  
J. W. Patten  
Tower Bldg., 1700 Broadway,  
Alpine 5-2981 (area code 303)

**ATLANTA (9):**  
Michael H. Miller, Robert C. Johnson  
1375 Peachtree St. N.E., Trinity 5-0523  
(area code 404)

**HOUSTON (2):**  
Joseph C. Page, Jr.  
Prudential Bldg., Holcomb Blvd.,  
Riverside 8-1280 (area code 713)

**DALLAS (1):**  
Frank Le Beau  
The Vaughn Bldg., 1712 Commerce St.  
Riverside 7-9721 (area code 214)

**LONDON W1:**  
Edwin S. Murphy Jr.  
34 Dover St.

**FRANKFURT/Main:**  
Matthée Herfurth  
85 Westendstrasse

**GENEVA:**  
Michael R. Zeynel  
2 Place du Port

### "Headquarters for Business Information"

### McGraw-Hill Technical and Business Publications

American Machinist/Metal-  
working Manufacturing  
Aviation Week and Space  
Technology  
Business Week  
Chemical Engineering  
Chemical Week  
Coal Age  
Construction Methods and  
Equipment  
Construction Daily  
Control Engineering  
Electrical Construction  
and Maintenance  
Electrical Merchandising Week  
Electrical Newsletter  
Electrical West

Electrical Wholesaling  
Electrical World  
Electronics  
Engineering Digest  
Engineering and Mining Journal  
E & MJ Metal and Mineral  
Markets  
Engineering News-Record  
Factory  
Fleet Owner  
Industrial Distribution  
National Petroleum News  
Nucleonics  
Nucleonics Week  
Platt's Oilgram News  
Platt's Oilgram Price Service  
Power

Product Engineering  
Purchasing Week  
Science Week  
Textile World

Overseas only:  
Automobile International  
(English, Spanish)  
Ingenieria Internacional  
Construccion (Spanish)  
International Management  
(English, Spanish)  
Portuguese editions)  
Metalworking Production  
(Great Britain)

Available by subscription only — to qualified persons actively engaged in the field of the publication. For subscription rates and information describing the editorial coverage of any of the above publications, write to: *Subscription Manager, Circulation Department, McGraw-Hill Publishing Company, 330 West 42nd Street, New York 36, N. Y.*



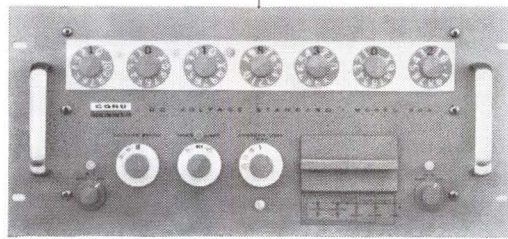

*KIN TEL's remarkable Model 303 DC Voltage Standard*

## NEW! DC STANDARD ACCURATE AND STABLE ENOUGH TO CALIBRATE ANY DIGITAL VOLTMETER!

Now there's a compact source of accurate, precisely adjustable DC from zero to over  $\pm 1100$  volts for just about any laboratory or industrial application—including calibrating and testing digital voltmeters! It's KIN TEL's Model 303 DC Voltage Standard.

*1  $\mu$ v-step adjustments.* Look at its seven decaded controls. These readout-type dials let you control output in microvolt steps from 0 to over  $\pm 11$  volts, in 10-microvolt steps to over  $\pm 110$  volts, and in 100-microvolt steps to over  $\pm 1100$  volts.

*0.01% accuracy, 0.005% stability.* The output is accurate to within 0.01% of the dial setting, and is stable to within 0.0025% for over eight hours and to within 0.005% for over 30 days. Resolution is 0.1 part per million of full scale.

*5, 10, 15, or 25 ma current.* With the 303, you can get up

to 25 milliamperes of current on any voltage range, or you may limit the output by panel control to 5, 10, or 15 milliamperes. If the current you select is exceeded or if the output voltage deviates from the dial setting, an overload relay automatically disconnects the output terminals and causes an indicator lamp to glow.

*Floating guarded circuit.* Because the circuit is fully isolated from both ground and chassis, and is completely shielded and guarded, you may operate it either grounded or floating. Common-mode rejection is 120 db at 60 cps. Separable, sampling terminals provide effective source impedance at the load of 0.001 ohm.

Price: \$2995. F.O.B., San Diego. (50-cps operation at additional cost; programmable, AC/DC, and cabinet versions at factory request.) Write for literature or demonstration.

*Representatives in all major cities. 5725 Kearny Villa Road, San Diego 12, California. Phone 277-6700 (Area Code 714)*



CIRCLE 901 READERS SERVICE CARD



# ON OFF

...In 6 Nanoseconds with RCA 2N955A  
1000-Mc NPN Germanium Epitaxial Mesa Switching Transistor

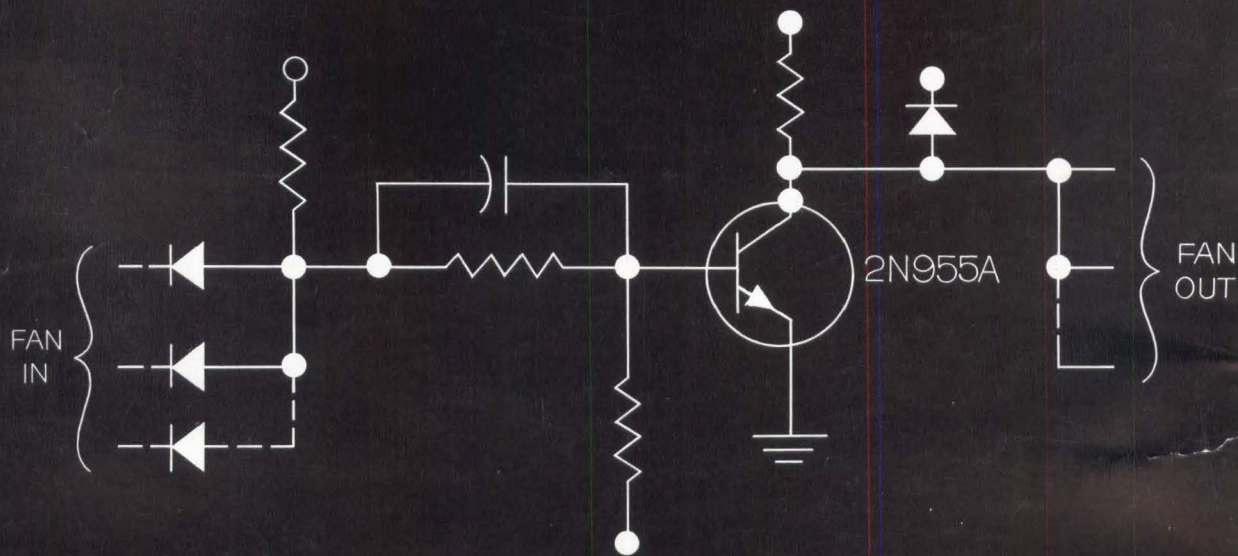

Six nanosecond stage delay in DTL logic circuits —  
seven nanosecond stage delay in RCTL circuits—under  
“worst-case” conditions and with a fan-out of three

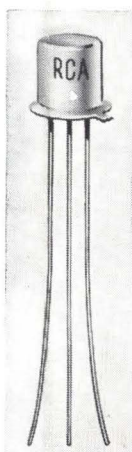

TO-18 Package

The Epitaxial Mesa construction of the 2N955A means new levels of performance in high speed data processing equipment. The outstanding features of this NPN Germanium Transistor include:

- High Gain-Bandwidth Product—1,000 mc typical
- Low stored charge in saturation...45 pC typical
- High dc current gain over a broad range of collector currents  $h_{FE} = 50$  typical
- Low output and input capacitances...6 pf and 10 pf respectively
- High dissipation capabilities...150 mw max. at 25°C free air temperature

In addition to the 2N955A, RCA's broad line now includes seventeen other high-speed germanium switching types. Specify RCA for top performance in both silicon and germanium types.

For additional technical information on the 2N955A, and for a free copy of the RCA Semiconductor Product Guide, use the reader reply card or write to RCA Semiconductor and Materials Division, Commercial Engineering, Section C-N-7-4, Somerville, N.J.

AVAILABLE THROUGH YOUR RCA DISTRIBUTOR

RCA 2N955A Electrical Characteristics Free Air Temperature = 25°C

Characteristics	Conditions	Min.	Typ.	Max.	Units
Collector Cutoff Current	$I_{CBO}$ $V_{CB} = 5V, I_E = 0$	—	0.6	5	$\mu a$
Collector to Base Breakdown Voltage	$BV_{CBO}$ $I_C = 100\mu a, I_E = 0$	12	25	—	volts
DC Forward Current Transfer Ratio	$h_{FE}$ $I_C = 30ma$ $V_{CE} = 0.3V$	30	50	—	—
Small Signal Forward Current Transfer Ratio	$h_{FE}$ $f = 100mc$ $I_C = 20ma$ $V_{CE} = 5V$	—	10	—	—
Rise Time	$t_r$ See Tech. Bulletin	—	6.5	10	nsec
Delay Time	$t_d$ See Tech. Bulletin	—	4.5	—	nsec
Storage Time	$t_s$ See Tech. Bulletin	—	5	—	nsec
Fall Time	$t_f$ See Tech. Bulletin	—	8	—	nsec

RCA SEMICONDUCTOR & MATERIALS DIVISION FIELD OFFICES ...  
EAST: Newark, N. J., 744 Broad St., HU 5-3900 • (Camden-Philadelphia Area) Erlton, N. J., 605 Marlton Pike, HA 8-4802 • Syracuse, N. Y., 731 James St., Rm. 402, GR 4-5591 • Baltimore, Md., EN 9-1850 • NORTHEAST: Needham Heights 94, Mass., 64 "A" St., HI 4-7200 • SOUTHEAST: Orlando, Fla., 1520 Edgewater Dr., Suite #1, GA 4-4768 • EAST CENTRAL: Detroit 2, Mich., 714 New Center Bldg., TR 5-5600 • CENTRAL: Chicago, Ill., Suite 1154, Merchandise Mart Plaza, WH 4-2900 • Indianapolis 5, Ind., 2132 East 52nd St., CL 1-1405 • Minneapolis 16, Minn., 5805 Excelsior Blvd., WE 9-0676 • Denver 11, Colorado, Continental Terrace Bldg., Suite 301, 2785 N. Speer Blvd., 477-1688 • WEST: Los Angeles 22, Calif., 6801 E. Washington Blvd., RA 8-8361 • (San Francisco Area) Burlingame, Calif., 1838 El Camino Real, OX 7-1620 • Seattle 4, Wash., 2250 First Ave. S., MA 2-8816 • SOUTHWEST: Dallas 7, Texas, 7905 Carpenter Freeway, ME 1-9720 • GOV'T: Dayton, Ohio, 224 N. Wilkinson St., BA 6-2366 • Washington, D. C., 1725 "K" St., N.W., FE 7-8500 • RCA INTERNATIONAL DIV., 30 Rockefeller Plaza, N. Y. 20, N. Y. Cable Address: RADIOINTER, N. Y.



The Most Trusted Name in Electronics

Visit the RCA Exhibit at WESCON Booth 1043-1050

CIRCLE 902 READERS SERVICE CARD