

electronics®

WHAT'S NEXT IN HIGH FIDELITY?

How to get realistic sound reproduction in the home. One way: a garden hose, p 33

WHERE WE STAND WITH TUNNEL DIODES

First of a four-part series summarizing five years with a new component, p 36

SKIN-DIVING ENGINEER adjusts underwater telemetry receiver



R D SKINNER
 1020 GOVINGTON RD
 LOS ALTOS CALIF
 C 3
 SUPV DEV
 1

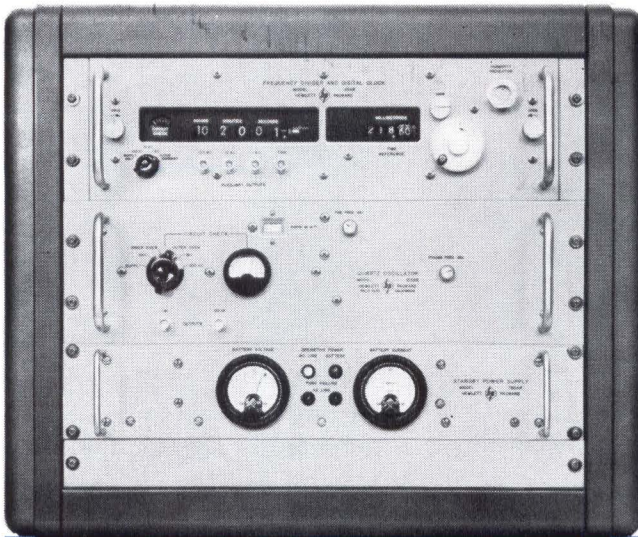

1 part
in 10^{10}
short-term
stability

103AR, 104AR Quartz Oscillators
115BR Digital Clock
725AR Standby Power Supply

In these hp quartz oscillators now available
for quick delivery

These two quartz oscillators, with 1 part in 10^{10} short-term stability (averaged over 1 second) are ideal as frequency sources in primary frequency/time standard systems. Recent advances in manufacturing and aging techniques for these oscillators and their quartz crystal resonators now allow quick delivery at much lower prices.

The 104AR, available for only \$2300, is identical to the 103AR, \$1900, except that it provides a 5 mc output of extreme spectral purity in addition to the 1 mc output. Spectra as little as 2 cps wide may be obtained in the X-band region with the 104AR by multiplication of the 5 mc output. This spectral purity is essential for doppler measurements, microwave spectroscopy and similar applications involving reference multiplication.

Driven by the quartz oscillator, the 115BR Frequency Divider and Clock provides precise time of

day information and permits comparison with standard broadcast signals for absolute accuracy. Continuous operation of the oscillators and related equipment in such a system can be assured by Hewlett-Packard Standby Power Supplies, which keep systems operating even when line power fails.

Both the 103AR and the 104AR provide 1 mc and 100 kc sinusoidal output signals, plus separate 100 kc outputs for driving the 115BR Frequency Divider and Clock. Completely solid state, all components are conservatively rated for assured high performance. A double oven with proportional control maintains precise temperature stability in both oscillators.

Here are the ultimate in low-cost, efficient and *stable* frequency-generating oscillators for primary and secondary standards applications. Ask your hp representative for a demonstration.

Specifications; 103AR, 104AR

Output Frequencies: 5 mc (104AR), 1 mc, 100 kc, 1 v rms into 50 ohms; 100 kc for driving 115BR Frequency Divider and Clock

Aging Rate: $< \pm 5$ parts in 10^{10} per 24 hours*

Stability: As a function of input voltage: $< \pm 1$ part in 10^{10} for changes of ± 4 v from 26 v dc; as a function of load: $< \pm 1$ part in 10^{10} for any load impedance change from 50 ohms; as a function of ambient temperature: $< \pm 3$ parts in 10^{10} for changes of $\pm 25^\circ$ C from 25° C; rms deviation, due to noise and frequency fluctuations, of 1 and 5 mc (104AR only) output; (constant input voltage, load and temperature):

Averaging Time	5 MC Output (104AR only)	1 MC Output (103AR, 104AR)
1 ms	5 parts in 10^9 rms	1 part in 10^7 rms
10 ms	5 parts in 10^{10} rms	1 part in 10^8 rms
0.1 sec	1 part in 10^{10} rms	1 part in 10^9 rms
1 sec	5 parts in 10^{11} rms	1 part in 10^{10} rms
10 sec	5 parts in 10^{11} rms	5 parts in 10^{11} rms

RMS phase deviation of 5 mc output (104AR only):

Averaging Time	RMS Phase Fluctuation at 5 MC
1 ms	1.6×10^{-4} radian
10 ms	1.6×10^{-4} radian
100 ms	3.2×10^{-4} radian
1 sec	1.6×10^{-3} radian
10 sec	1.6×10^{-2} radian

Harmonic Distortion: Down more than 40 db from rated output

Non-Harmonically Related Output: Down more than 80 db from rated 1 mc output; down more than 66 db from rated 5 mc output

Temperature Range: 0 to 50° C

Dimensions: 19" wide x $5\frac{1}{4}$ " high x $11\frac{1}{2}$ " deep behind front panel

Power Requirements: 22 to 30 volts dc, approximately 5 watts operating, 10 watts maximum during warmup; dual power connectors at rear; operates from 724BR or 725AR Standby Power Supply

Complementary Equipment: Model 725AR Standby Power Supply with battery, 2 ampere-hour standby capacity, \$645; Model 115BR Frequency Divider and Clock, \$2750

Price: Model 103AR, \$1900; Model 104AR, \$2300

*Achieved within 21 days of continuous operation

Data subject to change without notice. Prices f. o. b. factory.

HEWLETT-PACKARD COMPANY



1501 Page Mill Road, Palo Alto, California, Area Code 415, DA 6-7000. Sales and service representatives in all principal areas; Europe, Hewlett-Packard S.A., 54 bis Route des Acacias, Geneva; Canada, Hewlett-Packard (Canada) Ltd., 8270 Mayrand Street, Montreal

electronics

A McGraw-Hill Weekly 75 Cents



W. W. MacDONALD, Editor

J. M. CARROLL, Managing Editor

SENIOR EDITORS

Samuel Weber, George W. Sideris

SENIOR ASSOCIATE EDITORS

Michael F. Wolff, John F. Mason

ASSOCIATE EDITORS

Michael F. Tomaino, William P. O'Brien, Sy Vogel, George J. Flynn, Laurence D. Shergalis, George V. Novotny, Leon H. Dulberger, Alexander A. McKenzie

ASSISTANT EDITORS

Stanley Froud, Stephen B. Gray, Roy J. Bruun, Barry A. Briskman, Dan Smith, Joel A. Strasser

REGIONAL EDITORS

Harold C. Hood (Pacific Coast, Los Angeles), Thomas Maguire (New England, Boston), Cletus M. Wiley (Midwest, Chicago)

ART DIRECTOR

Howard R. Berry

ASSISTANT ART DIRECTOR

John C. Wright, Jr

EDITORIAL ASSISTANTS

Lorraine Rossi, Virginia T. Bastian, Lynn Emery, Ann Mella, Lorraine Werner, Alice M. O'Brien, Sharon Parks, Patricia Mitchell, Claire Benell

FOREIGN NEWS BUREAU

DIRECTOR, John Wilhelm;
Alyne Elias, Charles Obertance

LONDON—John Shinn, Derek Barlow, Nicholas Landon

BONN—Bruce Bendow,
Richard Mikton, Silke McQueen

BRUSSELS—Peter Forbath

PARIS—Robert Farrell,
Arthur Erikson

MILAN—Marc A. Messina

MEXICO CITY—Wesley Perry, Jr

RIO DE JANEIRO—Leslie Warren

MOSCOW—Stewart Ramsey

TOKYO—Richard Halloran,
Charles Cohen, John Yamaguchi

CIRCULATION MANAGER

Hugh J. Quinn

W. W. GAREY, Publisher

UNDERWATER TELEMETRY is studied in a 690,000-gallon sonar test tank at Bendix-Pacific. Yellow rod suspended at the right is a submarine detector. The yellow cylinder at the left is one type of underwater telemetry transducer under study. *Object at bottom, left, is a transducer housing for a torpedo* COVER

COMPUTER RUNS MISSILE TRACKER. New Mistram system for Atlantic Missile Range incorporates a digital computer for simpler operation. *Next-generation Mistram may be a mobile, global version* 12

MILITARY COMMUNICATIONS: Systems Get Simpler, Smaller, Faster. AFCEA exhibits last week put the emphasis on gear suited to tactical conditions. *Typical techniques: frequency synthesis to increase stability, broadband tanks for easier tuning* 14

TRANSMITTERS Fly to Troops. Army tests airlift broadcasting system. *It will be used for psychological warfare* 16

MICROPOWER CONFERENCE Hits the NATO Road. Traveling speakers will tell Europe about new military and space designs. *Accent is on practical techniques used in the U. S.* 22

MONICA Watches Her Weight. Integrated circuits and etched-plane memory keep new military computer slim. *First flyable model will be ready late this year* 22

FACTORY TRUCK TREND: More Remote Guidance. Magnetic and optical paths and sensors guide tractors. *One company reports sale of 22 radio controls for industrial operations* 24

SHRIKE MISSILE Will Be Big Buy. Mass production of radar-busting missile begins this year. *The missile was unveiled last week for the first time* 26

NEW RADAR Installed at Cape Canaveral. Six more AN/FPQ-6's are going into Atlantic range. *With modifications, its tracking range will stretch to the moon* 26

RFI IN MICROCIRCUITS. The problems are different from conventional circuits. *A major factor is how the circuit and the rfi source are coupled* 28

HOW HI IS FI? Fifteen years ago this month, Peter C. Goldmark and his associates at CBS Labs developed long-playing records. Senior Associate Editor Michael F. Wolff interviewed Dr. Goldmark to find where we stand today in the art of recording and reproducing sound. *Next step: achieving the real objective—realistic sound reproduction in the home* 33

Published weekly, with Electronics Buyers' Guide as part of the subscription, by McGraw-Hill Publishing Company, Inc. Founder: James H. McGraw (1860-1948).

Title ® registered U.S. Patent Office; © copyright 1963 by McGraw-Hill Publishing Co., Inc. All rights reserved, including the right to reproduce the contents of this publication, in whole or in part.

Executive, editorial, circulation and advertising offices: McGraw-Hill Building, 330 West 42nd Street, New York 36, N. Y. Telephone Longacre 4-3000. Teletype TWX N.Y. 212-640-4646. Cable McGrawhill, N. Y. PRINTED IN ALBANY, N. Y.; second class postage paid at Albany, N. Y.

OFFICERS OF THE PUBLICATIONS DIVISION: Shelton Fisher, President; Vice Presidents: Joseph H. Allen, Operations; John R. Callahan, Editorial; Ervin E. DeGraff, Circulation; Donald C. McGraw, Jr., Advertising Sales; Angelo R. Venezian, Marketing.

OFFICERS OF THE CORPORATION: Donald C. McGraw, President; Hugh J. Kelly, Harry L. Waddell, L. Keith Goodrich, Executive Vice Presidents; John L. McGraw, Treasurer; John J. Cooke, Vice President and Secretary.

Subscriptions are solicited only from those actively engaged in the field of the publication. Position and company connection must be indicated on orders. Subscription rates: United States and Possessions, \$6.00 one year, \$9.00 two years, \$12.00 three years. Canada: \$10.00 one year. All other countries \$20.00 one year. Single copies, United States and Possessions and Canada 75¢. Single copies all other countries \$1.50.

THE PUBLISHER, UPON WRITTEN REQUEST FROM ANY SUBSCRIBER TO OUR NEW YORK OFFICE AGREES TO REFUND THAT PART OF THE SUBSCRIPTION PRICE APPLYING TO COPIES NOT YET MAILED.

Subscribers: Please send change of address notices, subscription orders or complaints to Fulfillment Manager, Electronics, at the address below. Change of address notices should provide old as well as new address, including postal zone number if any. If possible, attach address label from recent issue. Allow one month for change to become effective.

Postmaster: Please send Form 3579 to Fulfillment Manager, Electronics, P. O. Box 430, Hightstown, New Jersey.



Audited Paid Circulation

CONTENTS continued

TUNNEL DIODES—Part I of a four-Part Series. In 1958, the tunnel diode was hailed as the answer to the designer's prayer but by 1959 engineers realized that this disarmingly simple appearing device was complex indeed electrically. *But four years of solid engineering have toted up an impressive box-score of achievements summarized in this series.*
By E. Gottlieb and J. Giorgis, GE Semiconductor Products Dept. 36

MORE SNAP IN LOGIC CIRCUITS With Field-Effect Transistors. Here is a new use for a new device. A field-effect transistor combined with a current-limiter load permits full excursion of output voltage within a small range of input voltage. *Result is faster switching as well as reduced drive requirements.*
By C. Csanky and R. M. Warner, Jr.,
Motorola Semiconductor Prod. Div. 43

NUCLEAR EXPERIMENTS WITHOUT HUMAN ERROR. Control unit decides when to take measurements and what to measure. It also reads data out onto magnetic or punched paper tape. *Heart of system is a multiple preset six-decade counter; present switches connected to output control counting interval.*
By R. Percina and T. E. Evans, Argonne National Lab. 46

DEPARTMENTS

Crosstalk. <i>What Price RFI Control?</i>	3
Comment. <i>Thermal Resistance</i>	4
Electronics Newsletter. <i>Should a Man or Machine Fly the Supersonic Transport?</i>	7
Washington This Week. <i>Pentagon Firms Up Barriers Between Advisors and Suppliers</i>	10
Meetings Ahead. <i>Electron Devices Meeting</i>	30
Research and Development. <i>Rapid Method Measures Diode Characteristics</i>	50
Components and Materials. <i>French Reveal New Field-Effect Structure</i>	56
Production Techniques. <i>Infrared Inspection Promises to Assure Production Reliability</i>	62
New Products. <i>Generator Simulates Megapulse Source</i>	68
Literature of the Week	74
People and Plants. <i>Hughes Fills Three Management Posts</i>	76
Index to Advertisers	84

What Price RFI Control?

RADIO-FREQUENCY interference (rfi) casts a surprisingly large shadow.

Some people say it costs the electronics industry as much as five percent of the industry's annual sales. The amount of time spent in engineering around rfi is incalculable.

Is five percent far-fetched? Probably not, when you consider rfi-control engineering, and consulting firms' fees, filters, shielding, instrumentation, rfi testing and other direct costs. Then add such indirect costs as engineering work normally charged to actual design, but involving rfi-control considerations like selecting a transmitter tube with low rfi output.

Anyone who delves into rfi and its control realizes that this field covers a broad area of electronics—a much broader area than the “rf” in “rfi” indicates. Rfi-control is the effort to prevent electronic systems, equipments and circuits from interfering with each other's operation and to minimize the effects of man-made and natural rfi. In other words, the aim is to make electronic equipments compatible in their electromagnetic environment.

The electromagnetic environments of a system and its parts may vary in size, but they have this in common: each environment constitutes a world that affects and/or is affected by the system, equipment and component. The electromagnetic world of a noisy computer diode, for example, might be limited to the few computer modules that its rfi directly affects. But the computer may live in a much larger world populated by other systems, each of which may in some way be affected by that obstreperous diode.

Since the rfi field involves all electrical and electronic equipment and components that produce interference and every electronic equipment susceptible to interference, just about every area of electronics from A displays to Z marker beacons is affected directly or indirectly by rfi considerations. And that means just about every electronics engineer, too:

- Government planners working on frequency allocations and assignments are involved in inter-systems considerations
- Weapons-systems planners must make sure that existing and future systems will mesh with each other and not create an electromagnetic bedlam
- Systems designers must—or should—con-

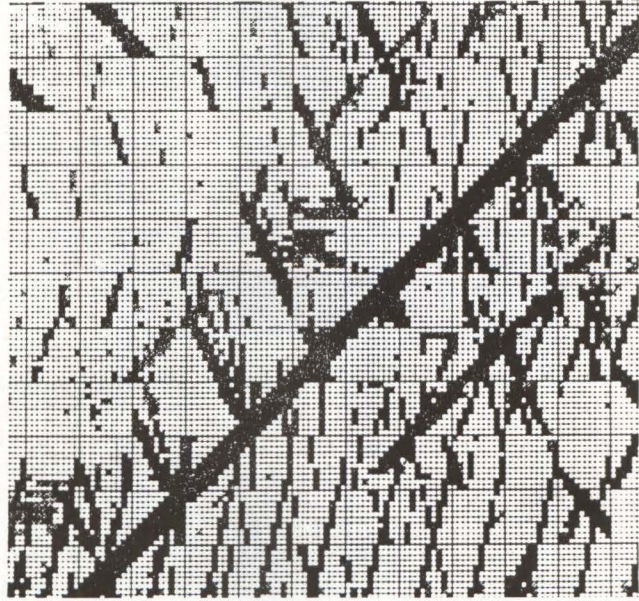

sider rfi and its control just as they consider costs, system performance and reliability when working out the design of a system

- Equipment engineers and circuit and component designers must develop electronic hardware that neither creates interference nor is susceptible to interference
- Test engineers must prove that a new system or equipment will meet rfi specifications
- Finally, after operational tests, field engineers may have to fix or modify the system so that it does not bother other systems and is unaffected by the rfi that other systems produce.

Company management, too, needs to consider and provide for rfi-control in equipment under development. Expenses such as the cost of setting up an rfi-control department or obtaining the services of an rfi consulting firm are frequently less than the costs incurred by winding up with a system or equipment incompatible with its environment.

These, then, are some of the considerations that make rfi a timeless and timely topic—timeless because engineers have been wrestling with it since it was called static, timely because of the present acceleration of efforts, especially by the military, to control rfi.

These are the reasons why we have set aside 24 pages in next week's issue for a special report on the battle against rfi and the latest techniques for its measurement, analysis and suppression.

New Bridge Design For Safe, Accurate, Easy Measurement of 'Lytic Capacitors

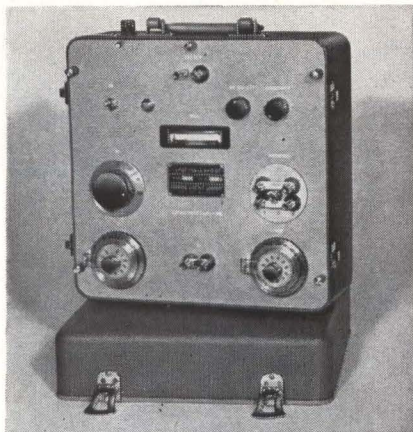

The Sprague Model 1W2A Capacitance Bridge introduces new, improved technical refinements as well as restyling for added attractiveness and ease of operation. Built by capacitor engineers for capacitor users, it incorporates the best features of bridges used for many years in Sprague laboratories and production facilities.

Precision Measurements over Entire Range from 0 to 120,000 μF

The internal generator of the 1W2A Bridge is a line-driven frequency converter, and detection is obtained from an internal tuned transistor amplifier-null detector, whose sensitivity increases as the balance point is approached. It has provision for 2-terminal, 3-terminal, and 4-terminal capacitance measurements, which are essential for accurate measurement... $\pm 1\%$ of reading + $10\mu\text{F}$... of medium, low, and high capacitance values, respectively.

No Damage to Capacitors

The model 1W2A Capacitance Bridge will not cause degradation or failure in electrolytic or low-voltage ceramic capacitors during test, as is the case in many conventional bridges and test circuits. The 120 cycle A-C voltage, applied to capacitors under test from a built-in source, never exceeds 0.5 volt! It is usually unnecessary to apply d-c polarizing voltage to electrolytic capacitors because of this safe, low voltage.

Complete Specifications Available

For complete technical data on this precision instrument, write for Engineering Bulletin 90,010A to Technical Literature Service, Sprague Electric Company, 35 Marshall Street, North Adams, Massachusetts.

455P-128-63

COMMENT

Thermal Resistance

I am sorry that I must write this letter to take very strong exception to the article, Practical Way to Measure Transistor Thermal Resistance (p 66, Feb. 15).

The very first sentence is not even true, although this is the least serious of the errors. A check on about ten arbitrary MIL specs showed most but not all referred to thermal resistance; none referred to thermal time constant.

The most serious error, and this invalidates the entire article, is the assumption that the leakage current is a linear function of the junction temperature (Fig. 2B). This is most definitely not so. The bulk leakage current obeys an approximately exponential law, doubling for every increase in temperature of roughly 10 deg C. Surface leakage effects, particularly in nonplanar silicon transistors, tend to be independent of temperature. I have found the reverse leakage in certain silicon rectifiers to be virtually constant from 25 to 100 deg C!

I would like to draw to your readers' attention MIL-STD-750, which in Section 3100 describes tests methods for transistor thermal parameters (also applicable to diodes). It is especially interesting to note that they recommend against using the leakage current method for silicon devices.

SIDNEY V. SOANES

Research Department
Ferranti-Packard Electric Ltd.
Toronto, Ontario, Canada

Author Bauman replies directly:

Initially, you state that an arbitrary survey of MIL-SPECS on your part showed no reference to the thermal time constant test. From this, you concluded that my first statement was false.

As of April, 1963, I do not know how many MIL-SPECS have been written governing transistors; however, I do know there are at least 600 devices on the market. Do you think a sampling of ten devices is sufficient to call my statement false?

A random check, made at my request, by an associate, revealed seven out of ten specs required a thermal time constant test!

Secondly, you state that leakage current is definitely not a linear function of temperature. You are correct. For a germanium transistor, I_{cbo} doubles for each increase of 10 deg C. For silicon transistors, a 10 deg C temperature change will increase the I_{cbo} by a factor of three. I therefore assume the curve to be linear only in the flat region, below 45 deg C. Test results bear out this assumption as being valid. The leakage versus junction temperature curve in my article was an approximation of a true exponential curve. As for your observation concerning a constant I_{cbo} reading from 25 to 100 deg C, in nonplanar silicon units, this is quite unusual. I would appreciate knowing what transistor types exhibit this characteristic.

Finally, you point to MIL-STD 750, Section 3100, a discussion of transistor thermal testing. You emphatically state that this MIL-STD "recommends against using the leakage current as the temperature sensing parameter for silicon devices." For the record, the MIL-STD, in fact, states, "When making thermal-resistance measurements of silicon transistors, the methods with V_{cb} and V_{cb} are preferred." This phrase concurs with a statement in my article that reads, "Although the most reliable temperature-sensitive parameter in junction transistors is the forward drop (V_f) of the collection junction, the I_{cbo} parameter is used in this test since it is a required parameter in qualification testing of transistors."

Getting back to MIL-STD 750, let me point out that Method 3126 outlines a procedure that features I_{cbo} as the temperature-sensing parameter. If the controlling government agency is against a procedure, would they, on the following page, recommend it? For information purposes at the November Ad Hoc Meeting for Semiconductor Devices, DESC, the Air Force, BuShips and the Signal Corps agreed to use I_{cbo} as well as V_f as temperature-sensing parameters.

HAROLD BAUMAN

Kearfott Division
General Precision Inc.
Little Falls, New Jersey

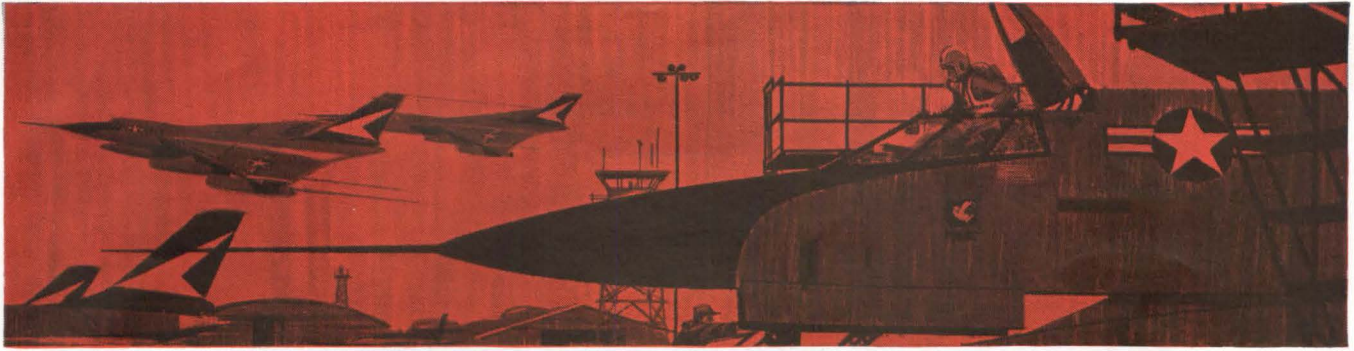

***in national defense—the words
“reliability” and “necessity” are synonymous***

■ With the Strategic Air Command at *instant readiness*, any break in communications could seriously impair its total defense capability—and possibly also our national survival. To achieve the unusually high reliability demanded in this critical military application, Electronic Communications, Inc., uses Allen-Bradley Type G controls in the airborne transmitters they build for the SAC.

In the Type G control, the solid resistance element, collector track, terminals, and insulating material are hot molded into a single, solid structure that—for all practical consideration—is indestructible. In addition, molded contact brushes are used—no sliding metal contacts. This design assures a low initial noise factor, which

actually improves with use. There's virtually infinite resolution—so control is always smooth and completely devoid of sudden changes in resistance during adjustment.

A-B Type G potentiometers are rated 0.5 watt at 70°C, and will operate reliably in ambient temperatures from -55°C to +120°C. Also, the operational life exceeds 50,000 cycles with less than 10% resistance change. They can be furnished in maximum resistance values from 100 ohms to 5 megohms. For full details on these quality controls, please write for Technical Bulletin B5201. Allen-Bradley Co., 110 W. Greenfield Ave., Milwaukee 4, Wisconsin. In Canada: Allen-Bradley Canada Ltd., Galt, Ontario.

ALLEN-BRADLEY TYPE G HOT MOLDED VARIABLE RESISTORS
Shown Actual Size

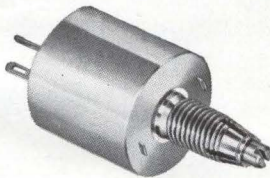

TYPE GWEL
WITH ENCAPSULATION

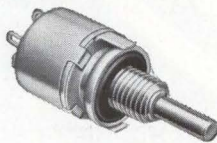

TYPE GWP AND LWP
WITH WATERTIGHT PANEL SEAL

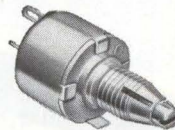

TYPE GWL AND LWL
WITH LOCKING BUSHING

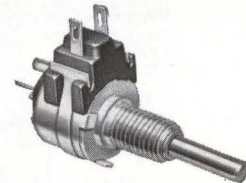

TYPE GWX
WITH LINE SWITCH

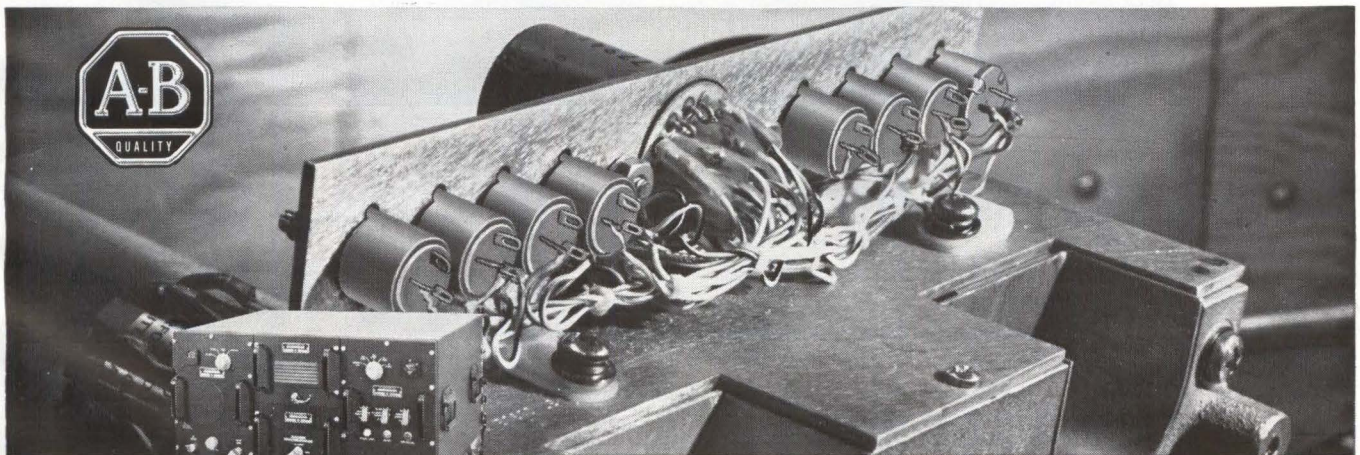

Electronic Communications' AN/ART-42 UHF 1 KW AM/FM Transmitter in service with the SAC, and internal view showing use of A-B's Type G controls.

ALLEN-BRADLEY

QUALITY ELECTRONIC COMPONENTS

\$.25

TYPICAL UNIT COST

Capacitors of "Mylar"® polyester film cost about the same as paper!

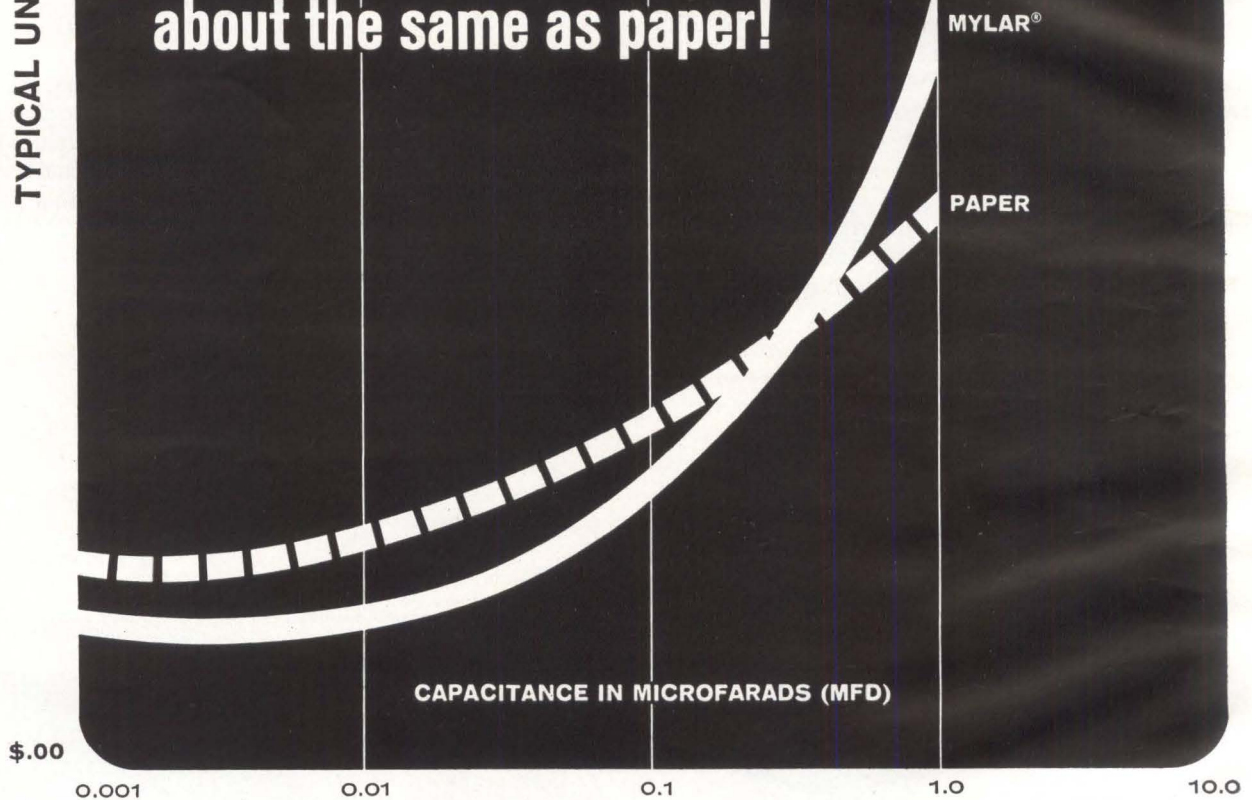

For capacitors, specify the extra performance of "Mylar"

Studies of manufacturers' average prices show that capacitors of "Mylar"® are comparable in cost with paper units, over a range of capacitances and voltages. At comparable cost, the higher reliability you get makes capacitors of "Mylar" a better value by far.

Only "Mylar" gives you the extra performance of higher dielectric strength, wider temperature range and higher moisture resistance—at about the same price! Also, capacitors of "Mylar" are smaller than paper units with the same capacitance. In circuits for home-entertainment radio and TV they're perfectly compatible with AC voltages imposed on a DC circuit as long as total voltage doesn't exceed the rated voltage of the capacitor,

and the AC component does not exceed the AC corona level. Remember, within the range from .001 to 1 mfd under 600 volts DC, you can get the added reliability of "Mylar"—at costs similar to paper.

For the full story, write for our detailed booklet comparing performance and prices of various insulation systems. Du Pont Co., Film Department, N-10452, Wilmington 98, Delaware.

*Du Pont's registered trademark



BETTER THINGS FOR BETTER LIVING
... THROUGH CHEMISTRY

only DU PONT makes

MYLAR®
POLYESTER FILM

Should a Man or Machine Fly the SST?

QUICK SURVEY of experts by **ELECTRONICS** indicates that some of the most difficult and controversial technical decisions involved in the U.S. development of a supersonic air transport (SST) will likely revolve around this question: To what extent should the aircraft be automated? There seems to be little doubt however that the plane—which was given the go-ahead signal last week by President Kennedy—will rely more on electronics than any civilian plane yet.

Here are the main electronic systems now contemplated for the craft:

- Fully-automated flight control system, necessary for stability at the mach-3 speeds being considered for the SST. A mechanical backup would probably be provided
- System for managing fuel, communications, air traffic control instructions and other functions the pilot might be too busy to handle
- All weather landing system. By 1970 a fully-automatic system may

Bids Asked on Huge Computer Order

BEDFORD, MASS.—The largest single purchase in the history of computers is now in the proposal stage. Invitations have been sent to 24 manufacturers for standardized, compatible EDP systems to perform inventory control at 152 Air Force bases throughout the world.

Contractor proposals—due July 20—will be evaluated by the Electronic Data Processing Equipment Office at Hanscom Field (p 24, Feb. 8). The award will be made by the General Services Administration. The manufacturer selected will be prime contractor for procurement, installation and maintenance of the entire integrated network.

The program will increase by 50 percent the computer inventory of the Air Force—already the industry's largest customer—and it will increase the government's computer inventory 20 percent. The first system is to be installed for February, 1964, with 10 installations a month beginning three months later

be feasible, although pilots have traditionally insisted on landing planes themselves

- Self-contained navigation system. The problem here is to reconcile speed with reliability. Some automation is probable however.

The FAA says improvements al-

ready planned for the air traffic control system should be able to take care of the SST but that a method will have to be developed to eliminate or cut down delays. "It would be terribly uneconomical to have these planes flying around at low levels," a spokesman said.

President Kennedy's decision on the SST followed by one day an announcement by Pan American that it had ordered six 1,500-mile-an-hour jetliners being developed jointly by British and French manufacturers. In Paris, Sud Aviation told **ELECTRONICS** that this plane will largely use electronic systems now flying in subsonic jets. Speculation has it that the six planes built for Pan American will be outfitted with U. S. electronic gear.

Computer Collects Data on Factory Floor

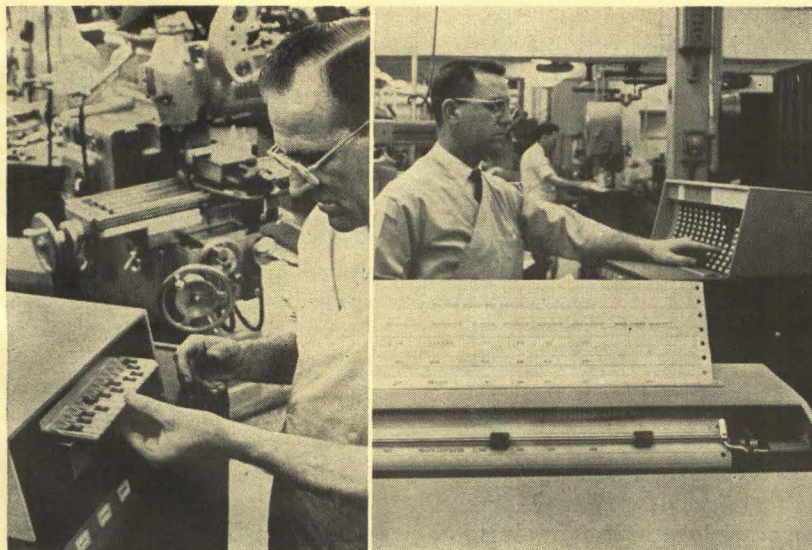

FEATURES OF IBM's new 1030 production data collection and processing system include plastic device used by individual employees to log work data (left) and factory stations that foremen can use to obtain printed inventory machine-tool availability or other data (right)

Nine Frequency Bands Proposed for ComSat

WASHINGTON — Preliminary decision on the type of communication satellite system to be used by the Communications Satellite Corporation is due at the Extraordinary Administrative Radio Conference of ITU in Geneva in October, accord-

ing to informed sources here. A medium-altitude system with satellites in circular, polar orbits from 6,000 to 12,000 miles continues to be favored as the method for going operational earliest (p 8, May 24).

Meanwhile, FCC will suggest to ITU nine frequency bands for "communication-satellite service" including: 3.7 to 4.2 Gc, downward direction only; 5.925 to 6.425 Gc, upward only; 6.425 to 7.150 Gc, either direction; 7.250 to 7.3 Gc, downward only (for exclusive use of ComSat service and space stations); 7.3 to 7.65 Gc, downward only; 7.650 to 7.750 Gc, downward (for meteorological as well as communication satellites, in addition to existing services); 7.9 to 7.975 Gc, upward; 7.975 to 8.025 Gc, upward (for exclusive ComSat use); and 8.025 to 8.4 Gc, upward.

C-W Operation Achieved For Indium Arsenide Laser

CAMBRIDGE, MASS. — Magnetically tunable c-w indium-arsenide diode lasers have been developed by MIT Lincoln Laboratory. I. Melngailis and R. H. Rediker operated forward-biased indium-arsenide diodes as c-w lasers, and essentially all the radiation output was stimulated emission. Previously, emission of coherent infrared radiation has been observed from indium-arsenide diodes in pulsed operation, but not c-w.

In gallium-arsenide diodes, c-w operation has been previously observed, but only 10 percent of the total radiation output was stimulated emission. Emission wavelength of the new diode lasers has been changed by shifting the radiation from one cavity mode to another by means of a magnetic field. By varying the field between 4.1 kilogauss and 9.1 kilogauss, the laser's ir emission can be tuned to either 31,168 or 31,125 A.

Computer Provides Nationwide Ad Data

NEW YORK—Standard Rate and Data Service, Inc. demonstrated this week its Honeywell 400 computer system, programmed to handle such advertising areas as scheduling and estimating, inser-

tions, billing and media mix.

A Honeywell data communications system links the computer with the Telex network, permitting agencies anywhere in the country to ask it questions directly. If a special button is pressed, a stored identification code at the querying agency tells who is on the line.

MM Radio Telescope Has Gain of 67.8 db

MILLIMETER-WAVELENGTH radio telescope capable of operating at up to 300 Gc has been built by Philco for the University of Texas. Normal operating range is 10 to 150 Gc. Gain of the instrument has been measured at 67.8 db, making it one of the most powerful in the world. The 16-foot-diameter parabolic dish will be used for basic research and explorations for NASA, which sponsored its construction. One of its assignments will be the accurate mapping of the surface of the moon, including spacecraft landing sites.

Thin-Film Costs Down in England

LONDON—The economics of thin-film and integrated circuits are becoming comparable with conventional component assembly techniques. Thin-film costs in the UK will be comparable with conventional techniques by January, 1964 and should be lower from then on. Costs of solid-state integrated circuits are not expected to become comparable in the UK until 1965.

These estimates were presented to 300 delegates at a two-day conference on solid circuits and micro-miniaturization at the West Ham College of Technology. In a comparative example presented by A. T. Lawton, of E.M.I. Electronics, design studies were performed on both thin-film and solid-circuit versions of a radar data processing unit. Using thin-film techniques operating at the same power level, the expected reliability increased by eight times. Using solid circuits operating at lower power levels, reliability increased even more, by factors of between 19 to 47 times according to the manufacturer chosen.

In Brief . . .

INSTRUMENTS designed at Dartmouth College will record natural radio signals from outer space when NASA sends up its Polar Orbiting Geophysical Observatory satellite next year.

RAYTHEON received \$900,000 initial funding for ATBM program to extend capability of Hawk missile to engage tactical ballistic missiles as well as low-altitude aircraft (p 8, May 31).

FRANCE PLANS to place a research satellite into orbit by late next year using Diamant three-stage launch vehicle it developed itself.

JAMES E. WEBB, NASA administrator, said last week he is against an MA-10 shot (p 7, May 24). He would prefer to concentrate on Gemini. A final decision is expected soon.

SPERRY will develop an automatic flight control system for the Douglas DC-9 jetliner. Initial contract is for \$4,262,000.

ASSOCIATED ELECTRICAL Industries Ltd. of England has sold the majority of its industrial vacuum tube interests to ITT.

ADMIRAL'S new hi-fi line includes four completely transistorized models. Peak output is 250 w.

SUD AVIATION has ordered 20 all-weather landing systems from Lear Siegler. By next January Sud hopes to retrofit all Caravelle airliners with the devices.

AGREEMENT to buy the assets of the Motorola aviation products business, Culver City, Calif. has been signed by Bendix; Hickok Electrical Instrument has purchased all outstanding stock of Stark Electronic Instruments Ltd., Ajax, Ont.; Electronic Devices Inc. purchased Columbus Semiconductor Division from Columbus Electronics Corp.

AUTOMATIC message-processing system called Amps will be installed by Burroughs at Ford Ritchie, Md., under a \$2,500,000 Army contract.

New!



NIXIE® TUBES the only segmented display that gives you:

- All DC operation +170 volts
- Uniform continuous line characters of equal height for easy readability
- Memory with simple solid state or gas tube drive circuits
- Readability in high ambient light . . . 200 foot lamberts brightness
- Maintenance-free operation . . . 200,000 hours rated life **WITH NO LOSS OF BRIGHTNESS**



actual size

And Burroughs Alpha Numeric NIXIE Tubes also feature • low power (100 mw per segment) • wide viewing angle (150°) • complete alphabet, numerals 0-9 and special symbols in a single tube • low cost (\$19.00 in single quantities)

Available now, the first in the series . . . Type B-5971 standard size with .780" characters. Tubes may be ordered singly or in groups as complete readout assemblies. The rectangular shape allows mounting on .800" centers.

Write today for technical bulletin #1037 which contains complete specifications on Alpha Numeric NIXIE Tubes from Burroughs.



CIRCLE 9 ON READER SERVICE CARD

WASHINGTON OUTLOOK

ADVISOR- SUPPLIER BARRIERS FIRM UP

PENTAGON'S new conflict-of-interest regulations spell out more precisely than ever restrictions on a contractor with systems engineering, technical direction or other advisory functions. He can't supply any of the system's major components unless he also has hardware development or production responsibilities.

Similarly, if he is hired to prepare specs, he can't get in on competitive bidding "for a reasonable time." If he helps detail performance characteristics for a new weapon to be bought competitively, he can only be a supplier if he is a recognized sole source. If, as a study contractor or military advisor, he has access to other firms' proprietary data, he is barred from exploiting the trade secrets in subsequent production work.

This sort of ban has been widely imposed in the past. But lack of firm guidelines has resulted in many cases of what one official calls "pseudo-competition."

WHO BUYS WHAT IN NAVY NOW?

NAVY PROCUREMENT organization is being centralized. Chief of Naval Material will get expanded power and authorities of the separate Bureaus will be trimmed. Bureaus will continue to award contracts, but the Chief of Naval Material will now supervise shipbuilding, aircraft and electronics production, and development. He will coordinate production schedules of the four bureaus, hold the purse strings and decide who handles specific projects.

One big area to be clarified: responsibilities for electronics procurement and design, now divided between the Bureaus of Ships and Weapons. BuShips now controls shipboard electronics (except "weapon-related" electronics) and most shore electronics. BuWeps buys airborne electronics, most equipment for air stations and weapon-related shipboard electronics. This fuzzy division, and the resulting deficiencies in mating electronic gear to new vessels, largely caused the reorganization.

FCC BOOSTS UHF TV AGAIN

FOUR UNRELATED FCC actions last week add up to a powerful boost for uhf tv. FCC abolished option time, which gave tv networks first call on certain hours of station affiliates' time. Networks were asked to make programs available to uhf outlets in intermixed markets. FCC refused to add vhf stations in seven major markets, leaving them open for third network service at uhf. It denied exemption from the all-channel set law. Motorola and others wanted to make vhf-only sets for use in schools, hospitals, hotels, and so on. FCC turned this down, but extended date of the all-channel requirements for school sets by two years, to April 30, 1966.

COMSAT TALKS GLOBAL, HIRES NEW EXECES

FIRST ROUND of discussions for a global satellite communications system have been successful, report Leo D. Welch, Communications Satellite Corp. Chairman, and Joseph V. Charyk, president, after talks with officials in Canada, England, Germany, France and Italy. Talks with other countries will come soon. European countries want to supply men and hardware and own part of the system.

Meanwhile, the corporation has named Sidney Metzger, formerly with RCA, manager for components development and systems research; S. N. Reiger, formerly with the Rand Corp., manager for systems analysis; and Edwin J. Istvan, formerly with the Air Force Office of Space Systems, technical assistant to the president.



(Photo 2¼ times actual size)

Got a match?

Any ordinary book match will do.

Placed over our AMPin-cert* 50-position Sub-miniature Pin and Socket Connector, the match completely covers the contact area which is a full 50% of the total! Compare this with other connectors of only 20% area-use efficiency and obviously this gives you the density you need. But we didn't stop there.

This is the only connector of its type which gives you crimped, snap-in type contacts. Here is an important plus feature when you're working in close quarters. It does away with cold solder joints, burned insulation, fine wire breakage and permanently fixed connections. Add to all this our controlled crimping process which delivers terminated contacts all perfectly identical in appearance and performance and you've got something that's difficult to match—density, versatility and reliability, at the lowest applied cost in the industry.

*Trademark of AMP INCORPORATED

That's it, except for—

- wire range—stranded or solid—26-36 AWG
- working voltage of 300 volts AC RMS or better
- .060 center to center spacing in single line (.050 in clusters)
- polarized for error free assembly
- self extinguishing housing

If you're looking for a sub-miniature connector that really packs in working features, send for complete information on our AMPin-cert Sub-miniature Pin and Socket Connector today!



AMP products and engineering assistance are available through subsidiary companies in: Australia • Canada • England • France • Holland • Italy • Japan • Mexico • West Germany

Computer Runs Missile Tracker

*Atlantic range's newest
giant interferometer is
a lot easier to work*

By JOHN W. WASIK
McGraw-Hill World News

CAPE CANAVERAL—The second of two Mistram (Missile Trajectory Measurement Systems) developed by General Electric for the Atlantic Missile Range is scheduled to become operational and begin supporting missile flight tests this July.

Located on the down-range island of Eleuthera, the huge interferometer will perform much the same as does the first system at Valkaria, Florida, will have the same operational requirements and approximately the same accuracies (ELECTRONICS, p 38, July 29, 1960 and p 109, Nov. 17, 1961).

But much of the equipment in the second system is new or revised. It will be much easier to operate

than at Valkaria thanks to a digital computer in the precision measuring subsystem. The computer replaces a number of other items and can perform several tasks.

Another big difference is in the layout of the site. Because of geographical limitations the station is laid out in a V shape rather than the L shape of the first site. Also, Eleuthera has only two remote stations while Valkaria has four.

The Eleuthera Mistram is called System II by GE and the Air Force. Valkaria, some 30 miles south of Cape Canaveral, is System I.

NEW SHAPE—Basically, Mistram is a missile tracking radar that employs interferometer techniques along very long baselines for extremely high accuracies. It transmits signals to a missile-borne transponder, receives the return signals and calculates the missile's position and velocity.

At Valkaria, two baselines stretch out at right angles from the central station. On each baseline is a 10,000-foot station and a 100,000-foot station.

In Eleuthera's V-shaped layout, the central station is at the vertex of the two baselines. One remote station is 88,000 feet from the central station. The other is 155,000 feet away, located across a bay.

The 10,000-foot stations at Valkaria are connected by buried cable and waveguide and the 100,000-foot stations by microwave. System II depends entirely on microwave.

PHASE STABILIZATION — At both sites, phase-stabilization methods developed by GE are used on the microwave links to overcome phase-shift due to changes in the electrical length of the baselines resulting from physical or circuit changes.

The signal received from a Mistram transponder at the central station goes to a mixer and also on a round-trip to a remote station. The round-trip phase shift is compared with the one-way shift of the signal received at the remote site from the transponder and sent directly to the central station over the baseline path. A mixing process then eliminates the baseline phase shift from the signals.

Another problem at the Eleuthera site resulted from one baseline link being over water. Atmospheric fading caused temporary loss of signals transmitted across this baseline.

The solution is to use two microwave antennas at the remote site. If the signal begins to fade, it is automatically switched to the second antenna, offset by a distance sufficient to slightly change the path of the signal across the water. This, in effect, cancels the fading area.

DIGITAL PROCESSOR—The digital data processor of System II makes operation much simpler with far less gear. In addition, a complete set of test and checkout programs is available on command from the operator's console. Special programs also permit post-flight analysis, trajectory synthesis and other similar tasks.

Global Mistram Next?

CAPE CANAVERAL—A General Electric study of mobile tracking stations could result in a global or even space version of Mistram.

Designated Cobra (Compatible On-Board Ranging), the system could be placed on land, at sea or in space vehicles. Unlike the Mistram sites, Cobra would need a navigation system to get accurate location data.

Mistram's range-measuring philosophy is employed in Cobra, making it compatible. Being compatible, Cobra elements in a missile would function as a Mistram transponder near a Mistram station, but would change their mode of operation once out of range and become a prime station, interrogating Cobra transponders spotted around the globe or in space. The

missile-borne system could then receive the responses and extract the ranges.

A modest data link, says GE, would provide a means of identifying the transponders and sending their position and velocity to the prime station aboard the missile.

All the ground-based equipment and about 80 percent of the airborne equipment could be constructed with existing Mistram modules and circuit elements. The "flying" part of Cobra would contain an X-band c-w transmitter, four receivers, data extraction equipment and telemetry gear.

General Electric says Cobra's measurement errors will not exceed 4 feet in range and 0.12-fps range rate (smoothed over one second), at ranges to 1,000 n. miles.



CONTROL CONSOLE at Eleuthera central station directs Mistram site and hand-over to Valkaria. Plotters show missile trajectory and position

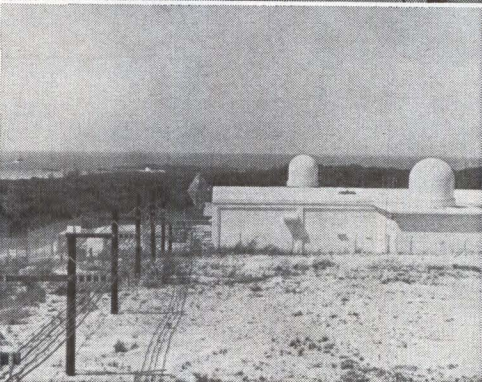
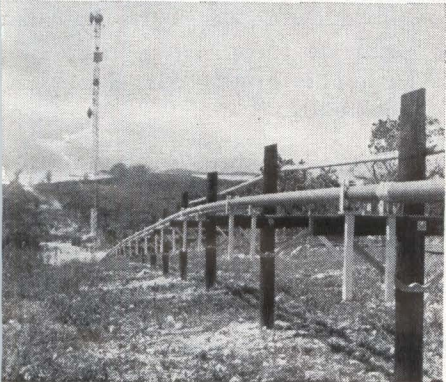
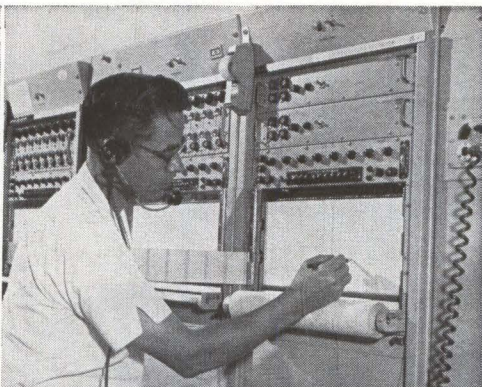

In System I, an analog computer subsystem drives the remote antennas. Analog pointing data received from the acquisition and tracking subsystem is converted into digital form for transmission to the remote sites, where the signals are corrected for parallax, reconverted to analog form and used to point the antennas.

System II's digital computer accepts the pointing data, corrects for parallax for each remote site, and points the remote antennas, all in one simple operation.

LESS EQUIPMENT—A great deal of equipment was eliminated from

DIGITAL DATA processor simplifies operation of the new system. This is the processor's control center (top left)

DATA FROM missile tests and system calibration tests within the system are recorded on these digital/analog recorders (top right)

WAVEGUIDE running from central station to microwave tower at Eleuthera carries simulated signals transmitted to the system during functional analysis (lower left)

RADOMES atop central station house the dishes for the precision measuring and the acquisition and tracking subsystems. Microwave antenna at left is link with a remote site (lower right)

the
Last Word in

HIGH SPEED

printer systems

from



POTTER

the
LP-1200 SYSTEM
provides:

- **LOW COST BUFFER STORAGE...**
Computer proven Magnetostrictive Delay Lines are compatible with the fastest computer systems.
- **NEW DELAY LINE AMPLIFIER...**
Peak Detection circuit improves reliability at higher frequencies.
- **QUALITY HIGH SPEED PRINT-OUT**
Vacuum Paper control, coupled with high speed paper feed produces clean, sharp impressions.
- **HUMAN ENGINEERING provides...**
quick, front paper loading, ease of ribbon change, access to drum and hammers, convenient operating controls.
- **ADDITIONAL FEATURES...**
non-wearing Elastomeric torsion bearings assure long hammer life; low inertia drive belts minimize clutch and brake wear.
- **12 WEEK DELIVERY**

To learn how the Potter LP-1200 Printer System can reduce the cost of your computer time, write to the General Manager, Printer Division, today.



POTTER INSTRUMENT CO., INC.
PRINTER DIVISION
East Bethpage Road • Plainview, New York

Military Communication Get Simpler, Smaller,

System II by the digital computer. System I employs the servo-loop technique, using phase delay and other equipment to keep the transponder signals' two frequencies—reference and calibrate—in phase. The digital data processor at Eleuthera does all this.

Other changes include a simpler antenna design, more GE equipment in the communication link subsystem and a slight revision in the data transmission subsystem. Data goes to Cape Canaveral over a submarine cable.

RANGE TESTS—Tests using aircraft are being run with the Eleuthera system and the data compared with ballistic camera data for evaluation. So far, the system is working within specs.

One attempt was made to track a Titan II passively, but an isolated malfunction precluded completion of the test. Engineers didn't anticipate getting very good data from the test, incidentally.

Since the beacon antenna in the missile was pointed toward Valkaria, the Eleuthera Mistram could get only side-lobe tracking.

Main-lobe tracking will be possible from both stations when the system is operational. A common transponder in the missile will be used with, first, the Valkaria site tracking actively and Eleuthera passively, and then at the most opportune time in the flight, switch to Eleuthera active and Valkaria passive.

The ultimate calibration and checkout of both Mistram systems will come only when a Mistram transponder is placed in a circular-orbit satellite with known orbital parameters.

Microwaves Will Link Western Power Project

CONSTRUCTION will begin soon on a \$2.3-million multichannel microwave system to link the Bureau of Reclamation's power generation and transmission facilities in the Colorado River Storage Project. Utah, Wyoming, Colorado, Arizona and New Mexico will be served by the federally operated system. General Dynamics' Stromberg-Carlson division will build the network.

AFCEA exhibits put emphasis on gear suited to tactical conditions

By **BARRY A. BRISKMAN**
Assistant Editor

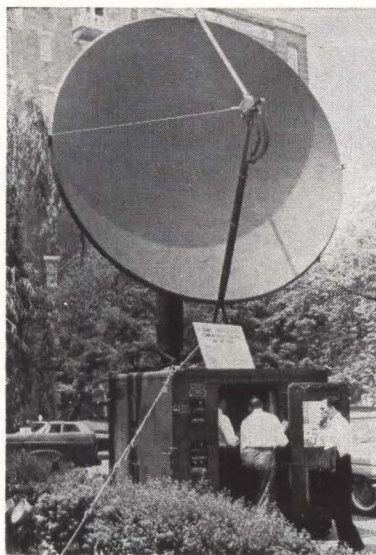

MOBILITY is emphasized in designs like the AN/TRC-66 C-band troposcatter system shown by General Instrument

WASHINGTON — Our national ability to meet rapidly expanding military communications demands was demonstrated last week at the 17th annual Armed Forces Communications and Electronics Convention and Exhibition.

Throughout the more than 175 exhibits, there was an obvious accent on improvements in communications speed, capacity, flexibility and reliability, and on reduction in equipment size and weight through solid-state techniques.

RADIO—The stability of military radio equipment is being raised by advanced frequency-synthesis techniques. Solid-state synthesizers result in receiver stabilities

as high as 1 part in 10^8 a day for practical 2 to 32-Mc superhets.

The Manson Laboratories ASR-2, for example, will receive a wide variety of signal modes, has sensitivity better than $6.2 \mu\text{V}$ for 10-db S + N/N, image rejection greater than 95 db at 16 Mc and four independent age's.

A number of companies emphasized modernization of operational military equipment by offering modification kits that allow in-the-field updating to state-of-the-art performance.

While multi-mode transmitters are still available, emphasis is strongly centered on single-sideband for voice communications. Compact linear amplifiers permit very high talk-power even for mobile use. New vacuum tube techniques and cooling systems allow equipment in one mobile van to do a job requiring three vans a few years ago. This greatly enhances tactical flexibility.

BROADBAND TANKS—To reduce operator error, transmitters eliminate complicated tuning by using broadband tank circuits. These have almost constant power output over a given frequency range between 1 and 30 Mc. Frequency is changed by selector switches. Some high-ranking military communications personnel feel that all h-f transmitters may be so equipped in the near future. Equip-



COMMERCIALLY styled equipment such as this SSB transceiver by RF Communications Associates drew high interest. Conventional squarish look may be on the way out in military gear

Systems Faster

ment of this type has already been delivered to the service; the AN/GRC-106 recently standardized on by the Army has a completely broadband final amplifier.

HIGH-SPEED DATA—Electronic teletypewriters with new characteristics were shown at AFCEA. Kleinschmidt's all-transistor printer, for one, prints 60 to 400



EMPHASIS on portability was demonstrated in Sylvania's new millimeter-wave communications set. Radiations from internal horn antenna produce a beam

wpm and could print 10,000 wpm, a line at a time. It can handle standard direct-wire communications and input and output for computers requiring high-speed printing.

Data equipment shown fills military needs for handling high-volume communications in limited bandwidths over wire, cable, carrier and microwave facilities. One duobinary system (ELECTRONICS, p 61, March 22) shown by Lenkurt, features switch-selected discrete rates of 2,400, 1,200 or 600 bits per second, with continuous rates at any speed up to 1,200 bps.

GE's AN/FCC-18 multiplexer set is typical of latest high-capacity,

our stock answer is YES!

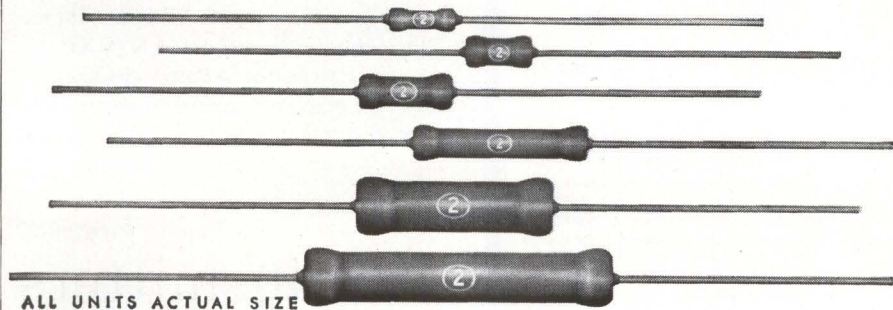

ALL UNITS ACTUAL SIZE

ALL AXIAL LEAD

BLUE JACKET RESISTORS

in 1, 2, 3, 5, 7 and 10-watt power ratings are carried in factory stock for immediate delivery.

Place your order now with your nearest Sprague District Office or Sales Representative.

Key Sprague Industrial Distributors carry most popular ratings in local stocks.

For application engineering assistance write: Marketing Dept., Resistor Division, Sprague Electric Co., Nashua, New Hampshire.

SPRAGUE COMPONENTS

RESISTORS
CAPACITORS
TRANSISTORS
INTERFERENCE FILTERS
PIEZOELECTRIC CERAMICS
PULSE-FORMING NETWORKS
4SR-107-63

PACKAGED COMPONENT ASSEMBLIES
FUNCTIONAL DIGITAL CIRCUITS
MAGNETIC COMPONENTS
PULSE TRANSFORMERS
CERAMIC-BASE PRINTED NETWORKS
HIGH TEMPERATURE MAGNET WIRE

SPRAGUE[®]
THE MARK OF RELIABILITY

Commercially Available
FOR THE FIRST TIME

X-BAND TRIODE Oscillator

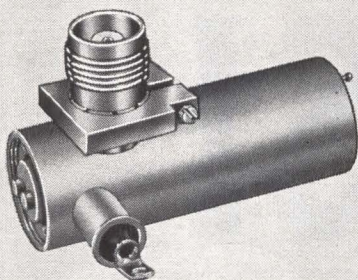

Trak Type 9170—Diameter $\frac{3}{8}$ in., length $2\frac{1}{4}$ in. including projections. Weight 2 ounces.

COMPARE ITS PERFORMANCE

... with any other type of local X-Band oscillator.

- It is tuneable over 500 Mc in the range from 8.0 to 9.6 Gc. (Compare this with solid state crystal oscillator-multiplier chains which are fixed frequency.)
- Power output is greater than 3 milliwatts, CW.
- Low voltage requirements—150 volts B+ and 6.3 volt heater supply. (Compare this with a Klystron.)
- Cleaner spectrum—residual AM and FM noise is far below reflex Klystrons.
- Frequency stable—5 ppm/ $^{\circ}$ C from -55° C to $+125^{\circ}$ C.
- Smaller and lighter—than any other X-Band local oscillator that we know of on the market today.
- Replacement cost is low. You almost get a second oscillator free because the tube is replaceable.
- It's much more rugged—meets the toughest environmental tests for shock and vibration.
- Delivery now—small quantities are immediately available. On large orders, Trak Microwave has production facilities to meet your requirements.

TRAK STOCK OSCILLATORS COVER 400 Mc to 10 Gc.

Trak offers a complete line of microwave oscillators, 400 Mc. to 10 Gc., harmonic generators and amplifiers.

You can get immediate delivery of stock items and quick delivery of modified devices or prototypes.

Send for full information, or, if you are in a hurry, PHONE COLLECT—TAMPA 877-6735.

TRAK
Microwave

**TRAK
MICROWAVE
CORPORATION**
5006 N. Coolidge Ave.
Tampa 3, Florida

**Specialists In Miniature
Microwave Energy Sources**

CIRCLE 16 ON READER SERVICE CARD

miniaturized, communications systems for fixed or portable use. An all-transistor duplex carrier unit for microwave relay, troposcatter or cable use, it operates on single-sideband suppressed carrier, offers up to 600 full duplex voice channels. Lenkurt Electric's AN/FCC-17 provides voice, teletypewriter data or graphic services over circuits of at least six tandem voice-frequency links covering a total of 6,000 miles or more.

FACSIMILE—Among improved facsimile systems is the UXH-2, developed by Litton's RADCOM-Westrex division and Navy. It prints on pressure-sensitive paper that has unlimited shelf life and can be copied. Carbon paper and plain white sheets can be used. Speed is 60, 90 or 120 scans a minute, resolution is 96 lines an inch. The company's mobile AN/GXC-4, manufactured for Army, will transmit photos or other copy half way around the world in $4\frac{1}{2}$ minutes.

RADAR—General Dynamics showed its new high-resolution radar (ELECTRONICS, p 36, May 31). It can identify a moving vehicle in a forest or it can discriminate between objects only a few inches apart.

The Bendix RDR-1E version of the RDR-1 airborne weather radar has a power of 50 Kw and extends range to 210 nautical miles. It uses 60 transistors, four vacuum tubes and three Nuvistors, while the RDR-1 has 38 tubes.

IONOSPHERIC SOUNDING—Military interest was high on systems that predict best selection of frequency for communications over a given path. Called synchronized-oblique ionosphere sounders, one system by Granger Associates devices provides direct, real-time display of maximum and lowest optimum frequencies and multipath distortion and input of propagation parameters to on-line computers programmed to give intermediate-term path predictions.

Transmitters Fly to Troops

ARMY'S Strategic Communications Command is now testing in the desert near Yuma, Ariz., an air-transportable broadcasting system designed for psychological warfare and for communicating with people in occupied areas.

Army says the need for such a system was demonstrated in Korea, Lebanon, Viet Nam and during the Cuban crisis. The system's main studios can be located in a rear area, while the transmitters go along with tactical forces.

The mobile transmitters, airlifted to the test site, broadcast programs originating at Fort Lewis, Wash., 1,000 miles away. Broadcasts are monitored in the

Canal Zone, for an overall test transmission distance of 5,000 miles. Both the field transmitting stations, and the base studios, can be transported by helicopter.

Gates Radio built the system for Army in less than a year, under a \$1.6-million contract awarded last summer (ELECTRONICS, p 8, Aug. 24, 1962).

Called the AN/TRQ-20, the system consists of two 50-Kw medium-wave a-m stations, a 50-Kw short-wave station, two receiving or monitoring stations, single-sideband 2 to 30-Mc studio-transmitter communications equipment with a range of 1,200 miles, and supporting equipment, in 23 vans.

SHELTERS in desert. These are two of six studio and transmitter shelters

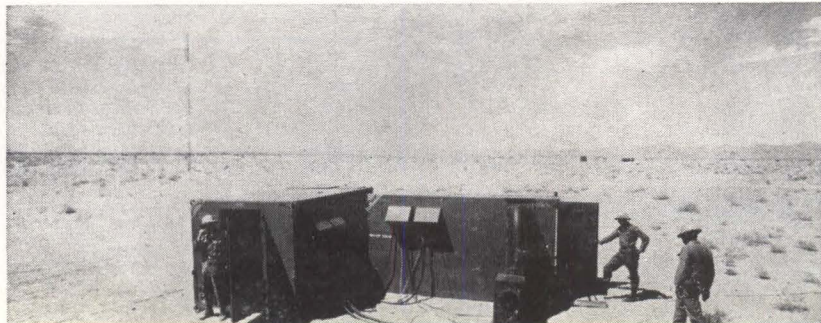

A MIGHTY BIG STEP



A MIGHTY IMPORTANT STEP FOR YOU! YOU CAN NOW BUY PRINTED CIRCUITS WITH YOUR CONDUCTOR AND HOLE PATTERN... WITHOUT ARTWORK... WITHOUT QUOTATIONS... WITHOUT TOOL CHARGES, AND IN MOST CASES, AT HALF THE USUAL COST AND IN HALF THE USUAL DELIVERY TIME!

Our new Standard Circuit Division reduces printed circuit manufacturing overhead to the barest minimum by automation and standardization. Mass production techniques drastically reduce costs, delivery time, and improve quality—yet still give you flexibility in board design. Sound exciting? For complete information write today for our 16 page brochure detailing this major printed circuit breakthrough.

Photocircuits

CORPORATION • GLEN COVE, N.Y. • ANAHEIM, CALIF.

CIRCLE 17 ON READER SERVICE CARD

CIRCLE 18 ON READER SERVICE CARD →

Objectivity

If you're tired of hearing about the "perfect" printed circuit connector, you're just the man we want to talk to.

We're here to offer you freedom of choice, because that's where objectivity begins. The boy blowing his last penny on candy wants to be able to choose between the 30-second delicacies and the stuff that lasts all afternoon. It's licorice versus jawbreakers, root-beer-barrels versus bubble-gum. They're all good, but none are perfect.

That's why we make such a variety of printed circuit connectors. Each type and style has its own special bailiwick. They're all "perfect" when they're applied properly.

OUR NEW BELLOWS-TYPE

Take the new Amphenol 225-series. This bellows-type connector has the smoothest, gentlest, most efficient mating action you'll find anyplace. Even after thousands of insertions, the delicate conductive surfaces of the printed board are unscathed by the 225.

The 225-series has remarkably low contact resistance, too. For the solder terminated style, it's under 25 millivolts at 5 amperes.

The bellows-type contact on the 225-series is split down the middle. You get two contact points for every interconnection. This helps keep the contact resistance low, of course, but it also conforms readily to irregular mating surfaces.

The 225 is convex. It meets and mates the printed circuit board with a wiping action that assures contact.

AND, FURTHERMORE

The 225-series contact is self anchored in the connector body. Con-

tact faces will not distort at the slightest pull on the terminals.

The 225-series has twice the flexing range that you'll find on other bellows-type contacts. This means you can rock the board twice as far with no danger of contact distortion.

The 225-series does not waste valuable contact space with a polarizing key. The key is sandwiched in between contacts.

The 225-series can be terminated with solder lugs, taper pins, removable crimps, or Wire-Wrap* terminals.

Contact styles? Contact positions? Mounting provisions? Well, let's just say that there are over 100,000 combinations available in the Amphenol 225-series bellows-type connector.

WHO NEEDS IT?

And now for the facts of life. Some people simply don't need the 225-series. Some printed circuit boards are inserted once and never disturbed again. Some printed circuits are never subjected to pull on the terminations. Some printed circuits are not really so delicate that they must be protected from contact wear. Some printed circuit boards never get rocked. And in some applications, the space taken up by a conventional polarizing key is of no consequence. And so forth.

And that is why Amphenol makes Prin-Cir® connectors, Micro-Edge® connectors, Micro-Min® connectors, and specials that haven't been named yet. They are all printed circuit connectors. They are all "right" where the need dictates their use.

The hero of this story is the Amphenol Sales Engineer. He's the only man who has access to a complete

*T.M. Gardner-Denver Co.

line. Thus he's the only man who can look you in the eye and tell you exactly which printed circuit connector you need. Objectivity.

You won't hear Amphenol Sales Engineers telling you about perfect connectors. They don't have to. They know better.

DETAILS, DETAILS

If you're *really* interested in seeing what a complete line of printed circuit connectors looks like, we invite you to write for our new 20-page catalog PC-1. Just contact your local Amphenol Sales Engineer, or write to Dick Hall, Vice President, Marketing, Amphenol Connector Division, 1830 South 54th Avenue, Chicago 50, Illinois.

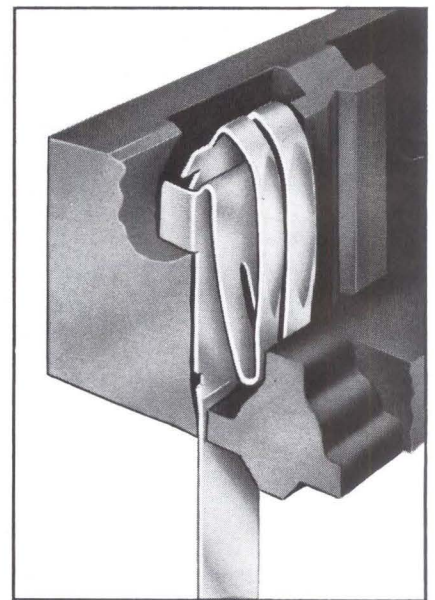

Problem: To make contacts that give an extremely low millivolt drop, yet do not mar printed circuit conductors, even after thousands of insertions.

Solution: Bifurcated, convex faces for sure contact. Double spring action with wide flexing range. Then double-plate and polish so smooth they caress the mating surface.



Connector Division / Amphenol-Borg Electronics Corporation





from Titan to Toothbrush

Sonotone batteries spark portable power to action!

Mite or might—if it's portable, the chances are it relies on Sonotone rechargeable sintered-plate, nickel-cadmium cells and batteries. That goes for everything from space satellites and missiles to cordless razors and toothbrushes, and even to small, delicate medical instruments. The reason is this: Sonotone pioneered in the development of high-power/low-weight rechargeable batteries. With more years of experience in this field than any other American company, Sonotone has built up an unmatched record of reliability...and an unmatched reputation for cooperation with design engineers. What new product are

you working on? Let Sonotone help you solve your power problem. Write today for technical data, stating your application requirements...and we'll be happy to lend you a hand.

Sonotone Batteries MM-13 have been used in U.S. ICBM Titan I and Sonotone Batteries MM-14 have been used in the emergency ground support. Many electric toothbrushes use Sonotone Sealed Battery S-113. These are just three of more than 300 Sonotone rechargeable sintered-plate, nickel-cadmium cells and batteries available to you. **Sonotone Batteries** portable power for progress

Battery Division, Dept. B 24-63, Sonotone Corporation, Elmsford, New York

Aircraft Batteries • Missile Batteries • Satellite Batteries • Power Supplies • Battery Chargers • Audio Products • Hearing Aids

SO HERSHEYER
COMES IN AND
I TELL HIM
I'M QUITTING!



AND HE SAYS
WHY? YOU'RE
GETTING AS MUCH
AS SIEFRIED
AND LUCAS!



SO I SAID: MONEY!
WHAT'S MONEY? YOU
BUSINESSMEN JUST
DON'T UNDERSTAND
THE MIND
OF AN
ENGINEER!

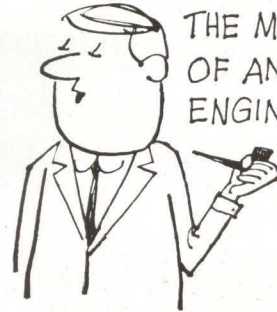

I'M AN ENGINEER
AND I OUGHT
TO KNOW
WHAT AN
ENGINEER
WANTS!

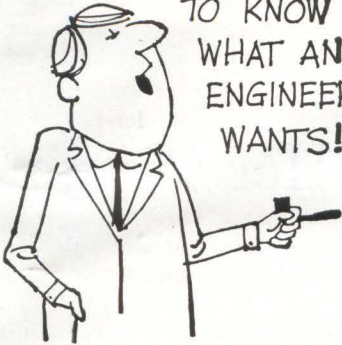

I WANT FULFILLMENT
I WANT TO WORK ON
THE SURVEYOR
AT HUGHES!



JUST THINK!
SOMEDAY THERE'LL
BE A LITTLE
PIECE OF ME
ON THE
MOON!



NO MORE ELECTRONIC
EGG-TIMERS! I'LL
BE CONTRIBUTING!
I'LL BE DOING
SOMETHING SIGNIFICANT!
SOMETHING INTER-PLANETARY!



BESIDES—
HUGHES
IS CLOSER
TO THE
BEACH.



Hughes is hiring! Numerous opportunities now exist on a variety of advanced projects and studies. For example: **MMRBM** Integration, Assembly & Checkout, **F-111B** PHOENIX Missile System, **TOW** Anti-Tank Missile, **SURVEYOR** Lunar Spacecraft, **SYNCOM** Communications Satellite, **ARPAT**, **POLARIS** Guidance, **VATE** Test Equipment, **ICBM** Defense Systems & others. Positions are open for experienced specialists with accredited degrees and U.S. citizenship.

CONTROLS ENGINEERS. Concerns airborne computers and other controls related areas for: missiles and space vehicles, satellites, radar tracking, control circuitry, control systems, control techniques, transistorized equalization networks and control servomechanisms.

CIRCUIT DESIGNERS. Involves analysis and synthesis of systems for: telemetering and command circuits for space vehicles, high efficiency power supplies for airborne and space electronic systems, space command, space television, guidance and control systems, and many others.

INFRARED SPECIALISTS. To perform systems analysis and preliminary design in infrared activities for satellite detection and identification, air-to-air missiles AICBM, infrared range measurement, air-to-air detection search sets, optical systems, detection cryogenics and others.

SYSTEMS ANALYSTS. To consider such basic problems as: requirements of manned space flight; automatic target recognition requirements for unmanned satellites or high speed strike reconnaissance systems; IR systems requirements for ballistic missile defense.



Please airmail
your resume to:

Mr. Robert A. Martin
Head of Employment
Hughes Aerospace Divisions
11940 W. Jefferson Blvd.
Culver City 39, California

Creating a new world with electronics

HUGHES

HUGHES AIRCRAFT COMPANY
AEROSPACE DIVISIONS

An equal opportunity employer.

"The Light Touch In Automation and Control"

IBM STARTED USING CLAIREX

PHOTOCONDUCTIVE CELLS

6 Years Ago

as

RELIABLE

System Components

And Still Does!



Reliability in computer components means a great deal to IBM and its customers; down time is extremely expensive. Clairex photoconductive cells, because of their rigidly controlled parameters and ability to perform indefinitely with little or no maintenance, have been among components used for years by IBM. The Clairex cells function as the "eyes" of important IBM light-actuated tape drive controls.

These tape drives are now operating in thousands of computer systems around the world — providing daily proof through performance of Clairex reliability!

You too can enjoy this confidence in supply. Clairex cells have been employed by hundreds of major firms in outer space, photography and dozens of other interesting fields. These cells offer a broad range of characteristics to the design engineer in the largest line of both glass and metal photoconductive cells available to the industry.



CLAIREX CORPORATION

The Oldest Manufacturer of Cadmium Sulfide and Cadmium Selenide Photoconductive Cells

8 West 30th Street, N. Y. 1, N. Y.

"New 16 page Photoconductive Cell Design Manual Free on Request".

CIRCLE 22 ON READER SERVICE CARD

Micropower Talks Hit the

Traveling speakers will tell Europe about new military and space designs

FIRST INTERNATIONAL conference on micropower electronics was slated to open in Paris yesterday. Sponsored by NATO's Advisory Group of Aeronautical Research and Development, the meeting will deal with new electronic devices and circuits that operate at very low power levels and permit high packaging densities.

Conference chairman Edward Keonjian, of American Bosch Arma, said AGARD recommended

the meeting because NATO as a whole is vitally interested in continued reduction in the size and weight of military electronics.

To enable maximum participation, the conference will be held in several European countries. It will end in Rome.

Robert C. Baron, of Computer Control Co., will speak on designing minimum power digital circuits for space applications. He will describe the scientific data conditioning system (SDCS) his company built for Mariner II.

Easiest way to reduce power requirements, says Baron, is to reduce voltages lower and lower, then devise circuit tricks to mini-

Monica Watches Her Weight

Integrated circuits and etched-plane memory keep new military computer slim

LOS ANGELES — Autonetics plans to have its new integrated-circuit Monica computer ready to fly late this year and follow up with a more powerful central computer next spring. The company expects reliability to be better than 2 years mean time between failures.

The computers are designed for airborne inertial guidance, flight control and automatic checkout, and for submarine navigation. There are two military models, C and J. Monica C is more powerful and features parallel operation.

Among packaging techniques

used to keep down size (Monica C measures $5\frac{3}{4} \times 9\frac{3}{8} \times 13$ inches) are:

- Multilayer circuit boards interconnect integrated circuits and modules. Photochemical methods build up and interconnect the layers with no holes drilled through the board

- Memory-core planes are made by fixing cores in holes etched in a copper-clad epoxy-glass board. Cores are through-plated and the board is then etched to get the conductor pattern.

- Power supply circuit boards are laminated to metal to conduct heat to the computer's sidewalls.

The computers have a random-access core memory of 8,192 words expandable to 32,768 words. A rapid-access memory of 256 words cycles in 1 microsecond.

ONE OF MONICA'S 4,096-bit memory planes is eyed by James Slason, project engineer (left). Multilayer boards (right) interconnect integrated circuits and modules

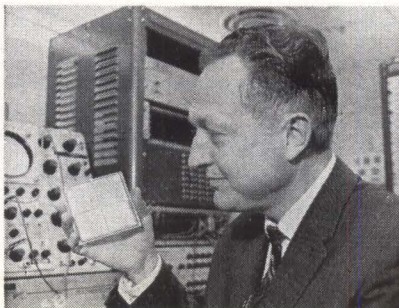

NATO Road

mize circuit inefficiency and further cut power requirements. One of the primary areas for circuit optimization, says Baron, is charge and discharge of stray capacitances.

SDCS weighed less than six pounds, occupied 144 cubic inches, required less than one watt. Equivalent circuitry of conventional design would have used about 50 watts, says Baron.

AMPLIFIER DESIGN—An optimum-design technique for applying micropower transistors in linear broadband amplifiers will be reported in a paper by J. D. Meindl, R. A. Gilson, O. Pitzalis and W. Kiss, of U. S. Army Electronics R & D Laboratory. The technique, which unifies d-c and large-signal a-c design, also serves as the basis for a worst-case design procedure for linear amplifiers considering transistor and resistor tolerance margins.

Micropower amplifiers have been designed using a simple thermistor-compensation technique whose gain and terminal impedances are virtually insensitive to large temperature changes between -50 C and 100 C . A common-emitter broadband amplifier operating from a 3-v supply with load and source impedance of 50 K can provide 180-mv peak a-c voltage over this range. Power drain is 23 microwatts, power gain is 25 db. If peak-load voltage capability is reduced to 150 mv, the amplifier can accept 10 percent worst case resistor tolerance.

Bandwidths vary from 7 Kc to 25 Kc but increases of 2 to 5 times are possible with a cascode circuit. (For a power drain of approximately 30 microwatts, 140-Kc bandwidths have been obtained at room temperature.)

Other speakers include J. W. Moll, of Stanford University; A. W. Lo, of Princeton University and IBM; W. W. Gaertner, of CBS Labs; G. E. Moore, of Fairchild Semiconductor; M. A. Boulter, of Semiconductor Ltd., and A. T. Watts, of Mullard Radio Valve Co., both of England.

THE ONLY HIGH RESISTIVITY ALLOY USED AS A RESISTANCE STANDARD

EVANOHM[®]

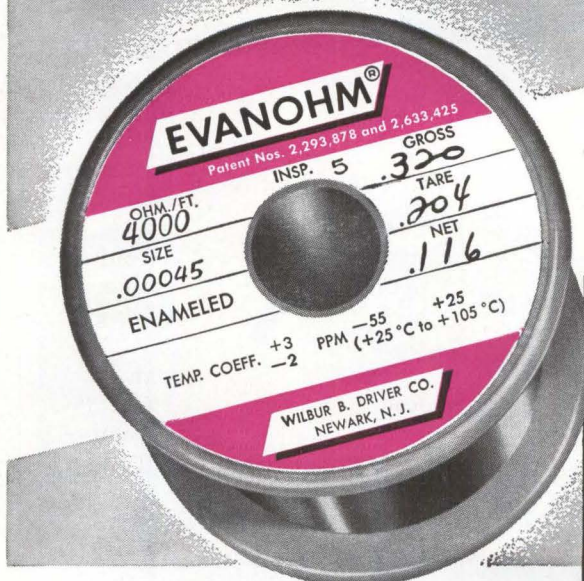

- High Resistivity
- Low TC of Resistance
- Low Thermal EMF to Copper
- High Reliability

SPECIFICATIONS

Nominal composition
75% Nickel
20% Chromium
2.5% Aluminum
2.5% Copper

Specific resistance 20°C
800 ohms/cm
134 microhm cm

Temperature Coefficient of Resistance
 -65°C to $+150^{\circ}\text{C}$
 $\pm .000005/^{\circ}\text{C}$

Coefficient of linear expansion
 20° to 100°C
.000014/ $^{\circ}\text{C}$

Magnetic permeability
1.0005

Average tensile strength
180,000 psi

Mean thermal EMF vs copper -65°C to $+150^{\circ}\text{C}$
.2 $\mu\text{V}/^{\circ}\text{C}$

Maintains Highest Stability Over Long Periods of Time and Wide Ranges of Temperature!

EVANOHM, the time-tested standard of the precision wire-wound resistor industry, features the lowest thermal EMF versus copper of all resistance alloys . . . with stability within a few parts per million per year. EVANOHM is recommended for all precision requirements where highest reliability is essential, and is well suited for analog computers and guidance equipment for space applications. EVANOHM, in .0004 and heavier gauges, can be supplied from stock, either bare or enameled, for immediate delivery. The Wilbur B. Driver Company's engineering "know how" is available to help solve your problems. Call or write WBD for recommendations on your requirements, or request EVANOHM brochure!

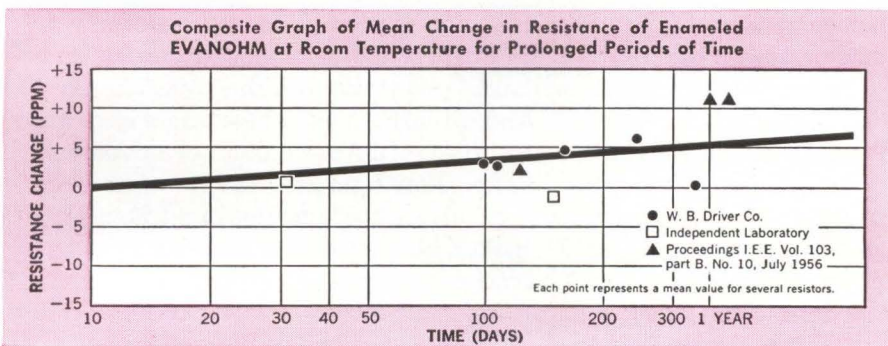

WILBUR B. DRIVER COMPANY
Newark 4, New Jersey—Tel. HUMBOLDT 2-5550 (Area Code 201)

MFG. PLANTS—1875 McCarter Highway, Newark 4, New Jersey; 50 Ronson Drive, Rexdale (Toronto), Ontario, Canada
BRANCH OFFICES—Chicago*, Philadelphia, Los Angeles*, Minneapolis, Cleveland*, Hartford (*Indicates Warehouse)

Melters and Manufacturers of Custom Electrical, Electronic, Mechanical and Chemical Alloys for all industries.

RELIABILITY BY DESIGN:

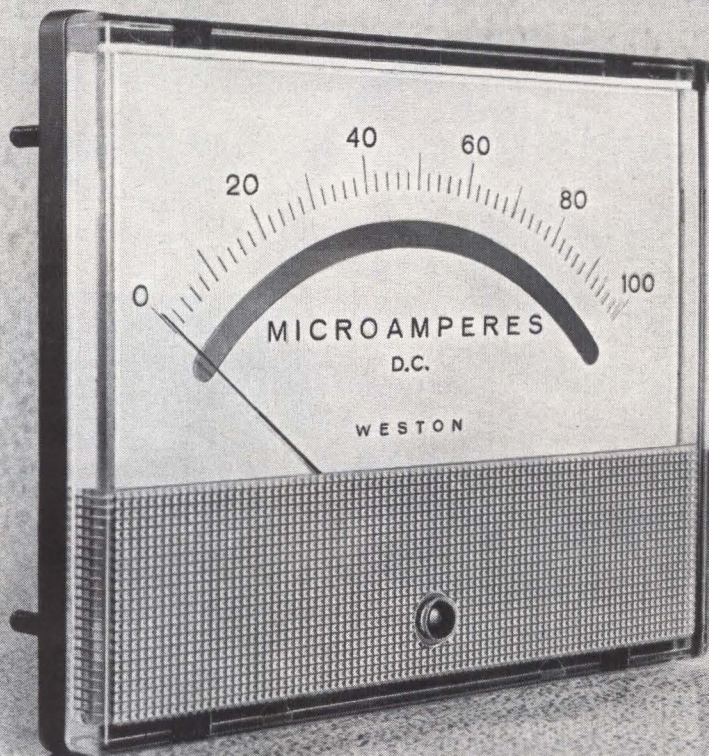

Unequaled flexibility
with one basic meter!

No other single line of matching panel meters can equal the flexibility and performance of Weston Series 1900. That's because these instruments are designed to give you almost unlimited freedom of choice in all important electrical and physical characteristics. Now, there's no need to compromise on any feature!

These instruments are supplied with Weston pivot and jewel movements or new Weston Taut Band Suspension for highest accuracy and sensitivity. You select the mechanism you want—self-shielded Cormag®, external magnet or iron vane. And all instruments of the same size are physically interchangeable... regardless of the mechanism or movement.

This unique line is supplied in five sizes from 2½" to 7½", in a wide variety of a-c and d-c functions, with full-scale accuracies of $\pm 2\%$, $\pm 1\%$, or higher on special order. All meters have 100° arcs for easy reading.

Styling is important, too. You can choose conventional Bakelite fronts or modern, clear plastic with provision for inserts for color coding. And only Weston Series 1900 Panel Meters offer a choice of three mounting methods—surface, flush or recess. Write for detailed technical bulletin.

 **WESTON**
INSTRUMENTS & ELECTRONICS

614 Frelinghuysen Ave.,
Newark 14, New Jersey
Division of
Daystrom, Incorporated

Factory Truck Trend: More Remote Control

CHICAGO—An accelerating trend toward solid-state electronic control of warehouse and factory vehicles was evident last week at the Materials Handling Show.

Jarvis Webb Company's new order-picker lets a warehouseman on an elevated platform pick orders from 20-foot-high shelves while the tractor follows a magnetic or optical guide path on the floor. Various switches and sensors provide for such functions as coupling, horn-blowing and opening doors.

For magnetic operation, wires carrying radio energy are buried in the floor. A blocking system allows several vehicles on the same circuit without collisions. For optical guidance, painted guidelines or colored tapes are placed on the floor. Radio controls can be adapted to either system.

Barrett Electronics showed an attachment for electric trucks that permits magnetic or optical guidance and dispatching. The company's radio-command system for overhead cranes uses a repetitive coding technique and redundant decoding receivers to prevent accidents being caused by stray rfi signals or loss of command signals.

Telemotive division of Dynascan Corp. reports it has sold 22 of its radio control systems for hot-metal, acid-pickling and high-carbon-dust area remote control applications.



ORDER-PICKER takes high road while truck follows guide path on warehouse floor

5½"

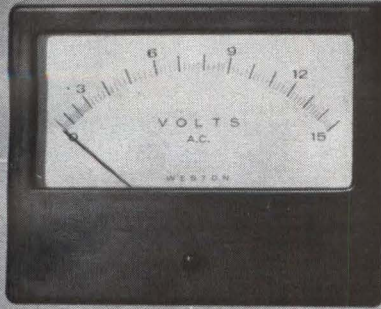

4½"

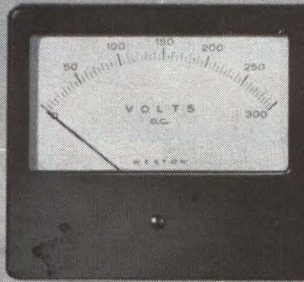

3½"



2½"

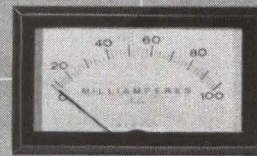
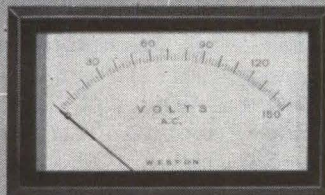
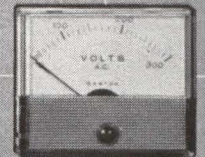
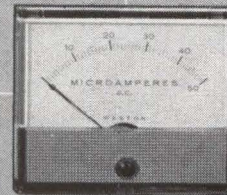
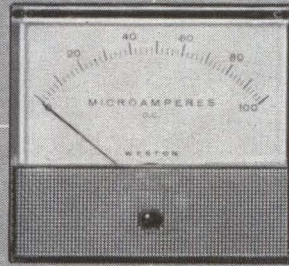

WESTON 1900 SERIES

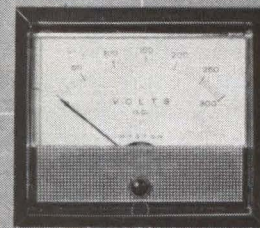
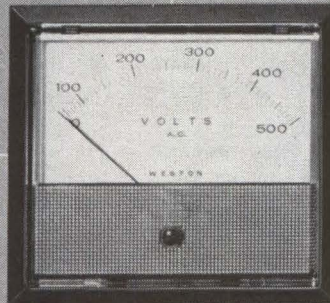

You choose size, function, accuracy, mounting and style!

Illustrated above are only 15 Weston Series 1900 Panel Meters. The possible combinations of features these instruments offer is almost unlimited. In fact, for any given function and range, you can select from more

than 100 possible configurations of size, accuracy, style and type of mounting. Specify the features you want, and you'll see why this line of matching instruments is the broadest and most flexible ever offered!

Size: Weston Series 1900 Panel Meters are available in five sizes: 2½", 3½", 4½", 5½", and 7½".

Function: d-c; a-c; VU; Thermo; Rectifier; and Log-scale.

Range, full scale: Ten standard d-c μ a ranges (20 to 500); d-c ma in 9 ranges (1 to 500); d-c amps in 7 ranges (100 to 500); d-c volts in 11 ranges (2 to 500). Three standard a-c μ a ranges (100 to 500); a-c ma in 9 ranges (1 to 500); a-c amps in 6 ranges (1 to 30); a-c volts in 16 ranges (3 to 500); Thermo amps in 5 ranges (1.5 to 15). Other ranges on request.

Accuracy: $\pm 2\%$; $\pm 1\%$; higher on request.

Pointers: Lance pointer, 100° arc scale; knife-edge pointer and mirror scale for highest accuracy.

Movement: Iron vane; external magnet; or Cormag®

THREE MOUNTING METHODS

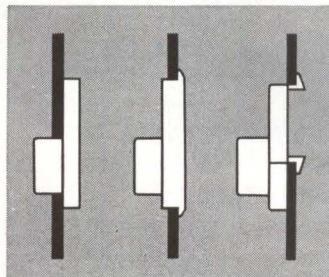

Surface Flush Recess

to protect against external magnetic fields. With proved Weston pivot and jewel movement, or new Weston Taut Band Suspension with Co-planar™ Suspension which provides complete control of ribbon length and movement.

Style: Conventional Bakelite fronts for all except 7½" size; all sizes available with modern clear plastic cases with provision for inserts for color coding or styling.

Mounting method: Only Weston Series 1900 can be mounted in three ways—surface, flush or recess.

Illumination: Available for recess mounting.

No matter what features you've indicated above, layout problems are simplified because all instruments of the same size are directly interchangeable.

Full information is contained in our technical bulletin.

 **WESTON**
INSTRUMENTS & ELECTRONICS

614 Frelinghuysen Ave.
Newark 14, New Jersey
Division of
Daystrom, Incorporated

CIRCLE 25 ON READER SERVICE CARD

NAVY'S SHRIKE missile is designed to home in on radiation of enemy radar and destroy it

Mass production to begin on air-launched radar-busting missile

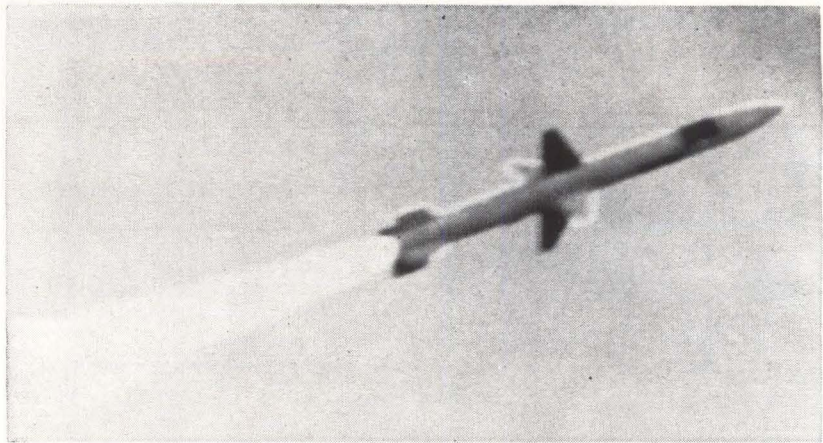

Shrike Will Be "BIG BUY"

WHILE THE \$1.5-million award just given to Texas Instruments Incorporated for the Shrike missile is relatively small as weapons contracts go, it signals the start of a major new missile-buying program by Navy and Air Force.

Shrike is slated to become one of the most important air-launched tactical missiles. The solid-fueled missile is designed to home in passively on enemy radar emissions and destroy the radar system while the plane that launched it remains a safe distance from enemy anti-aircraft missile batteries.

Shrike was one of the new weapons seen last Friday by President Kennedy on his tour of West Coast military bases. He saw it during a "turkey shoot" at the Naval Ordnance Test Station (NOTS), China Lake, Calif., where Shrike was developed.

PROCUREMENT—Navy and Air Force are mum on the number of missiles bought. However, defense officials say the 1963 procurement represents only pilot production, that there is going to be a "pretty big buy" of Shrike. The big purchase orders will come during fiscal 1964.

In 1964, Shrike will be introduced in Navy's fleet and in the Air Force. Navy will use it on fighter and attack aircraft. Air Force has halted work on a comparable anti-radar missile and is to adopt the Navy weapon.

Production models of Shrike will

be bought competitively, as is done with Sidewinder, Sparrow and other high-volume air-launched missiles. Procurement will be by fixed-price contracts with cost-plus incentive fee contracts. Initially, procurement will be on a sole-source basis, with assembly done at NOTS. NOTS is system manager and technical director of the project. Navy owns design rights on the missile.

Texas Instruments is building the guidance equipment and airframes and, has so far, received over \$5 million in development contracts. TI is building a 435,000-sq-ft building for mass production.

MISSION—Earlier in its develop-

ment, Shrike was known as ARM (Anti-Radiation Missile). Some of the experience Navy gained with its Corvus anti-radar missile project—cancelled some time ago—has been applied to Shrike.

While details of the missile's performance are secret, indications are that it is designed to operate against control radar like those employed by Nike batteries. It's mission may be to come in under the radar beam to avoid detection until it has zeroed in on the target. This could prevent radar operators from turning off the beam—the homing signal—until it is too late.

The Shrike is aptly named. A shrike is a bird that pecks at the eyes of its enemy.

Cape Gets New Radar

Design permits future adaptation for tracking as far as the moon

PATRICK AFB, FLA.—First of seven new-generation radar was officially turned over to the Atlantic Missile Range here last week by designer/builder RCA's Missile and Surface Radar division. Two more are scheduled to go to the National Aeronautics and Space Administration.

Designated AN/FPQ-6, the radar uses a 29-ft Cassegrainian antenna with 5-horn monopulse feed and a high power (3 Mw) transmitter. Its prime function is to make precise position and velocity measurements of missile and space vehicles (ELECTRONICS, p 26, Dec. 15, 1961).

Design of the system permits later adaptation to a number of design advances and applications. The basic echo-tracking range of 500 nautical miles for a one-square-meter target can be extended to 900 miles by using the full pulse-

SIMPSON INSTRUMENTS STAY ACCURATE

eight ^{migraine} headaches
you can't
get
with a
Simpson Meter



Simpson

SIMPSON ELECTRIC COMPANY 5203 West Kinzie Street, Chicago 44, Ill.

Phone: (312) ESTebrook 9-1121
In Canada: Bach-Simpson Ltd.,
London, Ontario

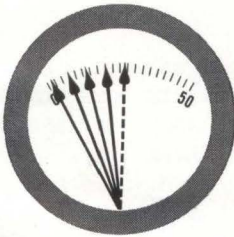

"STICKERS"

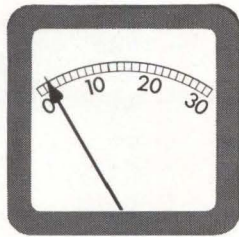

SHIFTY CALIBRATION

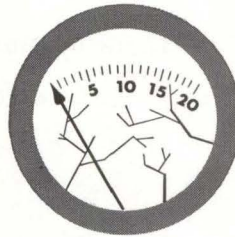

CRAZED CASES

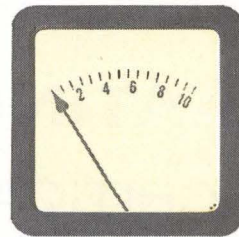

YELLOWING CASES

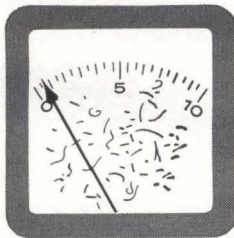

LINT
GRABBER

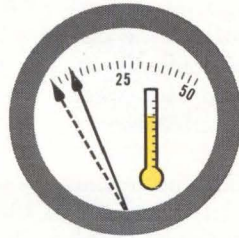

TEMP. DRIFT
(Composition Resistors)

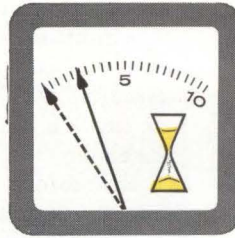

MIDDLE AGE
DRIFT

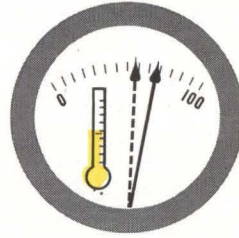

TEMP. SENSITIVE
(No Compensation)

If you are an equipment builder, you yourself may not come down with the headaches shown above. But your customers can. The shortcuts in meter quality which cause such malfunctions don't always show up during incoming inspection . . . but just wait 'til the equipment is in use.

That's what makes "price meters" so treacherous. You try to cut costs on one end, but lose your shirt on service calls and returned merchandise at the other.

The remedy is Simpson meters. Through experienced engineering, and a policy of no shortcuts in design, Simpson eliminates these meter troubles . . . and the price for this quality insurance is surprisingly close to so-called "price meters."

You can get stock Simpson meters immediately from your distributor in 1300 sizes and types . . . or custom meters from the factory in almost infinite variety. Write for General Catalog No. 18.

Representatives in Principal Cities
...See Telephone Yellow Pages

Your Only Source
Worthy Of The Name In

P
PRECIOUS

M
METAL

P
PLATING

of CRITICAL
ELECTRONIC
COMPONENTS

... DEMANDING:

- Purity of deposit
- Completeness of coverage
- Close tolerances
- Tight quality controls
- Rigid inspections

Our experienced staff specializes in high reliability, heat resistant plating with Gold, Silver, Rhodium and other precious metals. Prices on specific applications submitted promptly. Deliveries of completed assignments are on time, too. Write, wire or phone:

PMP

PRECIOUS METAL PLATING
DIVISION OF CHEMICAL PLATING COMPANY
120 Bruce Avenue, Stratford, Connecticut
Phone: EDison 7-3376 TWX: 203-337-9713

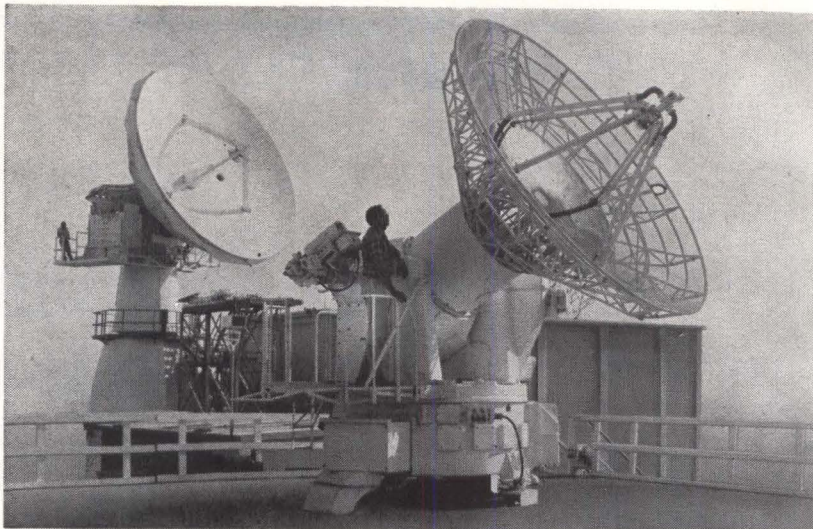

NEW AN/FPQ-6 (left) has a 29-ft antenna and 32,000-mile range. Older AN/FPS-16 (right) has 12-ft antenna and 5,000-mile range

energy capabilities of the transmitter. By using a new final amplifier, along with longer pulse width, the echo-tracking range can

be extended to 1,300 miles. By adding a low-noise maser to the receiver, range reaches 1,600 miles. Unambiguous transponder-tar-

RFI: In Microcircuits

*It all depends on
how the circuit and
source are coupled*

PHILADELPHIA — One of the first clear pictures of the radio-frequency interference (rfi) susceptibilities of microelectronic circuits, as compared to conventional circuits, was presented last week at the 5th National Conference on RFI.

Heretofore, little has been said about rfi problems in microelectronics. Generally, engineers think that microelectronics will simplify rfi control, because: smaller circuit areas mean less pickup and radiation of rfi; fewer interfaces between circuits provide fewer entry and escape points for rfi; smaller circuit sizes and weights allow proportionately more room for shields and filters. These factors should more than offset microelectronics' denser circuit and component spacings and lower operating levels, which tend to increase susceptibil-

ity to rfi.

The new analysis, by R. B. Schulz, of Boeing, gets right down to cases in analyzing the susceptibilities of three types of microelectronic circuits: discrete micro-miniature components such as micromodules, thin-film circuits, and semiconductor integrated circuits.

Here are Schulz's conclusions:

- For common-mode conductively-coupled rfi, where the interfering current flows through element that is common to the rfi source and the victimized circuit, the shorter common-mode paths of all microelectronic-circuit types make them less susceptible to this type of rfi than conventional circuits. However, the higher resistivities of thin-film and integrated circuits tend to enhance rfi that is coupled to them over common-mode paths.

- In most cases microelectronic circuits are less susceptible to rfi coupled by magnetic fields, but more susceptible to rfi coupled by electric fields than conventional electronics. Microcircuit designers

get tracking is possible at 32,000 n.mi. RCA is developing an expanded digital ranging unit that will extend the zoning capabilities and thus the unambiguous range to lunar range of 256,000 miles. Conceivably, the improved system could track an Apollo flight to the moon.

Second FPQ-6 will go to the island of Antigua on June 21. Other islands will get the air-transportable version of the system (designated AN/TPQ-18). Others go to Grand Turk on July 1; Ascension and Grand Bahama in September; Praetoria, South Africa, in March, 1964; Merritt Island (near Canaveral) in May, 1964.

One of NASA's two FPQ-6 systems will go to Wallops Island, Va. in December, the other to Australia in January, 1964.

It's Different

should try to use low-impedance circuits. Rfi sources should be placed on different substrates than circuits susceptible to rfi.

- It is not difficult to shield microelectronic circuits, but the lack of large inductances makes it difficult to adequately filter them.

Computer Rolls Steel

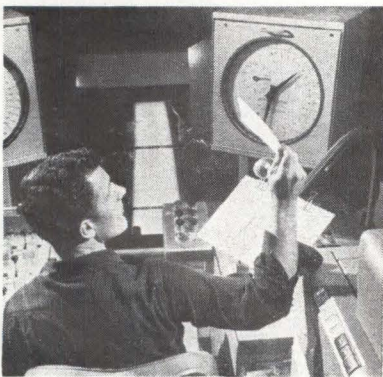

SLAB AND PLATE mill at Houston, Texas, says Armco Steel, is first to be controlled by digital computer. Computer used is Westinghouse Electric's Prodac 4449. Photo shows operator's pulpit

Fast, foolproof production testing and sorting of 2 and 3 terminal devices

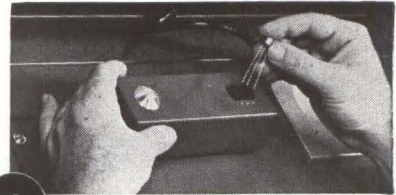
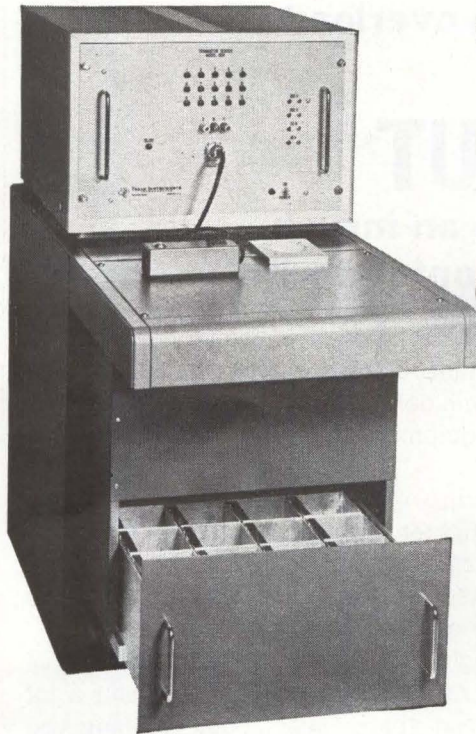

1 Insert Device

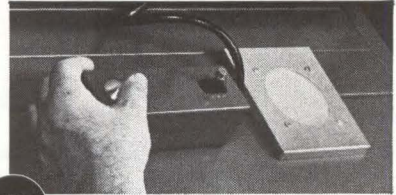

2 Press Button

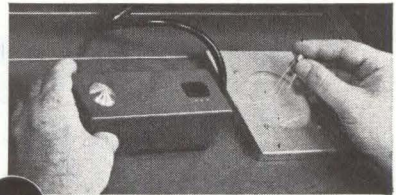

3 Drop in Chute

15 tests in less than a second

Automatic sorting to 16 categories

No operator decision

Texas Instruments Model 654 Transistor and Diode Tester with 16-Bin Automatic Sorter provides production-speed testing and accurate automatic grouping of two- and three-terminal devices.

Operation requires only three simple manual steps, completely eliminating operator decision. Sorting logic determined by printed plug-in circuit boards in the tester automatically routes the component to the proper bin. At the conclusion of the test, the operator merely drops the device into the entry chute. Sorting logic is held during the testing of the next device.

The Model 654 combines speed and accuracy with flexibility of circuit board programming. The Automatic Sorter and other accessory equipment insure continued maximum effectiveness of the basic instrument.

Write for complete information.

INDUSTRIAL
PRODUCTS
GROUP



TEXAS INSTRUMENTS
INCORPORATED
P. O. BOX 66027 HOUSTON 6, TEXAS

SENSING • RECORDING • TESTING • DIGITIZING INSTRUMENTS
THE INSTRUMENTS OF TEXAS INSTRUMENTS

IF
you need close-tolerance
overload protection

AND
fast interruption of
low-value overloads

BUT
you have an inrush
surge to contend with

then the Heinemann Type C overload relay is what you've been looking for. The Type C can provide instantaneous response to overloads as low as 300%—and still give you a time-delayed response to overcurrents of lesser magnitude, permitting equipment to get on the line without surge-caused interruptions.

These, we submit, are tight tripping specs. And two aspects of Type C design make them even tighter. First, you can get the exact ampere rating you need—any integral or fractional rating from 0.02 amps to 70 amps. Second, the rated must-hold and instantaneous-trip points are not affected by the rise and fall of ambient temperature.

If you want longer delays and higher instantaneous-trip points, we've got a selection of three standard response curves that give you a lot of latitude. Or, for specials, you can specify just about anything you want—within reason and within the limits set out on the small chart below.

The Type C comes in automatic or manual reset forms, with or without trip indication. All of these options are described fully in Bulletin 5103, a copy of which is yours for the asking.

HEINEMANN ELECTRIC COMPANY, 2600 BRUNSWICK PIKE, TRENTON 2, N. J.

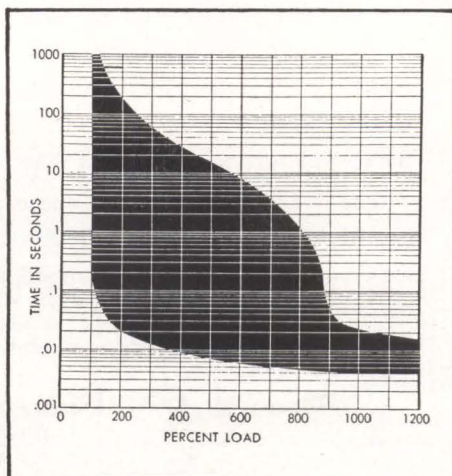
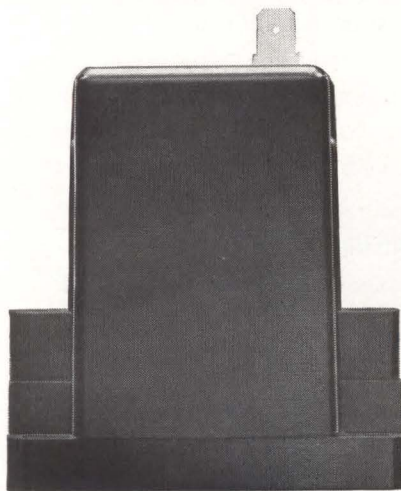

SA2788

MEETINGS AHEAD

SUMMER GENERAL MEETING IEEE; Royal York Hotel, Toronto, Canada, June 16-21.

BROADCAST & TV RECEIVERS CONFERENCE, IEEE-PTGTR; O'Hare Inn, Chicago, June 17-18.

JOINT AUTOMATIC CONTROL CONFERENCE, IEEE, ISA, et al; University of Minnesota, Minneapolis, Minn., June 19-21.

X-RAY AND ELECTRON PROBE ANALYSIS SYMPOSIUM, American Society for Testing and Materials; Chalfonte-Haddon Hall, Atlantic City, N. J., June 23-28.

IMPACT OF MICROELECTRONICS CONFERENCE, Armour Research Foundation and ELECTRONICS Magazine; Illinois Institute of Technology, Chicago, Illinois, June 26-27.

COMPUTERS & DATA PROCESSING SYMPOSIUM, University of Denver; at the University, Denver, Colorado, June 26-27.

LOUDSPEAKER INDUSTRY CONFERENCE, EIA; Pick Congress Hotel, Chicago, June 27.

INFORMATION THEORY IN SCIENCE & ENGINEERING SEMINAR, Dartmouth College; at Dartmouth, Hanover, New Hampshire, July 1-12.

ADVANCED CONTROL THEORY AND APPLICATIONS, Massachusetts Institute of Technology; at MIT, Cambridge, Mass., July 8-19.

ANTENNAS & PROPAGATION INTERNATIONAL SYMPOSIUM, IEEE-PTGAR; National Bureau of Standards, Boulder, Colo., July 9-11.

MEDICAL ELECTRONICS INTERNATIONAL CONFERENCE, IFME, University of Liege, Liege, Belgium, July 22-26.

ELECTROMAGNETIC MEASUREMENTS & STANDARDS SEMINAR, National Bureau of Standards; NBS Laboratory, Boulder, Colo., July 22-Aug. 9.

AEROSPACE SUPPORT INTERNATIONAL CONFERENCE & EXHIBIT, IEEE, ASME; Sheraton-Park Hotel, Washington, D. C., Aug. 4-9.

WESTERN ELECTRONIC SHOW AND CONFERENCE, WEMA, IEEE; Cow Palace San Francisco, Calif., August 20-23.

ADVANCE REPORT

ELECTRON DEVICES MEETING, IEEE-PTGED; Sheraton-Park Hotel, Washington, D. C., Oct. 31-Nov. 1. **Aug. 1** is the deadline for submitting 200-word abstracts (5 copies) to: Mason A. Clark, Technical Program Chairman, 1963 Electron Devices Meeting, HP Associates, 2900 Park Boulevard, Palo Alto, Calif. Areas of interest include: microwave tubes for high power, millimeter wave, low noise; storage and display devices; new diode and transistor structures; very high-power solid-state devices; Hall-effect devices; thin-film active devices; integrated circuits; optical devices, lasers, diode lasers, optical transistors; transducers, new electron device principles.

HIGH FREQUENCY CURRENT PROBE SYSTEMS

for your Tektronix
Oscilloscope



TEKTRONIX TYPE P6016 AC CURRENT PROBE

You can select from two current-detecting systems for use with your Tektronix Oscilloscope.

One system comprises the P6016 AC Current Probe and Type 131 Amplifier . . . with current range extending from less than one milliamper to 10 amperes . . . and pass-band, with a 30-Mc oscilloscope, covering 50 cps to 17 Mc.

A less versatile system comprises the P6016 AC Current Probe with a Passive Termination . . . for observation and measurement of current waveforms at frequencies to 20 Mc, with a 30-Mc oscilloscope.

Easy to use, the current probe has a long narrow shape and convenient thumb control. Just place probe slot over the conductor and close slide with your thumb—no direct electrical connection is required. Wiping action keeps the core surfaces clean. Loading introduced is so light that it can almost always be disregarded.

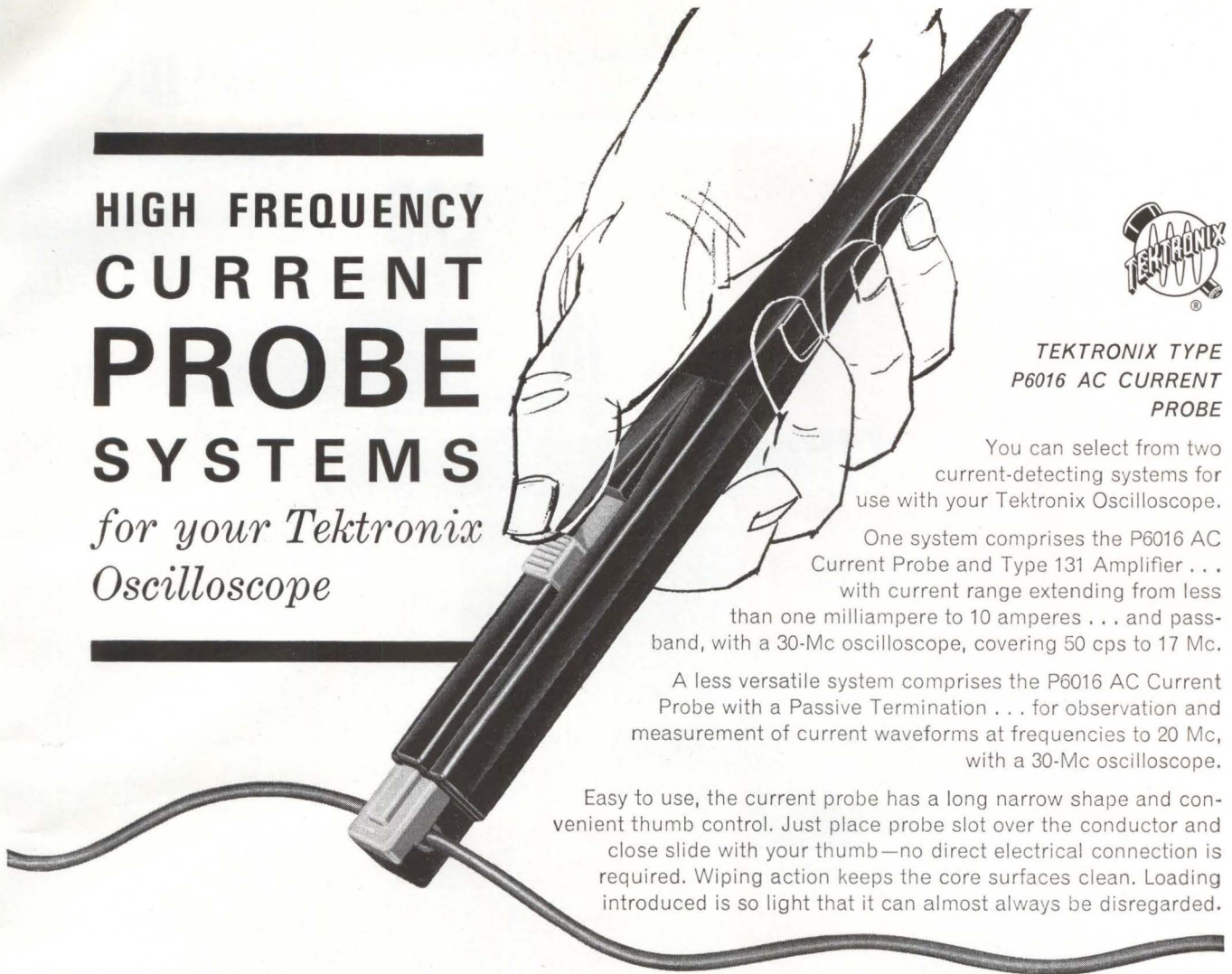

P6016 and CURRENT PROBE AMPLIFIER



Sensitivity with 50 mv/div Oscilloscope Input: 1 ma/div basic sensitivity. 10-position switch provides calibrated steps from 1 ma/div to 1 amp/div, 1-2-5 sequence, accuracy within 3%. Continuous uncalibrated adjustment is possible by using variable control on the oscilloscope. **Noise:** Equivalent to a 100 μ amp pk-to-pk input signal. **Risetime (with Fast-Rise Plug-In Unit in a Type 540-Series Oscilloscope):** 20 nsec (approximately 17-Mc passband at 3-db down). **Delay Time:** 40 nsec or less measured at the 50% pulse-amplitude points. **Low-frequency Response:** 50 cps at 3-db down. **AC Current Saturation Rating:** 15 amps pk-to-pk, decreasing to 8 amps at 400 cps, 400 ma at 50 cps. **Power Requirement:** 105-125 volts ac, approximately 1/2 watt at 117 volts (part number 015-030); 210-250 volts ac, approximately 1 watt at 234 volts (part number 015-045).

P6016 and PASSIVE TERMINATION

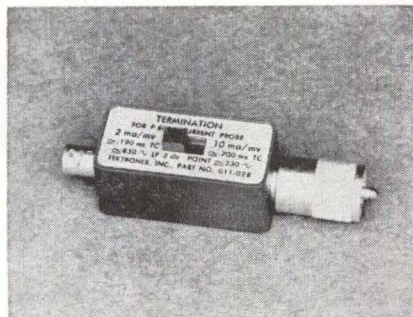

Sensitivity: Either 2 ma/mv or 10 ma/mv of oscilloscope sensitivity, accuracy within 3%. **Risetime (with Fast-Rise Plug-In Unit in a Type 540-Series Oscilloscope):** 18 nsec (approximately 20-Mc passband at 3-db down). **Delay Time:** 20 nsec or less measured at the 50% pulse-amplitude points. **Low Frequency Response:** At 2 ma/mv—about 850 cps at 3-db down (5% tilt of 10- μ sec square pulse). At 10 ma/mv—about 230 cps at 3-db down (5% tilt of 35- μ sec square pulse). **Maximum Current Rating:** 15 amps pk-to-pk.

COMMON TO BOTH SYSTEMS

Direct Current Saturation Threshold: 1/2 amp. **Maximum Breakdown Voltage Rating:** 600 v, with thumb slide closed. **Insertion Impedance:** After a step function has been applied to the conductor under test, the impedance inserted in series is: (1) 0.06 Ω after 50 nsec, (2) 0.04 Ω after 100 nsec, (3) 0.015 Ω after 1 μ sec, and (4) 0.006 Ω after 10 μ sec. Capacitance between conductor and probe case is typically 1 pf, depending upon wire size.

P6016 and CURRENT PROBE
AMPLIFIER SYSTEM \$235

For 117-volt operation, please order part number 015-030 — For 234-volt operation, please order part number 015-045.

P6016 and PASSIVE TERMINATION
SYSTEM \$ 90

Note: P6016, Current Probe Amplifier, and Passive Termination can be ordered separately if desired. Other Current Probe accessories also available.

U. S. Sales Prices, f.o.b. Beaverton, Oregon

**FOR A DEMONSTRATION, PLEASE CALL
YOUR TEKTRONIX FIELD ENGINEER**

Tektronix, Inc. / P. O. BOX 500 • BEAVERTON, OREGON 1 (Area Code 503) Mitchell 4-0161 • TWX: 503-291-6805 •
Telex: 036-691 • Cable: TEKTRONIX • OVERSEAS DISTRIBUTORS IN 27 COUNTRIES

Tektronix Field Offices are located in principal cities throughout the United States. Please consult your Telephone Directory.
Tektronix Canada Ltd: Montreal, Quebec • Toronto (Willowdale) Ontario • Tektronix Ltd., Guernsey, Channel Islands



SUPPLIES

LAB

IN

FORWARD

STEP

NEW

A

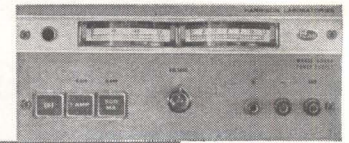

6206AM

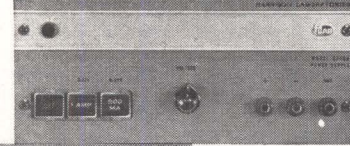

6206A

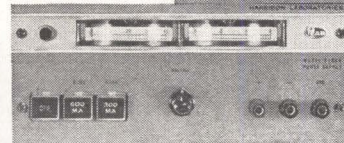

6204AM

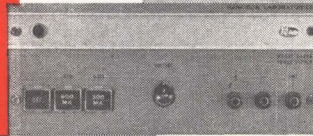

6204A



6202A



6201A

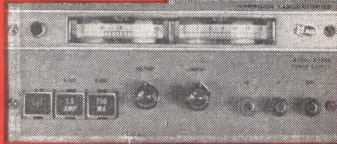

6200A

**NEW CONSTRUCTION AND
CIRCUIT TECHNIQUES OFFER
LOW COST, HIGH PERFORMANCE,
VERSATILITY**

Series 6200 Includes Dual Range Supplies

Now available! A series of 7 models of mechanically compatible power supplies — 3 of which feature Constant Voltage/Constant Current circuitry. All are designed as a "family" in dimensions and styling, and can easily be used in conjunction with other units of the series, either in bench or rack combinations.

Any number of units of mixed model numbers can be "stacked" in Auto-Series up to 300 volts off ground to obtain output voltages higher than that of one unit, or to achieve a chain of regulated voltages.

Other features include Auto-Parallel operation, short circuit proof operation, remote programming, remote sensing, floating output, front and rear output terminals, silicon transistor differential amplifier front end, and low series transistor dissipation. Open end construction makes all components and adjustments easily accessible. Design embodies epoxy glass laminate printed circuit board. Provision is made for standard rack mounting in a 3½" height.

Prices start at only \$99.00

Write for completely detailed specifications

HARRISON LABORATORIES

A DIVISION OF  HEWLETT-PACKARD

45 INDUSTRIAL ROAD BERKELEY HEIGHTS, NEW JERSEY
464-1234 Area Code 201 TWX-201-464-2117





PETER C. GOLDMARK, president of CBS Labs, talks to Senior Associate Editor Wolff

HOW HIGH IS FIDELITY?

By MICHAEL F. WOLFF,
Senior Associate Editor

Interviewing

PETER C. GOLDMARK
President, CBS Labs, Stamford, Conn.

*Next step in audio
reproduction: greater
realism. Here are some
things you can do now—
one method employs just
a garden hose*

FIFTEEN YEARS AGO this month Peter C. Goldmark and his associates at CBS Laboratories developed long-playing records. We felt this anniversary made a good time to step back from the more exotic areas of electronics and take a look at the state-of-the-art in one of our oldest fields—audio. Result was the following exclusive interview.

Q. In your opinion, Dr. Goldmark, where do we stand today in the art of recording and reproducing sound?

A. The technology has come a long way. Notable improvements have been made in all phases of sound recording so that it's possible now to have virtually noiseless records with extremely little distortion, good fidelity and more playing time. In reproduction the vast strides made in pickups, tone arms, amplifiers, loudspeaker packaging and so forth have all contributed to better sound, less distortion and long record life.

The question is, however, have we attained the real objective, namely to provide realism in the home so far as music reproduction goes?

The word high fidelity is a misnomer, I believe. First of all, either you have fidelity or you don't. If you have fidelity, then "high" doesn't add any more to it, and if we use the word "fidelity," the question arises: fidelity to what? What is it we are trying to copy properly? The paramount question is: given a 2,000-cubic-foot living room, what can you hope to reproduce that will give the maximum realism? Realism is a word I would like to stress and is the goal I believe much more effort should be directed to—an area, perhaps, which has been neglected. We have the technology for obtaining realism—we have abundant technology—but now we have to use common sense and apply this technology to give us this reality.

Q. Do you mean to say that our records are not realistic?

A. I always mean realism in reproduction. When I said we have sufficient technology I mean this also applies to the record. I believe what we have up to the point of the loudspeaker—even what acoustically comes out of the loudspeaker—has all the ingredients to give us realism, and we have other aids, other devices, which are all usable. It is how we apply these and how we educate people that we have to



“The technology has come a long way”



“The word high fidelity is a misnomer”



“Realism is a word I would like to stress”



“I believe we have to get back to the composer”

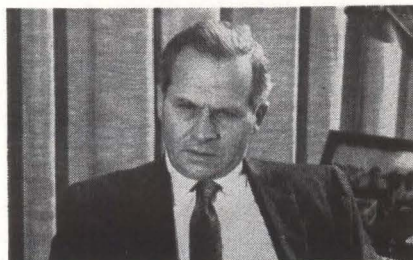

“Another means . . . is through the use of a hose”

think about now.

First, I believe we have to get back to the composer. Somewhere in the 18th century he wrote a symphony having in mind an orchestra of between 50 and 80 musicians. The composition was meant to be listened to in a concert hall—not in the home. If we wish to hear this symphony in the home and with realism (which I'm sure we all want) what choices do we have? We have amplifiers, loudspeakers and, of course, pickups and records, which are good enough and powerful enough to reproduce in our living room sound *volume* adequate to place us in the orchestra pit and perhaps give us the illusion that we are sitting where perhaps the conductor normally stands. This, however, I am sure is not what we want because very few of us ever sat in that place. What we really want is the effect of sitting in the concert hall, say, half way down or in the first or second balcony. These are difficult effects to reproduce in the home . . . very difficult.

Q. How then would you reproduce them?

A. Sound, as it now appears on the record, contains to a large extent the direct sound from the orchestra and to a lesser extent the spatial, indirect or ambient sound in the concert hall. We now have to try to reproduce this ambient sound. Let's consider a specific situation in which one was located about 150 feet from the orchestra. The original sound from the orchestra will take approximately one-sixth of a second to arrive. Let's assume that another 100 feet back of us the concert hall ends and sound which went past us is reflected from the wall and arrives another one-fifth of a second later. Now there are a great many sounds which fare similarly but not to the same extent. In other words, many sounds between the first one-sixth of a second and the next one-fifth of a second would arrive together at our ears. Also there are sounds which will reach us past the second one-fifth of a second period which travel around the hall and are reflected and bounced back to us so that the sum of all these sounds spreads over a period of a few seconds before they completely die out.

The overall effect is measured as the well known reverberation time. It is possible to capture a portion of this reverberation effect—together with the clarity of the original sound from the orchestra. In the home try to listen from another room or from the far end of the living room. Then do two things: first, cut the sound level and emphasize treble and bass (and not just the very low bass) to get a natural effect.

Now, the second item is not quite as easy to accomplish and requires some real enthusiasm to carry out. It is something we have experimented with in the Laboratories and resulted finally in placing auxiliary speakers in the rear of a listening room. These speakers need not be stereophonic, though there is no harm if they are. It is now necessary to take the sounds from the right and left track of the original record and mix them to create a sound signal, which would then be equivalent to a monaural content. Next, it is desirable to delay the sound by an amount of time that would simulate the distance between the listener and the rear wall of the auditorium. This may correspond to a total delay of approximately one-fifth of a second, keeping in mind that it is not a single slap of sound that returns to us in one-fifth of a second. This period is filled with sound impulses coming from walls nearer to us, for instance the sides. A single delayed sound impulse of one-fifth of a second would be objectionable.

It is thus desirable that this delayed sound be made to contain a large amount of reverberated sound as well as the original sound. One practical way of providing the reverberation would be to use one of the spring-type reverberation devices on the market.

Delaying this reverberated sound is a bit more difficult. We would like to delay it about one-fifth of a second and one way to accomplish this would be through an endless tape and a tape machine traveling at low speed to keep the tape wear at a minimum. Also it would augment the realism by providing speakers half way down the room carrying the sum signal reverberated and delayed by approximately one-tenth

of a second. A tape loop traveling at $3\frac{1}{2}$ inches per second several feet long and guided over rollers would do a credible job. This would provide a spacing of the pickup head with respect to the recording head of approximately 0.4 inch for the one-tenth of a second delay and 0.8 inch for the one-fifth of a second delay. If this is difficult, the tape speed should be increased to $7\frac{1}{2}$ ips, or some higher speed compatible with a minimum spacing between the record and reproduce head.

Another means of producing the desired delay is through the use of a hose—a garden hose, perhaps. If one can place this in one's basement sufficiently insulated from surrounding noises—a hundred feet of hose with a proper microphone and loudspeaker correctly coupled in and out of the hose—it can also create the desired delay. When using such a hose one would have the advantage of providing inbetween points of shorter delays such as one-tenth of a second through the use of an additional microphone tapping in half way along the hose. This hose now assumes the role of an acoustic delay line and permits having inbetween points to locate several speakers between the main speakers and the far end of the listening space, thereby simulating additional reflective surfaces such as in a concert hall.

Essentially what we are trying to do is to reproduce in time, but not in space, the spatial sound as generated in a concert hall and compress this by means of the artificial delays and reverberations into a given space of relatively small volume such as in one's own home. I do not want to create the impression that this approach, which would probably create maximum satisfaction, is easy to accomplish. The means are available—the techniques and the instrumentation are known—the experimentation, however, is not well known. It opens up a new field of challenge.

Q. Is there equipment adequate to help the listener do these things?

A. I think that one has to be a bit of an experimenter. I hope that it is possible, perhaps, to stimulate the industry to produce some of the auxiliary equipment such as delays and not have to use, maybe, a garden hose. I think the tape could be perfectly well used for this.

It may be of interest that we ourselves have provided for an effect such as this in one of our developments, the Minnesota Mining tape cartridge system which is now marketed by Revere. Originally it was intended that this would carry a third track. The dimensions of the cartridge system are such that the tape has two tracks, widely spaced, located at the outside of the tape, so that there's room for a third track. We actually built machines and gave demonstrations where we put into the center of the tape a third track which carried delayed reverberation of the left and right sum signal. The plan was that an optional instrument would carry a third amplifier to extract this delayed reverberation and channel it to an auxiliary speaker in the rear of the room. This, you see, would have made the problem much easier: you would have delayed sound, it would have been reverberated and there would be amplifiers and speakers provided for.

Q. These ideas for realistic sound reproduction are primarily for more engineering-minded listeners. Is anything in sight for the others?

A. Well, we have had an idea for a device that would give all the necessary delays and reverberations in one unit. This would be a magnetic tape or drum system. Sound is taken off from a number of heads and a continuous reverberation signal is generated by means of feedback. This reverberated signal would then be fed through various delays to a number of external speakers. The maximum delayed signal goes to a speaker in the rear of the room, the less delayed to a speaker half way down, and the undelayed but reverberated signal is added to the original signal at the front of the room. Since the nature and amount of reverberations and the amount of delay can be adjusted relatively easily, one can conceive of his own auditorium—a sort of "space box". In fact, we have built a reverberation generator and used it to simulate the effects of large halls and to liven sound in dead studios. We call it the "Reverbertron."

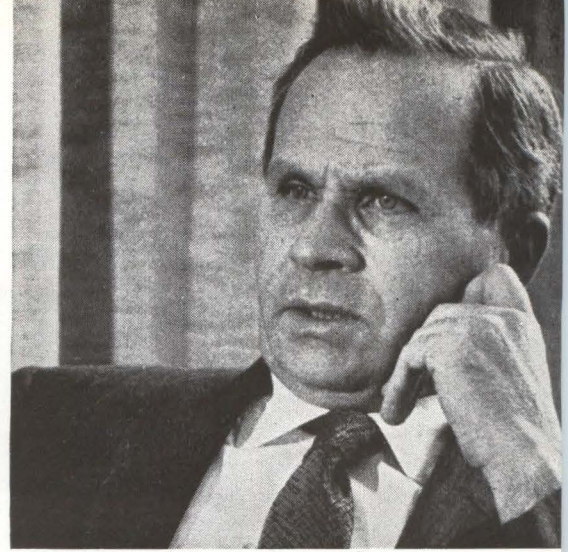

"One has to be a bit of an experimenter"



"Need to eliminate the needle has largely disappeared"



"I don't believe transducers are the bottleneck"



"One can conceive of ... a sort of space box"

TUNNEL DIODES Part I Using

First of a four-part survey discusses oscillator principles, stability criteria, electronic tuning circuits, temperature-frequency monitoring, wide-frequency operation, and ability to control remote receivers. Succeeding parts will cover amplifiers, mixers and converters, and switching circuits

By ERICH GOTTLIEB and JOHN GIORGIS, Consultants
GE Semiconductor Products Division, Syracuse, New York

FIVE YEARS have passed since the invention of the tunnel diode. Semiconductor manufacturers and users have investigated a great many of the potential applications for this device and the widespread interest is reflected in the great number of papers published in the literature since 1958.

The scope of this article is to check the "boxscore" of achievements to date. Emphasis is put not on the purely analytical achievements nor on crystal-ball forecasts but rather on the practical present and future uses of the tunnel diode.

In the early tunnel diode days its simple characteristics and two-terminal aspects prompted some exciting forecasts. Here was a device, which, with the simplest of circuits, could oscillate, amplify, convert, switch and even do several of these things simultaneously. It could do all these things at high speeds or frequencies with minute power consumption under extremes of temperature and nuclear radiation. Its small size would permit large packing densities while its light weight and simple circuitry would reduce equipment weight.

Generally speaking, all these claims were legitimate. However, in industry a device must enjoy quantity acceptance or it tends to become a high-priced specialty item. Mass acceptance reduces manufacturing costs which when passed on to the user promotes yet greater market acceptance. To obtain this industrial chain reaction, the device must offer competitive advantages not only in unit cost but also in

- Ease of design
- Total system cost
- Competitive circuit or system performance
- Reproducibility in manufactured equipment

The tunnel diode must compete in these areas with other devices, not only such solid-state ones as the transistor or parametric diode, but also with tubes, masers, and even electromechanical arrangements of relays, wiping contacts, pressure transducers, microphones, and so on. These considerations have influenced both the semiconductor applications engineer and the semiconductor circuit designer in their task of finding hardware uses for the device.

In the second half of 1959, tunnel diodes left the research stage and became available to the circuit designer. It became apparent quickly that the device although seemingly physically simple, is electrically complex. In those days the

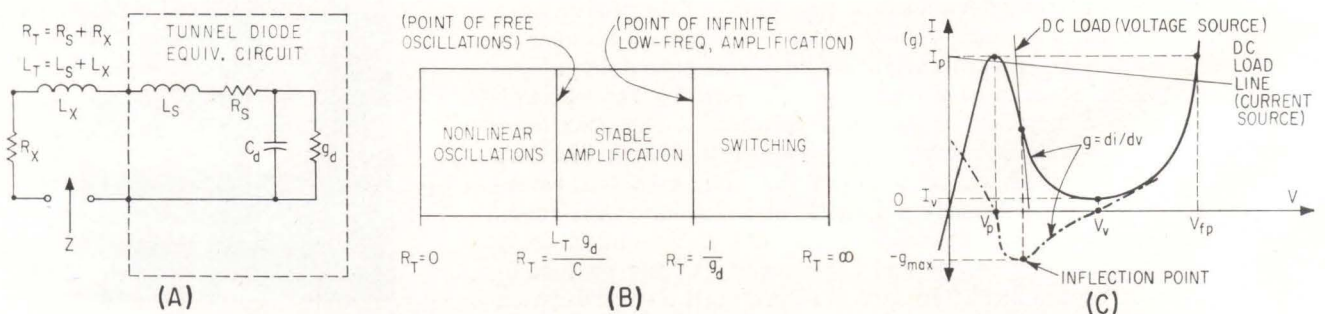

EQUIVALENT circuit of tunnel diode and its external circuit (A), graphical conditions for operating-stability (B), and evolution of tunnel diode package for minimum self-inductance, (photo, right)—Fig. 1

Them as Sinusoidal Generators

electronic circuit designer needed considerable help to understand the device and its operation. This need was quickly filled by a number of articles (see references) some of which have become classics.

UNDERSTANDING THE DEVICE

—The first essential requirement in applying the tunnel diode is to understand the equivalent circuit, Fig. 1A, and its stability conditions. A fundamental article⁴ analyzed this problem and illustrated it by a simple graph relating the parameters of the equivalent circuit of the diode, Fig. 1B, to stability.

The tunnel-diode V-I characteristic, Fig. 1C shows where to place the operating point for any given application. Thus, for an amplifier, oscillator, or self-oscillating converter, the tunnel diode must operate in the negative conductance part of the curve. In staying stably biased in these nonswitching applications the bias must come from a voltage source. For switching applications on the other hand a current-source drive will keep the operating point below the peak current point until a trigger pulse is applied. If this trigger pulse, when added to the operating bias current, is large enough to exceed the peak current, the operating point is tripped to a higher voltage state beyond the valley, thereby exhibiting a low voltage OFF state and a higher voltage ON state.

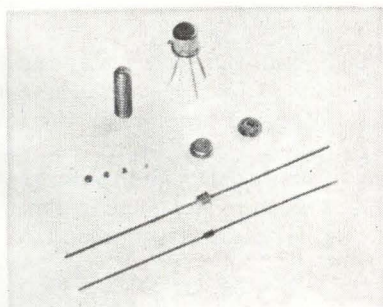

voltage-current and I-V character-

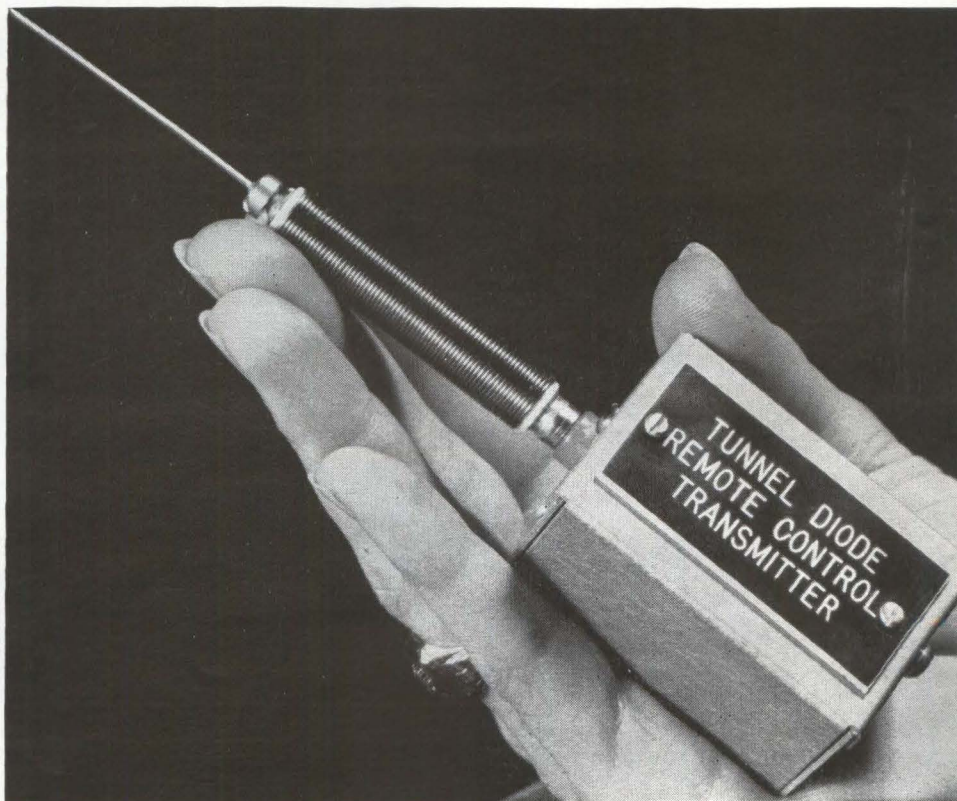

REMOTE-control transmitter features circuit simplicity, component economy, and long life from low-voltage batteries

The stability graph, Figure 1B, shows that an exact ratio of R_T , L_T , g_d and C_d must be maintained for the amplifier circuit's operation to stay within the boundaries of $R_T = L_T|g_d|/C_d$ and $R_T = 1/|g_d|$. Of these parameters, R_T is the total circuit series resistance, L_T the total circuit series inductance, C_d the diode's capacitance and $|g_d|$ is the absolute value of (negative) conductance.

The closer R_T gets to $1/|g_d|$ the greater the gain becomes, until, at $R_T = 1/|g_d|$ infinite gain is reached. At this point the circuit is prone to switch its operating point to the ON state and hence this point is unstable. On the other hand, if R_T is made equal to $L_T|g_d|/C$, the circuit will start breaking into sinusoidal oscillations. Lowering R_T further will increase the strength of these os-

cillations until the limit cycle reaches a contour V_p to V_{rp} down to V_v and back up to V_p (see Fig. 4D, p 40) constituting a relaxation-mode oscillation. This well defined stable ratio of circuit and device constants is not always easy to maintain since the negative conductance of the tunnel diode varies nonlinearly with bias voltage and temperature. Although the tunnel-diode capacitance varies slightly with voltage also, this is not generally a problem. The magnitude of the inductance of the diode package, however, is an important stability impediment and tunnel-diode packages of 6 to 12 nanohenry inductance have gradually given way to low inductance housings of 0.1 to 0.5 nh as seen in Fig. 1D.

Some of the early technical papers^{5, 6, 7} described converter appli-

cations; others^{8, 9, 10, 11} discussed noise topics, while still more papers^{12, 13, 14, 15} considered oscillator operation. Further papers on logic applications of tunnel diodes^{16, 17, 18}

helped set the foundation of technical knowledge.

TUNNEL-DIODE OSCILLATORS

—Tunnel-diode oscillators are at-

tractive because of their high frequency capability, low power consumption, good frequency stability, and circuit simplicity. These advantages enable a designer to produce stable miniature oscillators with a wide variety of uses as will be described in due course. The disadvantage of the tunnel diode is primarily its low power output owing to the small fixed voltage-swing between peak and valley.

The tunnel diode's negative conductance characteristic lends itself ideally to use in oscillator circuits. All the circuit designer has to do is to bias the device from a voltage source (making $R_T < |R_d|$) and adds sufficient inductance to the circuit such that

$$L_T(\omega) = R_T(\omega)C/|g_d| \quad (1)$$

When $L_T \approx R_T C/|g_d|$, the oscillation amplitude is small but reasonably sinusoidal. Increasing L_T increases the oscillator's amplitude and this expanding limit cycle eventually swings beyond the peak and valley points yielding a great deal of harmonic content.

Oscillator design starts with the choice of diode capable of delivering the required power output at the desired frequency. The maximum quasi-sinusoidal output obtainable from a tunnel diode is then given by

$$P_{o \max} = \frac{1}{8}(V_v - V_p)(I_p - I_v) \quad (2)$$

At this point the oscillator amplitude swings from peak to valley. The bulk of today's tunnel diode usage is in germanium units having typical peak voltages (V_p) of 65 mv, valley voltages (V_v) of 350 mv and peak-to-valley ratios (I_p/I_v) of eight. Hence a rule of thumb would make

$$P_{o \max} \approx \frac{1}{8}(0.35 - 0.065)(0.875I_p) \approx \frac{I_p}{40} \quad (3)$$

or

$$I_p(\min) \approx 40P_o \text{ (required)} \quad (4)$$

The required power determines the peak current of the diode since the voltage parameters of the tunnel diode are fixed by the semiconductor material. The conductance of the diode is also heavily dependent on the peak current since

$$g_d = d_i/d_v \text{ (for large swings } G_d = \Delta I/\Delta V \text{)} \quad (5)$$

Therefore the maximum voltage swing $\Delta V_{\max} = V_v - V_p$. These

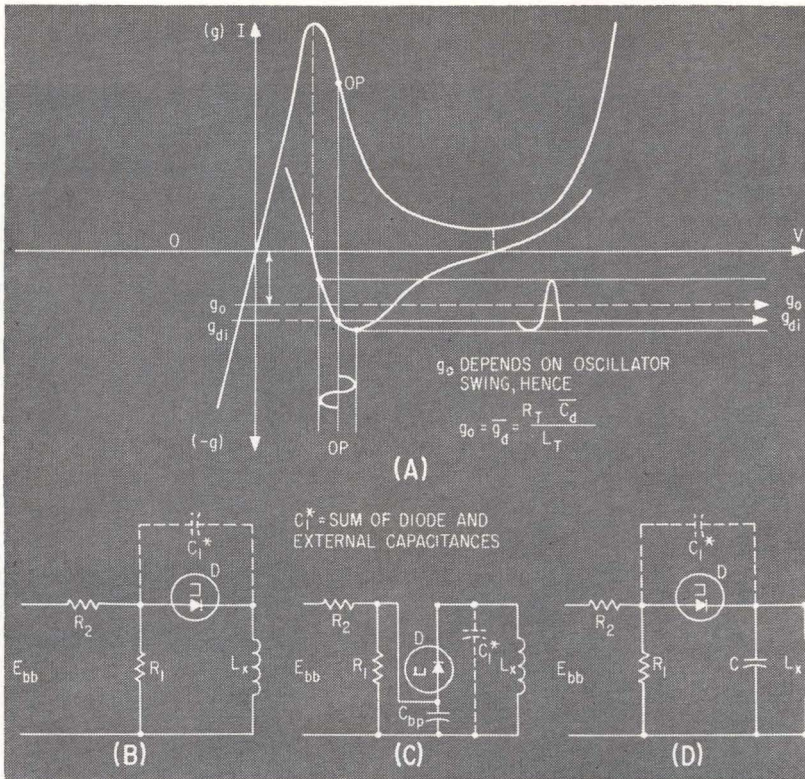

GRAPHICAL determination of time-average conductance $g_d(t)$ and of its average value $|g_o|$ (A). Lumped-constant circuits: series configuration (B), parallel circuit (C), series-parallel version (D)—Fig. 2

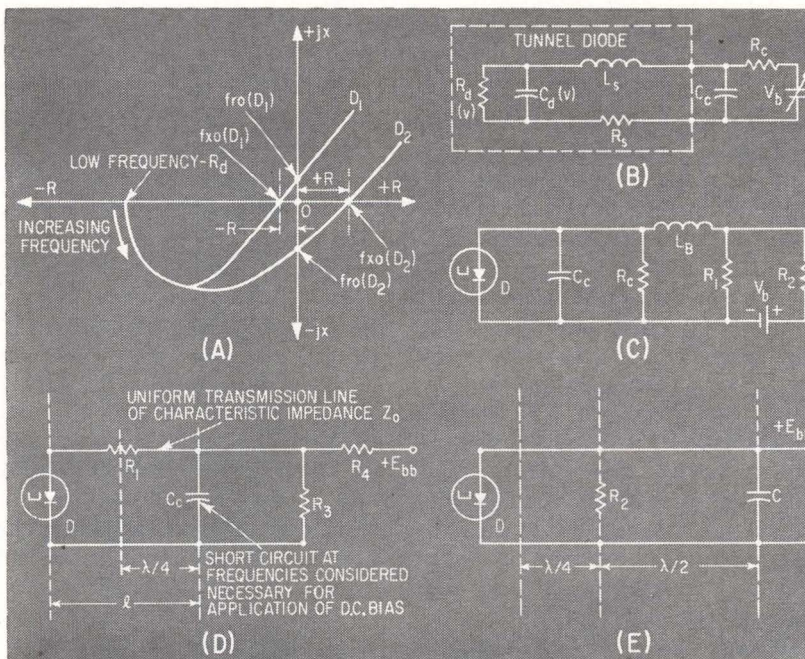

NYQUIST plot of tunnel-diode impedance-versus-frequency characteristic (A), theoretical oscillator circuit (B), practical circuit (C); series suppression of lower-frequency oscillations (D), parallel suppression of unwanted lower-frequency oscillations (E)—Fig. 3

voltages are fixed by the semiconductor material, hence only a change in the maximum ΔI will give an equivalent change in (large signal) conductance.

In an oscillator circuit, two conductances are important

- The initial *starting* small-signal conductance (g_{st})
- The *steady-state* large-signal conductance (g_o)

If the stability criteria is met, namely that there be a resonant circuit such that $I_m |Y| = 0$ and that there be effective negative resistance left in the circuit, such that $R_s |Y| < |g_{st}|$, the circuit will start to oscillate. Thus the starting of the oscillator depends on small-signal parameters. As the oscillations expand, they are limited by the losses in the circuit, expressed by

$$g_o = R_T \bar{C}_d / L_T \quad (6)$$

For a given L/C ratio, R_T determines the minimum value of g_o . If R_T is small, g_o becomes small, which means a large oscillator swing, Fig. 2A.

A designer can choose from several circuits, each with its own specific advantages. Choices are

- the series oscillator
- the parallel oscillator
- the series-parallel oscillator

For lumped-constant circuits, Figs. 2B, 2C and 2D, the series arrangement yields the highest operating frequency, since if C_1 is the diode capacitance (C_d) and C is eliminated, then both the parallel and the series-parallel circuits revert to the series connection. The maximum frequency of oscillation in this mode is

$$f_{o \max} = \frac{1}{2\pi} \sqrt{\frac{1}{LC} - \left(\frac{R_T}{L_T}\right)^2} \quad (7)$$

At lower frequencies, the series circuit would have to add C_1 across C_d to use reasonable L/C ratios. It is generally more convenient and stable to use the series-parallel connection. In this mode, the oscillation frequency⁽⁵⁾ is

$$f_o = \frac{1}{2\pi} \sqrt{\frac{1}{L_T(C+C_1)} - \frac{g_d^2}{C_1(C+C_1)}} \quad (8)$$

In the parallel oscillator circuit, R_T is bypassed (considering the d-c coil resistance negligible) which increases the limit cycle and the oscillator amplitude to yield a larger but nonsinusoidal output. To obtain a sinusoidal output from this

THERE was a time when it was possible for one man to comprehend all contemporary scientific knowledge. That time is long past. Nowadays, it puts a researcher on his mettle to keep abreast of developments in his own field—and usually his own field is a subdivision of a much broader discipline.

Tunnel diodes are a subdivision of the solid-state electronics art, which in turn is a subdivision of the total electronics effort. Yet in the five years since Esaki's celebrated paper on tunneling effects, the volume of technical tunnel diode literature, ranging from basic physics to circuit applications, has expanded enormously. Following tunnel diode developments has become a major effort.

In this and subsequent sections of a four-part survey on tunnel diode applications, authors Gottlieb and Giorgis have collated a wide range of application data and presented their material in easily assimilated form

connection, R_T must be considered to be only the series resistance of the diode (plus the d-c coil resistance) and the L/C ratio adjusted such that the limit cycle is kept small, which occurs when

$$R_s \approx \bar{g}_d L_T / \bar{C} \quad (9)$$

This means that the L/C ratio must be drastically reduced.

MICROWAVE OSCILLATORS —

At microwave frequencies, two basic modes of operations are possible

- Operation *below* the self-resonant frequency of the diode (f_{ro}).
- Operation *above* the self-resonant frequency of the diode.

The Nyquist plot of impedance versus frequency (Fig. 3A) shows that the diode has two characteristic frequencies. When the real part of the tunnel diode impedance goes to zero, the resistive cut-off frequency (f_{ro}) is reached since beyond that frequency there is no remaining negative resistance. Hence no active gain or oscillation can be obtained from this device as it exhibits only positive resistance and either inductive or capacitive reactance. The second frequency occurs where the imaginary part of the impedance goes to zero, hence, where the diode inductance and capacitance resonate. Below this frequency the device looks capacitive, above, it looks inductive. Figure 3A shows the two diode characteristics. Diode D_1 reaches f_{ro} before reaching f_{ro} , while diode D_2 reaches f_{ro} first. This means that

when D_1 reaches f_{ro} it still has a certain amount of negative resistance left and hence theoretically it could oscillate beyond f_{ro} . Diode D_2 , however, has passed f_{ro} first, hence has no negative resistance left and therefore cannot oscillate above f_{ro} (where f_{ro} is located). Assuming two diodes exactly identical in C_d , $|g_d|$, I_p , R_s and all other parameters, the difference between these two diodes can be found in the series inductance of the housing (L_s) as shown by Eq. 10 and 11

$$f_{ro} = \frac{|-g_d|}{2\pi C_d} \sqrt{\frac{1}{|-g_d| \cdot R_s} - 1} \quad (10)$$

$$f_{xo} = \frac{1}{2\pi} \sqrt{\frac{1}{L_s C_d} - \frac{|g_d|^2}{C_d^2}} \quad (11)$$

These equations show that both capacitance (C_d) and conductance ($-g_d$) are directly proportional to the peak current (I_p), hence to junction area. The resistive cutoff frequency is thus not affected by junction size or peak current (to a first approximation). The self-resonant frequency does, however, depend heavily on junction area, and therefore on peak current. If I_p is large, g_d^2/C_d^2 becomes appreciable compared to $1/L_s C_d$. When $1/L_s C_d = |g_d|^2/C_d^2$ the device ceases to function as a sinusoidal oscillator. Therefore a high current (high power) device generally has a low self-resonant frequency and high cut-off frequency. To obtain relatively high power (greater than 1 mw) at high frequencies with one diode, the series inductance (L_s) must be re-

duced. This can be done by using a circuit that presents a capacitive reactance at the resonant frequency, thereby tuning out some of the internal device inductance. Figure 3B illustrates a lumped-constant circuit¹⁴ of this kind.

In Fig. 3C, C_c is the capacitance necessary to tune out the undesirable tunnel diode inductance and R_c is the bias resistance whose d-c value is smaller than $|-R_d|_{d-c}$. Since $|-R_d|_{d-c}$ decreases as the cut-

off frequency is approached, its operating-frequency value will be smaller than R_c . The bias-circuit inductance, L_p , has now been put outside the main oscillator loop. Another paper¹² describes a similar approach using transmission-line techniques shown in Fig. 3D and 3E. The "negative inductance" is obtained by using a short-circuited transmission line having length $\lambda/4 < L < \lambda/2$ at the desired oscillation frequency. However, at a lower fre-

quency, the shorted line behaves like an inductance which can satisfy another resonance condition, so that oscillations can occur simultaneously at two frequencies. This undesirable lower frequency oscillation generally becomes the dominant mode and should be suppressed. Figures 3D and 3E show two possible strip-line circuit configurations used to suppress these undesirable oscillations where resistors R_1 and R_2 are damping resistors.

Straight strip cavity oscillators¹⁴ with 10 mw output at uhf have been reported. Other tuned elements such as reentrant-strip-cavity, ridge-waveguide and strip-waveguide have reportedly been used up to X band. Low-power fundamental oscillations have been reported up to 103 Gc (2.9-mm wavelength),¹⁹ and a further paper²⁵ uses the 1N3219A "S" band diode at "X" band frequencies. This paper gives a detailed view of the waveguide structure and tunnel-diode mount.

In a more recent paper,³⁰ an improved version of this oscillator is discussed. The increased circuit performance lies in the reduced r-f leakage of the tunnel-diode waveguide mount. The improved circuit yields higher power output and a greater tuning range (about 750 Mc) in the 8-9 KMc region. A 10-db power increase over the performance obtained in an earlier paper²⁶ (-15 dbm) is claimed using the same 1N3219A ($I_p = 2.2$ ma) tunnel diode.

MULTI-DIODE OSCILLATORS—

A paper given at the 1962 International Solid-State Circuits Conference discussed a 4 mw, 6 KMc distributed tunnel-diode oscillator.²⁹ This oscillator consists of two or more diodes placed in a half-wave cavity structure, Fig. 4A.

QUARTZ-CRYSTAL CONTROL—

The design of quartz-crystal-controlled tunnel-diode oscillators is an interesting problem. In tube or transistor circuits, the crystal can be inserted in many ways to lock the oscillator. It can be inserted in the main feedback loop to make the feedback effective at resonance only. Since the tunnel diode has only two terminals and no external feedback, introduction of crystal

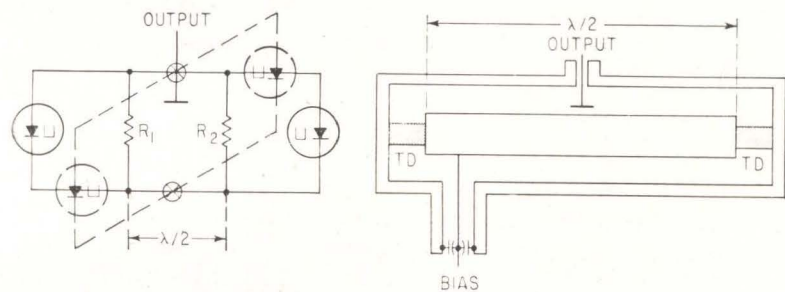

MATERIAL	(MA)	(MW)	FREQ. (GC)
Ge	40	1	6
Ga As	45	1.5	3
Ga As	80	3	6
Ga As	100	4	6

(A)

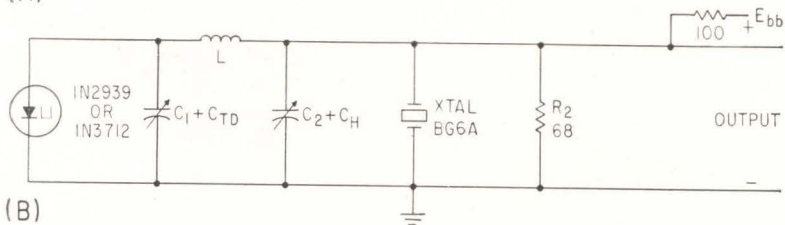

(B)

$$R < |R_{dl}| \quad R = \sqrt{L/C} \quad Z_{IN} = R \left(1 + \frac{R}{R_{CR}} \right)$$

WHERE R_{CR} IS SERIES-RESONANT RESISTANCE OF QUARTZ-CRYSTAL.

$$\text{FOR OSCILLATIONS: } \begin{cases} \text{Re } |Y| < |G_d| \\ \text{Im } |Y| = 0 \end{cases}$$

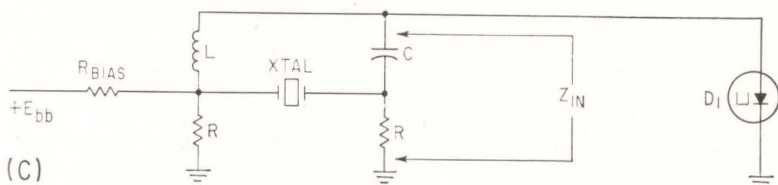

(C)

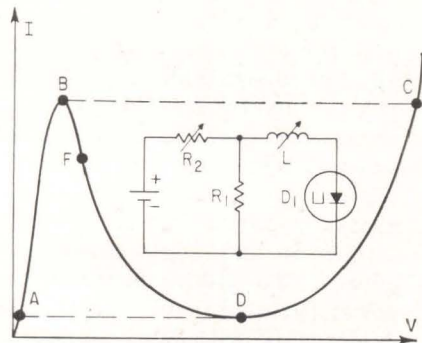

(D)

EQUIVALENT and practical circuits of multi-diode oscillator (A) with test results; crystal oscillator for 40 Mc (B), alternative oscillator locks onto 5th overtone of crystal at 160 Mc (C), characteristic curve traces operation of tunnel diode as it executes cycle of operation (D)—Fig. 4

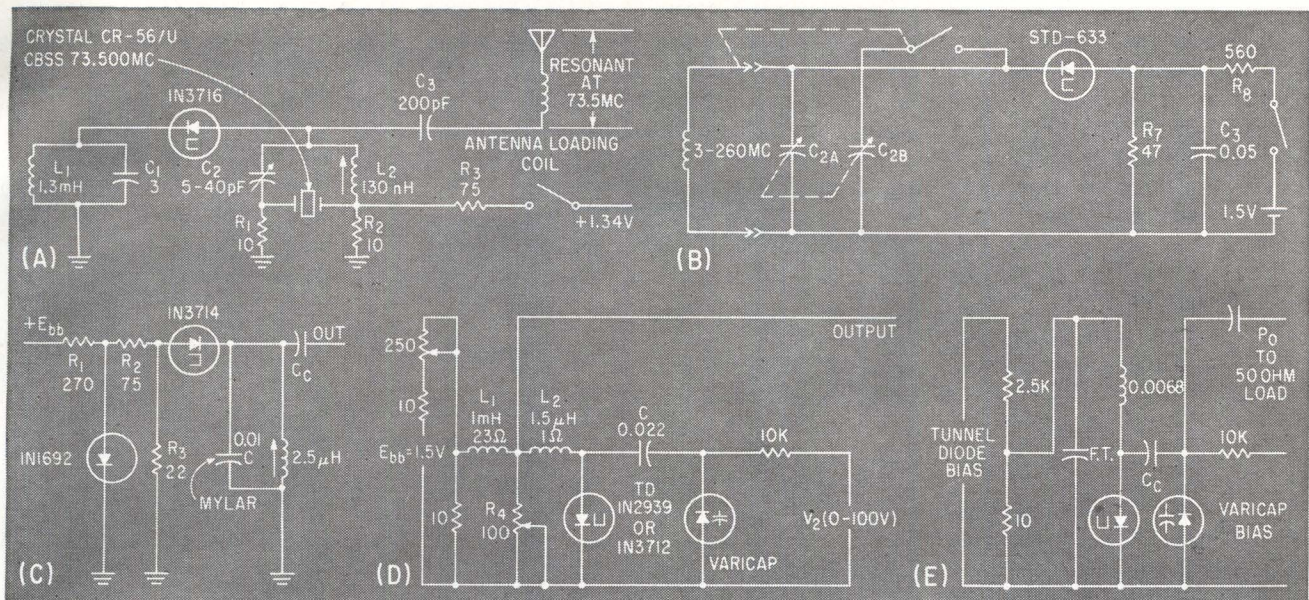

SELF-MODULATED low power transmitter (A) operates at 73.5 Mc; wide range oscillator (B) covers range 3 to 260 Mc using different plug-in tuning coils. Temperature-sensing oscillator changes frequency with changing temperature (C), voltage-variable capacitor enables oscillator to be tuned electrically over the 12-22 Mc range (D); high-frequency electrically tuned oscillator operates in the 200 to 400-Mc range (E)—Fig. 5

control is less straightforward. If a crystal is simply shunted across a tank circuit, it will lock in only weakly.

A more sophisticated crystal-controlled circuit discussed in the literature²² claims frequency variations of $7.5/10^6$ per degree centigrade in a 40-Mc oscillator. (Fig. 4B). This circuit works on the basis of matching the crystal impedance (10-30 ohm range) to the tunnel diode (1N2939 and 1N3712 have approximately 120 ohm negative R_d) by the use of a pi network.

Another extremely stable crystal-controlled oscillator^{23, 24} oscillates only at the series-resonant mode of the quartz crystal, Fig. 4C, and is said to exhibit excellent lock-in characteristics up to the 9th overtone (roughly 100 Mc) and some lock-in action up to the 15th overtone (about 160 Mc)²⁵.

The value of R is made slightly smaller than $-R_{di}$ at the operating point. This gives bias stability and prevents the circuit from oscillating at an undesired frequency. The L-C circuit is tuned to the series-resonant frequency of the crystal where the crystal appears as a low resistance. The resulting high impedance of the tank circuit is now in series with the parallel combination of the two equal-valued resistors (R). It is necessary that the series resonant crystal resistance

(R_{cr}) is small compared to R .

This high value of resonant impedance is now sufficient to permit the circuit to oscillate stably. The impedance seen by the crystal is

$$Z_{in} = R (1 + R/R_{cr}) \quad (12)$$

TUNNEL DIODE CHRONOMETER—One of the applications of this quartz crystal controlled oscillator circuit is in a ultra-table chronometer having a maximum error of only a few seconds per year⁽²⁶⁾.

In this circuit, tunnel diodes are also used as stable frequency dividers for division by 10, 10 and 20 respectively. The divider circuits are of the synchronized relaxation oscillator type. A tunnel-diode clock is shown, lower right.

REMOTE CONTROL TRANSMITTER—A 73.5 Mc crystal controlled oscillator was designed for use as self-modulated low-power transmitter.

This unit has sufficient energy to remote-control toys, trains, garage doors; it can also be voice modulated. Figure 5A shows the oscillator circuit^{20, 21}. The design of this circuit starts with the choice of diode to get adequate range. A 1N3716 diode having a peak current of about 4.7 ma was selected to give a power output of approximately 120 microwatts.

For the IN3716, tunnel diode $|g_{di}|$ at 130 mv is approximately 33 ohms.

In this circuit, Fig 5A, when $X_c = X_L$ at 73.5 Mc, L was calculated to be only about 22 nanohenries and C about 218 pf.

To use a more practical L/C ratio, L was increased to 130 nanohenries and C reduced to 35 pf. The effect was to reduce g_o , hence oscillations were larger (more output power) but distorted. The output taken across the tank circuit helps clean the waveform, however. The diode is operated at 130 mv and about 2.5 ma and the total battery drain is approximately 18 ma at 1.34 v. Line-of-sight transmission of 200 yards was achieved. The oscillator

TUNNEL diode clock features accuracy considerably better than maritime chronometers

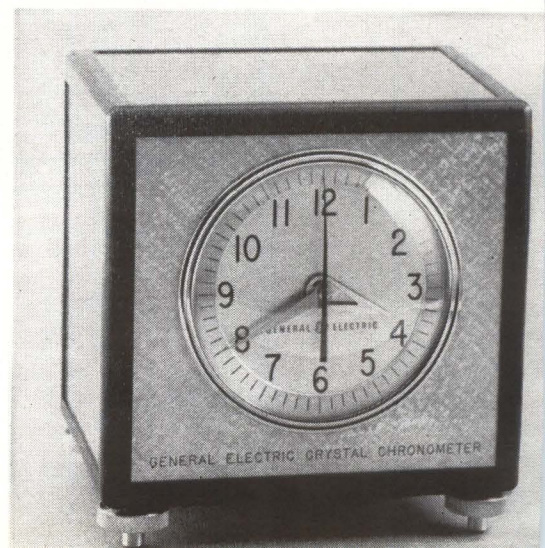

is self-modulated by an audio tank circuit (L_1 and C_1). The resulting audio tone activates a relay in the receiver. In place of L_1 and C_1 a microphone and a one-stage transistor amplifier to voice-modulate the transmitter could be used. External pulse modulation can be fed to the oscillator in a similar manner.

Frequency modulation is obtained by the conductance and capacitance variation of the diode when the d-c bias is voice modulated.

WIDE-RANGE OSCILLATOR —

One example of such a circuit is the Heathkit Tunnel Dipper, a tunnel-diode dip meter tunable from 3 to 260 Mc. The simplified oscillator portion of this circuit is shown in Fig. 5B.

This oscillator circuit is essentially of the parallel type, since C_3 bypasses R_7 . The reason for this is to enhance the oscillator amplitude at the high frequency end. The diode is a low current, low capacitance axial unit. The circuit is tunable over the 3-260 Mc band in 6 ranges of 3-7, 5-13, 12-32, 30-90, 80-160, and 150-260 Mc, using plug-in circuits. Capacitor C_{2a} tunes with each coil to cover the required band. Capacitor C_{2b} is in parallel with C_{2a} on the four lower frequency ranges only. This gives a smaller L/C ratio necessary at these lower frequencies

to obtain clean sinewave operation of the oscillator. (R_7 being bypassed, is small, making $R_7/|g_d|$ small. To maintain reasonable sine-wave oscillations $R_7/g_d = L_r/C_r$, hence L/C must be reduced.

A recent article²¹ discusses a tunnel diode r-f generator covering the 170 Kc to 46 Mc range in 5 bands of about 3/1 spreads.

TEMPERATURE SENSITIVITY—

A tunnel-diode oscillator can be made deliberately temperature-sensitive by the use of a capacitor or inductor with known and repeatable temperature characteristic.

The circuit shown in Fig 5C is a conventional series-parallel tunnel diode oscillator in which the sensor is a Mylar capacitor with known and reproducible temperature-versus-capacitance characteristics. To take care of frequency shifts due to bias-changes, a diode bias regulator circuit is used.

ELECTRONIC TUNING —

The simplest electronically tuned tunnel-diode oscillator uses the fact that $|g_d|$ can be varied with bias voltage. In the simple series oscillator for instance, the oscillator frequency is

$$f_o = \frac{1}{2\pi} \sqrt{\frac{1 - R_7 g_d}{LC}} \quad (13)$$

This expression shows that a variation of bias, which changes $|g_d|$, can affect f_o . One paper²⁵ on a

microwave oscillator discusses a circuit with a 12 percent tuning range.

EXTENDED-RANGE TUNING —

To extend electronic tuning ranges further, Varicaps can be used in conjunction with the tunnel-diode oscillator. Frequency ranges of almost 2:1 have been reported^{27, 28}.

One²⁷ low-frequency circuit, uses a 1N2939 germanium tunnel diode and a PC-117-47 Varicap with a maximum supply voltage of 60 volts. With a tunnel-diode bias of 150 mv, it achieves a tuning range of from 12-22 Mc by varying the Varicap bias from 0.4 to 60 v, Fig. 5D.

The high-frequency circuit operating in the 200-400 Mc range, Fig. 5E uses a higher-power tunnel diode capable of 0.6-milliwatt output.

Finally, a uhf varactor-tuned tunnel-diode oscillator has been described²⁸ having a power output of 0.45 to 0.65 mw delivered into a 50-ohm load. A voltage-variable capacitor, used above its self resonant frequency, is the tunable element. Using a 22-ma, low-inductance (0.3 nh) tunnel diode having a 20-percent capacitance variation for the voltage swings encountered, and a PC-117-Hi-Q Varicap having a capacitance change of 8 to 1 for a ΔV of 100 v below 400 Mc, a 600-900 Mc tuning range was achieved.

REFERENCES

1. I. Lesk, N. Holonyak; U. Davidsohn, M. Aarons, Germanium and Silicon Tunnel Diodes—Design, Operation and Applications, *IRE Wescon Convention Record*, 3, 1959.
2. I. A. Lesk, N. Holonyak, U. S. Davidsohn; The Tunnel Diode—Circuits and Applications, *ELECTRONICS*, 32 p 60, 1959.
3. W. Chow; U. Davidsohn, Y. Hwang, C. Kim, G. Ober, Tunnel Diode Circuit Aspects and Applications, *AIEE Conference Paper CP60-297*, January, 1960.
4. U. Davidsohn, Y. Hwang, G. Ober, Designing with Tunnel Diodes, *Electronics Design*, Feb. 3, Feb. 17, 1960.
5. KKN Chang, G. H. Heilmeyer, and H. J. Prager, Low Noise Tunnel Diode Down Converter having Conversion Gain, *Proc. IRE*, p 854, May, 1960.
6. D. I. Breitzer, Noise Figure of Tunnel Diode Mixer, *Proc. IRE*, 48, p 935, May 1960.
7. C. S. Kim, Tunnel Diode Converter Analysis, *Trans. IRE*, P. G. E. D. September, 1961.
8. J. J. Tieman, Shot Noise in Tunnel Diode Amplifiers, *Proc. IRE*, p 1418, Aug. 1960.
9. E. G. Nielsen, Noise in Tunnel Diode Circuits, *Proc. NEC 1960*, 18, p 785.
10. R. LaRosa, G. R. Wilhelmsen, Theoretical Justification for Shot-Noise Smoothing in the Esaki Diode, *Proc. IRE (correspondence)* p 1903, Nov. 1960.
11. A. Yariv, J. S. Cook, A Noise In-

vestigation of Tunnel Diode Microwave Amplifiers, *Proc. IRE*, pages 739-743, April 1961.

12. C. S. Kim, J. B. Hopkins, High Frequency and High Power Operation of Tunnel Diodes, Digest of Technical Papers—1961 International Solid State Circuits Conference, Philadelphia, Pa., p 22.

13. R. Trambarulo, C. A. Burrus, Esaki Diode Oscillators from 3-40 Kmc, *Proc. IRE (correspondence)*, p 1776, Oct. 1960.

14. F. Sterzer, D. E. Nelson, Tunnel Diode Microwave Oscillators, *Proc. IRE*, p 744, April 1961.

15. E. Gottlieb, Tunnel Diode Sinewave Oscillators, *Electronic Design*, Aug. 2 and Aug. 16, 1961.

16. W. F. Chow, Tunnel Diode Logic Circuits, *ELECTRONICS* 33, No. 26, p 103, June 24, 1960.

17. E. Goto, et al, Esaki Diode High-Speed Logical Circuits, *IRE Transactions on Electronic Computers*, Vol. EC-9, p 25, March 1960.

18. R. C. Sims, E. R. Beck, Jr., V. C. Kamm, A Survey of Tunnel Diode Digital Techniques, *Proc. IRE*, p 136, January 1961.

19. C. A. Burrus, Millimeter Wave Esaki Diode Oscillators, *Proc. IRE*, p 2024, Dec. 1960.

20. E. Gottlieb, Tunnel Diode Oscillators—Don't Sell Them Short, *Electronic Design*, March 1963.

21. E. Gottlieb, J. F. Cleary, Tunnel

Diode Remote Control Transmitters, *Radio Electronics*, June 1963.

22. John J. Nagle, Crystal-Stabilized Tunnel Diode Oscillators, *Electronics*, p 40, Sept. 1, 1961.

23. R. L. Watters, A Quartz Crystal Controlled Tunnel Diode Oscillator, G. E. Research Lab Memo Report P. 203.

24. R. L. Watters, A Quartz Crystal Chronometer, *Electronics*, p129, Sept. 29, 1961.

25. K. Ishii, C. C. Hoffins, Extending Tunnel Diode Operating Frequency, *Electronics*, p 43, June 1, 1962.

26. J. K. Pulfer, Voltage Tuning in Tunnel Diode Oscillators, *Proc. IRE*, page 1155, June 1960.

27. K. Temple, GE. LMED, Advanced Electronic Center, Ithaca, N. Y. Private-Communication.

28. F. G. Haneman, G. W. Thomson, Varactor-Tuned Tunnel Diode Oscillator Now Practical, *Electronics*, p. 50, Sept. 21, 1962.

29. W. B. Hauer, A 4 mw, 6 Kmc Tunnel Diode Oscillator, *Digest of Technical Papers, 1962, International Solid-State Circuits Conference*, p. 68.

30. K. Ishii, C. C. Hoffins, Microwave Tunnel Diode Operation Beyond Cutoff Frequency, *Proc IRE, (correspondence)*, p. 370, Feb. 1963.

31. S. E. Bammel, Tunnel Diode Radio Frequency Generator, *Popular Electronics*, p. 44, Feb. 1963.

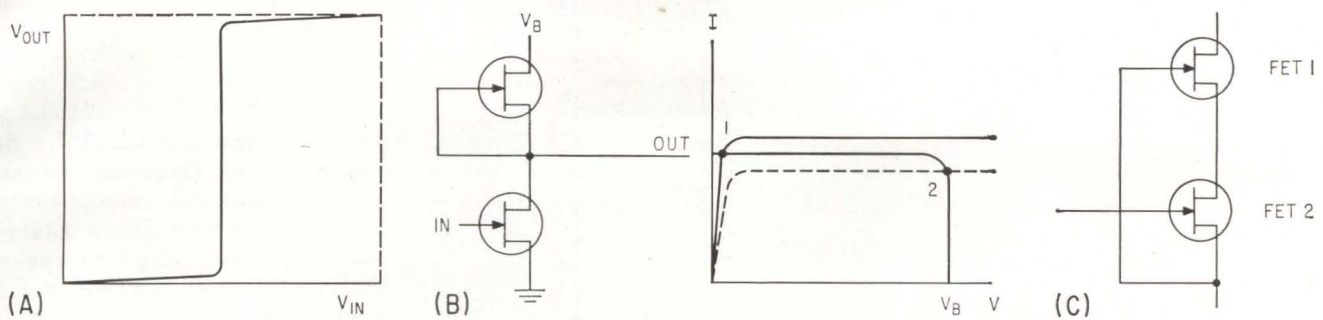

OUTPUT voltage versus input voltage for an ideal logic element (A); basic circuit for near-ideal output-input relationship and interaction of FET and current-limiter characteristics (B); and screen-electrode principle with two field-effect transistors (C)—Fig. 1

Put More Snap in Logic Circuits With Field-Effect Transistors

Circuits using field-effect transistors with a current-limiter load achieve a snapaction rapid transition between switching states with a very small range of input voltage

By G. CSANKY and R. M. WARNER JR., Semiconductor Prod. Div., Motorola, Phoenix, Arizona

FULL EXCURSION of output voltage in an ideal logic element occurs within a very small range of input voltage. Moreover, the output excursion should occur near the middle of the input range as shown in Fig. 1A. An analogous relationship between input and output currents would serve as well. This type of logic element is efficient because switching occurs within minimum input drive. Furthermore, large margins are allowed for the initial and final values of the input drive and a switching speed-up effect is realized to the minimum τ_{switch} of the logic element.

The ideal characteristic can be closely approximated in several respects by using a field-effect transistor¹ in combination with a current-limiter² load as shown in Fig. 1B. Here the characteristic of the current limiter is plotted as a load

line and is nearly parallel to the field-effect transistor characteristic over a wide voltage range. As a negative voltage is applied at the input, the transistor characteristic is driven down, and the intersection of the two curves moves very rapidly from point 1 to point 2. As a result, a behavior similar to that

shown in Fig. 1 is realized.

The transition can be adjusted to the center portion of the input range by proper selection of relative pinch-off currents. The speed of transition from point 1 to point 2 is dependent upon the transconductance of the field-effect transistor as well as the slope of the

SNAPPY LOGIC

Field-effect transistors are naturals for logic elements because switching occurs within minimum input drive when the FET's are combined with a current-limiter load. Moreover, both NAND and NOR functions can be performed with this circuit by varying FET and current-limiter diode pinch-off currents.

In this article, the authors describe the operation and applications of their circuit and point out the advantages that should allow it to find wide use

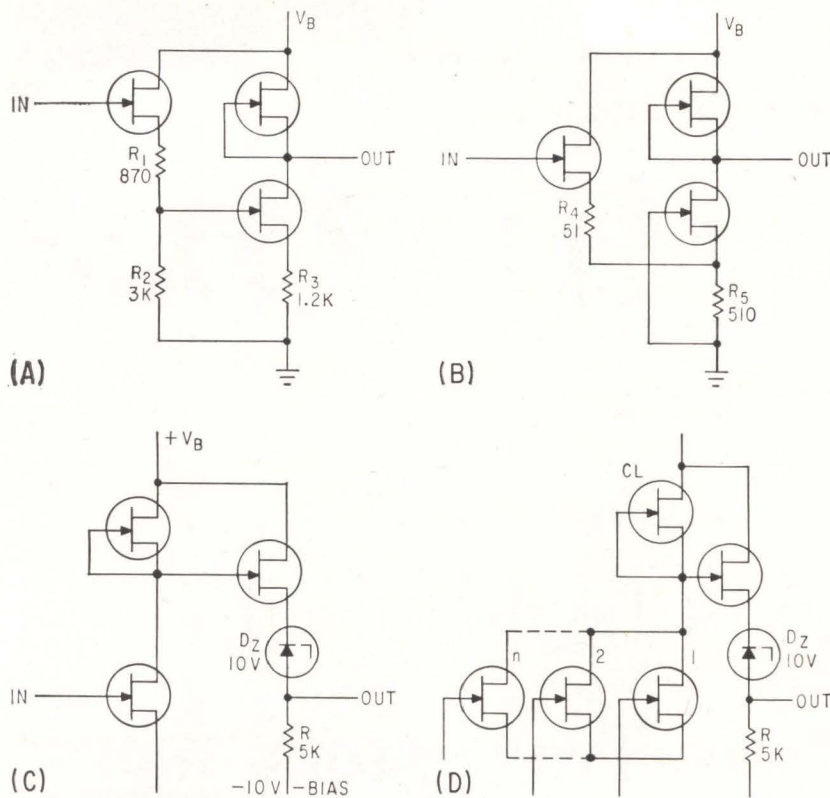

PHASE-INVERTING logic element with source follower (A); nonphase-inverting element with source follower (B); element with high fan-in/fan-out capability (C); and snap-action circuit for NAND and NOR functions (D)—Fig. 2

characteristic curves. Switching becomes more abrupt if the two interacting characteristics are flattened.

An appreciable increase in output impedance of a field-effect device can be achieved with the screen electrode principle.³ This principle may be applied to either or both of the devices shown in Fig. 1B. In the screen electrode principle two field-effect transistors are connected as shown in Fig. 1C. The basic requirement is that FET 1 has greater pinch-off current and voltage than FET 2. In this case, FET 1 will act like a voltage sponge; therefore, the drain of FET 2 will remain at a nearly constant voltage. This drain is the screen electrode which is analogous to the screen grid of a vacuum tube. This effect increases the output impedance of the field-effect transistor by two orders of magnitude; it has been shown experimentally that this reduces the switching time of the logic circuit comparably since the transconductance of the screen-electrode transistor is similar to that of FET 2 alone.

A steplike switching characteris-

tic can also be obtained with a negative resistance device under conditions where its characteristic makes multiple intersections with the load line during some portion of the switching cycle; however, in a case like this, hysteresis will occur. If the configuration shown in Fig. 1B is used, there is no hysteresis because the two characteristics intersect at only a single point during the entire cycle.

The circuit shown in Fig. 1B is a low-frequency configuration because the drain-gate capacitance imposes a frequency limitation that is similar to the Miller effect. During the transition from point 1 to point 2, the overall gain of the circuit approaches the μ of the field-effect transistor, and the input capacitance rises to a point where it has an important frequency limiting effect.

This circuit also poses a voltage translation problem. That is, negative voltages are required at the input, while positive voltages are delivered at the output. Therefore, a complementary element must follow this circuit, or a fairly large off-

set voltage must be provided.

MODIFICATION—Both problems can be solved with a slight modification of the basic element and two different solutions exist^{4, 5}. Both optimize the frequency response and eliminate the voltage translation problem by basically adding a source-follower stage to the circuitry. The two positions for the source follower lead to differing properties for the two circuits; however, both circuits make direct coupling possible (without voltage translation) and enhance frequency response. Moreover, they can be used to perform logic.

In case one, the source-follower stage is added to the input as shown in Fig. 2A. The source-follower voltage gain is close to unity so the effect of drain-gate capacitance is minimized. The output impedance of the source-follower stage is low, mitigating the high input capacitance of the field-effect transistor current-limiter combination.

The voltage translation problem is eliminated because the source of the field-effect transistor is kept above ground by R_3 ; therefore, the source-follower stage and voltage-divider R_1, R_2 can carry the gate of the field-effect transistor negative with respect to its source. Voltage divider R_1, R_2 is introduced only to compensate for voltage drop occurring in the field-effect transistor.

This circuit inverts the phase; if increasing voltage is applied at the input, decreasing voltage is delivered at the output. However, it is possible to modify the circuit so that it will be noninverting. A circuit that possesses all the advantages previously discussed and does not invert phase appears in Fig. 2B. Basically, it is a special type of difference amplifier with the snap-action feature added.

Logic functions can be performed with either phase-inverting or non-phase inverting circuits by the parallel connection of input source follower stages. However, in this way, NOR or OR circuits can be produced having a fan-in of only 3 to 5, because the range of currents permissible in the voltage divider is limited for satisfactory operation. The fan-out factor is also about 3 to 5 because of the high output impedance of the logic element that

is sensitive to capacitive loads.

In case two, a greater flexibility of circuit design is achieved with the added feature of high fan-in and fan-out. Here, the source-follower state is added to the output of the snap-action switch, as shown in Fig. 2C. This provides a low output impedance with the required voltage translation. Zener diode D_z acts as a level-translator voltage buffer; thus, approximately the full voltage swing is realized at the output of the source follower.

The input of the logic element is the gate of the field-effect transistor in the FET-CL combination. A great variation of input capacitance during the switching cycle is realized through the Miller effect; however, its effect is mitigated by driving with the source follower of a similar preceding stage.

Both NAND and NOR logic functions can be performed with this circuit by varying the pinch-off currents of the field-effect transistors and current-limiter diode. A circuit which will perform the two functions is shown in Fig. 2D. It is a single circuit and only the choice of current determines the type of function performed. If the currents of field-effect transistors 1 to n are selected so that when all are on, their current sum exceeds the current of the current-limiter diode CL, but will be less if any one is off, then the function performed will be NAND as this circuit inverts phase. However, if the drain current of any field-effect transistor 1 to n , if on, exceeds the current of the current limiter diode CL, the function will be NOR. This relationship is shown in Fig. 3A & 3B.

A limitation of the circuit shown in Fig. 2A is its relatively low fan-in and fan-out capability. The fan-in of the circuit shown in Fig. 2C and 2D is extremely high. An ultimate limitation is the value of the cut-off currents of the field-effect transistors. Another limitation for the NAND circuit is technological; how close can the drain currents of the FET's be held? The value of drain current is geometry dependent and therefore the problem reduces to one of geometry control. It appears possible to obtain a fan-in of 50.

The fan-out of the logic element is high too. When the logic element

is driven by a 10-Kc sinusoidal input having a peak value of 10 volts and operating into one and ten paralleled inputs, respectively, the waveform for ten inputs, though slightly distorted, is still quite satisfactory. A greater distortion of the output waveform results if the logic element is driven by fast pulses having a greater repetition rate.

An interesting feature of these elements is that if driven with a sinusoidal input, the switching time is a constant percentage of the complete cycle $1/f$ of the sine wave up to the maximum operational frequency. Also, the dimensionless factor of $f \tau_{switch}$ is constant within this frequency range.

It is possible to achieve snap action in a circuit analogous to that of Fig. 1B by substituting conventional transistors for the field-effect devices. The fact that an FET is voltage operated and can be self biased produces significant simplifications. Moreover, in all circuits, any kind of FET can be employed; that is, the principles are general and not applicable merely to an FET of certain special properties.

CONCLUSIONS—These elements cannot compete in speed at present with circuits employing conventional transistors, since the frequency range within which proper operation can be obtained is a few hundred kilocycles. However, in applications where speed is not a basic requirement, such as for peripheral equipment in computers, their advantages can be fully exploited.

In addition to snap-action and direct d-c coupling, these circuits have the potential advantage of very low power dissipation. This relates again to the fact that an FET is voltage operated, and that very low operating currents can be chosen.

Field-effect transistors can be easily integrated in a monolithic configuration, because the current axis of a field-effect transistor integrated circuit lies in the plane of the wafer, rather than normal to it. Since certain electrical parameters are geometry dependent, simple concentric patterns can be used to integrate the circuit.

Finally, an advantage of the circuits is temperature compensation, because both the current limiter and field effect transistor have the same relative temperature coefficient. This means that the shift in operating point caused by temperature variation is small. In addition, the negative temperature coefficient of the devices will prohibit the thermal runaway of the circuits, making it a useful tool for higher temperature operation.

REFERENCES

- (1) W. Shockley, A Unipolar "Field-Effect" Transistor, *Proc. IRE*, 40, p. 1365-1376; Nov 1952.
- (2) R. M. Warner, Jr., et al., A semiconductor Current Limiter, *Proc IRE*, 47, p. 44-56; Jan 1959.
- (3) G. Csanky, The Screen Electrode Principle with Field Effect Transistors, to be published.
- (4) G. Csanky and R. M. Warner, Jr., Two New Compatible Logic Elements, Digest of the 1963 *ISSCC*, p. 30-31, Feb 1963.
- (5) G. Csanky and R. M. Warner, Jr., High Input Impedance, Low Output Impedance, Snap-Action Logic, Digest of the 1963 Pacific Computer Conference, p 5-7 March 1963.

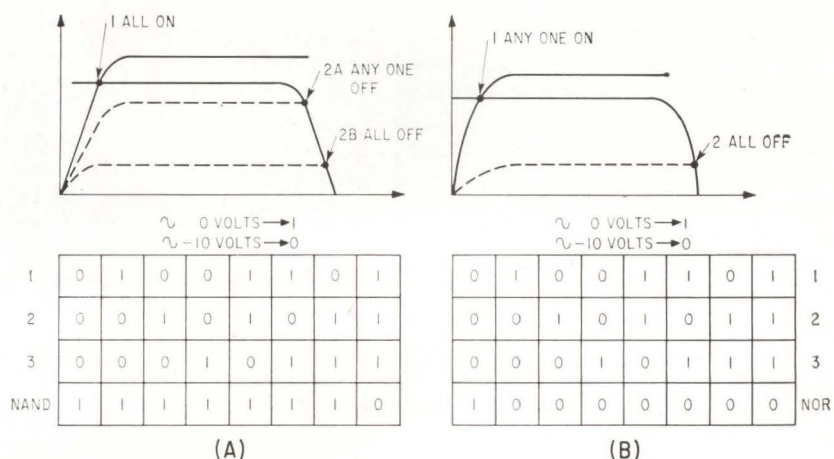

NAND function and table for 3 inputs (A) and NOR function and table for 3 inputs (B)—Fig. 3

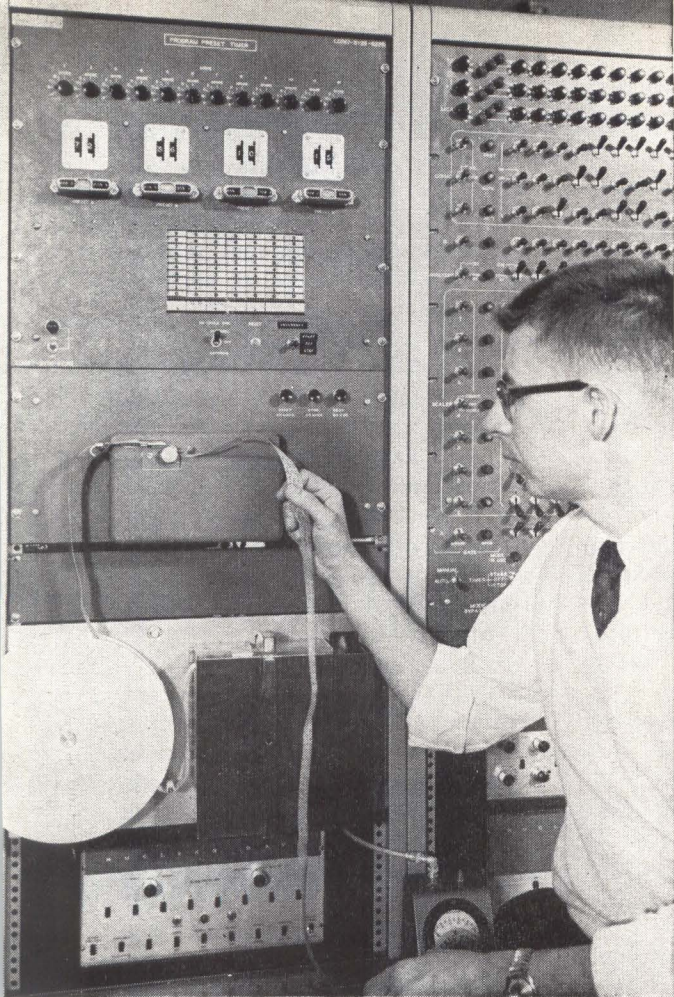

CO-AUTHOR Pecina inspects paper tape punch on the electronic timing equipment

By RONALD PECINA and THOMAS EVANS*
Argonne National Laboratory, Argonne, Illinois

Taking Human Error

THE ELECTRONIC TIMER described here provides both flexibility and accuracy. Time intervals can be varied from 0.1 sec to over 24 hrs with an accuracy dependent on the frequency standard used.

Figure 1 gives a breakdown of a programmed experiment where a number of runs make up an experiment. Each run has a set-up time and an active time interval. Set-up time is used to select the instruments and rotate the positioning equipment for the next run. At the same time, data from the previous run is read out. Active time intervals, ΔT_1 , ΔT_2 — ΔT_n , are independent preset intervals during which data is accumulated.

SYSTEM COMPONENTS—The active time interval is controlled by the present timer. The timer includes a multiple preset six decade counter with binary coded decimal (bcd) outputs. Preset switches connected to the decade output lines control the counting interval.

The programmer is a seven-level paper-tape reader. Six levels are decoded to give sixty-four command characters, which controls position, mode, and readout commands.

The program tape format includes a position, mode select, and readout command. The experiment is controlled by the tape program and the preset timer. Active time of a run depends on the timer capacity, while the only limit to the number of runs in an experiment is the quantity of programmed tape available. When a number of runs are identical, or cyclic, the program tape can be a closed loop. An experimental run includes the steps laid out in Fig. 2.

While readout onto punched paper tape is in progress, the program reader gives the next positioning command. This allows the two dead time processes of data readout and positioning to occur simultaneously.

OPERATION—The timer scaling unit (Fig. 2B) consists of six decimal counting units (dcu) and

AUTOMATED RESEARCHER

In many nuclear experiments where large amounts of data are collected, processed, and then further analyzed by computers, the experimenter can be relieved of time consuming operations by using a programming device. The equipment described allows for unattended operation where positioning devices are automatically controlled, and where detectors, gates, gate combinations, counters and pulse height analyzers are automatically selected in programmed combinations to collect data

* Presently attending Northwestern University.

Control unit decides when to take measurements and what to measure, and also reads out data at intervals onto magnetic or punched-paper tape

Out of NUCLEAR EXPERIMENTS

a seventh unit is a scale of six. The time base input can be either the 60 cycle line frequency or an external reference oscillator. When line frequency is the time base, the scale of six counting unit converts the 60 cps to 10 cps. Output pulses, occurring at 0.1 second rate, are counted in the six decade scaling unit. The full count capacity gives a time interval of 99,999.9 seconds. Each decade has four bcd output lines (1, 2, 4, 8 weights). The coded output lines of a decade connect to a thumbwheel switch. This is a 10 position printed circuit switch whose contacts are arranged to accept the four line bcd input. An output is produced when the count registered in the decade agrees with the number showing on the switch. For example, referring to Fig. 3, when a 7 is preset on the switch, the 1, 2, and 4 weight lines of the decade connect to the corresponding input lines on the switch. The 8 weight line is opened by the switch. When the decade registers 7, all three inputs to the switch are posi-

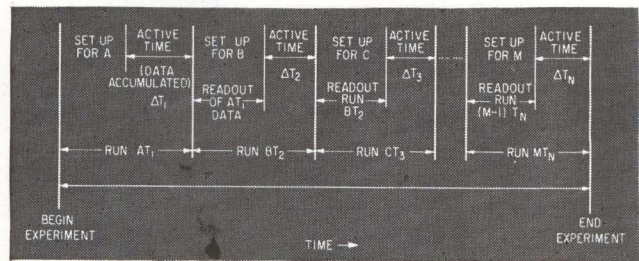

EXPERIMENTAL timetable is followed by automatic timing equipment—Fig. 1

tive and transistor Q_1 is cut off. A preset of 7 on the thumbwheel switch connected to the least significant decade gives an output when 7 pulses are registered (0.7 seconds). Assume a second switch is connected to the next decade (seconds register). When a 4 is preset on the switch, an output is gen-

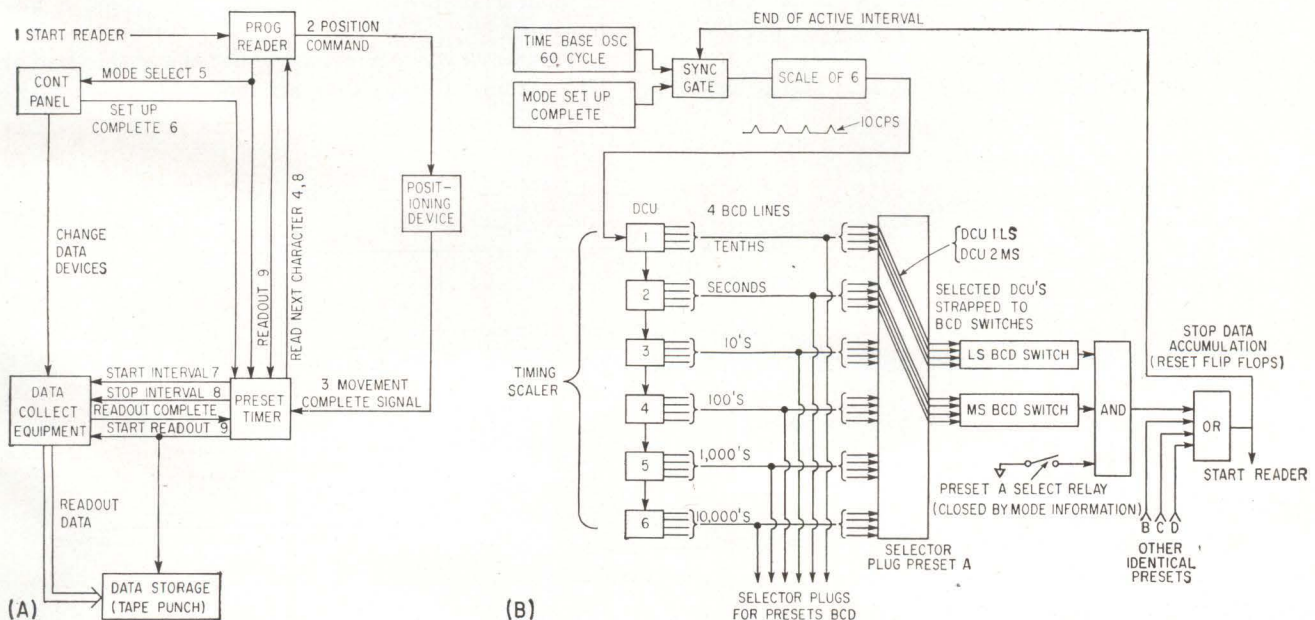

SEQUENCE of operations follows the numerical order shown in (A); logic diagram of timer unit (B)—Fig. 2

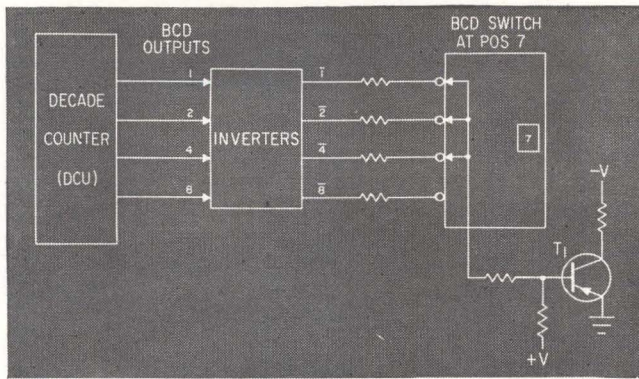

THUMBWHEEL logic requires all lines to be positive to produce an output—Fig. 3

erated when 4 counts are registered (4.0 seconds). The logical product of these two signals produces an output when 4.7 seconds have elapsed.

Up to this point, two decades of the timer have been connected to two thumbwheel switches. Preset intervals over the full time range are set up in the following way. A series of selector plugs have been prewired. Each plug connects two of the six decades to the two thumbwheel switches.

Four independent preset intervals (*A B C D*) are available to control the active time of each of the twelve modes. Each mode switch selects one of the four preset intervals as shown in Fig. 4A.

The timer provides the start command to all data collection equipment. At the end of the active time interval, the timer gives the stop command to all circuits. To provide accurately controlled ΔT 's the synchronizing circuits shown in Fig. 4B are used. These circuits ensure the active time interval is synchronized with the time base oscillator.

A Schmitt trigger shapes the sine wave output of the reference oscillator to a fast rising square wave. The square wave is differentiated and gated with the shaped mode setup complete signal such that the first negative pulse after the rise of the mode setup complete signal (pulse 1 in Fig. 4B) sets the REFERENCE flip-flop.

Pulse 2 sets the DELETE 1 flip-flop and starts the

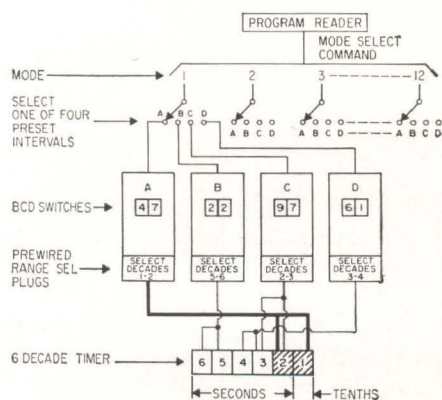

(A)

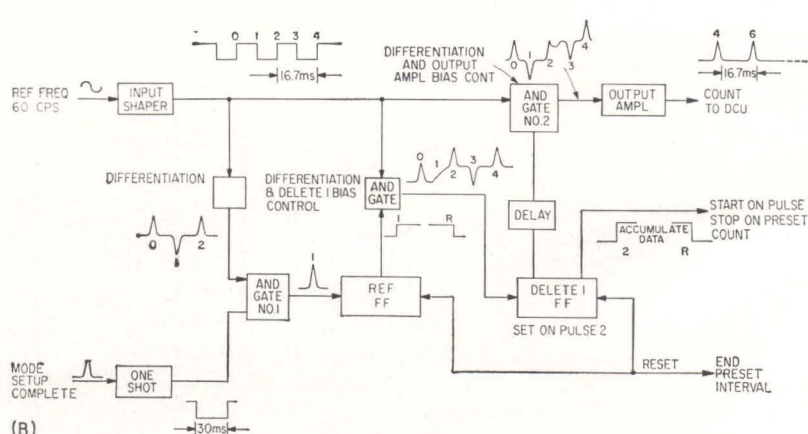

(B)

SIGNAL FLOW and switch-setup for a single preset time (A) synchronizing circuit shows how array of mode switches selects a preset time interval (B)—Fig. 4

active time interval. A delayed output of the DELETE 1 circuit is gated with the time base pulse train. This permits pulse 4 and each successive positive pulse to be counted.

The timer advances until the count registered is the same as the thumb-wheel switch preset. At this time, both the REFERENCE and DELETE 1 flip-flops are reset and the active time interval ends. Pulse 2 started the active time interval while pulse 4 was the first registered in the timer. This ensures that the active time and preset time intervals are of the same length. Since an advance timer pulse determines the end of a period, pulse 2 must be inhibited.

ALTERNATE DESIGN—The program preset timer is one variation of the idea of programming a series of time intervals by means of a program tape and reader. In another approach, the program reader can control the timing interval without the use of selector plugs and preset switches. Programmed commands directly select the timing interval. These commands consist of a group of characters. When the timer count agrees with the timer command, the active time interval stops.

A decision as to which of the two approaches to use depends on the particular application. In this experiment the programmer controls devices other than the timer, and was limited by sixty-four output commands. The four preset time intervals are sufficient for all anticipated ΔT 's. If more than 6 or 8 separate preset time intervals are required, controlling the timer directly from the program tape might prove more efficient. In this case it would have been necessary to record the time interval information of each data run in the experiment.

CONCLUSION—The programmable preset timer can be adapted to any sequentially dependent series of functions that contain a time variable. For the nuclear experiment at Argonne the timer provided the flexibility needed for useful automation. Once the program is written, the time setup and the modes of operation preset, the system will operate automatically.

This work was performed under the auspices of the U. S. Atomic Energy Commission.

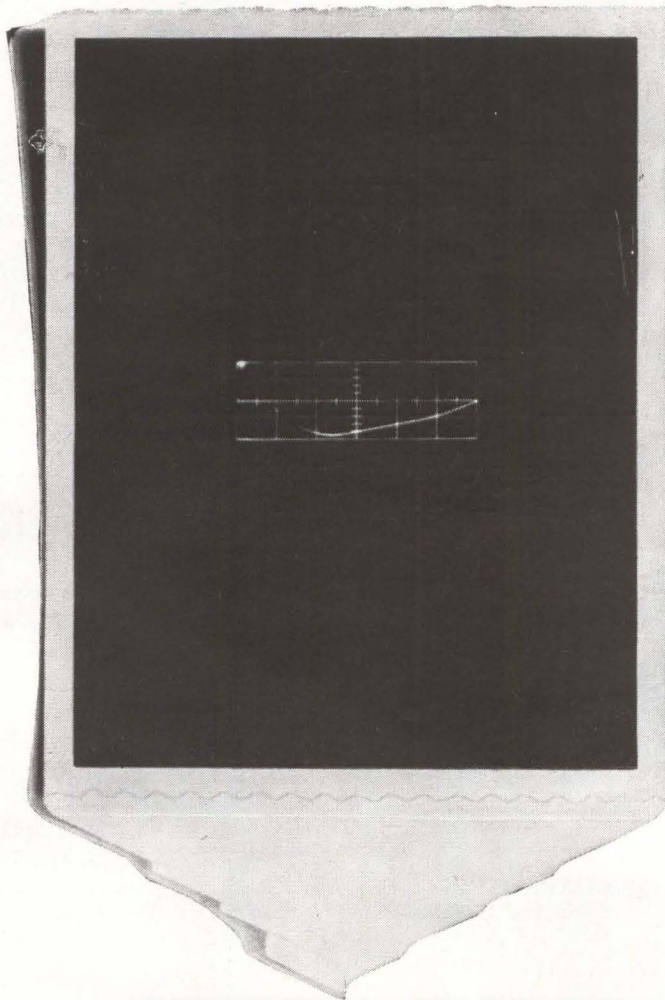

2 nanoseconds/cm: impossible to photograph until now

Polaroid has a new film that is so fast, it will reproduce scope traces that are almost invisible to the naked eye. The one above, a scintillation pulse, has never been photographed until now. Pulse duration was ten nanoseconds. Scope sweep speed was 2 nanoseconds/cm. *The new 10,000-speed Polaroid PolaScope Land film produced a finished usable print ten seconds after exposure.*

The maximum writing speed of the 10,000-speed film is about twice that of the Polaroid Land

3000-speed film, which is currently the standard for high speed photography. The new film not only gets "impossible" pictures, it also produces far better shots of slower pulses and steady state waveforms. Because of its high speed, less light is required; camera aperture and scope intensity can be reduced considerably, producing sharper pictures.

And besides oscillography, the PolaScope film opens up new possibilities in applications where light is at a premium, such as pho-

tomicrography and metallography. It is not suited, however, for pictorial work due to its high contrast and relatively coarse grain.

PolaScope film (designated Type 410) is packed twelve rolls to a carton. The price is about the same as the 3000-speed film.

The film can be obtained through industrial photographic dealers. For the name of the dealer nearest you, write to Technical Sales Department, Polaroid Corporation, Cambridge 39, Massachusetts.

New Polaroid Land 10,000-speed film for oscillography.

Rapid Method Measures Diode Characteristics

By M. HERNDON and A. C. MACPHERSON, U. S. Naval Research Laboratory, Washington, D. C.

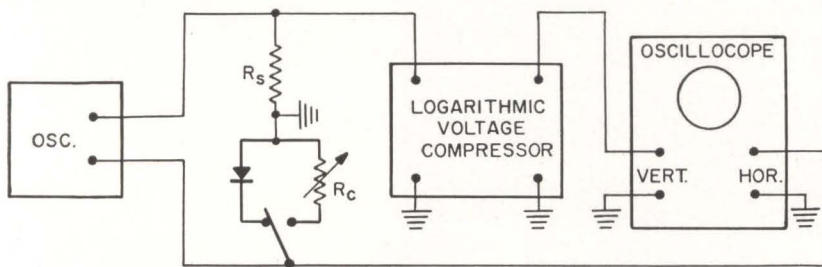

LOG I AGAINST V characteristics are viewed using this simple arrangement—Fig. 1

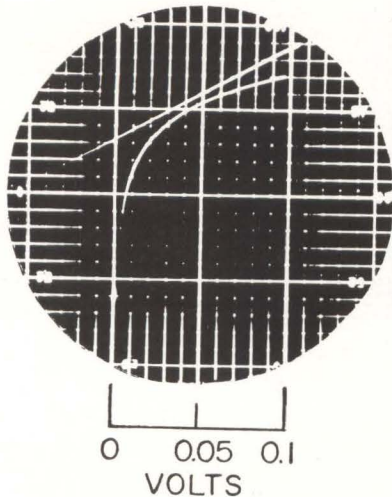

CHARACTERISTICS of a 1N263 diode and 150-ohm resistor, with $a = 25$ —Fig. 2

Diode parameters can be read off directly on scope screen

MOST USEFUL semiconductor diodes follow the law $I = I_0 (\epsilon^{aV} - 1)$, where I and V are the diode current and voltage, and I_0 and a are constants which characterize the diode. The parameter a is important since it is a measure of the diode non-linearity.

For $aV \gg 1$, $\log I = aV$, and thus a can be determined by plotting the characteristic on semilog paper and measuring the slope. This however is time consuming, and a faster method will be described.

The circuit of Fig. 1 will produce a display of $\log I$ against V on a scope face. The logarithmic voltage compressor unit, manufactured by Kane Engineering Laboratories, is capable of producing an output voltage proportional to the logarithm of the input voltage when the input voltage is greater than 0.3 volt. The current measuring resistor R_s must be small compared to the input impedance of the logarithmic voltage compressor, and at the same time high enough to develop the minimum input voltage at low diode current. A value of 50 K works well.

There is still the problem of measuring the slope. Consider that the I - V curve for a resistor is $I = GV$ where G is the inverse of the resistance. Taking the log of both sides, $\log I = \log G + \log V$. Thus $d \log I / dV = 1/V$, or the slope of $\log I$ against V is $1/V$. This means that if a resistor R_0 is substituted for the diode, the slope is given by $1/V$, independent of the value of the resistor. Figure 2 is a double-exposure photograph of curves for a 1N263 diode and for a

Thin-Film Growth In Electric Field

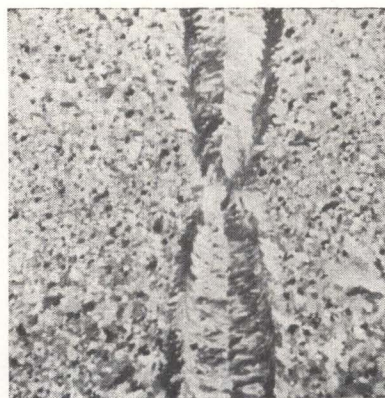

APPLIED ELECTRIC d - c field causes dendritic growth in silver telluride thin film. Recrystallization process is illustrated at left. Effect of a - c field on silver telluride growth is shown at right. From paper presented by C. Paparoditis of C.N.R.S. Laboratories, Bellevue, France, at single-crystal thin-film conference at Philco Research Center, Blue Bell, Pa.

12 'ABC' POWER SUPPLIES

FLEXIBILITY • HIGH QUALITY • LOW COST

**CHECK
KEPCO**



from 0-2V/1A to
0-2500V/2ma

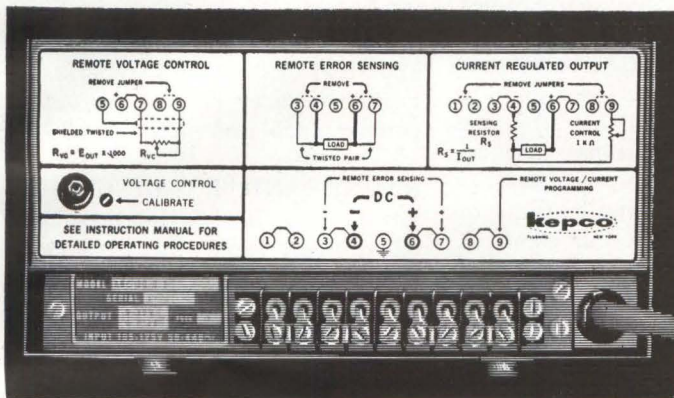
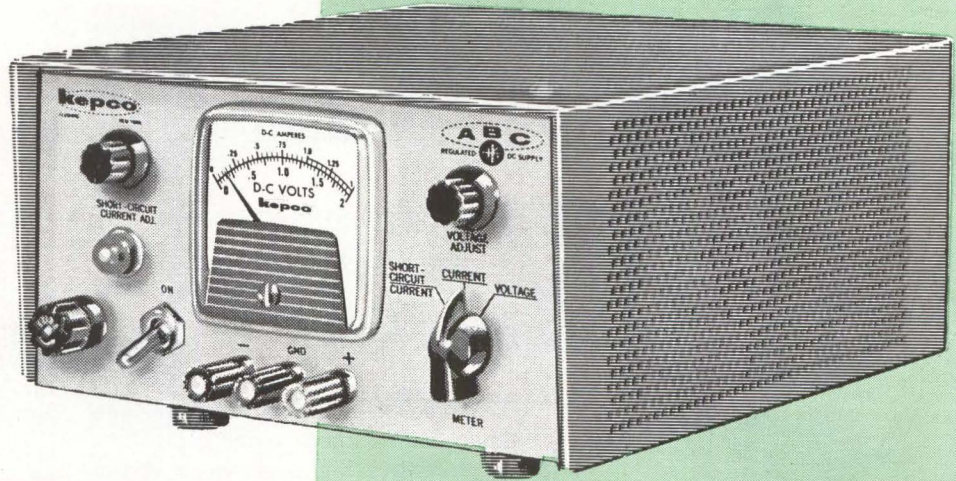

VOLTAGE / CURRENT REGULATED

Connections provide for:

- REMOTE PROGRAMMING OF VOLTAGE OR CURRENT BY RESISTANCE OR VOLTAGE
- REMOTE ERROR SENSING
- PARALLEL AND SERIES CONNECTION

**PROMPT DELIVERY
MOST MODELS FROM STOCK**

0.05% REGULATION and STABILITY

ALL-TRANSISTOR MODELS

DC OUTPUT		RIPPLE RMS MV	PRICE	*METERED MODEL
VOLTS	AMPS			
0-2	0-1	0.25	\$ 179.00	ABC 2-1M
0-7.5	0-2	0.25	159.00	ABC 7.5-2M
0-10	0-0.75	0.25	119.00	ABC 10-0.75M
0-15	0-1	0.25	159.00	ABC 15-1M
0-18	0-0.5	0.25	119.00	ABC 18-0.5M
0-30	0-0.3	0.25	119.00	ABC 30-0.3M
0-40	0-0.5	0.25	159.00	ABC 40-0.5M

HYBRID MODELS

0-200	0-0.1	0.5	199.00	ABC 200M
0-425	0-0.05	0.5	199.00	ABC 425M
0-1000	0-0.02	1.0	274.00	ABC 1000M
0-1500	0-0.005	1.0	274.00	ABC 1500M
0-2500	0-0.002	1.0	334.00	ABC 2500M

INPUT REQUIREMENTS: 105-125V AC, 50-440 cycles.

All-Transistor Circuit is illustrated below. The Hybrid Circuit is a unique design which achieves high efficiency and reliability through the use of Transistorized Reference and Amplifiers combined with a Vacuum Tube series pass element for reliable high voltage operation.

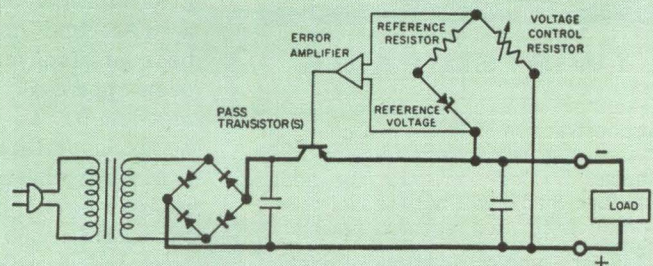

All models are designed for continuous operation without de-rating under all specified line, load and temperature conditions.

* UNITS are available without volt/amp meter; delete suffix "M" from model number and deduct \$20.00 from price (ABC 2500M, ABC 1500M, ABC 1000M voltmeter only; deduct \$15.00).

RACK MOUNTING ADAPTER (5-1/4" H x 19" W):

Model RA-4: for mounting 2 units\$15.00
Model RA-5: for single unit\$15.00



For complete specifications on more than 230 standard model Power Supplies, send for NEW Catalog B-631.

131-38 SANFORD AVENUE • FLUSHING 52, N.Y., U.S.A. • Phone (212) IN 1-7000 • TWX# (212) 539-6623 • Cable Address: KEPCOPOWER, NEW YORK

BONDABLE TEFLON*

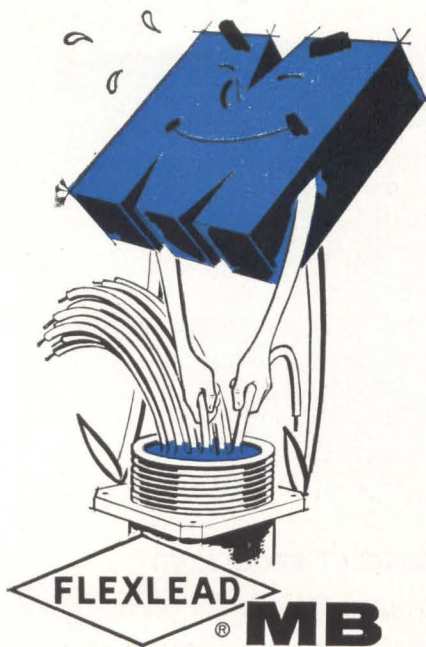

FLEXLEAD MB is Markel's answer to your bonding problems for applications requiring encapsulation of wires insulated with Teflon. Factory-applied to any of the **FLEXLEAD** Teflon Wires, extruded or tape-wrapped, the MB process renders the surface bondable with the commonly used elastomeric and epoxy-base potting and encapsulating compounds. Without affecting the color or electrical properties of the insulation, the MB treatment provides a bond with up to 150 psi pull-out strength, and a surface receptive to marking and printing.



TWISTED PAIRS

The new **FLEXLEAD** Fused Twisted Pair construction of Teflon insulated wire provides all the characteristics of a balanced twisted pair, with the added advantage that it will not unravel during installation or after repeated flexing.

Ask for Samples, Data, and Prices

L. FRANK **MARKEL** & SONS
SINCE 1922

NORRISTOWN, PA.



SOURCE FOR EXCELLENCE

Insulating Tubings and Sleeveings
High Temperature Wire and Cable

*Du Pont Trademark

150-ohm resistor. There must be some voltage, V_0 , at which the diode slope is equal to the resistor slope. This voltage is read off the horizontal scale and $\alpha = 1/V_0$. If R_c is too large, the minimum input voltage

will not be developed across R_c . If R_c is very small, the scale of the trace on the scope face will be inconvenient. A 2,000 ohm potentiometer was used for R_c , varying R_c to permit accurate slope comparison.

Laser Link in Gemini?

Next stage of manned space program may give lasers a tryout

HOUSTON—The future of the laser in manned space programs is getting a big boost here at the Instrumentation and Electronics System Division (IESD) of NASA's Manned Spacecraft Center. Several R&D study programs—designed to screen out the "plausible from the far-fetched" applications—are now in progress.

The first actual applications of MSC's laser work could come on one of the early two-man Gemini space flights, which will probably start in 1965.

Present plans call for an experiment in which an astronaut would point a small hand-carried, voice-modulated, gallium-arsenide laser transmitter from the Gemini spacecraft toward a flare-marked ground receiver. Upon command, a 30-second message would be beamed. This experiment has not been approved yet, but it is recommended by W. L. Thompson, who heads laser R&D at MSC.

MSC engineers say, citing a more sophisticated possible application, that a Mars-bound astronaut could be supplied with instantaneous information on altitude and rate of descent from laser beacons dropped earlier by unmanned probes. Three beacons, forming a triangle, could reflect the laser beam from a descending spacecraft without signal interruption by rocket blast, pin-pointing the landing spot.

COMMUNICATIONS — IESD has had Hughes Aircraft studying the feasibility of an ultimate deep space communication system for several months. **ELECTRONICS** was

told that extending the study has been recommended.

Hughes is studying three areas: beaming the laser between spacecraft and the earth; between a spacecraft and an earth-orbiting satellite, then relaying to earth by microwave; and beaming the laser between a spacecraft and a lunar-based laser station, then relaying the signal to earth by microwave.

The study compares the laser and microwave. First reports reveal "the laser is winning out in performance and poundage."

RADAR AND RANGING—IESD has also been studying development of optical radar, with Lincoln Laboratory. This may lead to the use of optical radar on later versions of the Apollo lunar excursion module (LEM). Presumably, says MSC, "it could replace a number of microwave systems now proposed for the Apollo mission amounting to a weight saving of about 100 pounds."

The division is studying laser beam attenuation through rocket exhaust. This may lead to a ranging device, or altimeter, aboard a later generation LEM. It could beam the laser directly downward through the exhaust's ion sheath to "feel" out the lunar surface for a safe descent.

MSC engineers also foresee a laser in an earth-orbiting satellite used as a navigation "fix" by a spacecraft returning from a deep-space mission.

Fuel Cell Runs on Regular Gasoline or Diesel Oil

NEW direct-conversion fuel cell, announced by General Electric's Research Laboratories, runs on inexpensive commercial fuels such as

NEW GEN-PRO 700 SERIES INDUSTRIAL TERMINAL BOARDS

ALL SIZES AVAILABLE NOW FOR
TIMED DELIVERY AS NEEDED

Superior features • Competitively priced • Conveniently packaged

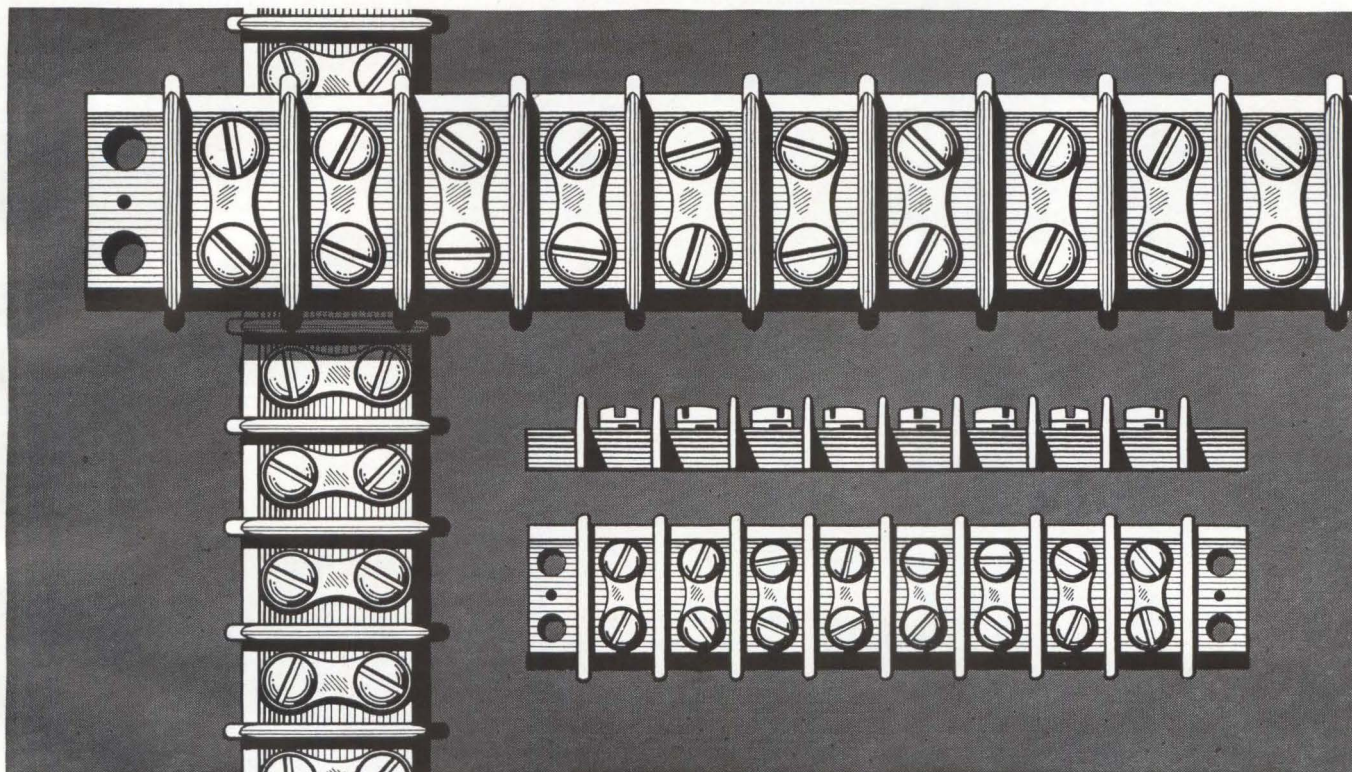

When you need terminal boards for any application, rely on Gen-Pro's great new 700 Series for the quality and interchangeability you want—on Gen-Pro's unique timed delivery for prompt as-needed shipments. Greater length—up to 46 terminals—permits a larger number of connections than ever before possible. Thicker, stronger barriers with rounded corners reduce breakage—creepage path is longer—saddle plates available for more secure mounting. All sizes and variations in number of stations—packaged in lots of 5, 10 and 20. The boards of your choice are delivered from stock in the quantities you require—when you need them. All types of hardware and special molding compounds are available in addition to standard-purpose phenolic. Write today to Dept. SMMD for illustrated literature.

Your assurance of quality.

700 Series terminal boards are subject to the same rigorous quality control procedures as Gen-Pro's famous 400 Series — the finest commercial terminal boards available anywhere today.

700 SERIES TERMINAL BOARDS

Model No.	Voltage, RMS	Terminals
740	1200	1-46
741	1600	1-39
742	2500	1-30
764*	1600	1-46

*32 screws



**GENERAL
PRODUCTS
CORPORATION**

UNION SPRINGS, N.Y.

TWX No. 169

Phone: (area code 315) TT9-7367

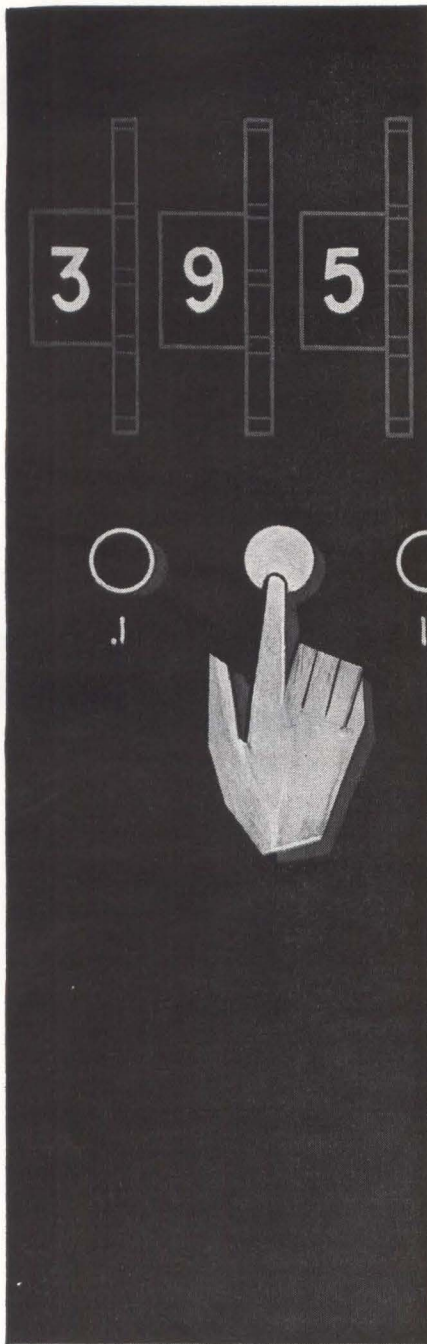

NEW from DEI

PUSH-BUTTON PCM SYNCHRONIZER

- Exceptional Stability and Calibration Accuracy
- Correlating Bit Detection
- All Digital Loop Filter
- Wide Dynamic Input Range

NOW—for the first time, push-button bit rate selection is possible!

From Defense Electronics, Inc. comes the latest in a line of PCM Digital Products.

The solid state BRS-1 Bit Synchronizer/Conditioner has been designed for PCM telemetry applications and features accurate setting (within 0.1 per cent) for a known bit rate prior to actual signal reception.

This exceptionally stable and highly accurate synchronizer accepts a serial PCM signal at rates up to 1 mc, automatically conditions the incoming data and generates a stable clock signal.

Automatic circuitry adjusts to input signals over a 40 db dynamic range. The unit incorporates a unique digital loop filter that maintains bandwidth proportional to bit rate at all frequencies. Output of the synchronizer is a reshaped, noise-free, serial PCM signal and a set of clock signals phase coherent with the output data.

The BRS-1—which can be remotely-controlled—performs the functions of data regeneration, format conversion and serves as the “front-end” for any digital telemetry system.

Write for DEI bulletin BRS-1 . . . or call:

Defense Electronics, Inc.

Main Office:

5455 Randolph Rd. Phone: WH 62600

Rockville, Md. TWX: 301-949-6788

Regional Office: Sherman Oaks, Calif. Phone: 873-4322

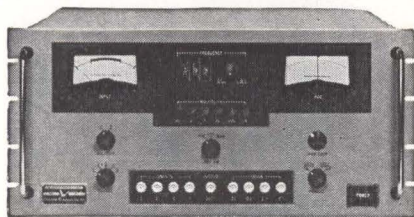

DEI

SERVING
GOVERNMENT
AND INDUSTRY

gasoline, diesel oil, methane and propane, operates at moderate temperatures (150 deg C), much lower than previous hydrocarbon cells.

Developed with support from ARPA, the new cell converts the complex-molecule hydrocarbon fuels directly to pure water and carbon dioxide, with 100 percent oxidation and no byproducts. Practical efficiency is 50 to 70 percent, compared to 20 to 25 percent for combustion engines. Power densities to 25 watts a square foot have been achieved.

Hybrid Computer Tells Pilot Where He Is Going

HYBRID AIRBORNE computer weighing 30 pounds has been developed by General Precision to supply pilots with position, ground track and wind information. Called the Minac-5, the system uses solid-state components and has a self-contained power supply. The pilot may change destinations, set required inputs and correct position information without loss of computations. The computer can store an alternate destination which may be selected at any time during flight.

100-Kilogauss Coil



SUPERCONDUCTING MAGNET has achieved 101,000-gauss magnetic field at General Electric's Research Lab (see ELECTRONICS p 7, June 7). Coil has 600 turns of special niobium-tin conductor 1/40 inch diameter, passed 266 amperes at 1.8 deg Kelvin to achieve a field that, without superconductivity, would require about two million watts

Counting knob

Zivy
Z1003



for mounting on precision multiturn potentiometers, controls of precision instruments, machine tools, etc.

Read to 1/500 of a turn
Estimate 1/1000th

Write to:
Victor George Herman
49 West 96th Street
New York 25, N.Y.

CIRCLE 201 ON READER SERVICE CARD



Are you a COMPLETELY INFORMED electronics engineer?

Today you may be working in microwaves. But on what project will you be working tomorrow? You *could* have read **electronics** this past year

and kept abreast of, say, microwave technology. *There were 96 individual microwave articles between July, 1961 and June, 1962!*

But suppose tomorrow you work in some area of standard electronic components, in semiconductors, in systems? Would you be up-to-date in these technologies? Did you read the more than 3,000 editorial pages that **electronics'** 28-man editorial staff prepared last year?

electronics is edited to keep you current *wherever* you work in the industry, *whatever* your job function(s). If you do not have your own copy of **electronics**, subscribe today via the Reader Service Card in this issue. Only 7½ cents a copy at the 3 year rate.

electronics

new

UNIVERSAL BRIDGE

TRANSISTORIZED • PORTABLE

\$375



Model 2700

RANGES:

C: 0.5pF to 1100 μ F
L: 0.3 μ H to 110 H
R: .010 Ω to 11 M Ω

ACCURACY:

$\pm 1\%$

FREQUENCY:

Internal 1kc
External 20cps to 20kc

ALSO MEASURES:

Incremental 'L'
Incremental 'R'
'C' with bias

Write for detailed catalog sheet.

MARCONI INSTRUMENTS

DIVISION OF ENGLISH ELECTRIC CORPORATION
111 CEDAR LANE • ENGLEWOOD, NEW JERSEY
MAIN PLANT: ST. ALBANS, ENGLAND

French Reveal New Field-Effect Structure

Overseas version uses majority carriers in a bulk conducting layer

By A. V. J. MARTIN,
Paris, France

AN EXPERIMENTAL semiconductor device, developed at Compagnie Generale De Telegraphie Sans Fil in France, works on basic principles proposed for field-effect devices.

Structure of the French version, called the Statistor, is shown in Fig. 1. The photo shows a model that has been constructed based on this basic configuration.

The insulated control electrode can be driven either positive or negative with no detrimental effect on input impedance, which exceeds one million megohms. The associated input capacitance is 0.4 pf.

The lower bar of silicon in the diagram has noninjecting ohmic contacts at each end. One contact is the source, the other is the drain. The thin insulating layer of silicon oxide, placed over the semiconductor, is partially metalized, and provides the control electrode or gate.

A suitable control voltage applied to the gate creates a depletion region inside the semiconductor and modifies semiconductor resistance between source and drain. Varying the control voltage results in conductance modulation of the semiconductor. The conducting region of the semiconductor, called the channel, can be either *p* or *n* type.

Input impedance to the gate reaches 10^{12} to 10^{14} ohms in laboratory samples. The basic device uses no junction, so that noise and production problems associated with junctions are eliminated.

In actual practice, these advantages are only partially realized, mainly because of the necessity of obtaining a thin enough layer of semiconductor for field effect to

become significant. This imposes production techniques based on injection transistor experience, so that a junction is incorporated in practical design. However, this junction is a convenient production process, and is in no way a requirement of the device.

Performance of the unit depends upon the particular technique used in constructing hand-made specimens. Several methods have been investigated, and these have resulted in sizable dispersion of characteristics. Representative parameter values of constructed units are as follows: pinch-off voltage, gate shorted to source: 6 to 20 volts;

pinch-off current: 200 to 800 microamps; gate transconductance (positive gate): 80 to 200 microamps/volt; gate transconductance (negative gate): 80 to 180 μ a/volt.

A production process results in a second gate, called the large gate, on the face opposite the control gate. This large gate can be used to bias the device and set the quiescent point in a better region of operation. Such a structure is properly called a tetrode. Diffusion, photolithography, mesa, epitaxy and planar techniques can be used to construct the basic structure.

A structure based on planar technology uses, as starting material, a *p*-type silicon monocrystal of 4-ohm resistivity. Oxide production and phosphorous diffusion are conducted through masks, those used for injection transistors.

In the present state of development, this device is relatively large (500×200 microns). The various points of the conducting channel are connected to the large gate (silicon body) not only through capacity, but also through the whole thickness of the high-resistivity silicon bulk. Consequently it would be advantageous to use a deep counter-diffusion and only a thin layer of high-resistivity silicon. Channel length may be reduced to ease voltage breakdown problems.

When used with a floating gate (no external resistor), the device can serve as a solid-state electrometer. A simple modification of structure leads to a symmetrical device that corresponds to double electrometer tubes. The device can be used in this way in all cases where a high input resistance is required.

BIOLOGICAL SIGNALS—Typical applications of the solid-state electrometer are in the measurement of very small potentials, as encountered in pH work or in biological signals, and also in the measurement of very small charges. Elec-

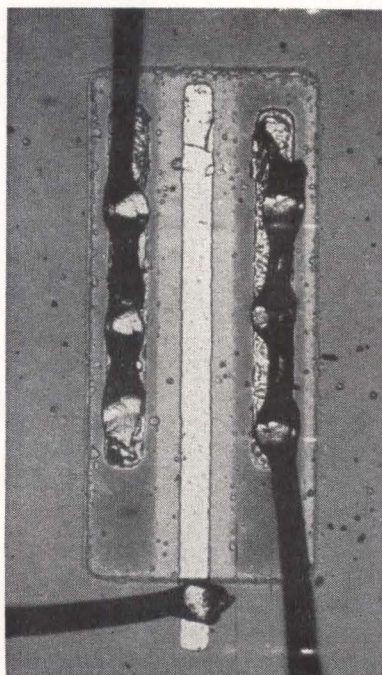
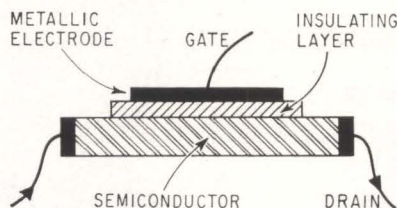

BASIC structure of field-effect device developed at CSF is shown in diagram. Photo shows actual construction of working model—Fig. 1

The new Clifton Servo Motors fight Temperature 2 ways

1 Reduce Heat Rise

The same or greater torque is achieved in these motors by considerably less wattage input. Result — a cooler running motor. In addition, heat rise is reduced by special designs and materials with high thermal conductivity for improved heat dissipation.

2 Materials Withstand 200°C

Special and improved high temperature resistant magnet wire, lubricant, slot insulation, impregnation and other materials in these new servo motors withstand, if necessary, 200°C.

Temperature problem? Call 215 MADison 2-1000, TWX 623 6068 or our Representatives.

CLIFTON PRECISION PRODUCTS CO., INC.

cppe

Clifton Heights, Pa.
Colorado Springs, Colo.

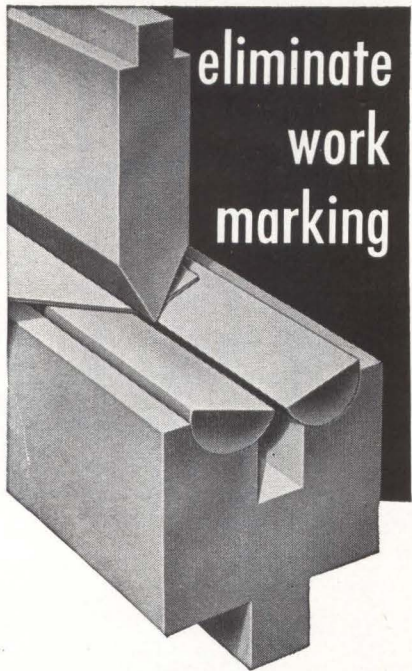

with a DI-ACRO ROL-FORM DIE

Workmarking from forming sheet materials in press brakes and punch presses is greatly reduced and in many metals completely eliminated when formed with the Di-Acro Rol-Form Die. Hardened and precision ground rolls pivot smoothly in the die block to fold material without strain. You save costs by discarding elaborate and time consuming preparation and work methods, reducing polishing time, eliminating scrap parts. You also cut costs in press brakes and punch presses by reducing the number of dies needed and the set-up time.

One Di-Acro Rol-Form Die with a 60° upper die forms any angle to 60° and any thickness of metal to 1/8" just by adjusting the ram or bed of the brake. Where ultra-high finish material is to be formed, nylon inserts can be used in the die block to further reduce the possibility of work marks.

The Rol-Form Die is offered in five styles and in lengths from 6 inches to 12 feet for use in all sizes and models of press brakes and punch presses.

For ordinary press brake forming ask about Di-Acro Standard Press Brake Dies.

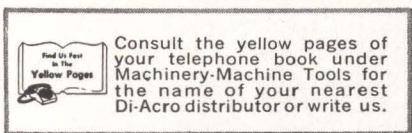

pronounced die-ack-ro



DI-ACRO CORPORATION
Formerly O'Neil Irwin Mfg. Co.
436 Eighth Avenue
Lake City, Minnesota

trical charges due to ionization can probably be measured, with eventual direct integration by the long input time constant.

High-sensitivity high-impedance voltmeters can be designed around these field-effect devices.

A Statistor has been connected in a simple arrangement shown in Fig. 2. The photo shows a working model of this circuit. The entire circuit, including the battery, is concealed inside the sphere. The gate is connected to the sphere, supported by an insulating bushing. A current of about 40 microamps flows in the circuit and is indicated by the meter. When the hand, or any conductor however poor, is brought within distance of the sphere, an electrostatic charge builds up on the gate, and blocks the Statistor. The current drops to zero. The transistor is added in series to limit current.

Figure 3 is a trace showing two voltage-current curves corresponding to the two states of the field-effect device in the demonstration.

The Statistor is only one of a family of devices, called dielectrons, whose operation is based on field effect through a dielectric layer.

The research laboratories of CSF have been investigating field effect for several years. Their first commercial product was the Alcatron, a high power (several watts), high-frequency (above 100 Mc) device.

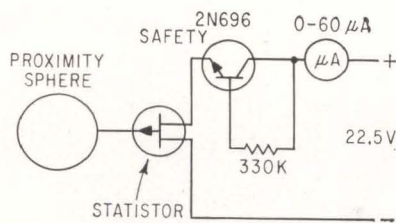

PROXIMITY detector circuit is constructed in sphere shown in photo. French cigarette case in photo indicates size of actual unit—Fig. 2

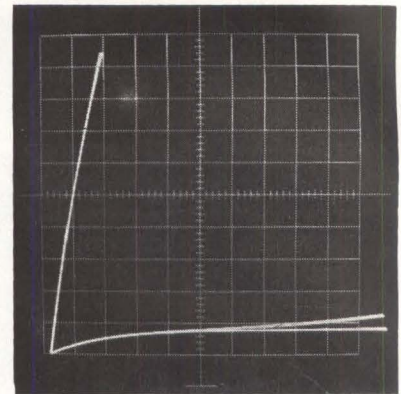

VOLTAGE-CURRENT curves correspond to the two states of the Statistor in the proximity indicator circuit—Fig. 3

Investigation of space-charge control in a semiconductor through a dielectric layer has been carried on at CSF by R. Tribes, assisted by J. Barthez at the solid-state laboratory headed by J. Grosvalet.

Low-Oxygen Silicon Crystals Hit Market

NEW PROCESS for manufacturing high-grade silicon semiconductor crystals has been developed by Texas Instruments. Crystals reportedly have low oxygen content and low etch-pit density.

Marketed under the name Lopex, the crystals have been sampled in industry since last November. Evaluation quantities have sold at prices ranging up to \$10 per gram, but the material now will be sold for \$2.90 per gram. Ralph Stroup, manager of TI's Materials & Sensors Department, reports this price is competitive with premium-grade conventional float-zone crystals, but higher than typical crucible-pull crystal prices of \$1.10.

TI's Dallas Materials Plant, which claims the industry's largest output of semiconductor silicon, will have converted at least one-third of its capacity to the new process by the end of 1963, E. O. Vetter, Vice-President, reports.

The new process, according to Stroup, combines some of the technique of the float zone and crucible pull manufacturing processes. Beside being low in both oxygen content and etch-pit density, the Lopex crystals are high in minority carrier lifetime, Stroup said. Available in resistivities up to 300 ohm-

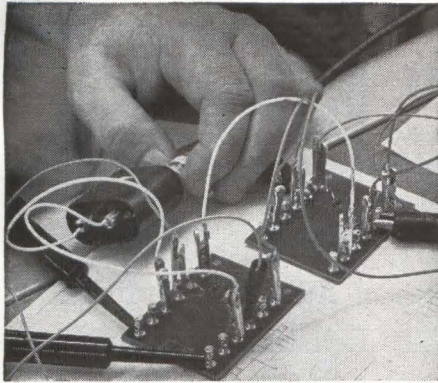

Despite the tremendous speed and ravenous appetite of today's most advanced computers, scientists at Lockheed Missiles & Space Company's Computer Research Laboratories feel that there is room for a great deal of improvement. They have dedicated themselves to the discovery and development of ways to increase the speed and reliability of computers while simplifying their operation.

Though today's computer circuits are capable of operating at speeds measured in tens of nanoseconds, the useful computation rate is far slower. One of the roadblocks hindering speed is the need for the computer to wait for the carryovers from one column of figures to catch up with the main calculation. A possible an-

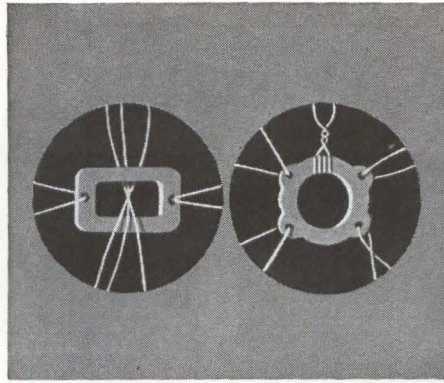

swer to this problem is modular arithmetic, which avoids carryover. Based on the ancient Chinese Remainder Theorem, this concept is being re-examined at Lockheed for potential computer applications.

Lockheed's Computer Research Laboratories are studying a very broad group of related computer research areas, and the company can boast that an unusual number of its specialists are at the very forefront of their specific fields.

Among the major areas of research being undertaken at this time are basic physical phenomena, such as phonons; quantum mechanics; switching theory; residue arithmetic (number system research); threshold logic and pattern recognition and logic design techniques.

LOOK AT LOCKHEED...AS A CAREER

Consider Lockheed's leadership in space technology. Evaluate its accomplishments—such as the Polaris missile, the Agena vehicle's superb record of space missions. Examine its outstanding advantages—location, advancement policies, creative climate, opportunity for recognition.

Then write for a brochure that gives you a more complete Look at Lockheed. Address: Research & Development Staff, Dept. M-48A, P.O. Box 504, Sunnyvale, California. Lockheed is an equal opportunity employer.

SCIENTISTS & ENGINEERS: In addition to positions relating to computer research, such as logical design specialists and mathematicians, other important openings exist for specialists in: Trajectory analysis • Inertial guidance • Electromagnetics • Orbit thermodynamics • Gas dynamics • Chemical & nuclear propulsion • Systems engineering • Electronic engineering • Communications & optics research

LOCKHEED

MISSILES & SPACE COMPANY

A GROUP DIVISION OF LOCKHEED AIRCRAFT CORPORATION

Sunnyvale, Palo Alto, Van Nuys, Santa Cruz, Santa Maria, California • Cape Canaveral, Florida • Huntsville, Alabama • Hawaii

LOOK AT LOCKHEED IN DIGITAL TECHNIQUES:

Basic research toward simpler, faster, more reliable computers

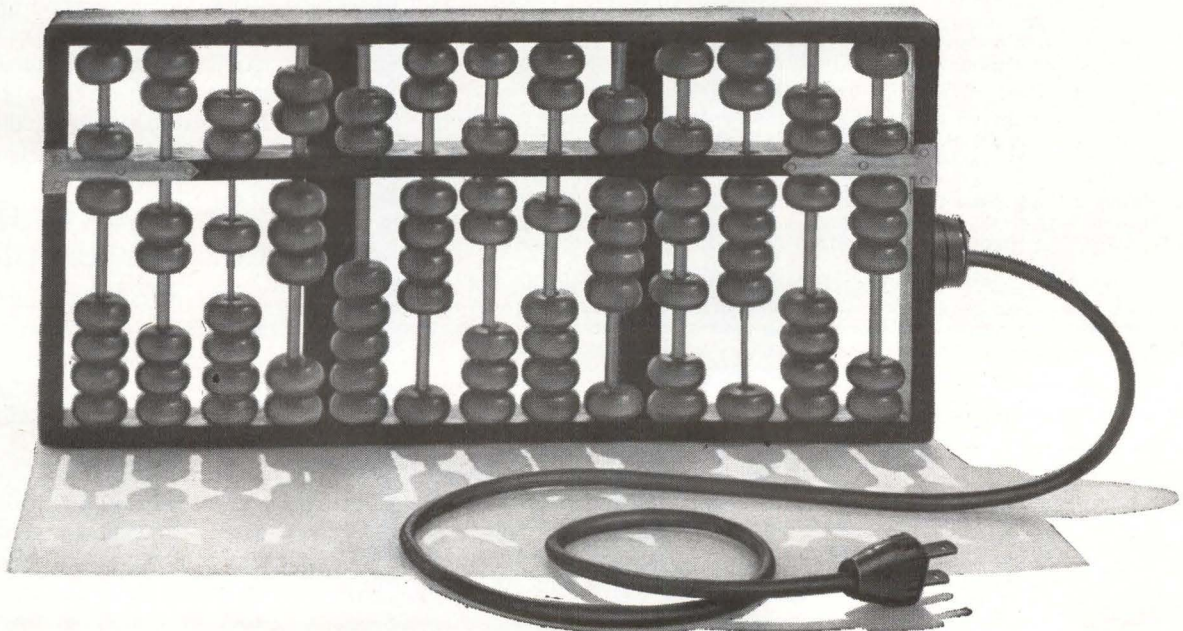

VOLTRON ANNOUNCES A FUNDAMENTAL ADVANCE IN THE CALIBRATION ART

The VOLTRON-GALMAN
AVERAGE VALUE TRANSFER STANDARD

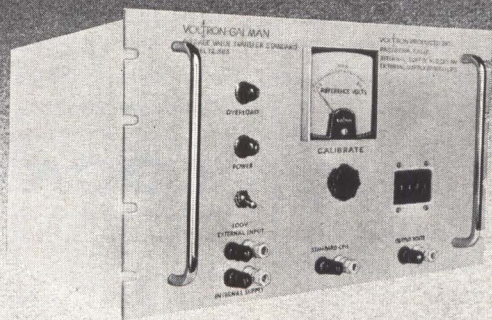

WITH { $\pm 0.01\% \pm 1$ MV absolute ACCURACY
 $\pm 0.001\%$ REPEATABILITY
10 MV RESOLUTION

Based on the unique Voltron-Galman Operational Rectifier configuration (patent applied for), this instrument permits rapid, positive calibration of digital voltmeters, transducers, analog data channels, and related average-sensing equipments, at secondary-standard levels of accuracy, with COMPLETE CONFIDENCE. Rectifier non-linearities, harmonic effects, and frequency distortion are all rendered negligible by this exclusive new circuit. This device responds to TRUE-FULL-WAVE-RECTIFIED-AVERAGE VALUES — it does not employ peak-sensing or RMS-sensing.

The Voltron-Galman circuit is as fundamental and as readily standardized for average values as the well-known Hermach thermal standard configuration is for RMS values. Performance levels are comparable.

Model 12.583, shown above, generates 0-300 volts, in 10 MV steps, at low impedance, at discrete frequencies between 50 and 3000 cps; distortion <0.1%. An unsaturated standard cell is the primary reference.

The Model 12.583 is COMPLETELY SELF-CONTAINED, including not only an ultra-stable oscillator, precision toroidal dividers, and operational rectifier, but also a standard cell, normalizing and standardizing networks, and a null-indicating galvanometer. No auxiliary equipment is required.

VOLTRON
PRODUCTS, INC.
1020 So. Arroyo Parkway, Pasadena, California

We have prepared a complete technical exposition of the theory of operation of this new circuit, including performance specifications. May we send you a copy?

centimeters, minority carrier lifetimes of crystals are more than 1 msec for resistivities over 50 ohm-cm.

Dislocation densities are reported to be so low that they generally are reported as nondetectable with presently used measuring techniques.

Seek Efficient Approach To Reliability Analysis

TIME AND MONEY spent on rigorous testing procedures for component parts for advanced systems are fast becoming prohibitive. At the same time the consequences of system failure are becoming more intolerable. What is needed, according to Morton E. Goldberg, is a new approach to the reliability problem. An approach that does not treat the development of every new system as a separate reliability problem.

Goldberg is manager of reliability and components at Armour. He heads a program for determining reliability through analysis of failure mechanisms.

A number of investigators, including several at Armour Research Foundation, have struck out a new path through a broad program initiated by the Rome Air Development Center. General name given to the program is Physics of Failure. As its name implies, it is concerned with establishing, through considerations of the laws of physics, the mechanisms which lead to failure.

The ultimate hope of such an approach, according to Goldberg, is that mathematical models for computer programming be developed for related types of components.

New Glass for CRT's Glow in Electron Beam

OWENS-ILLINOIS Glass Company reports it has developed a luminescent silica glass that may eventually permit fabrication of tv picture tubes without separate application of phosphors.

Normally colorless, the glass becomes colored, but still transparent when exposed to electron beams. The company says they may be used in the near future for radarscopes, displays and computer readouts.

FREE!

YOU PAY NO PREMIUM FOR
RELIABILITY



when you specify

TRUE CONCENTRIC STRANDED WIRE CONSTRUCTION

in your **TEFLON®** insulated wire components

Teflon wire suppliers can deliver premium products with the ultimate in conductor reliability built into them at no added cost by supplying true concentric conductor. Experience shows that true concentric strand costs less to insulate than second class substitutes.

And true concentric strand is the yardstick against which the performance of all other constructions is measured. No responsible authority has ever questioned the stature of true concentric as the ultimate in quality and reliability.

To engineer products that will endure, specify the construction that has withstood the test of time . . . specify True Concentric Strand.



**WRITE FOR FREE FACTUAL
SURVEY REPORT —**

TRUE CONCENTRIC VS UNILAY STRANDED WIRE!



INTERNATIONAL WIRE PRODUCTS CORPORATION

THE NATION'S LARGEST MANUFACTURERS
OF QUALITY WIRE SPECIALTIES.
ALL METALS — BARE AND PLATED — STRANDED
AND SINGLE END

300 Greenwood Ave., Midland Park, New Jersey
Gilbert 4-2151

CIRCLE 202 ON READER SERVICE CARD

electronics • June 14, 1963



Time after time engineers specify Johnson capacitors!

Whatever the choice . . . sub-miniature capacitors for printed circuit use—or large, heavy duty types . . . time and time again design and development engineers specify Johnson Air Variables!

More than 11 basic capacitor series are readily available in a wide selection of single section, dual section, butterfly and differential types. Units range in size from the diminutive sub-miniature Type "U" capacitors, requiring less than 0.2 square inch of mounting space, to large, rugged heavy duty "C" and "D" types. Standard stock capacitors in a wide range of plate spacings, capacity per section, breakdown ratings, and finishes will meet many military and commercial applications . . . specials to your specifications are also available in production quantities. Complete information on all Johnson capacitors and other electronic components is available on request—write for our newest components catalog today!



E. F. JOHNSON COMPANY

2820 TENTH AVENUE S.W. • WASECA, MINNESOTA

AIR VARIABLE CAPACITORS

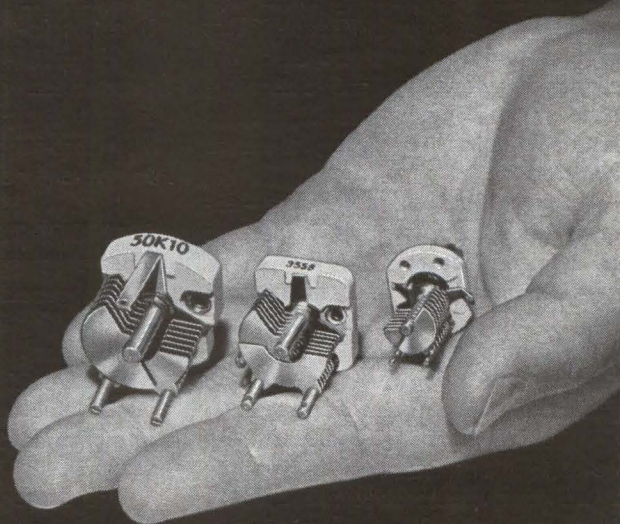

DETAILED COMPONENTS CATALOG AVAILABLE

— Write today on company letterhead!

• CAPACITORS • TUBE SOCKETS • CONNECTORS • PILOT LIGHTS
• INSULATORS • KNOBS AND DIALS • INDUCTORS • HARDWARE

CIRCLE 61 ON READER SERVICE CARD 61

Infrared Inspection Promises to Assure Production Reliability

R & D work explores new in-line checking techniques

EXPLORATORY work at Raytheon continues to uncover significant applications of infrared techniques in production reliability control as well as in maintainability of electronic equipment. Early phases of work, basic techniques and equipment needed were discussed in the July 6, 1962 issue of *ELECTRONICS* (p. 72). Although work accomplished since then has been rather limited and in some areas has only scratched the surface, the findings are definitely promising. Important initial developments have been made by Raytheon engineers at the Communications and Data Processing Operation in Norwood, Mass. under the direction of Riccardo Vanzetti. But it has become apparent that the scope of work in the following areas transcends possibility of a single company bringing them to completion:

- Recombination reflection—energy liberated by current carriers in semiconductors
- IR detecting and measuring equipment
- IR microscopes
- Advanced equipment needed to perform "close-distance" work
- IR transmitting fibers to help detection of infrared emissions from components that are hidden, inconveniently located, or inside potted units
- New lines of semiconductors with encapsulation transparent to recombination radiation
- Welded or soldered connection tester.

Though there is still a long way to go in perfecting infrared inspec-

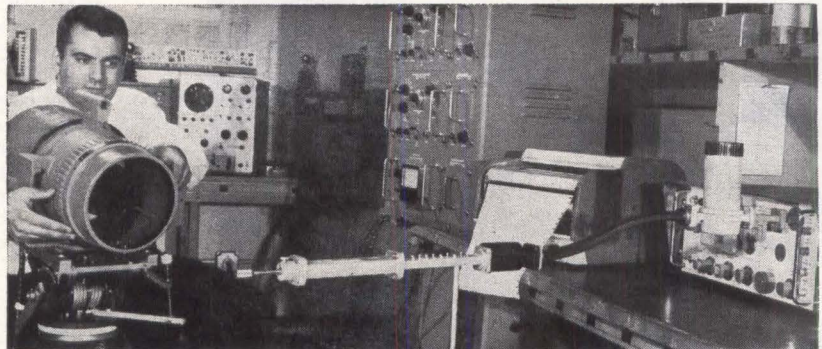

MICROWAVE plumbing is production-tested with Barnes Engineering radiometer. Infrared instrument pinpoints areas of r-f loss which manifest themselves as heat sources. This is one of numerous infrared manufacturing applications being investigated by Raytheon

tion, work already accomplished in the following areas provides a solid basis for further efforts:

- Checking components during manufacture
- Checking components at the receiving-inspection level
- Checking circuits and assemblies at in-process inspection level
- Locating failure causes during production test and troubleshooting
- Post-production maintainability of equipment.

MANUFACTURE CHECKING—Thermal resistance, heat flow lines, inhomogeneties, etc. might go undetected by most conventional test equipment. However, when examined with infrared equipment, such factors produce tell-tale anomalies in infrared emission patterns.

For example, in graphs showing recorded pattern of a wire-wound resistor variation in d-c resistance caused by a nick in wire is indicated by an abrupt pattern peaking caused by a localized increase in temperature. Poor welds between the wire and the terminal metal cap and winding irregularities would also show up as a local increase in

temperature and infrared radiation.

RECEIVING INSPECTION—Twenty power transistors (type JAN 2N174) will serve as a good example of the value of ir receiving inspection. These twenty transistors were meeting all the specifications of electrical inspection. Consequently, all were rated as good. But, when energized, ir inspection showed that each of them had different initial infrared characteristics as indicated in the curves recorded.

Some of them had a fast initial rise in infrared emission but soon settled to a rather low final level. While others showing a slow initial rise, eventually attained a higher final level. But with one transistor, the curve is drastically higher than other curves. Obviously, something was probably wrong with a transistor showing such a high operating temperature.

This was borne out when all twenty transistors were left running in a life test at 0.6 of their rated power dissipation. After 1,000 hours, this transistor was the first failure.

A second failure did not occur

How General Dynamics/Electric Boat precision-cleans missile launching-tube components for Polaris subs!

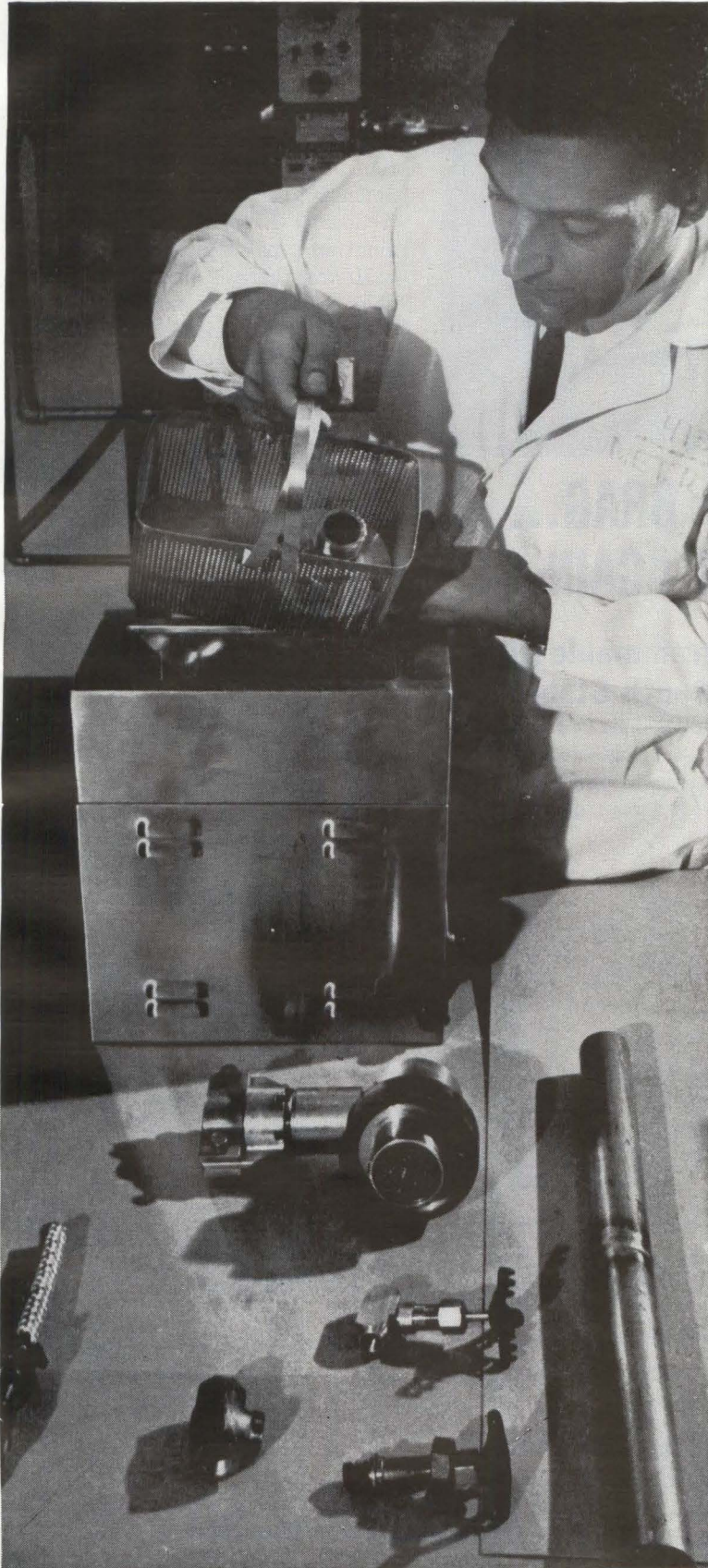

PROBLEM: Pneumatic launching-tube systems for the Polaris, involving miles of pipes, tees, valves, unions, etc., must be kept scrupulously clean at all times, according to Electric Boat. In an environment of high air pressure, the most minute organic contaminants could support a dangerous explosion. The previous cleaner was rated only 83 to 88% effective in removing a known hydrocarbon contaminant; also it had to be heated to 160°F. before use.

SOLUTION: All launching system components are now cleaned in an ultrasonic bath of FREON fluorocarbon solvent, both initially and during subsequent maintenance. FREON scores 100% every time on the hydrocarbon contaminant test, and works perfectly at ambient temperature.

Electric Boat continues, "Besides cleaning effectiveness, FREON has high purity, extremely low toxicity, nonflammability and ease of handling. Then, it's noncorrosive to metals and generally inert to plastics and elastomers—so FREON is ideal for cleaning when many different materials of construction are involved. Also, Du Pont supplied us with plenty of research data, which saved us time because we didn't have to run extensive analyses ourselves."

We'd be happy to show you how FREON can improve your own cleaning operation. First send the coupon or Reader Service Card for our new booklet on cleaning!

FREON[®]

solvents

BETTER THINGS FOR BETTER LIVING . . . THROUGH CHEMISTRY



**MAIL COUPON FOR NEW
BOOKLET ON CLEANING**

E. I. du Pont de Nemours & Co. (Inc.)
FREON Products Division
N-2420 E-6, Wilmington 98, Delaware

Name _____ Title _____

Company _____

Address _____

Please send new booklet on FREON solvents for precision cleaning.

I am interested in cleaning _____

I would like Du Pont to send a cleaning specialist.

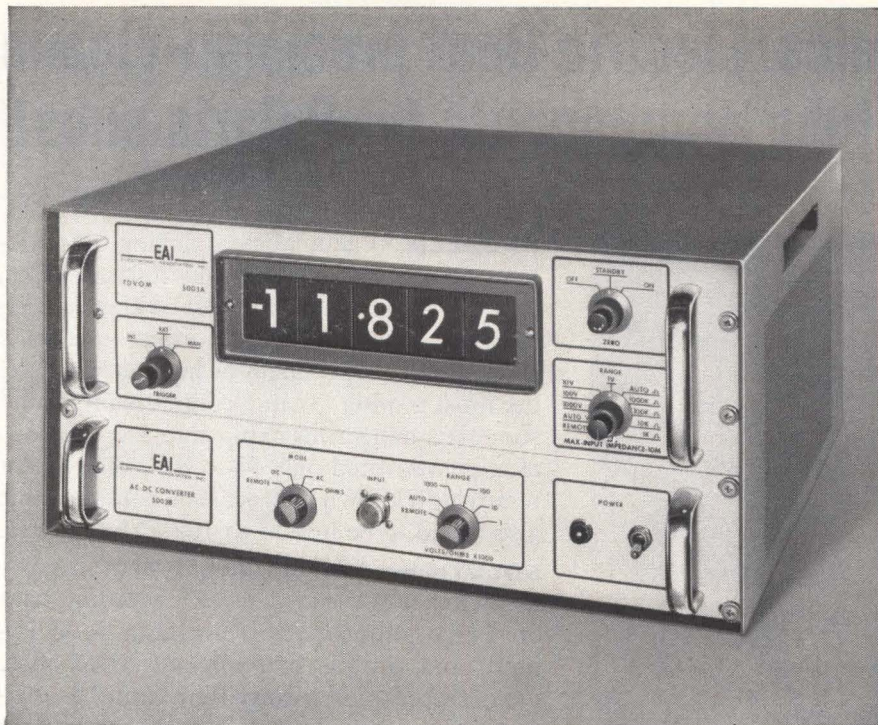

WE DON'T LIKE TO BRAG... BUT WE'VE DONE IT AGAIN

Two New, All Solid-State, Fully Programmable Digital Multimeters With Guaranteed Six-Month Stability

EAI leadership in digital instrumentation is again demonstrated in the new Series 5002 AC/DC DVM and Series 5003 AC/DC/OHMS Multimeter. All Solid-State, high speed, ultra-stable, automatic and programmable, these instruments provide the ultimate in performance, reliability and flexibility for automatic check-out systems, ground support equipment and laboratory instrumentation.

Series 5002 AC/DC Digital Voltmeter:

Absolute Accuracy: (DC) $\pm 0.01\%$ plus 1 digit
(AC) $\pm 0.06\%$ plus 1 digit to 5 KC,
 $\pm 0.1\%$ plus 1 digit to 10KC

Stability: 6 months without recalibration

Resolution: 100 microvolts AC and DC

Range: 0.0001 to 1199.9 volts in 4 ranges AC and DC

Reading Time: (DC) 10 ms without sign change
(AC) 160 ms maximum

Input Impedance: (DC) 10 megohms constant
(AC) 1 megohm resistive

Size: 8 $\frac{3}{4}$ inch by 19 inch RETMA panel Price **\$6250**

Series 5003 AC/DC/OHMS Digital Multimeter provides all features of the Series 5002 plus:

OHMS Accuracy: $\pm 0.05\%$ plus 1 digit

OHMS Range: 0.0001K to 1199.9K in 4 ranges

Reading Time: 10 ms Price **\$6650**

Write for details today. PRICES APPLY IN U.S.A. ONLY

EAI ELECTRONIC ASSOCIATES, INC. Long Branch, New Jersey

ADVANCED SYSTEMS ANALYSIS AND COMPUTATION SERVICES/ANALOG COMPUTERS/HYBRID ANALOG-DIGITAL COMPUTATION EQUIPMENT/SIMULATION SYSTEMS/SCIENTIFIC AND LABORATORY INSTRUMENTS/INDUSTRIAL PROCESS CONTROL SYSTEMS/PHOTOGRAMMETRIC EQUIPMENT/RANGE INSTRUMENTATION SYSTEMS/TEST AND CHECK-OUT SYSTEMS/MILITARY AND INDUSTRIAL RESEARCH AND DEVELOPMENT SERVICES/FIELD ENGINEERING AND EQUIPMENT MAINTENANCE SERVICES.

until after 2,000 hours. This time it appeared at first look rather surprising since its infrared characteristic curve lies at the bottom of the individual curves. However, subsequent transistor examination indicated that it possessed very high thermal resistance. This would cause a large temperature gradient between the junction and the outside envelope of the transistor. Thus, while the envelope looks rather cool under infrared examination, the junction inside runs at much higher temperature because it doesn't have adequate heat-dissipation capabilities.

Hence, there is promise of being able to detect at least two types of transistor failure mechanisms. However, further work has to be done to determine degree of success in weeding out early failures in transistors and diodes and how well ir can help one to predict life expectancy. The other eighteen transistors are still running in the life test. So far no further failures have developed—after a full year of continuous operation.

To further evaluate scope and capabilities of inspection system, Raytheon has recently started testing much larger groups of transistors and diodes, hoping to discover the correlation laws between ir readings and life expectancy.

IN-PROCESS INSPECTION—Infrared techniques should allow one to identify in-process defects that are otherwise not only difficult to detect but are also most often the causes for early system failures. Welded and soldered joints suffer their fair share of such defects.

Visual examination of these joints cannot disclose any faults hidden below the visible surface. Thus, poor spot welds and cold soldered joints often go undetected. However, infrared examination of heat developed when adequate electrical current flows through joints will tell whether area of fusion is large enough.

Another in-process inspection area is the identification of semi-conductors that have been damaged by heat of soldering. Presently, while there is information of a statistical nature for forecasting failures, nothing exists to locate damaged components *prior* to actual operational failure.

The implementation of infrared location techniques in this area calls for comparison of infrared radiation levels from semiconductors in their energized circuits, before and after soldering. This can be done in at least two ways:

- One way is to use semi-liquid solder paste that can be washed away for making temporary connections

- The other (when working on printed circuit boards) is to use a counter-bottom plate with small cavities filled with mercury to provide temporary connections between wires and lands.

Using these approaches, infrared recordings before soldering can be compared with those after soldering to point out components whose parameters have deteriorated.

ASSEMBLY CHECKS—When individual circuits are assembled into systems, the nature of resulting circuitry can bring out component defects not noticed during unit electrical tests. Frequently, no easy electrical measures will reveal conditions that are conspicuously indicated in infrared recordings:

One very interesting example involved detection of an overstressed transistor that would have caused an early failure. Transistor operated in a building block having three identical inverter circuits. After having passed all electrical specifications tests, the energized panel was scanned by an ir detector. Examination of resulting ir profile showed that transistor in center circuit had a much higher infrared emission than expected indicating an undesirably high power dissipation level.

TROUBLE SHOOTING—In production check-out of assemblies and subassemblies, an infrared profile obtained by scanning the energized units can be used to locate failure sources and their nature. Detection is based on the fact that every operating condition of an electronic assembly has a typical profile that could be called its "fingerprint" since it is unique in shape and configuration.

A graph illustrates such a normal pattern by means of solid blocks indicating "proper" infrared emission. Improper circuit functioning is shown by jagged lines related to



THIS IS THE DVM THAT REVOLUTIONIZED DIGITAL INSTRUMENTATION

Introduced in 1961, the all solid-state, automatic ranging Series 5001 has in the past two years become accepted as the standard for laboratory and digital systems instrumentation. □ Keystone of the EAI line of all solid-state digital voltmeter instruments, the Series 5001 is priced at only \$3,950 and features:

- ±.01% + 1 digit absolute accuracy
- 100 microvolt resolution
- 4 ranges to 1199.9 volts dc.
- 200 readings/second
- guaranteed 6 months stability
- all solid-state reliability
- completely automatic and programmable
- complete system flexibility

Companion instruments to the 5001 also feature 6 months stability, all solid-state reliability and complete system flexibility. They include:

- AC/DC and AC/DC/OHMS digital multimeters
- Digital volt-ohmmeters
- AC-DC Converters
- Input Scanners
- Output printers and serializers
- Remote display units

Write for details today. PRICES APPLY IN U.S.A. ONLY

EAI ELECTRONIC ASSOCIATES, INC. Long Branch, New Jersey

ADVANCED SYSTEMS ANALYSIS AND COMPUTATION SERVICES/ANALOG COMPUTERS/HYBRID ANALOG-DIGITAL COMPUTATION EQUIPMENT/SIMULATION SYSTEMS/SCIENTIFIC AND LABORATORY INSTRUMENTS/INDUSTRIAL PROCESS CONTROL SYSTEMS/PHOTOGAMMETRIC EQUIPMENT/RANGE INSTRUMENTATION SYSTEMS/TEST AND CHECK-OUT SYSTEMS/MILITARY AND INDUSTRIAL RESEARCH AND DEVELOPMENT SERVICES/FIELD ENGINEERING AND EQUIPMENT MAINTENANCE SERVICES.

UTICA

NEW 34-6 ELECTRONIC PLIER

FOR LONG REACH AND SNAP CUT!

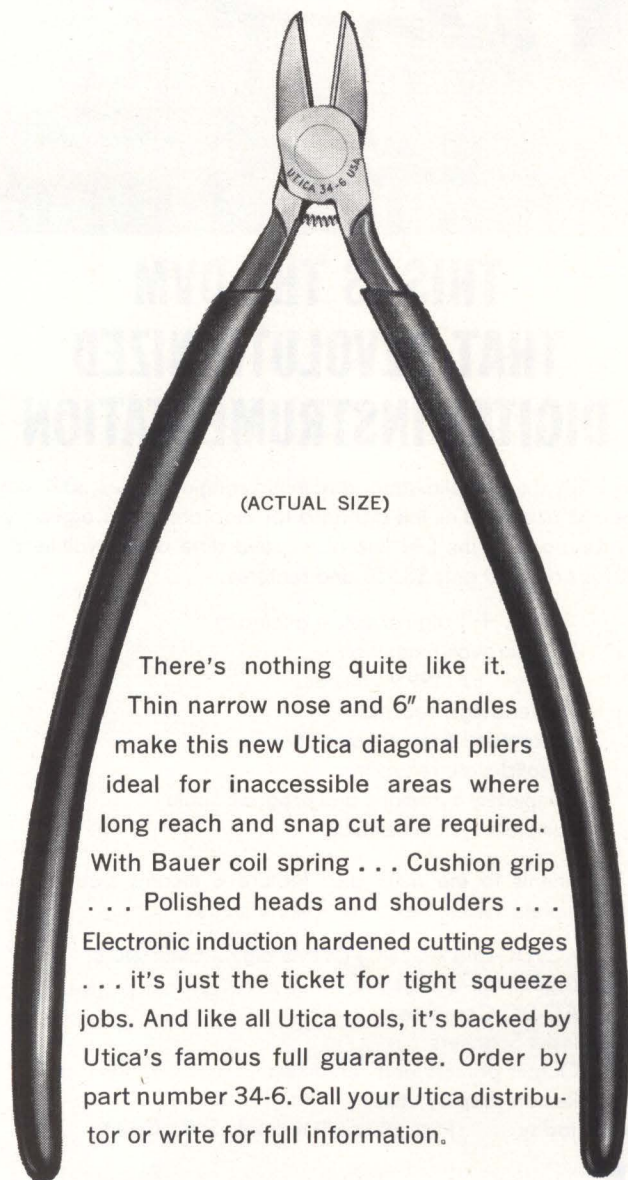

(ACTUAL SIZE)

There's nothing quite like it. Thin narrow nose and 6" handles make this new Utica diagonal pliers ideal for inaccessible areas where long reach and snap cut are required. With Bauer coil spring . . . Cushion grip . . . Polished heads and shoulders . . . Electronic induction hardened cutting edges . . . it's just the ticket for tight squeeze jobs. And like all Utica tools, it's backed by Utica's famous full guarantee. Order by part number 34-6. Call your Utica distributor or write for full information.

Tools the experts use!

UTICA DROP FORGE & HERBRAND TOOL DIVISION • KELSEY-HAYES CO.
ORANGEBURG, SOUTH CAROLINA

accompanying abnormal infrared emission. It often happens that infrared emission of almost every component has changes because the failure source is located at the front end of system thus altering performance of subsequent components in signal-flow path.

The fact that every type of failure has its own typical "fingerprint" should be extremely useful in an automated test and trouble shooting operation: The standard profile that units are supposed to meet is put into a memory along with all the infrared profiles of every possible failure. Coincidence comparison is made of "live" profile with standard and failure profiles to determine acceptance or failure classification indicating required corrective work.

25-Ton Press Features Large Mold Area

DESIGNED especially for encapsulation molding of resistors, capacitors, diodes, and similar electronic and electrical components, using epoxy or silicone resins requiring low to moderate pressures, a new 25-ton semi-automatic compression/transfer molding press has a relatively large platen area for a press of this tonnage. It was developed by F. J. Stokes Corporation, Philadelphia.

Mold area is 18 by 19 inches to allow a considerable number of pieces to be molded in a single shot. Multiple-cavity molds for as many as 120 capacitors can be accommodated.

A fixed lower platen makes it suited for automatic loading of work-holding fixtures. Height of platen above floor-level is 38 inches so that platform for the operator is not needed.

Standard configuration of the press (Model 735) utilizes top clamp and bottom transfer and ejection—an arrangement which reduces cycle-time. However, the press can be built to provide bottom clamping and top transfer if desired to accommodate existing tooling.

Separate hydraulic circuits for the clamping and transfer rams are provided, both fitted with pressure adjustments for rapid setup. Speed

of travel of the transfer ram can be regulated by a pressure-compensated flow control valve, providing fast movement, initially, then slowing to complete the transfer of material. Low-pressure clamping protects the mold from damage as well as providing protection for the items being encapsulated.

The mechanical ejection system is operated by the opening and closing motions of the clamping system. Hydraulic ejection is available as an optional feature.

The electrical control panel is mounted on one of the front tie-rods. The base of the press is designed with the hydraulic equipment to its left, so that an electronic preheater can be positioned close alongside the press. An oil filter and double heat-exchanger are included as standard equipment. Provision for electrically heating the mold, with pyrometer temperature controls, and a safety gate are optional features.

Verifies Linearity of Dial Indicators



MICROMETER instrument weighs 6 pounds and measures 5½ by 6½ inches

EASY-TO-USE instrument for verifying linearity of dial indicators on dimension gaging fixtures is available from Sheffield Corp. Instrument consists of an ultra-precise micrometer that is guaranteed to be accurate to within 10 millionths of an inch per inch. Operating over a measuring range of one inch, the instrument's 4-inch barrel provides the 10-millionth/inch vernier-scale reading. As shown in photo, micrometer's rotating anvil is worked-in against cartridge of gaging fixture. Linear verification is made by comparison of reading obtained from gage and that on micrometer barrel. Rotating thimble on micrometer zeroes instrument in with indicating system of inspected gage.

How to cut your handling time winding bobbin type coils

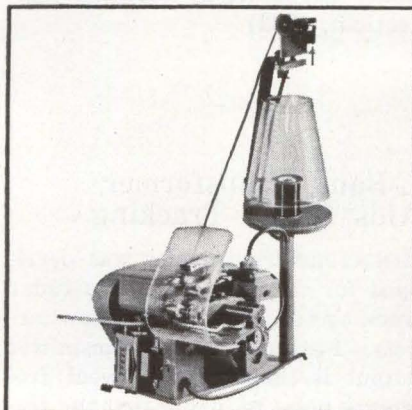

The Leeson No. 115 Bachi Bobbin Winder reduces coil handling time to a minimum for a single-head machine. All the operator has to do is load the bobbin on the arbor, close the tailstock, let the wire slip into the wire guide, and close the safety guard.

The No. 115 automatically:

- Starts
- Runs smoothly and quietly to 12,500 rpm
- Stops at ± 2 turns
- Re-indexes the wire guide
- Resets counter

Also available is the No. 115-B winder with bonding attachment to produce perfectly self-supporting coreless coils.

For full details write Leeson Corporation, Warwick, R. I. Or call Leeson at 5700 W. Diversey Avenue, Chicago 39, TUxedo 9-5735; 1500 Walnut St., Philadelphia 2, KIngsley 6-1720, or A. R. Campman & Co., 1762 Vernon Ave., Los Angeles, AXminister 3-6265.



23.3.27

Generator Simulates Megapulse Source

Four-pulse trains can be manipulated for parallel, serial, or staircase output

PULSE-TRAIN generator provides a versatile combination of four independent pulse sources, with outputs capable of being fed along separate lines, fed out serially, or superimposed, on common line. Spaced with 5 nanoseconds p-p separation the output-train simulates a 200-Mc pulse source of 25 volt amplitude. Individual pulses can be switched in or out, inverted, or combined to produce a single

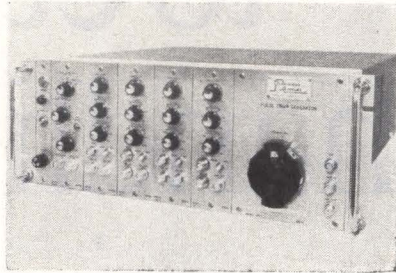

2.5 ns rise-time pulse delivering 2 amps into a 50 ohm load. The pulses can also be combined to produce a staircase waveform (top oscillogram) or simulate a 300 megapulse source with reduced

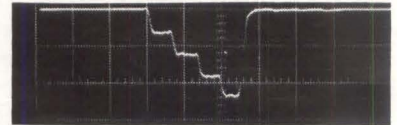

pulse height as shown in the bottom oscillogram. The generator manufacturer is Nanosecond Systems, Inc., 176 Linwood Avenue, Fairfield, Connecticut.

CIRCLE 301, READER SERVICE CARD

Linear Encoder Follows Absolute Motion

NEW one-brush linear-motion encoder translates absolute positional data with resolution of 1,000 counts in 11 inches and a one-count accuracy. Life of the unit is in excess of 4 million brush passes, starting force on the single brush is about 1 gram, and the unit accommodates a total count of 999 using only six wires rather than the customary 12. Owing to the unit's use of storage flip-flops the commutator is not obliged to feed-out continuous data but need only feed the flip-flops with change-of-position information.

Logic is binary coded decimal and the encoders come in 11 inch

lengths; they are intended for use in a wide range of industrial applications involving linear motion, including plotting tables, machine tools, strip-chart recorders, and so forth. The manufacturer is Perkin Elmer Corporation, Norwalk, Connecticut. (302)

L-Band Transformer Aids Radar Tracking

MINIATURE transponder was developed for the Air Force as a radar tracking aid for supersonic tow targets. Feature of the transmitter output is the use of a swept frequency pulse to insure that the signal is within the narrow bandpass of the search radar receiver when the radar is subject to frequency drift. Unit is also available in a variety of receiver sensitivities, transmitter power outputs and coding modes for use as a "poor man's iff beacon" for drone targets and other small aircraft. Weight is 3.75



lb.; size, approximately 75 cu in. Aero Geo Astro Corp., 179 North Eglin Parkway, Fort Walton Beach, Fla. (303)

Disk Store Accommodates 7,680,000 Logic Bits

ASSEMBLIES of up to six magnetic recording discs with diameter to 48 inches (photo, p 70) and storage capacities exceeding 7½ megabits are now available. The manufacturers claim long and trouble free operating life, plus built-in compensation against shock, vibration and beyond-spec. temperatures exceeding 140F.

Memory units operate in the speed range 3,600 to 6,000 rpm and

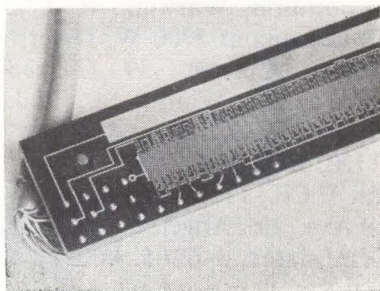

THE MOST WELL BALANCED STOCK OF MICRO-DRILLS IN THE U.S.A.



SPHINX

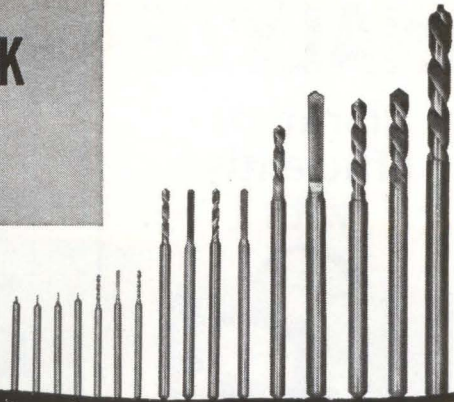
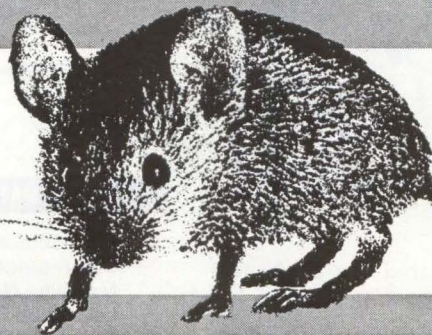

IN STOCK FOR IMMEDIATE DELIVERY

TYPE	STYLE	STOCK SIZES
Spirec Pivot Drills	Right Hand	0.10mm to 3.00mm by 0.01mm increments
Flat Pivot Drills	Right Hand	0.04mm to 1.00mm by 0.01mm increments
Spirec Pivot Drills	Left Hand	0.10mm to 1.00mm by 0.01mm increments
Spirec Center Drills	Right Hand	0.10mm to 0.70mm by 0.05mm increments

Other sizes and styles available on special request.

SPHINX known the world over as the symbol of the finest in micro-drills. Insist on them by name. Your best assurance of quality and precision.

SEND FOR COMPLETE DRILL CIRCULAR

LEVIN®

LOUIS LEVIN & SON, INC.

3573 Hayden Ave., Dept. E • Culver City, California

CIRCLE 203 ON READER SERVICE CARD

REDRAWN / GLASS TUBING GLASS ROD

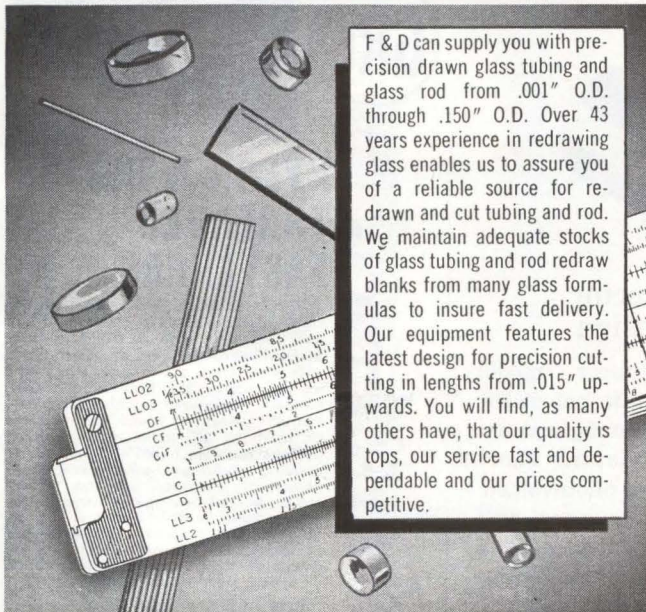

F & D can supply you with precision drawn glass tubing and glass rod from .001" O.D. through .150" O.D. Over 43 years experience in redrawing glass enables us to assure you of a reliable source for redrawn and cut tubing and rod. We maintain adequate stocks of glass tubing and rod redraw blanks from many glass formulas to insure fast delivery. Our equipment features the latest design for precision cutting in lengths from .015" upwards. You will find, as many others have, that our quality is tops, our service fast and dependable and our prices competitive.



For Further Information Call or Write
FRIEDRICH & DIMMOCK
INCORPORATED
BOX 230
MILLVILLE • NEW JERSEY
Serving industry for almost half a century

CIRCLE 204 ON READER SERVICE CARD

electronics • June 14, 1963



A NAME TO REMEMBER IN MACHINERY FOR ELECTRONICS

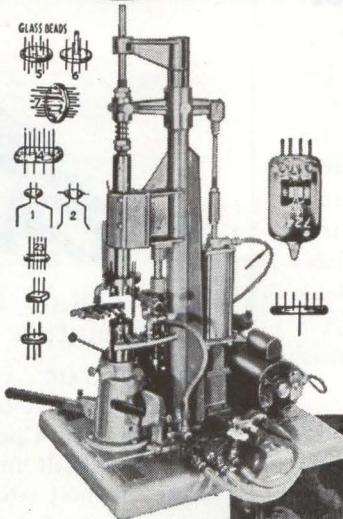

At left: No. 105-BST1 single position Button Stem and Wafer making machine—Fully automatic. Designed for small production runs on special tube parts or for laboratory use. Produces button stems up to 1/4" diameter. Machine can be supplied with up to 24 positions.

Illustrated below: An Eisler precision Vertical Spot Welder designed exclusively for welding of electronic components. Available in sizes from 1/2 to 7 1/2 KVA.



Write us today for full particulars!

EISLER ENGINEERING CO., INC.

Charles Eisler Jr., President

751 So. 13th St., Newark 3, N.J.

CIRCLE 69 ON READER SERVICE CARD

69

ANALYZE

vibration
efficiently
with

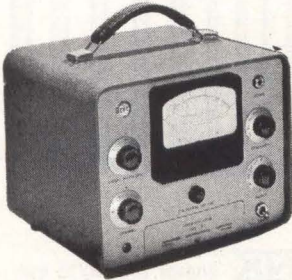

CEC's 1-117 Vibration Meter and



1-159 Variable Frequency Bandpass Filter

Teamed, CEC's 1-117 Vibration Meter and 1-159 Variable Frequency Bandpass Filter make an unbeatable vibration analyzer system... in field, lab, or production lines. CEC's 1-159 offers narrow-band frequency selection from 8-2500 cps. Lightweight, portable and all solid state, it is available for AC or DC operation. Dial accuracy? Within 1% of frequency reading.

CEC's 1-117 meters vibration velocity and peak-to-peak displacement at selected frequency. Features: 4 input channels; 4-stage single channel amplifier stabilized for extreme reliability. More information? Call or write for Bulletins CEC 1117-X2 and 1159-X5.

CEC

Transducer Division

CONSOLIDATED ELECTRODYNAMICS

A Subsidiary of Bell & Howell • Pasadena, Calif.

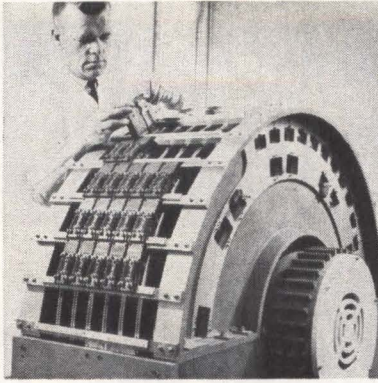

are grease-lubricated for a 10-year life. The larger-sized discs store information on both sides, with packing density to 400-bits/inch using phase modulation recording techniques. Head inductances lie in the 25-150 microhenries region while write current is around 40-100 milliamps. Readout voltage under most conditions is about 50 millivolts, read and write heads are air-supported for maximum effectiveness.

Besides these high capacity magnetic discs, the manufacturer, Information Systems Group, General Precision Systems, Glendale 1, California, make large capacity magnetic drum stores with overall performance similar to the disc stores.

CIRCLE 304, READER SERVICE CARD

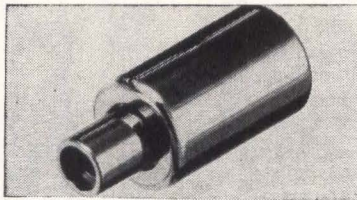

Photovoltaic Detector In Miniature Design

PHOTOVOLTAIC transducer model SA-120 is a photovoltaic generator in a miniature probe configuration. It has a built in miniature, short time constant selenium photovoltaic cell constructed in a rugged well shielded socket base protected by a threaded lens holder in the front. The d-c output voltage and the small superimposed a-c voltage of the photovoltaic transducer (while a-c light source is used) is proportional to the illumination intensity and frequency (below saturation level). Model SA-120 may be used in detecting and pinpointing the source

Telrex

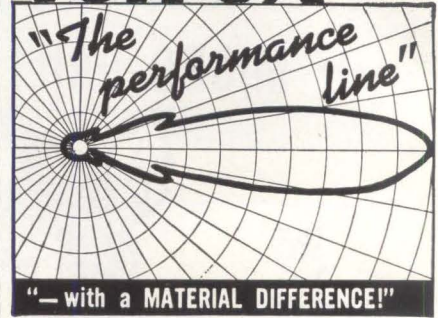

The Choice of the Discriminating Communication Engineer... the Man who Never Settles for Anything Less than THE-VERY-BEST!

telrex "BEAMED-POWER" ANTENNAS and ANTENNA SYSTEMS

Provide optimum performance and reliability per element, per dollar. Antennas from 500 Kc to 1500 Mc. Free PL88 condensed data and pricing catalog, describes military and commercial antennas, systems, accessories, Towers, Masts, Rotators, "Baluns" and transmission line data.

Communication and TV Antennas

ANTENNAS SINCE 1921 **telrex** LABORATORIES

Asbury Park 41, New Jersey, U.S.A.
CIRCLE 205 ON READER SERVICE CARD

GRC

SCREWS
HEX NUTS
WASHERS
INSULATORS & BUSHINGS
COIL BOBBINS
WIRE TIES
WIRE CLAMPS

NYLON & DELRIN THREADED FASTENERS

● GRC's complete line of high quality close tolerance molded screws and hex nuts include screws in standard commercial heads—Phillips or slotted types—in sizes from #4 thru 1/4"; hex nuts in ten sizes (#2 thru 5/16") GRC molded miniature machine screws—half the weight of aluminum—in sizes as small as #0 make more compact designs possible. GRC's single cavity molding technique adds exceptional uniformity, accuracy, economy to Nylon's & Delrin's high strength-to-weight ratio, built-in electrical insulating qualities, stability, resilience and elasticity. GRC's molded fasteners are available from stock in a wide range of types, sizes and lengths.

WRITE, WIRE, PHONE NOW for samples & GRC's new detailed Industrial fastener catalog.

GRIES

GRIES REPRODUCER CORP.

World's Foremost Producer of Small Die Castings
151 Beechwood Ave. • New Rochelle, N. Y.
Phone: (914) NEW Rochelle 3-8600

CIRCLE 206 ON READER SERVICE CARD
June 14, 1963 • electronics

of low level modulated or unmodulated light in fluctuating pulse, or continuous form. Don Bosco Electronics, Inc., 16 Littell Road, Hanover, N. J. (305)

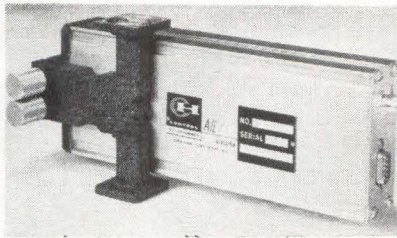

Mixer-Amplifiers Aid System Designer

NEW waveguide mixer-amplifier, type 135, solves the problem of matching the mixer and amplifier stages for the system design engineer. He is no longer reliant upon several sources of supply to ensure proper system operation. From r-f input to i-f output, the type 135 provides results that are predictable, specified, and guaranteed. Type 135 units use standard type 134 hybrid preamplifiers, and combination amplifiers, which have been designed and tested to meet the most demanding requirements. Units were tested to comply with the environmental requirements of MIL-E-5400E, Class 1 temperature and Curve IV vibration. The mixers are integrated with solid-state low-noise preamplifiers providing 30 or 60-Mc output. Airborne Instruments Laboratory, Deer Park, L. I., N. Y. (306)

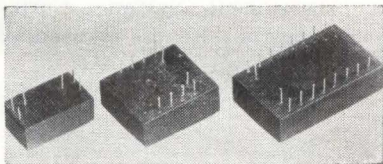

Magnetic Reed Relays Feature Long Life

DESIGNED for direct p-c board mounting, these magnetic reed relays feature contact ratings of 4 w, 0.125 amp, 250 v, from 1-12 contacts, in standard 6, 12, or 24 v coils. In addition to standard form A (spst) normally open contacts, combinations of form A and form B normally closed contacts are also available as are contact ratings up

"NAVCOR, OR EQUAL"

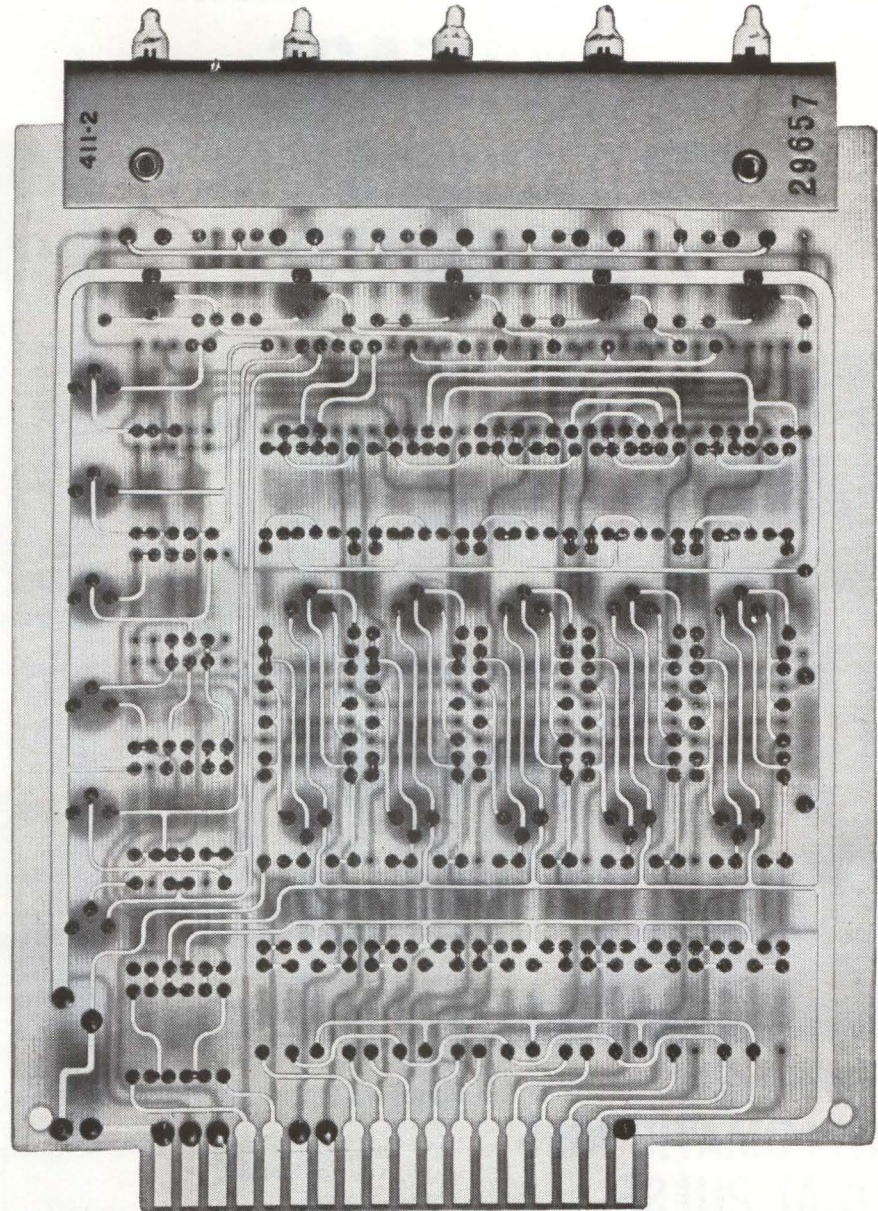

Why not specify the most carefully crafted digital systems modules made? All the printed circuitry of Navcor 400 Series modules is gold-plated. Every joint is precision soldered by hand. Each module is designed to 'worst case' tolerances, quality controlled in manufacture to meet highest MIL Standards. And each Series 400 is a system function module with unmatched packing density. Write for complete data.

Transistorized Digital System Function Modules

NAVCOR

VALLEY FORGE INDUSTRIAL PARK

930 RITTENHOUSE ROAD, NORRISTOWN, PA. • GL 2-6531

Attention Module Makers!

INCREASE WELD CONSISTENCY, RELIABILITY

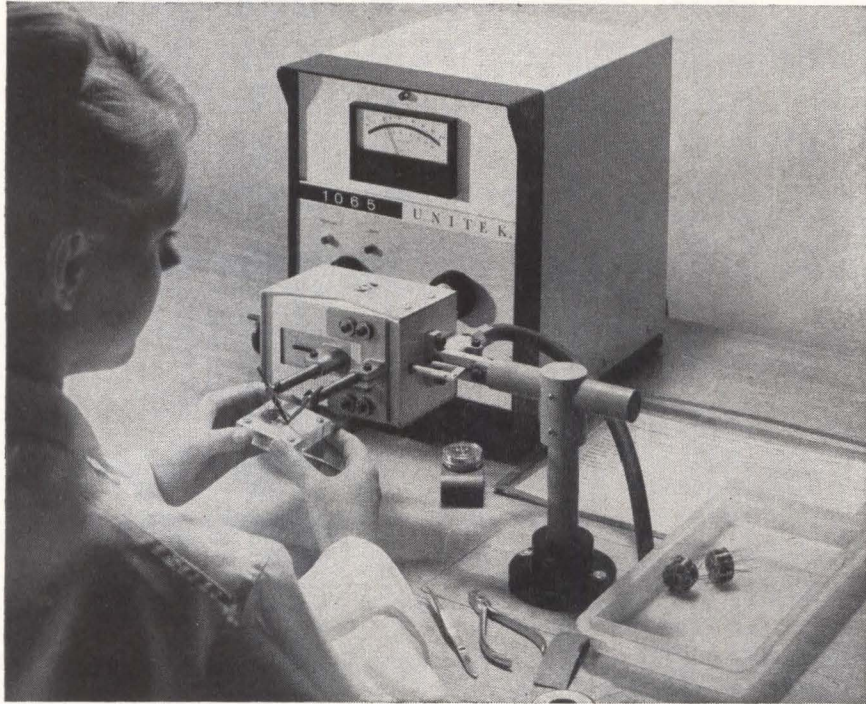

THIS NEW WELDMATIC 1065 DUAL PULSE POWER SUPPLY



Want more Facts? Write Weldmatic Division/Unitek, 950 Royal Oaks Drive, Monrovia, California. Request Bulletin PB-26.

Has Two Optimum Pulse Shapes

Long—for high conductivity metals like Tinned Copper

Normal—for high resistivity metal like Kovar, Dumet

FOR SUPERIOR QUALITY CONTROL—

Precise pulse of heat energy is accurately matched to metal's weld characteristics. Hence, a wider latitude of weld reliability on every joint you weld.

Each pulse has an ultra high stability. It is exactly repeatable, weld after weld.

Energy pulse generated by two separate circuits. Optimum shape of each pulse based on 18 months of intensive field research.

Dual range (20/100WS) power supply is further matched to follow up characteristics of Weldmatic 1032 head promoting even greater weld accuracy.

WELDMATIC DIVISION / UNITEK

to 10 w, 0.5 amp. Must-operate voltage is approximately 82 percent of nominal coil voltage at 25 C. Operate time is less than 0.8 millisecc for single contact unit, not including bounce, when coil is energized at nominal voltage. Minimum life expectancy is 110 million operations at max rating. Prices start from \$3.60 in 6 v, 1 form A to \$20.80 in 24 v, 12 form A. Wintronics, Inc., 1132 S. Prairie Ave., Hawthorne, Calif.

CIRCLE 307, READER SERVICE CARD

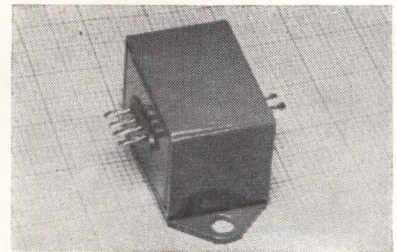

Hall Effect Modulator For Accurate Chopping

HALL EFFECT microvolt modulator, type RMY-11, functions as a solid-state chopper to convert small d-c or low frequency signals into a-c for amplification with minimum noise. The Hall effect element provides contactless, nonmechanical operation and preservation of the chopping signal waveform throughout its frequency range. The modulator's high output, low noise and small ohmic zero components suit it to such applications as: sensitive measurement amplifiers, servomechanism systems, low level modulation, frequency conversion, computation and small signal multiplication. Instrument Systems Corp., 111 Cantiague Road, Westbury, N. Y. (308)

Signal Generator Spans 170 to 940 Mc

NOW AVAILABLE is a uhf standard signal generator, type SDAF, which has a frequency range of 170 to 940 Mc in 9 sub-ranges. It is designed for use in conjunction with a-m, f-m and video equipment. Its output, continuously variable from 1 μ v to 0.5 v, may be either amplitude or frequency modulated, or both simultaneously. An internally supplied modulation frequency of 1,000

cps is provided for a-m and f-m, or an external source may be used. External video modulation from 3 cps to 6.5 Mc is also possible. Type SDAF has a vswr of less than 1.1 at 50 ohms output impedance, and less than 1.15 at 75 ohms. Rohde & Schwarz, 111 Lexington Ave., Passaic, N. J. (309)

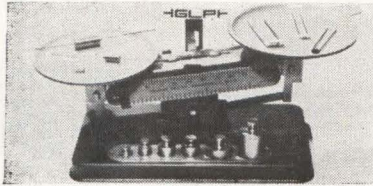

Tantalum Capacitors Feature Small Size

TYPE DPSD epoxy dipped, solid electrolyte, tantalum capacitors offer a substantial reduction in size over conventional type CS-12's and CS-13's of Mil 26655/2A, and are lower in cost. Their design suits them for printed circuit applications. They are also available with axial leads for conventional applications (all leads are weldable). Capacitance is 0.0047 μ f to 330 μ f. GLP Electronics, Inc., 350 Riverside Ave., Bristol, Conn. (310)



Tunable Magnetron Weighs Only 22 Ounces

MODEL BLM-104 is a 5 Kw tunable magnetron weighing only 22 oz. It is designed for Ku band beacon applications in airborne and missile environments, and for altimeters, and may be used in portable ground equipment where minimum weight and maximum efficiency are important. Tunable frequency is 15.8 to 16.2 Gc, peak power output (min), 5 Kw; peak anode voltage (max), 6.8 Kv; peak anode current (nom.), 3.75 amp. Varian Associates, Salem Road, Beverly, Mass. (311)

ON THE SHELF— ARNOLD CORES IN WAREHOUSE STOCK FOR IMMEDIATE DELIVERY

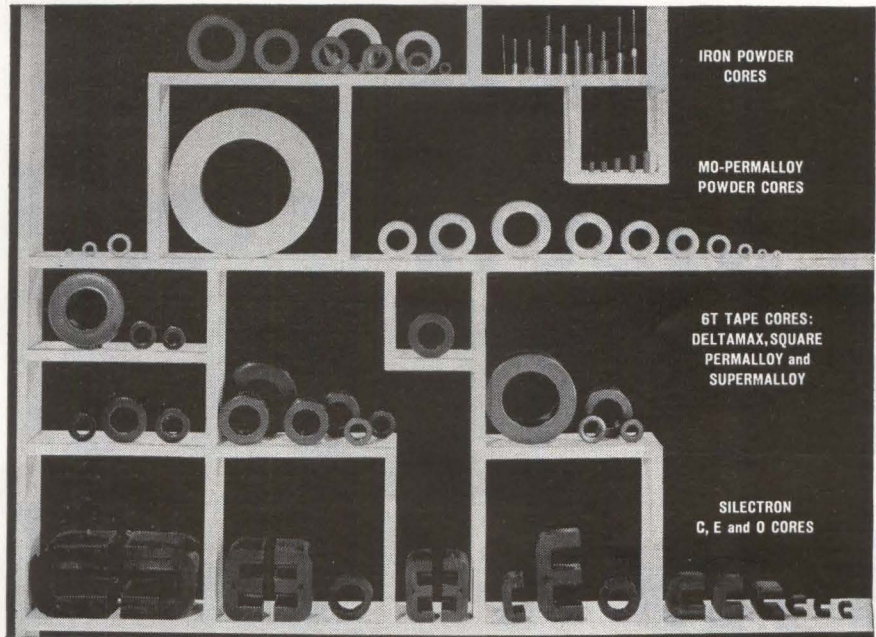

Let us handle your inventory problems and save you time and money on your magnetic core requirements.

Extensive stocks of four types of Arnold cores in the most popular sizes have been set up in our Marengo, Illinois and Fullerton, Calif. plants. Subject of course to temporary exhaustion of stock by prior sales, these cores will be shipped *the same day* on orders received at the warehouse by 12:00 noon. When cores are out of stock at the nearest plant, we may be able to ship within 24 hours from the other.

Arnold core products covered by this warehouse stock program

include: 1) Silectron C, E and O cores in 2, 4 and 12-mil tape. 2) Type 6T aluminum-cased cores of Deltamax, Square Permalloy and Supermalloy, in 1, 2 and 4-mil tape. 3) Mo-Permalloy powder cores, both temperature-stabilized and unstabilized types, ranging down to 0.260" diameter. 4) Iron powder toroids, threaded cores and insert cores.

All four products are available in a wide range of selection, for your convenience and economy in ordering either prototype design lots or regular production quantities. • Stock lists and technical material are available—write for data.

ADDRESS DEPT. E-6



ARNOLD

SPECIALISTS in MAGNETIC MATERIALS

THE ARNOLD ENGINEERING COMPANY, Main Office: MARENGO, ILL.
BRANCH OFFICES and REPRESENTATIVES in PRINCIPAL CITIES

2998 RIA

Great news in metal-to-plastic electrical laminates

Bend it
Stack it
Twist it
Roll it
Flex it
Test it!

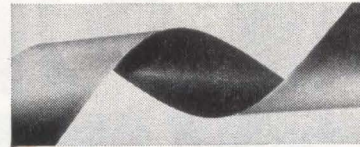
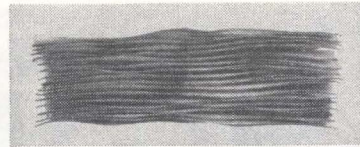
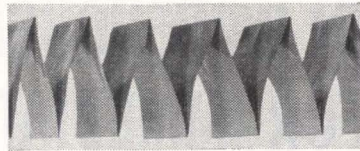

Replace expensive hand wiring with low-cost continuous processing of Schjel-Clad*.

This unique combination of flexibility and dimensional stability in Schjeldahl's metal-to-plastic electrical laminate, Schjel-Clad, can really cut costs. It permits reliable, continuous in-line processing to produce flexible wiring harnesses, computer memories and other flexible printed wiring.

Schjel-Clad is available in a variety of materials: Copper, Aluminum or Nickel bonded to Polypropylene, Mylar[†] or Teflon[†]. Each laminate is available in a wide variety of thicknesses and widths. Write or call for data sheets and samples in the sizes you need. Phone: Area Code 507, NI 5-5635.

*G. T. Schjeldahl Co., T.M. Reg. U.S. Pat. Off. [†]duPont trademarks for its polyester film; fluorocarbon resins

Putting Materials Together Through Chemistry and Mechanical Design

PRODUCTS



SERVICES

G.T. Schjeldahl Co.

SAY "SHELL-DOLL" • NORTHFIELD, MINNESOTA

Literature of the Week

WIREWOUND RESISTORS Ohmite Mfg. Co., 3664 Howard St., Skokie, Ill. Molded vitreous enamel insulation on wirewound, axial-lead resistors is described in bulletin 103. **CIRCLE 312, READER SERVICE CARD**

POWER MODULES Electronic Research Associates, Inc., 67 Factory Place, Cedar Grove, N. J., has published a catalog supplement covering its Transpac line of solid state power modules. (313)

PUSHBUTTON SWITCHES Chicago Dynamic Industries, Inc., 1725 Diversy Blvd., Chicago 14, Ill., has available catalog pages on digital and binary pushbutton switches. (314)

FAST SWITCH RECTIFIERS Hughes Semiconductor Division, 500 Superior Ave., Newport Beach, Calif., has available data sheets for 40 EIA approved Golden Line fast switch rectifiers. (315)

TELEMETRY TRANSMITTERS Advanced Electronics Corp., 2 Commercial St., Hicksville, L. I., N. Y., offers catalog 290 PC, a two-color brochure on airborne vhf/f-m 2-w telemetry transmitters. (316)

ROTARY POTENTIOMETERS Weston-Instruments & Electronics Division, 614 Frelinghuysen Ave., Newark 14, N. J. Technical data sheet covers the Daystrom 314 series subminiature rotary potentiometers. (317)

TROPO DATA Radio Engineering Laboratories, Inc., 29-01 Borden Ave., Long Island City 1, N. Y., has released a set of technical data sheets on tropospheric scatter radio equipment. (318)

SWITCH MODULES North Atlantic Industries, Inc., Terminal Drive, Plainview, N. Y. Two-page bulletin describes a series of sealed thumb-wheel switch assemblies. (319)

C-C TV Cohu Electronics, Inc., Kin Tel Division, 5725 Kearny Villa Road, San Diego 12, Calif. Use of closed-circuit tv in the development of solid-propellant rockets is described in application bulletin 8-35. (320)

SILICON READOUT CELLS Solar Systems Inc., Skokie, Ill. Advantages of using silicon photovoltaic readout cells in tape readers, punch card systems and control applications are described in brochure 63A. (321)

LINEAR MOTION POTS Computer Instruments Corp., 92 Madison Ave., Hempstead, N. Y., has issued a 16-page linear motion potentiometer catalog. (322)

SYSTEMS CATALOG Navigation Computer Corp., Valley Forge Industrial Park, Norristown, Pa. Six examples of complex, custom developed systems are described in a new brochure. (323)

VARIABLE RESISTOR CTS of Berne, Inc., Berne, Ind. Advance data sheet

8050 covers CeraTrols series 385 11/32 in. diameter Cermet variable resistor. (324)

SOLID TANTALUM CAPACITORS Sprague Electric Co., Marshall St., North Adams, Mass. Engineering bulletin No. 3530 describes molded cylindrical solid tantalum capacitors that are available in the same case sizes as $\frac{1}{4}$ and $\frac{1}{2}$ w composition resistors. Request on company letterhead.

VARIABLE TRANSFORMERS The Superior Electric Co., Bristol, Conn. Catalog P363G covers a line of 50/60 cycle Powerstat variable transformers in ratings from 0.13 to 374 Kva. (325)

CHART PAPER Brush Instruments division of Clevite Corp., 37th and Perkins, Cleveland 14, O. Brochure 2951A describes a line of chart paper engineered for all types of direct writing recorders. (326)

SENSITIVE RELAYS Hi-G Inc., Spring St. & Route 75, Windsor Locks, Conn., announces a complete catalog on its entire line of sensitive relays. (327)

OSCILLOSCOPE CATALOG Analab Instrument Corp., Cedar Grove, N. J. Short form catalog AN-C-501, "Precision Oscilloscopes and Scope-Recording Camera Systems", is now available. (328)

WRITE-READ CIRCUIT MODULE Delttime Inc., 603 Fayette Ave., Mamaroneck, N. Y. Data sheet DT-2 describes the RZ-1 digital write-read circuit module for magnetostrictive delay lines. (329)

WAVEGUIDE WINDOWS Sylvania Electric Products Inc., 1100 Main St., Buffalo 9, N. Y., offers a data sheet that summarizes the Microwave Device division's capabilities in flange-mounted mica and solderable Kovar glass waveguide windows. (330)

SILICONES Union Carbide Corp., 224 Market St., Newark 2, N. J., has available a new quarterly publication, *Silicology*, on silicones and silicone chemistry. (331)

DATA PROCESSING SYSTEM Honeywell Electronic Data Processing, 60 Walnut St., Wellesley Hills 81, Mass. A 20-page brochure describes major features of the 1800-II data processing system. (332)

CONTROL SERVO-DAMPING DEVICES Veritron Corp., 52 Gazza Blvd., Farmingdale, N. Y. Brochure contains engineering data and specifications on a new line of control servo-damping devices. (333)

VOLTAGE BREAKDOWN TESTER Microdot Inc., 220 Pasadena Ave., S. Pasadena, Calif. Data sheet describes model 1901A voltage breakdown tester. (334)

PRECISION INSTRUMENTS James G. Bidle Co., Township Line & Jolly Roads, Plymouth Meeting, Pa. Bulletin 60-63 details and illustrates a line of bridges, potentiometers, resistance standards and related equipment. (335)

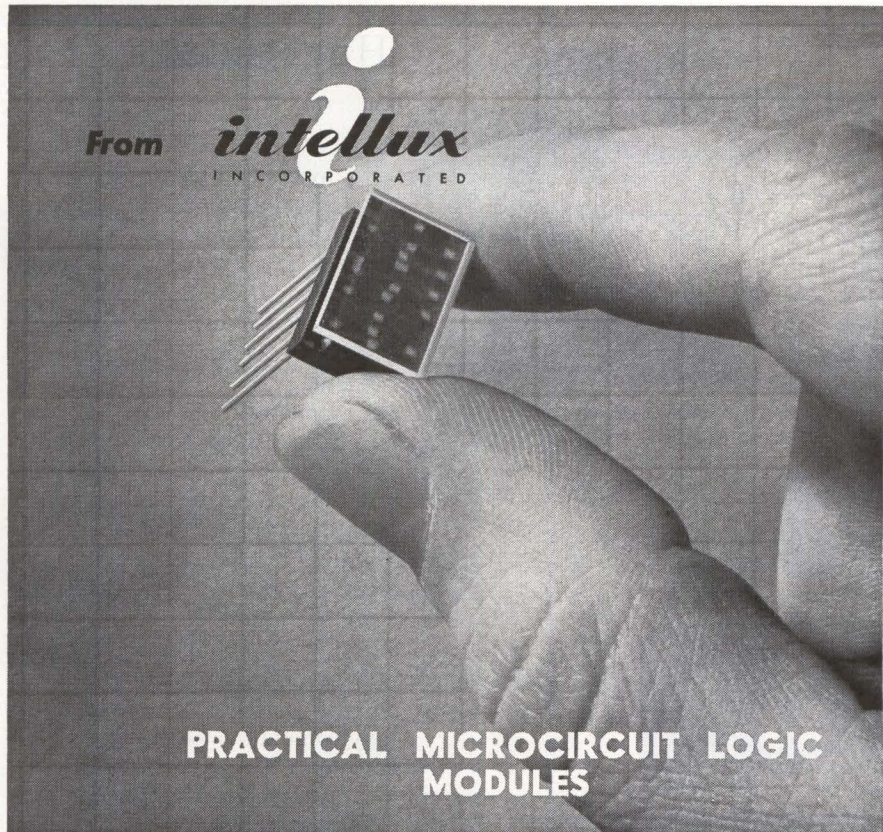

Tired of the "Madison Avenue Pitch" on micro-circuitry? Take a look at **practical logic modules.**

The INTELLUX approach is realistic—it's here today—in any volume (2, 3, 4 or 5,000 per week if you want)—and best of all their use can put profit back in your computer-sales.

Drop us a card for the complete story, but here are the brief facts:

- ▶ Available immediately . . . Flip Flops, Double NOR Gates, Gate Buffers and Free-running Multivibrators.
- ▶ They can be mounted physically adjacent to each other . . . and still be interconnected.
- ▶ Standard semiconductors are married to thin film passive components.
- ▶ Stability of resistors guaranteed to 30,000 hours.
- ▶ Outperforms discrete component modules . . . and on a par with the most sophisticated microcircuits.
- ▶ So rugged in construction they need no special handling—just treat them like any ordinary radio component.
- ▶ Unquestioned economic and reliability advantages.

For complete data and specifications write:

intellux
INCORPORATED

P.O. Box 929, Santa Barbara, Calif.

Hughes Fills Three Management Posts



F. J. Alterman

HUGHES AIRCRAFT Company's ground systems group, Fullerton, Calif., announces three appointments to management posts.

Francis J. Alterman has been named manager of the computer division. He was formerly president of Advanced Scientific Instruments, Inc.

The computer division is engaged in the development of high speed, general purpose, real-time computer systems for military and commercial application.

Adam E. Abel has been appointed manager of the communications division. Before joining Hughes, he was general manager of the radio division of Bendix Corp.

The communications division is engaged in the development and manufacture of advanced communications systems and components, including air-to-ground and point-to-point radio, signal processors for high-speed data transmission, ground terminals for space communications, and laser communications.

Lloyd C. Myers moves from manager of materiel department to manager of the engineering fabrication and procurement department.

This department maintains the fabrication, assembly and planning capabilities in support of the engineering divisions and incorporates the additional support functions of purchasing, quality assurance, finance, material control, receiving and stores under a single line responsibility.



A. E. Abel



L. C. Myers



Mallory Capacitor Appoints Etter

WAYNE ETTER has been named president and general manager of Mallory Capacitor Co., a division of P. R. Mallory & Co., Inc., Indianapolis, Ind.

Prior to this appointment, Etter was president of the Mallory Timers Co., another major Mallory division.

Mallory Capacitor Company manufactures a complete line of aluminum and tantalum as well as a-c dielectric capacitors. Plants are located in Huntsville, Ala., and Crawfordsville, Greencastle, and Indianapolis, Ind. Etter will direct all operations from company headquarters in Indianapolis.

Lear Siegler Reports Building Plans

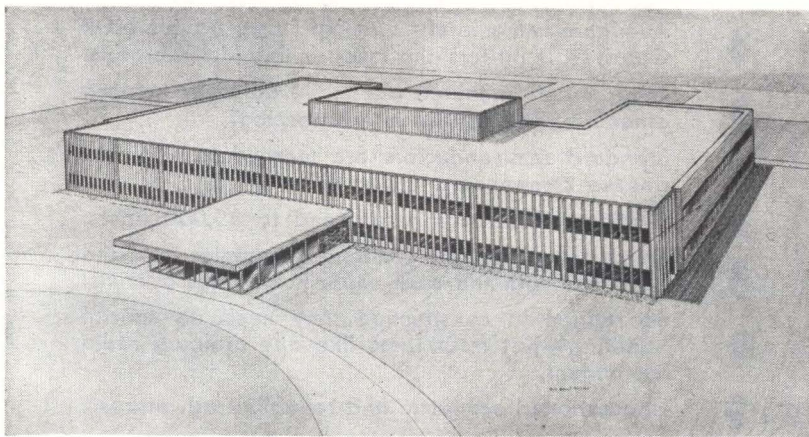

PLANS FOR CONSTRUCTION of a \$1.3-million, 100,000-square-foot building on the 65-acre Lear Siegler Aerospace Complex, in Grand Rapids, Mich., have been announced by Joseph M. Walsh, president of the Instrument division. The new administration building is in addition to the 270,000-square-foot manufacturing facility completed in 1959 and the 80,000-square-foot Aerospace Development Center dedicated in December 1962. Construction will begin this summer with completion scheduled for June, 1964.

General Technology Elects Heilman

LEONARD J. HEILMAN has been elected president of General Technology Corp., Torrance, Calif. He



**Are you a
COMPLETELY INFORMED
electronics engineer?**

Today you may be working in microwaves. But on what project will you be working tomorrow? You *could* have read **electronics** this past year and kept abreast of, say, microwave technology. *There were 96 individual microwave articles between July, 1961 and June, 1962!*

But suppose tomorrow you work in some area of standard electronic components, in semiconductors, in systems? Would you be up-to-date in these technologies? Did you read the more than 3,000 editorial pages that **electronics'** 28-man editorial staff prepared last year?

electronics is edited to keep you current *wherever* you work in the industry, *whatever* your job function(s). If you do not have your own copy of **electronics**, subscribe today via the Reader Service Card in this issue. Only 7½ cents a copy at the 3 year rate.

electronics



**NEMS-CLARKE Beats The Stork
With 1037A Receiver**

- FIRST** with optimized nuvistor/transistor design.
- FIRST** with improved basic reliability and space reduction.
- FIRST** with completely modularized construction.
- FIRST** with all front panel plug-in modules.
- FIRST** with integral plug-in spectrum display unit.

Now in production for fast delivery, the new 1037A receiver is specifically tailored for universal telemetry and surveillance applications where highest reliability, minimum power consumption and space economy are in greatest demand.

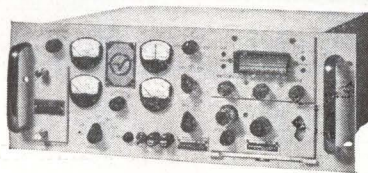

For further information write:
Vitro Electronics, 919 Jesup-Blair Drive,
Silver Spring, Maryland
Phone: Area Code 301 JU 5-1000
A Division of Vitro Corporation of America

Vitro ELECTRONICS

Specifications:

1. Nine plug-in RF modules: 55-2350 mc
2. IF bandwidths: 12.5, 25, 50, 100, 300, 500, 750, 1000, 1500, 2400 kc
3. Video output: High level FM; 1 cps to 2.0 mc \pm 3 db
Low level FM; dc to 250 kc \pm 3 db
Low level AM; dc to 250 kc \pm 3 db
4. Power consumption: 50 watts, 117/235 v \pm 10 percent, 50 to 450 cps
5. AFC: Standard for all RF heads
6. Optional Spectrum Display Unit: solid state plug-in with crystal controlled marker pips and 10 kc resolution
7. Size: 7" x 19" x 17"

BIG OUTPUT... SMALL SIZE... ONLY \$580⁰⁰

Winds Small Precision
Instrument-Type and
Miniaturized Coils

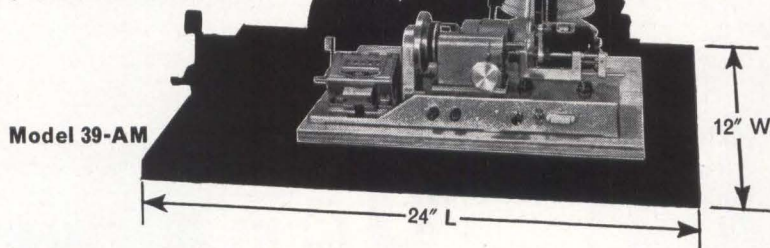

- Predetermining Automatic Counter—Instant Resetting
- Automatic Magnetic Brake—Instant, Positive Stopping
- Maintenance-Free Operation
- Compact Winding Head
(4-1/2" x 3-1/2" x 1-1/2")

The most complete line of coil winding equipment made
GEO. STEVENS MFG. CO., INC.
Pulaski Road at Peterson, Chicago 46, Ill.

Geo Stevens

CIRCLE 207 ON READER SERVICE CARD

DYNAMICS INSTRUMENTATION AMPLIFIERS



—high input impedance
AC amplifiers
permit use with
a wide variety of
piezoelectric
transducers

MODEL 6083—wideband, AC amplifier solves system amplification problems with one instrument. Provides 300 megohms input impedance—won't load down the source. Drives long output lines. Excellent signal-to-noise ratio. Input filter eliminates high-voltage peaks resulting from high "Q" piezoelectric transducers.

Voltage gain: 1.0 through 30.0 in 4 steps, continuously variable between steps.

Wide Bandwidth: ± 3 db at 0.6 cps and 200,000 cps (without filter).

Noise: 30 microvolts rms or less, with shorted input.

Input filter: low-pass, 12 db/octave. Customer can specify cutoff frequency.

Output Capability: 20 volts peak to peak into 0.05 mfd capacitive load from 1 cps to 25,000 cps.

Instrument is compatible with many other Dynamics amplifiers and signal conditioners for use in standard 6-channel, rack mounting module. Write for literature on Model 6083, or on the entire line.

DYNAMICS INSTRUMENTATION COMPANY
583 Monterey Pass Rd., Monterey Park, Calif.—Phone: CUMberland 3-7773

78 CIRCLE 78 ON READER SERVICE CARD

participated in the formation of GTC and for the past year was vice president and general manager.

General Technology Corp. is engaged in the development of advanced space simulation test facilities, electronic frequency control instrumentation and plasma propulsion research.



IMC Magnetics Promotes Morreale

ANTHONY MORREALE has been promoted to a vice presidency of IMC Magnetics Corporation's Western division, at Maywood, Calif. He was formerly manager of the division's rotating components section.

The Western division manufactures solenoids, synchros, servos and pulse-driven step-servo motors and systems for a variety of electronics and aerospace applications.

Corporate headquarters of IMC Magnetics is in Westbury, N. Y.



Harr Moves Up at Teleregister

LUTHER A. HARR, JR., has been named executive vice president, The Teleregister Corp., Stamford, Conn. He has been assistant to the chairman since January.

Harr had previously been director of Univac operations for Europe, Africa and the Middle

June 14, 1963 • electronics

EMPLOYMENT OPPORTUNITIES



The advertisements in this section include all employment opportunities—executive, management, technical, selling, office, skilled, manual, etc.

Look in the forward section of the magazine for additional Employment Opportunities advertising.

— RATES —

DISPLAYED: The advertising rate is \$40.17 per inch for all advertising appearing on other than a contract basis. Contract rates quoted on request.

An advertising inch is measured $\frac{3}{4}$ " vertically on a column—3 columns—30 inches to a page. Subject to Agency Commission.

UNDISPLAYED: \$2.70 per line, minimum 3 lines. To figure advance payment count 5 average words as a line.

Box numbers—count as 1 line.

Discount of 10% if full payment is made in advance for 4 consecutive insertions.

Not subject to Agency Commission.

INSTRUMENT TECHNICIANS THE OAK RIDGE NATIONAL LABORATORY Operated by UNION CARBIDE NUCLEAR COMPANY

at
Oak Ridge, Tennessee
HAS OPENINGS FOR

highly skilled instrument technicians to work with engineers in the installation and maintenance of process control and electronic instrumentation for nuclear reactors and associated experiments. Nuclear reactor control system experience desirable but not essential.

Minimum high school education, with additional training in either the physical sciences, instrumentation, or electronics, and at least 3 years experience in installation and maintenance of complex instrumentation and control systems. Entrance rate \$3.19 per hour; \$3.25 per hour after six months. Reasonable interview and relocation expenses paid by the Company.

Excellent Working Conditions
and

Employee Benefit Plans
An Equal Opportunity Employer
Send detailed resume to:

Central Employment Office

UNION CARBIDE NUCLEAR COMPANY
A Division of Union Carbide Corporation
Post Office Box M Oak Ridge, Tennessee



E. E.'s
for **FEE-PAID Positions**
WRITE US FIRST!

Use our confidential application for professional, individualized service... a complete national technical employment agency.

ATOMIC PERSONNEL, INC.
Suite 1207L, 1518 Walnut St., Phila. 2, Pa.

**ADDITIONAL
EMPLOYMENT OPPORTUNITY
ADVERTISEMENT**
on page 81

East for Sperry Rand International Corp., Lausanne, Switzerland.

Kollsman Motor Names Cohen

STANLEY COHEN, former chief engineer of Kollsman Motor Corp., Dublin, Pa., has moved up to vice president of engineering.

Kollsman Motor manufactures synchronous and servo motors, amplifiers, servo systems and components.

PEOPLE IN BRIEF

Joe Adkins moves up to mgr. of quality control of Stewart-Warner Electronics. William E. Brown, formerly with Fansteel Metallurgical Corp., named chief engineer of the Hi-Voltage div. of Wabash Magnetics, Inc. Richard W. Cobean leaves GE to join G-V Controls Inc. as mgr. of product engineering. IBM promotes Donald W. Seager to mgr. of corporate mfg. planning. Roy J. Keller advances to the post of mgr. of operations planning at Stromberg div., General Time Corp. Arthur F. Chace, Jr., elevated to president of Vitramon, Inc. David R. Steenhausen, previously with Shephard-Winters Co., appointed applications mgr. for the Berkeley div. of Beckman Instruments, Inc. He succeeds Edward F. Mullen who has been named product line mgr. for special projects. Alan J. Brown promoted to senior communication engineer, Lynch Communication Systems Inc. Kenneth R. Jackson moves up to asst. g-m of the Computer div. of Packard Bell Electronics. Elbert Leon Aiton, ex-United ElectroDynamics, Inc., joins Electro-Optical Systems, Inc., as mgr. of reliability. Lear-Siegler, Inc. ups George L. Loomis to director of operations, Power Equipment div. Edwin J. Deardrick, with Audio Devices, Inc., since 1959, elected v-p in charge of mfg. Nazzareno P. Cedrone, previously with Bendix Systems div., named chief engineer, defense products, at Singer Metrics div. of The Singer Mfg. Co. Robert A. Nelson leaves Litton Industries to become v-p and g-m of its Triad Transformer Corp. division.

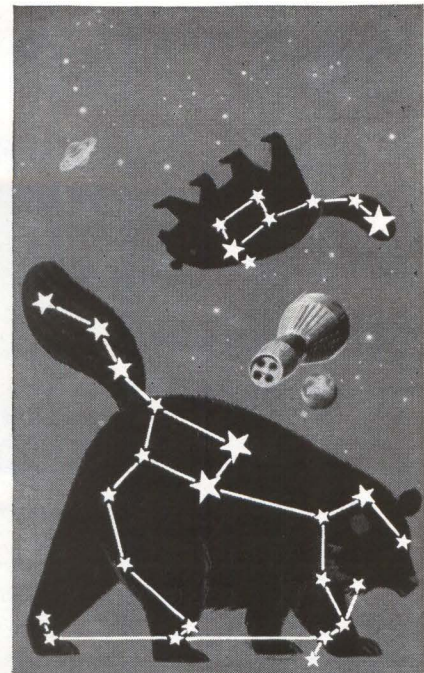

PERMANENCE

MEMORY—as constant as the North Star, as lively as the last incremental count. General Time's INCREMAG provides this needed characteristic in electronic digital systems. Peak of the current state of the art, this completely solid state magnetic counter has proven its reliability in scores of military and industrial applications. It performs many functions.

- Counting
- Frequency Dividing
- Programming
- Timing
- Memory Storage
- Pulse Delay
- Integrating

INCREMAG will count either periodic or random pulses without loss of prior count. Even if power fails, INCREMAG remembers. Like all General Time electronic systems and components, INCREMAG offers these advantages.

- Simplicity of design—dependability
- Low power consumption
- Minimum size and weight
- Rugged construction

INCREMAG is available on an off-the-shelf basis, or can be readily modified to meet special needs.

GENERAL TIME

CORPORATION
ELECTRONIC SYSTEMS DIVISION
201 Summer Street, Stamford, Conn.



electronics

WEEKLY QUALIFICATION FORM FOR POSITIONS AVAILABLE

ATTENTION: ENGINEERS, SCIENTISTS, PHYSICISTS

This Qualification Form is designed to help you advance in the electronics industry. It is unique and compact. Designed with the assistance of professional personnel management, it isolates specific experience in electronics and deals only in essential background information.

The advertisers listed here are seeking professional experience. Fill in the Qualification Form below.

STRICTLY CONFIDENTIAL

Your Qualification form will be handled as "Strictly Confidential" by ELECTRONICS. Our processing system is such that your form will be forwarded within 24 hours to the proper executives in the companies you select. You will be contacted at your home by the interested companies.

WHAT TO DO

1. Review the positions in the advertisements.
2. Select those for which you qualify.
3. Notice the key numbers.
4. Circle the corresponding key number below the Qualification Form.
5. Fill out the form completely. Please print clearly.
6. Mail to: Classified Advertising Div., ELECTRONICS, Box 12, New York 36, N. Y. (No charge, of course).

COMPANY	SEE PAGE	KEY #
ATOMIC ENERGY OF CANADA LIMITED Chalk River, Ontario, Canada	88*	1
ATOMIC PERSONNEL INC. Philadelphia, Penna.	79	2
GENERAL DYNAMICS/ASTRONAUTICS San Diego, California	33, 34*	3
GENERAL DYNAMICS/ELECTRONICS A Div. of General Dynamics Corp. Rochester, New York	81	4
INTERNATIONAL BUSINESS MACHINES CORP. New York, New York	89*	5
JERROLD ELECTRONICS CORPORATION Philadelphia, Penna.	88*	6
LOCKHEED MISSILES & SPACE CO. Div. of Lockheed Aircraft Corp. Sunnydale, California	59	7
UNION CARBIDE NUCLEAR COMPANY A Div. of Union Carbide Corporation Oak Ridge, Tennessee	79	8
U.S.A.F. AIR FORCE LOGISTICS COMMAND Joint Professional Placement Office New York, N. Y.	14*	9

* These advertisements appeared in the June 7th issue.

(cut here)

electronics WEEKLY QUALIFICATION FORM FOR POSITIONS AVAILABLE

(cut here)

(Please type or print clearly. Necessary for reproduction.)

Personal Background

NAME

HOME ADDRESS

CITYZONE.....STATE.....

HOME TELEPHONE

Education

PROFESSIONAL DEGREE(S)

MAJOR(S)

UNIVERSITY

DATE(S)

FIELDS OF EXPERIENCE (Please Check)

61463

- | | | |
|--|--|---------------------------------------|
| <input type="checkbox"/> Aerospace | <input type="checkbox"/> Fire Control | <input type="checkbox"/> Radar |
| <input type="checkbox"/> Antennas | <input type="checkbox"/> Human Factors | <input type="checkbox"/> Radio-TV |
| <input type="checkbox"/> ASW | <input type="checkbox"/> Infrared | <input type="checkbox"/> Simulators |
| <input type="checkbox"/> Circuits | <input type="checkbox"/> Instrumentation | <input type="checkbox"/> Solid State |
| <input type="checkbox"/> Communications | <input type="checkbox"/> Medicine | <input type="checkbox"/> Telemetry |
| <input type="checkbox"/> Components | <input type="checkbox"/> Microwave | <input type="checkbox"/> Transformers |
| <input type="checkbox"/> Computers | <input type="checkbox"/> Navigation | <input type="checkbox"/> Other |
| <input type="checkbox"/> ECM | <input type="checkbox"/> Operations Research | <input type="checkbox"/> |
| <input type="checkbox"/> Electron Tubes | <input type="checkbox"/> Optics | <input type="checkbox"/> |
| <input type="checkbox"/> Engineering Writing | <input type="checkbox"/> Packaging | <input type="checkbox"/> |

CATEGORY OF SPECIALIZATION

Please indicate number of months experience on proper lines.

	Technical Experience (Months)	Supervisory Experience (Months)
RESEARCH (pure, fundamental, basic)
RESEARCH (Applied)
SYSTEMS (New Concepts)
DEVELOPMENT (Model)	070
DESIGN (Product)	070
MANUFACTURING (Product)
FIELD (Service)
SALES (Proposals & Products)

CIRCLE KEY NUMBERS OF ABOVE COMPANIES' POSITIONS THAT INTEREST YOU

1 2 3 4 5 6 7 8 9 10 11 12 13 14 15 16 17 18 19 20 21 22 23 24 25

IF YOU ARE OR WANT TO BE A TOP
**ELECTRONIC
DESIGN
ENGINEER**

HAVE YOU CONSIDERED THE
**UNIQUE
OPPORTUNITIES**

...At General Dynamics / Electronics in Rochester, N.Y.?

Work is in progress here on electronic equipment intended for the most advanced tactical aircraft under design. This includes the most sophisticated equipment that can be designed in the areas of airborne radar, airborne communications, navigation and fire control.

The singular advantage to the Design Engineer at General Dynamics / Electronics is the opportunity to learn at the inception stage the complete equipment — its operation, capability, circuitry — and to grow with a long range program.

Positions Are Open for Graduate EE's with Design Experience in the Following Areas:

Space communications
Telemetry receivers & transmitters
Tracking equipment
Mobile communication sets
Reconnaissance/countermeasures
Doppler systems
Data communications

Computer logic circuits
Navigation aids
USW/ASW equipment
IFF equipment
Aerospace ground equipment
RF circuitry
Advanced pulse circuitry

UNIQUE LIVING ADVANTAGES, TOO. When you come to General Dynamics / Electronics you join two professional communities — the Company and the city of Rochester, which has the largest percentage of professional people for a city of its size (500,000) in the nation. And, in many ways Rochester is an ideal spot for an engineer or scientist to live and raise a family — noted for its cultural advantages, excellent educational opportunities, friendly neighborhoods, modern hospitals, unrivaled city parks, exciting nearby historical and vacation spots.

If you would like to get in on this unique opportunity, send a resume now to Mr. R. W. Holmes, Registered Engineer, Dept. 22

GENERAL DYNAMICS | ELECTRONICS

An Equal Opportunity Employer 1400 N. GOODMAN ST., ROCHESTER 1, N. Y.

SEARCHLIGHT SECTION

(Classified Advertising)

BUSINESS OPPORTUNITIES

EQUIPMENT - USED or RESALE

DISPLAYED

The advertising is \$27.25 per inch for all advertising other than on a contract basis. AN ADVERTISING INCH is measured 7/8" vert. on a column, 3 cols.—30 inches—to a page. EQUIPMENT WANTED or FOR SALE ADVERTISEMENTS acceptable only in Displayed Style.

Send NEW ADS or Inquiries to Classified Adv. Div. of Electronics, P. O. Box 12, N. Y. 36, N. Y.

RATES

\$2.70 a line, minimum 3 lines. To figure advance payment count 5 average words as a line. BOX NUMBERS count as one line additional. DISCOUNT of 10% if full payment is made in advance for four consecutive insertions.

UNDISPLAYED



RELAYS?

WHAT ARE YOU WORRIED ABOUT?

UNIVERSAL CAN SOLVE YOUR PROBLEMS
OVER 2,000,000 in STOCK

ALL TYPES • MOST MAKES
PRODUCTION QUANTITIES

DON'T BE A WORRY WART
Write for Catalogue EK

Universal RELAY CORP.

42A White St., New York 13, N. Y., WA 5-6900

CIRCLE 955 ON READER SERVICE CARD

U. S. MICROWAVE

AMERICA'S LEADING DISTRIBUTOR
OF ELECTRONIC TUBES

Klystrons, Transmitting, Magnetrons, Amplifiers, Rectifiers, Thyratrons, BWO, TWT, Exotic Types, XFA, MBK, COAX Mag, Image converters, Orthicon, Photomultiplier, Transistor, Zener, Cathode-Ray, Storage.

Distributors of Specialized Electronic
Equipment—Nuclear, Geophysical

EXPORT INQUIRIES INVITED—ALL LANGUAGES

U. S. MICROWAVE

P. O. Box "G"

Collingswood, New Jersey

Call Collect, Area Code 609 - WO 6-2929

CIRCLE 956 ON READER SERVICE CARD

MICROWAVE TEST EQUIPMENT

C-band Waveguide
New condition, FXR:
Attenuator, Slotted Line, Load, etc.
SELL OR TRADE

ESCA, 1426 W. Front St.
Plainfield, N. J. 201-756-1252

CIRCLE 957 ON READER SERVICE CARD

POTTING APPLICATORS MANUAL AND DISPOSABLE

6cc 12cc 30cc
FOR POTTING, ENCAPSULATING, AND
SEALING OF MINIATURE COMPONENTS
PHILIP FISHMAN CO.
7 CAMERON ST., WELLESLEY 81, MASS.



CIRCLE 958 ON READER SERVICE CARD

June 14, 1963 • electronics

ANTENNA PEDESTAL SCR 584-MP 61B

Full azimuth and elevation sweeps 360 degrees in azimuth, 210 degrees in elevation. Accurate to 1 mil. or better over system. Complete for full tracking response. Angle acceleration rate: AZ, 9 degrees per second squared EL, 4 degrees per second squared. Angle slewing rate: AZ 20

degrees per sec. EL, 10 degrees per sec. Can mount up to a 20 ft. dish. Angle tracking rate: 10 degrees per sec. Includes pedestal drives, selsyns, potentiometers, drive motors, control amplifiers. New condition. Quantity in stock for immediate shipment. Ideal for missile & satellite tracking, antenna pattern ranges, radar system, radio astronomy, any project requiring accurate response in elevation and azimuth. Complete description in McGraw-Hill Radiation Laboratory Series, Volume 1, page 284 and page 209, and Volume 26, page 233.

MIT MODEL 9 PULSER 1 MEGAWATT— HARD TUBE

Output 25kv 40 amp. Duty cycle .002. Pulse lengths, 25 to 2 microsec. Also .5 to 5 microsec. and 1 to .5 msec. Uses 6C21 Input 115v 60 cycle AC Mfr. GE. Complete with driver and high voltage power supply. Ref: MIT Rad. Lab. Series Vol. 5 pps. 152-160.

500KW THYRATON PULSER

Output 22kv at 28 amp. Rep. rates: 2.25 microsec. 300 pps, 1.75 msec 550 pps, 4 msec 2500 pps. Uses 5C22 hydrogen thyatron. Complete with driver and high voltage power supply. Input 115v 60 cy AC.

2 MEGAWATT PULSER

Output 30 kv at 70 amp. Duty cycle .001. Rep rates: 1 microsec 600 pps, 1 or 2 msec 300 pps. Uses 5948 hydrogen thyatron. Input 120/208 VAC 60 cycle. Mfr GE. Complete with high voltage power supply.

15KW PULSER—DRIVER

Biased multivibrator type pulse generator using 3E29. Output 3kv at 5 amp. Pulse lengths .5 to 5 microsec. easily adj. to .1 to .5 msec. Input 115v 60 cy AC. \$475. Ref: MIT Rad. Lab. Series Vol. 5 pp 157-160.

MIT MODEL 3 PULSER

Output: 144 kw (12 kv at 12 amp.) Duty ratio: .001 max. Pulse duration: .5 1 and 2 micro sec. Input: 115 v 400 to 2000 cps. and 24 vdc. \$325 ea. Full desc. Vol. 5 MIT Rad. Lab. Series pg. 140.

SCR 584 RADAR AUTO-TRACK

3 CM & 10 CM. Our 584s in like new condition, ready to go, and in stock for immediate delivery. Used on Atlantic Missile Range, Pacific Missile Range, NASA Wallaps Island, A.B.M.A. Write us, Fully Desc. MIT Rad. Lab. Series, Vol. 1, pps. 207-210, 228, 284-286.

300 TO 2400MC RF PKG.

300 to 2400MC CW. Tuneable, Transmitter 10 to 30 Watts. Output. As new \$475.

AN/TPS-1D RADAR

500 kw. 1220-1359 mcs. 160 nautical mile search range P.P.T. and A. Scopes, MTI, thyatron mod. 5426 magnetron. Complete system.

AN/TPS 10D HEIGHT FINDER

250 KW X-Band. 60 & 120 mile ranges to 60,000 feet. Complete.

AN/APS-15B 3 CM RADAR

Airborne radar. 40kw output using 725A magnetron. Model 3 pulser. 30 in. parabola stabilized antenna. PPI scope. Complete system. \$1200 each. New.

100 KW 3 CM. X BAND RADAR

Complete AN/APS-27 radar system using 4J52 magnetron, PPI, antenna 360 degree rotation azimuth, 60 degree elevation apx. Complete installation including gyro & AMTI \$2800.

L BAND RF PKG.

20KW peak 990 to 1040mc. Pulse width .7 to 1.2 micro sec. Rep rate 180 to 420 pps. Input 115 vac. Incl. Receiver \$1200.

CARCINOTRONS

Type CSF CM706A Freq. 3000 to 4000 mcs. Type CSF CM710A. Freq. 2400 to 3100 mcs. CW. Output 200 Watts minimum. New. Full wty.

AN/CPS-9 WEATHER RADAR

250 kw. 3 cm. 360 deg. az. 90 deg. elev. scan. PPI, RHI A scopes.

QUARTZ DELAY LINE

500 Microsecs. 30 MC. 1000 OHMS Termination Resistance—with Calib. Curve LFE Type 11445. Price \$275 each.



RADIO RESEARCH INSTRUMENT CO.

550 Fifth Ave., New York JUDSON 6-4691

CIRCLE 950 ON READER SERVICE CARD

ELECTRON TUBES

KLYSTRONS • ATR & TR • MAGNETRONS
SUBMINIATURES • C.R.T. • T.W.T. • 5000-
6000 SERIES
• SEND FOR NEW CATALOG A2 •
A & A ELECTRONICS CORP.
1063 PERRY ANNEX
WHITTIER, CALIF.
AN 92865 OR 943-2829

CIRCLE 953 ON READER SERVICE CARD

SMALL AD but BIG STOCK

of choice test equipment
and surplus electronics

Higher Quality—Lower Costs
Get our advice on your problem

ENGINEERING ASSOCIATES

434 Patterson Road — Dayton 19, Ohio

CIRCLE 951 ON READER SERVICE CARD

GLASS TUBING

PYREX - NONEX - URANIUM

BULB & CYLINDERS

WRITE FOR FREE MONTHLY LIST

HOUE GLASS COMPANY

PHONE COLFAX 4-4800

P.O. Box 206 Keyport, N. J.

CIRCLE 952 ON READER SERVICE CARD

TUBES & COMPONENT

**FREE...CATALOG
BARRY ELECTRONICS**

512 BROADWAY 212-WALKER 5-7000
NEW YORK 12, N.Y. TWX-571-0484

CIRCLE 954 ON READER SERVICE CARD

ELECTRONIC

WAR TERMINATION INVENTORIES

WRITE OR WIRE FOR INFORMATION ON OUR COMPLETE LINE OF SURPLUS ELECTRONIC COMPONENTS. ALL PRICES NET F.O.B. PASADENA, CALIFORNIA

C&H

SALES CO.

2176-E East Colorado St.
Pasadena 8, California
MUrray 1-7393

SELSYNS- SYNCHROS

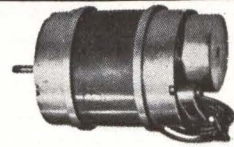

1CT cont. Trans 90/55V 60 cy.....	\$27.50
1DG Diff. Gen. 90/90V 60 cy.....	34.50
1F Syn. Mtr. 115/90V 60 cy.....	34.50
1G Gen. 115V 60 cy.....	34.50
1HDG	37.50
1HCT	37.50
1SF Syn. Mtr. 115/90V 400 cy.....	12.50
23TR4 torque receiver.....	34.50
23TR6 torque receiver.....	37.50
23CT6 control transformer.....	37.50
23CX6 control transmitter.....	37.50
23TX6 torque transmitter.....	37.50
7DG differential generator.....	37.50
2J1F1 Gen. 115/57.5V 400 cy.....	7.50
2J1F3 Gen. 115/57.5V 400 cy.....	10.00
2J1FA1 Gen. 115/57.5V 400 cy.....	7.50
2J1G1 57.5/57.5V 400 cy.....	5.00
2J1H1 Diff. Gen. 57.5V 400 cy.....	7.50
2J5D1 Cont. Trans. 105/55V 60 cy.....	17.50
2J5F1 Cont. Trans. 105/55V 60 cy.....	17.50
2J5H1 Gen. 115/105V 60 cy.....	17.50
2J15M1 Gen. 115/57.5V 400 cy.....	17.50
5CT Cont. Trans. 90/55V 60 cy.....	34.50
5D Diff. Mtr. 90/90V 60 cy.....	34.50
5DG Diff. Gen. 90/90V 60 cy.....	34.50
5F Syn. Mtr. 115/90 VAC 60 cy.....	34.50
5G Syn. Gen. 115/90VAC 60 cy.....	37.50
5HCT Cont. Trans. 90/55V 60 cy.....	12.50
5SDG Diff. Gen. 90/90V 400 cy.....	25.00
6DG Diff. Gen. 90/90V 60 cy.....	34.50
6G Syn. Gen. 115/90VAC 60 cy.....	42.50
7G Syn. Gen. 115/90VAC 60 cy.....	20.00
C56701 Type 11-4 Rep. 115V 60 cy.....	20.00
C69405-2 Type 1-1 Transm. 115V 60 cy.....	20.00
C69406 Syn. Transm. 115V 60 cy.....	20.00
C69406-1 Type 11-2 Rep. 115V 60 cy.....	20.00
C78248 Syn. Transm. 115V 60 cy.....	12.50
C78410 Repeater 115V 60 cy.....	20.00
FPE 49-7 Diehl servo motor, 115 volts, 60 cycle, 10 watts.....	30.00

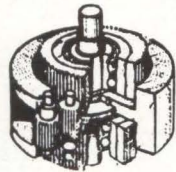

SIMPLE DIFFERENTIAL WITH BALL-BEARING SUN GEARS

The 1:1 reverse ratio spur gears are 48-tooth, 32 pitch brass with 3/16" available face. On one side, the shaft is 23.64" dia. for 11/16" and has a pin hole, then increases in dia. to .377" for the remaining 3/16" of length. On the other side, the shaft is .377 dia. 1/4" lg. 2-13/16" dia. is required to clear the body. Stock no. A6-115each \$15.00

RCA 6032 IMAGE-CONVERTER TUBE

Combined with suitable optical systems, this 3-electrode tube permits viewing of scene with infrared radiation. Scene to be viewed is imaged by optical objective upon semi-transparent photocathode. Spectral resp., S-1; good response up to about 1200A. Max. ratings, absolute, grid #2, 20,000VDC or peak AC, grid #1, 2700. \$9.95 ppd.



MINOR SWITCH 10-position, 3-pole, with stopper & reset coil 6-12 V. D.C. off-normal non-bridging wiper. wt.: 1 lb \$9.95

GENERAL ELECTRIC FULL WAVE BRIDGE GERMANIUM RECTIFIER

input 117 volt AC, output 115 volt DC at 10 amperes approximate dimensions: 4 3/4" x 4 3/4" x 7 1/2" long, weight: 3 1/2 lbs.

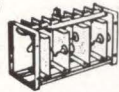

PRICE\$9.95 each

VARIAC TYPE V20
input 120 volt AC, 50/60 cycles output range 0-140 volts, 20 amperes. PRICE\$37.50 each

POWERSTAT TYPE 20
input 120 volt AC, 50/60 cycle output range 0-140 volts AC, 3 amperes. PRICE\$9.95 each

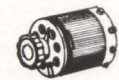

POWERSTAT TYPE 116
input 120 volts, 50/60 cycle output range 0-140 volts AC, 7.5 amperes. PRICE\$16.95 each

Here's an accurate time-control center that'll help you win your next rally. It not only tells you the date and time of day right to the second, it's a stop watch that gives you elapsed time in seconds, minutes, and hours! The 24-hour clock simplifies adding and subtracting elapsed time for your navigator. Manufactured by Elgin Watch Co. to exacting military specifications, it will remain accurate in spite of road bumps and vibrations. Uses no electrical connections. Does the job of high-cost equipment. Jeweled/Sweep Second Hand/Luminous Hands and Numerals/25-Hour Dial/Black Face and Plastic Case/3 1/2" Mounting. Cost the Government \$185.00

Only \$39.95 Postpaid

SPERRY VERTICAL GYRO

Part #673073, Moto, 115 volts, 3 phase, 400 cycle, 8 watts, 20,000 RPM. 3-minute runup, synchro pickoffs, roll 360°, pitch 85°. Synchro excitation 26 volts, 400 cycle, 150 m.a. Vertical accuracy ± 1/2". Weight 3 1/2 lbs. Approx. dim. 5 1/2" L., 4 1/2" W., 4 1/2" H. Price \$35.00

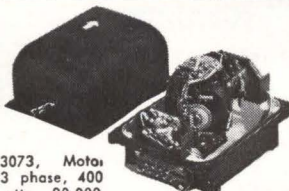

VARIABLE SPEED BALL DISC INTEGRATORS

(All Shafts Ball Bearing Supported)
No. 145 Forward & Reverse 2 1/4"-0-2 1/4" Input shaft spline gear 12 teeth 9/32" dia. 3/8" long. Output shaft 15/64" dia. x 15/32" long. Control shaft 11/32" x 3/8" long. Cast aluminum construction. Approx. size 3" x 3" x 2 1/4"\$17.50
No. 146 Forward & Reverse 4-0-4. Input shaft 5/16" dia. x 1/4" long. Output shaft 15/64" dia. x 9/16" long. Control shaft 11/64" dia. x 11/16" long. Cast aluminum construction. Approx. size 4 1/2" x 4 1/2" x 4"\$18.50 ea.

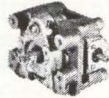

SMALL DC MOTORS

(approx. size over 3 1/4" x 1 1/4" dia.)
5067043 Delco 12 VDC PM 1" x 1" x 2", 10,000 rpm. \$7.50
5067126 Delco PM, 27 VDC, 125 RPM, Governor Controlled 15.00 ea.
5069600 Delco PM 27.5 VDC 250 rpm 12.50
#5069625 120 rpm, mfr. Delco, 27 VDC governor controlled\$15.00
5069230 Delco PM 27.5 VDC 145 rpm 15.00
5068750 Delco 27.5 VDC 160 rpm w. brake 6.50
5068571 Delco PM 27.5 VDC 10,000 rpm (1x1x2") 5.00
5069790 Delco PM, 27 VDC, 100 RPM, Governor Controlled 15.00 ea.
#5069800 575 rpm, mfr. Delco, 27 VDC, PM reversible governor controlled, equipped with 27 VDC clutch\$17.50
5072735 Delco 27 VDC 200 rpm governor controlled. 15.00
5BA10A118 GE 24 VDC 110 rpm 10.00
5BA10AJ37 GE 27 VDC 250 rpm reversible 10.00
5BA10AJ52 27 VDC 145 rpm reversible 12.50
5BA10AJ50, G.E., 12 VDC, 140 rpm 15.00
5BA10FJ401B, G.E. 28 VDC, 215 rpm, 10 oz. in., 7 amp. contains brake 15.00
5BA10FJ421, G.E. 26 VDC, 4 rpm, reversible, 6 oz. in., .65 amp 15.00

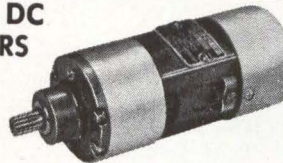

400 CYCLE, 3 PHASE GENERATOR

BY MASTER ELECTRIC Type AG, frame 364Y, 7.5 kw, 3428 rpm, pf .95 Star connected 120/208 3 phase, 22 amps. Delta connected 120 volt single phase 6 amps. Self excited. Complete with control box, voltage regulator, AC voltmeter and frequency meter. Shaft 1" dia., 2" long; overall dim. of unit: 21" x 18" x 20". Price \$395.00 each



SENSITIVE INTEGRATING GYROS

This is the famous HIG Gyro which is being used in missile guidance systems, radar stabilization and fine control systems. Government cost approximately \$1500. PRICE\$50.00



OIL CAPACITORS

1 MFD. 25,000 V. DC Westinghouse inter-ten type FP style 1313854. \$39.95 each

10 or more, \$35.00 each.

HONEYWELL VERTICAL GYRO MODEL JG7044A17

115 volts, 400 cycles, single phase, 35 watts. Pitch and roll potentiometer pickoffs 890 ohms, 40 volts max. AC or DC. Speed 20,000 rpm, ang. momentum 12,500,000 gm-cm 2/sec. Erection system 27 VAC, 400 cycles, time 5 min. to 1/2°; caging mechanism operates on 24 VDC. \$49.50

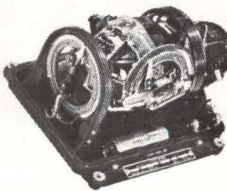

24 VOLT DC POWER SUPPLY

input: 115/440 volts A C, 60 cycle, single phase. Output: 24 volts D C at 25 amps tapped primary and secondary to vary voltage unit contains 0-30 volt D C meter and 0-30 amp meter, circuit breaker, filtered, selenium type rectifier approx. dim: 16" wide, 18" long, 8 1/2" high, approx wt.: 70 lbs. PRICE\$49.50 each

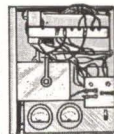

400 CYCLE PM GENERATOR

115/200 volts A.C. 1- or 3-phase, 200 watts. 4,000 r.p.m. Approx. dimensions: 4 3/4" dia.; 3" long; 1/2" shaft, AN connector. \$75.00



9KVA
400-CYCLE
GENERATOR



120/208 volts, 3-phase power factor 1.0 CCW rotation. Approx. 13 1/2 lg. x 8" dia. 4000 rpm, mfg. Bendix Aviation P/N 1633-1A. \$150.00

MINNEAPOLIS-HONEYWELL RATE GYRO (Control Flight)

Part no. JG7005A, 115 volts A.C., 400 cycle, single phase potentiometer take off resistance 530 ohms. Speed 21,000 r.p.m. Angular momentum 2 1/2 million, CM 2/sec. Weight 2 lbs. Dimensions 4-7/32 x 3-29/32 x 3-31/64. Price \$22.50



INDEX TO ADVERTISERS

• AMP Incorporated 11	• Kepco, Inc. 51	Weston Instruments & Electronics A Division of Daystrom Inc. .24, 25
Allen-Bradley Co. 5	Leesona Corp. 67	Zivy 55
• Amphenol-Borg Electronics Corp. Connector Division18, 19	Levin and Son, Inc., Louis. 69	
Arnold Engineering Co., The. 73	Lockheed Missiles & Space Co. 59	
		■
Burroughs Corporation 9	Marconi Instruments, Ltd. 55	CLASSIFIED ADVERTISING
	• Markel & Sons, L. Frank. 52	F. J. Eberle, Business Mgr.
• Clairex Corp. 22		EMPLOYMENT OPPORTUNITIES79, 81
• Clifton Precision Products Co., Inc. Consolidated ElectroDynamics Corp. 70	• NAVCOR 71	EQUIPMENT
	Photocircuits Corp. 17	(Used or Surplus New)
• Defense Electronics, Inc. 54	Polaroid Corp. 49	For Sale82, 83
Di-Acro Corp. 58	• Potter Instrument Co., Inc. 13	
• Driver Co., Wilbur B. 23	Precious Metal Plating Div. Chemical Plating Co. 28	CLASSIFIED INDEX
duPont de Nemours & Co., Inc., E. I.6, 63		• A & A Electronics Corp. 82
Dynamics Instrumentation Co. 78	• Radio Corporation of America 4th Cover	Atomic Personnel Inc. 79
		• Barry Electronics Corp. 82
• Eisler Engineering Co. 69	• Schjeldahl Co., G. T. 74	• C & H Sales 83
Electronic Associates, Inc.64, 65	Simpson Electric Company 27	ESCA 82
	Sonotone Corp. 20	• Engineering Associates 82
• Friedrich & Dimmock. 69	Sperry Electronic Tube Div. Sperry Rand Corp.3rd Cover	Fishman Co., Philip. 82
	Sprague Electric Co.4, 15	General Dynamics/Electronics ... 81
• General Products Corp. 53	Stevens Mfg. Co., Inc., Geo. 78	• Houde Glass Co. 82
General Time Corp. 79		• Radio Research Instrument Co. 82
Gries Reproducer Corp. 70	Tektronix, Inc. 31	Union Carbide Nuclear Company Div. of Union Carbide Corp. 79
	Telrex Laboratories 70	U. S. Microwave. 82
• Harrison Laboratories, Div. of Hewlett-Packard Co. 32	Texas Instruments Incorporated Industrial Products Group 29	• Universal Relay Corp. 82
Heinemann Electric Co. 30	Trak Microwave Corp. 16	
• Hewlett-Packard Company . .2nd Cover		■
Hughes Aircraft Co. Aerospace Divisions 21	• Utica Drop Forge & Herbrand Tool Division, Kelsey-Hayes Co. 66	• See advertisement in the July 25, 1962 issue of Electronics Buyers' Guide for complete line of products or services.
	Victor George Herman. 55	
Intellux Incorporated 75	• Vitro Electronics 77	
International Wire Products Corp. 61	Voltron Products, Inc. 60	
	Weldmatic Division/Unitek 72	
Johnson Company, E. F. 61		

electronics



Audited Paid Circulation

JAMES T. HAUPTLI

Advertising Sales Manager

DAVID CUNIFF

Promotion Manager

■
Electronics Buyers' Guide

R. S. QUINT
General Manager

■
RICHARD J. TOMLINSON

Business Manager

THEODORE R. GEIPEL
Production Manager



Associated Business
Publications

ADVERTISING REPRESENTATIVES

ATLANTA (9):

Michael H. Miller, Robert C. Johnson
1375 Peachtree St. N.E., Trinity 5-0523
(area code 404)

BOSTON (16):

William S. Hodgkinson, Donald R. Furth
McGraw-Hill Building, Copley Square,
Congress 2-1160 (area code 617)

CHICAGO (11):

Harvey W. Wernecke, Robert M. Denmead
645 North Michigan Avenue, Mohawk 4-5800
(area code 312)

CLEVELAND (13):

Paul T. Fegley
55 Public Square, Superior 1-7000
(area code 216)

DALLAS (1):

Frank Le Beau
The Vaughn Bldg., 1712 Commerce St.
Riverside 7-9721 (area code 214)

DENVER (2):

John W. Patten
Tower Bldg., 1700 Broadway,
Alpine 5-2981 (area code 303)

HOUSTON (25):

Kenneth George
Prudential Bldg., Halcombe Blvd.,
Riverside 8-1280 (area code 713)

LOS ANGELES (17):

Ashley P. Hartman, John G. Zisch,
William C. Gries
1125 W. 6th St., Huntley 2-5450
(area code 213)

NEW YORK (36):

Donald H. Miller, Henry M. Shaw,
George F. Werner
500 Fifth Avenue, LO-4-3000
(area code 212)

PHILADELPHIA (3):

Warren H. Gardner, William J. Boyle
6 Penn Center Plaza, LOcust 8-4330
(area code 215)

SAN FRANCISCO (11):

Richard C. Alcorn
255 California Street, Douglas 2-4600
(area code 415)

LONDON W1:

Edwin S. Murphy Jr.
34 Dover St.

FRANKFURT/Main:

Matthée Herfurth
85 Westendstrasse

GENEVA:

Michael R. Zeynel
2 Place du Port

TOKYO:

George Olcott,
1, Kotohiracho, Shiba, Minato-ku

For higher TWT efficiency...a hollow beam



STS-188, a 2 kW, S band TWT proves Sperry's capability in depressed collectors. Six other models ranging through S, C, and X bands, are also operational at 10 W, 20 W and 2 kW power levels.

This photograph of a hollow, high-perveance electron beam helps us measure our progress toward a goal of higher efficiency for traveling wave tubes. That's because its halo shows us how we're doing on beam control, and lets us know how our higher perveance electron gun designs are working out.

We do a lot of other things to increase TWT efficiency. Seven different types of depressed-collector TWT's are already in the field . . . operating at power levels as high as 2 kW. And we're making constant progress on the design and manufacture of shorter, more effective attenuators.

In short, Sperry is doing quite a job on the technical considerations that improve efficiency of traveling wave tubes. 25% efficiency is already a reality on many of our models, and better things are coming.

A FREE TECHNICAL PAPER gives the details, both theoretical and practical. If you are searching for higher efficiency in broadband microwave systems, get your copy today. Write Sperry, Gainesville, Florida, or contact your Cain & Co. representative. In Europe, contact Sperry Europe Continental, Paris.

SPERRY

**ELECTRONIC
TUBE
DIVISION**

SPERRY RAND CORPORATION
GAINESVILLE FLORIDA



RCA-A1230 Super-Power Klystron

KLYSTRON TUBE AIDS STUDY OF NUCLEAR STRUCTURES

The RCA-A1230, developed under the sponsorship of Stanford University, is the result of years of RCA experience in power tube design and development. It's the super-power klystron that will produce the tremendous pulse power required in electron linear accelerators like the one at Stanford University.

RCA-A1230 is designed to provide 24 Megawatts peak power output with better than 21 kilowatts of average power at 2,856 Mc. This fixed-frequency super-power klystron features permanent magnet focusing, 50

db gain, and long-life matrix cathode. The RCA-A1230 is offered with a choice of either single or double RF output ports, solenoid or permanent magnet focusing.

In other areas, RCA klystrons will soon be available for tropospheric scatter communications, telephone relay, and long-range radar.

Consult your RCA Industrial Tube Representative about klystrons in configurations to meet your special requirements. Or write: Manager, Super-Power Tube Marketing, RCA Electron Tube Division, Lancaster, Pa.



The Most Trusted Name in Electronics

INDUSTRIAL TUBE PRODUCTS FIELD OFFICES
OEM SALES: Newark 2, N. J., 32-36 Green St., (201) 485-3900 • Chicago 54, Ill., Suite 1154, Merchandise Mart Plaza, (312) 527-2900 • Los Angeles 22, Calif., 6801 E. Washington Blvd., (213) RA 3-8361 • GOVERNMENT SALES: Harrison, N. J., 415 South Fifth St., (201) 485-3900 • Dayton 2, Ohio, 224 N. Wilkinson St., (513) BA 6-2366 • Washington 6, D. C., 1725 "K" St., N.W., (202) FE 7-8500 • INTERNATIONAL SALES: RCA International Div., Clark, N. J., (201) 382-1000