

SPECIAL

RFI

*The growing problem of
radio frequency interference
and how to deal with it*

- MEASUREMENT
- ANALYSIS
- SUPPRESSION

R D SKINNER
1020 GOVINGTON RD
LOS ALTOS CALIF
C 3-5
L



ULTRAMINIATURE TRANSISTOR TRANSFORMERS & INDUCTORS

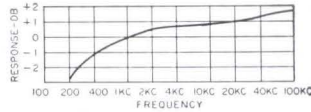
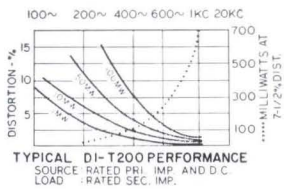

- ➔ **DUMET LEADS**
(gold plated, weldable and solderable)
- ➔ **STRAIGHT PIN TERMINALS**
(printed circuit application)
- ➔ **HIGHEST PERFORMANCE**
for size in the industry
- ➔ **METAL ENCASED**
(Grade 4, Ruggedized)

Type No.	Pri. Imp.	DCma [†] in Pri.	Sec. Imp.	Pri. Res.	Mw Level	Application
DI-T225	80 CT 100 CT	12 10	32 split 40 split	10	500	Interstage
DI-T230	300 CT	7	600 CT	20	500	Output or line to line
DI-T235	400 CT 500 CT	8 6	40 split 50 Split	50	500	Interstage
DI-T240	400 CT 500 CT	8 6	400 split 500 split	50	500	Interstage or output (Ratio 2:1:1)
DI-T245	500 CT 600 CT	3 3	50 CT 60 CT	65	500	Output or matching
DI-T250	500 CT	5.5	600 CT	35	500	Output or line to line or mixing
DI-T255	1,000 CT 1,200 CT	3 3	50 CT 60 CT	110	500	Output or matching
DI-T260	1,500 CT	3	600 CT	90	500	Output to line
DI-T265	2,000 CT 2,500 CT	3 3	8,000 split 10,000 split	180	100	Isol. or interstage (Ratio 1:1:1)
DI-T270	10,000 CT 12,000 CT	1 1	500 CT 600 CT	870	100	Output or driver
DI-T273	10,000 CT 12,500 CT	1 1	1,200 CT 1,500 CT	870	100	Output or driver
DI-T276	10,000 CT 12,000 CT	1 1	2,000 CT 2,400 CT	870	100	Interstage or driver
DI-T278	10,000 CT 12,500 CT	1 1	2,000 split 2,500 split	620	100	Interstage or driver
DI-T283	10,000 CT 12,000 CT	1 1	10,000 CT 12,000 CT	970	100	Isol. or interstage (Ratio 1:1)
DI-T288	20,000 CT 30,000 CT	.5 .5	800 CT 1,200 CT	870	50	Interstage or driver
DI-T204	Split Inductor (2 wds)	§ .1 Hys @ 4 maDC, .08 Hys @ 10 maDC, DCR 25Ω §§ .025 Hys @ 8 maDC, .02 Hys @ 20 maDC, DCR 6Ω				
DI-T208	Split Inductor (2 wds)	§ .9 Hys @ 2 maDC, .5 Hys @ 6 maDC, DCR 105Ω §§ .2 Hys @ 4 maDC, .1 Hys @ 12 maDC, DCR 26Ω				
DI-T212	Split Inductor (2 wds)	§ 2.5 Hys @ 2 maDC, .9 Hys @ 4 maDC, DCR 630Ω §§ .6 Hys @ 4 maDC, .2 Hys @ 8 maDC, DCR 157Ω				
DI-T216	Split Inductor (2 wds)	§ 4.5 Hys @ 2 maDC, 1.2 Hys @ 4 maDC, DCR 2300Ω §§ 1.1 Hys @ 4 maDC, .3 Hys @ 8 maDC, DCR 575Ω				

[†]DCma shown is for single ended usage (under 5% distortion—100mw—1 KC)... for push pull, DCma can be any balanced value taken by 5W transistors (under 5% distortion—500mw—1 KC)
 DI-T200 units have been designed for transistor application only... not for vacuum tube service.
 U.S. Pat. No. 2,949,591 other pending.
 Where windings are listed as split, ¼ of the listed impedance is available by paralleling the winding.
 §Series connected; §§Parallel connected.

ALL STOCK UNITS MIL TYPE TF4RX
Class "S" Available on Special Order

High Power Rating up to 100 times greater.
 Excellent Response twice as good at low end.
 Low Distortion reduced 80%.
 High Efficiency up to 30% better . . . compare DCR.
 Moisture Proof hermetically sealed to MIL-T-27B.
 Ultraminiature Size 5/16 Dia. x ¾" H, 1/15 Oz.

The unique structural design of the DI-T200 series transformers and inductors provides the excellent electrical characteristics, high reliability and wide application possibilities inherent in the UTC DO-T family of miniaturized units. The DI-T200 series units employ the same high quality design found in UTC's DO-T, DI-T, and PIP lines. This unique transformer structural concept affords unprecedented power handling capabilities coupled with extremely small size. Further, the high degree of reliability has been dynamically proven in the field. These characteristics are basic in the structure, which is ruggedized, hermetically sealed, employing a completely rigid bobbin, eliminating stress and wire movement. The turns are circular in shape rather than square, eliminating turn corner stress, and effecting uniform wire lay. The coil wire and external lead are rigidly anchored terminal board fashion, employing no tapes and brought out through strain relief. The curves illustrated indicate the superior performance of these units compared to similar size units now on the market.

The leads are uninsulated 1" long, .017 Dumet wire, spaced on a .1" radius circle to conform to terminal spacing techniques of the "TO-5" case semiconductors and micrologic elements.

IMMEDIATE DELIVERY FROM STOCK

Write for catalog of over
 1,200 UTC HIGH RELIABILITY
 STOCK ITEMS
 IMMEDIATELY AVAILABLE
 from your local distributor.



UNITED TRANSFORMER CORP.

150 VARICK STREET, NEW YORK 13, N.Y.

PACIFIC MFG. DIVISION: 3630 EASTHAM DRIVE, CULVER CITY, CALIF.
 EXPORT DIVISION: 13 EAST 40th STREET, NEW YORK 16, N.Y. CABLE: "ARLAB"

CIRCLE 900 ON READER SERVICE CARD

electronics

A McGraw-Hill Weekly 75 Cents



W. W. MacDONALD, Editor

J. M. CARROLL, Managing Editor

SENIOR EDITORS

Samuel Weber, George W. Sideris

SENIOR ASSOCIATE EDITORS

Michael F. Wolff, John F. Mason

ASSOCIATE EDITORS

Michael F. Tomaino, William P. O'Brien, Sy Vogel, George J. Flynn, Laurence D. Shergalis, George V. Novotny, Leon H. Dulberger, Alexander A. McKenzie

ASSISTANT EDITORS

Stanley Froud, Stephen B. Gray, Roy J. Bruun, Barry A. Briskman, Dan Smith, Joel A. Strasser

REGIONAL EDITORS

Harold C. Hood (Pacific Coast, Los Angeles), Thomas Maguire (New England, Boston), Cletus M. Wiley (Midwest, Chicago)

ART DIRECTOR

Howard R. Berry

ASSISTANT ART DIRECTOR

John C. Wright, Jr.

EDITORIAL ASSISTANTS

Lorraine Rossi, Virginia T. Bastian, Lynn Emery, Ann Mella, Lorraine Werner, Alice M. O'Brien, Sharon Parks, Patricia Mitchell, Claire Benell, Kay Fontana

FOREIGN NEWS BUREAUDIRECTOR, John Wilhelm;
Alyne Elias, Laurence Mihlon

LONDON—John Shinn, Derek Barlow, Nicholas Landon

BONN—Bruce Bendow,
Richard Mikton, Silke McQueen

BRUSSELS—Peter Forbath

PARIS—Robert Farrell,
Arthur Erikson

MILAN—Marc A. Messina

MEXICO CITY—Wesley Perry, Jr

RIO DE JANEIRO—Leslie Warren

MOSCOW—Stewart Ramsey

TOKYO—Richard Halloran,
Charles Cohen, John Yamaguchi**CIRCULATION MANAGER**

Hugh J. Quinn

W. W. GAREY, Publisher

IT'S ALWAYS GREENER—High grass is good for cattle and horses but not good for radar operators. The "grass" on the cover was photographed on the face of a radar A-scope and it darn near obscures the desired signal. *This week's 24-page special report on rfi tells how to cut a wide swath through all that high grass. See p 37*

COVER

F-104G: BOON TO EUROPE. NATO Program Squeezes 16 Years of Electronics Knowhow Into 2 Years. American technical aid is updating European electronics techniques. *As part of this \$2-billion program, U.S. specialists are teaching European manufacturers to produce advanced military airborne electronics*

16

DATA COMMUNICATIONS Become Faster and More Accurate. New sequential-coding technique achieves 7,500 bits per second over telephone line. *More than 1 billion consecutive bits have been delivered without an error*

18

HOLMES DENIES That NASA Snags Plagued Him. In an exclusive interview with ELECTRONICS, the resigning chief of the Apollo program discusses the termination of the Mercury program and defends the progress of the Gemini program. *He hopes to go back into government service again "sometime"*

22

NEW LASER STRUCTURE Drives Output Past One Watt. Key to high power and 25-percent efficiency is a tungsten sandwich that helps remove heat. *Among other solid-state advances reported last week: a gallium-arsenide block microwave oscillator*

24

TUNABLE TRANSMITTERS—Are They on the Way Out? Broadband tuning techniques now eliminate operator adjustments. *Here's how it's done in one Army transceiver*

30

SPECIAL—RFI. People have to be taught to get along together and the closer you squeeze them in, the harder you have to teach. It's the same way with electronic equipment—what's one man's air-to-ground contact is another man's tvi. *This special report describes sources of rfi and tells how to measure it, avoid it, suppress it and minimize its effects by proper design of systems and equipment and proper selection of components.*

By Sy Vogel, Associate Editor 37

HOMOGENEOUS SEMICONDUCTORS: The Coming Generation. We have gone from single-junction semiconductor devices to two-junction devices, to three or even more. Now it seems that semiconductors can oscillate and amplify without any *p-n* junction at all. *Here a world renowned expert tells how bulk properties of semiconductors make this possible. One of the new devices, the bokatron, bears his name.*

By Julien Bok, Ecole Normale Superieure, Paris, France 65

Published weekly, with Electronics Buyers' Guide as part of the subscription, by McGraw-Hill Publishing Company, Inc. Founder: James H. McGraw (1860-1948).

Title ® registered U.S. Patent Office; © copyright 1963 by McGraw-Hill Publishing Co., Inc. All rights reserved, including the right to reproduce the contents of this publication, in whole or in part.

Executive, editorial, circulation and advertising offices: McGraw-Hill Building, 330 West 42nd Street, New York 36, N. Y. Telephone Longacre 4-3000. Teletype TWX N.Y. 212-640-4646. Cable McGrawhill, N. Y. PRINTED IN ALBANY, N. Y.; second class postage paid at Albany, N. Y.

OFFICERS OF THE PUBLICATIONS DIVISION: Shelton Fisher, President; Vice Presidents: Joseph H. Allen, Operations; John R. Callahan, Editorial; Ervin E. DeGraff, Circulation; Donald C. McGraw, Jr., Advertising Sales; Angelo R. Venezian, Marketing.

OFFICERS OF THE CORPORATION: Donald C. McGraw, President; Hugh J. Kelly, Harry L. Waddell, L. Keith Goodrich, Executive Vice Presidents; John L. McGraw, Treasurer; John J. Cooke, Vice President and Secretary.

Subscriptions are solicited only from those actively engaged in the field of the publication. Position and company connection must be indicated on orders. Subscription rates: United States and Possessions, \$6.00 one year, \$9.00 two years, \$12.00 three years. Canada: \$10.00 one year. All other countries \$20.00 one year. Single copies, United States and Possessions and Canada 75¢. Single copies all other countries \$1.50.

THE PUBLISHER, UPON WRITTEN REQUEST TO OUR NEW YORK OFFICE FROM ANY SUBSCRIBER AGREES TO REFUND THAT PART OF THE SUBSCRIPTION PRICE APPLYING TO COPIES NOT YET MAILED.

Subscribers: Please send change of address notices, subscription orders or complaints to Fulfillment Manager, Electronics, at the address below. Change of address notices should provide old as well as new address, including postal zone number if any. If possible, attach address label from recent issue. Allow one month for change to become effective.

Postmaster: Please send Form 3579 to Fulfillment Manager, Electronics, P. O. Box 430, Hightstown, New Jersey.



Audited Paid Circulation

CONTENTS continued

TUNNEL DIODES, Part II—Working Beyond Transistor Capabilities. The versatile tunnel diode amplifies signals well into the gigacycle region and affords low-noise operation and circuit simplicity. *Ferrite isolators, circulators or hybrid couplers give unilateral impedance required for high gain.*

By E. Gottlieb and J. Giorgis,
GE Semiconductor Products Dept. 68

TVIST: New Concept In Storage Tubes. We haven't misspelled the name of last season's dance craze. It stands for Television Information Storage Tube and it can store a hundred billion information elements. *Writing can be done by either secondary emission or by electron bombardment induced conductivity (EBIC); readout is nondestructive.*

By A. S. Jensen and W. G. Reininger, Westinghouse Electric 74

DEPARTMENTS

Crosstalk. <i>Microelectronics. Failte Do, n Mac-Coinngh</i>	3
Comment. <i>FET Amplifier. Negative Resistance III. Different Companies</i>	4
Electronics Newsletter. <i>Semiconductor Research Provides Clues to Cancer Causes</i>	7
Washington This Week. <i>Advances in Seismic Detection Are Not Behind Upcoming Atomic Test-Ban Talks</i>	12
Meetings Ahead. <i>Vehicular Communications National Conference</i>	32
Research and Development. <i>Speech Operates Safety Switch</i>	78
Components and Materials. <i>New Circuit Board Planned for Apollo</i>	84
Production Techniques. <i>New Deplating Process Makes Circuit Boards</i>	92
New Products. <i>Stripe Design Improves VHF Transistor</i>	98
Literature of the Week	104
People and Plants. <i>GPI Opens Aerospace Research Center. Sperry Rand Reorganizes</i>	106
Index to Advertisers	111

The Impact of Microelectronics

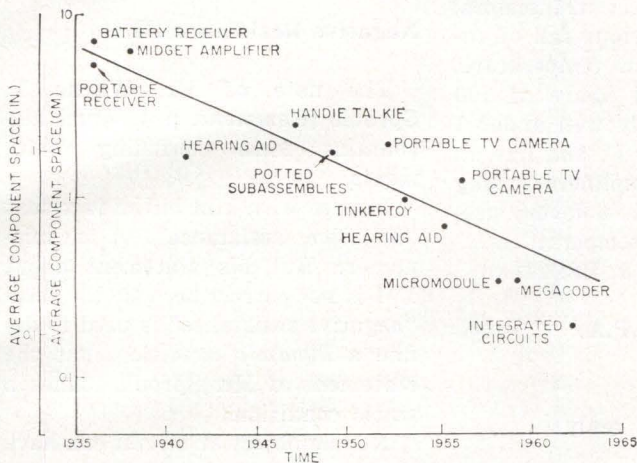

EQUIPMENTS are getting smaller, faster

THE WAY things are going in equipment size and component density as a result of micro-miniaturization is graphically illustrated by the chart shown above. It represents a chronological review of the trend, showing average size of components (the total volume of the equipment divided by the total number of components), plotted against date of publication.

The chart was developed by RCA's J. T. Wallmark for next week's conference, *The Impact of Microelectronics*, opening in Chicago on June 26 under the co-sponsorship of *ELECTRONICS* and Armour Research Foundation.

Obviously, the straight line cannot continue downward indefinitely. At what point it will begin to taper off—well, that's the point of Dr. Wallmark's talk, and we wouldn't want to anticipate his thoughts on the matter.

Less obvious, perhaps, than the technological changes indicated by the chart, are the anticipated structural changes in the electronics industry. That's really what next week's conference is mostly about. Already the indication is strong that areas certain to feel the effects of the new technology include circuit and system engineering, product specification and standardization, marketing, and education and recruitment of technical personnel. In other words, virtually the entire industry may be in for an overhaul in response to changes in the product and the marketplace.

That's why we're convinced that the conference is needed. The response to our announcement of

the conference has reinforced our belief that there is a tremendous interest and concern about these problems. Next week's meeting will serve to give them the airing they should have.

For those of you who can't make it, next week's issue will carry a comprehensive staff report on what the industry thinks about the impact of microelectronics. It will include the opinions of many of the conference speakers, as well as the views of other knowledgeable industry leaders, brought out in exclusive interviews with our field editors.

COUNTERMEASURES AGAIN Remember our mention here May 10 about the police radar detector for motorists? We called it "consumer countermeasures." Well, more recently we heard that someone in England had developed a device really worthy of the name, a jammer that could be used against portable transistor radios playing too loudly in public places. We instructed our London bureau to check up on the truth of the report, asking among other things whether the use of the device had led to any court or private disputes. The reply cabled from London:

"Re your cable on countermeasure equipment against transistor portables, as far as can be ascertained no one is in production, no court actions and no one using them. Final word from the General Post Office is that if anyone did make them commercially they, the Post Office, would not grant them a license as the equipment would come under the category of a transmitter. So reckon no soap on this one."

FAILTE DO, N MacCOINNGH A free translation from the Gaelic might be "McKenzie's return" and here refers specifically to Alexander A., who left the staff of *ELECTRONICS* exactly six years ago for other fields in McGraw-Hill's "Big Green Building" and now is back on our staff. During his interim with our Book Company, Alex kept in touch with industry developments through close contact with authors of electronics texts. More recently, he has been working with engineers in the review of abstracts on all phases of aerospace activity, including electronics. He returns eager to participate in the challenge of getting out a weekly publication. His only audible new vice is an inordinate enthusiasm for, and the active sounding of the Highland bagpipes, without electronic programming and, so far, restricted from the editorial precincts.

now
available
for
immediate
delivery:

**JERROLD
RF SWEEP
EQUIPMENT
...the industry's
finest!**



**Model 900B
Super Sweep Generator**

Wide plus narrow band in one versatile instrument. Handles all IF, VHF, UHF sweep requirements. Sweep widths from 10kc to 400mc. Frequency range from 500kc to 1,200mc. Built-in crystal-controlled harmonic markers, dc or ac scope preamplifier, precision attenuator. **\$1,980.00**



**Model LA-5100
rf Log Amplifier**

Accurate within ± 1 db over 80db dynamic range. Frequency range 500kc to 100mc. Lets you make exact measurements of attenuation in networks, filters, amplifiers with dynamic ranges down to 85 db. Total rf response displayed in precise log ratio on standard dc-coupled scope. **\$795.00**

Model 900A Wide-Band Sweeper

Sweep widths from 100kc to 400mc. Frequency range from 500kc to 1,200mc. **\$1,260.00**

Model 707 Ultra-Flat Sweeper

Flatness of ± 0.05 db in highest single octave. Plug-in oscillator heads. **\$840.00**

All for immediate delivery. Prices f.o.b. Philadelphia. Write for complete technical data on these and other Jerrold rf test instruments.



Industrial Products
Division,
Philadelphia 32, Pa.



A subsidiary of THE JERROLD CORPORATION

COMMENT

FET Amplifier

Fleenor's amplifier (E. G. Fleenor, Low-Noise Preamplifier Uses Field-Effect Transistors, p 67, April 12) is interesting but does not solve the main problem associated with field-effect transistors, namely the very serious fall of input impedance with temperature. In fact, his quoted figure of 100 megohms is probably well under 1 megohm at 100 deg C, and like all high-impedance amplifiers using field-effect devices, is not very useful except at room temperatures.

PAUL J. BÉNÉTEAU

Società Generale
Semiconduttori S.P.A.
Milan, Italy

Author Fleenor's reply:

The input impedance of my field-effect transistor preamplifier consists of a shunt resistance, R_i , and a shunt capacitance, C_i . The temperature dependence of the input resistance can be calculated as follows, taking into account the gate-drain resistance, r_{gd} , and the gate-source resistance, r_{gs} :

$$R_i = \frac{1}{\left[\frac{1}{R_s} + \frac{1}{r_{gs}} \right] \left[1 - \frac{E_s}{E_i} \right] + \frac{1}{r_{gd}} \left(1 - \frac{E_d}{E_i} \right)}$$

where $R_s = 6.2$ megohms, $E_s/E_i \cong 0.955$, $E_d/E_i \cong -0.076$, and calculated $R_i = 130$ megohms neglecting r_{gs} and r_{gd} , which at room temperature are about 10^{10} ohms and can be neglected. At elevated temperatures they decrease sufficiently to be taken into account. The input resistance of a production unit preamplifier was tested and found to be 140 megohms at temperature up to 80 deg C, decreasing to 80 megohms at 100 deg C. The input capacitance remained relatively constant at 6 to 8 pf over this temperature range. Therefore this circuit is useful as a high-impedance amplifier at high temperatures.

The points to keep in mind in designing a temperature-stable circuit are: (1) use a small gate resistor (R_s) to prevent the gate-drain leakage current at high temperatures from overcoming the

reverse bias on the gate-source junction; (2) use a source resistor (R_s) to minimize the gate-source voltage swing; (3) use a low-drain impedance to minimize the gate-drain voltage swing.

E. G. FLEENOR

Lockheed Missiles & Space Co.
Sunnyvale, California

Negative Resistance III

The note of Mr. Wayne T. Sproull (*Comment*, p 4, April 26) contains some confusing statements.

I agree with him in the fact that "negative resistance" is a misnomer. But his statement about V/I is not correct because the term "negative resistance" is used to define a *dynamic* condition, but the statement of Mr. Sproull defines a static condition.

No one object or circuit can have negative resistance when in a static condition, but in dynamic condition, it may *perform* as a positive or negative resistance.

Incidentally, a dry cell is *not* a negative resistance; it is equivalent to a d-c generator in series with a positive resistance and it performs according to Ohm's law.

My opinion is to use the term "dynamic negative resistance" or "equivalent negative resistance" instead of "negative resistance."

EDUARDO VILLASEÑOR

Productora de Artículos
Electronicos, S.A.
Mixcoac, Mexico

Different Companies

We appreciate and thank you for the publicity you have so generously given to the installation of the Brewer System at Providence Hospital, Seattle, on p 24 of your April 19 issue. I would point out, however, that you have given our company name erroneously as "Brewers Pharmacal Co.". Our correct name is "Brewer Pharmacal Engineering Corporation." It is the same Brewer but different companies.

H. WALTER CLUM

Brewer Pharmacal
Engineering Corp.
Upper Darby, Pennsylvania



Allen-Bradley's "time-proven" components bring the ultimate in reliability to your circuit design

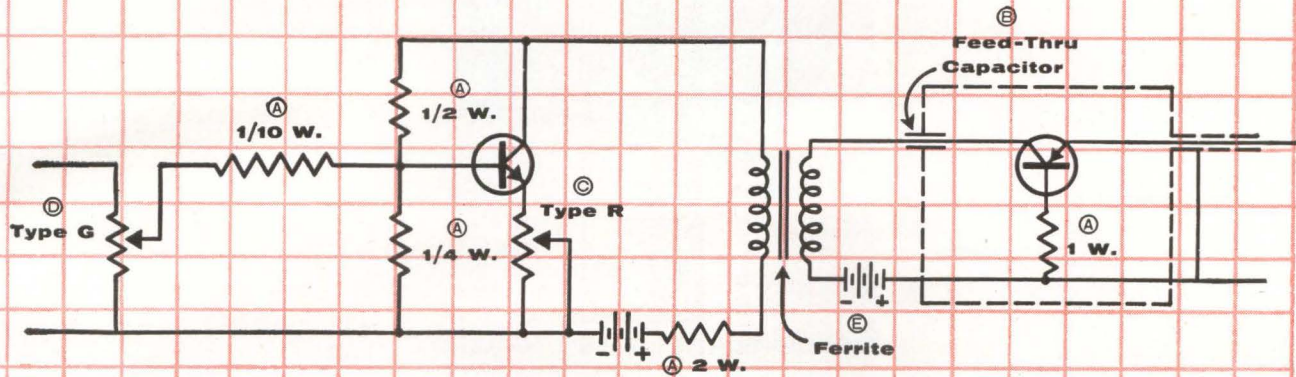

- Type TR 1/10 Watt MIL Type RC 06
- Type CB 1/4 Watt MIL Type RC 07
- Type EB 1/2 Watt MIL Type RC 20
- Type GB 1 Watt MIL Type RC 32
- Type HB 2 Watt MIL Type RC 42

A HOT MOLDED FIXED RESISTORS are available in all standard EIA and MIL-R-11 resistance values and tolerances.

B FEED-THRU CAPACITORS—Available in standard values of 470 mmf \pm 20% and 1000 mmf G. M. V. Special values from 6, 8 to 1000 mmf. Rated to 500 v DC max.

C HOT MOLDED ADJUSTABLE FIXED RESISTORS—Rated 1/2 watt at 70°C. Values to 2.5 meg. Tol: \pm 10 and 20%.

D TYPE G HOT MOLDED POTENTIOMETERS—Only 1/2" diam. Rated 1/2 watt at 70°C. Resistance values to 5 meg. Tol: \pm 10 and 20%.

E FERRITES in a wide range of "items," such as flared rings, quarter rounds, U cores, E cores, cup cores, etc., can be supplied.

With the quality of the components which you select, you automatically establish the "quality" of your product. Consequently, there's no surer way of making certain of optimum performance than by using Allen-Bradley electronic components. Such stable characteristics insure against catastrophic failure, and conservative ratings are way beyond the "promise" of any similar products. Hundreds of customers of many years standing have learned from their experience with Allen-Bradley hot molded resistors, that today's shipments are as uniform in quality as they were ten or twenty years ago—and such uniform quality can always be expected.

Remember also that with billions of A-B resistors in use, there is *not one instance* of catastrophic failure on record! Allen-Bradley's *exclusive* hot molding process results in such uniformity that long term resistor performance can be accurately predicted.

Then there's the compact Type G potentiometer. The solid, hot molded resistance element assures exceptionally smooth control throughout its long life—there are never any abrupt resistance changes during adjustment. The

noise factor is remarkably low initially, and it actually decreases with use.

Allen-Bradley's Type R adjustable fixed resistors are also made by this same hot molding process—resistance element, terminals, and insulating base are all molded into a solid unit. Stepless adjustment is provided, and the moving element is self-locking at its "setting."

In the higher frequencies—up to 1,000 mcps—A-B ceramic feed-thru and stand-off capacitors' unique discoidal design eliminates all parallel resonance effects.

Entirely new answers to design problems are possible with A-B's broad line of ferrites . . . reducing product size, weight, or cost, and improving performance. They can be supplied in a wide range of shapes and sizes—while maintaining extremely uniform electrical and mechanical characteristics.

For more details on all A-B quality electronic components—types, ratings, dimensions—please send for Publication 6024: Allen-Bradley Co., 110 W. Greenfield Ave., Milwaukee 4, Wisconsin. In Canada: Allen-Bradley Canada Ltd., Galt, Ontario.

QUALITY ELECTRONIC COMPONENTS

ALLEN-BRADLEY

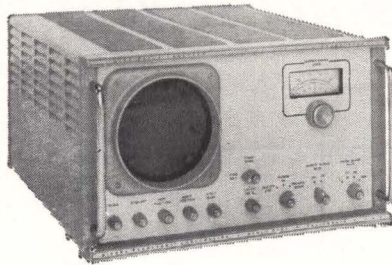

"made-to-measure precision"

Pip of a Fault-finder

Now you can bird-dog faults on an open wire line from the warmth and comfort of your powerhouse, carrier terminal, or sub-station, provided you have: 1. A Sierra 371A Line Fault Analyzer on tap, and 2. you occupy a warm, comfortable powerhouse, carrier terminal, or sub-station.

While you relax before a warm 371A, it sends a stream of high amplitude pulses streaking down the line, searching out trouble anywhere from less than $\frac{1}{2}$ mile to 200 miles away. Let an open, ground, short, drop, or tap strike, and PIP! You get an instantaneous report on the scope. The pip identifies the nature of the fault, and a direct-reading indicator pinpoints the distance in miles. The savings possible in fuel and shoe leather alone stagger the imagination.

The 371A costs \$1,040 — the price of 50 or 60 pairs of shoes. The technical brochure costs nothing. Write us for a copy — or get one from your nearest Sierra sales representative.

SIERRA ELECTRONIC DIV.

**OF
PHILCO**

A SUBSIDIARY OF *Ford Motor Company*

Sierra Electronic Division / 3885 Bohannon Drive / Menlo Park 1, California

Rats Fed Semiconductors Get Cancer

SEMICONDUCTOR research is providing clues to the causes of cancer. Those organic materials having the most favorable semiconductor properties can also induce cancer when fed to rats, researchers at New York University have discovered. Those compounds that do not exhibit semiconductor properties, even though closely related, do not produce cancer or contribute to cell destruction, results to date indicate.

The NYU group, headed by Dr. Walter Brenner, would like to find out if the electrical properties of polynuclear aromatic hydrocarbons can be directly correlated with cancer-causing properties, and what the mechanism is by which the material induces pathological conditions. Studies are being undertaken to test theories that the molecule of the organic semiconductor compound is bound to the tissue protein by formation of a charge transfer complex.

These experiments may also show something of the mechanism of cancer activity by chemical and radiation means. The NYU program is sponsored by Air Force Cambridge Research Laboratories.

Shrike Makes Debut

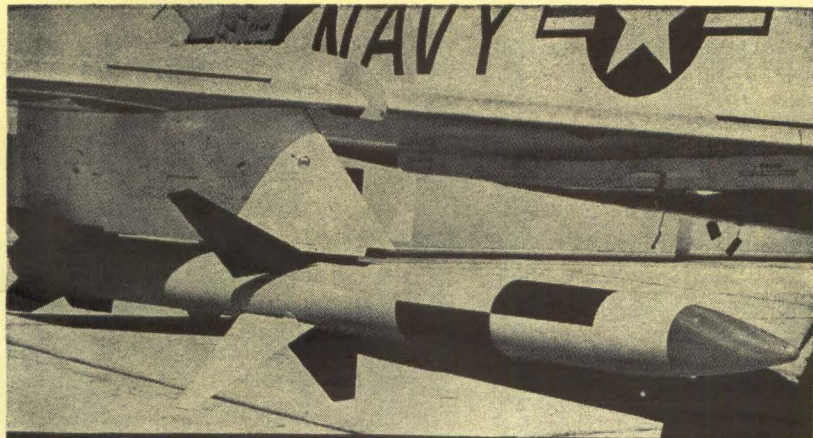

FIRST closeup photo of the Shrike was released by the Navy after President Kennedy viewed firings of the missile at China Lake, Calif. (p 26, June 14). Navy 'Skyhawks' launched air attacks against imaginary enemy radar installations during the demonstration

3 Newspapers Make History the Hard Way

LONDON—June 10 was scheduled to go down in history. It was to be the day of typesetting by satellite, with the help of an RCA 301 computer. On June 11 three British newspapers participating in the momentous occasion—the *Guardian*, the *Scotsman* and the *Glasgow Herald*—ran stories which had originated in Chicago and which the papers said had been set automatically after signals were bounced off the Relay I satellite.

Blushingly, the newspapers retracted the next day. Britain's General Post Office explained that a fault on the aerial control at Goonhilly Downs resulted in the signals being switched to transatlantic cable. "By a failure at the Post Office the three newspapers were wrongly informed that the satellite had been used," the Post Office said.

The experiment will be tried again when the gremlins have been ousted from Goonhilly

Equal-Pay Bill Signed, Practice Yet to Come

WASHINGTON—President Kennedy has signed the equal-pay-for-women bill into law but it's still far from reality. There are enough qualifications in the new legislation to permit a variety of pay systems for men and women in the same plant. Officially, the equal pay bill applies to workers in interstate com-

merce, after a period of one year.

But employers with men and women in the same line of work may still pay different rates depending on seniority, shift differentials, and merit increases. It's up to the Labor Dept. to interpret whether the law is being violated—and department investigators say they'll rely on education and persuasion, not tough penalties.

Sporadic-E Association With Wind Shears Shown

EXPERIMENTS performed for NASA show a definite relationship between wind shears and sporadic-E disturbances, reports the Geophysics Corp. of America (p 18, March 25, 1962). However, the sporadic-E layers measured were found to be associated with an existing east-west wind shear, rather than a north-south shear as had been theorized by J. D. Whitehead, the Australian scientist. The most pronounced sporadic-E layers observed were discovered near an altitude of 100 kilometers.

Three series of rocket flights were conducted from Wallops Island, Va. on Nov. 7, Nov. 30 and Dec. 5, 1962. Each used a Nike-Cajun sounding

Dual-Beam Laser

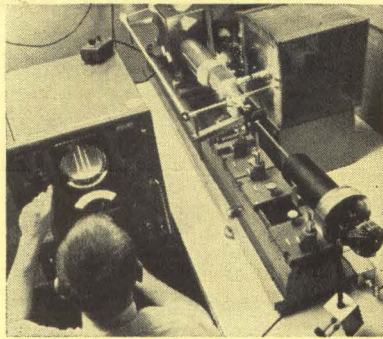

SIDE-BAND transmission over laser beams employed for communications is achieved with Westinghouse Electric technique. Gas laser emitting dual beams channels one through crystal resonant cavity r-f modulator. Side band frequencies are produced by mixing modulated and unmodulated beams

rocket equipped with Langmuir probe electrical equipment and a Nike-Apache rocket which released a trail of sodium vapor.

Japanese Will Inspect Competing 'Sage' Systems

TOKYO—Japan's Self Defense Agency is sending a second team to the U.S. for another survey of small-scale Sage systems made by Litton and Hughes (p 7, March 8). The agency so far has been unable to make a decision, which had been expected last week.

Takeshi Matsuda, chief of the Air Staff, favors the Litton system. Most civilian bureau chiefs on Air Staff favor the Hughes system, which is \$10 million cheaper. GE, which also submitted a bid, seems to be out of the running.

French Firm Develops Infrared Altimeter

PARIS—Sud Aviation has developed an altimeter for use at low altitudes that bounces an infrared beam off the ground and picks up the reflection to determine a plane's height within 2 inches at 40 feet and $\frac{1}{2}$ inch at 16 feet. The transmitting head uses an underheated 50-w tungsten filament as the infrared source, which is modulated at

13.2 and 8 Kc by a slotted disc and focused optically. Optics of the receiving head focus the reflected radiation on photodiodes. Their output is fed to a pair of transistorized amplifier channels and a discriminator to get the altitude signal.

Integrated Components Cut Power Sharply

PARIS—An analog-to-digital converter containing 250 transistor stages consuming less than 10 μ w each was reported by CBS Labs at NATO Agard conference on micro-power electronics (p 22, June 14). Integrated microcircuit transistors 10 microns in size are diffused into a silicon wafer and thin-film passive elements deposited.

A. T. Watts, of England's Mullard Radio Valve, said refinements in direct-coupled logic have reduced power consumption to 50 μ w. Number of transistors in binary counter circuit was cut from 17 to 6. Reporting on insulated-gate field-effect semiconductors, G. K. Moore, of Fairchild Semiconductors, described a planar silicon diode requiring only one nanowatt per stage standby power.

AF Backs Development Of Laser Gyroscope

SPERRY GYROSCOPE reported this week that it has significantly improved the laser gyroscope (p 7, Feb. 15) and that it now has a \$100,386 1-year Air Force Aeronautical Systems Division contract to develop the system further. AF is interested in using it for space vehicle guidance.

In February, the device used four gas lasers in a square and could measure rotation of 2 deg per minute by detecting changes in optical path lengths around the square. Now, only one laser is used to two configurations, making the sensors simpler and less expensive.

In one design, a gas laser is one side of the square and mirrors reflect the beams clockwise and counterclockwise around the square. At 1.15-micron beam wavelength, sensitivity is better than $\frac{1}{2}$ deg/min.

In Brief . . .

HOPES FOR another Mercury shot were killed last week by James E. Webb, NASA administrator, who said it would slow up the Gemini program. Webb had previously indicated he was opposed to an MA-10 shot (p 8, June 14).

SPECULATION has grown stronger that Russia will attempt a manned expedition to the moon within the next year. The sun is now entering a quiet period.

TECHNOGRAPH has appealed a court decision holding that Bendix did not infringe its patent rights on printed circuits (p 24, June 7).

RCA IS STUDYING the use of lasers in missile tracking and flight analysis systems under a \$70,000 Air Force contract.

RADAS SUBCONTRACT has been awarded Technical Communications Corp. by Motorola.

CONTROL DATA CORP. has delivered 19 of its 160-A computers for the Air Force Satellite Control Facility.

AC SPARKPLUG will make and test navigation and guidance systems for the Apollo space vehicle. Contract totals \$35.8 million.

FRIDEN will introduce a demi-size computer for business applications next week. Called the 6010, it will have a random-access core storage and a Flexowriter as standard input and output.

COMPREHENSIVE PLAN defining systems effectiveness—composed of maintainability, reliability and serviceability—will be issued shortly by Navy Bu Weps.

SOVIET electronics team has arrived in India to help build MIG factories. The Russians are carefully rationing the special fuel needed for takeoff by MIG 21s, of which India has six.

AIR FORCE plans to use from 160 to 174 NCR 390 data processing systems to make up the payrolls at major bases.

New from Sprague!

HIGH VOLTAGE • HIGH SPEED

2N1499B



TO-9 CASE

GERMANIUM P-N-P



LOW COST HIGH VOLTAGE LOGIC SWITCH

AVAILABLE IN PRODUCTION QUANTITIES NOW!

check these key parameters

BV_{CBO}	30 volts
BV_{CEO}	20 volts
I_{CBO} at 15V	3 μ A max.
H_{FE}	40 min.
V_{CE} (SAT)	0.15 volts max.
f_T	150 mc min.

Significant process improvements in the manufacture of the popular 2N1499A provide substantial increases in performance, power, and reliability. Sprague's new 2N1499B Transistor features improvements in voltage, leakage current, gain, saturation, and speed.

For application engineering assistance, write to Transistor Division, Sprague Electric Company, Concord, New Hampshire. For technical data, write for Engineering Bulletin 30,223 to Technical Literature Service, Sprague Electric Company, 35 Marshall Street, North Adams, Massachusetts.

SPRAGUE COMPONENTS

TRANSISTORS
CAPACITORS
RESISTORS
MICROCIRCUITS
INTERFERENCE FILTERS

PULSE TRANSFORMERS
PIEZOELECTRIC CERAMICS
PULSE-FORMING NETWORKS
TOROIDAL INDUCTORS
ELECTRIC WAVE FILTERS

CERAMIC-BASE PRINTED NETWORKS
PACKAGED COMPONENT ASSEMBLIES
BOBBIN and TAPE WOUND MAGNETIC CORES
SILICON RECTIFIER GATE CONTROLS
FUNCTIONAL DIGITAL CIRCUITS



'Sprague' and 'Ⓢ' are registered trademarks of the Sprague Electric Co.

WHAT MAKES "INSTRUMENTATION CABLE" DIFFERENT?

It is no more like power or control cable than a Ferrari is like the old family sedan. Not knowing this can cause you a lot of grief: project delays, costly replacements, malfunctions.

THE THIN BLACK LINE On your schematics, instrumentation cable is a black line from launching pad to blockhouse or from one part of a computer to another. In the broadest sense, it connects data or signal sources with display or recording or control devices. Its function is to carry those signals unflinchingly and with the required reliability. In this day and age, it's no easy job.

WHAT CAN GO WRONG The improperly designed cable can simply fail. This has happened and at important sites. An untried saturant, lacquer or compound ingredient used in the cable may destroy the electrical integrity of this primary insulation. This sort of deterioration need not be sudden; only experts know which impregnants will migrate in a week or a month or more.

Or a relative lack of art in manufacture may create problems for the future. Under certain circumstances in use, variations in insulation thickness, conductor placement, or conductor unbalance in the cable lay-up may cause spurious or ambiguous signals to arrive at the display, recording or control panel. Your sharp, precise pulses become displaced in time, are a little too fuzzy, or are joined by other unwanted signals from another line.

DESIGN IS HALF THE STORY Configuration of conductors within the cable is important, for physical as well as for electrical reasons. For example, positioning of coaxial components within the cable is critical in order to assure maintenance of minimum standards of concentricity between the inner and outer conductors when the cables may be subjected to bending operations during installation work.

Selection of insulating, filler and

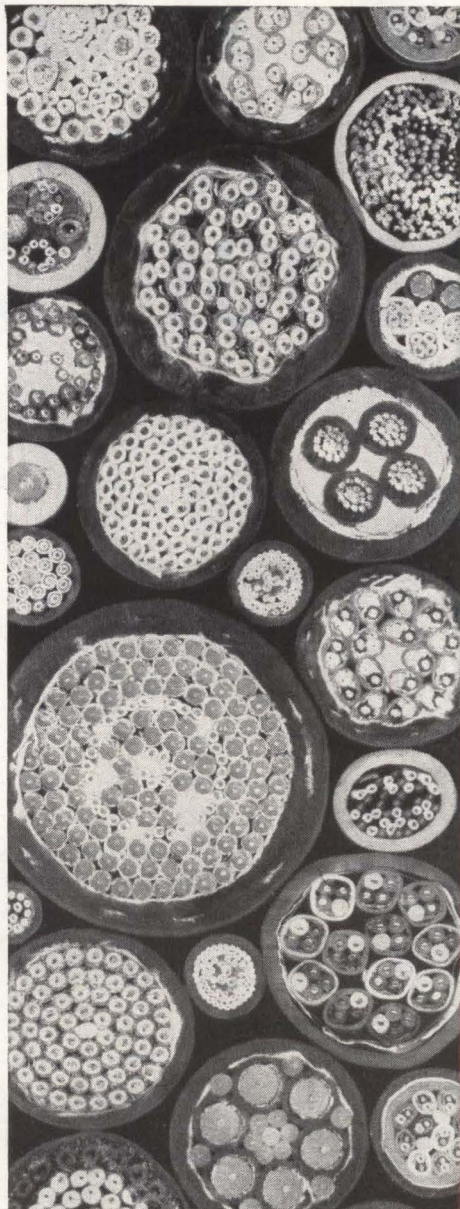

jacketing materials requires expert knowledge and judgment. Some materials, as mentioned above, tend to migrate. Others harden or soften with cold or heat. Some change their electrical characteristics in time. These are not fundamentally new problems in cable design, *but in instrumentation cable the standards are far more severe than ever before.*

MANUFACTURE IS THE OTHER HALF Even a properly designed cable may well become unacceptable sooner or later if it is not manufactured to new standards of precision. This requires stranding machines that reduce circular eccentricity to remarkably low figures and help assure insulation uniformity, insulating machines of considerable precision, and highly precise cabling equipment. It also requires, as is so often the case in precision manufacture, an indefinable skill on the part of machine operators.

ASK THE EXPERTS To protect the functioning of your system, there's only one way to make sure the thin black lines on your schematics become cables with the requisite dependability: have them designed by experts, in consultation with you, and constructed by experts.

Rome-Alcoa is, frankly, one of the very few companies that qualify. We've been designing and constructing these cables since their first conception. If you're going to need instrumentation cable soon, call us, the sooner the better.

We now have a 24-page booklet titled "Instrumentation Cables, Cable Assemblies and Hook-up Wires." In it, we describe instrumentation cable constructions, production, military specifications and our qualifications. For your copy, write Rome Cable Division of Alcoa, Dept. 27-63, Rome, N. Y.



ALCOA
ROME CABLE
DIVISION

75% smaller
than the smallest
(by volume)

new size Y Ohmite
tantalum slug capacitor



Size Y
Actual Size



Size U
MIL Size T1



Size F
MIL Size T2



Size G
MIL Size T3

ACTUAL
SIZES

NOW **7** CHOICES IN OHMITE
TANTALUM SLUG CAPACITORS

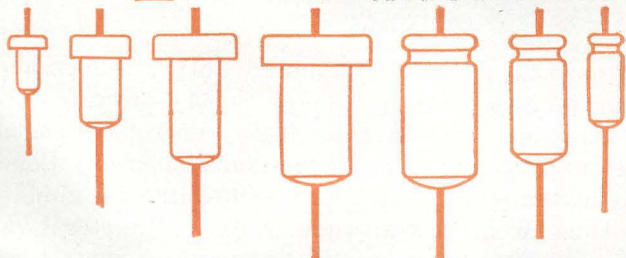

■ Size Y is the tiniest hat-shaped capacitor ever developed. Its case measures only $\frac{19}{64}$ " long with a flange diameter of $\frac{13}{64}$ " and body diameter of $\frac{1}{8}$ ". Yet this miniature unit offers characteristics equal to any of the larger sizes. Size Y meets all requirements of MIL-C-3965B.

Eleven stock values from 0.91 to 15 mfd (125 volts DC max.) are available for fast delivery. Tolerances of $\pm 10\%$ (K) and $\pm 20\%$ (M) are offered in all values. Operating temperature range is -55° to $+85^{\circ}\text{C}$.

WRITE FOR BULLETIN 159



OHMITE
MANUFACTURING COMPANY
3610 Howard Street, Skokie, Illinois

RHEOSTATS • POWER RESISTORS • PRECISION RESISTORS • VARIABLE TRANSFORMERS
TANTALUM CAPACITORS • TAP SWITCHES • RELAYS • R.F. CHOKES • SEMICONDUCTOR DIODES

WASHINGTON THIS WEEK

ADVANCES IN DETECTION NOT REASON FOR TEST-BAN TALKS

PRESIDENTIAL emissaries to high-level nuclear test ban talks in Moscow next month are preparing for their mission in a mood of quiet desperation. Neither the technology of underground test detection nor the politics in either nuclear capital has changed since the latest Geneva debacle.

Despite the lack of breakthroughs in seismic detection, present U.S. policy contends that there are technical reasons why a test ban is feasible. Existing U.S. and Soviet weapons technology is so advanced that for some time the margin of gain from successive series of nuclear tests has been diminishing at an increasing rate. By the same token, recent Project Vela experience indicates that underground tests small enough to escape detection contribute relatively little to weapons advancement.

So the U.S. negotiators see some additional leeway for bargaining. The wall at their backs is insistence by the treaty-monitoring U.S. Senate that the U.S. team get from the Soviets a solid commitment to on-site examination of suspicious seismic events. President Kennedy feels that if he can get concessions from the Soviets, he can sell a treaty to the Senate. A crucial imponderable remains in the amount of leeway Moscow politics will permit Soviet negotiators on the knotty inspection question.

SPOTLIGHT GOES ON X-22

SENATE preparedness subcommittee has the makings of another TFX case. It is investigating the Navy's recent award for development of the X-22 VTOL (vertical take-off and landing) aircraft. The contract was let to Bell Aerospace under orders from Deputy Defense Secretary Gilpatric even though a Navy evaluation board recommended selection of Douglas Aircraft.

MORE CHANGES IN CONTRACT SELECTIONS

McCLELLAN INQUIRY into the TFX spotlights a controversial plan to revamp the Pentagon's procedure for selecting major contractors.

Role of military evaluation boards would be limited to "measuring technical aspects" of contractor proposals. Actual contractor selection would be handled on the civilian secretarial level as in the TFX and X-22. The plan also involves two stages of bidding to narrow final competition and avoid high-cost bid preparation by companies with little chance to win the contract.

Sen. McClellan criticizes the plan as still another step to downgrade influence of military professionals. Defense Industry Advisory Council generally endorses it. Gilpatric says the plan will be restudied before it becomes official policy.

TFX ELECTRONICS AWARDS OK'D

PENTAGON has approved General Dynamics Corp.'s selection of major electronic subcontractors on the TFX—or F-111—aircraft development project. GE will supply attack radar, flight control system and missile launch computer; Avco, the countermeasures system; Bendix Eclipse-Pioneer, air-data computer; Litton Industries, inertial guidance system; Minneapolis-Honeywell, low-altitude radar altimeters; and AiResearch Manufacturing, refrigeration and temperature control sets. The Navy previously picked Hughes Aircraft to develop and build the Phoenix air-to-air missile.

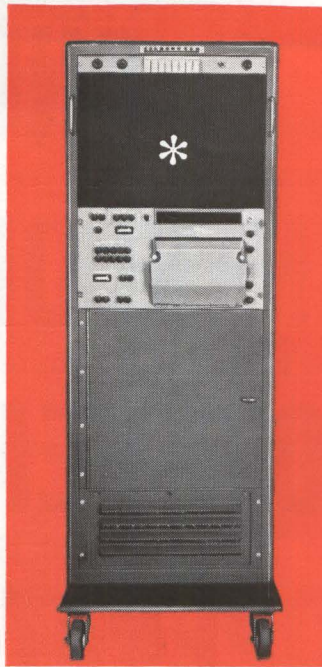
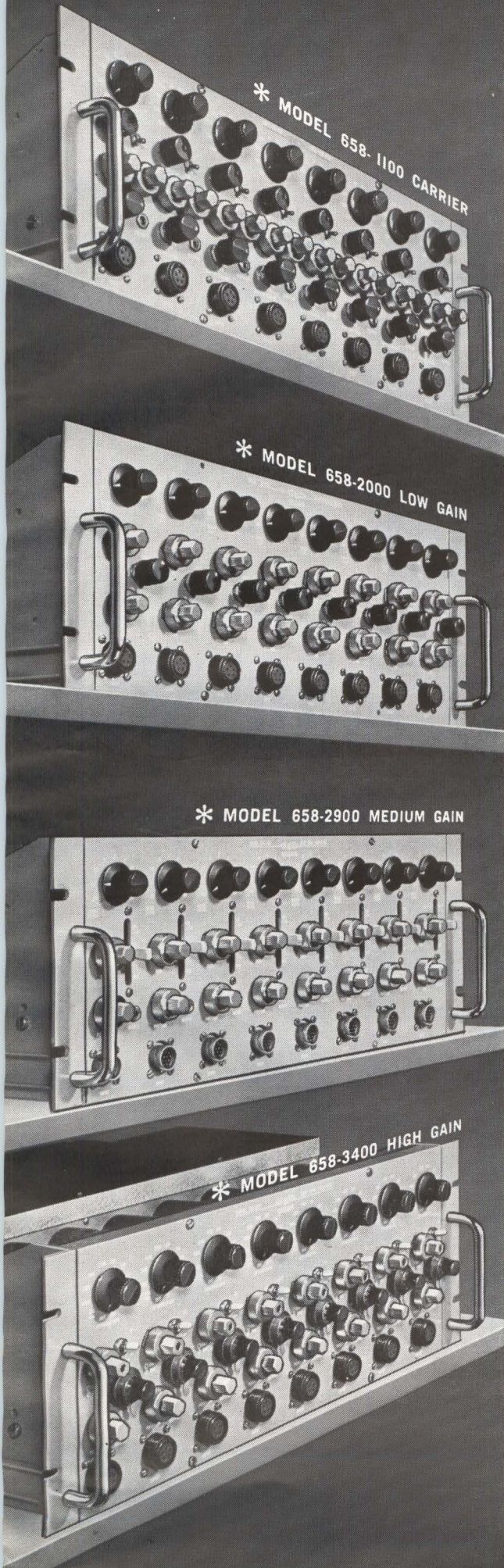

**Pick the
amplification
you want—
for this flexible
DC-5KC
Sanborn optical
oscillograph**

INPUT SIGNALS SIMPLE . . . OR SOPHISTICATED?

Now you can "custom-fit" this 6- to 24-channel high frequency "650 Series" Sanborn recording system to your *individual* recording requirements — with a choice of *four different* 6- or 8-channel amplifier modules. Each unit has complete circuitry from signal input to optical galvanometer output terminals, individual channel amplifiers and galvanometer matching networks on plug-in cards, and a common power supply for all channels. One, two or three amplifier modules, each occupying only 7" of panel space, may be combined with the 650-100 Recorder to provide 6 to 24 channels of direct readout recording over 8" amplitudes. System response — *with a single set of galvanometers* — is DC to 3 KC over full scale, DC to 5 KC over 4" amplitudes.

Systems using any of the four "650 Series" amplifiers have linearity 1½% of full scale, identical frequency response characteristics, low noise and drift, and high gain stability. The amplifiers differ mainly in sensitivity, input characteristics, additional front panel controls and price. For *high gain carrier amplification* of transducer outputs as low as 50 μ v rms, with 4.5 to 5 volts — 20 KC carrier excitation, the *Model 658-1100* amplifier provides maximum versatility. General purpose DC amplification is available with the *658-3400* amplifier, which has a *max. recording sensitivity in the system of 2.5 mv/inch* and provides floating and guarded inputs. Models 658-2900 and 2000 provide maximum sensitivities of *50mv/inch* and *0.5 volt/inch*, respectively.

For complete specifications and technical application help, call your nearby Sanborn Industrial Sales-Engineering Representative; offices throughout the U.S., Canada and foreign countries. Ask him for a copy of the complete Industrial Catalog — covering oscillographic, X-Y, magnetic tape and event recorders; data amplifiers; transducers; related instruments.

INDUSTRIAL DIVISION

SANBORN COMPANY

WALTHAM 54, MASS.

A subsidiary of Hewlett-Packard Company

CIRCLE 13 ON READER SERVICE CARD

ONLY

In Mincom's CM-100 instrumentation recorder/reproducer, the series elements before data

THE MINCOM CM-100

storage have been reduced to receiver and mixer, only one step from the antenna. With the

IS NOW PERFORMING

CM-100's 1.5-megacycle response and linear phase equalization at all speeds, an original

OPERATIONAL

IF signal thus can be heterodyned so that the carrier swing and its sidebands fall within the

PREDETECTION RECORDING

Mincom CM-100's frequency range—in FM, FM/FM modulation, PCM and PCM/FM.

...and actually doing it at defense facilities as you read this page.

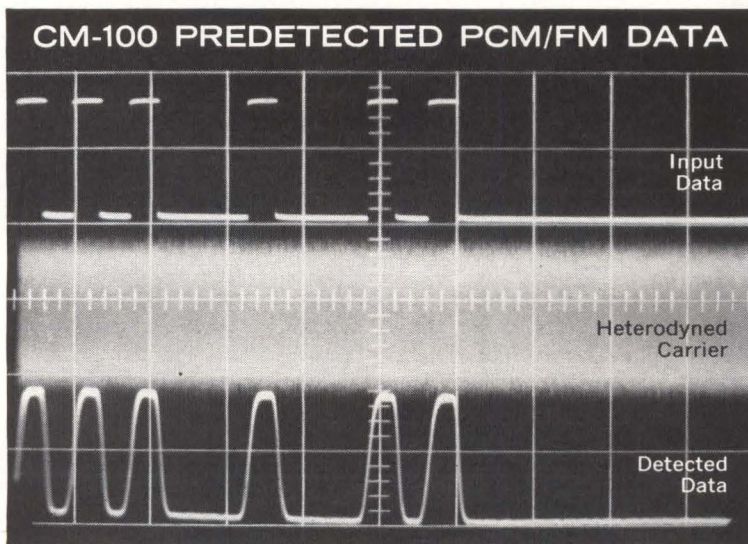

5.0-mc IF carrier heterodyned down to 750 kc. Random-spaced pulses, 20 μ s on-20 μ s off-type information. Sweep rate: 50 μ s/cm.

Write for brochure.



Mincom Division **3M**
COMPANY

2049 South Barrington Avenue, Los Angeles 25,
425 13th Street N.W., Washington 4, D. C.

SILICON PLANAR EPITAXIAL DIODES

TRANSITRON'S NEW SG5000-5400 SERIES — OUTSTANDING SUCCESSORS TO THE POPULAR SG5000 — PROVIDES THE MOST EFFECTIVE COMBINATION OF HIGH FORWARD CONDUCTANCE, LOW CAPACITANCE AND FAST SWITCHING EVER OFFERED TO THE INDUSTRY.

DEMANDED



Introduced a short time ago, the SG5000 offered a new high in reliability, performance and versatility that quickly made it a popular component for computer circuit design. Fully aware of the need for a complete range of similar devices, Transitron has now developed a series of premium subminiature glass silicon planar epitaxial diodes.

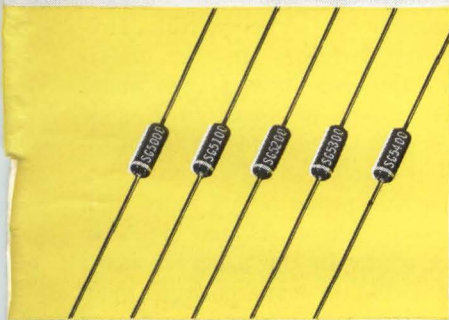

EXPANDED

Transitron's new SG5000-5400 series offers a combination of 3 major characteristics that is superior to any now available: higher forward conductance . . . 200 to 400 mA @ 1 Volt; lower capacitance . . . 2 to 4 pf @ 0 Volts; faster switching . . . down to 2 nsec. All types will fully meet the rigid requirements of military and space exploration high reliability systems.

SPECIFICATIONS AT 25°C				
Type	Minimum Forward Current @ 1 Volt (mA)	Minimum Breakdown Voltage @ 5 μ A (Volts)	Maximum Capacitance @ 0 Volts (pf)	Maximum Inverse Recovery Time (nsec)
SG5000	200	100	2	2
SG5100	400	50	4	2
SG5200	400	75	4	2
SG5300	300	100	2	2
SG5400	200	150	2	2

A balanced combination of very low capacitance and exceptional high current switching makes the diodes of the new SG5000 series ideal for memory core driving applications. And since all types can be custom-encapsulated as multiple-chip assemblies, they are

highly compatible with the critical space limitations of computer memory core systems.

Another important application is logic systems. The SG5000 series provides tightly controlled lower forward voltages at specified low current levels, and more units can be paralleled and still deliver fast switching.

Because these units fulfill maximum diode specifications, it is no longer necessary to use 2 or 3 diode types in a system. Now, only one diode need be evaluated for component procurement.

All SG5000-5400 silicon planar epitaxial diodes are digitally marked for quick diode type identification. And all types are also available through your Transitron Distributor... For further information, write for Transitron's "Silicon Planar Epitaxial Diode" bulletins.

Transitron 

electronic corporation
wakefield, melrose, boston, mass.

SALES OFFICES IN PRINCIPAL CITIES THROUGHOUT
THE U.S.A. AND EUROPE • CABLE ADDRESS: TRELCO

CIRCLE 15 ON READER SERVICE CARD

F-104G:

American technical aid is updating European electronics techniques

BONN—Production in Europe of the electronic subsystems for NATO's American-designed Lockheed F-104G Starfighters is now getting into high gear. This production is expected to make a lasting impact on the American and European electronics industries.

The program calls for 949 fighter-bombers, representing at least \$1 billion in orders for the 12 electronics subsystems being built by the U.S. licensors and 33 European contractors. These orders will be filled by 1965.

More lasting in effect will be the technical rejuvenation of European electronics, which has been largely devoted to the consumer market. In essence, several dozen European companies have been led through 16 years of technological progress in a matter of months by U.S. specialists.

The fact that Americans are doing the leading has caused some resentment among highly nationalistic companies—none will readily admit that without American technical aid they couldn't have carried through their project in the time available.

KNOWHOW EXPORTED—Nearly every U.S. company involved has pumped considerable material and advisory aid into the F-104G program—usually on orders from

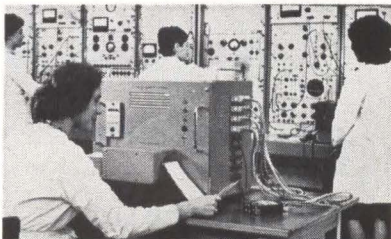

EQUIPMENT used to test Nasarr at Telefunken's plant is highly automated. This tester is punched-card controlled



STARFIGHTERS in flight. These are manned by Luftwaffe pilots. In addition to production in the U. S. and Europe, F-104's are made in Japan for Japanese forces

higher up, but often to enhance their reputation overseas. Most U.S. companies sent over detailed process instructions, drawings and tooling procedures, besides tech reps and advisors.

The presence of more than 150 American electronics specialists in the European contractors' plants, plus the training of more than 150 European technicians and engineers in U.S. plants, will one day enable Europe to produce electronic systems just as advanced as the F-104G's.

The experience will undoubtedly be used also in more sophisticated consumer electronics products, on which European companies have concentrated. European R&D lags U.S. R&D considerably.

Until recently, the U.S. supplied nearly all electronic equipment for European industry as well as for NATO forces, even though Europe's consumer electronics output is as large as the U.S.'s. Less than 10 percent of European electronics output was military in 1960.

The benefits are not all one-sided. The U.S. companies involved are acquiring new knowledge of the European market — market potential, customer expectations, possibilities for overseas manufacturing arrangements—that should help sales in Europe (some 110 U.S. firms have started operations in Europe since 1958).

U.S. companies, also, have been alerted to problems in such sensitive areas as profits, infrastructure funds, fixed-price type contracts and personnel policies. Although program regulations limit profits to

BOON TO NATO Of

5 percent, European accounting practices usually include some profit in costs. Advance contract payments have covered the capital needs of most firms. In Germany, for example, Americans new to Europe have been amazed at the high rate of absenteeism, which is both promoted and rewarded by liberal social security laws and benefits.

COSTS ARE RISING—When Lockheed initially signed development contracts with Germany, Italy, Holland and Belgium, it was understood the complete plane would eventually be produced in Europe at a cost not to exceed the U.S. production cost.

The Europeans bit off more than they could chew. As one U.S. Air Force officer in the program says: "The F-104 is more political than operational." Unit cost is well over the \$1.2 million estimated in 1959 (ELECTRONICS, p 7, April 26).

European production schedules are being met, but only by emergency purchases in the U.S. and the use of U.S. consultants. This is expensive, driving total program costs well over \$2 billion. U.S. companies are getting more than the \$1 billion originally allotted to them.

European electronics firms are hard-pressed, too, to meet strict U.S. specifications and quality-control standards. The relatively small-batch production of F-104G components does not enthrall European firms, so many items are still supplied from the U.S.

Often heard is the exhortation to buy European if the true value of the program is to be realized, but many subcontractors buy directly from the U.S. licensor, or his competitors, or the European agents of U.S. suppliers. Procurement practices have not been standardized.

European licensees for the airborne electronics systems were

EUROPE

By RICHARD MIKTON
McGraw-Hill World News

Program Squeezes 16 Years Knowhow Into 2 Years

selected by an industrial committee, with NATO participation (NASMO—NATO's Starfighter Management Office, in Koblenz, West Germany, coordinates all hardware production in the U.S. and Europe).

A slice of the pie was given each of the major electronics companies in the four nations. Whether the larger companies accepted contracts out of patriotic zeal, or to prevent competition from getting a jump on them, is a question often asked. These firms' F-104G contracts are only a tiny part of their total business and tend to become nuisances and minor irritants.

In spite of difficulties, however, astonishing progress has been made.

SUBSYSTEMS—The F-104G differs principally in its electronics features from USAF's F-104 versions. USAF's plane is an air-defense weapons system, but for the Europeans the F-104G must per-



PRODUCTION COMPLEX in 4 countries is producing 949 F-104G's: 604 for Germany, 120 for Holland, 100 for Belgium and 125 for Italy. There is one final assembly line in each country, each staffed by 10 to 20 American tech reps. Names are the aircraft companies involved

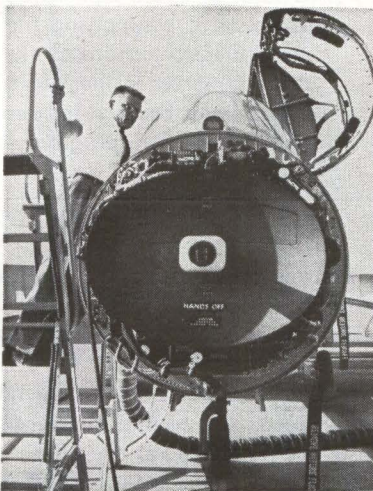

FIRE-CONTROL radar system (Nasarr) is now being made in Europe. This is front view of antenna in plane

form three missions: all-weather interceptor, fighter-bomber and reconnaissance aircraft.

The F-104G carries 12 electronics subsystems, representing half the cost of each plane. This could go even higher with more automatic checkout, now provided only for the autopilot. Feasibility studies have been made for the other systems, but cost will be the deciding factor.

Of the weapon-control systems, Autonetics' Nasarr (North American Search and Ranging Radar) monopulse radar is the most complex and expensive, about \$120,000. Nasarr serves for contour mapping and terrain avoidance as well as interception.

Assisting Nasarr in radar lead-computing in air-to-air gunnery, bombing, steering reference and lock-on during missile launching are GE's optical sight and in-range computer, and Lockheed's infrared sight. Bomb delivery is controlled by a Lear dual timer.

The navigation group of systems

WHAT ARE YOUR DELIVERY REQUIREMENTS?



STANDARD
TAPE TRANSPORTS
4 WEEKS

STANDARD
PRINTERS
12 WEEKS

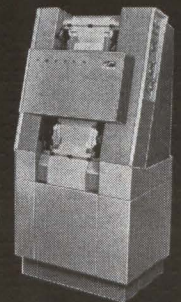

NEW PRINTER DIVISION

Broad acceptance of our product line coupled with the fact that so many Potter "specials" are now industry standards has resulted in such dramatic growth that we have increased our plant and production capacity by more than 65%. This new production capability can directly benefit you through faster delivery.

For example, we can deliver our standard transports in 4 weeks, and standard printers in 12 weeks from receipt of order.

If you require fast delivery — with no sacrifice in performance or reliability, write us today.



POTTER INSTRUMENT CO., INC.
TAPE TRANSPORT DIVISION
151 Sunnyside Boulevard • Plainview, New York
PRINTER DIVISION
East Bethpage Road • Plainview, New York

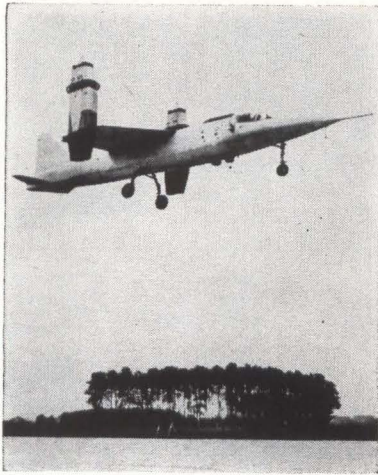

GERMANY is developing the VJ 101, a six-jet vertical takeoff and landing plane that could replace the F-104G in the 1970's

VTOL FOLLOW-ON?

BONN—A West German group is well along with development of a vertical take-off and landing (VTOL) version of a Mach-2-plus fighter-bomber. It could be the Starfighter's successor in the early 1970's. Called the VJ 101, it resembles the F-104G. The Bonn government is paying the \$62.5 million for R&D.

If successful, the VJ 101 will have heavy competition from Britain's P.1127 and France's Dassault Balzac for NATO's choice of a common VTOL design.

Among the 115 foreign firms participating in the project for a total of \$15.5 million, 60 are American. Honeywell and Perkin-Elmer are supplying the autopilot and associated electronics and Electromechanical Research, telemetry equipment. The strong interest in the VJ 101 by many U. S. F-104G contractors reflect their concern for keeping added European capacity busy after the F-104G program ends in 1965

is comprised of the Litton Industries LN-3 inertial system (reportedly costing about \$60,000), the Honeywell MH-97G autopilot (about \$40,000), the Computing Devices of Canada Position and Homing Indicator, and an air-data computer from Garrett AiResearch. These are highly integrated with the weapon control systems.

For communications - identification there are a Canadian Collins AN/ARC-522 uhf radio, a Hazeltine AN/APX-46 iff, ITT AN/ARN-52 Tacan and a three-channel uhf standby radio from RCA.

German Honeywell also delivers the UG-1000 automatic checkout tape units for the autopilot. Honeywell is now developing a UG-1000G version to check out the Litton inertial system, the air-data computer and other systems besides the autopilot.

SCHEDULING — The program's production planning is designed to phase out American-made systems and components and phase in European ones as domestic personnel are trained and suppliers located. Two or three companies are designated as sources—each supplying a portion of the system or components and all doing final assembly and test using parts from sister plants.

For example, 1,200 Nasarr sets are needed. Autonetics made the first 250 in the U.S. last year, 150 more are now being made in Europe with U.S. supplied parts, and the other 800 are supposed to be made

in Europe with European components by 1965.

Similar switchovers to European production are planned for the other 11 systems. Most of them are now deeply into the second phase and a few are already into the all-European stage. The Tacan and iff receiver skipped the second phase because the contractors (ITT's

Standard Elektrik Lorenz and Siemens) were experienced with similar models.

CONTRACTORS—The four prime contractors for portions of the Nasarr system are Telefunken in West Germany, N. V. Hollandse Signalapparentens, Manufacture Belge de Lamps et de Material

Is This the Ultimate in

Even over wire, technique sends 7,500 bps of error-free transmission

LEXINGTON, MASS.—An experimental communication technique in the breadboard stage at MIT Lincoln Laboratory provides the first tangible evidence that the operating characteristics predicted by information theory can be achieved in practice.

The Seco (Sequential Coding) tests conducted over a toll-grade telephone circuit 800 miles from Lincoln Laboratory to Syracuse, N. Y., and back has resulted in error-free transmission of digital data at an average rate of 7,500 bits per second, as compared to the 1,600 to 2,400 bps obtainable with conventional techniques.

In addition, conventional techniques produce an error probability

between 10^{-4} and 10^{-5} , but Seco has so far delivered more than a billion consecutive bits without an error.

Says MIT Prof. John W. Wozencraft: "It is the first communications system ever built which performs in accordance with the full implications of information theory." Wozencraft developed the fundamental theoretical concepts at the MIT Research Laboratory of Electronics.

USE IN WEST FORD—One of the principal objectives was the possibility of testing Seco in Project West Ford, the use of an orbiting belt of dipoles—now being formed in space—for scatter communications. The present Seco equipment was designed to operate with an experimental modulation-demodulation system called Dicon (ELECTRONICS, p 20, April 13, 1962).

A telephone line has been used thus far in the experiments simply for its convenience. Wozencraft

Electronique, and Fabbrica Italiana Apparechi Radio S.p.A.

Other contractors, manufacturing under U.S. licenses, include Allgemeine Elektrizitats Gesellschaft, optical sight and in-range computer; Eltro, in Germany, and Optische Industrie de Oude-Delft, in Holland, infrared sight; Interaero, of Germany, and Microtechnica, of Italy, the air-data computer; van der Heem, of Holland, the AN/ARC-522.

Several European subsidiaries or affiliates of U.S. firms are also involved in the program. Autonetics established a firm in Turin, Italy, last summer to coordinate Nasarr work. Honeywell G.m.b.H., long established in Germany, is building the autopilot. Litton Industries in Hamburg is responsible for the LN-3. Telefunken and Bendix formed Teldix Aviation Equipment G.m.b.H. in Heidelberg to make gyros and accelerometers.

In addition to these contractors, numerous subcontractors—some of them associated with U.S. companies—are employed in the four countries.

Data Coding?

says work is now under way at MIT laboratories on application to high frequency and satellite radio systems, deep space probes, and high-density magnetic tape recording for computer systems. Meanwhile, commercial applications of digital data transmission are mounting.

Sequential coding and decoding, which makes it possible for a system to detect and correct message errors and to adjust its own transmission rate to minimize error, resulted from Claude Shannon's classic 1948 paper on "The Mathematical Theory of Communication." Shannon proved that noise sets a limit, called channel capacity, on how high a rate of communication is possible over a given transmission facility, but that there is no limit on how accurately one can communicate at rates below this maximum.

CODING—The key to the speed and efficiency with which Seco ac-

2" Vidicon

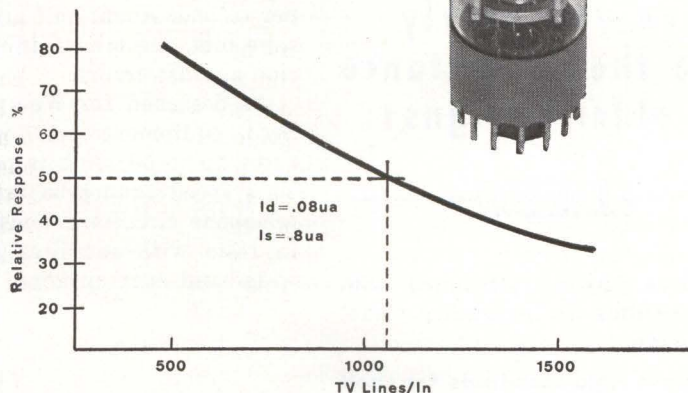
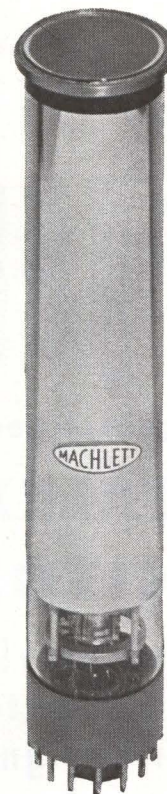

Only one vidicon has resolution exceeding 2000 TV lines

The new ML-2058G 2-inch diameter TV pickup vidicon is the only vidicon that provides this high detail resolution. Features of the ML-2058G include: 1.4" diagonal working area; a limiting resolution exceeding 2000 TV lines; 50% amplitude modulation at 1100 TV lines. It is designed for operation with conventional image orthicon deflection coils. Length is 12". Available with x-ray sensitive photoconductor.

For complete details write The Machlett Laboratories, Inc., Springdale, Conn. An affiliate of Raytheon Co.



2x μ F

new high-gain etched-foil

TANTALEX[®] CAPACITORS

give you nearly
twice the capacitance
of older designs!



- Improve filtering efficiency with no sacrifice in reliability, size, or weight.
- Maintain rigid standards for shelf and service life, unlike other "high-capacitance" foil tantalums.
- Leakage current has been halved, permitting use in many new applications.
- Available for 85 C and 125 C operation in polarized and non-polarized construction.



For complete technical data on 85 C capacitors, request Engineering Bulletin 3601B. For the full story on capacitors for 125 C operation, write for Engineering Bulletin 3602B. Address Technical Literature Section, Sprague Electric Company, 35 Marshall Street, North Adams, Mass.

SPRAGUE[®]
THE MARK OF RELIABILITY

45C-110-63

curately identifies the transmitted message when it receives a noise-corrupted one lies in the structure of the binary sequences that represent the messages.

When the circuit is relatively quiet, Seco transmits and receives 9,000 message bits per second. When the noise level increases, the rate is automatically reduced because the system introduces extra bits for redundancy and also it tests various message "trees" to determine which binary sequence is the proper one. When the noise decreases, the transmission rate automatically increases. When a strong burst of noise seriously disrupts the message, the Seco receiver asks for a retransmission.

The Seco telephone circuit system actually transmits 15,000 bits per second. About half are the message bits, the others afford protection against errors.

As designed for West Ford, the Seco equipment can operate at rates up to 50,000 bits per second. This speed cannot be exploited on telephone circuits but may be used in tests with satellites and other wide-band data circuits.

Britain Will Predict Weather by Computer

LONDON—Britain's Meteorological Office has ordered a KDF 9 data processing system costing \$1.2 million from English Electric-Leo Computers Ltd. One application will be numerical weather forecasting based on the mathematical solution of the equations of atmospheric motion.

COMPUTER BAKES CAKES

CHICAGO—Electronic process control has arrived in the bakery business. The Kitchens of Sara Lee will use a Honeywell 610 solid-state digital computer to direct the mixing, baking, warehouse random storage and retrieval for shipping of cakes at a plant being built in Deerfield, Ill. Later on, inputs from a quality control lab will modify recipes stored in the 610's memory, to compensate for variations in properties of ingredients

Rapid-Fire Laser Improves Tracking

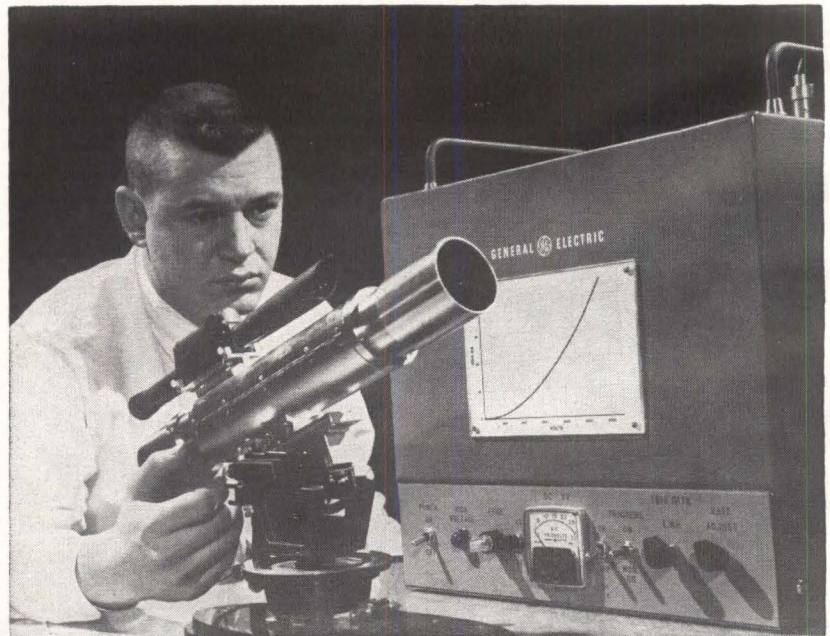

PENCIL-BEAM laser developed by General Electric for tracking airborne targets emits 40 light pulses a second. Return signal is received by optical telescope. Infrared laser uses neodymium-doped calcium-tungstate rod pumped by a flash lamp

NOW-ONLY 3 RFI METERS

COVER 20 cycles to 15,000 megacycles



NF-315 20 CPS - 15 KC



NF-105 14 KC-1000 MC



NF-112 1000 - 15,000 MC

With the addition of Model NF-315 to the already popular and proven Models NF-105 and NF-112, Empire consolidates its position of leadership in the field of RFI instrumentation.

Now, with three basic instruments you can handle all RFI testing requirements, both military and commercial.

ECONOMICAL: You need only three instruments, instead of the six or more required with competitive makes. And, throughout the ranges of the NF-105 and NF-112, you can select plug-in tuning units for only the ranges you need.

COMPACT: Empire's plug-in tuning unit design avoids bulky and costly circuit repetition. Valuable lab space is conserved and units are easily transportable for field assignments.

EASY TO USE: Uniformity of design philosophy among all three instruments results in simplest possible operating procedures and minimizes operator training.

DEPENDABLE: Conservative design, extensive use of solid-state components, and rugged mechanical construction result in longest possible service-free life.

TECHNICALLY SUPERIOR:

- ★ Better accuracy is assured by stable built-in calibrators for all models.
- ★ Greater stability is assured by well-regulated voltages and extensive use of feedback circuitry.
- ★ Unexcelled shielding effectiveness permits accurate readings despite high ambient electromagnetic levels.
- ★ All three instruments are provided with remote antennas, for maximum operating flexibility.
- ★ Provision for X-Y plotting is designed into all three instruments.

Write for latest catalog 634



EMPIRE DEVICES, Inc.
AMSTERDAM, NEW YORK • 518 VI 2-8400

ELECTRONIC INSTRUMENTATION • MICROWAVE COMPONENTS



By JOEL STRASSER,
Assistant Editor

Interviewing

D. BRAINERD HOLMES,
Deputy Associates Administrator, NASA

HOLMES, NASA's manned space chief, leaves the space agency later this year. He "expects to come back and do it again sometime"

Holmes: It Wasn't Frustration

*Apollo chief resigns;
calls term gratifying,
hints return to RCA*

WASHINGTON — Last week, as Russia prepared to send the first woman astronaut into orbit, D. Brainerd Holmes, director of America's manned space program, announced his decision to leave NASA for "personal reasons primarily, financial" amidst talk of budget problems, personal disagreements and program snags. In this exclusive interview with ELECTRONICS, Mr. Holmes comments on reasons given for halting his participation in the nation's race to the moon and reflects his satisfactions and frustrations in the job. Excerpts from the interview follow.

Your resignation from NASA followed closely the decision to halt Mercury. What were your feelings on the continuation of the Mercury program?

I felt that it should not be continued. We have a lot of work to do on Gemini and Apollo and continuation would affect over 300 men who are working on Mercury primarily. I felt we should go over on the other programs unless there was some very significant result we could get from another Mercury flight. Secondly, it would have cost another \$12 to \$15 million and while that's not a large percentage of my manned space budget, I'm short that kind of money.

Then you were in agreement with Mr. Webb on this point. Did any

disagreements with Mr. Webb influence your decision to leave NASA?

No. I think in any job like this, when you leave, people speculate on many reasons—problems internal to NASA, not getting what you want in the budget—but I think anyone who has any experience running large bodies for a number of years knows there are going to be frustrations and also gratifications. No, I look upon my period here as being highly gratifying.

Have you been frustrated by the progress of the Gemini program?

No more than I have in any project. You don't always get what you want in funds, you don't always get what you want in other things. This is true in any project I've worked on in the last ten years. But I've had none that were significant enough to make me want to leave.

Amidst the talk that Gemini is slipping, are you personally satisfied with the progress of Gemini?

Yes, I am. However, I think our initial schedules on Gemini were too optimistic. Further, while we've slipped the first manned shot about six months over the schedule, it's now a different program with a much more sophisticated spacecraft. And I might point out that the first unmanned shot, originally scheduled for December of this year is still scheduled for December of this year.

In terms of the electronics aboard Gemini, would you say that everything is proceeding as scheduled with no obstacles?

Yes, I think so. Certainly the

subsystems aren't fully developed but they are coming along reasonably well. These include the environmental subsystems, computation and guidance systems, communications, radar systems—to have them as planned we would expect them to be under development at this point.

Are you satisfied with the progress of Apollo?

Yes, I think so. We've come a long way in the last 1½ years that I've been associated with it. I'm very optimistic about the way it is going now and about the way it has gone. There is still a lot to be done. All I can say is that in the last 20 odd months I have given it everything I had and I expect to for the next couple of months up until two years. When I go back I don't expect I'll have to be ashamed that I haven't given something to the country. I expect to come back and do it again sometime, but I have a career and I have a family.

What obstacles do you still see to landing a man on the moon in this decade?

We should be able to do it in this decade barring unknown estimates including radiation, weightlessness and ability to rendezvous, all of which we don't really know about at this point.

After you leave NASA, are you returning to RCA?

Well, I haven't decided. I have a lot of loyalty to RCA and high regard for them but I have no commitment to anybody. I'm still in the saddle here and I've got to be a free agent while I'm running this job. But I have friends there and I like that company very much.

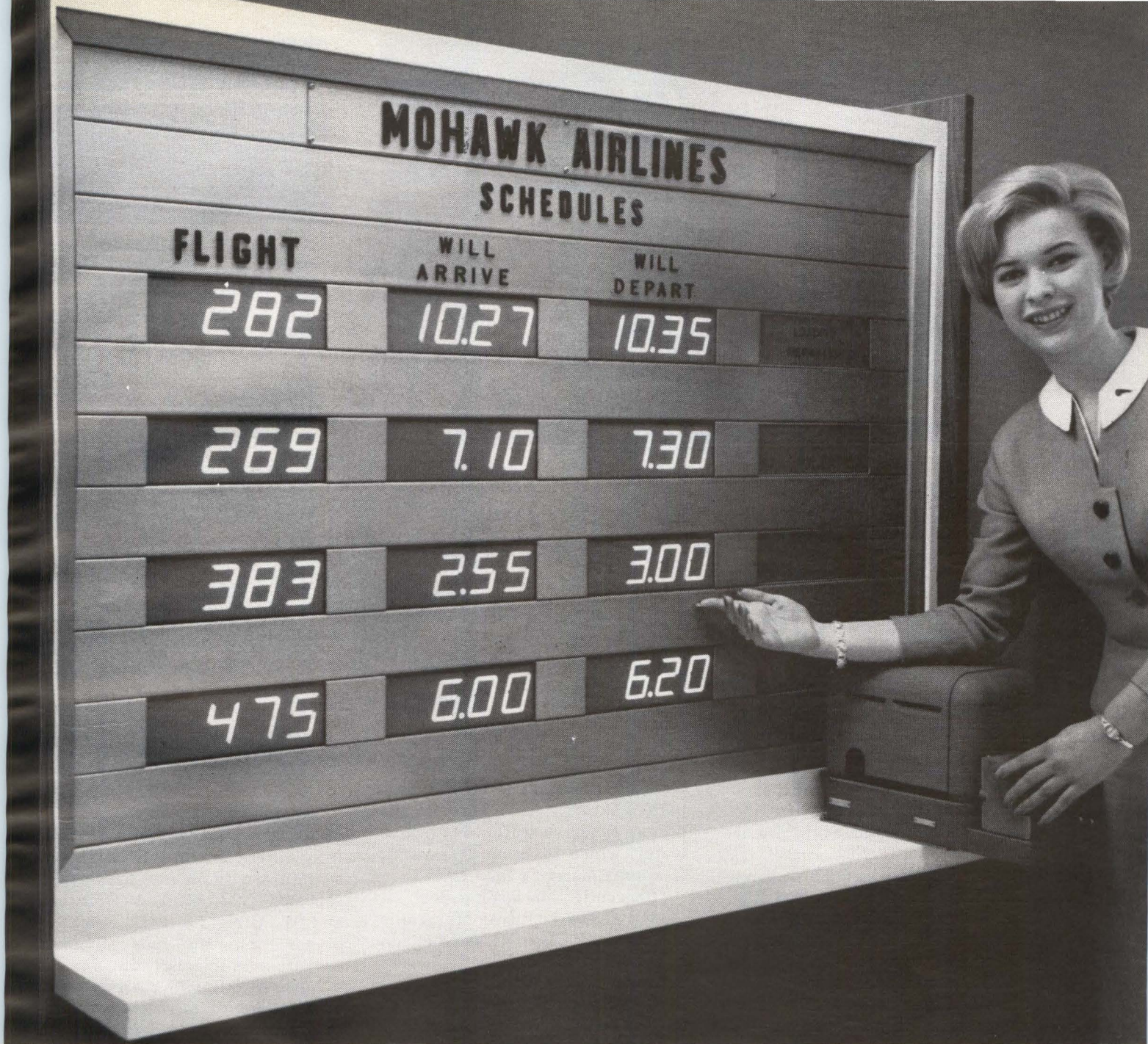

Sylvania EL—beautifully practical way to announce Mohawk flights

Quite a lot that's good about PANELESCENT® electroluminescent display shows up in this photo. Note the clear numbers with no lines between, the easy readability even from side views, the overall clean, modern appearance.

But looks are only a part of EL's attractiveness, as Mohawk Airlines discovered when they investigated display possibilities for a computer-controlled network of flight status boards. Because it uses

phosphors instead of filaments, EL has extremely long life and high reliability, with no catastrophic failures. You don't need a crew standing by to replace burned-out light bulbs. Compared to incandescent display, EL uses far less current and generates much less heat. Compared to electromechanical boards, EL has faster response and longer life with little maintenance. These advantages are the reasons why PANELESCENT

status boards by Sylvania will soon be in operation in the Mohawk system.

The versatility of EL makes it useful in many other applications as well—scoreboards, tote boards, stock quotation boards, computer and instrument read-out, for example.

What can EL do for you?

Electronic Tube Division, Sylvania Electric Products Inc., Box 87, Buffalo, New York.

SYLVANIA

SUBSIDIARY OF

GENERAL TELEPHONE & ELECTRONICS



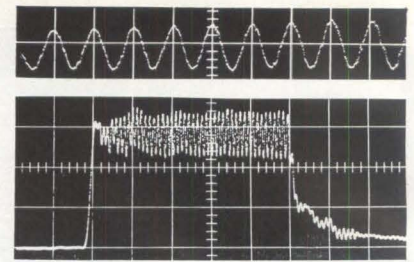

MICROWAVE oscillation in GaAs block are shown in lower trace (divisions are 2 nsec horizontally and 0.23 amp vertically). Upper trace shows oscillation magnification (IBM)

ONE-WATT C-W laser is shown by William Engeler and Marvin Garfinkel. They described it at solid-state conference last week

New Laser Structure Drives Output Past 1 W

By MICHAEL F. WOLFF
Senior Associate Editor

EAST LANSING, MICHIGAN—A junction laser that operates continuously at a power output of more than one watt was described at the IEEE Solid State Device Research Conference here last week by Marvin Garfinkel and William Engeler, of the General Electric Research Laboratory. This is believed the highest power yet achieved by a c-w laser.

Efficiency of the new gallium-arsenide laser at 8,400 angstroms is approximately 25 percent—6.3 of power produced a 1.5-w output at 20 deg K. This is accomplished with a unique heat-transfer design that makes it possible for a current equivalent to 4,000 amperes per sq cm to be passed through the 0.001-sq-cm diode junction.

As illustrated, the thin gallium-

arsenide diode is surrounded on three sides by a slotted gallium arsenide disk which serves simultaneously as heat conductor and electric insulator. A second heat path is directly down through the bottom tungsten wafer. The whole wafer, which rests on a cryostat, is approximately $\frac{1}{8}$ inch thick.

Other injection laser papers included a report by Ivar Melngailis and Robert Rediker, of MIT Lincoln Laboratory, describing coherent emission from mixed crystals of indium and gallium arsenide at 2.09 and 1.77 microns. They said this means semiconductor diode lasers can now be produced anywhere between 0.84 and 3.1 microns.

INTEGRATED CIRCUITS—While semiconductor luminescence and injection lasers dominated the

Diode sandwiched in tungsten one of several solid-state advances

meeting, which was held at Michigan State University, several papers revealed developments that could have important implications for integrated circuits.

Technique for simultaneously diffusing *n* and *p*-type impurities into different parts of a silicon structure without interaction was reported by J. Scott, J. Olmstead and W. Greig, of RCA Semiconductor and Materials division. Called solid-to-solid diffusion, it involves pyrolytic deposition of an oxide predoped to the desired impurity concentration. Portions of this surface can then be etched and another predoped oxide deposited. When this is now heated to the diffusion temperature, simultaneous diffusion of dopants of different concentration or type results. Surface concentrations of 10^{15} to 10^{18} atoms per cu cm have been obtained.

Gallium-arsenide transistors with diffused emitter and base have been fabricated as a result of this technique. The transistors produce 1 w at 70 Mc, run from -200 C to +250 C. They were described by H. Becke, D. Flatley and D. Stolnitz.

JUNCTION LASER developed at GE has two heat-flow paths

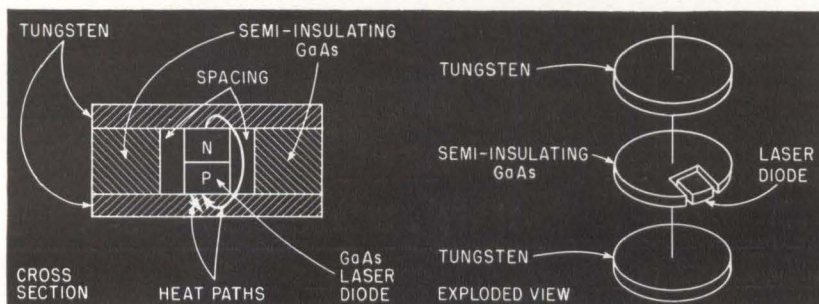

Demonstration that thermal feedback can provide low-frequency oscillators in silicon integrated circuits (ELECTRONICS, p 45, Feb. 15) was reported by R. A. Meadows and W. T. Matzen, of Texas Instruments, Inc. They said 10 to a few hundred cps could be obtained and that such an oscillator would have inherent temperature stabilization. A 45-cycle oscillator would vary 0.1 cycle over a 40-degree ambient temperature range. Technique is also considered feasible for low-pass filters.

ACTIVE THIN-FILM DEVICES—Improved performance with the cadmium sulfied thin-film transistor was reported by P. K. Weimer, F. V. Shallcross and H. Borkan, of RCA Labs. In the enhancement mode 28-Mc gain-bandwidth products have been obtained, and the TFT has operated in a tuned amplifier at 60 Mc with a voltage gain of 2.5.

Diodes have also been fabricated by putting the edge of the insulator layer under the inner edge of one of the electrodes. Rectification ratios of 10^5 have been obtained and the diode may be useful in integrated circuits since it can be fabricated at the same time as the TFT.

What may be the first all-thin-film metal base triode was described by L. W. Hershinger, J. P. Spratt and W. M. Kane, of Philco Corp. The device uses graded zinc-cadmium sulfied films on either side of a gold base to control the emitter and collector barrier heights. Power gains of 20 and common-emitter current gains of 6 have been observed. However, gain mechanism is not certain—it may be hot electrons or it may be a pinhole effect.

J. B. Gunn, of IBM's Thomas J. Watson Research Center, reported obtaining oscillations as high as 6.5 Gc by passing an electric current through a structure consisting of a thin layer of n-type gallium-arsenide and tin contacts. While the phenomenon is unexplained, it is believed due to a bulk effect (for a detailed report bulk effects, see p 65, this issue). Measurements of peak pulse power delivered to a matched load gave efficiencies of 1 to 2 percent. For a 29-w pulse power input 550 mw were delivered at 950 Mc. At 3 Gc, 155 mw was obtained from

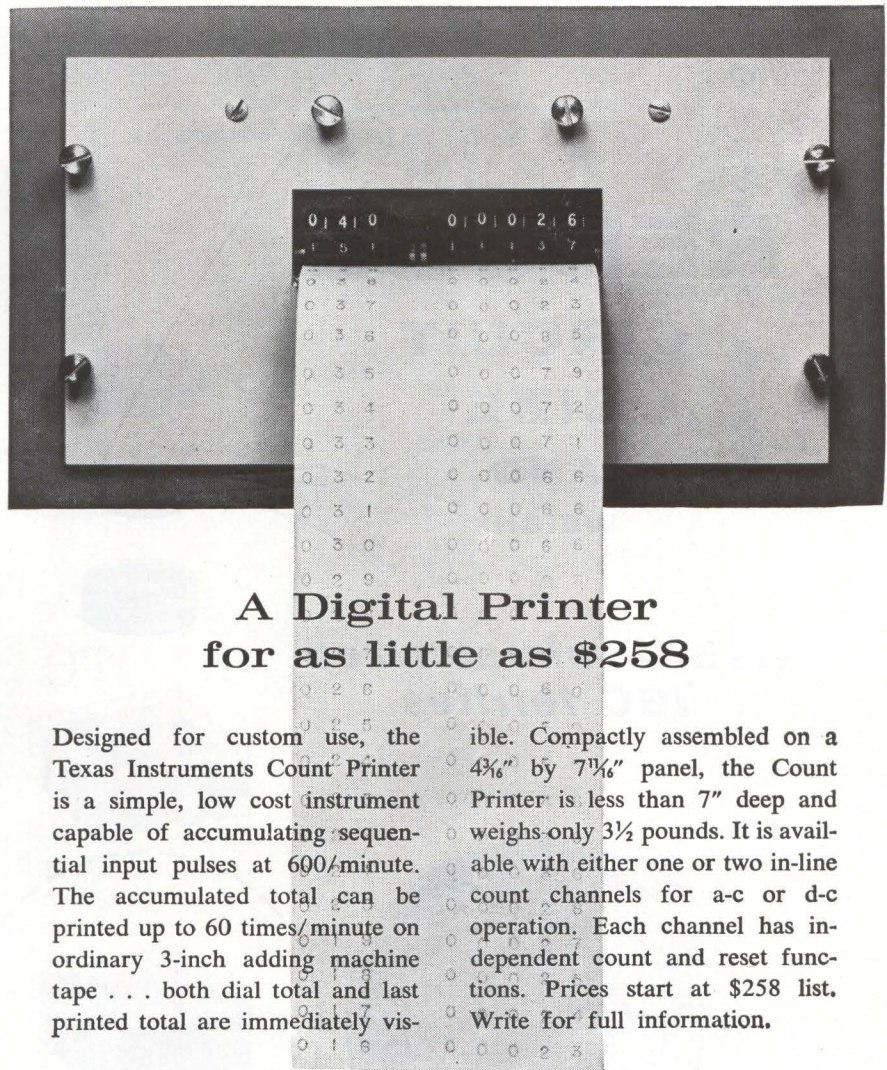

A Digital Printer for as little as \$258

Designed for custom use, the Texas Instruments Count Printer is a simple, low cost instrument capable of accumulating sequential input pulses at 600/minute. The accumulated total can be printed up to 60 times/minute on ordinary 3-inch adding machine tape . . . both dial total and last printed total are immediately vis-

ible. Compactly assembled on a 4 $\frac{1}{2}$ " by 7 $\frac{1}{8}$ " panel, the Count Printer is less than 7" deep and weighs only 3 $\frac{1}{2}$ pounds. It is available with either one or two in-line count channels for a-c or d-c operation. Each channel has independent count and reset functions. Prices start at \$258 list. Write for full information.

INDUSTRIAL
PRODUCTS
GROUP



TEXAS INSTRUMENTS
INCORPORATED
P. O. BOX 66027 HOUSTON 6, TEXAS

SENSING • RECORDING • TESTING • DIGITIZING INSTRUMENTS
THE INSTRUMENTS OF TEXAS INSTRUMENTS

664

CIRCLE 25 ON READER SERVICE CARD

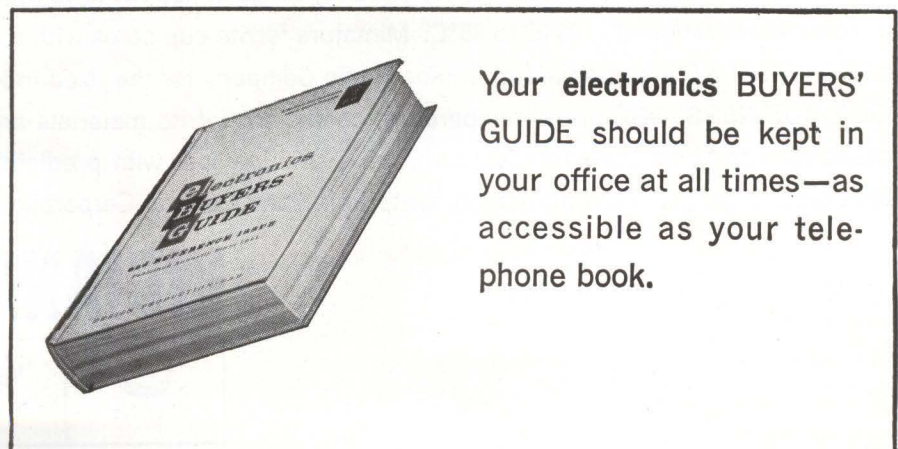

Your electronics BUYERS' GUIDE should be kept in your office at all times—as accessible as your telephone book.

REDUCE CIRCUIT SIZE AND WEIGHT

*...with miniaturized
IGC ferrites*

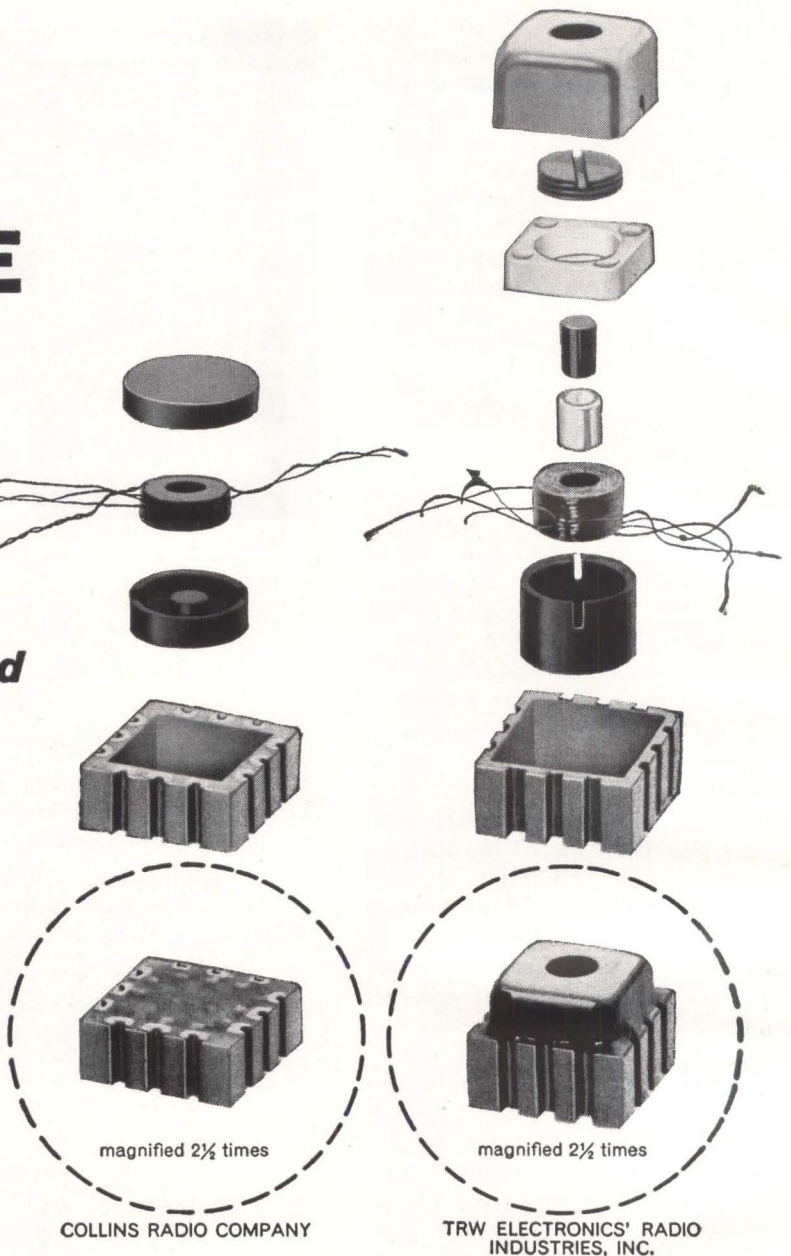

COLLINS RADIO COMPANY

TRW ELECTRONICS' RADIO INDUSTRIES, INC.

Extensive research by IGC engineers has resulted in a tenfold miniaturization of ferrite parts for the U. S. Army Signal Corp/RCA Micromodule Program. Typical of IGC's achievements are ferrite parts for fixed and adjustable inductor assemblies shown above. The adjustable inductor microelement, produced by TRW Electronics' Radio Industries, Inc., operates over a frequency range of 400 KC to 15 MC . . . has a tuning capability of 10% . . . a temperature range of -55°C to 85°C . Miniature ferrite cup cores with a Q of 100 to 115 over a frequency range of 200 to 1500 KC are supplied to Collins Radio Company for the fixed inductor assembly. ■ **MAGNETISM IS OUR BUSINESS.** IGC linear temperature coefficient ferrite materials are ideally suited to miniaturization because they combine the advantages of high Q and low loss with predictable change in inductance over a wide temperature range. For information, write to Indiana General Corporation, Electronics Division, Keasbey, N. J.

INDIANA GENERAL

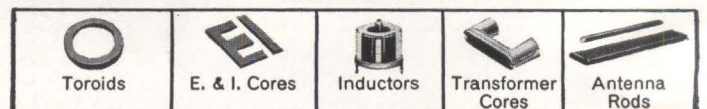

a 19-w input. Frequency of coherent oscillation is inversely proportional to specimen lengths under 0.02 cm.

New solid-state variable resistor was described by Y. Tarui and J. L. Moll, of Stanford University. Device works by applying a 50-v polarizing voltage to a ferroelectric slab. A cadmium sulfide bar with contacts at either end lies on top of the slab. Varying the sign and magnitude of the polarizing voltage varies the resistance between the contacts linearly. Estimates based on preliminary experiments indicate that over a range of ± 10 v, resistance will deviate from straightline by about 2-3 percent. Resistances of 50,000 ohms can be changed by approximately 25 percent but gigohm resistances can be varied by a factor of 40.

Inertial-Stellar Systems Urged for Civil Aircraft

INERTIAL NAVIGATION systems coupled with star-tracking devices are now feasible for commercial and military aircraft, as well as missiles and space vehicles, according to L. Lloyd Balsam, of Northrop. He said that star trackers can be used to overcome inherent inaccuracies in inertial navigation systems, to provide precise, long-range and long-duration navigation.

Balsam spoke before the Association Francaise des Ingenieurs et Techniciens de L'Aeronaute et de l'Espace (AFITAE) International Aeronautical Congress in Paris last week.

He described a hypothetical airliner flight from Paris to Cairo in which the effects of initial errors in the alignment of a pure inertial navigation system, as well as the effects of gyroscope drift or wander, were illustrated. The initial alignment errors introduced oscillatory errors in position and velocity (the so-called Schuler period). The gyroscope drift produced errors which continued to increase as the flight progressed. Balsam then explained how these errors in the pure inertial navigation system were removed by the incorporation of star trackers and external damping provisions.

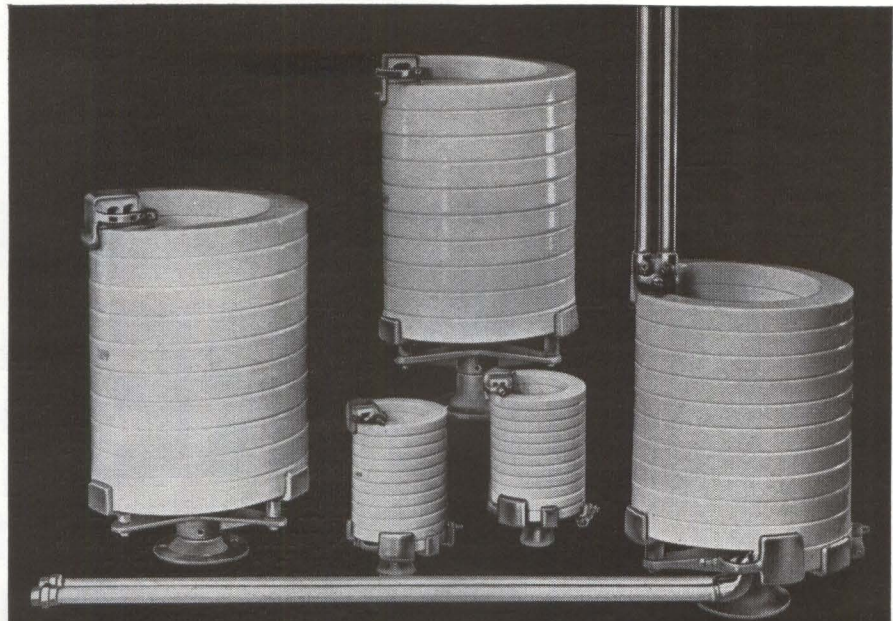

LAPP PORCELAIN WATER COILS

...in all these standard sizes to save you time and money

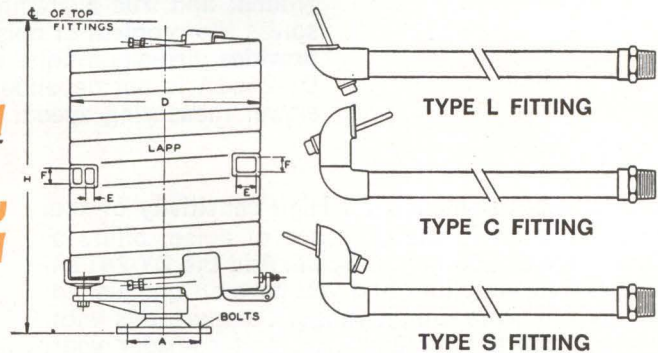

WATER COILS—DIMENSIONS IN INCHES

Cat. No. Basic Unit*	Single or Twin	Equiv. Pipe Size	A	D	E	F	H	Aver. Length In Feet	Number of Turns
22957	T	1/4	2 1/4	5 1/4	3/2	3/2	9 1/2	12	11
10723	T	3/4	4 5/8	12	3/6	3/4	18	29	10 3/4
10190	T	1	4 5/8	13 3/8	3/4	1 1/6	22 1/2	31	10 1/2
27016	S	3/8	2 1/4	5 1/4	1/2	3/6	10 1/4	12	11-30°
10719	S	1 1/4	4 5/8	12	1 1/4	1	22	28	10 1/2
10729	S	1 1/2	5	15	1 5/8	1 1/8	23 3/4	32	9 1/2-22°

*Basic unit includes ceramic coil, base, spider, cemented clamping fittings and leakage current tap. Specify type of fitting, top and bottom ("L" "C" or "S") and length of lead pipe required—36" is standard. Lead pipe is standard—flexible metal hose can be furnished. Special length coils and fittings are available—standard units only are shown here.



Save with our standards. But if you need specials, count on us for them too. Either way, Lapp gives you service and quality you can depend on.

WRITE for Bulletin 301-R.
Lapp Insulator Co., Inc.,
206 Sumner St., LeRoy, N. Y.

COM

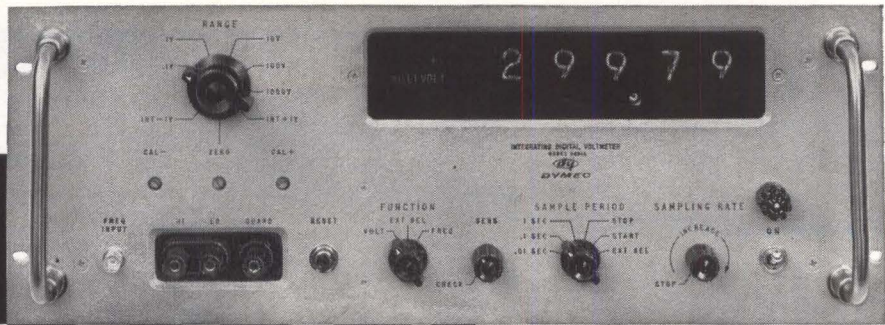

PARE! Measure microvolt signals accurately... in the presence of high common mode noise!

The bench-proved and system-proved DY-2401A Integrating Digital Voltmeter from Dymec is today's most accurate instrument of its kind for measuring low-level signals in the presence of high common mode noise. It's today's best digital voltmeter buy!

Ten volts of common mode noise on the signal results in a mere one microvolt error. No other digital voltmeter can match that performance. Dymec accomplishes this remarkable performance in the DY-2401A with two techniques: Guarding of the entire measuring circuit, which physically breaks the ground loop currents that circulate in systems with more than one ground; and true averaging of the signal over the sample period, which solves the problem of noise superimposed on the signal. Averaging alone provides virtually infinite rejection of 60 cps and 400 cps noise. The DY-2401A is not dependent on passive input filtering responsible for slower measuring speed.

Low-level measurement . . . High sensitivity of the DY-2401A, even in the presence of noise, offers a 5-digit range of 100 mv full scale. Add the DY-2411A Guarded Data Amplifier and you have an unequalled ± 10 mv full scale 5-digit range. Compare this with any other digital voltmeter . . . and consider your applications in measuring the outputs of thermocouples, strain gage bridge transducers or other millivolt level dc voltages.

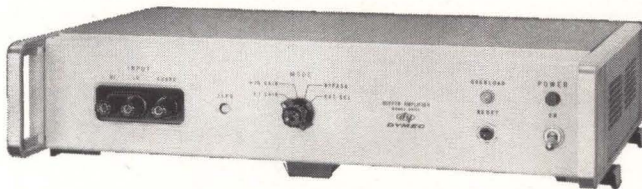

For 10 mv full scale sensitivity DY-2411A Guarded Data Amplifier adds the ± 10 mv full scale 5-digit range to the DY-2401A Voltmeter,

with overranging to 30 millivolts and constant 10,000 megohm input resistance. It preserves the guarded measurement features of the 2401A, providing 134 db effective CMR. Gain settings of +1, +10 and bypass are programmed by simple ground closures, with no effect on common mode rejection.

DY-2410A AC/Ohms Converter . . . provides floated and guarded broadband ac voltage and resistance measurements, with full programmability. AC measurements 50 cps to 100 kc, five ranges including 0.1 v rms full scale, 300% overranging on four most sensitive ranges, 110 db common mode rejection at 60 cps when used with the 2401A. Resistance measurement, 100 ohms to 10 megohms full scale in six ranges, with 300% overranging.*

COMPARE: DY-2401A, \$3950
DY-2411A, \$1150
DY-2410A, \$2250*

Data subject to change without notice. Prices f.o.b. factory.

* Available also in ac-only, ohms-only models.

DYMEC

A Division of Hewlett-Packard Company



ALITE[®] HIGH ALUMINA CERAMIC-TO-METAL SEAL ASSEMBLIES

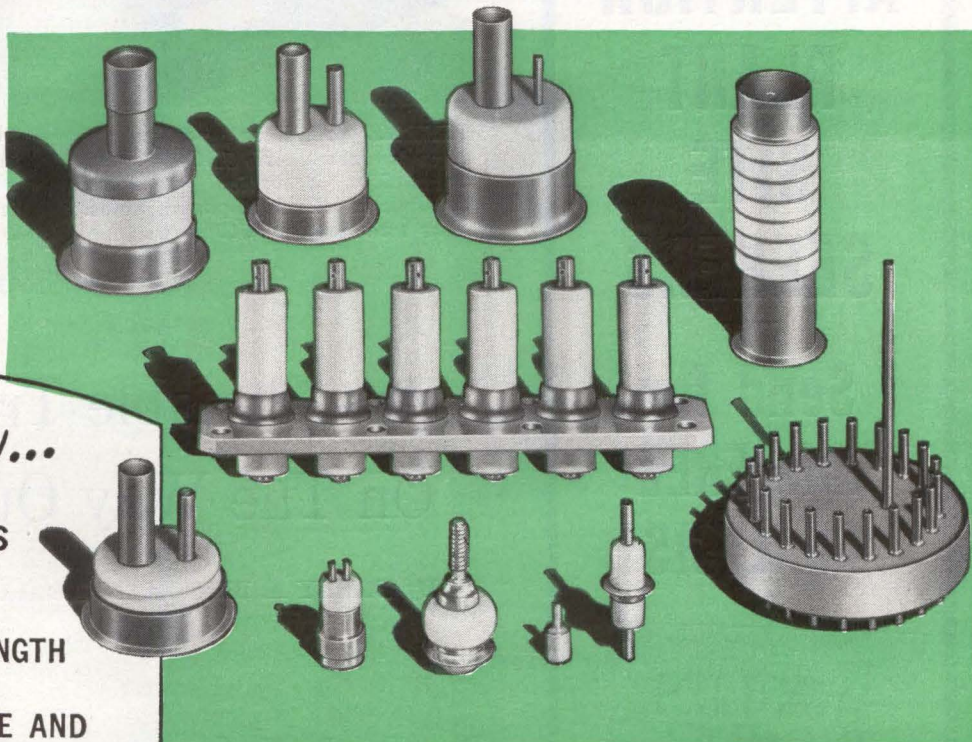

Combine...

- VACUUM-TIGHTNESS
- SUPERIOR MECHANICAL STRENGTH
- HIGH TEMPERATURE AND HEAT-SHOCK RESISTANCE
- RELIABLE ELECTRICAL CHARACTERISTICS
- HIGH RESISTANCE TO NUCLEAR RADIATION
- PRECISION TOLERANCES

Looking for ways to improve reliability, reduce maintenance problems? The unique advantages of high alumina ceramic-to-metal seals produced by Alite's exclusive process may be just what you need!

From design to finished part, every manufacturing step is handled within our own plant and carefully supervised by our strict Quality Control methods to assure absolute adherence to specifications, utmost uniformity and reliability.

Alite's production experience with braze materials such as silver and copper, and its continuous research and development work with high temperature/low vapor pressure braze alloys, assure you of the most reliable assemblies the industry can provide. Vacuum-tight, these seals can be made to withstand the most rigorous environmental conditions, including vacuum, pressure, high or low temperatures, mechanical shock, and the like.

Let us review your specific requirements and help you take advantage of Alite's superior properties.

Write For These Helpful Brochures

Bulletin A-8 provides detailed descriptions and specifications of Alite formulations. Bulletin A-40R gives complete data on Alite standard bushings, which are available for off-the-shelf delivery.



331-H

ALITE
DIVISION

U. S. STONEWARE

BOX 119

ORRVILLE, OHIO

ATTENTION PLANT SITE SEEKERS

Send for
this FREE
ANALYSIS!

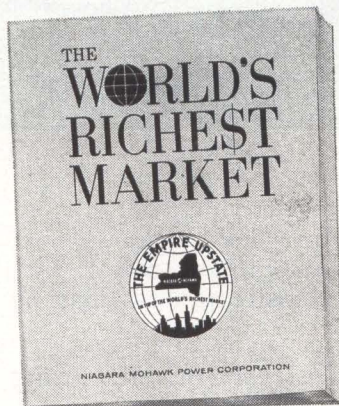

- 45 million customers live within 250 miles of the Empire Upstate.
- This area accounts for 28% of the nation's income.
- It has nearly twice the population and 3 times the population density of the West Coast—and will still have in 1975.

Write for your FREE copy of "The World's Richest Market" on your company letterhead to: Richard F. Torrey, Director of Area Development, Niagara Mohawk Power Corporation, Dept. E-6, 300 Erie Blvd. West, Syracuse 2, N. Y.

**NIAGARA
MOHAWK**
INVESTOR OWNED • TAXPAYING

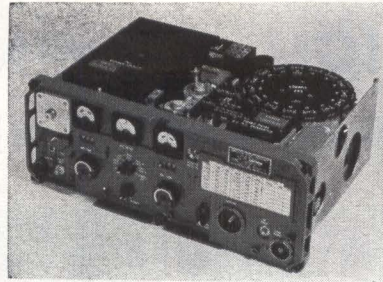

LINEAR amplifier portion of Army's new AN/GRC-106 ssb transceiver is typical of trend towards smaller high-power radios. This unit develops 400 watts

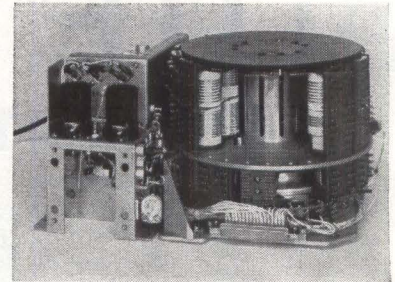

COMPACT turret assembly contains broadband r-f transformers with 1-Mc bandwidths. Equipment is made for the Army by General Dynamics/Electronics

Are Tunable Transmitters On The Way Out?

By BARRY A. BRISKMAN, Assistant Editor

*Broadband techniques
eliminate operator
adjustment of sets*

CONVENTIONAL high-frequency transmitters that used manual or automatic tuning are now being designed with broadband r-f transformers that replace conventional L-C networks. Some sources in industry and the military feel that broadband techniques may be used in most transmitters within the next decade. Moreover, broadband transmitters like the AN/GRC-106 are being delivered to the military now.

HOW THEY WORK—Broadband coils shown conform to the parameters governing any double-tuned transformer. The response curve of this network resembles that of a conventional i-f transformer with bandwidth dependent upon design requirements. Values of inductance and capacitance vary with frequency, bandwidth, tube characteristics and desired value of antenna impedance to be matched by the output winding.

These circuits require less space than an equivalent Pi-network since coils are smaller for a given power-handling capability. In order to achieve small size, large-diameter powdered-iron slugs are used to increase inductance without enlarging the windings.

The design method for double-tuned r-f transformers is derived by relating universal selectivity curves to the parameters of r-f power amplifiers. Circuit Q's as low as 4 to 5 and bandwidths up to 25 percent have been used with good second-harmonic rejection.

Rejection is obtained by connecting the load R_L to a tap near or at the center of the secondary winding as shown in the diagram. The part of the secondary coil on the high-potential side of the tap and the capacitor shunting this winding form a series L-C circuit that resonates at the second harmonic. This portion of the secondary looks like a short circuit at the second harmonic frequency and provides good attenuation.

While these circuits are flexible in terms of design bandwidth, there are various factors such as secondary current that do put some limitations on the design. However,

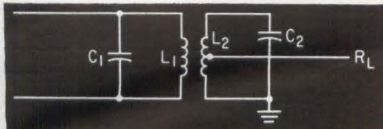
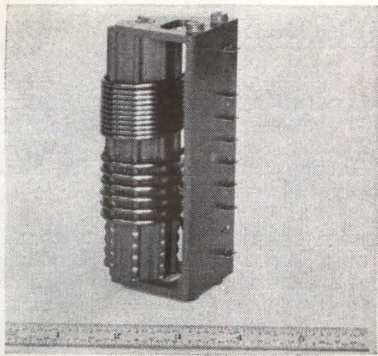

HIGHER-POWER transformer (top) for AN/GRC-107 linear amplifier will operate at 2 Kw. Each coil delivers nearly constant output across 1-Mc design range. Diagram is a typical double-tuned broadband transformer with second harmonic trap

bandwidths between 1 and 3 Mc for a typical transformer are feasible in a great many cases.

Since most tubes have different characteristics, broadband transformers are not usually interchangeable between amplifiers; neither will they tolerate substantial excursions from design secondary impedance or excessive feedline reactance.

ADVANTAGES—These networks are desirable because they permit design of intermediate transmitter stages and high-power amplifiers that are smaller, less expensive and faster to operate. Tuning procedures such as peaking grid drive and dipping and loading the final amplifier are completely eliminated as the circuit will produce nearly uniform r-f output over its design range without adjustments. Moreover, the lower Q of a broadband transformer offers less insertion loss and minimizes unwanted feedback.

Simplicity of operation is a key factor in military equipment as it reduces malfunctions due to operator error and permits rapid frequency changing to meet increasing traffic loads.

DATA PULSE 104 PULSE GENERATOR



The **DATAPULSE 104 PULSE GENERATOR**

is designed to accurately and reliably generate the pulses necessary to test this high speed flip flop module. The 104 meets this requirement and many others such as:

- | | |
|-------------------------------|-------------------------------------|
| • HIGH SPEED CLOCK GENERATION | • PULSE TELEMETRY SYSTEM DESIGN |
| • THIN FILM STUDIES | • IMPULSE GENERATION |
| • MAGNETIC CORE DRIVING | • KLYSTRON AND TWT PULSE MODULATION |
| • SEMICONDUCTOR EVALUATION | • PULSED DOPPLER RADAR DESIGN |
| • DIGITAL CIRCUIT DEVELOPMENT | • COUNTERMEASURES DEVELOPMENT |

The 104 provides very short duration, high power pulses at repetition rates to 10 mc, with variable delay and broad pulse width range permitting full general purpose use at lower rates.

ABBREVIATED SPECIFICATIONS

- | | |
|---|---|
| REPLICATION RATE — Variable, 5cps to 10mc, single shot or externally triggered. | PULSE DURATION — Variable 20 nanosec. to 500 μ sec. |
| AMPLITUDE — Variable to ± 40 v peak into 50 ohms. | DUTY CYCLE — Provide up to 300 ma average output current, with fully automatic overload protection. |
| RISE TIME — Variable 10 to 200 nanosec. | SIZE AND WEIGHT — 8 $\frac{3}{4}$ "h x 17" w x 15 $\frac{1}{4}$ "d, 45 lbs. |
| PULSE DELAY — Variable 50 nanosec to 10 millisecc. | |

Additional Datapulse products

102 PULSE GENERATOR



Repetition Rate to 3 mc
50v into 50 ohms
at 10 nanoseconds rise time

DATAPULSE
INCORPORATED

509 HINDRY AVE. INGLEWOOD 1, CALIFORNIA
Data Systems • Pulse Instrumentation
ORchard 1-7713 ORegon 8-3983

HOW WE TOOK THE SLIP OUT OF TEFLON*

Why Gudebrod's Common Sense Approach to Lacing Problems Pays Dividends For Customers!

Motor manufacturers came to us some time ago with a problem. They required a flat-braided lacing tape that would meet temperature requirements of -100°F to 500°F . A teflon lacing tape would meet the temperature requirements but teflon is slippery... knots were hard to tie... harnesses worked loose after installation. Valuable production time would be lost!

Gudebrod's answer to this problem was to coat teflon with a special synthetic rubber finish that was non-flaking and fungistatic. We then flat-braided it—we originated the flat braiding process! The result was TEMP-LACE® H, a teflon lacing tape that met the temperature requirements of motor manufacturers and assured them that knots would not slip, harnesses would stay tied and assemblies would remain firm long after installation.

Taking the slip out of teflon is but one of many ways in which Gudebrod's common sense approach to problems pays dividends for customers. Whatever your lacing needs—nylon, glass, dacron†, fungus proofing, color coding, special finishes, Gudebrod has the answer because:

1. *Gudebrod lacing tape increases production!*
2. *Gudebrod lacing tape reduces labor costs!*
3. *Gudebrod lacing tape means minimal maintenance after installation!*
4. *Gudebrod is quality—our standards for lacing tape are more exacting than those required for compliance with MIL-T!*

Write today for our Technical Products Data Book which explains the many advantages of Gudebrod lacing tape for both civilian and military use. Address inquiry and your lacing tape problems to Electronics Division.

*DuPont registered trademark for its TFE-fluorocarbon fiber.

†DuPont trade name for its polyester fiber.



GUDEBROD BROS. SILK CO., INC.

FOUNDED IN 1870

Electronics Division

12 SOUTH 12TH STREET, PHILADELPHIA 7, PENNA.

MEETINGS AHEAD

X-RAY AND ELECTRON PROBE ANALYSIS SYMPOSIUM, American Society for Testing and Materials; Chalfonte-Haddon Hall, Atlantic City, N. J., June 23-28.

IMPACT OF MICROELECTRONICS CONFERENCE, Armour Research Foundation and ELECTRONICS Magazine; Illinois Institute of Technology, Chicago, Illinois, June 26-27.

COMPUTERS & DATA PROCESSING SYMPOSIUM, University of Denver; at the University, Denver, Colorado, June 26-27.

LOUDSPEAKER INDUSTRY CONFERENCE, EIA; Pick Congress Hotel, Chicago, June 27.

INFORMATION THEORY IN SCIENCE & ENGINEERING SEMINAR, Dartmouth College; at Dartmouth, Hanover, New Hampshire, July 1-12.

ADVANCED CONTROL THEORY AND APPLICATIONS, Massachusetts Institute of Technology; at MIT, Cambridge, Mass., July 8-19.

ANTENNAS & PROPAGATION INTERNATIONAL SYMPOSIUM, IEEE-PTGAR; National Bureau of Standards, Boulder, Colo., July 9-11.

MEDICAL ELECTRONICS INTERNATIONAL CONFERENCE, IFME, University of Liege, Liege, Belgium, July 22-26.

ELECTROMAGNETIC MEASUREMENTS & STANDARDS SEMINAR, National Bureau of Standards; NBS Laboratory, Boulder, Colo., July 22-Aug. 9.

AEROSPACE SUPPORT INTERNATIONAL CONFERENCE & EXHIBIT, IEEE, ASME; Sheraton-Park Hotel, Washington, D. C., Aug. 4-9.

INTERNATIONAL ELECTRONICS CIRCUIT PACKING SYMPOSIUM, University of Colorado, et al; at the University, Boulder, Colo., Aug. 14-16.

WESTERN ELECTRONICS SHOW AND CONFERENCE, WEMA, IEEE; Cow Palace San Francisco, Calif., August 20-23.

AUTOMATIC CONTROL INTERNATIONAL CONGRESS, International Federation of Automatic Control; Basle, Switzerland, Aug. 27-Sept. 4.

ADVANCE REPORT

VEHICULAR COMMUNICATIONS NATIONAL CONFERENCE, IEEE-PTGVC; Adolphus Hotel, Dallas, Texas, Dec. 5-6. Aug. 17 is the deadline for submitting a 500-word abstract to: Jack Germain, Motorola, Inc., 4501 W. Augusta Blvd., Chicago 51, Ill. Of interest are the following subjects in the areas of vehicular systems, equipment and circuit designs: new or unusual techniques; applications of new types of components or related circuitry; interference reduction or spectrum utilization. Topics covered may include land vehicular communications, personal signaling, solid-state applications to communications, VHF maritime and air-ground communications.

OZALID NEWSLETTER

NEW IDEAS TO HELP YOU WITH ENGINEERING REPRODUCTION AND DRAWING

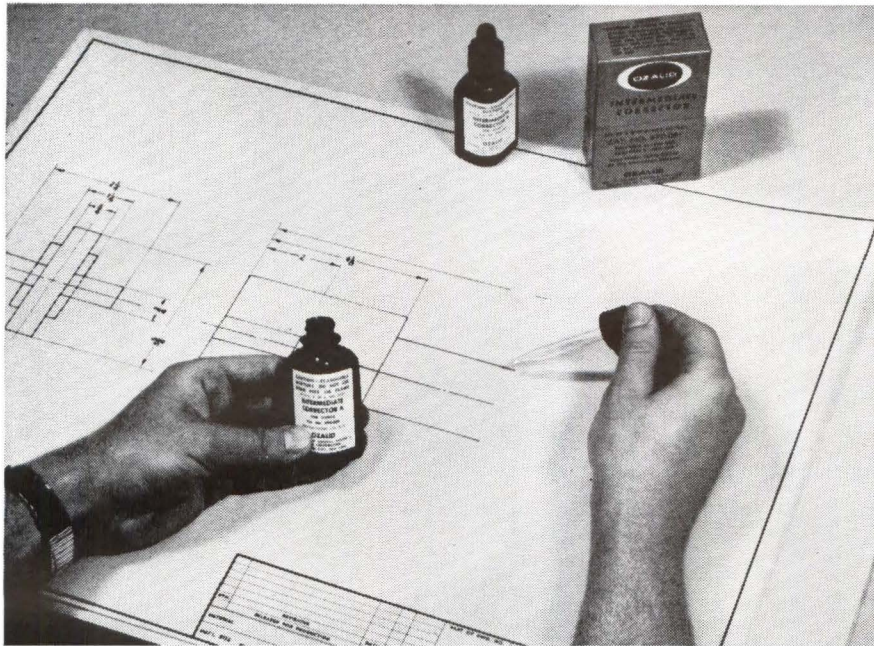

New Ozalid ITX line of intermediates offers finest-line pick-up and fastest printing speed of any intermediates!

Three new Ozalid diazo intermediates which fit their performance directly to your reproduction requirements are now available! They require no special equipment or processing and can be exposed on any Ozalid whiteprinter or similar machines.

Unmatched pencil-line pick-up power

The standard (402 ITX) and faster (404 ITX) intermediates reproduce faintest details faithfully. Their "pencil-line pick-up power"—the true measure of a good intermediate—is rated excellent by research and development technicians and by industry experts.

Improved 402 ITX—the standard intermediate in the new line, has greatest density and assures maximum readability in the final print.

All-new 404 ITX is a distinct im-

provement over other sepias and combines fast printing speed with high quality reprints. Its broad covering power results in sharpest images. The new 100% rag, transparentized and blue-tinted base gives faster printback speeds. 404 ITX narrows the gap between printing and reprint speeds; in many cases both speeds are identical.

Fastest intermediate you can get!

406 ITX—another new Ozalid intermediate, is twice as fast as 402 ITX. Density is a trifle less, but the remarkable increases in production, over 100%, offset its slight decrease in covering power.

New, easy-on-the-eyes, readability

The rich mahogany image color of the new ITX series contrasts sharply with the blue-tinted background, providing excellent visual acuity and exceptional readability.

Which to use? 402? 404? or 406?

402 ITX—because of its superior covering power—is of great value to architects, engineers and draftsmen who demand exceptional repro fidelity as well as good printback speed.

404 ITX (Fast Speed) and 406 ITX (Extra Fast Speed) increase productivity of slow speed machines. In production shops where the number of intermediates needed is consistently high, copies may be run off on both these new materials at far faster speeds.

The ITX intermediates, either separately or as a product family, offer important advantages to every diazo user.

Corrections are simple

Dye line eradications can be made quickly and easily with Ozalid® Intermediate Corrector. Special base stock readily accepts pencil and ink additions.

Repeated erasures don't ghost or lose "tooth"

The ITX product line has a 100% rag-tracing vellum stock as a base with a new plastic transparentizer. Even repeated erasures made on the same spot do not destroy the "tooth" or ghost in printbacks.

Get all the facts now!

For complete information about this new family of intermediates, write General Aniline and Film Corp., Ozalid Sales Dept., Binghamton, New York.

gaf **OZALID**
REPRO PRODUCTS OF
GENERAL ANILINE & FILM CORPORATION
BINGHAMTON, NEW YORK

In Canada: Hughes-Owens Co., Ltd., Montreal.

CIRCLE 33 ON READER SERVICE CARD

CIRCLE 34 ON READER SERVICE CARD →

Why so many?

We admit it.

Amphenol, more than any other connector manufacturer, accepts responsibility for confronting you with a seemingly endless selection of rack and panel connectors.

There's a good reason.

For some uses, a ten-contact connector the size of an Idaho potato will do just fine. In others, ten connections must be squeezed into a space no bigger than a jelly bean. Still other applications have unique requirements that relate to environment or mating force—even the technical skill of the operator.

WHY WE DO IT

We make a lot of different rack and panel connectors because it takes a lot to satisfy the wide range of applications.

For example: the Amphenol Blue Ribbon® rack and panel connector is widely used in "blind" mating applications. Part of Blue Ribbons' popularity is due to the fact that they mate with a smooth and gradual wedge-like force. Because they mate so smoothly, the "feeling" of correct alignment is unmistakable.

Another advantage of the Blue Ribbon design is the wiping action that occurs as connectors mate. Each time Blue Ribbons are mated, contact surfaces are wiped clean. Combine wiping action with high mated contact pressure, and the result is an extremely low-resistance connection.

THINKING SMALL?

As fine a connector as we know the Blue Ribbon is—it's just not right for the real tiny stuff. Thus, as miniaturized

electronic equipment became popular, Amphenol engineers developed the Micro Ribbon®—a rack and panel connector utilizing the ribbon contact principle, but in as little as one-half the space. Further development produced a circular Blue Ribbon connector which crammed 50 contacts into a diameter just under 3 inches.

Also, there's the question of terminating rack and panel connectors. Often, confined quarters or complex wired harnesses can tax the dexterity of even the most skilled worker

To solve this problem, Amphenol engineers developed rack and panel connectors with Poke-Home® contacts. Poke-Home contacts make it possible to terminate conductors independent of the connector. Contacts are crimped, soldered, or even welded to conductors, then inserted into the connector. Besides simplifying assembly, Poke-Home contacts can be easily removed *after* assembly should circuit changes or repairs later become necessary. Needless to say, Amphenol rack and panel connectors with Poke-Home contacts (Min-Rac 17®, 93 and 94 Series, for example) are popular items with engineers who are forced to think small, spacewise.

BEATING THE ELEMENTS

There's a need for environmentally resistant rack and panel connectors, too. High performance aircraft, missiles and space craft led to the development of Amphenol 126 and 217 Series environmentally sealed rack and panel connectors. (The 217 offers the added feature of Poke-Home contacts.) Other Amphenol rack and panel connectors

can accommodate coaxial connectors; many can be supplied with hermetically sealed contacts. There are rack-to-cable connectors available in every series. There are super-economy types and super-reliable types.

So, when you have a rack and panel connector problem, contact an Amphenol Sales Engineer (or an authorized Amphenol Industrial Distributor). With the broadest line of rack and panels in the industry—if he can't solve it, no one can. If you prefer, write directly to Dick Hall, Vice President, Marketing, Amphenol Connector Division, 1830 South 54th Avenue, Chicago 50, Illinois.

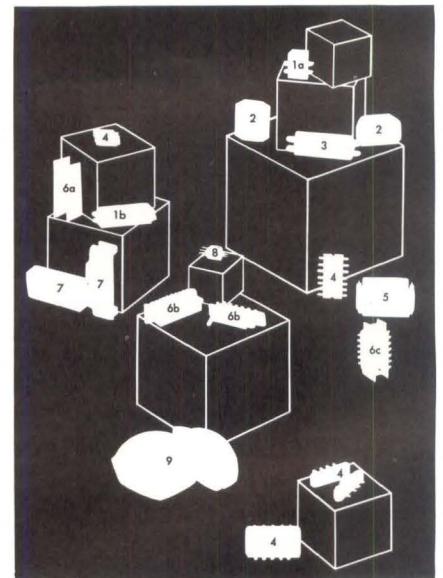

Amphenol connectors shown on the opposite page are: **1**—Min-Rac 17 with (a) crimp-type contacts and (b) solder-type contacts **2**—94 Series **3**—Micro-Ribbon **4**—126 Series Rectangular **5**—93 Series **6**—Blue Ribbon with (a) barrier polarization, (b) pin polarization and (c) keyed shell and barrier polarization **7**—126 Series "CNI" **8**—126 Series Hexagonal **9**—Circular Blue Ribbon



Connector Division / Amphenol-Borg Electronics Corporation



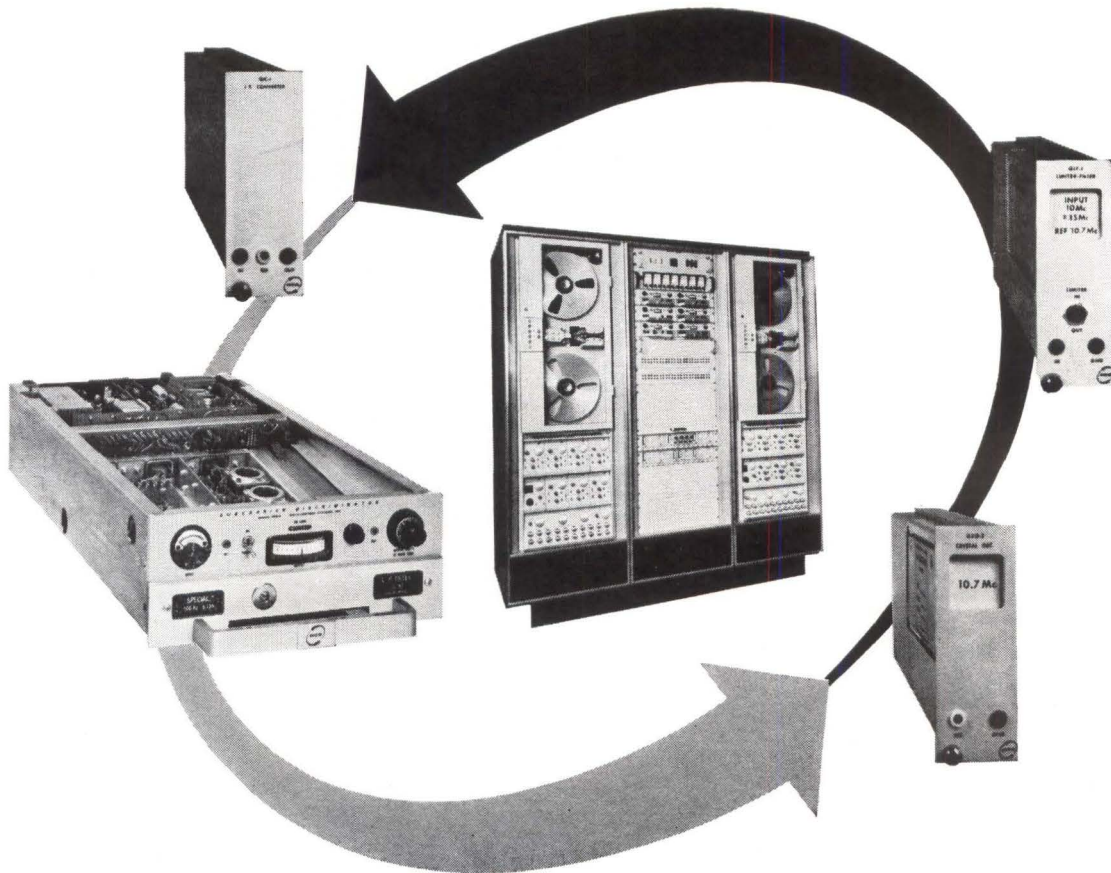

Predetection Recording by DCS gives you these 7 features:

- Best s/n performance • Best transient characteristics
- Up to 800,000 bit/second response • Tape speed compensation
- Off-the-shelf modular flexibility • 100% solid state • Usable with most receivers and recorders

Considering predetection recording? Only DCS can give you *all* these advantages:

First, the phase lock loop design of the GFD-4 Discriminator permits playback at the recorded frequency without incurring the noise and transient degradation typical of up-conversion systems. And in addition, response from DC to beyond that required for 800 Kilo-bit NRZ PCM is provided, for full IRIG requirements.

What's more, DCS has the only system providing tape speed compensation of reproduced data. Components are all solid state . . . modular (just plug 'em in!) . . . and available off the shelf.

Whether you need a complete predetection recording system, or want to build one using your present receiver and recorder (DCS components are compatible with most), DCS can help you.

Write us for complete information. Address: Dept. E-7

DATA-CONTROL SYSTEMS, INC.
Instrumentation for Research

Los Angeles • Santa Clara • Wash., D. C. • Cape Canaveral

Home Office: E. Liberty St., Danbury, Conn. • Pioneer 3-9241



RADIO FREQUENCY INTERFERENCE (rfi) has grown with our industry. More electronic and electrical equipment, higher powered transmitters, more sensitive receivers and faster transmission of information makes what was once a nuisance to a few an industry-wide problem

- **Introduction**
- **RFI Measurements and Instrumentation**
- **Intersystems and Systems Control of RFI**
- **Suppressing RFI**

RFI

CAUSES

EFFECTS

CURES

By **SY VOGEL**, Associate Editor



REPRINTS AVAILABLE
SEE READER SERVICE CARD

© copyright 1963 **electronics**® A MCGRAW-HILL WEEKLY

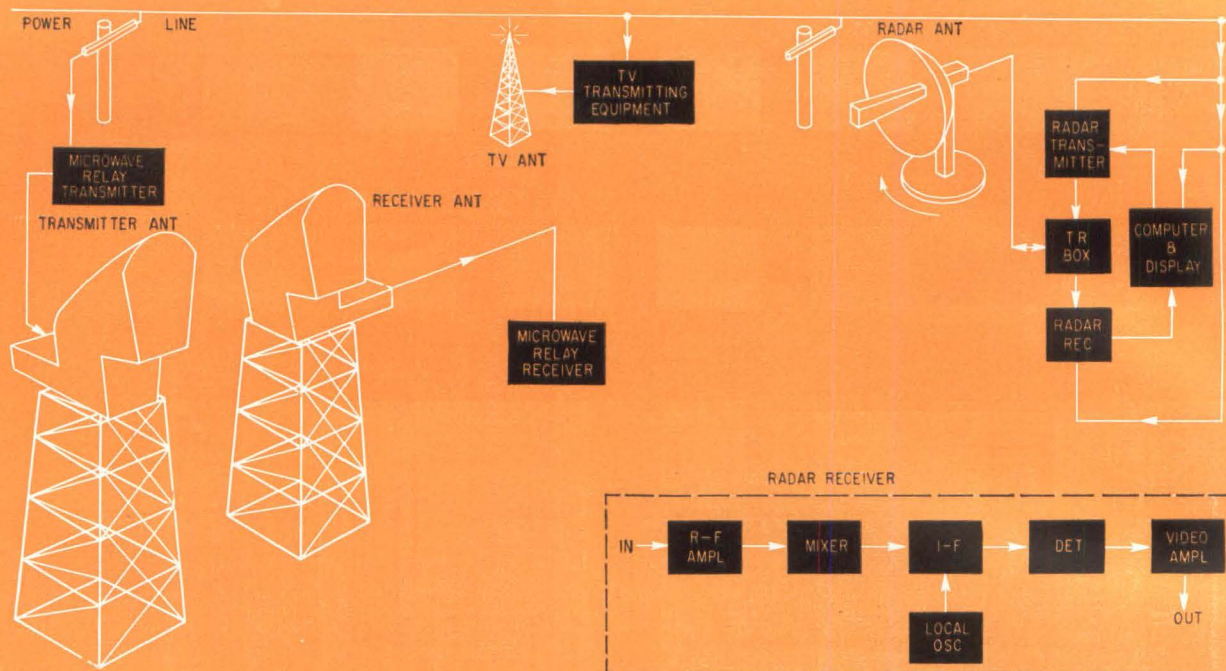

ELECTROMAGNETIC ENVIRONMENT of these three systems comprises the systems themselves and other transmitters and receivers that affect or are affected by them. Inset shows functional parts of a radar receiver—Fig. 1

INTRODUCTION

HUMAN BEINGS and electronic equipments have a similar problem: they've got to get along with others of their kind. This is called compatibility.

To be compatible with the electronic and electrical equipment that helps comprise its electromagnetic environment, an electronic equipment must not interfere with the functioning of other equipment and it must also be able to function properly in this environment; in other words, it must neither interfere with other equipment nor be susceptible to interference.

Figure 1 shows a simplified picture of an electromagnetic environment in which it is highly desirable that the systems be compatible with each other. The systems shown are a microwave-relay station, a television transmitter and a military search radar.

Assume that they are close enough to interfere with each other unless good rfi control measures are taken. To live with each other, not only must the operating frequencies of these systems differ, but their spurious radiations, which are undesired radiations such as the harmonics of a transmitter's fundamental frequency, must be minimized. The receivers must be sufficiently insensitive to radiation other than their operating frequencies so that they do not respond to spurious, that is, undesired, electromagnetic energy.

Consider all undesired electromagnetic energy, whether made by man or nature, as radio frequency interference (rfi).

When analyzing an environment such as that shown in Fig. 1, rfi engineers look at every source of radiation as a transmitter and at every equipment subjected to radiation as a receiver. Thus, consider both the transmitter and the receiver of the microwave-relay station as re-

ceivers of the high-power pulses emitted by the search radar; although the relay receiver is more susceptible to an interfering radar pulse than is the relay transmitter, if enough radar power gets into a transmitter circuit such as a low-power frequency-multiplier stage, the relay transmitter will not operate properly, that is, it will produce a spurious response.

Note that radiation is not the only means of transmission by which rfi can be coupled from a transmitter to a receiver. For example, the power lines shown in Fig. 1 can conduct undesired r-f energy such as that produced by arcing in the tv transmitter into the relay-station and radar power supplies, which may then pass enough rfi to adversely affect the functioning of susceptible circuits in the relay or the radar.

In a sense, much of this planet and much of the universe constitute the electromagnetic environment of the systems shown in Fig. 1; in other words, any source of rfi that is picked up by these systems, and any receiver of rfi produced by these systems, is a part of their electromagnetic environment. However, only those sources and receivers that deliver or receive enough energy to affect, or be affected by, the systems in Fig. 1 are considered to be part of their electromagnetic environment. Consequently, many sources and receivers are eliminated from consideration when estimating the potential rfi in the environment of a system, thus making it easier to design anti-rfi measures into the system.

Intersystem rfi is only one aspect of the compatibility problem. Others are: interference between the equipments comprising a system—for example, interference between the transmitter and computer-display subsystems of the radar systems; interference caused by the com-

AMBIENT NOISE levels of atmospheric, galactic, and man-made rfi (A); levels of man-made noise are going up with increased use of electronic and electrical equipment. Man-made rfi in (B) is random; spikes in (C) are impulse-type rfi; (D) shows desired fundamental and rfi emissions of a radar transmitter—Fig. 2

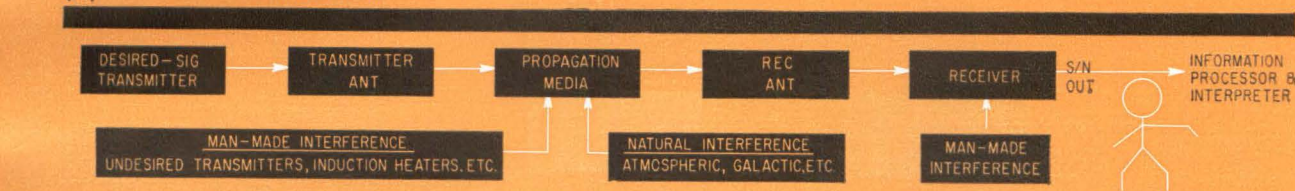
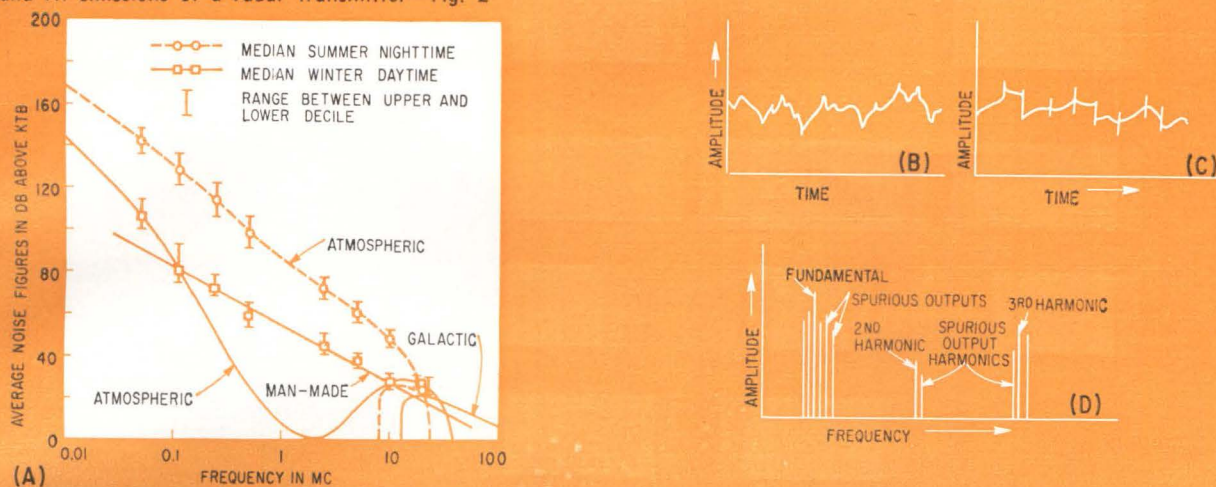

COMMUNICATIONS LINK in upper row of blocks can be affected by many sources of rfi—Fig. 3

ponent parts of an equipment such as the radar receiver—for example, spurious frequencies produced by the receiver's local oscillator (see inset) are a source of rfi.

SOURCES OF RFI—These sources consist of natural and man-made generators of rfi. Natural sources of rfi are: galactic noise such as noise from the sun and other stars, atmospheric noise, precipitation noise (such as that caused by blowing snow) and corona noise (produced by a corona discharge). Nature-made rfi usually consists of random noise. The amplitudes of the various frequency components comprising random noise vary randomly with time and generally cover a broad band of frequencies (Fig. 2A).¹ The overall level of natural noise varies greatly with time, with wide variations occurring during the day and night, over the seasons, and from year to year. The natural-noise level also varies greatly with geographical area.¹

Man-made sources of rfi fall into two categories: broadband and narrowband generators. Typical broadband generators of rfi include motors, switches, diathermy machines and high-voltage-line leakage.² The rfi energy produced by man-made broadband generators can be completely random (Fig. 2B) or exhibit at least some periodicity (Fig. 2C).³ Amplitudes of the spectral components of random noise vary randomly with time, whereas amplitudes of the spectra comprising the interference shown in Fig. 2D are more or less repeatable in phase.

The output harmonics of the radar transmitter shown in Fig. 1 are typical of narrow-band rfi. Although the spurious outputs of a transmitter may cover a wide range of frequencies, thereby exhibiting a characteristic of

broadband noise (Fig. 2D), the energy distribution with frequency is sharply defined.⁴

This article does not consider rfi produced by intentional jamming, that is, it assumes that man-made rfi is an innocent troublemaker.

Figure 3 shows how various rfi inputs can affect the operation of a communications system (upper row of blocks). Transmission conditions in the propagation media can affect the susceptibility of the system to rfi. For example, suppose the desired signal is transmitted to the receiver by tropospheric scatter; a change in propagation conditions might occur, thus favoring an undesired transmitter whose rfi goes to the receiving antenna over a line-of-sight path; consequently, the rfi might then override the desired signal, causing a loss of information.

Thus, the information processor and interpreter, whether man or machine, is a key link in a system chain. His or its ability to read out and interpret a signal in the presence of noise can provide the margin that enables a system to function successfully in spite of rfi.

Interpretation of the information delivered by the receiver is dependent on the *S/N* ratio at the receiver's output terminals. This *S/N* ratio is in turn dependent on the internal noise of the receiver and the natural and man-made rfi entering the receiver.

Thus, there are many interlocking factors affecting the influence of rfi on system performance.

There are no quick-and-easy solutions to rfi problems. Careful systems planning, consideration of inter-system affects, and good engineering design are all necessary. Accomplishing these jobs requires data on the electromagnetic environment; rfi measuring instruments are used to obtain this data.

MEASUREMENTS AND INSTRUMENTATION

GIANT SYSTEMS SUCH as the Ballistic Missile Early Warning System must have rfi control built into their design (Filtron). Shielding requirements were particularly severe because of the high-power radar and the critical operational requirements—Fig. 4

PERHAPS the first thing to do about a problem is to determine its magnitude. For rfi, this requires measurements with instruments that give a correct indication of the magnitude of interference.

These measurements should be made during all stages of a systems job. It is particularly important to take rfi measurements at the start of a job to obtain information on the electromagnetic environment. For example, consider the problem of deciding on the site location of an electronics-systems complex such as BMEWS (ballistic missile early warning system) (Fig. 4). First thing that was done here was to run a check of the electromagnetic environment.⁵ Although checks such as this are not entirely comprised of measurement taking, since information also is obtained from reports and other published data, all information should be verified by on-the-spot tests. In the case of the ballistic missile early warning system, the electromagnetic environment was not the sole factor determining the selection of sites for the radars, but

it was an important factor.

The evolution of a system takes place along parallel lines of development. Thus, work on predicting rfi goes on while rfi measurements are being made; consequently, predictions of rfi are corroborated or modified by measurement data. Similarly, as components of the system are designed and constructed, rfi measuring goes on, checking out various system equipments and construction (Fig. 5) and ascertaining their impact on and their susceptibility to the electromagnetic environment that they help comprise.

INSTRUMENTATION—The prime function of rfi instrumentation is to sense and indicate undesired energy. Some rfi checks may not require special-purpose rfi instruments; for example, a portable tv could be used to locate a source of interference to a tv broadcast channel. Other tests, such as rfi-compliance tests required by the armed forces, must be made with instrumentation that

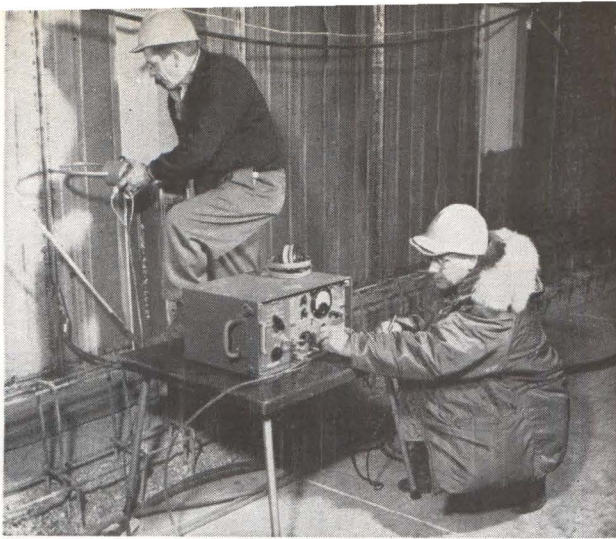

SHIELDING effectiveness of a wall in one of the interconnecting tunnels in a BMEWS site being checked by engineers (Filtron)—Fig. 5

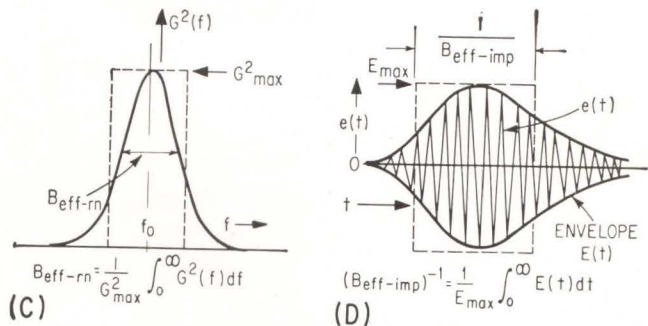
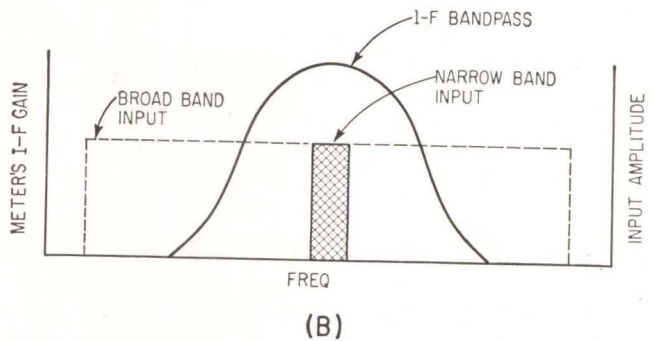
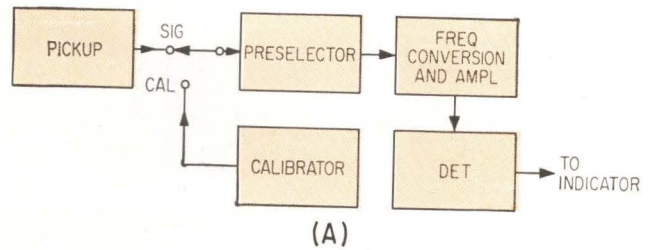

BASIC RIFIM is shown in (A). Its i-f bandwidth (B) affects its response to broadband inputs, which are inputs having a wider spectral content than that passed by the i-f strip. Instrument's response to random rfi (C) and impulse rfi (D) differ—Fig. 7

power crystal.⁸ In Fig. 6D, the rifim checks the shielding effectiveness of the shielded room, first measuring signal level with the door open, then with the door shut; the shielding effectiveness equals the difference between the two readings (in db).⁷ The rifim is being used as a harmonic analyzer in Fig. 6E.⁸

Figure 7A shows the basic structure of a field intensity meter. A radiation or conductive pickup sends the signal under test to a preselector that discriminates against frequencies other than the test signal. After frequency translation and amplification, the signal goes to a detection circuit and then to an output indicator. The calibrator, which may be a physical part of the rifim or be an external unit, is used as a comparison standard to determine signal magnitudes correctly.

INPUTS AND BANDWIDTH—Interference can be coupled in and out of an equipment by conduction, by the induction field created by current flowing in a con-

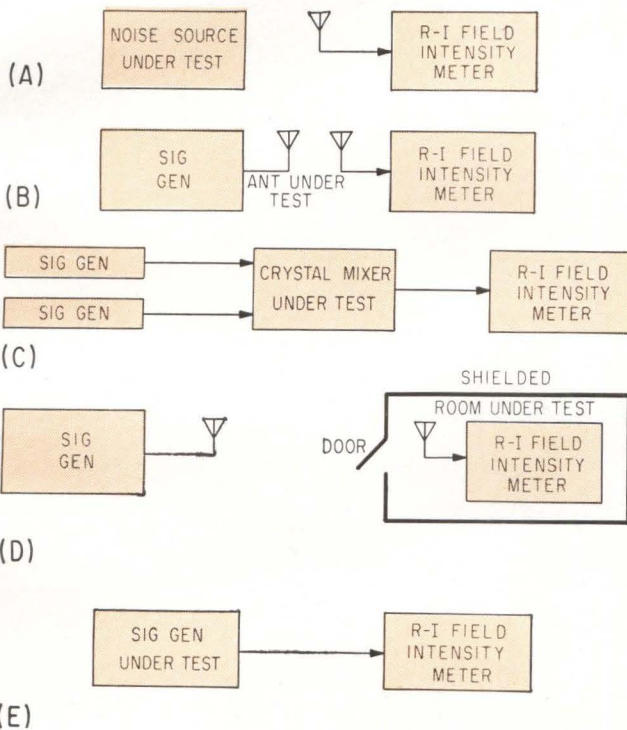

RFI MEASUREMENTS with the radio-interference field-intensity meter (Polarad and Stoddart)—Fig. 6

accurately indicates the characteristics of rfi energy.

Much of the instrumentation used in rfi measurements consists of test setups comprised of standard electronics equipment such as antennas, attenuators, signal generators, coupling networks, frequency-selective voltmeters and receivers.⁶ Some rfi instrumentation, such as that used to process rfi data for statistical analysis, constitutes special-purpose equipment.¹ However, the work horses of rfi engineering are radio-interference field-intensity meters and spectrum analyzers.

A radio-interference-field-intensity meter (rifim) is a calibrated receiver that indicates the magnitude of the energy applied to its input terminals. Figure 6 shows typical applications of an rifim. In Fig. 6A, the rifim, which has a calibrated receiving antenna, measures the random noise radiated from the source under test.⁷ Figure 6B shows a test setup for making antenna-pattern measurements.⁷ The high sensitivity of the rifim shown in Fig. 6C is utilized in determining the performance of the low-

ductor, by the electrostatic field created by movement of charge, and by radiation of an electromagnetic field. An rfi meter uses pickups such as current probes and networks to sense conducted interference and uses antennas to sense interference transmitted by a field.

From the viewpoint of an rfi meter, a radiated or conducted input signal is comprised of either a narrow or a broad band of frequencies, depending on whether the bandwidth of the input-signal is larger or smaller than the bandwidth of the rfi meter. Typically, the i-f bandwidth determines the overall bandwidth of the rfi meter since the bandwidth of its r-f section is broad compared to the bandwidth of its i-f strip.⁹

A narrowband or c-w input passes through the rfi meter without being affected by the bandwidth of the rfi meter; broadband inputs are affected by the bandwidth of the rfi meter. Figure 7B shows the relationships of a narrow and a broadband input to the frequency-response curve of the i-f strip. Frequency components of the broadband input that lie outside the i-f bandwidth and frequency components that fall within the outer edges of the passband are rejected or amplified much less than frequency components near the center of the passband. Consequently, the rfi meter is calibrated so that broadband inputs can be described in units of spectral intensity such as microvolts per Mc. This is done by dividing the peak-response indication of the rfi meter by its impulse bandwidth, which generally is determined by calibrating the instrument with an impulse-generator standard. Thus, if a broadband input is applied to an rfi meter having an impulse bandwidth of 5 Mc and the meter indicates 10 μV , the spectral intensity is $2\mu\text{V}/\text{Mc}$, or 6 db above 1 μV per Mc. Narrowband inputs are described in μV or db above 1 μV . Magnitudes expressed in μV or db and in $\mu\text{V}/\text{Mc}$ or db above $1\mu\text{V}/\text{Mc}$ are used to describe conducted interference.

The practical definition of an impulse states that it is a pulse whose duration is extremely short compared to the response time of the circuit that receives the impulse.¹⁰

In general, random and impulse-type noise are the two types of broadband rfi measured by the rfi meter. These input types are characterized by the input itself and the rfi meter's response to the input. Both random and

impulse rfi are comprised of many spectral components. However, the amplitude of a spectral component of random noise varies randomly in time, whereas the amplitude of a spectral component of one impulse of a train of identical impulses is equal to the amplitude of the same spectral component of other impulses in the train. Consider each spectral component of random noise to have been produced by many generators of the same frequency, each generator contributing or not contributing to this spectral component in a completely random manner; consider each spectral component of impulse noise to have been produced by a single generator, (that is, one generator per spectral component) whose amplitude is more or less constant.

The rfi meter responds differently to a random-noise input than to an impulse-type input. An instrument's response to random noise is described by the curves shown in Fig. 7C; here, the solid-line curve plots the square of the instrument's gain ($G^2(f)$) against frequency; the width of the dotted-line rectangle whose peak equals the peak of the $G^2(f)$ curve and whose area equals the area of the $G^2(f)$ curve, is the effective random-noise bandwidth $B_{\text{eff-rn}}$.¹⁰ The instrument's response to impulse-type noise is described by the curves shown in Fig. 7D; here, the solid-line curve plots the envelope ($E(t)$) of the instrument's response to an impulse against time; the width of the dotted-line rectangle, whose peak equals the peak of the $E(t)$ curve and whose area equals the area of the $E(t)$ curve, is the reciprocal of the effective impulse bandwidth ($B_{\text{eff-imp}}$); note that $B_{\text{eff-imp}}^{-1}$ equals the duration time of the effective i-f output pulse.¹⁰

Conversion tables such as Table I can be used to express one type of bandwidth in terms of another.¹⁰ Thus, when measuring random noise with an rfi meter whose impulse bandwidth is known, multiply the impulse bandwidth (in Mc) by 0.98 to obtain $B_{\text{eff-rn}}$ and then divide the readings in μV by $B_{\text{eff-rn}}$ to obtain $\mu\text{V}/\text{Mc}$.

RADIATION MEASUREMENTS—When an rfi meter is used to measure radiation, it requires an antenna and a cable or waveguide to couple the antenna to its input terminals (Fig. 6A). Since the quantity of interest in radiation measurements is the field intensity or power

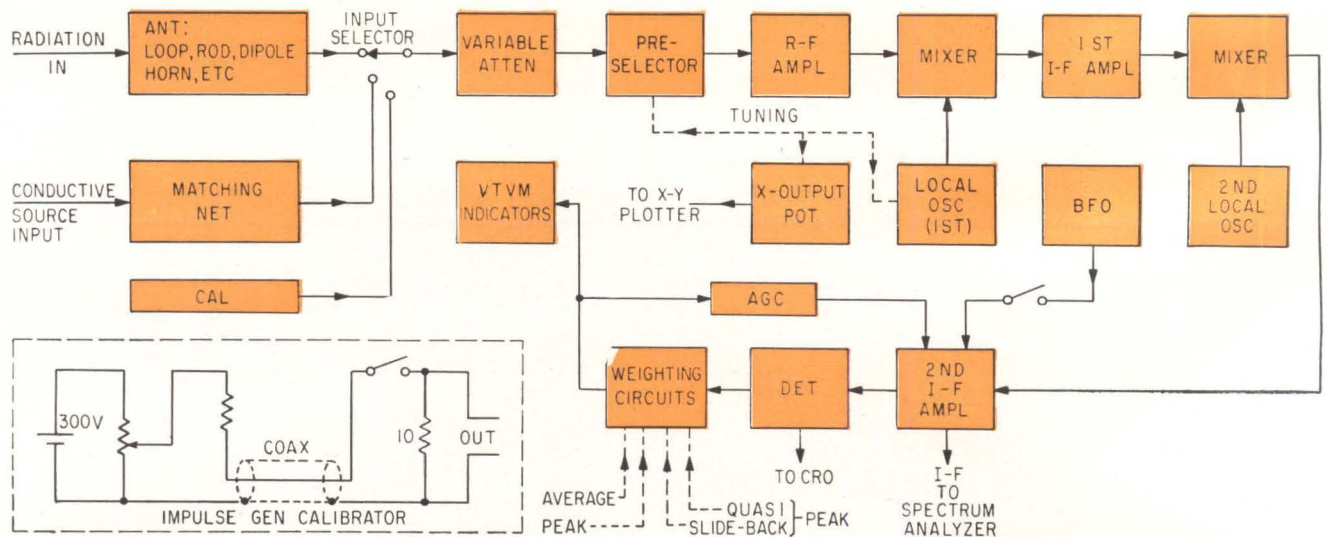

RFI METER measures rfi (or signal) energy coupled to it by radiation or conduction. Inset shows typical impulse-generator calibration source—Fig. 8

density in the radiation field, rather than the voltage at the receiver terminals, manufacturers of rfi meters usually supply data to correct for the effect of the coupling cable or waveguide and the antenna. Thus, field intensity (E) of narrowband radiation, which is expressed in $\mu\text{V}/\text{meter}$ or in db above $1 \mu\text{V}/\text{meter}$, is obtained by adding a correction to the indicator reading, which shows μV or db above $1 \mu\text{V}$. Similarly, the field intensity (E) of radiation distributed over a band of frequencies that is broad compared to the passband of the rfi meter is calculated by adding the same correction to $\mu\text{V}/\text{Mc}$ (or db above $1 \mu\text{V}/\text{Mc}$), thus obtaining $\mu\text{V}/\text{m}/\text{Mc}$ (or db above $1 \mu\text{V}/\text{m}/\text{Mc}$).⁷

The output indicators of some rfi meters are calibrated to show $\mu\text{V}/\text{Mc}$ and $\mu\text{V}/\text{m}/\text{Mc}$ directly.

The effect of the antenna on meter indications is sometimes expressed in terms of effective height H_{eff} (in meters). When this parameter is used, field intensity is obtained from

$$E = E_r / H_{\text{eff}}$$

where E_r is the voltage at the input terminals of the rfi meters. Effective height of an antenna can be obtained from manufacturer's data or computed;¹¹ for example, $H_{\text{eff}} = 1/\pi$ for a half-wave dipole.¹²

Instrument readings of radiated interference can be converted to "open circuit" or antenna-induced voltage by using correction factors supplied by the manufacturer.¹³ Antenna-induced voltage is the voltage that an rfi meter would indicate if it had an infinite impedance. Antenna-induced voltage (E_{ai}) can be calculated from

$$E_{\text{ai}} = E_r \times (1 + Z_{\text{ant}}/Z_{\text{load}})$$

INSTRUMENTS—Figure 8 shows a typical rfi meter.^{7, 11} The input can be a radiated or conducted r-f test signal or r-f from a calibration source, which may be internal or external; calibration sources are generally c-w or impulse generators (the inset shows an impulse generator), although random-noise generators are also used. The preselector, typically a tuned circuit for low-frequency rfi meters and a tunable cavity or cavities in higher frequency rfi meters, passes the selected input signal on to the r-f amplifier.

Design requirements of the r-f amplifier stages include:

TABLE I—CONVERSION TABLE OF BANDWIDTHS
MULTIPLIERS FOR RELATIVE BANDWIDTHS

To Obtain Bandwidth From Given Bandwidth		Effective				
		3-db	6-db	Sine Wave	Random Noise	Impulse
Effective	3-db	1	1.20	1.24	1.01	1.03
	6-db	0.833	1	1.03	0.841	0.858
	Sine-Wave	0.806	0.967	1	0.816	0.830
	Random Noise	0.991	1.19	1.23	1	1.02
	Impulse	0.971	1.17	1.20	0.980	1

NEAR AND FAR-FIELD MEASUREMENTS

The electromagnetic field emanating from a source of radiation is comprised of electric (E) and magnetic (H) components, that is, an electric and magnetic field. At measuring points that are far from the source of radiation, where the measuring antenna sees a plane wavefront, the ratio of the E and H components or intensities is

$$E/H = Z = 377 \text{ ohms}$$

where Z is the impedance of free space.

What distances are considered far? If the radiating source is an antenna, the generally used criterion is that the distance r from the source to the point of interest, that is, to the point at which an instrument performs a measurement, is

$$r = 2D^2 \lambda$$

or more; here D is the largest dimension of the radiating antenna (assuming that the radiating antenna is larger than the pickup antenna of the instrument) and λ is the wavelength of the radiation.¹ At these distances, measurements are made in the far field, or Fraunhofer region, of the radiating source.

Note that a far-field measurement of either the E or the H component determines the other component of the electromagnetic field since they are related by $E/H = 377$ ohms.

This relationship does not hold for measurements made at closer distances to the radiating antenna, where the measuring antenna no longer sees a plane wave of radiation. Note that there is no sharp demarcation line between the far field and the adjacent radiation region, the Fresnel, or intermediate region. Nor is there a sharp demarcation line denoting a boundary between the Fresnel region (which can be described by r being between 0.01 to 5 wavelengths) and the near field (which can be denoted by r being less than 0.01 wavelength) of the radiating antenna.²

Radiation measurements that are made at the higher frequencies are generally made in the far field. However, it is often difficult or inconvenient to make measurements in the far field at the longer wavelengths; for example, the far field of a dipole radiating at 300 Kc begins at about 3 miles away from the dipole (using $r > 5 \lambda$ as the criterion for the far-field boundary).²

Radiated waves in the near field and the intermediate region of a source of radiation have either a lower or higher impedance than that of free space, depending on whether the radiation source itself has a low or high impedance, respectively.³ Thus, measurements of both E and H should be made in the near field and the intermediate region to obtain their true magnitudes

REFERENCES

- (1) B. Lindeman, A New Look at Fresnel Region Phenomena, *Fourth Nat'l Symp on RFI*, San Francisco, June, 1962.
- (2) "Reference Data for Radio Engineers", p664, IT&T Corp., New York, 1957.
- (3) R. A. Bartfeld, Power Flow Measurements in the Near Field, *Fourth Nat'l Symp on RFI*, San Francisco, June 28, 1962.

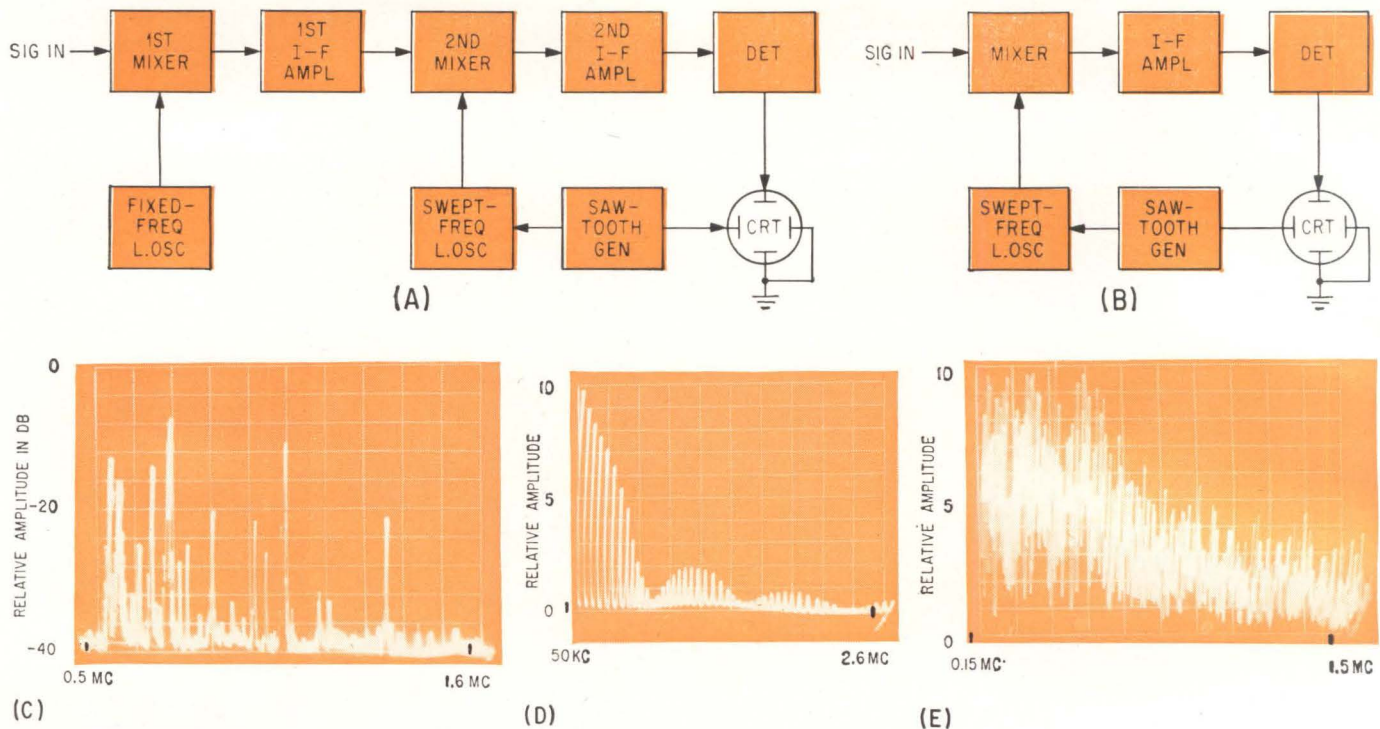

SPECTRUM ANALYZER in (A) scans the spectral content of incoming signal at an i-f; analyzer in (B) scans input signal in its front end. Photos (C), (D) and (E) show spectrum-analyzer displays (Electro-Magnetic Measurements)—Fig. 9

wide dynamic range (dynamic range is the spread between the lowest and highest signals that can be suitably reproduced); low internal noise; and constant gain and high selectivity over the tuning range.

The amplified signal goes to the first mixer, where its frequency is translated. The mixers and local oscillators must not produce or pass spurious responses.

The i-f bandpass should mesh with that of the r-f selectivity curve so that the overall bandwidth of the instrument, which is largely determined by the i-f bandwidth,¹⁰ is constant over the tuning range of the instrument. The i-f amplifiers must have a wide dynamic range; 60 db is typical.

A spectrum analyzer can be connected to the output of the second i-f to obtain a visual display of the signal's spectral structure.

The beat frequency oscillator can be used to help identify c-w signals.

The detector and weighting circuits respond to the signal in one of four ways selected by the operator. These responses are called average, peak, quasi-peak, and slide-back peak. The response that might be selected would depend on the type of signal and the kind of information desired about the signal.^{7, 11}

In the average-response mode, the detecting circuit responds to the average carrier level of a modulated or unmodulated carrier. Detector-load time constants are 600-msec charge and 600-msec discharge.

In the peak mode, the detecting circuit has a fast charge time and a slow discharge time. Thus, it responds to the peak level of the signal.

In the quasi-peak mode, the time constants are typically 1-msec charge and 600-msec discharge.

The slide-back-peak mode is used when the signal contains different peak levels and the operator wants to check one peak and disregard others that are higher.

The operator applies a negative bias to the detector, adjusting the bias until it equals the peak level of interest; he recognizes this condition by utilizing an aural or visual indicator. The bias voltage, which equals the peak of the signal, is indicated by the vtvm.

The inset in Fig. 8 shows a typical impulse-generator calibrator of rfi meters. The switch is mechanically driven; it is switched at a low prf and discharges the charged coax line, producing an 0.0005- μ sec-wide pulse. This pulse contains frequency components that have equal amplitudes between 150 Kc to 1,000 Mc.¹⁴ Since the supply voltage is regulated and all impulse-generator components are stable, its output amplitude is constant. Impulse generators that produce a flat spectrum to 10 Gc are available.

A c-w signal generator is used as a standard when calibrating impulse generators.

SPECTRUM ANALYZERS—These versatile instruments are powerful tools of rfi engineering. Figure 9A shows a swept i-f type of spectrum analyzer.¹⁵ The input signal is heterodyned in mixer No. 1 by a local oscillator whose frequency is fixed, though tunable. The resulting i-f output is amplified and then heterodyned in mixer No. 2, by the swept-frequency local oscillator. Each sawtooth of the sawtooth generator varies the local-oscillator frequency linearly with time. The resulting i-f output is amplified, detected and applied to the vertical plates of the crt display. Since the sawtooth generator also drives the horizontal plate of the crt, the spectral components of the input test signal are displayed as a plot of amplitude versus frequency.

A swept-front-end type of spectrum analyzer is shown in Fig. 9B.¹⁵ Here, the frequency-swept local oscillator heterodynes the input signal in the first mixer. This

system can produce a wider dispersion, that is, it can present a greater range of frequencies, than the swept i-f spectrum analyzer.

Typical analyzer displays are shown in Fig. 9C to 9E. The display in Fig. 9C shows spectrum monitoring of the radio broadcast band; Fig. 9D displays the spectrum of a 1.3- μ -sec-wide d-c pulse; Fig. 9E shows the spectrum of rfi radiated from a brush-type electric motor.¹⁰

Figure 10 illustrates several applications of spectrum analyzers to rfi control. In (A), the spectrum analyzer is used to detect radiation leaking out of an equipment and its connectors. The probe is moved over various parts of the equipment, especially those that are particularly likely to leak radiation; control shafts, doors, output connectors and cooling louvres are typical of such sources of radiation leakage.¹⁰

Figure 10B shows a setup for checking the output characteristics of a transmitter.^{6, 17} When S_1 is open, the high-power fundamental frequency is rejected, allowing the analyzer to locate and measure spurious-output frequencies of the transmitter. Throwing S_2 to B connects a standard signal generator that is used to calibrate various frequencies displayed by the analyzer. When S_1 is closed, the analyzer displays the fundamental as well as other frequency components of the input signal that have a sufficiently high amplitude to fall within the dynamic range of the analyzer. Harmonic amplitudes and frequency stability of the fundamental are among the rfi-control characteristics that are thus displayed by the analyzer.

The setup shown in Fig. 10B can be modified to measure the characteristics of the transmitting system as a whole, that is, with the transmitter under test coupled to its antenna.⁹ This is done (Fig. 10C) by replacing the signal sampler shown in Fig. 10B with a receiving antenna and coupling network. The shielded enclosure eliminates undesired radiation from the measuring setup.

Figure 10D shows how a spectrum analyzer can be used in spectrum surveillance. Here, the analyzer displays the amplitudes of all electromagnetic radiation—desired as well as undesired—in a missile-launching area. Note that more than one spectrum analyzer would be required to get a complete and accurate picture of the electromagnetic environment; the display range of typical wide-dispersion spectrum analyzers is only 4 Gc.

Unlike most spectrum analyzers, which respond to the voltage of the input signal, and hence produce a voltage-versus-frequency display, the analyzer shown in Fig. 11A responds to input power and displays power versus frequency.¹⁸ This is especially useful for spec-

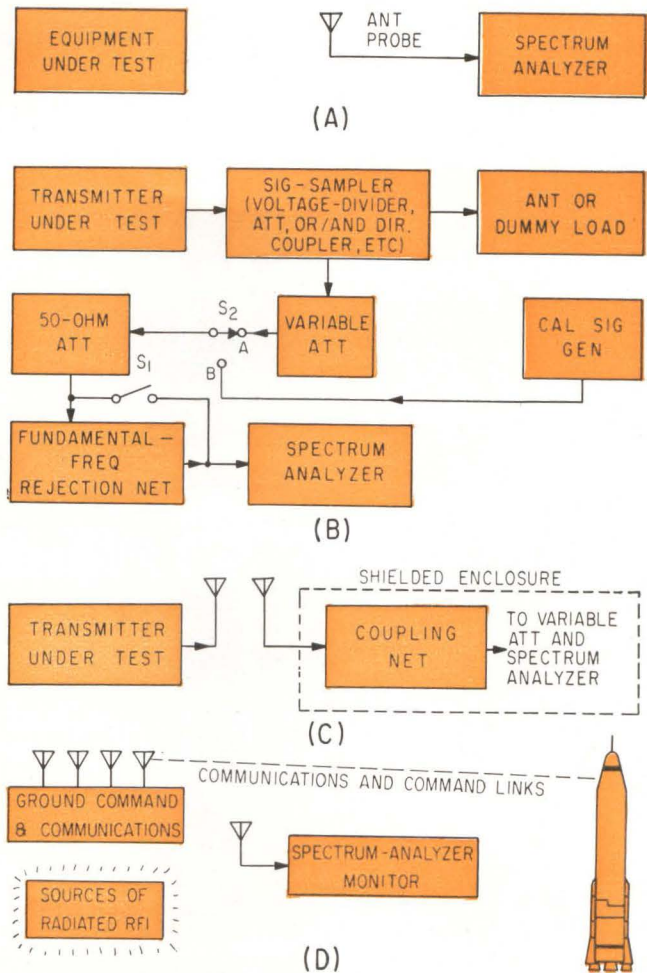

RFI APPLICATIONS of spectrum analyzers are shown in (A) through (D)—Fig. 10

trum-surveillance work, since the mischief caused by an interfering signal may be denoted better by its power level, rather than its voltage level; for example, two interferences having the same frequencies, amplitudes and pulse widths but differing in prf by a factor of ten, would indicate equal amplitudes on a conventional spectrum analyzer, although one has ten times the power of the other. In Fig. 11A, the barretter integrates the signal coming out of the i-f, which has a 1-Mc bandwidth and produces a d-c voltage whose level is proportional to the r-f power of the signal. The amplified d-c voltage drives the vertical plates of the crt. Thus, the average vertical displacement read over a small horizontal distance on the

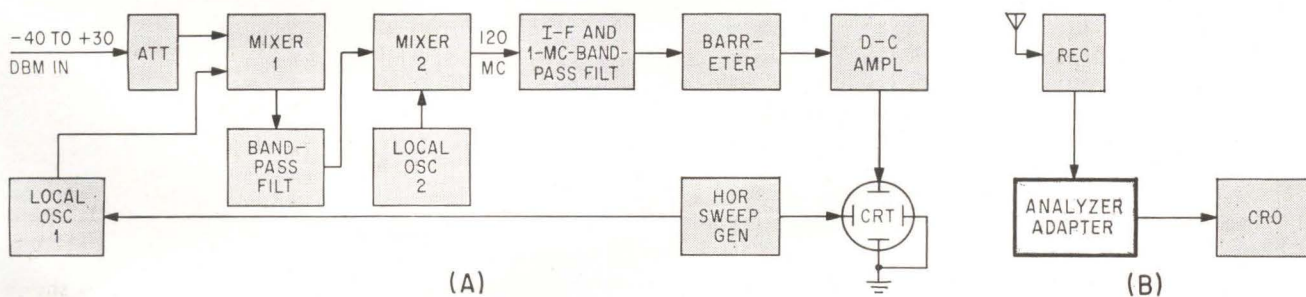

POWER-SENSING spectrum analyzer (A) produces display of input power versus frequency (GE Light Military Electronics Dept.). The adapter unit in (B) is used with a lab cro to make up a spectrum analyzer (Pentronix)—Fig. 11

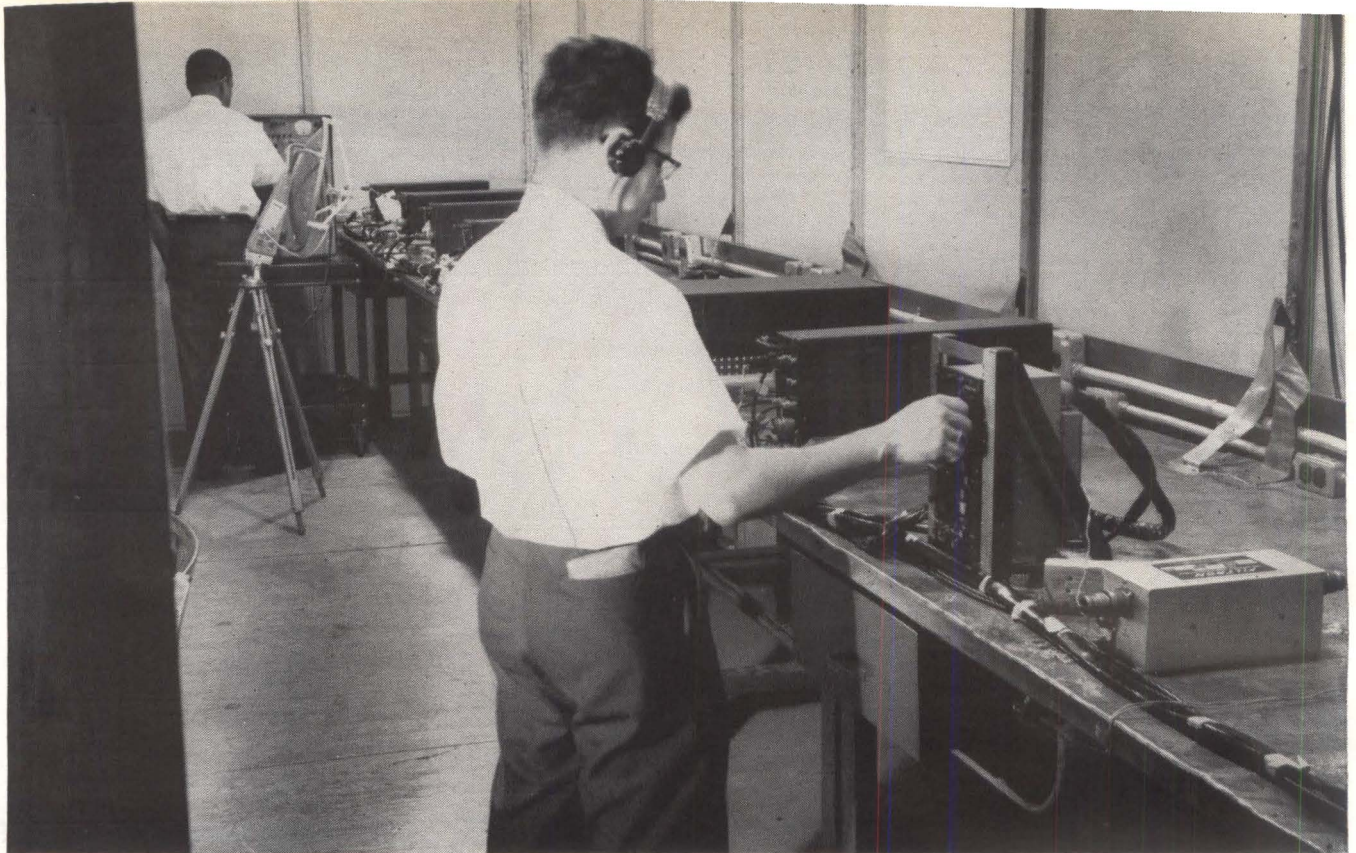

MEASURING the radiation leakage of a receiving system (Loral). Pickup antenna faces equipment being checked—Fig. 12

crt can be calibrated to indicate input-power density (in, for example, mw/Mc).

A recently developed instrument adapter can be hooked up to a standard laboratory cro so that the pair does the job of a spectrum analyzer.¹⁰ As shown in Fig. 11B, the adapter receives the converted test signal from the receiver's i-f, analyzes the signal as would a conventional spectrum analyzer, and sends the detected signal to the cro display. The adapter can accept any input source within its operating-frequency range.

Since the typical spectrum analyzer works like a super-heterodyne receiver that does not have (frequency) preselection, it is necessary to make sure that the analyzer is not indicating a spurious response. Such responses include: local-oscillator image or harmonic responses; feedthrough of a strong input signal that is equal to the i-f; input overloading; intermodulation in the mixer; mixer detection of a very narrow pulse, where the mixer detects spectral energy equal to the i-f.^{15, 17}

An rfi meter can be used to check a questionable indication of a spectrum analyzer. Other techniques can be used to identify spurious responses of a spectrum analyzer.¹⁷ Engineers are also developing a spectrum analyzer that checks itself for spurious responses; although this analyzer does not thereby get rid of its spurious responses, it indicates them, thus warning the operator to recheck or re-interpret the displayed signal.¹⁹

Multiple-filter spectrum analyzers can have high preselection, but may be too expensive and do not have the flexibility of the swept-frequency type of spectrum analyzer. A multiple-filter analyzer uses a large number of filters in its front end to sense the various spectral components of an input signal. The output of these filters is sequentially scanned and passed on to the display, which shows spectral amplitude versus frequency.

TRENDS AND PROBLEMS IN MEASUREMENT—

Taking rfi measurements is often a laborious, time-consuming and difficult job. Military specifications²⁰ on rfi compatibility require that enough tests be made on an equipment to ensure that it is compatible. Such tests (Fig. 12) include broadband and narrowband measurements of conducted and radiated rfi that determine whether the equipment will interfere with other equipment and whether the equipment will be susceptible to interference. These tests may be made over a range of frequencies that includes audio frequencies and extends to 10 Gc and beyond.

The Defense Department's spectrum-signature-collection program requires a formidable amount of testing of r-f transmitters and receivers.⁶ Purpose of this program is to gather enough rfi data on equipment to show whether they will trouble, or be troubled by, other equipment occupying the same electromagnetic environment. A spectrum signature consists of test data describing the performance characteristics of an equipment (or system) over a wide range of frequencies.

Thus, there is a real need for improved instrumentation that will speed up or automate rfi measurements and data processing.

One approach to speed up and automate data taking with an rfi meter is to use a motor to drive the rfi tuner and hence scan all frequencies over the band of the tuner.²¹ A recorder plots amplitude versus frequency (and time). A typical motor-driven tuner scans a 7.3 to 10 Gc tuning band in 2 minutes and 15 seconds.

The trend in rfi instrumentation design is to merge the good features of the rfi meter—particularly its immunity to spurious responses—with the fast-display capabilities of the swept-frequency spectrum analyzer. This trend goes beyond the widely used practice of hooking up a

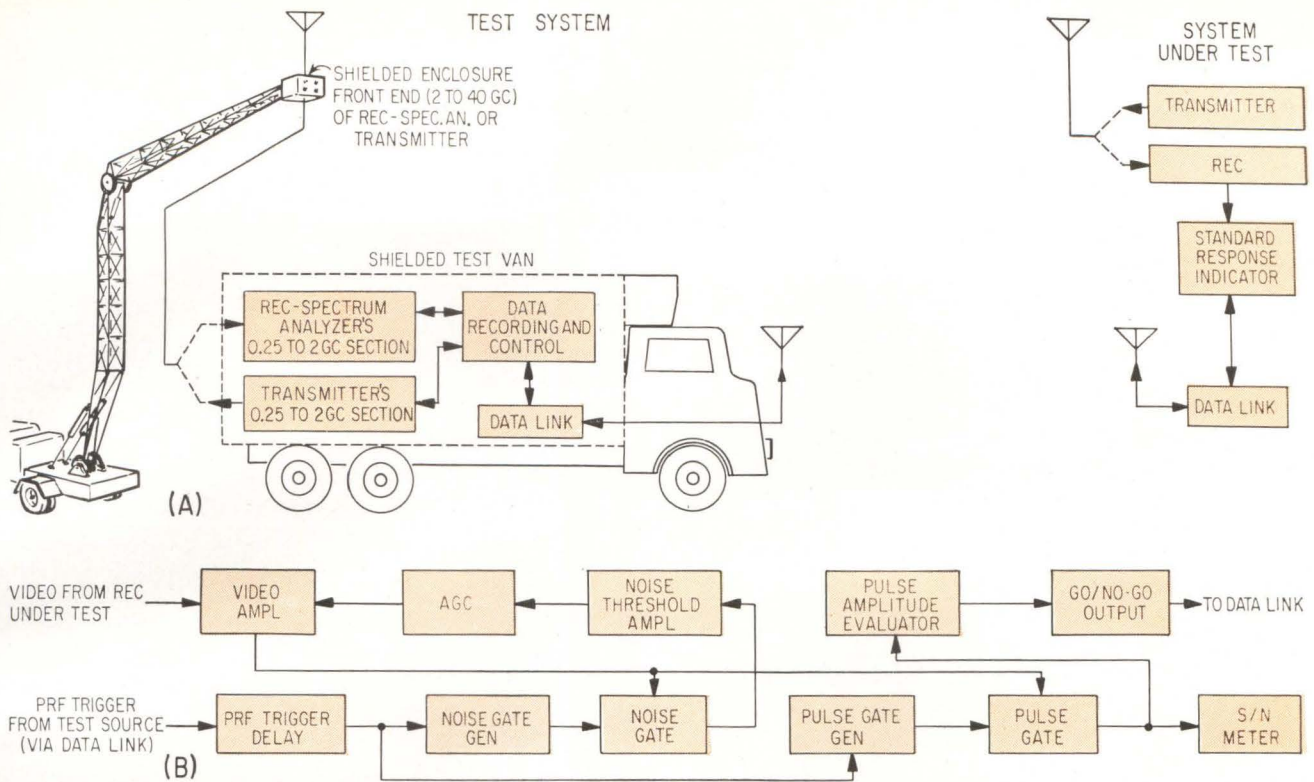

SPECTRUM SIGNATURES of receiver and transmitter (heavy blocks at right) are measured with instrumentation system contained in van and tower (A). The standard response indicator (A) and (B), speeds up and partially automates the measurements—Fig. 13

spectrum analyzer to the i-f of an rifim to obtain a display that is limited to the frequency bandpass of the i-f; this setup makes use of the preselection in the rifim to prevent spurious responses. Thus, the basic rifim instrument of the future probably will be an automated hybrid rifim-spectrum-analyzer²² or a spectrum analyzer that has the immunity of an rifim to spurious responses. Note that the rfi displays shown in Fig. 9C to 9E were taken with a new spectrum analyzer that incorporates preselection.¹⁶

The operational features that the Army requires of a yet-to-be built interference-measuring instrument illustrate design trends in rfi instrumentation.²³ Here are some of the requirements that are listed: electronically tunable preselection; output data to be presented in absolute engineering units on a record such as a magnetic tape; automatic viewing on a crt display of several i-f bandwidth windows; and automatic calibration.

Other goals for improving rfi instrumentation are:²⁴

- increased sensitivity;
- increased dynamic range;
- broader-band antennas
(to require fewer changes of antennas);
- better and wider-frequency-range current probes;
- extension of operating-frequency range;
- extension of the operating frequency range of impulse-generator calibrators;
- improved portability.

SPECIAL INSTRUMENTATION—A great deal of work is going on to develop special instrumentation for obtaining spectrum signatures of equipment in the field. Figure 13A shows a much simplified picture of an instrumenta-

tion setup being developed for the Air Force to measure the spectral characteristics of transmitters and receivers under field-operating conditions.²⁵ The test instrumentation (left) performs measurements over a 0.25 to 40 Gc range. When receiving or transmitting 0.25 to 2 Gc signals, the receiving or transmitting equipment in the shielded van is connected directly to the antenna, which is mounted on top of the adjustable tower. In the 2 to 40 Gc range, the front end of the receiver or transmitter is placed in the shielded enclosure at the top of the tower. The receiver and the transmitter can be tuned manually or automatically.

When the test system is measuring the spectral characteristics of the receiver under test, the standard response indicator (Fig. 13A and B) and the data-link transceivers between the system under test and the test system provide a means of automatically stopping the automatic tuning action of the test transmitter. Suppose the tower antenna is beaming a pulsed test signal to the receiver under test. The standard-response indicator picks off the amplified signal from the video output of the receiver. The prf trigger, which is controlled by the prf of the test transmitter, opens the pulse gate, passing the video signal to a *S/N* meter and to the pulse-amplitude evaluator; the prf trigger also generates a noise sample that develops a noise agc signal to keep the average noise level of the video amplifier constant. The evaluator controls a go, no-go output that indicates whether or not the video falls between two preset levels of the evaluator. These levels are adjustable; for example, the lower level can be set for an *S/N* ratio of 0 db and the upper level at an *S/N* of 20 db. Since the data link transmits the go, no-go output to the test system, it can stop the test transmitter at the frequency at which the receiver produces a spurious response.

SYSTEMS APPROACHES TO RFI SUPPRESSION

WAYS of fighting rfi range from actions taken at the intersystems level down to the circuit and component design level. Actions taken at the intersystem level, which may involve governmental—and international—policies and decisions, affect the course of systems and equipment development; in turn, state-of-the-art anti-rfi capabilities influence policy-level decisions and systems design.

Thus, the many facets of the rfi problem include:

- Inter-systems considerations of rfi. This is the broadest and most complex aspect of the compatibility problem. These considerations involve the interplay and intereffects of complex systems in various operational environments; frequency allocations and assignments, military doctrine and weapons-system operational requirements are among the factors that are involved.
- System-design considerations of rfi. These should begin when the basic concepts of a system are being worked out. System parameters such as location and size of equipment, modulation, operating frequency, signal-power levels and sensitivities are determined relatively early in the game. These parameters determine the course of equipment development and are important factors, perhaps the most important, affecting systems compatibility. Interference-analysis-and-prediction techniques and system-simulating techniques should be used to check the basic design concepts and to check a system's design as it evolves.
- Suppressing interference at the sources of rfi. These techniques include methods of designing circuits and equipment so that they do not generate rfi or so that they produce minimum rfi, as well as methods of suppressing (by shielding, for example) the minimal amount of rfi that is generated.
- Minimizing equipment susceptibility to rfi. These techniques are also used at the equipment and circuit-design level.

This section will discuss inter-systems and systems aspects of compatibility.

RFI AND THE DOD—Since the Department of Defense (DOD) is the biggest user of electronics equipment in America—and the world—it has the biggest rfi headaches. The purpose of the electromagnetic compatibility program of the DOD (Fig. 14) is to help military-electronics systems live harmoniously with each other and with other electronic equipments now and to learn ways to make life even more harmonious in the future. Note that the DOD does not hope to eliminate man-made rfi entirely;²⁶ even if it were feasible someday to prevent the generation of all man-made rfi, the cost of

prevention probably would be prohibitively high; the DOD's goal is to keep rfi generation to reasonably low levels, that is, levels that do not prevent electronic equipments and the people using them from doing their jobs.

Figure 14, which is a flow diagram depicting the DOD's program and its effects on industry, indicates the complexity of the rfi-control problem.²⁶ The DOD's foremost problem is to evaluate the compatibility of the equipment that it has on hand and that it will have in the near future. This job requires analysis and prediction of equipment performance in various environments (see Fig. 3). Thus, the military services are measuring the spectrum signatures of their electronic equipments and gathering data on equipment performance in various geographical areas and for different weather conditions (left-hand column Fig. 14).

Spectrum signatures and environmental data are being compiled at the Electromagnetic Compatibility Analysis Center (ECAC), which is developing techniques for analyzing and predicting rfi. Other DOD installations that are working on rfi analysis and prediction, such as the Army's Electromagnetic Environmental Test Facility (EMETF) at Ft. Huachuca, also utilize spectrum-signature and environmental data. Field testing is used to check the correctness, that is, the validity, of various interference-prediction models. An interference-prediction model is a mathematical representation of electronic equipment in an environment; it consists of data on electronic equipments and their environment and equations that express the performance of these equipment.

Another goal of the DOD's compatibility program is to improve its frequency-management methods and procedures²⁶ and hence get the most mileage out of its portion of the r-f spectrum. Note that this goal (top center block) and the two flanking goals, which are to increase the DOD's ability to analyze and predict interference in a given operational situation and to define an electromagnetic environment, supplement each other.

The DOD cannot as yet accurately define the electromagnetic environment that a proposed system will encounter, nor specify lab or factory tests that are completely satisfactory in demonstrating that a developed system will be compatible.²⁶ When the compatibility program develops the knowhow to completely define the environment of a proposed system, the systems' designers will know what they are shooting for and hence find it easier to come up with a system that does not require extensive redesign after it is tested in the field.

After the basic concepts of a system's design have been worked up, they should be checked out by interference analysis and prediction techniques or by environmental-simulation methods. The DOD is developing simulation methods and equipment that can produce a physical replica of electromagnetic environments in a laboratory.^{26, 27} Simulation methods that are entirely

AND EQUIPMENT COMPATIBILITY

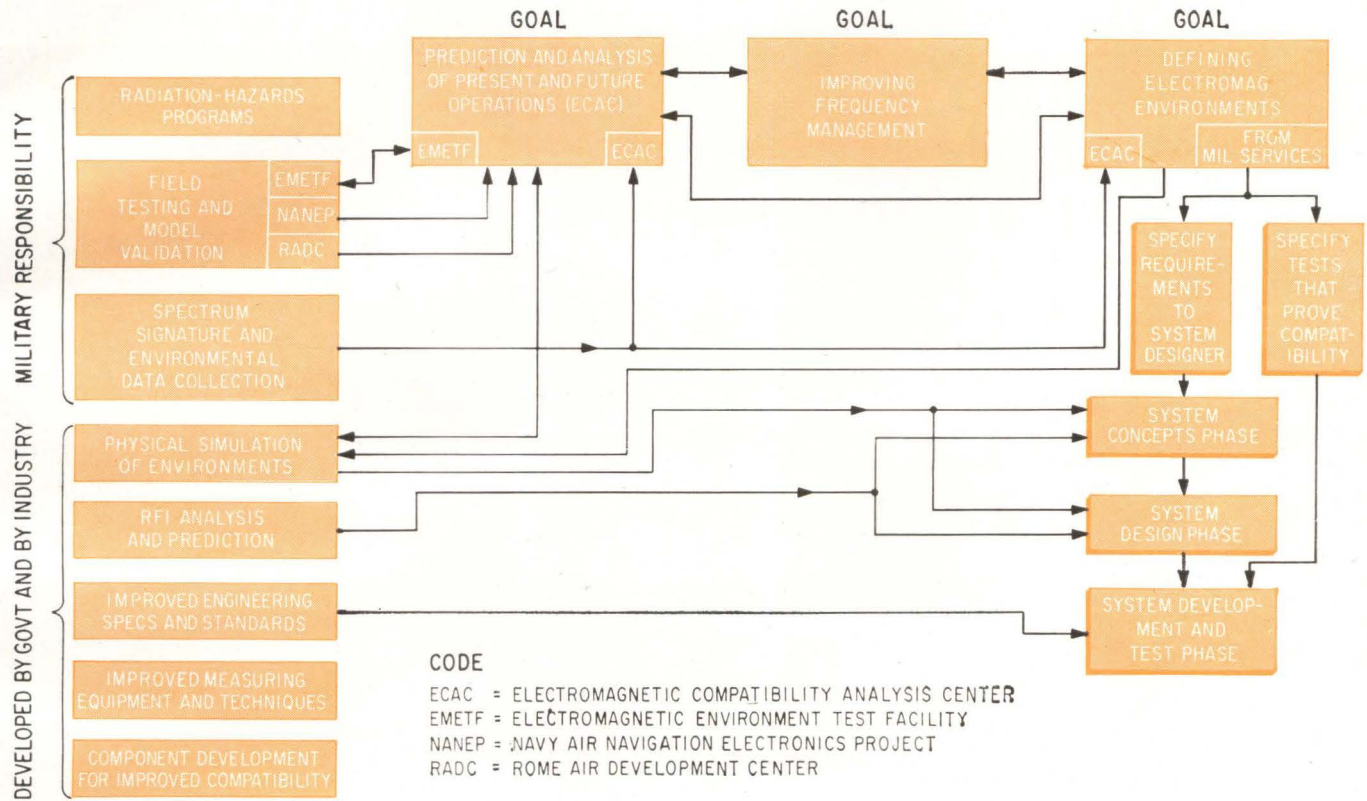

COMPATIBILITY PROGRAM of the Dept. of Defense should help the design of compatible systems (shaded blocks to right). Compatibility of a system will be determined to a great extent by its electromagnetic environment—Fig. 14

analytical, in other words, are run entirely by computers, also have been developed.

Other aims of the DOD's compatibility program include the development of improved engineering specifications and standards on rfi, and programs for developing improved rfi-measurement techniques and improved components that produce less rfi or are less susceptible to rfi.²⁰ Programs involving radiation hazards of rfi²⁰ have three aspects: • hazards to personnel (10 mw/cm² radiation has been tentatively established as the maximum exposure that a human can tolerate); • hazards to ordnance devices such as fuzes (project HERO and others; and • hazards to inflammable liquids (SPARKS project).

RFI PREDICTION—The basic approach that is taken to predict the performance of interacting electronic systems is to simulate them by setting up a mathematical model, or equivalent representation, of the systems and the parameters affecting their performance. Figure 15A outlines the interference-prediction model developed by the Army's EMETF²⁰ (see EMETF blocks in Fig. 14). The blocks represent data inputs and the arrows represent data flow in a computer that is programmed to predict the performance of the communications system indicated in

the upper row of blocks. The other rows represent various sources of rfi that travel to the communications-system receiver over different propagation paths (see Fig. 3).

This model (Fig. 15) is being used with field testing facilities at the EMETF to check the performance capabilities of Army electronic equipment and to investigate ways to improve their performance. The analytical model shown in Fig. 15A and the field-test facility are capable of simulating the 12,000 transmitters assigned to an Army corps, which normally occupies an area that is only 40 miles wide and 60 miles long. The analytical and field-test approaches will complement each other.²⁰

Figure 15B²⁰ shows how the computer is programmed to simulate the mathematical model shown in Fig. 15A.

The receiver and transmitter information inputs to the Interference Control (IC) block come from operational data such as location and assigned frequency and from a file of spectrum signatures that had been compiled in the lab and is now stored in the computer. The IC block (No. 1) processes the receiver's spectrum-signature data and prepares a table comprised of the receiver's spurious-response and intermodulation frequencies and cochannel and adjacent-channel interference-frequency

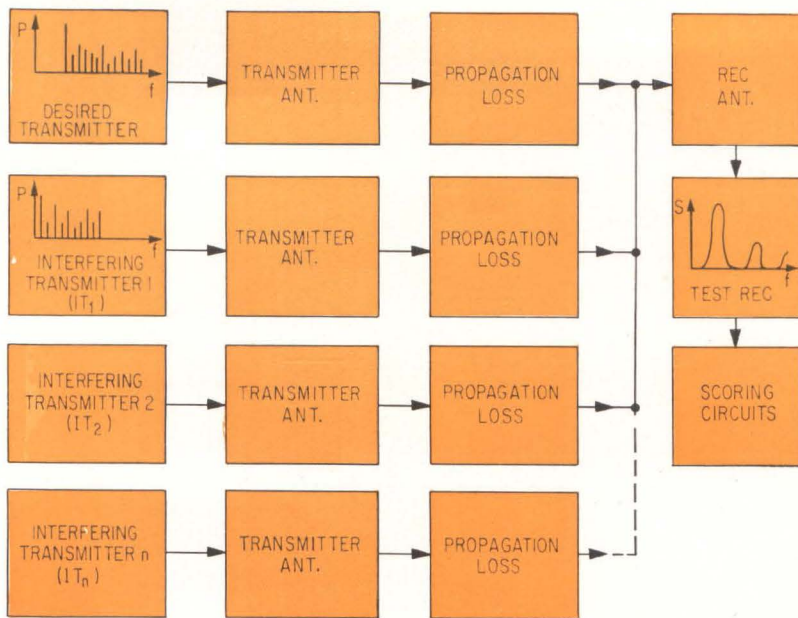

(A)

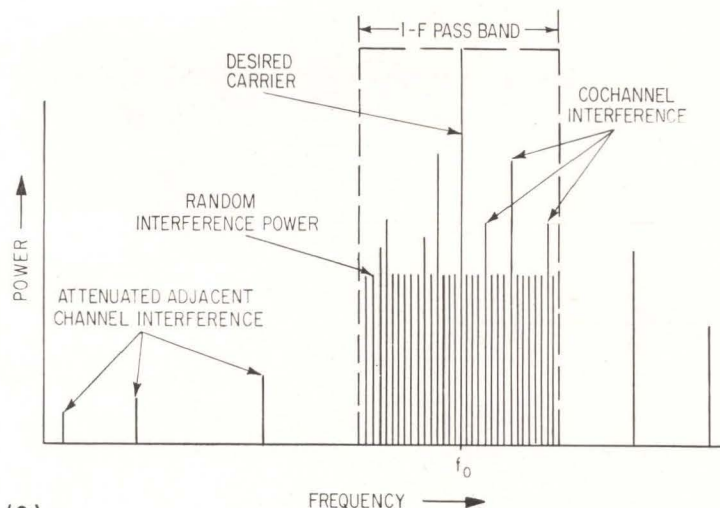

(C)

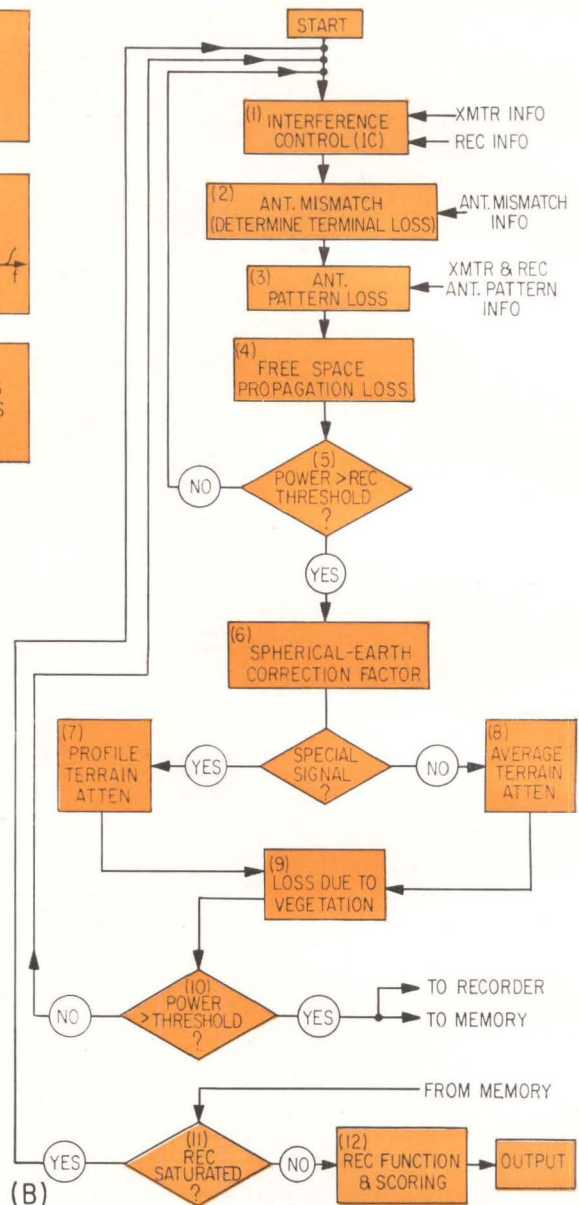

(B)

MATHEMATICAL MODEL of the electromagnetic environment of the communications system shown in the upper row of blocks (A). Computer programming is shown in (B) and the spectrum of the signals presented to the computer program that simulates the receiver demodulator is shown in (C)—Fig. 15

ranges (these terms are defined on page 58); this table of frequencies and corresponding sensitivities (the F table) is stored in the computer's memory.

The IC block then looks at the spectral characteristics of one of the transmitters, for example, Interfering Transmitter No. 1 (IT_1) of Fig. 15A. The IC block then compares the spectral components of IT_1 with the receiver-response frequencies stored in the F table. If none of the transmitter frequencies match any frequencies in the F table, the IC block eliminates IT_1 from further consideration as a source of trouble, and then looks at the spectral characteristics of IT_2 ; on the other hand, if one or more of the spectral components of IT_1 are of the same frequency as those in the F table, there is a possibility of interference and each of these spectral components is sequentially passed on to block 2 for further analysis.

The function of block 2 is to add a loss factor, where

necessary, to the output power of the transmitter-frequency component passed by the Interference Control. This is necessary because many spectrum-signature measurements involving a transmitter-antenna combination do not account for transmission-line loss or for the mismatch of the antenna and transmitter impedances; this mismatch is particularly likely to occur at frequencies other than the fundamental.

The third block accounts for the loss (or gain) that is due to the patterns and orientations of the transmitting and receiving antennas. Thus, the input to block 4 corresponds to the power that would be picked up by the receiving antenna if there were no propagation losses.

Block 4 calculates the power that the receiver would get if the transmitted frequency components were propagated through free space.

The comparator (5) compares this power with the

threshold sensitivity of the receiver. If the spectral-component's power is not greater than the receiver's threshold, this spectral component is dropped from further consideration (NO circle) and the IC block starts a new program cycle by sending another spectral component of IT_1 onto block 2 or by starting a comparison of the spectral components of IT_2 with the F-table frequencies. On the other hand, if the spectral component's power is greater than the receiver's threshold, it is passed on to block 6.

Here, a propagation-loss correction (a spherical-earth correction factor) further modifies the transmitted power, generally attenuating it.

The output of block 6 goes to block 7 or 8, depending on whether or not it is a special signal, such as the fundamental of the desired transmitter, or a typical signal. Block 7, which handles special signals, performs a more thorough analysis on path loss as a function of terrain than block 8, which handles most signals.

After block 9 throws in a loss factor that is due to vegetation in the propagation path, the comparator (10) compares the signal power level with the receiver's threshold sensitivity. If signal power is not greater than the receiver's threshold, the IT_1 signal is discarded and the IC block repeats the program with another rfi

signal; if signal power is greater than threshold, information identifying the signal is printed out for human analysis and is stored in the memory for subsequent use in an interference-scoring process that takes place after the computer runs through its analysis of all frequencies that can interfere with the receiver.

After all the rfi signal components that can affect the receiver have been determined, these signals, which include the desired as well as the interfering signals, are summed and applied to comparator 11. If the summed power exceeds the saturation point, or upper limit of the receiver's dynamic range, a condition of complete interference is assumed for the receiver under test. If the summed power input does not exceed the saturation point, the signals are passed on to block 12, which is the portion of the computer program that simulates the receiver demodulator and scores the performance, that is, the intelligibility, of the system.³⁰

Figure 15C shows the spectrum of the input to the demodulator simulator.²⁹ Note that this input corresponds to the signal that would be passed by the i-f of the receiver under test and sent to the receiver demodulator. The demodulator input consists of the desired carrier, transmitted rfi components and random noise that is present in the i-f amplifier of the receiver under test. To

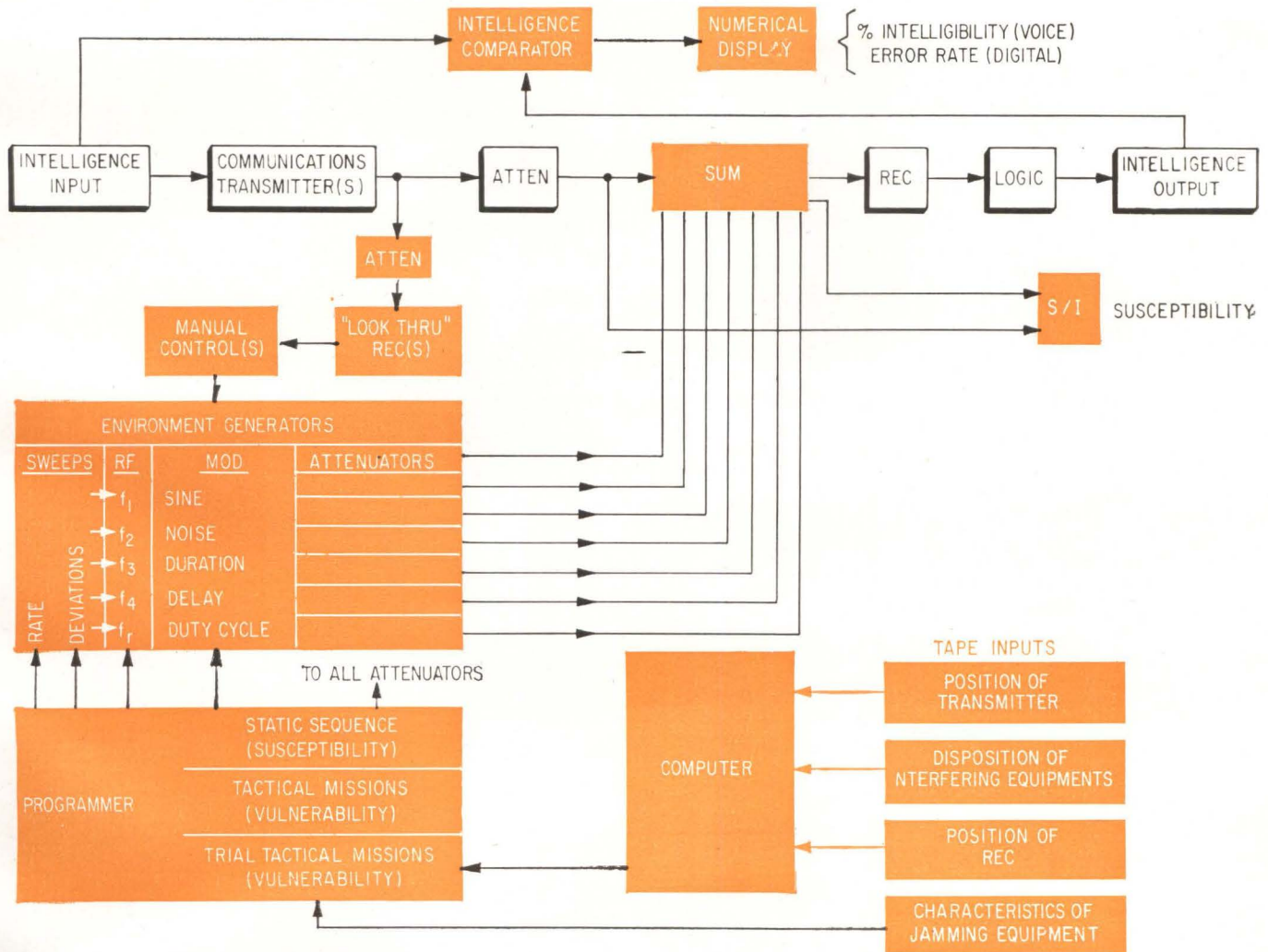

PHYSICAL SIMULATION of the environment of the communications system denoted by the black and white blocks is achieved by this simulation system (brown blocks) (White Electromagnetics)—Fig. 16

come up with the spectrum shown in Fig. 15C, the computer treats the desired carrier (the fundamental) and the relatively small number of rfi signal components that have amplitudes significantly greater than the amplitudes of the great majority of the rfi components, as discrete components; on the other hand, the computer sums the powers of the smaller rfi components. The random-noise power that is present in the i-f amplifier (for example, shot noise and atmospheric noise) is added to the power total of the smaller rfi components. The total expresses the normal distribution of the total noise power, which is denoted in Fig. 15C by the power level of the random-interference-power components; the equal height of these components represents the total random rfi power. The power of each of the discrete rfi components and the fundamental are added to the random-rfi-power level.

Note that the computer's decision-making procedures reduce the interference-prediction problem to manageable proportions.³⁰ If there were 15,000 sources of potential interference to a receiver (n equals 15,000 in Fig. 15A), each of which emitted 10 interfering signals, the computer would have to perform complete analysis of 15,000 transmissions if it did not have the elimination procedures indicated in blocks 1, 5 and 10 of Fig. 15B. Although computers are fast and a computer could run through a complete check of one rfi signal in a minute, 150,000 complete checkouts would add up to 2,500 computer hours!

PHYSICAL SIMULATION—Another approach to the problem of predicting the compatibility of electronic equipment is to physically simulate an rfi environment in the lab. The complexity of such physical-simulation setups ranges from those capable of simulating any type of complex environment²⁷ to simulators designed for equipment evaluation and testing and for training purposes.³¹

Figure 16 shows a simulation system that can be used to evaluate a communications system (shaded blocks) in the conceptual stage of its development as well as in its design-and-development phases.³²

The simulation system subjects the system under test to an environment that tests its capability to produce intelligible signals at the receiver's output.

Input tapes provide the computer with such data as the disposition of the interfering equipments. The computer controls the programmer, which drives the environmental generators. Outputs of the environmental generators are summed in a combining network that also receives the transmitted signal. Thus, the input to the receiver of the system under test consists of the desired signal and the interference signals. The capability of the communications system to transmit intelligence is measured by comparing the intelligence originally conveyed to the transmitter with the intelligence at the output of the receiving system, and by providing a suitable indication of the intelligibility of the system.

The susceptibility block measures the signal-to-interference (S/I) ratio applied to the receiver. The S/I ratio and the intelligibility readout together indicate the susceptibility of the system; for example, a low S/I and a high-percent intelligibility (for a voice-communications system) denote that the system has a relatively low susceptibility to rfi. The susceptibility of a complex system that might be subjected to many types of rfi could be described by a many S/I s and intelligibility indications.

Varying the intelligence input and the environmental generators over a period of time so as to simulate actual missions thereby subjects the communications system to an operational-type test. This type of test provides information on the system's vulnerability to rfi in performing its mission.

This simulation setup can also be used to check the basic concepts of a system as they are being worked out. To do this, the transfer functions of the system would be set up on a computer (these transfer functions would replace the system under test in Fig. 16).

SYSTEMS CONCEPTS AND RFI—How can the most efficient use be made out of the available spectrum? This question is faced by people responsible for allocating portions of the frequency spectrum "belonging" to the U.S.A. (by international agreement) as well as by engineers trying to design compatible systems that must operate in an allocated—and probably crowded—portion of the available spectrum.

The straightforward approach is to use smaller trans-

RFI: CAUSES, EFFECTS AND CURES

SUPPRESSING RFI AND

SYSTEMS and intersystems considerations of rfi, which were discussed in the preceding section, are only part of the rfi-control problem. Even the overall approach to the design of a compatible electronics system must take into account the anti-rfi capabilities of the equipments and components that will comprise the system. This section will discuss these capabilities from two viewpoints: (1) preventing or limiting the generation and propagation of man-made rfi; (2) making equipments less sus-

ceptible to the ambient rfi—natural as well as man-made—in their environment.

Although complete suppression of man-made rfi is probably either impossible, uneconomical or/and unnecessary, there's much that can be done to reduce rfi right at the source, that is at the points at which it is generated.

There are three general approaches to suppressing rfi at the source: improve the characteristics of the equip-

mission-channel bandwidths, thus allowing more channels to operate in a given slice of the spectrum. However, the state of the art limits the squeezing that is possible. Frequency stabilities of transmitters and receiver local oscillators, the accuracy with which tuned circuits can be designed, the bandpass characteristics of filters, and the amount of isolation required between channels are among the factors that impose minimum frequency-spacing requirements between channels.³³

Furthermore, a narrow-bandwidth system is generally more susceptible to rfi than an identical system having a wider bandwidth.³⁴ The wide-bandwidth approach appears to be particularly promising for networks whose assigned transmitting stations are off the air most of the time.^{33, 35} Among the techniques that can be used to transmit effectively over a wide band of frequencies are: • frequency hopping; • simultaneously transmitting the same signal over a large number of frequencies, dividing the power equally among the transmitted frequencies and then recombining the signal in the receiver; • modulating the carrier so as to spread the sidebands over a relatively broad band of frequencies on both sides of the carrier.

Coding techniques that may or may not use wide bandwidths can provide a high degree of relative immunity to rfi. For example, the RACEP system (Random Access and Correlation for Extended Performance),³⁶ which can handle several hundred users on 4-Mc channel, uses frequency-time coding. When a RACEP transmitter sends a message to one of the receivers in the network, it selects the code corresponding to the desired receiver; other receivers in the net cannot receive this transmission. In the transmitter, a data pulse (No. 1, Fig. 17A inset) is fed to three delay lines that have different delays. Thus, the pulses at the outputs of the delay lines are staggered in time (2, 3, 4 of Fig. 17A). These pulses are transmitted on three different frequencies. The receiver that has the correct delay-time address accepts these pulses since it has complementary delay lines (Fig. 17B) that recombine the three pulses at a coincidence gate circuit; the gate produces an output pulse that corresponds to the data pulse. Since other RACEP receivers have different sets of delay lines, their gates remain closed.

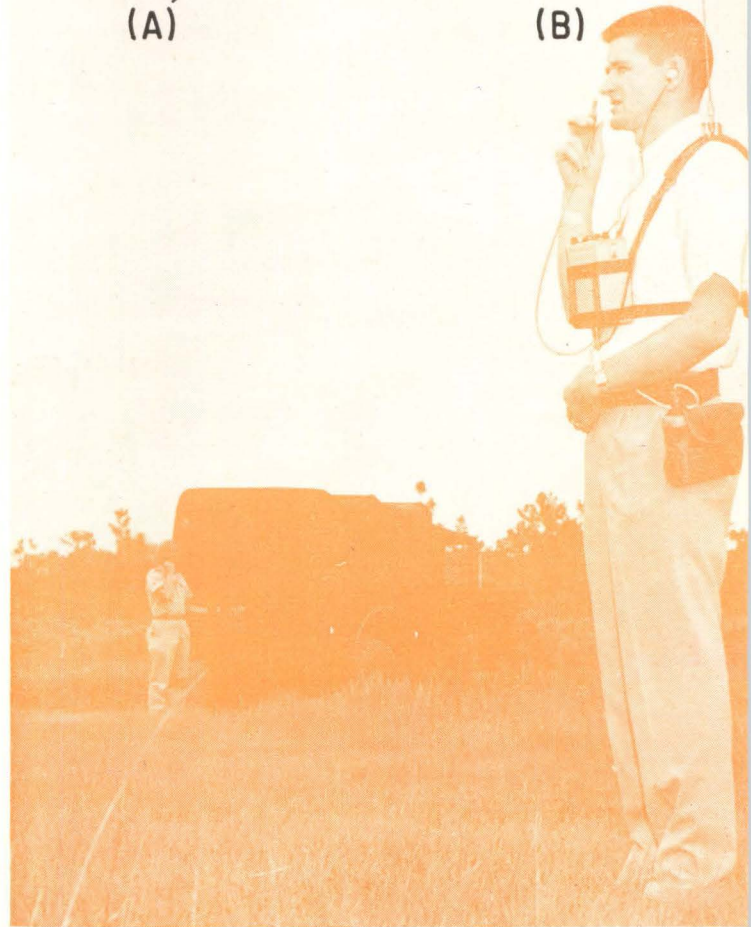
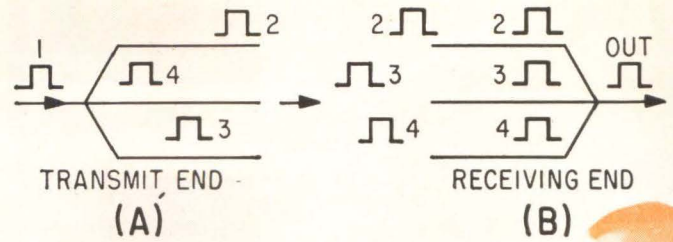

BASIC CONCEPTS of a system's design do much to make the system less susceptible to rfi. Photo shows such a communications system being tested in the field (Orlando Div. Martin). Insets show pulse shapes at transmitting (A) and receiving (B) ends of system—Fig. 17

MINIMIZING ITS EFFECTS

ment or component generating the rfi so that it will produce less rfi; attenuate the generated rfi—preferably as close to the generating source as is possible—before the rfi gets to equipment that is susceptible to it; operate the equipment so that the rfi it generates causes a minimum of trouble.

TRANSMITTERS AND TUBES—Ideally, a transmitter should transmit energy only on its assigned band of fre-

quencies and should transmit only the desired signal. However, transmitters produce undesired, that is, spurious, frequencies in addition to the desired signal frequency.

Some of the causes of spurious emissions in communications or/and radar transmitters are:^{6, 37}

- parasitic oscillations;
- overdriven amplifiers;

- nonlinear operation;
- intermodulation, where an undesired frequency combines with a desired frequency in a nonlinear element to form a third (undesired) frequency;
- cross modulation, where the undesired modulation of an undesired carrier affects the desired modulation of the transmitter;
- frequency multiplication;
- sideband splatter, that is, emissions appearing outside the transmitter's assigned bandwidth, which can be caused by overmodulation, excessive modulator bandwidths, short-duration modulator pulses, or modulator nonlinearity.

Parasitic oscillations are suppressed by neutralizing feedback circuits or using parasitic suppressors.³⁷

Proper operation and design should prevent overdriving of amplifiers and nonlinear operation; where nonlinear operation is desired, spurious emissions may be minimized by proper selection of the operating point.^{9, 37}

Since intermodulation and cross modulation can be caused by undesired frequencies entering the transmitter through its antenna, one-way isolators or directional filters might be used to eliminate or reduce this source of rfi. Selecting the best region of operation for the output tubes or transistors also helps.³⁸

Direct generation of the desired frequency will produce less spurious emissions than the frequency-multiplication method. When frequency-multiplication methods are used to obtain the desired transmitter frequency, use as low an order, that is, factor, of multiplication as is feasible; do the multiplying at low-power levels and use double-tuned circuits and filters.^{9, 37} Frequency synthesizers having low spurious outputs are used in some transmitters (Fig. 18A).³⁹

Sideband splatter can be limited by careful design of the modulator circuits, and for pulsed modulators, by shaping of the modulator pulse. Gaussian and cosine²-shaped modulation pulses should produce fewer and lower-level sideband spectra than rectangular-shaped modulation pulses.^{9, 40}

An isolator can be used to reduce frequency pulling in a magnetron, which is caused by changes in the impedance of its external load. Frequency pushing, which is a frequency change accompanied by a variation in anode current, in a voltage-tuned magnetron can be limited by regulating its anode, injection-electrode and filament voltages.⁴¹ Magnetron moding, where the magnetron oscillates in more than one mode, can be eliminated by matching the modulator network to the magnetron that it drives.⁴²

Automatic-frequency-control circuits can be used to stabilize microwave-oscillator frequencies.⁴³

TUBES—The high-power magnetrons and klystrons that are used in radars produce spurious emissions that have relatively high amounts of power. Note that a harmonic that is 30 db below a fundamental having a peak power of 1 Mw has a peak power of 1 Kw—this level is enough to affect receivers hundreds of miles away! Since typical specifications on spurious emissions set limits that apply to the transmitter's output, designers meet these specs by using filters to reduce spurious emissions (Fig. 18B). Frequency instability in oscillator tubes worsens the problems created by spurious emissions; for example, a transmitter fundamental could drift far enough in frequency to become a spurious input to a receiver that otherwise would not be susceptible to the assigned frequency of the transmitter.

Although filters do a good job (a typical commercial unit operating in the S-band can handle 5-Mw-peak fundamental power with an insertion loss of 0.15 db and provide up to 50-db insertion loss of the second, third and fourth harmonics), they add to the weight (this S-band filter weighs 50 pounds), size and cost of an installation. Ideally, the high-power oscillator or amplifier tubes at the output of a transmitter should not produce spurious emissions.

There appears to be no concerted drive by government or industry to develop tubes that are free from spurious outputs. However, tubes are being developed that pro-

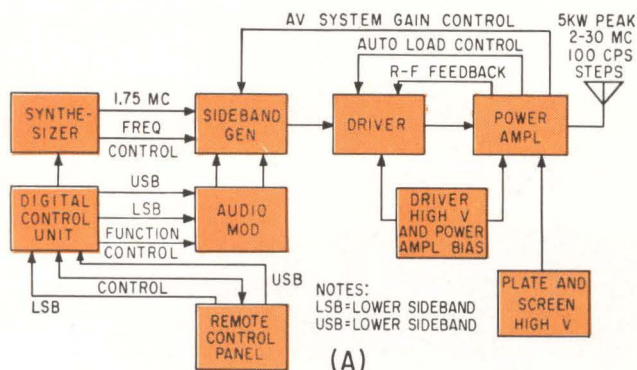

(A)

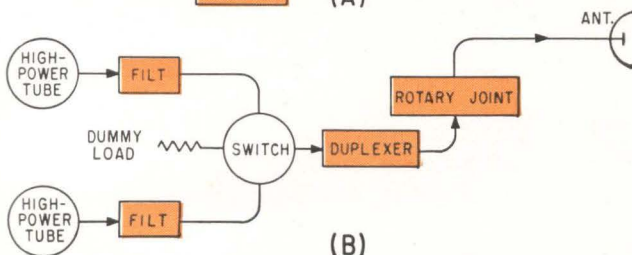

(B)

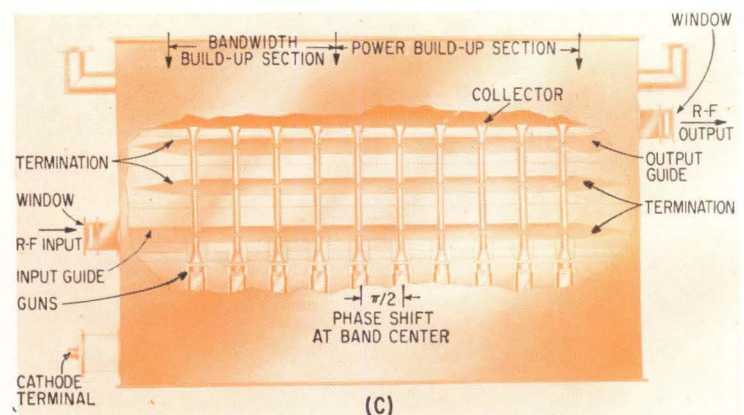

(C)

SYNTHESIZER (A) helps reduce spurious emissions in transmitter (Manson). Use of harmonic filters (B) at outputs of transmitting tubes cuts high-power harmonics. New traveling-wave multiple-beam klystron tube (GE Power Tube Dept.) produces fewer harmonics than conventional klystron (C)—Fig. 18

TABLE II—RFI GENERATORS AND WAYS TO MINIMIZE THEIR EFFECTS^a

Generators	RFI Causes & Effects	Ways to Suppress RFI
Antennas	Orientation or proximity to receivers that do not want its transmissions. Poorly bonded stays, dirty insulators, or corroded connectors produce broadband rfi.	Reorient antenna or relocate antenna or receiver; use antenna with better directivity; filter receiver input. Preventive maintenance and proper installation.
Components⁹	Underrating passive components (resistors, capacitors, inductors, transformers) and active devices (tubes and transistors).	Operate conservatively. This will prevent rfi from causes such as arcing in the dielectric of an under-rated capacitor.
Converters: Frequency and D-C to A-C Inverters	Conduct and radiate broadband rfi due to internal switching.	Weigh merits of rotary converters against electronic converters. Use shielding and filtering. Use pulse shaping to reduce rfi in electronic converters. ¹⁷
Fluorescent Lights	Produce rfi that is conducted by power lines and radiates rfi.	Replace with incandescent lighting or filter out the conducted rfi and use conductive glass to shield radiative rfi. ^{4,8}
Generators and Motors	Send broadband rfi into power lines and radiate rfi; a-c generators also produce harmonics.	Avoid use of brushes, commutators or slip-rings, ¹⁹ but use brush (or conductive grease) on shaft's ball bearings to prevent charge buildup in armature; machines should have good concentricity. Shield ventilation ports and filter output/input leads. In d-c machines, use preventive maintenance; a large number of commutator segments reduces rfi. ⁵⁰
Ignition Systems	Radiated broadband rfi is due to inherent arcing.	Shield the ignition system parts; shape (round out) the ignition pulse. ⁵¹
Mercury-arc Rectifiers	Produce radiated and conducted broadband rfi.	Shield and filter or replace with solid-state or hard-tube rectifiers, if possible.
Power Supplies (D-C)	Conductive rfi. Transients produce broadband rfi; also a-c ripple, which is usually negligible.	Suppress transients and filter out the a-c ripple.
Relays	Produce conducted and radiated rfi.	Place R-C circuit across protected contact or across the load. Shield.
Refrigerators	Motor-driven compressors produce conducted and radiated rfi.	Use thermoelectric coolers.
Switches	Produce conducted and radiated broadband rfi.	Place R-C circuit across switch, if possible.
Thermostats	Produce conducted and radiated broadband rfi.	Connect thermostat to ground side and place R-C across it. Shield.
Transmission Lines, High-Power⁵²	Conducted and radiate broadband rfi created by: distribution-system components; rfi sources at the loads; natural phenomena such as corona.	Preventive maintenance (avoid sharp points on line) and install properly; use filters where possible; avoid running communications lines parallel to high-power transmission lines; use corona shields on insulators.

(a) This Table was compiled mainly from Reference No. 46; other sources are References 47 through 52, which are noted above.

duce lower spurious emissions and have better frequency stability than their predecessors, even though the prime development goal may have been a target such as increased power.

Figure 18C shows a multiple-beam traveling-wave klystron amplifier whose structure reduces harmonic generation. Even though a special effort to reduce harmonic generation was not made, the harmonic content of this klystron is 10 to 15 db less than that of a single-beam klystron.⁴⁴ The input voltage travels along the input guide, velocity-modulating each of the ten electron beams in sequence.⁴⁵ The modulated beams produce a traveling wave in the output waveguide. Each waveguide has an array of 10 resonator gaps that provide $\pi/2$ radians phase delay per gap at the desired frequency. Tube dimensions are chosen to avoid resonances at the harmonic wavelengths. Wide bandwidths and high powers (a developmental model has delivered 32 Kw c-w at X-band) appear to be possible with this design approach. Further development will try to evaluate and improve the phase stability and harmonic content of these tubes.⁴⁴

OTHER RFI GENERATORS—Although communications and radar transmitters and transmitting tubes are perhaps the most important members of the rfi-generator family, this troublesome family has many other members. Table II lists some of these generators and suggests possible ways to prevent, or limit, their effects. Note that filtering and shielding, which are briefly discussed below, suppress rfi after it has been generated.

Selection of an rfi-suppression approach depends on

the design tradeoff, that is, the consideration of factors such as relative cost, size and efficiency, as well as the degree to which rfi must be suppressed. For example, a rotary converter might generate less rfi than an equivalent solid-state d-c to d-c converter; however, even though the solid-state unit consequently requires more filtering, it may still be more efficient than the rotary converter; also, the amount of pulse shaping used in the solid-state unit to limit rfi depends on an efficiency/rfi tradeoff.⁴⁷

OPERATIONAL TECHNIQUES—Many rfi problems are solved by positioning electronic equipment, especially antennas, and by routing cables so that they pick up and send out minimal interference. Antennas spacing and orientation are particularly important.⁵

The technique of time-sharing, or assigning operating times to equipments that would interfere with each other were they to go on the air simultaneously provides a practical, rather than ideal, solution to some rfi situations.⁵

Frequency assignment is another method that is used to prevent interference.⁵ Frequency-tunable systems have a built-in defense against rfi since the operator can avoid rfi in a crowded channel by shifting to another frequency; this also helps other users of the channel.

Good installation and maintenance procedures prevent many rfi-induced headaches. Finding and eliminating rfi sources in a poorly installed system can be extremely difficult and costly. Preventive maintenance programs locate and eliminate sources of potential rfi trouble such as: an aging tube that arcs occasionally; a corroded bond between equipment cabinet and the ground plane; motor brushes that should be adjusted or replaced.

SUGGESTED DEFINITIONS OF SHIELDING TERMS

By O. P. Schreiber, Technical Wire Products, Inc., Cranford, N.J.

Manufacturers of shielded rooms and shielding systems have used the terms "attenuation", "shielding effectiveness", and "overall system attenuation" to describe how well their systems work.

Here are some suggested definitions of these terms:

- **Attenuation** — This term should be used only to describe the intrinsic ability of a material to impede the propagation of an electromagnetic wave. The material's attenuation equals the sum of its absorption losses and the reflection losses. If E_1, H_1 and P_1 are, respectively, the electrical-field intensity, magnetic-field intensity and power density of the field on the r-f source side of the shielding material, and E_2, H_2 and P_2 manage to get through the material, then attenuation is

$$20 \log_{10} E_1/E_2 \text{ or } 20 \log_{10} \frac{H_1/H_2 \text{ or } 10 \log P_1/P_2}$$

- **Absorption** — Absorption is the loss of r-f energy due to resistive (I^2R) losses in the shielding material itself. Absorption A is

$$A = 3.34t (\sigma\mu)$$

where t is the thickness in mils, f is the field's frequency in Mc, σ is the conductivity relative to copper (copper's conductivity = 1) and μ is the permeability relative to a vacuum ($\mu = 1$ for nonmagnetic materials).

- **Shielding Effectiveness** — Defines how well a shielding system contains or excludes r-f. This term should be applied only to entire shielding systems, such as rooms, cabinets and other metal packages for electronic equipment. Although it would be measured in the same manner as attenuation, shielding effectiveness describes shielding systems whereas attenuation describes the inherent ability of a material to shield.

- **Insertion Loss** — Insertion loss describes the increase in shielding effectiveness of a system when some component is added. This added component might be an r-f gasket or a honeycomb panel. It is measured by comparing the shielding effectiveness before and after the component is installed. The increase in shielding effectiveness is the insertion loss.

- **Overall System Attenuation** — This term, which has been used recently, seems to define the same property as shielding effectiveness. Since shielding effectiveness is the more descriptive term, it should be used

FILTERING—Filters are used at the outputs of rfi-generator sources to prevent rfi from entering conduction-coupling paths; they are also used to attenuate rfi at receiver inputs that are coupled to conduction paths bringing rfi along with the desired signal or power input. Paths that can conduct rfi into a receiver include its r-f input line and power and control-line inputs and its output leads.

Although the term rfi filter is generally used to describe low-pass filters that suppress rfi, all filters are inherently anti-rfi devices; in addition to suppressing rfi that is generated outside the equipment in which they are located and preventing internally generated rfi from leaking out, they prevent internally generated rfi from affecting the operation of circuits within the equipment. Thus, filters that suppress rfi range in size and function from the massive-high-power harmonic-suppression filters used in transmitters (Fig. 18B) to tiny crystal filters used in low-power transmitter circuits and in receivers. Notch (reject), bandpass and low and high-pass filters, as well as wave-trap filters, can suppress rfi.

SHIELDING—The shielding effectiveness (S) of an enclosure is $S = A + R + B$ where A is the attenuation due to the absorption of the r-f by the shielding material, R is the loss due to reflected energy at both interfaces, and B is an internal-reflection loss that can be neglected if A is greater than 10 db.⁵³ Although increasing the thickness of a shielding material theoretically will provide any desired attenuation (see box), cost, weight and size usually limit this approach to obtaining a desired S . Since shielding effectiveness generally drops at low frequencies, the

lowest frequency for which a desired S is required normally determines the type of shielding material that is used. Ferrous materials, which have higher permeabilities than nonferrous materials, provide greater shielding effectiveness at low frequencies.⁵⁴ High permeability materials such as Mu-metal, Permalloy, Netic or Co-Netic can be used to improve enclosure S for low-frequency low-impedance fields.⁵⁵ Copper and aluminum, as well as ferrous materials, generally provide adequate shielding for above-audio frequencies.

Discontinuities in a shielded enclosure provide avenues of entry for rfi. For example, access covers, electrical connectors, ventilation openings, protruding dial shafts and panel meters allow rfi to enter or leave a shielded enclosure if adequate precautions are not taken.

Gaskets made of wire mesh or spring-contact fingers can be used to prevent leakage at mating surfaces such as cabinet doors or access covers.

Electrical input-output connectors should be bonded or otherwise grounded to the enclosure. The ends of cable shields should be bonded to their connectors.⁵⁶

Ventilation openings should be covered by electroformed mesh or honeycomb filters. The individual cells of the honeycomb filter (see frontispiece), which allow air to get through, act as waveguides, rejecting all r-f below their cutoff frequency.⁹

Interference leaks through the space between a control shaft and the cabinet can be prevented by passing the shaft through a metal tube that is attached to the cabinet; the tube acts as a waveguide, rejecting rfi below its cutoff frequency.⁹

Star washers or gaskets can be used to prevent rfi leaks

MICROWAVE ABSORBENT materials on surfaces of this test chamber absorb r-f energy, thus preventing unwanted reflections (Emerson and Cuming)—Fig. 19



UNDESIRE RESPONSES AND RFI EFFECTS IN RECEIVERS

Spurious Response. A spurious response (f_{sp}) is produced when

$$f_{sp} = \frac{\rho f_{10} \pm f_{i-f}}{q}$$

where f_{10} is the local oscillator frequency, f_{i-f} is the i-f frequency, ρ equals an integer (integers higher than 1 correspond to local-oscillator harmonics and ρ equals 0 represents the interference that can be produced by an rfi input equal to the receiver's i-f), and q is a nonzero integer.

Intermodulation Interference can be expressed as

$$f_t = f_x - f_y = 2f_x - f_y = 3f_x - 2f_y$$

and so on; f_t is an input frequency to which the receiver responds, and the f_x and f_y frequencies represent undesired inputs that interact when they combine in a nonlinear element in the receiver.

Cross-modulation. An undesired a-m signal interacts with the desired signal in a nonlinear element.

Co-channel Interference (f_{ci}). This can be defined³⁰ as

$$f_t - \frac{\delta}{2} \leq f_{ci} \leq f_t + \frac{\delta}{2}$$

where δ is the receiver input bandwidth and f_t is the receiver's tuned input frequency. This interference is caused by rfi falling within the input bandwidth of the receiver.

Adjacent Channel Interference (f_{aci}). This can be defined³⁰ as

$$k + f_t + \frac{3\delta}{2} > f_{aci} > f_t + \frac{\delta}{2} + k$$

where k takes into account guard bands between channels.

Desensitization. A relatively high-amplitude rfi input overloads the receiver, making it less sensitive to the desired signal.

Capture. This occurs in f-m or phase-modulated (p-m) receivers where a stronger rfi signal (f-m or p-m) effectively swamps the desired signal.

through enclosure hardware such as screws.⁹

The backs of panel meters and other indicators should be shielded (within the enclosure) and their electrical terminations filtered. Conductive glass is also being used to prevent rfi leakage through indicator faces.⁹

Note that rfi effects within a cabinet can be reduced by putting various subsections of the equipment in compartments, thus isolating susceptible portions from rfi-producing portions of the equipment.⁵⁵

Microwave-absorbent materials, which are made from materials such as urethane foam, vinyl and epoxies, are best known for their use in anechoic chambers where microwave equipment is tested. These materials are placed on the surfaces of the chamber to absorb stray microwave energy. Consequently, microwave energy emanating from the equipment under test or the test equipment (Fig. 19) that is not absorbed by the microwave equipment is absorbed by the walls and reflections are prevented. Cone-shaped sections of microwave-absorbent materials are also being used to suppress reflections of r-f energy when making measurements in shielded rooms.⁵⁶ This increases the repeatability and accuracy of the measurements.

GROUNDING—A unipotential (or nearly unipotential) ground plane⁵⁷ for a system helps prevent rfi problems caused by unequal ground potentials and ground-loop currents. The initial design of the system should provide for this ground plane (Fig. 20).

Shielded twisted-wire pairs minimize rfi pickup and radiation.⁵⁸ The twisted wiring decreases pickup from low-frequency low-impedance electromagnetic fields (where H , the magnetic component of the field, is relatively strong and the radiation is not a plane wave) and the shield attenuates the electrical component (E) of the field at low frequencies and attenuates both the E and the H components of plane-wave radiation at high frequencies.

If the circuits connected to the twisted-wire cable are susceptible to or produce high r-f frequencies, and the length of the cable is $> 0.15 \lambda$, where λ is the wavelength of the highest frequency that can interfere with the circuits, ground the cable shield at each end and at points along its length spaced 0.15λ apart or less. This method is called multi-point grounding. Ground one line of the twisted pair.⁵⁸

If the circuits connected to the twisted-wire cable are susceptible to or produce only low frequencies, ground the shield at one end only; this is single-point grounding. Ground one line of the twisted pair at one end of the cable.⁵⁸

Single-point grounding is more effective than multi-point grounding since different ground potentials at the cable terminations would produce an rfi current through a shield grounded at both ends; current through the shield would induce an rfi current in the signal line inside the shield. Furthermore, a low-frequency magnetic field could induce large enough currents in a shield that is grounded at more than one point to interfere with low

GROUNDING massive stays of a ballistic-missile-early-warning-system antenna (Filtron). Not visible is underground matrix of grounding grid that interconnects antenna-stay grounds—Fig. 20

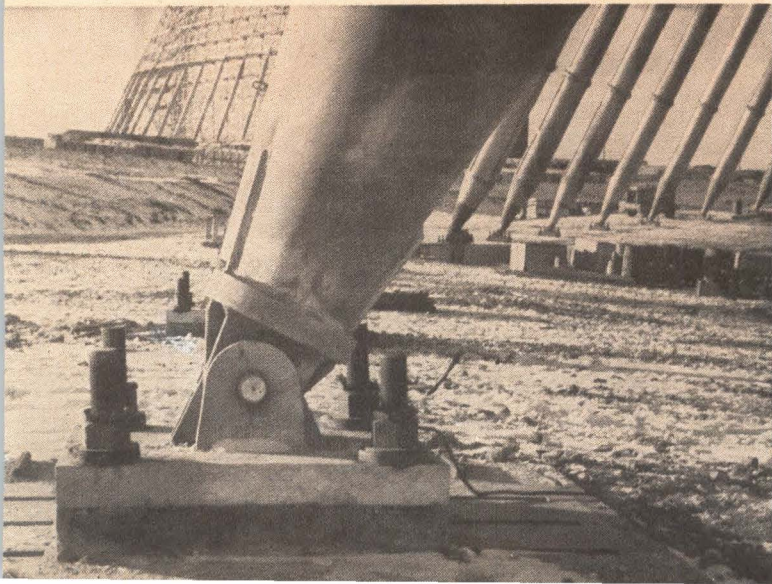

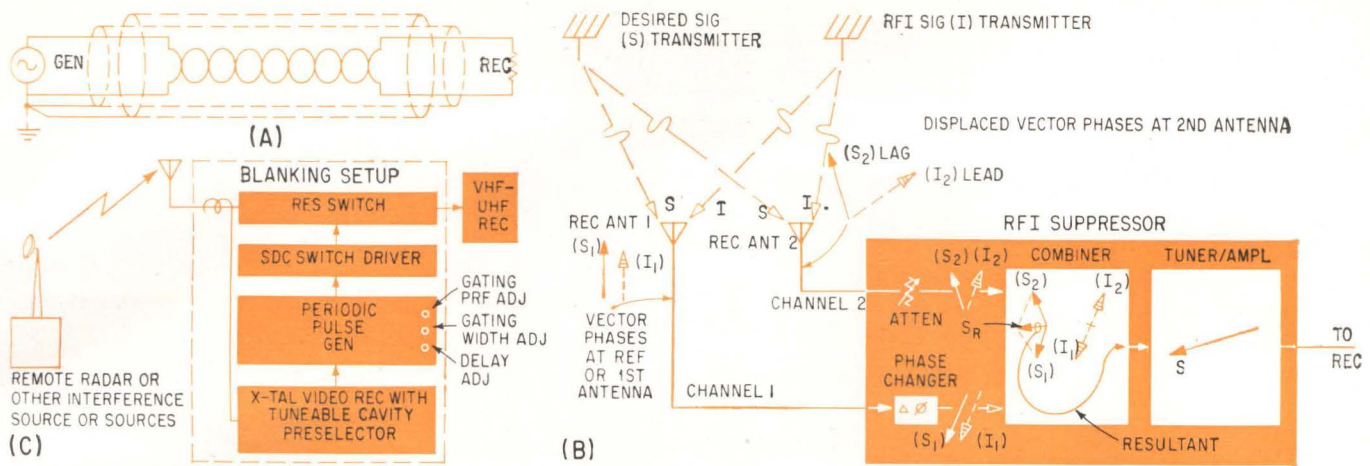

CABLE GROUNDING scheme (A) grounds outer shield at more than one point, whereas inner shield is grounded at only one end. Phase-selective action (B) can be used to suppress an rfi signal (Pioneer Electric & Research). Blanking setup (C) is used to protect vhf-uhf receiver from high-power radar pulses (RMS Engineering)—Fig. 21

signal currents in the signal leads.⁵³

Note that a conventional copper-braid shield provides negligible shielding at low (audio) frequencies. Ferrous shielding such as Mu-metal, Netic and Co-Netic foil and iron pipe attenuate low-frequency low-impedance fields more than copper braid.⁵³

When coax is used, ground the shield at both the generator and the receiver terminations when the terminations are susceptible to (or produce) high-frequency rfi.⁵⁷

When coax is used and the cable terminations are susceptible to or produce low-frequency (audio) rfi, ground the shield at one end only.⁵⁷

Double shields (Fig. 21A), where the inner shield is electrically isolated from the outer shield by insulation, can be used to provide more attenuation than a single shield. Ground both ends of the outer shield and ground one end of the inner shield.⁵⁸

Use transmission-circuit impedances that fall within the range of 300 to 600 ohms. This range of impedances is an rfi compromise since larger circuit impedances would reduce the rfi current induced in the circuits by a magnetic field whereas smaller circuit impedances would pick up less rfi voltage from an electrical field.⁵⁸

Cable routing should be optimized to minimize rfi reception and transmission.⁵⁷

Bond equipment and circuit compartments to chassis, chassis to racks or cabinets, racks to cable trays, and bond racks and cable trays to the grounding grid that comprises the system's unipotential ground plane.⁵⁷

Run a-c and d-c power lines in separate cables; run pulse cables separately; and separate low-level cables from high-level cables. Avoid long parallel runs of cabling where possible.

RECEIVERS—This section will describe ways to make communications and radar receivers less susceptible to rfi.

Although incoming rfi and its effects can be suppressed at the receiver antenna, its r-f, i-f detector, video or audio stages, or at the receiver output, it's best to suppress rfi before it gets far into the receiver.

Antenna location and orientation can prevent the entry of rfi or reduce the amount that enters.⁵ Reflecting and absorbing materials can be used to reduce side and back lobes.⁹

Directional antennas such as phased antenna arrays or loop antennas reduce rfi.^{9, 59} Note that both the feed pattern and the reflector of a parabolic antenna affect its directivity.⁹

Properly matching an antenna to the receiver helps minimize rfi trouble since a mismatch decreases receiver sensitivity to the desired frequency, thereby increasing its susceptibility to rfi. Since a wide-frequency-range communications receiver may require several antennas to cover its range of operation, tuned circuits should be provided to match the receiver input to the antennas over the receiver's operating range.³⁷

If the signal and the rfi inputs have different polarizations, it may be possible to optimize reception by using an antenna that has a suitable polarization.⁶⁰

Figure 21B displays a phase-cancellation technique that is used to attenuate an rfi input. Since the signal (S) and rfi (I) transmitters are located at different places, their respective wavefronts will, in general, have different phases at the two receiving antennas, which are spaced a substantial portion of wavefront apart. For example, S_2 , the phase of the desired signal at antenna No. 2, lags S_1 , the phase of the desired signal at antenna No. 1. The operator shifts the phase of I_1 and throws in enough attenuation to cause I_1 to cancel I_2 in the combiner. Although signal S_1 is also shifted in phase, since it is not shifted 180-degrees out of phase with S_2 , the vector sum of S_1 and S_2 produce the resultant signal, S_R , which is amplified and passed on to the receiver input.⁶¹

BLANKING—Undesired rfi into a radar receiver can be attenuated by using the side-lobe blanking method. When the main lobe of the radar antenna points in any direction but the direction of the rfi-signal source, an omnidirectional antenna connected to an auxiliary receiver picks up a stronger rfi signal than the radar antenna. Outputs of the receiver and the radar receiver are connected to an amplitude-comparison circuit that blanks the radar whenever the signal picked up by the omnidirectional antenna is stronger than the signal picked up by the radar antenna. This suppresses side-lobe rfi.⁹

Some radars use the sector-blanking method to blot out an rfi source. Here, the radar desensitizes the radar receiver whenever the radar antenna points towards the

REFERENCES

- (1) W. Q. Crichlow, The Prediction of Radio System Performance with Variable Propagation and Interference Conditions, *3rd Nat'l Symp On RFI*, Wash., D. C., June 12, 1961.
- (2) "Reference Data for Radio Engineers", 4th ed., IT & T Corp., N. Y., 1956.
- (3) "Design Techniques for Interference-Free Operation of Airborne Electronic Equipment", USAF, Wright-Patterson AFB, Dayton, O., 1952.
- (4) "Electromagnetic Compatibility Lecture Series", 1, by Armour Research Foundation for Aeronautical Systems Div., USAF, Contract AF33(616)-8507, Aug. 29, 1961.
- (5) L. Milton, Filtron, Flushing, N. Y., private communication, Mar. 1963.
- (6) "Measurement of Radio Frequency Spectrum Characteristics", MIL-STD-449A, Sept. 1, 1961.
- (7) "Microwave Receivers & RI/FI Meters", Polarad Electronic Instruments, L. I. C., N. Y., 1963.
- (8) "The Stoddart NM-62A Measuring Set as a Sensitive Two-Terminal Voltmeter", Stoddart Aircraft Radio Co., Hollywood, Cal., Mar. 1962.
- (9) "Electromagnetic Compatibility Lecture Series", 2, by Armour Research Foundation for Aeronautical Systems Div., USAF, Contract AF33(616)-8507, Aug. 29, 1961.
- (10) R. B. Schulz, Significance of IF Bandwidth in RFI Measurements, *3rd Nat'l Symp on RFI*, Wash., D. C., June 12, 1961.
- (11) G. P. Rothhammer, Instrumentation Requirements to Measure and Define RF Fields, *Inst of Environmental Sciences Conf*, 1963.
- (12) Empire Devices Catalog No. 634, Empire Devices, Amsterdam, N. Y., 1963.
- (13) "Interference Control Requirements, Aircraft Equipment", MIL-I-6181D, Nov. 25, 1959.
- (14) M. Harges, Empire Devices Seminar on RFI, Amsterdam, N. Y., Nov. 14, 1962.
- (15) "Microwave Spectrum Analyzers", Polarad Electronic Instruments, L. I. C., N. Y., 1963.
- (16) D. Fidelman, A Rapid-Display Technique for Radio Interference Measurements, *8th Tri-Service Conf on Electromagnetic Compatibility*, Chicago, Oct. 1962.
- (17) "Instruction Manual for Panoramic Spectrum Analyzer SPA-4a", Singer Metrics, Bridgeport, Conn., 1963.
- (18) "New Broadband Spectrum Analyzer", Light Military Electronics Dept., GE, Utica, N. Y., 1963.
- (19) M. Engelson, Pentronix, Brooklyn, N. Y., private commun., April 1963.
- (20) "Electrical-Electronic System Compatibility and Interference Control Requirements for Aeronautical Weapons Systems, Associated Subsystems and Aircraft", MIL-E-6051C, June 17, 1960.
- (21) J. R. Mahoney, A Recent Advance in Microwave RFI Instrumentation, *8th Tri-Service Conf on Emag Compat*, Chicago, Oct. 1962.
- (22) S. Weitz, U. S. Army Electronics R & D Laboratory, Ft. Monmouth, N. J., pvt. commun., April, 1963.
- (23) "Radio Interference Measuring Set AN/URM-100(XE-1), Signal Corps Tech'l Requirement, SCL-4566, U. S. AERDL, Ft. Monmouth, N. J., Dec. 7, 1962.
- (24) R. R. Stoddart, Trends in RFI Measuring Instruments, *8th Tri-Service Conf on Emag Compat*, Chicago, Oct. 1962.
- (25) R. Smith and G. H. Tikijan, Advanced Techniques for Ground Spectral Measurements, *8th Tri-Service Conf on Emag Compat*, Chicago, Oct. 1962.
- (26) J. M. Bridges, speech on electromagnetic compatibility to Boston Chapter of IEEE, Boston, Jan. 16, 1963.
- (27) B. C. Pierstoff, A. I. Matheson and S. Seideman, Real-Time Simulation of the Radio Frequency Environment, *4th Nat'l Symp on RFI*, San Francisco, June 28, 1962.
- (28) P. C. Constant and E. J. Martin, The Radiation Hazards (RAD HAZ) Program on the Formulation of Standards, *IEEE Trans RFI*, RFI 5, 1, Mar. 1963.
- (29) A. J. Hoehn, Engineering Aspects of the EMETF Interference-Prediction Model, *7th Conf on Radio Interference Reduction & Electronic Compatibility*, Chicago, Nov. 1961.
- (30) J. B. Scott, The Computer Approach to the Interference-Prediction Model of the Electromagnetic Environmental Test Facility, *7th Conf on RI Reduction & Emag Compat*, Chicago, Nov. 1961.
- (31) L. G. Fischer and G. Frenkel, Search-Radar Analog Simulator Reproduces Jamming, Scintillation, *ELECTRONICS*, p 58, Aug. 25, 1961.
- (32) White Electromagnetics, "Evaluating Complex Communication-Electronics Systems for Compatibility with Adverse Environments", WEI, Bethesda, Md., Nov. 1962.
- (33) H. Wamboldt, Spectrum Conservation Through Frequency Spreading, *Natl Aerospace Electronics Conf*, Dayton, O., May 8, 1961.
- (34) J. P. Costas, Poisson, Shannon and the Radio Amateur, *Proc IRE*, p 2,058, Dec. 1959.
- (35) J. J. Kepcke, Maximum Spectrum Utilization by Wide-Bandwidth Transmission, *13th Nat'l Conf of IRE PGVC*, Anaheim, Cal., Dec. 6, 1962.
- (36) H. E. McGuire, Combined Coding Increases Spectrum Usage, *ELECTRONICS*, p 64, Oct. 26, 1962.
- (37) R. B. Marcus, V. H. Ritter and J. G. Taylor, Good Design Practices for Reducing Interference Producing Properties of Receivers and Transmitters, *6th Conf on R I Reduction & Electronic Compat*, Chicago, Oct. 1960.
- (38) J. G. Arnold, Calculating R-F Intermodulation Interference, *ELECTRONICS*, p 71, Nov. 27, 1959.
- (39) "2-30 Mc Frequency Synthesized Independent Sideband Transmitter", Manson Laboratories, Stamford, Conn.
- (40) J. Roman and F. Murphy, Proposed Radar Spectrum Occupancy Design Standard, *8th Tri-Service Conf on Emag Compat*, Chicago, Oct. 1962.
- (41) "Voltage Tunable Magnetrons", GE Power Tube Dept., Schenectady, N. Y., Dec. 1962.
- (42) A. Vacaro and K. Falor, Mate the Modulator to the Magnetron, *Electron Design*, Dec. 20, 1962.
- (43) F. E. Terman, "Electronic and Radio Engineering", 4th ed., McGraw-Hill Book Co., N. Y., 1955.
- (44) A. C. Rowe, GE Power Tube Dept., Schenectady, N. Y., private commun., April, 1963.
- (45) M. R. Boyd, R. A. Dehn and T. G. Mihran, The Multiple-Beam Travelling Wave Klystron, *IEEE Nat'l Conv*, Mar. 1963.
- (46) E. H. Davis, Electronics Interference Reduction Aboard Naval Vessels, *3rd Conf on RI Reduction*, Chicago, Feb. 1957.
- (47) K. Kuny, Electronic Equip. Div., McDonnell Aircraft, St. Louis, Mo., pvt. commun., May 1963.
- (48) "Low Brightness Lens Panel for the Shielding of Radiated Radio Interference from Fluorescent Lamps", Corning Building Products Dept., Corning, N. Y., Jan. 1963.
- (49) A. M. Brown, Brushless, Regulated Generator of Radio Interference Free Design, *3rd Conf on R I Reduction*, Chicago, Feb. 1957.
- (50) L. W. Thomas, The Control of Interference Through Basic Design, *3rd Conf on R I Reduction*, Chicago, Feb. 1957.
- (51) J. D. Noyes, Commercial Mobile Radio Interference Shielding, *6th Conf on R I Reduction and Electronic Compat*, Chicago, Oct. 1960.
- (52) D. B. Wright, Interference Sources and Effective Reduction Procedures for Power Line Interference, *3rd Conf on R I Reduction*, Feb. 1957.
- (53) C. B. Pearlston, Case and Cable Shielding, Bonding and Grounding Considerations in Electromagnetic Interference, *IRE Trans on RFI*, RFI-4, 3, p1, Oct. 1962.
- (54) R. G. Klouda, Requirements of Measurements of Shielded Installations, *7th Conf on R I Reduction and Electronic Compat*, Chicago, Nov. 1961.
- (55) R. C. Follett, Sprague Electric, North Adams, Mass., pvt. commun., April, 1963.
- (56) M. Revzin, Loral Electronics, Bronx, N. Y., pvt. commun., April, 1963.
- (57) I. M. Newman and A. L. Albin, An Integrated Approach to Bonding, Grounding and Cable Selection, *7th Conf on RI Reduction and Electronic Compat*, Chicago, Nov. 1961.
- (58) B. H. Showalter, Radio Interference Report on Shielded Twisted Insulated Pairs, Light Military Electronics Dept., GE, Utica, N. Y.
- (59) C. E. Blakely and D. E. Gentry, A Summary of Design Methods and Trends in Communications Interference Suppression Devices, *4th Nat'l Symp on RFI*, San Francisco, June 28, 1962.
- (60) H. Jasik, "Antenna Engineering Handbook", p17-6, McGraw-Hill Book Co., N. Y., 1961.
- (61) D. V. Sinniger, Pioneer Electric & Research Corp., Forest Park, Ill., pvt. commun., April 3, 1963.
- (62) "Broadband Solid State RF Switches", RMS Engineering, Atlanta, Ga.
- (63) "Limiters", Sperry Microwave Electronics, Clearwater, Fla.
- (64) Tucor, Wilton, Conn., pvt. commun., May, 1963.

source of radio frequency interference.⁵

Figure 21C shows a blanking setup that uses a broadband solid-state switch to protect a vhf-uhf receiver from a high-power radar. The auxiliary receiver opens the diode switch whenever the common antenna picks up enough radar rfi to harm or desensitize the vhf-uhf receiver. Note that the auxiliary receiver is tuned to the frequency of the rfi source, rather than the vhf-uhf receiver frequency. If the radar were located near the vhf-uhf receiver, sync pulses from the radar prf could be sent directly to the pulse generator over a line.⁶²

A radar can block rfi from other radars that have different prf's by using prf-discrimination techniques. The radar samples the prf of a number of incoming pulses; if the prf equals the radar's prf, the radar tells its information-computing circuits that a target is present.⁹

When the amplitude of the desired signal is known,

amplitude-discrimination techniques can be used to discriminate against much stronger and much weaker signals.⁹

LIMITING AND PRESELECTION—Solid-state or tube limiters can be placed right at the front end of a sensitive receiver to protect it against high-power inputs.^{63, 64} Solid-state limiters can limit input peak powers that are in the order of hundreds of kilowatts to outputs in the tens of milliwatts.

Cavities, crystals or L-C filters can be used to reject rfi at the receiver input and pass the desired signal frequencies. Using r-f amplifiers that have double-tuned coupling circuits helps block rfi entry and decreases the amount of local-oscillator r-f that can leak through the antenna.

The author thanks the people and companies who have helped him during the preparation of this article.

New! from **POLARAD** at lowest unit cost!

MODULAR MICROWAVE SIGNAL INSTRUMENTATION

Waste not (today) Want not (tomorrow)

You'll never again need to waste a penny on features you don't need in the microwave signal generator you buy today. Better still, tomorrow, when you need more range, or extended modulation capabilities, you won't have a moment's regret—just add another inexpensive module, stack (or rack) it with the first, and you're all set!



PRODUCTION TESTING? Choose an X-band or C-band source... add the compatible doubler later, for Ku or Ks band.



ANTENNA RANGING? Why buy fancy modulation? The signal generator you need is available **without** that expense... add the universal modulator next year, when you move into the lab!



OUTFITTING A LABORATORY? One universal modulator, racked up with the generators, sources, or doublers you choose, will cut thousands of dollars off your equipment budget, at no loss in measurement capability.

You can build up literally dozens of versatile packages with the seven modules shown here. Soon you will be able to add L and S band modules... now in prototype production!

Want the complete Polarad Signal-Generator story? Turn the page!



MODULAR SIGNAL GENERATOR 1107
Freq. Range: 3.8 GC-8.2 GC



MODULAR SIGNAL GENERATOR 1108
Freq. Range: 6.95 GC-11.0 GC

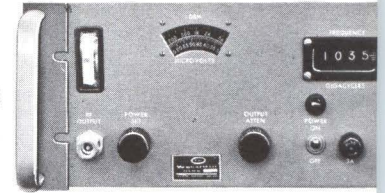

MODULAR COMMON MODULATOR 1001
Modulation and Sync Signals

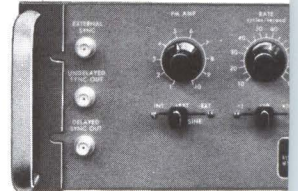

MODULAR SIGNAL SOURCE 1207
Freq. Range: 3.8 GC-8.2 GC



MODULAR SIGNAL SOURCE 1208
Freq. Range: 6.95 GC-11.0 GC

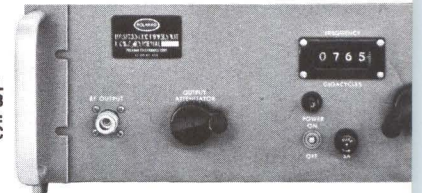

MODULAR FREQUENCY DOUBLER 1509
Freq. Range: 10.0 GC-15.5 GC out

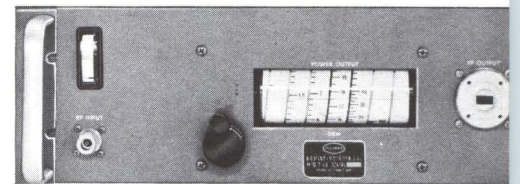

MODULAR FREQUENCY DOUBLER 1510
Freq. Range: 15.0 GC-21.0 GC out

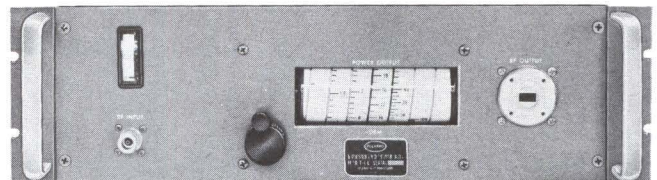

Polarad Electronic Instruments • Division of Polarad Electronics Corporation
34-02 Queens Blvd. • Long Island City 1, New York

Please send me your new 40-page Engineering Bulletin G63 on Microwave Signal Generators.

I may have an immediate requirement—have my local Polarad field engineer get in touch with me. (My telephone extension is _____.)

My application is _____

Name _____

Title _____ Dept. _____

Company _____

Address _____

City _____ Zone _____ State _____

1234567890

Choose from the industry's largest line of precision microwave signal generators & sources manufactured to the industry's highest standards of quality by the men who have made



World Leader in Microwave Instrumentation.

	MODEL-DESCRIPTION	FREQUENCY-GC	CALIBRATED POWER OUTPUT	INTERNAL MODULATION	NOTES
MODULAR	1107 Signal Generator	3.80-8.2	+3 dbm to -127 dbm (+10 dbm uncalibrated)	Square wave: 800-1200 cps	Completely modular design for stacking or rack-mounting. Single-band continuous UNIDIAL® tuning. ±0.5% accurate digital frequency indicators. Ultra-stable design; very low incidental AM and FM. Auxiliary RF output for phase lock capability and frequency monitoring. Panel height 5¼".
	1108 Signal Generator	6.95-11.0		FM deviation: 0 to ±5.0 mc	
	1207 Source	3.80-8.2	50 mw min	FM rate: 1 cps to 1 mc	
	1208 Source	6.95-11.0	25 mw min	External pulse: 40 cps to 1 mc	
	1509 Doubler	10.0-15.5 out	0 dbm to -100 dbm; max. input 250 mw; conversion loss less than 18 db	Pulse width: 0.2 to 2,500 μsec	
	1510 Doubler	15.0-21.0 out		External FM rate: 100 cps to 0.5 mc	
	1001 Modulator	Modulation and Sync Signals	Sufficient level to modulate all generators and sources	USE MODEL 1001 FOR EXTERNAL MODULATION	
TYPICAL MODULAR COMBINATIONS	1709	3.80-8.20/10.0-15.0	See 1207/1509	See 1207	Combines 1207 and 1509
	1710	6.95-11.0/15.0-21.0	See 1208/1510	See 1208	Combines 1208 and 1510
	1809	3.80-8.20/10.0-15.0	See 1207/1509	See 1207 and 1001	Combines 1207, 1509 and 1001
	1810	6.95-11.0/15.0-21.0	See 1208/1510	See 1208 and 1001	Combines 1208, 1510 and 1001
	1607	3.8-8.20	See 1107	See 1107 and 1001	Combines 1107 and 1001
	1608	6.95-11.0	See 1108	See 1108 and 1001	Combines 1108 and 1001
INTEGRAL	PMR-Signal Generator	0.5-1.0	-3 dbm (0.5 mw) to -127 dbm calibrated to ±2 db	Metered FM deviation to at least 0.3 mc; less than 1% harmonic distortion.	
	MSG 1R/2R/2PA Signal Generator	0.95 to 4.6 (2 plug-ins) MSG-2PA High Power Tuning Unit (10 mw cal. output)	0 dbm (1 mw) to -127 dbm calibrated to ±2 db	AM: Pulse and square wave;	Extended modulation capabilities w/interchangeable plug-in tuning units.
	PMX-Signal Generator	4.45-11.0 (2 plug-ins)		10-10,000 pps	
	MSG 34 Ultra-Broadband Signal Generator	4.2 to 11.0 (single tuner; digital indicator)	0 dbm (1 mw) to -127 dbm calibrated to ±2 db	Pulse width: 0.2-10 μsec	
UNIVERSAL INTEGRAL	KSS Source	1.05 to 11.0 (4 plug-ins)	14-400 mw, depending on frequency; uncalibrated	Square wave: 10-10,000 pps	
	EHF Generator	18.0 to 39.7 (7 plug-ins)	-10 dbm to -90 dbm calibrated to ±2 db	External: pulse, square wave, FM Sawtooth or sine wave	
	EHF Source	18.0 to 50.0 (9 plug-ins)	3 to 10 mw, depending on frequency; uncalibrated	Square wave: 1,000 cps	
	IC-120 A/B Impulse Generator	1 mc-10.0 GC continuous; flat within ±0.5 db	60-70 db above 1 μV/mc	External: pulse, FM	
				PRR: 1,000 cps	115 V AC and 12 V DC battery operation.
				Pulse width: 0.02 nanoseconds	
				Pulse train width: 0.06 nanoseconds	

If you do not find exactly what you need in this chart, call in your Polarad field engineer. (See the Yellow Pages for his listing.) He is a microwave expert. If you prefer, communicate directly . . . by calling EXeter 2-4500 (Area Code 212) . . . for prompt, informed assistance.

Postage Will be Paid by Addressee

No Postage Stamp Necessary If Mailed in the United States

BUSINESS REPLY MAIL
First Class Permit No. 18, Long Island City 1, N. Y.



POLARAD ELECTRONIC INSTRUMENTS
A Division of Polarad Electronics Corporation
34-02 Queens Blvd.
Long Island City 1, N. Y.

Our experience and facilities are always at your service!

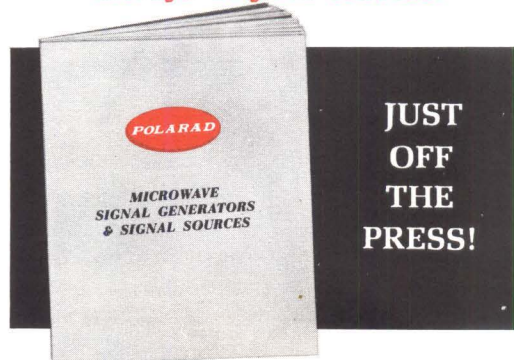

Free 40 page Engineering Bulletin includes a complete review of the design principles and application techniques of microwave signal generators, as well as complete specifications on the entire Polarad line. Write for yours today!

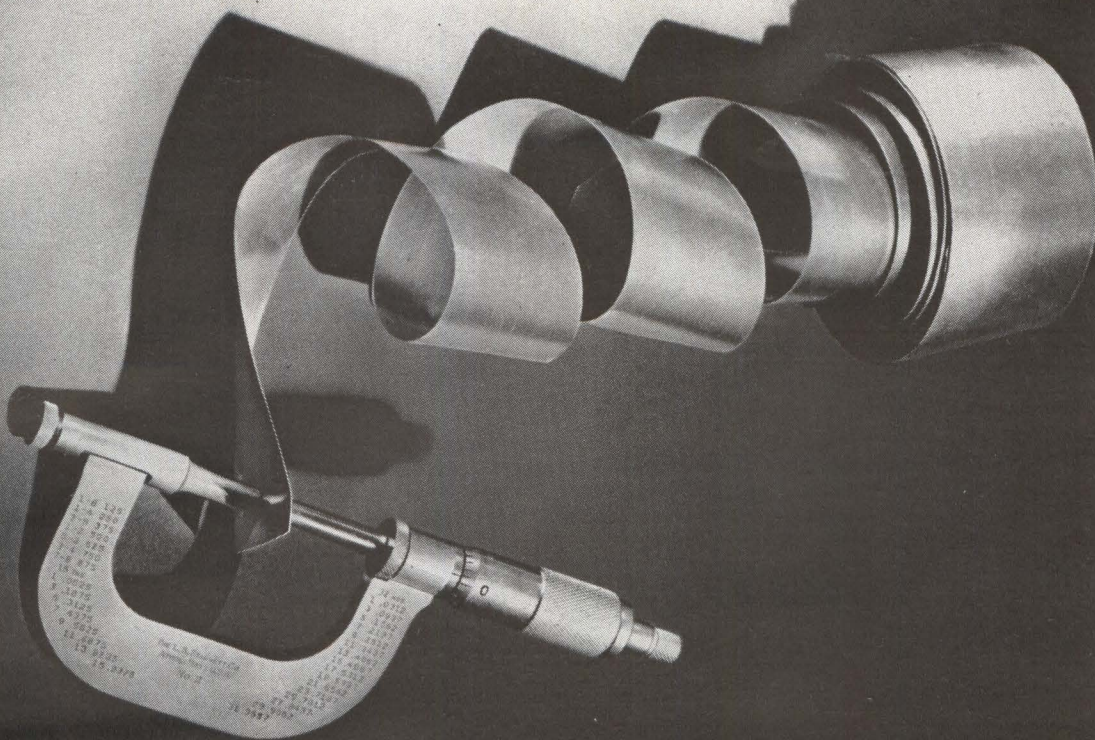

This Nickel foil strip is 1/3 as thick as this page!

0.00075-inch thick to be exact. So thin that every step in its production is a critical test of the metal worker's skill.

Even the air must be kept clean. One speck of dust or particle of grit allowed to enter the rolling operation could perforate the foil. It's *that* delicate.

This nickel foil is just one example of how you can get Huntington Alloys in any form or size you may want, right down to the fine sizes produced by specialists in strip, wire and tubing. These alloys offer exceptional combinations of high mechanical properties, corrosion resistance, magnetic or non-magnetic properties, good magnetostrictive properties, excellent high temperature performance and oxidation resistance, plus a wide variety of unusual electronic characteristics.

Who needs remarkably thin nickel foil...or heavy plates...or an exceptional combination of physical properties?

Perhaps you do. Or will some day. That's why we've prepared a booklet, "Huntington Alloys for Electronic Uses." It's packed with helpful information on composition, general characteristics, available forms, and specifications. A copy is yours for the asking.

HUNTINGTON ALLOY PRODUCTS DIVISION
The International Nickel Company, Inc.
Huntington 17  West Virginia

HUNTINGTON ALLOYS



**MEPCO
RESISTORS
WITH
HIGH
I.Q.**

***Identifiable
Quality**

MEPCO'S new quarter-million-dollar computer for on-line testing of precision resistors is the most advanced and sophisticated production testing facility in the industry.

Every serialized resistor tested carries an individual "personal history" IBM card recording ohmic values and ΔR readings at various separate stages of testing.

Data is fed to the IBM 1620 computer and 1405 disc storage units directly through a digital ohmmeter.

The computer can be programmed to test performance in accordance with any specification, for all types of MEPCO resistors.

High reliability components can be processed in quantities up to 20,000 units per day.

Any resistor which fails to meet specifications at any stage is automatically rejected and the mode of failure recorded.

Stored production, testing and specification data are utilized by MEPCO engineers for design, performance and reliability studies, and for quality assurance evaluation.

For information on programmed specifications and testing techniques, write or call



**MEPCO, INC.,
MORRISTOWN, NEW JERSEY**

HOMOGENEOUS SEMICONDUCTORS

A NEW GENERATION OF DEVICES

Bulk properties, rather than impurity variations, are the key to a new family of solid-state active components

By JULIEN BOK, Laboratoire de Physique, Ecole Normale Supérieure, Paris, France

DEVICES OPERATING on semiconductor bulk properties have been available for some time. Thermistors, for example, take advantage of the variation of carrier concentration with temperature. Photocells depend on production of excess free carriers by incident radiation. And a variety of devices use the Hall effect: multipliers, gyrators and the like.

But semiconductors have still other bulk properties that point to an entirely new family of devices. These properties arise from the existence in semiconductors of a solid-state plasma, analogous to a gaseous plasma. The plasma breaks down by impact ionization; electromagnetic waves can propagate through it; and under certain conditions, it becomes unstable and oscillates. All these phenomena

have been used to develop new homogeneous semiconductor devices.

Compared to a gaseous plasma, a solid-state plasma shows several important differences. For one thing, a certain free carrier density exists at thermal equilibrium because of the low ionization energy for the impurity atoms in the semiconductor; so no appreciable outside energy is necessary to ionize the plasma. Also, the free carrier density can be varied easily over wide limits by doping or temperature changes. And the density can run very high, as much as $10^{22}/\text{cm}^3$ for metals.

Further, the low-mass free carriers can be either electrons or holes, whereas in a gaseous plasma electrons are the only light particles. Finally, the ions are tightly linked to the crystal lattice, so

much so that they can be considered completely immobile, that is, of infinite mass.

IMPACT IONIZATION — The cryosar—Electrons bound to impurity atoms in a semiconductor lattice have low ionization energies (for example, 0.01 electron volt for arsenic in germanium). At room temperature these electrons are free, but at low enough temperature they are bound to the impurities. When a high electric field is applied, electrons are accelerated to energies high enough to ionize impurity atoms by impact. The released electrons in turn ionize other impurity atoms, causing the large decrease in resistivity called breakdown.

This phenomenon has been observed in germanium at liquid helium temperature by many workers¹⁻³. A typical I-V characteristic for breakdown in uncompensated germanium is shown in Fig. 1. McWhorter and Rediker found that for compensated germanium the I-V curve has a negative resistance characteristic (Fig. 1). They proposed to use this as a bistable memory element and baptized their device the "cryosar"^{4,5}. Cryosar circuits have already been developed (ELECTRONICS, Aug. 17, 1962, p 39).

Obviously, the liquid-helium temperature requirement of operation is a major drawback for the compensated germanium cryosar. But with other semiconductor materials, impact ionization at higher temperatures becomes possible. At the Ecole Normale Supérieure, im-

BYPASSING THE JUNCTION

Most present-day semiconductors amplify or oscillate because of their nonhomogeneous regions. This usually involves one or more p-n junctions, and leads to surface-effect difficulties, calling for delicate production techniques such as passivation.

These difficulties are sidestepped by devices that use the bulk properties of semiconductors for their operation.

Author Bok experiments with one of his brainchildren



compact ionization was obtained at 20 K (liquid hydrogen temperature) using silicon doped with phosphorus (ionization energy level of 0.04 eV)⁹. Here also, compensated samples had negative resistance.

Even better results were obtained with deep-level impurities in germanium. Using zinc-doped germanium compensated with antimony, Zylbersztein⁷ obtained at liquid nitrogen temperature a negative-resistance characteristic (Fig. 1), and room-temperature operation may be possible for silicon doped with indium. However, room-temperature devices consume considerably more power than the liquid-helium cryosar.

HELICON WAVES—Presence of free carriers in a medium modifies electromagnetic wave propagation because of the current produced by motion of the free carriers in the wave's electric field. Appleton⁸ investigated this in detail for wave propagation in the ionosphere, and in fact the "helicon" propagation mode in solid plasmas described by Aigrain⁶ was earlier noted in the ionosphere by Storey¹⁰, who dubbed the mode "whistler".

The mode occurs under the following conditions: first, the wave is TEM with a steady magnetic field B_0 imposed on it in the direction of propagation. The medium is then anisotropic and the dielectric constant a tensor; however, the constant reduces to a scalar for a circularly polarized wave. Second, the frequencies considered are

$\omega \ll \omega_c$, where ω_c is the cyclotron resonance frequency of the carriers. In MKSA units, $\omega_c = e B_0 / m$, where m is the effective mass of the free carriers under consideration. Third, the magnetic field must be strong enough so that $\omega_c \tau \gg 1$ (τ is the carrier relaxation time, that is, the average time between two collisions. $\omega_c \tau = \tan \theta_H = \mu B_0$, where θ_H is the Hall angle and μ the carrier mobility. Physically, this means the Hall angle is in the neighborhood of 90 deg; the current and the electric field lie almost at right angles.

When these three conditions are satisfied, Libchaber and Veilex¹¹ have shown, the real component of the dielectric constant is

$$\epsilon = \epsilon_e \pm \frac{Ne}{\epsilon_0 \omega B_0}$$

where ϵ_e is the dielectric constant of the lattice, N the number of free carriers, e the electron charge and ϵ_0 the permittivity of free space in MKSA units ($\epsilon_0 = 1/4\pi \times 10^9$). The \pm signs correspond to the two directions of rotation of the circularly polarized wave.

For most solids, the value of ϵ_e lies between 10 and 20 and is negligible compared to the second term of Eq. 1. Thus in helicon propagation a left-hand wave ($\epsilon > 0$) propagates but a right-hand wave ($\epsilon < 0$) does not. Thus the medium is gyromagnetic, as ferrites are, which suggests similar applications—isolators, directive couplers and the like, at frequencies where ferrites aren't satisfactory.

The dielectric constant ϵ for helicon waves can be very high, especially when the number of carriers is high and the frequency low. Metals, for example, show values in the order of 5×10^{17} ($N = 10^{22}/\text{cm}^3$, $\omega = 2\pi \times 50$ cps, and $B_0 = 10,000$ gauss). Under these conditions, the wavelength in the medium is about 1 cm and 50-cycle resonant cavities have reasonable dimensions, about 1 cm (Fig. 2). Helicon action in metals has been achieved by Bowers et al.¹²

For an indium antimonide (InSb) homogeneous semiconductor, again with B_0 of 10,000 gauss but frequency ω of $2\pi \times 10$ Gc, the dielectric constant ϵ is 30 at 77 K ($N = 10^{14}/\text{cm}^3$) and 5,000 at 300 K ambient temperature ($N = 1.6 \times 10^{16}/\text{cm}^3$). Here the helicon wave in the semiconductor has a wavelength of about 1 mm. Libchaber and Veilex¹¹ have observed helicon waves in semiconductors.

The equation (1) for dielectric constant holds only if losses are negligible. The angle of loss δ in a solid plasma is given by

$$\tan \delta = \frac{1}{2\omega_c \tau} = \frac{1}{2\mu B_0}$$

Since for practical purposes B_0 can't go higher than 10,000 gauss, μ must be high—at least 10,000 $\text{cm}^2/\text{v s}$ —to observe helicon resonance. For metals, then, liquid helium temperature becomes a condition for resonance; at that temperature $\mu \cong 10^5 \text{ cm}^2/\text{v s}$. However for indium antimonide semiconductor material, $\mu = 5 \times 10^5$ at 77 K and 7×10^4 at 300 K ambient temperature. In fact InSb is the only material found so far in which helicon waves propagate at room temperature.

Already, practical applications for the InSb helicon are in sight. Figure 3 shows a possible configuration for an isolator that would operate with a magnetic field of 10,000 gauss. The loss $\tan \delta$ runs about 1 percent at 77 K and 15 percent at 300 K.

Certainly, a magnetic field of 10,000 gauss represents an inconvenience; but there are important advantages that offset the drawback. For one thing, there's no lower limit on frequency—in metals helicon resonance occurs at frequencies as low as several cps. True, coupling to ordinary circuits

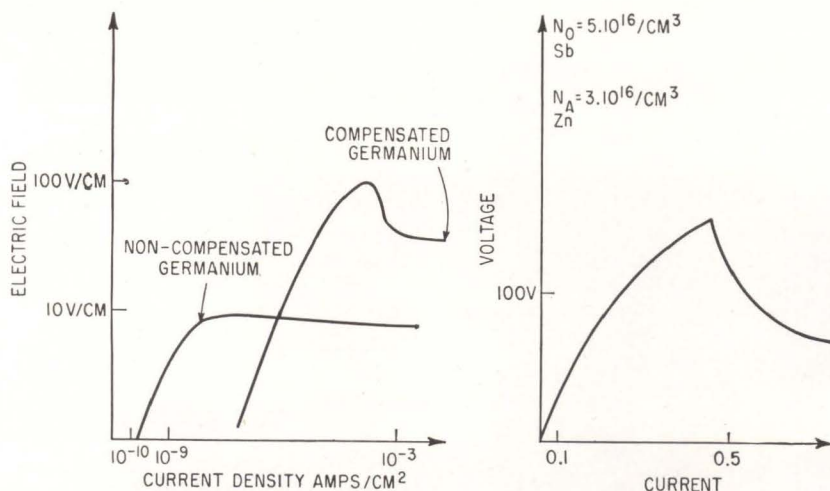

GERMANIUM CRYOSAR characteristics, left, shown for compensated and uncompensated unit. Right, I-V characteristic for germanium cryosar doped with zinc and compensated with antimony (Zylbersztein)—Fig. 1

becomes difficult at such low frequencies because of the very high dielectric constant ($\cong 10^{18}$). But although waveguides can't be used, it seems likely that coaxial structures could provide the necessary circular polarization. An InSb isolator covering the 100—1,000 Mc band is under development at CSF—Compagnie Generale de Telegraphie sans Fil by a research team headed by Gremillet (Fig. 4).

A second important advantage of the helicon isolator is an upper frequency limit in the millimetric and even the sub-millimetric range. The condition $\omega \ll \omega_c$ sets the upper limit. However, the cyclotron resonance frequency ω_c can be very high. For InSb at 10,000 gauss, for example, the value is in the order of 10^{13} cps ($\omega = eB_0/m$).

INSTABILITY DEVICES—Plasma instabilities in solids may lead to a new class of homogeneous semiconductor devices: oscillators and even amplifiers.

So far, two main kinds of instabilities have been described. Pines and Schrieffer¹³ demonstrated theoretically that in some solids "two-stream" instability can produce longitudinal oscillations. This supposes the existence in the solid of two different carriers with opposite charge. But up to now no one has been able to devise an experiment that establishes the conditions required.

However, several researchers have been able to make semiconductors oscillate by applying a longitudinal magnetic field¹⁴⁻¹⁶. An InSb oscillator, developed at the Ecole Normale Superieure, operates at liquid nitrogen temperature with a longitudinal magnetic field of 1,000 gauss. It has peak power output of several tens of watts at a maximum frequency of 600 Mc. Steele and Larrabee¹⁶ have described similar oscillators using germanium, silicon and InSb and suggested calling them "oscillistors".

Two different theoretical mecha-

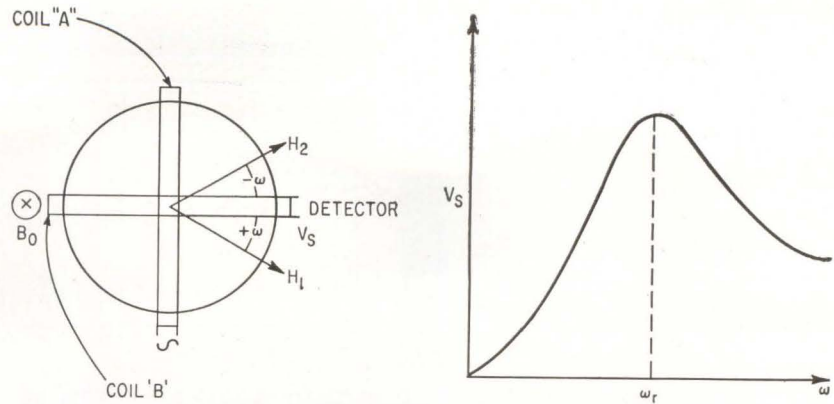

HELICON RESONANCE in metals. Coil A is fed with a-c at frequency ω , creating a magnetic field that can be resolved into two rotating fields $+\omega$ and $-\omega$. One is evanescent, the other propagates and induces an emf in coil B. Output voltage (plotted) in B is a function of frequency ω . Resonant frequency maximum V_s is determined by thickness $\lambda/2$ of metal sample—Fig. 2

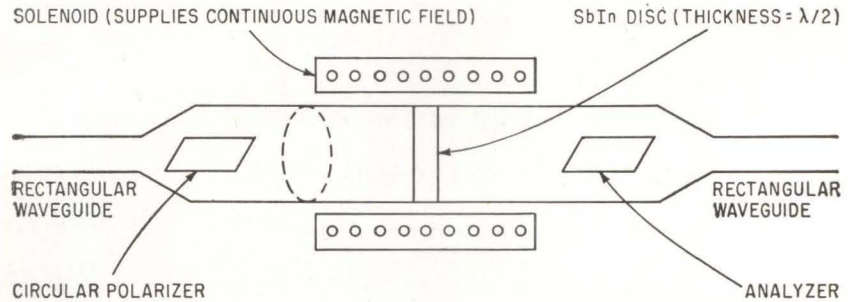

ISOLATOR uses indium antimonide disk in waveguide—Fig. 3

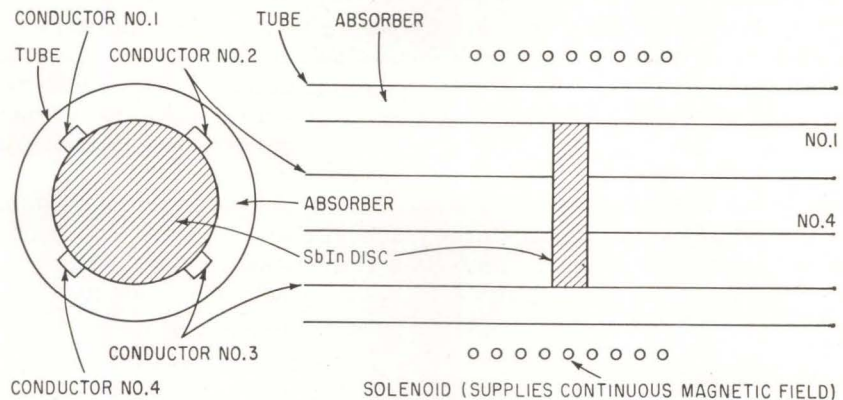

LOW FREQUENCY isolator (100 Mc). The four conductors are fed in quadrature to obtain circular polarization at the center—Fig. 4

nisms have been proposed to explain the instabilities that develop when a longitudinal magnetic field is applied to a solid-state plasma. One, called "screw instabilities",

supposes a helical fluctuation of density of electrons and holes. The second attributes oscillation to an action analogous to that of a traveling-wave tube.

REFERENCES

(1) F. J. Darnell and S. A. Friedberg *Phys Rev* **98**, p 1,860 (1955)
 (2) N. Sclar and E. Burstein *J Phys Chem Solids* **2**, p 2 (1957)
 (3) S. H. Koenig and G. R. Gunther-Mohr *J Phys and Chem Solids* **2**, p 268 (1957)
 (4) R. H. Rediker and A. L. McWhorter Int. Conf. on Solid State Physics Brussels,

Belgium, June 1958
 (5) A. L. McWhorter and R. H. Rediker *Proc IRE* **47**, p 1,207 (1959)
 (6) J. Bok, J. C. Sohm, A. Zylbersztejn Int Conf on Semiconductor Physics Prague (1960)
 (7) A. Zylberstein *J Phys Chem Solids* **23**, p 297 (1962)
 (8) E. V. Appleton *J Inst Elec Engrs Japan* **71**, p 642 (1932)
 (9) P. Algrain Int. Conf. on Semiconductor-Physics, Prague (1960)
 (10) L. R. O. Storey—*Phil Trans Roy*

Soc (London) A **246**, 113 (1953)
 (11) Libchaber et Veillex *Phys Rev* **127**, p 774 (1962)
 (12) R. Bowers, C. Legendy and F. Rose *Phys Rev Letters* **7**, p 339 (1961)
 (13) D. Pines and J. R. S. Schrieffer *Phys Rev* **124**, p 1,387 (1961)
 (14) Ivanov and Ryvkin *Sov. Phys J.E.T.P.* **3**, p 722 (1958)
 (15) J. Bok *Annales de la Radioelectricite—XV* No. 60 (1960)
 (16) M. C. Steele and R. D. Larrabee *J Appl Phys* **31**, p 1,959 (1960)

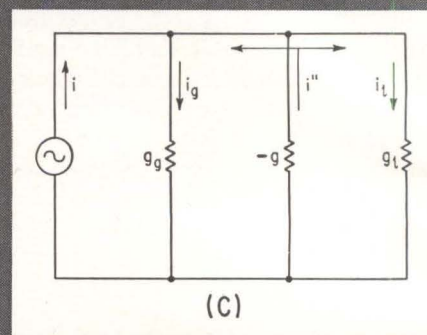
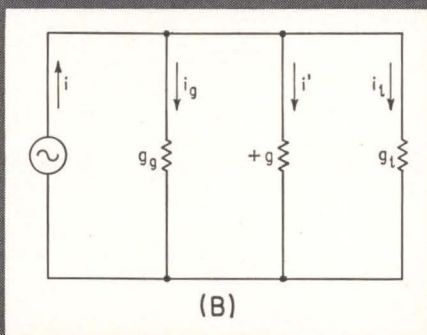
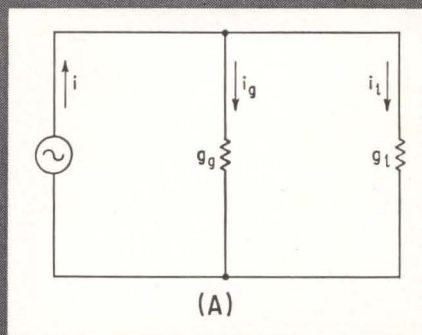

TUNNEL DIODES Part II: AMPLIFIERS

Tunnel diodes operate up in the klystron frequency region—at gigacycles rather than megacycles—where run-of-the-mill transistors can't reach. Second part of this four-part tunnel-diode application-survey discusses amplifiers that are characterized by high-frequency, low-noise, circuit simplicity and versatility of performance

By ERICH GOTTLIEB
JOHN GIORGIS
Consultants, GE Semiconductor
Products Department, Syracuse, N. Y.

THE PERFORMANCE of tunnel diodes in low-noise-amplifiers is especially attractive at uhf and microwave frequencies where ferrite isolators, circulators or hybrid cou-

plers give them the unilateralization necessary to obtain considerable stable gain. These circuits can be miniaturized easily due to their simple configuration and their low power consumption.

At the lower frequencies, stable amplification is hard to achieve with the tunnel diode while commercially available transistors with adequate performance and without

need for unilateralizing coupling devices are more economical from a system standpoint.

THEORY OF OPERATION — Since by definition a positive conductance dissipates energy, it follows that a negative conductance generates energy. This is the basis of negative conductance (or resistance) amplifiers.

Consider first the ideal sinusoidal generator, having an internal conductance g_g , delivering rms current i to a load g_l , illustrated by Fig. 1A. Suppose g_l is varied to maximize the power delivered to it. This does occur under matched condition, namely when $g_g = g_l$. Under this matched condition, the generator current splits evenly between the two branches of the circuit and the maximum power delivered to the load is

$$P_{\text{max}} = (i/2)^2 \times 1/g_l = i^2/4g_g \quad (\text{for } g_g = g_l) \quad (1)$$

As this is the maximum available power from the generator, this value may be used to find the transducer gain, defined as the power

OUTPACING THE TRANSISTOR

The tunnel diode's forte, at least in amplifier work (switching circuits are discussed in part IV) lies in making a small, robust, workhorse preamp, nudging X-band operation, and eschewing elaborate auxiliaries. Although the best amplifier for working the 1-10 gigacycle range (10^9 - 10^{10} cycles) is a parametric one, tunnel diodes can give adequate performance in all but Rolls Royce applications. Today's tunnel diodes come with upper frequency cutoff around the 30-Gc mark—You operate a tunnel diode amplifier in the 1 to 10-Gc range and a 4-db noise figure is common. Transistors, for example, have an upper frequency limit of around 500 Mc for this same noise figure, giving the tunnel diode something like a twentyfold operating edge

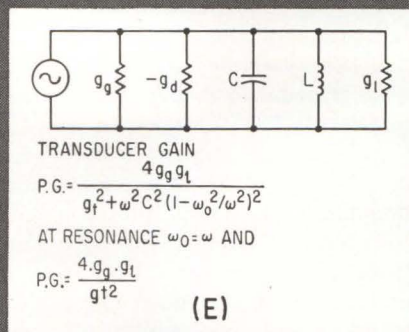
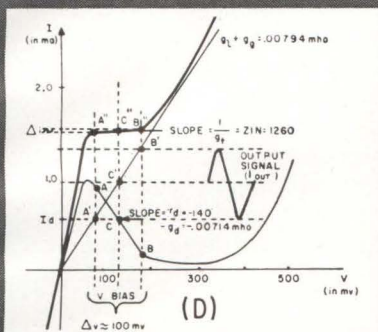

POWER TRANSFER from generator to load (A), power transfer when generator sees only positive conductances (B), power transfer with negative conductance in the circuit (C). Analyzing the operation of a parallel amplifier stage (D), equivalent circuit of tunnel diode parallel amplifier (E) —Fig. 1

Working Beyond Transistor Capabilities

delivered to an arbitrary load divided by the power available from the generator

$$PG = P_l / (i^2 / 4g_g) \quad (2)$$

This gain can obviously not exceed unity.

Suppose that a positive conductance (+g) is placed in parallel with the generator and load, Fig. 1B. Part of the generator current flows into this positive conductance and the transducer gain will be less than unity. If, however, a negative conductance (-g) replaces the positive shunt conductance, as in Fig. 1C, the current flowing in the added branch is out of phase to that of the previous case and hence current is coming out instead of going into this negative conductance branch. The branch therefore acts as a generator and drives additional current into the circuit. The transducer gain can now exceed unity since the load current i_l can now be greater than $i/2$. In this case the negative conductance (-g) can be the incremental conductance (g_d) of the tunnel diode at the bias operating point. By adjustment of the load, this gain may be infinite

$$PG = P_{load} / P_{av gen} = i_l^2 / g_l / i^2 / 4g_g = 4g_g g_l / (g_g + g_l - g_d)^2 \quad (3)$$

As the sum of the positive conductances ($g_g + g_l$) is made equal to the negative conductance $-g_d$, the denominator becomes zero and PG infinite. Hence, the degree of matching between $g_g + g_l$ and $-g_d$ will determine the gain. If $g_g + g_l$ is smaller than $-g_d$, the denomina-

tor is negative and the circuit unstable. Thus for stable values of gain $g_g + g_l$ must be made slightly larger than $-g_d$. Figure 1D shows a graphical representation of the tunnel diode V-I curve, the load line and the resultant parallel impedance.

The tunnel diode capacitance is in parallel with the negative conductance and as the frequency increases will become a more and more effective shunt. In a parallel tuned amplifier, an inductance L is put across the tunnel diode to resonate the circuit at frequency f_0 , where $f_0 = 1/2\pi \sqrt{LC}$ as shown in Fig. 1E. The generalized gain equation then becomes

$$PG = \frac{4g_g g_l}{g_t^2 + \omega^2 C^2 (1 - \omega_0^2 / \omega^2)^2} \quad (4)$$

and since at resonance $\omega = \omega_0$, the available power gain at resonance is still $PG = 4g_g g_l / g_t^2$ where $g_t = (g_g + g_l - g_d)$.

Equation 4 shows that gain decreases off-resonance and since bandwidth is defined as the difference between the two sideband frequencies at which the gain is 3 db down, bandwidth (B_w) is

$$B_w = \frac{\omega_2 - \omega_1}{2\pi} = \frac{g_g + g_l - g_d}{2\pi C} = \frac{g_t}{2\pi C} \quad (5)$$

Equations 4 and 5 shows that as the gain is increased (by decreasing g_t), the bandwidth decreases, becoming zero at the point where g_t is zero, which coincides with the point of infinite gain.

The gain-bandwidth product of the circuit of Fig. 1E can be expressed fully in the circuit parameters

$$\sqrt{PG} \times B_w = \sqrt{g_l g_g / \pi C} \quad (6)$$

If $g_g + g_l$ is approximately matched to $-g_d$, ($g_g + g_l \cong |-g_d|$), then

$$\sqrt{PG} \times B_w = \sqrt{g_l (g_g - g_l) / \pi C} \quad (7)$$

and the gain-bandwidth product will be largest when $g_l = g_g = g_d/2$, at which time it is equal to

$$\sqrt{PG} \times B_w = g_l / \pi C = g_d / 2\pi C \quad (8)$$

Thus the figure of merit (gain-bandwidth) for a tunnel diode is defined by its g_d/c ratio.

STABILITY CONSIDERATION—

An important consideration of amplifier stability is the variation of gain as a function of load or source impedance.¹

For high gain ($g_l + g_g - g_d$)²

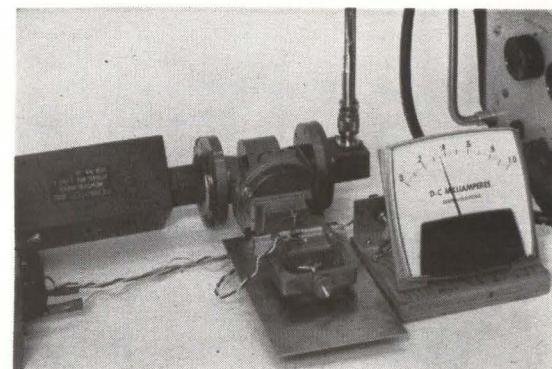

TUNNEL DIODE six-gigacycle waveguide amplifier

must be nearly zero. Any small change in the negative diode conductance (g_d) due to bias change, temperature variation, diode interchange or changes in source or load conductance, will have a large effect on gain. The source driving a tunnel diode amplifier might be an antenna. The load might be the input circuit of a receiver. These terminating impedances may vary with time, temperature, supply voltage and/or loading.

To visualize the magnitude of these effects, calculate the fractional change in resonance gain $\delta G/G$ as a function of a small fractional change in load conductance $\delta g_1/g_1$. This is done by differentiating Eq. 3 with respect to g_1 . Hence

$$\delta G = \left[\frac{4g_0}{(g_0 + g_1 - g_d)^2} - \frac{8g_0 g_1}{(g_0 + g_1 - g_d)^3} \right] \times \delta g_1 \quad (9)$$

or

$$\frac{\delta G}{G} = (1 - \sqrt{G/g_0}) \delta g_1/g_1 \quad (10)$$

Thus the stability problem becomes more serious as the gain increases. For example, if $g_1 = g_0$ and $G = 30$ db, a change of 1 percent in load conductance will cause a 30 percent change in resonance gain. This gain stability depends heavily on the three following factors.

- The negative conductance of the diode. This conductance is bias and temperature dependent, but appropriate stabilization circuits can be used with success.²

- The driving source conductance. Generally the conductance of an antenna.

- The load conductance. Generally the input conductance of a mixer circuit.

These latter two points make it difficult to use the tunnel diode as an amplifier using lumped-constant circuits. Matching networks between the antenna and the tunnel-diode amplifier, as well as similar networks between the amplifier and the load would have to be isolator-coupled to minimize the effect of load and source impedance variations on the tunnel-diode amplifier. Conversely it is also important to minimize the effect of negative conductance on source and load termination. Furthermore, transistors are available up to, and including, the vhf frequencies.

Above vhf frequencies, however, transistors with adequate gain-bandwidth products and low noise figures are not available. At those frequencies, transmission-line techniques do provide for isolators, circulators and hybrid couplers with low vswr and low insertion loss. These components have contributed to the successful application of tunnel-diode amplifiers with effective unilateralization and good circuit stability at and above uhf.

NOISE CONSIDERATION — The negative resistance of a tunnel diode exhibits shot noise; a tunnel diode also has a parasitic series resistance exhibiting thermal noise. At frequencies in the audio range the tunnel diode also exhibits 1/f noise. Yet despite these noise sources, tunnel-diode amplifiers can be constructed exhibiting noise figures as low as 3 db.

Two requirements must be met to obtain a low noise figure. First, the tunnel diode must itself exhibit low noise, and secondly, the circuit must be optimized for lowest noise. The tunnel diode's basic performance can be described by a noise figure of merit which is a function only of the diode parameters, its bias point, and the operating frequency.⁸ When the diode is used as an amplifier, the circuit noise figure can be made to asymptotically approach the noise figure of merit of the diode. The latter is normally the minimum limit. The amplifier's noise figure is made to approach the figure of merit of the diode by arrangement of circuit parameters.

One paper on the noise performance of tunnel diodes⁹ equates the noise figure of merit of the diode as

$$F = \left(1 + \frac{g_{eq}}{g_d} \right) \left[1 - \left(\frac{f}{f_{r0}} \right)^2 \right] \left(1 - \frac{R_S}{|R_D|} \right) \quad (11)$$

In this equation the ratio of g_{eq}/g_d assesses the shot noise relative to the diode negative conductance. At frequencies above the audio range, where $I_{eq} = I_{d-c}$ (d-c bias current through the tunnel diode), g_{eq} is equal to approximately $20 I_{d-c}$. At lower frequencies, I_{eq} is greater than I_{d-c} ($g_{eq} = eI_{eq}/2KT$).

A good commercial tunnel diode will generally have a large enough

ratio of $R_s/R_D \approx 0.1$ to 0.3 to make the thermal noise effect negligible. To ensure that the noise figure is not unduly increased, a tunnel diode should be chosen with a resistive-cut-off-frequency at least three times higher than the operating frequency. Under those conditions another figure of merit is sometimes used, the so-called noise constant, given by Eq. 12

$$\text{Noise constant} = 20 I_0 R_d \quad (12)$$

In this equation, I_0 is the operating point current and R_d the negative resistance at that point. Since I_0 and R_d vary independently, there is a minimum $I_0 \times R_d$ or I_0/g_d point. This point is generally beyond the inflection voltage, which, for germanium units, is about 150 mv.

The product $I_0 R_d$ and hence also the noise constant do vary radically with semiconductor material.

UHF AND MICROWAVES — A ferrite circulator is a three-port nonreciprocal passive device in which an incident signal is rotated by the action of a strong magnetic field in one direction only. Thus, an input signal at terminals 1—1', Fig. 2A, is transmitted to terminals 2—2' but no signal appears at 3—3' owing to phase polarization. The same clockwise circulation occurs when a signal is applied to any of the three terminals pairs. In other words a ferrite circulator can direct the flow of energy from the signal source to the tunnel diode at port 2 and to the load at port 3. Energy does not flow in the reverse direction.

Although commercial circulators do exhibit low forward loss (fractions of 1 db), their reverse isolation is only about 20—25 db. As a result, four-port circulators and cascaded three-port circulators, Fig. 2B and 2C, are used to improve the unilateralization of signal flow. Four-port circulators are usually preferred because they are less expensive than two separate three-ports. The four-port circulator also exhibits a lower vswr because matching is usually done by the circulator manufacturer rather than by the user. Generally a four-port circulator will exhibit a maximum vswr of 1.2 where two three-ports can have maximum aggregate vswr as high as 1.44. Since small load variations can cause large

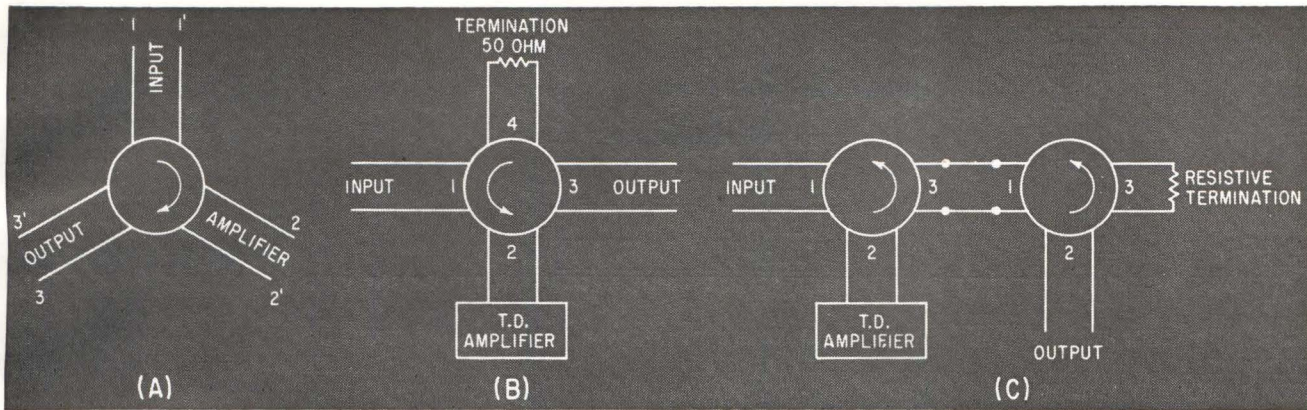

THREE PORT circulator (A), four-port circulator (B), two cascaded three-port circulators (C)—Fig. 2

gain variations, it is easy to see the importance of reducing vswr. There are several important factors to consider in the choice of circulator. First, its vswr must be kept at a minimum, to match the tunnel diode's negative resistance. Secondly, the circulator's insertion loss must be small since the circulator is situated at the amplifier input and its losses add noise directly to the total noise figure of the system, regardless of the gain of the amplifier. Thirdly, its unilateralization (or isolation) must be adequate to isolate the tunnel diode from the driving source and the load. Lastly, the circulator's bandpass characteristics must be adequate for the desired system performance. Both narrowband and broadband circulators are available commercially. Narrowband circulators exhibit 5 to 10-percent bandwidth, while broadband units exhibit bandwidths of 20 percent and greater.

To use a circulator with tunnel-diode amplifiers, another factor becomes important. Recalling the stability criteria for amplification, the real part of the total circuit admittance as seen by the diode must be greater than the diode's negative conductance, and the imaginary part of the total circuit admittance (including the tunnel-diode parasitic susceptances) must be zero.

Assuming that the vswr exhibited by the terminated circulator over its pass band is a fairly constant value close to unity, then the vswr at frequencies well above or below its passband can considerably exceed this level. Hence at those undesired frequencies the real part of the circuit admittance can

be equal or small than $|-g_d|$. Given this condition the tunnel diode can oscillate anywhere from the low frequencies to its resistive cut-off frequency.

Under oscillatory conditions, the amplifier gain is correspondingly reduced since the available energy must be reapportioned between oscillation and amplification. Because the oscillating limit cycle swings over a portion of the diode characteristic, the effective diode negative conductance is reduced as is the gain of the amplifier. A low-loss resonant network should therefore be inserted between the amplifier and the circulator having a passband narrower than that of the circulator but ample for the bandpass characteristic required. This network should transform the circulator impedance (if transformation is necessary) to the required real termination over the passband of the amplifier and provide a short circuit below and above it.

The gain of such an amplifier is most easily expressed in terms of the reflection coefficient, Γ^4

$$G = \Gamma^2 = (1 + \alpha)^2 + \beta^2 / (1 - \alpha)^2 + \beta^2 \quad (13)$$

where $\alpha = G'_d + G'_s / G_c$, G'_d and G'_s are the transformed values of tunnel-diode negative and series conductances respectively, G_c is the circulator conductance, and β is the total normalized circuit susceptance. As an example if $\alpha = 0.7$ and $\beta = 0$ then

$$G = \Gamma^2 = \frac{(1 + 0.7)^2}{(1 - 0.7)^2} = \frac{(1.7)^2}{(0.3)^2} \approx 15 \text{ db}$$

For a 50-ohm circulator, this implies the use of a 72-ohm negative resistance at the bias operating point. The bandwidth of the ampli-

fier then becomes

$$B_w = [(1 - \alpha) / \alpha] [1 - R_s / R'_d] / 2\pi R_d C_T \quad (14)$$

where C_T is the total diode capacitance and R'_d the series equivalent of the negative resistance. The noise figure, F , of the tunnel diode in terms of the diode parameters is

$$F = \frac{1 + (20 \alpha I_0 / G_d)}{(1 - R_s / R_d) (1 - f_0^2 / f_r^2)} \quad (15)$$

This essentially the same equation as Eq. 11 with the exception of the gain factor α , where

$$\alpha = (|G'_d| - G'_s) / G_c \quad (16)$$

In most noise figure analyses, it is assumed that the gain factor is high and α close to unity. However, a practical amplifier with 15-db gain can have an α as low as 0.7, hence the estimate of noise figure can be off considerably.

In system front-end design, where noise figure is of paramount importance, due consideration must be given to the choice of the lowest noise diode available. On the basis of the noise constant it might at first seem obvious to use a gallium antimonide (GaSb) tunnel diode, since its noise constant is 0.8 as compared to 1.3—1.4 for germanium (G_c). Hence with minimum noise figure for GaSb about 2.5 db as compared to 3.5 db for Ge, it is often assumed that a GaSb unit will produce less system noise. This does not always follow, because ^{4,7} for a given value of F_2 (second stage noise figure) more first stage gain is required for the antimonide unit to achieve optimum system noise (F_s).

The diode choice must thus be based on system considerations. The gain stability of the circulator coupled reflection amplifier is

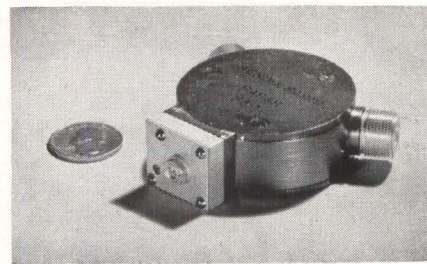
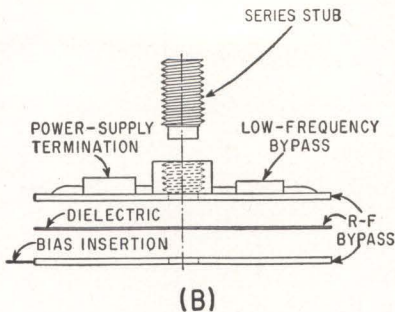
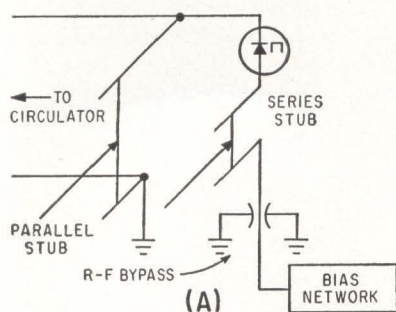

SIMPLIFIED tunnel diode preamplifier circuit (A) and its physical arrangement (B). Three-port circulator coupled L-band amplifier (C)—Fig. 3

primarily dependent on the stability of the negative conductance versus bias and temperature. As a result the diode material with the least change in negative resistance (conductance) versus temperature would provide the stablest results.

As for bias stability, a gallium antimonide unit with sharper I_o/G_a slope would see a larger change in diode conductance, hence in amplifier gain and noise figure, for any given change in bias voltage. Thus germanium has the edge

A remaining amplifier design consideration is how to adjust amplifier gain and noise figure from amplifier to amplifier, since terminations, circulators and tunnel diodes must necessarily have some tolerances. Naturally, since the negative conductance varies with voltage, the simplest solution would be to slightly vary the tunnel diode bias in order to adjust each amplifier for the desired value of gain. Although I_o/G_a has a rather broad minimum (versus bias voltage), this method would degrade the system noise figure since not all amplifiers would wind up biased at the minimum I_o/G_a point. Therefore it is preferable to bias stably at the minimum I_o/G_a point and adjust amplifier gain by another means.

It might be useful at this point to indicate that measurements have shown the tunnel diode inflection point to be located at approximately $1.8 V_p$ and the minimum I_o/G_a point at $2.4 V_p$ for germanium tunnel diodes.

The way to adjust gain without sacrificing noise figure is to add a small amount of variable series inductance, as shown in Fig. 3A. The parallel stub tunes out the diode capacitance, while the series stub alters the value of negative resistance. By making the series stub inductive, the gain can be in-

creased. When using this stub, it is better to employ a diode with 78 ohms negative resistance so that the gain can be adjusted to about the 15-db level. While a gain variation of 6 db can be realized with this technique, the added inductance cannot be allowed to exceed the value set by the stability criterion. Too much inductance will result in too much gain, in reduced stability, and since the gain-bandwidth product is fixed in a narrower bandwidth. The bandwidth can be increased by controlling the circulator impedance so that the real part is increased at the band edge, Fig. 3B, while the performance results of this approach are given in Fig. 3C and 3D. Figure 3E shows a complete 3-port circulator-coupled L-band amplifier.

The operating design procedure for the circulator type amplifier is summarized as follows. Circulator choice depends up minimum vswr, adequate isolation, proper bandwidth and minimum insertion loss. The tunnel diode is chosen after considering its negative resistance (to give required a and gain), and for lowest diode capacitance since capacitance has a direct effect on bandwidth, Eq. 14.

For any given value of $-R_d$ the diode capacitance can also determine the noise figure since it determines f_{r0} , Eqs. 11 and 15. This becomes important only when the operating frequency starts approaching f_{r0} . Further factors in choosing the tunnel diode are choice of unit with f_{r0} at least three times operating frequency for lowest noise figure, choice of unit with lowest R_s/R_d ratio for lowest noise performance, choice of lowest I_o/G ratio, to minimize noise figure, and choice of low diode package-inductance for stability considerations.

The basic inequality that sets the

conditions for stable gain is $L_T/R_a C_T < R_T < R_a$, where L_T = total circuit inductance, R_a = negative resistance, C_T = total circuit capacitance and R_T = total positive resistance. This expression holds for low frequencies and r-f. While the r-f instabilities are usually due to a poor circulator, low frequency instabilities are a result of improper bias network design. This problem can be overcome by keeping the r-f bypass and power-supply source termination physically close to the diode. Although theory suggests that the value of power supply impedance need only be less than $R_{d\ min}$, experience shows that a practical value should be about one third of $R_{d\ min}$.

Integral mounting of amplifier and circulator has advantages in bandwidth and stability. This mounting scheme permits the bandwidth to be controlled by the circulator impedance. Adding line length between the amplifier and circulator will alter the impedance presented to the tunnel diode, creating a potentially unstable condition. The amplifier should therefore be mounted as close to the circulator as possible.

Characteristics of one amplifier built along these lines are: center frequency 1,250 Mc, 1 db B_w at 200 Mc, 15 db gain, noise figure between 3.5 and 3.7 db, 1 db saturation level at -35 dbm input power, and r-f peak power capability of 5 to 10 watts.

Similar performance has been observed up to 6.0 Gc, since 25 to 35 Gc (f_{r0}) tunnel diodes have become available.

HYBRID COUPLING—The (3 db) hybrid coupler amplifier is a four-port network that splits a signal incident at one port into

two equal components 90 degrees out of phase and couples them to two other ports. The remaining port is isolated from the input port. If a signal at port 1 is designated by an amplitude e and zero phase angle, ($e \angle 0$) the voltages coupled to ports 2 and 3 are $\sqrt{e}/2 \angle 0$ and $\sqrt{e}/2 \angle -90$, Fig. 4A.

The input signal at port 1 is split into two components equal in magnitude and 90 degrees out of phase. These components appear at ports 2 and 3 where two identical amplifier modules provide the gain. The two amplified signals add in-phase at port 2, out of phase at port 1 and hence couple completely to port 4. The amplified-reflected waves are each split again and transmitted back to the input and output ports. The two waves arriving at the input port are 180 degrees out of phase and cancel. Consequently the entire output appears at the load. Due to some mismatch in the amplifiers and nonideal hybrid action, the hybrid coupled amplifier does have some bilateral transmission characteristic which can be unilateralized by the addition of isolators before or after the amplifier. The requirements for stability are that each amplifier module be itself stable when connected to the hybrid coupler and that the total effective isolation is larger than the gain (less than unity loop gain).

AMPLIFIER MODULES — Each amplifier module consists of the tunnel diode, the d-c bias network and an r-f—d-c decoupling circuit. This latter isolates the r-f from the bias network and blocks d-c from source and load. The amplifier module is illustrated in Fig. 4B. Resistors R_1 and R_2 form the bias voltage divider, whose Thevenin equivalent series resistance should be made equal or smaller than $|-R_d/3|$ to ensure a stable d-c voltage source. The r-f and d-c sources are decoupled by C_B and L_B . The remaining elements are the equivalent circuit parameters of the tunnel diode; L_p is the series-peaking inductance necessary to adjust the gain in matching modules. The performance obtained with such an amplifier depends largely on the characteristics of the hybrid coupler. Just as in the circulator am-

plifier, the maximum vswr seen by the modules is the most important stability consideration because it affects gain and stability. When operated at the minimum I_0/g_d point, each module is adjusted by L_p to a matched gain value.

Stable gains in the order of 10 db, with two to three-octave bandwidths and 4.5-db noise figures have been reported^{5, 6}, while 1-db saturation levels have been reported in the -28 dbm input range for GE 1N3218A tunnel diodes.

The schematic and gain equation of such an amplifier is illustrated in Fig. 4C.

For 10-db gain and $Z_0 = 50$ ohms, a negative resistance of about -100 ohms is indicated. An example of a diode with low-inductance-housing, with low C_d (5 pf max) and $|-R_d|$ in the 100-ohm range is the GE 1N3218A. Having a f_{r0} of 3 Gc and a f_{x0} of 3.8 Gc this unit is housed in a microwave pill package and exhibits a series inductance of 0.4 nh.

REFERENCES

- (1) R. A. Pucel, The Esaki Tunnel Diode, *Electrical Manufacturing*, Feb. 1960.
- (2) H. R. Lowry, J. Giorgis, E. Gottlieb, and R. C. Weischedel, "General Electric Tunnel Diode Manual," 1st. Edition G. E. Semiconductor Products Dept., Syracuse, New York.
- (3) E. G. Nielsen, Noise Performance of Tunnel Diodes, *Proc. IRE*, p. 1903, November 1960, and Noise in Tunnel Diode Circuits, *Proc. Nat'l Electronics Conference*, XVI, p. 785.
- (4) D. W. MacGlashan, New Tunnel Diode Preamplifier Improves Phased Array Radar, *ELECTRONICS*, p. 57, Sept. 28, 1962.
- (5) John J. Sie, Absolutely Stable Hybrid-Coupled Tunnel Diode Amplifier, *Proc. IRE*, p. 1321, July 1960.
- (6) D. Fleri, H. Boyet, Investigation of Traveling Wave Parametric and Hybrid-Coupled Tunnel Diode Amplifier, Technical Note RADC-TR-61-231.
- (7) D. W. MacGlashan, Modified Tunnel Diode Noise Figure Equation and its effect on System Noise, February 28, 1962 (unpublished).

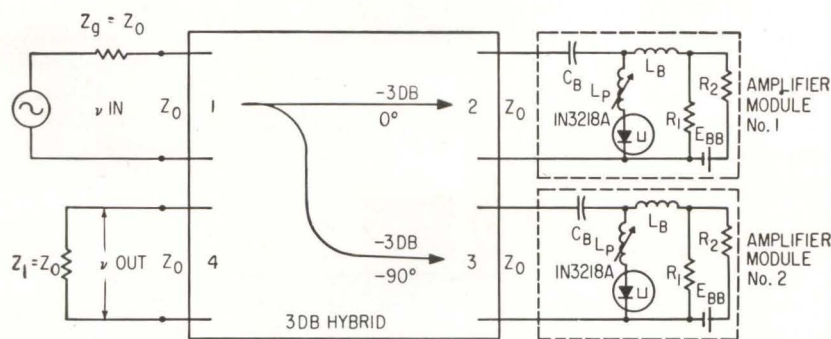
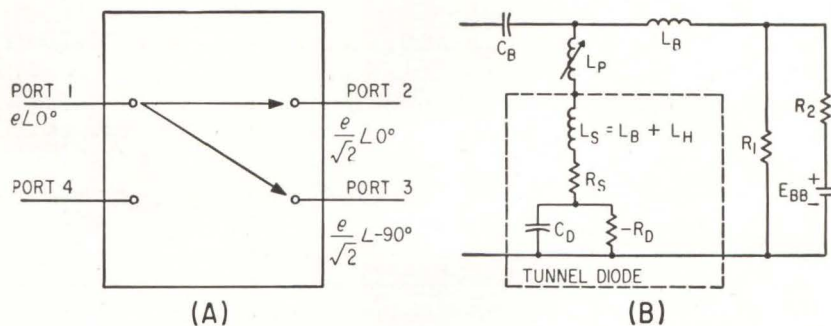

$$r^2 = \frac{\left[\frac{f_0^2}{f_1^2} - 1 - \frac{Z_0}{|-R_d|} + \frac{R_S}{|-R_d|} \right]^2 + \frac{f_0^2}{f_1^2} \left[\frac{Z}{|-R_d|} + \frac{Z_0/|-R_d|}{Z/|-R_d|} - \frac{R_S/|-R_d|}{Z/|-R_d|} \right]^2}{\left[\frac{f_0^2}{f_1^2} - 1 + \frac{Z_0}{|-R_d|} + \frac{R_S}{|-R_d|} \right]^2 + \frac{f_0^2}{f_1^2} \left[\frac{Z}{|-R_d|} - \frac{Z_0/|-R_d|}{Z/|-R_d|} - \frac{R_S/|-R_d|}{Z/|-R_d|} \right]^2}$$

$Z_0 =$ CHARACTERISTIC IMPEDANCE

$$Z = \sqrt{L/C}$$

$|-R_d| =$ NEGATIVE RESISTANCE OF THE DIODE

$$f_1 = \frac{1}{2\pi\sqrt{LC}}$$

(C)

SIGNAL distribution in hybrid coupler (A), tunnel-diode amplifier (B), hybrid-coupled tunnel-diode amplifier and its gain equation (C)—Fig. 4



READOUT of a stored picture from tape. Full scan is 0.62 inch high and retrace lines are visible

TVIST: New

ELECTRO-OPTICAL information storage is a valuable method of retaining pictorial data. Obtainable picture quality for this system includes a resolution greater than 3,800 tv lines-per-inch, eight to nine different shades of grey and sensitivities comparable to that of plus-X photographic pan film. TVIST is a television information storage tube with a capacity of 10^{11} information elements. Information is electrostatically written and stored as electric charges on a special tape. Writing is performed either by secondary emission or electron bombardment induced conductivity (EBIC). Readout is nondestructive, and more than 20,000 half-tones may be made from a single frame of stored data. Moreover, storage times greater than 80 hours with negligible signal loss have been achieved, all materials are reusable and the only quantity consumed is electrical operating power.

CAMERA TUBE OPERATION—The camera tube is shown in Fig. 1. A subject, (arrow) is imaged by an optical-lens system onto a photocathode. Photoelectrons are accelerated by about a 10 Kv potential and fed to the storage tape that originates on the left-hand spool. Before the tape reaches writing position, it passes the erase and priming device where it is negatively charged. An alternate gun with deflection similar to a 5CE gun can be provided before the writing position to permit any signal to be written on a tape moving either intermittently or with constant velocity.

The reading device is similar to the readout portion of a standard image orthicon and is designed to have an extremely fine focal point. The return beam is modulated and then amplified by several stages of an electron multiplier without electrons bombarding the stored information charges.

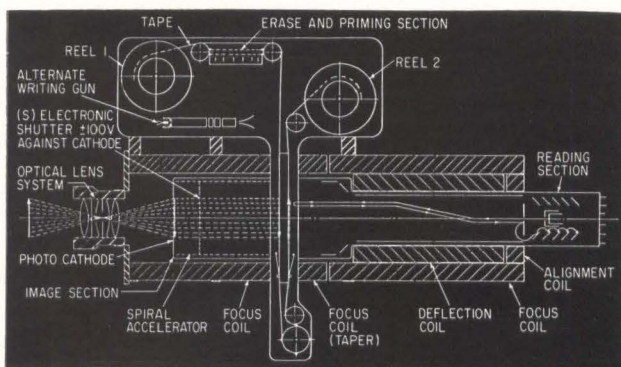

TELEVISION information storage tube including tape and optical systems is completely reusable and consumes only operating power—Fig. 1

A NEW TVIST

The concept of storing a picture on tape has been around for a while. However, the tube described here is a bit of a twist in that it can store 10^{11} information elements with a resolution that permits large numbers of pictures to be produced from any stored frame.

The sensitivity obtainable with TVIST is on a par with plus-X panchromatic film and dynamic range will probably exceed 20 steps with 8 to 9 shades of grey easily obtainable. Latest research has increased resolution to 3,800 tv lines-per-inch

Long-term, high-resolution image storage is becoming increasingly important. Here is a system with better characteristics that will store images for more than 80 hours. Moreover, it can produce more than 20,000 half-tones from a single stored frame

Look In Photoelectric Storage Tubes

By A. S. JENSEN and W. G. RENINGER, Westinghouse Electric Corp., Tube Div., Baltimore, Md.

After writing, the tape is collected on a second spool from where it may be reeled back into the reading position; both take-up and supply spools can accommodate up to several hundred feet of storage tape.

Photoelectrons can be repulsed by an electronic shutter within microsecond switch times, or an alternate mechanical shutter may be used.

The camera is equipped with all necessary magnetic coils including the image-section focus coil, reading-section focus coil, and alignment and deflection coils. On sealed tubes and demountable vacuum devices, the overall system consisting of several signal processing steps showed a resolution better than 3,800 tv lines-per-inch on the target tape. Stages considered include the camera lens, photocathode, magnetic and electrostatic focusing devices, charge deposition and storage, readout focal-spot and amplifier.

STORAGE TAPE—The storage tape is an electroformed replica of an optical grating produced in both nickel and copper of about 1.5 mil thickness, and has 6,000 sharply defined grooves-per-inch as shown in Fig. 2A. A dielectric with a specific resistance of about 10^{18} ohms-cm is shadow evaporated at an angle to form a deposit on the long slope of the grating. This system allows the steep slope of the grating to remain bare. Materials such as magnesium and calcium fluorides are being used in the evaporation process.

Present tapes are 35 mm wide but 70 mm tape with sprocket holes can be produced, permitting a usable storage width of 57 mm.

Grooves in the metal base of the tape permit pro-

* For the U. S. Air Force, under contract AF33 (616) 6666 and AF33 (657) 8715

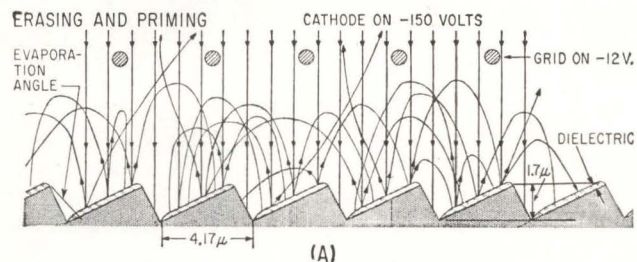

(A)

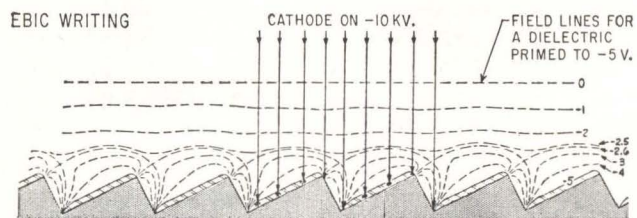

(B)

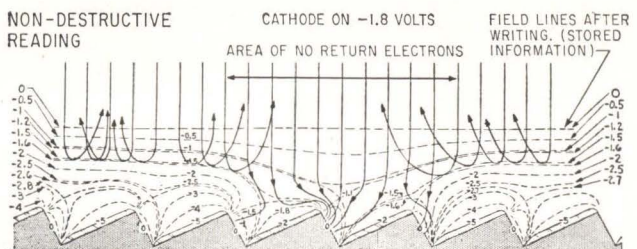

(C)

STORAGE tape is an electroformed replica of an optical grating with erasing and priming as shown (A); EBIC writing process (B) and nondestructive readout (C) —Fig. 2

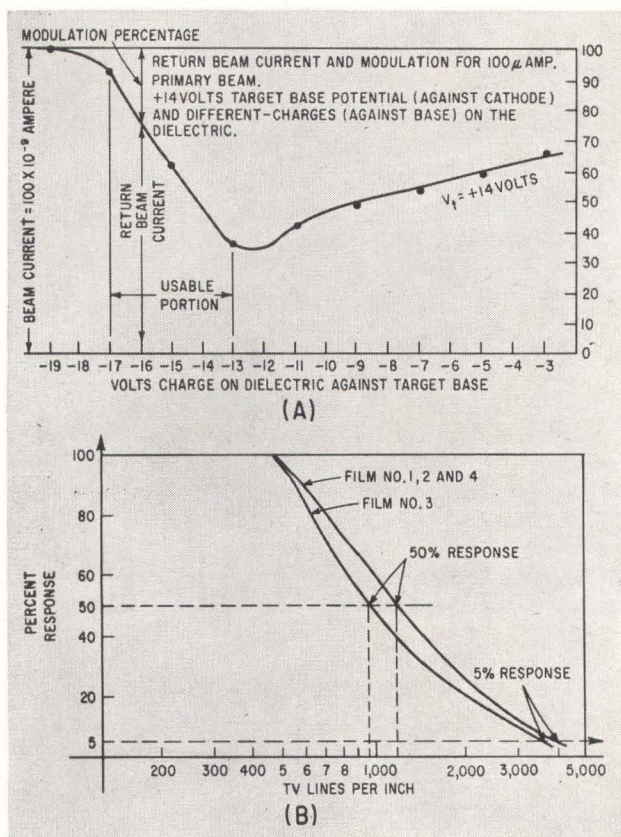

TRANSFER curve for reading (A) and resolution response curve (B)—Fig. 3

duction of a bare metal grille by shadow evaporation. This makes a nondestructive, noncharging reading method possible and also prevents the front side of the tape from shorting to the back side of the next layer during reeling. Since the bulk of the surface area of the storage dielectric is inside the grooves, physical contact cannot cause a short circuit.

Tape has been produced in lengths of several feet and techniques for fabricating it in lengths of several hundred feet have been defined. Rigid target pieces with a storage surface of 2×2 inches and about 20 mil thickness have been produced for storage targets in similar tubes.

Target base and dielectric consist of materials with high melting point and low vapor pressure. Targets can be baked at temperatures up to 450 C during tube processing in order to fulfill the required vacuum practice important in storage tube design.

PRIME AND WRITING PROCESSES—Design and operation of the storage tape is shown in Fig. 2A. Here, electrons from a cathode with a potential of -150 to -200 volts liberate secondary electrons that are repelled by the -12 volt grid potential and directed against the target. The electrons remain on the target until an equilibrium-charge potential of approximately -5 volts is reached. This process erases stored signals and primes the dielectric to the negative potential. The operation is analogous to some film sensitizing processes.

The primed portion of tape is positioned before

the writing gun or behind the photocathode. In both cases, electrons of about 10 Kev bombard the dielectric surface and their high energy levels momentarily induce an EBIC conductivity. For each electron arriving, ten or more charge electrons flow through the metal base^{1, 2, 3} from the dielectric surface as shown in Fig. 2B. The surface loses charge in proportion to the number of electrons bombarding it. Moreover, this number of electrons from the photocathode is also proportional to incident-light intensity.

During the writing process, the dielectric surface that had been uniformly charged at -5 volts is partially discharged, yielding the pattern shown in Fig. 2C. In more recent experiments, dielectrics are primed to about -16 volts and discharged to -13 volts in highlights.

READING PROCESS—The electron beam of a modified image orthicon electron gun with a small focal point scans the charge pattern. All electrons are returned in the region of the -5 volt dielectric and are collected by the bare metal base in areas of -2 volts potential as shown in Fig. 2C. This process is similar to that of a triode, where the charge on the dielectric is analogous to grid-bias voltage. The modulated-return beam is then amplified by several multiplier stages to produce the output signal.

Reading transfer curves were read and plotted. Figure 3A shows a curve for a -19 volt primed surface read with the cathode at -14 volts against the base. More than 60-percent modulation of the primary beam resulted and no electrons bombarded the dielectric during readout. Also, no change in the charge pattern resulted. More than 20,000 half-tones were produced with negligible loss in signal strength; eventual loss is due to positive ion bombardment.

Eight to nine shades of grey were obtained. Pictures were written and stored for more than 80 hours with only a small loss in contrast. The tape was tightly reeled during the storage period.

RESOLUTION—The overall writing and reading process has a measured resolution greater than 3,800 tv lines-per-inch of target. This is equivalent to 42.5 line pairs-per-mm. Resolution was measured in three different ways. Each yielded nearly the same response curve as shown in Fig. 3B. The response is 100 per cent up to 450 tv lines, 50 per cent up to 1,000 lines and 5 per cent at 3,800 lines.

Performance can be extended by improving the optical-lens system and the acceleration and focus system; by increasing the number of grooves on the target, further reducing the beam-focal point and increasing the bandwidth of the amplifier.

REFERENCES

1. L. Pensak, *Phys. Rev.*, 75, p. 472 1949.
2. R. J. Schneeberger, Bombardment Conductivity in Imaging Systems, Westinghouse Research Report No. 60-8-10-43-R1, April 1954.
3. R. W. Decker and R. J. Schneeberger, Image Tube Utilizing Bombardment Induced Conductivity, *IRE National Convention Record*, Part 3 1957.
4. J. F. Nicholson, Westinghouse Electronic Tube Divisions, private communications, to be published.

±0.0015
 ±0.003
 ±0.0005
 ±0.001

Large helpings? *precisely!*

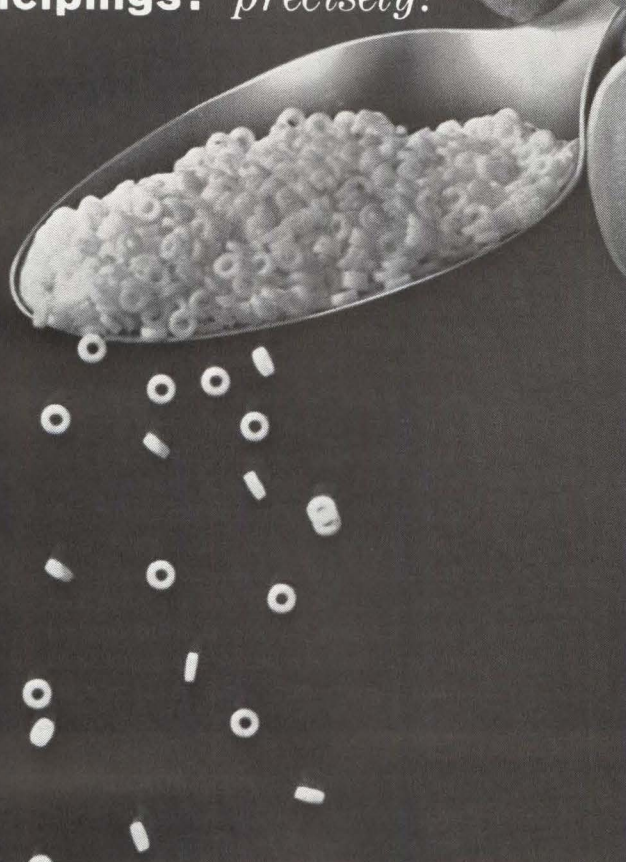

Smaller and smaller and smaller parts...tighter and tighter tolerances...in larger and larger quantities...this is the story of microceramics. Regular production includes substrates so tiny that a teaspoon holds more than 8,000 parts! Coors offers a complete facility for creating small, consistent, ceramic substrates - in several Coors Alumina and Beryllia ceramics, metallized or unmetallized. To assure economy, "as-fired" parts are produced in quantity, to extremely close tolerances (as shown at right). Let Coors provide the special help you need. Write for "Ceramic Substrate Design," Data Sheet No. 7002, or call your nearest Coors regional sales manager: SOUTHERN CALIFORNIA, Kenneth Lloyd, 536-8556, Huntington Beach, Calif.; BAY AREA AND NORTHWEST, John Marozeck, EM 6-8129, Redwood City, Calif.; MIDWEST, Tom Daly, 529-2510, Chicago, Ill.; CENTRAL, Donald Dobbins, GL 4-9638, Canton, Ohio; EAST COAST, John McManus, MA 7-3996, Manhasset, N. Y.; NEW ENGLAND, Warren G. McDonald, FR 4-0663, Schenectady, N. Y.; SOUTHWEST, William H. Ramsey, UN 4-6369, Houston, Texas.

Coors

ALUMINA CERAMICS

Coors Borelmain Co. Golden, Colo.

EXAMPLES OF AS-FIRED TOLERANCES HELD BY COORS IN REGULAR PRODUCTION

HOLE PATTERN
 DIA. .200
 ± .0005



.205 x .257 x .030
 LOCATION OF
 .016 DIA. HOLES
 HELD
 WITHIN .001

.060 DIA.
 .030 I.D.
 .001 CON-
 CENTRICITY



.097 x .222
 .007 THICK-
 NESS ± .0005
 .001 CAMBER

.143 DIA.
 .013 THICK-
 NESS ± .0005
 .001 CAMBER



.186 DIA.
 .013 THICK-
 NESS ± .0005
 .001 CAMBER

.268 DIA.
 .002 FLAT-
 NESS



.008 SLOT
 WIDTH

.010 THICK-
 NESS ± .001
 .001 MAX.
 CAMBER

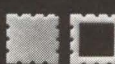

.015 THICK-
 NESS ± .001
 .001 MAX.
 CAMBER
 .230 I.D.

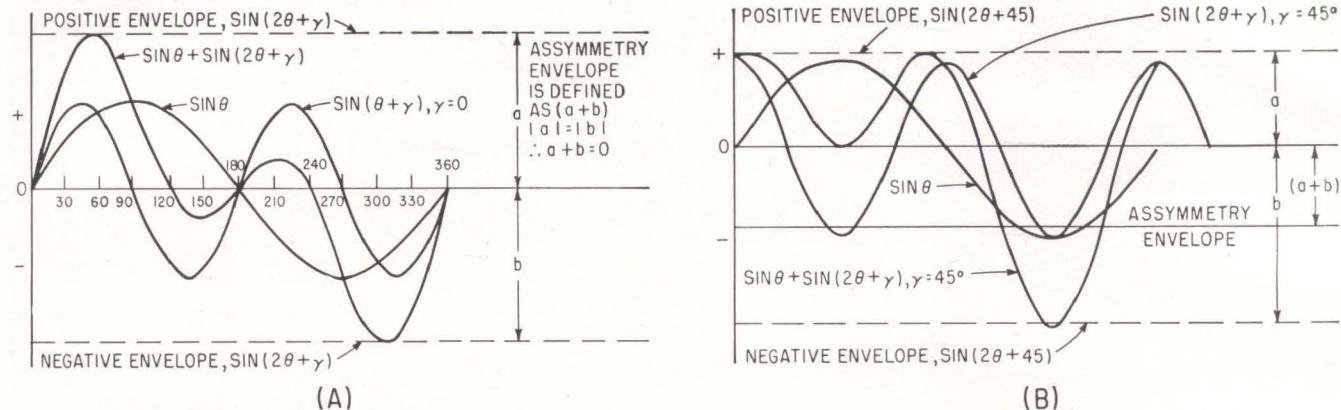

ASYMMETRY envelope of fundamental plus second harmonic is zero when the two are in phase, (A); when a 45-degree phase shift is introduced, the asymmetry envelope is strongly negative, (B)—Fig. 1

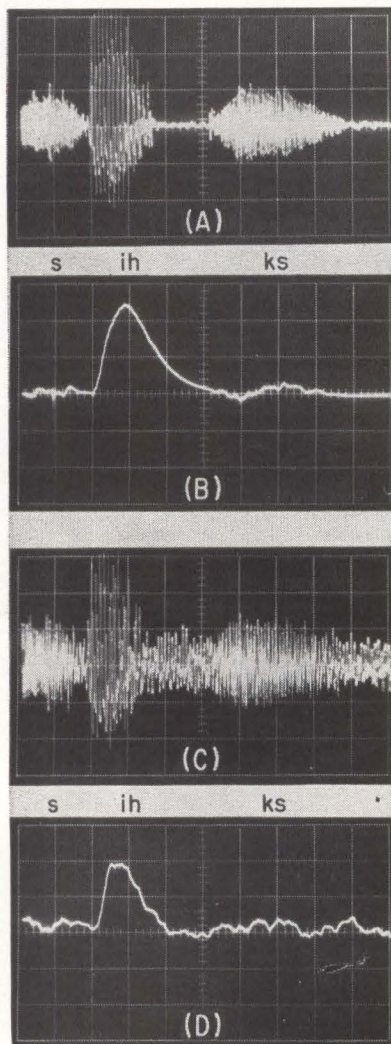

SPOKEN WORD "six", including noise, (A); demodulator output of asymmetry envelope, (B); spoken word "six" in an increased level of ambient noise, (C); demodulator output, showing unimpaired sensitivity of demodulator, (D)—Fig. 2

Speech Operates Safety Switch

Speech recognition circuit switches off machinery on command

By WILLIAM C. DERSCH
Voice Systems Inc., Campbell, Calif.

HUMAN VOICE has a unique quality known as "envelope asymmetry". This can be usefully applied in a simple safety switch that responds to sharply spoken commands or exclamations, but not to normal speech, and turns off a power machine such as a drill in an emergency.

Envelope asymmetry is a function of the average power axis and the average voltage axis of the electrical analog of the sound pressure wave.

The effect on the envelopes of relative phase shift of even harmonics in a complex wave shape is shown in Fig. 1. When the positive and negative envelopes of the sum wave shape are added, the envelopes cancel, and the asymmetry envelope is zero, Fig. 1A. However, when the second harmonic is shifted with respect to the fundamental, and a new sum wave shape is generated, its asymmetry envelope is strongly negative. This is

apparent in Fig. 1B.

The vowel wave shapes of the human voice are rich in evenly related harmonics, and with proper phase shift control, all vowels have strong asymmetry. Ambient noise does not have strong asymmetrical characteristics, and thus the superposition of large amounts of noise on the signal does not affect the original asymmetry envelope in proportion to the noise strength.

Fig. 2 shows the audio signal of the spoken word "six" and the asymmetry envelope output from the demodulator. The demodulator, seen in Fig. 3, extracts the positive and negative envelopes and algebraically adds them, resulting in the asymmetry envelope.

VOICE SENSITIVITY—When the ambient noise level is increased to a 1:1 signal to noise level by using a fan, the signal of the spoken word "six" including the noise is shown in Fig. 2C. The output of the asymmetry demodulator is shown in Figure 2D; the noise is largely symmetrical and thus self-cancelling. In a simplified form, the speech-operated switch will reject typical ambient noise at the 100 db level, but will respond to an 80-db voice signal. Since the sensitivity of the circuit to voice sounds increases with increasing noise



BELDFOIL

BREAKS THE NOISE BARRIER!

APPLICATIONS: Beldfoil is effective over the entire audio frequency range. Typical applications include instrumentation, data processing, and telemetry equipment, and any information and measurement circuits.

QUIET PERFORMANCE!

Yes, Beldfoil* shielding definitely breaks the noise barrier. It breaks the noise barrier by *being* a noise barrier. Beldfoil gives *total* shielding . . . 100% isolation between adjacent pairs. For audio and radio frequency, it completely eliminates cross talk, spurious signal impulses . . . and it's ideal for stationary or limited flexing. Beldfoil is lighter in weight, requires less space, and is usually lower in cost.

MINIATURIZES!

Beldfoil shielding reduces the diameter of multi-conductor cables . . . by as much as 66 $\frac{2}{3}$ %. It gives design engineers extra space . . . extra conduit space, extra raceway space, extra console and rack space. Beldfoil shielding means that you can "think small."

ASK FOR DATA SHEET. Get your copy of newly published bulletin 8-63-A and technical data sheet. They give complete information on Beldfoil shielding. Write Belden Manufacturing Company, 415 South Kilpatrick Avenue, Chicago 80, Illinois.

WHAT IS BELDFOIL? It's a lamination of aluminum foil with Mylar** that provides a high dielectric insulation. A patented Belden method of folding*** gives definite benefits. An inner fold creates a continuous metallic path around the surface of the cable. This eliminates any possible inductive effects. An outer fold tucks the cut edge of the aluminum under the Mylar. This gives complete isolation from other adjacent shielded cables.



Typical cross section looks like this.

*Belden Trademark Reg. U. S. Patent Office
du Pont Trademark *U. S. Patent 3,032,604

Belden

WIREMAKER FOR INDUSTRY
SINCE 1902 - CHICAGO

8-1-3

INSTRUMENT SERVOS

for measurement, remote display, data conversion, control, computation

North Atlantic's Series 7000 and 8000 Instrument Servos are designed to meet exacting requirements in airborne, ground support and industrial applications. Types available to accommodate most input signals, and providing a wide range of visual, shaft position and signal outputs.



MODEL	OUTPUT	ACCURACY (% full scale)
SBI-7000	single pointer dial	$\pm 0.2\%$ to $\pm 0.5\%$
	linear dial, single pointer	$\pm 0.2\%$ to $\pm 0.5\%$ f.s. numerator
SBI-7070	dual pointer; coarse and 10:1 vernier	$\pm 0.1\%$
SBI-8000	single or dual pointer; counter-pointer	$\pm 0.1\%$ to $\pm 0.5\%$
SBI-7080	counter or counter-pointer	$\pm 0.1\%$ to $\pm 0.5\%$
SBI-7090	digital encoder	$\pm 0.1\%$
SBI-8010	1/8" dia. shaft	$\pm 0.1\%$ to $\pm 0.5\%$ with 15 oz. in. load
SBI-8020	0-999 decimal counter	$\pm 0.05\%$ to $\pm 0.1\%$
SBI-8050	pointer and subdial vernier	$\pm 0.05\%$ to $\pm 0.1\%$

Specifications are for typical production models.

For complete data request SFC-1

NORTH ATLANTIC
industries, inc.
TERMINAL DRIVE, PLAINVIEW, L.I., NEW YORK
Telephone: OVerbrook 1-8600

WHAT DID THE MAN SAY?

The speech operated switch, aside of its obvious convenience, is a speech recognition machine that nicely gets around the problem of vocabulary and individual sounds; nevertheless, it reliably discriminates between the human voice and a background of ambient noise. In fact, its voice sensitivity increases with increasing noise level, and it will detect, claims the author, a voice level of 5 db in 100 db of noise

level, the circuit, without compensation, will respond to a voice level at the microphone of about 5 db in an ambient noise level of about 100 db. Simple gain controls adapt the switch to surrounding ambient noise to suit the operator. The gain setting is adjusted so that normal conversation will not activate the speech operated switch, but any sharply spoken command will be received.

Figure 3 shows the circuit diagram of the speech operated switch. Power is provided by conventional rectifier-filter circuit; power is taken for the switch before the interposed power switching relay. The voice command is connected through the microphone and amplifier — a commercially available unit with provision for an external feedback network—to the asymmetry demodulator, which responds with a positive impulse

to the voice portion of the speech command. This impulse is suitably amplified by Q_1 and Q_2 , and then energizes the relay driver K_1 . There is no hold circuit on K_1 and it returns to its de-energized position when the speech signal ceases. The normally closed contacts of power switching relay K_2 are across the line in series with the motor on-off switch, the motor load itself, and the K_2 normally closed contacts. Thus in the de-energized condition of K_2 , the machine motor load is connected to the power line.

When K_2 is energized, the motor load circuit is across the power line in series with the on-off switch, the motor load, the K_2 normally open contacts (now closed), and the K_2 coil. The high-impedance coil of K_2 is in series with the motor load, but its current is too small to affect the motor.

The power switching relay now

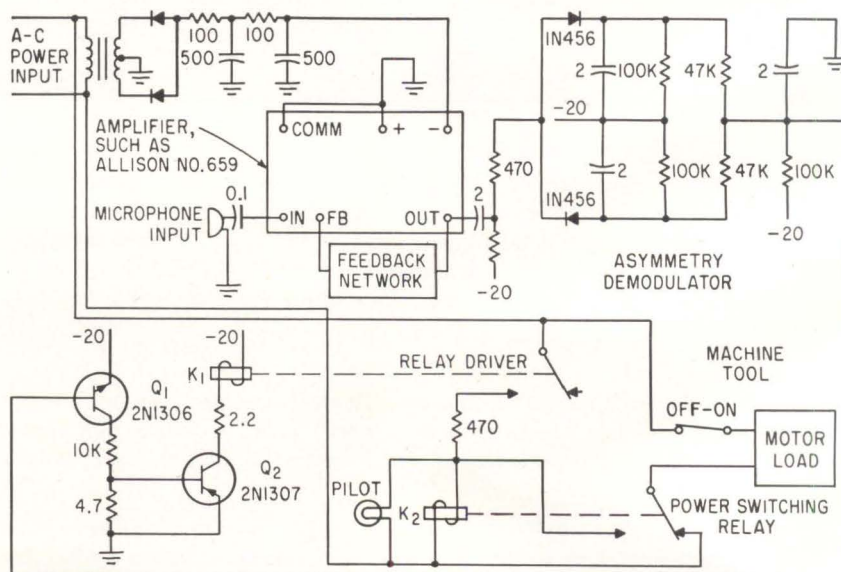

DEMULATOR for asymmetry envelope, in upper right hand corner of circuit diagram, is heart of system—Fig. 3

DUROTHERM* Non-freezing Soldering Tips

PATENT PENDING



POSITIVELY CANNOT FREEZE OR STICK IN ANY IRON BECAUSE OF PROTECTIVE ANTI-CORROSIVE ALLOY!

AT LAST! MAXIMUM LIFE AND PERFORMANCE FROM BOTH ENDS OF COATED SOLDERING TIPS!

***Inserted Section**— Inserted portion of tip protected by long-wearing 100% scale-resistant DUROTHERM coating, bonded to base copper so securely that they become one integral part, to insure maximum heat transfer. Because there are no air spaces or looseness between coating and base copper, tip cannot become dented or out of round, or move or slide out of place. This means faster and more constant delivery of heat with no tip maintenance.

A—Heavy Iron Coating
C—Pretinned Section
D—Multi-coated and immunized

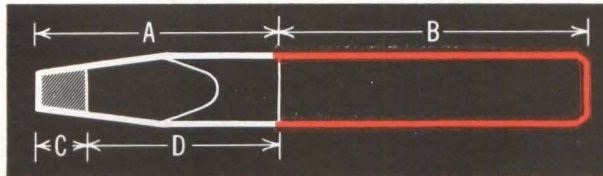

B—Scale-Resistant
DUROTHERM COATING
Bonded to base copper

***Exposed Section**— Factory pretinning by exclusive process insures best performance and minimum maintenance. Exposed section is also multi-coated for extra long wear. This multi-coating immunizes shank of tip from solder, thus preventing solder from creeping into tip hole and spilling on components.

***Resulting In—** The longest wearing and best performing tip ever produced!

***Both Features Exclusive Hexacon Developments**

HEXACON ELECTRIC COMPANY, 130 West Clay Ave., Roselle Park, N. J.

SERVING INDUSTRY FOR MORE THAN THIRTY YEARS—PIONEER DESIGNER OF INDUSTRIAL SOLDERING IRONS AND COATED TIPS

CIRCLE 201 ON READER SERVICE CARD

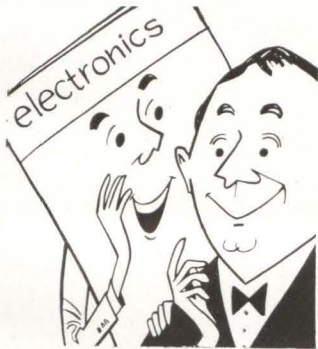

electronics
IS EDITED
TO KEEP YOU
FULLY INFORMED
— a "well-rounded"
engineer

What's your *present* job in electronics? Do you work on computers? (**electronics** ran 158 articles on computers between July, 1961 and June, 1962!) Are you in semi-conductors? (For the same period, **electronics** had 99 articles, not including transistors, solid-state physics, diodes, crystals, etc.) Are you in military electronics? (**electronics** had 179 articles, not including those on aircraft, missiles, radar, etc.)

In all, **electronics'** 28-man editorial staff provided more than 3,000 editorial pages to keep you abreast of all the technical developments in the industry. No matter where you work today or in which job function(s), **electronics** will keep you fully informed. Subscribe today via the Reader Service Card in this issue. Only 7½ cents a copy at the 3 year rate.

electronics

electronics • June 21, 1963



Hoffman
NOW OFFERS
RFI SHIELDED
ELECTRICAL ENCLOSURES*



NEMA
12
Cabinets



JIC Terminal
Boxes



Console
Cabinets



Pushbutton
Boxes

In compatibility packaging of electromagnetic energy, Hoffman has devised shielding that controls wanted energy while preventing escape of troublesome rogue signals. The details will interest you. Write us. Standard boxes or special boxes, with or without conduit hubs. Oil and dust-tight.
*Attenuation of 60-75db at 1.8-35mc

Write for Information

Hoffman ENGINEERING CORPORATION
"has the experience"
Dept. ED-221, Anoka, Minn.

CIRCLE 81 ON READER SERVICE CARD 81

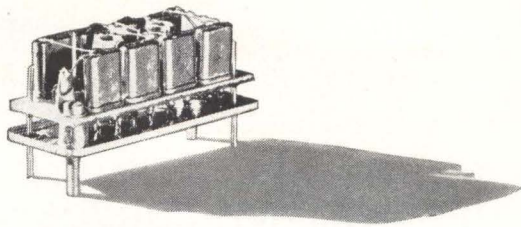

compare passbands

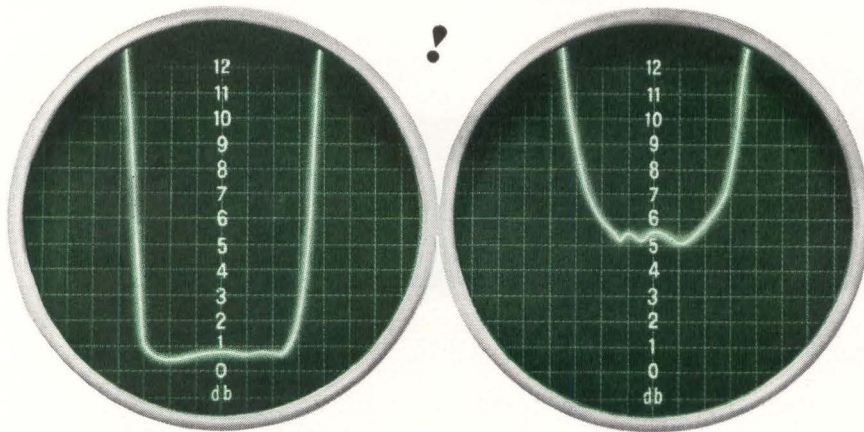

this is an ILo[®] filter

this is not

New ILo[®] crystal filters by Midland are designed by a technique radically different from conventional crystal filters — and nowhere is the difference more apparent than in the passband. Compare!

The passband of the ILo[®] filter starts a typical one-half db above the "no-loss" zero db point. The passband of the image parameter filter starts after a typical 3 or 4 db insertion loss. That's the first difference.

Second, look at the corners. ILo[®] filter design allows extremely close approximations of Chebyshev functions — square corners, flat passbands. Image parameter crystal filters — even the squarest — are round by comparison, fall off unsymmetrically, vary from filter to filter.

And there are no tradeoffs. We can think of no occasion where an image parameter filter would be better, or less expensive, than an ILo[®] filter.

The development of ILo[®] crystal filters by Midland may be the most important advance in filter design in the last five years. You owe it to yourself to get the facts.

Write the world's largest producer of crystals and crystal filters.



MIDLAND MANUFACTURING COMPANY

3155 FIBERGLAS ROAD

KANSAS CITY 15, KANSAS

An electronics division of Pacific Industries, Inc.



holds, through the motor load, keeping the motor load inoperable. It can be reset only by turning the machine load line switch off.

Navy Testing Map Reproducer

MAP REPRODUCER developed by RCA may replace an aircraft carrier's customary load of 15 tons of maps and charts with only five tons of blank paper, plus a library of film. Known as an "Electrofax" reproducer, the equipment can duplicate 22½ by 29½-inch maps directly from 70-mm film positive separation at a speed of about 25 an hour. The device is now being tested by the Navy.

Here are the basic steps:

Paper with a photo-conductive surface is given an electrostatic charge by placing it in the corona discharge field of a charging wand. The wand consists of several fine wires at a high negative potential. The photoconductive surface is covered uniformly with negative ions.

The charged paper is then exposed to a projected image. Incident light discharges localized areas, leaving a latent image of the projected pattern. Wiping the image with a dispersion of charged particles immediately yields a permanent image. The particles cling to the electrostatic image but not to the exposed areas. These particles can be a variety of colors, including black.

Accurate Simulator of Magnetic Fields for NASA

MAGNETIC FACILITY to simulate the magnetic environment encountered in space will be built at NASA's Goddard Space Flight Center in Greenbelt, Maryland, by Spectra-Physics Inc, of Mountain View, California, under a new \$585,000 contract.

Test magnetic field will be generated by three mutually perpendicular sets of coils, up to 22½ feet in diameter. The coils are designed so that in a 36-in.-diameter spherical region the field will be uniform to within three gammas (a gamma is 1×10^{-5} gauss). It will be possible

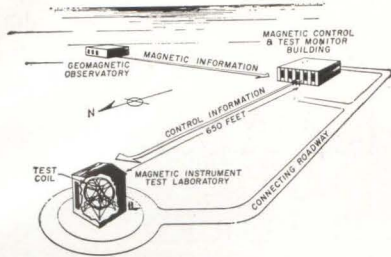

GEOMAGNETIC observatory, test lab and control building must be separated for freedom from magnetic disturbances

to establish a field of any value up to 60,000 gammas, oriented in any direction, or rotating at up to 10 revolutions a second about any axis.

Three geomagnetic detectors, using optical detection of gyromagnetic properties of rubidium atoms in a gas cell, will be placed along the axes of the three sets of coils. The magnetic information will control the coil currents and compensate for variations in the earth's field. The information can also be used for three-component continuous monitoring of the earth's field, more sensitive than has been obtained to date.

Franklin Institute To Get New Laboratories

PHILADELPHIA, PA.—Plans for a \$4.5-million, 151,000-square-foot research and development center in downtown Philadelphia have been announced by W. Laurence LePage, president of the Franklin Institute.

The new laboratories, intended to centralize and expand the facilities for the Institute's growing research facilities, will be sponsored by the Philadelphia Industrial Development Corporation. Mr. LePage said that the Institute's annual value of research and development contracts from both government and industry has grown from \$800,000 in 1946 to \$5.5 million in 1962. The research projects employ about 350 scientists and technicians; the new laboratory center will accommodate over 400.

The Franklin Institute is engaged in projects that include research in air pollution measurement systems, devices and materials for the aerospace industry, and planning of nuclear reactor systems.

RFI-SHIELDED ENCLOSURES

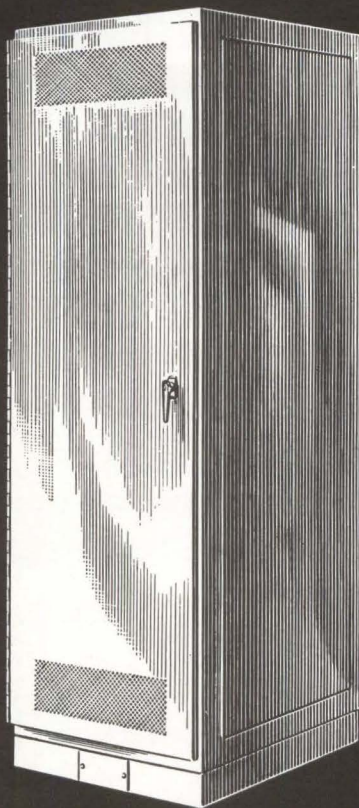

The enclosure shown above is only one of hundreds of AMCO RFI Shielded Modular Electronic Instrument enclosures presently in use in both government and commercial programs.

Amco is the first to develop a truly MODULAR RFI-Shielded Enclosure System conforming to EIA Hole & Panel Mounting Standards. Enclosures can be sealed individually, as combined groups or in combinations of both . . . essential for systems interwiring.

EFFECTIVE ATTENUATION CHARACTERISTICS in both electro-magnetic and electric fields:

.15 mc to 1000 mc—100 db to 45 db attenuation

These enclosures feature field-replaceable RFI gasketing and are available in vertical, slope-front and low silhouette frames for both 19" and 24" wide mounting panels, in vented or non-vented styles.

Write for complete specifications, or contact the Amco factory trained representative in principal cities of the U.S. & Canada.

TOTAL COVERAGE of your enclosure requirements through selection of Amco Custom, Semi-Custom, Aluminum and RFI Modular Instrument Enclosure Systems.



AMCO ENGINEERING CO.

7333 West Ainslie Street, Chicago 31, Illinois

New Circuit Board Planned for Apollo

ACCOMMODATES INTEGRATED CIRCUIT BLOCKS

Special mounting technique may find wide use throughout the industry

WIDESPREAD use of silicon-block circuits is foreseen with the development of simple mass-production techniques for attaching the integrated blocks to circuit boards.

One solution to this problem was developed by Photocircuits' Dmitry Grabbe. The integrated circuits are welded to company's new Fusicon boards as shown in the diagram.

Photocircuits' spokesmen say that their method is practical for general use throughout the industry.

TESTED—Packaging scheme has been tested at MIT Instrumentation Labs, where systems are being planned for the Apollo Computer.

Special construction avoids deformation of leads to integrated circuit and protects laminate from damage due to heat cycling.

The pins are made of carbon steel, plated with copper and indium. Some free indium remains at the rim on both sides of the board at the conclusion of the diffusion cycle. Thus the bond may be considered to consist of two structures in parallel.

The board material is either G-10 or G-11. Boards do change color from the initial green-grey to chocolate brown. This in no way degrades the electrical and mechanical properties of the laminate, according to company.

All test boards have been welded on a Unitek welder.

The circuits can be one or two sided, or they can be multilayer. Minimum board thickness of 0.026-in. and maximum 0.062-in. is practical for center distances of 0.050-

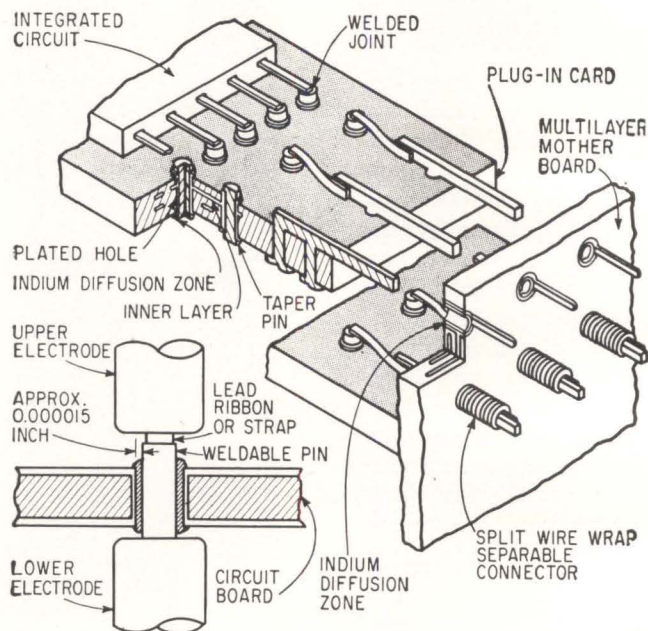

RAISED PINS permit mounting of integrated circuits without damage to leads or laminated board. A circuit board with plated-through holes is used regardless of the number of layers. Sketch shows arrangement of welding electrodes and work pieces

in. A maximum of 10 layers is possible at this time for this thickness of boards.

Test results have shown that neither the welding operations nor environmental tests affected the circuit continuity or intercircuit isolation of the circuit boards. There has been no evidence of cracked epoxy or delamination.

In the preparation of samples, it has been found necessary to remove a poor weld, resurface the top of the pin with a file, compensate for the reduced pin height due to filing by reduced heat setting, and re-weld. This process has been accomplished without substantial difficulty, demonstrating a measure of reparability for this type of board.

Five-Layer Diode Guards Cables

By H. R. MONTAGUE
Surface Communications Division
Radio Corporation of America
Camden, New Jersey

A **SOLID-STATE** diode was developed at RCA to protect cable terminating equipment from high-power surges due to lightning, electromagnetic

radiation, and power line faults. The *pnpnp* device can be applied to buried cable networks of missile systems, as well as aerial cables.

The diode can be best described as two controlled rectifiers placed back to back. Overvoltage and breakdown produces carrier multiplication and an eventual negative

\$.25

TYPICAL UNIT COST

Capacitors of "Mylar"® polyester film cost about the same as paper!

\$.00

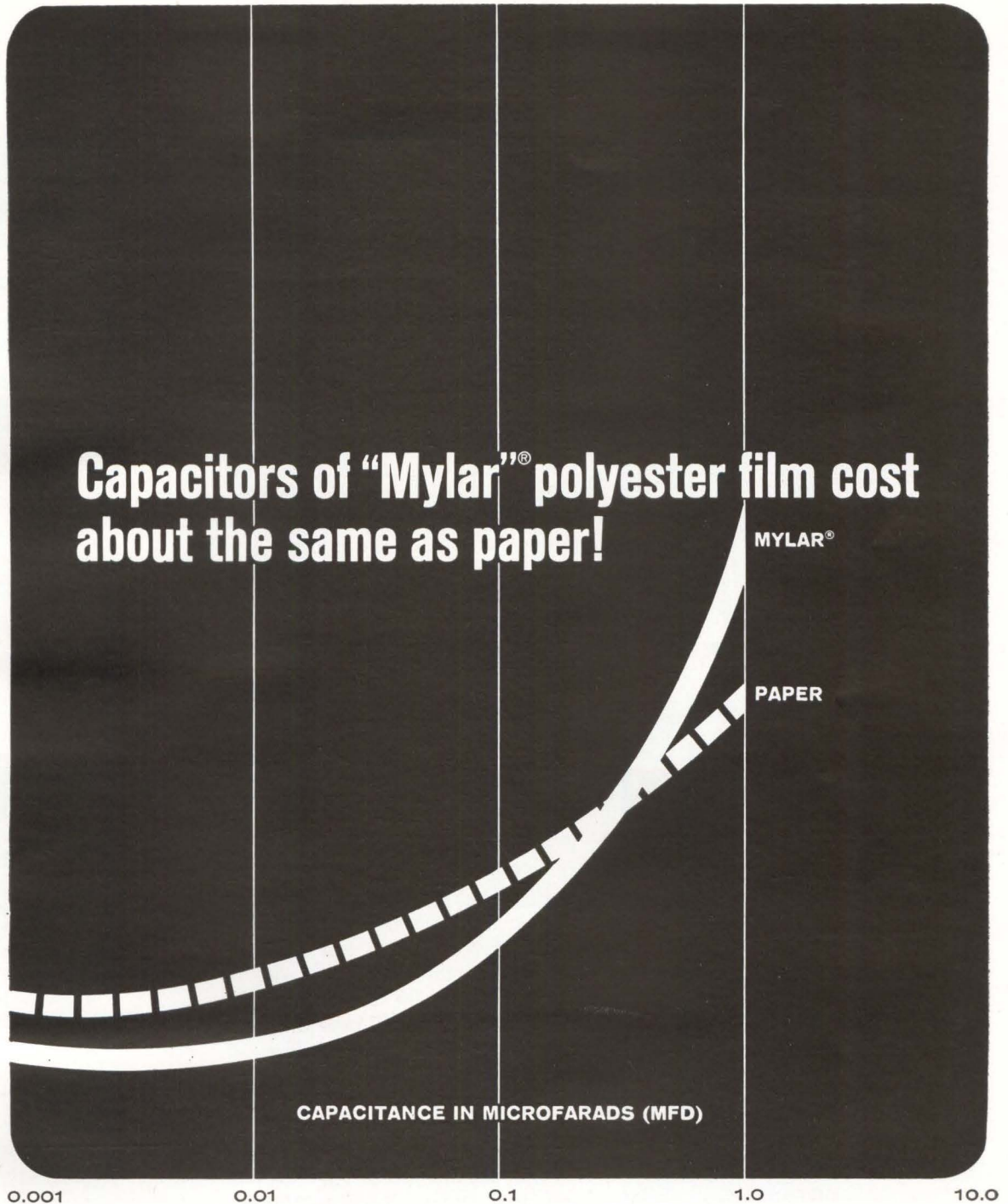

For capacitors, specify the extra performance of "Mylar"

Studies of manufacturers' average prices show that capacitors of "Mylar"* are comparable in cost with paper units, over a range of capacitances and voltages. At comparable cost, the higher reliability you get makes capacitors of "Mylar" a better value by far.

Only "Mylar" gives you the extra performance of higher dielectric strength, wider temperature range and higher moisture resistance—at about the same price! Also, capacitors of "Mylar" are smaller than paper units with the same capacitance. In circuits for home-entertainment radio and TV they're perfectly compatible with AC voltages imposed on a DC circuit as long as total voltage doesn't exceed the rated voltage of the capacitor,

and the AC component does not exceed the AC corona level. Remember, within the range from .001 to 1 mfd under 600 volts DC, you can get the added reliability of "Mylar"—at costs similar to paper.

For the full story, write for our detailed booklet comparing performance and prices of various insulation systems. Du Pont Co., Film Department, N-10452, Wilmington 98, Delaware.

*Du Pont's registered trademark



BETTER THINGS FOR BETTER LIVING
... THROUGH CHEMISTRY

only DU PONT makes

MYLAR®
POLYESTER FILM

and
now...

MASER
TUBES

in

VITREOSIL[®]

PURE

FUSED

QUARTZ

For experimental gaseous optical maser (laser) applications. Precision bore stock size tubes are ready for filling complete with graded seals to Pyrex or Kovar and quartz windows in half, quarter and tenth wave flatness — transmission from U.V. through I.R. Vitreosil permits high bake-out temperatures, does not contaminate gases and maintains dimensional stability over a wide temperature range. Write for details.



THERMAL AMERICAN
FUSED QUARTZ CO.
RT. 202 & CHANGE BRIDGE RD.
MONTVILLE, NEW JERSEY

resistance region which permit high conduction.

The solid-state cable protector undergoes a negative resistance region, so that after breakdown, the voltage drop across the device is comparable to that of an ordinary silicon rectifier. Thus, high surge currents can be conducted to ground. Inherent reliability of a solid-state protector is much greater than more commonly used devices.

Physical arrangement of the five-layer diode precludes failure due to overvoltage. The device will break down and conduct in either direction, so that limiting factor is the induced heating at the junction. The junction is designed so that it will not fail until failure of the copper conductors occurs.

PAIRS—Two five-layer diodes are connected in series across a typical cable pair, with ground between the diodes.

These semiconductors are selected in pairs for close tolerance and breakover voltage. For longitudinal surges, it is probable that both lines will be grounded simultaneously. When the diodes conduct, the voltage drop across each is limited to 1 or 2 volts, thus lowering the stress on electrical terminal equipment.

Voltage breakdown level is independent of the number of operations, and within its rating, the solid-state device will have the same mean time to failure independent of duty cycle.

Design parameters for the protector were current surge of 5,000 amps for 100 μ sec (dependent on specific cable system), conduction and recovery time less than 10 μ sec, and leakage resistance greater than 100 kilohms up to 0.9 of breakdown voltage. The holding current was specified to be greater than 5 amps and breakdown voltage of 300 volts. A five-layer device was required since overvoltage conditions may be of either polarity referred to ground.

Tests run on many samples showed no deterioration in performance after many surges at various combinations of current and pulse times.

Carbon blocks have been most commonly used as surge arrestors. While initial cost of the five-layer

diode is high compared to carbon blocks, the diode requires no maintenance nor frequent testing and replacement, as does the carbon type.

Will R-f Control Artificial Hearts?

LOWELL, MASS.—Although virtually untried, a motor that sustains controlled rotary motion by radio frequency has been suggested as a possible modus operandi for artificial hearts, inserted in the chest cavity.

The r-f motor was invented by

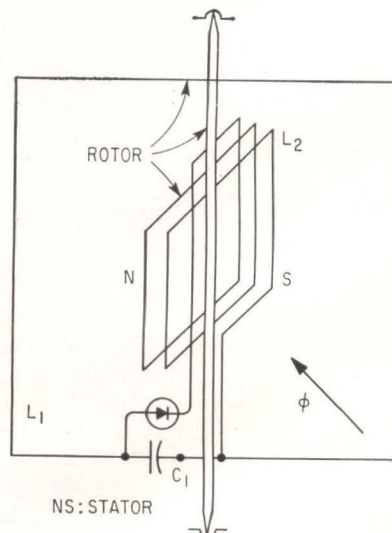
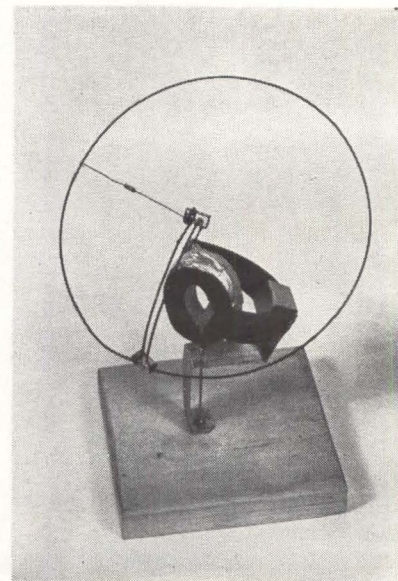

WORKING model of 70-Mc radio-frequency motor. Diagram shows loop arrangements in simplified form

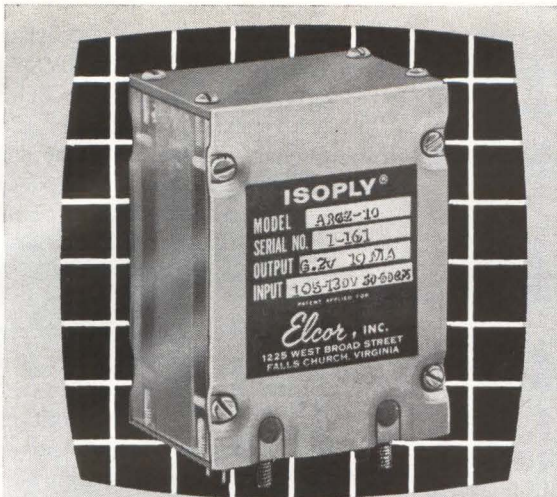

TYPICAL A4R SERIES ISOPLY

SPECIFICATIONS—MODEL AR6.2-10

Input	105-130 vac 50-60 cps
Output	6.2 vdc ± 5% fixed at 10 ma constant load
Output ripple	1 mv p-p
Stability	
a Line stability01% over 105-130 vac input (less than .001% per volt of input change)
b Load stability01% per-ohm of load change
c Temperature coefficient01% /°C from 0°C to 60°C
d Long term stability after 15 minutes warm-up01% per day (with line load and ambient temperature held constant)
Isolation	
a Intercircuit capacitance from dc output to primary winding1 pf
b Shunt capacitance from dc output to ground	20 pf
c Insulation voltage	1000 vdc
d Leakage resistance to ground	greater than 100,000 megohms
*Hum and noise induced in external circuit with power supply ungrounded (neither output terminal grounded)	less than 10 uv p-p per kilohm impedance to ground
Dimensions	1 1/2" x 2 1/4" x 3-1/16"
Weight	75 lb.

Elcor IsoPLY Circuitry Handbook (60 pages) Available.. **Price \$1.00**

What can a power supply contribute to circuit design?

PLENTY... if it's an *ISOPLY®

SPECIFY ELCOR FOR:

Servo design . . . ISOPLY substantially eliminates ground loop problems and zero errors.

Bridge design . . . ISOPLY eliminates common-mode signal . . . no differential amplifier needed. Ground referenced Bridge output available.

Digital design . . . ISOPLY allows DE-coupled DIRECT coupled circuits.

Amplifier design . . . ISOPLY is ideal for bootstrap cathode or emitter follower and related circuits.

Nuclear design . . . ISOPLY changes polarity from the detectors to suit the instrument.

RFI design . . . ISOPLY can meet MIL-I-16910 or other appropriate specifications.

Bio-medical design . . . ISOPLY provides the isolation required for neuro-physiological stimulation experiments.

Special designs . . . ISOPLY construction lends itself to design flexibility and variation capable of meeting many special requirements.

Multiple output design . . . ISOPLYS with as many as four outputs are available.

***Highly isolated power sources** . . . ISOPLYS . . . offer a completely new dimension in circuit design flexibility by removing the constraint imposed by dependence upon ground referenced power.

Other Elcor Products . . . ISOFORMERS® (Isolated Transformers) up to 1 KW . . . ISOREX® (Isolated Transformer-Rectifier) units and unregulated but isolated power packs . . . Current Indicators and Integrators and related measurement instruments . . . specify Elcor.

for further information, write, wire or phone:



ELCOR, Incorporated

Subsidiary of Welx Electronics Corporation
1225 West Broad Street, Falls Church, Va.
Telephone Code 703—JE 2-8850
(FAX No.-RFJ, Falls Church, Va.)
Some areas still open for representation

CIRCLE 206 ON READER SERVICE CARD

TOTAL CAPABILITY-through UTL Services

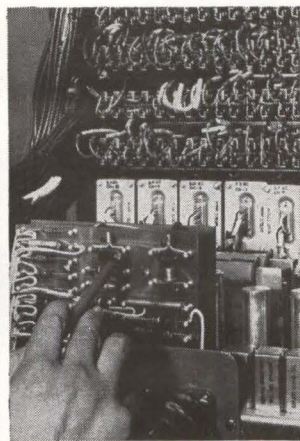
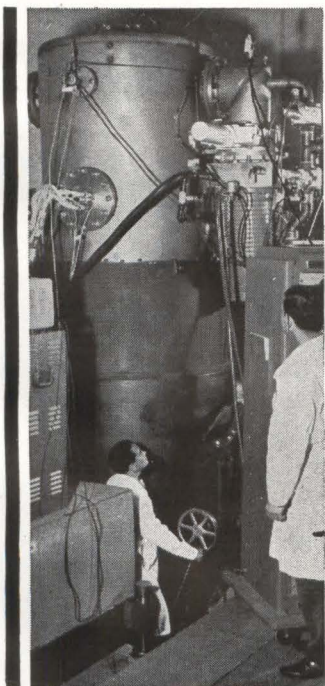

Your Company can attain total capability by utilizing UTL services in Reliability Engineering, Technical Services and Testing.

As an independent and objective organization, the technical assistance rendered by UTL on many major weapon and space programs has provided industry and government with highly valued and advanced developments in the fields of . . .

RELIABILITY ENGINEERING . . . program plans, training instruction, prediction, design review, part selection, quality assurance.

TECHNICAL SERVICES . . . installation, evaluation, logistic support, design, technical documentation.

TESTING . . . simulation of space environments and weapon system mission profiles, electronic ordnance and cryogenic parts and systems testing.

The UTL technical staff, with comprehensive nationwide facilities, can assist you from development through delivery and installation.

➔ Call or write to the address nearest you. Test Facilities • Sunnyvale, Calif. (San Francisco Area), 150 Wolfe Road, RE 9-5900.

• Monterey Park, Calif. (Los Angeles Area), 573 Monterey Pass Road, CU 3-4168. • Alexandria, Va. (Washington, D.C. Area), 4416 Wheeler Ave., 836-7200.

UNITED TESTING LABORATORIES a division of *United ElectroDynamics, Inc.*

MIL-C-19978B
MIL-C-19978B
MIL-C-19978B
MIL-C-19978B
MIL-C-19978B
MIL-C-19978B
MIL-C-19978B
MIL-C-19978B
MIL-C-19978B
MIL-C-19978B
MIL-C-19978B
MIL-C-19978B
MIL-C-19978B

Certifying data with respect to test qualifications available. All data compiled by a government approved testing laboratory.



MR-700



MR-330

Paktron MOLDED MINIATURE MYLAR* CAPACITORS—MR330 and MR700—provide the widest possible capacitance range and most useful voltage ratings in the smallest physical size consistent with HIGH PERFORMANCE AND RELIABILITY.

For specific information regarding performance characteristics, write today.

*Dupont Polyester Film

i t **PAKTRON**
w DIVISION ILLINOIS TOOL WORKS INC.
1321 LESLIE AVENUE • ALEXANDRIA, VIRGINIA

Harry E. Stockman, professor of electrical engineering at Lowell Technological Institute.

The rotor consists essentially of a circular loop antenna that is mounted in a plane that is tilted 45 degrees with respect to the shaft (see photo). The radiation angle also comes in at a 45 degree angle to the shaft.

For simplicity, the loop antenna is shown in rectangular form in the circuit diagram, and is in the plane of the paper. As a result of the tilt, the loop antenna receives radiation energy only during half of the turn. Automatic commutation is assured.

More than one loop antenna may be used on the same shaft.

The r-f current is rectified and applied to a multiturn inductor, L_s , arranged on the shaft for rotary motion in a permanent magnet stationary field NS . This arrangement obtains the torque required for rotation. Self starting is obtained with more than one loop, L_r ; and with tuning capacitance C , and associated winding L_e .

The motor was developed to solve the need for rotary action where direct wire connections are not feasible, or where local power is not available.

Stockman says that a definite need exists for maintenance-free rotary motion that can be controlled over great distances, but this problem can only be solved to the extent that narrower radar beams of increased power can be devised.

A miniature motor of this kind could indicate if the power is on in a microwave guide, and also measure the watt-hours delivered. A gigantic antenna could pick up sufficient radiation from lightning to maintain itself in rotary motion.

Predicting Reliability For Mechanical Systems

A NEW CENTER, established at Battelle Memorial Institute, Columbus, Ohio, will engage in a long-range research program to advance the state of the art of mechanical reliability and develop advanced techniques needed to meet the increasingly stringent requirements for mechanical parts, components and systems.

The Mechanical Reliability Re-

THE WORLD'S LARGEST AND MOST DEPENDABLE LINE OF HIGH VACUUM PUMPS

Single Stage, Compound and Triplex High Vacuum Pumps from 2 to 1100 cfm

KINNEY'S TRIPLEX HIGH VACUUM PUMPS Series KT

MODEL KT-300

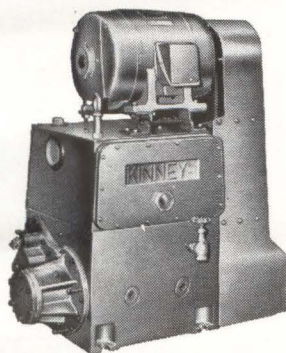

Triplex High Vacuum Pumps use the rotary-piston principle developed by Kinney. A new and original balancing technique utilizing three sets of cams and pistons offer compactness and vibration-free operation not available with any other pumps of comparable size. The complete line of Triplex pumps offers a range of displacements from 15 to 1100 cfm.

KINNEY'S COMPOUND HIGH VACUUM PUMPS Series KC

Kinney Compound Mechanical Pumps maintain lower pressures than are attainable with single stage pumps. Six models provide a range of displacements from 2 to 46 cfm. On test, each pump is required to produce an absolute pressure reading of 0.2 micron; readings of 0.1 micron are typical of standard production models. Dynamic balancing assures vibrationless performance.

KINNEY'S SIMPLEX HIGH VACUUM PUMPS Series KS

Kinney Simplex Pumps employ a single cam and piston principle, in a rotary piston design providing maximum performance, minimum wear and maintenance. They attain an ultimate pressure of 10 microns and have a displacement range from 13 to 47 cfm.

MODEL KC-5

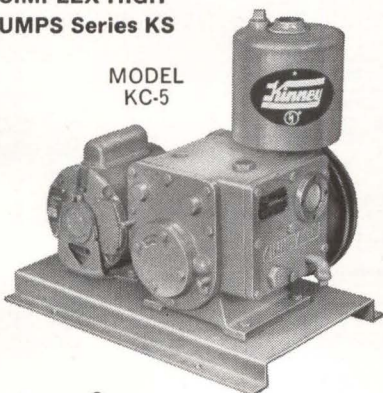

KINNEY VACUUM

DIVISION THE NEW YORK AIR BRAKE COMPANY

3529 WASHINGTON ST. • BOSTON, MASSACHUSETTS

KINNEY ... EVERYTHING IN VACUUM

CIRCLE 203 ON READER SERVICE CARD

electronics • June 21, 1963

NEW GLASS CAPPED MICROFUSES



Pigtail or plug in.
1/500 through 5 amps @ 125V



Interrupting capacity
10,000 amps DC @ 125V

AND MICROFUSE HOLDERS



Front panel



Indicating type

NEW IN YOUR CIRCUIT DESIGN PICTURE

LITTELFUSE

DES PLAINES, ILL.

CIRCLE 89 ON READER SERVICE CARD

89

YOUR INSTANT SOURCE FOR

TEFLON*

WIRE AND CABLE IS
BRAND-REX



YOU GET IMMEDIATE SHIPMENT OF YOUR REQUIREMENTS, BIG OR SMALL, FROM ONE OF THE COUNTRY'S LARGEST TEFLON STOCKS.

BRAND-REX TURBOTEMP® TEFLON* WIRE AND CABLE			
MILITARY TYPES			
MIL - W - 16878D	MIL - W - 22759	NAS - 703	COAXIAL CABLE
Types E, EE, ET (TFE Insulation)	Type 1, MS - 21985 MS - 21986 (TFE Insulation)	Types U, S, SJ Classes A & C (TFE Insulation)	MIL - C - 17C and MIL - C - 8721
Types K, KK, KT (FEP Insulation)	Type 1 MS - 17411 MS - 17412 MS - 18000 MS - 18001 (Filled TFE Insulation)		
U. I. TYPES			
Appliance Wire		Business Machine Wires	
200°C, 300V & 600V	105°C, No voltage rating	105°C, No voltage rating	
1/64" & 1/32" TFE Insulation	.006" FEP Insulation with nylon jacket	.010" TFE or FEP Insulation	
MULTICONDUCTOR CABLES			
Made to order for your military or commercial applications.			

Send for new 20-page catalog: "Brand-Rex TEFLON Wire and Cable, Section 6207"



DIVISION AMERICAN ENKA CORPORATION
31 Sudbury Road, Concord, Massachusetts

*DuPont Trademark

search Center at Battelle will be similar, in many respects, to the Electronic Component Reliability Center, in operation at Batelle since 1959.

Improved techniques will be developed for predicting reliabilities of given mechanical systems, and methods will be established for incorporating reliability criteria into the design process as primary design parameters.

In describing the new center, A. A. Mittenbergs, project director, noted that while there have been important advances in reliability engineering as it applies to electronic components, there has been an acknowledged lag in the area of mechanical reliability. The Mechanical Reliability Center will fill this gap.

Soviets Claim Improved UHF Cores

VIENNA — Ferromagnetic cores made from ferrocarybonyl particles of 0.5 to 3 micron diameter, a new product of an undisclosed Soviet component maker, is claimed to be superior to powdered-iron cores in frequency ranges between 50 and 250 Mc.

Chech Technical Digest says that these ferrocarybonyl particles are coated with a thin glass film and then cemented by suitable phenolic plastic.

Main advantage of these new cores is their high degree of resistance against sudden temperature changes.

Miniature Photocell

TOKYO—A cadmium sulphide cell that measures only 3 mm in diameter and 1.5 mm thick has been announced by Matsushita Electric Company claims good sensitivity for cell that weighs 18 milligrams.

Average current at 1 lux illumination is 10 microamp, with terminal voltage of 1.34. Average current at 500 lux illumination is 400 microamp. Maximum sensitivity of small cell is 5750 Å. Range is 4,000 to 7,000 Å.

FAST DELIVERY

ANYWHERE

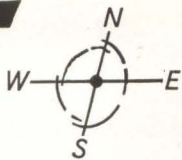

MIDWEC INSTRUMENT GRADE MYLAR* DIELECTRIC

Ca-pac-i-tor's

Best Shipping Interval In The Industry—3 Weeks Standard
High Reliability and Quality
Competitively Priced

Specialists In Low Tolerance Units

Approved for use in Talos, Minute Man, Titan, Typhon,
Telephone Companies ■ 100% Test for dielectric strength,
capacitance, insulation resistance and dissipation factor

MIDWEC
OSHKOSH, NEBRASKA

write for
data sheets
and prices

SALES OFFICE: 601 So. Jason St., Denver 23, Colo.
TWX: 292-3891—Telephone SH 4-3481—DDD 303

*DuPont TM for Polyester Film.

CIRCLE 204 ON READER SERVICE CARD

the finest precision
coaxial connectors*

*TNC & TM

General RF Fittings, Inc.

702 BEACON STREET, BOSTON 15, MASSACHUSETTS
Telephone: 617 267-5120

CIRCLE 205 ON READER SERVICE CARD

electronics • June 21, 1963

Zuverlässig | Consiance | Fidedigno | Pålitlig For Missile Designers and Manufacturers

In any language the Greeks had a word for it — **DEPENDABILITY**. At *Telerad*, we believe in stressing those factors that will establish us in your mind as a truly dependable source. A dependability that's built on creative research . . . on rigid electrical and mechanical testing as the standard for quality control . . . on our being customer-minded so that you get precisely what you require — and on time, too. ■ A small reflection of *Telerad's* capabilities are these recent airborne transponder beacon developments (C and X Band types). Besides the usual applications there is a substantial variety of ground to air or air to air conversions possible through *Telerad* "imagineering." ■ Whatever your field of interest — systems or component engineering, research and development or straight purchasing of standard components — don't you think it would be a good idea to try us at *Telerad* next time?

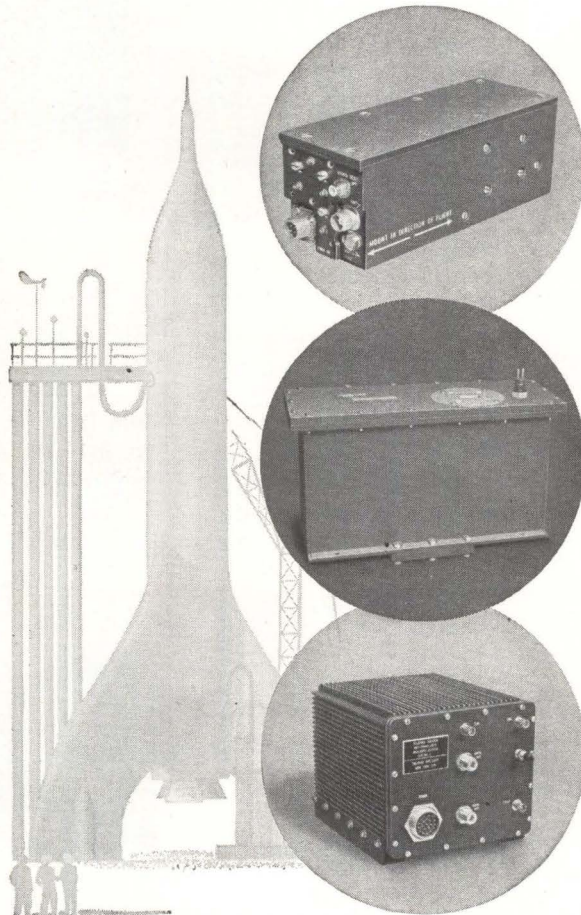

FROM AN
ESTABLISHED
SOURCE

TELERAD
A DIVISION OF LIONEL CORPORATION

Route 69-202 (South), Flemington, N. J. STate 2-2011, Area Code 201

CIRCLE 91 ON READER SERVICE CARD

91

New Deplating Process Makes Circuit Boards

Push button operation produces 3 boards a minute by electrolysis

DEPLATING by electrolysis is the basic technique of a machine process that reportedly can produce three circuit boards a minute. Stephen I. Marosi, inventor of process and president of Marosi Precision Products, El Cajon, California, says it provides line fidelity with a tolerance of 0.002 inch.

The machine operates somewhat like a mineograph machine. A master copper stencil on a drum functions as the cathode in the electrolysis process while a copper-clad laminated board that becomes the printed circuit is the anode. A special electrolyte enables close spacing between cathode and anode to permit effective deplating of board without plating cathode and stalling process. The process is being used by Friden Corp. at its San Leandro plant.

ELECTROLYTE—Development of an electrolyte for electrically neutralizing the copper taken into solution after removal from copper-clad board was critical to process operation. The electrolyte is a proprietary mixture of alkaline chemicals.

Also important to the process is a resin that removes copper from the electrolyte so it can be reused. Developed by Dow Chemical Company (Dowex A-1 Chelating Resin) it enables the electrolyte to emerge from an ion-exchange column in its original copper-free state. At present, the copper is not salvaged because savings would be small, but it could readily be done, says Marosi.

PROCESS — High purity spring-copper sheet is used to make the master stencil. Conventional etching makes the desired pattern which

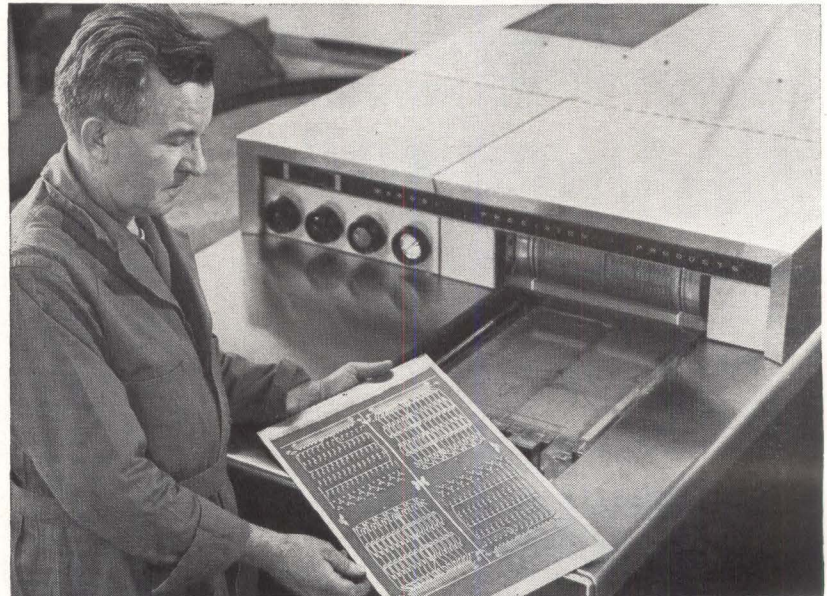

WHEN OPERATOR places copper-clad board and pushes a button, the machine produces printed circuit boards like one shown

has 30 indexing holes. After etching, an epoxy material is brushed over pattern, filling in etchings, and the surplus epoxy is sanded away. Epoxy remaining in etched channels acts as a dielectric to permit deplating the unwanted copper from the copper-clad board. Completed master is fastened around

the machine's drum.

As drum is brought down near surface of copper-clad board on machine table, the electrolyte solution is automatically pumped between drum and board surface at a rate of 5 gallons a minute. An electrical thickness-sensing mechanism associated with the anode clamps holding the copper-clad board on table gauges thickness of clad copper to within 0.0005 inch over a range of 0.001 to 0.005 inch.

Depending on thickness, the sensing device drives a variable speed motor at speeds ranging from 250 rpm to 2,500 rpm within a tolerance of ± 3 rpm to drive drum and table at suitable rates: the greater the thickness, the slower the speed to allow sufficient time for deplating of board.

FEATURES—To get the current densities needed at tangent point of drum and board, the drum is brought down to approximately 0.006 inch from board surface. This distance, set by wheels on either side of drum, could be closer to raise

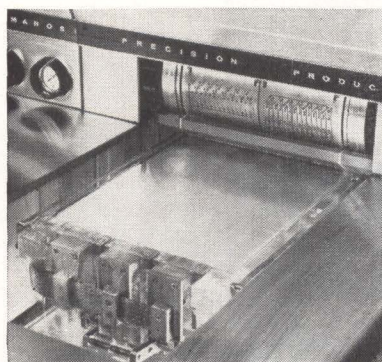

ANODE CLAMPS holding copper-clad board include a device for sensing thickness of copper. Device regulates machine's drum and table speed to provide optimum deplating of copper

RADIO INTERFERENCE FILTERS

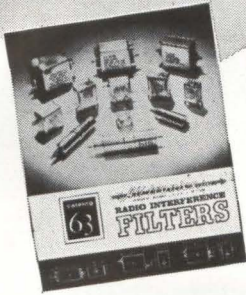

Send for latest catalog of power line filters — standardized to give you design flexibility and quick prototype delivery.

RFI TESTING

of your equipment in our shielded labs. Radio frequency interference testing to MIL-I-6181D, MIL-I-26600, MIL-I-16910 and other military and commercial specs.

All-tronics, inc.
45 Bond Street, Westbury, New York
516 ED 3-3090

CIRCLE 213 ON READER SERVICE CARD



Are you selling the whole buying team

Tough competition *demands* that the electronics man be reached and *sold* wherever you find him: *Research, Design, Production, and Management.* Only advertising in **electronics** reaches all four... the same men your salesmen call on. Put your advertising where it works *hardest*....

in **electronics**

WHAT BLOWERS GUARANTEE

20,000 HRS.

CONTINUOUS SERVICE LIFE?

2¼ Years . . . 27 Months . . .
833⅓ Days



McLEAN BLOWERS DO!

How's THAT FOR RELIABILITY?

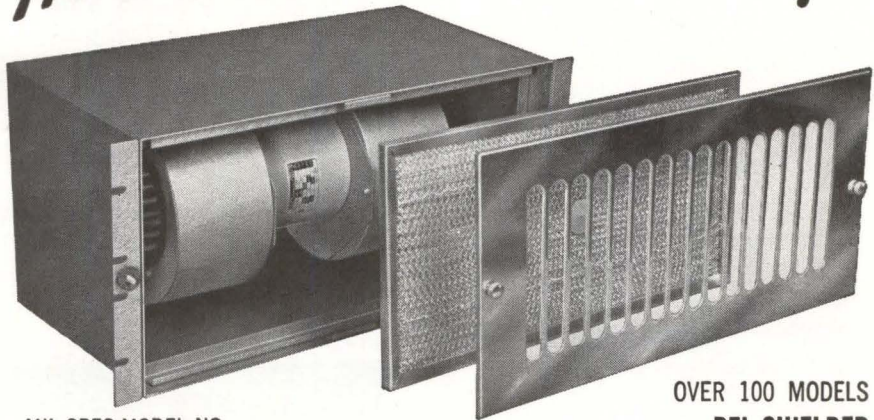

MIL-SPEC MODEL NO. M2EB512A

OVER 100 MODELS
RFI SHIELDED

MIL-SPEC & COMMERCIAL

A Wide Variety of Sizes and CFM's

PACKAGED BLOWERS, RING FANS, PANEL FANS, CENTRIFUGAL BLOWERS, ETC.

McLEAN ENGINEERING LABORATORIES

World Leader in Packaged Cooling
P.O. Box 228, Princeton, New Jersey
Phone Area Code 609 WALnut 4-4440
TWX 609-799-0245



Any Questions?

Send for our 44-page catalog

TOPS IN RELIABILITY AND PERFORMANCE FOR OVER 23 YEARS

For laboratory or field
research applications

MODEL 700/1400 SERIES NEW MAGNETIC TAPE RECORDING SYSTEMS



ACCURATE ± 0.2 linearity for analog data

FLEXIBLE as many data channels as you need from 2 to 14

COMPACT a 7-channel system fits in less than 2 ft. of rack space

LOW COST modest initial cost, true operating economy

MNEMOTRON NEW MODEL 700/1400 SERIES MAGNETIC TAPE RECORDING SYSTEMS record any electrical quantity from DC up to 5000 cps. A uniquely simple pulse-frequency modulation technique insures that data signal intelligence is free from non-linearity due to tape coating or other distortions.

Select as many data channels as you need, up to 14. Choose the tape format you want— $\frac{1}{4}$ " , $\frac{1}{2}$ " in-line, or standard IRIG. If standardization is desired, simply specify 7 channels on $\frac{1}{2}$ -inch tape in the standard IRIG configuration.

Record/Reproduce electronics for each channel are integrated in a single plug-in module featuring unity gain. An integral speed switch permits selection of data conversion for 2, 3 or 4 tape speeds — no additional plug-ins needed. For maximum flexibility, each multi-channel input is isolated. Data can be accepted from unbalanced, differential or push-pull outputs — or different DC levels on input signal ground returns can be preserved. Test points allow monitoring of input during recording, output voltage level when reproducing.

Write for the pleasant details.

MNEMOTRON

Division of
TECHNICAL MEASUREMENT
CORPORATION

TMC

Executive Sales Offices:
202 Mamaroneck Ave., White Plains, N.Y.

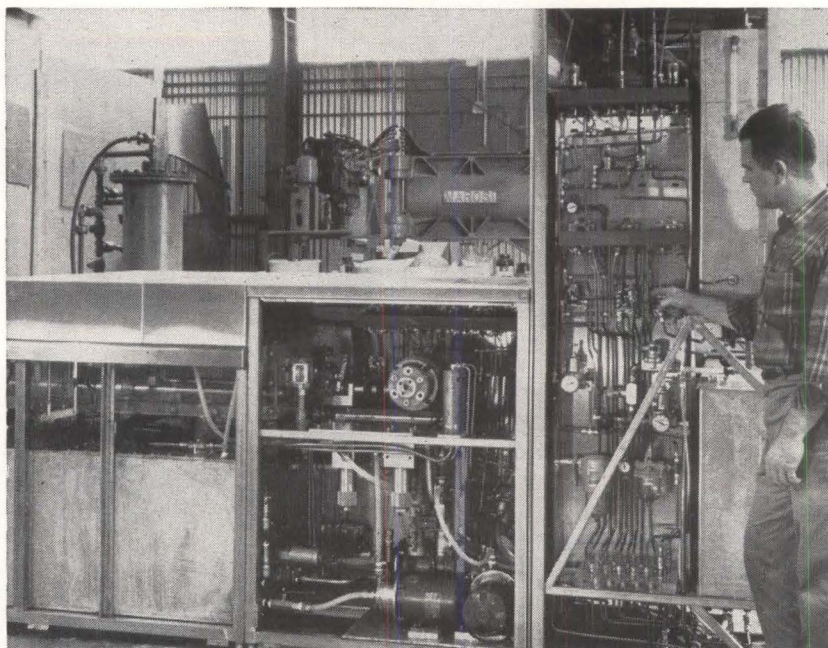

ION EXCHANGE column separates depleted copper from electrolyte. A special chelating resin is used

current densities and speed the process if boards were more universally flat. With the 0.006-inch gap, current densities are 1,500 amps/sq. ft., compared to conventional plating current densities of 70 amps/sq. ft. The small gap makes the special deplating agent necessary. Gap distance is critical to line fidelity on the finished circuit board.

Precleaning boards, says Marosi, is unnecessary since there is some electropolishing during electrolysis.

The process is kept efficient by continuously removing copper from the electrolyte. It is continually

pumped from a large tank into the space between drum and board. Retaining the depleted copper, it is pumped to the top of another tank containing the chelating resin which removes the copper. Copper-free electrolyte is then returned to deplating process.

EXPECTATIONS — Friden, the first purchaser of the process, says it has the capacity of 10 operators conventionally etching circuit boards. Studies by Friden reportedly show that process can produce 6 million square inches of circuit board per shift, per year. The company also says the process strengthens the bond between the copper and the base material, and that undercutting is completely eliminated.



INVENTOR of process, Stephen L. Marosi (at left), shows Philip R. Samwell, Friden v-p, a circuit board processed by machine. Friden is first purchaser of process

Hospital Technique Used in Work Station

CYLINDRICALLY shaped enclosure made of plastic film, originally developed as a hospital-bed isolator that permits optimum patient attention, has been adapted to use as an ultra-clean work station by Matthews Research of Alexandria, Va.

Basically the station, called White Bench is a work bench mounted between two vertical end panels and completely enclosed in the flexible plastics film cylinder. The enclosed work area is supplied with recirculating air which is filtered to class 4 (ultra-clean) requirements. Maintenance of positive pressure is sufficient to air-support the entire enclosure so that it floats between

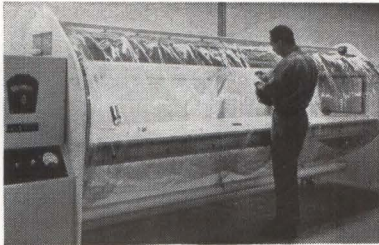

PLASTIC covering work station rides on hangers permitting operator to move to various table locations

end-panel mounting rings and horizontal suspension glides.

Gloves or diaphragm arm ports are provided for an operator to perform work inside enclosure. To give operator full-length access to bench, the filter cylinder is almost twice as long as bench. Excess film material is equally distributed on either side of operator so that he can move freely to either end of bench while keeping arms in arm ports.

An air lock is mounted on exterior sides of the end panels to permit entrance of tools and working materials. Temperature and humidity controls are provided. An inert atmosphere can be maintained inside cylinder.

Work stations are currently being used at the George C. Marshall Space Flight Center, Huntsville, Alabama. These incorporate two heavy-duty ultrasonic cleaners and two rinse tanks built into bench top. Three benches are interconnected through special vacuum drying ovens. Each one except that used for cleaning is temperature controlled to 75 degrees F ± 2 degrees and maintains a humidity of 40 percent ± 5 percent. Three benches can accommodate up to 20 operators.

QUALITY CONTROL Starts with Calibration

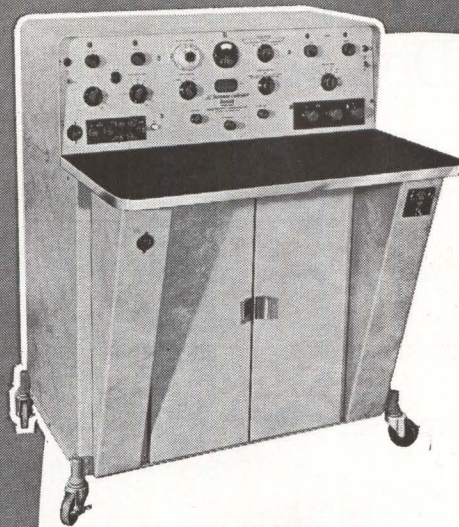

Model 1900
and
Model 1967

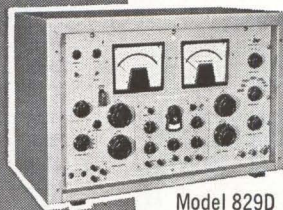

Model 829D

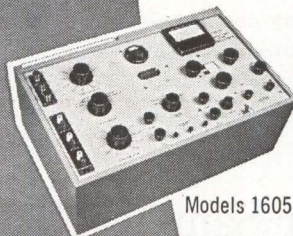

Models 1605/A

Model 2120

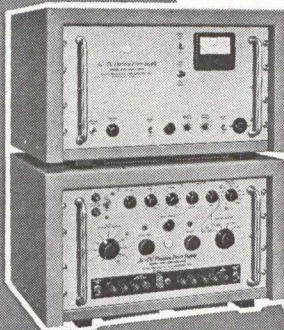

The advantages gained by calibrating and standardizing electrical measuring instruments using self-contained, console type standards are impossible to duplicate using individual components. Their ease of operation, long term stability, accuracy, wide current and voltage ranges, and built-in safety provisions yield economies which result in substantial cost savings over older methods of calibration.

Since development of the original self-contained instrument calibration standard for the U. S. Navy in 1947, RFL has produced many variations and offers the world's widest selection of such equipment. Choice of direct-comparison, regulated-power-supply and AC-DC transfer methods with accuracies to meet all commercial and military requirements for working or reference standards is available. Some of the models currently in production are illustrated. They can be seen at the factory or by arrangement with field representatives in most states and 20 overseas countries.

Performance warranty is unequivocal. Calibration certificates for every current and voltage range, on all models, are supplied. Accuracy is traceable to primary standards at the National Bureau of Standards.

SEND FOR TECH. DATA

For additional information, including application data, write or phone DE 4-3100. Demonstrations available by local representatives.



Radio Frequency
LABORATORIES, INC.
Boonton, New Jersey, U. S. A.

Stripe Design Improves VHF Transistor

New geometry permits broader semiconductor usage

NEWLY designed 2N2786 vhf power transistor has larger emitter and base regions due to a refined manufacturing process where stripe geometry is applied to a post-alloy diffusion technique (PADT). New geometry reduces thermal resistance and permits more conservative current densities.

Transistor's salient characteristics include high-frequency operation (f_t of 350 Mc, 100 ma at 5 v), high dissipation (P_d of 1.8 watts) and low base resistance (R_b of 18 ohms at 100 Mc and 100 ma). Using a 12 volt source, the 2N2786 has a minimum output power of

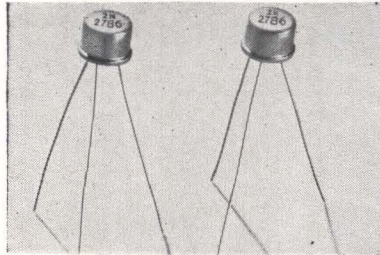

500 mw at 80 Mc, with a power gain of at least 10. At 180 Mc, minimum power output is 400 mw and minimum power gain is 9 db. The unit lists at \$2.75 in quantities of 1,000 and is supplied in a TO39 case.

Amperex Electronic Corp., 230 Duffy Avenue, Hicksville, New York, who pioneered the new manufacturing process, suggests that due to low unit cost, the transistor will fulfill uses formerly reserved for vacuum tubes. Amperex believes

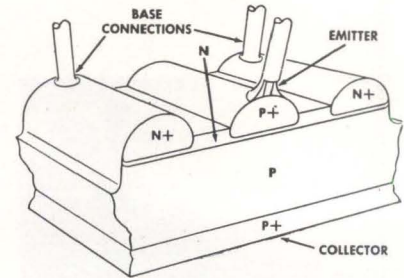

that the transistor's use in Navy sonarbuoys will be prominent among its applications due to increased ruggedness, smaller size and reduced dissipation. Other uses may include hand-held and professional communications equipment, tv-antenna distribution amplifiers, frequency multipliers and power-tube drivers. Detailed application reports may be obtained from the company.

CIRCLE 301, READER SERVICE CARD

Commutator Samples 150 Channels

MODEL 9100G Lo-Level Commu-data samples 150 analog data channels within 0 and 10-mv amplitude and speeds from d-c to 20 Kc. Unit delivers its information in PAM, PDM or PPM form to suit customer requirements. The sequencing system uses *pnpn* silicon semiconductors, and is said by the manufacturer, Data-Tronix Corporation, Penn and Arch Streets, Norristown, Pa., to afford unprecedented sim-

plicity and reliability.

Although more expensive than an electromechanical commutator for the same purpose, the 9100G has a guaranteed life of 5,000 hours and costs between \$100 and \$175 per channel depending upon specifications. Frequency stability using an internal clock is better than 0.2 percent; duty cycle is 50 percent, ± 5 percent; backcurrent is less than 0.25 percent and linearity exceeds

0.25 percent. The commutator can be supplied with a d-c amplifier for 5-volt output with common-mode rejection of -120 db. Power requirements are 28 volts nominal at about 140 ma. (302)

Scan Converter Storage Tube Gives Fast Response

SCAN CONVERTER storage tube records and stores transient phenomena with pulse rise times below 1-nanosecond. Newly designed tube permits slow scanning techniques to be used for relaying transient pulse data over 100-Kc bandwidth systems. Pulses may be recorded on tape, transmitted over low-cost telemetry links or transmitted over communications cables,

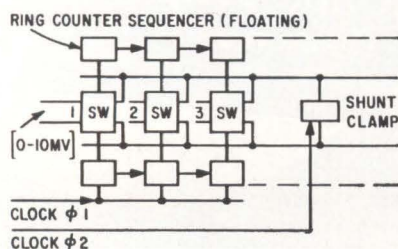



**Filtron tops the world with RFI control*

Atop the world at Thule, Greenland, Fylindales Moor, England and Clear, Alaska, sits the U.S.A.'s Ballistic Missile Early Warning System (BMEWS). Solved by Filtron were the staggering interference problems created by the world's largest radar site.

Filtron's System Engineering Division was assigned the RFI design criteria and installation techniques for the entire BMEWS complex. This *antenna* radiation complex is powered in the millions of watts to scan a missile the size of a barrel 3,000 miles away, and is capable of causing radiation hazards miles from the antenna.

Under subcontract to RCA, Filtron completed 19 major RFI assignments on time: electromagnetic radiation analysis of Thule AFB and the northern arctic, communications interference analysis, radar power density analysis, shielding and filtering requirements for buildings and equipment, radiation hazard investigation, Alaskan electromagnetic radiation analysis, and an inspection handbook on building and passageway shielding.

Some other Filtron RFI Systems projects include: Polaris, ASD-1, Kwajelein (Nike-Zeus) and Roi Namu (Tradex). Whether it is atop the world, around it or out of it, when RFI is involved, you can look with confidence to Filtron, the most experienced name in RFI control.

FILTRON CO., INC., 131-15 Fowler Avenue, Flushing 55, New York
10023 West Jefferson Boulevard, Culver City, California
Laboratories at Mountainview, California and Huntsville, Alabama

BUSS
quick-acting
fuses

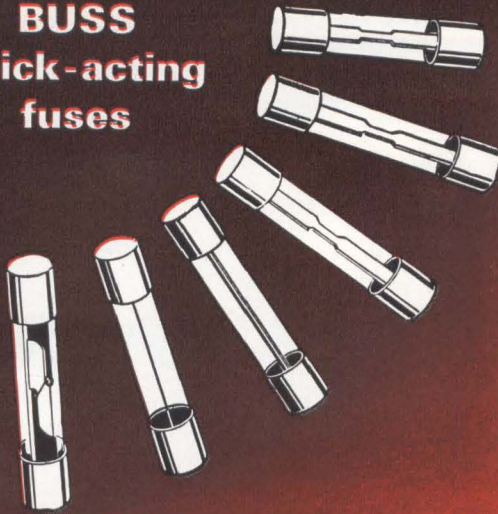

"Fast Acting" fuses for protection of sensitive instruments or delicate apparatus;—or normal acting fuses for protection where circuit is not subject to starting currents or surges.

BUSS

Write for BUSS
Bulletin SFB.

BUSSMANN MFG. DIVISION, McGraw-Edison Co., St. Louis 7, Mo.

950

FUSETRON
dual-element fuses
time-delay
type

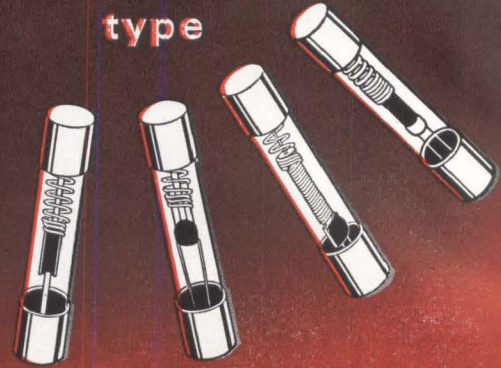

"Slow blowing" fuses for circuits where harmless surges occur. These fuses prevent needless outages by safely holding starting currents or surges,—yet they provide safe, positive protection against short-circuits or continued overloads.

BUSS

Write for BUSS
Bulletin SFB.

BUSSMANN MFG. DIVISION, McGraw-Edison Co., St. Louis 7, Mo.

949

BUSS : the complete line of fuses

CIRCLE 207 ON READER SERVICE CARD

CIRCLE 208 ON READER SERVICE CARD

up to 5000 feet at 500 feet per minute

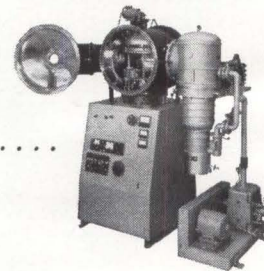

Model 24CE
with special
pumping system
and fixturing

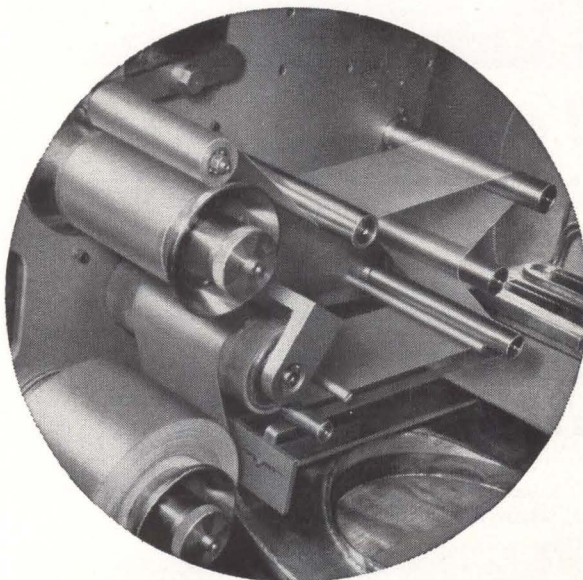

"SPEEDIVAC"

**CONTINUOUS COATING
EQUIPMENT FOR
DIELECTRIC MATERIALS**

Wherever zinc is preferred in the continuous roll coating of capacitor dielectric material, the "Speedivac" model 24CE unit provides the most efficient answer. The unit normally includes: horizontal work chamber, 24 in. dia. by 24 in. long; a full diameter swing door, fitted at one end, sealed by an "O" ring, with pumping aperture at the base of the chamber; and a "Speedivac" vapor booster pump Model 9B1 backed by a "Speedivac" Series 1SC450 gas ballast rotary pump. This combination evacuates the chamber to the working pressure, about 5×10^{-2} torr, in about 3 minutes. The system is fully valved for semi-automatic operation.

for complete information, write :

EDWARDS HIGH VACUUM, INC. 3279 GRAND ISLAND BLVD., GRAND ISLAND, N. Y.

CIRCLE 100 ON READER SERVICE CARD

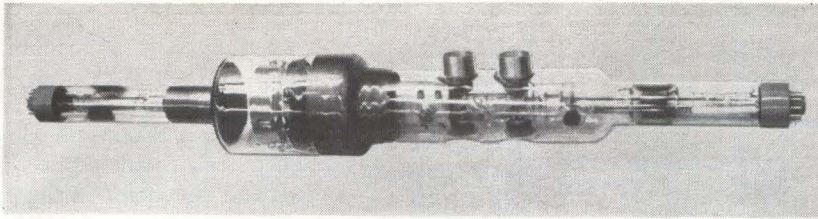

or displayed on television monitors and photographed using hand-camera exposure times.

The new tube enables fast phenomena to be displayed for several seconds on a tv monitor, permitting observations with the unaided eye. Pulses can be relayed or recorded simultaneously with the viewing. Designated R6253 by its manufacturers, The Rauland Corporation, 5600 West Jarvis Avenue, Chicago 48, the tube includes separate writing and reading guns, and is about 27 inches long and 4 inches in diameter at maximum width. A distributed deflection-system is used on the writing side and either magnetic or electrostatic deflection on the readout side; characteristic impedances of 50 and

75 ohms are available and series operation of several tubes is possible since the deflection system is a continuous transmission line.

CIRCLE 303, READER SERVICE CARD

Transducer Reads 1-Angstrom Motion

ULTRA-SENSITIVE seismometer detects 10^{-7} mm of motion, accelerations of $10^{-8}g$, change of tilt to better than 0.1 second of arc, change of azimuth better than 0.2 second of arc, temperature variation of 0.1 F and magnetic field strength and ripple of 0.1 gauss. The unit uses a low-noise amplifier to resolve accelerations down to $10^{-7}g$ covering the frequency range 0.1 to 10 cps and to 200 cps with a higher-

frequency amplifier. Natural frequency of the moving coil is 0.8 cps; the unit's 18 Kg mass is cantilever suspended and drifts less than 60 percent over temperature range -60 to 140 F.

Applications of the instruments, according to Geotechnical Corporation, 3411 Shiloh Road, Garland, Texas, lie in earth science measurements involved in high precision

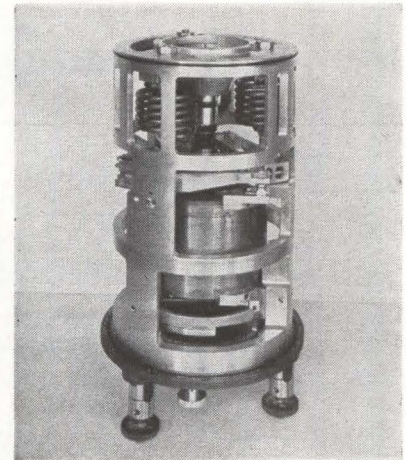

..... of unquestioned high quality

signal or visual
indicating
fuses

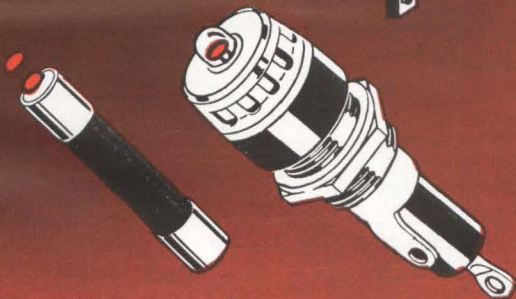
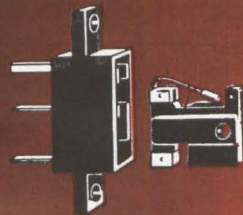

Indicating fuses provide quick, positive identification of a faulted circuit. There are fuses that give a visual signal; fuses that activate an alarm;— and fuses that give a visual signal and activate an alarm.

BUSS

Write for BUSS
Bulletin SFB.

BUSSMANN MFG. DIVISION, McGraw-Edison Co., St. Louis 7, Mo.



If you should have a
special problem
in electrical
protection...

... we welcome your request either to quote or to help in designing or selecting the special type of fuse or fuse mounting best suited to your particular conditions.

Submit description or sketch, showing type of fuse to be used, number of circuits, type of terminal, etc. If your protection problem is still in the engineering state, tell us current, voltage, load characteristics, etc. Be sure to get the latest information BEFORE final design is crystallized.

At any time our staff of fuse engineers is at your service to help solve your problems in electrical protection.

BUSS

Just call
or write:

BUSSMANN MFG. DIVISION, McGraw-Edison Co., St. Louis 7, Mo.

TWO NEW DESIGNERS MOLDED TUNABLE COILS

Conform to Grade 1 Class B MIL-C-15305

SERIES 4300

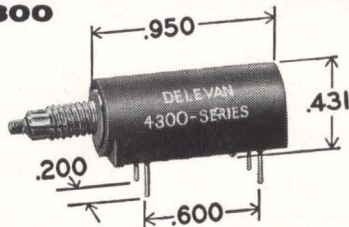

This molded tunable coil is the "Design Engineers" answer to always having just the right coil at the right time. It's referred to as the Designer's Series because prototypes can be wound and assembled from a component kit containing 25 coil forms, 39 assorted cores, 25 couplings and 80 assorted terminals; thus providing on-the-spot custom designing. Production winding and molding would be performed at Delevan. In addition to the custom designing, it can be furnished in standard L values ranging from .18 uh to 70,000 uh, two or four terminals as shown.

SERIES 4400

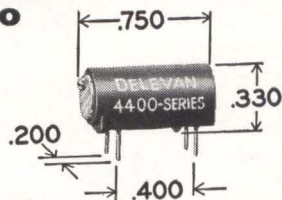

This is one of the finest packages ever designed. Molded, it is small and rugged. Four terminals permit great flexibility of coil/transformer design. It features a new unique vibration proof tuning core design that is without parallel. The coil tunes without core rotation! Torque is smooth and constant. The core is internally sealed. Externally, nothing moves in or out during tuning—a real space saver! Due to this core arrangement, it is necessary for Delevan to design and build your requirements in Designer's Series 4400.

Series 4000 offers a remarkable break-thru for all design engineers concerned with reliable high-quality molded tunable coils offering maximum Q values with guaranteed L values. Tuning ranges as high as three to one. For chassis or printed circuit applications. L values .18 uh to 70,000 uh physically similar to Series 4300 except with two terminals. Delevan Electronics Corporation, 270 Quaker Road, East Aurora, New York.

Delevan Electronics Corporation 
A SUBSIDIARY OF AMERICAN PRECISION INDUSTRIES INC.

CIRCLE 102 ON READER SERVICE CARD

**HELP YOUR POST OFFICE
TO SERVE YOU BETTER
BY
MAILING EARLY IN THE DAY
NATIONWIDE IMPROVED MAIL SERVICE
PROGRAM**

testing and tracking installations. For example, the seismometer is used in survey work to locate tremor-free sites where ballistic camera installations or inertial guidance test facilities can be installed, and also helps in the precise measurement of these facilities once the best site has been selected.

CIRCLE 304, READER SERVICE CARD

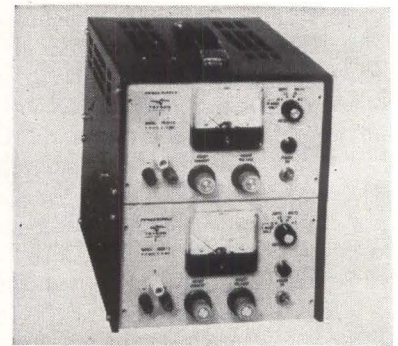

Stacked Power Supplies Offer Dual Polarity

CONVENIENCE of positive and negative potential from one package is provided in a new line of transistor power supplies. The stack shown with one-meter units, provides dual 0-40 v d-c at 500 ma or 0-20 v at 1.5 amp. Two-meter units for monitoring voltage and current simultaneously have model numbers HR20-5A, HR40-2.5A, HR40-5A and HR60-2.5A that are keyed to the top voltage and current values available. Any of 21 combinations can be stacked. Line regulation for the units is 0.01 percent or 2 mv and load regulation is 0.01 or 3 mv; ripple is less than 0.5 mv rms. Special features include provision for series or parallel operation of units, elimination of turn-on or-off transients preventing damage to transistor loads, adjustable overcurrent protection and optional overvoltage protection. Trygon Electronics, Inc., 111 Pleasant Ave., Roosevelt, L. I., N. Y. (305)

Relay Controller for Nanowatt Inputs

BY MEANS OF model III relay controller, an input as small as 15×10^{-9} w will produce a single-ended d-c output of more than 40 v across 1,000 ohms. Model III is a magnetic

amplifier designed to operate a relay whose coil current is rapidly changed from below to above relay pickup. It is sensitive to current changes as small as $5 \mu\text{a}$. Applications are monitoring and control of temperature, pressures, vacuums, and other go/no-go applications. Polyphase Instrument Co., Bridgeport, Pa. (306)

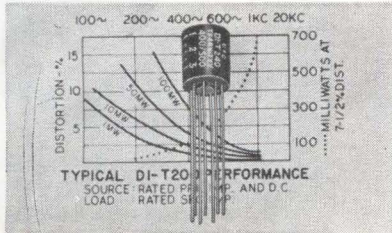

Transformers and Inductors Announced

SERIES DI-T200 ultraminiature transistor transformers and inductors are metal encased, hermetically sealed units, manufactured and guaranteed to MIL-T-27B; MIL Type TF4RX-YY. Gold plated Dumet leads afford weldable or solderable mounting. The leads are un-insulated, 1 in. long, spaced on a 0.1-in. radius circle to conform to terminal spacing techniques of the TO-5 case semiconductors and micrologic elements. United Transformer Corp., 150 Varick St., New York 13, N. Y. (307)

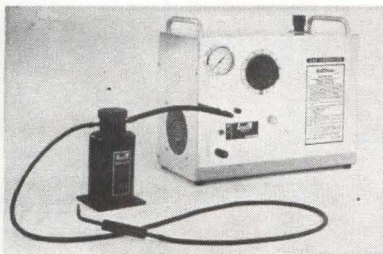

Welding Instrument Uses Water As Fuel

MODEL M, using distilled water as the primary fuel, can deliver temperatures up to 6,000 F. It comprises an oxy-hydrogen generator with d-c power supply and electrolytic reactor in a single package weighing 84 lb. Unit welds sheet metal up to 16 gage, fuses bars and rods up to $\frac{1}{4}$ in. diameter. Henes Manufacturing Co., 4300 E. Madison St., Phoenix, 34, Ariz. (308)

NEW! HIGH SENSITIVITY

GENERAL PURPOSE 247A

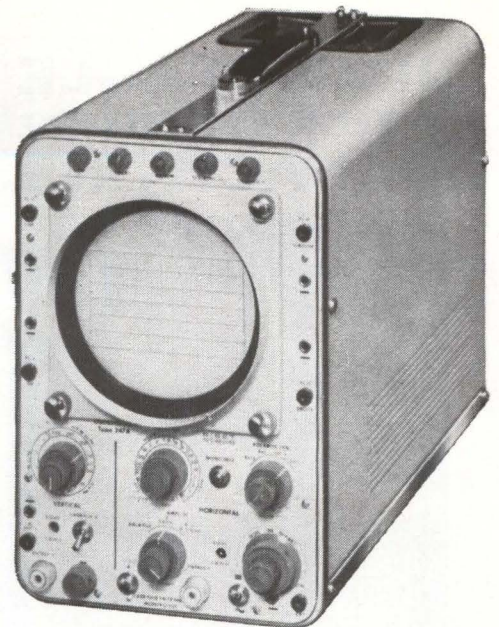

The type 247-A oscilloscope fully qualifies as a universal instrument because its performances and the size (13 cm (5") dia.) of its C.R. Tube authorize accurate measurements and tests in all fields of low-frequency instrumentation. Also, because of its simplicity of operation, the 247-A is ideally suited for practical laboratory work of an educational nature.

TECHNICAL SPECIFICATIONS

Vertical amplifier

1 channel; Frequency range: DC to 1 Mc/s (-3 dB)
Sensitivity: 50 mV/cm
AC: 10 c/s sinewave or 50 c/s square-wave to 100 Kc/s (-3 dB)
Sensitivity: 5 mV/cm
Calibrated attenuator: step-adjustable from 5 mV to 20 V/cm in 12 positions
Sequence: 1 - 2 - 5 - 10 etc...
Attenuator vernier ratio 1/3
Constant input impedance: 1 M Ω 47 pF

Sweep

Free-running - triggered - single sweep
Duration: 1 s/cm to 0.5 $\mu\text{s/cm}$ in 20 calibrated positions
Vernier: 1:3 ratio -
x 5 magnification expanding sweep durations from 3 s/cm to 0.1 $\mu\text{s/cm}$

Sync

5 positions: single-sweep, HF, LF, TV-line, TV-frame
Polarity: + or - internal or external
selection of triggering level

Horizontal Amplifier

Frequency range: 0 to 500 Kc/s (-3 dB)

Oscilloscopes

204 A - High speed and fast rise oscilloscope
241 A - 242 A - 243 A, Multi-function osc. with plug-in preamplifiers.
255 B - Portable oscilloscope
245 A - High performance portable oscilloscope
246 A - High sensitivity low-frequency oscilloscope
248 A - Maintenance oscilloscope.

Sweep frequency Generators

411 A - Laboratory sweep frequency generator
410 B - TV - FM sweep frequency generator
476 A - Radio sweep frequency generator

Signal Generators

405 A - Low frequency RC signal gen. (30 c/s-300 Kc/s)

Sensitivity: 1 V/cm or 10 V/cm (switch-selected)
Vernier: 0 to 1
Constant input impedance: 1 M Ω and 47 pF

Cathode-ray Tube

5 ADP 2 or equivalent type
Screen: 13 cm (5") dia.
Deflection factors:
X: 30 V/cm (approx.)
Y: 20 V/cm (approx.)

Direct drive of H and V plates
Acceleration voltage: 3 Kv

MECHANICAL FEATURES

Light-alloy chassis, readily-detachable panel for easy access to circuits.

1) Tube complement

9/ECF80 - 2 NM2L or equivalent types

2) Power supply

105 - 115 - 127 - 220 - 240 V - 50 or 60 c/s

3) Dimensions

Width: 20,5 cm - (8")
Depth: 38,5 cm - (15")
Height: 31 cm - (12")
Weight: 14 kg - (30 lbs)

OTHER INSTRUMENTS

428 A - HF constant amplitude signal generator (100 Kc/s-30Mc/s)
458 - Pulse generator (5 c/s - 50 Kc/s).

TV pattern generators

465 C - Portable electronic pattern generator
464 A - Test - pattern generator

Regulated power supplies

117 A - Transistorised regulated power supply
114 A - Regulated power supply

Cameras

1000 A - oscilloscope camera with Polaroid
1001 B - oscilloscope recorder

INTER-PLANS

RIBET-DESJARDINS

MEASURE & CONTROL DEPARTMENT, 13-17, rue Périer MONTROUGE/PARIS TEL: ALESIA 24-40
CANADIAN BRANCH: RIBET-DESJARDINS (CANADA) Room 114, 5757 Decelles Avenue - MONTREAL.

ADJUSTABLE PRECISION POLYSTYRENE CAPACITORS



**.01% ACCURACY
HERMETICALLY
SEALED**

**1st choice for
Critical Applications**

SOUTHERN ELECTRONICS hermetically sealed precision adjustable capacitors are being used for many applications in analog computers, network tuning circuits, differential analyzers, and similar circuitry requiring the utmost in accuracy and reliability.

SEC has pioneered in the design and manufacture of hermetically sealed adjustable capacitors, and this experience has resulted in a .01% accuracy standard, and a degree of in-circuit reliability not previously available. **SEC** adjustable capacitors incorporate features proven to be years ahead of any comparable product now available.

GENERAL SPECIFICATIONS

Adjustment Range: $\pm 1\frac{1}{2}\%$
Dielectric Absorption: 0.02%
Available from .01 mfd. to 10 mfd.
Accuracy: .001%
Long Term Stability: 0.03%
Temperature Coefficient: -100 PPM per $^{\circ}\text{C}$
Temperature Range: -40°F to $+140^{\circ}\text{F}$



Write today for complete specifications and general catalog.

**SOUTHERN
ELECTRONICS
Corporation**

150 West Cypress Ave., Burbank, California

Literature of the Week

SEMICONDUCTORS North American Electronics, Inc., 71 Linden St., West Lynn, Mass., announces availability of the new 1963 semiconductor condensed catalog. **CIRCLE 309, READER SERVICE CARD**

DIGITAL COMPUTER Daystrom, Inc., Control Systems Division, 4455 Miramar Road, LaJolla, Calif., offers a brochure fully describing the 636 digital computer. (310)

HIGH IMPEDANCE AMPLIFIER Halex, Inc., 139 Maryland St., El Segundo, Calif. Bulletin contains specifications and general description of a small solid state high impedance amplifier. (311)

TRANSISTOR TEST SET Trio Laboratories, Inc., Dupont Drive, Plainview, N. Y. Two-page technical bulletin describes model 400-1805 Tri/Lim transistor test set. (312)

HIGH VOLTAGE RELAY Resitron Laboratories, Inc., 3860 Centinela Ave., Los Angeles 66, Calif. Data sheet describes the R-7 miniature high voltage, high vacuum relay. (313)

FIXED CAPACITORS Sangamo Electric Co., Springfield, Ill., has published bulletin 2152F describing an extensive line of fixed capacitors. (314)

D-C POWER SUPPLIES Sorensen, A Unit of Raytheon Co., Richards Ave., South Norwalk, Conn. Applications of the QB series transistorized d-c power supplies are detailed in a 12-page booklet. (315)

ELECTRON PROBE MICROANALYZER Philips Electronic Instruments, 750 South Fulton Ave., Mount Vernon, N. Y. A 6-page folder contains complete technical information on the Norelco AMR/3 electron probe microanalyzer. (316)

MILITARY CONNECTORS Amphenol Connector Division, Amphenol-Borg Electronics Corp., 1830 S. 54th Ave., Chicago 50, Ill., offers an application manual for miniature military connectors. (317)

LEAK DETECTOR Consolidated Electrodynamics Corp., 360 Sierra Madre Villa, Pasadena, Calif. An 8-page bulletin describes the capabilities of the 24-120A mass-spectrometer type leak detector. (318)

MINIATURE COAX Hitemp Wires Co., Westbury, L. I., N. Y., has prepared technical bulletin No. 102 on its recently developed miniaturized coaxial cable. (319)

SILICON RECTIFIERS National Transistor, 500 Broadway, Lawrence, Mass. A 2-page catalog describes the electrical and mechanical characteristics of silicon rectifiers. (320)

SERVO AMPLIFIER Kearfott Division, General Precision Aerospace, Little

Fast, practical Handbook help

for all whose work
involves the
applications
of PHYSICS

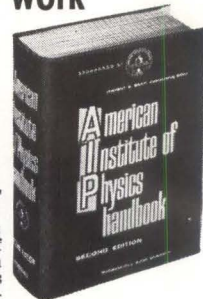

With the help of this Handbook, hours of searching through scattered references for facts or formulas in physics can be saved. This Second Edition has been thoroughly revised and expanded to reflect today's advances and discoveries in every major branch of physics. Included is a new section completely devoted to solid-state physics. Here is a comprehensive Handbook offering fast, reliable, and wide-range reference on all fields of physics—over 2000 pages of tables, graphs, and equations readily available when you want them.

Just Published—2nd Edition

American Institute of PHYSICS HANDBOOK

Coordinating Editor, D. E. GRAY
Prepared by a Staff of Specialists
2nd Edition, 2128 pp., illus., \$29.75

Terms: \$9.75 in 10 days, and \$10 monthly

Revised Second
Edition includes:

Prepared under the auspices of the American Institute of Physics, this Handbook brings together a tremendous fund of data on major areas of physics. It gives you ready access to essential information on mechanics, acoustics, heat, electricity and magnetism, optics, atomic physics, nuclear physics, and solid state physics. Included is a complete section on aids to computation.

New section on solid-state physics • chapters on analog and digital computers in physics research • expansion of seismological and geodetic data • recent data on propagation of sound in solids, liquids, and gases • data based on recent rocket sounding of upper atmosphere • low temperature thermoelectric data... and much more

**10-DAY FREE EXAMINATION
direct from MCGRAW-HILL**

McGraw-Hill Book Co., Dept. L-6-21
327 W. 41st St., New York 36, N. Y.

Send me the AMERICAN INSTITUTE OF PHYSICS HANDBOOK for 10 days' examination on approval. In 10 days I will check one remit \$29.75, plus few cents delivery costs; or \$9.75 in 10 days and \$10.00 a month for two months. Otherwise I will return book postpaid. (We pay delivery costs if you remit with orders; same examination and return privilege.)

Print name

Address

City..... Zone.... State.....

Company..... Position.....

For price and terms outside U.S.A.
write McGraw-Hill Int'l., N.Y.C.

L-6-21

Falls, N. J., has published advance data on a Micro-Block electronic control servo amplifier. (321)

MICROELEMENTS Aladdin Electronics, 703 Murfreesboro Road, Nashville 10, Tenn. Manual describes the company's facilities for providing microelement transformers and inductors. (322)

TIMER/COUNTER/FREQUENCY METERS Transistor Specialties, Inc., Terminal Drive, Plainview, L. I., N. Y. Catalog data sheet describes 100-percent solid-state digital timer/counter/frequency meters. (323)

STRAIN GAGE LOAD CELLS Baldwin-Lima-Hamilton Corp., Electronics Division, Waltham 54, Mass., has available a standard prepared by the Scientific Apparatus Makers Association entitled "Standard Load Cell Terminology and Definitions." (324)

ZENERS General Instrument Corp., 65 Gouverneur St., Newark 4, N. J., has published a partial listing of Zeners manufactured by the company, which have Military Approval, or are in the process of being approved. (325)

SPACE MODULES Tenney Engineering, Inc., 1090 Springfield Road, Union, N. J. Bulletin describes a new standard line of space modules that permit quick, custom assembly of space simulators in any of 1,200 combinations of temperature, altitude and work areas. (326)

PRINTER-PROCESSOR SYSTEMS Addressograph-Multigraph Corp., 1200 Babbitt Road, Cleveland 17, O., has published literature describing two new systems for providing present computer users flexible and economical off-line and on-line high speed printing facilities. (327)

OSCILLOSCOPES Fairchild Camera and Instrument Corp., DuMont Laboratories, 750 Bloomfield Ave., Clifton, N. J. A mailing piece illustrates and describes the 765H series 13 Kv transistorized, lightweight oscilloscopes. (328)

SAMPLING SCOPES Tektronix, Inc., Box 500, Beaverton, Ore., has prepared a 12-page illustrated report on sampling oscilloscope concepts and systems. Request on business letterhead.

INDICATOR LIGHTS Dialight Corp., 60 Stewart Ave., Brooklyn 37, N. Y., offers a catalog on subminiature transistorized and matching indicator lights. (329)

SINGLE COMPONENT COATING Columbia Technical Corp., 24-30 Brooklyn-Queens Expressway West, Woodside 77, N. Y. Data sheet describes HumiSeal 1A25, a polyurethane type coating that cures at room temperature in the presence of humidity. (330)

LOW PRESSURE TRANSDUCERS Taber Instrument Corp., 107 Goundry St., North Tonawanda, N. Y. Bulletin P-63187 covers the Teleflight pressure transducer series for space vehicle and rocket use. (331)

FOR PEACE OF MIND IN TOWERS

choose...



Trylon Guyed Towers are famous for long, reliable service all over the world—often in unfavorable environments. These triangular section steel ladder towers are backed by over 25 years' experience in design, fabrication and erection. They cost less than self-supporting towers, are superbly engineered for safety and long life, and offer these advantages:

1. They meet or exceed E.I.A. standards.
2. Are hot dip galvanized after fabrication.
3. Have strong horizontal members for safe, easy climbing.
4. Save time in erection.
5. Offer optimum suitability for communication needs due to our experience in both towers and antennas.

Whether your need is in towers, antennas, or both—it will pay you to contact TRYLON.

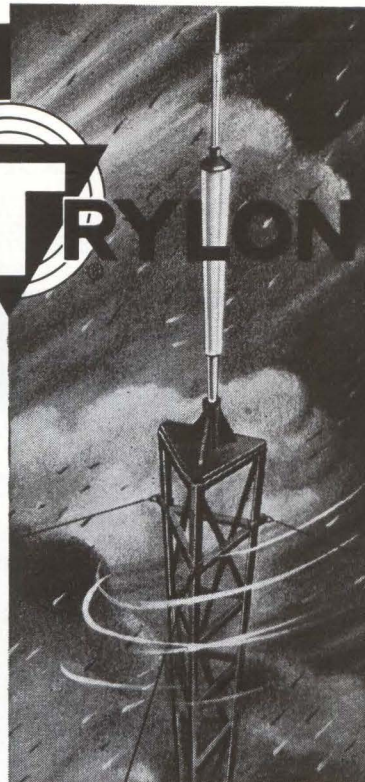

WIND TURBINE COMPANY

ELVERSON, PA. Phone: (215) WHitney 2-2981

TOWER AND ANTENNA SYSTEMS

RESEARCH • DEVELOPMENT • MANUFACTURE • INSTALLATION

CIRCLE 210 ON READER SERVICE CARD

CHRISTIE

SINCE 1929

"TRANSIENT FREE"

D-C POWER SUPPLIES

100-200-250-400-600 AMP.

15 to 36 volt d-c
50 microsec
Response

Impedance: 1 milliohm
Ripple: 1 millivolt

F. L. Regulation:
Static: .05%
Dynamic: .5v

Military & RFI Specs
Also Mobile & Rack

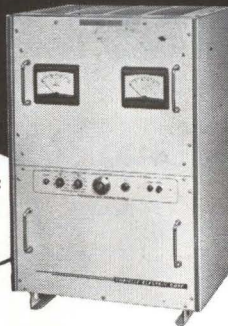

Also 200 other Models of Power Supplies & Battery Chargers • Write for Catalog

CHRISTIE ELECTRIC CORP. 3400 West 67th Street, Los Angeles 43, Calif.

GPI Opens Aerospace Research Center

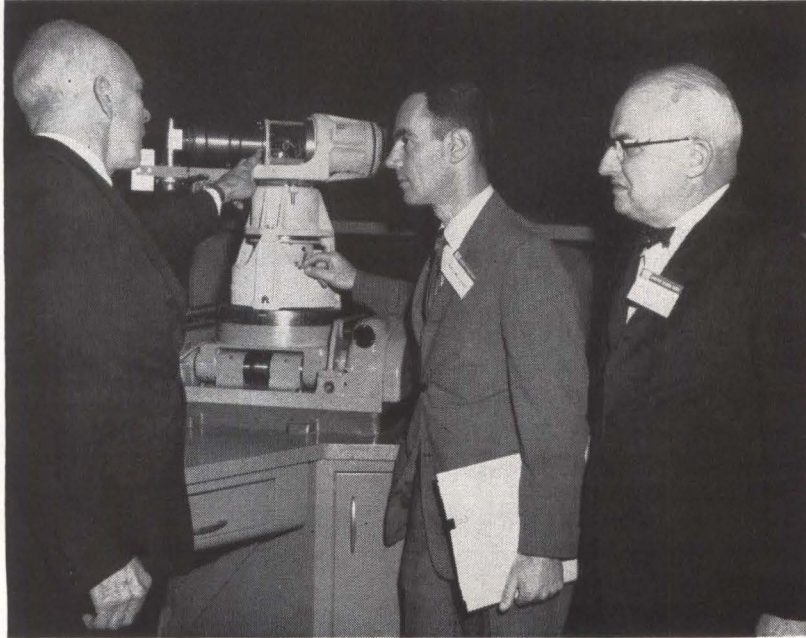

SHOWN during tour of new research center are (left to right) D. W. Smith, company president, Hon. John H. Rubel, Assistant Secretary of Defense, and F. D. Herbert, Jr., Aerospace Group president

OFFICIAL opening of a new two-story 80,000 square-foot Aerospace Research Center in Little Falls, N. J., has been announced by the Aerospace Group of General Precision, Inc. Guest speaker at the opening day ceremonies was The Honorable John H. Rubel, Assistant Secretary of Defense.

Rubel underscored the importance of research to the future of our country, from both economic and defense points of view. He commended General Precision, as representative of industry, for investing in a research center which will undoubtedly benefit the government as well as the firm itself. Rubel also traced the development of the Aerospace Group from its early days as a small manufacturer of marine gear, to a nationally known producer of aerospace components, to its present position as a prime systems contractor.

The Aerospace Research Center is directed by Robert C. Langford, who was recently appointed chairman of the American Institute

Continued on p 108



L. T. Rader



K. R. Herman



H. C. Landsiedel



D. L. Bibby



H. F. Vickers

Sperry Rand Reorganizes

THE SPERRY RAND Corporation, with headquarters in New York City, has announced the following organization changes:

The Univac division of Sperry Rand, with Louis T. Rader as its president will report directly to Sperry Rand's executive vice president, Kenneth R. Herman.

The present Systems and Office Machines divisions of Remington Rand will be known as the Remington Office Equipment division of Sperry Rand and H. C. Landsiedel is named as its president. Landsiedel was formerly a Remington Rand group vice president in charge of these divisions.

Landsiedel is also named president of the Remington Electric Shaver division of Sperry Rand which has been under his direction for a number of years. He will report directly to K. R. Herman.

Dause L. Bibby, president of the former Remington Rand division, which included Univac until last year, is named assistant to the president of Sperry Rand Corporation, H. F. Vickers.

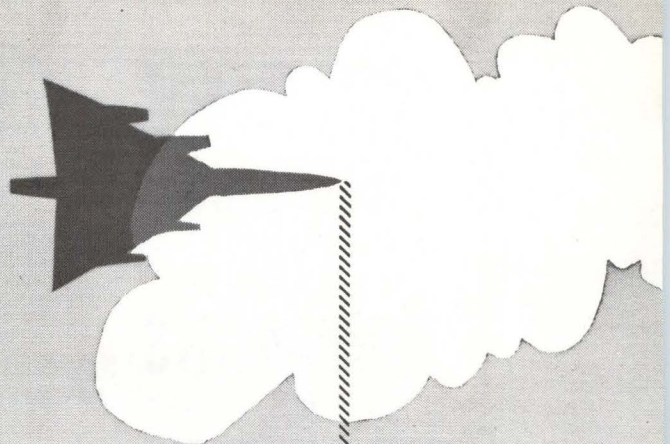
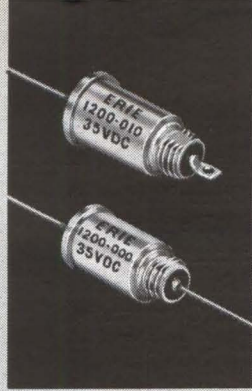

Electronic technology that works...

WIDE, WIDE RANGE FILTERS THAT REQUIRE LESS SPACE

By using barium titanate rolled tubes plus ferrite loading, technologists at Erie Resistor accomplished two important breakthroughs in filter design...

Wider range: 10kc to 2000mc.

Compact design: 0.343" diameter by 0.720" long.

These Erie wide range, low-pass filters offer efficient and compact RFI suppression in airborne communications, navigation, and identification-interrogation systems.

These new filters using Erie's ferroceramic techniques are another example of advanced research and production technologies at work at Erie Resistor... where reliability goals are 100% assured.

Tell us your ideas and needs for electronic components and assemblies to be resolved by Erie technological experience and staff. Address:

ERIE RESISTOR CORPORATION



644 West 12th Street
Erie, Pennsylvania

DESIGNER, PRODUCER AND MARKETER OF TECHNOLOGICAL PRODUCTS

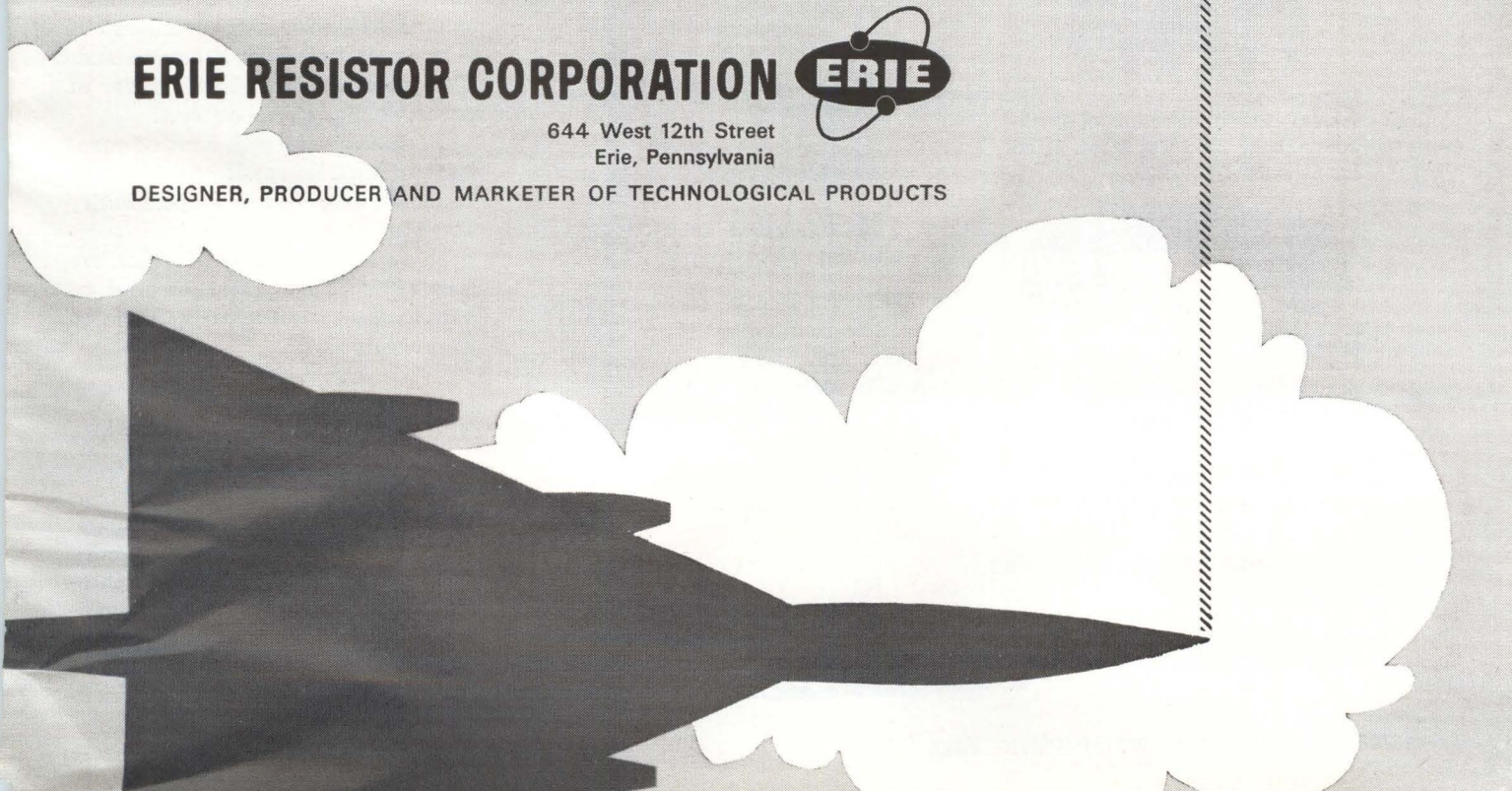



**SPECIFY
TELEPHONE
TYPE
COMPONENTS
BY
Stromberg-Carlson**

Thoroughly proved in telephone switching operations, Stromberg-Carlson components bring a new high in quality and reliability to many industrial applications.

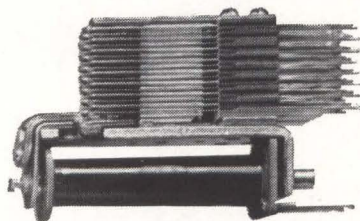

RELAYS Types A, B, BB, C and E. All standard spring combinations are available. Send for our Bulletin T-5000R3.

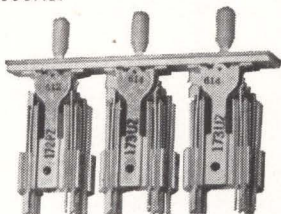

KEYS Broad selection of push-button, cam and twist types. Send for Bulletin T-5002R2.



HANDSETS High-efficiency models; standard or with switch assemblies. Send for Bulletin T-5017R.

Plus all other telephone switchboard components. For technical data on the full Stromberg-Carlson line, write to Industrial Sales Department.

STROMBERG-CARLSON
A DIVISION OF **GENERAL DYNAMICS**
114 CARLSON ROAD • ROCHESTER 3, N. Y.

of Aeronautics and Astronautics' Technical Committee on Guidance and Control. He is also on the National Aeronautics and Space Administration's Research Advisory Committee on Communications, Instrumentation, and Data Processing.

Within the Center's laboratories and offices, 190 scientific personnel are pursuing investigations to provide tomorrow's aerospace products. Fully equipped laboratories in chemistry, physics, metallurgy, spectroscopy, microelectronics, and optics as well as other smaller labs provide the necessary instrumentation for the scientists. Support in depth is supplied by a computer center, model shops, experimental assembly areas, and a technical information center.

General Precision's Aerospace Group now employs more than 8,000 people and has 21 plants located in New Jersey, New York, Massachusetts, North Carolina, and California. The Group was selected last year as prime contractor for the guidance and control portion of the Air Force's Mobile Mid-Range Ballistic Missile.



McFadden Sets Up Own Company

BERT MCFADDEN, former president and co-founder of Micro Gee Products, Inc., now a division of Menasco Mfg. Co. of Burbank, Calif., has resigned. He has established his own engineering and development firm, McFadden Electronics Company in South Gate, Calif.

RCA Announces Reassignments

THREE new appointments in the microwave engineering organization

of the RCA Electron Tube division, Harrison, N. J., have been announced.

Markus Nowogrodzki, formerly manager, microwave product engineering, has been named to the new post of manager, microwave engineering programs. In this position he will be responsible for planning and directing major microwave engineering programs.

Frank E. Vaccaro succeeds Nowogrodzki as manager, microwave product engineering. He was previously manager, microwave applied research for the division's laboratory in Princeton, N. J.

Fred Sterzer, formerly a microwave systems engineer, has been appointed manager, microwave applied research.



Simmonds Precision Advances Edwards

HARRISON F. EDWARDS has been named executive vice president of Simmonds Precision Products, Inc., Tarrytown, N. Y., manufacturer of airborne electronic systems.

Formerly vice president of manufacturing, Edwards, in his new capacity, has overall responsibility for the company's sales and engineering divisions, both of which are located in Tarrytown, as well as Simmonds manufacturing division at Vergennes, Vt.

Cook Electric Reorganizes

COOK ELECTRIC COMPANY, Morton Grove, Ill., aerospace, electronics and communications firm, has integrated three previously independent divisions into its Cook Technological Center division to form a systems-oriented government prod-

MICO

DESK AND DOOR PLATE ENGRAVER



FOR
Engraving most
sizes of Desk and
Door Plates in a
single set-up.

FEATURES

1. Six pantograph ratios—from 1.5:1 to 4:1.
2. Spindle has integral micrometer depth control of .250".
3. Uses standard tapered-shank engraving cutters.
4. New 19" Copy carriers hold 17" of master copy; Permits engraving about 11" line of characters in one set-up at the 1.5:1 ratio.
5. Three sizes of copy carriers available. Each positioned separately.
6. Work-holding fence speeds set-up and engraving time.

Send for illustrated Catalog

MICO INSTRUMENT CO.

77 Trowbridge St. Cambridge 38, Mass.
CIRCLE 211 ON READER SERVICE CARD

- SCAN CONVERSION
- FLICKERLESS DISPLAY STORE
- VIDEO STORAGE

RECORDING STORAGE TUBE SYSTEMS

Single-gun, dual-gun, multi-tube systems to convert scan for radar, sonar, television, and to perform analog processing, data analysis, contract or expand time scale, auto correlation.

- SLOWED TELEVISION TRANSMISSION

by telephone line or other narrow-band systems.

- IMAGE ENGINEERING

OPTICAL CHART READERS, FLYING SPOT SCANNERS, LOW-LIGHT-LEVEL CAMERAS, and IMAGE RECTIFICATION. Automatic inspection and recognition of size, shape, color, and texture.



Write or call for complete information:

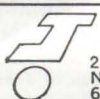

INSTRUMENTS, Inc.

2300 Washington Street
Newton 62, Massachusetts
617 WOODWARD 9-8440

CIRCLE 212 ON READER SERVICE CARD

electronics • June 21, 1963

ucts group, a major step toward aggressively seeking prime government systems research and development contracts, president John H. Mangle has announced.

Cook Research Laboratories, Inland Testing Laboratories, and Air Mod divisions have been integrated into the CTC division as departments, retaining their names but no longer operating independently. They now are under the overall supervision of Cook vice president Alton D. Anderson, general manager of CTC division, headquartered in Morton Grove.

PEOPLE IN BRIEF

Gustaf Lawson leaves Leviton Mfg. Co. to become chief engineer at The Thomas & Betts Co. Adolph Bodamer, formerly with Alois Zettler Co., named chief engineer at Babcock Relays. Russell A. Temple, previously with Aerojet General Corp., joins Electro-Optical Systems, Inc., as mgr. of optical design and fabrication. Jameson Dane Rigden, ex-Bell Telephone Laboratories, appointed group leader in gas laser R&D in the Optical Maser dept. of Perkin-Elmer Corp. Donald R. Humphreys, from East Coast Aviation Corp. to Antenna Systems, Inc., as project mgr. in the engineering dept. J. A. Nava moves up to v-p in charge of engineering for Pyle-National Co. Charles C. Williams raised to Navy liaison mgr. at Adler Electronics' Government Products div. John W. Savage advances to engineering head of the Radio Frequency Instrumentation Branch of Jansky & Bailey. Kent Mfg. Corp. announces three promotions with the election of Edward D. Thomas as president, David J. Crimmins as v-p, engineering, and R. W. Lancaster as v-p, marketing. Siliconix Inc. ups Arthur D. Evans to chief engineer. Warren B. Offutt and George I. Toumanoff elevated to technical assistants to the president of Airborne Instruments Laboratory. J. L. Brooks promoted to mgr. of research and engineering for sensor products at GD/Electronics.

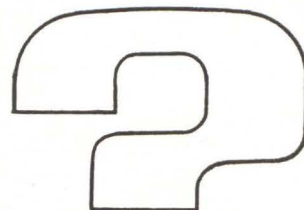

What do you need to know about

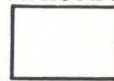

PURE FERRIC OXIDES
MAGNETIC IRON OXIDES



Since the final quality of your production of ferrites and magnetic recording media depends on the proper use of specialized iron oxides—you'll find it mighty helpful to have the latest, authoritative technical data describing the physical and chemical characteristics of these materials. This information is available to you just for the asking. Meanwhile, here are the highlights.

PURE FERRIC OXIDES—For the production of ferrites, both hard and soft, we manufacture a complete range of iron oxides having the required chemical and physical properties. They are produced in both the spheroidal and acicular shapes with average particle diameters from 0.2 to 0.8 microns. Impurities such as soluble salts, silica, alumina and calcium are at a minimum while Fe₂O₃ assay is 99.5+%. A Tech Report tabulating complete chemical analysis, particle shape, particle size distribution, surface area, etc., of several types of ferric oxides, hydrated ferric oxide, and ferrous-ferric oxide is available.

MAGNETIC IRON OXIDES—For magnetic recording—audio, video, computer, and instrumentation tapes; memory drums; cinema film striping; magnetic inks; carbon transfers; etc.—we produce special magnetic iron oxides with a range of controlled magnetic properties. Both the black ferrous-ferric and brown gamma ferric oxides are described in a Data Sheet listing magnetic properties of six grades.

If you have problems involving any of these materials, please let us go to work for you. We maintain fully equipped laboratories for the development of new and better inorganic materials. Write, stating your problem, to C.K. Williams & Co., Dept. 25, 640 N. 13th St., Easton, Pa.

WILLIAMS
COLORS & PIGMENTS

Pigment
Technology
at its
best

A Subsidiary of Chas. Pfizer & Co., Inc.

E. ST. LOUIS, ILL. • EASTON, PENNA. • EMERYVILLE, CALIF.

CIRCLE 109 ON READER SERVICE CARD

109

SYSTEMS ENGINEERS

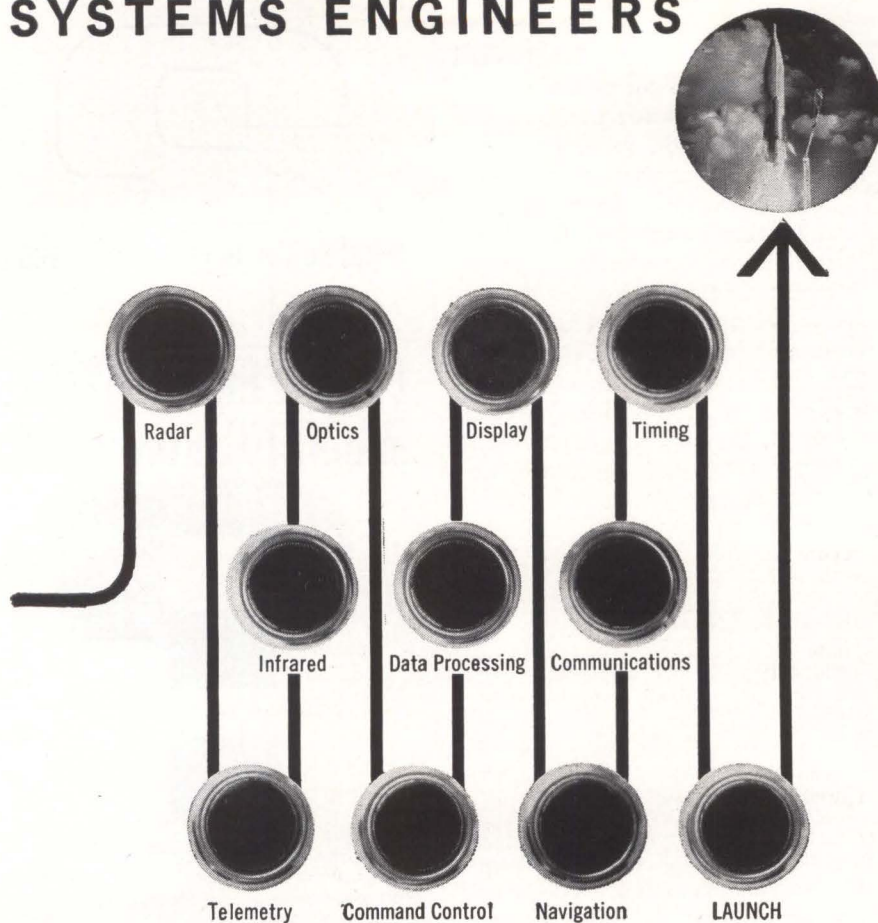

to reach "GO"

... vital decisions must be made between the drawing board concept of a range instrumentation system for a specific launch, and the final countdown at the Atlantic Missile Range.

The Systems Engineers of Pan Am's Guided Missiles Range Division are entrusted with these important assignments. They must develop systems studies for each new concept, prepare specifications, provide technical direction of contracted instrumentation for the Air Force, and phase it into operational status.

These varied programs encompass three major disciplines:

data acquisition, utilizing CW and pulse radar, optics, infrared, telemetry, and navigation.

data handling, including real-time transmission and computation, post-flight data processing, and data display.

data support, covering RFI, timing, command control and communications engineering.

Decision-making engineers with a minimum of 3 years applicable experience are invited to consider these important systems engineering positions.

For further information, write in confidence to Dr. Charles Carroll, Dept. 28F-3



GUIDED MISSILES RANGE DIVISION

PAN AMERICAN WORLD AIRWAYS, INC.
P. O. BOX 4465, PATRICK AIR FORCE BASE, FLORIDA
AN EQUAL OPPORTUNITY EMPLOYER

SEARCHLIGHT SECTION
(Classified Advertising)
BUSINESS OPPORTUNITIES
EQUIPMENT - USED or RESALE

LIFSCHULTZ

FASTEST...

4th DAY
between
Chicago and
West Coast

2nd DAY
between
Chicago —
Milwaukee and
Eastern
Terminals

Specialists in Shipment of Electronics Products

LIFSCHULTZ FAST FREIGHT

NEW YORK — CHICAGO — PHILADELPHIA — BOSTON
HOLYOKE — BALTIMORE — BLOOMFIELD, N. J.
NEW HAVEN — PROVIDENCE — MILWAUKEE
LOS ANGELES — SAN FRANCISCO

CIRCLE 950 ON READER SERVICE CARD

FOR SALE

Standard 3-channel open-wire Carrier Terminals and Repeaters.

Standard v-f carrier-telegraph terminals.

Standard v-f ringers, v-f repeaters, repeating coils, condensers, filters, retard coils, polar relays.

Complete list on request

FS-2435, Electronics
Class. Adv. Div., P.O. Box 12, N.Y. 36, N.Y.

CIRCLE 951 ON READER SERVICE CARD

RADIO RESEARCH INSTRUMENT CO.

AUTO-TRACK & TELEMETRY ANTENNA PEDESTALS
3 & 10 CM. SCR. 584 AUTOTRACK RADARS.
AN/TPS-10 SEARCH, AN/TPS-10 HT. FINDERS.
AN/FPN-300A, AN/APS-10 NAVIG. & WEATHER.
AN/APS-15B PRECISION, AN/APQ-35B PRECISION,
AN/APS-31A SEARCH, DOZENS MORE.
5-1-2 MEGAWATT HIGH POWER PULSERS.

RADIO RESEARCH INSTRUMENT CO.
550 Fifth Ave., New York Judson 6-4691

RADAR SYSTEMS & COMPONENTS/ IMMEDIATE DELIVERY

CIRCLE 952 ON READER SERVICE CARD

WANTED:

AN/TRC-24 RADIO SET COMPONENTS

AM-912/TRC
AM-913/TRC
AM-915/TRC
PP-685/TRC
R-417/TRC
T-302/TRC

W-2402, Electronics
Class. Adv. Div., P.O. Box 12, N.Y. 36, N.Y.

CIRCLE 953 ON READER SERVICE CARD

LOOKING FOR

USED/SURPLUS ELECTRONIC EQUIPMENT/COMPONENTS?

For an up-to-date listing of such equipment see Searchlight Section of June 14th.

INDEX TO ADVERTISERS

Allen-Bradley Co.	5	Kinney Vacuum Div. of New York Air Brake Co.....	89	• Telerad Div. of Lionel Corp.....	91
All-Tronics Inc.	93			Texas Instruments Incorporated	
Amco Engineering Co.....	83			Industrial Products Group.....	25
• Amphenol-Borg Electronics Corp. Connector Division	34, 35	• Lapp Insulator Co., Inc.....	27	Thermal American Fused Quartz Co., Inc.	86
		Littelfuse	89	• Transitron Electronic Corp.....	15
Belden Manufacturing Co.....	79				
Brand Rex, Division of American Enka Corp.....	90	Machlett Laboratories, The.....	19	U. S. Stoneware.....	29
• Bussmann Mfg. Co. Div. of McGraw Edison Co.....	100, 101	McGraw-Hill Book Co.....	104	United Testing Laboratories Div of United Electro Dynamics Inc....	87
		• McLean Engineering Laboratories..	93	• United Transformer Corp.....	2nd cover
		Mepco Inc.	64		
• Christie Electric Corp.....	105	• Mico Instrument Co.....	109		
Coors Porcelain Co.....	77	Midland Mfg. Co.....	82		
		Midwec	91		
		Minnesota Mining & Mfg. Co. Mincom Division	14		
		Mnemotron Corp.	94		
Data-Control Systems, Inc.....	36	Niagara Mohawk Power Corp.....	30		
• Data Pulse Inc.....	31	• North Atlantic Industries, Inc....	80		
Delavan Electronics Corp.....	102				
duPont de Nemours & Co., Inc. E. I.	85	• Ohmite Mfg. Co.....	11		
Dymec, A Division of Hewlett Packard Co.....	28	Ozalid A Div. of General Aniline & Film Corp.....	33		
Edwards High Vacuum, Inc.....	100	Paktron Div. of Illinois Tool Works	88		
Elcor, Inc.	87	• Polarad Electronic Div. of Polarad Electronics Corporation	61, 62		
• Empire Devices, Inc.....	21	• Potter Instrument Co., Inc.....	17		
Erie Resistor Corp. Electronics Div.	107				
• Fairchild Semiconductor Corp.....	112				
Filtron Co., Inc.	99				
• General RF Fittings, Inc.....	91	• Radio Corporation of America. 4th cover			
Gudebrod Bros. Silk Co., Inc.....	32	• Radio Frequency Laboratories, Inc.	97		
Hexacon Electric Co.....	81	Ribet-Desjardins	103		
Hoffman Engineering Corp.....	81	Rome Cable Div. of Alcoa.....	10		
Huntington Alloy Products Div. of International Nickel Co.....	63				
• Image Instruments Inc.....	109				
• Indiana General Corp.....	26				
Jerrod Electronics Corp.....	4				

CLASSIFIED ADVERTISING

F. J. Eberle, Business Mgr.

EMPLOYMENT OPPORTUNITIES 110

SPECIAL SERVICES 110

EQUIPMENT

(Used or Surplus New)

For Sale 110

WANTED

Equipment 110

CLASSIFIED INDEX

Lifschultz Fast Freight..... 110

Pan American World Airways Inc.. 110

• Radio Research Instrument Co.... 110

• See advertisement in the July 25, 1962 issue of Electronics Buyers' Guide for complete line of products or services.

This Index and our Reader Service Numbers are published as a service. Every precaution is taken to make them accurate, but **electronics** assumes no responsibilities for errors or omissions.

electronics



Audit Bureau
of Circulation



Associated Business
Publications

Audited Paid Circulation

JAMES T. HAUPTLI

Advertising Sales Manager

DAVID CUNNIFF

Promotion Manager

Electronics Buyers' Guide

R. S. QUINT
General Manager

RICHARD J. TOMLINSON

Business Manager

THEODORE R. GEIPEL
Production Manager

ADVERTISING REPRESENTATIVES

ATLANTA (9):

Michael H. Miller, Robert C. Johnson
1375 Peachtree St. N.E., Trinity 5-0523
(area code 404)

BOSTON (16):

William S. Hodgkinson, Donald R. Furth
McGraw-Hill Building, Copley Square,
Congress 2-1160 (area code 617)

CHICAGO (11):

Harvey W. Wernecke, Robert M. Denmead
645 North Michigan Avenue, Mohawk 4-5800
(area code 312)

CLEVELAND (13):

Paul T. Fegley
55 Public Square, Superior 1-7000
(area code 216)

DALLAS (1):

Frank Le Beau
The Vaughn Bldg., 1712 Commerce St.
Riverside 7-9721 (area code 214)

DENVER (2):

John W. Patten
Tower Bldg., 1700 Broadway,
Alpine 5-2981 (area code 303)

HOUSTON (25):

Kenneth George
Prudential Bldg., Halcombe Blvd.,
Riverside 8-1280 (area code 713)

LOS ANGELES (17):

Ashley P. Hartman, John G. Zisch,
William C. Gries
1125 W. 6th St., Huntley 2-5450
(area code 213)

NEW YORK (36):

Donald H. Miller, Henry M. Shaw,
George F. Werner
500 Fifth Avenue, LO-4-3000
(area code 212)

PHILADELPHIA (3):

Warren H. Gardner, William J. Boyle
6 Penn Center Plaza, LOcust 8-4330
(area code 215)

SAN FRANCISCO (11):

Richard C. Alcorn
255 California Street, Douglas 2-4600
(area code 415)

LONDON W1:

Edwin S. Murphy Jr.
34 Dover St.

FRANKFURT/Main:

Matthée Herfurth
85 Westendstrasse

GENEVA:

Michael R. Zeynel
2 Place du Port

TOKYO:

George Olcott,
1, Kotohiracho, Shiba, Minato-ku

SILICON PLANAR
EPITAXIAL TRANSISTORS:
THE FAIRCHILD 2N2845 SERIES

FASTEST CORE

HIGH SPEED

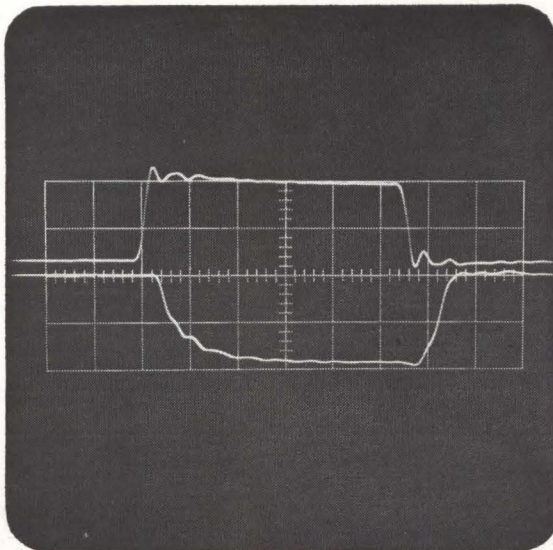

- $t_{on} = 40 \text{ nsec max}$
 $t_{off} = 40 \text{ nsec max}$
@ $I_C = 150 \text{ mA}, I_{B1} = I_{B2} = 15 \text{ mA}$

Photo above shows typical 500 mA
switching @ $I_{B1} = I_{B2} = 50 \text{ mA}$
Scale: Horizontal = 20 nsec/division

HIGH VOLTAGE

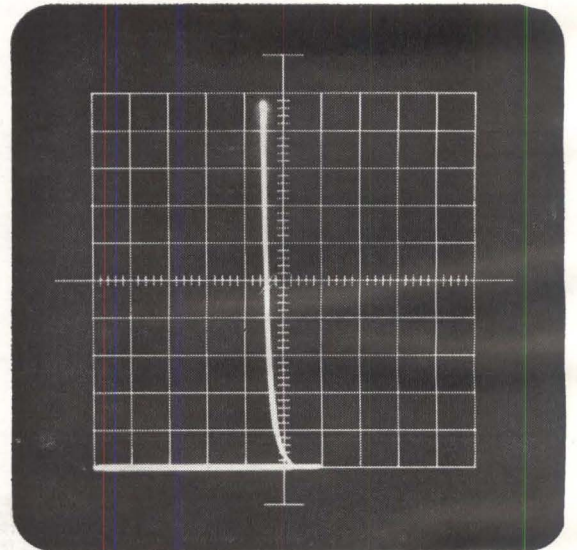

- $V_{CEO} (\text{sust}) = 30\text{V min}$
@ $I_C = 30 \text{ mA}, I_B = 0$

Scale: Vertical (I_C) = 5 mA/division
Horizontal (V_{CE}) = 10V/division

DRIVERS

LOW SAT.

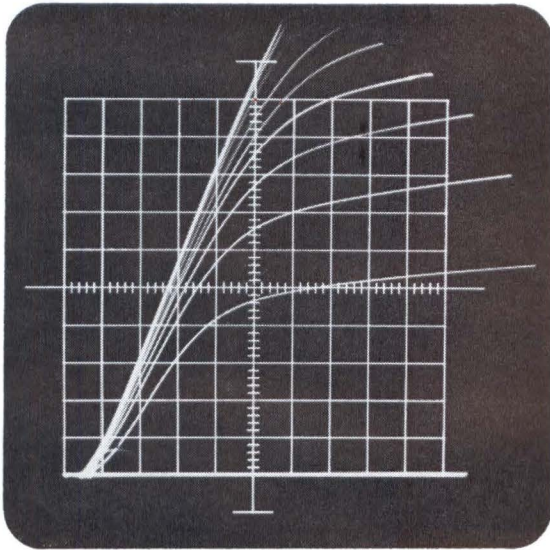

- $V_{CE(sat)} = 1V$ max
@ $I_C = 500$ mA, $I_B = 50$ mA

Scale: Vertical (I_C) = 50 mA/division
Horizontal (V_{CE}) = 0.1V/division
Ten I_B steps: 5 mA/step



The unique geometry utilized in the Fairchild 2N2845 Series features optimized emitter-to-collector/base ratio. This configuration results in ideal characteristics for both high-speed core driving and general purpose applications. The series of four Planar* transistors – 2N2845 through 2N2848 – covers both medium and low voltage requirements. For the 2N2845, a PNP complement is available: Fairchild's 2N2696, a Planar device of the same geometry. The 'scope photos to the left show characteristics of the 2N2845.

AVAILABLE DIRECTLY FROM DISTRIBUTOR STOCKS

FAIRCHILD
SEMICONDUCTOR

FAIRCHILD SEMICONDUCTOR/A DIVISION OF FAIRCHILD CAMERA & INSTRUMENT CORPORATION/545 WHISMAN RD., MOUNTAIN VIEW, CALIF./YORKSHIRE 8-8161/TWX: 415-969-9165

CIRCLE 901 ON READER SERVICE CARD

**EXCEPTIONAL
VOLTAGE
STABILITY
AT AN
ATTRACTIVE
PRICE...**

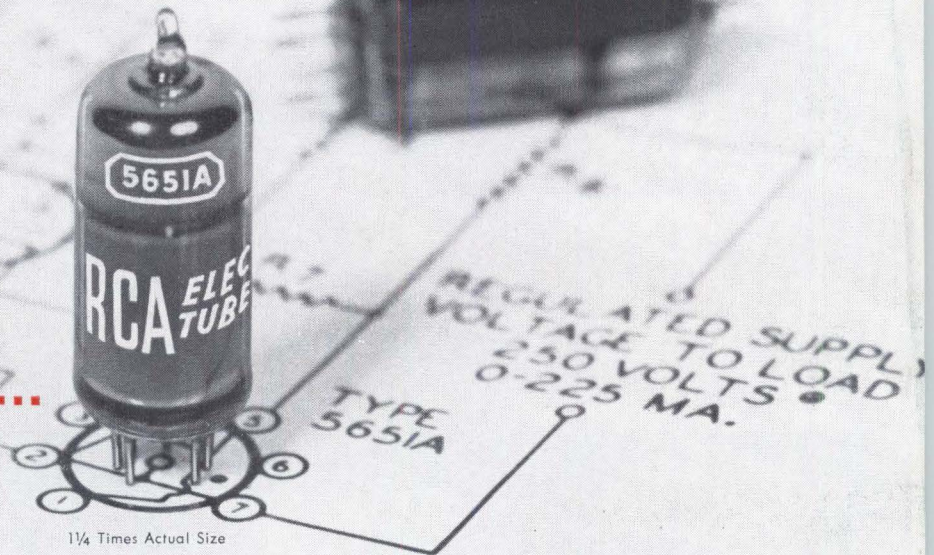

The new RCA-5651A miniature voltage-reference tube

The highest degree of voltage stability yet achieved in a miniature voltage-reference tube is available from the new RCA-5651A. A 7-pin, cold-cathode, glow-discharge type, it is similar to and unilaterally interchangeable with the popular 5651—but offers substantially better voltage stability. And the price is very attractive, when related to the 5651A's superior operating characteristics.

RCA-5651A CHARACTERISTICS AND ADVANTAGES

- Exceptionally stable voltage characteristic at a very low dc operating current. The maximum voltage drift for the RCA-5651A compared with that of the Type OG3 Voltage-Reference Tube is:

	RCA-5651A	OG3
DC Operating Current	2.5 ma	6 ma
Voltage Drift		
• During first 300 hours of operation (from initial dc operating voltage)	0.1% max.	0.3% max.
• Between 300 and 1,300 hours of operation (from dc operating voltage at 300 hours)	0.1% max.	0.2% max.
• During any 100-hour period between 300 and 1,300 hours of operation	0.05% max.	0.1% max.

- Small variation in initial tube drop from tube to tube: 4 volts max. at any specific current value within the operating range:

	DC Operating Voltage		
	Min.	Av.	Max.
At 1.5 ma	83	85	87 volts
At 2.5 ma	83.5	85.5	87.5 volts
At 3.5 ma	84.5	86.5	88.5 volts

- Excellent voltage stability—not only initially but throughout life. Instantaneous voltage fluctuation 0.1 volt max. at any current level within operating range (1.5 to 3.5 ma).
- Operating characteristic essentially independent of ambient temperature in the -55°C to $+90^{\circ}\text{C}$ range.

The exceptional performance of the 5651A is due to: ■ Special processing to stabilize tube characteristics ■ Special cathode design for effective utilization of cathode at all current values within the operating range ■ Special coating inside envelope to minimize slow voltage drift.

APPLICATIONS: for use in critical industrial and military dc power supplies incorporating electronic voltage regulation.



The Most Trusted Name in Electronics

Field Offices—EAST: 32-36 Green Street, Newark 2, N.J., (201) 485-3900.
MIDWEST: Suite 1154, Merchandise Mart Plaza, Chicago 54, Ill., (312) 527-2900 • WEST: 6801 E. Washington Blvd., Los Angeles 22, Calif., (213) RAYmond 3-8361 • 1838 El Camino Real, Burlingame, Calif., (415) 697-1620.

For full technical information, call your nearest RCA Field Office,
or write Commercial Engineering,
RCA Electronic Components and Devices, Harrison, N. J.