

# Electronics<sup>®</sup>

**Integrated circuits coupled by light: page 52**

**Negative resistance in the FET: page 57**

**Generating accurate waveforms: page 66**

July 26, 1965

75 cents

A McGraw-Hill Publication

Below: Testing four systems  
for automatic train control, page 71





# AUDIO TRANSFORMERS

DO-T No.	Pri. Imp.	D.C. Ma.† in Pri.	Sec. Imp.	Pri. Res. DO-T	Pri. Res. DI-T	Mw Level	DI-T No.
DO-T44	80 CT 100 CT	12 10	32 split 40 split	9.8	11.5	500	DI-T44*
DO-T29	120 CT 150 CT	10 10	3.2 4	10		500	
DO-T12	150 CT 200 CT	10 10	12 16	11		500	
DO-T13	300 CT 400 CT	7 7	12 16	20		500	
DO-T19	300 CT	7	600	19	20	500	DI-T19
DO-T30	320 CT 400 CT	7 7	3.2 4	20		500	
DO-T43	400 CT 500 CT	8 6	40 split 50 split	46	50	500	DI-T43*
DO-T42	400 CT 500 CT	8 6	120 split 150 split	46		500	
DO-T41	400 CT 500 CT	8 6	400 split 500 split	46	50	500	DI-T41*
DO-T2	500 600	3 3	50 60	60	65	100	DI-T2
DO-T20	500 CT	5.5	600	31	32	500	DI-T20
DO-T4	600	3	3.2	60		100	
DO-T14	600 CT 800 CT	5 5	12 16	43		500	
DO-T31	640 CT 800 CT	5 5	3.2 4	43		500	
DO-T32	800 CT 1000 CT	4 4	3.2 4	51		500	
DO-T15	800 CT 1070 CT	4 4	12 16	51		500	
DO-T21	900 CT	4	600	53	53	500	DI-T21
DO-T3	1000 1200	3 3	50 60	115	110	100	DI-T3
DO-T45	1000 CT 1250 CT	3.5 3.5	16,000 split 20,000 split	120		100	
DO-T16	1000 CT 1330 CT	3.5 3.5	12 16	71		500	
DO-T33	1060 CT 1330 CT	3.5 3.5	3.2 4	71		500	
DO-T5	1200	2	3.2	105	110	100	DI-T5
DO-T17	1500 CT 2000 CT	3 3	12 16	108		500	
DO-T22	1500 CT	3	600	86	87	500	DI-T22
DO-T34	1600 CT 2000 CT	3 3	3.2 4	109		500	
*DO-T51	2000 CT 2500 CT	3 3	2000 split 2500 split	195	180	100	DI-T51*
DO-T37	2000 CT 2500 CT	3 3	8000 split 10,000 split	195	180	100	DI-T37*
*DO-T52	4000 CT 5000 CT	2 2	8000 CT 10,000 CT	320	300	100	DI-T52*
DO-T18	7500 CT 10,000 CT	1 1	12 16	505		100	
DO-T35	8000 CT 10,000 CT	1 1	3.2 4	505		100	
*DO-T48	8,000 CT 10,000 CT	1 1	1200 CT 1500 CT	640		100	
*DO-T47	9,000 CT 10,000 CT	1 1	9000 CT 10,000 CT	850		100	
DO-T6	10,000	1	3.2	790		100	
DO-T9	10,000 12,000	1 1	500 CT 600 CT	780	870	100	DI-T9
DO-T10	10,000 12,500	1 1	1200 CT 1500 CT	780	870	100	DI-T10
DO-T25	10,000 CT 12,000 CT	1 1	1500 CT 1800 CT	780	870	100	DI-T25
DO-T38	10,000 CT 12,000 CT	1 1	2000 split 2400 split	560	620	100	DI-T38*
DO-T11	10,000 12,500	1 1	2000 CT 2500 CT	780	870	100	DI-T11
DO-T36	10,000 CT 12,000 CT	1 1	10,000 CT 12,000 CT	975	970	100	DI-T36
DO-T1	20,000 30,000	.5 .5	800 1200	830	815	50	DI-T1
DO-T23	20,000 CT 30,000 CT	.5 .5	800 CT 1200 CT	830	815	50	DI-T23
DO-T39	20,000 CT 30,000 CT	.5 .5	1000 split 1500 split	800		50	
DO-T40	40,000 CT 50,000 CT	.25 .25	400 split 500 split	1700		50	
DO-T46	100,000 CT	0	500 CT	7900		25	
DO-T7	200,000	0	1000	8500		25	
DO-T24	200,000 CT	0	1000 CT	8500		25	
DO-TSH	Drawn Hipermalloy shield and cover 20/30 db						DI-TSH

†DCMA shown is for single ended usage (under 5% distortion—100MW—1KC) ... for push pull DCMA can be any balanced value taken by .5W transistors (under 5% distortion—500MW—1KC) DO-T & DI-T units designed for transistor use only. U.S. Pat. No. 2,949,591; others pending. → \*Units newly added to series  
 §Series connected; §Parallel connected

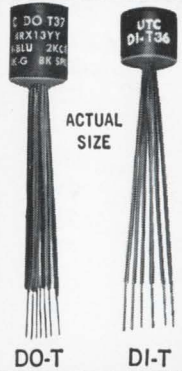

# DO-T & DI-T

## Transistor TRANSFORMERS and INDUCTORS

**NOW!** Hermetically Sealed to MIL-T-27B

\*16 New Items Added to Stock Line  
**IMMEDIATE DELIVERY FROM STOCK**

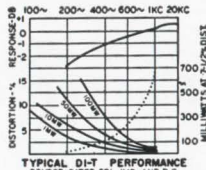
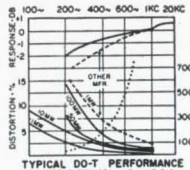

- High Power Rating ..... up to 10 times greater
- Excellent Response ..... twice as good at low end
- Low Distortion ..... reduced 80%
- High Efficiency ..... up to 30% better ... compare DCR
- Moisture Proof ..... hermetically sealed to MIL-T-27B
- Rugged ..... Grade 4, completely metal cased
- Anchored Leads ..... will withstand 10 pound pull test
- Printed Circuit Use ..... (solder melting) nylon insulated leads
- Suited to Clip Mounting ..... use Augat #6009-8A clip

### INDUCTORS

DO-T No.	Inductance Hys @ ma	DO-T DCR Ω	DI-T DCR Ω	DI-T No.
*DO-T50 (2 wdg.)	\$.075 Hy/10 ma, .06 Hy/30 ma \$.018 Hy/20 ma, .015 Hy/60 ma	10.5 2.6		
DO-T28	.3 Hy/4 ma, .15 Hy/20 ma .1 Hy/4 ma, .08 Hy/10 ma	25	25	DI-T28
DO-T27	1.25 Hys/2 ma, .5 Hy/11 ma .9 Hy/2 ma, .5 Hy/6 ma	100	105	DI-T27
DO-T8	3.5 Hys/2 ma, 1 Hy/5 ma 2.5 Hys/2 ma, .9 Hy/4 ma	560	630	DI-T8
DO-T26	6 Hys/2 ma, 1.5 Hys/5 ma 4.5 Hys/2 ma, 1.2 Hys/4 ma	2100	2300	DI-T26
*DO-T49 (2 wdg.)	\$.20 Hys/1 ma, 8 Hys/3 ma \$.5 Hys/2 ma, 2 Hys/6 ma	5100 1275		

### POWER TRANSFORMERS

*DO-T400	Pri 28V 380-1000 cycles, Sec 6.3V @ 60 ma
*DO-T410	Pri 28V 380-1000 cycles, 2-Sec 6.3 @ 30 ma each
*DO-T420	Pri 28V 380-1000 cycles, Sec 28V @ 20 ma (Isol. Electrostatic Shld.)

Write for catalog of over  
**1,300 UTC HIGH RELIABILITY STOCK ITEMS**  
**IMMEDIATELY AVAILABLE**  
 from your local distributor.

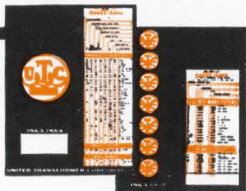

# UNITED TRANSFORMER CORP.

150 VARICK STREET, NEW YORK 13, N. Y.

PACIFIC MFG. DIVISION: 3630 EASTHAM DRIVE, CULVER CITY, CALIF.  
 EXPORT DIVISION: 13 EAST 40th STREET, NEW YORK 16, N. Y. CABLE: "ARLAB"



# DIRECT READING - DC to 350 MC

WITH YOUR



## HEWLETT-PACKARD 5245L COUNTER AND THE NEW 5252A PRESCALER

You get greater counter versatility than ever before when you add the new 5252A to your 5245L. The 5252A Prescaler Plug-in extends the direct counting capability of the 5245L to 350 mc. Prescaling is accomplished, without tuning, by transistor binary dividers. The 5252A electronically scales the input frequency and simultaneously adjusts the counter time base to provide a direct readout of the input frequency.

To permit a more rapid rate of readings in the lower frequency ranges, the 5252A offers multiple scale factors, which eliminate the need for keeping the counter gate open the full length of time required for 350 mc. Scale factors selectable by the front-panel switch permit convenient measurement dc to 100 mc, dc to 200 mc and dc to 350 mc.

### SPECIFICATIONS, 5252A\*

<b>Operating frequency range:</b>	dc to 350 mc
<b>Accuracy:</b>	same as the basic counter
<b>Input sensitivity:</b>	100 mv rms
<b>Maximum input:</b>	2 volts or +20 dbm
<b>Input impedance:</b>	50 ohms (nominal)
<b>Operating temperature range:</b>	-20°C to +55°C
<b>Trigger level control:</b>	±1 volt
<b>Scaled output:</b>	100 mv rms into 50 ohms available at the auxiliary output BNC connector of the basic counter

\*when plugged into the 5245L Counter

*Here are other available plug-ins that make your versatile, solid-state hp 5245L Counter today's best value at \$2950:*

100 mc frequency converter; 5251A	\$300
350 mc prescaler, described above; 5252A	\$685
500 mc frequency converter; 5253B	\$500
3000 mc frequency converter; 5254A	\$825
1 mv to 300 mv rms video amplifier; 5261A	\$325
Time interval unit; 5262A	\$300
Preset unit; 5264A	\$650
Digital voltmeter; 5265A	\$575

A demonstration of the 5245L Counter and its plug-ins is available from your Hewlett-Packard field engineer. Or you can get complete data on today's top-performing counter by writing Hewlett-Packard, Palo Alto, California 94304, Tel. (415) 326-7000; Europe: 54 Route des Acacias, Geneva; Canada: 8270 Mayrand Street, Montreal.

Data subject to change without notice. Prices f.o.b. factory.

**HEWLETT**  **PACKARD**  
An extra measure of quality



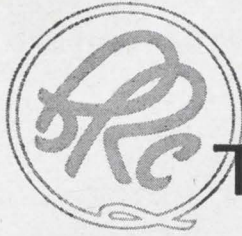

Type 230-A

# 10 to 500 MC POWER AMPLIFIER

— for Low-Level Applications

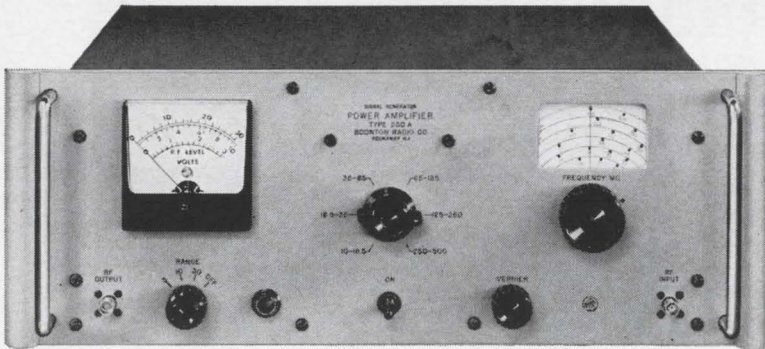

The BRC Power Amplifier Type 230-A is the ideal RF amplifier for low-level applications exhibiting a typical noise figure of 6 to 8 db. Three tuned, cascaded stages of grounded-grid amplification provide up to 30 db gain and a maximum power output of 5 watts. Typical applications include:

**RECEIVER PRE-SELECTOR** — The Type 230-A, when used as a pre-selector with conventional communications receivers, will readily provide fractional microvolt sensitivities.

**TUNED SELECTIVE FILTER** — BRC 230-A provides a convenient means for the selective amplification of RF signals in the 10 to 500 Mc. range with excellent rejection of undesired frequencies.

**HARMONIC AMPLIFIER** — The new power amplifier may be used to amplify desired harmonics in the output of signal generators and frequency synthesizers thereby extending their useful range.

**FREQUENCY COUNTER PRE-AMPLIFIER** — Type 230-A as a pre-amplifier for conventional frequency counters, such as the **hp** 524/525, will provide a 15 to 30 times improvement in input sensitivity. Remote, off-the-air frequency measurements of FM broadcast and communication transmitters may be readily performed.

**RF MILLIVOLTMETER PRE-AMPLIFIER** — When used as a pre-amplifier for RF millivoltmeters, such as the **hp** 411, the 230-A will provide 15 to 30 times improvement in sensitivity.

**HEWLETT  
PACKARD**  **BOONTON  
DIVISION**

GREEN POND ROAD, ROCKAWAY, NEW JERSEY 07866  
Tel. (201) 627-6400 TWX: (510) 238-8461 Cable Address: BOONRACO

**RF RANGE:** 10 to 500 Mc.

**BAND RANGES:** 10-18.5 Mc. 65-125 Mc.  
18.5-35 Mc. 125-250 Mc.  
35-65 Mc. 250-500 Mc.

**RF GAIN:** 30 db (10-125 Mc.)  
27 db (125-250 Mc.)  
24 db (250-500 Mc.)

**RF BANDWIDTH:** >700 Kc.\* (10-150 Mc.)  
>1.4 Mc.\* (150-500 Mc.)

\*Frequency interval between points 3db down from max. response

**RF OUTPUT:**

**RANGE:** Up to 15 volts\*  
\*Across external 50 ohm load  
**IMPEDANCE:** 50 ohms.

**CALIBRATION:**

0.2 to 3 volts f.s.;  
increments of approx. 5%.

1.0 to 10 volts f.s.;  
increments of approx. 5%.

2.0 to 30 volts f.s.;  
increments of approx. 5%.

**ACCURACY:** ±1.0 db of f.s. (10-250 Mc.)  
±1.5 db of f.s. (250-500 Mc.)

**LEAKAGE:** Effective shielding is greater than 40 db.

**RF INPUT:**

**LEVEL:** <0.316 volts\* (10-125 Mc.)  
<0.446 volts\* (125-250 Mc.)  
<0.630 volts\* (250-500 Mc.)

\*For 10 volt output into 50 ohms  
**IMPEDANCE:** 50 ohms

**AM RANGE:** Reproduces modulation of driving source 0-100% up to 5 volt max. carrier output

**AM DISTORTION:** <10% added to distortion of driving source

**FM RANGE:** Reproduces modulation of driving source except as limited by the RF bandwidth

**FM DISTORTION:** Negligible distortion added to distortion of driving source for deviations and modulation frequencies <150 Kc.

**INCIDENTAL AM:** <10% added to modulation of driving source at 150 Kc. deviation

**MOUNTING:** Cabinet for bench use; by removal of extruded strips suitable for 19" rack mounting

**POWER REQUIREMENTS:**

105-125/210-250 volts,  
50-60 cps, 150 watts

Price: \$1200.00 F.O.B. Rockaway, N. J.



# Electronics

July 26, 1965  
Volume 38, Number 15

Page 4	Readers Comment
8	People
10	Meetings
15	Editorial
17	Electronics Newsletter
37	Washington Newsletter
105	New Products
122	New Books
124	Technical Abstracts
129	New Literature

## Electronics Review

Page 25	Encore for Mariner	28	R-f sputtering
26	In living color	30	Yardstick for microwaves
26	Signs of life	32	Keeping track
27	Message by meteor	33	Beta tantalum
28	The good old ways	34	Electronics notes

## Probing the News

91	An ear to the underground
93	Thermovision: "Heat pictures" on an oscilloscope screen
98	Apollo hastens shift to S band

## Electronics Abroad

131	Water-supply simulator	133	Four firsts
132	Woven circuit board	134	Progress in the Pacific
132	NC gains	134	Around the world

## Technical articles

### I. Design

<b>Integrated circuits</b>	52	<b>Making light of the noise problem</b> Optoelectronic device solves the interface problem for computer and communication subsystems J.D. Merryman, Texas Instruments Incorporated
<b>Circuit design</b>	57	<b>Negative resistance in FET's: an aid or an ailment</b> Here is a way to turn a disadvantage of circuitry that uses field effect transistors into an advantage Carl D. Todd, Consultant
<b>Circuit design</b>	62	<b>Designer's casebook</b> Duty cycle is constant at any trigger frequency; scr monitors power failure; clamp and spark gap project twt modulator; FET increases Schmitt trigger input impedance
<b>Instrumentation</b>	66	<b>Step by step to a linear frequency sweep</b> A digital approach replaces analog when the ramp function has to be very linear R.B. Fenwick and G.H. Barry, Stanford University

### II. Applications

<b>Industrial electronics</b>	71	<b>Who's on the right track?</b> Four electronic systems are under test in the largest mass transportation experiment in the world W.B. Riley, computer editor, and L.S. Gomolak, McGraw-Hill News
	73	<b>I. Keeping the trains apart</b> Comparison of controls for separating trains
	79	<b>II. Safe, swift and smooth</b> Four ways to control speed and acceleration
	82	<b>III. Precise stopping</b> Tuned coils versus computer control for station stops
	85	<b>IV. System supervision</b> Central control to supervise the automatic equipment



# Electronics

**Editor:** Lewis H. Young

**Senior editors**

**Technical:** Samuel Weber  
**News:** Kemp Anderson, Jr.

**Senior associate editors:** John F. Mason, George Sideris

**Department editors**

**Advanced technology:** Joan Blum  
**Avionics:** W.J. Evezia  
**Circuit design:** Michael Elia  
**Components:** Michael F. Tomaino  
**Computers:** Wallace B. Riley  
**Consumer electronics:** Richard Lipkin  
**Industrial electronics:** Robert Cushman  
**Instrumentation:** Carl Moskowitz  
**Manufacturing:** George Sideris  
**Military electronics:** John F. Mason  
**New products:** William P. O'Brien  
**Solid state:** Jerome Eimbinder  
**Space electronics:** Peter R. Sigmund  
**Special projects:** Richard M. Machol  
**Staff writer:** Stanley Zarowin

**Regional editors**

**Boston:** Thomas Maguire, editor; Robin Carlson  
**Los Angeles:** William B. Wallace, editor; June Ranill  
**San Francisco:** Laurence D. Shergalis, Edmond G. Addeo, editors; Mary Jo Jadin

**Copy editors**

Howard Rausch, Sally Powell, Walter Barney

**Graphic design**

**Art director:** Saul Sussman  
**Assistant art director:** Donna M. Marchyn  
**Editorial production:** Ann Mella  
**Production editor:** Arthur C. Miller

**Editorial secretaries:** Claire Benell, Mary D'Angelo, Lynn Emery, Kay Fontana, Carolyn Michnowicz, Lorraine Longo, Lorraine Werner

**McGraw-Hill news service**

**Director:** John Wilhelm; **Atlanta:** Fran Ridgeway; **Chicago:** Bruce Cross, Louis S. Gomolak;  
**Cleveland:** Arthur Zimmerman; **Dallas:** Marvin Reid;  
**Detroit:** Donald MacDonald; **Los Angeles:** Michael Murphy, Ron Lovell;  
**San Francisco:** Margaret Ralston;  
**Seattle:** Ray Bloomberg; **Washington:** Arthur L. Moore, Charles Gardner, Herbert W. Cheshire, Seth Payne, Warren Burkett, Warren Kornberg

**McGraw-Hill world news service**

**Bonn:** Robert Dorang; **Brussels:** Arthur Erikson; **London:** John Shinn;  
**Mexico City:** Wesley Perry; **Milan:** Bruce Bendow;  
**Moscow:** Donald Winston; **Paris:** Dan Smith;  
**Rio de Janeiro:** Leslie Warren; **Tokyo:** Marvin Petal, Charles Cohen

**Circulation manager:** Hugh J. Quinn

**Reprints:** T.M. Egan

**Publisher:** C.C. Randolph

**Electronics:** July 26, 1965, Vol. 38, No. 15

Printed at 99 North Broadway, Albany, N.Y.  
Second class postage paid at Albany, N.Y.

Subscriptions are solicited only from those actively engaged in the field of the publication. Position and company connection must be indicated on orders. Subscription prices: United States and Possessions and Canada, \$6.00 one year, \$9.00 two years, \$12.00 three years. All other countries \$20.00 one year. Single copies, United States and Possessions and Canada 75¢. Single copies all other countries \$1.50.

Published every other Monday by McGraw-Hill Inc. 330 West 42nd Street, New York, N.Y. 10036. Founder: James H. McGraw, 1860-1948.

**Subscribers:** The Publisher, upon written request to our New York office from any subscriber, agrees to refund that part of the subscription price applying to copies not yet mailed. Please send change of address notices, subscription orders or complaints to Fulfillment Manager, Electronics, at the address below. Change of address notices should provide old as well as new address, including postal zone number if any. If possible, attach address label from recent issue. Allow one month for change to become effective.

**Postmaster:** Please send Form 3579 to Fulfillment Manager, Electronics, P.O. Box 430, Hightstown New Jersey 08520

## Readers Comment

### Frustrating struggle

To the Editor:

If you think better coordination of effort and understanding between Technology and Education has been "a frustrating struggle" [Editorial, June 28, 1965, p. 15], you should try working on the education side of the struggle for change toward workhorse application of new technological aids in education. I believe there never has been as much opportunity, resources, collective manpower potential for improving the quality and quantity aspects of all of education, in and out of schools. Technology can do for education what it did for relieving the manual workload on the society in the Industrial Revolution, if only technology and education could better listen to and understand the other. . . .

. . . Unless the engineer and educator can find a better way of cooperation and coordination in developing much wider understanding, respect, and participation in new human effort, then we may find these rising expectations and pressures of the great majority of "have nots" overpowering the "haves", to the greater loss of all. . . .

. . . What will it take to relieve this frustrating struggle, to apply more of the knowledge of both the engineer and educator to the common communications on problems of relieving the manpower loads of all segments of the society? Without such increased cooperation and understanding communication, your ". . . economic, political, and even sociological considerations" can sometimes torpedo a good technical proposal for both the educator and the engineer. You are right that "in this environment what's needed desperately is an articulate engineer who can put into plain language the advantages of electronic equipment and how it works," but this applies to the educator as well.

. . . If engineers and educators do not get together, to get things done, their clientele will look elsewhere, as indeed they already are, for some other source of action and fulfillment. Money and politics have a



**Now from Sprague!**

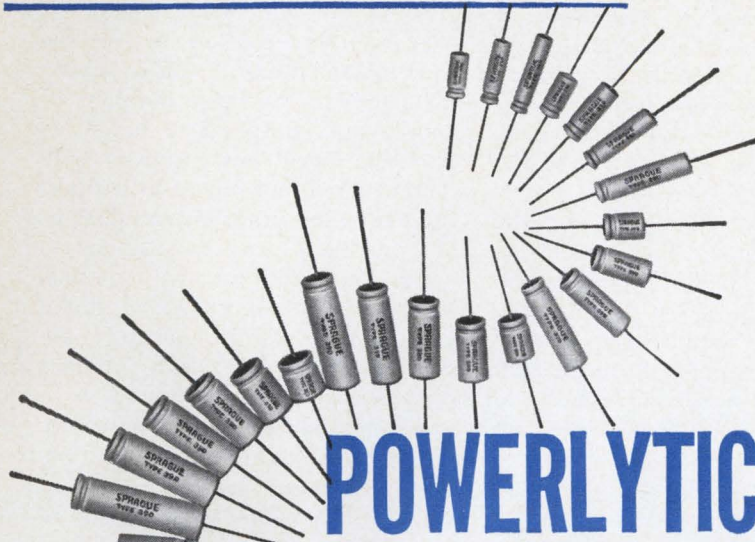

# POWERLYTIC<sup>®</sup> CAPACITORS IN 42 CASE SIZES...

**for maximum capacitance in minimum space!**

## Type 36D Cylindrical Case

Designed specifically for space economy, in applications such as computer power supplies, industrial controls, high gain amplifiers, etc. Case sizes from 1 3/8" x 2 1/8" to 3" x 5 5/8". Improved temperature capabilities—may now be operated at 85 C. Low equivalent series resistance, low leakage current, excellent shelf life, high ripple current capability. Superior seal employs molded cover with recessed rubber gasket. Reliable safety vents. Solder lug or tapped terminals. Standard ratings from 3 to 450 VDC, capacitance values to 270,000  $\mu$ F.

## Type 39D Tubular Case

Smaller companion to proven 36D capacitor, possessing same outstanding performance. Case sizes from 1/2" x 1 1/8" to 1" x 3 5/8". Designed for operation at temperatures up to 85 C. Unique construction—anode and cathode terminals are welded—no riveted or pressure connections—prevents open circuits, even in microvolt signal range. Improved molded phenolic end seals contribute to unusually long life (expectancy, 10 years or more). Low effective series resistance, low leakage current. Standard ratings include capacitance values to 18,000  $\mu$ F, voltages from 3 to 450 VDC.

*For complete technical data on Type 36D or Type 39D Powerlytic Capacitors, write for Engineering Bulletins 3431B and 3415, respectively, to Technical Literature Service, Sprague Electric Co., 35 Marshall Street, North Adams, Mass. 01248.*

**Popular ratings are now available for fast delivery from your Sprague Industrial Distributor.**

### SPRAGUE COMPONENTS

CAPACITORS	PULSE TRANSFORMERS	CERAMIC-BASE PRINTED NETWORKS
TRANSISTORS	INTERFERENCE FILTERS	PACKAGED COMPONENT ASSEMBLIES
RESISTORS	PULSE-FORMING NETWORKS	BOBBIN and TAPE WOUND MAGNETIC CORES
INTEGRATED CIRCUITS	TOROIDAL INDUCTORS	SILICON RECTIFIER GATE CONTROLS
THIN-FILM MICROCIRCUITS	ELECTRIC WAVE FILTERS	FUNCTIONAL DIGITAL CIRCUITS



®Sprague and ® are registered trademarks of the Sprague Electric Co.





**KEEP AUDIO LINES CLEAN**



with  
**SPRAGUE TELEFILTER<sup>★</sup> FILTERS**

- Telefilter Filters remove r-f interference from communication lines on which audio signals must remain clean.
- Intended for installation in audio lines which enter screen-rooms, for the protection of r-f susceptible audio or video circuits.
- Remove spurious signals from telephone lines which pass through areas of high intensity r-f energy.
- Equally suitable for low-pass applications on telegraph, program, remote control, and similar lines.
- Provided with pipe-thread and screw-neck terminations to facilitate passage through screen-room walls.
- Standard designs available for use on 600 ohm and 840 ohm lines.
- Exhibit linear phase shift and negligible (less than 0.5 db) insertion loss in the pass band.

**OFF-THE-SHELF DELIVERY**

For complete technical data, write for Engineering Bulletin 8105 to Technical Literature Service, Sprague Electric Co., 35 Marshall Street, North Adams, Mass.

★trademark

45F-151-63



\*Sprague' and '©' are registered trademarks of the Sprague Electric Co.

way of getting something done regardless of what others may think of the rightness or wrongness of their approach. Perhaps the politician may function as the comprehensivists now, because the engineering and educational specialists are too narrow in view to see the other side . . . ?

Whether we like it or not, the evidence seems rather conclusive that our over-all educational system has slipped until we do not have the teachers, facilities, or general local public support to do the job expected and needed. Through political action, our people have provided some significant dollars to get some action. Will the action bypass the engineer-educator combination, preoccupied with their specialties, or will we see people look elsewhere for more comprehensive action? If the questions above and in "Plain Talk" are not answered by better communications and comprehensive understandings of one another by actions of engineering and education, the latter seems the logical conclusions of those expecting educational action and results.

Lloyd P. Morris

Elmwood Park, Ill.

**Judge not . . .**

To the Editor:

I would like to reflect with you for a moment on the July 12th editorial concerning the arrogance and indefensibility of the attitude of the NASA scientists who wished to delay popular distribution of the prospective Mariner IV Mars photographs.

However eagerly you and I await these exciting pictures and deplore any attempt to keep them from us, we can surely find mitigating cir-

cumstances by trying to understand the new role the scientist has been given in this generation.

For the first time in history, the work of scientists is under immediate scrutiny by large numbers of people not equipped to judge its scientific merit, but endowed with direct or indirect power to support the work. The transient revelations of "raw data" are now subject to injudicious and impulsive appraisal by relative amateurs whose financial control can prematurely advance or retard the orderly progress of the concerned experiments.

To a scientist who has traditionally been allowed a hearing before his peers in the scientific journals where his work stands or falls on its very carefully considered merits, this unfortunate instant judgment can be a disconcerting experience. That such things happen is unarguably so; witness last autumn's dialogue between Dr. G. Kuiper and the science editor of Saturday Review over the first Ranger pictures of the moon. We've viewed similar episodes in other popular magazines such as Harper's and frequently observe it in the daily newspapers and weekly news magazines.

Rather than accuse the scientists of arrogance and public-bdamnedness it would be more charitable and perhaps more realistic to chide him on his sensitivity and public-be-patientness.

Louis Lavoie

Enrico Fermi Institute for Nuclear Studies  
University of Chicago

▪ It is because of the scientist's new role that we feel publication should not be limited to "in" journals.

**SUBSCRIPTION SERVICE**

Please include an Electronics Magazine address label to insure prompt service whenever you write us about your subscription.

Mail to: Fulfillment Manager  
Electronics  
P.O. Box 430  
Hightstown, N.J. 08520

To subscribe mail this form with your payment and check  new subscription  renew my present subscription

Subscription rates: in the U.S.: 1 year, \$6; two years, \$9; three years, \$12. Subscription rates for foreign countries available on request

**CHANGE OF ADDRESS**

**ATTACH LABEL HERE**

If you are moving, please let us know five weeks before changing your address. Place magazine address label here, print your new address below.

name

address

city

state

zip code



# Oscillator-Power-Supply Combinations



Continuous Frequency Coverage from 500 kc/s to 2000 Mc/s

- ★ Interchangeable Power Supplies
- ★ Several-Hundred-Milliwatt Output
- ★ Rack or Bench Mounting
- ★ Low Cost

**65-500 Mc/s  
oscillator**

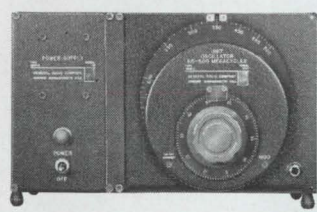

with a low-cost, unregulated 300-Vdc and 6.3-Vac power supply  
... \$340 (bench model)

**450-1050 Mc/s  
oscillator**

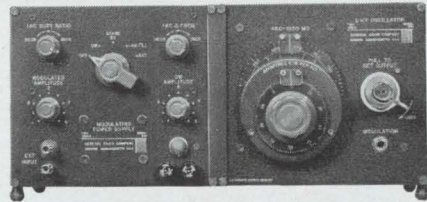

with power supply for 100% pulse and square-wave modulation  
... \$585 (bench model)

**900-2000 Mc/s  
oscillator**

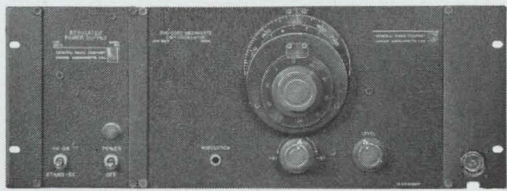

with a regulated 300-Vdc and 6.3-Vdc power supply  
providing ultimate CW stability ... \$656 (rack model)

Frequency Range and (Oscillator Type)	Performance		Stable CW; 100% square-wave & pulse modulation; internal 1-kc square-wave				Amplitude-leveled output behind 50-Ω source impedance; metered output level; 1-kc square-wave modulation, or CW	
			Maximum power; lowest cost		Ultimate CW stability; very low residual fm			
			(Power Supply Type)	(1269-A)	(1267-A)	(1267-AQ18)	(1264-A)	(1263-B)
	Input Line Voltage	105 to 125 V or 195 to 250 V	105 to 125 V	195 to 250 V	105 to 125 V or 210 to 250 V	105 to 125 V or 210 to 250 V		
500 kc/s-50 Mc/s (Type 1211-C)	Bench Mount	Type Price	1211-C9 \$415.00	1211-C7 \$510.00	1211-C7Q18 on request		1211-C3 \$765.00	
	Rack Mount	Type Price	1211-C9R \$435.00	1211-C7R \$530.00	1211-C7RQ18 on request		1211-C3R \$786.00	
50-250 Mc/s (Type 1215-C)	Bench Mount	Type Price	1215-C9 \$300.00	1215-C7 \$395.00	1215-C7Q18 on request	1215-C4 \$525.00	1215-C3 \$650.00	
	Rack Mount	Type Price	1215-C9R \$320.00	1215-C7R \$415.00	1215-C7RQ18 on request	1215-C4R \$546.00	1215-C3R \$671.00	
65-500 Mc/s (Type 1208-C)	Bench Mount	Type Price	1208-C9 \$340.00	1208-C7 \$435.00	1208-C7Q18 on request			
	Rack Mount	Type Price	1208-C9R \$360.00	1208-C7R \$455.00	1208-C7RQ18 on request			
180-600 Mc/s (Type 1209-CL)	Bench Mount	Type Price	1209-CL9 \$375.00	1209-CL7 \$470.00	1209-CL7Q18 on request	1209-CL4 \$600.00	1209-CL3 \$725.00	
	Rack Mount	Type Price	1209-CL9R \$395.00	1209-CL7R \$490.00	1209-CL7RQ18 on request	1209-CL4R \$621.00	1209-CL3R \$746.00	
250-960 Mc/s (Type 1209-C)	Bench Mount	Type Price	1209-C9 \$375.00	1209-C7 \$470.00	1209-C7Q18 on request	1209-C4 \$600.00	1209-C3 \$725.00	
	Rack Mount	Type Price	1209-C9R \$395.00	1209-C7R \$490.00	1209-C7RQ18 on request	1209-C4R \$621.00	1209-C3R \$746.00	
450-1050 Mc/s (Type 1361-A)	Bench Mount	Type Price	1361-A9 \$375.00	1361-A7 \$470.00	1361-A7Q18 on request	1361-A4 \$585.00	1361-A3 \$725.00	
	Rack Mount	Type Price	1361-A9R \$395.00	1361-A7R \$490.00	1361-A7RQ18 on request	1361-A4R \$606.00	1361-A3R \$746.00	
900-2000 Mc/s (Type 1218-B)	Bench Mount	Type Price	1218-B9 \$540.00	1218-B7 \$635.00	1218-B7Q18 on request	1218-B4 \$750.00	1218-B3 \$890.00	
	Rack Mount	Type Price	1218-B9R \$561.00	1218-B7R \$656.00	1218-B7RQ18 on request	1218-B4R \$774.00	1218-B3R \$914.00	

Prices apply in USA only — Please write for complete information

IN CANADA: Toronto 247-2171, Montreal (Mt. Royal) 737-367  
IN EUROPE: Zurich, Switzerland — London, England



**GENERAL RADIO COMPANY**

WEST CONCORD, MASSACHUSETTS

BOSTON NEW YORK, N. Y., 954-2722 CHICAGO PHILADELPHIA WASHINGTON, D. C. SYRACUSE DALLAS SAN FRANCISCO LOS ANGELES ORLANDO, FLA. CLEVELAND  
(W. Concord) 646-0550 (Ridgefield, N. J.) 943-3140 (Oak Park) 848-9400 (Ft. Washington) 646-8030 (Rockville, Md.) 946-1600 454-9323 FL 7-4031 (Los Altos) 948-8233 469-6201 425-4671 886-0150



## Magnetically Beamed Triode 250 kW CW with 1 kW Drive 8 Mw High Duty Pulse

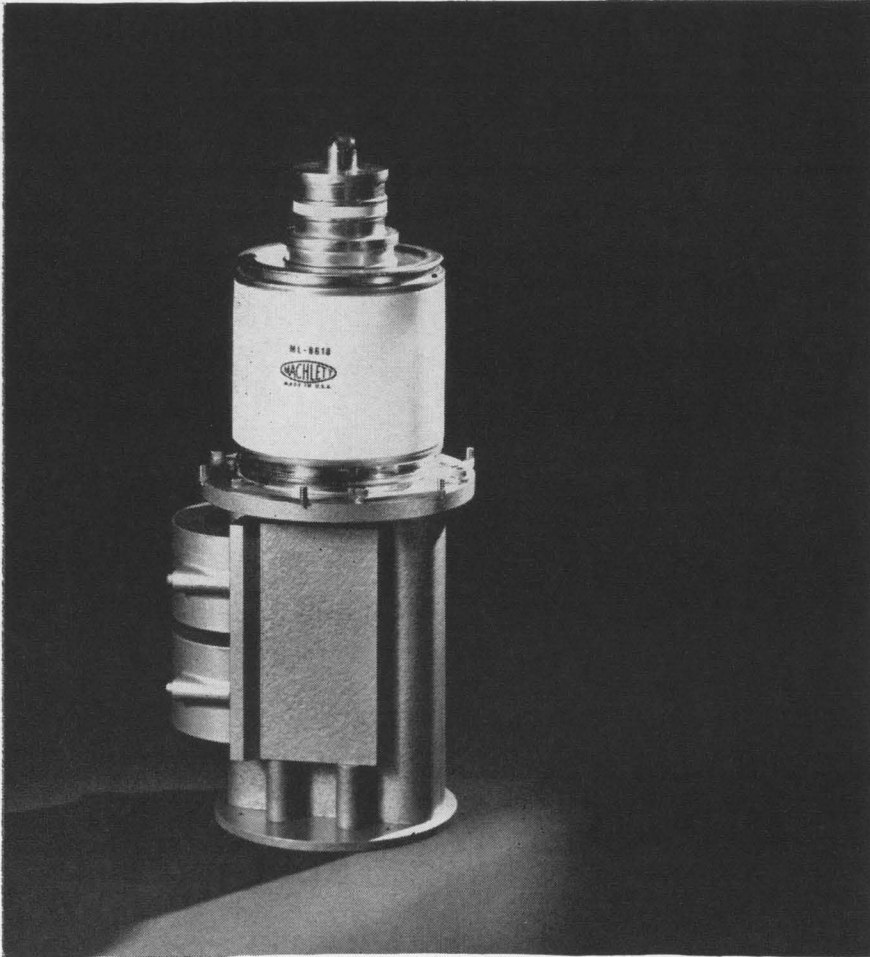

Machlett's new ML-8618 magnetically beamed water-cooled triode features high power gain, plate efficiency and maximum cathode utilization. As a Class C amplifier or oscillator, the ML-8618 is capable of a continuous output in excess of 250 kW with only 1000 W driving power. As a switch tube in pulse modulators, it can deliver more than 8Mw pulse power at long pulse widths and high duty. For details on this or the soon-to-be-available ML-8619 vapor-cooled or ML-8620 forced air-cooled versions, write: The Machlett Laboratories, Inc., Springdale, Conn. 06879. An affiliate of Raytheon Company.

**MACHLETT**  
ELECTRON TUBE SPECIALIST

## People

The promotion of **Alain Enthoven** to a new top-ranking job at the Pentagon as assistant secretary for systems analysis is further evidence to the military and industry that the cost-effective approach will remain fundamental to the operation of the Defense Department, at least as long as Robert S. McNamara remains chief.

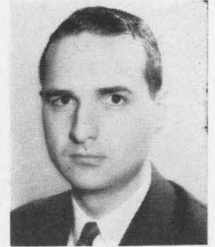

In the four and a half years that Enthoven has been on the McNamara team—he was formerly deputy assistant secretary in the comptroller's office at the Pentagon—he has frequently ruffled the feathers of both military and industry representatives by insisting on answers to these questions: "Is this program or weapon really necessary? Would a lower-cost alternative work as well?" In his new job, he will continue to ask these questions—but with more authority to get answers.

**Gerhard E. Weibel's** appointment as assistant director of research gives another sign of the Zenith Radio Corp.'s emphasis on the development of semiconductor and integrated circuits. Weibel is a specialist in solid state technology.



Zenith already is using integrated circuits in hearing aids, and is studying IC applications in radios, television sets and other consumer products.

Weibel will also direct research into luminescence in solids as part of Zenith's efforts to make its color-tv tubes brighter. For this research, Zenith plans to expand its Chicago laboratories.

Before joining Zenith last year, Weibel directed research in electron-beam optics and microwave tubes at the General Telephone and Electronics Corp.



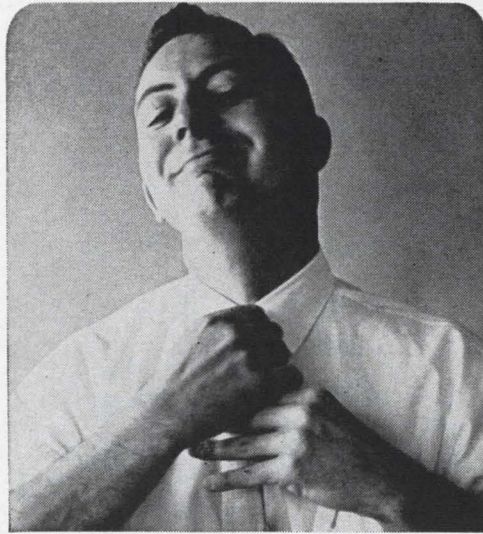

**We laughed when Chuck Carroll said he was going to make low-cost 2 amp silicon planars.**

**We've stopped laughing.**

Funny how our development engineer, Chuck Carroll, has a way of coming up with low-cost 2 amp silicon planars just when the industry needs them most. But he's done just that: B-3460 and B-3461 5 watt switches and B-3465, B-3466 RF power amplifiers. All offer a price/performance ratio that just can't be beat.

Already, these new epitaxial NPN transistors have found their way into high speed, high current core drivers; high frequency pulse generators and high voltage non-saturated switching applications. Also small power sup-

plies, relay and solenoid drivers, power amplifiers and oscillators for HF/VHF communications transceivers.

Just look at the performance figures below.

In addition, B-3460, B-3461 and B-3465's mechanical dimensions conform to the JEDEC TO-5 outline and feature a low thermal resistance of 20°C/W maximum for higher output-power operation. B-3466 is offered in the heat sink MT-27 package. Like more information? We thought so. Just write or phone our nearest sales office. Chuck will be tickled to know you called.

**ELECTRICAL CHARACTERISTICS: T<sub>J</sub>=25°C. B-3460, B-3461**

Characteristic	Symbol	Min	Typ	Max	Unit
Switching Time Measured in circuit of Figure 1	td	—	—	5	nsec
	tr	—	—	30	nsec
	ts	—	—	50	nsec
	tf	—	—	25	nsec
Saturation Voltage** I <sub>C</sub> =1 A, I <sub>B</sub> =100 mA	VCE(s)	—	0.32	0.5	V
Collector-to-Emitter Voltage** I <sub>CEO</sub> =10 mA (B-3460)	VCEO	40	—	—	V
Collector-to-Base Voltage I <sub>CBO</sub> =0.1 mA (B-3460)	VCBO	80	—	—	V
Collector-to-Emitter Voltage** I <sub>CEO</sub> =10 mA (B-3461)	VCEO	60	—	—	V
Collector-to-Base Voltage I <sub>CBO</sub> =0.1 mA (B-3461)	VCBO	100	—	—	V

\*\*Pulse width ≤ 300 μsec, duty cycle ≤ 2%.

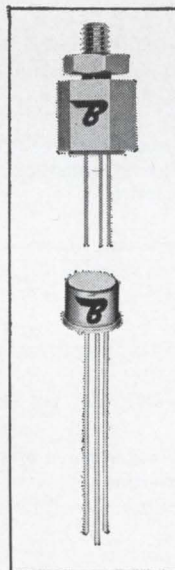
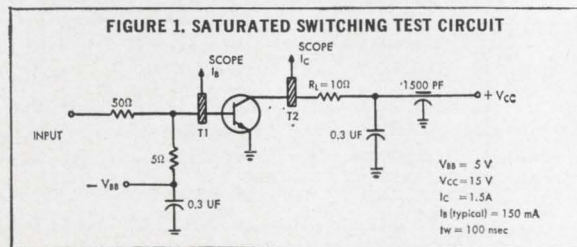

**ELECTRICAL CHARACTERISTICS: T<sub>J</sub>=25°C. B-3465, B-3466**

Characteristic	Symbol	Min	Typ	Max	Unit
AC Current Gain* VCE=20V, IC=250 mA, f=50 mc	hfe	4	—	—	—
Collector-to-Emitter Voltage** I <sub>CEO</sub> =10 mA	VCEO	60	—	—	V
Collector-to-Base Voltage I <sub>CBO</sub> =0.1 mA	VCBO	100	—	—	V
RF Power Output VCE=28V, IC=390 mA, f=50 mc, P <sub>in</sub> =0.5W, Rg=50Ω, measured in circuit of Figure 2	Po	4.5	—	—	W
Output Capacitance (Common Base) VCBO=10V, f=1 mc	Cob	—	18	25	pf

\*Pulse width ≤ 5 msec, duty cycle ≤ 10%.

\*\*Pulse width ≤ 300 μsec, duty cycle ≤ 2%.

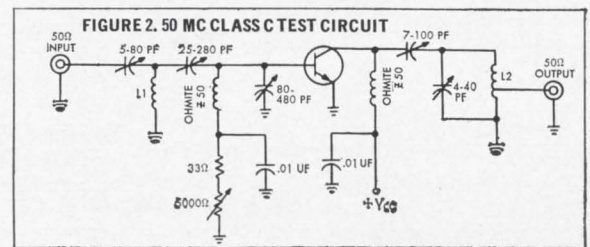

**Bendix Semiconductor Division**  
HOLMDEL, NEW JERSEY



Baltimore (Towson), Md.—(301) 828-6877; Chicago—(312) 637-6929; Dallas—(214) 357-1972; Detroit—(313) Jordan 6-1420; Holmdel, N. J.—(201) 747-5400; Los Angeles—(213) 776-4100; Miami Springs, Fla.—(305) 887-5521; Minneapolis—(612) 926-4633; Seattle—Ray Johnston Co., Inc., (206) LA-4-5170; Syracuse, N. Y.—(315) 474-7531; Waltham, Mass.—(617) 899-0770; Export—(212) 973-2121, Cable: "Bendixint," 605 Third Avenue, New York; Ottawa, Ont.—Computing Devices of Canada, P.O. Box 508—(613) TALbot 8-2711.



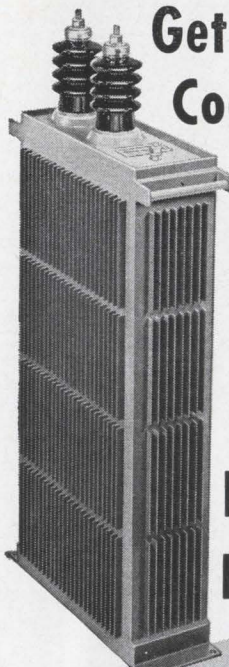

Get ~~QUICK~~  
Cooperation  
from  
**SPRAGUE**  
on your  
**PULSE**  
**NETWORK**  
**PROBLEMS**

Experienced  
Systems  
Engineers  
At Your Service!

Sprague has much to offer to designers of radar systems, laser systems, tube testing systems, and other specialized systems. A highly-technical special engineering section devoted exclusively to pulse capacitors and networks includes systems as well as pulse network engineers. *We can help you with your problems because we fully understand your problems!*

But Sprague service does not end here. Following up the design aspect, we can quickly and efficiently estimate pulse network sizes and prices for bidding purposes. We're also equipped to give quick reaction capabilities for your breadboard and prototype units.

A pioneer in pulse networks, Sprague is a major supplier of custom units from less than 1 KV up to 500 KV over a broad range of power levels.

For application engineering assistance, or additional information, write to Pulse Network Section, Sprague Electric Company, 35 Marshall Street, North Adams, Massachusetts 01248.

45 PH-4158



\*Sprague\* and \*®\* are registered trademarks of the Sprague Electric Co.

## Meetings

**Reliability and Maintainability Conference**, AIAA, ASME et al; Statler-Hilton Hotel, Los Angeles, Calif., July 28-30.

**Instrumentation Science Research Conference**, ISA; William Smith College, Geneva, N. Y., Aug. 2-6.

**Technical Instrumentation Symposium**, U. S. Air Force Systems Command, SPIE; Jack Tar Hotel, San Francisco, Aug. 16-20.

**American Astronautical Society National Meeting**, AAS; Sheraton-Palace Hotel, San Francisco, Aug. 18-20.

**International Conference on Medical Electronics**, Japan Society of Medical Electronics and Biological Engineering; Tokyo, Aug. 22-27.

**Electronic Circuit Packaging Symposium**, EDN; San Francisco Hilton Hotel, San Francisco, Aug. 23-24.

**Electron Devices Symposium**, IEEE Electron Devices Group; Fairmont Hotel, San Francisco, Aug. 23-24.

**Computing Machinery National Meeting**, ACM; Sheraton-Cleveland Hotel, Cleveland, Aug. 24-26.

**Western Electronic Show and Convention (WESCON/65)**, IEEE, WEMA; Cow Palace, San Francisco, Aug. 24-27.

**The '65 Show**, Industrial and Trade Fairs Ltd.; London, England, Aug. 24-Sept. 4.

**Systems Engineering for Control System Design Symposium**, IFAC; Tokyo, Aug. 25-26.

**Radio-Products Fair**, Stuttgarter Ausstellungs-GMBH; Stuttgart's Kellesburg, Germany, Aug. 27-Sept. 5.

**Antennas and Propagation International Symposium**, IEEE; Sheraton Park Hotel, Washington, D.C. Aug. 30-Sept. 1.

**Boulder Millimeter Wave and Far Infrared Conference**, IEEE et al; Stanley Hotel, Estes Park, Colorado, Aug. 30-Sept. 1.

**Opto-Electronic Components and Devices Symposium**, AGARD; Paris, Sept. 6-9.

**International Electronic Exhibit INEL**, Swiss Fair Authorities; Basel, Switzerland, Sept. 7-11.

**Industrial Electronics and Control Instrumentation International**

**Congress**, IEEE; Sheraton Hotel, Philadelphia, Sept. 8-10.

**International Inventors and New Products Exhibition**, International Institute for Patent Products Limited; New York Coliseum, Sept. 9-12.

**Electrical Insulation Conference**, IEEE, NEMA; New York Hilton Hotel, New York, Sept. 13-16.

**Joint Engineering Management Annual Conference**, IEEE/ASME; New York Hilton Hotel, N. Y., Sept. 13-14.

**Technical Association of the Pulp & Paper Industry Engineering Conference**, Engineering Div. of Tappi; Leamington Hotel, Minneapolis, Minn., Sept. 13-16.

**Engineering Materials and Design Conference**, Industrial & Trade Fairs Ltd., Olympia, London, Sept. 13-17.

**Integrated Circuit Seminar**, Integrated Circuit Engineering Corp.; Cambridge Charter House, Cambridge, Mass. Sept. 13-17.

**Microwave Behaviour of Ferrimagnetics and Plasmas Conference**, IEE; London, Sept. 13-17.

**Theory of Self Adaptive Control Systems Symposium**, IFAC/Teddington; Teddington, England, Sept. 14-17.

**National Standards and National Testing Laboratories Meeting**, Standards Engineers Society; Royal York Hotel, Toronto, Canada, Sept. 15-17.

## Call for papers

**Pan American Congress of Electrical, Electronics and Mechanical Engineering**, Mexico Section of IEEE, Mexico Section of ASME, Mexico Group of SAE; Hotel Del Prado and Auditoria Nacional, Mexico City, Oct. 9-17, Aug. 1 is deadline for submission of abstracts to Jorge Espinoza, Colegio de Ingenieros Mecanicos y Electricistas, Culiacan No. 115, Mexico City.

**Symposium on Information Display**, SID; Hotel Commodore, New York City, Sept. 28-30, Aug. 2 is deadline for submission of five copies of 500-word abstract and summary to Edmund J. Kennedy, 6260 Evening Road, Rome, N. Y. 13440.





## Apollo crews fly make-believe by hybrid computer

Training Apollo astronauts for their first trip to the moon is a complex study in simulation. Astrodata married a digital computer and an analog computer to produce a hybrid system qualified to help with this teaching job. The Astrodata system will simulate the Apollo launch, midcourse maneuvering, moon landing and earth's atmosphere re-entry. Astronauts inside an Apollo capsule will be trained in these simulated phases of the trip and their ability to react to over 2000 possible failures and malfunctions will be tested.

This is the largest hybrid computer yet built. The analog computer, provided by Astrodata's subsidiary, Comcor, Inc., has over 400 operational amplifiers, 30 function generators, 40 multipliers and 60 summing amplifiers.

A solid-state switch increases, by over a thousandfold, the speed of switching from one part of the problem to another. In the computer linkage system there are 104 DAC's, 48 channels of analog information multiplexed into the ADC and 180 channels of multiplexed digital information.

Perhaps you don't have to make a fledgling astronaut into a moon man, but you do have other problems in the data acquisition and processing, telemetry, or range timing instrumentation fields where Astrodata's vast experience in dynamic information handling and hybrid computer techniques can help you. *Write for your free copy of our 20-page brochure, "Astrodata's Systems Experience."*



**ASTRODATA**

P.O. Box 3003 ■ 240 E. Palais Road, Anaheim, California ■ 92803



# Total

from the

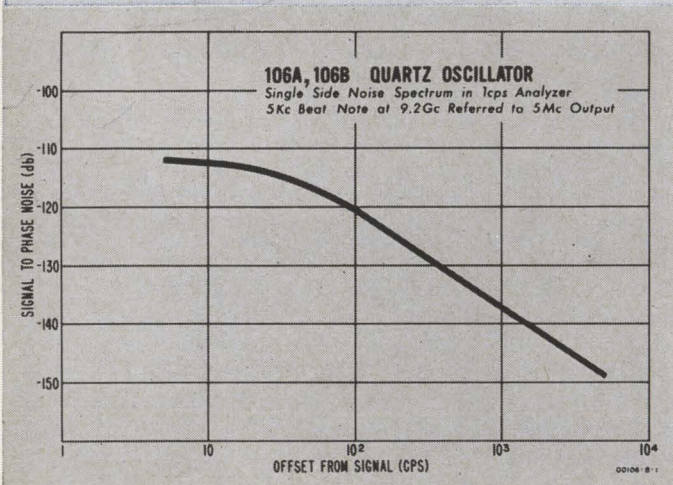

The above is a typical single side noise spectrum plot for a 106A or 106B quartz oscillator.

## 106A,B SPECIFICATIONS

- Output frequencies:** 5 mc, 1 mc, 100 kc sinusoidal, 1 volt rms into 50 ohms; 100 kc clock drive, 0.5 v rms into 1000 ohms
- Aging rate:**  $< \pm 5$  parts in  $10^{11}$  per 24 hours\*
- Stability:** as a function of ambient temperature:  $< \pm 1 \times 10^{-10}$  between  $0^\circ$  and  $+40^\circ\text{C}$   
as a function of humidity: no effect; basic oscillator sealed  
as a function of load:  $< \pm 2 \times 10^{-11}$  for open circuit to short, and 50 ohm R, L, C load change  
as a function of supply voltage (106A):  $< \pm 2 \times 10^{-11}$  for 22 to 30 v dc  
as a function of line voltage (106B):  $< \pm 1 \times 10^{-11}$  for  $\pm 10\%$  change from 115 or 230 v ac



# Performance

## *new Hewlett-Packard 106A,B Quartz Oscillators*

Optimum stability from a quartz oscillator—  $5 \times 10^{-11}/24$  hours aging rate

High spectral purity— 5 mc multiplied to the microwave region has a very low noise pedestal

Buffered outputs— load changes on one output cannot affect other outputs

5 mc, 1 mc, 100 kc outputs— plus an output to drive frequency divider and clock

Phase-locking capability— 2 parts in  $10^8$  frequency control from an external voltage source

New state-of-the-art instruments from Hewlett-Packard. Solid-state 106A,B Quartz Oscillators that deliver total performance to meet your most demanding requirements.

A 2.5 mc quartz oscillator is the heart of these new instruments. The crystal used is optimum for providing long-term stability. Its housing is a large proportionally controlled double oven, with all temperature-sensitive circuitry inside. Any ambient temperature change has negligible effect on the output of the instruments. Short-term variations are less than 1.5 parts in  $10^{11}$  for a 1-second averaging period.

Buffering between the outputs of the 106A,B makes it ideally suited for use in more elaborate frequency standard systems. The oscillators may be used with complete assurance that loading changes in other outputs will not disturb the frequency. Even if any other outputs are opened or shorted, the outputs of the 106A,B will remain constant within 2 parts in  $10^{11}$ . No other comparable oscillator can offer you this protection.

The instruments are also ideal for microwave spectroscopy, doppler measurements—anywhere you require the reference to be multiplied by a large factor. Special purity is excellent, with high signal-to-noise ratio and low distortion, both harmonic and non-harmonic. The 106A and 106B differ only in the supply voltage which operates them.

Discuss your application requirements for quality frequency standards with your Hewlett-Packard field engineer. His product line represents a broad range of quality instrumentation for such applications. Or obtain complete data on the 106A,B by writing Hewlett-Packard, Palo Alto, California 94304, Tel. (415) 326-7000; Europe: 54 Route des Acacias, Geneva; Canada: 8270 Mayrand Street, Montreal.

### **RMS deviation of 5 mc output (due to noise and frequency fluctuation):**

Averaging Time	Max. rms fractional-frequency deviation ( $\Delta f/f$ )	Max. rms phase deviation (milliradians)
1.0 msec	$8 \times 10^{-10}$	0.03
10.0 msec	$1.5 \times 10^{-10}$	0.04
0.1 sec	$1.5 \times 10^{-11}$	0.04
1.0 sec	$1.5 \times 10^{-11}$	0.4
10.0 sec	$1.5 \times 10^{-11}$	4.0

**Signal-to-noise ratio (5 mc):** at least 87 db for rated output; output filter bandwidth is approximately 125 cps

**Harmonic distortion (5 mc, 1 mc, and 100 kc):** down more than 40 db from rated output

**Non-harmonically related output (5 mc, 1 mc, and 100 kc):** down more than 80 db from rated output

**Frequency adjustments:** fine adjustment: 2 parts in  $10^8$  total  
coarse adjustment:  $5 \times 10^{-7}$  total ( $\pm 2.5 \times 10^{-7}$ )

**Phase-locking capability:** a voltage control feature allows 2 parts in  $10^8$  frequency control for locking to an external source; -5 to +5 v required from phase detector (not supplied)

**Power:** hp 106A: 22 to 30 v dc, approx. 8 watts operating; hp 106B: 115 or 230 v ac  $\pm 10\%$ , 50 to 1000 cps, approx. 17 watts operating; (106B has an internal battery capable of supplying 8 hours, continuous operation)

**Weight:** hp 106A, net 25 lbs (11,3 kg); hp 106B, net approx. 39 lbs (17,6 kg)

**Price:** hp 106A, \$3450; hp 106B, \$3900

\*No instrument is shipped until it exhibits an aging rate  $\pm 5 \times 10^{-11}$  per 24 hours

Data subject to change without notice. Prices f.o.b. factory.

**HEWLETT**  **PACKARD**  
An extra measure of quality

12660



ultra-stable zeners/silicon planar reliability  
no surface breakdown

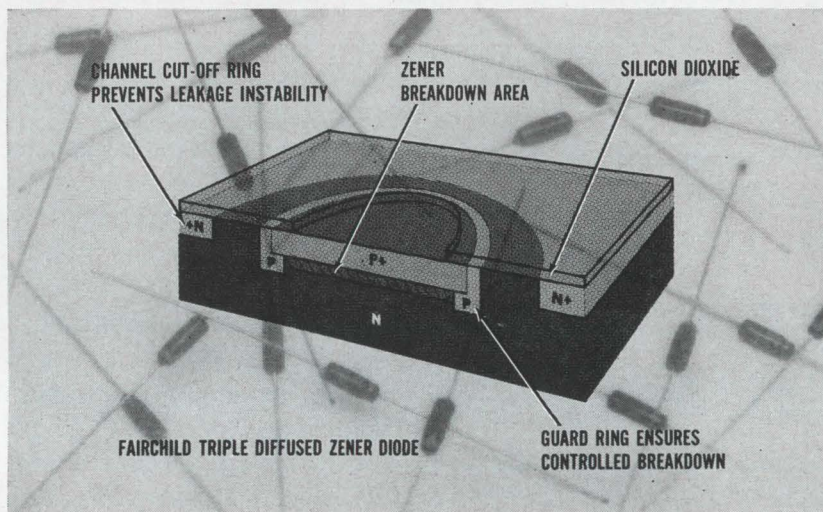

Fairchild now offers a unique family of planar passivated zener diodes with extremely high voltage stability. A new Fairchild production method has eliminated the problem of surface breakdown at reference voltages. The diffusion of a circular guard ring around the diode junction ensures well-controlled voltage breakdown characteristics. In addition, channeling has been eliminated by the use of a channel cut-off ring. These new developments plus the standard Fairchild features of low dynamic resistance, low voltage tolerance and high reliability make these the most advanced zener diodes available—and at no extra cost. Write Fairchild for detailed data sheet and price list.

planar passivated zeners from 6.2V to 100V in a standard glass DO-7 package ■ 1N753A through 1N759A: 6.2V to 12V ■ 1N962B through 1N985B: 11V to 100V ■

PLANAR: A PATENTED FAIRCHILD PROCESS

**FAIRCHILD**  
SEMICONDUCTOR



**Editorial**

# Our depleted society

"A process of technical, industrial and human deterioration has been set in motion within American society. The competence of the industrial system is being eroded at its base. Entire industries are falling into technical disrepair, and there is massive loss of productive employment because of inability to hold even domestic markets against foreign competition. Such depletion in economic life produces wide-ranging human deterioration at home."

Thus begins a bitter indictment of our present economy, contained in a book published today. Its author, Seymour Melman, of Columbia University's industrial engineering department, earned a reputation as an enfant terrible for his single-minded attacks on "overkill," the production of weapons far more powerful than necessary.

What Melman has to say in "Our Depleted Society" should be important reading to electronics engineers. He spells out some specific weaknesses of industry and accuses inept management of a horrible waste of engineers and their talents.

Not unexpectedly, Melman blames the defense effort for the depletion of the U.S. economy. While many will argue with his thesis that military spending should be cut by at least \$22 billion a year to eliminate "waste" on increasing overkill capacity, it is difficult to ignore some of the effects he describes. Bluntly, he is saying that even the rich United States cannot have guns and butter without some of the butter turning rancid.

Here are some of the results Melman attributes to 15 years of military and atomic energy spending that accounted for more than half of the federal budgets:

- Productive capabilities of industrial companies have been shrinking even though they have reported profits, the conventional test of success. As examples, he cites the machine tool industry, the railroads, shipyards, and sewing machine makers.

- Industries cannot compete with foreign producers. Some examples: transistor radios and

ships. Melman says technological obsolescence is the real reason, calls cheap foreign labor a paper tiger. Shipbuilding costs could be cut in half in the U. S., he says, if builders would introduce modern methods of assembly and use standardized parts.

- Technical manpower is wasted. In 1963, the electronics, aircraft and missile industries together employed 146,000 engineers and scientists for research and development. About 18% of the aerospace industry's top scientific and engineering talent has been working on proposals for government contracts, he says—and about 75% of the proposals are rejected.

- Morals have deteriorated in government and science. Government support for research and development has led some technical people into violating traditional rules of science. Political and military considerations have decided experiments, such as atomic tests, which have had long-range effects on man and the physical universe. "The violation of the essential procedure of science can only produce deterioration in the productivity of science and its serviceability on behalf of man," says a 1964 American Academy of Sciences report quoted by Melman.

Even worse, according to Melman, are the illegal or immoral acts committed by more and more government officials and agencies in the name of the cold war. Melman cites the Central Intelligence Agency (for the Bay of Pigs invasion of Cuba and actions in South Vietnam), the Justice Department (for illegal arrests), the United States Information Agency (for "privately publishing" books with federal funds without disclosure that they were federally supported) and a host of officials for "deliberately misleading statements."

To Melman, the industrial problem has two facets: companies predominantly in defense work have not diversified, and those not doing military work have become technologically inert.

Melman's book is weakest when he offers solutions to the problem. For a few specific industries, he offers complex solutions such as an inventory bank for machine tool builders, without appreciating that such a device would take away the very prerogatives of management that lead to success: for example, the ability to set prices. Alert, intelligent management is the prime requirement. Melman probably suggests the other measures because he recognizes that good management is the scarcest commodity. For example, in supporting his contention that U. S. companies can compete with foreign producers even if overseas wage rates are lower, he writes, "I regard these data [a comparison of wage rates around the world in the auto industry] as evidence against the proposition

Continued on page 123



# Is random vibration testing necessary for half-size crystal case relays?

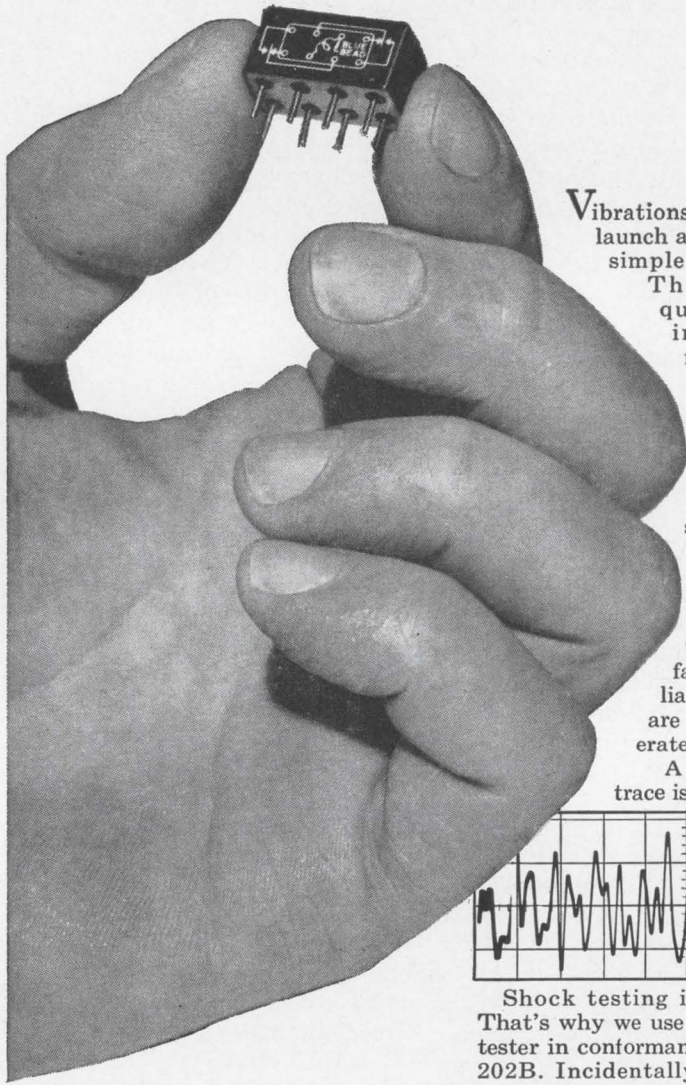

Vibrations of a missile upon launch are far from being a simple sinusoidal affair.

They are, indeed, quite random both in amplitude and frequency. It makes only good sense, then, to test our aerospace/military relays for their ability to withstand random vibrations.

This we do. Few if any other relay manufacturers test in this fashion. All high reliability P&B relays are constructed to tolerate random vibration.

A typical oscilloscope trace is shown below.

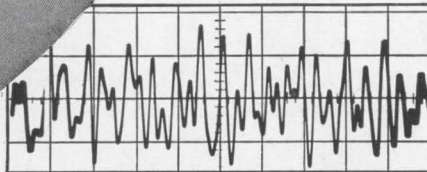

Shock testing is important, too. That's why we use a pneumatic shock tester in conformance with MIL-STD 202B. Incidentally, our HC relay is

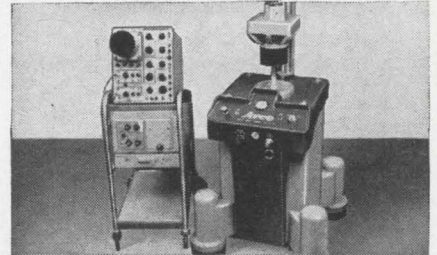

conservatively rated to withstand 150g shock for 11 milliseconds with no contact opening.

HC Series half-size crystal case relays are built with loving care and precisely controlled processes. Assembly is done at Whitfield-type laminar flow workbenches. They employ absolute filters which are capable of stopping cigarette smoke (or particles as small as .0000118") and provide what many experts consider to be the cleanest environment available.

Over and above all this, our HC relays are designed to be reliable. They have bifurcated contacts, and make use of some superior materials not found in similar relays. All-welded enclosures are available. Our Quality Assurance program keeps production within the scope of MIL-Q-9858A.



Remember . . . you can buy cheaper relays but you cannot buy P&B quality for less. For more information, call your P&B representative or write us direct.

## HC ENGINEERING DATA

**GENERAL:** Non-polarized half crystal case size.  
**Shock:** 150g for 11 ms.  
**Vibration:** 20g to 3000 cps. } No contact opening in either armature position.  
 Random vibration testing to customer specifications is available.

**Operate Time:** 3 milliseconds max. at nominal voltage @ +25°C coil temperature.

**Life:** 100,000 operations at maximum rated load.  
**Temperature Range:** -65°C to +125°C.  
**Size:** .810" long, .410" wide, .410" high (max.).  
**Weight:** Approx. ¼ oz.

### CONTACTS

**Arrangement:** DPDT (bifurcated, gold-plated silver-alloy).

**Rated:** Dry circuit to 2 amps at 28.0 VDC res.

**HC RELAYS ARE AVAILABLE FROM LEADING ELECTRONIC PARTS DISTRIBUTORS**

RIDE THE AMF MONORAIL  
 AT THE NEW YORK WORLD'S FAIR



## POTTER & BRUMFIELD

Division of American Machine & Foundry Company, Princeton, Indiana  
 In Canada: Potter & Brumfield, Division of AMF Canada Ltd., Guelph, Ont.  
 Export: AMF International, 261 Madison Avenue, New York, N. Y.



---

# Electronics Newsletter

---

July 26, 1965

## Uhf signals sent in deep water

Reliable underwater communications over about a quarter of a mile at depths of about 300 feet have been achieved by the Astro-Technology division of Page Communications, Inc., the company reports. It is already possible to transmit radio messages over great distances under water, but only at very low frequencies and no deeper than 40 feet.

Page engineers used a 250-watt transmitter and an antenna of special design to achieve transmission at 500 megacycles. They believe they can communicate at up to 2 gigacycles.

## Loss of memory in Gemini explained

Damage to the memory of Gemini 4's on-board computer was probably caused by loss of its auxiliary battery power, the National Aeronautics and Space Administration concluded after a detailed post-flight examination.

The space agency believes the fault was caused by frequent switching of the computer's main electric supply on and off to conserve power. Each time the main supply was cut off, the auxiliary supply was turned on automatically. "At one time, however, the main power was off a little too long and the load on the auxiliary power supply caused its battery to drain to a low voltage, causing the information in its memory to become scrambled, explains Charles W. Mathews, Gemini's project manager.

The computer was made by the International Business Machines Corp.

## Tantalum circuit on assembly line

The Western Electric Co. is swinging into mass production of tantalum thin-film circuits for the computer-like electronic switching systems in telephone networks [Electronics, Oct. 19, 1964, p. 71]. Western Electric is the manufacturing arm of the American Telephone & Telegraph Co.

The company hasn't announced it yet, but it has tantalum sputtering lines operating at two Pennsylvania plants, Allentown and Laureldale. The plants are tooling up for high-volume production of hybrid circuits based on tantalum thin-film networks.

The sputtering apparatus is similar to one used for more than two years for production research and development at Princeton, N. J. That line can deposit 50 square inches of tantalum a minute, enough for about 75 circuits. (See related story on page 33.)

## Computers lose a confidence vote

Until automatic information-handling systems are improved considerably, government engineers and researchers would rather put their questions to human specialists. More such men, not more computers, are wanted. That's the principal conclusion of a one-year study of the attitudes of 36,000 technical employees of the Defense Department, conducted by Walter Carlson, director of scientific and technical information at the Pentagon.

Those questioned approved generally of automatic systems' efficiency in delivering specific information and documents on request. But they complained that often the researcher does not know precisely what document he needs; in such cases, he prefers discussing his problem with a person who is knowledgeable in his field.

The next step in the study will be a comparison of the government



---

# Electronics Newsletter

---

workers' attitudes with those of the research-and-development employees of 100 contractors.

## GAO to soften critical reports

Often criticized for its free-swinging reports, the General Accounting Office has agreed to make some concessions to soothe outraged feelings in government, the military and industry. In the future, the GAO will:

- **Send contractors involved copies of critical reports a day before they are made public**, to meet complaints that companies learn of these findings from press accounts.

- **Qualify reports to make clear that they are not judgments on a company's entire operations**, or perhaps not even on total performance on a contract.

- **Try to assure that reports are couched in more objective language**, particularly in the use of such terms as "unwarranted and excessive."

## 18-cubic-inch tv has 3/4-inch screen

A television receiver the size of a deck of cards and a radio transmitter the size of a fountain pen have been built by the Westinghouse Electric Corp. in Baltimore. The company said they were developed to demonstrate uses of thin-film integrated circuits, but declined to elaborate.

The 18-cubic-inch tv set has a 3/4-inch screen. Its only discrete components are silicon controlled rectifiers used for electrostatic deflection in the picture tube. The set doesn't have a channel selector, but it can be pretuned to receive any vhf or uhf channel. The power supply is outside the receiver, which measures 1 1/2 by 3 by 4 inches.

Although the company says it has no plans to market the small receiver, the device could be adapted as a pocket tv set.

## NASA seeking satellite relay

The National Aeronautics and Space Administration wants a special satellite communications system to relay data from its worldwide network of tracking stations to the Manned Space Flight Center in Houston. The system would be in operation in time for the three-man Apollo project in mid-1967. A station would receive data from Apollo directly, then bounce it off the satellite system to Houston.

The Communications Satellite Corp. has reportedly offered to supply the satellite service for about \$9 million, not counting launching costs.

## Sylvania to double color tube output

Sylvania Electric Products, Inc., says it plans to double its production of color television tubes by 1966, bringing output to about 800,000 tubes a year. The General Telephone and Electronics Corp. subsidiary doubled its color-tube output in a major expansion only a year ago.

## The search for cheap labor

The Semiconductor division of the Fairchild Camera & Instrument Co. plans to build a transistor assembly plant on a Navajo Indian reservation at Shiprock, N. M., and the Control Data Corp. has acquired a plant in Hong Kong to produce magnetic cores for computers. Both sites offer pools of cheap labor.

Fairchild already has a transistor plant in Hong Kong; it decided to expand its U. S. facilities so it can increase its sales to the military, which has a "Buy American" policy. Later this year, Fairchild will build another Hong Kong plant.



Leakage  $< 1 \times 10^{-8}$  cc/sec

**DEUTSCH**

**MAKES**

**ONLY**

**THE BEST**

**HERMETICALLY**

**SEALED**

**CONNECTORS**

Withstands thermal shock  $-120^{\circ}$  to  $500^{\circ}$  F

Withstands 900 v rms at 110,000 feet

Operable in cryogenic liquids

30g, 10 to 2000 cps

Operative to  $500^{\circ}$  F

Moisture-proof

The most complete selection of only the best hermetically sealed connectors available. Round, rectangular, or square... threaded, bayonet-lock, or push-pull couplings... single-piece, fused compression glass inserts... any size, mounting style, metal finish, and pin arrangement — for every application and requirement.

Every part of a Deutsch Seal is designed, developed and manufactured within Deutsch facilities to guarantee performance beyond specification. We can't show everything we make, so when you have some environment to avoid... *don't* avoid your local Deutschman. Meanwhile, send for Data File H-5.

**DEUTSCH SEALS**



Electronic Components Division  
Municipal Airport, Banning, California

ADVANCED SPECIFICATION ELECTRICAL CONNECTORS



## LOCATE IN **NORTHERN IRELAND**

**... USE OUR POUNDS  
SAVE YOUR DOLLARS**

You can help the balance of payments problem—and still have access to a global marketplace—by taking advantage of Northern Ireland's sweeping industrial development program. It is a program designed to get you into fast, efficient production in Northern Ireland at the least possible cost to you.

It's not your dollars we want. What we seek are your pounds and shillings payrolls for our large labor force, your industrial know how, the added impetus you will give our economy. And we are more than willing to pay for those assets.

To help you cut costs, the Government of Northern Ireland will give you outright cash grants or loans—grants toward your plant, machinery and equipment; you may even get grants on the cost of importing that machinery. And, we will make grants for training the men who will operate that machinery. The Northern Ireland Government may provide you a plant—new, modern, ready-to-go—for a rental as low as 2¢ to 3¢ per square foot per month, or custom-build a factory to your firm's requirements.

You will find that you are in good company in Northern Ireland. Our development program has attracted nearly 200 outside firms—firms like the Ford Motor Company's Autolite Division, Du Pont, International Telephone & Telegraph, Hughes Tool, Chemstrand (Monsanto). They have found Northern Ireland the strategic location to manufacture and sell to the world.

And we think you will like your other neighbors: the people of Northern Ireland. You and your firm will be genuinely welcomed in Northern Ireland—and we are willing to spend our money to prove it.

Full assistance and prompt answers to your questions are available right here in the U.S. from highly qualified representatives of Northern Ireland's Ministry of Commerce. Write or phone Jack Quan or George McLaren, British Industrial Development Office, 845 Third Avenue, New York, N. Y. 10022. PLaza 2-8400. Ask for our informative brochure "Produce in Northern Ireland . . . Sell the World Over."



**SLASH  
YOUR  
OVERSEAS  
INVESTMENT!**



**UNITED KINGDOM** of Great Britain  
**AND NORTHERN IRELAND**



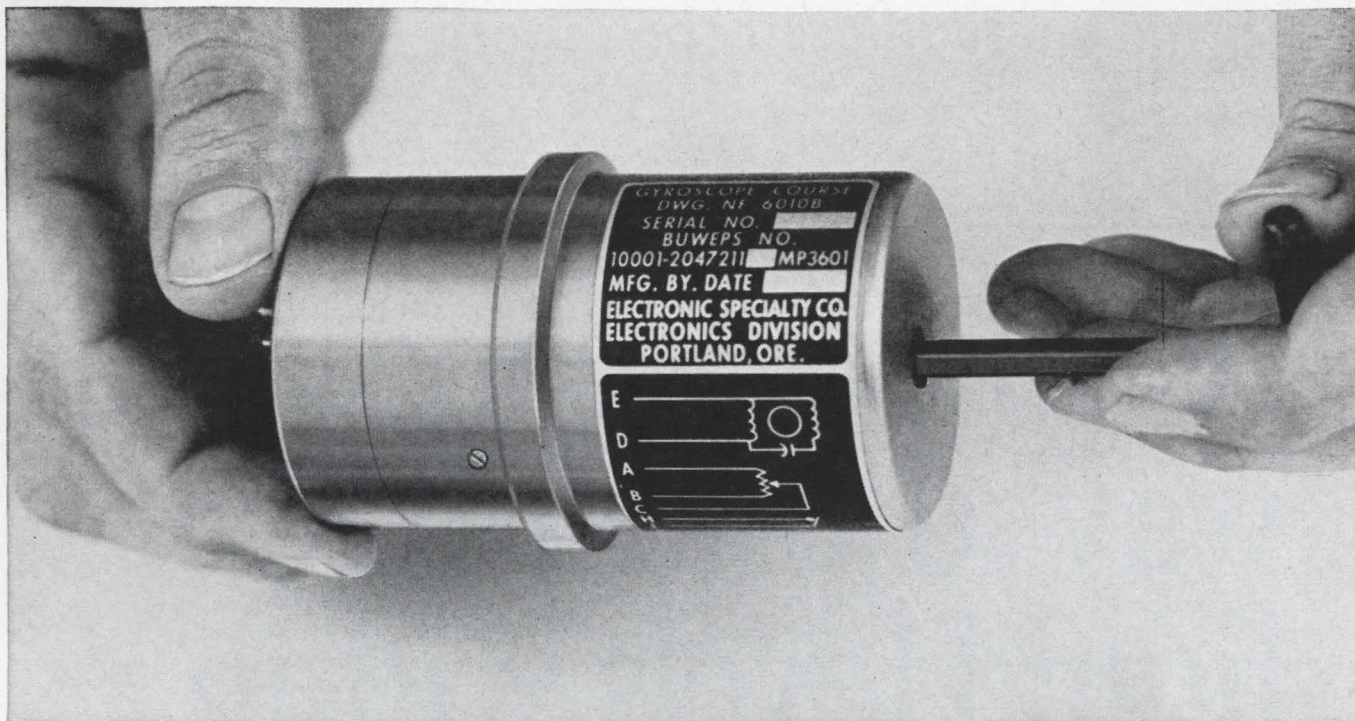

## Our gyros are tops

# This one can be rewound and rearmed without removing its cover

We build all our gyroscopes to be *tops* in quality and reliability. Important developments in vertical, free and directional gyros for drone, missile and aircraft applications are continually being developed by Electronic Specialty Co. in Portland, Oregon.

One of our newest gyros is the stored energy type NF 6010B, designed and produced by ES for a classified torpedo program. Used to provide a course reference, it was designed with emphasis on reliability and minimum size.

This state-of-the-art gyro has a unique rewinding feature: the gyro can be rewound and rearmed without removing the cover. This is accomplished by rotating the cover a quarter turn to expose the winding mechanism, then winding about twelve turns with a standard Allen wrench. The cover is then returned to its original position. When the process is completed a switch closes; this can be used in system readout to provide a "wound and caged" indication. This "permanent" cover further insures reliability because the mechanism

remains cleaner and is not subject to inadvertent change in adjustment.

Energy is supplied from a spring motor to bring the gyro up to running speed in less than 60 milliseconds. The gyro rotor is maintained at running speed by an A.C. induction type sustaining motor.

The unit has free gyro drift of 1 degree per minute maximum. It operates with 360° of freedom on both inner and outer gimbals, and provides potentiometer pick-off from the outer gimbal. Pick-off on both gimbals can also be provided. The gyro weighs 1.5 pounds and is approximately 2.5 inches in diameter and 3.5 inches long.

If you visit the Northwest, you are invited to inspect our new, ultra-clean modern facility in Portland, Oregon. It has the finest equipment available for the design and production of gyros and relays. For a complete description of our Portland capabilities and detailed information and specifications of the NF 6010B write for a data sheet.



ELECTRONIC SPECIALTY CO./ELECTRONICS DIVISION—Portland/18900 N.E. Sandy Blvd., Portland, Ore. (Formerly Iron Fireman Mfg. Co.)

Los Angeles, Calif./Anniston, Ala./Ft. Madison, Ia./Harrisonburg, Va./Hurst, Tex./Pomona, Calif./Portland, Ore./Thomaston, Conn./Toronto, Ont.



## Sigma relay idea of the month

# A simple, economical way to control liquid levels within prescribed limits.

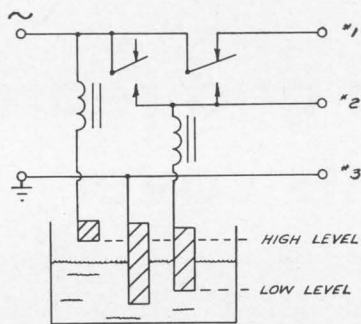

POWER FOR FILL TERMINALS 1 & 3

POWER FOR DRAIN TERMINALS 2 & 3

The circuit shown, utilizing a Sigma Series 5 relay, represents one of the simplest ways to control liquid levels in applications such as water treatment, chemical processing and the protection of immersion pumps in artesian wells.

As can be seen, the liquid level is sensed by immersion electrodes, a convenient and economical method when the liquid is sufficiently conductive. These electrodes can be arranged to give independently controlled high and low lim-

its, and to operate for either filling or draining.

Depending on the size and spacing of the electrodes, the purity of the water, or the type of solution, the equivalent resistance between the electrodes can vary from 100 to 100,000 ohms. In the circuit shown, the Sigma Series 5 relay would be suitable for almost any anticipated resistance. A refinement of the circuit would permit control of solution strength of soap, caustic or acid, between prescribed values.

If you have a relay idea, or can improve this one, we'd like to hear from you. Your idea could be the next one we publish.



## Sigma relay of the month

# Versatile SPDT Series 5 relay responds precisely to signals as small as 1 mw.

The Sigma Series 5 relay is one of the most versatile relays on the market today. Its 10,000 variations are performing in applications ranging from air navigation systems and liquid level controls, as shown on the left-hand page, to burglar alarms and meter protection equipment. It is particularly useful as an overload or underload device that reacts without amplification to minute changes or differences from normal values.

With the Sigma Series 5, adjustments to 1 mw are standard. Yet, its design enables it to have unusually high contact forces even at these low inputs. Some other reasons why this relay is in such widespread use are:

1. Narrow differential—Drop out to pick up ratios extending to 80% because of easily adjustable fixed contacts and spring force. 2. Accuracy—Trip values can be set readily to within  $\pm 5\%$ , with micrometer-type screw contacts. 3. Stability—Trip points will not

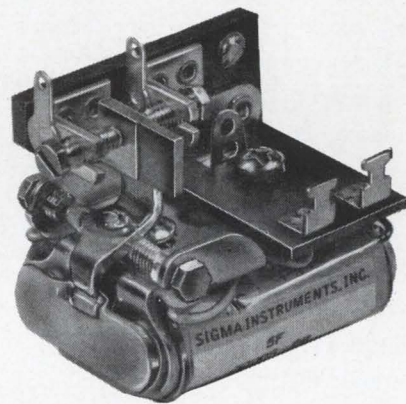

vary more than  $\pm 2\%$  throughout life, in the absence of contact erosion, as a result of low friction needle point bearings. 4. Ruggedness—Withstands 100 G's shock without damage, and heavy coil overloads of up to 30-to-1 for voltage or current. 5. Long life—Five million operations, barring contact damage by transients.

Try the Sigma Series 5 for yourself—free of charge. Just send for the Sigma Series 5 bulletin and a free relay redemption certificate.

SIGMA DIVISION  SIGMA INSTRUMENTS INC  
*Assured Reliability With Advanced Design / Braintree, Mass. 02185.*



# New PAR Lock-In Amplifier Measures Signals in the Presence of Noise by Crosscorrelation

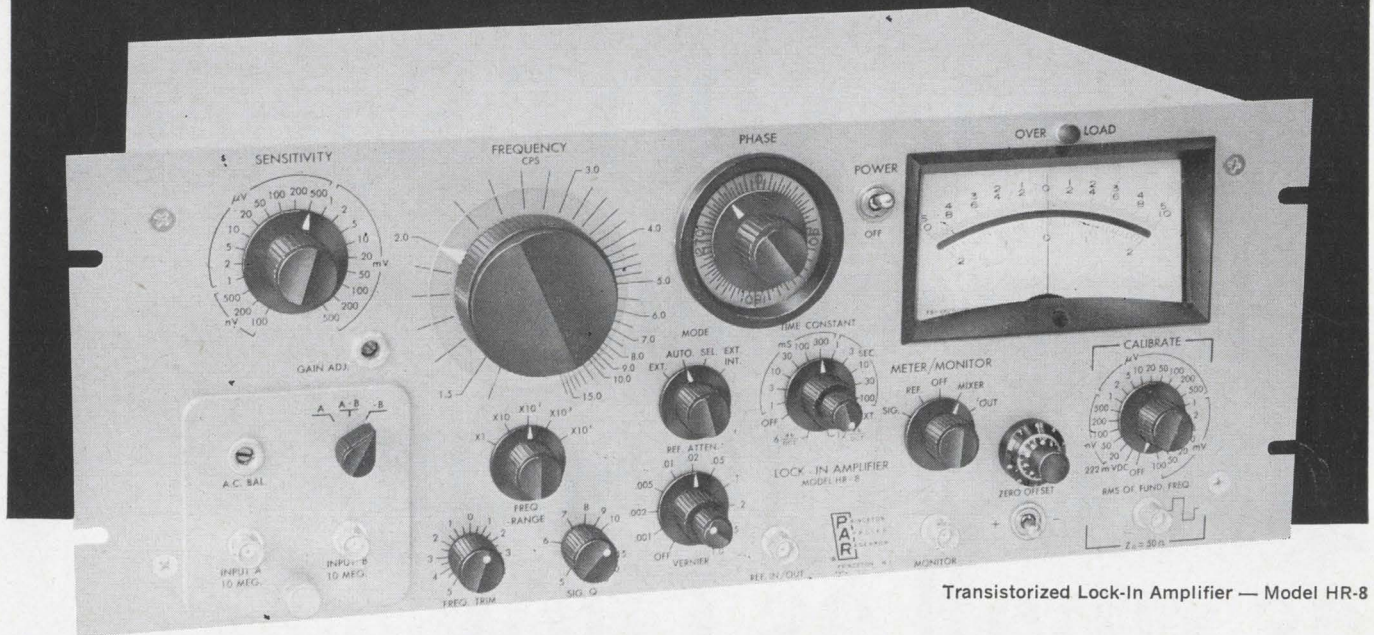

Transistorized Lock-In Amplifier — Model HR-8

The PAR Model HR-8 Lock-In Amplifier represents a significant advance in signal processing equipment for experimentalists who must measure low-level signal intensities in the presence of noise. It employs the theoretically optimum technique for signal recovery, and can be incorporated into a large class of experiments in which the signal of interest is, or can be made periodic, and in which a reference voltage related in frequency and phase to the signal can be obtained. The Model HR-8 first amplifies and bandlimits the input signal and then crosscorrelates it with the reference signal, suitably phase shifted and shaped. The crosscorrelation of input and reference signals yields a DC output voltage proportional to the signal of interest, while the crosscorrelation of the reference and noise results in no net DC voltage. The system can also be described as a continuously integrating, highly sensitive, phase conscious voltmeter, the response of which is "locked" to that particular frequency and phase at which the signal information has been made to appear.

## Technical Features:

**Frequency Range:** 1.5 cps to 150 KC continuously tunable in 5 ranges.

**Time Constants:** 11 values in 1-3 sequence extending from 0.001 to 100 seconds. Single or double section RC filtering.

**Pre-Amplifiers:** Interchangeable low-noise pre-amplifiers, operable either within the HR-8 or remotely, are used.

Type A: Differential 10 megohm input.

Type B: Low impedance transformer input for low source impedances.

**Sensitivity:** 21 calibrated full scale ranges in 1-2-5 sequence.

With Type A Pre-Amplifier: 100 nanovolts to 500 millivolts rms.

With Type B Pre-Amplifier: 1 nanovolt to 5 millivolts rms.

**Output:**  $\pm 10$  volts full scale, single-ended with respect to ground. Will drive galvanometric and servo recorders.

**Frequency Selective Amplifiers:** Notch network in negative feedback loop used in both signal and reference channel tuned amplifiers. Reference channel Q of 10. Signal channel Q adjustable from 5 to 25 with calibrated dial (no gain change with Q adjustment).

**Phase Adjustment:** Calibrated 360° phase shifter, providing continuous rotation as well as a four position quadrant switch which shifts phase in 90° increments.

**Price:** \$2,100 with either Type A or Type B Pre-Amplifier.

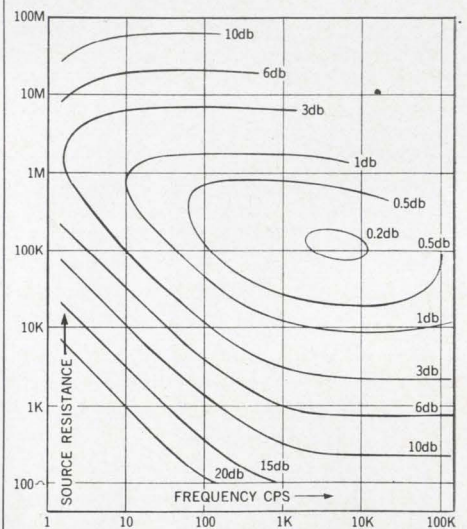

Contours of constant noise figure for a typical PAR Type A preamplifier plotted to show dependence on frequency and source resistance at 300° K. Amplifier operated single-ended.

Write for bulletin No. 120 on the HR-8 or ask for information on PAR's complete line of Lock-In Amplifiers and accessories.





# Electronics Review

Volume 38

Number 15

## Space electronics

### Encore for Mariner

Bombarded by space dust, jammed by radioactive solar flares, broiled by the sun on one side and frozen by the cold of deep space on the other, Mariner 4 nonetheless performed its mission brilliantly, sending back television pictures of Mars over 134 million miles after 8½ months in space. It was a spectacular success for the Jet Propulsion Laboratory; the space probe's most publicized "failure" was a signal that wrongly indicated a failure in the tape recorder.

**Once again.** While the public continues to applaud the results, the JPL plans to call on Mariner for an encore. A second Mars fly-by isn't in the stars, but the satellite can continue to talk to earth intermittently for a few years.

Mariner's navigational system is optically locked onto the sun and the star Canopus, the second brightest in the sky. As the satellite begins its slow trip around the sun, its high-gain directional antenna will slowly turn away from earth, and its signals will be lost.

But Mariner has another antenna—a low-gain device which has a beam broad enough to be picked up on earth whenever the satellite is in range. At the last possible moment—sometime in mid-September—the JPL will order Mariner to switch antennas. Sometime next year, when the satellite comes around again, the lab expects to pick up data about solar plasma, cosmic dust, cosmic rays, radiation and magnetism.

A fifth experiment, on the speed and distribution of ions in space, failed after Mariner's second month out.

**The next time.** Although data from Mariner will be analyzed for years to come, some basic conclu-

sions have already been reached that will affect future Mars probes:

- The atmosphere on Mars is so thin that space engineers will have to develop a new means of landing there. A life-detection capsule is

biting Mars laboratory will not have to worry about that radiation—but the lack of a belt indicates a new danger, since such belts absorb cosmic rays and radiation from solar flares.

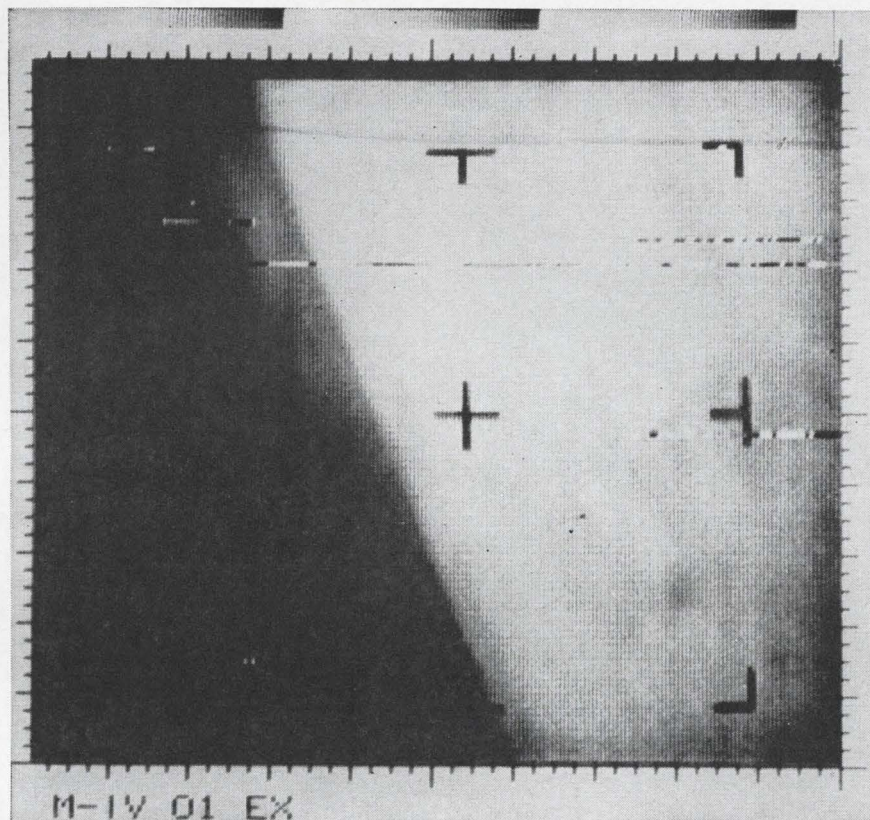

From 134 million miles out, the first close-up look at Mars.

to be placed on the red planet in 1971 or 1973 in the Voyager project (see related story on page 26). The thin atmosphere rules out parachutes or gliding to the surface, and retrorockets, which will be used on the moon, would singe the Martian crust and disrupt the experiments. (No one expects to find life on the moon, so no one worries about scorching its surface.)

- Mars has a weak magnetic field, which means that it has no counterpart to the earth's Van Allen radiation belt. Voyager's or-

**Placed on tape.** The most glamorous part of the Mariner experiment was the picture-taking sequence. All the pictures—taken during a 25-minute period as the spacecraft narrowed the distance from 10,000 to 6,500 miles—were recorded by a miniature video tape recorder.

The JPL engineers experienced a few tense moments shortly before the pictures were to be transmitted back to the earth. A spurious signal was interpreted by the engineers as a sign that the continuous-loop recorder tape wasn't properly shut off when the picture-taking



was finished—and that the earlier pictures were being erased.

Although it was possible to control the recorder by commands from the ground, it would have been too late to take corrective action, because by the time the engineers discovered the error, plus the time it would have taken to send back a signal—a total of 24 minutes—the picture-taking would have been completed.

**By the numbers.** Early on July 15, when the first recorded signals began to come in, the engineers still couldn't tell if the pictures were going to work out. The signals were being received in binary form. Each bit was made up of a

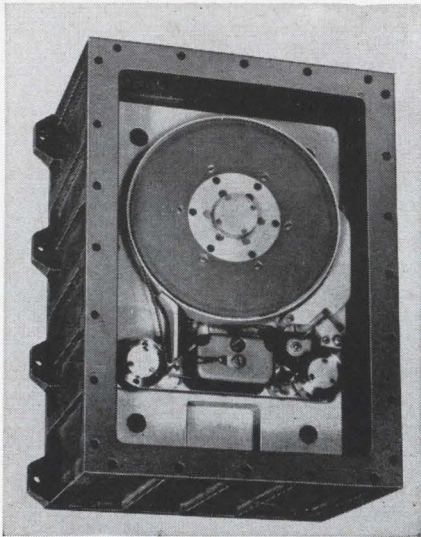

The tape recorder that didn't fail.

number from 0 to 63: 0 meant white and 63 black, with shades of grey in between.

When the JPL engineers had received only the first half of the signals from the first picture, they became impatient and decided to run them through the computer. To their delight, they had, in fact, captured a fine profile of Mars: the picture showed the limb, or edge, of the planet, with black space over the horizon.

For the engineers, photographing the limb was a bonanza, because by comparing the intensity of the black with the rest of the photograph, they could judge the performance of the entire system.

### In living color

The black-and-white television pictures of the red planet may be transformed into full color within a month or two.

The Springfield, Mass., Museum of Science suggested to Edwin H. Land, inventor of the Polaroid camera and president of the Polaroid Corp., that he demonstrate his two-color theory on pictures of Mars, says museum curator Richard Hoagland.

Under classical theory, three primary colors—red, yellow and blue—are needed to produce all the colors in the spectrum. Land, however, has shown that the spectrum can be produced with only two colors [Electronics, Oct. 27, 1961, p. 9].

Mariner's television camera took the Mars pictures sequentially, with each pair overlapping on the edges. Alternate frames were taken through green and red filters; thus the overlapped sections were taken through both filters. The filters were used to increase the contrast of the photos.

"It is the overlap portions that we are interested in," says Hoagland. In experiments done by Land and others, two black-and-white negatives have been projected on a screen, one through a red-orange slide and the other through a yellow-green slide. In each instance, the range of colors produced was greater than that predicted by the classical color theory.

**Similar method.** The method of taking the Mars pictures is so similar to the two-color projection experiments that Land agreed to join the museum in analysis of the Mariner photos. The project is not a part of the Mariner program, but the National Aeronautics and Space Administration has agreed to supply a 35-millimeter film of the Mars pictures. Hoagland estimates that it may be a month after receiving the pictures before results will be known.

The pictures will be taken to a Polaroid plant in Cambridge, Mass., where Land has a laboratory for his personal experiments. The engineering information tele-

metered by Mariner with the pictures is expected to tell exactly where the shots were taken through a green filter, where through a red filter and where the overlap begins and ends.

A spokesman for the Polaroid Corp. declined to confirm that Land or the company would perform the experiments. He said only that Polaroid personnel have had some conversations with NASA's space photography group and that the Polaroid specialists will help if called upon to try and extract color information from the Mars pictures.

### Signs of life

"If we could find footprints, that would settle it," says a space scientist working on an instrument package to detect life on Mars.

Since the chance of finding footprints is rather remote, the search for extraterrestrial life is taking a different tack. Next month, the National Aeronautics and Space Administration will take a close look at scores of proposals from industry and universities for instruments to detect life on the red planet. Many of the initial research projects were paid for by NASA.

"Our job now," says a space agency official, "will be to screen out proposals that are too advanced or not advanced enough—or just plain goofy."

The competition among the developers will be very keen, because out of the scores of possible instruments, only a handful can be selected for the package, whose weight and bulk will be severely limited. It will weigh between 50 and 100 pounds and will be rocketed to Mars either in 1971 or 1973 aboard one of a series of Voyager spacecraft.

Here are several likely candidates:

- Two instruments which very probably will be aboard are the gas chromatograph and the mass spectrometer, or an instrument that combines the two. They would be able to analyze atmospheric gases and organic compounds.

The chromatograph can identify



a gas by its electrical or thermal conductivity, for example, since every gas has its own specific signature. But since many organic substances don't exist as gases, the instrument would first have to vaporize the substance in an oven. Several models, weighing from 5 to 14 pounds, have already been designed for NASA by a number of companies.

The mass spectrometer can obtain reliable data on a sample that weighs only a few millionths of a milligram. Within seconds, such a device can identify amino acids, for instance, by determining the spectra of the sample's molecules.

- An instrument being developed by Melpar, Inc., uses two polarized filters arranged so their axes of polarization are at right angles. When light passes through the first filter, it is polarized in one direction so that it cannot pass through the second filter. But living material rotates polarized light, and each material has its own signature of rotation. Thus, when a sample is placed between the two filters, light will "leak" through the analyzer filter, and the amount can be attributed to the sample.

- Wolf Trap, a device that looks and works like a vacuum cleaner, is being designed to suck in Martian dust and drop it into a clear solution that is appetizing to most microorganisms. If the dust contains even a few microorganisms, they will multiply, causing the fluid to become cloudy. The cloudiness can then be measured by passing light through it and determining the degree of light scattering.

An experimental model, developed by the Ball Brothers Research Corp. recently detected microbes in a test on the floor of Death Valley in California.

- Gulliver is another instrument that is being designed to detect the presence of microorganisms. It contains probes that are fired several feet away from the "mother" instrument. The probes carry a food that contains radioactive carbon. By measuring the amount of radioactive carbon taken in by a microorganism, researchers hope to detect microbes and determine their rate of metabolism. A model is

being developed by the California Institute of Technology and Hazleton Laboratories, Inc.

## Communications

### Message by meteor

During World War II, radar operators had to distinguish between true and false targets that appeared as blips on their screens. They found that some of the false signals were propagated by the enemy to create confusion or to distract attention from real targets. But others, it was discovered, were caused by the thousands of meteors that enter the earth's atmosphere each day.

This wartime liability has been turned into a peacetime asset by researchers who believed they could use the tails of shooting stars as deflectors to bounce radio signals accurately hundreds of miles over the horizon, much more cheaply than by conventional means. The method is much the same as that used to relay signals by satellite, except that there is no amplification.

Earlier this summer, engineers at the Boeing Co. successfully tested

the technique, called meteor burst communications. Now they will build a system that the University of Washington will use in a study of the ocean environment. The meteor burst communications system will link a station near Seattle with an underwater laboratory more than 400 miles away in the Pacific Ocean. The university plans to build its undersea lab at the summit of a 10,000-foot submerged mountain, called Cobb Seamount, that rises to within 120 feet of the water's surface.

Engineers at the North Atlantic Treaty Organization have already installed an experimental two-way meteor burst communications system linking the Netherlands and southern France, a distance of about 620 miles.

**Telling time.** Although most of the early work in meteor burst has been limited to communications, some researchers say the technique can be used for a worldwide navigational system and for disseminating standard, precise time signals, a service performed by the National Bureau of Standards using very-high frequency radio signals. Boeing, in fact, already has an Air Force contract to study such as application.

Meteors enter the earth's atmosphere at random though frequent

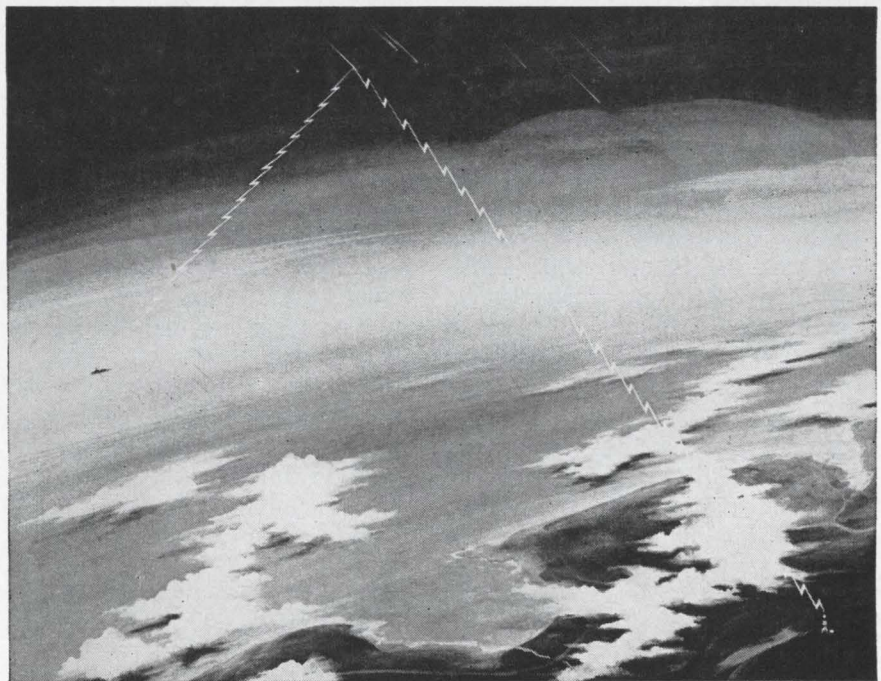

Tails of meteors deflect radio signals over the horizon for hundreds of miles.



intervals; some intervals between meteors within the range of the transmitting and receiving antennas may be as long as 30 minutes; at other times many meteors may blaze toward the earth simultaneously. Usually, however, the intervals are no more than a minute apart.

Despite the random intervals between signals, Boeing engineers report they've been able to transmit messages on experimental links at a rate between 5,000 and 10,000 words per minute. But because of the time gaps, the systems can't be considered for real-time communications.

**Sky surveillance.** With meteor burst techniques, a signal can be transmitted only when the meteor enters the atmosphere at about a 15° angle. Between 50 and 90 miles above the earth, the meteor begins to burn up, leaving behind it a tail of ionized molecules; it is off this tail of molecules that the radio signals are deflected. Usually, a tail can be used as a deflector for less than a second, although some large meteors have tails that are effective deflectors for as long as five seconds.

To coordinate the sending and receiving of signals, the antennas keep a constant watch on the same portion of the sky, waiting for a meteor tail to appear. During this waiting period, the transmitter constantly sends a complex code. When there are no meteors in the portion of the sky under surveillance, the coded signal is either lost in space, or, if part of the signal is deflected by the ionosphere, it reaches the receiving antenna in jumbled form. Data from the transmitter is only sent when the receiver signals that it has received the correct code, this switching operation is performed in nanoseconds.

Meteor burst has several advantages: it would cost less than conventional long-distance radio gear; it would operate on a less-crowded band of frequencies and it wouldn't be susceptible to blackouts caused by sunspots and atmospheric disturbances.

**Direct path.** Since the signals are bounced off evenly shaped

meteor tails, instead of irregular layers of the troposphere or ionosphere, the signals travel a more direct path, making for exceptional phase stability, the major reason for considering the system to transmit standard time signals and navigational information.

With the National Bureau of Standards' WWV high-frequency radio station, timing signals are accurate to within about a millisecond; with a meteor burst system, accuracies on the order of microseconds are expected.

Boeing engineers say that the accuracy of the meteor system in a navigational role could be equal to or better than the worldwide loran-C system and would cost less.

---

## Manufacturing

### The good old ways

The electronics industry is one place where the saying that there is nothing new under the sun is constantly being disproved. But, in one instance, the Ampex Corp. didn't find it so. A management team looking for methods to save space and money on assembly line techniques found its answer in a method used for years in the shoe and garment industries. Why quarrel with success? Ampex dressed up the method for its new tape recorder plant in Colorado Springs, Colo.—and found that it cut floor storage space from 200 square feet to 55 square feet per assembler, enabled one supervisor to control and deliver parts to 30 assembly stations instead of the usual 7 to 15, and improved production flexibility and quality control.

The assembly stations are laid out in the conventional straight line, but they work as though they were on the rim of a wheel. Parts and assemblies shuttle back and forth to a coordinator who controls the belt.

Material is moved into the line by the controller, who dials a number which stops the conveyor belt at the right place. When the assembler has completed his task, he

sends the part back and it is routed elsewhere in less than a minute. Since the assembly stations are not arranged progressively, competition between assemblers is reduced—resulting in better quality, Ampex says.

The company paid the Lamson Corp. of Syracuse, N. Y., \$8,000 to construct the line. Ampex figures it will pay for itself in 18 months in savings in personnel and wastage, and plans to install four more. The system has been in operation for the past month.

### R-f sputtering

Vacuum evaporation and direct-current reactive sputtering are the most commonly used methods of depositing thin films of capacitor dielectrics, conductor insulators and protective coatings on semiconductor devices and integrated circuits. Now the best features of both have been combined in a new technique—radio-frequency sputtering—that can deposit a greater variety of materials than either, according to its developer, the International Business Machines Corp.

Like evaporation, r-f sputtering is fast. Experimental equipment at IBM's labs in Poughkeepsie, N. Y., has attained deposition rates of 2,000 angstroms a minute. And like d-c sputtering, r-f sputtering deposits high-quality films.

**Tough and uniform.** Unlike either evaporation or d-c sputtering, r-f sputtering can deposit many different kinds of dielectrics, including complex compounds. IBM researchers have deposited quartz, alumina, mullite, boron nitride and several commercially available glasses on silicon wafers. A "virtually unlimited number" of layers can be deposited and their thermal, dielectric and moisture-permeability properties can be suitably tailored. The films, IBM adds, are tough and uniform and not likely to chip during wafer dicing.

In addition, r-f sputtering is economical, IBM reports. The company is considering the use of the technique for actual production as soon as development has been completed. Many wafers can be coated



# TRW EXHIBITS INCREDIBLE SHRUNKEN ZENER

TRW 1-watt zener  
as seen by the naked eye!



Now, through the magic of TRW technology, you can have the finest 1-watt zener ever made! How do we do it? We just put fatter leads on our world-famous half-watt zener. You get the same low leakage, sharp knee, small size, high quality and low price—*plus full 1-watt performance* in this brand-new 1N4649 series!

Come one, come all!—to 14520 Aviation Boulevard, Lawndale, California. Or call 213-679-4561 (ext. 263).

**TRW** SEMICONDUCTORS



at a time—seven in the experimental setup. The substrates don't have to be heated; in fact, r-f sputtering is fastest when the wafers are cooled to 40° C, a significant advantage in semiconductor processing.

**After a decade.** IBM's techniques were described this month by Peter D. Davidse and Leon I. Maissel at the International Vacuum Conference in Stuttgart, West Germany. Theirs was reportedly the first scientific paper on r-f sputtering of thin films, although the method was first suggested by other researchers in 1955 and its feasibility demonstrated in 1962.

For r-f sputtering, an insulator is alternately bombarded with ions and electrons from a glow dis-

charge produced in a gas by the application of r-f power. The ions eject molecules of the insulator, which deposit on the substrate. The electrons neutralize the buildup of positive charges on the substrate.

the deposition rate by putting the apparatus in a magnetic field. The field increases ion density by causing the electrons to spiral around the lines of force and confining the electrons in the glow discharge of the argon gas.

Deposition rate varies with field strength. In one case, with the substrate at 300° C and power at 1,500 watts, 400 angstroms of quartz film was deposited in one minute with no field. With a 120-gauss field, the rate was over 800 angstroms a minute.

**Colder, the better.** Another finding was that the deposition rate increases almost linearly with a decrease in substrate temperature. At a power of 800 watts and field intensity of 100 gauss, for example, deposition rate was nearly 500 angstroms at about 40° C and little more than 200 angstroms at 400° C. Apparently, the cooler the substrate, the more the ions stick to it.

Deposition rate can be varied by changing the input power, field intensity or substrate temperature. The only drawback to using a magnetic field is that the films are slightly thicker below the edges of the electrode, apparently because the confining action of the field raises ion density there.

Until now, the r-f sputtering process was too slow to be of much interest. IBM says that previously reported rates were about 1,700 angstroms an hour, as against up to 2,000 angstroms a minute with the IBM methods.

**Insulators.** Conventional direct-current sputtering is often used to deposit metal films, but it doesn't work for insulators. For insulators, a version called reactive sputtering is used. A metal is d-c sputtered in oxygen or other reactive gas, so an oxide film is deposited. The films are good insulators, provided the substrate temperature is kept above 500° C and the sputtering rate is kept below 200 angstroms a minute. Otherwise the film is of poor quality, so the method can only be used for thin films. It is not a good method for depositing glasses and other complex insulators, Davidse and Maissel point out.

If insulators are vacuum evaporated, the high temperature needed

to evaporate the material often decomposes it and the film's quality is poor.

## Instrumentation

### Yardstick for microwaves

It's no trick to get absolute measurement of microwave power at frequencies below 26 gigacycles. In fact, simply by refining existing measuring instruments, engineers at the National Bureau of Standards expect to extend that range to about 100 Gc. But above 100 Gc, it's a different story: none of the instruments now being used are effective in that area—the millimeter range. To fill this measurement gap, an NBS researcher is developing a simple instrument that resembles a dime-store radiometer.

With the instrument, consisting of two paddle wheels connected to a taut thread of quartz, Robert Zimmerer, a scientist at the microwave physics section of the NBS

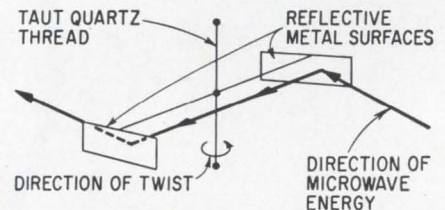

**Microwave measuring instrument** being designed by the National Bureau of Standards to provide absolute readings above 100 gigacycles.

labs at Boulder, Colo., is able to measure radiation from the 100-Gc level to visible light. The radiation pressure exerted on the paddles causes them to turn, twisting the thread; the degree of rotation is a measure of the microwave power.

**Pointing the paddles.** In an experimental model (see diagrams above) the surface of one paddle is pointed in such a way that the microwave radiation which strikes it is deflected 90° to the surface of the second paddle. The second paddle is also pointed so that the radiation is again deflected 90° and

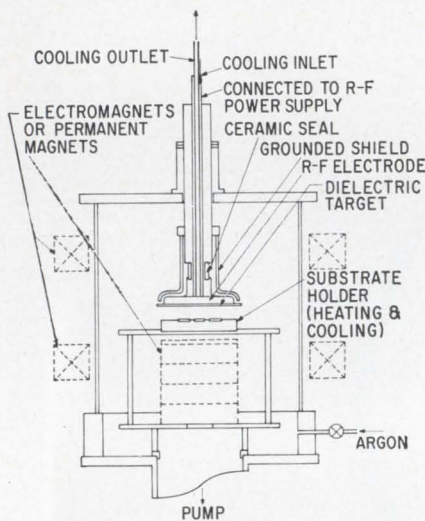

**Heart of the r-f sputtering apparatus** that deposits thin films on semiconductors and integrated circuits.

charge produced in a gas by the application of r-f power. The ions eject molecules of the insulator, which deposit on the substrate. The electrons neutralize the buildup of positive charges on the substrate.

In IBM's setup, the ions and electrons are produced by surrounding the insulator with argon gas. The insulator is mounted on an electrode that is fed r-f power from a 5-kilowatt, 13.56-megacycle power supply (a standard industrial frequency). The substrates are mounted 2.5 centimeters from the electrode.

IBM found that it could double





# MIL-TYPE T-POTS

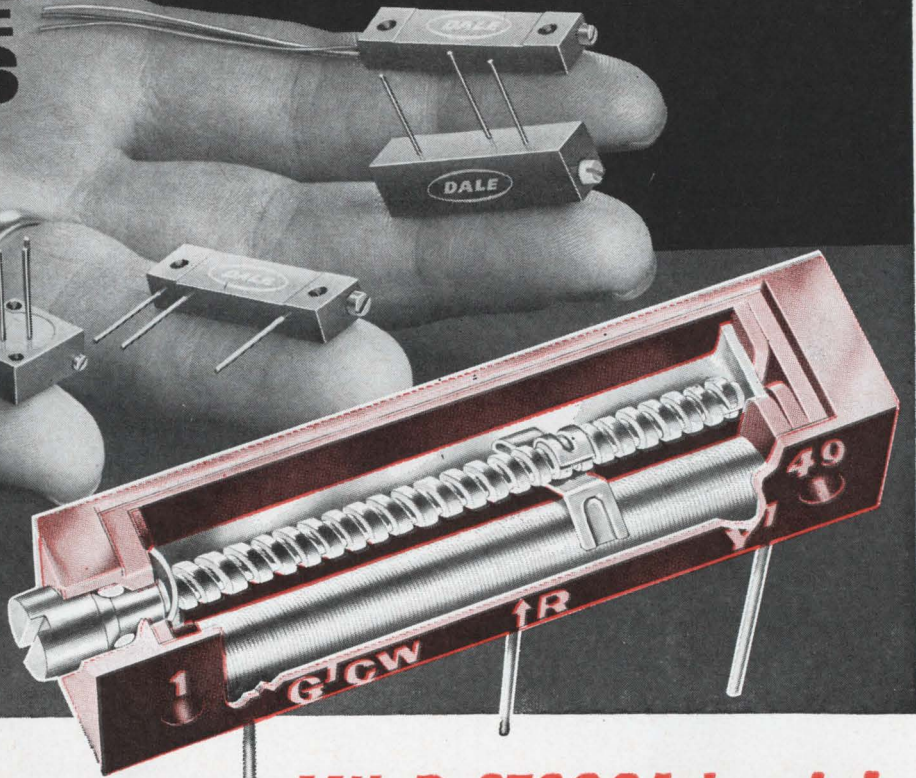

## More for your money at MIL-R-27208A levels!

**CHECK WITH DALE**—In a rigid value analysis program we've lowered prices and—in all cases—raised performance levels. The thoroughly reliable design you see here will do a wide range of Mil-level jobs—for less. Here are its components:

■ **HOUSING** of high temperature diallyl phthalate meets Mil Standard 202 and MIL-R-27208A.

■ **RESISTANCE ELEMENT** has maximum length and diameter to provide highest resolution values available. Unique winding process improves linearity and resolution by absolute captivation of individual turns of wire. Thermo-conductive mandrel forms high mass heat sink eliminating "hot spots." Special Dale "Captive-Weld" process forms strong, low-resistance termination.

■ **WIPER AND SCREW ASSEMBLY** provides positive settings under all environmental conditions. Stainless steel adjustment screw has clutching provision to prevent overtravel damage. Precious metal contacts maintain unvarying pressure and high temperature silicone rubber "O" ring provides excellent environmental insulation.

**WRITE FOR NEWLY EXPANDED CATALOG B**—containing complete specifications on 57 Dale T-Pots, including many special models—or call us if you want information today!

### SPECIFICATIONS MIL-R-27208A MODELS

Equiv. Mil Model	RT-10	RT-11	RT-12	RT-22
Dale P.C. Pin Model	691	1287	1680	5091*
Dale Flex. Leads Model	697	1288	1697	5050†
Height	.18	.28	.19	.22* - .19†
Width	.32	.31	.32	.500
Length	1.00	1.25	1.25	.500
Power Rating	1 watt at 70°C, derated to 0 at 175°C			
Oper. Temp. Range	-65°C to +175°C			
Adjustment Turns	15±2	25±2	22±3	23±2
Mounting Centers	.750	1.000	1.000	.520
Standard Tolerance	±5%	±5%	±5%	±5%
Standard Resistance Values	10 ohms 20 ohms 50 ohms 100 ohms 500 ohms 1K ohms	2K ohms 5K ohms 10K ohms 15K ohms 20K ohms	25K ohms 30K ohms 50K ohms (Max. Models 691, 697, 5091 & 5050)	100K ohms



**DALE ELECTRONICS, INC.**

1300 28th Avenue, Columbus, Nebraska  
Also Sold by Dale Electronics Canada, Ltd., Toronto, Ontario, Canada





## Who needs a slot-range system power supply?

You might—if you need up to 40 amps of precision power in a 5¼" package. It's the most economical power package available today and it's new from the Power-House of Trygon. Consider the advantages.

For \$450-475, the new silicon LR Series offers you three standard models, designed for 5¼" x 19" rack installation in critical systems applications— with the precision regulation and low noise demanded by today's semiconductor circuits.

The LR Series offers models at: 5-7V at 40A (LR6-40), 11-13V at 30A (LR12-30) and 24-32V at 20A (LR28-20). All provide: Automatic overload protection and warning light. .01% line and load regulation. Remote voltage programming. Remote sensing. 1mv rms ripple. .05% stability (with .01% optional). Maximum ambient temperature 60° C.

Who needs it? If you want a low-cost, precision regulated systems supply unmatched in performance and features,

**you do!**

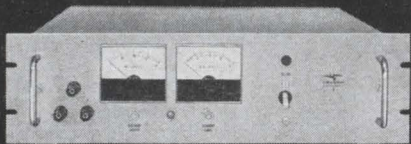

For all the exciting features, write

**TRYGON**  
POWER SUPPLIES  
Roosevelt, New York

TEL (516) 378-2800 • TWX (516) 868-7508

## Electronics Review

the microwaves leave the instrument in the same direction they entered—without any loss of energy.

The chamber containing the paddles and the quartz thread is kept at a high vacuum because the goal is a device that makes absolute measurements, and gas would affect the results.

However, the introduction of gas is an asset if the instrument is used as a measuring device, not as an absolute standard-setter. The passage of the microwaves through the gas produces heat, and the heat exerts a force on the paddles in the same direction as the microwaves. Since the microwaves and the heat work together to turn the paddles, the introduction of the gas serves to make the instrument more sensitive—a hundredfold more sensitive, the NBS engineers say.

In addition, the instrument—with or without gas—would be suitable for taking power measurements of infrared and laser beams.

**Other methods.** Two techniques are used to provide absolute standards below 26 gigacycles. For measurements under about 50 milliwatts, temperature-sensitive resistors are used in a bridge arrangement. Microwave power applied to one side of the bridge causes imbalance. The amount of current required to bring the bridge back into balance is proportional to microwave power being measured. For measurements above 50 milliwatts, a calorimeter method is used. Heat dissipated by a resistor in a path of microwave energy is compared with a known standard; the difference is interpreted as microwave power.

### Keeping track

The electronically monitored control systems being tested for the San Francisco Bay Area Rapid Transit District (see story on p. 71) are themselves being monitored electronically.

Because an enormous amount of complex data is being generated by the experimental systems, which control every operation from issuing tickets to stopping trains, BARTD is making sure that infor-

mation will be collected without bias and has hired the Philco Corp. to develop an electronic data collector.

The Philco system only collects data—it does not evaluate the information it picks up on BARTD's tracks.

**New design.** Most of the measuring equipment is straightforward; for example, a tachometer measures the speed of the trains' wheels, and that data is telemetered back to a control center. But some measuring devices were specially designed by Philco for the BARTD test.

Inert transponders can pinpoint a laboratory car's location on the nine miles of test track. Transponders, which derive their power by radio-frequency induction, were installed every 100 feet on top of the cover of the third rail. They emit a microwave tone—well above the electrical noise produced by other equipment aboard the train—each time a trainborne receiver passes over them. That signal is then transmitted to the control center, where the signals are counted, indicating the location of the test car. Signals from the location transponders are fed into a helix recorder, actually a converted facsimile machine, and plotted along two coordinates: one for time and the other for distance. So, a series of dots not only tells where the train is but also how fast it's going (by the slope of the line) and how quickly it accelerated.

**Count the lights.** To detect how accurately the test car has stopped at a station, Philco developed a three-foot long fluorescent-tube box that fits along the wayside. Along the surface of the box are 10 slits that face the car. A photocell mounted on the lab car counts each slit of light as the car stops in front of the box. By counting the number of lights, the electronic equipment can learn where the train halted. Five lights would indicate a bull's-eye; eight lights, for example, would mean an overshoot.

While a car is stopped at a station, the light-detection device signals the facsimile machine, so the accuracy of the stop also is recorded.



## Microelectronics

### Beta tantalum

The discovery of a new form of thin-film tantalum, called beta tantalum, is expected to lead to smaller resistors and to components that are more stable during temperature changes than are resistors and capacitors made with alpha tantalum.

Beta tantalum's resistivity is 180 to 220 microhm-cm, compared with 24 to 50 microhm-cm for the more common alpha structure. Its temperature coefficient of resistivity is -100 to 100 parts per million per degree centigrade, compared with 500 to 1,800 parts for alpha tantalum.

Tantalum films are used to make resistor-capacitor networks for hybrid microcircuits, also to make precision, high-value passive components atop silicon integrated circuits. The metal is converted to a capacitor dielectric by anodizing it.

**Discovered at AT&T labs.** The new form of tantalum was discovered by Mildred H. Read of the Bell Telephone Laboratories and Carl Altman of the Western Electric Co.'s Engineering Research Center. Both Bell and Western Electric are part of the American Telephone and Telegraph Corp. The researchers haven't determined whether the beta type is an allotrope (different crystal structure) of alpha tantalum or whether the difference is due to impurities. X-ray studies show that beta has a more complicated crystal structure.

**Films only.** So far, beta tantalum has been made only as thin film. It can be produced readily by the process normally used to deposit tantalum films—cathode sputtering in argon gas at a pressure of 10 to 30 x 10<sup>-3</sup> torr. However, the vacuum system must be unusually clean and total pressure of the other gases must be held below 10<sup>-5</sup> torr.

Beta tantalum has a much lower superconducting transition temperature (the point at which re-

# This new 10ns current driver assures perfect test correlation & repeatability

Linear Rise & Fall:  $\pm 5\%$  at 10ns, worst case

Two outputs: 600ma each, 1 amp bussed together

Low Output Capacitance: 50pf worst case, 30pf typical

Bi-Polar Output: either positive or negative output pulses

High Voltage Output: 60V in direction of drive; 60V back emf

Square Corners: 5% max deviation all waveform corners

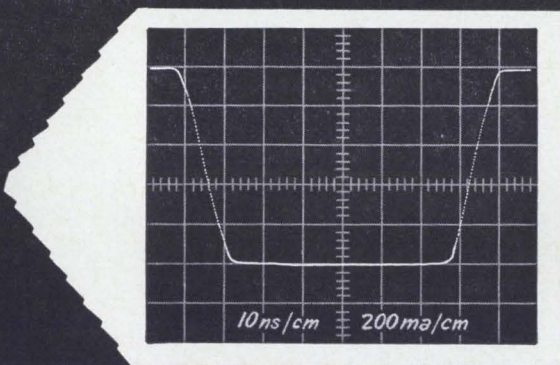

## highly linear rise and fall

In practical applications, most magnetic memory devices, such as cores, thin-films and plated wires, switch states as easily with an exponential drive as with a linear drive. Test applications, however, demand better performance from the driving source. Repeatability and correlation of test data can only be achieved if the driving pulse has a well-defined, unambiguous shape. Straight line linearity of the rising and falling edges is the critical factor.

**In linearity, in corner squareness and in low output capacitance, the Model 1720 Current Driver is way out in front in the memory test field.**

COMPUTER TEST CORPORATION  
CHERRY HILL, NEW JERSEY





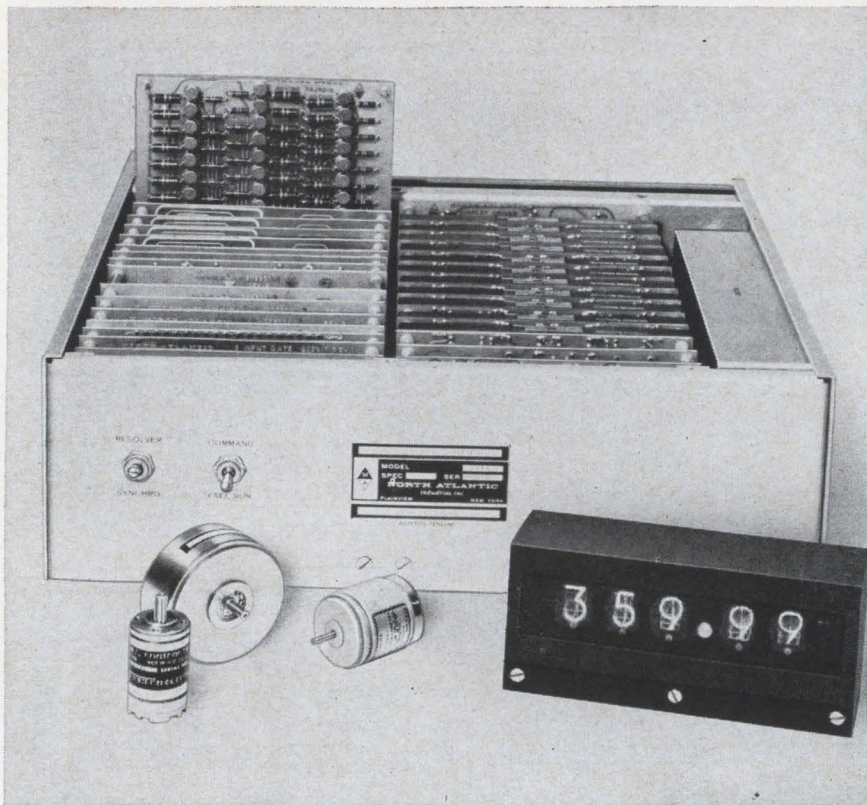

## how to convert resolver and synchro angles to digits (and vice versa)

North Atlantic now brings you a new family of solid-state analog-to-digital and digital-to-analog converters for resolver and synchro data. They offer a major advance in conversion accuracy in modern navigation, simulation, data processing and measurement systems.

Typical of these new instruments is the Model API-5450 shown here. It provides both continuous and command conversion of both resolver and synchro angles, accommodates all line-to-line voltages from 11.8 to 90 volts at 400 cps. Output data is in decimal digits and is presented both as a Nixie-tube display and a five-digit printer output with supplementary print command. Accuracy is  $0.01^\circ$  and update time is less than 1 second.

All instruments in this family are designed to MIL-T-21200 and feature all solid-state circuitry and precision transformers—there are no motors, gears, or relays. Their flexible plug-in modular circuit design permits a wide range of variations to suit your specific requirements. For example:

- 18 bit or 10 second accuracy and resolution
- binary, BCD, or decimal inputs/outputs
- multiplexed channels
- multi-speed inputs/outputs
- high conversion speeds
- other signal frequencies

Your North Atlantic representative has complete application information. He'll be glad to help you solve interface problems in measurement and data conversion. Simply call or write.



**NORTH ATLANTIC industries, inc.**  
TERMINAL DRIVE, PLAINVIEW, L. I., NEW YORK • OVERbrook 1-8600

## Electronics Review

sistivity drops to zero) than alpha  $-0.57^\circ$  to  $0.49^\circ$  K compared with  $3.3^\circ$  K for alpha. So far, Bell Labs hasn't figured out any unique use of this property, but it could come in handy for providing microcircuits in cryogenic equipment; such apparatus usually employs materials that are superconducting at the temperature of liquid helium, about  $4^\circ$  K.

Beta tantalum resistors and capacitors that are used at cryogenic temperatures would provide a safety margin of a couple of degrees Kelvin.

## Electronics notes

■ **Video tape recorders.** Less than a month after the Sony Corp. introduced a \$995 home video-tape recorder, the Ampex Corp. announced a \$1,095 machine. Both recorders will be marketed in the fall. The new Ampex machine makes obsolete a \$4,000 model introduced only six months ago. Ampex chose a 3.2-megacycle bandwidth, the minimum for capturing a color subcarrier, so that future color recorders operating at this speed will be able to play back a library of black-and-white tapes recorded with its current model; the Sony instrument has a 2.3-Mc bandwidth feature. In addition, for \$25 extra, the Ampex unit can be connected to any tv set for monitoring; the Sony machine, however, can only be monitored on a special nine-inch tv set that is included for the \$995 price.

■ **Laser on Gemini.** The National Aeronautics and Space Administration has decided to include a laser communication experiment on Gemini 7, scheduled early next year. During the 14-day flight an astronaut will aim a six-pound gallium-arsenide injection diode laser, which transmits 16-watt pulses, at the ground. After contact is made, the laser beam will be modulated to carry the astronaut's voice. The laser is being built by the Radio Corp. of America.





## TOTAL microCIRCUIT CAPABILITY

Here's one of the most all-inclusive lines of integrated circuits available anywhere: DTLs, TTLs, ECLs. Our advanced microcircuit facilities keep quality up and unit cost down. All processes and materials conform to the quality and reliability required in military components. And this at no extra cost.

Find out how easily your total microcircuit requirements can be filled at Stewart-Warner Microcircuits:

### PROPRIETARY LINE

- SW 702 • TTL LOWER POWER DUAL NAND GATE
- SW 708 • DTL HIDRIVE DUAL NAND GATE
- SW 720 • DTL HIDRIVE RS/JK CLOCKED FLIP-FLOP
- SW 700 • BINARY DECADE COUNTER
- SW 710 • RING DECADE COUNTER

## PIN REPLACEMENT SECOND SOURCE ITEMS

### DTL

- SW 930 • DUAL 4-INPUT NAND GATE WITH AND EXPANSION TERMINAL
- SW 931 • RS/JK CLOCKED FLIP-FLOP
- SW 932 • DUAL 4-INPUT BUFFER WITH AND EXPANSION TERMINAL
- SW 933 • DUAL 4-INPUT AND EXPANDER
- SW 944 • DUAL 4-INPUT LAMP DRIVER WITH AND EXPANSION TERMINAL
- SW 945 • RS/JK CLOCKED FLIP-FLOP
- SW 946 • QUADRUPLE 2-INPUT NAND GATE
- SW 948 • RS/JK CLOCKED FLIP-FLOP

### ECL

- SW 301 • 5-INPUT OR/NOR GATE
- SW 302 • RS FLIP-FLOP
- SW 303 • HALF ADDER
- SW 304 • BIAS DRIVER
- SW 305 • GATE EXPANDER
- SW 306 • 3-INPUT OR/NOR GATE WITH EXPANSION TERMINAL
- SW 307 • 3-INPUT OR/NOR GATE WITH EXPANSION TERMINAL
- SW 308 • J-K PULSE FLIP-FLOP
- SW 309 • DUAL 2-INPUT NOR GATE
- SW 310 • DUAL 3-INPUT NOR GATE
- SW 311 • DUAL 2-INPUT NOR GATE

ALSO PIN REPLACEMENT SECOND SOURCE DEVICES FOR THE MAJOR LINES OF DTL AND TTL FAMILIES WILL SOON BE AVAILABLE.

# STEWART WARNER MICROCIRCUITS, INC.

SUBSIDIARY OF STEWART-WARNER CORPORATION  
730 East Evelyn Avenue, Sunnyvale, California 94086 • Phone: (408) 245-9200

### REGIONAL SALES OFFICES

Western 12014 Wilshire Blvd.  
Los Angeles, California  
Phone 213-477-2544

Midwestern 1300 N. Kostner Ave.  
Chicago, Illinois  
Phone 312-AL 2-1000

Eastern Seaboard 84-40 153rd Ave.  
Howard Beach, New York  
Phone 212-835-0010

European Stewart-Warner Ltd.  
Elizabeth Way  
Harlow, Essex, England





## Wear this glorious medal

Everybody craves recognition... you do, and so do we. So let's help each other. We're asking you to display a certain kind of engineering courage that is the mark of a Crusading Engineer. In return we'll award you this glorious medal with our deepest and sincerest appreciation.

Here's our problem. We've got a line of electronic counters that, by spec and performance, are better buys than anything Beckman or Hewlett-Packard make. We just figured that would automatically get us the big share of the business. We were wrong. Oh, we're doing all right (an easy third in sales) but we haven't exactly pushed those other two big companies into complete bankruptcy.

We don't want your sympathy... just a bit of recognition. Sure, we know it takes a little extra courage to consider CMC when there are those two other "big name" brands around. So all we ask is that you have the guts to compare our specs and performance against those other guys'. If you do, there's a good chance you'll see why we honestly believe we make the world's best counters... and maybe next time you need a counter you'll buy a CMC counter.



To honor your courage we'll decorate you with this Crusading Engineers' medal to bolster your morale during battle. If more men follow your lead, soon it won't take courage to recommend CMC... it'll take courage **not** to.

Now that you know we exist, keep your eyes and ears open. As one of the "hottest" young electronics outfits in the business we're making big plans. We are going to compete with high-powered H-P and big, bad Beckman right up and down their full line. But that's news for later.

**Right now, act!** Join the crusade. Write for our stimulating technical catalog and earn your medal. Just think how proud your kids will be.

12981 Bradley • San Fernando, California • Phone (213) 367-2161 • TWX 213-764-5993



---

# Washington Newsletter

---

July 26, 1965

## Extra Viet cost put at over \$1 billion

Congressional leaders now expect that the increase in defense spending required to finance the war in Vietnam will exceed \$1 billion and may top \$2 billion. Up to 75% of the spending will be for equipment.

There no longer is any doubt that the Johnson Administration will soon seek—and get—a substantial increase in the \$49-billion defense budget it originally proposed for the current fiscal year. The only questions still to be decided are the precise dollar amount of the request and whether to propose a special supplemental appropriation or to add to the basic defense money bill still before Congress.

## Part of boost pegged for copters

One of the most pressing needs is for additional helicopters. Defense Secretary Robert S. McNamara is considering a 50% increase in Army helicopter companies—special transport and armed escort units.

The Army is also drawing up plans for a second air assault division that will rely almost wholly on helicopters for mobility. The original division, now called the 1st Cavalry and shifted from experimental to operational status, probably will be sent to Vietnam.

## McNamara ally heads Air Force

The surprise move of Harold Brown to the job of secretary of the Air Force from the post of director of defense research and engineering has double significance:

- McNamara wants Brown to put the Air Force's long-range weapons and space missions planning on a firmer footing.

- The McNamara philosophy is being planted more deeply in each of the military services, and will inevitably leave its mark on defense philosophy long after McNamara himself is gone.

The Air Force systems command so far seems to approve the switch. The Air Force has had difficulty in justifying some of its key long-range proposals to McNamara, particularly from a cost effectiveness standpoint. The major problems: whether to develop a new manned bomber, and what type; what the need is for a follow-on to the Minuteman intercontinental missile; and what the military's eventual role in space should be.

Brown's job is to provide McNamara with convincing answers. This explains the decision to break away from the usual pattern of putting a businessman, lawyer or political figure in charge of the Air Force, and to give the job to a scientist.

To provide Brown with the necessary administrative backup in running the Air Force's day-to-day nonscientific operations, McNamara named Norman Paul as undersecretary. Paul was assistant secretary of defense for manpower. Thomas Morris, the former Defense Department procurement chief who resigned in December to join a management consultant company, is returning as Paul's successor.

## Room at the top in DOD research

Brown's shift in jobs and the resignation of Eugene Fubini as his deputy will probably lead to some reorganization in the Pentagon's research and engineering operation. Word in Washington is that their replacements will probably come from outside the Defense Department.

Fubini specialized in electronics and communications developments.



---

# Washington Newsletter

---

He also held the title of assistant secretary of defense and had a key voice in establishment of R&D procurement policy. **His successor will not be an assistant secretary of defense;** he will have the title of deputy director of defense research and engineering. The job has gone to Alain Enthoven, McNamara's specialist in cost effectiveness (see story on page 8).

## **Comsat plans 3 ground stations**

The Communications Satellite Corp. has filed an application with the Federal Communications Commission to build two new satellite ground stations, and to buy the Andover, Maine, station from the American Telephone & Telegraph Co. If it can't buy the Andover station, Comsat said it would build its own station in the Northeast. The two new stations will be at Brewster Flat, Wash., and Paumalu, Oahu, Hawaii, about 25 miles north of Honolulu.

Comsat plans to install the necessary electronic equipment in New York, San Francisco and Honolulu to handle incoming traffic, which will be relayed by land lines to the ground stations.

Cost for all of the facilities will run about \$20 million to \$25 million, with each ground station costing about \$6 million.

Meanwhile, the Federal Communications Commission withdrew Comsat's temporary authorization to serve the three major U.S. television networks directly during the current preliminary period of commercial operations. The agency instead gave temporary authority to a consortium of four common carriers: AT&T, the International Telephone & Telegraph Corp., the Radio Corp. of America and Western Union International.

The change does not mean that Comsat is out of the running for the tv transmission business. The FCC is still conducting a broad study of the question.

## **... and seeks new business chief**

Comsat is looking for a businessman to fill the \$125,000 post of chairman and chief executive officer being vacated by Leo D. Welch. Elevation of the company's technically oriented president, Joseph V. Charyk, or of any present member of the board of directors, is not likely. **What Comsat is seeking is a financial expert with an outstanding reputation so he can deal with high U.S. government and foreign officials.**

## **Computers studied for U.S. agencies**

The stage is being set for the use of computers by all major federal regulatory agencies. The machines will be used, on a time-sharing basis, to retrieve legal information, to correlate data, and to set up predictive economic models. **Results of a year-long feasibility study will be outlined next month by Pennsylvania Research Associates, Inc., for top technical people from the regulatory agencies.**

## **MOL decision delayed a month**

A decision on the Air Force's proposed Manned Orbiting Laboratory (MOL) probably won't be made before early August. Secretary of State Dean Rusk reportedly has asked the National Space Council to delay action on MOL so he can prepare for the international impact the program may have, while Vice President Humphrey, chairman of the council, is said to be asking for more details on the \$1.5 billion program.



# You can cool with air...

*(if you have a lot of space)*

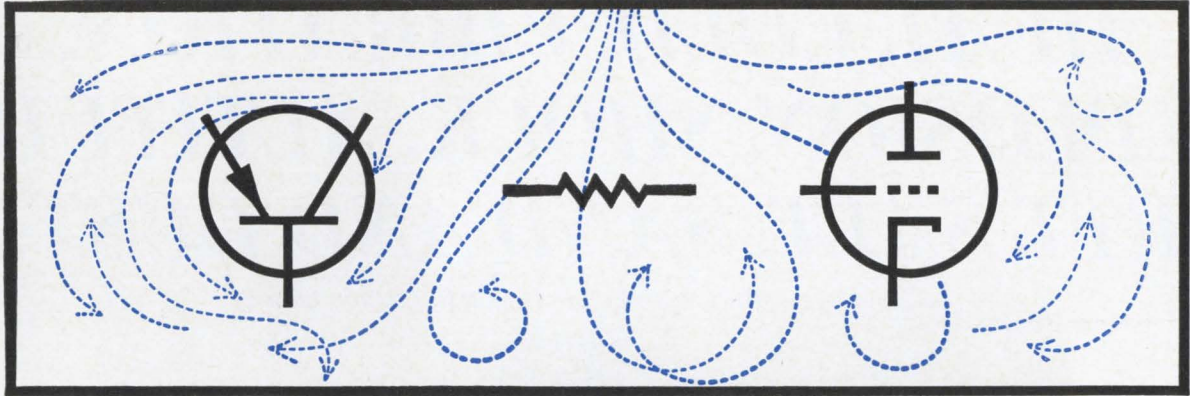

or

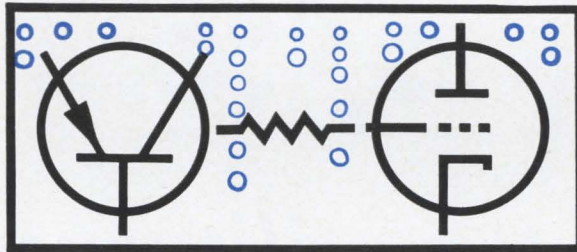

## use FREON<sup>®</sup> dielectric coolants

*(if you don't)*

FREON carries heat away hundreds of times better than air. Close-packed assemblies can operate efficiently at safe temperatures. FREON compounds have outstanding characteristics as heat transfer media either by boiling or by convection.

These inert coolants will work for you in your high-density electronic equipment—wherever you have a reliability problem from “hot spots” in power tubes, transistors, resistors, transformers, packaged electronics, etc. FREON coolants can make your design more compact—at low to moderate cost, while improving reliability through close thermal control.

These five FREON dielectric coolants range in boiling point from +38.8°F. to +237.0°F., offering a wide range of use:

FREON-114	CClF <sub>2</sub> CClF <sub>2</sub>	B.P. + 38.8°F.
FREON-113	CCl <sub>2</sub> FCClF <sub>2</sub>	B.P. +117.6°F.
FREON-215	CCl <sub>2</sub> CF <sub>2</sub> CF <sub>2</sub>	B.P. +165.0°F.
FREON-112	CCl <sub>2</sub> FCCl <sub>2</sub> F	B.P. +199.0°F.
FREON-214	CCl <sub>2</sub> CF <sub>2</sub> CF <sub>2</sub> Cl	B.P. +237.0°F.

Send the coupon for complete technical information based on our 33 years' experience with cooling problems.

**DU PONT** **FREON<sup>®</sup>**  
dielectric coolants  
Better Things for Better Living . . . through Chemistry

Du Pont Company  
Room 2923  
Wilmington, Delaware 19898

Please send me complete technical information on FREON dielectric coolants.

Name \_\_\_\_\_

Address \_\_\_\_\_

City \_\_\_\_\_

State \_\_\_\_\_ Zip \_\_\_\_\_

Offer good in U.S.A. only.



*Photocircuits' fully-militarized*  
**500 RM TAPE READER**  
*is the only reader to pass the tests for:*  
**HEAT, COLD, VIBRATION,**  
**EXPLOSION, SHOCK, ALTITUDE,**  
**RFI, SALT, SAND AND DUST!**

*(as required by MIL-E-16400 Class 3 and MIL-T-21200 Class 2)*

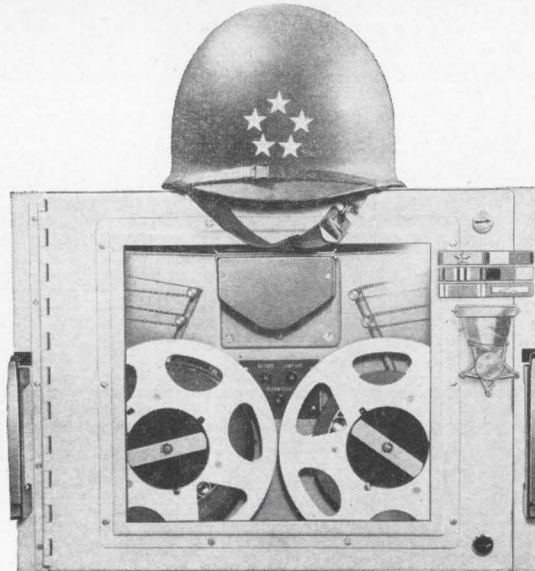

***Still...the top military performer***

*Users of the 500 RM fully-militarized Tape Reader will not be surprised that it passed successfully a complete "campaign" of military environmental tests. Its speed, accuracy and reliability provide a performance that meets all the worst case conditions of the above MIL specs.*

*Specifically designed as a military unit, the 500 RM is a high-speed photoelectric reader providing speeds to 1,000 char/sec. — with 8" reels to give you maximum data-storage. Its smooth power comes from a unique printed-motor, direct-capstan drive. This means that all tape-reading modes are electronically controlled. The 500 RM has none of the clutch, pulley, brake or pinch-roller*

*problems inherent in conventional or hybrid tape readers, since all of this high-maintenance hardware has been eliminated.*

*If your department or agency requirements demand top performance with MIL spec reliability — find out about the 500 RM Tape Reader today. Simply write or phone: Photocircuits Corporation, Tape Reader Division, Glen Cove, New York. Telephone: (516) ORiole 6-8000.*



**Photocircuits**  
CORPORATION  
**TAPE READER DIVISION**  
GLEN COVE, NEW YORK



# Spectrol introduces a new angle in trimmer design:

90°

## ...AND A NEW ANGLE FOR ECONOMY-MINDED INDUSTRIAL USERS, TOO!

Model 85, the right angled version of the popular top adjust Model 84 has been designed for quick access and convenient screwdriver adjustment. New ninety degree mounting angle is ideal for such applications as stacked PC boards.

Both Models are now being offered at a new low price. If you're already using conventional industrial quality trimmers, you can now have the application advantages of Spectrol's designed-in military performance at no additional cost.

Both Models 84 and 85 provide rapid setting with self-locking single turn adjustment and meet or exceed all environment requirements of MIL-R-27208.

**HIGH RELIABILITY:** Silicone rubber lining of both models, molded directly to the case, provides assured barrier against voltage breakdown. Larger, longer element dissipates heat evenly, preventing hot spots and burn-outs providing highest resistance value of any comparable unit: 100 K!

**HIGH RESOLUTION/MINIMUM SPACE:** Both trimmers cut down on the space normally required by 1¼" rectangular and conventional square configurations, yet offer a longer resistance element in only ½" diameter.

**FULL POTTING:** Crimping the case to the base provides positive moisture seal and permits complete immersion.

### SPECIFICATIONS

### MODEL 84 & 85

Standard Resistance Range	50 ohms to 100K ohms
Standard Resistance Tolerance	±5%
Power Rating	1½ watts at 70°C
Operating Temperature Range	-65 to +175°C
Rotation	300° nominal electric, 320° stop to stop

### Prices

### MODEL 84-3-8 MODEL 85-3-8

1-9	\$3.40	\$4.42
250	\$2.30	\$2.99

### COMPLETE SPECIFICATIONS AND DOCUMENTED TEST DATA AVAILABLE

The Model 84, already widely accepted as a standard in military applications is available in a wide range of mounting options, including printed circuit pins with screwdriver adjust for "trim and forget it" applications; printed circuit pins with knob adjust for finger tip tuning; and bushing panel mount with solder hook terminals for panel/chassis applications.

Call your nearest Spectrol distributor for immediate off-the-shelf delivery at factory prices. For a free copy of the documented test data report, write on your company letterhead direct to Spectrol, San Gabriel.

# SPECTROL ELECTRONICS CORPORATION

1704 SOUTH DEL MAR AVENUE, SAN GABRIEL, CALIFORNIA  
ADAMS COURT, PLAINVIEW, L. I., NEW YORK

Circle 41 on reader service card



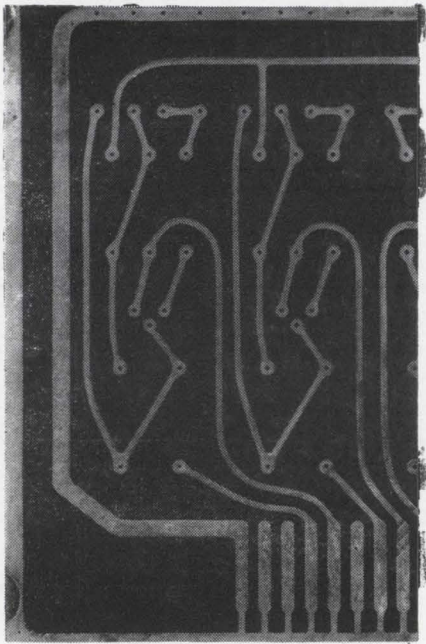

## Etching solder plate boards with chromic acid?

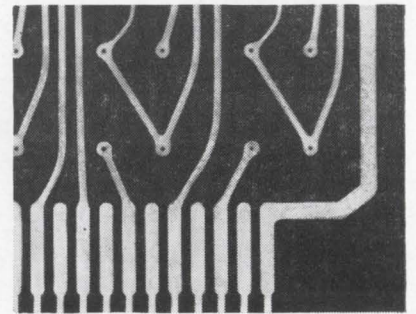
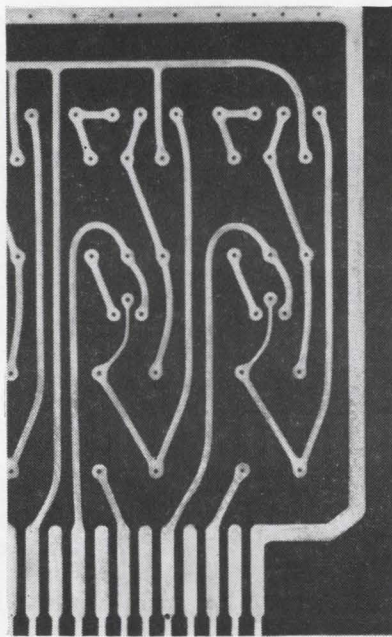
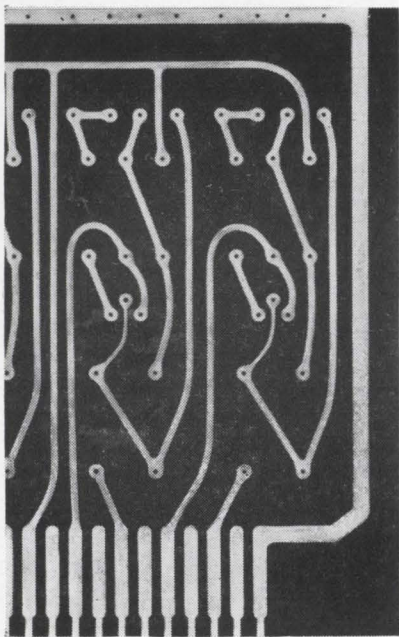

## Switch to ammonium persulfate.

Get  $2\frac{1}{2}$  times as many boards for your etchant dollar.

Use ammonium persulfate on solder boards and save 60% on every dollar you now spend on etchants.

Standardize on persulfate—for both copper and solder boards—and get further savings on storage and purchasing.

Get clean, shiny, ready-to-use solder boards with our new bright dip formula, for no more than it costs to

clean boards etched with chromic acid.

For full information (including our bright dip formula, easily mixed with standard chemicals), or for a demonstration in your own plant, write department 1087R.

**FMC CORPORATION**  
INORGANIC CHEMICALS DIVISION  
633 THIRD AVENUE, NEW YORK, N. Y. 10017





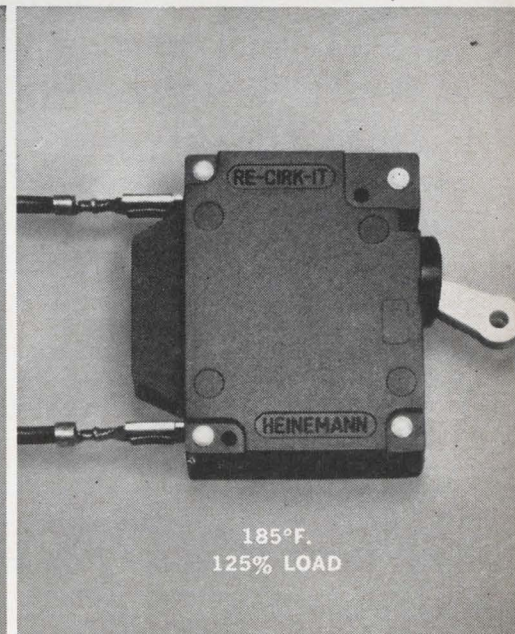
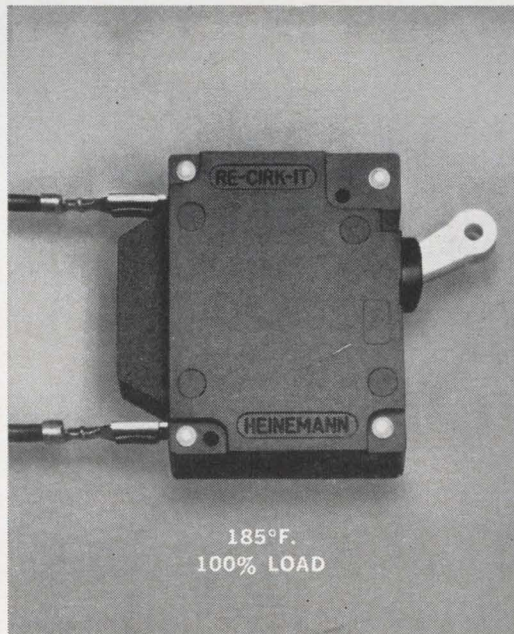
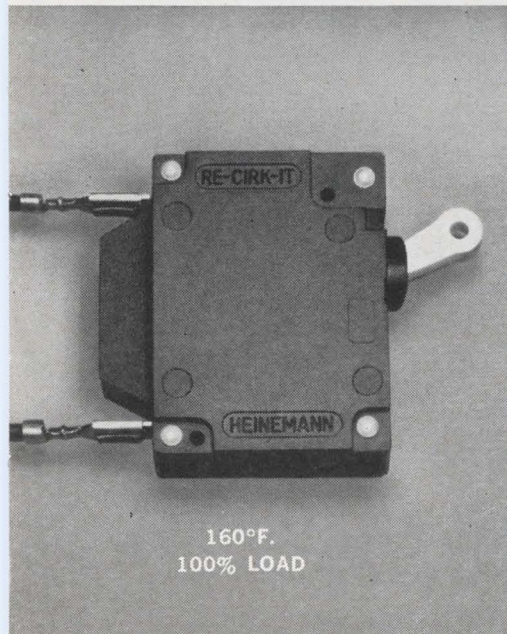
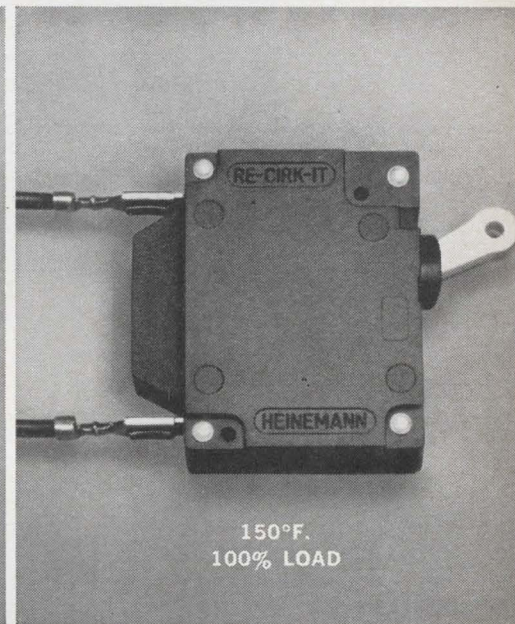
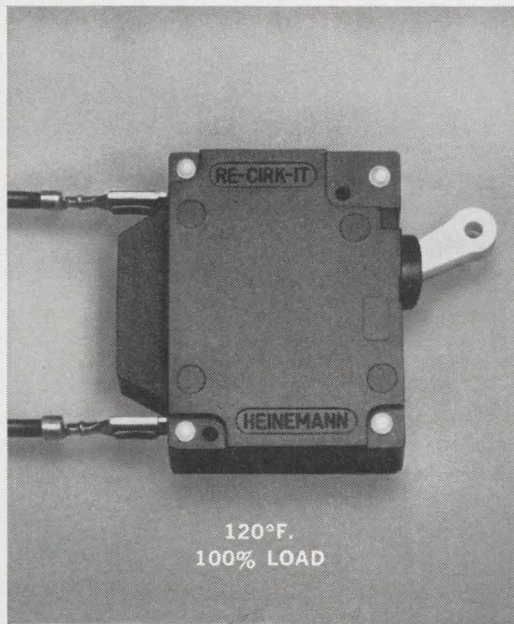
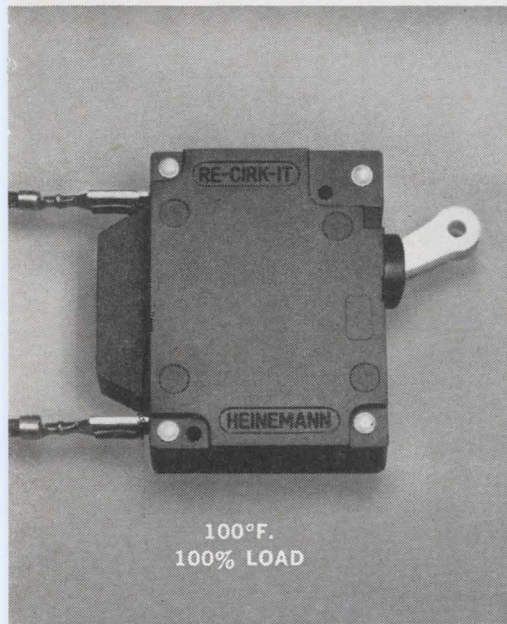
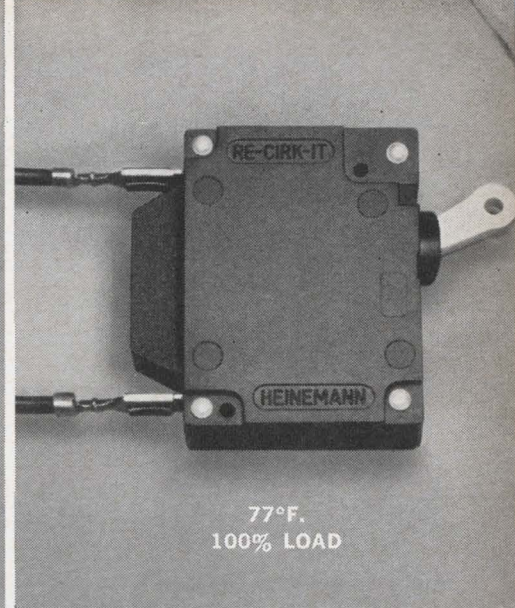
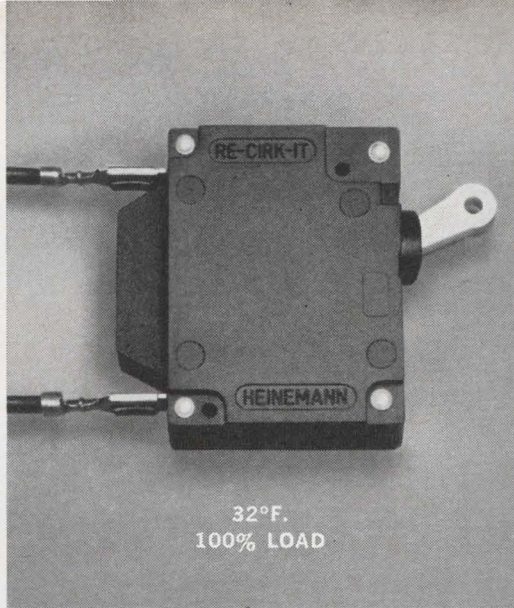
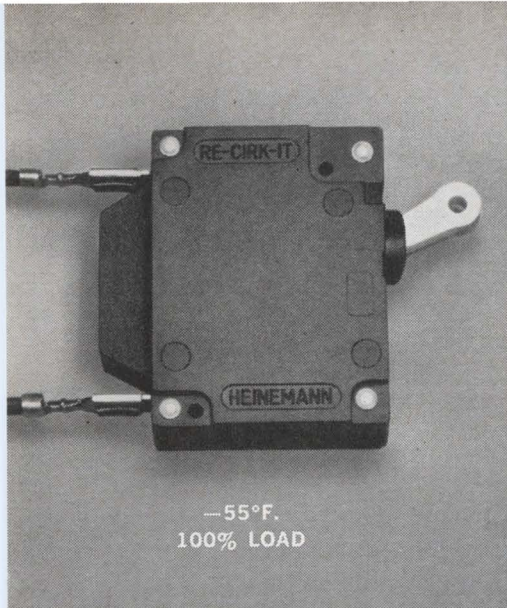

If you want temperature-stable overload protection at any current level from 0.010 amps on up, consider the Heinemann hydraulic-magnetic circuit breaker. Its current-carrying capacity and calibrated trip-points are totally unaffected by ambient temperature conditions. Bulletin 202 will bring you complete engineering information.

 HEINEMANN ELECTRIC COMPANY 2600 Brunswick Pike, Trenton, New Jersey 08602.



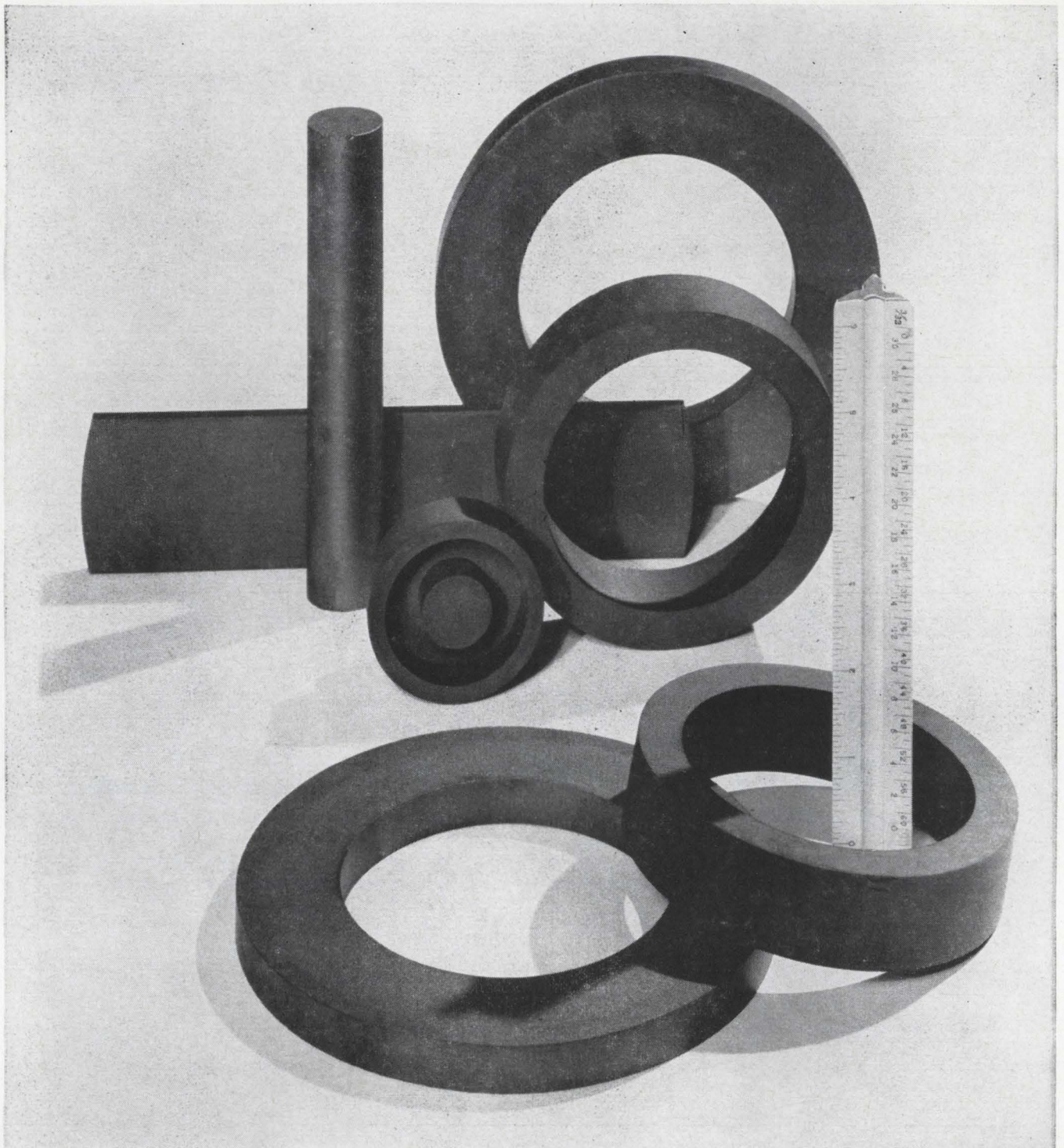

**No matter how big the ferrite piece,  
WHEN MECHANICAL AND ELECTRICAL  
SPECS ARE TIGHT ... SPECIFY STACKPOLE**

Stackpole makes them all:

- Toroids over 6.000" OD x .500" Long
- Cup Cores 2.500" OD x .960" O Hgt.
- Rods to 1.000" D x 2.812" Long
- Sleeves to 4.050" OD x 2.500" long
- Rectangular Solids of nearly 6" Length x 4.175" Width x .750" Thick.

But gross size isn't Stackpole's only claim to fame in ferrites. As one customer put it, "Your ferrite cores are more consistent from order to order than any of your competitors."

Over 30 grades. Isn't that what you're looking for?



**STACKPOLE**  
ELECTRONIC COMPONENTS DIVISION  
ST. MARYS, PENNSYLVANIA



*Leadership in Digital Measurement*

2 Gc

4 Gc

6 Gc

**THERE'S AN ELDORADO  
GIGACYCLE DIRECT FREQUENCY COUNTER  
THAT FITS YOUR NEEDS AND YOUR BUDGET!**



Where ease, speed, and economy in operation are important . . . where **total** elimination of operator error is advantageous, **only** Eldorado direct frequency counters will do the job. And they're available at the right price.

**10 cps to 6 Gc** — that's the range of the Model 950. No calculations . . . no heterodyne or transfer oscillators to confuse the operator. Readout is direct with minimum adjustment — correct measurements require milliseconds rather than minutes. And, Eldorado's unique parity check insures that the readout is either all zeros or the actual frequency.

**Check these specifications . . .**

- Frequency Bands: 10 cps to 110 Mc, 100 Mc to 900 Mc, and 800 Mc to 6 Gc.
- Sensitivity: 50 mv rms (Typical).

- Accuracy:  $\pm 1$  count  $\pm$  oscillator stability.
- Oscillator Stability:  $5 \times 10^{-6}$  per day (average),  $3 \times 10^{-7}$  per week after 24 hours (or your own external 1 Mc standard).
- Reset: manual, remote, automatic.
- Outputs: printout, print command, oscillator monitor.

**10 cps to 6 Gc (9 decades)** — Model 951, **10 cps to 4 Gc** — Model 945, **20 Mc to 2 Gc (with 3 switch-selectable offset frequencies)** — Model 920: Same outstanding features as the Model 950, but at a price commensurate with range and function. **0 to 110 Mc** — Model 910: readily measures events per unit time, or totalizes.

Get the full story on Eldorado's direct frequency counters today. Contact Eldorado's Sales Department, or phone your nearest Eldorado representative. He'll be happy to set up a demonstration for you.



**ELDORADO ELECTRONICS**

601 Chalomar Road • Concord, California

Telephone (415) 686-4200

*Senior Design Engineers: Are you interested in advancing the state-of-the-art in digital instrumentation? If so, we need you in our research and development group. Call or write David C. Condon, Chief Engineer.*



# *Test signals, 50 kc to 40 gc*

*Accurate microwave signal generators,  
signal sources, sweep oscillators for every application*

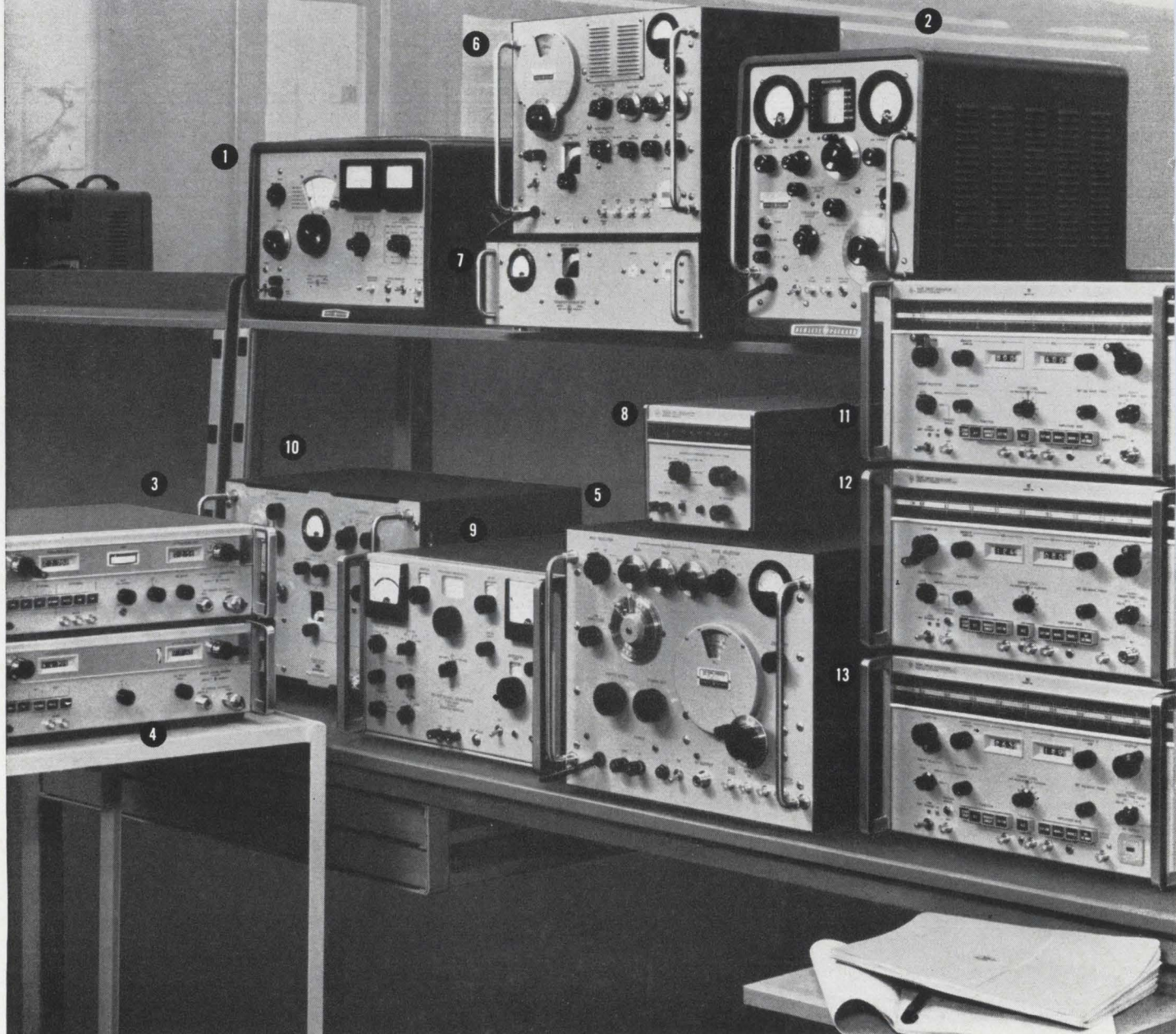

All microwave applications requiring signal generating instrumentation find Hewlett-Packard a source of equipment delivering the best performance and greatest flexibility at prices assuring the best value.

Hewlett-Packard offers a complete line of easy-to-use hf, vhf, uhf and shf signal generators, special-purpose signal sources and sweep oscillators. Auxiliary equipment available includes microwave

amplifiers, modulators, frequency stabilizing instruments and special-purpose equipment.

The charts give brief descriptions of generators, sources and sweepers. For complete data on those instruments of interest to you, just call your Hewlett-Packard field engineer or write Hewlett-Packard, Palo Alto, California 94304, Tel. (415) 326-7000; Europe: 54 Route des Acacias, Geneva; Canada: 8270 Mayrand Street, Montreal.



## hp signal generators, 50 kc to 40 gc

	hp Model	Frequency Range	Characteristics	Price
1	606A Signal Generator	50 kc to 65 mc	Output 3 v to 0.1 $\mu$ v into 50 ohms, mod. bandwidth dc to 20 kc, low drift and noise, low incidental FM, low distortion, direct calibration	\$1350
	608C Signal Generator	10 to 480 mc	Output 1 v to 0.1 $\mu$ v into 50 ohms; AM, pulse modulation, direct calibration	\$1200
2	608D Signal Generator	10 to 420 mc	Output 0.5 v to 0.1 $\mu$ v into 50 ohms; AM, pulse modulation, low incidental FM and drift, direct calibration	\$1300
	612A Signal Generator	450 to 1230 mc	Output 0.5 v to 0.1 $\mu$ v into 50 ohms; AM, pulse modulation, wide mod. bandwidth, direct calibration	\$1400
	614A Signal Generator	0.8 to 2.1 gc	Output at least 0.5 mw to -127 dbm (0.1 $\mu$ v) into 50 ohms; pulse or frequency modulation, direct calibration	\$1950
3	8614A Signal Generator	0.8 to 2.4 gc	Output +10 to -127 dbm into 50 ohms, leveled below 0 dbm; internal square-wave, external pulse, AM and FM; auxiliary rf output, direct calibration	\$2100
4	8614B Signal Source	0.8 to 2.4 gc	Output 15 mw; precision attenuator 130 db range; internal square-wave, external pulse and FM; auxiliary rf output	\$1450
	616B Signal Generator	1.8 to 4.2 gc	Output 1 mw to -127 dbm (0.1 $\mu$ v) into 50 ohms; pulse or frequency modulation, direct calibration	\$1950
	8616A Signal Generator	1.8 to 4.5 gc	Output +3 to -127 dbm into 50 ohms, leveled below 0 dbm; internal square-wave, external pulse, AM and FM; auxiliary rf output, direct calibration	\$2100
	8616B Signal Source	1.8 to 4.5 gc	Output 3 mw; precision attenuator 130 db range; internal square-wave, external pulse and FM; auxiliary rf output	\$1450
5	618B Signal Generator	3.8 to 7.6 gc	Output 1 mw to -127 dbm (0.1 $\mu$ v) into 50 ohms; pulse, frequency or square-wave modulation, direct calibration	\$2250
	620A Signal Generator	7 to 11 gc	Output 1 mw to -127 dbm (0.1 $\mu$ v) into 50 ohms; pulse, frequency or square-wave modulation, direct calibration	\$2250
	626A Signal Generator	10 to 15.5 gc	Output +10 dbm to -90 dbm; pulse, frequency or square-wave modulation, direct calibration	\$3400
6	628A Signal Generator	15 to 21 gc	Output +10 dbm to -90 dbm; pulse, frequency or square-wave modulation, direct calibration	\$3400
	938A Frequency Doubler	18 to 26.5 gc	Driven by 9 to 13.25 gc source; hp 626A, 694C,D or klystrons; 100 db precision attenuator	\$1700
7	940A Frequency Doubler	26.5 to 40 gc	Driven by 13.25 to 20 gc source, hp 628A, 695C or klystrons; 100 db precision attenuator	\$1700

## Boonton Division signal sources

	Boonton Model	Frequency Range	Characteristics	Price
8	3200A General-Purpose Oscillator	10 to 500 mc	Output to 200 mw; AM, 0 to 30%; high stability; also 13515A Frequency Doubler Probe (\$95); 500 - 1000 mc; 4 mw output	\$ 475
9	202H FM-AM Signal Generator	54 to 216 mc	Output 0.1 $\mu$ v to 0.2 v into 50 ohms; frequency, amplitude, pulse modulation; direct calibration	\$1475
	202J Telemetry Signal Generator	195 to 270 mc	Output 0.1 $\mu$ v to 0.2 v into 50 ohms; frequency, amplitude, pulse modulation; direct calibration	\$1595
	207H Univerter	100 ke to 55 mc	Output 0.01 $\mu$ v to 0.1 v; driven by 202H or 202J, reproduces modulation of driving signal	\$ 595
	240A Sweep Signal Generator	4.5 to 120 mc	Output 1 $\mu$ v to 0.3 v into 50 ohms; amplitude modulation, versatile swept-frequency characteristics, frequency markers	\$1995

## Dymec rf test sets — Combination signal generator, frequency meter, power meter

	Dymec Model	Frequency Range	Characteristics	Price
	623B	5.925 to 7.750 gc	Output 1 mw, 70 db attenuator, int. FM, ext. FM and pulse modulation, 0.03% cavity wavemeter, -6 to +3 dbm power meter	\$2250
	624C	8.5 to 10.0 gc	Output 1 mw, 100 db attenuator, int. FM, ext. FM and pulse modulation, 0.03% cavity wavemeter, -6 to +28 dbm power meter	\$2265
10	5636	7.1 to 8.5 gc	Output 30 mw, 100 db attenuator, int. FM, ext. FM and pulse modulation, 0.03% cavity wavemeter, -6 to +40 dbm power meter	\$3800

## Sweep Oscillators — Standard models listed here; extended range and other frequency bands available on special order

	Model	Frequency Range	Output	Frequency Accuracy	Characteristics	Price
	691C (Grid Mod.) 691D (PIN Mod.)	1 to 2 gc	100 mw 70 mw	$\pm 1\%$ $\pm 10$ mc	Versatile sweep functions for all measurement requirements: start-stop, marker, calibrated $\Delta f$ , cw	\$3200 \$3550
	692C (Grid Mod.) 692D (PIN Mod.)	2 to 4 gc	70 mw 40 mw	$\pm 1\%$ $\pm 10$ mc		\$3000 \$3350
11	693C (Grid Mod.) 693D (PIN Mod.)	4 to 8 gc	30 mw 15 mw	$\pm 1\%$ $\pm 20$ mc	Selectable sweep modes for best results and easiest operation: automatic recurring, ext. or manual trigger, manual sweep, sweep times 0.01 to 100 seconds	\$3000 \$3350
12	694C (Grid Mod.) 694D (PIN Mod.)	8 to 12.4 gc	40 mw 25 mw	$\pm 1\%$ $\pm 30$ mc	Digital markers, int. sq.-wave mod., ext. AM and FM, X-Y recorder compatibility, leveling amplifier for xtal or power meter, all models ext. level; Option 01: internal leveling available through 12.4 gc	\$3100 \$3450
	695C (Grid Mod.)	12.4 to 18 gc	40 mw	$\pm 1\%$		\$3500
13	696C (Grid Mod.)	18 to 26.5 gc	10 mw	$\pm 1\%$		\$4500
	697C (Grid Mod.)	26.5 to 40 gc	5 mw	$\pm 1\%$		\$6500

Data subject to change without notice. Prices f.o.b. factory.





# At Signetics we stick our neck out to get above the fog level.



## announcing a new kind of integrated circuit data sheet.

No foggy "typical characteristics" talk. Signetics new data sheets provide the systems designer with the clarity of *GUARANTEED WORST CASE DESIGN LIMITS*. Now you can design without calculating or worrying about any additional safety factors or guard bands. And for component and reliability engineers, each data sheet is a model procurement document, complete down to details of acceptance, quality assurance, and environmental test methods and limits in accordance with all applicable MIL specifications. Get above the fog level. Know exactly what you are buying. Mail the coupon today.

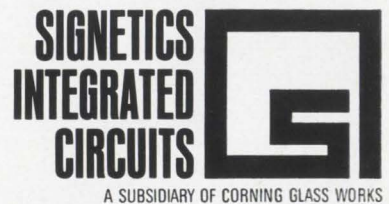

SIGNETICS CORPORATION, 811 E. ARQUES AVE., SUNNYVALE, CALIF.

All right, Signetics, prove it. I want your new Data Sheets on your complete line of DTL elements.

NAME \_\_\_\_\_

COMPANY \_\_\_\_\_

ADDRESS \_\_\_\_\_

CITY \_\_\_\_\_

STATE \_\_\_\_\_

ZIP \_\_\_\_\_



NOW YOU CAN MATCH THE AMPLIFIER TO THE SYSTEM

OFF THE  
SHELF!

Tired of designing analog systems to meet the limitations of available amplifiers? Nexus, with the broadest line of encapsulated operational amplifiers in the industry, gives you the greatest design freedom.

Perhaps you are concerned with space. Need a small-volume module? Try our "Q" case. How about an ultra-slim unit for tight card stacking? Our exclusive "K" case measures only 0.40" high.

Maybe cost is a problem. Nexus' wide selection of economy modules are the lowest in price and give the best performance per dollar available anywhere. Our premium amplifiers, on the other hand, have proven superiority in reli-

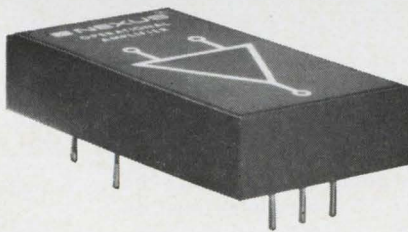

ability, can be made with MIL/QPL components, and can be assembled to NASA specifications.

Looking for high input impedance? We provide standard modules up to 1 megohm (5 megohms, common mode), while our new FET amplifiers provide a differential input impedance as high as  $10^5$  megohms.

How about low offset? Standard silicon-transistor units are available with offsets as low as  $\pm 3 \mu\text{V}/^\circ\text{C}$  and  $\pm 0.02 \text{ nA}/^\circ\text{C}$ , while the FET amplifiers have virtually no offset current.

In other words, at Nexus you stand the best chance of finding exactly what you need in operational amplifiers, without sacrificing design or going to the expense and delay of custom design.

Write for our new *short-form catalog*... a convenient guide to quick, easy component selection.

**NEXUS**  
RESEARCH LABORATORY, INC.  
480 NEPONSET STREET, CANTON, MASS. 02021 - TEL. (617) 828-9000

WESCON - BOOTH 1005

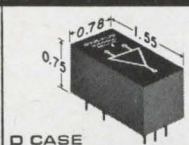
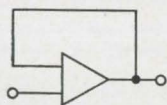

D CASE

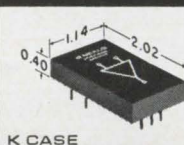

K CASE

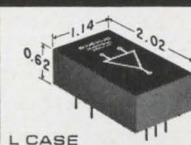

L CASE

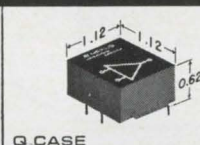

Q CASE

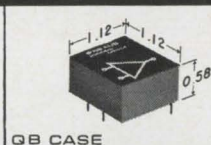

QB CASE



**We've Cut The Price**  
**We've Increased The Range**  
**We've Improved**  
**The Warranty**



**To bring you the best buy yet  
in a universal counter-timer!**

Starting July 1, TSI Model 361 All Solid-State Universal Counter-Timer carries a new price tag. Plus new specs—boosting its frequency range to 2.5 megacycles. And a new improved warranty—covering all parts, unconditionally, for 2 years.

	Model	Old Price	New Price
These new prices make the 361 the lowest cost 2.5 mc counter-timer on the market!	6-digits	\$1250	\$995
	5-digits	1175	925
	4-digits	1100	855

How can we do it? Production efficiencies resulting from five years of manufacturing experience with these instruments.

Model 361 contains every facility required for counting events and frequency, measuring period, frequency ratios, pulse width, time interval and phase angle—without plug-ins, adapters or attachments. In price, in performance—it's your best counter-timer buy for both today's and tomorrow's requirements.

Want proof? Send for the 361 specs today.



**TRANSISTOR SPECIALTIES, INC.**

TERMINAL DRIVE • PLAINVIEW, L. I., NEW YORK WELLS 5-8700



# Technical Articles

---

**Making light of the noise problem:**  
page 52

One attractive property of optoelectronic devices is their potential for isolation. They can get rid of noise that is generated when two subsystems are coupled. A new device, the optoelectronic pulse amplifier, can be used in computers, missile and aircraft subsystems, in communication systems, and between computers and peripheral equipment, to eliminate noise at an interface.

**Negative resistance in FET's—an aid or an ailment:**  
page 57

Circuits that use field effect transistors misbehave if unexpected negative resistance develops. In certain applications, however, an engineer can put negative resistance to work to increase the usefulness of the FET. One such application is a memory that is thermally bistable.

**Step by step to a linear frequency sweep:**  
page 66

Normally, frequency sweeps are generated by analog means. But for cases where a more linear sweep is desired, researchers at Stanford University have devised a digital approach that produces a ramp function within a few degrees of the ideal. They do it with commercially available equipment.

**Who's on the right track?**  
page 71



The biggest mass transportation experiment in the world is under way at Concord, Calif. From it will come an electronically controlled system for the San Francisco Bay area. Because there is no transit system now in the area, the authority responsible for building it has been able to start from scratch, to try every possible combination of cars, tracks, power and automatic control.

This summer, four electronics companies are testing their individual approaches to automatic control, from central digital computer control to an onboard electronic motorman. The stakes are gigantic; what comes out of this experiment could influence equipment used in mass transportation around the world. For the cover, photographer Norton Pearl caught the first of the experimental cars in a test run; on board are all four of the control systems.

- 
- Coming August 9**
- The changing face of the West
  - Integrated differential amplifiers
  - Antennas with built-in integrated circuits
  - Applying aerospace techniques to a consumer product



# Making light of the noise problem

Integrated circuit employs optical coupling to solve the 'interface problem' for computer subsystems, data transmission, and communications

By J. D. Merryman

Texas Instruments Incorporated, Dallas, Texas

**One attractive property** of optoelectronic devices is their potential for isolation; they can get rid of the noise that is generated when two subsystems are coupled. The noise problem is even tougher in integrated circuit systems, because the transformers used in traditional methods of isolation are too bulky.

Thus, in a growing number of applications, the best way to obtain no noise at an interface is to couple signals optically. A new device that will do this is an integrated circuit with a gallium-arsenide light-emitting diode mounted on top. The light is collected by a silicon photodetector diode which is diffused, together with the other components of the integrated circuit, onto a single monolithic silicon structure.

The manufacturer, Texas Instruments Incorporated, calls the device an optoelectronic pulse amplifier—OPA for short. It can be used in computers, missile and aircraft subsystems, in communications systems, and between computers and peripheral equipment—particularly between the central processor and the data transmission line.

In the subsystems of a large computer, one serious problem is ground plane noise—spurious signals generated by large currents flowing in circuits which have a common ground. These signals occur usually at the end of long transmission lines. Another noise nuisance arises when signals have to be coupled from two subsystems which are operating at widely different voltages. Lumped to-

gether, such difficulties are known as the "interface problem."

Transformers can reduce noise by decoupling a common ground but they have limited bandwidth, and are useless for d-c signals.

The OPA device can be used between a source subsystem and a receiving subsystem to eliminate ground plane noise or other undesirable noise. Or, if the difference in potential between systems is great, the OPA can still be used to transfer small signals. Although the light-emitting diode and the detector are only a few thousandths of an inch apart, they can withstand a 200-volt difference without breakdown.

## Diode drive

The OPA's gallium arsenide diode is driven by a 5-milliamper current at 1.2 volts, causing it to emit photons that are collected by the silicon detector. For these driving conditions, the light source emits about 30 microwatts of power. Radiation wavelength is in the near-infrared range at about 0.9 micron. The radiation power is sufficient to produce an output voltage pulse of about 5 volts with a 6-volt power supply connected to the output circuitry.

The magnitude of the output voltage level of the OPA and of the diode are completely compatible with commercially available integrated circuits (such as, for example, the TI series 51 circuits).

The OPA is built on a single chip. The GaAs

## The author



Jerry D. Merryman, a senior project engineer, joined the Semiconductor Research and Development Laboratory of Texas Instruments in 1963. He was previously with the Texas Research and Electronics Corp. In his present position, he is investigating new types of integrated circuits.

## Closeup of the OPA integrated circuit.

The circular gallium arsenide light source is at the top and the diffused resistors, transistors and capacitors at the bottom. The photodetector diode is located directly beneath the light source. The package is a standard  $\frac{1}{8}$  inch by  $\frac{1}{4}$  inch flatpack. The silicon bar measures 0.065 inch by 0.15 inch.



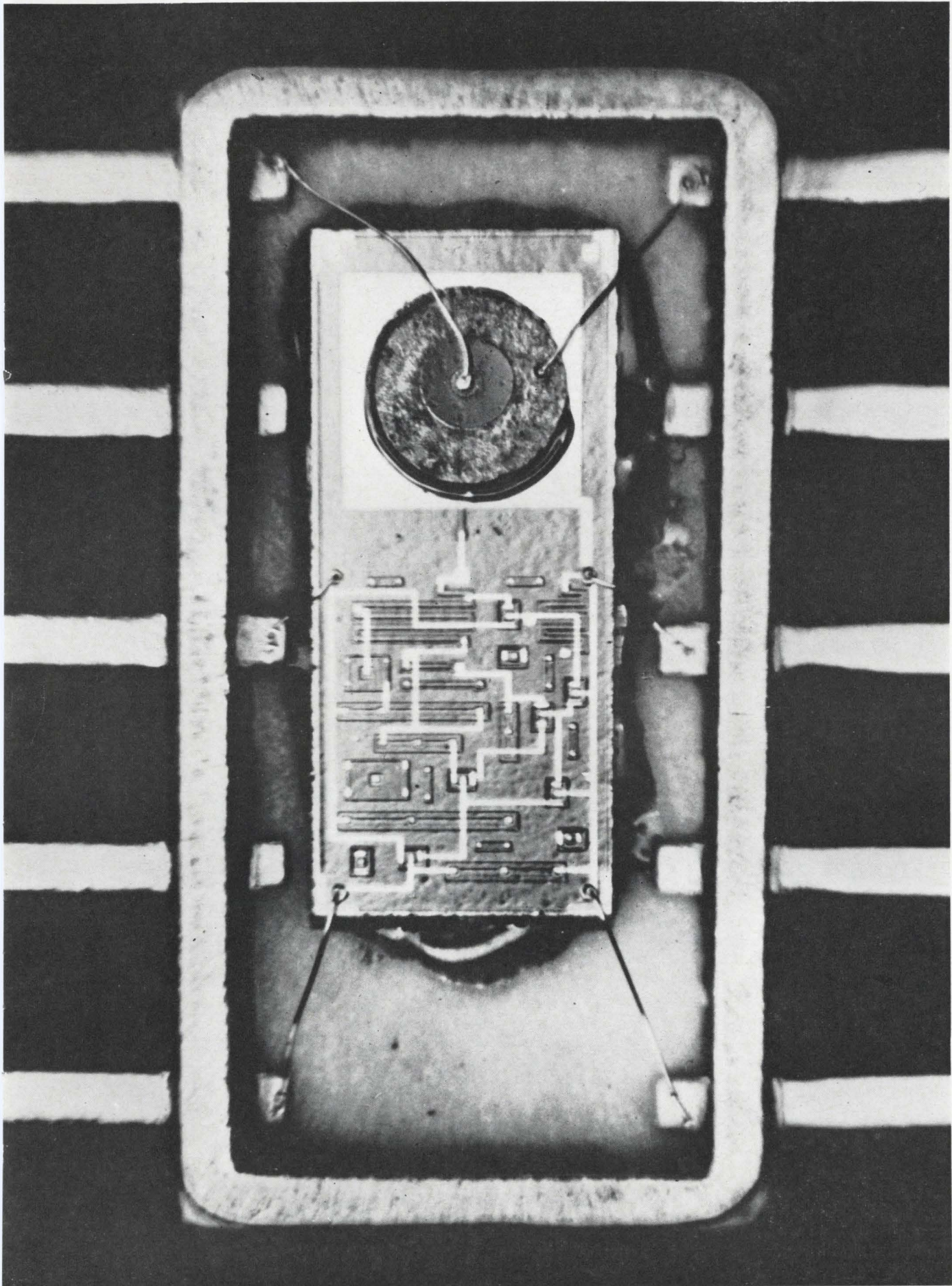



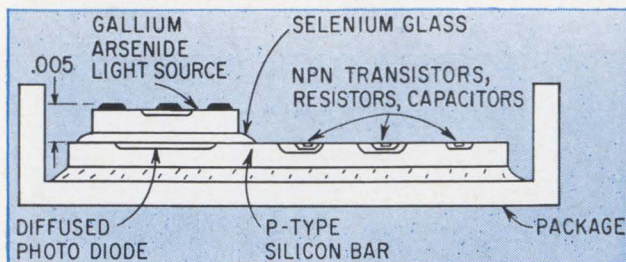

**Cross-sectional diagram** of the integrated circuit shows how the GaAs light source is positioned above the photo-detector diode. The addition of the light source and the selenium glass layer add only 0.005 inch to the height of the structure.

light source (circular object at top of the integrated circuit in the photo on page 53) is mounted above the photodetector.

The photodetector is part of the original monolithic structure and is fabricated at the same time that the transistors and other circuit components are made. The light source is the only component added to the original structure. It is held in place by a thin layer of selenium infrared optical glass, which forms a strong mechanical bond, has a high index of refraction and is highly transparent in the near-infrared range. The diameter of the photodetector is 0.020 inch.

The light source and the glass layer add only 0.005 inch to the height of the structure, so that it can fit easily into the standard flatpack, which is about  $\frac{1}{32}$  inch high, including the lid.

For the optoelectronic pulse amplifier, the optimum glass bond of those investigated turned out to be a combination of selenium, germanium, and phosphorus having a refractive index of 2.9. This particular glass has a light coupling efficiency which is 23 times the efficiency obtained with air.

### High-frequency shielding

Appreciable capacitance between the light source and the top layer (the n-type diffused layer) of the photodetector could provide a path for propagating high-frequency common-mode noise. This capacitance is reduced by placing an optically transparent and electrically conductive p+ diffused layer over the n-type photodetector layer. As a further safeguard against stray h-f noise, a

grounded aluminum sheet is placed above the structure; a narrow strip of the aluminum sheet is extended into the sensitive center area above the photodetector and connected to the detector's n layer. The position of the aluminum sheet is illustrated at the top of the next page.

The effectiveness of the aluminum-sheet shielding was tested by applying 50-volt, 10-nanosecond noise pulses to the light source. The pulses were rejected which implies an equivalent coupling capacitance of less than 0.01 picofarad.

### Phototransistor ruled out

Since the output current of the photodetector is low (considerably less than one percent of the drive current level), an amplifier is needed. At first, it might appear feasible to combine the detector and amplifier functions in a single phototransistor. But the required current gain for an overall amplifier gain of unity is about 400 and the bandwidth of a phototransistor with this high a gain would be only a few hundred kilocycles per second.

This limitation is made clear by an analysis of the equivalent circuit for a phototransistor shown in the right-hand sketch below. Here, the phototransistor is represented by a photodiode D, capacitor  $C_D$ , and high-gain transistor Q. The value of capacitance represented by  $C_D$  is considerable because of the large photosensitive area needed to collect the light emitted from the source. Nearly the entire output voltage supplied to load resistor  $R_L$  appears across  $C_D$ , and as a result,  $C_D$  is highly charged.

The slow discharge of  $C_D$  is controlled by the relatively feeble current  $I_D$ .

### High speed, wide band

The arrangement shown on page 55 (upper circuit) accomplishes the same job, but at high speed. With this arrangement, the voltage across the photodetector junction is small, limiting the amount of charge received by the capacitor. The value of load resistor  $R_L$  is also kept small thus reducing the time constant, which is approximately equal to  $R_L C_D$ . Thus, unlike the single phototransistor, this arrangement can be operated as a wideband amplifier. The circuit can be modified, as shown

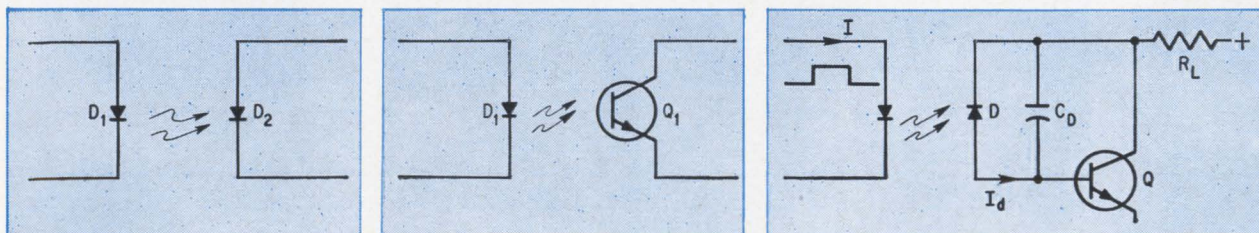

A light source ( $D_1$ ) optically coupled to a silicon photodetector ( $D_2$ ) is shown in the diagram at left; the detector photocurrent is very small compared to the current flowing in the source circuit. In center diagram, a phototransistor ( $Q_1$ ) provides an output current equal to the original current in the source circuit; but its equivalent circuit (right) has a large time constant, approximately  $R_L C_D$  times the transistor beta. This restricts the bandwidth capability.



in the middle circuit on page 55, by providing some negative feedback to improve the stability of operation for the amplifier.

The negative feedback arrangement reduces the input impedance to approximately the resistance of feedback resistor  $R_F$  divided by the voltage gain  $A$ .

### Integrated OPA

An integrated operational OPA amplifier is shown at the bottom of this page. In fabricating this circuit, the photodiode can be made by a single diffusion into the p-type substrate. Thus, one end of the photodiode is grounded on the substrate itself. This is an important advantage, since radiation at a wavelength of 0.9 micron travels easily through silicon material and it would be difficult to construct a diode arrangement in which both terminals were well insulated from the substrate.

In this circuit,  $Q_1$  and  $Q_2$  constitute an operational amplifier transistor pair;  $R_1$  is the feedback resistor. Transistors  $Q_4$  and  $Q_5$  provide additional amplification for high-level digital output. Under quiescent conditions, the photodiode current is zero,  $Q_4$  is off, and the output terminal voltage is nearly that of the power supply. When the drive current causes the light source to emit, about eight microamperes flow in the photodiode. The potential at the base of  $Q_4$  rises about 160 millivolts, and the voltage at the output terminal drops to about zero. The base potential of  $Q_1$ , however, shifts by only 3 millivolts and thus very little charge is stored by  $C_D$ .

The sum of the emitter-to-base voltages for  $Q_1$  and  $Q_2$  about equals the equivalent sum for  $Q_3$  and  $Q_4$ . Thus, neglecting the very small voltage drops across  $R_1$  and  $R_5$  at quiescent conditions,  $Q_2$  and  $Q_3$  have equal emitter-to-base voltage drops. (They carry the same current of about 1 milliamperes.) As a result,  $Q_1$  and  $Q_4$  carry equal currents, which are much smaller than 1 milliamperes. Actually, a small potential drop occurring across  $R_1$  due to the quiescent base current of  $Q_1$ , might appear to upset this relationship, but its effect is compensated for by an equal drop due to the much larger current flowing through  $R_5$ .

This circuit is insensitive to ambient temperature variations, since  $Q_1$  and  $Q_4$  are identical transistors and are in close proximity. The circuit has demonstrated good stability from  $-70^\circ\text{C}$  to  $+125^\circ\text{C}$ . It is also insensitive to minor variations in power supply potential. While designed for nominal 6-volt operation, the circuit works with supply voltages ranging from 1.5 to 15 volts. Of course, the magnitude of the output voltage pulse and the response times are affected by the supply voltage level.

### Feedback problem

There are, however, two drawbacks in this version of the amplifier. One is the effect of the feedback loop on high-frequency stability. Feedback resistor  $R_1$  is quite long, resulting in substantial distributed capacitance between it and the substrate. This produces phase shift around the loop

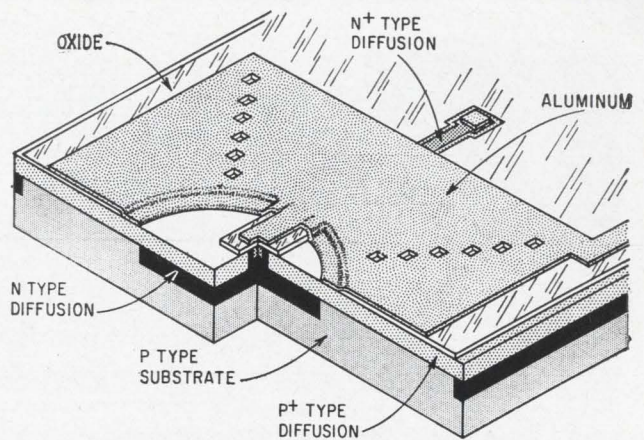

An extra p-layer is diffused into the structure so that it covers the photodetector. The n-type layer is surrounded on top, bottom, and sides by grounded p-layers. Electrical contact to the n-layer is made through a narrow n-stripe that runs below the grounded aluminum plate and the oxide isolation layer.

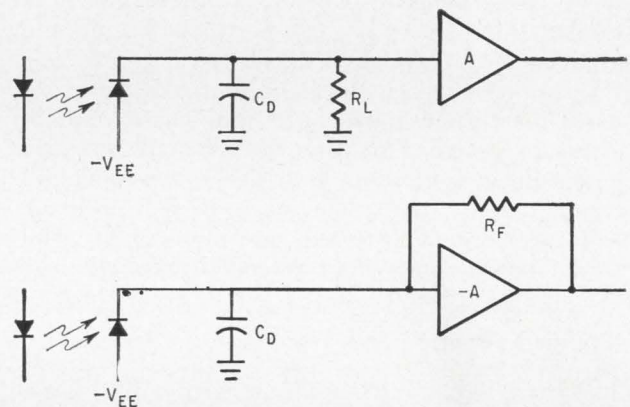

The top circuit provides the desired wideband amplification. The value of resistor  $R_L$  is kept small so that the time constant is short. Improved stability is obtained with the bottom circuit, which employs negative feedback.

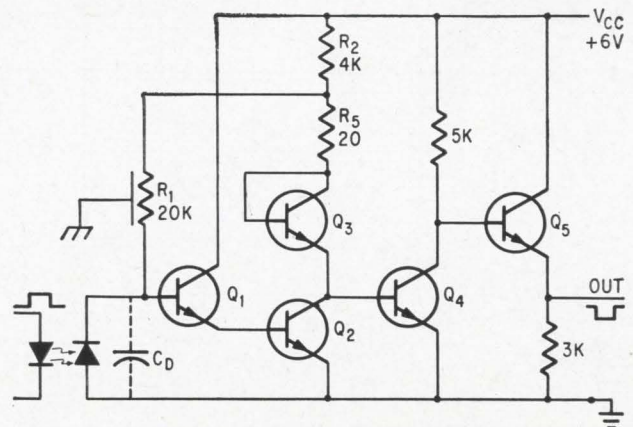

OPA circuit with the feedback resistor  $R_1$  providing a low load resistance for the photodiode. Drawbacks of this circuit are high-frequency instability caused by the long length of the feedback resistor  $R_1$  and slow recovery from overdriving of the GaAs diode.



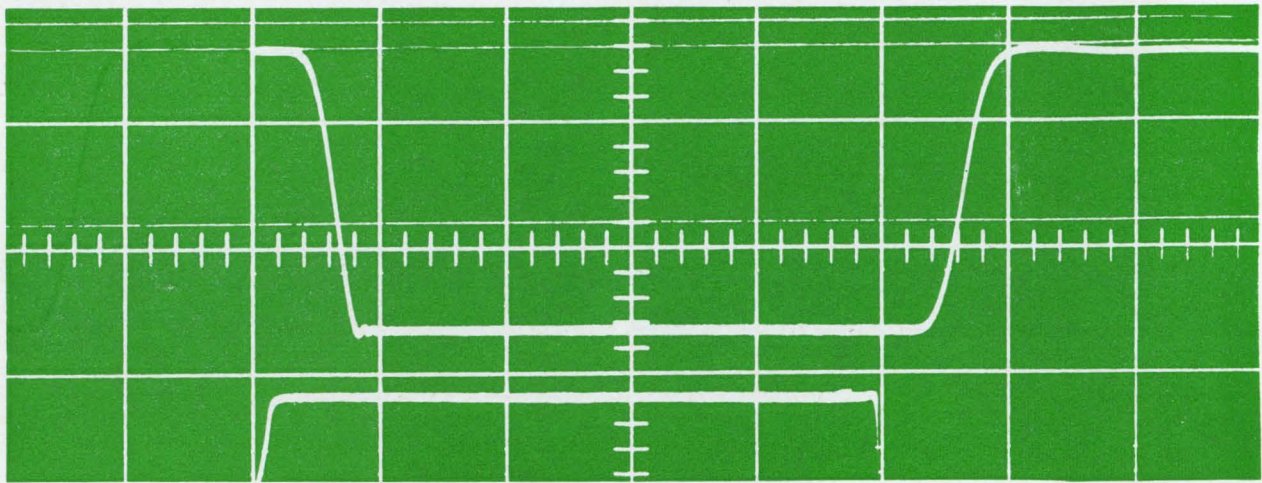

**Top waveform** illustrates 4.5-volt output pulse created by supplying 4-milliampere input current pulse (bottom waveform) to the GaAs diode. Each X-axis division represents 0.5 microseconds.

well in excess of that which would occur with an ideal two-terminal resistor; the shift can contribute to instability and may cause oscillation. Ringing in the pulse response is likely.

In addition, when the light source is driven too hard, the turnoff time of the amplifier circuit becomes excessive. Transistor  $Q_4$  is heavily saturated under these conditions and the  $Q_1$  base potential changes much more than the desired 3 millivolts. It is necessary to prevent saturation of  $Q_4$  while simultaneously allowing the feedback voltage to  $R_1$  to continue to increase.

### Modified circuit

Both problems are eliminated in the circuit shown below. Instability caused by the excess phase shift introduced by  $R_1$  is eliminated by connecting a 15-picofarad capacitor from a tap on  $R_1$  to a tap on  $R_2$ . At high frequencies, the feedback resistance is reduced. A proportionately smaller fraction of the total  $Q_2$  collector voltage swing is

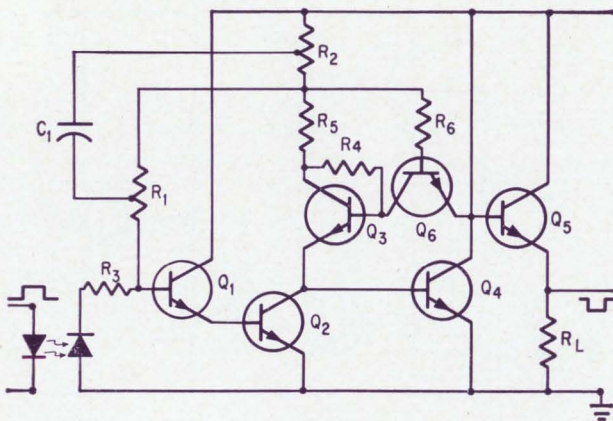

**Modified version** of the OPA circuit eliminates both drawbacks of the simplified version (bottom circuit, page 55). Tap arrangement for  $R_1$  and  $R_2$  and addition of  $C_2$  reduces high-frequency feedback resistance. Addition of  $Q_6$ ,  $R_1$  and  $R_6$  prevents  $Q_4$  from being saturated when the GaAs light source is overdriven.

fed back, and keeps the frequency response flat. With  $R_1$  tapped at 5,000 ohms from the base end, the frequency for any given amount of excess phase is increased by a factor of 16, and the effect of the excess phase becomes insignificant.

The saturation of  $Q_4$  is prevented by the adding of  $Q_6$ ,  $R_4$  and  $R_6$  to the circuit. If the input is overdriven, the collector potential of  $Q_4$  falls,  $Q_6$  conducts, and  $Q_3$  acts as an emitter-follower to stop the rise of the  $Q_2$  collector potential, thus preventing saturation of  $Q_4$ . At the same time  $Q_3$  functions as a common-emitter amplifier, and its collector potential rises, to continue the negative feedback through  $R_1$ . Thus, with normal drive the operational amplifier operation employs  $Q_1$  and  $Q_2$ , with  $Q_3$  operating as a diode. With overdrive, the operational amplifier stages of  $Q_3$ ,  $Q_4$ , and  $Q_6$  function automatically.

Typical waveforms for the OPA circuit are shown on this page. The lower waveform represents the input current pulse supplied to the gallium arsenide diode. The top pulse is the resultant output pulse between the emitter of  $Q_5$  and ground.

### Typical operation

Typical operating conditions for optoelectronic pulse amplifier circuits are: light source current = 5 milliamperes, photodetector current = 8 microamperes, with a 6-volt power supply. With a 5-milliampere input current, the source diode voltage is about 1.2 volts. Typical output voltages range from 0.3 to 5.3 volts with speeds in the order of 300 nanoseconds. Ten fanout stages provided by Texas Instruments series 51 integrated circuits can be handled. Although the photodetector current is only about eight microamperes, this current value is more than sufficient to drive the integrated circuit's pulse-amplifier transistor.

### Acknowledgment

The optoelectronic integrated circuit described into this article was developed under the sponsorship of the Electronics Technology Division, Air Force Avionics Laboratory, Wright-Patterson Air Force Base.



# Negative resistance in FET's: an aid or an ailment

When unexpected, it can make field effect circuits misbehave.  
With proper design, it can be used in a memory that's  
thermally bistable and therefore immune to spurious triggering

By Carl David Todd

Consultant, Costa Mesa, Calif.

**Variations in internal temperature** can produce negative resistance in a silicon field effect transistor (FET) with high pinchoff voltage. This condition can cause trouble in circuits, because its presence is not always evident when conventional measurement techniques are used. On the other hand, the effect can be exploited in a new type of memory that is thermally bistable and therefore immune to triggering by noise or transient currents and that will retain stored data despite loss of primary power.

The magnitude of negative resistance depends largely on three factors: amount of drain current, how much it changes with temperature, and thermal resistance between internal drain and ambient.

For the FET to exhibit a voltage-stable negative resistance, its drain current must have a negative temperature coefficient, and that coefficient must be large enough so that drain-current changes with temperature are significant; also, the thermal resistance between drain junction and ambient must be high.

For a particular pinchoff voltage, the temperature coefficient of the FET's drain current is the

result of two opposing effects, and may be either positive or negative. One effect occurs when the drain voltage is constant; the drain current tends to decrease as temperature increases because the resistivity of the silicon material in the channel has a positive temperature coefficient. The opposing effect is an increase in drain current, caused by variation in the width of the thermally generated depletion layer in the p-n junction between the gate and channel. This variation is caused by a change in the pinchoff voltage, which is a result of thermal changes in the gate-to-channel contact potential. The variations in gate-channel junction width tend to increase the drain current as temperature increases.

Negative resistance becomes evident only when the drain current in an FET is measured with slow, discrete changes in drain-to-source voltage and the data is plotted on a graph.

## Predicting negative resistance

The following mathematical analysis shows how to predict the magnitude of the drain resistance and whether it is positive or negative.

First, calculate the change in power dissipation that results when the value of the applied drain voltage changes. The drain-to-source voltage change is designated as  $\Delta V$  and the associated change in drain current as  $\Delta I$ . Therefore, the change in power dissipation is

$$\begin{aligned}\Delta P &= (V_D + \Delta V)(I_D + \Delta I) - V_D I_D \\ \Delta P &= I_D \Delta V + V_D \Delta I + \Delta I \Delta V\end{aligned}$$

The change in internal FET temperature  $\Delta T$  that results is equal to the product of  $\Delta P$  and the junction-to-ambient thermal resistivity  $\theta$ , usually

## The author



Carl David Todd has been a consultant in electronics since leaving the Hughes Aircraft Co. at Newport Beach, Calif., about a year ago. He is the author of more than 100 technical articles, most of them dealing with instrumentation and solid state circuit design; he also holds several patents.



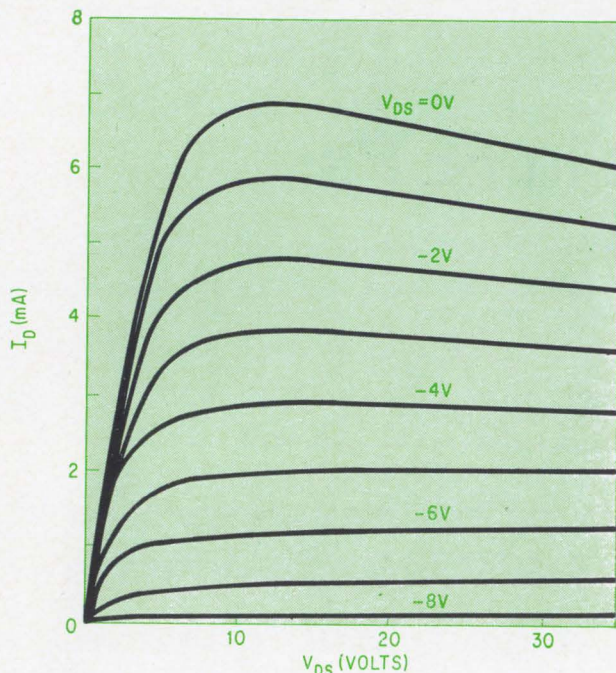

Characteristic curves for a 2N3368 FET measured with an X-Y recorder at slow sweep to show negative resistance.

given in degrees centigrade per watt.

$$\Delta T = \theta \Delta P$$

If the small-signal dynamic resistance  $r_{ds}$  associated with the FET output is neglected, the change in operating current will be due entirely to the change in internal temperature, so that

$$\Delta I = \alpha I_D \Delta T$$

where  $\alpha$  is the fractional thermal coefficient of the drain current as given by

$$\alpha = \frac{\partial I_D / \partial T}{I_D}$$

Combining these equations and solving for the incremental FET output resistance at thermal equilibrium:

$$r_{ds}^* = \frac{\Delta V}{\Delta I} = \left( \frac{1}{\alpha \theta I_D^2} \right) - \left( \frac{V_D + \Delta V}{I_D} \right)$$

In this equation, if  $\alpha$  is negative, then the value of  $r_{ds}^*$  must also be negative. In addition, the magnitude of  $r_{ds}^*$  becomes smaller, indicating that the slope of the output characteristic becomes more negative whenever the magnitude of either  $\alpha$ ,  $\theta$  or  $I_D$  increases.

The value of  $\alpha$ , which is a function of the gate-to-channel contact potential and the resistivity of the channel, can be calculated for a particular FET from the following relationship:

$$\alpha = 0.0023 \frac{g_{fs}}{I_D} - \frac{n}{T}$$

The first term in this equation results from the variation in the gate-to-channel contact potential, which has a negative temperature coefficient of

about 2.3 millivolts per degree centigrade and results in a positive temperature coefficient for  $I_D$  when the gate voltage is held constant. The transconductance of the FET is represented by  $g_{fs}$  where  $g_{fs} = \Delta I_D / \Delta V_{GS}$ .

The term  $\frac{n}{T}$  is a measure of how much the resistivity of the material in the channel changes with temperature and therefore affects drain current. The value of  $n$  is between 1.5 and 2.5 for n-channel silicon FET's and between about 2.3 and 2.7 for p-channel types.  $T$  is the absolute temperature in degrees Kelvin. A typical n-channel FET operated at an ambient temperature of 300°K would have an  $n/T$  value of about 0.006.

Note, that a FET with a low  $g_{fs}/I_D$  ratio, which indicates that the pinchoff voltage is relatively high, will have a net negative temperature coefficient of resistance whose magnitude is due primarily to the variation in channel resistivity and will be roughly constant for a given class of FET's.

When the expression for  $r_{ds}^*$  was derived, the small-signal instantaneous value of drain resistance  $r_{ds}$  was neglected. The total drain resistance at thermal equilibrium, therefore, is the equivalent parallel resistance of the two:

$$r_{ds (net)} = \frac{r_{ds} r_{ds}^*}{r_{ds} + r_{ds}^*}$$

In some cases the negative resistance  $r_{ds}^*$  will not be great enough to overcome the positive contribution of  $r_{ds}$ ; hence  $r_{ds (net)}$  will be positive and will have a much larger value than an instantaneous small-signal measurement might indicate. This possibility must be considered when performing a graphical analysis or designing biasing methods for negative resistance FET effects.

#### Slow measurement

The data plotted for  $V_{DS}$ - $I_D$  curves above, left, was obtained by sweeping the drain voltage very slowly to allow the internal FET temperature to

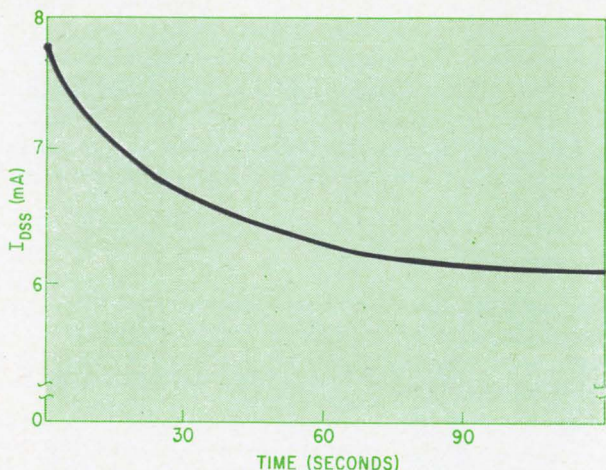

Thermal time constant for 2N3368 field effect transistor measured with  $V_{DS} = 40$  volts.  $I_{DSS}$  is drain current measured with gate shorted to source.



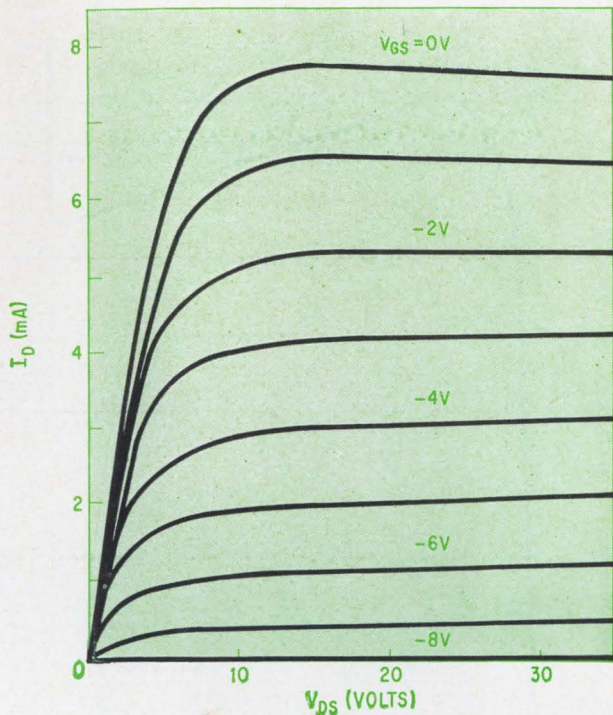

Characteristic curves for a 2N3368 FET, measured with an X-Y recorder at fast sweep, showing considerably less evidence of the negative resistance region. These measurements were taken with same heat sink and at same ambient as the measurements in graph on page 58.

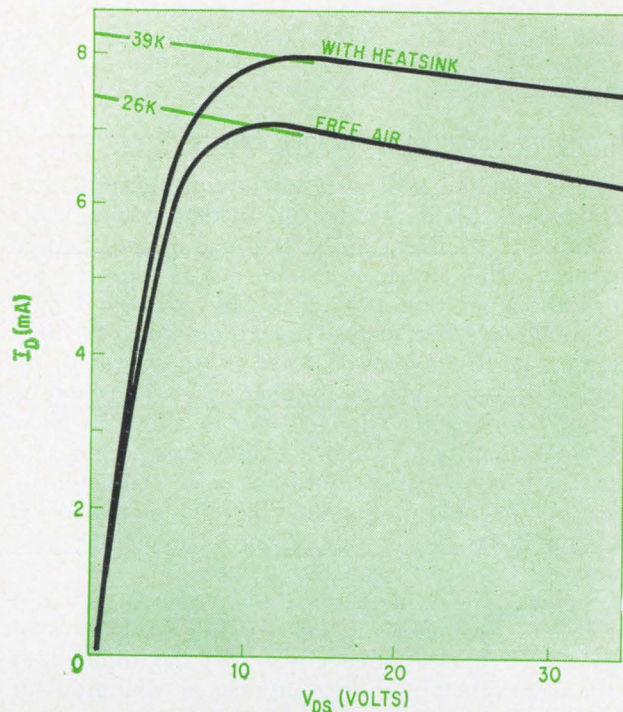

Slow-sweep drain characteristic curves show that the effect of mounting the FET on a heat sink tends to decrease its thermal resistivity and therefore reduces the negative resistance slope. Both curves were measured for a 2N3368 FET with  $V_{GS} = 0$  volts.

follow the variation in power dissipation. Thus, every point on the characteristic curve was measured at thermal equilibrium.

A typical range for an FET thermal time constant is between 20 and 30 seconds as shown in the graph at the bottom of page 58. This means that a characteristic curve obtained from an X-Y recorder will represent an appreciable variation in the FET's internal operating temperature if the  $V_{DS}$  voltage is not swept slowly enough. When data is taken for a negative FET characteristic, each data point must reach its stabilized operating temperature before the measurement is made.

The  $V_{DS}$ - $I_D$  characteristics shown directly above were measured for the same FET as in the preceding characteristic curves, but with a faster sweep rate. Note the decrease in negative slope.

The output characteristic for several FET's, both p-channel and n-channel types, were plotted at a very slow sweep rate, and the negative resistance observed was 10% to 20% of the predicted value.

The negative resistance effect for any FET may be enhanced or diminished by controlling its thermal resistance. In some applications, the negative resistance effect may be undesirable. It can be eliminated by mounting the FET on a heat sink to decrease its thermal resistance,  $\theta$ . The difference between the slopes in the graph above, right, illustrates the effectiveness of the heat sink in reducing the negative resistance.

On the other hand, if the negative resistance characteristic is desirable, then  $\theta$  must be as large

as possible; this is accomplished by reducing the leakage of heat away from the FET, using thermal insulation and lead wires with low thermal conductivity, being careful not to exceed the FET's rated maximum junction temperature.

In the expression for  $r_{ds}^*$ , note that the negative resistance appears to be an inverse function of the square of the operating current. Thus the negative resistance effect may be diminished by reducing  $I_D$ , although at a sacrifice of gain. To increase the negative resistance, a small gate voltage is applied in the forward direction, increasing  $I_D$  slightly.

### The intrusion of negative resistance

It is important to consider thermal heating effects when using the FET in a circuit where the duration of a signal applied to the FET may cause a substantial change in internal temperature. A load line, selected to give maximum voltage gain by making  $R_L$  very high, may result in an undesirable bistable condition if the FET has a negative resistance.

When a graphical analysis is used, the characteristic curves used in the analysis should be obtained at the same sweep rate as the FET will experience in the actual circuit application.

Negative resistance can make it difficult to correlate measurements of  $I_{DSS}$  (value of drain current that flows when the gate is shorted to the source) and  $g_{fs}$  for FET's having relatively large values of pinchoff voltage and operating at high current levels. To avoid this difficulty, a sufficient



time should elapse before any readings are taken, so that these values are measured at thermal equilibrium.

### Applying negative resistance effects

The negative resistance effect can be applied to design a bistable memory circuit that is practically immune to transient noise. Because of the thermal nature of this effect, a certain time is required before the operating point can shift on the FET's characteristic curve; the time required is a function of the thermal mass. Thus, to trigger the memory from one state to another, a pulse must be applied for a long enough time to allow the new thermal condition to be reached. Noise signals or any pulses of short duration will momentarily change the operating point, but the memory will remain in the same state. Even a momentary loss of power will not reset the memory.

Since changes in external temperature will also shift the characteristic curves, full utilization of the negative resistance effect may be difficult to attain if substantial fluctuations in the ambient temperature are expected.

### Practical memory circuits

To establish a bistable operating condition, it is only necessary to select an operating load line that intersects the FET's output characteristic curve measured at thermal equilibrium, as indicated in the chart at the right, with the two stable operating points at A and C.

One circuit that exhibits the condition given in the chart is shown in the top diagram on page 61. A load line of relatively constant current is provided for the FET by transistor  $Q_2$ . Several possible trigger inputs are indicated on the diagram.

### Triggering from A to C

Assume that the circuit's operating point is at A. If it is desired to move it to C, the internal junction temperature,  $T_J$ , must exceed  $T_B$ , the junction temperature corresponding to point B where the load line intersects the negative resistance region of the characteristic. This intersection may be accomplished in several different ways.

One way is to apply a carefully controlled gate voltage to reduce the level of the drain current just below normal load-line conditions. This causes the drain voltage to rise to a maximum value, which is limited either by the breakdown voltage of the FET or by the maximum voltage available from the current source. If this condition is allowed to exist long enough, the power dissipation in the FET junction will be greater than the power dissipation,  $V_B I_B$ , at point B, and the internal temperature will rise above  $T_B$ . The time required for the FET to change state depends upon the amount by which the junction power dissipation exceeds the value  $V_B I_B$ . This method of changing states is provided by trigger 1 in the circuit diagram. If the input voltage is known and constant, then the voltage-regulating diode  $D_1$  is unnecessary.

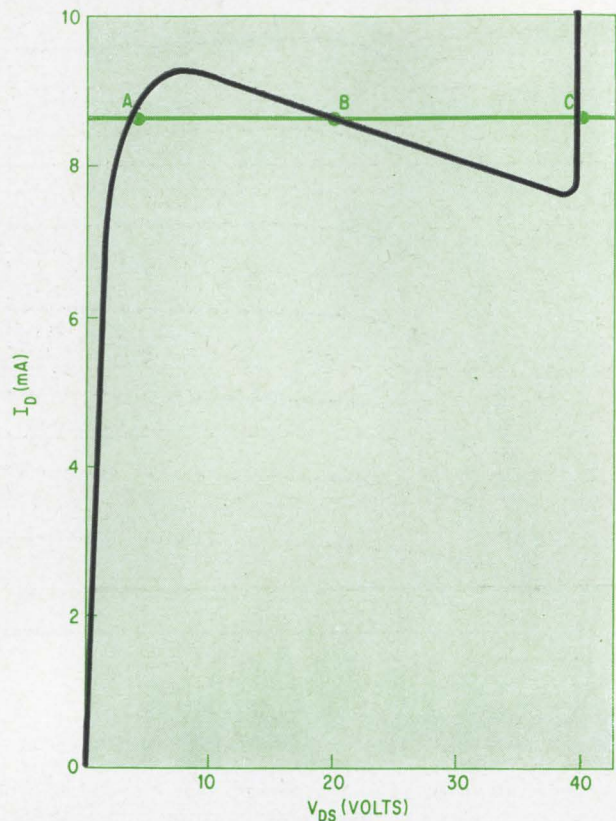

**Load line through the negative resistance region** illustrates the bistable nature of slow-swept FET output characteristic. Load line is provided by a constant current generator. To cause the FET to change from state A to C, the internal FET temperature must be increased above its temperature at point B. In changing from state C to A, the internal temperature must be decreased to below that at point B. Curve was measured for a Dickson 2N3436 FET with  $V_{GS} = 0$  volts.

Another way to increase the internal temperature is to apply a drain voltage from an external source momentarily as at trigger 2 in the circuit diagram. This trigger increases the power dissipation and the internal temperature rises above  $T_B$  if the trigger is applied for a sufficient time.

A third method is to increase the level of the load current; this forces the operating point to go to a higher voltage level. In the circuit diagram, trigger 3 increases the load current.

With any of the methods described, when the temperature has been increased to a value above  $T_B$ , the operating point will move toward point C, even when the trigger is removed. If the temperature rise is insufficient, the operating point will return to A. In either case, a certain time will be required before steady-state conditions can again be achieved.

### Triggering from C back to A

Assume that it is necessary to trigger the memory from a stable operating condition at C back to the low-voltage operating point A. This may be done by reducing the internal junction temperature to a value below  $T_B$ . The temperature is de-



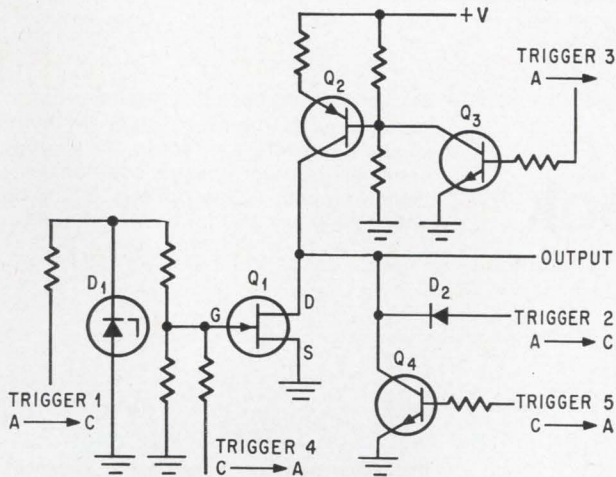

**Bistable circuit using negative FET output resistance.** Constant drain current is provided by  $Q_2$ . Several possible methods are shown for triggering the circuit from either state.

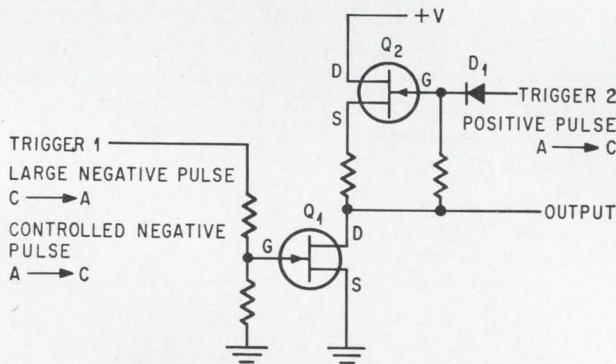

**Bistable circuit** whose temperature stability is improved by an FET constant-current generator  $Q_2$  that provides load line for the negative resistance FET  $Q_1$ .

creased by reducing the power dissipation.

The simplest way to reduce power dissipation is to apply a substantial negative bias voltage to the gate of the FET, indicated in the circuit diagram by trigger 4. This reduces the drain current.

The closer the FET is driven toward cutoff, the shorter this trigger period may be.

Another method, provided by trigger 5, introduces a shunt path for the drain current, reducing the total drain current in the FET. With either method, reducing the temperature below  $T_B$  will cause the operating point to stabilize at point A upon removal of the trigger.

Transient signals, unless they are severe, cannot change the operating state of the memory, although they may cause a temporary change in the output-signal voltage. Even if the power-supply voltage is removed, the state of the memory will not change when it is at A. When the state of the memory is initially at point C, however, it will change to A if power is removed.

The FET's characteristic curve is sensitive to changes in external temperature and to internal temperature changes caused by variation in the power dissipation. An ambient temperature that

varies significantly presents a problem in using the basic bistable circuit shown.

### Experimental results

A bistable memory was constructed with the Dickson 2N3436 FET. A gate voltage of approximately  $-1$  volt, applied for a minimum of about 30 seconds, caused the FET to switch from point A to C. On the other hand, a gate voltage—either much lower or much greater than  $-1$  volt—did not cause the operating point to change from point A.

The operating point was also switched from A to C by applying a trigger voltage of  $+20$  volts or more through diode  $D_2$ . At  $+20$  volts, the time required to insure triggering was approximately 160 seconds. With a  $+30$ -v trigger, the required time was reduced to about 20 seconds.

To switch states from C to A, a  $-10$ -volt gate voltage (trigger 4) or a positive voltage at  $Q_4$ 's base (trigger 5), applied for a minimum of 23 seconds, was required. The circuit power was removed for up to 22 seconds without loss of memory.

### Stabilizing the temperature

The temperature stability of the triggered memory circuit can be improved substantially by causing the bias current that established the load line to vary in the same manner as the FET drain current. This can be done by using a diode or thermistor to compensate for temperature changes in the current generator  $Q_2$  in the basic circuit. Another way is to use an FET as the current generator, as shown in the bottom diagram at the left.

The complete analysis of this circuit is more complex than for the basic circuit, since additional thermal delays and negative resistance are associated with the FET current generator. However, the basic operation and triggering mechanisms are similar.

### Pinchoff voltage and negative resistance

Field effect transistors that have low  $g_{fs}/I_D$  and hence a relatively high pinchoff voltage will exhibit the negative resistance effect if the operating current is above a few milliamperes. FET's that have a high  $g_{fs}/I_D$  ratio, and hence a low pinchoff voltage, will not exhibit the negative resistance because the polarity of  $a$  will be positive, although the slope of the output characteristic curve will be increased and hence the value of  $r_{ds}^*$  will be decreased. FET's with an intermediate value of pinchoff voltage will exhibit a positive output resistance whose magnitude may be much larger than the instantaneous small-signal value.

### Bibliography

- L. Evans, "Biasing FET's for Zero D-c Drift," *Electro-Technology*, Vol. 74, pp. 93-96, August, 1964.
- J. Hoerni and B. Weir, "Conditions for a Temperature Compensated Silicon Field Effect Transistor," *Proceedings of the IEEE (Correspondence)* Vol. 51, pp. 1058-1059, July, 1963.
- L. Sevin, "Effect of Temperature on FET Characteristic," *Electro-Technology*, Vol. 73, pp. 103-107, April, 1964.



# Designer's casebook

Designer's casebook is a regular feature in Electronics. Readers are invited to submit novel circuit ideas, packaging schemes, or other unusual solutions to design problems. Descriptions should be short. We'll pay \$50 for each item published.

## Duty cycle is constant at any trigger frequency

By George P. Klein

Andersen Laboratories, Inc., West Hartford, Conn.

By varying the width of the output pulse as its frequency varies, the pulse generator diagramed below maintains a constant duty cycle regardless of the frequency of the input pulse.

The heart of the circuit is a monostable multivibrator and a voltage-to-current converter, which together form a voltage-controlled monostable multivibrator. The input trigger produces a pulse whose width is determined by feedback current from the converter.

The input, a periodic voltage spike, triggers multivibrator 1, whose output triggers multivibrator 2. The period of multi 2 is constant, and its frequency is the same as the external trigger frequency. An integrator averages the pulses from

multi 2 and feeds the voltage-to-current converter; and the current, which is thus a direct function of the input frequency, is fed back to multi 1.

The period of multi 1 is inversely proportional to the control current; that is, when the trigger frequency increases, so do the integrator output and the control current, resulting in the reduction of the output pulse period of multi 1.

Monostable multi 1 is made up of transistors  $Q_1$ ,  $Q_3$  and  $Q_4$ . Transistor  $Q_1$  is normally off, while  $Q_3$  and  $Q_4$ —connected in a Darlington pair to provide long periods from a small timing capacitor—are normally on. This pair is held in saturation by the collector current of  $Q_2$ , the voltage-to-current converter. A negative-going trigger of 5 volts starts to turn off  $Q_3$ , which in turn drives  $Q_4$  toward cutoff. The collector voltage of  $Q_4$  goes more positive, forward-biasing  $Q_1$ . As  $Q_1$  conducts, its collector voltage drops toward ground potential, driving  $Q_3$  further toward cutoff through timing capacitor  $C_T$ , until  $Q_3$  is completely cut off and multi 1 is in its quasi-stable state.

The duration of the quasi-stable period depends on the collector current of  $Q_2$ , which in turn de-

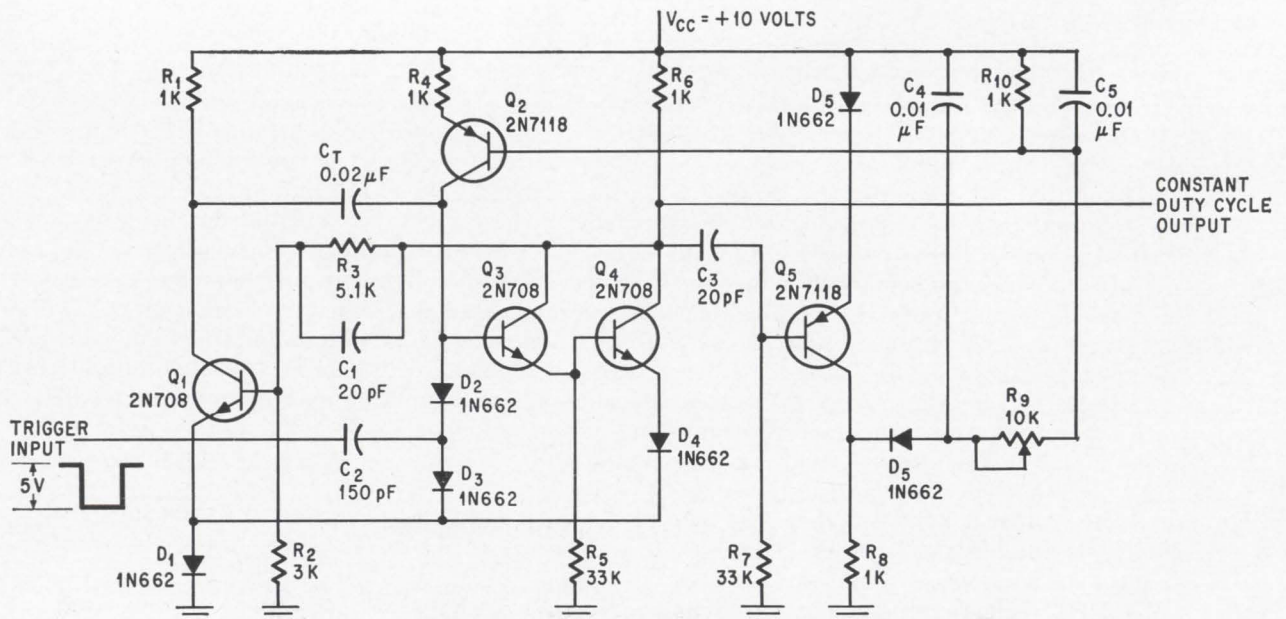

Circuit diagram of pulse generator.  $Q_1$ ,  $Q_3$  and  $Q_4$  form multivibrator 1. Multi 2 consists of  $Q_5$  only. The integrator consists of  $R_8$  and  $C_4$ , and  $Q_2$  is the voltage-to-current converter.



pends on the voltage applied to its base. The quasi-stable period is given by  $t = C_T V_C / I_{C2}$ , where  $C_T$  is the value of the timing capacitor,  $V_C$  is the voltage excursion at the collector of  $Q_1$  and  $I_{C2}$  is the collector current of  $Q_2$ . The period of multi 1 depends only on the value of  $I_{C2}$ , since the other values in the equation are fixed.

As the base voltage at  $Q_3$  becomes positive, it starts to turn on, and regeneration returns the multi to its stable state. Diode  $D_1$  establishes a reverse voltage on the bases of the off transistors.  $D_4$  protects the base-to-emitter of  $Q_3$  and  $Q_4$ .

Monostable multi 2 consists only of transistor  $Q_5$ , which is normally held in saturation by the voltage across  $R_7$  connected to its base. When multi 1 goes through its quasi-stable state, the voltage at the collector of  $Q_4$  goes positive and is coupled to the base of  $Q_5$  through  $C_3$ . This voltage turns off  $Q_5$ , which remains off until its base is forward-biased. Since the  $R_7 C_3$  time constant is very short, the voltage rise across  $R_7$  quickly drives  $Q_5$  into saturation again, and makes its period independent of multi 1's period. The off time of  $Q_5$  is given by

$$t = R_7 C_3 \ln \left( \frac{V_{C4} + V_{CC}}{V_{CC}} \right)$$

where  $V_{C4}$  is the voltage excursion at the collector

of  $Q_4$  and  $V_{CC}$  is the supply voltage. For the circuit components shown, the quasi-stable period of multi 2 is 450 nanoseconds.

Diode  $D_5$  protects the base-to-emitter junction of  $Q_5$  from exceeding its voltage rating.

While  $Q_5$  is off, diode  $D_6$  is forward-biased and  $C_4$  discharges through  $R_8$ . While  $Q_5$  conducts, diode  $D_6$  is reverse biased and  $C_4$  recharges through the 10-kilohm potentiometer. The voltage across  $C_4$  depends on the rate at which  $Q_5$  turns off, which is proportional to the input trigger frequency.

Resistor  $R_8$  and capacitor  $C_4$  form the integrator circuit. Capacitor  $C_5$  smoothes the ripple voltage. The 10K potentiometer can be varied to adjust total loop gain.

The current flowing in the emitter of  $Q_2$ , the voltage-to-current converter, depends only on the voltage drop across  $R_4$ , which is directly related to the input frequency.

The duty cycle can be adjusted initially by varying the loop gain, which depends somewhat on the efficiency of the integrator.

When the input trigger is varied from 100 to 5,000 pulses per second, the duty cycle remains essentially constant. Duty cycle can be adjusted continuously from 25% and 75%. The circuit was designed to drive a counter that responds only to pulses with a duty cycle greater than 40%.

## Scr monitors power failure

By R. Kent Honeycutt

Warner and Swasey Observatory, Case Institute of Technology, East Cleveland, Ohio

**Where recording** of an unobserved power failure is important—so as, for instance, not to attribute circuit failure to a component—the circuit below can be used as a monitor. It contains a silicon controlled rectifier that will not fire when power returns, so that current is directed through a relaxation oscillator which activates a flashing light.

The scr, a low-power type, is normally held on

by 0.5 milliamperes current through  $R_4$ . After the power failure has been removed, the scr will not fire because it has no gate current. The line voltage across the open scr causes the relaxation oscillator, consisting of the neon lamp and  $C_3$ , to flash a warning signal.

Depressing the reset button  $S_1$  momentarily permits enough current to flow through the gate circuit to fire the scr and extinguish the neon lamp.

The interval of power failure that the device will ignore is determined by the time it takes for the current through the scr to decay to its minimum holding current. For the values shown, a power failure of less than one second will not be detected. This interval may be adjusted by varying  $C_1$ .

The circuit has low power consumption and stability in spite of line voltage fluctuation.

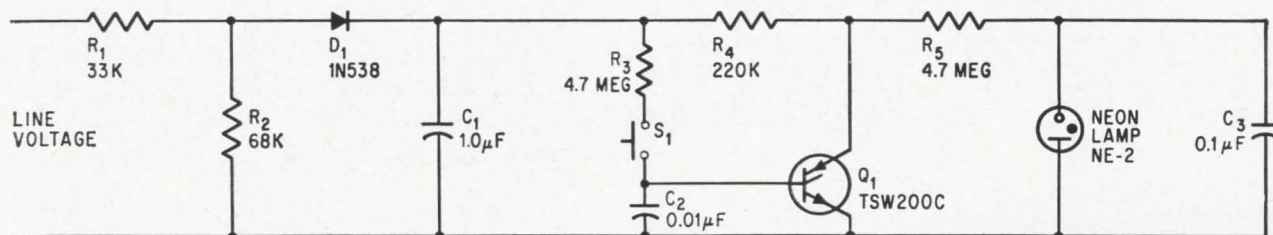

**Power failure monitor.** After a failure has been detected by flashing neon lamp, depressing  $S_1$  resets circuit.



## Clamp and spark gap protect twt modulator

By Walter Milberger and Melvin Gray

Westinghouse Electric Corp., Baltimore

If a modulator on a floating deck pulses the grid of a traveling wave tube, the modulator circuit must be protected from damage due to the excessive energy that is reflected when a high voltage breakdown occurs between the elements of the tube. In a radar system using a traveling wave tube with an intercepting type grid, the twt grid and cathode are usually at the same large negative potential with respect to ground. Actually, the grid is biased at a slightly more negative potential than the cathode to assure that the tube will not conduct during interpulse time. The twt turns on when very low level positive pulses are applied to the grid. Since these pulses are small, they are formed by low voltage components in a modulator that is electrically connected to the cathode and insulated, or floating, above ground potential.

When there is excessive gassing in the twt, a high voltage breakdown will often occur, usually between the grid and the body, or anode, of the twt, which is at ground potential. The arc represents an extremely low resistance path, and instantaneously connects one side of the modulator to ground, while the other side is still at the cathode potential—a voltage many times larger than the voltage ratings of the components in the modulator.

There are two basic ways to keep this voltage from appearing across the modulator.

One solution is shown in the circuit below. Here,

the pulse modulator assembly is at ground potential and the grid pulse is coupled to the grid through a pulse transformer whose secondary is at the cathode potential. The secondary is bifilar-wound and connected so that any high voltage transient in the load will induce equal and opposite magnetic fields that cancel, preventing the transient from entering the primary winding. If the bifilar winding is perfectly balanced, the spark gap shown in the circuit diagram is unnecessary.  $R_1$  is a high-power resistor of low value that limits the peak current through the spark gap, while  $R_2$  isolates the spark gap from the transformer.

The purpose of the clamp is to flatten the top of the modulator pulse, to approximate the ideal rectangular waveshape. (Phase sensitivity is a function of grid pulse waveshape and is an important consideration in phase coherent radar.) The clamp also acts as a short circuit to voltage transients in the bifilar winding. But because the clamp diodes, which can be either conventional or zener diodes, have an extremely fast breakdown characteristic, they are particularly susceptible to damage by the transient energy that may be reflected when a high-voltage breakdown occurs. Therefore, the spark gap must divert this energy from the clamp by breaking down immediately after an arc.

Another method of protecting the grid modulator components is shown on the next page. With this approach, a bifilar wound pulse transformer is unnecessary because the modulator is on the high-voltage floating deck. The protective circuit is a simple spark gap that breaks down at a voltage slightly higher than the peak grid pulse voltage.

A more subtle cause of modulator failure is also prevented by the same spark gap. If the grid arcs over to the body, and the cathode arcs over to the grid, because cathode and grid are so close, it would appear that cathode and grid are shorted to

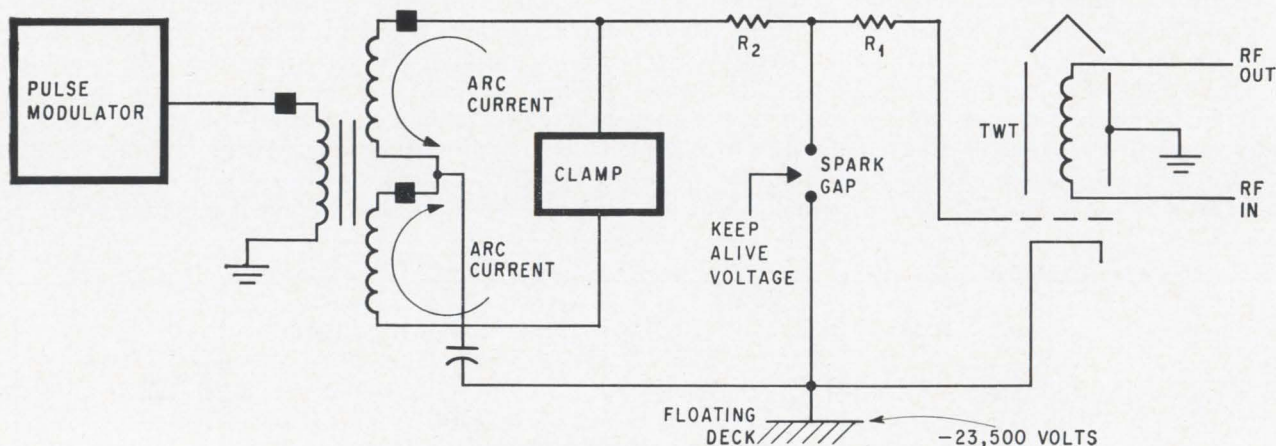

**Modulator is at ground potential.** Voltage pulses are coupled to grid through pulse transformer that also maintains d-c voltage difference between modulator and cathode. Because pulse transformer secondary is bifilar wound, high voltage transients cannot be coupled back to the modulator.



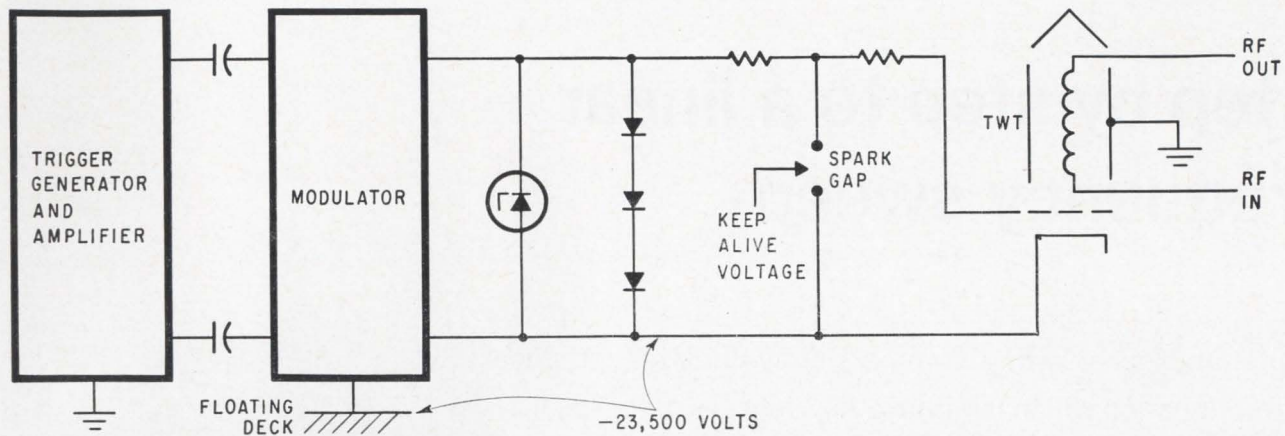

Modulator of floating deck at cathode potential is protected by spark gap. When gap breaks down, entire modulator circuit is at same potential. A crowbar across cathode power supply (not shown) protects twt by diverting arc current.

each other through the arc and rising on the same transient towards ground potential. But this is not necessarily true. Between different parts of the modulator circuit, there are stray capacitances and inductances which, though small, become significant when the voltage impressed across them changes at a rate of 100,000 volts per microsecond. Because of these stray inductances and capacitances, every point within the modulator does not rise to ground potential at the same rate. During the transient, a voltage difference of several thousand volts may exist across the modulator. But when the spark gap breaks down, the entire mod-

ulator circuit is at the same potential at any instant during the transient, and the circuit is protected.

The XG-1139 spark gap was especially designed by the Bendix Corp. to protect a floating deck modulator in a phased array radar system. The gap contains a fast ionizing gas and it requires a keep-alive voltage. The XG-1139 breaks down five times faster than other spark gaps.

In the circuit shown, only one zener diode, type 10M200Z, is required in parallel with the clamp and spark gap, to absorb the energy in the leading edge of the transient until the 1N697 clamp diodes conduct.

## FET increases Schmitt trigger input impedance

By Lauren R. Lott

Naval Ordnance Laboratory, Corona, Calif.

A conventional transistor Schmitt trigger presents a low input impedance, which may be a drawback in a threshold detector circuit. The Schmitt trigger shown at the right solves this problem because the input stage  $Q_1$  is a field-effect transistor.

Since the FET gate-source junction operates as a reverse-biased diode, a small positive bias establishes the threshold voltage below which  $Q_1$  is cut off. The bias voltage of about 2 volts is established with potentiometer  $R_2$ .

As in the two-transistor Schmitt trigger, when  $Q_1$  is cut off,  $Q_2$  conducts. In this circuit  $Q_2$  is biased on by common coupling through emitter

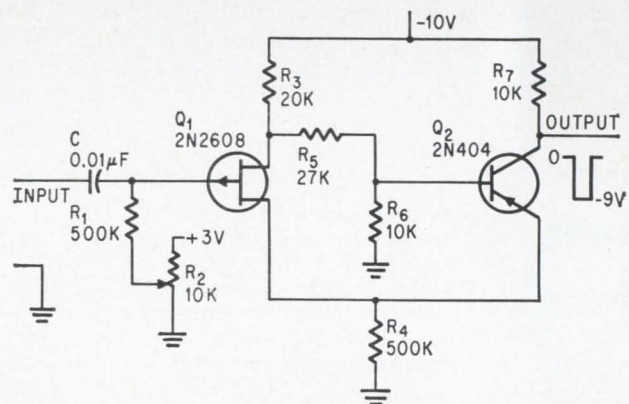

Schmitt trigger with an FET input stage is accurate threshold detector because the input impedance is extremely high.

resistor  $R_4$  and drain-to-base divider  $R_5$ - $R_6$ .

The turn-off threshold is about 0.2 volts below the turn-on threshold. A -9-volt output pulse appears at the collector of  $Q_2$ . This pulse is a nearly perfect square wave at triggering rates up to 100 kc.



# Step by step to a linear frequency sweep

Digital approach, with a commercial synthesizer, produces a ramp function which is within a few degrees of the ideal

By Robert B. Fenwick and George H. Barry

Radioscience Laboratory, Stanford University, Stanford, Calif.

**When researchers** at the Radioscience Laboratory of Stanford University began work on f-m radar for tracking meteors, they found that the standard ways of generating frequencies as functions of time produced "ramps" that were not linear enough to give them the range and doppler resolution required. What was wrong, they decided, was the analog method of generating such signals. Ramp-function driven reactance modulators or reflex klystrons make relatively crude frequency sweeps, accurate to only one part in one thousand or ten thousand.

By changing the frequency in small finite steps with a commercial frequency synthesizer, the Stanford researchers were able to generate a frequency

sweep that deviated no more than a few degrees from the ideal. It provided the necessary resolution for the f-m meteor radar application and appears usable in other applications where a signal whose frequency is a continuously varying function of time is needed.

The technique: one approximates a variable frequency signal by adding together a succession of small signal segments, each having constant frequency. The approximation can be made as accurate as necessary by making the time between frequency changes so short that the stepped constant-frequency waveform never departs significantly in phase from the ideal one.

To accomplish the frequency switching quickly and with phase coherence, it is desirable to synthesize each of the constant frequencies directly.

## The authors



As a research associate at Stanford University's Radioscience Laboratory, R. B. Fenwick has worked on around-the-world propagation of high-frequency radio waves and high-frequency backscatter.



Prior to returning to Stanford to complete his doctoral studies, G.H. Barry was engaged in the development of modulation techniques for data transmission at the Collins Radio Co. His studies extended his work into the fields of high-frequency radio and radar.

## Off the shelf

Stanford found the Hewlett-Packard Co.'s Model 5100A-5110A frequency synthesizer a suitable instrument on which to base its sweep frequency synthesizer. The H-P system is a stable source of any output frequency from d-c to 50 megacycles. The driver module supplies the synthesizer with 22 fixed-frequency, spectrally pure signals derived from an internal 1 Mc quartz oscillator. These signals are the basis for the digital synthesis of the output frequency.

The desired output frequency is generated, digit by digit, by a straightforward mathematical process in which one of ten frequencies is chosen, divided by ten and added to the next choice. The process is repeated until the selected frequency has been completely generated. The output frequency may be selected with push-buttons located on the front panel, or it may be programed via



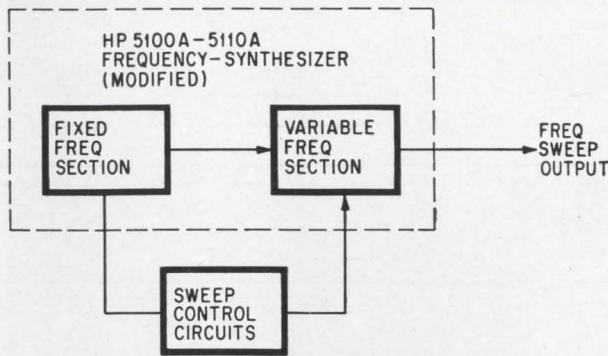

Equipment built around a commercial synthesizer generates linear time-frequency function. For phase coherence, all time dependent functions are related back to the fixed-frequency section of the digital synthesizer.

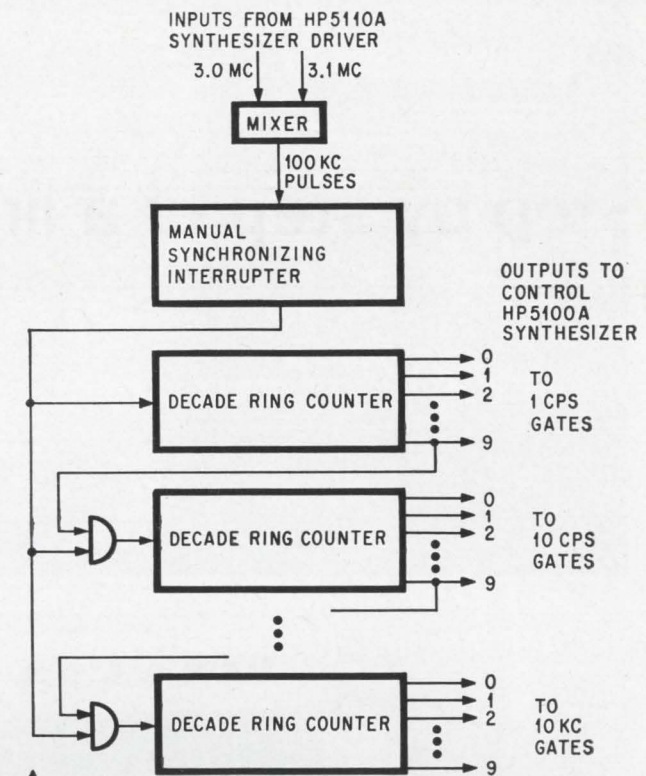
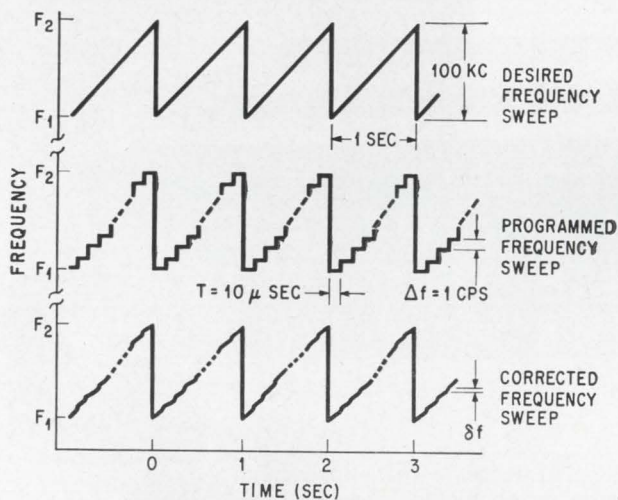

Five ring-counters program the synthesizer. They are driven by 100-kc pulses derived from the fixed frequency source within the synthesizer. The interrupter provides the required phase shift for the decades.

▲ Ideal frequency sweep, (top) is a smooth ramp. The digital approximation, (center) is composed by adding a series of constantly increasing discrete frequencies in increments of 1 cps. Further linearity could be accomplished by adding 1-cps ramps, as shown in the lower figure.

three 50-wire connectors on the rear of the instrument.

The block diagram above shows the basic design of Stanford's synthesis equipment, which gave the f-m radar a range resolution of 1.5 kilometers and doppler resolution of one cycle per second. Such resolutions required a frequency sweep of 100 kilocycles per second and were unattainable with conventional methods of sweep generation.

### Frequency vs. time

The top figure of the three waveforms above shows the desired sweep as a function of time. It is the waveform in the middle, which is obtained by switching in increments of 1 cps every 10 microseconds, that Stanford settled for, since it never departs from the ideal by more than a few degrees. An even better approximation, the lower figure, could be obtained by switching in ramps, rather than steps, of 1 cps, but such a correction would require additional equipment and is unnecessary for the f-m radar application.

The H-P synthesizer can be programed by ap-

plying a voltage to one wire of the ten associated with each of the decades to be controlled. The synthesizer actually has 10 decades, from 0.01 cps to 50 Mc. Since Stanford was interested in a 1 cps-100 kc sweep, it used only five of the decades, and controlled them with five 10-element ring counters, which were developed at the Stanford Electronics labs.

The wires are at the rear of the H-P instrument; a voltage applied to them activates the appropriate decade switching circuit.

The counters are cascaded as frequency dividers, as shown in the block diagram above, right. They consist of high-speed transistor flip-flops assembled on printed-circuit cards. Typical cards are shown in the top photograph on the next page. The bottom photograph on the same page shows enough digital control circuitry to sweep eight decades of the synthesizer.

### One frequency source

Frequency switching must be accomplished with phase coherence, or a transient amplitude variation will be produced in succeeding tuned circuits



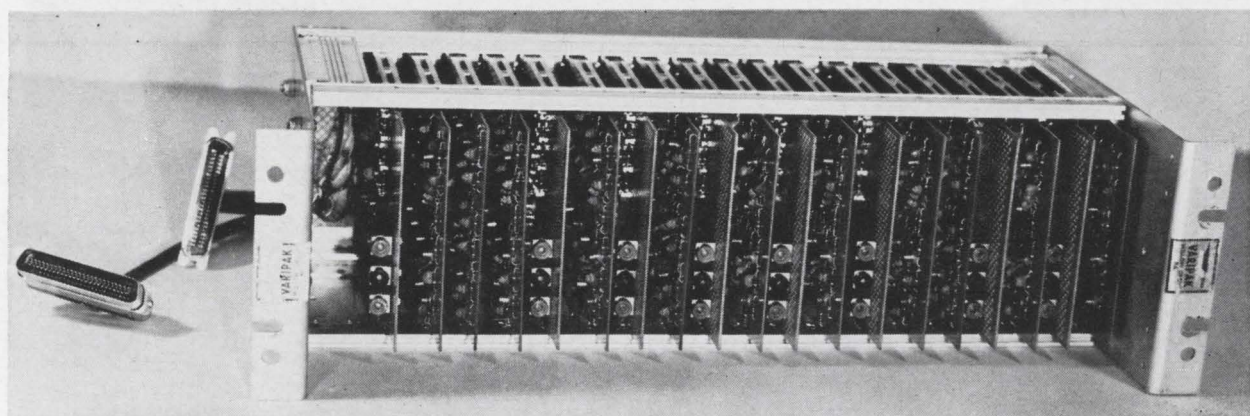
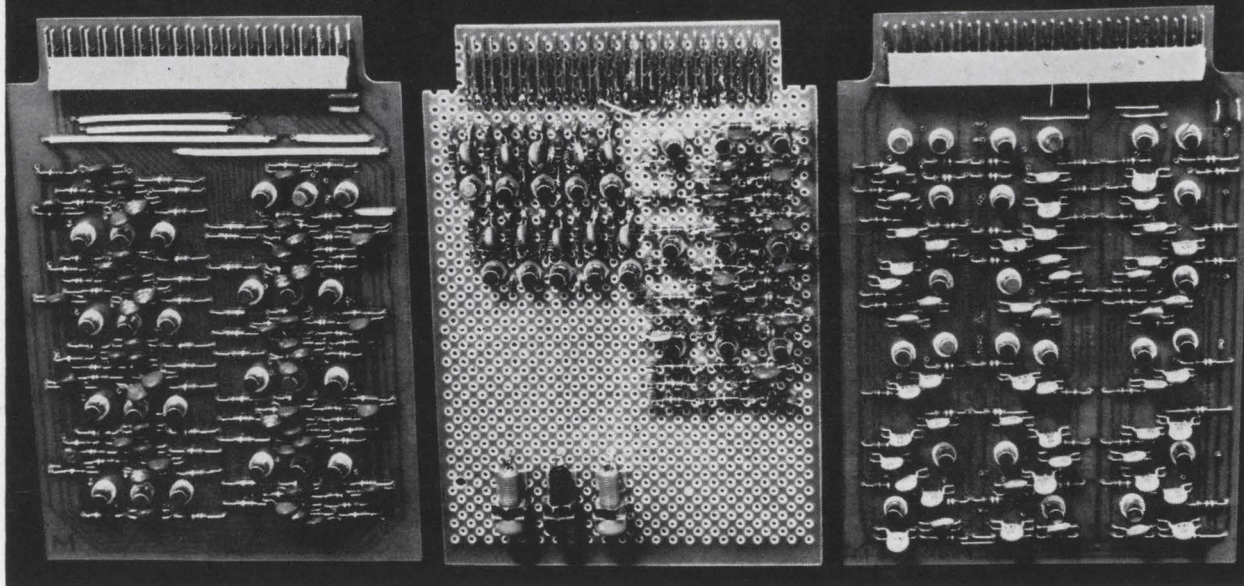

Solid state circuitry is used throughout the control circuits. Fifty ring stages, five gate drivers and two ring drivers, mounted on printed circuit cards as shown in the top photograph, are necessary for the control of five decades. Each ring counter, a modification of a design by G.A. Maley of International Business Machines Corp., consists of three transistor-resistor NOR blocks.<sup>3</sup> The completed cards are then assembled into a rack like the one in the lower photograph, which has enough circuitry to control eight decades.

## Frequency-modulated radar

Three important characteristics of any radar are range, range resolution, and doppler resolution. Simple pulse radar is limited in range by the average power radiated, in range resolution by the pulse length (resolution being approximately equal to pulse length divided by twice the velocity of light), and in doppler resolution by the pulse repetition rate. The best doppler resolution that it can achieve is one-half the pulse repetition frequency.

A high degree of range resolution is often paramount, a requirement that restricts the pulse length to a small value. To avoid ambiguity, the minimum time between pulses must be greater than the time a pulse takes to return from the most distant target. Therefore, the operation of a pulse radar with high range resolution and distant targets results in a low transmitter duty cycle.

The radar's average power is normally determined by the maximum peak power that can be generated and is often much smaller than can be generated on a continuous-wave basis. But the transmission of modulated pulses has made it possible to obtain a range resolution which is smaller than the pulse length, often by

very large factors, thus increasing the average power by the same factor without increasing the peak power of the system.

The factor that describes the power increase ratio,  $P_2/P_1$ , obtainable from a pulse radar, is commonly known as the time-bandwidth product. It is approximately equal to  $BT$ , where  $P_2$  is the average power of the modulated pulse,  $P_1$  the average power of the unmodulated pulse, and  $T$  and  $B$  the length and spectral bandwidth of the modulated pulse.

Conventional methods provide a time-bandwidth product of 100 to 1,000; the digital technique described in the accompanying article permits products of more than 100,000.

Using any modulation technique that distributes the signal energy fairly uniformly makes it possible to obtain a range resolution equal to that obtained from a single pulse having the same spectral width.

Although many modulation techniques can be used, linear f-m pulses have commonly been employed to obtain high time-bandwidth products. Many papers have been written giving a comprehensive description of this technique.<sup>1,2</sup> F-m radar can use high efficiency (class C rather than linear) transmitters. And it is relatively easy to process the received signals to obtain a target-range display.



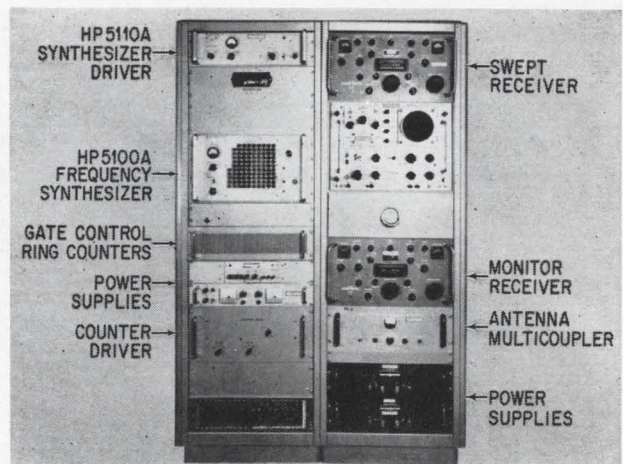
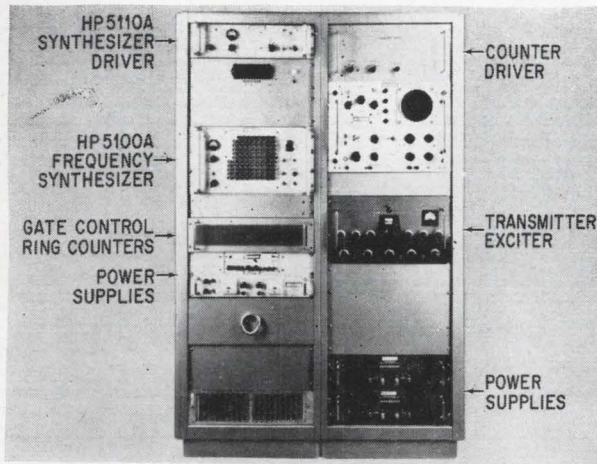

F-m radar transmitting and receiving systems are completely contained in separate instrument bays.

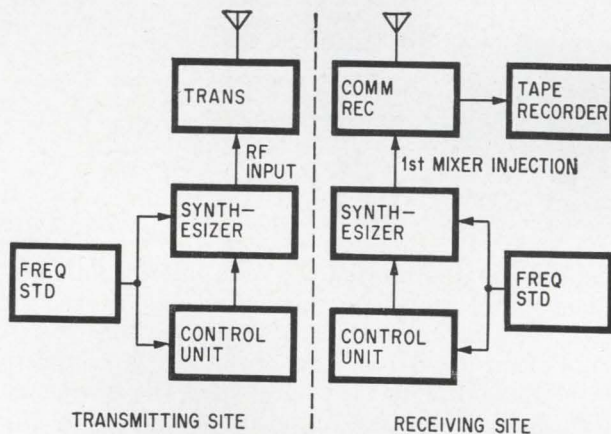

**Common frequency standard** at the f-m radar transmitting and receiving sites controls the switching rates and times in the synthesizer and controller. This is necessary to eliminate phase discontinuities.

within the synthesizer, upsetting its operation. For deriving frequency increments of 100 kc or less, signals of 3.0, 3.1, . . . 3.9 Mc are selected from the fixed frequencies available from the driver. Since the spacing between them is 100 kc, any two will be of identical phase at 10-microsecond intervals. Any switching must occur close to these times of phase equality, which are determined by the frequency standard that drives the synthesizer. Hence, the same frequency source must control the switching counters.

The time required for the H-P 5100A-5110A synthesizer to settle on a new frequency after switching is specified by the manufacturer as 1 millisecond, although most of the frequency changes are actually much faster than that. The present application, however, requires that the synthesizer be switched to a new frequency every 10 microseconds, so major modifications to the H-P equipment were necessary. In the original synthesizer design, no attempt was made to obtain phase coherence among the ten signals. It was therefore

necessary to adjust the ten basic frequencies so that all were in phase at the desired switching times.

### Short pauses

For f-m radar operation, it is only necessary to achieve a phase accuracy that does not result in an appreciable amplitude transient at the input to the succeeding frequency divider stages. This phase adjustment is easily accomplished, since each of the basic signals is derived in the H-P 5110A fixed-frequency section by division by 10 from the 30-39 Mc signals available. Causing the dividing circuits to skip entire cycles (at their inputs) shifts the phase of their outputs in one-tenth cycle increments; this adjustment is sufficiently fine. To do this, a front panel switch was installed for interrupting input power to nine of the 10 dividers.

### Opening the gate

For rapid switching, it is also necessary to accomplish the actual signal gating rapidly (compared to the period of the chosen frequencies of 3.0 to 3.9 Mc). Gates within the H-P 5100A synthesizer were not designed with this requirement in mind. The Stanford researchers therefore removed all blocking and bypass capacitors associated with these gates to shorten their transient response, and installed emitter followers in the ten signal lines to provide low impedance signal sources for the gates. The redesigned gates have a switching time on the order of 50 nanoseconds.

These modifications degrade the spurious signal suppression to only about -55 decibels. This aspect of performance could be improved, but not without major redesign of the synthesizer frequency-gating circuits.

### Increasing the range

F-m has been put to wide use in radar because it greatly increases the transmitted power over



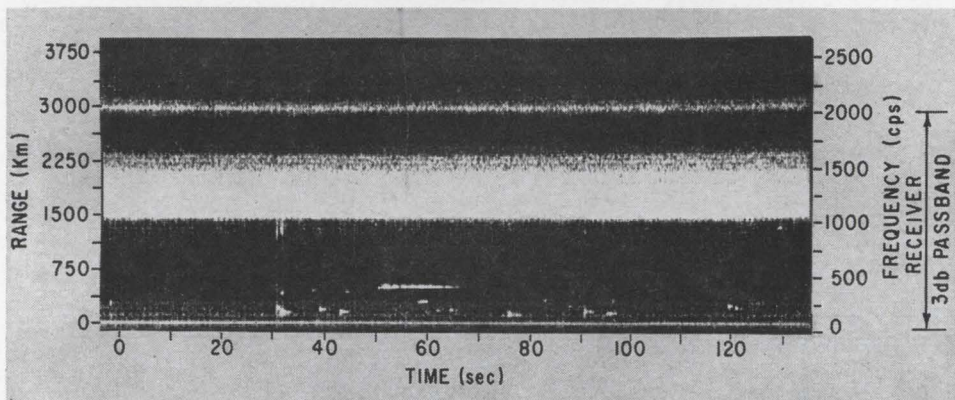
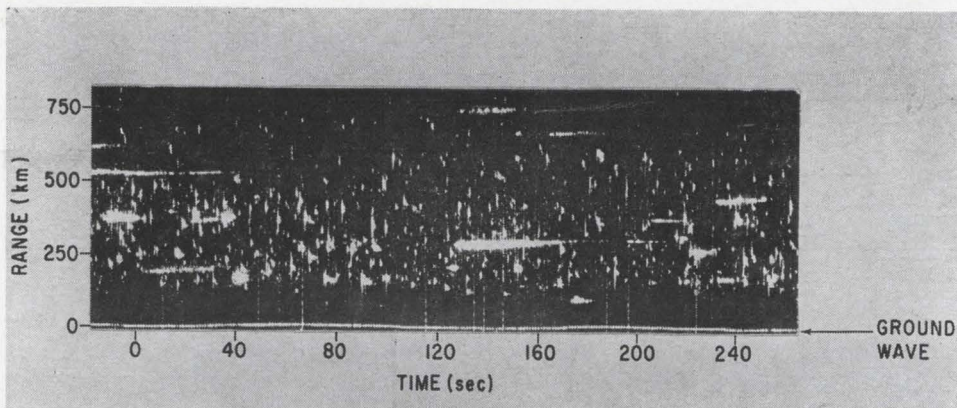

**Recordings**, produced by spectrum analysis of the receiver detector output voltage, made from a 500-watt f-m radar using frequency synthesizer. Top photo shows echoes from meteors; the bottom picture shows backscatter from the ground following an ionospheric reflection. The theoretical doppler resolution of 1 cps and range resolution of 1,500 meters were very closely approached. Sensitivity is comparable to a c-w system with a 1 cps bandwidth. Photos were made last November at San Luis Obispo, Calif.

that obtained in straightforward short-pulse operation, thus increasing radar range. In continuous-wave f-m radar, the frequency of the transmitted signal is a linear sweep with respect to time. The delayed echo, which is a replica of the transmitted ramp, is mixed with the output ramp in a receiver; the resulting beat note in the receiver output has a frequency directly proportional to the target range.

The range resolution, therefore, is limited by the accuracy to which the received beat frequency can be measured. This accuracy, in turn, depends on the length of time the beat frequency is available for measurement (related ultimately to sweep width), and on the extent to which it remains constant throughout the sweep. For a constant-frequency beat note, the frequency ramp must be absolutely linear. Digitally synthesizing the necessary ramp has provided a source sufficiently linear so that no significant inaccuracies are introduced.

The complete f-m radar system, which employs the sweep frequency synthesizer, is shown in the block diagram on page 69. To observe short-range targets using a one-second transmission requires that the transmitting and receiving equipment be sufficiently separated so that direct signals from the transmitter do not jam the receiver. Two synchronized synthesizers are required, one each at the transmitting and receiving sites.

### Synthesizer synchronization

At the transmitting site, the synthesizer output is amplified to the desired power level using an ordinary class-C high-frequency amplifier. The re-

ceived signal is translated to the intermediate frequency of a conventional communications receiver by using the second synthesizer as a local oscillator. Time synchronization of the two synthesizers is performed at the receiving site. The frequency difference is observed on an oscilloscope, and the ramp from one is delayed by interrupting the counter advance for short calibrated periods until the desired sweep alignment is achieved.

The usefulness of commercially available, direct-frequency synthesizers may now be extended for applications other than the generation of constant- or stepped-frequency signals. Signals of continuously varying frequency may be approximated with considerable accuracy by rapidly programming such a synthesizer. It is not clear yet whether the technique will be useful wherever a frequency sweep is required, such as in radio broadcasting, but the f-m radar applications should lead to others.

### References

1. J.R. Klauder, A.C. Price, S. Darlington, and W.J. Albersheim, "The theory and design of chirp radars," Bell System Technical Journal, Vol. 39, No. 4, July, 1960, pp. 745-808.
2. D.R. Shearman, W.C. Brain, and K. Weekes, "Analysis of radar systems for the observation of incoherent radio-wave scattering in the ionosphere," Proceedings of the IEEE, Vol. 110, No. 5, May, 1963.
3. G.A. Maley and J. Earle, "Logic design of transistor digital computers," Prentice-Hall, 1963.

### Acknowledgement

The technique described was developed at the Radioscience Laboratory with support from the Office of Naval Research, Code 418, Contract Nonr 225(64), and the Advanced Research Projects Agency, ARPA order 196-65.



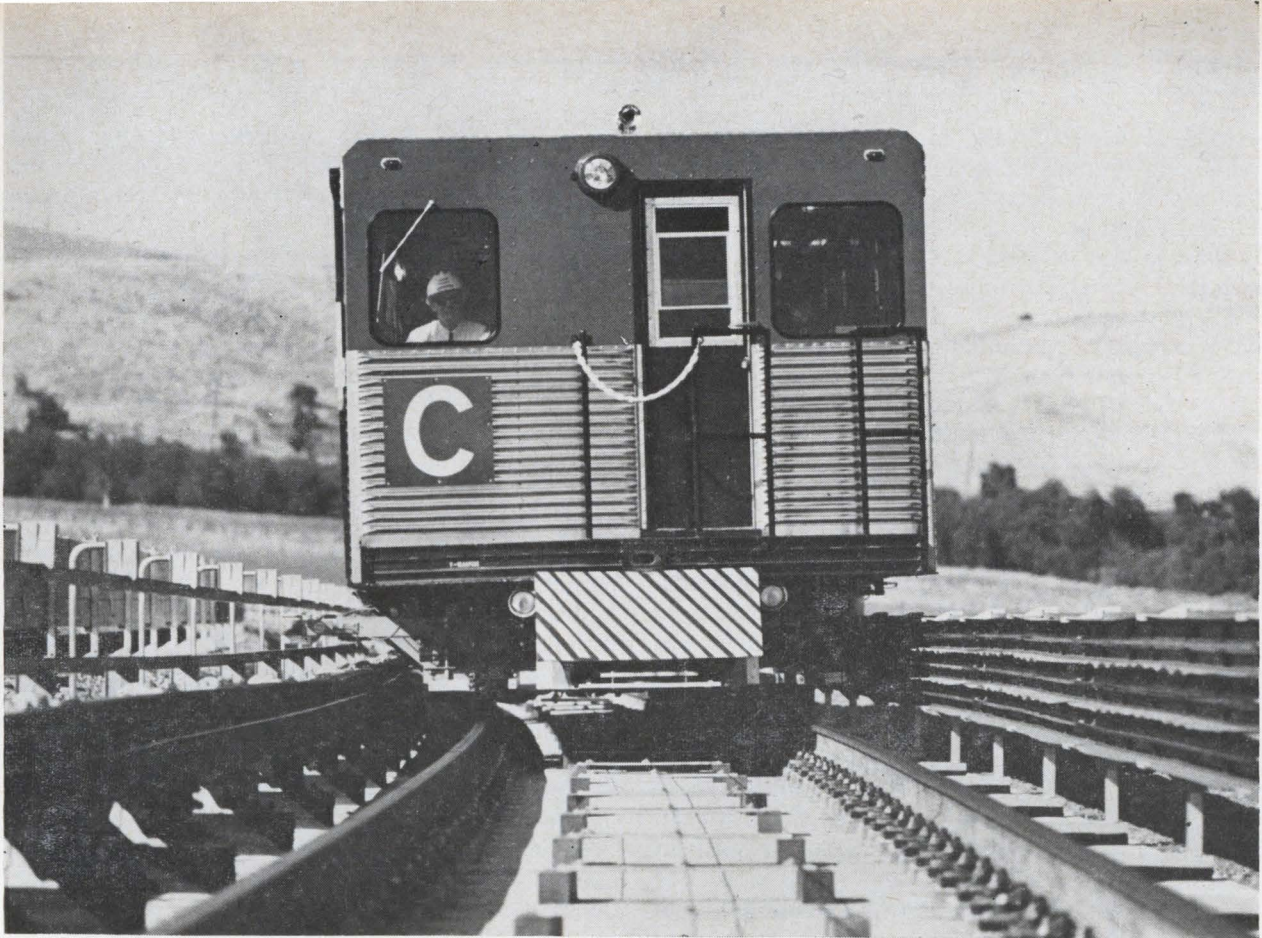

Industrial electronics

## Who's on the right track?

Four electronics companies are testing that number of approaches to fully automatic train control on a test track near San Francisco. There's more at stake than a \$10-million electronic equipment contract

By Wallace B. Riley, Computer Editor  
and Louis S. Gomolak, McGraw-Hill World News

**Near Mt. Diablo**, about 20 miles east of San Francisco, the suburbs of Walnut Creek (pop. 9,903) and Concord (pop. 36,208) are linked by four and a half miles of unusual track. For the next three years, the Bay Area Rapid Transit District (BARTD) will use this nine-mile round trip run as the testing ground for four competing electronic train-control systems.

There's more at stake at the end of the ride than the \$10-million contract for electronic controls for San Francisco's rapid transit system. The four companies whose systems are being tested—the General Electric Co., General Railway Signal Co., the

Westinghouse Air Brake Co. and the Westinghouse Electric Corp.—know that city planners in Seattle, Los Angeles, St. Louis, Pittsburgh, Baltimore, Miami, Washington, D. C., and other urban centers without mass transportation are watching the trial runs at the Diablo test track.

### Fresh start

The planners of San Francisco's rapid transit network, which is expected to serve four million people in three counties, had an unusual opportunity. They were not hemmed in by the existence of any transit



system, as in New York, for instance. They were free to consider any approach, no matter how novel, that would transport passengers quickly, safely, efficiently and economically. And they were helped by the passage, in 1964, of the Urban Mass Transportation Act [Electronics, July 13, 1964, p. 87]. The government has put up over \$7 million for the San Francisco experiment in mass transportation. The rail-transit system that will be built, operated and financed by BARTD will cost nearly \$1 billion.

Electronically controlled trains traveling between stations at up to 80 miles an hour, with headway between trains of as little as 90 seconds, will be among the world's fastest. The four control systems under test are replacing train crews with radar, computers, digital-data transmitters and accelerometers. Every operation, from selling train tickets to adjusting speeds, is controlled by black boxes. When the system is in operation, one employee will be aboard each train, but only for emergencies.

Trains will start operating on the first spur of the network in 1968, and the entire system should be in operation in 1971 (see chart below). There will be 75 miles of double track—one track in each direction. From Daly City, trains will run north to the foot of Market Street in San Francisco, thence under the bay to Oakland. At Oakland the line will branch; north to Richmond, east to Concord and southeast to Fremont. The map opposite shows the route that passengers from the three counties of San Francisco, Alameda and Contra Costa will follow. Only 37 stations, some of them as much as two miles apart, will cover the 75-mile network. The planners of the system estimate that 450 cars will carry some 60,000 people an hour, in both directions, with no standees.

### The control task

Test specifications were drawn up by three engineering consulting organizations that are jointly responsible for the design, construction and testing of the system. Two companies are based in San Francisco, the Tudor Engineering Co. and the Bechtel

Corp.; the third, Parsons, Brinckerhoff, Quade and Douglas, is in New York. The combined group is called Parsons, Brinckerhoff-Tudor-Bechtel or, more simply, PBTB.

Testing of the four competing automatic control systems began two months ago and will continue for three years. At the end of the test period, PBTB will draw up final specifications and award contracts. The engineering group has full system responsibility and, while each of the four systems manufacturers hopes to get a contract for the entire control system, PBTB may decide to award contracts to different companies for individual pieces of equipment.

At the Diablo test track each manufacturer will be operating his own system, made up of four separate subsystems. The first subsystem controls train separation, to maintain safe braking distance between trains; the second regulates the speed of individual trains; the third regulates station stops, and the fourth controls and supervises the entire system.

From the time it leaves the terminal yard until it returns for servicing or storage, each train will be electronically controlled to maintain specified speeds, to slow down and stop at stations within one foot or less of a designated spot, to open and close its doors, and to start again. As yet, the stopping accuracy has not been completely defined. Great accuracy is desired because BARTD is contemplating the idea of walled platforms at certain stations, with doors, like elevator doors, that open as the train comes to a stop. The doors on the train would have to stop exactly opposite the doors on the platform if this proposal were adopted.

### Differing views

The controversy among the electronics companies over control methods may be settled on the Diablo track. Westinghouse Electric holds that the transit system of the future should be completely computer-controlled, with a centralized

**BARTD SCHEDULE OF CONSTRUCTION AND OPERATION**

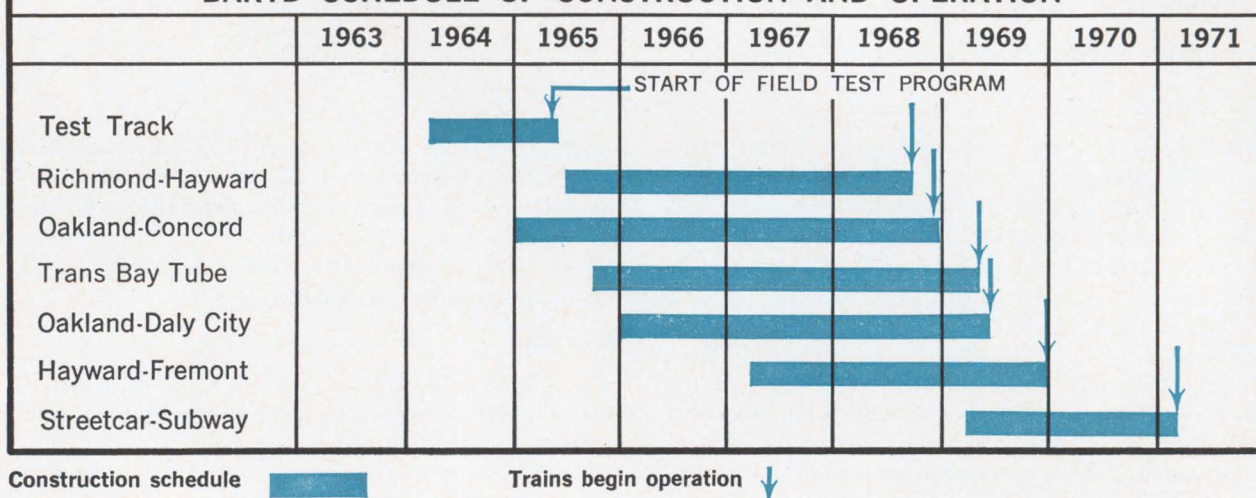



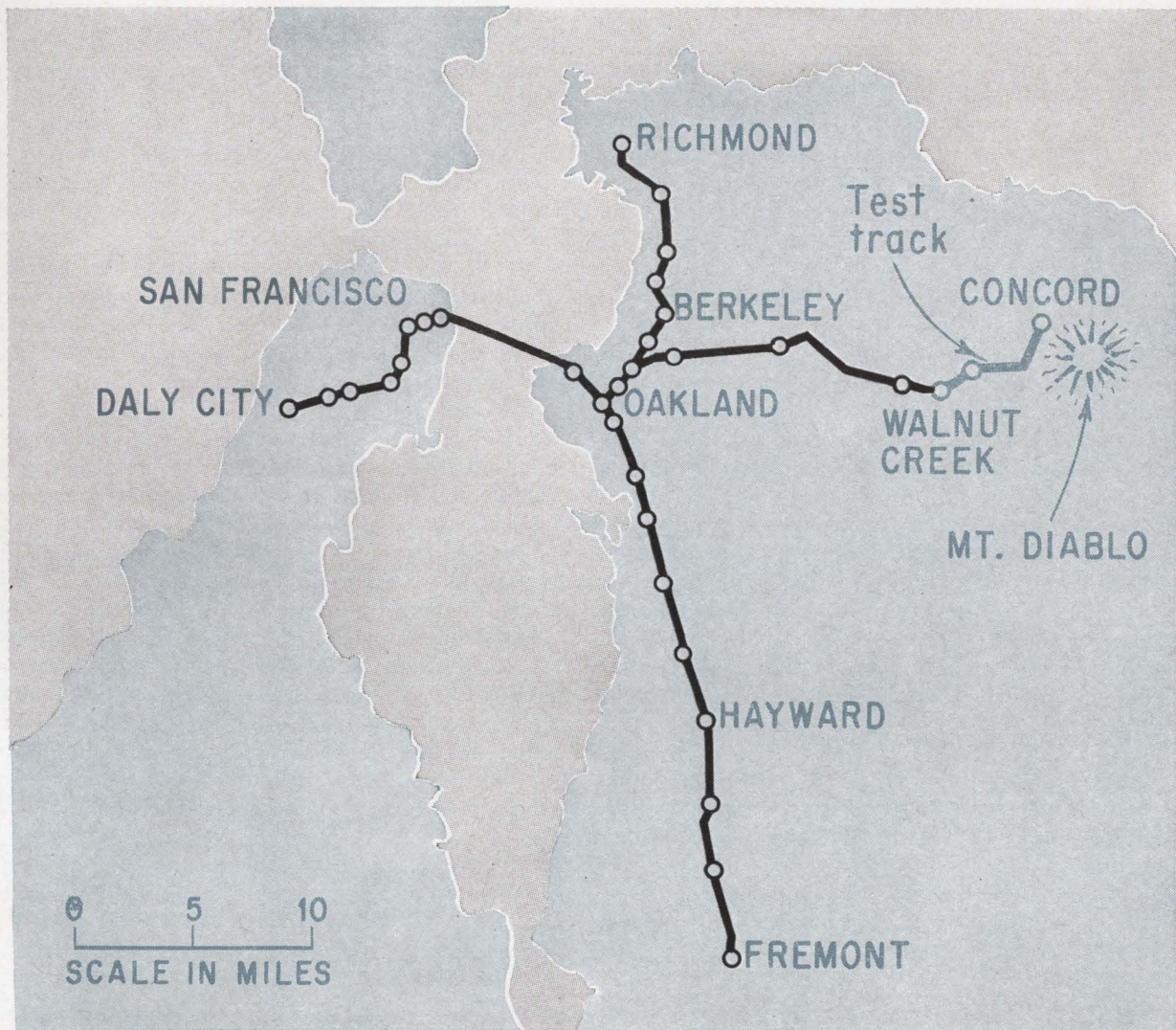

Rapid-transit routes for San Francisco Bay area. Trains on the 75 miles of double track will be fully automatic.

digital computer to do all the figuring, commanding and monitoring. The goal of this approach is to keep as much control equipment as possible off the cars and place it at a limited number of control stations. This, Westinghouse says, will reduce cost, improve flexibility, reliability and accessibility, provide a more suitable environment for the equipment, and allow control commands to be sent to the car in a form that can actuate the propulsion and braking systems directly, thus reducing the amount of translation equipment carried on the car.

The three other companies dispute this view. General Railway and Westinghouse Air Brake (Wabco), which worked together on a two-year automated-subway test for New York City's transit system,\* advocate decentralizing most of the command and control functions. They would leave the decision-making and subsequent actions to electronic equipment, acting as a sort of electronic

\* The 0.44-mile subway shuttle was destroyed by fire in April, 1964, and was not replaced. The fire was caused by a spark from the third rail; the control system was in no way responsible for the blaze. The shuttle is now in manual operation.

motorman on the train, with only the communications and signaling equipment remaining at the trackside. General Electric also is following this approach.

These differing design philosophies are reflected in the weights of the equipment carried on the car: Westinghouse Electric, 300 pounds; General Railway, 600 pounds; Wabco, 600 pounds; General Electric, 700 pounds.

## 1. Keeping the trains apart

The first of the major control problems in automatic rapid transit is train separation—that is, keeping one train from running into the rear of another. In conventional transit systems, this is accomplished by a so-called block system. The entire length of the track is divided into blocks of fixed length, in each of which there is a specified maximum speed. If three blocks separate two trains, the first signal seen by the motorman of the second train is a green light, allowing him to run full speed. If there are two blocks between



the trains, the motorman sees a yellow light, which tells him to start slowing down. If the trains are only one block apart, a red light alerts him of danger and calls for an immediate stop.

The length of the blocks allows a fully loaded train traveling at the maximum speed plenty of time to come to a complete nonemergency stop without hitting the train ahead. It is always assumed that a red light means that the train ahead is just entering its block. It could, of course, be just leaving it, which would mean a whole extra block of track between the trains.

The electronics companies disagree on the control method for train separation. Wabco and General Railway favor the fixed-block concept, modified for automatic control in which a computer plays only a minor role. Westinghouse Electric backs the same fixed-block approach, but with a digital process controller to provide the flexibility and versatility required in the system. General Electric prefers a moving-block arrangement with block lengths and locations determined by the positions of the trains; it says this will provide the needed flexibility in a more satisfactory manner than the fixed-block approach.

#### GE uses radar beams

"You can't run trains efficiently 90 seconds apart at 80 miles an hour, using a conventional wayside signal system," says J. E. Wallace, G.E.'s project coordinator for BARTD. "As you increase the train's speed, you have to either increase the length of the signal block or use a more complicated sig-

nal arrangement. Long blocks increase the time between trains; the maximum number of trains you can run at once decreases; and service suffers.

"But with a train-carried radar system that continually tracks and computes the distance between itself and the train ahead and can stop a train in time, you can stack trains one after the other for fast, frequent service."

In keeping with this moving-block concept, G.E.'s train-separation radar (see diagram, opposite) operates continuously, and does not depend on fixed zones. All separation signaling is generated and detected on board each train.

A crystal-controlled transmitter produces a continuous 31.1-Mc carrier which is frequency-modulated at 8 kc. Frequency modulation provides sharper discrimination between true and spurious signals as well as between true signals and noise.

On each train the carrier signal is coupled to two parallel aluminum I-beams that can be seen in the photograph on page 75, which form a transmission line alongside the tracks. The I-beams are two inches deep and spaced nine inches apart, with their webs vertical. The signal-coupling device transmits the beam forward only. The signal travels along the I-beams to an energy reflector mounted on the train ahead. The reflected signal returns along the I-beams to the train that generated the signal.

If there is no train ahead, the signal travels a maximum of about three miles to a point beyond the next station where a tuned short-circuit is

### Overview of competing control methods

Company	Signal technique	Blocks	Control	Carried on train	On wayside
General Electric Co.	Radar	Moving	Decentralized	Radar unit Analog computer Signal pickups	Transmission line Tuned coils at station approach Central computer (GE/PAC 4000)
General Railway Signal Co.	Audio frequency signals on rails	Fixed	Decentralized	Analog computer Signal pickups	Transmitters Receivers Tuned coils at station approach
Westinghouse Electric Corp.	Audio frequency signals on square-wave wire loop	Fixed	Centralized	Audio generators Signal pickups Accelerometer	Square-wave wire loop Wayside Controller (Prodac 50) Central computer (Prodac 500)
Westinghouse Air Brake Co.	Audio frequency signals on rails	Fixed	Decentralized	Analog computer Signal pickups	Transmitters Receivers Relay circuits Tuned coils at station approach Central computer (DDP-24)



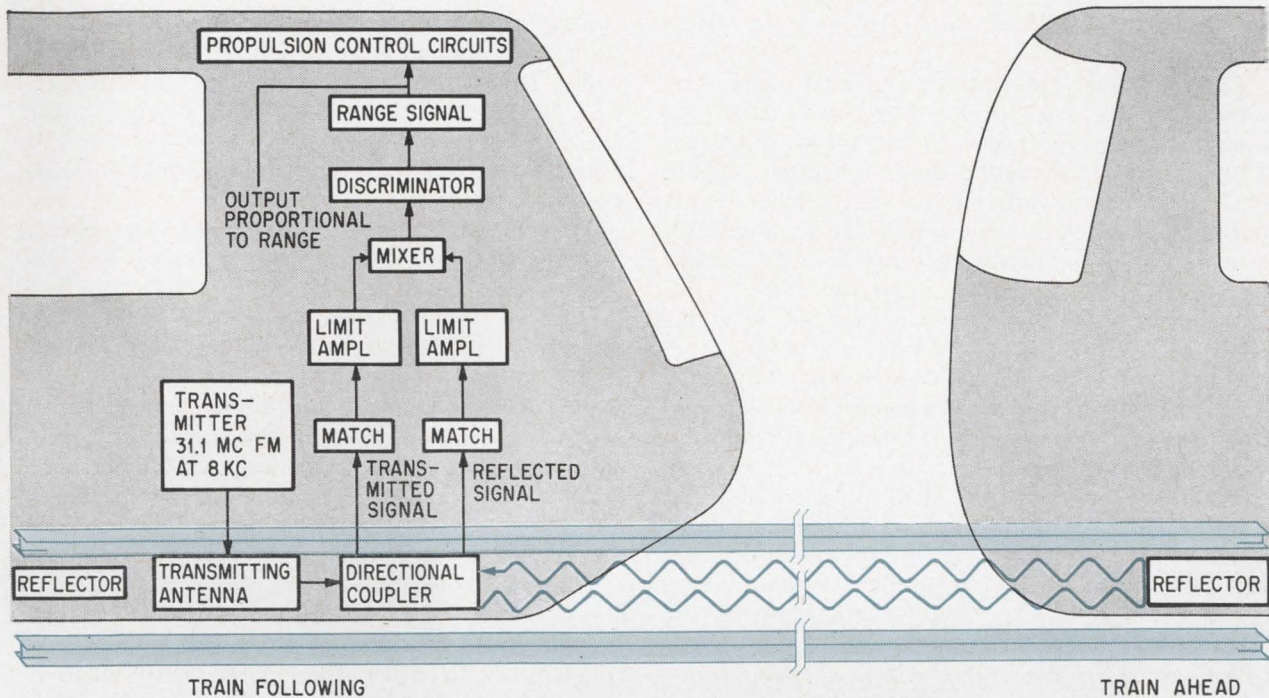

**Radar system for safe train separation** proposed by General Electric. The radar signals are generated aboard each train and transmitted forward along the twin-I-beam transmission line, shown in color, to the train ahead. The signal is reflected back, picked up, and decoded to indicate when braking is needed to avoid a collision.

placed across the transmission line to force a reflection of the train-separation signal. This tuned short is automatically switched out before the train leaves the station. Other tuned shorts are placed at the end of the line. The train always stops automatically at least 100 feet from any obstacle, including these shorts; closer operation, as

in a terminal or yard, is manual.

The transmitted and reflected signals are extracted by a directional coupler mounted on the train and moving alongside the I-beams. The coupler is about eight feet long, the approximate spacing between the axles of a single railroad truck. This is one reason the 31.1-Mc frequency

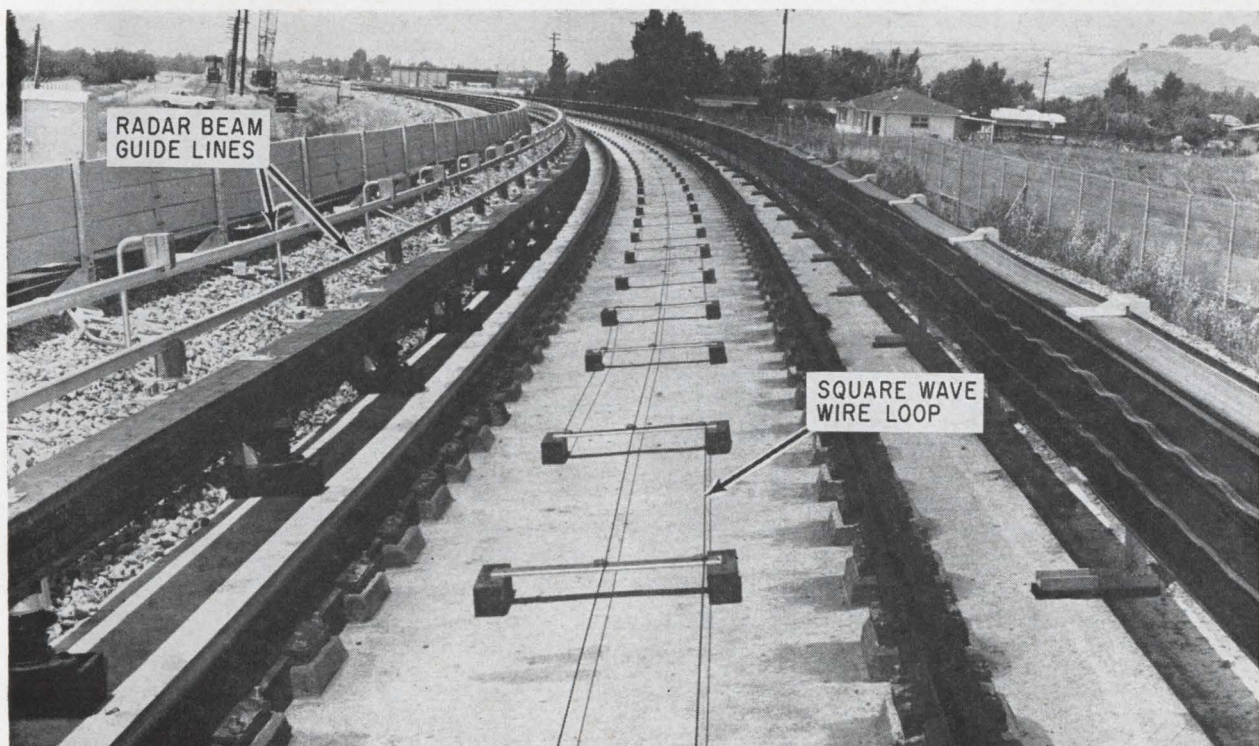

**Westinghouse wire loop** shaped like square wave, and General Electric radar transmission line, for train control. Westinghouse system counts the square-wave alternations as the train moves; G.E.'s sends signals along the I-beams.



was chosen; it allows the coupler to fit neatly on the truck.

The signals are fed into an onboard phase-comparison receiver that furnishes an a-c signal whose amplitude is proportional to the phase difference between the transmitted and reflected signals. This amplitude-modulated signal is further amplified, then rectified to a d-c signal whose magnitude is proportional to the distance between two trains; one sending the signal, the other reflecting it.

In conventional radar systems the output signal would be used to generate a pip on a radar scope. But for BARTD it is fed into a speed-distance regulator (built of elements similar to those found in an analog computer) to provide a train-separation override signal.

"This is the first practical application of radar to railroading," says Wallace, "and it gives our system the flexibility needed in the world's first completely automated rapid transit system."

### Westinghouse's wire loops

"You don't need a radar system to keep trains apart when you have a digital computer on hand," says T. E. Hopkins, the BARTD project manager for Westinghouse Electric. "Measuring train speed and acceleration from the wayside reduces the amount of equipment needed aboard the trains. There'll be 450 cars, each of which can run independently. Equipping each car with radar only runs up the cost."

In Westinghouse Electric's system, communications between the transit car and the control computers is through a loop of No. 10 wire laid between the rails in a square-wave pattern that can be seen in the photo on p. 75. The pattern extends one foot on each side of the center line. The wavelength of the square-wave in each loop depends on the top speed allowed for the train traveling over it. Since only one train at a time is allowed in a loop, the loops correspond to the conventional fixed blocks. The wavelengths, and their respective speed ranges, are 17.5 feet for 25 to 80 mph, 4.4 feet for 15 to 25 mph, and 2.2 feet for the last 50 yards or so before arriving at a station stop.

At both ends of each train are audio generators. Operating continuously, they drive transmitting coils that are placed directly over the right and left extremities of the square-wave loop. The generators operate at different frequencies—865 and 1,070 cycles per second. One transmitting coil is at the head of the train, the other is at the rear end; they are spaced a multiple of 17.5 feet apart so that at any instant one and only one coil is inductively coupled to the square-wave loop. As the train moves along the track, a signal alternating between 865 and 1,070 cps is picked up by the square-wave loop and transmitted to the nearest control site.

Tone receivers pick up the signals, demodulate them, and feed them to a Wayside Controller (see diagram, opposite page), the Westinghouse Electric

control unit, which uses them to determine the train's velocity and acceleration. The Wayside Controller checks the speed limit for the section of track being traveled, the distance to the train ahead, and the distance to the next stop or speed restriction, then signals the propulsion or brake information back to the train.

These control signals—plus signals for opening and closing doors, reversing, emergency stops, and so on—are transmitted via the square-wave loop to tone receivers on board the train, using eight discrete frequencies between 1,500 and 2,300 cps, at transmitted power of 30 watts. One of these eight frequencies is a safety signal, switching on and off at a rate of 7.5 cps. As long as the train-carried receivers detect this safety frequency, the train reacts to all other commands. If that signal is missing, emergency brakes are applied regardless of any other signals.

Thirty-five possible combinations of the other seven frequencies, transmitted three at a time, provide up to 35 different control commands. No command with other than three frequencies is recognized. Seven band-pass filters on the train sort out the frequencies; a decoder matrix provides a specific signal for each valid combination of input frequencies; and this signal actuates the proper control circuit.

The completely transistorized tone-generating receiving and detection equipment was built to Westinghouse specifications by Quindar Electronics, Inc. of Bloomfield, N. J.

Each signal receiver is a Quindar QR-10 AM unit supplemented by a tone module. Upon this setup depends the safety of the transit car and its passengers.

Each train will always have no less than two cars with propulsion power. It will be able to move under its own power even if one car has motor burnout or other propulsion trouble. Since the audio generators are at opposite ends of the train, they will immediately detect a broken coupling that separates a train into two parts.

While the initial programming job for the Westinghouse Electric system is immense, equipment costs are low and reliability is high. Two computers are used at each control point, connected in parallel; if one were to fail, the other would take over automatically until the first machine was back on-line. This type of parallel operation is estimated to give a 100% control-reliability factor for 10 years or more.

Westinghouse Electric ran a five-month simulation of three BARTD cars in its laboratory. A Pace 231R analog computer, built by Electronic Associates, Inc., simulated the cars; the two Wayside Controllers, later shipped to the Diablo test track, were the control units.

### Wabco uses the rails

C. William Woods, project manager for Wabco, says, "When steel rails are used to guide and support vehicles in a transit system, it is only



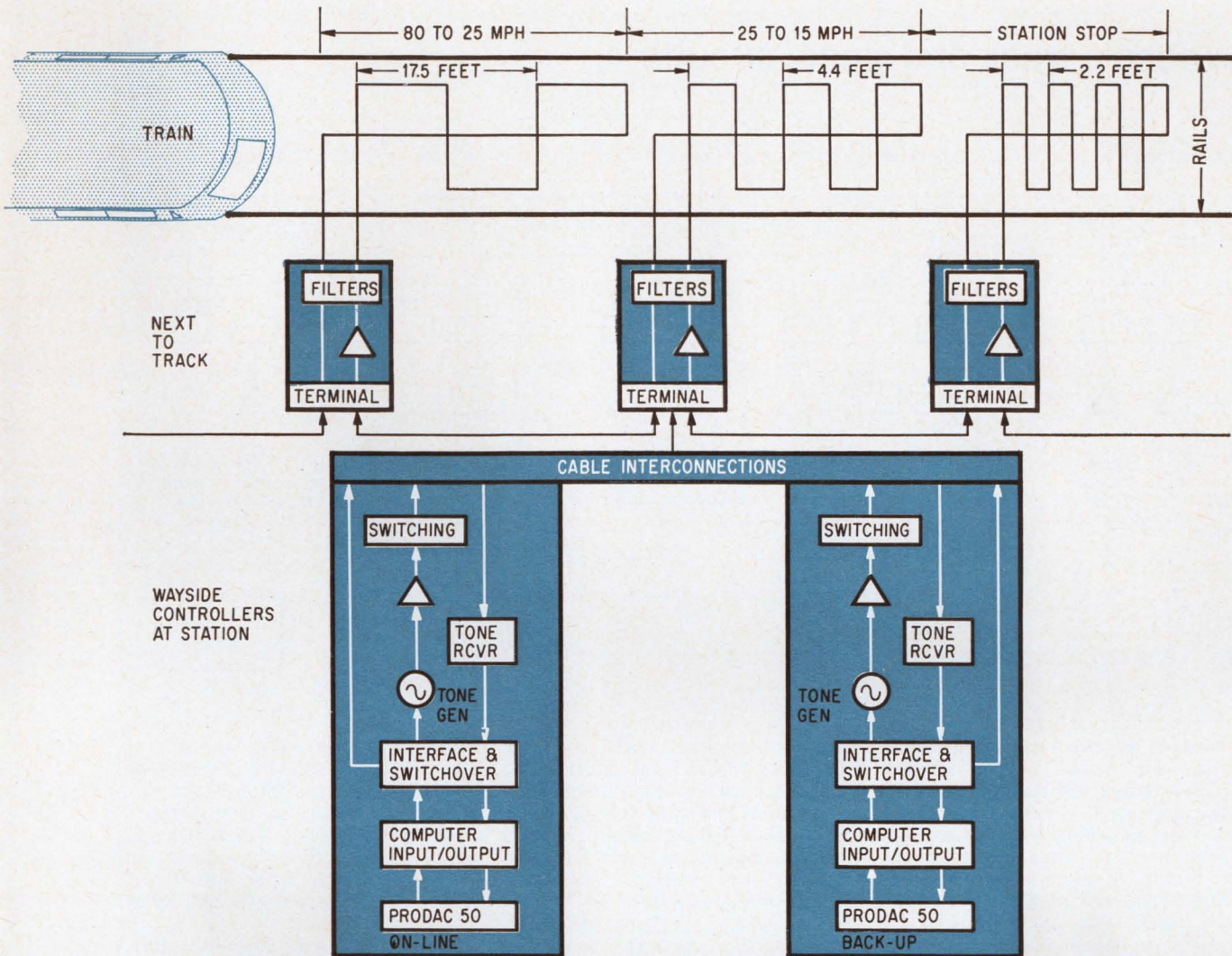

**Square-wave-shaped wire loop** between the rails transmits signals to and from trains in Westinghouse Electric's control scheme. Local control equipment, duplicated at several selected stations, is shown at bottom.

logical to use these rails as part of the electrical circuit for detection of trains and induction of running commands for safe automatic-train operation. The rails make an excellent, readily available transmission line for this purpose. This keeps the track free of other communication lines, permitting ready access for track maintenance equipment."

For BARTD, Wabco is offering an audio-frequency train-separation and speed-control system that eliminates insulated joints, massive impedance bonds, and other high-cost, high-maintenance items.

Because the Wabco system uses audio frequencies as a source of energy for the rail circuits, it is not necessary to define block limits with costly insulated rail joints. This eliminates the need for cutting the rail and permits maximum economic benefit from welded rail. Reliance on audio frequency also allows the use of small, inexpensive impedance bonds for propulsion return current and cross-bonding.

In the Wabco setup, transmitter and receiver-

transmitter units are alternately connected to the rails, at intervals that depend on the train separation required for a specific block of track. One transmitter feeds two receivers, one ahead and one behind. The transmitters and receivers are connected by cable to small, transformer-like devices that transfer the signals to and from the rails. Relatively high voltage is used on the cables; low voltages, superimposed on the propulsion return, are used on the rails.

The transmitters and receivers are interconnected in track circuits and signal circuits. The track circuits detect the presence of trains and establish relay contacts accordingly. The signal circuits provide speed indications to the trains depending on the position of the relay contacts, (see panel, p. 78).

All stop or go train-separation signals are fed to an onboard analog computer. This device generates signals for the propulsion and braking equipment on the train (see diagram, across top of pp. 82-83).



# Wabco's track and signal circuits

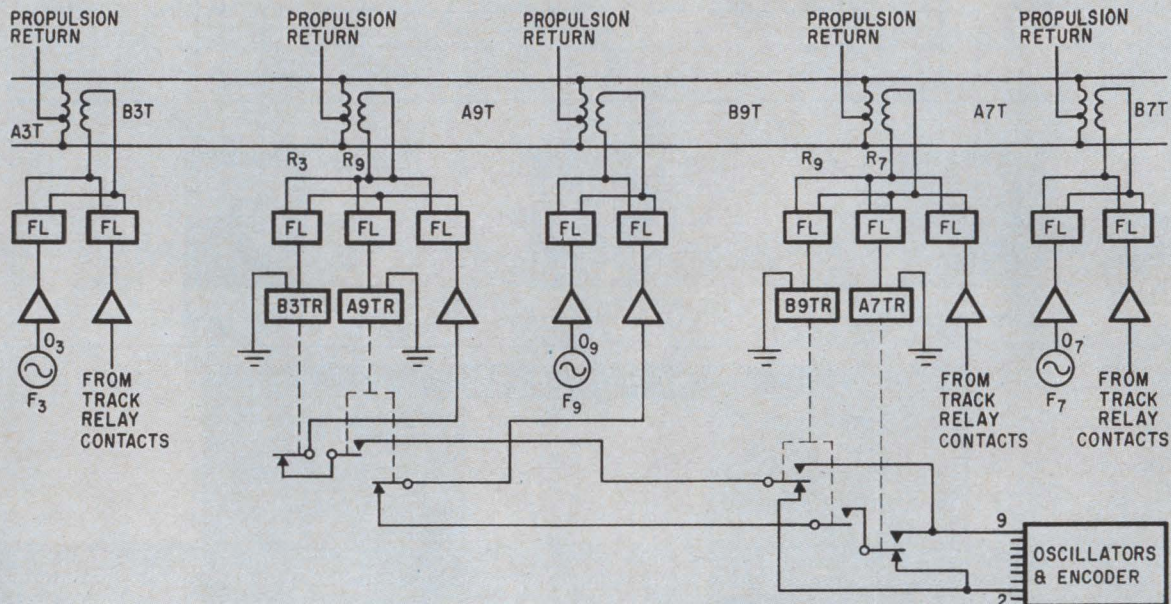

Portions of five typical Wabco circuits are shown in the diagram above. Three are track circuits and two are signal circuits. Oscillator  $O_3$  and its amplifiers make up a transmitter unit; the filter-amplifier circuit  $R_3$  and  $R_9$ , the track relays B3TR and A9TR, and the amplifier driven via the track relay contacts from the signal encoder make up a transmitter-receiver unit.

A track circuit consists of an oscillator,  $O_3$  in the diagram, its amplifier, two track sections, A9T and B9T, two filter-amplifier circuits,  $R_3$  and  $R_9$ , and two track relays, A9TR and B9TR.

A signal circuit consists of two oscillators, an encoder, contacts on the track relays, a section of track, pick-up coils on the train, and amplifying and decoding equipment aboard the train.

Ten different signal levels are provided. The encoder produces a series of pulses at 6, 7.5 or 10 cps. Each pulse is a burst of one or the

other of the two frequencies produced by the two oscillators in the signal circuit, or both frequencies alternately. The three kinds of pulses at three different repetition rates produce nine signal levels. The tenth is the absence of signal, which calls for an emergency stop.

In a typical application, the track sections A3T and B3T are fed frequency  $F_3$ ; sections A9T and B9T are fed frequency  $F_9$ ; and sections A7T and B7T are fed frequency  $F_7$ . Frequencies  $F_3$  and  $F_9$  energize track relays B3TR and A9TR respectively; frequencies  $F_9$  and  $F_7$  energize track relays B9TR and A7TR respectively.

Thus one transmitter, represented by oscillator  $O_3$ , feeds two receivers, represented by the track relays A9TR and B9TR. Adjacent pairs of track sections are fed different frequencies, which are isolated by filter circuits in the receivers.

If a train is in track section B3T, for example, this is how it receives

a signal: An 80-mph command is generated at terminal 9 of the signal encoder. It passes through the normally-open (N/O) contacts of track relay B9TR and A9TR and the normally-closed (N/C) contacts of B3TR, to the amplifier and thence to the track, where it is picked up by the train.

If there is a train in section B9T, then B9TR is short-circuited, its contacts drop and the signal (for 15 mph) comes from terminal 2 on the encoder through the N/C contacts on B9TR. If there is a train in section A9T, then A9TR is short-circuited, its N/O contacts open and no signal reaches the track, calling for an emergency stop.

Should the train in B3T be allowed to proceed, it short-circuits A9TR when it approaches the junction between B3T and A9T. The contacts drop on this relay, cutting off the signal from track section B3T and applying it to track section A9T.

## GRS backs block signaling

Simon Reich, designer of General Railway's separation subsystem, is an advocate of block signaling. "It's been used for years on the railroads," he points out. Reich considers radar an unknown quantity in rapid transit; he says he doesn't want to "put all our eggs in one computerized basket."

"San Francisco's system runs on rails," he says, "and block signaling works for railroads. The major change in our system is using the signals as inputs to the automatic train-protection sub-

system instead of using them to activate indicator lights on the wayside or in the cab."

General Railway, like Wabco, uses audio frequencies transmitted through the rails to signal the trains but it modulates these frequencies differently, shutting them off when there are no trains around. Also, train separation signals are either full-speed ahead or stop; there is no slow-down signal. As a result, speed commands are constant for any given point on the track; specific speed limits depend only on such things as curves and grades (see panel on next page).



# General Railway's speed blocks

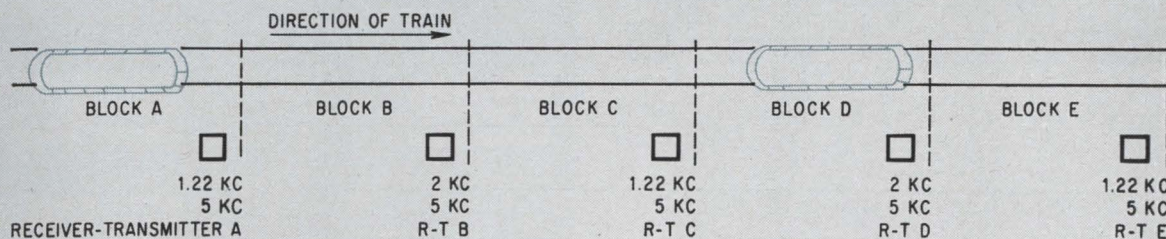

Receiver-transmitter units divide the track into speed blocks in General Railway's scheme; each block is 150 to 1,600 feet long. All transmitters can generate a signal of 5 kc frequency, modulated as described below. Each alternate transmitter can generate a signal of either 1.22 kc or 2 kc, that is also modulated. A unit will transmit 1.22 kc and receive 2 kc, or vice versa.

The modulation or coding of the two lower carrier frequencies is in the form of a frequency shift of 30 cps, occurring 120 times per minute for trains headed toward San Francisco, and 180 times per minute for outbound trains. Thus the nominal 1.22- and 2-kc signals vary between the limits 1,220-1,250 and 2,000-2,030 cps, respectively.

The 5-kc signal is frequency-modulated with pairs of tone signals chosen from seven frequencies between 69 and 132 cps; each of the 21 possible pairs indicate a different speed or train operation command. This modulation is also chopped at 120 or 180 pulses per minute.

No transmitter ever generates two frequencies at once; it generates 1.22 or 2 kc when the train is two blocks away, and switches to 5 kc when the train enters the nearest block. At this time it "sees" 2 kc or 1.22 kc from the next transmitter down the track. When the train passes, the signal from downtrack is short-circuited; the transmitter then shuts off. It stays off until another train arrives two blocks up the track.

An individual transmitter, for example C in the diagram, that generates 1.22 kc, looks for the frequency it cannot itself generate. Thus C looks for 2 kc. This can only come from D, because E generates 1.22 kc and the next one down is either shut off or short-circuited. C also looks for 5 kc coming from B; A is short-circuited and D is either off or short-circuited. Thus the 1.22 and 2 kc signals travel up the track to the train, in the second block, while the 5 kc signal goes up the track to the train and down to the next unit.

In the diagram, the train in block D receives a 5-kc speed signal from

transmitter D and a 1.22-kc safety signal from transmitter E. The transmitters beyond E are quiescent—generating no signal. The train sees the two frequencies and knows the track ahead is clear.

Suppose this train is stopped for some reason and a second train approaches from the left. The second train receives a 5-kc speed signal from A and a 2-kc safety signal from B. When it passes A, it shorts the 5-kc signal going to B; this tells B to switch off the 2 kc and start its own 5-kc signal. Then B sends a signal to C via wire. When C gets this signal, it sees the 5-kc signal on the rail from B and turns on its 1.22-kc safety signal.

Now the second train passes B, shutting off the 5-kc signal that was going to C. Then C switches to 5-kc. The signal from D is short-circuited by the train still in the block; so the second train sees only the 5-kc from C. Because it does not see two frequencies, the second train stops and waits until the first train moves out of the way.

## II. Safe, swift and smooth

The second major control problem is speed and acceleration. Unless there is a specific order from central control to slow down, trains will zip along each section of track at the maximum speed allowed. Nonetheless, it is claimed that with electronic controls the ride will be smoother than with a man at the throttle.

All four companies have come up with unconventional systems to control speed. Present systems use incremental or step-by-step control—power to the propulsion system is varied in small discrete steps. The proposed automatic control systems for BARTD continuously adjust the tractive effort as required by speed changes, changes in grade, and other variables.

A ride on the high-speed system must not only be safe, it must be smooth. The problem is complicated by the fact that each train is run as a unit, yet the individual cars must be capable of independent operation so that train lengths can be

varied as traffic demands, and so that any car can be its own prime mover in an emergency.

### Westinghouse Electric's Wayside Controller

Westinghouse Electric is applying to the "smooth-ride" problem its design philosophy of minimizing car-carried equipment. Calculations of the correct speed and acceleration are performed by 40 Wayside Controllers placed in pairs at stations throughout the system. In the Diablo tests, only two controllers are being used; either can handle the nine miles of track.

Acceleration is measured by an 0.2-gravity-sensitive Systron-Donner accelerometer on the train. The unit produces a voltage that is fed into a summing amplifier and compared to an acceleration signal transmitted from the controller. Any error is amplified and converted to a tractive effort command that is used in the propulsion and braking control equipment.

By counting the pulses generated as the train passes over the alternating parts of the square-



wave wire loop, the computer knows just when the train should begin to slow down for a curve or increase power for an upgrade. Its signals to the train for acceleration or deceleration are compared with the train's actual acceleration or deceleration; if necessary, the propulsion or braking effort is changed.

If the acceleration is too low, the tractive effort command increases power so that the car speeds up to the maximum allowable for that section of track, according to a table stored in the computer's memory.

When the car must be slowed, a deceleration calculation is made at every alternation of the square-wave loop—that is, every time the train moves another 17.5 feet (the length of a single "wave" of the square-wave pattern) another calculation is made by the computer—until the train is moving slowly enough. In low-speed areas, the square-wave pattern is shorter—4.4 feet or 2.2 feet—and calculations are made at shorter time intervals.

For constant speed and stopping accuracy, the control system is a closed-loop type with both acceleration and velocity data feedback (see diagram, below).

One feedback path is an acceleration loop that compensates for the time lags due to calculation time in the computer, delay time in the measuring

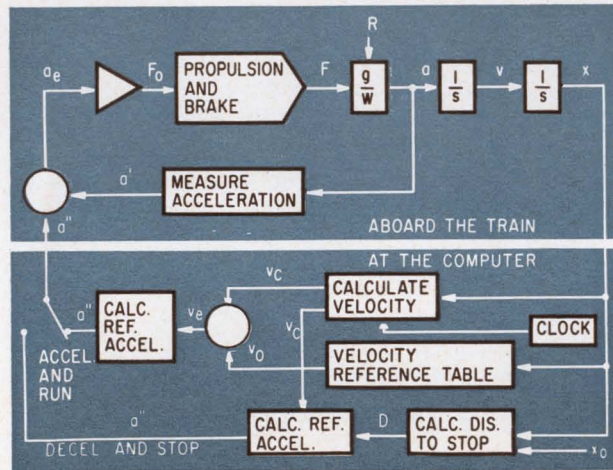

- KEY**
- $W$  = Train weight (lbs.)
  - $F$  = Tractive effort (lbs.)
  - $F_o$  = Tractive effort command (amperes)
  - $R$  = Train resistance (lbs.)
  - $g$  = Acceleration of gravity (ft./sec.<sup>2</sup>)
  - $a$  = Actual train acceleration (ft./sec.<sup>2</sup>)
  - $a'$  = Measured train acceleration signal (volts)
  - $v$  = Actual train velocity (ft./sec.)
  - $v_o$  = Computed train velocity signal (volts)
  - $x$  = Train position (ft.)
  - $x_o$  = Desired stopping point (ft.)
  - $v_o$  = Velocity reference signal (volts)
  - $s$  = Laplace operator
  - $a''$  = Reference acceleration rate (ft./sec.<sup>2</sup>)
  - $a_e$  = Acceleration error
  - $D$  = Distance to stopping point

Train control with limited onboard equipment is the goal of Westinghouse Electric, to reduce cost.

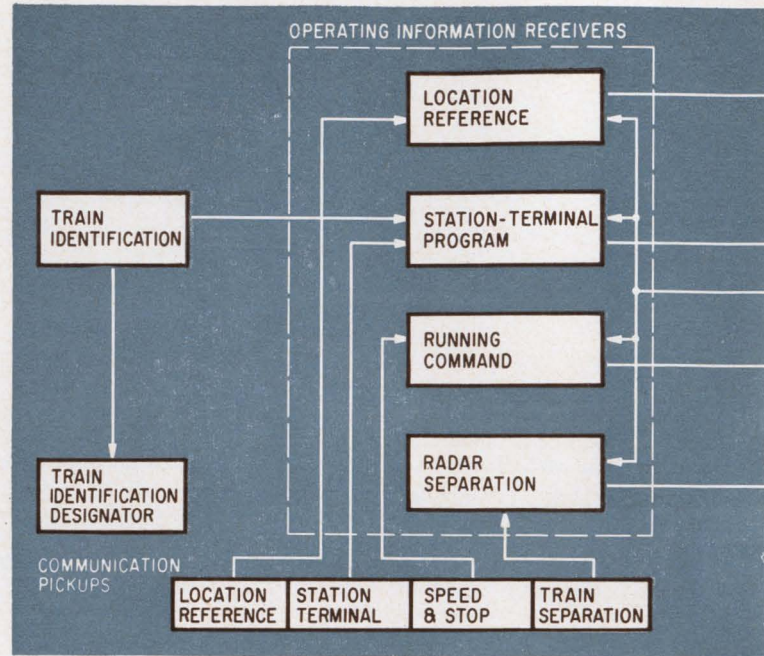

system and propagation time through the communications equipment. The acceleration loop also compensates for delays in the propulsion and braking system, such as wearing of brakes, varying of power circuit component parameters, and others, which directly affect acceleration.

But even if the accelerometer should fail, the system is still operable and safe.

### G.E.'s speed-distance regulator

For speed control, General Electric uses the radar transmission line which is primarily designed for train separation. For normal train operation, control units on the wayside generate speed commands representing the maximum speed for a particular section of track. The speed command is transmitted from the control units via carrier-current communications equipment and the radar transmission line to pick-up coils on the train.

The 200-kc carrier is frequency-modulated by nine low-frequency tones between 67 and 115 cps to indicate different speed commands. Tuned circuits on the transmission line isolate adjacent speed-command zones, but permit the radar train-separation signal to pass.

The speed regulator (see diagram above) compares the speed reference established for the track section with the car's actual speed—taken from two tachometers on the axles—and a speed-error signal is generated in the running-speed block. This signal causes the translator to operate the propulsion or braking system to reduce the speed error to zero.

If headway errors begin to accumulate, the supervising computer commands a train to run at other than normal speed (within safety requirements) to reduce the errors.

No matter what speed-control signals are received, however, the safety-stop portion of the reg-



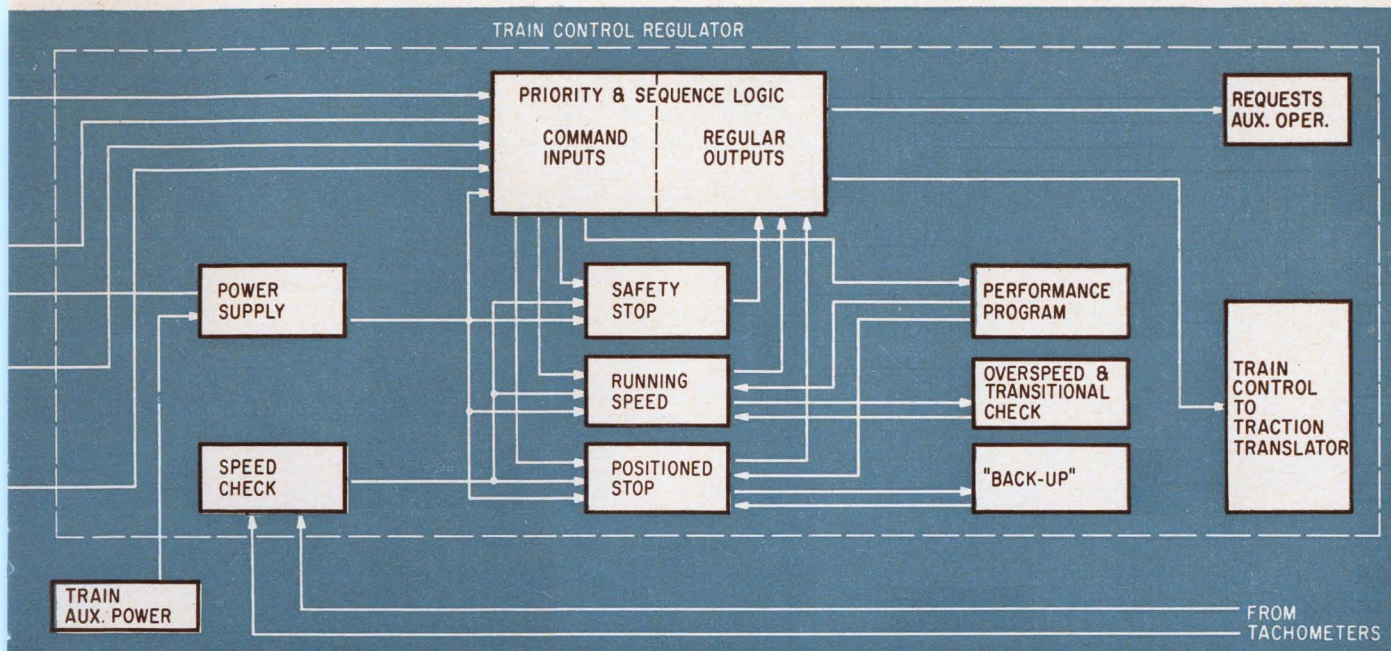

Speed-distance regulator, part of General Electric's radar train-separation and speed control arrangement.

ulator, which is the train-separation radar, always has overriding control of the vehicle.

The speed-error signal is generated in the form of a voltage somewhere between a negative maximum and a positive maximum—for example, between  $-10$  volts and  $+10$  volts. In this example, a negative voltage indicates an overspeed condition calling for some degree of braking:  $-10$  volts would indicate a drastic overspeed requiring full braking effort, whereas a positive voltage indicates an underspeed condition calling for acceleration. A zero voltage indicates that the present speed is correct. The speed-error signal is translated upward to a control signal between  $0$  and  $+20$  volts, again using the hypothetical example, so that power failure in the control system would automatically call for full braking effort.

Station and terminal program commands, which open doors, reverse direction, etc., are transmitted

via a  $175$ -kc carrier-current signal, to differentiate them from speed commands. This carrier is also frequency modulated between  $67$  and  $115$  cps to give individual program commands. Station and terminal program command signals are inductively coupled to car-carried pickup coils through local wire communication loops, without using the radar system.

### General Railway's analog computer

In the General Railway setup, actuating signals for the speed-control system are generated by an on-board analog computer. There are three modes of operation: velocity, acceleration, and programed stop. The first operates the train at a prescribed velocity, the second imposes a prescribed acceleration level, and the third brings the train to a precisely controlled station stop.

The functions executed by the operational amplifiers in the computer are listed in the table at the left. The velocity term is generated by a tachogenerator directly coupled to an axle of the train. The traction system has a potentially slow response that tends to introduce oscillations in the velocity and programed-stop modes. To damp out the oscillations, an internally generated acceleration term is included in the functions for these two modes. The three modes are shown in the simplified schematics, at the bottom of page 83.

The actuating signals are again integrated within the computer to produce the propulsion and braking signals transmitted to the traction system. Thus, when the actuating signal is zero, no change is made in the level of the tractive effort. Fail-safe logic circuits compare the desired speed with the actual train speed. The train-protection system overrides control by the feedback traction control system if the speed limit is exceeded.

### Functions of GRS' analog computer

Mode	Actuating function
Velocity	$v_R - v - ka$
Acceleration	$a_R - a$
Programed Stop	$v_P - v + k(-a_P - a)$

$v$  = velocity

$a$  = acceleration

$k$  = a constant multiple applied to the variable to adjust its value. As shown in the schematic,  $k$  is defined by the setting of a potentiometer.

$R$  = (subscript) reference value of variable

$P$  = (subscript) programed value of variable

The programed velocity is derived from the actual velocity  $v$ , the programed acceleration  $a_P$ , and the initial distance to the stopping point  $s_0$ , by the equation

$$v_P^2 = 2a_P (s_0 - \int v dt)$$

which is solved in the analog computer.



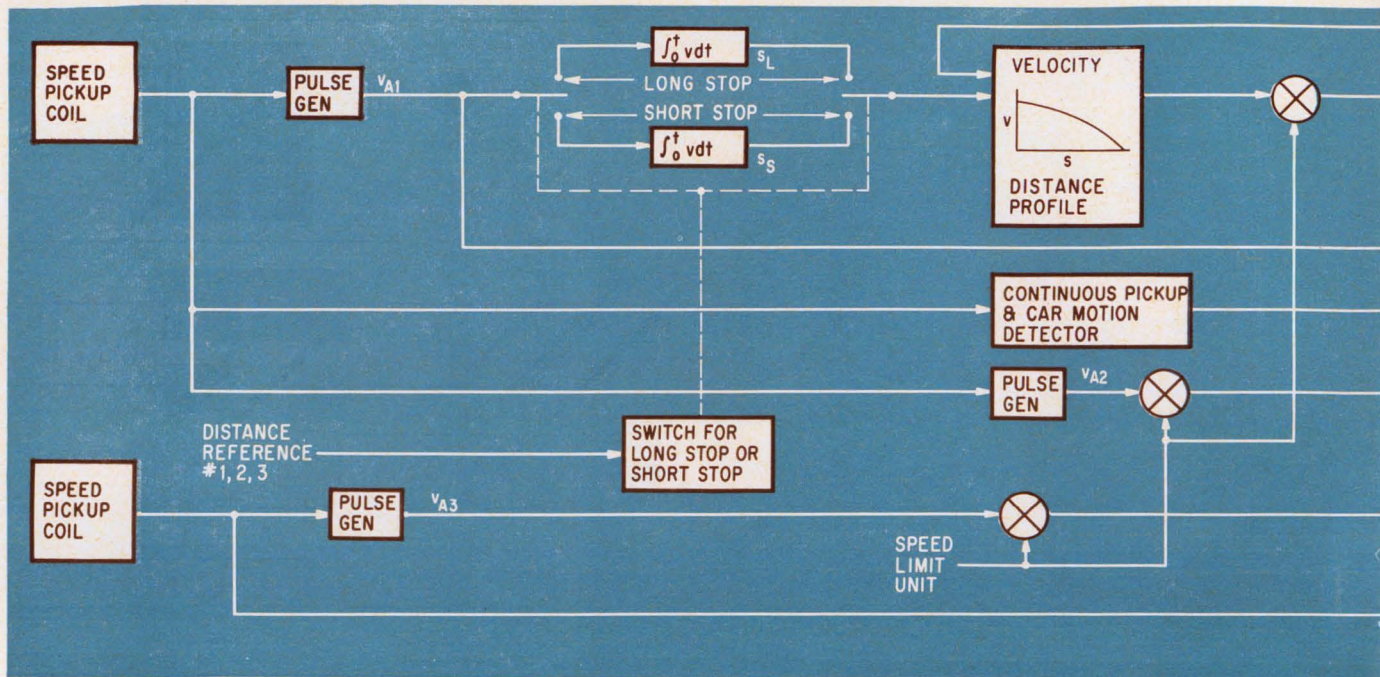

Control system proposed by the Westinghouse Air Brake Co. for train separation, speed control, and station stops.

### Wabco's track and signal circuits

Speed commands are transmitted to trains in Wabco's design with the same network of amplifiers, filters and relays used for train separation (see p. 77 and panel, p. 78). The two oscillators and an encoder generate specific speed-control signals that are transmitted through the signal circuits and the rails to the equipment aboard the train, just as train-separation signals are handled. Ten different signal levels are available for speed control, of which only three refer to train separation. The most restrictive, or slowest-speed, signal governs the train if two or more signals are received.

## III. Precise stopping

Three of the four control-systems manufacturers use similar techniques to tackle the problem of bringing trains to a full stop within one foot of a precisely specified point at the railway station. With their approach, tuned coils spaced along the track act as station-distance markers. Westinghouse Electric, however, gives the job of stopping trains to its ubiquitous Wayside Controller.

### Wabco's station-stop system

In the system designed by Wabco, tuned coils are placed 2,700, 300 and 100 feet from the stopping point. These coils are tuned at 8, 10 and 6.2 kc respectively. As a car passes over each distance-marker coil, the signal is picked up by receiving coils on the train, passed through a low-pass filter and used as a distance reference signal (see diagram, above).

This reference signal resets the velocity-control programmer, an analog computer, to the car's actual distance from the station. To stop the train, the computer matches the train's speed to a standard curve in the velocity-distance profile stage and thus smoothly and automatically brings the car to a stop at the exact point desired, by gradually decreasing propulsion power and gradually increasing braking power. An electronic controller at the station orders the doors opened and closed, and

### At the test track

The three laboratory cars zipping along the nine miles of track that make up the test bed for San Francisco's rapid-transit system bear no resemblance to the sleek cars (see p. 85) that will be carrying four million passengers by 1971.

All tests are being run on three individual cars, dubbed Lab Cars A, B and C, and built by the Budd Co. They are loaded with propulsion and control equipment and vast quantities of instrumentation. In late June, Lab Car C had been in part-time operation for about two months; Car B was at the site and being made ready for tests. Car A is expected to arrive at the test track later this month.

Because each car carries all four competing systems—it can switch readily from one to another—each electronics company had to ship three complete sets of electronic gear to San Francisco.

It appears that an individual system will be tested over a substantial period—from several days to a couple of weeks—until a sizable amount of performance data is collected on it. Then the car will switch to another system and be tested for the same length of time.

Even the test track is being tested. Several kinds of rail, different methods of mounting the third rail, and various kinds of ballast under the ties are being tried.



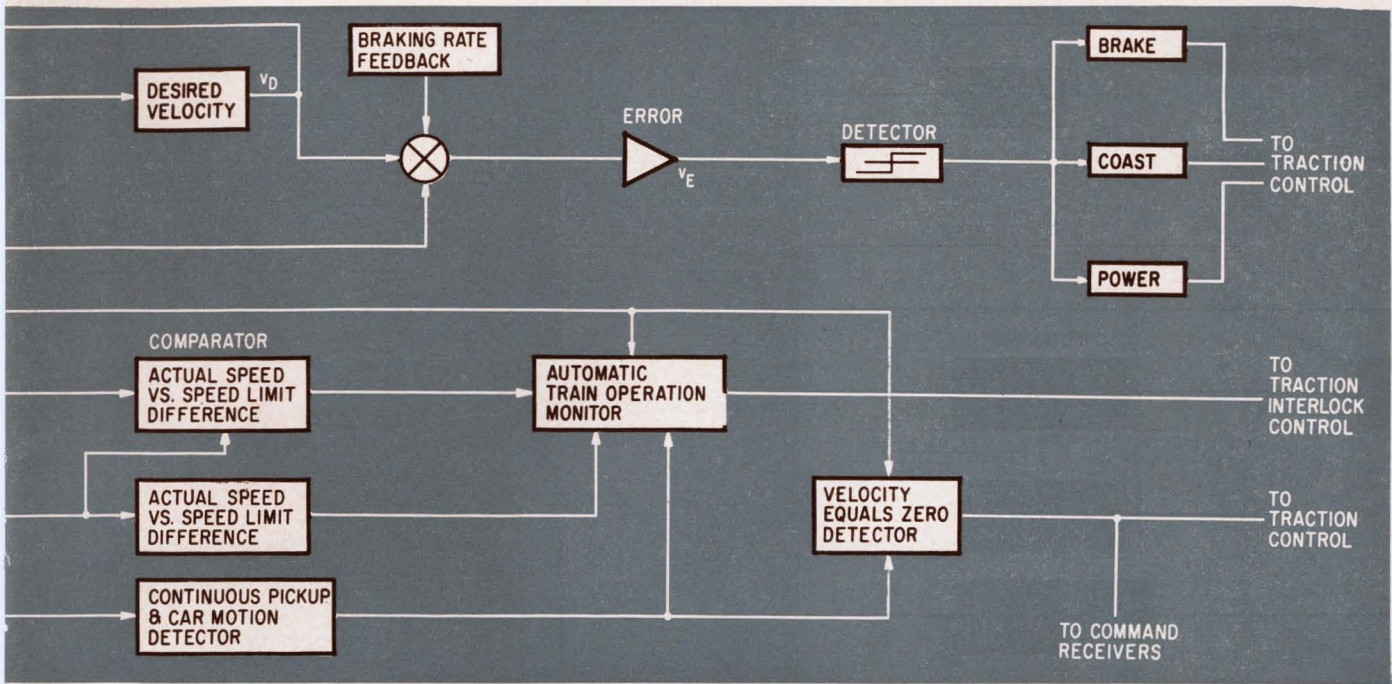

starts the car on its way to the next station.

### General Railway's train-stopper

When a station stop is to be made, an analog computer, the same one that controls speed in the GRS system (see diagram below), draws a speed-distance profile in accordance with

$$s = s_0 - \int_0^t v(t) dt$$

where  $s$  is the continuously changing distance to the stopping point,  $s_0$  is the initial distance of 3,000 feet to that point,  $v$  is the continuously changing

velocity, and  $t$  is time. The result is compared in the computer to the quantity  $v^2/2a$ , where  $a$  is a preset deceleration constant chosen to insure a smooth stop. The computer generates a signal that adjusts the velocity to keep the two quantities numerically equal.

The first tuned coil is 3,000 feet from the stopping point. When the train passes over it, the stopping sequence begins. The other tuned coils are 500 and 100 feet from the stopping point; they are used to recalibrate the stopping-profile generator (see diagram below).

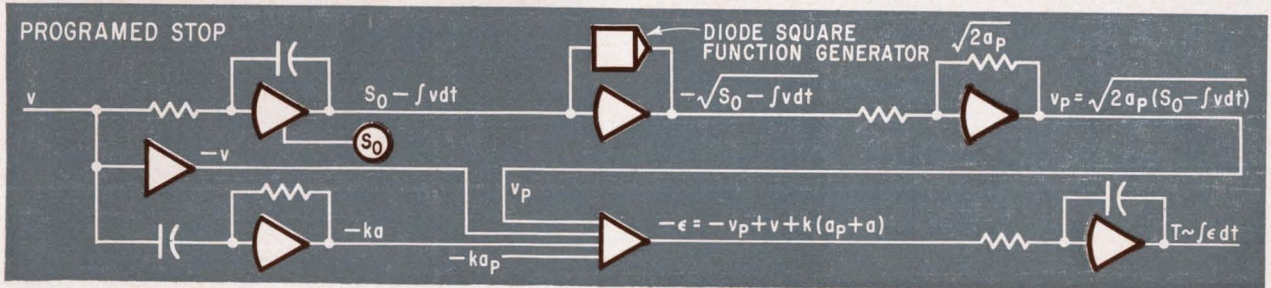
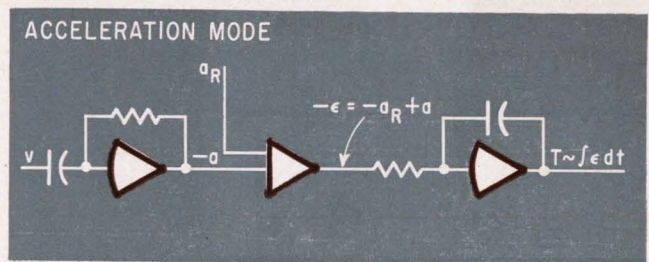
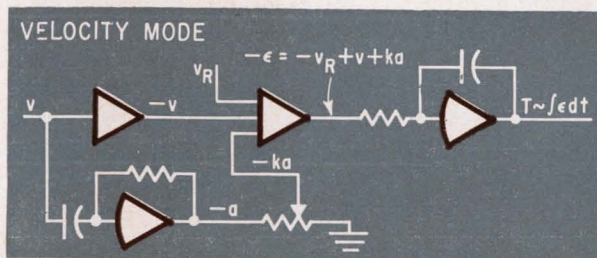

LEGEND: OPERATIONAL AMPLIFIER SUMMING AMPLIFIER

Analog computer for speed control, in simplified form, as used by General Railway Signal system.





**Interior of detachable pod at front of BARTD train.** One man sits here to take control in case of emergency. With the control panel the crewman monitors the electronic control equipment on board; through the large front window he watches for fallen boulders and other track obstructions. He won't have to watch for people or for stalled cars; the track is completely fenced and there will be no grade crossings.



**Interior of passenger section of BARTD rapid-transit car.** The upholstered seats—charcoal and brown in this prototype model—are 22 inches wide, compared with the usual 17 or 18 inches for bus seats. The decor includes beige carpeting and vinyl wood-grain paneling. The prototype car is now on display near San Francisco, and BARTD officials have invited the public to inspect it and make suggestions.

The stopping sequence begins when the initial distance  $s_0$ , is set into the integrator. Then the true velocity, which is signaled from the tachogenerator on the axle (see p. 81), is connected to the integrator, which produces a voltage that is proportional to the distance remaining to the stopping point. The output of the integrator therefore is a voltage that continually decreases toward zero. This distance voltage is transformed into a voltage signal proportional to the velocity the train should have. After the theoretical velocity and acceleration are compared with the actual velocity and acceleration the difference is used to increase or decrease power to the traction motors.

When the train passes over the other two coils, their signals correct, or recalibrate, the integrator's output to compensate for variations caused by wheel slip and long-term car equipment changes such as wheel wear.

The pick-up equipment on the car includes an amplifier, set for zero feedback, that has overlapping input and output coils. When a tuned coil along the rails comes within coupling distance of the overlapped input-output coils, the amplifier oscillates; this frequency, which depends on the coil the car passed over, is filtered and used to

actuate the proper circuits to turn on the stopping-profile generator, give the first distance calibration and recalibrate the integrator.

After the train stops, a signal is generated to open the doors. A delay between train-to-wayside and wayside-to-train communication insures zero speed before the doors open. A timer at each station, normally set for 20 seconds, begins to close the doors of each car. If the edge of a door meets any obstacle, the door will reopen, then attempt to close again. This is repeated until the door closes all the way and is locked. The train cannot move until all doors on the train are locked.

#### **General Electric's regulator**

To control a normal station stop, GE's system uses four inert coils between the rails, at distances of about 1,700, 400, 200 and 50 feet from the stopping point. The stop signal is generated in the same way as the speed commands (p. 80) 2,300 feet from the stopping point; the four coils provide definite distance indications to correct for accumulated errors caused by wheel wear, tachometer inaccuracies, wheel slip, and so on. Each coil contains a piezoelectric element that causes the coil to resonate at one of four frequencies in the range of 520 to 580



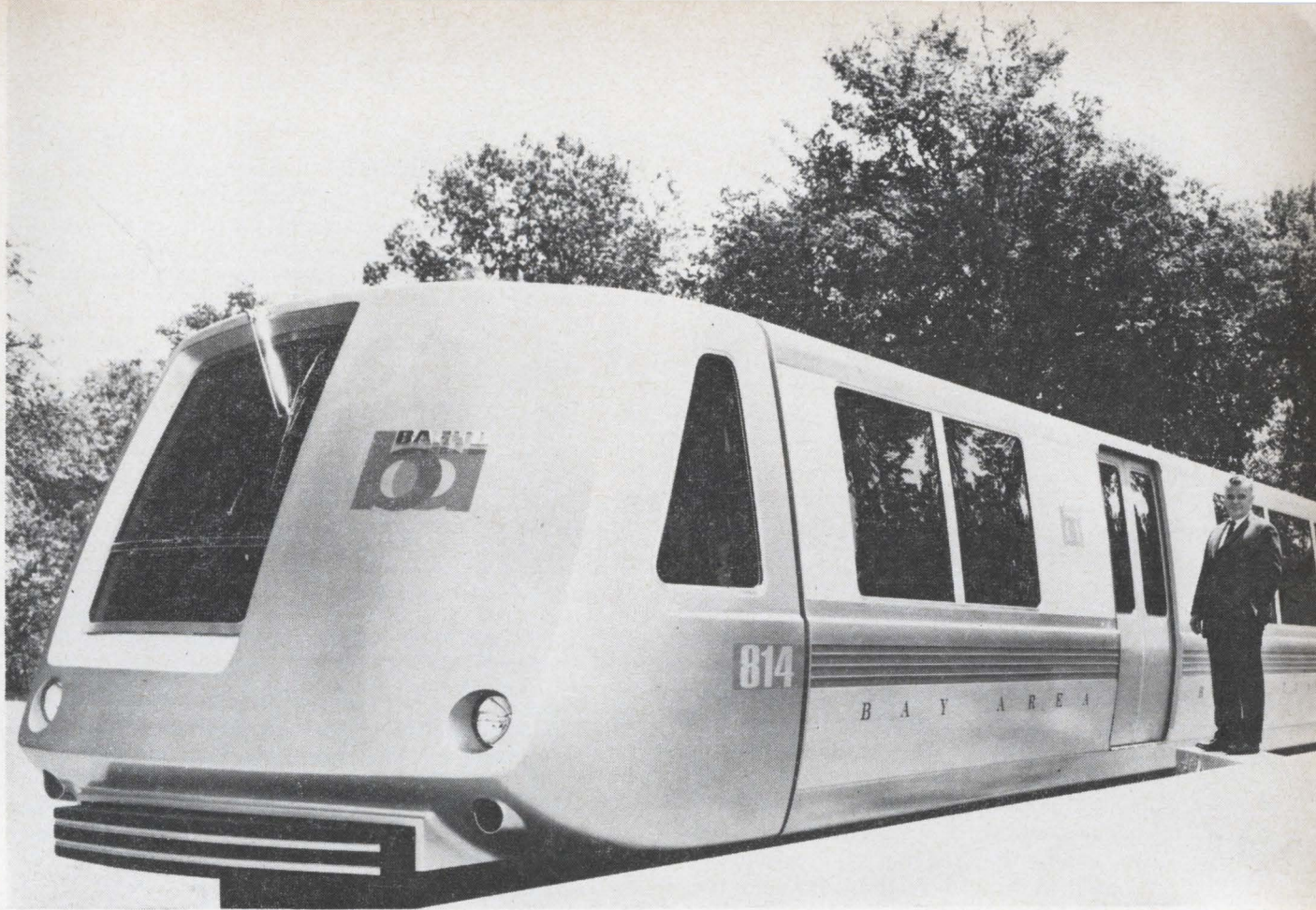

**Prototype of rapid-transit car** for the BARTD system. It is 72 feet long, air-conditioned, and carries 70 riders who can look out through tinted windows as they relax in upholstered comfort. The car runs on a wide-gauge 5½-ft. track (standard gauge is 4 ft. 8½ inches) for greater stability and a smoother ride. The detachable front section, or pod, carries all the electronic equipment and the one crewman aboard the train. The exact specifications of the pod will depend on the control system chosen after the test period on the Mt. Diablo track.

kc. A transceiver on the train constantly sweeps this range. As it sweeps past the frequencies at which the inert coils resonate, an antenna on the train picks up the resonant state.

When the train receives the platform-stop signal, the speed-distance regulator described on page 80 is switched from the speed-control to the distance-regulation mode.

In both modes, tachometers on the axles of the car generate a signal proportional to train speed. In the distance-regulation mode, this signal is fed to an integrating amplifier whose output represents distance traveled by the train toward the stopping point.

Subsequent signals coming in from the coils indicate the exact distance remaining to the stopping point. This distance, compared with the measured distance traveled by the train, produces a distance error. The error signal indirectly operates the propulsion and braking system and reduces the error, in the same way that the speed-error signal (p. 80) maintains correct speed.

Opening and closing the car doors and restarting the train at the station is handled by station-located equipment that operates in a manner similar to the Wabco and GRS systems.

### Westinghouse's computer, again

The simplest approach to stopping the trains seems to be Westinghouse Electric's. Near the station, the wavelength of the square-wave wire loop decreases and the signals generated by the passage of the train over the square-wave pattern increase in frequency, causing the computer to branch to a deceleration program. With each pulse received from the square-wave pattern, the computer recalculates the correct deceleration, just as it does for speed control (pp. 79 and 80) except that this time deceleration is continued until the car is brought to a smooth stop. Door opening, station waiting time, door closing and start-up are signaled from the Wayside Controller for that section of the track.

## IV. System supervision

**All four competing manufacturers** have provided for a central control room from which the entire rapid transit system will be supervised by automatic equipment, and at which certain manual operations will be carried out. This central control room will be situated next to the Oak Street



station in Oakland, just southwest of the junction of the Fremont line, the Richmond line, and the tunnel under the bay.

The central control room, according to present plans, will be included in the BARTD administrative headquarters building. This six-story structure will also house a multilevel garage where automobiles can be parked. At the Oak Street station the rapid transit tracks will be underground. In the station, between street level and track level, will be a mezzanine level where automatic fare collection equipment (see panel at right) will be located. The central control room will be visible from the mezzanine level, behind a large plate glass window. Passengers getting on and off trains at the Oak Street station will be able to see the central control complex in action.

Actually, Westinghouse Electric is the only manufacturer that uses a computer in a major control role. It will use its own Prodac 500 as the central control with 40 Wayside Controllers, each built around a smaller Westinghouse Prodac 50. The Prodac computers are Westinghouse Electric's process control machines. The Prodac 500 will be placed in the central control room, and the Wayside Controllers will be placed in pairs, for reliability, at selected stations throughout the system.

General Railway did not send a computer to the test track because in the completed system a computer would be used only at the central control section for routine data processing jobs. The bulk of General Railway's equipment will be alongside the track in enclosures resembling those presently used in fixed-block signaling systems.

General Electric's plans call for four GE/PAC 4000 process control computers—one computer system for each of the four arms of the rapid-transit line. Each GE/PAC 4000 will have a GE Directo-Matic II connected to it. The Directo-Matic supplies the counters, shift registers, code converters and amplifiers for input and output functions. Another GE/PAC 4000 will provide system-wide integration and scheduling. All five systems will be housed at the central control room. GE's wayside equipment is the radar transmission line and the speed-command generators located at suitable points along the track. At the BARTD test site, GE is using one computer for all control.

To communicate with its wayside transmitter-receiver units, Wabco is using a Computer Control Co. DDP-24 computer as a supervisor. One of these is at the test track but two would be used in the complete system: one would be for train scheduling and override control, the other would handle maintenance records and fare collection. The latter would take over for the first machine in case of malfunction. A Wabco 549 digital-data transmission unit will act as the middleman between the computer and the wayside.

Three of the four central supervisory systems include a dispatcher's console, with which trains brought manually from storage and maintenance yards are set up for automatic operation. This

## Tickets, please

Even fare collection will be automated for the Bay area Rapid Transit passenger. Three systems are being tested, all of which employ a magnetically coded ticket that is the rider's key to the track area.

The rider buys his ticket from a machine that accepts bills or coins; the machine bears a map of the system, and the passenger pushes the button corresponding to his destination. At the gate to the train area, he feeds the ticket to a machine which resets the code, returns the ticket, and lets him through.

For commuters, who use multiride tickets, the machine at the gate may add a code showing the station of departure.

At his destination, the passenger puts the ticket into a slot at an exit gate, where it is read for point of origin. The magnetic code is changed to subtract the fare, and the gate opens. The passenger is given a visual reading of the amount remaining; he can use the ticket again and again until the magnetic code indicates that there is no money left.

The passenger who rides past his station, and finds that his ticket won't open the exit gate, will be directed to a "deficit fare collector," which will take additional coins till the fare is met, and change the code on the ticket so that it will unlock the gate. For passengers who have bills too large for the vending machines (the present ones take only ones and fives, though they will be modified for tens and twenties by the time they are installed in two years), BARTD will have a special desk with a human being behind it at each station.

The systems being tested were devised by the Advanced Data Corp., a subsidiary of Litton Industries, Inc., by the General Electric Co., and by the FMC Corp. and the Control Data Corp. acting jointly. One problem still being studied is how to code the ticket but still make it readable to the passenger. A printed message could be added, or the code could be made understandable to the buyer.

function is analogous to the dispatcher's office in conventional railroad operation, where the dispatcher says to the motorman or locomotive engineer, "Get on train No. XXX which has just been made up in the yard and take it to such and such a destination, at such and such a speed and headway." For automatic operation the same instructions must be given to every train leaving a terminal, but there is no motorman. There is no dispatcher's console in the GRS system; the dispatcher's function is executed by a crewman who inserts a punched card into a card reader on the train.

Each of the four approaches to the San Francisco Bay Area Rapid Transit District system are examples of electronic engineering moving into a brand-new application area. A better day lies ahead for harried commuters in cities all over the world because of what's happening now on the nine-mile stretch of railroad track between Walnut Creek and Concord.

Reprints of this report are available. See the reader service card at the back of this issue.

© copyright 1965, Electronics ® A McGraw-Hill Publication



# The AE Type 45 Rotary Stepping Switch can solve almost any circuit-transfer problem

There's an economical, rugged and reliable way to simplify many of today's complex switching circuits. Just replace entire groups of relays or transistors with an AE Type 45 "stepper." One of these large-size, general-duty rotary stepping switches can provide up to twelve 25-point bank levels, or up to eight 50-point bank levels.

Choose between the Type 45 (with normally open levels) or the Type 45NC (with normally closed levels). The latter is designed so that, when the rotor is stepped, pairs of bank contacts are *opened* successively. For true versatility, NO and NC levels can be combined on the same switch!

When you specify AE rotary stepping switches you get the benefit of continuous research—in design, in metals

and insulating materials. Plus *positive positioning*, a unique AE design feature that locks the rotor, makes overthrow impossible.

For helpful application information, we offer the 160-page book, "How to Use Rotary Stepping Switches." To get your copy, just ask your AE representative. Or write the Director, Relay Control Equipment Sales, Automatic Electric, Northlake, Illinois 60164.

**AUTOMATIC ELECTRIC**  
SUBSIDIARY OF  
GENERAL TELEPHONE & ELECTRONICS **GTE**

**Counting**  
**Controlling**  
**Monitoring**  
**Selecting**  
**Indicating**  
**Timing**

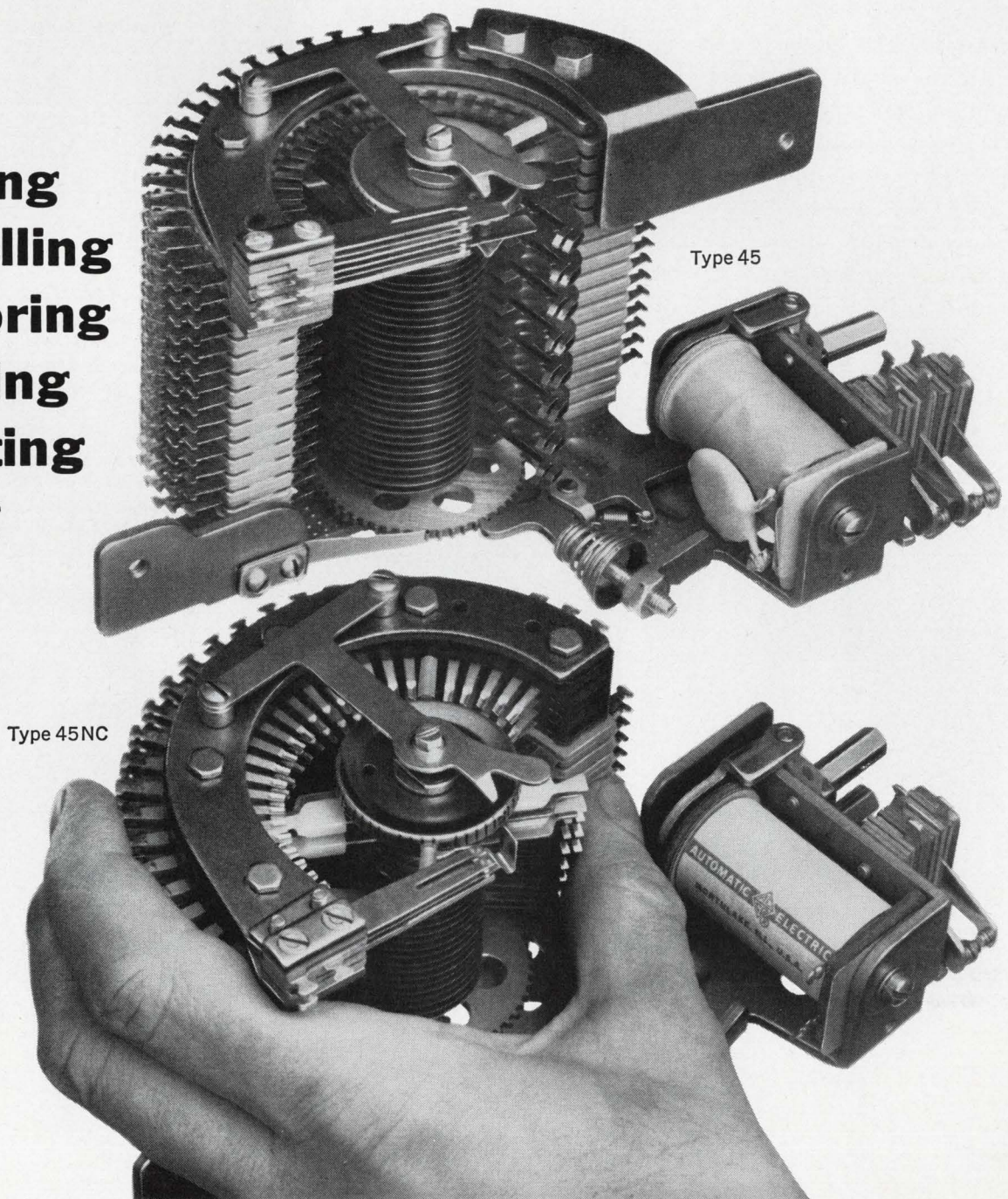



# Nine RTV silicones designed to meet MIL-S-23586



General Electric now offers a full range of RTV silicone compounds designed to meet high performance and reliability requirements for RTV's in aerospace and weapons applications as set forth under MIL-S-23586 (Wep). A new addition to G-E's proven aerospace silicones, the RTV-8000 series includes pourable compounds and spreadable pastes, with the required type and amount of catalyst to permit fast, medium and slow cures.

All compounds cure at room temperature. All have excellent electrical

properties. And in common with all G-E RTV silicone rubber compounds, they have excellent resistance to temperature extremes from  $-90^{\circ}\text{F}$  to  $+600^{\circ}\text{F}$ ; they resist ozone, weathering and aging under conditions that break down ordinary elastomers; they resist attack by many oils, solvents and chemicals; and they bond so well after priming that the bond is actually stronger than the rubber itself.

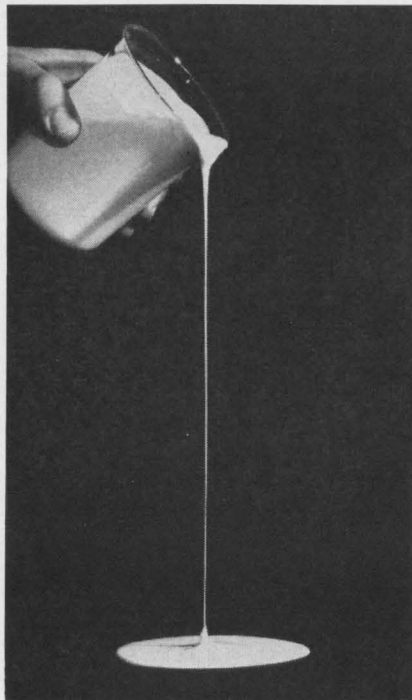
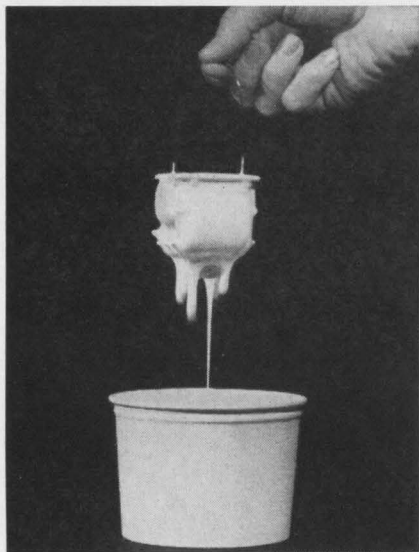

G-E RTV's QUALIFIED UNDER MIL-S-23586 (WEP)		
Type I Low Viscosity	Type II Moderate Viscosity	Type III Thixotropic
RTV-8111 Fast Cure	RTV-8262 Medium Cure	RTV-8372 Medium Cure
RTV-8112 Medium Cure	RTV-8263 Slow Cure	RTV-8373 Slow Cure
RTV-8113 Slow Cure		RTV-8382 Medium Cure
		RTV-8383 Slow Cure

The low and medium viscosity compounds in the new RTV-8000 series are recommended for potting and encapsulating. The high viscosity pastes are recommended for sealing, patching, and caulking, as well as for thermal insulation where a high degree of radiant heat is involved. Like to know more? For complete technical information, write to Section N7154, Silicone Products Dept., General Electric Co., Waterford, N. Y.

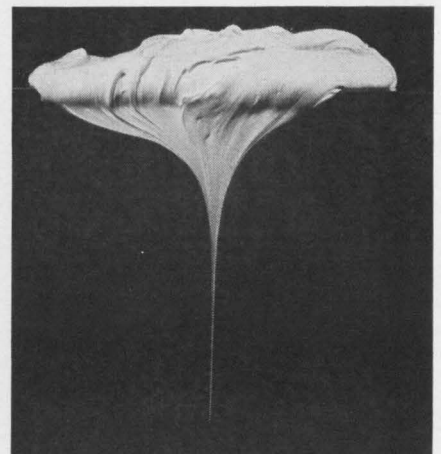

GENERAL  ELECTRIC



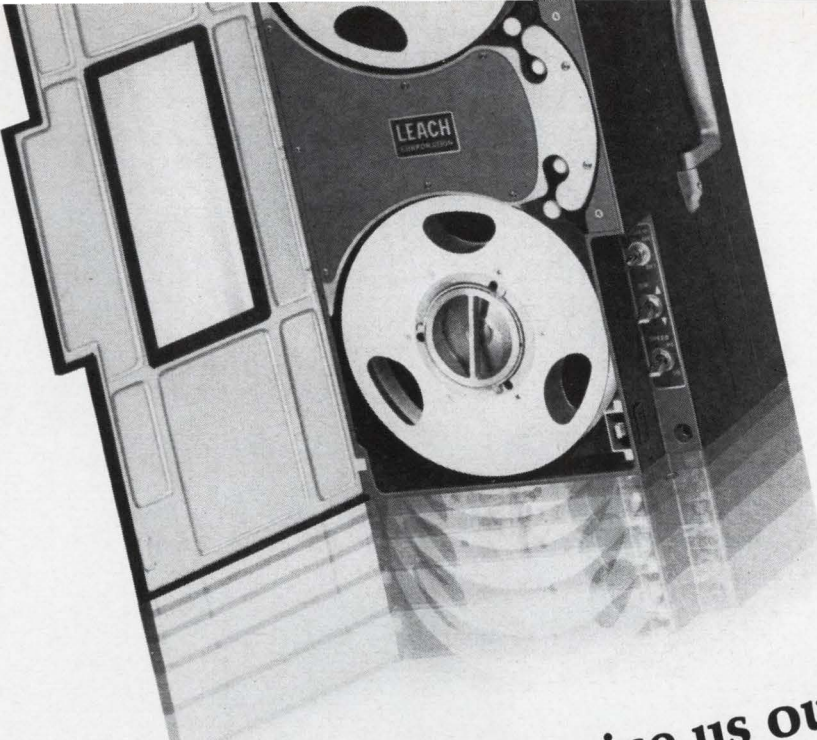

does \$18,000 price us out  
of your tape recorder picture?

Perhaps. But where critical applications demand maximum performance, the MTR-3200 is really the only one *in* the picture. Check these environmental specs against any recorder/reproducer at any price. Shock: 10g, 11ms, 1/2 sine — 3% peak to peak flutter. Vibration: 10g rms random operating — 6% peak to peak flutter. Flutter: less than 0.5% peak to peak at 60 ips. Acceleration: 25g operating. Temperature: —40°C to +70°C operating. Humidity: 95% operating. Altitude: 150,000 ft. (unlimited for 20 hours).

The MTR-3200 is rugged. Versatile. Maddeningly precise. And all in a portable 44 lb. package. In exchange for a modest power requirement of only 55 watts at 28 VDC, it records, stores and reproduces data anywhere. Need as many as 7 tape speeds? Got 'em. Up to 14 channels analog and FM, or 16 digital channels. And you can utilize them in any combination.

Even data bandwidths are extended beyond IRIG standards. What's more, the entire unit is compatible with IRIG standard data reduction equipment.

For really big spenders, a wide range of little luxuries are available such as special analog to digital, serial to parallel and parallel to serial conversion equipment. Or extended broadband FM recording and reproduction with a frequency response of DC to 800 KC or analog from 500 cps to 2.4 mc. We'll supply just about anything in the way of electronic options, on special order. Just ask.

If you're not quite ready to write a P.O., then send for our brochure on the MTR-3200. It has all the details.

# LEACH CORPORATION

**CONTROLS DIVISION:** 717 North Coney Avenue, Azusa, California. Phone: (213) 334-8211. Export: LEACH INTERNATIONAL S.A.





## One Cubic Instrument System performs the function of four separate instruments!

The industry-leading approach to digital instrumentation is offered by Cubic Corporation's Instrument Systems. Each employs plug-in modules to perform five different measurements. These include DC volts, bipolar DC ratio, AC volts, ohms, and low-level DC to 1 micro-volt. Function Selector Knob on the instrument face changes function... without changing plug-in modules. A Cubic Instrument System eliminates the need for other instruments to make basic measurements.

### Designed for easy expansion

Each Instrument System is based on a flexible design. Adding basic input and output devices or separate peripheral equipment quickly

alters capabilities. Accessory connector modifications or field programming of accessory plugs also changes an Instrument System to meet new requirements. Front panel functions are programmable, for adaptation to varied systems.

### Four models available

**Instrument System 150**—Low-cost industrial 5-digit DVM unit.

**Instrument System 250**—Current-summing, reed relay DVM for reliability.

**Instrument System 350**—5-digit DVM features solid state switching for speed.

**Instrument System 240**—Cubic's rugged 4-digit, reed relay DVM.

### Accessories

**Input Modules:** Preamplifiers, AC-DC Converters, Ohms-to-volt Converters, Scanners.

**Output Modules:** Data Translators and Buffers.

**Peripheral Accessories #640** Scanner, #800 Data Translator, #811 Printer, Typewriters, Tape Punches. For information about Instrument Systems, write: Cubic Corporation, Dept. D-188, 9330 Balboa Ave., San Diego, Calif. 92123.



**CUBIC**  
CORPORATION  
SAN DIEGO, CALIFORNIA 92123  
INDUSTRIAL DIV.



# Probing the News

Instrumentation

## An ear to the underground

Forming a giant circle 125 miles in diameter, a sensitive seismic array will be able to detect underground nuclear blasts anywhere in the world

By Thomas Maguire

Boston Regional Editor

Across seven million uninhabited acres of southeastern Montana, workmen are digging 525 carefully placed holes, 200 feet deep, part of the world's most delicate instrument for detecting earth tremors. A seismometer will rest at the bottom of each hole and the network will form a seismic antenna so sensitive it can pick up the vibrations generated by an underground nuclear explosion anywhere in the world.

For the first time, engineers are applying the full range of sophis-

ticated electronic techniques—communications theory, radar array design and data processing—to the perplexing problem of nuclear test detection. Politically, the nuclear listening post promises to cause a stir too. It could sweep away the obstacle of on-the-spot inspection that stymied the international meeting on a test-ban treaty in Geneva two years ago. At that time, underground explosions had to be excluded because they were not always distinguishable from an earthquake. Already, British seismolo-

gists are urging that test-ban negotiations be reopened because of the potential of the new system.

Meanwhile, the United States and the Soviet Union have agreed that nuclear test ban talks be reopened after a 10-month recess. President Johnson suggested that the discussions, which would include extending the current ban on atmospheric tests to underground tests, be started by July 27.

The goal of the Montana array is to increase bomb detection sensitivity at least tenfold over the

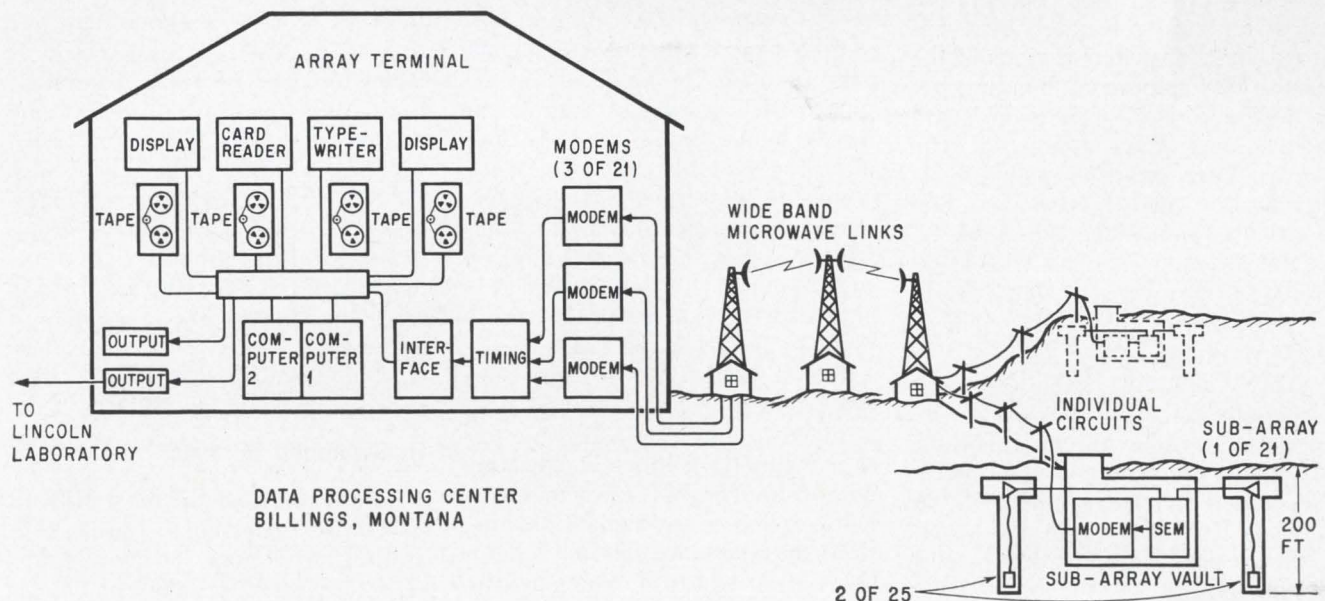

Listening post for underground nuclear explosions is expected to detect blasts anywhere in the world. Seismic array can be pointed, like a radar antenna, at the Soviet Union or China to receive signals from underground nuclear tests.



best that instruments can do today. It is part of Project Vela, the national program to increase nuclear test detection capability, and is sponsored by the Defense Department's Advanced Research Projects Agency. Supervising the installation and test is ARPA's Nuclear Test Detection Office.

### I. The array

In size, the new array dwarfs anything like it that has ever been built. Its 525 seismometers are in a circle whose diameter is 125 miles and whose center is in the town of Miles City. The seismometers convert acoustic waves—generated by a nuclear blast and transmitted through the earth—to voltages which are amplified, digitized, arranged as a series of bits, and then transmitted by telephone line and radio relay to a central data processing center 140 miles away in Billings, where the source of the shock wave is calculated.

ARPA assigned responsibility for the sensing portion of the \$8-million system to the Air Force Technical Applications Center in Alexandria, Va.; the Lincoln Laboratory of the Massachusetts Institute of Technology designed the signal processing, transmission and data processing portion.

**Following seismic waves.** The sensing portion of the system reflects the unusual characteristics of seismic waves. From the source of disturbance, seismic waves travel downward toward the center of the earth and are refracted, bent upward, by the various regions of the earth. The amount of bending depends on how deep the layer is and helps locate the source of the waves. There are two main waves: P-waves, compression-refraction waves that move, like sound waves, in the direction of wave travel and S-waves, shear waves that vibrate at right angles to the direction of wave progress.

AFTAC engineers laid out the seismometers as if they were elements of a radar antenna. The instruments are arranged in 21 asterisk-shaped subarrays, each with 25 devices. To get the gain and sensitivity desired so the array would not be swamped by the long waves, they needed an antenna with an aperture 25 times the wavelength

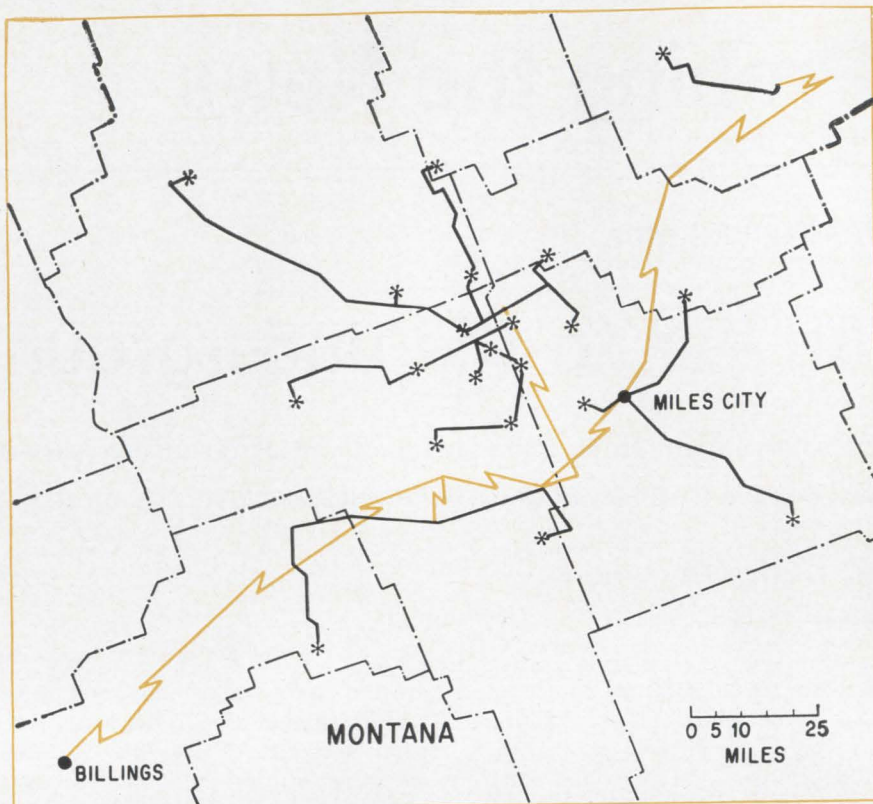

Asterisk-shaped subarrays, holding 525 seismometers, are 200 feet underground. World's largest seismic listening post will be tested this fall.

to be received. That meant an aperture of at least 125 miles since the waves have a frequency that ranges from 1 cycle per second to 8 cycles per second and a central wavelength of 5 miles. Thus the project was named Large Aperture Seismic Array or Lasa. Incidentally, each subarray, measuring  $4\frac{1}{2}$  miles across, has about the same sensitivity as the best seismic array built to date in the Vela program.

Like a radar antenna, the seismic array can be "pointed" at any region of the world, for example the Soviet Union or China. It is done after the fact by data processing. A specific pattern of seismometers would receive the strongest signals from a test in the Soviet Union, so processing just their output is equivalent to narrowing the search to that one geographic area.

**Signal processing.** In the seismometer, a mass of weight constrained to move vertically in a coil in a magnetic field is set vibrating by seismic waves to generate a voltage. Before any signal transmission can take place this tiny microvolt output has to be magnified by a solid state parametric amplifier which is positioned on the surface

directly above the seismometer.

To simplify handling the signals from so many instruments, the 25 seismometers in each subarray are connected to a junction point where electronic equipment samples the outputs, codes them, converts them to digital signals and arranges them in serial bit streams, to be fed into telephone company modulators-demodulators so they can be impressed onto telephone lines and carried to Miles City at a rate of 9,600 bits per second. "Telephone lines are cheap, require no repeaters and have plenty of bandwidth at 50 to 100 kilocycles," says Paul E. Green, who directs the 35-man Lincoln Laboratory group working on the project.

At Miles City, data from Lasa feeds into the telephone company's augmented microwave relay network for transmission to the data processing center in Billings.

### II. Swamped in noise.

Unquestionably the most difficult part of the operation of Lasa is separating noise from seismic signals. "It's the classic problem of detecting a signal swamped in noise," says Green. Lasa's prime job is to



improve the signal-to-noise ratio and the signal-to-reverberation ratio.

Since noise comes from a lot of places—natural earthquake waves which travel in all directions; small vibrations caused by weather and ocean waves; the reverberations from a strong bomb test; and local traffic and surface noise which has been minimized by putting Lasa in a nearly deserted section of the country—the techniques to strain it out vary.

**Bomb or quake?** Differentiating bomb tests from an earthquake is the trickiest problem; but it can be done with electronic data processing provided the input signals are strong enough. For example, the disturbance caused by a bomb lasts longer than that from an earthquake. A bomb does not excite aftershocks while an earthquake does. And earthquake waves tend to come from deeper in the earth compared to bomb waves, a fact that can be identified by the difference in time for P and S waves to arrive at the detector.

With Lasa's giant aperture and many seismometers, low-noise parametric amplifiers, and signal processing techniques, Lincoln Laboratory's Green believes signal-to-noise ratio can be raised 20 decibels which would amount to an improvement by a factor of 10 in the detection of bomb yield. "In other words, if we can now detect a bomb of 100 kiloton, Lasa will allow the detection and identification of a 10-kiloton bomb," Green believes.

According to the current timetable, the last hardware will be delivered next month. Tests will start in the fall. By early 1966, engineers expect they will be able to report just how effective the array is.

At the start of operation, data from Lasa will be recorded on tapes that will be flown to Lincoln Laboratory in Cambridge, Mass. for processing on a Digital Equipment Corp. PDP-7, the same machine on which research was conducted to perfect the signal processing techniques and test the computer programs for processing the data. Eventually, two PDP-7 computers will be installed in Billings at the data center. Then the array will be a full time monitor of

seismic events with the system programmed so that only signals of interest are processed, off line, for display and evaluation.

**Jigsaw puzzle.** Calculating the source of the disturbance is a complex mathematical job, a little bit like putting a jigsaw puzzle together because it takes a lot of pieces of information. It requires the times when each seismometer first felt the disturbance and an analysis of the differences in time between instruments in widely separated parts of the array; it requires the pattern of instruments that receive a strong signal from the disturbance and those that receive a weak one; it takes a study of the length of the seismic disturbance and whether or not after-

shocks occur; and, as previously mentioned, it takes a measurement of the time difference for the two main kinds of seismic waves to reach the seismometers. Finally triangulation techniques are applied to pinpoint the source of the underground disturbance.

**Politics.** Just how Lasa will operate after it is finally checked out next year will depend more on national policies and international agreements than on technical considerations. During next year's tests, engineers and technicians from the prime contractors will operate the system. After that, however, a national defense agency or an international policing group might take over the seismic listening post.

---

## Medical electronics

# Thermovision: 'Heat pictures' on an oscilloscope screen

Swedish engineers use tv techniques to speed medical diagnoses. The new system proves valuable in a steel mill, war zone and even on a race track

By Robert Skole

Stockholm Correspondent

**Swedish engineers** have applied television techniques to medical thermography, enabling doctors to get an immediate look at heat patterns in the body.

Physicians have used heat pictures for years to detect local infections, which are always warmer than the adjacent areas; also to measure the intensity of burns and to follow the progress of healing after plastic surgery. The biggest drawback has been the delay and nuisance of making a time exposure for these thermographs and then of developing the infrared film; this

can take a day or more, during which the patient's condition can change markedly.

Now engineers at AGA, a big electronics and optical company in Lidingö, have developed Thermovision, which converts infrared rays into pictures on an oscilloscope. The system was shown publicly for the first time last month at an international show of hospital equipment in Stockholm.

Nils Björk, manager of electronics development at AGA, says systems are being tested at several hospitals in Sweden. AGA plans to market



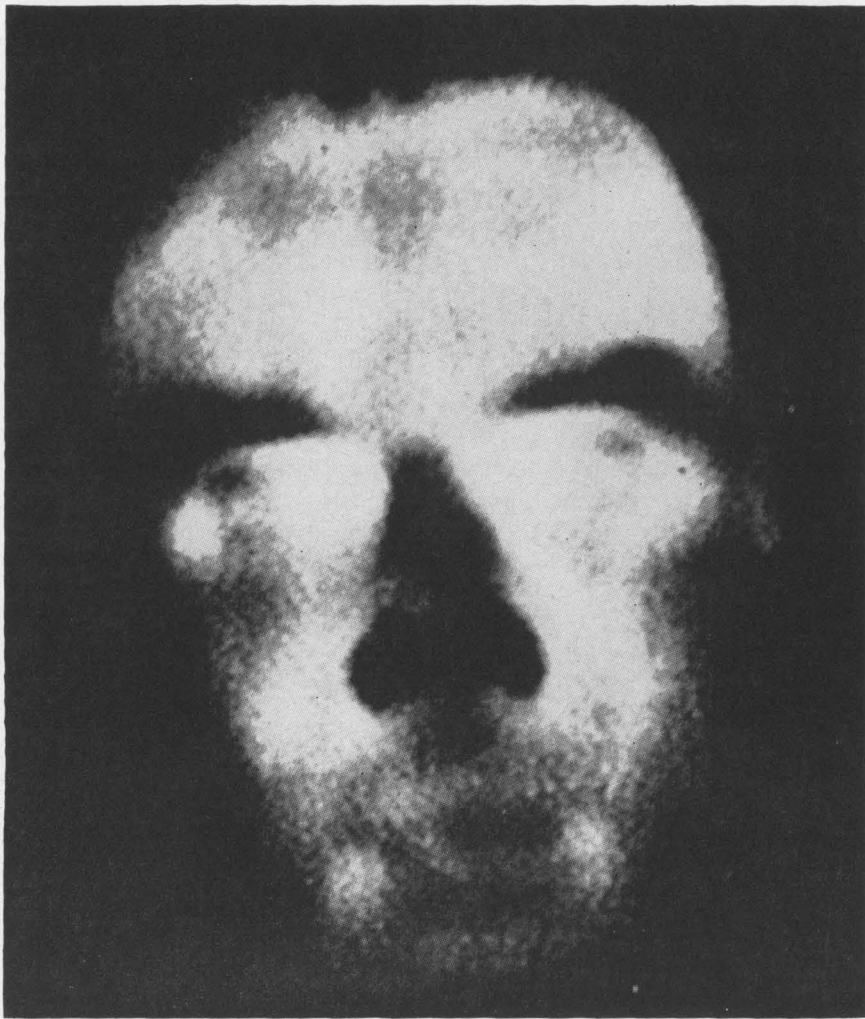

Heat picture of a face on Thermovision. Dark areas are cool, light areas warm. Difference between warmest and coolest area is only 3°C.

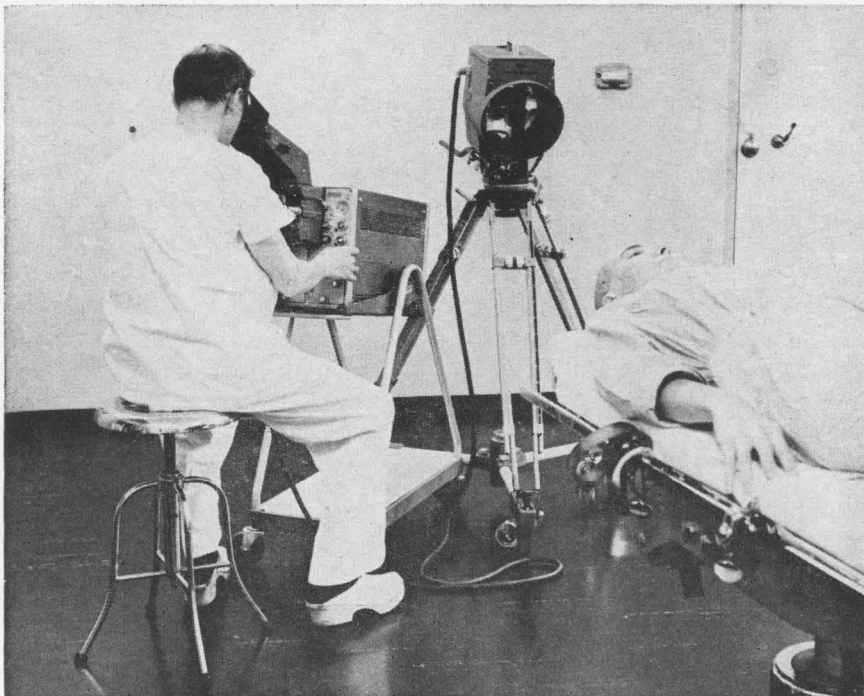

Peering into oscilloscope shaded from room light, diagnostician examines Thermovision picture of patient.

Thermovision this fall; its price in Sweden is \$20,000 for a complete system including an oscilloscope monitor and a camera with mechanical scanning. The company also expects to lease the equipment.

### I. Adjusting the picture

A Thermovision picture can be adjusted much like the picture on a tv screen at home. Darkness can be controlled so that light areas, corresponding to high temperatures, begin as low as  $-25^{\circ}$  or as high as  $150^{\circ}\text{C}$ . A contrast dial allows the picture to cover a temperature range as broad as 100 degrees, where only large changes are noticeable on the oscilloscope screen, or as narrow as one degree, where a fluctuation of only  $0.1^{\circ}\text{C}$  will be apparent to a viewer.

The contrast adjustment also governs the range of shades, from black to white, of a temperature scale displayed at the bottom of the picture. The scale allows temperature comparisons.

The Swedish system can also produce an isotherm—a picture of all surfaces at specific temperatures. A dial adjusts the video amplifier so that the light intensity on the screen is greatest at locations corresponding to those at the given temperature.

**Scanning.** The big difference between Thermovision and conventional thermography equipment is the camera's ability to scan at 16 pictures a second to produce a flicker-free display. Vertical scanning is performed with an oscillating plane mirror, horizontal scanning with a four-cornered prism that rotates 400 times a second to deflect 1,600 lines a second.

From the prism, infrared radiation is focused on a sensitive detector that converts it to an electrical signal. The detector is cooled by liquid nitrogen.

A cable that can be extended to 100 feet connects the oscilloscope monitor to the tripod-mounted camera. The camera can be focused remotely, from seven feet to infinity, by a motor controlled at the monitor. Björk says later models of Thermovision may use a conventional tv tube for the display monitor instead of an oscilloscope. He adds that operational amplifiers in the next series of models will use



ERIE ANNOUNCES A DRAMATIC ADVANCE  
IN MONOBLOC® CAPACITOR CAPABILITY...

# SUBMINIATURE Hermetically Sealed-in-Glass CERAMIC CAPACITORS To **.01** or **.068** mf. CAPACITANCE

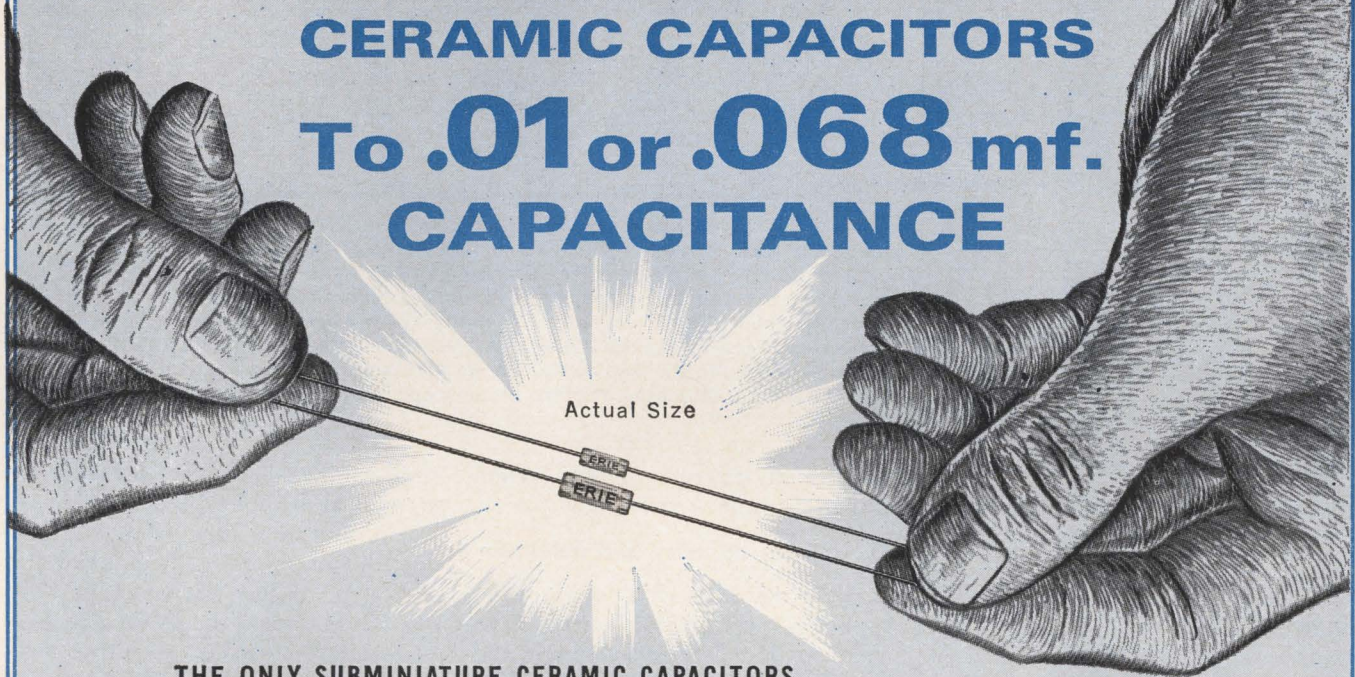

## THE ONLY SUBMINIATURE CERAMIC CAPACITORS REALLY PROTECTED AGAINST HAZARDOUS ENVIRONMENTS

If your Aerospace, Military or Commercial capacitor applications demand the following requirements, Erie now offers the only ceramic capacitors designed to meet or exceed them ALL . . . *subminiaturization; very high capacitance-to-volume ratio; manufactured to Established Reliability Standards or to Custom Standards; positive hermetic-seal against critical environments; 100 WVDC.*

These new, glass encased MONOBLOC ceramic capacitors are produced in two subminiature sizes. Type 8005 measures .100" in diameter x .260" in length and is available in a capacitance range to .01 mf. Type 8025 measures .130" in diameter x .390" in length in a capacitance range to .068 mf.

Both of these extremely reliable units are manufactured by Erie's MONOBLOC PROCESS®, whereby ceramic films are bonded into solid structures yielding high capacitance-to-volume ratio. This rugged structure is then hermetically sealed in glass for the ultimate in protection from hazardous environments. Insulation Resistance after 20 days of moisture cycling per MIL std. 202, method 106A is 20K megohms.

Consider the proved advantages of these advanced components in the equipment now on your drawing board! Write for specific data and literature to . . . Erie Technological Products, Inc., 644 West 12th Street, Erie, Pennsylvania.

TYPE 8005 CAPACITANCE RANGE TO .01 mf.

TYPE 8025 CAPACITANCE RANGE TO .068 mf.

Another series of components in Erie's Project "ACTIVE."  
Advanced Components through Increased Volumetric Efficiency.



644 West 12th Street  
Erie, Pennsylvania



# High-Protean Diet of Optical Devices

## Photo-Coupled Transistors:

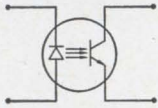

DC, AC, and pulsed signals • True electrical isolation (up to 25 kv in special packaging) • High current output • GaAs light source drives photosensitive multijunction device • Hermetically sealed TO-5 or TO-18 case; 4 leads

## Phototransistor:

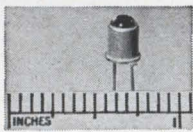

Quantum efficiency of photoconductive sensor  $>1000$  • Spectral response, visible region to near infrared • Low unit cost • Applications for computer systems, industrial controls, optical tracking, optical relays • Standard enclosure, hermetically sealed TO-18 with lens • Special, line arrays and mosaics up to  $100 \times 100$

## Ultra-Low Capacitance Silicon Optical Detector:

Capacitance down to 3 pf/cm<sup>2</sup> • Peak response at 1.06 microns • Available in singles, arrays, quadrants

## High D\* Silicon Photovoltaic Sensor:

D\* to  $10^{13}$  • Peak at 9000A • Single chip and multiple chip mosaics up to 1000 detectors

## Two-Color Detector:

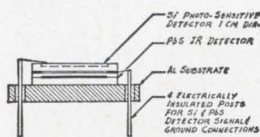

Antireflection-coated Si detects visible and transmits infrared to rear detector (PbS or other). Circular and quadrant assemblies. Special hemispherical Si acts as a  $2\pi$  front detector and as an IR lens.

## GaAs Light Sources:

• High efficiency diodes for DC, AC, and pulsed operation • TO-5, TO-18, Varactor diode mount (0.050 dia.  $\times$  0.125 L) • Peak emission  $>10^{-3}$  watts/steradian DC at room temp. (TO-5 lens mount)

For a rich and varied diet of technical data, write or call ENL. You're also invited to ask for special servings in configurations designed to meet the requirements of specific applications.



**ELECTRO-NUCLEAR  
LABORATORIES**

2433 Leghorn St., Mountain View, Calif. 94041

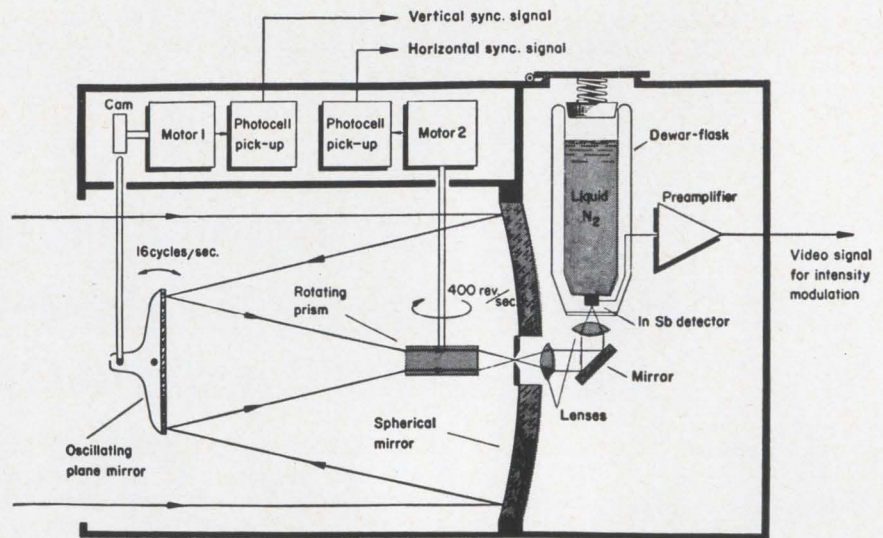

Camera for Thermovision system uses a spherical mirror to focus incoming infrared radiation on a plane mirror. The plane mirror tilts up and down to deflect the infrared signal vertically, and reflects the scanned beam to a four-sided prism. From the prism, the beam is optically focused on a crystal detector in the dewar where they are converted to low-level electrical signals; then the signals are amplified and transmitted to the display equipment. All the power required for the camera is transmitted from the oscilloscope via the connecting cable.

integrated circuits. Thermovision already employs transistors.

## II. Uses in industry and defense

Although AGA won't confirm the report, the company is said to have developed Thermovision for the Swedish armed forces. Military applications stem from the fact that the camera emits no infrared light that can be spotted by an enemy's detectors. Although Thermovision's range is secret, the company says the system has detected heat from vehicles 1,500 feet away in almost any weather.

The system also is finding uses in industry. AGA is already using Thermovision to inspect for hot spots in electronic equipment and products. Björk also believes it could be used to detect potential burnouts in radio and tv sets on the assembly line.

The Swedish State Power Board is using a Thermovision camera, mounted on a truck, to inspect power lines for hot spots. And it has been suggested that Thermovision be sent aloft in helicopters to inspect transmission lines in remote areas.

**In a steel mill.** A steel mill has used Thermovision to detect burned or cracking crucible bricks that line the smelting furnaces. Spotting a crack before the molten steel can burn through the furnace

shell can save the steel maker a great deal of money and time.

Thermovision has scanned the outside of buildings under construction, to test various types of insulation and to detect heat leaks. In Sweden, a cold country that has to import all of her heating oil, efficient insulation is valuable.

Fire underwriters also can use Thermovision to test and inspect boilers, heating equipment and electrical gear.

## III. Medical applications

The most exciting applications, however, remain in the medical field. Doctors have found thermographs helpful in observing disease activity in rheumatoid arthritis; presumably, faster pictures can speed diagnosis and treatment.

Some physicians expect the technique to be valuable in prenatal examinations, particularly for finding the exact location of the placenta. Others mention the possibility of using the system as a screening test for breast cancer.

Thermovision also has been found to be valuable in veterinary medicine, notably at the race track. It has disclosed sinus trouble in one horse, and helped a veterinarian discover that a mild knee infection caused a trotting horse to break his gait and gallop—and thereby lose the race.



# Only with the 175A

push a button  
and get a  
permanent  
trace recording

Sensitivity,  
0.2 v/cm.  
Sweep speed,  
200 ns/cm.

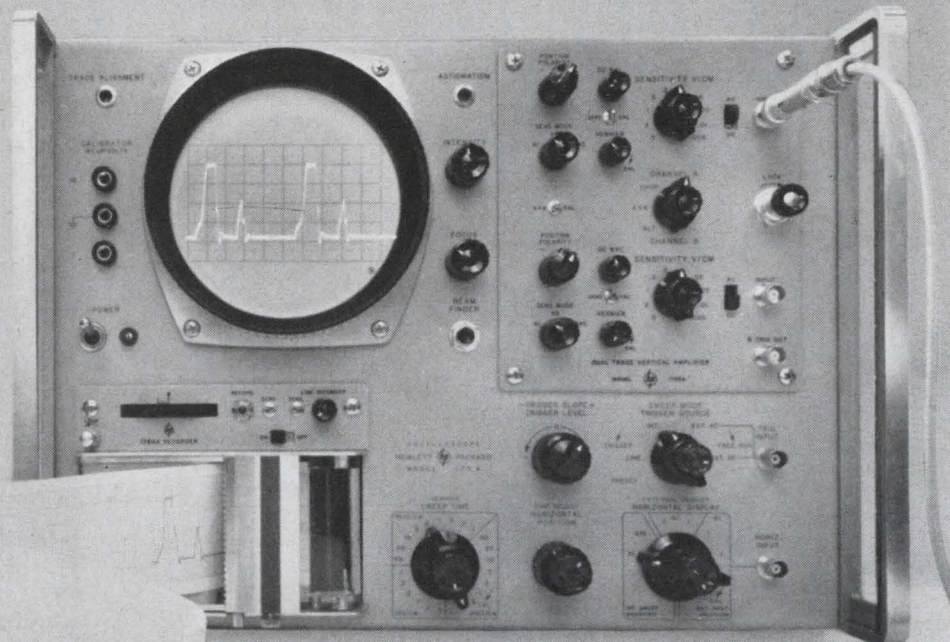

## in 10 seconds... the first time

Dual plug-in capability of the Hewlett-Packard 175A Oscilloscope, plus the new hp 1784A Recorder Plug-in give you unique trace recording capabilities on today's top-performing 50 mc scope. Now, in breadboarding circuits, for example, you can make inexpensive recordings of traces and actually compare signal changes as you change circuit components. All you do is push a button and get a recording. A perfect "picture" the first time . . . and you get 20 recordings from the 1784A at the cost of one photograph. No lens settings to worry about, no camera to block your view of the scope screen. An ideal recording technique for production and quality assurance.

Consider these exclusives with the 175A, \$1325: 1 mv/cm sensitivity at 20 mc, dual channel; 50 mc bandwidth at 10 mv/cm with the new 1755A vertical plug-in, \$575; 4 channels with 40 mc bandwidth with the 1754A, \$595; trace scanner for recording on an external x-y recorder, \$425; sweep delay with mixed sweep, \$325; time mark generator plug-in, \$130; and, of course, the new 1784A recorder, \$775.

Comparison proves: spec by spec and dollar for dollar, the 175A is your best . . . and most promising 50 mc scope investment. Get all the details and a demonstration from your Hewlett-Packard field engineer or write Hewlett-Packard, Palo Alto, California, 94304, Tel. (415) 326-7000; Europe: 54 Route des Acacias, Geneva; Canada: 8270 Mayrand St., Montreal.

*Data subject to change without notice. Prices f. o. b. factory.*

**HEWLETT**  **PACKARD**  
An extra measure of quality



# LAPP HEAVY-DUTY STAND-OFF INSULATORS

Space electronics

## Apollo hastens shift to S band

By Peter R. Sigmund

Space Electronics Editor

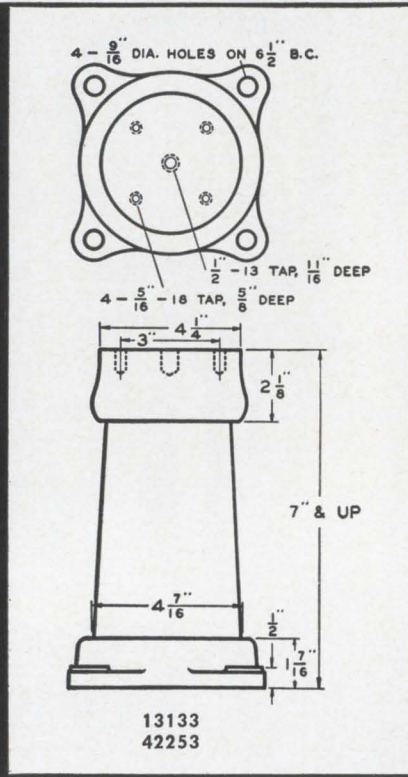
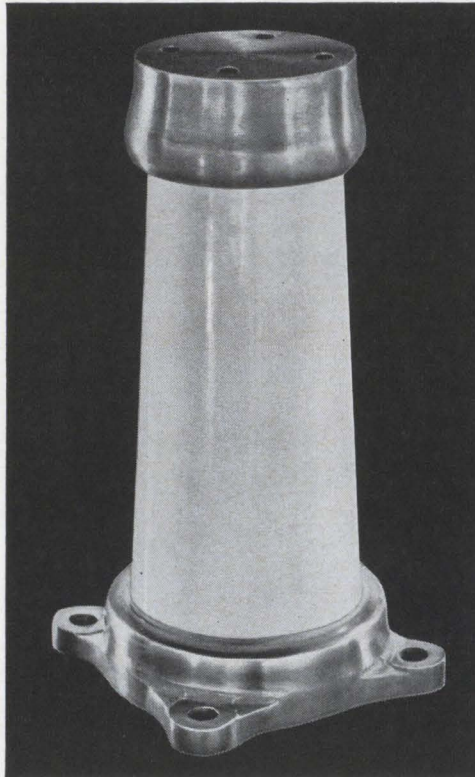

...in all these standard sizes to save you time and money

FLASHOVER AND RADIO RATINGS							
DRY FLASHOVER 60 kv eff.			RADIO RATING kv eff.				
Height in inches	13133	9063 26006	13133	42253	9063	26006	
6	37	*48			12 1/2	23	
8	57	*62	13 1/2	25	15 3/4	29	
10	*71	*72	16	30	18	33 1/2	
12	*82	*80	18	33 1/2	20	37	
14	*92		20	37			
16	*101		21 1/2	40			
18	107		22 1/2	41			

NOTE: \*indicates in stock.

Other sizes available on special order, for fast delivery, and at a price you know is fair. Write for Bulletin 301-R.



Lapp Insulator Co., Inc.,  
 234 Sumner Street,  
 LeRoy, N. Y.

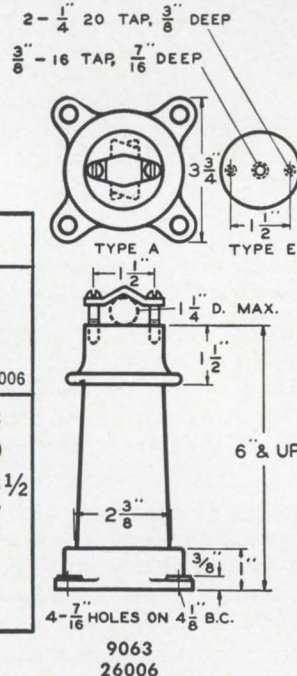

The United States' shift to higher frequencies for space communications will receive a powerful thrust from Project Apollo next month. That's when construction will begin, on Guam, of the first of 13 ground-based tracking stations in a world-wide S-band (1,550 Mc to 5,200 Mc) network.

The move to S band conforms with a Defense Department order to raise frequencies used on missile ranges; more important, it allows high gain and permits many different kinds of messages to be transmitted over a single frequency. With only one frequency, an Apollo station will be able to handle tracking, command, telemetry, television and voice communication. Project Gemini, in contrast, uses several frequencies, each with its own transmitters and receivers.

By combining communications and tracking on a single carrier, Apollo will reduce the amount of equipment required on the spacecraft and on the ground.

The decision requires new families of electronic components to be developed; it also gives prominence to recent innovations such as the overlay transistor with its high-frequency, high-power capability. Several companies—the Radio Corp. of America, Texas Instruments Incorporated, Motorola, Inc., National Semiconductor Corp. and Vector division of the United Aircraft Corp.—have begun crash programs to develop and produce commercial lines of overlay semiconductors.

By early 1967, Apollo's unified S-band system is scheduled to be fully operational around the globe. The test station, now at the Collins Radio Co. in Dallas, prime contractor for the equipment, will be one of 10 stations with 30-foot antennas. While Apollo is in earth



orbit and during the first 20 minutes of its trip to the moon, it will be monitored by 10 ground stations with 30-foot antennas; after the spacecraft has completed the first 8,000 miles of its trip, unified S-band support will be given by three stations with 85-foot antennas.

### I. Ground stations

All the antennas are basically similar, except that the smaller one has one transmitter and the 85-footer has two. Each tracks as low as 2° above the horizon with an accuracy of 1.5 minutes of arc, and each consists of one basic antenna for communications and tracking with a small acquisition antenna mounted at its center for acquiring the spacecraft as it comes over the horizon. The S-band antennas have high gain—a requirement for Apollo. The 30-foot antenna's gain is about 44 decibels; the 85-foot antenna's is 51 decibels.

Each ground station will consist of about 40 racks of equipment—computers, receivers, amplifier, servo systems, encoders and check-out gear. Information from Apollo will be received on one S-band carrier. If voice, digitized telemetered measurements and television are sent simultaneously, they will be separated and processed by a computer and relayed in real time to the Mission Control Center in Houston.

### II. Spacecraft gear

One S-band transponder in the Apollo command module will handle most of the communication and tracking jobs after the spacecraft leaves earth orbit for the moon. It will receive digitized commands and voice communications from earth; it will also send voice, tv and telemetry data, and provide the ground with range and range-rate information. Although a back-up transponder will be carried along, it may not be needed.

When the transponder receives a coded signal from the ground, it will return a signal that is coherent in phase with the original signal. The ground station will measure the time difference between the transmitted and received signal, and from that computation it will figure the spacecraft's range. The rate at which the range is changing will be measured by using the

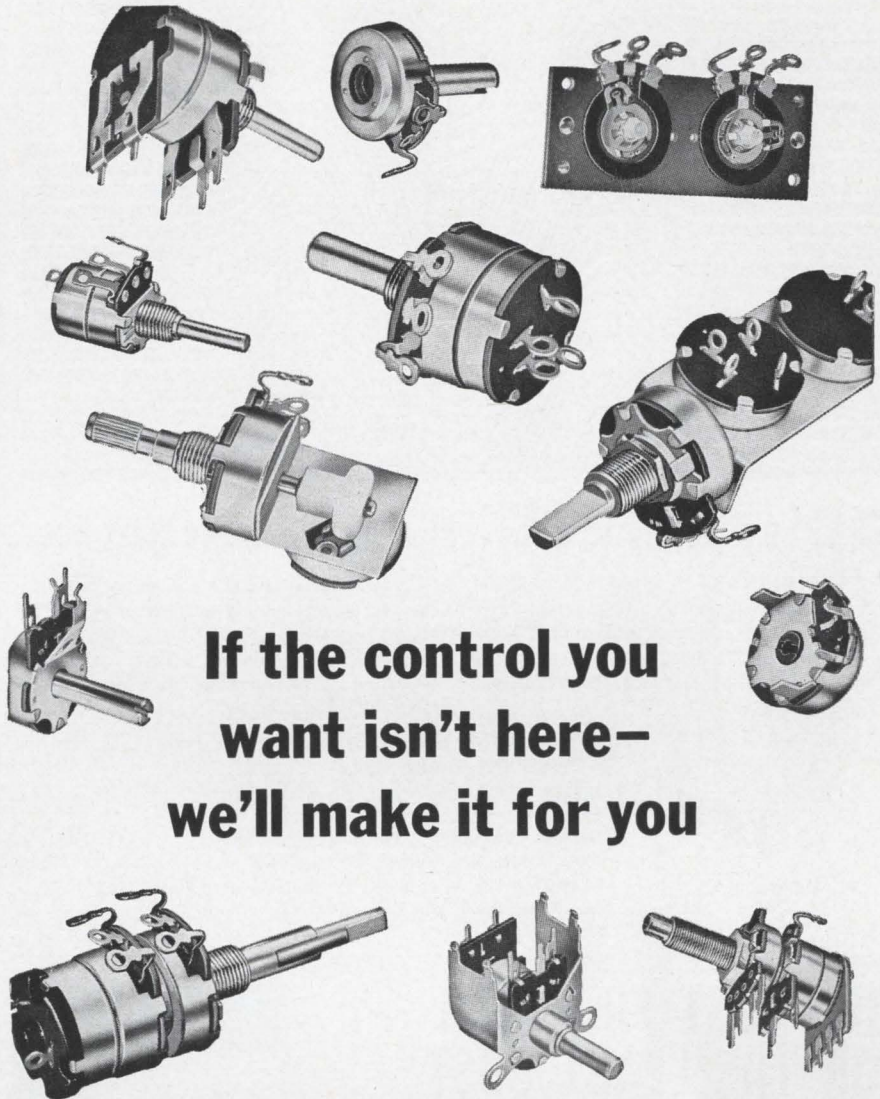

**If the control you  
want isn't here—  
we'll make it for you**

Our standard control line includes just about any model you might need. Singles; duals, tandem and concentric; miniatures; printed circuit types; economy-priced strip controls. With rotary, push-pull, push-push, or momentary action switches. In linear, audio, modified and special tapers, single and double taps; low end-resistance for transistor circuitry. Every mounting configuration imaginable. All of them with the famous long-life, high-stability Mallory resistance element.

And if you need a special design, we'll be glad to design and manufacture it for you. We've saved many dollars for many people with our value-conscious engineering.

Write today for a copy of our Bulletin 98-51. And let us have the opportunity of quoting on your next order. Mallory Controls Company, a division of P. R. Mallory & Co. Inc., Frankfort, Indiana 46041.

**MALLORY**



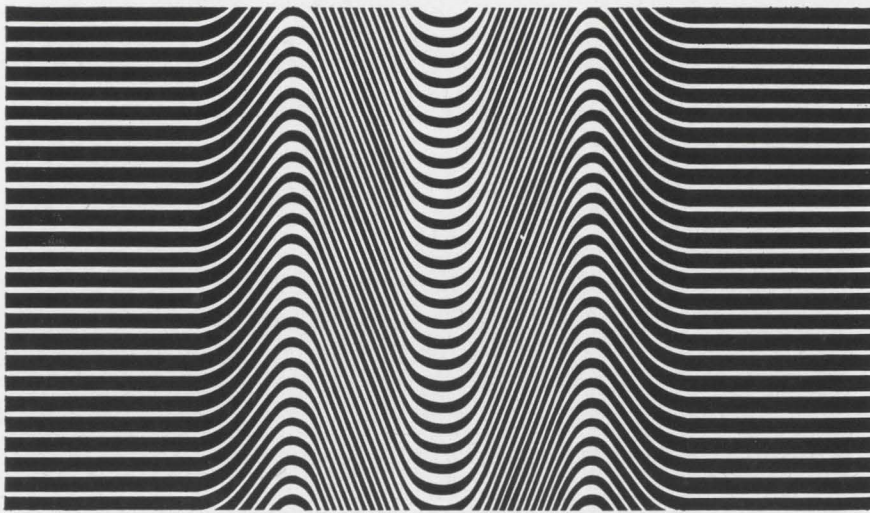

## optimizing the art ... in magnetostrictive delay lines

**LFE STANDARDS** • Designed for commercial and military applications □ Delays from 5 to 10,000  $\mu$ sec □ Frequencies 300 Kc to 2 Mc □ Delay Drift due to temperature less than 1 PPM/C □ Compatible standard input and output circuitry available.

**CUSTOM DESIGNED** • For special commercial and exotic military applications □ Fixed, tapped, adjustable and variable □ Frequencies to 5 MC RZ and 10 MC NRZ □ Delay Systems to 100,000  $\mu$ sec incorporating amplifiers and related interface circuitry.

To Optimize your design, OPT LFE  
WESCON Booth 4212



**LFE ELECTRONICS**

A Division of Laboratory For Electronics, Inc.  
WALTHAM, MASSACHUSETTS 02154

Delay Lines • Filters • Transformers • Amplifiers, and Associated Electronics  
Microwave Measurement & Signal Generation Equipment

Circle 205 on reader service card

doppler shift technique.

### III. Spacecraft antennas

The command module will carry a steerable, high-gain S-band antenna for use during most of its journey to the moon. The antenna is made up of five dish-shaped elements of varying sizes. For maximum beam, the center element—a small one—will be used; for medium beamwidth, there will be a larger dish. For maximum gain four big dishes, phased together, act as a single antenna and provide a sharp pencil beam.

The command module also will carry two S-band omnidirectional antennas for use during reentry; each antenna will give complete hemispheric coverage, so there will be no loss of data in case the spacecraft should roll.

LEM has a fixed antenna and a steerable antenna transmitting in the 2,282.5-Mc range, and a vhf antenna at 296.8 Mc.

### IV. On the moon

When the astronaut is walking on the lunar surface, he will transmit voice and biotelemetry to LEM at 259.7 Mc, using a shortwave transceiver. LEM will relay this to the command module at the same frequency or convert it to S band for retransmission. The Manned Space Center will be able to talk to the astronaut during his walk, S-band will carry the voice signals to LEM, where they will be converted to vhf (296.8 Mc) for retransmission to the astronaut. LEM will also initiate commands to the astronaut over this frequency.

LEM's S-band antennas will not have sufficient gain to transmit a good tv picture to earth; hence, one of the astronaut's first duties on the moon will be to erect a high-gain, 10-foot S-band parabolic antenna within about 50 feet of the landing craft. Television signals from his hand-held camera will go by wire to LEM, where they will be converted to S band and sent to the surface antenna via another cable.

The equipment now being developed for LEM will transmit the television picture over a 500-kc bandwidth. When the S-band video signals are received on earth, they will be converted to commercial tv and no doubt will be seen by everyone who can get to a tv set.

## THE MOST FILTERING FOR THE LEAST COST MEANS KROHN-HITE

Why keep on worrying about the cost of eliminating noise from your measurements? Select the frequency pass-band you're interested in, and the type of filter action you need, and K-H has a variable electronic filter that will do the job with finesse and finality — at a cost that can be as low as \$375. Or suppose you need all four filter modes. K-H has that flexibility for you too, in the Model 335 multi-function filter for only \$975.

Krohn-Hite filters offer more outstanding features of performance and versatility, at less cost for initial investment and subsequent upkeep, than you can possibly find anywhere else. Here are just a few of their advantages: ■ Independent continuously variable cutoff-frequency tuning ■ Stable calibration accuracy of 5% ■ Pass-bands extending from dc to 3 megacycles, with 0 db insertion loss ■ Cutoff tuning from 0.02 cps to 200 kc ■ 24 db per octave attenuation rate ■ Greater than 80 db maximum attenuation ■ Infinite-rejection tunable single-frequency null ■ 0.1 db pulse overshoot where required for maximum waveform fidelity ■ High input and low output impedances.

Whatever your filter requirements, check Krohn-Hite first.

Write today for data on our full line of filters



**KROHN-HITE CORPORATION**  
580 Mass. Ave. Cambridge, Mass. 02139

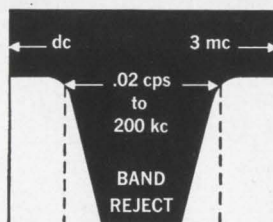
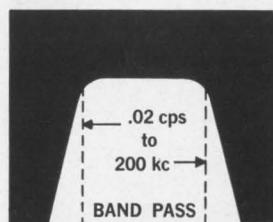
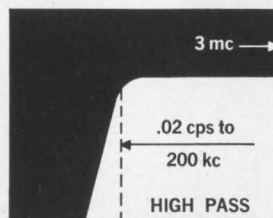
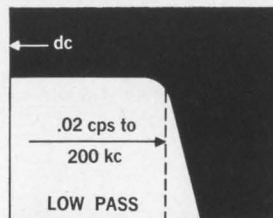



**ELECTRO INSTRUMENTS**

**NOW SPANS**

**ENTIRE**

**PRECISION VOLTMETER**

**FIELD**

**WITH ACQUISITION OF  
CALIBRATION STANDARDS CORPORATION!**

NOW, WITH THE ADDITION OF CALIBRATION STANDARDS CORPORATION, EI BECOMES THE SOLE SINGLE SOURCE OF SOLID STATE VOLTMETERS IN THE ENTIRE UNDER-AND-OVER \$1,000 PRICE RANGE; TOGETHER WITH PRECISION DIGITAL CALIBRATOR AND PRECISION VOLTAGE SOURCES.



**1. AC-DC VOLTMETERS**



**2. DC VOLTMETERS**



**3. CALIBRATORS & POWER SOURCES**

Now there is no precision measuring job on which you should not get a quote from Electro Instruments! With acquisition of Calibration Standards Corporation, Electro Instruments becomes the first manufacturer of precision digital instruments to enter the lower price voltmeter field. With CSC's eleven new manual-type AC or DC differential voltmeters, Electro Instruments now spans the entire voltmeter spectrum — performance-wise and price-wise. Also, the Electro Instruments line now includes precision power sources of voltages from 0-2, 111VDC up to 20,000 VDC; precision calibrators; ultra-stable, low-sensitivity monitors. Ask your Electro Instruments representative for full information about E.I.'s expanded new product line. Or write:

**E Electro Instruments, Inc.**

**I** 8611 Balboa Avenue, San Diego, California 92112  
Electro International, Inc., Annapolis, Md.  
Electro Instruments s. a., 512 rue de Geneve, Brussels 3, Belgium





## These new ferrite device catalogs belong on your desk!

And here's why: 1. The catalogs describe the hundreds of standard isolators and circulators available to you from Raytheon. 2. They indicate Raytheon's in-depth capabilities for providing custom units at all power levels and frequencies. 3. They present information about the Raytheon line in a few fact-filled, easy-to-use pages.

For example: The catalog being read, **Low and Medium Power Waveguide Isolators**, contains specs for 112 different models, including Faraday rotational, H-Plane resonance and miniature

types. Descriptions cover frequency ranges, electrical characteristics, mechanical data.

A second catalog, **High Power Differential Phase-Shift Circulators**, offers data on the more than 75 units Raytheon makes as stock items. **High Power Waveguide Isolators** provides data on more than 70 Raytheon UHF, L, S, C, X and Ku-Band isolators.

The fourth catalog describes our complete line of standard **Coaxial Circulators and Isolators**.

For copies of all four catalogs, call or write:

Raytheon Company, Special Microwave Devices Operation,  
Waltham, Massachusetts 02154. Telephone 617 899-8080.

**RAYTHEON**



# there are 500 people standing behind this connector

to assure you of the reliability,  
depth of experience and service  
you want from your connector source

Progress Webster Corporation has long been a supplier of MIL Spec (10544, 12520) audio and power connectors to the electronics, communication and defense industries. Now they offer this same kind of dependability in their new line of PW Series (MIL-C-26482) miniature connectors. The same rigid testing procedures, the same exhaustive quality control, the same scrupulous attention to customer service and requirements stand behind the new PW Series. If you require MIL-C-26482 connectors, your first order with us could well change your buying habits!

## MIL-C-26482 PROGRESS WEBSTER

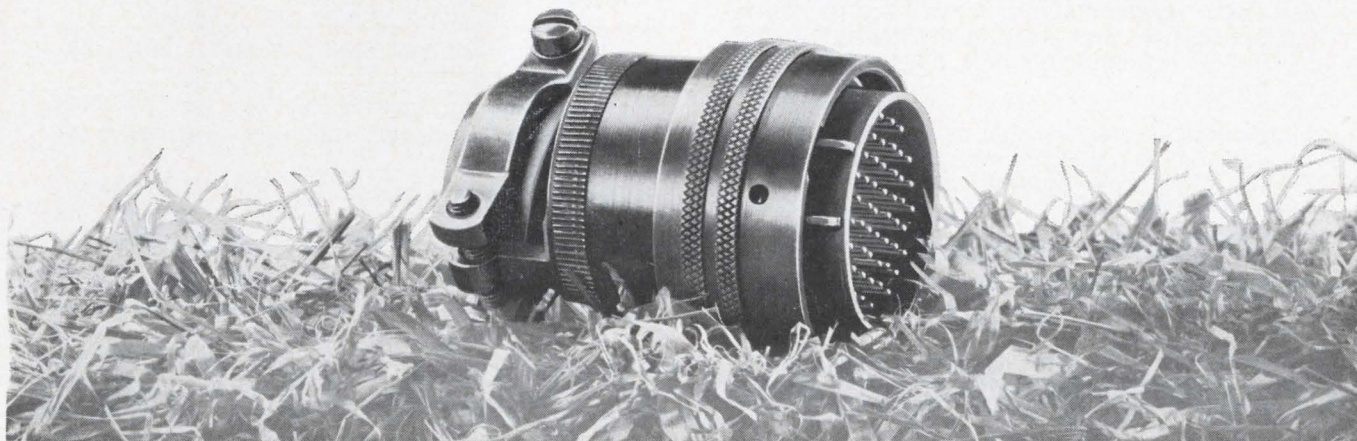

**PROGRESS WEBSTER CORP.** 5 Bridge Street, Watertown, Mass. (617) 926-2100



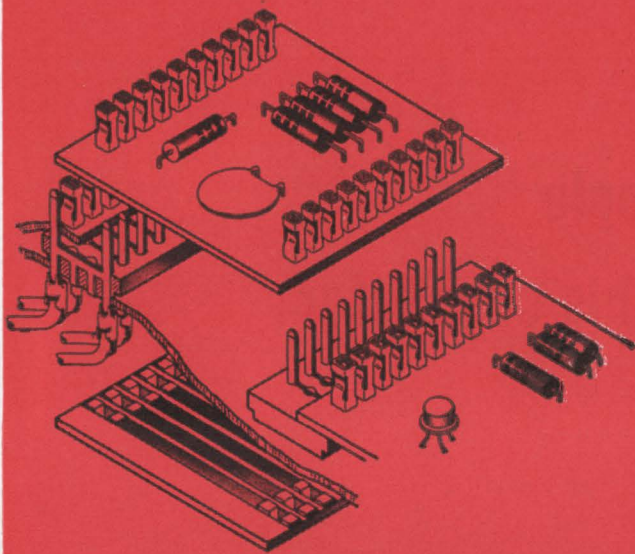

Horizontal mounting utilizing feed through posts.

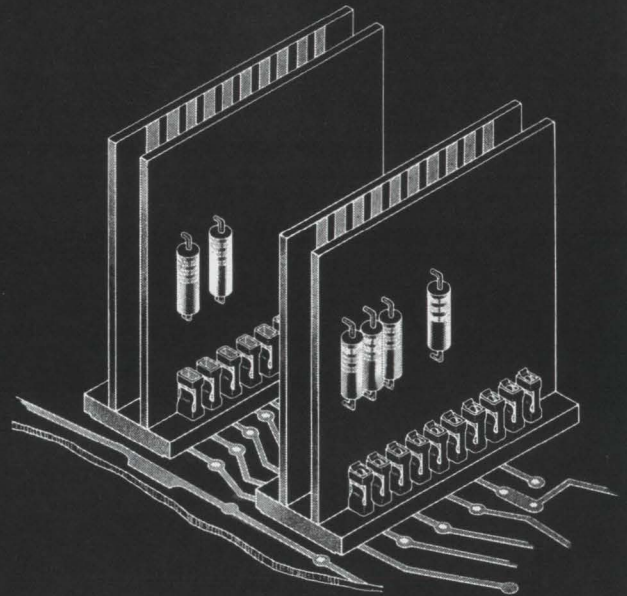

Vertical mounting utilizing incremental connectors.

## Flexibility across the board

Here's a two-piece connector that offers unlimited design potential in printed circuit and modular applications. Plan the layout any way you want—horizontal, vertical, end-to-end. The AMPMODU\* Interconnection System not only gives you *reliable* interconnections, but its sound contact design and adaptability to automated assembly techniques reduce installed costs with the bargain.

Male contacts are available as incremental connectors or as feed-through posts to accept TERMI-POINT\* clip applications and other automated wire terminations. Female contacts come in strip form for automatic staking to printed circuit boards. They are designed to overcome mating misalignments, can be mounted with center-to-center densities up to .100 inch.

Reliability is increased by the contact design which features redundant cantilever beams with built-in anti-overstress protection. In addition, modular circuits can be conveniently job-lot assembled on a true production line basis . . . no need to solder or test until they're all assembled.

Before you start working on that new design, check these features:

- Lowest per line cost
- Compatible with TERMI-POINT Terminals and tools
- Automatic staking of contacts to board
- Reliability—simple spring contact and built-in anti-overstress
- Versatility—for boards  $\frac{1}{32}$ ,  $\frac{1}{16}$ ,  $\frac{3}{32}$ -inch thick
- Flexibility—contacts mounted vertically or horizontally

Why not design it with the AMPMODU Interconnection System and get all these benefits at the lowest installed cost? Write today for complete details.

\*Trademark of AMP INCORPORATED



AMP\* products and engineering assistance are available through subsidiary companies in: Australia • Canada • England • France • Holland • Italy • Japan • Mexico • West Germany



# Volt/ohmmeter switches range automatically

Solid state instrument selects scale in 300 milliseconds, gives protection against burnout from overloading

There's a knob twirler in every crowd. He's the engineer who likes to turn dials, flip switches and push buttons. But this doesn't make for efficiency, and sometimes the wrong twist can mean a burned-out meter. Hewlett-Packard Co., Loveland, Colo., has developed a volt/ohmmeter that eliminates knob turning, speeds measurements and protects itself from burnout.

The model 414A autoranging meter can't burn out because it senses the voltage being measured and automatically switches to the right range (of twelve available) within 300 milliseconds. And the time saved in making a lot of readings that vary widely, as in production line testing, is considerable.

Operation is simple. The function switch is set to volts d-c or ohms, and the probes touched to the points to be measured. The meter displays the correct range and polarity on a lighted digital display in less than 300 milliseconds. Readings are made from a mirror-backed, taut-band, pointer type meter.

A hold switch is provided which disables the autoranging feature and permits use of the full scale of any one range. But even under these conditions, if the meter is accidentally overloaded by more than 104%, it switches automatically to the highest range—1,500 volts. A down range button allows the operator to back down, one range at a time.

Unknown voltages are applied, through an input attenuator, to a chopper-stabilized direct-coupled amplifier. One output of the amplifier is fed to a transistor circuit which senses the polarity of the voltage and displays it. Another output is fed to an amplitude comparator which senses the voltage level. If the input voltage is less

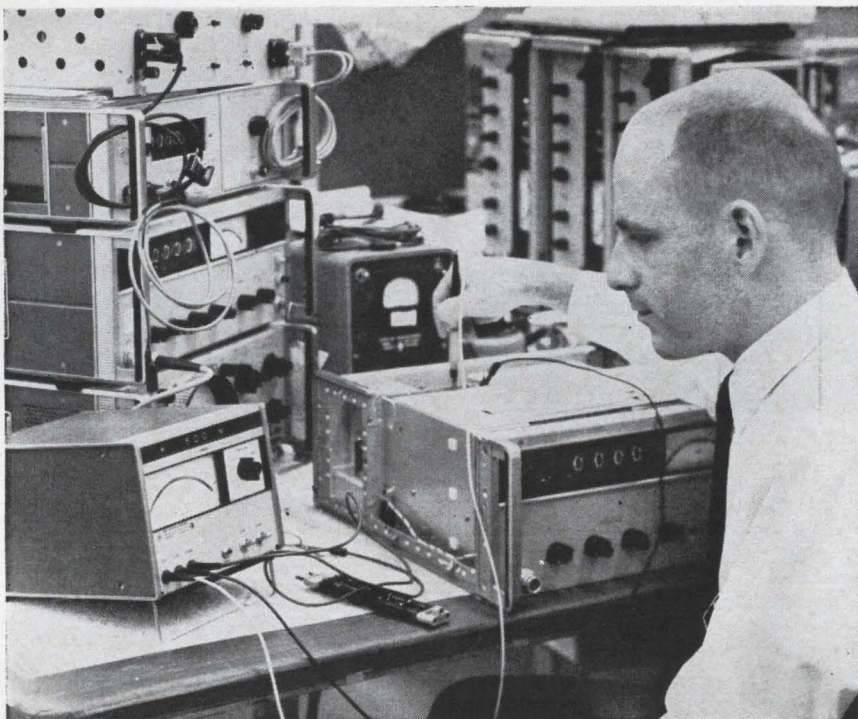

Technician uses probe to obtain voltage reading from high-speed Hewlett-Packard meter. Display at top shows polarity scale, and whether potential or resistance is being measured; reading is off pointer scale.

than 25% of full scale, the meter switches to a more sensitive range. At 95% of full scale, the meter automatically switches to a higher range.

James Kistler, research and development engineer for the instrument, says reed relays for switching in the input attenuator and gain attenuator are responsible for the high performance level. He says that transistor switches are not satisfactory for such an application, since they are three-terminal devices, and the drive control circuitry cannot be completely isolated. With reed relays, a magnetic field is the only link between the drive and control. Until recently, reed relays have been relatively expensive, but production improvements have lowered the price to a

reasonable level.

The instrument has been under development for about a year and a half. It is expected to have a wide application in production line operations and others where rapid readings of widely differing voltages are needed.

### Specifications

Voltage range	5 mv to 1.5 kv full-scale
Resistance range	5 ohms to 1.5 megohms full-scale
Response speed	<300 msec
Accuracy	± 0.5 % of voltage reading ± 1 % of resistance reading

### Dimensions

Height	<7 in.
Width	7 7/8 in.
Depth	12 in.
Price	\$650
Delivery	Begins in September

Hewlett-Packard Co., 1501 Page Mill Road, Palo Alto, Calif., 94304.  
Circle 350 on reader service card.



THE MARK OF QUALITY



# Ultra-sensitive relays

## HELPFUL DATA FOR YOUR CIRCUITRY IDEA FILE

The circuit drawing below indicates just one of the hundreds of ways many manufacturers utilize Micropositioner® polarized relays to solve complex control problems.

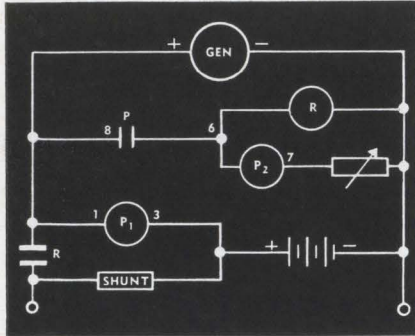

### BATTERY REVERSE CURRENT DETECTOR

Among the many applications for the Barber-Colman Micropositioner in the railroad and industrial fields is that of reverse current protection between the generator and battery on diesel locomotives and industrial trucks. In the circuit illustrated, the Micropositioner, P<sub>1</sub>, is energized when the generator voltage exceeds the battery voltage by approximately one-half volt. A secondary relay, R, connects the generator to the battery and simultaneously energizes an auxiliary coil, P<sub>2</sub>, on the Micropositioner which aids the main coil in holding the contact closed until a predetermined amount of reverse current is flowing from the battery. The point of drop-out is controlled by the variable resistor in series with the auxiliary coil. This system offers accurate control of the points at which the generator is connected and disconnected from the battery, thereby eliminating unnecessary discharging of the battery or hunting between generator and battery control.

### BARBER-COLMAN MICROPOSITIONER®

#### POLARIZED D-C RELAYS

Operate on input power as low as 40 microwatts. Available in null-seeking and magnetic-latching "memory" types of adjustment. Also transistorized types with built-in preamplifier. Write for our latest catalog with full information on polarized relays.

**BARBER-COLMAN COMPANY**  
Electro-Mechanical Products Division  
Dept. G, 1259 Rock Street, Rockford, Illinois

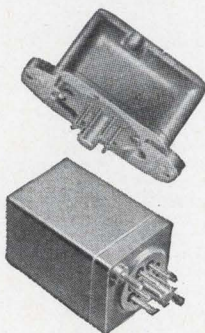

## New Components and Hardware

### Bobbin protects reed relay

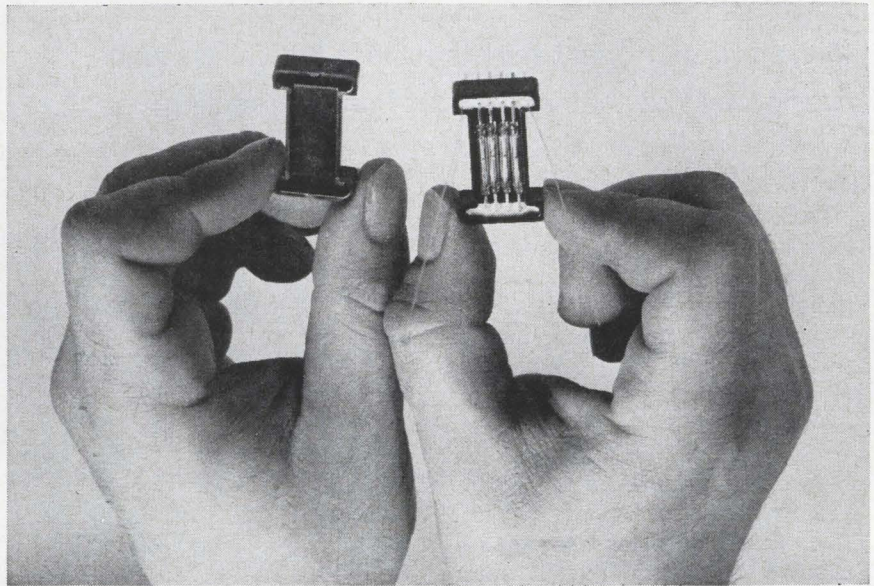

**Glass-encapsulated** reed switches frequently fail because the glass end seals crack when the terminals are bent or clipped for insertion in a printed circuit board. Since the switch is buried in its coil, the source of failure is hard to detect. Even if the glass remains intact, the electrical characteristics of the leads may be changed. Dormeyer Industries has eliminated this trouble spot by preforming the terminals, enclosing the relay in a split bobbin, and then wrapping the coil around the entire assembly.

The terminals are thus completely protected. If it is necessary to encapsulate the relay coil as well, to meet extreme environmental conditions, the potting compound cannot come in contact with the switch, and good electrical con-

tact is ensured. The rugged construction of the terminals also eliminates problems of open or shorted coils under the high temperatures encountered in printed-circuit assembly production.

#### Specifications

<b>Model DD-R-4000</b>	
Series 1A	One reed
Series 2A	Two reeds
Series 3A	Three reeds
Series 4A	Four reeds
Maximum current	125 milliamps
Maximum voltage	250 volts
Maximum wattage	4 watts
Operating time	2 millisecc max.
Release time	1 millisecc max.
Life	3 million operations at rated load
Closed contact resistance	200 milliohms max.
Insulation resistance	5 x 10 <sup>10</sup> ohms/min.
Terminal grid spacing	0.100 inch

Dormeyer Industries, Dept. EC-2, 3420 North Milwaukee Ave., Chicago, Ill. [351]

### Tiny switching relay responds to light

The LA-7 is a miniature, light-activated switching relay with many electronic applications. The solid state device, less than one-half inch in diameter, is a fast-acting, highly sensitive unit that can be used for control by sensing when a

particular function exceeds or falls below preset limits.

The relay is optically coupled to an intense-point light source, enabling it to respond to reflected light from a mirrored surface or from any light-colored surface such as tape, paper, paint or brushed metal. It will directly activate 6-volt to 12-volt relays, solenoid valves, signal lamps or control mo-



tors, without the need for additional power amplification.

The standard LA-7 operates directly from a 12-volt a-c source and can be activated by light transmitted up to several feet, including light from an infrared source. The unit can be used as a contactless meter relay for monitoring preset levels for voltmeters, milliammeters, pressure gauges, thermometers, velocity indicators and flowmeters.

Because of its high speed, the relay can be used to read digital information or reflective digital information from punched cards or tapes. Its small size makes it useful in infrared-surveillance alarm or enunciator systems.

The light-activated relay is supplied as a self-contained unit ready to be wired into the user's circuitry, and is priced at \$31.50.

Datatron Laboratories, Inc., 633 Third Ave., New York, N.Y. [352]

## Patchboard module selector switch

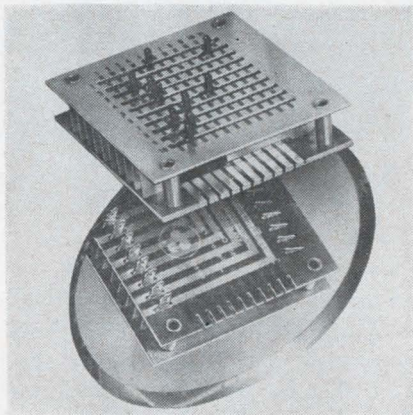

A crossbar type selector switch with interconnections to provide the same circuit capabilities as a 100 jack patchboard fits easily in a space 4 in. by 4 in. by 2 in. Model C10-19A miniature patchboard module measures 3½ in. by 3¾ in. by 1⅞ in. Interconnectability between all "x" and "y" circuits, with off positions, is provided by means of added printed circuitry on the back side of the baseboard.

Basic construction employs: rhodium plated, printed circuit base of parallel conductors, transverse rails with indexing sliders to permit cross-point contacting, anodized aluminum face plate with

# BIG POWER SMALL PACKAGE CERMET™ STABILITY UNDER \$2.00 each

(in production quan.)

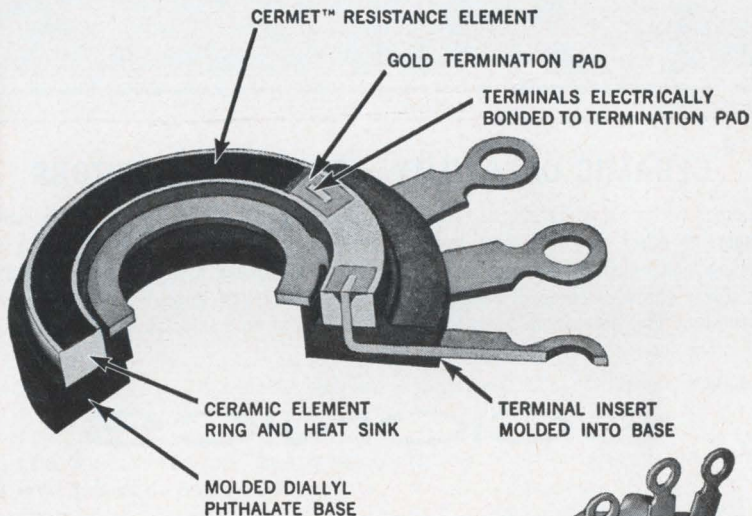

Series 550 has long life—no catastrophic failures



## New 2-watt, 3/4" diameter CERMET Variable Resistor

Applications: computers, instruments, medical electronics, communications equipment, electronic machine controls, electronic processing equipment, aerospace electronics, microwave transmission, etc.

### Outstanding features:

- Closed construction*—Cover entirely protects against dust and dirt. Exceeds MIL-R-23285 (Navy) metal film, Cermet; also far exceeds MIL-R-94B.
- Extreme stability* under severe environmental conditions.
- Resistance range*—50 ohms through 1 Megohm.
- Infinite resolution.*
- Low noise and long life.*
- Excellent high frequency characteristics.*



Founded 1896

Request data sheet 3550.

**CTS OF BERNE, INC.**  
**BERNE, INDIANA**

a subsidiary of

**CTS Corporation, Elkhart, Indiana**



**\* CERAMIC CAPABILITY = QUALITY CAPACITORS**

At Scionics we manufacture all the ceramic dielectric that goes into our capacitors (we even sell some to other manufacturers). In-house ceramic capability is a must for the company producing high reliability miniature ceramic capacitors, and we have had this capability for years. Every phase of ceramic manufacturing from formulation through firing is supervised by a full-time PhD ceramicist. Standard values, from 1 pf to 1 mfd, 50 volts and 200 volts, are in stock for immediate delivery.

THE SCIONICS CORPORATION-8900 Winnetka Avenue, Northridge, California / 213-341-5500 / TWX 213-341-7559

**SCIONICS**

SCIONICS-SCIENCE AND ELECTRONICS FOR INDUSTRY AND DEFENSE  
Circle 206 on reader service card

**New Components**

numbered coordinates, and black nylon handles for manual positioning. The compact package, in a 10 by 11 arrangement, provides 100 switching positions plus an off position for each circuit. Rapid circuit selection is assured and cumbersome wires, pins, clips and soldering are eliminated.

Electrical capacity is as follows: current carrying only (no make or break) is 3 amps/125 v a-c or d-c; make or break, 1 amp/15 v d-c, 150 ma/125 v a-c. List price is \$21 each; net price, \$10.92 each in 1,000 quantities.

Cherry Electrical Products Corp., P.O. Box 438, Highland Park, Ill., [353]

**Pin/socket connector doubles contacts**

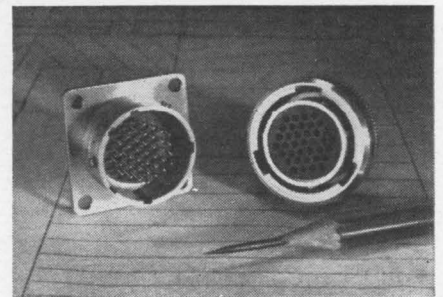

This circular pin and socket connector is said to provide over twice as many contacts as conventional connectors with the same shell sizes. The bayonet-coupled connector features a keyed stainless steel shell for radiation shielding. Hard insert dielectrics with resilient face seal prevent stubbing and aid in positive searing of the contacts. Designed for high altitude performance over a broad temperature range, the new connector is ideal for outer space applications. A four-indent circular crimp is used to attach the contacts, the socket member of which is of closed entry design. Contacts are inserted in the rear of the numbered cavities and no retention clips are required for a retention value of 10 lb. minimum per contact. Both rear and front extraction are possible. The subminiature connector is available in five shell sizes with 14, 23,

**POSITIVE SAFETY FACTORS provided by patented PRESS-TO-TEST INDICATOR LIGHTS MEET REQUIREMENTS OF MIL-L-7961B**

Checks lamps—instantly—without removal from the assembly. Light pressure on the lens cap assembly breaks the normal circuit and makes a test circuit. If the lamp lights when pressed in, it is proven satisfactory. If the lamp fails to light when pressed in, it is defective; (lamps can be quickly replaced from the front of panel). Release of finger pressure restores the lens cap assembly to operating position.

Press-to-Test Indicator Lights mount from back of panel in a 15/32", 5/8" or 1" clearance hole, and are available in a wide range of lens styles and colors. Many of the units are offered with or without dimmer caps.

SAMPLES ON REQUEST—AT ONCE—NO CHARGE!

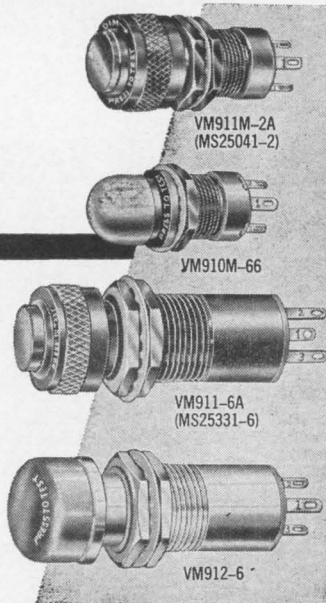

(Illus. approx. 3/4 actual size)  
Every assembly is available complete with lamp.

For complete data, request current catalog.

**DIALCO**

Foremost Manufacturer of Indicator Lights

**DIALIGHT** CORPORATION

60 STEWART AVENUE, BROOKLYN, N.Y. 11237 212 HYACINTH 7-7600



37, 55 and 70 pin and socket positions. A number 22 contact accepts wire ranges 22-14 and 26-30 Awg. AMP Inc., Harrisburg, Pa. [354]

## Push-button switches feature snap-in lens

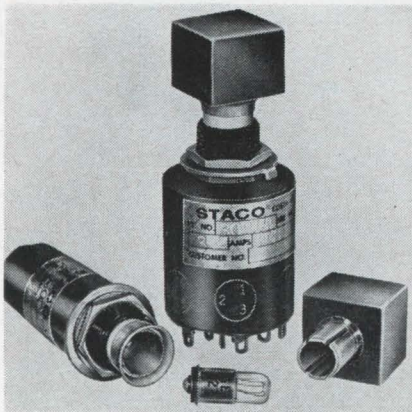

A line of illuminated push-button switches now offered features a square, snap-in lens that can be environmentally sealed. A specially designed "flex seal" is mounted between the lens and the switch plunger. The seal protects the lamp cavity against moisture, dust, salt spray and humidity. In addition, the plunger and housing are sealed to military specifications. Panel seals are also available.

The square, snap-in lens is easily removed for lamp replacement, and is keyed to the switch plunger for proper orientation of legends. Lenses are available in two sizes— $\frac{5}{8}$  in. square and  $\frac{3}{4}$  in. square.

The switches are designed to meet or exceed the operating and environmental requirements of MIL-S-22885. The line provides a choice of single pole through six pole, double or single throw configurations with alternate or momentary actions. Contacts are made of gold alloy and are rated for 3 amps current switching capacity. A 2-amp version is also available. The 3-amp switch has a maximum diameter of less than one inch. Diameter of the 2-amp switch is 0.62 in. Life expectancy of the switches is 30,000 operations at rated load and 100,000 operations at reduced load.

Staco, Inc., 1139 Baker St., Costa Mesa, Calif. [355]

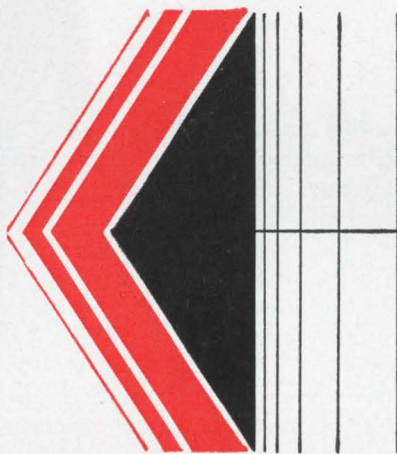

## IT'S NEW RJ2A



### High Current Ceramic Vacuum Relay

The era of ceramic vacuum relays was first ushered in by Jennings with the introduction of the fabulous 50 kw interruptive RF10. Now comes the equally great RJ2A with outstanding design features of its own.

In the RJ2A Jennings has combined field-proven patented design with two important additions not usually found in lesser relays.

1. A thorough knowledge of the problems involved in designing relays for high voltage airborne, mobile or marine communications systems.
2. The best combination of elements; vacuum for unchanging, low, contact resistance and high voltage withstand, copper to carry high current, and ceramic to withstand shock and high temperature.

In such applications as airborne electronic systems these advantages are invaluable. Especially for antenna switching, switching between antenna couplers, tap changing on RF coils, switching between transmitter and receiver, or pulse forming networks. The proof of superiority is evident in the following ratings which reflect only the minimum capabilities of the relay.

Contact Arrangement	SPDT
Operating Voltage (60 cycles)	12 KV peak
16 mc	8 KV peak
Test Voltage (60 cycles)	18 KV peak
Continuous Current	
60 cycle	25 Amps RMS
16 mc	15 Amps RMS
Contact Resistance	.012 Ohm
Net Weight	3 oz. Nom.

We will be pleased to send you more detailed information about the RJ2A and the rest of our complete line of vacuum transfer relays.

RELIABILITY MEANS VACUUM-  
VACUUM MEANS

**ITT Jennings**

JENNINGS RADIO MFG. CORP., 970 McLAUGHLIN AVE., SAN JOSE, CALIF. 95108, PHONE 292-4025



Want to design for  
INSTANT STARTING? ...  
SPLIT-SECOND ACCURACY?  
REVERSIBILITY? ...  
MIXED SPEEDS? ...

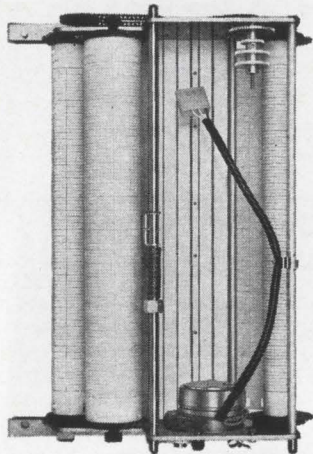

turn the  
job over to

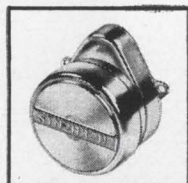

**SYNCHRON® MOTORS!**

No matter whether you want a motor to withstand swiftly changing temperatures, meet fast-reversing stresses, turn a small part with exact accuracy to 1 Rev. per week or 600 Rev. per minute, there's a SYNCHRON Motor that can do it! It can do a hundred other things as demanding as these — if you tell us how you want it to function. Before you start any design that calls for small drive or timing motors, think of SYNCHRON Motors, and call or write us at Hansen Manufacturing Company. We'll be there at once to help — with experience. Better still — don't wait till you face a problem. Write us now — let us tell you about SYNCHRON Motors and the ways we design them to work for you.



HANSEN REPRESENTATIVES: CAREY & ASSOCIATES, Houston, Tex., R. S. HOPKINS CO., Sherman Oaks, Calif., EICHORN & MELCHIOR, INC., San Carlos, Calif., THE FROMM CO., Chicago, Ill., H. C. JOHNSON AGENCY, INC., Rochester, N. Y., WINSLOW ELECTRIC CO., Essex, Conn., and New York, N.Y. EXPORT DEPARTMENT, 64-14 Woodside Ave., Woodside, N. Y. Handled exclusively in Canada by Sperry Gyroscope Ltd., Ottawa, Canada.

## New Instruments

### Radar range unit accurate to 0.65 meter



A radar signal moves one meter in 6.676 nanoseconds. A Radar/Laser Ranging Unit introduced by the Eldorado Electronics Co. measures the time between a radar pulse and its echo, divides by twice that figure, and displays a digital range reading accurate to within 0.65 meter for any distance up to 100,000 meters. Such accuracy is possible because the device operates independently of the radar system's sweep generators, and is thus unaffected by ramp nonlinearities. The best range accuracy the system itself can obtain is 20 to 30 meters at a range of 10,000 meters.

The instrument can also determine range when coupled to a laser radar.

Eldorado's model 5420 has a multiple target selector with which the operator can determine the range of any one of seven targets by successively eliminating the targets and clutter below a given range. A start-inhibit switch prevents measurements at other than the predetermined azimuth.

A digital interpolation technique allows the counters to achieve a one-meter resolution at 15 megacycles, only one-tenth the frequency necessary for such resolution with conventional counting methods. The lower operating frequency increases the reliability of the instrument and reduces maintenance problems.

The unit has all solid state circuitry, with components mounted

on plug-in cards. There is a Nixie-tube display panel and a binary-coded output connection for a computer.

#### Specifications

<b>Input sensitivity</b>	0.5 volt minimum
<b>Input signal</b>	Pulses 0.5 to 12 volts amplitude, negative polarity, width of 20 nanoseconds
<b>Overload</b>	20 volts
<b>Input impedance</b>	50 ohms
<b>Reset modes</b>	Manual, automatic, remote
<b>Power requirement</b>	115 volts, 60 cps, 115 watts (including crystal oven power)
<b>Size</b>	17" x 17" x 5 1/4"
<b>Price</b>	\$6550
<b>Availability</b>	120 days

Eldorado Electronics Co., 601 Chalomar Rd., Concord, Calif. [381]

### Test set measures transistor noise

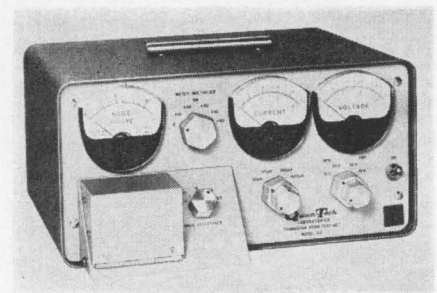

A compact, simplified transistor noise test set features automatic self-calibration. Model 512 is designed to measure accurately the broadband noise figure of transistors in the frequency range of 10



cps to 10 kc. Noise figures are read directly in db for the most popular values of base resistance. Other values may be used by applying a simple correction factor. In addition to standard junction types, it will also measure field effect transistors including insulated gate types.

Model 512 is claimed to be ideal for routine laboratory use, incoming inspection and production applications. Price is \$1,145.

Quan-Tech Laboratories, 43 S. Jefferson Road, Whippany, N.J. [382]

## Pulse generator has modular design

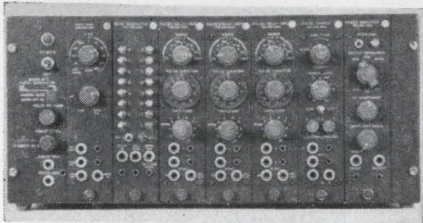

The plug-in concept in instrument design is used to maximum advantage in the new type 1395-A modular pulse generator. The main frame is a rack-width cabinet that includes the main power supply. Seven cavities accept a virtually unlimited combination of plug-ins, which can be interconnected to produce pulse words, multiple pulses, ramps, or other specialized pulse waveforms often required in radar, telemetry, and data-handling applications.

Five plug-ins are presently available for the modular pulse generator. The prf provides repetition rates up to 1.2 Mc or up to 2 Mc with external drive. The pulse/delay unit can produce pulses or time delays from 100 nsec to 1 sec. The pulse shaper adjusts rise and fall times from 100 nsec to 10 millisecond; these times can be set independently of one another or equal rise and fall times can be set from the same control. The power amplifier produces pulses of up to 20-v amplitude, positive or negative, into a 50-ohm load. The word generator produces patterns of up to 16 bits. As many as seven word generators can be cascaded to provide 112-bit capacity. General Radio Co., West Concord, Mass. [383]

# "NO LIGHT?" JUST RIGHT FOR MTI ORTH CAMERAS!

# mti

World's Largest Manufacturer of Low Light Level TV Systems

## This is the MTI ORTH III IMAGE ORTHICON CAMERA...



... unequaled in performance and adaptability. Simplified operation makes you an expert in a matter of minutes.

The advanced engineering, rugged construction, compact size and light weight of the MTI Orthicon TV Cameras permit adaptability in many situations where other image orthicon cameras are rendered useless.

Stability is assured by: Solid State regulated power supplies and the generous use of self-compensating feedback circuits in both sweep and video sections. Controls pre-set stay set.

Solid State, modular construction used throughout the camera and control unit. Reliability is "designed in."

With selected Image Orthicon tubes, (available at MTI) MTI Image Orthicon TV Cameras will produce high resolution pictures even at  $1 \times 10^{-5}$  foot candles of ambient darkness (approaching total darkness).

THE ORTH III IS ONE OF ELEVEN DIFFERENT MODELS AVAILABLE. LINE SCAN FREQUENCIES INCLUDE: 525; 675; 875; 945; 1023; 1029 OR 1201. CHOICE OF INTERNALLY GENERATED FULLY INTERLACED SYNC OR EIA SYNCHRONIZATION.

**CALL AN MTI MAN TODAY!**

# mti

**MARYLAND TELECOMMUNICATIONS, INC.**

**VIDEO INSTRUMENTATION**

York & Video Roads — Cockeysville, Maryland (301) 666-2727



To order reprints  
from Electronics

fill in, cut out

coupon below,

insert in envelope

and mail to:

Electronics Reprint  
Dept.

330 West 42nd Street

New York, N. Y. 10036

**Reprint order form**

For listing of reprints available see  
the reader service card

To help expedite mailing of your  
reprints please send cash, check  
or money order with your order.

For reprints of the latest  
Special report:

Unijunction Transistors

Send me . . . . reprints of key  
no. R-74 at 50¢ each.

For reprints of previous special  
reports fill in below:

Send me . . . . reprints of key no.(s)  
..... at . . . . ¢ each.

For prices see the reader service  
card.

Name .....

Number & Street .....

City, State .....

Zip Code .....

**New Semiconductors**

**GE aims 35-cent scr at consumer market**

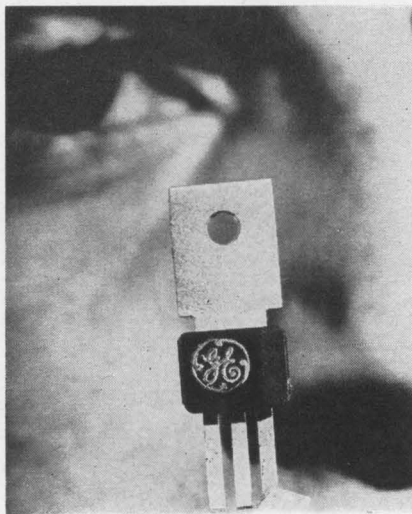

The versatility of silicon controlled rectifiers has long been recognized by the consumer appliance industry, but wistfully, because high cost has prevented their use in the highly competitive appliance marketplace. A survey by the General Electric Co. indicated that scr's wouldn't be acceptable until they were offered at less than 50 cents a unit.

With this goal in mind, GE developed an automatic manufacturing technique that produces scr lead frames in continuous strips and designed a plastic package for the devices. The result: a 35-cent scr that GE hopes will break the appliance market wide open.

Leonard C. Maier, general manager of semiconductor products department, says this price, the lowest ever for scr's, opens up the consumer appliance market to electronics. He predicts that more than one-half of the electrical appliances built for home use in 1970 will include electronic devices [Electronics, July 12, p. 17].

F. W. Gutzwiller, GE's manager of applications engineering, says that consumer product manufacturers are already building equipment prototypes although the factory won't begin shipping units until October.

Controlling the firing time of an scr permits smooth, stepless variation in applied power without the

large dissipation that occurs in rheostats. Furthermore, feedback circuits designed with scr's can compensate for variations in power supply or load conditions, thereby maintaining heat, light or motor speed at the desired setting.

Gutzwiller sees scr's being used in food mixers, toasters, sewing machines, table lamps, slide projectors, heating units, electric knives, clothes washers and dryers, sump pumps, and other products.

In designing the new device, GE's biggest problem was in preventing interaction between the packaging material and the silicon pellet. This problem was solved by using a planar structure similar to that used for integrated circuits. A silicon dioxide layer provides the required isolation between the scr and the plastic encapsulant.

Plastic-encapsulated transistors and integrated circuits are commercially available, but the plastic-encapsulated scr was considered a formidable challenge because of the deep diffusion levels required for high-power applications.

Engineering samples will be available in 30 days, priced from \$1.05 to \$1.50. When shipments from stock begin during the fourth quarter of this year, unit prices will range from 35 to 50 cents, GE says. Three different lead configurations will be available: single-ended, double-ended and single-ended with heat sink.

**Specifications**

Voltage	200 volts
Current	
with heat sink	1.6 amps
Power	200 watts
Package material	Plastic
Leads	3
Price	35 to 50 cents

General Electric Co., Auburn, N. Y. [371]

**Silicon trigger diode  
with 1-w power rating**

Type ST trigger diode is a symmetrical three-layer avalanche diode used in activating silicon controlled rectifiers and bi-switches. It features a symmetrical switching



mode that fires whenever the break-over voltage is exceeded in either direction. The average power dissipation at 50° C is 1 watt with a peak current capability of 1 amp for 20  $\mu$ sec duration. Breakover voltage is  $36 \pm 4$  v; max breakover current, 150  $\mu$ a. The diode has both commercial and industrial applications. Its case is insulated to permit tight packaging.

Mallory Semiconductor Co., a division of P.R. Mallory & Co. Inc., 424 S. Madison, DuQuoin, Ill., 62832. [372]

## High surge rating with small zener

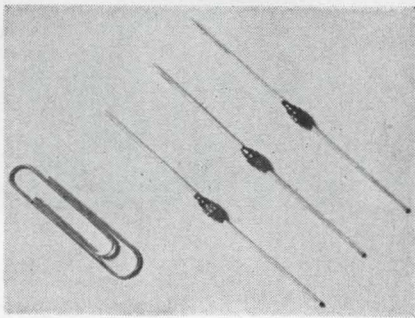

Capable of handling 250-w transients, the surge rating of this miniature zener is twice that of a conventional 10-w stud-mounted zener and close to that of a 50-w unit. Only 0.145 in. in diameter, it has a continuous rating of 5 w. Able to substitute for stud-mounted types many times its size, it is available in voltages from 6.8 to 400 v.

Also featured are low dynamic impedances for all voltage ratings, combined with extremely sharp knees. This performance level is obtainable because of the unique construction—a pure silicon dice metallurgically bonded to pins of identical diameter across full face. A hard glass sleeve is then fused over the entire junction, forming a monolithic void-free, hermetically sealed part.

These zeners remain completely stable in electrical characteristics, even after overload or exposure to extreme environments. After 1,000-hour life testing at full rating, they will conform to initial electrical specifications. Prices vary from \$1.50 to \$3, depending upon voltage, tolerance and quantity.

Unitrode Corp., 580 Pleasant St., Watertown, Mass. [373]

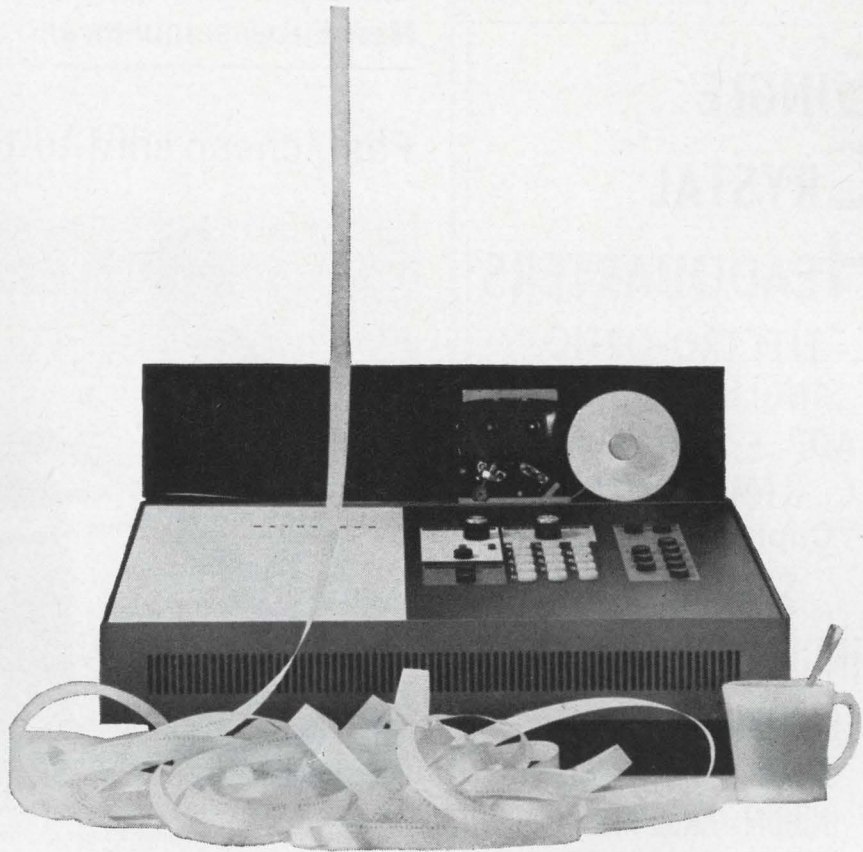

*This*  
*\$5,000*

## *Mathatron digital computer uses a new computer language... ...algebra*

Tap in the problem, digit by digit, sign by sign, with decimal points and parentheses and power of 10 exponents, just as if you were writing it out. The Mathatron prints the problem on paper tape, then prints out the answer. As simple as that.

Four or eight independent storage registers, 24 or 48 step ferrite core memory, 100 column number capacity, 8 to 9 significant digit accuracy, automatic decimal placement, electronic speeds, optional pre-wired programs, all solid state logic and circuitry. It won't solve everything, of course.

If you already have a large data processor, consider this: 80% of the Mathatron owners have big computers, too.

But they can't stand the time lag, or the hourly cost, or the gaff. The Mathatron is twice the size of a typewriter and is accessible, immediately, to the whole department.

Write for further information.

## **MATHATRONICS, INC.**

257 Crescent St., Waltham, Mass. 02154 (617) 894-0835



# SINGLE CRYSTAL HEADQUARTERS

ELECTRO-OPTIC  
SINGLE CRYSTALS  
ADP • KDP • KDA  
KTM • HTMA  
Cuprous Chloride

## SEMI-CONDUCTOR SINGLE CRYSTALS

- GALLIUM ARSENIDE
- GALLIUM ANTIMONIDE
- INDIUM ARSENIDE
- INDIUM PHOSPHIDE
- GALLIUM PHOSPHIDE
- SILICON CARBIDE
- GERMANIUM

## LASER DIODE SYSTEMS Complete

GB—13 (Diode and Dewar)  
**\$495**

GB—24 (Diode and Dewar)  
**\$2495**

GB—24D (Diode and Dewar)  
**\$3495**

## LASER DIODES

Sold 1 8400 Angs **\$85**  
Sold 2 8400 Angs **\$985**  
Sold 3 7200 Angs **\$225**  
Sold 4 7200 Angs **\$1975**



FOR COMPLETE LITERATURE  
WRITE DEPT. E-6

**semi-elements, inc.**

Saxonburg Boulevard,  
Saxonburg, Pa.  
Phone: 412-352-1548

## New Subassemblies and Systems

### Fast, cheap card-to-tape translation



The Ampex CTS-2000 transfers computer data from 2,000 tab cards to magnetic tape in one minute.

If you use a computer to put punched card information on magnetic tape, you waste money, because the computer is tied up doing a job that uses little of its capability.

Because it saw a substantial industrial market for a low-cost, efficient card conversion system, the Ampex Corp. developed a system that can convert computer data from punched cards to magnetic tape at twice the speed and one-third the cost of the computer method. The system comprises a high speed card reader, a digital tape transport, and solid-state editing and error-control electronics. It reads up to 2,000 51-column or 1,500 80-column punched cards in one minute.

The punched cards are fed into an input hopper, picked up by an impact-and-friction mechanism, and driven through the read station, which has a photo diode for reading and a timing head. The electronic image of the card data goes through amplification and gating, and is then transferred to the control unit.

The input hopper can hold up to 2,500 cards; each of two output hoppers holds 2,000. A detection circuit stops the operation when a

card jam is spotted. Lights on the card reader's central control panel indicate the trouble spot.

The data core buffer, core memory buffer, timing and control and circuitry and control logic are all located within the control console. Card data flow is regulated by the timing and control circuitry, which also performs code translation and editing functions and forms the output into blocks of data, as it is transferred onto the magnetic tape. As the columns are read, the data is loaded into a register from which the card code is converted to a corresponding tape code. The characters are then stored sequentially in the core buffer of the control unit.

This technique gives the system an "any-code-to-any-code" conversion capability. By loading appropriate control instruction cards, a code conversion catalog may be entered into the system's core memory, allowing cards and tapes of varying formats to be handled.

The core memory is also used for spotting errors. Information written on magnetic tape after its conversion from cards is checked by another read head. If the check shows an error in the input data, the entire block of data can be re-



written automatically. Because temporary errors can be caused by oxide buildup on magnetic tape surfaces, the system will attempt to rewrite data three times before concluding that the problem is the data itself and not the surface.

Four versions of the converter ranging in speeds from 400 to 2,000 cards per minute and in price from \$24,000 to \$38,000, are available. The equipment may also be leased.

#### Specifications

<b>Card speed</b>	2,000 51-column cards per min. 1,500 80-column cards per min.
<b>Tape</b>	1/2 inch, compatible with IBM or NARTB reels
<b>Tape speed</b>	36 to 45 inches per second
<b>Size</b>	90 inches long x 40 inches wide x 33 inches deep
<b>Weight</b>	1350 pounds
<b>Power</b>	110v ± 10v 48 to 63 cycles per sec.

Ampex Corp., 401 Broadway, Redwood City, Calif. [401]

### Dual-output, plug-in power modules



A broad line of silicon, dual-output, plug-in power supplies has been introduced. Either identical or different outputs may be selected. Output voltages are available from 3 to 75 v and output current from 100 to 500 ma. Load regulation is ±0.1% and line regulation is ±0.05% for most models. Ripple is 1 mv rms.

All models operate continuously at full load from -20° to +71°C ambient with no additional heat sinking of any kind required. Prices range from \$156 to \$198, depending on the model. Shipment is guaranteed three days after receipt of order.

Acopian Corp., P.O. Box 585, Easton, Pa., 18043. [402]

## MONOLITHIC DIFFERENTIAL AMPLIFIER BY AMELCO PROVIDES EXCELLENT TRACKING

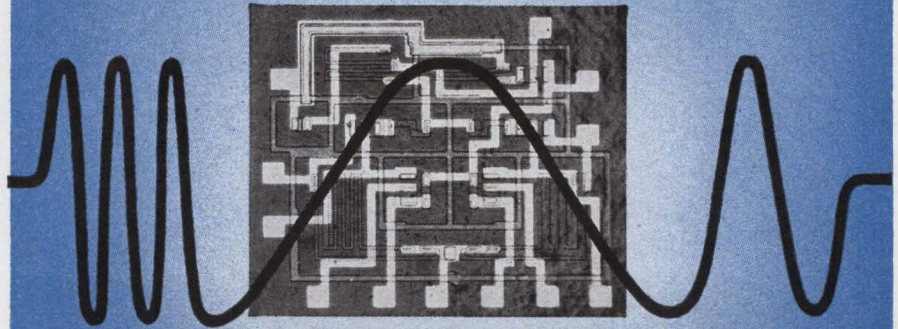

**DESIGNED** for low level differential input applications, type D13-001 provides excellent tracking and great stability. It is manufactured in a single silicon chip using diffused resistors and transistors. Because of this, beta and  $V_{BE}$  are closely matched and thermal coupling is very tight. The result is shown by the specifications below. Type D13-001 is available from stock at \$35.00 for 1-99 and \$28.00 for hundred quantities.

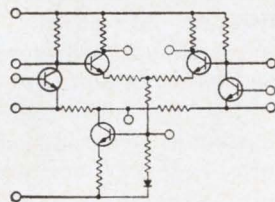

#### SPECIFICATIONS:

- ▲ TRACKING =  $5 \mu V/^\circ C$   
(-55°C to +125°C)
- ▲ OFFSET = 8 mV (untrimmed)
- ▲ COMMON MODE REJECTION = 90 db
- ▲ GAIN = 400
- ▲ BANDWIDTH = 400 Kc

Other Types of This Family Are Also Available



## AMELCO SEMICONDUCTOR

DIVISION OF TELEDYNE, INC.

1300 TERRA BELLA AVE., MOUNTAIN VIEW, CALIFORNIA

Mail Address: P. O. Box 1030, Mountain View, Calif./Phone: (415) 968-9241/TWX: (415) 969-9112/Telex: 033-914

#### REGIONAL OFFICES

##### Southwest

12525 South Daphne  
Hawthorne, California  
(213) 756-9121, 756-9122

##### Northwest

1300 Terra Bella Avenue  
Mountain View, California  
(415) 968-9241

##### East

P. O. Box 1927  
Paterson, New Jersey 07509  
(516) 334-7997

##### Northeast

543 High Street  
Westwood, Massachusetts  
(617) 326-6600

##### Midwest

103 North State Road  
Arlington Heights, Illinois  
(312) 392-8810  
2428 West 22nd Street  
Minneapolis, Minnesota  
(612) 374-1969



WRITE FOR THIS  
NEW  
DC POWER  
SUPPLY DATA

ALL SILICON  
15S SERIES  
1 TO 100 VOLTS  
@ 750 TO  
65MA

ALL SILICON  
20S SERIES  
1 TO 200 VOLTS  
@ 1400 TO  
75MA

ALL SILICON  
30S SERIES  
1 TO 200 VOLTS  
@ 3000 TO  
150MA

110 SERIES  
PROGRAMMABLE  
DC POWER  
SUPPLIES

22 SERIES  
VACUUM TUBE  
MODULES

UNREGULATED  
DC POWER  
SUPPLY  
MODULES

OVERVOLTAGE  
LOAD  
PROTECTOR  
(OVLP)

SEE US AT  
WESCON BOOTH  
2920, 2921



DRESSEN-BARNES  
ELECTRONICS CORP.

250 N. VINEDO • PASADENA, CALIF.  
681-0643 • TWX: 213-449-2556

New Microwave

Solid state source oscillates at 1 Gc

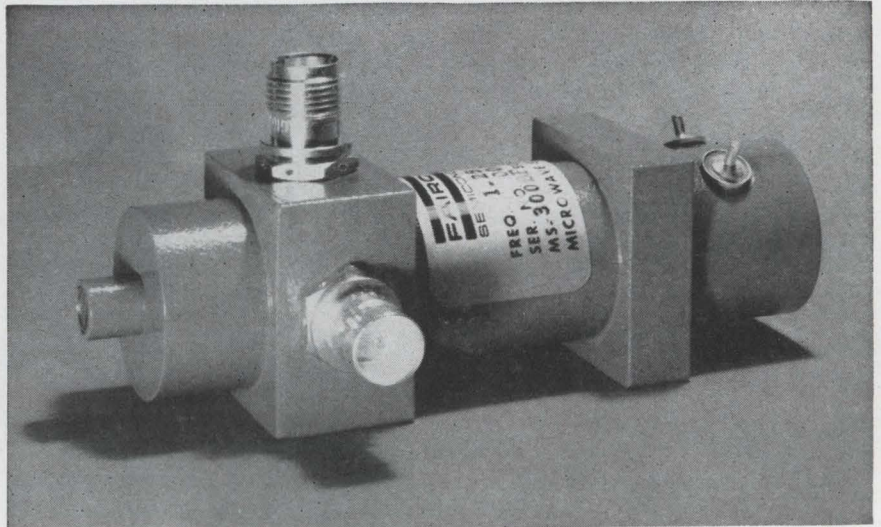

MS300BF solid state oscillator has fundamental frequency range of 1.25 to 1.60 Gc with automatic frequency control.

Designers of radar and communication systems can forget about unwanted harmonic frequencies when they use the MS 300, said to be the first solid state source that oscillates directly at over 1,000 megacycles. The manufacturer, the semiconductor division of the Fairchild Camera & Instrument Corp., says the MS 300 oscillates directly at fundamental frequencies up to 2,300 megacycles.

The heart of the Fairchild oscillator is a 1,000-megacycle power transistor, the MT 1038.

The oscillator, which was developed as a standard product, is also suitable as a low-noise driver for harmonic generators because its noise level is 60 decibels below the output signal level—at least as low as the noise level of klystron oscillators, and much lower than frequency-multiplied oscillators.

Fairchild has available four units that cover the L and lower S bands. Optionally available with any unit is automatic frequency control to within three megacycles.

Output power, 250 milliwatts at 1,000 megacycles, decreases almost linearly with increasing frequency, down to 30 milliwatts from a 2,000-megacycle oscillator. The efficiency of the MS 300A is about 15%—approximately three times that of

a frequency-multiplied oscillator. The MS 300 oscillators are about one-half the size of frequency-multiplied oscillators, which contain about 30 components.

The units are mechanically tunable up to 10% over their frequency range by means of a single screw adjustment. Automatic frequency-control sensitivity is 200 kilocycles per volt.

Cost of the MS 300 Fairchild oscillators is \$300 each in quantities of one to nine units.

Specifications

Operating voltage	22 volts d-c
Short-term (less than one second) frequency stability	±3 parts in 10 <sup>8</sup> at 25°C
Long-term (two weeks) frequency stability	±5 parts in 10 <sup>4</sup> at 25°C
Operating temperature range	-55°C to +125°C
Frequency range	
MS 300A	1 to 1.25 Gc
MS 300B	1.25 to 1.6 Gc
MS 300C	1.6 to 2 Gc
MS 302A	2 to 2.3 Gc

Fairchild Semiconductor, Mountain View, Calif. [421]

Conduction-cooled reflex klystrons

A series of reflex klystrons now available operate at frequencies of 10.7 to 12.7 Gc. The high efficiency



tubes, designated the VA-287 series, provide one watt output power at 750 beam volts. The conduction-cooled, long-life, low-distortion klystrons have been designed for use in microwave relay systems as transmitters or local oscillators.

The Federal Communications Commission is encouraging local carriers and suppliers to use higher frequencies, due to crowding of the C-band spectrum. The VA-287 series is expected to prove especially useful in this transition. Varian Associates, Tube Division, 611 Hansen Way, Palo Alto, Calif., [422]

### Flat, broadband variable attenuator



This broadband, continuously variable attenuator exhibits flat attenuation vs frequency characteristics to high values of attenuation. The units are suited for panel mounting applications and may be used as laboratory or system devices. Full attenuation is reached in less than one turn, and attenuation may be easily read from a directly calibrated dial in attenuation db.

Frequency range of the model 3952-90 is 1 to 2 Gc; minimum attenuation range, 90 db dynamic; maximum insertion loss, 5 db; maximum vswr, 1.5 after 3 db; attenuation vs frequency,  $\pm 1$  db max; average power, 10 w; size, 5 in. diameter by 1.6 in. excluding connectors and dial.

Model 3952-90 is designed to meet applicable military specifications for ground and airborne applications. It costs \$350 uncalibrated, and \$400 with directly engraved dial in 1-db attenuation steps. Delivery is 4 to 6 weeks. Antenna & Radome Research Associates, 27 Bond St., Westbury, N.Y. [423]

# NOW...

## at low cost digitize & record 500 characters per second on magnetic tape.

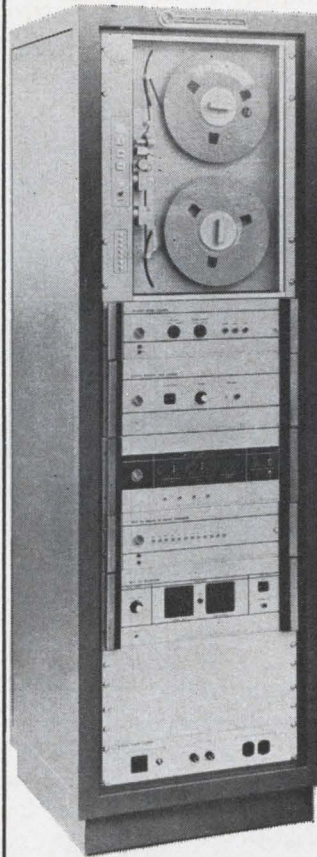

With EECO's new low-cost 755 Data Recording System, you digitize 100 or more dc inputs and record them on magnetic tape for direct entry into IBM or other computers. The system is all solid state, providing great reliability over a wide range of needs—a lot of data recording flexibility per dollar invested.

The 755 features a recording speed of 500 characters/sec... input impedance of 100 megohms... input levels variable from  $\pm 50$  millivolts to  $\pm 5$  volts... programmable input selection, solid state multiplexing and many scanning options. Basic price of the 755 is \$18,000—lower than many slower systems with fewer useful features. Write, phone or wire for complete information.

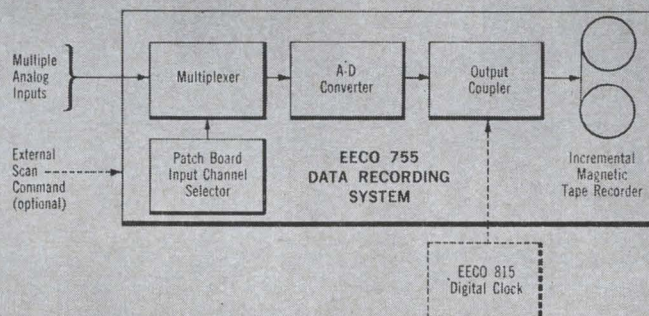

LOOK TO EECO FOR EXCELLENCE IN Precision timing products... Automatic programming equipment... Test instrumentation... Data handling equipment... Complete timing and data systems.



**Electronic Engineering Company**  
of California

1601 E. Chestnut Ave. (Box 58) Santa Ana, Calif. 92702  
Phone: Kimberly 7-5501 Area Code 714 • TWX: S Ana 5263



we are your best bet  
for electronic materials

“What did you say?”

**“WE SAID, WE ARE  
YOUR BEST BET  
FOR ELECTRONIC  
MATERIALS!”**

We are a primary fabricator and supplier of high purity metals and alloys, compound semiconductors and thermoelectric cooling materials.

PHONE AREA CODE 509 747-6111  
TWX 509-328-1464 Telex 032 610

IMMEDIATE SHIPMENT BY AIR PRE-PAID

**COMINCO PRODUCTS, INC.**

electronic materials division  
818 West Riverside Ave.,  
Spokane, Washington 99201

5603

Circle 118 on reader service card

#### Reprint order form

Send to: **Electronics Reprint Dept.**  
330 West 42nd Street  
New York, N. Y. 10036

For listing of reprints available see  
the reader service card.

To help expedite mailing of your  
reprints please send cash, check or  
money order with your order.

For reprints of the latest special  
report:

#### Unijunction Transistors

Send me . . . . . reprints of key no  
R-74 at 50¢ each.

For reprints of previous special  
reports fill in below:

Send me . . . . . reprints of key  
no.(s) . . . . . at . . . . . ¢ each.

For prices see the reader service  
card.

Name . . . . .

Number & Street . . . . .

City, State . . . . .

Zip code . . . . .

## New Production Equipment

### Self-adjusting, portable welder

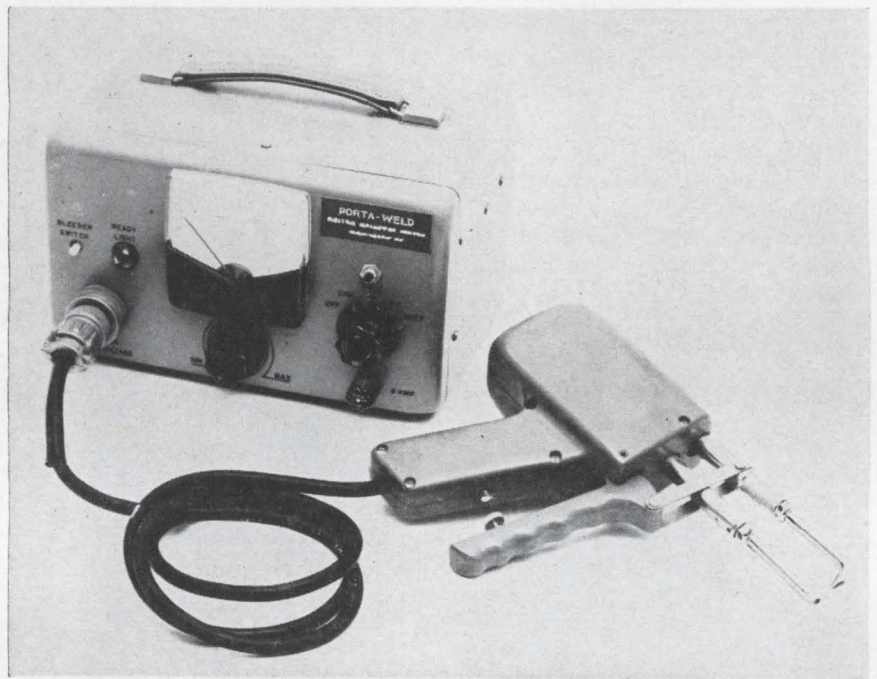

A **battery-operated** spotwelder with a gun that weighs 2½ pounds and can be used inside cabinets like a soldering iron is in itself an innovation. Even more unusual is this portable spotwelder that can adjust itself to differences in the resistance of the materials being welded, yet costs only \$475.

The welder can be used with the welding gun in a bench mount for welding the leads of miniature cordwood assemblies and similar work, but the self-adjusting feature makes it unnecessary to adjust welding schedules for every change in lead materials and resistivity.

Because it's lightweight, the welder can be carried into the field to repair equipment, or to in-plant work or laboratory equipment too large for bench handling. The developers say it's fine for making welds inside instruments, for repairing large tubes, such as klystrons, and for chores like welding thermocouples to the walls of environmental chambers.

According to David Fidelman, director of engineering at the Electro-Magnetics Co., the welder is the first one to use a weld-con-

trol technique which the company has patented. He says that the operation of the welding circuit is analogous to that of a feedback amplifier.

The portable device is a direct-current, capacitance-discharge, resistance welder. The driving circuit is designed so that the load, the resistance of the material being welded, is part of the feedback circuit. This enables the circuit to compensate for changes in weld resistance to keep the welding current constant. Since energy levels are uniform, Fidelman adds, burn-through of fine wires due to energy variations are avoided.

Energy output is adjustable up to 100 watt-seconds. This rating is determined by the amount of capacitor voltage, which the control circuit maintains as a constant at each setting. This setting depends upon the thickness or diameter of the materials being welded; the resistivity of the material is not critical, so the setting can be approximately that required. Wire as fine as 2-mil stainless steel or as large as 20-gage in copper, or larger in higher-resistivity materials, can be welded.



He adds that the relative simplicity of the system accounts for the cost being much lower than previous self-adjusting welders. Special subsystems to detect weld conditions and adjust weld energy are not required with the Electro-Magnetics design.

Weld pressure is applied by squeezing the hand gun. Adjustments are by fingertip control and a variety of electrode tips can be used.

The power unit contains the power supply, control circuit and a watt-second meter. The d-c source, in portable operation, is rechargeable nickel-cadmium batteries. These can be used for up to 1,000 welds, depending on weld energy, and recharged from a-c lines by a built-in charger. A-c power can be used in bench operation, since the unit contains a rectifier.

#### Specifications

Energy output	100 watt-seconds, max.
Power supply	Batteries or a-c
Weight	Power unit, 12 pounds Welding gun, 2½ pounds
Price	\$475
Delivery	From stock to within 30 days

Electro-Magnetics Co., 50 Baiting Place Road, Farmingdale, N.Y., 11736 [451]

### Motorized stripper removes metal sheath

A motorized Tempak stripper simplifies the removal of metal sheath to expose the conductors of metal sheathed, mineral oxide insulated thermocouple materials, cables and heaters. The stripper features quick interchangeable cutting heads to handle materials ranging in size from 0.040 in. to 0.250 in. in diameter. The heads may also be used for hand stripping operations.

Since the material is held stationary while the cutting head revolves, the unit can strip materials that have already been installed. Also, because of its light weight (approximately 21 lbs) and size (20 in. long by 7¾ in. high by 4¼ in. wide) the unit is portable.

The standard unit can strip up to 6 in. of sheath. Its ¼ h-p motor requires 2 amps of 115 v 60 cps from a standard a-c receptacle. Consolidated Controls Corp., 2338 Alaska Ave., El Segundo, Calif., [452]

#### TRYLON ROTATABLE LOG PERIODIC ANTENNA

Single-layer, horizontally polarized, for 6.5 to 32 mc. 65° azimuth beamwidth. 6 db gain/std. dipole. Power to 50 kw PEP

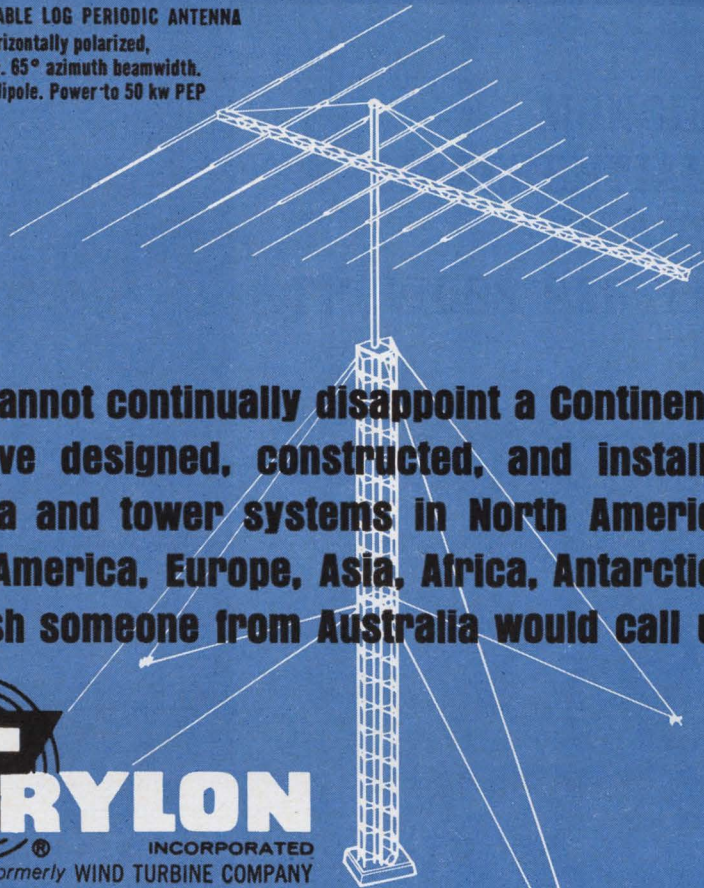

**"One cannot continually disappoint a Continent."**  
**We have designed, constructed, and installed antenna and tower systems in North America, South America, Europe, Asia, Africa, Antarctica. We wish someone from Australia would call us.**



Elverson, Pa. 19520 (215) 942-2981 — International Division, 750 Third Ave., New York, N.Y. 10017, U.S.A.

Circle 207 on reader service card

## ULTRA-COMPACT 4 CRYSTAL FILTERS for 4.0 to 7.5 MEG. RANGE\*

Sharpens band pass of IF's in AM receivers.

Good shape factor and low insertion loss.

Only 5/8" square x 1 17/32" high.

Temperature range: -30°C to +65°C.

\*Other filters from 1 kc to 100 meg. available.



-15      -10      -5      0      +5      +10      +15<sup>0</sup>  
KC



### CTS KNIGHTS, INC.

(Formerly the James Knights Company)  
SANDWICH, ILLINOIS

a subsidiary of CTS Corporation, Elkhart, Indiana





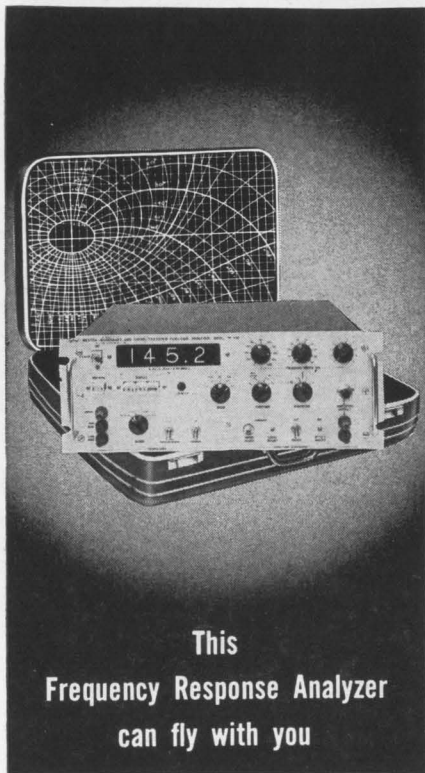









**This  
Frequency Response Analyzer  
can fly with you**

It measures only 7" x 17" x 16"  
and weighs just 38 lbs.  
Yet it has all these features . . .

-  Frequency response measurements from 0.001 to 1000 cps.
-  Direct digital readout of phase and amplitude.
-  40 db of noise rejection.
-  No drift adjustment.
-  High-speed, automatic operation.
-  Self-checking and calibrating.
-  All solid state.
-  Low cost.

Request Bulletin



**WESTON-BOONSHAFT & FUCHS**  
WESTON INSTRUMENTS, INC.  
HATBORO INDUSTRIAL PARK  
HATBORO • PENNSYLVANIA 19040

## New Materials

### Conductive resin needs no heat



A two-part epoxy resin (100% solids content) is available with both parts containing extremely fine particle size silver flakes. Electrobond 1777 can be used for r-f shielding, electrical connections, and as a replacement for solder. It is recommended for applications needing low electrical resistance and good bonding.

After mixing, the cement is easily applied to the work and will air dry. No heat is required. Volume resistance is less than 0.01 ohm centimeter. Tensile strength is rated at 800 psi (lap shear). Temperature range is from -65° F to +300° F.

Electrofilm, Inc., 7116 Laurel Canyon Blvd., North Hollywood, Calif. [441]

### Thermoplastic offers high stability

Polysulfone, a new family of plastics is one of the strongest, most heat-resistant thermoplastics available to date. It can be molded, extruded or thermoformed into a wide variety of shapes. For the materials and design engineer, Polysulfone offers useful properties which are maintained to a high degree over a temperature range from -150° to over 300°F, and for long periods of time. Polysulfone is available in both clear and opaque forms which are flame-resistant, self-extinguishing, and thermally stable—qualities that are inherent in the natural plastic. With most plastics, these qualities are obtained by the addition of chemical modifiers which can undesir-

ably affect the strength and other properties. The new material has found application in several commercial products and is being investigated for many more. Such uses include computer parts where exceptionally high dimensional stability, good electrical properties and resistance to overheating are provided.

Union Carbide Corp., Plastics Division, 270 Park Ave., New York, N.Y. 10017. [442]

### Tungsten coatings protect substrates

Flame-sprayed coatings of tungsten demonstrate an ability to protect base materials against damage by hot spots. This company reports that flame-sprayed tungsten (melting point: 6170° F) has undergone field tests as a heat-sink coating and demonstrated that coatings of 0.100-in. thickness are strong enough to stand by themselves even if the base is disintegrated by heat. Coatings are applied with the type 2M plasma flame system using Metco 61 tungsten powder, and a nitrogen-hydrogen blend of gases. The company reports that the coatings bond well to steel, quartz, and high density alumina. By using an intermediary layer of tantalum, coatings can be applied over graphite.

Metco Inc., Westbury, N.Y. [443]

### P-c board coatings resist chemicals

Two new HumiSeal coatings have been introduced. Both types 251 and 1014 are chemical resistant p-c board coatings that protect printing on components and boards from cleaning solvents. Type 251 has a short pot life, is cured at room temperature and is applicable by brush. Type 1014 has an eight-hour pot life, elevated temperature cure and is recommended for spray application.

Columbia Technical Corp., Woodside, N.Y., 11377. [444]



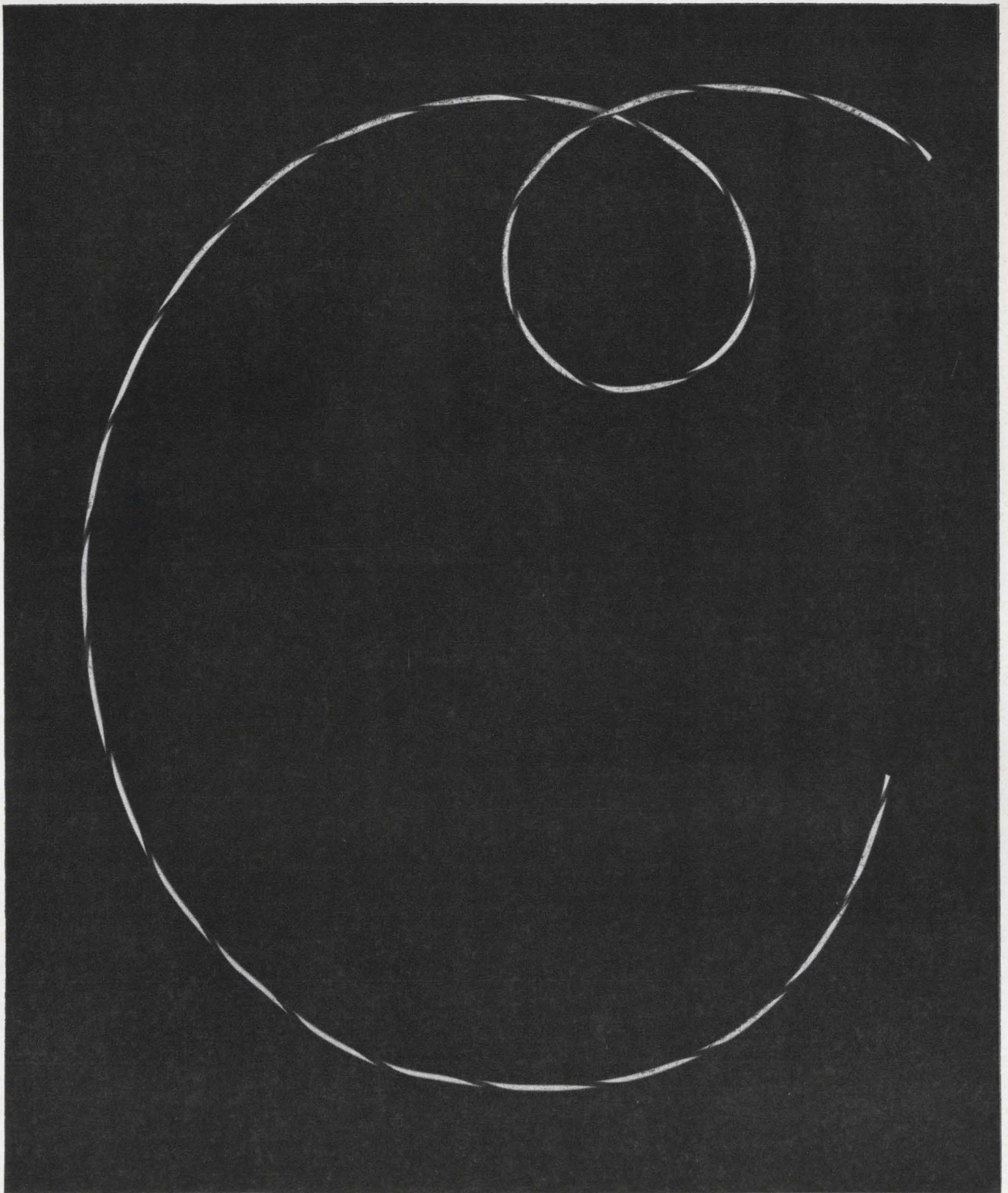

## If you ask us for our 3¢ hookup wire, expect a little static.

Before we accept your order, we ask: "What are you using it for? Where? How? When?"

Static? Sure, but we think we know more about wire than any other manufacturer. And we like to pass it on where it'll help.

Based on your answers, maybe we can suggest an equivalent wire that costs less. Or introduce you to a new wire just marketed last week that will work better.

So next time you call Alpha, expect a little static. It'll keep you from getting burned.

**Alpha Wire** Headquarters: Elizabeth, New Jersey 07207. Write for our new 108-page catalog.  
A Division of Loral Corporation



**If you're starting from scratch this way...**

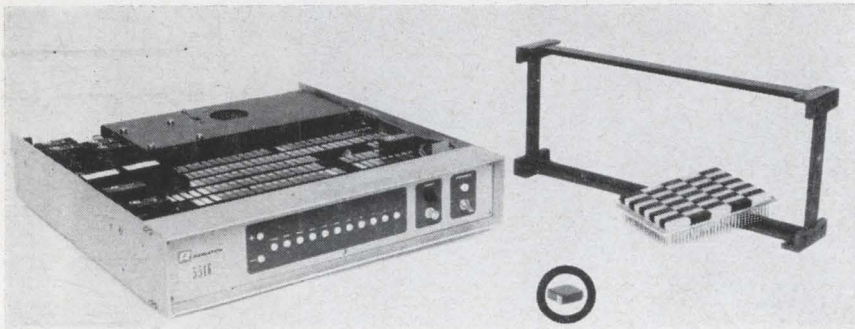
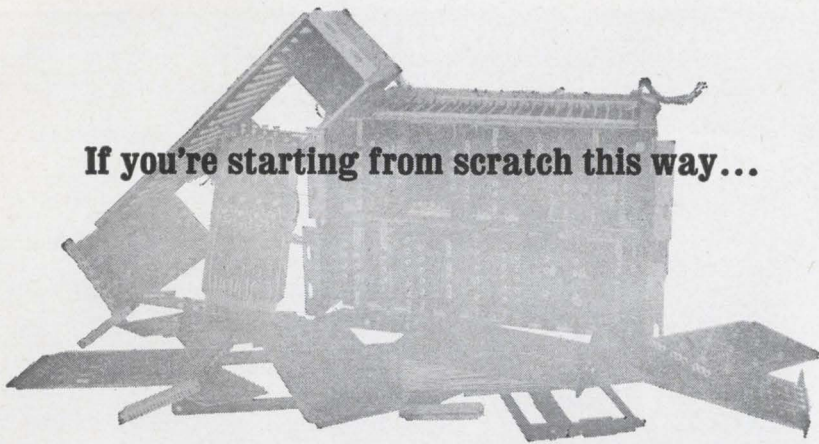

**Check the advantages of Radiation's pre-engineered packaging and plug-in modules**

- Packaging density compares with integrated circuits
- Cold solder joints and complex wiring eliminated—all components are welded and interconnections made by manual or automatic wirewrap
- Spare parts and logistics reduced *drastically*
- Circuits are individually encapsu-

- lated plug-in units, 0.4"x1"x1.1"
- High reliability—up to 5,330,000 hours MTBF

CUT COST on both logic circuits and mounting hardware. For example, a 1 Mc 4-input NOR is priced at \$5.00. Hardware for mounting 400 NOR's is only \$370.00. For more specification data or price information write:

See our complete line of data processing building blocks and communications maintenance/operation equipment at WESCON, Booths 2207-2208 and ISA Instrument-Automation Conference Booth 2014.



Products Division • Dept. EL-07 • P.O. Box 220 • Melbourne, Florida • Ph. (305) 727-3711  
Circle 122 on reader service card

To order reprints: Fill in, cut out coupon below, insert in envelope and mail to: **Electronics Reprint Dept., 330 W. 42nd Street, New York, N.Y. 10036**

**Reprint order form**

For listing of reprints available see the Reader Service Card.

Unijunction Transistors

Send me ..... reprints of Key no. R-74 at 50¢ each.

For reprints of previous special reports fill in below:

Send me ..... reprints of Key No.(s) ..... @ .....¢ each.

(For prices, see Reader Service Card)

Name .....

Number of street .....

City, State, Zip code .....

**New Books**

**Solid state devices**

**Fundamentals of Semiconductor Devices**  
Joseph Lindmayer and  
Charles Y. Wrigley  
D. Van Nostrand Co., 486 pp., \$11.95.

This book is devoted to the physics of semiconductor devices. However, its discussions of device parameters and how they are affected by structure, impurity distribution and operating conditions may be of interest to the circuit designer.

The book appears to be reasonably up-to-date in its coverage of field effect transistors; both junction and metal-oxide-semiconductor types are analyzed. Hot-electron devices, surface properties, insulation properties, impurity diffusion, and planar and epitaxial construction are also explored.

The treatment of band structure includes a detailed study of carrier energy distribution, Fermi level, doping and effects of bias. A chapter on mechanisms of carrier transport at high current densities explains the crowding of injected current toward the rim of the emitter.

Carrier collision effects and avalanche multiplication are also analyzed.

The fabrication of monolithic integrated circuits is treated extensively; the discussion includes an analysis of distributed resistor-capacitor components.

The index is extremely brief. For example, the backward diode and the Shockley diode are both discussed in the text, but neither device is listed in the index.

A book of this nature should have a very extensive index, since it is likely to be used as a reference book rather than as a textbook by many of its purchasers. Fortunately, most of the material is presented in separate sections, so that the practicing engineer will not have to reread earlier portions of the book to understand a particular passage elsewhere.

Lindmayer is the head of the semiconductor physics department at the Sprague Electric Research Center. Wrigley is a physicist at the center.



## Our depleted society

Continued from page 15

that a high wage automatically means high product cost and price. What counts is the wage and other cost per unit of product. Modern technology makes it feasible to offset high labor costs by efficient methods of production and organization. High wages can be combined with low prices.

"Making this happen takes some doing; capital, management talent and technical skills must be systematically applied in a self-renewal process. During the 1950's and 1960's capital has been available in large amounts in the U.S. On the other hand, management talent and industrial skills have been in short supply," Melman says.

Melman is not happy with what is happening to defense producers either. He bemoans the failure of diversification schemes by military producers, projects which failed because the companies are so inept in industrial markets. "These companies, and their employees, no longer had the capability to design, manufacture and sell to the civilian markets. Long experience in serving the defense agencies of the government, under conditions where cost had been a secondary matter, resulted in a trained incapacity, among many military-industrial firms and their staffs, to operate in a civilian market."

To renew industries which have become depleted, he sees similar difficulties. "The most difficult management situation is the technical renewal and reorganization of existing industrial operations. When the designs of products are changed, and new manufacturing methods are introduced, this immediately implies a requirement for learning new occupational skills by managers, engineers, foremen and workers. Re-equipping factories, learning new skills, and regrouping job responsibilities on a large scale are the most difficult sorts of tasks for an industrial management."

Melman feels that it will take 20 years to get the economy on the right track. His waspish book may sting industry and government into taking the first steps.

Our Depleted Society, by Seymour Melman; Holt, Rinehart and Winston, 366 pp., \$5.95

## draw yourself a circuit to control TEMPERATURE

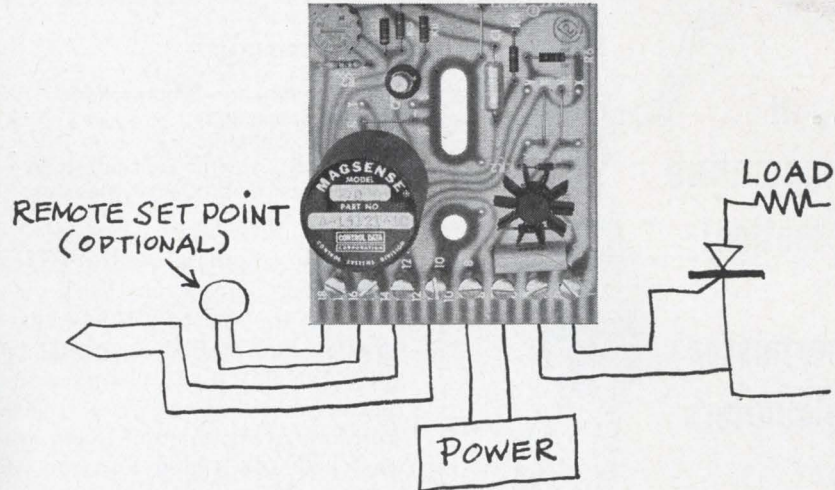

## PUT MAGSENSE® IN THE MIDDLE

Connect a thermocouple, thermistor, or R.T.D. to one side of a MAGSENSE controller and an alarm or relay to the other. It's just about that simple to control temperature accurately and reliably. Solid-state MAGSENSE controllers have a 100 billion power gain and will accept the output of the transducers directly *without amplifiers*. Set point or dual set points are adjustable. Cold junction and copper compensation are self-contained in models for thermocouple applications. Examine these specifications for the Model 70. Versions to meet Mil E 5272 and a variety of special application controllers are also available. Prices are from \$60 up, with quantity discounts.

### BRIEF SPECIFICATIONS FOR MODEL 70

RESPONSE TIME:	100 ms max., 50 ms typical
POWER REQUIRED:	10 to 14 VDC at approx. 30 ma exclusive of load current.
OUTPUT:	Non-latching for inputs with ranges of 100 $\mu$ a, 1 ma, 10 ma or 100 ma. Latching or pulse outputs also available.
SIZE:	3" x 3.35" x 1.25"
WEIGHT:	Approx. 3 ounces
DELIVERY:	From stock

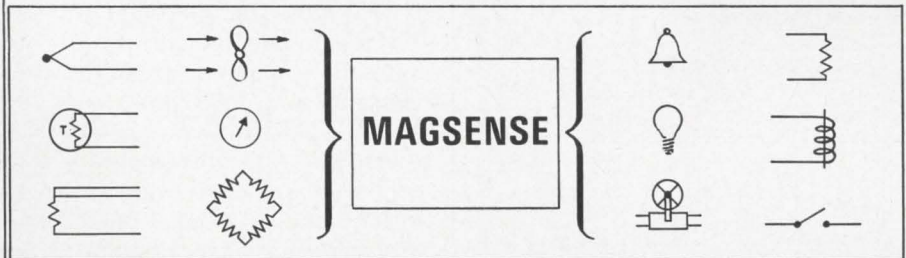

FOR SPECIFIC APPLICATIONS DATA ON TEMPERATURE, contact MAGSENSE Products, Dept. 101, Control Systems Division, Control Data Corporation, 4455 Miramar Rd., La Jolla, California. (Area code 714, 453-2500).

FOR INFORMATION about the complete line of MAGSENSE products for military and industrial applications, circle the inquiry number below.

**CONTROL DATA**

**CORPORATION**

4455 Miramar Road, La Jolla, Calif.

See MAGSENSE at Booth 2003, Wescon



vive la difference

... in  
temperature  
detection!

with

Thermistor  
Bolometers  
by  
**SERVO**



"Ooh la la! Such amazing men zeese SERVO engineers. Zey developpe a line of IR Thermistor Bolometers wiz a degree of sensitivity zat is seemply fantastique! Not only zat . . . zey need no cooling off. And ze difference? Listen . . . zey can detect ze most minute temperature changes in a variety of substances. 'Ot or cold, makes no matter . . . zey can see even room temperature and below . . . as much as a mile from ze source (depending upon ze optical system used)."

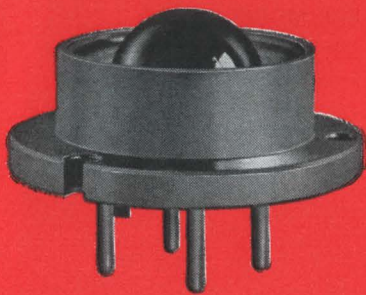

What else is different about the Thermistor Bolometers Fifi's raving about? First, they're available in a number of different types and sizes for use in detection, measurement, analysis and control systems . . . next, they're designed and constructed to withstand the widest possible range of operating conditions. Best difference of all, they're produced by Servo, leader in research and development of advanced infrared devices . . . that's your assurance of the highest standards of performance and reliability, with the greatest possible economy. Send for complete information, "tout-de-suite"!

Experienced personnel are invited to submit resumes.



**SERVO  
CORPORATION  
OF AMERICA**

111 New South Rd., Hicksville, L. I., N. Y.  
516 WE 8-9700

## Technical Abstracts

### Digital command

Digital command—a network for manned spaceflight  
Vernon M. Dauphin, Jr.  
Information Systems Division, NASA  
Manned Spacecraft Center, Houston,  
Texas

The radio command control system for Project Gemini must feed computers in the spacecraft data based on such information as orbital position, orbital plane changes, and rendezvous maneuvers. A phase-shift-keyed modulation technique was chosen for the ground network because this type of modulation occupies minimal bandwidths, allows circuitry to be simplified, and provides high performance margins.

A one-kilocycle tone provides the phase and synchronization reference; a biphas-modulated 2 kc tone containing the binary information is linearly added. Power is divided equally between the two tones. Simple modulation and demodulation techniques can be used in recovering command data.

The command format consists of three vehicle address bits, three system address bits, and six to 29 data bits. Each bit is encoded into five sub-bits of a predetermined fixed pattern. The sub-bit pattern for addressing the vehicle is different from that used for addressing the system and for receiving data. The probability of a random sequence of bits being received is thus about 1 in  $2^{60}$ .

Once this basic format was arrived at, a network was set up with all radio command transmitter sites controlled in real time from the Mission Control Center in Houston. Remote sites beyond real-time control were provided with means to receive and store data from the control center for transmission to the spacecraft when required.

The launch site and the two real time sites are connected to the control center by high speed data lines with a transmission rate of a thousand bits per second. All remote site equipment receives 100-word-per-minute teletype communications.

The control center includes redundant 7094 computers, a redund-

ant communications processor, and two master digital command systems. Two identical mission operations control rooms house the flight controller consoles, which contain the command initiation and display equipment.

Presented at the 1965 Aerospace Technical Conference and Exhibit, Houston, Tex., June 21-24.

### Rendezvous sensor

Unified S-band rendezvous sensor  
J. T. Knudsen, Military Electronics  
division, Motorola, Inc., Western  
Center, Scottsdale, Ariz.

A unified S-band system has been selected for tracking and communicating with the Apollo spacecraft in earth orbit, in deep space, and in lunar orbit. The system saves considerable weight over an earlier Apollo configuration which had several communication and tracking links, including vhf f-m, vhf a-m, and C-band radar.

The sensor provides range, range rate, and angle data to the tracking spacecraft's guidance computer. The computer then derives a fourth measurement, angle rate, from the angle measurement.

The pilot of the tracking spacecraft—which may be either LEM or the command module—searches for the target vehicle by manually controlling an antenna, or by allowing the guidance computer to point it.

After target acquisition, the carrier is phase-modulated by a ranging subcarrier. The signal is received through the omnidirectional antenna of the target spacecraft. The transponder receives, amplifies, and demodulates the subcarrier, and imposes it on a new carrier. The new carrier frequency is 240/221 times the received frequency if LEM is the target, and 220/239 the frequency if the command module is the target. The carrier is retransmitted and received by the tracking spacecraft and demodulated.

The ranging subcarrier is extracted from the demodulated signal and range is determined by comparison with the transmitted





*When this headline was current news...  
digital recording tapes  
had a packing rate of 200 bpi.*

*Today, 800 bpi is standard;  
improvement in tape and base is the reason.*

In analyzing the sensational development of EDP over the past decade, most of us naturally talk in terms of improvement of hardware. But when you stop to examine them, the contributions made by tape manufacturers have been quite remarkable.

The tape of today looks like the tape of 1954 . . . but think of the differences: improved oxide coatings to increase total capacity, reduce fluctuations in performance; much stronger binders to reduce dropouts and flaking, lengthen tape life; smoother surfaces to give longer, error-free wear; thinner coatings and better production controls to guarantee reel-to-reel uniformity.

Working hand in hand with the tape manufacturers during this time has been Du Pont. Improvements in the uniformity, stability and overall reliability of the base of MYLAR\* have played a vital role in making possible the sophisticated tape in use today. Continuing cooperation of research and development facilities assures continuing improvements in the future. Your guarantee of the most advanced tape is the manufacturer's brand and a base of MYLAR polyester film.

\*Du Pont's registered trademark for its polyester film.



Better Things for Better Living . . . through Chemistry

*At the base of all tape improvements: Mylar®*



# for RF POWER: specify Vector "integrated amplifier" TRANSISTORS

a minimum of 18 watts out at 260 mc, 28 volt operation!!

A typical application:

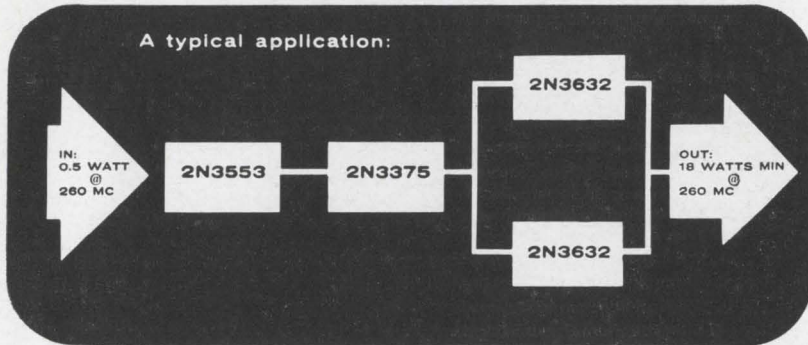

Every communications and telemetry engineer working with RF transmitters should have data on these VHF-UHF "integrated" power transistors from Vector Solid State Laboratories. Here's why:

- Efficiencies of 50%-60% are attainable with them.
- They are designed for 28 volt operation.
- They can be supplied to MIL 19500C standards.
- Lower voltage versions are available for mobile communication applications.

For data sheets, contact Sales Manager, Solid State Laboratories, Vector, Tel. 215 EL 7-7600.

**Vector** DIVISION OF UNITED AIRCRAFT CORPORATION  
SOUTHAMPTON, PENNSYLVANIA

**U  
A**

See us at WESCON, Booths 3208-11

Circle 208 on reader service card

## FINE WIRE

Completely Integrated Facilities—  
Alloying—Melting—Rolling—Drawing—  
Atmosphere and Vacuum Annealing—  
Enameling and Plating.



WRITE for valuable brochure containing fine wire compositions, pertinent properties and applications.

for

- Semiconductors
- Resistance Thermometers
- Strain Gauges
- Potentiometers
- Transducers
- Other Electronic Applications

in

precious, base, exotic  
and special alloys  
— bare or  
insulated



**CONSOLIDATED REACTIVE METALS, inc.**

115 Hoyt Avenue — Mamaroneck, N. Y. — OWens 8-2300

## Technical Abstracts

range code. The doppler data on the carrier is extracted and from it the range rate is determined. Angle information is obtained from the shaft angle encoders on the antenna.

Presented at the National Space Navigation and Communication Meeting, Houston, Tex., April 29-30.

### Solid-state radar components

Advanced ferrite duplexing-limiting techniques

J. E. Andrews, J. L. Brediger and D. H. Landry, Sperry Microwave Electronics Co., Clearwater, Fla.

Newly developed high-power ferrite devices that operate at microwave frequencies have been combined in a compact C-band all solid state radar front end. The unit is completely passive and exhibits a 10% instantaneous bandwidth, with optional frequency preselection. The assembly serves as a fail-safe duplexer limiter, which gives the receiver absolute protection, with the system operating at 500 kw peak, into a 2:1 load mismatch or an intermittent antenna short circuit.

The unit consists of a four-port single junction circulator and three limiters. The circulator, made of ferrimagnetic disks in waveguide, handles high power with minimum size and weight, and exhibits isolation and loss characteristics comparable to those of larger duplexers.

An arc former and three stages of limiting provide the receiver protection. The arc former provides an abrupt short circuit by breaking down when the received incident power exceeds 70 kw. The first limiter is a subsidiary resonance type, consisting of yttrium iron garnet (YIG) slabs in waveguide. Energy above a threshold of 500 watts is absorbed; below this level, the limiter shows little loss. It exhibits a dynamic range in excess of 20 db.

The second and third limiters consist of series-connected YIG and lithium ferrite limiters of identical design, housed in rectangular coaxial line. They exhibit a composite dynamic range in excess of 40 db.

Presented at the 1965 Microwave Theory and Techniques Symposium, Clearwater, Fla., May 5-7.



# We've made a practice of good ideas.

Our staff has had plenty of them. That's how we've stacked up all the "firsts" behind our name. (First magnetic element used in computers, first commercial magnetic core memory, fastest ferrite memory system to date, first magnetic thin film memory in use, delivery of first time-limited partial switching core memory.)

If your thinking is as good, you can make it count. At UNIVAC-St. Paul, laboratory research constantly nourishes design and development efforts. It produces not only "hows," but "whys." A recent example is in multi-aperture core behavior.

Look what is being done right now in memory development using multi-aperture core techniques. We came up with an analog magnetic storage device—a practical application of time-limited, partial-switching representing significant technical progress in the field of simplified analog recording through the use of discrete magnetic elements. Transient effects are received as analog data and stored for later read-out.

There are several other advanced development programs which show the same pioneering spirit. Our minimum employment requirements are a BS in Engineering or Physics and 2 or more years experience in memory development including traditional ferrite core configurations, multi-aperture cores (Biax, Transfluxor) and/or thin films. A concentration on advanced development and advanced manufacturing is particularly desired. Send a resume at once to Mr. R. K. Patterson, Employment Manager, Dept. G-17, UNIVAC Division of Sperry Rand Corp., Univac Park, St. Paul, Minn. 55116. An Equal Opportunity Employer.

**UNIVAC**  
DIVISION OF SPERRY RAND CORPORATION



## EMPLOYMENT OPPORTUNITIES

### Sr. Development Engineers

- *High Power Electron Tubes*

BS or MS in electrical engineering or physics, plus a minimum of 5 years experience in high power electron or x-ray tube design, manufacture, applications or related activities. Capable of managing design and development personnel.

- *Image Intensification Devices*

BS or MS in electrical engineering or physics, plus a minimum of 5 years experience in photosensitive, storage, and display tube design, manufacture, applications or related activities.

Knowledge of some or all of the following desirable: phosphors, electron optics, photosensitive surfaces, vacuum tube processing and design.

### Application Engineers

BS or MS in electrical engineering or physics, plus a minimum of 5 years experience required in the electrical design of high-power transmitters, pulse modulators, and rf heating generators and the application of power tubes in such equipment. Experience in the design of power tubes is not essential.

Prime assignment: Working on application of our triodes and tetrodes in equipment under design or planned by our customers.

Machlett provides outstanding remuneration and working conditions . . . is located in a charming Connecticut community near New York City . . . has an enlightened benefits program . . . will relocate you if necessary.



ELECTRON TUBE SPECIALIST

Submit detailed resumes to  
Mr. Robert C. Donovan  
Employment Manager

An equal opportunity employer.

### THE MACHLETT LABORATORIES, INC.

1063 HOPE ST., SPRINGDALE (STAMFORD), CONN.  
An Affiliate of Raytheon Company

#### Your Inquiries to Advertisers Will Have Special Value . . .

—for you—the advertiser—and the publisher, if you mention this publication. Advertisers value highly this evidence of the publication you read. Satisfied advertisers enable the publishers to secure more advertisers and—more advertisers mean more information on more products or better service—more value—to YOU.

#### PROFESSIONAL SERVICES

**GIBBS & HILL, Inc.**  
Consulting Engineers  
Systems Engineering  
Operations Research • Development  
Field Studies • Design • Procurement  
Power • Transportation • Communications  
Water Supply • Waste Treatment  
393 Seventh Avenue New York 1, N. Y.



# VALVO

in  
West Germany

As a leading West-German tube manufacturer we are seeking for our application and quality laboratory an outstanding engineer with vigorous and effective leadership in the expanding branch of microwave tubes, especially for high power klystrons.

This position requires a highly technical competence and broad industrial experience as a basis for the productive cooperation with top technical personnel of the different divisions and with the customers. He will supervise a group of engineers in the quality and application laboratory for klystrons, will work closely with the R & D laboratory, the factory and with the customers. He must have the ability and desire to initiate an engineering group for the technical resources required for the growing branch of microwave tubes.

Qualified engineers with appropriate degree and experience speaking excellent German are invited to contact.



## VALVO GMBH

Rohren-und Halbleiterwerke  
2 Hamburg 54  
Stresemannallee 101  
West-Germany

## INSTRUMENT TECHNICIANS

### THE OAK RIDGE NATIONAL LABORATORY

Highly skilled instrument technicians to assist in the installation and maintenance of process control instrumentation systems and devices for chemical pilot plants, nuclear reactors and other large experimental installations.

High school education, plus additional training in either the physical sciences, instrumentation, or electronics, and at least 4 years experience in installation and maintenance of complex instrumentation and control systems. Entrance rate \$3.39 per hour; \$3.45 per hour after six months. Reasonable interview and relocation expenses paid by Company.

Excellent Working Conditions  
and  
Employee Benefit Plans

An Equal Opportunity Employer

Send detailed resume to:

Central Employment Office

UNION CARBIDE

CORPORATION

Nuclear Division

P. O. Box M

Oak Ridge, Tennessee 37831

UNION  
CARBIDE

## It's Time To Be Your Own BOSS ... Time to TRIPLE Your Income!

Aamco, The World's Largest Transmission Specialists, seeks men with foresight and ambition. Here's a golden opportunity to blend your ability and Aamco's vast experience into your own successful business. Aamco now has 165 franchised shops coast to coast, will have a total of 270 by the end of 1965. Aamco shops average gross is \$100,000 per year, and the best shops gross over \$250,000. Aamco trains you in the latest management and merchandising techniques, provides the promotional backing to assure your success. Growth-potential unlimited... no automotive experience necessary. Modest, partly financeable investment of \$12,500 to \$23,500, depending on territory. Please furnish complete personal details. Write or telephone

## AAMCO TRANSMISSIONS

4500 N. Front St., Philadelphia, Pa.

(215) GL 5-5411

Put Yourself in the Other Fellow's Place

## TO EMPLOYERS - TO EMPLOYEES

Letters written offering Employment or applying for same are written with the hope of satisfying a current need. An answer, regardless of whether it is favorable or not, is usually expected.

Mr. Employer, won't you remove the mystery about the status of an employee's application by acknowledging all applicants and not just the promising candidates.

Mr. Employee you, too, can help by acknowledging applications and job offers. This would encourage more companies to answer position wanted ads in this section.

We make this suggestion in a spirit of helpful cooperation between employers and employees.

This section will be the more useful to all as a result of this consideration.

Classified Advertising Division

McGRAW-HILL, INC.

330 West 42nd St., New York, N. Y. 10036

CLASSIFIED ADVERTISING

## SEARCHLIGHT SECTION

BUSINESS OPPORTUNITIES  
USED OR SURPLUS EQUIPMENT

## BIG CATALOG

World's "BEST BUYS"  
in GOV'T. SURPLUS  
Electronic Equipment

FULL OF TOP QUALITY ITEMS—  
Transmitters, Receivers, Power Supplies,  
Inverters, Microphones, Filters, Meters,  
Cable, Keys, Phones, Antennas, Chokes,  
Dynamotors, Blowers, Switches, Test Equip-  
ment, Headsets, Amplifiers, etc. etc. SEND  
25¢ (stamps or coin) for CATALOG and  
receive 50¢ CREDIT on your order. Address  
Dept. E-5

FAIR RADIO SALES

P. O. Box 1105 • LIMA, OHIO • 45802

CIRCLE 951 ON READER SERVICE CARD

WRITE FOR NEW  KEYSTONE

## free catalog

We are the leading producers of BATTERY HOLDERS, TER-  
MINALS, TERMINAL BOARDS & ELECTRONIC HARDWARE.

KEYSTONE ELECTRONICS CORP., 49 BLEECKER ST. NEW YORK 12, N. Y.

CIRCLE 952 ON READER SERVICE CARD

SEMICONDUCTORS  
MAJOR BRANDS

INTERGRATED CIRCUITS • DIF. AMPS DAR-  
LINGTONS • POWER DIODES & TRANSISTORS  
• SPECIAL DEVICES

Write for Catalog S-1

SEMICONDUCTOR SALES OF CALIF.

1063 Perry Annex Whittier, Calif.  
(213) 696-7544

CIRCLE 953 ON READER SERVICE CARD

RADAR AUTO-TRACK & TELEMETRY ANTENNA PEDESTALS  
3 & 10 CM. SCR 584 AUTOTRACK RADARS, M-33 RADAR  
TPS-1D SEARCH, APS-45 TPS-10D HT. FINDERS, WX RADARS,  
FRN-32GCA, APS-10 APS-15B APS-27 (AMTI) SEARCH, ■ ■ ■  
APN-102 DOPPLER, DOZENS MORE CARCINOTRONS, PFM'S,  
25-5-1-2-3-6 MEGAWATT PULSE MODULATORS, CAVITIES,  
PULSE TRANSFORMERS, IF STRIPS, WAVEGUIDE, BENDS  
200 MC. 1 KMC. 3 KMC. 6 KMC. 9 KMC. 24 KMC. RF PKGS.

RADIO RESEARCH INSTRUMENT CO.

550 5TH AVE., NEW YORK 36, N. Y. JU 6-4691

CIRCLE 954 ON READER SERVICE CARD

Let us manufacture your electronically controlled  
equipment. Small or large quantities. Good del-  
iveries. Representative will call.

Universal Laboratories

1085 Manhattan Avenue  
Brooklyn 22, New York, EV 3-4255

CIRCLE 955 ON READER SERVICE CARD

SPECIAL SERVICES

Nameplates, Decals, Hard-Hat Labels, Tool  
checks, Signs of all kinds. Free catalog. Seton  
Corp., Dept. Elec, New Haven 15, Conn.

## "SEARCHLIGHT" Can Help You!

When you want to buy or sell  
used or surplus new equipment  
and/or accessories, or have  
other business wants—advertise  
them in the SEARCHLIGHT SEC-  
TION for quick, profitable re-  
sults!



## New Literature

**Numerical displays.** Transatron Electronic Corp., 168 Albion St., Wakefield, Mass., has available a fold-out chart that outlines in detail the specifications and functional characteristics of Trans-indicator continuous and latching numerical displays.

Circle 461 on reader service card

**Adjustable interval timer.** The A.W. Haydon Co., 232 North Elm St., Waterbury, Conn., 06720. Product Newsletter No. 115 gives technical parameters of a microminiature, adjustable interval timer. [462]

**Volt-ratio dialer.** Idalee Electronics Corp., 891 Fulton St., Valley Stream, N.Y., has issued technical bulletin No. 104 describing model 300 a-c volt-ratio dialer, a portable, multipurpose, secondary-standard instrument. [463]

**Component insertion systems.** Universal Instruments Corp., 139 E. Frederick St., Binghamton, N. Y. A 16-page brochure reviews the latest numerically controlled and semiautomatic systems for high-speed insertion of components into p-c boards. [464]

**Variable coaxial attenuators.** PRD Electronics, Inc., 1200 Prospect Ave., Westbury, N.Y., 11590, offers a two-page data sheet covering five types of variable coaxial attenuators. [465]

**Integrated-circuit sockets.** Nugent Electronics Co., Inc., Box 486, New Albany, Ind., 47150, has published a four-page brochure illustrating and describing a line of integrated-circuit sockets. [466]

**Wirewound resistors.** Daven, division of Thomas A. Edison Industries, Livingston, N.J. A 16-page catalog covers the company's complete line of precision wirewound resistors. [467]

**Microwave diodes.** The Micro State Electronics Corp., a subsidiary of Raytheon Co., 152 Floral Ave., Murray Hill, N.J. Specifications for a broad line of microwave diodes are tabulated in a new short form catalog. [468]

**Digital circuit card modules.** Engineered Electronics Co., 1441 E. Chestnut Ave., Santa Ana, Calif., has released a four-page flyer on low cost, high quality GA-digital circuit card modules. [469]

**High-power tubes.** Tung-Sol Electric Inc., one Summer Ave., Newark 4, N.J., offers a technical brochure describing a line of high-power tubes designed for radar and microwave modulators. [470]

**Tone telemetering system.** Solid State Electronics Co., 15321 Rayen St., Sepulveda, Calif., has available literature on the model T-108 silicon solid state, tone telemetering system. [471]

**Military plating specifications.** Spec Tech Publications, Inc., 13434 South Normandie, Gardena, Calif., offers the 1965 edition of its wall chart that presents a concise summary of military plating specification information including latest revision reference, classes, types, grades, etc. [472]

**Semiconductor catalog.** Sprague Electric Co., Semiconductor Division, Concord, N.H. Short form catalog CN-116H1 covers a line of Unicircuit monolithic networks, compatible components and transistors. [473]

**Polyurethanes.** Columbia Technical Corp., Woodside, N.Y., 11377, announces availability of a brochure entitled "Fundamentals of Polyurethanes", which contains basic properties and applications of this particular resin. [474]

**Automatic voltage regulators.** The Superior Electric Co., Bristol, Conn., 06012. Bulletin SVR365 consolidates complete features, specifications and outline drawings on Stabiline automatic voltage regulators used to maintain a constant-output voltage regardless of line or load changes. [475]

**Telemetry modules.** Astrodata, Inc., 240 E. Palais Road, Anaheim, Calif. Technical data bulletins describe a solid state, Astrolock-loop, f-m sub-carrier discriminator, voltage controlled oscillators and other data modules for all f-m telemetry data reduction and data processing applications. [476]

**Predetermining impulse counter.** Landis & Gyr, Inc., 45 W. 45th St., New York, N.Y., 10036. Bulletin 401 is designed to assist engineers in specifying predetermining electromagnetic counters for all types of applications. [477]

**Digital-to-synchro converters.** Astrosystems Inc., 521 Homestead Ave., Mount Vernon, N.Y., has published a data sheet covering digital-to-synchro converters with accuracy and resolutions to 18 bits. [478]

**Microwave diodes.** Micro Optics, a division of Alpha Industries, Inc., 381 Elliot St., Newton Upper Falls, Mass., 02164, has released data sheet 4000A describing ceramic cartridge microwave diodes for mixer and video detector applications. [479]

**Microwave products.** Lectronic Research Laboratories, Inc., 715 Arch St., Philadelphia, Pa., 19106. Bulletin 83 contains a comprehensive presentation of microwave equipment, waveguide components, regulated power supplies, test equipment and precision electronic components of interest to industry, R&D, broadcasting and educational institutions. [480]



# Great editorial is something he takes home

(What a climate for selling!)

**Electronics**



A McGraw-Hill Market-Directed Publication  
330 West 42nd Street, New York, N.Y. 10036



# Data Amplifiers: Cohu claims reliability record

*With over  $10^8$  total hours of on-the-job operation, Cohu amplifiers are optimized for reliability, consistent performance and minimum maintenance. Experience makes the difference.*

As today's data systems are built bigger and cost more, they are used longer and more often. And reliability becomes a major factor in the system and its components. This is particularly true of DC data amplifiers.

## Drift current must be considered



Mechanical chopper stabilized DC amplifiers have been the work horse of truly reliable and high-accuracy data reduction systems for the past decade. All solid-state designs have an important place in measuring systems, but careful consideration should be given to the all important specification of "Drift Current"...that undesirable feedback to the source, or transducer. Cohu/Kin Tel chopper stabilized DC amplifiers typically produce a drift current of  $10^{-14}$  amperes while most solid-state types produce currents in the realm  $10^{-9}$  amperes. Absence of drift under a wide range of temperatures (stability controlled by a "Zero Set") is another key feature of Cohu's proven design.

## Maximum reliability is a factor

Cohu DC data amplifiers are built for maximum reliability, consistent performance and minimum maintenance! (And fit six-to-the-rack, with a power supply in each amplifier.) Our *experience* tells us we must not stint on quality components, thorough testing and all the things that go into a truly reliable amplifier. And our performance specs are selected from *experience* to provide an instrument that is practical and functional for the job...not one that sounds better on the salesman's tongue.

## 18,000 prove the point

Our experience stands squarely behind the reliability of Cohu DC data amplifiers: Over 18,000 of them manufactured and put in use... more than 100,000,000 hours of on-the-job operation logged! Check the brief specs on Cohu's Model 112A Amplifier. Engineering representatives in all major cities can give you further details.

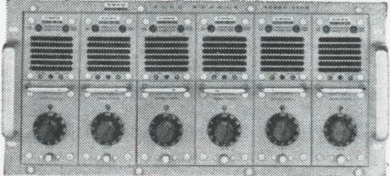
<b>AMPLIFIER</b> Model 112A, wideband	
<b>RESPONSE</b> DC to 40KC	
<b>IMPEDANCE</b> 100 K $\Omega$	
<b>OUTPUT</b> $\pm 35$ volts 40 ma	
<b>STABILITY</b> $\pm 2 \mu V$ for over 400 hrs.	
<b>NOISE</b> < $5 \mu V$	
<b>PRICE</b> \$530	
	
Model 112A/A amplifiers in 6-unit standard rack module.	

**COHU**  
ELECTRONICS, INC  
KINTEL DIVISION

Box 623  
San Diego, Calif. 92112  
Phone 714-277-6700

See us at WESCON, booth 3923



## Israel

### Water-supply simulator

In Biblical days, Moses needed divine help to obtain water from a rock. Today Israel is employing the more mundane miracles of electronics to help alleviate her chronic water shortage.

Since May, an analog simulator of underground water supply has been used by Tahal, the country's water-planning authority. The AWPS-100 simulator, made in Haifa by Elron Electronic Industries, Ltd., gives a picture of existing underground water supplies and a preview of future supplies in the event, for example, of a sharp increase in use in a specific area. The system is said to be accurate within 5%.

The Elron equipment is said to be the first of its type that's commercially available, although similar systems are in use elsewhere, including the United States Coast and Geodetic Survey's research office in Phoenix, Ariz.

**Electronic map.** The passive-network analyzer consists basically of

a large patch board representing an area of about 900 square miles around Tel Aviv—most of that section of Israel that has any appreciable amount of ground water. The board contains a matrix of connection points, 15 across and 35 down.

Wherever water enters the area, a current is applied to the patch board from programmable constant-current sources controlled by 12 potentiometers, one for each month or for any other time period. Current levels are adjusted to simulate water sources—either month-by-month rainfall or flow from underground springs. Typically, one second of running time of the simulator represents events of several years.

Wherever a layer of rock is able to trap and store water, a capacitor is connected on the patch board. Electrical resistors represent the physical resistance of geological substrates to water flow—a large resistance value for rock, a low value for sand.

**Outflow.** Negative currents simulate water flowing out of the area, for example when wells are drawing water out.

The system is stepped through 12 intervals by a clock running at 130 to 4,000 pulses a second. The timing also generates a sweep ramp for an oscilloscope's horizontal input. A variation in water pressure at any point can be found by connecting that point on the patch board to the oscilloscope's vertical channel. Read-out is on an oscilloscope.

**Trial and error.** There's an art to using this type of simulator for studying underground water supply. It's impossible to set up the resistors and capacitors in a straightforward mathematical manner because of the complexity of the interrelated partial differential equations. Instead, it is necessary to calibrate the model, in a cut-and-try manner, against previous fluctuation of the area's water supply. The components are repeatedly adjusted until the model accurately reflects events of the past.

This calibration can take several years or, as in the case of Israel's use of the AWPS-100, only a month.

Yoav Harpaz, a Tahal engineer, says the simulator will be used to help plan the most efficient system

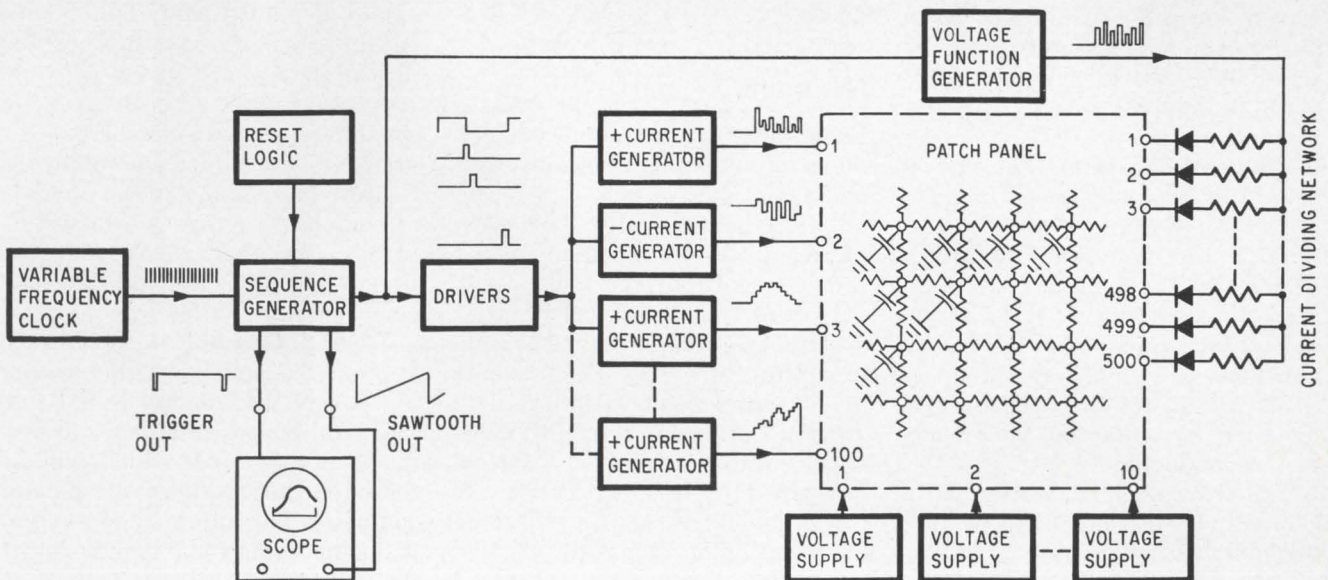

Simulator of underground water supply. Patch panel at right represents supply in one geological area.



of water storage and to preserve and exploit ground water in the foothills of Judea and Samaria.

### Great Britain

#### Woven circuit board

The ancient art of weaving may soon simplify design and manufacture in the modern science of microelectronics. Standard Telecommunication Laboratories, Ltd., says that woven matrices, when used instead of printed wiring boards, also allow higher reliability of the interconnections between microcircuits mounted on them.

The labs are the research arm of Standard Telephones and Cables, Ltd., a subsidiary of the International Telephone and Telegraph Corp.

**Conductors on tape.** The new matrix contains conductors 50 mils wide enclosed in fiber glass insulation 97 mils (0.097 inch) wide. These prefabricated tapes of insulated conductors are woven, like wires in a window screen, into a mesh of 100-mil squares.

In conventional matrices, wires running in one direction are in a different plane than those in another direction. The planes are insulated by a thin film of plastic. To make interconnections, it is necessary to cut the plastic open to expose the crossover, and to weld the wires. A break in a conductor is made by clipping out a portion of the wire.

**Fruits of the loom.** The woven "cloth" is mounted in a frame to provide good contact and registration. Joints between conductors running in the X and Y axes are made by soldering tin disks at the crosspoints. Conductors are cut by abrasion or by punching out a section. Microcircuit packages are mounted by soldering their leads to the conductors.

The woven matrix works like a printed wiring board except that assembly and soldering are done on the same side of the matrix.

**Logic pattern.** To set up an inter-

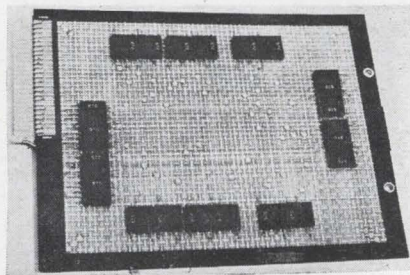

**Woven tape matrix**, about 7 inches long, carries 20 thin-film resistor-transistor logic circuits. Circles in matrix are soldered disks that establish crosspoints.

connection, the first step is to draw a logic pattern on a card corresponding to the matrix pattern. The card, with the logic pattern, is reduced photographically to the matrix size and is used as a production template. Ultimately the card and matrix may be prepared automatically, according to Standard Telecommunications.

Reliability can be increased with woven matrices because a standardized wiring matrix can be used that has been made under factory conditions; with printed wiring boards, the operator has to wire up the integrated circuit blocks individually.

Weaving techniques for interconnection have been in development for at least five years in Japan and the United States. One result is woven memory planes containing densely packed memory elements.

#### NC gains

Encouraged by an unprecedented boom in numerical controls, Britain's two pace-setters in the field are introducing systems designed to increase NC's appeal to smaller producers of machine tools.

Ferranti, Ltd., says its newest system will employ time-sharing to control three axes with a single-axis control unit, permitting a "drastic" price cut. And EMI Electronics, Ltd., is offering a system developed by Ing. C. Olivetti & Co. of Italy, which uses two-stage computation to transform the designer's dimensions into start and stop points.

**Government role.** Despite a surge in orders—800 NC systems are expected to be in operation at year's end compared with 500 in March, 1964—the industry is urging the government to offer tax inducements for small companies to install numerical controls. This step, company officials say, would lead toward the government's goal of making British industry more efficient.

Ferranti has suggested that the government also prepare software for the NC industry because it isn't profitable for any one company to do it properly.

Frank Cousins, Minister of Technology, hinted recently that the government might do just that. He said the National Engineering Laboratory had ordered a Univac 1108 to help in finding new applications for NC. The computer will be used mainly to design three-dimensional programs for numerical controls.

**Modular approach.** Ferranti's new system, called Scope (for specifiable coordinate positioning equipment), consists of modular building blocks that can be arranged to suit a customer's specifications.

Ferranti's paper tape readers operate at 300 characters a second; the company says positioning can be performed at 300 inches a minute to within 0.0001 inch.

Scope operates from either absolute or difference measurements. In the absolute system, position measurements are given with respect to fixed reference axes. In the difference method, where measurements are added cumulatively, Ferranti has eliminated the problem of cumulative errors with a system of dividers that checks out the progressive steps and indicates any count error.

**Tape in, tape out.** In the Olivetti approach, a punched tape containing design information is fed into a general-purpose computer to produce another tape, which will be the input to a Mina interpolator computer. The interpolator's output is magnetic tape that contains only the digital drive information necessary to control the machine.



Workpiece information is programmed either in Olivetti Paget or IBM Automap language. The designer does not have to specify start and end points of the various segments of the workpiece; all he needs are dimensions with respect to different reference axes. Circles are indicated by their center coordinates, radii and the direction in which the tool is to pass. An ATP language (automatic technological programming) inserts feed rates and cutter diameters.

The general-purpose computer calculates the series of arcs and straight lines that make up the workpiece, and for each segment it specifies tool velocity, acceleration, radius and direction of curvature. This information is fed to the Mina, which interpolates rapidly between the cardinal points to produce closely spaced coordinates for each direction in which the tool is to move. This calculation is recorded on magnetic tape. A plotter, coupled to the computer, draws out the cutter's calculated center path for checking. The three coordinates for each point are computed within five milliseconds, according to EMI.

In the machine shop, a transistorized control unit accepts the interpolated magnetic tape and uses the instructions to drive the machine tool. Built into the system are cutter-radius compensation systems and the ability to perform with continuously variable feed rates.

**Gains elsewhere.** The boom in Britain seems to be shared on the continent. In the past 18 months one United States concern, the General Electric Co., has sold 114 point-to-point and contouring systems in Europe, 89 of them on the continent. GE's system is the Mark Century.

## Soviet Union

### Four firsts

Communist countries are notoriously slow in disclosing information about new computers, and

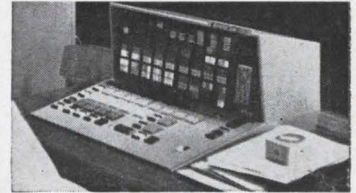
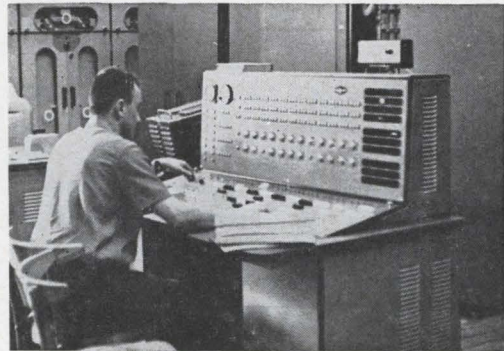
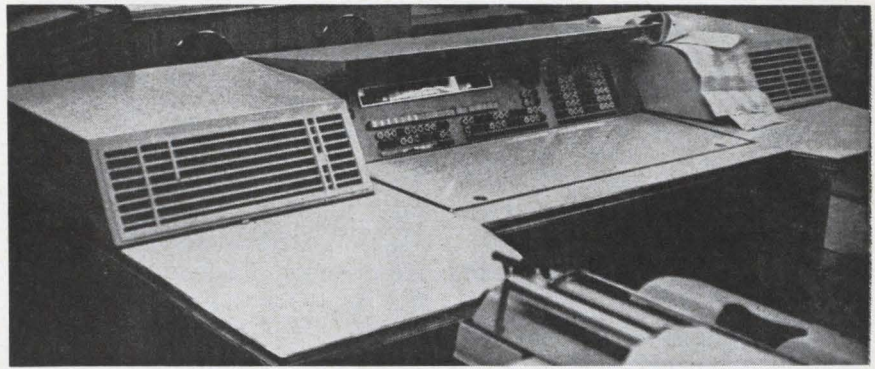

New Soviet computers are the Minsk-22 (top), Vnien-3 (above), Nairi (left) and Resdan-3 (below).

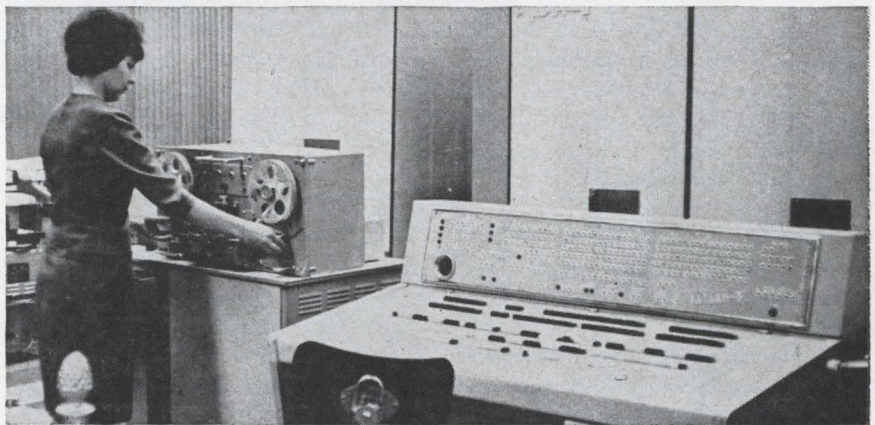

what they do release is often meager. So Western observers at Interfora, the Soviet-bloc exhibition of information-handling equipment, were surprised at the public debut of four Russian computers.

The 80,000-square-foot exhibition, which closed this month in Moscow, had equipment from Poland, East Germany, Czechoslovakia, Hungary, Rumania and Bulgaria. "Interfora" is a combination of the Russian words for "information" and "organization."

**Modern design.** The consensus was that Communist scientists and engineers have improved both the technical capabilities and the appearance of their equipment. But there was little sign of progress

toward a common computer language and toward compatibility of equipment among members of Comecon, the Council for Mutual Economic Assistance—the Soviet-bloc counterpart to the Common Market in Western Europe.

The four Russian computers shown were:

- **Minsk-22** is the latest in the Minsk series of general-purpose machines. With its full complement of peripheral equipment, the Minsk-22 occupies 1,200 square feet of floor space. It consists of a control console, a central logic system, magnetic memory of 8,192 words, and alphanumeric print-out of a 128-character line at normal speed, or a 13-character line at higher speed.



The computer can handle external tape memory of up to 1.6 million words, and can receive data via an alphanumeric keyboard, perforated tape (using a photoelectric scan system), or from punched cards.

The big advantages over its predecessor, the Minsk-2, are a larger memory and more peripheral equipment. The speed is the same—5,000 to 6,000 operations a second—and the computer has a memory cycle of 24 microseconds. It can answer 101 commands from its dual-address command system and can handle 800 lines of perforated tape a second, and 250 punched cards.

It uses 64 different symbols and can take information from a keyboard at a rate of seven symbols a second.

▪ **Nairi**, occupying only about 50 square feet, was designed for solving engineering and scientific problems in institutes and large factories. It requires a simplified language because it has automatic programming and an internal library of subprograms; this means it can accept, in ordinary symbols, a problem such as  $y = f(x)$ .

Nairi derives functions such as sine or logarithms in 70 to 100 microseconds. Its average speed is 1,500 to 2,000 operations a second, and it has a 1,024-word magnetic memory with a 24-microsecond cycle time. Input and output are solely through a keyboard at seven symbols a second.

▪ **Razdan-3** is a large general-purpose computer using solid state components put together in modular blocks. It can perform up to 20,000 operations a second with a magnetic core memory of 32,000 words of 48 bits each. Magnetic tape memory can run to five million words; a magnetic external drum can handle 120,000 words.

Input-output can be handled with perforated or magnetic tape, a keyboard or punched cards. The Razdan-3 occupies more than 2,000 square feet.

▪ **Vniem-3** is a process-control computer capable of 75,000 operations a second, controlling up to 512 channels.

## Hong Kong

### Progress in the Pacific

Three years ago the International Telephone and Telegraph Corp., encouraged by sales in the Far East, created a company in Hong Kong to administer its affairs in the area. Since then sales in the Far East have climbed more than 87%—to the point where ITT has decided to begin manufacturing there.

By the end of this year the company, Far East and Pacific, Inc., plans to open ITT's first manufacturing plant in the Orient. 600 workers will produce transistor radio chassis in Hong Kong at a rate of more than one million a year. Some of these employees will come to the United States for training.

**Just a start.** The company's top man in the area, Gerhard R. Andlinger, calls the radio plant the first step in a network that one day may mass-produce many consumer electronic products in the Far East.

ITT will manufacture most of its own components in Hong Kong, but plans to buy transistors from other companies. In the beginning, most of the new plant's output is scheduled to go to the U. S.

Another concern is expected to own part of the new company, but ITT says the participant is not yet certain.

**Scrutable Orient.** Andlinger, who joined ITT in 1960, insists that doing business in Asia is not basically different from business activity in America.

It is particularly important, however, to keep ahead of government plans in the various countries. ITT has a resident manager in each country, who notifies regional headquarters in Hong Kong of projects in which a government may be interested. Before bids are requested, ITT sends in a team to plan the project and show what the company can do at every stage, from financing through maintenance.

**Finding the money.** The company recently won a \$12-million contract to expand India's telephone net-

work and install crossbar switching equipment. Besides technical equipment and services, ITT made a loan to India and helped her to negotiate another loan through the International Monetary Fund.

## Around the world

**Japan.** Presidents of five big Japanese electronics companies have urged Prime Minister Eisaku Sato to follow the United States' example by eliminating some excise taxes—in Japan they're commodity taxes. They said color television, a best seller in American stores, could help Japan's economy out of its recession if the 7.1% tax were lifted. The industrialists represented the Tokyo Shibaura Electric Co., Hitachi, Ltd., Sony Corp., Mitsubishi Electric Co. and Sanwo Electric Co. Also present was Masao Tsuchiya, managing director of the Electronic Industries Association of Japan.

**France.** The Conseil National du Patronat Français, the French equivalent of the National Association of Manufacturers in the United States, warns of "the gravest" economic consequences if President de Gaulle pulls his country out of the Common Market, as seems possible. But electronics leaders are less upset than most others. They point out that only 20% of France's electronics production is exported, and that only 10% goes to her five partners in the European Economic Community.

**West Germany.** Telefunken AG has introduced a low-cost, two-step method of creating a hybrid computer by plugging digital logic elements into its RA-800 analog computer. Logic cards can be inserted at 24 plug-in positions on a digital patch panel, which also contains the outputs of four timers of a control unit as well as control inputs for the computer's operating modes and integrators, inputs of electronic switches and high-speed relay switches, also various basic clock frequencies.



# LOW-COST SOLID-STATE



ONLY \$600



ONLY \$825

## INDUSTRIAL COUNTERS

Solid-state reliability, compactness and low power consumption make the Hewlett-Packard 5211A/B Electronic Counters ideal for a wide variety of industrial applications. Using the power line as a time base (with typically 0.1% accuracy), they count frequency to 300 kc and also make direct ratio measurements.

Features include extreme versatility and operational convenience, minimum calibration problems, simple maintenance and operation over a wide temperature range,  $-20$  to  $+50^{\circ}\text{C}$ .

The 5211A and B have a standard 4-digit display in improved neon columns with an in-line digital readout available as a modification, H22-5211B. Display storage holds the current display while the counter is gated for a new count, changing only if the count changes. The 5211A has gate times of 0.1 and 1 sec., while the 5211B has an additional gate time of 10 sec. Display time is determined by the front-panel Sample Rate control and is independent of gate time and variable 0.2 to 5 sec.

Manual control of gate time is by front-panel Function switch or by contact closure applied to the rear EXT con-

ductor. Manual reset is required in both modes, with automatic reset available in the EXT Ratio mode when gating by an external pulse or contact closure.

As a printer output the 5211B provides four-line 1-2-2-4 ("1" state positive with respect to "0" state) BCD to a rear panel connector. A similar output is available with the 5211A under the designation C05-5211A. Options include a 1-2-4-8 BCD output, "1" state negative or positive.

The counters are housed in hp modular cabinets only  $3\frac{1}{2}$ " high, bench or rack mount instrument in one. Access for maintenance is simple. Prices: 5211A, \$600; 5211B, \$725; H22-5211B, \$825; C05-5211A, \$650.

To learn how useful these counters can be in measuring rpm, rps, weight, pressure, temperature, acceleration and other quantities convertible by transducers into electrical phenomena, call your Hewlett-Packard field engineer for a demonstration. Or write for complete information, Hewlett-Packard, Palo Alto, California 94304, Tel. (415) 326-7000; Europe: 54 Route des Acacias, Geneva; Canada: 8270 Mayrand Street, Montreal.

*Data subject to change without notice. Prices f.o.b. factory.*

**HEWLETT**  **PACKARD**  
An extra measure of quality



# NEW!

## 40 AMP. BINDING POST offers these plus features

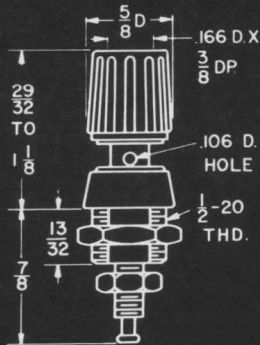
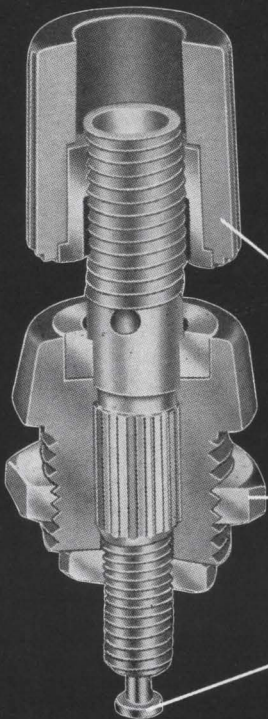

self captivated thumb nut

single 1/2-20 mounting nut

silver-plated brass stud

Here's a new compact, pre-assembled "6-way" binding post that's designed for fast, easy installation and high reliability! Designated the 111-300 Series, it's rated at 40 amps, with a voltage breakdown of 7,000 volts DC. Insulation resistance is greater than 200 megohms after MIL-T-5422B humidity test. Capacity to 1/8 inch panel is 3.5 pf. Mounts in 1/2 inch diameter circular hole, "D", or double flat hole—.422 across flats. Post is available in six standard colors to Federal Standard 595 for coded application. Molded of tough, low-loss polyamide; 6 methods of electrical connection; single 1/2-20 mounting nut; silver-plated brass stud; self captivated fluted thumb nut; circuit connection may be made at the solder terminal, or a lug may be slipped over the threaded portion of the stud and secured with a nut.

Also available—111-100 Series binding post, rated at 15 amps, with voltage breakdown of 8,000 volts DC.

### NEW SET SCREW TYPE BANANA PLUG

Versatile... designed for wide variety of applications! Voltage breakdown: 10,000 volts DC. Capacity plug-to-plug: 1.3 mmf. Current carrying capacity: 15 amps. Available in 10 colors for coded applications.

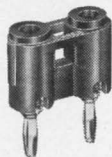

**WRITE TODAY** for your FREE copy of the E. F. Johnson Company Components Catalog!



**E. F. JOHNSON COMPANY**  
3039 TENTH AVE. S.W. • WASECA, MINNESOTA 56093

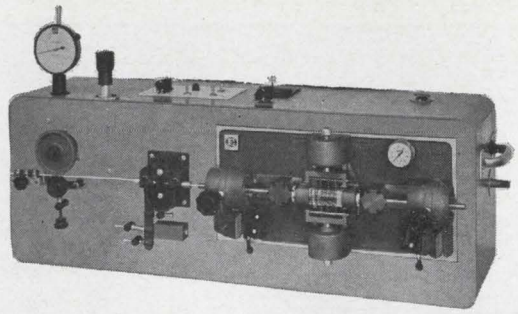

## Cut your wire preparation costs with high-speed wire strippers

Eubanks wire strippers are noted for easy set-up changes, high-speed operation, and clean stripping without nicking or scraping. Whether you need battery cables, printed circuit board jumpers, leads for electric watches, coaxial cables, or washing machine harnesses, chances are excellent that we have a machine to meet your requirements. Pictured is our Model 87 Utility Wire Stripper, which produces up to 12,000 leads an hour. Write for free information on this and other Eubanks wire stripping machines to Eubanks Engineering Co., 225 W. Duarte Rd., Monrovia, California.



**EUBANKS**  
ENGINEERING COMPANY

Circle 209 on reader service card

**WORLD'S FIRST**  
**MINIATURE**  
PUSH TO MAKE — PUSH TO BREAK  
**PUSH BUTTON**  
FOR "REVERSE" APPLICATIONS

Controls 2 circuits — PUSH to make contacts and PUSH again to reverse action. Fast make and break snap-action to handle a high current of 5 amps @ 115VAC. Solid silver contacts and terminals. Compact 1/2" size.

PUSH FOR CONTACT	PUSH FOR CONTACT
ON	ON
(1) — (2)	(2) — (3)
(4) — (5)	(5) — (6)

**ALCOSWITCH**  
Lawrence, Mass. Dept. S-50

**CERAMIC**  
**TERMINAL STRIPS**

UPGRADE YOUR EQUIPMENT QUALITY

ASK FOR **ALCOSTRIPS**

Features a permanent bond between metal and ceramic, not just an adhesion. Fired copper-plate on ceramic is silver-plated and tinned which facilitates soldering and re-soldering of components and leads. Superior to temperature afflicted plastic. Withstands excessive heat.

**ALCOSWITCH**  
SEND FOR FREE CATALOG LAWRENCE, MASS. Dept. S-50



# Electronics advertisers

July 26, 1965



■ AMP Incorporated Garceau, Hargrave & McCullough Inc.	104	■ General Electric Co., Silicone Product Dept. Ross Roy Inc.	88	Scionics Corporation, The Burruss Advertising	108
<b>Alcoswitch</b> Marketronics Advertising	136	<b>General Radio Company</b> K.E. Morang Company	7	■ Semi-Elements, Inc. Axelband, & Brown Associates	114
■ Alpha Wire Corporation Div. of Loral Corporation Campbell-Ewald Company	121	<b>Government of Northern Ireland</b> Oliver-Beckman Inc.	20	<b>Servo Corporation</b> Snow & Depew Advertising	124
<b>Amelco Semiconductor, Div. of Teledyne Inc.</b> Sturges and Associates	115			<b>Sigma Instruments Inc. The</b> The Marschalk Company Inc.	22, 23
<b>Astrodata Inc.</b> Bonfield Associates Inc.	11	<b>Hansen Mfg. Co. Inc.</b> Keller-Crescent Company	110	<b>Signetics Corporation</b> Cunningham & Walsh Inc.	48
<b>Automatic Electric Company</b> Kudner Agency Inc.	87	<b>Heinemann Electric Company</b> Thomas R. Sundheim Inc.	43	<b>Spectral Electronics Corporation</b> Bonfield Associates Inc.	41
		■ <b>Hewlett-Packard Company</b> Lennen & Newell Inc.	1, 12, 13, 46 47, 97, 135	<b>Sprague Electric Company</b> The Harry P. Bridge Company	5, 6, 10
<b>Barber-Colman Company</b> Howard H. Monk & Associates Inc.	106			<b>Stackpole Carbon Company</b> Meek and Thomas Inc.	44
<b>Bendix Semiconductor Products</b> MacManus, John & Adams Inc.	9	■ <b>Jennings Radio Manufacturing Corp</b> L.H. Waldron Advertising	109	<b>Stewart Warner</b> Hoefler, Dieterich & Brown, Inc.	35
■ <b>Boonton, Div. of Hewlett Packard Co</b> George Homer Martin Associates	2	<b>Johnson Company, E.F.</b> Firestone Advertising	136	<b>TRW Electronics</b> Fuller & Smith & Ross Inc.	29
■ <b>Brush Instruments, Div. of Clevite Corporation</b> Carr Liggett Adv. Inc.	3rd Cover			<b>Transistor Specialties Inc.</b> Murray Heyert Associates	50
		<b>Krohn-Hite Corporation</b> Stern/Frank Advertising Inc.	100	■ <b>Trygon Electronics</b> The Wexton Company Inc.	32
■ <b>CTS Corporation</b> Burton Brown Advertising	107			■ <b>Trylon Inc.</b> George Moll Advertising Inc.	119
<b>CTS Knights Inc.</b> Burton Browne Advertising	119	<b>Laboratory for Electronics</b> Hepler & Gibney Inc.	100		
<b>Cohu Electronics, Kin Tel Division</b> Erwin Wasey, Ruthrauff & Ryan Inc.	130	■ <b>Lapp Insulator Company Inc.</b> Wolff Associates Inc.	98	<b>Vector Department of Norden Div. of United Aircraft Corporation</b> Cunningham & Walsh Inc.	126
<b>Cominco Products Inc.</b> McKim Productions Limited	118	■ <b>Leach Corporation</b> Jay Chait & Associates	89		
<b>Computer Measurements Company</b> Charles Bowes Advertising Inc.	36			■ <b>United Transformer Corporation</b> Philip Stogel Company Inc.	2nd Cover
<b>Computer Test Corporation</b> Technical Marketing	33	<b>Machlett Laboratories Inc., The</b> Fuller & Smith Ross Inc.	8	<b>Weston-Boonschaft &amp; Fuchs</b> Basford Incorporated	120
<b>Consolidated Reactive Metals Inc.</b> Charles V. Corbin Associates	126	<b>Mallory &amp; Company, Inc. P.R.</b> The Aitkin-Kynett Company	99		
<b>Control Data Corporation</b> Barnes Chase Advertising	123	<b>Maryland Telecommunications</b> Richard N. Berry Advertising	111		
<b>Cubic Corporation</b> Phillips-Ramsey Inc.	90	<b>Mathatronics Inc.</b> Kalb & Schneider Inc.	113		
				<b>Classified advertising</b>	
■ <b>Dale Electronics Inc.</b> Swanson, Sinkey, Ellis Inc.	31	<b>Nexus Research Laboratories</b> Larcom Randall Advertising	49	F.J. Eberle, Business Mgr.	
<b>Deutsch Electronic Components Div.</b> Michael York/Adv. Consultant	19	<b>North Atlantic Industries Inc.</b> Murray Heyert Associates	34	<b>PROFESSIONAL SERVICES</b>	127
<b>Dialight Corporation</b> H.J. Gold Company Advertising	108			<b>EMPLOYMENT OPPORTUNITIES</b>	127-128
<b>Dressen-Barnes Corporation</b> Writing and Advertising Inc.	116	<b>Photocircuits Corporation</b> Duncan-Brooks, Inc.	40	<b>EQUIPMENT</b> (Used or Surplus New) For Sale	128
<b>DuPont de Nemours &amp; Co. Inc. E.I.</b> Batten, Barton, Durstine & Osborne Inc.	39, 125	<b>Potter &amp; Brumfield Div. of American Machine &amp; Foundry Company</b> Grant, Schwenck & Baker Inc.	16		
		<b>Princeton Applied Research Corp.</b> Mort Barish Associates	24	<b>Classified advertisers index</b>	
<b>Eldorado Electronics</b> Sturges and Associates	45	<b>Progress Webster Corporation</b> Stern/Frank Advertising Inc.	103	<b>Aamco Transmissions</b>	128
■ <b>Electro Instruments Inc.</b> Teawell Inc. Advertising	101			<b>Fair Radio Sales</b>	128
<b>Electro Nuclear Laboratories</b> Hal Lawrence Incorporated	96	■ <b>Radiation Inc.</b> G.M. Basford Company	122	<b>Keystone Electronics Corp.</b>	128
<b>Electronic Engineering Co. of California</b> Barnes Chase Advertising	117	<b>Radio Corporation of America</b> Al Paul Lefton Company	4th Cover	<b>Machlett Laboratories Inc.</b>	127
<b>Electronic Specialty Company</b> Gaynor & Ducas Inc.	21	<b>Raytheon Company</b> Fuller & Smith & Ross Inc.	102	<b>Radio Research Instrument Co.</b>	128
<b>Erie Technological Products Inc.</b> Altman-Hall Associates	95			<b>Semiconductor Sales of Calif.</b>	128
<b>Eubanks Engineering Company</b> Moore-Bergstrom Company	136			<b>Union Carbide Corporation</b>	128
				<b>Univac Div. of Sperry Rand Corp.</b>	127
<b>FMC Corporation Inorganic Chemicals Division</b> Muller, Jordan & Herrick Inc.	42			<b>Universal Laboratories</b>	128
<b>Fairchild Semiconductor</b> Faust/Day Inc. Advertising	14			<b>Valvo GmbH</b>	128

Executive, editorial, circulation and advertising offices: McGraw-Hill Building, 330 West 42nd Street, New York, N.Y., 10036. Telephone Area Code 212-971-3333. Teletype TWX N.Y., 212-640-4646. Cable: McGrawhill, N.Y. Officers of the Publications Division: Shelton Fisher, President; Vice Presidents: Joseph H. Allen, Operations; Robert F. Boger, Administration; John R. Callahan, Editorial; Ervin E. DeGraff, Circulation; Donald C. McGraw, Jr., Advertising Sales; Angelo R. Venezian, Marketing. Officers of the Corporation: Donald C. McGraw, President; L. Keith Goodrich and Hugh J. Kelly, Executive Vice Presidents; John J. Cooke, Vice President and Secretary; John L. McGraw, Treasurer. Title R registered U.S. Patent Office; © copyright 1965 by McGraw-Hill, Inc. All rights reserved, including the right to reproduce the contents of this publication, in whole or in part.





**Great editorial is  
something he takes to lunch**

(What a climate for selling!)

## Electronics

A McGraw-Hill Market-Directed Publication  
330 West 42nd Street, New York, N.Y. 10036



### Advertising sales staff

**Gordon Jones** [212] 971-2210  
Advertising sales manager

**Atlanta, Ga. 30309:** Gus H. Krimsier,  
Michael H. Miller, 1375 Peachtree St. N.E.,  
[404] TR 5-0523

**Boston, Mass. 02116:** William S. Hodgkinson  
McGraw-Hill Building, Copley Square,  
[617] CO 2-1160

**Chicago, Ill. 60611:** Robert M. Denmead,  
J. Bradley MacKimm  
645 North Michigan Avenue,  
[312] MO 4-5800

**Cleveland, Ohio 44113:** Paul T. Fegley, 55  
Public Square, [216] SU 1-7000

**Dallas, Texas 75201:** Richard P. Poole, The  
Vaughn Building, 1712 Commerce Street,  
[214] RI 7-9721

**Denver, Colo. 80202:** Joseph C. Page, David  
M. Watson, Tower Bldg., 1700 Broadway,  
[303] AL 5-2981

**Houston, Texas 77025:** Kenneth George,  
2270 Humble Bldg.,  
[713] CA 4-8381

**Los Angeles, Calif. 90017:** Ashley P.  
Hartman, John G. Zisch, 1125 W. 6th St.,  
[213] HU 2-5450

**New York, N. Y. 10036:**  
Donald R. Furth [212] 971-3615  
Frank LeBeau [212] 571-3615  
George F. Werner [212] 971-3615  
500 Fifth Avenue

**Philadelphia, Pa. 19103:** William J. Boyle,  
Warren H. Gardner, 6 Penn Center Plaza,  
[215] LO 8-6161

**San Francisco, Calif. 94111:**  
James T. Hauptli, 255 California Street,  
[415] DO 2-4600

**London W1:** John W. Patten, Edwin S.  
Murphy Jr., 34 Dover Street,  
Hyde Park 1451

**Milan: 1,** via  
Baracchini Phone: 86-90-617

**Frankfurt/Main:** Gerd Hinske, 85  
Westendstrasse Phone: 77 26 65 and  
77 30 59

**Geneva:** Michael R. Zeynel, Joseph Wuensch,  
2 Place du Port 244275

**Paris VIII:** Denis Jacob, 17 Avenue  
Matignon ALMA-0452

**Tokyo:** Nobuyuki Sato  
Shiba, Minato-Ku (502) 0656

**Osaka:** Kazutaka, Miura, 163, Umegee-cho,  
Kita-ku [362] 8771

**Nagoya:** International Media Representatives,  
Yamagishi Bldg., 13, 2-Chome,  
Oike-cho Naka-ku

**Hugh J. Quinn:** [212] 971-2335  
Manager Electronics Buyers' Guide

**David M. Tempest:** [212] 971-3139  
Promotion manager

**Milton Drake:** [212] 971-3485  
Market research manager

**Wallace C. Carmichael** [212] 971-3191  
Business manager

**Theodore R. Geipel:** [212] 971-2044  
Production manager



Another Brush Innovation in Recording:

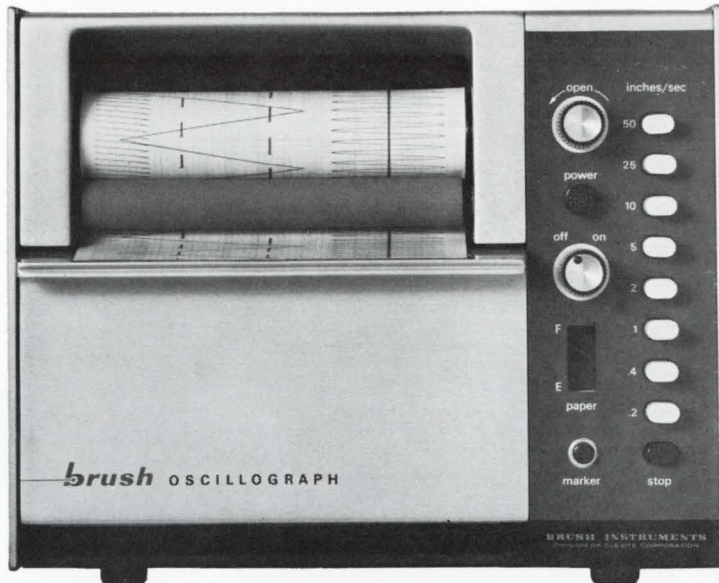

## The Brush 2300.

**Best recorder around  
for getting lots of data down  
on one piece of paper.**

No wonder the Brush 2300 light beam recorder can handle just about any industrial recording job you can name.

It's available with 1 to 16 analog channels. Writing speeds from 0 to 30,000 inches per second. Push-button choice of eight different chart speeds—or sixteen if you like. And all the frequency response you'll ever need.

Power requirements? Next to nothing . . . even operates off a car battery. One model operates off flashlight batteries!

And here's the topper. *Anyone, anywhere* can operate a 2300. The controls are logically grouped, chart paper loads from the front and the

galvos can be switched and adjusted in seconds. Simple. Rugged. Lightweight. Low cost per channel. That's the 2300. The common-sense selection for almost every industrial recording requirement.

A demonstration will prove it.

Get in touch with your local Brush Sales Engineer. Or, call us collect . . . 216—EN 1-3315. An illustrated brochure is yours for the asking. Brush Instruments Division, Clevite Corporation, 37th & Perkins, Cleveland, Ohio 44114.

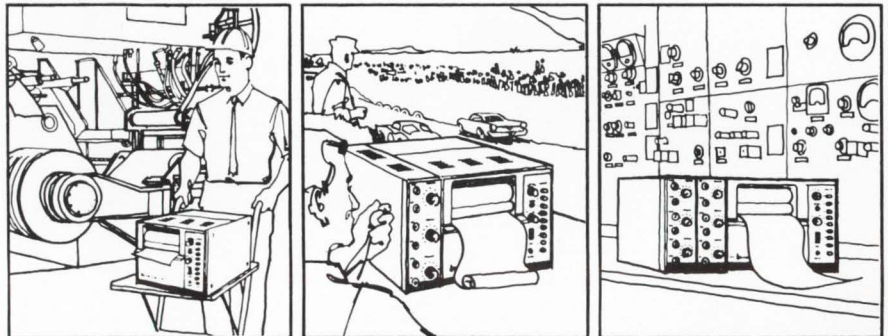

**brush** **CLEVITE**  
INSTRUMENTS DIVISION

Circle 901 on reader service card



## CERMOLOX® design means power...

Here's an RCA family of ruggedly constructed tubes for use from DC through UHF. There is a tube for virtually every type of electronic application: Communications • Control • UHF-TV • Radar • Phased Array • ECM • Industrial Processing.

These compact RCA ceramic-metal Beam Power Tubes offer long life and high reliability. They feature precision-aligned grids for outstanding efficiency, and coaxial electrode construction designed for use in coaxial-cavity as well as parallel-line and lumped-constant circuits. They are designed for power levels from watts to megawatts.

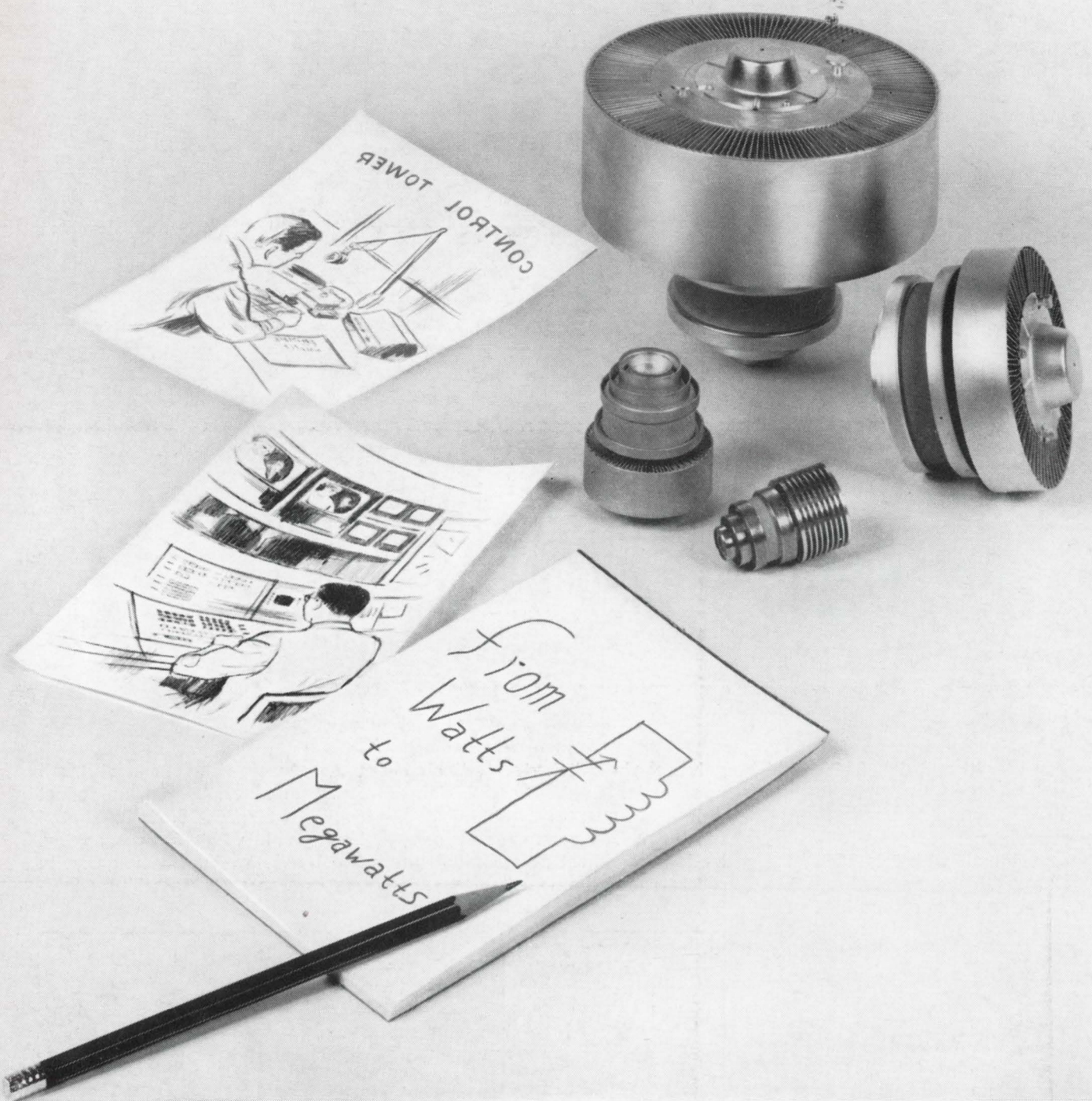

RCA ELECTRONIC COMPONENTS AND DEVICES

**The Most Trusted Name in Electronics**

To meet the increasing demand for dependable power sources, choose one of the more than 25 types in the RCA Cermolox line of forced-air-, liquid-, or conduction-cooled types. Check into this RCA concept in Beam Power Tube technology with your RCA Representative. For technical data on specific types, write: RCA Commercial Engineering, Section G19Q-4, Harrison, New Jersey.

**ALSO AVAILABLE FROM YOUR RCA INDUSTRIAL TUBE DISTRIBUTOR**